

OrCAD[®] CAPTURE[®] FOR WINDOWS[®]

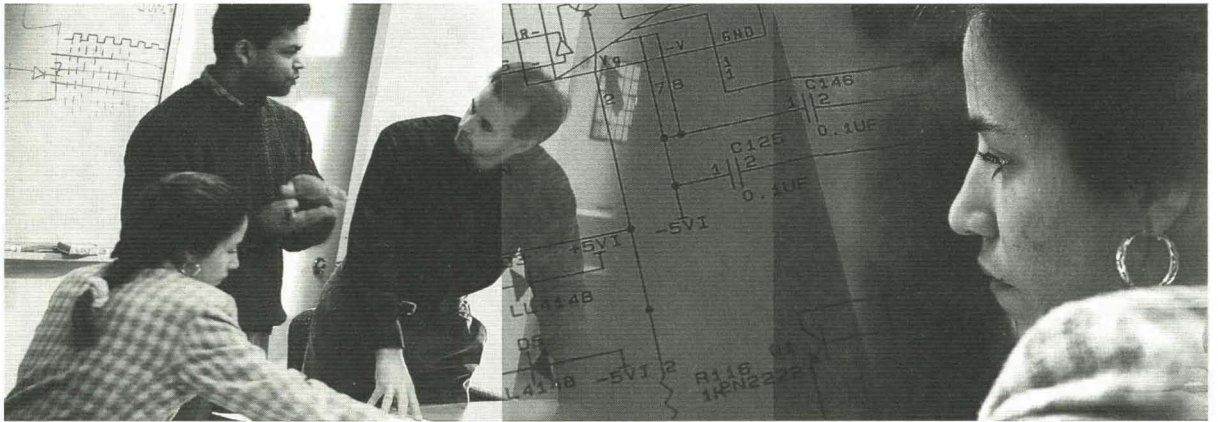

USER'S GUIDE

VERSION 7.10

OrCAD Capture[®] for Windows[®]

User's Guide

This manual provides step-by-step process descriptions that explain how to use OrCAD Capture for Windows. Reference information is in the online help. Placing reference information in the online help makes it possible for OrCAD to provide complete and up-to-date information to you. In addition, information is easier to find in the online help because of its search capabilities.

Use this manual as a tool to help you become familiar with OrCAD Capture for Windows. As you have questions, or want to find information about particular commands, tools, or dialog boxes, use the online help.

Copyright © 1997 OrCAD, Inc. All rights reserved.

OrCAD, OrCAD Capture, OrCAD Design Desktop, OrCAD Layout, and OrCAD Simulate are registered trademarks, and OrCAD Express, SmartDrag, SmartPlace, SmartRoute, and SmartWire are trademarks of OrCAD, Inc.

Microsoft, Visual Basic, Windows, Windows NT, and other names of Microsoft products referenced herein are trademarks or registered trademarks of Microsoft Corporation.

TrueType is a registered trademark of Apple Computer, Inc.

PostScript is a registered trademark of Adobe Systems, Inc.

All other brand and product names mentioned herein are used for identification purposes only, and are trademarks or registered trademarks of their respective holders.

MN-01-5090

Third Edition 9 June 97

Technical support	(503) 671-9400
Corporate offices	(503) 671-9500
Fax	(503) 671-9501
General email	info@orcad.com
Technical support email	techsupport@orcad.com
Web site	www.orcad.com



9300 S.W. Nimbus Avenue
Beaverton, Oregon 97008 • USA

Contents

About this manual	ix	
Before you begin.....	ix	
Symbols and conventions	ix	
Part One	Capture basics	
Chapter 1	Getting started	3
	Starting Capture	3
	The Capture session frame.....	3
Chapter 2	The Capture work environment	5
	The project manager	5
	The browse window.....	13
	The schematic page editor	14
	The part editor.....	15
	The text editor.....	16
	The session log	17
	The toolbar.....	18
	The tool palettes.....	20
	The status bar.....	23
	Using help and the online tutorial.....	24
	Using the Accessories menu	24
	Selecting and deselecting objects.....	25
	Grouping objects.....	26
	Editing objects	27
	Undoing, redoing, and repeating an action.....	30

Chapter 3	Starting a project.....	33
	Creating new designs, libraries, and VHDL files	33
	Opening files.....	35
	Working with files in a project	36
	Saving projects, designs, and libraries.....	37
	Closing a project.....	38
Chapter 4	Setting up your project	39
	Defining your preferences	40
	Setting up your project template.....	49
	Changing properties of existing projects	58
	Changing properties of existing schematic pages	61
Chapter 5	Printing and plotting	63
	Configuring a printer or plotter.....	63
	Printing or plotting schematic pages.....	64
	Printing or plotting parts or packages.....	64
	Printing or plotting text editor windows	65
	Previewing printer or plotter output.....	65
	Scaling printer or plotter output.....	66
	Special considerations for plotting	67
Part Two	Creating designs	
Chapter 6	Design structure.....	71
	Flat designs	72
	Hierarchical designs.....	73
	Connecting schematic folders and schematic pages	76
	An example: creating a simple hierarchy.....	78
Chapter 7	Placing, editing, and connecting parts and electrical symbols.....	81
	Placing and editing parts.....	82
	Placing and editing power and ground symbols	89
	Placing and editing no-connect symbols.....	93
	Placing and editing hierarchical blocks	94
	Placing and editing hierarchical ports and hierarchical pins.....	99
	Placing and editing off-page connectors.....	104
	Placing and connecting wires and buses.....	108

Chapter 8	Adding and editing graphics and text	115
	Drawing tools.....	115
	Drawing lines.....	116
	Drawing rectangles and squares	117
	Drawing circles and ellipses	118
	Drawing arcs.....	119
	Drawing polylines and polygons	120
	Adding fill to an object.....	121
	Mirroring an object.....	121
	Rotating an object.....	121
	Cutting an object.....	121
	Copying an object.....	121
	Pasting an object.....	122
	Deleting an object.....	122
	Placing a bitmap.....	123
	Placing text	124
Chapter 9	Using macros.....	131
	Recording a macro.....	132
	Playing a macro	132
	Configuring a macro	133
	Naming a macro.....	135
	Assigning a shortcut key to a macro	137
	About the Capture to Layout macros.....	138
Chapter 10	Changing your view of a schematic page	139
	Zooming.....	139
	Moving to a new location	142
	Displaying the grid and grid references	145
	Finding parts in a project.....	145

Part Three Libraries and parts

Chapter 11	About libraries and parts	149
	Libraries	149
	Parts	151
	The design cache.....	152
	Primitive and nonprimitive parts	154
Chapter 12	Creating and editing parts	155
	Creating a new part.....	156
	About power and ground pins.....	168
	Editing an existing part	170
	Viewing parts in a package.....	172
	Editing parts in a package.....	173
	Viewing a part's convert.....	173

Part Four Processing your design

Chapter 13	About the processing tools	177
	Tools overview	178
Chapter 14	Preparing to create a netlist	179
	Updating part references.....	179
	Updating properties	183
	Checking for design rules violations	186
	Swapping gates and swapping pins	194
Chapter 15	Creating a netlist	197
	Using the Create Netlist tool.....	197
	Netlist format files	199
	Netname resolution	200
	Creating a netlist for use with OrCAD Simulate for Windows	201
Chapter 16	Creating reports.....	203
	Creating a bill of materials.....	203
	Creating a cross reference report	206
Chapter 17	Exporting and importing schematic data	207
	Exporting and importing designs.....	207
	Exporting and importing properties.....	210

Chapter 18	Using Capture with OrCAD Layout for Windows.....	215
	Preparing your Capture design for use with Layout	217
	Creating a netlist for use in Layout.....	225
	Loading a new netlist into Layout	226
	Back annotating board information from Layout	226
	Forward annotating schematic data to Layout	228
	Cross probing between Capture and Layout.....	229
Chapter 19	Using Capture with OrCAD Simulate for Windows	233
	Analyzing your Capture project with Simulate.....	233
	Viewing signal values in Capture using intertool communication	235
	Selecting signal sets in Capture for use in Simulate	236
	Incorporating Capture netlist changes into a Simulate project	238
Glossary		239
Index		247

About this manual

The *OrCAD Capture for Windows User's Guide* contains the procedures you need to work with Capture. To help you learn and use Capture efficiently, this manual is organized by tasks, beginning with the most common schematic design tasks (parts one and two), and moving on to more advanced Capture features (parts three and four). Many of the procedures described in this manual are also covered in the online tutorial, *Learning Capture*.

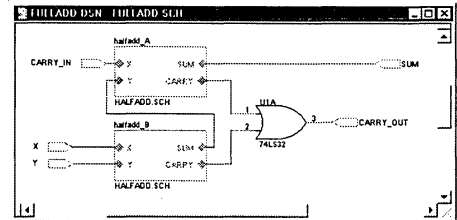

Before you begin

Before you can use Capture, you must install Microsoft Windows on your computer, then install Capture. For information on installing Windows, see your Windows documentation.

To install Capture, follow the installation instructions that accompany Capture.

Symbols and conventions

OrCAD printed documentation uses a few special symbols and conventions.

The keyboard

- The keys on your keyboard may not be labeled exactly as they are in this manual. All key names are shown using small capital letters. For example, the Control key is shown as CTRL; the Escape key is shown as ESC.
- Keys are frequently used in combinations or sequences. For example, SHIFT+F1 means to hold down the SHIFT key while pressing F1. ALT, F, A, means to press and release each of these keys in order: first ALT, then F, then A.
- *Arrow keys* is the collective name for the UP ARROW, DOWN ARROW, LEFT ARROW, and RIGHT ARROW keys.
- To choose a command from a menu, you can use the mouse or press a key combination. For example: from the File menu, choose Open (ALT, F, O).

Text

- Text you are instructed to type is shown in bold. For example, if the manual instructs you to type ***.dsn**, you type an asterisk, a period, and the lowercase letters **dsn**. The text you type is usually shown in lowercase letters, unless it must be typed in uppercase letters to work properly.
- Placeholders for information that you supply (such as filenames) are shown in italic. For example, if the manual instructs you to type **cd *directoryname***, you type the letters **cd** followed by a space and the name of a directory. For example, for a directory named CIRCUITS, you would type **cd *circuits***.
- Examples of syntax, netlist output, and source code are displayed in monospace font. For example: `/N0001 U1(8) U2(1);.`

Capture basics

Part One contains the basic information you need to get started in Capture. It gives you an overview of the structure and work environment of Capture, and describes how to open and save projects. Part One includes these chapters:

Chapter 1: Getting started describes how to start Capture.

Chapter 2: The Capture work environment describes the things you'll need to know to find your way around in Capture. It shows the windows you'll see in Capture: the project manager, the browse window, the schematic page editor, the part editor, the text editor, and the session log. It also introduces you to the toolbar and tool palettes, and general concepts such as selecting and editing objects, and undoing and repeating actions.

Chapter 3: Starting a project shows how to open a project and work with the schematic folders and schematic pages in a project. It also shows how to save a project or an individual schematic page.

Chapter 4: Setting up your project describes how to customize the working environment specific to your system, how to create default settings for new projects, and how to override default settings in existing projects.

Chapter 5: Printing and plotting describes how to print and plot your design.

Part One

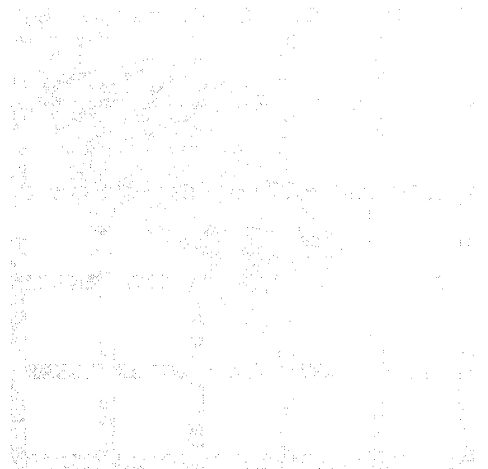

Getting started

This chapter describes how to start OrCAD Capture for Windows.

Starting Capture

The Capture installation process puts Capture in the ORCADWIN folder, and adds OrCAD Design Desktop and Capture to the Programs menu (available from the Start button).

To start Capture

If Windows is not running, type **win** at the DOS prompt, then perform these steps:

- 1 From the Start menu, choose Programs. The Programs menu displays.
- 2 From the OrCAD Design Desktop menu item, choose Capture.

The Capture session frame

Once you start Capture, you see the Capture *session frame*. You do all your schematic design and processing within this window.

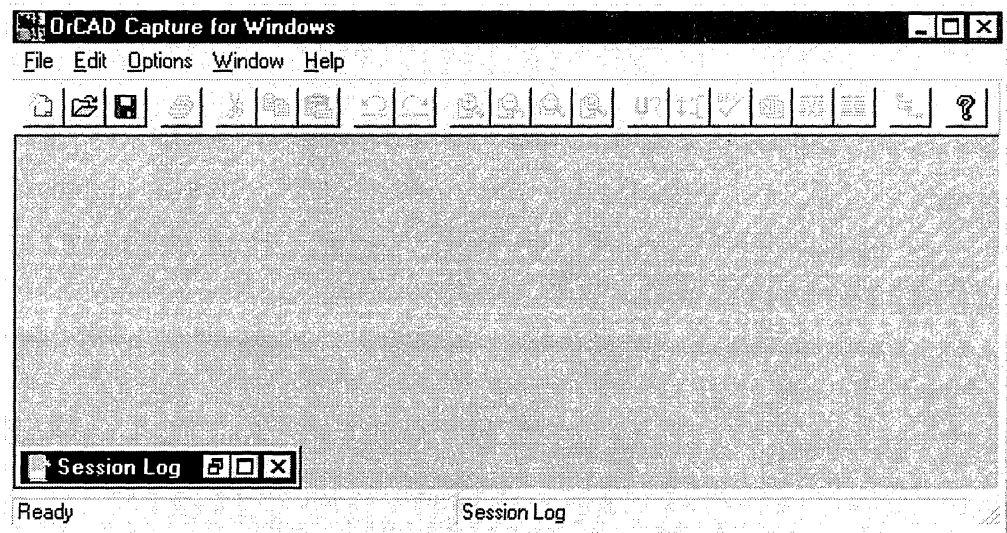

The minimized Session Log icon in the lower left portion of the Capture session frame is the session log. The session log provides information about everything you have done in the current Capture session. Detailed information about this—and the other windows in Capture—is given in chapter 2.

In Capture, each design that you open is in a separate window. You may open as many designs in as many windows as your computer's resources can handle. If you want to work with three schematic pages, or with three parts, each is available in its own window. If you need to work simultaneously with several designs, you can open them all, and each will have its own project manager window.

Depending on which type of window you have *active* (an active window is one whose title bar is highlighted), certain buttons on the toolbar and certain items on the menus may be unavailable, since you perform tasks and use tools based upon the type of window that is active. Also, the menus and menu choices vary, depending on which type of window is active.

The Capture work environment

This chapter describes the things you need to know to find your way around in Capture. It shows the windows you'll see in Capture: the project manager, the browse window, the schematic page editor, the part editor, the text editor, and the session log. It also introduces you to the toolbar, tool palettes, and general Capture concepts such as selecting and editing objects, and undoing and repeating actions.

The project manager

You use the project manager to collect and organize all the resources you need for your project. These resources include schematic folders, schematic pages, part libraries, parts, VHDL files, and output reports such as bills of materials and netlists.



Note A project doesn't actually *contain* all the resources. It merely "points to" the various files that the project uses. For this reason, be sure you don't move or delete any files referenced by a project. If you do, the project won't be able to find them.

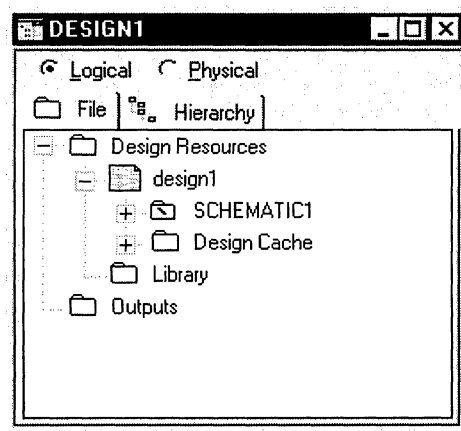

Project manager folders

The project manager provides a graphical display of a project's resources by grouping them into appropriate folders, as described below.

- The Design Resources folder shows a design folder with the design's schematic folders and schematic pages, and a Design Cache folder that shows all the parts used on the schematic pages. Any schematic folders or schematic pages that you create are automatically added to the design folder within the Design Resources folder, but you can also add other files or information using the Project command on the Edit menu. For example, you can add an existing VHDL file to the design folder and later attach the models within that VHDL file to hierarchical blocks on a schematic page.



See For information about hierarchical designs, see *Chapter 6: Design structure*.

- The Library folder (in the Design Resources folder) shows the schematic part library files you've added to the project using the Project command on the Edit menu.
- The Outputs folder shows the output of Capture's processing tools. Generally, these files include bill of materials reports and technology-specific netlists. Capture adds the appropriate files to this folder as each is created.

Each project may have only one design, but may have multiple libraries. The design may consist of any number of schematics or VHDL models, but it must have a single *root module*. The root module is defined as the top level of the design. That is, all other modules in the design are referenced within the root module.



Tip The *root schematic* folder for a design has a backslash in its folder icon.

Within the project manager, you can expand or collapse the structure you are seeing by double-clicking on a folder, or by clicking on the plus sign or minus sign to the left of a folder. A plus sign indicates that the folder has contents that are not currently visible; a minus sign indicates that the folder is open and its contents are visible, listed below the folder.

Each project you open has its own project manager window. You can move or copy folders or files between projects by dragging them from one project manager window to another (as well as to and from Windows Explorer). To copy rather than move items, press and hold the CTRL key while you drag them. If you close a project manager window, you close the project.

In the project manager's File tab, double-clicking on a schematic folder opens it and displays icons for each schematic page within the schematic folder. Then, if you double-click on a schematic page icon, the schematic page opens in a schematic page editor window. Or, if the page is already open, its window becomes active.



Note If a schematic page is open, you cannot drag its icon to a different location.

A design can consist of a single schematic page within a single schematic folder, or a number of schematic pages within a number of schematic folders. A schematic folder “contains” schematic pages in a relationship similar to the relationship between a directory and the files it contains. Files are contained in a directory; schematic pages are contained in a schematic folder.

A schematic page provides a graphical description of the electrical connectivity of a design. It is made up of parts, wires, and other electrical symbols. A schematic page may also contain borders, title blocks, text, and graphics.



Note The project manager is also used to manage libraries and the parts they contain. This is covered in detail in *Chapter 11: About libraries and parts*.

Any schematic folders or schematic pages you have selected within an active project manager window limit the scope of various commands, such as the Find and Browse commands on the project manager's Edit menu, the Print command on the project manager's File menu, and the various tools on the Tools menu.

Project manager tabs—File and Hierarchy

The project manager provides two ways to display a project's resources.

If you choose the File tab, the project manager displays all the project's folders, schematic folders, and schematic pages.

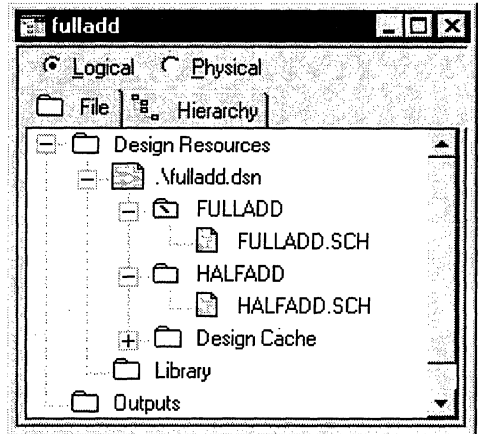

File tab.

If you choose the Hierarchy tab, the project manager displays the hierarchical relationship among the project's schematic folders and schematic pages.

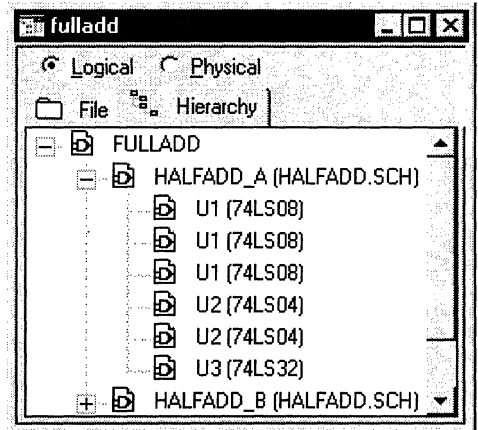

Hierarchy tab.



See For information about hierarchical designs, see *Chapter 6: Design structure*.

Project manager options—Logical and Physical

Projects can display in either logical mode or physical mode, corresponding to the Logical option and Physical option in the project manager. Each of these modes offers a unique method for interpreting your design.

In logical mode, a part may be referenced multiple times in the design hierarchy; however, only one instance of that part exists. For example, in the picture at right, there are three instances of U1 in HALFADD_A and three instances of U1 in HALFADD_B. Any editing changes you make to parts instances apply to the part occurrences as well.

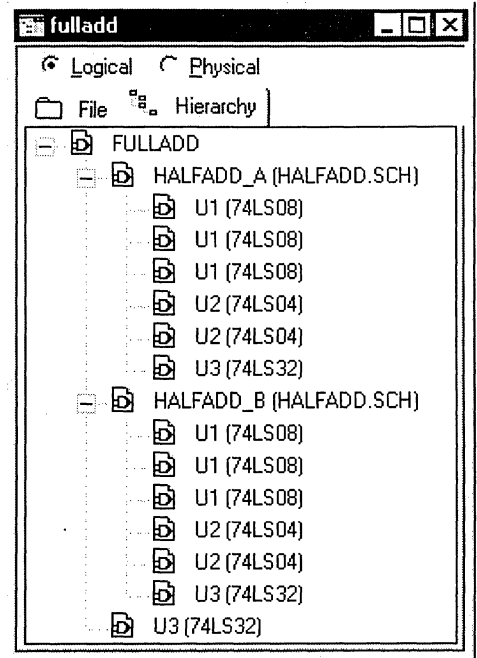

Logical mode.

In physical mode, a part is duplicated each time it is referenced in the design hierarchy. That is, a copy of it is created each time it occurs in the design hierarchy. For example, the three instances of U1 in logical mode (in the previous picture) have now changed to three occurrences (U1A, U1B, and U1C) in HALFADD_A and three occurrences in HALFADD_B. Notice, also, that the icons for the occurrences are grayed out. This serves as a visual reminder that any editing changes you make to parts in physical mode only apply to the part occurrences: the editing changes do not apply to the part instances.

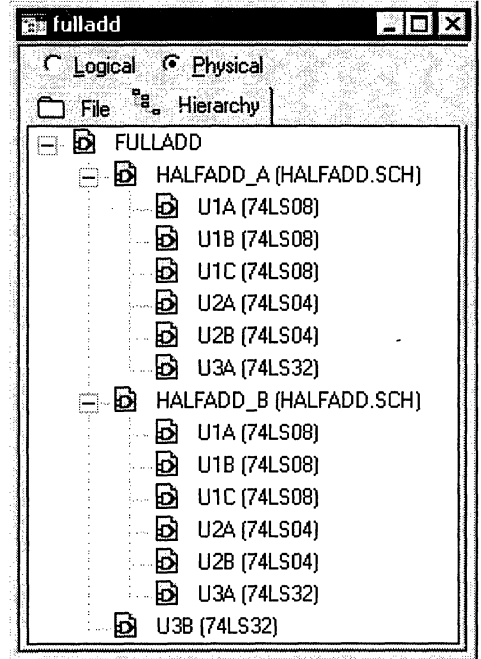

Physical mode.

Part instances and part occurrences

A *part instance* is a part as it exists in logical mode. Since the part instance may be referenced in one or more schematic pages, any change you make to a part instance affects each schematic page that refers to that part instance. For flat and simple hierarchical designs, this is straightforward: each part instance has a unique reference designator and set of associated properties that apply each time the part instance is referenced.

In a complex hierarchy, a part instance that is referenced more than once in the design will only have one reference designator and set of properties assigned to it, regardless of the number of times it is referenced. This presents a problem when you need to create a netlist for use with Layout or some other board layout tool. Physical mode provides a method to uniquely annotate each occurrence of a part instance. Hence, *part occurrence* refers to a particular instantiation of a part instance in the netlist.



See For information about simple and complex hierarchical designs, see *Chapter 6: Design structure*.



Note You cannot change design connectivity while in physical mode. Any changes to design structure must be performed in logical mode. In physical mode, you can only edit properties for part occurrences.

When to use physical mode

Physical mode is typically necessary for PCB designs where all parts must be assigned unique reference designators and properties. In fact, in nearly all cases, the *only* time you should use physical mode is when you update part references or properties, or create a netlist for a PCB design that has a complex hierarchical design structure. For FPGA designs, or for PCB designs that use a flat or simple hierarchical structure, use logical mode at all times.

The following table summarizes the mode you should use for your design as a function of the structure and the type of the design.

<i>Design structure</i>	<i>For FPGA/CPLD designs, use mode:</i>	<i>For PCB designs, use mode:</i>
Flat design	Logical	Logical
Simple hierarchy	Logical	Logical
Complex hierarchy	Logical	Physical

Even if your PCB design employs a complex hierarchy you should use physical mode only when you are processing your design (updating references, creating a netlist, updating properties, creating a bill of materials or cross reference report, swapping gates or pins, or assigning part packages). Use logical mode to perform design entry for your PCB design then, when you want to begin processing your design, switch to physical mode.

There is one additional case that requires you to use physical mode: when you cross probe your Capture schematic with its corresponding board layout in Layout.



See For more information about cross probing your schematic with a board layout, see *Chapter 18: Using Capture with OrCAD Layout for Windows*.

Project manager pop-up menus

There are a number of pop-up menu commands available in the project manager window. Using the commands on these pop-up menus, you can open a file or schematic page, or edit and view the properties of the currently selected item. For information on each pop-up menu command, refer to Capture's online help.

The browse window

The browse window displays the items that are found using either the Browse command or the Find command from the project manager's Edit menu. Both the Browse and Find commands apply to all the schematic folders and schematic pages you select in the project manager.

If you double-click on one of the items in the first column of the browse window, the schematic page that contains that item displays in the schematic page editor window, with the item selected.

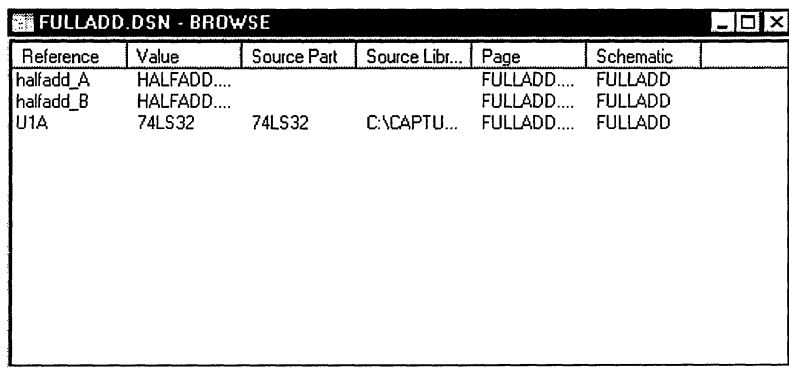

Reference	Value	Source Part	Source Libr...	Page	Schematic
halfadd_A	HALFADD...			FULLADD...	FULLADD
halfadd_B	HALFADD...			FULLADD...	FULLADD
U1A	74LS32	74LS32	C:\CAPTU...	FULLADD...	FULLADD

You can sort the browse results using the buttons along the top of the browse window. When you choose one of the buttons, the rows of information in the browse window are reordered alphabetically based on the information in the column you are sorting. Each type of browse provides a different set of sort buttons. For example, the sort buttons provided for parts are part reference, part value, source part, source library, schematic page, and schematic folder, but the sort buttons provided for nets are net alias name, net name, schematic page, and schematic folder.

Once the sort results display, you can adjust the column widths by dragging the vertical lines between the column names to the left or right. You can close or minimize the browse window using the standard Windows buttons in the upper right corner of the window.

The schematic page editor

The schematic page editor window is used to display and edit schematic pages. You can place parts, wires, buses, and draw graphics. The schematic page editor has a tool palette that you can use to draw and place everything you need to create a schematic page. You can print from within the schematic page editor.

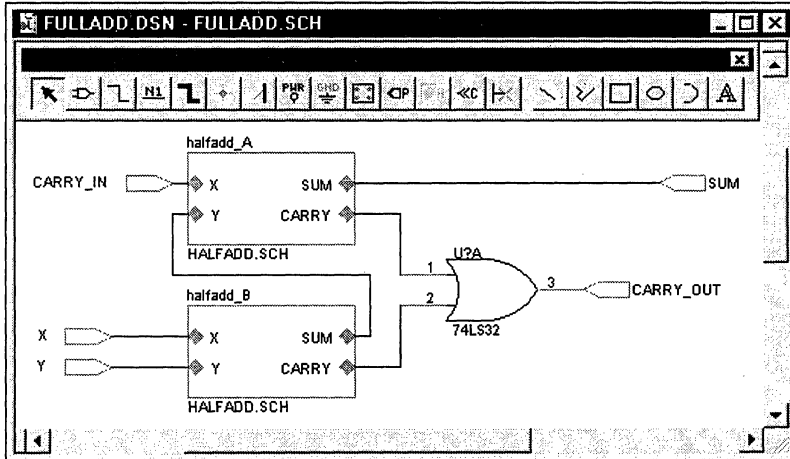

The part editor

The part editor window is used to create and edit parts.

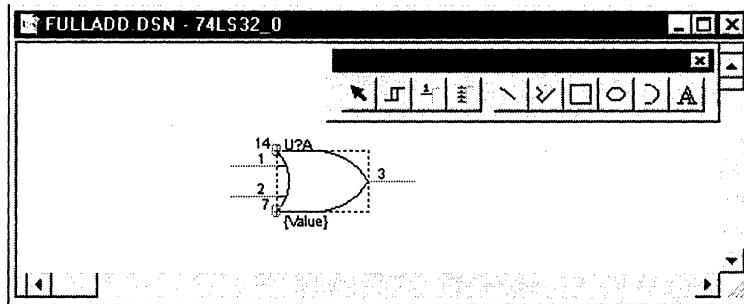

From the View menu of the part editor you can choose either Part or Package. In Part view you can:

- Create and edit parts and symbols, then store them in new or existing libraries.
- Create and edit power and ground symbols, off-page connector symbols, and title blocks.
- Use the tool palette's electrical tools to place pins on parts, and its drawing tools to draw parts and symbols. (See *Part editor tool palette* later in this chapter.)

Package view shows you the entire *package*. You can edit the properties of the entire package, such as part reference, prefix, part alias, and so on. You cannot edit individual parts in this view, but you can select individual parts to edit by double-clicking on them.



See also See *Chapter 11: About libraries and parts* for complete definitions of parts and packages. See *Chapter 12: Creating and editing parts* for a complete description of the part editor.

The text editor

Use the text editor to create or view VHDL files or other text files within Capture. VHDL keywords and comments are displayed in the colors you specify in the Text Editor tab in the Preferences dialog box (from the Options menu, choose Preferences).

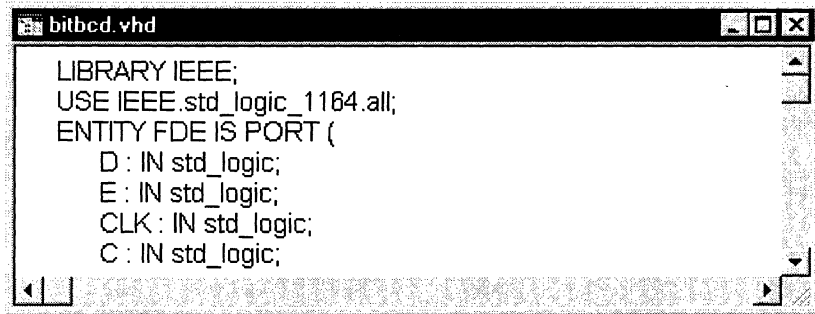

```
LIBRARY IEEE;
USE IEEE.std_logic_1164.all;
ENTITY FDE IS PORT (
  D : IN std_logic;
  E : IN std_logic;
  CLK : IN std_logic;
  C : IN std_logic;
```

To create a new VHDL file in the text editor

➤ From the File menu, choose New, then choose VHDL File. A blank VHDL file displays in the text editor.

To open a VHDL file in the text editor

1 From the File menu, choose Open, then choose VHDL File. The Open VHDL File dialog box displays.

2 Select a file, then choose the OK button.

or

1 In the project manager, select a VHDL file.

2 From the pop-up menu, choose Edit.



See For more information on editing VHDL files in the text editor, see Capture's online help.

The session log

The session log lists the events that have occurred during the current Capture session, including messages resulting from using tools. To display context-sensitive help for an error message, put the cursor in the error message line in the session log and press F1.

The ruler along the top displays in either inches or millimeters, depending on which measurement system (U.S. or Metric) is selected in the Windows Control Panel. You can add tab settings to the ruler by clicking in the ruler bar, drag the tabs to different positions, or remove them by dragging them down into the session log window. Your tab settings are saved and used each time you start Capture.

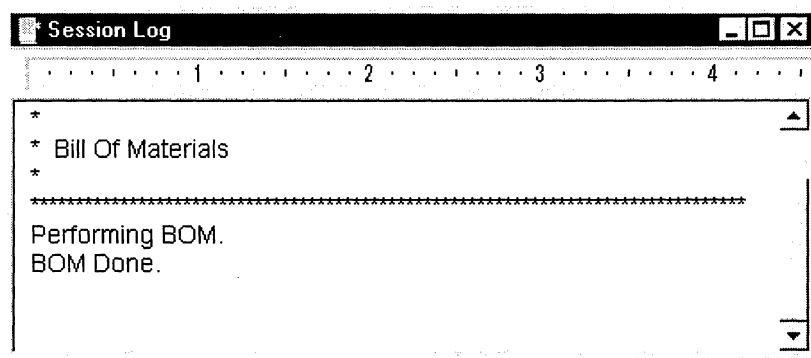

You can search for information in the session log using the Find command on the Edit menu. You can also save the contents of the session log to a file, which is useful when working with OrCAD's technical support staff to solve technical problems. The default filename is SESSION.TXT.













Tip To clear the session log, choose Clear Session Log from the Edit menu, or use the CTRL+DEL shortcut key combination.

The toolbar











Capture's toolbar is *dockable* (that is, you can select an area between buttons and drag the toolbar to a new location) and resizable, and displays tooltips for each tool. By choosing a tool button, you can quickly perform a task. If a tool button is dimmed, you can't perform that task in the current situation.



Some of the tools operate only on what you have selected, while others give you a choice of either operating on what is selected or expanding the scope to the entire project. The table below summarizes the tools on the toolbar. The tasks that these tools perform are described throughout this manual.

<i>Tool</i>	<i>Name</i>	<i>Description</i>
	New	Create a new document based on the active document. Similar to the New command on the File menu.
	Open	Open an existing project or library. Similar to the Open command on the File menu.
	Save	Save the active schematic page or part. Equivalent to the Save command on the File menu.
	Print	Print the active schematic page or part. Equivalent to the Print command on the File menu.
	Cut	Remove the selected object and place it on the Clipboard. Equivalent to the Cut command on the Edit menu.
	Copy	Copy the selected object to the Clipboard. Equivalent to the Copy command on the Edit menu.
	Paste	Paste the contents of the Clipboard at the cursor. Equivalent to the Paste command on the Edit menu.
	Undo	Undo the last command performed, if possible. Equivalent to the Undo command on the Edit menu.
	Redo	Redo the last command performed, if possible. Equivalent to the Redo command on the Edit menu.
	Zoom In	Zoom in to see a closer, enlarged view. Equivalent to choosing Zoom and In from the View menu.
	Zoom Out	Zoom out to see more of your document. Equivalent to choosing Zoom and Out from the View menu.

Tools on the Capture toolbar (page 1 of 2).

<i>Tool</i>	<i>Name</i>	<i>Description</i>
	Zoom Area	Specify an area of the schematic page or part to enlarge to fill the entire window. Equivalent to choosing Zoom and Area from the View menu.
	Zoom All	View the entire document. Equivalent to choosing Zoom and All from the View menu.
	Update Part References	Assign part references to parts on the selected schematic pages. Equivalent to the Update Part References command on the Tools menu.
	Gate and Pin Swap	Back annotate the selected schematic pages. Equivalent to the Gate and Pin Swap command on the Tools menu.
	Design Rules Check	Check for design rules violations on the selected schematic pages. Equivalent to the Design Rules Check command on the Tools menu.
	Create Netlist	Create a netlist for the selected schematic pages. Equivalent to the Create Netlist command on the Tools menu.
	Cross Reference	Create a cross reference report for the selected schematic pages. Equivalent to the Cross Reference command on the Tools menu.
	Bill of Materials	Create a bill of materials report for the selected schematic pages. Equivalent to the Bill of Materials command on the Tools menu.
	Project Manager	Display a project manager window for the active document, providing an overview of project contents. Equivalent to choosing a project manager window by number from the Window menu.
	Help Topics	Open online help. Equivalent to the Help Topics command on the Help menu.

Tools on the Capture toolbar (page 2 of 2).

Displaying or hiding the toolbar

You can hide the toolbar, then display it again when you need it.

To display or hide the toolbar

-  From the schematic page editor's View menu, choose Toolbar (ALT, V, T).
- or
- From the part editor's View menu, choose Toolbar (ALT, V, T).

The tool palettes



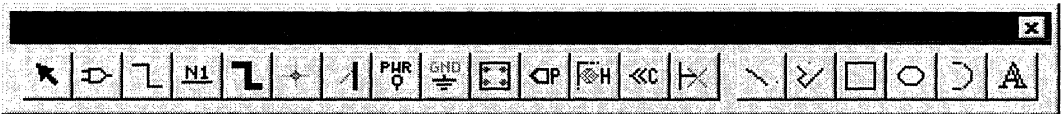

Capture has two tool palettes: one for the schematic page editor window and one for the part editor window. Both tool palettes are *dockable* (that is, you can click on an area between buttons and drag a tool palette to a new location) and resizable, and display tooltips that identify each tool. While the drawing tools on the two tool palettes are identical, each tool palette has different electrical tools. After you choose a tool (and, in the case of some tools, after you respond to the tool's dialog box), you press the right mouse button to display a context-sensitive pop-up menu.

The schematic page editor tool palette

















The first group of tools on the tool palette are electrical tools, used to place electrical-connectivity objects. The second group of tools are drawing tools, used to create graphical objects without electrical connectivity.



The tools on the schematic page editor tool palette are described in the table below. For descriptions of how to use the electrical tools, see *Chapter 7: Placing, editing, and connecting parts and electrical symbols*. For descriptions of how to use the drawing tools, see *Chapter 8: Adding and editing graphics and text*.

<i>Tool</i>	<i>Name</i>	<i>Description</i>
	Select	Select objects. This is the normal mode.
	Part	Select parts from a library for placement. Equivalent to the Part command on the Place menu.
	Wire	Draw wires. Press SHIFT to draw non-orthogonal (not a multiple of 90°) wires. Equivalent to the Wire command on the Place menu.
	Net Alias	Place aliases on wires and buses. Equivalent to the Net Alias command on the Place menu.

Tools on the schematic page editor tool palette (page 1 of 2).

<i>Tool</i>	<i>Name</i>	<i>Description</i>
	Bus	Draw buses. Press SHIFT to draw non-orthogonal buses. Equivalent to the Bus command on the Place menu.
	Junction	Place junctions. Equivalent to the Junction command on the Place menu.
	Bus Entry	Draw bus entries. Equivalent to the Bus Entry command on the Place menu.
	Power	Place power symbols. Equivalent to the Power command on the Place menu.
	Ground	Place ground symbols. Equivalent to the Ground command on the Place menu.
	Hierarchical Block	Place hierarchical blocks. Equivalent to the Hierarchical Block command on the Place menu.
	Hierarchical Port	Place hierarchical ports on schematic pages. Equivalent to the Hierarchical Port command on the Place menu.
	Hierarchical Pin	Place hierarchical pins in hierarchical blocks. Equivalent to the Hierarchical Pin command on the Place menu.
	Off-Page Connector	Place off-page connectors. Equivalent to the Off-Page Connector command on the Place menu.
	No Connect	Place no-connect symbols on pins. Equivalent to the No Connect command on the Place menu.
	Line	Draw lines. Equivalent to the Line command on the Place menu.
	Polyline	Draw polylines. Press SHIFT to draw non-orthogonal polylines. Equivalent to the Polyline command on the Place menu.
	Rectangle	Draw rectangles. SHIFT constrains to a square. Equivalent to the Rectangle command on the Place menu.
	Ellipse	Draw ellipses. SHIFT constrains shape to a circle. Equivalent to the Ellipse command on the Place menu.
	Arc	Draw arcs. Equivalent to the Arc command on the Place menu.
	Text	Place text. Equivalent to the Text command on the Place menu.

Tools on the schematic page editor tool palette (page 2 of 2).

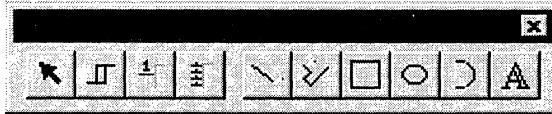

The part editor tool palette

The first group of tools on the part editor tool palette are electrical tools, used to place pins and IEEE symbols. The second group of tools are drawing tools, used to create graphical objects without electrical connectivity.



The tools unique to the part editor tool palette are described in the table below. The drawing tools are described in the previous section *Schematic page editor tool palette*.

For information on how to use the electrical tools, see *Chapter 12: Creating and editing parts*. For information on how to use the drawing tools, see *Chapter 8: Adding and editing graphics and text*.

Tool	Name	Description
	IEEE Symbol	Place IEEE symbols on a part. Equivalent to the IEEE Symbol command on the Place menu.
	Pin	Place pins on a part. Equivalent to the Pin command on the Place menu.
	Pin Array	Place multiple pins on a part. Equivalent to the Pin Array command on the Place menu.

Tools on the part editor tool palette.

Displaying or hiding a tool palette

Like the toolbar, you can hide a tool palette, then display it again when you need it.

To display or hide a tool palette

- From the schematic page editor's View menu, choose Tool Palette (ALT, V, P).
- or
- From the part editor's View menu, choose Tool Palette (ALT, V, P).

The status bar

The status bar is located at the bottom of the Capture session frame, and reports on current actions, number of items selected, zoom scale, and pointer location.



Left field

Displays descriptions of selected tools or menu items, prompts, or the current status.

Center field

Displays the number of items selected in the schematic page editor or part editor.



Note When a session log or a project manager window is active, the center field of the status bar doesn't display.

Right field

Displays the current scale and pointer location (such as: Scale=50% X=10.0 Y=5.0). The location in the schematic page editor is measured in either inches or millimeters, depending on the Units settings in the Page Size tab in the Schematic Page Properties dialog box. The location in the part editor is measured in grid units.

Displaying or hiding the status bar

You can hide the status bar, then display it again when you need it.

To display or hide the status bar

- From the schematic page editor's View menu, choose Status Bar (ALT, V, S).
- or
- From the part editor's View menu, choose Status Bar (ALT, V, S).

Using help and the online tutorial

Capture's online help includes information to help you become familiar with Capture. You can access help from the menu bar in the session frame, by choosing the Help button in a dialog box, or by pressing F1.

Topics include:

- Explanations and instructions for common tasks.
- Descriptions of menu commands, dialog boxes, tools on the toolbar and tool palettes, and the status bar.
- Netlist format samples, error messages, and glossary terms.
- Reference information.
- Product support information.

You can get context-sensitive help for an error message by placing your cursor in the error message line in the session log and pressing F1.

Capture's online tutorial takes you through a series of self-paced, interactive lessons. You can practice what you've learned by going through the tutorial's specially designed exercises.

Using the Accessories menu

You can use extensions to the OrCAD-supplied functionality of Capture if you purchase software developed by associates of OrCAD. These associates create .DLL files that address specific Capture functionality, such as customized netlisting. The associates configure their .DLL files so that they are listed as menu choices on the Accessories menu, available in either the project manager window or the schematic page editor window, once you install a third-party extension. OrCAD's Enterprise Edition software displays commands in this menu.

Selecting and deselecting objects

Once you select an object, you can perform operations on it, including moving, copying, cutting, mirroring, rotating, resizing, or editing. You can also select multiple objects and edit them, or group them into a single object. Grouping objects maintains the relationship among them while you move them to another location.



See You can edit the properties of a group of objects using the spreadsheet editor. See *Using the spreadsheet editor to edit properties* in this chapter.

This section describes different ways to select individual objects and groups of objects in both the schematic page editor and the part editor.

To select an object



Position the pointer on the object and click the left mouse button. The object displays in the *selection color*.



Tip To change the selection color: from the Options menu, choose Preferences, then choose the Colors tab. Click the left mouse button over the Selection color. Select a new color from the color palette window, choose the OK button to dismiss the color palette, then choose the OK button to dismiss the dialog box.

To select multiple objects



For each object to select, position the pointer on the object and press CTRL while you click the left mouse button. Every object in the selection set displays in the selection color.



Tip To select a part, click within the part itself. To select a graphical object, click on an outside edge of the object (it is easier to do this if you zoom in).

To select all objects in an area

- 1 From the tool palette, choose the selection tool.
- 2 Click on an area where there are no objects or parts to deselect any items that may be selected. Move the pointer to one corner of the area to select. Press and hold the left mouse button while you drag the mouse to the opposite corner, then release the left mouse button. Every object in the selection set displays in the selection color.



Tip You can control whether the selection set includes all objects intersected by your selection rectangle or only those objects entirely inside the selection rectangle. From the Options menu, choose Preferences, then choose the Select tab. Select one of the Area Select options, then choose the OK button.

To select all objects on a schematic page or part

 From the Edit menu, choose Select All. All objects display in the selection color.



Note The selection set behaves as if it is one object, so that you can move, copy, cut, delete, mirror, or rotate the entire selection set. Be aware, however, that the Select All command also selects the title block on the schematic page. If you copy or move the selection set, you could create a duplicate title block, or inadvertently move the title block off the schematic page.

To deselect objects

 Click on an area where there are no objects. Selected objects become deselected. Note that a part occupies a rectangular area encompassing all its graphics. This means that a part may occupy a larger area than is initially apparent.

To remove one object from a selection set

 Place the pointer over the object, press CTRL, and click the left mouse button.



Note To select from objects stacked atop one another, position the pointer over the stack of objects and press the TAB key while you click the left mouse button. This cycles through the objects in the stack.

Grouping objects

Use the Group command on the Edit menu to group multiple objects into one selectable object. This is a convenient way to maintain the relationship among several objects while moving them to another location. You can *nest* groups, meaning a group can contain other groups as well as objects. The Group command is only available when multiple objects are selected.



Note Objects remain grouped until you ungroup them or close all windows on the schematic page or part that contains them.

To group multiple selected objects

- 1 Select the objects you want to group, as described in the previous section.
- 2 From the Edit menu, choose Group. You can move the objects as a group.
- 3 When you are through manipulating the objects as a group, you can ungroup them. From the Edit menu, choose Ungroup.

Editing objects

Each object has a set of properties, and you can edit the value associated with each property. For some objects (parts, packages, hierarchical blocks, pins, nets, and buses), you can add your own *user-defined properties*.



Note You cannot add user-defined properties to graphic objects, bookmarks, IEEE symbols, no-connect symbols, net aliases, power and ground symbols, off-page connectors, or bus entries.

Properties can be used to store information, such as a part's value or reference. They can also be used to define the appearance of an object. For example, properties are used to define the color, line weight, and fill of graphic objects.

For some objects—such as wires, buses, lines, ellipses, rectangles, and so on—you can edit the object's size and shape by clicking on it and dragging its resize handles.

Editing properties

Capture uses properties to describe objects. A property consists of a property name (for example, Part Value or Part Reference) and a property value (for example, TIP31C or Q2).



See For a sample listing showing property names and property values, see Capture's online help topic *Bill of Materials sample report file*. Each type of object (text, wire, and so on) has its own set of properties. For information about editing specific properties of an object, see Capture's online help topic *Editing properties*.

To edit an object's properties

- 1 Double-click on the object. A dialog box containing properties for the object displays.

- 2 Edit the properties, then choose the OK button.

or

- 1 Click on the object to select it.

- 2 From the Edit menu, choose Properties (ALT, E, I). A dialog box containing properties for the object displays.

- 3 Edit the properties, then choose the OK button.

Using the spreadsheet editor to edit properties

The properties of a group of objects can be edited using the spreadsheet editor. In the spreadsheet editor, you can edit:

- Multiple parts
- Pins on parts
- Hierarchical ports
- Hierarchical pins
- Wires
- Buses
- Nets
- Off-page connectors
- DRC markers
- Bookmarks
- A set of objects selected from the Browse window

To edit an object's properties using the spreadsheet editor

- 1 Select the group of objects, as described earlier in this chapter.
- 2 From the Edit menu, choose Properties (ALT, E, I). Note that if the objects in the selection set are not of the same type, the Properties command is unavailable.

The spreadsheet editor displays. You can use the spreadsheet editor to:

- Click the left mouse button to select a cell for copying or pasting. Double-click to select the cell for editing.
- Click on a row or column heading to select the entire row or column.
- With one or more cells selected, press and hold the SHIFT key while you click on an adjacent cell to extend the selection set.
- Choose the New button to display the New Property dialog box. Enter the property name. If you want all members of the current selection set to have a particular value, enter the value also.

- 3 Choose the OK button to close the spreadsheet editor.



Tip To assign a cell's value to all of the cells within the same column in the spreadsheet editor, select a cell's value, choose Copy, select the entire column, and choose Paste.

Adding user-defined properties

You can add user-defined properties to electrical objects. For example, if you want to include the name of the supplier, you create a user-defined property for the information. You can add as many user-defined properties as you like, edit them as described in the section *Editing properties*, make them visible or invisible using the Display Properties dialog box (choose the Display button in the User Properties dialog box), and remove them if you no longer need them.



Note You cannot add user-defined properties to graphic objects, bookmarks, IEEE symbols, no-connect symbols, net aliases, power and ground symbols, off-page connectors, or bus entries.

If you add a user-defined property to one part in a *homogeneous package* (multiple parts that are graphically identical), all parts in the package inherit the property and its value. If you add a user-defined property to one part in a *heterogeneous package* (multiple parts that are graphically different or contain different numbers of pins), the other parts in the package are not affected. You can also edit properties on multiple-part packages, in which case the changes appear on every part in the package, and on every part instance. You cannot add user-defined properties to packages.

To add a user-defined property

- 1 Select an object.
- 2 From the Edit menu, choose Properties. An appropriate dialog box, such as the Edit Part dialog box, displays.
- 3 Choose the User Properties button. The User Properties dialog box displays.
- 4 Choose the New button. The New Property dialog box displays.
- 5 Enter a name and a value for the new property, then choose the OK button three times to close all the dialog boxes.

You can include a user-defined property in a netlist or a Bill of Materials report by specifying its property name, in curly braces, in a combined property string.



See For information about using combined property strings, see Capture's online help.

Moving and resizing graphic objects

Before you can move or resize a graphic object, you must first select it. A selected object has resize handles that you use to change the size of the graphical object.

To resize and move objects

- 1 Select the object to resize or move.
- 2 To resize the object, press the left mouse button on a resize handle, and drag the handle until the object is the size you would like it. Release the mouse button.
or
To move the object, press the left mouse button anywhere on the object—except on a resize handle—and drag the object until it is where you want it. Release the mouse button.
- 3 To deselect the object, click in an area where there are no parts or objects.



See also For descriptions of other ways to manipulate objects, see *Chapter 8: Adding and editing graphics and text*.

Undoing, redoing, and repeating an action

You use the Undo command to undo your action. To repeat an edit action, use the Repeat command. For example, you might move a selected object five grid units, then realize you also need to move a different object the same distance. Select the second object, then from the Edit menu, choose the Repeat command. You can use the Undo, Redo, and Repeat commands with the following actions:

- Placing objects
- Deleting objects (except for the Repeat command)
- Copying objects
- Moving objects
- Resizing objects
- Rotating objects
- Mirroring objects

To undo an action

 From the Edit menu, choose Undo.

To undo an Undo command

 From the Edit menu, choose Redo.

To repeat a command

- 1 Perform the command once.
- 2 From the Edit menu, choose Repeat.



Tip You can use the Repeat command to align objects or to quickly create repetitive structures such as buses.

To repeat a place operation

- 1 Place an object on a schematic page.
- 2 Press CTRL and drag the object to a new location. This creates a copy of the object. Leave the object selected.
- 3 From the Edit menu, choose Repeat. The pointer repeats the relative move in step 2 and an additional object is placed.

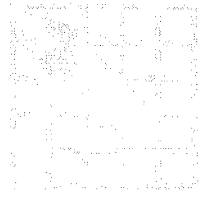

Starting a project

All the schematic folders and schematic pages in a design, as well as libraries, VHDL files, and output reports for a project are stored in a single file that has an .OPJ extension. A project contains one or more schematic folders, in which one or more schematic pages are stored. A project also contains a design cache, which is like an embedded library—it contains a copy of all the parts and symbols used on the schematic pages.

 **Note** Parts reside in a library the same way schematic pages reside in schematic folders. Symbols and title blocks also reside in libraries. A project can use any number of libraries, and a library can be included in any number of projects. However, a project may have only one design (.DSN).

Creating new designs, libraries, and VHDL files

You can create new designs, libraries, and VHDL files.

To create a new design

- 1 From the File menu, choose New, then choose Design.
- 2 The design opens in the project manager and a new schematic page displays.

To create a new library

- 1 From the File menu, choose New, then choose Library.
- 2 The library opens in the project manager and a Library Cache folder is added to the project manager.



See For information on how to create parts for inclusion in a library, see *Chapter 12: Creating and editing parts*.

To create a new VHDL file

- 1 From the File menu, choose New, then choose VHDL File.
- 2 The VHDL file opens in Capture's text editor.

To create a VHDL file and add it to a project

- 1 From the project manager's Design menu, choose New VHDL File (ALT, D, V). The file opens in the text editor, and a dialog box asking if you want to add the file to the project displays.
- 2 Choose the Yes button. The Save As dialog box displays.
- 3 Select a directory for the file and supply a filename. By default, the VHDL file's name is VHDL*n*.VHD (where *n* is an integer).
- 4 Choose the Save button. The file is saved and put into the project's Design Resources folder.

Opening files

You can open an existing design, library, project, or VHDL file.



Tip The four files that were last opened are listed at the bottom of the File menu. To open one of these files, select it from the File menu.

To open an existing design

- 1 From the File menu, choose Open, then choose Design. The Open Design dialog box displays.
- 2 Select a design (.DSN) or type a name in the File name text box, then choose the Open button. The design opens in the project manager.

To open an existing library

- 1 From the File menu, choose Open, then choose Library. The Open Library dialog box displays.
- 2 Select a library (.OLB) or type a name in the File name text box, then choose the Open button. The library opens in the project manager.

To open an existing project

- 1 From the File menu, choose Open, then choose Project. The Open Project dialog box displays.
- 2 Select a project (.OPJ) or type a name in the File name text box, then choose the Open button. The project opens in the project manager.

To open an existing VHDL file

- 1 From the File menu, choose Open, then choose VHDL File. The Open VHDL File dialog box displays.
- 2 Select a VHDL file (.VHD) or type a name in the File name text box, then choose the Open button. The VHDL file opens in Capture's text editor.

Working with files in a project

Using the project manager, you can add or delete project files.

To add a file to your project

- 1 In the project manager, select the folder to which you want to add a file.
- 2 From the Edit menu, choose Project (ALT, E, R). The Add File to Project Folder dialog box displays.
- 3 Select the file you want to add and choose the Open button. The file is added to the project.

Or

 Drag the file from the Windows Explorer into the folder in the project manager.



Note You can also add files to your project interactively. When you create a design using the New command on the File menu, it is placed in the project manager's Design Resources folder. Note, however, that your project can include only one design (.DSN) file. If you try to add a second .DSN file to your project, the Overwrite dialog box displays, asking if you want to replace the existing design.

To delete a file from a project

- 1 In the project manager, select the file you want to delete.
- 2 Press the DELETE key. The file is removed from the project.

Saving projects, designs, and libraries

When the project manager window is active, you can save a new or existing project, design, or library. The Save command saves all open documents referenced by the project, as well as the project itself.

The Save As command saves files depending on what you have selected in the project manager.

- If one or more designs or libraries are selected, you are prompted to save each file in turn.
- If no top-level folders (Design Resources or Outputs) are selected, and items other than designs or libraries are selected, the Save As command is unavailable.
- If no designs or libraries are selected in the project manager, you are prompted to save the project.



See To protect your work in the event of a system crash or power outage, you can enable Autosave, and set the interval at which your design, library, or VHDL file is saved. For information about the Autosave option, see *Setting miscellaneous options* in Chapter 4.

To save a new design or library

- 1 With the design or library selected in the project manager, from the File menu, choose Save (ALT, F, S). The Save As dialog box displays.
- 2 Enter a name for the design or library in the File name text box, specify a location, then choose the Save button.

The design or library is saved, and the project manager remains open.



Note If you choose Save when a schematic page window is active, only that page's design is saved, not the entire project. However, when you attempt to close the project, a dialog box asks if you want to save any project files that have been edited but not yet saved.

To save an existing project

- From the File menu, choose Save (ALT, F, S).

The project is saved, and remains open in the project manager.

Closing a project

When the project manager window is active, you can close a project without quitting Capture, or you can close and save your project as you quit.

To close a project

➤ From the project manager's File menu, choose Close Project (ALT, F, C).

When you close a project, a dialog box displays, asking if you want to save your changes.

To quit Capture

➤ From the project manager's File menu, choose Exit (ALT, F, X).

When you choose the Exit command, a dialog box displays, asking if you want to save your changes.



Setting up your project

Capture provides different levels of configuration. Using commands on the Options menu, you can:

- Customize the working environment specific to your system (using Preferences).
- Create default settings for new designs (using Design Template). These settings stay with the design even if it is moved to another system with different preferences.
- Override settings in individual designs (using Design Properties) or individual schematic pages (using Schematic Page Properties).

Regardless of which Capture window is active, the Options menu has a Preferences command and a Design Template command. In addition, the Options menu contains commands specific to the current active window. For example, the project manager's Options menu contains the Design Properties command, while the schematic page editor's Options menu contains the Schematic Page Properties command.

The settings in the Preferences dialog box determine how Capture works on your system, and persist from one Capture session to the next because they are stored in the Capture initialization (.INI) file on your system. If you pass projects to others, they won't inherit your Preferences settings. This means that you can set colors, grid display options, pan and zoom options, and so on to your liking and be assured that your settings will remain, even if you work on a project created on another system.

The Design Template dialog box determines the default characteristics of all the projects created on your system. Because a new project inherits characteristics from the current Design Template settings, it's a good idea to check the settings before you create a new project.

Once you begin working on a project, you can customize its particular characteristics by choosing Design Properties from the Options menu when you are in the project manager, or Schematic Page Properties when you are in the schematic page editor.

Defining your preferences

The options that you define in the tabs of the Preferences dialog box affect how Capture works with your projects.

- **Colors/Print.** Set up colors for objects such as off-page connectors, hierarchical blocks and ports, text, title blocks, and so on, and specify which objects will be printed or plotted. You can also change the background color and the color of the grid.
- **Grid Display.** Select dots or lines for your grid, and whether to display or print your grid. You can select whether to have your pointer snap to grid as you place objects. You can set these options independently for the schematic page editor and the part editor.
- **Pan and Zoom.** Define how you want autoscrolling to work, and what the zoom factor should be. You can set these options independently for the schematic page editor and the part editor.
- **Select.** Define whether you want to select objects enclosed by a selection rectangle or objects intersecting a selection rectangle, the maximum number of objects to display at high resolution while dragging, and whether to show the tool palette. You can set these options independently for the schematic page editor and the part editor.
- **Miscellaneous.** Define the default fill, line style and width, and color for graphic objects, define the font used in the project manager and session log, render TrueType fonts with strokes (for printing and plotting), and set whether to autosave your project and how often. In addition, you can enable intertool communication, which is the method that Capture uses to communicate with other OrCAD software, such as OrCAD Layout for Windows.
- **Text Editor.** Define which (if any) VHDL keywords are highlighted, and the font and tab settings used within the text editor.

Defining colors/print options

You control the color in which different schematic page objects display by using the Colors/Print tab in the Preferences dialog box.

 **Note** The color that you select for Title Block is also the color used for borders and grid references.

If an object's Print box is checked, the object is printed or plotted. Clicking on a check box toggles its check mark on or off. Objects are always displayed on your screen, regardless of the setting of their check boxes.

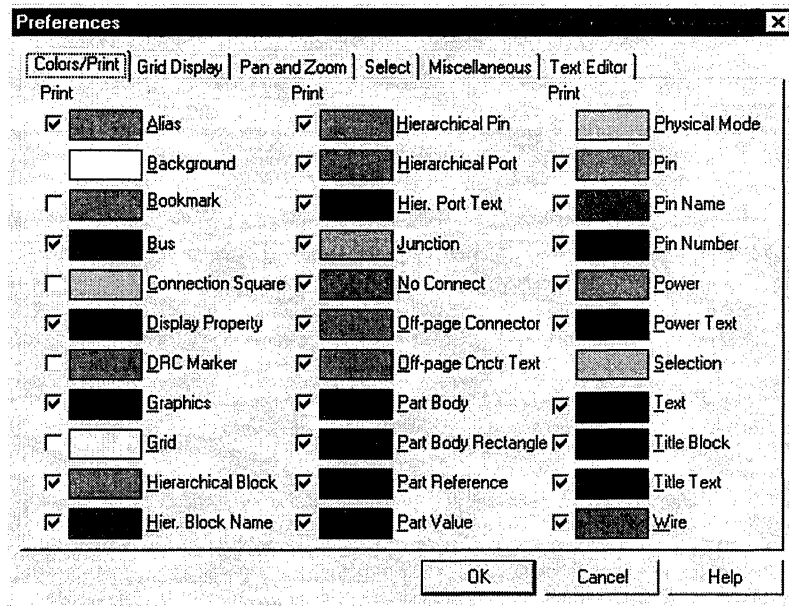

To define an object's color

- 1 From the Options menu, choose Preferences (ALT, O, P), then choose the Colors/Print tab.
- 2 Click on the color of an item. The color palette window opens.
- 3 Select a new color. Choose the OK button to dismiss the color palette.
- 4 Choose the OK button.

 **Note** The color that you select for Graphics defines the color for lines, polylines, and arcs drawn in the schematic page editor, and for all graphics drawn in the part editor. If you change the Color option in the Miscellaneous tab, then rectangles, ellipses, and closed polyline shapes that you draw in the schematic page editor are created in that color. Lines, polylines, and arcs, however, are drawn in the color you chose for Graphics in the Colors/Print tab.

Controlling the grid

You can control whether Capture displays or prints a grid independently in the schematic page editor and the part editor, and whether the grid uses dots or lines. You can also specify whether the pointer snaps to grid in each editor.



Caution If you disable the Pointer snap to grid option while you are drawing, be sure to enable it before you place electrical objects. Otherwise, your part pins may be placed off-grid, making it difficult to connect them properly.

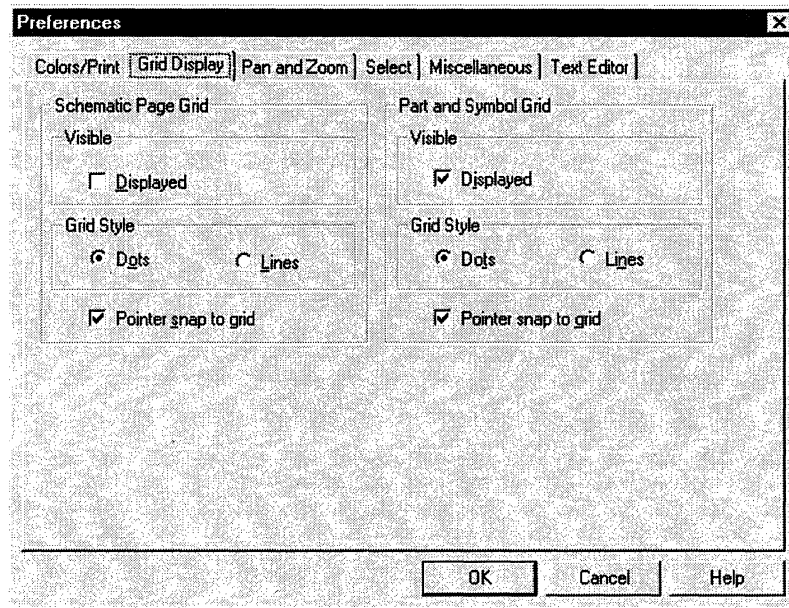

To control the grid

- 1 From the Options menu, choose Preferences (ALT, O, P), then choose the Grid Display tab.
- 2 For the schematic page editor and the part editor, specify:
 - Whether to display the grid, print the grid, or both.
 - Whether the grid uses dots or lines.
 - Whether the pointer snaps to grid as you place objects.
- 3 Choose the OK button.



Tip You can also show or hide the grid using the Grid command on the View menu in the schematic page editor or the part editor.

Setting pan and zoom

When you have an object attached to the pointer and you move the pointer near the edge of the window while holding the left mouse button down, the display changes to a different region of the document. This change is called *panning*. The display automatically pans only if you have an object attached to the pointer and you hold the left mouse button down; otherwise, you must use the window's scroll buttons to view a different region of the document. You configure the percent by which the display changes using the Auto Scroll Percent setting.

When you zoom in or out, the view changes by the zoom factor. You can define pan and zoom settings for the schematic page editor and the part editor.

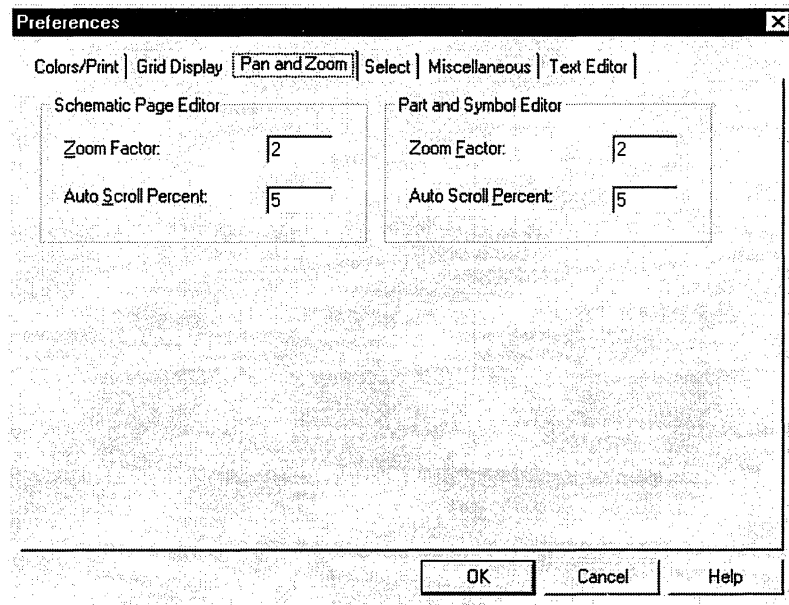

To configure zoom factor and auto scroll percent

- 1 From the Options menu, choose Preferences, then choose the Pan and Zoom tab.
- 2 For the schematic page editor and the part editor, set these options:
 - **Zoom Factor.** Enter a number to indicate the magnification or reduction of the objects shown in the window when you zoom in or zoom out.
 - **Auto Scroll Percent.** Enter the percent of the window's horizontal or vertical dimension by which the display will scroll.
- 3 Choose the OK button.

Defining selection options

You can specify whether objects are selected when the selection border intersects them or if the objects are selected only when they are completely enclosed in the selection area. You can also change the maximum number of objects displayed at high resolution while dragging, and set tool palette visibility in both the schematic page editor and the part editor.

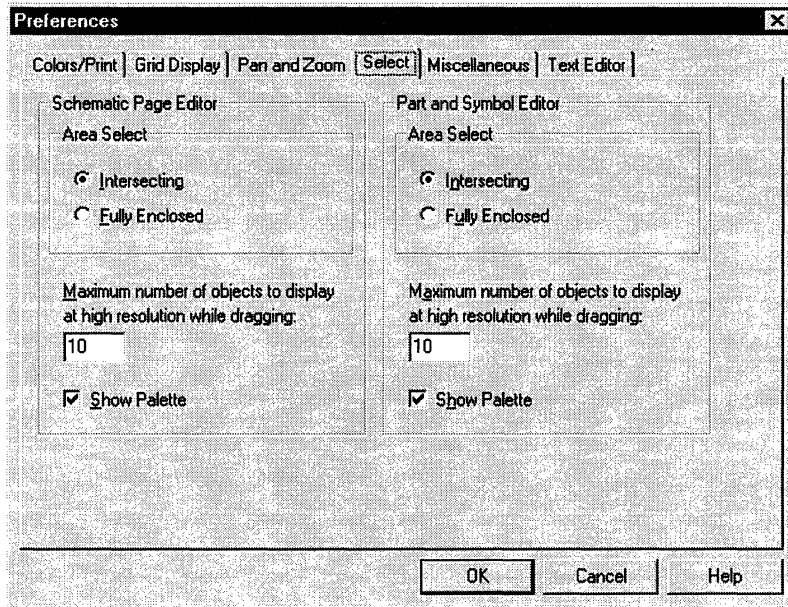

To define selection options

- 1 From the Options menu, choose Preferences (ALT, O, P), then choose the Select tab.
- 2 For the schematic page editor and the part editor, set these options:
 - **Area Select.** Specify whether to select objects that are intersecting the selection border or only objects that are fully enclosed by the selection border.
 - **Maximum number of objects to display at high resolution while dragging.** If you drag more objects than you specify here, you will see rectangular placeholders for the objects as you drag them.
 - **Show Palette.** Select this check box to make the tool palette visible; deselect it to make the tool palette invisible.
- 3 Choose the OK button.

Setting miscellaneous options

You can specify the default fill, line style and width, and color for graphic objects, define the font used in the project manager and session log, render TrueType fonts with strokes (for printing and plotting), and set whether to autosave your project and how often. In addition, you can enable intertool communication, which is the method that Capture uses to communicate with other OrCAD software, such as OrCAD Layout for Windows.



Note You can change the fill style, line style and width, and color on graphic objects on an individual basis once they are drawn on a schematic page. Select the object, then from the Edit menu, choose Properties. For specific instructions, see *Chapter 8: Adding and editing graphics and text*.



See For information about intertool communication between Capture and Layout, see *Chapter 18: Using Capture with OrCAD Layout for Windows*.

For information about intertool communication between Capture and Simulate, see *Chapter 19: Using Capture with OrCAD Simulate for Windows*.

The text rendering options affect how text on a schematic page appears on your screen, and how it is printed or plotted. The Render TrueType fonts with strokes option displays text as a series of lines, connected to resemble the outlines of the corresponding TrueType letters or numbers they represent. Enabling the Fill text option causes the text outlines to be filled in.



Tip The Render TrueType fonts with strokes option produces text that is printed or plotted quickly, but is not as aesthetically pleasing as TrueType text. For this reason, you may want to enable the option when you print or plot drafts of your schematic pages, then disable the option when you print or plot the final versions of your schematic pages.

To protect your work in the event of a system crash or power outage, you can enable Autosave, and set the interval at which your design, library, or VHDL file is saved.

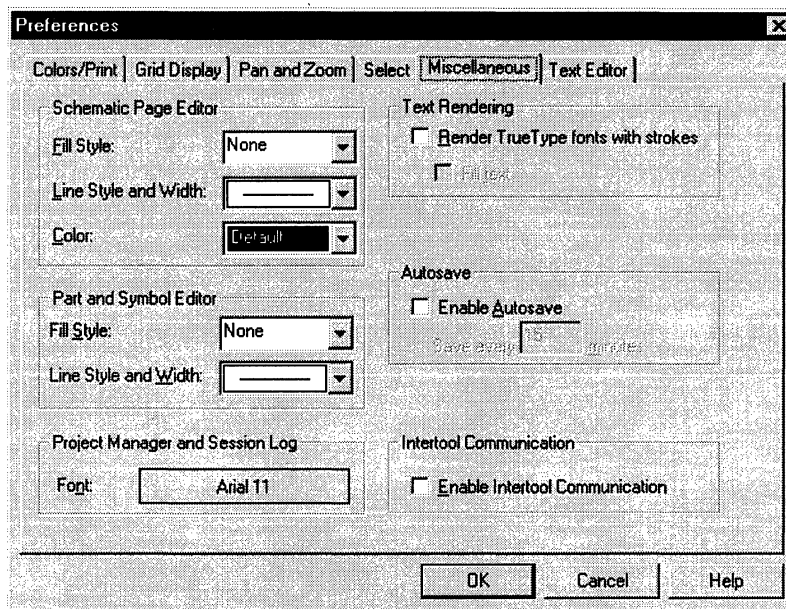

To set miscellaneous options

- 1 From the Options menu, choose Preferences (ALT, O, P), then choose the Miscellaneous tab.
- 2 For the schematic page editor and the part editor, set these options:
 - **Fill Style.** Select the fill pattern to be used when drawing rectangles, ellipses, and closed shapes drawn with the polyline tool.
 - **Line Style and Width.** Select the line style and width used for lines, polylines, rectangles, ellipses, and arcs.
- 3 For the schematic page editor, set this option:
 - **Color.** Select the color used for rectangles, ellipses, and closed polylines.

 **Note** The Default color is the color defined in the Graphics box in the Colors/Print tab in the Preferences dialog box.

The color for lines, polylines, and arcs drawn in the schematic page editor is defined in the Graphics box in the Colors/Print tab in the Preferences dialog box.

- 4 Set the following options:
 - **Project Manager and Session Log.** Select a font for display text in the project manager and session log. If you select this option, a standard Windows dialog box for font selection displays. Select a font, style, and size from the dialog box, then choose the OK button.

- **Text Rendering.** Select whether to enable rendering TrueType fonts with strokes and, if so, whether to fill the strokes.
 - **Autosave.** Select whether to autosave your project and, if so, the interval between saves. You can specify any interval between 1 minute and 720 minutes. When the time interval is up, any design, library, or VHDL file in your project that hasn't been saved, or has been modified since the last save, is saved as a temporary file (with an .ASP extension) in the WINDOWS/TEMP/AUTOSAVE directory. When you close your project normally, the /AUTOSAVE directory and temporary files are deleted. In cases of power outages or system crashes, however, the temporary files are saved. When you restart Capture, it loads the autosaved files, showing "Restored" in their title bars. You must use the Save As command and provide a filename to have an autosaved file overwrite the original file.
 - **Intertool Communication.** Select whether to enable intertool communication (also known as ITC), so that you can test and display design information using other OrCAD software (such as Layout) in conjunction with Capture.
- 5 Choose the OK button.

Setting text editor options

Capture's text editor options include automatic highlighting of VHDL keywords, comments, or quoted strings. You can also set the font, the tab spacing, and enable or disable the highlighting feature.

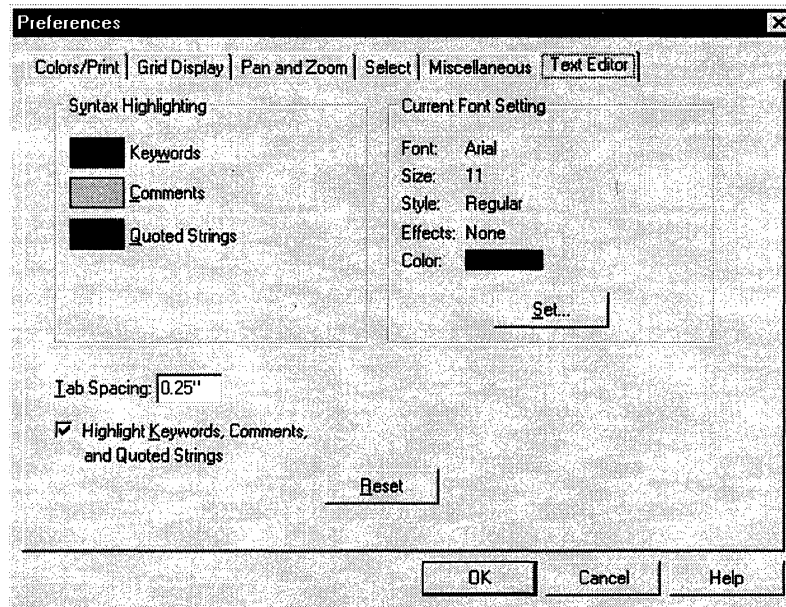

To set text editor options

- 1 From the Options menu, choose Preferences (ALT, O, P), then choose the Text Editor tab.
- 2 Set these options:
 - **Syntax Highlighting.** Select the color to use to highlight VHDL keywords, comments, and quoted strings. You can choose a different color for each.
 - **Current Font Setting.** Choose the Set button to change the font setting for the text editor to values other than those displayed.
 - **Tab Spacing.** Set the tab spacing for the text editor.
- 3 Check the Highlight Keywords, Comments, and Quoted Strings option to have those VHDL items highlighted in the text editor. The colors used to highlight these items are the ones set in the Syntax Highlighting group box.
- 4 Choose the OK button.

Setting up your project template

The options that you define in the Design Template dialog box are the default settings for all new projects, and for schematic pages you add to an existing project. You can override some of these options for individual projects or schematic pages. Some of the things you can define in the Design Template dialog box are:

- **Fonts.** You can define the fonts for schematic page objects that contain text, such as part references and values.
- **Title Block.** You can specify the text to appear in title block fields, as well as the path and filename of the library containing the title block. This affects new projects, as well as new schematic pages in existing projects.
- **Page Size.** You can specify whether inches or millimeters are used as the unit of measure, the width and height of a schematic page, and the spacing between pins.
- **Grid Reference.** For horizontal and vertical grid references, you can set the number of grid references to display in either direction, whether the grid references are alphabetic or numeric, whether they increment or decrement across the schematic page, and how wide grid reference cells are. You can also make the border, grid references, and title block visible or invisible. This affects new projects, as well as new schematic pages in existing projects.
- **Hierarchy.** For hierarchical blocks and part instances that have their Primitive property set to Default, you can specify if you want Capture to treat each as primitive (cannot descend into attached schematic folders) or nonprimitive (can descend into attached schematic folders).
- **SDT Compatibility.** You can specify which Capture properties map to which SDT part fields when saving a project in SDT format.

Setting up fonts for new projects

You can define the fonts assigned to the text associated with different schematic page objects in new designs. The fonts specified here do not affect existing designs.

 **Note** To change the fonts for an existing project, use the Fonts tab in the Design Properties dialog box. You can access this dialog box by choosing Design Properties from the project manager's Options menu.

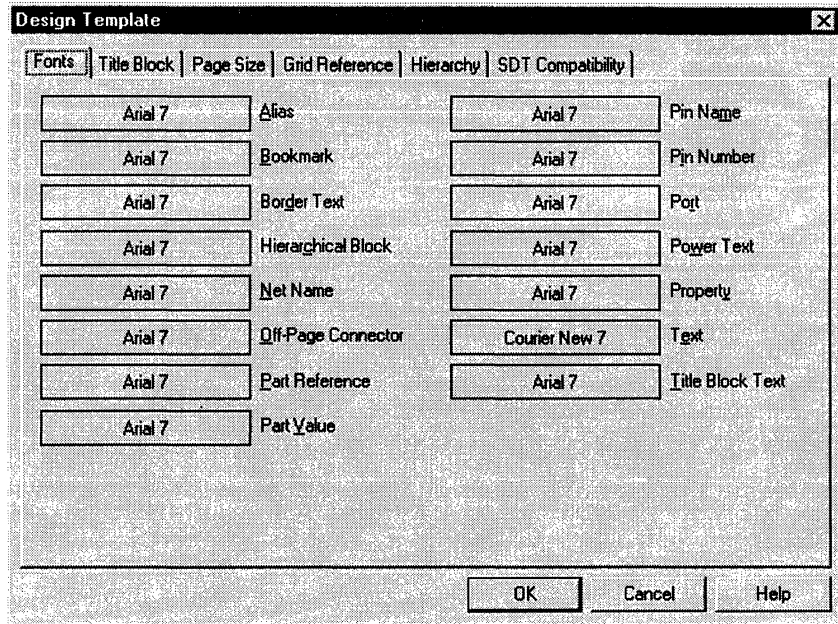

To assign fonts used for new designs

- 1 From the Options menu, choose Design Template (ALT, O, D), then choose the Fonts tab.
- 2 Click the left mouse button on the font of an item. A standard Windows font dialog box displays.
- 3 Select a font, font style, and size. Choose the OK button to dismiss the font dialog box.
- 4 Choose the OK button.

 **Note** The default fonts were selected for optimal compatibility with SDT. Changing these fonts may result in less optimal text sizes for translated projects.

Defining title block information

There are two types of title blocks: default and optional.

- You specify the information that goes into the default title block in the Title Block tab of the Design Template dialog box. Capture places a default title block in the lower right corner of each schematic page (if a library and title block name are specified), and places the information you enter in the text fields in the Title Block tab into the title block. This information is also used in reports created by the commands on the Tools menu. This affects new projects, as well as new schematic pages in existing projects. You can set the default title block to be visible or invisible on an existing schematic page by changing the setting in the Grid References tab in the Schematic Page Properties dialog box.
- You can place any number of optional title blocks anywhere on the schematic page using the Title Block command on the Place menu. Optional title blocks display information that you define as property values for the title block symbol.

Capture provides default title block symbols in the CAPSYM.OLB library. One such title block is shown below. The text shown in curly braces acts as property text placeholders. You can specify the value by double-clicking on the text and supplying a value. You can control the visibility by selecting or deselecting the Visible check box in the Display Properties dialog box.

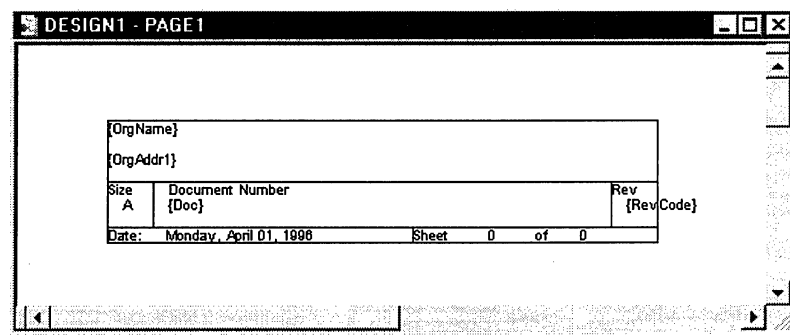

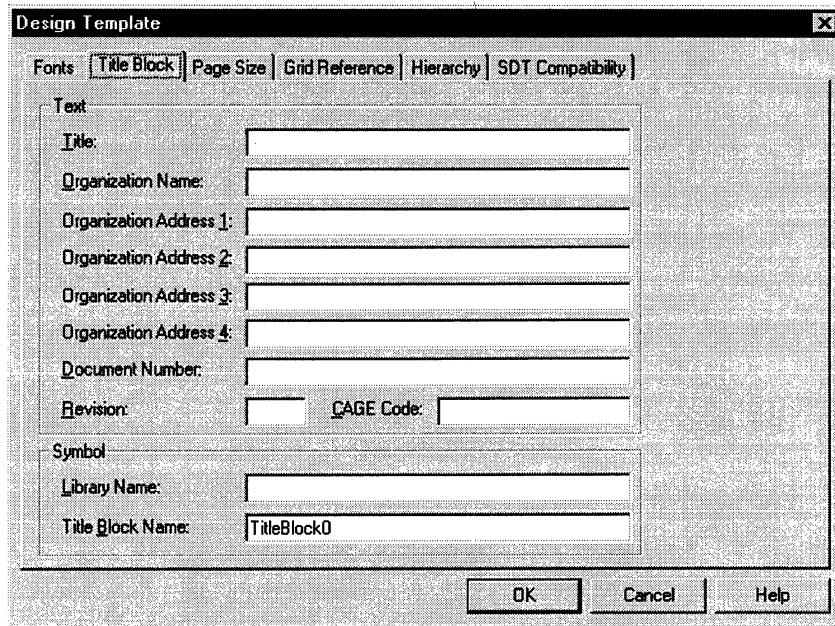

To choose a title block and define the text it contains

- 1 From the Options menu, choose Design Template (ALT, O, D), then choose the Title Block tab.
- 2 In the Text group box, enter the information you want to appear in the title block.
- 3 In the Symbol group box, enter the path and filename of the library containing the title block, and enter the name of the title block.
- 4 Choose the OK button.



Tip You can create custom title blocks and store them in a library using the New Symbol command from the project manager's Design menu. If you specify the name of the custom library and title block in the Symbol group box of the Design Template's Title Block tab, then the custom title block appears in the lower right corner of each schematic page. See Capture's online help for specific instructions.

Setting the schematic page size for new projects

For new projects, you can specify the default unit of measure, the default width and height of schematic pages, and the spacing between pins. The value you enter in the Pin-to-Pin Spacing text box defines how close together pins are placed in the part editor. It also defines the grid spacing (the space between grid dots or grid lines).

 **Note** You can select a different unit of measure or page size (A, B, C, D, E, and Custom if the unit of measure is Inches; or A4, A3, A2, A1, A0, and Custom if the unit of measure is Millimeters) for individual schematic pages in existing projects using the Page Size tab in the Schematic Page Properties dialog box (choose Schematic Page Properties from the schematic page editor's Options menu).

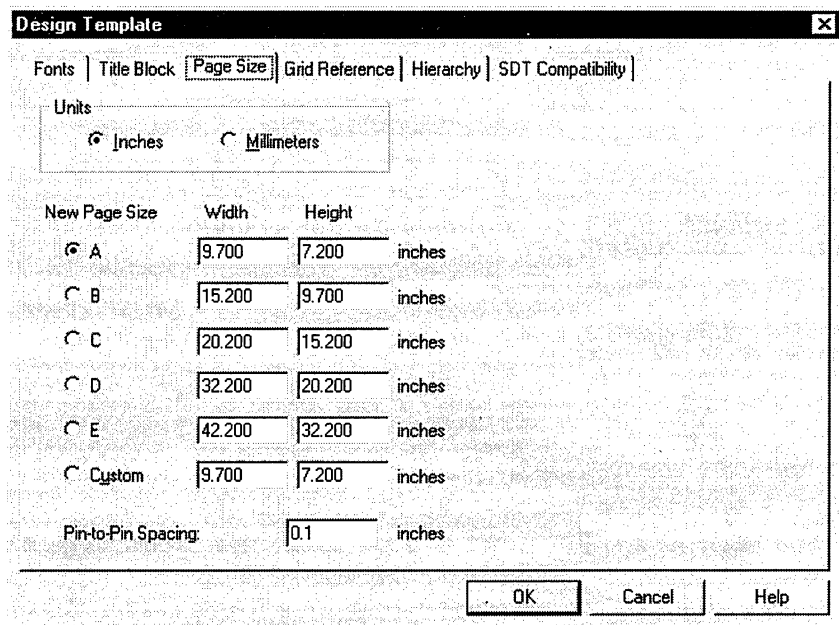

To set up the schematic page size

- 1 From the Options menu, choose Design Template (ALT, O, D), then choose the Page Size tab.
- 2 In the Units area, select the default unit of measure for new projects. This setting only affects the schematic page editor, not the part editor.



Caution Changing from Inches to Millimeters resets the page sizes to their defaults; therefore, if you make any changes to the standard page size dimensions, then change the units, the page size changes are not translated between the two types of units.

- 3 Select the default schematic page size for new projects. For each schematic page size (A, B, C, D, E, and Custom if the unit of measure is Inches; or A4, A3, A2, A1, A0, and Custom if the unit of measure is Millimeters) you can specify the width and height. The values that you enter in the Width and Height text boxes become the dimensions for each page size. You cannot change these dimensions for individual schematic pages, although you can select a different page size.
- 4 In the Pin-to-Pin Spacing text box, specify the default spacing between pins. The value you enter in this text box defines how close together pins are when you place them on a part in the part editor. It also defines the grid spacing (the space between grid dots or grid lines). You cannot change this value for existing projects or individual schematic pages.
- 5 Choose the OK button.

Defining the grid reference

You set grid references to display either horizontally or vertically, whether they are alphabetic or numeric, whether they increment or decrement across the schematic page, and the width of their cells. You can also make the border, grid references, and title block visible or invisible on the screen and on schematic pages you print. The settings affect new projects and new schematic pages in existing projects.



Note You can change these settings for existing schematic pages. Choose Schematic Page Properties from the schematic page editor's Options menu, then choose the Grid Reference tab in the Schematic Page Properties dialog box.

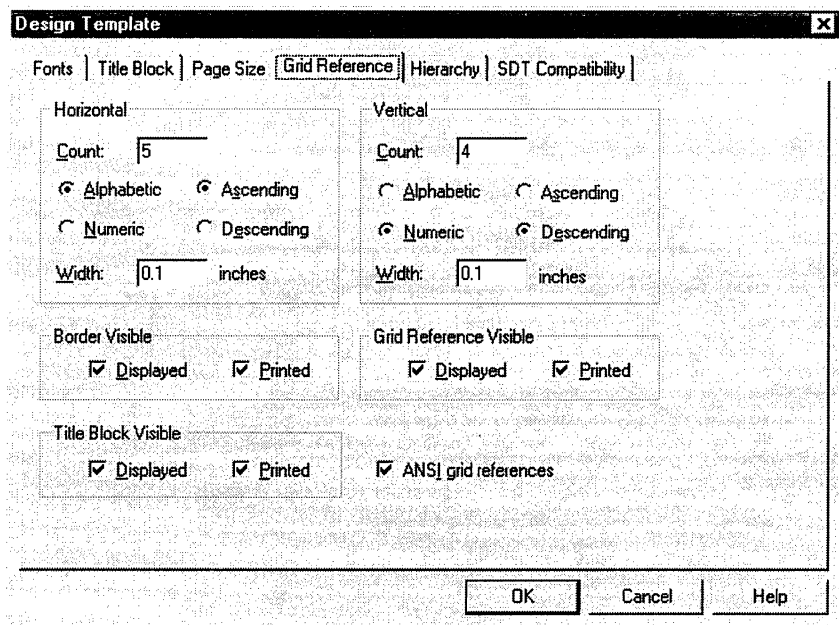

To define the grid reference

- 1 From the Options menu, choose Design Template (ALT, O, D), then choose the Grid Reference tab.
- 2 Specify the number of grid references, whether they are alphabetic or numeric, whether the grid references increment (Ascending) or decrement (Descending) across the schematic page, and how wide the grid reference cells are.
- 3 For the border, title block, and grid reference, select Displayed to have the item display on the screen or Printed to have the item appear on schematic pages you print. Select ANSI grid references to display the grid references in accordance with ANSI standards (see the glossary entry ANSI).
- 4 Choose the OK button.

Defining the default hierarchy option for new projects

For hierarchical blocks and part instances that have their Primitive property set to Default, you can specify if you want Capture to treat each as primitive (cannot descend into attached schematic folders) or nonprimitive (can descend into attached schematic folders). The Primitive and Nonprimitive options in the Hierarchy tab of the Design Template dialog box only affect new projects.

 **Note** You can change this option for existing projects using the Hierarchy tab in the Design Properties dialog box. You can access this dialog box by choosing Design Properties from the project manager's Options menu.

Note that this setting affects how the options on the Tools menu process projects.

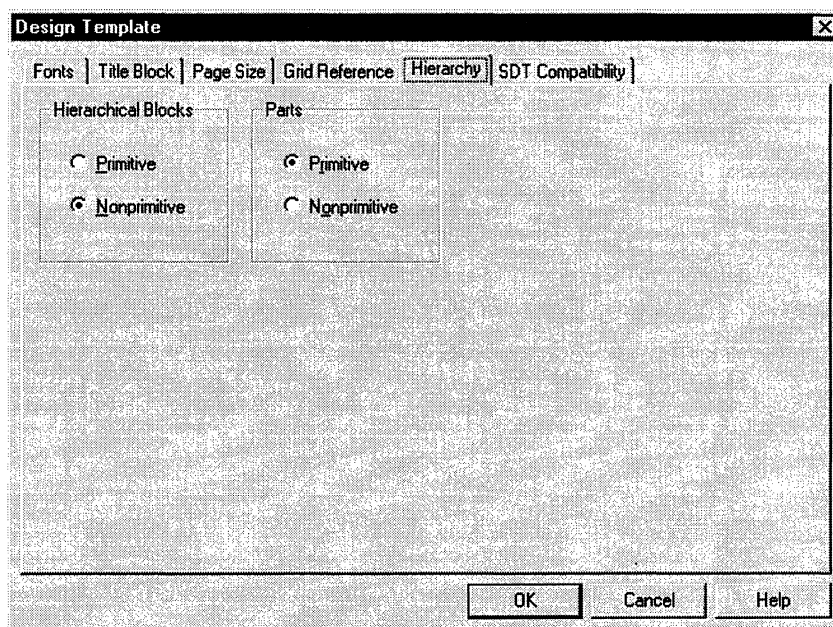

To define the default hierarchy option

- 1 From the Options menu, choose Design Template (ALT, O, D), then choose the Hierarchy tab.
- 2 For hierarchical blocks and parts, select Primitive or Nonprimitive. All hierarchical blocks and part instances that have their Primitive property set to Default will use the setting selected here.
- 3 Choose the OK button.

Setting up compatibility with OrCAD's Schematic Design Tools

You can specify which properties Capture stores in the eight SDT part fields when saving a project in SDT format.

Note You can also use the fields for mapping netlists that use part field information. For information on creating these types of netlists and the combined property strings they require, see Capture's online help.

In the dialog box shown below, the part fields listed on the left are SDT's part fields. The text boxes on the right are used to specify which of Capture's properties map to the part fields in SDT. The options in the SDT Compatibility tab of the Design Template dialog box only affect new projects.

Note To change the part field to property mapping for existing projects, use the SDT Compatibility tab in the Design Properties dialog box (from the project manager's Options menu, choose Design Properties).

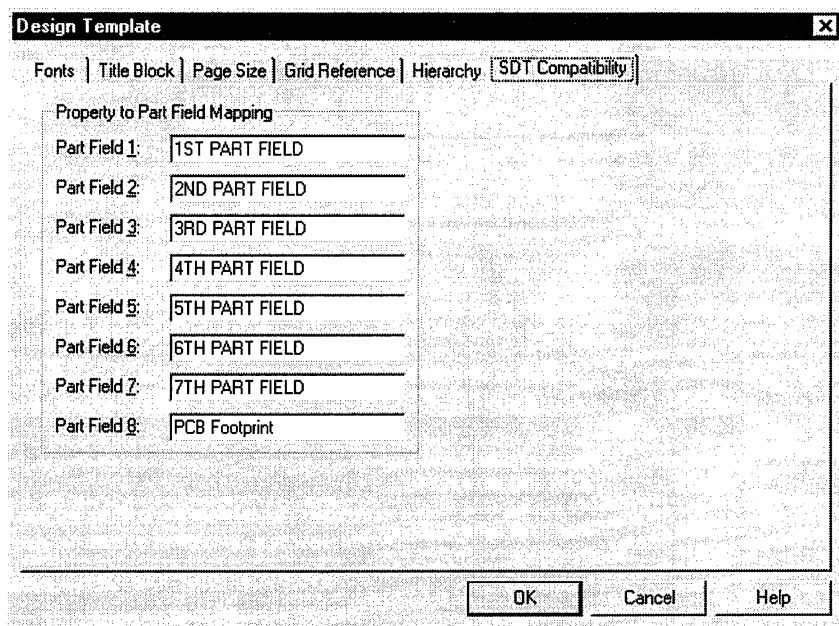

To set up compatibility with OrCAD's Schematic Design Tools

- 1 From the Options menu, choose Design Template (ALT, O, D), then choose the SDT Compatibility tab.
- 2 For each SDT part field, specify the Capture property to be placed in the part field when you save a Capture project in SDT format.
- 3 Choose the OK button.

Changing properties of existing projects

When you create a new project, it uses the options defined in the Design Template dialog box. You can set the options on existing projects using the Design Properties dialog box (from the project manager's Options menu). The options are:

- **Fonts.** You can define the fonts for schematic page objects that contain text, such as part references and part values.
- **Hierarchy.** You can specify hierarchical blocks and part instances whose Primitive property is set to Default be treated as primitive (cannot descend into attached schematic folders) or nonprimitive (can descend into attached schematic folders).
- **SDT Compatibility.** You can specify which Capture properties map to which SDT part fields when saving a project in SDT format.
- **Miscellaneous.** You can view the project name, root schematic folder name, creation time, and modification time. Also, if you need to see the power pins on a schematic page for documentation or debugging purposes, you can display them on the screen.



See You can override other Design Template options (page size and grid reference) using the Schematic Page Properties dialog box. For further information, see *Changing properties of existing schematic pages*.

Assigning fonts

Fonts are assigned to new projects using the Fonts tab in the Design Template dialog box. You can change fonts for individual projects using the Fonts tab in the Design Properties dialog box (choose Design Properties from the project manager's Options menu). See *Setting up fonts for new projects* in this chapter for more information.

Defining hierarchy

The behavior for hierarchical blocks and part instances whose Primitive property is set to Default (whether to act as primitive or nonprimitive) is defined for new projects using the Hierarchy tab in the Design Template dialog box. You can change this behavior for individual projects using the Hierarchy tab in the Design Properties dialog box (choose Design Properties from the project manager's Options menu). See *Defining the default hierarchy option for new projects* in this chapter for more information.

Using Capture with SDT

The mapping of Schematic Design Tools to Capture properties for new projects is defined using the SDT Compatibility tab in the Design Template dialog box. You can change this mapping for individual projects using the SDT Compatibility tab in the Design Properties dialog box (choose Design Properties from the project manager's Options menu). See *Setting up compatibility with OrCAD's Schematic Design Tools* in this chapter for more information.

Viewing invisible power pins without isolating them

Normally, power pins are invisible, and thus global. Selecting the Display Invisible Power Pins (for documentation purposes only) option in the Miscellaneous tab will display the pins on the screen, and they will still be considered global. However, you can only view the power pins—you cannot connect to them.



Note To be able to connect wires and other electrical objects to power pins, you must make them visible on the part or instance. Select the part and then, from the Edit menu, choose Properties. Select the Power Pins Visible option and choose the OK button. If you connect a wire or other electrical object to a power pin made visible by this method, that pin is isolated from the global net.

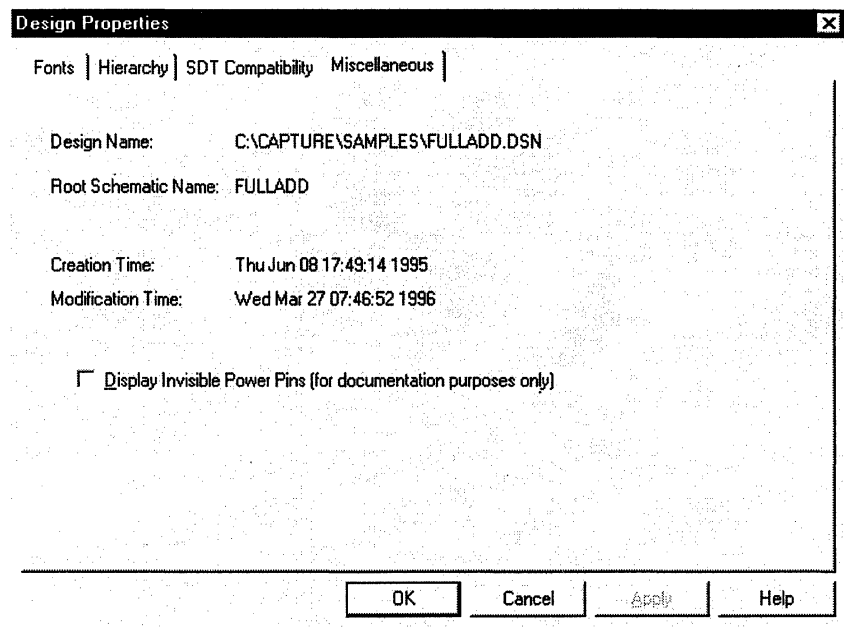

To view invisible power pins without isolating them

- 1 From the project manager's Options menu, choose Design Properties (ALT, O, R), then choose the Miscellaneous tab.
- 2 Select the Display Invisible Power Pins option.
- 3 Choose the OK button.

Changing properties of existing schematic pages

When you add a new schematic page, the options defined in the Design Template dialog box are used. You can override these options on existing schematic pages by using the options in the Schematic Page Properties dialog box. You access this dialog box by choosing Schematic Page Properties from the schematic page editor's Options menu. The options in the Schematic Page Properties dialog box are:

- **Page Size.** You can specify the unit of measure and the page size.
- **Grid Reference.** You can set the number of horizontal or vertical grid references to display, whether the grid references are alphabetic or numeric, whether they increment or decrement across the schematic page, and how wide the grid reference cells are. You can also make the border, grid references, and title block visible or invisible.
- **Miscellaneous.** You can view information about the schematic page, such as creation time, modification time, and page number.



See You can override other Design Template options (fonts, hierarchy, and SDT compatibility) using the Design Properties dialog box. For further information, see *Changing properties of existing projects*.

Changing page size

For existing schematic pages, you can change the unit of measure from Inches to Millimeters or select a different page size. Since the width and height for each page size (except Custom) and the pin-to-pin spacing are set in the Design Template Page Size tab, you cannot change these particular items in the Schematic Page Properties Page Size tab. You can access the Schematic Page Properties dialog box by choosing Schematic Page Properties from the schematic page editor's Options menu. See *Setting the schematic page size for new projects* in this chapter for more information.

Setting up new grid references

Horizontal and vertical grid references for new schematic pages are set up in the Grid Reference tab of the Design Template dialog box. You can change these settings for existing schematic pages using the Grid Reference tab in the Schematic Page Properties dialog box (choose Schematic Page Properties from the schematic page editor's Options menu). See *Defining the grid reference* in this chapter for more information.

Viewing miscellaneous schematic page properties

The Miscellaneous tab in the Schematic Page Properties dialog box displays the creation time and the last modification time of the schematic page, as well as the page number.

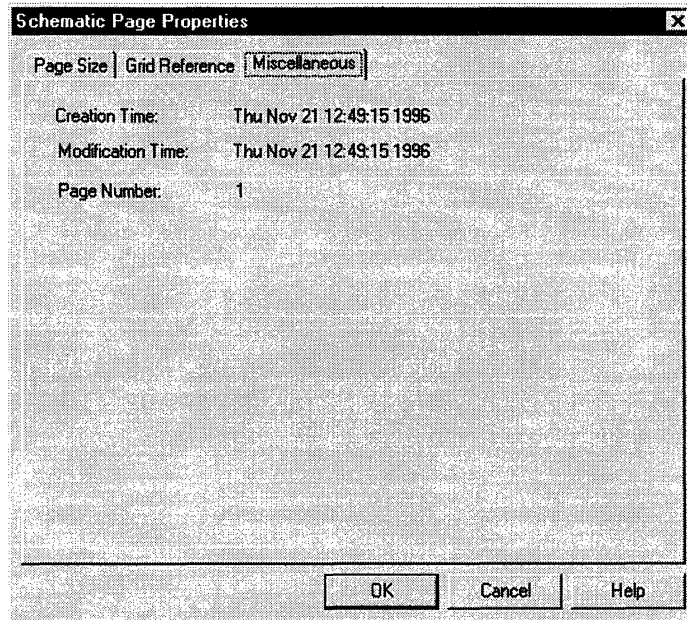

To view miscellaneous schematic page properties

- 1 From the schematic page editor's Options menu, choose Schematic Page Properties (ALT, O, E), then choose the Miscellaneous tab.
- 2 When you are done viewing the information, choose the OK button.

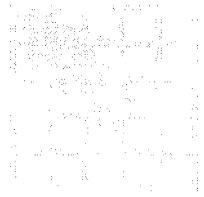

Printing and plotting

To send output to a printer, a plotter, or an encapsulated PostScript® file, you use the standard Windows Print Setup, Print Preview, and Print dialog boxes.



Note Capture can send output to any print driver that Windows supports. For additional information on print drivers, see the Windows documentation.

The printing commands can be accessed from the File menu in the project manager, the schematic page editor, or the part editor. You can print schematic pages, parts, or packages.

Configuring a printer or plotter



From the File menu, choose the Print Setup command. Select an appropriate printer or plotter, or change the printer settings, then choose the OK button.



See To install and remove printers and plotters, and to set additional printing options, see the Windows documentation regarding the Windows Control Panel.

Printing or plotting schematic pages

You can print or plot a schematic page, or several schematic pages, from the project manager. With the schematic page editor active and open to a specific schematic page, you can create a print or a plot of that schematic page.

To print or plot a schematic page or pages

- 1 Activate the schematic page editor window for the page you want to print.
or
In the project manager, select the schematic page or pages.
- 2 From the File menu, choose Print (ALT, F, P). The Print dialog box displays.
- 3 Select the scale, print offsets, print quality, number of copies, and whether to print to file.
- 4 Choose the OK button to send the image to the output device.

Printing or plotting parts or packages

With the part editor active and open to a specific part or package, you can create a print or a plot of that part or package. You can also print a library part from the project manager.

To print or plot a part or package

- 1 Select the part or package you want to print in the schematic page editor.
or
Select the library part in the project manager.
- 2 From the right mouse button pop-up menu in the schematic page editor, choose Edit Part. The part appears in the part editor.
- 3 From the part editor's View menu, choose Part to print a part or choose Package to print a package.
- 4 From the File menu, choose Print (ALT, F, P). The Print dialog box displays.
- 5 Select the scale, the print quality, and the number of copies.
- 6 Choose the OK button to send the image to the output device.

Printing or plotting text editor windows

With the text editor window active, you can create a print or a plot of the window.

To print or plot a text editor window

- 1 From the File menu, choose Print (ALT, F, P). The Print Range Selection dialog box displays.
- 2 Select whether to print highlighted text or the entire file.
- 3 Choose the OK button to send the image to the output device.

Previewing printer or plotter output

Using the Print Preview command, you can preview your schematic page, part, or package output to check its appearance before you commit it to paper.

To preview a schematic page

- 1 From the File menu, choose Print Preview (ALT, F, V). The Print Preview dialog box displays.
- 2 Specify the values in the dialog box, then choose the OK button. The Print Preview display window opens with a display of your schematic page, part, or package.
- 3 Use the Previous page and Next page buttons to look at other printer pages.
- 4 To zoom in, move the magnifier pointer to a specific area and click the left mouse button.
- 5 Choose the Close button to close the Print Preview window.

Scaling printer or plotter output

You can manually scale, or have Capture automatically scale, printer output and plots to fit the paper size you choose.

To scale a print or a plot

- 1 From the File menu, choose Print (ALT, F, P). The Print dialog box displays.
- 2 Select one of the three options in the Scale box.
 - The Scale to paper size option scales each schematic page to fit a single sheet of paper (as configured in the printer driver).
 - The Scale to page size option scales each schematic page to the sheet size you select in the Page size area. The sheet size is configured in the Page Size tab in the Design Template dialog box.
 - The Scaling option scales your schematic page to a factor of your choice. The acceptable range of factors is 0.1 to 10.0; up to three decimal places are allowed.
- 3 If you select the Scale to page size option in step 2, the Page size area becomes available. Select a sheet size. This results in multiple sheets of paper if you select a sheet size larger than your printer paper.
- 4 Choose the OK button to send the image to the output device.

Special considerations for plotting

Many plotters do not support bitmaps directly. If you are sending Capture output to a plotter, your bitmaps may not be plotted.

Plotter pen colors

The plotter driver maps your color choice to the closest available pen color as established in your plotter driver configuration. See your plotter's driver setup and documentation for more details.



See The plotter setup dialog boxes are only accessible from the Windows Control Panel. See the Windows documentation regarding the Windows Control Panel.

Many plotters do not have drivers that ship with Windows. If you do not see the plotter you are looking for in the list of available drivers, contact your plotter manufacturer and ask for a Windows driver. If your plotter emulates HPGL, an alternative solution is to use the HPGL driver.

Creating designs

Part Two contains information relating to schematic design tasks. It provides instructions for setting up your design environment, adding parts and graphics to your design, using macros, and navigating around in your design. Part Two includes these chapters:

Chapter 6: Design structure describes how to customize the working environment specific to your system, how to create default settings for new designs, and how to override default settings in individual designs.

Chapter 7: Placing, editing, and connecting parts and electrical symbols describes how to place and edit parts and symbols. It also describes how to connect the elements of your design using hierarchical blocks, hierarchical ports, off-page connectors, wires, and buses.

Chapter 8: Adding and editing graphics and text describes the drawing tools you can use to add text and a variety of graphic shapes to your design.

Chapter 9: Using macros describes how to create and run macros.

Chapter 10: Changing your view of a schematic page describes how to view specific areas of a schematic page using the Zoom command. It also describes jumping to different locations within a schematic using the Location, Reference, and Bookmark commands.

Part Two

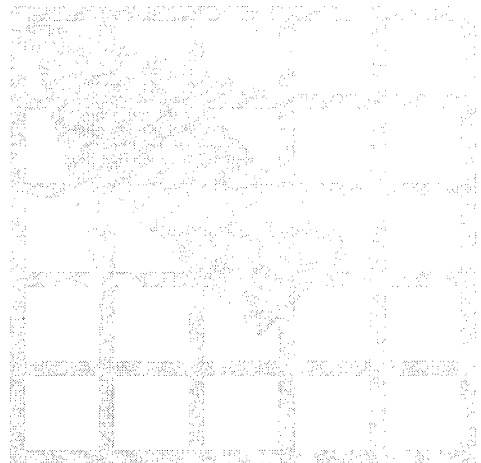

Design structure

Many schematic designs can fit on one schematic page. Some designs, however, are too large for even the biggest page, and even if a complex design could fit on one page, there are good reasons for dividing it:

- To fit at full scale on your printer's page.
- To partition a design so that several people can work on it at once.
- To develop the design using a top-down approach. That is, you may want to begin with a block diagram in which each block represents a major function and then construct more detailed diagrams for each of the blocks.
- To organize your design by functional parts.

Capture offers two ways of handling multiple-page designs: flat designs and hierarchical designs.

Flat designs

Flat designs are practical for small designs with few schematic pages. A flat design is a structure in which the output lines of one schematic page connect laterally to the input lines of another schematic page in the same schematic folder through objects called *off-page connectors*. A flat design has no hierarchy (no hierarchical blocks, hierarchical ports, hierarchical pins, or parts with attached schematic folders).

All schematic pages in a flat design are contained within a single schematic folder, and are on a single level, as shown at right.

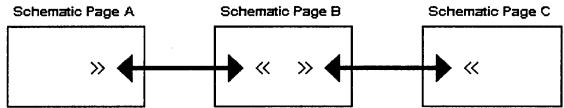

Flat design.

Since you must manage all of the interconnections between the pages of a flat design using the names assigned to the off-page connectors, it is best to keep a flat design relatively small.

In the project manager, a flat design displays as shown at right.

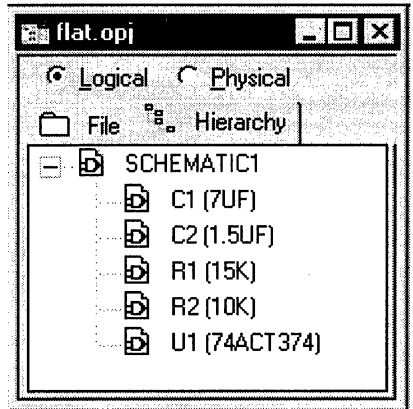

Hierarchical designs

Instead of a flat design, you can create symbols on schematic pages that represent other schematic folders. These symbols are called *hierarchical blocks*. The layered arrangement created by placing schematic folders inside schematic pages is called a *hierarchy*. Any schematic page can contain hierarchical blocks (or parts with attached schematic folders) that refer to other schematic folders, and this nesting structure can be many levels deep. The schematic folder at the top of a hierarchy, which directly or indirectly refers to all other schematic folders in the project, is called the *root schematic folder*. In the project manager, the root schematic folder has a backslash in its folder icon. The root schematic folder, as well as any other schematic folder, can contain as many schematic pages as are necessary.

Simple hierarchical designs

A one-to-one correspondence between hierarchical blocks (or parts with attached schematic folders) and the schematic folders they reference is called a *simple hierarchy*. The picture at right is an example of a simple hierarchy.

In a simple hierarchy, each hierarchical block or part with an attached schematic folder represents a unique schematic folder.

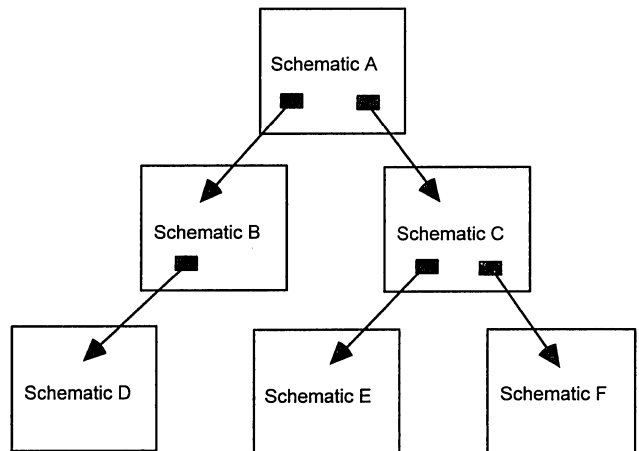

In the project manager, a simple hierarchical design displays as shown at right.

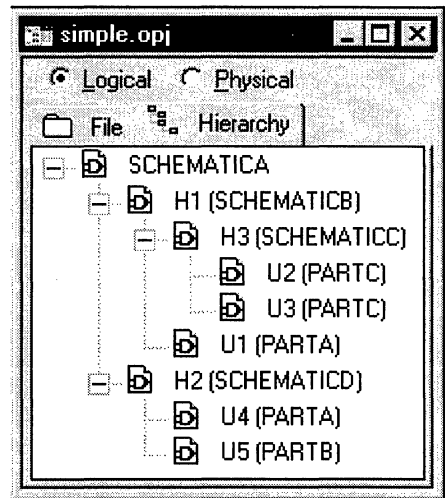

Complex hierarchies

A many-to-one correspondence between hierarchical blocks (or parts with attached schematic folders) and the schematic folders they reference is called a *complex hierarchy*. In the picture at right, schematic A references schematic B three different times. These references can be via hierarchical blocks or parts with attached schematic folders.

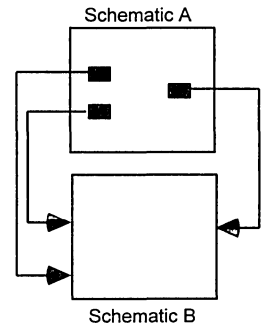

In the project manager, a complex hierarchical design displays as shown at right.

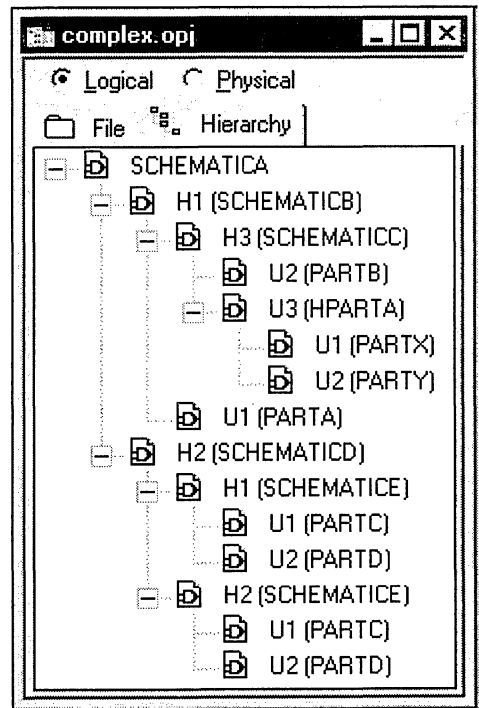

Connecting schematic folders and schematic pages

In Capture, you connect schematic folders and schematic pages by extending nets between them using hierarchical blocks (or parts with attached schematic folders), hierarchical ports, hierarchical pins, and off-page connectors. Hierarchical blocks (or parts with attached schematic folders), hierarchical ports, and hierarchical pins carry signals between schematic folders and schematic pages, while off-page connectors carry signals between schematic pages within a single schematic folder.



See also For information about placing hierarchical blocks, hierarchical ports, hierarchical pins, and off-page connectors, see *Chapter 7: Placing, editing, and connecting parts and electrical symbols*.

Hierarchical blocks

Hierarchical blocks (or parts with attached schematic folders) refer to child schematics in a design, providing vertical (downward-pointing) connection only.

Hierarchical pins in a hierarchical block, and hierarchical ports outside a hierarchical block, act as points of attachment for any connections between the hierarchical

block and other electrical objects in an attached schematic folder. The picture at right shows hierarchical pins (X, Y, SUM, and CARRY) within a hierarchical block, and a hierarchical port (CARRY_IN) outside a hierarchical block.

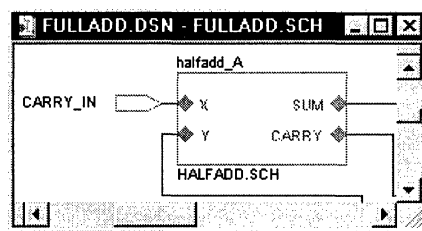

A part with an attached schematic folder functions like a hierarchical block, and pins on a part with an attached schematic folder function like hierarchical pins within a hierarchical block. You can use either method to define a hierarchy. The only difference between the methods is that a part with an attached schematic folder can be reused. You can attach a schematic folder that is external to a project to a hierarchical block, but be aware that you won't be able to use any of Capture's tools to make changes to the external design.



Caution If you attach a schematic folder that is external to a project to a hierarchical block, be sure to include the schematic folder when you give the project to another engineer or to a board fabrication house. Attached schematic folders external to a project *are not* carried along automatically when you copy or move a schematic folder to another project. Only the name of the attached schematic folder is carried along. For this reason, you should copy all attached schematic folders into your project if you want your project to be “portable.”



Note Before you create or resize a hierarchical block, make sure the Snap to grid option is turned on (from the schematic page editor's Options menu, choose Preferences). If the hierarchical block is off grid, then hierarchical pins inside it are also off grid—even if you change the Snap to grid setting before you place them—and it may be difficult to connect to these off-grid hierarchical pins.

Hierarchical ports

Hierarchical ports, such as those shown in the picture at right, are placed outside hierarchical blocks to provide vertical (upward-pointing) and lateral connections.

A hierarchical port connects vertically to a like-named hierarchical pin inside a hierarchical block, and connects laterally to like-named nets, hierarchical ports, and off-page connectors within the same schematic folder.

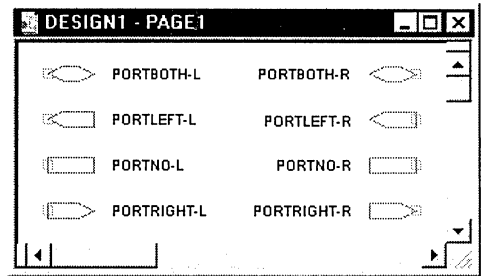

Hierarchical pins

Hierarchical pins, such as the four shown in the picture at right, provide vertical (downward-pointing) connection only.

Hierarchical pins are connected by name to hierarchical ports on schematic pages in an attached schematic folder. You can think of hierarchical pins as bringing a net “up” from an attached schematic folder into the hierarchical block, but not out onto the schematic page.

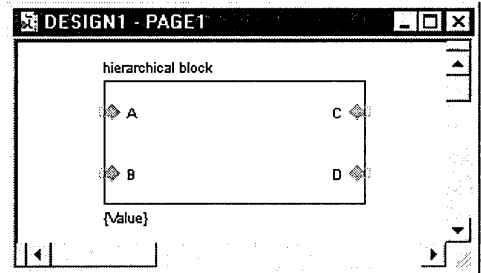

Off-page connectors

Off-page connectors provide connection between schematic pages within the same schematic folder. An off-page connector is connected by name to other off-page connectors within the same schematic folder. Like-named off-page connectors in different schematic folders are not connected. Capture’s symbol library CAPSYM.OLB contains two types of off-page connectors, shown in the picture at right.

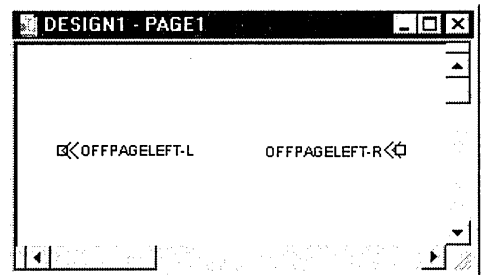

An example: creating a simple hierarchy

As described earlier in this chapter, you connect schematic folders and schematic pages by extending nets between them using off-page connectors, hierarchical ports, hierarchical pins, and hierarchical blocks. Off-page connectors carry nets between schematic pages within a single schematic folder. Hierarchical blocks, hierarchical ports, and hierarchical pins carry nets between schematic folders, which need not be in the same design.

The rest of this section contains an example of how to use off-page connectors, hierarchical ports, hierarchical pins, and hierarchical blocks to create a simple hierarchy.



See also For information about placing hierarchical blocks, hierarchical ports, hierarchical pins, and off-page connectors, see *Chapter 7: Placing, editing, and connecting parts and electrical symbols*.

This figure shows two schematic folders (Sch. A and Sch. B), each with two schematic pages. The schematic folder marked with a backslash (\) is called the *root schematic folder*.

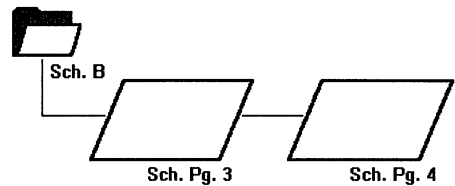
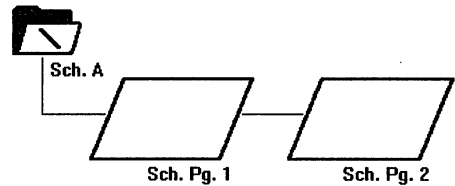

To establish the hierarchy with schematic folder A “above” schematic folder B:

- 1 Place a hierarchical block on schematic page 1.
- 2 In the Place Hierarchical Block dialog box, specify options in the Implementation group box to attach schematic folder B.

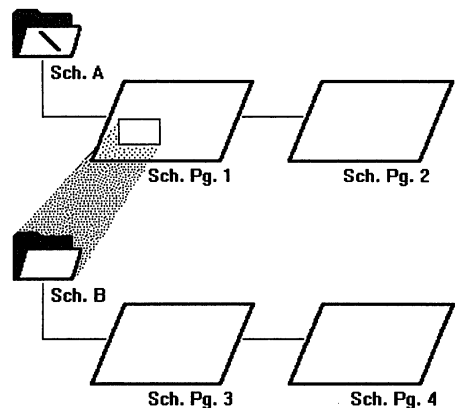

To carry a net between schematic folder A and schematic folder B:

- 1 Select the hierarchical block on schematic page 1 and place a hierarchical pin named “X” inside it.

The hierarchical pin is a point of attachment for electrical connections between the hierarchical block and other objects on schematic page 1.

- 2 Place a hierarchical port named X on schematic page 3.

The hierarchical port is a point of attachment for electrical connections between schematic page 3 and other schematic pages within schematic folder B. It is connected by name to the hierarchical pin inside the hierarchical block on schematic page 1.

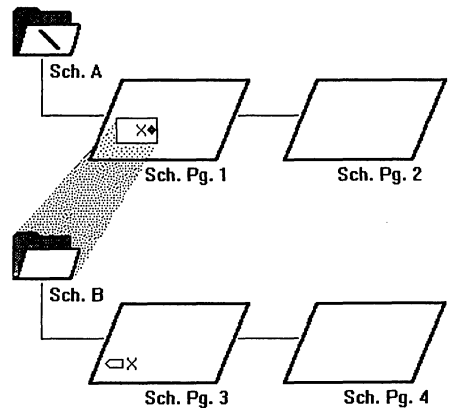

Hierarchical ports generally carry a net “up” through a hierarchy. In a root schematic folder, they usually represent external signals, such as a hierarchical block in another project.

The two hierarchical ports added to schematic folder A are electrically connected to each other by the name “Y,” so any electrical objects (such as power or ground symbols) on schematic pages 1 and 2 named Y are part of the net named Y. You could make one or both of these hierarchical ports off-page connectors without affecting the electrical connections.

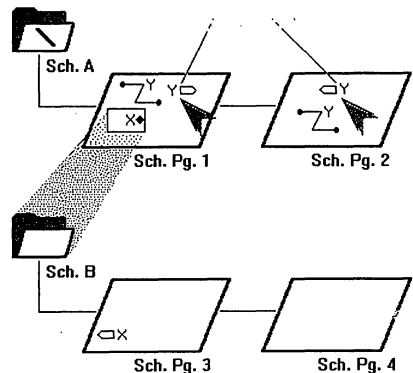

To connect the schematic pages in schematic folder B, place an off-page connector named X on schematic page 4. Any like-named electrical objects on schematic pages 3 and 4 are now part of a single net named X.

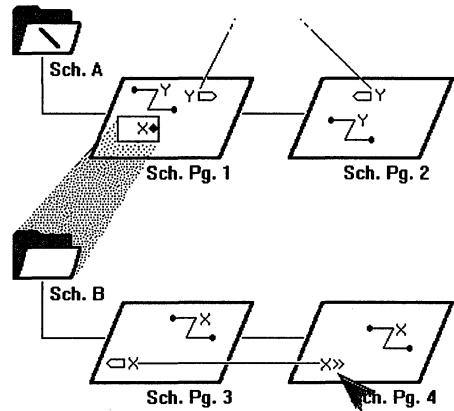

To connect the X nets in schematic folder B and the Y nets in schematic folder A, you cannot simply rename one set of objects to match the other set of objects. Remember, the hierarchical pin X inside the hierarchical block on schematic page 1 does not bring net X out onto schematic page 1. You must physically connect hierarchical pin X to net Y in order to join the two nets.

In the illustration at right, the Y nets on schematic pages 1 and 2 have become X nets because of the physical connection made between schematic page 1's hierarchical block and the net formerly named Y.

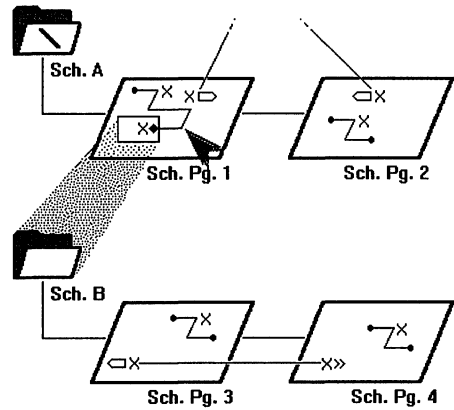

Placing, editing, and connecting parts and electrical symbols

Capture includes libraries containing parts, power symbols, and ground symbols. You can place instances of these objects on a schematic page. Once you have placed a part, you can edit its appearance, properties, or location. Once you have placed a power or ground symbol, you can rotate it or edit its name.

This chapter contains information about placing and editing these objects. It also explains how to connect these objects using wires and buses.

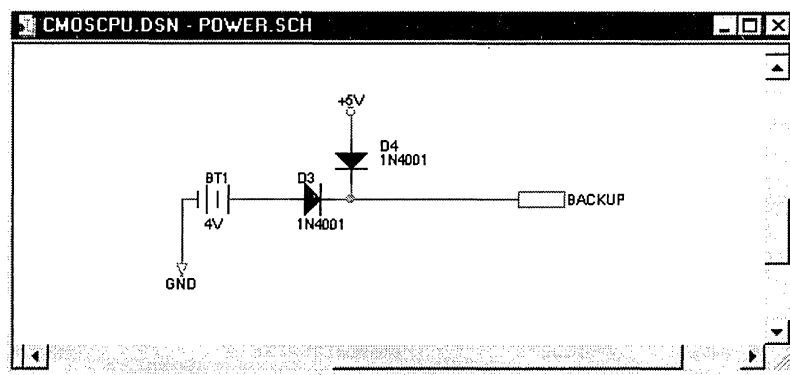

Capture also includes symbols used to establish connectivity between schematic pages. You use off-page connectors to connect signals between schematic pages within a schematic folder. You use hierarchical blocks, hierarchical ports, and hierarchical pins to connect signals from one schematic folder to another, or from an attached schematic folder.

Wires and buses are used to conduct signals between parts and electrical objects. Nets are made up of one or more wires that represent the net; a bus represents multiple signals or nets.

Placing and editing parts

Capture includes libraries with over 20,000 parts that you can use on your schematic pages. In addition, you can create your own parts.



See For information about creating your own parts, see *Chapter 12: Creating and editing parts*.

A library part has a *package* view, which corresponds to the actual physical object that could be placed, for example, on a printed circuit board. The package view identifies the physical pin numbers and how many logical objects (for example, parts or devices) are contained within the package.

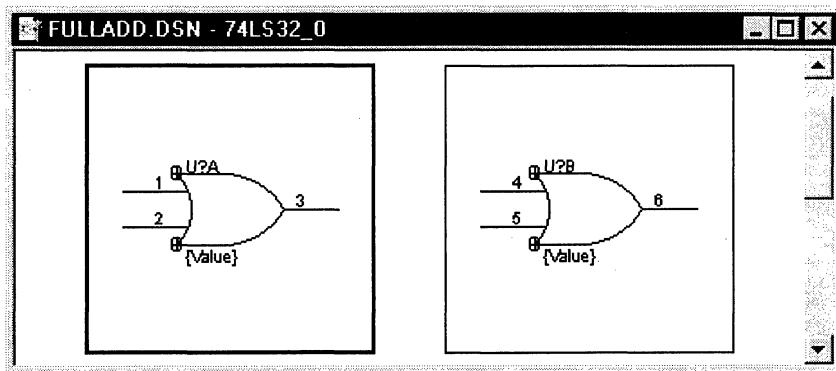

The different parts that make up a package can be identical in their graphic appearance and electrical connectivity (*homogeneous*) or they can be dissimilar in their graphic appearance or electrical connectivity (*heterogeneous*).

In addition to the package view, a library part has a *part* view, which is a graphical representation used to define a single, logical, electrical object whose electrical connectivity is represented by pins.

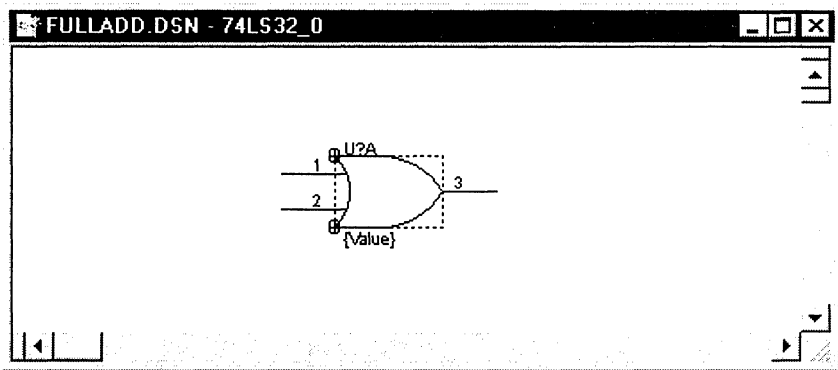

Each part has a set of properties that contain information—such as part value and reference designator—used by layout or simulation tools. In addition, you can create your own unique part properties to carry information relevant to your application.

Parts have pins that define the part's electrical connectivity. Pins carry information in properties that define the characteristics of each pin. This information includes the pin's name, number, shape (clock, dot, dot-clock, line, short, or zero length), type (3-state, bidirectional, input, open collector, open emitter, output, passive, or power), width (scalar or bus), and visibility. The pin type is used by the Design Rules Check command on the Tools menu to check conformance to basic electrical rules.



Tip A part doesn't have to have pins. If a part doesn't have pins, it is listed in a bill of materials report, but doesn't appear in a netlist. This is useful if you want to show hardware—such as screws, nuts, or washers—in a bill of materials report.

A primitive part is a basic part without any underlying hierarchy. A nonprimitive part is a part that has an underlying hierarchy, such as an attached schematic folder or VHDL code. Placing a nonprimitive part adds all the schematic pages that are part of the attached schematic folder to your project, making it easy to add levels of hierarchy to your project. You can see these additional schematic pages in physical mode, but not in logical mode.

Placing parts

You select parts from libraries and place them on schematic pages using the Part command on the Place menu, or using the part tool on the schematic page editor tool palette.

To place a part

- 1 From the schematic page editor's Place menu, choose Part (ALT, P, P).

or

Choose the part tool on the schematic page editor's tool palette.

The Place Part dialog box displays.

- 2 Select a part from the list that displays.

or

In the Part text box, type the name of the part. If you aren't sure of the name of the part, enter wildcard characters to constrain the list of parts, then choose the OK button. Valid wildcard characters are an asterisk (*) to match multiple characters and a question mark (?) to match a single character.

After you type the name of the part to place, choose the OK button. All parts in the libraries (listed in the Libraries list box) that match the part name are listed in the box below the Part text box. When you select a part from this box, its graphic image displays in the preview box.



Tips You can add more libraries to the Libraries list box by choosing the Add Library button. Capture displays a standard Open dialog box that you can use to locate a library to add to the list.

You can remove a library from the Libraries list box by selecting it and choosing the Remove Library button.

You can switch between the Normal view of a part and the Convert view of a part by choosing the appropriate option in the Graphic section.

If your part is a package that contains multiple parts, you can use the Part drop-down list in the Packaging area to select which part in the package to view, after you've selected a part from the list that displays.

- 3 When you have located the part you want to place, choose the OK button.

An image of the selected part is attached to your pointer. You can press the right mouse button to display a pop-up menu with commands that you can use to change the attributes of the part before you place it. You can mirror the part horizontally or vertically, rotate the part, or edit the part's properties.



Note All schematic page objects have right mouse button pop-up menus. These menus are context sensitive, displaying commands appropriate for the selected object. For information about pop-up menu commands, see Capture's online help.

- 4 Move to the location on your schematic page where you want to place the part, then click the left mouse button. This places an instance of the part on your schematic page. (You can place multiple instances of the part by clicking the left mouse button at each location where you want an instance of the part.)
- 5 When you are done placing instances of the selected part, choose End Mode from the right mouse button pop-up menu, or press ESC.

Place Part dialog box

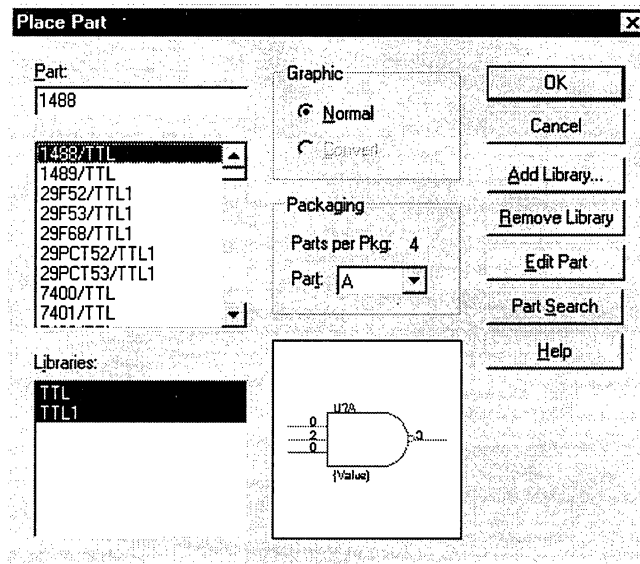

Part Specifies the name of the part. If you aren't sure of the exact name of the part, you can enter wildcard characters to constrain the list of parts, then choose the OK button. Valid wildcard characters are an asterisk (*) to match multiple characters and a question mark (?) to match a single character. The names of all parts in the selected libraries that match the wildcard appear in the Part list box.

Part list Lists the names of all parts in the selected libraries that match the name entered in the Part text box. If more than one library is selected, the part name is followed by a slash (/) and a library name. When you select a part in this list, its name displays in the Part text box, and its graphic displays in the preview box.

Libraries Lists the library names currently available. All parts in the selected libraries that match the Part text box display in the Part list. To select more than one library, press CTRL while you click the mouse.

Graphic You can choose the view of the part: Normal or Convert. Some parts have a Convert view that is used for things such as a DeMorgan equivalent of a part.

Packaging Parts per package indicates the number of parts in the package you are editing. Part indicates which part of a multiple-part package you are placing.

Preview box Displays the graphic of the selected part.

Add Library Displays a standard Open dialog box that you can use to locate a library and add it to the Libraries list.

 **Note** If you select an SDT 386+ or SDT Release IV library from the dialog box that displays when you choose Add Library, Capture automatically translates the file after you specify the name of the new Capture library.

Remove Library Removes the selected libraries from the Libraries list.

Edit Part Opens a part editor window for the selected part, and a project manager window for the part's library.

Editing parts

You can move a part on a schematic page by selecting it and dragging it to a new location. You can use the Rotate or the Mirror command from the Edit menu. You can use the part editor to change the part's physical appearance, and you can edit the part's properties. When you edit a part on a schematic page, your edited part differs from the part in the library and exists only in your project; the only way to place another copy of the part you edited is to use the Copy command from the Edit menu.



See also For more information about editing parts, see *Chapter 12: Creating and editing parts*.

To edit the physical appearance of a part, select it, and either choose Part from the Edit menu or choose Edit Part from the right mouse button pop-up menu. This opens the part in a part editor window. After you finish editing the part and choose Save, you're given a choice of updating the single instance, or updating all instances in the project. If you update only the single instance, Capture creates a new part in the design cache. If you update all instances, Capture replaces the library part in the design cache with your edited part.

To edit the properties of a part, select the part on the schematic page, and either choose Properties from the Edit menu, or choose Edit Properties from the right mouse button pop-up menu. You can also double-click on the part. This displays the Edit Part dialog box, which is described below.

Edit Part dialog box

Part Value Specifies the part value name. By default, the part value is set to the name of the part if you don't specify a part value in the library.

Part Reference Specifies the part reference.

Primitive Default indicates that the part uses the setting in the Hierarchy tab of the Design Properties dialog box. Yes indicates that the part is primitive. No indicates that the part is nonprimitive.

Graphic Indicates whether the part you are editing is in Normal view or in Convert view.

Packaging Parts per package indicates the number of parts in the package you are editing. Part indicates which part of a multiple-part package you are editing.

PCB Footprint The PCB physical package name to be included for this part in the netlist.

Power Pins Visible Specifies the visibility of the part's power pins.



See For information on power pin visibility and how it affects a global net, see Capture's online help.

User Properties Displays a dialog box that you can use to edit the part's property names and their respective property values.

Attach Implementation Displays a dialog box that you can use to attach a schematic folder, VHDL entity, netlist, or project, thus creating a hierarchy.



Caution An attached schematic folder or other file external to the project or library is not stored with the project or library. If you copy or move the project or library to a new location, you must also move or copy the attached object to keep them together. In addition, you may need to edit the path to the attached schematic folder or file if you move the project to a new location with a different directory structure.

Placing and editing power and ground symbols

You can place power and ground symbols, and you can edit their names before or after placing them. You can also edit the text associated with the symbols. The name of a power symbol is the name of the global net that is created.

Placing power and ground symbols

Power and ground symbols are placed on a schematic page using the Power command or Ground command on the Place menu, or using the power tool or ground tool on the tool palette. Power and ground symbols are selected from libraries the same way parts are selected from libraries.

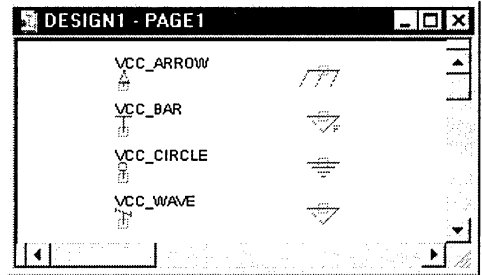

To place a power symbol

- 1 From the schematic page editor's Place menu, choose Power (ALT, P, O).
or
Choose the power tool on the schematic page editor's tool palette.

The Place Power dialog box displays.
- 2 In the Symbol text box, type the name of the symbol to place. If you aren't sure of the exact name of the symbol, you can enter wildcard characters to constrain the list of symbols, then choose ENTER. Valid wildcard characters are an asterisk (*) to match multiple characters and a question mark (?) to match a single character. All power symbols in the libraries selected in the Libraries list box that match the name of the power symbol are listed in the box below the Power Symbol text box. When you select a symbol from this box, its graphic image displays.



Tips You can add more libraries to the Libraries list box by choosing the Add Library button. Capture displays a standard Open dialog box that you can use to locate a library to add to the list.

You can remove a library from the Libraries list box by selecting it and choosing the Remove Library button.

You can assign a name (such as +5, GND, +5VDC, -12VDC, VSS, or VEE) by typing it in the Name text box. You can also assign a name after the power symbol is placed.

- 3 When you have located the power symbol you want to place, choose the OK button. An image of the power symbol is attached to your pointer. You can press the right mouse button to display a pop-up menu with commands to change the attributes of the power symbol before you place it. You can mirror the power symbol horizontally or vertically, or rotate it.



Note All objects that you can place on a schematic page have right mouse button pop-up menus. These menus are context sensitive, meaning they display commands that are appropriate for the selected object. For information about the commands on a pop-up menu, see Capture's online help.

- 4 Move the pointer to the location on your schematic page where you want the power symbol and click the left mouse button. This places the power symbol on your schematic page.

You can place multiple instances of the power symbol by clicking the left mouse button each place you want an instance of the symbol.

- 5 When you are done placing power symbols, choose End Mode from the right mouse button pop-up menu, or press ESC.



Note You can create custom power, ground, and other symbols for hierarchical ports, off-page connectors, title blocks, and power objects by using the New Symbol command from the Design menu in the project manager window. For information on how to use this command, see Capture's online help.

To place a ground symbol

Follow the instructions in the previous section, *To place a power symbol*, but substitute the Ground command or the ground tool in the appropriate places.

Place Power or Place Ground dialog box

The Place Power and Place Ground dialog boxes are identical, except that each displays the last power or ground symbol you placed. This figure shows the Place Power dialog box.

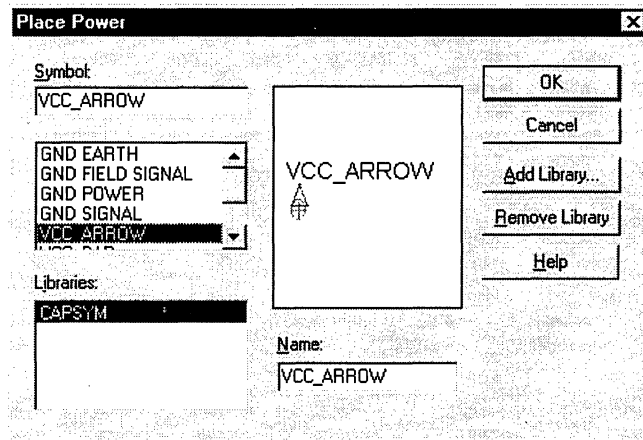

Symbol Specifies the name of the power or ground symbol in the library. If you aren't sure of the exact name of the symbol, you can enter wildcard characters to constrain the list of symbols, then choose the OK button. Valid wildcard characters are an asterisk (*) to match multiple characters and a question mark (?) to match a single character. The names of all symbols in the selected libraries that match the wildcard appear in the Symbol list box.

Symbol list Lists the names of all symbols in the selected libraries that match the name entered in the Symbol text box. If more than one library is selected, the symbol name is followed by a slash (/) and a library name. When you select a symbol in this list, its name displays in the Symbol text box, and its graphic displays in the preview box.

Libraries Lists the library names currently available. Select the libraries from which to select power or ground symbols. All symbols in the selected libraries that match the Symbol text box display in the Symbol list. To select more than one library, press CTRL while you click the mouse.

Preview box Displays the graphic of the selected symbol.

Add Library Displays a standard Open dialog box that you can use to locate a library and add it to the Libraries list.

Remove Library Removes the selected libraries from the Libraries list.

Name Assigns a name—such as +5, GND, +5VDC, -12 VDC, VSS, or VEE—to the symbol.

Editing power and ground symbols

You can change the name of a power or ground symbol by selecting the symbol on the schematic page, and either choosing Properties from the Edit menu, or choosing Edit Properties from the right mouse button pop-up menu. You can also double-click on the symbol. This displays a dialog box in which you can edit the name, then choose the OK button.

You can also edit the display properties of the text associated with the power or ground symbol. Select only the text of the symbol, then either choose Properties from the Edit menu, or choose Edit Properties from the right mouse button pop-up menu. You can also double-click on the text. This displays a Display Properties dialog box. Once you have finished editing the properties, choose the OK button. You can also use this dialog box to edit the name of the symbol.

You cannot assign user properties to power or ground symbols.

Placing and editing no-connect symbols

A no-connect symbol (shown as an “X” attached to a pin) causes unused pins to be ignored by reports (such as Design Rules Check and netlists) that show unconnected pins. If a pin is connected, the no-connect symbol doesn’t affect the pin.

Placing no-connect symbols

No-connect symbols are placed on a schematic page using the No Connect command on the Place menu, or using the no-connect tool on the schematic page editor’s tool palette.

To place a no-connect symbol

- 1 From the schematic page editor’s Place menu, choose No Connect (ALT, P, C).
or
Choose the no-connect tool on the schematic page editor’s tool palette.
- 2 Position the mouse over the pin and click the left mouse button. The end of the pin changes from a square (unconnected) to an X (not connected).

Editing no-connect symbols

No-connect symbols cannot be deleted using DELETE. To remove a no-connect symbol, place another no-connect symbol on top of the existing no-connect symbol. You can temporarily override a no-connect symbol by attaching a wire to the pin, but if you delete the wire, you’ll again be able to see the no-connect symbol.

Placing and editing hierarchical blocks

Hierarchical blocks (or parts with attached schematic folders) refer to child schematic folders in a project, providing vertical (downward-pointing) connection only. Hierarchical pins in a hierarchical block, and hierarchical ports outside a hierarchical block, act as points of attachment for any electrical connections between the hierarchical block and other electrical objects in an attached schematic folder.

A part with an attached schematic folder functions like a hierarchical block, and pins on a part with an attached schematic folder function like hierarchical pins within a hierarchical block. You can use either method to define a hierarchy. The only difference between the two methods is that a part with an attached schematic folder can be reused.

Placing hierarchical blocks

You create hierarchical designs using hierarchical blocks to represent child schematic folders. When you create a hierarchical block, you specify the name of the child schematic folder that the hierarchical block represents. Once you've created the hierarchical block, you place hierarchical pins inside it to connect it to hierarchical ports on the child schematic folder's schematic pages.

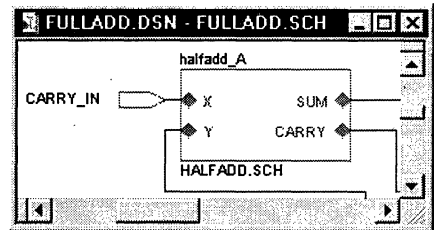

Note If the child schematic folder you specify as the hierarchical block's attached schematic folder already exists, Capture automatically adds hierarchical pins to the hierarchical block that match the corresponding ports on the schematic pages in the child schematic folder. If the child schematic folder doesn't yet exist and you place the hierarchical block and choose Descend Hierarchy from the right mouse button pop-up menu, Capture creates a new schematic folder and creates a new schematic page containing hierarchical ports that match the hierarchical pins in the hierarchical block.



See also For information on connecting hierarchical designs using hierarchical blocks, hierarchical ports, and hierarchical pins, see *Connecting schematic folders and schematic pages* in *Chapter 6: Design structure*.

To place a hierarchical block

- 1 From the schematic page editor's Place menu, choose Hierarchical Block (ALT, P, H).
or
Choose the hierarchical block tool on the schematic page editor's tool palette.
The Place Hierarchical Block dialog box displays.
- 2 In the Reference text box, type the name of the hierarchical block.
- 3 Accept the Primitive setting of Default, or choose Yes or No. (See *Primitive* on the next page for more information.)
- 4 If necessary, choose the User Properties button, add or change property names and their associated values in the dialog box that displays, then choose the OK button.
- 5 Specify the type of implementation. (See *Place Hierarchical Block dialog box* on the next page for a description of implementation types.)
- 6 Specify the name of the attached schematic folder, VHDL entity, netlist, or project.
- 7 Specify the path and filename of the attached schematic folder, VHDL entity, netlist, or project.
- 8 Choose the OK button to close the Place Hierarchical Block dialog box.
- 9 Draw the hierarchical block. Press the left mouse button, drag the mouse to draw a rectangle, and release the mouse button when the rectangle is the desired size. Click on an open space on the page to deselect the block.



See Once you've placed a hierarchical block, you must place hierarchical pins inside it, then name the pins so that they connect to like-named hierarchical ports in the schematic pages in the child schematic folder. See *Placing hierarchical pins* later in this chapter.

Place Hierarchical Block dialog box

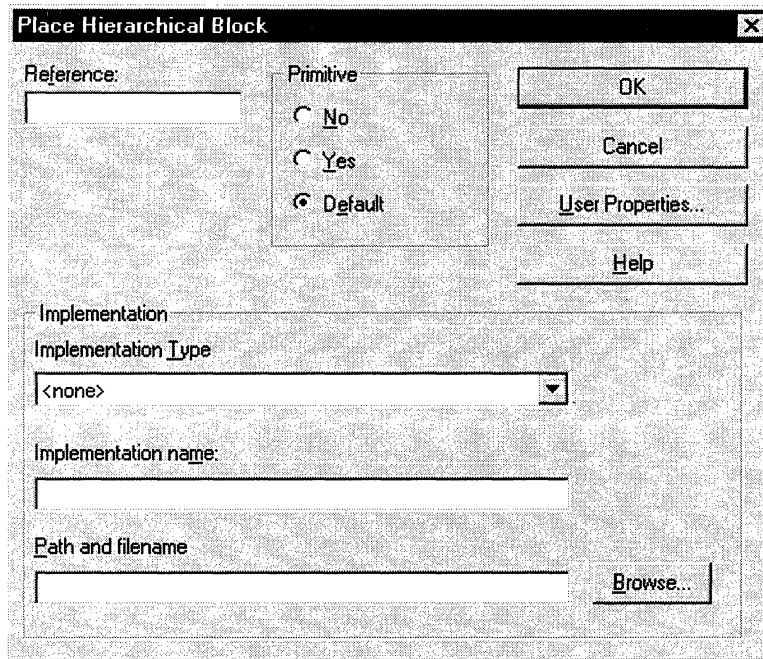

Reference The name of the hierarchical block.

Primitive Default indicates that the part uses the setting in the Hierarchy tab of the Design Template dialog box. Yes indicates that the part is primitive. No indicates that the part is nonprimitive.

User Properties Displays a dialog box that you can use to edit the part's property names and their respective property values.

Implementation Type Specifies the type of implementation from one of the following:

- **Schematic View.** Indicates that the attached implementation is a schematic folder. Capture will automatically generate the appropriate hierarchical pins for the block based on the schematic ports.
- **VHDL.** Indicates that the attached implementation is a VHDL entity. Capture will automatically generate the appropriate hierarchical pins for the block based on the port declarations in the VHDL entity.
- **EDIF.** Indicates that the attached implementation is an EDIF netlist. If your design includes EDIF implementations for hierarchical blocks, you must specify the hierarchical pins for the block; Capture will not generate them from the EDIF netlist.

- **Project.** Indicates that the attached implementation is a programmable logic project. You must specify the hierarchical pins for the block; Capture will not generate them.

Implementation Name Specifies the name of the attached schematic folder, VHDL entity, netlist, or project for the hierarchical block.

Path and filename Specifies the path and filename of the attached schematic folder, VHDL entity, netlist, or project for the hierarchical block.



Notes If you specify a library or project that you haven't yet saved to disk, Capture creates the library or project in the directory specified by your TEMP environment variable.

Attaching an implementation does not automatically add that file, project, or schematic folder to the project. You must specifically add the implementation to the project with the Project command (on the Edit menu).



Caution An attached schematic folder or other file external to the project or library is not stored with the project or library. If you copy or move your project or library to a new location, you must also move or copy the attached file, to keep them together. In addition, you may need to edit the path to the attached schematic folder or file if you move your project to a new location with a different directory structure.

Editing hierarchical blocks

You can edit a hierarchical block after it is placed. Select the hierarchical block and do one of the following:

- Double-click on it.
- Choose Properties from the Edit menu.
- Choose Edit Properties from the pop-up menu.

Each of these methods displays the Edit Hierarchical Block dialog box, in which you can change the block's reference, choose among the options in the Primitive group box, or modify the attached schematic folder's name or path. If you choose the User Properties button in the Edit Hierarchical Block dialog box, the User Properties dialog box displays, in which you can modify existing user properties or add new ones.

You can also edit the display properties of the text associated with the hierarchical block. Select the text of the hierarchical block and do one of the following:

- Double-click on it.
- Choose Properties from the Edit menu.
- Choose Edit Properties from the pop-up menu.

Each of these methods displays the Display Properties dialog box, in which you can edit the visibility, color, font, or rotation of the text of the hierarchical block.

You can click on a hierarchical block and move it to another location, or you can drag its selection handles to resize it. You can also use the Mirror or Rotate commands to change the appearance of the block.

Placing and editing hierarchical ports and hierarchical pins



See For information on how hierarchical designs are connected using hierarchical blocks, hierarchical ports, and hierarchical pins, see *Connecting schematic folders and schematic pages* in *Chapter 6: Design structure*.

Placing hierarchical ports

You place hierarchical ports on schematic pages in child schematic folders, then name the ports so that they connect to like-named hierarchical pins inside hierarchical blocks on schematic pages in parent schematic folders.

Hierarchical ports also connect to like-named hierarchical ports, and to off-page connectors with the same name, on schematic pages within the same schematic folder.

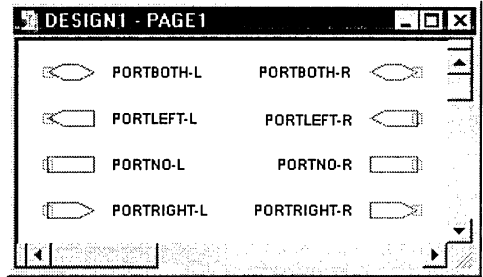

To place a hierarchical port



Tip You can place a hierarchical port anywhere on a schematic page. A hierarchical port connects to like-named hierarchical ports and off-page connectors on schematic pages in the same schematic folder, and connects to like-named hierarchical pins inside hierarchical blocks in parent schematic folders.

- 1 From the schematic page editor's Place menu, choose Hierarchical Port (ALT, P, I).
The Place Hierarchical Port dialog box displays.
- 2 Select one or more libraries from those listed in the Libraries field, or use the Add Library and Remove Library buttons to change what is listed in the Libraries field and select one or more libraries.
- 3 In the list below the Symbol text box, select the type of the hierarchical port. The selection's name appears in the Symbol text box and its graphic displays in the preview box.
- 4 Type in the name for the hierarchical port. The name is added to the attached net, and is used to determine which like-named hierarchical pins and hierarchical ports the port connects to.
- 5 When you have specified the characteristics of the hierarchical port, choose the OK button. The Place Hierarchical Port dialog box closes.
- 6 You can now place the hierarchical port anywhere on the schematic page. If you want to move the port, you can select it and drag it to another location after you place it.

Place Hierarchical Port dialog box

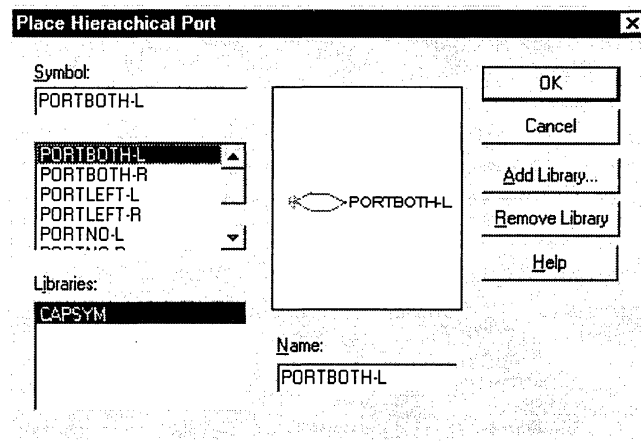

Symbol Specifies the hierarchical port symbol to use. If you aren't sure of the exact name of the symbol, you can enter wildcard characters to constrain the list of symbols, then choose the OK button. Valid wildcard characters are an asterisk (*) to match multiple characters and a question mark (?) to match a single character. The names of all symbols in the selected libraries that match the wildcard appear in the Symbol list box.

Symbol list Lists the names of all symbols in the selected libraries that match the text entered in the Symbol text box. If more than one library is selected, the symbol name is followed by a slash (/) and a library name. When you select a part in this list, its name displays in the Symbol text box, and its graphic displays in the preview box.

Libraries Lists the library names currently available. Select the libraries from which to select symbols. All symbols in the selected libraries that match the Symbol text box display in the Symbol list. To select more than one library, press CTRL while you click the mouse.

Preview box Displays the graphic of the selected symbol.

Name Specifies the symbol's name. This name is used to determine which like-named hierarchical ports the port will connect to.

Add Library Displays a standard Open dialog box that you can use to locate a library and add it to the Libraries list.

Remove Library Removes the selected libraries from the Libraries list.

Placing hierarchical pins

You place hierarchical pins inside hierarchical blocks on schematic pages in parent schematic folders. You name the hierarchical pins to correspond to hierarchical port names on schematic pages in child schematic folders.



Caution Since it may be difficult to connect to hierarchical pins that are off-grid, you should be aware of the following situation:

- If the Pointer snap to grid option in the Grid Display tab of the Preferences dialog box is not selected, any hierarchical pins you place in a hierarchical block may not snap to grid.
-

To place a hierarchical pin



Tip You can only place a hierarchical pin within the boundaries of a hierarchical block. A hierarchical pin connects to any like-named hierarchical port on the schematic pages in the schematic folder you attached to the hierarchical block.

- 1 Select a hierarchical block.
- 2 From the schematic page editor's Place menu, choose Hierarchical Pin. The Place Hierarchical Pin dialog box displays.
- 3 In the Name text box, type in a name for the hierarchical pin. This name, which is also the net name, is used to determine which like-named hierarchical ports the pin will connect to.
- 4 From the drop-down list box under Type, select a pin type for the hierarchical pin.
- 5 In the Width group box, select either Scalar or Bus.
- 6 Choose the User Properties button to display a dialog box where you can add or change property names and their associated values. When you've finished editing the hierarchical pin's properties, choose the OK button.
- 7 Choose the OK button to close the Place Hierarchical Pin dialog box.
- 8 Position the hierarchical pin within the hierarchical block and click the left mouse button to place the pin.

Place Hierarchical Pin dialog box

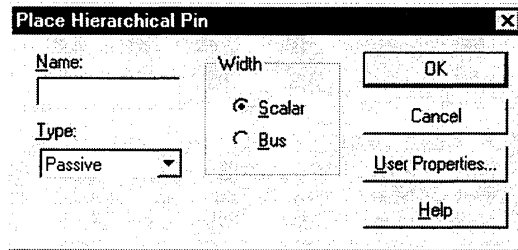

Name Specifies the hierarchical pin's name.

Type Specifies the type of pin.

Width Specifies whether the pin is Scalar or Bus.

User Properties Displays a dialog box that you can use to edit the pin's property names and their respective property values.

Editing hierarchical ports and hierarchical pins

 **Note** You can create custom power, ground, and other symbols for hierarchical ports, hierarchical pins, off-page connectors, title blocks, and power objects by using the New Symbol command on the Design menu in the project manager window. For information on how to use this command, see Capture's online help.

You can edit a hierarchical port or hierarchical pin after it is placed by selecting it and choosing Properties from the Edit menu, choosing Edit Properties from the right mouse button pop-up menu, or double-clicking on it. This displays a dialog box that lets you change the information for Name and Type. Once you have finished editing the information in the dialog box, choose the OK button.

You can edit the display properties of the text associated with a hierarchical port by selecting the text of the port, and choosing Properties from the Edit menu, choosing Edit Properties from the right mouse button pop-up menu, or double-clicking on it. Using the Display Properties dialog box, you can change the text itself, or change the text's color, font, or rotation. Once you have finished editing the text's properties, choose the OK button.

Placing and editing off-page connectors

Off-page connectors are used to connect signals to like-named off-page connectors and hierarchical ports on other schematic pages within the same schematic folder.

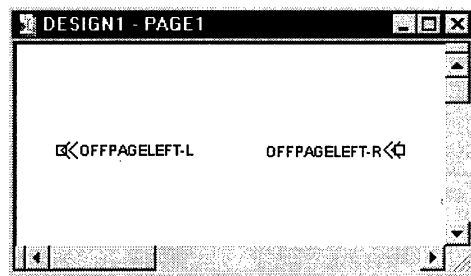

See also For more information about connecting designs using off-page connectors, see *Connecting schematic folders and schematic pages* in *Chapter 6: Design structure*.

Placing off-page connectors

To place an off-page connector, you use the Off-Page Connector command on the Place menu or the off-page connector tool on the tool palette.

To place an off-page connector

- 1 From the schematic page editor's Place menu, choose Off-Page Connector (ALT, P, F).
or
Choose the off-page connector tool on the schematic page editor's tool palette.
The Place Off-Page Connector dialog box displays.
- 2 In the Symbol text box, type the name of the symbol to place. If you aren't sure of the exact name of the symbol, you can enter wildcard characters to constrain the list of symbols, then choose the OK button. Valid wildcard characters are an asterisk (*) to match multiple characters and a question mark (?) to match a single character.

After you type the name of the symbol to place, choose the OK button. All symbols in the libraries listed in the Libraries list box that match the symbol name are listed in the box below the Symbol text box. When you select a symbol from this box, its graphic image displays.



Tips You can add more libraries to the Libraries list box by choosing the Add Library button. Capture displays a standard Open dialog box that you can use to locate a library to add to the list.

You can remove a library from the Libraries list box by selecting it and choosing the Remove Library button.

You can assign a name by typing it in the Name text box. The name is used to connect to other off-page connectors in the same schematic folder. You can also assign a name after the symbol is placed.

All of the options on the Place Off-Page Connector dialog box are described later in this section.

3 When you have located the symbol you want to place, choose the OK button.

An image of the symbol is attached to your pointer. You can press the right mouse button to display a pop-up menu with commands that you can use to change the appearance of the symbol before you place it. You can mirror the symbol horizontally or vertically, rotate the symbol, or edit its properties.



Note All objects that you can place on a schematic page have right mouse button pop-up menus. These menus are context sensitive, meaning they display commands that are appropriate for the selected object. For information about the commands on a pop-up menu, see Capture's online help.

4 Move the pointer to the location on your schematic page where you want the symbol and click the left mouse button. This places the symbol on your schematic page.

You can place multiple instances of the symbol by clicking the left mouse button each place you want an instance of the symbol.

5 When you are done placing symbols, choose End Mode from the right mouse button pop-up menu, or press ESC.

Place Off-Page Connector dialog box

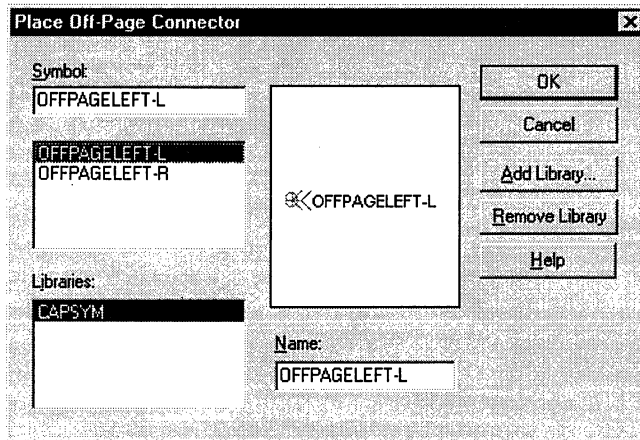

Symbol Specifies the off-page connector symbol to use. If you aren't sure of the exact name of the symbol, you can enter wildcard characters to constrain the list of symbols, then choose the OK button. Valid wildcard characters are an asterisk (*) to match multiple characters and a question mark (?) to match a single character. The names of all symbols in the selected libraries that match the wildcard appear in the Symbol list box.

Symbol list Lists the names of all symbols in the selected libraries that match the text entered in the Symbol text box. If more than one library is selected, the symbol name is followed by a slash (/) and a library name. When you select a part in this list, its name displays in the Symbol text box, and its graphic displays in the preview box.

Libraries Lists the library names currently available. Select the libraries from which to select symbols. All symbols in the selected libraries that match the Symbol text box display in the Symbol list. To select more than one library, press CTRL while you click the mouse.

Preview box Displays the graphic of the selected symbol.

Name The name of the symbol. Other off-page connectors in the same schematic folder that have this name are connected to this off-page connector.

Add Library Displays a standard Open dialog box that you can use to locate a library and add it to the Libraries list.

Remove Library Removes the selected libraries from the Libraries list.

Editing off-page connectors

You can edit an off-page connector after it is placed by selecting it and either choosing Properties from the Edit menu, or choosing Edit Properties from the right mouse button pop-up menu. You can also double-click on the off-page connector. This displays the Edit Off-Page Connector dialog box, which lets you change the Name. Once you have finished editing the information in the Edit Off-Page Connector dialog box, choose the OK button.

You can also edit the display properties of the text associated with the off-page connector. Select only the text of the off-page connector, then either choose Properties from the Edit menu, or choose Edit Properties from the right mouse button pop-up menu. You can also double-click on the off-page connector. This displays a Display Properties dialog box. Once you have finished editing the properties, choose the OK button.

You can click on an off-page connector and move it to another location. You can also use both the Mirror and Rotate commands from the Edit menu to change the appearance of the off-page connector.



Note You can create custom power, ground, and other symbols for hierarchical ports, off-page connectors, title blocks, and power objects by using the New Symbol command from the Design menu in the project manager window. For information on how to use this command, see Capture's online help.

Placing and connecting wires and buses

You can determine whether wires or buses that cross each other are connected by the presence or absence of a junction. Unless a junction is present, wires or buses that cross each other are not connected. Likewise, if you drag a net up to another net so that they touch, the two nets are not connected unless you add a junction at the location where the nets meet.

You can add a junction using the Place junction button on the schematic page editor's toolbar, or by choosing Junction from the Place menu in the schematic page editor. You can place junctions anywhere on a wire, but they only take effect when another object is connected at the junction's location. You can remove a junction by selecting it and using the DELETE key, or by placing another junction on top of the existing one.



Note Junctions can only be placed on wires and buses. A junction cannot be placed in an open area, or on an object such as a pin or a port.

Two wires or two buses can be connected physically by the following methods:

- If you cross a wire segment of another wire and add a junction where the wires meet, a junction displays, and the wires are connected.
- If you begin or end a wire segment on a segment of another wire, a junction is added automatically, and the wires are connected.
- If you begin or end a bus segment on a segment of another bus, a junction is added automatically, and the buses are connected.

A wire and a bus can be connected in name only by the following methods:

- If you begin or end a wire segment on a segment of a bus, a junction is added, and they will be connected.
- If you begin or end a bus segment on a segment of a wire, a junction is added, and they will be connected.

Wires and buses, along with other parts and symbols in the project that are logically connected via net names, form a net. When you place a wire, it is assigned a system-generated netname, which you can replace with an alias or a different netname. Once a bus acquires a valid name or alias, then that name or alias defines the signals carried by the bus and connects those signals to the corresponding nets. For example, the alias A[0:3] defines a four-signal bus and connects the four signals it carries with nets A0, A1, A2, and A3.

Like wires, buses can acquire names and aliases by two means:

- Direct application of a valid bus name
- Electrical connection to a hierarchical port, off-page connector, or global bus pin with a valid bus name



See also For more information about placing and connecting wires and buses, see Capture's online help.

Placing wires

When you connect a wire to a pin, Capture provides visual confirmation of the connection by removing the unconnected pin box on the pin. If two continuous wires cross at 90°, they are not electrically connected unless you create a junction by double-clicking the left mouse button on one wire as you draw the other across it.



Note If you place parts so that two pins meet end to end, the pins are connected.



Tip To find out the name of the net a pin is on, double-click on the pin, then choose the User Properties button in the Pin Properties dialog box. The Net Name property is the name of the net.

To place a wire

- 1 From the schematic page editor's Place menu, choose Wire (ALT, P, W).
or
Choose the wire tool on the schematic page editor's tool palette.
- 2 Click the left mouse button to start the wire.
- 3 Move the mouse to draw the wire. Click the left mouse button if you want to place a vertex and change directions, or connect to another wire as you pass over it.



Note The wire is constrained to multiples of 90° unless you hold down the SHIFT key while you draw the wire.

- 4 Double-click to end the wire. The wire displays in the selection color.
- 5 When you are done placing wires, choose End Mode from the right mouse button pop-up menu, or press ESC.

Editing wires

Select the wire and choose Properties from the Edit menu, choose Edit Properties from the pop-up menu, or double-click on the wire. This displays the Net Properties dialog box, in which you can select a net alias to be the netname in the netlist. Once you have finished selecting a net alias, choose the OK button.



Note When you click on a wire, all its graphical handles are highlighted. To add another wire to the selection, hold down the CTRL key and click on the additional wire. To select the entire net, click on the wire, then choose Select Entire Net from the right mouse button pop-up menu.

You can also edit the display properties of the text associated with the wire. Select only the text of the wire, then either choose Properties from the Edit menu, or choose Edit Properties from the right mouse button pop-up menu. You can also double-click on the text. This displays a Display Properties dialog box. Once you have finished editing the properties, choose the OK button.



Tip To edit a net alias, double-click on the alias. This displays the Edit Net Alias dialog box, in which you can change the Alias, Color, Rotation, or Font. Once you have finished editing the properties, choose the OK button.

To move a wire, select it and drag it to a new location; the wire stretches to maintain its connectivity. To break the wire's connectivity, press ALT while you move it. To move a vertex, select a wire segment next to the vertex and drag the vertex to the new location.



See also For more information about editing wires and nets, see Capture's online help.

Placing buses

A bus is a group of scalar signals (wires), and is never connected to a net. Once the bus acquires a valid name or alias, then that name or alias defines the signals carried by the bus and connects those signals to the corresponding nets. For example, the alias A[0:3] defines a four-signal bus that connects the four bus signals to the individual wires named A0, A1, A2, and A3. Net aliases on wires do not use brackets.

To place a bus

- 1 From the schematic page editor's Place menu, choose Bus (ALT, P, B).
or
Choose the bus tool on the schematic page editor's tool palette.
- 2 Click the left mouse button to start the bus.
- 3 Move the mouse to draw the bus. Click the left mouse button if you want to place a vertex and change directions, or to connect to another bus as you pass over it. The bus is constrained to multiples of 90° unless you hold down the SHIFT key while you draw the bus.
- 4 Double-click to end the bus.
- 5 Highlight the bus, then choose Net Alias from the Place menu. Enter an alias for the bus in the Place Net Alias dialog box that displays, then choose the OK button.



Note Bus names and aliases have the form $X[m..n]$. X represents the “base name.” The portion $m..n$ represents the range of signals carried by the bus. Note that m may be less than or greater than n . In other words, both A[0..3] and A[3..0] are valid bus aliases. You can use two periods (..), a colon (:), or a dash (-) to separate m and n . Do not use two digits for single-digit signals (for example, use A[0..3], but don't use A[00..33]).

- 6 When you are done placing buses, choose the selection tool or press ESC to dismiss the bus tool.

Editing buses

Select the bus and either choose Properties from the Edit menu, or choose Edit Properties from the right mouse button pop-up menu. You can also double-click on the bus. This displays the Net Properties dialog box, in which you can add or change the bus's properties. Once you have finished editing the information in the Net Properties dialog box, choose the OK button.

You can also edit the display properties of the text associated with the bus. Select only the text of the bus, then either choose Properties from the Edit menu, or choose Edit Properties from the right mouse button pop-up menu. You can also double-click on the text. This displays the Edit Net Alias dialog box, which allows you to change the Alias, Color, Rotation, or Font. Once you have finished editing the properties, choose the OK button.

Placing bus entries

Bus entries are used to bring a net into a bus. They are optional. The only distinction between a bus entry and a wire segment is that two wires that touch are connected, whereas two bus entries that touch are not connected.

To place a bus entry

- 1 From the schematic page editor's Place menu, choose Bus Entry (ALT, P, E). The bus entry is attached to the pointer.
- 2 From the Edit menu, choose Rotate (ALT, E, O) to rotate the bus entry 90° counterclockwise if the bus entry is not at the angle you need.
- 3 Use the mouse to position one end of the bus entry on the bus, then click the left mouse button to place the bus entry.
- 4 Repeat step 3 until all of the bus entries are placed.
- 5 Choose the selection tool or press ESC to dismiss the bus entry tool.

To connect multiple bus entries

- 1 Place a wire to connect the first bus entry to a net.
- 2 Place an alias on the wire using the lowest value in the bus range. For example, if you're using a bus alias of A[0:3], the lowest value in the bus range is A0.



Tip To place an alias, choose Net Alias from the Place menu. Enter the net alias text (following the naming conventions for buses and nets), then choose the OK button. A rectangle representing the alias text attaches to the pointer. Click the left mouse button on the bus or net to place the alias. The alias text displays in the selection color. When you are done placing aliases, press ESC.

- 3 Select the wire, then press CTRL while you drag a copy a specific distance so that it connects the next net to the bus. The alias value is increased by one.
- 4 From the Edit menu, choose Repeat (ALT, E, R). The wire and the incremented alias text are placed at the specified distance from the previous set.
- 5 Repeat step 4 for every bus entry in the bus, or repeat steps 3 and 4 as needed.
- 6 When you are done connecting bus entries, press ESC.

Editing bus entries

To move a bus entry's text, select it and drag it to a new location. To rotate a bus entry, select it and choose Rotate from the Edit menu.

Adding and editing graphics and text

You can create a wide variety of graphic shapes to add to your schematic pages. You can work with the snap-to-grid option turned on or turned off. For close work, you may want to zoom in on your graphic using the Go To command on the View menu.

Before you begin drawing, you may want to specify default line and fill styles, because all lines and shapes you draw will use the current line style, and closed shapes that you draw will use the current fill style. You can use a variety of line or fill styles for any part. You can specify these styles in the Miscellaneous tab in the Preferences dialog box.

Drawing tools

Capture has two tool palettes: one for the schematic page editor window, and one for the part editor window. Both tool palettes are movable and resizable, and display tooltips that identify each tool. The tool palettes are each divided into two groups of tools. The electrical tools are in the first group and the drawing tools are in the second group.

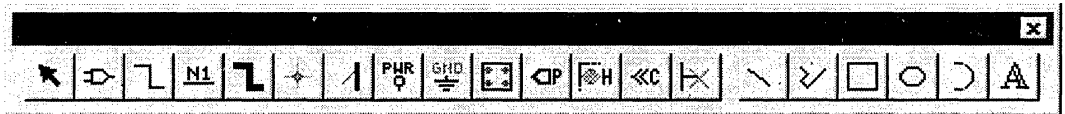

Schematic page editor tool palette.



Part editor tool palette.

General rules for all drawing tools:

- If you choose a drawing tool and press ESC before you begin drawing an object, the drawing tool changes to the selection tool.
- If you choose a drawing tool, and click in an empty area before you begin drawing an object, the drawing tool changes to the selection tool. Note that this doesn't work when drawing arcs or polylines/polygons, or placing text or bitmaps.
- If you choose a drawing tool, start drawing an object, and then press ESC, the unfinished object is removed, and the drawing tool changes to the selection tool.

Drawing lines

You use the line tool to draw a single line. The line you draw adopts the current line style. If you want to draw a line with multiple contiguous segments, use the polyline tool.

To draw a line segment

- 1 From the Place menu, choose Line (ALT, P, L).
or
Choose the line tool on the tool palette.
- 2 Move the pointer to the line's beginning.
- 3 Press and hold the left mouse button while moving the mouse to draw the line.
- 4 Release the left mouse button to end the line. The line displays in the selection color.
- 5 Choose the selection tool or press ESC to dismiss the line tool.

To resize a line

Use the selection tool to select a line. Edit handles appear at either end of the line. With the pointer on one of the two edit handles, press the left mouse button and drag the line. You can change the angle of the line in the process of resizing it.

Drawing rectangles and squares

You use the rectangle tool to create orthogonal shapes. To create a square, hold down the SHIFT key before you begin drawing. Any rectangles or squares you create will have the current fill style and line style.

To draw a rectangle or a square

- 1 From the Place menu, choose Rectangle (ALT, P, R).
or
Choose the rectangle tool on the tool palette.
- 2 Move the pointer to one corner of the intended rectangle.
- 3 Press and hold the left mouse button while you drag the mouse. The rectangle changes shape as you move the mouse. Release the left mouse button when you have the correct shape. To draw a square, hold down the SHIFT key while you perform this step. The rectangle displays in the selection color.
- 4 Choose the selection tool or press ESC to dismiss the rectangle tool.

To resize a rectangle or square

Use the selection tool to select a rectangle or square. Edit handles appear on the four corners. With the pointer on one of the handles, press the mouse and drag the handle.

Drawing circles and ellipses

You use the ellipse tool to draw a closed ellipse; if you want to draw an arc, use the arc tool. To draw a circle, hold down the **SHIFT** key while you drag the mouse. Because they are closed shapes, circles and ellipses will have the current fill style. They will also have the current line style.

To draw an ellipse or a circle

- 1 From the Place menu, choose Ellipse (**ALT, P, S**).
or
Choose the ellipse tool on the tool palette.
- 2 Move the pointer to an edge of the intended ellipse.
- 3 Press and hold the left mouse button while you drag the mouse. The ellipse changes shape as you move the mouse. If you want to draw a circle, hold down the **SHIFT** key while you perform this step. Release the left mouse button when you have the correct shape. The ellipse appears in the selection color.
- 4 Choose the selection tool or press **ESC** to dismiss the ellipse tool.

To resize an ellipse or circle

Use the selection tool to select an ellipse or a circle. Edit handles appear on all four corners of the rectangle that encloses it. With the pointer on one of the handles, press the mouse and drag the handle.

Drawing arcs

You create an arc of any angle using the arc tool. Because it is a line, an arc adopts the current line style. If you want to create a full circle, use the ellipse tool.

Drawing an arc is done in three stages:

- Specify the center of the arc with the first mouse click.
- Specify the radius of the arc with the second mouse click.
- Specify the arc segment endpoint with the third mouse click.

The arc is drawn counterclockwise from the endpoint, and displays in the selection color.

To draw an arc

- 1 From the Place menu, choose Arc (ALT, P, A).
or
Choose the arc tool on the tool palette.
- 2 Move the pointer to establish the center of the arc, and press and hold the left mouse button.
- 3 Drag the mouse out from the center to establish the radius of the arc, then click the left mouse button to establish the location of one end of the arc.
- 4 Use the mouse to establish the other end of the arc and click the left mouse button. The arc is drawn counterclockwise from the endpoint, and displays in the selection color.
- 5 Choose the selection tool or press ESC to dismiss the arc tool.

To resize an arc

Use the selection tool to select an arc. Edit handles appear at the ends of the arc. With the pointer on one of the handles, press the mouse and drag. The center remains the same. The other arc endpoint uses the new radius.

Drawing polylines and polygons

To draw a line with multiple contiguous segments, use the polyline tool. The line you draw adopts the current line style. Polygons can be created with the polyline tool, and they adopt the current fill style. To create a non-orthogonal polyline, hold down the SHIFT key while you draw.

To draw a polyline

- 1 From the Place menu, choose Polyline (ALT, P, Y).
or
Choose the polyline tool on the tool palette.
- 2 Click the left mouse button to begin drawing, click to change directions, and double-click to end the final segment. To draw non-orthogonal polylines, press SHIFT. After you double-click, the polyline displays in the selection color.
- 3 Choose the selection tool or press ESC to dismiss the polyline tool.

To draw a polygon

-  Follow the instructions above, ending the line with a single mouse-button click at the beginning point. The polygon adopts the current line and fill style.

To resize a polyline or polygon

Use the selection tool to select a polyline or polygon. Edit handles appear at the ends of all the lines in the polyline/polygon. With the pointer on a handle, press the left mouse button and drag the handle.

Adding fill to an object

To add fill to an object, select the object, then from the Edit menu, choose Properties. Select a fill style from the Fill Style drop-down box, then choose the OK button.

You can have closed shapes automatically filled in after you finish drawing them by defining a default fill. From the Options menu, choose Preferences, then choose the Miscellaneous tab. Click on the Fill Style drop-down box to display the options. Note that you can specify separate options for the schematic page editor and the part editor. Select one of the options and choose the OK button.

Mirroring an object

You can mirror objects horizontally, vertically, or both horizontally and vertically. Some objects, such as text and bitmaps, cannot be mirrored. If the Mirror command appears dimmed on the Edit menu, the object cannot be mirrored.

To mirror an object, select the object. From the Edit menu, choose Mirror, then choose Horizontally, Vertically or Both from the pop-up menu. The object flips in the chosen direction.

Rotating an object

You can rotate objects by 90° increments. Some objects, such as bitmaps, cannot be rotated. If the Rotate command appears dimmed on the Edit menu, the object cannot be rotated. To rotate an object, select the object. From the Edit menu, choose Rotate. The selection rotates 90° counterclockwise.

Cutting an object

Select the object. From the Edit menu, choose Cut. The object is removed from the schematic page and placed on the Clipboard.

Copying an object

There are two ways to copy an object:

- Select the object. From the Edit menu, choose Copy. The object remains on the schematic page and a copy of it is placed on the Clipboard. It can be pasted in Capture or in other Windows programs.
- Position the pointer on the object. Press the left mouse button, hold down the CTRL key, and drag a copy of the object to the new location.



Tip After you copy an object using the second method above, you can use the Repeat command (from the Edit menu) to place multiple copies of the object using the same spacing. This is a quick way to create an array of aligned objects.

Pasting an object

To use the Paste command, an object must already be on the Clipboard via the Cut or Copy command. Place the pointer where you want the object to be pasted. From the Edit menu, choose Paste. The object is removed from the Clipboard and placed on the schematic page.



Note Capture can only paste text from other Windows applications.

Deleting an object

There are several ways to delete a selected object:

- From the Edit menu, choose Delete.
- From the right mouse button's pop-up menu, choose Delete.
- Press DELETE.
- Press BACKSPACE.

Placing a bitmap

You can create a bitmap in another application and place it on a schematic page, on a library part, or in a custom title block.



Note Because some printers and plotters do not interpret bitmaps correctly, you should place one bitmap and print or plot it, to ensure that the output is what you want before you place multiple bitmaps.

To place a bitmap

- 1 From the Place menu, choose Picture. A standard Open dialog box displays.
- 2 Select the bitmap file. If the file is not listed in the File name text box:
 - In the Look in drop-down list, select a new drive.
 - Choose the Up One Level button.
 - In the Files of type box, select the type of file you want to open.
- 3 Choose the OK button. A rectangle representing the bitmap image is attached to the pointer.
- 4 Click the left mouse button to place the bitmap at the desired location. If you want to place multiple copies of the bitmap, repeat this step.
- 5 Press ESC or choose the selection tool.

To resize a bitmap

To resize a bitmap, select it so that it displays in the selection color with resize handles at the four corners. Position the pointer over a resize handle and drag the handle. The bitmap's size and shape change to accommodate the new dimensions.

Placing text

You can place text, in the font of your choice, on a schematic page or on a part to document your schematic page.

To place text on a schematic page

- 1 From the Place menu, choose Text (ALT, P, T).
or
Choose the text tool on the tool palette.
- 2 Enter the text. To type numbers using the numeric keypad on your keyboard, you must first enable the NUM LOCK key.
- 3 Complete the dialog box selections by specifying font, color, and rotation.
- 4 Choose the OK button to close the dialog box. A rectangle representing the text is attached to the pointer.
- 5 Click the left mouse button to place the text at the desired location. You can place multiple copies of the text by clicking the left mouse button at each location where you would like text.
- 6 When you are done placing text, choose End Mode from the right mouse button pop-up menu or press ESC.



Tip If you have text in another Windows application, you can copy it to the Clipboard and paste it into the text dialog box using the CTRL+V shortcut keys.

To move text

- 1 Select the text so that it displays in the selection color with resize handles at the four corners.
- 2 Position the pointer over the text—not a resize handle—and drag the text to the new location.
- 3 Click an area where there are no parts or objects to deselect the text.

To move or copy text using the Clipboard

- 1 Select the text.
- 2 From the Edit menu, choose Cut (ALT, E, T). The text is placed on the Clipboard.
or
From the Edit menu, choose Copy (ALT, E, C). A copy of the text is placed on the Clipboard.
- 3 From the Edit menu, choose Paste (ALT, E, P). The text is attached to the pointer.
- 4 Move the pointer to the location where you want to place the text and click the left mouse button. The text is placed and displays in the selection color.
- 5 Click an area where there are no parts or objects to deselect the text.

To rotate text

- 1 Select the text so that it displays in the selection color with resize handles at the four corners.
- 2 From the Edit menu, choose Rotate (ALT, E, O). The text rotates 90° counterclockwise.
- 3 Repeat step 2 as necessary.
- 4 Click an area where there are no parts or objects to deselect the text.

The text bounding box

Text that you place wraps according to the dimensions of its bounding box. To change how the text wraps, select it so that it displays in the selection color with edit handles at the four corners. Position the pointer over an edit handle and drag the edit handle. The text inside the bounding box rewraps within the new dimensions.

Deleting text

To delete the text and its bounding box, select the text so that it displays in the selection color with edit handles at the four corners. Press either the DELETE key or the BACKSPACE key.

To delete text when it is highlighted in the Edit Text dialog box, press the DELETE key, the BACKSPACE key, or begin typing new text.

To delete individual words within the text, double-click on the text, or select the text and choose Properties from the Edit menu. The Edit Text dialog box displays, with the text highlighted. Press one of the four arrow keys to remove the text highlighting. Double-click on the word you want to remove. Press the DELETE key or the BACKSPACE key.

Modifying text

To add more text to text you have already placed, double-click on the text, or select the text and choose Properties from the Edit menu. The Edit Text dialog box displays, with the text highlighted. Press one of the four arrow keys to remove the text highlighting. Type the additional text. When you are done, choose the OK button.

Finding text

You can use the Find command to search for text in an entire project, in selected schematic pages, on one schematic page, or in the part editor.

To find text

- 1 In the project manager, select the root schematic folder (to search the entire project) or select specific schematic pages.
or
Make the schematic page editor or the part editor the active window.
- 2 From the Edit menu, choose Find. The Find dialog box displays.
- 3 Leave the asterisk in the Find What text box to locate all occurrences of all text.
or
Narrow the text search by entering specific text in the Find What text box.
- 4 Verify that the Match Case option is as you want it.
- 5 Select Text from the object types in the Scope area.
- 6 Choose the OK button.

If you search the entire project or selected schematic pages from the project manager, the search results are listed in the browse window. If you search with either the schematic page editor window or the part editor window as the active window, the results of the search display in the selection color in either the schematic page editor window or the part editor window.

Replacing text

Schematic page editor or part editor text can be replaced by entering the replacement text from the keyboard, or copying the replacement text from another application.

To replace text

- 1 Select the text so that it displays in the selection color with resize handles at the four corners.
- 2 From the Edit menu, choose Properties. The Edit Text dialog box displays, with the text highlighted.
- 3 Enter the replacement text, then choose the OK button.

Importing text

You can import text from any Windows program that copies text to the Clipboard.

To import text from other Windows applications

- 1 In the other Windows application, copy the text to the Clipboard using that program's Copy command.
- 2 Make the schematic page editor or part editor the active window.
- 3 From the Place menu, choose Text. The Place Text dialog box displays.
- 4 Press CTRL+V to paste the text into the text box, then verify that the color, font, and rotation are as you want them and choose the OK button. A rectangle representing the text is attached to the pointer.
- 5 Click the left mouse button to place the text at the desired location.
- 6 When you are done placing text, press ESC or choose the selection tool.

Exporting text

You can export Capture text to any Windows program that uses the Clipboard.

To export text to other Windows applications

- 1 In Capture, select the text you want to export.
- 2 From the Edit menu, choose Cut or Copy. The text is placed on the Clipboard.
- 3 Activate the other Windows application and use that application's Paste command to place the text.

Character formatting

You may want the text to have a distinctive appearance, or to fit a specific space. Capture supports TrueType® fonts. You can preview a sample of the selected font before you choose it. You can also select the default font that you set up in the Fonts tab in either the Design Template dialog box or the Design Properties dialog box (available from the Options menu).

To change fonts and point sizes

- 1 If you are placing the text, choose Text from the Place menu. The Place Text dialog box displays.
or
If the text has already been placed, double-click on the text. The Edit Text dialog box displays.
- 2 In the Font group box, choose the Change button. The Font dialog box displays.
- 3 Select a font, style, and size. Sample text displays in the Sample group box.
- 4 Choose the OK button twice.

About screen fonts



See For information about setting up your screen fonts, see *Chapter 4: Setting up your project*.

Using macros

In the schematic page editor, you can create a macro by recording a series of editing actions. For example, you can begin a macro recording, place a wire, place text that names the wire, then stop the macro recording. Macros are recorded at the command level (not at the keystroke level) and each macro is stored as a separate file. You can also create a macro in ASCII text, using valid Visual Basic syntax.



See For samples of valid Visual Basic syntax, see Capture's online help.

When you record a macro, Capture assigns it a temporary name, and it is treated as a temporary macro. Temporary macros can be run during the current Capture session, but they are not saved for use in subsequent Capture sessions. You can make a temporary macro permanent by saving it using the Configure Macro dialog box (choose Configure from the Macro menu).



Note Since you cannot edit schematic pages in physical mode, the macro recorder and the macros are only available in logical mode.

In general, you can record a macro command for each menu command available in the schematic page editor. However, because the macro commands are limited to the schematic page editor window, the following commands that result in moving to a new window are unavailable:

- Ascend
- Descend
- Edit Part in Place

When recording a macro, the Undo command is not recorded as a part of the macro. For this reason, you cannot create an undo macro using the Undo command.

Recording a macro

A location recorded within a macro is relative to the previous action, not relative to where you began recording the macro. For example, you can record a macro to place a wire, move the cursor down one grid space, then place another wire. When you run the macro at a different location on your schematic page, the macro places a wire, moves down one grid space, then places another wire.

To record a macro

- 1 Click the left mouse button on the schematic page to set a location to begin recording the macro.
- 2 From the schematic page editor's Macro menu, choose Record. The macro recorder tool palette containing three buttons displays, as shown below.

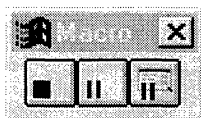

- 3 Perform the series of edits that you want to record as a macro, using the three macro record buttons as necessary.
 - Use the left button to stop recording the macro.
 - Use the center button to pause recording. The pause mode is in effect until you choose the center button again.
 - Use the right button to cause a command to record in a “with dialog” mode. If a command is recorded in this mode, the value you enter while recording the macro is not saved. Instead, when the macro is run, the command displays a dialog box so that you can fill in a value. When recording, the “with dialog” mode is in effect until you choose the right button again.
- 4 Choose the left macro record button to stop recording the macro.

Playing a macro

Choose Play from the Macro menu to play back the most recently recorded macro or any macro you choose in the Configure Macro dialog box.

To play a macro

- 1 Click the left mouse button on the schematic page to set a location to begin playing the macro.
- 2 From the schematic page editor's Macro menu, choose Play.
or
From the Configure Macro dialog box, choose Play.

Configuring a macro

After you record a macro, you give it a name, and you can also assign it a menu entry, a shortcut key definition, and a description. Once you give a macro a name and save it, it automatically displays in the Macro name list box in the Configure Macro dialog box the next time you run Capture. The text you enter as the menu entry displays on the Macro menu, along with the macro's shortcut key definition, if you specified one. The text you enter as the description displays in the Description text box in the Configure Macro dialog box when you highlight the macro name.

To configure a macro

- 1 From the schematic page editor's Macro menu, choose Configure. The Configure Macro dialog box displays.
- 2 If the macro you want is not selected, select it.
- 3 In the Macro Name text box, enter a name for the macro and choose the Save button. The Macro Name dialog box displays.
- 4 To assign a shortcut key, enter text corresponding to a shortcut key or key combination (for example, CTRL+7) in the Keyboard Assignment text box.
- 5 To have the macro appear as an entry on the Macro menu, enter the appropriate text (for example, Wirenames) in the Menu Assignment text box.
- 6 To describe the macro, enter the appropriate text in the Description text box.
- 7 Choose the OK button. The Save As dialog box displays.
- 8 Select a file location and filename, choose the Save button, then choose the Close button.

Configure Macro dialog box

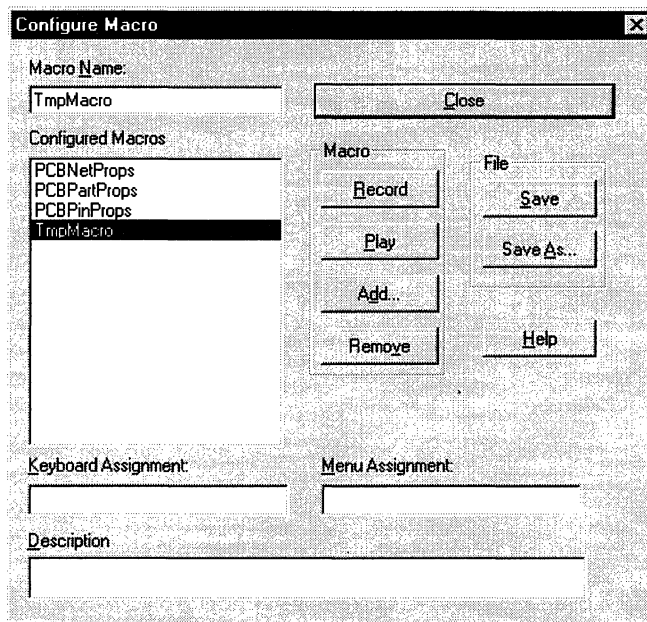

Macro Name Displays the macro name. You can either select a macro from the macro name list box or type in a macro's name. The macro shown in the Macro Name field is the macro that is run if you choose Play from the Macro menu or choose the Run button in the Configure Macro dialog box.

Configured Macros Displays the currently configured macros and any currently available temporary recordings. Selecting a name from the list fills in the dialog box fields with the appropriate values.

Close Closes the dialog box. Since the editing changes you make in the dialog box are immediately saved to memory, the edits are not permanently saved to the file unless you use the Save command before you use the Close command.

Record Closes the dialog box, displays the macro record dialog box, and records your editing actions until you choose the Stop button in the macro record dialog box. A recording is temporary (only available for the current Capture session) unless you assign it a macro name and save it using either Save or Save As.

Play Runs the active macro.

Add Displays a dialog box that you use to add a macro you have created. The macro must be in ASCII text, and use valid Visual Basic syntax. A newly added macro is highlighted in the list of macros and becomes the active macro.

Remove Removes a macro from the list of permanent macros, but does not remove the macro from your hard disk.

Save Updates an existing macro on your hard drive or saves a temporary macro to your hard drive. Saving a macro adds it to the list of configured macros and makes it the active macro.

Save As Displays a Macro Name dialog box that you use to assign the macro a name, keyboard assignment, menu assignment, and description. Saving a macro adds it to the list of configured macros and makes it the active macro.

Keyboard Assignment Specifies the shortcut key associated with the macro. You can specify a shortcut key for a temporary macro recording or change the shortcut key used for an existing macro by entering the text equivalent of a keyboard sequence in the Keyboard Assignment text box.

Menu Assignment Specifies the menu assignment associated with the macro. You can specify a menu assignment for a temporary macro recording or change the menu assignment used for an existing macro by entering a menu entry in the Menu Assignment text box.

Description Specifies the description associated with the macro. You can specify a description for a temporary macro recording or change the description used for an existing macro by entering text in the Description text box.

Naming a macro

You can assign a macro a name of any length, but be aware that Windows systems such as Windows 3.11 will truncate your filename to eight characters. Since periods aren't allowed in macro filenames, don't specify a file extension for your macro filename: Capture will assign an extension of .BAS to your macro filename. If you want, you can rename the file with a different file extension using the Rename command in Windows Explorer.

There are some restrictions regarding the names you give your macros. These restrictions are given below.

- You cannot use spaces in a filename.
- You cannot use the following filename extensions for your macro names, since they are reserved for Capture's use: .DBK, .DLL, .DSN, .EXE, .INI, .LLG, .OBK, and .OLB.

- You cannot use any of the names in the list below for your macro names, since they are reserved for use by Capture's macro subroutines.

Copy	PlaceBus	PlaceTitleBlock
Cut	PlaceBusEntry	PlaceTitleBlockWithDialog
Delete	PlaceEllipse	PlaceWire
DisplayProperty	PlaceGround	RemoveDisplayProperty
DisplayPropertyEx	PlaceGroundWithDialog	RemoveProperty
Drag	PlaceJunction	ReplacePart
Duplicate	PlaceLine	Rotate
FindBookMarks	PlaceNetAlias	SelectAll
FindDRCMarks	PlaceNetAliasWithDialog	SelectBlock
FindHierarchicalPorts	PlaceNextPolygonPoint	SelectObject
FindNets	PlaceNextPolylinePoint	SetColor
FindOffPageConnectors	PlaceNoConnect	SetFillStyle
FindParts	PlaceOffPage	SetFont
FindText	PlaceOffPageWithDialog	SetFontEx
GoToAbsolute	PlacePicture	SetHatchStyle
GoToBookMark	PlacePin	SetLineStyle
GoToGridReference	PlacePinWithDialog	SetLineWidth
GoToRelative	PlacePart	SetProperty
Group	PlacePartWithDialog	Ungroup
MirrorHorizontal	PlacePolygon	ViewGrid
MirrorVertical	PlacePolyline	ViewGridReference
Move	PlacePort	ViewZoomScale
Paste	PlacePortWithDialog	ZoomAll
PlaceArc	PlacePower	ZoomArea
PlaceBlock	PlacePowerWithDialog	ZoomIn
PlaceBlockWithDialog	PlaceRectangle	ZoomOut
PlaceBookMark	PlaceText	ZoomSelection
PlaceBookMarkWithDialog	PlaceTextWithDialog	

Assigning a shortcut key to a macro

To assign a shortcut key to a macro, enter an alphanumeric character (such as K) in the Keyboard Assignment text box in the Configure Macro dialog box, then save the macro. To enter a combination of keyboard keys and alphanumeric characters, add a plus sign (+), either with or without spaces, between the items (for example: ALT+2 or ALT + 2). Shortcut keys are not case-sensitive: you can specify ALT+2 or Alt+2.



Note Any shortcut keys you assign to your macros take precedence over the shortcut keys assigned to other Capture functions. For example, you can use CTRL+DEL as a key combination for a macro, even though it is the key combination assigned to clear the Capture session log. To restore an original shortcut key assignment (in this example, restoring CTRL+DEL to its original function of clearing the session log), assign a different shortcut key to your macro using the Keyboard Assignment text box in the Configure Macro dialog box, choose Save, then choose Close.

To assist you in assigning shortcut keys to your macros, Capture has reserved the following shortcut-key starting sequences:

CTRL
 ALT
 SHIFT
 CTRL+ALT
 CTRL+SHIFT
 CTRL+ALT+SHIFT
 ALT+SHIFT

To use one of the starting sequences, enter it in the Keyboard Assignment text box, add a plus sign (+), then add an alphanumeric character (for example: CTRL+P). You have to use the starting sequences in the same order, and in the same format, as shown in the list above. For example, you cannot reverse the order of the keys, nor can you use CONTROL instead of CTRL. You cannot use a shortcut-key starting sequence by itself: SHIFT by itself will not function as a shortcut key. The following table shows all of the alphanumeric characters, function keys, punctuation keys, special keys, and arrow keys that you can use with the shortcut key starting sequences listed above.

<i>Type of key</i>	<i>Available keys</i>
Alphabetic character	A through Z, inclusive
Numeric character	0 through 9, inclusive
Function key	F1 through F24, inclusive
Punctuation key	!, @, #, \$, %, ^, &, *, (,)
Special key	ESC, INS, DEL, PGUP, PGDN, HOME, END
Arrow key	LT, RT, UP, DN

About the Capture to Layout macros

Included with Capture are three macros designed to reduce any problems you may have when preparing your Capture design for use in Layout. These macros are available on the Macro menu, and are:

- Set Layout Part Properties
- Set Layout Pin Properties
- Set Layout Net Properties

In addition, these three commands are available in the Configure Macro dialog box, as PCBPartProps, PCBPinProps, and PCBNetProps, respectively. When you play any of these macros, they bring up an appropriate dialog box in which you enter the values you want transmitted to Layout.



See For illustrations of the three dialog boxes that these three macros display, and descriptions and example values for their respective properties, see *Transferring user-defined properties to Layout* in *Chapter 18: Using Capture with OrCAD Layout for Windows*.

Changing your view of a schematic page

There are several ways to change your view of a schematic page. They include zooming to a smaller or larger view of the schematic page; centering a view on a particular position; and moving to a different location. You can also choose whether or not to display a grid or grid references.

Zooming

In the schematic page editor and in the part editor, you can look closely at a particular area by using the Zoom In command on the View menu. Conversely, you can change your viewing perspective to increase the portion of the drawing board that is visible by using the Zoom Out command. When you zoom in or out, Capture centers your view on the current pointer position, if possible. If the pointer is outside the window, or if you choose the Zoom In or Zoom Out toolbar button, Capture centers your view on any selected objects. Otherwise, Capture zooms in or out on the center of the active window.



Note If you choose an editing function, then choose a command to change the view, your next mouse click implements the editing function. For example, if you have the circle tool selected and then zoom in or out, your next mouse click will start a circle.

To zoom in

- From the View menu, choose Zoom, then choose In (ALT, V, Z, I).
- or
- Choose the zoom in tool on the toolbar.

The current zoom scale is multiplied by the zoom factor. With a zoom factor of two, zooming in makes the image twice as large and displays half the area of the previous view.

To zoom out

-  From the View menu, choose Zoom, then choose Out (ALT, V, Z, O).
or
Choose the zoom out tool on the toolbar.

The current zoom scale is divided by the zoom factor. With a zoom factor of two, zooming out halves the image size and shows twice the area of the previous view.

To change the zoom factor

- 1 From the Options menu, choose Preferences (ALT, O, P), then choose the Pan and Zoom tab.
- 2 In the Zoom Factor text box, enter the new zoom factor. Note that you can specify separate values for the schematic page editor and the part editor.
- 3 Choose the OK button.

Zooming to a specified scale

The Zoom Scale dialog box provides predefined scales (25%, 50%, 100%, 200%, 300%, and 400%). You can also type in a custom scale value (as a percentage). The scaling limits the size of the schematic page that can be displayed (for example, if 1 unit = .01", then you can display: 320" at 100%, 160" at 200%, 80" at 400%, and so on).



Tip You can view the current scale in the status bar at the bottom of the schematic page editor window. It displays to the left of the X and Y coordinates.

To zoom to a specific scale

- 1 From the View menu, choose Zoom, then choose Scale (ALT, V, Z, S).
- 2 Select one of the preset scales, or enter a custom scale.
- 3 Choose the OK button.

Other viewing options

You can view a selected area or the entire page, or you can center your view.

To view a selected area

- 1 From the View menu, choose Zoom, then choose Area (ALT, V, Z, A).
or
Choose the zoom area tool on the toolbar.
- 2 Move the pointer to one corner of the area to view.
- 3 Press and hold the left mouse button as you move the pointer to the opposite corner of the area to view.
- 4 Release the mouse button. The area is enlarged to fill the window.

To view the entire page or part

-  From the View menu, choose Zoom, then choose All (ALT, V, Z, L).
or
Choose the zoom all tool on the toolbar.

The entire schematic page or part is reduced or enlarged to fit the window.

To center the view on an object or area

- 1 Select objects or an area.
- 2 From the View menu, choose Zoom, then choose Selection (ALT, V, Z, E).

The display scrolls so that the selected objects or selected area is in the center of the window. The zoom scale does not change.

To center the view on your pointer

-  Press SHIFT+C.

The display scrolls so that the pointer's selection is in the center of the window. The zoom scale does not change.

Moving to a new location

There are several different ways you can move to a new location on a schematic page. To move using the methods listed below, use the Go To command and dialog box. You can:

- Move to a particular set of X, Y coordinates or to an X, Y location offset from the pointer's current position.
- Move to a grid reference area, as indicated by the horizontal and vertical grid reference headings.
- Move to a location previously marked by a bookmark.

From the View menu, choose Go To to display the Go To dialog box, which has three tabs labeled Location, Grid Reference, and Bookmark, shown below and on the next page.

Moving to an X, Y location

The X and Y coordinates of your pointer's current location are displayed on the right side of the status bar.

To move to a specific location

- 1 From the View menu, choose Go To (ALT, V, G).
- 2 Choose the Location tab.
- 3 Enter the X and Y values, select the Absolute option, then choose the OK button. The coordinates are measured in inches or millimeters, depending on what you have configured in the Page Size tab on the Schematic Page Properties dialog box. Your pointer moves to the new coordinates.

To move a specific distance

- 1 From the View menu, choose Go To (ALT, V, G).
- 2 Choose the Location tab.
- 3 Enter the X and Y values that you want the pointer to move, select the Relative option, then choose the OK button. The jump distance is measured in inches or millimeters, depending on what you have configured in the Page Size tab on the Schematic Page Properties dialog box. Your pointer moves the specified distance.

Go To dialog box, Location tab

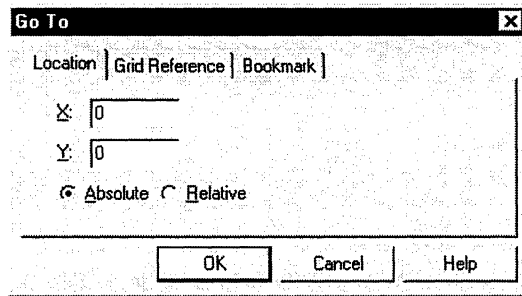

X Specifies the X-axis coordinate for the jump.

Y Specifies the Y-axis coordinate for the jump.

Absolute and **Relative** Specifies the jump as absolute (to the indicated coordinates) or relative (the coordinates are offset to the pointer's current position).

Jumping to a specific grid reference

Grid references are marked on the left and upper edges of the schematic page.

To jump to a reference area

- 1 From the View menu, choose Go To (ALT, V, G).
- 2 Choose the Grid Reference tab.
- 3 Select a horizontal grid reference from the Horizontal drop-down list.
- 4 Select a vertical grid reference from the Vertical drop-down list.
- 5 Choose the OK button.

Go To dialog box, Grid Reference tab

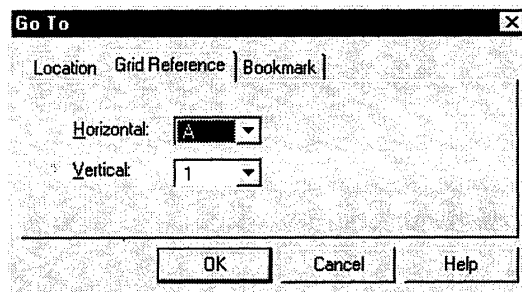

Horizontal Specifies a horizontal grid reference for the jump.

Vertical Specifies a vertical grid reference for the jump.

Jumping to a marked location

To return repeatedly to a specific area of a schematic page, or to direct attention to a particular location, you can use a *bookmark*. To use a bookmark, you assign it a name and place it on a schematic page. When you want to return to it, use the Go To command. You can also reuse existing bookmarks by selecting them and moving them to new locations. Bookmarks are saved with your project.

To place a bookmark

- 1 From the Place menu, choose Bookmark (ALT, P, M).
- 2 Enter the name of the bookmark, then choose the OK button.
- 3 Position the pointer where you want the bookmark and click the left mouse button. The bookmark is placed, and displays in the selection color.
- 4 Click an area where there are no parts or objects to deselect the bookmark.

To rename a bookmark

- 1 Select the bookmark.
- 2 From the Edit menu, choose Properties (ALT, E, I). The Rename Bookmark dialog box displays.
- 3 Enter a new name in the text box.
- 4 Choose the OK button.

To move to a specific bookmark

- 1 From the View menu, choose Go To (ALT, V, G).
- 2 Choose the Bookmark tab.
- 3 Enter the name of the bookmark and choose the OK button.

Go To dialog box, Bookmark tab

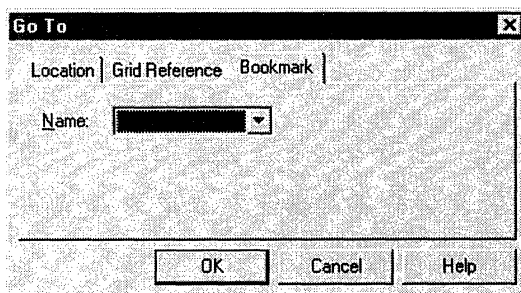

Name Specifies a name of a bookmark for the jump.

Displaying the grid and grid references

You can hide the grid display and grid references, then display them again later.

To display or hide the grid

 From the View menu, choose Grid (ALT, V, I).

To display or hide the grid references

 From the View menu, choose Grid References (ALT, V, R).

 **Note** The settings in the Grid Display tab in the Preferences dialog box (from the Options menu) control whether the grid appears as grid dots or lines. The Grid Display tab setting also controls whether the pointer snaps to grid.

Finding parts in a project

Using the Find command and a part property value, you can locate a part in a project, schematic folder, or on a schematic page. In the Find dialog box, you enter a property value string and specify that you want to find a part. Capture searches all the parts to find those with a property value that matches the string. If you aren't sure of the exact property value string, you can enter wildcard characters to constrain the search list, then choose the OK button. Valid wildcard characters are an asterisk (*) to match multiple characters and a question mark (?) to match individual characters.

To find a part on a schematic page

- 1 Open the schematic page.
- 2 From the Edit menu, choose Find (ALT, E, F).
- 3 Enter the property value string that defines the part you want to search for.
- 4 Select Parts from the object types in the Scope area.
- 5 Choose the OK button to start the search. Parts that have a property value matching the property value string of step 3 are selected on the schematic page.



Tip You can edit the properties of multiple parts when they are selected using the spreadsheet editor. From the Edit menu, choose the Properties command, or choose Edit Properties from the right mouse button's pop-up menu. For information on using the spreadsheet editor, see the section *Using the spreadsheet editor to edit properties* in *Chapter 2: The Capture work environment*.

To find a part in a project

- 1 In the project manager, select the schematic folder or schematic pages you want to search.
- 2 From the Edit menu, choose Find (ALT, E, F).
- 3 Enter the property value string that defines the part you want to search for.
- 4 Select Parts from the object types in the Scope area.
- 5 Choose the OK button to start the search. Parts that have a property value matching the property value string of step 3 are listed in the browse window.
- 6 Double-click on the part in the browse window to open the schematic page editor with the found part displayed and selected.

Libraries and parts

Part Three provides information about libraries and parts. A library is a file that stores parts, symbols, title blocks, and schematics. Capture provides over 20,000 parts contained in more than 80 libraries. You can create additional custom libraries to store any combination of items. Part Three includes these chapters:

Chapter 11: About libraries and parts describes libraries and parts, how the parts in a design are stored in the design cache, and how you can replace or update parts in the design cache.

Chapter 12: Creating and editing parts describes how to create new parts and store them in a library, how to edit parts in a library, and how to edit parts after they are placed on a schematic page.

Part Three

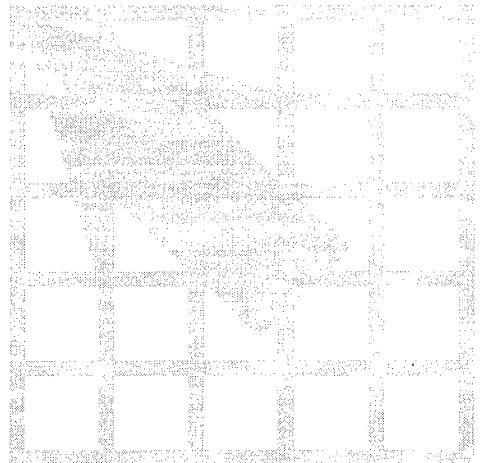

About libraries and parts

Capture's libraries contain more than 20,000 parts. This chapter describes Capture's libraries, and explains how parts, packages, and electrical symbols are stored in libraries.

Libraries

Libraries are files that contain reusable part data. They contain parts that you can place as instances on schematic pages. Libraries may also contain a variety of symbols (such as power symbols, ground symbols, and so on) and title blocks that you can reuse in your projects.

The relationship between the library and the parts and symbols it contains is similar to the relationship between a schematic folder and its contents. The contents of the library move with the library and are deleted with the library.

You can create custom libraries to store any combination of items. You can, for example, create a library to hold schematic pages that you use often. There is no need to create a library for a project, because the design cache holds all the parts and symbols used in the project.



Caution If you edit a library provided by Capture, you should give it a new and unique name so that you will not copy over your changes when you receive updated libraries.

When you work with a library in Capture, you use the project manager. The project manager lists the parts and symbols contained in the library.

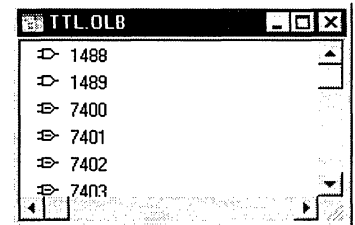

To edit a part, double-click on it. The part opens in a part editor window.

To move a part to a different library, open the source library and the destination library in separate project manager windows. Select the part and drag it from one library to the other.

To copy a part to a different library, follow the same procedure but hold the CTRL key down while you drag the part.



See For information about printing a part, see *Chapter 5: Printing and plotting*.



Tip You can also use the Cut, Copy, and Paste commands on the Edit menu to move or copy parts between libraries.



See For general information about using the project manager, see *Chapter 2: The Capture work environment*.

Because a library is a file, you can work with it in the Windows Explorer as well as in Capture. When you need to back up a library, use Windows Explorer to create a copy.

Parts

Parts are the basic building blocks of a project. A part may represent one or more physical elements, or it may represent a function, a simulation model, or a text description for use by an external application. A part's behavior is described by a PCB footprint, an HDL statement, or an attached schematic folder.

Parts usually correspond to physical objects—gates, chips, connectors, and so on—that come in packages of one or more parts. Packages that have more than one part are sometimes referred to as *multiple-part packages*. For simplicity, Capture usually refers to both parts and multiple-part packages as *parts*.

You can specify packaging information when you create a part, or you can change it in the part editor (from the Options menu, choose Package Properties).

Each part has graphics, pins, and properties that describe it. As you place the parts in a package to suit your design requirements, Capture maintains the identity of the single physical part—the package—for back annotation, netlisting, bills of materials, and processes that require it.

The parts in a package may have different pin assignments, graphics, and user properties. If all the parts in a package are identical except for the pin names and numbers, the package is *homogeneous*. If the parts in a package have different graphics, numbers of pins, or properties, the package is *heterogeneous*.

Part instances

A part instance is a part you have placed on a schematic page. You place part instances in logical mode. If you change to physical mode, you see occurrences of the part instances.



See For more information on how logical mode and physical mode affect parts and part instances, see *Modes—logical and physical* in *Chapter 2: The Capture work environment*.

The design cache

When you place the first instance of a part in a design, a copy of the part is created in the design cache. The design cache stores one copy of every part used in the design. Normally, all instances of the part refer to this copy in the design cache.

 **Note** Updating or replacing a part in the design cache affects every instance of the part in the design, as long as the part instances have retained their links to their original libraries.

An original cache part also retains a link to the library part on which it is based, so you can update all of the parts in the design cache to synchronize them with the parts in the libraries. If you update all instances of a part, the new part replaces the old in the design cache, and the link with the original library is broken. If you update only the current part instance, you create a new part in the design cache, and the new part has no link to the original library.

 **Note** Once you edit a part instance, the link to the original library no longer exists. This means:

- Because it doesn't exist in a library, the only way to place a copy of the part is to use the Copy and Paste commands on the schematic page editor's Edit menu.
 - The part instance is not affected by the Update Cache command.
 - To restore its link with the original library, choose the Replace Cache command from the project manager's Design menu.
-

To replace a design cache part instance with a different library part

- 1 Open the project containing the part instance you want to replace.
- 2 Open the design cache and select the part instance you want to replace.
- 3 From the Design menu, choose Replace Cache (ALT, D, C). The Replace Cache dialog box displays.

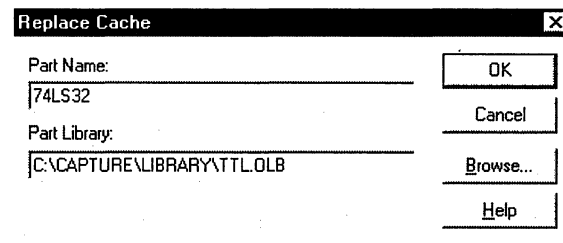

Tip The text boxes in the Replace Cache dialog box contain the name of the part instance you are replacing and its original source library. You can leave these fields unchanged to update the part instance with its original version. This is useful if you have changed the part instance in the design cache and would like to use its original version, or if you have received an update to a library and want to use the new version of the library part.

- 4 In the Part Name text box, type the name of the library part you want to use to replace the selected part instance, using appropriate upper case and lower case letters. (The part names are case-sensitive.)
- 5 In the Part Library text box, type the path and filename of the part's library.
- 6 Choose the OK button. Capture replaces the part instance you selected in step 2 with the library part you specified in steps 4 and 5.

To update selected parts in the design cache so they match their corresponding library parts

When you update parts in the cache, any user-defined properties are preserved.



Note When you update parts in the cache, user-defined properties on pins are deleted.

- 1 If it's not already open, open the project containing the parts you want to update.
- 2 Open the design cache and select the parts you want to update.
- 3 From the Design menu, choose Update Cache (ALT, D, U). Capture warns you that you will update the selected parts with parts from their original libraries.
- 4 Choose Yes. Capture updates the parts you selected in step 2 with their corresponding library parts. Other projects that use these parts are not affected.

Primitive and nonprimitive parts

A *primitive* part contains no hierarchy. A *nonprimitive* part has an underlying hierarchical description, such as an attached schematic folder. In Capture, this characteristic is defined in a property, called Primitive, on every part instance. When a part is specified as primitive, all of Capture's tools treat it as such. You cannot descend into a primitive part, even if it has an attached schematic folder.

 **Note** If you attach a schematic folder to a part in a homogeneous package in a library, the schematic folder is attached to each part in the package. Once the part is placed on a schematic page, you can attach different schematic folders to each part in the package. You cannot attach a schematic folder to a part in a heterogeneous package.

You can change the Primitive property as often as you like during the design process. For example, you might create a part and attach a schematic folder whose schematic pages describe the part's gates and wiring, then attach schematic folders to some of those parts to describe their transistors.

The following are some guidelines for using the Primitive property:

- Before you create a netlist for simulation, specify the parts as nonprimitive, so that Create Netlist can descend far enough to find the transistor-level descriptions.
- Before you create a netlist for board layout, specify the parts as primitive, so that Create Netlist stops at the gate-level descriptions.

For part instances that have their Primitive property set to Default, you can set them as primitive or nonprimitive on a project-wide basis using the Design Properties command on the Options menu. Choose the Hierarchy tab, select either Primitive or Nonprimitive in the Parts group box, then choose the OK button. This is useful when you are describing and simulating your design at varying levels of abstraction (as when using top-down design).

Creating and editing parts

In Capture you can create parts and add them to a new or existing library. You can also edit existing parts in a library or on a schematic page. All of these processes are described in this chapter.

To create or edit a part, you use the part editor. There are many different ways to access the part editor:

- To create a new part, open a new or existing library in the project manager. From the Design menu, choose the New Part command.
- To edit an existing part, open a library in the project manager, then double-click on the part.
- To edit a part instance on a schematic page, select it. From the Edit menu, choose Part.



Tip—Parts and packages: homogeneous or heterogeneous

A part may be divided into several *logical* parts all contained in a single *physical* package. You can distribute the individual logical parts throughout your project, while maintaining the part's identity as a single physical part.

Each logical part has graphics, pins, and properties that describe it. If you define a package in which all the logical parts are identical except the pins, the package is homogeneous. For example, a hex inverter is a homogeneous package. If the logical parts vary in graphics, number of pins, or properties, the package is heterogeneous. An example of a heterogeneous package is a relay with a normally open switch, a normally closed switch, and a coil.

Both homogeneous and heterogeneous packages may have shared pins, such as supply pins that are used by every logical part in the package. Often, these pins are invisible, but are connected by name to a power or ground net.

Creating a new part

You can create your own custom parts and save them in a library. A custom part can be a single part, or it can be a package that contains multiple parts. It can contain pins, graphics, text, and IEEE symbols. Graphics must be within the part's body, while text and IEEE symbols can be either inside or outside the part's body. Pins are attached to the part at the *part body border*, which defines the size and shape of the region in which you create the part body.

To create a part, you complete three processes: you define the part, you add graphics to the part, and you place pins on the part. This section describes these processes.

Defining a part

Before you begin drawing a part, you must provide Capture with specific information about the part, such as the part's name. If the part is a multiple-part package, you can specify how many parts are in the package and whether the part is homogeneous or heterogeneous. Once you provide this information, you can draw the part, place graphics, and place pins.

To define a new part

- 1 In the project manager, select the library you want to add the new part to.
- 2 From the right mouse button's pop-up menu, choose New Part. The New Part Properties dialog box displays.
- 3 In the Name text box, type a name for the part you are creating. You can use the default settings for the other options on this dialog box, or you can change them to fit your requirements. For example, if this part is a multiple-part package, enter the number of parts in the package. All fields on the New Part Properties dialog box are described later in this section.



Note Once you designate the package type as either Homogeneous or Heterogeneous and choose the OK button to close the New Part Properties dialog box, the package type is set, and cannot be changed.

- 4 When the part is specified to your requirements, choose the OK button.

The part editor window displays, showing a dashed outline, which is the part body border. Pins will be placed on the part outside of this region, touching the part body border. The part's value displays below the part, and the part's reference displays above the part. The part editor window's title bar shows the name of the library, followed by the name of the part you are creating.

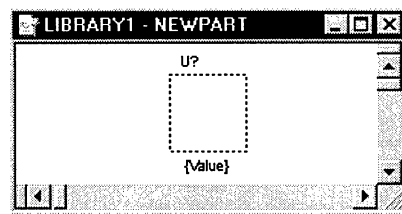

 **Notes** If you're creating a multiple-part package, the part editor window contains the first part in the package. If you are creating a homogeneous part, all edits you make to this part (with the exception of changes to pin numbers) apply to all parts in the package. If you are creating a heterogeneous part, edits you make to this part apply to *this part only*. To edit a different part in the package, choose Next Part or Previous Part from the View menu.

To view all the parts in the package, choose Package from the View menu. You can edit a part by double-clicking on it in the package view.

To view all of the package information, choose Package from the View menu, then choose Properties from the Edit menu. The Package Properties spreadsheet displays, showing the order of the pins, the groups of pins that are swappable, the pin numbers, the pin names, the pin types (normal or convert), and whether the pins are marked as Ignore.

- 5 To change the size and shape of the part body border, select the border and drag the selection handles until the part body border is the size you want.
- 6 Once you have established the part's border, you can use the drawing tools on the part editor's tool palette to draw the part and place text on the part. All graphics that make up the part must fit within the boundaries of the part body border—with the exception of IEEE symbols and text. If you draw or place something other than IEEE symbols or text outside of the part body border, the part's border expands to encompass the graphics.



See also For general information about adding graphics and text, and detailed information about placing IEEE symbols, see *Adding graphics, text, and IEEE symbols to a part* in this chapter. For details about each of the graphic and text tools, see *Chapter 8: Adding and editing graphics and text*.

- 7 You can add pins to the part using the pin tool or the pin array tool. This is described in *Placing pins on a part* later in this chapter.
- 8 When you are done creating the part, you must save it. From the File menu, choose Save (ALT, F, S).

If you are creating this part in a new library that hasn't yet been saved, the Save As dialog box displays, giving you the opportunity to name the library file. If you are creating this part in a library that already exists, the part is saved in that library.

New Part Properties dialog box

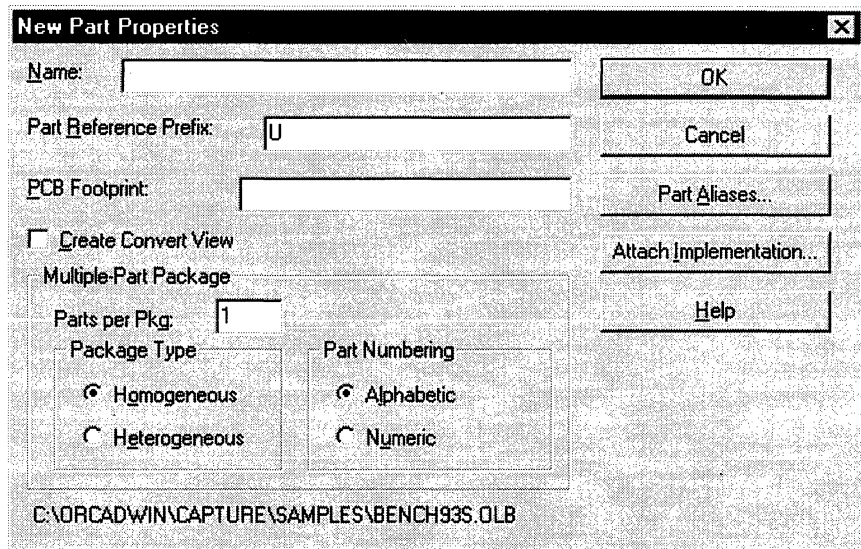

Tip After you have defined the part in the New Part Properties dialog box, you can edit the part (except for changing the Package Type) using the Edit Part Properties dialog box. From the View menu, choose Package, then from the Options menu, choose Package Properties.

Name The name of the part. This is used as the default part value when the part is placed on a schematic page.

Part Reference Prefix Specifies the part reference prefix, such as C for capacitor or R for resistor.

PCB Footprint The PCB physical package name to be included for this part in the netlist.

Create Convert View Some library parts have a second form, such as a DeMorgan equivalent, as well as the standard representation. Select this option to give the part a convert view. If a part has a convert view, you can switch between the part's normal and convert views once the part is placed on a schematic page.



Tip If a part has a convert view, you can change to it by choosing Convert from the part editor's View menu. You can also place a convert view of a part by selecting a part in the Place Part dialog box, selecting the Convert option, then choosing the OK button.

Parts per Pkg Specifies the number of parts in the package.

Homogeneous or Heterogeneous If the part is a multiple-part package, this specifies whether all the parts in the package have the same graphical representation (homogeneous) or different graphical representations (heterogeneous).

Alphabetic or Numeric If the part is a multiple-part package, this specifies whether parts in the package are identified by letter or number. For example:

- U?A (alphabetic)
- U?-1 (numeric—usually used for connectors)



Caution If you use Alphabetic identifiers, you are limited to 26 parts per package that will use letters. After the 26th part, Capture begins to use numbers as identifiers, instead of doubling up the letters, as in AA, AB, and so on.



Note The path and filename of the library that contains the part are displayed at the bottom left corner of the dialog box.

Part Aliases Displays a dialog box that you use to add or remove *part aliases*, which are duplicate copies of parts that use different names in a library. Part aliases use the same graphics, attached schematic folders, and properties as the originals, with the exception of the part values.



Tip When you view a list of parts in a library, any parts that are placed via part alias display with lines through their centers.

Attach Implementation Displays a dialog box that you can use to attach a schematic folder, VHDL entity, netlist, or project, thus creating a hierarchy.



Caution An attached schematic folder or other file external to the project or library is not stored with the project or library. If you copy or move the project or library to a new location, you must also move or copy the attached object to keep them together. In addition, you may need to edit the path to the attached schematic folder or file if you move the project to a new location with a different directory structure.

Attaching a schematic folder to a part



Note Library parts, part instances, part occurrences, and hierarchical blocks can have attached schematic folders. This section provides information about attaching a schematic folder to a library part. This information also applies, however, to part instances, part occurrences, and hierarchical blocks.

Attaching a schematic folder to a part creates hierarchy in Capture. When you attach a schematic folder to a part, you specify the schematic folder's name or, optionally, specify a project containing the schematic folder. If you don't, Capture assumes the schematic folder is contained in the current project. If you attach a schematic folder to a part, you can move or copy the child schematic folder into the same library as the part after the schematic folder is created. This permits the part and attached schematic folder to be reused in other projects. If you specify an attached schematic folder, but the schematic folder has not yet been created, Capture creates the schematic folder when you descend the hierarchy on the part. To descend the hierarchy, you must define the part instance as nonprimitive.



See also For more information about the primitive and nonprimitive settings, see *Primitive and nonprimitive parts* in *Chapter 11: About libraries and parts*.



Tip To define a part instance as nonprimitive, double-click on it, then set the Primitive option to No in the Edit Part dialog box. In physical mode, you can also define part occurrences as nonprimitive. This lets you control whether or not to descend the hierarchy on an occurrence-by-occurrence basis.

Part instances with their Primitive property set to Default can be changed to primitive or nonprimitive on a project-wide basis using the Design Template or Design Properties commands on the Options menu. Choose the Hierarchy tab, select either Primitive or Nonprimitive in the Parts group box, then choose the OK button.

To attach a schematic folder to a part

- 1 From the project manager's Design menu, choose New Part (ALT, D, T).
or
From the part editor's Options menu, choose Package Properties (ALT, O, R).
or
Select a part instance on a schematic page. From the schematic page editor's Edit menu, choose Properties (ALT, E, P).
- 2 Choose the Attach Implementation button. The Attach Implementation dialog box displays.
- 3 Enter the name of the child schematic folder.
- 4 If the child schematic folder is not in the current project, specify the project where the schematic folder is located.
- 5 Choose the OK button twice.

Adding graphics, text, and IEEE symbols to a part

Once you have defined a part, you can draw an outline to reflect the part's shape, and you can add graphics to add detail to the part. To add graphics to a part, you use the Line, Rectangle, Ellipse, Arc, Polyline, and Picture commands on the Place menu or the corresponding tools on the tool palette. You can also add text to the part using the Text command on the Place menu or the text tool on the tool palette.



See also For details about each of the graphic and text tools, see *Chapter 8: Adding and editing graphics and text*.



Note When you place graphics in a part, they must be within the part's body. If they don't fit within the part's body, the part body border expands to enclose the graphics.



Tip Like the schematic page editor, the part editor can display the part you are working on at several levels of detail. Just use the Zoom command on the View menu or the right mouse button pop-up menu.

A part can include IEEE symbols (shown at right). Unlike graphics, IEEE symbols do not have to be within the part's body.



To place an IEEE symbol

- 1 From the part editor's Place menu, choose IEEE Symbol (ALT, P, E).
or
Choose the IEEE symbol tool from the part editor's tool palette.
- 2 In the Place IEEE Symbol dialog box, select a symbol from the Symbol list box. The symbol displays in the preview box. When you have selected the symbol you want to place, choose the OK button. The IEEE Symbol dialog box closes.

An image of the IEEE symbol is attached to your pointer. You can press the right mouse button to display a pop-up menu with commands that you can use to change the appearance of the symbol before you place it. You can mirror the symbol horizontally or vertically, rotate the symbol, or choose another IEEE symbol to place.

- 3 Move the pointer on your part to where you want the symbol and click the left mouse button to place the symbol. You can place multiple instances of the symbol by clicking the left mouse button each place you want the symbol.
- 4 When you are done placing symbols, choose the selection tool or press ESC to dismiss the IEEE symbol tool.



Tip Once you've placed an IEEE symbol, you can change its size and shape by selecting it and dragging its selection handles.

Placing pins on a part

There are several ways you can place pins on a part. You can use the Pin command on the part editor's Place menu or the pin tool on the tool palette to place individual pins; or you can use the Pin Array command on the Place menu or the pin array tool on the tool palette to place several pins at once.

Pins must connect to the part body border (the dotted line around the part). If the edge of a part body coincides with this border, pins can connect directly to the part body. However, if the part body is inside this border, you can draw a line between the part body and the pin on the part body border to make the pin look as though it connects to the part body.

To place a pin

- 1 From the part editor's Place menu, choose Pin (ALT, P, P).

or

From the part editor's tool palette, choose the pin tool.

The Place Pin dialog box displays. You must provide information about the pin you are placing.

- 2 In the Name text box, type a name and pin number for the pin you are placing. If a pin name is not specified, Capture generates one, because pins must be named.
- 3 You can use the default settings for the other options on this dialog box or change them to fit your requirements. When the pin is specified to your requirements, choose the OK button.
- 4 Using the pointer, drag the pin to the desired location along the part body border.
- 5 Click the left mouse button to place the pin. You can place multiple instances of the pin by clicking the left mouse button each time you want to place an instance of the pin. The pin number and name increment automatically.



Tip To place multiple pins that are slightly different, you can click the right mouse button and choose the Edit Properties command.

- 6 When you are done placing pins, choose End Mode from the right mouse button pop-up menu, or press ESC.

Place Pin dialog box

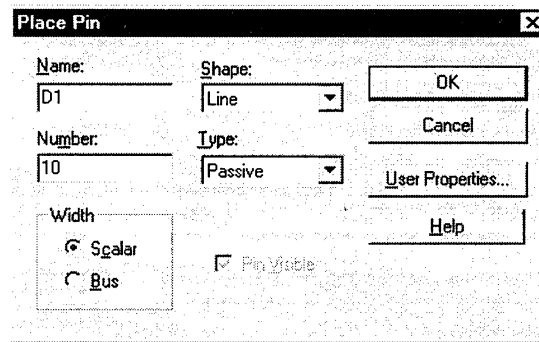

Name The name of the pin.

If a pin connects to a bus, the pin should be named in the format *busname [range]*, for example A[0..3]. You can use two periods (..), a colon (:), or a dash (-) to separate the numbers in the range. Bus pins are expanded into separate pins in a netlist, just as a bus is separated into separate signals.



Note Bus pins can only be used for simulation purposes. They will not netlist properly for board layout.

To enter a pin name with a bar over it (indicating negation), type a backslash character after each letter you want a bar over. For example, type `R\E\S\E\T\` to define the name:

RESET









Tip You can make each part's pin names visible or invisible. From the part editor's Options menu, choose Part Properties (ALT, O, R). When the User Properties dialog box displays, set Pin Names Visible to either True or False.

Number The pin's number.

Width If a pin connects to a wire, select Scalar. If a pin connects to a bus, select Bus.

Pin Visible If this option is selected, the pin is visible when the part is placed on the schematic page. Otherwise, the pin is not visible on the schematic page. This option is only available for power pins.

Shape The shape of the pin, as shown at right.

<i>Shape</i>		<i>Description</i>
Dot		An inversion bubble.
Clock		A clock symbol.
Dot-Clock		A clock symbol with an inversion bubble.
Zero		A normal pin with a lead zero grid units in length.
Short		A normal pin with a lead one grid unit in length.
Line		A normal pin with a lead three grid units in length.

Pin shapes.

Type The type of the pin, as described in the table below.

<i>Pin type</i>	<i>Description</i>
3-state	A 3-state pin has three possible states: low, high, and high impedance. In its high impedance state, a 3-state pin looks like an open circuit. For example, the 74LS373 latch has 3-state pins.
Bidirectional	A bidirectional pin acts as both input and output. For example, pin 2 on the 74LS245 bus transceiver is a bidirectional pin. The value at pin 1 (an input) determines the activity of pin 2, as well as others.
Input	An input pin is one to which you apply a signal. For example, pins 1 and 2 on the 74LS00 NAND gate are input pins.
Open collector	An open collector gate omits the collector pull-up. Use an open collector to make “wired-OR” connections between the collectors of several gates and to connect with a single pull-up resistor. For example, pin 1 on the 74LS01 NAND gate is an open collector gate.
Open emitter	An open emitter gate omits the emitter pull-down. The proper resistance is added externally. ECL logic uses an open emitter gate and is analogous to an open collector gate. For example, the MC10100 has an open emitter gate.
Output	An output pin is one to which the part applies a signal. For example, pin 3 on the 74LS00 NAND gate is an output pin.
Passive	A passive pin is typically connected to a passive device. A passive device does not have a source of energy. For example, a resistor lead is a passive pin.
Power	A power pin expects either supply voltage or ground. For example, on the 74LS00 NAND gate, pin 14 is VCC and pin 7 is GND.

Pin types.



Note Power pins that are invisible are not connected using wires and buses, but instead are connected globally via name.

User Properties Displays the User Properties dialog box. You can use this dialog box to define additional properties for the pin.

To place several pins at once

- 1 From the part editor's Place menu, choose Pin Array (ALT, P, I).

or

From the part editor's tool palette, choose the pin array tool.

The Place Pin Array dialog box displays. This dialog box is similar to the Place Pin dialog box, with these exceptions:

- The Starting Name and Starting Number text boxes are used to specify a name and pin number that is incremented for each pin that is placed.



Note The pin name only increments if the starting name ends with a number. Otherwise, all of the pins in the array have identical names.

- The Number of Pins, Increment, and Pin Spacing text boxes are used to specify how the pins are placed.
- 2 In the Starting Name text box, enter the name of the first pin. If the pin name ends in a digit (0–9), subsequent pin names in the array will be incremented by the value in the Increment text box (if there is no value in the Increment text box, the pin names are incremented by 1).
 - 3 In the Starting Number text box, enter the number of the first pin. Subsequent pin numbers will be incremented by the value in the Increment text box (if there is no value in the Increment text box, the pin names are incremented by 1). If you leave the Starting Number text box blank, the pins are not numbered.
 - 4 In the Number of Pins text box, specify how many pins you want to place.
 - 5 In the Increment text box, specify the number by which you want to increment the pin name (if it ends in a digit) and pin number for each pin in the array.
 - 6 In the Pin Spacing text box, specify the number of grid units you would like between each pin.
 - 7 If necessary, change the default settings for Shape and Type to fit your requirements, then choose the OK button.
 - 8 Using the pointer, drag the pin array to the desired location along the part body border, then click the left mouse button to place the array. The array is positioned so that the first pin in the array is at the pointer.



Tip You can place multiple copies of the array by clicking the left mouse button each time you want to place an array. Each time you place the array, the pin names and pin numbers are incremented based on the number of the last pin placed.



Note If the pin array is longer than the edge of the part body, the part body border expands to accommodate the extra pins.

- 9 When you are done placing arrays, choose End Mode from the right mouse button pop-up menu, or press ESC.



Tip Once you place an array of pins, you can edit their properties as a group by selecting the pins, then choosing Properties from the Edit menu. This opens the spreadsheet editor, which you can use to edit the information for the pins.

Place Pin Array dialog box

Starting Name The name of the first pin in the array. If the name ends with a digit (0–9), each pin in the array is incremented by the value specified in the Increment text box.

For a name with a bar over it (indicating negation), type a backslash character after each letter you want a bar over. For example, type `R\E\S\E\T` to define the name:

`R\E\S\E\T`

Starting Number The number of the first pin in the array. Each pin in the array is incremented by the value specified in the Increment text box.

Number of Pins The number of pins in the array.

Increment The number by which to increment the pin name (if it ends in a digit) and pin number for each pin in the array. This can be a negative number.

Pin Spacing The number of grid units between each pin in the array.

Shape The shape of the pins in the array, as described in *Place Pin dialog box*, earlier in this chapter.

Type The type of the pins in the array, as described in *Place Pin dialog box*, earlier in this chapter.

About power and ground pins

Both homogeneous and heterogeneous parts may have shared pins. A common use of shared pins is for supply pins (power or ground), which are referred to in Capture as *power pins*. Normally, power pins are invisible and *global* (meaning that they are connected to like-named power objects, power nets, and invisible power pins throughout the design).

Merely displaying an invisible power pin does not change its global nature; however, connecting a wire or other electrical object to a power pin isolates it from the design-wide (global) net. For information on displaying invisible power pins, see the section *Displaying invisible power pins* later in this chapter.

On heterogeneous parts, power pins cannot appear on every part in the package. If you make the power pins visible, you must place them on at least one part in the package, then place that part in the design in order for the power connections to appear in a netlist.

On homogeneous parts, power pins appear on every part in the package. The pin names are filled in automatically, but you must specify the pin numbers. To share the pins, make sure that the pin names and the numbers are the same for every part in the package.



Caution If you connect the same pin on multiple parts in a package, you can inadvertently short two nets. Use care to avoid this, and always run Design Rules Check before creating a netlist.

Displaying invisible power pins

You can display power pins on individual part instances or throughout a design. Merely displaying invisible power pins does not change their global nature. The method you choose to display power pins determines whether you can connect to them. Invisible power pins are always displayed in the part editor.

To display invisible power pins on a part instance

- 1 In the part editor, select a power pin.
- 2 From the Edit menu, choose Properties. The Pin Properties dialog box displays.
- 3 Select the Pin Visible option.
- 4 Choose the OK button.



Note If you connect to an invisible power pin that is displayed by this method, the pin is isolated from the design-wide power net.

To display invisible power pins throughout a design

- 1 From the project manager's Options menu, choose Design Properties, then choose the Miscellaneous tab.
- 2 Select the Display Invisible Power Pins (for documentation purposes only) option, then choose the OK button.



Note You cannot connect to an invisible power pin that is displayed by this method.

Editing an existing part

You can edit an existing part in the library in which it resides, or you can edit a part after it is placed on a schematic page.

Editing a part in a library

Once you edit a part in a library, you can update existing projects with the new part using the Update Cache or Replace Cache commands on the project manager's Design menu.

To edit a part in a library

- 1 From the File menu, choose Open (ALT, F, O). A standard Open dialog box displays.
- 2 Choose the library containing the part you want to edit. The library opens, showing all its parts.
- 3 Double-click on the part you want to edit. The selected part appears in the part editor.
- 4 Edit the part.

You can resize it, add or delete graphics or symbols, and add or delete pins. These processes are all described in *Creating a new part* earlier in this chapter. You can also edit the part's properties. Editing properties is described in *Chapter 2: The Capture work environment*.

- 5 When you are done editing the part, you must save it. From the File menu, choose Save (ALT, F, S). The part is saved in the library.



Tips In the project manager, you can create a new part from an existing part by dragging a copy of the part (press the CTRL key while you drag the part) to a new library and then editing the part.

You can also create an alias of the part by changing to package view in the part editor, choosing Package Properties from the Options menu, then choosing the Part Alias button. Once you create a part alias, you must save the part to have the alias show up in the library. In the library, part aliases display with lines through their part icons.

Editing a part on a schematic page

Once you edit a part on a schematic page, you can apply the edits to all instances of the same part in the project, or you can apply the edits only to the particular part instance you edit.



Caution Once you edit a part instance on a schematic page, it is no longer linked to its corresponding library part. In addition, a new part (with *_n* appended to the original part name) appears in the design cache. This means that you can't perform a cache update on an edited part, since there is no link to the original library.

To edit a part instance on a schematic page

- 1 Select a part instance on a schematic page.
- 2 From the Edit menu, choose Part (ALT, E, A).

The library part that was used to define the part instance appears in the part editor.

- 3 Edit the part.

You can resize it, add graphics or symbols, and add or delete pins. These processes are all described in *Creating a new part* earlier in this chapter. You can also edit the part's properties. Editing properties is described in *Chapter 2: The Capture work environment*.

- 4 When you are done editing the part, you must close it and save the changes on the schematic page. From the File menu, choose Close (ALT, F, C).

A dialog box displays asking if you would like to:

- Update only the part instance being edited (Update Current).
- Update all instances of the part in the project (Update All).
- Discard the edits to the part and return to the schematic page editor (Discard).
- Cancel the close operation and return to the part editor to continue making changes to the part (Cancel).

After you choose a response, the part editor window closes. Depending on your response, the change is reflected in the selected part or in all instances of the selected part.

A new part (with *_n* appended to the part name) displays in the design cache, indicating that the link to the library part no longer exists.

Viewing parts in a package

For a package containing multiple parts, you can use the Package command on the View menu to view all the parts in the package at once. You can then choose which part in the package to edit. If the package is homogeneous, you can only edit pin names and pin numbers, since each part in a package must have the same graphic representation. If the package is heterogeneous, you can make each part in the package graphically distinct.

To view a package

- 1 From the part editor's View menu, choose Package (ALT, V, K). The package view window (shown below) replaces the part editor window.

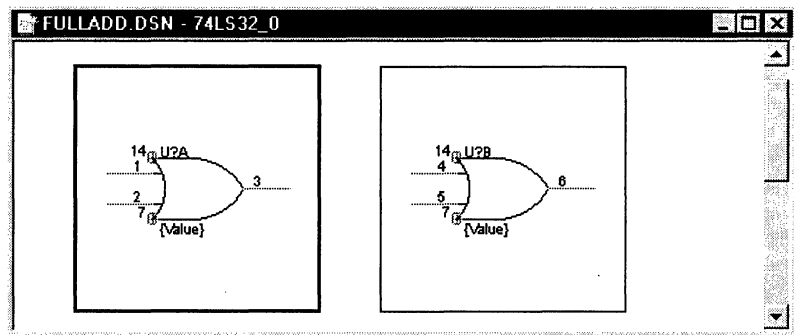

- 2 You can move from part to part using the ARROW and TAB keys.

If the package is heterogeneous, you can select which part to edit by double-clicking on it. The package view window closes and the selected part opens in the part editor window.

If the part is homogeneous, double-clicking on any of the parts in the package closes the package view window and opens the part in the part editor window.



Tip When editing a heterogeneous package, a quick way to move from one part in a package to another is to use the Next Part (ALT, V, X) and Previous Part (ALT, V, V) commands on the View menu.

Editing parts in a package

For a package containing multiple parts, you can use the Package Properties spreadsheet to edit all the parts in the package at once. If the package is homogeneous, you can only edit pin names and pin numbers, since each part in a package must have the same graphic representation. If the package is heterogeneous, you can make each part in the package graphically distinct. When a normal and convert part are both available, the normal and convert names and types will appear on the spreadsheet.

To edit parts in a package

- 1 From the part editor's View menu, choose Package (ALT, V, K). The package view window replaces the part editor window.
- 2 From the Edit menu, choose Properties. The Package Properties spreadsheet displays.
- 3 Edit the pin location, pin order, pin group (for pin swapping), pin number, pin name, pin type, and whether the pin is to be ignored (for shared pins) as needed.
- 4 Choose the OK button.

Viewing a part's convert

A convert view is an alternate view of a part. It can be used for things such as a DeMorgan equivalent of a part. If a part has a convert view, you can easily switch between the normal view and convert view in the part editor.

To view a part's convert

- 1 From the part editor's View menu, choose Convert (ALT, V, C).
- 2 To go back to the normal view of the part, choose Normal from the View menu (ALT, V, N).



Note If you're editing a part that doesn't have a convert view, the Convert command is not available.

Processing your design

Part Four provides details about processing your design once you have created it. It provides an overview of the design process, as well as detailed information about the project manager's Tools menu. Part Four contains these chapters:

Chapter 13: About the processing tools provides general guidelines for processing your design and describes when to use Capture's different processing tools.

Chapter 14: Preparing to create a netlist describes the tools you use to prepare a design for creating a netlist. It describes the Update Part References, Update Properties, Design Rules Check, and Gate and Pin Swap tools.

Chapter 15: Creating a netlist explains how to create a netlist using the Create Netlist tool.

Chapter 16: Creating reports explains how to create reports using the Bill of Materials and Cross Reference tools.

Chapter 17: Exporting and importing schematic data describes the Export Properties and Import Properties tools used to move data into and out of Capture.

Chapter 18: Using Capture with OrCAD Layout for Windows explains how to perform forward annotation, back annotation, and cross probing using Capture and Layout.

Chapter 19: Using Capture with OrCAD Simulate for Windows describes intertool communication between Capture and Simulate, and explains how to use this feature to debug your Capture schematic interactively.

Part Four



About the processing tools

A design process typically involves placing and connecting parts in the schematic page editor, then using Capture's tools to specify how parts are to be packaged and uniquely identified. You add information for simulation, synthesis, board layout, purchasing, or other external functions, then create a netlist and incorporate back annotation information from external applications.

As shown in the figure at right, you use Update Part References, Design Rules Check, and Cross Reference to package the parts in your project and to check that there are no invalid conditions. In practice, you might run these tools several times before moving on to the next phase.

You can add properties or change their values (see *Using the spreadsheet editor to edit properties in Chapter 2: The Capture work environment*). If you prefer editing in a full-featured spreadsheet or database program, use Export Properties to write data out and Import Properties to read it back in.

Use Create Netlist to convey project information to Layout or Simulate. Layout can create a back annotation file detailing packaging changes that are needed because of routing or manufacturing constraints. Use Gate and Pin Swap to incorporate this information into your Capture project. Use Bill of Materials to create a list of the parts.

After you do this, you may need to make additional changes to your project, then repeat some or all phases of the design process. In addition, you may want to analyze your project using intertool communication to communicate interactively with Layout for cross probing, or with Simulate to view signals in Capture as their states change during simulation.

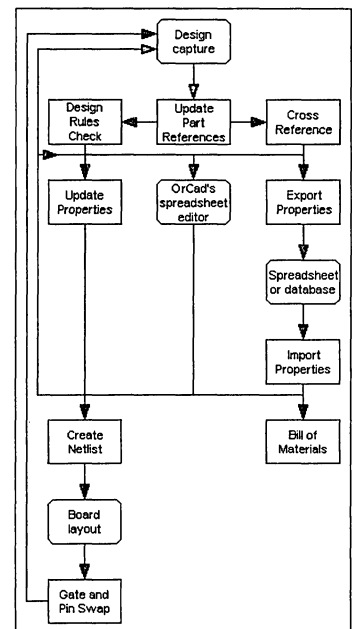

Tools overview

Once you finish placing and connecting parts in the schematic page editor, use the project manager's Tools menu commands to help you complete the design process.



Note You won't be able to use any of these tools to modify a schematic design attached to a hierarchical block if the design is external to the current project.

<i>Command</i>	<i>Overview</i>	<i>Described in</i>
Update Part References	Packages parts by resolving part references and pin numbers, or removes packaging information by resetting part references to their unassigned values.	<i>Chapter 14: Preparing to create a netlist</i>
Gate and Pin Swap	Swaps pins or gates, or changes packaging, based on a swap file created by you or your board layout program.	<i>Chapter 14: Preparing to create a netlist</i>
Update Properties	Adds properties, or changes the values of properties, based on an update file you create.	<i>Chapter 14: Preparing to create a netlist</i>
Design Rules Check	Reports and flags violations of electrical rules and other design constraints. Starts by removing existing DRC markers.	<i>Chapter 14: Preparing to create a netlist</i>
Create Netlist	Creates a file that lists the logical interconnections between signals and pins in one of more than thirty standard formats.	<i>Chapter 15: Creating a netlist</i>
Cross Reference	Reports the schematic page and location of parts (used in developing or documenting a project).	<i>Chapter 16: Creating reports</i>
Bill of Materials	Creates a formatted list of electrical and other parts in the project. Optionally adds information, based on an include file you create.	<i>Chapter 16: Creating reports</i>
Export Properties	Creates a tab-delimited list—for manipulation in a spreadsheet or database program—of properties and values for each part in the project.	<i>Chapter 17: Exporting and importing schematic data</i>
Import Properties	Adds properties, or changes the values of properties, based on a tab-delimited list in the format created by the Export Properties command.	<i>Chapter 17: Exporting and importing schematic data</i>

Preparing to create a netlist

Updating part references

After you place parts on a schematic page, all parts need to be uniquely identified using the Update Part References command on the project manager's Tools menu. This tool assigns unique part references to each part in a project. You use Update Part References after you've placed all parts and before you use other Capture tools. You can update part references incrementally (so that previously assigned part references are not changed), or you can update part references unconditionally, changing all the parts across all the schematic pages processed.



Caution After you have created a netlist and read it into Layout, if you make further changes to your Capture design, only use the Incremental reference update option in the Update Part References dialog box when you update part references. Do not use the Unconditional reference update option.



Tip Update Part References also assigns individual parts to a multiple-part package, thereby assigning unique pin numbers to each part in a multiple-part package. This process is sometimes called *packaging*. For more information on controlling packaging in multiple-part packages, see Capture's online help.

Parts are updated in the order in which they appear on a schematic page, going from left to right and top to bottom, as shown in the figure below.

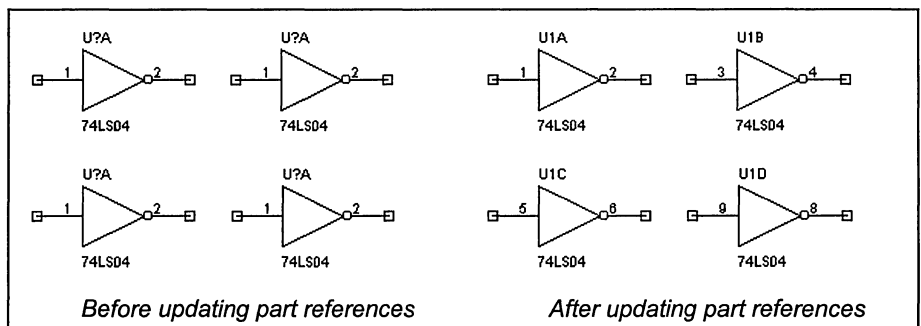

Parts are updated from left to right, and from top to bottom.

To update part references

- 1 In the project manager, choose the Logical option to update part references on part instances.
or
In the project manager, choose the Physical option to update part references on part occurrences.
- 2 In the project manager, select the schematic pages on which to update part references.
- 3 From the project manager's Tools menu, choose Update Part References (ALT, T, U).
or
Choose the update part references tool from the toolbar.

The Update Part References dialog box displays.
- 4 Set the options in this dialog box as necessary. You can specify whether to update the entire project or just the schematic pages selected in the project manager, whether to update the part references that haven't yet been updated, update all part references, or reset part references so that they have question marks in their names. These options are described in the section *Update Part References dialog box*.
- 5 When the Update Part References dialog box has the settings you want, choose the OK button to begin the update.

Update Part References dialog box

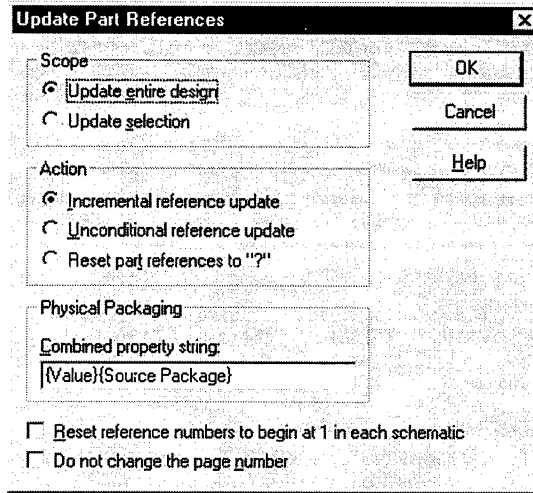

Scope Specifies whether to update all the part references in the design or just those on the selected schematic pages.

Incremental reference update or **Unconditional reference update** or **Reset part references to “?”** Specifies whether to incrementally update parts with question marks in their part references, unconditionally update the parts in the selected schematic pages, or reset all the part references using a question mark (?).



Caution After you have created a netlist and read it into Layout, if you make further changes to your Capture design, only use the Incremental reference update option in the Update Part References dialog box when you update part references. Do not use the Unconditional reference update option.

Physical Packaging Specifies the properties that must match for Capture to group parts in a single package. See Capture’s online help for information on how the Update Part References tool packages individual parts into multiple-part packages, as well as information about combined property strings.

Reset reference numbers to begin at 1 in each schematic If this option is selected, Capture numbers part references beginning with 1 in each schematic folder.



Caution If you don’t instruct Capture to begin the reference numbers at 1, it looks at the selected schematic pages, finds the highest part reference number, and begins numbering from that number. This can result in duplicate reference numbers if the highest numbered part for each reference prefix is not represented in the schematic pages you have selected. If you suspect you have duplicate reference numbers, run Design Rules Check before you attempt to create a netlist.

Do not change the page number If you are in logical mode, the schematic pages are renumbered based on their order in the project manager. If you select this option, the pages are not renumbered.



Tip The properties that contain the page number (Page Number and Page Count) are part of the title block. If you create a custom title block, you can give it these two properties, so that they are updated when you run Update Part References.

Updating properties

If you need to edit the properties for a few parts or nets, you can do so in the schematic page editor. If, however, you want to make changes to a number of parts or nets, the Update Properties tool is much quicker and easier than hand-editing each property you'd like to change. You can use Update Properties to edit any properties except part reference, net name, and net ID. You can also use Update Properties to add properties. In essence, it is a search-and-add-or-replace tool.

To update properties, you create a file, called an *update file*, with one line for each part or net to change. The leftmost column identifies the part or net (by specifying the property value to match), and the remaining columns provide the new property value. The format of the update file is described in *Update file format* later in this section.

You can run Update Properties on projects in both logical and physical mode.

To update part or net properties

- 1 Using a text editor, create an update file, as described in *Update file format* later in this section.
- 2 In the project manager, choose the Logical option to update part or net properties on part instances.
or
In the project manager, choose the Physical option to update part or net properties on part occurrences.
- 3 To process only part of your project, select the pages to process in the project manager.
- 4 From the project manager's Tools menu, choose Update Properties (ALT, T, P).
The Update Properties dialog box displays.
- 5 Set the options in this dialog box as necessary. You can specify whether to process the entire project or just the schematic pages selected in the project manager, and whether to update parts or nets. You can customize your update further by specifying that your comparison and update strings be converted to uppercase. You can also have Capture create a report file listing the properties that it changes. You must specify the name of the update file containing the properties to match and the text to place in the specified properties. These options and others are described in the section *Update Properties dialog box*.
- 6 When the dialog box has the settings you want, choose the OK button. Capture updates the properties you specified. If you set up the dialog box to create a report file, you can use a text editor to view the file when the Update Properties tool is done.

Update Properties dialog box

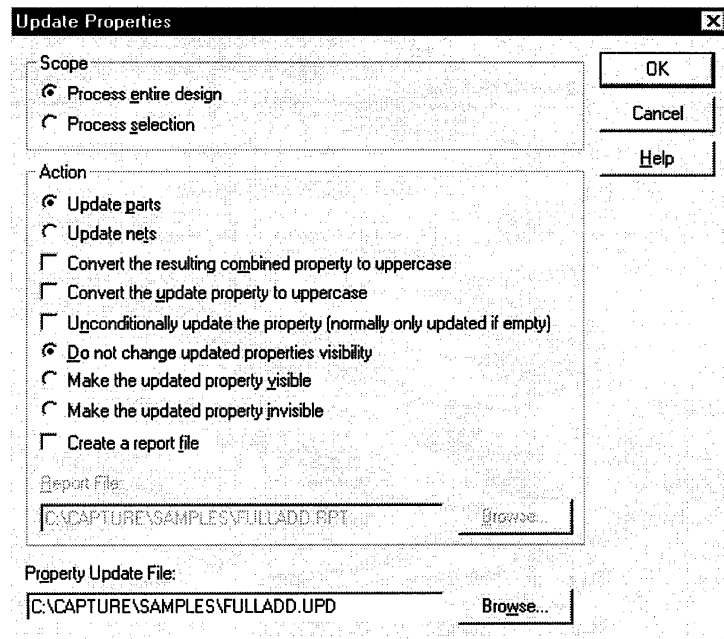

Scope Specifies whether to process the project or what is selected.

Update parts or **Update nets** Specifies whether to update the properties of parts or nets.

Convert the resulting combined property to uppercase Converts the combined property values to uppercase before a comparison is done.

Convert the update property to uppercase Converts the update property to uppercase before it is placed in an object's property.

Unconditionally update the property By default, a property is updated only if it is empty: properties with values are not updated. If this option is selected, the specified property is changed, regardless of whether it's empty.

Do not change updated properties visibility Specifies that the visibility of the updated properties is not changed.

Make the updated property visible/invisible Specifies that the updated property is to be made visible or invisible.

Create a report file Specifies whether or not Capture creates a report file. If you select this option, enter the name of the report file in the Report File text box.

Property Update File The name of the update file containing the properties to match, the properties to update, and the values to use to update the properties. This file has an extension of .UPD.

Update file format

The update file is an ASCII text file that you create to specify the properties to match, the properties to update, and the values to use to update the properties. The file can include comments—any text to the right of a semicolon is ignored by the Update Properties tool.

The first line of the update file has this format:

```
CombinedPropString PropToUpdate1 PropToUpdate2 ...
```

The first field is a combined property string specifying which properties to combine into a match string (note that property names in a property string must be enclosed in braces). The remaining fields in the line are the properties to update on each part or net to be updated. The combined property string and the property names entered in these fields must be enclosed in quotation marks.



See For information about combined property strings, see Capture's online help.

Subsequent lines of the update file have this format:

```
MatchString1 Update1 Update2 ...
MatchString2 Update1 Update2 ...
.
.
.
```

The match string is the text used to compare with the values of the properties specified by the combined property string in the first line. The update fields are the values placed in the properties specified in the first line, if the match string matches the expanded combined property string. These values must also be enclosed in quotation marks. For example:

```
"{Value}" "PCB Footprint"
"74LS00" "14DIP300"
"74LS138" "16DIP300"
"74LS163" "16DIP300"
"8259A" "28DIP600"
```

This indicates that the property to use as a match string is Value. Each time an object's Value matches the value listed in the left column of the update file, the corresponding text in the right column is placed in the object's PCB Footprint property. In this example, each time a part has a value of 74LS00, the text 14DIP300 is placed in the part's PCB Footprint property; each time a part has a Value of 74LS138, 16DIP300 is placed in the part's PCB Footprint property, and so on.

Checking for design rules violations

The Design Rules Check tool scans schematic designs and checks for conformance to basic design and electrical rules. The results of this check are marked on the schematic pages with DRC markers, and are also listed in a report. This makes it easy to locate and fix design or electrical errors. You can search for DRC markers using the Browse command on the project manager's Edit menu, and then double-click on any item in the resulting list to go immediately to the location of the marker on your schematic page. Once you are viewing the marker on the schematic page, you can display the marker's text by double-clicking on it.

You can specify the conditions that cause errors to be generated. Optional checks performed by the Design Rules Check tool include off-grid parts; unconnected nets, pins, ports, and off-page connectors; identical part references; type mismatch parts; and design elements that are not compatible with OrCAD's Schematic Design Tools product.



Note When Design Rules Check checks for unconnected nets, it looks for nets with less than two connection points. Thus, a net can still have unconnected endpoints that aren't reported by Design Rules Check.

The Design Rules Check is helpful in preparing your project for use with other tools. For example, you can use the Design Rules Check tool to catch problems such as bus contention or shorted power pins before you generate a netlist to be used by simulation or synthesis tools.

The Design Rules Check reports two categories of electrical rules violations:

- Errors that should be fixed.
- Warnings of situations that may or may not be acceptable in your project.

You can control whether electrical rules violations are reported as errors or warnings in the ERC Matrix tab of the Design Rules Check dialog box. Errors are always marked with DRC markers on the schematic page. Warnings are also marked with DRC markers if you select the Create DRC markers for warnings option in the Design Rules Check dialog box. In the report generated by Design Rules Check, however, the problems are categorized as WARNING or ERROR so that you can immediately identify the more critical problems.

Once the Design Rules Check begins, it first removes existing DRC markers from the schematic pages being processed. This means that each time you run this process, the error markers on your schematic pages reflect the current state of your project. You can also use the Design Rules Check tool to remove DRC markers from schematic pages, but not do any further checking. Just select the Delete existing DRC markers option on the Design Rules Check dialog box.



Caution You should ALWAYS run Design Rules Check before you create a netlist.

To check for design rules violations

- 1 In the project manager, select the schematic pages that you want to check for design rules violations.
- 2 From the project manager's Tools menu, choose Design Rules Check (ALT, T, D).
or

Choose the design rules check tool from the toolbar.

The Design Rules Check dialog box displays.

- 3 Select the settings you want in the Design Rules Check tab and in the ERC Matrix tab. For information about the settings in these tabs, see *Design Rules Check dialog box*, *Design Rules Check tab* and *Design Rules Check dialog box, ERC Matrix tab* later in this section.
- 4 When both tabs of the Design Rules Check dialog box have the settings you want, choose the OK button.

As Capture checks your project, it displays status information about the check. If you stop the design rules check midstream (by choosing the Cancel button in the status information dialog box), the schematic pages that have already been processed will have DRC markers marking any error situations that were encountered.

- 5 Once the design rules check is complete, there are two ways to view the results:
 - You can open the DRC report file using a text editor or word processor. This file has a default extension of .DRC. The session log also contains the same information.



Tip To view the information contained in a .DRC report, set up a file association using the Open With dialog box in Windows Explorer. By doing this, you can open the .DRC report by double-clicking on it in Windows Explorer.

- You can use the Browse command on the project manager's Edit menu to display a list of all DRC markers in the project.

This list gives information about each error and warning. Each DRC marker on a schematic page displays this same information. Once this list displays in the browse window, you can double-click on an item to go directly to it on its schematic page. Once you are viewing the marker on the schematic page, you can display the marker's text by double-clicking on it. You can also use the schematic page editor's Find command to find specific DRC markers. To do this, you must enter the text associated with the marker.

Design Rules Check dialog box, Design Rules Check tab

The Design Rules Check tab contains options for things to include in the report generated by Design Rules Check. You can specify if you want to create DRC markers on the selected schematic pages for both errors and warnings, create DRC markers just for errors, or delete existing DRC markers instead of adding new ones. Note that if you select the option to delete existing DRC markers, the options that customize the DRC report become dimmed and aren't available for selection.

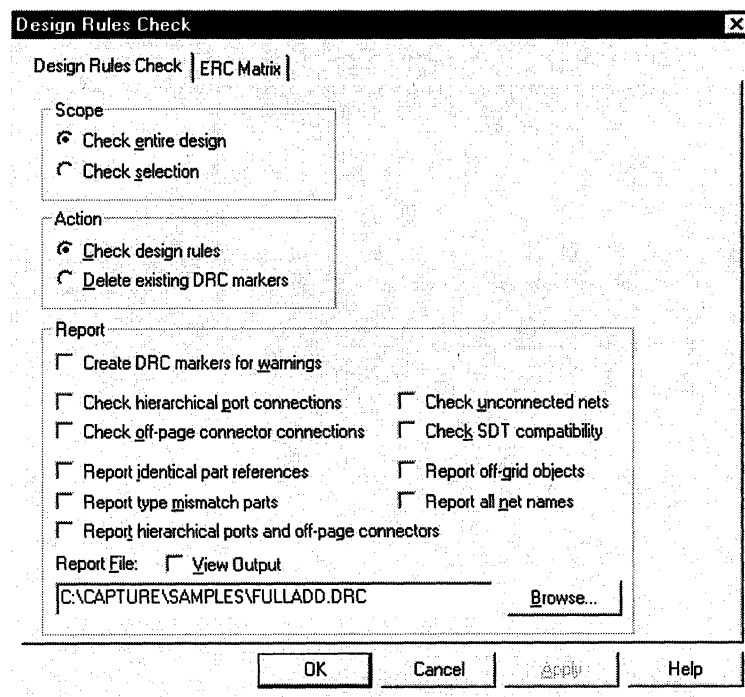

Scope Specifies whether to process the entire project or just the selected schematic page or pages.

Check design rules or **Delete existing DRC markers** Specifies whether to check for design rules violations or just delete existing DRC markers. Note that if you select the Check design rules option, Capture deletes existing DRC markers before it begins the design rules check.

Report All the remaining options on the dialog box are report options, and leave messages and reports in the session log. Selected report options are also included in the specified report file.

Create DRC markers for warnings Design Rules Check always places DRC markers on the schematic page for errors defined in the ERC Matrix tab. If you select this option, it also places DRC symbols on the schematic page for warnings defined in the ERC Matrix tab.

Check hierarchical port connections Verifies that hierarchical pins on schematic pages in the parent schematic folder match hierarchical ports on schematic pages in the child schematic folder. Errors are generated if a hierarchical pin specified on a schematic page in a parent schematic folder doesn't have a corresponding hierarchical port *with an identical name* on a schematic page in the child schematic folder; if the number of hierarchical pins and hierarchical ports are different between the parent and child schematic folders; and if the type of the hierarchical pins and hierarchical ports doesn't match.

Check off-page connector connections Verifies that off-page connector nets on a schematic page match those on other schematic pages.

Check unconnected nets Checks for these conditions: nets that aren't connected to at least two pins or hierarchical ports; nets that don't have a driving signal; and two nets with the same name in a schematic folder, but no off-page connector or hierarchical port to connect them.

Check SDT compatibility Checks for compatibility with OrCAD's SDT product in case you plan on saving the project in SDT format. See Capture's online help for information about the rules you should follow if you are planning to use a Capture project in SDT.

Report identical part references Checks for unique part references, and reports parts that use the same part reference. For example, Capture considers two U1's to be identical, two U1A's to be identical, and U1 and U1A to be identical.

Report type mismatch parts Reports parts that are packaged into the same physical package, but whose package properties conflict (primarily source package and PCB footprint).

Report hierarchical ports and off-page connectors In the report file, lists all hierarchical ports and off-page connectors.

Report off-grid objects In the report file, lists the names and locations of objects that are off grid.

Report all net names In the report file, lists the names of all nets.

Report File The name of the report file containing the information prepared by Design Rules Check. This file usually has an extension of .DRC. For an example of the report generated by the Design Rules Check tool, see the section *Sample Design Rules Check report*.

Design Rules Check dialog box, ERC Matrix tab

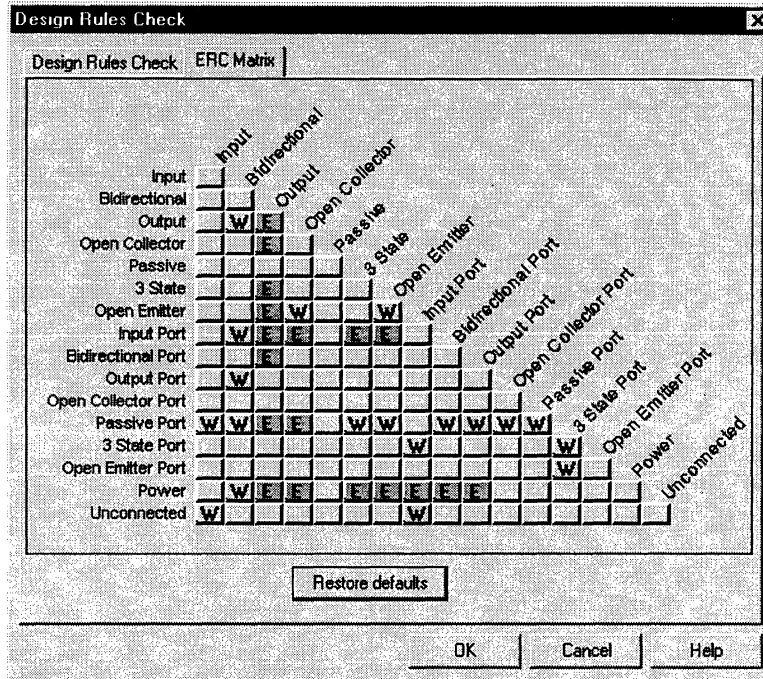

You use the ERC matrix to set the electrical rules that Design Rules Check uses when testing connections between pins, hierarchical ports, and off-page connectors. All types of pins, hierarchical ports, and off-page connectors are listed in the columns and rows in the table. A test is represented by the intersection of a row and column. Either the intersection is empty, or it contains a W, or it contains an E.

- An empty intersection represents a valid connection, in which case nothing is reported if you specify a report file.
- A W represents a warning.
- An E represents an error.

You can cycle through these settings by pointing to an intersection and clicking the mouse button until the desired setting appears. For all rows except the Unconnected row, the DRC reports an error or warning for any net that has two connections as specified in the ERC matrix. For example, consider the dialog box above. If a net has an output pin and a bidirectional pin, a warning is issued based on the W in the intersection of the Output row and the Bidirectional column. For the Unconnected row, the DRC checks to see if the specified pin or port type is unconnected.



Tip You can also type **W** for warning, **E** for error and **N** for an empty intersection. In addition, you can use the arrow keys to select other intersections.

Sample Design Rules Check report

```
Design Rules Check
Checking Schematic: 4BIT
Checking Electrical Rules
Checking for Unconnected Wires
Checking Off-Page Connections
Checking Pin to Port Connections
WARNING: [DRC0014] Type of pin above does not match the pin type of
           corresponding port below fulladd_1,SUM
WARNING: [DRC0014] Type of pin above does not match the pin type of
           corresponding port below fulladd_2,SUM
WARNING: [DRC0014] Type of pin above does not match the pin type of
           corresponding port below fulladd_3,SUM
WARNING: [DRC0014] Type of pin above does not match the pin type of
           corresponding port below fulladd_4,SUM
Checking for Invalid References
Checking for Duplicate References
Checking for Compatibility with SDT
Reporting Off-Grid Objects
Reporting Ports
S1
S2
S3
CIN
S[0..3]
X[0..3]
Y[0..3]
Y0
Y1
X0
COUT
Y2
X1
Y3
X2
X3
S0
Reporting Off-Page Connections
Reporting Globals
Reporting Net Names
S0
N00074
N00072
N00070
COUT
CIN
S[0..3]
X[0..3]
Y[0..3]
```

Sample Design Rules Check report for 4BIT.DSN (page 1 of 3).

```
Y3
Y2
Y1
Y0
X3
X2
X1
X0
S3
S2
S1

-----
Checking Schematic: FULLADD
-----
Checking Electrical Rules
ERROR: [DRC0004] Possible pin type conflict halfadd_A,SUM Output
        Connected to Bidirectional Port

Checking for Unconnected Wires

Checking Off-Page Connections

Checking Pin to Port Connections

Checking for Invalid References

Checking for Duplicate References

Checking for Compatibility with SDT

Reporting Off-Grid Objects

Reporting Ports
X
Y
CARRY_IN
CARRY_OUT
SUM

Reporting Off-Page Connections

Reporting Globals
VCC
GND

Reporting Net Names
VCC
CARRY_OUT
N00040
N00038
N00036
Y
X
SUM
CARRY_IN
GND

-----
Checking Schematic: HALFADD
-----
Checking Electrical Rules
```

Sample Design Rules Check report for 4BIT.DSN (page 2 of 3).

```
Checking for Unconnected Wires
Checking Off-Page Connections
Checking Pin to Port Connections
Checking for Invalid References
Checking for Duplicate References
Checking for Compatibility with SDT
Reporting Off-Grid Objects
Reporting Ports
  X
  Y
  CARRY
  SUM
Reporting Off-Page Connections
Reporting Globals
  VCC
  GND
Reporting Net Names
  SUM
  N00039
  GND
  VCC
  N00033
  N00031
  X_BAR
  Y
  X
  CARRY
```

Sample Design Rules Check report for 4BIT.DSN (page 3 of 3).

Swapping gates and swapping pins

Using Gate and Pin Swap, you can import changes created by external tools, such as a PCB layout application. Capture uses a simple file format (see *Swap file format* later in this section) to allow gate swapping, pin swapping, changing pins, and changing part references. If the external tool creates a back annotation file, edit the file to match the format described in *Swap file format* in this section.



Note To back annotate properties, use the Update Properties tool.

When should you use Gate and Pin Swap? After you've completed your schematic design, or while you are routing a printed circuit board, you might discover that you can reduce via count, track length, or routing complexity by exchanging two gates of one part. You would use the PCB layout tool to rewire the board to exchange (or swap) the connections of U1A and U1B. To ensure that your project reflects the rewired board, you create a swap file using the PCB layout tool and then run Capture's Gate and Pin Swap. When you look at the schematic page, you will see that U1A is where U1B was before, and vice versa.

To swap gates and swap pins

- 1 Generally, a swap file is created by another application such as OrCAD Layout for Windows. Alternatively, you can create a swap file using a text editor, following the format described in *Swap file format* later in this section.
- 2 In the project manager, choose the Logical option to swap gates or pins on part instances.
or
In the project manager, choose the Physical option to swap gates or pins on part occurrences.
- 3 To process only part of your project, select the pages to process in the project manager.
- 4 From the project manager's Tools menu, choose Gate and Pin Swap.
or
Choose the gate and pin swap tool from the toolbar.

The Gate and Pin Swap dialog box displays.
- 5 Set the options in this dialog box as necessary. You can specify whether to process the entire project or just the selected schematic pages. You can also specify the name of the swap file containing the gates and pins to swap. These options are described in the section *Gate and Pin Swap dialog box*.
- 6 When the dialog box has the settings you want, choose the OK button. Capture swaps the gates and pins you specified.

Gate and Pin Swap dialog box

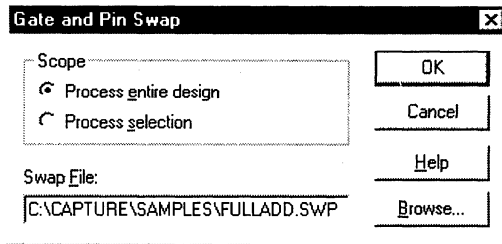

Scope Specifies whether to process the entire project or just the selected schematic page or pages.

File Specifies the swap file. For more information, see *Swap file format*.

Swap file format

A swap file is an ASCII text file containing old and new part references. A swap file is typically created by another application, such as OrCAD Layout for Windows. You can also create a swap (.SWP) file using a text editor that can save the file in ASCII format. The file can include comments; any text to the right of a semicolon is ignored by the Gate and Pin Swap tool. Each line in a swap file, unless preceded by a semicolon, causes one action. The elements of each line may be separated with any number of space or tab characters. In general, the first element of the line specifies the type of swap. If no swap type is specified, CHANGEREf is assumed. The other swap types are GATESWAP, PINSWAP, and CHANGEPIN.

The following example illustrates a swap file. The comments to the right of the semicolons describe what the swap file will do.

```
CHANGEREf      U1      U2                ;Change part reference U1 to U2
                U1C     U2C                ;Change part reference U1C to U2C
GATESWAP       U1      U2                  ;Swap parts U1 and U2
GATESWAP       U1A     U1B                ;Swap gates U1A and U1B
CHANGEPIN      U7      1      2           ;Change pin 1 to pin 2
CHANGEPIN      U7      2      1           ;Change pin 2 to pin 1
CHANGEPIN      U5B     "D0"  "D1"        ;Change pin named D0 to D1
CHANGEPIN      U5B     "D1"  "D0"        ;Change pin named D1 to D0
```

Note that there are two CHANGEPIN commands for each pin swap. If you entered just one line to change pins, for example:

```
CHANGEPIN      U7      1      2
```

The original pin 1 is changed to pin 2; however, if you already have a pin 2, you will end up with two of them, unless you change the original pin 2 to something else. For this reason, a second line is needed to go with the first line. The complete command lines needed to perform a pin swap between pins 1 and 2 are:

```
CHANGEPIN      U7      1      2
CHANGEPIN      U7      2      1
```



Note Swap files created by OrCAD's PCB 386+ are was/is files. These files contain no keyword identifiers; therefore, each line is assumed to be a .CHANGEREf instruction. In the swap file example above, the line without a keyword identifier (the second line) is an example of how changes are specified in a was/is file generated by PCB 386+.

With the exception of the PINSWAP command, the commands in a swap file are was/is based. That is, the commands specify what the original values were and what the new values will be. For this reason, unlike some board layout programs, you cannot specify intermediate steps for the commands, except for PINSWAP.

The PINSWAP command works off the present state of the pin. For this reason, you can perform intermediate steps, such as:

```
PINSWAP U1 1 2 ;First swap
PINSWAP U1 2 3 ;Second swap
```

After both lines of the example above are processed, what was pin 1 is now pin 2, what was pin 2 is now pin 3, and what was pin 3 is now pin 1. The series of changes is shown in the following figure.

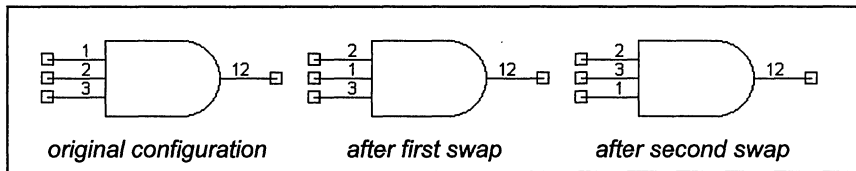

For PINSWAP and CHANGEpin, the part reference must be specified in the swap file, as well as the old and new values. Pin swaps are limited to pins of the same type and shape on the same part. For example, you can swap pins on U5B, but you cannot swap a pin on U5B with a pin on U5C.



Caution Unlike CHANGEpin commands, PINSWAP commands are order-dependent within the swap file. For this reason, if you change the order of the PINSWAP commands, or use both PINSWAP and CHANGEpin commands on the same part, you may get unexpected results.

Gate and Pin Swap *does not* check to make sure that parts are the same type before a swap is performed. Therefore, if you swap gates between dissimilar part types (as shown in the example below), odd results may occur in your project.

```
GATESWAP U1C U2B ;Swap gates U1C and U2B
```

Creating a netlist

After you create a project, you can create a netlist to exchange schematic information with other EDA tools. You can choose from more than 30 industry-recognized netlist formats. Your choice of netlist depends on the destination application.

Using the Create Netlist tool

Before you create a netlist, be sure your project is complete, has been annotated (using Capture's Update Part References command), and is free from electrical rule violations. *Chapter 14: Preparing to create a netlist* describes how to use Capture's tools to prepare your design before you create a netlist.



See For information on creating a Capture netlist for use with Layout, see *Chapter 18: Using Capture with OrCAD Layout for Windows*.

The table below summarizes the type of netlist you will get (flat or hierarchical), depending on the nature of your design and the netlist formatter you choose.

	<i>EDIF 2 0 0, SPICE, VHDL, Verilog, VST, or XNF netlist format</i>	<i>Layout, PCB 386+, OHDL, or other netlist format</i>
<i>Flat design</i>	Flat netlist	Flat netlist
<i>Simple hierarchical design</i>	Hierarchical netlist	Flat netlist
<i>Complex hierarchical design</i>	Hierarchical netlist	Flat netlist, but it must be netlisted in physical mode

To create a netlist

- 1 In the project manager, select your design.
- 2 From the Tools menu, choose Create Netlist. The Create Netlist dialog box displays.
- 3 Choose a netlist format tab.
- 4 In the Netlist File text box, enter a name for the output file. If the selected format creates an additional file (such as a map file or pinlist file), enter its filename in the second text box.
- 5 If necessary, set the Part Value and PCB Footprint combined property strings to reflect the information you want in the netlist.



See For information about using combined property strings, see Capture's online help.

- 6 If necessary, set the format-specific options in the Options group box, and choose the OK button to close the Netlist Options dialog box.



See For information about the options for individual netlist formats, see Capture's online help.

- 7 Choose the OK button to create the netlist.



See For information about the options in the Create Netlist dialog box, see Capture's online help.

Netlist format files

Capture includes over 30 netlist format file types. They include:

Algoresx	EEDESIGNER	PCB
Allegro	FutureNet	RacalRedac
AlteraADF	HiLo	Scicards
AppliconBRAVO	IntelADF	SPICE
AppliconLEAP	Intergraph	Tango
Cadnetix	Layout	Telesis
Calay	Mentor	Vectron
Calay 90	MultiWire	Verilog
Case	OHDL	VHDL
CBDS	PADS 2000	VST
ComputerVision	PADS-PCB	VST Model
DUMP	PCAD	WireList
EDIF 2 0 0	PCADnlt	XNF



See For information about the characteristics, formatting options, and an example of each netlist format, see Capture's online help.

Netname resolution

In your schematic designs, you can assign a variety of netnames and aliases to signals that are connected. A netlist, however, needs exactly one name for each net.

If the Create Netlist tool encounters multiple names for a single net, higher priority netnames override lower priority netnames. Priority is determined by the source of the name, ranked from highest to lowest, as follows:

- Named nets
- Hierarchical port names
- Off-page connectors
- Power object names
- Aliases
- System-generated names

If there are any conflicts at any level of the comparison (if, for example, there are two power objects on a bus), they are resolved according to these rules:

- Between netnames of equal precedence, priority follows alphabetical order.
- If the net is a bus, the net alias assigned to the greatest number of bus members has highest priority.

A net may change names several times as Create Netlist works. For example, a net may start with an alias of Battery on one page, become ToBattery from an off-page connector, change again to become DC as a hierarchical port is encountered, and finally change to BatteryBackup when Create Netlist finds a named net with higher priority.

Creating a netlist for use with OrCAD Simulate for Windows

You can easily create a netlist in Capture that you can use in Simulate. Or, you can use any other schematic or synthesis tool that creates an EDIF 2 0 0 or VHDL netlist targeted to devices for which you have acceptable VHDL simulation models.

Creating netlists within Capture

Before you create a netlist, be sure your Capture project is complete, has been annotated, and is free from electrical rule violations. It is very important to observe all port connectivity rules pertaining to EDIF 2 0 0 and VHDL netlists for use in Simulate. A good way to check your project is by using the DRC (Design Rules Check) command in Capture. This command reports and flags violations of electrical rules and other design constraints, including identical part references, unconnected electrical objects, part type mismatches, off-grid parts, and so on. Once you are confident that your project is ready, you can generate a netlist representation for use with Simulate.



Tip Capture's electrical rule check matrix can be customized to reflect VHDL port connection rules.

To create a netlist

- 1 In Capture's project manager, open your project.
- 2 From the project manager, choose either the Logical option or the Physical option, depending on the type of netlist you are creating.



Tip The project manager in Capture is typically set to logical mode when you generate a hierarchical netlist like EDIF 2 0 0 or VHDL. With the Logical option selected, it is possible to construct a complex hierarchy in which multiple hierarchical blocks or parts (like vendor-supplied soft macros) are associated with the same schematic page.

- 3 From the project manager's Tools menu, choose Create Netlist. The Create Netlist dialog box displays.

- 4 Choose either the VHDL or EDIF 2 0 0 tab.



Tip When you create your netlist, be sure to specify the hierarchy option for parts as *nonprimitive*. This allows Capture to descend the hierarchy of any soft macros that exist in your project to identify their primitive elements.

- 5 Set the dialog box options, including directory and filename, as desired. If you're using the VHDL tab, select the 1076-93 option.
- 6 Choose the OK button. Capture creates a netlist for your project.



See For information on using Capture netlists in Simulate, see *Chapter 19: Using Capture with OrCAD Simulate for Windows*.

Creating reports

Capture provides two report tools that you can use to produce lists of the things contained in your project: Bill of Materials and Cross Reference.

Creating a bill of materials

You can use the Bill of Materials command from the project manager's Tools menu to create a bill of materials in a file which you can then print using a word processor or text editor. The bill of materials includes the properties item, quantity, reference, and part value. You can customize the report to include other properties.



Tip A bill of materials includes parts that don't have pins. This makes it possible to include non-electrical parts such as screws, washers, and other hardware that you may have in your project. These parts won't, however, appear in a netlist because they don't have pins.

To create a bill of materials

- 1 If desired, use a text editor to create an include file, as described in *Include file format* later in this section.
- 2 In the project manager, choose the Physical option if you have a complex hierarchical design; otherwise, choose the Logical option.
- 3 From the project manager's Tools menu, choose Bill of Materials. The Bill of Materials dialog box displays.
- 4 Fill in this dialog box as desired. If you want to customize the information contained in the bill of materials report, fill in the information in the Line Item Definition area. If you are using an include file, be sure to check the Merge an include file with report check box, enter the combined property string, and specify the name of the include file.
- 5 Choose the OK button when you are ready to create the report.

Bill of Materials dialog box

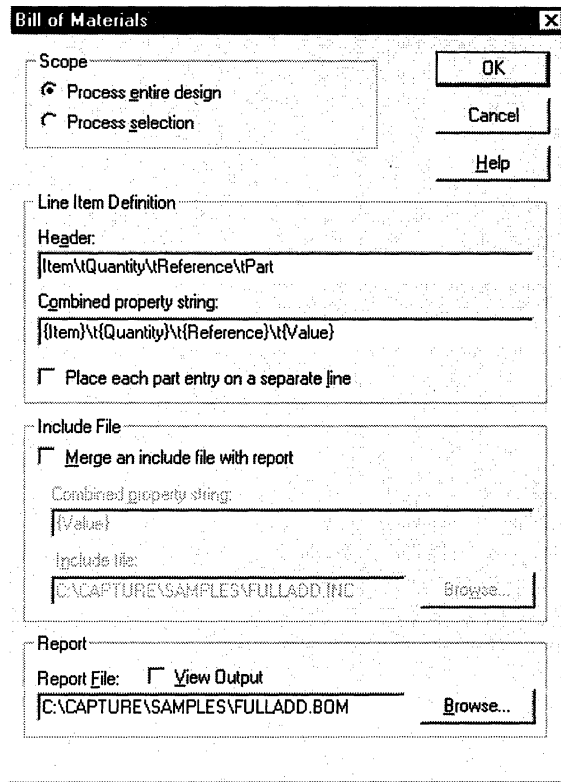

Scope Processes the entire design or selected schematic pages.

Header Text placed at the top of the first page. If this text box is left blank, there is no header on the first page. You can use this to specify column headers to match the data reported as defined by the combined property string. If you want the header items separated by tabs, use the `\t` character sequence in the header text box, then insert corresponding tabs in the Combined property string text box.

Combined property string Specifies which properties are included in or excluded from the bill of materials, and formats the output according to the tabs you insert and the order in which you specify the properties. When you specify the combined property string, you enclose property names in curly braces. When the Bill Of Materials is run, the properties in the curly braces are substituted with property values for the part (or left empty if the property is empty or doesn't exist on the part). The properties are left justified and separated by the characters you type outside the curly brackets. To insert a tab, use `\t`. `{Reference}\t{Value}` prints a part's reference, a tab character, and the part's value.

Place each part entry on a separate line Select this item if you want each part to be listed on a separate line.

Merge an include file with report Select this item if you want to use an include file.

Combined property string Specify the property to use to match the property value specified in quotes on each line of the include file. This is the *search string*, and is compared with *match strings* specified in the include file.

Report File The name of the file to contain the bill of materials report.

Include file format

You can use an include file to have Bill of Materials add additional information to each line of the bill of materials. You create an include (.INC) file using any text editor that saves files in ASCII format.

The first line of an include file is a header. The bill of materials is always keyed to the part value, so the first line begins with a pair of single quotes with no spaces or other characters between them. The rest of the first line contains any information you want to include to make the file and the bill of materials more readable—this usually consists of headers for the values in the rest of the file. If the include file has combined property strings separated by spaces, then the properties you specify in curly braces have to be separated with spaces also.

The rest of the file contains a separate line for each part. Each line must begin with the property value (as specified in the Include File Combined property string in the Bill of Materials dialog box) enclosed in single quotes. This is the *match string*, and is compared with the *search string* specified in the Include File combined property string in the Bill of Materials dialog box. Following the property value (and on the same line) is the information that you want to add to the bill of materials. You can separate the part value from the additional information by any number of spaces or tab characters—Capture will align the first nonblank character in each line when it creates the bill of materials.

The following example illustrates an include file.

```
' '      DESCRIPTION                PART ORDER CODE
'1K'     Resistor 1/4 Watt 5%      10000111003
'4.7K'   Resistor 1/4 Watt 5%      10000114703
'22K'    Resistor 1/4 Watt 5%      10000112204
'1uF'    Capacitor Ceramic Disk   10000211006
'.1uF'   Capacitor Ceramic Disk   10000211007
```

In the example above, the first column contains the match strings. If a match string matches the Include File Combined property string for the current part, the rest of the line (in the example above, the second and third columns) is tacked on to the end of the line item in the bill of materials.



Tip You can use an include file from OrCAD's Schematic Design Tools without modifying it.

Creating a cross reference report

The Cross Reference tool creates a report of all parts with their part references and part names. You may specify that the report also give the coordinates of each part.

To create a cross reference report

- 1 In the project manager, choose the desired mode (Logical or Physical).
- 2 From the project manager's Tools menu, choose Cross Reference. The Cross Reference Parts dialog box displays.
- 3 Fill in this dialog box as desired. If you want to customize the information contained in the cross reference report, fill in the information in the Report area.
- 4 Choose the OK button when you are ready to create the report.

Cross Reference Parts dialog box

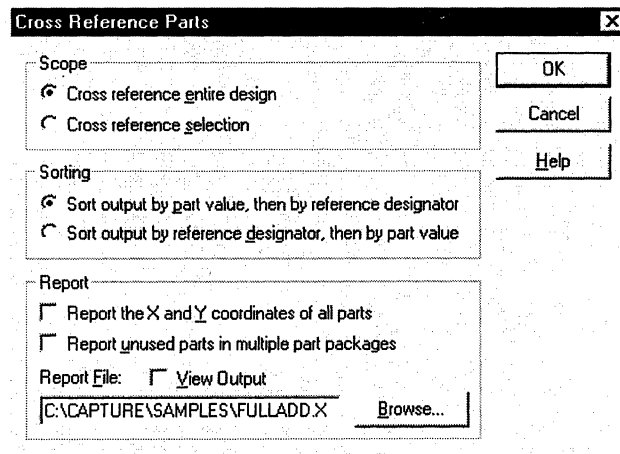

Scope Specifies whether to process the entire design or just the selected schematic page or pages.

Sorting Specifies whether to sort output by part value or part reference.

Report the X and Y coordinates of all parts If you check this option, the report includes the X and Y coordinates of all parts.

Report unused parts in multiple part packages If you check this option, the report identifies unused parts in multiple part packages.

Report File The name of the file to contain the cross reference report.

Exporting and importing schematic data

Exporting and importing designs

You use the Export Design command to export a design or library in an EDIF or a DXF format. You use the Import Design command to import a design or library in an EDIF or a PDIF format.

Exporting designs

You can export either designs or libraries.

To export a design or library

- 1 Open the project containing the design or library to export.
- 2 If you are exporting a design, select the design's folder.
or
If you are exporting a library, select the library's folder.
- 3 From the project manager's File menu, choose Export Design. The Export Design dialog box displays.

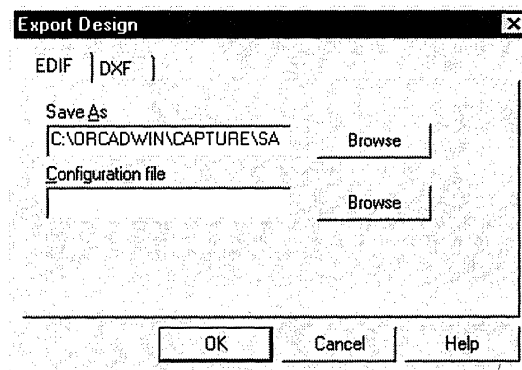

- 4 Choose either the EDIF or the DXF tab.
- 5 Specify a path and filename in the Save As text box.
- 6 If you're using the EDIF tab, locate and select an EDIF configuration (.CFG) file, if you have one (it is not required).
- 7 Choose the OK button. The design or library is exported to a file.

Importing designs

You can import either designs or libraries.

To import a design or library

- 1 Open a project that will contain the design or library you're importing.
- 2 If you are importing a design, select the project's Design Resources folder.
or
If you are importing a library, select the project's Library folder.
- 3 From the project manager's File menu, choose Import Design. The Import Design dialog box displays.

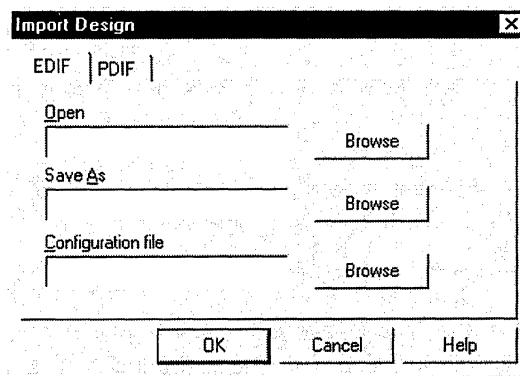

- 4 Choose either the EDIF or the PDIF tab.
- 5 Locate and select the file to import in the Open text box.
- 6 Specify a path and filename in the Save As text box.
- 7 If you're using the EDIF tab, locate and select an EDIF configuration (.CFG) file, if you have one (it is not required).
- 8 Choose the OK button. The design or library is imported into your project.

Exporting and importing properties

You use the Export Properties and Import Properties commands to change properties of parts and pins in a spreadsheet application, a database application, or in a text editor that preserves tab characters. First export the properties to a property file, edit the property file in the application of your choice, then import the edited properties.



Tip Capture can import properties with or without quotation marks around each field in the property file. The fields must be tab-delimited, though—all other characters, including commas and spaces, are treated as part of a field's text. Be sure your spreadsheet or database application can save in a tab-delimited format.

Exporting properties

You can export properties from a design or a library.



Tip It is a good idea to update part references in the active mode (logical or physical) before you export properties.



Note When you use the Export Properties command, only non-aliased parts are included in the property file, regardless of what you've selected; however, once you run Import Properties, the aliased parts change to match the non-aliased parts.

To export properties

- 1 In the project manager, open the project containing the part properties to export.
- 2 If you are exporting properties from a design, select the schematic folders or schematic pages containing the properties to export.
or
If you are exporting properties from a library, select the parts to export.
- 3 From the project manager's Tools menu, choose Export Properties. The Export Properties dialog box displays.

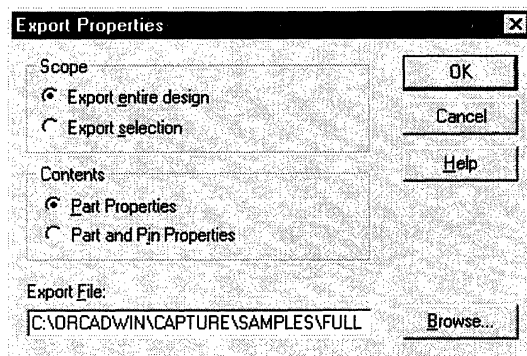

- 4 Specify whether the property file is to include all documents in the file, or just the documents you selected.
- 5 Specify whether you want to export properties for parts only, or for parts *and* pins.
- 6 Specify a filename for the output file using an .EXP extension.
- 7 Choose the OK button. The property file is created.

Property file format

When you export properties, Capture creates a tab-delimited list of keywords, identifiers, and properties, each of which is enclosed in double quotation marks. The first line of a property file begins with either the keyword DESIGN or the keyword LIBRARY, to identify the data as being from either a project or a library. Subsequent lines of the property file begin with one of the following keywords: PAGE, HEADER, PART, PIN, or SYMBOL.

If you export multiple pages in logical mode, a PAGE and a HEADER line are listed for each page; if you export in physical mode, only one HEADER line, but no PAGE lines, are listed. If you export both parts and pins, each PART line is followed by a PIN line. If you export symbols, there are no PIN lines following the SYMBOL lines, since symbols have no pins.

The HEADER lines are compiled from a superset of the property names found on parts (and pins, if applicable) from the whole page (for logical mode), from the whole project (for physical mode), or from the whole library. This means that (for logical mode) if part 1 has properties named A, B, and C, part 2 has properties named D, E and F, and a pin has properties named G, H, and I, then the HEADER line will have (after the first two columns) nine columns titled A, B, C, D, E, F, G, H, and I.

Editing a property file

You can edit a property file in a spreadsheet or database application, or in a text editor as long as it doesn't convert the tabs to spaces. Depending on which application you use, the property file displays as rows and columns of cells or fields, or as lines of text. There are a few restrictions on the changes you can make in a property file:

- You *must not* change or delete the first line.
- You *must not* change or delete the first two fields in any line.
- In logical mode, you *must not* change the sequence or number of lines. Also, *do not* change the sequence or number of lines in physical mode.
- Do not delete a field from a HEADER line without also deleting the corresponding fields from subsequent lines.



Caution If you add, delete, or reorder lines in a design property file created in logical mode, the file cannot be imported. If you move a PART line in a design property file (created in physical mode) or in a library property file, be sure to move all the PIN lines associated with it, and keep them in the same order; otherwise, importing the file may fail, or the file may cause unwanted changes to your project or library. In every case, it is much safer to make changes without adding, deleting, or reordering the lines in a property file.

Keeping these restrictions in mind, you can generally make the following changes:

- Add a field to a HEADER line and subsequent lines (add a column). This adds a property to parts and pins with a value in this field. The name of the property is the string in the HEADER line, and the value assigned to the part or pin is the string in the corresponding field.
- Delete a field from a HEADER line and subsequent lines (delete a column). This has no effect on any part or pin. Deleting columns for properties you don't want to change may make the property file easier to edit. If you delete a field from a HEADER line without also deleting the corresponding fields from subsequent lines, Capture reports an error when you import the property file.



Caution Column deletion must be done with care. Columns may be deleted only from HEADER, PART, PIN, and SYMBOL lines. For example, if you want to delete column 3 from a property file, but accidentally include column 3 of the DESIGN line, Capture reports an error when you import the property file.

- Change the value of a field. This resets the value of the property on all parts or pins with that property.



Note You can change part references by editing the References column of the property file, but in a multiple-part package the final element of the reference does not change. That is, changing U1A to U2B will result in the part reference U2A. You can also use Gate and Pin Swap to change part references.

Importing properties

You can use the Import Properties command to import a file that you created with the Export Properties command and edited using a spreadsheet, database, or text editor application.



Cautions Do not edit the project or library from which the properties were exported until after you import the changed properties. If you do, and the Import Properties procedure fails, you will have to export and edit the properties again.

Be sure the same mode (logical or physical) is active in the project manager when you import properties as when you exported them.

To import properties

- 1 In the project manager, open the library or project containing the parts to import.
- 2 From the project manager's Tools menu, choose Import Properties. The Import Properties dialog box displays.

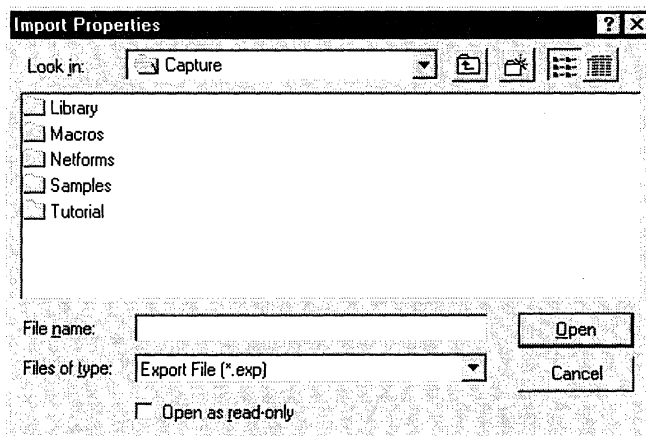

- 3 Select the file containing the properties.
- 4 Choose the Open button. The properties are imported.

Using Capture with OrCAD Layout for Windows

Layout has the ability to communicate interactively with Capture and other schematic design tools. This chapter explains how to use Capture with Layout to perform back annotation, forward annotation, and cross probing.

When you make changes to your board in Layout, you can back annotate the information to Capture using the OrCAD Backannotation File (.SWP) option in Layout's Generate Reports dialog box.

Select the Run ECO to Layout option in Capture's Create Netlist dialog box to automatically communicate changes you made in your Capture design to Layout. If the Layout file is open when you update the netlist file, Layout displays a dialog box asking if you want to load the new netlist file. If the Layout file is not open when the netlist changes, Layout prompts you to load the modified netlist when you reopen the Layout file.



Tip You can also use Layout's AutoECO command to forward annotate design properties, part information, and netlist changes to Layout from Capture. For information on using this command, see *AutoECO* in Capture's online help.

You can also perform cross probing with Capture and Layout. With cross probing, you can select a part or net on a Capture schematic page or Layout board, and the corresponding object in the other application is highlighted.

Moving a design from Capture into Layout is a three-part process:

- Create a valid Capture design with footprints that Layout supports.
- Generate a netlist in the Layout format.
- Create a Layout board file. You can also transmit information concerning parts, nets, and pins by creating user-defined properties on the parts, nets, or pins.

Maintaining the integration between your Layout board and your Capture design requires that you periodically perform these tasks:

- Create an OrCAD Backannotation File (.SWP) in Layout.
- Perform a gate and pin swap in Capture using the back annotation file.
- Use Layout's AutoECO command to forward annotate any edits you make in your Capture design into Layout.

 **Note** Layout uses reference designators as identification for forward and back annotation. For this reason, all changes to reference designators must be made in Layout and back annotated to Capture.

 **Caution** If you change existing reference designators in your Capture design and forward annotate them into your Layout board, your board will no longer be usable.

 **Note** When you add new parts to your Capture design, use the Incremental reference update option in the Update Part References dialog box (as opposed to the Unconditional reference update option) when you update part references.

 **Note** Any connections added to or deleted from your Layout board are not back annotated into Capture. For this reason, when you want to modify connections, make the changes in Capture and forward annotate them to Layout.

Preparing your Capture design for use with Layout

To prepare a Capture design for Layout you must first modify the design, assigning special properties and Layout-supported footprints to your parts. The tables in this section list the part, net, or pin properties supported by Layout.

To prepare your Capture design for use with Layout

- 1 Create a schematic design using Capture.
 - If you are creating a flat design or a simple hierarchical design, perform annotation, design rules checking, and netlist creation in logical mode.
 - If you are creating a complex hierarchical design, perform annotation, design rules checking, and netlist creation in physical mode.



See For information about simple and complex hierarchical designs, see *Chapter 6: Design structure*.

For information about logical mode and physical mode, see *Project manager options—Logical and Physical* in Chapter 2.



Caution In order to use intertool communication (ITC) between Capture and Layout, you must create netlists in physical mode.

- 2 To transfer part, net, or pin information to Layout, assign values to the appropriate properties in the Set Layout Part Properties dialog box, the Set Layout Net Properties dialog box, or the Set Layout Pin Properties dialog box.



See For illustrations of these three dialog boxes, and descriptions and example values for their respective properties, see *Transferring user-defined properties to Layout* in this chapter.

- 3 Assign PCB footprints to each of your parts. Use only Layout-compatible footprints, choosing from those in the *OrCAD Layout for Windows Footprint Libraries* document, or those in your custom footprint libraries.
- 4 If you are using parts from non-Layout libraries, such as discrete parts and custom footprints, check that the pin numbers of your part match the pad numbers of your Layout footprint. You may need to work with Capture's part editor or Layout's footprint libraries. In addition, you need to make sure that each pin has a pin number, as well as a pin name.



Note Layout doesn't accept PCB footprint names or part values that include spaces or tabs. Use the Capture spreadsheet editor to eliminate the spaces or tabs.

- 5 With the project manager set to the correct mode (Logical or Physical, depending on the structure of your design), run Design Rules Check (from the Tools menu) to check for design rule violations.

Transferring user-defined properties to Layout

To transfer part, net, or pin information to Layout, assign values to the appropriate properties in the Set Layout Part Properties dialog box, the Set Layout Net Properties dialog box, or the Set Layout Pin Properties dialog box. These three dialog boxes display when you choose their corresponding commands on the schematic page editor's Macro menu.

In order to have the properties in the dialog boxes added to the parts, nets, or pins, you need to have the appropriate objects selected on the schematic page before you play any of the three macros.

The value you enter for each property must be in uppercase, as shown in the tables.

To add Layout part properties to a part

- 1 Select a part on the schematic page.
- 2 From the Macro menu, choose Set Layout Part Properties. The Set Layout Part Properties dialog box displays.

Property Name	Input Field
CompFixed	<input type="text"/>
CompGroup	<input type="text"/>
CompKey	<input type="text"/>
CompLoc	<input type="text"/>
CompLocked	<input type="text"/>
CompRot	<input type="text"/>
CompSide	<input type="text"/>
Footprint	<input type="text"/>
FPList	<input type="text"/>
GateGroup	<input type="text"/>
MirrorFootPrint	<input type="text"/>
PartNum	<input type="text"/>
PartShape	<input type="text"/>
PowerPin	<input type="text"/>

Buttons: **OK**, **Cancel**

- 3 Enter values for those properties you want to add to the part, then choose the OK button. The properties are added to the part. See the table below for a description and example value for each of the properties in the dialog box.

<i>Property name</i>	<i>Example value</i>	<i>Description</i>
COMPFIXED	YES	If the value is YES, the part (such as an edge connector) is permanently fixed to the board.
COMPGROUP	2	An integer value that assigns the part to a group for placement.
COMPKEY	YES	Used to designate a component as the key component in a given group. The key component is placed first, with all the other components in the group placed in proximity to it.
COMPLOC	[1000, 1000]	Part location on the board as X and Y coordinates. Use the following format [X, Y], where X and Y represent the coordinates. Both must be integers in mils or microns.
COMPLOCKED	YES	If the value is YES, the part is temporarily locked in position.
COMPROT	270.00	Part rotation in degrees and minutes counterclockwise from the orientation defined in the Layout library. Use a period (.) to separate degrees and minutes.
COMPSIDE	BOT	Determines which side of a board a part will reside on, TOP or BOT.
FOOTPRINT	DIP24	An explicit definition of the footprint name to attach to the component.
FPLIST	DIP24\400	Comma-delimited list of alternate footprints to attach to components, to ease switching between footprints.
GATEGROUP	1	Identifies gate swapping restrictions within a component. In order to be swapped, two gates must belong to the same gate group.
MIRRORFOOTPRINT	DIP24-M	An explicit mirror shape for the component, in the event you don't want Layout to perform mirroring.
PARTNUM	489746	A customer part number that is generally unique for each customer and identifies the exact part, including manufacturer and case type.

PARTSHAPE	74LS04	A generic part number (such as 74LS04 or CK05) that represents a certain part throughout the industry, but may not identify the manufacturer or case type. If no footprint is defined, or the correct footprint isn't found, PARTSHAPE's value is compared to the data in SYSTEM.PRT (in ORCADWIN/LAYOUT/DATA) and the footprint listed in SYSTEM.PRT is used.
POWERPIN	YES	Defines non-wired pins (such as unusual voltages) as belonging to a particular net. POWERPIN is typically used to override the standard GND or VCC attachments to particular pins of an IC.

To add Layout net properties to a net

- 1 Select a net on the schematic page.
- 2 From the Macro menu, choose Set Layout Net Properties. The Set Layout Net Properties dialog box displays.

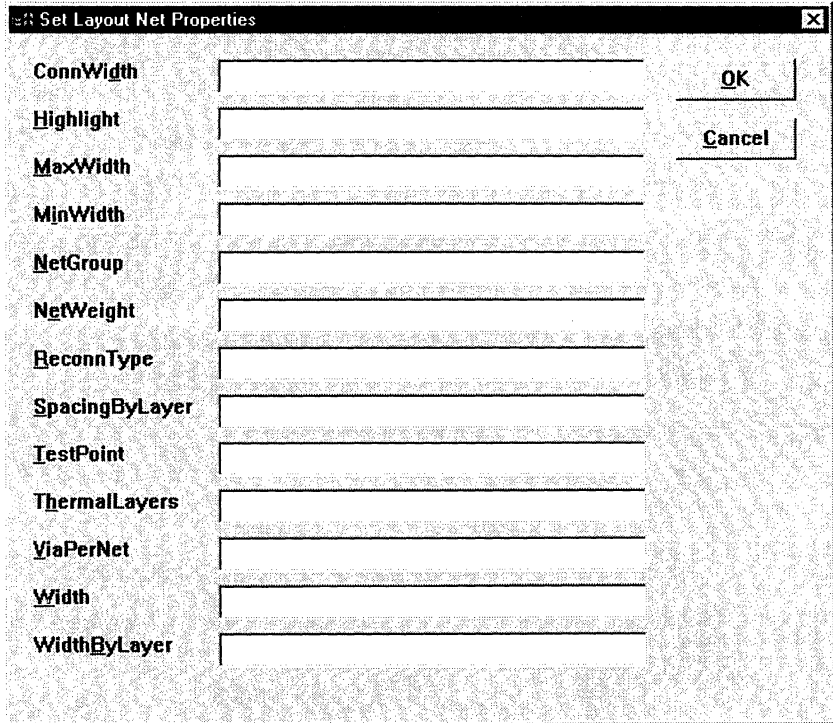

- 3 Enter values for those properties you want to add to the net, then choose the OK button. The properties are added to the net. See the table below for a description and example value for each of the properties in the dialog box.

<i>Property name</i>	<i>Example value</i>	<i>Description</i>
CONNWIDTH	10	Sets the track width, leaving MINWIDTH and MAXWIDTH at their defaults.
HIGHLIGHT	YES	If the value is YES, the net is highlighted.
MAXWIDTH	12	Sets the maximum track width.
MINWIDTH	8	Sets the minimum track width.
NETGROUP	2	Identifies grouped nets. Use this to select or color nets as a group in Layout (for editing or routing).
NETWEIGHT	60	Integer between 1 and 100 assigning relative priority to the net. The default value is 50.
RECONNTYPE	ECL	Specifies the reconnect rules for each type of reconnect. Values are STD, HORZ, VERT, MIN, MAX, or ECL.
SPACINGBYLAYER	TOP=13, BOT=8	Net spacing for one or more layers.
TESTPOINT	YES	If the value is YES, a test point is automatically assigned to the net.
THERMALLAYERS	GND	Comma-delimited list assigning the net to specific plane layers.
VIAPERNET	VIA1	Via types allowed for net.
WIDTH	12	Track width value assigned to the MINWIDTH, MAXWIDTH, and CONNWIDTH properties unless overridden.
WIDTHBYLAYER	TOP=6, BOT=12	Net width for one or more layers.

To add Layout pin properties to a pin

- 1 Select a pin on the schematic page.
- 2 From the Macro menu, choose Set Layout Pin Properties. The Set Layout Pin Properties dialog box displays.

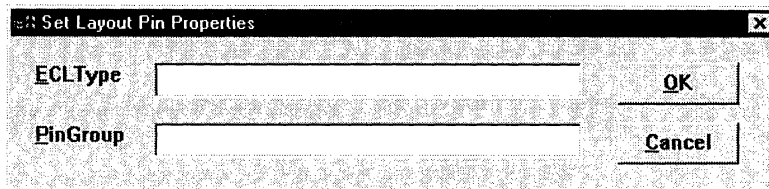

- 3 Enter values for those properties you want to add to the pin, then choose the OK button. The properties are added to the pin. See the table below for a description and example value for each of the properties in the dialog box.

<i>Property name</i>	<i>Example value</i>	<i>Description</i>
ECLTYPE	SOURCE	Defines a pin as a Source, Load, or Target in terms of daisy-chain reconnection.
PINGROUP	1	Identifies pin swapping restrictions within a gate. In order to be swapped, two pins must belong to the same gate, and to the same pin group.

Creating a netlist for use in Layout

After you have prepared your design in Capture and it is free from design rules violations, you can create a netlist (.MNL) file for use with Layout. A copy of the LAYOUT.INI file must exist in the same directory as CAPTURE.EXE to generate a netlist.



Tip You must save your Capture design before creating a netlist.

To create a netlist for use in Layout

- 1 Open the Capture design.
- 2 In the project manager, choose the Logical option. (If you have a complex hierarchical design, or if you intend to perform cross probing, choose the Physical option.)
- 3 From the Tools menu, choose Create Netlist. The Create Netlist dialog box displays.
- 4 Choose the Layout tab. The Layout tab displays.
- 5 In the PCB Footprint group box, ensure that {PCB Footprint} is displayed in the Combined property string text box.



See For information about combined property strings, see Capture's online help.

- 6 In the Netlist File text box, ensure that the path to the netlist file is correct. The netlist takes the name of the Capture design and adds a .MNL extension.
- 7 Choose the OK button. Capture processes the netlist, then creates a .MNL file and saves it in the directory you specified in the previous step.



Note You may choose to exit Capture at this time. It is not necessary to run Capture and Layout simultaneously to take advantage of forward annotation. It takes a minimum of 16 MB of RAM to run both Capture and Layout.



Note If Capture is unable to create a .MNL file, the errors are written to the Capture session log and to the .ERR file in the target directory for the .MNL file.

Loading a new netlist into Layout



See For information on loading a new netlist into Layout, see Capture's online help topic *Creating a new Layout project from a Capture design*.

Back annotating board information from Layout



Note Layout uses reference designators as identification for forward and back annotation. For this reason, all changes to reference designators must be made in Layout and back annotated to Capture.



Caution If you change existing reference designators in your Capture design and forward annotate them into your Layout board, your board will no longer be usable.



Note When you add new parts to your Capture design, use the Incremental reference update option in the Update Part References dialog box (as opposed to the Unconditional reference update option) when you update part references.

In Layout, you can back annotate board changes for Capture using the OrCAD Backannotation File (.SWP).



Caution Don't create a second .SWP file without back annotating the first .SWP file to Capture; otherwise, the swap information in the first .SWP is overwritten by the second .SWP file.

To back annotate

- 1 From Layout's File menu, choose Reports. The Generate Reports dialog box displays.
- 2 Select OrCAD Backannotation File (.SWP), then choose the OK button.



Note Once the .SWP file is created, the current Layout file no longer contains swap information. A copy of the board file is saved as BACKANNO.MAX.



Caution If you have renamed your components in your Layout board and created a .SWP file, those changes in reference designators are removed from the current board file (.MAX). Only the BACKANNO.MAX file retains the information on the original and current reference designators, but it is overwritten once you generate another .SWP file. So, if you want to retain the information on original and current reference designators, rename the BACKANNO.MAX file.

- 3 In Capture, open the design in physical mode if you're using a complex hierarchical design or if you created a netlist in physical mode.
- 4 From Capture's Tools menu, choose Gate and Pin Swap. The Gate and Pin Swap dialog box displays.
- 5 Ensure that the Process entire design option is enabled.
- 6 Choose the Browse button, locate and select the report you created in Layout (*design_name.SWP*), then choose the OK button. The Layout information is back annotated to the design in Capture.
- 7 If you're using a flat design or a simple hierarchical design, and you created a netlist in physical mode, open the .SWP file in a text editor (such as Notepad).
- 8 Edit the line:

```
View=Physical
```

to:

```
View=Logical
```

then save and close the .SWP file.
- 9 In Capture, open your design in the project manager and choose the Logical option.
- 10 From Capture's Tools menu, choose Gate and Pin Swap. The Gate and Pin Swap dialog box displays.
- 11 Ensure that the Process entire design option is enabled.
- 12 Choose the Browse button, locate and select the .SWP file you edited, then choose the OK button. The Layout information is back annotated to the logical mode of your Capture design.

Forward annotating schematic data to Layout



Note A copy of the LAYOUT.INI file must exist in the same directory as CAPTURE.EXE to perform forward annotation to Layout.

To forward annotate

- 1 In Capture, choose the Create Netlist toolbar button. The Create Netlist dialog box displays.
- 2 Choose the Layout tab, then choose the OK button.
- 3 In Layout's session frame, choose Tools, then ECO's, then one of the AutoECO options. The File A dialog box displays.



See For information on Layout's AutoECO options, see *AutoECO* in Capture's online help.

- 4 Select a .MAX file to which you want to add the new schematic information, then choose the Open button. The File B dialog box displays.
- 5 Locate and select the netlist (.MNL) that you created in step 2, then choose the Open button. The Output report dialog box displays.
- 6 Specify a name for the output report (usually *design_name.LIS*) and a location, then choose the Save button. The output report displays in a text editor and the Merged Output Binary dialog box displays.
- 7 Specify a name and a location for the merged board, then choose the Save button. Layout merges the files based on the type of AutoECO you chose.



See You can also bring Capture netlist information into Layout by using the Run ECO to Layout option in the Layout tab in the Create Netlist dialog box. For information on this option, see the *OrCAD Layout for Windows User's Guide*.

Cross probing between Capture and Layout

Using cross probing, you can select an object in Layout or Capture and have the corresponding object highlight in the other application. For example, you can select a net on a schematic page in Capture and see the corresponding net highlighted in Layout.



Note It is necessary to run Capture and Layout simultaneously to use cross probing. It takes a minimum of 16 MB of RAM to run both Capture and Layout.

Enabling intertool communication between Capture and Layout

To use cross probing, you must have created a netlist in physical mode and have the same design open in Layout as in Capture. In Capture you must be in physical mode, and you must enable intertool communication (ITC). It is not necessary to enable ITC in Layout, because cross probing is always active in Layout.



Tip You use Layout's Half Screen command (from the Window menu) to tile the Capture and Layout windows so that you can view both on your screen.

To enable ITC in Capture

- 1 From Capture's Options menu, choose Preferences. The Preferences dialog box displays.
- 2 Choose the Miscellaneous tab, select Enable intertool communication, then choose the OK button.

Cross probing from Capture to Layout

When ITC is enabled in Capture and you select certain items on your schematic page, cross probing highlights the corresponding items in Layout. If you select a part or gate in a multiple-part package in Capture, cross probing highlights the corresponding module in Layout. If you select a wire segment or net in Capture, cross probing highlights the corresponding net (in its entirety) in Layout.

 **Note** Capture must be in physical mode when cross probing.

 **Note** When you use block selection in Capture, cross probing only highlights the last item selected in the block. There is no way to predict the order in which items are selected in a block selection.

Any action you perform to select an object on your Capture schematic page (selecting using the mouse, using the Find command, or performing a browse of parts) causes the corresponding object in Layout to be highlighted. For more information, see the following table.

<i>Selecting this in Capture</i>	<i>Highlights this in Layout</i>
Part	Corresponding module
Gate (multiple parts per package)	Corresponding module
Wire segment	Entire net
Net	All routes for the net
Pin on part	Corresponding module

To select an object in Capture for cross probing with Layout

- 1 Open a Capture schematic page and a matching Layout design.
- 2 Choose Half Screen from Layout's Window menu, then position the Capture and Layout session frames so that you can see both.
- 3 In Capture, choose the Physical option in the project manager.
- 4 From Capture's Options menu, choose Preferences. The Preferences dialog box displays.
- 5 Choose the Miscellaneous tab, select Enable intertool communication, then choose the OK button.
- 6 Select an object in Capture. The corresponding object is highlighted on the board in Layout.

Cross probing from Layout to Capture

When ITC is enabled in Capture, selecting objects in Layout causes Capture to highlight the corresponding items in the schematic page editor. Selecting a module (or a module pad) causes Capture to highlight all the parts included in that module. Selecting a track or net causes Capture to highlight the corresponding net on the schematic page.

Any action you perform to select an object on your Layout board (selecting using the mouse, using query, or using the Find command) causes the corresponding object on the Capture schematic page to be highlighted. For more information, refer to the following table.

<i>Selecting this in Layout</i>	<i>Highlights this in Capture</i>
Module	All parts in the package
Track	Corresponding wire connection
Net	Corresponding nets
Pad on module	Corresponding part (if the Manual Route tool is selected in Layout, the net is highlighted)

To select an object in Layout for cross probing with Capture

- 1 Open a Capture design and a matching Layout design.
- 2 Choose Half Screen from Layout's Window menu, then position the Capture and Layout session frames so that you can see both.
- 3 In Capture, choose the Physical option in the project manager.
- 4 From Capture's Options menu, choose Preferences. The Preferences dialog box displays.
- 5 Choose the Miscellaneous tab, select Enable intertool communication, then choose the OK button.
- 6 Select an object in Layout. The corresponding object is highlighted on the schematic page in Capture.



Note In Capture, the schematic folder automatically opens and displays the schematic page on which the corresponding symbol is located. Scroll the window until the highlighted symbol is visible.

Using Capture with OrCAD Simulate for Windows

Analyzing your Capture project with Simulate

Simulate has the capability to communicate interactively with Capture using intertool communication (ITC). When ITC is enabled in both applications, signal values in Simulate are displayed in Capture, and signals selected in Simulate are highlighted in Capture. In addition, you can perform actions in Simulate on signals selected in Capture.

If you determine that there is a problem with your project, you can modify your Capture project, create a new netlist, reload your Simulate project (incorporating the new netlist), and rerun simulation without exiting either tool.

You can view simulation values on the schematic page even if the simulation netlist has been optimized or flattened by another EDA tool. Capture will attempt to match context/signal pairs with a hierarchy/net of the project. It is possible for illegitimate signal annotation to occur when the simulation netlist and Capture project differ.

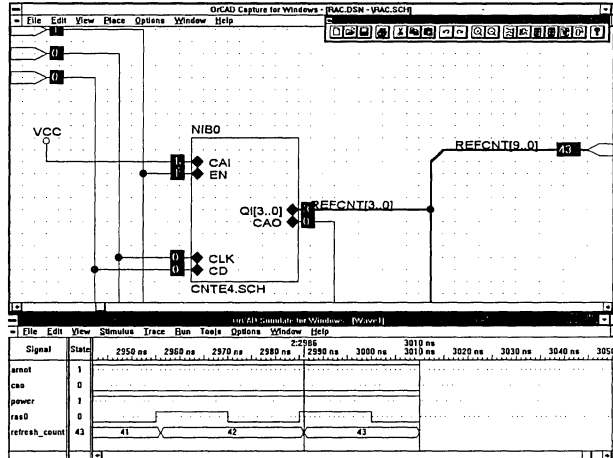

Debug your Capture project using intertool communication.

To enable ITC in Capture and Simulate

- 1 In Capture, choose Preferences from the Options menu. The Preferences dialog box displays.
- 2 Choose the Miscellaneous tab, select Enable intertool communication, then choose the OK button.
- 3 In Simulate, choose Preferences from the Options menu. The Preferences dialog box displays.
- 4 Choose the Run tab, select Enable intertool communication, then choose the OK button.



Note In order for ITC to function properly, a project must exist in Simulate that corresponds to the root schematic folder in Capture.

Viewing signal values in Capture using intertool communication

Using ITC, you can view selected signals in Capture as their states change during simulation. The values for all signals display on the Capture schematic page at the *current* simulation run time. When examining signal history (signal values at simulation times earlier than the current simulation time) on the Capture schematic page, you will only see the values of the signals that you have selected to trace in Simulate.

To display simulation states on your Capture schematic page

- 1 In Simulate, select signals to view during simulation, as explained in *Chapter 9: Selecting signals to view* in the *OrCAD Simulate for Windows User's Guide*.
- 2 In Capture, open the project and schematic page you want to view during simulation.
- 3 In Capture, choose Physical in the project manager.
- 4 Position the Capture and Simulate session frames so that you can see both.
- 5 In Simulate, choose Start from the Run menu. The states for the selected signals are reflected at the current simulation time on the schematic page in Capture and in the wave, list, and/or watch windows in Simulate.
- 6 If viewing the signal values in a wave window, position the time cursor anywhere in the waveform pane and release the left mouse button. Capture updates the schematic page to reflect the state values for the selected signals.

Selecting signal sets in Capture for use in Simulate

You can select a set of signals on your Capture schematic page, then choose this signal set in Simulate when performing any Simulate function that involves selecting signals. These functions include selecting signals to trace in wave, list, and watch windows, viewing the signals' current values, applying stimuli to signals, and setting break on expression commands. Via ITC, when you select a signal set in Capture, Simulate assigns a signal context to that set—the “ITC” context. The ITC context is then available for selection in the Context window of the Select Signals and Browse Signals dialog boxes. The Browse Signals dialog box is accessible from the Stimulus and Break on Expression dialog boxes.

For example (assuming that ITC is enabled in both applications), when you select a set of signals in Capture, they are available in the ITC context in the Select Signals dialog box in Simulate.

To view signals selected in Capture in wave, list, and watch windows

- 1 Ensure that ITC is enabled in Capture and Simulate, then open the Capture project and schematic page you want to view during simulation.
- 2 In Capture, choose Physical in the project manager.
- 3 On the schematic page, select the pin or net that you want to add to the signal display.
- 4 In Simulate, select the wave, list, or watch window in which you want to view the signal.
or
From the Trace menu, choose New Wave Window, New List Window, or Watch Window. The Select Signals dialog box displays.
- 5 In the Context window, choose ITC. The context and signal name display in the Signals in Context window.
- 6 Select the context and signal name entry, move it to the Selected Signals window using the > button, then choose the OK button. The signal you selected on the Capture schematic page appears in the wave, list, or watch window in Simulate.

To specify interactive stimuli for signals selected in Capture

- 1 Ensure that ITC is enabled in Capture and Simulate, then open the Capture project and schematic page you want to view during simulation.
- 2 In Capture, choose Physical in the project manager.
- 3 On the schematic page, select the pin or net to which you want to apply interactive stimuli.
- 4 In Simulate, choose New Interactive from the Stimulus menu. The Stimulus dialog box displays.
- 5 Choose the Absolute, Relative, or Clock tab from the upper left corner of the dialog box, then choose the Browse button. The Browse Signals dialog box displays.
- 6 In the Context window, choose ITC. The context and signal name display in the Signals in Context window.
- 7 Select the context and signal name entry, move it to the Selected Signals window using the > button, then choose the OK button. The signal you have selected appears in the Stimulate Signal Named text field.
- 8 Create stimuli to apply to the selected signals during simulation.
- 9 Repeat the process with the other tabs (Absolute, Relative, and/or Clock) as desired.
- 10 When you choose the OK button to exit the Stimulus dialog box, Simulate asks if you want to load the new stimulus file.
- 11 Choose the Yes button to load the stimulus file immediately. Simulate displays the new interactive stimulus file in a stimulus window. If the file has been loaded, the word “Loaded” displays with the title.



See For more detailed instructions on specifying stimuli in the Absolute, Relative, and Clock tabs in the Stimulus dialog box, see *Chapter 5: Creating stimuli* in the *OrCAD Simulate for Windows User's Guide*.

To set breakpoints on signals selected in Capture

- 1 Ensure that ITC is enabled in Capture and Simulate, then open the Capture project and schematic page you want to view during simulation.
- 2 In Capture, choose Physical in the project manager.
- 3 On the schematic page, select the pin or net to which you want to add a breakpoint.
- 4 In Simulate, choose the Break on Expression command from the Run menu (ALT, R, X). The Break on Signal Expression dialog box displays.
- 5 Choose the Browse button. The Browse Signals dialog box displays.
- 6 In the Context window, choose ITC. The context and signal name display in the Signals in Context window.
- 7 Select the context and signal name entry, move it to the Selected Signals window using the > button, then choose the OK button.
- 8 In the Operator drop-down list, choose the expression you want.
- 9 In the Compare drop-down list, choose the comparison value, if necessary.
- 10 Choose the Add button. The breakpoint appears in the Breakpoints window.
- 11 Choose the OK button. Simulate executes the Breakpoint if the conditions are met.

Incorporating Capture netlist changes into a Simulate project

After you have used ITC to view selected signal values during simulation, you can edit your Capture schematic page as needed, add it to your Simulate project, and rerun simulation without exiting either tool.

To incorporate netlist changes into a Simulate project

- 1 In Capture, choose Logical in the project manager.
- 2 Edit the schematic page as desired, using Capture's schematic page editor.
- 3 In Capture, create a new netlist for the modified project. Use the same netlist name, in order to overwrite the old netlist.
- 4 In Simulate, choose Load from the Run menu. Simulate loads the new version of the netlist and resets the simulation time to 0.
- 5 In Simulate, choose Start from the Run menu to run a simulation.

A

alias See net alias, part alias.

ANSI Acronym for *American National Standards Institute*.

arrow keys The directional keyboard keys used to navigate around your screen. Each key is marked with an arrow and is named for the direction in which the arrow points. There is an UP ARROW, DOWN ARROW, LEFT ARROW, and RIGHT ARROW key.

ascend In a hierarchical design, to move from the child schematic folder to the parent schematic page. This is done in the schematic page editor using the Ascend Hierarchy command on the View menu. See also child, descend, parent.

ASCII Acronym for *American Standard Code for Information Interchange*. The ASCII character-coding set enables different applications to exchange information.

AutoECO Acronym for *automatic engineering change order*. Layout's AutoECO command translates schematic netlist information from Capture to Layout. See also forward annotate.

B

back annotate To apply modifications to part properties in a design, such as updating part references and pin numbers, swapping gates, or swapping pins. Parts are back annotated in the project manager, using the Gate and Pin Swap command or the Update Properties command on the Tools menu. In Layout: to transmit data, such as gate and pin swaps, back to the schematic pages. See also forward annotate.

bitmap Bitmaps are graphic images made up of pixels, which are tiny dots on a computer screen. Each pixel in a bitmap is represented by a number between 0 and 255, inclusive, with 0 being the darkest (no luminance) and 255 being the lightest (full luminance). Bitmaps have a .BMP extension, and can be placed on a schematic page using the Picture command on the schematic page editor's Place menu.

bookmark Just as you can place a bookmark in a book to mark a specific page, you can place a bookmark on a schematic page to mark a location you would like to return to. To place a bookmark, use the Bookmark command on the Place menu in the schematic page editor. To go to a bookmark when in the schematic page editor, use the Go To command on the View menu. To go to a bookmark when in the project manager, use the Browse command on the Edit menu to display bookmarks in the browse window, then choose a bookmark. To edit a bookmark, double-click on it.

browse window This window displays the results of queries done using the Browse command on the Edit menu. You can double-click on an object in the browse window to go to that item on its schematic page.

bus A group of scalar signals (wires) that is never connected to a net. A bus name defines the bus signals and connects those signals to the corresponding nets. For example, the bus name A[0:3] defines a four-signal bus and connects the four signals A[0], A[1], A[2], and A[3] with nets A0, A1, A2, and A3. *See also* bus entry, bus pin.

bus entry A bus entry is used to tie a signal to a bus. The advantage of using bus entries instead of wires is that two bus entries can be connected at the same point on a bus without connecting the signals. If two wires are run directly to a bus at the same location, the signals are connected. *See also* bus, bus pin.

bus pin A pin width that can carry multiple signals, as opposed to a scalar pin that only carries one signal. A bus pin represents all the pins for a bus, and they use the same naming conventions as buses. *See also* bus, bus entry.

C

CAGE code An acronym for *Commercial and Government Entity Code*. A number—provided by the federal government to its suppliers—that can be present in the title block of a schematic page.

child In a hierarchical design, a schematic folder whose circuitry is represented by a hierarchical block on the parent schematic page. To move from parent to child is to descend the hierarchy. A child contains circuitry referenced by its parent. *See also* ascend, descend, parent.

Clipboard A temporary storage location used to transfer data between files and between applications. You transfer data to the Clipboard by using the Copy or Cut command on the Edit menu, and you insert data from the Clipboard by using the Paste command on the Edit menu.

complex hierarchy A design in which two or more hierarchical blocks (or parts with attached schematic folders) reference the same schematic folder. In the project manager, you can view a complex hierarchy two ways: in logical mode, you see one schematic folder that represents all references to that schematic folder; in physical mode, you see a separate schematic folder for each reference to that schematic folder. *See also* hierarchical design, logical mode, physical mode, simple hierarchy.

convert An alternate form—such as a DeMorgan equivalent—that can be stored with each part. *See also* DeMorgan equivalent.

cross probing When intertool communication is enabled in Capture, selecting objects in Capture causes the corresponding objects to be highlighted in Layout. Also, selecting objects in Layout causes the corresponding objects to be highlighted in Capture. Both applications must be open. *See also* intertool communication.

D

DeMorgan equivalent An electrically-equivalent part based on the DeMorgan rules of equivalence. These rules represent the duality of AND and OR in Boolean expressions: if all AND operations are changed to OR operations, all OR operations are changed to AND operations, and all variables and constants are negated, then the value of the expression remains unchanged. A DeMorgan equivalent can be stored in the convert of a part. *See also* convert.

descend In a hierarchical design, to open and view the child schematic folder represented by a hierarchical block on the parent schematic page. To descend a hierarchical design, you select a hierarchical block in the schematic page editor, then choose the Descend Hierarchy command on the View menu. *See also* ascend, child, parent.

design cache A local library contained in each project that contains all the parts and symbols used in the project.

design rules check (DRC) This tool, on the project manager's Tools menu, checks a design or part of a design for conformance to a set of configurable design criteria and electrical rules.

document A schematic folder, schematic page, library, part, or symbol. Each of these is part of a project.

E

EDA Acronym for *Electronic Design Automation*. Software and hardware tools used to ascertain the viability of an electronic design. These tools perform simulation, synthesis, verification, analysis, and testing of a project.

EDIF Acronym for *Electronic Design Interchange Format*. A standard published by the EIA (Electronic Industries Association) that defines semantics and syntax for an interchange format that communicates electronic design information.

equivalent *See* convert, DeMorgan equivalent.

ERC Acronym for *Electrical Rules Check*, a subset of the *Design Rules Check* tool. The ERC matrix is used by Design Rules Check to evaluate connections between pins, off-page connectors, hierarchical ports, and hierarchical pins.

F

flat design A schematic structure with no hierarchy (no hierarchical blocks; no parts with attached schematic folders). A flat design can include schematic pages in which output signals of one schematic page connect laterally to input signals of another schematic page through objects called *off-page connectors*. You place these objects using the Off-Page Connector command on the Place menu in the schematic page editor. Flat designs are practical for small designs with few schematic pages. *See also* hierarchical design, complex hierarchy, simple hierarchy, off-page connector.

forward annotate The process of sending netlist data in the form of an .MNL file from Capture to Layout.

G

graphic object An object drawn or placed on a schematic page or part—such as an arc, line, rectangle, ellipse, polygon, bitmap, text, or title block—that has no electrical connectivity.

grid reference The border around a schematic page that acts as a visual reference for the grid. Grid references can be used as a destination for the Go To command on the View menu, and can be set to visible or hidden in both the Design Template and Schematic Page Properties dialog boxes.

H

heterogeneous package A package with multiple parts that are graphically different or contain different numbers of pins (for example, a relay). *See also* homogeneous package.

hierarchical block A symbol on a parent schematic page that refers to a child schematic folder. Hierarchical pins are placed within a hierarchical block, and hierarchical ports that refer to the hierarchical pins are placed on a schematic page within the child schematic folder. *See also* hierarchical pin, hierarchical port.

hierarchical design A design in which schematic pages are interconnected vertically with hierarchical blocks (or parts with attached schematic folders). The root schematic folder's schematic pages contain symbols representing other schematic folders. *See also* complex hierarchy, flat design, root schematic folder, simple hierarchy.

hierarchical pin A symbol, placed within a hierarchical block, that represents a signal connected to a like-named hierarchical port on another schematic page. *See also* hierarchical block, hierarchical port.

hierarchical port A symbol, placed outside a hierarchical block, that represents a signal connected to a like-named hierarchical pin. Hierarchical ports can also connect to like-named hierarchical pins. *See also* hierarchical block, hierarchical pin.

homogeneous package A package with multiple parts that are graphically identical. *See also* heterogeneous package.

HPGL Acronym for *Hewlett-Packard Graphics Language*, which is a plotter protocol.

I

IEEE Acronym for *Institute of Electrical and Electronics Engineers*.

inherent property One of the set of properties required for a given object. Unlike user-defined properties, inherent properties cannot be removed.

instance A part or symbol placed on a schematic page. You place part instances in logical mode. If you change to physical mode, you see occurrences of the part instances. *See also* instance property, logical mode, occurrence, physical mode.

instance property A property that is attached to an instance, as opposed to a property that is attached to an occurrence or added to a part in a library. You edit instance properties in logical mode. Instance properties can be overridden by occurrence properties, which are not reflected on the instance. *See also* instance, logical mode, occurrence, physical mode.

intertool communication (ITC) A capability that allows OrCAD products to share information for display and transfer. *See also* cross probing.

J-K

junction A junction, shown as a small dot, is placed at the connection point where two perpendicular wires or buses cross, to give visual confirmation that the items are electrically connected. If you draw a wire across another wire at a 90-degree angle, the wires are not electrically connected unless you create a junction by clicking the left mouse button on the existing wire as you draw the new wire across it.

L

library A collection of often-used parts, graphics, schematic pages, and symbols.

location An X, Y coordinate on a schematic page or part. You can move to a location using the Go To command on the View menu in the schematic page editor.

logical mode A mode that displays the “folded” view of a design, and thus part references and pin numbers (that can be edited) on part instances. These can be seen in physical mode, but not edited. Logical mode doesn’t reflect any changes made to occurrences in physical mode. To display the logical mode of a design, use the Logical option in the project manager. *See also* instance, occurrence, part instance, physical mode.

M

macro A series of commands you can record, then execute by pressing one key or a combination of keys. Macros greatly reduce the number of keystrokes required to perform complex or repetitive actions.

mirror To flip along the X (horizontal) or Y (vertical) axis, or both.

N

net The wires, buses, parts, and symbols that are logically connected via net names, aliases, off-page connectors, and hierarchical ports.

net alias A name used to specify signal connections between unconnected wires or buses. For example, if you have wires in two remote locations in a schematic folder, you can assign each wire an alias (such as ABC) to connect the signals without physically drawing a wire between them.

netlist A file that lists the interconnections of the project elements by the names of the connected signals, parts, and pins.

nonprimitive A part with an underlying hierarchy, such as an attached schematic folder.

O

occurrence An instance placed on a schematic page, as displayed in physical mode. You can edit properties on occurrences, but you cannot edit an occurrence’s physical appearance (such as the shape of a hierarchical block). *See also* instance.

occurrence property A property attached to an occurrence, as opposed to a property attached to an instance or added to a part in a library. You can edit occurrence properties in physical mode. Occurrence properties override instance properties, but are not reflected on the instance.

off-page connector An object that conducts signals between schematic pages within the same schematic folder. *See also* flat design.

P–Q

package A physical part that contains more than one logical part. For example, a 2N3905 transistor, a fuse, and a 74LS00 are packages. Each part in a package has a unique part reference comprised of an alphanumeric prefix common to all the parts in the package, and a letter unique to each part. For example, a 74LS00 with a part reference prefix of U15 would have four parts with part references of U15A, U15B, U15C, and U15D. *See also* heterogeneous part, homogeneous part.

pan To change the portion of the schematic page or part being viewed by dragging objects from one location to another. As you drag an object while holding the left mouse button down, the schematic page or part *pans* across the active window.

parent A schematic page containing a hierarchical block that references another schematic folder (called a *child*). *See also* child, hierarchical block.

part A part is a basic building block of a project that may represent one or more physical elements, or a function, a simulation model, or a text description for use by another application. A part's behavior is described by a SPICE model, an attached schematic folder, HDL statements, or other means. Parts usually correspond to physical objects (gates, connectors, and so on) that come in packages of one or more parts. You can think of these packages as physical parts and the parts you place on a schematic page as logical parts. Physical parts with more than one logical part are sometimes referred to as "multiple-part packages." For simplicity, Capture usually refers to both as parts. *See also* package.

part alias A duplicate copy of a part that uses a different name. A part alias uses the same graphics, attached schematic folders, and properties as the original, with the exception of the part value.

part editor The editor used to create and edit parts and symbols.

part instance An instance of a part. *See also* instance.

part primitive *See* primitive.

PCB Acronym for printed circuit board.

physical mode A mode that displays the "unfolded" view of a design, and thus part references, pin numbers, or properties on *occurrences* of part instances. Even though they are visible, part references and pin numbers are not editable in physical mode. Since changes made to part references and pin numbers on occurrences of part instances override the values on the original part instance, this mode gives you an opportunity to customize specific part instance occurrences without affecting the original part instance. *See also* instance, logical mode, occurrence.

pin A pin acts as a point of connectivity for the part it is attached to. In addition to input and output pins, there are also 3-state, bidirectional, open collector, open emitter, passive, and power pins. If a pin connects to a wire, it is a scalar pin; if it connects to a bus, it is a bus pin. *See also* hierarchical pin.

pin swap The exchange of identical pins in order to decrease route lengths.

pin-to-pin spacing The physical spacing between pins on a device.

polygon A graphic object made up of polylines (multiple contiguous segments) whose beginning and end are attached to form a closed shape that can be filled. *See also* polyline.

polyline A line with multiple contiguous segments. You place a polyline using the Polyline command on the Place menu.

port *See* hierarchical port.

primitive A part or hierarchical block with no underlying hierarchy.

project A single file that includes all of the schematic folders, schematic pages, parts, and symbols that make up a project. You can view these project elements in the project manager. A basic project contains one schematic folder and one schematic page, while a complex project may contain a number of schematic folders, each containing several schematic pages.

project manager The window used to perform project-wide tasks, such as locating objects, creating a netlist, or generating reports. This window displays the structure of the schematic folders and schematic pages contained in a design. You can view the project structure in logical mode or in physical mode. *See also* hierarchical design, logical mode, physical mode, simple hierarchy.

property A characteristic of an object that can be edited. A property consists of a name and a value. Examples of property names are part value and color. Their respective property values can be something such as capacitor and red.

R

root schematic folder The schematic folder at the top of a hierarchical design. The root schematic folder displays a backslash in its folder icon in the project manager. A project has only one root schematic folder.

S

scalar A pin width that carries only one signal, as opposed to a bus pin that can carry multiple signals.

schematic design A graphical representation of a circuit using a set of electronic symbols, hierarchical blocks, and connections. Typically used by system and programmable logic designers to express a structural design description.

schematic folder A collection of all schematic pages at the same level of hierarchy in a design. In the project manager, a schematic folder behaves like a container. *See also* flat design, hierarchical design, root schematic folder, schematic page.

schematic page The pages on which a design is drawn. Schematic pages display in a window, called the *schematic page editor*, in which you can place parts and draw wires.

schematic page editor The editor used to create and edit schematic pages.

session frame The window in which the various elements of Capture—such as the session log, project manager, schematic page editor, and part editor—run.

session log A window that displays text messages generated by Capture, such as errors and informational messages. The session log starts empty with each new Capture session, but you can save its contents to a text file.

signal An electrical impulse of a predetermined voltage, current, polarity, and pulse width.

simple hierarchy A design in which there is a one-to-one correspondence between hierarchical blocks (or parts with attached schematic folders) and the schematic folders they reference. Each hierarchical block (or part with an attached schematic folder) represents a unique schematic folder. *See also* complex hierarchy, hierarchical design.

source library The path and filename where a part's definition resides. A filename with an .OLB extension indicates that the part was placed "as is" from the library. A filename with a .DSN extension indicates that the part no longer matches the original library part, and the changed part's definition only resides in the design where the part was edited.

spreadsheet editor A window used to edit the properties of multiple objects at once.

T

tabbed dialog box A dialog box that has different views that can be displayed by clicking on tabs along the top of the dialog box.

TrueType A font (typeface) that displays in a printout exactly the way it displays on the screen. TrueType fonts are scaleable to any font size, and several of these fonts are installed automatically when you install Windows.

U

user-defined property A property you add to an object. Unlike inherent properties, user-defined properties can be removed. *See also* inherent property.

V

vertex The point at which the sides of an angle meet. You create this by drawing a wire or line in one direction, then changing direction to create an L-shaped or V-shaped wire or line.

W

wildcard A symbol, usually used in searches, that represents a missing or unknown character or sequence of characters. Valid wildcard characters are an asterisk (*) to match multiple characters and a question mark (?) to match individual characters.

X

X axis The horizontal or left-to-right direction in a two-dimensional system of coordinates. The X axis is perpendicular to the Y axis.

Y

Y axis The vertical or bottom-to-top direction in a two-dimensional system of coordinates. The Y axis is perpendicular to the X axis.

Z

zoom To change the view of a window, making the objects appear larger or smaller. When you zoom out, the objects are smaller and you see more of the schematic page or part. When you zoom in, the objects are larger, but you see less of the schematic page or part.

zoom factor The amount by which the zoom scale is multiplied or divided when you choose Zoom In or Zoom Out on the schematic page editor's View menu. The Zoom factor is normally 2, but you can change it using the Preferences command on the Options menu. For example, a zoom scale of two makes the image of the screen twice as large when you zoom in and half as large when you zoom out.

zoom scale The relative size of the image on the screen, as a percentage of the normal size. For example, a zoom scale of 250% means the image on the screen is two and one-half times as large as normal.

A

- adding macros, *134*
- annotation
 - back, *226*
 - forward, *228*
- Arc command
 - tool palette button, *21*
- arcs
 - drawing, *119*
 - resizing, *119*
- area selection, *25*
- arrow keys, *ix*
- attached implementation, *88, 96, 159*
- attached schematic folders, *77, 88, 96, 154, 159, 160*
 - descending, *154, 160*
 - homogeneous package, *154, 160*
 - in complex hierarchical designs, *75*
 - in simple hierarchical designs, *73*
- attaching implementations to hierarchical blocks, *94*
- AutoECO, *215*
- autosaving files, *45*
- autoscrolling, defining, *43*

B

- back annotation, *226*
- BACKANNO.MAX file, *226*
- backslash, in root schematic folder icon, *6, 73*
- bidirectional, pin type, *165*
- Bill of Materials
 - command, *177, 178, 203*
 - dialog box, *204*
 - include file format, *205*
 - toolbar button, *19*

bitmaps

- placing, *123*
- plotting, *67*
- resizing, *123*

Bookmark command, *144*

bookmarks

- jumping to, *144*
- placing, *144*
- properties, editing, *28*
- renaming, *144*

border visibility, defining for new designs, *55*

Browse command, *13*

browse window, *13*

- sort buttons, *13*

browsing a project or library, *13*

Bus command, *112*

- tool palette button, *21*

bus entries, placing, *114*

Bus Entry command, *114*

- tool palette button, *21*

buses

- editing, *108*
- names, *108, 112*
- placing, *108*
- properties, editing, *28*
- user-defined properties, *27, 29*

C

CAPSYM.OLB, *77*

Capture

- configuration, *39*
- properties for use with Layout, *138*
- SDT compatibility, *57, 59*

CAPTURE.INI, *86*

character formatting, *129*

- circles
 - drawing, *118*
 - resizing, *118*
- Clear Session Log command, *17*
- Close Project command, *38*
- colors
 - defining for graphics, *45*
 - defining for VHDL syntax, *48*
 - defining preferences, *41*
- commands
 - Arc, *21*
 - Bill of Materials, *19*
 - Browse, *13*
 - Bus, *21*
 - Bus Entry, *21*
 - Clear Session Log, *17*
 - Close Project, *38*
 - Copy, *18*
 - Create Netlist, *19*
 - Cross Reference, *19*
 - Cut, *18*
 - Design Properties, *39*
 - Design Rules Check, *19*
 - Design Template, *39*
 - Ellipse, *21*
 - Exit, *38*
 - Export Design, *207*
 - Export Properties, *210*
 - Find, *13, 17*
 - Gate and Pin Swap, *19*
 - Ground, *21*
 - Group, *26*
 - Help Topics, *19*
 - Hierarchical Block, *21*
 - Hierarchical Pin, *21*
 - Hierarchical Port, *21*
 - IEEE Symbol, *22*
 - Import Design, *209*
 - Import Properties, *214*
 - Junction, *21*
 - Line, *21*
 - Net Alias, *20*
 - New, *18*
 - No Connect, *21*
 - Off-Page Connector, *21*
 - Open, *18, 35*
 - Part, *20*
 - Paste, *18*
 - Pin, *22*
 - Pin Array, *22*
 - Polyline, *21*
 - Power, *21*
 - Preferences, *39*
 - Print, *18*
 - Properties, *27, 28, 29*
 - Rectangle, *21*
 - Redo, *18, 30*
 - Repeat, *31*
 - Save, *18, 37*
 - Schematic Page Properties, *39*
 - Select All, *26*
 - Status Bar, *23*
 - Text, *21*
 - Tool Palette, *22*
 - Toolbar, *19*
 - Undo, *18, 30*
 - Ungroup, *26*
 - Update Part References, *19*
 - Wire, *20*
 - Zoom All, *19*
 - Zoom Area, *19*
 - Zoom In, *18*
 - Zoom Out, *18*
- complex hierarchy, *75*
- Configure Macro dialog box, *134*
- configuring macros, *133*
- Control key, *ix*
- Convert command, *158, 173*
- convert view of a part, *158, 173*
- Copy command, *121, 122, 125, 128*
 - toolbar button, *18*
- Create Netlist
 - command, *154, 160, 177, 178*
 - dialog box, *198*
 - format files, *199*
 - toolbar button, *19*
- creating macros, *131*
- cross probing, *229*
 - Capture to Layout, *230*
 - Layout to Capture, *231*

- Cross Reference
 - command, *178*
 - dialog box, *206*
 - toolbar button, *19*
- custom
 - libraries, *149*
 - parts, *156*
- Cut command, *121, 128*
 - toolbar button, *18*
- D**
- defining
 - autosaving interval, *45*
 - autoscrolling, *43*
 - Capture settings, *39*
 - colors, *41*
 - for graphics, *45*
 - for VHDL syntax, *48*
 - fill style for graphics, *45*
 - fonts for VHDL syntax, *48*
 - grid display, *42*
 - grid references, *61*
 - highlighting for VHDL syntax, *48*
 - line style for graphics, *45*
 - line width for graphics, *45*
 - macros
 - for display on Macro menu, *133, 135*
 - names, *134, 135*
 - shortcut keys, *133, 135, 137*
 - panning, *43*
 - project manager fonts, *45*
 - schematic page size, *61*
 - schematic page units, *61*
 - session log fonts, *45*
 - text editor preferences, *48*
 - TrueType fonts as strokes, *45*
 - zoom factor, *43*
- deleting an object, *122*
- DeMorgan equivalent, *158*
- descending into attached schematic folders, *154, 160*
- deselecting, *26*
- design cache, *153*
- Design Cache folder, *6*
- design folder, *6*
- design process, *177*
- Design Properties
 - command, *39*
 - dialog box
 - Fonts tab, *58*
 - Hierarchy tab, *58, 154*
 - Miscellaneous tab, *60*
 - SDT Compatibility tab, *59*
- Design Resources folder, *6, 34, 36, 209*
- Design Rules Check
 - command, *178*
 - dialog box, *188*
 - ERC Matrix tab, *190*
 - sample report, *191*
 - toolbar button, *19*
- design rules violations, checking for, *178*
- design structure
 - complex hierarchical, *75*
 - flat, *72*
 - hierarchical, *73*
 - simple hierarchical, *73*
- Design Template
 - command, *39*
 - dialog box
 - Fonts tab, *50*
 - Grid Reference tab, *55*
 - Hierarchy tab, *56, 154*
 - Page Size tab, *53*
 - SDT Compatibility tab, *57*
 - Title Block tab, *51*
- designs
 - exporting to a file, *207*
 - importing to a project, *209*
 - opening, *35*
- displaying invisible power pins, *169*
- drag, maximum number of objects displayed, *44*
- drawing
 - adding fill, *121*
 - arcs, *119*
 - circles, *118*
 - ellipses, *118*
 - lines, *116*
 - polygons, *120*
 - polylines, *120*
 - rectangles, *117*
 - squares, *117*

DRC markers, *178, 186*
 properties, editing, *28*
drivers
 plotter, *63*
 printer, *63*
DXF files, *207*

E

ECO, *215*
 Run ECO to Layout, *215*
EDIF files, *207*
 configuration files, *208, 209*
Edit Part dialog box, *87*
editing, *27*
 ground symbols, *92*
 hierarchical blocks, *98*
 off-page connectors, *107*
 power symbols, *92*
 properties, *27*
 property files, *213*
 spreadsheet editor, *28*
 user-defined properties, *27, 29*
Ellipse command
 tool palette button, *21*
ellipses
 drawing, *118*
 resizing, *118*
Escape key, *ix*
Exit command, *38*
Export Design
 command, *207*
 dialog box
 DXF tab, *207*
 EDIF tab, *207*
Export Properties
 command, *178, 210*
 dialog box, *210*
exporting
 designs, *207*
 libraries, *207*
 properties, *210*
 to a file, *178*
 text, *128*
extensions for filenames
 .INI, *39*
 .OLB, *51*

F

file extensions
 .INI, *39*
 .MNL, *225*
 .OLB, *51*
 .SWP, *226*
file formats
 DXF, *207*
 EDIF, *207*
 include file, *205*
 netlist format files, *199*
 PDIF, *207*
 property file, *212*
 swap file, *195*
 update file, *185*
file types
 netlist files, *225*
 swap files, *226*
files
 autosaving, *45*
 BACKANNO.MAX, *226*
 DXF, *207*
 EDIF, *207*
 configuration files, *208, 209*
 LAYOUT.INI, *225*
 opening, *35*
 PDIF, *207*
 property files, *212*
fill style, *115*
 defining for graphics, *45*
fill, adding to a graphic object, *121*
Find command, *13, 17*
finding
 parts in a design, *145*
 parts on a schematic page, *145*
flat designs, *72*
 off-page connectors, *72*
folders
 Design Cache folder, *6*
 design folder, *6*
 Design Resources folder, *6, 34, 36, 209*
 Library folder, *6, 209*
 Outputs folder, *6*
 schematic folders, *6, 33*

fonts

- changing placed text, *129*
 - defining
 - for existing designs, *58*
 - for new designs, *50*
 - for VHDL syntax, *48*
 - project manager, *45*
 - screen, *129*
 - session log, *45*
 - TrueType, *45*
- format files, netlist, *199*
- forward annotation, *228*

G

- Gate and Pin Swap
- command, *177, 178*
 - dialog box, *195*
 - swap file format, *195*
 - toolbar button, *19*
- global power pins, *60, 88, 165, 168*
- Go To
- command, *142*
 - dialog box
 - Bookmark tab, *144*
 - Grid Reference tab, *143*
 - Location tab, *143*
- Grid command, *145*
- grid display
- dots or lines, *42*
 - setting visibility, *42*
 - snap-to-grid, *42*
- grid references
- defining for new designs, *55*
 - displaying or hiding, *145*
- Grid References command, *145*
- grid spacing, defining, *53*
- Ground command, *90*
- tool palette button, *21*
- ground pins, *168*
- ground symbols, placing, *92*
- Group command, *26*
- grouping, *26*

H

- Help Topics command, toolbar button, *19*
- help, online, *24*
- heterogeneous package, *151, 154, 155*
- Hierarchical Block command
- dialog box, *96*
 - tool palette button, *21*
- hierarchical blocks
- attached implementation, *94, 96*
 - complex hierarchical designs, *75*
 - hierarchical designs, *73*
 - nets between schematic folders and schematic pages, *76*
 - placing, *98*
 - simple hierarchical designs, *73*
 - user-defined properties, *27, 29*
- hierarchical designs, *73*
- complex, *75*
 - hierarchical blocks, *73*
 - simple, *73*
- Hierarchical Pin command, *102*
- tool palette button, *21*
- hierarchical pins, *77*
- nets between schematic folders and schematic pages, *76*
 - off-grid, *102*
 - properties, editing, *28*
- Hierarchical Port command, *100*
- tool palette button, *21*
- hierarchical ports, *77*
- nets between schematic folders and schematic pages, *76*
 - placing, *100*
 - properties, editing, *28*
- hierarchy, *73, 154, 160*
- attached implementation, *88, 94, 159*
 - complex, *75*
 - defining
 - for existing designs, *58*
 - for new designs, *56*
 - placing hierarchical blocks, *94*
 - simple, *73*
- highlighting, defining for VHDL syntax, *48*
- homogeneous package, *151, 155*
- attaching schematic folders, *154*

I

- IEEE Symbol command, *161*
 - tool palette button, *22*
- IEEE symbols
 - adding to a part, *161*
- Import Design
 - command, *209*
 - dialog box
 - EDIF tab, *209*
 - PDFIF tab, *209*
- Import Properties
 - command, *178, 214*
 - dialog box, *214*
- importing
 - designs, *209*
 - libraries, *209*
 - properties, *214*
 - from a file, *178*
 - text, *128*
- include file format, *205*
- input, pin type, *165*
- instances, *11*
- intertool communication (ITC)
 - enabling in Capture, *229, 234*
 - enabling in Layout, *229*
 - enabling in Simulate, *234*

J

- jumping
 - to a bookmark, *144*
 - to a grid reference, *143*
 - to a marked location, *144*
 - to a new location, *142*
- Junction command, tool palette button, *21*
- junctions, *110*

K

- keyboard keys, *ix*

L

- LAYOUT.INI file, *225*
- libraries, *150*
 - copying parts to a different library, *150*
 - custom, *149*
 - exporting to a file, *207*
 - importing to a project, *209*
 - moving parts to a different library, *150*
 - opening, *35*
- Library folder, *6, 209*
- Line command, tool palette button, *21*
- line style, *115*
 - defining for graphics, *45*
- line width, defining for graphics, *45*
- lines
 - drawing, *116*
 - resizing, *116*
- Logical command, *75*
- logical mode, *9*

M

- Macro Name dialog box, *133*
- macros
 - adding, *134*
 - Capture to Layout, *138*
 - configuring, *133*
 - creating, *131*
 - defining
 - for display on Macro menu, *133, 135*
 - shortcut keys, *133, 135, 137*
 - naming, *134, 135*
 - playing, *132*
 - recording, *132*
 - removing, *134*
 - saving, *135*
 - shortcut key assignments, *137*
 - temporary, *131*
- Mirror command, *121*
- modes
 - logical, *9*
 - physical, *10*
 - when to use, *12*
- multiple objects, selecting, *25*
- multiple-part packages, *151*
 - creating, *156*

N

naming macros, *134, 135*
 Net Alias command, tool palette button, *20*
 net aliases, *108, 112*
 editing, *111*
 net names, *108*
 net properties, transferring to Layout, *222*
 netlist
 creating, *178*
 for Layout, *225*
 for simulation, *201*
 format files, *199*
 netname resolution, *200*
 nets
 hierarchical blocks, between schematic folders and schematic pages, *76*
 hierarchical pins, between schematic folders and schematic pages, *76*
 hierarchical ports, between schematic folders and schematic pages, *76*
 off-page connectors, between schematic pages in a single schematic, *76*
 properties, editing, *28*
 user-defined properties, *27, 29*
 New command, toolbar button, *18*
 New Part command, *156*
 New Part Properties dialog box, *158*
 Next Part command, *172*
 No Connect command, *93*
 tool palette button, *21*
 nonprimitive parts, *83, 154, 160*

O

occurrences, *11*
 Off-Page Connector command, *104*
 tool palette button, *21*
 off-page connectors, *77*
 in flat designs, *72*
 example, *78*
 nets between schematic pages in a single schematic, *76*
 placing, *107*
 properties, editing, *28*

online
 help, *24*
 tutorial, *24*
 open collector, pin type, *165*
 Open command, *35*
 toolbar button, *18*
 open emitter, pin type, *165*
 output pin type, *165*
 Outputs folder, *6*

P–Q

Package command, *172, 173*
 package view, part editor, *15*
 packages, *82, 151*
 heterogeneous, *151, 155*
 homogeneous, *151, 155*
 attaching schematic folders, *154*
 plotting, *64*
 printing, *64*
 user-defined properties, *27, 29*
 viewing, *172, 173*
 page size, defining for new designs, *53*
 panning, defining, *43*
 Part command, *84*
 tool palette button, *20*
 part editor, *15*
 tool palette, *22, 115*
 part instances, *11, 153*
 editing, *171*
 properties, editing, *28*
 user-defined properties, *27, 29*
 part occurrences, *11, 29*
 part properties, transferring to Layout, *219*
 part view, part editor, *15*
 parts
 attached schematic folders, *73, 75, 77*
 convert view, *158, 173*
 copying to a different library, *150*
 editing
 in a library, *170*
 on a schematic page, *171*
 finding, *145*
 heterogeneous package, *151, 155*
 homogeneous package, *151, 155*
 attaching schematic folders, *154*
 IEEE symbols, placing, *161*

- instances, *11, 28, 153*
- moving to a different library, *150*
- multiple-part packages, *151*
- occurrences, *11*
- packages, *151*
- part body, *156*
- part body border, *156*
- part reference, *159*
- PCB footprint, *158*
- pins, placing, *162*
- plotting, *64*
- printing, *64*
- user-defined properties, *27, 29*
- passive, pin type, *165*
- Paste command, *122*
 - toolbar button, *18*
- PCB footprint property, *88, 185, 198, 225*
- PDF files, *207*
- Physical command, *75*
- physical mode, *10*
 - when to use, *12*
- Picture command, *123*
- Pin Array command, *166*
 - tool palette button, *22*
- Pin command, *162*
 - tool palette button, *22*
- pin properties, transferring to Layout, *224*
- pins
 - connecting to wires, *110*
 - ground, *168*
 - invisible, displaying, *169*
 - name, *163*
 - number, *163*
 - placing multiple, *166*
 - placing on a part, *162*
 - power, *168*
 - shape, *164*
 - shared, *155, 168*
 - types, *165*
 - user-defined properties, *27, 29*
 - visibility, *163, 168*
 - width, *163*
- pin-to-pin spacing, defining for new designs, *53*
- Place Ground Symbol dialog box, *91*
- Place Hierarchical Block dialog box, *96*
- Place Hierarchical Pin dialog box, *103*
- Place Hierarchical Port dialog box, *101*
- Place Off-Page Connector dialog box, *106*
- Place Part dialog box, *85*
- Place Pin Array dialog box, *167*
- Place Pin dialog box, *163*
- Place Power Symbol dialog box, *91*
- placing
 - bitmaps, *123*
 - bus entries, *114*
 - ground symbols, *92*
 - hierarchical blocks, *98*
 - hierarchical pins, *102*
 - off-page connectors, *107*
 - power symbols, *92*
 - text, *124*
- playing macros, *132*
- plotting, *63*
 - bitmaps, *67*
 - drivers, *63, 67*
 - HPGL emulation, *67*
 - parts or packages, *64*
 - pen colors, *67*
 - previewing, *65*
 - rendering TrueType fonts as strokes, *45*
 - scaling output, *66*
 - schematic pages, *64*
 - text editor, *65*
- polygons
 - drawing, *120*
 - resizing, *120*
- Polyline command, tool palette button, *21*
- polylines
 - drawing, *120*
 - resizing, *120*
- Power command, *89*
 - tool palette button, *21*
- power pin visibility, defining, *60*
- power pins, *168*
 - visibility, *88*
- power symbols, placing, *92*
- power, pin type, *165*

- Preferences
 - command, 39
 - dialog box
 - Colors tab, 25
 - Colors/Print tab, 41
 - Grid Display tab, 42
 - Miscellaneous tab, 45
 - Pan and Zoom tab, 43, 140
 - Select tab, 25, 44
 - Text Editor tab, 48
 - previewing print output, 65
 - Previous Part command, 172
 - primitive parts, 83, 154
 - Primitive property, 88, 154, 160
 - Default option, 154, 160
 - on hierarchical blocks, 96
 - Print command, 64
 - toolbar button, 18
 - Print Preview command, 65
 - Print Setup command, 63
 - printing, 63
 - drivers, 63
 - parts or packages, 64
 - previewing, 65
 - rendering TrueType fonts as strokes, 45
 - scaling output, 66
 - schematic pages, 64
 - setting up, 63
 - text editor, 65
 - project manager, 5
 - browse window, 13
 - File tab, 8
 - folders
 - Design Cache folder, 6
 - design folder, 6
 - Design Resources folder, 6
 - Library folder, 6
 - Outputs folder, 6
 - schematic folders, 6
 - font, 45
 - Hierarchy tab, 8
 - Logical option, 9
 - Physical option, 9
 - pop-up menus, 12
 - schematic pages, 6
 - toolbar button, 19
 - projects
 - adding
 - files, 36
 - VHDL files, 34
 - closing, 38
 - deleting files, 36
 - folders
 - Design Resources, 34, 36, 209
 - Library, 209
 - schematic, 33
 - opening, 35
 - saving, 37
 - properties
 - editing, 27, 177
 - a property file, 213
 - exporting, 210
 - to a file, 178
 - importing, 214
 - from a file, 178
 - Layout net properties, 222
 - Layout part properties, 219
 - Layout pin properties, 224
 - spreadsheet editor, 177
 - user-defined, 27, 29
 - Properties command, 27, 28, 29
 - property file format, 212

R

- recording macros, 132
- Rectangle command, tool palette button, 21
- rectangles, drawing, 117
- Redo command, 30
 - toolbar button, 18
- redoing actions, 30
- removing macros, 134
- Repeat command, 31
- repeating actions, 30
- Replace Cache command, 153
- replacing a part instance in the design cache, 153
- reports
 - bill of materials, 178, 203
 - cross reference, 178
- root schematic folder, 6, 73
- Rotate command, 121
- Run ECO to Layout, 215

S

- Save command, 37
 - toolbar button, 18
- saving macros, 135
- scaling
 - plotter output, 66
 - printer output, 66
- schematic folders, 6, 33
 - attaching to a part, 160
- schematic page editor, 14
 - tool palette, 115
- Schematic Page Properties
 - command, 39
 - dialog box
 - Grid References tab, 61
 - Page Size tab, 61
 - Miscellaneous tab, 62
- schematic page size, defining for new designs, 53
- schematic pages, 6
 - creation date, 62
 - defining
 - grid references, 61
 - page size, 61
 - units, 61
 - modification date, 62
 - plotting, 64
 - printing, 64
- screen fonts, 129
- SDT compatibility with Capture, 57, 59
- Select All command, 26
- selecting
 - all objects, 26
 - area, 25
 - deselecting, 26
 - multiple objects, 25
 - one object, 25
- selection border, intersect or enclosed, 44
- session frame, 3
- session log, 17
 - font, 45
- shared pins, 155, 168
- shortcut key assignments for macros, 137

- signals
 - selecting for simulation, 236
 - setting breakpoints, 238
 - viewing during simulation, 235
- simple hierarchy, 73
 - example, 78
- simulation
 - creating a netlist for, 201
 - incorporating netlist changes, 238
 - selecting signal values, 236
 - setting breakpoints on signals, 238
 - specifying interactive stimuli, 237
 - viewing signal values, 235
- snap-to-grid, defining, 42
- spreadsheet editor, 28, 177
- squares
 - drawing, 117
 - resizing, 117
- status bar visibility, 23
- Status Bar command, 23
- swap file format, 195
- swapping gates or pins, 178

T

- tab spacing, defining for text editor, 48
- temporary macros, 131
- text
 - bounding box, 126
 - character formatting, 129
 - deleting, 126
 - editing, 126
 - exporting, 128
 - finding, 127
 - importing, 128
 - moving, 124
 - placing, 124
 - rendering TrueType fonts as strokes, 45
 - replacing, 127
 - rotating, 125
 - typing, *x*
- Text command, 124, 129
 - tool palette button, 21
- text editor, 16
 - defining preferences, 48
 - plotting, 65
 - printing, 65

three-state, pin type, *165*

title blocks, *149*

- defining for new designs, *51*
- visibility, defining for new designs, *55*

tool palette

- part editor, *20, 115*
 - IEEE Symbol command, *22*
 - Pin Array command, *22*
 - Pin command, *22*
- schematic page editor, *20, 115*
 - Arc command, *21*
 - Bus command, *21*
 - Bus Entry command, *21*
 - Ellipse command, *21*
 - Ground command, *21*
 - Hierarchical Block command, *21*
 - Hierarchical Pin command, *21*
 - Hierarchical Port command, *21*
 - Junction command, *21*
 - Line command, *21*
 - Net Alias command, *20*
 - No Connect command, *21*
 - Off-Page Connector command, *21*
 - Part command, *20*
 - Polyline command, *21*
 - Power command, *21*
 - Rectangle command, *21*
 - selection tool, *20*
 - Text command, *21*
 - Wire command, *20*
- visibility, *22, 44*

Tool Palette command, *22*

toolbar, *18*

- Bill of Materials command, *19*
- Copy command, *18*
- Create Netlist command, *19*
- Cross Reference command, *19*
- Cut command, *18*
- Design Rules Check command, *19*
- Gate and Pin Swap command, *19*
- Help Topics command, *19*
- New command, *18*
- Open command, *18*
- Paste command, *18*
- Print command, *18*
- project manager tool, *19*

- Redo command, *18*
- Save command, *18*
- Undo command, *18*
- Update Part References command, *19*
- visibility, *19*
- Zoom All command, *19*
- Zoom Area command, *19*
- Zoom In command, *18*
- Zoom Out command, *18*

Toolbar command, *19*

tutorial, online, *24*

U

Undo command, *30*

- toolbar button, *18*

undoing actions, *30*

Ungroup command, *26*

unit of measure, defining for new designs, *53*

Update Cache command, *153*

Update Part References

- command, *178, 182*
- dialog box, *181*
- toolbar button, *19*

Update Properties

- command, *178, 185*
- dialog box, *184*
- update file format, *185*

updating

- part references, *178, 182*
- properties, *178, 185*
- selected parts in the design cache, *153*

user-defined properties, *27, 29*

V

VHDL files

- creating, *16*
- opening, *35*
- viewing, *16*

VHDL syntax

- defining
 - colors, *48*
 - fonts, *48*
 - highlighting, *48*

viewing

- centering, *141*
- entire page or part, *141*
- selected area, *141*

visibility

- power pins, *60, 88*
- status bar, *23*
- tool palette, *22, 44*
- toolbar, *19*

W–Y

window

- active, *3*
- browse, *13*
- part editor, *15*
- project manager, *5*
- schematic page editor, *14*
- session frame, *3*
- session log, *17*
- text editor, *16*

Wire command, *110*

- tool palette button, *20*

wires

- editing, *108*
- placing, *108*
- properties, editing, *28*

Z

Zoom All command, *141*

- toolbar button, *19*

Zoom Area command, *141*

- toolbar button, *19*

zoom factor, *140*

- defining, *43*

Zoom In command, *139*

- toolbar button, *18*

Zoom Out command, *140*

- toolbar button, *18*

zoom scale, *140*

zooming, *139*

OrCAD[®] CAPTURE[™] FOR WINDOWS[®]

QUICK REFERENCE CARD

Email *info@orcad.com*
 International email *intl@orcad.com*
 Technical support email *techsupport@orcad.com*
 Web site *http://www.orcad.com*
 FTP site *ftp.orcad.com*
 Technical support (503) 671-9400
 Corporate offices (503) 671-9500
 Fax (503) 671-9501
 Sales, North America 800-671-9505
 Sales, outside North America Contact local OrCAD representative
 Maintenance sales 800-671-9505 (North America)

Project manager

Project manager Tool tips Dockable toolbar
 Logical or physical mode
 File tab
 Design file
 Root schematic folder
 Schematic page
 Design cache
 Outputs folder
 Design Rules Check report
 Session log
 Status bar

Schematic page editor
 Browse window
 Library manager
 Part editor
 Session frame
 Path to current file

Reference	Value	Source Part	Source Libr...	Page	Schematic
C1	30 pF	CAPACITOR	C:\MKTG\...	CMOSCPU...	CMOSCPU
C2	30 pF	CAPACITOR	C:\MKTG\...	CMOSCPU...	CMOSCPU
C3	10 uF	CAPACITO...	C:\MKTG\...	CMOSCPU...	CMOSCPU

C:\ORCAD\WIN\CAPTURE\SAMPLES\CMOSCPU.DSN

Double-click on error number to display context-sensitive help for errors

Toolbar

Create document
 Open document
 Save document
 Print
 Cut to Clipboard
 Copy to Clipboard
 Paste from Clipboard
 Undo
 Redo
 Zoom in
 Zoom out
 Zoom to region
 Zoom to all
 Update part references
 Gate and pin swap
 Design rules check
 Create netlist
 Cross reference parts
 Bill of materials
 Project manager
 Help topics

Project manager menu set

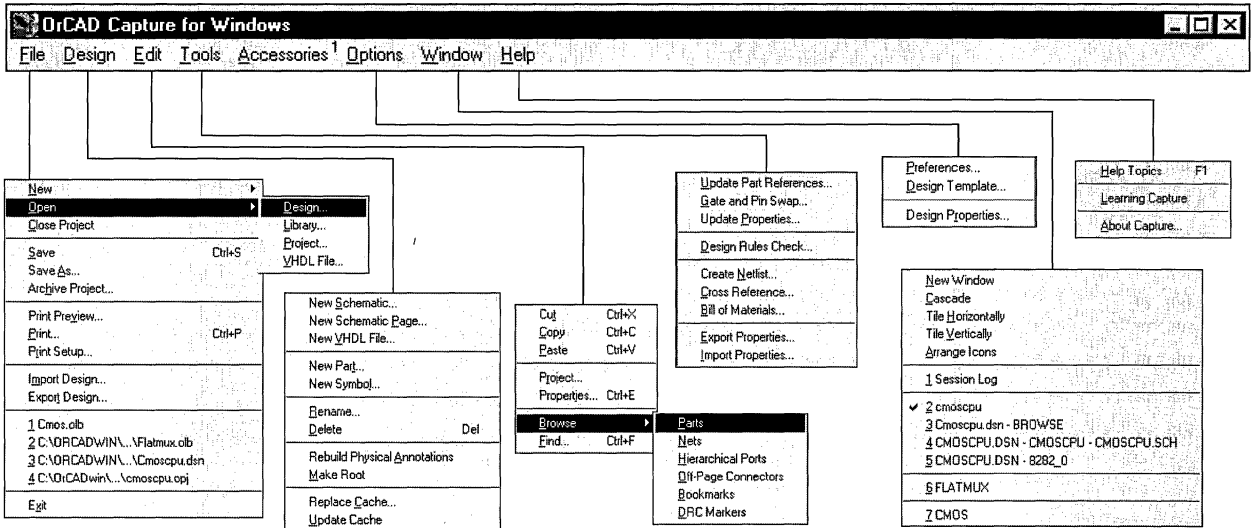

¹ The Accessories menu displays commands for third-party vendor tools.

Shortcut keys

Keystroke	Action	Keystroke	Action
Operating the mouse		Changing the view	
SPACEBAR	Click left mouse button	C	Center view around cursor
Press/hold SPACEBAR	Press/hold left mouse button	I	Zoom in
Release the SPACEBAR	Release the left mouse button	O	Zoom out
ENTER	Double-click on selected item	F5	Redraw active window
Getting help		CTRL+G	Go to
F1	Help command	CTRL+A	Ascend hierarchy
Printing and saving		CTRL+D	Descend hierarchy
CTRL+P	Print active schematic or part	PAGE UP	Pan up
CTRL+S	Save active schematic or part	PAGE DOWN	Pan down
Editing		CTRL+PAGE UP	Pan left
CTRL+Z	Undo	CTRL+PAGE DOWN	Pan right
F4	Repeat	Placing	
CTRL+X	Cut	B	Bus
CTRL+C	Copy	E	Bus entry
CTRL+SHIFT+C	Copy image to Clipboard	N	Net alias
CTRL+V	Paste	P	Part
DELETE	Delete	T	Text
CTRL+E	Edit properties of selection	W	Wire
CTRL+R or R	Rotate selection	Y	Polyline
CTRL+U	Ungroup selection	J	Junction
CTRL+F	Find	Macros	
H	Mirror horizontally	F7	Macro record
V	Mirror vertically	F8	Macro play
CTRL+T	Toggle grid snap on and off	F9	Macro configure
CTRL+N	View next part	CTRL+F1	Set Layout part properties
CTRL+B	View previous part	CTRL+F2	Set Layout pin properties
		CTRL+F3	Set Layout net properties

Schematic page editor

Project manager

Logical or physical mode

Hierarchy tab

Hierarchical design structure

Session log (minimized)

Status bar

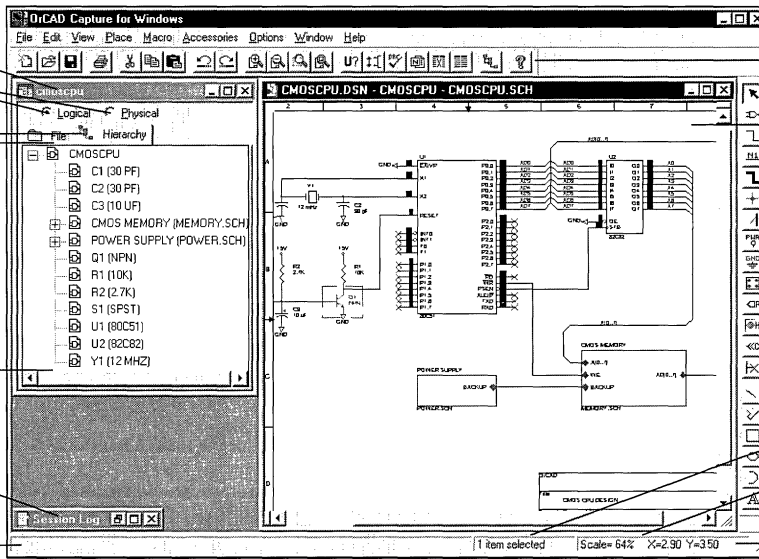

Dockable toolbar

Schematic page editor

Dockable tool palette

Selected items

Zoom scale

Cursor position

Schematic page editor tool palette

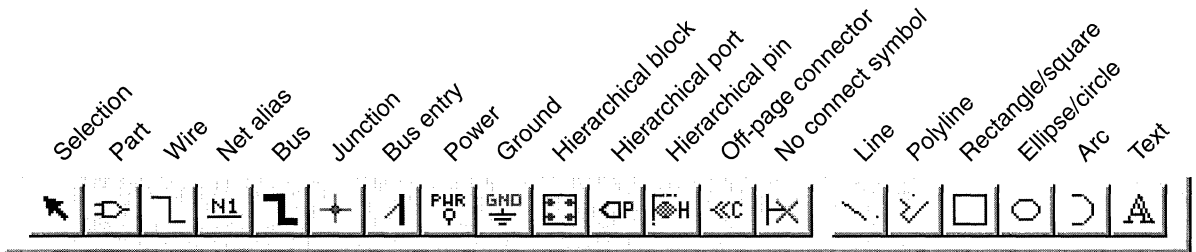

Schematic page editor menu set

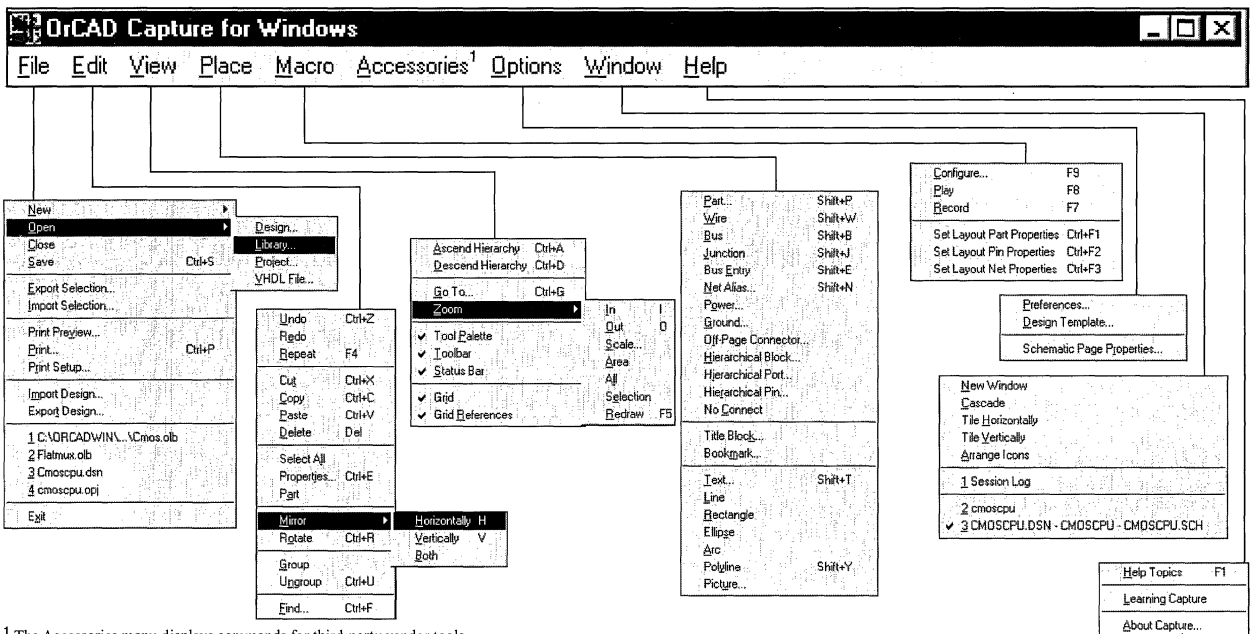

¹ The Accessories menu displays commands for third-party vendor tools.

Part editor

Dockable toolbar

Library manager

Part listing

Package properties spreadsheet

Project manager (minimized)

Session log (minimized)

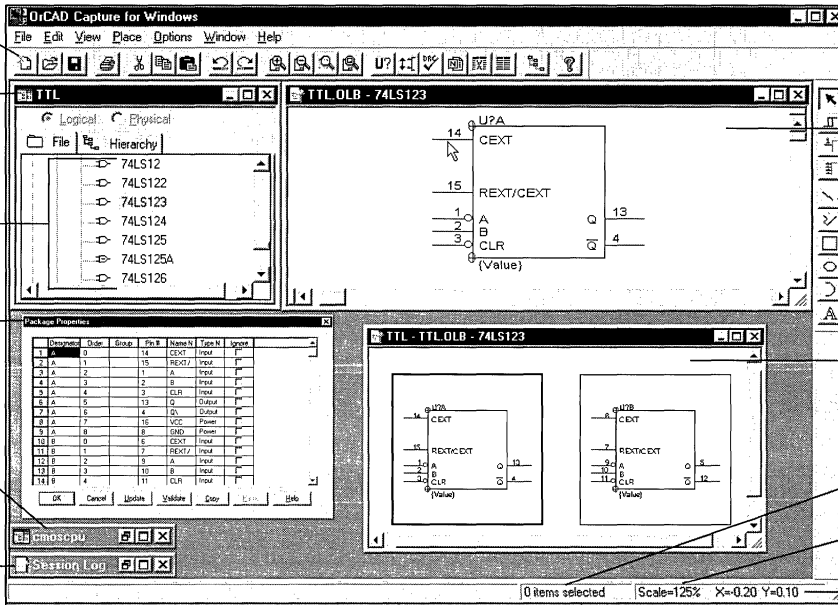

Part editor

Dockable tool palette

Package view

Selected items

Zoom scale

Cursor position

Part editor tool palette

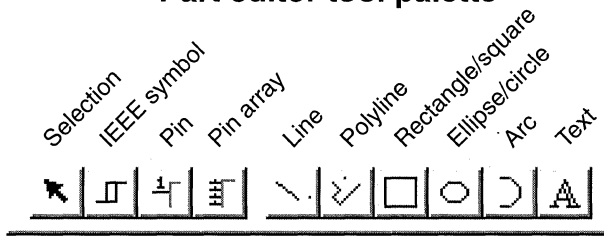

Part editor menu set

