

THE OPTIMUM USE OF WATER STORAGE  
IN HYDRO-THERMAL ELECTRIC SYSTEMS

by

RUDOLPH JOHN CYPSEK

B.E.E., Pratt Institute  
(1944)

M.S., Columbia University  
(1947)

SUBMITTED IN PARTIAL FULFILLMENT OF THE  
REQUIREMENTS FOR THE DEGREE OF  
DOCTOR OF SCIENCE

at the

MASSACHUSETTS INSTITUTE OF TECHNOLOGY  
(1953)

Signature of Author **Signature Redacted**  
Department of Electrical Engineering, January 12, 1953

Certified by **Signature Redacted**  
Thesis Supervisor

**Signature Redacted**  
Chairman, Departmental Committee of Graduate Students

THE OPTIMUM USE OF WATER STORAGE  
IN HYDRO-THERMAL ELECTRIC SYSTEMS

38

by

RUDOLPH JOHN CYPSEK

Submitted to the Department of Electrical Engineering on  
January 12, 1953 in partial fulfillment of the requirements  
for the degree of Doctor of Science.

ABSTRACT

This thesis is a contribution to the developing art of  
computer analysis for management guidance and computer control  
for economic operation of large electric generating systems.  
Particular attention is given to systems having large amounts  
of hydro storage where plant efficiencies depend on the cumula-  
tive effects of past storage drawdown and where present operation  
must take into account predictions of future water resources and  
system load. For this type of system, the problem is mathemat-  
ically formulated and procedures are developed for successively  
improving a proposed mode of operation so as to reduce an ef-  
fective cost of system operation, using specific predictions of  
stream flows and system load and taking into account various  
operating limitations. The semi-automatic implementation of  
these procedures is demonstrated using the Whirlwind I digital  
computer.

*Vol. (E.E.) May 15, 1953*

Thesis Supervisor: Eugene W. Boehne  
Title: Professor of Electrical Engineering

## Acknowledgement

The writer is indebted to a large group at M.I.T. and at the Bonneville Power Administration, Portland, Oregon for assistance in completing this work. He wishes to express particular gratitude to Prof. E. W. Boehne, faculty supervisor of the thesis, for the benefit of his vision and understanding of the broad aspects of this work, and for his assistance in coordinating the activities of many persons in this effort; to Prof. A. E. Fitzgerald and Prof. W. M. Pease, faculty advisors for the thesis, for their encouragement of the study and the sympathetic guidance they gave to it; to the management of the Bonneville Power Administration, for their sponsorship of this research and for their wholehearted encouragement of progress in this field; to Mr. B. V. Hoard and Mr. W. Whitbeck, who with others of the B.P.A. staff have contributed much to the formulation and understanding of the problem; to Prof. P. Franklin, of the Mathematics Department, for the benefit of his counsel on the mathematical approach to the problem; to Mr. C. A. Powel, lecturer at M.I.T. and Mr. H. Stuart of the New England Power Company, for their cooperation and assistance in informing the writer on current practices in the industry; to Prof. G. S. Brown, who made available the facilities of the Servomechanisms Laboratory for the initial study of this problem; to Prof. W. Linvill, who gave generously of his time and counsel in the writer's selection of the thesis topic; to the staff of the M.I.T. Digital Computer Laboratory, particularly J. Gilmore

and M. Demurjian, whose zeal in the after midnight hours made possible the perfecting of the computer programs; to my wife, Betty, for patient cooperation and assistance in performing the study and preparing the manuscript, and to Mrs. Anna Nagy for a conscientious job of typing the final report.



## GLOSSARY

- $A_1(t)$  = composite plant characteristic of hydro plant 1, as a function of  $D_1(t)$  and  $S_1(t)$ .
- $A$  = constant obtained from the system loss coefficients.
- $B_{ij}$  = loss coefficient determining loss attributed to plants i and j.
- $B_1(t)$  = composite plant characteristic of hydro plant 1 as a function of  $D_1(t)$  and  $S_1(t)$ .
- $b(K)$  = value of computation CK evaluated at the next preceding (backward) ordinate.
- $C_1(t)$  = composite plant characteristic of hydro plant 1 as a function of  $D_1(t)$  and  $S_1(t)$ .
- $D_n(t)$  = turbine discharge at plant n (ksf).
- $D_u(t)$  = turbine discharge from upstream plant u (ksf).
- $E_n(t)$  = Euler-type expression associated with plant n (\$/hr/ksfd).
- $f_{in}$  = positive constant associated with costs of plant 1.
- $f(k)$  = computation CK at next forward ordinate.
- $F_{n,n+1}(t)$  = natural runoff between plant n and the next upstream plants (ksf).
- $F_u(t)$  = natural inflow to upstream plant u (ksf).
- $F_b(t)$  = natural inflow to downstream plant b (ksf).
- $g_1(t)$  = power generation at plant 1 (mw).
- $g_{im}$  = maximum allowable generation at plant 1 (mw).
- $g_d(t)$  = hydro deficiency power (mw).
- $h_1(t)$  = net head at plant 1 (ft).
- $h_{1i}$  = reference head at plant 1 (ft).
- $h_{1o}$  = constant head loss at plant 1 (ft).
- $L(t)$  = total system load (mw).
- $m_{ig}$  = linear coefficient in generation expression for plant 1 (ft/ksf).

- $m_{igm}$  = linear coefficient in maximum generation expression for plant 1 (mw/ft).
- $m_{is}$  = linear coefficient in incremental storage expression for plant 1 (ksfd/ft<sup>2</sup>).
- $m_{iy}$  = linear coefficient in storage elevation expression for plant 1 (ft/hsfd).
- $m_{iT}$  = linear coefficient in tailwater elevation expression for plant 1 (ft/ksf).
- $m(P_y)$  = coefficient in expression for penalty cost associated with storage elevation (\$/hr/ft<sup>2</sup>).
- $m(P_g)$  = coefficient in expression for penalty cost associated with generation (\$/hr/mw<sup>2</sup>).
- $o_{iy}$  = cubic coefficient in storage elevation expression for plant 1 (ft/ksfd<sup>3</sup>).
- $p_{is}$  = penalty cost dependent on storage at plant 1 (\$/hr).
- $p_{is}^i(t)$  =  $dp_{is}(t) / ds_1(t)$  (\$/hr/ksfd)
- $p_{iD}$  = penalty cost dependent on turbine discharge at plant 1 (\$/hr).
- $p_{iD}^i(t)$  =  $\frac{dp_{iD}(t)}{dD_1(t)}$  (\$/hr/ksf)
- $P_L$  = power loss in transmission (mw).
- $Q_1(t)$  = total plant discharge at plant 1 (ksf).  
=  $D_1(t) + S_1(t)$ .
- $S_1(t)$  = spillage at plant 1 (ksf).
- $S_1^i(t)$  = slope of spillage vs storage curve of plant 1 (ksf/ksfd).
- $S_1(t)$  = useful reservoir storage at plant 1 (ksfd).
- $s_1(t)$  = incremental storage at plant 1 (ksfd/ft).
- $t$  = time (days).
- $T$  = time at the end of interval being optimized.
- $\tau_{jk}$  = time for water to flow between plants j and k (days).

- $y_1(t)$  = storage elevation at dam 1 (ft).
- $y_{10}$  =  $y_{1min}$  = minimum allowable storage elevation at dam 1 (ft).
- $y_{1T}(t)$  = tailwater elevation at dam 1 (ft).
- $y_{1c}$  = crest height of spillway at dam 1.
- $y_{1l}$  = Storage elevation above crest height at dam 1.
- $\$$  = cost index of system performance (dollars).
- $\$/hr(t)$  = effective hourly cost of system operation (dollars/hour).
- $\alpha$  = factor determining size of correction when proceeding along path of steepest descent.
- $\gamma(t)$  = incremental cost of replacing hydro deficiency ( $\$/mw\ hr$ )
- $\gamma'(t)$  = modified incremental cost of replacing hydro deficiency ( $\$/mwhr$ ) to take into account transmission loss.
- $\delta S_1(t)$  = finite change made in  $S_1$  at time  $t$  (ft).
- $\epsilon$  = simplified plant efficiency which is constant at a given head (kw/cfs).
- $\eta_1$  = conversion factor times generator and transformer efficiencies at plant 1 (mw/ft.ksf).
- $\Delta y_1$  = perturbation used to evaluate partial derivative with respect to  $y_1$ .

## CONTENTS

### Chapter I

#### The Economic Coordination of Power Systems

- 1.1 Introduction
- 1.2 Types of Power System Economy Control

### Chapter II

#### The Present State of the Art

- 2.1 Introduction
- 2.2 Loading Dissimilar Units
- 2.3 Incremental Loading
- 2.4 Transmission Loss Formulas
- 2.5 Coordination of Fuel Cost And Transmission Loss
- 2.6 Hydro-Thermal System Operation

### Chapter III

#### The Long Range Water Utilization Problem

- 3.1 Nature of the Long Range Problem
- 3.2 Seasonal Variations
- 3.3 Accuracy of Flow Forecasts
- 3.4 Project And Operating Limitations
- 3.5 Multiple Benefits
- 3.6 Length of Future Time Interval Considered

### Chapter IV

#### The Role of the Computer in the Optimization of Performance

- 4.1 Introduction
- 4.2 The Process Function

- 4.3 Thermal System Controller
- 4.4 Short Range Hydro-Thermal System Controller
- 4.5 Long Range Hydro-Thermal System Controller
- 4.6 Effective Cost of Operation
- 4.7 The Performance Surface
- 4.8 Computer Procedures
- 4.9 Path of Steepest Descent

## Chapter V

### Development of the Determining Equations

for the Long Range Solution of the Three Plant System

- 5.1 Introduction
- 5.2 The Cost Index
- 5.3 Plant Characteristics
- 5.4 Establishing the Functional Character of the Cost Index
- 5.5 Setting Up Changes in the Cost Index by the Calculus of Variations
- 5.6 Role of the Gradient
- 5.7 Proofs of the Determining Equations

## Chapter VI

### Generalization And Further Evolution of Determining Equations

- 6.1 The Determining Equations for Larger Systems
- 6.2 Analytic Expressions for the Partial Derivatives
- 6.3 Final Form of the Determining Equations
- 6.4 Transmission Loss in the Long Range Solution

## Chapter VII

### Solving the Determining Equations

- 7.1 Introduction
- 7.2 Digital vs Analog Computers
- 7.3 Philosophy of Approach
- 7.4 Whirlwind I Computer
- 7.5 Computer Control Cycles
  - a) Magnetic Tape Layout
  - b) Main Flow Chart
  - c) Data Handling Routine
  - d) Examination of Cost Index
  - e) Adjustment of Size of Step
  - f) Recycling
- 7.6 Computer Programs
- 7.7 Use of the Gradient Method on Three Plant System
- 7.8 Nature of the Modifications
- 7.9 Future Work

#### Appendix A

Path of Steepest Descent With Certain Coordinates Fixed

#### Appendix B

First Proof of the Determining Equations for Three Plant System

#### Appendix C

Second Proof of the Determining Equations for Three Plant System

#### Appendix D

A Formulation of the Short Range Optimization

## Appendix E

Table of Calculations Used to Demonstrate the Gradient  
Method in the Three Plant System

## Appendix F

Programs Used on Whirlwind I to Demonstrate Gradient Method

## Appendix G

Examination of Round Off And Truncation Errors

- G.1 Introduction
- G.2 Desired Accuracy of End Results
- G.3 Magnitudes of Terms in Euler Expressions
- G.4 Accuracy Requirements on Terms in Euler Expression
- G.5 Time Derivatives
- G.6 Estimates of Truncation Errors
- G.7 Higher Order Lagrange Formula
- G.8 Round Off Error

## Chapter I

### THE ECONOMIC COORDINATION OF POWER SYSTEMS

#### 1.1 Introduction

The electric power systems are today the custodian and dispenser of a large portion of the nation's energy resources. The economic conversion of this energy from potential to usable form and its economic distribution contribute to the well-being of the nation. The electric industry is currently witnessing the physical and operational integration of formerly isolated power systems into more effective organizations for the coordination of resource-consumption over large areas (Sporn, 51)<sup>1</sup>. This coordination seeks to expend these resources prudently so as to give maximum return, or to require minimum expenditure for the fulfillment of the needs of the area. This requires the maximum exploitation of the most economical sources of energy, the minimization of transportation loss, the economic and social balance among the several benefits in multi-purpose river developments, and the use of minimum amounts of equipment, supplies and personnel.

This marshalling of the energy resources, generating plants and power distribution systems of a large area into an integrated power system promotes economy in many ways. It makes possible the use of the largest units or plants justified

<sup>1</sup>Refers to item 51 in the bibliography, by P. Sporn. This notation is used throughout this treatise.



by the requirements of the system, regardless of the requirements of the local area, allowing for the development of all resources to their maximum. It also makes possible the integration of loads of diverse characteristics, thereby improving load factors. It makes available multi-source supplies to all points of the system, allowing thereby a reduction of safety factors in design and construction and reduction in the amount of capacity designated for spinning reserves.

Thus, as the integration grows the opportunities for sizable operational economies and resource conservation increase. At the same time, however, the number of variables and their interrelationships also multiply so that the tasks of evaluating and coordinating system operations become increasingly complex. The precise coordination and evaluation of the large integrated power system become matters of great importance, of increasing complexity, and worthy of considerable effort and investment.

## 1.2 Types of Power System Economy Control

First requirements of precise control are the mathematical formulations of the relationships among system variables, and the criterion for best operation of a given system with specified plants, distribution system, loads and resources. The existence of procedures for determining optimum operation of a given system then makes possible the measure of best performance of different systems and hence, makes possible an evaluation of alternate proposals.

Different types of plants and resources, in different

systems, require different mathematical models, somewhat modified criteria for best performance, and different procedures for determining optimum operation. For discussion purposes, we establish four categories of systems, which we call urban thermal, interconnected thermal, short-range hydro-thermal, and long-range hydro-thermal.

In the first type, thermal energy is used exclusively and all generating plants are close to a load center. Therefore, transmission loss can be neglected and reduction of fuel costs is the primary consideration. The problem is the allocation of load among the generation plants in accordance with their capacities and efficiencies, so as to minimize the combined fuel costs with the sum of the power generations equal to the system load.

Systems in the second category are characterized by appreciable transmission loss in long-interconnections between plants using exclusively thermal energy. Hence, transmission loss as a function of load allocation must be added to the mathematical model. The problem then is the allocation of load among the generation plants so as to minimize the combined fuel costs with the sum of the power generation equal to the system load plus the transmission loss.

Systems employing hydro-sources in conjunction with thermal sources are sub-divided into two categories, long-range hydro-thermal and short-range hydro-thermal systems, both of which may or may not require the consideration of transmission loss. In the short-range problem, load allocations are constrained so as to consume only a specified amount

of water at each hydro-plant over a short future time interval, such as one week. Variations in elevations and plant efficiencies during this short interval have small net effect on the optimum operation, so generations are still the basic plant variables. In systems with run of river and pondage plants, the specifications on the weekly amounts of water to be used at each plant are the anticipated availabilities based on short-range predictions of stream flows. In systems with large storage, where appreciable cumulative changes in plant elevations and efficiencies occur, these weekly specifications must be the results of a long-range optimization. The short range problem is the allocation of load among the hydro- and thermal-plants, within their capacities, so as to minimize the total fuel cost over a short future time interval with a specified average power from each hydro-plant and with the sum of hydro and thermal powers equal to the system loads plus transmission losses.

Systems in the long-range category are characterized by appreciable influence of current operation on long-range economy due to cumulative changes in storage elevation and plant efficiencies. Thus in these cases operation is not adequately described by power generation alone, but rather by the particular combinations of elevation and rate of change of elevation which, together with natural stream flows, determine generation. It follows that long-range prediction of stream flows and system load enter the problem explicitly. Furthermore, unilateral constraints imposed by various hydro operating limitations must be accounted for in the mathematical

model. In a more general case, the thermal sources are supplemented by imports from outside the system under study or contracted-for industrial curtailments in times of power deficiency. All such sources of energy are high-cost replacement of hydro deficiency. The problem is the allocation of load among the hydro plants within their operating limitations so as to minimize over a long future time interval the cost of replacement of hydro deficiency, with proper hydraulic dependencies among hydro plants on interconnected streams, and with the sum of the power generations equal to system load plus transmission losses. This treatise is concerned primarily with systems in the long range category.

## Chapter II

### THE PRESENT STATE OF THE ART

#### 2.1 Introduction

In the following a brief resume is presented of current practices and recent developments in economic loading of power systems. The past fifteen years have seen wide-spread interest and activity in this field. As a result system operation is rapidly progressing from an art toward a science.

System economy is determined by decisions made at several levels of supervision. Adequate treatment of the system control problem requires an understanding of the elements involved in economy loading at each level, the development of methods peculiar to the needs of problems in each level, and the coordination of operations at the different levels. At progressively higher levels of supervision in an integrated system are: the allocation of load among different units within a thermal plant; the allocation of load among thermal plants; the allocation of load on a short range basis, among hydro and thermal plants; and lastly, the timing of the use of water resources in hydro storage plants and the average load allocation between hydro and thermal sources, on a long-range basis. Particular progress in the study of the lower levels of this control hierarchy are discussed below.

## 2.2 Loading Dissimilar Units

Various methods have been devised for allocating load among turbine-generator units with different heat rates (btu per kilowatt hour) in the same thermal plant (Steinberg and Smith, 56, p. 89). Among them are (1) base loading to capacity, in which machines are loaded to capacity in the order of their over-all efficiencies, (2) base loading to most efficient load, which is similar except that all machines are loaded in sequence according to their heat rates up to their most efficient loads and then to capacity in the same order, (3) proportionate to capacity loading, (4) loading proportionate to most efficient load, in which proportionate loading is used up to the most efficient loads of each machine after which loads are allocated in proportion to the difference between capacity and most efficient load, (5) incremental loading in which all units operate at equal incremental heat rates. The differences in economy obtained by the various methods depend upon the characteristics of the units involved, but it has been shown that the latter, incremental loading, in all cases gives best economy.

## 2.3 Incremental Loading

An illustration of incremental loading, given by Steinberg and Smith (56, p. 9), for an idealized case, is shown in figure 2.1. The combined curve of figure 2.1b is easily constructed as follows: At an incremental rate of 2.0, machine A delivers 5.0 units output and machine B delivers 2.5 units output, providing a point, at an output of 7.5 and a rate of 2.0, on the

combined curve. Other points are similarly obtained. From the combined curve, then, for a given total load, the machine loadings giving equal incremental rates can be read off directly. In practice, the loading sequence is conveniently set up by tabulating all units at all valve settings, in the order of the average incremental heat rate per valve setting (Steinberg and Smith, 56, p. 97; Hahn, 24).

In some cases, with machines of unusual characteristics, care must be exercised in applying the incremental loading criterion. In general, conditions for its applicability are (56, p. 7):

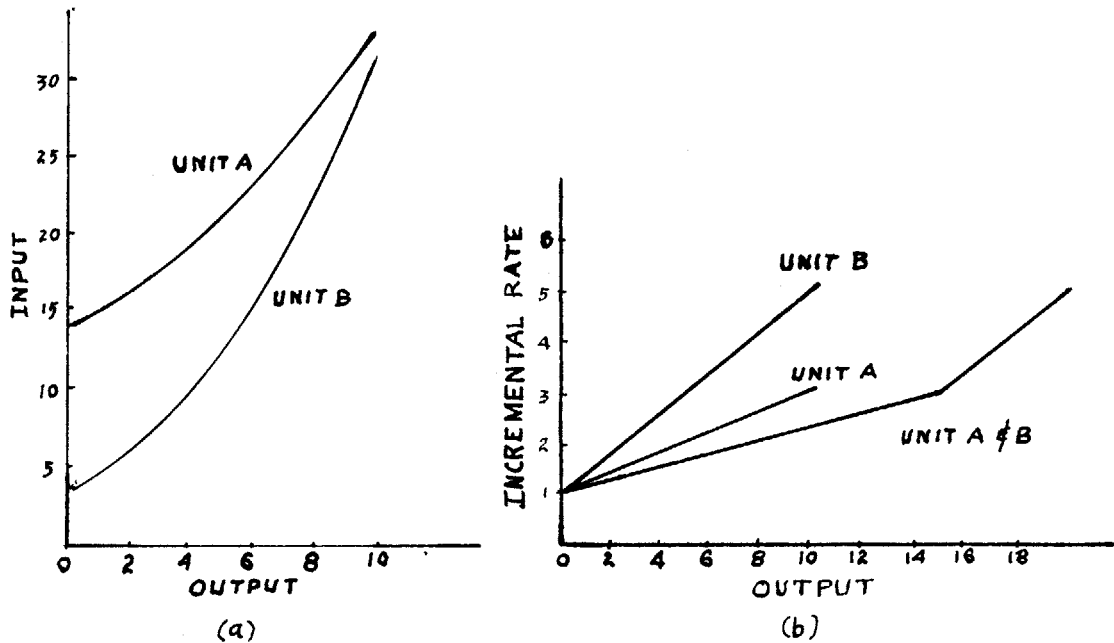

Fig. 2.1 a) Unit input-output curves. b) Incremental Rate Curves

- a) the unit input-output curves must be continuous,
- b) the input-output curves must be well-behaved, so that only one cost minimum exists in the region of operation. This is the case if the incremental rate curves are monotonic increasing, even though they may have points of discontinuities.

Use of the incremental heat rate takes into account unit efficiency and consequently fuel costs. Production costs other than fuel costs, particularly maintenance costs, may also be included as a percentage of incremental fuel costs based on the long-term ratio between maintenance costs and fuel costs. However, this refinement ordinarily does not appreciably influence the plant operation.

The allocation of load among plants in an urban thermal system likewise is determined by incremental loading. The actual incremental heat rate curves for each plant have discontinuities at the points where units are added. However, good solutions are obtained by using smoothed heat rate curves, and the corresponding smooth incremental heat rate curves (Steinberg and Smith, 56).

Incremental loading, in effect, determines the minimum of a multi-dimensional surface. It does not determine what elements go in to form that surface; that is, it does not determine which units should be on the line for a given load. It determines only how to load a given set of units. The determination of which units to be placed on the line for a given total plant load depends on the actual heat rates of the units rather than their incremental heat rates. The less efficient



unit is added to the line when the combined heat rates including the new unit becomes less than the combined heat rates without the new unit. Spinning reserve, of course, modifies the number of units on the line with consequent sacrifice of efficiency.

#### 2.4 Transmission Loss Formulas

Transmission losses are generally considered to be of secondary importance compared to the fuel costs or the availability of water resources. For this reason, it has been felt that transmission losses can be taken into account through the use of somewhat approximate loss formulas (George, 23; Ward, 64; Ward, Eaton and Hale, 65; Kirchmeyer and Stagg, 28). A compact loss formula has been developed based on assumptions that are not materially violated in the ordinary operation of many systems. The basic assumptions made are (Kirchmeyer and Stagg, 28):

1. The equivalent load current at any bus remains a constant complex fraction of the total equivalent load current. The equivalent load current at a bus is defined to be the sum of the line charging, synchronous condenser, and load currents at the bus.
2. The generator bus voltage magnitudes are assumed to remain constant.
3. The ratio of reactive power to real power of any source is assumed to remain at a fixed value.
4. The generator bus angles are assumed to remain

constant.

The resulting transmission loss formula is:

$$P_L = \sum g_m B_{nm} g_n \quad (2-1)$$

where  $g_m$  = real power output of generator M

$B_{nm}$  = system constants determined usually from network analyzer tests

## 2.5 Coordination of Fuel Costs and Transmission Loss

To coordinate fuel costs with transmission losses one seeks that load allocation which will minimize total system fuel costs subject to the constraint that the summation of the plant generations shall equal the system load plus the transmission loss. The latter, of course, is a function of the load allocation. A convenient form for the necessary and sufficient conditions for such a minimum (or a maximum or saddle-point) to exist is (Kirchmeyer and Stagg, 29):

$$\frac{\partial F_n}{\partial g_n} + \lambda \frac{\partial P_L}{\partial g_n} = \lambda \quad (2-2)$$

$n = 1, 2, 3, \dots$  plants

where  $F_n$  = the fuel costs of plant n (\$/hr)

$g_n$  = the power output of plant n (mw)

$P_L$  = the transmission loss (mw)

$\lambda$  = the Lagrangian multiplier

Often smoothed plant heat-rate curves and the corresponding incremental heat rates are used, neglecting discontinuities where additional units are placed on the line. It is then possible to obtain approximate analytical expressions for the

fuel costs and incremental fuel costs as follows:

$$F_n = f_{n0} + f_{n1} \epsilon_n + f_{n2} \epsilon_n^2 \quad (\$/hr) \quad (2-3)$$

$$\frac{\partial F_n}{\partial \epsilon_n} = f_{n1} + f_{n2} \epsilon_n \quad (\$/mwhr) \quad (2-4)$$

Also, using the above mentioned approximate expressions for transmission loss, the incremental transmission loss is given by:

$$\frac{\partial P_L}{\partial \epsilon_n} = \sum_i^2 B_{ni} \epsilon_i \quad (2-5)$$

Equation (2-2), which must be satisfied at each plant, becomes therefore:

$$f_{n2} \epsilon_n + \lambda \sum_i^2 B_{ni} \epsilon_i = \lambda - f_{n1}. \quad n = 1, 2, 3, \dots \quad (2-6)$$

Some further approximations to these conditional equations have also been proposed, facilitating the solution of these equations on the network analyzer (George, Page, and Ward, 22) or on standard digital computers (Kirchmeyer and McDaniels, 30). The errors due to these approximations were evaluated by Kirchmeyer and Stagg (29), and were found to be small.

## 2.6 Hydro Plant Characteristics

Typical plant efficiencies for hydro plants are shown in Figs. 2.2 and 2.3 (Strowger, 58, 59). In practice, loads are assigned so as to keep operation as much as possible near the points of maximum efficiency on the curves for a given head. The envelope of these curves may either increase or decrease with increased plant output. For the low-head plants improve-

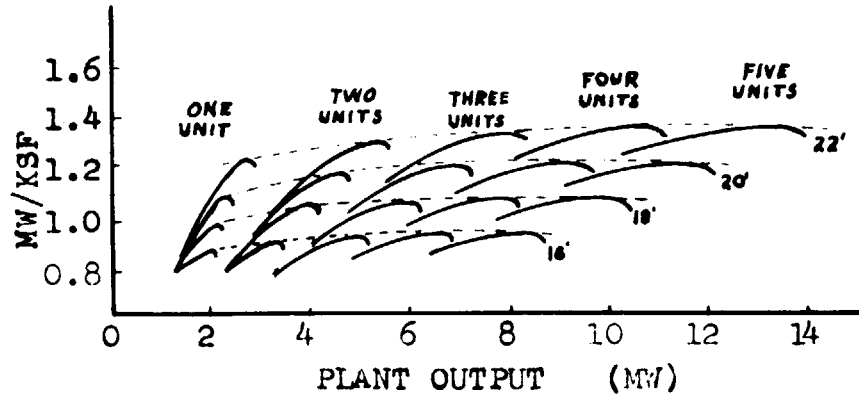

FIGURE 2.2 PLANT EFFICIENCIES FOR A LOW HEAD PLANT

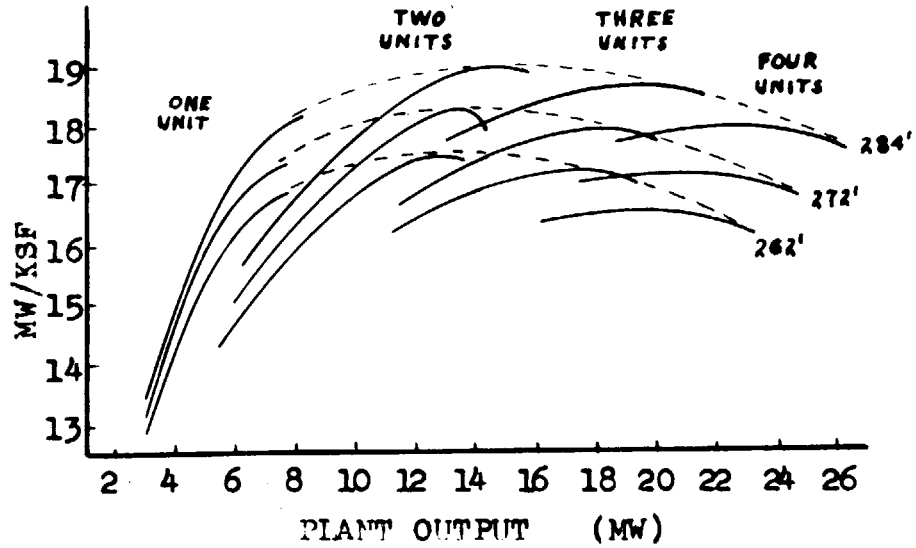

FIGURE 2.3 PLANT EFFICIENCIES FOR A HIGH HEAD PLANT

ment in efficiency is obtained as units are added because the leakage loss in the standby units is either reduced or eliminated. On the other hand, long pipe lines in high-head plants have conduit loss which varies as the square of velocity. Thus, as units are added in high-head plants, leakage loss is reduced, but conduit loss increases, producing an eventual decrease in efficiency.

Ordinarily all units in a hydro-plant are identical so that the load is divided equally among generating units. If the generating units are not identical, station load should be divided among the units operating so as to obtain equal values of incremental efficiency. That station load should be carried which corresponds to the highest efficiency point of the station or at least the highest efficiency point for a given number of units on the line (Reid, 46; Schamberger, 49; Strowger, 58, 59).

## 2.7 Hydro Thermal System Operation

Little has been published on the economy loading problem involving hydro-plants (Justin and Mervine, 27; Lane, 35). However, certain operating practices are well established, particularly in the case of run of the river and pondage plants concerned with short term optimization.

The short-range hydro load allocation is constrained so that a specified amount of water is used at each hydro plant during a short future time interval, such as one week. Some features of the load allocation among thermal plants, run of the river, and pondage plants are as follows:

- 1) Gauge readings of pondage levels and stream flows are made periodically (perhaps twice daily)
- 2) From current records of the discharges at each dam and the time of flow between dams, run-off between dams can be evaluated.
- 3) River flow and run-off can then be extrapolated several days in advance with reasonable accuracy.  
(Flash floods are extrapolated differently from stream flow, depending upon precipitation run-off relations for the area.)
- 4) The stream flows must be used immediately for generation in run of the river plants.
- 5) The total water in-flow into each pond minus the decided upon change in pondage level for the coming week determine the amount of water to be used at each pondage plant for the coming week.
- 6) Pondage water use is distributed throughout the week so as to "fill-in" the upper portion of the week's hourly load pattern.
- 7) There should remain a nearly flat hydro deficiency which must be taken care of by thermal sources allocated according to incremental rates. Flat steam is a sign of good operating economy.

Only an inadequate amount has as yet been published on the mathematical formulation of the load allocation among hydro plants and between hydro plants and thermal plants (Masse, 38). An interesting first step in this direction was taken by

Chandler and Gabriel in 1950 (11), in their coordination of water utilization with transmission loss. As an extension of the work of George Page and Ward (22), the problem was formulated on the basis of a given head at each hydro plant. Instead of fuel consumption and transmission loss, transmission loss and the reduction of storage heads were minimized at any one time. However, it did not include the essential ingredients of either the short-range or long-range load allocation problems, namely: a) the constraint to utilize to best advantage a predetermined amount of water at each plant during a coming short-time interval in a short-range problem, and b) the taking into account of the effects of cumulative changes in head and plant efficiency in the long-range load allocation problem.

Work is progressing on both the long and short range problems at the Bonneville Power Administration. A series of unpublished memoranda give the results of some of their work to date. Hoard (26) has given a clear description of factors entering the long range problem, together with an analysis of various modes of operating Grand Coulee, and an outline of the development program undertaken at B.P.A. (Whitbeck (68) presented a report on the mathematical classification of the problem, identifying it with the calculus of variations. A mathematical formulation and solution of the short range problem have been evolved by Hoard, Whitbeck and Wiener (Weiner and Whitbeck, 66, 67), which allocates load so that the sum of generations equals system load plus an estimate of system losses, with each hydro plant

constrained to deliver a specified average output for a short interval. As yet, this method causes violation of operating limitations because they have not been included in the mathematical formulation. There is, however, a strong likelihood that the use of fictitious costs as functions of limitation-violations will remedy this. A contribution to this development of a solution for the short range problem is presented in Appendix D, which does include limitations on plant capacities.



## Chapter III

### THE LONG-RANGE WATER UTILIZATION PROBLEM

#### 3.1 Nature of the Long Range Problem

The determination of operations for one week at a time is not adequate when cumulative effects of weekly operations can materially influence plant efficiencies. This is the case in systems with large amounts of storage drawdown, where variations in head over relatively long periods of time result in changes in the amount of energy yield from a given flow through the turbines. This appreciably changes the character of the problem. This dependence of future plant efficiencies on prior operation requires that an optimization be sought over a sufficiently long future time interval. What is needed is not a set of load allocations for a given system load at any one time, but rather sets of time functions of generations over a long future time interval corresponding to the time functions of total system load. The dependence of plant efficiencies on elevation changes means that the principal variables are no longer plant generations but rather the specific combinations of elevation and discharge that determine these generations. These in turn require explicit use of natural stream flow and load predictions for this future time interval. The net head and discharge are further dependent on the

characteristics of the storage basin at each plant, and also on the characteristics of the tail water rise at each plant. In addition, with several widely separated plants on the same stream, the time of flow for water to flow between these plants must be taken into account. Thus a host of more elementary system characteristics and functions must be introduced into this problem.

Again, the shape of the cost curve for thermal or other non-hydro energy sources is of importance. The cost of such energy, in general, rises faster than linearly with increasing generation. In some cases the duration of such energy demand may also influence the effective costs of the hydro deficiency. Such would be the case, for example, if loads have to be interrupted because of inadequate thermal replacement for hydro deficiency. In each application of a long-range optimization, therefore, careful consideration must be given to the determination of an effective cost for the replacement of hydro deficiency. The optimization, then, would seek to reduce the integrated cost of operation over the time interval considered.

### 3.2 Seasonal Variations

The long-range problem is characterized by seasonal shifts of load requirements and non-coinciding seasonal variations in stream flows and hydro plant capabilities. Usually the peak in the over-all system load requirements and the lowest values of total natural flow energy occur in mid-winter. This combination often results in the necessity for appreciable storage drawdown and thermal use during this period. Such storage use

naturally reduces the energy yield from subsequent natural stream flow because of the reduction in plant head. This condition prevails until the reservoir is refilled, so that drawdown early in the season may cause a cumulative loss of energy of considerable magnitude. On the other hand, failure to have a storage reservoir sufficiently drawn down at the beginning of the high-flow season results in spillage of water that otherwise could have been utilized for generation. Normally more than one storage reservoir must be drawn down simultaneously in order to meet the load demand or to "create a hole" for the spring flood. Proper coordination of drawdown is necessary in order to obtain best system operation, taking into account hydraulic connections at various storage dams and a time delay of water flow between dams.

### 3.3 Accuracy of Flow Forecasts

Of fundamental importance in the determination of long-range optimization is the accuracy of forecasts of stream flows and loads. Any one optimization can be only as accurate as the stream forecasts. It is imperative that such optimizations be kept continuously or periodically up to date as often as fresh information on stream flow predictions becomes available.

Flow records for a long time in the past and ground-water-level measurements enable flow forecasters to make predictions that flows will exceed a certain minimum, with practically a 100% probability. Various techniques can be used to predict the probabilities of the flow exceeding levels above this mini-

mum (Light and Kohler, 37; Stanley and Kennedy, 53; Bernard, 7). Whether operation is to be based on the expectation of just exceeding the minimum flow, or on a lesser probability of exceeding some higher flow, is today a management decision. The use of conservative estimates, and consequent loss of energy through spillage, must be charged to insurance. Perhaps the greatest deficiency of the work presented here is that the various probabilities of flows are not used explicitly in the optimization. This eventually should be done, particularly when further developments in the science of stream flow forecasting make available stream flow probability distributions, as functions of time.<sup>1</sup> However, in the following, it is assumed that only a "best" estimate of each flow is available, or that solutions may be carried out for more than one set of flows, such as median, minimum, and probable flows.

### 3.4 Project and Operating Limitations

Of great effect on the mathematical formulation of the long-range optimization are the project and operating limitations. The principal project limitations are the maximum discharge that can pass through the turbines at maximum gate opening as a function of the net head at each plant, and limitations on the minimum drawdown elevation because of the location of intakes or the limits of the storage basin. A less common project limitation involves channel restrictions which limit the flow of water as a function of water elevation. Operating

<sup>1</sup>Work has been started on this feature by Mr. J. Little in a companion Ph.D. thesis.

limitations include minimum plant discharges for navigation or fish-life purposes, and maximum storage elevations as dictated by flood prospects. Many of these limitations are inequalities in form and present difficulties in the setting up of the mathematical models.

### 3.5 Multiple Benefits

A further generalization of the mathematical formulation may be necessary when the optimization is to be performed with respect to more than one system benefit. This is the case, for example, when irrigation water is required at times of no spillage. Then best operation would require economic and social balance between the benefits of power generation and irrigation. However, this is simply handled if it is decided to demand a specified amount of water for irrigation as a function of time and to then perform the optimization with respect to power generation having this demand as a constraint. Thus, in the following, it is assumed that irrigation has already been accounted for in the prediction of natural stream flow availability.

### 3.6 Length of Future Time Interval Considered

A decision must also be made on the length of the future time interval to be used in the long-range optimization. To a considerable extent the economic operation will depend on requirements set down for the potential hydro energy remaining in the storage basins at the end of this time interval. This in turn must depend on a management decided risk to be taken

on predicted water resources beyond the end of this time interval. The selection of the end or the beginning of the spillage season as a future boundary has the advantage of simply requiring that all dams that spill be full at the end of the time interval. However, in those dams which do not spill, it is necessary to decide whether a net increase or decrease in storage is desirable during the future time interval. In a fully developed system where a large number of plants do not spill during any portion of the year, time intervals greater than one year may be advantageous.

There is some question concerning the effect of increasing uncertainties in flow prediction, as the length of the future time interval is increased. A point of diminishing returns may be reached in some cases as the length is increased. However, the nature of the problem seems to require that the interval include at least the forthcoming refill season, because the ability to refill using water that otherwise would be spilled is the justification for draw-down.

Chapter IV  
THE ROLE OF THE COMPUTER  
IN THE OPTIMIZATION OF SYSTEM PERFORMANCE

4.1 Introduction

In electric power systems, several types of supervisory-control are exercised to achieve economic operation. It is the purpose of this chapter to consider the nature of such supervision, from a computer-control viewpoint. Although the ingredients of control systems vary in different electric systems, depending chiefly on the nature of the energy resources used, certain basic concepts apply to each, and are discussed.

4.2 The Process Function

The process we are concerned with is the conversion of energy into electrical form. The cost of operation is dependent upon a great many factors, but only a few of these ordinarily are variable and need be considered in the optimization of performance. The functional dependence between the performance of the system and these pertinent characteristics of the actuating inputs alone determines the "process function" as far as the optimizing controller is concerned. This relationship is sketched in figure 4.1. Parameters of this functional relationship are the load allocations, which can be adjusted by a controller so as to achieve an optimization of performance. The

process function and its actuating inputs are all a computer-controller need know about the physical system being controlled.

#### 4.3 Thermal System Controller

Simplified block diagrams of system economic controls are shown in figures 4.2, 4.3, and 4.4. In figure 4.2 is the block diagram of a purely thermal system control. The performance variables in this case are fuel costs and the operation of plants within their capabilities. The pertinent input characteristic is fuel prices and the adjustable parameters are load allocations. In the case of urban thermal systems, the process function must contain information on fuel cost characteristics of each thermal plant. In the case of interconnected thermal systems, the process function must, in addition, contain information on transmission losses as functions of load allocations. The controller provides instantaneous load allocations in accordance with the instantaneous total system load.

#### 4.4 Short Range Hydro-Thermal System Controller

In Fig. 4.3 is shown a block diagram for the economic control of a hydro-thermal system having run of the river plants and pondage plants with no appreciable cumulative variation in plant head and efficiencies. The controller dictates load allocation based on an optimization over a short future time interval. Instantaneous load allocations are given in accordance with the instantaneous total system load, and knowledge of the weekly load pattern. The optimization by the short-range controller is in turn dependent on the specification of the weekly allot-



ment of water for each hydro plant. This is determined at a higher level evaluation of past flow records, extrapolated into the future time interval.

#### 4.5 Long Range Hydro-Thermal System Controller

In Fig. 4.4 is shown the block diagram of the economic control of the system where some plants experience cumulative changes in heads and plant efficiencies during a long time interval. Storage elevations are added as pertinent inputs to the process function. Benefits other than purely electrical generation must often also be considered as performance variables. The short-range controller in this case is influenced by the weekly water allotment dictated by a higher-level long-range controller. The long-range controller in turn receives as inputs predictions of flows and loads over the long-range future time interval. This process function includes, in addition to the cost characteristics of the thermal plants and transmission loss relations, information on storage basin characteristics, variation of hydro-plant efficiency with net head and discharge, and the tail water characteristics of the hydro-plants.

The long-range hydro-thermal system-controller is the special concern of this treatise. Therefore it will be further elaborated on. A pictorial sketch of such a control system, in a simple case involving two hydro plants and one source of thermal power, is shown in figure 4.5. In this integrated system, there are a number of semi-independent control systems superimposed upon one another so that each

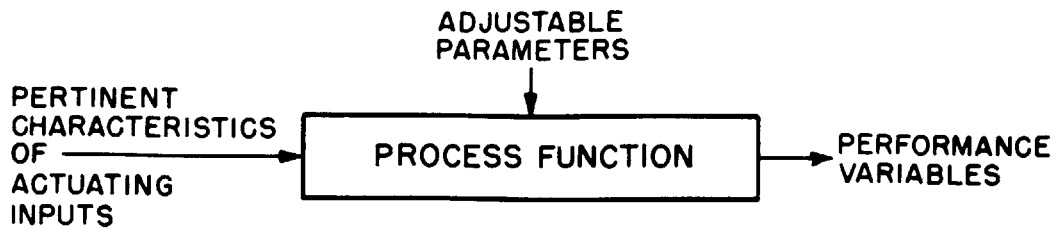

FIG. 4.1 THE CONTROLLED SYSTEM AS SEEN BY A CONTROLLER

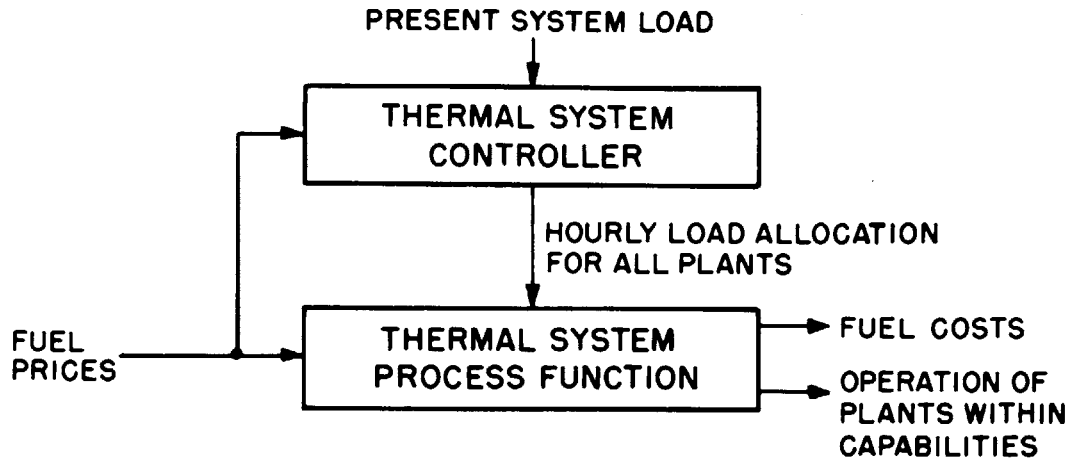

FIG. 4.2 BLOCK DIAGRAM OF THERMAL SYSTEM CONTROL

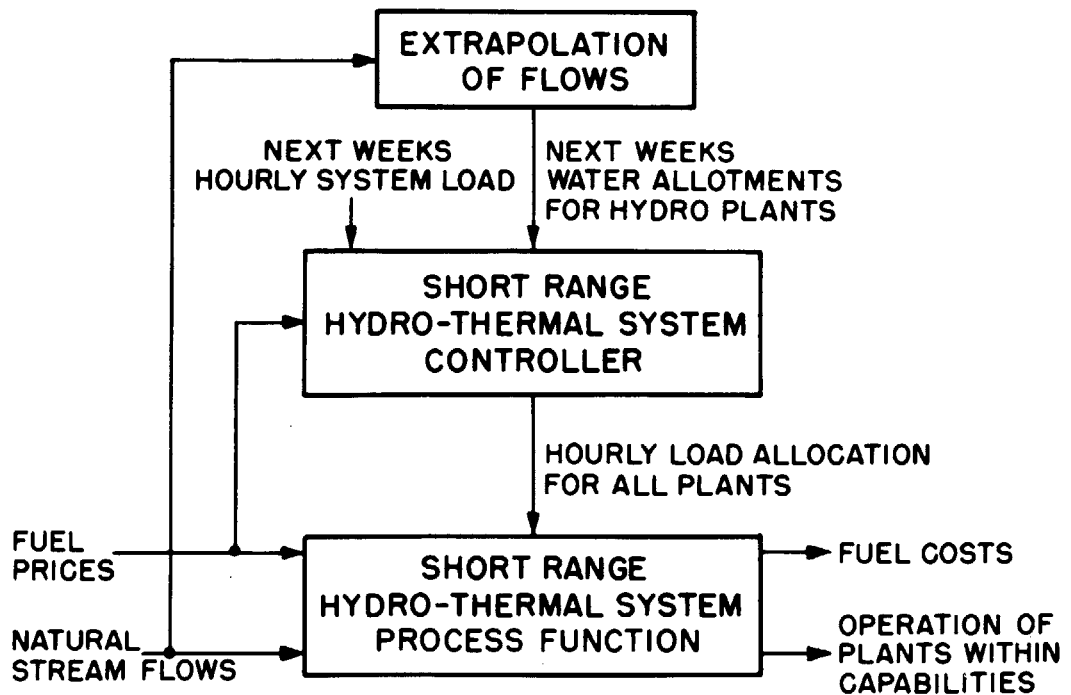

FIG. 4.3 BLOCK DIAGRAM OF SHORT RANGE HYDRO-THERMAL SYSTEM CONTROL

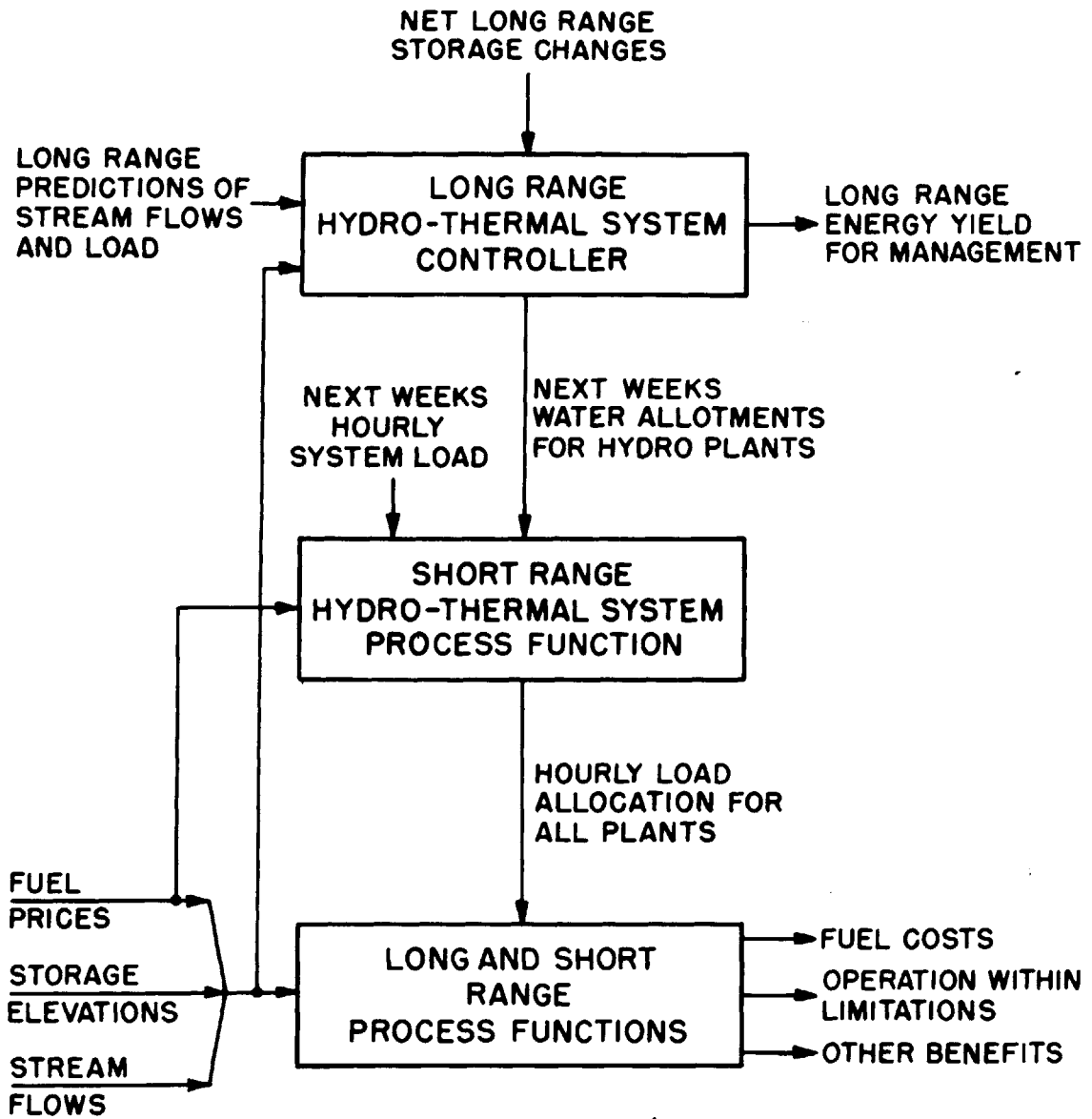

FIG. 4.4 BLOCK DIAGRAM OF LONG RANGE HYDRO-THERMAL CONTROL SYSTEM

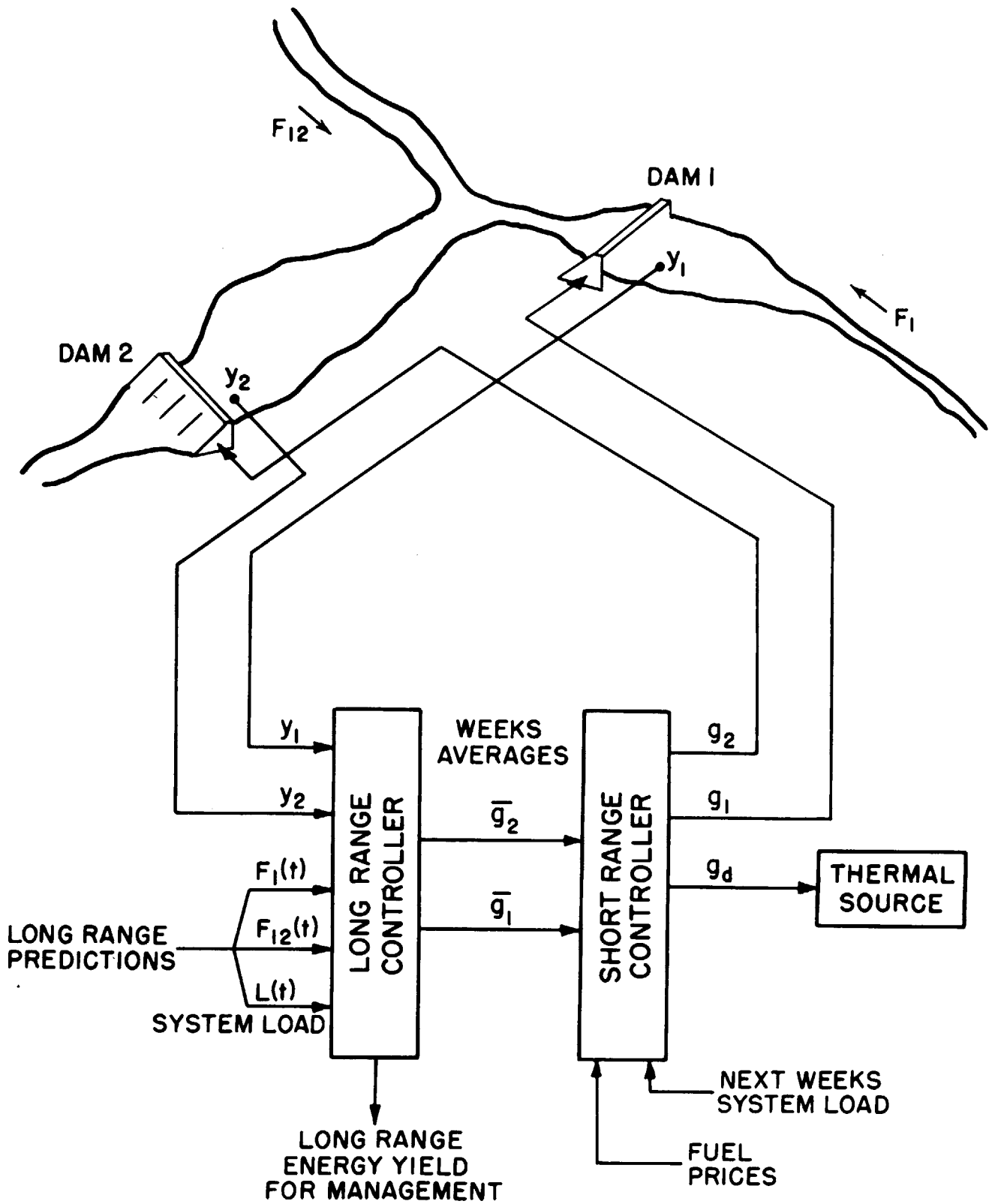

FIG.4.5 SCHEMATIC OF LONG RANGE HYDRO-THERMAL CONTROL SYSTEM

in turn forms a part of a higher level control system. Within each plant there are many regulators to maintain a given operation. Above these are the supervisory control for allocation of load among units in the plant. Each plant then becomes part of a control system under the direction of the dispatching office which allocates hourly loads on a short range basis. This unit in turn is part of a higher level of long range supervisory control which evaluates long-term operation and determines the amount of water to be made available to the dispatcher for the week's operation.

At each level, the supervision is concerned not with the details of lower level controls but only with overall characteristics. Moreover, the time scale of operations changes with the level of control so that at each level operation is based on time-averaged behavior of lower-level controls. Thus, at the dispatching level, an hourly average load is assigned; and at the next level the weekly allocation of water is made. The latter is dependent on the proper functioning of the former, because the average efficiencies of each plant depend on the dispatching practice used. Hence, the long-range water allocation is dependent on the weekly performance of the dispatcher's short range allocation, and in particular on the weekly average energy yield per volume of water consumed at each hydro plant and the weekly average cost per mw hour at each thermal plant.

At a given time, the state of the system water resources is in part a consequence of past orders from the controller.

In determining the weekly water allocations over a future time interval, the controller must take into account the present state of the system, the average operating characteristics of hydro plants and thermal plants as controlled by the dispatching center, the distribution system, and predictions of load and stream flow conditions for the future time interval.

#### 4.6 Effective Cost of Operation

The objectives of each controller must be clearly defined in terms of the minimization of an effective cost of operation. To obtain a single index of cost of operation, the concept of cost must be generalized to take into account all performance variables. The effective cost must be an aggregate of all factors considered to be of economic or social significance weighted according to their relative importance. To obtain a quantitative measure of cost of operation, an equivalent dollar cost must be assigned to each of these factors. In particular, the undesirability of the violation of project and operating limitations can be taken into account by the assignment of effective penalty costs when such violations occur. These costs as functions of the degree of limitation violation must be designed so that only operations with an arbitrarily small amount of violation of limitation will be economical. The effective cost per hour then is a summation of terms, one of which is the dollars per hour fuel cost of the thermal plants.

#### 4.7 The Performance Surface

The cost index is functionally related to all of the

process-function inputs, that is, the pertinent characteristics of the actuating inputs, and the adjustable parameters. The objective of the controller is to minimize the cost index by proper adjustments of the adjustable parameters. A geometrical interpretation of this minimization enables one to visualize the problem. In three-dimensional space, for example, a surface is defined by a function,  $z(x,y)$ , such that the values of  $x$  and  $y$  as points along two axes locate a point on the surface, whose projection onto the third axis is equal to  $z$ . A fixed value of  $y$  determines a curved line on this surface. The curve of  $z$  versus  $x$  with fixed  $y$  will have certain minimum values of  $z$ , and  $x$  can be adjusted to seek these minima. This same concept can be extended to more dimensions. One coordinate is, of course, the cost index which is to be minimized. The other coordinates are the variable relevant characteristics of the actuating inputs and the adjustable parameters. For a given set of actuating inputs, the parameters are to be adjusted so as to minimize the cost index. As the actuating inputs change, operation takes place in a different region of the surface, so that a revised set of parameter adjustments is needed to minimize the cost index. In many physical problems the shape of the minimum is relatively broad and only one minimum exists within the limitations of the problem.

A slightly different interpretation is to consider only the adjustable parameters as coordinates in this multi-dimensional space so that the relevant characteristics of the actuating inputs are included in the functional character of the

surface itself. The surface then changes as the relevant characteristics of the actuating inputs change, but for a given set of actuating inputs, the surface is stationary. The parameters are then to be adjusted to seek the actual minimum in this surface with respect to the cost index ordinate. A single point on either surface determines a mode of operation.

#### 4.8 Computer Procedures

Consider a mode of operation that differs somewhat from the optimum. In the surface having only adjustable parameters as coordinates, the operating point is somewhat removed from the surface minimum. Two courses of action are then open to the controller. It can determine the location of the minimum for the given set of actuating inputs. Then, the parameters can be adjusted in one step so as to move the operating point to the minimum. Alternatively, the controller can determine the path to be followed on this surface toward the minimum and can adjust the parameters in steps so as to move step-wise towards the minimum. Computers following these two procedures will be referred to as destination-finding computers and path-finding computers respectively.

In the case of load allocation among thermal plants, the necessary conditions for the gradient of the surface to be zero can be solved, in order to obtain the load allocations for different system loads. The results of these computations can be stored in a variety of forms. The function of the



controller may then be simply to obtain from storage the load allocations corresponding to the current system load. This is clearly a "destination-finding" type of controller. This obtaining the solution from storage has in fact been mechanized in the case of allocating load among units within a plant (Purcell, 44; Purcell and Powell, 45). Conceivably, it can also be mechanized on the system level.

In the case of purely thermal systems, with fixed fuel prices, the only input that must be carried to storage is total system load. In systems containing hydro plants, however, the short range controller inputs also include water allotments for each hydro plant for a short future time interval. While it is still conceivable to store the load allocations for all expected combinations of the controller inputs, the multivariable storage requirements would be very great with more than a few hydro plants. It appears that under certain assumptions, in this case, it is possible to obtain an analytic solution (to the equations setting the gradient equal to zero) in terms of the controller inputs (Weiner and Whitbeck, 66 and 67). Hence, a simpler controller would store the solution in terms of this functional relationship. The controller would then operate by computing this function for the current controller inputs. This still would clearly be a destination finding controller.

In the long range optimization of hydro-thermal system operation, it appears that analytic expressions for the solution to the equations setting the gradient equal to zero, can

be obtained only with unrealistic assumptions and unjustifiable simplifications. This is true primarily because of the additional unilateral project and operating limitations in hydro plants, that must be included to obtain realistic operation. Hence neither the storage of complete solutions or the storage of analytic expressions for the solutions appear feasible in this case. What can be stored are the determining equations themselves; that is, the expressions for the gradient of the surface. The long range controller must, therefore, store these determining equations, in either analog or numerical form, and re-execute their solution for each new set of controller inputs.

Whether the gradient is evaluated to determine the path to be taken, or whether the minimum is obtained by setting the gradient equal to zero, the possibility of more than one minimum must be contended with. The destination-finding computer using the path of steepest descent is best used to periodically correct for small deviations from the best operation. This is the case, for example, when periodic corrections are made during a season as revised predictions of stream flows become available. In general, with this method, it is necessary that a first approximation to the best operation be available which will set operation within the "bowl" of the correct minimum. Similarly, if the equations setting the gradient equal to zero are solved, more than one solution may result. The one with least cost and yet physically realizable must then be selected.

#### 4.9 Path of Steepest Descent

When moving the operating point toward the minimum with a path-finding computer, one intuitively would make changes in each adjustable parameter in proportion to the reduction in the cost index achieved by a small change in each adjustable parameter. That this would move the operating point along the path of steepest descent is demonstrated in Appendix A. The magnitudes of the components of the vector:

$$\sum_i \frac{\partial \mathcal{J}}{\partial X_i} \vec{u}_i$$

where  $X_i$  = the adjustable parameter

$\vec{u}_i$  = unit vectors

give the relative improvements in performance to be gained by a change in each of the adjustable parameters. The algebraic sign of each component determines the direction in which it would be advantageous to adjust each parameter. (Appendix A).

## Chapter V

### DEVELOPMENT OF THE DETERMINING EQUATIONS

#### FOR THE LONG RANGE SOLUTION OF THE THREE PLANT SYSTEM

##### 5.1 Introduction

The basic ingredients of a solution to the long range problem are (a) the mathematical formulation of the problem and (b) the mathematical development to the point where the solution rests only on the evaluation or solution of a specified set of equations. These equations, which determine economic operation, are referred to as the "determining equations".

To avoid unnecessary complexity, while retaining the principle elements in the problem, the determining equations are first found for the simple three plant system shown in figure 4.5. They are then generalized to apply to larger systems.

##### 5.2 The Cost Index

The effective hourly cost of operation is defined as the hourly cost of replacing the hydro-deficiency plus penalty costs, depending on storage elevations and plant discharges, for violations of project or operating limitations. Thus:

$$\$/\text{hr} = \$/\text{hr} (g_d) + \sum_{i=1}^k P_{iy} + \sum_{i=1}^k P_{id} \quad (5-1)$$

Sketches of penalty functions, which must be designed to make even a small violation of limitations uneconomical, are shown in figure 5.1. (The maximum generation or discharge is, of course, a function of the net head.) The objective of economy control is then the minimization of the integrated cost over a future time interval, that is to minimize

$$\$ = \int_0^T \$/hr (t) dt . \quad (5-2)$$

### 5.3 Plant Characteristics

The cost index is dependent on various hydro and thermal plant characteristics. These, sketched in figures 5.2 through 5.11, are:

- (a) tailwater elevation vs total plant discharge
- (b) plant efficiency vs turbine discharge with net head as a parameter
- (c) spillage vs storage elevation above crest
- (d) storage vs storage elevation
- (e) maximum plant generation (or discharge) vs net head
- (f) incremental cost for replacement of hydro deficiency vs hydro deficiency.

These are largely based on actual data, supplied by B.P.A., for specific installations. In those cases where inadequate data was on hand, attempts were made to make the functions flexible enough to characterize a variety of plants. The plant efficiencies, in particular, were so formed.

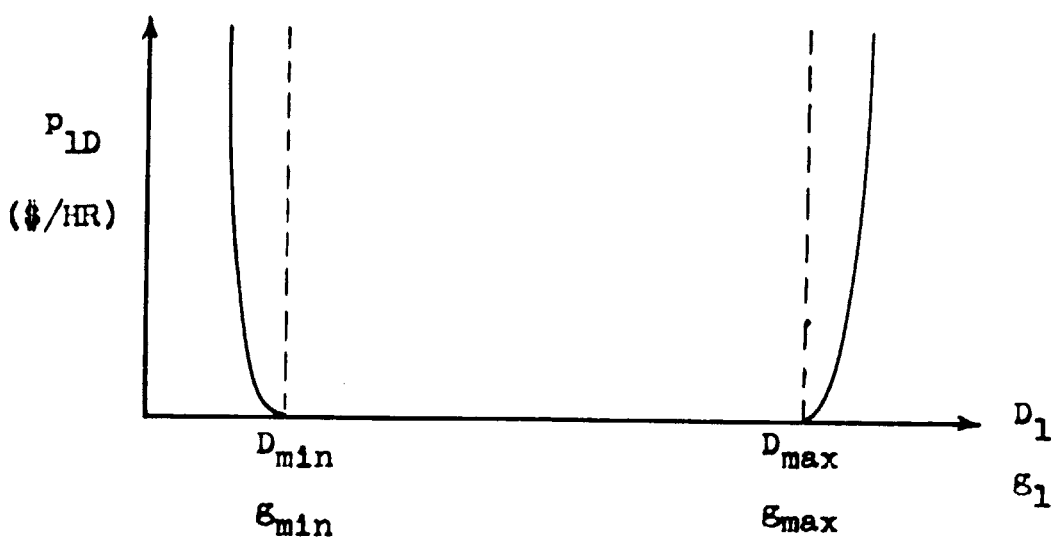
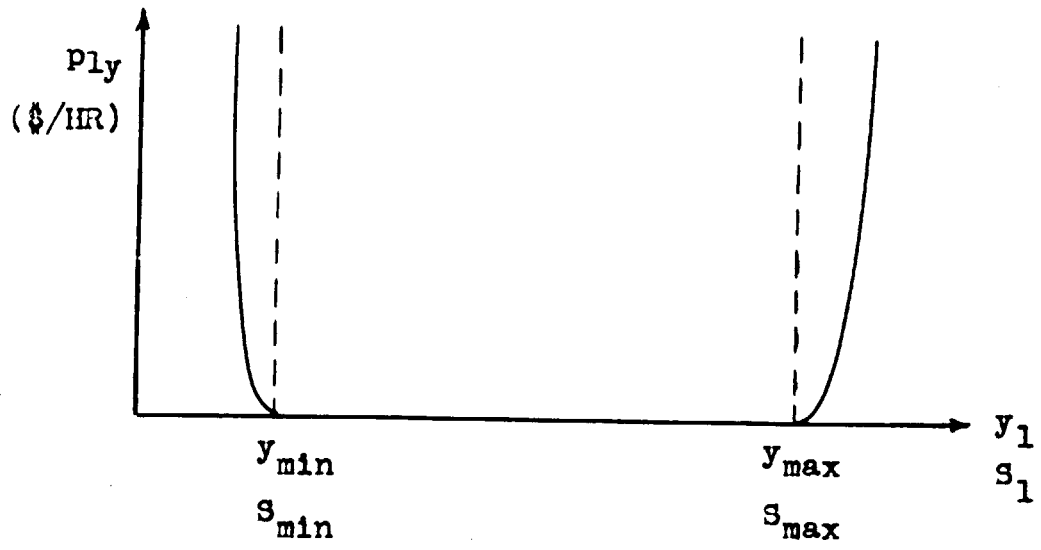
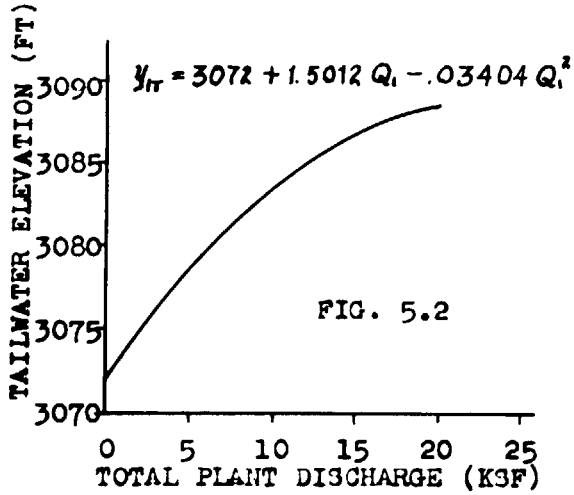
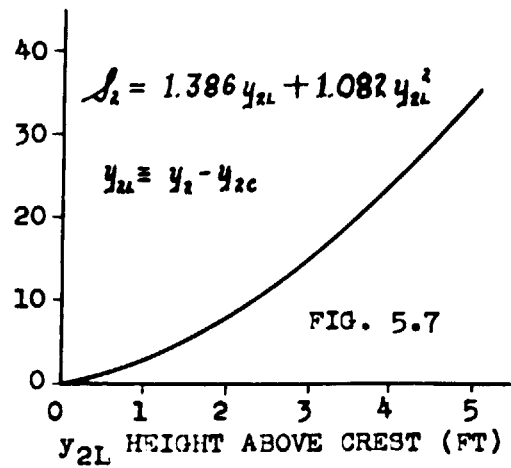
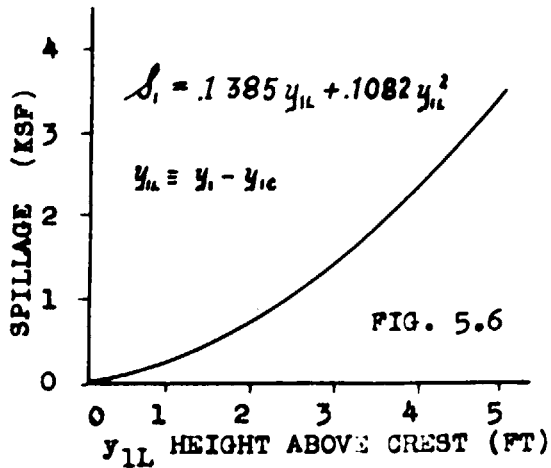
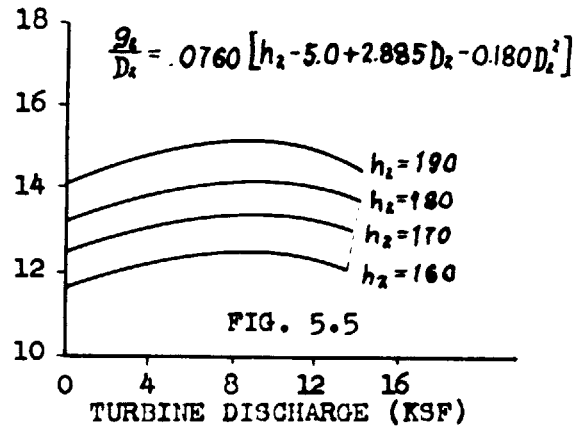
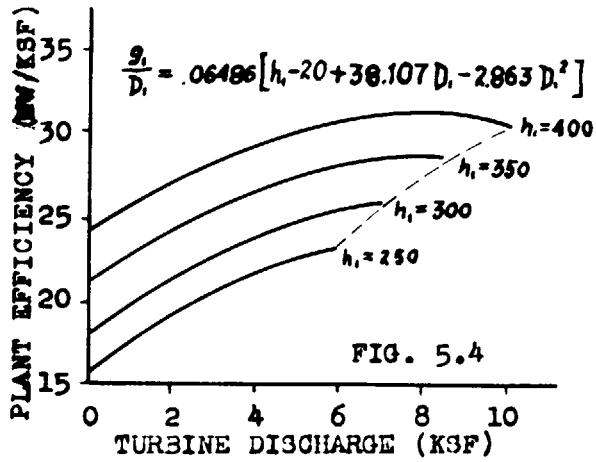
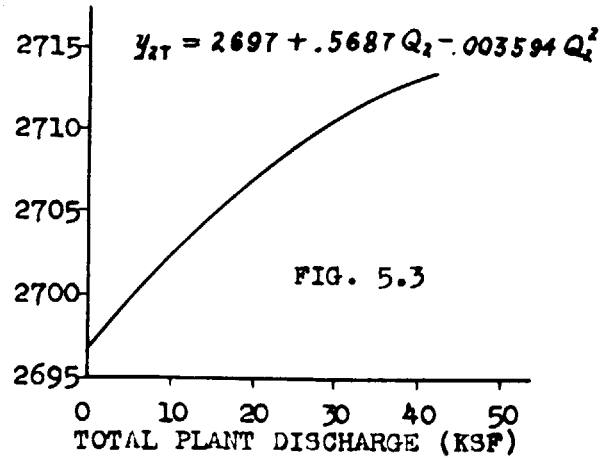

FIGURE 5.1 SKETCHES OF PENALTY COSTS FOR VIOLATION OF PROJECT AND OPERATING LIMITATIONS.

DAM 1



DAM 2



DAM 1

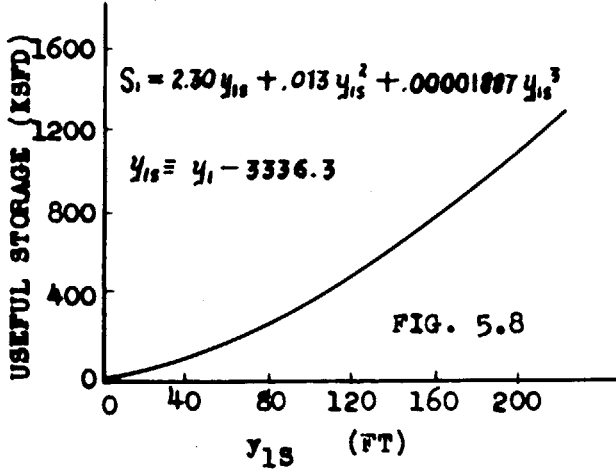

DAM 2

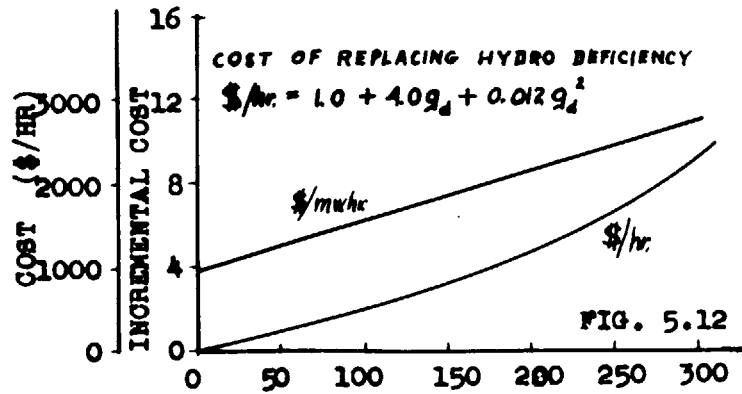
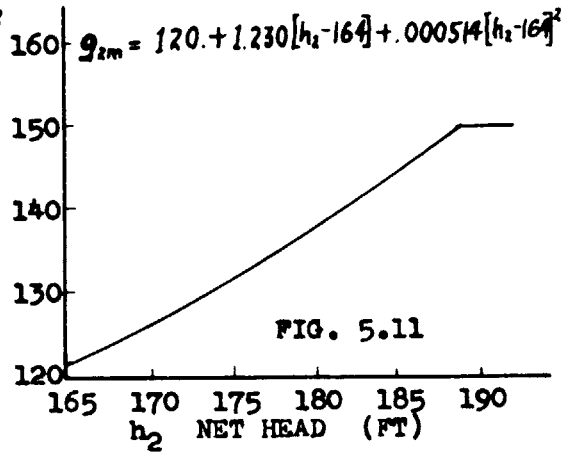
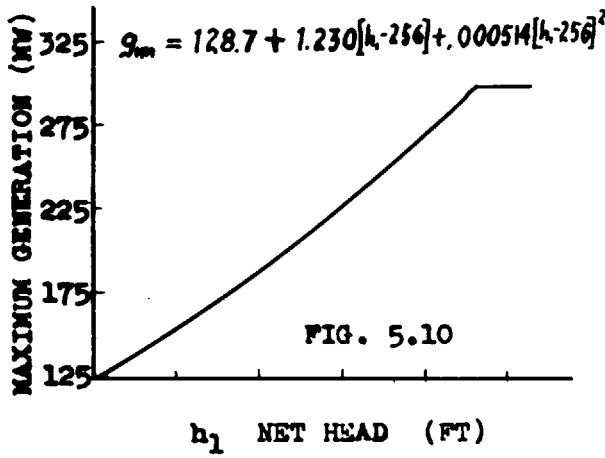
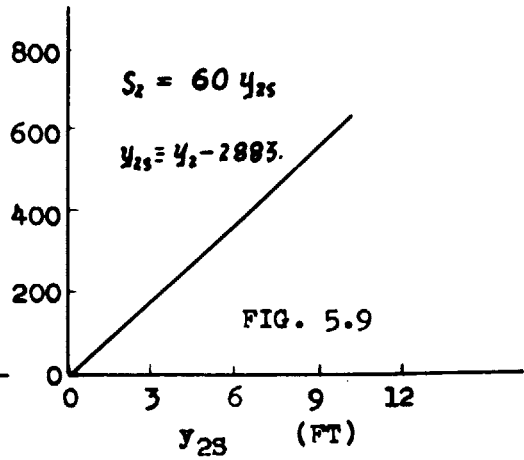



It was explained in section 4.5 that since the long range solution seeks only weekly water allocations to each hydro plant (and the corresponding energy required from thermal sources) it is concerned only with average plant characteristics for that period. Instantaneous hydro plant efficiencies are shown in figures 2.2 and 2.3 as functions of plant output. However, for the long range optimization, an averaged set of curves consistent with operating practice should be used. For a given number of machines on the line in a hydro plant, at a given head, figures 2.2 and 2.3 show there is one discharge which will give highest plant efficiency. Good operating practice is to operate at or near these points. The flatness of these peaks is dependent on the type and number of machines used. Adjustable blade turbines, for example, have relatively flat characteristics. Hoard has pointed out (26) that with many units on the line, operation can always be had at very nearly peak efficiency. With 1065 mw load at Grand Coulee, he illustrates, operation of 10 units above their points of maximum efficiency or operation of 11 units below their points of maximum efficiency requires the loading of each unit only 5 per cent from their most efficient load, with a reduction in plant efficiency of only 0.12 per cent. In any case, it is reasonable to assume that the short range load-dispatching procedure will usually load all plants near points of peak efficiency. Loadings at different hours of the day may be at different peaks, so that an average efficiency between these points may result. Therefore, the average plant efficiency at

a given head is characterized as a function of discharge by a smooth curve, passing through the regions of highest efficiencies in figures 2.2 and 2.3. In order to allow considerable flexibility, which might be needed in plants of widely different characters, these curves are expressed as:

$$\frac{\xi_i(t)}{D_i(t)} = \eta_i \left[ h_i(t) - h_{i0} - m_{ig} D_i(t) - n_{ig} D_i(t)^2 \right] \quad (5-3)$$

Plots of these curves, for cases with somewhat exaggerated variation of efficiency with discharge, are shown in figures 5.4 and 5.5.

The replacement of hydro-deficiency is provided, in the 3 plant problem, from a thermal plant. The cost of such energy has three major components: one which is independent of the load (such as overhead and capitalization), one which is proportional to load, and one which varies as the square of the load (due in part to losses, reduction of efficiencies at higher loadings, and limited capacities of equipment). The cost characteristic used for this problem, figure 5.12, corresponds to that of a relatively large, efficient, thermal station, taken from the plant data given by George Page and Ward (22).

#### 5.4 Establishing the Functional Character of the Cost Index

In what follows, storage and rate of change of storage are treated as the fundamental variables. Alternatively, storage elevation and its rate of change could be used. However, in different plants a foot change in elevation can involve vastly different changes in amounts of water, depending on the

storage basin characteristics. Hence storage is considered more basic. At any rate, the two are related by storage characteristics, figures 5.8 and 5.9, and by the incremental storage in:

$$s(y(t)) \dot{y}(t) = \dot{S}(t) \quad (5-4)$$

The three plant system of figure 4.5 is now used as a pilot system to establish basic relations. The storage at dam F, at a future time  $t$  is:

$$S_1(t) = S_1(t=0) + \int_0^T [F_1(x) - D_1(x) - S_1(x)] dx \quad (5-5)$$

Continuity requires that at each plant the outflow equal the inflow minus the rate of change of storage, i.e.:

$$D_1(t) + S_1(t) = F_1(t) - \dot{S}_1(t) \quad (5-6)$$

The inflow to plant 2 (see fig. 4.5) includes the output from plant 1 at a previous time plus the tributary inflow (or runoff between plants). Hence, as above:

$$S_2(t) = S_2(t=0) + \int_0^T [F_{12}(x) + D_1(x-\tau_{12}) + S_1(x-\tau_{12}) - D_2(x) - S_2(x)] dx \quad (5-7)$$

and also:

$$D_2(t) + S_2(t) = F_{12}(t) + D_1(t-\tau_{12}) + S_1(t-\tau_{12}) - \dot{S}_2(t) \quad (5-8)$$

Then, substituting (5-6) in (5-8):

$$D_2(t) + S_2(t) = F_{12}(t) + F_1(t-\tau_{12}) - \dot{S}_1(t-\tau_{12}) - \dot{S}_2(t) \quad (5-9)$$

Consider  $g_1(t)$ . From figure 5.4, it depends on  $h_1$  and  $D_1$ . By definition, net head is the difference between storage elevation and tailwater elevation. Hence  $g_1(t)$  depends on  $y_1(t)$ ,  $y_{1T}(t)$  and  $D_1(t)$ . From figure 5.2,  $y_{1T}$  is dependent on

$Q_1(t)$ , equal to turbine discharge plus spillage. The latter is, from figure 5.6, dependent on storage elevation alone. Hence we know that  $g_1(t)$  depends only on  $y_1(t)$  and  $D_1(t)$ . From equation 5-6, turbine discharge is dependent on natural inflow, rate of change of storage, and spillage. Again, the latter is dependent only on  $y_1(t)$ . Hence  $g_1(t)$  depends only on  $y_1(t)$ ,  $F_1(t)$  and  $\dot{S}_1(t)$ . These are fundamental quantities. Since  $y_1(t)$  is directly related to  $S_1(t)$  by figure 5.8, we establish the functional character of  $g_1(t)$  as:

$$g_1(t) = g_1 \left( F_1(t), S_1(t), \dot{S}_1(t) \right) \quad (5-10)$$

In like manner, it is easily shown that the functional character of  $g_2(t)$  is:

$$g_2(t) = g_2 \left( F_1(t - \tau_{12}), F_{12}(t), S_1(t - \tau_{12}), S_2(t), \dot{S}_2(t) \right) \quad (5-11)$$

By definition, the hydro deficiency is the difference between system load requirements and the total hydro generation. In this case, therefore:

$$g_d(t) = L(t) - g_1(t) - g_2(t) \quad (5-12)$$

Consequently, using both (5-10) and (5-11), the hydro deficiency is seen to depend on:

$$g_d(t) = g_d \left( L(t), F_1(t), F_1(t - \tau_{12}), F_{12}(t), S_1(t), S_2(t), \dot{S}_1(t), \dot{S}_1(t - \tau_{12}), \dot{S}_2(t) \right) \quad (5-13)$$

Since the penalty costs, sketched in figure 5.1, are likewise functions of turbine discharge and storage elevations, it follows from (5-1) that the effective \$/hr cost has the same functional character as in (5-13).

### 5.5 Setting Up Changes in the Cost Index by the Calculus of Variations

The objective is to determine the curves  $S_1(t)$  and  $S_2(t)$  for the time interval chosen which will minimize the cost index defined in 5.2 as:

$$\$ = \int_0^T \$/hr(t) dt \quad (5-2)$$

No generality is lost in specifying that  $S_1(t)$  and  $S_2(t)$  are continuous and have continuous first and second derivatives. Then, since all system characteristics are at least sectionally continuous,  $\$/hr(t)$  will be sectionally continuous. Hence, the conditions of admission for problems in the calculus of variations are fulfilled (Courant, 12).

In practice, the optimization is to be carried out over a future time interval. Hence, for  $t \leq 0$ , the storages are all fixed, and no variations of the storages are allowed. Also, the end of the time interval must be interpreted in terms of the physics of the problem. If the operation of plant 1 is specified up to time  $T - \tau_{12}$ , the effects of this operation will be felt at plant 2 up till time  $T$ . Plants further downstream would be affected at still later times. To consider the delayed consequences of operation, then, the time interval must be extended for the downstream plants. The upper limit on 5-2 is to be so interpreted. Hence, in modifying a given set of storage curves in order to improve operation, we are constrained so that:

$$\delta S_1(t \leq 0) = \delta S_2(t \leq 0) = 0 \quad (5-14)$$

$$\delta S_2 (t \geq T) = 0 \quad (5-15)$$

$$\delta S_1 (t \geq T - \tau_{12}) = 0 \quad (5-16)$$

The functional character of the integrand of (5-2) has been established in 5.4 as:

$$\begin{aligned} \$/hr (t) = \$/hr (L(t), F_1(t), F_1(t-\tau_{12}), F_{12}(t), S_1(t), S_2(t), \\ \dot{S}_1(t), \dot{S}_1(t-\tau_{12}), \dot{S}_2(t)) \end{aligned} \quad (5-17)$$

In the usual manner of setting up such problems (Courant, 12), let the actual storage curves be set equal to the optimum curves plus an "error function". i.e., let:

$$S_1(t) = S_{1o}(t) + u \phi(t) \quad (5-18)$$

$$S_2(t) = S_{2o}(t) + v \psi(t) \quad (5-19)$$

$S_{10}(t)$  and  $S_{20}(t)$  are the curves sought, which give the minimum value of the cost index.  $\phi(t)$  and  $\psi(t)$  are fixed but undetermined curves which are constrained by equations (5-14, 15, 16) so that

$$\phi(t \leq 0) = \psi(t \leq 0) = 0 \quad (5-20)$$

$$\phi(t \geq T - \tau_{12}) = 0 \quad (5-21)$$

$$\psi(t \geq T) = 0 \quad (5-22)$$

$u$  and  $v$  are variables whose magnitudes determine the differences between the actual and the sought-for curves. It follows that changes of  $u$  and  $v$  can bring each storage curve closer to the optimum curves.

In (5-17), the only terms dependent on  $u$  are  $S_1(t)$ ,  $\dot{S}_1(t)$ , and  $\dot{S}_1(t - \tau_{12})$ . Hence:

$$\begin{aligned} \frac{\partial \$/hr(t)}{\partial u} &= \frac{\partial \$/hr}{\partial S_1(t)} \frac{\partial S_1(t)}{\partial u} + \frac{\partial \$/hr}{\partial \dot{S}_1(t)} \frac{\partial \dot{S}_1(t)}{\partial u} + \frac{\partial \$/hr}{\partial \dot{S}_1(t-\tau_{12})} \frac{\partial \dot{S}_1(t-\tau_{12})}{\partial u} \\ &= \frac{\partial \$/hr}{\partial S_1(t)} \phi(t) + \frac{\partial \$/hr}{\partial \dot{S}_1(t)} \dot{\phi}(t) + \frac{\partial \$/hr}{\partial \dot{S}_1(t-\tau_{12})} \dot{\phi}(t-\tau_{12}) \end{aligned} \quad (5-23)$$

Now:

$$\frac{\partial \mathcal{F}}{\partial u} = \frac{\partial}{\partial u} \int_0^T \mathcal{F}/hr(t) dt = \int_0^T \frac{\partial \mathcal{F}/hr(t)}{\partial u} dt \quad (5-24)$$

Substituting (5-23) in (5-24), the second and third terms are integrated by parts. For the second term:

$$\int_0^T \dot{\phi}(t) \frac{\partial \mathcal{F}/hr}{\partial \dot{S}_1(t)} dt = \phi(t) \frac{\partial \mathcal{F}/hr}{\partial \dot{S}_1(t)} \Big|_0^T - \int_0^T \phi(t) \frac{d}{dt} \frac{\partial \mathcal{F}/hr}{\partial \dot{S}_1(t)} dt \quad (5-25)$$

Similarly, the third term of (5-24) gives, on integration:

$$\int_0^T \dot{\phi}(t-\tau_{12}) \frac{\partial \mathcal{F}/hr(t)}{\partial \dot{S}_1(t-\tau_{12})} dt = \phi(t-\tau_{12}) \frac{\partial \mathcal{F}/hr(t)}{\partial \dot{S}_1(t-\tau_{12})} \Big|_0^T - \int_0^T \phi(t-\tau_{12}) \frac{d}{dt} \frac{\partial \mathcal{F}/hr(t)}{\partial \dot{S}_1(t-\tau_{12})} dt \quad (5-26)$$

Using the constraints of (5-20) and (5-21), it is seen that the integrated parts of (5-25) and (5-26) are zero. The integration of (5-23) thus becomes:

$$\begin{aligned} \frac{\partial \mathcal{F}}{\partial u} &= \int_0^T \phi(t) \left[ \frac{\partial \mathcal{F}/hr(t)}{\partial S_1(t)} - \frac{d}{dt} \frac{\partial \mathcal{F}/hr(t)}{\partial \dot{S}_1(t)} \right] dt \\ &\quad - \int_0^T \phi(t-\tau_{12}) \left[ \frac{d}{dt} \frac{\partial \mathcal{F}/hr(t)}{\partial \dot{S}_1(t-\tau_{12})} \right] dt \end{aligned} \quad (5-27)$$

In like manner, since in (5-17) only  $S_2(t)$  and  $\dot{S}_2(t)$  depend on  $v$  :

$$\frac{\partial \mathcal{F}/hr(t)}{\partial v} = \psi(t) \frac{\partial \mathcal{F}/hr(t)}{\partial S_2(t)} + \dot{\psi}(t) \frac{\partial \mathcal{F}/hr(t)}{\partial \dot{S}_2(t)} \quad (5-28)$$

The second term of (5-28) is likewise integrated by parts.

This using (5-20) and (5-22) to eliminate the integrated part, one gets:

$$\int_0^T \dot{\psi}(t) \frac{\partial \mathcal{F}/hr(t)}{\partial \dot{S}_2(t)} dt = - \int_0^T \psi(t) \frac{d}{dt} \frac{\partial \mathcal{F}/hr(t)}{\partial \dot{S}_2(t)} dt \quad (5-29)$$

Again, 
$$\int_0^T \frac{\partial \$/hr(t)}{\partial v} dt = \frac{\partial \$}{\partial v} \tag{5-30}$$

Therefore, using (5-29) in (5-28) in (5-30)

$$\frac{\partial \$}{\partial v} = \int_0^T \psi(t) \left[ \frac{\partial \$/hr(t)}{\partial S_2(t)} - \frac{d}{dt} \frac{\partial \$/hr(t)}{\partial \dot{S}_2(t)} \right] dt \tag{5-31}$$

The total change in the cost index is:

$$\delta \$ = \frac{\partial \$}{\partial \mu} \delta \mu + \frac{\partial \$}{\partial v} \delta v \tag{5-32}$$

Substituting (5-27) and (5-31) in (5-32) one gets:

$$\begin{aligned} \delta \$ &= \delta \mu \int_0^T \phi(t) \left[ \frac{\partial \$/hr(t)}{\partial S_1(t)} - \frac{d}{dt} \frac{\partial \$/hr(t)}{\partial \dot{S}_1(t)} \right] dt \\ &\quad - \delta \mu \int_0^T \phi(t-\tau_{12}) \left[ \frac{d}{dt} \frac{\partial \$/hr(t)}{\partial \dot{S}_1(t-\tau_{12})} \right] dt \\ &\quad + \delta v \int_0^T \psi(t) \left[ \frac{\partial \$/hr(t)}{\partial S_2(t)} - \frac{d}{dt} \frac{\partial \$/hr(t)}{\partial \dot{S}_2(t)} \right] dt \end{aligned} \tag{5-33}$$

Because  $\delta \mu$  and  $\delta v$  are independent of  $t$ , they can be brought inside the integrals. Furthermore:

$$\begin{aligned} \phi(t) \delta \mu &= \frac{\partial S_1(t)}{\partial \mu} \delta \mu = \delta S_1(t) \\ \phi(t-\tau_{12}) \delta \mu &= \frac{\partial S_1(t-\tau_{12})}{\partial \mu} \delta \mu = \delta S_1(t-\tau_{12}) \\ \psi(t) \delta v &= \frac{\partial S_2(t)}{\partial v} \delta v = \delta S_2(t) \end{aligned} \tag{5-34}$$

Equation (5-33) then gives:

$$\begin{aligned} \delta \$ &= \int_0^T \delta S_1(t) \left[ \frac{\partial \$/hr(t)}{\partial S_1(t)} - \frac{d}{dt} \frac{\partial \$/hr(t)}{\partial \dot{S}_1(t)} \right] dt \\ &\quad - \int_0^T \delta S_1(t-\tau_{12}) \left[ \frac{d}{dt} \frac{\partial \$/hr(t)}{\partial \dot{S}_1(t-\tau_{12})} \right] dt \\ &\quad + \int_0^T \delta S_2(t) \left[ \frac{\partial \$/hr(t)}{\partial S_2(t)} - \frac{d}{dt} \frac{\partial \$/hr(t)}{\partial \dot{S}_2(t)} \right] dt \end{aligned} \tag{5-35}$$

In order to combine the first two integrals in (5-35), with

$\delta S_1(t)$  as a common factor, the integrand of the second integral must be shifted in time an amount  $\tau_{12}$  days. The limits



of integration must be changed accordingly. Thus:

$$\begin{aligned}
 & - \int_0^T \delta S_1(t - \tau_{12}) \left[ \frac{d}{dt} \frac{\partial \$/hr(t)}{\partial \dot{S}_1(t - \tau_{12})} \right] dt \\
 & = - \int_{0 - \tau_{12}}^{T - \tau_{12}} \delta S_1(t) \left[ \frac{d}{dt} \frac{\partial \$/hr(t + \tau_{12})}{\partial \dot{S}_1(t)} \right] dt \quad (5-36)
 \end{aligned}$$

As the problem has been set up, however, time  $t < 0$  is past time for which  $\delta S_1(t)$  is constrained to be zero. Hence the lower limit of integration in (5-36) may be set at zero. Also, using (5-15), the upper limit of integration in the first integral of (5-35) may be set at  $T - \tau_{12}$ . Equation (5-35) is then rewritten as:

$$\begin{aligned}
 \delta \$ & = \int_0^{T - \tau_{12}} \delta S_1(t) \left[ \frac{\partial \$/hr(t)}{\partial S_1(t)} - \frac{d}{dt} \frac{\partial \$/hr(t)}{\partial \dot{S}_1(t)} - \frac{d}{dt} \frac{\partial \$/hr(t + \tau_{12})}{\partial \dot{S}_1(t)} \right] dt \\
 & + \int_0^T \delta S_2(t) \left[ \frac{\partial \$/hr(t)}{\partial S_2(t)} - \frac{d}{dt} \frac{\partial \$/hr(t)}{\partial \dot{S}_2(t)} \right] dt \quad (5-37)
 \end{aligned}$$

This equation relates the storage corrections, made throughout the interval considered, to their net effect on the system cost index.

## 5.6 Role of the Gradient

As described in 4.8, the determining equations may be used in either of two ways. They may be used to express the necessary and sufficient conditions for a solution to exist. That is, in terms of the surface of 4.7, they may express the conditions for a stationary point\* on this surface. These conditions are that all components of the surface gradient be zero. Alternatively, the determining equation may be used to

\*A stationary point is a maximum, minimum, or saddle point.

determine a path to be followed towards a solution, or towards a minimum in the surface of 4.7. When the path of steepest descent is to be followed, the determining equations should give the components of the gradient of the surface at the operating point. Thus, for either procedure, we need expressions for the gradient of the surface.

We seek to optimize operation over a future time interval. Hence we seek time functions of storage throughout this interval. These continuous curves contain a finite amount of information, depending on the highest frequency components in these curves. Hence, for these relatively smooth curves, knowledge of the storages at a finite number of points (to within a reasonable tolerance) adequately characterizes them. These ordinates of the storage curves are, then, the variable parameters in the optimization. The components of the surface gradient are then nothing more than the changes in system cost index per unit change of each of these ordinates.

### 5.7 Proof of the Determining Equations

From equation (5-37) the components of the gradient and hence the determining equations can be derived. This was indicated by Courant (13) who observed the correspondence, in calculus of variations problems, between the gradient of a surface and the Euler expression, typified by the bracket in the second integral of (5-37). Two derivations of the determining equations from (5-37) are given in this treatise. Because of their length and the reasonableness of the results, these

proofs are relegated to the appendices. The first, presented in Appendix B, involves a geometrical interpretation in multi-dimensional space using the analogy to a surface gradient. The second, presented in Appendix C, does not involve the assumption of a finite number of storage ordinates, or the gradient concept, and relies on bounding the changes in cost index using Schwartz's inequality.

Both proofs involve the identification of the gradient with these changes in the storage curves (throughout the time interval considered) which produce the maximum reduction in the cost index per unit of "integrated storage change squared". In the more general proof of Appendix C, the latter is defined as:

$$\delta R^2 = \sum_{i=1}^n \int_0^T [\delta S_i(t)]^2 dt \quad (5-38)$$

In the geometrical interpretation involving a finite number of ordinates, presented in Appendix B, the corresponding "summed storage-change-squared" is used:

$$|\delta R|^2 = \sum_{i=1}^n \sum_{k=1}^L [\delta S_{ik}(t_k)]^2 \quad \begin{array}{l} L \text{ ordinates/plant} \\ n \text{ plants} \end{array} \quad (5-39)$$

Here  $|\delta R|$  is the size of step taken in a performance surface<sup>1</sup> having the storage ordinates as orthogonal coordinates. Thus the maximizing of the ratio: reduction of  $\$/|\delta R|$  is synonymous with taking the path of steepest descent and proceeding opposite

<sup>1</sup>section 4.7

to the direction of the surface gradient. The final results are as follows:

- a) In order to obtain the largest reduction in the cost index per unit of integrated storage-change-squared, i.e., to move along the path of steepest descent, storage changes throughout the time interval considered should be made according to the following formulas:

$$\delta S_1(t) = -\alpha \left\{ \frac{\partial \$/hr(t)}{\partial S_1(t)} - \frac{d}{dt} \frac{\partial \$/hr(t)}{\partial \dot{S}_1(t)} - \frac{d}{dt} \frac{\partial \$/hr(t+\tau_2)}{\partial \dot{S}_1(t)} \right\} \quad (5-40)$$

$$\delta S_2(t) = -\alpha \left\{ \frac{\partial \$/hr(t)}{\partial S_2(t)} - \frac{d}{dt} \frac{\partial \$/hr(t)}{\partial \dot{S}_2(t)} \right\} \quad (5-41)$$

where  $\alpha$  is a positive constant determining the size of step taken.

- b) The necessary and sufficient conditions for a solution to be stationary is that the above equations be equal to zero throughout the time interval considered.

These expressions are further discussed and developed in the following chapter.

Chapter VI  
GENERALIZATION AND FURTHER EVOLUTION  
OF DETERMINING EQUATIONS

6.1 The Determining Equations for Larger Systems

The results of chapter V can be generalized to apply to an arbitrarily large system. The basic objective is kept the same, that of reducing the cost of hydro-deficiency replacement. It is presumed that a given hydro deficiency could be divided up among the non-hydro sources so as to minimize its cost. If thermal plants supply the deficiency, the incremental loading procedures outlined in chapter II could be used. There exists, then, in general, a curve of minimum cost of hydro replacement as a function of mw hydro deficiency, as in chapter V.

There remains to be considered the effects of additional hydro plants on the same and different streams. These additions add nothing fundamentally new to the problem, and their effects can be ascertained from the interpretation of components in equations (5-40) and (5-41). Naturally, changing the discharge of an upstream plant affects operation of the downstream plants. This is reflected in the equation for storage change, (5-40), whose major bracket has, from eq. (5-37), the dimensions of \$/hr/ksfd. The influence of  $\mathcal{S}_i(t)$  on operating costs at time (t), due to affected output of

plant 1, is given by the first two terms of the bracket in (5-40):

$$\frac{\delta \$/\text{hr}(t)}{\delta S_1(t)} = \frac{\partial \$/\text{hr}(t)}{\partial S_1(t)} - \frac{d}{dt} \frac{\partial \$/\text{hr}(t)}{\partial \dot{S}_1(t)} \quad (6-1)$$

The influence of  $\delta S_1(t)$  on operating costs at a later time,  $(t + \tau_{12})$ , due to affected output at the downstream plant is given by the third term of this bracket:

$$\frac{\delta \$/\text{hr}(t + \tau_{12})}{\delta S_1(t)} = - \frac{d}{dt} \frac{\partial \$/\text{hr}(t + \tau_{12})}{\partial \dot{S}_1(t)} \quad (6-2)$$

Additional downstream plants would logically cause additional changes in operating costs at still later times, so that additional terms of the type in (6-2) would be added to equation (5-40). In the three plant problems, the evaluation of (6-2) depends on the presence of the tributary between plants 1 and 2, but this presence does not affect the form of (6-2). Similarly, the terms added to (5-40) to account for additional downstream plants have the form of (6-2) regardless of the presence of other joining streams. Regardless of whether the streams of a system are arranged in parallel or series-parallel, each plant finds itself in the position just described where changes in its output affect operation at a series of "downstream" plants. (Plants downstream from plant i are simply those through which water from plant i passes). A change in the operation of any plant must rest on an evaluation of the effects of such change on all downstream plants. Hence, the general expression for the correct change at each plant i is obtained by direct extension of (5-40) as:

$$\delta S_i(t) = -\alpha \left\{ \frac{\partial \$/hr(t)}{\partial S_i(t)} - \sum_{b=1}^i \frac{d}{dt} \frac{\partial \$/hr(t+\tau_{ib})}{\partial S_i(t)} \right\} \quad (6-3)$$

$i = 1, 2, \dots, n$  hydro plants.\*

Here the summation must be interpreted to include the  $i$ th plant and all plants downstream from it. It is understood that the addition of other downstream plants involves delayed consequences of upstream plant operation, so that the time interval under consideration must be extended for downstream plants, as discussed in 5.5. An expanded form of (6-3) is developed in the following.

## 6.2 Analytic Expressions for the Partial Derivatives

It is advisable, to reduce truncation and round off errors, to use analytic expressions instead of taking differences to evaluate the partial derivatives in (6-3). These are now derived.

a) "Basic Relations". The following expressions are used to fit the characteristic curves presented in section 5.3.

Tailwater Elevation:

$$y_{iT} = y_{iT}(Q_i=0) + m_{iT}[D_i + S_i] + n_{iT}[D_i + S_i]^2 \quad (6-4)$$

Spillage:

$$S_i = m_{iL} S_i + n_{iL} S_i^2 \quad (6-5)$$

Generation:

$$g_i = \eta_i \left[ y_i - y_{iT} - h_{i0} - m_{ig} D_i - n_{ig} D_i^2 \right] D_i \quad (6-6)$$

Storage Elevation:

$$y_i = y_{i0} + m_{iy} S_i + n_{iy} S_i^2 + o_{iy} S_i^3 \quad (6-7)$$

\* In the generalized equations, plant 1 is the furthest downstream.

The logical extension of the continuity equation (5-6) is given by:

$$D_i(t) + S_i(t) = \sum_{u=i}^n F_{u,u+1}(t-\tau_{ui}) - \sum_{u=i}^n \dot{S}_u(t-\tau_{ui}) \quad (6-8)$$

Where the summation includes plant i and all upstream plants, defined as those plants whose discharge passes through plant i. It follows that for a plant downstream from plant i:

$$D_b(t+\tau_{ib}) = \sum_{u=b}^n F_{u,u+1}(t+\tau_{ib}-\tau_{ub}) - \sum_{u=b}^n \dot{S}_u(t+\tau_{ib}-\tau_{ub}) - S_b(t+\tau_{ib}) \quad (6-9)$$

These show the fundamental dependence of turbine discharge on the basic variables  $S_i(t)$  and  $\dot{S}_i(t)$  to be:

$$\frac{\partial D_i(t)}{\partial S_i(t)} = - \frac{d S_i(t)}{d S_i(t)} \equiv - S_i'(t) \quad (6-10)$$

$$\frac{\partial D_b(t+\tau_{ib})}{\partial S_i(t)} = 0 \quad b \neq i \quad (6-11)$$

$$\frac{\partial D_b(t+\tau_{ib})}{\partial \dot{S}_i(t)} = -1 \quad (6-12)$$

b) "Effects of Storage Changes on Plant Generations." Combining equations (6-4) and (6-6), one gets:

$$g_i(t) \equiv \left[ \frac{g_i}{D_i} \right] D_i(t) = \eta_i \left\{ y_i(t) - m_{i\tau} [D_i + S_i(t)] - n_{i\tau} [D_i(t) + S_i(t)]^2 - h_{i0} - y_{i\tau}(0) - m_{i\theta} D_i(t) - n_{i\theta} D_i(t)^2 \right\} D_i(t) \quad (6-13)$$

The dependence of  $g_i(t)$  on the basic variables  $S_i(t)$  and  $\dot{S}_i(t)$  can now be found. Let x represent either of these



variables. Then:

$$\frac{\partial g_i(t)}{\partial x} = A_i(D_i(t), S_i(t)) \frac{\partial D_i(t)}{\partial x} + \eta_i D_i(t) \frac{\partial y_i(t)}{\partial x} - B_i(D_i(t), S_i(t)) \frac{\partial S_i(t)}{\partial x} \quad (6-14)$$

where:

$$A_i(D_i(t), S_i(t)) \equiv \left[ \frac{g_i}{D_i} \right] (t) - \eta_i \left\{ [m_{i,g} + m_{i,\tau}] D_i(t) + 2 \eta_{i,g} D_i(t)^2 + 2 \eta_{i,\tau} D_i(t) [D_i(t) + S_i(t)] \right\} \quad (6-15)$$

$$B_i(t) \equiv \eta_i D_i(t) \left\{ m_{i,\tau} + 2 \eta_{i,\tau} [D_i(t) + S_i(t)] \right\} \quad (6-16)$$

$\frac{g_i}{D_i}(t)$  is defined by equation (6-13)

Since  $S_b(t + \tau_{ib})$  is independent of  $S_i(t)$  and  $\dot{S}_i(t)$ :

$$\frac{\partial y_b(t + \tau_{ib})}{\partial x_i(t)} = \frac{\partial S_b(t + \tau_{ib})}{\partial x_i(t)} = 0 \quad (6-17)$$

Therefore, one gets from (6-14) and (6-17) the following dependence of future generation on present changes in  $S_i(t)$  or  $\dot{S}_i(t)$ :

$$\frac{\partial g_b(t + \tau_{ib})}{\partial x_i(t)} = A_b(D_b(t + \tau_{ib}), S_b(t + \tau_{ib})) \frac{\partial D_b(t + \tau_{ib})}{\partial x_i(t)} \quad (6-18)$$

The expressions presented in 6.2a are now made use of.

Letting  $X_i(t) = S_i(t)$  and substituting (6-10) in (6-14)

$$\frac{\partial g_i(t)}{\partial S_i(t)} = \eta_i \frac{d y_i(t)}{d S_i(t)} - C_i(D_i(t), S_i(t)) S_i'(t) \quad (6-19)$$

where:

$$\begin{aligned} C_i(t) &\equiv A_i(t) + B_i(t) \\ &= \left[ \frac{g_i}{D_i} \right] (t) - \eta_i \left\{ m_{ig} D_i(t) + 2 n_{ig} D_i(t)^2 \right\} \end{aligned} \quad (6-20)$$

Using (6-11) and (6-18):

$$\frac{\partial g_b(t+\tau_{ib})}{\partial S_i(t)} = 0 \quad b \neq i \quad (6-21)$$

Using (6-12) and (6-18):

$$\frac{\partial g_b(t+\tau_{ib})}{\partial \dot{S}_i(t)} = - A_b(D_b(t+\tau_{ib}), S_b(t+\tau_{ib})) \quad (6-22)$$

Thus equations (6-19), (6-21), and (6-22) determine the effects of storage change on plant generations.

### 6.3 Final Form of Determining Equations

The hourly effective cost of the enlarged system is defined similar to (5-1) as:

$$\$/hr(t) = \$/hr(g_d(t)) + \sum_{i=1}^n P_{is}(S_i(t)) + \sum_{i=1}^n P_{id}(D_i(t)) \quad (6-23)$$

where the summations are over all hydro plants. Also, by definition of hydro deficiency:

$$g_d(t) = L(t) - \sum_{i=1}^n g_i(t) \quad (6-24)$$

From (6-24) and the physics of the problem, it is known that

$$\frac{\partial g_b(t+\tau_{ib})}{\partial S_i(t)} = 0 \quad i \neq b \quad (6-24a)$$

and

$$\frac{\partial g_d(t+\tau_{ib})}{\partial \dot{S}_i(t)} = - \frac{\partial g_b(t+\tau_{ib})}{\partial \dot{S}_i(t)}$$

Neglecting the penalty cost terms in (6-23) for the moment, and using (6-24a), equation (6-3) becomes:

$$\delta S_i(t) = +\alpha \left\{ \gamma(g_d(t)) \frac{\partial g_i(t)}{\partial S_i(t)} - \sum_{b=1}^i \frac{d}{dt} \gamma(g_d(t+\tau_{ib})) \frac{\partial g_b(t+\tau_{ib})}{\partial S_i(t)} \right\} \quad (6-25)$$

where

$$\gamma(g_d(t)) \equiv \frac{d \$/hr(g_d)}{d g_d} \quad (6-26)$$

$\equiv$  the incremental replacement cost.

Using (6-19) and (6-22) in (6-25), one gets:

$$\delta S_i(t) = \alpha \left\{ \gamma(g_d(t)) \left[ \eta_i \frac{d y_i(t)}{d S_i(t)} D_i(t) - C_i(t) S_i'(t) \right] + \frac{d}{dt} \sum_{b=1}^i \gamma(g_d(t+\tau_{ib})) A_b(t+\tau_{ib}) \right\} \quad (6-27)$$

Next, the penalty cost terms of (6-23) must be included in (6-3). The additional terms are:

$$- \alpha \left\{ \frac{d P_{is}(t)}{d S_i(t)} + \frac{d P_{id}(t)}{d D_i(t)} \frac{\partial D_i(t)}{\partial S_i(t)} - \frac{d}{dt} \sum_{b=1}^i \frac{d P_{bd}(t+\tau_{ib})}{d D_b(t+\tau_{ib})} \frac{\partial D_b(t+\tau_{ib})}{\partial S_i(t)} \right\} \quad (6-28)$$

Using (6-10) and (6-12), this becomes:

$$- \alpha \left\{ P_{is}'(t) - P_{id}'(t) S_i'(t) + \frac{d}{dt} \sum_{b=1}^i P_{bd}'(t+\tau_{ib}) \right\} \quad (6-29)$$

Adding (6-29) to (6-27), the complete expression is, finally:

$$\delta S_i(t) = \alpha \left\{ \gamma(g_d(t)) \left[ \eta_i \frac{d y_i(t)}{d S_i(t)} D_i(t) - C_i(t) S_i'(t) \right] - P_{is}'(t) + P_{id}'(t) S_i'(t) + \frac{d}{dt} \sum_{b=1}^i \gamma(g_d(t+\tau_{ib})) A_b(t+\tau_{ib}) - P_{bd}'(t+\tau_{ib}) \right\} \quad (6-30)$$

$i = 1, 2, \dots, n$  hydro plants

The indicated summation includes the  $i$ th plant and all downstream plants. One such equation exists for each hydro plant in the system. This completes the derivation of the generalized "determining equations", which determine the most economical operation of the system as described in section 5.6.

Equation (6-30) is the final form for the general expression determining the storage changes to be made in order to lower costs, following the path of steepest descent. Again, a necessary condition for best economy is that (6-30) be equal to zero throughout the time interval considered.

#### 6.4 Transmission Loss in the Long Range Solution

The determining equations thus developed do not take into account the effect of transmission loss on long range water allocation. This effect is present because some freedom exists in selecting the time when the water resources of a given plant should be used. It follows that this timing should be adjusted to reduce transmission loss if this does not materially increase the hydro deficiency at any time. If, for example, a hydro plant delivers its energy via a heavily loaded grid, the "transportation loss" of its own energy would be less if it were delivered during a week having lower average system load.

Transmission loss can be added to the formulation developed above. The additional complexity is appreciable, however, and the necessity for this addition is still in doubt.<sup>1</sup> Formulae

<sup>1</sup>A study of the relative changes in operating costs due to inclusion of transmission loss factors and changes in predicted stream flow has been undertaken by P. Johannesson in a companion M.S. thesis.

for the transmission loss in terms of weekly average generations have been developed (Weiner and Whitbeck, 67) but require further evaluation.<sup>1</sup> While this phase of the development is very incomplete, a formulation including transmission loss will be presented in order to indicate the order of magnitude of additional complexity incurred.

Again, it is necessary to attempt simplifications of the formulation consistent with system operation. In the following, attention is focused on the load allocation among hydro plants, and an assumption is made that all sources for replacement of hydro deficiency can be characterized by a single cost characteristic<sup>2</sup> and loss coefficients for a single equivalent source. (The latter assumption will introduce errors depending on the distribution and size of non-hydro sources, but should be allowable for systems with relatively little steam). Adding transmission loss, equation (6-24) becomes:

$$g_d(t) = L(t) + p_L(t) - \sum_{k=1}^n g_k(t) \quad (6-31)$$

and

$$\frac{\partial g_d}{\partial x} = \frac{\partial p_L}{\partial x} - \sum_{k=1}^n \frac{\partial g_k}{\partial x} \quad (6-32)$$

The loss formula developed by Weiner and Whitbeck (67) from eq. (2-1) is:

<sup>1</sup>A study of the accuracy of loss formulas has been undertaken by Mr. E. Greve in a companion M.S. thesis.

<sup>2</sup>section 6.1

$$P_L(t) = \sum_{\ell=1}^{n+1} \sum_{m=1}^{n+1} g_{\ell}(t) B_{\ell m} g_m(t) + \frac{L(t)K(t)}{A} \quad (6-33)$$

where  $K(t)$  is a nearly constant factor taking into account the deviation of hourly loads from the weekly average. The  $A$  and  $B$ 's are constants depending on the transmission system. Separating out the terms pertaining to non-hydro sources:

$$P_L = \sum_{\ell=1}^n \sum_{m=1}^n g_{\ell} B_{\ell m} g_m + \sum_{\ell=1}^n 2 B_{\ell d} g_{\ell} g_d + B_{dd} g_d^2 + \frac{L(t)K(t)}{A} \quad (6-34)$$

Using (6-34) in (6-31), one gets:

$$g_d \left[ 1 - \sum_{\ell=1}^n 2 B_{\ell d} g_{\ell} - B_{dd} g_d \right] = L(t) \left[ 1 + \frac{K(t)}{A} \right] + \sum_{\ell=1}^n \sum_{m=1}^n g_{\ell} B_{\ell m} g_m - \sum_{k=1}^n g_k \quad (6-35)$$

This equation must be solved to determine  $g_d(t)$ . It is evidently more involved than (6-24) where transmission losses are omitted. It can be handled, however, and simplifies considerably when

$$B_{dd} g_d \ll \sum_{\ell=1}^n 2 B_{\ell d} g_{\ell} \quad (6-36)$$

The expanded form of (6-32) is next obtained. From (6-33):

$$\frac{\partial P_L}{\partial g_k} = \sum_{\ell=1}^{n+1} 2 B_{k\ell} g_{\ell} \quad (6-37)$$

Hence:

$$\begin{aligned} \frac{\partial P_L}{\partial X} &= \sum_{k=1}^{n+1} \frac{\partial P_L}{\partial g_k} \frac{\partial g_k}{\partial X} = \sum_{k=1}^{n+1} \left[ \sum_{\ell=1}^{n+1} 2 B_{k\ell} g_{\ell} \right] \frac{\partial g_k}{\partial X} \\ &= \sum_{k=1}^n \left[ \sum_{\ell=1}^{n+1} 2 B_{k\ell} g_{\ell} \right] \frac{\partial g_k}{\partial X} + \left[ \sum_{\ell=1}^{n+1} 2 B_{d\ell} g_{\ell} \right] \frac{\partial g_d}{\partial X} \end{aligned} \quad (6-38)$$

Using this in (6-32) one gets:

$$\frac{\partial g_d}{\partial X} \left[ 1 - \sum_{\ell=1}^{n+1} 2B_{d\ell} g_\ell \right] = - \sum_{k=1}^n \left[ 1 - \sum_{\ell=1}^{n+1} 2B_{k\ell} g_\ell \right] \frac{\partial g_k}{\partial X} \quad (6-39)$$

In general, then:

$$\frac{\partial g_d(t+\tau_{ib})}{\partial X} = - \sum_{k=1}^n \left[ \frac{1 - \sum_{\ell=1}^{n+1} 2B_{k\ell} g_\ell(t+\tau_{ib})}{1 - \sum_{\ell=1}^{n+1} 2B_{d\ell} g_\ell(t+\tau_{ib})} \right] \frac{\partial g_k(t+\tau_{ib})}{\partial X} \quad (6-40)$$

From the physics of the problem, it is known that:

$$\frac{\partial g_k(t+\tau_{ib})}{\partial S_i(t)} = 0 \quad \begin{matrix} k \neq i \\ b \neq i \end{matrix} \quad (6-41)$$

$$\frac{\partial g_k(t+\tau_{ib})}{\partial S_i(t)} = 0 \quad k \neq b$$

Therefore, using (6-41) and (6-40), and neglecting penalty functions, the two terms of the basic determining equation (6-3), are:

$$\frac{\partial \$/hr(g_d(t))}{\partial S_i(t)} = - \gamma(g_d(t)) \left[ \frac{1 - \sum_{\ell=1}^{n+1} 2B_{d\ell} g_\ell(t)}{1 - \sum_{\ell=1}^{n+1} 2B_{d\ell} g_\ell(t)} \right] \frac{\partial g_i(t)}{\partial S_i(t)} \quad (6-42)$$

and:

$$\frac{d}{dt} \sum_{b=1}^i \frac{\partial \$/hr(g_d(t+\tau_{ib}))}{\partial S_i(t)} = \frac{d}{dt} \sum_{b=1}^i \gamma(g_d(t+\tau_{ib})) \left[ \frac{1 - \sum_{\ell=1}^{n+1} 2B_{d\ell} g_\ell(t+\tau_{ib})}{1 - \sum_{\ell=1}^{n+1} 2B_{d\ell} g_\ell(t+\tau_{ib})} \right] \frac{\partial g_b(t+\tau_{ib})}{\partial S_i(t)} \quad (6-43)$$

These are the same as those appearing in (6-25) except that

each  $\gamma$  is multiplied by a correction factor. It follows, therefore, that equations (6-30) are also the determining equations for the case involving transmission loss, if the incremental cost,  $\gamma$ , is replaced by:

$$\gamma'(g_d(t+\tau_{ib})) \equiv \gamma(g_d(t+\tau_{ib})) \left[ \frac{1 - \sum_{\lambda=1}^{n+1} 2B_{b,\lambda} g_{\lambda}(t+\tau_{ib})}{1 - \sum_{\lambda=1}^{n+1} 2B_{d,\lambda} g_{\lambda}(t+\tau_{ib})} \right] \quad (6-44)$$

This correction plus the fact that  $g_d$  must be evaluated using the more complex form (6-35), makes (6-30) applicable to a more general class of problems including transmission loss, but under the assumption that a single effective source of hydro-deficiency replacement can be formulated.



## Chapter VII

### SOLVING THE DETERMINING EQUATIONS

#### 7.1 Introduction

The problem remaining is to solve a set of ordinary differential equations, the determining equations in (6-30), subject to boundary conditions at the beginning and end of the time interval to be optimized. The number of variables and the complexity of the functions involved make the mechanization of the solution imperative.

#### 7.2 Digital vs. Analog Computers

Both digital and analog computers are capable of solving this type of problem.<sup>1</sup> Digital computers have the advantages of a) higher accuracy obtainable by increasing the number of digits carried in the computations, b) versatility, in that a general purpose machine capable of performing other management and operational functions can be used, and c) size stability, for a single arithmetic element is used for all operations, and does not increase in size with growth of the system. As the system grows, some increase in digital storage capacity would be desirable in order to speed up the solution. However, the analog computer must add components corresponding to each system addition, thus increasing in size and multiplying cumulative errors. A further disadvantage of the analog type is

<sup>1</sup> Information on the use of the differential analyzer for solving the three plant problem will be included in the Master's Thesis by P. Johanneson.

the inability to satisfy future boundary conditions for each plant except by successive trials. This is countered, of course, by the argument that the digital solution is inherently iterative. However, in the digital solution proposed, each iteration gives a useful solution that satisfies boundary conditions, and is an improvement, economically, over former steps. This type of solution lends itself particularly to cases where modified solutions are periodically called for corresponding to changes in system resources or loads. For these reasons, emphasis has been placed on the use of digital procedures for solving the determining equations.

### 7.3 Philosophy of Approach

Equation 6-30 in effect is an evaluation of the gradient of the performance surface<sup>1</sup>, telling in what direction the operating point should be moved or what changes should be made in storage elevations throughout the interval being optimized. The computer must evaluate this expression to modify operating curves and to improve economy by the path of steepest descent.

The operator is to submit to the computer a set of drawdown curves representing a first approximation to good operating practice, together with stream flow and load predictions. The computer is then to automatically successively modify these proposed curves, giving with each modification an improved operation with reduced effective cost, while maintaining the initial boundary conditions. The movement of the operating

<sup>1</sup>Section 4.7

point by the path of steepest descent involves the coordination of all storage changes at all plants throughout the time interval being optimized, so as to obtain the maximum possible reduction of the cost index for each increment of "integrated-storage-change-squared" given by:

$$\sum_{i=1}^n \int_0^T \delta S_i(t)^2 dt$$

However, since the curves operated on are relatively smooth, changes are made at a finite number of samples, say weekly samples, of the storage curves of each plant.

Also certain approximations are used to evaluate (6-30) and finite rather than infinitesimal steps will be taken on the performance surface. Hence the path of steepest descent will not be followed perfectly. The essential feature is that each modification to system operation gives a more economic operation, while satisfying boundary conditions and avoiding or reducing the violation of operating limitations.

#### 7.4 Whirlwind I Computer

The gradient method of solution involves repeating a fixed sequence of calculations on successive sets of variables, namely stream flows, system load, and storage elevations at selected time intervals. This requires 1) a high speed computer which can execute each sequence of calculations in a relatively short time and 2) efficient data handling equipment which will rapidly and conveniently supply the computer with the successive sets of variables to be operated on.

The Whirlwind I digital computer has been made available for the economy loading study, and hence the demonstration of the gradient method is described in WWI terminology. However, any high speed digital computer is capable of performing this optimization with more or less speed and convenience, depending on its particular features. WWI computes at unusually high speeds, performing an average of ten thousand operations such as addition, subtraction, multiplication and division in one second. However, it is at present somewhat deficient in data handling or input-output devices. Hence the time spent by WWI in carrying out the sequences of calculations is negligible in comparison with the time spent in feeding data into the computer and obtaining printed results. Equally fast results could be obtained on a slower computer with faster in-out equipment. Before the delayed print out by magnetic tape was made available, each step of the iteration required about 15 minutes of WWI time to execute. Additional time was required to transfer the results from punched paper tape to typewritten sheets. With the magnetic tape output, each iteration will consume less than five minutes of computer time. Again, most of this time is needed for data handling.

A photograph of the control panel of WWI is shown in figure 7.9. Here the progress of the program is indicated and the location of component or program failures are presented. A photograph of the magnetic tape data handling equipment is shown in figure 7.14.

## 7.5 Computer Control Cycles

Obtaining a solution on the WWI digital computer is divided in three parts:

1) All the data that is to be used in the solution must be put in a form that is readily accessible to the computer. In this case, one must record on magnetic tape the values of the stream flows, system load, and original storage elevation curves, for each of fifty four weeks.

2) Every step of the data handling and computational procedures must be coded on paper tape and these instructions must be delivered to the electrostatic storage of the computer. The computer then carries through the entire solution automatically and prints the desired results in final or intermediate form. Final form in the hydro problem is now typewritten results. However, present internal storage limitations require that an intermediate form, either punched paper tape or magnetic tape, be used.

3) Results on an intermediate medium must be converted and transferred to final form.

### a) Magnetic Tape Layout

At the top of figure 7.2 is shown a sketch of the magnetic tape with fifty-four blocks of data laid out, one for each week of the year being optimized, plus end weeks. Each such block contains twenty numbers, of which some are system resources and load for that week and some are the results of intermediate computations for that week. Initially only the former are recorded, with space left for the latter. The

former include:  $F_1(t)$ ,  $F_1(t+\tau_2)$ ,  $F_2(t)$ ,  $F_2(t+\tau_2)$ ,  $L(t)$ ,  $L(t+\tau_2)$ ,  $y_1(t)$  and  $y_2(t)$ . When read by the computer, these are first transferred to electrostatic storage registers designated 8bl through 22bl in Appendix F.18.<sup>1</sup> When a block is re-recorded by the computer during the optimization, the contents of registers bl through 38bl are transferred to tape, thus laying out the results of intermediate computations as well as the original data. Each block is preceded by a block marker which enables the computer to locate each new block. Searching or skipping is achieved by counting block markers. Each block occupies approximately five inches of magnetic tape.

b) Main Flow Chart

A flow chart of the routine followed by the computer in carrying out the solution shown in figure 7.1. The order-by-order cycle-control program which executes this is given in Appendix F.2. As shown, two passes of the magnetic tape, over the fifty-four blocks of information, are needed to obtain one step of the iteration process, or one "run".<sup>2</sup> The number of such runs to be performed by the computer is preselected, and the "run counter" in figure 7.1 keeps the computer on the job until the called for number of runs is completed. The "pass counter" keeps track of whether the magnetic tape is being passed for the first or second time in each run. The ordinate counter counts the weeks that are processed during each pass.

<sup>1</sup>Each number on the tape occupies two 16 binary digit registers in electrostatic storage.

<sup>2</sup>In the following the terms iteration, step, and run are used interchangeably.

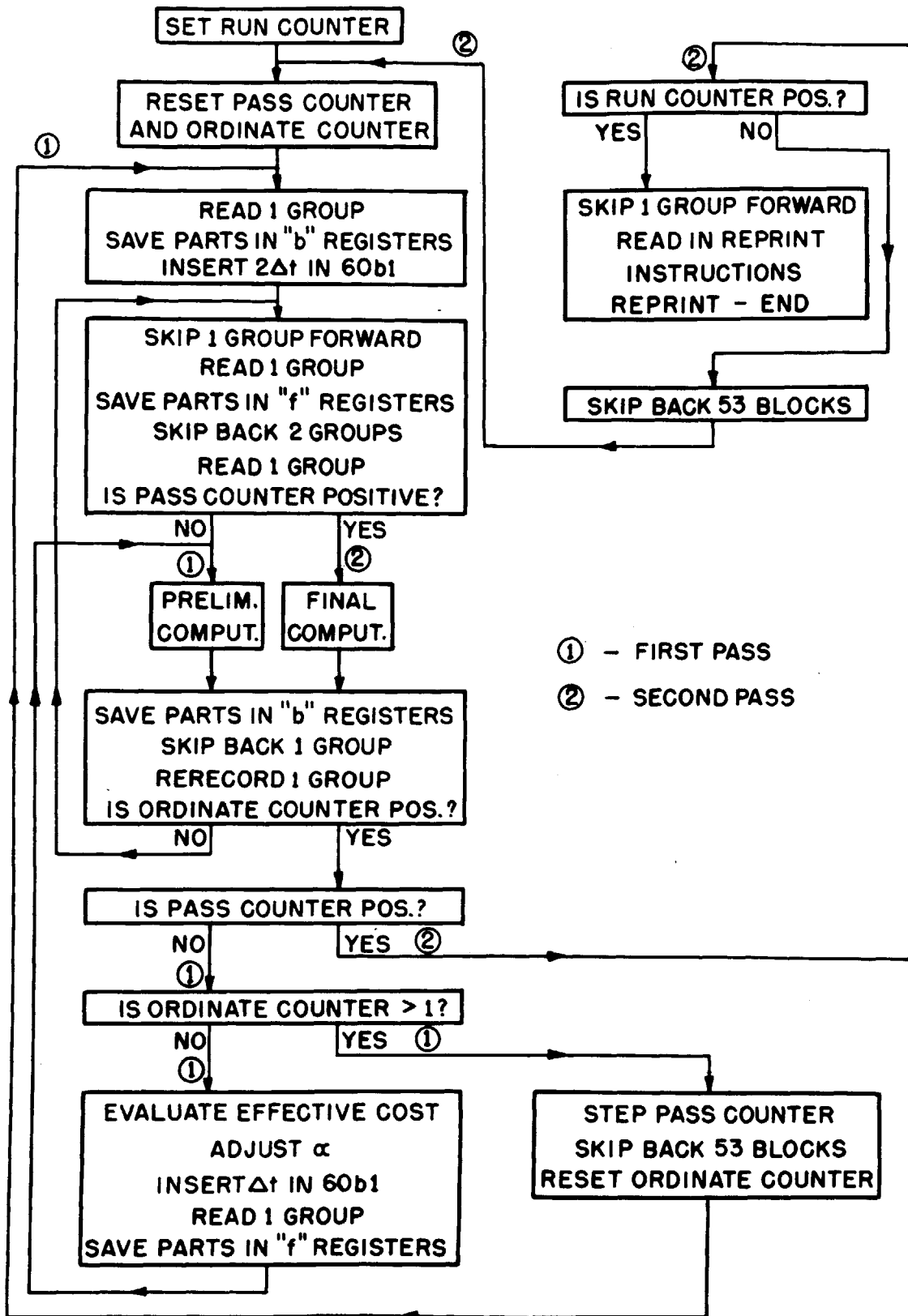
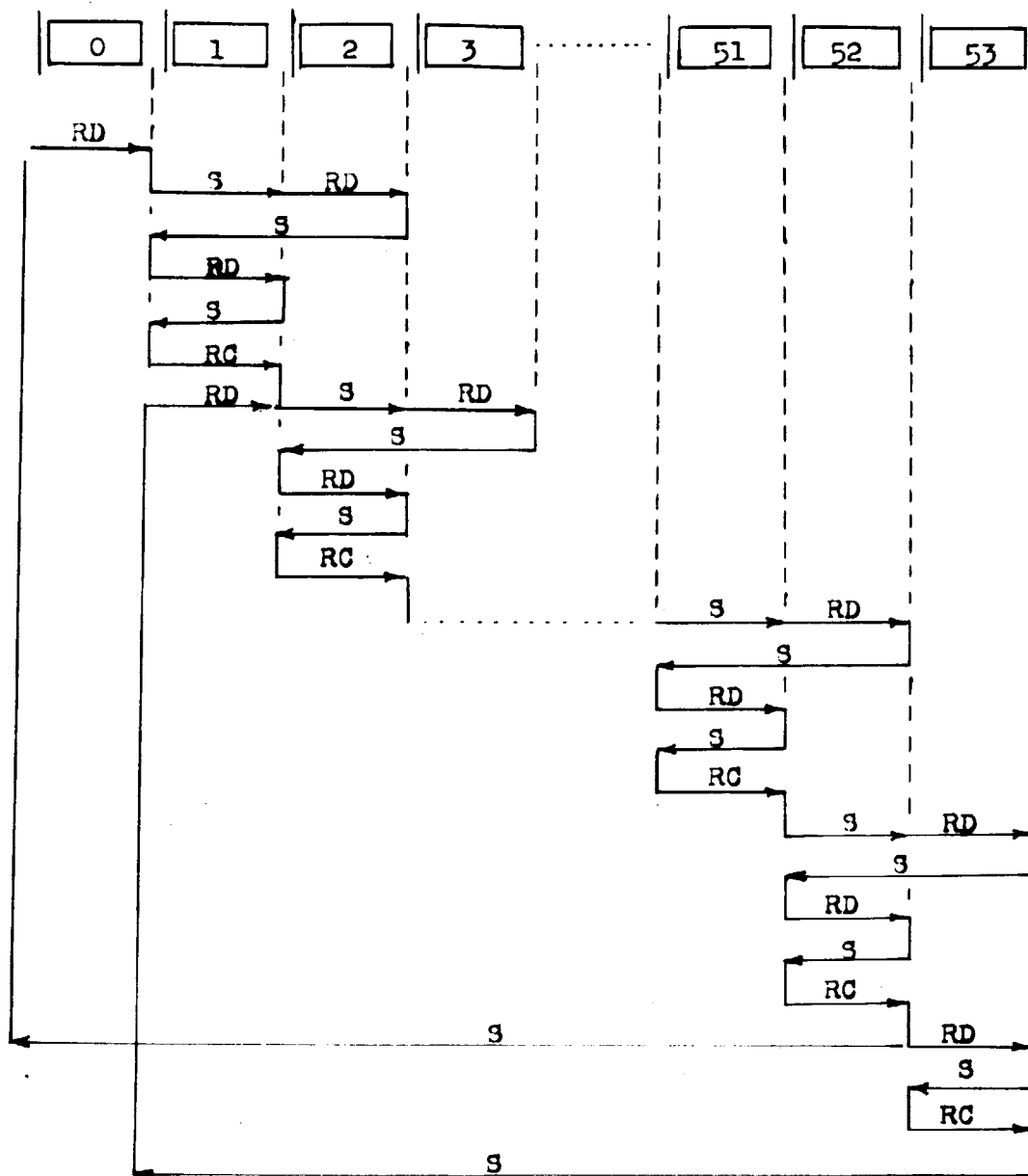



FIGURE 7.1 FLOW DIAGRAM OF COMPUTING PROCEDURE



 BLOCK MARKER AND A BLOCK OF TWENTY  
 NUMBERS RECORDED ON MAGNETIC TAPE

RD READ ONE BLOCK OF DATA FROM MAGNETIC TAPE AND  
 TRANSFER TO ELECTROSTATIC STORAGE

S SKIP OVER RECORDED DATA

RC RECORD ONE BLOCK OF DATA ON MAGNETIC TAPE

FIGURE 7.2 DATA HANDLING ROUTINE USING MAGNETIC TAPE



c) Data Handling Routine

Although different computations are made and different quantities are re-recorded on the magnetic tape during the two passes, the same cycle of tape operations occurs in both passes, as indicated in figure 7.2. The starting and end points of the two passes are also different, the second pass omitting the end ordinates. The tape cycle of figure 7.2 serves to a) bring to the computer data needed for the computation of corrections at one week, say week n, and b) re-record the data of block n including either intermediate results or modified storage elevations, depending on whether a first or second pass is being executed.

Data needed for computations at block n include some stored at adjacent blocks, n+1 and n-1, which are used to obtain derivatives with respect to time. Data so used on the first pass are the storage elevations; and data so used on the second pass are computed values of the partials:

$$\frac{\partial \dot{S}_i / \text{hr} (t + T_{ib})}{\partial \dot{S}_i (t)}$$

The routine followed by the computer in calling for and temporarily storing magnetic tape data, as outlined in figures 7.1 and 7.2, proceeds as follows:

1) If at the beginning of a pass, read in the first block of that pass (block 0 for first pass; block 1 for second pass) and save portions of this block (needed for time derivatives) in electrostatic storage designated as "b" registers. If not

at the beginning of a pass, after computing for block  $n-1$ , save the corresponding portions of block  $n-1$  in  $b$  registers. This stores certain data concerning the week prior to the one where corrections are next to be made.

2) If not at the 53rd block: a) skip forward over the next block,  $n$ , and read forward the one following,  $n+1$ . Save the corresponding time-derivative portions of this block in the "f" registers. b) skip backwards over two blocks,  $n+1$  and  $n$ ; and read forward block  $n$ . Thus complete data for block  $n$  and time-derivative data from blocks  $n+1$  and  $n-1$  are then available in electrostatic storage.

If at the 53rd block: read forward block  $n$  and transfer time-derivative portions to "f" register. Thus complete data for block  $n$  and certain data from blocks  $n$  and  $n-1$  for time derivatives are available in electrostatic storage.

3) After computations are made, skip back over block  $n$  and re-record forward block  $n$ , containing both the original stream flow and system load data for week  $n$  and also either the intermediate results of pass one or the storage elevation corrections of pass two.

The above-described data handling cycle is repeated for each week in the interval being optimized. Operations progress from week to week as indicated in figure 7.2, in effect "leveling-off the economic peaks" at each week in proportion to its magnitude. This recycling, indicated by the inner loop in figure 7.1, is achieved by a) adding one, after each week has

been processed, to a counter which initially has been set to minus fifty-one, b) recycling so long as this counter remains negative or zero.

d) Examination of Cost Index

After weeks one through fifty-two have been processed on the first pass, making the ordinate counter +1, the cost index is examined approximately by summing up the dollars per hour average costs for weeks one through fifty-two. (This corresponds to a rectangle approximation for each weeks' area under the dollars per hour curve, so that the summation of weekly dollars per hour times 168 hours per week gives an approximation to the annual cost index.

e) Adjustment of Size of Step

At this time, the change in cost index achieved by the last iteration is also examined. If the change is negative, and is greater in magnitude than a preset amount, say \$5000, the factor  $\alpha$  is left unchanged. If the change in cost index is negative, but is less in magnitude than, say \$5000, the factor  $\alpha$  and hence the "size of step" is doubled. If the change in cost index is positive, indicating an overshoot of the performance surface minimum, the factor  $\alpha$  is halved.

f) Recycling

Following this procedure, the preliminary computations of the first pass are then completed for the 53rd block, as

indicated by the central return loop in figure 7.1. After this is done, the ordinate counter is again stepped (add one) making it +2. As shown in figure 7.1, the path is then clear to step the pass counter, making it +1, reset the ordinate counter to -50, and recycle via the outer loop to begin the second pass.

The second pass inner-cycle in figure 7.1 is like the first, except that the positive pass counter "opens the channel" for the final computations instead of the preliminary computations and, if the run counter is still negative, recycles to begin another first pass after fifty-one ordinates have been processed.

#### 7.6 Computer Programs Used in the Demonstration of the Gradient Method

The determining equations used to demonstrate the gradient method were the forerunners of equations (6-3), expressed in terms of elevations rather than storages.<sup>1</sup> These are:

$$\delta y_i(t) = \frac{-\alpha}{s_i(y_i(t))^2} \sum_b \frac{\partial \$/hr(t+T_{i,b})}{\partial y_i(t)} - \frac{d}{dt} \frac{\partial \$/hr(t+T_{i,b})}{\partial \dot{y}_i(t)} \quad (7-1)$$

where the summation must include the *i*th plant and all its downstream plants. With two hydro plants, dam 2 downstream from dam 1, one has therefore:

<sup>1</sup>Cypser, R. J. Engineering Memorandum No. 1, D.I.C. 7042, MIT, October, 1952.

$$\delta y_1(t) = \frac{-\alpha}{s_1(y_1(t))^2} \left\{ \frac{\partial \$/\text{hr}(t)}{\partial y_1(t)} + \frac{\partial \$/\text{hr}(t+\tau_{12})}{\partial y_1(t)} - \frac{d}{dt} \frac{\partial \$/\text{hr}(t)}{\partial \dot{y}_1(t)} - \frac{d}{dt} \frac{\partial \$/\text{hr}(t+\tau_{12})}{\partial \dot{y}_1(t)} \right\} \quad (7-2)$$

$$\delta y_2(t) = \frac{-\alpha}{s_2(y_2(t))^2} \left\{ \frac{\partial \$/\text{hr}(t)}{\partial y_2(t)} - \frac{d}{dt} \frac{\partial \$/\text{hr}(t)}{\partial \dot{y}_2(t)} \right\} \quad (7-3)$$

a) Procedure

The procedure used was to compute the dollars per hour cost for the given operation and also with small changes in each elevation and rate of change of elevation. That is, operating costs were computed at each weekly ordinate for the following conditions:

TABLE 7-I

|    |                       |                                   |                       |                                   |
|----|-----------------------|-----------------------------------|-----------------------|-----------------------------------|
| 1. | $y_1(t)$              | $\dot{y}_1(t)$                    | $y_2(t)$              | $\dot{y}_2(t)$                    |
| 2. | $y_1(t) + \Delta y_1$ | $\dot{y}_1(t)$                    | $y_2(t)$              | $\dot{y}_2(t)$                    |
| 3. | $y_1(t)$              | $\dot{y}_1(t) + \Delta \dot{y}_1$ | $y_2(t)$              | $\dot{y}_2(t)$                    |
| 4. | $y_1(t)$              | $\dot{y}_1(t)$                    | $y_2(t) + \Delta y_2$ | $\dot{y}_2(t)$                    |
| 5. | $y_1(t)$              | $\dot{y}_1(t)$                    | $y_2(t)$              | $\dot{y}_2(t) + \Delta \dot{y}_2$ |

The differences in operating costs thus obtained were used to approximate the derivatives in (7-2) and (7-3).<sup>1</sup>

<sup>1</sup>Because of truncation and round-off errors, this method of evaluating the partial derivatives is inferior to that described in 6.2 and 6.3 leading to equation 6-30.

A list of the computations used to evaluate (7-2) and (7-3) at each ordinate is given in Appendix E in the following groups:

- a) Slopes of the drawdown curves
- b) Total plant discharge
- c) Net head
- d) Turbine discharge
- e) Hydro generation
- f) Hydro deficiency
- g) Effective hourly cost
- h) Components of (7-2) and (7-3)
- i) Storage elevation corrections

At each ordinate, each of the quantities (a) through (g) is computed for each of the conditions in table 7-I. Used in these computations are expressions for  $y_{i,r}(Q_i)$ ,  $\frac{G_i}{D_i}(y_i, D_i)$ ,  $S_i(y_{iL})$ ,  $G_{i,max}$ , and  $\$/hr (g_d)$ , shown in figures 5.2, 5.3, 5.4, 5.5, 5.6, 5.7, 5.10, 5.11, and 5.12. Also used were incremental storage curves given by the slopes of the storage curves shown in figures 5.8 and 5.9. The implementation of the computations listed in Appendix E was carried out using the computer programs listed order by order in Appendix F.

#### b) Subroutines

Groups of orders that are used repeatedly are catalogued in Appendices F.3 through F.16. The principal groups are subroutines p and k, the preliminary computations and final computations, used in the first and second passes, respectively,

as shown in figure 7.1. These in turn call upon the other subroutines listed, some being called upon repeatedly for different arguments, as described above. In the following, only a brief description of each subroutine is presented, with complete information relegated to the appendices.

(F.3) Subroutine f compiles effective hourly cost from the relation:

$$\$/hr = \$/hr(\mathcal{E}_d=0) + m_{\$/\mathcal{E}_d} \mathcal{E}_d + n_{\$/\mathcal{E}_d^2} \mathcal{E}_d^2 + \sum_n p_{1n} + \sum_n p_{2n}$$

(F.4) Subroutine g is used to limit the size of elevation corrections when penalty functions or spillage occur. The necessity for this limiter has not been definitely established, but it was included as a safety device to damp out possible overshoots and oscillations. These may be caused by larger corrections at certain weeks where operating-limitations are violated or spillage occurs, coinciding with an abrupt steepness in the performance surface in certain directions. The limiter characteristic used is sketched in figure 7.3.

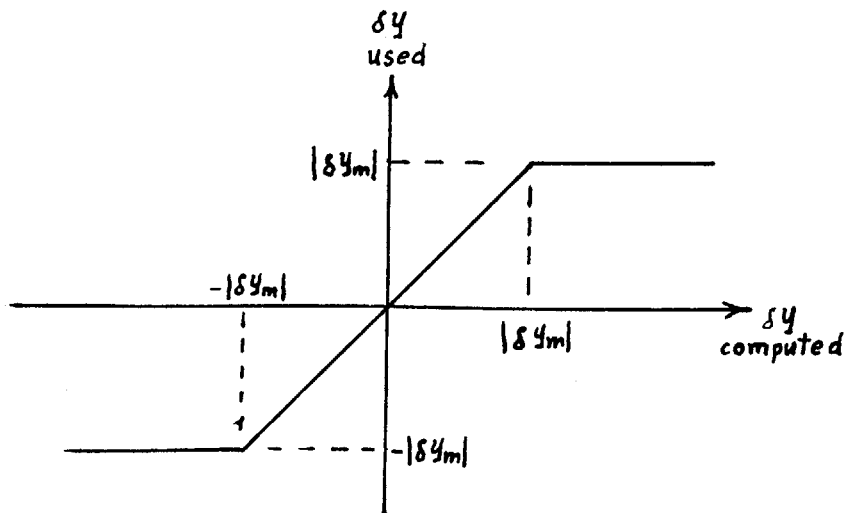

FIGURE 7.3 CHARACTERISTIC OF ELEVATION CHANGE LIMITER

The limit  $|\delta y_m|$  is of course adjustable, and such limiting was not used unless penalty costs or spillage existed, at the week being corrected, after one of the last two iterations. This was kept track of in counters occupying registers bl through 6bl as shown in F. 18 and subroutines m and n in F.7 and F.8.

(F.5) Subroutine h computes incremental storages by the relations:

$$s_1 = s_{10} + m_{15} y_{15} + n_{15} y_{15}^2$$

$$s_2 = s_{20} + m_{25} y_{25}$$

(F.6) Subroutine k contains final computations for second pass, involving evaluation of:

$$\frac{d}{dt} \frac{\partial \$/hr(t)}{\partial \dot{y}_1(t)} ; \quad \frac{d}{dt} \frac{\partial \$/hr(t+T_{12})}{\partial \dot{y}_1(t)} ; \quad \frac{d}{dt} \frac{\partial \$/hr(t)}{\partial \dot{y}_2(t)} ;$$

$$\delta y_1(t) = \frac{-\alpha}{s_1(y_1(t))^2} E_1(t) ; \quad \delta y_2(t) = \frac{-\alpha}{s_2(y_2(t))^2} E_2(t)$$

(F.7, F.8) Subroutines m and n evaluate

$$g_i = \eta_i \left[ y_i - y_{i,T} - m_{ig} D_i - n_{ig} D_i^2 \right] D_i$$

and sum penalty costs.

(F.9) Subroutine p contains preliminary computations for first pass, involving evaluation of:

$$\frac{\partial \$/hr(t)}{\partial y_1(t)} \qquad \frac{\partial \$/hr(t+T_{12})}{\partial y_1(t)} \qquad \frac{\partial \$/hr(t)}{\partial \dot{y}_1(t)}$$



$$\frac{\partial \$/hr (t + \tau_{12})}{\partial \dot{y}_1 (t)} \quad \frac{\partial \$/hr (t)}{\partial y_2 (t)} \quad \frac{\partial \$/hr (t)}{\partial \dot{y}_2 (t)}$$

- (F.10) Subroutine d directs the computer to read the next block of magnetic tape data into electrostatic storage registers bl through 38bl.
- (F.11) Subroutine s directs the computer to move the magnetic tape backwards over N block markers, when the number N has been previously placed in the accumulator (computer arithmetic element).
- (F.12) Subroutine w directs the computer to delay further operations for a preselected time (3-20 milliseconds) to allow the magnetic tape to come to a complete stop.
- (F.13) Subroutine t transfers data needed for time derivatives from registers 20bl through 29bl to either the "f" registers, 40bl through 49bl, or to the "b" registers, 50bl through 59bl, depending on whether 40bl or 50bl has been previously inserted in t3.
- (F.14) Subroutine r serves to print on magnetic tape intermediate and final results which later can be transferred to final form as typewritten results. The routine records one nine decimal digit number, with sign and exponent, at a time, taking this information from the "multiple register accumulator" registers 1050, 1051 and 1052. Hence each result appears on

magnetic tape as three "numbers" preceded by two block markers to facilitate later transfer.

- (F.15) Subroutine z evaluates the storage elevation penalty cost by the expression

$$P_y = m_y y_x^2$$

where  $y_x$  is zero unless a violation occurs and is equal to the amount of violation otherwise. i.e.,

$$y_x = \begin{cases} y - y_{max} \\ y_{min} - y \end{cases} \geq 0$$

The slope of the penalty cost, fixed by the coefficient  $m_y$ , is made different for costs applied to the two dams by previously inserting either  $m_{1y}$  or  $m_{2y}$  in 50bl.

- (F.16) Subroutine u evaluates the penalty costs for exceeding either a computed maximum allowable generation or a minimum generation taken as zero. The maximum allowable generation, as a function of net head or machine ratings, whichever is lower, is precomputed in subroutine m or n. The penalty cost is then given by

$$P_g = m_g g_x^2$$

where  $g_x$  is zero unless a violation occurs. i.e.,

$$g_x = \begin{cases} g - g_{max} \\ 0 - g \end{cases} \geq 0$$

It is noted that an equivalent penalty cost as a function of turbine discharge would be preferable in this case, to facilitate use of lower limits on discharge for navigation and fish life.

#### 7.7 Use of the Gradient Method on the Three Plant System

The procedures described in 7.5 and 7.6 were applied to the three plant system shown schematically in figure 4.5, using the computations listed in Appendix E, the characteristics shown in figures 5.2 through 5.12, and the system parameters in Appendix F.1. Operation during one complete year, starting with the last week in July, was considered, using the stream flows and system load shown in figure 7.12.

The computer was provided with a proposed set of draw-down curves, sampled each week, shown in figure 7.13. By the programs discussed above, the computer was directed to evaluate the effective cost of the proposed operation, and to make small modifications in both storage elevation curves throughout the year in order to reduce the effective operating cost, coordinating all such changes so as to move the "operating point" to one of lower cost by the path of steepest descent. Because the proposed elevation curves would, if used, involve the violation of project limitations during the spillage season, the reduction of effective cost had to include the reduction of the cost of replacement energy and the reduction of limitation-violation penalty costs.

The successive reductions of effective operating cost, in

each of five such small steps of the gradient method, are tabulated in table 7-I. Operating costs for both the first forty weeks, during which no penalty-costs occurred, and the full fifty-two weeks are tabulated. The reductions of replacement energy costs in the first forty weeks, and the reduction of limitation-violations penalty costs, which predominate in the latter twelve weeks, are substantial at each step. Due to these five modifications, the reduction in fuel costs for the first forty weeks is \$167,988. or 1.45% of the original fuel cost for this period. The yearly reduction in effective cost, consisting mostly of reduction of limitation violation penalty costs in the latter period, is \$1,085,397 or 8.36% of the initial effective cost. This higher percentage is indicative of the fact that modifications are made throughout the year in proportion to the savings that a given change will net, so that limitation violations and peaks in the fuel costs will be more quickly reduced.

Each successive step tabulated in table 7-I gives a substantial saving without indicating the approach of a point of diminishing returns or a minimum in the performance surface. Further information on the nature of the surface being traversed can be obtained by examining the surface gradients tabulated in table 7-II. The gradient method has been set up to make storage changes at each ordinate in proportion to the value of the component of the surface gradient

TABLE 7-I

SUCCESSIVE REDUCTIONS OF EFFECTIVE COST  
IN EACH OF FIVE STEPS OF THE GRADIENT METHOD

|                      | First 40 Weeks | Saving                | 52 Weeks      | Saving                   |
|----------------------|----------------|-----------------------|---------------|--------------------------|
| Original Cost        | \$11,522,512.  |                       | \$12,971,719. |                          |
|                      |                | \$33,649.             |               | \$172,981.               |
| First Modified Cost  | \$11,488,863.  |                       | \$12,798,738. |                          |
|                      |                | \$35,901.             |               | \$396,556.               |
| Second Modified Cost | \$11,452,962.  |                       | \$12,402,182. |                          |
|                      |                | \$34,354.             |               | \$ 88,280.               |
| Third Modified Cost  | \$11,418,608.  |                       | \$12,313,902. |                          |
|                      |                | \$32,376.             |               | \$202,761.               |
| Fourth Modified Cost | \$11,386,232.  |                       | \$12,111,141. |                          |
|                      |                | \$31,708.             |               | \$224,819.               |
| Fifth Modified Cost  | \$11,354,524.  |                       | \$11,886,322. |                          |
| Total Cost Reduction |                | \$167,988<br>or 1.45% |               | \$1,085,397.<br>or 8.36% |

TABLE 7-II

$$\sum \delta S^2$$

GIVING RELATIVE MAGNITUDES OF THE SURFACE GRADIENTS  
IN VARIOUS DIRECTIONS

| Step      | $\sum_{k=2}^{30} \delta S_k^2$ | $\sum_{k=31}^{37} \delta S_k^2$ | $\sum_{k=38}^{52} \delta S_k^2$ | $\sum_{k=2}^{52} \delta S_k^2$ |
|-----------|--------------------------------|---------------------------------|---------------------------------|--------------------------------|
| Dam 1     |                                |                                 |                                 |                                |
| 1         | 1.5766                         | 0.6881                          | 394.56                          | 396.73                         |
| 2         | 1.0439                         | 0.8430                          | 275.80                          | 277.69                         |
| 3         | 0.8494                         | 0.9179                          | 188.06                          | 189.83                         |
| 4         | 0.5969                         | 1.0165                          | 154.26                          | 155.87                         |
| 5         | 0.5398                         | 1.1116                          | 338.02                          | 342.09                         |
| 6         | 0.5020                         | 1.2319                          | 393.25                          | 394.98                         |
| Dam 2     |                                |                                 |                                 |                                |
| 1         | 5.791                          | 1.408                           | 1572.5                          | 1579.7                         |
| 2         | 5.381                          | 1.828                           | 1123.8                          | 1131.0                         |
| 3         | 4.838                          | 1.652                           | 1064.5                          | 1070.1                         |
| 4         | 4.692                          | 2.262                           | 1266.3                          | 1273.2                         |
| 5         | 4.855                          | 2.551                           | 1398.1                          | 1405.5                         |
| 6         | 4.740                          | 2.776                           | 1672.8                          | 1680.3                         |
| Both Dams |                                |                                 |                                 |                                |
| 1         | 7.368                          | 2.096                           | 1967.1                          | 1976.4                         |
| 2         | 6.424                          | 2.671                           | 1399.6                          | 1408.7                         |
| 3         | 5.687                          | 2.570                           | 1252.6                          | 1259.9                         |
| 4         | 5.289                          | 3.279                           | 1420.6                          | 1429.1                         |
| 5         | 5.395                          | 3.663                           | 1786.1                          | 1747.6                         |
| 6         | 5.242                          | 4.008                           | 2066.1                          | 2075.3                         |

along the corresponding axis of the space having weekly storage as coordinates. Therefore the computed values of storage change will be used as a measure of the components of the surface gradient. Since the space is orthogonal, when motion is considered having components only along certain axis,  $i = 1, 2, \dots, n$ , the surface gradient in this restricted direction is given by

$$|\nabla \Phi| = K \sum_{k=1}^n \delta S_k^2$$

Accordingly, at each step described above, a measure is given in table 7-II of the surface gradients in several directions, corresponding to motion along the axis of the first twenty-nine weeks, the next seven weeks, the following fifteen weeks, and the entire year, for the ordinates of dam 1 alone, dam 2 alone, and both dams. It is seen from table 7-II that with each step the surface gets flatter in the directions of the first twenty-nine ordinates, indicating diminishing returns from further such changes. However, while the surface levels in the first four steps in the direction of the last fifteen ordinates, it becomes steeper again in the following two steps, indicating increased savings to be made by further corrections at these weeks. Also, in the intermediate seven week period toward the end of the drawdown season, the slope quite steadily increases, promising further savings.

### 7.8 Nature of the Modifications

In the following, data is presented which indicates how the optimization works, in affecting weekly costs and storage

elevations. The method involves a gradual reshaping of the cost curve for the entire year, making the larger modifications in storage where changes are most beneficial to cost reduction. The result is that the method inherently attacks peaks in the cost curve, cutting down the tops and eating into the sides. The numerical methods used to evaluate derivatives are imperfect, particularly when rapid fluctuations are present, so that with rapid fluctuations in the cost curve one observes a levelling of the peaks and an inadvertent secondary filling of the valleys.

The hourly effective cost of operation with the original storage elevation curves is shown in figure 7.4. The peaks during the last twelve weeks are attributable to limitation violations. The time scale corresponds to that given in figure 7.12. The smoothing action of the gradient method is clearly demonstrated in figure 7.5b, showing the modifications made by five small steps of the gradient method during weeks eleven through thirty-one. Here the relatively large high frequency components are cut down and smoothed out. The corresponding modifications to the cost curve in the first nine weeks and weeks thirty-four through thirty-nine are shown in figures 7.5a and 7.5c. These sections are relatively smooth and the modifications demonstrate an "eating away" of the sides of very smooth cost curves.

A closer look at weeks twenty-three through twenty-nine is given in figure 7.6, where the original cost curve and all five modifications are plotted. The consistent, stepwise



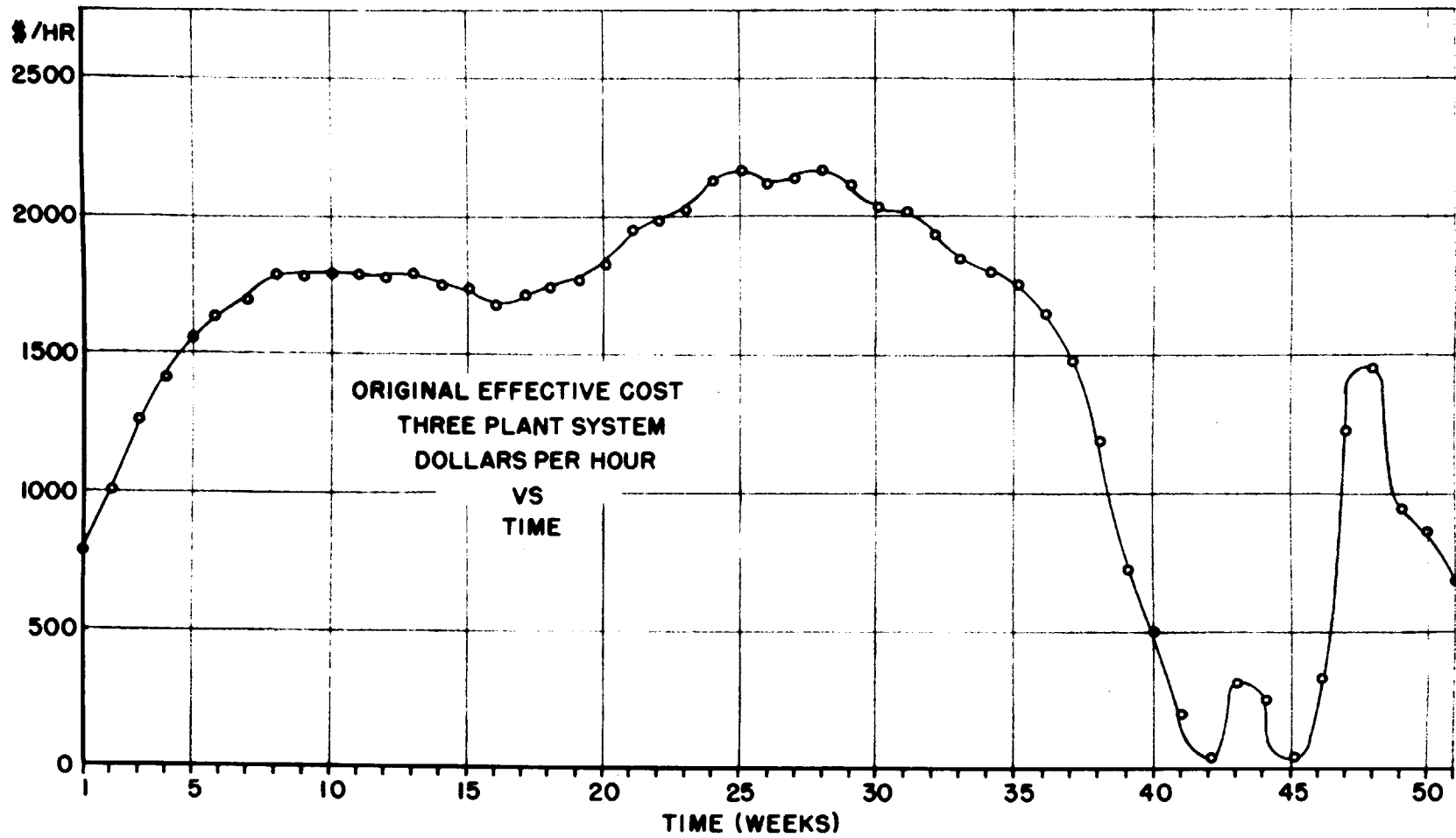

FIGURE 7.4 THREE PLANT SYSTEM EFFECTIVE COST

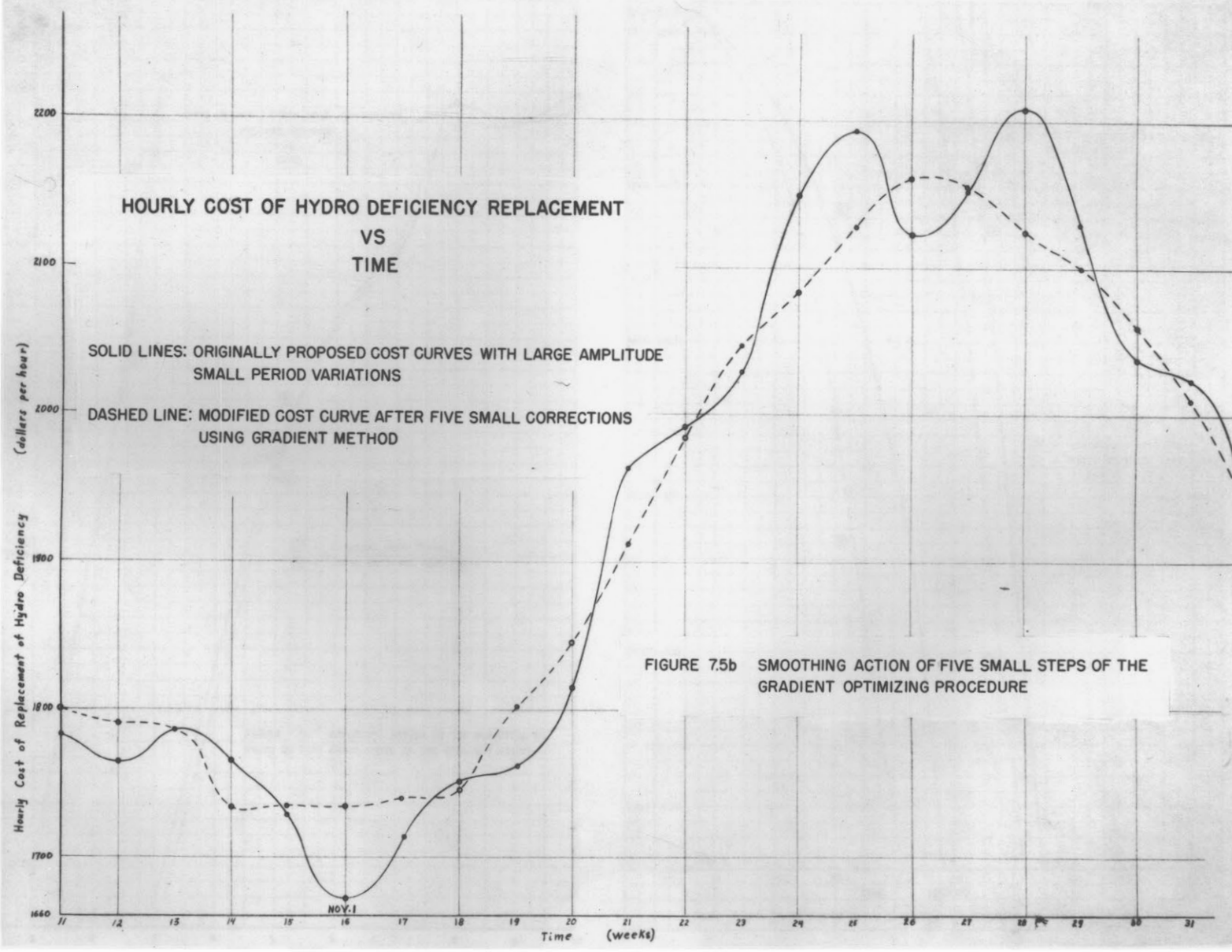
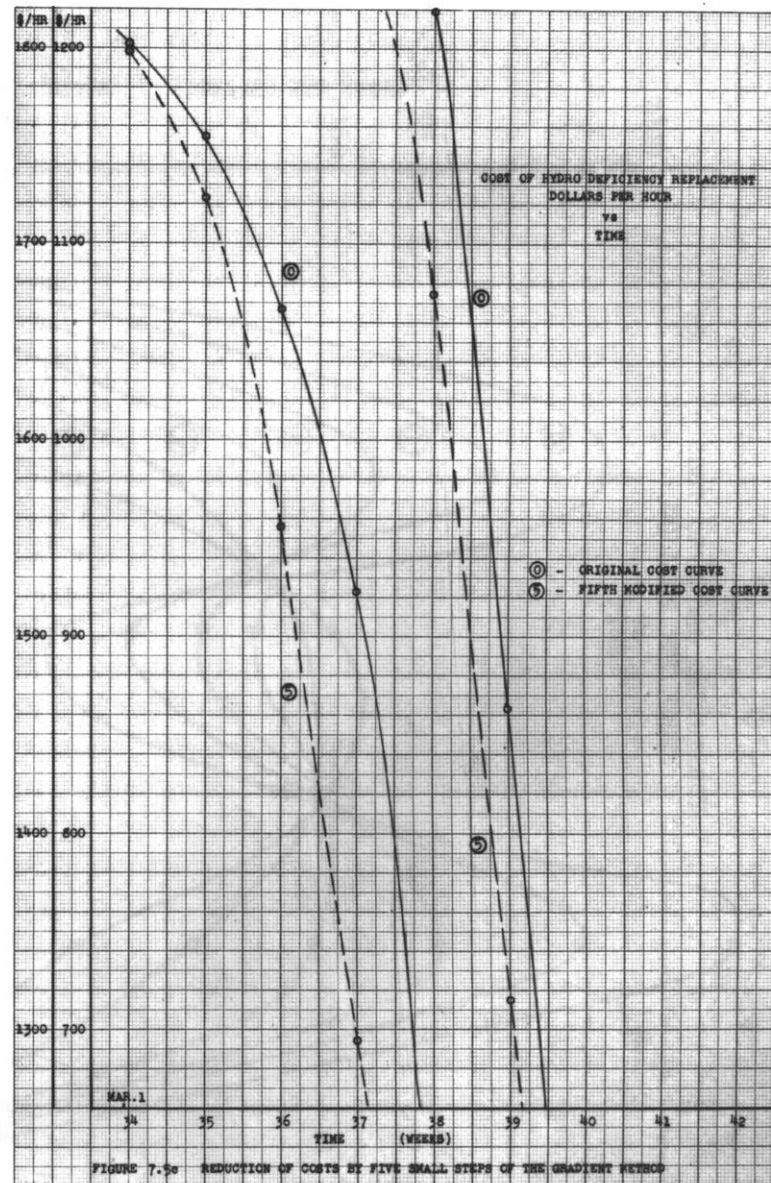
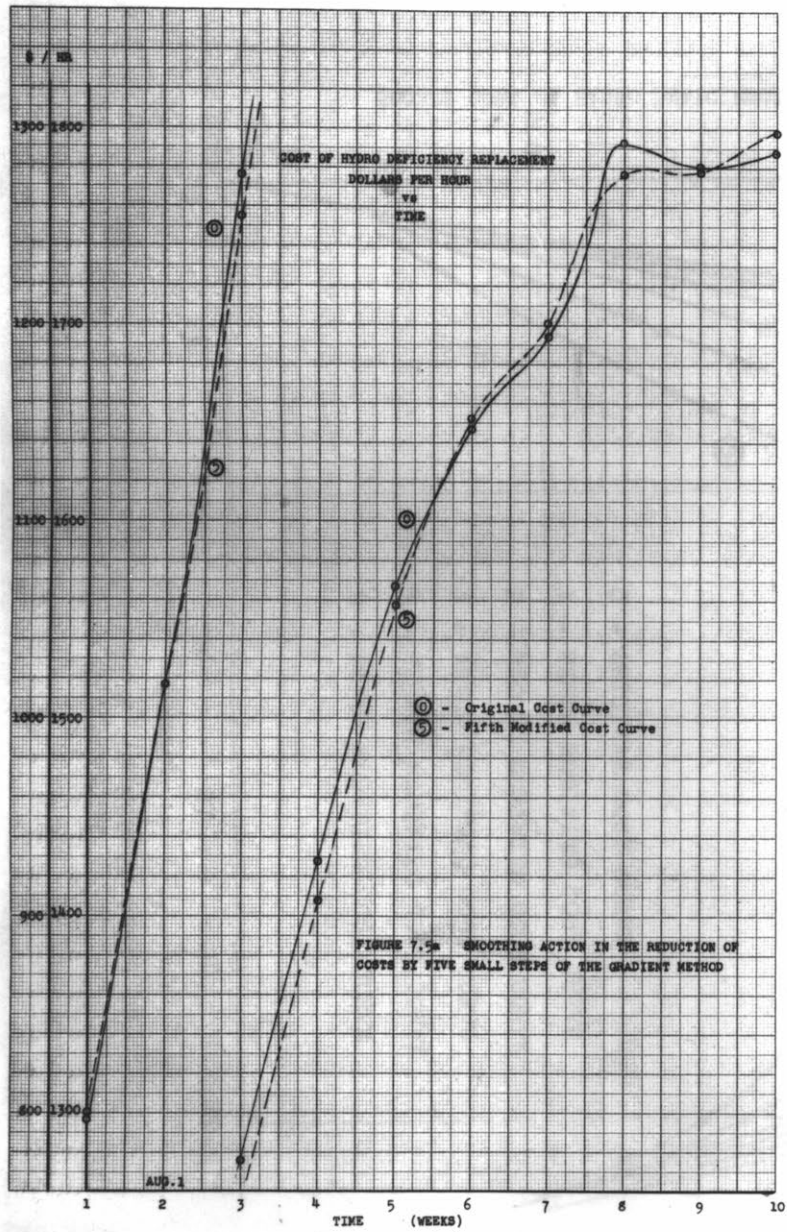
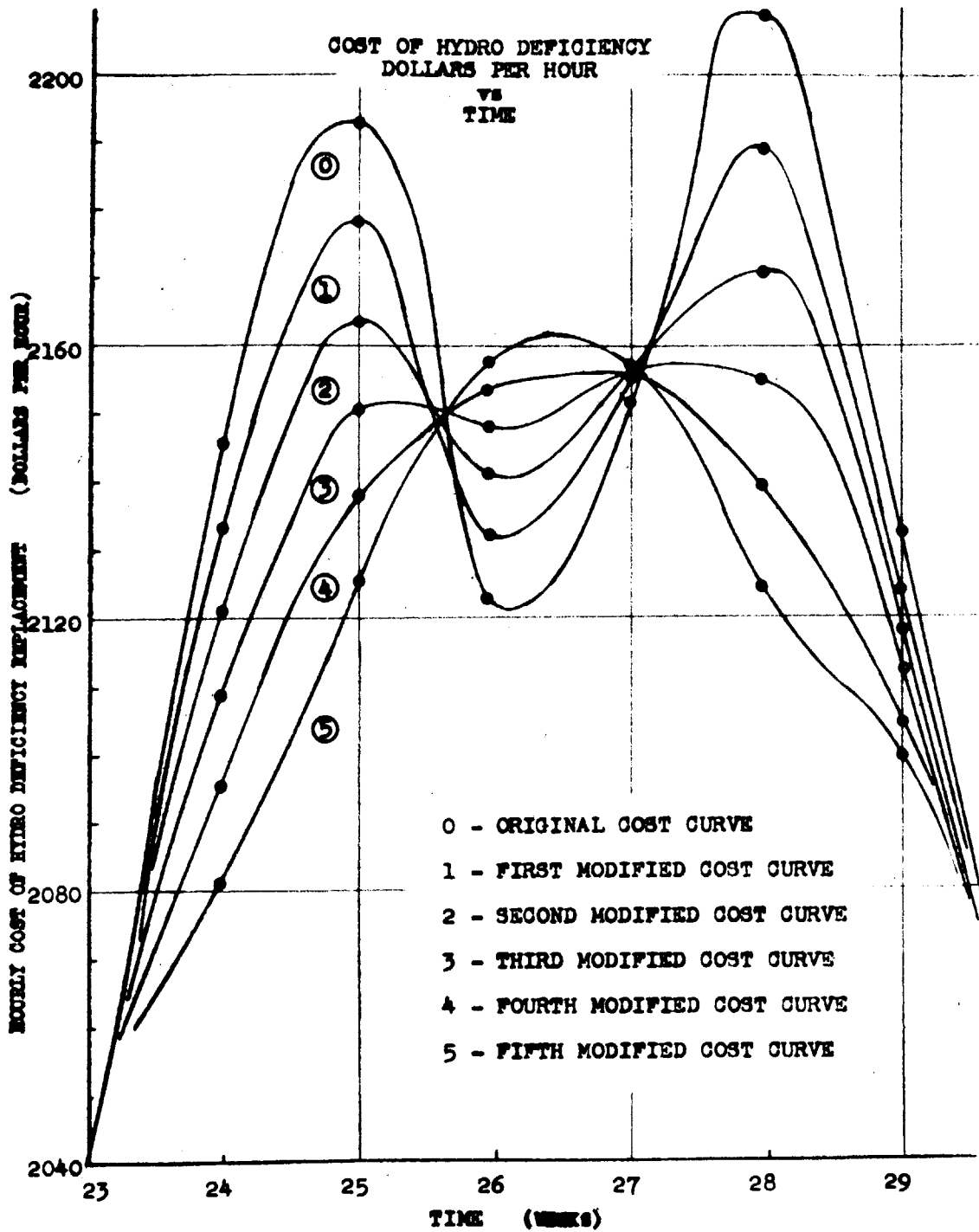

FIGURE 7.5b SMOOTHING ACTION OF FIVE SMALL STEPS OF THE GRADIENT OPTIMIZING PROCEDURE

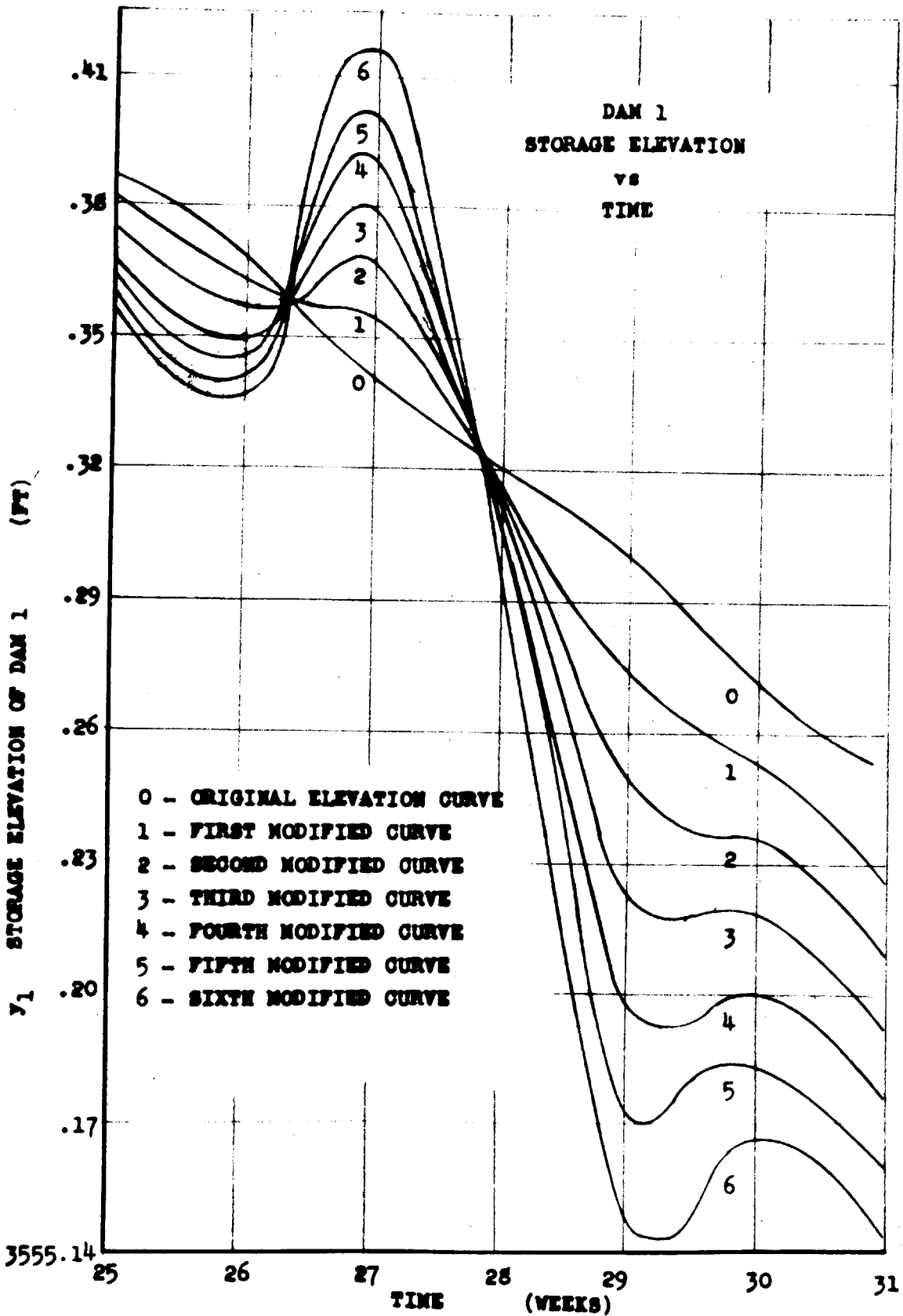



**FIGURE 7.6 - SUCCESSIVE REDUCTION OF HOURLY COSTS OF HYDRO DEFICIENCY REPLACEMENT**

reduction of the two sharp peaks to a lower, broader peak is clear. The same procedure that cut down each peak would thereafter reduce the remaining single hump in like manner. The nature of the terms in the Euler expression for dam 1 during this period is illustrated in figure 7.8. Evident are the relatively small, well behaved nature of  $\partial \$/hr(t)/\partial y, (t)$  and the larger, oscillatory nature of the partials with respect to slope. The latter largely determine the sign of the elevation corrections. The term  $\partial \$/hr(t + T_{12})/\partial y, (t)$  was found to be completely negligible and was not plotted. The consistent stepwise revisions of the storage elevation curve of dam 1 during this same period are shown on an expanded scale in figure 7.7. The modifications at dam 2 were very similar.

The reductions of effective cost during the last twelve weeks was due primarily to the reduction of limitation violations in the form of overloaded machines at times of high flow. This condition was caused by a) inadequate drawdown with early refill, and b) inadequate height above crest to spill high flows after dam was refilled. The successive modifications served to simultaneously, stepwise, relieve both conditions, as shown in the storage elevation curve for this period in figure 7.11. The drawdown is increased, and refill delayed. So long as the dam is full at a time of high flow, increased spillage is needed to reduce exceeding the maximum turbine discharge. Therefore, elevation is increased temporarily



**FIGURE 7.7 SUCCESSIVE STORAGE ELEVATION CURVES**

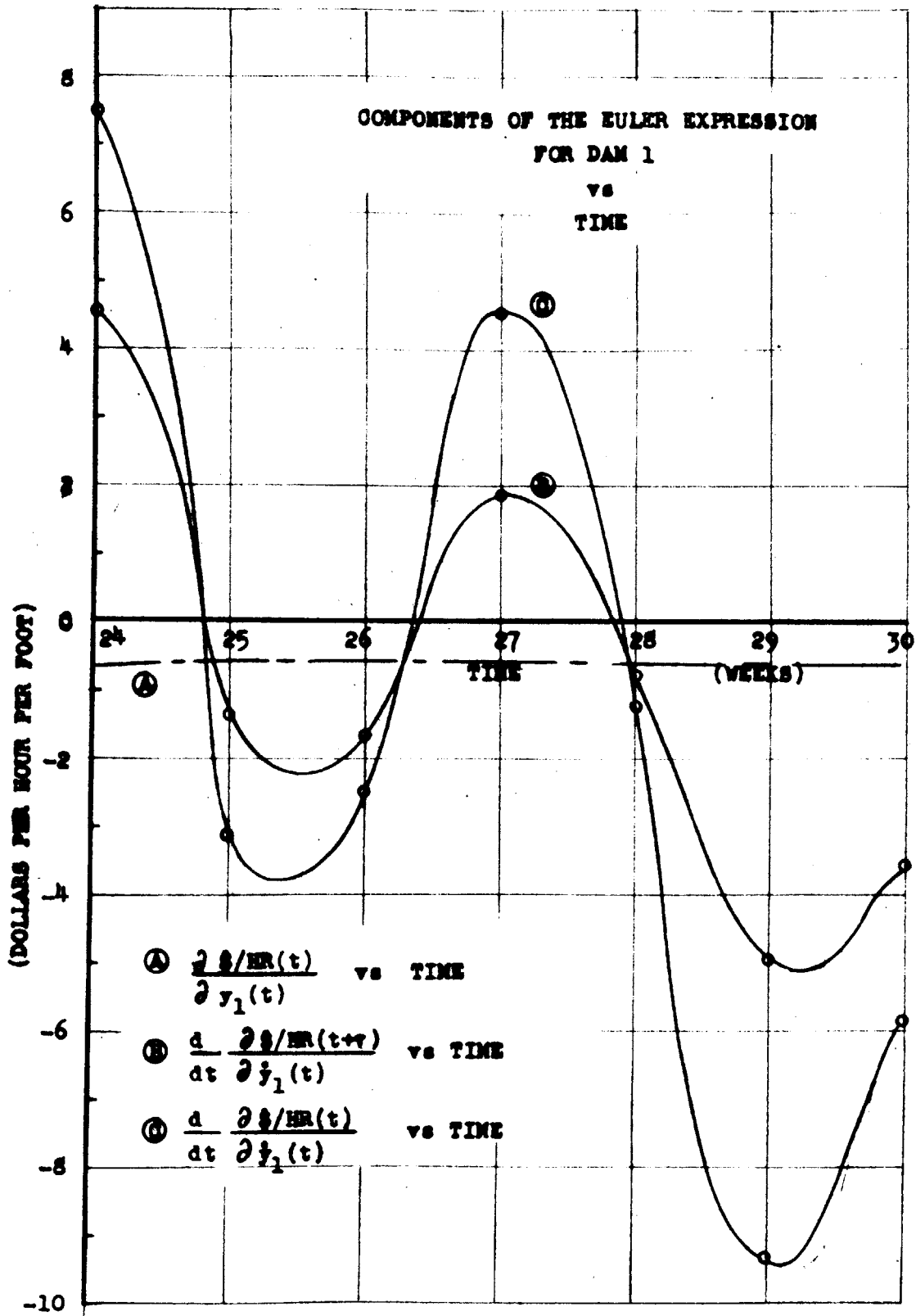

FIGURE 7.6 COMPONENTS OF THE EULER EXPRESSION FOR DAM 1



F-1533

Fig. 7.9 W.W.I. CONTROL CENTER



during that period. Continuation of the process of delaying refill would cut into this elevation peak and gradually eliminate spillage. This occurrence is indicative of the manner in which "local" conditions, in the vicinity of the week being optimized, determine the change to be made, and successive iterations stepwise "propagate" relatively remote effects into a local area. This is basic to the method.

Changes made in the storage elevation of dam 1 are shown in figures 7.10a, 7.10b, and 7.10c. The elevation reductions in the first ten weeks shown in figure 7.10a are due largely to the fact that during this period the dam was nearly full, and the small explorations,  $\Delta y$ , caused spillage. Hence elevation was reduced, providing a margin of safety of  $\Delta y$ , ft below crest. Successive corrections become smaller and smoother, indicating the approach of an equilibrium condition in this region. Elevation corrections during weeks twelve through twenty-five, shown in figure 7.10b, are characterized by the oscillations described above superimposed on a trend towards reducing the amount of drawdown in this region. The amplitudes of the oscillations become successively smaller with each iteration, corresponding to the leveling of the peaks in the cost curve, described above. In the later portion of the drawdown season, shown in figure 7.10c, the trend in elevation corrections is such as to increase drawdown by increasing amounts, indicating the propagation of effects into this region which make increased drawdown more advantageous.

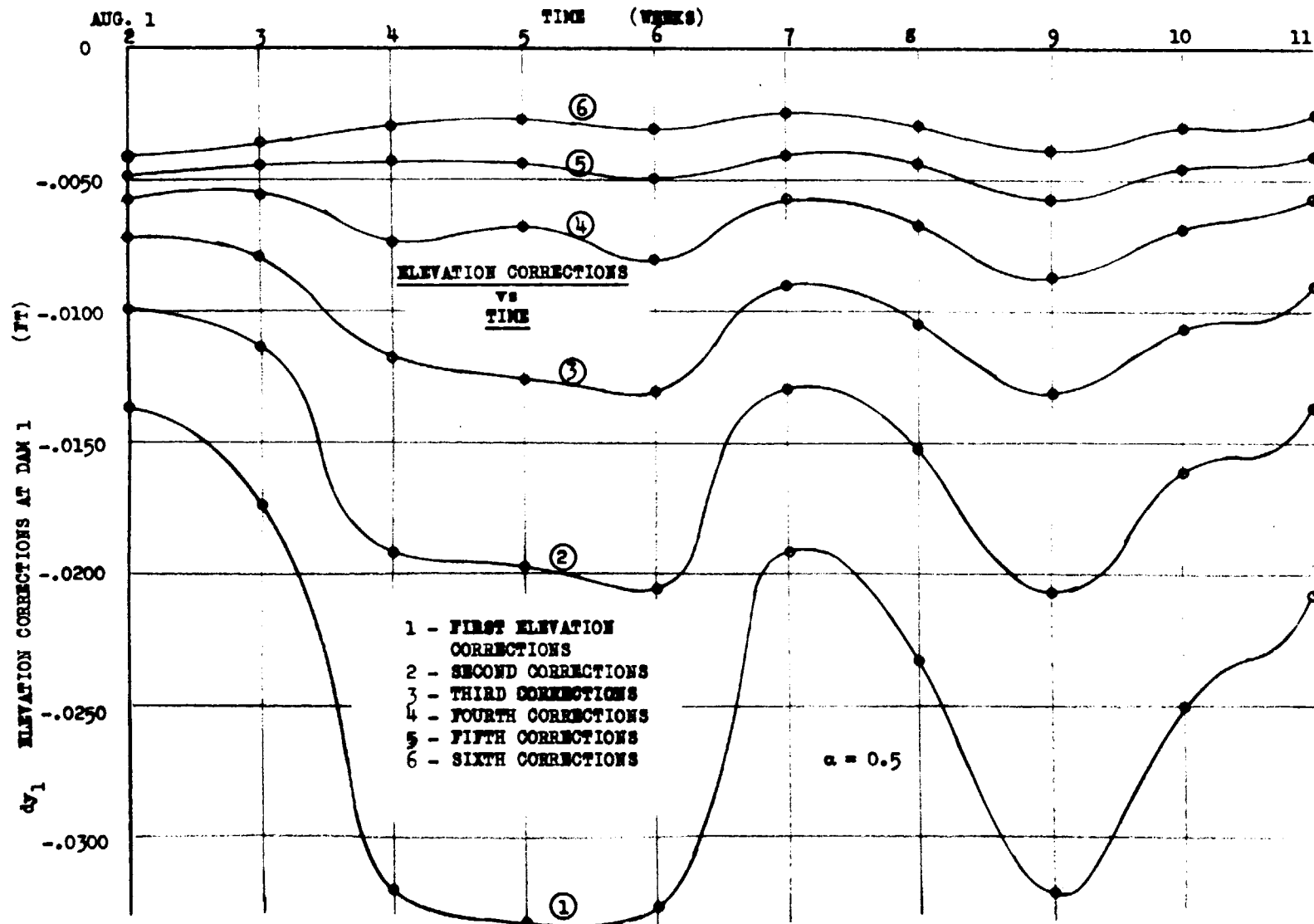

FIGURE 7.10a ELEVATION CORRECTIONS AT BEGINNING OF SEASON WITH DAM "FULL".

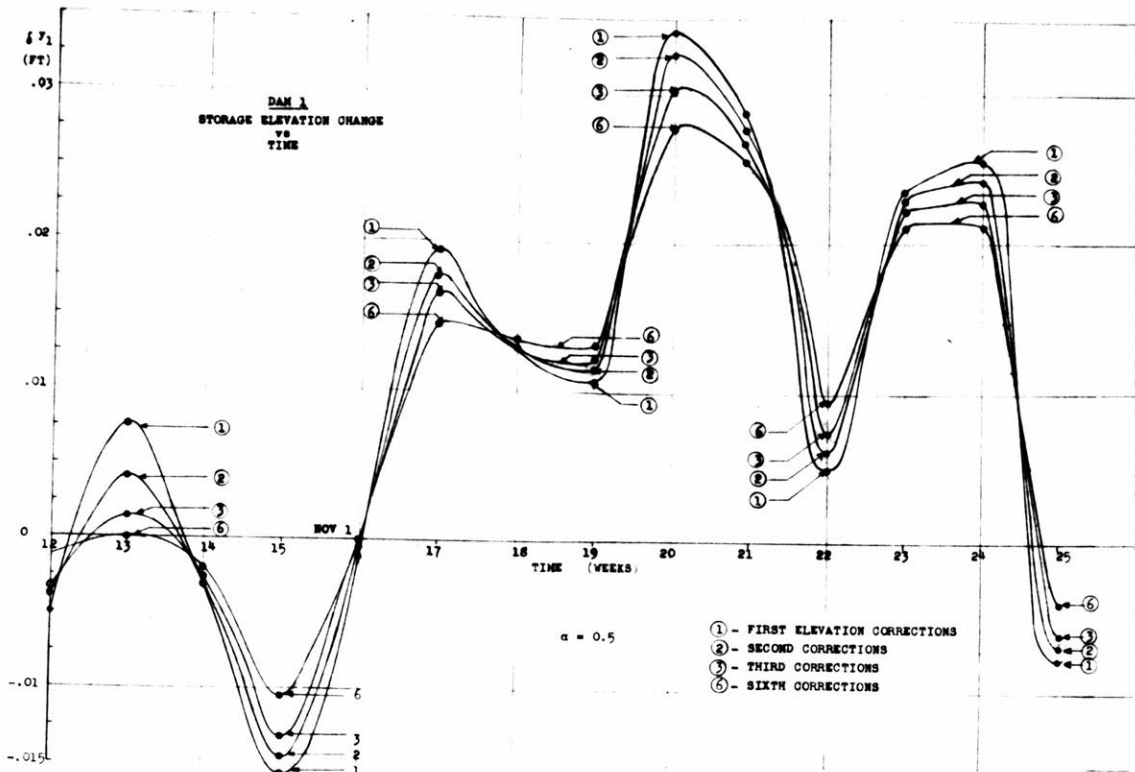

FIGURE 7.10b STORAGE CHANGES SHOWING SUCCESSIVELY SMALLER ELEVATION CORRECTIONS AND RAISING OF STORAGE ELEVATION IN EARLY PART OF DRAWDOWN SEASON.

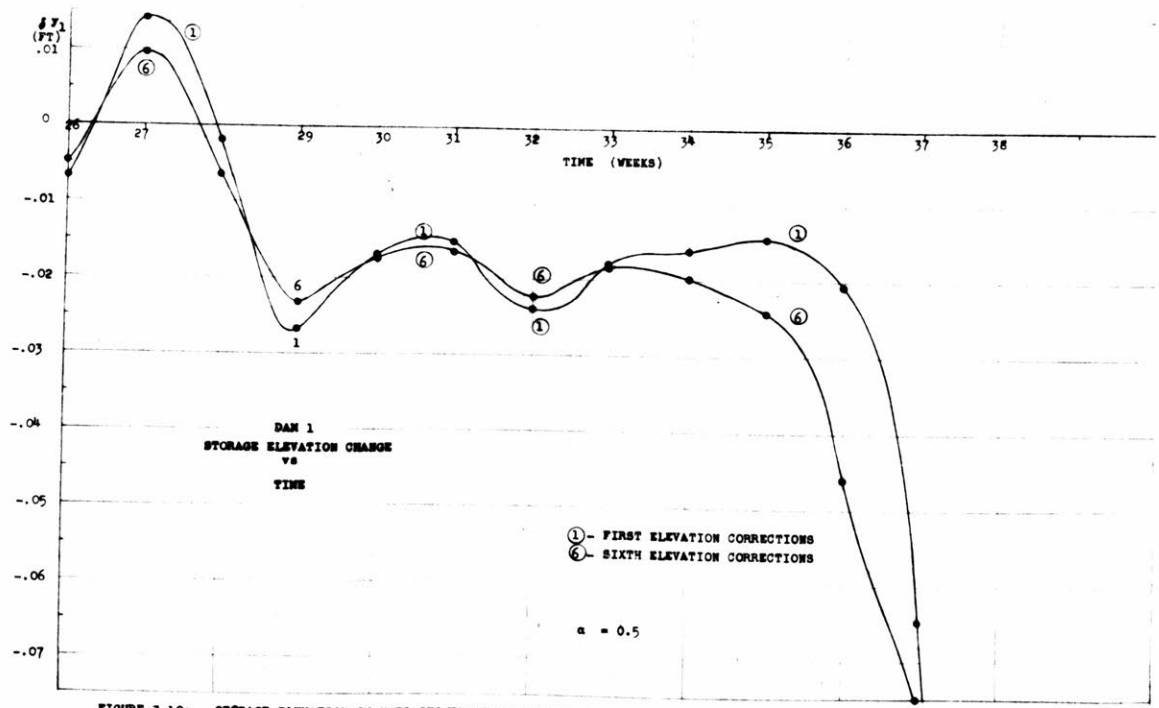
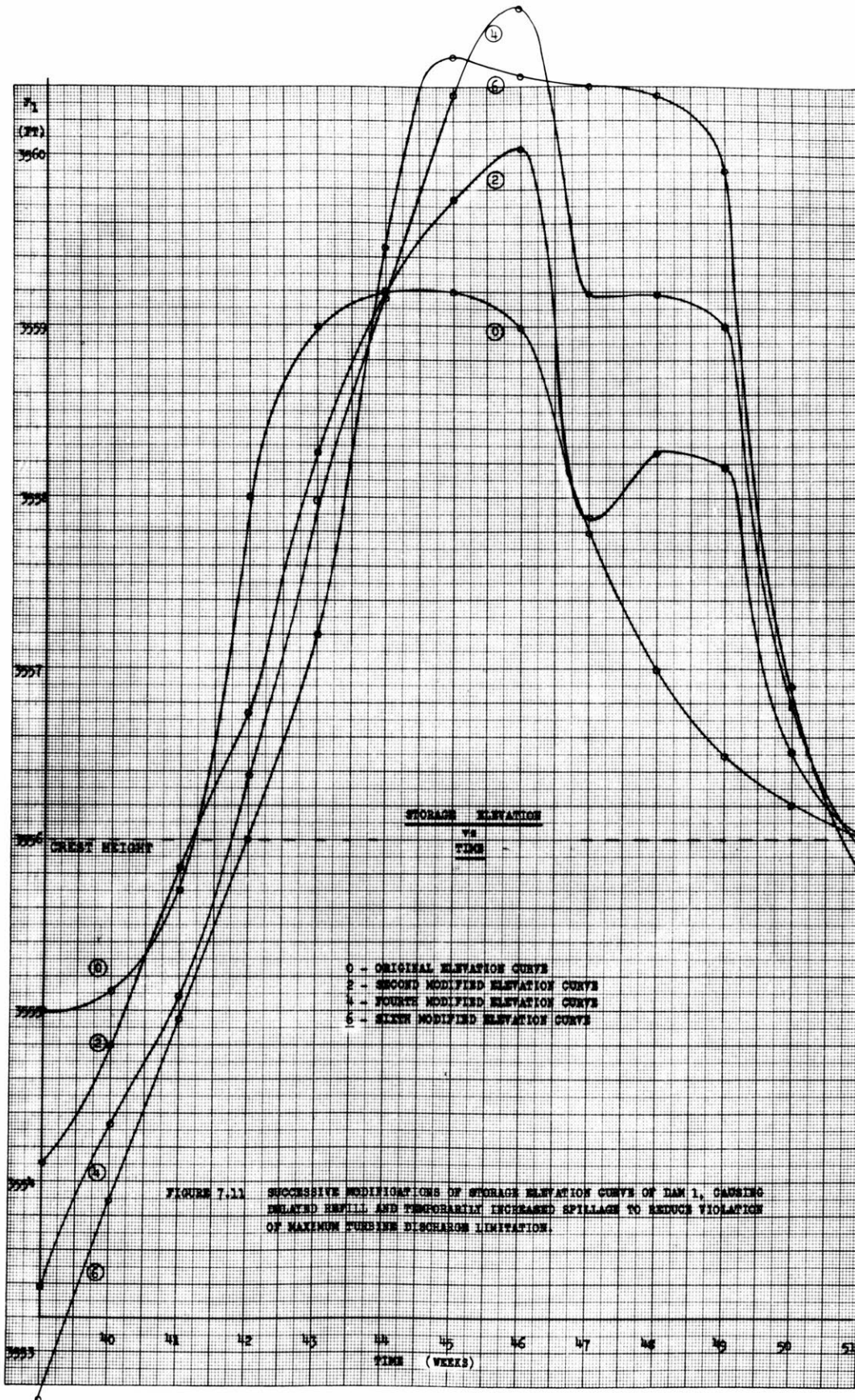
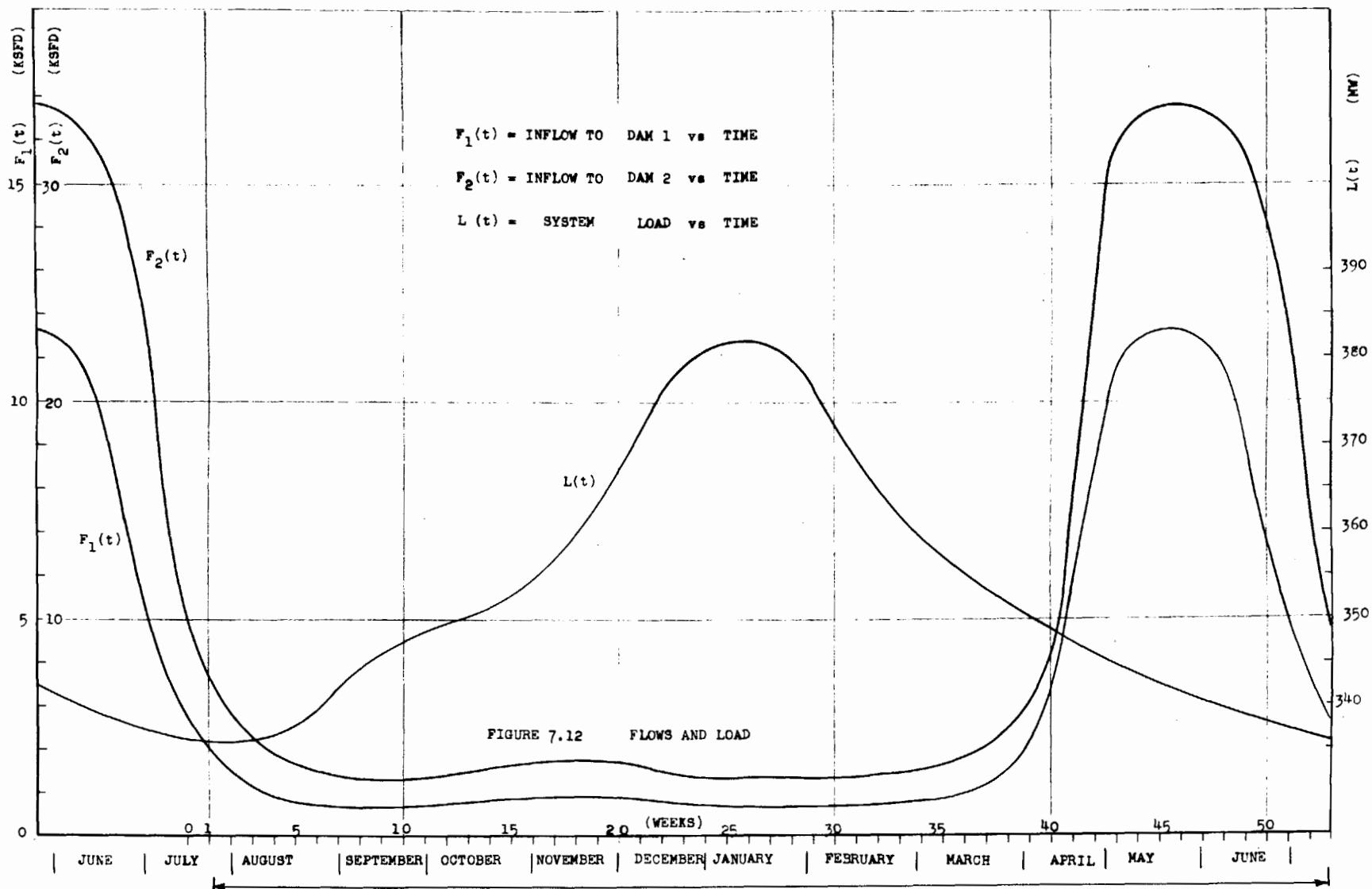

FIGURE 7.10c STORAGE ELEVATION CHANGES SHOWING INCREASED DRAWDOWN IN LATER PART OF DRAWDOWN SEASON





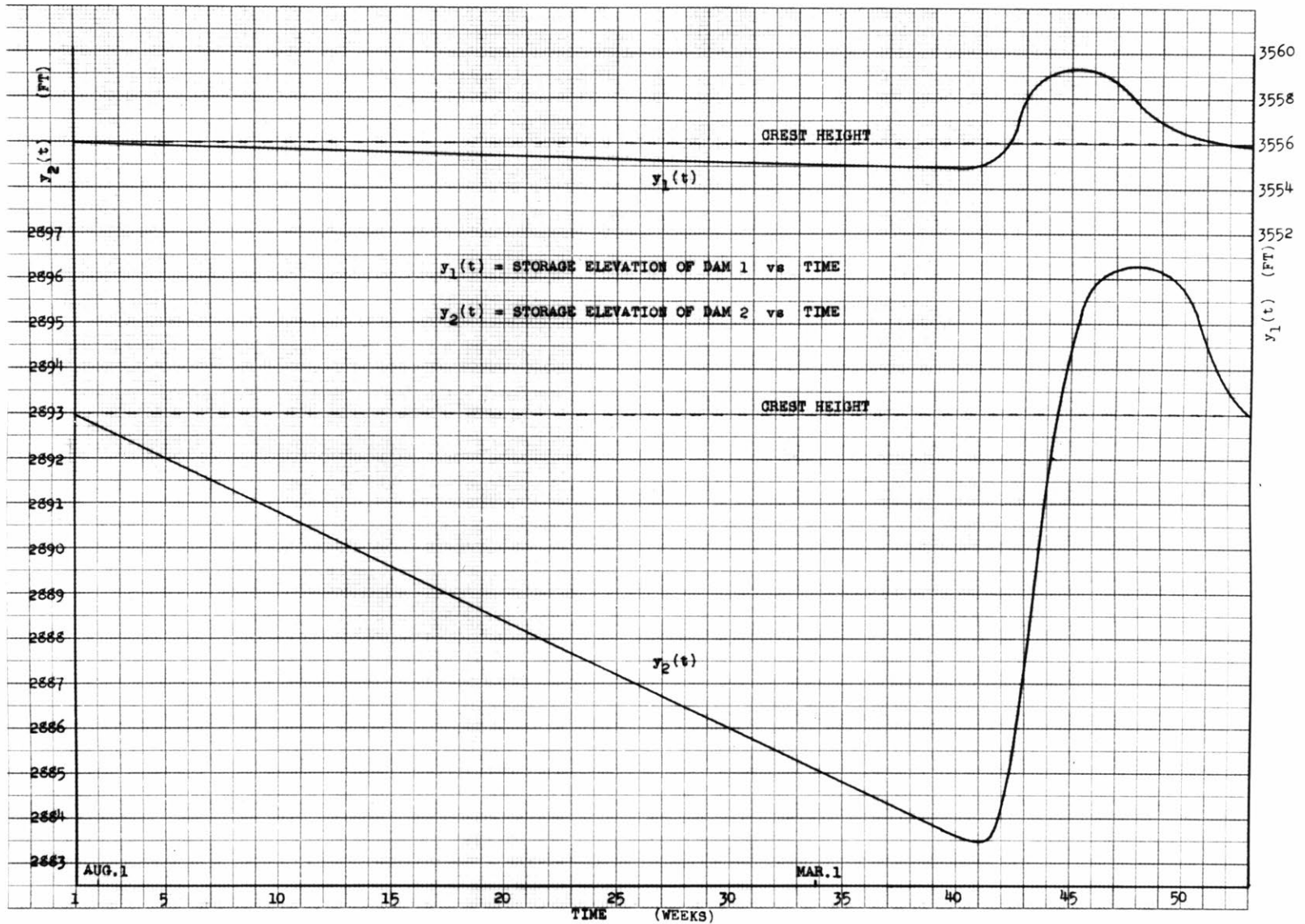

FIGURE 7.13 ORIGINAL STORAGE ELEVATION CURVES USED IN EXAMINATION OF GRADIENT METHOD

Fig. 7.14

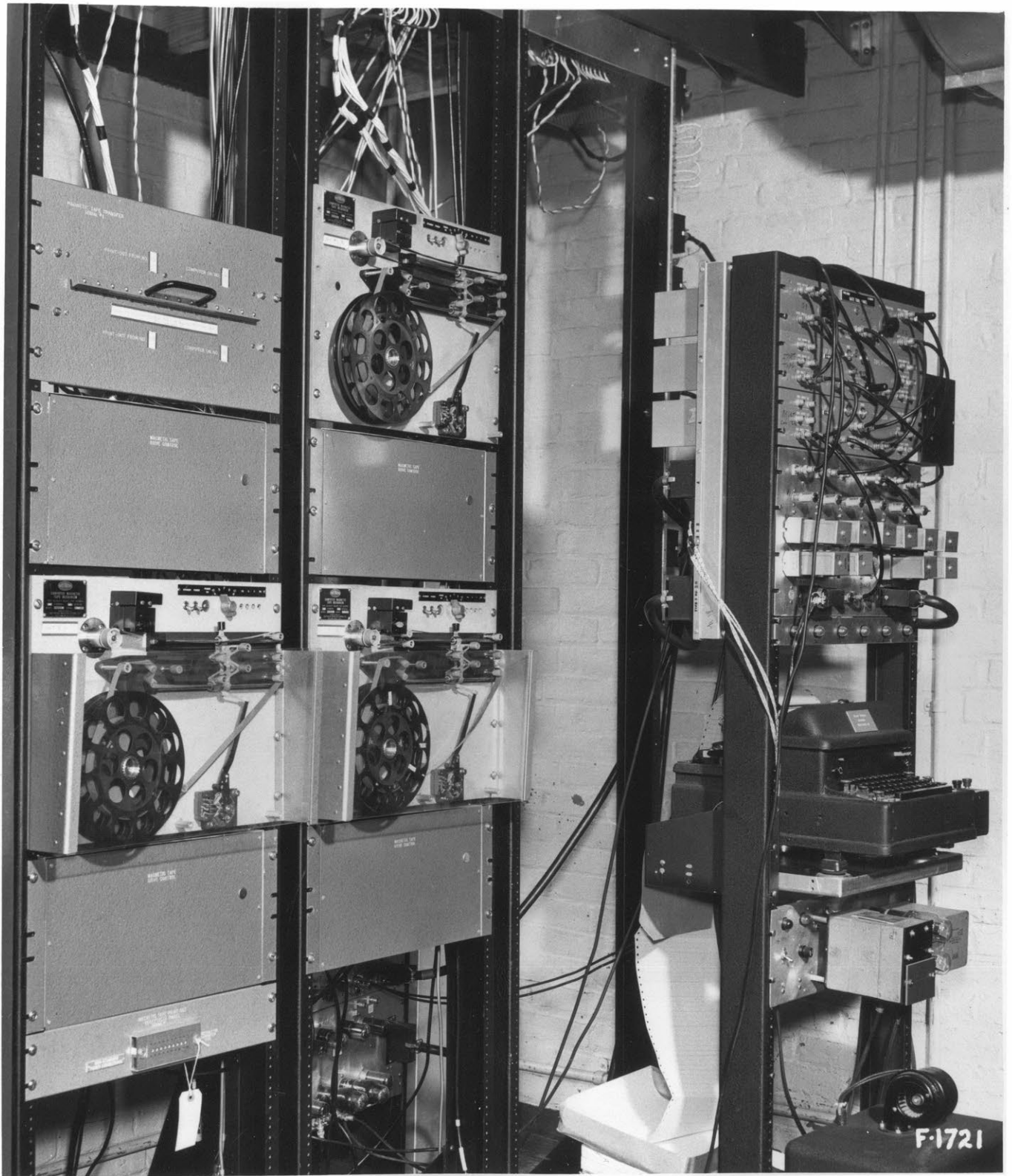

Fig. 7.14 MAGNETIC TAPE DATA HANDLING EQUIPMENT



Numerical tabulations complementing the curves presented above are given in tables 7-III, 7-IV, 7-V and 7-VI.

A study of truncation and round-off errors arising in numerical evaluation of time derivatives in the Euler expressions is presented in Appendix G. The errors obtained using the simplest Lagrange formula are significant but are not a serious problem. The magnitude of errors can be limited, in a given application, by appropriate selection of sampling interval and approximation formula. The method tends to cancel rather than accumulate such errors since each iteration evaluates anew the path of steepest descent. Furthermore, as the solution progresses, the smoothing action inherent in the method reduces truncation errors.

### 7.9 Future Work

It is hoped that the study presented in this treatise will be a stepping stone towards efficient system evaluation and automatized system operation. Much, however, remains to be done. In the following, some of the more important areas requiring further study are listed.

a) The investigation of the feasibility of using existing commercially available digital computers to implement the evaluation of large systems by the gradient method.

b) The introduction of probability distributions of stream flows in place of sets of expected stream flows, to organize operational optimization on the basis of "expected costs".



c) The evaluation of the importance of transmission loss, and the importance and feasibility of obtaining accurate predictions of stream flows, in the long range optimization.

d) The use of the derived determining equations to study the relative value of changing certain plant parameters or capacities.

e) Further development of methods of handling the short range optimization, coordinating this with the long range problem to obtain integrated procedures embodying both.

f) Further study of the accuracy and utility of existing transmission loss formulae when basic assumptions made in their derivation are violated.

g) Development of procedures or mechanisms to semi-automatically carry out the load dispatching of a system, based on long and short range economy optimization.

TABLE 7-III

WEEKLY CHANGES IN EFFECTIVE HOURLY COSTS IN  
FIVE SMALL STEPS OF THE GRADIENT METHOD

| Week | \$/hr    | Week | \$/hr      |
|------|----------|------|------------|
| 1    | 4.3147   | 27   | 5.0206     |
| 2    | -.2827   | 28   | -84.6826   |
| 3    | -21.3853 | 29   | -31.0994   |
| 4    | -19.5570 | 30   | 20.3609    |
| 5    | -9.6518  | 31   | -14.8281   |
| 6    | 4.8525   | 32   | -4.4982    |
| 7    | 6.0224   | 33   | 13.1685    |
| 8    | -16.1041 | 34   | -2.9234    |
| 9    | -3.6550  | 35   | -31.6775   |
| 10   | 10.1499  | 36   | -111.0235  |
| 11   | 17.8525  | 37   | -242.4290  |
| 12   | 26.1250  | 38   | -140.9879  |
| 13   | -.4127   | 39   | -362.7776  |
| 14   | -33.2300 | 40   | -43.2316   |
| 15   | 5.2933   | 41   | -5.8817    |
| 16   | 62.5895  | 42   | -192.8019  |
| 17   | 28.5768  | 43   | -304.2860  |
| 18   | -9.4204  | 44   | -20.9225   |
| 19   | 39.9895  | 45   | -380.4501  |
| 20   | 31.7313  | 46   | -1160.8759 |
| 21   | -53.2634 | 47   | -1583.2603 |
| 22   | -9.6960  | 48   | -1247.2256 |
| 23   | 35.5472  | 49   | -974.7128  |
| 24   | -64.6423 | 50   | -3.3722    |
| 25   | -67.0715 | 51   | -709.4002  |
| 26   | 38.8489  | 52   | -43.3397   |

TABLE 7-IV  
AVERAGE CHANGES IN EFFECTIVE COSTS  
AFTER FIVE SMALL STEPS OF THE GRADIENT METHOD

| Weeks   |                |                 |
|---------|----------------|-----------------|
| 1 - 5   | -\$ 7,822.432  | } -\$ 4,984.27  |
| 6 - 10  | \$ 212.637     |                 |
| 11 - 15 | \$ 2,625.521   |                 |
| 16 - 20 | \$ 25,782.406  | } -\$ 9,611.43  |
| 21 - 25 | -\$ 26,733.168 |                 |
| 26 - 30 | -\$ 8,660.669  |                 |
| 31 - 35 | -\$ 6,847.462  | } -\$311,732.48 |
| 36 - 40 | -\$151,275.533 |                 |
| 41 - 45 | -\$153,609.490 |                 |
| 46 - 50 | -\$834,867.062 | } -\$961,327.36 |
| 51 - 52 | -\$126,460.303 |                 |

TABLE 7-V

STORAGE ELEVATION CHANGES AT DAM 1  
IN SIX SMALL STEPS OF THE GRADIENT METHOD

| Week |        | Week |         |
|------|--------|------|---------|
| 2    | -.0460 | 27   | .0705   |
| 3    | -.0207 | 28   | -.0210  |
| 4    | -.0783 | 29   | -.1499  |
| 5    | -.0800 | 30   | -.1031  |
| 6    | -.0835 | 31   | -.0953  |
| 7    | -.0535 | 32   | -.1400  |
| 8    | -.0724 | 33   | -.1073  |
| 9    | -.0808 | 34   | -.1069  |
| 10   | -.0774 | 35   | -.1162  |
| 11   | -.0565 | 36   | -.1973  |
| 12   | -.0175 | 37   | -.4288  |
| 13   | .0148  | 38   | -.9503  |
| 14   | -.0148 | 39   | -.8834  |
| 15   | -.0776 | 40   | -2.2818 |
| 16   | -.0037 | 41   | -1.1428 |
| 17   | .0994  | 42   | -1.9211 |
| 18   | .0949  | 43   | -1.9867 |
| 19   | .0732  | 44   | -1.7774 |
| 20   | .1842  | 45   | .2682   |
| 21   | .1566  | 46   | 1.4381  |
| 22   | .0453  | 47   | 1.4621  |
| 23   | .1334  | 48   | 1.9440  |
| 24   | .1175  | 49   | 3.3683  |
| 25   | -.0341 | 50   | 3.4447  |
| 26   | -.0337 | 51   | .7286   |
|      |        | 52   | -.2681  |

TABLE 7-VI

STORAGE ELEVATION CHANGES AT DAM 2  
IN SIX SMALL STEPS OF THE GRADIENT METHOD

| Week |        | Week |        |
|------|--------|------|--------|
| 2    | .0447  | 27   | .0015  |
| 3    | .0360  | 28   | -.0009 |
| 4    | .0248  | 29   | -.0062 |
| 5    | .0189  | 30   | -.0047 |
| 6    | .0049  | 31   | -.0057 |
| 7    | .0092  | 32   | -.0083 |
| 8    | .0060  | 33   | -.0067 |
| 9    | .0012  | 34   | -.0069 |
| 10   | .0016  | 35   | -.0108 |
| 11   | .0002  | 36   | -.0220 |
| 12   | .0002  | 37   | -.0352 |
| 13   | -.0013 | 38   | -.0678 |
| 14   | -.0030 | 39   | -.0601 |
| 15   | -.0026 | 40   | -.0904 |
| 16   | .0003  | 41   | -.0424 |
| 17   | .0042  | 42   | .1538  |
| 18   | .0039  | 43   | .0050  |
| 19   | .0057  | 44   | -.1997 |
| 20   | .0110  | 45   | -.2475 |
| 21   | .0113  | 46   | -.1037 |
| 22   | .0053  | 47   | .3002  |
| 23   | .0084  | 48   | .5310  |
| 24   | .0081  | 49   | .5858  |
| 25   | .0016  | 50   | .3932  |
| 26   | .0001  | 51   | -.2675 |
|      |        | 52   | -.2681 |

Biographical Note

Rudolph J. Cypser was born in Jersey City, New Jersey on August 19, 1923. In 1937 he entered Seton Hall Preparatory School in South Orange, N.J., graduating in 1941. In the fall of that year he entered Pratt Institute in Brooklyn, N.Y., completing five terms of the Electrical Engineering course by June, 1943. Enlisting in the U.S. Navy, he was then sent to Columbia University under the V-12 training program where he completed three additional terms of Electrical Engineering, thereby earning his B.E.E. from Pratt Institute in June, 1944.

After Midshipman School at the University of Notre Dame, he was commissioned and assigned to engineering duties at the Ames Aeronautical Research Laboratory, Moffett Field, California, in October, 1944. He served there as electrical engineer until discharged in August, 1946.

In September, 1946, he returned to Columbia University and received his M.S. in Electrical Engineering in June, 1947. The summer of 1947 was spent at the Research Laboratory of the General Electric Company, Schenectady, N.Y.

In September, 1947, he joined the staff of the Electrical Engineering Department at the Massachusetts Institute of Technology with the rank of Instructor; and in addition to teaching took part in research projects at the M.I.T. Servomechanisms Laboratory. In July, 1952, he received an appointment as Assistant Professor in the Department of Electrical Engineering of M.I.T.

BIBLIOGRAPHY

1. ADAMS, C. W., Policy on Outside Users of Whirlwind I, Engineering Note E-484, Digital Computer Laboratory, MIT, September 29, 1952.
2. BAGLEY, P. R., Programming for In-Out Units, Memorandum M-1623, Digital Computer Laboratory, MIT, September 17, 1952.
3. BAGLEY, P. R., Short Guide to Coding and WW1 Operating Code, Memorandum M1624, Digital Computer Laboratory, MIT, September 2, 1952.
4. BARROWS, H. K., Water Power Engineering, New York: McGraw Hill Book Company, 1943.
5. BECK, W. D., Proc. of Scientific Computation Forum, New York: IBM Machines, 1948.
6. BELCHER, W. E., Jr., "High Speed Supervision of Process Variables," AIEE Tech. Paper, pp. 50-218.
7. BERNARD, M., "The Long Term Precipitation-Runoff Relation as the Basis for Forecasting Water Supply," Trans Amer. Geophys. Un., Vol. 30, No. 3. June 1949.
8. BOEHNE, E. W., "Incremental Loading of a Hydraulic Network," Bonneville Power Admin. Memo., Br. of Systems Engrg., BPA, Portland, Oregon. August, 1951.
9. BOOTH, A. D., "An Application of the Method of Steepest Descents to the Solution of Systems of Non Linear Simultaneous Equations," Quart. J. of Mechanics and Applied Math, Vol. II, part 4, p. 460. December, 1949.
10. BURR, H. A., "Load Division between Common-Flow Hydroelectric Stations," MIT, E.E. Thesis: 1941.
11. CHANDLER, W. M. and A. F. GABRIELLE, "Economy Loading of Hydroelectric Systems," MIT: Elec. Engrg. M. S. Thesis, Sept., 1950.

12. COURANT, R., "Maxima and Minima with Subsidiary Conditions," Differential and Integral Calculus, pp. 188-211, Vol. II, New York, Interscience Publishers, 1936.
13. COURANT, R., "Variational Methods for the Solution of Problems of Equilibrium and Vibrations," Bulletin of the Am. Math. Soc., Vol. 49, pp. 1-23, 1943.
14. CURRY, H. B., "The Method of Steepest Descent for non-linear minimization problems," Quart. Applied Math., Vol. 2, p. 258, 1944.
15. CYPSEK, R. J., "Economic Loading of an Electric System," Interim Report, MIT: DIC 7042, June 30, 1952.
16. CYPSEK, R. J., "Optimization of Process Performance by automatic Parameter Adjustment," Memo to A. Sise, MIT: Servomechanisms Laboratory, September 10, 1951.
17. DORFMAN, ROBERT, "Application of Linear Programming to the Theory of the Firm," Bureau of Business and Economic Research, Los Angeles: Univ. of Calif. Press.
18. DRAPER, C. S., Y. T. LI, and Y. C. LOB, Optimalizing Control for the Internal Combustion Engine. Paper presented at the semi-annual meeting, Instruments and Regulators Division, ASME, June 28, 1949.
19. EMMONS, H. W., "The numerical solution of partial differential equations," Quart. of Applied Math., Vol. 2, p. 173, 1944.
20. FORGIE, J. W., Visual Display Facilities in Final WW1, Engineering Note E-469, Digital Computer Laboratory, MIT, August 5, 1952.
21. FOX, C., Calculus of Variations, London: Oxford Univ. Press, 1950.
22. GEORGE, E. E., H. W. PAGE, and J. B. WARD, "Coordination of Fuel Cost and Transmission Loss by Use of the Network Analyzer," Trans. AIEE, Vol. 68, pp. 1152-1163, 1949.
23. HAHN, G. R., "Load Division by the Incremental Method," Power, June, 1931.



25. High Speed Computing Devices, Staff of Engineering Research Associates, Inc., New York: McGraw Hill Book Co, Inc., 1950.
26. HOARD, B. V., "Economical Loading of the BPA System, Second Progress Report," Bonneville Power Administration Memo., Branch of System Engrg., December 1951.
27. JUSTIN, J. D. and W. G. MERVINE, Power Supply Economics, New York: John Wiley and Sons, Inc., 1934.
28. KIRCHMAYER, L. K. and G. W. STAGG, "Analysis of Total and Incremental Losses in Transmission Systems," AIEE Tech Paper 51-204, May, 1951.
29. KIRCHMAYER, L. K. and G. W. STAGG, "Evaluation of Methods of Coordinating Incremental Fuel Costs and Transmission Losses," AIEE Tech Paper 52-112.
30. KIRCHMAYER, L. K. and G. H. McDANIEL, "Transmission Losses and Economic Loading of Power Systems," General Electric Review, October, 1951.
31. KORNES, M., "Numerical Solution of Boundary Value Problems Using Punched Cards," Rev. Sci. Instr., 14, 1943.
32. KRON, G., "Tensorial Analysis of Integrated Transmission Systems," Part I, AIEE Tech. Paper 51-225.  
Part III, AIEE Tech Paper 52-192.
33. KUHN, H. W. and A. W. TUCKER, "Non Linear Programming," Second Berkeley Symposium on Mathematical Statistics and Probability, Univ. of Calif. Press.
34. LAMB, HORACE, Hydrodynamics, New York: Dover Publications, 1945.
35. LANE, E. W., "The Control of the TVA Storage Reservoirs for the Most Economical Power Production," TVA, October 12, 1944.
36. LEVENBERG, "A Method For The Solution of Certain Non Linear Problems in Least Squares," Quart. of Applied Math., Vol. 2, 164, 1944.

37. LIGHT, P. and M. A. KOHLER, "Forecasting Seasonal Runoff by Statistical Methods," Trans. Amer. Geophys. Union, Vol. 24, pp. 719-736, 1943.
38. MASSE, PIERRE, Les Reserves et la Regulation de L'Avenir dans la vie Economique, Vol. I and II, Paris: Hermann and Cie.
39. MAYNE, ROBERT, "Some Engineering Aspects of the Mechanism of Body Control," Elec. Engrg., Vol. 70, No. 3, pp. 207-212.
40. MILNE, W. E., Numerical Calculus, Princeton Univ. Press., 1949.
41. MORRISS, B. E., Operation of Magnetic Tape Units, Engineering Note E-482, Digital Computer Laboratory, MIT, September 11, 1952.
42. MORSE, P. M. and G. E. KIMBALL, Methods of Operations Research, The Technology Press and John Wiley and Sons, Inc.
43. NORTHWEST POWER POOL, Operating Program 1951-52, Coordinating Group of NWPP, Portland Oregon.
44. PURCELL, T. E., "Program Load Control for Turbines," Power Plant Engineering, April, 1935.
45. PURCELL, T. E. and C. A. POWEL, "Tie Line Control of Inter-connected Networks," AIEE Trans., Vol. 51, p. 40, 1932.
46. REID, A. W., "Dividing Hydro Load to Obtain Maximum Efficiency," Power, May 24, 1932.
47. RUSSELL, L. "Characteristics of the Human As a Linear Servo Element," M. S. Thesis, MIT, May, 1951.
48. SCARBOROUGH, J. B., Numerical Mathematical Analysis, 2nd Edition, Johns Hopkins Press, 1950.
49. SCHANBERGER, S. O., "Hydro Station Operation with Minimum Loss," E.E.I. Bulletin, January, 1935.
50. SCHODER, E. W. and F. M. DAWSON, Hydraulics, McGraw Hill, 1934.
51. SPORN, P., The Integrated Power System, New York: McGraw Hill, 1950.
52. STANLEY, J. W. and R. E. KENNEDY, "Forecasting Colorado River Flow," Trans. Geophys. Union, Vol. 28, No. 5, October, 1947.

53. STEWART, E. C., "The Determination of What Units and What Plants On A System Should Be Assigned to Load Regulation," AIEE Winter General Meeting, Conference Session, January 25, 1951.
54. STIEFEL, E. and M. R. HESTENES, "Method of Conjugate Gradients for solving linear equations," N. B. S. Report 1659 (1952).
55. STIEFEL, Von Eduard, "Vber einige Methoden der Relaxationsrechnung," Zeitschrift fur Angewandte Mathematik and Physik, Zurich.
56. STEINBERG, M. J. and J. H. SMITH, Economic Loading of Steam Power Plants and Electric Systems, New York: McGraw Hill Book Co., 1943.
57. STEINBERG, M. J. and J. H. SMITH, "The Theory of Incremental Rates," Part I Elec. Engrg., pp. 432-445, 1934.  
Part II Elec. Engrg., pp. 571-584, 1934.
58. STROWGER, E. B., "How We Raise Hydro Efficiencies," Electrical World, April 14, 1934.
59. STROWGER, E. B., "Operating a Hydraulic System for Best Economy," N. E. L. A. Bulletin, December, 1929.
60. STAGE, S., "Control of Economic Loading of a Large Hydro and Thermal Power System," Swedish Water Power Assn. Publication 400. (1948:3). Translated by Bonneville Power Adm., Br. of Systems Engrg., Portland, Oregon.
61. SYNGE, J. L., "A Geometrical Interpretation of the relaxation Method," Quart. Applied Math., Vol. 2 87, 1944.
62. VERZUH, F., "The solution of Simultaneous Linear Equations with the aid of the 602 Calculation Punch," Math. Tables and other aids to Computation, No. 27, July, 1949.
63. VON EFF, H. A. and C. W. Watchorn, "Charts Aid Control of Hydro Economy," Electrical World, May 5, 1934.

64. WARD, J. B., "Calculation of Power System Losses," AIEE Conference Paper, Great Lakes District Meeting, Indianapolis, Indiana, October 9-11, 1946.
65. WARD, J. B., J. R. EATON and H. W. HALE, "Total and Incremental Losses in Power Transmission Networks," AIEE Tech Paper 50-97, December, 1947.
66. WEINER, L. and W. WHITEBECK, "Report on Economic Loading," Br. of Systems Engrg., Bonneville Power Admin., Portland, Oregon, July 10, 1952.
67. WEINER, L. and W. WHITEBECK, "Short Range Economic Loading-Second Report," Office Memorandum, Br. of System Engrg., Bonneville Power Administration, Portland, Oregon, August 29, 1952.
68. WHITEBECK, W. F., "Economy Loading of a Multiple Dam Hydroelectric System," Report on Mathematical Classification, Br. of System Engrg., Bonneville Power Adm., Portland, Oregon, February 21, 1952.

### Appendix A

#### Path of Steepest Descent With Certain Coordinates Fixed

In the following it is demonstrated that even though the coordinates corresponding to pertinent characteristics of the actuating inputs are fixed, maximum reduction of cost per length of step taken is obtained by making each change in the adjustable parameters equal (or proportional) to the corresponding partial derivatives of cost with respect to adjustable parameter change.

Consider the space having the relevant characteristics of the actuating inputs as well as the adjustable parameters as coordinates. As the actuating inputs change, the operating point moves over the surface which is stationary. At each operating point however, a unique gradient exists on this surface whose direction determines the desirable change in the input variables. Of the input variables, only the adjustable parameters are controllable, so only the components of the surface gradient along these axes are of interest in the control problem. The gradient at any point on the surface may be expressed as:

$$\vec{\text{grad}} \ \$ = \sum_i \frac{\partial \$}{\partial x_i} \vec{u}_i + \text{terms dependent on } \frac{\partial \$}{\partial y_i}$$

where  $\vec{u}_i$  are unit vectors along the adjustable parameter axes,  $x_i$ , are the adjustable parameters, and  $y_i$  are the rele-

vant characteristics of the actuating inputs. The gradient  $\$$  is a vector which points along the direction of maximum slope of the surface at the point where it is evaluated. This equation is rewritten:

$$\vec{\text{grad}} \$ = \frac{\partial \$}{\partial \mathbf{x}} + \vec{b}$$

The vector  $\vec{b}$  includes all terms not in the above summation and has no components along the adjustable parameter coordinates. An incremental change in operating point is equal to the corresponding incremental change in the radius vector from the origin to the surface. Hence, the performance change corresponding to an incremental change in operating point is given by

$$d\$ = \vec{\text{grad}} \$ \cdot d\vec{R}$$

The slope of the surface in the direction of the incremental change in operating point is given by

$$d\$/ds = \vec{\text{Grad}} \$ \cdot d\vec{R}/ds$$

where  $s$  is the scalar distance moved along the surface, Separating gradient  $\$$  as above:

$$\frac{d\$}{ds} = \frac{\partial \$}{\partial \mathbf{x}} \cdot d\vec{R}/ds + \vec{b} \cdot d\vec{R}/ds.$$

If the change in operating point is obtained by changes only in the adjustable parameters,  $d\vec{R}$  is constrained to have components only along these axes. Since,  $\vec{b}$  does not have any components along these axes, the latter term  $\vec{b} \cdot d\vec{R} = 0$ , and  $d\$/ds = \frac{d\$}{d\mathbf{x}} \cdot d\vec{R}/ds$  (with constrained  $d\vec{R}$ ). Since  $d\vec{R}/ds$  is a unit vector, the dot product is a maximum when the two vectors are parallel. It follows, therefore, that under this constraint the maximum possible slope will be followed if the direction

of motion is parallel to the vector,  $\frac{\partial \bar{J}}{\partial \mathbf{x}}$ . The relative magnitude of the components in this vector give the relative improvements in performance to be gained by a change in each of the adjustable parameters. The algebraic sign of each component determines the direction in which it would be advantageous to adjust each parameter. Regardless of how the operating point moves, because of changes in the actuating inputs, and regardless of possible malfunctions in previous steps of the path-finding process, each evaluation of the new gradient gives a fresh start toward the minimum.

Appendix B

First Proof of Determining Equations for Three Plant System

This first proof is obtained by a geometrical interpretation in a multidimensional, orthogonal, coordinate system. This approach enables one to visualize the optimizing procedure. Let there be:

l sampled ordinates of  $S_1(t)$  in the interval  $0 \leq t \leq T - T_{12}$

m sampled ordinates of  $S_2(t)$  in the interval  $0 \leq t \leq T$

Equation (5-37) is then expressed as:

$$\delta \$ = \sum_{i=1}^l \delta S_1(t_i) E_1(t_i) \Delta t + \sum_{i=l+1}^{l+m} \delta S_2(t_i) E_2(t_i) \Delta t + \epsilon \quad (\text{B-1})$$

where

$$E_1(t_i) \equiv \frac{\partial \$/\text{hr}(t_i)}{\partial S_1(t_i)} - \frac{d}{dt} \frac{\partial \$/\text{hr}(t_i)}{\partial \dot{S}_1(t_i)} - \frac{d}{dt} \frac{\partial \$/\text{hr}(t_i + T_{12})}{\partial \dot{S}_1(t_i)} \quad (\text{B-2})$$

$$E_2(t_i) \equiv \frac{\partial \$/\text{hr}(t_i)}{\partial S_2(t_i)} - \frac{d}{dt} \frac{\partial \$/\text{hr}(t_i)}{\partial \dot{S}_2(t_i)} \quad (\text{B-3})$$

The number,  $\epsilon$ , can be made arbitrarily small by letting l and m



be finite but arbitrarily large. Therefore even neglecting  $\epsilon$  in (B-1),  $\delta \$$  can still be found to any desired accuracy by increasing  $l$  and  $m$ .

Although the cost index is also dependent on the physical and economic characteristics of the system and on the predictions of stream flows and system load, only the storage curves  $S_1(t)$  and  $S_2(t)$  are controllable and are here considered as variables in the optimization. For the case considered here, where the cost index is made a function of a large but finite number ( $l + m$ ) of storage ordinates, ordinary calculus gives us:

$$\delta \$ = \sum_{i=1}^l \frac{\partial \$}{\partial S_1(t_i)} \delta S_1(t_i) + \sum_{i=l+1}^{l+m} \frac{\partial \$}{\partial S_2(t_i)} \delta S_2(t_i) \quad (\text{B-4})$$

If  $l$  and  $m$  are large enough so that  $\epsilon$  may be neglected in (B-1), then the forms of (B-1) and (B-4) are identical. It follows, then, that:

$$\frac{\partial \$}{\partial S_1(t_i)} = E_1(t_i) \Delta t \quad 1 \leq i \leq l \quad (\text{B-5})$$

$$\frac{\partial \$}{\partial S_2(t_i)} = E_2(t_i) \Delta t \quad l+1 \leq i \leq l+m \quad (\text{B-6})$$

A vector space is now defined, containing:

$l$  orthogonal axis  $S_1(t_i)$   $i = 1, 2, \dots, l$

$m$  orthogonal axis  $S_2(t_i)$   $i = l+1, l+2, \dots, l+m$

Corresponding to each point in this space, there are, as its

projections, specific values of the  $S_1(t_i)$  and  $S_2(t_i)$ , and hence there is a specific value of the system's cost index. Associated with each axis is a unit vector:  $\hat{v}_i \quad i = 1, 2, \dots, l+m$

A small step taken in this space is expressed as the change in the radius vector:

$$\delta \vec{R} = \sum_{i=1}^l \delta S_1(t_i) \hat{v}_i + \sum_{i=l+1}^{l+m} \delta S_2(t_i) \hat{v}_i \quad (\text{B-7})$$

Also, the gradient of the cost index is defined as:

$$\vec{\nabla} \$ = \sum_{i=1}^l \frac{\partial \$}{\partial S_1(t_i)} \hat{v}_i + \sum_{i=l+1}^{l+m} \frac{\partial \$}{\partial S_2(t_i)} \hat{v}_i \quad (\text{B-8})$$

Therefore, since the dot product of two vectors is the sum of the products of corresponding components, equation (B-1), modified by (B-5) and (B-6), may be rewritten as:

$$\delta \$ = \delta \vec{R} \cdot \vec{\nabla} \$ \quad (\text{B-9})$$

$\delta \vec{R}$  is an incremental line segment in space, along which the "operating point" moves, and whose direction depends on the relative magnitudes and the signs of all the  $\delta S_1$  and  $\delta S_2$ . The problem is the selection of the direction of  $\delta \vec{R}$ , that is, the relative changes in all the ordinates, so as to obtain the greatest reduction of the cost index for a given size of step,  $|\delta \vec{R}|$ .

Although the cost index is a single-valued function of the storage ordinates, there are many sets of ordinates having the same cost index. Hence, since the cost index is a continuous function of the ordinates, through each point in space there passes a surface of constant cost index.

With a given size of step, the magnitude of  $\delta \$$  will be a maximum when  $\overline{\delta R}$  is oriented perpendicular to a surface of constant cost index and parallel to the gradient of the cost index. This is seen from (B-9), for the magnitude of a dot-product of two vectors with fixed magnitudes is a maximum when they are parallel. To make  $\delta \$$  negative,  $\overline{\delta R}$  should be in a direction opposite to  $\overline{\nabla \$}$ . This requires that the components of  $\overline{\delta R}$  be equal to the corresponding components of  $\overline{\nabla \$}$  except for a common negative scale factor. That is, one needs:

$$\delta S_1(t_i) = -\alpha \frac{\partial \$}{\partial S_1(t_i)} \quad i = 1, 2, \dots, l \quad (B-10)$$

$$\delta S_2(t_i) = -\alpha \frac{\partial \$}{\partial S_2(t_i)} \quad i = l+1, l+2, \dots, l+m$$

Where  $\alpha$  is a positive constant determining the size of step. Using (B-5) and (B-6) in (B-10), the desired changes are given by:

$$\delta S_1(t_i) = -\alpha \left[ \frac{\partial \$/hr(t_i)}{\partial S_1(t_i)} - \frac{d}{dt} \frac{\partial \$/hr(t_i)}{\partial \dot{S}_1(t_i)} - \frac{d}{dt} \frac{\partial \$/hr(t+\tau_{12})}{\partial \dot{S}_1(t_i)} \right] \Delta t \quad (B-11)$$

$$i = 1, 2, \dots, l$$

$$\delta S_2(t_i) = -\alpha \left[ \frac{\partial \$/hr(t_i)}{\partial S_2(t_i)} - \frac{d}{dt} \frac{\partial \$/hr(t_i)}{\partial \dot{S}_2(t_i)} \right] \Delta t \quad (\text{B-12})$$

$i = l+1, l+2, \dots, l+m$

These equations are identical, to within a constant factor, to equations 5-40 and 5-41 and so complete the proof.

Appendix C

Second Proof of the Determining Equations  
for the Three Plant System

A second proof, which does not require shifting to finite sums, is given below. The objective, again, is to make  $\delta \mathcal{J}$  of (5-37) as large, negative, as possible, with a limited magnitude of "integrated storage change squared".

To proceed along the path of steepest descent, only changes in  $S_1(t)$  and  $S_2(t)$  which definitely contribute to reducing cost must be made, and hence both integrals in (5-37) must be negative or zero. The problem is attacked by first making each integral of (5-37) as large, negative, as possible; then the relationship between the integrals is fixed. Equation (5-37) is expressed simply as:

$$\delta \mathcal{J} = \int_0^{T-\tau_{12}} \delta S_1(t) E_1(t) dt + \int_0^T \delta S_2(t) E_2(t) dt \quad (C-1)$$

where  $E_1$  and  $E_2$  are the Euler-type brackets in the first and second integrals, respectively, of (5-37). The measure of storage change at plant 1 is given by:

$$(\delta R_1)^2 \equiv \int_0^{T-\tau_{12}} \delta S_1(t)^2 dt \quad (C-2)$$

It is now assumed fixed, with a magnitude to be later specified. Schwartz's inequality states that:

$$\left( \int_a^b f(x)g(x) dx \right)^2 \leq \int_a^b f(x)^2 dx \cdot \int_a^b g(x)^2 dx \quad (C-3)$$

It follows that:

$$\left| \int_0^{T-T_{12}} \delta S_i(t) E_i(t) dt \right| \leq \sqrt{\int_0^{T-T_{12}} \delta S_i(t)^2 dt} \sqrt{\int_0^{T-T_{12}} E_i(t)^2 dt} \quad (C-4)$$

Using (C-2) in (C-4), one gets:

$$\left| \int_0^{T-T_{12}} \delta S_i(t) E_i(t) dt \right| \leq \delta R_i \sqrt{\int_0^{T-T_{12}} E_i(t)^2 dt} \quad (C-5)$$

It follows, therefore, that the first integral of (C-1) must lie in the interval

$$\left( -\delta R_i \sqrt{\int_0^{T-T_{12}} E_i(t)^2 dt}, +\delta R_i \sqrt{\int_0^{T-T_{12}} E_i(t)^2 dt} \right) \quad (C-6)$$

Hence, the most negative value possible for this integral is the lower bound of the integral (C-6), namely:

$$- \delta R_1 \sqrt{\int_0^{T-T_{12}} E_1(t)^2 dt} \quad (C-7)$$

The storage changes needed to obtain this lower bound are given by:

$$\delta S_1(t) = \frac{-\delta R_1}{\sqrt{\int_0^{T-T_{12}} E_1(t)^2 dt}} E_1(t) \quad (C-8)$$

This is easily demonstrated. Using (C-8) in the first integral of (C-1), one obtains (C-7) as follows:

$$\begin{aligned} \int_0^{T-T_{12}} \delta S_1(t) E_1(t) dt &= -\delta R_1 \int_0^{T-T_{12}} \frac{E_1(t)^2 dt}{\sqrt{\int_0^{T-T_{12}} E_1(t)^2 dt}} \\ &= -\delta R_1 \sqrt{\int_0^{T-T_{12}} E_1(t)^2 dt} \end{aligned} \quad (C-9)$$

In like manner, the second integral of (C-1) can be bounded; and this lower bound can be obtained by making storage changes:

$$\delta S_2(t) = \frac{-\delta R_2}{\sqrt{\int_0^T E_2(t)^2 dt}} E_2(t) \quad (C-10)$$

Where the measure of storage change at dam 2 is given by:

$$(\delta R_2)^2 = \int_0^T \delta S_2(t)^2 dt \quad (C-11)$$

Equations (C-8) and (C-10) are sufficient to make each of the integrals in (C-1) as large, negative, as possible, for specified values of  $\delta R_1$  and  $\delta R_2$ . There remains to be demonstrated that the coefficients of  $E_1(t)$  and  $E_2(t)$  in (C-8) and (C-10) should be equal if the sum of these integrals is to be the largest, negative, possible under a constraint on the total storage change. The latter is defined as:

$$\begin{aligned} \delta R^2 &\equiv \int_0^{T-\tau_{12}} \delta S_1(t)^2 dt + \int_0^T \delta S_2(t)^2 dt \\ &= \delta R_1^2 + \delta R_2^2 \end{aligned} \quad (C-12)$$

Substituting (C-8) and (C-10) in (C-1) one gets:

$$\delta \$ = -\delta R_1 \sqrt{\int_0^{T-\tau_{12}} E_1(t)^2 dt} - \delta R_2 \sqrt{\int_0^T E_2(t)^2 dt} \quad (C-13)$$

The objective is to determine the relationship between  $\delta R_1$  and  $\delta R_2$  which will make (C-13) stationary under the subsidiary condition that  $\delta R$  be a specified value, or that:



$$\Phi \equiv \delta R_1^2 + \delta R_2^2 - \delta R = 0 \quad (C-14)$$

From the calculus<sup>1</sup>, the necessary condition for this is that:

$$\frac{\partial(\delta R)}{\partial(\delta R_i)} + K \frac{\partial \Phi}{\partial(\delta R_i)} = 0 \quad i = 1, 2 \quad (C-15)$$

where k is a constant, Lagrange's multiplier.

Using (C-13) and (C-14) in (C-15), one gets:

$$-\sqrt{\int_0^{T-T_2} E_1(t)^2 dt} + 2K \delta R_1 = 0 \quad (C-16)$$

$$-\sqrt{\int_0^T E_2(t)^2 dt} + 2K \delta R_2 = 0$$

Solving these for  $\delta R_1$  and  $\delta R_2$ :

$$\delta R_1 = \frac{1}{2K} \sqrt{\int_0^{T-T_2} E_1(t)^2 dt} \quad (C-17)$$

$$\delta R_2 = \frac{1}{2K} \sqrt{\int_0^T E_2(t)^2 dt} \quad (C-18)$$

<sup>1</sup>Courant, 12

Substituting (C-17) in (C-8) and (C-18) in (C-10) one finds that the coefficients of  $E_1(t)$  and  $E_2(t)$  are equal to

$$-\frac{1}{2K} \equiv -\alpha \quad (C-19)$$

This establishes the relations for storage changes, so as to follow the path of steepest descent, as:

$$\delta S_1(t) = -\alpha E_1(t) \quad (C-20)$$

$$\delta S_2(t) = -\alpha E_2(t)$$

thus completing the proof.

## Appendix D

### A Formulation of the Short Range Optimization

Because cumulative variations of plant efficiencies during any one week can be neglected, the short range optimization simplifies to an ordinary minimization in calculus.

This is developed for the following case:

1. Loadings of each hydro plant at any load below a predetermined capability limit are equally efficient.
2. The cost of replacement of hydro deficiency is a known quadratic function for each source.
3. Each hydro plant is constrained to deliver a specified average weekly power.
4. Transmission loss is appreciable.
5. n hydro plants and m non-hydro sources comprise the system.

The cost of supplying hydro deficiency from plant j is given by:

$$\$/hr (G_{dj}) = f_{j0} + f_{j1} G_{dj} + \frac{1}{2} f_{j2} G_{dj}^2 \quad j=1, 2, \dots, m \quad (D-1)$$

The corresponding incremental cost is therefore:

$$\$/mw. hr (G_{dj}) = \frac{\partial \$/hr}{\partial G_{dj}} = f_{j1} + f_{j2} G_{dj} \quad j=1, \dots, m \quad (D-2)$$

The undesirability of exceeding a predetermined loading on each hydro plant is accounted for by using a penalty cost which increases abruptly when this limit is exceeded. This fictitious incremental cost is given by:

$$\begin{aligned} \$/\text{mw.hr} (G_{hi}) &= -a + \left(\frac{a}{G_{him}}\right) G_{hi} \\ &= P_{i1} + P_{i2} G_{hi} \end{aligned} \quad (\text{D-3})$$

where  $a = 0$  for  $G_{hi} < G_{him}$  and  $a \gg 1$  for  $G_{hi} > G_{him}$

The incremental costs for one source of deficiency power and one hydro plant are sketched in figure D.1.

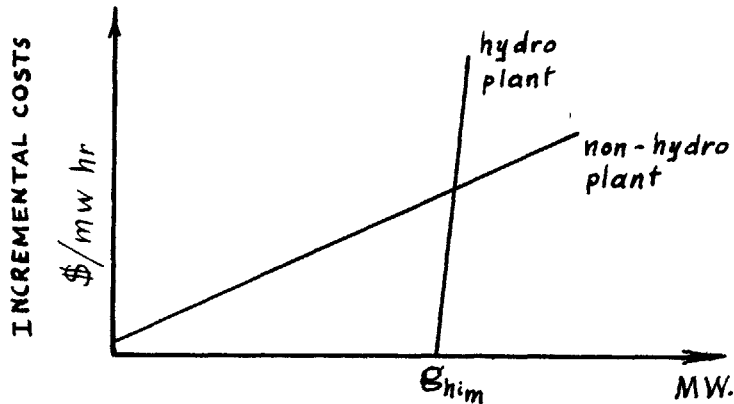

Figure D.1 Sketch of incremental cost of hydro deficiency and incremental penalty cost for overloading hydro plant.

If the penalty cost curve is made sufficiently steep (sufficiently large  $a$ ) only small violations of the generation limit can occur.

The specification of an average weekly generation<sup>A</sup> at the hydro plants requires that:

$$\int_0^T (\mathcal{E}_{hi} - \mathcal{E}_{hiA}) dt = 0 \quad i = 1, 2, \dots, n \quad (D-4)$$

The necessity of meeting the load requires that:

$$L(t) + p_L(t) - \sum_{j=1}^m \mathcal{E}_{dj} - \sum_{i=1}^n \mathcal{E}_{hi} = 0 \quad (D-5)$$

We seek to minimize the effective cost given by:

$$\mathcal{E} = \int_0^T \left[ \sum_{j=1}^m \$/hr(\mathcal{E}_{dj}) + \sum_{i=1}^n \$/hr(\mathcal{E}_{hi}) \right] dt \quad (D-6)$$

subject to the constraints (D-4) and (D-5). These constraints are included in the minimization by adding terms to the integrand of (D-6).<sup>1</sup> We then seek to minimize

$$I \equiv \int_0^T F(t) dt \quad (D-7)$$

where

$$F(t) \equiv \sum_{j=1}^m \$/hr(\mathcal{E}_{dj}) + \sum_{i=1}^n \$/hr(\mathcal{E}_{hi}) - \sum_{i=1}^n \lambda_i [\mathcal{E}_{hi} - \mathcal{E}_{hiA}] - \mu(t) \left[ L + p_L - \sum_{j=1}^m \mathcal{E}_{dj} - \sum_{i=1}^n \mathcal{E}_{hi} \right] \quad (D-8)$$

<sup>1</sup>Methods of Advanced Calculus, P. Franklin, McGraw Hill Book Co., 1944, p.439-442.

where the  $\lambda_i$  are constants and  $\mathcal{U}$  is a function of time, all definite but unknown.

The necessary conditions for a minimum of the integral of (D-7) are the Euler equations:

$$\frac{\partial F}{\partial g_{hi}} - \frac{d}{dt} \frac{\partial F}{\partial \dot{g}_{hi}} = 0 \quad i = 1, 2, \dots, n \quad (D-9)$$

$$\frac{\partial F}{\partial g_{dj}} - \frac{d}{dt} \frac{\partial F}{\partial \dot{g}_{dj}} = 0 \quad j = 1, 2, \dots, m$$

Since  $F$  is not a function of  $\dot{g}_i$  or  $\dot{g}_j$ , this reduces to:

$$\frac{\partial F}{\partial g_{hi}} = 0 \quad i = 1, 2, \dots, n \quad (D-10)$$

$$\frac{\partial F}{\partial g_{dj}} = 0 \quad j = 1, 2, \dots, m$$

Using (D-2) (D-3) and (D-8), (D-10) becomes:

$$p_{i1} + p_{i2} g_{hi} - \lambda_i - \mathcal{U}(t) \left[ \sum_{l=1}^n 2 B_{i,hl} g_{hl} + \sum_{l=1}^m 2 B_{i,dl} g_{dl} \right] = 0 \quad i = 1, 2, \dots, n \quad (D-11)$$

$$f_{j1} + f_{j2} g_{dj} - \mathcal{U}(t) \left[ \sum_{l=1}^n 2 B_{j,hl} g_{hl} + \sum_{l=1}^m 2 B_{j,dl} g_{dl} \right] = 0 \quad j = 1, 2, \dots, m$$

These, together with (D-4) and (D-5) involve  $2n + m + 1$  unknowns and an equal number of equations, which can be solved by either analog computer or numerical iteration.

APPENDIX E

TABLE OF COMPUTATIONS

USED IN THE DEMONSTRATION OF THE GRADIENT METHOD

IN A THREE PLANT SYSTEM

using the following approximations with small  $\tau_{12}$ :

$$\dot{y}_1(t) = \dot{y}_1(t + \tau_{12}) = \dot{y}_1(t - \tau_{12})$$

$$\dot{y}_2(t) = \dot{y}_2(t + \tau_{12}) = \dot{y}_2(t - \tau_{12})$$

$$s_1(y_1(t)) = s_1(y_1(t + \tau_{12})) = s_1(y_1(t - \tau_{12}))$$

$$s_2(y_2(t)) = s_2(y_2(t + \tau_{12})) = s_2(y_2(t - \tau_{12}))$$

a) Slopes:

$$C1 \quad \dot{y}_1(t) = \frac{y_1(t + \Delta t) - y_1(t - \Delta t)}{2\Delta t}$$

$$C4 \quad \dot{y}_2(t) = \frac{y_2(t + \Delta t) - y_2(t - \Delta t)}{2\Delta t}$$

b) Plant Discharge:

$$C6 \quad Q_1(t) = F_1(t) - \dot{S}_1(t)$$

$$C7 \quad Q_1(t, y_1 + \Delta y_1) = F_1(t) - \dot{S}_1(t, y_1 + \Delta y_1)$$

$$C8 \quad Q_1(t, \dot{y}_1 + \Delta \dot{y}_1) = F_1(t) - \dot{S}_1(t, \dot{y}_1 + \Delta \dot{y}_1)$$

$$C9 \quad Q_1(t + \tau_{12}) \cong F_1(t + \tau_{12}) - \dot{S}_1(t)$$

$$C10 \quad Q_2(t) \cong F_2(t) - \dot{S}_1(t) - \dot{S}_2(t)$$

$$C11 \quad Q_2(t, y_2 + \Delta y_2) \cong F_2(t) - \dot{S}_1(t) - \dot{S}_2(t, y_2 + \Delta y_2)$$

$$C12 \quad Q_2(t, \dot{y}_2 + \Delta\dot{y}_2) = F_2(t) - \dot{s}_1(t) - \dot{s}_2(t, \dot{y}_2 + \Delta\dot{y}_2)$$

$$C13 \quad Q_2(t + \tau_{12}) \cong F_2(t + \tau_{12}) - \dot{s}_1(t) - \dot{s}_2(t)$$

$$C14 \quad Q_2(t + \tau_{12}, y_1 + \Delta y_1) \cong F_2(t + \tau_{12}) - \dot{s}_1(t, y_1 + \Delta y_1) - \dot{s}_2(t)$$

$$C15 \quad Q_2(t + \tau_{12}, \dot{y}_1 + \Delta\dot{y}_1) \cong F_2(t + \tau_{12}) - \dot{s}_1(t, \dot{y}_1 + \Delta\dot{y}_1) - \dot{s}_2(t)$$

NOTE:  $\dot{s}_i(t) = s_i(y_i(t)) \dot{y}_i(t)$

c) Net Head:

$$C16 \quad h_1(t) = y_1(t) - y_{1T} \quad (C6)$$

$$C17 \quad h_1(t, y_1 + \Delta y_1) = y_1(t) + \Delta y_1 - y_{1T} \quad (C7)$$

$$C18 \quad h_1(t, \dot{y}_1 + \Delta\dot{y}_1) = y_1(t) - y_{1T} \quad (C8)$$

$$C19 \quad h_1(t + \tau_{12}) = y_1(t + \tau_{12}) - y_{1T} \quad (C9)$$

$$C20 \quad h_2(t) = y_2(t) - y_{2T} \quad (C10)$$

$$C21 \quad h_2(t, y_2 + \Delta y_2) = y_2(t) + \Delta y_2 - y_{2T} \quad (C11)$$

$$C22 \quad h_2(t, \dot{y}_2 + \Delta\dot{y}_2) = y_2(t) - y_{2T} \quad (C12)$$

$$C23 \quad h_2(t + \tau_{12}) = y_2(t + \tau_{12}) - y_{2T} \quad (C13)$$

$$C24 \quad h_2(t + \tau_{12}, y_1 + \Delta y_1) = y_2(t + \tau_{12}) - y_{2T} \quad (C14)$$

$$C25 \quad h_2(t + \tau_{12}, \dot{y}_1 + \Delta\dot{y}_1) = y_2(t + \tau_{12}) - y_{2T} \quad (C15)$$

d) Turbine Discharge:

$$C26 \quad D_1(t) = C6 - f_1(y_1(t))$$

$$C27 \quad D_1(t, y_1 + \Delta y_1) = C7 - f_1(y_1(t) + \Delta y_1)$$



$$C28 \quad D_1(t, \dot{y}_1 + \Delta \dot{y}_1) = C8 - \mathcal{J}_1(y_1(t))$$

$$C29 \quad D_1(t + \tau_{12}) = C9 - \mathcal{J}_1(y_1(t + \tau_{12}))$$

$$C30 \quad D_2(t) = C10 - \mathcal{J}_2(y_2(t))$$

$$C31 \quad D_2(t, y_2 + \Delta y_2) = C11 - \mathcal{J}_2(y_2(t) + \Delta y_2)$$

$$C32 \quad D_2(t, \dot{y}_2 + \Delta \dot{y}_2) = C12 - \mathcal{J}_2(y_2(t))$$

$$C33 \quad D_2(t + \tau_{12}) = C13 - \mathcal{J}_2(y_2(t + \tau_{12}))$$

$$C34 \quad D_2(t + \tau_{12}, y_1 + \Delta y_1) = C14 - \mathcal{J}_2(y_2(t + \tau_{12}))$$

$$C35 \quad D_2(t + \tau_{12}, \dot{y}_1 + \Delta \dot{y}_1) = C15 - \mathcal{J}_2(y_2(t + \tau_{12}))$$

e) Hydro Generation:

$$C36 \quad \varepsilon_1(t) = \frac{\varepsilon_1}{D_1} (C16) \cdot C26$$

$$C37 \quad \varepsilon_1(t, y_1 + \Delta y_1) = \frac{\varepsilon_1}{D_1} (C17) \cdot C27$$

$$C38 \quad \varepsilon_1(t, y_1 + \Delta y_1) = \frac{\varepsilon_1}{D_1} (C18) \cdot C28$$

$$C39 \quad \varepsilon_1(t + \tau_{12}) = \frac{\varepsilon_1}{D_1} (C19) \cdot C29$$

$$C40 \quad \varepsilon_2(t) = \frac{\varepsilon_2}{D_2} (C20) \cdot C30$$

$$C41 \quad \varepsilon_2(t, y_2 + \Delta y_2) = \frac{\varepsilon_2}{D_2} (C21) \cdot C31$$

$$C42 \quad \varepsilon_2(t, y_2 + \Delta y_2) = \frac{\varepsilon_2}{D_2} (C22) \cdot C32$$

$$C43 \quad \varepsilon_2(t + \tau_{12}) = \frac{\varepsilon_2}{D_2} (C23) \cdot C33$$

$$C44 \quad \varepsilon_2(t + \tau_{12}, y_1 + \Delta y_1) = \frac{\varepsilon_2}{D_2} (C24) \cdot C34$$

$$C45 \quad g_2(t + \tau_{12}, \dot{y}_1 + \Delta \dot{y}_1) = \frac{g_2}{D_2} (C25) \cdot C35$$

f) Hydro Deficiency:

$$C46 \quad g_d(t) = L(t) - C36 - C40$$

$$C47 \quad g_d(t, y_1 + \Delta y_1) = L(t) - C37 - C40$$

$$C48 \quad g_d(t, \dot{y}_1 + \Delta \dot{y}_1) = L(t) - C38 - C40$$

$$C49 \quad g_d(t + \tau_{12}) = L(t + \tau_{12}) - C39 - C43$$

$$C50 \quad g_d(t, y_2 + \Delta y_2) = L(t) - C36 - C41$$

$$C51 \quad g_d(t, y_2 + \Delta y_2) = L(t) - C36 - C42$$

$$C52 \quad g_d(t + \tau_{12}, y_1 + \Delta y_1) = L(t + \tau_{12}) - C39 - C44$$

$$C53 \quad g_d(t + \tau_{12}, y_1 + \Delta y_1) = L(t + \tau_{12}) - C39 - C45$$

g) Effective Hourly Cost:

$$C54 \quad \$/hr(t) = \$/hr (C46) + p_{1g} (C36) + p_{1y}(y_1(t)) \\ + p_{2g} (C40) + p_{2y}(y_2(t))$$

$$C55 \quad \$/hr(t, y_1 + \Delta y_1) = \$/hr (C47) + p_{1g} (C37) + p_{1y}(y_1(t) + \Delta y_1) \\ + p_{2g} (C40) + p_{2y}(y_2(t))$$

$$C56 \quad \$/hr(t, y_1 + \Delta y_1) = \$/hr (C48) + p_{1g} (C38) + p_{1y}(y_1(t)) \\ + p_{2g} (C40) + p_{2y}(y_2(t))$$

$$C57 \quad \$/hr(t + \tau_{12}) = \$/hr (C49) + p_{1g} (C39) + p_{1y}(y_1(t + \tau_{12})) \\ + p_{2g} (C43) + p_{2y}(y_2(t + \tau_{12}))$$

$$\begin{aligned} \text{C58} \quad \$/\text{hr}(t, y_2 + \Delta y_2) &= \$/\text{hr} \text{ (C50)} + p_{1g} \text{ (C36)} + p_{1y}(y_1(t)) \\ &+ p_{2g} \text{ (C41)} + p_{2y}(y_2(t) + \Delta y_2) \end{aligned}$$

$$\begin{aligned} \text{C59} \quad \$/\text{hr}(t, \dot{y}_2 + \Delta \dot{y}_2) &= \$/\text{hr} \text{ (C51)} + p_{1g} \text{ (C36)} + p_{1y}(y_1(t)) \\ &+ p_{2g} \text{ (C42)} + p_{2y}(y_2(t)) \end{aligned}$$

$$\begin{aligned} \text{C60} \quad \$/\text{hr}(t + \tau_{12}, y_1 + \Delta y_1) &= \$/\text{hr} \text{ (C52)} + p_{1g} \text{ (C39)} + p_{1y}(y_1(t + \tau_{12})) \\ &+ p_{2g} \text{ (C44)} + p_{2y}(y_2(t + \tau_{12})) \end{aligned}$$

$$\begin{aligned} \text{C61} \quad \$/\text{hr}(t + \tau_{12}, \dot{y}_1 + \Delta \dot{y}_1) &= \$/\text{hr} \text{ (C53)} + p_{1g} \text{ (C39)} + p_{1y}(y_1(t + \tau_{12})) \\ &+ p_{2g} \text{ (C45)} + p_{2y}(y_2(t + \tau_{12})) \end{aligned}$$

h) Components of the Euler Expressions:

$$\text{C62} \quad \frac{\partial \$/\text{hr}(t)}{\partial y_1(t)} = \frac{\text{C55} - \text{C54}}{\Delta y_1}$$

$$\text{C63} \quad \frac{\partial \$/\text{hr}(t + \tau_{12})}{\partial y_1(t)} = \frac{\text{C60} - \text{C57}}{\Delta y_1}$$

$$\text{C64} \quad \frac{\partial \$/\text{hr}(t)}{\partial \dot{y}_1(t)} = \frac{\text{C56} - \text{C54}}{\Delta y_1}$$

$$\text{C65} \quad \frac{\partial \$/\text{hr}(t + \tau_{12})}{\partial y_1(t)} = \frac{\text{C61} - \text{C57}}{\Delta y_1}$$

$$\text{C66} \quad \frac{\partial \$/\text{hr}(t)}{\partial y_2(t)} = \frac{\text{C58} - \text{C54}}{\Delta y_2}$$

$$\text{C67} \quad \frac{\partial \$/\text{hr}(t)}{\partial \dot{y}_2(t)} = \frac{\text{C59} - \text{C54}}{\Delta y_2}$$

$$C68 \quad \frac{d}{dt} \frac{\partial \$/hr(t)}{\partial y_1(t)} = \frac{f64 - b64}{2\Delta t}$$

$$C69 \quad \frac{d}{dt} \frac{\partial \$/hr(t + \tau_{12})}{\partial y_1(t)} = \frac{f65 - b65}{2\Delta t}$$

$$C70 \quad \frac{d}{dt} \frac{\partial \$/hr(t)}{\partial y_2(t)} = \frac{f67 - b67}{2\Delta t}$$

1) Elevation Changes:

$$C71 \quad \delta y_1(t) = \frac{\alpha}{s_1(y_1(t))^2} [-C62 - C63 + C68 + C69]$$

$$C72 \quad \delta y_2(t) = \frac{\alpha}{s_2(y_2(t))^2} [-C66 + C70]$$

Appendix F

Programs Used to Implement the Gradient Method  
on Whirlwind I  
for the Three Planet System

F. 1  
DOUBLE LENGTH  
PARAMETER STORAGE

TAPE NO. 2260 P 1  
(24, 6)  
Storage  
Register

|           |             | TEMPORARY STORAGE    |
|-----------|-------------|----------------------|
| 32/b1,    | +0          |                      |
|           | DITTO THRU  |                      |
| 74r/74b1, | +3336.30    | $y_{10} = y_1 \min$  |
| 76b1      | +2.800      | $s_1(y_{10})$        |
| 78b1      | +0.02599    | $m_{1s}$             |
| 80b1      | +0.00005663 | $n_{1s}$             |
| 82b1      | +3072.0     | $y_{1t}(Q_1 = 0)$    |
| 84b1      | +1.5012     | $m_{1t}$             |
| 86b1      | +0.034039   | $-n_{1t}$            |
| 88b1      | +20.0       | $h_{10}$             |
| 90b1      | +256.00     | $h_{11}$             |
| 92b1      | +0.06486    | $\zeta_1$            |
| 94b1      | -38.1075    | $m_{1g}$             |
| 96b1      | -2.8626     | $-n_{1g}$            |
| 98b1      | +128.7      | $g_{1m}(h = h_{11})$ |
| 100b1     | +1.2299     | $m_{1g_m}$           |
| 102b1     | -0.0005136  | $-n_{1g_m}$          |
| 104b1     | +3556.0     | $y_{1c}$             |
| 106b1     | +0.69265    | $m_{1L}$             |

|       |            |                            |
|-------|------------|----------------------------|
| 108b1 | +0.541125  | $n_{1L}$                   |
| 110b1 | +300       | $g_{1m}(\text{rated})$     |
| 112b1 | +0.300     | $\Delta y_1$               |
| 114b1 | +0.03      | $\Delta \dot{y}_1$         |
| 116b1 | +2883.0    | $y_{20} = y_2 \text{ min}$ |
| 118b1 | +60.0      | $s_2(y_{20})$              |
| 120b1 | +0         | $m_{2s}$                   |
| 122b1 | +2697.00   | $y_{2t}(Q_2 = 0)$          |
| 124b1 | +0.56875   | $m_{2t}$                   |
| 126b1 | +0.003594  | $-n_{2t}$                  |
| 128b1 | +5.0       | $h_{20}$                   |
| 130b1 | +164.0     | $h_{22}$                   |
| 132b1 | +0.0760    | $\eta_2$                   |
| 134b1 | -2.885     | $m_{2g}$                   |
| 136b1 | -0.180     | $-n_{2g}$                  |
| 138b1 | +120       | $g_{2m}(h_2 = h_{22})$     |
| 140b1 | +1.2299    | $m_{2gm}$                  |
| 142b1 | -0.0005136 | $-n_{2gm}$                 |
| 144b1 | +2893.0    | $y_{2c}$                   |
| 146b1 | +0.27706   | $m_{2L}$                   |

|       |          |                          |
|-------|----------|--------------------------|
| 148b1 | +0.21645 | $n_{2L}$                 |
| 150b1 | +150     | $g_{2m}(\text{rated})$   |
| 152b1 | +0.1     | $\Delta y_2$             |
| 154b1 | +0.003   | $\Delta \dot{y}_2$       |
| 156b1 | +7.0     | $\Delta t$               |
| 158b1 | +14.0    | $2\Delta t$              |
| 160b1 | +0.65    | $\tau_{12}$              |
| 162b1 | +4.0     | $m_{\#}$                 |
| 164b1 | +0.012   | $n_{\#}$                 |
| 166b1 | +10.0    | $\alpha$                 |
| 168b1 | -0.0     | } numbers                |
| 170b1 | +0.5     |                          |
| 172b1 | +1.0     | $\$/\text{hr} (g_d = 0)$ |
| 174b1 | +20.0    | $k \Delta \$$            |
| 176b1 | +10.0    | $m(p_g)$                 |
| 178b1 | +10.0    | $m(p_{1y})$              |
| 180b1 | +3570.0  | $ y_{1m} $               |
| 182b1 | +2897.0  | $ y_{2m} $               |
| 184b1 | +2.0     | $ \delta y_{1m} $        |
| 186b1 | +0.2     | $ \delta y_{2m} $        |
| 188b1 | +100     | $m(p_{2y})$              |



190b1           +.0           Temporary storage  
192b1           +.0

F. 2  
CYCLE CONTROL PROGRAM

TAPE NO. 2260 MO  
(24,6)

|      |             |   |                   |
|------|-------------|---|-------------------|
| c1,  | c s x 2 0   | } | set run           |
|      | t s x 1     |   | counter           |
| c8,  | c s o       | } | reset pass        |
|      | t s x 1 3   |   | counter           |
|      | c s x 2     | } | reset ordinate    |
|      | t s x 3     |   | counter           |
| c10, | s p d 1     |   | Read 1 Group      |
|      | c a x 6     | } | save parts in     |
|      | t d t 3     |   | " b " registers   |
|      | s p t 1     |   |                   |
|      | I N         |   |                   |
|      | i c a 158b1 | } | insert 2Δt        |
|      | i t s 60b1  |   | in 60b1           |
|      | s p c 2     |   |                   |
| c2,  | s i 72      |   | skip 1 Group fwd. |
|      | s p d 1     |   | read 1 Group fwd. |
|      | c a x 5     | } | save parts in     |
|      | t d t 3     |   | " f " registers   |
|      | s p t 1     |   |                   |
|      | s p w 1     |   | delay             |

|     |           |   |   |                 |              |
|-----|-----------|---|---|-----------------|--------------|
|     | c s l     | } | { | skip back       |              |
|     | s p s l   |   |   | 2 Groups        |              |
|     | s p w l   |   |   | delay           |              |
|     | s p d l   |   |   | read 1 Group    |              |
|     | c a x l 3 | } | { | is pass counter |              |
|     | c p c 4   |   |   | positive?       |              |
| c3, | s p k l   |   |   | final comp.     |              |
|     | s p l c 4 |   |   |                 |              |
| c4, | s p p l   |   |   | prelim. comp.   |              |
|     | c a x 6   | } | { | save parts      |              |
|     | t d t 3   |   |   | in "b" reg.     |              |
|     | s p t l   |   |   |                 |              |
|     | c s 0     | } | { | skip back       |              |
|     | s p s l   |   |   | 1 Group         |              |
|     | c a x l 6 | } |   |                 |              |
|     | t d c 5   |   |   |                 |              |
|     | s i 72    |   |   |                 |              |
| c5, | c a 0     |   |   |                 | rerecord     |
| c6, | r c c 6   |   |   |                 | 1 Group fwd. |
|     | a o c 5   |   |   |                 |              |
|     | s u x l 4 |   |   |                 |              |
|     | c p c 5   |   |   |                 |              |
|     | s p w l   |   |   | delay           |              |
|     | a o x 3   | } | { | recycle if ord. |              |
|     | c p c 2   |   |   | counter is neg. |              |

|      |                 |   |                   |
|------|-----------------|---|-------------------|
|      | s 1 4 0 8       |   | stop tape         |
|      | c a x 1 3       | } | { is pass counter |
|      | c p c 9         |   |                   |
|      | a o x 1         | } | { is run counter  |
|      | c p c 7         |   |                   |
|      | s p 2 1         |   | final reprint     |
| c7,  | c s x 1 2       | } | { skip back       |
|      | s p s 1         |   |                   |
|      | s p c 8         |   | recycle           |
| c9,  | c a x 3         | } | { is ordinate     |
|      | s u 1           |   |                   |
|      | c p c 1 1       |   |                   |
|      | a o x 1 3       |   | step pass counter |
|      | c s x 1 2       | } | { skip back       |
|      | s p s 1         |   |                   |
|      | c s x 2         | } | { reset ordinate  |
|      | t s x 3         |   |                   |
|      | a o x 3         |   |                   |
|      | s p c 1 0       |   | to 2nd pass       |
| c11, | I N             |   |                   |
|      | i c a 1 9 2 b 1 | } | { delayed Print   |
|      | i s p r 1       |   |                   |
|      | i c a 72b1      | } | { delayed Print   |
|      | i s p r 1       |   |                   |
|      |                 |   | k\$               |

|      |             |   |                  |
|------|-------------|---|------------------|
|      | i c a 72b1  | } | kΔ\$             |
|      | i s u 70b1  |   |                  |
|      | i c p c 1 2 |   |                  |
|      | i c a 166b1 |   | α                |
|      | i m r 170b1 |   | .5α = α'         |
|      | i t s 166b1 |   |                  |
|      | i s p c 1 3 |   |                  |
| c12, | i a d 174b1 |   | kΔ\$ + 30        |
|      | i c p c 1 3 |   |                  |
|      | i c a 166b1 |   | α                |
|      | i d v 170b1 |   | 2α = α'          |
|      | i t s 166b1 |   |                  |
| c13, | i c a 166b1 |   |                  |
|      | i s p r 1   |   | delayed Print    |
|      | i c a 72b1  | } | {                |
|      | i t s 70b1  |   |                  |
|      | i c a 168b1 | } | {                |
|      | i t s 192b1 |   |                  |
|      | i t s 72b1  |   |                  |
|      | i c a 156b1 | } | }                |
|      | i t s 60b1  |   |                  |
|      | s p d 1     |   | read 1 Group     |
|      | c a x 5     | } | {                |
|      | t d t 3     |   |                  |
|      | s p t 1     |   |                  |
|      | s p c 4     |   |                  |
|      |             |   | save parts       |
|      |             |   | in "r" registers |
|      |             |   | to Prelim. Comp. |

F. 3 SUBROUTINE f  
DOLLARS PER HOUR SUMMATION

f1,            i t a f 2  
              i c a 66b1                    L  
              i a d 62 b1                  L - g<sub>1</sub>  
              i a d 26b1                  L - g<sub>1</sub> - g<sub>2</sub> = g<sub>d</sub>  
              i t s 52b1                  g<sub>d</sub>  
              i m r 164b1                 n<sub>\$</sub> g<sub>d</sub>  
              i a d 162b1                 m<sub>\$</sub> + n<sub>\$</sub> g<sub>d</sub>  
              i m r 52b1                 m<sub>\$</sub>g<sub>d</sub> + n<sub>\$</sub> g<sub>d</sub><sup>2</sup>  
              i a d 172b1                 \$/hr(g<sub>d</sub>=0)+m<sub>\$</sub>g<sub>d</sub>+n<sub>\$</sub>g<sub>d</sub><sup>2</sup>  
              i t s 52b1                 \$/hr(g<sub>d</sub>)  
              i a d 64b1                 \$/hr(g<sub>d</sub>) + P<sub>1n</sub>  
              i a d 68b1                 \$/hr(g<sub>d</sub>) + P<sub>1n</sub> + P<sub>2n</sub> = \$/hr  
+2,            i s p 0

F.4 SUBROUTINE g  
ELEVATION CHANGE LIMITER

g1,            i t a g 5  
              i c a 66b1                    δy  
              i c p g 3  
              i s u 68b1                  δy - |δym|  
              i c p g 2  
              i c a 68b1                  |δym|  
              i s p g 5  
g2,            i c a 66b1                    δy

g3,           i s p g 5  
              i a d 68b1            $\delta y + |\delta y_m|$   
              i c p g 4  
              i c a 66b1            $\delta y$   
              i s p g 5  
g4,           i c s 68b1            $\delta y_m$   
g5,           i s p 0

F. 5 SUBROUTINES h  
INCREMENTAL STORAGE, DAM 1

h1,           i t a h 3  
              i s u 74b1            $y_1 - y_{10} = y_{1s}$   
              i t s 52b1            $y_{1s}$   
              i m r 80b1            $n_{1s}y_{1s}$   
              i a d 78b1            $m_{1s} + n_{1s}y_{1s}$   
              i m r 52b1            $m_{1s}y_{1s} + n_{1s}y_{1s}^2$   
              i a d 76b1            $s_{10} + m_{1s}y_{1s} + n_{1s}y_{1s}^2$   
h3,           i s p 0

INCREMENTAL STORAGE, DAM 2

h2,           i t a h 4  
              i s u 116b1            $y_2 - y_{20} = y_{2s}$   
              i m r 120b1            $m_{2s}y_{2s}$   
              i a d 118b1            $s_{20} + m_{2s}y_{2s}$   
h4,           i s p 0

F. 6 SUBROUTINE k  
FINAL COMPUTATIONS

k1,           t a k 8  
              I N

i c a 44b1  $f[\partial \$/hr(t)/\partial \dot{y}_1(t)] = f64$

i s u 54b1  $f64 - b64$

i d v 158b1  $[f64 - b64] / 2\Delta t$

i t s 64b1  $= \frac{d}{dt} \frac{\partial \$/hr(t)}{\partial \dot{y}_1(t)}$

i s p k 2 space for occasional print out

k2, i c a 46b1  $f[\partial \$/hr(t+\tau_{12})/\partial \dot{y}_1(t)] = f65$

i s u 56b1  $f65 - b65$

i d v 158b1  $[f65 - b65] / 2\Delta t$

i t s 52b1  $= \frac{d}{dt} \frac{\partial \$/hr(t+\tau_{12})}{\partial \dot{y}_1(t)}$

i s p k 3 space for occasional print out

k3, i c a 52b1  $\frac{d}{dt} \frac{\partial \$/hr(t+\tau_{12})}{\partial \dot{y}_1(t)}$

i a d 64b1  $\frac{d}{dt} \frac{\partial \$/hr(t)}{\partial \dot{y}_1(t)} + \frac{d}{dt} \frac{\partial \$/hr(t+\tau_{12})}{\partial \dot{y}_1(t)}$

i s u 30b1  $-\frac{\partial \$/hr(t)}{\partial y_1(t)} + \frac{d}{dt} \frac{\partial \$/hr(t)}{\partial \dot{y}_1(t)} + \frac{d}{dt} \frac{\partial \$/hr(t+\tau_{12})}{\partial \dot{y}_1(t)}$

i s u 34b1  $-\frac{\partial \$/hr(t)}{\partial y_1(t)} - \frac{\partial \$/hr(t+\tau_{12})}{\partial y_1(t)} + \frac{d}{dt} \frac{\partial \$/hr(t)}{\partial \dot{y}_1(t)} + \frac{d}{dt}$

$$\frac{\partial \$/hr(t+\tau_{12})}{\partial \dot{y}_1(t)} = -E_1(t)$$

i d v 36b1  $-E_1(t) / s_1(y_1(t))$

i m r 166b1  $-\frac{\alpha}{s_1(y_1(t))} E_1(t)$

i d v 36b1  $-\frac{\alpha}{s_1(y_1(t))^2} E_1(t) = \delta y_1(t)$

- i t s 66b1  $\delta y_1(t)$   
 i m r 66b1  $\delta y_1^2$   
 i m r 36b1  $e_1 \delta y_1^2$   
 i m r 36b1  $\delta S_1^2$   
 i a d 192b1  $\left. \begin{array}{l} \\ \\ \end{array} \right\} \sum \delta S^2$   
 i t s 192b1  
 i c a 184b1  $/\delta y_{1m}/$   
 i t s 68b1 "  
 i c a b 1  $P \Sigma(\Sigma P_1 + \delta_1)$   
 i a d 4b1  $P \Sigma(\Sigma P_1 + \delta_1)^{**} + \Sigma(\Sigma P_1 + \delta_1)^*$   
 i c p k 4  
 i s p g 1 Limiter  
 i s p k 5  
 k4, i c a 66b1  $\delta y_1$   
 k5, i a d 20b1  $\delta y_1(t) + y_1(t)$   
 i t s 20b1 "  
 i s p r 1 delayed print out  
 i c a 48b1  $f[\partial \$/hr(t)/\partial \dot{y}_2(t)] = f67$   
 i s u 58b1  $f67 - b67$   
 i d v 158b1  $[f67-b67] / 2\Delta t = \frac{d}{dt} \frac{\partial \$/hr(t)}{\partial \dot{y}_2(t)}$   
 i s u 32b1  $-\left\{ \frac{\partial \$/hr(t)}{\partial y_2(t)} - \frac{d}{dt} \frac{\partial \$/hr(t)}{\partial \dot{y}_2(t)} \right\} = -E_2(t)$   
 i d v 38b1  $-\frac{1}{s_2(y_2(t))} E_2(t)$   
 i m r 166b1  $-\frac{\alpha}{s_2(y_2(t))} E_2(t)$

\* Summation of all dam 1 penalty costs and spillage, for each variation described in 7.6a.

\*\* Similar sums for previous iteration.



i d v 38b1  $-\frac{\alpha}{s_2(y_2(t))^2} E_2(t) = \delta y_2(t)$

i t s 66b1  $\delta y_2$

i m r 66 b1  $\delta y_2^2$

i m r 38b1  $s_2 \delta y_2^2$

i m r 38b1  $\delta s_2^2$

i a d 192b1  $\left. \begin{array}{l} \\ \end{array} \right\} \Sigma \delta s^2$

i t s 192b1  $\left. \begin{array}{l} \\ \end{array} \right\}$

i c a 186b1  $|\delta y_{2m}|$

i t s 68b1  $"$

i c a 2b1  $P \Sigma (\Sigma P_2 + \delta_2)$

i a d 6b1  $P \Sigma (\Sigma P_2 + \delta_2) + (\Sigma P_2 + \delta_2)$

i c p k 6

i s p g 1 Limiter

i s p k 7

k6, i c a 66b1  $\delta y_2$

k7, i a d 22b1  $y_2(t) + \delta y_2$

i t s 22b1  $"$

i s p r 1 delayed print out

i c a 4b1  $\left. \begin{array}{l} \\ \\ \end{array} \right\}$

i t s b 1  $\left. \begin{array}{l} \\ \\ \end{array} \right\}$  set up violations counter.

i c a 6b1  $\left. \begin{array}{l} \\ \\ \end{array} \right\}$

i t s 2b1  $\left. \begin{array}{l} \\ \\ \end{array} \right\}$

k8, s p 0

F. 7 SIBROUTINE m  
PLANT 1 GENERATIONS

m1, i t a m 6  
i t s 50b1  $-Q_1$   
i m r 86b1  $n_{1t}Q_1$   
i a d 84b1  $m_{1t} + n_{1t}Q_1$   
i m r 50b1  $-m_{1t}Q_1 - n_{1t}Q_1^2$   
i s u 82b1  $-y_{1t}(Q_1=0) - m_{1t}Q_1 - n_{1t}Q_1^2$   
i a d 48b1  $y_1 - y_{1t} = h_1$   
i t s 56b1  $h_1$   
i c a 48b1  $y_1$   
i s u 104b1  $y_1 - y_{1c} = y_{1L}$   
i t s 52b1  $y_{1L}$   
i c p m 2  
i m r 108b1  $n_{1L}y_{1L}$   
i a d 106b1  $m_{1L} + n_{1L}y_{1L}$   
i m r 52b1  $m_{1L}y_{1L} + n_{1L}y_{1L}^2 = S_1$   
i s p m 3  
m2, i c s 168b1  $S_1 = 0$   
m3, i t s 52b1  $S_1$   
i a d 4b1 save  $S_1 + \Sigma P$   
i t s 4b1  
i c a 52b1  $S_1$   
i a d 50b1  $-Q_1 + S_1 = -D_1$   
i t s 52b1

- i m r 96b1  $n_{lg}^{D_1}$
- i a d 94b1  $m_{lg} + n_{lg}^{D_1}$
- i m r 52b1  $-m_{lg}^{D_1} - n_{lg}^{D_1^2}$
- i s u 88b1  $-h_{10} - m_{lg}^{D_1} - n_{lg}^{D_1^2}$
- i a d 56b1  $h_1 - h_{10} - m_{lg}^{D_1} - n_{lg}^{D_1^2}$
- i m r 92b1  $\eta_1 [h_1 - h_{10} - m_{lg}^{D_1} - n_{lg}^{D_1^2}] = g_1/D_1$
- i m r 52 b1  $[g_1/D_1] [-D_1] = -g_1$
- i t s 62b1  $-g_1$
- i c a 56b1  $h_1$
- i s u 90b1  $h_1 - h_{11} = h_{1n}$
- i t s 56b1  $h_{1n}$
- i m r 102b1  $-n(g_{1m}) h_{1n}$
- i s u 100b1  $-m(g_{1m}) - n(g_{1m}) h_{1n}$
- i m r 56b1  $-m(g_{1m})h_{1n} - n(g_{1m})h_{1n}^2$
- i s u 98b1  $-g_{1m}(h=h_{11}) - m(g_{1m})h_{1n} - n(g_{1m})h_{1n}^2$
- i t s 52b1  $-g_{1m}(h_1)$
- i a d 110b1  $g_{1m}(\text{rated}) - g_{1m}(h_1)$
- i c p m 4
- i c a 52b1  $-g_{1m}(h_1)$
- i s p m 5
- m4, i c s 110b1  $-g_{1m}(\text{rated})$
- m5, i s u 62b1  $g_1 - g_{1m}$
- i s p u l } upper generation
- i t s 64b1 } penalty cost

i c a 62b1  $-g_1$   
i s p u l negative generation penalty cost  
i a d 64b1  
i t s 64b1  $\sum p_1$   
i c a 178b1  $m(P_{1y})$   
i t s 50b1  
i c a 48b1  $y_1$   
i s u 180b1  $y_1 - y_{1m}$   
i s p z 1  
i a d 64b1  $\sum P_1$   
i t s 64b1  
i c a 74b1  $y_1 \text{ min}$   
i s u 48b1  $y_1 \text{ min} - y_1$   
i s p z 1  
i a d 64b1  
i t s 64b1  $\sum P_1$   
i a d 4b1  $\sum(\sum P_1 + \beta_1)$   
i t s 4b1 "  
m6, i s p o

F. 8 SUBROUTINE n  
PLANT 2 GENERATIONS

n1, i t a n 6  
i t s 50b1  $-Q_2$   
i m r 126b1  $n_{2t} Q_2$   
i a d 124b1  $m_{2t} + n_{2t} Q_2$

i m r 50b1  $-m_{2t}Q_2 - n_{2t}Q_2^2$   
i s u 122b1  $-y_{2t}(Q_2 = 0) - m_{2t}Q_2 - n_{2t}Q_2^2$   
i a d 48b1  $y_2 - y_{2t} = h_2$   
i t s 56 b1  $h_2$   
i c a 48b1  $y_2$   
i s u 144b1  $y_2 - y_{2c} = y_{2L}$   
i t s 52b1  $y_{2L}$   
i c p n 2  
i m r 148b1  $n_{2L}y_{2L}$   
i a d 146b1  $m_{2L} + n_{2L}y_{2L}$   
i m r 52b1  $m_{2L}y_{2L} + n_{2L}y_{2L} = \mathcal{J}_2$   
i s p n 3  
n2, i c s 168b1 0  
n3, i t s 52b1  
i a d 6b1  $\Sigma(\Sigma P_2 + \mathcal{J}_2)$   
i t s 6b1 "  
i c a 52b1  $\mathcal{J}_2$   
i a d 50b1  $-Q_2 + \mathcal{J}_2 = -D_2$   
i t s 52b1  $-D_2$   
i m r 136b1  $+n_{2g}D_2$   
i a d 134b1  $m_{2g} + n_{2g}D_2$   
i m r 52b1  $-m_{2g}D_2 - n_{2g}D_2^2$   
i s u 128b1  $-h_{20} - m_{2g}D_2 - n_{2g}D_2^2$   
i a d 56b1  $h_2 - h_{20} - m_{2g}D_2 - n_{2g}D_2^2$

- i m r 132b1  $\gamma_2 [h_2 - h_{20} - m_2 g^D_2 - n_2 g^D_2^2] = g_2/D_2$
- i m r 52b1  $[g_2/D_2] [-D_2] = -g_2$
- i t s 26b1  $-g_2$
- i c d 56b1  $h_2$
- i s u 130b1  $h_2 - h_{22} = h_{2n}$
- i t s 56b1  $h_{2n}$
- i m r 142b1  $-n(g_2 \text{ max}) h_{2n}$
- i s u 140b1  $-m(g_2 \text{ max}) - n(g_{2m}) h_{2n}$
- i m r 56b1  $-m(g_{2m})h_{2n} - n(g_{2m}) h_{2n}^2$
- i s u 138b1  $-g_{2m}(h_{2n}=0) - m(g_{2m})h_{2n} - n(g_{2m})h_{2n}^2$
- i t s 52b1  $-g_{2m}(h_2)$
- i a d 150b1  $g_{2m}(\text{rated}) - g_{2m}(h_2)$
- i c p n 4
- i c a 52b1  $-g_{2m}(h_2)$
- i s p n 5
- n4, i c s 150b1  $-g_{2m}(\text{rated})$
- n5, i s u 26b1  $g_2 - g_{2m}$
- i s p u l }  $\sum P_2$
- i t s 68b1 }  $\sum P_2$
- i c a 26b1  $-g_2$
- i s p u l }  $\sum P_2$
- i a d 68b1 }  $\sum P_2$
- i t s 68b1 }  $\sum P_2$
- i c a 188b1  $m(P_{2y})$

i t s 50b1  
i c a 48b1  $y_2$   
i s u 182b1  $y_2 - y_2 \text{ max}$   
i s p Z1  
i a d 68b1 }  $\sum P_2$   
i t s 68b1 }  
i c a 116b1  $y_2 \text{ min}$   
i s u 48b1  $y_2 \text{ min} - y_2$   
i s p Z1  
i a d 68b1 }  $\sum P_2$   
i t s 68b1 }  
i a d 6b1  $\sum (P_2 + \beta_2)$   
i t s 6b1 "

n6, i s p 0

F. 9 SUBROUTINE p  
PRELIMINARY COMPUTATIONS

pl, t a p 4

I N  
i c s 168b1 } clear violations-count register  
i t s 4b1 }  
i t s 6b1 }  
i c a 40b1  $fy_1(t)$   
i s u 50b1  $fy_1(t) - by_1(t)$   
i d v 60b1  $[fy_1(t) - by_1(t)] / \Delta t \text{ or } 2\Delta t = \dot{y}_1(t)$   
i t s 44b1  $\dot{y}_1(t)$

i c a 42b1  $fy_2(t)$   
i s u 52b1  $fy_2(t) - by_2(t)$   
i d v 60b1  $[fy_2(t) - by_2(t)]/\Delta t$  or  $2\Delta t = \dot{y}_2(t)$   
i t s 46b1  $\dot{y}_2(t)$   
i c a 16b1  $L(t)$   
i t s 66b1  
i c a 20b1  $y_1(t)$   
i t s 48b1  
i s p h 1  $s_1(y_1(t))$   
i t s 36b1  
i m r 44b1  $s_1(y_1(t)) / [c1] = \dot{S}_1(t)$   
i t s 58b1  
i s u 86b1  $\dot{S}_1(t) - F_1(t) = -Q_1(t)$   
i s p m 1  $-g_1(t)$   
i c a 62b1 save  $-g_1(t)$   
i t s 32b1  
i s p r 1 delayed print out  
i c a 64b1 save  $\sum P_1(t)$   
i t s 42b1  
i c a 22b1  $y_2(t)$   
i t s 48b1  
i s p h 2  $s_2(y_2(t))$   
i t s 38b1



i m r 46b1  $s_2(y_2(t)) \dot{y}_2(t)$   
i t s 54b1  $= \dot{S}_2(t)$   
i a d 58b1  $\dot{S}_2(t) + \dot{S}_1(t)$   
i s u 12b1  $\dot{S}_2(t) + \dot{S}_1(t) - F_2(t)$   
i s p n l  
i c a 26b1  $g_2(t)$   
i s p r l delayed print out  
i s p f l  $\$/hr(t)$   
i t s 40b1  
i s p r l delayed print out  
i c a 40b1  
i a d 72b1  $\sum \$/hr(t)$   
i t s 72b1  
i c a 20b1  $y_1(t)$   
i a d 112b1  $y_1(t) + \Delta y_1$   
i t s 48b1 "  
i s p h l  $s_1(y_1(t) + \Delta y_1)$   
i m r 44b1  $s_1(y_1(t) + \Delta y_1) \dot{y}_1(t) = \dot{S}_1(t, y_1 + \Delta y_1)$   
i t s 34b1 "  
i s u 8b1  $\dot{S}_1(t, y_1 + \Delta y_1) - F_1(t) = -Q_1(t, y_1 + \Delta y_1)$   
i s p m l  $g_1(t, y_1 + \Delta y_1)$   
i s p f l  $\$/hr(t, y_1 + \Delta y_1)$   
i s u 40b1  $\$/hr(t, y_1 + \Delta y_1) - \$/hr(t)$

i d v 112b1  $[\$/hr(t, y_1 + \Delta y_1) - \$/hr(t)] / \Delta y_1$   
i t s 30b1  $= \partial \$/hr(t) / \partial y_1$   
i s p p 2 space for occasional print out  
p2, i c a 20b1  $y_1(t)$   
i t s 48b1 "  
i c a 44b1  $\dot{y}_1(t)$   
i a d 114b1  $\dot{y}_1(t) + \Delta \dot{y}_1$   
i m r 36b1  $s_1(y_1(t)) \times [\dot{y}_1(t) + \Delta \dot{y}_1] = \dot{S}_1(t, \dot{y}_1 + \Delta \dot{y}_1)$   
i s u 8b1  $\dot{S}_1(t, \dot{y}_1 + \Delta \dot{y}_1) - F_1(t) = -Q_1(t, \dot{y}_1 + \Delta \dot{y}_1)$   
i s p m 1  $g_1(t, \dot{y}_1 + \Delta \dot{y}_1)$   
i s p f 1  $\$/hr(t, \dot{y}_1 + \Delta \dot{y}_1)$   
i s u 40b1  $\$/hr(t, \dot{y}_1 + \Delta \dot{y}_1) - \$/hr(t)$   
i d v 114b1  $[\$/hr(t, \dot{y}_1 + \Delta \dot{y}_1) - \$/hr(t)] / \Delta \dot{y}_1 = \partial \$/hr(t) / \partial \dot{y}_1$   
i t s 24b1 "  
i c a 32b1 save  $-g_1(t)$   
i t s 62b1  
i c a 42b1 save  $\sum P_1(t)$   
i t s 64b1  
i c a 22b1  $y_2(t)$   
i a d 152b1  $y_2(t) + \Delta y_2$   
i t s 48b1 "  
i s p h 2  $s_2(y_2 + \Delta y_2)$   
i m r 46b1  $s_2(y_2 + \Delta y_2) \dot{y}_2(t) = \dot{S}_2(t, y_2 + \Delta y_2)$

- i a d 58b1  $\dot{S}_2(t, y_2 + \Delta y_2) + \dot{S}_1(t)$
- i s u 12b1  $\dot{S}_2(t, y_2 + \Delta y_2) + \dot{S}_1(t) - F_2(t) = -Q_2(t, y_2 + y_2)$
- i s p n 1  $g_2(t, y_2 + \Delta y_2)$
- i s p f 1  $\$/hr(t, y_2 + \Delta y_2)$
- i s u 40b1  $\$/hr(t, y_2 + \Delta y_2) - \$/hr(t)$
- i d v 152b1  $[\$/hr(t, y_2 + \Delta y_2) - \$/hr(t)] / \Delta y_2$
- i t s 32b1  $= \partial \$/hr / \partial y_2$
- i c a 22b1  $y_2(t)$
- i t s 48b1
- i c a 46b1  $\dot{y}_2(t)$
- i a d 154b1  $\dot{y}_2 + \Delta \dot{y}_2$
- i m r 38b1  $s_2(y_2) [\dot{y}_2(t) + \Delta \dot{y}_2] = \dot{S}_2(t, \dot{y}_2 + \Delta \dot{y}_2)$
- i a d 58b1  $\dot{S}_1(t) + \dot{S}_2(t, \dot{y}_2 + \Delta \dot{y}_2)$
- i s u 12b1  $\dot{S}_1(t) + \dot{S}_2(t, \dot{y}_2 + \Delta \dot{y}_2) - F_2(t) = -Q_2(t, \dot{y}_2 + \Delta \dot{y}_2)$
- i s p n 1  $g_2(t, \dot{y}_2 + \Delta \dot{y}_2)$
- i s p f 1  $\$/hr(t, \dot{y}_2 + \Delta \dot{y}_2)$
- i s u 40b1  $\$/hr(t, \dot{y}_2 + \Delta \dot{y}_2) - \$/hr(t)$
- i d v 154b1  $[\$/hr(t, \dot{y}_2 + \Delta \dot{y}_2) - \$/hr(t)] / \Delta \dot{y}_2$
- i t s 28b1  $= \partial \$/hr / \partial \dot{y}_2$
- i c a 44b1  $\dot{y}_1(t)$
- i m r 160b1  $\dot{y}_1(t) [\tau_{12}]$
- i a d 20b1  $y_1(t) + \dot{y}_1(t) [\tau_{12}] = y_1(t + \tau_{12})$
- i t s 48b1  $y_1(t + \tau_{12})$

- i c a 58b1  $\dot{S}_1(t) \cong \dot{S}_1(t + \tau_{12})$
- i s u 10b1  $\dot{S}_1(t) - F_1(t + \tau_{12}) \cong -Q_1(t + \tau_{12})$
- i s p m 1  $g_1(t + \tau_{12})$
- i c a 46b1  $\dot{y}_2(t)$
- i m r 160b1  $\dot{y}_2(t)[\tau_{12}]$
- i a d 22b1  $y_2(t) + \dot{y}_2(t)[\tau_{12}] = y_2(t + \tau_{12})$
- i t s 48b1  $y_2(t + \tau_{12})$
- i c a 54b1  $\dot{S}_2(t)$
- i a d 58b1  $\dot{S}_1(t) + \dot{S}_2(t)$
- i s u 14b1  $\dot{S}_1(t) + \dot{S}_2(t) - F_2(t + \tau_{12}) \cong -Q_2(t + \tau_{12})$
- i s p n 1  $g_2(t + \tau_{12})$
- i c a 18b1  $L(t + \tau_{12})$
- i t s 66b1
- i s p f 1  $\$/hr(t + \tau_{12})$
- i t s 40b1
- i c a 54b1  $\dot{S}_2(t)$
- i a d 34b1  $\dot{S}_2(t) + \dot{S}_1(t, y_1 + \Delta y_1)$
- i s u 14b1  $\dot{S}_2(t) + \dot{S}_1(t, y_1 + \Delta y_1) - F_2(t + \tau_{12})$   
 $\cong -Q_2(t + \tau_{12}, y_1 + \Delta y_1)$
- i s p n 1  $g_2(t + \tau_{12}, y_1 + \Delta y_1)$
- i s p f 1  $\$/hr(t + \tau_{12}, y_1 + \Delta y_1)$
- i s u 40b1  $\$/hr(t + \tau_{12}, y_1 + \Delta y_1) - \$/hr(t + \tau_{12})$

i d v 112b1  $\frac{\partial \$/hr(t + \tau_{12})}{\partial y_1(t)}$   
 i t s 34b1

space for occasional print out

p3, i c a 44b1  $\dot{y}_1(t)$   
 i a d 114b1  $\dot{y}_1(t) + \Delta \dot{y}_1$   
 i m r 36b1  $s_1(y_1(t)) [\dot{y}_1(t) + \Delta \dot{y}_1] = \dot{S}_1(t, y_1 + \Delta y_1)$   
 i a d 54b1  $\dot{S}_1(t, \dot{y}_1 + \Delta \dot{y}_1) + \dot{S}_2(t)$   
 i s u 14b1  $\dot{S}_1(t, \dot{y}_1 + \Delta \dot{y}_1) + \dot{S}_2(t) - F_2(t + \tau_{12})$   
 $\cong -Q_2(t + \tau_{12}, \dot{y}_1 + \Delta \dot{y}_1)$   
 i s p n 1  $g_2(t + \tau_{12}, \dot{y}_1 + \Delta \dot{y}_1)$   
 i s p f 1  $\$/hr(t + \tau_{12}, \dot{y}_1 + \Delta \dot{y}_1)$   
 i s u 40b1  $\$/hr(t + \tau_{12}, \dot{y}_1 + \Delta \dot{y}_1) - \$/hr(t + \tau_{12})$   
 i d v 114b1  $\frac{\partial \$/hr(t + \tau_{12})}{\partial \dot{y}_1(t)}$   
 i t s 26b1

p4, s p 0

F. 10 SUBROUTINE d  
READ IN ONE GROUP

d1, t a d 4  
 c a d 5 } set up first  
 t d d 3 } address  
 s i 7 4 select tape  
 d2, r d d 2  
 d3, t s --

a o d 3  
s u d 6 } count  
c p d 2 }  
s i 4 0 8 stop tape  
d4, s p o  
d5, t s b 1 1st address  
d6, t s 39b1 last address

F. 11 SUBROUTINE s  
SKIP BACK OVER N GROUPS

s1, t a s 3  
t s x 1 1 set up counter  
s2, s i 7 3 pick up Bl. Marker  
a o x 1 1  
c p s 2  
s i 408 stop tape  
s p w 1 delay  
s3, s p o

F. 12 SUBROUTINE w  
DELAY

w1, t a w 3  
c s x 7  
t s 2 7  
w2, a o 2 7  
c p w 2  
w3, s p o

F. 13 SUBROUTINE t  
STORAGE TRANSFER

t1, t a t 6  
c s x 1 8 } set up no. of  
t s x 1 9 } registers transferred  
c a x 4 } 1st initial  
t d t 2 } address  
  
t2, c a --  
t3, t s --  
t5, a o t 2  
a o t 3  
a o x 1 9  
c p t 2  
t6, s p 0

F. 14 SUBROUTINE r  
DELAYED OUTPUT via MAG. TAPE

r1, i t a r 2  
O U T  
s 1 7 0 } 2 block markers  
s 1 7 0 }  
c a 1 0 5 2 }  
r3, r c r 3 } record  
c a 1 0 5 1 }  
r4, r c r 4 } the parts  
c a 1 0 5 0 } of m r a

```
r5, r c r 5
  s i 7 0 } stop in
  s i 7 1 } erased region
  s i 4 0 8 }
  I N
r2, i s p 0
```

F. 15 SUBROUTINE z  
STORAGE ELEVATION PENALTY COST

```
z1, i t a z 3
  i c p z 2
  i t s 52b1 violation  $y_x$ 
  i m r 52b1  $y_x^2$ 
  i m r 50b1  $m_1 y_x^2$  or  $m_2 y_x^2$ 
  i s p z 3
z2, i c s 168b1 0
z3, i s p 0
```

F. 16 SUBROUTINE u  
GENERATION PENALTY COST

```
u1, i t a u 3
  i c p u 2
  i t s 52b1 violation  $g_x$ 
  i m r 52b1  $g_x^2$ 
  i m r 176b1  $m g_x^2$ 
  i s p u 3
u2, i c s 168b1 0
u3, i s p 0
```



F. 17 SUBROUTINE x  
SINGLE LENGTH PARAMETERS

|               |  |
|---------------|--|
| x1, +0        | run counter                            |
| x2, + 5 1     | no. weeks - 1                          |
| x3, +0        | ordinate counter                       |
| x4, s i 20b1  | address of 1st register transferred    |
| x5, s i 40b1  | fwd. new address                       |
| x6, s i 50b1  | bwd. new address                       |
| x7, s i 4 0   | 3.1 millisec. delay                    |
| x9, + 1 9     | no. words in group -1                  |
| x10, + 1      | no. block markers in 2 Groups -1       |
| x11, +0       | skip back counter                      |
| x12, + 5 2    | no. block markers in $l + 1$ Groups -1 |
| x13, +0       | pass counter                           |
| x14, c a 39b1 | c a address of last word transferred   |
| x16, c a b 1  | c a address of 1st word transferred    |
| x18, + 9      | # words transferred -1                 |
| x19, +0       |  |
| x20, + 9      | # runs -1                              |

START AT c 1

F. 18  
CONTENTS OF TEMPORARY STORAGE REGISTERS  
IN THE ORDER OF INSERTION

|       |   |                         |               |  |
|-------|---|-------------------------|---------------|--|
| b 1   | P | $\sum (\sum p_1 + s_1)$ | previous step |  |
| 2 b 1 | P | $\sum (\sum p_2 + s_2)$ | previous step | violation<br>and<br>spillage<br>checks |
| 4 b 1 |   | $\sum (\sum p_1 + s_1)$ | current step  |  |
| 6 b 1 |   | $\sum (\sum p_2 + s_2)$ | current step  |  |

|         |  |               |
|---------|--|---------------|
| 8 b 1   | $F_1(t)$   |               |
| 1 0 b 1 | $F_1(t + \tau_{12})$   |               |
| 1 2 b 1 | $F_2(t)$   |               |
| 1 4 b 1 | $F_2(t + \tau_{12})$   |               |
| 1 6 b 1 | $L(t)$   |               |
| 1 8 b 1 | $L(t + \tau_{12})$   |               |
| 2 0 b 1 | $y_1(t)$   |               |
| 2 2 b 1 | $y_2(t)$   |               |
| 2 4 b 1 | C 6 4  | C64           |
| 2 6 b 1 | C 6 5, -C40, -C41, -C42, -C43, -C44, -C45,   | C65           |
| 2 8 b 1 | C 6 7  | C67           |
| 3 0 b 1 | C 6 2  | C62           |
| 3 2 b 1 | C 6 6, -C 3 6  | C66           |
| 3 4 b 1 | C 6 3, $[s_1(y_1(t) + \Delta y_1)] [\dot{y}_1(t)]$   | C63           |
| 3 6 b 1 | $s_1(y_1(t))$  | $s_1(y_1(t))$ |
| 3 8 b 1 | $s_2(y_2(t))$  | $s_2(y_2(t))$ |
| 4 0 b 1 | f $y_1(t)$ , C 54, C 57  |               |
| 4 2 b 1 | f $y_2(t)$ , $P_1(t)$  |               |
| 4 4 b 1 | f 6 4, C 1   |               |
| 4 6 b 1 | f 6 5, C 4   |               |
| 4 8 b 1 | f 6 7, y   |               |
| 5 0 b 1 | b $y_1(t)$ , Q, $m(P_{1y})$ , $m(P_{2y})$  |               |
| 5 2 b 1 | b $y_2(t)$ , $y_{1s}y_{1L}, \beta_1, -D_1, -g_{1m}(h_1), g_{1x}y_{1x}, g_s, C69$<br>$y_{2s}y_{2L}, \beta_2, -D_2, -g_{2m}(h_2), g_{2x}y_{2x}, \$/hr$ |               |

|         |                        |  |
|---------|------------------------|--|
| 5 4 b 1 | b 6 4 ,                | $\dot{S}_2(t)$                         |
| 5 6 b 1 | b 6 5 ,                | $h_1, h_2, [h_1-h_{11}], [h_2-h_{22}]$ |
| 5 8 b 1 | b 6 7 ,                | $\dot{S}_1(t)$                         |
| 6 0 b 1 | $\Delta t$ ,           | $2\Delta t$                            |
| 6 2 b 1 | -C36, -C37, -C38, -C39 |  |
| 6 4 b 1 | $\sum P_1$ ,           | C68                                    |
| 6 6 b 1 | L(t),                  | $\delta y_1, \delta y_2$               |
| 6 8 b 1 | $\sum P_2$             |  |
| 7 0 b 1 | P $\sum$ \$/hr         |  |
| 7 2 b 1 | $\sum$ \$/hr           |  |

## Appendix G

### Examination of Round Off and Truncation Errors

#### G.1 Introduction

In the application of the gradient method to the three plant problem, the simplest Lagrange formula for approximating derivatives was used. This type of approximation is a source of inaccuracy that is fundamental to the method used, involving both truncation errors because of the finite sampling and round-off errors because of the taking of differences of nearly equal quantities. On the other hand, the method operates to nullify rather than accumulate such errors in successive iterations, since each step evaluates anew the path of steepest descent from the latest operating point. What is desired, then, is an examination of the order of magnitude of such errors in the trials made to establish that they are not excessive.

#### G.2 Desired Accuracy of End Results

The accuracy desired is dependent on the use to be made of the solution. In system operation, the inaccuracies in flow prediction will limit the desired accuracy of optimization. In project planning, uncertainties of other estimates will similarly make great accuracy unwarranted. In the following, rather severe requirements on the accuracy of the end result is assumed, and the consequent accuracy requirements on intermediate computations are examined.

In practice, the accuracy of each computation will fluctuate because of the variability of the flow, load, and original drawdown curves. The objective of the following is, rather, to check order of magnitudes. Data obtained from the Whirlwind I digital computer is used to do this.

In the case of dam I elevation ordinates are to be found to six decimal digits, (3552.12 ft.) so that with round-off, the elevations will be certain to the nearest tenth of a foot. The incremental storage of dam 2 is roughly ten times that of dam I. Hence the corresponding significant increment of elevation is one-hundredth of a foot. To allow for round-off, then, the elevations of dam 2 should be found to seven decimal digits (2885.123).

The changes in elevation to be made in the final steps of the iteration process should ordinarily be the same order of magnitude or less than the significant increments, i.e., 0.1 ft. for dam I and 0.01 ft. for dam 2. Accordingly, both  $\delta y_1$  and  $\delta y_2$ , the changes in elevation at each step, should be found to two significant figures.

### G.3 Magnitudes of Terms in Euler Expressions

The final equation, C71, given in Appendix E is:

$$\delta y_1(t) = \frac{-\alpha}{s_1(y_1(t))^2} \left\{ \frac{\partial \$/hr(t)}{\partial y_1(t)} + \frac{\partial \$/hr(t+\tau_{12})}{\partial y_1(t)} - \frac{d}{dt} \frac{\partial \$/hr(t)}{\partial \dot{y}_1(t)} - \frac{d}{dt} \frac{\partial \$/hr(t+\tau_{12})}{\partial \dot{y}_1(t)} \right\} \quad (G-1)$$

The magnitudes of the terms in the bracket vary over a moderate range in normal operation<sup>1</sup> but vary over a much larger range when violations of operating limitations or spillage occur. From the data of the three plant problem, six sample weeks have been chosen to be representative. These sample weeks are chosen from the following periods:

- a) first ten weeks
- b) middle twenty-five weeks
- c) last sixteen weeks

The values of the terms in (G-2) for these six weeks are tabulated in Table G-1.

TABLE G-1  
COMPUTED VALUES

|  | 1st 10 weeks |        | middle 25 weeks |        | last 16 weeks |          |
|--|--------------|--------|-----------------|--------|---------------|----------|
| Weeks:   | a            | b      | c               | d      | e             | f        |
| $\frac{\partial S/hr(t)}{\partial y_i(t)}$                     | 14.432       | 46.385 | -0.591          | -0.684 | -0.744        | 130.021  |
| $\frac{\partial S/hr(t+\tau_a)}{\partial y_i(t)}$              | negl.        | negl.  | negl.           | negl.  | negl.         | negl.    |
| $\frac{d}{dt} \frac{\partial S/hr(t)}{\partial y_i(t)}$        | -0.249       | 23.489 | -1.188          | 10.425 | -17.969       | -368.727 |
| $\frac{d}{dt} \frac{\partial S/hr(t+\tau_a)}{\partial y_i(t)}$ | -1.152       | 18.391 | -0.778          | 5.928  | -15.877       | -171.661 |

The magnitudes shown for the middle 25 weeks are representative of normal operation during the drawdown season. The large positive values of  $\partial S/hr(t)/y_i(t)$  during the first 10 weeks are due to the fact that dams are near full in this interval and small explorations to higher elevations cause

<sup>1</sup>see figure 7.8

spillage and waste of water. (Thus, a safety margin is produced by decreasing elevation  $\Delta y$ , ft. below crest.) Large values are also found in the last 16 weeks period. However, these are due to severe violations of operating limitations (exceeding plant capacities) under the original operating mode. These large values reflect the necessity of relatively large corrections in this time interval to relieve the operating-limitation violations.

#### G.4 Accuracy Requirements on Terms in the Euler Expression

When taking the products of two numbers of differing accuracies, the more accurate number should be rounded off to contain one more significant figure than the least accurate factor. The total error is then taken to be the error of the least accurate factor. The final result is carried to the number of significant figures in the least accurate number (Scarborough, 48). Presuming  $\alpha$  and  $s.(y_i(t))^2$  to be available to three significant figures the bracket

$$\left\{ \frac{\partial \$/hr(t)}{\partial y_i(t)} + \frac{\partial \$/hr(t+T_{12})}{\partial y_i(t)} - \frac{d}{dt} \frac{\partial \$/hr(t)}{\partial \dot{y}_i(t)} - \frac{d}{dt} \frac{\partial \$/hr(t+T_{12})}{\partial \dot{y}_i(t)} \right\} \quad (G-2)$$

should be accurate to two significant figures .

In the case of addition and subtraction of numbers of unequal accuracy, one should use in the numbers known to higher digits only one more decimal digit (tenths, hundredths, etc.) than is contained in the number known to the lowest digit

(Scarborough, 48). Presumably, some term in (G-2) may be known to only the minimum number of decimal places needed to obtain two significant figures for the bracket. The others then should have one additional decimal place. In line with this reasoning, we find the number of significant figures required of each term in order that all have one more decimal digit (tenths, etc.) than the minimum. These are tabulated in Table G-II for each of the six weeks sampled for Table G-I.

TABLE G-II  
SIGNIFICANT FIGURES ASKED

|  | 1st 10 weeks |   | middle 25 weeks |   | last 16 weeks |   |
|--|--------------|---|-----------------|---|---------------|---|
| Weeks:   | a            | b | c               | d | e             | f |
| $\frac{\partial \$/hr(t)}{\partial y_i(t)}$                        | 3            | 3 | 2               | 1 | 1             | 3 |
| $\frac{d}{dt} \frac{\partial \$/hr(t)}{\partial y_i(t)}$           | 1            | 3 | 3               | 3 | 3             | 3 |
| $\frac{d}{dt} \frac{\partial \$/hr(t+\tau_{12})}{\partial y_i(t)}$ | 2            | 3 | 2               | 2 | 3             | 3 |

Thus, if a standard is to be set, it would be desirable to obtain all terms of (G-2) to three significant figures (or at least have only few terms to only two significant figures.)

#### G.5 The Time Derivatives

Computations C68 and C69 are first derivatives of continuous functions. As such, the computations involve both round-off errors and truncation errors. The latter results from the use of a "truncated" series to approximate the time derivative, instead of an infinite series. Both types of errors depend on the number of terms used in this approximation,



and on the spacing of the ordinates which sample the curve whose derivative is sought.

To simplify programming and to save computer storage space, the Lagrange type of formula involving ordinates was chosen rather than the Newton type of formula involving differences. Since it can be shown that the Newton and Lagrange interpolation formulas are basically identical, it follows that the truncation error made by using either will be the same if both employ the same number of terms. To further simplify programming, expressions using equally spaced ordinates were chosen.

An examination of differentiation formulas for equally spaced ordinates reveals advantage for those having an odd number of points and the derivative obtained at the midpoint. Not only is the formula simpler than others of the same degree, but also the truncation error is smaller. Such symmetrical formulas are thus to be preferred for all but the end points of the time interval being optimized. (Milne, 40, pp 96-99). The derivatives with respect to time have, except at the end points, been approximated by the simple expression:

$$\dot{y} = \frac{1}{2h} [y_2 - y_0] \quad (G-3)$$

where  $h$  is the spacing between ordinates  $y_0, y_1, y_2$ , and the derivative is being evaluated at the  $y_1$  ordinate.<sup>1</sup> This expression is the three point Lagrange formula for central

<sup>1</sup>  $y$  is here considered to be a general variable, not necessarily storage elevation.

derivatives. The remainder term or truncation error for this expression can be shown to be (40, p.96):

$$\frac{h^2}{6} y^{(3)} \quad (G-4)$$

where  $y^{(3)}$  is the value of the third derivative of  $y$  for some value of the independent variable between  $y_0$  and  $y_1$ .

#### G.6 Estimates of Truncation Errors

As is evident from (G-4), the truncation error is dependent on the higher derivatives or high frequency content of the function being differentiated. This will naturally vary with different stream flow, load, and original drawdown curves. Moreover, it will vary markedly at different steps of the solution by the gradient method. As shown in figures 7.5b and 7.6, the gradient method successively smooths the cost curves, as the solution progresses. In fact, the solution tends towards a flat cost curve, as far as resource and operating limitations will allow. Therefore, the truncation errors decrease as the solution is approached, which is of course very desirable.

The data thus far obtained from Whirlwind gives successive reductions in cost without reaching a point of diminishing returns or otherwise indicating that a minimum has been approached. Therefore, the initial data will be examined, with relatively large-magnitude high-frequency components in the cost curves, to obtain order of magnitudes of truncation errors at the beginning of the smoothing process.

The cost function is known only at the sampled points. Hence an exact determination of the third derivative in (G-4) cannot be obtained. A reasonable approximation can be obtained, however, under the assumption that the derivative sought does not change rapidly in the short time interval between  $y_0$  and  $y_2$ . Under such conditions, an approximation to the  $(n+1)$ th derivative is given by the formula (Milne, 40, p.128):

$$h^{(n+1)} y^{(n+1)}(z) = y_{n+1} - \binom{n+1}{1} y_n + \binom{n+1}{2} y_{n-1} - \binom{n+1}{3} y_{n-2} + \dots \quad (G-5)$$

where  $\binom{n+1}{1}$ ,  $\binom{n+1}{2}$ , etc. are the binomial coefficients belonging to the exponent  $n+1$ ;  $Z$  is a value of the independent variable between the ordinates  $y_0$  and  $y_n$ . This value of  $Z$  is not necessarily equal to the value of the independent variable occurring in the error formula (G-4), but is useful under the above mentioned assumption that the derivative sought changes slowly in the interval considered.

The best data on hand gives the values of the first derivatives

$$\frac{d}{dt} \frac{\partial \$/hr(t)}{\partial \dot{y}(t)} \quad \text{and} \quad \frac{d}{dt} \frac{\partial \$/hr(t+T_{12})}{\partial \dot{y}(t)} \quad (G-6)$$

Therefore, equation (G-5) is used to obtain an estimate of the third derivative as the second derivative of the computed first

derivatives. Using (G-5):

$$\begin{aligned}
 h^2 f^{(2)}(z) &= y_2 - \binom{2}{1} y_1 + \binom{2}{2} y_0 \\
 &= y_2 - 2 y_1 + y_0
 \end{aligned}
 \tag{G-7}$$

Therefore:

$$h^2 f^{(3)}(z) = \dot{y}_2 - 2 \dot{y}_1 + \dot{y}_0
 \tag{G-8}$$

The values of  $\frac{d}{dt} \frac{\partial \mathcal{B}/hr(t)}{\partial \dot{y}_i(t)}$  and  $\frac{d}{dt} \frac{\partial \mathcal{B}/hr(t+\tau_{12})}{\partial \dot{y}_i(t)}$  are relatively smooth in each of the three regions selected above, but change more abruptly at the boundaries of these regions. To better examine the range of the corresponding third derivatives, they have been computed by equation (G-8) and tabulated in Table G-III for sampled weeks near the beginning and the center of each region.<sup>1</sup>

TABLE G-III  
THIRD DERIVATIVES

|   | 1st 10 weeks |         | middle 25 weeks |        | last 16 weeks |        |
|---|--------------|---------|-----------------|--------|---------------|--------|
|   | beginning    | center  | beginning       | center | beginning     | center |
| $\frac{d^3}{dt^3} \frac{\partial \mathcal{B}/hr(t)}{\partial \dot{y}_i(t)}$           | 0.0002       | +0.0646 | 0.1950          | 0.2372 | 0.0290        | 0.8274 |
| $\frac{d^3}{dt^3} \frac{\partial \mathcal{B}/hr(t+\tau_{12})}{\partial \dot{y}_i(t)}$ | 0.0758       | 0.3815  | 0.0225          | 0.1151 | 0.0455        | 1.556  |

In Table G-IV are shown the corresponding values of C68 and C69 plus or minus their probable truncation error with one week

<sup>1</sup>Extreme variations in C68 and C69 were selected and were not necessarily chosen from the same weeks.

spacing of ordinates. Using the same values for the third derivatives, the corresponding truncation errors with h equal to one-half week are shown in Table G-V.

TABLE G-IV  
TIME DERIVATIVES  $\pm$  ESTIMATED TRUNCATION ERRORS  
WEEKLY SPACING

|        |           | $\frac{d}{dt} \frac{\partial \$/hr(t)}{\partial \dot{y}_i(t)}$ | $\frac{d}{dt} \frac{\partial \$/hr(t+T_{12})}{\partial \dot{y}_i(t)}$ |
|--------|-----------|--|---|
| 1st    | beginning | 17.11 $\pm$ 0.0016   | 15.83 $\pm$ 0.619   |
| 10     |           |  |   |
| weeks  | center    | 5.901 $\pm$ 0.5275   | 3.717 $\pm$ 0.312   |
| middle | beginning | 6.677 $\pm$ 1.592  | 1.152 $\pm$ 0.183   |
| 25     |           |  |   |
| weeks  | center    | 9.318 $\pm$ 1.937  | 1.370 $\pm$ 0.939   |
| last   | beginning | 17.96 $\pm$ 0.236  | 1.587 $\pm$ 0.371   |
| 16     |           |  |   |
| weeks  | center    | 31.61 $\pm$ 6.757  | 103.1 $\pm$ 12.707  |

TABLE G-V  
TIME DERIVATIVES  $\pm$  ESTIMATED TRUNCATION ERRORS  
HALF WEEK SPACING

|        |           | $\frac{d}{dt} \frac{\partial \$/hr(t)}{\partial \dot{y}_i(t)}$ | $\frac{d}{dt} \frac{\partial \$/hr(t+T_{12})}{\partial \dot{y}_i(t)}$ |
|--------|-----------|--|---|
| 1st    | beginning | 17.11 $\pm$ 0.0004   | 15.83 $\pm$ 0.15  |
| 10     |           |  |   |
| weeks  | center    | 5.901 $\pm$ 0.13   | 3.717 $\pm$ 0.078   |
| middle | beginning | 6.677 $\pm$ 0.39   | 1.152 $\pm$ 0.045   |
| 25     |           |  |   |
| weeks  | center    | 9.318 $\pm$ 0.48   | 1.370 $\pm$ 0.235   |
| last   | beginning | 17.96 $\pm$ 0.059  | 1.587 $\pm$ 0.093   |
| 16     |           |  |   |
| weeks  | center    | 31.61 $\pm$ 1.68   | 103.1 $\pm$ 3.17  |

TABLE G-VI  
 ESTIMATES OF NUMBER OF SIGNIFICANT FIGURES  
 OBTAINABLE IN EARLY ITERATIONS  
 WITH ESTIMATED TRUNCATION ERRORS

|        |           | C68   |         | C69   |         |
|--------|-----------|-------|---------|-------|---------|
|        |           | h = 7 | h = 3.5 | h = 7 | h = 3.5 |
| 1st    | beginning | 5     | 5       | 2     | 3       |
| 10     |           |       |         |       |         |
| weeks  | center    | 1     | 2       | 2     | 2       |
| middle | beginning | 1     | 2       | 2     | 3       |
| 25     |           |       |         |       |         |
| weeks  | center    | 1     | 2       | 1     | 2       |
| last   | beginning | 3     | 3       | 2     | 2       |
| 16     |           |       |         |       |         |
| weeks  | center    | 2     | 2       | 2     | 3       |

Considering truncation errors alone, and assuming the truncation errors of tables G-IV and G-V to be precise, the number of figures to which C68 and C69 are known, with an accuracy of better than one-half the highest digit, are tabulated in table G-VI, for one week and half-week ordinate spacings. It is seen that with one week spacings the original desire that all terms in the bracket be known to two or three significant figures is not met at the start of the smoothing process, whereas with half-week spacing this desire is met. Remembering that this evaluation is for the beginning of the smoothing process, and expecting the higher derivatives to be reduced at each step of the iteration, it is concluded

that the order of magnitude of error is not excessive and that one weeks spacing for this data is probably appropriate as far as truncation error is concerned.

### G.7 Higher Order Lagrange Formulae

To examine the variation of truncation error as the order of the Lagrange formula increases, consider the next higher symmetric differentiation formula, the five point formula:

$$\dot{y}_2 = \frac{1}{12h} [y_0 - 8y_1 + 8y_3 - y_4] + \frac{h^{(4)}}{30} y^{(5)} \quad (G-9)$$

To evaluate this error, we obtain from (G-5):

$$\begin{aligned} h^4 y^{(4)}(z) &= y_4 - \binom{4}{1} y_3 + \binom{4}{2} y_2 - \binom{4}{3} y_1 + \binom{4}{4} y_0 \\ &= y_4 - 4y_3 + 6y_2 - 4y_1 + y_0 \end{aligned} \quad (G-10)$$

Hence

$$h^4 y^{(5)}(z) = \dot{y}_4 - 4\dot{y}_3 + 6\dot{y}_2 - 4\dot{y}_1 + \dot{y}_0 \quad (G-11)$$

The fifth derivatives have been computed using (G-11) at an ordinate in each of the three regions considered above. The corresponding truncation errors are tabulated in table G-VII. Comparison of these errors with those of table G-V indicates that the truncation errors in the five point formula are, in these cases, larger than those in the three point formula,

when one week spacing is used. Thus, with one week spacing, five points are spread over too large an interval, with excessive variations in the derivatives (C68, C69) therein.

TABLE G-VII

Weeks Spacing

Truncation Errors with 5 Point Formula

|                        | $\frac{d}{dt} \frac{\partial \$/hr(t)}{\partial \dot{y}_1(t)}$ | $\frac{d}{dt} \frac{\partial \$/hr(t+\tau_{12})}{\partial \dot{y}_1(t)}$ |
|------------------------|--|--|
| 1st 10 wks (center)    | .3778  | .2057  |
| Middle 25 wks (center) | -.9484   | -.4715   |
| Last 16 wks (center)   | -11.685  | -7.979   |

6.8 Round Off Error

To examine roundoff errors in obtaining C68 and C69, information is needed on the magnitudes of  $\frac{\partial \$/hr(t)}{\partial \dot{y}_1(t)}$  and  $\frac{\partial \$/hr(t+\tau_{12})}{\partial \dot{y}_1(t)}$ . Values of these quantities were obtained in computer runs made on June 16, 1952. Plant characteristics, load, and flows used in this run were the same as those in the runs considered above. However, the dams were operated with full reservoirs instead of being drawn-down. Nevertheless, the data obtained makes possible an estimate of roundoff error. In table G-VIII are tabulated values of  $\$/hr(t)$ ,  $\frac{\partial \$/hr(t)}{\partial \dot{y}_1(t)}$ ,  $\frac{\partial \$/hr(t)}{\partial \dot{y}_2(t)}$ ,  $\frac{\partial \$/hr(t)}{\partial \dot{y}_2(t)}$ ,  $\frac{\partial \$/hr(t+\tau_{12})}{\partial \dot{y}_1(t)}$  and  $\frac{\partial \$/hr(t+\tau_{12})}{\partial \dot{y}_1(t)}$  for every fifth week taken from the data of June 16. This provides a good



comparison of effects of each change on the \$/hr cost of operation. Note that all  $\partial \$/\text{hr}(t)/\partial y_i$  are positive because under this operation any increase in elevation increases spillage. The last three weeks sampled are during the spillage season. Proposed operation would have overloaded machines, and the derivatives are governed almost entirely by penalty functions which dictate a reduction in loading. In all cases it is seen that the term

$$\frac{\partial \$/\text{hr}(t+T_{12})}{\partial y_i(t)}$$

is negligible in comparison to some other terms which enter into the bracket, eq. (G-2), in spite of the fact that elevations were at crest height, where variations in elevation are more influential due to the imminence of spillage.

Again, values are selected from the three periods used above, sampling data at weeks 2, 6, 16, 28, 36 and 45. These are tabulated in table G-IX along with the number of significant figures needed in each in order that the bracket, eq. (G-2) be accurate to two significant figures.

In all the time derivatives, we have used the simple form

$$\frac{y_2 - y_0}{2 \Delta t} \quad (G-12)$$

If the resultant is to be known to  $q$  significant figures, the numerator should be known to  $q$  figures and the denominator to  $q+1$ . Considering the denominator to be exact, we require only that the numerator be known to  $q$  significant figures.

TABLE G-VIII

COMPUTED VALUES AT SAMPLE WEEKS

| Week | $\$/hr(t)$         | $\frac{\partial \$/hr(t)}{\partial y_1(t)}$ | $\frac{\partial \$/hr(t)}{\partial y_2(t)}$ | $\frac{\partial \$/hr(t)}{\partial y_2(t)}$ |
|------|--------------------|---|---|---|
| 5    | 1882.983           | 58.654                                      | 3855.13                                     | 42.423                                      |
| 10   | 2138.885           | 61.222                                      | 4014.68                                     | 45.068                                      |
| 15   | 2048.016           | 60.995                                      | 4009.32                                     | 44.018                                      |
| 20   | 2162.194           | 62.705                                      | 4123.39                                     | 44.987                                      |
| 25   | 2506.848           | 65.801                                      | 4313.75                                     | 48.828                                      |
| 30   | 2343.302           | 63.880                                      | 4189.05                                     | 46.834                                      |
| 35   | 2078.47            | 61.449                                      | 4039.56                                     | 44.263                                      |
| 40   | 43,282.18          | 11.974                                      | 889.66                                      | -15,415.03                                  |
| 45   | $.567 \times 10^7$ | $-.247 \times 10^6$                         | $-.265 \times 10^8$                         | 2.0833                                      |
| 50   | $.127 \times 10^7$ | .48177                                      | 76.432                                      | $.223 \times 10^6$                          |

| Week | $\frac{\partial \$/hr(t)}{\partial y_2(t)}$ | $\frac{\partial \$/hr(t+\tau_{12})}{\partial y_1(t)}$ | $\frac{\partial \$/hr(t+\tau_{12})}{\partial y_1(t)}$ |
|------|---|---|---|
| 5    | 9453.98                                     | $-.6 \times 10^{-24}$                                 | 1780.529  |
| 10   | 9927.41                                     | $-.1 \times 10^{-23}$                                 | 1863.91   |
| 15   | 9792.48                                     | $-.6 \times 10^{-24}$                                 | 1833.95   |
| 20   | 10,035.73                                   | $-.1 \times 10^{-23}$                                 | 1888.85   |
| 25   | 10,643.96                                   | $-.1 \times 10^{-23}$                                 | 1999.61   |
| 30   | 10,343.34                                   | $-.1 \times 10^{-23}$                                 | 1936.56   |
| 35   | 9861.16                                     | $-.6 \times 10^{-24}$                                 | 1840.52   |
| 40   | $-.45 \times 10^7$                          | .0358   | $-.252 \times 10^7$                                   |
| 45   | 1364.58                                     | .6250   | 275.520   |
| 50   | $.342 \times 10^8$                          | .0651   | $.634 \times 10^7$                                    |

TABLE G-IX  
VALUES AND SIGNIFICANT FIGURES  
ASKED OF TERMS IN EULER EXPRESSION

| Week | $\frac{\partial \$/\text{hr}(t)}{\partial \dot{y}_i(t)}$ |              | $\frac{d}{dt} \frac{\partial \$/\text{hr}(t)}{\partial \dot{y}_i(t)}$ |              | $\frac{d}{dt} \frac{\partial \$/\text{hr}(t+\tau_{12})}{\partial \dot{y}_i(t)}$ |              |
|------|--|--------------|---|--------------|---|--------------|
|      | Value  | Sig. Figures | Value   | Sig. Figures | Value   | Sig. Figures |
| 2    | 53.7711  | 3            | 10.26   | 3            | 21.78   | 3            |
| 6    | 59.4771  | 3            | 6.32  | 2            | 3.79  | 2            |
| 16   | 61.0901  | 3            | 1.35  | 2            | 0.549   | 1            |
| 28   | 65.6234  | 3            | -3.19   | 2            | -1.46   | 2            |
| 36   | 60.8227  | 3            | -7.47   | 2            | -8.12   | 2            |
| 45   | 247,020.6  | 3            | -110,800  | 3            | 1.225   | 0            |

Data of June 16, 1952

The differences corresponding to the numerator of (G-12) are tabulated in table G-X for the selected weeks. Using the required number of significant figures, tabulated in table G-IX for

$$\frac{d}{dt} \frac{\partial \$/\text{hr}(t)}{\partial \dot{y}_i(t)} \quad \text{and} \quad \frac{d}{dt} \frac{\partial \$/\text{hr}(t+\tau_{12})}{\partial \dot{y}_i(t)}$$

one then obtains the number of significant figures needed in

$$\frac{\partial \$/\text{hr}(t)}{\partial \dot{y}_i(t)} \quad \text{and} \quad \frac{\partial \$/\text{hr}(t+\tau_{12})}{\partial \dot{y}_i(t)}$$

These are also tabulated in table G-X. To illustrate the procedure used, consider week two. From table G-X, in week 2,

$$\frac{d}{dt} \frac{\partial \$/\text{hr}(t)}{\partial \dot{y}_i(t)}$$

is needed to three significant figures. It follows that the

TABLE G-X

COMPUTED VALUES AND ACCURACIES ASKED OF PARTIAL DERIVATIVES

TO LIMIT ROUND OFF ERROR IN TIME DERIVATIVES

| Week   | 2        | 6        | 16       | 28       | 36       | 45          |
|--|----------|----------|----------|----------|----------|-------------|
| $\$/hr(t)$   | 1305.87  | 1972.245 | 2040.178 | 2497.963 | 1956.699 | 5,670,040   |
| $\frac{\partial \$/hr(t)}{\partial \dot{y}_i(t)}$  | 3576.603 | 3901.254 | 4017.607 | 4301.489 | 4008.883 | -26,516,305 |
| $\Delta \frac{\partial \$/hr(t)}{\partial \dot{y}_i(t)} = \frac{\partial \$/hr(t+\Delta t)}{\partial \dot{y}_i(t+\Delta t)} - \frac{\partial \$/hr(t-\Delta t)}{\partial \dot{y}_i(t-\Delta t)}$ | 413.756  | 88.290   | 18.901   | -44.702  | -104.744 | -1,551,157  |
| # sig. fig. needed in $\frac{\partial \$/hr(t)}{\partial \dot{y}_i(t)}$  | 4        | 4        | 4        | 4        | 3        | 4           |
|  | 5        | 5        | 5        | 5        | 4        | 5           |
| $\frac{\partial \$/hr(t+T_{12})}{\partial \dot{y}_i(t)}$   | 1540.194 | 1812.195 | 1837.329 | 1992.692 | 1798.393 | 275.521     |
| $\frac{\partial \$/hr(t+T_{12}+\Delta t)}{\partial \dot{y}_i(t+\Delta t)} - \frac{\partial \$/hr(t+T_{12}-\Delta t)}{\partial \dot{y}_i(t-\Delta t)}$  | 304.513  | 53.08    | 7.70     | -20.427  | -113.847 | 17.188      |
| # sig. figures needed in $\frac{\partial \$/hr(t+T_{12})}{\partial \dot{y}_i(t)}$  | 4        | 4        | 4        | 4        | 3        | 0           |
|  | 5        | 5        | 5        | 5        | 4        | 1           |

difference:

$$\Delta \frac{\partial \$/hr(t)}{\partial \dot{y}_i(t)} = \frac{\partial \$/hr(t+\Delta t)}{\partial \dot{y}_i(t+\Delta t)} - \frac{\partial \$/hr(t-\Delta t)}{\partial \dot{y}_i(t-\Delta t)} \quad (G-13)$$

is also needed to three significant figures. Examination of the relative magnitudes of

$$\Delta \frac{\partial \$/hr(t)}{\partial \dot{y}_i(t)} \quad \text{and} \quad \frac{\partial \$/hr(t)}{\partial \dot{y}_i(t)}$$

in table G-X shows that the less accurate term in (G-13) should be known to four figures and the other should be known to five figures.

It is recalled that these requirements stem from the rather severe requirement that elevations be accurate to better than the nearest tenth and nearest hundredth at dams 1 and 2 respectively. Lesser requirements on the accuracy of the end results will naturally need less accuracy in the intermediate computations.

#### G.9 Other Errors

Truncation errors involved in the difference-method of evaluating

$$\frac{\partial \$/hr(t+\tau_0)}{\partial \dot{y}_i(t)} \quad \text{and} \quad \frac{\partial \$/hr(t+\tau_0)}{\partial \dot{y}_i(t)}$$

are not treated, because such errors are eliminated by the methods of 6.2 and 6.3 using analytic expressions for these partials.

Further evaluations of the accuracy requirements of plant characteristics are being made but are not ready for this publication. Indications are, however, that this is not

a serious problem unless very accurate results are required. Rather, the problem is to determine how much simpler the characterization can be made and still obtain a desired accuracy.

#### G.10 Conclusions

As stated previously, such error analysis can only provide estimates of errors and guides for future work. The examination presented indicates that truncation and round off errors in the application considered are not excessive, and no fundamental limitation that would prevent the use of the method has appeared. Adjustment of sample spacing and modification of the degree of the Lagrange formulas for different problems should of course be investigated. In the use of the method on an actual system, only periodic checking of errors will insure satisfactory operation.

**A SHORT GUIDE TO CODING**

**Using the Whirlwind I Code of October 1949  
With Revisions through May 1951**

**DIGITAL COMPUTER LABORATORY  
MASSACHUSETTS INSTITUTE OF TECHNOLOGY  
Cambridge, Massachusetts**

## A SHORT GUIDE TO CODING (Using the Whirlwind I code of October 1949)

### COMPUTER PROGRAMS

**Program.** A program is a sequence of actions by which a computer handles a problem. The process of determining the sequence of actions is known as programming.

**Flow diagrams.** A flow diagram is a series of statements of what the computer has to do at various stages in a program. Lines of flow indicate how the computer passes from one stage of the program to another.

**Coded program.** Programs and flow diagrams are largely independent of computer characteristics, but instructions for a computer must be expressed in terms of a code. A set of instructions that will enable a computer to execute a program is called a coded program, and the process of preparing a coded program is known as coding.

**Orders and operations.** Individual coded instructions are known as orders and call for specific operations such as multiply, add, shift, etc.

**The computer code.** The computer code described here is that of Whirlwind I, an experimental computer using binary digits, single-address order code, parallel operation, and electrostatic storage. It is expected that computers of this type will ultimately achieve an average speed of 50,000 operations per second.

### COMPUTER COMPONENTS

**Registers and words.** A register has 16 digit positions each able to store a one or a zero. A word is a set of 16 digits that may be stored in a register. A word can represent an order or a number.

**Arithmetic element.** Arithmetic operations take place in the arithmetic element, whose main components are three flip-flop registers, the A-register, the accumulator, and the B-register (AR, AC, BR). The 16 digit positions of AR starting from the left are denoted by AR 0, AR 1, . . . , AR 15. Similarly for AC, BR. Words enter AC through AR; BR is an extension of AC.

**Storage.** The term "register" by itself refers to the main electrostatic storage, which consists of  $2^{11}$  or 2048 registers, each of which is identified by an address. These addresses are 11-digit binary numbers from 0 to 2047. The computer identifies a register by its address.

**Input-output.** All information entering or leaving the computer is temporarily stored in the input-output register (IOR). The computer regulates the flow of information between the internal storage and IOR, and also calls for any necessary manipulation of external units. The descriptive names of the input-output orders were chosen for photographic film reader-recorder units, but the orders are applicable to other types of external equipment.

**Control element.** The control element controls the sequence of computer operations and their execution. Instructions are obtained from storage in the form of individual orders, each of which is represented by a single word.

**Inter-connections.** The four main elements (storage, control, arithmetic, and input-output) are connected by a parallel communications system, known as the bus.

### REPRESENTATION OF ORDERS

**Operation section.** When a word is used to represent an order the first (left-hand) 5 digits, or operation section, specify a particular operation in accordance with the order code.

**Address section.** The remaining 11 digits, or address section, are interpreted as a number with the binary point at the right-hand end. In the majority of orders this number is the address of the register whose contents will be used in the operation. In orders sl, sr, the number specifies the extent of a shift; in rf, rb, the number specifies an external unit; in ri, rs, the address section is not used.

**Example.** The order ca x has the effect of clearing AC (making all the digits zero) and then putting into AC the word that is in the register whose address is x. If q is a quantity in some register, the order needed to put q in AC is not ca q but ca x, where x is the address of the register that contains q.

### REPRESENTATION OF NUMBERS

**Single-word representations.** When a word is used to represent a number the first digit indicates the sign and the remaining 15 are numerical digits. For a positive number the sign digit is zero, and the 15 numerical digits with a binary point at their left specify the magnitude of the number. The negative -y of a positive number y is represented by complementing all the digits, including the sign digit, that would represent y. (The complement is formed by replacing every zero by a one and every one by a zero.) In this way a word can represent any multiple of  $2^{-15}$  from  $2^{-15} - 1$  to  $1 - 2^{-15}$ . Neither +1 nor -1 can be represented by a single word. Zero has two representations, either 16 zeros or 16 ones, which are called +0 and -0 respectively.

**Overflow — increase of range and accuracy.** With single-word representation the range is limited to numbers between  $2^{-15} - 1$  and  $1 - 2^{-15}$ . Programs must be so planned that arithmetic operations will not cause an overflow beyond this range. The range may be extended by using a scale factor, which must be separately stored. Accuracy can be increased by using two words to represent a 30-digit number.

### COMPUTER PROCEDURE

**Sequence of operations.** After the execution of an order the program counter in the control element holds the address of the register from which the next order is to be taken. Control calls for this order and carries out the specified operation. If the order is not sp or cp(-) the address in the program counter then increases by one so that the next order is taken from the next consecutive register. The sp and cp(-) orders permit a change in this sequential procedure.

**Transfers.** A transfer of a digit from one digit position to another affects only the latter digit position, whose previous content is lost.

**Negative zero.** The subtraction of equal numbers produces a negative zero in AC, except when AC contains +0, and -0 is subtracted from it.

**Manipulation of orders.** Words representing orders may be handled in the arithmetic element as numbers.

**Procedure in the arithmetic element.** The execution of an addition includes the process of adding in carries; this process treats all 16 digits as if they were numerical digits, a carry from AC 0 being added into AC 15. A subtraction is executed by adding the complement. Multiplication, division, shifting and round-off are all executed with positive numbers, complementing being performed before and after the process when necessary. For round-off the digit in BR 0 is added into AC 15.

### NOTATION FOR CODING

**Addresses.** A coded program requires certain registers to be used for specified purposes. The addresses of these registers must be chosen before the program can be put into a computer, but for study purposes this final choice is unnecessary, and the addresses can be indicated by a system of symbols or index numbers.

**Writing a coded program.** Registers from which control obtains orders may be called action registers, and should be listed separately from registers containing other information, which may be called data registers. A coded program is written out in two columns; the first contains the index number of each action or data register, and the second column indicates the word that is initially stored in that register. In many cases part or all of a word may be immaterial because the contents of the register in question will be changed during the course of the program. This state of affairs is indicated by two dashes, for example, ca --.

**The abbreviations RC, CR.** Abbreviations used in referring to the register that contains a certain word or to the word in a certain register are

RC . . . = (Address of) Register Containing . . .  
CR . . . = Contents of Register (whose address is) . . .

**The symbol ri x.** When an address forms part of an order it is represented by the last 11 digits of a word whose first 5 digits specify an operation. An address x that is not part of an order is represented by the last 11 digits of a word whose first 5 digits are zero, which is equivalent to specifying the operation ri. Thus the word for an unattached address x may be written ri x. It could also be written  $x \times 2^{-15}$ .



THE ORDER CODE

AC = Accumulator AR = A-Register BR = B-Register

x is the address of a storage register; n is a positive integer; k designates an external unit

| Order  | Operation               |         |        | Function  |
|--------|-------------------------|---------|--------|---|
|        | Name                    | Code    |        |   |
|        |                         | Decimal | Binary |   |
| ri --  | read initially          | 0       | 00000  | Take words from external unit until internal storage is full.   |
| rs --  | remote unit stop        | 1       | 00001  | Stop external unit.   |
| rf k   | run forward             | 2       | 00010  | Prepare to use external unit k in forward direction.  |
| rb k   | run backward            | 3       | 00011  | Prepare to use external unit k in backward direction.   |
| rd x   | read                    | 4       | 00100  | Transfer to register x a word supplied by external unit.  |
| rc x   | record                  | 5       | 00101  | Arrange for transfer of contents of register x to external unit.  |
| ts x   | transfer to storage     | 8       | 01000  | Transfer contents of AC to register x.  |
| td x   | transfer digits         | 9       | 01001  | Transfer last 11 digits from AC to last 11 digit positions of register x.   |
| ta x   | transfer address        | 10      | 01010  | Transfer last 11 digits from AR to last 11 digit positions of register x.   |
| cp(-)x | conditional program     | 14      | 01110  | If number in AC is negative, proceed as in sp; if number is positive disregard the cp(-) order, but clear the AR.   |
| sp x   | subprogram              | 15      | 01111  | Take next order from register x. If the sp order was at address y, store y + 1 in last 11 digit positions of AR.  |
| ca x   | clear and add           | 16      | 10000  | Clear AC and BR, then put contents of register x into AC. If necessary, add in carry from previous sa addition.   |
| cs x   | clear and subtract      | 17      | 10001  | Clear AC and BR, then put complement of contents of register x into AC. If necessary, add in carry from previous sa addition.   |
| ad x   | add                     | 18      | 10010  | Add contents of register x to contents of AC, storing result in AC.   |
| su x   | subtract                | 19      | 10011  | Subtract contents of register x from contents of AC, storing result in AC.  |
| cm x   | clear and add magnitude | 20      | 10100  | Clear AC and BR, then put positive magnitude of contents of register x into AC. If necessary add in carry from previous sa addition.  |
| sa x   | special add             | 21      | 10101  | Add contents of register x to contents of AC, storing result in AC and retaining any overflow for next ca, cs, or cm order. Only orders 1 through 15 may be used between the sa order and ca, cs, or cm orders for which the sa is a preparation.   |
| ao x   | add one                 | 22      | 10110  | Add the number $1 \times 2^{-15}$ to the contents of register x. Store result in AC and in register x.  |
| mr x   | multiply and round off  | 24      | 11000  | Multiply contents of register x by contents of AC; round off result to 15 numerical digits and store in AC. Clear BR.   |
| mh x   | multiply and hold       | 25      | 11001  | Multiply contents of register x by contents of AC and retain the full product in AC and the first 15 digit positions of BR, the last digit position of BR being cleared.  |
| dv x   | divide                  | 26      | 11010  | Divide contents of AC by contents of register x, leaving 16 numerical digits of the quotient in BR and $\pm 0$ in AC according to sign of the quotient. (The order sl 15 following the dv order will round off the quotient to 15 numerical digits and store it in AC.)   |
| sl n   | shift left              | 27      | 11011  | Multiply the number represented by the contents of AC and BR by $2^n$ . Round off the result to 15 numerical digits and store it in AC. Disregard overflow caused by the multiplication, but not that caused by round-off. Clear BR.  |
| sr n   | shift right             | 28      | 11100  | Multiply the number represented by the contents of AC and BR by $2^{-n}$ . Round off the result to 15 numerical digits and store it in AC. Clear BR.  |
| sf x   | scale factor            | 29      | 11101  | Multiply the number represented by the contents of AC and BR by 2 sufficiently often to make the positive magnitude of the product equal to or greater than 1/2. Leave the final product in AC and BR. Store the number of multiplications as last 11 digits of register x, the first 5 digits being undisturbed. |

NOTES ON THE ORDER CODE

**Effect of operations.** The functions of the various orders are described above. It is to be assumed that AR, AC, BR, and the register whose address is x are undisturbed unless the contrary is stated.

**AR.** AR is primarily a buffer register for passing words into AC. After orders ca x, cs x, ad x, su x, sa x, and ao x it contains the number originally contained in register x. After orders cm x, mr x, mh x, and dv x it contains the magnitude of the contents of x. The effect of sp x and cp(-)x is stated above. No other order changes the contents of AR.

**BR.** A number stored in BR always appears as a positive magnitude, the sign of the number being assumed to be that indicated by the sign digit in AC. This convention has no effect on the logical result of the operations involving BR except that when BR contains a number that will be used later it is necessary to retain the appropriate sign digit.

**Alarms.** If the result of an arithmetic operation exceeds the register

capacity (i.e., if overflow occurs), a suitable alarm is given except as mentioned in connection with orders sa x and sl n.

**Shift orders.** A multiplication overflow in sl is lost without giving an alarm, but an overflow from round-off gives an alarm. Orders sr 0 and sl 0 only cause round-off, an alarm being given if an overflow occurs. The integer n is treated modulo 32, i.e., sl32 = sl0, sl33 = sl1, etc.

**Scale factors.** If all the digits in BR are zero and AC contains  $\pm 0$ , the order sf x leaves AC and BR undisturbed and stores the number 33 in the last 11 digit positions of register x.

**Division.** Let u and v be the numbers in AC and register x when the order dv x is used. If  $|u| < |v|$  the correct quotient is obtained and no overflow can arise. If  $|u| > |v|$  overflow occurs and gives an alarm. If  $u = v \neq 0$  the dv order leaves 16 ones in BR and round-off in a subsequent sl 15 would cause overflow and give an alarm. If  $u = v = 0$  a zero quotient is obtained.

REVISIONS IN THE WHIRLWIND I ORDER CODE

October, 1949 through May, 1951

| Order  | Operation                    |      | Code<br>Binary | Function   |
|--|------------------------------|------|----------------|--|
|  | Name                         | Dec. |                |  |
| <b>A. Permanent addition to the Code:</b>  |                              |      |                |  |
| ck x   | check                        | 11   | 01011          | Stop the computer and ring an alarm if contents of register x is not identical with contents of AC; otherwise proceed to next order.   |
| <b>B. Minor changes not affecting previous functions of certain orders:</b>  |                              |      |                |  |
| sa x   | special add                  | 21   | 10101          | Add contents of register x to contents of AC, storing result in AC and retaining any overflow for the next <u>ca</u> , <u>cs</u> , or <u>cm</u> . Only orders 1 through 15, 23, 30, and 31 may be used between <u>sa</u> and the <u>ca</u> , <u>cs</u> , or <u>cm</u> for which the <u>sa</u> is a preparation. Use of any other operation between <u>sa</u> and <u>ca</u> , <u>cs</u> , or <u>cm</u> will result in the overflow being lost completely, with no other effect on the normal function of the intervening operation.   |
| sl*n   | shift left without roundoff  | 27   | 11011          | Multiply contents of AC and BR by $2^n$ , as in <u>sl n</u> , but do not roundoff nor clear BR.  |
| sr*n   | shift right without roundoff | 28   | 11100          | Multiply contents of AC and BR by $2^{-n}$ , as in <u>sr n</u> , but do not roundoff nor clear BR.   |
| <b>C. Temporary order likely to become permanent:</b>  |                              |      |                |  |
| qe x   | exchange                     | 13   | 01101          | Exchange contents of AC with contents of register x (original contents of AC to register x, original contents of register x to AC).  |
| <b>D. Major changes in the order code:</b>   |                              |      |                |  |
| rs--   | (remote unit) stop           | 1    | 00001          | To be discontinued: at present it has the temporary function of stopping the computer.   |
| rf k   | run forward                  | 2    | 00010          | Discontinued. Replaced by operation <u>si</u> (described below).   |
| rb k   | run backward                 | 3    | 00011          | Discontinued. Replaced by operation <u>si</u> (described below).   |
| <b>E. Tentative new order (not yet completely defined):</b>  |                              |      |                |  |
| si k   | select in-out unit           |      |                | Select the particular piece of terminal equipment (with mode and direction of operation, if necessary) specified by the address.   |
| <b>F. Present temporary orders (to be discontinued when replaced by the more general <u>si</u>, <u>rd</u> and <u>rc</u> operations):</b> |                              |      |                |  |
| qh x   | h-axis set                   | 6    | 00110          | Transfer contents of AC to register x; set the horizontal position of all display scope beams to correspond to the numerical value of the contents of AC.  |
| qd x   | D-scopes display             | 7    | 00111          | Transfer contents of AC to register x; set the vertical position of the beams of the display scopes to correspond to the numerical value of the contents of AC; display (by intensifying) a spot on the face of the D-display scopes.  |
| qf x   | F-scope display              | 23   | 10111          | Same as operation <u>qd</u> , except display a spot on the face of the F-display scopes.   |
| qr n   | read/ shift right            | 30   | 11110          | Perform two logically distinct functions: 1) Cause the photoelectric tape input reader to read the next character containing a hole in position 7 from tape into digits 0 through 5 of FF Register #3 (holes or no holes in tape positions 1 to 6 becoming ones or zeros in digit columns 0 to 5 respectively). 2) Shift the contents of AC and BR to the right n times. The sign digit is shifted like any other digit and zeros are introduced into the left end. (no roundoff, no BR clear, no sign control). Note: If more than 3 milliseconds (= about 60 orders) elapses between one <u>qr</u> and the next, the reader stops. This must not happen except where 3" of blank tape has been provided for the purpose. |
| qr*n   |                              |      |                | Same as <u>qr n</u> above, except the mechanical tape reader, rather than the photoelectric tape reader, is caused to read. The mechanical reader can read line-by-line (i.e. no blank tape is required at places where the reader is allowed to stop).  |
| qp n   | punch/ shift right           | 31   | 11111          | Perform two logically distinct functions: 1) Cause the paper tape output equipment (punch or printer or both, depending on the settings of the switches) to record one character with holes or no holes in positions 1 to 6 on tape corresponding respectively to ones or zeros in digit columns 10 through 15 of AC, and with a hole in position 7. 2) Shift right as in operation <u>qr</u> .  |
| qp*n   |                              |      |                | Same as <u>qp n</u> above, except no hole is put in position 7.  |
| qs n   | index camera                 | 12   | 01100          | Perform two logically distinct functions: 1) Move the next frame of film into place in the display scope camera and open the shutter if it is not already open. The shutter is closed manually when the film is removed for developing. 2) Shift right as in operation <u>qr</u> .   |

\*The fact that the six largest binary digits of the address section of orders sl n, sr n, qr n and qp n are normally zero (and in any case are disregarded by the step counter which counts the shifts) is exploited to permit the addition of an extra variant, as described, to each of the orders mentioned. The star (\*) in sl\*n, sr\*n, qr\*n, and qp\*n implies that digit 6 (the  $2^9 = 512$  digit of the address) will be a one, while in sl n, etc., with no star, digit 6 is to be a zero. This can be accomplished during preparation of tape by typing sl (800 + n) for sl\*n.