

MIT/LCS/TR-322

ROUTING THE POWER AND GROUND WIRES
ON A VLSI CHIP

Andrew Strout Moulton

This blank page was inserted to preserve pagination.

ROUTING THE POWER AND GROUND WIRES ON A VLSI CHIP

by

ANDREW STROUT MOULTON

submitted to the

DEPARTMENT OF ELECTRICAL ENGINEERING AND COMPUTER SCIENCE

in partial fulfillment
of the requirements for the degree of

MASTER OF SCIENCE

at

MASSACHUSETTS INSTITUTE OF TECHNOLOGY

May, 1984

© Massachusetts Institute of Technology, 1984

This research was supported by the Defense Advanced Research Projects Agency under Contract No. N00014-80-C-0622, by the Air Force under Contract No. AFOSR-F49620-81-0054, and by General Electric.

Signature of Author _____

Andrew S. Moulton

Department of Electrical Engineering and Computer Science

May 25, 1984

Certified by _____

Ronald L. Rivest

Prof. Ronald Linn Rivest

Thesis Supervisor

Accepted by _____

Prof. Arthur C. Smith

Chairman, Department Committee

Routing the Power and Ground Wires on a VLSI Chip

by

Andrew Strout Moulton

Submitted to the Department of Electrical Engineering and Computer Science
on May 25, 1984, in partial fulfillment of the requirements for
the degree of Master of Science

ABSTRACT

This thesis presents four new algorithms to route noncrossing power and ground trees in one metal layer of a VLSI chip. The implementation of the best algorithm forms MIT's Placement-Interconnect (PI) Project's power-ground routing phase. The input to this power-ground algorithm is a set of rectangular modules on a rectangular chip. Because of bonding limitations, the pads are placed along the chip's perimeter, while the logic modules are placed in the interior. In constructing the power-ground layout, the algorithm first lays a ground ring between the pads and the chip's perimeter, then a power ring between the logic modules and the pads. Next, a tree of wires connects the ground pad with the logic modules' ground connection points. Then, starting at various points on the power ring, several branches of wires connect the power ring to the logic modules' power connection points. A tree-traversal algorithm then uses the modules' current requirements to determine how much current will flow through each power-ground wire during the chip's operation. An algorithm then widens each wire to the width appropriate for carrying that current.

Keywords: power-ground routing, VLSI chip layout, design automation, graph algorithms

Thesis Supervisor: Prof. Ronald L. Rivest

Title: Professor of Electrical Engineering and Computer Science

ACKNOWLEDGMENTS

I would like to thank my thesis advisor for first introducing me to the power-ground problem, for making many helpful suggestions, and for guiding my research toward the problem's solution.

I am grateful to all members of the Placement-Interconnect Research Group. In a close-knit effort such as PI, the quality of one's work depends upon the quality of everyone else's. It is important to have a group that applies the time, effort, and ability to produce high-quality work.

I wish to acknowledge the generosity of the organizations that contributed to my financial support, and I appreciate MIT and the Laboratory for Computer Science for making so many facilities available to me.

I am thankful for the many times the support staff of the Theory of Computation Group came to my aid. Also, I am indebted to the people who read the many drafts of this thesis and gave me many helpful suggestions on my writing style.

Finally, I would like to thank my family for their constant and dependable love, understanding, confidence, and support.

TABLE OF CONTENTS

1. OVERVIEW	6
1.1 Summary of results	6
1.2 Problem definition	6
1.3 Approaches to the power-ground problem	8
1.4 The Placement-Interconnect System	8
1.5 Similarities between power-ground routing and signal routing	9
1.6 Differences between power-ground routing and signal routing	10
1.7 Description of the power-ground algorithm	11
1.8 Determining which power-ground problems are solvable	13
1.9 Summary of the power-ground algorithm	14
2. GOALS IN AUTOMATING POWER-GROUND ROUTING	15
3. PROBLEM DEFINITION	16
3.1 Restrictions imposed on the problem	16
3.1.1 Restrictions imposed by the fabrication technology	16
3.1.2 Restrictions imposed by the design methodology	17
3.1.3 Restrictions imposed by the PI System	18
3.1.4 Optimization Criteria	18
3.2 Definitions of terms	19
3.3 Definition of the power-ground problem	20
4. HISTORY	22
4.1 Syed and Gamal's algorithm	22
4.2 Rothermel and Mlynski's algorithm	26
4.3 Lhota's algorithm	26
5. THE PI SYSTEM	29
5.1 Overview of the PI System	29
5.2 Placing the modules on the chip	30
5.2.1 Placing the pads	30
5.2.2 Placing the logic modules	30
5.3 Routing the power and ground nets	32
5.4 Routing the signal nets	32
5.4.1 Defining the channels	32
5.4.2 Routing the nets globally	33
5.4.3 A power-ground modification of global routing	34
5.4.4 Deciding where the wires should cross the channel edge	35
5.4.5 Routing the channels	35
5.5 Resizing the chip regions to reduce the chip's size	36

6. FOUR ALGORITHMIC METHODS TO GROW NONCROSSING TREES . . .	38
6.1 Growing the trees sequentially, one after the other	38
6.1.1 Successively rerouting branches	
to shorten the trees' combined length	39
6.1.2 Constructing one tree, then a forest of trees	42
6.2 Constructing the trees concurrently, one branch at a time	43
6.3 Drawing a Hamiltonian cycle through the modules,	
then constructing the trees	46
6.3.1 Using the Hamiltonian cycle to divide the chip into regions	46
6.3.2 Defining distance from one module to another	47
6.3.3 Finding a short Hamiltonian cycle	48
6.3.4 Routing the Hamiltonian cycle	49
6.3.5 Routing the VDD and GND nets	52
6.3.6 Advantages and disadvantages of using the Hamiltonian cycle	54
6.4 Laying two rings to connect the pads, then growing the trees	
sequentially to connect the logic modules	54
6.4.1 Laying two rings to connect the pads	54
6.4.2 Growing the trees sequentially to connect the logic modules	55
6.4.3 Advantages and disadvantages of laying the rings	
and growing the trees sequentially	57
7. THE TREE-TRAVERSAL ALGORITHM	
THAT DETERMINES WIRE WIDTH	58
8. EXPERIMENTAL RESULTS	61
9. PROBLEMS FOR FURTHER RESEARCH	64
10. CONCLUSIONS	65
11. BIBLIOGRAPHY	66

1. OVERVIEW

1.1. Summary of results

This thesis presents new algorithms that route power and ground wires to the modules of a custom-designed VLSI chip. The algorithms produce two noncrossing, interdigitated trees of metal wires, each wire being wide enough to carry the current that will flow through it during the operation of the chip. The LISP implementation of these algorithms forms one part of the Placement-Interconnect (PI) System under development at Massachusetts Institute of Technology.

1.2. Problem definition

The general power-ground problem is to lay wires that connect every power connection point on the modules to the power pad(s) and every ground connection point to the ground pad(s). Each wire must be wide enough to carry the current that will flow through it during the operation of the chip. Any layout that meets these specifications is a solution to the problem.

The power-ground problem is part of the larger problem of automating chip layout. Developments in VLSI technology have greatly increased the number of modules and nets on a chip. The time and complexity of laying the wires that interconnect the modules have aroused interest in automating the layout process.

This thesis mostly deals with the design of layouts for chips that have one power pad, one ground pad, and one metal layer. However, Section 1.7, paragraph 4, describes how multiple power-ground pads could connect to the rings that route the signal pads.

Electrical considerations make it highly desirable to lay the power-ground wires entirely in the metal layer. For example, reliable connections are particularly important in the power and ground nets because proper operation of the chip components depends critically on a stable voltage difference between power wires and ground wires. Also, the amount of current in the power-ground wires is often large. A layout of metal wires provides more reliable connections and can handle larger amounts of current than a layout of wires that shift between layers.

On the other hand, with only a single layer of metal available, using only metal imposes the restriction that wires of one net cannot cross those of the other net. For one wire to cross another without connecting to it, the first wire would have to shift to another layer, run under the other wire, and then shift back to the original layer.

The metal area taken up by power-ground wires should be as small as possible. The reason for this is that decreasing chip size is one goal of VLSI design, and wires take up so much of the chip area that decreasing wire area significantly decreases chip size. Also, using less metal area for power-ground routing leaves more for signal routing, enabling the signal-routing algorithms to run more efficiently and produce better results.

Describing a specific power-ground problem instance involves describing the modules, power net, and ground net of the chip. A module is a collection of various chip components. For the power-ground problem, the most important facts about a module are the size and location of the rectangular region it occupies, the amount of current it will use, and the locations of its connection points. A connection point is a point, usually on the module's perimeter, where the module can connect to wires outside the module. A power connection point should connect to a wire running to the power pad, and a ground connection point should connect to a wire running to the ground pad. The power net is a set of connection points that are to be connected by wires in the power-ground layout. These power connection points lie on all modules of the chip. The ground net is the set of all ground connection points. Chapter 3 describes in more detail the facts, forms, and assumptions in a description of a specific power-ground problem.

When regarded as a problem in graph theory, the power-ground problem is the problem of finding two short, noncrossing Steiner trees in the plane. In this model, connection points and wires are equivalent to points and edges in the plane. An edge's cost is defined to be the amount of metal used by the corresponding wire. The power-ground trees are regarded as Steiner trees because the fabrication technology allows connections between wires at locations other than modules' connection points.

1.3. Approches to the power-ground problem

Chapter 4 presents other researchers' work on the power-ground problem. Syed and El Gamal keep the power and ground trees from crossing by imposing traffic rules governing where wires may run in each channel. Rothermal and Mlynski grow the power tree from one side of the chip and the ground tree from the other. Lhota studies the related problem in graph theory of finding two noncrossing spanning trees. His "Saran-Wrap" solution produces trees within $3/2$ of optimal.

Chapters 6 and 7 present the main original results of this thesis. Four new solution techniques arose during this research in the power-ground problem. With respect to the goals of running efficiently and producing high-quality output, the fourth solution technique seems to be the best. The four techniques are:

- Routing one tree, then routing the other tree without crossing the first, then modifying both in an attempt to find shorter trees.
- Routing the two trees in parallel, one branch at a time. In deciding which branch to route next, this technique looks ahead and routes the trees so that the final result will be short trees.
- Keeping the two trees from crossing by drawing a Hamiltonian cycle through the modules, routing one tree inside and the other outside the cycle.
- Using bus rings to connect the pads, then routing one tree to the logic modules, then routing a forest of small trees to the logic modules.

1.4. The Placement-Interconnect System

The Placement-Interconnect (PI) Research Group under Prof. Ronald Rivest at Massachusetts Institute of Technology is developing algorithms to solve theoretical and practical problems that arise in designing chip layout. This group's work is described in [RI82]. This group's goal is to automate the entire placement and interconnect phases of chip design, producing high-quality output with a minimum amount of human interaction. The chip design follows the simplified rules of Mead and Conway [MC80]

as applied to standard single-layer metal, n-channel metal-oxide-semiconductor (nMOS) fabrication technology. In this thesis, *PI* refers to a computer system developed by this research group that implements the algorithms to do module placement and interconnect.

The input to *PI* specifies a set of rectangular modules and a set of nets. The input information for each module is the module's dimensions, its current requirements, and the locations of its connection points.

To produce the final chip design, *PI* goes through four steps:

- Placing the modules (including the pads) on the chip.
- Routing the power and ground nets.
- Routing the signal nets.
- Compacting the placement of the modules and wires to reduce the chip's size.

This thesis describes algorithms developed for *PI*'s second phase, which routes the power and ground nets. This phase occurs after *PI* has placed the modules and before it has laid any signal wires. The power-ground algorithms are compatible with the rest of *PI*, work within its restrictions and assumptions, and use its data base and algorithms. Therefore, many aspects of *PI*, such as its signal-routing techniques, have greatly influenced the form and scope of the power-ground algorithms. Chapter 5 describes *PI* in more detail.

1.5. Similarities between power-ground routing and signal routing

Power-ground routing is in many respects like signal routing. In both routings, wires connect a set of connection points on various modules. Both routings have the goal of keeping the wire area small. In *PI*, both routings route a net by laying a short Steiner tree of wires that spans the net's connection points.

Dr. Alan Baratz designed PI's algorithm that constructs the Steiner trees. A more detailed description of this algorithm is in Section 5.4.2 and a full presentation is in [B81]. To route a net with n connection points, the algorithm builds a graph where each connection point is represented by a vertex. It then adds to this graph vertices that represent intermediate points lying in free, unoccupied regions of the chip (see Section 5.4.2, paragraph 4, for the exact placement of these points). The distance between a pair of vertices reflects the distance between the represented points. There are initially n basis groups, each consisting of one connection point vertex.

Paths are made to grow simultaneously in all directions from all basis groups. For each basis group, the path grows by adding the vertex that is closest to that basis group. In this aspect, the algorithm is similar to Dijkstra's algorithm for finding a single-source shortest path.

As soon as two paths meet, forming a bridge between two basis groups, the vertices of the two groups plus the vertices along the bridge form a new basis group that replaces the two old ones. In the next step, paths grow from each of the $n - 1$ remaining basis groups. The process repeats until there is just one basis group. Reconstructing each bridge that connected two basis groups builds a Steiner tree that connects the n connection point vertices.

1.6. Differences between power-ground routing and signal routing

One difference between power-ground routing and signal routing is that a wire of one signal net can switch layers to cross under a wire of another signal net whereas a power wire cannot cross under a ground wire, under the assumption that there is only a single metal layer available.

The difficulties with one wire crossing another are reflected in the cost the algorithms associate with each edge. A change in the cost rules results in algorithms that grow noncrossing Steiner trees. For signal routing, if an edge represents a wire that crosses another wire, the edge's cost is increased by an amount that reflects the disadvantages of shifting to another layer. For power-ground routing, the crossing cost

is set so high that the Steiner tree algorithms, looking for cheap paths, will never choose an edge representing a wire that gives rise to a crossing.

Another difference between power-ground routing and signal routing is that the current in signal wires is typically small enough to permit the wire's width to be the minimum allowed by the fabrication technology whereas the larger currents flowing through power-ground wires require wire widths to be determined individually in each case.

This paragraph describes the technique, presented in Chapter 7, for determining how wide each power-ground wire should be. The Steiner tree algorithms produce complete trees of minimum-width wires. The trees' roots are the power and ground pads, and the leaves are the modules' connection points. Using each module's current requirement, a tree-traversal algorithm calculates how much current flows through each wire. The design rules are then used to compute the required width for each wire.

The PI Research Group is developing a resizer that modifies the placement of modules and wires to accomplish any of three tasks:

- Widen power-ground wires.
- Provide more room for signal routing.
- Compact a complete layout of modules and wires.

The power-ground algorithms use the resizer to make each power-ground wire grow to its required width. For each wire, input to the resizer consists of one side of the wire, the other side of the wire, and the required width of the wire. The resizer modifies the placement of the sides of the wire so that they are separated by the required distance, producing a wire of the appropriate width.

1.7. Description of the power-ground algorithm

This section describes the original power-ground routing techniques developed to implement PI's power-ground routing phase.

PI's method of placing modules influences the power-ground layout. PI places along the chip's perimeter the power, ground, and signal pads, signal pads being the modules that carry communications to and from the chip. PI places in the chip's interior the logic modules, which are the modules that perform the desired logical or functional operations.

This placement makes it natural to separate laying power-ground wires to the signal pads from laying wires to the logic modules. There are two reasons for this:

- The placement of the signal pads is uniform.
- The current requirements of signal pads are often much greater than those of logic modules.

Laying wires to the signal pads creates a uniform pattern of wires. One ground wire, called the ground ring, runs from the ground pad along the chip's perimeter, between the signal pads and the chip's edge. One power wire, called the power ring, runs from the power pad along the inside edge of the signal pads, between the logic modules and the signal pads. This power ring does not run along the inside edge of the ground pad, but leaves a gap there to give the ground pad access to the logic modules. Short wires connect the rings to the connection points on the signal pads. The result is that for the signal pads the rings connect every ground connection point to the ground pad and every power connection point to the power pad.

This ring pattern also works with chips that have multiple power and ground pads. For such chips, the rings lie in the same place. Since all pads lie between the power ring and the ground ring, a short wire can connect each power-ground pad to the appropriate ring.

Once the ring layout is complete, the power-ground algorithms route one Steiner tree that connects the ground pad to every ground connection point on the logic modules.

Then the power-ground algorithms route a set of small Steiner trees that connect the power ring to the power connection points on the logic modules. Each tree has its root in the power ring and grows so that its wires never cross a wire of the previously laid ground tree.

When the Steiner trees are routed, the power and ground trees are complete in the sense that minimum-width wires connect every power and ground connection point to the appropriate pad. At this point, running the tree-traversal algorithm to determine each wire's required width and then executing the resizer produces the final power-ground layout.

1.8. Determining which power-ground problems are solvable

A power-ground problem is solvable if and only if every module's perimeter consists of two segments, one containing all the module's power connection points, the other containing all its ground connection points. A layout that is a solution to the power-ground problem connects all the connection points within each net. This means that from every connection point to every other connection point on the same net, there is a path of metal wires. If there is a module whose perimeter does not satisfy the above condition, the module has the following sequence of connection points: one for power, one for ground, one for power, one for ground. It is topologically impossible to lay noncrossing wires outside the module in one layer that connect the two power connection points to each other and the two ground ones to each other.

If a power-ground problem satisfies the above condition, the algorithms of this thesis always succeed in connecting every connection point to the appropriate pad. In the following justification of this statement, *the logic region* refers to the region occupied by the logic modules. In routing the chip, the algorithms first consider the signal pads. Since all pads lie between the power ring and the ground ring, short, local wires can make the appropriate connections. Routing the logic modules comes next. There are as yet no wires in the logic region, and the ground pad has access to the logic region through the gap in the power ring. Therefore, there is a path from the ground pad to every ground connection point in the logic region, and a tree can make the appropriate connections. Laying this tree's wires leaves the logic region as one

continuous region because a tree has no cycles that would isolate one area. There is therefore a path from every power connection point in the logic region to some point on the power ring. A set of small trees can make the appropriate connections, thus completing the layout. At each step, being able to call the resizer guarantees that there will be enough room for the wires of the power-ground layout.

1.9. Summary of the power-ground algorithm

PI's power-ground routing phase occurs after the placing of the modules. Its power-ground algorithms lay a ground ring along the chip's perimeter and connect this ring to the ground connection points on the signal pads. Then a power ring along the signal pads' inside edges connects to the power connection points on the signal pads. Next, one Steiner tree is routed that connects the ground connection points on the logic modules to the ground pad. Several small Steiner trees that grow from the power ring without crossing the ground tree connect the power connection points on the logic modules. Regarding the power and ground pads as the power and ground trees' roots, a tree-traversal algorithm determines how much current flows through each wire and, hence, how wide each wire must be. The resizer accordingly widens the wires to produce the final power-ground layout. PI then proceeds to its signal-routing phase.

Chapter 8 contains a sequence of photographs showing the original module placement, then the power and ground rings for the pads, then the trees for the logic modules, and finally the power-ground layout with wires of the correct width.

2. GOALS IN AUTOMATING POWER-GROUND ROUTING

The work on automating power-ground routing described in this thesis is part of a larger research effort to automate the placement-interconnect phases of chip design. This in turn is part of a larger effort studying what is sometimes known as "silicon compilation", the goal of which is to automate the entire chip design process as much as possible.

As with compilation of a high-level language, the goals of silicon compilation are to

- produce high-quality output
- run efficiently
- require minimum human interaction

Automation is desirable because recent fabrication technology advances are greatly increasing the number of objects on a chip. Thus, the algorithms implementing the automation will be applied to huge problems. This makes the algorithms' efficiency particularly important.

In finding efficient algorithms, it is important to note that, according to the models commonly used, many placement and interconnect problems are NP-complete. This indicates finding good heuristics is more fruitful than searching for algorithms that produce provably optimal results.

Looking at the underlying problems gives an indication of whether the power-ground problem is NP-complete. This thesis models the power-ground problem as the problem of constructing two noncrossing geometric Steiner trees using the rectilinear metric. In the rectilinear metric, the distance from (x_1, y_1) to (x_2, y_2) is $|x_2 - x_1| + |y_2 - y_1|$. The problem of constructing one such Steiner tree is NP-complete in the strong sense ([GJ79]), but the complexity of constructing two noncrossing Steiner trees on the same set of vertices is not known, although we conjecture that it, too, is NP-complete.

3. PROBLEM DEFINITION

This chapter defines the power-ground problem studied in this thesis. The first section discusses the restrictions imposed on the problem. The second defines the terms used in describing the problem. The third describes the problem's input and the desired solution.

3.1. Restrictions imposed on the problem

3.1.1. Restrictions imposed by the fabrication technology

The methods in use for manufacturing chips have greatly influenced the specifics of the power-ground problem in this thesis. This section presents the main assumptions these methods impose.

This thesis assumes the chip has one metal layer. Since the metal layer is the only layer that can easily handle the large currents the power-ground wires carry, the entire power tree and ground tree must lie wholly in the metal layer. That there is only one metal layer imposes the very important restriction that one tree's wires cannot cross the other's.

Some fabrication methods make chips with two metal layers. For such chips, one routing method is to route all horizontal wire segments in one layer and all vertical segments in the other. The algorithms of this thesis cannot be applied when such a method is used.

For other methods for routing on chips with two layers of metal, one solution to the power-ground problem is to route the power tree on one metal layer and the ground tree on the other. To do this efficiently, a Steiner tree could connect each net's connection points. However, putting both trees in one layer is sometimes desirable because this leaves the other metal layer free for signal routing. The algorithms of this thesis can be used for this.

Another restriction imposed by the technology is that the trees' metal wires must vary in width according to how much current they must carry. This leads to a difference

between signal routing and power-ground routing. The current in signal wires is almost always so low that a minimum-width wire suffices, whereas the current in power-ground wires is often very great, even in the lower power CMOS technology. Because of this, power-ground wires must vary greatly in width. Also, a power-ground wire's width must be able to handle the peak loads. For example, one wire may supply power to several modules, all of which may be drawing their maximum currents simultaneously.

This thesis assumes there are no buried contacts. This means that wire layouts that carry out the chip's logical functions cannot lie under power-ground wires. Signal wires are allowed to cross under power-ground wires, but they cannot change layers under the wire.

Some packaging and bonding techniques require that pads are placed on the chip's perimeter. This affects placement of not only the pads but also the logic modules and greatly influences the pattern of power-ground wires that connects the pads, as explained in Section 6.4. Also, some automatic handling techniques require that the chip's corners are left free of modules, pads, and wires. This, too, influences the pattern of power-ground wires that connects the pads.

3.1.2. Restrictions imposed by the design methodology

This thesis deals with custom-designed chips. It makes very few assumptions about the placement of the modules. This makes the problem much harder and makes applying the work of researchers who studied gate arrays or standard cell layouts more difficult. This thesis does make assumptions about the placement of pads, as described in Section 6.4.

This thesis uses a rectilinear model for chip objects. This means that objects such as modules, wires, and connection points are represented by rectangles whose sides are parallel to the sides of the chip. Also, it is assumed one module does not abut another.

The algorithms of this thesis regard a module as a self-contained unit and do not know the layout of wires internal to the module. Two consequences of this are that the algorithms cannot lay a wire over a module and that the module's connection points must be on its perimeter.

The algorithms assume there is a single VDD pad and a single GND pad for the chip. Section 1.7, paragraph 4, describes how multiple power-ground pads could connect to the rings that route the signal pads.

The algorithms also assume each module has one VDD connection point and one GND connection point. However, this assumption is not necessary. The algorithms work with multiple connection points, as long as the connection points' placement is such that a solution is possible, as described in Section 1.8.

The algorithms search for solutions in which the wire layouts are acyclic, forming trees. There are three reasons for this. Many chip designs use trees for power-ground distribution. Also, this assumption enables the algorithms to use many powerful techniques from graph theory that construct trees. Finally, having wires in a tree facilitates many tasks. One such task is determining the maximum current that will flow through every wire. Chapter 7 describes the tree-traversal technique that accomplishes this task.

3.1.3. Restrictions imposed by the PI System

The code that implements the power-ground algorithms of this thesis forms part of the PI System. As such, the algorithms have been greatly influenced by the data structure PI uses to represent the chip and by its assumptions. PI adopts that assumptions presented in the two preceding sections.

3.1.4. Optimization Criteria

This section presents the characteristics that are used, when choosing between various power-ground layouts, to determine which layout is best.

The metal area used for power-ground wires should be minimum. There are two reasons for this. The amount of metal used for wiring is an important factor in determining the chip's size. Using less metal for power-ground routing is apt to produce a smaller chip. Also, using less metal for power-ground routing leaves more metal for signal routing. Given more metal, the signal-routing algorithms are apt to run more efficiently and produce better results.

The power-ground layout should divide the chip into simple, regular regions. Signal routing occurs after power-ground routing and must route around the power-ground wires. Working with simple, regular regions enhances the signal router's performance.

The power and ground trees' combined length should be minimum. In general, this goal is compatible with the two given above—short trees tend to use less metal and form more regular regions. Also, short trees decrease the worst-case distance from a pad to a connection point. This is desirable because it decreases resistance and makes the system less susceptible to noise.

3.2. Definitions of terms

This section defines the terms used throughout this thesis to refer to chip objects.

The *chip* is a custom-designed VLSI chip with three layers—diffusion, polysilicon, and a single metal layer. Since this thesis deals only with objects on the metal layer, it regards the chip as a rectangular region in the plane.

The following objects lie on the chip. The algorithms model each object as a rectangle whose sides are parallel to the chip's sides.

A *module* is the basic unit of the chip. The designer creates the module's internal wire layout to carry out a specific logical function. Being of such general purpose, modules vary greatly in size, complexity, and current requirements. The algorithms of this thesis know nothing of the module's internal wire layout but know the module's exact dimensions and maximum current requirement.

A *pad* is a module to be located on the chip's perimeter that communicates with objects outside the chip, enabling current and information to enter and leave the chip.

A *logic module* is a module to be located in the chip's interior that carries out the chip's logical functions.

A *wire* carries current or information among the modules. The algorithms regard a wire as a set of metal rectangles. A wire can abut a module. When the algorithms first lay wires, each wire has minimum width. Later, each rectangular wire is widened until it is wide enough to carry the appropriate amount of current.

Laying a wire means calculating the wire's exact placement or location.

A *connection point* is a rectangle on the module's perimeter at which a wire can make contact with a module. This allows one module to communicate with another.

A *net* is a set of connection points to be connected. If two connection points lie on the same net, the final chip design will have a wire running from one connection point to the other.

Routing a chip, module, net, or connection point means laying wires to connect all appropriate chip objects.

Power and *VDD* are interchangeable terms that refer to the pad, net, wires, and connection points that carry electrical current to the modules.

Ground and *GND* are interchangeable terms that refer to the pad, net, wires, and connection points that provide the modules with an electrical ground.

Signal describes something involved in carrying information.

A *layout* is a description of the exact locations of the chip objects.

3.3. Definition of the power-ground problem

The power-ground problem is the problem of routing two nets—the VDD net and the GND net. There is one VDD pad, with a VDD connection point, and one GND pad, with a GND connection point. Except for these two pads, it is assumed every module has one VDD connection point and one GND connection point.

A solution to the power-ground problem is a wire layout that

- connects the VDD connection points to each other
- connects the GND connection points to each other
- has no wire from one net crossing a wire from the other net
- has wires wide enough to carry the current that might flow through them during the operation of the chip.

In solving the problem, the goal is to find a wire layout that uses a minimum amount of the metal layer.

4. HISTORY

This chapter presents three previous algorithms that solve the power-ground problem:

- Syed and Gamal give a rule-based algorithm, where the rules specify where to route power-ground wires in the “streets” between the modules.
- Rothermel and Mlynski give an algorithm that divides the chip into left and right halves, routes the VDD connection points that are in the left half, routes the GND connection points that are in the right half, and then completes the trees.
- Lhota gives an algorithm that solves a special type of power-ground problem in which modules are points. The algorithm uses a “Saran-Wrap” technique that produces a pair of non-crossing trees, each of which spans the set of points. The combined length of the edges of this pair of trees is within $3/2$ of the combined length of the edges of the shortest possible pair of non-crossing spanning trees.

4.1. Syed and Gamal’s algorithm [SG82]

Three assumptions facilitate applying this algorithm:

- The VDD pad is in the upper left corner.
- The GND pad is in the lower right corner.
- There is enough room for the final trees.

The algorithm first routes the VDD tree. Starting from the VDD pad in the upper left corner, the VDD tree grows down and to the right. These rules control the tree's growth so that its branches will not interfere with the growing of the GND tree:

For a horizontal channel, run the wire to the right along the bottom of the channel until the wire is obstructed by a module or the edge of the chip. Then delete the wire back to just above the right vertical edge of the module just above which the wire was running just before it encountered the obstruction.

For a vertical channel, run the wire down along the right side of the channel until the wire is obstructed by meeting a four-way intersection (where four channels meet), a module, or the edge of the chip. Then delete the wire back to just to the left of the bottom horizontal edge of the module to the left of which the wire was running just before it encountered the obstruction.

The wires keep from crossing the opposing tree's wires not by referring to the opposing tree's wires' positions but by keeping to one side of the street. Thus, there are several valid orders for growing each tree's branches. The algorithm can route the tree in a breadth-first manner: it runs a wire to the right along the top horizontal channel, then runs a wire down each vertical channel that meets this horizontal channel, then to the right along each horizontal channel that meets one of these vertical channels, etc. When this tree is complete, every module has a VDD wire running along its left and top sides.

The algorithm then routes the GND tree. Starting from the GND pad in the lower right corner, the GND tree grows up and to the left. The following rules control the GND tree's branches so that they do not cross the VDD tree's branches:

For a horizontal channel, run the wire to the left along the top of the channel until it meets a module or the edge of the chip. Then delete the wire back to the left edge of the module below which the wire was running just before it encountered the obstruction.

For a vertical channel, run the wire up along the left side of the channel until it meets a four-way intersection (where four channels meet), a module, or the edge of the chip. Then delete the wire back to the top edge of the module to the right of which the wire was running just before it encountered the obstruction.

Again, there are several valid orders for routing the GND tree. One technique is to route it in a breadth-first manner. When this tree is complete, every module has a GND wire running along its right and bottom sides.

The algorithm then connects the trees' branches to the modules' connection points. Every module has VDD wires along its left and top sides and GND wires along its right and bottom sides. Local routing connects each module's VDD and GND connection points to the appropriate wires.

At this point, the algorithm deletes all useless wire segments. A wire segment is useless if it does not lie on a simple path between a connection point and a pad.

A tree traversal algorithm examines the modules' current requirements and determines the maximum current that will flow through each wire segment. The algorithm's final step widens each wire segment so that it can carry its current.

The following shows Syed and Gamal's algorithm routing a chip. The solid lines show power wires, and the dashed lines show ground wires.

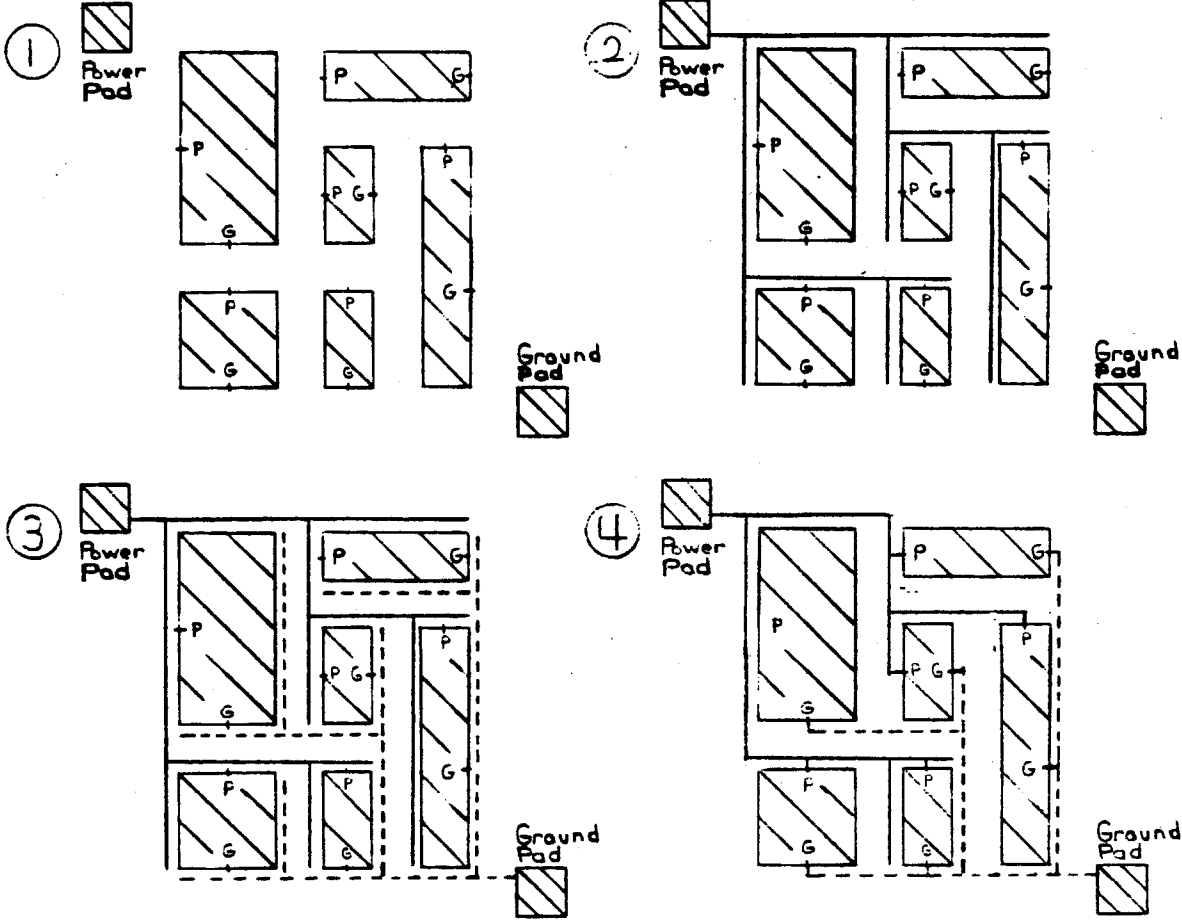

4.2. Rothermel and Mlynski's algorithm [RM81]

Rothermel and Mlynski's algorithm divides the chip into left and right halves, routes the VDD connection points that are in the left half, routes the GND connection points that are in the right half, and then completes the trees. This algorithm's use of a vertical line to divide the chip into regions so that a tree can grow separately in each region is similar to Section 6.3's algorithm's use of a Hamiltonian cycle.

This algorithm assumes that there is one VDD pad in the chip's left half and one GND pad in the chip's right half.

The algorithm first uses a vertical line to divide the chip into halves. A line-search algorithm similar to Hightower's routes one tree that connects the VDD pad to all the VDD connection points in the left half and another tree that connects the GND pad to all the GND connection points. An algorithm similar to Lee's completes the trees. Then, tree traversal calculates each branch's required width. The algorithm then appropriately widens the wires. If necessary, the algorithm adjusts the modules' placement to accommodate the thicker wires.

4.3. Lhota's algorithm [LHO80]

To obtain insight on the best way to lay power and ground wires, Frank J. Lhota studies the problem in graph theory of finding two trees that span a set of vertices in the Cartesian plane, that lie in the plane, and that do not intersect each other. An optimal solution to this problem is one in which the two trees' combined length is minimum.

One method of solving this problem is to find a minimum spanning tree and then find the shortest tree that spans the vertices but does not cross the first tree. This method is similar to Section 6.1's algorithm.

Lhota's first result is a lower bound on the combined length of the trees in the optimal solution. Each of the optimal solution's two trees spans the vertices. As such, the length of each is at least a minimum spanning tree's. Thus, the optimal solution's trees' combined length is at least twice a minimum spanning tree's.

Now consider the technique of finding the trees by first finding a minimum spanning tree and then finding another spanning tree that does not cross the first. It sometimes happens that a certain minimum spanning tree forces the second tree to have twice the length of the minimum spanning tree. This solution's trees' combined length is then three times a minimum spanning tree's.

In the following, the first row shows how the first minimum spanning tree forces the second, noncrossing spanning tree to be so long that the two trees' combined length is not optimal. The second row shows two noncrossing spanning trees with optimal combined length. In both rows, the dashed lines are the edges of the first tree, and the solid lines are the edges of the second tree.

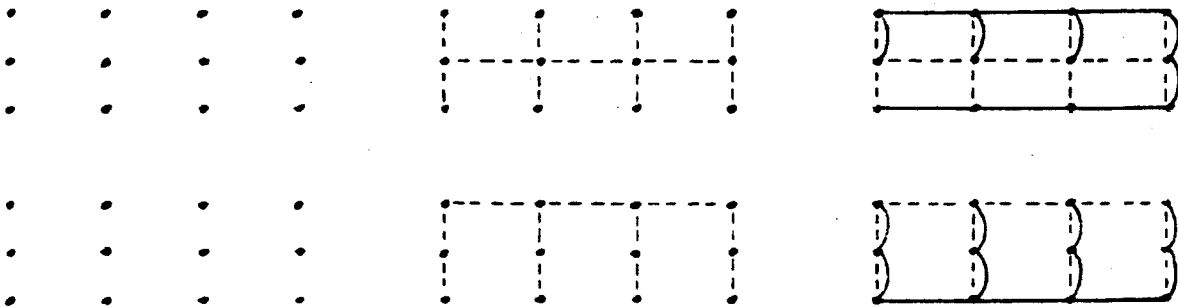

Combining the results of the third and fourth paragraphs reveals that there are cases where the technique of finding a minimum spanning tree and then finding a second noncrossing tree produces trees with a combined length no less than $3/2$ an optimal solution's.

Lhota devises the "Saran-Wrap" technique to find the second noncrossing spanning tree. Given a minimum spanning tree, start drawing the second by drawing a path down the left side of the leftmost branch, visiting each vertex. Then draw a path up the right side of the branch until another branch is encountered. Continue down this branch's left side and up its right side. continue until the path reaches its starting point and forms a cycle. The cycle spans the vertices, and its length is twice the minimum spanning tree's.

Modifying this cycle turns it into a tree. First, note that the cycle visits every vertex more than once. So, first change the cycle so that it visits every vertex exactly

once. Deleting one edge from the resulting cycle produces a path that visits every vertex exactly once. This path is a noncrossing spanning tree with length twice the minimum spanning tree's. Call this second tree the *Saran-Wrap tree*.

Note how this Saran-Wrap tree differs from Section 6.1's second, noncrossing tree. The Saran-Wrap tree is a spanning tree whereas Section 6.1's tree is a Steiner tree. In general, Steiner trees are shorter. Therefore, the following results cannot be directly applied to determine Section 6.1's trees' length.

The solution containing a minimum spanning tree and a Saran-Wrap tree has a combined length three times the minimum spanning tree's. This length is within $3/2$ of optimal.

Since the shortest noncrossing tree's length must be less than or equal to the Saran-Wrap tree's, the solution containing a minimum spanning tree and the shortest noncrossing spanning tree is also within $3/2$ of optimal. However, a previous result indicated that there are cases where this solution is no better than $3/2$ of optimal.

Thus, in some cases the Saran-Wrap tree's length is very close to the shortest noncrossing tree's. However, there are cases where the Saran-Wrap tree's length is twice that of the shortest noncrossing tree.

The following shows the constructing of the Saran-Wrap tree around a minimum spanning tree. The dashed lines are edges of the minimum spanning tree, and the solid lines are edges of the Saran-Wrap tree.

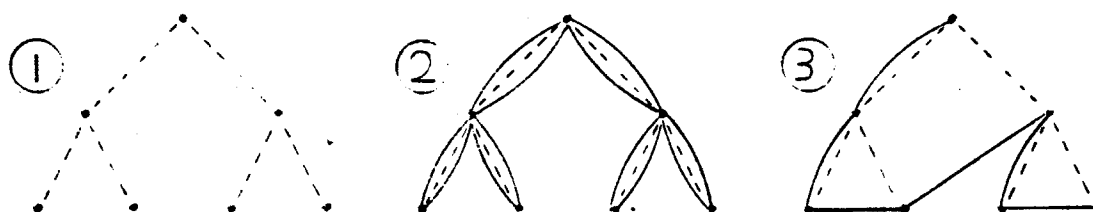

5. THE PI SYSTEM

5.1. Overview of the PI System

The Placement-Interconnect (PI) Research Group under Prof. Ronald Rivest at Massachusetts Institute of Technology is implementing in LISP an automated design system for custom, single-layer metal, NMOS and CMOS chips. The PI group is taking an algorithmic approach to the problem of completely automating the placement and interconnect phases of chip design. This group's goal is to create a system that produces high-quality output with a minimum amount of human interaction. Prof. Rivest described this system, called *PI*, at the 19th DAC Conference ([R182]).

The following are two important aspects of how PI views the chip design problem:

- In dealing with chip objects, PI uses the absolute coordinates of their locations on the chip instead of describing their positions symbolically or relative to other chip objects.
- PI regards modules as rectangles with connection points to connect to wires outside the module. Since PI does not know the wiring internal to the module, it never lays a wire over a module.

When PI routes a chip, it divides the placement-interconnect design process into four phases:

- Placing the modules on the chip.
- Routing the power and ground nets.
- Routing the signal nets.
- Compacting the chip regions to reduce the chip's size.

PI subdivides the third phase (signal routing) into four subphases:

- Defining the channels.
- Routing the nets globally.
- Deciding where the wires should cross the channel edges.
- Routing the channels.

The rest of this chapter on PI describes each phase and subphase with comments on how each relates to the power-ground algorithms.

5.2. Placing the modules on the chip

The placement phase puts each rectangular module into a specific location on the chip. Upon input, PI knows each module's dimensions and the locations of its connection points. After placement, each module has an exact, absolute location. Placement has two subphases: one places the pads, which are the modules that carry communications to and from the chip; the other places the logic modules, which are the modules that perform the desired logical or functional operations.

5.2.1. Placing the pads

PI places pads (power pad(s), ground pad(s), and signal pads) along the chip's perimeter. The goals are to place the pads on as few sides as possible and to orient each pad so its user-specified outside edge is closest to the chip's edge. This pattern of lining up pads along the chip's perimeter was a major reason for arranging the power-ground wires in rings, described in Section 6.4.

5.2.2. Placing the logic modules

When PI places the logic modules, it first goes through a top-down, min-cut procedure to determine the approximate locations of each one, then goes through a bottom-up, successive-pairing procedure to determine each module's orientation and exact location.

At each step, the min-cut procedure uses a line to divide the modules into two groups so that many of the wires connecting the signal nets' connection points will lie

within each group and few will lie between groups. In the first step, the line divides the chip into two regions. The min-cut procedure puts some modules on either side of the line. Subject to balancing constraints that ensure all modules will not lie on one side, the goal is to minimize the number of signal wires that will cross the line. To divide the chip into regions, the procedure uses either a vertical or a horizontal line, depending on which provides the minimum cut.

The procedure continues in a binary, top-down manner. Each region is divided into two by either a vertical or horizontal line. Moving modules within each region minimizes the number of wires that cross each line. This process continues until each module is in its own region.

Then the bottom-up procedure considers two adjacent regions, each containing one module, to determine for each module its orientation and its placement relative to the other module. Each module has eight possible orientations, produced by rotating it 90 degrees four times, flipping it, and rotating it four more times. The definition of one module's placement relative to another is the differences between the x -coordinates of the modules' left sides and between the y -coordinates of their bottom sides. In the next two paragraphs, *placement* refers to both the orientation and relative placement of a module.

The bottom-up procedure chooses the best placement for the two modules. When choosing, the procedure has as its goal minimizing the area of the final layout of wires and modules. At this point, the procedure has to estimate how much room the signal routing will require. After it finds the best placement, the two regions become one. Within the new region, the modules' placements are fixed.

The procedure continues in a bottom-up, successive-pairing manner. When every region has a pair of modules, the procedure considers the best placement for an adjacent pair of regions and merges this pair into a new region. This process continues until all the logic modules are in one region. At this point, each module's location becomes its exact, absolute location.

5.3. Routing the power and ground nets

This phase uses the algorithms described more fully in Section 6.4 and Chapter 7. These algorithms lay a ground ring and a power ring to connect the pads, lay a ground tree and a forest of power trees to connect the logic modules, and use the resizer to widen each wire to its appropriate width.

5.4. Routing the signal nets

Signal routing's goal is, for each signal net, to lay a tree of wires that span the signal net's connection points. The following sections describe each of signal routing's subphases.

5.4.1. Defining the channels

Channel definition divides the chip area into nonoverlapping rectangular chip objects. Each object is one of the following:

- a module
- a free channel—a routing region that contains no wires or modules
- a covered channel—a routing region with a power or ground wire occupying the region's entire metal layer but nothing on the other layers

The channel definition algorithm is executed during many stages in the PI system. For example, it may be executed immediately after placement, before power-ground routing is done. Since at this stage there are no power or ground wires, the algorithm divides the chip into modules and free channels. On the other hand, executing the algorithm after the power-ground routing is completed divides the chip into modules, free channels, and covered channels.

Channel definition draws lines on the chip until every chip region is a rectangle. A line separating two channels is a *channel edge*. In choosing among possible sizes and shapes for the channel layout, channel definition's goal is to minimize the total length of the channel edges it must draw to form the channels.

The following shows a chip's channel edges as dotted lines.

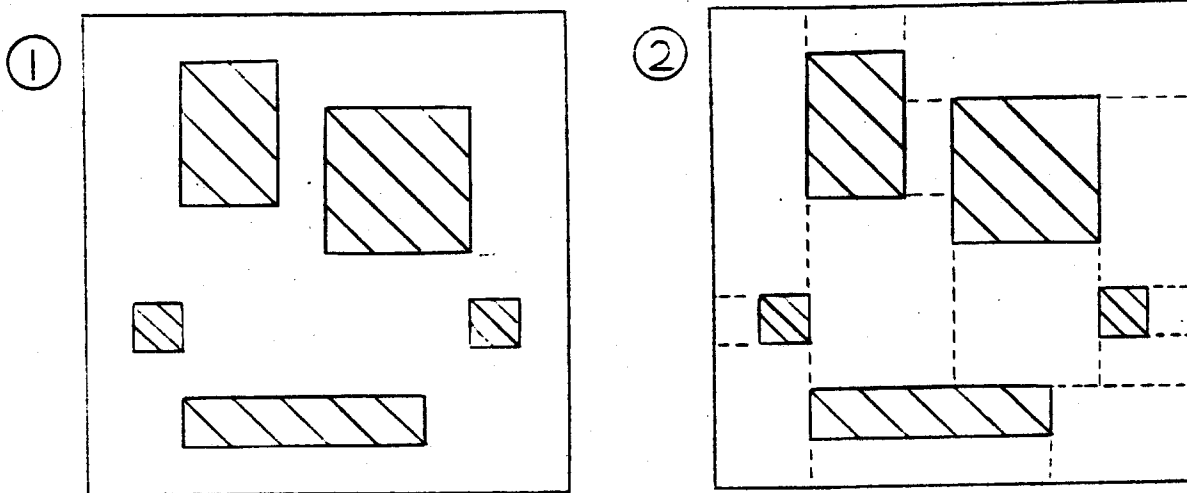

5.4.2. Routing the nets globally

The global router determines, for each net, which channels the nets' wires will pass through and which channel edges these wires will cross as they pass from one channel to the next. It routes the signal nets one at a time, starting with those that have the fewest connection points. During this process, it creates, for each channel edge, a list of nets that have a wire crossing this channel edge. These lists are input to the next phase, which decides exactly where on the channel edge the wires should cross.

The following paragraphs describe the global routing algorithms developed by Dr. Alan Baratz. These algorithms are fully presented in [B81]. When Chapter 6's algorithms construct a tree, path, or forest, they use these global routing algorithms.

To route a net globally, these algorithms first create a graph whose vertices represent the nets' connection points and the chip's channel edges. The algorithms then find in this graph a short Steiner tree that spans the connection point vertices. This tree roughly corresponds to the final Steiner tree of wires that will connect the net's connection points.

At first, the global router creates a graph that has a vertex for every connection point of the net and every channel edge of the chip. It draws an edge between two vertices if the two corresponding chip objects are on the perimeter of the same channel.

Each edge's cost reflects how far one chip object is from the other, how crowded the common channel is because of other nets that have already been routed through it, and whether it is a free or covered channel.

After creating the graph, the algorithms grow paths from the connection point vertices until the paths meet to form a tree. If there are n connection point vertices, there are initially n *basis groups*, each consisting of one connection point vertex. Paths grow simultaneously in all directions from all basis groups. Eventually, two paths meet, forming a bridge between two basis groups. The vertices along this bridge are two connection point vertices plus a number intermediate vertices representing channel edges. Then a new basis group consisting of all the vertices on the bridge replaces the two old ones. In the next step, paths grow from the $n - 1$ basis groups. This process repeats until there is just one basis group. At this point, reconstructing each bridge that connected two basis groups builds a Steiner tree that connects the n connection point vertices.

The method of growing the paths ensures the process results in a short Steiner tree. To see why the tree is short, consider how the algorithms grow the bridge that connects two basis groups. They grow the shortest bridge because they grow the path from each basis group by adding the shortest edges first, as in Dijkstra's algorithm. To see why the final tree is a Steiner tree, consider the branch points that can occur at channel edge vertices. Paths grow simultaneously from each vertex in the basis group, channel edge vertices as well as connection point vertices. The path from a channel edge vertex may be the first to meet a path from another basis group. The final tree will then have a branch point at this channel edge vertex. Since this channel edge vertex is not one of the original vertices to be spanned by the tree, this branch point is a Steiner point.

5.4.3. A power-ground modification of global routing

When determining the cost of each edge in the original graph, the global router considers whether the edge crosses a free or a covered channel. If it crosses a covered channel, the global router increases the edge's cost to reflect the disadvantages of running a signal wire over the metal wire that creates the covered channel.

Imposing a high penalty on edges that cross covered channels ensures such edge will never appear in the final Steiner tree. The power-ground phase uses this technique to construct noncrossing trees of metal wires. After connecting the logic modules with a ground tree of metal wires, the power-ground algorithms call channel definition, which turns the metal wires into covered channels. They then construct a forest of power trees to connect the logic modules. A high penalty at this point prevents these power trees from crossing the metal wires of the previously laid ground tree.

5.4.4. Deciding where the wires should cross the channel edge

The crossing placement phase determines where the signal wires cross the channel edge. At the end of the global routing phase, each channel edge vertex has a list of signal nets. A signal net appears on a vertex's list if that vertex appears in the Steiner tree that routes the signal net. Thus, a vertex's list indicates which signal wires will cross the channel edge that corresponds to the vertex. Using such information as where the wire comes from and where it is going, crossing placement assigns to each wire a crossing location.

5.4.5. Routing the channels

The channel router determines exactly where the wires run in each channel. At this point, crossing placement has already determined the exact location where a wire enters and exits the channel. The channel router lays wires to connect each entry point with its exit point. Because the entry and exit points are fixed, the channel router can attack each channel as a separate, independent, self-contained routing problem.

PI has three channel routers. The channel routing phase first calls the simplest router, which handles many common layouts. If this router cannot find a valid routing, the second router searches for a routing by dividing the channel into slices. If the second router fails, the third router searches for a routing by using Lee's algorithm.

5.5. Resizing the chip regions to reduce the chip's size

The resizer modifies the placement of wires and modules to accomplish any of three tasks:

- Widen power-ground wires.
- Provide more room for signal routing.
- Compact a complete layout of modules and wires.

The resizer modifies placement once in the x direction and then once in the y direction. The next two paragraphs describe resizing in the x direction. A similar process resizes in the y direction.

First, the resizer creates a graph. Each vertex of the graph corresponds to a vertical side of a chip object, such as the vertical side of a wire or module. Between two vertices, the resizer creates a constraint, which is either a minimum or an equality constraint. For instance, the constraint between a module's left and right sides is an equality constraint because the module's dimensions are fixed. On the other hand, the constraint between a channel's left and right sides is a minimum constraint because a channel can be wider than its required width.

Once the graph is complete, the resizer finds the longest path from the vertex that represents the chip's left side to the vertex that represents the chip's right side. The resizer uses information about this path to find an x -coordinate for each vertex in the graph so that all constraints are satisfied. Then, for each vertex and its x -coordinate, the resizer moves the chip objects so the corresponding vertical side is located at the x -coordinate. This completes resizing in the x -direction.

The next three paragraphs describe how the resizer is used by the power-ground phase, the signal-routing phase, and the compaction phase.

The power-ground phase uses the resizer to widen the power-ground wires. A tree-traversal algorithm, described in Chapter 7, finds how much current flows through

each power-ground wire. The amount of current determines each wire's minimum width. The power-ground phase, for each wire, calls the resizer, indicating the wire's left and right sides and its minimum width constraint. Resizing produces wires of the appropriate width.

The signal-routing phase calls the resizer either in its crossing placement subphase or its channel routing subphase. Crossing placement uses the resizer to lengthen channel edges. After global routing, crossing placement may find that a channel edge is not wide enough to accommodate all the wires that must cross it. Crossing placement calls the resizer, indicating the channel's endpoints and the length required by the crossings. The channel router uses the resizer to give it more room for routing. If, at first, the channel router fails because the channel is too small, it calls the resizer, indicating the channel's left and right edges, to increase the width of the channel.

After the channel router succeeds, the reduction phase uses the resizer to compact the layout. Given a layout of wires and modules, the resizer collects constraints that ensure the layout satisfies the design rules. Subject to the constraints, the resizer reduces the size of the chip as much as possible.

6. FOUR ALGORITHMIC METHODS TO GROW NONCROSSING TREES

This chapter describes four new methods to construct the power and ground trees and discusses each one's advantages and disadvantages. As for running efficiently and producing high-quality results, the fourth method is the best. The implementation of this fourth method forms part of PI's power-ground phase. The four methods are:

- Constructing the trees sequentially, one after the other.
- Constructing the trees concurrently, one branch at a time.
- Drawing a Hamiltonian cycle through the modules, then constructing the trees, respecting the boundary defined by the cycle.
- Laying two rings to connect the pads, then constructing the trees sequentially to connect the logic modules.

The algorithms use Section 5.4.2's signal-routing algorithm or Section 5.4.3's modified signal-routing algorithm to construct Steiner trees to connect various sets of points. In discussing running times of the algorithms, $ST(V)$ is the time each algorithm takes to route V vertices.

6.1. Constructing the trees sequentially, one after the other

This algorithm constructs one tree and then constructs the second tree so that it does not cross the first. To construct the first tree, Section 5.4.2's signal-routing algorithm finds a short Steiner tree that connects the first net's connection points. To construct the second tree, Section 5.4.3's modified signal-routing algorithm constructs a short Steiner tree that connects the second net's connection points and that does not cross any wire of the first tree.

The advantage of this algorithm is that it quickly produces a valid power-ground layout in time $O(2ST(V))$. The layout is valid because one tree connects all the first

net's connection points, the other tree connects all the second net's connection points, and the trees do not cross each other.

The disadvantage of this algorithm is that the trees' combined length may not be near optimal. The first tree's length is near the optimal for a spanning Steiner tree. However, when routing the second tree, the facts that the first is already complete and that the wires of the second cannot cross those of the first often require the second tree to have long branches. According to the result in Section 4.3, paragraph 5, there are cases where constructing the trees sequentially produces trees with a combined length at least $3/2$ of optimal. It should be noted, however, that the result in Section 4.3, paragraph 9, indicates that, for most cases, with effective algorithms to grow Steiner trees, the trees' length will be within $3/2$ of optimal.

The following repeats Section 4.3's example of how the choice for the first minimum spanning tree greatly influences the length of the second noncrossing spanning tree. The dashed lines are the edges of the first tree, and the solid lines are the edges of the second tree.

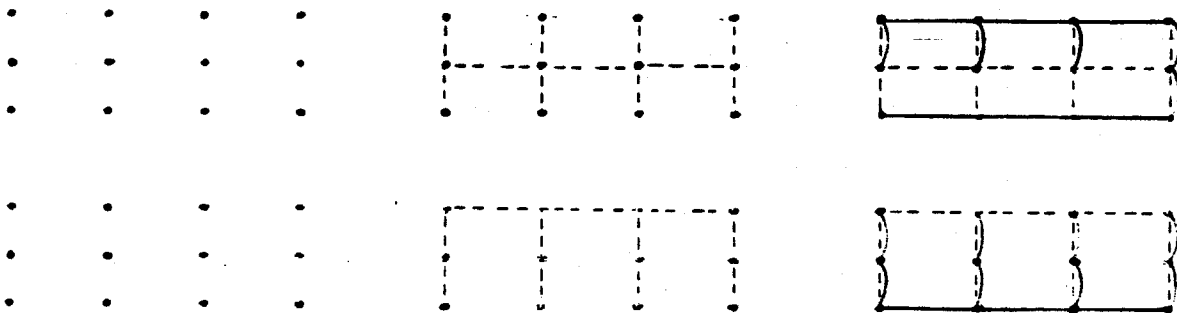

The next two sections describe two algorithms derived from this one. The first algorithm successively reroutes the trees' branches so as to shorten the trees' combined length. The second algorithm provides a different way to connect the second net's connection points after the first tree is complete. Instead of growing one tree for the second net, this algorithm grows several trees from several roots. PI's power-ground algorithm, described in Section 6.4, includes a version of this technique.

6.1.1. Successively rerouting branches to shorten the trees' combined length

This algorithm starts with the trees produced by Section 6.1's algorithm. The

disadvantage of these trees is that one tree is very short whereas the other tends to be very long. The algorithm described in this section shortens the second while slightly lengthening the first. This reduces the trees' combined length.

The second tree may be longer than necessary because it may have long, branchless paths. In general, short trees are very bushy, with frequent branching. In order to connect a few connection points to the rest of the second tree, there is often a branchless path that goes around an obstructing branch of the first tree. This path greatly increases the second tree's length.

The algorithm shortens the second tree by deleting that tree's longest branchless path and then connecting the resulting components of the tree. Deleting the path leaves two connected components. Ignoring the first tree, the algorithm finds the shortest path that connects these components. Because the algorithm ignored the first tree, this path probably crosses wires of the first tree. The algorithm then deletes any wire of the first tree that the new path crosses. Because of this, the first tree has now become several connected components. The algorithm finds paths that connect these components and that do not cross the wires of the second tree. The result is two complete, connected trees.

The following shows the results of applying this algorithm. In the first figure, the solid lines show the first tree, and the dashed lines show the second, noncrossing tree. In the second figure, the algorithm has deleted the second tree's longest branchless path and constructed another branch. In the third figure, the algorithm has rerouted one branch of the first tree so that the first tree no longer crosses the second.

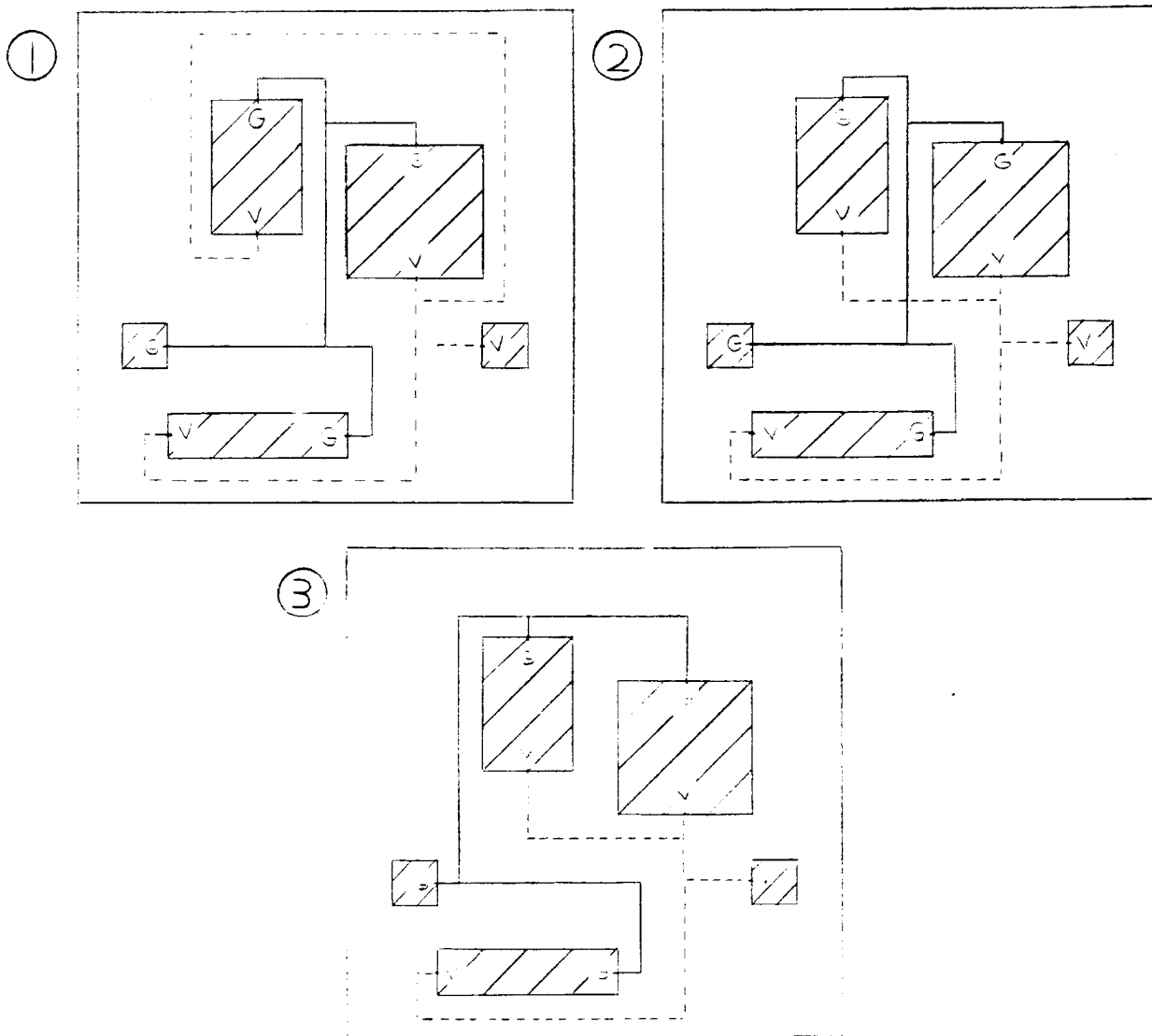

At this point, the algorithm compares the new trees' combined length with the original trees'. If the length decreased, as in the above example, the new trees become the best layout yet found. If not, the original trees remain the best layout yet found, and the algorithm marks the longest branchless path to tell future iterations that deleting this path will not lead to shorter trees.

The algorithm continues by searching in the best layout yet found for the longest branchless path not yet considered. These iterations continue until the algorithm has considered every branchless path in the current second tree without reducing the trees' combined length. At this point, the trees of the current layout become the final power and ground trees.

The advantage of this algorithm is that at each step the layout is a valid power tree and ground tree and that at the end of each step the trees' combined length is never greater than it was at the end of the previous step. This gives the user flexibility. One user may tolerate a large combined length for the trees but require a short computation time. This user should run the algorithm through just a few iterations. Another may tolerate a long computation time but require a short combined length for the trees. This user should run the algorithm to completion.

The disadvantage of this algorithm is that running it to completion requires a long computation time. This is due to the large number of branchless paths to be considered for deletion and the extensive rerouting required after deleting each branchless path.

6.1.2. Constructing one tree, then a forest of trees

This algorithm grows the first tree in the same way Section 6.1's algorithm does. To connect the second net's connection points, this algorithm grows several trees.

This technique makes it more likely that the second tree will be short. Constructing the second tree is difficult because the wires have to avoid crossing the first tree. Constructing several trees makes it less likely that a long, branchless path will be needed to get around a branch of the first tree. For example, the algorithm could place one root for the second tree between the tips of two main branches of the first tree. A

tree constructed from this root could connect the second net's connection points that lie between those branches without worrying about crossing the branches.

The advantage of this algorithm is that growing the small trees requires less computation time and results in trees of smaller total length than growing one large tree.

The disadvantage of this algorithm is that only special layouts allow one of the trees to have multiple roots. PI's power-ground phase uses this algorithm to grow the VDD tree for the logic modules. Since a VDD ring surrounds the logic modules, as described in Section 6.4.1, the power-ground phase can pick points along this ring as the VDD trees' roots. These roots and the trees that grow from them are connected to the VDD pad through the VDD ring.

6.2. Constructing the trees concurrently, one branch at a time

This algorithm constructs the two trees concurrently, one branch at a time. At each step, the algorithm constructs the branch that will least hinder the other tree's growth.

The trees' edges are of two kinds:

- *tentative edges* that indicate the tree's probable future growth
- *committed edges* that will definitely appear in the final layout

No edge, tentative or committed, can cross a committed edge. One tentative edge can cross another.

The algorithm begins by laying two complete trees of tentative edges. For each tree, the algorithm finds a short Steiner tree that spans the connection points. Since all the edges are tentative edges, crossings are allowed, and the algorithm can grow each tree without considering the other.

The algorithm then determines which tentative edge should turn into a committed edge. To do this, it observes, for each tentative edge, the changes that would occur if the edge became a committed edge. Suppose that the algorithm is considering a

tentative edge in the first tree that a tentative edge in the second tree crosses. Turning the first tree's tentative edge into a committed edge would require some rerouting of the second tree's tentative part to avoid crossing the new committed edge. The algorithm notes how much longer the new second tree is than the former.

After considering all the trees' tentative edges, the algorithm changes some tentative edge into a committed edge such that this change produces the least increase in the length of the opposite tentative tree. After changing the tentative edge to a committed edge, the algorithm appropriately redraws the opposite tentative tree.

Considering the current layout of trees, the algorithm again searches for the best tentative edge to change into a committed edge. This continues until there are no more tentative edges. At this point, the two trees of committed edges are the final power and ground trees.

The following figures show this algorithm constructing two trees. In these figures, a dotted line represents a tentative ground edge, a solid line is a committed ground edge, a line of plusses is a tentative power edge, and a dashed line is a committed power edge.

The first figure shows the two complete tentative trees. The algorithms commit the power branch to the upper right module with no change in the tentative ground tree. Committing the power branch to the upper left module requires a rerouting of the tentative ground tree, as shown in the second figure. Committing the ground tree's upper branch requires no rerouting. Committing the ground tree's lower branch requires a rerouting of the tentative power tree. Committing this last tentative power branch results in the final trees.

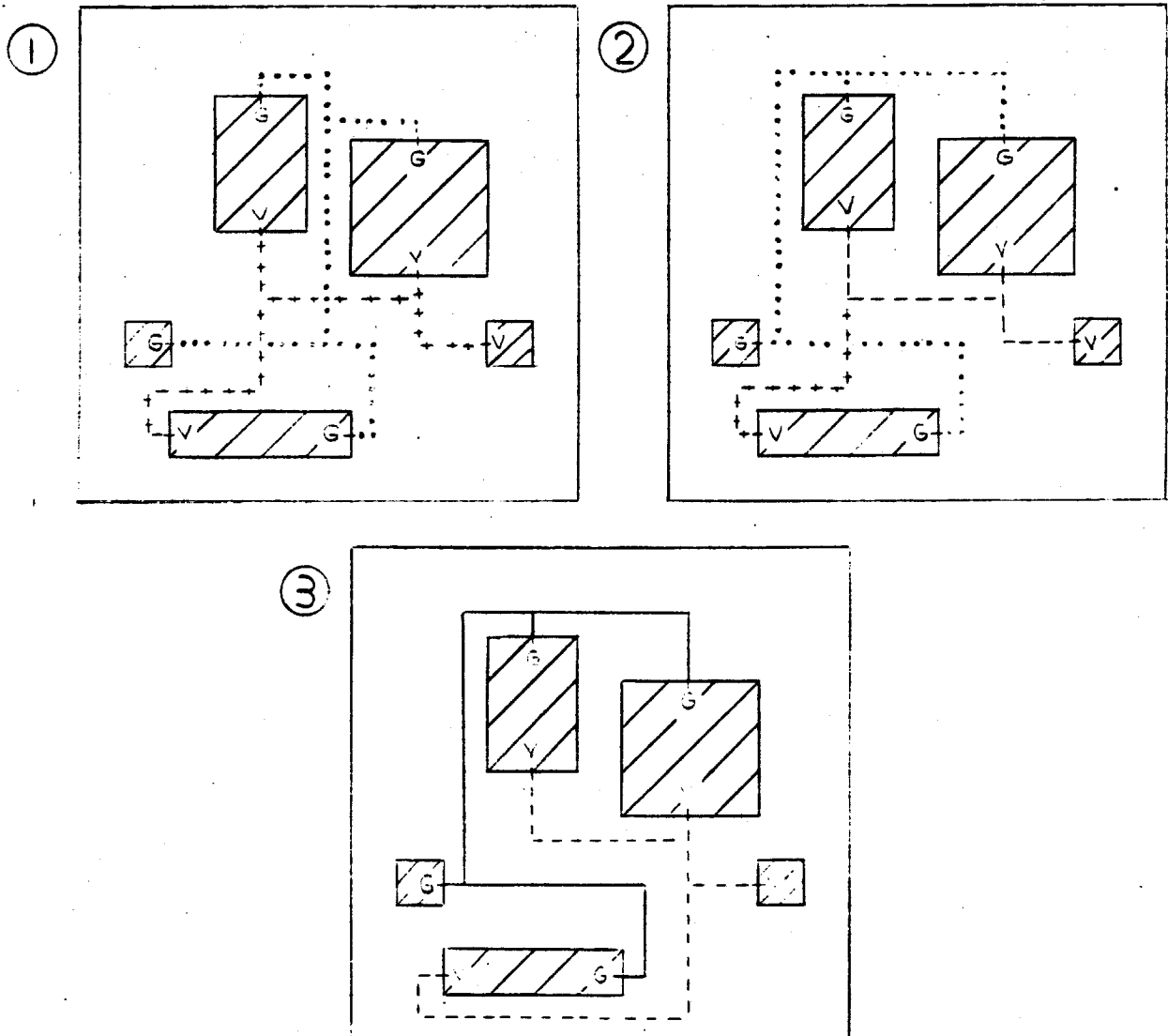

The advantage of this algorithm is that it provides a balanced, symmetric approach to constructing the trees. This contrasts with the algorithm described in Section 6.1, which from the beginning gives the advantage to the first tree.

The disadvantage of this algorithm is that it requires a long computation time. This is due to the large number of tentative edges it must consider and, for each tentative edge considered, the extensive rerouting of the opposite tentative tree that must be carried out. However, there are several characteristics of the algorithm that keep the running time reasonable.

During the algorithm's first steps, there are many tentative edges near the trees' roots that tentative edges of the opposite tree do not cross. Since no edge crosses them, turning these tentative edges into committed edges will not increase the length of the opposite tentative tree. Thus, the first steps require little computation time.

During the algorithm's last steps, most of the trees' edges are committed edges. Reconstructing the trees' tentative parts is quick because the tentative parts are so small. Thus, the final steps require little computation time.

6.3. Drawing a Hamiltonian cycle through the modules, then constructing the trees, respecting the boundary defined by the cycle

This technique of keeping the power and ground trees from crossing was presented at the 20th DAC Conference ([MO83]).

6.3.1. Using the Hamiltonian cycle to divide the chip into regions

A Hamiltonian cycle helps construct noncrossing trees because it divides the chip into two regions—one outside and one inside the cycle. If the cycle has all one net's connection points inside and all the other's outside, the cycle divides the chip into a VDD region and a GND region. The tree that connects each net's connection points lies within that net's region. Since the regions are separate, the trees do not cross.

For a set of modules, there are many Hamiltonian cycles, and each relates to a different power-ground layout. To see this relationship, consider a chip with the power and ground trees already laid. Imagine standing on a module with its VDD connection

points to your right and its GND connection points to your left. When you try to walk to another module, keeping the VDD wires on your right and the GND wires on your left will determine the next module you encounter. Continuing the walk takes you through every module and back to where you started. Thus, a layout of power and ground trees determines a Hamiltonian cycle through the modules.

Using the reverse of the above technique, drawing the Hamiltonian cycle first determines the layout of power and ground trees. In deciding which Hamiltonian cycle to draw, the algorithm should pick the cycle that will produce the shortest power and ground trees. It is therefore instructive to consider how a cycle's characteristics relate to the corresponding layout's characteristics.

Such a consideration shows that the desired Hamiltonian cycle is the shortest one that can be found in a reasonable amount of time. One support for this conclusion arises from the need for the Hamiltonian cycle to split the chip into two regions. To produce two regions, the cycle must not cross itself. The shortest cycle does not cross itself, and, in general, shorter cycles have fewer crossings. This indicates a short cycle is desirable. Another support for this conclusion is that shorter cycles produce regions of simpler shape. Routing in such regions produces simpler, shorter, more regular trees.

6.3.2. Defining distance from one module to another

This section defines the distance from one module to another. The calculation of the cycle's length uses this distance, which is basically the Manhattan distance between the modules.

In keeping with the notion of walking along the cycle, a module's OUT point is defined to be the point where the cycle leaves the module. As it leaves the module, the VDD connection points are to its right, the GND connection points to the left. To make this more specific, find the most counterclockwise VDD connection point and the most clockwise GND connection point. The module's OUT point is on the module's perimeter halfway between these two connection points. The OUT point is counterclockwise from the VDD connection point and clockwise from the GND connection point.

A module's IN point is defined to be the point where the cycle enters the module. To locate it, find the most clockwise VDD connection point and the most counterclockwise GND connection point. The IN point is halfway between them, clockwise from the VDD connection point, counterclockwise from the GND connection point.

The Manhattan distance from (x_1, y_1) to (x_2, y_2) is $|x_2 - x_1| + |y_2 - y_1|$.

The distance from Module A to Module B is defined to be the Manhattan distance from A's OUT point to B's IN point. Note that this definition of distance is not symmetric.

6.3.3. Finding a short Hamiltonian cycle

This section describes an algorithm that finds a short Hamiltonian cycle. This cycle consists of abstract edges, each edge having a module at each end. An edge indicates that the cycle goes from one module to the other but does not specify exactly where the cycle runs.

It is convenient to think of a Hamiltonian cycle as an ordering of the modules. If the modules are $M_1, M_2, M_3, \dots, M_n$, any ordering $(M_{i_1}, M_{i_2}, M_{i_3}, \dots, M_{i_n})$ designates a Hamiltonian cycle with abstract edges $(M_{i_1}, M_{i_2}), (M_{i_2}, M_{i_3}), \dots, (M_{i_n}, M_{i_1})$.

Shen Lin's algorithm ([LIN65]) is one of many algorithms to find a short Hamiltonian cycle (see [C79]). It starts with a random, directed Hamiltonian cycle. As shown in the preceding paragraph, any ordering of the modules suffices for this initial cycle. The algorithm then deletes three edges, producing three segments. It then adds three edges that reconnect the segments. There is only one set of three edges whose addition at this point will produce a directed Hamiltonian cycle, as shown by the following figures.

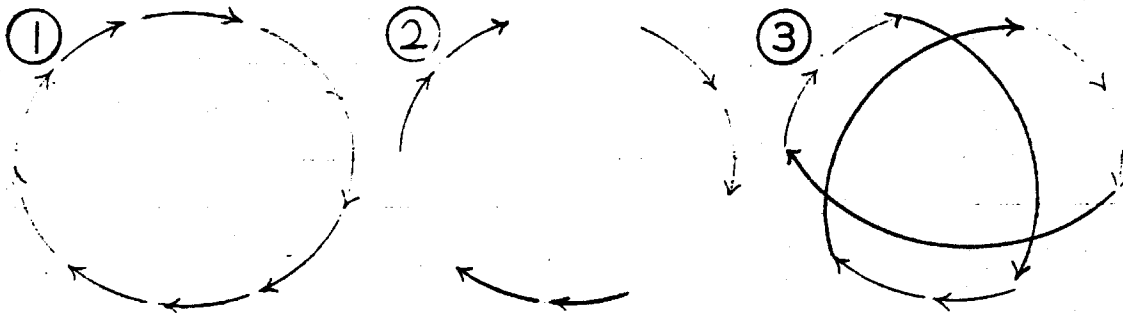

At this point, the algorithm compares the new cycle's length with the initial cycle's. If the length decreased, the new cycle becomes the shortest cycle yet found. If not, the initial cycle remains the shortest cycle yet found, and the algorithm marks the set of three edges to tell future iterations that deleting these edges will not lead to a shorter cycle.

The algorithm continues by picking another set of three edges to delete from the cycle. If trying all possible sets of three edges fails to reduce a cycle's length, the algorithm ends with the cycle as its output.

6.3.4. Routing the Hamiltonian cycle

The preceding section's algorithm provides the order in which the Hamiltonian cycle traverses the modules. The next step is to determine the cycle's exact path from one module to the next.

Suppose that there is a Hamiltonian cycle of n edges. Routing the cycle involves routing each of the n edges, and routing each edge involves connecting one module's OUT point to another's IN point. Note that connecting these two points is very similar

to routing a signal net that has two connection points. For this reason, the algorithms of Section 5.4 can route each edge of the Hamiltonian cycle.

Specifically, using Section 5.4.3's modified algorithm to route the edges ensures that the cycle will not cross itself. The algorithm routes one edge at a time. When routing an edge, the algorithm ensures that its path does not cross a previously routed edge's path.

The order in which the algorithm should route the nets is not obvious. Because one edge's path cannot cross another, a different order for routing could produce quite different paths for the cycle.

The following example shows how the order of routing the edges affects the final layout of the cycle. The Hamiltonian cycle goes from Module 1 to Module 2 to Module 3. The second figure shows the result of routing the edges in the following order: Module 2 to Module 3, Module 3 to Module 1, and Module 1 to Module 2. The third figure shows the result of the following routing order: Module 1 to Module 2, Module 3 to Module 1, and Module 2 to Module 3.

①

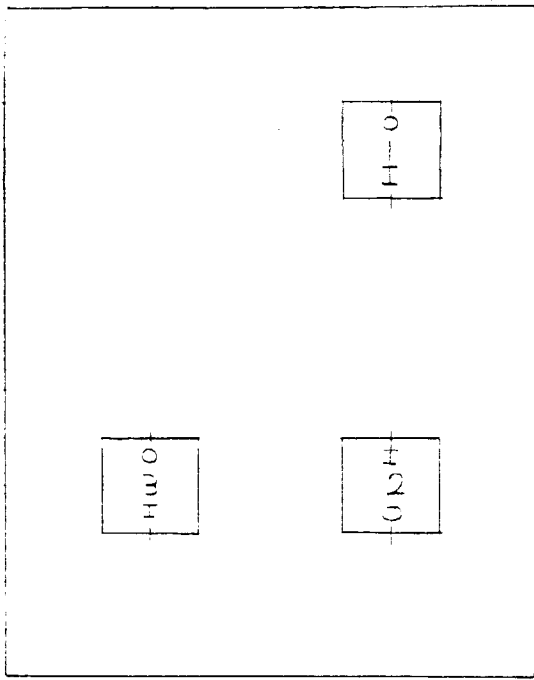

②

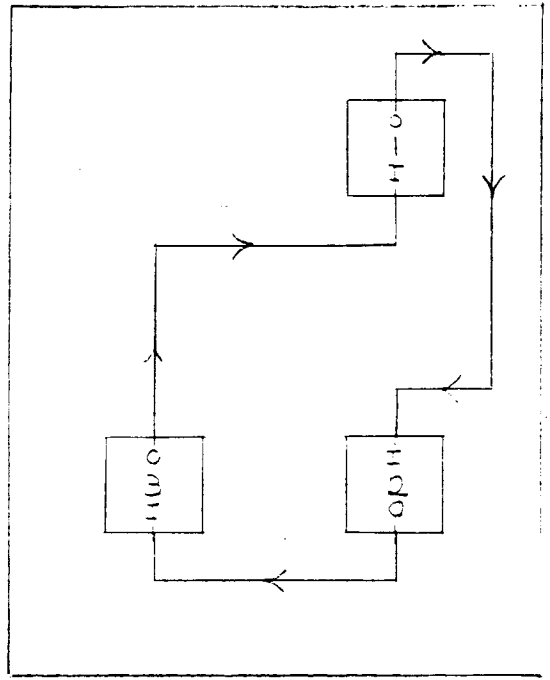

③

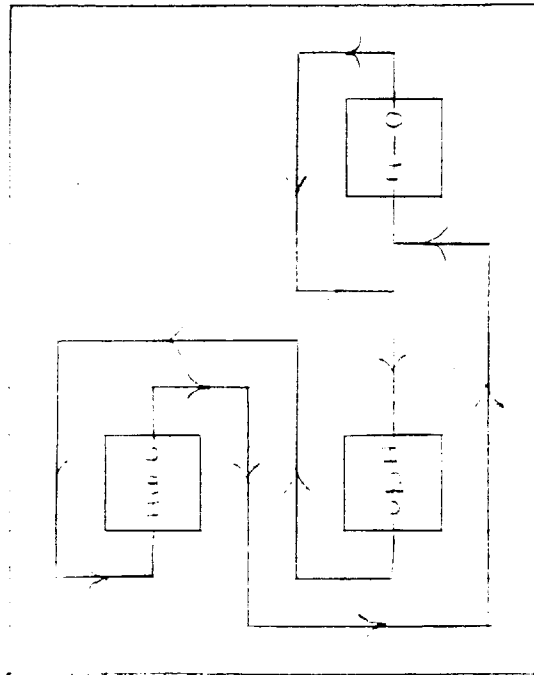

The cycle in the third figure is longer and less desirable than that in the second. This example shows that laying one edge's wires could block a path that would provide a short routing for a later edge. This later edge's routing may require long wires to avoid previously laid wires.

Because of this, the algorithm routes the Hamiltonian cycle's edges in ascending order according to the edges' lengths, where length is defined in Section 6.3.2. The algorithm routes in this order because the harmful effects of blocking an edge's path, such as the increase in wire length, is more noticeable for shorter edges. For longer edges, there is a greater choice of paths that connect one module's OUT point to another's IN point using wires of approximately the same length. Therefore, cutting off one of these paths is less likely to increase significantly the cycle's final length.

6.3.5. Routing the VDD and GND nets

After the complete routing of the Hamiltonian cycle, all of one net's connection points are inside the cycle, all of the other's are outside.

Routing the inside net comes first. To do this, Section 5.4.3's modified signal-routing algorithm finds a short Steiner tree that spans the connection points and that lies entirely inside the cycle. The tree lies inside the cycle because the algorithm regards the routed cycle as (temporary) metal wires. Since the algorithm never routes across a metal wire, the tree's edges will never cross the cycle and will therefore remain inside it.

The algorithm then deletes the Hamiltonian cycle and uses the same signal-routing algorithm to route the outside net. The signal-routing algorithm finds a short Steiner tree that spans the connection points and that does not cross the previously routed inside tree, which consists of metal wires. The chip now has the complete power and ground trees.

Conceptually, the algorithm produces one net's tree inside the cycle, the other's outside. The algorithm could route the inside net, then route the outside net, then delete the cycle. However, even without the Hamiltonian cycle, the modified signal-routing algorithm ensures that the trees will not cross, and preventing it from crossing the

Hamiltonian cycle may prevent it from finding a shorter, noncrossing Steiner tree. Thus, deleting the Hamiltonian cycle before routing the outside net cannot hurt and could help.

Routing the nets in a different order in some cases might produce better results. In such cases, the algorithm would route the net outside the Hamiltonian cycle, then delete the cycle, then route the net that was inside the cycle.

The following shows the results of routing the Hamiltonian cycle, routing the inside net, deleting the cycle, then routing the outside net.

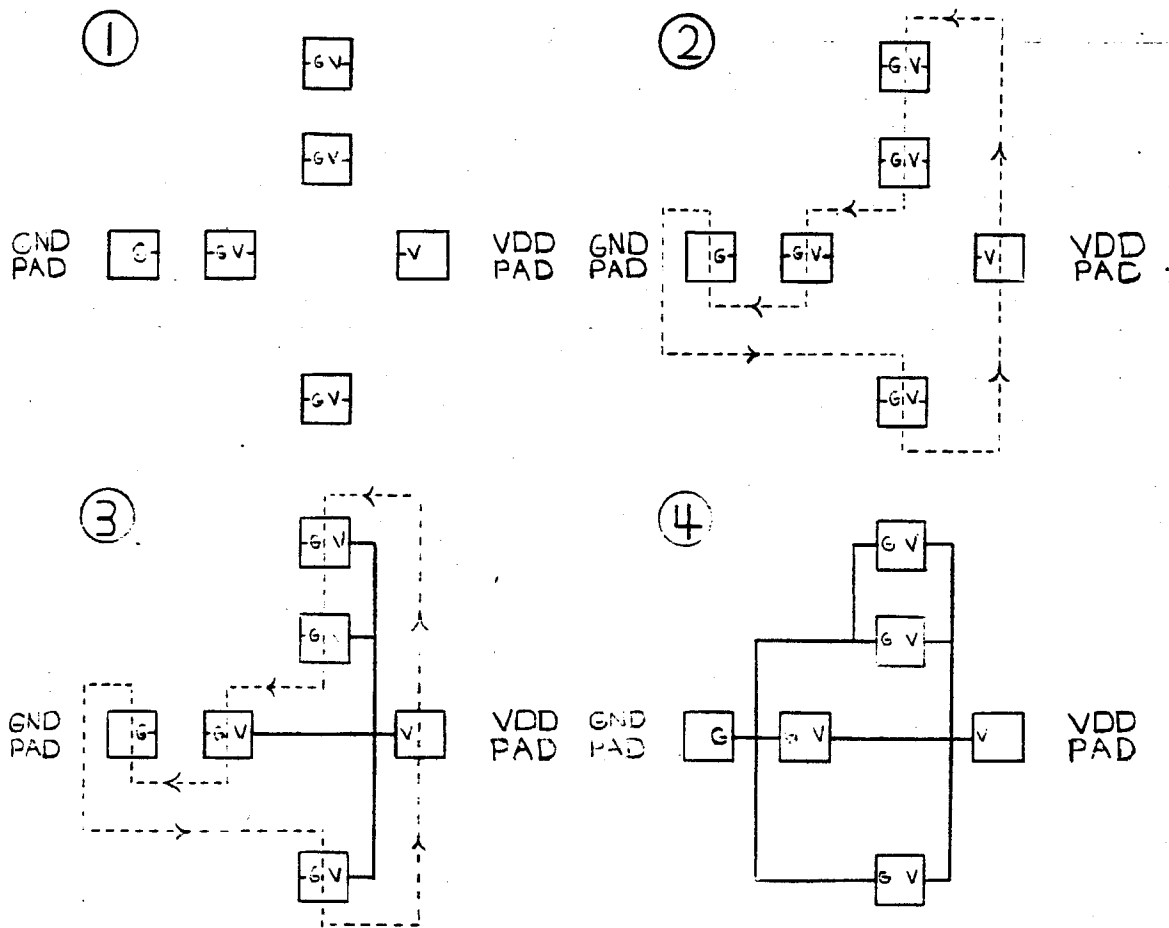

6.3.6. Advantages and disadvantages of using the Hamiltonian cycle

The advantage is that it provides a method to keep the routing the trees separate and thus to keep them from crossing.

There are two disadvantages. The first is the long computation time required to find the Hamiltonian cycle. The second is the difficulty in determining the relation between the Hamiltonian cycle's characteristics and the corresponding trees'. Specifically, what kind of Hamiltonian cycle results in the shortest trees is not clear.

6.4. Laying two rings to connect the pads, then constructing the trees sequentially to connect the logic modules

This algorithm uses two rings to connect the pads. Then a ground tree connects all the logic modules' GND connection points. Then several branches from points on the VDD ring connect all the logic modules' VDD connection points. The next two sections describe the algorithm in more detail.

6.4.1. Laying two rings to connect the pads

Two reasons suggest routing pads separately from logic modules:

- Bonding limitations require the pads to lie on the chip's perimeter.
- Pads often require much more current.

PI places pads along the chip's perimeter. This placement's regularity suggests a regular wire layout. The pads' large current needs require thick wires. Laying such thick wires along the chip's perimeter does not interfere with the logic modules' placement and routing.

Conceptually, there is a VDD ring between the logic modules and the pads and a GND ring between the pads and the chip's perimeter.

The following restriction on the pads facilitates laying the rings: a signal pad's GND connection points must be on its outside edge and its VDD connection points on its inside edge. Since the GND ring runs along the pad's outside edge, one short,

straight wire can connect the ring to the pad's GND connection points. If there were no restrictions on the pads, local routing could connect the ring to the connection points.

The VDD ring's actual placement is that it runs along the signal pad's inside edges. It is not truly a ring because there is a gap next to the GND pad. One reason for this gap is that a wire must connect the GND pad to the logic modules. A solid VDD ring would cut the GND pad off from the logic modules. Another reason is that the gap ensures that the VDD wires form a tree.

The GND ring's actual placement is that it runs along the pads' outside edges. A gap in the GND ring next to the VDD pad ensures that the GND wires form a tree. Also, the GND rings avoids the corners of the chip, as some automatic handling techniques require.

The following shows the complete VDD and GND rings.

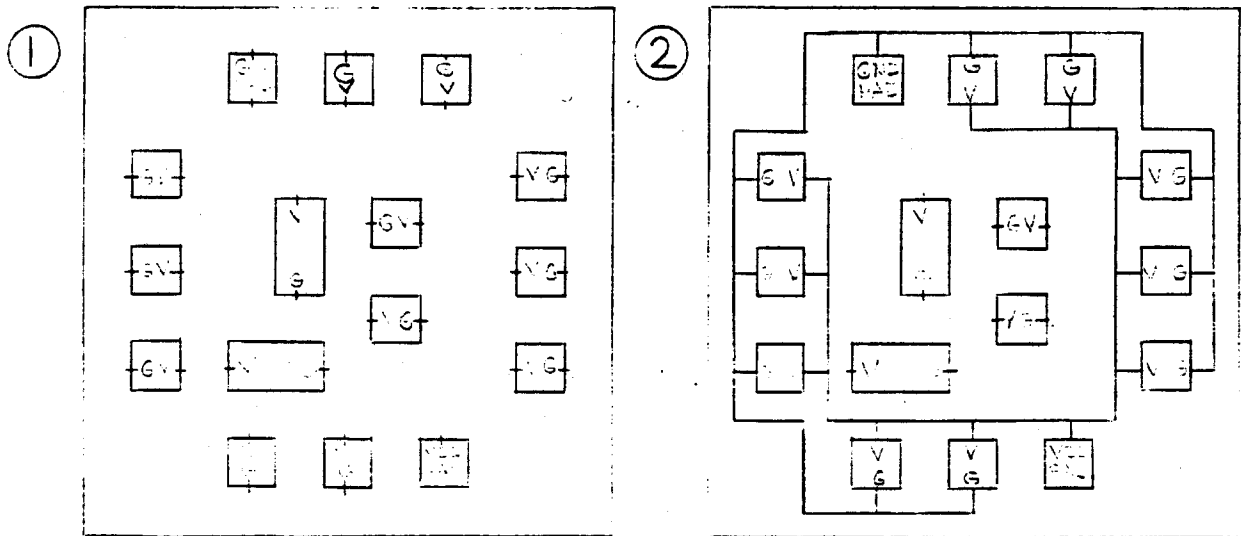

6.4.2. Constructing the trees sequentially to connect the logic modules

Next, the algorithm constructs a GND tree to connect all the logic modules. The GND pad has a GND connection point on its inside edge. The tree that will grow from

this connection point will reach the logic modules through the gap left in the VDD ring. Section 5.4.3's modified algorithm grows the tree so that it stays within the metal wires of the VDD ring.

The algorithm then decides which points along the VDD ring should act as roots for the forest of trees that will connect the logic modules' VDD connection points. As a first step, Section 5.4.1's channel definition algorithm divides the VDD ring into many covered channels. The algorithm then creates an imaginary connection point at the midpoint of each covered channel's inside edge.

Then, Section 5.4.3's modified algorithm connects the set of VDD connection points consisting of the real ones of the logic modules and the imaginary ones of the VDD ring. It grows wires that do not cross the previously laid GND tree. Note that the imaginary connection points are already connected to the VDD pad through the VDD ring. Thus, if needed, a wire can run from an imaginary connection point to a real one on a logic module. If this is not needed, the imaginary connection points are harmless in that they do not produce any unnecessary wiring.

The following shows the logic modules' connection points connected by one GND tree and several VDD branches.

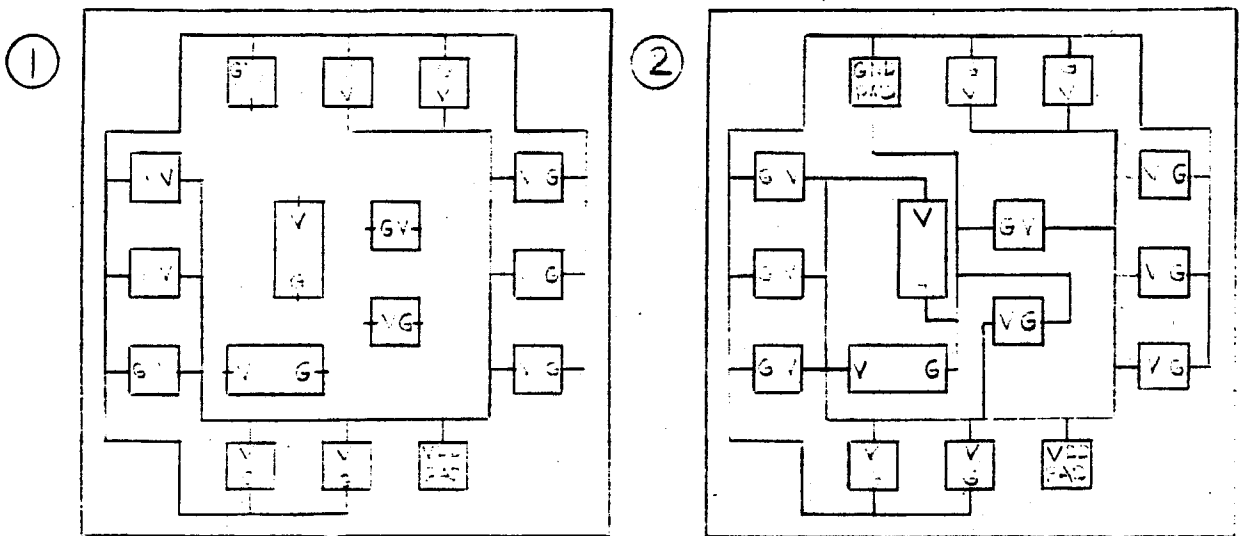

6.4.3. Advantages and disadvantages of laying the rings and growing the trees sequentially

The advantages of this algorithm are that it requires little computation time, makes use of the pads' special placement, and produces short trees. The GND tree is short because Section 5.4.3's algorithm produces short Steiner trees. The VDD tree is short because the branches coming from many points on the VDD ring split the problem of connecting the VDD connection points into smaller, more easily solved problems.

The disadvantage of this algorithm is that it makes certain assumptions on the placement of the pads and connection points.

7. THE TREE-TRAVERSAL ALGORITHM THAT DETERMINES WIRE WIDTH

The preceding chapter presented several algorithms to construct two noncrossing interdigitated trees. This chapter describes an algorithm that determines how wide each wire in the trees should be to carry the current that will flow through it during the operation of the chip.

The following description of the algorithm traverses through one tree rooted at a pad. PI's power-ground phase runs this algorithm twice, once for the VDD tree and once for the GND tree.

After the algorithm has determined each wire's required width, it runs PI's resizing algorithms to change the wire's dimensions until it attains its required width. The fact that the tree-traversal algorithm works so closely with the resizer greatly influences the algorithm's design.

One important feature of the resizer is that it resizes in one direction at a time. For example, to adjust the placement of chip objects, it would resize in the x -direction, then in the y -direction. Resizing in the x -direction means that the chip objects' vertical sides are moved to different x -coordinates. Resizing in the y -direction means that the horizontal sides are moved to different y -coordinates. These two resizings achieve the desired placement of the chip objects.

The tree-traversal algorithm also considers only one direction at a time. It does one tree-traversal for the x -direction and one for the y -direction.

Dealing with only one direction is often counterintuitive. One can consider a wire as having a length and a width and the current as flowing along the wire. However, applying these notions is more difficult when a wire is merely a rectangle in the plane. Which dimension is the "length" is not clear. Its "length" could be less than its "width". At intersections, the direction of current flow is not clear.

Thus, when the algorithm traverses the tree in the x -direction, it worries only about whether the rectangle's horizontal dimension is sufficient to carry the current

that will flow through the rectangle. It does not worry about the direction of current flow.

The following description traverses the tree in the x -direction. Traversing in the y -direction is similar.

The basic step in the tree traversal is adding the children's currents to find the parent's current. Suppose that a wire comes from a pad and forks into two wires that connect to two modules requiring 3 and 5 units of current. 3 units will flow through one fork, 5 units through the other, and 8 through the base wire.

The algorithm traverses the tree in postorder, finding each child's current and then summing to find the parent's current. As usual with a postorder traversal, the algorithm recursively finds a child's current by finding its children's currents and summing.

The tree traversal finds the current for every wire of the tree. Multiplying by a design rule constant gives each wire's required width. Then, for each wire, the algorithm passes as parameters to the resizer the left side of the wire rectangle, the right side of the wire rectangle, and the required width. Running the resizer adjusts the rectangle's sides' placement so that the wire attains its required width.

The algorithm must define a tree node in a way that is compatible with considering only the x -direction. One tree node often corresponds with one metal rectangle representing a metal wire. The rectangle's left side is the node's left side and the rectangle's right side is the node's right side.

In some cases, one tree node could be several rectangles. Suppose there are several rectangles lined up horizontally. The rectangles' bottom sides have the same y -coordinate, and their top sides have the same y -coordinate. In this case, the node's left side is the leftmost rectangle's left side, and the node's right side is the rightmost rectangle's right side.

The following shows how tree nodes are created from the layout of metal rectangles. There is one tree node for each module and for each row of rectangular metal wires.

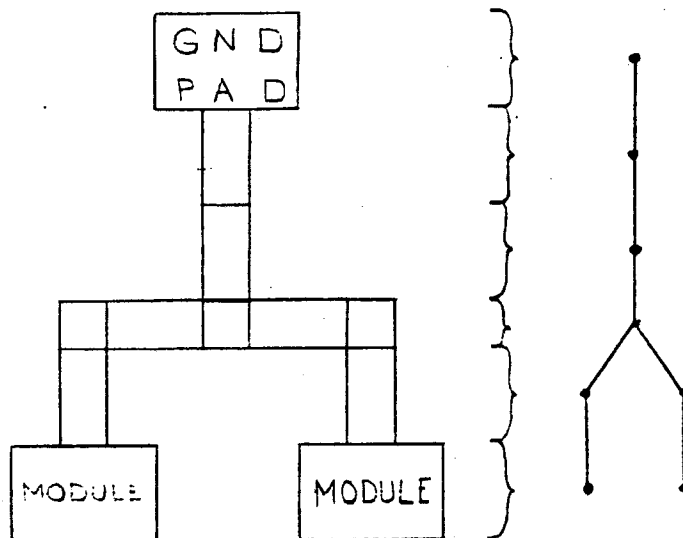

This notion of a node is compatible with the idea of making a horizontal cut. One way to determine the current flow through a node is to delete the node and find the total current of the tree fragment that has just been disconnected from the pad. Since a node can be a horizontal row of rectangles, this corresponds to the notion of cutting the tree by a horizontal line that runs through the rectangles and asking how much current flows across that line.

8. EXPERIMENTAL RESULTS

The following photographs show the images of a computer screen during the execution of PI's power-ground phase.

As input to the power-ground phase, a chip specification was created containing 18 pads of uniform size and 2 logic modules of random size. PI's placement phase then used the algorithm mentioned in Section 5.2 to place the pads and logic modules, resulting in the following layout:

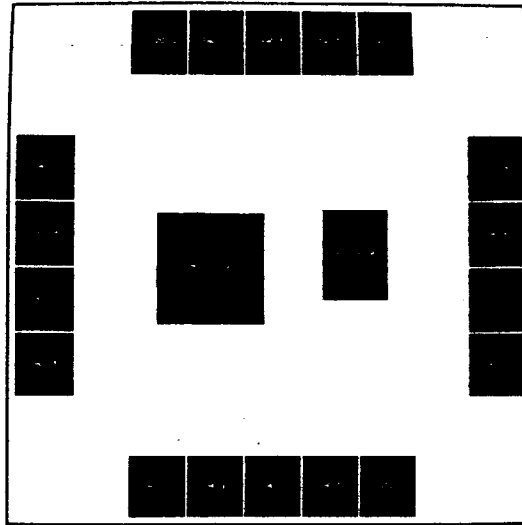

The power-ground phase uses the algorithm of Section 6.4.1 to lay a GND ring outside the pads and a VDD ring inside the pads, producing the following layout:

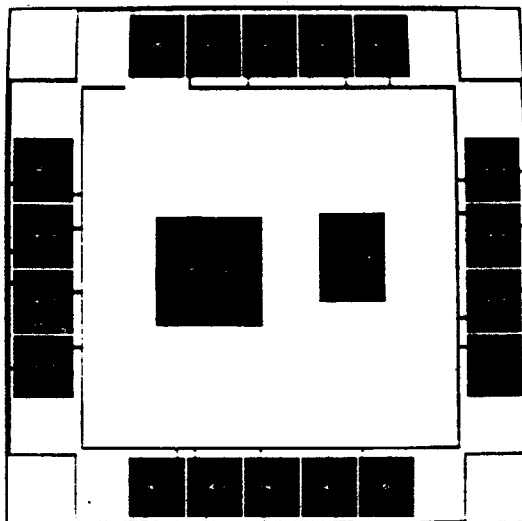

The power-ground phase then uses the algorithm of Section 6.4.2 to lay the GND tree to connect the logic modules.

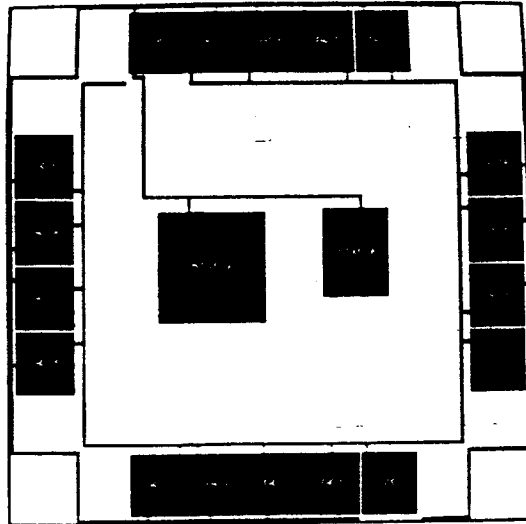

The power-ground phase uses the algorithm of Section 6.4.2 to lay branches from the VDD ring to the logic modules' terminals. The branches grow so that they do not cross the branches of the GND tree.

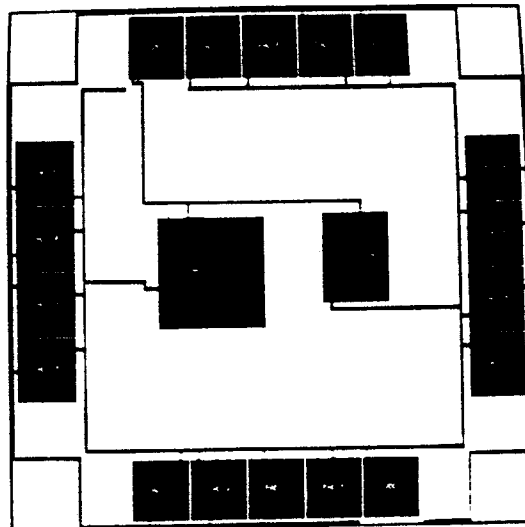

The power-ground phase uses the algorithm of Section 7 to determine how much current flows through each power-ground wire and how wide it has to be to handle this current. PI's resizer first stretches each power-ground wires to its appropriate width in the x direction.

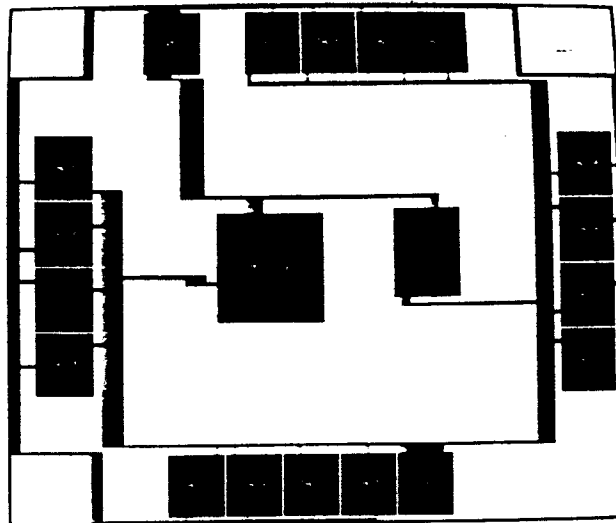

The resizer then stretches the wires in the y direction, resulting in the final layout of power-ground wires.

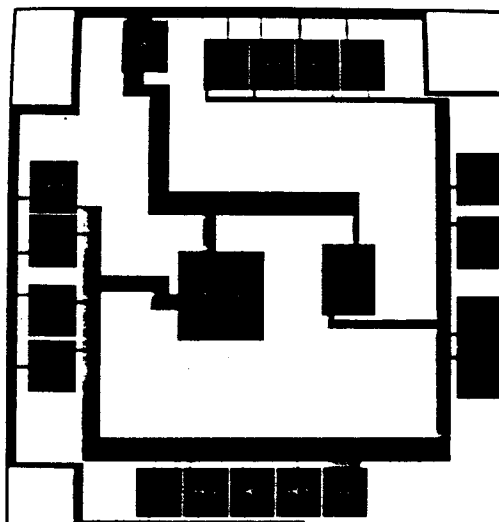

From this point, the PI system will continue with signal routing to complete the design of the chip.

9. PROBLEMS FOR FURTHER RESEARCH

It is not known whether the following problem is NP-complete:

Given two sets of points in the plane, find two noncrossing Steiner trees such that one tree spans one set, the other tree spans the other set, and the trees' combined length is minimum.

The metric for determining length can be either Euclidean ($\sqrt{(x_2 - x_1)^2 + (y_2 - y_1)^2}$) or Manhattan ($|x_2 - x_1| + |y_2 - y_1|$). Since this problem models the power-ground problem, knowing its complexity would greatly influence this part of VLSI research.

Using the Hamiltonian cycle to divide the chip into separate routing regions raises the question of how the cycle's characteristics relate to the resulting tree's length and other characteristics.

This suggests a more general question of the best method to divide the chip into routing regions. There are three such methods in this thesis:

- Section 6.3's Hamiltonian cycle separating GND routing from VDD routing.
- Section 6.4's VDD ring separating logic module routing from pad routing.
- Rothermel and Mlynski's method, described in Section 4.2, separating routing the chip's left half from routing the right half.

Further research could determine how effective each method is at constructing short trees and could develop new methods for creating separate routing regions.

The goal of the algorithms of this thesis is to minimize the amount of metal used by the trees. Further research might reveal other desirable characteristics the trees should possess. An interesting part of this aspect would be to determine what characteristics of the trees result in better signal routing.

10. CONCLUSIONS

As the preceding chapter shows, PI's power-ground phase successfully automates the power-ground phase of chip design. The algorithm's high success rate, its low running time, and the high quality of its output make it a useful tool in chip design.

The research that produced the algorithms explored the similarities and differences between signal routing and power-ground routing. It showed that many signal-routing techniques are applicable to power-ground routing.

Through its application of signal-routing techniques, the research showed new applications of techniques in graph theory, such as growing Steiner trees.

To keep the trees from crossing, the algorithm introduced the idea of using a Hamiltonian cycle to separate the chip into two separate routing regions. By extension, using this concept in other situations could control the growth of trees. Extending the idea of separate routing regions, other lines besides a Hamiltonian cycle could control tree growth. For example, the VDD ring, described in Section 6.4, separates logic module routing from pad routing. This relates to Rothermel and Mlynski's work, where a vertical line divides the chip into two routing regions.

11. BIBLIOGRAPHY

- [B81] Baratz, Alan. *A Graph Theoretic VLSI Layout Procedure*, Ph. D. Thesis, Massachusetts Institute of Technology, August, 1981.
- [C79] Nicos Christofides. "The Traveling Salesman Problem", Chapter 6, *Combinatorial Optimization*, Wiley & Sons, 1979, pages 148-149.
- [GJ79] Michael R. Garey and David S. Johnson. *Computers and Intractability: A Guide to the Theory of NP-Completeness*, Freeman and Company, 1979, page 209.
- [H82] Hassett, James E. "Automated Layout in ASHLAR: An Approach to the Problems of 'General Cell' Layout for VLSI", *ACM IEEE Nineteenth Design Automation Conference Proceedings*, July, 1982, pages 777-784.
- [LHO80] Lhota, Frank J. *Dual Spanning Trees*. Term paper for Course 6.854, Massachusetts Institute of Technology, May, 1980.
- [LH82] Lie, Margaret, and Chi-Song Horng. "A Bus Router for IC Layout", *ACM IEEE Nineteenth Design Automation Conference Proceedings*, July, 1982, pages 129-132.
- [LIN65] Lin, Shen. "Some Computer Solutions of the Traveling-Salesman Problem", *Bell System Technical Journal* 44, 2245-2269 (1965).
- [MC80] Mead, C. A., and L. A. Conway. *Introduction to VLSI Systems*, Addison-Wesley Publishing Co., Reading, Massachusetts, 1980.
- [MO83] Moulton, Andrew. "Laying the Power and Ground Wires on a VLSI Chip", *ACM IEEE 20th Design Automation Conference*, 1983, pages 754-755.
- [RI82] Rivest, Ronald L. "The 'PI' (Placement and Interconnect) System", *ACM IEEE Nineteenth Design Automation Conference Proceedings*, July, 1982, pages 475-481.
- [RM81] Rothermel, H-J., and D. A. Mlynski. "Computation of Power Supply Nets in VLSI Layout", *ACM IEEE Eighteenth Design Automation Conference Proceedings*, 1981, pages 37-42.
- [SG82] Syed, Zahir A., and Abbas El Gamal. "Single Layer Routing of Power and Ground Networks in Integrated Circuits", *Journal of Digital Systems*, Volume VI, Number 1, Spring, 1982, pages 53-63.
- [SGB82] Syed, Zahir A., Abbas El Gamal, and M. A. Breuer. "On Routing for Custom Integrated Circuits", *ACM IEEE Nineteenth Design Automation Conference Proceedings*, July, 1982, pages 887-893.