

**The
MDL
Programming Language
Primer**

**Michael Dornbrook
Marc Blank**

**Laboratory for Computer Science
Massachusetts Institute of Technology
Cambridge, Massachusetts 02139**



| | |
|---|-----------|
| 6. Simple Functions | 27 |
| 6.1. General | 27 |
| 6.2. Defining FUNCTIONS | 27 |
| 6.3. Application of FUNCTIONs : Binding | 28 |
| 6.4. DEFINE ing Some Simple FUNCTIONs | 30 |
| 6.5. Pretty-Printing | 33 |
| 6.5.1. Editors and Pretty Printing | 34 |
| 6.6. Loading a File | 34 |
| 7. MDL TYPEs | 35 |
| 7.1. TYPEs and PRIMTYPEs | 35 |
| 7.2. Introduction to MDL Structures | 36 |
| 7.3. The TYPE? Predicate | 36 |
| 7.4. Printing of MDL Objects | 37 |
| 7.5. Significance of PRIMTYPEs / CHTYPE | 37 |
| 7.6. Creating new TYPEs | 38 |
| 8. MDL Structures | 41 |
| 8.1. Equality | 41 |
| 8.2. PRIMTYPE LIST | 41 |
| 8.2.1. Creating LISTs | 43 |
| 8.2.2. EVAL ing LISTs | 45 |
| 8.2.3. Manipulating LISTs | 45 |
| 8.2.4. FIX es First in FORMs | 52 |
| 8.2.5. FORMs | 52 |
| 8.2.6. FALSEs | 53 |
| 8.2.7. SEGMENTs | 53 |
| 8.3. PRIMTYPE VECTOR | 55 |
| 8.3.1. Creating VECTORs | 55 |
| 8.3.2. EVAL ing VECTORs | 56 |
| 8.3.3. Manipulating VECTORs | 56 |
| 8.3.4. UVECTORs | 58 |
| 8.4. PRIMTYPE STRING | 59 |
| 8.4.1. ASCII | 60 |
| 8.4.2. Creating STRINGs | 60 |
| 8.4.3. EVAL ing STRINGs | 61 |
| 8.4.4. Manipulating STRINGs | 61 |
| 8.5. Building Large Structures | 62 |
| 8.6. Searching Structures | 62 |
| 8.7. Garbage: Quoting Structures | 63 |
| 8.8. Garbage: Building Lists | 63 |
| 8.9. Structured NEWTYPES | 65 |
| 8.10. Summary of MDL Structures | 65 |
| 8.11. Practice Quiz | 66 |
| 9. Programming Constructs | 69 |
| 9.1. Boolean Operators | 69 |

| | |
|--|----|
| 9.1.1. NOT | 69 |
| 9.1.2. AND | 69 |
| 9.1.3. OR | 70 |
| 9.2. COND | 70 |
| 9.2.1. Examples | 71 |
| 9.3. Shortcuts with Conditionals | 72 |
| 9.3.1. Using AND and OR with CONDS | 72 |
| 9.3.2. Embedded Unconditionals | 73 |
| 9.4. Examples | 74 |
| 10. Looping | 77 |
| 10.1. PROG | 77 |
| 10.2. REPEAT | 78 |
| 10.3. Non-local RETURNS, etc. | 78 |
| 10.4. MAPF | 79 |
| 10.4.1. Looping Through a Structure | 79 |
| 10.4.2. Other Than One Structure | 80 |
| 10.4.3. Using Intermediate Results | 81 |
| 10.4.4. MAPRET and MAPSTOP | 81 |
| 10.4.5. MAPR | 83 |
| 10.4.6. MAPF/R Summary | 84 |
| 10.5. Looping vs. Recursion | 85 |
| 11. Argument Lists in FUNCTIONS | 87 |
| 11.1. Arguments Not EVALed | 87 |
| 11.2. Optional Arguments | 88 |
| 11.3. Arbitrary Numbers of EVALed Arguments | 88 |
| 11.4. Arbitrary Numbers of un-EVALed Arguments | 89 |
| 11.5. Temporary Variables | 90 |
| 11.6. Order of Evaluation in Argument Lists | 91 |
| 11.7. Variable Declarations | 91 |
| 11.8. Structures: DECLs and NEWTYPEs | 93 |
| 11.8.1. To NEWTYPE or Not To NEWTYPE | 94 |
| 11.9. Good Habits / Bad Habits | 95 |
| 11.10. Review of Argument List Syntax | 95 |
| 12. Input/Output | 97 |
| 12.1. Basics of I/O | 97 |
| 12.2. Conversion I/O - Input | 98 |
| 12.2.1. READ | 98 |
| 12.2.2. READCHR | 98 |
| 12.2.2.1. NEXTCHR | 98 |
| 12.3. Conversion I/O - Output | 98 |
| 12.3.1. PRINT | 99 |
| 12.3.2. PRIN1 | 99 |
| 12.3.3. PRINC | 99 |
| 12.3.4. CRLF | 99 |

| | |
|---|------------|
| 12.4. CHANNEL (the TYPE) | 100 |
| 12.4.1. OPEN | 100 |
| 12.4.2. FILE-EXISTS? | 101 |
| 12.4.3. CLOSE | 101 |
| 12.4.4. CHANLIST | 101 |
| 12.4.5. INCHAN and OUTCHAN | 101 |
| 12.5. End-of-File "Routine" | 102 |
| 12.6. Additional I/O SUBRs | 102 |
| 12.6.1. READSTRING | 103 |
| 12.6.2. PRINTSTRING | 104 |
| 12.7. SAVE Files | 105 |
| 12.7.1. SAVE | 105 |
| 12.7.2. RESTORE | 105 |
| 12.8. PARSE, LPARSE, and UNPARSE | 105 |
| 12.9. Other I/O Functions | 106 |
| 12.9.1. FLOAD | 106 |
| 12.9.2. SNAME | 106 |
| 12.9.3. FILE-LENGTH | 107 |
| 12.9.4. RESET | 107 |
| 12.9.5. RENAME | 107 |
| 12.10. Terminal CHANNELs | 108 |
| 12.10.1. TYI | 108 |
| 13. Making Tables | 109 |
| 13.1. Use a LIST | 109 |
| 13.2. Use a VECTOR | 110 |
| 13.3. Use an ATOM | 110 |
| 13.4. Use an Association | 111 |
| 13.4.1. Hashing | 112 |
| 13.5. Use an OBLIST | 112 |
| 13.6. OBLISTs, READ, and PRINT | 114 |
| 14. Debugging MDL Programs - An Introduction | 115 |
| 14.1. Method 1: Start Over | 116 |
| 14.2. Method 2: Forcing FRAMEs to Return Values | 117 |
| 14.3. Method 3: Use EDIT to Repair your FUNCTIONs | 118 |
| 14.4. Method 4: Altering FRAMEs / RETRY | 120 |
| 14.5. Summary | 120 |
| Index | 123 |

List of Figures

| | |
|--|-----|
| Figure 8-1: The MDL notion of equality is demonstrated in this figure, which shows the distinction between single-equal =? and double-equal ==?. | 42 |
| Figure 8-2: The LIST (1 2 3) | 43 |
| Figure 8-3: Removing a LIST element by moving only one pointer | 43 |
| Figure 8-4: REST of a LIST | 46 |
| Figure 8-5: PUTs into LISTS | 46 |
| Figure 8-6: Pointers vs. Structures | 47 |
| Figure 8-7: PUTREST | 48 |
| Figure 8-8: Removing an element from a LIST using PUTREST | 49 |
| Figure 8-9: Splicing LISTS together using PUTREST | 50 |
| Figure 8-10: The VECTOR [1 2 3 4] | 55 |
| Figure 8-11: REST of a VECTOR | 57 |
| Figure 8-12: BACK of a VECTOR | 58 |
| Figure 14-1: Diagram for the example in this chapter | 121 |



Introduction

Over the years the original MDL (pronounced "Muddle") Primer by Greg Pfister [Pfister 72] became more and more a reference manual and less a Primer from which a novice could learn the language. Some of the text of the original has been re-used in this document, but much has been eliminated, changed, or re-ordered, and a reasonable amount of new material has been added. In particular, a number of figures and many more examples have been added to make some of the more difficult concepts easier to understand.

This Primer is intended as an introduction to MDL. After assimilating the information contained herein, you should be able to write very good programs. However, for any individual topic in the MDL Primer there is likely to be more information available in *The MDL Programming Language* [Galley 79] and *The MDL Programming Environment* [Lebling 80], and there are many topics in these documents which are not addressed in the Primer. Anyone who plans to do any serious work with MDL should read these documents.

One of the difficulties in writing a Primer is to make it useful to those who don't know anything at all about programming without boring those who know a lot of the basics. Hopefully those at both extremes will find this to be easy to read. If you are a complete novice, however, there may be some unfamiliar references and some material which doesn't make sense on your first reading.

Why MDL?

Many people ask this. It is often hard for those who use MDL to put into words their reasons for liking it. Those of us who use MDL are convinced that it is a better language than any other we've encountered. Unfortunately, very little has been done to convince others of this and spread the use of this marvelous tool.

MDL was created in the early 1970's by a group at the Dynamic Modelling/Computer Graphics division of MIT's Project MAC (later renamed the Laboratory for Computer Science). It is an offshoot of the original Lisp. There have been quite a few offshoots of Lisp in the past 10 years - MacLisp, InterLisp, Lisp Machine Lisp, Lisp1.5, UCI Lisp, Franz Lisp, etc., etc. - but none of them are like MDL.

Since MDL is a distant relative of Lisp and many of those first learning MDL have some familiarity with Lisp, a short comparison of the two languages follows. If you are not familiar with Lisp (or, better still, with any other languages) count your blessings (you don't have any bad habits to unlearn) and skip the following discussion.

MDL's similarities to Lisp: MDL shares the advantages of Lisp over the more popular languages such as Basic, Fortran, Cobol, Algol, Pascal, etc.

- It has an interpreter which allows real-time interaction and allows you to define and test individual functions separately.

- Its syntax is very simple.
- Any data object or function can be passed as an argument or returned as a value.
- It has list structures equivalent to Lisp's.
- Recursive functions can be written quite easily.

The similarities between MDL and Lisp are such that in many cases a few minor changes to Lisp code will convert it into working MDL code. Given the other features of MDL, no MDL programmer would write the program in the same Lisp style.

MDL's dissimilarities to Lisp: Many objections to Lisp are answered in MDL.

- Strongly typed languages provide much better error detection tools than Lisp. MDL allows declarations of all variable types to whatever level of complexity is desired. A variable can be declared to be one of several types.
- Recursion is a useful tool, but often is not a very efficient way to solve the problem. Lisp's motto "To iterate is human, to recurse divine," is not one of MDL's tenets. MDL allows recursion, but provides excellent facilities for iteration.
- MDL has a very powerful set of data structures - Lists, Strings, Vectors, and Uniform Vectors. Although lists are a very useful and flexible form of structure, they are certainly not optimal in all cases. MDL's various structures allow the user to save space and access time. MDL's structures are also "first class," in that the standard functions for manipulating data structures can be used on all of them equivalently.
- Probably the biggest complaint against Lisp-like languages is that they are unsuitable for "production programming" because they are too slow. MDL has an excellent compiler which as far as we know is the best compiler for a Lisp-like language. It produces machine code equivalent in efficiency to Fortran and Cobol, which are considered very efficient.
- MDL has a rich library of useful program aids. The editing and debugging functions are among the best. The package system allows building of very large programs from small sections, usually written by different people, without worrying about variable name conflicts.
- Probably the most distinctive feature of MDL is its mechanism for user-defined types, which is the best of any language with which we are familiar. User-defined types have been retrofitted on some of the newer versions of Lisp, but in most cases they can be used only with special functions and cannot be used in the same general way that Lists can.

Hopefully some of your questions have been answered and you have some ready answers when you get flak from your non-MDL programming friends. Learning MDL should be an enjoyable and worthwhile experience. Your reactions to this Primer and suggestions for changes are always welcome. Good luck!

Warning! You are about to embark on an undertaking fraught with peril. MDL programming has been proven to be habit-forming. Once you begin, you may find the habit hard to kick!

[Faint, illegible text]

Acknowledgments

We are deeply indebted to our predecessors for their work on this topic: Greg Pfister, who wrote the original *A Muddle Primer* [Pfister 72], and Stuart Galley, who updated that document and added significantly to it to create *The MDL Programming Language* [Galley 79] document. Some of the text and examples of the original documents survive here, and some other material was simply rewritten in an order and style which we consider more comprehensible.

Special thanks to Chris Reeve, Dave Lebling, Stu Galley, Poh Lim, Thomas Michalek, Dave Scrimshaw, Tim Anderson, Mark Plotnick, and Prof. J.C.R. Licklider for their many comments and suggestions.

No document on MDL would be complete without acknowledging the "original implementors." If not for their inspiring work, this fine language would not exist. We are forever grateful to Gerald Sussman, Carl Hewitt, Chris Reeve, Dave Cressey, and Bruce Daniels. Thanks are also extended to the many unnamed hackers who have improved the language and the programming environment over the years.

This work was supported by the Advanced Research Projects Agency of the Department of Defense and was monitored by the Office of Naval Research under contract N00014-75-C-0661.

This document was prepared using Scribe and printed on the Xerox Dover printer.

1. Basic Interaction

The purpose of this chapter is to provide you with that minimal amount of information needed to experiment with MDL (pronounced, affectionately, as Muddle) while reading this document. It is strongly recommended that you do experiment, especially upon reaching chapter 6 (page 27) (Simple Functions).

1.1. Loading MDL

First, catch your rabbit. Somehow get the interpreter running -- the program in the file `SYS:TSMDL` in the ITS version or `SYS:MDL.SAV` in the Tenex version or `SYS:MDL.EXE` in the Tops-20 version. [Just type `:MDL` to ITS, `MDL` or `MUDDLE` to Tops-20.] The interpreter will then type

```
MUDDLE nnn IN OPERATION.  
LISTENING-AT-LEVEL 1 PROCESS 1
```

and then wait for you to type something.

The program which you are now running is an interpreter for the language MDL. All it knows how to do is interpret MDL expressions. There is no special "command language"; you communicate with the program -- make it do things for you -- by actually typing legal MDL expressions, which it then interprets. Everything you can do at a terminal can be done in a program, and vice versa, in exactly the same way.

The program will be referred to as just "MDL" (or "the interpreter") from here on.

1.2. Typing

Typing a character at MDL normally just causes that character to be echoed (printed on your terminal) and remembered in a buffer. The only characters for which this is normally not true act as follows:

Typing the "Escape" or "Alt-Mode" key, which we will always refer to as \$ (dollar-sign), causes

MDL to echo dollar-sign and causes the contents of the buffer (the characters which you've typed) to be interpreted as an expression(s) in MDL. When this interpretation is done, the result will be printed and MDL will wait for more typing.

Typing the rubout character (DEL in the ITS and Tops-20 versions, control-A in the Tenex version) causes the last character in the buffer -- the one most recently typed -- to be thrown away (deleted). If you now immediately type another rubout, once again the last character is deleted -- namely, the second most recently typed. Etc. The character deleted is echoed, so you can see what you're doing. On some "display" terminals, rubout will "echo" by causing the deleted character to disappear. If no characters are in the buffer, rubout echoes as carriage-return line-feed.

Typing $\uparrow\text{O}$ (control-atsign) deletes everything you have typed since the last $\$$, and prints a carriage-return line-feed.

Typing $\uparrow\text{D}$ (control-D) causes the current input buffer to be typed back out at you. This allows you to see what you really have, without the confusing re-echoed characters produced by rubout.

Typing $\uparrow\text{L}$ (control-L) produces the same effect as typing $\uparrow\text{D}$, except that, if your terminal is a "display" terminal (for example, VT100, VT52, H19, ...), the screen is cleared before the input buffer is retyped.

Typing $\uparrow\text{G}$ (control-G) causes MDL to stop whatever it is doing and act as if an error had occurred (section 1.3 (page 9)). $\uparrow\text{G}$ is generally most useful for temporary interruptions to check the progress of a computation. $\uparrow\text{G}$ is "reversible" -- that is, it does not destroy any of the "state" of the computation it interrupts. To "undo" a $\uparrow\text{G}$, type the characters

<ERRET T>\$

(This is discussed more fully far below, in chapter 14, page 115 (Debugging MDL Programs).)

Typing $\uparrow\text{S}$ (control-S) causes MDL to throw away what it is currently doing and return to a normal "listening" state. (In the Tenex and Tops-20 versions, $\uparrow\text{O}$ also should have the same effect.) $\uparrow\text{S}$ is generally most useful for aborting infinite loops and similar terrible things. $\uparrow\text{S}$ destroys whatever is going on, and so it is not reversible.

Most expressions in MDL include "brackets" (generically meant) that must be correctly paired and nested. If you end your typing with the pair of characters $\text{I}\$$ (exclamation-point ESC), all currently unpaired brackets (but not double-quotes, which bracket strings of characters) will automatically be paired and interpretation will start. Without the I , MDL will just sit there waiting for you to pair them. If you have improperly nested parentheses, brackets, etc., within the expression you typed, an error will occur, and MDL will tell you what is wrong.

Once the brackets are properly paired and $\$$ (ESC) is typed, MDL will immediately echo carriage-return and line-feed, and the next thing it prints will be the result of the evaluation. Thus, if a plain $\$$ is not so echoed, you have some expression unclosed. In that case, if you have not typed any

characters beyond the \$, you can usually rub out the \$ and other characters back to the beginning of the unclosed expression. Otherwise, what you have typed is beyond the help of rubout and ↑0; if you want to abort it, use ↑S.

MDL accepts and distinguishes between upper and lower case. All "built-in functions" must be referenced in upper case.

1.3. Errors -- Simple Considerations

When MDL decides for some reason that something is wrong, the standard sequence of evaluation is interrupted and an error function is called. This produces the following terminal output:

```
*ERROR*
often-hyphenated-reason
function-in-which-error-occurred
LISTENING-AT-LEVEL integer PROCESS integer
```

You can now interact with MDL as usual, typing expressions and having them evaluated. There exist facilities (built-in functions) allowing you to find out what went wrong, restart, or abandon whatever was going on. In particular, you can recover from an error -- that is, undo everything but side effects and return to the initial typing phase -- by typing the following first line, to which MDL will respond with the second line:

```
<ERRET>$
LISTENING-AT-LEVEL 1 PROCESS 1
```

If you type the following line while still in the error state (before <ERRET>), MDL will print the **FRAMES** it went through to evaluate the function:

```
<FRAMES>$
```

Typing **FR&** (pronounced 'frampersand') instead of **FRAMES** will cause MDL to print a condensed, usually more readable output.

This will also be explained in chapter 14.

2. MDL Basics

In a general sense, when you are interacting with MDL, you are dealing with a world inhabited only by a particular set of things: MDL objects.

2.1. Introduction to MDL TYPES

MDL objects are best considered as abstract entities with abstract properties. The properties of a particular MDL object depend upon the class of MDL objects to which it belongs. This class is known as the **TYPE** of the object, and every MDL object has one. Easily recognized **TYPES** include **FIX** (integers) and **FLOAT** (real numbers). Examples of these might be **1** and **2.67**, respectively. An abbreviation often used is to refer to "a **FIX**" when referring to a MDL object whose **TYPE** is **FIX**. For example, **1** is a **FIX** and **2.67** is a **FLOAT**.

MDL **TYPES** can be divided into two general classes: those with internal structure and those without internal structure. The former will be referred to as being *structured*. *Structured* objects are those which can be thought of as an ordered series of items held together in some way. There are a number of ways in which these items can be held together, and each of these is represented by a series of MDL objects between a set of matched brackets (e.g. `<>`, `()`, `[]`, `{ }` `" "`). As will be seen later, each bracket type represents a different **TYPE** of MDL object, and some represent different ways of internally storing the series of objects. Depending on the application, one of these may be more suitable than another.

Here are some MDL objects which are *not structured*:

```
20
20.0
TWENTY
```

The first two are examples of **TYPES** **FIX** and **FLOAT**, as noted above. The last is an **ATOM**, roughly speaking an identifier or a variable, and will be discussed in Chapter 3.

Here are some MDL objects which are *structured*:

```
<+ 1 2>
(+ 1 2)
[+ 1 2]
"+ 1 2"
```

These represent very similar notions: an ordered series of the MDL objects `+`, `1`, and `2`, the first of these being an `ATOM` and the rest `FIXEs`. These brackets correspond to the `TYPEs` `FORM`, `LIST`, and `VECTOR`. The first of these, a `FORM`, is central to MDL, as it represents the application of a *function* to arguments. The others will be considered later.

2.2. Printing of MDL Objects

We have already seen the printed representation of some MDL objects: `FIXEs`, `FLOATs`, `FORMs`, `LISTs` and `VECTORs`. As will be mentioned later, MDL allows an almost unlimited number of data types. Obviously, there are not enough bracket types to make each data type recognizable. Therefore, most MDL types have a kind of generalized way of printing. This format is like this:

```
#type-name value
```

where *type-name* is the name of a MDL `TYPE` and *value* describes the 'value' of the object. Suffice it for now to say that an object which prints like:

```
#FALSE ()
```

is of `TYPE FALSE` and an object which prints like

```
#MUMBLE [1 2 3]
```

is of `TYPE MUMBLE`.

2.3. MDL FORMS

A `FORM` in MDL is printed as: an open angle bracket (`<`), the name of the *function* to be applied, the arguments to which the *function* is being applied, and finally a closing angle bracket (`>`). MDL's angle brackets are one of its distinguishing features (almost as distinctive as Lisp's parentheses).

MDL has a large number of built-in *functions*. These are usually of `TYPE SUBR` (short for subroutine). For example:

<+ 1 2 3>

will, when given to the MDL interpreter, return 6. The way in which the name for a *function*, in this case +, is associated with its functional part (i.e. in this case, the *thing* which actually performs the addition) is described later. Suffice it for now to say that these *functions* can be referenced by their name (an ATOM), as was done in the example.

2.4. Prefix Notation

MDL is a distant relative, a much-improved descendant of LISP. The "desirable features" of LISP were included in MDL. One of those features, prefix notation, you have just seen.

Prefix notation, sometimes referred to as Polish notation, is different from the infix notation of ordinary arithmetic and reverse-Polish notation of some calculators. Below are some examples of equivalents in infix and prefix notation:

4 + 7
<+ 4 7>

8 - 6
<- 8 6>

6 - (3 + 2)
<- 6 <+ 3 2>>

9 + (4 * 6 - 6 / 3)
<+ 9 <- <* 4 6> </ 6 3>>>

7 + 3 + 4 + 8 + 11
<+ 7 3 4 8 11>

It will take you some time to become accustomed to prefix notation. One thing you will have to keep in mind is balancing of brackets. Notice that with prefix notation an operator can take an arbitrary number of arguments and that the nesting is never ambiguous (i.e. the parentheses of infix notation are not necessary).

2.5. Evaluation of FORMS

Evaluation of a MDL FORM proceeds from left to right. The first item is the name of the function which will be applied to the arguments which follow. The arguments may themselves be FORMS which

will be evaluated in the same way. For example, this FORM:

```
<+ <+ 1 2> 3>
```

when evaluated will apply the addition function to the evaluation of the first argument (which, since it is itself a form, will be recursively evaluated until it returns a value) and then to the evaluation of the second argument. The arguments may be much more complex than this and require many levels of evaluation before a result is returned. It is important to note that unlike many other languages, every evaluation has a resulting value. As we will see, even such operations as printing or setting the values of variables return values.

2.6. Introduction to Truth

In MDL, anything which does not evaluate to an object of TYPE FALSE is considered true. If an expression returns false, MDL usually prints it as #FALSE ().

3. Read, Evaluate, and Print

3.1. General

Once you type \$ and all brackets are correctly paired and nested, the current contents of the input buffer go through processing by three functions successively: first READ, which passes its output to EVAL ("evaluate"), which passes its output to PRINT, which types its output on the terminal.

Functionally,

READ: printed representations --> MDL objects

EVAL: MDL objects --> MDL objects

PRINT: MDL objects --> printed representations

That is, READ takes ASCII text, such as is typed in at a terminal, and creates the MDL objects represented by that text. PRINT takes MDL objects, creates ASCII text representations of them, and types them out. EVAL, which is the really important one, performs transformations on MDL objects.

3.2. EVAL and TYPEs

The laws of the MDL world are defined by EVAL. In a very real sense, EVAL is the only MDL object which "acts", which "does something". In "acting", EVAL is always "following the directions" of some MDL object. Every MDL object should be looked upon as supplying a set of directions to EVAL; what these directions are depends heavily on the TYPE of the MDL object.

Since EVAL is so ever-present, an abbreviation is in order: "evaluates to *something*" or "EVALs to *something*" should be taken as an abbreviation for "when given to EVAL, causes EVAL to return *something*".

3.3. Example (TYPE FIX)

```
1$  
1
```

The following has occurred:

First, READ recognized the character 1 as the representation for an object of TYPE FIX, in particular the one which corresponds to the integer one. (FIX means integer, because the decimal point is understood always to be in a fixed position: at the right-hand end.) READ built the MDL object corresponding to the decimal representation typed, and returned it.

Then EVAL noted that its input was of TYPE FIX. An object of TYPE FIX evaluates to itself, so EVAL returned its input undisturbed.

Then PRINT saw that its input was of TYPE FIX, and printed on the terminal the decimal character representation of the corresponding integer.

3.4. Example (TYPE FLOAT)

```
1.0$  
1.0
```

What went on was entirely analogous to the preceding example, except that the MDL object was of TYPE FLOAT. (FLOAT means a real number (of limited precision), because the decimal point can float around to any convenient position: an internal exponent part tells where it "really" belongs.)

3.5. FIXes and FLOATs versus READ: Specifics

3.5.1. READ and FIXed-point Numbers

READ considers any grouping of characters which are solely digits to be a FIX, and the radix of the representation is decimal (*i.e.* the base is 10) by default. A - (hyphen) immediately preceding such a grouping represents a negative FIX. The largest FIX representable on the PDP-10 is two to the 35th power minus one, or 34,359,738,367 (decimal); the smallest is one less than the negative of that number. If you attempt to type in a FIX outside that range, READ converts it to a FLOAT; if a program you write attempts to produce a FIX outside that range, an overflow error will occur (unless overflow errors are disabled).

3.5.2. READ and PRINT versus FLOATing-point Numbers

PRINT can produce, and **READ** can understand, two different formats for objects of **TYPE FLOAT**. The first is "decimal-point" notation, the second is "scientific" notation. Decimal radix is always used for representations of **FLOATs**.

"Decimal-point" notation for a **FLOAT** consists of an arbitrarily long string of digits containing one . (period) which is followed by at least one digit. **READ** will make a **FLOAT** out of any such object, with a limit of precision of one part in 2 to the 27th power. (**FIXed** and **FLOATing-point** numbers are stored in one 36-bit PDP-10 word. **FLOATing-point** numbers give up precision to gain their greater range.)

"Scientific" notation consists of:

1. a number, the mantissa
2. immediately followed by **E** or **e** (upper or lower case letter **E**),
3. immediately followed by an exponent,

where the mantissa is an arbitrarily long string of digits, with or without a decimal point (see following note); and the "exponent" is up to two digits worth of **FIX**. This notation represents the "number" to the "exponent" power of ten. Note: if the mantissa as above would by itself be a **FIX**, and if the "exponent" is positive, and if the result is within the allowed range of **FIXes**, then the result will be a **FIX**. For example, **READ** understands **10E1** as **100** (a **FIX**), but **10E-1** as **1.0000000** (a **FLOAT**).

The largest-magnitude **FLOAT** which can be handled without overflow is **1.7014118E+38** (decimal radix). The smallest-magnitude **FLOAT** which can be handled without underflow is **.14693679E-38**.

Examples:

```
1.001$
1.001000
```

```
.001$
1.0E-3
```

```
143E2$
14300
```

```
1234567891234$
1.2345678E+12
```

4. Atoms and Their Values

4.1. Example (TYPE ATOM, PNAME)

In the previous chapter, the handling of **FIXed** and **Floating** point numbers by **READ**, **EVAL**, and **PRINT** was discussed. If you type:

```
GEORGES  
GEORGE
```

a lot more happens.

READ noted that what was typed had no special meaning, and therefore assumed that it was the representation of an object of **TYPE ATOM**. ("Atom" means "more or less indivisible.") **READ** therefore attempted to look up the representation in a table it keeps for such purposes. If **READ** finds an **ATOM** in its table whose representation matches the representation just received, that **ATOM** is returned as **READ**'s value. If the look-up fails, **READ** creates a new **ATOM**, puts it in the table with the representation read, and returns the new **ATOM**. Nothing which could in any way be referenced as a legal "value" is attached to the new **ATOM**. The initially-typed representation of an **ATOM** becomes its **PNAME**, meaning its name for **PRINT** (**PRINT PNAME**). One often abbreviates "object of **TYPE ATOM** with **PNAME name**" by saying "**ATOM name**". There is a reason for making this careful distinction. Unlike other languages where atoms are names associated with values, a **MDL ATOM** is an object which may have values (global and/or local) but which is distinct from its value(s).

EVAL, given an **ATOM**, returned just that **ATOM**.

PRINT, given an **ATOM**, typed out its **PNAME**.

4.2. READ and PNAMEs

The question "what is a legal **PNAME**?" is actually not a reasonable one to ask; any non-empty string of arbitrary characters can be the **PNAME** of an **ATOM**. However, some **PNAMEs** are easier to type to **READ** than others. But even the question "what are easily typed **PNAMEs**?" is not too reasonable, because: **READ** decides that a group of characters is a **PNAME** by default; if it can't possibly be anything else, it's a **PNAME**. So, the rules governing the specification of **PNAMEs** are messy, and best

expressed in terms of what is not a PNAME. For simplicity, you can just consider any uninterrupted group of upper- and lower-case letters and (customarily) hyphens to be a PNAME; that will always work. If, for some reason, you need to know all the gory details about legal PNAMEs, see Subsection 2.6.3 of *The MDL Programming Language* [Galley 79].

4.3. Values of ATOMS

4.3.1. General

Typing GEORGE to the MDL interpreter and causing it to create the ATOM with PNAME GEORGE does not appear to be very useful. ATOMS in MDL serve as variables and as names for functions and data structures. They are definitely useful.

The ATOM has itself as its value. There are two additional kinds of "value" which can be attached to an ATOM. An ATOM can have either, both, or neither. They interact in no way. These two additional values are referred to as the local value and the global value of an ATOM. The functions which reference the local and global values of an ATOM, and some of the characteristics of local versus global values, follow.

4.3.2. SETG

A global value can be assigned to an ATOM by the SUBR SETG ("set global," pronounced 'set-gee'), as in

```
<SETG atom any>
```

where *atom* must EVAL to an ATOM, and *any* can EVAL to anything. EVAL of the second argument becomes the global value of EVAL of the first argument. The value returned by the SETG is its second argument, namely the new global value of *atom*.

Examples:

```
<SETG FOO <SETG BAR 469>>$  
469
```

The above made the global values of both the ATOM FOO and the ATOM BAR equal to the FIXED-point number 469.

```
<SETG BAR FOO>$
FOO
```

That made the global value of the ATOM BAR equal to the ATOM FOO.

4.3.3. GVAL

The SUBR GVAL ("global value") is used to reference the global value of an ATOM.

```
<GVAL atom>
```

returns as a value the global value of *atom*. If *atom* does not evaluate to an ATOM, or if the ATOM to which it evaluates has no global value, an error occurs.

GVAL applied to an ATOM anywhere, in any function, will return the same value. Any SETG anywhere changes the global value for everybody. Global values are context-independent.

READ understands the character , (comma) as an abbreviation for an application of GVAL to whatever follows it. PRINT always translates an application of GVAL into the comma format. The following are absolutely equivalent:

```
,atom     <GVAL atom>
```

Assuming the examples in section 4.3.2 (page 20) were carried out in the order given, the following will evaluate as indicated:

```
,FOO$
489
<GVAL FOO>$
489
,BAR$
FOO
,,BAR$
489
```

4.3.4. SET

The SUBR SET is used to assign a local value to an ATOM. Applications of SET are of the form

```
<SET atom any>
```

SET returns EVAL of *any* just as SETG does.

Examples:

```
<SET BAR <SET FOO 100>>$
100
```

Both BAR and FOO have been given local values equal to the FIXED-point number 100.

```
<SET FOO BAR>$
BAR
```

FOO has been given the local value BAR.

Note that neither of the above did anything to any global values FOO and BAR had or might have had.

4.3.5. LVAL

The SUBR LVAL is used to return the local value of an ATOM. As with GVAL, READ understands an abbreviation for an application of LVAL: the character . (period), and PRINT produces it. The following two representations are equivalent, and when EVAL operates on the corresponding MDL object, it returns the current local value of *atom*:

```
<LVAL atom>      .atom
```

(Note: you will generally hear .FOO pronounced as 'dot-foo'). Assume all of the previous examples in this chapter have been done. Then the following evaluate as indicated:

```
.BAR$
100
<LVAL BAR>$
100
.FOO$
BAR
..FOO$
FOO
...FOO$
469
```

5. Built-in Functions

5.1. Evaluation of FORMs

EVAL applied to a FORM acts as if following these directions:

First, examine the *func* (first member) of the FORM. If it is an ATOM, look at its GVAL. If it is not an ATOM, EVAL it and look at the result of the evaluation. If what you are looking at is not something which can be applied to arguments, complain (via the ERROR function). Otherwise, inspect what you are looking at and follow its directions in evaluating or not evaluating the arguments and then "apply the function" -- that is, EVAL the body of the object gotten from *func*.

5.2. Built-in Functions (TYPE SUBR, TYPE FSUBR)

The built-in functions of MDL come in two varieties: those which have all their arguments EVALed before operating on them (TYPE SUBR, for "subroutine", pronounced 'subber') and those which have none of their arguments EVALed (TYPE FSUBR, historically from Lisp [Weinreb 78], pronounced 'effsubber,' for 'funny-SUBR'). Collectively they will be called F/SUBRs, although that term is not meaningful to the interpreter. See Appendix 2, Predefined Subroutines, in *The MDL Programming Language* [Galley 79] manual for a listing of all F/SUBRs and short descriptions. The term "Subroutine" will be used herein to mean both F/SUBRs and compiled user functions.

Unless otherwise stated, every MDL built-in Subroutine mentioned is of TYPE SUBR. Also, when it is stated that an argument of a SUBR must be of a particular TYPE, note that this means that EVAL of the argument must be of the particular TYPE.

Another convenient abbreviation which will be used is "the SUBR *pname*" in place of "the SUBR which is initially the GVAL of the ATOM of PNAME *pname*". "The FSUBR *pname*" will be used with a similar meaning. These distinctions are necessary. The SUBR is actually the global value of the ATOM of PNAME *pname*. The important point is that the ATOM effectively points at the "real function." For instance,

```
<GVAL SET>$  
#SUBR *000000746516*
```

If you were so inclined, you could change the **ATOM** which points to a given **FUNCTION** or have many **ATOMs** point to the same **FUNCTION**. All built-in **SUBRs** and **FSUBRs** shall be referred to in this book by the **ATOM** which points to them when **MDL** starts up. The point is that there is nothing sacred about these names, but for clarity's sake it is recommended that you not rename them.

5.3. Examples (+ and FIX; Arithmetic)

```
<+ 2 4 6>$
12
```

The **SUBR +** adds numbers. Most of the usual arithmetic functions are **MDL SUBRs**: **+**, **-**, *****, **/**, **MIN**, **MAX**, **MOD**, **SIN**, **COS**, **ATAN**, **SQRT**, **LOG**, **EXP**, **ABS**. (See Appendix 2 of *The MDL Programming Language* [Galley 79] manual for short descriptions of these.) All except **MOD**, which wants **FIXes**, are indifferent as to whether their arguments are **FLOAT** or **FIX** or a mixture. In the last case, they exhibit "contagious **FLOATing**": one argument of **TYPE FLOAT** forces the result to be of **TYPE FLOAT**.

```
<FIX 1.0>$ 1
```

The **SUBR FIX** explicitly returns a **FIXed**-point number corresponding to a **FLOATing**-point number (it truncates). The **SUBR FLOAT** returns the **FLOATing** point number equivalent to its argument.

```
<+ 5 <* 2 3>>$
11
<SQRT <+ <* 3 3> <* 4 4>>>$
5.0
<- 5 3 2>$
0
<- 5>$
-5
<MIN 1 2.0>$
1.0
</ 11 7 2.0>$
0.5
```

Note this last result: the division of two **FIXes** gives a **FIX** with truncation, not rounding, of the remainder; the intermediate result remains a **FIX** until a **FLOAT** argument is encountered.

5.4. Arithmetic: Details

+, **-**, *****, **/**, **MIN**, and **MAX** all take any number of arguments, doing the operation with the first argument and the second, then with that result and the third argument, etc. If called with no arguments, each returns the identity for its operation (0, 0, 1, 1, the greatest **FLOAT**, and the least **FLOAT**, respectively); if called with one argument, each acts as if the identity and the argument had been supplied. They all will cause an overflow or underflow error if any result, intermediate or final, is too large or too small for the machine's capacity. Examples:

```

<+>$      </>$      </ 3.0>$      <- 2>$
0          1          0.33333333      -2
    
```

One arithmetic function that always requires some discussion is the pseudo-random-number generator. MDL's is named **RANDOM**, and it always returns a **FIX**, uniformly distributed over the whole range of **FIX**s. Example ("pick a number from one to ten"):

```

<+ 1 <MOD <RANDOM> 10>>$
4
    
```

5.5. Simple Predicates

The best analogy for a predicate in MDL (or LISP) is the predicate of an English-language question such as "Is John taller than Jim?" MDL answers such a question with true or false. If there is no other useful information to return, MDL will return **T** for true (à la LISP) or **#FALSE** () for false.

The MDL predicate **0?** takes one argument which can be either a **FIX** or a **FLOAT**. It evaluates to **T** only if its argument is exactly equal to 0 or 0.0.

```

<0? 1.2>$
#FALSE ( )
    
```

The predicate **1?** evaluates to **T** only if its argument is exactly equal to 1 or 1.0. The predicate **G?** takes two arguments, which again can be either **FIX**s or **FLOAT**s. It evaluates to **T** only if the first argument is algebraically greater than the second. **L=?** is the Boolean complement of **G?**; that is, it is **T** only if the first argument is not algebraically greater than the second.

```

<L=? 3 4>$
T
    
```

Similarly, **L?** evaluates to **T** only if its first argument is algebraically less than its second argument. **G=?** is the Boolean complement of **L?**.

==? takes two arguments of any **TYPE**. In the case of arguments which are **FIX**s or **FLOAT**s, it

returns T for two FIXes of the same value or for two FLOATs of exactly the same value. A FIX can never be ==? to a FLOAT.

```
<==? 17 17>$
T
<==? 1.0 1>$
#FALSE ()
```

To compare a FIX to an equivalent FLOAT, the SUBRs FIX or FLOAT are used:

```
<SET A 17>$
17
<SET B 17.0>$
17.0
<==? .A <FIX .B>>$
T
<==? <FLOAT .A> .B>$
T
```

N==? is the Boolean complement of ==?.

GASSIGNED? checks whether an ATOM has been assigned a global value.

```
<GASSIGNED? GAFWEEP>$
#FALSE ()
<SETG GAFWEEP 4023>$
4023
<GASSIGNED? GAFWEEP>$
T
```

ASSIGNED? is the corresponding predicate which checks whether an ATOM has been assigned a local value.

If you wish to compare the LVALs of two ATOMs, A and B, where the LVAL of A is known to be a FIX and the LVAL of B is known to be a FLOAT, use the SUBRs FIX or FLOAT:

```
<==? <FLOAT .A> .B>$
```

or

```
<==? .A <FIX .B>>$
```

6. Simple Functions

6.1. General

The MDL equivalent of a "program" (uncompiled) is an object of TYPE FUNCTION. Actually, full-blown "programs" are usually composed of sets of FUNCTIONS, with most FUNCTIONS in the set acting as "subprograms".

A FUNCTION may be considered to be a SUBR or FSUBR which you yourself define. It is "run" by using a FORM to apply it to arguments (for example, `<function arg-1 arg-2 ... >`), and it always "returns" a single object, which becomes the value of the FORM that applied it. The single object may be ignored by whatever "ran" the FUNCTION (equivalent to "returning no value"), or it may be a structured object containing many objects (equivalent to "returning many values"). MDL is an "applicative" language, in contrast to "imperative" languages such as Fortran. In MDL, it is impossible to return values through arguments in the normal case (i.e. "call by name"); they are returned normally as the value of the FORM itself, or as side effects to structured objects or global values.

In this chapter a simple subset of the FUNCTIONS you can write is presented, namely FUNCTIONS which "act like" SUBRs with a fixed number of arguments. While this class corresponds to about 90% of the FUNCTIONS ever written, you won't be able to do very much with them until you read further and learn more about MDL's control and manipulatory machinery. However, all that machinery is just a bunch of SUBRs and FSUBRs, and you already know how to "use" them; you just need to be told what they do. Once you have FUNCTIONS under your belt, you can immediately make use of everything presented from this point on in this document. In fact, we recommend that you do so.

6.2. Defining FUNCTIONS

```
<DEFINE SQUARE (X) <* .X .X>>$
SQUARE
```

DEFINE is a MDL FSUBR (remember that FSUBRs have none of their arguments EVALed) for defining your own FUNCTIONS. It takes an ATOM as the "name" for the FUNCTION, a list of arguments, and the FORMs which make up the body of the FUNCTION. DEFINE SETGs EVAL of its first argument (the ATOM) to an object of TYPE FUNCTION made from the other arguments and returns EVAL of the

first argument (the ATOM "naming" the FUNCTION).

If EVAL of DEFINE's first argument already has a GVAL, DEFINE produces an error. This helps to keep you from accidentally redefining things -- such as MDL SUBRs and FSUBRs (if you want to be able to redefine without getting this error, type <SET REDEFINE T>. The ATOM SQUARE has been SETGed to the FUNCTION which computes the square of a number. To use SQUARE, apply it to an argument in a FORM:

```
<SQUARE 5>$
25
<SQUARE 1.5>$
2.25
```

Using SQUARE with the wrong type of argument (anything other than a FIX or FLOAT) will produce an error. Using SQUARE with the wrong number of arguments (anything other than one) will also produce an error.

Taking the GVAL of SQUARE will show you what a FUNCTION looks like:

```
,SQUARE$
#FUNCTION ((X) <* .X .X>)
```

What DEFINE did was to SETG SQUARE to #FUNCTION ((X) <* .X .X>). You could define a FUNCTION the same way, if you wished, or you could apply the FUNCTION directly:

```
<#FUNCTION ((X) <* .X .X>) 5>$
25
<#FUNCTION ((X) <* .X .X>) 1.5>$
2.25
```

Obviously, this would become quite tedious.

6.3. Application of FUNCTIONS: Binding

In order to make clear exactly what is happening in each of the examples in this section, FUNCTIONS will be applied in the tedious, non-standard method just shown.

FUNCTIONs, like SUBRs and FSUBRs, are applied using FORMs. So,

```
<#FUNCTION ((X) <* .X .X>) 5>$
25
```

applied the indicated FUNCTION to 5 and returned 25.

What EVAL does when applying a FUNCTION is the following:

1. Create a "world" in which the ATOMs of the argument LIST have been SET to the values to which the FUNCTION was applied, and all other ATOMs have their original values. This is called "binding". (In the above, this is a "world" in which X is SET to 5.)
2. In that new "world", evaluate all the objects in the body of the FUNCTION, one after the other, from first to last. (In the above, this means evaluate <* .X .X> in a "world" where X is SET to 5.)
3. Throw away the "world" created, and restore the LVALs of all ATOMs bound in this application of the FUNCTION to their originals (if any). This is called "unbinding". (In the above, this simply gives X back the local value, if any, that it had before binding.)
4. Return as a value the last value obtained when the FUNCTION's body was evaluated in step (2). (In the above, this means return 25 as the value.)

The fact that such "worlds" are separate from the FUNCTIONs which cause their generation means that all MDL FUNCTIONs can be used recursively. (For those of you who understand the term, MDL is "dynamically scoped.")

The only thing that is at all troublesome in this sequence is the effect of creating these new "worlds", in particular, the fact that the previous world is restored. This means that if, inside a FUNCTION, you SET one of its argument ATOMs to something, that new LVAL will not be remembered when EVAL leaves the FUNCTION. However, if you SET an ATOM which is not in the argument LIST (or SETG any ATOM) the new local (or global) value will be remembered. Examples:

```
<SET X 0>$
0
<#FUNCTION ((X) <SET X <* .X .X>>) 5>$
25
.X$
0
```

On the other hand,

```
<SET Z 0>$
0
<#FUNCTION ((X) <SET Z <* .X .X>>) 5>$
25
.Z$
25
```

By using PRINT as a SUBR, we can "see" that an argument's LVAL really is changed while EVALuating the body of a FUNCTION:

```
<SET X 5>$
5
<#FUNCTION ((X) <PRINT .X> <+ .X 10>) 3>$

3 13
.X$
5
```

The first number after the application FORM was typed out by the PRINT; the second is the value of the application.

Remembering that LVALs of ATOMs not in argument LISTS are not changed, we can reference them within FUNCTIONS, as in

```
<SET Z 100>$
100
<#FUNCTION ((Y) </ .Z .Y>) 5>$
20
```

ATOMs used like Z in the above examples are referred to as "free variables". The use of free variables, while often quite convenient, is rather dangerous unless you know exactly how a FUNCTION will always be used: if a FUNCTION containing free variables is used within a FUNCTION within a FUNCTION within . . ., one of those FUNCTIONS might just happen to use your free variable in its argument LIST, binding it to some unknown value and possibly causing your use of it to be erroneous. Please note that "dangerous", as used above, really means that it may be effectively impossible (1) for other people to use your FUNCTIONS, and (2) for you to use your FUNCTIONS a month (two weeks?) later.

6.4. DEFINEing Some Simple FUNCTIONS

Using SQUARE as defined above, let's DEFINE a FUNCTION to compute the length of the hypotenuse of a right triangle given the lengths of the two sides:

```
<DEFINE HYPOT (SIDE-1 SIDE-2)
  <SQRT <+ <SQUARE .SIDE-1> <SQUARE .SIDE-2>>>>$
HYPOT
<HYPOT 3 4>$
5.0
```

SQRT is the SUBR which returns the square root of its argument. It always returns a FLOAT.

A whimsical FUNCTION:

```

<DEFINE ONE (THETA)
  <+ <SQUARE <SIN .THETA>>
    <SQUARE <COS .THETA>>>>$

ONE
<ONE 6>$
0.99999994
<ONE 0.23>$
0.99999999

```

ONE always returns (approximately) one, since the sum of the squares of $\sin(x)$ and $\cos(x)$ is unity for any x . (SIN and COS always return FLOATs, and each takes its argument in radians. ATAN (arctangent) returns its value in radians. Any other trigonometric function can be composed from these three.)

MDL doesn't have a general "to the power" SUBR, so let's define one using LOG and EXP (log base e , and e to a power, respectively; again, they return FLOATs).

```

<DEFINE ** (NUM PWR)
  <EXP <* .PWR <LOG .NUM>>>>$

**
<** 2 2>$
4.0000001
<** 5 3>$
125.00000
<** 25 0.5>$
5.0000001

```

Two FUNCTIONs which use a single global variable (Since the GVAL is used, it cannot be rebound.):

```

<DEFINE START ()
    <SETG GV 0>>$
START
<DEFINE STEP ()
    <SETG GV <+ ,GV 1>>>$
STEP
<START>$
0
<STEP>$
1
<STEP>$
2
<STEP>$
3

```

START and STEP take no arguments, so their argument LISTS are empty.

An interesting, but pathological, FUNCTION:

```

<DEFINE INC (ATM)
    <SET .ATM <+ ..ATM 1>>>$
INC
<SET A 0>$
0
<INC A>$
1
<INC A>$
2
.A$
2

```

INC takes an ATOM as an argument, and SETs that ATOM to its current LVAL plus 1. Note that inside INC, the ATOM ATM is SET to the ATOM which is its argument; thus . .ATM returns the LVAL of the argument. However, there is a problem:

```

<SET ATM 0>$
0
<INC ATM>$

*ERROR*
ARG-WRONG-TYPE
+
LISTENING-AT-LEVEL 2 PROCESS 1

```

The error occurred because .ATM was ATM, the argument to INC, and thus . .ATM was ATM also. We

really want the outermost . in . . ATM to be done in the "world" (ENVIRONMENT) which existed just before INC was entered -- and this definition of INC does both applications of LVAL in its own "world".

6.5. Pretty-Printing

In MDL, carriage-returns, linefeeds, tabs, etc., are just separators, like spaces. At least one space is needed between MDL objects, but there is no maximum number.

```
< **      3
                                     4 > $
81
```

Using only one space at all times results in code which is effectively unreadable. This is even demonstrable with tiny FUNCTIONS similar to the ones created in this chapter. For example:

```
< DEFINE ZERO (THETA)
      <- <+ < SQUARE < SIN .THETA >>
          < SQUARE < COS .THETA >>>
          <+ < SQUARE < SIN .THETA >>
              < SQUARE < COS .THETA >>>>> $
ZERO
```

Typing , ZERO \$ to MDL will cause it to return:

```
#FUNCTION ((THETA) <- <+ < SQUARE < SIN .THETA >> < SQUARE < COS
.THETA >>> <+ < SQUARE < SIN .THETA >> < SQUARE < COS .THETA >>>>>)
```

Long FUNCTIONS printed like this would be very difficult to read. MDL has a "pretty-printer" (for full details see *The MDL Programming Environment* [Lebling 80]), called PPRINT which prints functions with spacing similar to the examples in this chapter.

```
< PPRINT ZERO > $
< DEFINE ZERO (THETA)
      <- <+ < SQUARE < SIN .THETA >> < SQUARE < COS .THETA >>>
          <+ < SQUARE < SIN .THETA >> < SQUARE < COS .THETA >>>>>
```

The general idea behind MDL pretty printing is: if all the arguments to a *function* fit on one line they are printed on one line, if not, arguments are printed on successive lines indented by the same amount. This allows you to see the level of "nesting" at a glance, and makes it easier to see what is happening.

6.5.1. Editors and Pretty Printing

A good display editor (such as RMODE [Lebling 77] or EMACS [Stallman 79]) will have built-in commands which assist you in formatting your programs in pretty-print style. It is strongly recommended that you get in the habit of using these tools from the beginning. Your code will be more easily understood by others and, more importantly, by you several months after you write it. Bracket balancing also becomes much easier and errors with brackets become quite rare.

6.6. Loading a File

If you have a MDL program in a file, you can "load" it by typing

```
<FLOAD file>$
```

where *file* is the name of the file, in standard operating-system syntax, enclosed in "s (double-quotes). In the Tenex and Tops-20 versions, if the file name extension is .MUD, the extension can be omitted. For instance, to load the file ZERO.MUD you could type one of the following:

```
<FLOAD "ZERO">$    <FLOAD "ZERO.MUD">$
```

Once you type \$, MDL will process the text in the file (including FLOADs of yet other files) exactly as if you had typed it on a terminal and followed it with \$, except that "values" produced by the computations are not printed. When MDL is finished processing the file, it will print "DONE".

If there is more than one generation of the file ZERO.MUD, MDL will load the highest one unless a generation number is specifically included in the argument to FLOAD (e.g. <FLOAD "ZERO.MUD.69106">).

When MDL starts running, it will FLOAD the file "MUDDLE.INIT" (Tenex and Tops-20 versions), if it exists. This allows you to have your working file or any other files you wish loaded into your MDL when you begin a session. It also allows you to "customize" your MDL by setting certain flags, redefining FUNCTIONS, etc.

7. MDL TYPES

In Chapter 2, we provided an introduction to the MDL TYPE system. This chapter will expand on that introduction and explain the creation of user-definable MDL TYPES.

7.1. TYPES and PRIMTYPES

In Chapter 2 it was stated that every MDL object has a TYPE. The SUBR TYPE, given a MDL object, returns an ATOM which is the name of the object's TYPE.

```
<TYPE 12>$  
FIX  
<TYPE (1 2 3)>$  
LIST
```

In MDL, each TYPE can be thought of as a member of a smaller number of more 'primitive' TYPES. In MDL, these 'primitive' TYPES are known as PRIMTYPES. Just as every MDL object has a TYPE, so every MDL object has a PRIMTYPE. A SUBR called PRIMTYPE, given a MDL object, returns an ATOM which is the name of the object's PRIMTYPE.

We have already seen examples of a number of MDL PRIMTYPES without ever mentioning the notion of PRIMTYPE. Here are the most important PRIMTYPES in MDL.

- WORD - the PRIMTYPE of all FIXes, FLOATs, and CHARACTERs. Any MDL object which can be thought of as a number will be of PRIMTYPE WORD (CHARACTERs are internally stored as their ASCII values).
- ATOM - the PRIMTYPE of ATOMs.
- LIST - the PRIMTYPE of LISTs, FORMs, and FALSEs.
- VECTOR - the PRIMTYPE of VECTORs.
- STRING - the PRIMTYPE of STRINGs.

7.2. Introduction to MDL Structures

As we saw in Chapter 2, MDL objects may be either *structured* or not. A *Structure* can be thought of as an ordered series of MDL objects. MDL has a number of different 'classes' of *structures*, each with different properties. These 'classes' are the *structured* PRIMTYPEs: LIST, VECTOR, and STRING. In Chapter 2, it was also noted that matching brackets are used to represent these *structured* objects. Each of the *structured* PRIMTYPEs has its own unique bracket type by which it can be identified. The brackets used for the *structured* PRIMTYPEs are as follows:

- LIST - matching parentheses
- VECTOR - matching square brackets
- STRING - paired double quotes

```

<SET A (1 2 3)>>$
(1 2 3)
<TYPE .A>$
LIST
<TYPE <TYPE .A>>$
ATOM
<PRIMTYPE .A>$
LIST
<SET B <+ 1 2>>$
3                               ;"Oops!"
<SET B '<+ 1 2>>$
<+ 1 2>                          ;"That's better!"
<TYPE .B>$
FORM
<PRIMTYPE .B>$
LIST

```

In the example, notice that the FORM `<+ 1 2>` will get evaluated in the call to SET. In order to SET B to the FORM instead of the result of its evaluation, a single-quote is placed before the FORM. The single-quote tells MDL *not* to evaluate the following object.

7.3. The TYPE? Predicate

The SUBR TYPE? can be used to check the TYPE of a given object against a particular set of TYPE names. TYPE? takes a MDL object and any number of ATOMs, which must each be the name of a MDL TYPE. If the object is not one of those TYPE names given, TYPE? returns #FALSE (). Otherwise, it returns the TYPE of the object.

```

<TYPE? 10 ATOM VECTOR>$
#FALSE ()
<TYPE? 10 FIX FLOAT ATOM>$
FIX

```

7.4. Printing of MDL Objects

In general, the printing of a MDL object is dependent on the PRIMTYPE of that object. MDL objects will usually be printed as follows:

```
#type-name object-as-if-PRIMTYPE
```

Usually, if the TYPE of the object and the PRIMTYPE of the object *are not* the same, the number-sign and *type-name* are printed. There are a few exceptions to this: the TYPEs FIX, FLOAT, CHARACTER, and FORM all print in a more simplified manner because of their common use.

We have already seen an example of this 'number-sign notation' with the TYPE FALSE. You may have noticed that it prints as a number-sign, the ATOM FALSE, and an 'empty' LIST. The meaning of this is that FALSEs are of PRIMTYPE LIST: the #FALSE must be used in both input and output to distinguish the object from objects of TYPE LIST. In general, you can tell the PRIMTYPE of an unknown type in 'number-sign notation' by looking at the part *after* the *type-name*. If it has square-brackets, it's a PRIMTYPE VECTOR. Parentheses, it's a PRIMTYPE LIST. Etc.

```

<PRIMTYPE #TABLE [1 2 3]>$
VECTOR
<PRIMTYPE #TEXT "ABCDE">$
STRING
<PRIMTYPE #NUMBER 10>
WORD

```

Note that the TYPEs TABLE, TEXT, and NUMBER are not defined in MDL; a user might have created them, however (see later), and their PRIMTYPEs are obvious from the part *after* the *type-name*.

7.5. Significance of PRIMTYPEs / CHTYPE

The notion of PRIMTYPE is very important. The PRIMTYPE of an object tells MDL what the object looks like *internally to MDL*. As far as MDL is concerned, any two objects of the same PRIMTYPE are more or less interchangeable (e.g. most SUBRs which can be used on LISTS can also be used on FALSEs.)

This notion of interchangeability is a very powerful one. In fact, MDL allows you to arbitrarily change the TYPE of virtually *any* MDL object to another TYPE, as long as objects of that other TYPE have the same PRIMTYPE as the original. The SUBR which 'changes' TYPES is called CHTYPE (pronounced 'chitype'). It takes a MDL object and the name of a TYPE (ATOM), and returns the MDL object 'changed' to that TYPE.

```
<CHTYPE (+ 1 2) FORM>$
<+ 1 2>
<CHTYPE (A B C) FALSE>$
#FALSE (A B C)
<CHTYPE 2.5 LIST>$

*ERROR*
STORAGE-TYPES-DIFFER
CHTYPE
LISTENING-AT-LEVEL 2 PROCESS 1
```

Often one would like to know what the PRIMTYPE of an object of a certain TYPE would be. This can be found out by using the SUBR TYPEPRIM: given a name of a TYPE, it returns the name of the PRIMTYPE of objects of that TYPE.

```
<TYPEPRIM FALSE>$
LIST
<TYPEPRIM FLOAT>$
WORD
```

To restate the conditions for a successful CHTYPE in terms of TYPEPRIM: the PRIMTYPE of the first argument must be the same as the TYPEPRIM of the second. Isn't that much clearer?

7.6. Creating new TYPES

Given the interchangeability among objects with the same PRIMTYPE, it should not be surprising that MDL will allow you to create any arbitrary new TYPE, so long as you define it to have a known MDL PRIMTYPE. The SUBR which creates new TYPES is, not surprisingly, NEWTYPE. NEWTYPE takes an ATOM (the name for your new TYPE) and the name of the TYPEPRIM for that new TYPE (also an ATOM). It returns its first argument. NEWTYPES will defaultly print out (and can be read back) in 'number-sign notation'.

```
<NEWTYPE TABLE VECTOR>$  
TABLE  
<SET X #TABLE [JOE 1 JOHN 2]>$  
#TABLE [JOE 1 JOHN 2]  
<CHTYPE .X VECTOR>$  
[JOE 1 JOHN 2]
```

There are only two ways to create an object of a user-defined TYPE: type the object in directly (as was done in the previous example) or to use the SUBR CHTYPE explicitly.

```
<CHTYPE [JIM 2 JANE 4] TABLE>$  
#TABLE [JIM 2 JANE 4]
```

8. MDL Structures

As we saw in Chapter 2, MDL objects may be either *structured* or not. It was stated that structures can be thought of as ordered series of MDL objects and that different classes of structures existed. In this chapter we will describe the common structures used in MDL.

8.1. Equality

It is necessary here to mention the notion of equality. In MDL, there are two types of equal: double-equal and single-equal. The SUBRs which represent these concepts are ==? and =?, respectively. Simply stated, two MDL objects which are the same thing are double-equal. Two objects which *look* the same, i.e. are printed the same way, are single-equal. This confusing distinction is unimportant for objects which aren't *structured*. Two *non-structured* objects which print the same *are* the same. For example, there is one and only one MDL object representing the FIX 19. However, one can easily build two *structures* at two different times which *look* the same, but which are not the same. This will be explained below in the discussion about LISTS. As an example of the use of =?, assume that you have written a program which takes some input from the user and wants to see if he typed the word FOO. Let's assume an input routine called INPUT which returns a STRING.

```
<SET STR <INPUT>>$
"FOO"
<==? .STR "FOO">$
#FALSE ()
<=? .STR "FOO">$
T
```

This is because the two STRINGS were not identical; they look the same, however, and therefore are =?. Figure 8-1 purports to demonstrate the distinction between types of equality.

8.2. PRIMTYPE LIST

MDL objects of PRIMTYPE LIST may be thought of as an ordered series of MDL objects, whose connective link is a 'pointer'. This means that in order to find the Nth element of a LIST one must look at each of the previous N-1 elements. This is shown in Figure 8-2. This becomes rather tedious

The representation of a MDL object is:

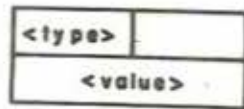

where <type> is the TYPE of the object and <value> is a pointer for *structured* types, or a number.

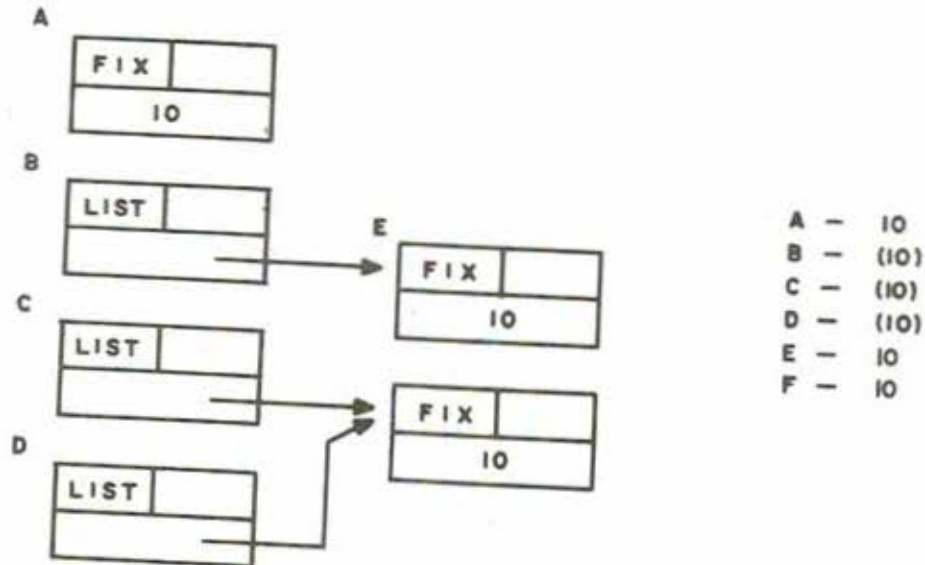

Definition: Two MDL objects are ==? if and only if the <type> and <value> parts are the same. They are =? if they look the same.

Question: Are any of B, C, or D ==? to each other?

Answer: C and D. They have the same TYPE and point to the same structure. B and C are =?, as are B and D - they look alike, but are not identical.

Question: Are any of A, E, or F ==? to each other?

Answer: They are all ==? to each other.

Figure 8-1: The MDL notion of equality is demonstrated in this figure, which shows the distinction between single-equal =? and double-equal ==?.

when one is interested in finding the 245th element of a LIST. You can see that large LISTS have the property of being rather inefficient to 'random-access'. On the other hand, LISTS can easily be modified (adding elements, removing elements, etc) simply by changing the linking 'pointers'. In Figure 8-3 you can see pictorially how an element of a LIST might be removed. Notice that the removed element still 'exists', but that the LIST is no longer 'pointing' at it.

Two SUBRs which should be mentioned here are LENGTH and EMPTY?: the first, given a LIST, returns the number of elements in that LIST (as a FIX), and the second, given a LIST, returns the ATOM T or #FALSE (), i.e. whether the LIST had no elements.

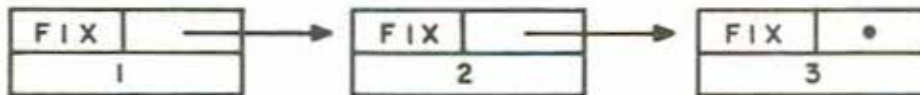
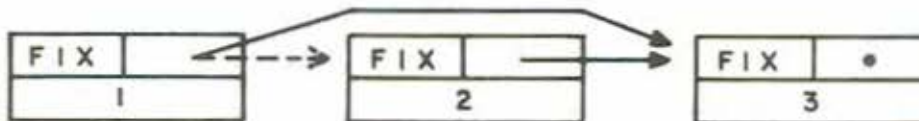

Figure 8-2: The LIST (1 2 3)



This LIST is now (1 3).

Figure 8-3: Removing a LIST element by moving only one pointer

8.2.1. Creating LISTS

Creating a LIST is very simple. Simply type in the printed representation of it, which (as described before) is a series of MDL objects surrounded by parentheses.

```

<SET A (1 TWO 3.0)>$
(1 TWO 3.0)
<SET B (A .A C)>$
(A (1 TWO 3.0) C)

```

Using this method, every MDL object placed between the matching parentheses is EVALed. Thus, the LVAL of A was placed in the LIST.

```

<SET B (X Y Z)>$
(X Y Z)
<LENGTH .B>$
3
<EMPTY? .B>$
#FALSE ()
<DEFINE EMPTY? (LIST) <=? <LENGTH .LIST> 0>>$
EMPTY?

```

The end of the previous example gives a definition of EMPTY? in MDL, given only the SUBRs LENGTH and ==?.

A second way to create a LIST is with the SUBR LIST. This SUBR takes any number of arguments, which are EVALed, and makes a list with the evaluated arguments as elements. The effect is the same as in the first method.

```

<SET A <LIST 1 TWO 3.0>>$
(1 TWO 3.0)

```

In both methods, a *new* LIST is created.

```

<SET A (1 2 3)>$
(1 2 3)
<SET B (1 2 3)>$
(1 2 3)
<=? .A .B>$
#FALSE ()
<=? .A .B>$
T

```

The two lists A and B are not double-equal because the construction of LISTS is guaranteed to generate a *new* LIST. They are single-equal by the definition of single-equal.

8.2.2. EVALing LISTS

LISTs, when EVALed, make a *new* copy of the LIST with all of the elements re-EVALed.

```
<SET A (1 2 3)>$
(1 2 3)
<=? <EVAL .A> .A>$
#FALSE ()
```

8.2.3. Manipulating LISTS

In order to discuss LISTs more fully, we need to know a few ways to manipulate them. We will introduce two SUBRs here, NTH (pronounced 'enth') and REST. The SUBR NTH, given a LIST and a FIX, will return the FIXth element of the LIST. REST, given a LIST and a FIX, will return the LIST, with the first FIX elements at the beginning removed. The second argument to both NTH and REST has a default value of 1. Some examples:

```
<SET L (A B C D)>$
(A B C D)
<NTH .L 3>$
C
<NTH .L 2>$
B
<SET LL <REST .L 2>>$
(C D)
<REST .L 4>$
()
.L$
(A B C D)
```

Notice that REST has no side-effects. In other words, it simply returns a pointer farther down the 'chain' of elements in the LIST without changing anything. This is illustrated in Figure 8-4. Another important operation on LISTs is called PUT. As its name suggests, PUT puts an element into a LIST. Given a LIST, an element number (FIX, as in NTH), and an arbitrary object, PUT makes the FIXth element of LIST become that object, and returns the LIST. Let's continue from the example given in Figure 8-4 with L and LL already defined.

```
<PUT .LL 1 HAHA>$
(HAHA D)
.L$
(A B HAHA D)
```

What happened here is shown in Figure 8-5. Since LL was a 'subset' of L, any change in LL was reflected in L (the opposite would also be true, i.e. a PUT into the third or fourth elements of L would

```
<SET L (A B C D)>>$
(A B C D)
```



```
<SET LL <REST .L 2>>$
(C D)
```



Notice that the LIST (C D) is a subset of the LIST (A B C D) because of the way REST works.

Figure 8-4: REST of a LIST

be reflected in LL.)

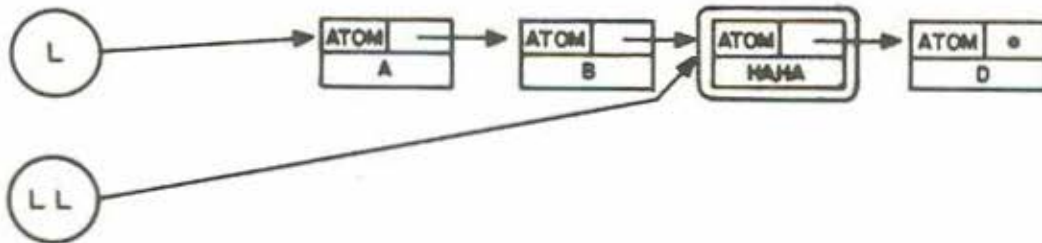

The only effect is that the contents of the third element was changed,

moved. from

| | |
|------|--|
| ATOM | |
| C | |

 to

| | |
|------|--|
| ATOM | |
| HAHA | |

. No pointers have

Figure 8-5: PUTs into LISTS

Let's continue:

```

<SET M .L>$
(A B HAHA D)
<SET L (1 2 3)>$
(1 2 3)
.M$
(A B HAHA D)
.LL$
(HAHA D)
<==? <REST .M 2> .LL>$
T

```

If you understand this, good. Otherwise, pay close attention to Figure 8-6, in which this example is diagrammed. It is of crucial importance that the distinction be learned between a *structure* and a *pointer* to a *structure*. Changing a *structure* (e.g. with PUT) will be reflected in any object which points to it. Changing the *pointer* to a *structure* doesn't affect any other pointers. If you don't understand this distinction, you will probably become more and more lost. Ask someone for help.

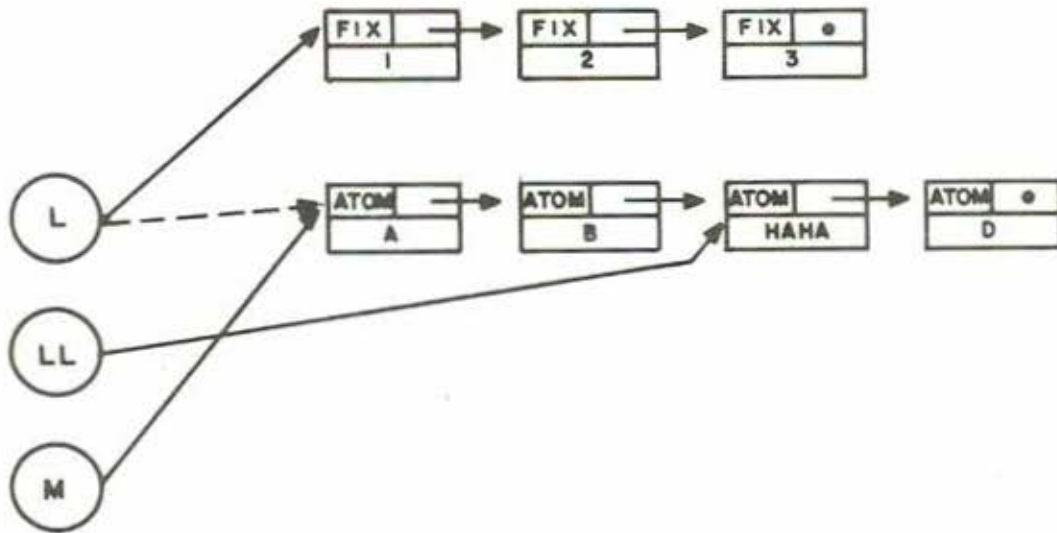

<SET M .L> made M point to where L pointed at that time.
 <SET L (1 2 3)> merely pointed L somewhere else.
 The values of M and LL are not affected, then, by reSETTING L.

Figure 8-6: Pointers vs. Structures

Now things get a little more complex. However, if you understood the previous examples, this should be no different. Earlier, we talked about 'moving' pointers to effect removal of objects from a LIST.

This movement can be accomplished in MDL using the SUBR PUTREST. PUTREST (equivalent to Lisp's replacd) is probably the most confusing SUBR to beginners, and even to accomplished MDLers. Its effect is very simple: given two LISTS, say A and B, it causes the REST of A to become B, and then returns A. This probably sounds very obscure. Before total confusion sets in, take a look at the example and then at Figure 8-7.

```
<SET A (1 2 3)>$
(1 2 3)
<SET B (4 5 6)>$
<PUTREST .A .B>$
(1 4 5 6)
.B$
(4 5 6)
```

All that has happened is that one pointer has been moved: the one connecting the first element of A to its succeeding element has been changed to a pointer to B. That's all. Notice that any object which points to the same place that A points has been changed. However, also notice that any object which points to the REST of A has *not* been changed.

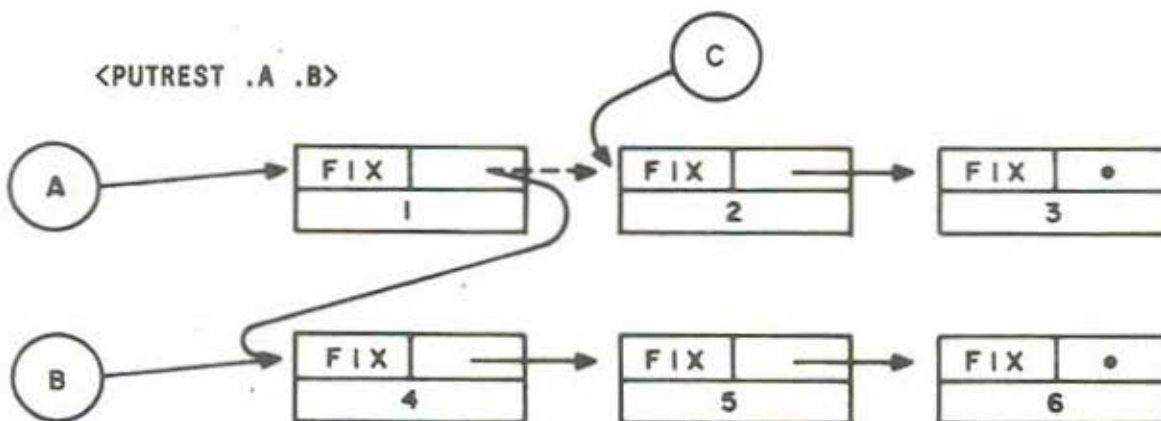

Only one pointer has been moved. A is changed, but B is not. Notice that a hypothetical C, previously SET to REST of A, is also not changed.

Figure 8-7: PUTREST

Using PUTREST, it is easy to remove elements from a LIST.

```

<SET A (1 2 3 4)>$
(1 2 3 4)
<PUTREST .A <REST .A 2>>$
(1 3 4)

```

What we have done is to make the first element of A (1 in the example) point to the value of A RESTed twice. This is demonstrated in Figure 8-8.

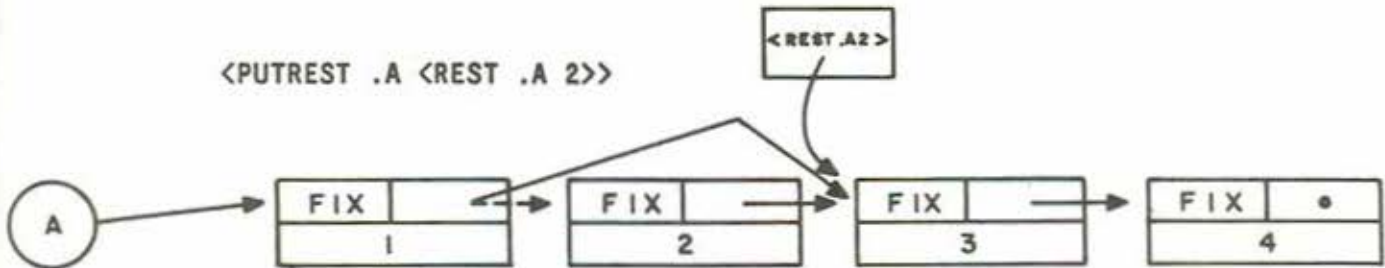

The REST of A has become A RESTed twice. The effect is to remove the FIX 2 from the LIST.

Figure 8-8: Removing an element from a LIST using PUTREST

Notice that you can *not* use this method to remove the first element of a LIST, since PUTREST only changes the pointer which connects the first element to the second element. However, one can always use REST for this purpose, but be careful:

```

<SET A (1 2 3 4)>$
(1 2 3 4)
<REST .A>$
(2 3 4)
.A$
(1 2 3 4)

```

As we noted earlier, REST has no side-effects, unlike PUTREST, which does. The right thing to do is

```

<SET A <REST .A>>$
(2 3 4)
.A$
(2 3 4)

```

One can cause a LIST to terminate at any point by giving PUTREST a second argument of an empty

LIST.

```

<SET A (1 2 3 4)>$
(1 2 3 4)
<PUTREST .A (>$
(1)

```

As advertised, the REST of A has been made the second argument to PUTREST, i.e. the empty LIST.

To combine LISTS, one can use PUTREST also. Try to think of how you would combine the LISTS in the following example. Think pointers.

```

<SET A (1 2 3)>$
(1 2 3)
<SET B (4 5 6)>$
(4 5 6)

```

The idea is to make the third element of A (the FIX 3) to point to the LIST B. In terms of PUTREST, we want B to become the REST of which LIST? The answer is

```

<PUTREST <REST .A 2> .B>$
(3 4 5 6)
.A$
(1 2 3 4 5 6)

```

PUTREST returned its first argument, which was A RESTed twice. A, however, was changed. Refer to figure 8-9 if confused.

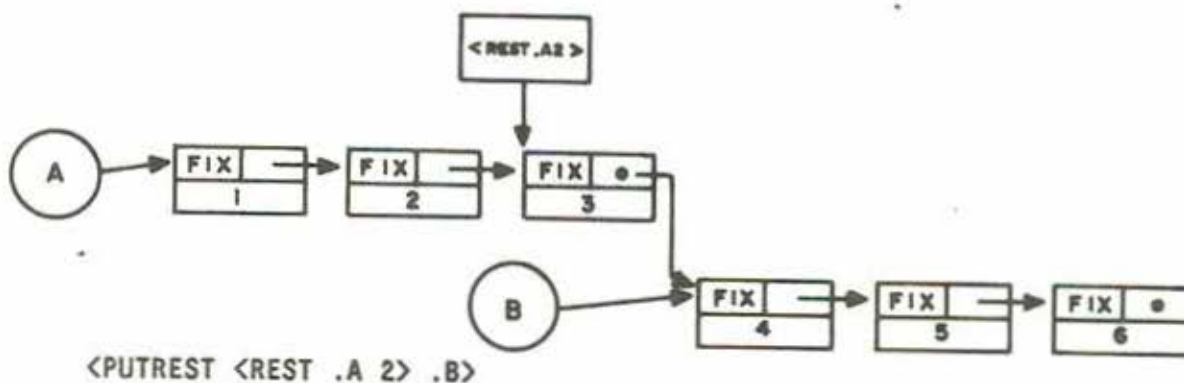

Figure 8-9: Splicing LISTS together using PUTREST

With your new-found expertise in PUTRESTing, you should take a moment and think about how you would build a LIST backwards. For example, you wish to append the FIX 7 to the LIST from the last example. What is the correct MDL expression? Hint: You have to create a LIST with the FIX 7 in it.

```
<PUTREST <REST .A 6> (7)>>$
(6 7)
.A$
(1 2 3 4 5 6 7)
```

Here are some problems to think about:

```
<SET L (1 2 3 4)>>$
(1 2 3 4)
<SET LL <REST .L 1>>>$
(2 3 4)
<SET LLL <REST .L 2>>>$
(3 4)
<PUTREST <REST .L> <REST .L 3>>>$
(2 4)
```

What are the LVALs of L, LL, and LLL now?

```
<SET WALTZ (2 3 1)>>$
(2 3 1)
<PUTREST <REST .WALTZ 2> .WALTZ>>$
```

If you try this, be ready to type +S. What has happened? What is the LENGTH of L now? Why shouldn't you try to find out? Why is this a waltz?

```
<SET ONES (1 2 3)>>$
(1 2 3)
<PUTREST .ONES .ONES>>$
```

What about this?

The last two examples demonstrate an important notion, that of circularity. There is absolutely no restriction on the creation of circular and self-referencing structures. However, you should be sure you know what you're doing. For example, finding the LENGTH of ONES or of WALTZ in the previous examples is quite time-consuming. The SUBR called LENGTH? can be of use here. Given a LIST and a FIX, LENGTH? will return the LENGTH of the LIST if it is less than or equal to FIX. Otherwise, it will return #FALSE (). This is useful if you suspect a LIST is self-referencing or to check on whether a LIST is at least a certain length. For example, prior to trying to get the 12th element of a LIST of uncertain size, one might check that

```
<LENGTH? .LIST 11>
```

returned #FALSE (), i.e. there are at least 12 elements in the LIST.

8.2.4. FIXes First in FORMs

If the first element of a FORM is a FIX or an ATOM whose GVAL is a FIX, this is considered to be a shorthand call to NTH or PUT, depending on whether it is given one or two arguments, respectively. Thus, the following two are EVALuated identically.

```
<11 .FOO>
<NTH .FOO 11>
```

So are these:

```
<11 .FOO .BAR>
<PUT .FOO 11 .BAR>
```

Here is an example of an ATOM being used first in a FORM with the same effect:

```
<SET L (FOO BAR BLETCH)>>$
(FOO BAR BLETCH)
<SETG FIRST 1>$
1
<SETG SECOND 2>$
2
<FIRST .L>$
FOO
<SECOND .L>$
BAR
<FIRST .L FROB>$
(FROB BAR BLETCH)
```

8.2.5. FORMs

As described earlier, FORMs are used to apply *functions* to arguments, and are printed with angle brackets. However, FORMs are simply another variety of PRINTYPE LIST and all of the operations which can be done on LISTs can be done on them. Since they are evaluated in a special way, creating a FORM by inputting elements between angle brackets will require a single-quote. This is not true if you are using the SUBR FORM.

```

<SET A <+ 1 2 3>>$
0
<SET A '<+ 1 2 3>>$
<+ 1 2 3>
<SET A <FORM + 1 2 3>>$
<+ 1 2 3>

```

A special note should be made of the empty **FORM**: it evaluates to an empty **FALSE**. This is simply a shorthand notation.

```

<>$
#FALSE ()

```

8.2.6. FALSEs

Previously, you have seen examples of MDL objects of **TYPE FALSE**. All of them thus far have been **EMPTY?**, although this is not always the case. MDL objects of **TYPE FALSE** are **PRIMTYPE LISTS** and, as has been stated before, can be used in the same ways as any other **PRIMTYPE LIST**. In particular, one can create **FALSEs** with any number of arbitrary elements. One use of this might be to distinguish between two types of failures in a *function*. Thus, the **FALSE** can have two types of meaning: its **TYPE** (which is **FALSE**) and its contents. One might simply want to detect failure by checking the **TYPE**, but one might additionally want to detect failure and also have other information about the failure available.

```

<SET VAL <OPEN "READ" "FOO.BAR">>$
#FALSE ("File not found" "FOO.BAR" 69105)
<1 .VAL>$
"File not found"

```

In this example, the **SUBR OPEN** was called in an attempt to open a file called **FOO.BAR**. The **OPEN** failed, and returned a **FALSE** which contained three pieces of information: the reason (a **STRING**), the file name (a **STRING**), and an internal error code (a **FIX**). One might have written a **FUNCTION** using **OPEN** which only cares if **OPEN** returns a **FALSE** or not. On the other hand, one might want to print out the reason for the failure to the **FUNCTION's** user. This would have been impossible had **FALSEs** not been able to carry additional information. As you will find when doing your own programming, this is a significant feature of MDL.

8.2.7. SEGMENTS

A **SEGMENT** is a **PRIMTYPE LIST**, which is handled very specially by MDL. **SEGMENTS** print as an exclamation point followed by a **FORM**. When **EVALed** inside an expression, its meaning is as follows: pretend that instead of using this **SEGMENT**, use instead all of the elements you get from **EVALing** the **FORM**. There is an important implication here: that the **FORM**, when **EVALed**, returns a *structure*. An

error will occur if this is not the case. Here are some examples:

```

<SET A (1 2 3)>$
(1 2 3)
<SET B (1.A 4 5 6)>$
(1 2 3 4 5 6) ;"This is a new list, not shared with A"
<SET C (1.A 1.B 7)>$
(1 2 3 1 2 3 4 5 6 7) ;"No sharing here, either"

<+ 1.A>$
6

<SET L (BAR 10)>$
(BAR 10)
<SET 1.L>$
10
.BAR$
10

```

This last example is quite pathological: note, however, that it is perfectly legitimate. The FORM was read by MDL as having two elements, the ATOM SET and a SEGMENT. When the FORM was EVALed, the SEGMENT acted as if it was really all of the elements of .L, i.e. the ATOM BAR and the FIX 10. This is simply the case of SETting BAR to 10.

One last very important note: There is one way to add elements to the beginning of a LIST without copying. This is the case in which a SEGMENT is the last element of a LIST and the SEGMENT's FORM EVALs to a LIST. In this case only, there is no copying and the structures will share. This is similar to CONS in LISP.

```

<SET L (FOO BAR BLETCH)>$
(FOO BAR BLETCH)
<SET LL (1 2 3 1.L)>$ ;"The last element is a SEGMENT which
                        evaluates to a LIST"

(1 2 3 FOO BAR BLETCH)
<PUT .LL 4 SHARED>$
(1 2 3 SHARED BAR BLETCH)
.L$
(SHARED BAR BLETCH)

```

LISTs are the most appropriate *structure* to use when elements are going to be added or removed. The special use of SEGMENTS shown in the last example is the best way of adding elements to the front of a LIST. However, the resulting LIST will be 'backward', in that the most recently added element will be at the 'front' rather than at the 'back' of the LIST. Later on, we will demonstrate the correct way to add elements to the end of a LIST. As an exercise, see if you can figure out a method for doing so using PUTREST.

Remember that the previous use of **SEGMENTS** is an exception: in the case of objects of **PRIMTYPE VECTOR** and **STRING** (next sections) the use of a **SEGMENT** will cause copying of the elements from the *structure* which is the **EVALUATION** of the **FORM**.

8.3. PRIMTYPE VECTOR

A MDL object of **PRIMTYPE VECTOR** can be thought of as a linear array of MDL objects. In a **VECTOR**, it is trivial to access the Nth element, as this simply requires finding the correct offset into the structure (see Figure 8-10). Similarly, it is trivial to replace the Nth element with something else. On the other hand, there is *no* way to add elements to a **VECTOR** without creating a new one, and removing elements can be simulated, although it is rather difficult. If your eyes skipped back to the section on **PRIMTYPE LIST**, you might notice that these properties of the two **PRIMTYPE**s are reversed. This, then, is the rationale for having different structure 'classes'. The programmer is free to choose the structure 'class' (i.e. **PRIMTYPE**) he wants, based on the way in which it is to be used in a program. For example, a structure which is always of known length should probably be a **VECTOR**, while one which must undergo changes in size should probably be a **LIST**.

Schematic representation of a **VECTOR**

[1 2 3 4]

| | |
|-----|---|
| FIX | |
| | 1 |
| FIX | |
| | 2 |
| FIX | |
| | 3 |
| FIX | |
| | 4 |

Figure 8-10: The **VECTOR** [1 2 3 4]

8.3.1. Creating **VECTORS**

Creating a **VECTOR** is completely analogous to creating a **LIST**. There are two options: you can type in the printed representation of a **VECTOR**, or you can use the **SUBR VECTOR**.

```

<SET A [1 2 3]>$
[1 2 3]
<SET B <VECTOR 1 2 3>>$
[1 2 3]
<=? .A .B>$
#FALSE ()
<=? .A .B>$
T

```

```

<SET C [.A 1.B]>$
[[1 2 3] 1 2 3] ;"C does not share with B!"

```

Both of these methods always create a *new* VECTOR. Therefore, two objects created in separate calls to VECTOR will never be ==?.

8.3.2. EVALing VECTORS

As with LISTS, EVAL of a VECTOR makes a *new* copy of the VECTOR, with all of the elements EVALed.

```

<SET A [<+ 1 2> '<+ 1 2>' '<+ 1 2>']>$
[3 <+ 1 2> '<+ 1 2>']
<SET A <EVAL .A>>$
[3 3 <+ 1 2>]
<EVAL .A>$
[3 3 3]

```

8.3.3. Manipulating VECTORS

The SUBRs NTH, REST, PUT, LENGTH, EMPTY?, and LENGTH? all work on VECTORS just as they do on LISTS.

```

<SET A [ONE TWO 3]>$
[ONE TWO 3]
<NTH .A 2>$
TWO

<PUT .A 3 THREE>$
[ONE TWO THREE]
.A$
[ONE TWO THREE]

```

```

<LENGTH .A>$
3
<REST .A 2>$
[THREE]
.A$
[ONE TWO THREE]

```

RESTing VECTORS is shown in Figure 8-11.

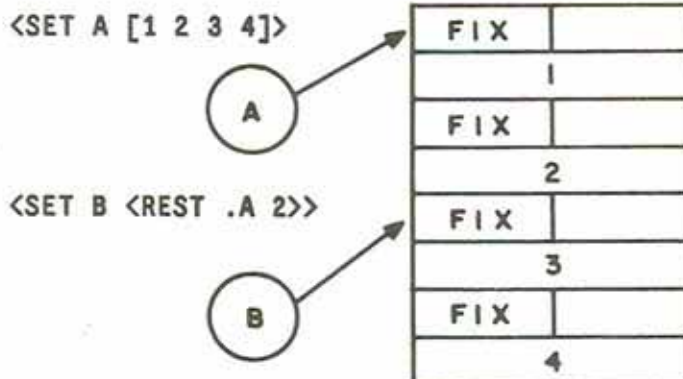

Figure 8-11: REST of a VECTOR

Since VECTORS are not pointer structures, the PUTREST operation will not work on them. However, there are a few operations which are possible with VECTORS which are not possible with LISTS due to their structure. The first of these is the inverse of REST: it is called BACK. Given a VECTOR and a FIX, it tries to replace elements to the front of the VECTOR which were previously RESTed off. Like REST, BACK has no side-effects. It simply returns a pointer to a different location in the VECTOR. An error will occur if you attempt to BACK more elements than have been RESTed. The SUBR TOP, however, given a VECTOR, will BACK as far as is legally possible.

```

<SET A [1 2 3 4]>$
[1 2 3 4]
<SET B <REST .A 2>>$
[3 4]
<PUT .B 1 HAHA>$
[HAHA 4]
.A$
[1 2 HAHA 4]           ;"B is a subset of A"

```



```

<BACK .B>$
[2 HAHA 4]
.B$
[HAHA 4]
<TOP .B>$
[1 2 HAHA 4]
<==? <TOP .B> .A>$
T

```

;"BACK has no side-effects"

BACKing of VECTORs is diagrammed in Figure 8-12.

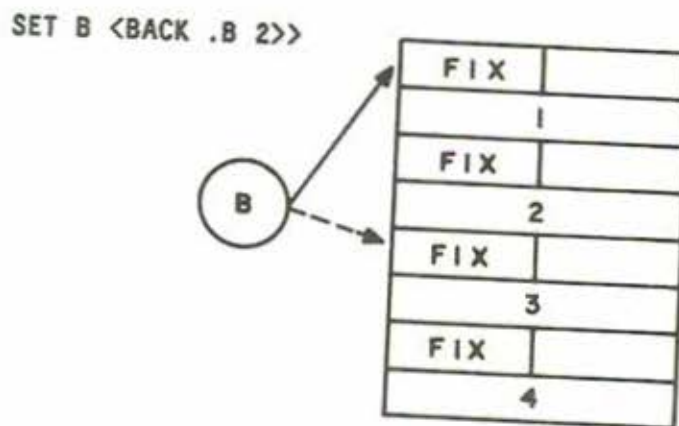

Figure 8-12: BACK of a VECTOR

8.3.4. UVECTORS

Although infrequently used, MDL has a PRIMITIVE called UVECTOR, for Uniform VECTOR. UVECTORS are identical to VECTORS in most ways *except* that every element of a UVECTOR must have the same TYPE. UVECTORS have a special input and output form: an exclamation point followed by paired square brackets. Here are some UVECTORS:

```

<SET A I[A B C]>$
I[A B C] ;"Don't worry about the other I before the ]"
<1 .A>$
A
<REST .A 2>$
I[C]

```

Analogously to a VECTOR, there are two ways to create a UVECTOR: type it in, or use the SUBR UVECTOR. When typing in a UVECTOR be careful that everything you type in is of the same TYPE, before EVALUATION, as well as after!

```

<SET X 10>$
10
<SET A I[20 .X]>$

*ERROR*
TYPES-DIFFER-IN-UNIFORM-VECTOR
READ
LISTENING-AT-LEVEL 2 PROCESS 1

```

This error occurred because .X is a FORM, *even though* it EVALs to a FIX. To do this properly,

```

<SET A <UVECTOR 20 .X>>$
I[20 10]

```

A SUBR called UTYPE returns the name of the TYPE of the elements of a given UVECTOR. There are a few TYPES which are illegal elements of UVECTORS: the only one you are likely to come across is STRING.

UVECTORS are useful only for efficiency. They take up roughly half the storage of VECTORS. All other considerations are the same as for VECTORS.

8.4. PRIMTYPE STRING

A MDL STRING is a sequence of MDL objects of TYPE CHARACTER. Objects of TYPE CHARACTER are represented by the sequence of characters: exclamation-point, backslash, and the character itself.

```

I\A$
I\A
<TYPE I\A>$
CHARACTER
<ASCII I\A>$
66
<ASCII 66>$
I\A

```

This example has also demonstrated the use of the `SUBR ASCII`, which given a `CHARACTER` returns its ASCII value, or given a `FIX` gives the `CHARACTER` with that ASCII value. A `STRING` is represented as a sequence of characters surrounded by double-quotes.

8.4.1. ASCII

ASCII, as used in MDL, is the name of a 7-bit code (i.e. 0000000 - 1111111 base two, corresponding to 0 - 127 in base ten) used to represent keyboard characters (upper and lower case, control characters, punctuation, etc.) as small integers.

8.4.2. Creating STRINGS

`STRING`s are created in exactly the same ways as the other structures.

```

<SET A "THIS IS A STRING">$
"THIS IS A STRING"
<SET A <STRING I\T I\H I\I I\S>>$
"THIS"

```

However, `STRING` is more powerful than this, as its arguments can be either `CHARACTERS` or other `STRING`s.

```

<SET A "THIS IS A">$
"THIS IS A"
<STRING .A " STRING">$
"THIS IS A STRING"
.A$
"THIS IS A"

```

As with `VECTORS`, all `STRING`s created this way are new, i.e. not shared. To put a double-quote inside a string, you must place a backslash before the double-quote. This can be confusing.

```

<SET A "\"\">$
"\"\"
<LENGTH .A>$
2

```

This **STRING** has two elements, each a double-quote. To put a backslash into a **STRING**, the backslash must be preceded by another backslash. This is even more confusing.

```

<SET A "\\\">$
"\\\"
<LENGTH .A>$
2

```

This is another **STRING** of two elements: a backslash and a double-quote.

8.4.3. EVALing STRINGS

STRINGs are unlike **LIST**s and **VECTOR**s in that they evaluate to themselves, rather than to copies of themselves.

8.4.4. Manipulating STRINGS

STRINGs are manipulated exactly as are **VECTOR**s. The **CHARACTER**s are stored sequentially; thus **PUTREST** will not work, but **BACK** and **TOP** will. The only difference is that the only legal third argument to **PUT** of a **STRING** is a **CHARACTER**. Anything else will cause an error.

It is important to note that **STRING**s contain only **CHARACTER**s. **CHARACTER**s with special meanings elsewhere in MDL are simply **CHARACTER**s in **STRING**s.

```

<SET A "1 2 3 <+ 2 2>">$
"1 2 3 <+ 2 2>"
<3 .A>$
2

```

The above example shows that the 'FORM' in the **STRING** is not **EVAL**ed, it is merely 7 **CHARACTER**s in a **STRING**. Spaces are **CHARACTER**s.

There is a major difference between the following two structures:

```

<SET L ("1 2 3" "4 5 6" "7 8 9")>$
("1 2 3" "4 5 6" "7 8 9")
<SET S "(1 2 3) (4 5 6) (7 8 9)">$
"(1 2 3) (4 5 6) (7 8 9)"
<LENGTH .L>$
3
<LENGTH .S>$
23

```

8.5. Building Large Structures

It is occasionally useful to create a large *structure*. It would be very painful to create, say, a **VECTOR** of 100 elements by calling the SUBR **VECTOR** with 100 arguments. MDL provides a way to create *structures* of a specific size, namely the SUBRs **ILIST**, **IVECTOR**, and **ISTRING**. These take two arguments, a **FIX** (the number of elements) and a MDL object. MDL will build a *structure* (**LIST**, **VECTOR**, or **STRING**, respectively) with **FIX** elements, each of which is the result of evaluating the second argument to the SUBR. Some examples:

```

<ILIST 10 0>$
(0 0 0 0 0 0 0 0 0 0)
<IVECTOR 5 <>>$
[#FALSE () #FALSE () #FALSE () #FALSE () #FALSE ()]
<ISTRING 30 !\W>$
"!!!!!!!!!!!!!!!!!!!!!!!!!!!!!!!!!!!!!!!!!!!!"

```

The second argument to **ILIST** and **IVECTOR** can be any MDL object. The second argument to **ISTRING** must be a **CHARACTER**.

8.6. Searching Structures

There are two SUBRs which, given an arbitrary MDL object and an arbitrary *structure*, will look through the *structure* for that object. They are called **MEMQ** and **MEMBER**. What they do is this: starting with the *structure*, they look at the first element and see if it is *equal* to the object in question. If so, they return the *structure*. Otherwise, they **REST** the structure by 1, and repeat the procedure. When the *structure* becomes **EMPTY?** (i.e. the object wasn't in the original *structure*), these SUBRs return **#FALSE ()**. This means that a successful **MEMQ** or **MEMBER** will return the original *structure* **RESTED** down such that its first element is the object searched for.

You may have noticed a rather ambiguous 'equal' in the last paragraph, and this is the distinction between **MEMQ** and **MEMBER**. In **MEMQ**, the test is double-equal (**=?**), while in **MEMBER** the test is single-equal (**=**).

```

<SET L (ONE 2 3.0 "FOUR")>$
(ONE 2 3.0 "FOUR")
<MEMQ 2 .L>$
(2 3.0 "FOUR")
<MEMQ "FOUR" .L>$
#FALSE ()
<MEMBER "FOUR" .L>$
("FOUR")

```

8.7. Garbage: Quoting Structures

Often in writing programs, one includes a structure in a FORM. For example, one might have a FORM that looks like this:

```
<NTH [ADD SUB MUL DIV] .OPCODE>
```

This is very inefficient because the VECTOR in the FORM is EVALed every time the FORM is EVALed with the result that a *new* VECTOR is created. This creates a lot of 'garbage', where 'garbage' is defined as some piece of structure which is no longer used (i.e. there are no pointers to it). Since your MDL resides in a machine with finite memory, it pays to think about ways of making programs relatively storage-efficient. The proper way of writing the FORM in the previous example is

```
<NTH '[ADD SUB MUL DIV] .OPCODE>
```

As mentioned earlier, the quote will ensure that the VECTOR will not be EVALed when the FORM is EVALed. Thus, only one copy of the VECTOR will exist. Note that 'quoting' structures in this way should be used for VECTORS and LISTS. STRINGS EVAL to themselves! You are warned: NEVER do a PUT into a quoted structure!

8.8. Garbage: Building Lists

It is often necessary in a program to build up a LIST of elements. Assume that you have a FUNCTION which gets elements one at a time and wants to build a list in the order in which they were received. Assume a LIST L and an element to be added, say .OBJ. One way of doing this is as follows:

```
<SET L (I.L .OBJ)>
```

This is not good practice, as the LIST created is a copy of the old one with an element added at the

end. Assuming that nothing else but the value of `L` points to the `LIST .L`, the *old* `LIST .L` will become garbage. If you assume adding 100 elements using this method, it becomes clear that thousands of `LIST` elements are needlessly becoming garbage. Equally as bad would be to use a `VECTOR`. The best way of doing this is using `PUTREST`. Follow this example:

```
<SET L (1 2 3)>>$
(1 2 3)
<PUTREST <REST .L 2> (4)>>$
(3 4)
.L$
(1 2 3 4)
```

Notice that in the general case, one can add an element to the end of a `LIST` by saying:

```
<PUTREST <REST .LIST <- <LENGTH .LIST> 1>> (.ELEMENT)>
```

This is good programming except that `LENGTH` and `REST` get called, both of which are quite slow for long `LIST`s. Remember that `LENGTH` must follow all of the pointers to the end to count up the elements. Here's another way of doing this:

```
<SETG L (T)>>$
(T)
<SETG LL ,L>>$
(T)
<DEFINE ADD-TO-END (ELEMENT)
  <SETG LL <REST <PUTREST .LL (.ELEMENT)> 1>>>>$
ADD-TO-END
<ADD-TO-END 100>>$
(100)
<ADD-TO-END 200>>$
(200)
.L$
(T 100 200)
```

Notice that both `L` and `LL` needed to have at least one element at the beginning so that `PUTREST` would work. Remember that the first argument to `PUTREST` cannot be `EMPTY?`, by definition. The effect of the program `ADD-TO-END` is to append the element to a `LIST (LL)` which is `REST`ed each time. This saves having to perform long `LENGTH` and `REST` operations. Since `LL` is a sub-list of `L`, `L` is being changed with every `PUTREST`. Thus, `L` is the complete `LIST`, and `LL` is always `L REST`ed down to its last element. You should remember, of course, that the initial `T` in the `LIST` should be removed at a later time....

8.9. Structured NEWTYPEs

In the previous chapter, we saw that MDL is a type-extensible language in that the programmer can create his own TYPEs. Typically, an object of a NEWTYPE will be a structure that is a model of some real world entity with the elements of the structure models of parts or aspects of that entity. The creator of the NEWTYPE will usually provide *functions* for manipulating the NEWTYPE objects in all of the ways which are considered meaningful for the intended uses of that NEWTYPE. This means that other users of the NEWTYPE can use these creator-defined manipulation routines and *never need to know the internal structure of the NEWTYPE*. This provides both modularity of programming and data abstraction.

For example, suppose you wanted to deal with airline schedules. If you were to construct a set of programs that define and manipulate a NEWTYPE called FLIGHT, then you could make that set into a standard package of programs and call on it to handle all information pertaining to scheduled airline flights. Since all FLIGHTs would have the same quantity of information (more or less) and you would want quick access to individual elements, you would not want the TYPEPRIM to be LIST. Since the elements would be of various TYPEs, you would not want the TYPEPRIM to be UVECTOR. The natural choice would be a TYPEPRIM of VECTOR.

Now, the individual elements of a FLIGHT would, no doubt, have TYPEs and meanings that don't change. The elements of a FLIGHT might be airline code, flight number, originating-airport code, list of intermediate stops, destination-airport code, type of aircraft, days of operation, etc. Each and every FLIGHT would have the airline code for its first element (say), the flight number for its second, and so on. It is natural to invent names (ATOMs) for these elements and always refer to the elements by name. For example, you could `<SETG AIRLINE 1>`. Then, if the local value of F were a FLIGHT, `<AIRLINE .F>` would return the airline code, and `<AIRLINE .F AA>` would set the airline code to AA. Once that is done, you can forget about which element comes first; all you need to know are the names of the offsets.

The next step is to notice that, outside the package of FLIGHT functions, no one needs to know whether AIRLINE is just an offset or in fact a function of some kind. For example, the scheduled duration of a flight might not be explicitly stored in a FLIGHT, just the scheduled times of departure and arrival. But, if the package had the proper DURATION function for calculating the duration, then the call `<DURATION .F>` could return the duration, no matter how it is found. In this way the internal details of the package are conveniently hidden from view and abstracted away.

8.10. Summary of MDL Structures

A few points should be obvious from the previous discussions of the various *structured* PRIMTYPEs:

1. All *structures* can be created in the same two ways: Either type in the printed representation, or use the SUBR whose name is the name of the PRIMTYPE.
2. When LISTs and VECTORs are EVALed, a *new copy* of the *structure* is made, whose

- elements are **EVAL** of the elements of the original. **STRING**s **EVAL**uate to themselves.
3. **SEGMENT**s are a very important and powerful feature of MDL. If you don't understand their uses, re-read the appropriate section.
 4. The **SUBR**s **NTH**, **REST**, **PUT**, **LENGTH**, **LENGTH?**, **EMPTY?**, **MEMBER**, and **MEMQ** work on all structures.
 5. The **SUBR**s **BACK** and **TOP** work on all consecutively stored structures (i.e. **VECTOR**s, **UVECTOR**s, and **STRING**s).
 6. The **SUBR** **PUTREST** works on **LIST**s only, and should be used to append elements to the end of **LIST**s. To add elements to the 'front' of **LIST**s, use the construct (**.ELEMENT** **! .LIST**). Other ways of adding elements to **LIST**s create unnecessary garbage.
 7. The **SUBR**s **MEMQ** and **MEMBER** can be used to find a MDL object in an arbitrary structure. **MEMQ** uses **==?** as a test; **MEMBER** uses **=?**. Both return the original structure **REST**ed down to the MDL object which was found, or **#FALSE** (**).**

8.11. Practice Quiz

A large amount of important material has been covered in this chapter. Test your understanding by trying the following quiz, then check your answers by typing them to the MDL interpreter.

Please write below each line the result of typing that line into a MDL.

9. Programming Constructs

In order to write any interesting programs, an ability is required to test for various conditions and take action only if those conditions are met. This chapter introduces the MDL SUBRs and FSUBRs needed to do this.

9.1. Boolean Operators

9.1.1. NOT

The MDL predicate NOT takes one argument of any TYPE. It evaluates to T only if its argument evaluates to a FALSE, and to #FALSE () otherwise.

```
<NOT <L=? 4 3>>$
T
```

9.1.2. AND

AND is an FSUBR, and it takes any number of arguments. It evaluates its arguments from first toward last as they appear in the FORM. As soon as one of them evaluates to a FALSE, it returns that FALSE, ignoring any remaining arguments. If none of them evaluate to FALSE, it returns EVAL of its last argument. <AND> returns T.

```
<AND <G? 4 3> <SET A 5> <L? 4 3> <SET B 7>>$
#FALSE ( )
.A$
5
```

```

.B$
*ERROR*
UNBOUND VARIABLE
B
LVAL
LISTENING AT LEVEL n PROCESS 1

<AND <G? 4 3> <L? 3 4> <SET C 10>>$
10
.C$
10

```

AND? is the SUBR equivalent to AND (all its arguments are evaluated before any of them is tested).

9.1.3. OR

OR is also an FSUBR and also takes any number of arguments. It evaluates its arguments from first to last as they appear in the FORM. As soon as one of them evaluates to a non-FALSE, OR returns that non-FALSE value, ignoring any remaining arguments. If this never occurs, it returns the last FALSE it saw. <OR> returns #FALSE ().

```

<OR <L? 4 3> <SET D 6> <SET E 13>>$
6

```

Setting D to 6 returned 6, which is not a FALSE, so it was returned by OR and E was never set to 13.

OR? is the SUBR equivalent to OR.

When you understand the following example, you should have no trouble with MDL's boolean operators. What is interesting about these two expressions?

```

<NOT <OR .FOO .BAR .BLETCH>>

```

```

<AND <NOT .FOO> <NOT .BAR> <NOT .BLETCH>>

```

9.2. COND

The MDL subroutine which is most used for varying evaluation depending on a truth value is the FSUBR COND ("conditional"). The arguments to COND, called COND clauses, must be LISTs, and

there must be at least one. COND always returns the result of the last evaluation it performs. The following rules determine the order of evaluations performed.

1. Evaluate the first element of each clause (from first toward last) until either a non-**FALSE** object results or the clauses are exhausted.
2. If a non-**FALSE** object is found in (1), immediately evaluate the remaining elements (if any) of that clause and ignore any remaining clauses.

In other words, COND goes walking down its clauses, EVALuating the first element of each clause, looking for a non-**FALSE** result. As soon as it finds a non-**FALSE**, it forgets about all the other clauses and evaluates, in order, the other elements (if any) of the current clause and returns the last thing it evaluates. If it can't find a non-**FALSE** first element, it returns the last **FALSE** it saw.

9.2.1. Examples

```
<SET F '(1)>$
(1)
<COND (<EMPTY? .F>
      EMP)
      (<1? <LENGTH .F>>
       ONE)>$
```

ONE

```
<SET F ()>$
()
<COND (<EMPTY? .F>
      EMP)
      (<1? <LENGTH .F>>
       ONE)>$
```

EMP

```
<SET F '(1 2 3)>$
(1 2 3)
<COND (<EMPTY? .F>
      EMP)
      (<1? <LENGTH .F>>
       ONE)>$
```

#FALSE ()

```
<COND (<LENGTH? .F 2>
      SMALL)
      (BIG)>$
```

BIG

```

<DEFINE FACT (N)          : "the standard recursive factorial"
      <COND (<0? .N> 1)
      (ELSE <* .N <FACT <- .N 1>>>>>>$
FACT
<FACT 5>$
120

```

In the last example, the use of ELSE was not necessary, but it makes it a bit easier to read the program. The atom T is often used for the same purpose.

9.3. Shortcuts with Conditionals

9.3.1. Using AND and OR with CONDS

Since AND and OR are FSUBRs, they can be used as miniature CONDS, but this is usually bad programming style. A construct of the form

```
<AND pre-conditions action(s)>
```

or

```
<OR pre-exclusions action(s)>
```

will allow *action(s)* to be evaluated only if all the *pre-conditions* are true or only if all the *pre-exclusions* are false, respectively. By nesting and using both AND and OR, fairly powerful constructs can be made. However, using AND and OR in this way can lead to some major problems. If any of your *actions* returns false or true unexpectedly, the following ones will never be evaluated. Even worse, programmers who get in the habit of doing this tend to write programs which are very difficult for anyone else to follow.

AND and OR are intended to be used in COND clauses. If you wanted to make sure that an argument called ARG passed to a function was a FIX between 5 and 10 inclusively:

```

<COND (<AND <==? <TYPE .ARG> FIX>
      <G=? .ARG 5>
      <L=? .ARG 10>>
      <what you want to do>)
(ELSE <what you want to do otherwise>>>

```

If, instead, you wanted to make sure the argument was a **FIX** outside that range:

```

<COND (<AND <==? <TYPE .ARG> FIX>
      <OR <G? .ARG 10>
      <L? .ARG 5>>>
      <what you want to do>)
(ELSE <what you want to do otherwise>>>

```

9.3.2. Embedded Unconditionals

One of the disadvantages of **COND** is that there is no straightforward way to do things unconditionally in between tests. One way around this problem is to insert a dummy clause that never succeeds, because its only element is an **AND** that returns a **FALSE** for the test (this method is strongly discouraged). Example:

```

<COND (<0? .N> <F0 .N>)
      (<1? .N> <F1 .N>)
      (<AND <SET N <* 2 <FIX </ .N 2>>>>
       ;"Round .N down to even number."
       <>>)
      (<LENGTH? .VEC .N> '[])
      (T <REST .VEC <+ 1 .N>>>>

```

The preferred method is to increase the nesting with a new **COND** after the unconditional part. This method does not make the code appear to a human reader as though it does something other than what it really does. The above example should be done this way:

```

<COND (<0? .N> <F0 .N>)
      (<1? .N> <F1 .N>)
      (T
       <SET N <* 2 <FIX </ .N 2>>>>
       <COND (<LENGTH? .VEC .N> '[])
             (T <REST .VEC <+ 1 .N>>>>>>

```

9.4. Examples

The following program will print all the prime factors of a given number:

```

<DEFINE FACTOR (N)
  <FACTOR-FROM .N 2>>
<DEFINE FACTOR-FROM (N TEST-DIVISOR)
  <COND (<G? <* .TEST-DIVISOR .TEST-DIVISOR> .N>
    <CRLF>
    .N)
    (<0? <MOD .N .TEST-DIVISOR>>
     <PRINT .TEST-DIVISOR>
     <FACTOR-FROM </ .N .TEST-DIVISOR>
                 .TEST-DIVISOR>)
    (ELSE <FACTOR-FROM .N <+ .TEST-DIVISOR 1>>>>

```

If you are not familiar with recursion you should trace this by hand for a simple case like `<FACTOR 12>`. The first `COND` clause tests to see if the test divisor is greater than the square root of `N`. If it is, `N` must be prime so a carriage-return/line-feed is printed (see chapter 12) and the value of `N` is returned. The second clause checks whether `N` is divisible by `TEST-DIVISOR` and, if it is, prints that `TEST-DIVISOR` and then recursively calls `FACTOR-FROM` with the quotient of `N` and `TEST-DIVISOR` and with `TEST-DIVISOR` again. The third clause is executed if both the first and second return a `FALSE`. In that case, `FACTOR-FROM` is called recursively with `N` and `TEST-DIVISOR` incremented by one.

If you are confused about how this works, try typing it to a Muddle and experiment with it. You should be able to improve it (for instance there is no reason to test even numbers after 2 has been tested). Why does the program return only prime factors? Can you improve the program so that it tests only with prime numbers?

One way to write a test for prime numbers would be:

```

<DEFINE PRIME? (X)
  <=? .X <FACTOR .X>>>$

```

This would work, however you would probably want to write a new version of `FACTOR` for this which didn't print anything. Would this test for prime numbers improve `FACTOR-FROM`? Why not?

It is hard to imagine a program of any complexity without `COND` clauses. The following example is a very small part of a fairly famous program called Zork. (One of the implementors of Zork has been heard to say that Zork is a huge conditional).

```

<DEFINE RUSTY-KNIFE-FUNCTION ()
  <COND (<=? ,VERB TAKE>
    <COND (<IN? ,SWORD ,PLAYER>
      <PRINC
        "As you pick up the rusty knife, your sword gives a single
        pulse of blinding blue light.">
      <CRLF>>
    <>
    (<OR <AND <=? ,INDIRECT-OBJECT ,RUSTY-KNIFE>
      <MEMQ ,VERB '[ATTACK KILL]>>
      <AND <MEMQ ,VERB '[SWING THROW]>
        <=? ,DIRECT-OBJECT ,RUSTY-KNIFE>
        ,INDIRECT-OBJECT>>
      <REMOVE ,RUSTY-KNIFE>
      <JIGS-UP
        "As the knife approaches its victim, your mind is submerged by
        an overmastering will. Slowly, your hand turns, until the
        rusty blade is an inch from your neck. The knife seems to sing
        as it savagely slits your throat.">>>

```

This function is called whenever "the rusty knife" is referred to in any way. This function checks whether the verb is "take" and the player has the "sword." If so the first message is printed and #FALSE () is returned. If the verb was not "take", it checks whether either the indirect object is "rusty knife" and the verb is "attack" or "kill", or the verb is "swing" or "throw" and the direct object is "rusty knife" and there is an indirect object. If so, the "rusty knife" is removed from the game, an interesting message is printed, and the player dies.

10. Looping

One of MDL's strongest points is its variety of powerful looping constructs. These will be covered in this chapter.

10.1. PROG

PROG makes it possible to encapsulate sections of MDL code. A PROG is very much like a FUNCTION in syntax. It takes a LIST which is similar in some respects to an argument list, and an arbitrary number of MDL objects which are EVALuated in turn. It returns the result of the EVALuation of the last object in its body. Here is a prosaic PROG:

```
<PROG () <SETG A <>> <SETG B <>> <INITIALIZE>>
```

Notice that each of the three FORMs in the PROG could have been done without using a PROG. PROGs, however, are a bit more useful than this would indicate.

First, the LIST can contain any number of

- ATOMs
- LISTs containing an ATOM and an arbitrary initial value for that ATOM.

All of these ATOMs will be re-bound inside the PROG (i.e. as if a new FUNCTION were entered.) When the PROG returns, the ATOMs will be unbound (i.e. re-bound to their old values, if any.) Thus, a PROG can be thought of as a mini-FUNCTION of no arguments.

```
<PROG (A B (C 10) (D .FOO)) ....>
```

In this example, four new bindings are made. The ATOMs A and B are bound, but not assigned a value. The ATOM C is bound to 10 and the ATOM D is bound to the current LVAL of the ATOM FOO. ATOMs should be placed in this 'argument' LIST when they are used as temporary variables inside the PROG. A full explanation of the use of temporary variables is in section 11.5.

More importantly, a PROG can be restarted or caused to return from the middle *any time* using the SUBRs AGAIN and RETURN. At this point, it is sufficient to say that AGAIN with no arguments starts

executing the body of the **PROG** from the beginning (but bindings are *not* redone). **RETURN** of one argument forces the **PROG** to return that argument. Notice that **AGAIN** and **RETURN** as described will always refer to the nearest surrounding **PROG** in the *current FUNCTION*.

PROG turns out to be fairly useless in MDL, but the **FSUBR REPEAT**, which is very similar, is enormously useful.

10.2. REPEAT

REPEAT has the same syntax as **PROG** and may be thought of as a **PROG** in which the last item in the body is **<AGAIN>**. In other words, the body of the **REPEAT** will be repeatedly executed until a **RETURN** is done. There is no other way to leave a **REPEAT** except with a **RETURN**.

```

<REPEAT ((CNT 5))
  #DECL ((CNT) FIX)
  <COND (<L? <SET CNT <- .CNT 1>> 0) <RETURN T>>
  (T <PRINT .CNT>>>)$

4
3
2
1
0 T

```

10.3. Non-local RETURNS, etc.

There are cases in which one might like to **RETURN** or **AGAIN** to someplace other than the nearest **PROG** or **REPEAT**, or for that matter someplace in a different **FUNCTION**. MDL allows you to 'name' any **PROG**, **REPEAT**, or **FUNCTION** by placing the **STRING "NAME"** followed by an **ATOM** at the *end* of an argument list or **PROG/REPEAT** list. This has the effect of binding that **ATOM** to an object of **TYPE ACTIVATION** which becomes a legal additional argument to both **AGAIN** and **RETURN**. Thus, **AGAIN** can take an optional **ACTIVATION**, and **RETURN** takes a return value and an optional **ACTIVATION**.

The most common use of **RETURN/AGAINs** to 'named activations' is in error handling. Assume that you have a **FUNCTION FOO** which calls a **FUNCTION BAR** which calls a **FUNCTION BLETCH** which notices something wrong. **BLETCH** might want to cause **FUNCTION FOO** to return a **FALSE**, for example, or print an error message. This is only possible if the **FUNCTION FOO** is defined to have a 'named activation', whose 'name' is known to **FUNCTION BLETCH**.

```

<DEFINE FOO (A)
  <COND (<PROG ("NAME" ACT) <BAR .A>>
    <PRINT .A> T)
    (T <PRINT "ERROR IN YOUR PROGRAM"> T)>>$
FOO
<DEFINE BAR (X)
  <BLETCH <* .X .X>>>$
BAR
<DEFINE BLETCH (Z)
  <COND (<G? .Z 10> <RETURN #FALSE () .ACT>)
    (T <SQRT .Z>>>$
BLETCH
<FOO 2>$
2 T
<FOO 4>$
"ERROR IN YOUR PROGRAM" T

```

10.4. MAPF

10.4.1. Looping Through a Structure

MAPF (pronounced 'map-eff' for 'map-first') is mainly used to apply a *function* to each element of a *structure*, in turn. In this most simple form, its first argument is a *FALSE*, its second argument a *loop-function*, and its third argument a *structure*. Here is a simple MAPF:

```

<MAPF <>
  <FUNCTION (X)
    <PRINT .X>>
  (1 2 3 4)>>$
1
2
3
4 4

```

The last 4 is the result of the MAPF (the result of the last application of the *loop-function* to an element of the *structure*).

An FSUBR called FUNCTION is used in many places in this chapter. FUNCTION is very much like DEFINE, except that no name is specified. FUNCTIONS created with FUNCTION are said to be 'anonymous'. They cannot be used outside the FORM in which they are imbedded, since they have no name by which they can be referenced. Of course, if the *loop function* you wish to use had already been DEFINED, you would refer to it in a MAPF as the global value of its name.

```

<DEFINE FOO (A B) <+ .A .B>>$
FOO
,FOOS
#FUNCTION ((A B) <+ .A .B>)
<FUNCTION (A B) <+ .A .B>>$
#FUNCTION ((A B) <+ .A .B>)

```

A MAPF can be prematurely stopped at any time if the *loop-function* calls the SUBR MAPLEAVE. MAPLEAVE takes one argument: it stops the MAPF and causes the MAPF to return its argument.

```

<DEFINE BAR (L)
  <MAPF <>
    <FUNCTION (X)
      <COND (<G? .X 10> <MAPLEAVE FOO>)
        (T <PRINT .X>>>
      .L>>$
BAR
<BAR (1 2 3 4)>$
1
2
3
4 4
<BAR (1 2 16 7 6 2)>$
1
2 FOO

```

10.4.2. Other Than One Structure

One can simultaneously loop through any number of *structures* using MAPF. MAPF will apply the *loop-function* to the first elements of each of the *structures*. The MAPF will stop when any of the *structures* becomes EMPTY?

```

<MAPF <>
  <FUNCTION (A B C)
    <PRINT <+ .A .B .C>>>
    (1 3 5 7)
    (2 4 6 8)
    (3 5 7 9)>>$
6
12
18
24 24

```

```

<MAPF <>
  <FUNCTION (A B C)
    <PRINT <+ .A .B .C>>>
    (1 3 5)
    (2 4 6)
    (3)>$
6 6

```

'Other Than One' also includes zero, but this is a special case. A MAPF with only two arguments is something like a REPEAT loop. It can only be terminated by an explicit call to MAPLEAVE. See section 10.5. If any of the structures is empty to begin with, MAPF returns #FALSE ().

10.4.3. Using Intermediate Results

By now you must be wondering why there is a FALSE as the first argument to MAPF. In fact, a FALSE tells MDL not to do anything with the results of applying the *loop-function* to the elements of the *structure*. However, if the first argument to MAPF is something which can be applied to arguments (i.e. a FUNCTION or SUBR), then MDL will 'save' the results of applying the *loop-function* and, when the looping is finished, apply the first argument (called the *final-function*) to all of the 'saved' results. An example:

```

<MAPF .LIST
  <FUNCTION (X Y)
    <+ .X <SQRT .Y>>>
    (1 2 3)
    (1 4 9)>$
(2 4 6)

<MAPF .+
  <FUNCTION (X Y)
    <+ .X <SQRT .Y>>>
    (1 2 3)
    (1 4 9)>$
12

```

In the first case, we built a LIST out of the results of the *loop-function*. In the second, we simply added up all of the results.

10.4.4. MAPRET and MAPSTOP

There are cases in which you might want to have an arbitrary number of results 'saved'. This can be done with the SUBR MAPRET which takes any number of arguments (including zero), causes the

function to terminate, and 'saves' all of its arguments.

```

<DEFINE PRIME-LIST (L)
  <MAPF ,LIST
    <FUNCTION (NUM)
      <COND (<PRIME? .NUM> .NUM)
        (T <MAPRET>)>>
    .L>>$
PRIME-LIST
<PRIME-LIST (2 4 11 55 73)>$
(2 11 73)

```

What happened here was that only prime numbers were allowed to be 'saved'. Whenever PRIME? returned FALSE, a MAPRET of no arguments was done; thus, no values were 'saved' for this call to the loop-function. MAPRET, of course, will not work if there is no final-function to return results to.

Assuming the function PRIME? described in chapter 9 has been written:

```

<DEFINE PRIME-AND-SQUARES-LIST (L)
  <MAPF ,LIST
    <FUNCTION (NUM)
      <COND (<PRIME? .NUM> <MAPRET .NUM <* .NUM .NUM>>)
        (T <MAPRET>)>>
    .L>>$
PRIME-AND-SQUARES-LIST
<PRIME-AND-SQUARES-LIST (2 4 11 55)>$
(2 4 11 121)

```

A more useful function:

```

<DEFINE UPPERCASIFY-1 (STR)
  <MAPF ,STRING
    <FUNCTION (CHAR)
      <SET ASC <ASCII .CHAR>>
      <COND (<AND <G=? .ASC <ASCII I\A>>
        <L=? .ASC <ASCII I\Z>>>)
        <MAPRET <ASCII <- .ASC 32>>>)
      (ELSE <MAPRET .CHAR>)>>
    .STR>>$
UPPERCASIFY
<SET Z-STR "Now is the time for all good men to <FOO .BAR>">
<UPPERCASIFY .Z-STR>$
"NOW IS THE TIME FOR ALL GOOD MEN TO <FOO .BAR>"
.Z-STR$
"Now is the time for all good men to <FOO .BAR>"

```

The SUBR MAPSTOP is the same as MAPRET, except that, after 'saving' its arguments, it finishes the MAPF, allowing the *final-function* to be applied to all of the 'saved' results. Like MAPRET, MAPSTOP can only be used if there is a *final-function*.

10.4.5. MAPR

The SUBR MAPR (for 'map-rest,' pronounced 'map-ar') is exactly like MAPF in every respect except that the arguments passed to the *loop-function*, rather than being successive elements of the *structures*, are the *structures* themselves RESTed down successively. The names for the two *map* SUBRs are mnemonic: MAPFirst and MAPRest.

```
<MAPR <>
  <FUNCTION (X)
    <PRINT .X>>
  (1 2 3 4)>$
(1 2 3 4)
(2 3 4)
(3 4)
(4) (4)
```

MAPR is useful if it is necessary to change elements of the *structure(s)* that you are *mapping* down. Here is a FUNCTION which takes a structure full of numbers and changes it to contain double the old values:

```
<DEFINE DOUBLE (STR)
  <MAPR <>
    <FUNCTION (S)
      <PUT .S 1 < * <1 .S> 2>>>
    .STR>>$
DOUBLE
<SET L (1 2 3)>$
(1 2 3)
<DOUBLE .L>$
(6)
.L$
(2 4 6)
```

In UPPERCASIFY-1 a MAPF was used which generated a new structure. Using MAPR, a new function can be written which modifies the original string:

```

<DEFINE UPPERCASIFY-2 (STR)
  <MAPR <>
    <FUNCTION (STR1)
      <SET ASC <ASCII <1 .STR1>>>
      <COND (<AND <G=? .ASC <ASCII !\a>>
        <L=? .ASC <ASCII !\z>>>
        <PUT .STR1 1 <ASCII <- .ASC 32>>>>>>
    .STR>
  .STR>$
UPPERCASIFY-2
<UPPERCASIFY-2 <SET STR "Now is the time for <BAR .BLETCH>">>$
"NOW IS THE TIME FOR <BAR .BLETCH>"
.STR$
"NOW IS THE TIME FOR <BAR .BLETCH>"

```

MAPR is not always used to change an existing structure. The following example shows another use. This function marches down a structure and builds a new structure of the same type in which the elements of the first structure appear only once.

```

<DEFINE UNIQUIFY (STRUC)
  <COND (<NOT <STRUCTURED? .STRUC>>
    #FALSE ("WRONG TYPE OF ARGUMENT"))
  (ELSE
    <CHTYPE
      <MAPR .<PRIMTYPE .STRUC>
        <FUNCTION (S)
          <COND (<MEMQ <1 .S> <REST .S>>
            <MAPRET>)
          (ELSE <MAPRET <1 .S>>>>
        .STRUC>
      <TYPE .STRUC>>>>$
UNIQUIFY
<UNIQUIFY #FROB (1 2 33 2 1 5)>>$
#FROB (33 2 1 5)

```

If you wished to be able to remove elements which "look the same," such as structures which are =? (like (1 2 3) and (1 2 3)), or "FROTZ" and "FROTZ"), you would have to replace the MEMQ with MEMBER, which is slower.

10.4.6. MAPF/R Summary

The syntax for MAPF/R is as follows:

```

<MAPF/R final-function
        loop-function
        structure-1
        ...
        structure-n>

```

with only the first two arguments required.

10.5. Looping vs. Recursion

In the previous chapter, the "standard recursive factorial" was shown. It can now be rewritten using the looping constructs introduced in this chapter.

```

<DEFINE FACT (N)
  <REPEAT ((ANS 1))
    <COND (<0? .N> <RETURN .ANS>)
      (ELSE <SET ANS <* .ANS .N>>
           <SET N <- .N 1>>)>>>

```

Some might argue that this is a larger and more complicated program to write than the recursive form, and therefore inferior. The iterative form just shown, however, is faster and more efficient.

The same program can also be written using MAPF.

```

<DEFINE FACT (N)
  <SET ANS 1>
  <MAPF <>
    <FUNCTION ()
      <COND (<0? .N> <MAPLEAVE .ANS>)
        (ELSE <SET ANS <* .ANS .N>>
             <SET N <- .N 1>>)>>>>

```

Or, more elegantly:

```

<DEFINE FACT (N)
  <MAPF ,*
    <FUNCTION ()
      <COND (<0? .N> <MAPSTOP>)
        (ELSE <+ 1 <SET N <- .N 1>>>>>>>
  ;"FACT 0> will return 1 since * of no arguments
  returns 1."

```

As pointed out earlier, a MAPF does not have to take any structures as arguments as long as the second argument, the *looping function*, does not take any arguments.

Although recursion can be a very simple and elegant way to solve a problem, iteration is often more efficient. Take, for example, the factorial example of chapter 9. If you only intend to use the function with very small numbers the recursive form will not cost much to use and does have the advantage of being slightly easier to write. However, since every recursive call of a function requires the creation of a new 'environment,' calculating factorial of a large number will take a lot of time and computer memory. The iterative forms of factorial shown above would be *much* more efficient.

In summary, the advantage of the looping techniques described in this chapter over recursion is that the overhead of calls is eliminated. However, a long program (say, bigger than half a printed page) may be more difficult to write iteratively than recursively and hence more difficult to maintain. A program whose repetition is controlled by a structured object (for example, "walking a tree" to visit each monad in the object) often should use looping for covering one "level" of the structure and recursion to change "levels".

11. Argument Lists in FUNCTIONS

In Chapter 6, the creation of a simple type of **FUNCTION** was explained: a **FUNCTION** taking a fixed number of arguments all of which get **EVAL**ed. While this may be sufficient for writing most of your **FUNCTION**s, there are other ways in which you might like arguments to be handled. Some of these might include:

- **FUNCTION**s which can take an arbitrary number of arguments (like the **SUBR**s **+**, **-**, **LIST**, **VECTOR**, etc.)
- **FUNCTION**s which act more like **FSUBR**s (i.e. they don't have their arguments **EVAL**ed.)
- **FUNCTION**s which can take optional arguments, which can be defaulted.

In fact, all of these things (and a few more) can be done easily by specifying them in the argument list of the **FUNCTION**. The remainder of this chapter will describe the complete syntax for MDL argument lists.

11.1. Arguments Not EVALed

Placing a single-quote before an **ATOM** in the argument list will cause that **ATOM** to be given the value of its respective argument *without* **EVAL**uation.

```
<DEFINE FOO ('ITEM) .ITEM>$  
FOO  
<FOO <+ 1 2>>$  
<+ 1 2>
```

Were the **ATOM** **ITEM** not quoted in the argument list, the **FUNCTION** would have returned the **FIX** 3. Quoting arguments, as it turns out, is not used often in MDL.

11.2. Optional Arguments

MDL can be told to expect optional arguments by placing the **STRING** "OPTIONAL" in the argument list *after* all of the required arguments. Following the **STRING** can be any number of **ATOMs**, which will be bound to the values of the optional arguments, if given. To specify that an optional argument is to have a default value (i.e. if not passed as an argument), place a **LIST** containing the **ATOM** and the default value in place of just the **ATOM**. Here's an example:

```
<DEFINE ADD-ONE (NUM "OPTIONAL" (HOW-MANY 1))
  <+ .NUM .HOW-MANY>>$
ADD-ONE
<ADD-ONE 10>$
11
<ADD-ONE 10 2>$
12
```

This rather useless **FUNCTION** adds the **LVAL** of **HOW-MANY** to its first argument. **HOW-MANY** is an optional argument, whose default value is the **FIX** 1. Therefore, with one argument, **ADD-ONE** adds one to its argument. With two arguments, it adds them.

As was mentioned earlier, it isn't necessary to supply a default value for an optional argument. If there is no default value, and the optional argument is not supplied, the **ATOM** gets bound, but is not assigned a value. **LVAL** of that **ATOM** will generate an error, because an **ATOM** must be *both* bound and assigned to have a local value. One can tell whether an **ATOM** has been assigned a value by using the **SUBR** **ASSIGNED?**, which returns **T** if its argument (an **ATOM**) is assigned; otherwise **#FALSE** (**).** The following definition of **ADD-ONE** acts identically to the previous one:

```
<DEFINE ADD-ONE (NUM "OPTIONAL" HOW-MANY)
  <COND (<NOT <ASSIGNED? HOW-MANY>>
    <SET HOW-MANY 1>>)
  <+ .NUM .HOW-MANY>>$
ADD-ONE
```

The use of single-quoted **ATOMs** is allowed with optional arguments as well as required ones. You may supply your own example, if you can think of one. We can't.

11.3. Arbitrary Numbers of EVALed Arguments

At any place in the argument list, after any required and optional (if any) arguments, you can specify that *all* of the remaining arguments (supplied at the time of call) be **EVALed** and grouped together in a special structure called a **TUPLE** (for all practical purposes, **TUPLEs** may be thought of as **VECTORs**, and can be manipulated in the same ways). To do this, place the **STRING** "TUPLE" followed by an **ATOM** in the argument list. The **ATOM** will be bound to the **TUPLE**. Here are

some examples:

```

<DEFINE MY+ ("TUPLE" NUMBERS) <+ I.NUMBERS>>>$
MY+
<MY+ 1 2 3 4 5 6>$
21
<MY+>$
0

<DEFINE MY-STRING ("TUPLE" STRINGS) <STRING I.STRING>>>$
MY-STRING
<MY-STRING "THIS" "IS" "A" "BIG" "STRING" I\I>$
"THISISABIGSTRING!"

<DEFINE TIMES-PLUS (NUM "TUPLE" NUMBERS)
  <* .NUM <+ I.NUMBERS>>>>$
TIMES-PLUS
<TIMES-PLUS 4 1 2 3>$
24

```

11.4. Arbitrary Numbers of un-EVALed Arguments

Instead of using "TUPLE", one could have used the STRING "ARGS". This has the effect of binding the following ATOM to a LIST of all of the remaining arguments, *unEVALuated*. In fact, the ATOM is bound to the LIST which is the FORM used to call the FUNCTION RESTed down to the remaining arguments. The use of "ARGS" allows one to write FSUBRs in MDL.

```

<DEFINE FOO ("ARGS" L) .L>$
FOO
<SET F '<FOO 1 2 3>>>$
<FOO 1 2 3>
<SET LL <EVAL .F>>>$
(1 2 3)
<=? .LL <REST .F 1>>>$
T

```

In the previous example, we explicitly called the SUBR EVAL, which caused EVALuation of the FORM <FOO 1 2 3>. This returned the LIST (1 2 3), which is ==? to <REST .F 1>.

Now we will write a FUNCTION to simulate the FSUBR DEFINE in MDL: this is just what MDL does internally when the FSUBR DEFINE is called.

```

<DEFINE MY-DEFINE (NAM "ARGS" L)
  <SETG .NAM <CHTYPE .L FUNCTION>>
  .NAM>$
MY-DEFINE
<MY-DEFINE FOO (A B C) <+ .A .B .C>>$
FOO
,FOO$
#FUNCTION ((A B C) <+ .A .B .C>)
<FOO 1 2 3>$
8

```

Now that we have simulated DEFINE, let's try our hand at AND.

```

<DEFINE MY-AND ("ARGS" L)
  <REPEAT ((LAST T))
    <COND (<EMPTY? .L> <RETURN .LAST>)
      (<NOT <SET LAST <EVAL <1 .L>>>>
        <RETURN .LAST>)
      (T <SET L <REST .L>>>>)>>>$
MY-AND

```

This will exactly simulate the behavior of AND. The REPEAT loop initializes the ATOM LAST to T, because AND of no arguments is defined to return T. The loop itself first checks on whether the LIST L has become EMPTY?. If so, the AND was successful, and LAST is returned. Otherwise, LAST is SET to EVAL of <1 .L>. If that is a FALSE, it is returned. Otherwise, L is RESTed once and the loop is repeated.

As an exercise, write OR and COND. It is legitimate to use COND in your COND simulator, but if you call your simulator COND, watch out.

11.5. Temporary Variables

You may recall that chapter 6 referred to "free variables" as those variables (ATOMs) whose local values are SET or accessed inside a FUNCTION, but which are not bound inside that function. One should always avoid using "free variables" in MDL programs, but there is often a need for variables whose values will contain temporary results. You can specify such variables to be bound inside a FUNCTION by including the "AUX" (for auxiliary) followed by any number of ATOMs or LISTs of ATOMs and values (like "OPTIONAL" arguments) at the end of the argument list.

```

<DEFINE SUM ("TUPLE" NUMS "AUX" (SUM 0))
  <REPEAT ()
    <COND (<EMPTY? .NUMS> <RETURN .SUM>)
      (T
        <SET SUM <+ .SUM <1 .NUMS>>>
        <SET NUMS <REST .NUMS>>>>>>$
SUM
<SUM 1 2 3 4>$
10

```

The FUNCTION SUM, in this example, simulates the SUBR +. The ATOM SUM is initialized to zero in the argument list. The following is identical in effect, although poor in style:

```

<DEFINE SUM ("TUPLE" NUMS "AUX" SUM)
  <SET SUM 0>
  <REPEAT ... >>

```

It should be noted that the part of the argument list which follows "EXTRA" or "AUX" is identical in syntax and meaning to the 'argument list' which is the first argument to PROG and REPEAT.

11.6. Order of Evaluation in Argument Lists

Unlike many other languages, including LISP, ATOMIC bindings *after* the required arguments are done from left to right, rather than simultaneously. This means that, for example, the default values for optional arguments and extra variables can refer to the values of other ATOMS to their left in the argument list.

```

<DEFINE FOO (A "OPTIONAL" (B <+ .A 10>) "AUX" (C <FOOBAR .B>))
....>

```

The previous example shows an example of what is possible in argument lists due to MDL's order of evaluation.

11.7. Variable Declarations

MDL has a built-in facility for checking the TYPES of arguments to FUNCTIONS as well as other temporary variables. This is analogous to the checking which is done when F/SUBRts are called: if you call the SUBR + with an ATOM, for example, MDL will generate an error. In MDL, variables can be declared to be of a certain TYPE or group of TYPES. This is done by placing an object of TYPE DECL (PRINTYPE LIST) immediately after the FUNCTION's argument list. It may also follow the

argument list of a PROG or REPEAT and declare the variables bound within. The DECL (for "declaration," pronounced 'deckle') has the form of repeating pairs of LISTS of ATOMs (the ATOMs to be declared) and the declaration proper. The simplest TYPE declaration is the name of a TYPE or the ATOM ANY.

```
#DECL ((FOO BAR) FIX (BLETCH) ATOM (MUMBLE) ANY)
```

This declares the ATOMs FOO and BAR to be FIXes, the ATOM BLETCH to be an ATOM, and the ATOM MUMBLE to be anything.

Another declaration form is the union of different TYPEs, which is specified by a FORM whose first element is the ATOM OR and the remainder legal TYPE names.

```
#DECL ((NUM) <OR FIX FLOAT> (STRUC) <OR LIST VECTOR>)
```

Also useful is the form <PRIMTYPE name-of-a-PRIMTYPE>, which specifies anything of that PRIMTYPE. For example:

```
#DECL ((PL) <PRIMTYPE LIST>)
```

will allow PL to be a LIST, a FORM, a SEGMENT, or any other PRIMTYPE LIST.

In fact, the full-blown MDL declaration syntax is far more baroque than has been described, but these simple forms will suffice in almost all cases. For more information on DECL, consult *The MDL Programming Language* [Galley 79]. Here are some examples of old friends, now including DECLs.

```
<DEFINE MY-AND ("ARGS" L)
  #DECL ((L) LIST)
  <REPEAT ((LAST T))
    #DECL ((LAST) ANY)
    <COND (<EMPTY? .L> <RETURN .LAST>)
      (<NOT <SET LAST <EVAL <1 .L>>>>
        <RETURN .LAST>)
      (T <SET L <REST .L>>>>>>)>
MY-AND
```

```

<DEFINE ADD-ONE (NUM "OPTIONAL" (HOW-MANY 1))
  #DECL ((NUM) <OR FIX FLOAT> (HOW-MANY) FIX)
  <+ .NUM .HOW-MANY>>$
ADD-ONE
<ADD-ONE 2.3 1.2>$

*ERROR*
TYPE-MISMATCH
HOW-MANY ;"The ATOM of incorrect TYPE"
FIX      ;"The DECL for that ATOM"
1.2      ;"What the ATOM was about to be SET to"
EVAL     ;"EVALing the FORM <ADD-ONE 2.3 1.2> caused it"
LISTENING-AT-LEVEL 2 PROCESS 1

```

Declarations have a number of purposes. First, they make your code easier for someone else to understand, as the sorts of arguments your FUNCTIONS take can be deduced from them. It will also help you read your own code at a later time when you may have forgotten how it all works. Second, it helps in debugging your programs, since an error will be caused if the declaration is violated. Finally, when your FUNCTIONS eventually get compiled, much better code can be produced with the information given by your declarations. Always DECL your FUNCTIONS!

11.8. Structures: DECLs and NEWTYPEs

Before closing our discussion of DECLs, one special type of declaration should be considered: that of *structures*. The syntax for this declaration is:

```

<type-name <PRIMTYPE typeprim>
  declaration-for-first-element
  declaration-for-second-element
  ...
  declaration-for-last-element>

```

For example, we could DECL a VECTOR of three elements as follows:

```

<VECTOR FIX LIST <VECTOR ATOM ATOM>>

```

This declares the VECTOR to have a FIX, a LIST, and a VECTOR which must contain two ATOMs. There may be more elements in a *structure* than those DECLed. Any additional elements will be considered to have the DECL ANY.

```

<<PRIMTYPE LIST> ATOM <OR FIX FLOAT>>

```

This declares a *structure* of PRIMTYPE LIST containing an ATOM and either a FIX or a FLOAT.

We originally described the SUBR NEWTYPE as taking two arguments: the new TYPE name and its TYPEPRIM. *Structured* NEWTYPES can take a third argument as well: a declaration, as described above. Let's use the airline problem from our earlier discussion. We will define a FLIGHT as follows:

```

<NEWTYPE FLIGHT
      VECTOR
      '<<PRIMTYPE VECTOR> ATOM FIX FIX>>'$
FLIGHT
<SETG AIRLINE 1>$
1
<SETG FLIGHT-NUMBER 2>$
2
<SETG DURATION 3>$
3

```

Notice that the declaration of FLIGHT is quoted: this is because it is a FORM and NEWTYPE is a SUBR.

Now that FLIGHT is a legal TYPE, it can be used in declarations. In fact, it is a lot easier to say

```
#DECL ((FL) FLIGHT)
```

than to say

```
#DECL ((FL) <VECTOR ATOM FIX FIX>)
```

especially when you add another ten elements to the definition of FLIGHTs. It is also a lot clearer for both yourself and others to read.

11.8.1. To NEWTYPE or Not To NEWTYPE

That is the question most frequently asked. Should I make my table of house members a NEWTYPE? Should it just be a VECTOR? Sad to tell, there is no cut and dried answer. In general, whenever a structure has a 'significant' amount of internal structure, or some readily understood 'outside world meaning', it is a good idea to make it a NEWTYPE. Most people would deem a structure to have 'significant' internal structure at the point when they type out the whole darn DECL for the ninety-fourth time. Others think ahead.

11.9. Good Habits / Bad Habits

This chapter has some suggestions for good programming practice. You may ignore them at your risk, but we have found that people learning MDL are always more successful if they develop good habits early on in their MDLing. Here are the good habits:

- Always use "AUX" to bind temporary variables in your functions. *Don't* use "free variables"!
- Always DECL your FUNCTIONS, PROGs, and REPEATs. Even if a variable can have any value, it is good practice to DECL it as such, so that it is clear that you haven't simply forgotten.

11.10. Review of Argument List Syntax

Here is a full-blown, ultra-hairy, and incredibly strange argument list:

```

<DEFINE HAIR (A 'B "OPTIONAL" (C 10) D
              "TUPLE" NUMS
              "AUX" (E <+ .A .B>)
                    (F <SQRT </ .E .C>>)
              "NAME" FOO)
#DECL ((B C E) FIX
       (A E) <OR FIX FLOAT>
       (F D) FLOAT
       (NUMS) TUPLE
       (FOO) ACTIVATION)
<COND (<NOT <ASSIGNED? D>>
       <SET D <ATAN .B>>>)
<+ .A .B .C .D .E .F I.NUMS>>$
HAIR

```

This poor excuse for a FUNCTION takes two required arguments, the second of which is unEVALuated, two optional arguments, one of which defaults to 10, and any number of other arguments, bunched together in a TUPLE called NUMS. Two temporary variables E and F are also used, both of which refer to the LVALs of other ATOMs to their left in the argument list.

12.2. Conversion I/O - Input

All of the following input Subroutines, when directed at a terminal, hang until \$ (ESC) is typed and allow normal use of rubout, ↑D, ↑L and ↑θ.

12.2.1. READ

<READ>

This returns the entire MDL object whose character representation is next in the input stream. Successive <READ>s return successive objects. This is precisely the SUBR READ mentioned in chapter 3 (page 15).

12.2.2. READCHR

<READCHR>

("read character") returns the next CHARACTER in the input stream. Successive <READCHR>s return successive CHARACTERS.

12.2.2.1. NEXTCHR

<NEXTCHR>

("next character") returns the CHARACTER which READCHR will return the next time READCHR is called (if READCHR is the next input SUBR called. Multiple <NEXTCHR>s, with no input operations between them, all return the same thing.

12.3. Conversion I/O - Output

If an object to be output requires (or can tolerate) separators within it (for example, between the elements in a structured object or after the TYPE name in "# notation"), these conversion-output SUBRs will use a carriage-return/line-feed separator to prevent overflowing a line. Overflow is detected in advance from elements of the CHANNEL in use.

12.3.1. PRINT

<PRINT *any*>

This outputs, in order,

1. a carriage-return line-feed,
2. the character representation of EVAL of its argument (PRINT is a SUBR), and
3. a space

and then returns EVAL of its argument. This is precisely the SUBR PRINT mentioned in chapter 3 (page 15).

12.3.2. PRIN1

<PRIN1 *any*>

outputs just the character representation of, and returns, EVAL of *any*.

12.3.3. PRINC

<PRINC *any*>

("print characters") acts exactly like PRIN1, except that

1. if its argument is a STRING or a CHARACTER, it suppresses the surrounding "s or initial \n respectively; or,
2. if its argument is an ATOM, it suppresses any \s or OBLIST trailers which would otherwise be necessary.

If PRINC's argument is a structure containing STRINGS, CHARACTERS, or ATOMs, the services mentioned will be done for all of them. Ditto for the ATOM used to name the TYPE in "# notation".

12.3.4. CRLF

<CRLF>

("carriage-return line-feed") outputs a carriage-return line-feed and then returns T.

12.4. CHANNEL (the TYPE)

MDL I/O 'channels' are represented by an object of TYPE CHANNEL, which is of PRIMTYPE VECTOR. The internal structure of a CHANNELs is not frequently examined or manipulated. Those interested can consult the MDL manual for details.

12.4.1. OPEN

The SUBR OPEN is used to create and return a CHANNEL. It takes two arguments, a *mode* and a *file-name*, both of which must be STRINGS. If successful, OPEN returns a CHANNEL; otherwise, it returns a FALSE containing the reason for the failure and the *file-name* (both STRINGS.)

There are two commonly used *modes*: "READ" and "PRINT". These are used, reasonably enough, for input and output, respectively. These modes input and output ASCII characters (i.e. conversion I/O).

File names are dependent on the host operating system. The following applies only to TOPS-20 systems. File names are composed of four parts: the device, the directory, a first file name, and a second file name. A typical file name might be:

"DSK:<MARC>CALCULATOR.MUD"

MDL will use certain defaults for these four parts, if they are not specified explicitly. These are DSK, your working directory, INPUT, and MUD, respectively. These defaults can be overridden by SETGing the ATOMs DEV, SNM, NM1, and NM2 to the defaults you desire. These defaults must be STRINGS. For some devices, some of the four parts of the file name are ignored, for example the line printer and the terminal (called TPL and TTY).

Here are some examples of the uses of OPEN:

<OPEN "PRINT" "TPL:"> opens an output channel to the line printer.

<OPEN "PRINT" "<MARC>FOO"> opens an output channel to a disk file called FOO.MUD. Remember that the default device is DSK (i.e. the disk) and the default second file name is MUD.

<OPEN "READ" "FOO.TEST"> opens an input channel to a disk file called FOO.TEST in the default file directory (i.e. MARC).

It is good practice to give all of your MDL files a second name of MUD. This allows you to make use of the MDL default second file name and also makes it easier for both you and others to find files of

MDL code. In general, files containing only text should be given the second file name **TXT**.

12.4.2. FILE-EXISTS?

FILE-EXISTS? tests for the existence of a file without creating a **CHANNEL**, which occupies about a hundred machine words of storage. It takes a file-name argument (like **OPEN**) and returns either **T** or a **FALSE** containing the reason (a **STRING**).

12.4.3. CLOSE

CLOSE, given a **CHANNEL**, closes that **CHANNEL**. An error will occur if any input or output is directed to a **CLOSEd CHANNEL**.

It is possible to tell whether a **CHANNEL** is currently 'open' or has been **CLOSEd** by looking at the first element of the **CHANNEL** itself. This will always be a **FIX**, and is the 'channel number' assigned by the operating system. A 'channel number' of zero indicates a **CLOSEd CHANNEL**.

12.4.4. CHANLIST

<CHANLIST>

returns a **LIST** whose elements are all the currently open **CHANNELS**.

12.4.5. INCHAN and OUTCHAN

The channel used by default for input **SUBRs** is the local value of the **ATOM INCHAN**. The channel used by default for output **SUBRs** is the local value of the **ATOM OUTCHAN**.

You can direct I/O to a **CHANNEL** by **SETting INCHAN** or **OUTCHAN** (remembering their old values somewhere), or by giving the **SUBR** you wish to use an argument of **TYPE CHANNEL**. (These actually have the same effect, because **READ** binds **INCHAN** to an explicit argument, and **PRINT** binds **OUTCHAN** similarly.

By the way, a good trick for playing with **INCHAN** and **OUTCHAN** within a function is to use the **ATOMs INCHAN** and **OUTCHAN** as "AUX" variables, re-binding their local values to the **CHANNEL** you want. When you leave, of course, the old **LVALs** are restored (which is the whole point).

INCHAN and **OUTCHAN** also have global values, initially the **CHANNELs** directed at the terminal running MDL. Initially, **INCHAN's** and **OUTCHAN's** local and global values are the same. Whenever an error occurs in MDL, the local values of **INCHAN** and **OUTCHAN** are rebound to the global values of the

12.6.1. READSTRING

READSTRING provides a mechanism of reading characters into a **STRING** until a specified condition is met. This condition may be one of two types:

1. A specified number of characters has been read.
2. One of a specified set of characters has been read.

READSTRING takes a **STRING** which will be filled with **CHARACTERS** read from its second argument, a **CHANNEL**. An optional third argument specifies the condition on which the **READSTRING** will terminate. If the argument is a **FIX**, **FIX** **CHARACTERS** will be read from **CHANNEL**. If the argument is a **STRING**, **CHARACTERS** will be read until one is a **MEMBER** of the that **STRING** (**MEMQ** really). *In either case* **READSTRING** will terminate when the **STRING** (i.e. the first argument) is filled, should this occur prior to the meeting of the 'stop condition', or if the end-of-file is reached. If there is no third argument, these latter two conditions are the only ways in which **READSTRING** will terminate.

READSTRING returns the number of **CHARACTERS** read at the time of its termination. Here's how to interpret the return from **READSTRING** (it really isn't all that complicated, but it's hard to explain):

- If there was no third argument, the return will either be the length of the **STRING** or a smaller number. If a smaller number, the end-of-file was reached and that smaller number is the number of **CHARACTERS** read before end-of-file was reached.
- If the third argument was a **FIX** and the return was less than that **FIX**, then end-of-file was reached.
- If the third argument was a **STRING**, the return was the number of **CHARACTERS** read before the termination **CHARACTER** was seen. It is very important to realize that the termination **CHARACTER** is *not* read. In other words, it will not be in the **STRING**, and the next time you try to input from **CHANNEL**, that termination **CHARACTER** will be lying in wait. Not taking this into account is the cause of many an error for novice MDLers.

If the terminating event was end-of-file and *another* **READSTRING** is performed, the end-of-file routine will be **EVALed**. As with the other non-terminal-directed I/O input routines, the default end-of-file routine is a call to **ERROR**.

This must seem very confusing, but many of your programs will require reading from the terminal and **READSTRING** is by far the best way to do this in MDL. One of the reasons for this is that **READSTRING** will allow the person inputting to your program to edit his input by means of the rubout key and the like. This facility is *very* hard to simulate if you are reading one **CHARACTER** at a time (e.g. with **READCHR**).

A very important warning regarding **READSTRING**: MDL, you will recall, only starts processing terminal input *after* an escape is typed. This is true also for calls to **READSTRING**. This means that you cannot expect to get a line of input from a user by doing a **READSTRING** with a 'stop condition' of a carriage-return or a line-feed unless this is followed by an escape. There are ways around this 'feature', but they are beyond the scope of this primer. Please consult the manual or a seasoned MDLer for help.

Here's a skeleton of a calculator program:

```

<DEFINE CALC (... "AUX" .. CNT (BUFFER <ISTRING 100 I\ >) ..)
  #DECL (... (CNT) FIX (BUFFER) STRING ...)
  <REPEAT ()
    <PRINC "
>">
    <SET CNT <READSTRING .BUFFER
      .INCHAN
      <STRING <ASCII 27>>>>
    <READCHR .INCHAN>
    <COND (<0? .CNT>
      <PRINC " Thanks for using the calculator!">
      <RETURN>)
      (<=? .CNT 100>
      <PRINC "
Sorry, that one's too big for me. Please try
something a bit easier, like 2 + 2.">)
      (T <CALCULATE .BUFFER .CNT>>>>

```

This calculator program is essentially a large REPEAT loop, as you might expect. Each time through, it starts by printing a prompt (a carriage-return followed by a closing angle-bracket). It then reads some input from the terminal into a STRING which is initialized at the start of the FUNCTION as having a LENGTH of 100. The stop-condition is the presence of an escape (27 decimal in ASCII). Since READSTRING will not read the terminating escape, a READCHR is performed. If one were to check on what the READCHR was returning, one would find it to always be an escape. If the value of the call to READSTRING is zero, no input was typed before the escape. In this example, the program terminates. If the return from READSTRING were 100, then the person typing to the program has given an excessively long input (this is only true in this example; the FUNCTION could have been written to accept much longer inputs) and he is told this. Otherwise, the function CALCULATE is called with the user's input (.BUFFER) and the number of CHARACTERS that the user typed (.CNT, i.e. the number of 'valid' CHARACTERS in .BUFFER). With any luck, CALCULATE will do something useful with its arguments, like performing the requested calculation and printing the result(s).

Could you write this skeleton without using a REPEAT? There are at least two other reasonable ways. If you cannot, try rereading Chapter 10.

12.6.2. PRINTSTRING

The SUBR PRINTSTRING is analogous to the SUBR READSTRING. It takes three arguments, a STRING (the STRING to print), a CHANNEL (on which to print it), and a FIX (the number of characters from the STRING to print). If the LENGTH of the STRING is less than the third argument, PRINTSTRING just prints the STRING. In any event, PRINTSTRING returns the number of characters actually printed.

12.7. SAVE Files

The entire state of MDL can be saved away in a file for later restoration: this is done with the SUBRs SAVE and RESTORE. This is a very different form of I/O from any mentioned up to now; the file used contains an actual image of your MDL address space and is not, in general, "legible" to other MDL routines. RESTOREing a SAVE file is much faster than re-READING the objects it contains.

12.7.1. SAVE

Calling the SUBR SAVE with a file-name will save away the entire state of your MDL in a file with that name. It then returns "SAVED". When a RESTORE is done later (to return to the 'saved' state), the call to SAVE returns "RESTORED".

```

<DEFINE SAVE-IT ("OPTIONAL"
                 (FILE "<GUEST>PUBLIC.SAVE")
                 "AUX" (SNM ""))
  <SETUP>
  <COND (<=? "SAVED" <SAVE .FILE>>
        <CLEANUP>
        "Saved.")
  (T
   <PRINC "
Amazing program at your service.">
   <START-RUNNING>>>

```

12.7.2. RESTORE

RESTORE, given a file-name, completely replaces the contents of the MDL from that file, including the state of execution existing when the SAVE was done and the state of all open I/O CHANNELs. If a file which was open when the SAVE was done does not exist when the RESTORE is done, a message to that effect will appear on the terminal.

A RESTORE never returns (unless it gets an error): it causes a SAVE done some time ago to return again (this time with the value "RESTORED"), even if the SAVE was done in the midst of running a program. In the latter case, the program will continue its execution upon RESTOREation.

12.8. PARSE, LPARSE, and UNPARSE

These SUBRs are borderline I/O routines. PARSE, given a STRING, uses READ₃ algorithm for converting text into MDL objects and returns the first one found.

```

<SET STR "(FOO 1 2.3) HO-HUM">$
"(FOO 1 2.3) HO-HUM"
<PARSE .STR>$
(FOO 1 2.3)

```

LPARSE, given a STRING, returns a LIST containing all of the items which READ would have found in the STRING. Using the same example:

```

<LPARSE .STR>$
((FOO 1 2.3) HO-HUM)

```

UNPARSE is the inverse of PARSE. Given a MDL object, UNPARSE returns a STRING, suitable for MDL PRINTing.

```

<UNPARSE (A B C)>$
"(A B C)"
<UNPARSE 3.4>
"3.40000000"

```

All of these SUBRs are very expensive CPU-wise. They should be avoided if at all possible.

12.9. Other I/O Functions

12.9.1. FLOAD

FLOAD, given a file-name, READs and EVALuates everything in the file, in order, and returns "DONE". If the file specified does not exist, FLOAD returns a FALSE containing the reason why.

12.9.2. SNAME

<SNAME *string*> is identical in effect with <SETG SNM *string*>, that is, it causes *string* to become the *dir* argument used by default by all SUBRs which want file specifications (in the absence of a local value for SNM). SNAME returns its argument.

<SNAME> is identical in effect with <GVAL SNM>, that is, it returns the current *dir* used by default.

12.9.3. FILE-LENGTH

FILE-LENGTH, given a **CHANNEL** open for input, returns the length in characters of the file associated with that **CHANNEL**. Doing a **FILE-LENGTH** on an terminal **CHANNEL** is silly.

12.9.4. RESET

`<RESET channel>`

returns *channel*, after "resetting" it. Resetting a **CHANNEL** is like **OPENING** it afresh, with only the file-name slots preserved. For an input **CHANNEL**, this means emptying all input buffers and, if it is a **CHANNEL** to a file, doing an **ACCESS** to 0 on it. For an output **CHANNEL**, this means returning to the beginning of the file -- which implies, if the mode is not "**PRINTO**", destroying any output done to it so far. If the opening fails (for example, if the mode slot of *channel* says input, and if the file specified in its real-name slots does not exist), **RESET** (like **OPEN**) returns **#FALSE** (*reason:string file-spec:string status:fix*).

12.9.5. RENAME

RENAME is for renaming and deleting files. It takes two kinds of arguments:

- (a) two file names, separated by the **ATOM TO**
- (b) one file name

Omitted file-name parts use the same values by default as does **OPEN**. If the operation is successful, **RENAME** returns **T**, otherwise **#FALSE** (*reason:string status:fix*).

In case (a) the file specified by the first argument is renamed to the second argument. For example:

```
<RENAME "FOO" TO "BAR"> ;"Rename FOO.MUD to BAR.MUD."
```

In case (b) the single file name specifies a file to be deleted. For example:

```
<RENAME "<MARC>FOO.MUD"> ;"Delete file FOO.MUD
                           from MARC's directory."
```

12.10. Terminal CHANNELs

MDL automatically adds a line-feed, whenever a carriage-return is input from a terminal CHANNEL. In order to type in a lone carriage-return, a carriage-return followed by a rubout must be input. PRINT, PRIN1 and PRINC do not automatically add a line-feed when a carriage-return is output. This enables overstriking on a terminal that lacks backspacing capability. It also means that what goes on a terminal and what goes in a file are more likely to look the same.

12.10.1. TYI

TYI, given a terminal input channel, returns one CHARACTER from it *when it is typed*, rather than after \$ (ESC) is typed, as is the case with READCHR. Novice MDLers tend to use TYI to read input from the terminal. This is not recommended as a rule. Use READSTRING instead.

13. Making Tables

It seems that MDL programmers are always making tables of one thing or another. Someone's Whois program may want a table relating a person's login name to his full name. Someone's Calculator program may want a table to associate arbitrary variable names with values.

There are any number of ways to implement tables for these types of purposes; some of these may already have come to mind. For our discussion, let's use the example of a calculator program which accepts inputs of the form:

```
A = 4 + 3
B = (A * A) + 7
```

Without considering the actual details of how the calculator might be written, something must be done to keep track of the fact that the variable A has a value of 7, and that B has a value of 56. What follows are a number of different approaches to solving this sort of problem. Each should be examined carefully and the advantages and disadvantages noted.

13.1. Use a LIST

This is the most common and possibly the most useful approach. For the given example, we can create a LIST, which, for example, is the GVAL of the ATOM VARIABLES.

```
,VARIABLES
(A 7 B 56)
```

If one wants to add a new variable, say C, with a value, say 100, one can do the following:

```
<SETG VARIABLES (C 100 !,VARIABLES)>
```

To check if a variable, say D, has a value, one can do this:

```
<MEMQ D ,VARIABLES>
```

To actually get D's most recent value,

```
<COND (<SET M <MEMQ D ,VARIABLES>>
      <2 .M>>>
```

This **COND** clause returns a **FALSE** if **D** doesn't have a value; otherwise, it returns the value.

Removing variables from the **LIST** can be done with **PUTREST**. As an exercise, write a **FUNCTION** which, given a variable name and a **LIST** (like the one we used above), removes the variable and its value from the **LIST**. Be sure you handle the case in which the variable isn't in the **LIST**. One solution to this is given at the end of the chapter. Don't peek, and don't be too frustrated. The **FUNCTION** isn't *that* easy to write.

LISTs are very space-efficient. However, while **LISTs** are practical for smallish tables, larger ones will tend to become very slow to access, since **LISTs** are not random-access structures (see Chapter 7). If your table needs to be more than a hundred elements long, you should probably try something else.

13.2. Use a VECTOR

Think twice before you do. As we saw in Chapter 7, **VECTORs** have the property that they cannot be added to and cannot have elements removed without creating an entirely new structure (which is very garbage-creating). Therefore, using **VECTORs** is not a good idea unless the table is 'pre-formed' and elements need never be removed or added. If you have a table of ordered elements of relatively fixed size, use of **VECTORs** with some sort of binary-searching algorithm is appropriate. For the calculator example, don't use a **VECTOR**.

13.3. Use an ATOM

Another simple approach would be to **SETG** the variable name (which is an **ATOM**) to its value. Then, you can use **GASSIGNED?** to check if it has a value, **GVAL** to get it, and **GUNASSIGN** to remove it. Lookup using **GVALs** is moderately fast, but there is a problem. Imagine the result of your poor calculator user setting a variable whose name is the name of your program. The use of **SET** and **LVAL** is also perilous.

13.4. Use an Association

MDL allows you to assign a value to a *pair* of MDL objects. This can be done using the `SUBR PUTPROP`. The value of such an 'association' can be retrieved with the `SUBR GETPROP`.

```
<PUTPROP MICHAEL AGE 28>$
MICHAEL
<GETPROP MICHAEL AGE>$
28
```

One can associate *any* three MDL objects using `PUTPROP`. A useless, but legal, use might be:

```
<PUTPROP [1 2 3] (4 5 6) "FOOBAR">$
[1 2 3]
<GETPROP [1 2 3] (4 5 6)>$
#FALSE ()
```

Why did the last `GETPROP` return `#FALSE ()`? Hint: Are either of the arguments to `GETPROP` `==?` to the arguments to `PUTPROP`?

By giving `PUTPROP` only two arguments, it returns what `GETPROP` would have returned, and then *removes* the association.

```
<PUTPROP MICHAEL AGE>$
28
<GETPROP MICHAEL AGE>$
#FALSE ()
```

In the calculator example, one could do something like this:

```
<PUTPROP A VARIABLE 7>$
A
<PUTPROP B VARIABLE 56>$
B
```

to set the variables' value. One would retrieve the values like this:

```
<GETPROP A VARIABLE>$
7
<GETPROP B VARIABLE>$
56
```

Associations are fast (they use a hashing scheme with a fixed number of buckets), but rather

space-inefficient. Large numbers of them will tend to crowd your core-image.

13.4.1. Hashing

Hashing, for those unfamiliar with the notion, is an algorithm for table lookup which is based on a 'directed search'. A hash table can be thought of as a VECTOR of LISTS. These LISTS are commonly called 'buckets'. Each actual item in the hash table is found in one of these 'buckets'. What makes hash lookup fast is that there is a simple algorithm for determining which 'bucket' an item is in. Once that determination is made, the 'bucket' is searched linearly for the item. Thus, a hash table of length 100, which contains 1000 items, would have an average of 10 items per 'bucket'. Thus, the access time for looking up an item would be the same as that for MEMQ'ing a LIST of 10 elements plus the small overhead of determining which 'bucket' the item is in. This is obviously much faster than linearly searching a LIST of 1000 elements, by a factor approaching 100.

13.5. Use an OBLIST

OBLISTS are tables of ATOMs which are hashed in such a way that finding an ATOM in one is very fast. Similarly, inserting and removing ATOMs is simple.

To create an OBLIST of your own, use the SUBR MOBLIST (Make OBLIST), which takes a name (ATOM) and the number of hash buckets for the OBLIST (defaultly 17). For best results, the number of buckets should be prime.

```
<SETG FOOBAR <MOBLIST FOOBAR 7>>$
#OBLIST ![( ) ( ) ( ) ( ) ( ) ( )]
```

Note that there are seven empty LISTS in the OBLIST -- you guessed it ... each LIST is a bucket!

To insert an ATOM into an OBLIST, use the SUBR INSERT. To remove an ATOM from an OBLIST, use the SUBR REMOVE. To look up an ATOM in an OBLIST, use the SUBR LOOKUP. Each of these three SUBRs takes a STRING, the PNAME of the ATOM, and an OBLIST.

```
<INSERT "MIKE" ,FOOBAR>$
MIKE!-FOOBAR
,FOOBAR$
#OBLIST ![( ) ( ) ( ) ( ) (MIKE!-FOOBAR) ( ) ( )]
<LOOKUP "MIKE" ,FOOBAR>$
MIKE!-FOOBAR
<LOOKUP "BLETCH" ,FOOBAR>$
#FALSE ( )
```

There's something new here, namely the suffix to the name of the ATOM: an exclamation point, a hyphen, and an ATOM. This suffix is called an 'oblist-trailer' or simply a 'trailer'. It is there so that READ and PRINT can distinguish this new ATOM whose PNAME is FOOBAR from an ATOM on another OBLIST whose PNAME is FOOBAR. Therefore, to directly reference the ATOM of PNAME BLETC in the FOOBAR OBLIST, one must type in the following:

```
BLETC!-FOOBAR
```

In fact, typing BLETC!-FOOBAR causes READ to create an ATOM with PNAME BLETC in the FOOBAR OBLIST if none already existed. Not only that, but typing FROB!-MUMBLE causes READ to create an ATOM of PNAME FROB in the MUMBLE OBLIST (creating a MUMBLE OBLIST if necessary) if none already existed.

If you are interested in a more complete description of OBLISTS, refer to the next section. To continue with the calculator example, we might start by creating an OBLIST for variables.

```
<SETG VARIABLES <MOBLIST VARIABLES>>$
#OBLIST ....
```

Then, we assign values to A and B as follows:

```
<DEFINE SET-VARIABLE (NAM VAL "AUX" (PNM <PNAME .NAM>))
  #DECL ((NAM) ATOM (VAL) ANY (PNM) STRING)
  <SETG <COND (<LOOKUP .PNM ,VARIABLES>)
            (T <INSERT .PNM ,VARIABLES>)>
    .VAL>>$
SET-VARIABLE
<SET-VARIABLE A 7>$
7
<SET-VARIABLE B 56>$
56
```

To retrieve values, we might do this:

```
<DEFINE GET-VARIABLE (NAM "AUX" ATM)
  #DECL ((NAM) ATOM (ATM) <OR FALSE ATOM>)
  <COND (<SET ATM <LOOKUP <PNAME .NAM> ,VARIABLES>
        ..ATM)>>$
GET-VARIABLE
<GET-VARIABLE B>$
56
<GET-VARIABLE D>$
#FALSE ()
```

Using OBLISTS in this way solves the problem mentioned earlier regarding the use of ATOMS: that of

variable conflicts. By using ATOMs in your own private OBLIST, there is no danger of mistakenly changing the value of someone else's (or your own...) ATOM. Now, your calculator user can use variable names which are the same as those of your calculator FUNCTIONS without fear of disaster.

To summarize, using OBLISTs is fast. ATOMs are rather large; about the same size as an association. Whereas the hashing table for associations is a fixed size, the hashing table for an OBLIST can be determined when the OBLIST is created. ATOMs are more versatile than associations, and can be used in more ways. Good MDL programmers, given the choice, will use OBLISTs over associations.

13.6. OBLISTs, READ, and PRINT

It was stated in section 4.1 that typing GEORGE to MDL caused READ to "look up the representation [of GEORGE]" in a "table it keeps for such purposes...." It should now be clear that the "table it keeps" is, in fact, an OBLIST, and that it "looks up the representation" by using the SUBR LOOKUP. You are now ready to understand what, in fact, READ does.

When READ encounters something that it determines must be an ATOM (i.e. it can't be anything else), it does LOOKUPs of the PNAME sequentially in all of the OBLISTs in .OBLIST (i.e. the LVAL of the ATOM OBLIST). [MDL sets up .OBLIST to be a LIST of OBLISTs. Initially, .OBLIST has two OBLISTs in it: the INITIAL OBLIST (user ATOMs) and the ROOT OBLIST (MDL's ATOMs). The ATOMs which point to the F/SUBRs all live in ROOT.] The value of the first LOOKUP to succeed becomes the value of the call to READ. If the PNAME isn't found, an ATOM with that PNAME is INSERTed into <1 .OBLIST>.

If READ (of ATOMs) were written in MDL, it might look like this:

```
<DEFINE READ-ATOM (STR)
  #DECL ((STR) STRING)
  <COND (<MAPF <>
    <FUNCTION (OBL "AUX" ATM)
      #DECL ((OBL) OBLIST (ATM) <OR FALSE ATOM>)
      <COND (<SET ATM <LOOKUP .STR .OBL>>
        <MAPLEAVE .ATM>>>
      .OBLIST))
  (T <INSERT .STR <1 .OBLIST>>>>>
```

However, if an explicit trailer is given, the ATOM is placed in the OBLIST named in the trailer. Trailers may be 'recursive'. For example, A1-B1-C1-D1-E is an ATOM with PNAME A which is in an OBLIST whose name is an ATOM with PNAME B which is on an OBLIST whose name.... The ATOM with PNAME E will reside in one of the OBLISTs in .OBLIST. When PRINT attempts to print an ATOM of this kind, it prints trailers until one of the OBLIST names can be found on an OBLIST in .OBLIST.

14. Debugging MDL Programs - An Introduction

If you have ever written a program which works completely correctly on the first attempt, you most likely have benefited from divine intervention. In the more likely event that one of your MDL programs is "buggy", you will see messages which look like this:

```
*ERROR*
reason
information-about-error
function-which-generated-it
LISTENING-AT-LEVEL n PROCESS m
```

The *information-about-error* may be one or more than one object. The *n* is an indication of how many levels of errors have occurred, and *m* should be completely ignored. If you ever see a number other than 1 in that position, you probably don't need to be reading this.

The meaning of this gobbledygook is that the MDL SUBR ERROR was invoked. This may have happened from an explicit call to ERROR, as in the following:

```
<ERROR YOU-LOSE BECAUSE MY-FUNCTION>
```

More likely, however, the MDL interpreter discovered an error in your program, such as a variable without a value, or a bad argument to a *function*, and called ERROR internally. The effect is the same: *ERROR* is printed, followed by all of the arguments to ERROR, and MDL starts LISTENING at the next higher level. In other words, LISTEN has been called recursively.

In the remainder of this chapter, we will be discussing the debugging of a particularly trivial error in a sample FUNCTION. Please refer frequently to the figure at the end of the chapter in which parts of the example are diagrammed and commented.

In order to correct an error, it is necessary to have some information about the history of MDL's execution at the time of the error. To do this, the *function* FR& is called, usually without arguments. Let us assume that the following FUNCTION is being called as follows:

```

<DEFINE GT10 (ARG) <G? .AGR 10>>$
GT10
<GT10 11>$
*ERROR*
UNBOUND-VARIABLE
AGR
LVAL
LISTENING-AT-LEVEL 2 PROCESS 1

<FR&>$

0 ERROR          [UNBOUND-VARIABLE!-ERRORS AGR LVAL]
1 LVAL           [AGR]
2 EVAL           [.AGR]
3 EVAL           [<G? .AGR 10>]
4 EVAL           [<GT10 11>]
5 LISTEN         []
TOPLEVEL

```

What is shown here, one to a line, are the **FRAMEs** which have been generated by MDL, starting from the one called **LISTEN**, which is where MDL was waiting when the **FORM** `<GT10 11>` was input. The lines above this one are the steps which MDL took until the error occurred, namely in the code for **LVAL**. Each line has a number, by which the **FRAME** can be identified, the **FUNCT** of the **FRAME** (always an **ATOM**), and the **ARGS** of the **FRAME** (always a **TUPLE**). For these purposes, a **TUPLE** can be considered to be a **VECTOR**. Given a **FRAME** number, the **FRAME** can be referenced by invoking the *function* **FRM**, as follows:

```

<SET F <FRM 3>>$
#FRAME EVAL
<FUNCT .F>$
EVAL
<ARGS .F>$
[<G? .AGR 10>]

```

Having gotten this far, it has become obvious that the problem is that the function **GT10** is incorrect, in that the reference to **AGR** was intended to be a reference to **ARG**. What follows are some ways of fixing the problem, all of which will work. Although this is a trivial example of an error, as the problem itself was easy to spot, the methods of error recovery are always the same!

14.1. Method 1: Start Over

Edit the **FUNCTION** with your favorite text editor and reload it, retype it in to MDL directly, or whatever. Then invoke the **SUBR ERRET** with no arguments. This will cause MDL to return to its "top

level", i.e. LISTENING-AT-LEVEL 1. All parts of the execution in progress including all ATOMIC bindings (except those made at "top level") will be lost.

```
<ERRET>$
```

```
LISTENING-AT-LEVEL 1 PROCESS 1
```

14.2. Method 2: Forcing FRAMEs to Return Values

It is possible to cause MDL to force an arbitrary FRAME to return an arbitrary value and to continue execution from that point. This is done by calling ERRET with either one or two arguments. The first argument is the value for the FRAME to return, and the second, if given, is the FRAME which is to return that value. If no second argument is given, the FRAME immediately previous to the ERROR FRAME will be used as a default.

```
<ERRET 9>$
#FALSE ()
```

What happened was that the LVAL FRAME (i.e. <FRM 1>) was caused to return 9. Execution continued, such that the EVAL FRAME above (i.e. <FRM 3>) also returned 9, and the next frame evaluated <G? 9 10>, which returned an empty FALSE, which became the value of the call to GT10. Notice that in this case, the fact that 11 was originally passed to GT10 has become unimportant. Another way of doing the same thing would have been to say

```
<ERRET 9 <FRM 1>>$
#FALSE () or
<ERRET 9 <FRM 2>>$
#FALSE ()
```

However, saying

```
<ERRET 9 <FRM 3>>$
9
```

has a different result. What happened was that the FORM <G? .AGR 10> was forced to return 9. Since that FORM was the last in the body of the FUNCTION, the result of its evaluation became the result of the evaluation of the FUNCTION. Therefore, GT10 returned 9.

14.3. Method 3: Use EDIT to Repair your FUNCTIONS

In the last method, nothing has been done to correct the real problem, i.e. that the program has a bug in it. One way to solve this is to use the MDL editor, a *function* called **EDIT** to alter the program itself. **EDIT** is usually invoked with the name of a **FUNCTION** to be edited as the only argument. You will now be "talking" to the MDL editor. Commands to the editor should be terminated with an escape, and are one or two characters followed by some arguments, which are usually optional. **EDIT** will display after each command your current "location" in the **FUNCTION** you are editing. To move around, the commands L (left), R (right), U (up), and D (down) are used. These may be followed by a numerical argument, the number of times to perform the command. The arguments must be preceded by a space. A vertical bar is used here to indicate your "position" in the edited **FUNCTION**. In the real MDL editor, the "position" may be indicated by some other characters.

```
<EDIT GT10>$
#FUNCTION (| (ARG) <G? .AGR 10>)
R 2$
#FUNCTION ((ARG) <G? .AGR 10> |)
L$
#FUNCTION ((ARG) | <G? .AGR 10>)

D$
<| G? .AGR 10>
D$
ERROR, YOU CAN'T GO DOWN
<| G? .AGR 10>
R$
<G? | .AGR 10>)
```

To alter the **FUNCTION** the following commands may be used: I (insert), K (kill), and C (change). Insert takes any number of objects as arguments and inserts them all to the right of your "location". Kill takes an optional number (default 1) and removes that many objects from the right of your "location". Change takes one argument and changes the object to the right of your "location" to it.

```
<G? | .AGR 10>
C .ARG$
<G? | .ARG 10>
```

This has had the effect of fixing the error in the program. To exit the editor, use the Q command.

```
<G? | .ARG 10>
Q$T
```

The T was the returned value of the call to **EDIT**. Now, a look at the **FRAMEs** using **FR&** shows the following:

```

<FRM>$
0 ERROR      [UNBOUND-VARIABLE|-ERRORS AGR LVAL]
1 LVAL       [AGR]
2 EVAL       [.AGR]
3 EVAL       [<G? .ARG 10>]
4 EVAL       [<GT10 11>]
5 LISTEN     []
TOPLEVEL

```

Make sure you understand what has happened. The way the editor works for the case of the C command is to PUT the argument to C into the *structure*. The FORMs contained in the ARGs of FRAMEs are simply pointers directly into the FUNCTION being executed. Thus, the PUT into the FORM will change the argument to the FRAME which points to it! This is extremely important, and is illustrated in the diagram at the end of the chapter. Think about this very carefully if you don't understand this, and then be sure you convince yourself of why the argument to <FRM 2> has *not* changed.

Now that you have done this, it would be useful if you could tell MDL to go back and retry <FRM 3>. In fact you can, using the SUBR RETRY which takes a FRAME as an argument, and simply pretends that nothing past that point in execution has ever happened. This works completely as long as the execution below that point hasn't had any side-effects. A MDL *function* is said to have side-effects if it does anything other than manipulate its local variables and return a value. Stated another way, a *function* with *no* side-effects is a black-box with an input (arguments) and an output (value), but no effect on the 'outside world'. The most blatant side-effecting SUBRs are PUT, PUTREST, SETG, and PRINT. SETting ATOMs which are not bound in a currently executing FUNCTION also has side-effects. In a purist structured-programming sense, no *function* should have side-effects (with the obvious exception of printing output). However, there are certainly cases in which PUT, PUTREST, and SETG are tremendously useful, if not vital. Care should be taken, however, since many bugs can be traced to one *function's* causing a side-effect which causes another *function* to fail.

```

<RETRY <FRM 3>>$
T

```

Question: Would

```

<RETRY <FRM 4>>$

```

have the same effect? The answer is yes, because you are restarting from an earlier level of execution. What would be the effect of RETRYing <FRM 5>? Hint: It isn't a return of T. What would be the effect of RETRYing <FRM 2>? Hint: It isn't good. If you aren't completely sure of the answer to these, try it in MDL.

14.4. Method 4: Altering FRAMEs / RETRY

Let's try the following, starting from the point of the error:

```
<SET X <1 <ARGS <FRM 3>>>>>$
<G? .AGR 10>
<PUT .X 2 '.ARG>$           ;"Why the quote?"
<G? .ARG 10>
<RETRY <FRM 3>>>$
T
```

We have done the same thing as we did using method 3, but from a different angle. Question: What does the FUNCTION GT10 look like now? Hint: Not the same. If you don't see this, you didn't understand why editing the FUNCTION worked either.

14.5. Summary

We have presented four different ways of handling errors in MDL. This list is not exhaustive, but it should provide enough background to enable you to handle most situations. If this chapter has been totally confusing, ask someone for help and use method 1 in the meantime. Notice that method 2 does *not* prevent the same error from recurring; it merely corrects the current instance of that error. Methods 3 and 4 correct the general problem and the current instance of the error generated by the problem. However, even though the FUNCTION is changed in your MDL, you still must alter it using your favorite editor at a later time (or write out an updated copy of the file directly from MDL). The changes made while in MDL are *not* reflected in your files! They will, however, allow you to proceed without moving back and forth constantly between MDL and your editor.

MDL has many other debugging aids including breakpoints (in EDIT), tracing, monitoring the values of local and global variables, and more. For a detailed description of these facilities, consult *The MDL Programming Environment* [Lebling 80].

Selected FRAMES during execution of GT10 as described in the text. Note that the FRAMES point directly at the structure of GT10 (e.g. the FORM in FRM3 is ==? to the second element of the FUNCTION).

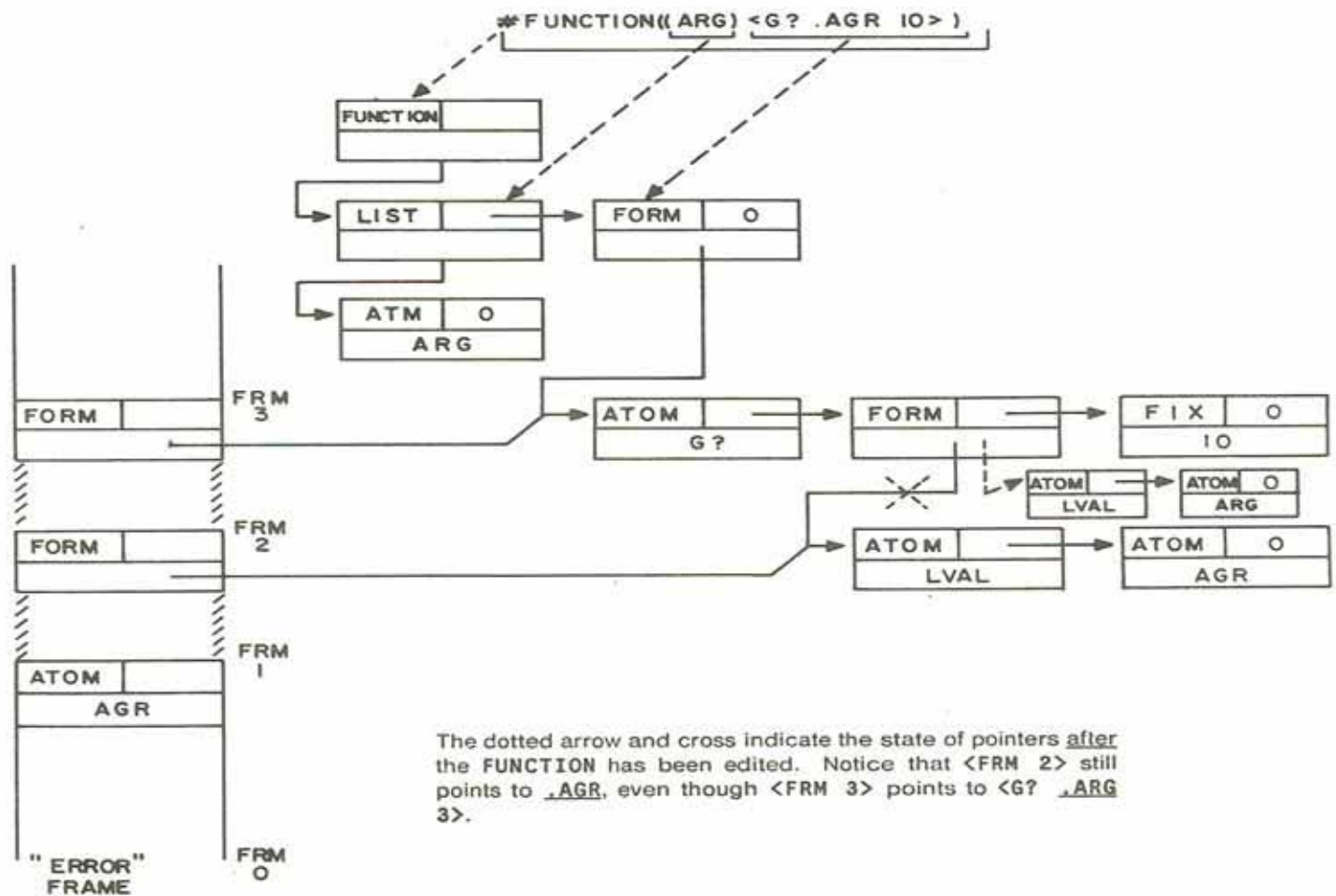

Figure 14-1: Diagram for the example in this chapter

References

- [Galley 79]
S. W. Galley and Greg Pfister.
The MDL Programming Language.
M.I.T. Laboratory for Computer Science, 1979.
- [Lebling 77]
P. David Lebling, R. V. Baron and Bruce K. Daniels.
RMODE: A Real-time Edit Facility.
Technical Report SYS.04.07-1, MIT LCS Programming Technology Division, October, 1977.
- [Lebling 80]
P. David Lebling.
The MDL Programming Environment.
M.I.T. Laboratory for Computer Science, 1980.
- [Pfister 72]
Greg Pfister.
A Muddle Primer.
Technical Report SYS.11.01, MIT Project Mac DM/CGS, May, 1972.
- [Stallman 79]
Richard M. Stallman.
EMACS.
MIT AI Laboratory, 1979.
- [Weinreb 78]
Daniel Weinreb and David Moon.
Lisp Machine Manual.
MIT AI Laboratory, 1978.

Index

! 54
 !\$ 8
 !- 113
 ![58
 !\ 59, 99
 !] 58

 " 11, 99

 # 12, 37, 99

 \$ 7, 98, 108

 ' 36, 63, 87

 (11

) 11

 * 24

 + 24

 , 21

 - 24

 . 22

 / 24

 0? 25

 1? 25

 < 11

 ==? 25, 41
 =? 41

 > 11

 ABS 24
 ACTIVATION 78
 AGAIN 77
 AND 69, 72, 90
 AND? 70

 "ARGS" 89
 ASCII 60
 ASSIGNED? 26, 88
 ATAN 24, 31
 ATOM 19, 35, 99
 "AUX" 90, 101

 BACK 57, 66
 Binding 29, 77

 CHANLIST 101
 CHANNEL 100, 101
 CHARACTER 35, 59, 61, 99
 CHTYPE 38
 CLOSE 101
 . 21
 COND 70
 COS 24, 31
 CRLF 99

 DECL 91, 93
 DEFINE 89
 . 22

 EDIT 118
 EMPTY? 43, 66
 =? 41
 ==? 25, 41
 Equality 41
 ERRET 9, 116, 117
 ERROR 9, 115
 EVAL 15, 23, 45, 65, 87, 89
 ! 54
 !\ 59
 !- 113
 !\$ 8
 ![58
 !] 58
 EXP 24, 31

 False 14, 25
 FALSE 35, 37, 53
 FILE-EXISTS? 101
 FILE-LENGTH 107
 FIX 11, 16, 17, 24, 26, 35
 FLOAD 34, 106
 FLOAT 11, 16, 17, 24, 26, 35
 FORM 12, 35

FR& 9, 115
 FRAME 116
 FRAMES 9
 Free variables 30, 90
 FSUBR 23, 69, 70, 89
 FUNCTION 27, 79

G=? 25
 G? 25
 Garbage 63
 GASSIGNED? 26, 110
 GETPROP 111
 GUNASSIGN 110
 GVAL 21, 31

Hashing 112

ILIST 62
 INCHAN 101
 INIT 34
 INSERT 112
 ISTRING 62
 Iteration 86
 ITS 8
 IVECTOR 62

L=? 25
 L? 25
 LENGTH 43, 66
 LENGTH? 51, 66
 Lisp 1
 LIST 12, 35, 41, 44, 66
 LISTEN 115
 LOG 24, 31
 LOOKUP 112
 LPARSE 106
 LVAL 22, 29

MAPF 79, 84
 MAPLEAVE 80
 MAPR 83, 84
 MAPRET 81
 MAPSTOP 82
 MAX 24
 MDL 1
 MEMBER 62, 66
 MEMQ 62, 66
 MIN 24
 NOBLIST 112
 MOD 24
 MUDDLE 34
 "MUDDLE.INIT" 34

N==? 26
 "NAME" 78
 NEWTYPE 38, 65, 93
 NEXTCHR 98
 NOT 69
 NTH 45, 52, 66

OBLIST 99, 112, 114
 OPEN 100, 107
 OPTIONAL 88
 OR 70, 72
 OR? 70
 OUTCHAN 101

PARSE 105
 . 22
 PNAME 19, 114
 PPRINT 33
 Predicates 25
 Prefix Notation 13
 Pretty Printing 33
 PRINTYPE 35, 41, 65
 PRIM1 99, 108
 PRINC 99, 108
 PRINT 15, 17, 99, 108
 PRINTSTRING 104
 PROG 77
 PUT 45, 52, 66
 PUTPROP 111
 PUTREST 47, 66

* 36, 63, 87

RANDOM 25
 READ 15, 16, 98, 114
 READCHR 98, 108
 READSTRING 103
 Recursion 74, 86
 REMOVE 112
 RENAME 107
 REPEAT 78
 RESET 107
 REST 45, 66
 RESTORE 105
 RETRY 119
 RETURN 77, 78
 Rubout 8, 98

SAVE 105
 SEGMENT 53, 66
 SET 21, 29
 SETG 20, 29
 SIM 24, 31
 SNAME 106
 SNM 106
 SQRT 24, 30
 STRING 35, 59, 66, 99
 SUBR 23
 Subroutine 23

T 25
 Tenex 8, 34
 TO 107
 TOP 57, 66
 Tops-20 8, 34
 Trailer 113
 True 25

Truth 14
"TUPLE" 88
TYI 108
TYPE 11, 15, 35
TYPE? 38
TYPEPRIM 38

UNPARSE 108
UTYPE 59
UVECTOR 58, 66

VECTOR 12, 35, 54, 66

WORD 35

Zork 74

[11
\
99
]
11

+@ 8, 98
+D 8, 98
+G 8
+L 8, 98
+O 8
+S 8, 51

{ 11
} 11