

Programmer's Guide

Microsoft  
**MASM**

# Programmer's Guide

## **Microsoft® MASM**

**Assembly-Language Development System  
Version 6.1**

**For MS-DOS® and Windows™ Operating Systems**

Information in this document is subject to change without notice. Companies, names, and data used in examples herein are fictitious unless otherwise noted. No part of this document may be reproduced or transmitted in any form or by any means, electronic or mechanical, for any purpose, without the express written permission of Microsoft Corporation.

©1992 Microsoft Corporation. All rights reserved.

Microsoft, MS, MS-DOS, XENIX, CodeView, and QuickC are registered trademarks and Microsoft QuickBasic, QuickPascal, Windows and Windows NT are trademarks of Microsoft Corporation in the USA and other countries.

U.S. Patent No. 4,955,066

Hercules is a registered trademark of Hercules Computer Technology.

IBM, PS/2, and OS/2 are registered trademarks of International Business Machines Corporation.

Intel is a registered trademark of Intel Corporation.

NEC and V25 are registered trademarks and V35 is a trademark of NEC Corporation.

# Contents

<b>Introduction</b> .....	<b>xiii</b>
New and Extended Features in MASM 6.1. ....	xiii
MASM Features New Since Version 5.1 .....	xiv
MASM Features New Since Version 6.0. ....	xv
ML and MASM Command Lines .....	xvi
Compatibility with Earlier Versions of MASM .....	xvi
A Word About Instruction Timings .....	xvii
Books for Further Reading .....	xviii
Document Conventions .....	xix
Getting Assistance and Reporting Problems .....	xx
<b>Chapter 1 Understanding Global Concepts</b> .....	<b>1</b>
The Processing Environment .....	1
8086-Based Processors .....	2
Operating Systems .....	4
Segmented Architecture .....	5
Segment Protection .....	6
Segmented Addressing .....	7
Segment Arithmetic .....	7
Language Components of MASM .....	8
Reserved Words .....	8
Identifiers .....	9
Predefined Symbols .....	10
Integer Constants and Constant Expressions .....	11
Operators .....	13
Data Types .....	14
Registers .....	16
Statements .....	21
The Assembly Process .....	22
Generating and Running Executable Programs .....	23
Using the OPTION Directive .....	24
Conditional Directives .....	28
<b>Chapter 2 Organizing Segments</b> .....	<b>31</b>
Physical Memory Segments .....	32
Logical Segments .....	32



Using Simplified Segment Directives . . . . .	33
Defining Basic Attributes with .MODEL . . . . .	34
Specifying a Processor and Coprocessor . . . . .	38
Creating a Stack . . . . .	38
Creating Data Segments . . . . .	39
Creating Code Segments . . . . .	40
Starting and Ending Code with .STARTUP and .EXIT . . . . .	41
Using Full Segment Definitions . . . . .	44
Defining Segments with the SEGMENT Directive . . . . .	44
Controlling the Segment Order . . . . .	47
Setting the ASSUME Directive for Segment Registers . . . . .	49
Defining Segment Groups . . . . .	51
<b>Chapter 3 Using Addresses and Pointers . . . . .</b>	<b>53</b>
Programming Segmented Addresses . . . . .	53
Initializing Default Segment Registers . . . . .	53
Near and Far Addresses . . . . .	57
Operands . . . . .	60
Register Operands . . . . .	61
Immediate Operands . . . . .	61
Direct Memory Operands . . . . .	62
Indirect Memory Operands . . . . .	64
The Program Stack . . . . .	71
Saving Operands on the Stack . . . . .	71
Saving Flags on the Stack . . . . .	73
Saving Registers on the Stack (80186–80486 Only) . . . . .	74
Accessing Data with Pointers and Addresses . . . . .	74
Defining Pointer Types with TYPEDEF . . . . .	75
Defining Register Types with ASSUME . . . . .	77
Basic Pointer and Address Operations . . . . .	78
<b>Chapter 4 Defining and Using Simple Data Types . . . . .</b>	<b>85</b>
Declaring Integer Variables . . . . .	85
Allocating Memory for Integer Variables . . . . .	85
Data Initialization . . . . .	87
Working with Simple Variables . . . . .	88
Copying Data . . . . .	89
Adding and Subtracting Integers . . . . .	92
Multiplying and Dividing Integers . . . . .	95
Manipulating Numbers at the Bit Level . . . . .	98

Logical Instructions . . . . .	99
Shifting and Rotating Bits . . . . .	100
Multiplying and Dividing with Shift Instructions . . . . .	102
<b>Chapter 5 Defining and Using Complex Data Types . . . . .</b>	<b>105</b>
Arrays and Strings . . . . .	105
Declaring and Referencing Arrays . . . . .	105
Declaring and Initializing Strings . . . . .	108
Processing Strings . . . . .	110
Structures and Unions . . . . .	117
Declaring Structure and Union Types . . . . .	118
Defining Structure and Union Variables . . . . .	121
Referencing Structures, Unions, and Fields . . . . .	126
Nested Structures and Unions . . . . .	128
Records . . . . .	129
Declaring Record Types . . . . .	130
Defining Record Variables . . . . .	131
Record Operators . . . . .	133
<b>Chapter 6 Using Floating-Point and Binary Coded Decimal Numbers . . . . .</b>	<b>135</b>
Using Floating-Point Numbers . . . . .	136
Declaring Floating-Point Variables and Constants . . . . .	136
Storing Numbers in Floating-Point Format . . . . .	138
Using a Math Coprocessor . . . . .	139
Coprocessor Architecture . . . . .	140
Instruction and Operand Formats . . . . .	141
Coordinating Memory Access . . . . .	145
Using Coprocessor Instructions . . . . .	146
Using An Emulator Library . . . . .	155
Using Binary Coded Decimal Numbers . . . . .	156
Defining BCD Constants and Variables . . . . .	157
BCD Calculations on a Coprocessor . . . . .	157
BCD Calculations on the Main Processor . . . . .	158
<b>Chapter 7 Controlling Program Flow . . . . .</b>	<b>161</b>
Jumps . . . . .	161
Unconditional Jumps . . . . .	162
Conditional Jumps . . . . .	164
Loops . . . . .	172
Loop-Generating Directives . . . . .	173
Writing Loop Conditions . . . . .	178

---

Procedures . . . . .	180
Defining Procedures . . . . .	180
Passing Arguments on the Stack. . . . .	182
Declaring Parameters with the PROC Directive . . . . .	184
Using Local Variables . . . . .	188
Creating Local Variables Automatically . . . . .	190
Declaring Procedure Prototypes . . . . .	193
Calling Procedures with INVOKE . . . . .	194
Generating Prologue and Epilogue Code . . . . .	198
MS-DOS Interrupts . . . . .	204
Calling MS-DOS and ROM-BIOS Interrupts . . . . .	204
Replacing an Interrupt Routine . . . . .	206
<b>Chapter 8 Sharing Data and Procedures Among Modules and Libraries . . . . .</b>	<b>211</b>
Selecting Data-Sharing Methods. . . . .	211
Sharing Symbols with Include Files. . . . .	212
Organizing Modules . . . . .	212
Declaring Symbols Public and External . . . . .	214
Positioning External Declarations . . . . .	228
Using Alternatives to Include Files . . . . .	219
PUBLIC and EXTERN. . . . .	220
Other Alternatives . . . . .	221
Developing Libraries . . . . .	221
Associating Libraries with Modules . . . . .	222
Using EXTERN with Library Routines . . . . .	223
<b>Chapter 9 Using Macros . . . . .</b>	<b>225</b>
Text Macros . . . . .	226
Macro Procedures . . . . .	226
Creating Macro Procedures . . . . .	227
Passing Arguments to Macros . . . . .	228
Specifying Required and Default Parameters. . . . .	229
Defining Local Symbols in Macros . . . . .	232
Assembly-Time Variables and Macro Operators . . . . .	233
Text Delimiters and the Literal-Character Operator . . . . .	234
Expansion Operator . . . . .	235
Substitution Operator . . . . .	237
Defining Repeat Blocks with Loop Directives . . . . .	239
REPEAT Loops . . . . .	240
WHILE Loops . . . . .	241

---

FOR Loops and Variable-Length Parameters . . . . .	242
FORC Loops . . . . .	244
String Directives and Predefined Functions . . . . .	245
Returning Values with Macro Functions . . . . .	248
Returning Values with EXITM . . . . .	248
Using Macro Functions with Variable-Length Parameter Lists . . . . .	249
Expansion Operator in Macro Functions . . . . .	251
Advanced Macro Techniques . . . . .	251
Defining Macros within Macros . . . . .	251
Testing for Argument Type and Environment . . . . .	252
Using Recursive Macros . . . . .	255
<b>Chapter 10 Writing a Dynamic-Link Library For Windows . . . . .</b>	<b>257</b>
Overview of DLLs . . . . .	257
Loading a DLL . . . . .	258
Building a DLL . . . . .	260
DLL Code . . . . .	261
DLL Data . . . . .	265
DLL Stack . . . . .	265
DLL Extension Names . . . . .	266
Summary . . . . .	266
Example of a DLL: SYSINFO . . . . .	267
Entry Routine for SYSINFO . . . . .	268
Expanding SYSINFO . . . . .	270
<b>Chapter 11 Writing Memory-Resident Software . . . . .</b>	<b>273</b>
Terminate-and-Stay-Resident Programs . . . . .	273
Structure of a TSR . . . . .	274
Passive TSRs . . . . .	274
Active TSRs . . . . .	275
Interrupt Handlers in Active TSRs . . . . .	275
Auditing Hardware Events for TSR Requests . . . . .	275
Monitoring System Status . . . . .	277
Determining Whether to Invoke the TSR . . . . .	279
Example of a Simple TSR: ALARM . . . . .	279
Using MS-DOS in Active TSRs . . . . .	285
Understanding MS-DOS Stacks . . . . .	285
Determining MS-DOS Activity . . . . .	285
Interrupting MS-DOS Functions . . . . .	286
Monitoring the Critical Error Flag . . . . .	287

Preventing Interference . . . . .	288
Trapping Errors . . . . .	288
Preserving an Existing Condition . . . . .	289
Preserving Existing Data . . . . .	290
Communicating Through the Multiplex Interrupt . . . . .	290
The Multiplex Handler . . . . .	291
Using the Multiplex Interrupt Under MS-DOS Version 2.x . . . . .	292
Deinstalling a TSR . . . . .	292
Example of an Advanced TSR: SNAP . . . . .	293
Building SNAP.EXE . . . . .	294
Outline of SNAP . . . . .	295
<b>Chapter 12 Mixed-Language Programming . . . . .</b>	<b>307</b>
Naming and Calling Conventions . . . . .	308
Naming Conventions . . . . .	309
The C Calling Convention . . . . .	309
The Pascal Calling Convention . . . . .	310
The STDCALL and SYSCALL Calling Conventions . . . . .	311
Writing an Assembly Procedure For a Mixed-Language Program . . . . .	312
The MASM/High-Level-Language Interface . . . . .	313
The C/MASM Interface . . . . .	315
The C++/MASM Interface . . . . .	322
The FORTRAN/MASM Interface . . . . .	323
The Basic/MASM Interface . . . . .	328
<b>Chapter 13 Writing 32-Bit Applications . . . . .</b>	<b>335</b>
32-Bit Memory Addressing . . . . .	335
MASM Directives for 32-Bit Programming . . . . .	336
Sample Program . . . . .	337

## Appendixes

<b>Appendix A Differences Between MASM 6.1 and 5.1 . . . . .</b>	<b>341</b>
New Features of Version 6.1 . . . . .	342
The Assembler, Environment, and Utilities . . . . .	342
Segment Management . . . . .	343
Data Types . . . . .	344
Procedures, Loops, and Jumps . . . . .	347
Simplifying Multiple-Module Projects . . . . .	348
Expanded State Control . . . . .	349

New Processor Instructions . . . . .	350
Renamed Directives . . . . .	350
Macro Enhancements . . . . .	351
MASM 6.1 Programming Practices. . . . .	352
Compatibility Between MASM 5.1 and 6.1 . . . . .	352
Rewriting Code for Compatibility . . . . .	353
Using the OPTION Directive . . . . .	361
Changes to Instruction Encodings . . . . .	377
<b>Appendix B BNF Grammar . . . . .</b>	<b>379</b>
<b>Appendix C Generating and Reading Assembly Listings . . . . .</b>	<b>397</b>
Generating Listing Files . . . . .	397
Precedence of Command-Line Options and Listing Directives . . . . .	399
Reading the Listing File . . . . .	399
Generated Code . . . . .	399
Error Messages. . . . .	400
Symbols and Abbreviations . . . . .	400
Reading Tables in a Listing File . . . . .	404
<b>Appendix D MASM Reserved Words . . . . .</b>	<b>407</b>
Operands and Symbols . . . . .	407
Special Operands for the 80386/486 . . . . .	409
Predefined Symbols. . . . .	409
Registers. . . . .	409
Operators and Directives . . . . .	410
Processor Instructions. . . . .	412
8086/8088 Processor Instructions . . . . .	412
80186 Processor Instructions . . . . .	413
80286 Processor Instructions . . . . .	413
80286 and 80386 Privileged-Mode Instructions . . . . .	413
80386 Processor Instructions . . . . .	413
80486 Processor Instructions . . . . .	414
Instruction Prefixes . . . . .	414
Coprocessor Instructions. . . . .	414
8087 Coprocessor Instructions . . . . .	414
80287 Privileged-Mode Instruction. . . . .	415
80387 Instructions. . . . .	415
<b>Appendix E Default Segment Names . . . . .</b>	<b>417</b>

Glossary..... 421

Index..... 435

# Figures and Tables

## Figures

1.1 Segment Allocation . . . . .	6
1.2 Calculating Physical Addresses. . . . .	8
1.3 Registers for 8088-80286 Processors. . . . .	17
1.4 Extended Registers for the 80386/486 Processors. . . . .	18
1.5 Flags for 8088-80486 Processors . . . . .	20
3.1 Stack Status Before and After Pushes and Pops . . . . .	72
4.1 Integer Formats . . . . .	87
4.2 Shifts and Rotates . . . . .	101
6.1 Encoding for Real Numbers in IEEE Format . . . . .	138
6.2 Coprocessor Data Registers . . . . .	140
6.3 Status of the Register Stack . . . . .	142
6.4 Status of the Register Stack and Memory Locations . . . . .	143
6.5 Status of the Previously Initialized Register Stack. . . . .	144
6.6 Status of the Already Initialized Register Stack . . . . .	144
6.7 Status of the Register Stack: Main Memory and Coprocessor. . . . .	148
6.8 Coprocessor Control Registers . . . . .	154
6.9 Coprocessor and Processor Control Flags. . . . .	155
7.1 Program Arguments on the Stack . . . . .	183
7.2 Local Variables on the Stack . . . . .	190
7.3 Operation of Interrupts. . . . .	206
8.1 Using EXTERNDEF for Variables . . . . .	215
8.2 Using PROTO and INVOKE . . . . .	217
8.3 Using PUBLIC and EXTERN . . . . .	221
11.1 Time Line of Interaction Between Interrupt Handlers for a Typical TSR . . . . .	278
11.2 Flowchart for SNAP.EXE: Installation Phase. . . . .	296
11.3 Flowchart for SNAP.EXE Resident Phase . . . . .	297
11.4 Flowchart for SNAP.EXE Deinstallation Phase . . . . .	298
12.1 C String Format. . . . .	316
12.2 C Stack Frame. . . . .	320
12.3 FORTRAN String Frame . . . . .	324
12.4 FORTRAN Stack Frame . . . . .	327
12.5 Basic String Descriptor Format. . . . .	330
12.6 Basic Stack Frame. . . . .	333
B.1 BNF Definition of the TYPEDEF Directive . . . . .	380



**Tables**

1.1	8086 Family of Processors . . . . .	2
1.2	The MS-DOS and Windows Operating Systems Compared . . . . .	4
1.3	Operator Precedence . . . . .	14
2.1	Attributes of Memory Models . . . . .	35
3.1	Indirect Addressing with 16-Bit Registers . . . . .	68
4.1	Division Operations . . . . .	97
5.1	Requirements for String Instructions . . . . .	112
6.1	Ranges of Floating-Point Variables . . . . .	136
6.2	Coprocessor Operand Formats . . . . .	141
6.3	Control-Flag Settings After Comparison or Test . . . . .	151
7.1	Conditional Jumps Based on Comparisons of Two Values . . . . .	167
9.1	MASM Macro Operators . . . . .	234
11.1	MS-DOS Internal Stacks . . . . .	286
12.1	Naming and Calling Conventions . . . . .	309
12.2	Register Conventions for Simple Return Values . . . . .	317
A.1	Requirements for String Instructions . . . . .	353
C.1	Options for Generating or Modifying Listing Files . . . . .	398
C.2	Symbols and Abbreviations in Listings . . . . .	400
C.3	Symbols in Timing Column . . . . .	401

---

# Introduction

The Microsoft® Macro Assembler *Programmer's Guide* provides the information you need to write and debug assembly-language programs with the Microsoft Macro Assembler (MASM), version 6.1. This book documents enhanced features of the language and the programming environment for MASM 6.1.

This *Programmer's Guide* is written for experienced programmers who know assembly language and are familiar with an assembler. The book does not teach the basics of assembly language; it does explain Microsoft-specific features. If you want to learn or review the basics of assembly language, refer to “Books for Further Reading” in this introduction.

This book teaches you how to write efficient code with the new and advanced features of MASM. *Getting Started* explains how to set up MASM 6.1. *Environment and Tools* introduces the integrated development environment called the Programmer's WorkBench (PWB). It also includes a detailed reference to Microsoft tools and utilities such as Microsoft® CodeView®, LINK, and NMAKE. The Microsoft Macro Assembler *Reference* provides a full listing of all MASM instructions, directives, statements, and operators, and it serves as a quick reference to utility commands.

For more information on these same topics, see the online Microsoft Advisor, which is a complete reference to Macro Assembler language topics, to the utilities, and to PWB. You should be able to find most of the information you need in the Microsoft Advisor.

## New and Extended Features in MASM 6.1

MASM 6.1 continues the break with tradition established by version 6.0. It incorporates conveniences of high-level languages while offering all the traditional advantages of assembly-language programming.

For example, MASM 6.1 includes the Programmer's WorkBench, which provides the same integrated software development environment enjoyed by programmers of Microsoft high-level languages such as C and Basic. From within PWB you can edit, build, debug, or run a program. You can perform most of these operations with either menu selections or keyboard commands. You can also customize PWB to suit your individual programming and editing requirements and preferences.

## MASM Features New Since Version 5.1

MASM 6.1 includes several features designed to make programming more efficient and productive. The following list briefly describes how MASM 6.1 improves on the language features of the popular version 5.1.

- MASM 6.1 has many enhancements related to types. You can now use the same type specifiers in initializations as in other contexts (**BYTE** instead of **DB**). You can also define your own types, including pointer types, with the new **TYPDEF** directive. See Chapter 3, “Using Addresses and Pointers,” and Chapter 4, “Defining and Using Simple Data Types.”
- The syntax for defining and using structures and records has been enhanced since version 5.1. You can also define unions with the new **UNION** directive. See Chapter 5, “Defining and Using Complex Data Types.”
- MASM now generates complete CodeView information for all types. See Chapter 3, “Using Addresses and Pointers,” and Chapter 4, “Defining and Using Simple Data Types.”
- New control-flow directives let you use high-level–language constructs such as loops and if-then-else blocks defined with **.REPEAT** and **.UNTIL** (or **.UNTILCXZ**); **.WHILE** and **.ENDW**; and **.IF**, **.ELSE**, and **.ELSEIF**. The assembler generates the appropriate code to implement the control structure. See Chapter 7, “Controlling Program Flow.”
- MASM now has more powerful features for defining and calling procedures. The extended **PROC** syntax for generating stack frames has been enhanced since version 5.1. You can also use the **PROTO** directive to prototype a procedure, which you can then call with the **INVOKE** directive. **INVOKE** automatically generates code to pass arguments (converting them to a related type, if appropriate) and makes the call according to the specified calling convention. See Chapter 7, “Controlling Program Flow.”
- MASM optimizes jumps by automatically determining the most efficient coding for a jump and then generating the appropriate code. See Chapter 7, “Controlling Program Flow.”
- Maintaining multiple-module programs is easier in MASM 6.1 than in version 5.1. The **EXTERNDEF** and **PROTO** directives make it easy to maintain all global definitions in include files shared by all the source modules of a project. See Chapter 8, “Sharing Data and Procedures Among Modules and Libraries.”

The assembler has many new macro features that make complex macros clearer and easier to write:

- You can specify default values for macro arguments or mark arguments as required. And with the **VARARG** keyword, one parameter can accept a variable number of arguments.

- You can implement loops inside of macros in various ways. For example, the new **WHILE** directive expands the statements in a macro body while an expression is not zero.
- You can define macro functions, which return text macros. Several predefined text macros are also provided for processing strings. Macro operators and other features related to processing text macros and macro arguments have been enhanced. For more information on all these macro features, see Chapter 9, “Using Macros.”

MASM 6.1 has other improved capabilities, such as:

- The **.STARTUP** and **.EXIT** directives automatically generate appropriate startup and exit code for your assembly-language programs. See Chapter 2, “Organizing Segments.”
- MASM 6.1 supports flat memory model, available with the new Microsoft® Windows NT™ operating system. Flat model allows segments as large as 4 gigabytes instead of 64K (kilobytes). Offsets are 32 bits instead of 16 bits. See Chapter 2, “Organizing Segments.”
- The program H2INC.EXE converts C include files to MASM include files and translates data structures and declarations. See Chapter 20 in *Environment and Tools*.
- MASM 6.1 provides a library of assembly routines that let you create a terminate-and-stay-resident program (TSR) in a high-level language.

MASM 6.1 includes many other minor new features as well as extensive support for features of earlier versions of MASM. For a complete list of enhancements, refer to Appendix A, “Differences between MASM 6.1 and 5.1.” The cross-references in Appendix A guide you to the chapters where the new features are described in detail.

## MASM Features New Since Version 6.0

MASM 6.1 offers several new features:

- ML now runs in 32-bit protected mode under MS-DOS, giving it direct access to extended memory for assembling very large source files.
- A collection of tools lets you write a dynamic-link library (DLL) for the Microsoft® Windows™ operating system without the Windows Software Development Kit. The LIBW.LIB library provides access to all functions in the Windows application programming interface (API), so your DLL can display menus, dialog boxes, and scroll bars. Chapter 10, “Writing a Dynamic-Link Library for Windows,” shows you how.

- Program listings now show instruction timings. The number of required processor cycles appears adjacent to each instruction in the listing, based on the selected processor. For an example listing and instructions on how to use this feature, see Appendix C, “Generating and Reading Assembly Listings.”
- All utilities have been updated for version 6.1. Documentation is clearer and better arranged, with a new *Environment and Tools* reference book.
- Version 6.1 generates debugging information for CodeView version 4.0 and later.
- MASM 6.1 provides even greater compatibility with version 5.1 than does MASM 6.0. Many programs written with version 5.1 will assemble unchanged under MASM 6.1.

## ML and MASM Command Lines

MASM 6.1 provides an updated version of the command-line driver, ML, introduced in version 6.0. ML is more powerful and flexible than the MASM driver of version 5.1. ML assembles and links with one command. It recognizes all the old MASM driver command syntax, however, to support existing batch files and makefiles that use MASM command lines.

---

**Note** The name MASM has traditionally referred to the Microsoft Macro Assembler. It is used in that context throughout this book. However, MASM also refers to MASM.EXE, which has been replaced by ML.EXE. In MASM 6.1, MASM.EXE is a small utility that translates command-line options to those accepted by ML.EXE, and then calls ML.EXE. The distinction between ML.EXE and MASM.EXE is made whenever necessary. Otherwise, MASM refers to the assembler and its features.

---

## Compatibility with Earlier Versions of MASM

MASM 6.1 is fully compatible with version 6.0 and, in many cases, with version 5.1. Code written for MASM 5.1 will often assemble correctly without modification under MASM 6.1. However, MASM 6.1 provides the **OPTION** directive to let you selectively modify the assembly process. In particular, you can use the **M510** argument with **OPTION** or the **/Zm** command-line option to set most features to be compatible with version 5.1 code.

For information about obsolete features that will not assemble correctly under MASM 6.1, see Appendix A, “Differences Between MASM 6.1 and 5.1.” The appendix also explains how to update code to use the new features.

## A Word About Instruction Timings

As an assembly-language programmer, whether novice or expert, you are probably interested in producing lightning-fast code. After all, one of the main reasons to program in assembly is to take advantage of its ability to streamline execution speeds to the limit of the processor. This book will help you write efficient and fast programs.

When discussing the speed of individual instructions, the chapters in this book often speak of “timing,” which is the number of processor cycles required to carry out an instruction. The *Reference* lists instruction timings for processors in the 8086 family. It is tempting to use timing as the only criterion when judging an instruction’s actual execution speed, but the world within the processor is not so simple.

The clock for instruction timing does not begin ticking until the processor has read and begins to execute an instruction. When you read about instruction timings (in this book or any other), keep in mind that other factors also influence the real speed of an instruction: the instruction’s size, whether it resides in cache memory, whether it accesses memory, its position in the processor’s prefetch queue, and the processor type. These factors make it impossible to say precisely how fast an instruction executes. Accept the references to timing in this book as guidelines, but use these simple rules to write fast code:

- Whenever possible, use registers rather than constant values, and constant values rather than memory.
- Minimize changes in program flow.
- Smaller is often better. For example, the instructions

```
dec  bx
sub  bx, 1
```

accomplish the same thing and have the same timings on 80386/486 processors. But the first instruction is 3 bytes smaller than the second, and so may reach the processor faster.

- When possible, use the string instructions described in Chapter 5, “Defining and Using Complex Data Types.”

## Books for Further Reading

The following books may help you learn to program in assembly language or write specialized programs. These books are listed only for your convenience. Microsoft makes no specific recommendations concerning any of these books.

### Books About Programming in Assembly Language

Abrash, Michael. *Zen of Assembly Language*. Glenview, IL: Scott, Foresman and Co., 1990. Out of print.

Duntemann, Jeff. *Assembly Language from Square One: For the PC AT and Compatibles*. Glenview, IL: Scott, Foresman and Co., 1990. Out of print.

Fernandez, Judi N., and Ruth Ashley. *Assembly Language Programming for the 80386*. New York: McGraw-Hill, 1990.

Miller, Alan R. *DOS Assembly Language Programming*. San Francisco: SYBEX, 1988. Out of print.

Scanlon, Leo J. *80286 Assembly Language Programming on MS-DOS Computers*. New York: Brady Communications, 1986. Out of print.

Turley, James L. *Advanced 80386 Programming Techniques*. Berkeley, CA: Osborne McGraw-Hill, 1988.

### Books About MS-DOS and BIOS

"Terminate-and-Stay-Resident Utilities." *MS-DOS Encyclopedia*. Redmond, WA: Microsoft Press, 1989.

Duncan, Ray. *Advanced MS-DOS Programming: The Microsoft Guide for Assembly Language and C Programmers*. 2d ed. Redmond, WA: Microsoft Press, 1988.

Duncan, Ray. *Extending DOS: Programmer's Guide to Protected-Mode DOS*. Redding, MA: Addison-Wesley, 1991.

Jourdain, Robert. *Programmer's Problem Solver for the IBM PC, XT and AT*. New York: Brady Communications, 1985. Out of print.

*Microsoft MS-DOS Programmer's Reference*. Redmond, WA: Microsoft Press, 1991.

Norton, Peter and Richard Wilton. *The New Peter Norton Programmer's Guide to the IBM PC and PS/2*. Redmond, WA: Microsoft Press, 1988.

Wilton, Richard. *Programmer's Guide to PC & PS/2 Video Systems: Maximum Video Performance from the EGA, VGA, HGC, and MCGA*. Redmond, WA: Microsoft Press, 1987. Out of print.

## Books and Articles About Windows

Kauler, Barry. *Windows Assembly Language & Systems Programming: Object-Oriented & Systems Programming in Assembly Language for Windows 3.0 and 3.1*. New York, NY: Prentice Hall, 1993.

Klein, Mike. *Windows Programmer's Guide to DLLs & Memory Management*. Carmel, IN: Sams, 1992.

Petzold, Charles. *Programming Windows*. 3d ed. Redmond, WA: Microsoft Press, 1992.

Petzold, Charles. "Environments." *PC Magazine*. New York, NY: Ziff-Davis Publishing Company, June 1990–1992.

*Programmer's Reference*. 4 vols. Microsoft Windows Software Development Kit (SDK). Redmond, WA: Microsoft Press, 1992.

## Books About Other Topics

Nelson, Ross P. *The 80386/80486 Programming Guide*. 2d ed. Redmond, WA: Microsoft Press, 1991.

Startz, Richard. *8087/80287/80387 for the IBM PC and Compatibles: Applications and Programming with Intel's Math Coprocessors*. Bowie, MD: Robert J. Brady Co., 1988. Out of print.

## Document Conventions

The following document conventions are used throughout this manual:

Example of Convention	Description
SAMPLE2.ASM	Uppercase letters indicate filenames, segment names, registers, and terms used at the command level.
<b>.MODEL</b>	Boldface type indicates assembly-language directives, instructions, type specifiers, and predefined macros, as well as keywords in other programming languages.
<i>placeholder</i>	Italic letters indicate placeholders for information you must supply, such as a filename. Italics are used occasionally for emphasis in the text.
target	This font is used to indicate example programs, user input, and screen output.
;	A semicolon in the first column of an example signals illegal code. A semicolon also marks a comment.



SHIFT	Small capital letters signify names of keys on the keyboard. Notice that a plus (+) indicates a combination of keys. For example, CTRL+E means to hold down the CTRL key while pressing the E key.
[[ <i>argument</i> ]]	Items inside double square brackets are optional.
{ <i>register</i>   <i>memory</i> }	Braces and a vertical bar indicate a choice between two or more items. You must choose one of the items unless double square brackets surround the braces.
Repeating elements...	A horizontal ellipsis (...) following an item indicates that more items having the same form may appear.
Program . . . Fragment	A vertical ellipsis tells you that part of a program has been intentionally omitted.

## Getting Assistance and Reporting Problems

If you need help or think you have discovered a problem in the software, please provide the following information to help us locate the source of the problem:

- The version of MS-DOS or Windows you run.
- Your system configuration: the type of machine you use, its total memory, and its total free memory at assembler execution time, as well as any other information you think might be useful.
- The command line you used for the assembler, linker, or other MASM tool that was running when the problem occurred.
- Any object files or libraries you linked with if the problem occurred at link time.

If your program is very large, reduce it to the smallest possible program that still produces the problem.

Note the circumstances of the error and notify Microsoft Corporation by following the instructions in the section "Microsoft Support Services" in the introduction to *Environment and Tools*. If you have comments or suggestions regarding any of the books accompanying this product, please indicate them on the Document Feedback page at the back of this book and send it to Microsoft.

If you have not yet registered your copy of the Macro Assembler, you should fill out and return the Registration Card. This enables Microsoft to keep you informed of updates and other information about the assembler.

# Understanding Global Concepts

With the development of the Microsoft Macro Assembler (MASM) version 6.1, you now have more options available to you for approaching a programming task. This chapter explains the general concepts of programming in assembly language, beginning with the environment and a review of the components you need to work in the assembler environment. Even if you are familiar with previous versions of MASM, you should examine this chapter for information on new terms and features.

The first section of this chapter reviews available processors and operating systems and how they work together. The section also discusses segmented architecture and how it affects a protected-mode operating environment such as Windows.

The second section describes some of the language components of MASM that are common to most programs, such as reserved words, constant expressions, operators, and registers. The remainder of this book was written with the assumption that you understand the information presented in this section.

The last section summarizes the assembly process, from assembling a program through running it. You can affect this process by the way you develop your code. Finally, this section explores how you can change the assembly process with the **OPTION** directive and conditional assembly.

## The Processing Environment

The processing environment for MASM 6.1 includes the processor on which your programs run, the operating system your programs use, and the aspects of the segmented architecture that influence the choice of programming models. This section summarizes these elements of the environment and how they affect your programming choices.

## 8086-Based Processors

The 8086 “family” of processors uses segments to control data and code. The later 8086-based processors have larger instruction sets and more memory capacity, but they still support the same segmented architecture. Knowing the differences between the various 8086-based processors can help you select the appropriate target processor for your programs.

The instruction set of the 8086 processor is upwardly compatible with its successors. To write code that runs on the widest number of machines, select the 8086 instruction set. By using the instruction set of a more advanced processor, you increase the capabilities and efficiency of your program, but you also reduce the number of systems on which the program can run.

Table 1.1 lists modes, memory, and segment size of processors on which your application may need to run. Each processor is discussed in more detail following.

**Table 1.1 8086 Family of Processors**

Processor	Available Modes	Addressable Memory	Segment Size
8086/8088	Real	1 megabyte	16 bits
80186/80188	Real	1 megabyte	16 bits
80286	Real and Protected	16 megabytes	16 bits
80386	Real and Protected	4 gigabytes	16 or 32 bits
80486	Real and Protected	4 gigabytes	16 or 32 bits

### Processor Modes

Real mode allows only one process to run at a time. The mode gets its name from the fact that addresses in real mode always correspond to real locations in memory. The MS-DOS operating system runs in real mode.

Windows 3.1 operates only in protected mode, but runs MS-DOS programs in real mode or in a simulation of real mode called virtual-86 mode. In protected mode, more than one process can be active at any one time. The operating system protects memory belonging to one process from access by another process; hence the name protected mode.

Protected-mode addresses do not correspond directly to physical memory. Under protected-mode operating systems, the processor allocates and manages memory dynamically. Additional privileged instructions initialize protected mode and control multiple processes. For more information, see “Operating Systems,” following.

### **8086 and 8088**

The 8086 is faster than the 8088 because of its 16-bit data bus; the 8088 has only an 8-bit data bus. The 16-bit data bus allows you to use **EVEN** and **ALIGN** on an 8086 processor to word-align data and thus improve data-handling efficiency. Memory addresses on the 8086 and 8088 refer to actual physical addresses.

### **80186 and 80188**

These two processors are identical to the 8086 and 8088 except that new instructions have been added and several old instructions have been optimized. These processors run significantly faster than the 8086.

### **80286**

The 80286 processor adds some instructions to control protected mode, and it runs faster. It also provides protected mode services, allowing the operating system to run multiple processes at the same time. The 80286 is the minimum for running Windows 3.1 and 16-bit versions of OS/2®.

### **80386**

Unlike its predecessors, the 80386 processor can handle both 16-bit and 32-bit data. It supports the entire instruction set of the 80286, and adds several new instructions as well. Software written for the 80286 runs unchanged on the 80386, but is faster because the chip operates at higher speeds.

The 80386 implements many new hardware-level features, including paged memory, multiple virtual 8086 processes, addressing of up to 4 gigabytes of memory, and specialized debugging registers. Thirty-two-bit operating systems such as Windows NT and OS/2 2.0 can run only on an 80386 or higher processor.

### **80486**

The 80486 processor is an enhanced version of the 80386, with instruction “pipelining” that executes many instructions two to three times faster. The chip incorporates both a math coprocessor and an 8K (kilobyte) memory cache. (The math coprocessor is disabled on a variation of the chip called the 80486SX.) The 80486 includes new instructions and is fully compatible with 80386 software.

### **8087, 80287, and 80387**

These math coprocessors work concurrently with the 8086 family of processors. Performing floating-point calculations with math coprocessors is up to 100 times faster than emulating the calculations with integer instructions. Although there are technical and performance differences among the three coprocessors, the main difference to the applications programmer is that the 80287 and 80387 can operate in protected mode. The 80387 also has several new instructions. The 80486 does not use any of these coprocessors; its floating-point processor is built in and is functionally equivalent to the 80387.

## Operating Systems

With MASM, you can create programs that run under MS-DOS, Windows, or Windows NT—or all three, in some cases. For example, ML.EXE can produce executable files that run in any of the target environments, regardless of the programmer's environment. For information on building programs for different environments, see “Building and Running Programs” in Help for PWB.

MS-DOS and Windows 3.1 provide different processing modes. MS-DOS runs in the single-process real mode. Windows 3.1 operates in protected mode, allowing multiple processes to run simultaneously.

Although Windows requires another operating system for loading and file services, it provides many functions normally associated with an operating system. When an application requests an MS-DOS service, Windows often provides the service without invoking MS-DOS. For consistency, this book refers to Windows as an operating system.

MS-DOS and Windows (in protected mode) differ primarily in system access methods, size of addressable memory, and segment selection. Table 1.2 summarizes these differences.

**Table 1.2 The MS-DOS and Windows Operating Systems Compared**

Operating System	System Access	Available Active Processes	Addressable Memory	Contents of Segment Register	Word Length
MS-DOS and Windows real mode	Direct to hardware and OS call	One	1 megabyte	Actual address	16 bits
Windows virtual-86 mode	Operating system call	Multiple	1 megabyte	Segment selectors	16 bits
Windows protected mode	Operating system call	Multiple	16 megabytes	Segment selectors	16 bits
Windows NT	Operating system call	Multiple	512 megabytes	Segment selectors	32 bits

### MS-DOS

In real-mode programming, you can access system functions by calling MS-DOS, calling the basic input/output system (BIOS), or directly addressing hardware. Access is through MS-DOS Interrupt 21h.

## Windows

As you can see in Table 1.2, protected mode allows for much larger data structures than real mode, since addressable memory extends to 16 megabytes. In protected mode, segment registers contain selector values rather than actual segment addresses. These selectors cannot be calculated by the program; they must be obtained by calling the operating system. Programs that attempt to calculate segment values or to address memory directly do not work in protected mode.

Protected mode uses privilege levels to maintain system integrity and security. Programs cannot access data or code that is in a higher privilege level. Some instructions that directly access ports or affect interrupts (such as **CLI**, **STI**, **IN**, and **OUT**) are available at privilege levels normally used only by systems programmers.

Windows protected mode provides each application with up to 16 megabytes of “virtual memory,” even on computers that have less physical memory. The term virtual memory refers to the operating system’s ability to use a swap area on the hard disk as an extension of real memory. When a Windows application requires more memory than is available, Windows writes sections of occupied memory to the swap area, thus freeing those sections for other use. It then provides the memory to the application that made the memory request. When the owner of the swapped data regains control, Windows restores the data from disk to memory, swapping out other memory if required.

## Windows NT

Windows NT uses the so-called “flat model” of 80386/486 processors. This model places the processor’s entire address space within one 32-bit segment. The section “Defining Basic Attributes with **.MODEL**” in Chapter 2 explains how to use the flat model. In flat model, your program can (in theory) access up to 4 gigabytes of virtual memory. Since code, data, and stack reside in the same segment, each segment register can hold the same value, which need never change.

## Segmented Architecture

The 8086 family of processors employs a segmented architecture—that is, each address is represented as a segment and an offset. Segmented addresses affect many aspects of assembly-language programming, especially addresses and pointers.

Segmented architecture was originally designed to enable a 16-bit processor to access an address space larger than 64K. (The section “Segmented Addressing,” later in this chapter, explains how the processor uses both the segment and offset to create addresses larger than 64K.) MS-DOS is an example of an operating system that uses segmented architecture on a 16-bit processor.

With the advent of protected-mode processors such as the 80286, segmented architecture gained a second purpose. Segments can separate different blocks of

code and data to protect them from undesirable interactions. Windows takes advantage of the protection features of the 16-bit segments on the 80286.

Segmented architecture went through another significant change with the release of 32-bit processors, starting with the 80386. These processors are compatible with the older 16-bit processors, but allow flat model 32-bit offset values up to 4 gigabytes. Offset values of this magnitude remove the memory limitations of segmented architecture. The Windows NT operating system uses 32-bit addressing.

## Segment Protection

Segmented architecture is an important part of the Windows memory-protection scheme. In a “multitasking” operating system in which numerous programs can run simultaneously, programs cannot access the code and data of another process without permission.

In MS-DOS, the data and code segments are usually allocated adjacent to each other, as shown in Figure 1.1. In Windows, the data and code segments can be anywhere in memory. The programmer knows nothing about, and has no control over, their location. The operating system can even move the segments to a new memory location or to disk while the program is running.

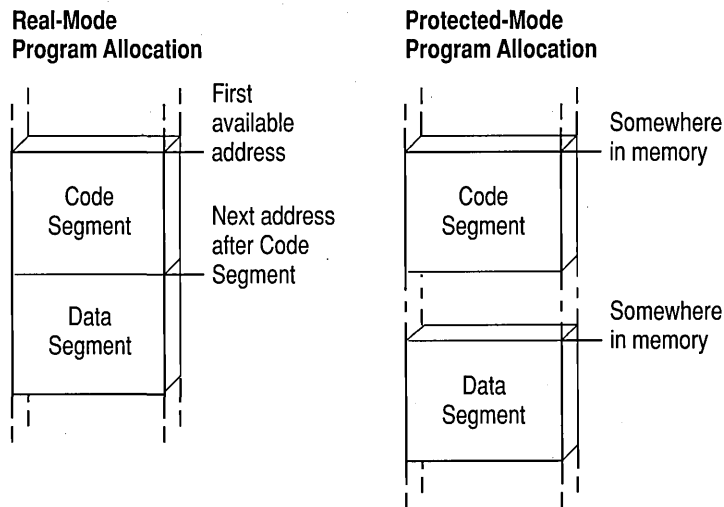

**Figure 1.1** Segment Allocation

Segment protection makes software development easier and more reliable in Windows than in MS-DOS, because Windows immediately detects illegal memory accesses. The operating system intercepts illegal memory accesses, terminates the program, and displays a message. This makes it easier for you to track down and fix the bug.

Because it runs in real mode, MS-DOS contains no mechanism for detecting an improper memory access. A program that overwrites data not belonging to it may continue to run and even terminate correctly. The error may not surface until later, when MS-DOS or another program reads the corrupted memory.

## Segmented Addressing

Segmented addressing refers to the internal mechanism that combines a segment value and an offset value to form a complete memory address. The two parts of an address are represented as

*segment:offset*

The *segment* portion always consists of a 16-bit value. The *offset* portion is a 16-bit value in 16-bit mode or a 32-bit value in 32-bit mode.

In real mode, the segment value is a physical address that has an arithmetic relationship to the offset value. The segment and offset together create a 20-bit physical address (explained in the next section). Although 20-bit addresses can access up to 1 megabyte of memory, the BIOS and operating system on International Standard Architecture (IBM PC/AT and compatible) computers use part of this memory, leaving the remainder available for programs.

## Segment Arithmetic

Manipulating segment and offset addresses directly in real-mode programming is called “segment arithmetic.” Programs that perform segment arithmetic are not portable to protected-mode operating systems, in which addresses do not correspond to a known segment and offset.

To perform segment arithmetic successfully, it helps to understand how the processor combines a 16-bit segment and a 16-bit offset to form a 20-bit linear address. In effect, the segment selects a 64K region of memory, and the offset selects the byte within that region. Here’s how it works:

1. The processor shifts the segment address to the left by four binary places, producing a 20-bit address ending in four zeros. This operation has the effect of multiplying the segment address by 16.
2. The processor adds this 20-bit segment address to the 16-bit offset address. The offset address is not shifted.
3. The processor uses the resulting 20-bit address, called the “physical address,” to access an actual location in the 1-megabyte address space.

Figure 1.2 illustrates this process.



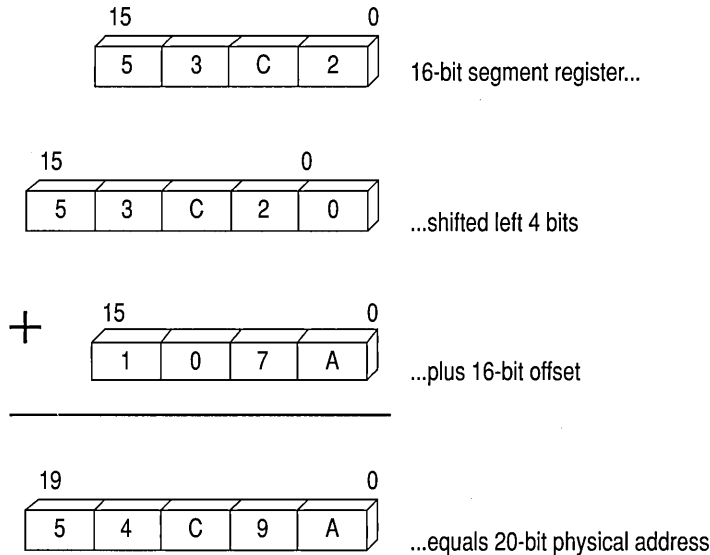

**Figure 1.2** Calculating Physical Addresses

A 20-bit physical address may actually be specified by 4,096 equivalent *segment:offset* addresses. For example, the addresses 0000:F800, 0F00:0800, and 0F80:0000 all refer to the same physical address 0F800.

## Language Components of MASM

Programming with MASM requires that you understand the MASM concepts of reserved words, identifiers, predefined symbols, constants, expressions, operators, data types, registers, and statements. This section defines important terms and provides lists that summarize these topics. For detailed information, see *Help* or the *Reference*.

### Reserved Words

A reserved word has a special meaning fixed by the language. You can use it only under certain conditions. Reserved words in MASM include:

- Instructions, which correspond to operations the processor can execute.
- Directives, which give commands to the assembler.
- Attributes, which provide a value for a field, such as segment alignment.
- Operators, which are used in expressions.
- Predefined symbols, which return information to your program.

MASM reserved words are not case sensitive except for predefined symbols (see “Predefined Symbols,” later in this chapter).

The assembler generates an error if you use a reserved word as a variable, code label, or other identifier within your source code. However, if you need to use a reserved word for another purpose, the **OPTION NOKEYWORD** directive can selectively disable a word’s status as a reserved word.

For example, to remove the **STR** instruction, the **MASK** operator, and the **NAME** directive from the set of words MASM recognizes as reserved, use this statement in the code segment of your program before the first reference to **STR**, **MASK**, or **NAME**:

```
OPTION NOKEYWORD:<STR MASK NAME>
```

The section “Using the **OPTION** Directive,” later in this chapter, discusses the **OPTION** directive. Appendix D provides a complete list of MASM reserved words.

With the **/Zm** command-line option or **OPTION M510** in effect, MASM does not reserve any operators or instructions that do not apply to the current CPU mode. For example, you can use the symbol **ENTER** when assembling under the default CPU mode but not under **.286** mode, since the 80186/486 processors recognize **ENTER** as an instruction. The **USE32**, **FLAT**, **FAR32**, and **NEAR32** segment types and the 80386/486 register names are not keywords with processors other than the 80386/486.

## Identifiers

An identifier is a name that you invent and attach to a definition. Identifiers can be symbols representing variables, constants, procedure names, code labels, segment names, and user-defined data types such as structures, unions, records, and types defined with **TYPDEF**. Identifiers longer than 247 characters generate an error.

Certain restrictions limit the names you can use for identifiers. Follow these rules to define a name for an identifier:

- The first character of the identifier can be an alphabetic character (A–Z) or any of these four characters: @ \_ \$ ?
- The other characters in the identifier can be any of the characters listed above or a decimal digit (0–9).

Avoid starting an identifier with the at sign (@), because MASM 6.1 predefines some special symbols starting with @ (see “Predefined Symbols,” following). Beginning an identifier with @ may also cause conflicts with future versions of the Macro Assembler.

The symbol—and thus the identifier—is visible as long as it remains within scope. (For more information about visibility and scope, see “Sharing Symbols with Include Files” in Chapter 8.)

## Predefined Symbols

The assembler includes a number of predefined symbols (also called predefined equates). You can use these symbol names at any point in your code to represent the equate value. For example, the predefined equate **@FileName** represents the base name of the current file. If the current source file is **TASK.ASM**, the value of **@FileName** is **TASK**. The MASM predefined symbols are listed according to the kinds of information they provide. Case is important only if the **/Cp** option is used. (For additional details, see Help on ML command-line options.)

The predefined symbols for segment information include:

Symbol	Description
<b>@code</b>	Returns the name of the code segment.
<b>@CodeSize</b>	Returns an integer representing the default code distance.
<b>@CurSeg</b>	Returns the name of the current segment.
<b>@data</b>	Expands to <b>DGROUP</b> .
<b>@DataSize</b>	Returns an integer representing the default data distance.
<b>@fardata</b>	Returns the name of the segment defined by the <b>.FARDATA</b> directive.
<b>@fardata?</b>	Returns the name of the segment defined by the <b>.FARDATA?</b> directive.
<b>@Model</b>	Returns the selected memory model.
<b>@stack</b>	Expands to <b>DGROUP</b> for near stacks or <b>STACK</b> for far stacks. (See “Creating a Stack” in Chapter 2.)
<b>@WordSize</b>	Provides the size attribute of the current segment.

The predefined symbols for environment information include:

Symbol	Description
<b>@Cpu</b>	Contains a bit mask specifying the processor mode.
<b>@Environ</b>	Returns values of environment variables during assembly.
<b>@Interface</b>	Contains information about the language parameters.
<b>@Version</b>	Represents the text equivalent of the MASM version number. In MASM 6.1, this expands to 610.

The predefined symbols for date and time information include:

Symbol	Description
<b>@Date</b>	Supplies the current system date during assembly.
<b>@Time</b>	Supplies the current system time during assembly.

The predefined symbols for file information include:

Symbol	Description
<b>@FileCur</b>	Names the current file (base and suffix).
<b>@FileName</b>	Names the base name of the main file being assembled as it appears on the command line.
<b>@Line</b>	Gives the source line number in the current file.

The predefined symbols for macro string manipulation include:

Symbol	Description
<b>@CatStr</b>	Returns concatenation of two strings.
<b>@InStr</b>	Returns the starting position of a string within another string.
<b>@SizeStr</b>	Returns the length of a given string.
<b>@SubStr</b>	Returns substring from a given string.

## Integer Constants and Constant Expressions

An integer constant is a series of one or more numerals followed by an optional radix specifier. For example, in these statements

```
mov    ax, 25
mov    bx, 0B3h
```

the numbers 25 and 0B3h are integer constants. The h appended to 0B3 is a radix specifier. The specifiers are:

- y for binary (or b if the default radix is not hexadecimal)
- o or q for octal
- t for decimal (or d if the default radix is not hexadecimal)
- h for hexadecimal

Radix specifiers can be either uppercase or lowercase letters; sample code in this book is in lowercase. If you do not specify a radix, the assembler interprets the integer according to the current radix. The default radix is decimal, but you can change the default with the **.RADIX** directive.

Hexadecimal numbers must always start with a decimal digit (0–9). If necessary, add a leading zero to distinguish between symbols and hexadecimal numbers that start with a letter. For example, MASM interprets ABCh as an identifier. The hexadecimal digits A through F can be either uppercase or lowercase letters. Sample code in this book is in uppercase letters.

Constant expressions contain integer constants and (optionally) operators such as shift, logical, and arithmetic operators. The assembler evaluates constant expressions at assembly time. (In addition to constants, expressions can contain labels, types, registers, and their attributes.) Constant expressions do not change value during program execution.

### Symbolic Integer Constants

You can define symbolic integer constants with either of the data assignment directives, **EQU** or the equal sign (=). These directives assign values to symbols during assembly, not during program execution. Symbolic constants are used to assign names to constant values. You can use a symbol with an assigned value in place of an immediate operand. For example, instead of referring in your code to keyboard scan codes with numbers such as 30 or 48, you can create more recognizable symbols:

```
SCAN_A EQU 30
SCAN_B EQU 48
```

then use the appropriate symbol in your program rather than the number. Using symbolic constants instead of undescriptive numbers makes your code more readable and easier to maintain. The assembler does not allocate data storage when you use either **EQU** or =. It simply replaces each occurrence of the symbol with the value of the expression.

The directives **EQU** and = have slightly different purposes. Integers defined with the = directive can be redefined with another value in your source code, but those defined with **EQU** cannot. Once you've defined a symbolic constant with the **EQU** directive, attempting to redefine it generates an error. The syntax is:

*symbol EQU expression*

The *symbol* is a unique name of your choice, except for words reserved by MASM. The *expression* can be an integer, a constant expression, a one- or two-character string constant (four-character on the 80386/486), or an expression that evaluates to an address. Symbolic constants let you change a constant value used throughout your source code by merely altering *expression* in the definition. This removes the potential for error and saves you the inconvenience of having to find and replace each occurrence of the constant in your program.

The following example shows the correct use of **EQU** to define symbolic integers.

```

column EQU 80 ; Constant - 80
row EQU 25 ; Constant - 25
screen EQU column * row ; Constant - 2000
line EQU row ; Constant - 25

.DATA

.CODE
.
.
.
mov cx, column
mov bx, line

```

The value of a symbol defined with the = directive can be different at different places in the source code. However, a constant value is assigned during assembly for each use, and that value does not change at run time.

The syntax for the = directive is:

*symbol = expression*

### Size of Constants

The default word size for MASM 6.1 expressions is 32 bits. This behavior can be modified using **OPTION EXPR16** or **OPTION M510**. Both of these options set the expression word size to 16 bits, but **OPTION M510** affects other assembler behavior as well (see Appendix A).

It is illegal to change the expression word size once it has been set with **OPTION M510**, **OPTION EXPR16**, or **OPTION EXPR32**. However, you can repeat the same directive in your source code as often as you wish. You can place the same directive in every include file, for example.

## Operators

Operators are used in expressions. The value of the expression is determined at assembly time and does not change when the program runs.

Operators should not be confused with processor instructions. The reserved word **ADD** is an instruction; the plus sign (+) is an operator. For example, `Amount+2` illustrates a valid use of the plus operator (+). It tells the assembler to add 2 to the constant value `Amount`, which might be a value or an address. Contrast this operation, which occurs at assembly time, with the processor's **ADD** instruction. **ADD** tells the processor at run time to add two numbers and store the result.

The assembler evaluates expressions that contain more than one operator according to the following rules:

- Operations in parentheses are performed before adjacent operations.
- Binary operations of highest precedence are performed first.
- Operations of equal precedence are performed from left to right.
- Unary operations of equal precedence are performed right to left.

Table 1.3 lists the order of precedence for all operators. Operators on the same line have equal precedence.

**Table 1.3 Operator Precedence**

Precedence	Operators
1	( ), [ ]
2	LENGTH, SIZE, WIDTH, MASK, LENGTHOF, SIZEOF
3	. (structure-field-name operator)
4	: (segment-override operator), PTR
5	LROFFSET, OFFSET, SEG, THIS, TYPE
6	HIGH, HIGHWORD, LOW, LOWWORD
7	+ , - (unary)
8	*, /, MOD, SHL, SHR
9	+, - (binary)
10	EQ, NE, LT, LE, GT, GE
11	NOT
12	AND
13	OR, XOR
14	OPATTR, SHORT, .TYPE

## Data Types

A “data type” describes a set of values. A variable of a given type can have any of a set of values within the range specified for that type.

The intrinsic types for MASM 6.1 are **BYTE**, **SBYTE**, **WORD**, **SWORD**, **DWORD**, **SDWORD**, **FWORD**, **QWORD**, and **TBYTE**. These types define integers and binary coded decimals (BCDs), as discussed in Chapter 6. The signed data types **SBYTE**, **SWORD**, and **SDWORD** work in conjunction with directives such as **INVOKE** (for calling procedures) and **.IF** (introduced in Chapter 7). The **REAL4**, **REAL8**, and **REAL10** directives define floating-point types. (See Chapter 6.)

Versions of MASM prior to 6.0 had separate directives for types and initializers. For example, **BYTE** is a type and **DB** is the corresponding initializer. The distinction does not apply in MASM 6.1. You can use any type (intrinsic or user-defined) as an initializer.

MASM does not have specific types for arrays and strings. However, you can treat a sequence of data units as arrays, and character or byte sequences as strings. (See “Arrays and Strings” in Chapter 5.)

Types can also have attributes such as *langtype* and *distance* (**NEAR** and **FAR**). For information on these attributes, see “Declaring Parameters with the PROC Directive” in Chapter 7.

You can also define your own types with **STRUCT**, **UNION**, and **RECORD**. The types have fields that contain string or numeric data, or records that contain bits. These data types are similar to the user-defined data types in high-level languages such as C, Pascal, and FORTRAN. (See Chapter 5, “Defining and Using Complex Data Types.”)

You can define new types, including pointer types, with the **TYPEDEF** directive. **TYPEDEF** assigns a *qualifiedtype* (explained in the following) to a *typename* of your choice. This lets you build new types with descriptive names of your choosing, making your programs more readable. For example, the following statement makes the symbol **CHAR** a synonym for the intrinsic type **BYTE**:

```
CHAR    TYPEDEF BYTE
```

The *qualifiedtype* is any type or pointer to a type of the form:

```
[[distance]] PTR [[qualifiedtype]]
```

where *distance* is **NEAR**, **FAR**, or any distance modifier. (For more information on *distance*, see “Declaring Parameters with the PROC Directive” in Chapter 7.)

The *qualifiedtype* can also be any type previously defined with **TYPEDEF**. For example, if you use **TYPEDEF** to create an alias for **BYTE**—say, **CHAR** as in the preceding example—you can use **CHAR** as a *qualifiedtype* when defining the pointer type **PCHAR**, like this:

```
CHAR    TYPEDEF BYTE
PCHAR   TYPEDEF PTR CHAR
```

The typename **CHAR** in the first line becomes a *qualifiedtype* in the second line. Use of the **TYPEDEF** directive to define pointers is explained in “Accessing Data with Pointers and Addresses” in Chapter 3.

Since *distance* and *qualifiedtype* are optional syntax elements, you can use variables of type **PTR** or **FAR PTR**. You can also define procedure prototypes



with *qualifiedtype*. For more information about procedure prototypes, see “Declaring Procedure Prototypes” in Chapter 7.

These rules govern the use of *qualifiedtype*:

- The only component of a *qualifiedtype* definition that can be forward-referenced is a structure or union type identifier.
- If you do not specify *distance*, the assembler assumes a distance that corresponds to the memory model. The assumed distance is **NEAR** for tiny, small, and medium models, and **FAR** for other models.
- If you do not specify a memory model with **.MODEL**, the assembler assumes **SMALL** model (and therefore **NEAR** pointers).

You can use a *qualifiedtype* in seven places:

Use	Example
In procedure arguments	proc1 PROC pMsg:PTR BYTE
In prototype arguments	proc2 PROTO pMsg:FAR PTR WORD
With local variables declared inside procedures	LOCAL pMsg:PTR
With the <b>LABEL</b> directive	TempMsg LABEL PTR WORD
With the <b>EXTERN</b> and <b>EXTERNDEF</b> directives	EXTERN pMsg:FAR PTR BYTE EXTERNDEF MyProc:PROTO
With the <b>COMM</b> directive	COMM var1:WORD:3
With the <b>TYPDEF</b> directive	PBYTE TYPDEF PTR BYTE PFUNC TYPDEF PROTO MyProc

“Defining Pointer Types with TYPDEF” in Chapter 3 shows ways to write a **TYPDEF** type for a *qualifiedtype*. Attributes such as **NEAR** and **FAR** can also apply to a *qualifiedtype*.

You can determine an accurate definition for **TYPDEF** and *qualifiedtype* from the BNF grammar definitions given in Appendix B. The BNF grammar defines each component of the syntax for any directive, showing the recursive properties of components such as *qualifiedtype*.

## Registers

The 8086 family of processors have the same base set of 16-bit registers. Each processor can treat certain registers as two separate 8-bit registers. The 80386/486 processors have extended 32-bit registers. To maintain compatibility with their predecessors, 80386/486 processors can access their registers as 16-bit or, where appropriate, as 8-bit values.

Figure 1.3 shows the registers common to all the 8086-based processors. Each register has its own special uses and limitations.

### General-Purpose Registers

15	7	0	
AH	AX	AL	Accumulator - Multiply, divide, I/O, and optimized moves
DH	DX	DL	Data - Multiply, divide, and I/O
CH	CX	CL	Count - Count for loops, repeats, shifts, and rotates
BH	BX	BL	Base - Pointer to base address (data segment)
BP			Base Pointer - Pointer to base address (stack segment)
SI			Source Index - Source string and index pointer
DI			Destination Index - Destination string and index pointer
SP			Stack Pointer - Pointer to top of stack

### Segment Registers

CS	Code Segment
DS	Data Segment
SS	Stack Segment
ES	Extra Segment

### Other Registers

Flags	Flags
IP	Instruction Pointer

Figure 1.3 Registers for 8088–80286 Processors

### 80386/486 Only

The 80386/486 processors use the same 8-bit and 16-bit registers used by the rest of the 8086 family. All of these registers can be further extended to 32 bits, except segment registers, which always occupy 16 bits. The extended register names begin with the letter “E.” For example, the 32-bit extension of AX is EAX. The 80386/486 processors have two additional segment registers, FS and GS. Figure 1.4 shows the extended registers of the 80386/486.

**General-Purpose Registers**

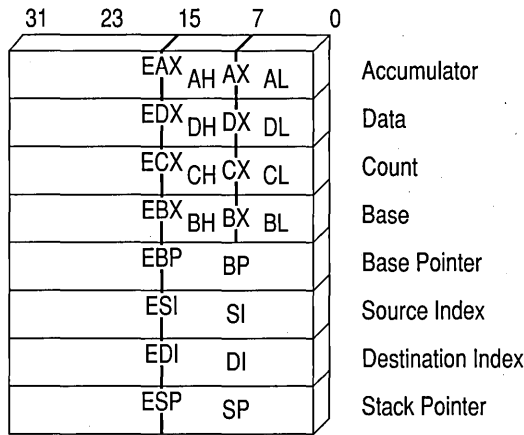

**Segment Registers**

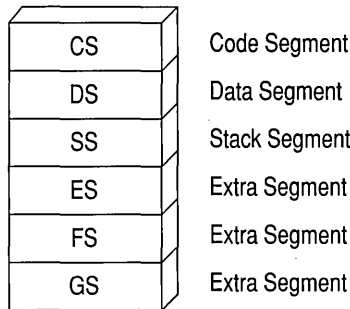

**Other Registers**

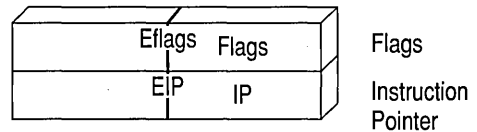

**Figure 1.4** Extended Registers for the 80386/486 Processors

**Segment Registers**

At run time, all addresses are relative to one of four segment registers: CS, DS, SS, or ES. (The 80386/486 processors add two more: FS and GS.) These registers, their segments, and their purposes include:

Register and Segment	Purpose
CS (Code Segment)	Contains processor instructions and their immediate operands.
DS (Data Segment)	Normally contains data allocated by the program.
SS (Stack Segment)	Contains the program stack for use by <b>PUSH</b> , <b>POP</b> , <b>CALL</b> , and <b>RET</b> .

---

Register and Segment	Purpose
ES (Extra Segment)	References secondary data segment. Used by string instructions.
FS, GS	Provides extra segments on the 80386/486.

---

## General-Purpose Registers

The AX, DX, CX, BX, BP, DI, and SI registers are 16-bit general-purpose registers, used for temporary data storage. Since the processor accesses registers more quickly than it accesses memory, you can make your programs run faster by keeping the most-frequently used data in registers.

The 8086-based processors do not perform memory-to-memory operations. For example, the processor cannot directly copy a variable from one location in memory to another. You must first copy from memory to a register, then from the register to the new memory location. Similarly, to add two variables in memory, you must first copy one variable to a register, then add the contents of the register to the other variable in memory.

The processor can access four of the general registers—AX, DX, CX, and BX—either as two 8-bit registers or as a single 16-bit register. The AH, DH, CH, and BH registers represent the high-order 8 bits of the corresponding registers. Similarly, AL, DL, CL, and BL represent the low-order 8 bits of the registers.

The 80386/486 processors can extend all the general registers to 32 bits, though as Figure 1.4 shows, you cannot treat the upper 16 bits as a separate register as you can the lower 16 bits. To use EAX as an example, you can directly reference the low byte as AL, the next lowest byte as AH, and the low word as AX. To access the high word of EAX, however, you must first shift the upper 16 bits into the lower 16 bits.

## Special-Purpose Registers

The 8086 family of processors has two additional registers, SP and IP, whose values are changed automatically by the processor.

### SP (Stack Pointer)

The SP register points to the current location within the stack segment. Pushing a value onto the stack decreases the value of SP by two; popping from the stack increases the value of SP by two. Thirty-two-bit operands on 80386/486 processors increase or decrease SP by four instead of two. The **CALL** and **INT** instructions store the return address on the stack and reduce SP accordingly. Return instructions retrieve the stored address from the stack and reset SP to its value before the call. SP can also be adjusted with instructions such as **ADD**. The program stack is described in detail in Chapter 3.

## IP (Instruction Pointer)

The IP register always contains the address of the next instruction to be executed. You cannot directly access or change the instruction pointer. However, instructions that control program flow (such as calls, jumps, loops, and interrupts) automatically change the instruction pointer.

## Flags Register

The 16 bits in the flags register control the execution of certain instructions and reflect the current status of the processor. In 80386/486 processors, the flags register is extended to 32 bits. Some bits are undefined, so there are actually 9 flags for real mode, 11 flags (including a 2-bit flag) for 80286 protected mode, 13 for the 80386, and 14 for the 80486. The extended flags register of the 80386/486 is sometimes called “Eflags.”

Figure 1.5 shows the bits of the 32-bit flags register for the 80386/486. Earlier 8086-family processors use only the lower word. The unmarked bits are reserved for processor use, and should not be modified.

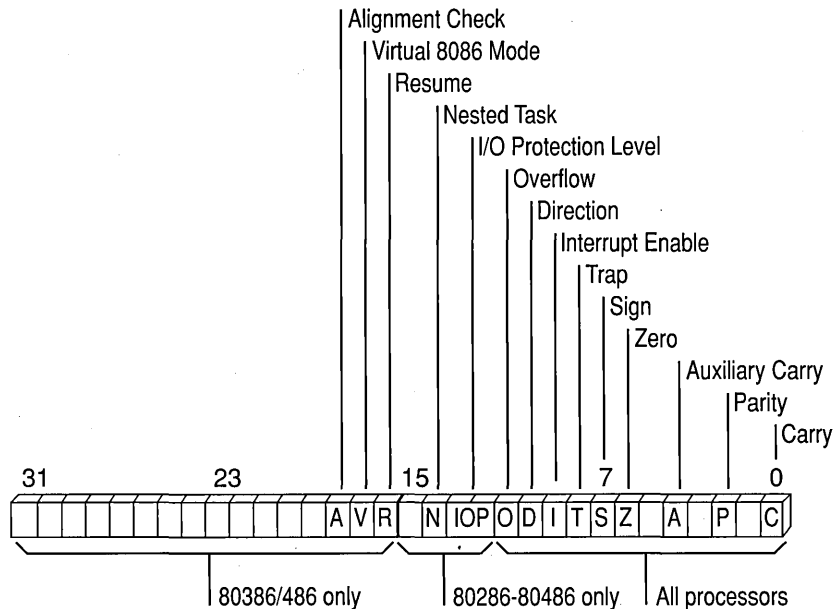

**Figure 1.5** Flags for 8088-80486 Processors

In the following descriptions and throughout this book, “set” means a bit value of 1, and “cleared” means the bit value is 0. The nine flags common to all 8086-family processors, starting with the low-order flags, include:

Flag	Description
Carry	Set if an operation generates a carry to or a borrow from a destination operand.
Parity	Set if the low-order bits of the result of an operation contain an even number of set bits.
Auxiliary Carry	Set if an operation generates a carry to or a borrow from the low-order 4 bits of an operand. This flag is used for binary coded decimal (BCD) arithmetic.
Zero	Set if the result of an operation is 0.
Sign	Equal to the high-order bit of the result of an operation (0 is positive, 1 is negative).
Trap	If set, the processor generates a single-step interrupt after each instruction. A debugging program can use this feature to execute a program one instruction at a time.
Interrupt Enable	If set, interrupts are recognized and acted on as they are received. The bit can be cleared to turn off interrupt processing temporarily.
Direction	If set, string operations process down from high addresses to low addresses. If cleared, string operations process up from low addresses to high addresses.
Overflow	Set if the result of an operation is too large or small to fit in the destination operand.

Although all flags serve a purpose, most programs require only the carry, zero, sign, and direction flags.

## Statements

Statements are the line-by-line components of source files. Each MASM statement specifies an instruction or directive for the assembler. Statements have up to four fields, as shown here:

```
[[name:]] [[operation]] [[operands]] [[;comment]]
```

The following list explains each field:

Field	Purpose
<i>name</i>	Labels the statement, so that instructions elsewhere in the program can refer to the statement by name. The <i>name</i> field can label a variable, type, segment, or code location.
<i>operation</i>	Defines the action of the statement. This field contains either an instruction or an assembler directive.
<i>operands</i>	Lists one or more items on which the instruction or directive operates.
<i>comment</i>	Provides a comment for the programmer. Comments are for documentation only; they are ignored by the assembler.

The following line contains all four fields:

```
mainlp: mov     ax, 7     ; Load AX with the value 7
```

Here, `mainlp` is the label, `mov` is the operation, and `ax` and `7` are the operands, separated by a comma. The comment follows the semicolon.

All fields are optional, although certain directives and instructions require an entry in the name or operand field. Some instructions and directives place restrictions on the choice of operands. By default, MASM is not case sensitive.

Each field (except the comment field) must be separated from other fields by white-space characters (spaces or tabs). MASM also requires code labels to be followed by a colon, operands to be separated by commas, and comments to be preceded by a semicolon.

A logical line can contain up to 512 characters and occupy one or more physical lines. To extend a logical line into two or more physical lines, put the backslash character (`\`) as the last non-whitespace character before the comment or end of the line. You can place a comment after the backslash as shown in this example:

```
.IF     (x > 0)   \ ; X must be positive
&&     (ax > x)   \ ; Result from function must be > x
&&     (cx == 0) \ ; Check loop counter, too
mov     dx, 20h
.ENDIF
```

Multiline comments can also be specified with the **COMMENT** directive. The assembler ignores all text and code between the delimiters or on the same line as the delimiters. This example illustrates the use of **COMMENT**.

```
COMMENT ^           The assembler
                ignores this text
^           mov     ax, 1   and this code
```

## The Assembly Process

Creating and running an executable file involves four steps:

1. Assembling the source code into an object file
2. Linking the object file with other modules or libraries into an executable program
3. Loading the program into memory
4. Running the program

Once you have written your assembly-language program, MASM provides several options for assembling it. The **OPTION** directive has several different arguments that let you control the way MASM assembles your programs.

Conditional assembly allows you to create one source file that can generate a variety of programs, depending on the status of various conditional-assembly statements.

## Generating and Running Executable Programs

This section briefly lists all the actions that take place during each of the assembly steps. You can change the behavior of some of these actions in various ways, such as using macros instead of procedures, or using the **OPTION** directive or conditional assembly. The other chapters in this book include specific programming methods; this section simply gives you an overview.

### Assembling

The `ML.EXE` program does two things to create an executable program. First, it assembles the source code into an intermediate object file. Second, it calls the linker, `LINK.EXE`, which links the object files and libraries into an executable program.

At assembly time, the assembler:

- Evaluates conditional-assembly directives, assembling if the conditions are true.
- Expands macros and macro functions.
- Evaluates constant expressions such as `MYFLAG AND 80H`, substituting the calculated value for the expression.
- Encodes instructions and nonaddress operands. For example, `mov cx, 13` can be encoded at assembly time because the instruction does not access memory.
- Saves memory offsets as offsets from their segments.
- Places segments and segment attributes in the object file.
- Saves placeholders for offsets and segments (relocatable addresses).
- Outputs a listing if requested.
- Passes messages (such as **INCLUDELIB** and **.DOSSEG**) directly to the linker.

For information about conditional assembly, see “Conditional Directives” in this chapter; for macros, see Chapter 9. Further details about segments and offsets are included in Chapters 2 and 3. Assembly listings are explained in Appendix C.



## Linking

Once your source code is assembled, the resulting object file is passed to the linker. At this point, the linker may combine several object files into an executable program. The linker:

- Combines segments according to the instructions in the object files, rearranging the positions of segments that share the same class or group.
- Fills in placeholders for offsets (relocatable addresses).
- Writes relocations for segments into the header of .EXE files (but not .COM files).
- Writes the result as an executable program file.

Classes and groups are defined in “Defining Segment Groups” in Chapter 2. Segments and offsets are explained in Chapter 3, “Using Addresses and Pointers.”

## Loading

After loading the executable file into memory, the operating system:

- Creates the program segment prefix (PSP) header in memory.
- Allocates memory for the program, based on the values in the PSP.
- Loads the program.
- Calculates the correct values for absolute addresses from the relocation table.
- Loads the segment registers SS, CS, DS, and ES with values that point to the proper areas of memory.

For information about segment registers, the instruction pointer (IP), and the stack pointer (SP), see “Registers” earlier in this chapter. For more information on the PSP see Help or an MS-DOS reference.

## Running

To run your program, MS-DOS jumps to the program's first instruction. Some program operations, such as resolving indirect memory operands, cannot be handled until the program runs. For a description of indirect references, see “Indirect Operands” in Chapter 7.

## Using the OPTION Directive

The **OPTION** directive lets you modify global aspects of the assembly process. With **OPTION**, you can change command-line options and default arguments. These changes affect only statements that follow the **OPTION** keyword.

For example, you may have MASM code in which the first character of a variable, macro, structure, or field name is a dot (.). Since a leading dot causes MASM 6.1 to generate an error, you can use this statement in your program:

```
OPTION DOTNAME
```

This enables the use of the dot for the first character.

Changes made with **OPTION** override any corresponding command-line option. For example, suppose you compile a module with this command line (which enables M510 compatibility):

```
ML /Zm TEST.ASM
```

The assembler disables M510 compatibility options for all code following this statement:

```
OPTION NOM510
```

The following lists explain each of the arguments for the **OPTION** directive. Where appropriate, an underline identifies the default argument. If you wish to place more than one **OPTION** statement on a line, separate them by commas.

Options for M510 compatibility include:

Argument	Description
<b>CASEMAP:</b> <i>maptype</i>	<b>CASEMAP:NONE</b> (or /Cx) causes internal symbol recognition to be case sensitive and causes the case of identifiers in the .OBJ file to be the same as specified in the <b>EXTERNDEF</b> , <b>PUBLIC</b> , or <b>COMM</b> statement. The default is <b>CASEMAP:NOTPUBLIC</b> (or /Cp). It specifies case insensitivity for internal symbol recognition and the same behavior as <b>CASEMAP:NONE</b> for case of identifiers in .OBJ files. <b>CASEMAP:ALL</b> (/Cu) specifies case insensitivity for identifiers and converts all identifier names to uppercase.
<b>DOTNAME</b>   <u><b>NODOTNAME</b></u>	Enables the use of the dot (.) as the leading character in variable, macro, structure, union, and member names.
<b>M510</b>   <u><b>NOM510</b></u>	Sets all features to be compatible with MASM version 5.1, disabling the <b>SCOPED</b> argument and enabling <b>OLDMACROS</b> , <b>DOTNAME</b> , and <b>OLDSTRUCTS</b> . <b>OPTION M510</b> conditionally sets other arguments for the <b>OPTION</b> directive. For more information on using <b>OPTION M510</b> , see Appendix A.

Argument	Description
<b>OLDMACROS</b>   <b><u>NOOLDMACROS</u></b>	Enables the version 5.1 treatment of macros. MASM 6.1 treats macros differently.
<b>OLDSTRUCTS</b>   <b><u>NOOLDSTRUCTS</u></b>	Enables compatibility with MASM 5.1 for treatment of structure members. See Chapter 5 for information on structures.
<b><u>SCOPED</u></b>   <b>NOSCOPE</b>	Guarantees that all labels inside procedures are local to the procedure when <b>SCOPED</b> (the default) is enabled.
<b>SETIF2: TRUE</b>   <b>FALSE</b>	If <b>TRUE</b> , <b>.ERR2</b> statements and <b>IF2</b> and <b>ELSEIF2</b> conditional blocks are evaluated on every pass. If <b>FALSE</b> , they are not evaluated. If <b>SETIF2</b> is not specified (or implied), <b>.ERR2</b> , <b>IF2</b> , and <b>ELSEIF2</b> expressions cause an error. Both the <b>/Zm</b> command-line argument and <b>OPTION M510</b> imply <b>SETIF2:TRUE</b> .

Options for procedure use include:

Argument	Description
<b>LANGUAGE:</b> <i>langtype</i>	Specifies the default language type ( <b>C</b> , <b>PASCAL</b> , <b>FORTRAN</b> , <b>BASIC</b> , <b>SYSCALL</b> , or <b>STDCALL</b> ) to be used with <b>PROC</b> , <b>EXTERN</b> , and <b>PUBLIC</b> . This use of the <b>OPTION</b> directive overrides the <b>.MODEL</b> directive but is normally used when <b>.MODEL</b> is not given.
<b>EPILOGUE:</b> <i>macroname</i>	Instructs the assembler to call the <i>macroname</i> to generate a user-defined epilogue instead of the standard epilogue code when a <b>RET</b> instruction is encountered. See Chapter 7.
<b>PROLOGUE:</b> <i>macroname</i>	Instructs the assembler to call <i>macroname</i> to generate a user-defined prologue instead of generating the standard prologue code. See Chapter 7.
<b>PROC:</b> <i>visibility</i>	Lets you explicitly set the default visibility as <b>PUBLIC</b> , <b>EXPORT</b> , or <b>PRIVATE</b> .

Other options include:

Argument	Description
<b>EXPR16</b>   <b><u>EXPR32</u></b>	Sets the expression word size to 16 or 32 bits. The default is 32 bits. The <b>M510</b> argument to the <b>OPTION</b> directive sets the word size to 16 bits. Once set with the <b>OPTION</b> directive, the expression word size cannot be changed.

Argument	Description
<b>EMULATOR</b>   <b>NOEMULATOR</b>	Controls the generation of floating-point instructions. The <b>NOEMULATOR</b> option generates the coprocessor instructions directly. The <b>EMULATOR</b> option generates instructions with special fixup records for the linker so that the Microsoft floating-point emulator, supplied with other Microsoft languages, can be used. It produces the same result as setting the <code>/Fpi</code> command-line option. You can set this option only once per module.
<b>LJMP</b>   <b>NOLJMP</b>	Enables automatic conditional-jump lengthening. For information about conditional-jump lengthening, see Chapter 7.
<b>NOKEYWORD</b> :<keywordlist>	Disables the specified reserved words. For an example of the syntax for this argument, see “Reserved Words” in this chapter.
<b>NOSIGNEXTEND</b>	Overrides the default sign-extended opcodes for the <b>AND</b> , <b>OR</b> , and <b>XOR</b> instructions and generates the larger non-sign-extended forms of these instructions. Provided for compatibility with NEC V25 and NEC V35 controllers.
<b>OFFSET</b> : <i>offsettype</i>	Determines the result of <b>OFFSET</b> operator fixups. <b>SEGMENT</b> sets the defaults for fixups to be segment-relative (compatible with MASM 5.1). <b>GROUP</b> , the default, generates fixups relative to the group (if the label is in a group). <b>FLAT</b> causes fixups to be relative to a flat frame. (The <code>.386</code> mode must be enabled to use <b>FLAT</b> .) See Appendix A.
<b>READONLY</b>   <b>NOREADONLY</b>	Enables checking for instructions that modify code segments, thereby guaranteeing that read-only code segments are not modified. Same as the <code>/p</code> command-line option of MASM 5.1, except that it affects only segments with at least one assembly instruction, not all segments. The argument is useful for protected mode programs, where code segments must remain read-only.
<b>SEGMENT</b> : <i>segSize</i>	Allows global default segment size to be set. Also determines the default address size for external symbols defined outside any segment. The <i>segSize</i> can be <b>USE16</b> , <b>USE32</b> , or <b>FLAT</b> .

## Conditional Directives

MASM 6.1 provides conditional-assembly directives and conditional-error directives. Conditional-assembly directives let you test for a specified condition and assemble a block of statements if the condition is true. Conditional-error directives allow you to test for a specified condition and generate an assembly error if the condition is true.

Both kinds of conditional directives test assembly-time conditions, not run-time conditions. You can test only expressions that evaluate to constants during assembly. For a list of the predefined symbols often used in conditional assembly, see "Predefined Symbols," earlier in this chapter.

### Conditional-Assembly Directives

The **IF** and **ENDIF** directives enclose the conditional statements. The optional **ELSEIF** and **ELSE** blocks follow the **IF** directive. There are many forms of the **IF** and **ELSE** directives. Help provides a complete list.

The following statements show the syntax for the **IF** directives. The syntax for other condition-assembly directives follow the same form.

```
IF expression1
ifstatements
[[ELSEIF expression2
elseifstatements]]
[[ELSE
elsestatements]]
ENDIF
```

The *statements* within an **IF** block can be any valid instructions, including other conditional blocks, which in turn can contain any number of **ELSEIF** blocks. **ENDIF** ends the block.

MASM assembles the statements following the **IF** directive only if the corresponding condition is true. If the condition is not true and the block contains an **ELSEIF** directive, the assembler checks to see if the corresponding condition is true. If so, it assembles the statements following the **ELSEIF** directive. If no **IF** or **ELSEIF** conditions are satisfied, the assembler processes only the statements following the **ELSE** directive.

For example, you may want to assemble a line of code only if your program defines a particular variable. In this example,

```
IFDEF   buffer
buff   BYTE   buffer DUP(?)
ENDIF
```

the assembler allocates `buff` only if `buffer` has been previously defined.

MASM 6.1 provides the directives **IF1**, **IF2**, **ELSEIF1**, and **ELSIF2** to grant assembly only on pass one or pass two. To use these directives, you must either enable 5.1 compatibility (with the `/Zm` command-line switch or **OPTION M510**) or set **OPTION SETIF2:TRUE**, as described in the previous section.

The following list summarizes the conditional-assembly directives:

The Directive	Grants Assembly If
<b>IF</b> <i>expression</i>	<i>expression</i> is true (nonzero)
<b>IFE</b> <i>expression</i>	<i>expression</i> is false (zero)
<b>IFDEF</b> <i>name</i>	<i>name</i> has been previously defined
<b>IFNDEF</b> <i>name</i>	<i>name</i> has not been previously defined
<b>IFB</b> <i>argument</i> *	<i>argument</i> is blank
<b>IFNB</b> <i>argument</i> *	<i>argument</i> is not blank
<b>IFIDN</b> [I] <i>arg1</i> , <i>arg2</i> *	<i>arg1</i> equals <i>arg2</i>
<b>IFDIF</b> [I] <i>arg1</i> , <i>arg2</i> *	<i>arg1</i> does not equal <i>arg2</i>

The optional **I** suffix (**IFIDNI** and **IFDIFI**) makes comparisons insensitive to differences in case.

\* Used only in macros.

## Conditional-Error Directives

You can use conditional-error directives to debug programs and check for assembly-time errors. By inserting a conditional-error directive at a key point in your code, you can test assembly-time conditions at that point. You can also use conditional-error directives to test for boundary conditions in macros.

Like other severe errors, those generated by conditional-error directives cause the assembler to return a nonzero exit code. If MASM encounters a severe error during assembly, it does not generate the object module.

For example, the **.ERRNDEF** directive produces an error if the program has not defined a given label. In the following example, **.ERRNDEF** makes sure a label called `publevel` actually exists.

```
.ERRNDEF    publevel
IF          publevel LE 2
PUBLIC     var1, var2
ELSE
PUBLIC     var1, var2, var3
ENDIF
```

The conditional-error directives use the syntax given in the previous section. The following list summarizes the conditional-error directives. Note their close correspondence with the previous list of conditional-assembly directives.

The Directive	Generates an Error
<b>.ERR</b>	Unconditionally where it occurs in the source file. Usually placed within a conditional-assembly block.
<b>.ERRE</b> <i>expression</i>	If <i>expression</i> is false (zero).
<b>.ERRNZ</b> <i>expression</i>	If <i>expression</i> is true (nonzero).
<b>.ERRDEF</b> <i>name</i>	If <i>name</i> has been defined.
<b>.ERRNDEF</b> <i>name</i>	If <i>name</i> has not been defined.
<b>.ERRB</b> <i>argument</i> *	If <i>argument</i> is blank.
<b>.ERRNB</b> <i>argument</i> *	If <i>argument</i> is not blank.
<b>.ERRIDN</b> [I] <i>arg1, arg2</i> *	If <i>arg1</i> equals <i>arg2</i> .
<b>.ERRDIF</b> [I] <i>arg1, arg2</i> *	If <i>arg1</i> does not equal <i>arg2</i> . The optional <b>I</b> suffix ( <b>.ERRIDNI</b> and <b>.ERRDIFI</b> ) makes comparisons insensitive to case.

\* Used only in macros

Two special conditional-error directives, **.ERR1** and **.ERR2**, generate an error only on pass one or pass two. To use these directives, you must either enable 5.1 compatibility (with the **/Zm** command-line switch or **OPTION M510**) or set **OPTION SETIF2:TRUE**, as described in the previous section.

# Organizing Segments

Understanding segments is an essential part of programming in assembly language. In the family of 8086-based processors, the term segment has two meanings:

- A block of memory of discrete size, called a “physical segment.” The number of bytes in a physical memory segment is 64K for 16-bit processors or 4 gigabytes for 32-bit processors.
- A variable-sized block of memory, called a “logical segment,” occupied by a program’s code or data.

As you read this chapter, the distinction between the two definitions will become clear. The adjectives “physical” and “logical” are not often used when speaking of segments. The beginning programmer is left to infer from context which definition applies. Fortunately, this is not difficult, and a distinction is often not required.

This chapter begins with a close look at physical memory segments. This lays the foundation for understanding logical segments, which form the subject of most of the following sections.

The section “Using Simplified Segment Directives” explains how to begin, end, and organize segments. It also explains how to access far data and code with simplified segment directives.

The next section, “Using Full Segment Definitions,” describes how to order, combine, and divide segments, and how to use the **SEGMENT** directive to define full segments. It also explains how to create a segment group so that you can use one segment address to access all the data.

Most of the information in this chapter also applies to writing modules to be called from other programs. Exceptions are noted when they apply. For more information about multiple-module programming, see Chapter 8, “Sharing Data and Procedures Among Modules and Libraries.”



## Physical Memory Segments

As explained in Chapter 1, a physical segment can begin only at memory locations evenly divisible by 16, including address 0. Intel calls such locations “paragraphs.” You can easily recognize a paragraph location because its hexadecimal address always ends with 0, as in 10000h or 2EA70h. The 8086/286 processors allow segments 64K in size, the largest number 16 bits can represent. The 80386/486 processors still adhere to the 64K limit when running in real mode. In protected mode, however, they use 32-bit registers that can hold addresses up to 4 gigabytes.

Segmented architecture presents certain hurdles for the assembly-language programmer. For small programs, the limitations lose importance. Code and data each occupy less than 64K and reside in individual segments. A simple offset locates each variable or instruction within a segment.

Larger programs, however, must contend with problems of segmented memory areas. If data occupies two or more segments, the program must specify both segment and offset to access a variable. When the data forms a continuous stream across segments—such as the text in a word processor’s workspace—the problems become more acute. Whenever it adds or deletes text in the first segment, the word processor must seamlessly move data back and forth over the boundaries of each following segment.

The problem of segment boundaries disappears in the so-called flat address space of 32-bit protected mode. Although segments still exist, they easily hold all the code and data of the largest programs. Even a very large program becomes in effect a small application, able to reach all code and data with a single offset address.

## Logical Segments

Logical segments contain the three components of a program: code, data, and stack. MASM organizes the three parts for you so they occupy physical segments of memory. The segment registers CS, DS, and SS contain the addresses of the physical memory segments where the logical segments reside.

You can define segments in two ways: with simplified segment directives and with full segment definitions. You can also use both kinds of segment definitions in the same program.

Simplified segment directives hide many of the details of segment definition and assume the same conventions used by Microsoft high-level languages. (See the following section, “Using Simplified Segment Directives.”) The simplified segment directives generate necessary code, specify segment attributes, and arrange segment order.

Full segment definitions require more complex syntax but provide more complete control over how the assembler generates segments. (See “Using Full Segment

Definitions” later in this chapter.) If you use full segment definitions, you must write code to handle all the tasks performed automatically by the simplified segment directives.

## Using Simplified Segment Directives

Structuring a MASM program using simplified segments requires use of several directives to assign standard names, alignment, and attributes to the segments in your program. These directives define the segments in such a way that linking with Microsoft high-level languages is easy.

The simplified segment directives are **.MODEL**, **.CODE**, **.CONST**, **.DATA**, **.DATA?**, **.FARDATA**, **.FARDATA?**, **.STACK**, **.STARTUP**, and **.EXIT**. The following sections discuss these directives and the arguments they take.

MASM programs consist of modules made up of segments. Every program written only in MASM has one main module, where program execution begins. This main module can contain code, data, or stack segments defined with all of the simplified segment directives. Any additional modules should contain only code and data segments. Every module that uses simplified segments must, however, begin with the **.MODEL** directive.

The following example shows the structure of a main module using simplified segment directives. It uses the default processor (8086) and the default stack distance (**NEARSTACK**). Additional modules linked to this main program would use only the **.MODEL**, **.CODE**, and **.DATA** directives and the **END** statement.

```
; This is the structure of a main module
; using simplified segment directives

.MODEL small, c ; This statement is required before you
                ; can use other simplified segment directives

.STACK         ; Use default 1-kilobyte stack

.DATA          ; Begin data segment
                ; Place data declarations here

.CODE          ; Begin code segment
.STARTUP       ; Generate start-up code
                ; Place instructions here

.EXIT         ; Generate exit code
END
```

The **.DATA** and **.CODE** statements do not require any separate statements to define the end of a segment. They close the preceding segment and then open a new segment. The **.STACK** directive opens and closes the stack segment but does not close the current segment. The **END** statement closes the last segment and marks the end of the source code. It must be at the end of every module.

## Defining Basic Attributes with **.MODEL**

The **.MODEL** directive defines the attributes that affect the entire module: memory model, default calling and naming conventions, operating system, and stack type. This directive enables use of simplified segments and controls the name of the code segment and the default distance for procedures.

You must place **.MODEL** in your source file before any other simplified segment directive. The syntax is:

```
.MODEL memorymodel [, modeloptions ]
```

The *memorymodel* field is required and must appear immediately after the **.MODEL** directive. The use of *modeloptions*, which define the other attributes, is optional. The *modeloptions* must be separated by commas. You can also use equates passed from the ML command line to define the *modeloptions*.

The following list summarizes the *memorymodel* field and the *modeloptions* fields, which specify language and stack distance:

Field	Description
Memory model	<b>TINY, SMALL, COMPACT, MEDIUM, LARGE, HUGE, or FLAT.</b> Determines size of code and data pointers. This field is required.
Language	<b>C, BASIC, FORTRAN, PASCAL, SYSCALL, or STDCALL.</b> Sets calling and naming conventions for procedures and public symbols.
Stack distance	<b>NEARSTACK or FARSTACK.</b> Specifying <b>NEARSTACK</b> groups the stack segment into a single physical segment (DGROUP) along with data. <b>SS</b> is assumed to equal <b>DS</b> . <b>FARSTACK</b> does not group the stack with DGROUP; thus <b>SS</b> does not equal <b>DS</b> .

You can use no more than one reserved word from each field. The following examples show how you can combine various fields:

```
.MODEL    small                ; Small memory model
.MODEL    large, c, farstack   ; Large memory model,
                                ; C conventions,
                                ; separate stack
.MODEL    medium, pascal      ; Medium memory model,
                                ; Pascal conventions,
                                ; near stack (default)
```

The next four sections give more detail on each field.

### Defining the Memory Model

MASM supports the standard memory models used by Microsoft high-level languages—tiny, small, medium, compact, large, huge, and flat. You specify the memory model with attributes of the same name placed after the **.MODEL** directive. With the exception of the flat model, which requires instructions specific to the 80386/486, your choice of a memory model does not limit the kind of instructions you can write. The memory model does, however, control segment defaults and determine whether data and code are near or far by default, as indicated in the following table.

**Table 2.1** Attributes of Memory Models

Memory Model	Default Code	Default Data	Operating System	Data and Code Combined
Tiny	Near	Near	MS-DOS	Yes
Small	Near	Near	MS-DOS, Windows	No
Medium	Far	Near	MS-DOS, Windows	No
Compact	Near	Far	MS-DOS, Windows	No
Large	Far	Far	MS-DOS, Windows	No
Huge	Far	Far	MS-DOS, Windows	No
Flat	Near	Near	Windows NT	Yes

When writing assembler modules for a high-level language, you should use the same memory model as the calling language. Choose the smallest memory model available that can contain your data and code, since near references operate more efficiently than far references.

The predefined symbol **@Model** returns the memory model, encoding memory models as integers 1 through 7. For more information on predefined symbols, see “Predefined Symbols” in Chapter 1. For an example of how to use them, see Help.

The seven memory models supported by MASM 6.1 fall into three groups, described in the following paragraphs.

### **Small, Medium, Compact, Large, and Huge Models**

The traditional memory models recognized by many languages are small, medium, compact, large, and huge. Small model supports one data segment and one code segment. All data and code are near by default. Large model supports multiple code and multiple data segments. All data and code are far by default. Medium and compact models are in-between. Medium model supports multiple code and single data segments; compact model supports multiple data segments and a single code segment.

Huge model implies individual data items larger than a single segment, but the implementation of huge data items must be coded by the programmer. Since the assembler provides no direct support for this feature, huge model is essentially the same as large model.

In each of these models, you can override the default. For example, you can make large data items far in small model, or internal procedures near in large model.

### **Tiny Model**

Tiny-model programs run only under MS-DOS. Tiny model places all data and code in a single segment. Therefore, the total program file size can occupy no more than 64K. The default is near for code and static data items; you cannot override this default. However, you can allocate far data dynamically at run time using MS-DOS memory allocation services.

Tiny model produces MS-DOS .COM files. Specifying `.MODEL tiny` automatically sends the `/TINY` argument to the linker. Therefore, the `/AT` argument is not necessary with `.MODEL tiny`. However, `/AT` does not insert a `.MODEL` directive. It only verifies that there are no base or pointer fixups, and sends `/TINY` to the linker.

### **Flat Model**

The flat memory model is a nonsegmented configuration available in 32-bit operating systems. It is similar to tiny model in that all code and data go in a single 32-bit segment.

To write a flat model program, specify the `.386` or `.486` directive before `.MODEL FLAT`. All data and code (including system resources) are in a single 32-bit segment. The operating system automatically initializes segment registers at load time; you need to modify them only when mixing 16-bit and 32-bit segments in a single application. CS, DS, ES, and SS all occupy the supergroup `FLAT`. Addresses and pointers passed to system services are always 32-bit near addresses and pointers.

## Choosing the Language Convention

The language option facilitates compatibility with high-level languages by determining the internal encoding for external and public symbol names, the code generated for procedure initialization and cleanup, and the order that arguments are passed to a procedure with **INVOKE**. It also facilitates compatibility with high-level-language modules. The **PASCAL**, **BASIC**, and **FORTRAN** conventions are identical. **C** and **SYSCALL** have the same calling convention but different naming conventions. Functions in the Windows API use the Pascal calling convention.

Procedure definitions (**PROC**) and high-level procedure calls (**INVOKE**) automatically generate code consistent with the calling convention of the specified language. The **PROC**, **INVOKE**, **PUBLIC**, and **EXTERN** directives all use the naming convention of the language. These directives follow the default language conventions from the **.MODEL** directive unless you specifically override the default. Use of these directives is explained in “Controlling Program Flow,” Chapter 7. You can also use the **OPTION** directive to set the language type. (See “Using the **OPTION** Directive” in Chapter 1.) Not specifying a language type in either the **.MODEL**, **OPTION**, **EXTERN**, **PROC**, **INVOKE**, or **PROTO** statement causes the assembler to generate an error.

The predefined symbol **@Interface** provides information about the language parameters. For a description of the bit flags, see Help.

For more information on calling and naming conventions, see Chapter 12, “Mixed-Language Programming.” For information about writing procedures and prototypes, see Chapter 7, “Controlling Program Flow.” For information on multiple-module programming, refer to Chapter 8, “Sharing Data and Procedures Among Modules and Libraries.”

## Setting the Stack Distance

The **NEARSTACK** keyword places the stack segment in the group **DGROUP** along with the data segment. The **.STARTUP** directive then generates code to adjust **SS:SP** so that **SS** (Stack Segment register) holds the same address as **DS** (Data Segment register). If you do not use **.STARTUP**, you must make this adjustment or your program may fail to run. (For information about startup code, see “Starting and Ending Code with **.STARTUP** and **.EXIT**,” later in this chapter.) In this case, you can use **DS** to access stack items (including parameters and local variables) and **SS** to access near data. Furthermore, since stack items share the same segment address as near data, you can reliably pass near pointers to stack items.

The **FARSTACK** setting gives the stack a segment of its own. That is, **SS** does not equal **DS**. The default stack type, **NEARSTACK**, is a convenient setting for most programs. Use **FARSTACK** for special cases such as memory-resident programs

and dynamic-link libraries (discussed in Chapters 10 and 11) when you cannot assume that the caller's stack is near. You can use the predefined symbol **@Stack** to determine if the stack location is **DGROUP** (for near stacks) or **STACK** (for far stacks).

## Specifying a Processor and Coprocessor

MASM supports a set of directives for selecting processors and coprocessors. Once you select a processor, you must use only the instruction set for that processor. The default is the 8086 processor. If you always want your code to run on this processor, you do not need to add any processor directives.

To enable a different processor mode and the additional instructions available on that processor, use the directives **.186**, **.286**, **.386**, and **.486**. The instruction timings on a listing (see Appendix C, "Generating and Reading Assembly Listings") correspond to whichever processor directive you select.

The **.286P**, **.386P**, and **.486P** directives enable the instructions available only at higher privilege levels in addition to the normal instruction set for the given processor. Generally, you don't need privileged instructions unless you are writing operating-systems code or device drivers.

In addition to enabling different instruction sets, the processor directives also affect the behavior of extended language features. For example, the **INVOKE** directive pushes arguments onto the stack. If the **.286** directive is in effect, **INVOKE** takes advantage of operations possible only on 80286 and later processors.

Use the directives **.8087** (the default), **.287**, **.387**, and **.NO87** to select a math coprocessor instruction set. The **.NO87** directive turns off assembly of all coprocessor instructions. Note that **.486** also enables assembly of all coprocessor instructions because the 80486 processor has a complete set of coprocessor registers and instructions built into the chip. The processor instructions imply the corresponding coprocessor directive. The coprocessor directives are provided to override the defaults.

## Creating a Stack

The stack is the section of memory used for pushing or popping registers and storing the return address when a subroutine is called. The stack often holds temporary and local variables.

If your main module is written in a high-level language, that language handles the details of creating a stack. Use the **.STACK** directive only when you write a main module in assembly language.

The **.STACK** directive creates a stack segment. By default, the assembler allocates 1K of memory for the stack. This size is sufficient for most small programs.

To create a stack of a size other than the default size, give `.STACK` a single numeric argument indicating stack size in bytes:

```
.STACK 2048 ; Use 2K stack
```

For a description of how stack memory is used with procedure calls and local variables, see Chapter 7, “Controlling Program Flow.”

## Creating Data Segments

Programs can contain both near and far data. In general, you should place important and frequently used data in the near data area, where data access is faster. This area can get crowded, however, because in 16-bit operating systems the total amount of all near data in all modules cannot exceed 64K. Therefore, you may want to place infrequently used or particularly large data items in a far data segment.

The `.DATA`, `.DATA?`, `.CONST`, `.FARDATA`, and `.FARDATA?` directives create data segments. You can access the various segments within `DGROUP` without reloading segment registers (see “Defining Segment Groups,” later in this chapter). These five directives also prevent instructions from appearing in data segments by assuming `CS` to `ERROR`.

### Near Data Segments

The `.DATA` directive creates a near data segment. This segment contains the frequently used data for your program. It can occupy up to 64K in MS-DOS or 512 megabytes under flat model in Windows NT. It is placed in a special group identified as `DGROUP`, which is also limited to 64K.

When you use `.MODEL`, the assembler automatically defines `DGROUP` for your near data segment. The segments in `DGROUP` form near data, which can normally be accessed directly through `DS` or `SS`.

You can also define the `.DATA?` and `.CONST` segments that go into `DGROUP` unless you are using flat model. Although all of these segments (along with the stack) are eventually grouped together and handled as data segments, `.DATA?` and `.CONST` enhance compatibility with Microsoft high-level languages. In Microsoft languages, `.CONST` is used to define constant data such as strings and floating-point numbers that must be stored in memory. The `.DATA?` segment is used for storing uninitialized variables. You can follow this convention if you want. If you use C startup code, `.DATA?` is initialized to 0.

You can use `@data` to determine the group of the data segment and `@DataSize` to determine the size of the memory model set by the `.MODEL` directive. The predefined symbols `@WordSize` and `@CurSeg` return the size attribute and name of the current segment, respectively. See “Predefined Symbols” in Chapter 1.



## Far Data Segments

The compact, large, and huge memory models use far data addresses by default. With these memory models, however, you can still construct data segments using **.DATA**, **.DATA?**, and **.CONST**. The effect of these directives does not change from one memory model to the next. They always contribute segments to the default data area, **DGROUP**, which has a total limit of 64K.

When you use **.FARDATA** or **.FARDATA?** in the small and medium memory models, the assembler creates far data segments **FAR\_DATA** and **FAR\_BSS**, respectively. You can access variables with:

```
mov     ax, SEG farvar2
mov     ds, ax
```

For more information on far data, see “Near and Far Addresses” in Chapter 3.

## Creating Code Segments

Whether you are writing a main module or a module to be called from another module, you can have both near and far code segments. This section explains how to use near and far code segments and how to use the directives and predefined equates that relate to code segments.

### Near Code Segments

The small memory model is often the best choice for assembly programs that are not linked to modules in other languages, especially if you do not need more than 64K of code. This memory model defaults to near (two-byte) addresses for code and data, which makes the program run faster and use less memory.

When you use **.MODEL** and simplified segment directives, the **.CODE** directive in your program instructs the assembler to start a code segment. The next segment directive closes the previous segment; the **END** directive at the end of your program closes remaining segments. The example at the beginning of “Using Simplified Segment Directives,” earlier in this chapter, shows how to do this.

You can use the predefined symbol **@CodeSize** to determine whether code pointers default to **NEAR** or **FAR**.

### Far Code Segments

When you need more than 64K of code, use the medium, large, or huge memory model to create far segments.

The medium, large, and huge memory models use far code addresses by default. In the larger memory models, the assembler creates a different code segment for each module. If you use multiple code segments in the small, compact, or tiny model, the linker combines the **.CODE** segments for all modules into one segment.

For far code segments, the assembler names each code segment `MODNAME_TEXT`, in which `MODNAME` is the name of the module. With near code, the assembler names every code segment `_TEXT`, causing the linker to concatenate these segments into one. You can override the default name by providing an argument after `.CODE`. (For a complete list of segment names generated by MASM, see Appendix E, “Default Segment Names.”)

With far code, a single module can contain multiple code segments. The `.CODE` directive takes an optional text argument that names the segment. For instance, the following example creates two distinct code segments, `FIRST_TEXT` and `SECOND_TEXT`.

```
.CODE FIRST
.
.      ; First set of instructions here
.
.CODE SECOND
.
.      ; Second set of instructions here
.
```

Whenever the processor executes a far call or jump, it loads `CS` with the new segment address. No special action is necessary other than making sure that you use far calls and jumps. See “Near and Far Addresses” in Chapter 3.

---

**Note** The assembler always assumes that the `CS` register contains the address of the current code segment or group.

---

## Starting and Ending Code with `.STARTUP` and `.EXIT`

The easiest way to begin and end an MS-DOS program is to use the `.STARTUP` and `.EXIT` directives in the main module. The main module contains the starting point and usually the termination point. You do not need these directives in a module called by another module.

These directives make MS-DOS programs easy to maintain. They automatically generate code appropriate to the stack distance specified with `.MODEL`. However, they do not apply to flat-model programs written for 32-bit operating systems. Thus, you should not use `.STARTUP` or `.EXIT` in programs written for Windows NT.

To start a program, place the **.STARTUP** directive where you want execution to begin. Usually, this location immediately follows the **.CODE** directive:

```
.CODE
.STARTUP
.           ; Place executable code here
.
.EXIT
END
```

Note that **.EXIT** generates executable code, while **END** does not. The **END** directive informs the assembler that it has reached the end of the module. All modules must end with the **END** directive whether you use simplified or full segments.

If you do not use **.STARTUP**, you must give the starting address as an argument to the **END** directive. For example, the following fragment shows how to identify a program's starting instruction with the label `start`:

```
.CODE
start:
.           ; Place executable code here
.
END      start
```

Only the **END** directive for the module with the starting instruction should have an argument. When **.STARTUP** is present, the assembler ignores any argument to **END**.

For the default **NEARSTACK** attribute, **.STARTUP** points **DS** to **DGROUP** and sets **SS:SP** relative to **DGROUP**, generating the following code:

```

@Startup:
    mov     dx, DGROUP
    mov     ds, dx
    mov     bx, ss
    sub     bx, dx
    shl     bx, 1           ; If .286 or higher, this is
    shl     bx, 1           ;   shortened to shl bx, 4
    shl     bx, 1
    shl     bx, 1
    cli                               ; Not necessary in .286 or higher
    mov     ss, dx
    add     sp, bx
    sti                               ; Not necessary in .286 or higher
    .
    .
    .
    END     @Startup

```

An MS-DOS program with the **FARSTACK** attribute does not need to adjust **SS:SP**, so **.STARTUP** just initializes **DS**, like this:

```

@Startup:
    mov     dx, DGROUP
    mov     ds, dx
    .
    .
    .
    END     @Startup

```

When the program terminates, you can return an exit code to the operating system. Applications that check exit codes usually assume that an exit code of 0 means no problem occurred, and that an exit code of 1 means an error terminated the program. The **.EXIT** directive accepts a 1-byte exit code as its optional argument:

```

.EXIT 1           ; Return exit code 1

```

**.EXIT** generates the following code that returns control to MS-DOS, thus terminating the program. The return value, which can be a constant, memory reference, or 1-byte register, goes into **AL**:

```

    mov     al, value
    mov     ah, 04Ch
    int     21h

```

If your program does not specify a return value, **.EXIT** returns whatever value happens to be in **AL**.

## Using Full Segment Definitions

If you need complete control over segments, you can fully define the segments in your program. This section explains segment definitions, including how to order segments and how to define the segment types.

If you write a program under MS-DOS without **.MODEL** and **.STARTUP**, you must initialize registers yourself and use the **END** directive to indicate the starting address. The Windows operating system does not require you to initialize registers, as described in Chapter 3. For a description of typical startup code, see “Controlling the Segment Order,” later in this chapter.

## Defining Segments with the SEGMENT Directive

A defined segment begins with the **SEGMENT** directive and ends with the **ENDS** directive:

```
name SEGMENT [align] [[READONLY] [combine] [use] ['class']]
statements
name ENDS
```

The *name* defines the name of the segment. Within a module, all segment definitions with the same name are treated as though they reference the same segment. The linker also combines identically named segments from different modules unless the combine type is **PRIVATE**. In addition, segments can be nested.

The optional types that follow the **SEGMENT** directive give the linker and the assembler instructions on how to set up and combine segments. The optional types, which are explained in detail in the following sections, include:

Type	Description
<i>align</i>	Defines the memory boundary on which a new segment begins.
<b>READONLY</b>	Tells the assembler to report an error if it detects an instruction modifying any item in a <b>READONLY</b> segment.
<i>combine</i>	Determines how the linker combines segments from different modules when building executable files.
<i>use</i> (80386/486 only)	Determines the size of a segment. <b>USE16</b> indicates that offsets in the segment are 16 bits wide. <b>USE32</b> indicates 32-bit offsets.
<i>class</i>	Provides a class name for the segment. The linker automatically groups segments of the same class in memory.

Types can be specified in any order. You can specify only one attribute from each of these fields; for example, you cannot have two different *align* types.

You can close a segment and reopen it later with another **SEGMENT** directive. When you reopen a segment, you need only give the segment name. You cannot change the attributes of a segment once you have defined it.

---

**Note** The **PAGE** *align* type and the **PUBLIC** *combine* type are distinct from the **PAGE** and **PUBLIC** directives. The assembler distinguishes them by means of context.

---

## Aligning Segments

The optional *align* type in the **SEGMENT** directive defines the range of memory addresses from which a starting address for the segment can be selected. The *align* type can be any of the following:

Align Type	Starting Address
<b>BYTE</b>	Next available byte address.
<b>WORD</b>	Next available word address.
<b>DWORD</b>	Next available doubleword address.
<b>PARA</b>	Next available paragraph address (16 bytes per paragraph). Default.
<b>PAGE</b>	Next available page address (256 bytes per page).

The linker uses the alignment information to determine the relative starting address for each segment. The operating system calculates the actual starting address when the program is loaded.

## Making Segments Read-Only

The optional **READONLY** attribute is helpful when creating read-only code segments for protected mode, or when writing code to be placed in read-only memory (ROM). It protects against illegal self-modifying code.

The **READONLY** attribute causes the assembler to check for instructions that modify the segment and to generate an error if it finds any. The assembler generates an error if you attempt to write directly to a read-only segment.

## Combining Segments

The optional *combine* type in the **SEGMENT** directive defines how the linker combines segments having the same name but appearing in different modules.

The *combine* type controls linker behavior, not assembler behavior. The *combine* types, which are described in full detail in Help, include:

Combine Type	Linker Action
<b>PRIVATE</b>	Does not combine the segment with segments from other modules, even if they have the same name. Default.
<b>PUBLIC</b>	Concatenates all segments having the same name to form a single, contiguous segment.
<b>STACK</b>	Concatenates all segments having the same name and causes the operating system to set SS:00 to the bottom and SS:SP to the top of the resulting segment. Data initialization is unreliable, as discussed following.
<b>COMMON</b>	Overlaps segments. The length of the resulting area is the length of the largest of the combined segments. Data initialization is unreliable, as discussed following.
<b>MEMORY</b>	Used as a synonym for the <b>PUBLIC</b> <i>combine</i> type.
<b>AT address</b>	Assumes <i>address</i> as the segment location. An <b>AT</b> segment cannot contain any code or initialized data, but is useful for defining structures or variables that correspond to specific far memory locations, such as a screen buffer or low memory. You cannot use the <b>AT</b> <i>combine</i> type in protected-mode programs.

Do not place initialized data in **STACK** or **COMMON** segments. With these *combine* types, the linker overlays initialized data for each module at the beginning of the segment. The last module containing initialized data writes over any data from other modules.

---

**Note** Normally, you should provide at least one stack segment (having **STACK** *combine* type) in a program. If no stack segment is declared, LINK displays a warning message. You can ignore this message if you have a specific reason for not declaring a stack segment. For example, you would not have a separate stack segment in a MS-DOS tiny model (.COM) program, nor would you need a separate stack in a DLL that uses the caller's stack.

---

### Setting Segment Word Sizes (80386/486 Only)

The *use* type in the **SEGMENT** directive specifies the segment word size on the 80386/486 processors. Segment word size determines the default operand and address size of all items in a segment.

The size attribute can be **USE16**, **USE32**, or **FLAT**. If you specify the **.386** or **.486** directive before the **.MODEL** directive, **USE32** is the default. This attribute specifies that items in the segment are addressed with a 32-bit offset rather than a

16-bit offset. If **.MODEL** precedes the **.386** or **.486** directive, **USE16** is the default. To make **USE32** the default, put **.386** or **.486** before **.MODEL**. You can override the **USE32** default with the **USE16** attribute, or vice versa.

---

**Note** Programs written for MS-DOS must not specify **USE32**. Mixing 16-bit and 32-bit segments in the same program is possible but usually applies only to systems programming.

---

### Setting Segment Order with Class Type

The optional *class* type in the **SEGMENT** directive helps control segment ordering. Two segments with the same name are not combined if their class is different. The linker arranges segments so that all segments identified with a given *class* type are next to each other in the executable file. However, within a particular class, the linker arranges segments in the order encountered. The **.ALPHA**, **.SEQ**, or **.DOSSEG** directive determines this order in each **.OBJ** file. The most common method for specifying a *class* type is to place all code segments first in the executable file.

## Controlling the Segment Order

The assembler normally positions segments in the object file in the order in which they appear in source code. The linker, in turn, processes object files in the order in which they appear on the command line. Within each object file, the linker outputs segments in the order they appear, subject to any group, class, and **.DOSSEG** requirements.

You can usually ignore segment ordering. However, it is important whenever you want certain segments to appear at the beginning or end of a program or when you make assumptions about which segments are next to each other in memory. For tiny model (**.COM**) programs, code segments must appear first in the executable file, because execution must start at the address 100h.

### Segment Order Directives

You can control the order in which segments appear in the executable program with three directives. The default, **.SEQ**, arranges segments in the order in which you declare them.

The **.ALPHA** directive specifies alphabetical segment ordering within a module. **.ALPHA** is provided for compatibility with early versions of the IBM assembler. If you have trouble running code from older books on assembly language, try using **.ALPHA**.

The **.DOSSEG** directive specifies the MS-DOS segment-ordering convention. It places segments in the standard order required by Microsoft languages. Do not use **.DOSSEG** in a module to be called from another module.



The **.DOSSEG** directive orders segments as follows:

1. Code segments
2. Data segments, in this order:
  - a. Segments not in class BSS or STACK
  - b. Class BSS segments
  - c. Class STACK segments

When you declare two or more segments to be in the same class, the linker automatically makes them contiguous. This rule overrides the segment-ordering directives. (For more about segment classes, see “Setting Segment Order with Class Type” in the previous section.)

### Linker Control

Most of the segment-ordering techniques (class names, **.ALPHA**, and **.SEQ**) control the order in which the assembler outputs segments. Usually, you are more interested in the order in which segments appear in the executable file. The linker controls this order.

The linker processes object files in the order in which they appear on the command line. Within each module, it then outputs segments in the order given in the object file. If the first module defines segments DSEG and STACK and the second module defines CSEG, then CSEG is output last. If you want to place CSEG first, there are two ways to do so.

The simpler method is to use **.DOSSEG**. This directive is output as a special record to the object file linker, and it tells the linker to use the Microsoft segment-ordering convention. This convention overrides command-line order of object files, and it places all segments of class 'CODE' first. (See “Defining Segments with the SEGMENT Directive,” previous.)

The other method is to define all the segments as early as possible (in an include file, for example, or in the first module). These definitions can be “dummy segments”—that is, segments with no content. The linker observes the segment ordering given, then later combines the empty segments with segments in other modules that have the same name.

For example, you might include the following at the start of the first module of your program or in an include file:

```
_TEXT    SEGMENT WORD PUBLIC 'CODE'  
_TEXT    ENDS  
_DATA    SEGMENT WORD PUBLIC 'DATA'  
_DATA    ENDS  
CONST    SEGMENT WORD PUBLIC 'CONST'  
CONST    ENDS  
STACK    SEGMENT PARA STACK 'STACK'  
STACK    ENDS
```

Later in the program, the order in which you write `_TEXT`, `_DATA`, or other segments does not matter because the ultimate order is controlled by the segment order defined in the include file.

## Setting the `ASSUME` Directive for Segment Registers

Many of the assembler instructions assume a default segment. For example, `JMP` assumes the segment associated with the `CS` register, `PUSH` and `POP` assume the segment associated with the `SS` register, and `MOV` instructions assume the segment associated with the `DS` register.

When the assembler needs to reference an address, it must know what segment contains the address. It finds this by using the default segment or group addresses assigned with the `ASSUME` directive. The syntax is:

```
ASSUME segregister : seglocation [, segregister : seglocation] ]  
ASSUME dataregister : qualifiedtype [, dataregister : qualifiedtype]  
ASSUME register : ERROR [, register : ERROR]  
ASSUME [register :] NOTHING [, register : NOTHING]  
ASSUME register : FLAT [, register : FLAT]
```

The *seglocation* must be the name of the segment or group that is to be associated with *segregister*. Subsequent instructions that assume a default register for referencing labels or variables automatically assume that if the default segment is *segregister*, the label or variable is in the *seglocation*. MASM 6.1 automatically gives `CS` the address of the current code segment. Therefore, you do not need to include

```
ASSUME CS : MY_CODE
```

at the beginning of your program if you want the current segment associated with `CS`.

**Note** Using the **ASSUME** directive to tell the assembler which segment to associate with a segment register is not the same as telling the processor. The **ASSUME** directive affects only assembly-time assumptions. You may need to use instructions to change run-time conditions. Initializing segment registers at run time is discussed in “Informing the Assembler About Segment Values,” Chapter 3.

---

The **ASSUME** directive can define a segment for each of the segment registers. The *segregister* can be CS, DS, ES, or SS (and FS and GS on the 80386/486). The *seglocation* must be one of the following:

- The name of a segment defined in the source file with the **SEGMENT** directive.
- The name of a group defined in the source file with the **GROUP** directive.
- The keyword **NOTHING**, **ERROR**, or **FLAT**.
- A **SEG** expression (see “Immediate Operands” in Chapter 3).
- A string equate (text macro) that evaluates to a segment or group name (but not a string equate that evaluates to a **SEG** expression).

It is legal to combine assumes to **FLAT** with assumes to specific segments. Combinations might be necessary in operating-system code that handles both 16- and 32-bit segments.

The keyword **NOTHING** cancels the current segment assumptions. For example, the statement **ASSUME NOTHING** cancels all register assumptions made by previous **ASSUME** statements.

Usually, a single **ASSUME** statement defines all four segment registers at the start of the source file. However, you can use the **ASSUME** directive at any point to change segment assumptions.

Using the **ASSUME** directive to change segment assumptions is often equivalent to changing assumptions with the segment-override operator (:). See “Direct Memory Operands” in Chapter 3. The segment-override operator is more convenient for one-time overrides. The **ASSUME** directive may be more convenient if previous assumptions must be overridden for a sequence of instructions.

However, in either case, your program must explicitly load a segment register with a segment address before accessing data within the segment. **ASSUME** only tells the assembler to assume that the register is correctly initialized; it does not by itself generate any code to load the register.

You can also prevent the use of a register with:

```
ASSUME SegRegister : ERROR
```

The assembler generates an `ASSUME CS:ERROR` when you use simplified directives to create data segments, effectively preventing instructions or code labels from appearing in a data segment.

For more information about **ASSUME**, refer to “Defining Register Types with **ASSUME**” in Chapter 3.

## Defining Segment Groups

A group is a collection of segments totalling not more than 64K in 16-bit mode. A program addresses a code or data item in the group relative to the beginning of the group.

A group lets you develop separate logical segments for different kinds of data and then combine these into one segment (a group) for all the data. Using a group can save you from having to continually reload segment registers to access different segments. As a result, the program uses fewer instructions and runs faster.

The most common example of a group is the specially named group for near data, `DGROUP`. In the Microsoft segment model, several segments (`_DATA`, `_BSS`, `CONST`, and `STACK`) are combined into a single group called `DGROUP`. Microsoft high-level languages place all near data segments in this group. (By default, the stack is placed here, too.) The `.MODEL` directive automatically defines `DGROUP`. The `DS` register normally points to the beginning of the group, giving you relatively fast access to all data in `DGROUP`.

The syntax of the group directive is:

```
name GROUP segment [, segment]]...
```

The *name* labels the group. It can refer to a group that was previously defined. This feature lets you add segments to a group one at a time. For example, if `MYGROUP` was previously defined to include `ASEG` and `BSEG`, then the statement

```
MYGROUP GROUP CSEG
```

is perfectly legal. It simply adds `CSEG` to the group `MYGROUP`; `ASEG` and `BSEG` are not removed.

Each *segment* can be any valid segment name (including a segment defined later in source code), with one restriction: a segment cannot belong to more than one group.

The **GROUP** directive does not affect the order in which segments of a group are loaded. You can place any number of 16-bit segments in a group as long as the total size does not exceed 65,536 bytes. If the processor is in 32-bit mode, the maximum size is 4 gigabytes. You need to make sure that non-grouped segments do not get placed between grouped segments in such a way that the size of the group exceeds 64K or 4 gigabytes. Neither can you place a 16-bit and a 32-bit segment in the same group.

# Using Addresses and Pointers

MASM applications running in real mode require segmented addresses to access code and data. The address of the code or data in a segment is relative to a segment address in a segment register. You can also use pointers to access data in assembly language programs. (A pointer is a variable that contains an address as its value.)

The first section of this chapter describes how to initialize default segment registers to access near and far addresses. The next section describes how to access code and data. It also describes related operators, syntax, and displacements. The discussion of memory operands lays the foundation for the third section, which describes the stack.

The fourth section of this chapter explains how to use the **TYPEDEF** directive to declare pointers and the **ASSUME** directive to give the assembler information about registers containing pointers. This section also shows you how to do typical pointer operations and how to write code that works for pointer variables in any memory model.

## Programming Segmented Addresses

Before you use segmented addresses in your programs, you need to initialize the segment registers. The initialization process depends on the registers used and on your choice of simplified segment directives or full segment definitions. The simplified segment directives (introduced in Chapter 2) handle most of the initialization process for you. This section explains how to inform the assembler and the processor of segment addresses, and how to access the near and far code and data in those segments.

## Initializing Default Segment Registers

The segmented architecture of the 8086-family of processors does not require that you specify two addresses every time you access memory. As explained in Chapter 2, “Organizing Segments,” the 8086 family of processors uses a system of default segment registers to simplify access to the most commonly used data and code.

The segment registers DS, SS, and CS are normally initialized to default segments at the beginning of a program. If you write the main module in a high-level language, the compiler initializes the segment registers. If you write the main module in assembly language, you must initialize the segment registers yourself. Follow these steps to initialize segments:

1. Tell the assembler which segment is associated with a register. The assembler must know the default segments at assembly time.
2. Tell the processor which segment is associated with a register by writing the necessary code to load the correct segment value into the segment register on the processor.

These steps are discussed separately in the following sections.

## Informing the Assembler About Segment Values

The first step in initializing segments is to tell the assembler which segment to associate with a register. You do this with the **ASSUME** directive. If you use simplified segment directives, the assembler automatically generates the appropriate **ASSUME** statements. If you use full segment definitions, you must code the **ASSUME** statements for registers other than CS yourself. (**ASSUME** can also be used on general-purpose registers, as explained in “Defining Register Types with **ASSUME**” later in this chapter.)

The **.STARTUP** directive generates startup code that sets DS equal to SS (unless you specify **FARSTACK**), allowing default data to be accessed through either SS or DS. This can improve efficiency in the code generated by compilers. The “DS equals SS” convention may not work with certain applications, such as memory-resident programs in MS-DOS and Windows dynamic-link libraries (see Chapter 10). The code generated for **.STARTUP** is shown in “Starting and Ending Code with **.STARTUP** and **.EXIT**” in Chapter 2. You can use similar code to set DS equal to SS in programs using full segment definitions.

Here is an example of **ASSUME** using full segment definitions:

```
ASSUME cs:_TEXT, ds:DGROUP, ss:DGROUP
```

This example is equivalent to the **ASSUME** statement generated with simplified segment directives in small model with **NEARSTACK**. Note that DS and SS are part of the same segment group. It is also possible to have different segments for data and code, and to use **ASSUME** to set ES, as shown here:

```
ASSUME cs:MYCODE, ds:MYDATA, ss:MYSTACK, es:OTHER
```

Correct use of the **ASSUME** statement can help find addressing errors. With **.CODE**, the assembler assumes CS is the current segment. When you use the simplified segment directives **.DATA**, **.DATA?**, **.CONST**, **.FARDATA**, or

**.FARDATA?**, the assembler automatically assumes CS is the **ERROR** segment. This prevents instructions from appearing in these segments. If you use full segment definitions, you can accomplish the same by placing **ASSUME CS:ERROR** in a data segment.

With simple or full segments, you can cancel the control of an **ASSUME** statement by assuming **NOTHING**. You can cancel the previous assumption for ES with the following statement:

```
ASSUME es:NOTHING
```

Prior to the **.MODEL** statement (or in its absence), the assembler sets the **ASSUME** statement for DS, ES, and SS to the current segment.

## Informing the Processor About Segment Values

The second and final step in initializing segments is to inform the processor of segment values at run time. How segment values are initialized at run time differs for each segment register and depends on the operating system and on your use of simplified segment directives or full segment definitions.

### Specifying a Starting Address

A program's starting address determines where execution begins. After the operating system loads a program, it simply jumps to the starting address, giving processor control to the program. The true starting address is known only to the loader; the linker determines only the offset of the address within an undetermined code segment. That's why a normal application is often referred to as "relocatable code," because it runs regardless of where the loader places it in memory.

The offset of the starting address depends on the program type. Programs with an **.EXE** extension contain a header from which the loader reads the offset and combines it with a segment to form the starting address. Programs with a **.COM** extension (tiny model) have no such header, so by convention the loader jumps to the first byte of the program.

In either case, the **.STARTUP** directive identifies where execution begins, provided you use simplified segment directives. For an **.EXE** program, place **.STARTUP** immediately before the instruction where you want execution to start. In a **.COM** program, place **.STARTUP** before the first assembly instruction in your source code.

If you use full segment directives or prefer not to use **.STARTUP**, you must identify the starting instruction in two steps:

1. Label the starting instruction.
2. Provide the same label in the **END** directive.



These steps tell the linker where execution begins in the program. The following example illustrates the two steps for a tiny model program:

```
_TEXT SEGMENT WORD PUBLIC 'CODE'  
      ORG      100h      ; Use this declaration for .COM files only  
start: .                ; First instruction here  
      .  
      .  
_TEXT ENDS  
      END      start    ; Name of starting label
```

Notice the **ORG** statement in this example. This statement is mandatory in a tiny model program without the **.STARTUP** directive. It places the first instruction at offset 100h in the code segment to create space for a 256-byte (100h) data area called the Program Segment Prefix (PSP). The operating system takes care of initializing the PSP, so you need only make sure the area exists. (For a description of what data resides in the PSP, refer to the “Tables” chapter in the *Reference*.)

### Initializing DS

The DS register is automatically initialized to the correct value (DGROUP) if you use **.STARTUP** or if you are writing a program for Windows. If you do not use **.STARTUP** with MS-DOS, you must initialize DS using the following instructions:

```
      mov     ax, DGROUP  
      mov     ds, ax
```

The initialization requires two instructions because the segment name is a constant and the assembler does not allow a constant to be loaded directly to a segment register. The previous example loads DGROUP, but you can load any valid segment or group.

### Initializing SS and SP

The SS and SP registers are initialized automatically if you use the **.STACK** directive with simplified segments or if you define a segment that has the **STACK** combine type with full segment definitions. Using the **STACK** directive initializes SS to the stack segment. If you want SS to be equal to DS, use **.STARTUP** or its equivalent. (See “Combining Segments,” page 45.) For an .EXE file, the stack address is encoded into the executable header and resolved at load time. For a .COM file, the loader sets SS equal to CS and initializes SP to 0FFFEh.

If your program does not access far data, you do not need to initialize the ES register. If you choose to initialize, use the same technique as for the DS register. You can initialize SS to a far stack in the same way.

## Near and Far Addresses

Addresses that have an implied segment name or segment registers associated with them are called “near addresses.” Addresses that have an explicit segment associated with them are called “far addresses.” The assembler handles near and far code automatically, as described in the following sections. You must specify how to handle far data.

The Microsoft segment model puts all near data and the stack in a group called DGROUP. Near code is put in a segment called `_TEXT`. Each module’s far code or far data is placed in a separate segment. This convention is described in “Controlling the Segment Order” in Chapter 2.

The assembler cannot determine the address for some program components; these are said to be relocatable. The assembler generates a fixup record and the linker provides the address once it has determined the location of all segments. Usually a relocatable operand references a label, but there are exceptions. Examples in the next two sections include information about relocating near and far data.

### Near Code

Control transfers within near code do not require changes to segment registers. The processor automatically handles changes to the offset in the IP register when control-flow instructions such as **JMP**, **CALL**, and **RET** are used. The statement

```
call nearproc ; Change code offset
```

changes the IP register to the new address but leaves the segment unchanged. When the procedure returns, the processor resets IP to the offset of the next instruction after the **CALL** instruction.

### Far Code

The processor automatically handles segment register changes when dealing with far code. The statement

```
call farproc ; Change code segment and offset
```

automatically moves the segment and offset of the `farproc` procedure to the CS and IP registers. When the procedure returns, the processor sets CS to the original code segment and sets IP to the offset of the next instruction after the call.

### Near Data

A program can access near data directly, because a segment register already holds the correct segment for the data item. The term “near data” is often used to refer to the data in the DGROUP group.

After the first initialization of the DS and SS registers, these registers normally point into DGROUP. If you modify the contents of either of these registers during



```

; Second method
mov     ax, SEG farvar2 ; Load the segment of the
mov     es, ax          ; far address into ES
ASSUME  ES:SEG farvar2 ; Tell the assembler that ES points
                    ; to the segment containing farvar2
mov     ax, farvar2    ; The assembler provides the ES
                    ; override since it knows that
                    ; the label is addressable

```

After loading the segment of the address into the ES segment register, you can explicitly override the segment register so that the addressing is correct (method 1) or allow the assembler to insert the override for you (method 2). The assembler uses **ASSUME** statements to determine which segment register can be used to address a segment of memory. To use the segment override operator, the left operand must be a segment register, not a segment name. (For more information on segment overrides, see “Direct Memory Operands” on page 62.)

If an instruction needs a segment override, the resulting code is slightly larger and slower, since the override must be encoded into the instruction. However, the resulting code may still be smaller than the code for multiple loads of the default segment register for the instruction.

The DS, SS, FS, and GS segment registers (FS and GS are available only on the 80386/486 processors) may also be used for addressing through other segments.

If a program uses ES to access far data, it need not restore ES when finished (unless the program uses flat model). However, some compilers require that you restore ES before returning to a module written in a high-level language.

To access far data, first set DS to the far segment and then restore the original DS when finished. Use the **ASSUME** directive to let the assembler know that DS no longer points to the default data segment, as shown here:

```

push    ds                ; Save original segment
mov     ax, SEG fararray  ; Move segment into data register
mov     ds, ax            ; Initialize segment register
ASSUME  ds:SEG fararray  ; Tell assembler where data is
mov     ax, fararray[0]   ; Set DX:AX = dword variable
mov     dx, fararray[2]   ; fararray
.
.
.
pop     ds                ; Restore segment
ASSUME  ds:@DATA         ; and default assumption

```

“Direct Memory Operands,” on page 62, describes an alternative method for accessing far data. The technique of resetting DS as shown in the previous example is best for a lengthy series of far data references. The segment override method described in “Direct Memory Operands” serves best when accessing only one or two far variables.

If your program changes DS to access far data, it should restore DS when finished. This allows procedures to assume that DS is the segment for near data. Many compilers, including Microsoft compilers, use this convention.

## Operands

With few exceptions, assembly language instructions work on sources of data called operands. In a listing of assembly code (such as the examples in this book), operands appear in the operand field immediately to the right of the instructions.

This section describes the four kinds of instruction operands: register, immediate, direct memory, and indirect memory. Some instructions, such as POPF and STI, have implied operands which do not appear in the operand field. Otherwise, an implied operand is just as real as one stated explicitly.

Certain other instructions such as NOP and WAIT deserve special mention. These instructions affect only processor control and do not require an operand.

The following four types of operands are described in the rest of this section:

<b>Operand Type</b>	<b>Addressing Mode</b>
Register	An 8-bit or 16-bit register on the 8086–80486; can also be 32-bit on the 80386/486.
Immediate	A constant value contained in the instruction itself.
Direct memory	A fixed location in memory.
Indirect memory	A memory location determined at run time by using the address stored in one or two registers.

Instructions that take two or more operands always work right to left. The right operand is the source operand. It specifies data that will be read, but not changed, in the operation. The left operand is the destination operand. It specifies the data that will be acted on and possibly changed by the instruction.

## Register Operands

Register operands refer to data stored in registers. The following examples show typical register operands:

```

mov     bx, 10           ; Load constant to BX
add     ax, bx          ; Add BX to AX
jmp     di              ; Jump to the address in DI

```

An offset stored in a base or index register often serves as a pointer into memory. You can store an offset in one of the base or index registers, then use the register as an indirect memory operand. (See “Indirect Memory Operands,” following.) For example:

```

mov     [bx], dl        ; Store DL in indirect memory operand
inc     bx              ; Increment register operand
mov     [bx], dl        ; Store DL in new indirect memory operand

```

This example moves the value in DL to 2 consecutive bytes of a memory location pointed to by BX. Any instruction that changes the register value also changes the data item pointed to by the register.

## Immediate Operands

An immediate operand is a constant or the result of a constant expression. The assembler encodes immediate values into the instruction at assembly time. Here are some typical examples showing immediate operands:

```

mov     cx, 20          ; Load constant to register
add     var, 1Fh        ; Add hex constant to variable
sub     bx, 25 * 80     ; Subtract constant expression

```

Immediate data is never permitted in the destination operand. If the source operand is immediate, the destination operand must be either a register or direct memory to provide a place to store the result of the operation.

Immediate expressions often involve the useful **OFFSET** and **SEG** operators, described in the following paragraphs.

### The OFFSET Operator

An address constant is a special type of immediate operand that consists of an offset or segment value. The **OFFSET** operator returns the offset of a memory location, as shown here:

```

mov     bx, OFFSET var ; Load offset address

```

For information on differences between MASM 5.1 behavior and MASM 6.1 behavior related to **OFFSET**, see Appendix A.

Since data in different modules may belong to a single segment, the assembler cannot know for each module the true offsets within a segment. Thus, the offset for `var`, although an immediate value, is not determined until link time.

## The SEG Operator

The **SEG** operator returns the segment of a memory location:

```
mov    ax, SEG farvar ; Load segment address
mov    es, ax
```

The actual value of a particular segment is not known until the program is loaded into memory. For `.EXE` programs, the linker makes a list in the program's header of all locations in which the **SEG** operator appears. The loader reads this list and fills in the required segment address at each location. Since `.COM` programs have no header, the assembler does not allow relocatable segment expressions in tiny model programs.

The **SEG** operator returns a variable's "frame" if it appears in the instruction. The frame is the value of the segment, group, or segment override of a nonexternal variable. For example, the instruction

```
mov    ax, SEG DGROUP:var
```

places in `AX` the value of `DGROUP`, where `var` is located. If you do not include a frame, **SEG** returns the value of the variable's group if one exists. If the variable is not defined in a group, **SEG** returns the variable's segment address.

This behavior can be changed with the `/Zm` command-line option or with the **OPTION OFFSET:SEGMENT** statement. (See Appendix A, "Differences between MASM 6.1 and 5.1.") "Using the **OPTION** Directive" in Chapter 1 introduces the **OPTION** directive.

## Direct Memory Operands

A direct memory operand specifies the data at a given address. The instruction acts on the contents of the address, not the address itself. Except when size is implied by another operand, you must specify the size of a direct memory operand so the instruction accesses the correct amount of memory. The following example shows how to explicitly specify data size with the **BYTE** directive:

```

        .DATA?                ; Segment for uninitialized data
var     BYTE ?                ; Reserve one byte, labeled "var"
        .CODE
        .
        .
        .
        mov     var, al       ; Copy AL to byte at var

```

Any location in memory can be a direct memory operand as long as a size is specified (or implied) and the location is fixed. The data at the address can change, but the address cannot. By default, instructions that use direct memory addressing use the DS register. You can create an expression that points to a memory location using any of the following operators:

Operator Name	Symbol
Plus	+
Minus	-
Index	[ ]
Structure member	.
Segment override	:

These operators are discussed in more detail in the following section.

### Plus, Minus, and Index

The plus and index operators perform in exactly the same way when applied to direct memory operands. For example, both the following statements move the second word value from an array into the AX register:

```

        mov     ax, array[2]
        mov     ax, array+2

```

The index operator can contain any direct memory operand. The following statements are equivalent:

```

        mov     ax, var
        mov     ax, [var]

```

Some programmers prefer to enclose the operand in brackets to show that the contents, not the address, are used.



The minus operator behaves as you would expect. Both the following instructions retrieve the value located at the word preceding array:

```
mov    ax, array[-2]
mov    ax, array-2
```

### Structure Field

The structure operator (.) references a particular element of a structure or “field,” to use C terminology:

```
mov    bx, structvar.field1
```

The address of the structure operand is the sum of the offsets of `structvar` and `field1`. For more information about structures, see “Structures and Unions” in Chapter 5.

### Segment Override

The segment override operator (:) specifies a segment portion of the address that is different from the default segment. When used with instructions, this operator can apply to segment registers or segment names:

```
mov    ax, es:farvar           ; Use segment override
```

The assembler will not generate a segment override if the default segment is explicitly provided. Thus, the following two statements assemble in exactly the same way:

```
mov    [bx], ax
mov    ds:[bx], ax
```

A segment name override or the segment override operator identifies the operand as an address expression.

```
mov    WORD PTR FARSEG:0, ax   ; Segment name override
mov    WORD PTR es:100h, ax    ; Legal and equivalent
mov    WORD PTR es:[100h], ax  ; expressions
; mov    WORD PTR [100h], ax    ; Illegal, not an address
```

As the example shows, a constant expression cannot be an address expression unless it has a segment override.

## Indirect Memory Operands

Like direct memory operands, indirect memory operands specify the contents of a given address. However, the processor calculates the address at run time by referring to the contents of registers. Since values in the registers can change at run time, indirect memory operands provide dynamic access to memory.

Indirect memory operands make possible run-time operations such as pointer indirection and dynamic indexing of array elements, including indexing of multidimensional arrays.

Strict rules govern which registers you can use for indirect memory operands under 16-bit versions of the 8086-based processors. The rules change significantly for 32-bit processors starting with the 80386. However, the new rules apply only to code that does not need to be compatible with earlier processors.

This section covers features of indirect operands in either mode. The specific 16-bit rules and 32-bit rules are then explained separately.

## Indirect Operands with 16- and 32-Bit Registers

Some rules and options for indirect memory operands always apply, regardless of the size of the register. For example, you must always specify the register and operand size for indirect memory operands. But you can use various syntaxes to indicate an indirect memory operand. This section describes the rules that apply to both 16-bit and 32-bit register modes.

### Specifying Indirect Memory Operands

The index operator specifies the register or registers for indirect operands. The processor uses the data pointed to by the register. For example, the following instruction moves into AX the word value at the address in DS:BX.

```
mov    ax, WORD PTR [bx]
```

When you specify more than one register, the processor adds the contents of the two addresses together to determine the effective address (the address of the data to operate on):

```
mov    ax, [bx+si]
```

### Specifying Displacements

You can specify an address displacement, which is a constant value added to the effective address. A direct memory specifier is the most common displacement:

```
mov    ax, table[si]
```

In this relocatable expression, the displacement `table` is the base address of an array; `SI` holds an index to an array element. The `SI` value is calculated at run time, often in a loop. The element loaded into `AX` depends on the value of `SI` at the time the instruction executes.

Each displacement can be an address or numeric constant. If there is more than one displacement, the assembler totals them at assembly time and encodes the total displacement. For example, in the statement

```
table WORD 100 DUP (0)
      .
      .
      .
      mov ax, table[bx][di]+6
```

both `table` and `6` are displacements. The assembler adds the value of `6` to `table` to get the total displacement. However, the statement

```
mov ax, mem1[si] + mem2
```

is not legal, because it attempts to use a single command to join the contents of two different addresses.

### Specifying Operand Size

You must give the size of an indirect memory operand in one of three ways:

- By the variable's declared size
- With the **PTR** operator
- Implied by the size of the other operand

The following lines illustrate all three methods. Assume the size of the `table` array is **WORD**, as declared earlier.

```
mov table[bx], 0 ; 2 bytes - from size of table
mov BYTE PTR table, 0 ; 1 byte - specified by BYTE
mov ax, [bx] ; 2 bytes - implied by AX
```

### Syntax Options

The assembler allows a variety of syntaxes for indirect memory operands. However, all registers must be inside brackets. You can enclose each register in its own pair of brackets, or you can place the registers in the same pair of brackets separated by a plus operator (+). All the following variations are legal and assemble the same way:

```
mov ax, table[bx][di]
mov ax, table[di][bx]
mov ax, table[bx+di]
mov ax, [table+bx+di]
mov ax, [bx][di]+table
```

All of these statements move the value in `table` indexed by `BX+DI` into `AX`.

## Scaling Indexes

The value of index registers pointing into arrays must often be adjusted for zero-based arrays and scaled according to the size of the array items. For a word array, the item number must be multiplied by two (shifted left by one place). When using 16-bit registers, you must scale with separate instructions, as shown here:

```

mov     bx, 5           ; Get sixth element (adjust for 0)
shl    bx, 1           ; Scale by two (word size)
inc    wtable[bx]     ; Increment sixth element in table

```

When using 32-bit registers on the 80386/486 processor, you can include scaling in the operand, as described in “Indirect Memory Operands with 32-Bit Registers,” following.

## Accessing Structure Elements

The structure member operator can be used in indirect memory operands to access structure elements. In this example, the structure member operator loads the year field of the fourth element of the `students` array into AL:

```

STUDENT STRUCT
    grade WORD    ?
    name  BYTE    20 DUP (?)
    year  BYTE    ?
STUDENT ENDS

students      STUDENT < >
.
.
mov     bx, OFFSET students ; Assume array is initialized
mov     ax, 4                ; Point to array of students
mov     di, SIZE STUDENT    ; Get fourth element
mul     di                   ; Get size of STUDENT
mov     di, ax               ; Multiply size times
mov     di, ax               ; elements to point DI
mov     di, ax               ; to current element
mov     al, (STUDENT PTR[bx+di]).year

```

For more information on MASM structures, see “Structures and Unions” in Chapter 5.

## Indirect Memory Operands with 16-Bit Registers

For 8086-based computers and MS-DOS, you must follow the strict indexing rules established for the 8086 processor. Only four registers are allowed—BP, BX, SI, and DI—those only in certain combinations.

BP and BX are base registers. SI and DI are index registers. You can use either a base or an index register by itself. But if you combine two registers, one must be a base and one an index. Here are legal and illegal forms:

```

mov    ax, [bx+di]    ; Legal
mov    ax, [bx+si]    ; Legal
mov    ax, [bp+di]    ; Legal
mov    ax, [bp+si]    ; Legal
;     mov    ax, [bx+bp]    ; Illegal - two base registers
;     mov    ax, [di+si]    ; Illegal - two index registers

```

Table 3.1 shows the register modes in which you can specify indirect memory operands.

**Table 3.1 Indirect Addressing with 16-Bit Registers**

Mode	Syntax	Effective Address
Register indirect	[BX] [BP] [DI] [SI]	Contents of register
Base or index	<i>displacement</i> [BX] <i>displacement</i> [BP] <i>displacement</i> [DI] <i>displacement</i> [SI]	Contents of register plus <i>displacement</i>
Base plus index	[BX][DI] [BP][DI] [BX][SI] [BP][SI]	Contents of base register plus contents of index register
Base plus index with displacement	<i>displacement</i> [BX][DI] <i>displacement</i> [BP][DI] <i>displacement</i> [BX][SI] <i>displacement</i> [BP][SI]	Sum of base register, index register, and <i>displacement</i>

Different combinations of registers and displacements have different timings, as shown in *Reference*.

## Indirect Memory Operands with 32-Bit Registers

You can write instructions for the 80386/486 processor using either 16-bit or 32-bit segments. Indirect memory operands are different in each case.

In 16-bit real mode, the 80386/486 operates the same way as earlier 8086-based processors, with one difference: you can use 32-bit registers. If the 80386/486 processor is enabled (with the `.386` or `.486` directive), 32-bit general-purpose registers are available with either 16-bit or 32-bit segments. Thirty-two-bit

registers eliminate many of the limitations of 16-bit indirect memory operands. You can use 80386/486 features to make your MS-DOS programs run faster and more efficiently if you are willing to sacrifice compatibility with earlier processors.

In 32-bit mode, an offset address can be up to 4 gigabytes. (Segments are still represented in 16 bits.) This effectively eliminates size restrictions on each segment, since few programs need 4 gigabytes of memory. Windows NT uses 32-bit mode and flat model, which spans all segments. XENIX 386 uses 32-bit mode with multiple segments.

### 80386/486 Enhancements

On the 80386/486, the processor allows you to use any general-purpose 32-bit register as a base or index register, except ESP, which can be a base but not an index. However, you cannot combine 16-bit and 32-bit registers. Several examples are shown here:

```

add     edx, [eax]           ; Add double
mov     dl, [esp+10]        ; Copy byte from stack
dec     WORD PTR [edx][eax] ; Decrement word
cmp     ax, array[ebx][ecx] ; Compare word from array
jmp     FWORD PTR table[ecx] ; Jump into pointer table

```

### Scaling Factors

With 80386/486 registers, the index register can have a scaling factor of 1, 2, 4, or 8. Any register except ESP can be the index register and can have a scaling factor. To specify the scaling factor, use the multiplication operator (\*) adjacent to the register.

You can use scaling to index into arrays with different sizes of elements. For example, the scaling factor is 1 for byte arrays (no scaling needed), 2 for word arrays, 4 for doubleword arrays, and 8 for quadword arrays. There is no performance penalty for using a scaling factor. Scaling is illustrated in the following examples:

```

mov     eax, darray[edx*4]   ; Load double of double array
mov     eax, [esi*8][edi]    ; Load double of quad array
mov     ax, wtbl[ecx+2][edx*2] ; Load word of word array

```

Scaling is also necessary on earlier processors, but it must be done with separate instructions before the indirect memory operand is used, as described in “Indirect Memory Operands with 16-Bit Registers,” previous.

The default segment register is SS if the base register is EBP or ESP. However, if EBP is scaled, the processor treats it as an index register with a value relative to DS, not SS.

All other base registers are relative to DS. If two registers are used, only one can have a scaling factor. The register with the scaling factor is defined as the index register. The other register is defined as the base. If scaling is not used, the first register is the base. If only one register is used, it is considered the base for deciding the default segment unless it is scaled. The following examples illustrate how to determine the base register:

```

mov    eax, [edx][ebp*4] ; EDX base (not scaled - seg DS)
mov    eax, [edx*1][ebp] ; EBP base (not scaled - seg SS)
mov    eax, [edx][ebp]   ; EDX base (first - seg DS)
mov    eax, [ebp][edx]   ; EBP base (first - seg SS)
mov    eax, [ebp]       ; EBP base (only - seg SS)
mov    eax, [ebp*2]     ; EBP*2 index (seg DS)

```

### Mixing 16-Bit and 32-Bit Registers

Assembly statements can mix 16-bit and 32-bit registers. For example, the following statement is legal for 16-bit and 32-bit segments:

```

mov    eax, [bx]

```

This statement moves the 32-bit value pointed to by BX into the EAX register. Although BX is a 16-bit pointer, it can still point into a 32-bit segment.

However, the following statement is never legal, since you cannot use the CX register as a 16-bit pointer:

```

;    mov    eax, [cx]    ; illegal

```

Operands that mix 16-bit and 32-bit registers are also illegal:

```

;    mov    eax, [ebx+si] ; illegal

```

The following statement is legal in either 16-bit or 32-bit mode:

```

mov    bx, [eax]

```

This statement moves the 16-bit value pointed to by EAX into the BX register. This works in 32-bit mode. However, in 16-bit mode, moving a 32-bit pointer into a 16-bit segment is illegal. If EAX contains a 16-bit value (the top half of the 32-bit register is 0), the statement works. However, if the top half of the EAX register is not 0, the operand points into a part of the segment that doesn't exist, generating an error. If you use 32-bit registers as indexes in 16-bit mode, you must make sure that the index registers contain valid 16-bit addresses.

## The Program Stack

The preceding discussion on memory operands lays the groundwork for understanding the important data area known as the “stack.”

A stack is an area of memory for storing data temporarily. Unlike other segments that store data starting from low memory, the stack stores data starting from high memory. Data is always pushed onto, or “popped” from the top of the stack.

The stack gets its name from its similarity to the spring-loaded plate holders in cafeterias. You add and remove plates from only the top of the stack. To retrieve the third plate, you must remove—that is, “pop”—the first two plates. Stacks are often referred to as LIFO buffers, from their last-in-first-out operation.

A stack is an essential part of any nontrivial program. A program continually uses its stack to temporarily store return addresses, procedure arguments, memory data, flags, or registers.

The SP register serves as an indirect memory operand to the top of the stack. At first, the stack is an uninitialized segment of a finite size. As your program adds data to the stack, the stack grows downward from high memory to low memory. When you remove items from the stack, it shrinks upward from low to high memory.

## Saving Operands on the Stack

The **PUSH** instruction stores a 2-byte operand on the stack. The **POP** instruction retrieves the most recent pushed value. When a value is pushed onto the stack, the assembler decreases the SP (Stack Pointer) register by 2. On 8086-based processors, the SP register always points to the top of the stack. The **PUSH** and **POP** instructions use the SP register to keep track of the current position.

When a value is popped off the stack, the assembler increases the SP register by 2. Since the stack always contains word values, the SP register changes in multiples of two. When a **PUSH** or **POP** instruction executes in a 32-bit code segment (one with **USE32** use type), the assembler transfers a 4-byte value, and ESP changes in multiples of four.

---

**Note** The 8086 and 8088 processors differ from later Intel processors in how they push and pop the SP register. If you give the statement `push sp` with the 8086 or 8088, the word pushed is the word in SP after the push operation.

---



Figure 3.1 illustrates how pushes and pops change the SP register.

### Pushing Words onto the Stack

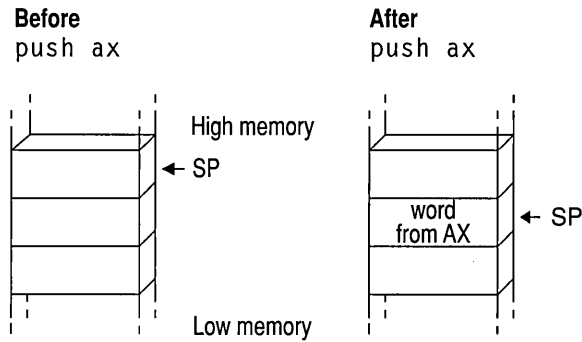

### Popping Words from the Stack

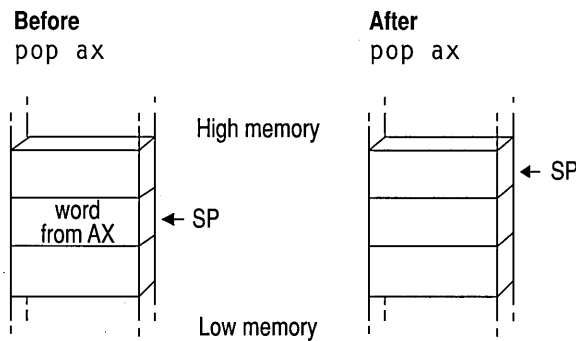

Figure 3.1 Stack Status Before and After Pushes and Pops

On the 8086, **PUSH** and **POP** take only registers or memory expressions as their operands. The other processors allow an immediate value to be an operand for **PUSH**. For example, the following statement is legal on the 80186–80486 processors:

```
push    7                ; 3 clocks on 80286
```

That statement is faster than these equivalent statements, which are required on the 8088 or 8086:

```
mov     ax, 7            ; 2 clocks plus
push   ax                ; 3 clocks on 80286
```

Words are popped off the stack in reverse order: the last item pushed is the first popped. To return the stack to its original status, you do the same number of pops as

pushes. You can subtract the correct number of words from the SP register if you want to restore the stack without using the values on it.

To reference operands on the stack, remember that the values pointed to by the BP (Base Pointer) and SP registers are relative to the SS (Stack Segment) register. The BP register is often used to point to the base of a frame of reference (a stack frame) within the stack. This example shows how you can access values on the stack using indirect memory operands with BP as the base register.

```

push    bp                ; Save current value of BP
mov     bp, sp            ; Set stack frame
push    ax                ; Push first; SP = BP - 2
push    bx                ; Push second; SP = BP - 4
push    cx                ; Push third; SP = BP - 6
.
.
.
mov     ax, [bp-6]        ; Put third word in AX
mov     bx, [bp-4]        ; Put second word in BX
mov     cx, [bp-2]        ; Put first word in CX
.
.
.
add     sp, 6             ; Restore stack pointer
                        ; (two bytes per push)
pop     bp                ; Restore BP

```

If you often use these stack values in your program, you may want to give them labels. For example, you can use **TEXTEQU** to create a label such as `count` **TEXTEQU** `<[bp-6]>`. Now you can replace the `mov ax, [bp - 6]` statement in the previous example with `mov ax, count`. For more information about the **TEXTEQU** directive, see “Text Macros” in Chapter 9.

## Saving Flags on the Stack

Your program can push and pop flags onto the stack with the **PUSHF** and **POPF** instructions. These instructions save and then restore the status of the flags. You can also use them within a procedure to save and restore the flag status of the caller. The 32-bit versions of these instructions are **PUSHFD** and **POPFD**.

This example saves the flags register before calling the `sys task` procedure:

```

pushf
call   systask
popf

```

If you do not need to store the entire flags register, you can use the **LAHF** instruction to manually load and store the status of the lower byte of the flag register in the AH register. **SAHF** restores the value.

## Saving Registers on the Stack (80186–80486 Only)

Starting with the 80186 processor, the **PUSHA** and **POPA** instructions push or pop all the general-purpose registers with only one instruction. These instructions save the status of all registers before a procedure call and restore them after the return. Using **PUSHA** and **POPA** is significantly faster and takes fewer bytes of code than pushing and popping each register individually.

The processor pushes the registers in the following order: AX, CX, DX, BX, SP, BP, SI, and DI. The SP word pushed is the value before the first register is pushed.

The processor pops the registers in the opposite order. The 32-bit versions of these instructions are **PUSHAD** and **POPAD**.

## Accessing Data with Pointers and Addresses

A pointer is simply a variable that contains an address of some other variable. The address in the pointer “points” to the other object. Pointers are useful when transferring a large data object (such as an array) to a procedure. The caller places only the pointer on the stack, which the called procedure uses to locate the array. This eliminates the impractical step of having to pass the entire array back and forth through the stack.

There is a difference between a far address and a far pointer. A “far address” is the address of a variable located in a far data segment. A “far pointer” is a variable that contains the segment address and offset of some other data. Like any other variable, a pointer can be located in either the default (near) data segment or in a far segment.

Previous versions of MASM allow pointer variables but provide little support for them. In previous versions, any address loaded into a variable can be considered a pointer, as in the following statements:

```
Var      BYTE    0           ; Variable
npVar   WORD    Var         ; Near pointer to variable
fpVar   DWORD   Var         ; Far pointer to variable
```

If a variable is initialized with the name of another variable, the initialized variable is a pointer, as shown in this example. However, in previous versions of MASM, the CodeView debugger recognizes npVar and fpVar as word and doubleword variables. CodeView does not treat them as pointers, nor does it recognize the type of data they point to (bytes, in the example).

The **TYPEDEF** directive and enhanced capabilities of **ASSUME** (introduced in MASM 6.0) make it easier to manage pointers in registers and variables. The rest of this chapter describes these directives and how they apply to basic pointer operations.

## Defining Pointer Types with TYPEDEF

The **TYPEDEF** directive can define types for pointer variables. A type so defined is considered the same as the intrinsic types provided by the assembler and can be used in the same contexts. When used to define pointers, the syntax for **TYPEDEF** is:

```
typename TYPEDEF [distance] PTR qualifiedtype
```

The *typename* is the name assigned to the new type. The *distance* can be **NEAR**, **FAR**, or any distance modifier. The *qualifiedtype* can be any previously intrinsic or defined MASM type, or a type previously defined with **TYPEDEF**. (For a full definition of *qualifiedtype*, see “Data Types” in Chapter 1.)

Here are some examples of user-defined types:

```
PBYTE   TYPEDEF      PTR BYTE   ; Pointer to bytes
NPBYTE  TYPEDEF NEAR PTR BYTE   ; Near pointer to bytes
FPBYTE  TYPEDEF FAR  PTR BYTE   ; Far pointer to bytes
PWORD   TYPEDEF      PTR WORD   ; Pointer to words
NPWORD  TYPEDEF NEAR PTR WORD   ; Near pointer to words
FPWORD  TYPEDEF FAR  PTR WORD   ; Far pointer to words

PPBYTE  TYPEDEF      PTR PBYTE  ; Pointer to pointer to bytes
                                   ; (in C, an array of strings)
PVOID   TYPEDEF      PTR        ; Pointer to any type of data

PERSON  STRUCT
    name BYTE    20 DUP (?)
    num  WORD    ?
PERSON  ENDS
PPERSON TYPEDEF      PTR PERSON ; Pointer to structure type
```

The distance of a pointer can be set specifically or determined automatically by the memory model (set by **.MODEL**) and the segment size (16 or 32 bits). If you don't use **.MODEL**, near pointers are the default.

In 16-bit mode, a near pointer is 2 bytes that contain the offset of the object pointed to. A far pointer requires 4 bytes, and contains both the segment and offset. In 32-bit mode, a near pointer is 4 bytes and a far pointer is 6 bytes, since segments are

still word values in 32-bit mode. If you specify the distance with **NEAR** or **FAR**, the processor uses the default distance of the current segment size. You can use **NEAR16**, **NEAR32**, **FAR16**, and **FAR32** to override the defaults set by the current segment size. In flat model, **NEAR** is the default.

You can declare pointer variables with a pointer type created with **TYPEDDEF**. Here are some examples using these pointer types.

```

; Type declarations
Array  WORD    25 DUP (0)
Msg    BYTE    "This is a string", 0
pMsg   PBYTE   Msg           ; Pointer to string
pArray PWORD   Array        ; Pointer to word array
npMsg  NPBYTE  Msg           ; Near pointer to string
npArray NPWORD Array        ; Near pointer to word array
fpArray FPWORD Array        ; Far pointer to word array
fpMsg  FPBYTE  Msg           ; Far pointer to string

S1     BYTE    "first", 0    ; Some strings
S2     BYTE    "second", 0
S3     BYTE    "third", 0
pS123  PBYTE   S1, S2, S3, 0 ; Array of pointers to strings
ppS123 PPBYTE  pS123        ; A pointer to pointers to strings

Andy   PERSON  <>           ; Structure variable
pAndy  PPERSON Andy        ; Pointer to structure variable

; Procedure prototype

EXTERN ptrArray:PBYTE      ; External variable
Sort   PROTO  pArray:PBYTE ; Parameter for prototype

; Parameter for procedure
Sort   PROC  pArray:PBYTE
        LOCAL pTmp:PBYTE   ; Local variable
        .
        .
        .
        ret
Sort   ENDP

```

Once defined, pointer types can be used in any context where intrinsic types are allowed.

## Defining Register Types with ASSUME

You can use the **ASSUME** directive with general-purpose registers to specify that a register is a pointer to a certain size of object. For example:

```

ASSUME  bx:PTR WORD      ; Assume BX is now a word pointer
inc     [bx]             ; Increment word pointed to by BX
add     bx, 2            ; Point to next word
mov     [bx], 0          ; Word pointed to by BX = 0
.
.                         ; Other pointer operations with BX
.
ASSUME  bx:NOTHING      ; Cancel assumption

```

In this example, **BX** is specified as a pointer to a word. After a sequence of using **BX** as a pointer, the assumption is canceled by assuming **NOTHING**.

Without the assumption to **PTR WORD**, many instructions need a size specifier. The **INC** and **MOV** statements from the previous examples would have to be written like this to specify the sizes of the memory operands:

```

inc     WORD PTR [bx]
mov     WORD PTR [bx], 0

```

When you have used **ASSUME**, attempts to use the register for other purposes generate assembly errors. In this example, while the **PTR WORD** assumption is in effect, any use of **BX** inconsistent with its **ASSUME** declaration generates an error. For example,

```

;      mov     al, [bx]      ; Can't move word to byte register

```

You can also use the **PTR** operator to override defaults:

```

mov     al, BYTE PTR [bx]   ; Legal

```

Similarly, you can use **ASSUME** to prevent the use of a register as a pointer, or even to disable a register:

```

ASSUME  bx:WORD, dx:ERROR
;      mov     al, [bx] ; Error - BX is an integer, not a pointer
;      mov     ax, dx  ; Error - DX disabled

```

For information on using **ASSUME** with segment registers, refer to “Setting the **ASSUME** Directive for Segment Registers” in Chapter 2.



## Dynamic Addresses

Often a pointer must point to a dynamic address, meaning the address depends on a run-time condition. Typical situations include memory allocated by MS-DOS (see “Interrupt 21h Function 48h” in Help) and addresses found by the **SCAS** or **CMPS** instructions (see “Processing Strings” in Chapter 5). The following illustrates the technique for saving dynamic addresses:

```

; Dynamically allocated buffer
fpBuf  FPBYTE  0          ; Initialize so offset will be zero
      .
      .
      .
      mov     ah, 48h      ; Allocate memory
      mov     bx, 10h     ; Request 16 paragraphs
      int     21h        ; Call DOS
      jc     error       ; Return segment in AX
      mov     WORD PTR fpBuf[2], ax ; Load segment
      .                  ; (offset is already 0)
      .
      .
error: ; Handle error

```

## Copying Pointers

Sometimes one pointer variable must be initialized by copying from another. Here are two ways to copy a far pointer:

```

fpBuf1  FPBYTE  ?
fpBuf2  FPBYTE  ?
      .
      .
      .
; Copy through registers is faster, but requires a spare register
      mov     ax, WORD PTR fpBuf1[0]
      mov     WORD PTR fpBuf2[0], ax
      mov     ax, WORD PTR fpBuf1[2]
      mov     WORD PTR fpBuf2[2], ax

; Copy through stack is slower, but does not use a register
      push   WORD PTR fpBuf1[0]
      push   WORD PTR fpBuf1[2]
      pop    WORD PTR fpBuf2[2]
      pop    WORD PTR fpBuf2[0]

```



## Pointers as Arguments

Most high-level-language procedures and library functions accept arguments passed on the stack. "Passing Arguments on the Stack" in Chapter 7 covers this subject in detail. A pointer is passed in the same way as any other variable, as this fragment shows:

```
; Push a far pointer (segment always pushed first)
  push   WORD PTR fpMsg[2]      ; Push segment
  push   WORD PTR fpMsg[0]      ; Push offset
```

Pushing an address has the same result as pushing a pointer to the address:

```
; Push a far address as a far pointer
  mov    ax, SEG fVar          ; Load and push segment
  push  ax
  mov    ax, OFFSET fVar      ; Load and push offset
  push  ax
```

On the 80186 and later processors, you can push a constant in one step:

```
push   SEG fVar              ; Push segment
push   OFFSET fVar           ; Push offset
```

## Loading Addresses into Registers

Loading a near address into a register (or a far address into a pair of registers) is a common task in assembly-language programming. To reference data pointed to by a pointer, your program must first place the pointer into a register or pair of registers.

Load far addresses as *segment:offset* pairs. The following pairs have specific uses:

Segment:Offset Pair	Standard Use
DS:SI	Source for string operations
ES:DI	Destination for string operations
DS:DX	Input for certain DOS functions
ES:BX	Output from certain DOS functions

## Addresses from Data Segments

For near addresses, you need only load the offset; the segment is assumed as SS for stack-based data and as DS for other data. You must load both segment and offset for far pointers.

Here is an example of loading an address into DS:BX from a near data segment:

```
.DATA
Msg    BYTE    "String"
      .
      .
      .
      mov     bx, OFFSET Msg    ; Load address to BX
                                ; (DS already loaded)
```

Far data can be loaded like this:

```
.FARDATA
Msg    BYTE    "String"
      .
      .
      .
      mov     ax, SEG Msg      ; Load address to ES:BX
      mov     es, ax
      mov     bx, OFFSET Msg
```

You can also read a far address from a pointer in one step, using the **LES** and **LDS** instructions described next.

### Far Pointers

The **LES** and **LDS** instructions load a far pointer into a segment pair. The instructions copy the pointer's low word into either ES or DS, and the high word into a given register. The following example shows how to load a far pointer into ES:DI:

```
OutBuf BYTE    20 DUP (0)

fpOut  FPBYTE  OutBuf
      .
      .
      .
      les   di, fpOut      ; Load far pointer into ES:DI
```

## Stack Variables

The technique for loading the address of a stack variable is significantly different from the technique for loading near addresses. You may need to put the correct segment value into ES for string operations. The following example illustrates how to load the address of a local (stack) variable to ES:DI:

```
Task    PROC
        LOCAL   Arg[4]:BYTE

        push    ss        ; Since it's stack-based, segment is SS
        pop     es        ; Copy SS to ES
        lea     di, Arg    ; Load offset to DI
```

The local variable in this case actually evaluates to SS:[BP-4]. This is an offset from the stack frame (described in “Passing Arguments on the Stack,” Chapter 7). Since you cannot use the **OFFSET** operator to get the offset of an indirect memory operand, you must use the **LEA** (Load Effective Address) instruction.

## Direct Memory Operands

To get the address of a direct memory operand, use either the **LEA** instruction or the **MOV** instruction with **OFFSET**. Though both methods have the same effect, the **MOV** instruction produces smaller and faster code, as shown in this example:

```
        lea     si, Msg        ; Four byte instruction
        mov     si, OFFSET Msg ; Three byte equivalent
```

## Copying Between Segment Pairs

Copying from one register pair to another is complicated by the fact that you cannot copy one segment register directly to another. Two copying methods are shown here. Timings are for the 8088 processor.

```
; Copy DS:SI to ES:DI, generating smaller code
        push    ds            ; 1 byte, 14 clocks
        pop     es            ; 1 byte, 12 clocks
        mov     di, si        ; 2 bytes, 2 clocks

; Copy DS:SI to ES:DI, generating faster code
        mov     di, ds        ; 2 bytes, 2 clocks
        mov     es, di        ; 2 bytes, 2 clocks
        mov     di, si        ; 2 bytes, 2 clocks
```

## Model-Independent Techniques

Often you may want to write code that is memory-model independent. If you are writing libraries that must be available for different memory models, you can use conditional assembly to handle different sizes of pointers. You can use the predefined symbols **@DataSize** and **@Model** to test the current assumptions.

You can use conditional assembly to write code that works with pointer variables that have no specified distance. The predefined symbol **@DataSize** tests the pointer size for the current memory model:

```
Msg1    BYTE    "String1"
pMsg    PBYTE   ?
        .
        .
        .
        IF     @DataSize                ; @DataSize > 0 for far
mov     WORD PTR pMsg[0], OFFSET Msg1   ; Load far offset
mov     WORD PTR pMsg[2], SEG Msg1      ; Load far segment
        ELSE
mov     pMsg, OFFSET Msg1               ; @DataSize = 0 for near
        ; Load near pointer
        ENDIF
```

In the following example, a procedure receives as an argument a pointer to a word variable. The code inside the procedure uses **@DataSize** to determine whether the current memory model supports far or near data. It loads and processes the data accordingly:

```
; Procedure that receives an argument by reference
mu18    PROC    arg:PTR WORD

        IF     @DataSize
les     bx, arg        ; Load far pointer to ES:BX
mov     ax, es:[bx]   ; Load the data pointed to
        ELSE
mov     bx, arg        ; Load near pointer to BX (assume DS)
mov     ax, [bx]      ; Load the data pointed to
        ENDIF
shl     ax, 1          ; Multiply by 8
shl     ax, 1
shl     ax, 1
ret
mu18    ENDP
```

If you have many routines, writing the conditionals for each case can be tedious. The following conditional statements automatically generate the proper instructions and segment overrides.

```
; Equates for conditional handling of pointers
      IF @DataSize
lesIF  TEXT EQU   <les>
ldsIF  TEXT EQU   <lds>
esIF   TEXT EQU   <es:>
      ELSE
lesIF  TEXT EQU   <mov>
ldsIF  TEXT EQU   <mov>
esIF   TEXT EQU   <>
      ENDIF
```

Once you define these conditionals, you can use them to simplify code that must handle several types of pointers. This next example rewrites the above `mul8` procedure to use conditional code.

```
mul8  PROC    arg:PTR WORD

      lesIF  bx, arg          ; Load pointer to BX or ES:BX
      mov   ax, esIF [bx]    ; Load the data from [BX] or ES:[BX]
      shl  ax, 1             ; Multiply by 8
      shl  ax, 1
      shl  ax, 1
      ret
mul8  ENDP
```

The conditional statements from these examples can be defined once in an include file and used whenever you need to handle pointers.

---

## CHAPTER 4

# Defining and Using Simple Data Types

This chapter covers the concepts essential for working with simple data types in assembly-language programs. The first section shows how to declare integer variables. The second section describes basic operations including moving, loading, and sign-extending numbers, as well as calculating. The last section describes how to do various operations with numbers at the bit level, such as using bitwise logical instructions and shifting and rotating bits.

The complex data types introduced in the next chapter—arrays, strings, structures, unions, and records—use many of the operations illustrated in this chapter. Floating-point operations require a different set of instructions and techniques. These are covered in Chapter 6, “Using Floating-Point and Binary Coded Decimal Numbers.”

## Declaring Integer Variables

An integer is a whole number, such as 4 or 4,444. Integers have no fractional part, as do the real numbers discussed in Chapter 6. You can initialize integer variables in several ways with the data allocation directives. This section explains how to use the **SIZEOF** and **TYPE** operators to provide information to the assembler about the types in your program. For information on symbolic integer constants, see “Integer Constants and Constant Expressions” in Chapter 1.

## Allocating Memory for Integer Variables

When you declare an integer variable by assigning a label to a data allocation directive, the assembler allocates memory space for the integer. The variable’s name becomes a label for the memory space. The syntax is:

`[[name]] directive initializer`

The following directives indicate the integer's size and value range:

Directive	Description of Initializers
<b>BYTE, DB</b> (byte)	Allocates unsigned numbers from 0 to 255.
<b>SBYTE</b> (signed byte)	Allocates signed numbers from -128 to +127.
<b>WORD, DW</b> (word = 2 bytes)	Allocates unsigned numbers from 0 to 65,535 (64K).
<b>SWORD</b> (signed word)	Allocates signed numbers from -32,768 to +32,767.
<b>DWORD, DD</b> (doubleword = 4 bytes),	Allocates unsigned numbers from 0 to 4,294,967,295 (4 megabytes).
<b>SDWORD</b> (signed doubleword)	Allocates signed numbers from -2,147,483,648 to +2,147,483,647.
<b>FWORD, DF</b> (farword = 6 bytes)	Allocates 6-byte (48-bit) integers. These values are normally used only as pointer variables on the 80386/486 processors.
<b>QWORD, DQ</b> (quadword = 8 bytes)	Allocates 8-byte integers used with 8087-family coprocessor instructions.
<b>TBYTE, DT</b> (10 bytes),	Allocates 10-byte (80-bit) integers if the initializer has a radix specifying the base of the number.

See Chapter 6 for information on the **REAL4**, **REAL8**, and **REAL10** directives that allocate real numbers.

The **SIZEOF** and **TYPE** operators, when applied to a type, return the size of an integer of that type. The size attribute associated with each data type is:

Data Type	Bytes
<b>BYTE, SBYTE</b>	1
<b>WORD, SWORD</b>	2
<b>DWORD, SDWORD</b>	4
<b>FWORD</b>	6
<b>QWORD</b>	8
<b>TBYTE</b>	10

The data types **SBYTE**, **SWORD**, and **SDWORD** tell the assembler to treat the initializers as signed data. It is important to use these signed types with high-level constructs such as **.IF**, **.WHILE**, and **.REPEAT**, and with **PROTO** and **INVOKE** directives. For descriptions of these directives, see the sections "Loop-Generating Directives," "Declaring Procedure Prototypes," and "Calling Procedures with **INVOKE**" in Chapter 7.

The assembler stores integers with the least significant bytes lowest in memory. Note that assembler listings and most debuggers show the bytes of a word in the opposite order—high byte first.

Figure 4.1 illustrates the integer formats.

#### Word

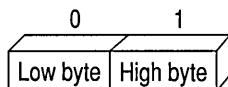

#### Doubleword

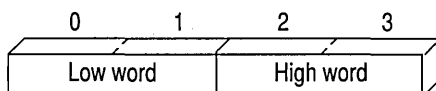

#### Quadword

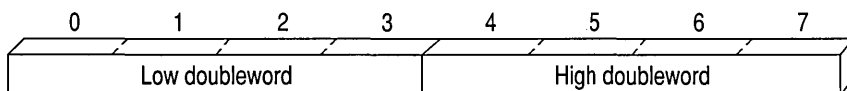

**Figure 4.1** Integer Formats

Although the **TYPEDEF** directive's primary purpose is to define pointer variables (see "Defining Pointer Types with **TYPEDEF**" in Chapter 3), you can also use **TYPEDEF** to create an alias for any integer type. For example, these declarations

```
char    TYPEDEF SBYTE
long   TYPEDEF DWORD
float  TYPEDEF REAL4
double TYPEDEF REAL8
```

allow you to use `char`, `long`, `float`, or `double` in your programs if you prefer the C data labels.

## Data Initialization

You can initialize variables when you declare them with constants or expressions that evaluate to constants. The assembler generates an error if you specify an initial value too large for the variable type.

A `?` in place of an initializer indicates you do not require the assembler to initialize the variable. The assembler allocates the space but does not write in it. Use `?` for buffer areas or variables your program will initialize at run time.



You can declare and initialize variables in one step with the data directives, as these examples show.

```
integer      BYTE    16          ; Initialize byte to 16
negint       SBYTE   -16         ; Initialize signed byte to -16
expression   WORD    4*3        ; Initialize word to 12
signedexp    SWORD   4*3        ; Initialize signed word to 12
empty        QWORD   ?          ; Allocate uninitialized long int
long         BYTE    1,2,3,4,5,6 ; Initialize six unnamed bytes
long         DWORD   4294967295 ; Initialize doubleword to
                                ; 4,294,967,295
longnum      SDWORD  -2147433648 ; Initialize signed doubleword
                                ; to -2,147,433,648
tb           TBYTE   2345t       ; Initialize 10-byte binary number
```

For information on arrays and on using the **DUP** operator to allocate initializer lists, see “Arrays and Strings” in Chapter 5.

## Working with Simple Variables

Once you have declared integer variables in your program, you can use them to copy, move, and sign-extend integer variables in your MASM code. This section shows how to do these operations as well as how to add, subtract, multiply, and divide numbers and do bit-level manipulations with logical, shift, and rotate instructions.

Since MASM instructions require operands to be the same size, you may need to operate on data in a size other than that originally declared. You can do this with the **PTR** operator. For example, you can use the **PTR** operator to access the high-order word of a **DWORD**-size variable. The syntax for the **PTR** operator is

*type PTR expression*

where the **PTR** operator forces *expression* to be treated as having the type specified. An example of this use is

```
num          .DATA
             DWORD  0
             .CODE

             mov   ax, WORD PTR num[0] ; Loads a word-size value from
             mov   dx, WORD PTR num[2] ; a doubleword variable
```

## Copying Data

The primary instructions for moving data from operand to operand and loading them into registers are **MOV** (Move), **XCHG** (Exchange), **CWD** (Convert Word to Double), and **CBW** (Convert Byte to Word).

### Moving Data

The most common method of moving data, the **MOV** instruction, is essentially a copy instruction, since it always copies the source operand to the destination operand without affecting the source. After a **MOV** instruction, the source and destination operands contain the same value.

The following example illustrates the **MOV** instruction. As explained in “General-Purpose Registers,” Chapter 1, you cannot move a value from one location in memory to another in a single operation.

```
; Immediate value moves
mov     ax, 7           ; Immediate to register
mov     mem, 7          ; Immediate to memory direct
mov     mem[bx], 7     ; Immediate to memory indirect

; Register moves
mov     mem, ax         ; Register to memory direct
mov     mem[bx], ax    ; Register to memory indirect
mov     ax, bx         ; Register to register
mov     ds, ax         ; General register to segment register

; Direct memory moves
mov     ax, mem        ; Memory direct to register
mov     ds, mem        ; Memory to segment register

; Indirect memory moves
mov     ax, mem[bx]    ; Memory indirect to register
mov     ds, mem[bx]    ; Memory indirect to segment register

; Segment register moves
mov     mem, ds        ; Segment register to memory
mov     mem[bx], ds    ; Segment register to memory indirect
mov     ax, ds         ; Segment register to general register
```

The following example shows several common types of moves that require two instructions.

```

; Move immediate to segment register
  mov     ax, DGROUP    ; Load AX with immediate value
  mov     ds, ax        ; Copy AX to segment register

; Move memory to memory
  mov     ax, mem1      ; Load AX with memory value
  mov     mem2, ax      ; Copy AX to other memory

; Move segment register to segment register
  mov     ax, ds        ; Load AX with segment register
  mov     es, ax        ; Copy AX to segment register

```

The **MOVSX** and **MOVZX** instructions for the 80386/486 processors extend and copy values in one step. See “Extending Signed and Unsigned Integers,” following.

## Exchanging Integers

The **XCHG** (Exchange) instruction exchanges the data in the source and destination operands. You can exchange data between registers or between registers and memory, but not from memory to memory:

```

      xchg     ax, bx        ; Put AX in BX and BX in AX
      xchg     memory, ax   ; Put "memory" in AX and AX in "memory"
;     xchg     mem1, mem2   ; Illegal- can't exchange memory locations

```

## Extending Signed and Unsigned Integers

Since moving data between registers of different sizes is illegal, you must “sign-extend” integers to convert signed data to a larger size. Sign-extending means copying the sign bit of the unextended operand to all bits of the operand’s next larger size. This widens the operand while maintaining its sign and value.

8086-based processors provide four instructions specifically for sign-extending. The four instructions act only on the accumulator register (AL, AX, or EAX), as shown in the following list.

Instruction	Sign-extend
<b>CBW</b> (convert byte to word)	AL to AX
<b>CWD</b> (convert word to doubleword)	AX to DX:AX
<b>CWDE</b> (convert word to doubleword extended)*	AX to EAX
<b>CDQ</b> (convert doubleword to quadword)*	EAX to EDX:EAX

\*Requires an extended register and applies only to 80386/486 processors.

On the 80386/486 processors, the **CWDE** instruction converts a signed 16-bit value in **AX** to a signed 32-bit value in **EAX**. The **CDQ** instruction converts a signed 32-bit value in **EAX** to a signed 64-bit value in the **EDX:EAX** register pair.

This example converts signed integers using **CBW**, **CWD**, **CWDE**, and **CDQ**.

```

        .DATA
mem8    SBYTE    -5
mem16   SWORD    +5
mem32   SDWORD   -5
        .CODE
        .
        .
        .
mov     al, mem8    ; Load 8-bit -5 (FBh)
cbw    ; Convert to 16-bit -5 (FFFBh) in AX
mov     ax, mem16   ; Load 16-bit +5
cwd    ; Convert to 32-bit +5 (0000:0005h) in DX:AX
mov     ax, mem16   ; Load 16-bit +5
cwde   ; Convert to 32-bit +5 (00000005h) in EAX
mov     eax, mem32  ; Load 32-bit -5 (FFFFFFFFBh)
cdq    ; Convert to 64-bit -5
        ; (FFFFFFFF:FFFFFFFFBh) in EDX:EAX

```

These four instructions efficiently convert unsigned values as well, provided the sign bit is zero. This example, for instance, correctly widens **mem16** whether you treat the variable as signed or unsigned.

The processor does not differentiate between signed and unsigned values. For instance, the value of **mem8** in the previous example is literally 251 (0FBh) to the processor. It ignores the human convention of treating the highest bit as an indicator of sign. The processor can ignore the distinction between signed and unsigned numbers because binary arithmetic works the same in either case.

If you add 7 to **mem8**, for example, the result is 258 (102h), a value too large to fit into a single byte. The byte-sized **mem8** can accommodate only the least-significant digits of the result (02h), and so receives the value of 2. The result is the same whether we treat **mem8** as a signed value (-5) or unsigned value (251).

This overview illustrates how the programmer, not the processor, must keep track of which values are signed or unsigned, and treat them accordingly. If **AL=127** (01111111y), the instruction **CBW** sets **AX=127** because the sign bit is zero. If **AL=128** (10000000y), however, the sign bit is 1. **CBW** thus sets **AX=65,280**

(FF00h), which may not be what you had in mind if you assumed AL originally held an unsigned value. To widen unsigned values, explicitly set the higher register to zero, as shown in the following example:

```

        .DATA
mem8    BYTE    251
mem16   WORD    251
        .CODE
        .
        .
        .
mov     al, mem8 ; Load 251 (FBh) from 8-bit memory
sub     ah, ah   ; Zero upper half (AH)

mov     ax, mem16 ; Load 251 (FBh) from 16-bit memory
sub     dx, dx   ; Zero upper half (DX)

sub     eax, eax ; Zero entire extended register (EAX)
mov     ax, mem16 ; Load 251 (FBh) from 16-bit memory

```

The 80386/486 processors provide instructions that move and extend a value to a larger data size in a single step. **MOVSX** moves a signed value into a register and sign-extends it. **MOVZX** moves an unsigned value into a register and zero-extends it.

```

; 80386/486 instructions
movzx  dx, bl   ; Load unsigned 8-bit value into
                ; 16-bit register and zero-extend

```

These special 80386/486 instructions usually execute much faster than the equivalent 8086/286 instructions.

## Adding and Subtracting Integers

You can use the **ADD**, **ADC**, **INC**, **SUB**, **SBB**, and **DEC** instructions for adding, incrementing, subtracting, and decrementing values in single registers. You can also combine them to handle larger values that require two registers for storage.

### Adding and Subtracting Integers Directly

The **ADD**, **INC** (Increment), **SUB**, and **DEC** (Decrement) instructions operate on 8- and 16-bit values on the 8086–80286 processors, and on 8-, 16-, and 32-bit values on the 80386/486 processors. They can be combined with the **ADC** and **SBB** instructions to work on 32-bit values on the 8086 and 64-bit values on the 80386/486 processors. (See “Adding and Subtracting in Multiple Registers,” following.)

These instructions have two requirements:

1. If there are two operands, only one operand can be a memory operand.
2. If there are two operands, both must be the same size.

To meet the second requirement, you can use the **PTR** operator to force an operand to the size required. (See “Working with Simple Variables,” previous.) For example, if `Buffer` is an array of bytes and `BX` points to an element of the array, you can add a word from `Buffer` with

```
add    ax, WORD PTR Buffer[bx] ; Add word from byte array
```

The next example shows 8-bit signed and unsigned addition and subtraction.

```
.DATA
mem8  BYTE  39
.CODE

; Addition
      ;
      ; signed      unsigned
mov   al, 26 ; Start with register 26      26
inc   al     ; Increment           1       1
add   al, 76 ; Add immediate       76     + 76
      ;
      ;           103      103
add   al, mem8 ; Add memory        39     + 39
      ;
      ;           -114     142
mov   ah, al  ; Copy to AH
      ;
      ;           +overflow
add   al, ah  ; Add register
      ;
      ;
      ;
      ;
      ;           28+carry

; Subtraction
      ;
      ; signed      unsigned
mov   al, 95 ; Load register       95      95
dec   al     ; Decrement            -1      -1
sub   al, 23 ; Subtract immediate  -23     -23
      ;
      ;           71       71
sub   al, mem8 ; Subtract memory   -122    -122
      ;
      ;           -51      205+sign
      ;

mov   ah, 119 ; Load register      119
sub   al, ah  ; and subtract        -51
      ;
      ;
      ;
      ;           86+overflow
```



For 32-bit registers on the 80386/486 processors, only two steps are necessary. If your program needs to be assembled for more than one processor, you can assemble the statements conditionally, as shown in this example:

```

        .DATA
mem32   DWORD   316423
mem32a  DWORD   316423
mem32b  DWORD   156739
p386    TEXTEQU (@Cpu AND 08h)
        .CODE
        .
        .
        .
; Addition
        IF      p386
mov     eax, 43981 ; Load immediate
add    eax, mem32 ; Result in EAX
        ELSE
        .
        .      ; do steps in previous example
        .
        ENDIF

; Subtraction
        IF      p386
mov     eax, mem32a ; Load memory
sub    eax, mem32b ; Result in EAX
        ELSE
        .
        .      ; do steps in previous example
        .
        ENDIF

```

Since the status of the carry flag affects the results of calculations with **ADC** and **SBB**, be sure to turn off the carry flag with the **CLC** (Clear Carry Flag) instruction or use **ADD** or **SUB** for the first calculation, when appropriate.

## Multiplying and Dividing Integers

The 8086 family of processors uses different multiplication and division instructions for signed and unsigned integers. Multiplication and division instructions also have special requirements depending on the size of the operands and the processor the code runs on.

### Using Multiplication Instructions

The **MUL** instruction multiplies unsigned numbers. **IMUL** multiplies signed numbers. For both instructions, one factor must be in the accumulator register (**AL**



for 8-bit numbers, AX for 16-bit numbers, EAX for 32-bit numbers). The other factor can be in any single register or memory operand. The result overwrites the contents of the accumulator register.

Multiplying two 8-bit numbers produces a 16-bit result returned in AX. Multiplying two 16-bit operands yields a 32-bit result in DX:AX. The 80386/486 processor handles 64-bit products in the same way in the EDX:EAX pair.

This example illustrates multiplication of signed 16- and 32-bit integers.

```

        .DATA
mem16  SWORD  -30000
        .CODE
        .
        .
; 8-bit unsigned multiply
        mov    al, 23      ; Load AL          23
        mov    bl, 24      ; Load BL          * 24
        mul   bl           ; Multiply BL       -----
                                ; Product in AX          552
                                ; overflow and carry set

; 16-bit signed multiply
        mov    ax, 50      ; Load AX          50
                                ;                               -30000
        imul  mem16        ; Multiply memory  -----
                                ; Product in DX:AX      -1500000
                                ; overflow and carry set

```

A nonzero number in the upper half of the result (AH for byte, DX or EDX for word) sets the overflow and carry flags.

On the 80186–80486 processors, the **IMUL** instruction supports three additional operand combinations. The first syntax option allows for 16-bit multipliers producing a 16-bit product or 32-bit multipliers for 32-bit products on the 80386/486. The result overwrites the destination. The syntax for this operation is:

**IMUL** *register16*, *immediate*

The second syntax option specifies three operands for **IMUL**. The first operand must be a 16-bit *register* operand, the second a 16-bit *memory* (or *register*) operand, and the third a 16-bit *immediate* operand. **IMUL** multiplies the memory (or register) and immediate operands and stores the product in the register operand with this syntax:

**IMUL** *register16*, { *memory16* | *register16* }, *immediate*

For the 80386/486 only, a third option for **IMUL** allows an additional operand for multiplication of a register value by a register or memory value. The syntax is:

**IMUL** *register*, {*register* | *memory*}

The destination can be any 16-bit or 32-bit register. The source must be the same size as the destination.

In all of these options, products too large to fit in 16 or 32 bits set the overflow and carry flags. The following examples show these three options for **IMUL**.

```

imul  dx, 456      ; Multiply DX times 456 on 80186-80486
imul  ax, [bx],6   ; Multiply the value pointed to by BX
                        ; by 6 and put the result in AX

imul  dx, ax       ; Multiply DX times AX on 80386
imul  ax, [bx]     ; Multiply AX by the value pointed to
                        ; by BX on 80386

```

The **IMUL** instruction with multiple operands can be used for either signed or unsigned multiplication, since the 16-bit product is the same in either case. To get a 32-bit result, you must use the single-operand version of **MUL** or **IMUL**.

## Using Division Instructions

The **DIV** instruction divides unsigned numbers, and **IDIV** divides signed numbers. Both return a quotient and a remainder.

Table 4.1 summarizes the division operations. The dividend is the number to be divided, and the divisor is the number to divide by. The quotient is the result. The divisor can be in any register or memory location except the registers where the quotient and remainder are returned.

**Table 4.1** Division Operations

Size of Operand	Dividend Register	Size of Divisor	Quotient	Remainder
16 bits	AX	8 bits	AL	AH
32 bits	DX:AX	16 bits	AX	DX
64 bits (80386 and 80486)	EDX:EAX	32 bits	EAX	EDX

Unsigned division does not require careful attention to flags. The following examples illustrate signed division, which can be more complex.

```

        .DATA
mem16   SWORD   -2000
mem32   SDWORD  500000
        .CODE
        :
        :
; Divide 16-bit unsigned by 8-bit
        mov     ax, 700           ; Load dividend      700
        mov     bl, 36           ; Load divisor DIV  36
        div     bl               ; Divide BL         -----
                                   ; Quotient in AL     19
                                   ; Remainder in AH      16

; Divide 32-bit signed by 16-bit
        mov     ax, WORD PTR mem32[0] ; Load into DX:AX
        mov     dx, WORD PTR mem32[2] ;                   500000
        idiv    mem16            ;                   DIV -2000
                                   ; Divide memory     -----
                                   ; Quotient in AX     -250
                                   ; Remainder in DX      0

; Divide 16-bit signed by 16-bit
        mov     ax, WORD PTR mem16    ; Load into AX     -2000
        cwd                    ; Extend to DX:AX
        mov     bx, -421              ;                   DIV -421
        idiv    bx                   ; Divide by BX     -----
                                   ; Quotient in AX     4
                                   ; Remainder in DX     -316

```

If the dividend and divisor are the same size, sign-extend or zero-extend the dividend so that it is the length expected by the division instruction. See “Extending Signed and Unsigned Integers,” earlier in this chapter.

## Manipulating Numbers at the Bit Level

The instructions introduced so far in this chapter access numbers at the byte or word level. The logical, shift, and rotate instructions described in this section access individual bits in a number. You can use logical instructions to evaluate characters and do other text and screen operations. The shift and rotate instructions do similar tasks by shifting and rotating bits through registers. This section reviews some applications of these bit-level operations.

## Logical Instructions

The logical instructions **AND**, **OR**, and **XOR** compare bits in two operands. Based on the results of the comparisons, the instructions alter bits in the first (destination) operand. The logical instruction **NOT** also changes bits, but operates on a single operand.

The following list summarizes these four logical instructions. The list makes reference to the “destination bit,” meaning the bit in the destination operand. The terms “both bits” and “either bit” refer to the corresponding bits in the source and destination operands. These instructions include:

Instruction	Sets Destination Bit If	Clears Destination Bit If
<b>AND</b>	Both bits set	Either or both bits clear
<b>OR</b>	Either or both bits set	Both bits clear
<b>XOR</b>	Either bit (but not both) set	Both bits set or both clear
<b>NOT</b>	Destination bit clear	Destination bit set

---

**Note** Do not confuse logical instructions with the logical operators, which perform these operations at assembly time, not run time. Although the names are the same, the assembler recognizes the difference.

---

The following example shows the result of the **AND**, **OR**, **XOR**, and **NOT** instructions operating on a value in the **AX** register and in a mask. A mask is any number with a pattern of bits set for an intended operation.

```

mov     ax, 035h    ; Load value           00110101
and     ax, 0FBh    ; Clear bit 2         AND 11111011
;
; Value is now 31h           00110001
or      ax, 016h    ; Set bits 4,2,1       OR 00010110
;
; Value is now 37h           00110111
xor     ax, 0ADh    ; Toggle bits 7,5,3,2,0  XOR 10101101
;
; Value is now 9Ah           10011010
not     ax          ; Value is now 65h       01100101

```

The **AND** instruction clears unmasked bits—that is, bits not protected by 1 in the mask. To mask off certain bits in an operand and clear the others, use an appropriate masking value in the source operand. The bits of the mask should be 0 for any bit positions you want to clear and 1 for any bit positions you want to remain unchanged.

The **OR** instruction forces specific bits to 1 regardless of their current settings. The bits of the mask should be 1 for any bit positions you want to set and 0 for any bit positions you want to remain unchanged.

The **XOR** instruction toggles the value of specific bits on and off—that is, reverses them from their current settings. This instruction sets a bit to 1 if the corresponding bits are different or to 0 if they are the same. The bits of the mask should be 1 for any bit positions you want to toggle and 0 for any bit positions you want to remain unchanged.

The following examples show an application for each of these instructions. The code illustrating the **AND** instruction converts a “y” or “n” read from the keyboard to uppercase, since bit 5 is always clear in uppercase letters. In the example for **OR**, the first statement is faster and uses fewer bytes than `cmp bx, 0`. When the operands for **XOR** are identical, each bit cancels itself, producing 0.

```
;AND example - converts characters to uppercase
    mov     ah, 7           ; Get character without echo
    int     21h
    and     al, 11011111y  ; Convert to uppercase by clearing bit 5
    cmp     al, 'Y'        ; Is it Y?
    je      yes            ; If so, do Yes actions
    .
    .                     ; Else do No actions
    .
yes:  .

;OR example - compares operand to 0
    or      bx, bx         ; Compare to 0
    jg      positive      ; BX is positive
    jl      negative      ; BX is negative
    .
    .                     ; else BX is zero

;XOR example - sets a register to 0
    xor     cx, cx         ; 2 bytes, 3 clocks on 8088
    sub     cx, cx         ; 2 bytes, 3 clocks on 8088
    mov     cx, 0          ; 3 bytes, 4 clocks on 8088
```

On the 80386/486 processors, the **BSF** (Bit Scan Forward) and the **BSR** (Bit Scan Reverse) instructions perform operations like those of the logical instructions. They scan the contents of a register to find the first-set or last-set bit. You can use **BSF** or **BSR** to find the position of a set bit in a mask or to check if a register value is 0.

## Shifting and Rotating Bits

The 8086-based processors provide a complete set of instructions for shifting and rotating bits. Shift instructions move bits a specified number of places to the right or left. The last bit in the direction of the shift goes into the carry flag, and the first bit is filled with 0 or with the previous value of the first bit.

Rotate instructions also move bits a specified number of places to the right or left. For each bit rotated, the last bit in the direction of the rotate operation moves into the first bit position at the other end of the operand. With some variations, the carry bit is used as an additional bit of the operand. Figure 4.2 illustrates the eight variations of shift and rotate instructions for 8-bit operands. Notice that **SHL** and **SAL** are identical.

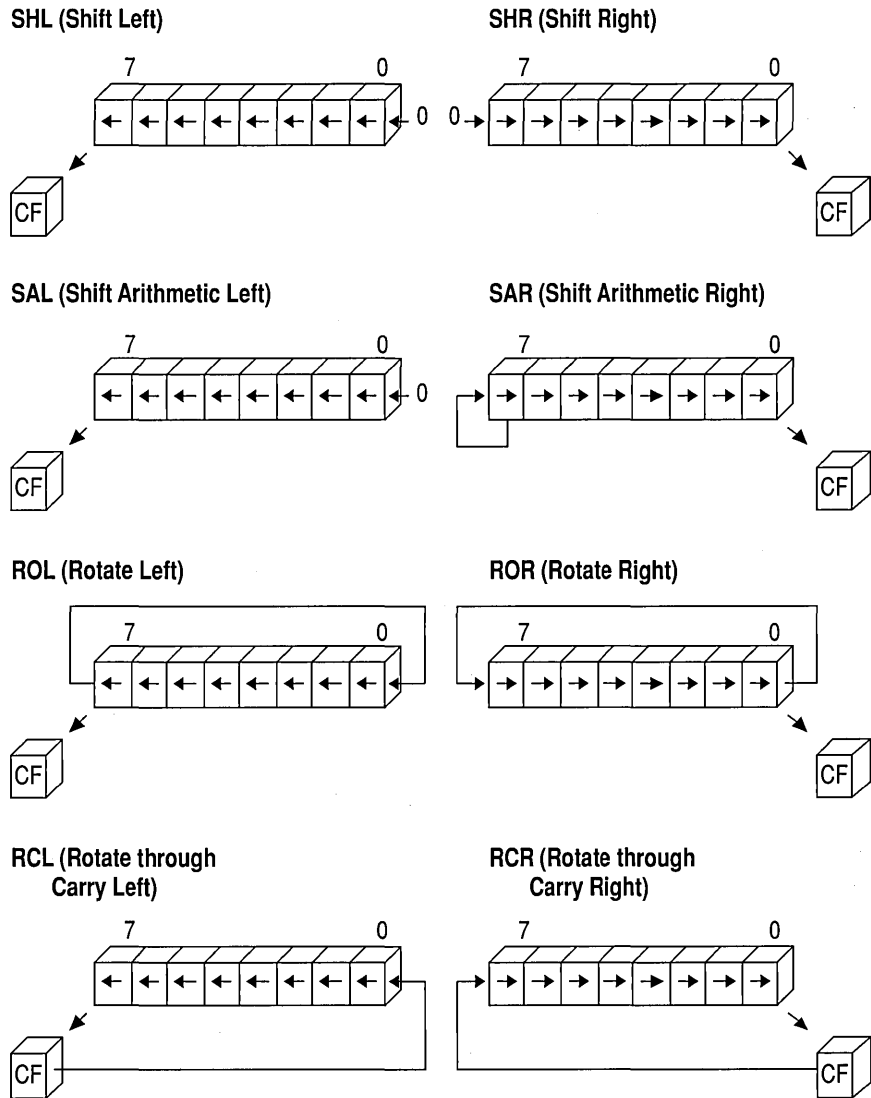

Figure 4.2 Shifts and Rotates

All shift instructions use the same format. Before the instruction executes, the destination operand contains the value to be shifted; after the instruction executes, it contains the shifted operand. The source operand contains the number of bits to shift or rotate. It can be the immediate value 1 or the CL register. The 8088 and 8086 processors do not accept any other values or registers with these instructions.

Starting with the 80186 processor, you can use 8-bit immediate values larger than 1 as the source operand for shift or rotate instructions, as shown here:

```
shr    bx, 4    ; 9 clocks, 3 bytes on 80286
```

The following statements are equivalent if the program must run on the 8088 or 8086 processor:

```
mov    cl, 4    ; 2 clocks, 3 bytes on 80286
shr    bx, cl   ; 9 clocks, 2 bytes on 80286
                    ; 11 clocks, 5 bytes total
```

Masks for logical instructions can be shifted to new bit positions. For example, an operand that masks off a bit or group of bits can be shifted to move the mask to a different position, allowing you to mask off a different bit each time the mask is used. This technique, illustrated in the following example, is useful only if the mask value is unknown until run time.

```
.DATA
masker BYTE 00000010y ; Mask that may change at run time
.CODE
.
.
.
mov    cl, 2        ; Rotate two at a time
mov    bl, 57h     ; Load value to be changed 01010111y
rol    masker, cl  ; Rotate two to left      00001000y
or     bl, masker  ; Turn on masked values   -----
                    ; New value is 05Fh     01011111y
rol    masker, cl  ; Rotate two more       00100000y
or     bl, masker  ; Turn on masked values   -----
                    ; New value is 07Fh     01111111y
```

## Multiplying and Dividing with Shift Instructions

You can use the shift and rotate instructions (**SHR**, **SHL**, **SAR**, and **SAL**) for multiplication and division. Shifting a value right by one bit has the effect of dividing by two; shifting left by 1 bit has the effect of multiplying by two. You can take advantage of shifts to do fast multiplication and division by powers of two. For example, shifting left twice multiplies by four, shifting left three times multiplies by eight, and so on.

Use **SHR** (Shift Right) to divide unsigned numbers. You can use **SAR** (Shift Arithmetic Right) to divide signed numbers, but **SAR** rounds negative numbers down—**IDIV** always rounds negative numbers up (toward 0). Division using **SAR** must adjust for this difference. Multiplication by shifting is the same for signed and unsigned numbers, so you can use either **SAL** or **SHL**.

Multiply and divide instructions are relatively slow, particularly on the 8088 and 8086 processors. When multiplying or dividing by a power of two, use shifts to speed operations by a factor of 10 or more. For example, these statements take only four clocks on an 8088 or 8086 processor:

```
sub    ah, ah    ; Clear AH
shl   ax, 1     ; Multiply byte in AL by 2
```

The following statements produce the same results, but take between 74 and 81 clocks on the 8088 or 8086 processors. The same statements take 15 clocks on the 80286 and between 11 and 16 clocks on the 80386. (For a discussion about instruction timings, see “A Word on Instruction Timings” in the Introduction.)

```
mov    bl, 2     ; Multiply byte in AL by 2
mul   bl
```

As the following macro shows, it’s possible to multiply by any number—in this case, 10—without resorting to the **MUL** instruction. However, such a procedure is no more than an interesting arithmetic exercise, since the additional code almost certainly takes more time to execute than a single **MUL**. You should consider using shifts in your program only when multiplying or dividing by a power of two.

```
mul_10 MACRO    factor          ; Factor must be unsigned
mov    ax, factor ; Load into AX
shl   ax, 1     ; AX = factor * 2
mov    bx, ax   ; Save copy in BX
shl   ax, 1     ; AX = factor * 4
shl   ax, 1     ; AX = factor * 8
add   ax, bx    ; AX = (factor * 8) + (factor * 2)
ENDM          ; AX = factor * 10
```

Here’s another macro that divides by 512. In contrast to the previous example, this macro uses little code and operates faster than an equivalent **DIV** instruction.

```
div_512 MACRO    dividend      ; Dividend must be unsigned
mov    ax, dividend ; Load into AX
shr   ax, 1     ; AX = dividend / 2 (unsigned)
xchg  al, ah    ; XCHG is like rotate right 8
                        ; AL = (dividend / 2) / 256
cbw                                ; Clear upper byte
ENDM          ; AX = (dividend / 512)
```



If you need to shift a value that is too large to fit in one register, you can shift each part separately. The **RCR** (Register Carry Right) and **RCL** (Register Carry Left) instructions carry values from the first register to the second by passing the leftmost or rightmost bit through the carry flag.

This example shifts a multiword value.

```

        .DATA
mem32   DWORD   500000
        .CODE

; Divide 32-bit unsigned by 16
        mov     cx, 4                ; Shift right 4      500000
again:   shr    WORD PTR mem32[2], 1 ; Shift into carry DIV   16
        rcr    WORD PTR mem32[0], 1 ; Rotate carry in  -----
        loop   again                ;                  31250

```

Since the carry flag is treated as part of the operand (it's like using a 9-bit or 17-bit operand), the flag value before the operation is crucial. The carry flag can be adjusted by a previous instruction, but you can also set or clear the flag directly with the **CLC** (Clear Carry Flag), **CMC** (Complement Carry Flag), and **STC** (Set Carry Flag) instructions.

On the 80386 and 80486 processors, an alternate method for multiplying quickly by constants takes advantage of the **LEA** (Load Effective Address) instruction and the scaling of indirect memory operands. By using a 32-bit value as both the index and the base register in an indirect memory operand, you can multiply by the constants 2, 3, 4, 5, 8, and 9 more quickly than you can by using the **MUL** instruction. **LEA** calculates the offset of the source operand and stores it into the destination register, **EBX**, as this example shows:

```

leae    ebx, [eax*2]                ; EBX = 2 * EAX
leae    ebx, [eax*2+eax]            ; EBX = 3 * EAX
leae    ebx, [eax*4]                ; EBX = 4 * EAX
leae    ebx, [eax*4+eax]            ; EBX = 5 * EAX
leae    ebx, [eax*8]                ; EBX = 8 * EAX
leae    ebx, [eax*8+eax]            ; EBX = 9 * EAX

```

Scaling of 80386 indirect memory operands is reviewed in “Indirect Memory Operands with 32-Bit Registers” in Chapter 3. **LEA** is introduced in “Loading Addresses into Registers” in Chapter 3.

The next chapter deals with more complex data types—arrays, strings, structures, unions, and records. Many of the operations presented in this chapter can also be applied to the data structures covered in Chapter 5, “Defining and Using Complex Data Types.”

# Defining and Using Complex Data Types

With the complex data types available in MASM 6.1—arrays, strings, records, structures, and unions—you can access data as a unit or as individual elements that make up a unit. The individual elements of complex data types are often the integer types discussed in Chapter 4, “Defining and Using Simple Data Types.”

“Arrays and Strings” reviews how to declare, reference, and initialize arrays and strings. This section summarizes the general steps needed to process arrays and strings and describes the MASM instructions for moving, comparing, searching, loading, and storing.

“Structures and Unions” covers similar information for structures and unions: how to declare structure and union types, how to define structure and union variables, and how to reference structures and unions and their fields.

“Records” explains how to declare record types, define record variables, and use record operators.

## Arrays and Strings

An array is a sequential collection of variables, all of the same size and type, called “elements.” A string is an array of characters. For example, in the string “ABC,” each letter is an element. You can access the elements in an array or string relative to the first element. This section explains how to handle arrays and strings in your programs.

## Declaring and Referencing Arrays

Array elements occupy memory contiguously, so a program references each element relative to the start of the array. To declare an array, supply a label name, the element type, and a series of initializing values or ? placeholders. The following examples declare the arrays `warray` and `xarray`:

```
warray WORD 1, 2, 3, 4
xarray DWORD 0FFFFFFFFh, 789ABCDEh
```



## Referencing Arrays

Each element in an array is referenced with an index number, beginning with zero. The array index appears in brackets after the array name, as in

```
array[9]
```

Assembly-language indexes differ from indexes in high-level languages, where the index number always corresponds to the element's position. In C, for example, `array[9]` references the array's tenth element, regardless of whether each element is 1 byte or 8 bytes in size.

In assembly language, an element's index refers to the number of bytes between the element and the start of the array. This distinction can be ignored for arrays of byte-sized elements, since an element's position number matches its index. For example, defining the array

```
prime BYTE 1, 3, 5, 7, 11, 13, 17
```

gives a value of 1 to `prime[0]`, a value of 3 to `prime[1]`, and so forth.

However, in arrays with elements larger than 1 byte, index numbers (except zero) do not correspond to an element's position. You must multiply an element's position by its size to determine the element's index. Thus, for the array

```
wprime WORD 1, 3, 5, 7, 11, 13, 17
```

`wprime[4]` represents the third element (5), which is 4 bytes from the beginning of the array. Similarly, the expression `wprime[6]` represents the fourth element (7) and `wprime[10]` represents the sixth element (13).

The following example determines an index at run time. It multiplies the position by two (the size of a word element) by shifting it left:

```
mov     si, cx           ; CX holds position number
shl     si, 1           ; Scale for word referencing
mov     ax, wprime[si] ; Move element into AX
```

The offset required to access an array element can be calculated with the following formula:

$$n\text{th element of array} = \text{array}[(n-1) * \text{size of element}]$$

Referencing an array element by distance rather than position is not difficult to master, and is actually very consistent with how assembly language works. Recall that a variable name is a symbol that represents the contents of a particular address in memory. Thus, if the array `wprime` begins at address `DS:2400h`, the reference `wprime[6]` means to the processor "the word value contained in the DS segment at offset `2400h-plus-6-bytes`."

As described in “Direct Memory Operands,” Chapter 3, you can substitute the plus operator (+) for brackets, as in:

```
wprime[9]
wprime+9
```

Since brackets simply add a number to an address, you don't need them when referencing the first element. Thus, `wprime` and `wprime[0]` both refer to the first element of the array `wprime`.

If your program runs only on an 80186 processor or higher, you can use the **BOUND** instruction to verify that an index value is within the bounds of an array. For a description of **BOUND**, see the *Reference*.

### LENGTHOF, SIZEOF, and TYPE for Arrays

When applied to arrays, the **LENGTHOF**, **SIZEOF**, and **TYPE** operators return information about the length and size of the array and about the type of the initializers.

The **LENGTHOF** operator returns the number of elements in the array. The **SIZEOF** operator returns the number of bytes used by the initializers in the array definition. **TYPE** returns the size of the elements of the array. The following examples illustrate these operators:

```
array  WORD  40 DUP (5)

larray EQU  LENGTHOF array  ; 40 elements
sarray EQU  SIZEOF  array  ; 80 bytes
tarray EQU  TYPE    array  ; 2 bytes per element

num    DWORD  4, 5, 6, 7, 8, 9, 10, 11

lnum   EQU  LENGTHOF num    ; 8 elements
snum   EQU  SIZEOF  num    ; 32 bytes
tnum   EQU  TYPE    num    ; 4 bytes per element

warray WORD  40 DUP (40 DUP (5))

len    EQU  LENGTHOF warray ; 1600 elements
siz    EQU  SIZEOF  warray ; 3200 bytes
typ    EQU  TYPE    warray ; 2 bytes per element
```

## Declaring and Initializing Strings

A string is an array of characters. Initializing a string like "Hello, there" allocates and initializes 1 byte for each character in the string. An initialized string can be no longer than 255 characters.

For data directives other than **BYTE**, a string may initialize only the first element. The initializer value must fit into the specified size and conform to the expression word size in effect (see “Integer Constants and Constant Expressions” in Chapter 1), as shown in these examples:

```
wstr    WORD    "OK"
dstr    DWORD   "DATA" ; Legal under EXPR32 only
```

As with arrays, string initializers can span multiple lines. The line must end with a comma if you want the string to continue to the next line.

```
str1    BYTE    "This is a long string that does not ",
          "fit on one line."
```

You can also have an array of pointers to strings.

```
PBYTE   TYPEDEF PTR BYTE
        .DATA
msg1    BYTE    "Operation completed successfully."
msg2    BYTE    "Unknown command"
msg3    BYTE    "File not found"
pmsg    PBYTE   msg1          ; pmsg is an array
        PBYTE   msg2          ; of pointers to
        PBYTE   msg3          ; above messages
```

Strings must be enclosed in single (!) or double (") quotation marks. To put a single quotation mark inside a string enclosed by single quotation marks, use two single quotation marks. Likewise, if you need quotation marks inside a string enclosed by double quotation marks, use two sets. These examples show the various uses of quotation marks:

```
char    BYTE    'a'
message BYTE    "That's the message." ; That's the message.
warn    BYTE    'Can't find file.' ; Can't find file.
string  BYTE    "This ""value"" not found." ; This "value" not found.
```

You can always use single quotation marks inside a string enclosed by double quotation marks, as the initialization for `message` shows, and vice versa.

## The ? Initializer

You do not have to initialize an array. The `?` operator lets you allocate space for the array without placing specific values in it. Object files contain records for initialized data. Unspecified space left in the object file means that no records contain initialized data for that address. The actual values stored in arrays allocated with `?` depend on certain conditions. The `?` initializer is treated as a zero in a **DUP** statement that contains initializers in addition to the `?` initializer. If the `?` initializer does not appear in a **DUP** statement, or if the **DUP** statement contains only `?` initializers, the assembler leaves the allocated space unspecified.

## LENGTHOF, SIZEOF, and TYPE for Strings

Because strings are simply arrays of byte elements, the **LENGTHOF**, **SIZEOF**, and **TYPE** operators behave as you would expect, as illustrated in this example:

```
msg     BYTE    "This string extends ",
          "over three ",
          "lines."

lmsg    EQU    LENGTHOF msg    ; 37 elements
smsg    EQU    SIZEOF  msg     ; 37 bytes
tmsg    EQU    TYPE    msg     ; 1 byte per element
```

## Processing Strings

The 8086-family instruction set has seven string instructions for fast and efficient processing of entire strings and arrays. The term “string” in “string instructions” refers to a sequence of elements, not just character strings. These instructions work directly only on arrays of bytes and words on the 8086–80486 processors, and on arrays of bytes, words, and doublewords on the 80386/486 processors. Processing larger elements must be done indirectly with loops.

The following list gives capsule descriptions of the five instructions discussed in this section.

Instruction	Description
<b>MOVS</b>	Copies a string from one location to another
<b>STOS</b>	Stores contents of the accumulator register to a string
<b>CMPS</b>	Compares one string with another
<b>LODS</b>	Loads values from a string to the accumulator register
<b>SCAS</b>	Scans a string for a specified value

All of these instructions use registers in a similar way and have a similar syntax. Most are used with the repeat instruction prefixes **REP**, **REPE** (or **REPZ**), and **REPNE** (or **REPNZ**). **REPZ** is a synonym for **REPE** (Repeat While Equal) and **REPNZ** is a synonym for **REPNE** (Repeat While Not Equal).

This section first explains the general procedures for using all string instructions. It then illustrates each instruction with an example.

## Overview of String Instructions

The string instructions have specific requirements for the location of strings and the use of registers. To operate on any string, follow these three steps:

1. Set the direction flag to indicate the direction in which you want to process the string. The **STD** instruction sets the flag, while **CLD** clears it.

If the direction flag is clear, the string is processed upward (from low addresses to high addresses, which is from left to right through the string). If the direction flag is set, the string is processed downward (from high addresses to low addresses, or from right to left). Under MS-DOS, the direction flag is normally clear if your program has not changed it.

2. Load the number of iterations for the string instruction into the CX register.  
If you want to process 100 elements in a string, move 100 into CX. If you wish the string instruction to terminate conditionally (for example, during a search when a match is found), load the maximum number of iterations that can be performed without an error.
3. Load the starting offset address of the source string into DS:SI and the starting address of the destination string into ES:DI. Some string instructions take only a destination or source, not both (see Table 5.1).

Normally, the segment address of the source string should be DS, but you can use a segment override to specify a different segment for the source operand. You cannot override the segment address for the destination string. Therefore, you may need to change the value of ES. For information on changing segment registers, see “Programming Segmented Addresses” in Chapter 3.

---

**Note** Although you can use a segment override on the source operand, a segment override combined with a repeat prefix can cause problems in certain situations on all processors except the 80386/486. If an interrupt occurs during the string operation, the segment override is lost and the rest of the string operation processes incorrectly. Segment overrides can be used safely when interrupts are turned off or with the 80386/486 processors.

---

You can adapt these steps to the requirements of any particular string operation. The syntax for the string instructions is:

```

[[prefix]] CMPS [[segmentregister:]] source, [[ES:]] destination
           LDS  [[segmentregister:]] source
[[prefix]] MOVS [[ES:]] destination, [[segmentregister:]] source
[[prefix]] SCAS [[ES:]] destination
[[prefix]] STOS [[ES:]] destination

```

Some instructions have special forms for byte, word, or doubleword operands. If you use the form of the instruction that ends in **B** (**BYTE**), **W** (**WORD**), or **D** (**DWORD**) with **LDS**, **SCAS**, and **STOS**, the assembler knows whether the element is in the AL, AX, or EAX register. Therefore, these instruction forms do not require operands.



Table 5.1 lists each string instruction with the type of repeat prefix it uses and indicates whether the instruction works on a source, a destination, or both.

**Table 5.1 Requirements for String Instructions**

Instruction	Repeat Prefix	Source/Destination	Register Pair
<b>MOVS</b>	<b>REP</b>	Both	DS:SI, ES:DI
<b>SCAS</b>	<b>REPE/REPNE</b>	Destination	ES:DI
<b>CMPS</b>	<b>REPE/REPNE</b>	Both	DS:SI, ES:DI
<b>LODS</b>	None	Source	DS:SI
<b>STOS</b>	<b>REP</b>	Destination	ES:DI
<b>INS</b>	<b>REP</b>	Destination	ES:DI
<b>OUTS</b>	<b>REP</b>	Source	DS:SI

The repeat prefix causes the instruction that follows it to repeat for the number of times specified in the count register or until a condition becomes true. After each iteration, the instruction increments or decrements SI and DI so that it points to the next array element. The direction flag determines whether SI and DI are incremented (flag clear) or decremented (flag set). The size of the instruction determines whether SI and DI are altered by 1, 2, or 4 bytes each time.

Each prefix governs the number of repetitions as follows:

Prefix	Description
<b>REP</b>	Repeats instruction CX times
<b>REPE, REPZ</b>	Repeats instruction maximum CX times while values are equal
<b>REPNE, REPNZ</b>	Repeats instruction maximum CX times while values are not equal

The prefixes apply to only one string instruction at a time. To repeat a block of instructions, use a loop construction. (See “Loops” in Chapter 7.)

At run time, if a string instruction is preceded by a repeat sequence, the processor:

1. Checks the CX register and exits if CX is 0.
2. Performs the string operation once.
3. Increases SI and/or DI if the direction flag is clear. Decreases SI and/or DI if the direction flag is set. The amount of increase or decrease is 1 for byte operations, 2 for word operations, and 4 for doubleword operations.
4. Decrements CX without modifying the flags.
5. Checks the zero flag (for **SCAS** or **CMPS**) if the **REPE** or **REPNE** prefix is used. If the repeat condition holds, loops back to step 1. Otherwise, the loop ends and execution proceeds to the next instruction.

When the repeat loop ends, SI (or DI) points to the position following a match (when using **SCAS** or **CMPS**), so you need to decrement or increment DI or SI to point to the element where the last match occurred.

Although string instructions (except **LODS**) are used most often with repeat prefixes, they can also be used by themselves. In these cases, the SI and/or DI registers are adjusted as specified by the direction flag and the size of operands.

## Using String Instructions

To use the 8086-family string instructions, follow the steps outlined in the previous section. Examples in this section illustrate each instruction.

You can also use the techniques in this section with structures and unions, since arrays and strings can be fields in structures and unions. (See the section “Structures and Unions,” following.)

### Moving Array Data

The **MOVS** instruction copies data from one area of memory to another. To move data, first load the count, source and destination addresses into the appropriate registers. Then use **REP** with the **MOVS** instruction.

```

.MODEL    small
.DATA
source   BYTE    10 DUP ('0123456789')
destin   BYTE    100 DUP (?)
.CODE
mov      ax, @data           ; Load same segment
mov      ds, ax              ; to both DS
mov      es, ax              ; and ES
.
.
.
cld                                           ; Work upward
mov      cx, LENGTHOF source ; Set iteration count to 100
mov      si, OFFSET source   ; Load address of source
mov      di, OFFSET destin   ; Load address of destination
rep     movsb                 ; Move 100 bytes

```

### Filling Arrays

The **STOS** instruction stores a specified value in each position of a string. The string is the destination, so it must be pointed to by ES:DI. The value to store must be in the accumulator.

The next example stores the character 'a' in each byte of a 100-byte string, filling the entire string with “aaaa....” Notice how the code stores 50 words rather than

100 bytes. This makes the fill operation faster by reducing the number of iterations. To fill an odd number of bytes, you need to adjust for the last byte.

```

.MODEL    small, C
.DATA
destin   BYTE    100 DUP (?)
ldestin  EQU     (LENGTHOF destin) / 2
.CODE
.
; Assume ES = DS
.
.
cld
; Work upward
mov     ax, 'aa'
; Load character to fill
mov     cx, ldestin
; Load length of string
mov     di, OFFSET destin
; Load address of destination
rep     stosw
; Store 'aa' into array

```

### Comparing Arrays

The **CMPS** instruction compares two strings and points to the address after which a match or nonmatch occurs. If the values are the same, the zero flag is set. Either string can be considered the destination or the source unless a segment override is used. This example using **CMPSB** assumes that the strings are in different segments. Both segments must be initialized to the appropriate segment register.

```

.MODEL    large, C
.DATA
string1  BYTE    "The quick brown fox jumps over the lazy dog"
.FARDATA
string2  BYTE    "The quick brown dog jumps over the lazy fox"
lstring  EQU     LENGTHOF string2
.CODE
mov     ax, @data
; Load data segment
mov     ds, ax
; into DS
mov     ax, @fardata
; Load far data segment
mov     es, ax
; into ES
.
.
.
cld
; Work upward
mov     cx, lstring
; Load length of string
mov     si, OFFSET string1
; Load offset of string1
mov     di, OFFSET string2
; Load offset of string2
repe   cmpsb
; Compare
je     allmatch
; Jump if all match
.
.
.
allmatch:
; Special case for all match

```

## Loading Data from Arrays

The **LODS** instruction loads a value from a string into the accumulator register. This instruction is not used with a repeat instruction prefix, since continually reloading the accumulator serves no purpose.

The code in this example loads, processes, and displays each byte in a string.

```

        .DATA
info    BYTE    0, 1, 2, 3, 4, 5, 6, 7, 8, 9
linfo   WORD    LENGTHOF info
        .CODE
        .
        .
        .
        cld                                ; Work upward
        mov     cx, linfo                   ; Load length
        mov     si, OFFSET info            ; Load offset of source
        mov     ah, 2                       ; Display character function

get:
        lodsb                               ; Get a character
        add     al, '0'                     ; Convert to ASCII
        mov     dl, al                      ; Move to DL
        int     21h                         ; Call DOS to display character
        loop   get                          ; Repeat

```

## Searching Arrays

The **SCAS** instruction compares the value pointed to by **ES:DI** with the value in the accumulator. If both values are the same, it sets the zero flag.

A repeat prefix lets **SCAS** work on an entire string, scanning (from which **SCAS** gets its name) for a particular value called the target. **REPNE SCAS** sets the zero flag if it finds the target value in the array. **REPE SCAS** sets the zero flag if the scanned array contains nothing but the target value.

This example assumes that ES is not the same as DS and that the address of the string is stored in a pointer variable. The **LES** instruction loads the far address of the string into ES:DI.

```

        .DATA
string  BYTE    "The quick brown fox jumps over the lazy dog"
pstring  PBYTE  string          ; Far pointer to string
lstring  EQU    LENGTHOF string ; Length of string
        .CODE
        .
        .
        .
        cld                                ; Work upward
        mov     cx, lstring                 ; Load length of string
        les     di, pstring                 ; Load address of string
        mov     al, 'z'                    ; Load character to find
        repne  scasb                       ; Search
        jne    notfound                    ; Jump if not found
        .                                    ; ES:DI points to character
        .                                    ; after first 'z'
        .
notfound:                                ; Special case for not found

```

## Translating Data in Byte Arrays

The **XLAT** (Translate) instruction copies a byte from an array of bytes into the AL register. The instruction takes its name from its ability to translate an element's number into the element itself. For example, given the number 7, **XLAT** returns byte #7 from the array. The array may hold byte-sized integers or, very often, a table or list of characters. The syntax for **XLAT** is:

**XLAT**[[**B**]] [[*segment:*]*memory*]

The optional **B** suffix (for “byte”) reflects the size of data the instruction handles. Both **XLAT** and **XLATB** assemble to exactly the same machine code.

To use **XLAT**, place the offset of the start of the array in the BX register and the desired index value in AL. Array indexes always begin with 0 in assembly language. To retrieve the first byte of the array, set AL to 0; to retrieve the second byte, set AL to 1, and so forth. **XLAT** returns the byte element in AL, overwriting the index number.

By default, the DS register contains the segment of the table, but you can use a segment override to specify a different segment. You need not give an operand except when specifying a segment override. (For information about the segment override operator, see “Direct Memory Operands” in Chapter 3.)

This example illustrates **XLAT** by looking up hexadecimal characters in a list. The code converts an eight-bit binary number to a string representing a hexadecimal number.

```

; Table of hexadecimal digits
hex      BYTE    "0123456789ABCDEF"
convert  BYTE    "You pressed the key with ASCII code "
key      BYTE    "?,"h",13,10,"$"
        .CODE
        .
        .
        .
mov      ah, 8          ; Get a key in AL
int      21h           ; Call DOS
mov      bx, OFFSET hex ; Load table address
mov      ah, al        ; Save a copy in high byte
and      al, 00001111y ; Mask out top character
xlat                    ; Translate
mov      key[1], al    ; Store the character
mov      cl, 12        ; Load shift count
shr      ax, cl        ; Shift high char into position
xlat                    ; Translate
mov      key, al       ; Store the character
mov      dx, OFFSET convert ; Load message
mov      ah, 9         ; Display character
int      21h          ; Call DOS

```

Although AL cannot contain an index value greater than 255, you can use **XLAT** with arrays containing more than 256 elements. Simply treat each 256-byte block of the array as a smaller sub-array. For example, to retrieve the 260th element of an array, add 256 to BX and set AL=3 (260-256-1).

## Structures and Unions

A structure is a group of possibly dissimilar data types and variables that can be accessed as a unit or by any of its components. The fields within the structure can have different sizes and data types.

Unions are identical to structures, except that the fields of a union overlap in memory, which allows you to define different data formats for the same memory space. Unions can store different types of data depending on the situation. They also can store data as one data type and retrieve it as another data type.

Whereas each field in a structure has an offset relative to the first byte of the structure, all the fields in a union start at the same offset. The size of a structure is the sum of its components; the size of a union is the length of the longest field.

A MASM structure is similar to a **struct** in the C language, a **STRUCTURE** in FORTRAN, and a **RECORD** in Pascal. Unions in MASM are similar to unions in C and FORTRAN, and to variant records in Pascal.

Follow these steps when using structures and unions:

1. Declare a structure (or union) type.
2. Define one or more variables having that type.
3. Reference the fields directly or indirectly with the field (dot) operator.

You can use the entire structure or union variable or just the individual fields as operands in assembler statements. This section explains the allocating, initializing, and nesting of structures and unions.

MASM 6.1 extends the functionality of structures and also makes some changes to MASM 5.1 behavior. If you prefer, you can retain MASM 5.1 behavior by specifying **OPTION OLDSTRUCTS** in your program.

## Declaring Structure and Union Types

When you declare a structure or union type, you create a template for data. The template states the sizes and, optionally, the initial values in the structure or union, but allocates no memory.

The **STRUCT** keyword marks the beginning of a type declaration for a structure. (**STRUCT** and **STRUC** are synonyms.) The format for **STRUCT** and **UNION** type declarations is:

```
name {STRUCT | UNION} [alignment] [,NONUNIQUE ]  
fielddeclarations  
name ENDS
```

The *fielddeclarations* is a series of one or more variable declarations. You can declare default initial values individually or with the **DUP** operator. (See “Defining Structure and Union Variables,” following.) “Referencing Structures, Unions, and Fields,” later in this chapter, explains the **NONUNIQUE** keyword. You can nest structures and unions, as explained in “Nested Structures and Unions,” also later in this chapter.

### Initializing Fields

If you provide initializers for the fields of a structure or union when you declare the type, these initializers become the default value for the fields when you define a variable of that type. “Defining Structure and Union Variables,” following, explains default initializers.

When you initialize the fields of a union type, the type and value of the first field become the default value and type for the union. In this example of an initialized union declaration, the default type for the union is **DWORD**:

```
DWB    UNION
      d    DWORD    00FFh
      w    WORD     ?
      b    BYTE     ?
DWB    ENDS
```

If the size of the first member is less than the size of the union, the assembler initializes the rest of the union to zeros. When initializing strings in a type, make sure the initial values are long enough to accommodate the largest possible string.

### Field Names

Structure and union field names must be unique within a nesting level because they represent the offset from the beginning of the structure to the corresponding field.

A label elsewhere in the code may have the same name as a structure field, but a text macro cannot. Also, field names between structures need not be unique. Field names must be unique if you place **OPTION M510** or **OPTION OLDSTRUCTS** in your code or use the */Zm* option from the command line, since versions of MASM prior to 6.0 require unique field names. (See Appendix A.)

### Alignment Value and Offsets for Structures

Data access to structures is faster on aligned fields than on unaligned fields. Therefore, alignment gains speed at the cost of space. Alignment improves access on 16-bit and 32-bit processors but makes no difference in programs executing on an 8-bit 8088 processor.

The way the assembler aligns structure fields determines the amount of space required to store a variable of that type. Each field in a structure has an offset relative to 0. If you specify an *alignment* in the structure declaration (or with the */Zpn* command-line option), the offset for each field may be modified by the *alignment* (or *n*).

The only values accepted for *alignment* are 1, 2, and 4. The default is 1. If the type declaration includes an *alignment*, each field is aligned to either the field's size or the *alignment* value, whichever is less. If the field size in bytes is greater than the alignment value, the field is padded so that its offset is evenly divisible by the alignment value. Otherwise, the field is padded so that its offset is evenly divisible by the field size.

Any padding required to reach the correct offset for the field is added prior to allocating the field. The padding consists of zeros and always precedes the aligned field. The size of the structure must also be evenly divisible by the structure alignment value, so zeros may be added at the end of the structure.



If neither the *alignment* nor the */Zp* command-line option is used, the offset is incremented by the size of each data directive. This is the same as a default *alignment* equal to 1. The *alignment* specified in the type declaration overrides the */Zp* command-line option.

These examples show how the assembler determines offsets:

```
STUDENT2    STRUCT    2    ; Alignment value is 2
    score    WORD     1    ; Offset = 0
    id       BYTE     2    ; Offset = 2 (1 byte padding added)
    year     DWORD    3    ; Offset = 4
    sname    BYTE     4    ; Offset = 8 (1 byte padding added)
STUDENT2    ENDS
```

One byte of padding is added at the end of the first byte-sized field. Otherwise, the offset of the `year` field would be 3, which is not divisible by the alignment value of 2. The size of this structure is now 9 bytes. Since 9 is not evenly divisible by 2, 1 byte of padding is added at the end of `student2`.

```
STUDENT4    STRUCT    4                ; Alignment value is 4
    sname    BYTE     1                ; Offset = 0 (1 byte padding added)
    score    WORD    10 DUP (100)    ; Offset = 2
    year     BYTE     2                ; Offset = 22 (1 byte padding
                                        ; added so offset of next field
                                        ; is divisible by 4)
    id       DWORD    3                ; Offset = 24
STUDENT4    ENDS
```

The alignment value affects the alignment of structure variables, so adding an alignment value affects memory usage. This feature provides compatibility with structures in Microsoft C. MASM 6.1 provides an improved H2INC utility, which C programmers can use to translate C structures to assembly. (See *Environment and Tools*, Chapter 20.)

The **ALIGN**, **EVEN**, and **ORG** directives can modify how field offsets are placed during structure definition. The **EVEN** and **ALIGN** directives insert padding bytes to round the field offset up to the specified alignment boundary. The **ORG** directive changes the offset of the next field to a given value, either positive or negative. If you use **ORG** when declaring a structure, you cannot define a structure of that type. **ORG** is useful when accessing existing data structures, such as a stack frame created by a high-level language.

## Defining Structure and Union Variables

Once you have declared a structure or union type, you can define variables of that type. For each variable defined, memory is allocated in the current segment in the format declared by the type. The syntax for defining a structure or union variable is:

```
[[name]] typename < [[initializer [[,initializer]]...]] >
```

```
[[name]] typename { [[initializer [[,initializer]]...]] }
```

```
[[name]] typename constant DUP ({ [[initializer [[,initializer]]...]] })
```

The *name* is the label assigned to the variable. If you do not provide a name, the assembler allocates space for the variable but does not give it a symbolic name. The *typename* is the name of a previously declared structure or union type.

You can give an *initializer* for each field. Each initializer must correspond in type with the field defined in the type declaration. For unions, the type of the initializer must be the same as the type for the first field. An initialization list can also use the **DUP** operator.

The list of initializers can be broken only after a comma unless you end the line with a continuation character (\). The last curly brace or angle bracket must appear on the same line as the last initializer. You can also use the line continuation character to extend a line as shown in the `Item4` declaration that follows. Angle brackets and curly braces can be intermixed in an initialization as long as they match. This example illustrates the options for initializing lists in structures of type `ITEMS`:

```
ITEMS      STRUCT
  Iname     BYTE      'Item Name'
  Inum      WORD      ?
  UNION     ITYPE          ; UNION keyword appears first
    oldtype BYTE      0      ; when nested in structure.
    newtype WORD      ?      ; (See "Nested Structures
  ENDS          ; and Unions," following ).
ITEMS      ENDS

.
.
.
.DATA
Item1     ITEMS  < >          ; Accepts default initializers
Item2     ITEMS  { }          ; Accepts default initializers
Item3     ITEMS  <'Bolts', 126> ; Overrides default value of first
                                           ; 2 fields; use default of
                                           ; the third field

Item4     ITEMS  { \
                'Bolts',      ; Item name
                126 \          ; Part number
                }
```

The example defines—that is, allocates space for—four structures of the `ITEMS` type. The structures are named `Item1` through `Item4`. Each definition requires the angle brackets or curly braces even when not initialized. If you initialize more than one field, separate the values with commas, as shown in `Item3` and `Item4`.

You need not initialize all fields in a structure. If a field is blank, the assembler uses the structure's initial value given for that field in the declaration. If there is no default value, the field value is left unspecified.

For nested structures or unions, however, these are equivalent:

```
Item5  ITEMS  {'Bolts', ,      }
Item6  ITEMS  {'Bolts', , { } }
```

A variable and an array of union type `WB` look like this:

```
WB      UNION
  w     WORD   ?
  b     BYTE   ?
WB      ENDS

num     WB     {0Fh}                ; Store 0Fh
array   WB     (40 / SIZEOF WB) DUP ({2}) ; Allocates and
                                           ; initializes 20 unions
```

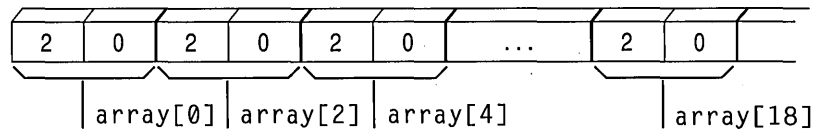

## Arrays as Field Initializers

The size of the initializer determines the length of the array that can override the contents of a field in a variable definition. The override cannot contain more elements than the default. Specifying fewer override array elements changes the first  $n$  values of the default where  $n$  is the number of values in the override. The rest of the array elements take their default values from the initializer.

## Strings as Field Initializers

If the override is shorter, the assembler pads the override with spaces to equal the length of the initializer. If the initializer is a string and the override value is not a string, the override value must be enclosed in angle brackets or curly braces.

A string can override any member of type **BYTE** (or **SBYTE**). You need not enclose the string in angle brackets or curly braces unless mixed with other override methods.

If a structure has an initialized string field or an array of bytes, any new string assigned to a variable of the field that is smaller than the default is padded with spaces. The assembler adds four spaces at the end of 'Bolts' in the variables of type ITEMS previously shown. The Iname field in the ITEMS structure cannot contain a field initializer longer than 'Item Name'.

### Structures as Field Initializers

Initializers for structure variables must be enclosed in curly braces or angle brackets, but you can specify overrides with fewer elements than the defaults.

This example illustrates the use of default values with structures as field initializers:

```
DISKDRIVES    STRUCT
  a1          BYTE ?
  b1          BYTE ?
  c1          BYTE ?
DISKDRIVES    ENDS

INFO          STRUCT
  buffer      BYTE    100 DUP (?)
  crlf        BYTE    13, 10
  query       BYTE    'Filename: ' ; String <= can override
  endmark     BYTE    36
  drives      DISKDRIVES <0, 1, 1>
INFO          ENDS

info1 INFO    { , , 'Dir' }

; Next line illegal since name in query field is too long:
; info2 INFO  {"TESTFILE", , "DirectoryName"}

lotsof INFO   { , , 'file1', , {0,0,0} },
              { , , 'file2', , {0,0,1} },
              { , , 'file3', , {0,0,2} }
```

The following diagram shows how the assembler stores info1.

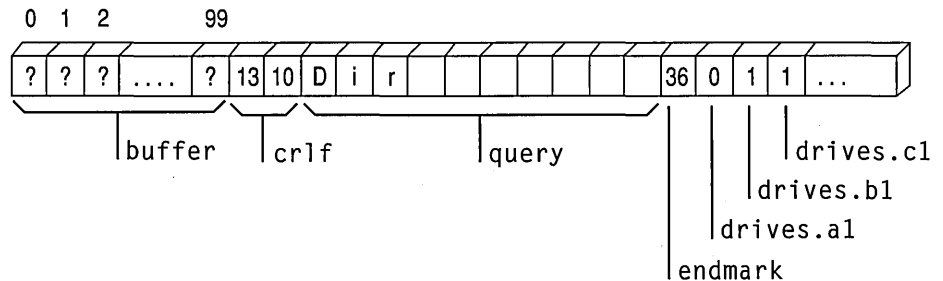

The initialization for `drives` gives default values for all three fields of the structure. The fields left blank in `info1` use the default values for those fields. The `info2` declaration is illegal because “`DirectoryName`” is longer than the initial string for that field.

### Arrays of Structures and Unions

You can define an array of structures using the **DUP** operator (see “Declaring and Referencing Arrays,” earlier in this chapter) or by creating a list of structures. For example, you can define an array of structure variables like this:

```
Item7  ITEMS    30 DUP ( { , , {10} } )
```

The `Item7` array defined here has 30 elements of type `ITEMS`, with the third field of each element (the union) initialized to 10.

You can also list array elements as shown in the following example.

```
Item8  ITEMS    { 'Bolts', 126, 10 },
           { 'Pliers', 139, 10 },
           { 'Saws', 414, 10 }
```

### Redeclaring a Structure

The assembler generates an error when you declare a structure more than once unless the following are the same:

- Field names
- Offsets of named fields
- Initialization lists
- Field alignment value

### LENGTHOF, SIZEOF, and TYPE for Structures

The size of a structure determined by **SIZEOF** is the offset of the last field, plus the size of the last field, plus any padding required for proper alignment. (For information about alignment, see “Declaring Structure and Union Types,” earlier in this chapter.)

This example, using the preceding data declarations, shows how to use the **LENGTHOF**, **SIZEOF**, and **TYPE** operators with structures.

```

INFO          STRUCT
  buffer      BYTE    100 DUP (?)
  crlf        BYTE    13, 10
  query       BYTE    'Filename: '
  endmark     BYTE    36
  drives      DISKDRIVES <0, 1, 1>
INFO          ENDS

info1  INFO    { , , 'Dir' }
lotsof INFO    { , , 'file1', , {0,0,0} },
          { , , 'file2', , {0,0,1} },
          { , , 'file3', , {0,0,2} }

sinfo1 EQU    SIZEOF    info1 ; 116 = number of bytes in
                    ;   initializers
linfo1 EQU    LENGTHOF  info1 ; 1 = number of items
tinfo1 EQU    TYPE      info1 ; 116 = same as size

slotsof EQU    SIZEOF    lotsof ; 116 * 3 = number of bytes in
                    ;   initializers
lslotsof EQU   LENGTHOF  lotsof ; 3 = number of items
tlotsof EQU    TYPE      lotsof ; 116 = same as size for structure
                    ;   of type INFO

```

### LENGTHOF, SIZEOF, and TYPE for Unions

The size of a union determined by **SIZEOF** is the size of the longest field plus any padding required. The length of a union variable determined by **LENGTHOF** equals the number of initializers defined inside angle brackets or curly braces. **TYPE** returns a value indicating the type of the longest field.

```

DWB          UNION
  d          DWORD    ?
  w          WORD     ?
  b          BYTE     ?
DWB          ENDS

num          DWB      {0FFFFh}
array       DWB      (100 / SIZEOF DWB) DUP ({0})

snum        EQU      SIZEOF    num      ; = 4
lnum        EQU      LENGTHOF  num      ; = 1
tnum        EQU      TYPE      num      ; = 4
sarray      EQU      SIZEOF    array     ; = 100 (4*25)
larray      EQU      LENGTHOF  array     ; = 25
tarray      EQU      TYPE      array     ; = 4

```

## Referencing Structures, Unions, and Fields

Like other variables, structure variables can be accessed by name. You can access fields within structure variables with this syntax:

*variable.field*

References to fields must always be fully qualified, with the structure or union names and the dot operator preceding the field name. The assembler requires that you use the dot operator only with structure fields, not as an alternative to the plus operator; nor can you use the plus operator as an alternative to the dot operator.

The following example shows several ways to reference the fields of a structure of type DATE.

```
DATE    STRUCT                                ; Defines structure type
    month BYTE    ?
    day   BYTE    ?
    year  WORD    ?
DATE    ENDS

yesterday    DATE    {1, 20, 1993}    ; Declare structure
                                           ; variable

.
.
.
    mov     al, yesterday.day           ; Use structure variables
    mov     bx, OFFSET yesterday       ; Load structure address
    mov     al, (DATE PTR [bx]).month  ; Use as indirect operand
    mov     al, [bx].date.month        ; This is necessary only if
                                           ; month is already a
                                           ; field in a different
                                           ; structure
```

Under **OPTION M510** or **OPTION OLDSTRUCTS**, unique structure names do not need to be qualified. However, if the **NONUNIQUE** keyword appears in a structure definition, all fields of the structure must be fully qualified when referenced, even if the **OPTION OLDSTRUCTS** directive appears in the code. Also, you must qualify all references to a field. (For information on the **OPTION** directive, see Chapter 1.)

Even if the initialized union is the size of a **WORD** or **DWORD**, members of structures or unions are accessible only through the field's names.

In the following example, the two **MOV** statements show how you can access the elements of an array of unions.

```

WB      UNION
  w     WORD   ?
  b     BYTE   ?
WB      ENDS

array  WB      (100 / SIZEOF WB) DUP ({0})

      mov     array[12].w, 40h
      mov     array[32].b, 2

```

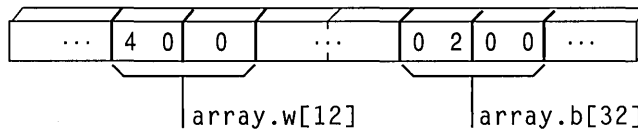

As the preceding code illustrates, you can use unions to access the same data in more than one form. One application of structures and unions is to simplify the task of reinitializing a far pointer. For a far pointer declared as

```

FPWORD  TYPEDEF FAR PTR WORD

      .DATA
WordPtr FPWORD ?

```

you must follow these steps to point `WordPtr` to a word value named `ThisWord` in the current data segment.

```

      mov     WORD PTR WordPtr[2], ds
      mov     WORD PTR WordPtr, OFFSET ThisWord

```

The preceding method requires that you remember whether the segment or the offset is stored first. However, if your program declares a union like this:

```

uptr    UNION
  dwptr FPWORD 0
  STRUCT
    offs WORD    0
    segm WORD    0
  ENDS
uptr    ENDS

```



You can initialize a far pointer with these steps:

```

        .DATA
WrdPtr2 uptr  <>
        .
        .
        .
        mov   WrdPtr2.segm, ds
        mov   WrdPtr2.off, OFFSET ThisWord

```

This code moves the segment and the offset into the pointer and then moves the pointer into a register with the other field of the union. Although this technique does not reduce the code size, it avoids confusion about the order for loading the segment and offset.

## Nested Structures and Unions

You can nest structures and unions in several ways. This section explains how to refer to the fields in a nested structure or union. The following example illustrates the four techniques for nesting, and how to reference the fields. Note the syntax for nested structures. The techniques are reviewed following the example.

```

ITEMS          STRUCT
  Inum         WORD   ?
  Iname        BYTE   'Item Name'
ITEMS          ENDS

INVENTORY      STRUCT
  UpDate       WORD   ?
  oldItem      ITEMS  { \
                    100,
                    'AF8' \      ; Named variable of
                    }          ; existing structure
                    ITEMS  { ?, '94C' } ; Unnamed variable of
                                ; existing type
                                ; Named nested structure
  STRUCT ups
    source     WORD   ?
    shipmode   BYTE   ?
  ENDS
  STRUCT                                ; Unnamed nested structure
    f1         WORD   ?
    f2         WORD   ?
  ENDS
INVENTORY      ENDS

        .DATA

yearly INVENTORY { }

```

; Referencing each type of data in the yearly structure:

```
mov    ax, yearly.oldItem.Inum
mov    yearly.ups.shipmode, 'A'
mov    yearly.Inum, 'C'
mov    ax, yearly.fl
```

To nest structures and unions, you can use any of these techniques:

- The field of a structure or union can be a named variable of an existing structure or union type, as in the `oldItem` field. Because `INVENTORY` contains two structures of type `ITEMS`, the field names in `oldItem` are not unique. Therefore, you must use the full field names when referencing those fields, as in the statement

```
mov    ax, yearly.oldItem.Inum
```

- To declare a named structure or union inside another structure or union, give the **STRUCT** or **UNION** keyword first and then define a label for it. Fields of the nested structure or union must always be qualified:

```
mov    yearly.ups.shipmode, 'A'
```

- As shown in the `Items` field of `Inventory`, you also can use unnamed variables of existing structures or unions inside another structure or union. In these cases, you can reference fields directly:

```
mov    yearly.Inum, 'C'
mov    ax, yearly.fl
```

## Records

Records are similar to structures, except that fields in records are bit strings. Each bit field in a record variable can be used separately in constant operands or expressions. The processor cannot access bits individually at run time, but it can access bit fields with instructions that manipulate bits.

Records are bytes, words, or doublewords in which the individual bits or groups of bits are considered fields. In general, the three steps for using record variables are the same as those for using other complex data types:

1. Declare a record type.
2. Define one or more variables having the record type.
3. Reference record variables using shifts and masks.

Once it is defined, you can use the record variable as an operand in assembler statements.

This section explains the record declaration syntax and the use of the **MASK** and **WIDTH** operators. It also shows some applications of record variables and constants.

## Declaring Record Types

A record type creates a template for data with the sizes and, optionally, the initial values for bit fields in the record. It does not allocate memory space for the record.

The **RECORD** directive declares a record type for an 8-bit, 16-bit, or 32-bit record that contains one or more bit fields. The maximum size is based on the expression word size. See **OPTION EXPR16** and **OPTION EXPR32** in Chapter 1. The syntax is:

```
recordname RECORD field [[, field]]...
```

The *field* declares the name, width, and initial value for the field. The syntax for each *field* is:

```
fieldname:width[[=expression]]
```

Global labels, macro names, and record field names must all be unique, but record field names can have the same names as structure field names. *Width* is the number of bits in the field, and *expression* is a constant giving the initial (or default) value for the field. Record definitions can span more than one line if the continued lines end with commas.

If *expression* is given, it declares the initial value for the field. The assembler generates an error message if an initial value is too large for the width of its field.

The first field in the declaration always goes into the most significant bits of the record. Subsequent fields are placed to the right in the succeeding bits. If the fields do not total exactly 8, 16, or 32 bits as appropriate, the entire record is shifted right, so the last bit of the last field is the lowest bit of the record. Unused bits in the high end of the record are initialized to 0.

The following example creates a byte record type **COLOR** having four fields: *blink*, *back*, *intense*, and *fore*. The contents of the record type are shown after the example. Since no initial values are given, all bits are set to 0. Note that this is only a template maintained by the assembler. It allocates no space in the data segment.

```
COLOR RECORD blink:1, back:3, intense:1, fore:3
```

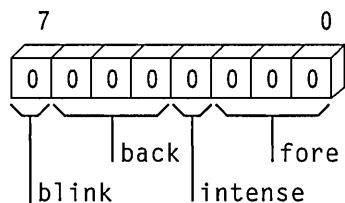

The next example creates a record type CW that has six fields. Each record declared with this type occupies 16 bits of memory. Initial (default) values are given for each field. You can use them when declaring data for the record. The bit diagram after the example shows the contents of the record type.

```
CW RECORD r1:3=0, ic:1=0, rc:2=0, pc:2=3, r2:2=1, masks:6=63
```

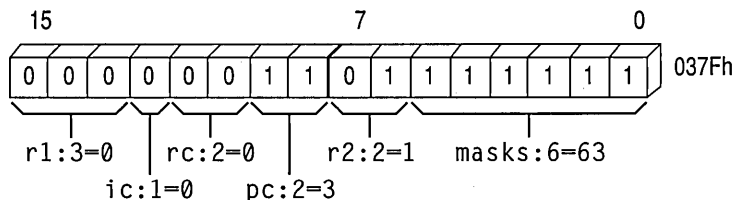

## Defining Record Variables

Once you have declared a record type, you can define record variables of that type. For each variable, the assembler allocates memory in the format declared by the type. The syntax is:

```
[[name]] recordname <[[initializer] [[,initializer]]...]>
```

```
[[name]] recordname { [[initializer] [[,initializer]]... ] }
```

```
[[name]] recordname constant DUP ( [[initializer] [[,initializer]]... ] )
```

The *recordname* is the name of a record type previously declared with the **RECORD** directive.

A *fieldlist* for each field in the record can be a list of integers, character constants, or expressions that correspond to a value compatible with the size of the field. You must include curly braces or angle brackets even when you do not specify an initial value.

If you use the **DUP** operator (see “Declaring and Referencing Arrays,” earlier in this chapter) to initialize multiple record variables, only the angle brackets and any

initial values need to be enclosed in parentheses. For example, you can define an array of record variables with

```
xmas    COLOR    50 DUP ( <1, 2, 0, 4> )
```

You do not have to initialize all fields in a record. If an initial value is blank, the assembler automatically stores the default initial value of the field. If there is no default value, the assembler clears each bit in the field.

The definition in the following example creates a variable named `warning` whose type is given by the record type `COLOR`. The initial values of the fields in the variable are set to the values given in the record definition. The initial values override any default record values given in the declaration.

```
COLOR    RECORD    blink:1,back:3,intense:1,fore:3 ; Record
                                                ; declaration
warning COLOR    <1, 0, 1, 4>                ; Record
                                                ; definition
```

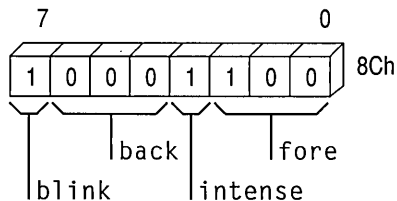

## LENGTHOF, SIZEOF, and TYPE with Records

The **SIZEOF** and **TYPE** operators applied to a record name return the number of bytes used by the record. **SIZEOF** returns the number of bytes a record variable occupies. You cannot use **LENGTHOF** with a record declaration, but you can use it with defined record variables. **LENGTHOF** returns the number of records in an array of records, or 1 for a single record variable. The following example illustrates these points.

```
; Record definition
; 9 bits stored in 2 bytes
RGBCOLOR    RECORD    red:3, green:3, blue:3

    mov     ax, RGBCOLOR          ; Equivalent to "mov ax, 01FFh"
;    mov     ax, LENGTHOF RGBCOLOR ; Illegal since LENGTHOF can
;                                           ; apply only to data label
    mov     ax, SIZEOF    RGBCOLOR ; Equivalent to "mov ax, 2"
    mov     ax, TYPE      RGBCOLOR ; Equivalent to "mov ax, 2"
```

```

; Record instance
; 8 bits stored in 1 byte
RGBCOLOR2      RECORD red:3, green:3, blue:2
rgb            RGBCOLOR2 <1, 1, 1> ; Initialize to 00100101y

        mov     ax, RGBCOLOR2      ; Equivalent to
                                   ; "mov ax, 00FFh"
        mov     ax, LENGTHOF rgb   ; Equivalent to "mov ax, 1"
        mov     ax, SIZEOF  rgb    ; Equivalent to "mov ax, 1"
        mov     ax, TYPE    rgb    ; Equivalent to "mov ax, 1"

```

## Record Operators

The **WIDTH** operator (used only with records) returns the width in bits of a record or record field. The **MASK** operator returns a bit mask for the bit positions occupied by the given record field. A bit in the mask contains a 1 if that bit corresponds to a bit field. The following example shows how to use **MASK** and **WIDTH**.

```

        .DATA
COLOR      RECORD  blink:1, back:3, intense:1, fore:3
message    COLOR  <1, 5, 1, 1>
wblink    EQU   WIDTH blink      ; "wblink"    = 1
wback     EQU   WIDTH back       ; "wback"    = 3
wintens   EQU   WIDTH intense    ; "wintens"  = 1
wfore     EQU   WIDTH fore       ; "wfore"    = 3
wcolor    EQU   WIDTH COLOR      ; "wcolor"   = 8

        .CODE
        .
        .
        .
        mov     ah, message      ; Load initial  1101 1001
        and     ah, NOT MASK back ; Turn off     AND 1000 1111
                                   ; "back"      -----
                                   ;             1000 1001
        or      ah, MASK blink   ; Turn on     OR 1000 0000
                                   ; "blink"    -----
                                   ;             1000 1001
        xor     ah, MASK intense ; Toggle     XOR 0000 1000
                                   ; "intense"  -----
                                   ;             1000 0001

        IF     (WIDTH COLOR) GT 8 ; If color is 16 bit, load
        mov     ax, message      ; into 16-bit register
        ELSE
        mov     al, message      ; load into low 8-bit register
        xor     ah, ah          ; and clear high 8-bits
        ENDIF

```

The example continues by illustrating several ways in which record fields can serve as operands and expressions:

```

; Rotate "back" of "message" without changing other values

mov    al, message      ; Load value from memory
mov    ah, al           ; Save a copy for work      1101 1001=ah/al
and    al, NOT MASK back; Mask out old bits      AND 1000 1111=mask
; to save old message  -----
;                               1000 1001=al

mov    cl, back         ; Load bit position
shr    ah, cl           ; Shift to right          0000 1101=ah
inc    ah               ; Increment              0000 1110=ah

shl    ah, cl           ; Shift left again        1110 0000=ah
and    ah, MASK back    ; Mask off extra bits  AND 0111 0000=mask
; to get new message  -----
;                               0110 0000 ah

or     ah, al           ; Combine old and new   OR 1000 1001 al
;                               -----

mov    message, ah     ; Write back to memory    1110 1001 ah

```

Record variables are often used with the logical operators to perform logical operations on the bit fields of the record, as in the previous example using the **MASK** operator.

## CHAPTER 6

# Using Floating-Point and Binary Coded Decimal Numbers

MASM requires different techniques for handling floating-point (real) numbers and binary coded decimal (BCD) numbers than for handling integers. You have two choices for working with real numbers—a math coprocessor or emulation routines.

Math coprocessors—the 8087, 80287, and 80387 chips—work with the main processor to handle real-number calculations. The 80486 processor performs floating-point operations directly. All information in this chapter pertaining to the 80387 coprocessor applies to the 80486DX processor as well. It does not apply to the 80486SX, which does not provide an on-chip coprocessor.

This chapter begins with a summary of the directives and formats of floating-point data that you need to allocate memory storage and initialize variables before you can work with floating-point numbers.

The chapter then explains how to use a math coprocessor for floating-point operations. It covers:

- The architecture of the registers.
- The operands for the coprocessor instruction formats.
- The coordination of coprocessor and main processor memory access.
- The basic groups of coprocessor instructions—for loading and storing data, doing arithmetic calculations, and controlling program flow.

The next main section describes emulation libraries. The emulation routines provided with all Microsoft high-level languages enable you to use coprocessor instructions as though your computer had a math coprocessor. However, some coprocessor instructions are not handled by emulation, as this section explains.

Finally, because math coprocessor and emulation routines can also operate on BCD numbers, this chapter includes the instruction set for these numbers.



## Using Floating-Point Numbers

Before using floating-point data in your program, you need to allocate the memory storage for the data. You can then initialize variables either as real numbers in decimal form or as encoded hexadecimals. The assembler stores allocated data in 10-byte IEEE format. This section covers floating-point declarations and floating-point data formats.

## Declaring Floating-Point Variables and Constants

You can allocate real constants using the **REAL4**, **REAL8**, and **REAL10** directives. These directives allocate the following floating-point numbers:

Directive	Size
<b>REAL4</b>	Short (32-bit) real numbers
<b>REAL8</b>	Long (64-bit) real numbers
<b>REAL10</b>	10-byte (80-bit) real numbers and BCD numbers

Table 6.1 lists the possible ranges for floating-point variables. The number of significant digits can vary in an arithmetic operation as the least-significant digit may be lost through rounding errors. This occurs regularly for short and long real numbers, so you should assume the lesser value of significant digits shown in Table 6.1. Ten-byte real numbers are much less susceptible to rounding errors for reasons described in the next section. However, under certain circumstances, 10-byte real operations can have a precision of only 18 digits.

**Table 6.1 Ranges of Floating-Point Variables**

Data Type	Bits	Significant Digits	Approximate Range
Short real	32	6–7	$1.18 \times 10^{-38}$ to $3.40 \times 10^{38}$
Long real	64	15–16	$2.23 \times 10^{-308}$ to $1.79 \times 10^{308}$
10-byte real	80	19	$3.37 \times 10^{-4932}$ to $1.18 \times 10^{4932}$

With versions of MASM prior to 6.0, the **DD**, **DQ**, and **DT** directives could allocate real constants. MASM 6.1 still supports these directives, but the variables are integers rather than floating-point values. Although this makes no difference in the assembly code, CodeView displays the values incorrectly.

You can specify floating-point constants either as decimal constants or as encoded hexadecimal constants. You can express decimal real-number constants in the form:

```
[ [+ | - ] integer [ / fraction ] [ [ E [ + | - ] ] exponent ]
```

For example, the numbers 2.523E1 and -3.6E-2 are written in the correct decimal format. You can use these numbers as initializers for real-number variables.

The assembler always evaluates digits of real numbers as base 10. It converts real-number constants given in decimal format to a binary format. The sign, exponent, and decimal part of the real number are encoded as bit fields within the number.

You can also specify the encoded format directly with hexadecimal digits (0–9 plus A–F). The number must begin with a decimal digit (0–9) and end with the real-number designator (R). It cannot be signed. For example, the hexadecimal number 3F800000r can serve as an initializer for a doubleword-sized variable.

The maximum range of exponent values and the number of digits required in the hexadecimal number depend on the directive. The number of digits for encoded numbers used with **REAL4**, **REAL8**, and **REAL10** must be 8, 16, and 20 digits, respectively. If the number has a leading zero, the number must be 9, 17, or 21 digits.

Examples of decimal constant and hexadecimal specifications are shown here:

```

; Real numbers
short   REAL4    25.23                ; IEEE format
double  REAL8    2.523E1              ; IEEE format
tenbyte REAL10   2523.0E-2            ; 10-byte real format

; Encoded as hexadecimals
ieeshort   REAL4    3F800000r        ; 1.0 as IEEE short
ieedouble  REAL8    3FF0000000000000r ; 1.0 as IEEE long
temporary  REAL10   3FFF8000000000000000r ; 1.0 as 10-byte
                                                ; real

```

The section “Storing Numbers in Floating-Point Format,” following, explains the IEEE formats—the way the assembler actually stores the data.

Pascal or C programmers may prefer to create language-specific **TYPEDEF** declarations, as illustrated in this example:

```

; C-language specific
float      TYPEDEF REAL4
double     TYPEDEF REAL8
long_double TYPEDEF REAL10
; Pascal-language specific
SINGLE     TYPEDEF REAL4
DOUBLE    TYPEDEF REAL8
EXTENDED  TYPEDEF REAL10

```

For applications of **TYPEDEF**, see “Defining Pointer Types with **TYPEDEF**,” page 75.

## Storing Numbers in Floating-Point Format

The assembler stores floating-point variables in the IEEE format. MASM 6.1 does not support `.MSFLOAT` and Microsoft binary format, which are available in version 5.1 and earlier. Figure 6.1 illustrates the IEEE format for encoding short (4-byte), long (8-byte), and 10-byte real numbers. Although this figure places the most significant bit first for illustration, low bytes actually appear first in memory.

### Typical Real Number in Binary Form

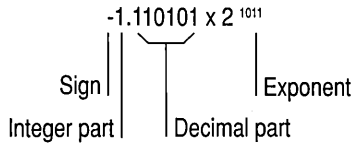

### Short Real Number

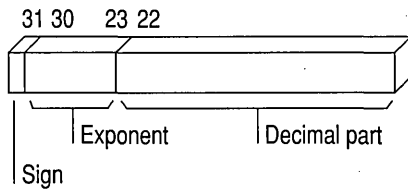

### Long Real Number

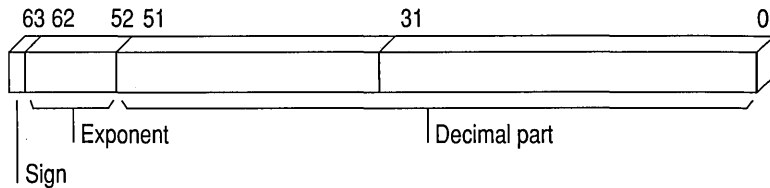

### 10-Byte Real Number

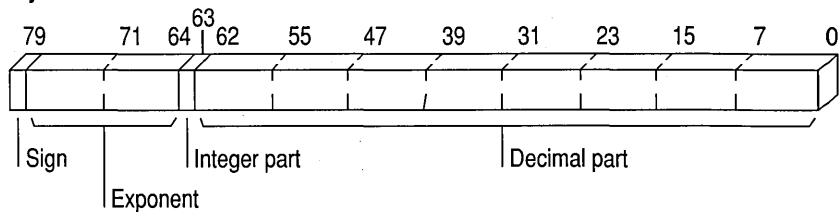

Figure 6.1 Encoding for Real Numbers in IEEE Format

The following list explains how the parts of a real number are stored in the IEEE format. Each item in the list refers to an item in Figure 6.1.

- Sign bit (0 for positive or 1 for negative) in the upper bit of the first byte.
- Exponent in the next bits in sequence (8 bits for a short real number, 11 bits for a long real number, and 15 bits for a 10-byte real number).
- The integer part of the significand in bit 63 for the 10-byte real format. By absorbing carry values, this bit allows 10-byte real operations to preserve precision to 19 digits. The integer part is always 1 in short and long real numbers; consequently, these formats do not provide a bit for the integer, since there is no point in storing it.
- Decimal part of the significand in the remaining bits. The length is 23 bits for short real numbers, 52 bits for long real numbers, and 63 bits for 10-byte real numbers.

The exponent field represents a multiplier  $2^n$ . To accommodate negative exponents (such as  $2^{-6}$ ), the value in the exponent field is biased; that is, the actual exponent is determined by subtracting the appropriate bias value from the value in the exponent field. For example, the bias for short real numbers is 127. If the value in the exponent field is 130, the exponent represents a value of  $2^{130-127}$ , or  $2^3$ . The bias for long real numbers is 1,023. The bias for 10-byte real numbers is 16,383.

Once you have declared floating-point data for your program, you can use coprocessor or emulator instructions to access the data. The next section focuses on the coprocessor architecture, instructions, and operands required for floating-point operations.

## Using a Math Coprocessor

When used with real numbers, packed BCD numbers, or long integers, coprocessors (the 8087, 80287, 80387, and 80486) calculate many times faster than the 8086-based processors. The coprocessor handles data with its own registers. The organization of these registers can be one of the four formats for using operands explained in “Instruction and Operand Formats,” later in this section.

This section describes how the coprocessor transfers data to and from the coprocessor, coordinates processor and coprocessor operations, and controls program flow.

## Coprocessor Architecture

The coprocessor accesses memory as the CPU does, but it has its own data and control registers—eight data registers organized as a stack and seven control registers similar to the 8086 flag registers. The coprocessor's instruction set provides direct access to these registers.

The eight 80-bit data registers of the 8087-based coprocessors are organized as a stack, although they need not be used as a stack. As data items are pushed into the top register, previous data items move into higher-numbered registers, which are lower on the stack. Register 0 is the top of the stack; register 7 is the bottom. The syntax for specifying registers is:

**ST** [(*number*)]

The *number* must be a digit between 0 and 7 or a constant expression that evaluates to a number from 0 to 7. **ST** is another way to refer to **ST(0)**.

All coprocessor data is stored in registers in the 10-byte real format. The registers and the register format are shown in Figure 6.2.

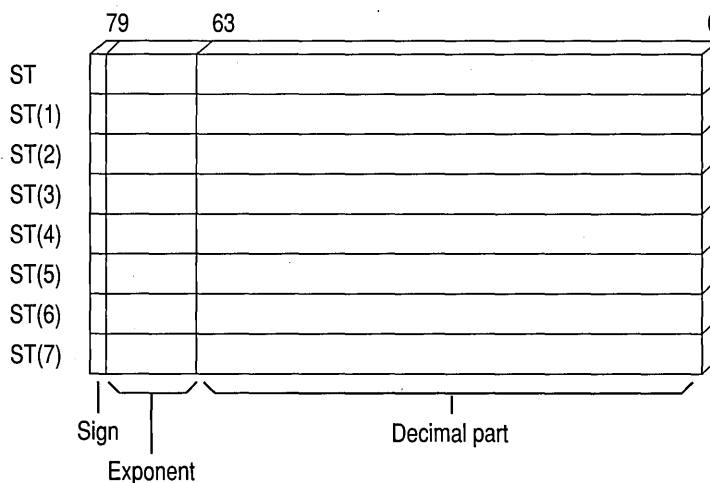

**Figure 6.2** Coprocessor Data Registers

Internally, all calculations are done on numbers of the same type. Since 10-byte real numbers have the greatest precision, lower-precision numbers are guaranteed not to lose precision as a result of calculations. The instructions that transfer values between the main memory and the coprocessor automatically convert numbers to and from the 10-byte real format.

## Instruction and Operand Formats

Because of the stack organization of registers, you can consider registers either as elements on a stack or as registers much like 8086-family registers. Table 6.2 lists the four main groups of coprocessor instructions and the general syntax for each. The names given to the instruction format reflect the way the instruction uses the coprocessor registers. The instruction operands are placed in the coprocessor data registers before the instruction executes.

**Table 6.2 Coprocessor Operand Formats**

<b>Instruction Format</b>	<b>Syntax</b>	<b>Implied Operands</b>	<b>Example</b>
Classical stack	<i>Finstruction</i>	ST, ST(1)	fadd
Memory	<i>Finstruction memory</i>	ST	fadd memloc
Register	<i>Finstruction</i> ST( <i>num</i> ), ST <i>Finstruction</i> ST, ST( <i>num</i> )	—	fadd st(5), st fadd st, st(3)
Register pop	<i>FinstructionP</i> ST( <i>num</i> ), ST	—	faddp st(4), st

You can easily recognize coprocessor instructions because, unlike all 8086-family instruction mnemonics, they start with the letter **F**. Coprocessor instructions can never have immediate operands and, with the exception of the **FSTSW** instruction, they cannot have processor registers as operands.

### Classical-Stack Format

Instructions in the classical-stack format treat the coprocessor registers like items on a stack—thus its name. Items are pushed onto or popped off the top elements of the stack. Since only the top item can be accessed on a traditional stack, there is no need to specify operands. The first (top) register (and the second, if the instruction needs two operands) is always assumed.

ST (the top of the stack) is the source operand in coprocessor arithmetic operations. ST(1), the second register, is the destination. The result of the operation replaces the destination operand, and the source is popped off the stack. This leaves the result at the top of the stack.

The following example illustrates the classical-stack format; Figure 6.3 shows the status of the register stack after each instruction.

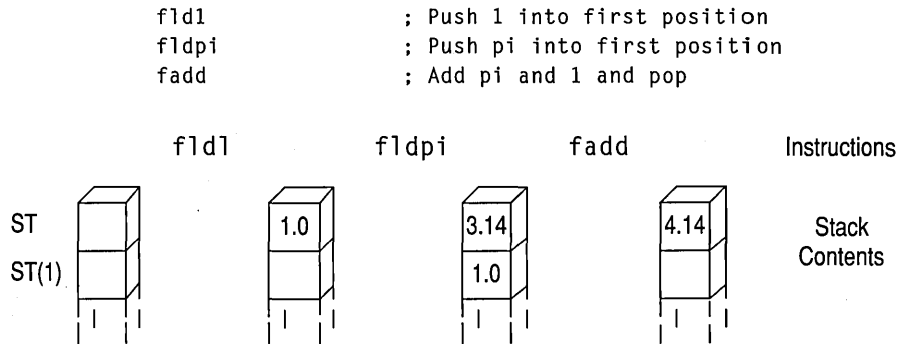

Figure 6.3 Status of the Register Stack

## Memory Format

Instructions that use the memory format, such as data transfer instructions, also treat coprocessor registers like items on a stack. However, with this format, items are pushed from memory onto the top element of the stack, or popped from the top element to memory. You must specify the memory operand.

Some instructions that use the memory format specify how a memory operand is to be interpreted—as an integer (**I**) or as a binary coded decimal (**B**). The letter **I** or **B** follows the initial **F** in the syntax. For example, **FILD** interprets its operand as an integer and **FBLD** interprets its operand as a BCD number. If the instruction name does not include a type letter, the instruction works on real numbers.

You can also use memory operands in calculation instructions that operate on two values (see “Using Coprocessor Instructions,” later in this section). The memory operand is always the source. The stack top (ST) is always the implied destination.

The result of the operation replaces the destination without changing its stack position, as shown in this example and in Figure 6.4:

```

.DATA
m1    REAL4  1.0
m2    REAL4  2.0
.CODE
.
.
.
fld   m1     ; Push m1 into first position
fld   m2     ; Push m2 into first position
fadd  m1     ; Add m2 to first position
fstp  m1     ; Pop first position into m1
fst   m2     ; Copy first position to m2

```

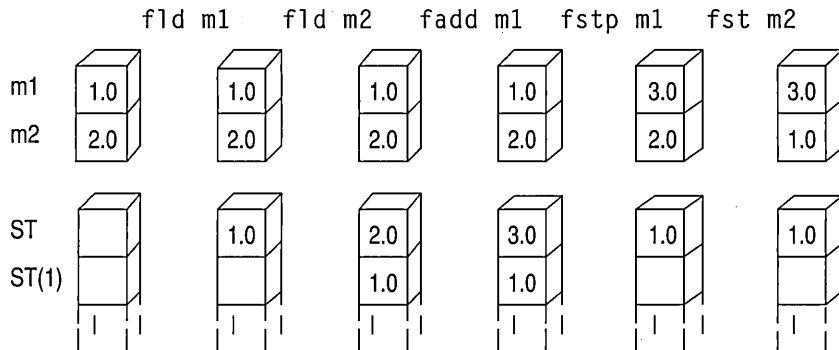

Figure 6.4 Status of the Register Stack and Memory Locations

## Register Format

Instructions that use the register format treat coprocessor registers as registers rather than as stack elements. Instructions that use this format require two register operands; one of them must be the stack top (ST).

In the register format, specify all operands by name. The first operand is the destination; its value is replaced with the result of the operation. The second operand is the source; it is not affected by the operation. The stack positions of the operands do not change.



The only instructions that use the register operand format are the **FXCH** instruction and arithmetic instructions for calculations on two values. With the **FXCH** instruction, the stack top is implied and need not be specified, as shown in this example and in Figure 6.5:

```
fadd  st(1), st  ; Add second position to first -
                    ; result goes in second position
fadd  st, st(2)  ; Add first position to third -
                    ; result goes in first position
fxch  st(1)      ; Exchange first and second positions
```

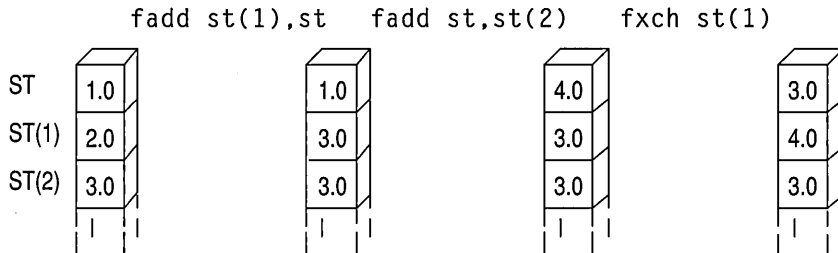

Figure 6.5 Status of the Previously Initialized Register Stack

## Register-Pop Format

The register-pop format treats coprocessor registers as a modified stack. The source register must always be the stack top. Specify the destination with the register's name.

Instructions with this format place the result of the operation into the destination operand, and the top pops off the stack. The register-pop format is used only for instructions for calculations on two values, as in this example and in Figure 6.6:

```
faddp st(2), st ; Add first and third positions and pop -
                    ; first position destroyed;
                    ; third moves to second and holds result
```

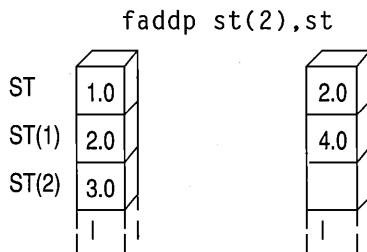

Figure 6.6 Status of the Already Initialized Register Stack

## Coordinating Memory Access

The math coprocessor and main processor work simultaneously. However, since the coprocessor cannot handle device input or output, data originates in the main processor.

The main processor and the coprocessor have their own registers, which are separate and inaccessible to each other. They exchange data through memory, since memory is available to both.

When using the coprocessor, follow these three steps:

1. Load data from memory to coprocessor registers.
2. Process the data.
3. Store the data from coprocessor registers back to memory.

Step 2, processing the data, can occur while the main processor is handling other tasks. Steps 1 and 3 must be coordinated with the main processor so that the processor and coprocessor do not try to access the same memory at the same time; otherwise, problems of coordinating memory access can occur. Since the processor and coprocessor work independently, they may not finish working on memory in the order in which you give instructions. The two potential timing conflicts that can occur are handled in different ways.

One timing conflict results from a coprocessor instruction following a processor instruction. The processor may have to wait until the coprocessor finishes if the next processor instruction requires the result of the coprocessor's calculation. You do not have to write your code to avoid this conflict, however. The assembler coordinates this timing automatically for the 8088 and 8086 processors, and the processor coordinates it automatically on the 80186–80486 processors. This is the case shown in the first example that follows.

Another conflict results from a processor instruction that accesses memory following a coprocessor instruction that accesses the same memory. The processor can try to load a variable that is still being used by the coprocessor. You need careful synchronization to control the timing, and this synchronization is not automatic on the 8087 coprocessor. For code to run correctly on the 8087, you must include **WAIT** or **FWAIT** (mnemonics for the same instruction) to ensure that the coprocessor finishes before the processor begins, as shown in the second example.

In this situation, the processor does not generate the **FWAIT** instruction automatically.

```

; Processor instruction first - No wait needed
    mov     WORD PTR mem32[0], ax    ; Load memory
    mov     WORD PTR mem32[2], dx
    fild   mem32                    ; Load to register

; Coprocessor instruction first - Wait needed (for 8087)
    fist   mem32                    ; Store to memory
    fwait                                     ; Wait until coprocessor
                                           ; is done
    mov    ax, WORD PTR mem32[0]    ; Move to register
    mov    dx, WORD PTR mem32[2]

```

When generating code for the 8087 coprocessor, the assembler automatically inserts a **WAIT** instruction before the coprocessor instruction. However, if you use the **.286** or **.386** directive, the compiler assumes that the coprocessor instructions are for the 80287 or 80387 and does not insert the **WAIT** instruction. If your code does not need to run on an 8086 or 8088 processor, you can make your programs smaller and more efficient by using the **.286** or **.386** directive.

## Using Coprocessor Instructions

The 8087 family of coprocessors has separate instructions for each of the following operations:

- Loading and storing data
- Doing arithmetic calculations
- Controlling program flow

The following sections explain the available instructions and show how to use them for each of these operations. For general syntax information, see “Instruction and Operand Formats,” earlier in this section.

### Loading and Storing Data

Data-transfer instructions copy data between main memory and the coprocessor registers or between different coprocessor registers. Two principles govern data transfers:

- The choice of instruction determines whether a value in memory is considered an integer, a BCD number, or a real number. The value is always considered a 10-byte real number once transferred to the coprocessor.
- The size of the operand determines the size of a value in memory. Values in the coprocessor always take up 10 bytes.

You can transfer data to stack registers using load commands. These commands push data onto the stack from memory or from coprocessor registers. Store commands remove data. Some store commands pop data off the register stack into memory or coprocessor registers; others simply copy the data without changing it on the stack.

If you use constants as operands, you cannot load them directly into coprocessor registers. You must allocate memory and initialize a variable to a constant value. That variable can then be loaded by using one of the load instructions in the following list.

The math coprocessor offers a few special instructions for loading certain constants. You can load 0, 1, pi, and several common logarithmic values directly. Using these instructions is faster and often more precise than loading the values from initialized variables.

All instructions that load constants have the stack top as the implied destination operand. The constant to be loaded is the implied source operand.

The coprocessor data area, or parts of it, can also be moved to memory and later loaded back. You may want to do this to save the current state of the coprocessor before executing a procedure. After the procedure ends, restore the previous status. Saving coprocessor data is also useful when you want to modify coprocessor behavior by writing certain data to main memory, operating on the data with 8086-family instructions, and then loading it back to the coprocessor data area.

Use the following instructions for transferring numbers to and from registers:

Instruction(s)	Description
<b>FLD, FST, FSTP</b>	Loads and stores real numbers
<b>FILD, FIST, FISTP</b>	Loads and stores binary integers
<b>FBLD</b>	Loads BCD
<b>FBSTP</b>	Stores BCD
<b>FXCH</b>	Exchanges register values
<b>FLDZ</b>	Pushes 0 into ST
<b>FLDI</b>	Pushes 1 into ST
<b>FLDPI</b>	Pushes the value of pi into ST
<b>FLDCW <i>mem2byte</i></b>	Loads the control word into the coprocessor
<b>F[[N]]STCW <i>mem2byte</i></b>	Stores the control word in memory
<b>FLDENV <i>mem14byte</i></b>	Loads environment from memory
<b>F[[N]]STENV <i>mem14byte</i></b>	Stores environment in memory

Instruction(s)	Description
<b>FRSTOR</b> <i>mem94byte</i>	Restores state from memory
<b>F[[N]]SAVE</b> <i>mem94byte</i>	Saves state in memory
<b>FLDL2E</b>	Pushes the value of $\log_2 e$ into ST
<b>FLDL2T</b>	Pushes $\log_2 10$ into ST
<b>FLDLG2</b>	Pushes $\log_{10} 2$ into ST
<b>FLDLN2</b>	Pushes $\log_e 2$ into ST

The following example and Figure 6.7 illustrate some of these instructions:

```

.DATA
m1    REAL4    1.0
m2    REAL4    2.0
.CODE
fld   m1      ; Push m1 into first item
fld   st(2)   ; Push third item into first
fst   m2      ; Copy first item to m2
fxch  st(2)   ; Exchange first and third items
fstp  m1      ; Pop first item into m1

```

### Main Memory

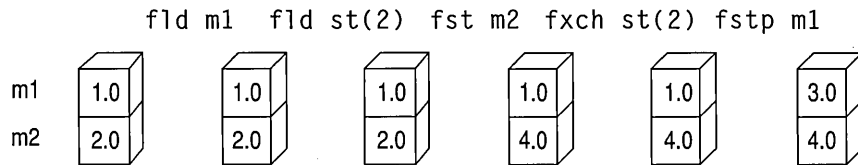

### Coprocessor Registers

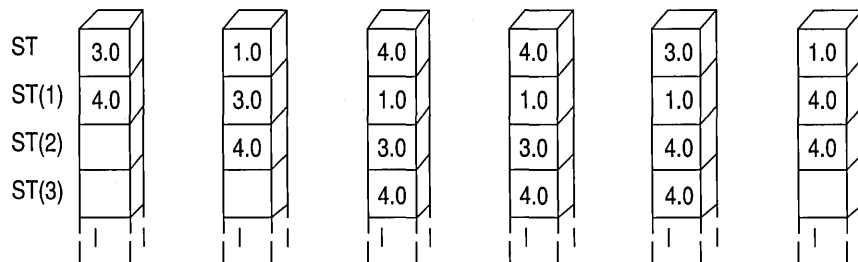

Figure 6.7 Status of the Register Stack: Main Memory and Coprocessor

## Doing Arithmetic Calculations

Most of the coprocessor instructions for arithmetic operations have several forms, depending on the operand used. You do not need to specify the operand type in the

instruction if both operands are stack registers, since register values are always 10-byte real numbers. In most of the arithmetic instructions listed here, the result replaces the destination register. The instructions include:

<b>Instruction</b>	<b>Description</b>
<b>FADD</b>	Adds the source and destination
<b>FSUB</b>	Subtracts the source from the destination
<b>FSUBR</b>	Subtracts the destination from the source
<b>FMUL</b>	Multiplies the source and the destination
<b>FDIV</b>	Divides the destination by the source
<b>FDIVR</b>	Divides the source by the destination
<b>FABS</b>	Sets the sign of ST to positive
<b>FCHS</b>	Reverses the sign of ST
<b>FRNDINT</b>	Rounds ST to an integer
<b>FSQRT</b>	Replaces the contents of ST with its square root
<b>FSCALE</b>	Multiplies the stack-top value by 2 to the power contained in ST(1)
<b>FPREM</b>	Calculates the remainder of ST divided by ST(1)

## 80387 Only

<b>Instruction</b>	<b>Description</b>
<b>FSIN</b>	Calculates the sine of the value in ST
<b>FCOS</b>	Calculates the cosine of the value in ST
<b>FSINCOS</b>	Calculates the sine and cosine of the value in ST
<b>FPREM1</b>	Calculates the partial remainder by performing modulo division on the top two stack registers
<b>FXTRACT</b>	Breaks a number down into its exponent and mantissa and pushes the mantissa onto the register stack
<b>F2XM1</b>	Calculates $2^X - 1$
<b>FYL2X</b>	Calculates $Y * \log_2 X$
<b>FYL2XP1</b>	Calculates $Y * \log_2 (X+1)$
<b>FPTAN</b>	Calculates the tangent of the value in ST
<b>FPATAN</b>	Calculates the arctangent of the ratio $Y/X$
<b>F[[N]]INIT</b>	Resets the coprocessor and restores all the default conditions in the control and status words
<b>F[[N]]CLEX</b>	Clears all exception flags and the busy flag of the status word
<b>FINCSTP</b>	Adds 1 to the stack pointer in the status word
<b>FDECSTP</b>	Subtracts 1 from the stack pointer in the status word
<b>FFREE</b>	Marks the specified register as empty

The following example illustrates several arithmetic instructions. The code solves quadratic equations, but does no error checking and fails for some values because it attempts to find the square root of a negative number. Both Help and the MATH.ASM sample file show a complete version of this procedure. The complete form uses the FTST (Test for Zero) instruction to check for a negative number or 0 before calculating the square root.

```

        .DATA
a       REAL4   3.0
b       REAL4   7.0
cc      REAL4   2.0
posx    REAL4   0.0
negx    REAL4   0.0

        .CODE
        .
        .
        .
; Solve quadratic equation - no error checking
; The formula is: -b +/- squareroot(b2 - 4ac) / (2a)
        fldl          ; Get constants 2 and 4
        fadd         st,st      ; 2 at bottom
        fld          st          ; Copy it
        fmul         a          ; = 2a

        fmul         st(1),st    ; = 4a
        fxch         ; Exchange
        fmul         cc         ; = 4ac

        fld          b          ; Load b
        fmul         st,st      ; = b2
        fsubr        ; = b2 - 4ac
        ; Negative value here produces error
        fsqrt        ; = square root(b2 - 4ac)
        fld          b          ; Load b
        fchs         ; Make it negative
        fxch         ; Exchange

        fld          st          ; Copy square root
        fadd         st,st(2)    ; Plus version = -b + root(b2 - 4ac)
        fxch         ; Exchange
        fsubp        st(2),st    ; Minus version = -b - root(b2 - 4ac)

        fdiv         st,st(2)    ; Divide plus version
        fstp         posx        ; Store it
        fdivr        ; Divide minus version
        fstp         negx        ; Store it

```

## Controlling Program Flow

The math coprocessor has several instructions that set control flags in the status word. The 8087-family control flags can be used with conditional jumps to direct program flow in the same way that 8086-family flags are used. Since the coprocessor does not have jump instructions, you must transfer the status word to memory so that the flags can be used by 8086-family instructions.

An easy way to use the status word with conditional jumps is to move its upper byte into the lower byte of the processor flags, as shown in this example:

```

fstsw  mem16          ; Store status word in memory
fwait                                     ; Make sure coprocessor is done
mov    ax, mem16      ; Move to AX
sahf                                       ; Store upper word in flags

```

The **SAHF** (Store AH into Flags) instruction in this example transfers AH into the low bits of the flags register.

You can save several steps by loading the status word directly to AX on the 80287 with the **FSTSW** and **FNSTSW** instructions. This is the only case in which data can be transferred directly between processor and coprocessor registers, as shown in this example:

```

fstsw  ax

```

The coprocessor control flags and their relationship to the status word are described in “Control Registers,” following.

The 8087-family coprocessors provide several instructions for comparing operands and testing control flags. All these instructions compare the stack top (ST) to a source operand, which may either be specified or implied as ST(1).

The compare instructions affect the C3, C2, and C0 control flags, but not the C1 flag. Table 6.3 shows the flags’ settings for each possible result of a comparison or test.

**Table 6.3 Control-Flag Settings After Comparison or Test**

After FCOM	After FTEST	C3	C2	C0
ST > source	ST is positive	0	0	0
ST < source	ST is negative	0	0	1
ST = source	ST is 0	1	0	0
Not comparable	ST is NAN or projective infinity	1	1	1

Variations on the compare instructions allow you to pop the stack once or twice and to compare integers and zero. For each instruction, the stack top is always the



implied destination operand. If you do not give an operand, ST(1) is the implied source. With some compare instructions, you can specify the source as a memory or register operand.

All instructions summarized in the following list have implied operands: either ST as a single-destination operand or ST as the destination and ST(1) as the source. Each instruction in the list has implied operands. Some instructions have a wait version and a no-wait version. The no-wait versions have **N** as the second letter. The instructions for comparing and testing flags include:

Instruction	Description
<b>FCOM</b>	Compares the stack top to the source. The source and destination are unaffected by the comparison.
<b>FTST</b>	Compares ST to 0.
<b>FCOMP</b>	Compares the stack top to the source and then pops the stack.
<b>FUCOM, FUCOMP, FUCOMPP</b>	Compares the source to ST and sets the condition codes of the status word according to the result (80386/486 only).
<b>F[[N]]STSW <i>mem2byte</i></b>	Stores the status word in memory.
<b>FXAM</b>	Sets the value of the control flags based on the type of the number in ST.
<b>FPREM</b>	Finds a correct remainder for large operands. It uses the C2 flag to indicate whether the remainder returned is partial (C2 is set) or complete (C2 is clear). If the bit is set, the operation should be repeated. It also returns the least-significant three bits of the quotient in C0, C3, and C1.
<b>FNOP</b>	Copies the stack top onto itself, thus padding the executable file and taking up processing time without having any effect on registers or memory.
<b>FDISI, FNDISI, FENI, FNENI</b>	Enables or disables interrupts (8087 only).
<b>FSETPM</b>	Sets protected mode. Requires a <b>.286P</b> or <b>.386P</b> directive (80287, 80387, and 80486 only).

The following example illustrates some of these instructions. Notice how conditional blocks are used to enhance 80287 code.

```

        .DATA
down    REAL4    10.35    ; Sides of a rectangle
across  REAL4    13.07
diamtr  REAL4    12.93    ; Diameter of a circle
status  WORD     ?

```

```

P287 EQU (@Cpu AND 00111y)
      .CODE
      .
      .
; Get area of rectangle
      fld  across      ; Load one side
      fmul down        ; Multiply by the other

; Get area of circle: Area = PI * (D/2)2
      fldl              ; Load one and
      fadd  st, st     ; double it to get constant 2
      fdivr diamtr    ; Divide diameter to get radius
      fmul  st, st     ; Square radius
      fldpi            ; Load pi
      fmul              ; Multiply it

; Compare area of circle and rectangle
      fcompp            ; Compare and throw both away
      IF p287
      fstsw  ax        ; (For 287+, skip memory)
      ELSE
      fnstsw status   ; Load from coprocessor to memory
      mov  ax, status ; Transfer memory to register
      ENDF
      sahf              ; Transfer AH to flags register
      jp   nocomp      ; If parity set, can't compare
      jz   same        ; If zero set, they're the same
      jc   rectangle   ; If carry set, rectangle is bigger
      jmp  circle      ; else circle is bigger

nocomp:                                ; Error handler
      .
      .
same:                                    ; Both equal
      .
      .
rectangle:                              ; Rectangle bigger
      .
      .
circle:                                  ; Circle bigger

```

Additional instructions for the 80387/486 are **FLDENVD** and **FLDENVW** for loading the environment; **FNSTENVD**, **FNSTENVW**, **FSTENVD**, and **FSTENVW** for storing the environment state; **FNSAVED**, **FNSAVEW**, **FSAVED**, and **FSAVEW** for saving the coprocessor state; and **FRSTORD** and **FRSTORW** for restoring the coprocessor state.

The size of the code segment, not the operand size, determines the number of bytes loaded or stored with these instructions. The instructions ending with **W** store the 16-bit form of the control register data, and the instructions ending with **D** store the 32-bit form. For example, in 16-bit mode **FSAVEW** saves the 16-bit control register data. If you need to store the 32-bit form of the control register data, use **FSAVED**.

## Control Registers

Some of the flags of the seven 16-bit control registers control coprocessor operations, while others maintain the current status of the coprocessor. In this sense, they are much like the 8086-family flags registers (see Figure 6.8).

### Control Registers

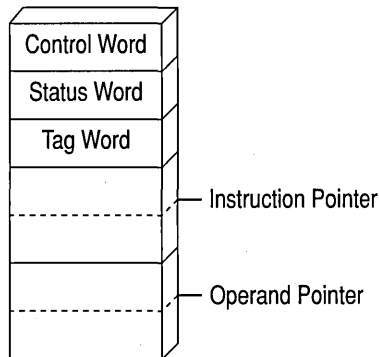
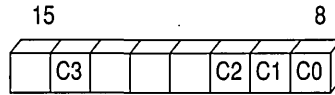

**Figure 6.8** Coprocessor Control Registers

The status word register is the only commonly used control register. (The others are used mostly by systems programmers.) The format of the status word register is shown in Figure 6.9, which shows how the coprocessor control flags align with the processor flags. C3 overwrites the zero flag, C2 overwrites the parity flag, and C0 overwrites the carry flag. C1 overwrites an undefined bit, so it cannot be used directly with conditional jumps, although you can use the **TEST** instruction to

check C1 in memory or in a register. The status word register also overwrites the sign and auxiliary-carry flags, so you cannot count on their being unchanged after the operation.

#### Status Word



#### Flags

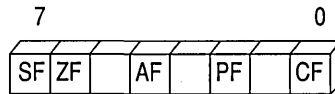

Figure 6.9 Coprocessor and Processor Control Flags

## Using An Emulator Library

If you do not have a math coprocessor or an 80486 processor, you can do most floating-point operations by writing assembly-language procedures and accessing an emulator from a high-level language. All Microsoft high-level languages come with emulator libraries for all memory models.

To use emulator functions, first write your assembly-language procedure using coprocessor instructions. Then assemble the module with the `/FPi` option and link it with your high-level-language modules. You can enter options in the Programmer's WorkBench (PWB) environment, or you can use the **OPTION EMULATOR** in your source code.

In emulation mode, the assembler generates instructions for the linker that the Microsoft emulator can use. The form of the **OPTION** directive in the following example tells the assembler to use emulation mode. This option (introduced in Chapter 1) can be defined only once in a module.

```
OPTION EMULATOR
```

You can use emulator functions in a stand-alone assembler program by assembling with the /Cx command-line option and linking with the appropriate emulator library. The following fragment outlines a small-model program that contains floating-point instructions served by an emulator:

```

.MODEL small, c
OPTION EMULATOR
.
.
.
PUBLIC main
.CODE
main:                                ; Program entry point must
.STARTUP                             ;   have name 'main'
.
fadd  st, st                          ; Floating-point instructions
fldpi                                ;   emulated

```

Emulator libraries do not allow for all of the coprocessor instructions. The following floating-point instructions are not emulated:

<b>FBLD</b>	<b>FLDENV</b>	<b>FSAVE</b>	<b>FSTENV</b>
<b>FBSTP</b>	<b>FNOP</b>	<b>FSAVEW</b>	<b>FUCOM</b>
<b>FCOS</b>	<b>FPREM1</b>	<b>FSAVED</b>	<b>FUCOMP</b>
<b>FDECSTP</b>	<b>FRSTOR</b>	<b>FSETPM</b>	<b>FUCOMPP</b>
<b>FINCSTP</b>	<b>FRSTORW</b>	<b>FSIN</b>	<b>EXTRACT</b>
<b>FINIT</b>	<b>FRSTORD</b>	<b>FSINCOS</b>	

For information about writing assembly-language procedures for high-level languages, see Chapter 12, “Mixed-Language Programming.”

## Using Binary Coded Decimal Numbers

Binary coded decimal (BCD) numbers allow calculations on large numbers without rounding errors. This characteristic makes BCD numbers a common choice for monetary calculations. Although BCDs can represent integers of any precision, the 8087-based coprocessors accommodate BCD numbers only in the range  $\pm 999,999,999,999,999,999$ .

This section explains how to define BCD numbers, how to access them with a math coprocessor or emulator, and how to perform simple BCD calculations on the main processor.

## Defining BCD Constants and Variables

Unpacked BCD numbers are made up of bytes containing a single decimal digit in the lower 4 bits of each byte. Packed BCD numbers are made up of bytes containing two decimal digits: one in the upper 4 bits and one in the lower 4 bits. The leftmost digit holds the sign (0 for positive, 1 for negative).

Packed BCD numbers are encoded in the 8087 coprocessor's packed BCD format. They can be up to 18 digits long, packed two digits per byte. The assembler zero-pads BCDs initialized with fewer than 18 digits. Digit 20 is the sign bit, and digit 19 is reserved.

When you define an integer constant with the **TBYTE** directive and the current radix is decimal (t), the assembler interprets the number as a packed BCD number.

The syntax for specifying packed BCDs is the same as for other integers.

```
pos1    TBYTE    1234567890    ; Encoded as 00000000001234567890h
neg1    TBYTE    -1234567890   ; Encoded as 80000000001234567890h
```

Unpacked BCD numbers are stored one digit to a byte, with the value in the lower 4 bits. They can be defined using the **BYTE** directive. For example, an unpacked BCD number could be defined and initialized as follows:

```
unpackedr    BYTE    1,5,8,2,5,2,9    ; Initialized to 9,252,851
unpackedf    BYTE    9,2,5,2,8,5,1    ; Initialized to 9,252,851
```

As these two lines show, you can arrange digits backward or forward, depending on how you write the calculation routines that handle the numbers.

## BCD Calculations on a Coprocessor

As the previous section explains, BCDs differ from other numbers only in the way a program stores them in memory. Internally, a math coprocessor does not distinguish BCD integers from any other type. The coprocessor can load, calculate, and store packed BCD integers up to 18 digits long.

The coprocessor instruction

```
        fbl d          bcd1
```

pushes the packed BCD number at `bcd1` onto the coprocessor stack. When your code completes calculations on the number, place the result back into memory in BCD format with the instruction

```
        fbstp         bcd1
```

which discards the variable from the stack top.

## BCD Calculations on the Main Processor

The 8086-family of processors can perform simple arithmetic operations on BCD integers, but only one digit at a time. The main processor, like the coprocessor, operates internally on the number's binary value. It requires additional code to translate the binary result back into BCD format.

The main processor provides instructions specifically designed to translate to and from BCD format. These instructions are called "ASCII-adjust" and "decimal-adjust" instructions. They get their names from Intel mnemonics that use the term "ASCII" to refer to unpacked BCD numbers and "decimal" to refer to packed BCD numbers.

### Unpacked BCD Numbers

When a calculation using two one-digit values produces a two-digit result, the instructions **AAA**, **AAS**, **AAM**, and **AAD** place the first digit in AL and the second in AH. If the digit in AL needs to carry to or borrow from the digit in AH, the instructions set the carry and auxiliary carry flags. The four ASCII-adjust instructions for unpacked BCDs are:

Instruction	Description
<b>AAA</b>	Adjusts after an addition operation.
<b>AAS</b>	Adjusts after a subtraction operation.
<b>AAM</b>	Adjusts after a multiplication operation. Always use with <b>MUL</b> , not with <b>IMUL</b> .
<b>AAD</b>	Adjusts before a division operation. Unlike other BCD instructions, <b>AAD</b> converts a BCD value to a binary value before the operation. After the operation, use <b>AAM</b> to adjust the quotient. The remainder is lost. If you need the remainder, save it in another register before adjusting the quotient. Then move it back to AL and adjust if necessary.

For processor arithmetic on unpacked BCD numbers, you must do the 8-bit arithmetic calculations on each digit separately, and assign the result to the AL register. After each operation, use the corresponding BCD instruction to adjust the result. The ASCII-adjust instructions do not take an operand and always work on the value in the AL register.

The following examples show how to use each of these instructions in BCD addition, subtraction, multiplication, and division.

```

; To add 9 and 3 as BCDs:
    mov     ax, 9           ; Load 9
    mov     bx, 3           ; and 3 as unpacked BCDs
    add     al, bl          ; Add 09h and 03h to get 0Ch
    aaa                    ; Adjust 0Ch in AL to 02h,
                          ; increment AH to 01h, set carry
                          ; Result 12 (unpacked BCD in AX)

; To subtract 4 from 13:
    mov     ax, 103h       ; Load 13
    mov     bx, 4           ; and 4 as unpacked BCDs
    sub     al, bl          ; Subtract 4 from 3 to get FFh (-1)
    aas                    ; Adjust 0FFh in AL to 9,
                          ; decrement AH to 0, set carry
                          ; Result 9 (unpacked BCD in AX)

; To multiply 9 times 3:
    mov     ax, 903h       ; Load 9 and 3 as unpacked BCDs
    mul     ah              ; Multiply 9 and 3 to get 1Bh
    aam                    ; Adjust 1Bh in AL
                          ; to get 27 (unpacked BCD in AX)

; To divide 25 by 2:
    mov     ax, 205h       ; Load 25
    mov     bl, 2           ; and 2 as unpacked BCDs
    aad                    ; Adjust 0205h in AX
                          ; to get 19h in AX
    div     bl              ; Divide by 2 to get
                          ; quotient 0Ch in AL
                          ; remainder 1 in AH
    aam                    ; Adjust 0Ch in AL
                          ; to 12 (unpacked BCD in AX)
                          ; (remainder destroyed)

```

If you process multidigit BCD numbers in loops, each digit is processed and adjusted in turn.

## Packed BCD Numbers

Packed BCD numbers are made up of bytes containing two decimal digits: one in the upper 4 bits and one in the lower 4 bits. The 8086-family processors provide instructions for adjusting packed BCD numbers after addition and subtraction. You must write your own routines to adjust for multiplication and division.



For processor calculations on packed BCD numbers, you must do the 8-bit arithmetic calculations on each byte separately, placing the result in the AL register. After each operation, use the corresponding decimal-adjust instruction to adjust the result. The decimal-adjust instructions do not take an operand and always work on the value in the AL register.

The 8086-family processors provide the instructions **DAA** (Decimal Adjust after Addition) and **DAS** (Decimal Adjust after Subtraction) for adjusting packed BCD numbers after addition and subtraction.

These examples use **DAA** and **DAS** to add and subtract BCDs.

```
;To add 88 and 33:
    mov     ax, 8833h    ; Load 88 and 33 as packed BCDs
    add     al, ah      ; Add 88 and 33 to get 0BBh
    daa     ; Adjust 0BBh to 121 (packed BCD:)
                ; 1 in carry and 21 in AL

;To subtract 38 from 83:
    mov     ax, 3883h    ; Load 83 and 38 as packed BCDs
    sub     al, ah      ; Subtract 38 from 83 to get 04Bh
    das     ; Adjust 04Bh to 45 (packed BCD:)
                ; 0 in carry and 45 in AL
```

Unlike the ASCII-adjust instructions, the decimal-adjust instructions never affect AH. The assembler sets the auxiliary carry flag if the digit in the lower 4 bits carries to or borrows from the digit in the upper 4 bits, and it sets the carry flag if the digit in the upper 4 bits needs to carry to or borrow from another byte.

Multidigit BCD numbers are usually processed in loops. Each byte is processed and adjusted in turn.

# Controlling Program Flow

Very few programs execute all lines sequentially from **.STARTUP** to **.EXIT**. Rather, complex program logic and efficiency dictate that you control the flow of your program—jumping from one point to another, repeating an action until a condition is reached, and passing control to and from procedures. This chapter describes various ways for controlling program flow and several features that simplify coding program-control constructs.

The first section covers jumps from one point in the program to another. It explains how MASM 6.1 optimizes both unconditional and conditional jumps under certain circumstances, so that you do not have to specify every attribute. The section also describes instructions you can use to test conditional jumps.

The next section describes loop structures that repeat actions or evaluate conditions. It discusses MASM directives, such as **.WHILE** and **.REPEAT**, that generate appropriate compare, loop, and jump instructions for you, and the **.IF**, **.ELSE**, and **.ELSEIF** directives that generate jump instructions.

The “Procedures” section in this chapter explains how to write an assembly-language procedure. It covers the extended functionality for **PROC**, a **PROTO** directive that lets you write procedure prototypes similar to those used in C, an **INVOKE** directive that automates parameter passing, and options for the stack-frame setup inside procedures.

The last section explains how to pass program control to an interrupt routine.

## Jumps

Jumps are the most direct way to change program control from one location to another. At the processor level, jumps work by changing the value of the IP (Instruction Pointer) register to a target offset and, for far jumps, by changing the CS register to a new segment address. Jump instructions fall into only two categories: conditional and unconditional.

## Unconditional Jumps

The **JMP** instruction transfers control unconditionally to another instruction. **JMP**'s single operand contains the address of the target instruction.

Unconditional jumps skip over code that should not be executed, as shown here:

```
; Handle one case
label1: .
      .
      .
      jmp continue

; Handle second case
label2: .
      .
      .
      jmp continue
      .
      .
      .
continue:
```

The distance of the target from the jump instruction and the size of the operand determine the assembler's encoding of the instruction. The longer the distance, the more bytes the assembler uses to code the instruction. In versions of MASM prior to 6.0, unconditional **NEAR** jumps sometimes generated inefficient code, but MASM can now optimize unconditional jumps.

## Jump Optimizing

The assembler determines the smallest encoding possible for the direct unconditional jump. MASM does not require a distance operator, so you do not have to determine the correct distance of the jump. If you specify a distance, it overrides any assembler optimization. If the specified distance falls short of the target address, the assembler generates an error. If the specified distance is longer than the jump requires, the assembler encodes the given distance and does not optimize it.

The assembler optimizes jumps when the following conditions are met:

- You do not specify **SHORT**, **NEAR**, **FAR**, **NEAR16**, **NEAR32**, **FAR16**, **FAR32**, or **PROC** as the distance of the target.
- The target of the jump is not external and is in the same segment as the jump instruction. If the target is in a different segment (but in the same group), it is treated as though it were external.

If these two conditions are met, MASM uses the instruction, distance, and size of the operand to determine how to optimize the encoding for the jump. No syntax changes are necessary.

---

**Note** This information about jump optimizing also applies to conditional jumps on the 80386/486.

---

## Indirect Operands

An indirect operand provides a pointer to the target address, rather than the address itself. A pointer is a variable that contains an address. The processor distinguishes indirect (pointer) operands from direct (address) operands by the instruction's context.

You can specify the pointer's size with the **WORD**, **DWORD**, or **FWORD** attributes. Default sizes are based on **.MODEL** and the default segment size.

```

jmp    [bx]           ; Uses .MODEL and segment size defaults
jmp    WORD PTR [bx] ; A NEAR16 indirect call

```

If the indirect operand is a register, the jump is always a **NEAR16** jump for a 16-bit register, and **NEAR32** for a 32-bit register:

```

jmp    bx             ; NEAR16 jump
jmp    ebx            ; NEAR32 jump

```

A **DWORD** indirect operand, however, is ambiguous to the assembler.

```

jmp    DWORD PTR [var] ; A NEAR32 jump in a 32-bit segment;
                        ; a FAR16 jump in a 16-bit segment

```

In this case, your code must clear the ambiguity with the **NEAR32** or **FAR16** keywords. The following example shows how to use **TYPEDEF** to define **NEAR32** and **FAR16** pointer types.

```

NFP    TYPEDEF PTR NEAR32
FFP    TYPEDEF PTR FAR16
jmp    NFP PTR [var] ; NEAR32 indirect jump
jmp    FFP PTR [var] ; FAR16 indirect jump

```

You can use an unconditional jump as a form of conditional jump by specifying the address in a register or indirect memory operand. Also, you can use indirect memory operands to construct jump tables that work like C **switch** statements, Pascal **CASE** statements, or Basic **ON GOTO**, **ON GOSUB**, or **SELECT CASE** statements, as shown in the following example.

```

NPVOID TYPEDEF NEAR PTR
.DATA
ctl_tbl NPVOID extended, ; Null key (extended code)
        ctrl_a, ; Address of CONTROL-A key routine
        ctrl_b ; Address of CONTROL-B key routine

.CODE
.
.
.
mov     ah, 8h ; Get a key
int     21h
cbw    ; Stretch AL into AX
mov     bx, ax ; Copy
shl     bx, 1 ; Convert to address
jmp     ctl_tbl[bx] ; Jump to key routine

extended:
mov     ah, 8h ; Get second key of extended key
int     21h
. ; Use another jump table
. ; for extended keys
.
jmp     next

ctrl_a: . ; CONTROL-A code here
.
.
jmp     next

ctrl_b: . ; CONTROL-B code here
.
.
.
jmp     next

.
.
next: . ; Continue

```

In this instance, the indirect memory operands point to addresses of routines for handling different keystrokes.

## Conditional Jumps

The most common way to transfer control in assembly language is to use a conditional jump. This is a two-step process:

1. First test the condition.
2. Then jump if the condition is true or continue if it is false.

All conditional jumps except two (**JCXZ** and **JECXZ**) use the processor flags for their criteria. Thus, any statement that sets or clears a flag can serve as a test basis for a conditional jump. The jump statement can be any one of 30 conditional-jump instructions. A conditional-jump instruction takes a single operand containing the target address. You cannot use a pointer value as a target as you can with unconditional jumps.

## Jumping Based on the CX Register

**JCXZ** and **JECXZ** are special conditional jumps that do not consult the processor flags. Instead, as their names imply, these instructions cause a jump only if the **CX** or **ECX** register is zero. The use of **JCXZ** and **JECXZ** with program loops is covered in the next section, “Loops.”

## Jumping Based on the Processor Flags

The remaining conditional jumps in the processor’s repertoire all depend on the status of the flags register. As the following list shows, several conditional jumps have two or three names—**JE** (Jump if Equal) and **JZ** (Jump if Zero), for example. Shared names assemble to exactly the same machine instruction, so you may choose whichever mnemonic seems more appropriate. Jumps that depend on the status of the flags register include:

Instruction	Jumps if
<b>JC/JB/JNAE</b>	Carry flag is set
<b>JNC/JNB/JAE</b>	Carry flag is clear
<b>JBE/JNA</b>	Either carry or zero flag is set
<b>JA/JNBE</b>	Carry and zero flag are clear
<b>JE/JZ</b>	Zero flag is set
<b>JNE/JNZ</b>	Zero flag is clear
<b>JL/JNGE</b>	Sign flag $\neq$ overflow flag
<b>JGE/JNL</b>	Sign flag = overflow flag
<b>JLE/JNG</b>	Zero flag is set or sign $\neq$ overflow
<b>JG/JNLE</b>	Zero flag is clear and sign = overflow
<b>JS</b>	Sign flag is set
<b>JNS</b>	Sign flag is clear
<b>JO</b>	Overflow flag is set
<b>JNO</b>	Overflow flag is clear
<b>JP/JPE</b>	Parity flag is set (even parity)
<b>JNP/JPO</b>	Parity flag is clear (odd parity)

The last two jumps in the list, **JPE** (Jump if Parity Even) and **JPO** (Jump if Parity Odd), are useful only for communications programs. The processor sets the parity flag if an operation produces a result with an even number of set bits. A communications program can compare the flag against the parity bit received through the serial port to test for transmission errors.

The conditional jumps in the preceding list can follow any instruction that changes the processor flags, as these examples show:

```
; Uses JO to handle overflow condition
    add    ax, bx        ; Add two values
    jo     overflow     ; If value too large, adjust

; Uses JNZ to check for zero as the result of subtraction
    sub    ax, bx        ; Subtract
    mov    cx, Count    ; First, initialize CX
    jnz   skip          ; If the result is not zero, continue
    call  zhandler      ; Else do special case
```

As the second example shows, the jump does not have to immediately follow the instruction that alters the flags. Since **MOV** does not change the flags, it can appear between the **SUB** instruction and the dependent jump.

There are three categories of conditional jumps:

- Comparison of two values
- Individual bit settings in a value
- Whether a value is zero or nonzero

### Jumps Based on Comparison of Two Values

The **CMP** instruction is the most common way to test for conditional jumps. It compares two values without changing either, then sets or clears the processor flags according to the results of the comparison.

Internally, the **CMP** instruction is the same as the **SUB** instruction, except that **CMP** does not change the destination operand. Both set flags according to the result of the subtraction.

You can compare signed or unsigned values, but you must choose the subsequent conditional jump to reflect the correct value type. For example, **JL** (Jump if Less Than) and **JB** (Jump if Below) may seem conceptually similar, but a failure to understand the difference between them can result in program bugs. Table 7.1 shows the correct conditional jumps for comparisons of signed and unsigned values. The table shows the zero, carry, sign, and overflow flags as ZF, CF, SF, and OF, respectively.

**Table 7.1 Conditional Jumps Based on Comparisons of Two Values**

Signed Comparisons		Unsigned Comparisons	
Instruction	Jump if True	Instruction	Jump if True
<b>JE</b>	ZF = 1	<b>JE</b>	ZF = 1
<b>JNE</b>	ZF = 0	<b>JNE</b>	ZF = 0
<b>JG/JNLE</b>	ZF = 0 and SF = OF	<b>JA/JNBE</b>	CF = 0 and ZF = 0
<b>JLE/JNG</b>	ZF = 1 or SF ≠ OF	<b>JBE/JNA</b>	CF = 1 or ZF = 1
<b>JL/JNGE</b>	SF ≠ OF	<b>JB/JNAE</b>	CF = 1
<b>JGE/JNL</b>	SF = OF	<b>JAE/JNB</b>	CF = 0

The mnemonic names of jumps always refer to the comparison of **CMP**'s first operand (destination) with the second operand (source). For instance, in this example, **JG** tests whether the first operand is greater than the second.

```

cmp    ax, bx ; Compare AX and BX
jg     next1  ; Equivalent to: If ( AX > BX ) goto next1
jl     next2  ; Equivalent to: If ( AX < BX ) goto next2

```

### Jumps Based on Bit Settings

The individual bit settings in a single value can also serve as the criteria for a conditional jump. The **TEST** instruction tests whether specific bits in an operand are on or off (set or clear), and sets the zero flag accordingly.



The **TEST** instruction is the same as the **AND** instruction, except that **TEST** changes neither operand. The following example shows an application of **TEST**.

```

        .DATA
bits    BYTE    ?
        .CODE
        .
        .
        .
; If bit 2 or bit 4 is set, then call task_a
        ; Assume "bits" is 0D3h    11010011
        test    bits, 10100y    ; If 2 or 4 is set    AND 00010100
        jz      skip1           ; -----
        call    task_a         ; Then call task_a    00010000
skip1:   ; Jump taken
        .
        .
        .
; If bits 2 and 4 are clear, then call task_b
        ; Assume "bits" is 0E9h    11101001
        test    bits, 10100y    ; If 2 and 4 are clear AND 00010100
        jnz     skip2           ; -----
        call    task_b         ; Then call task_b    00000000
skip2:   ; Jump taken

```

The source operand for **TEST** is often a mask in which the test bits are the only bits set. The destination operand contains the value to be tested. If all the bits set in the mask are clear in the destination operand, **TEST** sets the zero flag. If any of the flags set in the mask are also set in the destination operand, **TEST** clears the zero flag.

The 80386/486 processors provide additional bit-testing instructions. The **BT** (Bit Test) series of instructions copy a specified bit from the destination operand to the carry flag. A **JC** or **JNC** can then route program flow depending on the result. For variations on the **BT** instruction, see the *Reference*.

### Jumps Based on a Value of Zero

A program often needs to jump based on whether a particular register contains a value of zero. We've seen how the **JCXZ** instruction jumps depending on the value in the **CX** register. You can test for zero in other data registers nearly as efficiently with the **OR** instruction. A program can **OR** a register with itself without changing the register's contents, then act on the resulting flags status. For example, the following example tests whether **BX** is zero:

```

        or      bx, bx          ; Is BX = 0?
        jz      is_zero        ; Jump if so

```

This code is functionally equivalent to:

```

cmp    bx, 0           ; Is BX = 0?
je     is_zero        ; Jump if so

```

but produces smaller and faster code, since it does not use an immediate number as an operand. The same technique also lets you test a register's sign bit:

```

or     dx, dx         ; Is DX sign bit set?
js     sign_set       ; Jump if so

```

## Jump Extending

Unlike an unconditional jump, a conditional jump cannot reference a label more than 128 bytes away. For example, the following statement is valid as long as `target` is within a distance of 128 bytes:

```

; Jump to target less than 128 bytes away
jz     target         ; If previous operation resulted
                    ; in zero, jump to target

```

However, if `target` is too distant, the following sequence is necessary to enable a longer jump. Note this sequence is logically equivalent to the preceding example:

```

; Jumps to distant targets previously required two steps
jnz    skip          ; If previous operation result is
                    ; NOT zero, jump to "skip"
jmp    target        ; Otherwise, jump to target
skip:

```

MASM can automate jump-extending for you. If you target a conditional jump to a label farther than 128 bytes away, MASM rewrites the instruction with an unconditional jump, which ensures that the jump can reach its target. If `target` lies within a 128-byte range, the assembler encodes the instruction `jz target` as is. Otherwise, MASM generates two substitute instructions:

```

jne $ + 2 + (length in bytes of the next instruction)
jmp NEAR PTR target

```

The assembler generates this same code sequence if you specify the distance with **NEAR PTR**, **FAR PTR**, or **SHORT**. Therefore,

```

jz     NEAR PTR target

```

becomes

```

jne    $ + 5
jmp    NEAR PTR target

```

even if `target` is less than 128 bytes away.

MASM enables automatic jump expansion by default, but you can turn it off with the **NOLJMP** form of the **OPTION** directive. For information about the **OPTION** directive, see page 24.

If the assembler generates code to extend a conditional jump, it issues a level 3 warning saying that the conditional jump has been lengthened. You can set the warning level to 1 for development and to level 3 for a final optimizing pass to see if you can shorten jumps by reorganizing.

If you specify the distance for the jump and the target is out of range for that distance, a “Jump out of Range” error results.

Since the **JCXZ** and **JECXZ** instructions do not have logical negations, expansion of the jump instruction to handle targets with unspecified distances cannot be performed for those instructions. Therefore, the distance must always be short.

The size and distance of the target operand determines the encoding for conditional or unconditional jumps to externals or targets in different segments. The jump-extending and optimization features do not apply in this case.

---

**Note** Conditional jumps on the 80386 and 80486 processors can be to targets up to 32K away, so jump extension occurs only for targets greater than that distance.

---

## Anonymous Labels

When you code jumps in assembly language, you must invent many label names. One alternative to continually thinking up new label names is to use anonymous labels, which you can use anywhere in your program. But because anonymous labels do not provide meaningful names, they are best used for jumping over only a few lines of code. You should mark major divisions of a program with actual named labels.

Use two at signs (**@@**) followed by a colon (**:**) as an anonymous label. To jump to the nearest preceding anonymous label, use **@B** (back) in the jump instruction's operand field; to jump to the nearest following anonymous label, use **@F** (forward) in the operand field.

The jump in the following example targets an anonymous label:

```

        jge     @F
        .
        .
        .
@@:

```

The items **@B** and **@F** always refer to the nearest occurrences of **@@:**, so there is never any conflict between different anonymous labels.

## Decision Directives

The high-level structures you can use for decision-making are the **.IF**, **.ELSEIF**, and **.ELSE** statements. These directives generate conditional jumps. The expression following the **.IF** directive is evaluated, and if true, the following instructions are executed until the next **.ENDIF**, **.ELSE**, or **.ELSEIF** directive is reached. The **.ELSE** statements execute if the expression is false. Using the **.ELSEIF** directive puts a new expression inside the alternative part of the original **.IF** statement to be evaluated. The syntax is:

```
.IF condition1
statements
[[.ELSEIF condition2
statements]]
[[.ELSE
statements]]
.ENDIF
```

The decision structure

```
.IF    cx == 20
mov     dx, 20
.ELSE
mov     dx, 30
.ENDIF
```

generates this code:

```
0017 83 F9 14      *      .IF  cx == 20
001A 75 05          *          cmp  cx, 014h
001C BA 0014          *          jne  @C0001
                                mov  dx, 20
                                .ELSE
001F EB 03          *          jmp  @C0003
0021                                *@C0001:
0021 BA 001E          *          mov  dx, 30
                                .ENDIF
0024                                *@C0003:
```

# Loops

Loops repeat an action until a termination condition is reached. This condition can be a counter or the result of an expression's evaluation. MASM 6.1 offers many ways to set up loops in your programs. The following list compares MASM loop structures:

Instructions	Action
<b>LOOP</b>	Automatically decrements CX. When CX = 0, the loop ends. The top of the loop cannot be greater than 128 bytes from the <b>LOOP</b> instruction. (This is true for all <b>LOOP</b> instructions.)
<b>LOOPE/LOOPZ,</b> <b>LOOPNE/LOOPNZ</b>	Loops while equal or not equal. Checks both CX and the state of the zero flag. <b>LOOPZ</b> ends when either CX=0 or the zero flag is clear, whichever occurs first. <b>LOOPNZ</b> ends when either CX=0 or the zero flag is set, whichever occurs first. <b>LOOPE</b> and <b>LOOPZ</b> assemble to the same machine instruction, as do <b>LOOPNE</b> and <b>LOOPNZ</b> . Use whichever mnemonic best fits the context of your loop. Set CX to a number out of range if you don't want a count to control the loop.
<b>JCXZ, JECXZ</b>	Branches to a label only if CX = 0 or ECX = 0. Unlike other conditional-jump instructions, which can jump to either a near or a short label under the 80386 or 80486, <b>JCXZ</b> and <b>JECXZ</b> always jump to a short label.
Conditional jumps	Acts only if certain conditions met. Necessary if several conditions must be tested. See "Conditional Jumps," page 164.

The following examples illustrate these loop constructions.

```
; The LOOP instruction: For 200 to 0 do task
      mov     cx, 200           ; Set counter
next:  .                ; Do the task here
      .
      .
      loop   next             ; Do again
                                ; Continue after loop

; The LOOPNE instruction: While AX is not 'Y', do task
      mov     cx, 256          ; Set count too high to interfere
wend:  .                ; But don't do more than 256 times
      .                ; Some statements that change AX
      .
      cmp     al, 'Y'          ; Is it Y or too many times?
      loopne wend             ; No? Repeat
                                ; Yes? Continue
```

The **JCXZ** and **JECXZ** instructions provide an efficient way to avoid executing loops when the loop counter **CX** is empty. For example, consider the following loops:

```

mov     cx, LoopCount           ; Load loop counter
next:   .                       ; Iterate loop CX times
        .
        .
        loop    next           ; Do again

```

If **LoopCount** is zero, **CX** decrements to -1 on the first pass. It then must decrement 65,535 more times before reaching 0. Use a **JCXZ** to avoid this problem:

```

mov     cx, LoopCount           ; Load loop counter
        jcxz   done           ; Skip loop if count is 0
next:   .                       ; Else iterate loop CX times
        .
        .
        loop    next           ; Do again
done:   .                       ; Continue after loop

```

## Loop-Generating Directives

The high-level control structures generate loop structures for you. These directives are similar to the **while** and **repeat** loops of C or Pascal, and can make your assembly programs easier to code and to read. The assembler generates the appropriate assembly code. These directives are summarized as follows:

Directives	Action
<b>.WHILE ... .ENDW</b>	The statements between <b>.WHILE</b> <i>condition</i> and <b>.ENDW</b> execute while the condition is true.
<b>.REPEAT ... .UNTIL</b>	The loop executes at least once and continues until the condition given after <b>.UNTIL</b> is true. Generates conditional jumps.
<b>.REPEAT ... .UNTILCXZ</b>	Compares label to an expression and generates appropriate loop instructions.
<b>.BREAK</b>	End a <b>.REPEAT</b> or a <b>.WHILE</b> loop unconditionally.
<b>.CONTINUE</b>	Jump unconditionally past any remaining code to bottom of loop.

These constructs work much as they do in a high-level language such as C or Pascal. Keep in mind the following points:

- These directives generate appropriate processor instructions. They are not new instructions.
- They require proper use of signed and unsigned data declarations.

These directives cause a set of instructions to execute based on the evaluation of some *condition*. This *condition* can be an expression that evaluates to a signed or unsigned value, an expression using the binary operators in C (&&, ||, or !), or the state of a flag. For more information about expression operators, see page 178.

The evaluation of the *condition* requires the assembler to know if the operands in the condition are signed or unsigned. To state explicitly that a named memory location contains a signed integer, use the signed data allocation directives **SBYTE**, **SWORD**, and **SDWORD**.

## **.WHILE** Loops

As with **while** loops in C or Pascal, the test condition for **.WHILE** is checked before the statements inside the loop execute. If the test condition is false, the loop does not execute. While the condition is true, the statements inside the loop repeat.

Use the **.ENDW** directive to mark the end of the **.WHILE** loop. When the condition becomes false, program execution begins at the first statement following the **.ENDW** directive. The **.WHILE** directive generates appropriate compare and jump statements. The syntax is:

```
.WHILE condition
statements
.ENDW
```

For example, this loop copies the contents of one buffer to another until a '\$' character (marking the end of the string) is found:

```
.DATA
buf1  BYTE "This is a string",'$'
buf2  BYTE 100 DUP (?)
.CODE
sub   bx, bx           ; Zero out bx
.WHILE (buf1[bx] != '$')
mov   al, buf1[bx]    ; Get a character
mov   buf2[bx], al    ; Move it to buffer 2
inc   bx              ; Count forward
.ENDW
```

## .REPEAT Loops

MASM's **.REPEAT** directive allows for loop constructions like the **do** loop of C and the **REPEAT** loop of Pascal. The loop executes until the condition following the **.UNTIL** (or **.UNTILCXZ**) directive becomes true. Since the condition is checked at the end of the loop, the loop always executes at least once. The **.REPEAT** directive generates conditional jumps. The syntax is:

```
.REPEAT  
statements  
.UNTIL condition
```

```
.REPEAT  
statements  
.UNTILCXZ [condition]
```

where *condition* can also be *expr1 == expr2* or *expr1 != expr2*. When two conditions are used, *expr2* can be an immediate expression, a register, or (if *expr1* is a register) a memory location.

For example, the following code fills a buffer with characters typed at the keyboard. The loop ends when the ENTER key (character 13) is pressed:

```
        .DATA  
buffer  BYTE    100 DUP (0)  
        .CODE  
        sub     bx, bx           ; Zero out bx  
        .REPEAT  
        mov    ah, 01h  
        int   21h               ; Get a key  
        mov   buffer[bx], al    ; Put it in the buffer  
        inc   bx                ; Increment the count  
        .UNTIL (al == 13)      ; Continue until al is 13
```



The `.UNTIL` directive generates conditional jumps, but the `.UNTILCXZ` directive generates a `LOOP` instruction, as shown by the listing file code for these examples. In a listing file, assembler-generated code is preceded by an asterisk.

```
ASSUME  bx:PTR SomeStruct

        .REPEAT
*@C0001:
        inc    ax
        .UNTIL ax==6
*        cmp    ax, 006h
*        jne    @C0001
.REPEAT
*@C0003:
        mov    ax, 1
        .UNTILCXZ
*        loop   @C0003

        .REPEAT
*@C0004:
        .UNTILCXZ [bx].field != 6
*        cmp    [bx].field, 006h
*        loope  @C0004
```

## **.BREAK and .CONTINUE Directives**

The `.BREAK` and `.CONTINUE` directives terminate a `.REPEAT` or `.WHILE` loop prematurely. These directives allow an optional `.IF` clause for conditional breaks. The syntax is:

**.BREAK** [`.IF` *condition*]

**.CONTINUE** [`.IF` *condition*]

Note that `.ENDIF` is not used with the `.IF` forms of `.BREAK` and `.CONTINUE` in this context. The `.BREAK` and `.CONTINUE` directives work the same way as the `break` and `continue` instructions in C. Execution continues at the instruction following the `.UNTIL`, `.UNTILCXZ`, or `.ENDW` of the nearest enclosing loop.

Instead of ending the loop execution as `.BREAK` does, `.CONTINUE` causes loop execution to jump directly to the code that evaluates the loop condition of the nearest enclosing loop.

The following loop accepts only the keys in the range '0' to '9' and terminates when you press ENTER.

```

.WHILE 1                ; Loop forever
mov     ah, 08h         ; Get key without echo
int     21h
.BREAK .IF al == 13    ; If ENTER, break out of the loop
.CONTINUE .IF (al < '0') || (al > '9')
                    ; If not a digit, continue looping
mov     dl, al         ; Save the character for processing
mov     ah, 02h         ; Output the character
int     21h
.ENDW

```

If you assemble the preceding source code with the /Fl and /Sg command-line options and then view the results in the listing file, you will see this code:

```

                                .WHILE 1
0017                                *@C0001:
0017 B4 08                        mov     ah, 08h
0019 CD 21                        int     21h
                                .BREAK .IF al == 13
001B 3C 0D                        *      cmp     al, 00Dh
001D 74 10                        *      je     @C0002
                                .CONTINUE .IF (al < '0') || (al > '9')
001F 3C 30                        *      cmp     al, '0'
0021 72 F4                        *      jb     @C0001
0023 3C 39                        *      cmp     al, '9'
0025 77 F0                        *      ja     @C0001
0027 8A D0                        mov     dl, al
0029 B4 02                        mov     ah, 02h
002B CD 21                        int     21h
                                .ENDW
002D EB E8                        *      jmp     @C0001
002F                                *@C0002:

```

The high-level control structures can be nested. That is, **.REPEAT** or **.WHILE** loops can contain **.REPEAT** or **.WHILE** loops as well as **.IF** statements.

If the code generated by a **.WHILE** loop, **.REPEAT** loop, or **.IF** statement generates a conditional or unconditional jump, MASM encodes the jump using the jump extension and jump optimization techniques described in “Unconditional Jumps,” page 162, and “Conditional Jumps,” page 164.

## Writing Loop Conditions

You can express the conditions of the **.IF**, **.REPEAT**, and **.WHILE** directives using relational operators, and you can express the attributes of the operand with the **PTR** operator. To write loop conditions, you also need to know how the assembler evaluates the operators and operands in the condition. This section explains the operators, attributes, precedence level, and expression evaluation order for the conditions used with loop-generating directives.

### Expression Operators

The binary relational operators in MASM 6.1 are the same binary operators used in C. These operators generate MASM compare, test, and conditional jump instructions. High-level control instructions include:

Operator	Meaning
==	Equal
!=	Not equal
>	Greater than
>=	Greater than or equal to
<	Less than
<=	Less than or equal to
&	Bit test
!	Logical NOT
&&	Logical AND
	Logical OR

A condition without operators (other than **!**) tests for nonzero as it does in C. For example, **.WHILE (x)** is the same as **.WHILE (x != 0)**, and **.WHILE (!x)** is the same as **.WHILE (x == 0)**.

You can also use the flag names (**ZERO?**, **CARRY?**, **OVERFLOW?**, **SIGN?**, and **PARITY?**) as operands in conditions with the high-level control structures. For example, in **.WHILE (CARRY?)**, the value of the carry flag determines the outcome of the condition.

### Signed and Unsigned Operands

Expression operators generate unsigned jumps by default. However, if either side of the operation is signed, the assembler considers the entire operation signed.

You can use the **PTR** operator to tell the assembler that a particular operand in a register or constant is a signed number, as in these examples:

```
.WHILE SWORD PTR [bx] <= 0
      .IF SWORD PTR mem1 > 0
```

Without the **PTR** operator, the assembler would treat the contents of **BX** as an unsigned value.

You can also specify the size attributes of operands in memory locations with **SBYTE**, **WORD**, and **SDWORD**, for use with **.IF**, **.WHILE**, and **.REPEAT**.

```
.DATA
mem1 SBYTE ?
mem2 WORD ?
      .IF mem1 > 0
      .WHILE mem2 < bx
      .WHILE SWORD PTR ax < count
```

## Precedence Level

As with C, you can concatenate conditions with the **&&** operator for AND, the **||** operator for OR, and the **!** operator for negate. The precedence level is **!**, **&&**, and **||**, with **!** having the highest priority. Like expressions in high-level languages, precedence is evaluated left to right.

## Expression Evaluation

The assembler evaluates conditions created with high-level control structures according to short-circuit evaluation. If the evaluation of a particular condition automatically determines the final result (such as a condition that evaluates to false in a compound statement concatenated with **AND**), the evaluation does not continue.

For example, in this **.WHILE** statement,

```
.WHILE (ax > 0) && (WORD PTR [bx] == 0)
```

the assembler evaluates the first condition. If this condition is false (that is, if **AX** is less than or equal to 0), the evaluation is finished. The second condition is not checked and the loop does not execute, because a compound condition containing **&&** requires both expressions to be true for the entire condition to be true.

## Procedures

Organizing your code into procedures that execute specific tasks divides large programs into manageable units, allows for separate testing, and makes code more efficient for repetitive tasks.

Assembly-language procedures are similar to functions, subroutines, and procedures in high-level languages such as C, FORTRAN, and Pascal. Two instructions control the use of assembly-language procedures. **CALL** pushes the return address onto the stack and transfers control to a procedure, and **RET** pops the return address off the stack and returns control to that location.

The **PROC** and **ENDP** directives mark the beginning and end of a procedure. Additionally, **PROC** can automatically:

- Preserve register values that should not change but that the procedure might otherwise alter.
- Set up a local stack pointer, so that you can access parameters and local variables placed on the stack.
- Adjust the stack when the procedure ends.

## Defining Procedures

Procedures require a label at the start of the procedure and a **RET** instruction at the end. Procedures are normally defined by using the **PROC** directive at the start of the procedure and the **ENDP** directive at the end. The **RET** instruction normally is placed immediately before the **ENDP** directive. The assembler makes sure the distance of the **RET** instruction matches the distance defined by the **PROC** directive. The basic syntax for **PROC** is:

```
label PROC [[NEAR | FAR]]
```

```
.
```

```
.
```

```
.
```

```
RET [[constant]]
```

```
label ENDP
```

The **CALL** instruction pushes the address of the next instruction in your code onto the stack and passes control to a specified address. The syntax is:

```
CALL {label | register | memory}
```

The operand contains a value calculated at run time. Since that operand can be a register, direct memory operand, or indirect memory operand, you can write call tables similar to the example code on page 164.

Calls can be near or far. Near calls push only the offset portion of the calling address and therefore must target a procedure within the same segment or group. You can specify the type for the target operand. If you do not, MASM uses the declared distance (**NEAR** or **FAR**) for operands that are labels and for the size of register or memory operands. The assembler then encodes the call appropriately, as it does with unconditional jumps. (See previous “Unconditional Jumps” and “Conditional Jumps.”)

MASM optimizes a call to a far non-external label when the label is in the current segment by generating the code for a near call, saving one byte.

You can define procedures without **PROC** and **ENDP**, but if you do, you must make sure that the size of the **CALL** matches the size of the **RET**. You can specify the **RET** instruction as **RETN** (Return Near) or **RETF** (Return Far) to override the default size:

```

        call    NEAR PTR task    ; Call is declared near
        .
        .
        .
task:
        .
        .
        .
        retn   ; Return declared near

```

The syntax for **RETN** and **RETF** is:

```

label: | label LABEL NEAR
statements
RETN [constant]

```

```

label LABEL FAR
statements
RETF [constant]

```

The **RET** instruction (and its **RETF** and **RETN** variations) allows an optional constant operand that specifies a number of bytes to be added to the value of the SP register after the return. This operand adjusts for arguments passed to the procedure before the call, as shown in the example in “Using Local Variables,” following.

When you define procedures without **PROC** and **ENDP**, you must make sure that calls have the same size as corresponding returns. For example, **RETF** pops two words off the stack. If a **NEAR** call is made to a procedure with a far return, the popped value is meaningless, and the stack status may cause the execution to return to a random memory location, resulting in program failure.



Figure 7.1 shows the stack condition at key points in the process.

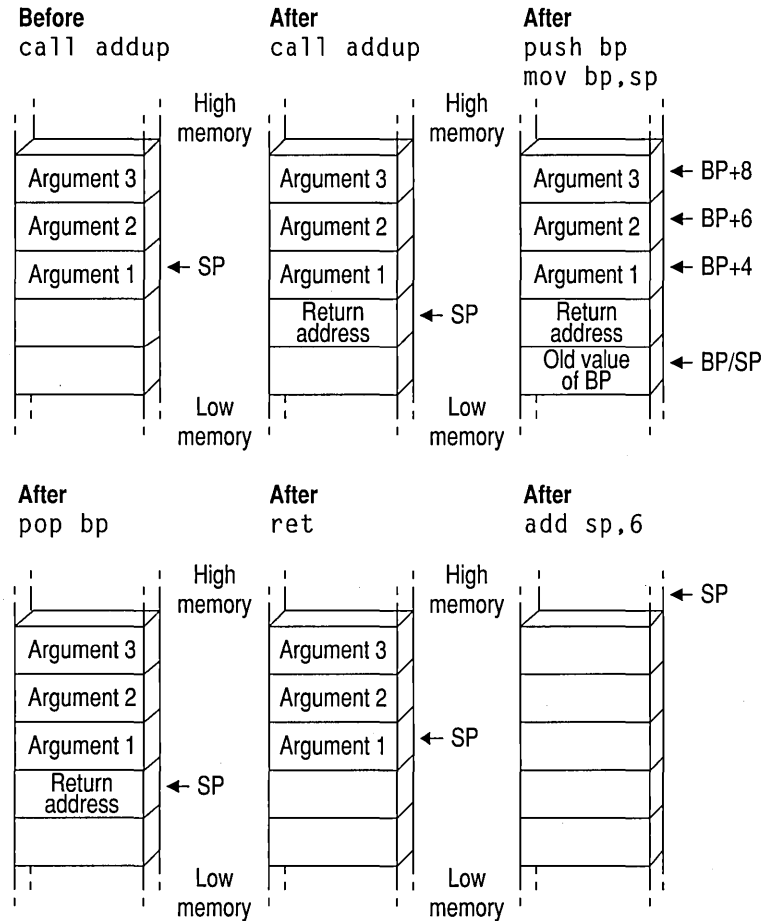

Figure 7.1 Procedure Arguments on the Stack

Starting with the 80186 processor, the **ENTER** and **LEAVE** instructions simplify the stack setup and restore instructions at the beginning and end of procedures. However, **ENTER** uses a lot of time. It is necessary only with nested, statically-scoped procedures. Thus, a Pascal compiler may sometimes generate **ENTER**. The **LEAVE** instruction, on the other hand, is an efficient way to do the stack cleanup. **LEAVE** reverses the effect of the last **ENTER** instruction by restoring BP and SP to their values before the procedure call.





## Attributes

The syntax for the attributes field is:

```
[[distance]] [[langtype]] [[visibility]] [[<prologuearg>]]
```

The explanations for these options include:

Argument	Description
<i>distance</i>	Controls the form of the <b>RET</b> instruction generated. Can be <b>NEAR</b> or <b>FAR</b> . If <i>distance</i> is not specified, it is determined from the model declared with the <b>.MODEL</b> directive. <b>NEAR</b> distance is assumed for <b>TINY</b> , <b>SMALL</b> , <b>COMPACT</b> , and <b>FLAT</b> . The assembler assumes <b>FAR</b> distance for <b>MEDIUM</b> , <b>LARGE</b> , and <b>HUGE</b> . For 80386/486 programming with 16- and 32-bit segments, you can specify <b>NEAR16</b> , <b>NEAR32</b> , <b>FAR16</b> , or <b>FAR32</b> .
<i>langtype</i>	Determines the calling convention used to access parameters and restore the stack. The <b>BASIC</b> , <b>FORTRAN</b> , and <b>PASCAL</b> <i>langtypes</i> convert procedure names to uppercase, place the last parameter in the parameter list lowest on the stack, and generate a <b>RET num</b> instruction to end the procedure. The <b>RET</b> adjusts the stack upward by <i>num</i> , which represents the number of bytes in the argument list. This step, called “cleaning the stack,” returns the stack pointer <b>SP</b> to the value it had before the caller pushed any arguments.  The <b>C</b> and <b>STDCALL</b> <i>langtype</i> prefixes an underscore to the procedure name when the procedure’s scope is <b>PUBLIC</b> or <b>EXPORT</b> and places the first parameter lowest on the stack. <b>SYSCALL</b> is equivalent to the <b>C</b> calling convention with no underscore prefixed to the procedure’s name. <b>STDCALL</b> uses caller stack cleanup when <b>:VARARG</b> is specified; otherwise the called routine must clean up the stack (see Chapter 12).
<i>visibility</i>	Indicates whether the procedure is available to other modules. The <i>visibility</i> can be <b>PRIVATE</b> , <b>PUBLIC</b> , or <b>EXPORT</b> . A procedure name is <b>PUBLIC</b> unless it is explicitly declared as <b>PRIVATE</b> . If the <i>visibility</i> is <b>EXPORT</b> , the linker places the procedure’s name in the export table for segmented executables. <b>EXPORT</b> also enables <b>PUBLIC</b> visibility.  You can explicitly set the default <i>visibility</i> with the <b>OPTION</b> directive. <b>OPTION PROC:PUBLIC</b> sets the default to public. For more information, see Chapter 1, “Using the Option Directive.”
<i>prologuearg</i>	Specifies the arguments that affect the generation of prologue and epilogue code (the code <b>MASM</b> generates when it encounters a <b>PROC</b> directive or the end of a procedure). For an explanation of prologue and epilogue code, see “Generating Prologue and Epilogue Code,” later in this chapter.

## Parameters

The comma that separates *parameters* from *reglist* is optional, if both fields appear on the same line. If *parameters* appears on a separate line, you must end the *reglist* field with a comma. In the syntax:

*parmname* `[[:tag]`

*parmname* is the name of the parameter. The *tag* can be the *qualifiedtype* or the keyword **VARARG**. However, only the last parameter in a list of parameters can use the **VARARG** keyword. The *qualifiedtype* is discussed in “Data Types,” Chapter 1. An example showing how to reference **VARARG** parameters appears later in this section. You can nest procedures if they do not have parameters or **USES** register lists. This diagram shows a procedure definition with one parameter definition.

```

myproc PROC FAR C PUBLIC USES di si, var1:WORD, arg1:VARARG

```

The procedure presented in “Passing Arguments on the Stack,” page 182, is here rewritten using the extended **PROC** functionality. Prior to the procedure call, you must push the arguments onto the stack unless you use **INVOKE**. (See “Calling Procedures with **INVOKE**,” later in this chapter.)

```

addup  PROC NEAR C,
        arg1:WORD, arg2:WORD, count:WORD
        mov     ax, arg1
        add     ax, count
        add     ax, arg2
        ret
addup  ENDP

```

If the arguments for a procedure are pointers, the assembler does not generate any code to get the value or values that the pointers reference; your program must still explicitly treat the argument as a pointer. (For more information about using pointers, see Chapter 3, “Using Addresses and Pointers.”)

In the following example, even though the procedure declares the parameters as near pointers, you must code two **MOV** instructions to get the values of the parameters. The first **MOV** gets the address of the parameters, and the second **MOV** gets the parameter.

```
; Call from C as a FUNCTION returning an integer

        .MODEL medium, c
        .CODE
myadd PROC  arg1:NEAR PTR WORD, arg2:NEAR PTR WORD

        mov     bx, arg1      ; Load first argument
        mov     ax, [bx]
        mov     bx, arg2      ; Add second argument
        add     ax, [bx]

        ret

myadd  ENDP
```

You can use conditional-assembly directives to make sure your pointer parameters are loaded correctly for the memory model. For example, the following version of `myadd` treats the parameters as **FAR** parameters, if necessary.

```
        .MODEL medium, c      ; Could be any model
        .CODE
myadd PROC  arg1:PTR WORD,    arg2:PTR WORD

        IF      @DataSize
        les     bx, arg1      ; Far parameters
        mov     ax, es:[bx]
        les     bx, arg2
        add     ax, es:[bx]
        ELSE
        mov     bx, arg1      ; Near parameters
        mov     ax, [bx]
        mov     bx, arg2
        add     ax, [bx]
        ENDIF

        ret

myadd  ENDP
```

## Using VARARG

In the **PROC** statement, you can append the **:VARARG** keyword to the last parameter to indicate that the procedure accepts a variable number of arguments. However, **:VARARG** applies only to the **C**, **SYSCALL**, or **STDCALL** calling conventions (see Chapter 12). A symbol must precede **:VARARG** so the procedure can access arguments as offsets from the given variable name, as this example illustrates:

```

addup3  PROTO NEAR C, argcount:WORD, arg1:VARARG

        invoke  addup3, 3, 5, 2, 4

addup3  PROC    NEAR C, argcount:WORD, arg1:VARARG
sub     ax, ax      ; Clear work register
sub     si, si

        .WHILE  argcount > 0 ; Argcount has number of arguments
add     ax, arg1[si] ; Arg1 has the first argument
dec     argcount    ; Point to next argument
inc     si
inc     si
        .ENDW

        ret                                ; Total is in AX
addup3  ENDP

```

You can pass non-default-sized pointers in the **VARARG** portion of the parameter list by separately passing the segment portion and the offset portion of the address.

---

**Note** When you use the extended **PROC** features and the assembler encounters a **RET** instruction, it automatically generates instructions to pop saved registers, remove local variables from the stack, and, if necessary, remove parameters. It generates this code for each **RET** instruction it encounters. You can reduce code size by having only one return and jumping to it from various locations.

---

## Using Local Variables

In high-level languages, local variables are visible only within a procedure. In Microsoft languages, these variables are usually stored on the stack. In assembly-language programs, you can also have local variables. These variables should not be confused with labels or variable names that are local to a module, as described in Chapter 8, "Sharing Data and Procedures Among Modules and Libraries."

This section outlines the standard methods for creating local variables. The next section shows how to use the **LOCAL** directive to make the assembler

automatically generate local variables. When you use this directive, the assembler generates the same instructions as those demonstrated in this section but handles some of the details for you.

If your procedure has relatively few variables, you can usually write the most efficient code by placing these values in registers. Use local (stack) data when you have a large amount of temporary data for the procedure.

To use a local variable, you must save stack space for it at the start of the procedure. A procedure can then reference the variable by its position in the stack. At the end of the procedure, you must clean the stack by restoring the stack pointer. This effectively throws away all local variables and regains the stack space they occupied.

This example subtracts 2 bytes from the SP register to make room for a local word variable, then accesses the variable as [bp-2].

```

        push    ax                ; Push one argument
        call   task              ; Call
        .
        .
        .
task    PROC    NEAR
        push   bp                ; Save base pointer
        mov   bp, sp            ; Load stack into base pointer
        sub   sp, 2             ; Save two bytes for local variable
        .
        .
        .
        mov   WORD PTR [bp-2], 3 ; Initialize local variable
        add   ax, [bp-2]        ; Add local variable to AX
        sub   [bp+4], ax        ; Subtract local from argument
        .                       ; Use [bp-2] and [bp+4] in
        .                       ; other operations
        .
        mov   sp, bp            ; Clear local variables
        pop   bp                ; Restore base
        ret   2                 ; Return result in AX and pop
task    ENDP                    ; two bytes to clear parameter

```

Notice the instruction `mov sp, bp` at the end of the procedure restores the original value of SP. The statement is required only if the value of SP changes inside the procedure (usually by allocating local variables). The argument passed to the procedure is removed with the **RET** instruction. Contrast this to the example in “Passing Arguments on the Stack,” page 182, in which the calling code adjusts the stack for the argument.

Figure 7.2 shows the stack at key points in the process.

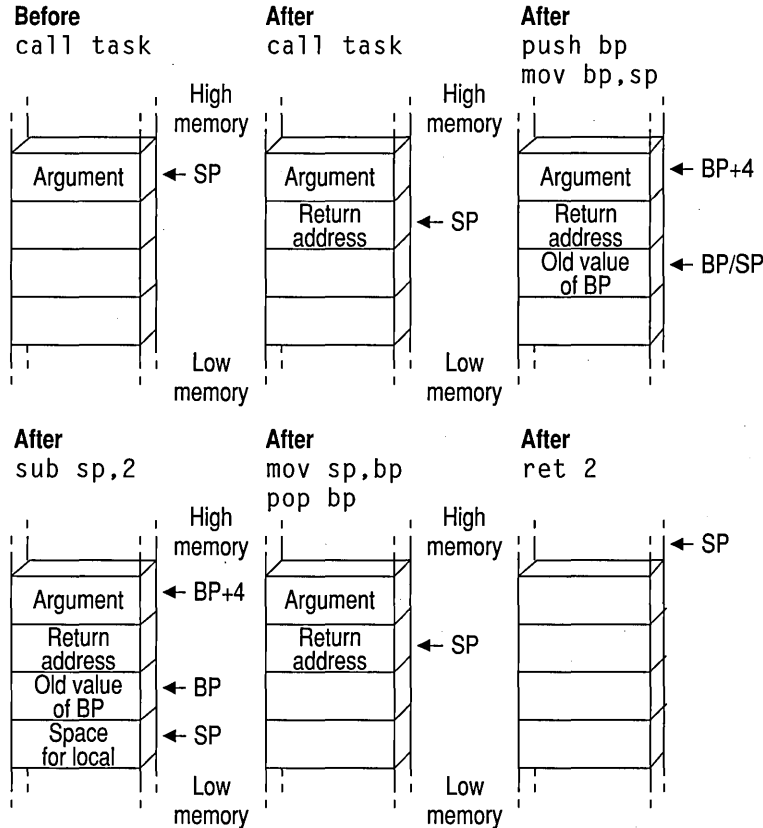

Figure 7.2 Local Variables on the Stack

## Creating Local Variables Automatically

MASM's **LOCAL** directive automates the process for creating local variables on the stack. **LOCAL** frees you from having to count stack words, and it makes your code easier to write and maintain. This section illustrates the advantages of creating temporary data with the **LOCAL** directive.

To use the **LOCAL** directive, list the variables you want to create, giving a type for each one. The assembler calculates how much space is required on the stack. It also generates instructions to properly decrement **SP** (as described in the previous section) and to reset **SP** when you return from the procedure.

When you create local variables this way, your source code can refer to each local variable by name rather than as an offset of the stack pointer. Moreover, the

assembler generates debugging information for each local variable. If you have programmed before in a high-level language that allows scoping, local variables will seem familiar. For example, a C compiler sets up variables with automatic storage class in the same way as the **LOCAL** directive.

We can simplify the procedure in the previous section with the following code:

```
task   PROC    NEAR    arg:WORD
        LOCAL  loc:WORD
        .
        .
        .
        mov    loc, 3      ; Initialize local variable
        add    ax, loc     ; Add local variable to AX
        sub    arg, ax     ; Subtract local from argument
        .                ; Use "loc" and "arg" in other operations
        .
        .
        ret
task   ENDP
```

The **LOCAL** directive must be on the line immediately following the **PROC** statement with the following syntax:

**LOCAL** *vardef* [[, *vardef*]]...

Each *vardef* defines a local variable. A local variable definition has this form:

*label*[[*count*]][[*:qualifiedtype*]]

These are the parameters in local variable definitions:

Argument	Description
<i>label</i>	The name given to the local variable. You can use this name to access the variable.
<i>count</i>	The number of elements of this name and type to allocate on the stack. You can allocate a simple array on the stack with <i>count</i> . The brackets around <i>count</i> are required. If this field is omitted, one data object is assumed.
<i>qualifiedtype</i>	A simple MASM type or a type defined with other types and attributes. For more information, see “Data Types” in Chapter 1.

If the number of local variables exceeds one line, you can place a comma at the end of the first line and continue the list on the next line. Alternatively, you can use several consecutive **LOCAL** directives.



The assembler does not initialize local variables. Your program must include code to perform any necessary initializations. For example, the following code fragment sets up a local array and initializes it to zero:

```
arraysz EQU    20

aproc  PROC    USES di
        LOCAL  var1[arraysz]:WORD, var2:WORD
        .
        .
        .
; Initialize local array to zero
        push  ss
        pop   es           ; Set ES=SS
        lea  di, var1      ; ES:DI now points to array
        mov  cx, arraysz   ; Load count
        sub  ax, ax
        rep  stosw        ; Store zeros
; Use the array...
        .
        .
        .
        ret
aproc  ENDP
```

Even though you can reference stack variables by name, the assembler treats them as offsets of BP, and they are not visible outside the procedure. In the following procedure, `array` is a local variable.

```
index  EQU    10
test   PROC   NEAR
LOCAL  array[index]:WORD
        .
        .
        .
        mov  bx, index
;       mov  array[bx], 5           ; Not legal!
```

The second **MOV** statement may appear to be legal, but since `array` is an offset of BP, this statement is the same as

```
;       mov [bp + bx + arrayoffset], 5 ; Not legal!
```

BP and BX can be added only to SI and DI. This example would be legal, however, if the `index` value were moved to SI or DI. This type of error in your program can be difficult to find unless you keep in mind that local variables in procedures are offsets of BP.

## Declaring Procedure Prototypes

MASM provides the **INVOKE** directive to handle many of the details important to procedure calls, such as pushing parameters according to the correct calling conventions. To use **INVOKE**, the procedure called must have been declared previously with a **PROC** statement, an **EXTERNDEF** (or **EXTERN**) statement, or a **TYPDEF**. You can also place a prototype defined with **PROTO** before the **INVOKE** if the procedure type does not appear before the **INVOKE**. Procedure prototypes defined with **PROTO** inform the assembler of types and numbers of arguments so the assembler can check for errors and provide automatic conversions when **INVOKE** calls the procedure.

Declaring procedure prototypes is good programming practice, but is optional. Prototypes in MASM perform the same function as prototypes in C and other high-level languages. A procedure prototype includes the procedure name, the types, and (optionally) the names of all parameters the procedure expects. Prototypes usually are placed at the beginning of an assembly program or in a separate include file so the assembler encounters the prototype before the actual procedure.

Prototypes enable the assembler to check for unmatched parameters and are especially useful for procedures called from other modules and other languages. If you write routines for a library, you may want to put prototypes into an include file for all the procedures used in that library. For more information about using include files, see Chapter 8, “Sharing Data and Procedures among Modules and Libraries.”

The **PROTO** directive provides one way to define a procedure prototype. The syntax for a prototype definition is the same as for a procedure declaration (see “Declaring Parameters with the **PROC** Directive,” earlier in this chapter), except that you do not include the list of registers, *prologuearg* list, or the scope of the procedure.

Also, the **PROTO** keyword precedes the *langtype* and *distance* attributes. The attributes (like **C** and **FAR**) are optional. However, if they are not specified, the defaults are based on any **.MODEL** or **OPTION LANGUAGE** statement. The names of the parameters are also optional, but you must list parameter types. A label preceding **:VARARG** is also optional in the prototype but not in the **PROC** statement.

If a **PROTO** and a **PROC** for the same function appear in the same module, they must match in attribute, number of parameters, and parameter types. The easiest way to create prototypes with **PROTO** is to write your procedure and then copy the first line (the line that contains the **PROC** keyword) to a location in your program that follows the data declarations. Change **PROC** to **PROTO** and remove the **USES reglist**, the *prologuearg* field, and the *visibility* field. It is important that the prototype follow the declarations for any types used in it to avoid any forward references used by the parameters in the prototype.

The following example illustrates how to define and then declare two typical procedures. In both prototype and declaration, the comma before the argument list is optional only when the list does not appear on a separate line:

```

; Procedure prototypes.

addup      PROTO NEAR C argcount:WORD, arg2:WORD, arg3:WORD
myproc     PROTO FAR C, argcount:WORD, arg2:VARARG

; Procedure declarations

addup      PROC NEAR C, argcount:WORD, arg2:WORD, arg3:WORD
.
.
.
myproc     PROC FAR C PUBLIC <callcount> USES di si,
           argcount:WORD,
           arg2:VARARG

```

When you call a procedure with **INVOKE**, the assembler checks the arguments given by **INVOKE** against the parameters expected by the procedure. If the data types of the arguments do not match, **MASM** reports an error or converts the type to the expected type. These conversions are explained in the next section.

## Calling Procedures with **INVOKE**

**INVOKE** generates a sequence of instructions that push arguments and call a procedure. This helps maintain code if arguments or *langtype* for a procedure are changed. **INVOKE** generates procedure calls and automatically:

- Converts arguments to the expected types.
- Pushes arguments on the stack in the correct order.
- Cleans the stack when the procedure returns.

If arguments do not match in number or if the type is not one the assembler can convert, an error results.

If the procedure uses **VARARG**, **INVOKE** can pass a number of arguments different from the number in the parameter list without generating an error or warning. Any additional arguments must be at the end of the **INVOKE** argument list. All other arguments must match those in the prototype parameter list.

The syntax for **INVOKE** is:

**INVOKE** *expression* [[, *arguments*]]

where *expression* can be the procedure's label or an indirect reference to a procedure, and *arguments* can be an expression, a register pair, or an expression preceded with **ADDR**. (The **ADDR** operator is discussed later in this chapter.)

Procedures with these prototypes

```
addup   PROTO NEAR C argcount:WORD, arg2:WORD, arg3:WORD
myproc  PROTO FAR C, argcount:WORD, arg2:VARARG
```

and these procedure declarations

```
addup   PROC NEAR C, argcount:WORD, arg2:WORD, arg3:WORD
.
.
.
myproc  PROC FAR C PUBLIC <callcount> USES di si,
        argcount:WORD,
        arg2:VARARG
```

can be called with **INVOKE** statements like this:

```
INVOKE addup, ax, x, y
INVOKE myproc, bx, cx, 100, 10
```

The assembler can convert some arguments and parameter type combinations so that the correct type can be passed. The signed or unsigned qualities of the arguments in the **INVOKE** statements determine how the assembler converts them to the types expected by the procedure.

The `addup` procedure, for example, expects parameters of type **WORD**, but the arguments passed by **INVOKE** to the `addup` procedure can be any of these types:

- **BYTE**, **SBYTE**, **WORD**, or **WORD**
- An expression whose type is specified with the **PTR** operator to be one of those types
- An 8-bit or 16-bit register
- An immediate expression in the range  $-32\text{K}$  to  $+64\text{K}$
- A **NEAR PTR**

If the type is smaller than that expected by the procedure, MASM widens the argument to match.

## Widening Arguments

For **INVOKE** to correctly handle type conversions, you must use the signed data types for any signed assignments. MASM widens an argument to match the type expected by a procedure's parameters in these cases:

Type Passed	Type Expected
<b>BYTE, SBYTE</b>	<b>WORD, SWORD, DWORD, SDWORD</b>
<b>WORD, SWORD</b>	<b>DWORD, SDWORD</b>

The assembler can extend a segment if far data is expected, and it can convert the type given in the list to the types expected. If the assembler cannot convert the type, however, it generates an error.

## Detecting Errors

If the assembler needs to widen an argument, it first copies the value to **AL** or **AX**. It widens an unsigned value by placing a zero in the higher register area, and widens a signed value with a **CBW**, **CWD**, or **CWDE** instruction as required. Similarly, the assembler copies a constant argument value into **AL** or **AX** when the **.8086** directive is in effect. You can see these generated instructions in the listing file when you include the **/Sg** command-line option.

Using the accumulator register to widen or copy an argument may lead to an error if you attempt to pass **AX** as another argument. For example, consider the following **INVOKE** statement for a procedure with the **C** calling convention

```
INVOKE myprocA, ax, cx, 100, arg
```

where **arg** is a **BYTE** variable and **myproc** expects four arguments of type **WORD**. The assembler widens and then pushes **arg** like this:

```
mov    al, DGROUP:arg
xor    ah, ah
push  ax
```

The generated code thus overwrites the last argument (**AX**) passed to the procedure. The assembler generates an error in this case, requiring you to rewrite the **INVOKE** statement.

To summarize, the **INVOKE** directive overwrites **AX** and perhaps **DX** when widening arguments. It also uses **AX** to push constants on the 8088 and 8086. If you use these registers (or **EAX** and **EDX** on an 80386/486) to pass arguments, they may be overwritten. The assembler's error detection prevents this from ever becoming a run-time bug, but **AX** and **DX** should remain your last choice for holding arguments.

## Invoking Far Addresses

You can pass a **FAR** pointer in a *segment::offset* pair, as shown in the following. Note the use of double colons to separate the register pair. The registers could be any other register pair, including a pair that an MS-DOS call uses to return values.

```
FPWORD  TYPEDEF FAR PTR WORD
SomeProc PROTO var1:DWORD, var2:WORD, var3:WORD

        pfaritem    FPWORD·    faritem
        .
        .
        .
        les         bx, pfaritem
        INVOKE     SomeProc, ES::BX, arg1, arg2
```

However, **INVOKE** cannot combine into a single address one argument for the segment and one for the offset.

## Passing an Address

You can use the **ADDR** operator to pass the address of an expression to a procedure that expects a **NEAR** or **FAR** pointer. This example generates code to pass a far pointer (to `arg1`) to the procedure `proc1`.

```
PBYTE  TYPEDEF FAR PTR BYTE
arg1   BYTE    "This is a string"
proc1  PROTO   NEAR C fparg:PBYTE

        .
        .
        .
        INVOKE  proc1, ADDR arg1
```

For information on defining pointers with **TYPEDEF**, see “Defining Pointer Types with **TYPEDEF**” in Chapter 3.

## Invoking Procedures Indirectly

You can make an indirect procedure call such as `call [bx + si]` by using a pointer to a function prototype with **TYPEDEF**, as shown in this example:

```

FUNCPROTO      TYPEDEF PROTO NEAR ARG1:WORD
FUNCPTR        TYPEDEF PTR  FUNCPROTO

        .DATA
pfunc    FUNCPTR OFFSET proc1, OFFSET proc2

        .CODE
        .
        .
        .
        mov     bx, OFFSET pfunc           ; BX points to table
        mov     si, Num                   ; Num contains 0 or 2
        INVOKE  FUNCPTR PTR [bx+si], arg1 ; Call proc1 if Num=0
                                                ; or proc2 if Num=2

```

You can also use **ASSUME** to accomplish the same task. The following **ASSUME** statement associates the type **FUNCPTR** with the **BX** register.

```

ASSUME  BX:FUNCPTR
mov     bx, OFFSET pfunc
mov     si, Num
INVOKE [bx+si], arg1

```

## Checking the Code Generated

Code generated by the **INVOKE** directive may vary depending on the processor mode and calling conventions in effect. You can check your listing files to see the code generated by the **INVOKE** directive if you use the **/Sg** command-line option.

## Generating Prologue and Epilogue Code

When you use the **PROC** directive with its extended syntax and argument list, the assembler automatically generates the prologue and epilogue code in your procedure. “Prologue code” is generated at the start of the procedure. It sets up a stack pointer so you can access parameters from within the procedure. It also saves space on the stack for local variables, initializes registers such as **DS**, and pushes registers that the procedure uses. Similarly, “epilogue code” is the code at the end of the procedure that pops registers and returns from the procedure.

The assembler automatically generates the prologue code when it encounters the first instruction or label after the **PROC** directive. This means you cannot label the prologue for the purpose of jumping to it. The assembler generates the epilogue code when it encounters a **RET** or **IRET** instruction. Using the assembler-generated prologue and epilogue code saves time and decreases the number of repetitive lines of code in your procedures.

The generated prologue or epilogue code depends on the:

- Local variables defined.
- Arguments passed to the procedure.
- Current processor selected (affects epilogue code only).
- Current calling convention.
- Options passed in the *prologuearg* of the **PROC** directive.
- Registers being saved.

The *prologuearg* list contains options specifying how to generate the prologue or epilogue code. The next section explains how to use these options, gives the standard prologue and epilogue code, and explains the techniques for defining your own prologue and epilogue code.

## Using Automatic Prologue and Epilogue Code

The standard prologue and epilogue code handles parameters and local variables. If a procedure does not have any parameters or local variables, the prologue and epilogue code that sets up and restores a stack pointer is omitted, unless **FORCEFRAME** is included in the *prologuearg* list. (**FORCEFRAME** is discussed later in this section.) Prologue and epilogue code also generates a push and pop for each register in the register list.

The prologue code consists of three steps:

1. Point BP to top of stack.
2. Make space on stack for local variables.
3. Save registers the procedure must preserve.



The epilogue cancels these three steps in reverse order, then cleans the stack, if necessary, with a **RET** *num* instruction. For example, the procedure declaration

```
myproc PROC NEAR PASCAL USES di si,
        arg1:WORD, arg2:WORD, arg3:WORD
        LOCAL local1:WORD, local2:WORD
```

generates the following prologue code:

```
push    bp                ; Step 1:
mov     bp, sp            ; point BP to stack top
sub     sp, 4             ; Step 2: space for 2 local words
push    di                ; Step 3:
push    si                ; save registers listed in USES
```

The corresponding epilogue code looks like this:

```
pop     si                ; Undo Step 3
pop     di                ; Undo Step 3
mov     sp, bp           ; Undo Step 2
pop     bp                ; Undo Step 1
ret     6                ; Clean stack of pushed arguments
```

Notice the **RET 6** instruction cleans the stack of the three word-sized arguments. The instruction appears in the epilogue because the procedure does not use the C calling convention. If `myproc` used C conventions, the epilogue would end with a **RET** instruction without an operand.

The assembler generates standard epilogue code when it encounters a **RET** instruction without an operand. It does not generate an epilogue if **RET** has a nonzero operand. To suppress generation of a standard epilogue, use **RETN** or **RETF** with or without an operand, or use **RET 0**.

The standard prologue and epilogue code recognizes two operands passed in the *prologuearg* list, **LOADDS** and **FORCEFRAME**. These operands modify the prologue code. Specifying **LOADDS** saves and initializes DS. Specifying **FORCEFRAME** as an argument generates a stack frame even if no arguments are sent to the procedure and no local variables are declared. If your procedure has any parameters or locals, you do not need to specify **FORCEFRAME**.

For example, adding **LOADDS** to the argument list for `myproc` creates this prologue:

```

push    bp                ; Step 1:
mov     bp, sp            ;   point BP to stack top
sub     sp, 4             ; Step 2: space for 2 locals
push    ds                ; Save DS and point it
mov     ax, DGROUP        ;   to DGROUP, as
mov     ds, ax            ;   instructed by LOADDS
push    di                ; Step 3:
push    si                ;   save registers listed in USES

```

The epilogue code restores DS:

```

pop     si                ; Undo Step 3
pop     di
pop     ds                ; Restore DS
mov     sp, bp            ; Undo Step 2
pop     bp                ; Undo Step 1
ret     6                 ; Clean stack of pushed arguments

```

## User-Defined Prologue and Epilogue Code

If you want a different set of instructions for prologue and epilogue code in your procedures, you can write macros that run in place of the standard prologue and epilogue code. For example, while you are debugging your procedures, you may want to include a stack check or track the number of times a procedure is called. You can write your own prologue code to do these things whenever a procedure executes. Different prologue code may also be necessary if you are writing applications for Windows. User-defined prologue macros will respond correctly if you specify **FORCEFRAME** in the *prologuearg* of a procedure.

To write your own prologue or epilogue code, the **OPTION** directive must appear in your program. It disables automatic prologue and epilogue code generation. When you specify

**OPTION PROLOGUE** : *macroname*

**OPTION EPILOGUE** : *macroname*

the assembler calls the macro specified in the **OPTION** directive instead of generating the standard prologue and epilogue code. The prologue macro must be a macro function, and the epilogue macro must be a macro procedure.

The assembler expects your prologue or epilogue macro to have this form:

```

macroname MACRO procname, \
                flag, \
                parmbytes, \
                localbytes, \
                <reglist>, \
                userparms

```

Your macro must have formal parameters to match all the actual arguments passed. The arguments passed to your macro include:

Argument	Description																		
<i>procname</i>	The name of the procedure.																		
<i>flag</i>	A 16-bit flag containing the following information: <table border="1"> <thead> <tr> <th>Bit = Value</th> <th>Description</th> </tr> </thead> <tbody> <tr> <td>Bit 0, 1, 2</td> <td>For calling conventions (000=unspecified language type, 001=C, 010=SYSCALL, 011=STDCALL, 100=PASCAL, 101=FORTRAN, 110=BASIC).</td> </tr> <tr> <td>Bit 3</td> <td>Undefined (not necessarily zero).</td> </tr> <tr> <td>Bit 4</td> <td>Set if the caller restores the stack (use <b>RET</b>, not <b>RETn</b>).</td> </tr> <tr> <td>Bit 5</td> <td>Set if procedure is <b>FAR</b>.</td> </tr> <tr> <td>Bit 6</td> <td>Set if procedure is <b>PRIVATE</b>.</td> </tr> <tr> <td>Bit 7</td> <td>Set if procedure is <b>EXPORT</b>.</td> </tr> <tr> <td>Bit 8</td> <td>Set if the epilogue is generated as a result of an <b>IRET</b> instruction and cleared if the epilogue is generated as a result of a <b>RET</b> instruction.</td> </tr> <tr> <td>Bits 9–15</td> <td>Undefined (not necessarily zero).</td> </tr> </tbody> </table>	Bit = Value	Description	Bit 0, 1, 2	For calling conventions (000=unspecified language type, 001=C, 010=SYSCALL, 011=STDCALL, 100=PASCAL, 101=FORTRAN, 110=BASIC).	Bit 3	Undefined (not necessarily zero).	Bit 4	Set if the caller restores the stack (use <b>RET</b> , not <b>RETn</b> ).	Bit 5	Set if procedure is <b>FAR</b> .	Bit 6	Set if procedure is <b>PRIVATE</b> .	Bit 7	Set if procedure is <b>EXPORT</b> .	Bit 8	Set if the epilogue is generated as a result of an <b>IRET</b> instruction and cleared if the epilogue is generated as a result of a <b>RET</b> instruction.	Bits 9–15	Undefined (not necessarily zero).
Bit = Value	Description																		
Bit 0, 1, 2	For calling conventions (000=unspecified language type, 001=C, 010=SYSCALL, 011=STDCALL, 100=PASCAL, 101=FORTRAN, 110=BASIC).																		
Bit 3	Undefined (not necessarily zero).																		
Bit 4	Set if the caller restores the stack (use <b>RET</b> , not <b>RETn</b> ).																		
Bit 5	Set if procedure is <b>FAR</b> .																		
Bit 6	Set if procedure is <b>PRIVATE</b> .																		
Bit 7	Set if procedure is <b>EXPORT</b> .																		
Bit 8	Set if the epilogue is generated as a result of an <b>IRET</b> instruction and cleared if the epilogue is generated as a result of a <b>RET</b> instruction.																		
Bits 9–15	Undefined (not necessarily zero).																		
<i>parmbytes</i>	The accumulated count in bytes of all parameters given in the <b>PROC</b> statement.																		
<i>localbytes</i>	The count in bytes of all locals defined with the <b>LOCAL</b> directive.																		
<i>reglist</i>	A list of the registers following the <b>USES</b> operator in the procedure declaration. Enclose this list with angle brackets (<>) and separate each item with commas. Reverse the list for epilogues.																		
<i>userparms</i>	Any argument you want to pass to the macro. The prologuearg (if there is one) specified in the <b>PROC</b> directive is passed to this argument.																		

Your macro function must return the *parmbytes* parameter. However, if the prologue places other values on the stack after pushing BP and these values are not referenced by any of the local variables, the exit value must be the number of bytes for procedure locals plus any space between BP and the locals. Therefore, *parmbytes* is not always equal to the bytes occupied by the locals.

The following macro is an example of a user-defined prologue that counts the number of times a procedure is called.

```

ProfilePro      MACRO procname,      \
                  flag,              \
                  bytecount,        \
                  numlocals,        \
                  regs,              \
                  macroargs
                .DATA
procname&count  WORD 0
                .CODE
                inc   procname&count ; Accumulates count of times the
                                ; procedure is called
                push  bp
                mov   bp, sp
                                ; Other BP operations
                IFNB <regs>
                FOR r, regs
                push r
                ENDM
                ENDIF
                EXITM %bytecount
            ENDM

```

Your program must also include this statement before calling any procedures that use the prologue:

```
OPTION PROLOGUE:ProfilePro
```

If you define either a prologue or an epilogue macro, the assembler uses the standard prologue or epilogue code for the one you do not define. The form of the code generated depends on the **.MODEL** and **PROC** options used.

If you want to revert to the standard prologue or epilogue code, use **PROLOGUEDEF** or **EPILOGUEDEF** as the *macroname* in the **OPTION** statement.

```
OPTION EPILOGUE:EPILOGUEDEF
```

You can completely suppress prologue or epilogue generation with

```
OPTION PROLOGUE:None
OPTION EPILOGUE:None
```

In this case, no user-defined macro is called, and the assembler does not generate a default code sequence. This state remains in effect until the next **OPTION PROLOGUE** or **OPTION EPILOGUE** is encountered.

For additional information about writing macros, see Chapter 9, “Using Macros.” The PROLOGUE.INC file provided in the MASM 6.1 distribution disks can create the prologue and epilogue sequences for the Microsoft C professional development system.

## MS-DOS Interrupts

In addition to jumps, loops, and procedures that alter program execution, interrupt routines transfer execution to a different location. In this case, control goes to an interrupt routine.

You can write your own interrupt routines, either to replace an existing routine or to use an undefined interrupt number. For example, you may want to replace an MS-DOS interrupt handler, such as the Critical Error (Interrupt 24h) and CONTROL+C (Interrupt 23h) handlers. The **BOUND** instruction checks array bounds and calls Interrupt 5 when an error occurs. If you use this instruction, you need to write an interrupt handler for it.

This section summarizes the following:

- How to call interrupts
- How the processor handles interrupts
- How to redefine an existing interrupt routine

The example routine in this section handles addition or multiplication overflow and illustrates the steps necessary for writing an interrupt routine. For additional information about MS-DOS and BIOS interrupts, see Chapter 11, “Writing Memory-Resident Software.”

## Calling MS-DOS and ROM-BIOS Interrupts

Interrupts provide a way to access MS-DOS and ROM-BIOS from assembly language. They are called with the **INT** instruction, which takes an immediate value between 0 and 255 as its only operand.

MS-DOS and ROM-BIOS interrupt routines accept data through registers. For instance, most MS-DOS routines (and many BIOS routines) require a function number in the AH register. Many handler routines also return values in registers. To use an interrupt, you must know what data the handler routine expects and what data, if any, it returns. For information, consult Help or one of the other references mentioned in the Introduction.

The following fragment illustrates a simple call to MS-DOS Function 9, which displays the string `msg` on the screen:

```
msg      .DATA
        BYTE    "This writes to the screen$"
        .CODE
        mov     ax, SEG msg      ; Necessary only if DS does not
        mov     ds, ax          ; already point to data segment
        mov     dx, offset msg   ; DS:DX points to msg
        mov     ah, 09h         ; Request Function 9
        int     21h
```

When the **INT** instruction executes, the processor:

1. Looks up the address of the interrupt routine in the Interrupt Vector Table. This table starts at the lowest point in memory (segment 0, offset 0) and consists of a series of far pointers called vectors. Each vector comprises a 4-byte address (segment:offset) pointing to an interrupt handler routine. The table sequence implies the number of the interrupt the vector references: the first vector points to the Interrupt 0 handler, the second vector to the Interrupt 1 handler, and so forth. Thus, the vector at  $0000:i*4$  holds the address of the handler routine for Interrupt  $i$ .
2. Clears the trap flag (TF) and interrupt enable flag (IF).
3. Pushes the flags register, the current code segment (CS), and the current instruction pointer (IP), in that order. (The current instruction is the one following the **INT** statement.) As with a **CALL**, this ensures control returns to the next logical position in the program.
4. Jumps to the address of the interrupt routine, as specified in the Interrupt Vector Table.
5. Executes the code of the interrupt routine until it encounters an **IRET** instruction.
6. Pops the instruction pointer, code segment, and flags.

Figure 7.3 illustrates how interrupts work.

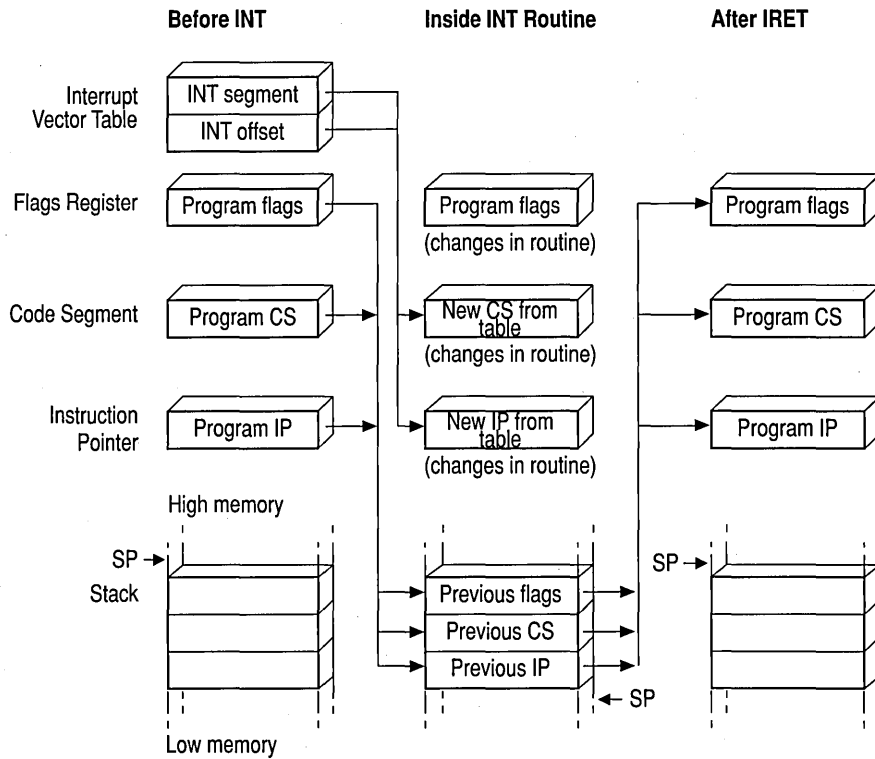

Figure 7.3 Operation of Interrupts

## Replacing an Interrupt Routine

To replace an existing interrupt routine, your program must:

- Provide a new routine to handle the interrupt.
- Replace the old routine's address in the Interrupt Vector Table with the address of your new routine.
- Replace the old address back into the vector table before your program ends.

You can write an interrupt routine as a procedure by using the **PROC** and **ENDP** directives. The routine should always be defined as **FAR** and should end with an **IRET** instruction instead of a **RET** instruction.

---

**Note** You can use the full extended **PROC** syntax (described in “Declaring Parameters with the **PROC** Directive,” earlier in this chapter) to write interrupt procedures. However, you should not make interrupt procedures **NEAR** or specify arguments for them. You can use the **USES** keyword, however, to correctly generate code to save and restore a register list in interrupt procedures.

---

The **IRET** instruction in MASM 6.1 has two forms that suppress epilogue code. This allows an interrupt to have local variables or use a user-defined prologue. **IRETF** pops a **FAR16** return address, and **IRETFD** pops a **FAR32** return address.

The following example shows how to replace the handler for Interrupt 4. Once registered in the Interrupt Vector Table, the new routine takes control when the processor encounters either an **INT 4** instruction or its special variation **INTO** (Interrupt on Overflow). **INTO** is a conditional instruction that acts only when the overflow flag is set. With **INTO** after a numerical calculation, your code can automatically route control to a handler routine if the calculation results in a numerical overflow. By default, the routine for Interrupt 4 simply consists of an **IRET**, so it returns without doing anything. Using **INTO** is an alternative to using **JO** (Jump on Overflow) to jump to another set of instructions.

The following example program first executes **INT 21h** to invoke MS-DOS Function 35h (Get Interrupt Vector). This function returns the existing vector for Interrupt 4. The program stores the vector, then invokes MS-DOS Function 25h (Set Interrupt Vector) to place the address of the `overflow` procedure in the Interrupt Vector Table. From this point on, `overflow` gains control whenever the processor executes **INTO** while the overflow flag is set. The new routine displays a message and returns with **AX** and **DX** set to 0.

```

        .MODEL LARGE, C
FPFUNC  TYPEDEF FAR PTR
        .DATA
msg      BYTE    "Overflow - result set to 0",13,10,'$'
vector  FPFUNC ?
        .CODE
        .STARTUP

        mov     ax, 3504h           ; Load Interrupt 4 and call DOS
        int    21h                 ; Get Interrupt Vector
        mov     WORD PTR vector[2],es ; Save segment
        mov     WORD PTR vector[0],bx ; and offset

```



```

        push    ds                ; Save DS
        mov     ax, cs            ; Load segment of new routine
        mov     ds, ax
        mov     dx, OFFSET ovrflow ; Load offset of new routine
        mov     ax, 2504h        ; Load Interrupt 4 and call DOS
        int     21h              ; Set Interrupt Vector
        pop     ds                ; Restore
        .
        .
        add     ax, bx            ; Do arithmetic
        into    ; Call Interrupt 4 if overflow
        .
        .
        lds     dx, vector        ; Load original address
        mov     ax, 2504h        ; Restore it to vector table
        int     21h              ; with DOS set vector function
        mov     ax, 4C00h        ; Terminate function
        int     21h

ovrflow PROC FAR
        sti                ; Enable interrupts
                        ; (turned off by INT)
        mov     ah, 09h        ; Display string function
        mov     dx, OFFSET msg  ; Load address
        int     21h           ; Call DOS
        sub     ax, ax         ; Set AX to 0
        cwd                ; Set DX to 0
        iret                ; Return
ovrflow ENDP
END

```

Before the program ends, it again uses MS-DOS Function 25h to reset the original Interrupt 4 vector back into the Interrupt Vector Table. This reestablishes the original routine as the handler for Interrupt 4.

The first instruction of the `ovrflow` routine warrants further discussion. When the processor encounters an `INT` instruction, it clears the interrupt flag before branching to the specified interrupt handler routine. The interrupt flag serves a crucial role in smoothing the processor's tasks, but must not be abused. When clear, the flag inhibits hardware interrupts such as the keyboard or system timer. It should be left clear only briefly and only when absolutely necessary. Unless you have a

compelling reason to leave the flag clear, always include an **STI** (Set Interrupt Flag) instruction at the beginning of your interrupt handler routine to reenable hardware interrupts.

**CLI** (Clear Interrupt Flag) and its corollary **STI** are designed to protect small sections of time-dependent code from interruptions by the hardware. If you use **CLI** in your program, be sure to include a matching **STI** instruction as well. The sample interrupt handlers in Chapter 11, “Writing Memory-Resident Software,” illustrate how to use these important instructions.



# Sharing Data and Procedures Among Modules and Libraries

To use symbols and procedures in more than one module, the assembler must be able to recognize the shared data as global to all the modules where they are used. MASM provides techniques to simplify data-sharing and give a high-level interface to multiple-module programming. With these techniques, you can place shared symbols in include files. This makes the data declarations in the file available to all modules that use the include file.

This chapter explains the two data-sharing methods MASM 6.1 offers. The first method simplifies data sharing between modules with include files. The second does not involve include files. Instead, this method allows modules to share procedures and data items using the **PUBLIC** and **EXTERN** directives.

The last section of this chapter explains how to create program libraries and access their routines.

## Selecting Data-Sharing Methods

If data defined in one module is to be used in other modules of a program, you must declare the data public and external. MASM provides several ways to do this:

- Declare a symbol public with the **PUBLIC** directive in the module where it is defined. This makes the symbol available to other modules. You must also place an **EXTERN** statement for that symbol in all other modules that refer to the public symbol. This statement informs the assembler that the symbol is external—that is, defined in another module.
- Declare the data communal with the **COMM** directive. However, communal variables have limitations. You cannot depend on their location in memory because they are allocated by the linker, and they cannot be initialized.

The **EXTERNDEF** directive declares a symbol either public or external, as appropriate. **EXTERNDEF** simplifies the declarations for global (public and external) variables and encourages the use of include files.

The next section provides further details on using include files. For more information on **PUBLIC** and **EXTERN**, see “Using Alternatives to Include Files,” page 219.

## Sharing Symbols with Include Files

Include files can contain any valid MASM statement, but typically consist of type and symbol declarations. The assembler inserts the contents of the include file into a module at the location of the **INCLUDE** directive. Include files are optional, but can simplify project organization by eliminating the need to insert common declarations into all modules of a program. An alternative to using include files is described in “Using Alternatives to Include Files,” page 219.

This section explains how to organize symbol definitions and the declarations that make them global (available to all modules); how to make both variables and procedures public with **EXTERNDEF**, **PROTO**, and **COMM.**; and where to place these directives in the modules and include files.

## Organizing Modules

This section summarizes the organization of declarations and definitions in modules and include files and the use of the **INCLUDE** directive.

### Include Files

Type declarations that need to be identical in every module should be placed in an include file. This ensures consistency and saves time when you update programs. Include files should contain only symbol declarations and any other declarations that are resolved at assembly time. (For a list of assembly-time operations, see “Generating and Running Executable Programs” in Chapter 1.)

If more than one module accesses the include file, the file cannot contain statements that define and allocate memory for symbols. Otherwise, the assembler would attempt to allocate the same symbol more than once.

---

**Note** An include file used in two or more modules should not allocate data variables.

---

### Modules

An **INCLUDE** statement is usually placed before data and code segments in your modules. When the assembler encounters an **INCLUDE** directive, it opens the specified file and assembles all its statements. The assembler then returns to the original module and continues the assembly.

The **INCLUDE** directive takes the form:

**INCLUDE** *filename*

where *filename* is the full name of the include file. For example, the following declaration inserts the contents of the include file SCREEN.INC in your program:

```
INCLUDE SCREEN.INC
```

The filename in the **INCLUDE** directive must be fully specified; no extensions are assumed. If a full pathname is not given, the assembler first searches the directory of the source file containing the **INCLUDE** directive.

If the include file is not in the source file directory, the assembler searches the paths specified in the assembler's command-line option **/I**, or in PWB's Include Paths field in the MASM Option dialog box (accessed from the Option menu). The **/I** option takes this form:

**/I** *path*

You can include more than one **/I** option on the command line. The assembler then searches for include files within each specified path in the order given. If none of these directories contains the include file, the assembler finally searches in the paths specified in the **INCLUDE** environment variable. If the include file still cannot be found, an assembly error occurs. (The **/x** command-line option tells the assembler to ignore the **INCLUDE** environment variable when searching for include files.)

An include file may specify another include file. The assembler processes the second include file before returning to the first. Your program can nest include files this way as deeply as the amount of free memory allows.

### Include Files or Modules

You can use the **EQU** directive to create named constants that cannot be redefined in your program. (For information about the **EQU** directive, see "Integer Constants and Constant Expressions," page 11.) Placing a constant defined with **EQU** in an include file makes it available to all modules that use that include file.

Placing **TYPDEF**, **STRUCT**, **UNION**, and **RECORD** definitions in an include file guarantees consistency in type definitions. If required, the variable instances derived from these definitions can be made public among the modules with **EXTERNDEF** declarations (see the next section). Macros, including macros defined with **TEXTEQU**, must be placed in include files to make them visible in other modules.

If you elect to use full segment definitions with, or instead of, simplified definitions, you can force a consistent segment order in all files by defining segments in an include file. This technique is explained in "Controlling the Segment Order," page 47.

## Declaring Symbols Public and External

It is sometimes useful to make certain procedures and variables (such as status flags) global to all program modules. Global variables are freely accessible within all routines; you do not have to explicitly pass them to the routines that need them. This section describes how to make variables and procedures global using the **EXTERNDEF**, **PROTO**, or **COMM** declarations within include files.

When a procedure is defined in one module and called in another module, it must be declared public in the defining module and external in the calling module(s).

MASM offers three ways to declare a procedure public and external:

- Use the **PUBLIC** directive in the defining module and **EXTERN** in all other modules that reference the procedure. The **PUBLIC** and **EXTERN** directives are explained on page 220.
- Declare the procedure with **EXTERNDEF**.
- Prototype the procedure with the **PROTO** directive.

### Using EXTERNDEF

MASM treats **EXTERNDEF** as a public declaration in the defining module, and as an external declaration in the referencing module(s). You can use the **EXTERNDEF** statement in your include file to make a variable common to two or more modules. **EXTERNDEF** works with all types of variables, including arrays, structures, unions, and records. It also works with procedures.

As a result, a single include file can contain an **EXTERNDEF** declaration that works in both the defining module and any referencing module. It is ignored in modules that neither define nor reference the variable. Therefore, an include file for a library which is used in multiple .EXE files does not force the definition of a symbol as **EXTERN** does.

The **EXTERNDEF** statement takes this form:

```
EXTERNDEF [langtype] name:qualifiedtype
```

The *name* is the variable's identifier. The *qualifiedtype* is explained in detail in "Data Types," page 14.

The optional *langtype* specifier sets the naming conventions for the *name* it precedes. It overrides any language specified in the **.MODEL** directive. The specifier can be **C**, **SYSCALL**, **STDCALL**, **PASCAL**, **FORTTRAN**, or **BASIC**. For information on selecting the appropriate *langtype* type, see "Naming and Calling Conventions," page 308.

The following diagram shows the statements that declare an array, make it public, and use it in another module.

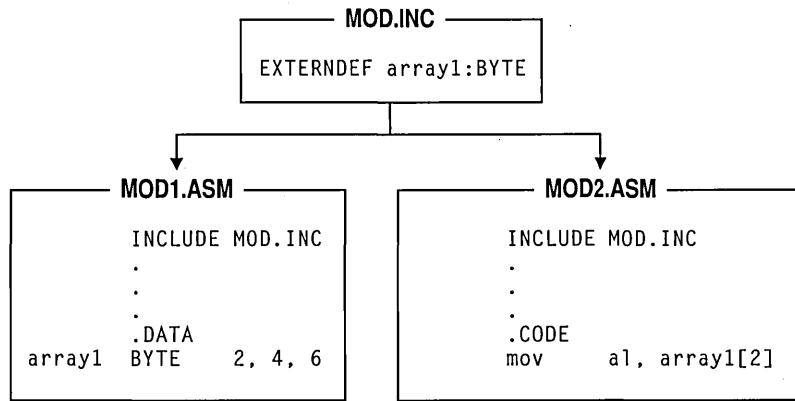

**Figure 8.1** Using **EXTERNDEF** for Variables

The file position of **EXTERNDEF** directives is important. For more information, see “Positioning External Declarations,” following.

You can also make procedures visible by using **EXTERNDEF** without **PROTO** inside an include file. This method treats the procedure name as a simple identifier, without the parameter list, so you forgo the assembler’s ability to check for the correct parameters during assembly. Use **EXTERNDEF** with procedures in the same way as variables:

```
EXTERNDEF MyProc:FAR           ; Declare far procedure external
```

You can also use **EXTERNDEF** to make a code label global between modules so that one module can reference a label in another module. Give the label global scope with the double colon operator, like this:

```
EXTERNDEF codeLabel:NEAR
.
.
.
codeLabel::
```

Another module can reference `codeLabel` like this:

```
EXTERNDEF codeLabel:NEAR
.
.
.
    jmp    codeLabel
```



## Using PROTO

This section describes how to prototype a procedure with the **PROTO** directive. **PROTO** automatically issues an **EXTERNDEF** for the procedure unless the **PROC** statement declares the procedure **PRIVATE**. Defining a prototype enables type-checking for the procedure arguments.

Follow these steps to create an interface for a procedure defined in one module and called from other modules:

1. Place the **PROTO** declaration in the include file.
2. Define the procedure with **PROC** in one module. The **PROC** directive declares the procedure **PUBLIC** by default.
3. Call the procedure with the **INVOKE** statement (or with **CALL**). Make sure that all calling modules access the include file.

For descriptions, syntax, and examples of **PROTO**, **PROC**, and **INVOKE**, see Chapter 7, "Controlling Program Flow."

The following example illustrates these three steps. In the example, a **PROTO** statement defines the far procedure `CopyFile`, which uses the C parameter-passing and naming conventions, and takes the arguments `filename` and `numberlines`. The diagram following the example shows the file placement for these statements.

This definition goes into the include file:

```
CopyFile PROTO FAR C filename:BYTE, numberlines:WORD
```

The procedure definition for `CopyFile` is:

```
CopyFile PROC FAR C USES cx, filename:BYTE, numberlines:WORD
```

To call the `CopyFile` procedure, you can use this **INVOKE** statement:

```
INVOKE CopyFile, NameVar, 200
```

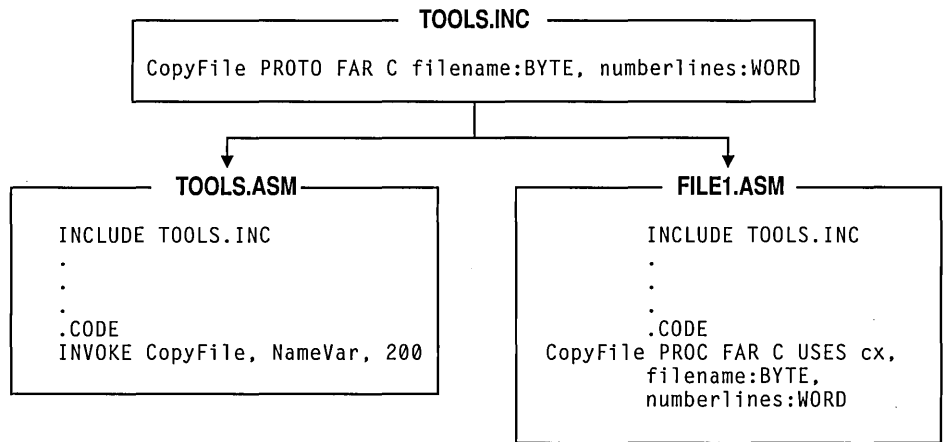

Figure 8.2 Using **PROTO** and **INVOKE**

## Using **COMM**

Another way to share variables among modules is to add the **COMM** (communal) declaration to your include file. Since communal variables are allocated by the linker and cannot be initialized, you cannot depend on their location or sequence.

Communal variables are supported by MASM primarily for compatibility with communal variables in Microsoft C. Communal variables are not used in any other Microsoft language, and they are not compatible with C++ and some other languages.

**COMM** declares a data variable external and instructs the linker to allocate the variable if it has not been explicitly defined in a module. The memory space for communal variables may not be assigned until load time, so using communal variables may reduce the size of your executable file.

The **COMM** declaration has the syntax:

```
COMM [[langtype]] [[NEAR | FAR]] label:type[:count]
```

The *label* is the name of the variable. The *langtype* sets the naming conventions for the name it precedes. It overrides any language specified in the **.MODEL** directive.

If **NEAR** or **FAR** is not specified, the variable determines the default from the current memory model (**NEAR** for **TINY**, **SMALL**, **COMPACT**, and **FLAT**; **FAR** for **MEDIUM**, **LARGE**, and **HUGE**). If you do not provide a memory model with the **.MODEL** directive, you must specify a distance when accessing a communal variable, like this:

```
mov    ax, NEAR PTR CommNear
mov    bx, FAR  PTR CommFar
```

The *type* can be a constant expression, but it is usually a type such as **BYTE**, **WORD**, or **DWORD**, or a structure, union, or record. If you first declare the *type* with **TYPEDEF**, CodeView can provide type information. The *count* is the number of elements. If no *count* is given, one element is assumed.

The following example creates the on far variable `DataBlock`, which is a 1,024-element array of uninitialized signed doublewords:

```
COMM FAR DataBlock:SDWORD:1024
```

---

**Note** C variables declared outside functions (except static variables) are communal unless explicitly initialized; they are the same as assembly-language communal variables. If you are writing assembly-language modules for C, you can declare the same communal variables in both C and MASM include files. However, communal variables in C do not have to be declared communal in assembler. The linker will match the **EXTERN**, **PUBLIC**, and **COMM** statements for the variable.

---

**EXTERNDEF** (explained in the previous section) is more flexible than **COMM** because you can initialize variables defined with it, and your code can rely on the position and sequence of the defined data.

## Positioning External Declarations

Although **LINK** determines the actual address of an external symbol, the assembler assumes a default segment for the symbol, based on the location of the external directive in the source code. You should therefore position **EXTERN** and **EXTERNDEF** directives according to these rules:

- If you know which segment defines an external symbol, put the **EXTERN** statement in that segment.

- If you know the group but not the segment, position the **EXTERN** statement outside any segment and reference the variable with the group name. For example, if `var1` is in `DGROUP`, reference the variable as

```
mov DGROUP:var1, 10
```

- If you know nothing about the location of an external variable, put the **EXTERN** statement outside any segment. You can use the **SEG** directive to access the external variable like this:

```
mov ax, SEG var1
mov es, ax
mov ax, es:var1
```

- If the symbol is an absolute symbol or a far code label, you can declare it external anywhere in the source code.

Always close any segments opened in include files so that external declarations following an include statement are not incorrectly placed inside a segment. If you want to be certain an external definition lies outside a segment, you can use **@CurSeg**. The **@CurSeg** predefined symbol returns a blank if the definition is not in a segment. For example,

```
.DATA
.
.
.
@CurSeg ENDS ; Close segment
EXTERNDEF var:WORD
```

For information about predefined symbols such as **@CurSeg**, see “Predefined Symbols,” page 10.

## Using Alternatives to Include Files

If your project uses only two modules (or if it is written with a version of MASM prior to 6.0), you may want to continue using **PUBLIC** in the defining module and **EXTERN** in the referencing module, and not create an include file for the project. The **EXTERN** directive can be used in an include file, but the include file containing **EXTERN** cannot be added to the module that contains the corresponding **PUBLIC** directive for that symbol. This section assumes that you are not using include files.

## PUBLIC and EXTERN

The **PUBLIC** and **EXTERN** directives are less flexible than **EXTERNDEF** and **PROTO** because they are module-specific: **PUBLIC** must appear in the defining module and **EXTERN** must appear in the calling modules. This section shows how to use **PUBLIC** and **EXTERN**. Information on where to place the external declarations in your file is in “Positioning External Declarations,” previous.

The **PUBLIC** directive makes a name visible outside the module in which it is defined. This gives other program modules access to that identifier.

The **EXTERN** directive performs the complementary function. It tells the assembler that a name referenced within a particular module is actually defined and declared public in another module that will be specified at link time.

A **PUBLIC** directive can appear anywhere in a file. Its syntax is:

```
PUBLIC [[langtype]] name[[, [[langtype]] name]]...
```

The *name* must be the name of an identifier defined within the current source file. Only code labels, data labels, procedures, and numeric equates can be declared public.

If you specify the *langtype* field here, it overrides the language specified by **.MODEL**. The *langtype* field can be **C**, **SYSCALL**, **STDCALL**, **PASCAL**, **FORTRAN**, or **BASIC**. For more information on specifying *langtype* types, see “Declaring Parameters with the PROC Directive,” page 184, and “Naming and Calling Conventions,” page 308.

The **EXTERN** directive tells the assembler that an identifier is external—defined in some other module that will be supplied at link time. Its syntax is:

```
EXTERN [[langtype]] name:{ABS | qualifiedtype}
```

“Data Types,” page 14, describes *qualifiedtype*. You can use the **ABS** (absolute) keyword only with external numeric constants. **ABS** causes the identifier to be imported as a relocatable unsized constant. This identifier can then be used anywhere a constant can be used. If the identifier is not found in another module at link time, the linker generates an error.

In the following example, the procedure `BuildTable` and the variable `Var` are declared `public`. The procedure uses the Pascal naming and data-passing conventions:

MOD1.ASM	MOD2.ASM
<pre> .MODEL small, pascal PUBLIC BuildTable, Var . . . .DATA Var BYTE 0 . . .CODE BuildTable PROC USES cx dx, sizevar:WORD . . ret BuildTable ENDP </pre>	<pre> .MODEL small, pascal EXTERN var:BYTE, BuildTable:NEAR .CODE . . mov al, var call BuildTable . . </pre>

Figure 8.3 Using **PUBLIC** and **EXTERN**

## Other Alternatives

You can also use the directives discussed earlier (**EXTERNDDEF**, **PROTO**, and **COMM**) without the include file. In this case, place the declarations to make a symbol global in the same module where the symbol is defined. You might want to use this technique if you are linking only a few modules that have very little data in common.

## Developing Libraries

As you create reusable procedures, you can place them in a library file for convenient access. Although you can put any routine into a library, each library file, recognizable by its `.LIB` extension, usually contains related routines. For example, you might place string-manipulation functions in one library, matrix calculations in another, and port communications in another. Do not place communal variables (defined with the **COMM** directive) in a library.

A library consists of combined object modules, each created from a single source file. The object module is the smallest independent unit in a library. If you link with one symbol in a module, the linker adds the entire module to your program, but not the entire library.

## Associating Libraries with Modules

You can choose either of two methods for associating your libraries with the modules that use them: you can use the **INCLUDELIB** directive inside your source files, or link the modules from the command line.

To associate a specified library with your object code, use **INCLUDELIB**. You can add this directive to the source file to specify the libraries you want linked, rather than specifying them in the **LINK** command line. The **INCLUDELIB** syntax is:

**INCLUDELIB** *libraryname*

The *libraryname* can be a file name or a complete path specification. If you do not specify an extension, **.LIB** is assumed. The *libraryname* is placed in the comment record of the object file. **LINK** reads this record and links with the specified library file.

For example, the statement **INCLUDELIB GRAPHICS** passes a message from the assembler to the linker telling **LINK** to use library routines from the file **GRAPHICS.LIB**. If you place this statement in the source file **DRAW.ASM** and **GRAPHICS.LIB** is in the same directory, you can assemble and link the program with the following command:

```
ML DRAW.ASM
```

Without the **INCLUDELIB** directive, you must link the program **DRAW.ASM** with either of the following commands:

```
ML DRAW.ASM GRAPHICS.LIB  
ML DRAW /link GRAPHICS
```

If you want to assemble and link separately, type

```
ML /c DRAW.ASM  
LINK DRAW,,,GRAPHICS
```

If you do not specify a complete path in the **INCLUDELIB** statement or at the command line, **LINK** searches for the library file in the following order:

1. In the current directory.
2. In any directories in the library field of the **LINK** command line.
3. In any directories specified by the **LIB** environment variable.

The **LIB.EXE** utility helps you create, organize, and maintain run-time libraries. Refer to *Environment and Tools* for instructions on **LIB.EXE**.

## Using EXTERN with Library Routines

In some cases, **EXTERN** helps you limit the size of your executable file by specifying in the syntax an alternative name for a procedure. You would use this form of the **EXTERN** directive when declaring a procedure or symbol that may not need to be used.

The syntax looks like this:

```
EXTERN [langtype] name [ (altname) ] :qualifiedtype
```

The addition of the *altname* to the syntax provides the name of an alternate procedure that the linker uses to resolve the external reference if the procedure given by *name* is not needed. Both *name* and *altname* must have the same *qualifiedtype*.

When the linker encounters an external definition for a procedure that gives an *altname*, the linker finishes processing that module before it links the object module that contains the procedure given by *name*. If the program does not reference any symbols in the *name* file's object from any of the linked modules, the linker uses *altname* to satisfy the external reference. This saves space because the library object module is not brought in.

For example, assume that the contents of `STARTUP.ASM` include these statements:

```
EXTERN  init(dummy):PROC
        .
        .
dummy   PROC
        .
        .
        .                               ; A procedure definition containing no
        ret                               ; executable code

dummy   ENDP
        .
        .
        call  init                       ; Defined in FLOAT.OBJ
```

In this example, the reference to the routine `init` (defined in `FLOAT.OBJ`) does not force the module `FLOAT.OBJ` to be linked into the executable file. If another reference causes `FLOAT.OBJ` to be linked into the executable file, then `init` will refer to the `init` label in `FLOAT.OBJ`. If there are no references that force linkage with `FLOAT.OBJ`, the linker will use the alternate name for `init(dummy)`.



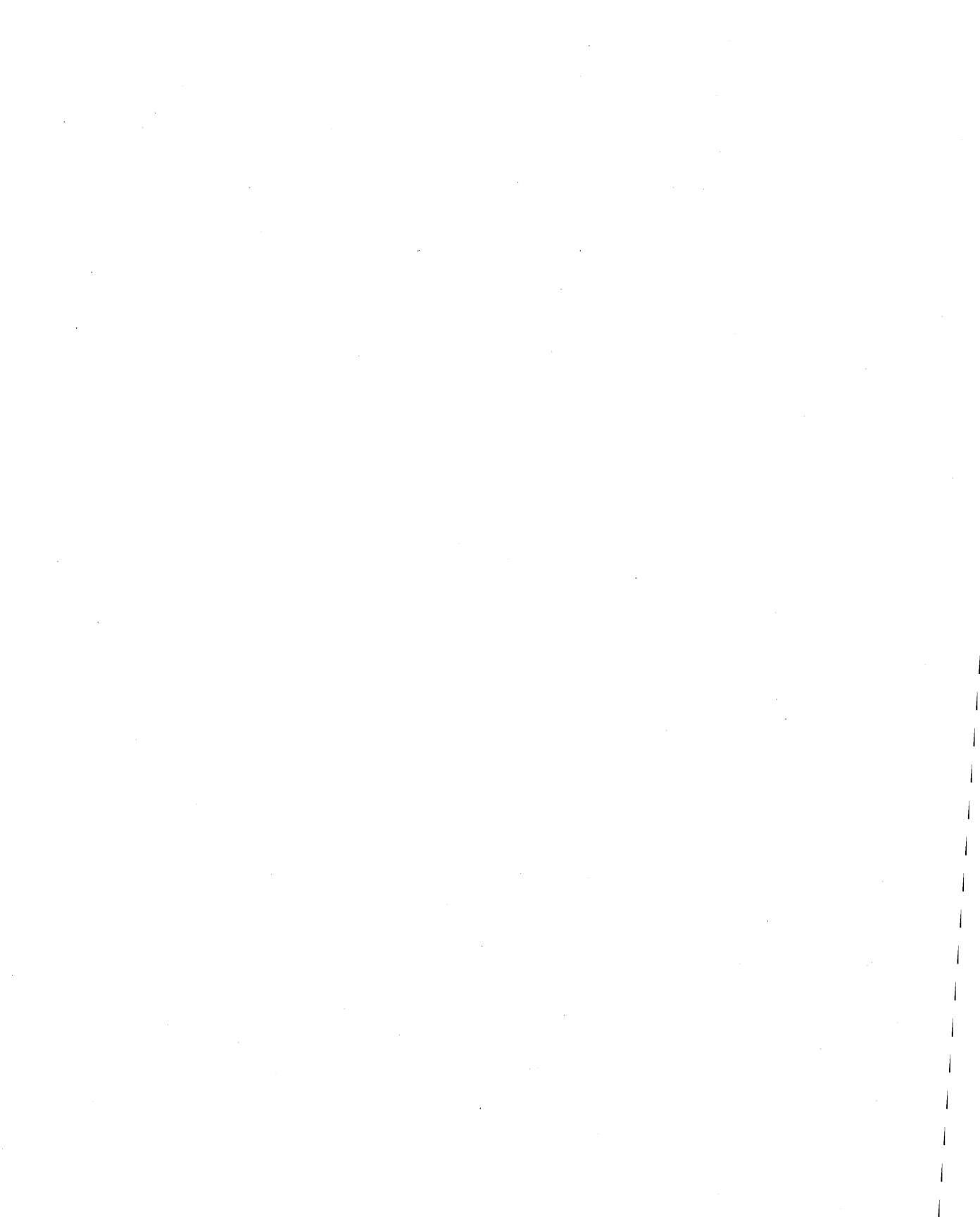

## CHAPTER 9

# Using Macros

A “macro” is a symbolic name you give to a series of characters (a text macro) or to one or more statements (a macro procedure or function). As the assembler evaluates each line of your program, it scans the source code for names of previously defined macros. When it finds one, it substitutes the macro text for the macro name. In this way, you can avoid writing the same code several places in your program.

This chapter describes the following types of macros:

- Text macros, which expand to text within a source statement.
- Macro procedures, which expand to one or more complete statements and can optionally take parameters.
- Repeat blocks, which generate a group of statements a specified number of times or until a specified condition becomes true.
- Macro functions, which look like macro procedures and can be used like text macros but which also return a value.
- Predefined macro functions and string directives, which perform string operations.

This chapter explains how to use macros for simple code substitutions and how to write sophisticated macros with parameter lists and repeat loops. It also describes how to use these features in conjunction with local symbols, macro operators, and predefined macro functions.

## Text Macros

You can give a sequence of characters a symbolic name and then use the name in place of the text later in the source code. The named text is called a text macro.

The `TEXTEQU` directive defines a text macro, as these examples show:

```
name TEXTEQU <text>
name TEXTEQU macroId | textmacro
name TEXTEQU %constExpr
```

In the previous lines, *text* is a sequence of characters enclosed in angle brackets, *macroId* is a previously defined macro function, *textmacro* is a previously defined text macro, and *%constExpr* is an expression that evaluates to text.

Here are some examples:

```
msg      TEXTEQU <Some text>           ; Text assigned to symbol
string   TEXTEQU msg                   ; Text macro assigned to symbol
msg      TEXTEQU <Some other text>      ; New text assigned to symbol
value    TEXTEQU %(3 + num)            ; Text representation of resolved
                                           ; expression assigned to symbol
```

The first line assigns text to the symbol `msg`. The second line equates the text of the `msg` text macro with a new text macro called `string`. The third line assigns new text to `msg`. Although `msg` has new text, `string` retains its original text value. The fourth line assigns 7 to `value` if `num` equals 4. If a text macro expands to another text macro (or macro function, as discussed on page 248), the resulting text macro will expand recursively.

Text macros are useful for naming strings of text that do not evaluate to integers. For example, you might use a text macro to name a floating-point constant or a bracketed expression. Here are some practical examples:

```
pi        TEXTEQU <3.1416>              ; Floating point constant
WPT       TEXTEQU <WORD PTR>           ; Sequence of key words
arg1      TEXTEQU <[bp+4]>              ; Bracketed expression
```

## Macro Procedures

If your program must perform the same task many times, you can avoid repeatedly typing the same statements each time by writing a macro procedure. Think of macro procedures (commonly called macros) as text-processing mechanisms that automatically generate repeated text.

This section uses the term “macro procedure” rather than “macro” when necessary to distinguish between a macro procedure and a macro function. Macro functions are described in “Returning Values with Macro Functions.”

Conforming to common usage, this chapter occasionally speaks of “calling” a macro, a term that deserves further scrutiny. It’s natural to think of a program calling a macro procedure in the same way it calls a normal subroutine procedure, because they seem to perform identically. However, a macro is simply a representative for real code. Wherever a macro name appears in your program, so in reality does all the code the macro represents. A macro does not cause the processor to vector off to a new location as does a normal procedure. Thus, the expression “calling a macro” may imply the effect, but does not accurately describe what actually occurs.

## Creating Macro Procedures

You can define a macro procedure without parameters by placing the desired statements between the **MACRO** and **ENDM** directives:

```
name MACRO  
statements  
ENDM
```

For example, suppose you want a program to beep when it encounters certain errors. You could define a beep macro as follows:

```
beep    MACRO  
    mov    ah, 2        ;; Select DOS Print Char function  
    mov    dl, 7        ;; Select ASCII 7 (bell)  
    int    21h          ;; Call DOS  
ENDM
```

The double semicolons mark the beginning of macro comments. Macro comments appear in a listing file only at the macro’s initial definition, not at the point where the macro is referenced and expanded. Listings are usually easier to read if the comments aren’t repeatedly expanded. However, regular comments (those with a single semicolon) are listed in macro expansions. See Appendix C for listing files and examples of how macros are expanded in listings.

Once you define a macro, you can call it anywhere in the program by using the macro’s name as a statement. The following example calls the beep macro two times if an error flag has been set.

```
.IF     error    ; If error flag is true  
beep    ; execute macro two times  
beep  
.ENDIF
```

During assembly, the instructions in the macro replace the macro reference. The listing file shows:

```

                                .IF                                error
0017  80 3E 0000 R 00          *          cmp    error, 000h
001C  74 0C                    *          je     @C0001
                                beep
001E  B4 02                    1          mov    ah, 2
0020  B2 07                    1          mov    dl, 7
0022  CD 21                    1          int   21h
                                beep
0024  B4 02                    1          mov    ah, 2
0026  B2 07                    1          mov    dl, 7
0028  CD 21                    1          int   21h
                                .ENDIF
002A                                *@C0001:

```

Contrast this with the results of defining `beep` as a procedure using the **PROC** directive and then calling it with the **CALL** instruction.

Many such tasks can be handled as either a macro or a procedure. In deciding which method to use, you must choose between speed and size. For repetitive tasks, a procedure produces smaller code, because the instructions physically appear only once in the assembled program. However, each call to the procedure involves the additional overhead of a **CALL** and **RET** instruction. Macros do not require a change in program flow and so execute faster, but generate the same code multiple times rather than just once.

## Passing Arguments to Macros

By defining parameters for macros, you can define a general task and then execute variations of it by passing different arguments each time you call the macro. The complete syntax for a macro procedure includes a parameter list:

```

name MACRO parameterlist
statements
ENDM

```

The *parameterlist* can contain any number of parameters. Use commas to separate each parameter in the list. You cannot use reserved words as parameter names unless you disable the keyword with **OPTION NOKEYWORD**. You must also set the compatibility mode with **OPTION M510** or the `/Zm` command-line option.

To pass arguments to a macro, place the arguments after the macro name when you call the macro:

```

macroname arglist

```

The assembler treats as one item all text between matching quotation marks in an *arglist*.

The beep macro introduced in the previous section used the MS-DOS interrupt to write only the bell character (ASCII 7). We can rewrite the macro with a parameter that accepts any character:

```
writechar MACRO char
    mov ah, 2                ;; Select DOS Print Char function
    mov dl, char            ;; Select ASCII char
    int 21h                 ;; Call DOS
ENDM
```

Whenever it expands the macro, the assembler replaces each instance of `char` with the given argument value. The rewritten macro now writes any character to the screen, not just ASCII 7:

```
writechar 7                ; Causes computer to beep
writechar 'A'              ; Writes A to screen
```

If you pass more arguments than there are parameters, the additional arguments generate a warning (unless you use the **VARARG** keyword; see page 242). If you pass fewer arguments than the macro procedure expects, the assembler assigns empty strings to the remaining parameters (unless you have specified default values). This may cause errors. For example, a reference to the `w r i t e c h a r` macro with no argument results in the following line:

```
mov dl,
```

The assembler generates an error for the expanded statement but not for the macro definition or the macro call.

You can make macros more flexible by leaving off arguments or adding additional arguments. The next section tells some of the ways your macros can handle missing or extra arguments.

## Specifying Required and Default Parameters

Macro parameters can have special attributes to make them more flexible and improve error handling. You can make parameters required, give them default values, or vary their number. Variable parameters are used almost exclusively with the **FOR** directive, so are covered in “FOR Loops and Variable-Length Parameters,” later in this chapter.

The syntax for a required parameter is:

*parameter*:**REQ**

For example, you can rewrite the `writchar` macro to require the `char` parameter:

```
writchar MACRO char:REQ
    mov ah, 2                ;; Select DOS Print Char function
    mov dl, char             ;; Select ASCII char
    int 21h                 ;; Call DOS
ENDM
```

If the call does not include a matching argument, the assembler reports the error in the line that contains the macro reference. **REQ** can thus improve error reporting.

You can also accommodate missing parameters by specifying a default value, like this:

*parameter*:=*textvalue*

Suppose that you often use `writchar` to beep by printing ASCII 7. The following macro definition uses an equal sign to tell the assembler to assume the parameter `char` is 7 unless you specify otherwise:

```
writchar MACRO char:=<7>
    mov ah, 2                ;; Select DOS Print Char function
    mov dl, char             ;; Select ASCII char
    int 21h                 ;; Call DOS
ENDM
```

If a reference to this macro does not include the argument `char`, the assembler fills in the blank with the default value of 7 and the macro beeps when called.

Enclose the default parameter value in angle brackets so the assembler recognizes the supplied value as a text value. This is explained in detail in “Text Delimiters and the Literal-Character Operator,” later in this chapter.

Missing arguments can also be handled with the **IFB**, **IFNB**, **.ERRB**, and **.ERRNB** directives. They are described in the section “Conditional Directives” in chapter 1 and in Help. Here is a slightly more complex macro that uses some of these techniques:

```

Scroll MACRO distance:REQ, attrib:=<7>, tcol, trow, bcol, brow
    IFNB <tcol>                ;; Ignore arguments if blank
        mov    cl, tcol
    ENDIF
    IFNB <trow>
        mov    ch, trow
    ENDIF
    IFNB <bcol>
        mov    dl, bcol
    ENDIF
    IFNB <brow>
        mov    dh, brow
    ENDIF
    IFDIFI <attrib>, <bh>      ;; Don't move BH onto itself
        mov    bh, attrib
    ENDIF
    IF distance LE 0          ;; Negative scrolls up, positive down
        mov    ax, 0600h + (-(distance) AND 0FFh)
    ELSE
        mov    ax, 0700h + (distance AND 0FFh)
    ENDIF
    int    10h
ENDM

```

In this macro, the `distance` parameter is required. The `attrib` parameter has a default value of 7 (white on black), but the macro also tests to make sure the corresponding argument isn't BH, since it would be inefficient (though legal) to load a register onto itself. The **IFNB** directive is used to test for blank arguments. These are ignored to allow the user to manipulate rows and columns directly in registers CX and DX at run time.

The following shows two valid ways to call the macro:

```

; Assume DL and CL already loaded
dec    dh                ; Decrement top row
inc    ch                ; Increment bottom row
Scroll -3                ; Scroll white on black dynamic
                        ; window up three lines
Scroll 5, 17h, 2, 2, 14, 12 ; Scroll white on blue constant
                        ; window down five lines

```

This macro can generate completely different code, depending on its arguments. In this sense, it is not comparable to a procedure, which always has the same code regardless of arguments.



## Defining Local Symbols in Macros

You can make a symbol local to a macro by identifying it at the start of the macro with the **LOCAL** directive. Any identifier may be declared local.

You can choose whether you want numeric equates and text macros to be local or global. If a symbol will be used only inside a particular macro, you can declare it local so that the name will be available for other declarations outside the macro.

You must declare as local any labels within a macro, since a label can occur only once in the source. The **LOCAL** directive makes a special instance of the label each time the macro appears. This prevents redefinition of the label when expanding the macro. It also allows you to reuse the label elsewhere in your code.

You must declare all local symbols immediately following the **MACRO** statement (although blank lines and comments may precede the local symbol). Separate each symbol with a comma. You can attach comments to the **LOCAL** statement and list multiple **LOCAL** statements in the macro. Here is an example macro that declares local labels:

```
power  MACRO  factor:REQ, exponent:REQ
    LOCAL  again, gotzero      ;; Local symbols
    sub    dx, dx               ;; Clear top
    mov    ax, 1                ;; Multiply by one on first loop
    mov    cx, exponent         ;; Load count
    jcxz   gotzero             ;; Done if zero exponent
    mov    bx, factor           ;; Load factor
again:
    mul    bx                  ;; Multiply factor times exponent
    loop  again                ;; Result in AX
gotzero:
ENDM
```

If the labels `again` and `gotzero` were not declared local, the macro would work the first time it is called, but it would generate redefinition errors on subsequent calls. MASM implements local labels by generating different names for them each time the macro is called. You can see this in listing files. The labels in the `power` macro might be expanded to `??0000` and `??0001` on the first call and to `??0002` and `??0003` on the second.

You should avoid using anonymous labels in macros (see “Anonymous Labels” in Chapter 7). Although legal, they can produce unwanted results if you expand a macro near another anonymous label. For example, consider what happens in the following:

```
Update MACRO arg1
@@: .
.
.
loop @B
ENDM

.
.
.
jcxz @F
Update ax
@@:
```

Expanding `Update` places another anonymous label between the jump and its target. The line

```
jcxz @F
```

consequently jumps to the start of the loop rather than over the loop—exactly the opposite of what the programmer intended.

## Assembly-Time Variables and Macro Operators

In writing macros, you will often assign and modify values assigned to symbols. Think of these symbols as assembly-time variables. Like memory variables, they are symbols that represent values. But since macros are processed at assembly time, any symbol modified in a macro must be resolved as a constant by the end of assembly.

The three kinds of assembly-time variables are:

- Macro parameters
- Text macros
- Macro functions

When the assembler expands a macro, it processes the symbols in the order shown here. MASM first replaces macro parameters with the text of their actual arguments, then expands text macros.

Macro parameters are similar to procedure parameters in some ways, but they also have important differences. In a procedure, a parameter has a type and a memory location. Its value can be modified within the procedure. In a macro, a parameter is a placeholder for the argument text. The value can only be assigned to another symbol or used directly; it cannot be modified. The macro may interpret the argument text it receives either as a numeric value or as a text value.

It is important to understand the difference between text values and numeric values. Numeric values can be processed with arithmetic operators and assigned to numeric equates. Text values can be processed with macro functions and assigned to text macros.

Macro operators are often helpful when processing assembly-time variables. Table 9.1 shows the macro operators that MASM provides.

**Table 9.1 MASM Macro Operators**

Symbol	Name	Description
< >	Text Delimiters	Opens and closes a literal string.
!	Literal-Character Operator	Treats the next character as a literal character, even if it would normally have another meaning.
%	Expansion Operator	Causes the assembler to expand a constant expression or text macro.
&	Substitution Operator	Tells the assembler to replace a macro parameter or text macro name with its actual value.

The next sections explain these operators in detail.

## Text Delimiters and the Literal-Character Operator

The angle brackets (< >) are text delimiters. A text value is usually delimited when assigning a text macro. You can do this with **TEXTEQU**, as previously shown, or with the **SUBSTR** and **CATSTR** directives discussed in “String Directives and Predefined Functions,” later in this chapter.

By delimiting the text of macro arguments, you can pass text that includes spaces, commas, semicolons, and other special characters. The following example expands a macro called `work` in two different ways:

```
work    <1, 2, 3, 4, 5> ; Passes one argument with 13 chars,
                        ; including commas and spaces
work    1, 2, 3, 4, 5 ; Passes five arguments, each
                        ; with 1 character
```

The literal-character operator (!) lets you include angle brackets as part of a delimited text value, so the assembler does not interpret them as delimiters. The assembler treats the character following ! literally rather than as a special character, like this:

```
errstr TEXTEQU <Expression !> 255> ; errstr = "Expression > 255"
```

Text delimiters also have a special use with the **FOR** directive, as explained in “FOR Loops and Variable-Length Parameters,” later in this chapter.

## Expansion Operator

The expansion operator (%) expands text macros or converts constant expressions into their text representations. It performs these tasks differently in different contexts, as discussed in the following.

### Converting Numeric Expressions to Text

The expansion operator can convert numbers to text. The operator forces immediate evaluation of a constant expression and replaces it with a text value consisting of the digits of the result. The digits are generated in the current radix (default decimal).

This application of the expansion operator is useful when defining a text macro, as the following lines show. Notice how you can enclose expressions with parentheses to make them more readable:

```
a      TEXTEQU <3 + 4>           ; a = "3 + 4"
b      TEXTEQU %3 + 4           ; b = "7"
c      TEXTEQU %(3 + 4)         ; c = "7"
```

When assigning text macros, you can use numeric equates in the constant expressions, but not text macros:

```
num    EQU    4                 ; num = 4
numstr TEXTEQU <4>              ; numstr = <4>
a      TEXTEQU %3 + num         ; a = <7>
b      TEXTEQU %3 + numstr      ; b = <7>
```

The expansion operator gives you flexibility when passing arguments to macros. It lets you pass a computed value rather than the literal text of an expression. The following example illustrates by defining a macro

```
work   MACRO  arg
        mov ax, arg * 4
ENDM
```

which accepts different arguments:

```

work    2 + 3          ; Passes "2 + 3"
                    ; Code: mov ax, 2 + (3 * 4)
work    %2 + 3        ; Passes 5
                    ; Code: mov ax, 5 * 4
work    2 + num       ; Passes "2 + num"
work    %2 + num      ; Passes "6"
work    2 + numstr    ; Passes "2 + numstr"
work    %2 + numstr   ; Passes "6"

```

You must consider operator precedence when using the expansion operator. Parentheses inside the macro can force evaluation in a desired order:

```

work    MACRO    arg
        mov ax, (arg) * 4
    ENDM

work    2 + 3          ; Code: mov ax, (2 + 3) * 4
work    %2 + 3        ; Code: mov ax, (5) * 4

```

Several other uses for the expansion operator are reviewed in "Returning Values with Macro Functions," later in this chapter.

## Expansion Operator as First Character on a Line

The expansion operator has a different meaning when used as the first character on a line. In this case, it instructs the assembler to expand any text macros and macro functions it finds on the rest of the line.

This feature makes it possible to use text macros with directives such as **ECHO**, **TITLE**, and **SUBTITLE**, which take an argument consisting of a single text value. For instance, **ECHO** displays its argument to the standard output device during assembly. Such expansion can be useful for debugging macros and expressions, but the requirement that its argument be a single text value may have unexpected results. Consider this example:

```
ECHO    Bytes per element: %(SIZEOF array / LENGTHOF array)
```

Instead of evaluating the expression, this line echoes it:

```
Bytes per element: %(SIZEOF array / LENGTHOF array)
```

However, you can achieve the desired result by assigning the text of the expression to a text macro and then using the expansion operator at the beginning of the line to force expansion of the text macro.

```
temp    TEXTEQU %(SIZEOF array / LENGTHOF array)
%       ECHO    Bytes per element: temp
```

Note that you cannot get the same results simply by putting the `%` at the beginning of the first echo line, because `%` expands only text macros, not numeric equates or constant expressions.

Here are more examples of the expansion operator at the start of a line:

```
; Assume memmod, lang, and os specified with /D option
%   SUBTITLE Model: memmod Language: lang Operating System: os

; Assume num defined earlier
tnum    TEXTEQU %num
%       .ERRE    num LE 255, <Failed because tnum !> 255>
```

## Substitution Operator

References to a parameter within a macro can sometimes be ambiguous. In such cases, the assembler may not expand the argument as you intend. The substitution operator (`&`) lets you identify unambiguously any parameter within a macro.

As an example, consider the following macro:

```
errgen MACRO    num, msg
    PUBLIC  errnum
    errnum BYTE    "Error num: msg"
ENDM
```

This macro is open to several interpretations:

- Is `errnum` a distinct word or the word `err` next to the parameter `num`?
- Should `num` and `msg` within the string be treated literally as part of the string or as arguments?

In each case, the assembler chooses the most literal interpretation. That is, it treats `errnum` as a distinct word, and `num` and `msg` as literal parts of the string.

The substitution operator can force different interpretations. If we rewrite the macro with the `&` operator, it looks like this:

```
errgen MACRO    num, msg
    PUBLIC  err&num
    err&num BYTE    "Error &num: &msg"
ENDM
```

When called with the following arguments,

```
errgen 5, <Unreadable disk>
```

the macro now generates this code:

```
        PUBLIC  err5
err5    BYTE    "Error 5: Unreadable disk"
```

When it encounters the `&` operator, the assembler interprets subsequent text as a parameter name until the next `&` or until the next separator character (such as a space, tab, or comma). Thus, the assembler correctly parses the expression `err&num` because `num` is delimited by `&` and a space. The expression could also be written as `err&num&`, which again unambiguously identifies `num` as a parameter.

The rule also works in reverse. You can delimit a parameter reference with `&` at the end rather than at the beginning. For example, if `num` is 5, the expression `num&12` resolves to "512."

The assembler processes substitution operators from left to right. This can have unexpected results when you are pasting together two macro parameters. For example, if `arg1` has the value `var` and `arg2` has the value 3, you could paste them together with this statement:

```
&arg1&&arg2&    BYTE    "Text"
```

Eliminating extra substitution operators, you might expect the following to be equivalent:

```
&arg1&arg2      BYTE    "Text"
```

However, this actually produces the symbol `var arg2`, because in processing from left to right, the assembler associates both the first and the second `&` symbols with the first parameter. The assembler replaces `&arg1&` by `var`, producing `var arg2`. The `arg2` is never evaluated. The correct abbreviation is:

```
arg1&&arg2      BYTE    "Text"
```

which produces the desired symbol `var3`. The symbol `arg1&&arg2` is replaced by `var&arg2`, which is replaced by `var3`.

The substitution operator is also necessary if you want to substitute a text macro inside quotes. For example,

```
arg      TEXTEQU <hello>
%echo   This is a string "&arg" ; Produces: This is a string "hello"
%echo   This is a string "arg"  ; Produces: This is a string "arg"
```

You can also use the substitution operator in lines beginning with the expansion operator (`%`) symbol, even outside macros (see page 236). It may be necessary to

use the substitution operator to paste text macro names to adjacent characters or symbol names, as shown here:

```
text    TEXTEQU <var>
value   TEXTEQU %5
%       ECHO    textvalue is text&&value
```

This echoes the message

```
textvalue is var5
```

Macro substitution always occurs before evaluation of the high-level control structures. The assembler may therefore mistake a bit-test operator (**&**) in your macro for a substitution operator. You can guarantee the assembler correctly recognizes a bit-test operator by enclosing its operands in parentheses, as shown here:

```
test    MACRO    x
        .IF ax==&x      ; &x substituted with parameter value
        mov     ax, 10
        .ELSEIF ax&(x) ; & is bitwise AND
        mov ax, 20
        .ENDIF
ENDM
```

The rules for using the substitution operator have changed significantly since MASM 5.1, making macro behavior more consistent and flexible. If you have macros written for MASM 5.1 or earlier, you can specify the old behavior by using **OLDMACROS** or **M510** with the **OPTION** directive (see page 24).

## Defining Repeat Blocks with Loop Directives

A “repeat block” is an unnamed macro defined with a loop directive. The loop directive generates the statements inside the repeat block a specified number of times or until a given condition becomes true.

MASM provides several loop directives, which let you specify the number of loop iterations in different ways. Some loop directives can also accept arguments for each iteration. Although the number of iterations is usually specified in the directive, you can use the **EXITM** directive to exit the loop early.

Repeat blocks can be used outside macros, but they frequently appear inside macro definitions to perform some repeated operation in the macro. Since repeat blocks are macros themselves, they end with the **ENDM** directive.



This section explains the following four loop directives: **REPEAT**, **WHILE**, **FOR**, and **FORC**. In versions of MASM prior to 6.0, **REPEAT** was called **REPT**, **FOR** was called **IRP**, and **FORC** was called **IRPC**. MASM 6.1 recognizes the old names.

The assembler evaluates repeat blocks on the first pass only. You should therefore avoid using address spans as loop counters, as in this example:

```
REPEAT (OFFSET label1 - OFFSET label2) ; Don't do this!
```

Since the distance between two labels may change on subsequent assembly passes as the assembler optimizes code, you should not assume that address spans remain constant between passes.

---

**Note** The **REPEAT** and **WHILE** directives should not be confused with the **REPEAT** and **WHILE** directives (see “Loop-Generating Directives” in Chapter 7), which generate loop and jump instructions for run-time program control.

---

## REPEAT Loops

**REPEAT** is the simplest loop directive. It specifies the number of times to generate the statements inside the macro. The syntax is:

```
REPEAT constexpr
statements
ENDM
```

The *constexpr* can be a constant or a constant expression, and must contain no forward references. Since the repeat block expands at assembly time, the number of iterations must be known then.

Here is an example of a repeat block used to generate data. It initializes an array containing sequential ASCII values for all uppercase letters.

```
alpha LABEL BYTE ; Name the data generated
letter = 'A' ; Initialize counter
REPEAT 26 ;; Repeat for each letter
    BYTE letter ; Allocate ASCII code for letter
    letter = letter + 1 ; Increment counter
ENDM
```

Here is another use of **REPEAT**, this time inside a macro:

```
beep    MACRO    iter:=<3>
        mov ah, 2                ;; Character output function
        mov dl, 7                ;; Bell character
        REPEAT iter              ;; Repeat number specified by macro
            int 21h              ;; Call DOS
        ENDM
ENDM
```

## WHILE Loops

The **WHILE** directive is similar to **REPEAT**, but the loop continues as long as a given condition is true. The syntax is:

```
WHILE expression
    statements
ENDM
```

The *expression* must be a value that can be calculated at assembly time. Normally, the expression uses relational operators, but it can be any expression that evaluates to zero (false) or nonzero (true). Usually, the condition changes during the evaluation of the macro so that the loop won't attempt to generate an infinite amount of code. However, you can use the **EXITM** directive to break out of the loop.

The following repeat block uses the **WHILE** directive to allocate variables initialized to calculated values. This is a common technique for generating lookup tables. (A lookup table is any list of precalculated results, such as a table of interest payments or trigonometric values or logarithms. Programs optimized for speed often use lookup tables, since calculating a value often takes more time than looking it up in a table.)

```
cubes   LABEL   BYTE                ;; Name the data generated
root    =      1                    ;; Initialize root
cube    =      root * root * root   ;; Calculate first cube
WHILE  cube LE 32767                ;; Repeat until result too large
        WORD   cube                  ;; Allocate cube
        root  =      root + 1        ;; Calculate next root and cube
        cube  =      root * root * root
ENDM
```

## FOR Loops and Variable-Length Parameters

With the **FOR** directive you can iterate through a list of arguments, working on each of them in turn. It has the following syntax:

```
FOR parameter, <argumentlist>
statements
ENDM
```

The *parameter* is a placeholder that represents the name of each argument inside the **FOR** block. The argument list must contain comma-separated arguments and must always be enclosed in angle brackets. Here's an example of a **FOR** block:

```
series LABEL BYTE
FOR arg, <1,2,3,4,5,6,7,8,9,10>
    BYTE arg DUP (arg)
ENDM
```

On the first iteration, the *arg* parameter is replaced with the first argument, the value 1. On the second iteration, *arg* is replaced with 2. The result is an array with the first byte initialized to 1, the next 2 bytes initialized to 2, the next 3 bytes initialized to 3, and so on.

The argument list is given specifically in this example, but in some cases the list must be generated as a text macro. The value of the text macro must include the angle brackets.

```
arglist TEXTEQU <!<3,6,9!>> ; Generate list as text macro
%FOR arg, arglist
    . ; Do something to arg
    .
    .
ENDM
```

Note the use of the literal character operator (!) to identify angle brackets as characters, not delimiters. See “Text Delimiters (<>) and the Literal-Character Operator,” earlier in this chapter.

The **FOR** directive also provides a convenient way to process macros with a variable number of arguments. To do this, add **VARARG** to the last parameter to indicate that a single named parameter will have the actual value of all additional arguments. For example, the following macro definition includes the three possible parameter attributes—required, default, and variable.

```
work MACRO rarg:REQ, darg:=<5>, varg:VARARG
```

The variable argument must always be last. If this macro is called with the statement

```
show 4, , 6, 7, a, b
```

the first argument is received as the value 4, the second is replaced by the default value 5, and the last four are received as the single argument <6, 7, a, b>. This is the same format expected by the **FOR** directive. The **FOR** directive discards leading spaces but recognizes trailing spaces.

The following macro illustrates variable arguments:

```
show  MACRO chr:VARARG
      mov     ah, 02h
      FOR arg, <chr>
          mov     dl, arg
          int     21h
      ENDM
ENDM
```

When called with

```
show '0', 'K', 13, 10
```

the macro displays each of the specified characters one at a time.

The parameter in a **FOR** loop can have the required or default attribute. You can modify the `show` macro to make blank arguments generate errors:

```
show  MACRO chr:VARARG
      mov     ah, 02h
      FOR arg:REQ, <chr>
          mov     dl, arg
          int     21h
      ENDM
ENDM
```

The macro now generates an error if called with

```
show '0',, 'K', 13, 10
```

Another approach would be to use a default argument:

```
show    MACRO chr:VARARG
        mov     ah, 02h
        FOR arg:=<' '>, <chr>
            mov     dl, arg
            int     21h
        ENDM
ENDM
```

Now calling the macro with

```
show '0',, 'K', 13, 10
```

inserts the default character, a space, for the blank argument.

## FORC Loops

The **FORC** directive is similar to **FOR**, but takes a string of text rather than a list of arguments. The statements are assembled once for each character (including spaces) in the string, substituting a different character for the parameter each time through.

The syntax looks like this:

```
FORC parameter, <text>
    statements
ENDM
```

The *text* must be enclosed in angle brackets. The following example illustrates **FORC**:

```
FORC arg, <ABCDEFGHIJKLMNOPQRSTUVWXYZ>
    BYTE '&arg'           ;; Allocate uppercase letter
    BYTE '&arg' + 20h     ;; Allocate lowercase letter
    BYTE '&arg' - 40h     ;; Allocate ordinal of letter
ENDM
```

Notice that the substitution operator must be used inside the quotation marks to make sure that *arg* is expanded to a character rather than treated as a literal string.

With versions of MASM earlier than 6.0, **FORC** is often used for complex parsing tasks. A long sentence can be examined character by character. Each character is then either thrown away or pasted onto a token string, depending on whether it is a separator character. The new predefined macro functions and string processing directives discussed in the following section are usually more efficient for these tasks.

## String Directives and Predefined Functions

The assembler provides four directives for manipulating text:

Directive	Description
<b>SUBSTR</b>	Assigns part of string to a new symbol.
<b>INSTR</b>	Searches for one string within another.
<b>SIZESTR</b>	Determines the size of a string.
<b>CATSTR</b>	Concatenates one or more strings to a single string.

These directives assign a processed value to a text macro or numeric equate. For example, the following lines

```
num      =      7
newstr   CATSTR <3 + >, %num, < = > , %3 + num ; "3 + 7 = 10"
```

assign the string "3 + 7 = 10" to `newstr`. **CATSTR** and **SUBSTR** assign text in the same way as the **TEXTEQU** directive. **SIZESTR** and **INSTR** assign a number in the same way as the `=` operator. The four string directives take only text values as arguments. Use the expansion operator (`%`) when you need to make sure that constants and numeric equates expand to text, as shown in the preceding lines.

Each of the string directives has a corresponding predefined macro function version: **@SubStr**, **@InStr**, **@SizeStr**, and **@CatStr**. Macro functions are similar to the string directives, but you must enclose their arguments in parentheses. Macro functions return text values and can appear in any context where text is expected. The following section, "Returning Values with Macro Functions," tells how to write your own macro functions. The following example is equivalent to the previous **CATSTR** example:

```
num      =      7
newstr   TEXTEQU @CatStr( <3 + >, %num, < = > , %3 + num )
```

Macro functions are often more convenient than their directive counterparts because you can use a macro function as an argument to a string directive or to another macro function. Unlike string directives, predefined macro function names are case sensitive when you use the `/Cp` command-line option.

Each string directive and predefined function acts on a string, which can be any *textItem*. The *textItem* can be text enclosed in angle brackets (`<>`), the name of a text macro, or a constant expression preceded by `%` (as in `%constExpr`). Refer to Appendix B, "BNF Grammar," for a list of types that *textItem* can represent.

The following sections summarize the syntax for each of the string directives and functions. The explanations focus on the directives, but the functions work the same except where noted.

## SUBSTR

*name* **SUBSTR** *string*, *start*[[, *length*]]  
**@SubStr**( *string*, *start*[[, *length*]] )

The **SUBSTR** directive assigns a substring from a given *string* to the symbol *name*. The *start* parameter specifies the position in *string*, beginning with 1, to start the substring. The *length* gives the length of the substring. If you do not specify *length*, **SUBSTR** returns the remainder of the string, including the *start* character.

## INSTR

*name* **INSTR** [[*start*,]] *string*, *substring*  
**@InStr**( [[*start*]], *string*, *substring* )

The **INSTR** directive searches a specified *string* for an occurrence of *substring* and assigns its position number to *name*. The search is case sensitive. The *start* parameter is the position in *string* to start the search for *substring*. If you do not specify *start*, it is assumed to be position 1, the start of the string. If **INSTR** does not find *substring*, it assigns position 0 to *name*.

The **INSTR** directive assigns the position value *name* as if it were a numeric equate. In contrast, the **@InStr** returns the value as a string of digits in the current radix.

The **@InStr** function has a slightly different syntax than the **INSTR** directive. You can omit the first argument and its associated comma from the directive. You can leave the first argument blank with the function, but a blank function argument must still have a comma. For example,

```
pos      INSTR  <person>, <son>
```

is the same as

```
pos      = @InStr( , <person>, <son> )
```

You can also assign the return value to a text macro, like this:

```
strpos  TEXTEQU @InStr( , <person>, <son> )
```

## SIZESTR

*name* **SIZESTR** *string*  
**@SizeStr**( *string* )

The **SIZESTR** directive assigns the number of characters in *string* to *name*. An empty string returns a length of zero. The **SIZESTR** directive assigns the size value to a name as if it were a numeric equate. The **@SizeStr** function returns the value as a string of digits in the current radix.

## CATSTR

*name* CATSTR *string*[, *string*]...  
 @CatStr( *string*[, *string*]... )

The **CATSTR** directive concatenates a list of text values into a single text value and assigns it to *name*. **TEXTEQU** is technically a synonym for **CATSTR**. **TEXTEQU** is normally used for single-string assignments, while **CATSTR** is used for multistring concatenations.

The following example pushes and pops one set of registers, illustrating several uses of string directives and functions:

```

; SaveRegs - Macro to generate a push instruction for each
; register in argument list. Saves each register name in the
; regpushed text macro.
regpushed TEXTEQU <>                ;; Initialize empty string

SaveRegs MACRO regs:VARARG
    LOCAL reg
    FOR reg, <regs>                    ;; Push each register
        push reg                        ;; and add it to the list
        regpushed CATSTR <reg>, <,>, regpushed
    ENDM                                ;; Strip off last comma
    regpushed CATSTR <!<>, regpushed    ;; Mark start of list with <
    regpushed SUBSTR regpushed, 1, @SizeStr( regpushed )
    regpushed CATSTR regpushed, <!>>    ;; Mark end with >
ENDM

; RestoreRegs - Macro to generate a pop instruction for registers
; saved by the SaveRegs macro. Restores one group of registers.

RestoreRegs MACRO
    LOCAL reg
    %FOR reg, regpushed                ;; Pop each register
        pop reg
    ENDM
ENDM

```

Notice how the **SaveRegs** macro saves its result in the **regpushed** text macro for later use by the **RestoreRegs** macro. In this case, a text macro is used as a global variable. By contrast, the **reg** text macro is used only in **RestoreRegs**. It is declared **LOCAL** so it won't take the name **reg** from the global name space. The **MACROS.INC** file provided with **MASM 6.1** includes expanded versions of these same two macros.



## Returning Values with Macro Functions

A macro function is a named group of statements that returns a value. When calling a macro function, you must enclose its argument list in parentheses, even if the list is empty. The function always returns text.

MASM 6.1 provides several predefined macro functions for common tasks. The predefined macros include **@Environ** (see page 10) and the string functions **@SizeStr**, **@CatStr**, **@SubStr**, and **@InStr** (discussed in the preceding section).

You define macro functions in exactly the same way as macro procedures, except that a macro function always returns a value through the **EXITM** directive. Here is an example:

```
DEFINED MACRO    symbol:REQ
    IFDEF symbol
        EXITM <-1>                ;; True
    ELSE
        EXITM <0>                 ;; False
    ENDIF
ENDM
```

This macro works like the **defined** operator in the C language. You can use it to test the defined state of several different symbols with a single statement, as shown here:

```
IF DEFINED( DOS ) AND NOT DEFINED( XENIX )
    ;; Do something
ENDIF
```

Notice that the macro returns integer values as strings of digits, but the **IF** statement evaluates numeric values or expressions. There is no conflict because the assembler sees the value returned by the macro function exactly as if the user had typed the values directly into the program:

```
IF -1 AND NOT 0
```

## Returning Values with EXITM

The return value must be text, a text equate name, or the result of another macro function. A macro function must first convert a numeric value—such as a constant, a numeric equate, or the result of a numeric expression—before returning it. The macro function can use angle brackets or the expansion operator (**%**) to convert numbers to text. The **DEFINED** macro, for instance, could have returned its value as

```
EXITM    %-1
```

Here is another example of a macro function that uses the **WHILE** directive to calculate factorials:

```
factorial MACRO num:REQ
  LOCAL i, factor
  factor = num
  i      = 1
  WHILE factor GT 1
    i      = i * factor
    factor = factor - 1
  ENDM
  EXITM %i
ENDM
```

The integer result of the calculation is changed to a text string with the expansion operator (%). The `factorial` macro can define data, as shown here:

```
var WORD factorial( 4 )
```

This statement initializes `var` with the number 24 (the factorial of 4).

## Using Macro Functions with Variable-Length Parameter Lists

You can use the **FOR** directive to handle macro parameters with the **VARARG** attribute. “FOR Loops and Variable-Length Parameters,” page 242, explains how to do this in simple cases where the variable parameters are handled sequentially, from first to last. However, you may sometimes need to process the parameters in reverse order or nonsequentially. Macro functions make these techniques possible.

For example, the following macro function determines the number of arguments in a **VARARG** parameter:

```
@ArgCount MACRO arglist:VARARG
  LOCAL count
  count = 0
  FOR arg, <arglist>
    count = count + 1.      ;; Count the arguments
  ENDM
  EXITM %count
ENDM
```



Here is an example showing @ArgRev in use:

```
work    MACRO    args:VARARG
%    FOR    arg, @ArgRev( <args> )    ;; Process in reverse order
        ECHO    arg
    ENDM
ENDM
```

These three macro functions appear in the MACROS.INC include file, located on one of the MASM distribution disks.

## Expansion Operator in Macro Functions

This list summarizes the behavior of the expansion operator (%) with macro functions.

- If a macro function is preceded by a %, it will be expanded. However, if it expands to a text macro or a macro function call, it will not expand further.
- If you use a macro function call as an argument for another macro function call, a % is not needed.
- If a macro function is called inside angle brackets and is preceded by %, it will be expanded.

## Advanced Macro Techniques

The concept of replacing macro names with predefined macro text is simple in theory, but it has many implications and complications. Here is a brief summary of some advanced techniques you can use in macros.

### Defining Macros within Macros

Macros can define other macros, a technique called “nesting macros.” MASM expands macros as it encounters them, so nested macros are always processed in nesting order. You cannot reference a nested macro directly in your program, since the assembler begins expansion from the outer macro. In effect, a nested macro is local to the macro that defines it. Only the amount of available memory limits the number of macros a program can nest.

The following example demonstrates how one macro can define another. The macro takes as an argument the name of a shift or rotate instruction, then creates another macro that simplifies the instruction for 8088/86 processors.

```
shifts MACRO  opname                ;; Macro generates macros
  opname&s  MACRO operand:REQ, rotates:=<1>
    IF rotates LE 2                  ;; One at a time is faster
      REPEAT rotate                  ;; for 2 or less
        opname operand, 1
      ENDM
    ELSE                               ;; Using CL is faster for
      mov    cl, rotates             ;; more than 2
      opname operand, cl
    ENDIF
  ENDM
ENDM
```

Recall that the 8086 processor allows only 1 or CL as an operand for shift and rotate instructions. Expanding `shifts` generates a macro for the shift instruction that uses whichever operand is more efficient. You create the entire series of macros, one for each shift instruction, like this:

```
;; Call macro repeatedly to make new macros
shifts ror                ;; Generates rors
shifts rol                ;; Generates rols
shifts shr                ;; Generates shrs
shifts shl                ;; Generates shls
shifts rcl                ;; Generates rcls
shifts rcr                ;; Generates rcrs
shifts sal                ;; Generates sals
shifts sar                ;; Generates sars
```

Then use the new macros as replacements for shift instructions, like this:

```
shrs    ax, 5
rols    bx, 3
```

## Testing for Argument Type and Environment

Macros can expand conditional blocks of code by testing for argument type with the **OPATTR** operator. **OPATTR** returns a single word constant that indicates the type and scope of an expression, like this:

**OPATTR** *expression*

If *expression* is not valid or is forward-referenced, **OPATTR** returns a 0. Otherwise, the return value incorporates the bit flags shown in the table below.

**OPATTR** serves as an enhanced version of the **.TYPE** operator, which returns only the low byte (bits 0–7) shown in the table. Bits 11–15 of the return value are undefined.

Bit	Set If expression
0	References a code label
1	Is a memory variable or has a relocatable data label
2	Is an immediate value
3	Uses direct memory addressing
4	Is a register value
5	References no undefined symbols and is without error
6	Is relative to SS
7	References an external label
8–10	Has the following language type: <ul style="list-style-type: none"> <li>▪ 000—No language type</li> <li>▪ 001—C</li> <li>▪ 010—SYSCALL</li> <li>▪ 011—STDCALL</li> <li>▪ 100—Pascal</li> <li>▪ 101—FORTRAN</li> <li>▪ 110—Basic</li> </ul>

A macro can use **OPATTR** to determine if an argument is a constant, a register, or a memory operand. With this information, the macro can conditionally generate the most efficient code depending on argument type.

For example, given a constant argument, a macro can test it for 0. Depending on the argument's value, the code can select the most effective method to load the value into a register:

```

IF CONST
mov    bx, CONST    ; If CONST > 0, move into BX
ELSE
sub    bx, bx       ; More efficient if CONST = 0
ENDIF

```

The second method is faster than the first, yet has the same result (with the byproduct of changing the processor flags).

The following macro illustrates some techniques using **OPATTR** by loading an address into a specified offset register:

```
load    MACRO reg:REQ, adr:REQ
        IF (OPATTR (adr)) AND 00010000y    ;; Register
            IFDIFI reg, adr                ;; Don't load register
                mov    reg, adr            ;; onto itself
            ENDIF
        ELSEIF (OPATTR (adr)) AND 00000100y
            mov    reg, adr                ;; Constant
        ELSEIF (TYPE (adr) EQ BYTE) OR (TYPE (adr) EQ SBYTE)
            mov    reg, OFFSET adr        ;; Bytes
        ELSEIF (SIZE (TYPE (adr)) EQ 2)
            mov    reg, adr                ;; Near pointer
        ELSEIF (SIZE (TYPE (adr)) EQ 4)
            mov    reg, WORD PTR adr[0]   ;; Far pointer
            mov    ds, WORD PTR adr[2]
        ELSE
            .ERR <Illegal argument>
        ENDIF
    ENDM
```

A macro also can generate different code depending on the assembly environment. The predefined text macro **@Cpu** returns a flag for processor type. The following example uses the more efficient constant variation of the **PUSH** instruction if the processor is an 80186 or higher.

```
IF @Cpu AND 00000010y
    pushc MACRO op                ;; 80186 or higher
        push op
    ENDM
ELSE
    pushc MACRO op                ;; 8088/8086
        mov ax, op
        push ax
    ENDM
ENDIF
```

Another macro can now use **pushc** rather than conditionally testing for processor type itself. Although either case produces the same code, using **pushc** assembles faster because the environment is checked only once.

You can test the language and operating system using the **@Interface** text macro. The memory model can be tested with the **@Model**, **@DataSize**, or **@CodeSize** text macros.

You can save the contexts inside macros with **PUSHCONTEXT** and **POPCONTEXT**. The options for these keywords are:

Option	Description
<b>ASSUMES</b>	Saves segment register information
<b>RADIX</b>	Saves current default radix
<b>LISTING</b>	Saves listing and CREF information
<b>CPU</b>	Saves current CPU and processor
<b>ALL</b>	All of the above

## Using Recursive Macros

Macros can call themselves. In MASM 5.1 and earlier, recursion is an important technique for handling variable arguments. MASM 6.1 handles variable arguments much more cleanly with the **FOR** directive and the **VARARG** attribute, as described in “FOR Loops and Variable-Length Parameters,” earlier in this chapter. However, recursion is still available and may be useful for some macros.





# Writing a Dynamic-Link Library For Windows

The Windows operating system relies heavily on service routines and data contained in special libraries called “dynamic-link libraries,” or DLLs for short. Most of what Windows comprises, from the collections of screen fonts to the routines that handle the graphical interface, is provided by DLLs. MASM 6.1 contains tools that you can use to write DLLs in assembly language. This chapter shows you how.

DLLs do not run under MS-DOS. The information in this chapter applies only to Windows, drawing in part on the chapter “Writing a Module-Definition File” in *Environment and Tools*. The acronym API, which appears throughout this chapter, refers to the application programming interface that Windows provides for programs. For documentation of API functions, see the *Programmer’s Reference, Volume 2* of the Windows Software Development Kit (SDK).

The first section of this chapter gives an overview of DLLs and their similarities to normal libraries. The next section explores the parts of a DLL and the rules you must follow to create one. The third section applies this information to an example DLL.

## Overview of DLLs

A dynamic-link library is similar to a normal run-time library. Both types of libraries contain a collection of compiled procedures, which serve one or more calling modules. To link a normal library, the linker copies the required functions from the library file (which usually has a .LIB extension) and combines them with other modules to form an executable program in .EXE format. This process is called static linking.

In dynamic linking, the library functions are not copied to an .EXE file. Instead, they reside in a separate file in executable form, ready to serve any calling program, called a “client.” When the first client requires the library, Windows takes care of loading the functions into memory and establishing linkage. If subsequent clients

also need the library, Windows dynamically links them with the proper library functions already in memory.

## Loading a DLL

How Windows loads a DLL affects the client rather than the DLL itself. Accordingly, this section focuses on how to set up a client program to use a DLL. Since the client can itself be a DLL, this is information a DLL programmer should know. However, MASM 6.1 does not provide all the tools required to create a stand-alone program for Windows. To create such a program, called an “application,” you must use tools in the Windows SDK.

Windows provides two methods for loading a dynamic-link library into memory:

Method	Description
Implicit loading	Windows loads the DLL along with the first client program and links it before the client begins execution.
Explicit loading	Windows does not load the DLL until the first client explicitly requests it during execution.

When you write a DLL, you do not need to know beforehand which of the two methods will be used to load the library. The loading method is determined by how the client is written, not the DLL.

### Implicit Loading

The implicit method of loading a DLL offers the advantage of simplicity. The client requires no extra programming effort and can call the library functions as if they were normal run-time functions. However, implicit loading carries two constraints:

- The name of the library file must have a .DLL extension.
- You must either list all DLL functions the client calls in the IMPORTS section of the client's module-definition file, or link the client with an import library.

An import library contains no executable code. It consists of only the names and locations of exported functions in a DLL. The linker uses the locations in the import library to resolve references to DLL functions in the client and to build an executable header. For example, the file LIBW.LIB provided with MASM 6.1 is the import library for the DLL files that contain the Windows API functions.

The IMPLIB utility described in *Environment and Tools* creates an import library. Run IMPLIB from the MS-DOS command line like this:

```
IMPLIB implibfile dllfile
```

where *implibfile* is the name of the import library you want to create from the DLL file *dllfile*. Once you have created an import library from a DLL, link it with a

client program that relies on implicit loading, but does not list imported functions in its module-definition file. Continuing the preceding example, here's the link step for a client program that calls library procedures in the DLL *dllfile*:

```
LINK client.OBJ, client.EXE, , implibfile, client.DEF
```

This simplified example creates the client program *client.EXE*, linking it with the import library *implibfile*, which in turn was created from the DLL file *dllfile*.

To summarize implicit loading, a client program must either

- List DLL functions in the IMPORTS section of its module-definition file, or
- Link with an import library created from the DLL.

Implicit loading is best when a client always requires at least one procedure in the library, since Windows automatically loads the library with the client. If the client does not always require the library service, or if the client must choose at run time between several libraries, you should use explicit loading, discussed next.

## Explicit Loading

To explicitly load a DLL, the client does not require linking with an import library, nor must the DLL file have an extension of *.DLL*. Explicit loading involves three steps in which the client calls Windows API functions:

1. The client calls **LoadLibrary** to load the DLL.
2. The client calls **GetProcAddress** to obtain the address of each DLL function it requires.
3. When finished with the DLL, the client calls **FreeLibrary** to unload the DLL from memory.

The following example fragment shows how a client written in assembly language explicitly loads a DLL called *SYSINFO.DLL* and calls the DLL function *GetSysDate*.

```
        INCLUDE windows.inc
        .DATA
hInstance    HINSTANCE 0
szDLL        BYTE      'SYSINFO.DLL', 0
szDate       BYTE      'GetSysDate', 0
lpProc       DWORD     0
```

```

.CODE
.
.
.
INVOKE LoadLibrary, ADDR szDLL      ; Load SYSINFO.DLL
mov    hInstance, ax                ; Save instance count
INVOKE GetProcAddress, ax, ADDR szDate ; Get and save
mov    lpProc, ax                   ; far address of
mov    lpProc[2], dx                 ; GetSysDate
call   lpProc                        ; Call GetSysDate
.
.
.
INVOKE FreeLibrary, hInstance ; Unload SYSINFO.DLL

```

For simplicity, the above example contains no error-checking code. An actual program should check all values returned from the API functions.

The explicit method of loading a DLL requires more programming effort in the client program. However, the method allows the client to control which (if any) dynamic-link libraries to load at run time.

## Searching for a DLL File

To load a DLL, whether implicitly or explicitly, Windows searches for the DLL file in the following directories in the order shown:

1. The current directory
2. The Windows directory, which contains WIN.COM
3. The Windows system directory, which contains system files such as GDILEXE
4. The directory where the client program resides (except Windows 3.0 and earlier)
5. Directories listed in the PATH environment string
6. Directories mapped in a network

If Windows does not locate the DLL in any of these directories, it prompts the user with a message box.

## Building a DLL

A DLL has additional programming requirements beyond those for a normal run-time library. This section describes the requirements pertaining to the library's code, data, and stack. It also discusses the effects of the library's extension name.

## DLL Code

The code in a DLL consists of exported and nonexported functions. Exported functions, listed in the **EXPORTS** section of the module-definition file, are public routines serving clients. Nonexported functions provide private, internal support for the exported procedures. They are not visible to a client.

Under Windows, an exported library routine must appear to the caller as a far procedure. Your DLL routines can use any calling convention you wish, provided the caller assumes the same convention. You can think of dynamic-link code as code for a normal run-time library with the following additions:

- An entry procedure
- A termination procedure
- Special prologue and epilogue code

### Entry Procedure

A DLL, like any Windows-based program, must have an entry procedure. Windows calls the entry procedure only once when it first loads the DLL, passing the following information in registers:

- DS contains the library's data segment address.
- DI holds the library's instance handle.
- CX holds the library's heap size in bytes.

---

**Note** Windows API functions destroy all registers except DI, SI, BP, DS, and the stack pointer. To preserve the contents of other registers, your program must save the registers before an API call and restore them afterwards.

---

This information corresponds to the data provided to an application. Since a DLL has only one occurrence in memory, called an "instance," the value in DI is not usually important. However, a DLL can use its instance handle to obtain resources from its own executable file.

The entry procedure does not need to record the address of the data segment. Windows automatically ensures that each exported routine in the DLL has access to the library's data segment, as explained in "Prologue and Epilogue Code," on page 264.

The heap size contained in CX reflects the value provided in the **HEAPSIZE** statement of the module-definition file. You need not make an accurate guess in the **HEAPSIZE** statement about the library's heap requirements, provided you specify a moveable data segment. With a moveable segment, Windows automatically allocates more heap when needed. However, Windows can provide no more heap in

a fixed data segment than the amount specified in the **HEAPSIZE** statement. In any case, a library's total heap cannot exceed 64K, less the amount of static data. Static data and heap reside in the same segment.

Windows does not automatically deallocate unneeded heap while the DLL is in memory. Therefore, you should not set an unnecessarily large value in the **HEAPSIZE** statement, since doing so wastes memory.

The entry procedure calls the Windows API function **LocalInit** to allocate the heap. The library must create a heap before its routines call any heap functions, such as **LocalAlloc**. The following example illustrates these steps:

```

DLLEntry PROC FAR PASCAL PUBLIC           ; Entry point for DLL

        jcxz    @F                         ; If no heap, skip
        INVOKE LocalInit, ds, 0, cx       ; Else set up the heap
        .IF    ( ax )                     ; If successful,
        INVOKE UnlockSegment, -1        ; unlock the data segment
@@:     call    LibMain                   ; Call DLL's data init routine
        mov    ax, TRUE                  ; Return AX = 1 if okay,
        .ENDIF                            ; else if LocalInit error,
        ret                                ; return AX = 0

DLLEntry ENDP

```

This example code is taken from the **DLENTY.ASM** module, contained in the **LIB** subdirectory on one of the **MASM 6.1** distribution disks. After allocating the heap, the procedure calls the library's initialization procedure—called **LibMain** in this case. **LibMain** initializes the library's static data (if required), then returns to **DLEnty**, which returns to Windows. If Windows receives a return value of **0** (**FALSE**) from **DLEnty**, it unloads the library and displays an error message.

The process is similar to the way **MS-DOS** loads a terminate-and-stay-resident program (**TSR**), described in the next chapter. Both the **DLL** and **TSR** return control immediately to the operating system, then wait passively in memory to be called.

The following section explains how a **DLL** gains control when Windows unloads it from memory.

## Termination Procedure

Windows maintains a **DLL** in memory until the last client program terminates or explicitly unloads the library. When unloading a **DLL**, Windows first calls the library's termination procedure. This allows the **DLL** to return resources and do any necessary cleanup operations before Windows unloads the library from memory.





Usually, the WEP procedure takes the same actions regardless of the parameter value, since in either case Windows will unload the DLL.

Under Windows 3.0, the WEP procedure receives stack space of about 256 bytes. This allows the procedure to unhook interrupts, but little else. Any other action, such as calling an API function, usually results in an unrecoverable application error because of stack overflow. Later versions of Windows provide at least 4K of stack to the WEP procedure, allowing it to call many API functions.

However, WEP should not send or post a message to a client, because the client may already be terminated. The WEP procedure should also not attempt file I/O, since only application processes—not DLLs—can own files. When control reaches WEP, the client may no longer exist and its files are closed.

## Prologue and Epilogue Code

Exported procedures in a Windows-based program require special epilogue and prologue code. (For a definition of these terms, see “Generating Prologue and Epilogue Code” in Chapter 7.) The SAMPLES subdirectory on one of the MASM 6.1 distribution disks contains macros you can use for far procedures in your Windows-based programs. Here's a listing of the prologue macro:

```

Prolog  MACRO
        mov     ax, ds           ; Must be 1st, since Windows overwrites
        nop                    ; Placeholder for 3rd byte
        inc     bp              ; Push odd BP. Not required, but
        push   bp              ; allows CodeView to recognize frame
        mov     bp, sp         ; Set up stack frame to access params
        push   ds              ; Save DS
        mov     ds, ax         ; Point DS to DLL's data segment
        ENDM

```

The instruction

```
inc     bp
```

marks the beginning of the stack frame with an odd number. This allows real-mode Windows to locate segment addresses on the stack and update the addresses when it moves or discards the corresponding segments. In protected mode, selector values do not change when segments are moved, so marking the stack frame is not required. However, certain debugging applications, such as Microsoft Codeview for Windows and the Microsoft Windows 80386 Debugger (both documented in *Programming Tools* of the SDK), search for a marked frame to determine if the frame belongs to a far procedure. Without the mark, these debuggers give meaningless information when backtracing through the stack. Therefore, you should include the **INC BP** instruction for Windows-based programs that may run in real mode or that require debugging with a Microsoft debugger.

Another characteristic of the prologue macro may seem puzzling at first glance. The macro moves DS into AX, then AX back into DS. This sequence of instructions lets Windows selectively overwrite the prologue code in far procedures. When Windows loads a program, it compares the names of far procedures with the list of exported procedures in the module-definition file. For procedures that do not appear on the list, Windows leaves their prologue code untouched. However, Windows overwrites the first 3 bytes of all exported procedures with

```
mov ax, DGROUP
```

where DGROUP represents the selector value for the library's data segment. This explains why the prologue macro reserves the third byte with a **NOP** instruction. The 1-byte instruction serves as padding to provide a 3-byte area for Windows to overwrite.

The epilogue code returns BP to normal, like this:

```
Epilog MACRO
    pop ds          ; Recover original DS
    pop bp         ; and BP+1
    dec bp        ; Reset to original BP
ENDM
```

## DLL Data

A DLL can have its own local data segment up to 64K. Besides static data, the segment contains the heap from which a procedure can allocate memory through the **LocalAlloc** API function. You should minimize static data in a DLL to reserve as much memory as possible for temporary allocations. Furthermore, all procedures in the DLL draw from the same heap space. If more than one procedure in the library accesses the heap, a procedure should not hold allocated space unnecessarily at the expense of the other procedures.

A Windows-based program must reserve a "task header" in the first 16 bytes of its data segment. If you link your program with a C run-time function, the C startup code automatically allocates the task header. Otherwise, you must explicitly reserve and initialize the header with zeros. The sample program described in "Example of a DLL:SYSINFO," page 267, shows how to allocate a task header.

## DLL Stack

A DLL does not declare a stack segment and does not allocate stack space. A client program calls a library's exported procedure through a simple far call, and the stack does not change. The procedure is, in effect, part of the calling program, and therefore uses the caller's stack.

This simple arrangement differs from that used in small and medium models, in which many C run-time functions accept near pointers as arguments. Such functions assume the pointer is relative to the current data segment. In applications, the call works even if the argument points to a local variable on the stack, since DS and SS contain the same segment address.

However, in a DLL, DS and SS point to different segments. Under small and medium models, a library procedure must always pass pointers to static variables located in the data segment, not to local variables on the stack.

When you write a DLL, include the **FARSTACK** keyword with the **.MODEL** directive, like this:

```
.MODEL small, pascal, farstack
```

This informs the assembler that SS points to a segment other than DGROUP. With full segment definitions, also add the line:

```
ASSUME DS:DGROUP, SS:NOTHING
```

## DLL Extension Names

You can name an explicitly-loaded DLL file with any extension. The many files in your Windows directory with extensions such as .DRV and .FON are almost certainly DLLs. Many DLLs have an .EXE extension, though they are not true executable files.

A library with an .EXE extension should always include stub code, specified by the **STUB** statement in the module-definition file. The stub code activates when run under MS-DOS, usually displaying a message to inform the user that the program requires Windows. Without the stub code, the system hangs if a user attempts to run a DLL with an .EXE extension.

Do not name a DLL with a .COM extension, since MS-DOS will give control to the first byte of the program header. The header does not contain executable instructions, and the system will hang even if the DLL has stub code.

## Summary

Following is a summary of the previous information in this chapter.

- A dynamic-link library has only one instance—that is, it can load only once during a Windows session.
- A single DLL can service calls from many client programs. Windows takes care of linkage between the DLL and each client.

- Windows loads a DLL either implicitly (along with the first client) or explicitly (when the first client calls **LoadLibrary**). It unloads the DLL when the last client either terminates or calls **FreeLibrary**.
- A client calls a DLL routine as a simple far procedure. The routine can use any calling convention.
- Windows ensures that the first instruction in a DLL procedure moves the address of the library's data segment into AX. You must provide the proper prologue code to allow space for this 3-byte instruction and to copy AX to DS.
- All procedures in a DLL have access to a single common data segment. The segment contains both static variables and heap space, and cannot exceed 64K.
- A DLL procedure uses the caller's stack.
- All exported procedures in a DLL must appear in the **EXPORTS** list in the library's module-definition file.

## Example of a DLL: SYSINFO

Like any library, a DLL should be as small and fast as possible—a good argument for writing it in assembly language. This section describes an example library called SYSINFO, written entirely in assembly language. The following text applies previous information in this chapter to an actual DLL.

SYSINFO contains three callable procedures. The acronym ASCIIZ refers to a string of ASCII characters terminated with a zero. The callable procedures are:

Procedure	Description
GetSysTime	Returns a far pointer to a 12-byte ASCIIZ string containing the current time in <i>hh:mm:ss</i> format.
GetSysDate	Returns a far pointer to an ASCIIZ string containing the current date in any of six languages.
GetSysInfo	Returns a far pointer to a structure containing the following system data: <ul style="list-style-type: none"> <li>▪ ASCIIZ string of Windows version</li> <li>▪ ASCIIZ string of MS-DOS version</li> <li>▪ Current keyboard status</li> <li>▪ Current video mode</li> <li>▪ Math coprocessor flag</li> <li>▪ Processor type</li> <li>▪ ASCIIZ string of ROM-BIOS release date</li> </ul>

To see SYSINFO in action, follow the steps below. The file SYSDATA.EXE resides in the SAMPLES\WINDLL subdirectory of MASM if you requested

example files when installing MASM. Otherwise, you must first install the file with the MASM 6.1 SETUP utility.

- Create SYSINFO.DLL as described in the following section and place it in the SAMPLESWINDLL subdirectory for MASM 6.1.
- From the Windows File Manager, make the SAMPLESWINDLL subdirectory the current directory.
- In the Program Manager, choose Run from the File menu and type  
 SYSDATA  
 to run the example program SYSDATA.EXE. This program calls the routines in SYSINFO.DLL and displays the returned data.

## Entry Routine for SYSINFO

SYSINFO links with the DLENTRY module, which serves as the library's entry point when Windows first loads the program. For a listing and description of DLENTRY.ASM, see the previous section, "Entry Procedure."

DLENTRY replaces the LIBENTRY module provided with the Windows SDK, but unlocks the data segment after calling the API function **InitTask**. LIBENTRY does not unlock the segment. DLENTRY saves some space over LIBENTRY, because it does not pass any arguments to **LibMain**.

The **LibMain** procedure handles the library's initialization tasks. You can name the procedure whatever you want, provided you make the same change in

DLENTRY.ASM and reassemble both modules. You can even combine DLENTRY with **LibMain** to form one procedure, like this:

```
DLLInit PROC FAR PASCAL PUBLIC          ; Entry point for DLL

        jcxz   @F                        ; If no heap, skip
        INVOKE LocalInit, ds, 0, cx     ; Else set up the heap
        .IF   ( ax )                    ; If successful,
        INVOKE UnlockSegment, -1       ; unlock the data segment
@@:     .                                           ; Initialize DLL data. This
        .                                           ; replaces the call to the
        .                                           ; LibMain procedure.
        mov   ax, TRUE                  ; Return AX = 1 if okay,
        .ENDIF                          ; else if LocalInit error,
        ret                               ; return AX = 0

DLLInit ENDP
END    DLLInit
```

Whatever you call your combined procedure (DLLInit in the preceding example), place the name on the **END** statement as shown. This identifies the procedure as the one that first executes when Windows loads the DLL.

SYSINFO accommodates several international languages. Currently, SYSINFO recognizes English, French, Spanish, German, Italian, and Swedish, but you can easily extend the code to include other languages. LibMain calls **GetProfileString** to determine the current language, then initializes the variable `indx` accordingly. The variable indirectly points to an array of strings containing days and months in different languages. The `GetSysDate` procedure uses these strings to create a full date in the correct language.

## Static Data

SYSINFO stores the strings in its static data segment. This data remains in memory along with the library's code. All procedures have equal access to the data segment.

Because the library does not call any C run-time functions, it explicitly allocates the low paragraph of the data segment with the variable `TaskHead`. This 16-byte area serves as the required Windows task header, described in "DLL Data," earlier in this chapter.

## Module-Definition File

The library's module-definition file, named SYSINFO.DEF, looks like this:

```

LIBRARY          SYSINFO
DESCRIPTION      'Sample assembly-language DLL'
EXETYPE          WINDOWS
CODE             PRELOAD MOVEABLE DISCARDABLE
DATA            PRELOAD MOVEABLE SINGLE
SEGMENTS CODE2  PRELOAD FIXED
EXPORTS          WEP             @1             RESIDENTNAME
                GetSysTime      @2
                GetSysDate      @3
                GetSysInfo      @4

```

Note the following points about the module-definition file:

- The **LIBRARY** statement identifies SYSINFO as a dynamic-link library.
- SYSINFO places its termination procedure WEP in a separate code segment, called CODE2, which the **SEGMENTS** statement declares as **FIXED**. This keeps the WEP routine fixed in memory, while all other code remains moveable.
- The **EXPORTS** section lists all procedures the library exports, including WEP.
- None of the library's procedures require heap space, so SYSINFO.DEF includes no **HEAPSIZ**E statement.

## Assembling and Linking SYSINFO

The following listing shows the description file for SYSINFO:

```
sysinfo.obj: sysinfo.asm dll.inc
    ML /c /W3 sysinfo.asm
dllentry.obj: dllentry.asm dll.inc.
    ML /c /W3 dllentry.asm
sysinfo.dll: dllentry.obj sysinfo.obj
    LINK dllentry sysinfo, sysinfo.dll,, libw.lib mnocrt dw.lib,
sysinfo.def
```

To create SYSINFO.DLL, run the **NMAKE** utility described in Chapter 16 of *Environments and Tools*. Or assemble and link SYSINFO with the three command lines shown in the preceding listing. This does not require running **NMAKE**.

SYSINFO links with the library modules **MNOCRTDW.LIB** and **LIBW.LIB**. The first supplies the required Windows startup code for a medium-model DLL that does not use any C run-time functions. **LIBW.LIB** is the Windows import library, which contains no executable code. The import library provides linkage information for the Windows API functions referenced in the DLL. Windows establishes the final links when it loads the program.

## Expanding SYSINFO

SYSINFO is an example of how to write an assembly-language DLL without overwhelming detail. It has plenty of room for expansion and improvements. The following list may give you some ideas:

- To create a heap area for the library, add the line

**HEAPSIZE** *value*

to the module-definition file, where *value* is an approximate guess for the amount of heap required in bytes. The **DLLEntry** procedure automatically allocates the indicated amount of heap. Keep the data segment moveable, because Windows then provides more heap space if required by the DLL procedures.

- If you want to add a procedure that calls C run-time functions, you must replace **MNOCRTDW.LIB** with **MDLLCW.LIB**, which is supplied with the Windows SDK. The **MDLLCW.LIB** library contains the run-time functions for medium-model DLLs.

- Each time the `GetSysInfo` procedure is called, it retrieves the version number of MS-DOS and Windows, gets the processor type, checks for a coprocessor, and reads the ROM-BIOS release date. Since this information does not change throughout a Windows session, it would be handled more efficiently in the `LibMain` procedure, which executes only once. The code is currently placed in `GetSysInfo` for the sake of clarity at the expense of efficiency.
- `SYSINFO` is not a true international program. You can easily add more languages, extending the `days` and `months` arrays accordingly. Moreover, for the sake of simplicity, the `GetSysDate` procedure arranges the date with an American bias. For example, in many parts of the world, the date numeral appears before the month rather than after. If you use `SYSINFO` in your own applications, you should include code in `LibMain` to determine the correct date format with additional calls to `GetProfileString`. You can find more information on how to do this in Chapter 18 of the *Microsoft Windows Programmer's Reference, Volume 1*, supplied with the Windows SDK.





# Writing Memory-Resident Software

Through its memory-management system, MS-DOS allows a program to remain resident in memory after terminating. The resident program can later regain control of the processor to perform tasks such as background printing or “popping up” a calculator on the screen. Such a program is commonly called a TSR, from the terminate-and-stay-resident function it uses to return to MS-DOS.

This chapter explains the techniques of writing memory-resident software. The first two sections present introductory material. Following sections describe important MS-DOS and BIOS interrupts and focus on how to write safe, compatible, memory-resident software. Two example programs illustrate the techniques described in the chapter. The MASM 6.1 disks contain complete source code for the two example TSR programs.

## Terminate-and-Stay-Resident Programs

MS-DOS maintains a pointer to the beginning of unused memory. Programs load into memory at this position and terminate execution by returning control to MS-DOS. Normally, the pointer remains unchanged, allowing MS-DOS to reuse the same memory when loading other programs.

A terminating program can, however, prevent other programs from loading on top of it. These programs exit to MS-DOS through the terminate-and-stay-resident function, which resets the free-memory pointer to a higher position. This leaves the program resident in a protected block of memory, even though it is no longer running.

The terminate-and-stay-resident function (Function 31h) is one of the MS-DOS services invoked through Interrupt 21h. The following fragment shows how a TSR program terminates through Function 31h and remains resident in a 1000h-byte block of memory:

```
mov    ah, 31h        ; Request DOS Function 31h
mov    al, err        ; Set return code
mov    dx, 100h       ; Reserve 100h paragraphs
                        ; (1000h bytes)
int    21h           ; Terminate-and-stay-resident
```

---

**Note** In current versions of MS-DOS, Interrupt 27h also provides a terminate-and-stay-resident service. However, Microsoft cannot guarantee future support for Interrupt 27h and does not recommend its use.

---

## Structure of a TSR

TSRs consist of two distinct parts that execute at different times. The first part is the installation section, which executes only once, when MS-DOS loads the program. The installation code performs any initialization tasks required by the TSR and then exits through the terminate-and-stay-resident function.

The second part of the TSR, called the resident section, consists of code and data left in memory after termination. Though often identified with the TSR itself, the resident section makes up only part of the entire program.

The TSR's resident code must be able to regain control of the processor and execute after the program has terminated. Methods of executing a TSR are classified as either passive or active.

## Passive TSRs

The simplest way to execute a TSR is to transfer control to it explicitly from another program. Because the TSR in this case does not solicit processor control, it is said to be passive. If the calling program can determine the TSR's memory address, it can grant control via a far jump or call. More commonly, a program activates a passive TSR through a software interrupt. The installation section of the TSR writes the address of its resident code to the proper position in the interrupt vector table (see "MS-DOS Interrupts" in Chapter 7). Any subsequent program can then execute the TSR by calling the interrupt.

Passive TSRs often replace existing software interrupts. For example, a passive TSR might replace Interrupt 10h, the BIOS video service. By intercepting calls that read or write to the screen, the TSR can access the video buffer directly, increasing display speed.

Passive TSRs allow limited access since they can be invoked only from another program. They have the advantage of executing within the context of the calling program, and thus run no risk of interfering with another process. Such a risk does exist with active TSRs.

## Active TSRs

The second method of executing a TSR involves signaling it through some hardware event, such as a predetermined sequence of keystrokes. This type of TSR is “active” because it must continually search for its startup signal. The advantage of active TSRs lies in their accessibility. They can take control from any running application, execute, and return, all on demand.

An active TSR, however, must not seize processor control blindly. It must contain additional code that determines the proper moment at which to execute. The extra code consists of one or more routines called “interrupt handlers,” described in the following section.

## Interrupt Handlers in Active TSRs

The memory-resident portion of an active TSR consists of two parts. One part contains the body of the TSR—the code and data that perform the program’s main tasks. The other part contains the TSR’s interrupt handlers.

An interrupt handler is a routine that takes control when a specific interrupt occurs. Although sometimes called an “interrupt service routine,” a TSR’s handler usually does not service the interrupt. Instead, it passes control to the original interrupt routine, which does the actual interrupt servicing. (See the section “Replacing an Interrupt Routine” in Chapter 7 for information on how to write an interrupt handler.)

Collectively, interrupt handlers ensure that a TSR operates compatibly with the rest of the system. Individually, each handler fulfills one or more of the following functions:

- Auditing hardware events that may signal a request for the TSR
- Monitoring system status
- Determining whether a request for the TSR should be honored, based on current system status

## Auditing Hardware Events for TSR Requests

Active TSRs commonly use a special keystroke sequence or the timer as a request signal. A TSR invoked through one of these channels must be equipped with handlers that audit keyboard or timer events.

A keyboard handler receives control at every keystroke. It examines each key, searching for the proper signal or "hot key." Generally, a keyboard handler should not attempt to call the TSR directly when it detects the hot key. If the TSR cannot safely interrupt the current process at that moment, the keyboard handler is forced to exit to allow the process to continue. Since the handler cannot regain control until the next keystroke, the user has to press the hot key repeatedly until the handler can comply with the request.

Instead, the handler should merely set a request flag when it detects a hot-key signal and then exit normally. Examples in the following paragraphs illustrate this technique.

For computers other than MCA (IBM PS/2 and compatible), an active TSR audits keystrokes through a handler for Interrupt 09, the keyboard interrupt:

```

Keybrd  PROC    FAR
        sti                    ; Interrupts are okay
        push   ax              ; Save AX register
        in     al, 60h         ; AL = key scan code
        call  CheckHotKey     ; Check for hot key
        .IF   carry?          ; If hot key pressed,
        mov   cs:TsrRequestFlag, TRUE ; raise flag and
        .    ; set up for exit
        .
        .

```

A TSR running on a PS/2 computer cannot reliably read key scan codes using this method. Instead, the TSR must search for its hot key through a handler for Interrupt 15h (Miscellaneous System Services). The handler determines the current keypress from the AL register when AH equals 4Fh, as shown here:

```

MiscServ PROC    FAR
        sti                    ; Interrupts okay
        .IF   ah == 4Fh        ; If Keyboard Intercept Service:
        call  CheckHotKey     ; Check for hot key
        .IF   carry?          ; If hot key pressed,
        mov   cs:TsrRequestFlag, TRUE ; raise flag and
        .    ; set up for exit
        .
        .

```

The example program on page 293 shows how a TSR tests for a PS/2 machine and then sets up a handler for either Interrupt 09 or Interrupt 15h to audit keystrokes.

Setting a request flag in the keyboard handler allows other code, such as the timer handler (Interrupt 08), to recognize a request for the TSR. The timer handler gains control at every timer interrupt, which occurs an average of 18.2 times per second.

The following fragment shows how a timer handler tests the request flag and continually polls until it can safely execute the TSR.

```
NewTimer PROC FAR
    .
    .
    .
    cmp     TsrRequestFlag, FALSE    ; Has TSR been requested?
    .IF    !zero?                    ; If so, can system be
    call   CheckSystem                ; interrupted safely?
    .IF    carry?                    ; If so,
    call   ActivateTsr                ; activate TSR
    .
    .
    .
```

## Monitoring System Status

A TSR that uses a hardware device such as the video or disk must not interrupt while the device is active. A TSR monitors a device by handling the device's interrupt. Each interrupt handler simply sets a flag to indicate the device is in use, and then clears the flag when the interrupt finishes.

The following shows a typical monitor handler:

```
NewHandler PROC FAR
    mov     cs:ActiveFlag, TRUE      ; Set active flag
    pushf                                     ; Simulate interrupt by
                                           ; pushing flags, then
    call   OldHandler                ; far-calling original routine
    mov     cs:ActiveFlag, FALSE     ; Clear active flag
    iret                                     ; Return from interrupt
NewHandler ENDP
```

Only hardware used by the TSR requires monitoring. For example, a TSR that performs disk input/output (I/O) must monitor disk use through Interrupt 13h. The disk handler sets an active flag that prevents the TSR from executing during a read or write operation. Otherwise, the TSR's own I/O would move the disk head. This would cause the suspended disk operation to continue with the head incorrectly positioned when the TSR returned control to the interrupted program.

In the same way, an active TSR that displays to the screen must monitor calls to Interrupt 10h. The Interrupt 10h BIOS routine does not protect critical sections of code that program the video controller. The TSR must therefore ensure it does not interrupt such nonreentrant operations.

The activities of the operating system also affect the system status. With few exceptions, MS-DOS functions are not reentrant and must not be interrupted.

However, monitoring MS-DOS is somewhat more complicated than monitoring hardware. This subject is discussed in "Using MS-DOS in Active TSRs," later in this chapter.

Figure 11.1 illustrates the process described so far. It shows a time line for a typical TSR signaled from the keyboard. When the keyboard handler detects the proper hot key, it sets a request flag called `TsrRequestFlag`. Thereafter, the timer handler continually checks the system status until it can safely call the TSR.

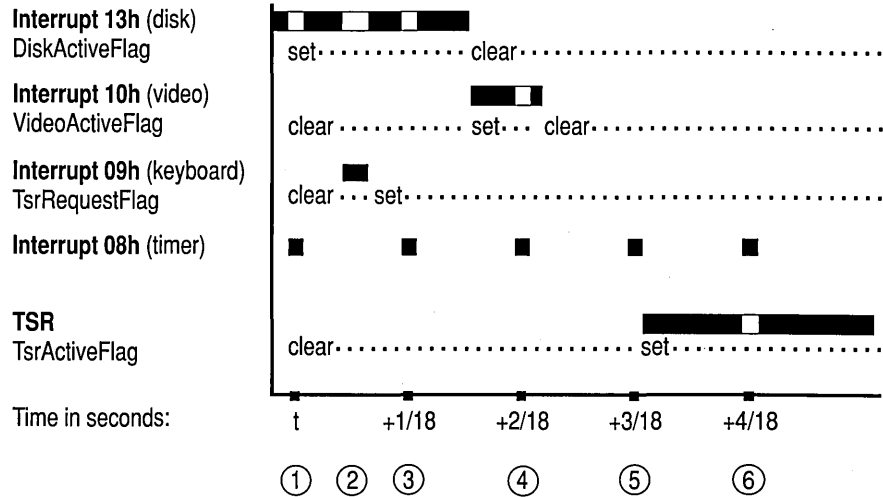

**Figure 11.1** Time Line of Interactions Between Interrupt Handlers for a Typical TSR

The following comments describe the chain of events depicted in Figure 11.1. Each comment refers to one of the numbered pointers in the figure.

1. At time =  $t$ , the timer handler activates. It finds the flag `TsrRequestFlag` clear, indicating the user has not requested the TSR. The handler terminates without taking further action. Notice that Interrupt 13h is currently processing a disk I/O operation.
2. Before the next timer interrupt, the keyboard handler detects the hot key, signaling a request for the TSR. The keyboard handler sets `TsrRequestFlag` and returns.
3. At time =  $t + 1/18$  second, the timer handler again activates and finds `TsrRequestFlag` set. The handler checks other active flags to determine if the TSR can safely execute. Since Interrupt 13h has not yet completed its disk operation, the timer handler finds `DiskActiveFlag` set. The handler therefore terminates without activating the TSR.

4. At time =  $t + 2/18$  second, the timer handler again finds `TsrRequestFlag` set and repeats its scan of the active flags. `DiskActiveFlag` is now clear, but in the interim, Interrupt 10h has activated as indicated by the flag `VideoActiveFlag`. The timer handler accordingly terminates without activating the TSR.
5. At time =  $t + 3/18$  second, the timer handler repeats the process. This time it finds all active flags clear, indicating the TSR can safely execute. The timer handler calls the TSR, which sets its own active flag to ensure it will not interrupt itself if requested again.
6. The timer and other interrupts continue to function normally while the TSR executes.

The timer itself can serve as the startup signal if the TSR executes periodically. Screen clocks that continuously show seconds and minutes are examples of TSRs that use the timer this way. `ALARM.ASM`, a program described in the next section, shows another example of a timer-driven TSR.

## Determining Whether to Invoke the TSR

Once a handler receives a request signal for the TSR, it checks the various active flags maintained by the handlers that monitor system status. If any of the flags are set, the handler ignores the request and exits. If the flags are clear, the handler invokes the TSR, usually through a near or far call. Figure 11.1 illustrates how a timer handler detects a request and then periodically scans various active flags until all the flags are clear.

A TSR that changes stacks must not interrupt itself. Otherwise, the second execution would overwrite the stack data belonging to the first. A TSR prevents this by setting its own active flag before executing, as shown in Figure 11.1. A handler must check this flag along with the other active flags when determining whether the TSR can safely execute.

## Example of a Simple TSR: ALARM

This section presents a simple alarm clock TSR that demonstrates some of the material covered so far. The program accepts an argument from the command line that specifies the alarm setting in military form, such as 1635 for 4:35 P.M. For simplicity, the argument must consist of four digits, including leading zeros. To set the alarm at 7:45 A.M., for example, enter the command:

```
ALARM 0745
```

The installation section of the program begins with the `Install` procedure. `Install` computes the number of five-second intervals that must elapse before the alarm sounds and stores this number in the word `CountDown`. The procedure then



obtains the vector for Interrupt 08 (timer) through MS-DOS Function 35h and stores it in the far pointer OldTimer. Function 25h replaces the vector with the far address of the new timer handler NewTimer. Once installed, the new timer handler executes at every timer interrupt. These interrupts occur 18.2 times per second or 91 times every five seconds.

Each time it executes, NewTimer subtracts one from a secondary counter called Tick91. By counting 91 timer ticks, Tick91 accurately measures a period of five seconds. When Tick91 reaches zero, it's reset to 91 and Countdown is decremented by one. When Countdown reaches zero, the alarm sounds.

```
;* ALARM.ASM - A simple memory-resident program that beeps the speaker
;* at a prearranged time. Can be loaded more than once for multiple
;* alarm settings. During installation, ALARM establishes a handler
;* for the timer interrupt (Interrupt 08). It then terminates through
;* the terminate-and-stay-resident function (Function 31h). After the
;* alarm sounds, the resident portion of the program retires by setting
;* a flag that prevents further processing in the handler.
```

```
        .MODEL tiny                ; Create ALARM.COM
        .STACK
        .CODE
        ORG     5Dh                ; Location of time argument in PSP,
CountDown LABEL WORD              ; converted to number of 5-second
                                   ; intervals to elapse

        .STARTUP
        jmp     Install            ; Jump over data and resident code

; Data must be in code segment so it won't be thrown away with Install code.
OldTimer    DWORD    ?            ; Address of original timer routine
tick_91     BYTE     91           ; Counts 91 clock ticks (5 seconds)
TimerActiveFlag BYTE    0         ; Active flag for timer handler
```

```
;* NewTimer - Handler routine for timer interrupt (Interrupt 08).
;* Decrements Countdown every 5 seconds. No other action is taken
;* until Countdown reaches 0, at which time the speaker sounds.
```

```
NewTimer PROC FAR
        .IF     cs:TimerActiveFlag != 0 ; If timer busy or retired,
        jmp     cs:OldTimer            ; jump to original timer routine
        .ENDIF
        inc     cs:TimerActiveFlag     ; Set active flag
        pushf                                ; Simulate interrupt by pushing flags,
        call    cs:OldTimer            ; then far-calling original routine
        sti                                ; Enable interrupts
        push    ds                        ; Preserve DS register
        push    cs                        ; Point DS to current segment for
        pop     ds                        ; further memory access
        dec     tick_91                  ; Count down for 91 ticks
```

```

    .IF      zero?                ; If 91 ticks have elapsed,
    mov     tick_91, 91          ; reset secondary counter and
    dec     Countdown            ; subtract one 5-second interval
    .IF      zero?                ; If Countdown drained,
    call    Sound                ; sound speaker
    inc     TimerActiveFlag      ; Alarm has sounded--inc flag
    .ENDIF                                ; again so it remains set
    .ENDIF

    dec     TimerActiveFlag      ; Decrement active flag
    pop     ds                    ; Recover DS
    iret                          ; Return from interrupt handler
NewTimer ENDP

;* Sound - Sounds speaker with the following tone and duration:

BEEP_TONE      EQU      440          ; Beep tone in hertz
BEEP_DURATION  EQU      6           ; Number of clocks during beep,
                                   ; where 18 clocks = approx 1 second

Sound PROC     USES ax bx cx dx es  ; Save registers used in this routine
    mov     al, 0B6h              ; Initialize channel 2 of
    out     43h, al               ; timer chip
    mov     dx, 12h               ; Divide 1,193,180 hertz
    mov     ax, 34DCh             ; (clock frequency) by
    mov     bx, BEEP_TONE         ; desired frequency
    div     bx                    ; Result is timer clock count
    out     42h, al               ; Low byte of count to timer
    mov     al, ah                ; High byte of count to timer
    out     42h, al
    in     al, 61h                ; Read value from port 61h
    or     al, 3                  ; Set first two bits
    out     61h, al               ; Turn speaker on
; Pause for specified number of clock ticks

    mov     dx, BEEP_DURATION     ; Beep duration in clock ticks
    sub     cx, cx                 ; CX:DX = tick count for pause
    mov     es, cx                ; Point ES to low memory data
    add     dx, es:[46Ch]         ; Add current tick count to CX:DX
    adc     cx, es:[46Eh]         ; Result is target count in CX:DX
    .REPEAT
    mov     bx, es:[46Ch]         ; Now repeatedly poll clock
    mov     ax, es:[46Eh]         ; count until the target
    sub     bx, dx                 ; time is reached
    sbb     ax, cx
    .UNTIL !carry?

```

```

        in      al, 61h          ; When time elapses, get port value
        xor     al, 3           ; Kill bits 0-1 to turn
        out    61h, al         ; speaker off
        ret
Sound   ENDP

```

```

;* Install - Converts ASCII argument to valid binary number, replaces
;* NewTimer as the interrupt handler for the timer, then makes program
;* memory-resident by exiting through Function 31h.
;*
;* This procedure marks the end of the TSR's resident section and the
;* beginning of the installation section. When ALARM terminates through
;* Function 31h, the above code and data remain resident in memory. The
;* memory occupied by the following code is returned to DOS.

```

#### Install PROC

```

; Time argument is in hhmm military format. Converts ASCII digits to
; number of minutes since midnight, then converts current time to number
; of minutes since midnight. Difference is number of minutes to elapse
; until alarm sounds. Converts to seconds-to-elapse, divides by 5 seconds,
; and stores result in word Countdown.
DEFAULT_TIME   EQU      3600          ; Default alarm setting = 1 hour
                                           ; (in seconds) from present time

        mov     ax, DEFAULT_TIME

        cwd                    ; DX:AX = default time in seconds
        .IF     BYTE PTR Countdown != ' ' ; If not blank argument,
        xor     Countdown[0], '00'      ; convert 4 bytes of ASCII
        xor     Countdown[2], '00'      ; argument to binary

        mov     al, 10           ; Multiply 1st hour digit by 10
        mul     BYTE PTR Countdown[0]   ; and add to 2nd hour digit
        add     al, BYTE PTR Countdown[1]
        mov     bh, al          ; BH = hour for alarm to go off
        mov     al, 10         ; Repeat procedure for minutes
        mul     BYTE PTR Countdown[2]   ; Multiply 1st minute digit by 10
        add     al, BYTE PTR Countdown[3] ; and add to 2nd minute digit
        mov     bl, al          ; BL = minute for alarm to go off
        mov     ah, 2Ch         ; Request Function 2Ch
        int     21h            ; Get Time (CX = current hour/min)

```

```

mov     dl, dh
sub     dh, dh
push   dx                ; Save DX = current seconds
mov     al, 60           ; Multiply current hour by 60
mul     ch                ; to convert to minutes
sub     ch, ch
add     cx, ax           ; Add current minutes to result
                        ; CX = minutes since midnight

mov     al, 60           ; Multiply alarm hour by 60
mul     bh                ; to convert to minutes
sub     bh, bh
add     ax, bx           ; AX = number of minutes since
                        ; midnight for alarm setting
sub     ax, cx           ; AX = time in minutes to elapse
                        ; before alarm sounds

.if     carry?           ; If alarm time is tomorrow,
add     ax, 24 * 60     ; add minutes in a day
.ENDIF

mov     bx, 60
mul     bx                ; DX:AX = minutes-to-elapsed-times-60
pop     bx                ; Recover current seconds
sub     ax, bx           ; DX:AX = seconds to elapse before
sbb     dx, 0            ; alarm activates
.if     carry?           ; If negative,
mov     ax, 5            ; assume 5 seconds
cwd
.ENDIF
.ENDIF

mov     bx, 5            ; Divide result by 5 seconds
div     bx                ; AX = number of 5-second intervals
mov     CountDown, ax    ; to elapse before alarm sounds

mov     ax, 3508h        ; Request Function 35h
int     21h              ; Get Vector for timer (Interrupt 08)
mov     WORD PTR OldTimer[0], bx ; Store address of original
mov     WORD PTR OldTimer[2], es ; timer interrupt
mov     ax, 2508h        ; Request Function 25h
mov     dx, OFFSET NewTimer ; DS:DX points to new timer handler
int     21h              ; Set Vector with address of NewTimer

```

```

mov     dx, OFFSET Install      ; DX = bytes in resident section
mov     cl, 4
shr     dx, cl                  ; Convert to number of paragraphs
inc     dx                      ; plus one
mov     ax, 3100h              ; Request Function 31h, error code=0
int     21h                    ; Terminate-and-stay-resident
Install ENDP
END

```

Note the following points about ALARM:

- The constant BEEP\_TONE specifies the alarm tone. Practical values for the tone range from approximately 100 to 4,000 hertz.
- The Install procedure marks the beginning of the installation section of the program. Execution begins here when ALARM.COM is loaded. A TSR generally places its installation code after the resident section. This allows the terminating TSR to include the installation code with the rest of the memory it returns to MS-DOS. Since the installation section executes only once, the TSR can discard it after becoming resident.
- You can install ALARM any number of times in quick succession, each time with a new alarm setting. The timer handler does not restore the original vector for Interrupt 08 after the alarm sounds. In effect, the multiple installations remain daisy-chained in memory. The address in OldTimer for one installation is the address of NewTimer in the preceding installation.
- Until a system reboot, NewTimer remains in place as the Interrupt 08 handler, even after the alarm sounds. To save unnecessary activity, the byte TimerActiveFlag remains set after the alarm sounds. This forces an immediate jump to the original handler for all subsequent executions of NewTimer.
- NewTimer and Sound alter registers DS, AX, BX, CX, DX, and ES. To preserve the original values in these registers, the procedures first push them onto the stack and then restore the original values before exiting. This ensures that the process interrupted by NewTimer continues with valid registers after NewTimer returns.
- ALARM requires little stack space. It assumes the current stack is adequate and makes no attempt to set up a new one. More sophisticated TSRs, however, should as a matter of course provide their own stacks to ensure adequate stack depth. The example program presented in “Example of an Advanced TSR: SNAP,” later in this chapter, demonstrates this safety measure.

## Using MS-DOS in Active TSRs

This section explains how to write active TSRs that can safely call MS-DOS functions. The material explores the problems imposed by the nonreentrant nature of MS-DOS and explains how a TSR can resolve those problems. The solution consists of four parts:

- Understanding how MS-DOS uses stacks
- Determining when MS-DOS is active
- Determining whether a TSR can safely interrupt an active MS-DOS function
- Monitoring the Critical Error flag

## Understanding MS-DOS Stacks

MS-DOS functions set up their own stacks, which makes them nonreentrant. If a TSR interrupts an MS-DOS function and then executes another function that sets up the same stack, the second function will overwrite everything placed on the stack by the first function. The problem occurs when the second function returns and the first is left with unusable stack data. A TSR that calls an MS-DOS function must not interrupt any function that uses the same stack.

MS-DOS versions 2.0 and later use three internal stacks: an I/O stack, a disk stack, and an auxiliary stack. The current stack depends on the MS-DOS function. Functions 01 through 0Ch set up the I/O stack. Functions higher than 0Ch (with few exceptions) use the disk stack, as do Interrupts 25h and 26h. MS-DOS normally uses the auxiliary stack only when it executes Interrupt 24h (Critical Error Handler).

## Determining MS-DOS Activity

A TSR's handlers can determine when MS-DOS is active by consulting a 1-byte flag called the InDos flag. Every MS-DOS function sets this flag upon entry and clears it upon termination. During installation, a TSR locates the flag through Function 34h (Get Address of InDos Flag), which returns the address as ES:BX. The installation portion then stores the address so the handlers can later find the flag without again calling Function 34h.

Theoretically, a TSR can wait to execute until the InDos flag is clear, thus sidestepping the entire issue of interrupting MS-DOS. However, several low-order functions — such as Function 0Ah (Get Buffered Keyboard Input) — wait idly for an expected keystroke before they terminate. If a TSR were allowed to execute only after MS-DOS returned, it too would have to wait for the terminating event.

The solution lies in determining when the low-order functions 01 through 0Ch are active. MS-DOS provides another service for this purpose: Interrupt 28h, the Idle Interrupt.

## Interrupting MS-DOS Functions

MS-DOS continually calls Interrupt 28h from the low-order polling functions as they wait for keyboard input. This signal says that MS-DOS is idle and that a TSR may interrupt provided it does not overwrite the I/O stack. Put another way, a TSR can safely interrupt MS-DOS Functions 01 through 0Ch provided it does not call them.

An active TSR that calls MS-DOS must monitor Interrupt 28h with a handler. When the handler gains control, it checks the TSR request flag. If the flag indicates the TSR has been requested and if system hardware is inactive, the handler executes the TSR. Since control must eventually return to the idle MS-DOS function which has stored data on the I/O stack, the TSR in this case must not call any MS-DOS function that also uses the I/O stack. Table 11.1 shows which functions set up the I/O stack for various versions of MS-DOS.

**Table 11.1 MS-DOS Internal Stacks**

Function	Critical Error flag	MS-DOS 2.x	MS-DOS 3.0	MS-DOS 3.1+
01-0Ch	Clear	I/O*	I/O	I/O
	Set	Aux*	Aux	Aux
33h	Clear	Disk*	Disk	Caller*
	Set	Disk	Disk	Caller
50h-51h	Clear	I/O	Caller	Caller
	Set	Aux	Caller	Caller
59h	Clear	n/a*	I/O	Disk
	Set	n/a	Aux	Disk
5D0Ah	Clear	n/a	n/a	Disk
	Set	n/a	n/a	Disk
62h	Clear	n/a	Caller	Caller
	Set	n/a	Caller	Caller
All others	Clear	Disk	Disk	Disk
	Set	Disk	Disk	Disk

\* I/O=I/O stack, Aux = auxiliary stack, Disk = disk stack, Caller = caller's stack, n/a = function not available.

TSRs that perform tasks of long or indefinite duration should themselves call Interrupt 28h. For example, a TSR that polls for keyboard input should include an **INT 28h** instruction in the polling loop, as shown here:

```
poll:    int     28h           ; Signal idle state
         mov     ah, 1
         int     16h           ; Key waiting?
         jnz    poll          ; If not, repeat polling loop
         sub     ah, ah
         int     16h           ; Otherwise, get key
```

This courtesy gives other TSRs a chance to execute if the InDos flag happens to be set.

## Monitoring the Critical Error Flag

MS-DOS sets the Critical Error flag to a nonzero value when it detects a critical error. It then invokes Interrupt 24h (Critical Error Handler) and clears the flag when Interrupt 24h returns. MS-DOS functions higher than 0Ch are illegal during critical error processing. Therefore, a TSR that calls MS-DOS must not execute while the Critical Error flag is set.

MS-DOS versions 3.1 and later locate the Critical Error flag in the byte preceding the InDos flag. A single call to Function 34h (Get Address of InDos Flag) thus effectively returns the addresses of both flags. For earlier versions of MS-DOS or for the compatibility version of MS-DOS in OS/2 1.x, a TSR must call Function 34h and then scan the segment returned in the ES register for one of the two following sequences of instructions:

; Sequence of instructions in DOS Versions 2.0 - 3.0

```
    cmp     ss:[CriticalErrorFlag], 0
    jne     @F
    int     28h
```

; Sequence of instructions in DOS compatibility version for OS/2 1.x

```
    test    [CriticalErrorFlag], 0FFh
    jnz     @F
    push    ss:[ ? ]
    int     28h
```

The question mark inside brackets in the preceding **PUSH** statement indicates that the operand for the **PUSH** instruction can be any legal operand.

In either version of MS-DOS, the operand field in the first instruction gives the flag's offset. The value in ES determines the segment address. "Example of an Advanced TSR: SNAP," later in the chapter, presents a program that shows how to locate the Critical Error flag with this technique.



## Preventing Interference

This section describes how an active TSR can avoid interfering with the process it interrupts. Interference occurs when a TSR commits an error or performs an action that affects the interrupted process after the TSR returns. Examples of interference range from relatively harmless, such as moving the cursor, to serious, such as overrunning a stack.

Although a TSR can interfere with another process in many different ways, protection against interference involves only three steps:

1. Recording a current configuration
2. Changing the configuration so it applies to the TSR
3. Restoring the original configuration before terminating

The example program described on page 293 demonstrates all the noninterference safeguards described in this section. These safeguards by no means exhaust the subject of noninterference. More sophisticated TSRs may require more sophisticated methods. However, noninterference methods generally fall into one of the following categories:

- Trapping errors
- Preserving an existing condition
- Preserving existing data

## Trapping Errors

A TSR committing an error that triggers an interrupt must handle the interrupt to trap the error. Otherwise, the existing interrupt routine, which belongs to the underlying process, would attempt to service an error the underlying process did not commit.

For example, a TSR that accepts keyboard input should include handlers for Interrupts 23h and 1Bh to trap keyboard break signals. When MS-DOS detects CTRL+C from the keyboard or input stream, it transfers control to Interrupt 23h (CTRL+C Handler). Similarly, the BIOS keyboard routine calls Interrupt 1Bh (CTRL+BREAK Handler) when it detects a CTRL+BREAK key combination. Both routines normally terminate the current process.

A TSR that calls MS-DOS should also trap critical errors through Interrupt 24h (Critical Error Handler). MS-DOS functions call Interrupt 24h when they encounter certain hardware errors. The TSR must not allow the existing interrupt routine to service the error, since the routine might allow the user to abort service and return control to MS-DOS. This would terminate both the TSR and the underlying

process. By handling Interrupt 24h, the TSR retains control if a critical error occurs.

An error-trapping handler differs in two ways from a TSR's other handlers:

1. It is temporary, in service only while the TSR executes. At startup, the TSR copies the handler's address to the interrupt vector table; it then restores the original vector before returning.
2. It provides complete service for the interrupt; it does not pass control on to the original routine.

Error-trapping handlers often set a flag to let the TSR know the error has occurred. For example, a handler for Interrupt 1Bh might set a flag when the user presses CTRL+BREAK. The TSR can check the flag as it polls for keyboard input, as shown here:

```

BrkHandler PROC FAR                                ; Handler for Interrupt 1Bh
    .
    .
    .
    mov     cs:BreakFlag, TRUE ; Raise break flag
    iret                    ; Terminate interrupt

BrkHandler ENDP

    .
    .
    .
    mov     BreakFlag, FALSE ; Initialize break flag
poll:     .
    .
    .
    cmp     BreakFlag, TRUE  ; Keyboard break pressed?
    je     exit              ; If so, break polling loop
    mov     ah, 1
    int     16h              ; Key waiting?
    jnz    poll              ; If not, repeat polling loop

```

## Preserving an Existing Condition

A TSR and its interrupt handlers must preserve register values so that all registers are returned intact to the interrupted process. This is usually done by pushing the registers onto the stack before changing them, then popping the original values before returning.

Setting up a new stack is another important safeguard against interference. A TSR should usually provide its own stack to avoid the possibility of overrunning the current stack. Exceptions to this rule are simple TSRs such as the sample program ALARM that make minimal stack demands.

A TSR that alters the video configuration should return the configuration to its original state upon return. Video configuration includes cursor position, cursor shape, and video mode. The services provided through Interrupt 10h enable a TSR to determine the existing configuration and alter it if necessary.

However, some applications set video parameters by directly programming the video controller. When this happens, BIOS remains unaware of the new configuration and consequently returns inaccurate information to the TSR. Unfortunately, there is no solution to this problem if the controller's data registers provide write-only access and thus cannot be queried directly. For more information on video controllers, refer to Richard Wilton, *Programmer's Guide to the PC & PS/2 Video Systems*. (See "Books for Further Reading" in the Introduction.)

## Preserving Existing Data

A TSR requires its own disk transfer area (DTA) if it calls MS-DOS functions that access the DTA. These include file control block functions and Functions 11h, 12h, 4Eh, and 4Fh. The TSR must switch to a new DTA to avoid overwriting the one belonging to the interrupted process. On becoming active, the TSR calls Function 2Fh to obtain the address of the current DTA. The TSR stores the address and then calls Function 1Ah to establish a new DTA. Before returning, the TSR again calls Function 1Ah to restore the address of the original DTA.

MS-DOS versions 3.1 and later allow a TSR to preserve extended error information. This prevents the TSR from destroying the original information if it commits an MS-DOS error. The TSR retrieves the current extended error data by calling MS-DOS Function 59h. It then copies registers AX, BX, CX, DX, SI, DI, DS, and ES to an 11-word data structure in the order given. MS-DOS reserves the last three words of the structure, which should each be set to zero. Before returning, the TSR calls Function 5Dh with AL = 0Ah and DS:DX pointing to the data structure. This call restores the extended error data to their original state.

## Communicating Through the Multiplex Interrupt

The Multiplex interrupt (Interrupt 2Fh) provides the Microsoft-approved way for a program to verify the presence of an installed TSR and to exchange information with it. MS-DOS version 2.x uses Interrupt 2Fh only as an interface for the resident print spooler utility PRINT.COM. Later MS-DOS versions standardize calling conventions so that multiple TSRs can share the interrupt.

A TSR chains to the Multiplex interrupt by setting up a handler. The TSR's installation code records the Interrupt 2Fh vector and then replaces it with the address of the new multiplex handler.

## The Multiplex Handler

A program communicates with a multiplex handler by calling Interrupt 2Fh with an identity number in the AH register. As each handler in the chain gains control, it compares the value in AH with its own identity number. If the handler finds that it is not the intended recipient of the call, it passes control to the previous handler. The process continues until control reaches the target handler. When the target handler finishes its tasks, it returns via an **IRET** instruction to terminate the interrupt.

The target handler determines its tasks from the function number in AL. Convention reserves Function 0 as a request for installation status. A multiplex handler must respond to Function 0 by setting AL to 0FFh, to inform the caller of the handler's presence in memory. The handler should also return other information to provide a completely reliable identification. For example, it might return in ES:BX a far pointer to the TSR's copyright notice. This assures the caller it has located the intended TSR and not another TSR that has already claimed the identity number in AH.

Identity numbers range from 192 to 255, since MS-DOS reserves lesser values for its own use. During installation, a TSR must verify the uniqueness of its number. It must not set up a multiplex handler identified by a number already in use. A TSR usually obtains its identity number through one of the following methods:

- The programmer assigns the number in the program.
- The user chooses the number by entering it as an argument in the command line, placing it into an environment variable, or by altering the contents of an initialization file.
- The TSR selects its own number through a process of trial and error.

The last method offers the most flexibility. It finds an identity number not currently in use among the installed multiplex handlers and does not require intervention from the user.

To use this method, a TSR calls Interrupt 2Fh during installation with AH = 192 and AL = 0. If the call returns AL = 0FFh, the program tests other registers to determine if it has found a prior installation of itself. If the test fails, the program resets AL to zero, increments AH to 193, and again calls Interrupt 2Fh. The process repeats with incrementing values in AH until the TSR locates a prior installation of itself—in which case it should abort with an appropriate message to the user—or until AL returns as zero. The TSR can then use the value in AH as its identity number and proceed with installation.

The SNAP.ASM program in this chapter demonstrates how a TSR can use this trial-and-error method to select a unique identity number. During installation, the program calls Interrupt 2Fh to verify that SNAP is not already installed. When deinstalling, the program again calls Interrupt 2Fh to locate the resident TSR in

memory. SNAP's multiplex handler services the call and returns the address of the resident code's program-segment prefix. The calling program can then locate the resident code and deinstall it, as explained in "Deinstalling a TSR," following.

## Using the Multiplex Interrupt Under MS-DOS Version 2.x

A TSR can use the Multiplex interrupt under MS-DOS version 2.x, with certain limitations. Under version 2.x, only MS-DOS's print spooler PRINT, itself a TSR program, provides an Interrupt 2Fh service. The Interrupt 2Fh vector remains null until PRINT or another TSR is installed that sets up a multiplex handler.

Therefore, a TSR running under version 2.x must first check the existing Interrupt 2Fh vector before installing a multiplex handler. The TSR locates the current Interrupt 2Fh handler through Function 35h (Get Interrupt Vector). If the function returns a null vector, the TSR's handler will be last in the chain of Interrupt 2Fh handlers. The handler must terminate with an **IRET** instruction rather than pass control to a nonexistent routine.

PRINT in MS-DOS version 2.x does not pass control to the previous handler. If you intend to run PRINT under version 2.x, the program must be installed before other TSRs that also handle Interrupt 2Fh. This places PRINT's multiplex handler last in the chain of handlers.

## Deinstalling a TSR

A TSR should provide a means for the user to remove or "deinstall" it from memory. Deinstallation returns occupied memory to the system, offering these benefits:

- The freed memory becomes available to subsequent programs that may require additional memory space.
- Deinstallation restores the system to a normal state. Thus, sensitive programs that may be incompatible with TSRs can execute without the presence of installed routines.

A deinstallation program must first locate the TSR in memory, usually by requesting an address from the TSR's multiplex handler. When it has located the TSR, the deinstallation program should then compare addresses in the vector table with the addresses of the TSR's handlers. A mismatch indicates that another TSR has chained a handler to the interrupt routine. In this case, the deinstallation program should deny the request to deinstall. If the addresses of the TSR's handlers match those in the vector table, deinstallation can safely continue.

You can deinstall the TSR with these three steps:

1. Restore to the vector table the original interrupt vectors replaced by the handler addresses.
2. Read the segment address stored at offset 2Ch of the resident TSR's program segment prefix (PSP). This address points to the TSR's "environment block," a list of environment variables that MS-DOS copies into memory when it loads a program. Place the block's address in the ES register and call MS-DOS Function 49h (Release Memory Block) to return the block's memory to the operating system.
3. Place the resident PSP segment address in ES and again call Function 49h. This call releases the block of memory occupied by the TSR's code and data.

The example program in the next section demonstrates how to locate a resident TSR through its multiplex handler, and deinstall it from memory.

## Example of an Advanced TSR: SNAP

This section presents SNAP, a memory-resident program that demonstrates most of the techniques discussed in this chapter. SNAP takes a snapshot of the current screen and copies the text to a specified file. SNAP accommodates screens with various column and line counts, such as CGA's 40-column mode or VGA's 50-line mode. The program ignores graphics screens.

Once installed, SNAP occupies approximately 7.5K of memory. When it detects the ALT+LEFT SHIFT+S key combination, SNAP displays a prompt for a file specification. The user can type a new filename, accept the previous filename by pressing ENTER, or cancel the request by pressing ESC.

SNAP reads text directly from the video buffer and copies it to the specified file. The program sets the file pointer to the end of the file so that text is appended without overwriting previous data. SNAP copies each line only to the last character, ignoring trailing spaces. The program adds a carriage return–linefeed sequence (0D0Ah) to the end of each line. This makes the file accessible to any text editor that can read ASCII files.

To demonstrate how a program accesses resident data through the Multiplex interrupt, SNAP can reset the display attribute of its prompt box. After installing SNAP, run the main program with the /C option to change box colors:

```
SNAP /Cxx
```

The argument *xx* specifies the desired attribute as a two-digit hexadecimal number—for example, 7C for red on white, or 0F for monochrome high intensity. For a list of color and monochrome display attributes, refer to the "Tables" section of the *Reference*.

SNAP can deinstall itself, provided another TSR has not been loaded after it. Deinstall SNAP by executing the main program with the /D option:

```
SNAP /D
```

If SNAP successfully deinstalls, it displays the following message:

```
TSR deinstalled
```

## Building SNAP.EXE

SNAP combines four modules: SNAP.ASM, COMMON.ASM, HANDLERS.ASM, and INSTALL.ASM. Source files are located on one of your distribution disks. Each module stores temporary code and data in the segments INSTALLCODE and INSTALLDATA. These segments apply only to SNAP's installation phase; MS-DOS recovers the memory they occupy when the program exits through the terminate-and-stay-resident function. The following briefly describes each module:

- SNAP.ASM contains the TSR's main code and data.
- COMMON.ASM contains procedures used by other example programs.
- HANDLERS.ASM contains interrupt handler routines for Interrupts 08, 09, 10h, 13h, 15h, 28h, and 2Fh. It also provides simple error-trapping handlers for Interrupts 1Bh, 23h, and 24h. Additional routines set up and deinstall the handlers.
- INSTALL.ASM contains an exit routine that calls the terminate-and-stay-resident function and a deinstallation routine that removes the program from memory. The module includes error-checking services and a command-line parser.

This building-block approach allows you to create other TSRs by replacing SNAP.ASM and linking with the HANDLERS and INSTALL object modules. The library of routines accommodates both keyboard-activated and time-activated TSRs. A time-activated TSR is a program that activates at a predetermined time of day, similar to the example program ALARM introduced earlier in this chapter. The header comments for the `Install` procedure in HANDLERS.ASM explain how to install a time-activated TSR.

You can write new TSRs in assembly language or any high-level language that conforms to the Microsoft conventions for ordering segments. Regardless of the language, the new code must not invoke an MS-DOS function that sets up the I/O stack (see "Interrupting MS-DOS Functions," earlier in this chapter). Code in Microsoft C, for example, must not call `getche` or `kbhit`, since these functions in turn call MS-DOS Functions 01 and 0Bh.

Code written in a high-level language must not check for stack overflows. Compiler-generated stack probes do not recognize the new stack setup when the TSR executes, and therefore must be disabled. The example program `BELL.C`, included on disk with the TSR library routines, demonstrates how to disable stack checking in Microsoft C using the `check_stack` pragma.

## Outline of SNAP

The following sections outline in detail how SNAP works. Each part of the outline covers a specific portion of SNAP's code. Headings refer to earlier sections of this chapter, providing cross-references to SNAP's key procedures. For example, the part of the outline that describes how SNAP searches for its startup signal refers to the section "Auditing Hardware Events for TSR Requests," earlier in this chapter.

Figures 11.2 through 11.4 are flowcharts of the SNAP program. Each chart illustrates a separate phase of SNAP's operation, from installation through memory-residency to deinstallation.



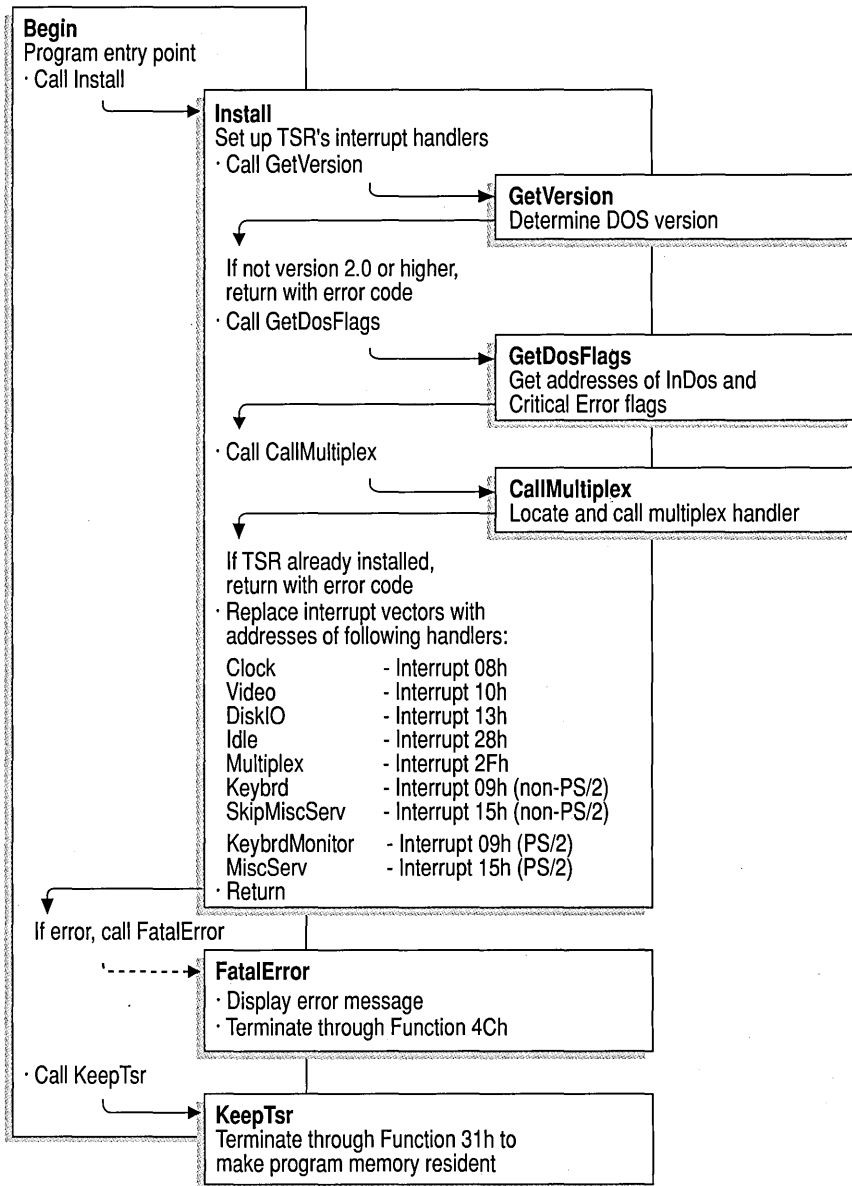

Figure 11.2 Flowchart for SNAP.EXE: Installation Phase

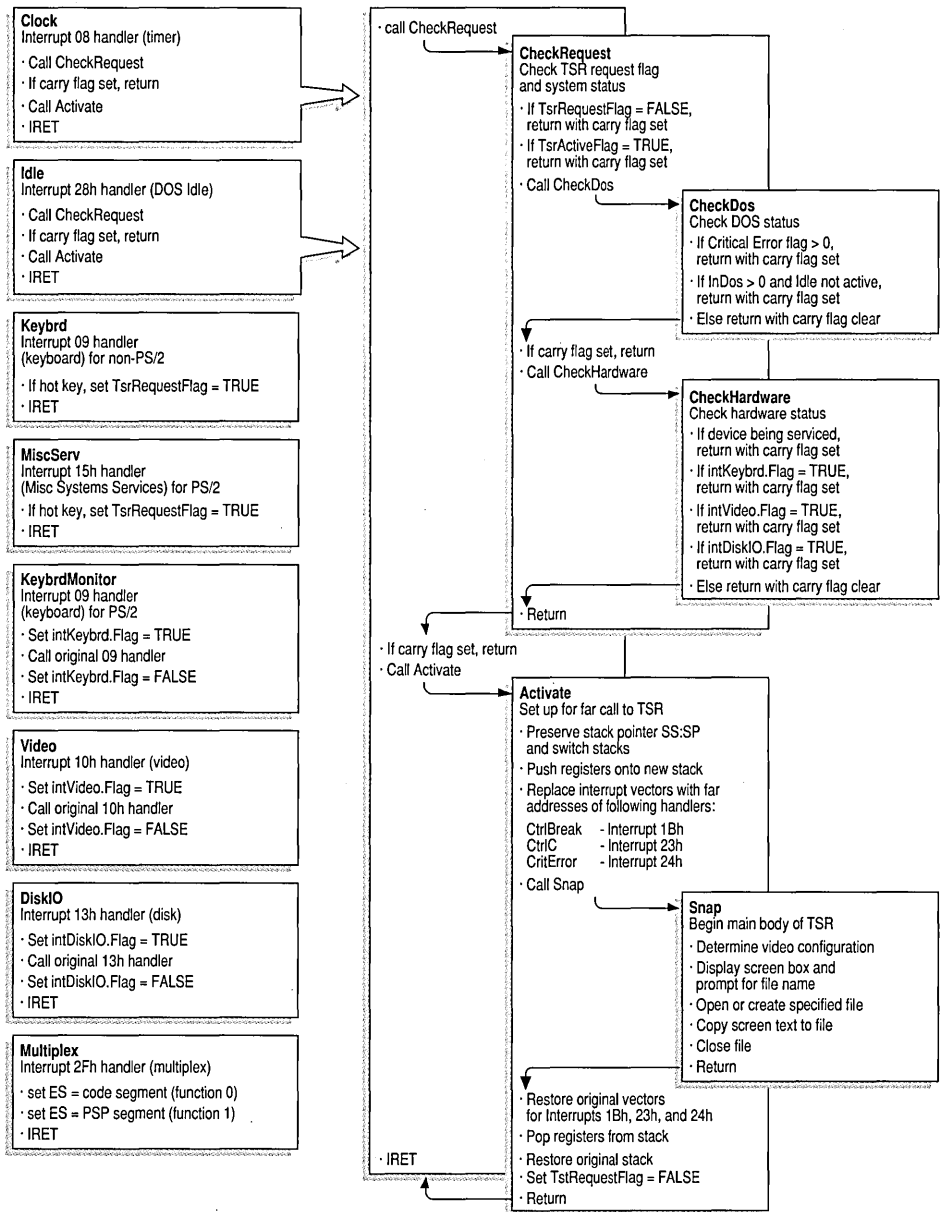
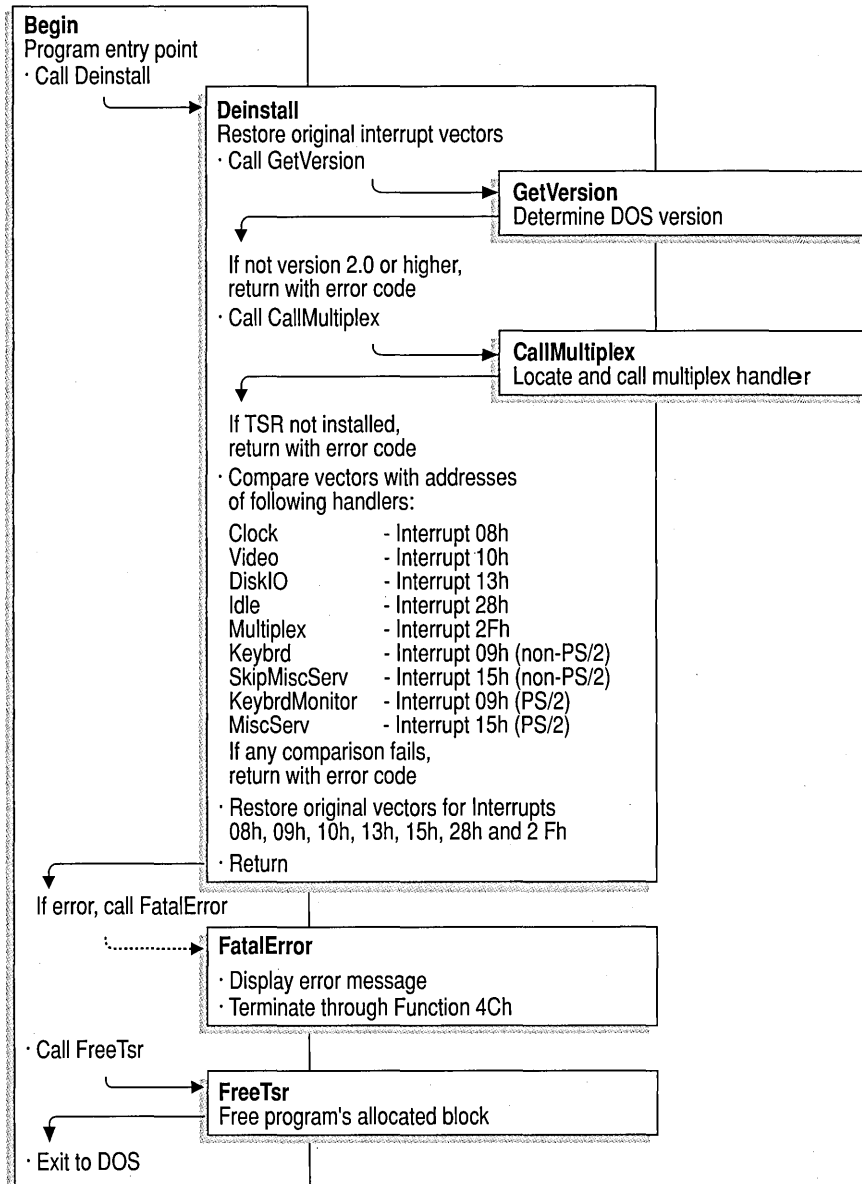

Figure 11.3 Flowchart for SNAP.EXE: Resident Phase



**Figure 11.4** Flowchart for SNAP.EXE: Deinstallation Phase

Refer to the flowcharts as you read the following outline. They will help you maintain perspective while exploring the details of SNAP's operation. Text in the outline cross-references the charts.

Note that information in both the outline and the flowcharts is generic. Except for references to the SNAP procedure, all descriptions in the outline and the flowcharts apply to any TSR created with the HANDLERS and INSTALL modules.

### Auditing Hardware Events for TSR Requests

To search for its startup signal, SNAP audits the keyboard with an interrupt handler for either Interrupt 09 (keyboard) or Interrupt 15h (Miscellaneous System Services). The Install procedure determines which of the two interrupts to handle based on the following code:

```

        .IF      HotScan == 0      ; If valid scan code given:
        mov     ah, HotShift      ; AH = hour to activate
        mov     al, HotMask      ; AL = minute to activate
        call   GetTimeToElapse   ; Get number of 5-second intervals
        mov     CountDown, ax    ; to elapse before activation

        .ELSE                      ; Force use of KeybrdMonitor as
                                   ; keyboard handler
        cmp     Version, 031Eh    ; DOS Version 3.3 or higher?
        jb     setup             ; No? Skip next step

; Test for IBM PS/2 series. If not PS/2, use Keybrd and
; SkipMiscServ as handlers for Interrupts 09 and 15h
; respectively. If PS/2 system, set up KeybrdMonitor as the
; Interrupt 09 handler. Audit keystrokes with MiscServ
; handler, which searches for the hot key by handling calls
; to Interrupt 15h (Miscellaneous System Services). Refer to
; Section 11.2.1 for more information about keyboard handlers.

        mov     ax, 0C00h        ; Function 0Ch (Get System
        int     15h              ; Configuration Parameters)
        sti                      ; Compaq ROM may leave disabled

        jc     setup             ; If carry set,
        or     ah, ah            ; or if AH not 0,
        jnz    setup             ; services are not supported

; Test bit 4 to see if Intercept is implemented
        test   BYTE PTR es:[bx+5], 00010000y
        jz     setup

; If so, set up MiscServ as Interrupt 15h handler
        mov     ax, OFFSET MiscServ
        mov     WORD PTR intMisc.NewHand, ax
        .ENDIF

; Set up KeybrdMonitor as Interrupt 09 handler
        mov     ax, OFFSET KeybrdMonitor
        mov     WORD PTR intKeybrd.NewHand, ax

```

The following describes the code's logic:

- If the program is running under MS-DOS version 3.3 or higher and if Interrupt 15h supports Function 4Fh, set up handler `MiscServ` to search for the hot key. Handle Interrupt 09 with `KeybrdMonitor` only to maintain the keyboard active flag.
- Otherwise, set up a handler for Interrupt 09 to search for the hot key. Handle calls to Interrupt 15h with the routine `SkipMiscServ`, which contains this single instruction:

```
jmp     cs:intMisc.01dHand
```

The jump immediately passes control to the original Interrupt 15h routine; thus, `SkipMiscServ` has no effect. It serves only to simplify coding in other parts of the program.

At each keystroke, the keyboard interrupt handler (either `Keybrd` or `MiscServ`) calls the procedure `CheckHotKey` with the scan code of the current key. `CheckHotKey` compares the scan code and shift status with the bytes `HotScan` and `HotShift`. If the current key matches, `CheckHotKey` returns the carry flag clear to indicate that the user has pressed the hot key.

If the keyboard handler finds the carry flag clear, it sets the flag `TsrRequestFlag` and exits. Otherwise, the handler transfers control to the original interrupt routine to service the interrupt.

The timer handler `Clock` reads the request flag at every occurrence of the timer interrupt. `Clock` takes no action if it finds a zero value in `TsrRequestFlag`. Figures 11.1 and 11.3 depict the relationship between the keyboard and timer handlers.

## Monitoring System Status

Because SNAP produces output to both video and disk, it avoids interrupting either video or disk operations. The program uses interrupt handlers `Video` and `DiskIO` to monitor Interrupts 10h (video) and 13h (disk). SNAP also avoids interrupting keyboard use. The instructions at the far label `KeybrdMonitor` serve as the monitor handler for Interrupt 09 (keyboard).

The three handlers perform similar functions. Each sets an active flag and then calls the original routine to service the interrupt. When the service routine returns, the handler clears the active flag to indicate that the device is no longer in use.

The BIOS Interrupt 13h routine clears or sets the carry flag to indicate the operation's success or failure. DiskIO therefore preserves the flags register when returning, as shown here:

```
DiskIO PROC FAR
    mov     cs:intDiskIO.Flag, TRUE ; Set active flag
; Simulate interrupt by pushing flags and far-calling old
; Int 13h routine
    pushf
    call    cs:intDiskIO.OldHand
; Clear active flag without disturbing flags register
    mov     cs:intDiskIO.Flag, FALSE
    sti                                ; Enable interrupts
; Simulate IRET without popping flags (since services use
; carry flag)
    ret     2
DiskIO ENDP
```

The terminating **RET 2** instruction discards the original flags from the stack when the handler returns.

### Determining Whether to Invoke the TSR

The procedure `CheckRequest` determines whether the TSR:

- Has been requested.
- Can safely interrupt the system.

Each time it executes, the timer handler `Clock` calls `CheckRequest` to read the flag `TsrRequestFlag`. If `CheckRequest` finds the flag set, it scans other flags maintained by the TSR's interrupt handlers and by MS-DOS. These flags indicate the current system status. As the flowchart in Figure 11.3 shows, `CheckRequest` calls `CheckDos` (described following) to determine the status of the operating system. `CheckRequest` then calls `CheckHardware` to check hardware status.

`CheckHardware` queries the interrupt controller to determine if any device is currently being serviced. It also reads the active flags maintained by the `KeybrdMonitor`, `Video`, and `DiskIO` handlers. If the controller, keyboard, video, and disk are all inactive, `CheckHardware` clears the carry flag and returns.

`CheckRequest` indicates system status with the carry flag. If the procedure returns the carry flag set, the caller exits without invoking the TSR. A clear carry signals that the caller can safely execute the TSR.

### Determining MS-DOS Activity

As Figure 11.2 shows, the procedure `GetDosFlags` locates the `InDos` flag during SNAP's installation phase. `GetDosFlags` calls Function 34h (Get Address of InDos Flag) and then stores the flag's address in the far pointer `InDosAddr`.

When called from the `CheckRequest` procedure, `CheckDos` reads `InDos` to determine whether the operating system is active. Note that `CheckDos` reads the flag directly from the address in `InDosAddr`. It does not call Function 34h to locate the flag, since it has not yet established whether MS-DOS is active. This follows from the general rule that interrupt handlers must not call any MS-DOS function.

The next two sections more fully describe the procedure `CheckDos`.

### Interrupting MS-DOS Functions

Figure 11.3 shows that the call to `CheckDos` can initiate either from `Clock` (timer handler) or `Idle` (Interrupt 28h handler). If `CheckDos` finds the `InDos` flag set, it reacts in different ways, depending on the caller:

- If called from `Clock`, `CheckDos` cannot know which MS-DOS function is active. In this case, it returns the carry flag set, indicating that `Clock` must deny the request for the TSR.
- If called from `Idle`, `CheckDos` assumes that one of the low-order polling functions is active. It therefore clears the carry flag to let the caller know the TSR can safely interrupt the function.

For more information on this topic, see the section “Interrupting MS-DOS Functions,” earlier in this chapter.

### Monitoring the Critical Error Flag

The procedure `GetDosFlags` (Figure 11.2) determines the address of the Critical Error flag. The procedure stores the flag's address in the far pointer `CritErrAddr`.

When called from either the `Clock` or `Idle` handlers, `CheckDos` reads the Critical Error flag. A nonzero value in the flag indicates that the Critical Error Handler (Interrupt 24h) is processing a critical error and the TSR must not interrupt. In this case, `CheckDos` sets the carry flag and returns, causing the caller to exit without executing the TSR.

### Trapping Errors

As Figure 11.3 shows, `Clock` and `Idle` invoke the TSR by calling the procedure `Activate`. Before calling the main body of the TSR, `Activate` sets up the following handlers:

Handler Name	For Interrupt	Receives Control When
<code>CtrlBreak</code>	1Bh (CTRL+BREAK Handler)	CTRL+BREAK sequence entered at keyboard
<code>CtrlC</code>	23h (CTRL+C Handler)	MS-DOS detects a CTRL+C sequence from the keyboard or input stream
<code>CritError</code>	24h (Critical Error Handler)	MS-DOS encounters a critical error

These handlers trap keyboard break signals and critical errors that would otherwise trigger the original handler routines. The `CtrlBreak` and `CtrlC` handlers contain a single **IRET** instruction, thus rendering a keyboard break ineffective. The `CritError` handler contains the following instructions:

```
CritError PROC FAR
    sti
    sub    al, al          ; Assume DOS 2.x
                          ; Set AL = 0 for ignore error
    .IF   cs:major != 2   ; If DOS 3.x, set AL = 3
    mov   al, 3          ; DOS call fails
    .ENDIF
    iret
CritError ENDP
```

The return code in `AL` stops MS-DOS from taking further action when it encounters a critical error.

As an added precaution, `Activate` also calls Function 33h (Get or Set `CTRL+BREAK` Flag) to determine the current setting of the checking flag. `Activate` stores the setting, then calls Function 33h again to turn off break checking.

When the TSR's main procedure finishes its work, it returns to `Activate`, which restores the original setting for the checking flag. It also replaces the original vectors for Interrupts 1Bh, 23h, and 24h.

SNAP's error-trapping safeguards enable the TSR to retain control in the event of an error. Pressing `CTRL+BREAK` or `CTRL+C` at SNAP's prompt has no effect. If the user specifies a nonexistent drive—a critical error—SNAP merely beeps the speaker and returns normally.

### Preserving an Existing Condition

`Activate` records the stack pointer `SS:SP` in the doubleword `OldStackAddr`. The procedure then resets the pointer to the address of a new stack before calling the TSR. Switching stacks ensures that SNAP has adequate stack depth while it executes.

The label `NewStack` points to the top of the new stack buffer, located in the code segment of the `HANDLERS.ASM` module. The equate constant `STACK_SIZ` determines the size of the stack. The include file `TSR.INC` contains the declaration for `STACK_SIZ`.

`Activate` preserves the values in all registers by pushing them onto the new stack. It does not push `DS`, since that register is already preserved in the `Clock` or `Idle` handler.



SNAP does not alter the application's video configuration other than by moving the cursor. Figure 11.3 shows that `Activate` calls the procedure `Snap`, which executes Interrupt 10h to determine the current cursor position. `Snap` stores the row and column in the word `OldPos`. The procedure restores the cursor to its original location before returning to `Activate`.

### Preserving Existing Data

Because SNAP does not call an MS-DOS function that writes to the DTA, it does not need to preserve the DTA belonging to the interrupted process. However, the code for switching and restoring the DTA is included within `IFDEF` blocks in the procedure `Activate`. The equate constant `DTA_SIZ`, declared in the `TSR.INC` file, governs the assembly of the blocks as well as the size of the new DTA.

It is possible for SNAP to overwrite existing extended error information by committing a file error. The program does not attempt to preserve the original information by calling Functions 59h and 5Dh. In certain rare instances, this may confuse the interrupted process after SNAP returns.

### Communicating Through the Multiplex Interrupt

The program uses the Multiplex interrupt (Interrupt 2Fh) to

- Verify that SNAP is installed.
- Select a unique multiplex identity number.
- Locate resident data.

For more information about Interrupt 2Fh, see the section "Communicating through the Multiplex Interrupt," earlier in this chapter.

SNAP accesses Interrupt 2Fh through the procedure `CallMultiplex`, as shown in Figures 11.2 and 11.4. By searching for a prior installation, `CallMultiplex` ensures that SNAP is not installed more than once. During deinstallation, `CallMultiplex` locates data required to deinstall the resident TSR.

The procedure `Multiplex` serves as SNAP's multiplex handler. When it recognizes its identity number in AH, `Multiplex` determines its tasks from the function number in the AL register. The handler responds to Function 0 by returning AL equalling `OFFh` and ES:DI pointing to an identifier string unique to SNAP.

`CallMultiplex` searches for the handler by invoking Interrupt 2Fh in a loop, beginning with a trial identity number of 192 in AH. At the start of each iteration of the loop, the procedure sets AL to zero to request presence verification from the multiplex handler. If the handler returns `OFFh` in AL, `CallMultiplex` compares its copy of SNAP's identifier string with the text at memory location ES:DI. A failed match indicates that the multiplex handler servicing the call is not SNAP's handler. In this case, `CallMultiplex` increments AH and cycles back to the beginning of the loop.

The process repeats until the call to Interrupt 2Fh returns a matching identifier string at ES:DI, or until AL returns as zero. A matching string verifies that SNAP is installed, since its multiplex handler has serviced the call. A return value of zero indicates that SNAP is not installed and that no multiplex handler claims the trial identity number in AH. In this case, SNAP assigns the number to its own handler.

## Deinstalling a TSR

During deinstallation, `CallMultiplex` locates SNAP's multiplex handler as described previously. The handler `Multiplex` receives the verification request and returns in ES the code segment of the resident program.

`Deinstall` reads the addresses of the following interrupt handlers from the data structure in the resident code segment:

Handler Name	Description
Clock	Timer handler
Keybrd	Keyboard handler (non-PS/2)
KeybrdMonitor	Keyboard monitor handler (PS/2)
Video	Video monitor handler
DiskIO	Disk monitor handler
SkipMiscServ	Miscellaneous Systems Services handler (non-PS/2)
MiscServ	Miscellaneous Systems Services handler (PS/2)
Idle	MS-DOS Idle handler
Multiplex	Multiplex handler

`Deinstall` calls MS-DOS Function 35h (Get Interrupt Vector) to retrieve the current vectors for each of the listed interrupts. By comparing each handler address with the corresponding vector, `Deinstall` ensures that SNAP can be safely deinstalled. Failure in any of the comparisons indicates that another TSR has been installed after SNAP and has set up a handler for the same interrupt. In this case, `Deinstall` returns an error code, stopping the program with the following message:

```
Can't deinstall TSR
```

If all addresses match, `Deinstall` calls Interrupt 2Fh with SNAP's identity number in AH and AL set to 1. The handler `Multiplex` responds by returning in ES the address of the resident code's PSP. `Deinstall` then calls MS-DOS Function 25h (Set Interrupt Vector) to restore the vectors for the original service routines. This is called "unhooking" or "unchaining" the interrupt handlers.

After unhooking all of SNAP's interrupt handlers, `Deinstall` returns with AX pointing to the resident code's PSP. The procedure `FreeTsr` then calls MS-DOS

Function 49h (Release Memory) to return SNAP's memory to the operating system. The program ends with the message

```
TSR deinstalled
```

to indicate a successful deinstallation.

Deinstalling SNAP does not guarantee more available memory space for the next program. If another TSR loads after SNAP but handles interrupts other than 08, 09, 10h, 13h, 15h, 28h, or 2Fh, SNAP still deinstalls properly. The result is a harmless gap of deallocated memory formerly occupied by SNAP. MS-DOS can use the free memory to store the next program's environment block. However, MS-DOS loads the program itself above the still-resident TSR.

# Mixed-Language Programming

Mixed-language programming allows you to combine the unique strengths of Microsoft Basic, C, C++, and FORTRAN with your assembly-language routines. Any one of these languages can call MASM routines, and you can call any of these languages from within your assembly-language programs. This makes virtually all the routines from high-level-language libraries available to a mixed-language program.

MASM 6.1 provides mixed-language features similar to those in high-level languages. For example, you can use the **INVOKE** directive to call high-level-language procedures, and the assembler handles the argument-passing details for you. You can also use **H2INC** to translate C header files to MASM include files, as explained in Chapter 20 of *Environment and Tools*.

The mixed-language features of MASM 6.1 do not make older methods of defining mixed-language interfaces obsolete. In most cases, mixed-language programs written with earlier versions of MASM will assemble and link correctly under MASM 6.1. (For more information, see Appendix A.)

This chapter explains how to write assembly routines that can be called from high-level-language modules and how to call high-level language routines from MASM. You should already understand the languages you want to combine and should know how to write, compile, and link multiple-module programs with these languages.

This chapter covers only assembly-language interface with C, C++, Basic, and FORTRAN; it does not cover mixed-language programming between high-level languages. The focus here is the Microsoft versions of C, C++, Basic, and FORTRAN, but the same principles apply to other languages and compilers. Many of the techniques used in this chapter are explained in the material in Chapter 7 on writing procedures in assembly language, and in Chapter 8 on multiple-module programming.

The first section of this chapter discusses naming and calling conventions. The next section, "Writing an Assembly Procedure for a Mixed-Language Program," provides a template for writing an assembly-language procedure that can be called

from another module written in a high-level language. This represents the essence of mixed-language programming. Assembly language is often used for creating fast secondary routines in a large program written in a high-level language.

The third section describes specific conventions for linking assembly-language procedures with modules in C, C++, Basic, and FORTRAN. These language-specific sections also provide details on how the language manages various data structures so that your MASM programs are compatible with the data from the high-level language.

## Naming and Calling Conventions

Each language has its own set of conventions, which fall into two categories:

- The “naming convention” specifies how or if the compiler or assembler alters the name of an identifier before placing it into an object file.
- The “calling convention” determines how a language implements a call to a procedure and how the procedure returns to the caller.

MASM supports several different conventions. The assembler uses C convention when you specify a language type (*langtype*) of C, and Pascal convention for language types PASCAL, BASIC, or FORTRAN. To the assembler, the keywords BASIC, PASCAL, and FORTRAN are synonymous. MASM also supports the SYSCALL and STDCALL conventions, which mix elements of the C and Pascal conventions.

MASM gives you several ways to set the naming and calling conventions in your assembly-language program. Using **.MODEL** with a *langtype* sets the default for the module. This can also be done with the **OPTION** directive. This is equivalent to the /Gc or /Gd option from the command line. Procedure prototypes and declarations can specify a *langtype* to override the default.

When you write mixed-language routines, the easiest way to ensure convention compatibility is to adopt the conventions of the called procedure's language. However, Microsoft languages can change the naming and calling conventions for different procedures. If your program must call a procedure that uses an argument-passing method different from that of the default language, prototype the procedure first with the desired language type. This tells the assembler to override the conventions of the default language and assume the proper conventions for the prototyped procedure. “The MASM/High-Level-Language Interface” section in this chapter explains how to change the default conventions. The following sections provide more detail on the information summarized in Table 12.1.

**Table 12.1 Naming and Calling Conventions**

Convention	C	SYSCALL	STDCALL	BASIC	FORTRAN	PASCAL
Leading underscore	X		X			
Capitalize all				X	X	X
Arguments pushed left to right				X	X	X
Arguments pushed right to left	X	X	X			
Caller stack cleanup	X	X	*			
:VARARG allowed	X	X	X			

\* The STDCALL language type uses caller stack cleanup if the :VARARG parameter is used. Otherwise, the called routine must clean up the stack.

## Naming Conventions

“Naming convention” refers to the way a compiler or assembler stores the names of identifiers. The first two rows of Table 12.1 show how each language type affects symbol names. **SYSCALL** leaves symbol names as they appear in the source code, but **C** and **STDCALL** add an underscore prefix. **PASCAL**, **BASIC**, and **FORTRAN** change symbols to all uppercase.

The following list describes how these naming conventions affect a variable called `Big Time` in your source code:

Langtype Specified	Characteristics
<b>SYSCALL</b>	Leaves the name unmodified. The linker sees the variable as <code>Big Time</code> .
<b>C, STDCALL</b>	The assembler (or compiler) adds a leading underscore to the name, but does not change case. The linker sees the variable as <code>_Big Time</code> .
<b>PASCAL, FORTRAN, BASIC</b>	Converts all names to uppercase. The linker sees the variable as <code>Big Time</code> .

## The C Calling Convention

Specify the C language type for assembly-language procedures called from programs that assume the C calling convention. Note that such programs are not necessarily written in C, since other languages can mimic C conventions.

## Argument Passing

With the C calling convention, the caller pushes arguments from right to left as they appear in the caller's argument list. The called procedure returns without removing the arguments from the stack. It is the caller's responsibility to clean the stack after the call, either by popping the arguments or by adding an appropriate value to the stack pointer SP.

## Register Preservation

The called routine must return with the original values in BP, SI, DI, DS, and SS. It must also preserve the direction flag.

## Varying Number of Arguments

The additional overhead of cleaning the stack after each call has compensations. It frees the caller from having to pass a set number of arguments to the called procedure each time. Because the first argument in the list is always the last one pushed, it is always on the top of the stack. Thus, it has the same address relative to the frame pointer, regardless of how many arguments were actually passed.

For example, consider the C library function **printf**, which accepts different numbers of arguments. A C program calls the function like this:

```
printf( "Numbers: %f %f %.2f\n", n1, n2, n3 );  
printf( "Also: %f", n4 );
```

The first line passes four arguments (including the string in quotes) and the second line passes only two arguments. Notice that **printf** has no reliable way of determining how many arguments the caller has pushed. Therefore, the function returns without adjusting the stack. The C calling convention requires the caller to take responsibility for removing the arguments from the stack, since only the caller knows how many arguments it passed.

Use **INVOKE** to call a C-callable function from your assembly-language program, since **INVOKE** automatically generates the necessary stack-cleaning code after the call. You must also prototype the function with the **VARARG** keyword if appropriate, as explained in "Procedures," Chapter 7. Similarly, when you write a C-callable procedure that accepts a varying number of arguments, include **VARARG** in the procedure's **PROC** statement.

## The Pascal Calling Convention

By default, the *langtype* for **FORTTRAN**, **BASIC**, and **PASCAL** selects the Pascal calling convention. This convention pushes arguments left to right so that the last argument is lowest on the stack, and it requires that the called routine remove arguments from the stack.

### Argument Passing

Arguments are placed on the stack in the same order in which they appear in the source code. The first argument is highest in memory (because it is also the first argument to be placed on the stack), and the stack grows downward.

### Register Preservation

A routine that uses the Pascal calling convention must preserve SI, DI, BP, DS, and SS. For 32-bit code, the EBX, ES, FS, and GS registers must be preserved as well as EBP, ESI, and EDI. The direction flag is also cleared upon entry and must be preserved.

### Varying Number of Arguments

Passing a variable number of arguments is not possible with the Pascal calling convention.

## The STDCALL and SYSCALL Calling Conventions

A **STDCALL** procedure adopts the C name and calling conventions when prototyped with the **VARARG** keyword. Refer to the section “Declaring Parameters with the PROC Directive” in Chapter 7. Without **VARARG**, the procedure uses the C naming and Pascal calling conventions. **STDCALL** provides compatibility with 32-bit versions of Microsoft compilers.

As Table 12.1 shows, **SYSCALL** is identical to the C calling convention, but does not add an underscore prefix to symbols.

### Argument Passing

Argument passing order for both **STDCALL** and **SYSCALL** is the same as the C calling convention. The caller pushes the arguments from right to left and must remove the parameters from the stack after the call. However, **STDCALL** requires the called procedure to clean the stack if the procedure does not accept a variable number of arguments.

### Register Preservation

Both conventions require the called procedure to preserve the registers BP, SI, DI, DS, and SS. Under **STDCALL**, the direction flag is clear on entry and must be returned clear.

### Varying Number of Arguments

**SYSCALL** allows a variable number of arguments in the same way as the C calling convention. **STDCALL** also mimics the C convention when **VARARG** appears in the called procedure’s declaration or definition. It allows a varying number of arguments and requires the caller to clean the stack. If not declared or



defined with **VARARG**, the called procedure does not accept a variable argument list and must clean the stack before it returns.

## Writing an Assembly Procedure For a Mixed-Language Program

MASM 6.1 simplifies the coding required for linking MASM routines to high-level-language routines. You can use the **PROTO** directive to write procedure prototypes, and the **INVOKE** directive to call external routines. MASM simplifies procedure-related tasks in the following ways:

- The **PROTO** directive improves error checking on argument types.
- **INVOKE** pushes arguments onto the stack and converts argument types to types expected when possible. These arguments can be referenced by their parameter label, rather than as offsets of the stack pointer.
- The **LOCAL** directive following the **PROC** statement saves places on the stack for local variables. These variables can also be referenced by name, rather than as offsets of the stack pointer.
- **PROC** sets up the appropriate stack frame according to the processor mode.
- The **USES** keyword preserves registers given as arguments.
- The C calling conventions specified in the **PROC** syntax allow for a variable number of arguments to be passed to the procedure.
- The **RET** keyword adjusts the stack upward by the number of bytes in the argument list, removes local variables from the stack, and pops saved registers.
- The **PROC** statement lists parameter names and types. The parameters can be referenced by name inside the procedure.

The complete syntax and parameter descriptions for these procedure directives are explained in “Procedures” in Chapter 7. This section provides a template that you can use for writing a MASM routine to be called from a high-level language.

The template looks like this:

```

Label PROC [distance langtype visibility <prologueargs> USES reglist
parmlist]
    LOCAL varlist
    .
    .
    .
    RET
Label ENDP

```

Replace the italicized words with appropriate keywords, registers, or variables as defined by the syntax in “Declaring Parameters with the **PROC** Directive” in Chapter 7.

The *distance* (**NEAR** or **FAR**) and *visibility* (**PUBLIC**, **PRIVATE**, or **EXPORT**) that you give in the procedure declaration override the current defaults. In some languages, the model can also be specified with command-line options.

The *langtype* determines the calling convention for accessing arguments and restoring the stack. For information on calling conventions, see “Naming and Calling Conventions” earlier in this chapter.

The types for the parameters listed in the *parmlist* must be given. Also, if any of the parameters are pointers, the assembler does not generate code to get the value of the pointer references. You must write this code yourself. An example of how to write such code is provided in “Declaring Parameters with the **PROC** Directive” in Chapter 7.

If you need to code your own stack-frame setup manually, or if you do not want the assembler to generate the standard stack setup and cleanup, see “Passing Arguments on the Stack” and “User-Defined Prologue and Epilogue Code” in Chapter 7.

## The MASM/High-Level–Language Interface

Since high-level–language programs require initialization, you must write the main routine of a mixed-language program in the high-level language, or link with the startup code supplied by the high-level–language compiler. This gives the assembly code access to high-level routines or library functions. The next section explains how to link an assembly-language program with C-language startup code.

For procedures with prototypes, **INVOKE** makes calls from MASM to high-level–language programs, much like procedure or function calls in the high-level language. **INVOKE** calls procedures and generates the code to push arguments in the order specified by the procedure’s calling convention, and to remove arguments from the stack at the end of the procedure.

**INVOKE** can also do type checking and data conversion for the argument types so that the procedure receives compatible data. For explanations of how to write procedure prototypes and several examples of procedure declarations and the corresponding prototypes, see “Declaring Procedure Prototypes” in Chapter 7.

For programs that mix assembly language and C, the **H2INC** utility makes it easy to write prototypes and data declarations for the C procedures you want to call from MASM. **H2INC** translates the C prototypes and declarations into the corresponding MASM prototypes and declarations, which **INVOKE** can use to call the procedure. The use of **H2INC** is explained in Chapter 20 in *Environment and Tools*.

Mixed-language programming also allows the main program or a routine to use external data—data defined in the other module. External data is the data that is stored in a set place in memory (unlike dynamic and local data, which is allocated on the stack and heap) and is visible to other modules.

External data is shared by all routines. One of the modules must define the static data, which causes the compiler to allocate storage for the data. The other modules that access the data must declare the data as external.

## Argument Passing

Each language has its own convention for how an argument is actually passed. If the argument-passing conventions of your routines do not agree, then a called routine receives bad data. Microsoft languages support three different methods for passing an argument:

- **Near reference.** Passes a variable's near (offset) address, expressed as an offset from the default data segment. This method gives the called routine direct access to the variable itself. Any change the routine makes to the parameter is reflected in the calling routine.
- **Far reference.** Passes a variable's far (segmented) address. Though slower than passing a near reference, this method is necessary for passing data that lies outside the default data segment. (This is not an issue in Basic unless you have specifically requested far memory.)
- **Value.** Passes only a copy of the variable, not its address. With this method, the called routine gets a copy of the argument on the stack, but has no access to the original variable. The copy is discarded when the routine returns, and the variable retains its original value.

When you pass arguments between routines written in different languages, you must ensure that the caller and the called routine use the same conventions for passing and receiving arguments. In most cases, you should check the argument-passing defaults used by each language and make any necessary adjustments. Most languages have features that allow you to change argument-passing methods.

## Register Preservation

A procedure called from any high-level language should preserve the direction flag and the values of BP, SI, DI, SS, and DS. Routines called from MASM must not alter SI, DI, SS, DS, or BP.

## Pushing Addresses

Microsoft high-level languages push segment addresses before offsets. This lets the called routine use the **LES** and **LDS** instructions to read far addresses from the stack. Furthermore, each word of an argument is placed on the stack in order of significance. Thus, the high word of a long integer is pushed first, followed by the low word.

## Array Storage

Most high-level-language compilers store arrays in row-major order. This means that all elements of a row are stored consecutively. The first five elements of an array with four rows and three columns are stored in row-major order as

```
A[1, 1], A[1, 2], A[1, 3], A[2, 1], A[2, 2]
```

In column-major order, the column elements are stored consecutively. For example, this same array would be stored in column-major order as

```
A[1, 1], A[2, 1], A[3, 1], A[4, 1], A[1, 2], A[2, 2]
```

## The C/MASM Interface

This section summarizes the characteristics of the interface between MASM and Microsoft C and QuickC compilers. With the default naming and calling convention, the assembler (or compiler) pushes arguments right to left and adds a leading underscore to routine names.

### Compatible Data Types

This list shows the 16-bit C data types and equivalent data types in MASM 6.1. For 32-bit C compilers, **int** and **unsigned int** are equivalent to the MASM types **SDWORD** and **DWORD**, respectively.

C Type	Equivalent MASM Type
<b>unsigned char</b>	<b>BYTE</b>
<b>char</b>	<b>SBYTE</b>
<b>unsigned short, unsigned int</b>	<b>WORD</b>
<b>int, short</b>	<b>SWORD</b>
<b>unsigned long</b>	<b>DWORD</b>
<b>long</b>	<b>SDWORD</b>
<b>float</b>	<b>REAL4</b>
<b>double</b>	<b>REAL8</b>
<b>long double</b>	<b>REAL10</b>

### Naming Restrictions

C is case-sensitive and does not convert names to uppercase. Since C normally links with the **/NOI** command-line option, you should assemble MASM modules with the **/Cx** or **/Cp** option to prevent the assembler from converting names to uppercase.

## Argument-Passing Defaults

C always passes arrays by reference and all other variables (including structures) by value. C programs in tiny, small, and medium model pass near addresses for arrays, unless another distance is specified. Compact-, large-, and huge-model programs pass far addresses by default. To pass by reference a variable type other than array, use the C-language address-of operator (&).

If you need to pass an array by value, declare the array as a structure member and pass a copy of the entire structure. However, this practice is rarely necessary and usually impractical except for very small arrays, since it can make substantial demands on stack space. If your program must maintain an array through a procedure call, create a temporary copy of the array in heap and provide the copy to the procedure by reference.

## Changing the Calling Convention

Put `_pascal` or `_fortran` in the C function declaration to specify the Pascal calling convention.

## Array Storage

Array declarations give the number of elements. `A1[a][b]` declares a two-dimensional array in C with `a` rows and `b` columns. By default, the array's lower bound is zero. Arrays are stored by the compiler in row-major order. By default, passing arrays from C passes a pointer to the first element of the array.

## String Format

C stores strings as arrays of bytes and uses a null character as the end-of-string delimiter. For example, consider the string declared as follows:

```
char msg[] = "string of text"
```

The string occupies 15 bytes of memory as:

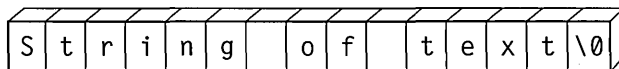

**Figure 12.1** C String Format

Since `msg` is an array of characters, it is passed by reference.

## External Data

In C, the `extern` keyword tells the compiler that the data or function is external. You can define a static data object in a C module by defining a data object outside all functions and subroutines. Do not use the `static` keyword in C with a data object that you want to be public.

## Structure Alignment

By default, C uses word alignment (unpacked storage) for all data objects longer than 1 byte. This storage method specifies that occasional bytes may be added as padding, so that word and doubleword objects start on an even boundary. In addition, all nested structures and records start on a word boundary. MASM aligns on byte boundaries by default.

When converting .H files with H2INC, you can use the `/Zp` command-line option to specify structure alignment. If you do not specify the `/Zp` option, H2INC uses word-alignment. Without H2INC, set the alignment to 2 when declaring the MASM structure, compile the C module with `/Zp1`, or assemble the MASM module with `/Zp2`.

## Compiling and Linking

Use the same memory model for both C and MASM.

## Returning Values

The assembler returns simple data types in registers. Table 12.2 shows the register conventions for returning simple data types to a C program.

**Table 12.2 Register Conventions for Simple Return Values**

Data Type	Registers
char	AL
short, near, int (16-bit)	AX
short, near, int (32-bit)	EAX
long, far (16-bit)	High-order portion (or segment address) in DX; low-order portion (or offset address) in AX
long, far (32-bit)	High-order portion (or segment address) in EDX; low-order portion (or offset address) in EAX

Procedures using the C calling convention and returning type **float** or type **double** store their return values into static variables. In multi-threaded programs, this could mean that the return value may be overwritten. You can avoid this by using the Pascal calling convention for multi-threaded programs so **float** or **double** values are passed on the stack.

Structures less than 4 bytes long are returned in DX:AX. To return a longer structure from a procedure that uses the C calling convention, you must copy the structure to a global variable and then return a pointer to that variable in the AX register (DX:AX, if you compiled in compact, large, or huge model or if the variable is declared as a far pointer).

## Structures, Records, and User-Defined Data Types

You can pass structures, records, and user-defined types as arguments by value or by reference.

### Writing Procedure Prototypes

The H2INC utility simplifies the task of writing prototypes for the C functions you want to call from MASM. The C prototype converted by H2INC into a MASM prototype allows **INVOKE** to correctly call the C function. Here are some examples of C functions and the MASM prototypes created with H2INC.

```
/* Function Prototype Declarations to Convert with H2INC */
```

```
long checktypes (
    char *name,
    unsigned char a,
    int b,
    float d,
    unsigned int *num );
```

```
my_func (float fNum, unsigned int x);
```

```
extern my_func1 (char *argv[]);
```

```
struct videoconfig_far * _far pascal my_func2 (int, scri );
```

For these C prototypes, H2INC generates this code:

```
@proto_0      TYPEDEF      PROTO C :PTR SBYTE, :BYTE,
                :SWORD, :REAL4, :PTR WORD
checktypes    PROTO        @proto_0

@proto_1      TYPEDEF      PROTO C :REAL4, :WORD
my_func       PROTO        @proto_1

@proto_2      TYPEDEF      PROTO C :PTR PTR SBYTE
my_func1      PROTO        @proto_2

@proto_3      TYPEDEF      PROTO FAR PASCAL :SWORD, :scri
my_func2      PROTO        @proto_3
```

**Example**

As shown in the following short example, the main module (written in C) calls an assembly routine, `Power2`.

```
#include <stdio.h>

extern int Power2( int factor, int power );

void main()
{
    printf( "3 times 2 to the power of 5 is %d\n", Power2( 3, 5 ) );
}
```



Figure 12.2 shows how functions that observe the C calling convention use the stack frame.

### Near Function Call

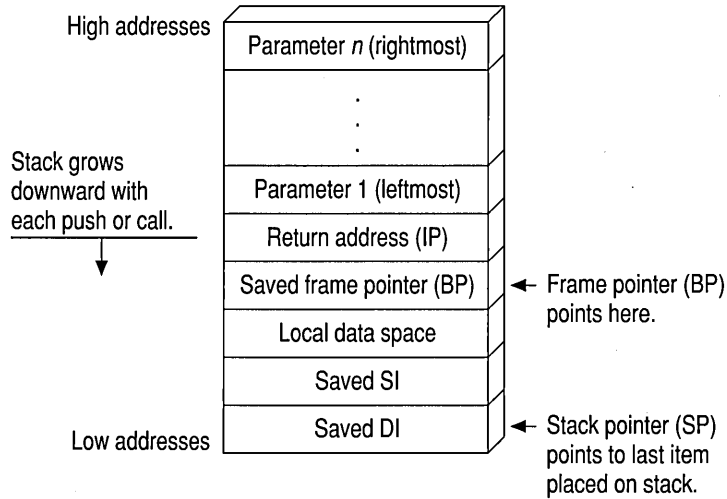

### Far Function Call

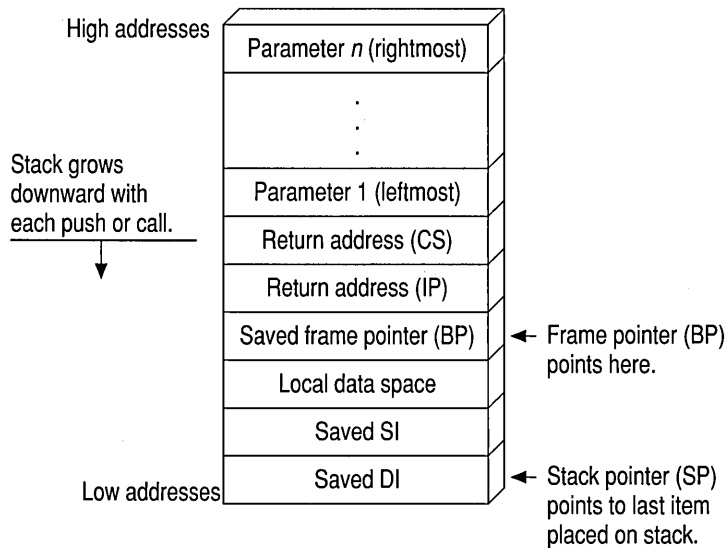

Figure 12.2 C Stack Frame

The MASM module that contains the Power2 routine looks like this:

```

.MODEL small, c

Power2 PROTO C factor:SWORD, power:SWORD
.CODE

Power2 PROC C factor:SWORD, power:SWORD
    mov     ax, factor      ; Load Arg1 into AX
    mov     cx, power      ; Load Arg2 into CX
    shl     ax, cl         ; AX = AX * (2 to power of CX)
                                ; Leave return value in AX
    ret
Power2 ENDP
END

```

The MASM procedure declaration for the Power2 routine specifies the C *langtype* and the parameters expected by the procedure. The *langtype* specifies the calling and naming conventions for the interface between MASM and C. The routine is public by default. When the C module calls Power2, it passes two arguments, 3 and 5 by value.

## Using the C Startup Code

This section explains how to write an assembly-language program that can call C library functions. It links with the C startup module, which performs the necessary initialization required by the library functions.

You must follow these steps when writing such a program:

1. Specify the C convention in the **.MODEL** statement.
2. Include the following (optional) statement to note linkage with the C startup module:

```

        EXTERN _acrtused:abs

```
3. Prototype or declare as external all C functions the program references.
4. Include a public procedure called `main` in your assembly-language module. The C startup code calls `_main` (which is why all C programs begin with a `main` function). This procedure serves as the effective entry point for your program.
5. Omit an entry point in the program's **END** directive. The C startup code serves as the true entry point when the program runs.
6. Assemble with ML's `/Cx` switch to preserve the case of nonlocal names.

The following example serves as a template for these steps. The program calls the C run-time function **printf** to display two variables.

```
.MODEL    small, c                ; Step 1: declare C conventions
EXTERN  _acrtused:abs            ; Step 2: bring in C startup
.
.
.
printf  PROTO    NEAR,            ; Step 3: prototype
                pstring:NEAR PTR BYTE, ;      external C
                num1:WORD, num2:VARARG ;      routines
.
.DATA
format  BYTE    '%i  %i', 13, 0
.
.CODE
main    PROC     PUBLIC            ; Step 4: C startup calls here
.
.
.
        INVOKE  printf, OFFSET format, ax, bx
.
.
.
        END                ; Step 5: no label on END
```

## The C++/MASM Interface

C++ can apply a protocol called a “linkage specification” to mixed-language procedures. This lets you link C++ code in the same way as C code. All information in the preceding section applies when linking assembly-language and C++ routines through the C linkage specification.

The C linkage specification forces the C++ compiler to adopt C conventions—which are not the same as C++ conventions—for listed routines. Since MASM does not specifically support C++ conventions, set the C linkage specification in your C++ code for all mixed-language routines, as shown here:

### **extern “C” declaration**

where *declaration* is the prototype of an exported C++ function or an imported assembly-language procedure. You can bracket a list of declarations:

```
extern "C"
{
    int    WriteLine( short attr, char *string );
    void   GoExit( int err );
}
```

or apply the specification to individual prototypes:

```
extern "C" int   WriteLine( short attr, char *string );
extern "C" void  GoExit( int err );
```

Note the syntax remains the same whether `WriteLine` and `GoExit` are exported C++ functions or imported assembly-language routines. The linkage specification applies only to called routines, not to external variables. Use the **extern** keyword (without the “C”) as you normally would when identifying objects external to the C++ module.

## The FORTRAN/MASM Interface

This section summarizes the specific details important to calling FORTRAN procedures or receiving arguments from FORTRAN routines that call MASM routines. It includes a sample MASM and FORTRAN module.

A FORTRAN procedure follows the Pascal calling convention by default. This convention passes arguments in the order listed, and the calling procedure removes the arguments from the stack. The naming convention converts all exported names to uppercase.

### Compatible Data Types

This list shows the FORTRAN data types that are equivalent to the MASM 6.1 data types.

FORTRAN Type	Equivalent MASM Type
CHARACTER*1	BYTE
INTEGER*1	SBYTE
INTEGER*2	WORD
REAL*4	REAL4
INTEGER*4	SDWORD
REAL*8, DOUBLE PRECISION	REAL8

### Naming Restrictions

FORTRAN allows 31 characters for identifier names. A digit or an underscore cannot be the first character in an identifier name.

### Argument-Passing Defaults

By default, FORTRAN passes arguments by reference as far addresses if the FORTRAN module is compiled in large or huge memory model. It passes them as near addresses if the FORTRAN module is compiled in medium model. Versions of FORTRAN prior to Version 4.0 always require large model.

The FORTRAN compiler passes an argument by value when declared with the **VALUE** attribute. This declaration can occur either in a FORTRAN **INTERFACE** block (which determines how to pass an argument) or in a function or subroutine declaration (which determines how to receive an argument).

In FORTRAN you can apply the **NEAR** (or **FAR**) attribute to reference parameters. These keywords override the default. They have no effect when they specify the same method as the default.

### Changing the Calling Convention

A call to a FORTRAN function or subroutine declared with the **PASCAL** or **C** attribute passes all arguments by value in the parameter list (except for parameters declared with the **REFERENCE** attribute). This change in default passing method applies to function and subroutine definitions as well as to the functions and subroutines described by **INTERFACE** blocks.

### Array Storage

When you declare FORTRAN arrays, you can specify any integer for the lower bound (the default is 1). The FORTRAN compiler stores all arrays in column-major order—that is, the leftmost subscript increments most rapidly. For example, the first seven elements of an array defined as `A[3, 4]` are stored as

`A[1,1], A[2,1], A[3,1], A[1,2], A[2,2], A[3,2], A[1,3]`

### String Format

FORTRAN stores strings as a series of bytes at a fixed location in memory, with no delimiter at the end of the string. When passing a variable-length FORTRAN string to another language, you need to devise a method by which the target routine can find the end of the string.

Consider the string declared as

```
CHARACTER*14 MSG
MSG = 'String of text'
```

The string is stored in 14 bytes of memory like this:

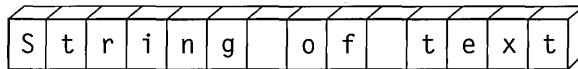

**Figure 12.3** FORTRAN String Format

Strings are passed by reference. Although FORTRAN has a method for passing length, the variable-length FORTRAN strings cannot be used in a mixed-language interface because other languages cannot access the temporary variable that FORTRAN uses to communicate string length. However, fixed-length strings can be passed if the FORTRAN **INTERFACE** statement declares the length of the string in advance.

### External Data

FORTRAN routines can directly access external data. In FORTRAN you can declare data to be external by adding the **EXTERN** attribute to the data declaration. You can also access a FORTRAN variable from MASM if it is declared in a **COMMON** block.

A FORTRAN program can call an external assembly procedure with the use of the **INTERFACE** statement. However, the **INTERFACE** statement is not strictly necessary unless you intend to change one of the FORTRAN defaults.

### Structure Alignment

By default, FORTRAN uses word alignment (unpacked storage) for all data objects larger than 1 byte. This storage method specifies that occasional bytes may be added as padding, so that word and doubleword objects start on an even boundary. In addition, all nested structures and records start on a word boundary. The MASM default is byte-alignment, so you should specify an *alignment* of 2 for MASM structures or use the `/Zp1` option when compiling in FORTRAN.

### Compiling and Linking

Use the same memory model for the MASM and FORTRAN modules.

### Returning Values

You must use a special convention to return floating-point values, records, user-defined types, arrays, and values larger than 4 bytes to a FORTRAN module from an assembly procedure. The FORTRAN module creates space in the stack segment to hold the actual return value. When the call to the assembly procedure is made, an extra parameter is passed. This parameter is the last one pushed. The segment address of the return value is contained in SS.

In the assembly procedure, put the data for the return value at the location pointed to by the return value offset. Then copy the return-value offset (located at BP + 6) to AX, and copy SS to DX. This is necessary because the calling module expects DX:AX to point to the return value.

## Structures, Records, and User-Defined Data Types

The FORTRAN structure variable, defined with the **STRUCTURE** keyword and declared with the **RECORD** statement, is equivalent to the Pascal **RECORD** and the C **struct**. You can pass structures as arguments by value or by reference (the default).

The FORTRAN types **COMPLEX\*8** and **COMPLEX\*16** are not directly implemented in MASM. However, you can write structures that are equivalent. The type **COMPLEX\*8** has two fields, both of which are 4-byte floating-point numbers; the first contains the real component, and the second contains the imaginary component. The type **COMPLEX** is equivalent to the type **COMPLEX\*8**.

The type **COMPLEX\*16** is similar to **COMPLEX\*8**. The only difference is that each field of the former contains an 8-byte floating-point number.

A FORTRAN **LOGICAL\*2** is stored as a 1-byte indicator value (1=true, 0=false) followed by an unused byte. A FORTRAN **LOGICAL\*4** is stored as a 1-byte indicator value followed by three unused bytes. The type **LOGICAL** is equivalent to **LOGICAL\*4**, unless **\$STORAGE:2** is in effect.

To pass or receive a FORTRAN **LOGICAL** type, declare a MASM structure with the appropriate fields.

## Varying Number of Arguments

In FORTRAN, you can call routines with a variable number of arguments by including the **VARYING** attribute in your interface to the routine, along with the **C** attribute. You must use the **C** attribute because a variable number of arguments is possible only with the **C** calling convention. The **VARYING** attribute prevents FORTRAN from enforcing a matching number of parameters.

## Pointers and Addresses

FORTRAN programs can determine near and far addresses with the **LOCNEAR** and **LOCFAR** functions. Store the result as **INTEGER\*2** (with the **LOCNEAR** function) or as **INTEGER\*4** (with the **LOCFAR** function). If you pass the result of **LOCNEAR** or **LOCFAR** to another language, be sure to pass by value.

### Example

In the following example, the FORTRAN module calls an assembly procedure that calculates  $A \cdot 2^B$ , where A and B are the first and second parameters, respectively. This is done by shifting the bits in A to the left B times.

```

INTERFACE TO INTEGER*2 FUNCTION POWER2(A, B)
INTEGER*2 A, B
END

PROGRAM MAIN
INTEGER*2 POWER2
INTEGER*2 A, B
A = 3
B = 5
WRITE (*, *) '3 TIMES 2 TO THE B OR 5 IS ', POWER2(A, B)
END

```

To understand the assembly procedure, consider how the parameters are placed on the stack, as illustrated in Figure 12.4.

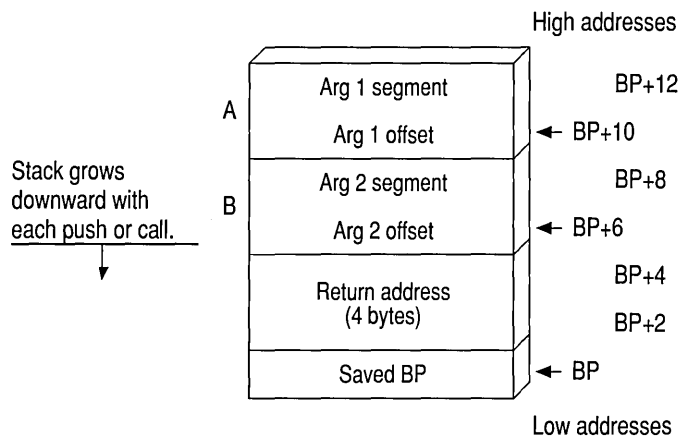

Figure 12.4 FORTRAN Stack Frame

Figure 12.4 assumes that the FORTRAN module is compiled in large model. If you compile the FORTRAN module in medium model, then each argument is passed as a 2-byte, not 4-byte, address. The return address is 4 bytes long because procedures called from FORTRAN must always be **FAR**.



The assembler code looks like this:

```

.MODEL LARGE, FORTRAN

Power2 PROTO   FORTRAN, pFactor:FAR PTR SWORD, pPower:FAR PTR SWORD

.CODE

Power2 PROC    FORTRAN, pFactor:FAR PTR SWORD, pPower:FAR PTR SWORD

    les     bx, pFactor      ; ES:BX points to factor
    mov     ax, es:[bx]     ; AX = value of factor
    les     bx, pPower      ; ES:BX points to power
    mov     cx, es:[bx]    ; CX = value of power
    shl     ax, cl         ; Multiply by 2^power
    ret                               ; Return result in AX

Power2 ENDP
END

```

## The Basic/MASM Interface

This section explains how to call MASM procedures or functions from Basic and how to receive Basic arguments for the MASM procedure. Pascal is the default naming and calling convention, so all lowercase letters are converted to uppercase. Routines defined with the **FUNCTION** keyword return values, but routines defined with **SUB** do not. Basic **DEF FN** functions and **GOSUB** routines cannot be called from another language.

The information provided pertains to Microsoft's Basic and QuickBasic compilers. Differences between the two compilers are noted when necessary.

### Compatible Data Types

The following list shows the Basic data types that are equivalent to the MASM 6.1 data types.

Basic Type	Equivalent MASM Type
STRING*1	WORD
INTEGER (X%)	SWORD
SINGLE (X!)	REAL4
LONG (X&), CURRENCY	SDWORD
DOUBLE (X#)	REAL8

## Naming Conventions

Basic recognizes up to 40 characters of a name. In the object code, Basic also drops any of its reserved characters: %, &, !, #, @, &.

## Argument-Passing Defaults

Basic can pass data in several ways and can receive it by value or by near reference. By default, Basic arguments are passed by near reference as 2-byte addresses. To pass a near address, pass only the offset; if you need to pass a far address, pass the segment and offset separately as integer arguments. Pass the segment address first, unless you have specified C compatibility with the **CDECL** keyword.

Basic passes each argument in a call by far reference when **CALLS** is used to invoke a routine. You can also use **SEG** to modify a parameter in a preceding **DECLARE** statement so that Basic passes that argument by far reference. To pass any other variable type by value, apply the **BYVAL** keyword to the argument in the **DECLARE** statement. You cannot pass arrays and user-defined types by value.

```
DECLARE SUB Test(BYVAL a%, b%, SEG c%)
```

```
CALL Test(x%, y%, z%)  
CALLS Test(x%, y%, z%)
```

This **CALL** statement passes the first argument (a%) by value, the second argument (b%) by near reference, and the third argument (c%) by far reference. The statement

```
CALLS Test2(x%, y%, z%)
```

passes each argument by far reference.

## Changing the Calling Convention

Including the **CDECL** keyword in the Basic **DECLARE** statement enables the C calling and naming conventions. This also allows a call to a MASM procedure with a varying number of arguments.

## Array Storage

The **DIM** statement sets the number of dimensions for a Basic array and also sets the array's maximum subscript value. In the array declaration **DIM x(a, b)**, the upper bounds (the maximum number of values possible) of the array are a and b. The default lower bound is 0. The default upper bound for an array subscript is 10.

The default for column storage in Basic is column-major order, as in FORTRAN. For an array defined as **DIM Arr%(3, 3)**, reference the last element as **Arr%(3, 3)**. The first five elements of **Arr (3, 3)** are

```
Arr(0,0), Arr(1,0), Arr(2,0), Arr(0,1), Arr(1,1)
```

When you pass an array from Basic to a language that stores arrays in row-major order, use the command-line option /R when compiling the Basic module.

Most Microsoft languages permit you to reference arrays directly. Basic uses an array descriptor, however, which is similar in some respects to a Basic string descriptor. The array descriptor is necessary because Basic handles memory allocation for arrays dynamically, and thus may shift the location of the array in memory.

A reference to an array in Basic is really a near reference to an array descriptor. Array descriptors are always in DGROUP, even though the data may be in far memory. Array descriptors contain information about type, dimensions, and memory locations of data. You can safely pass arrays to MASM routines only if you follow three rules:

- Pass the array's address by applying the **VARPTR** function to the first element of the Basic array and passing the result by value. To pass the far address of the array, apply both the **VARPTR** and **VARSEG** functions and pass each result by value. The receiving language gets the address of the first element and considers it to be the address of the entire array. It can then access the array with its normal array-indexing syntax.
- The MASM routine that receives the array should not call back to one of the calling program's routines before it has finished processing the array. Changing data within the caller's heap—even data unrelated to the array—may change the array's location in the heap. This would invalidate any further work the called routine performs, since the routine would be operating on the array's old location.
- Basic can pass any member of an array by value. When passing individual array elements, these restrictions do not apply.

You can apply **LBOUND** and **UBOUND** to a Basic array to determine lower and upper bounds, and then pass the results to another routine. This way, the size of the array does not need to be determined in advance.

### String Format

Basic maintains a 4-byte string descriptor for each string, as shown in the following. The first field of the string descriptor contains a 2-byte integer indicating the length of the actual string text. The second field contains the offset address of this text within the caller's data segment.



**Figure 12.5 Basic String Descriptor Format**

An assembly-language procedure can store a Basic string descriptor as a simple structure, like this:

```
DESC    STRUCT
    len  WORD    ?        ; Length of string
    off  WORD    ?        ; Offset of string
DESC    ENDS

string  BYTE    "This text referenced by a string descriptor"
sdsc    DESC    (LENGTHOF string, string)
```

Version 7.0 or later of the Microsoft Basic Compiler provides new functions that access string descriptors. These functions simplify the process of sharing Basic string data with routines written in other languages.

Earlier versions of Basic offer the **LEN** (Length) and **SADD** (String Address) functions, which together obtain the information stored in a string descriptor. **LEN** returns the length of a string in bytes. **SADD** returns the offset address of a string in the data segment. The caller must provide both pieces of information so the called procedure can locate and read the entire string. The address returned by **SADD** is declared as type **INTEGER** but is actually equivalent to a C near pointer.

If you need to pass the far address of a string, use the **SSEGADD** (String Segment Address) function of Microsoft Basic version 7.0 or later. You can also determine the segment address of the first element with **VARSEG**.

## External Data

Declaring global data in Basic follows the same two-step process as in other languages:

1. Declare shareable data in Basic with the **COMMON** statement.
2. Identify the shared variables in your assembly-language procedures with the **EXTERN** keyword. Place the **EXTERN** statement outside of a code or data segment when declaring far data.

## Structure Alignment

Basic packs user-defined types. For MASM structures to be compatible, select byte-alignment.

## Compiling and Linking

Always use medium model in assembly-language procedures linked with Basic modules. If you are listing other libraries on the **LINK** command line, specify Basic libraries first. (There are differences between the QBX and command-line compilation. See your Basic documentation.)

## Returning Values

Basic follows the usual convention of returning values in AX or DX:AX. If the value is not floating point, an array, or a structured type, or if it is less than 4 bytes long, then the 2-byte integers should be returned from the MASM procedure in AX and 4-byte integers should be returned in DX:AX. For all other types, return the near offset in AX.

## User-Defined Data Types

The Basic **TYPE** statement defines structures composed of individual fields. These types are equivalent to the C **struct**, FORTRAN record (declared with the **STRUCTURE** keyword), and Pascal **Record** types.

You can use any of the Basic data types except variable-length strings or dynamic arrays in a user-defined type. Once defined, Basic types can be passed only by reference.

## Varying Number of Arguments

You can vary the number of arguments in Basic when you change the calling convention with **CDECL**. To call a function with a varying number of arguments, you also need to suppress the type checking that normally forces a call to be made with a fixed number of arguments. In Basic, you can remove this type checking by omitting a parameter list from the **DECLARE** statement.

## Pointers and Addresses

**VARSEG** returns a variable's segment address, and **VARPTR** returns a variable's offset address. These intrinsic Basic functions enable your program to pass near or far addresses.

## Example

This example calls the `Power2` procedure in the MASM 6.1 module.

```
DEFINT A-Z

DECLARE FUNCTION Power2 (A AS INTEGER, B AS INTEGER)
PRINT "3 times 2 to the power of 5 is ";
PRINT Power2(3, 5)

END
```

The first argument, A, is higher in memory than B because Basic pushes arguments in the same order in which they appear.

Figure 12.6 shows how the arguments are placed on the stack.

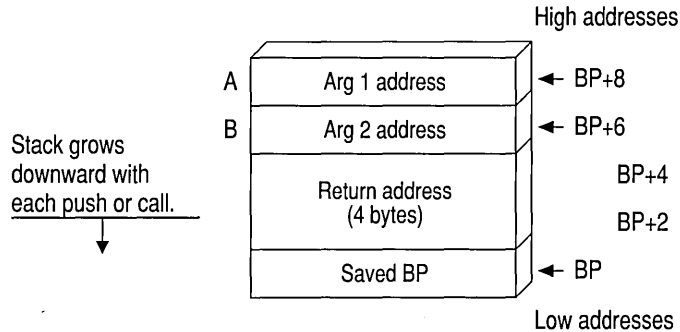

**Figure 12.6 Basic Stack Frame**

The assembly procedure can be written as follows:

```

.MODEL medium

Power2 PROTO PASCAL, factor:PTR WORD, power:PTR WORD
.CODE
Power2 PROC PASCAL, factor:PTR WORD, power:PTR WORD

    mov     bx, WORD PTR factor      ; BX points to factor
    mov     ax, [bx]                 ; Load factor into AX
    mov     bx, WORD PTR power      ; BX points to power
    mov     cx, [bx]                 ; Load power into CX
    shl     ax, c1                    ; AX = AX * (2 to power of CX)
    ret

Power2 ENDP
END

```

Note that each parameter must be loaded in a two-step process because the address of each is passed rather than the value. The return address is 4 bytes long because procedures called from Basic must be **FAR**.

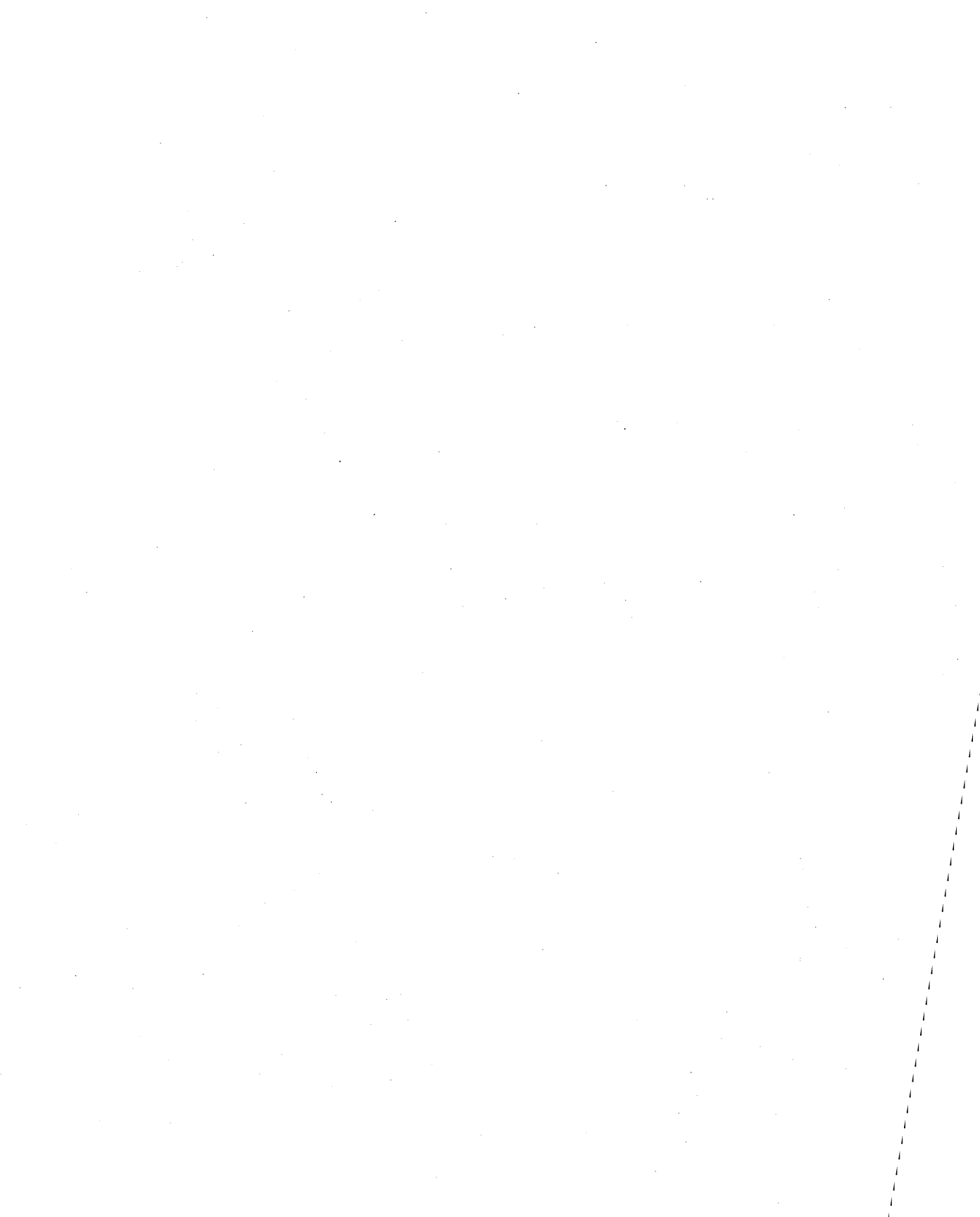

# Writing 32-Bit Applications

This chapter is an introduction to 32-bit programming for the 80386. The guidelines in this chapter also apply to the 80486 processor, which is basically a faster 80386 with the equivalent of a 80387 floating-point processor. Since you are already familiar with 16-bit real-mode programming, this chapter covers the differences between 16-bit programming and 32-bit protected-mode programming.

The 80386 processor (and its successors such as the 80486) can run in real mode, virtual-86 mode, and in protected mode. In real and virtual-86 modes, the 80386 can run 8086/8088 programs. In protected mode, it can run 80286 programs. The 386 also extends the features of protected mode to include 32-bit operations and segments larger than 64K.

The MS-DOS operating system directly supports 8086/8088 programs, which it runs either in real mode or virtual-86 mode. Native 32-bit 80386 programs can be run by using a “DOS extender,” by using the WINMEM32.DLL facility of Microsoft Windows 3.x, or by running a native 32-bit operating system, such as Microsoft Windows NT. You can use MASM to generate object code (OMF or COFF) for 32-bit programs. To do this, you will need a software development kit such as the Windows SDK for the target environment. Such kits include the linker and other components specific to your chosen operating environment.

## 32-Bit Memory Addressing

The 80386 has six segment registers. Four of these are familiar to 8086/8088 programmers: CS (Code Segment), SS (Stack Segment), DS (Data Segment), and ES (Extra Segment). The two additional registers, FS and GS, are used as data segment registers.

Memory addresses on 80x86 machines consist of two parts—a segment and an offset. In real-mode programs, the segment is a 16-bit number and the offset is a 16-bit number. Effective addresses are calculated by multiplying the segment by 16 and adding the offset to it. In protected mode, the segment value is not used directly



as a number, but instead is an index to a table of “selectors.” Each selector describes a block of memory, including attributes such as the size and location of the block, and the access rights the program has to it (read, write, execute). The effective address is calculated by adding the offset to the base address of the memory block described by the selector.

All segment registers are 16 bits wide. The offset in a 32-bit protected-mode program is itself 32 bits wide, which means that a single segment can address up to 4 gigabytes of memory. Because of this large range, there is little need to use segment registers to extend the range of addresses in 32-bit programs. If all six segment registers are initially set to the same value, then the rest of the program can ignore them and treat the processor as if it used a 32-bit linear address space. This is called 0:32, or flat, addressing. (The full segmented 32-bit addressing mode, in which the segment registers can contain different values, is called 16:32 addressing.) Flat addressing is used by the Windows NT operating system.

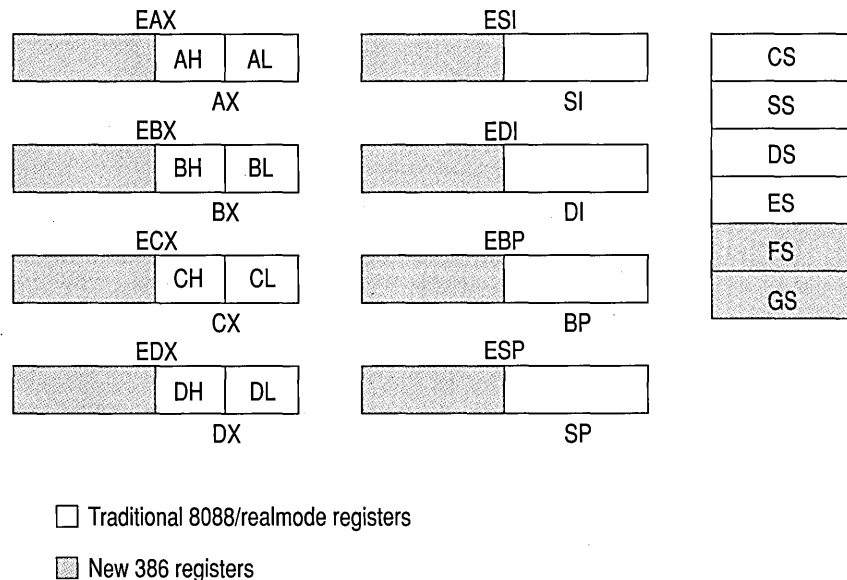

Figure 13.1 32-Bit Register Set

## MASM Directives for 32-Bit Programming

If you use the simplified segment directives, a 32-bit program is surprisingly similar to a program for MS-DOS. Here are the differences:

- Supply the **.386** directive, which enables the 32-bit programming features of the 386 and its successors. The **.386** directive must precede the **.MODEL** directive.

- For flat-model programming, use the directive

```
.MODEL flat, stdcall
```

which tells the assembler to assume flat model (0:32) and to use the Windows NT standard calling convention for subroutine calls.

- Precede your data declarations with the **.DATA** directive.
- Precede your instruction codes with the **.CODE** directive.
- At the end of the source file, place an **END** directive.

## Sample Program

The following sample is a 32-bit assembly language subroutine, such as might be called from a 32-bit C program written for the Windows NT operating system. The program illustrates the use of a variety of directives to make assembly language easier to read and maintain. Note that with 32-bit flat model programming, there is no longer any need to refer to segment registers, since these are artifacts of segmented addressing.

```
;* szSearch - An example of 32-bit assembly programming using MASM 6.1
;*
;* Purpose: Search a buffer (rgbSearch) of length cbSearch for the
;*          first occurrence of szTok (null terminated string).
;*
;* Method:  A variation of the Boyer-Moore method
;*          1. Determine length of szTok (n)
;*          2. Set array of flags (rgfInTok) to TRUE for each character
;*             in szTok
;*          3. Set current position of search to rgbSearch (pbCur)
;*          4. Compare current position to szTok by searching backwards
;*             from the nth position. When a comparison fails at
;*             position (m), check to see if the current character
;*             in rgbSearch is in szTok by using rgfInTok. If not,
;*             set pbCur to pbCur+(m)+1 and restart compare. If
;*             pbCur reached, increment pbCur and restart compare.
;*          5. Reset rgfInTok to all 0 for next instantiation of the
;*             routine.

        .386
        .MODEL flat, stdcall

FALSE   EQU    0
TRUE    EQU    NOT FALSE
```

```
.DATA
; Flags buffer - data initialized to FALSE. We will
; set the appropriate flags to TRUE during initialization
; of szSearch and reset them to FALSE before exit.
rgfInTok      BYTE    256 DUP (FALSE);

.CODE

PBYTE  TYPEDEF PTR BYTE

szSearch PROC PUBLIC USES esi edi,
    rgbSearch:PBYTE,
    cbSearch:DWORD,
    szTok:PBYTE

; Initialize flags buffer. This tells us if a character is in
; the search token - Note how we use EAX as an index
; register. This can be done with all extended registers.
    mov     esi, szTok
    xor     eax, eax
    .REPEAT
    lodsb
    mov     BYTE PTR rgfInTok[eax], TRUE
    .UNTIL (!AL)

; Save count of szTok bytes in EDX
    mov     edx, esi
    sub     edx, szTok
    dec     edx

; ESI will always point to beginning of szTok
    mov     esi, szTok

; EDI will point to current search position
; and will also contain the return value
    mov     edi, rgbSearch

; Store pointer to end of rgbSearch in EBX
    mov     ebx, edi
    add     ebx, cbSearch
    sub     ebx, edx
```

```
; Initialize ECX with length of szTok
    mov     ecx, edx
    .WHILE ( ecx != 0 )
        dec     ecx          ; Move index to current
        mov     al, [edi+ecx] ; characters to compare

; If the current byte in the buffer doesn't exist in the
; search token, increment buffer pointer to current position
; +1 and start over. This can skip up to 'EDX'
; bytes and reduce search time.
    .IF     !(rgfInTok[eax])
        add     edi, ecx
        inc     edi          ; Initialize ECX with
        mov     ecx, edx      ; length of szTok
; Otherwise, if the characters match, continue on as if
; we have a matching token
    .ELSEIF (al == [esi+ecx])
        .CONTINUE
; Finally, if we have searched all szTok characters,
; and land here, we have a mismatch and we increment
; our pointer into rgbSearch by one and start over.
    .ELSEIF (!ecx)
        inc     edi
        mov     ecx, edx
    .ENDIF

; Verify that we haven't searched beyond the buffer.
    .IF     (edi > ebx)
        mov     edi, 0      ; Error value
    .BREAK
    .ENDIF
    .ENDW

; Restore flags in rgfInTok to 0 (for next time).
    mov     esi, szTok
    xor     eax, eax
    .REPEAT
    lodsb
    mov     BYTE PTR rgfInTok[eax], FALSE
    .UNTIL !AL

; Put return value in eax
    mov     eax, edi
    ret
szSearch ENDP

end
```



# Differences Between MASM 6.1 and 5.1

For the many users who come to version 6.1 of the Microsoft Macro Assembler directly from the popular MASM 5.1, this appendix describes the differences between the two versions. Version 6.1 contains significant changes, including:

- An integrated development environment called Programmer's WorkBench (PWB) from which you can write, edit, debug, and execute code.
- Expanded functionality for structures, unions, and type definitions.
- New directives for generating loops and decision statements, and for declaring and calling procedures.
- Simplified methods for applying public attributes to variables and routines in multiple-module programs.
- Enhancements for writing and using macros.
- Flat-model support for Windows NT and new instructions for the 80486 processor.

The **OPTION M510** directive (or the `/Zm` command-line switch) assures nearly complete compatibility between MASM 6.1 and MASM 5.1. However, to take full advantage of the enhancements in MASM 6.1, you will need to rewrite some code written for MASM 5.1.

The first section of this appendix describes the new or enhanced features in MASM 6.1. The second section, "Compatibility Between MASM 5.1 and 6.1," explains how to:

- Minimize the number of required changes with the **OPTION** directive.
- Rewrite your existing assembly code, if necessary, to take advantage of the assembler's enhancements.

## New Features of Version 6.1

This section gives an overview of the new features of MASM 6.1 and provides references to more detailed information elsewhere in the documentation. For full explanations and coding examples, see the documentation listed in the cross-references.

### The Assembler, Environment, and Utilities

Most of the executable files provided with MASM 6.1 are new or revised. For a complete list of these files, read the PACKING.TXT file on the distribution disk. The book *Getting Started* also provides information about setting up the environment, assembler, and Help system.

#### The Assembler

The macro assembler, named ML.EXE, can assemble and link in one step. Its new 32-bit operation gives ML.EXE the ability to handle much larger source files than MASM 5.1. The command-line options are new. For example, the /F1 and /Sc options generate instruction timings in the listing file. Command-line options are case-sensitive and must be separated by spaces.

For backward compatibility with MASM 5.1 makefiles, MASM 6.1 includes the MASM.EXE utility. MASM.EXE translates MASM 5.1 command-line options to the new MASM 6.1 command-line options and calls ML.EXE. See the *Reference* book for details.

#### H2INC

H2INC converts C include files to MASM include files. It translates data structures and declarations but does not translate executable code. For more information, see Chapter 20 of *Environment and Tools*.

#### NMAKE

NMAKE replaces the MAKE utility. NMAKE provides new functions for evaluating target files and more flexibility with macros and command-line options. For more information, see *Environment and Tools*.

#### Integrated Environment

PWB is an integrated development environment for writing, developing, and debugging programs. For information on PWB and the CodeView debugging application, see *Environment and Tools*.

#### Online Help

MASM 6.1 incorporates the Microsoft Advisor Help system. Help provides a vast database of online help about all aspects of MASM, including the syntax and

timings for processor and coprocessor instructions, directives, command-line options, and support programs such as LINK and PWB.

For information on how to set up the help system, see *Getting Started*. You can invoke the help system from within PWB or from the QuickHelp program (QH).

## HELPMAKE

You can use the HELPMAKE utility to create additional help files from ASCII text files, allowing you to customize the online help system. For more information, see *Environment and Tools*.

## Other Programs

MASM 6.1 contains the most recent versions of LINK, LIB, BIND, CodeView, and the mouse driver. The CREF program is not included in MASM 6.1. The Source Browser provides the information that CREF provided under MASM 5.1. For more information on the Source Browser, see Chapter 5 of *Environment and Tools* or Help.

# Segment Management

This section lists the changes and additions to memory-model support and directives that relate to memory model.

## Predefined Symbols

The following predefined symbols (also called predefined equates) provide information about simplified segments:

Predefined Symbol	Value
<b>@stack</b>	<b>DGROUP</b> for near stacks, <b>STACK</b> for far stacks
<b>@Interface</b>	Information about language parameters
<b>@Model</b>	Information about the current memory model
<b>@Line</b>	The source line in the current file
<b>@Date</b>	The current date
<b>@FileCur</b>	The current file
<b>@Time</b>	The current time
<b>@Environ</b>	The current environment variables

For more information about predefined symbols, see “Predefined Symbols” in Chapter 1.



## Enhancements to the ASSUME Directive

MASM automatically generates **ASSUME** values for the code segment register (CS). It is no longer necessary to include lines such as

```
ASSUME CS:MyCodeSegment
```

in your programs. In addition, the **ASSUME** directive can include **ERROR**, **FLAT**, or *register:type*. MASM 6.1 issues a warning when you specify **ASSUME** values for CS other than the current segment or group.

For more information, see “Setting the ASSUME Directive for Segment Registers” in Chapter 2 and “Defining Register Types with ASSUME” in Chapter 3.

## Relocatable Offsets

For compatibility with applications for Windows, the **LROFFSET** operator can calculate a relocatable offset, which is resolved by the loader at run time. See Help for details.

## Flat Model

MASM 6.1 supports the flat-memory model of Windows NT, which allows segments as large as 4 gigabytes. All other memory models limit segment size to 64K for MS-DOS and Windows. For more information about memory models, see “Defining Basic Attributes with .MODEL” in Chapter 2.

# Data Types

MASM 6.1 supports an improved data typing. This section summarizes the improved forms of data declarations in MASM 6.1.

## Defining Typed Variables

You can now use the type names as directives to define variables. Initializers are unsigned by default. The following example lines are equivalent:

```
var1    DB    25  
var1    BYTE 25
```

## Signed Types

You can use the **SBYTE**, **SWORD**, and **SDWORD** directives to declare signed data. For more information about these directives, see “Allocating Memory for Integer Variables” in Chapter 4.

## Floating-Point Types

MASM 6.1 provides the **REAL4**, **REAL8**, and **REAL10** directives for declaring floating-point variables. For information on these type directives, see “Declaring Floating-Point Variables and Constants” in Chapter 6.

## Qualified Types

Type definitions can now include distance and language type attributes. Procedures, procedure prototypes, and external declarations let you specify the type as a qualified type. A complete description of qualified types is provided in the section “Data Types” in Chapter 1.

## Structures

Changes to structures since MASM 5.1 include:

- Structures can be nested.
- The names of structure fields need not be unique. As a result, you must qualify references to field names.
- Initialization of structure variables can continue over multiple lines provided the last character in the line before the comment field is a comma.
- Curly braces and angle brackets are equivalent.

For example, this code works in MASM 6.1:

```
SCORE          STRUCT
  team1        BYTE    10 DUP (?)
  score1       BYTE    ?
  team2        BYTE    10 DUP (?)
  score2       BYTE    ?
SCORE          ENDS

first  SCORE {"BEARS", 20,           ; This comment is allowed.
             "CUBS", 10 }

        mov    al, [bx].score.team1 ; Field name must be qualified
                                     ; with structure name.
```

You can use **OPTION OLDSTRUCTS** or **OPTION M510** to enable MASM 5.1 behavior for structures. See “Compatibility between MASM 5.1 and 6.1,” later in this appendix. For more information on structures and unions, see “Structures and Unions” in Chapter 5.

## Unions

MASM 6.1 allows the definition of unions with the **UNION** directive. Unions differ from structures in that all fields within a union occupy the same data space. For more information, see “Structures and Unions” in Chapter 5.

## Types Defined with TYPEDEF

The **TYPEDEF** directive defines a type for use later in the program. It is most useful for defining pointer types. For more information on defining types, see “Data Types” in Chapter 1, and “Defining Pointer Types with TYPEDEF” in Chapter 3.

## Names of Identifiers

MASM 6.1 accepts identifier names up to 247 characters long. All characters are significant, whereas under MASM 5.1, names are significant to 31 characters only. For more information on identifiers, see “Identifiers” in Chapter 1.

## Multiple-Line Initializers

In MASM 6.1, a comma at the end of a line (except in the comment field) implies that the line continues. For example, the following code is legal in MASM 6.1:

```
longstring    BYTE    "This string ",
               "continues over two lines."
bitmasks     BYTE    80h, 40h, 20h, 10h,
                   08h, 04h, 02h, 01h
```

For more information, see “Statements” in Chapter 1.

## Comments in Extended Lines

MASM 5.1 allows a backslash (\) as the line-continuation character if it is the last nonspace character in the line. MASM 6.1 permits a comment to follow the backslash.

## Determining Size and Length of Data Labels

The **LENGTHOF** operator returns the number of data items allocated for a data label. MASM 6.1 also provides the **SIZEOF** operator. When applied to a type, **SIZEOF** returns the size attribute of the type expression. When applied to a data label, **SIZEOF** returns the number of bytes used by the initializer in the label's definition. In this case, **SIZEOF** for a variable equals the number of bytes in the type multiplied by **LENGTHOF** for the variable.

MASM 6.1 recognizes the **LENGTH** and **SIZE** operators for backward compatibility. For a description of the behavior of **SIZE** under **OPTION M510**, see “Length and Size of Labels with **OPTION M510**,” later in this appendix. For obsolete behavior with the **LENGTH** operator, see also “**LENGTH** Operator Applied to Record Types,” page 356.

For information on **LENGTHOF** and **SIZEOF**, see the following sections in chapter 5: “Declaring and Referencing Arrays,” “Declaring and Initializing Strings,” “Declaring Structure and Union Variables,” and “Defining Record Variables.”

## HIGHWORD and LOWWORD Operators

These operators return the high and low words for a given 32-bit operand. They are similar to the **HIGH** and **LOW** operators of MASM 5.1 except that **HIGHWORD** and **LOWWORD** can take only constants as operands, not relocatables (labels).

## PTR and CodeView

Under MASM 5.1, applying the **PTR** operator to a data initializer determines the size of the data displayed by CodeView. You can still use **PTR** in this manner in MASM 6.1, but it does not affect CodeView typing. Defining pointers with the **TYPEDDEF** directive allows CodeView to generate correct information. See “Defining Pointer Types with TYPEDDEF” in Chapter 3.

## Procedures, Loops, and Jumps

With its significant improvements for procedure and jump handling, MASM 6.1 closely resembles high-level–language implementations of procedure calls. MASM 6.1 generates the code to correctly handle argument passing, check type compatibility between parameters and arguments, and process a variable number of arguments. MASM 6.1 can also automatically recast jump instructions to correct for insufficient jump distance.

### Function Prototypes and Calls

The **PROTO** directive lets you prototype procedures in the same way as high-level languages. **PROTO** enables type-checking and type conversion of arguments when calling the procedure with **INVOKE**. For more information, see “Declaring Procedure Prototypes” in Chapter 7.

The **INVOKE** directive sets up code to call a procedure and correctly pass arguments according to the prototype. MASM 6.1 also provides the **VARARG** keyword to pass a variable number of arguments to a procedure with **INVOKE**. For more information about **INVOKE** and **VARARG**, see “Calling Procedures with INVOKE” and “Declaring Parameters with the PROC Directive” in Chapter 7.

The **ADDR** keyword is new since MASM 5.1. When used with **INVOKE**, it provides the address of a variable, in the same way as the address-of operator (&) in C. This lets you conveniently pass an argument by reference rather than value. See “Calling Procedures with INVOKE” in Chapter 7.

### High-Level Flow-Control Constructions

MASM 6.1 contains several directives that generate code for loops and decisions depending on the status of a conditional statement. The conditions are tested at run time rather than at assembly time.

Directives new since MASM 5.1 include **.IF**, **.ELSE**, **.ELSEIF**, **.REPEAT**, **.UNTIL**, **.UNTILCXZ**, **.WHILE**, and **.ENDW**. MASM 6.1 also provides the associated **.BREAK** and **.CONTINUE** directives for loops and **IF** statements. For more information, see “Loops” in Chapter 7 and “Decision Directives” on page 171.

### **Automatic Optimization for Unconditional Jumps**

MASM 6.1 automatically determines the smallest encoding for direct unconditional jumps. See “Unconditional Jumps” in Chapter 7.

### **Automatic Lengthening for Conditional Jumps**

If a conditional jump cannot reach its target destination, MASM automatically recasts the code to use an unconditional jump to the target. See “Jump Extending,” page 169.

### **User-Defined Stack Frame Setup and Cleanup**

The prologue code generated immediately after a **PROC** statement sets up the stack for parameters and local variables. The epilogue code handles stack cleanup. MASM 6.1 allows user-defined prologues and epilogues, as described in “Generating Prologue and Epilogue Code” in Chapter 7.

## **Simplifying Multiple-Module Projects**

MASM 6.1 simplifies the sharing of code and data among modules and makes the use of include files more efficient.

### **EXTERNDEF in Include Files**

MASM 5.1 requires that you declare public and external all data and routines used in more than one module. With MASM 6.1, a single **EXTERNDEF** directive accomplishes the same task. **EXTERNDEF** lets you put global data declarations within an include file, making the data visible to all source files that include the file. For more information, see “Using **EXTERNDEF**” in Chapter 8.

### **Search Order for Include Files**

MASM 6.1 searches for include files in the directory of the main source file rather than in the current directory. Similarly, it searches for nested include files in the directory of the include file. You can specify additional paths to search with the **/I** command-line option. For more information on include files, see “Organizing Modules” in Chapter 8.

### **Enforcing Case Sensitivity**

In MASM 5.1, sensitivity to case is influenced only by command-line options such as **/MX**, not the language type given with the **.MODEL** directive. In MASM 6.1, the language type takes precedence over the command-line options in specifying case sensitivity.

## Alternate Names for Externals

The syntax for **EXTERN** allows you to specify an alternate symbol name, which the linker can use to resolve an external reference to an unused symbol. This prevents linkage with unneeded library code, as explained in “Using **EXTERN** with Library Routines,” Chapter 8.

## Expanded State Control

Several directives in MASM 6.1 enable or disable various aspects of the assembler control. These include 80486 coprocessor instructions and use of compatibility options.

### The **OPTION** Directive

The new **OPTION** directive allows you to selectively define the assembler’s behavior, including its compatibility with MASM 5.1. See “Using the **OPTION** Directive” in Chapter 1 and “Compatibility between MASM 5.1 and 6.1,” later in this appendix.

### The **.NO87** Directive

The **.NO87** directive disables all coprocessor instructions. For more information, see Help.

### The **.486** and **.486P** Directives

MASM 6.1 can assemble instructions specific to the 80486, enabled with the **.486** directive. The **.486P** directive enables 80486 instructions at the highest privilege level (recommended for systems-level programs only). For more information, see Help.

### The **PUSHCONTEXT** and **POPCONTEXT** Directives

The directive **PUSHCONTEXT** saves the assembly environment, and **POPCONTEXT** restores it. The environment includes the segment register assumes, the radix, the listing and CREF flags, and the current processor and coprocessor. Note that **.NOCREF** (the MASM 6.1 equivalent to **.XCREF**) still determines whether information for a given symbol will be added to Browser information and to the symbol table in the listing file. For more information on listing files, see Appendix C or Help.

## New Processor Instructions

MASM 6.1 supports these instructions for the 80486 processor:

80486 Instruction	Description
BSWAP	Byte swap
CMPXCHG	Compare and exchange
INVD	Invalidate data cache
INVLPG	Invalidate Translation Lookaside Buffer entry
WBINVD	Write back and invalidate data cache
XADD	Exchange and add

For full descriptions of these instructions, see the *Reference* or *Help*.

## Renamed Directives

Although MASM 6.1 still supports the old names in MASM 5.1, the following directives have been renamed for language consistency:

MASM 6.1	MASM 5.1
.DOSSEG	DOSSEG
.LISTIF	.LFCOND
.LISTMACRO	.XALL
.LISTMACROALL	.LALL
.NOCREF	.XCREF
.NOLIST	.XLIST
.NOLISTIF	.SFCOND
.NOLISTMACRO	.SALL
ECHO	%OUT
EXTERN	EXTRN
FOR	IRP
FORC	IRPC
REPEAT	REPT
STRUCT	STRUC
SUBTITLE	SUBTTL

### Specifying 16-Bit and 32-Bit Instructions

MASM 6.1 supports all instructions that work with the extended 32-bit registers of the 80386/486. For certain instructions, you can override the default operand size

with the **W** (word) and the **D** (doubleword) suffixes. For details, see the *Reference* or *Help*.

## Macro Enhancements

There are significant enhancements to macro functions in MASM 6.1. Directives provide for a variable number of arguments, loop constructions, definitions of text equates, and macro functions.

### Variable Arguments

MASM 5.1 ignores extra arguments passed to macros. In MASM 6.1, you can pass a variable number of arguments to a macro by appending the **VARARG** keyword to the last macro parameter in the macro definition. The macro can then reference additional arguments relative to the last declared parameter. This procedure is explained in “Returning Values with Macro Functions” in Chapter 9.

### Required and Default Macro Arguments

With MASM 6.1, you can use **REQ** or the **:=** operator to specify required or default arguments. See “Specifying Required and Default Parameters” in Chapter 9.

### New Directives for Macro Loops

Within a macro definition, **WHILE** repeats assembly as long as a condition remains true. Other macro loop directives, **IRP**, **IRPC**, and **REPT**, have been renamed **FOR**, **FORC**, and **REPEAT**. For more information, see “Defining Repeat Blocks with Loop Directives” in Chapter 9.

### Text Macros

The **EQU** directive retains its old functionality, but MASM 6.1 also incorporates a **TEXTEQU** directive for defining text macros. **TEXTEQU** allows greater flexibility than **EQU**. For example, **TEXTEQU** can assign to a label the value calculated by a macro function. For more information, see “Text Macros” in Chapter 9.

### The GOTO Directive for Macros

Within a macro definition, **GOTO** transfers assembly to a line labeled with a leading colon(:). For more information on **GOTO**, see *Help*.

### Macro Functions

At assembly time, macro functions can determine and return a text value using **EXITM**. Predefined macro string functions concatenate strings, return the size of a string, and return the position of a substring within a string. For information on writing your own macro functions, see “Returning Values with Macro Functions” in Chapter 9.



## Predefined Macro Functions

MASM 6.1 provides the following predefined text macro functions:

Symbol	Value Returned
@CatStr	A concatenated string
@InStr	The position of one string within another
@SizeStr	The size of a string
@SubStr	A substring

For more information on predefined macros, see “String Directives and Predefined Functions” in Chapter 9.

## MASM 6.1 Programming Practices

MASM 6.1 provides many features that make it easier for you to write assembly code. If you are familiar with MASM 5.1 programming, you may find it helpful to adopt the following list of new programming practices for programming with MASM 6.1. The list summarizes many of the changes covered in the following section, “Compatibility Between MASM 5.1 and 6.1.”

- Select identifier names that do not begin with the dot operator (.).
- Use the dot operator (.) only to reference structure fields, and the plus operator (+) when not referencing structures.
- Different structures can have the same field names. However, the assembler does not allow ambiguous references. You must include the structure type when referring to field names common to two or more structures.
- Separate macro arguments with commas, not spaces.
- Avoid adding extra ampersands in macros. For a list of the new rules about using ampersands in macros, see “Substitution Operator” in Chapter 9 and “OPTION OLDMACROS,” page 372.
- By default, code labels defined with a colon are local. Place two colons after code labels if you want to reference the label outside the procedure.

## Compatibility Between MASM 5.1 and 6.1

MASM 6.1 provides a “compatibility mode,” making it easy for you to transfer existing MASM 5.1 code to the new version. You invoke the compatibility mode through the **OPTION M510** directive or the **/Zm** command-line switch. This section explains the changes you may need to make to get your MASM 5.1 code to run under MASM 6.1 in compatibility mode.

## Rewriting Code for Compatibility

In some cases, MASM 6.1 with **OPTION M510** does not support MASM 5.1 behavior. In several cases, this is because bugs in MASM 5.1 were corrected. To update your code to MASM 6.1, use the instructions in this section. This usually requires only minor changes.

Many of the topics listed here will not apply to your code. This section discusses topics in order of likelihood, beginning with the most common. In addition, you may have conflicts between identifier names and new reserved words. **OPTION NOKEYWORD** resolves errors generated from the use of reserved words as identifiers. See “**OPTION NOKEYWORD**,” page 376, for more information.

### Bug Fixes Since MASM 5.1

This section lists the differences between MASM 5.1 and MASM 6.1 due to bug corrections since MASM 5.1.

#### Invalid Use of **LOCK**, **REPNE**, and **REPZ**

Except in compatibility mode, MASM 6.1 flags illegal uses of the instruction prefixes **LOCK**, **REPNE**, and **REPZ**. The error generated for invalid uses of the **LOCK**, **REPNE**, and **REPZ** prefixes is error A2068:

```
instruction prefix not allowed
```

Table A.1 summarizes the correct use of the instruction prefixes. It lists each string instruction with the type of repeat prefix it uses, and indicates whether the instruction works on a source, a destination, or both.

**Table A.1 Requirements for String Instructions**

Instruction	Repeat Prefix	Source/Destination	Register Pair
MOVS	REP	Both	DS:SI, ES:DI
SCAS	REPE/REPNE	Destination	ES:DI
CMPS	REPE/REPNE	Both	DS:SI, ES:DI
LODS	--	Source	DS:SI
STOS	REP	Destination	ES:DI
INS	REP	Destination	ES:DI
OUTS	REP	Source	DS:SI

#### No Closing Quotation Marks in Macro Arguments

In MASM 5.1, you can use both single and double quotation marks (' and ") to begin strings in macro arguments. The assembler does not generate an error or warning if the string does not end with quotation marks on a macro call. Instead,

MASM 5.1 considers the remainder of the line to be part of the macro argument containing the opening quote, as if there were a closing quotation mark at the end of the line.

By default, MASM 6.1 now generates error A2046:

```
missing single or double quotation mark in string
```

so all single and double quotation marks in macro arguments must be matched.

To correct such errors in MASM 6.1, either end the string with a closing quotation mark as shown in the following example, or use the macro escape character (!) to treat the quotation mark literally.

```
; MASM 5.1 code
MyMacro    "all this in one argument

; Default MASM 6.1 code
MyMacro    "all this in one argument"
```

### Making a Scoped Label Public

MASM 5.1 considers code labels defined with a single colon inside a procedure to be local to that procedure if the module contains a **.MODEL** directive with a language type. Although the label is local, MASM 5.1 does not generate an error if it is also declared **PUBLIC**. MASM 6.1 generates error A2203:

```
cannot declare scoped code label as PUBLIC
```

If you want to make a label **PUBLIC**, it must not be local. You can use the double colon operator to define a non-scoped label, as shown in this example:

```
        PUBLIC publicLabel
publicLabel::                ; Non-scoped label MASM 6.1
```

### Byte Form of BT, BTS, BTC, and BTR Instructions

MASM 5.1 allows a byte argument for the 80386 bit-test instructions, but encodes it as a word argument. The byte form is not supported by the processor.

MASM 6.1 does not support this behavior and generates error A2024:

```
invalid operand size for instruction
```

Rewrite your code to use a word-sized argument.

### Default Values for Record Fields

In MASM 5.1, default values for record fields can range down to  $-2^n$ , where  $n$  is the number of bits in the field. This results in the loss of the sign bit.

MASM 6.1 allows a range of  $-2^{n-1}$  to  $2^{n-1}$  for default values. Illegal initializers generate error A2071:

```
initializer too large for specified size
```

## Design Change Issues

MASM 6.1 includes design changes that make the language more consistent. These changes are not affected by the **OPTION** directive, discussed later in this appendix. Therefore, the changes require revisions in your code. In most cases, the necessary revisions are minor and the circumstances requiring changes are rare.

### Operands of Different Size

MASM 5.1 does not require operands to agree in size, as the following code illustrates:

```
.DATA?
var1  DB      ?
var2  DB      ?
.CODE
.
.
.
mov   var1, ax      ; Copy AX to word at var1
```

The operands for the **MOV** instruction do not match in size, yet the instruction assembles correctly. It places the contents of AL into `var1` and AH into `var2`, moving a word of data in one step. If the code defined `var1` as a word value, the instruction

```
mov   var1, al
```

would also assemble correctly, copying AL into the low byte of `var1` while leaving the high byte unaffected. Except at warning level 0, MASM 5.1 issues a warning to inform you of the size mismatch, but both scenarios are legal.

MASM 6.1 does not accept instructions with operands that do not agree in size. You must specifically “coerce” the size of the memory operand, like this:

```
mov   BYTE PTR var1, al
```

### Conflicting Structure Declarations

MASM 5.1 allows you to declare two or more structures with the same name. Each declaration replaces the previous declaration. However, the field names from previous declarations still remain in the assembler’s list of declared values.

MASM 6.1 does not allow conflicting declarations of a structure. It generates errors A2160 through A2165 for each conflicting declaration. The errors note a specific

conflict, such as conflicting number of fields, conflicting names of fields, or conflicting initializers.

### Forward References to Text Macros Outside of Expressions

MASM 5.1 allows forward references to text macros in specialized cases. MASM 6.1 with **OPTION M510** also permits forward references, but only when the text macro is referenced in an expression. To revise your code, place all macro definitions at the beginning of the file.

### HIGH and LOW Applied to Relocatable Operands

In some cases, MASM 5.1 accepts **HIGH** and **LOW** applied to relocatable memory expressions. For example, MASM 5.1 allows this code sequence:

```
; MASM 5.1 code
EXTRN  var1:WORD
var2   DW    0
      mov   al, LOW var1   ; These two instructions yield the
      mov   ah, HIGH var1  ; same as mov ax, OFFSET var1
```

However, the instruction

```
mov ax, LOW var2
```

is not legal. MASM 6.1 generates error A2105:

HIGH and LOW require immediate operands

The **OFFSET** operator is required on these operands in MASM 6.1, as shown in the following. Rewrite your code if necessary.

```
; MASM 6.1 code
      mov   al, LOW OFFSET var1
      mov   ah, HIGH OFFSET var2
```

### OFFSET Applied to Group Names and Indirect Memory Operands

In MASM 6.1, you cannot apply **OFFSET** to a group name, indirect argument, or procedure argument. Doing so generates error A2098:

```
invalid operand for OFFSET
```

### LENGTH Operator Applied to Record Types

In MASM 5.1, the **LENGTH** operator, when applied to a record type, returns the total number of bits in a record definition.

In MASM 6.1, the statement `LENGTH recordName` returns error A2143:

```
expected data label
```

Rewrite your code if necessary. The new **SIZEOF** operator returns information about records in MASM 6.1. For more information, see “Defining Record Variables” in Chapter 5.

### Signed Comparison of Hexadecimal Values Using **GT**, **GE**, **LE**, or **LT**

The rules for two’s-complement comparisons have changed. In MASM 5.1, the expression

```
0FFFFh GT -1
```

is false because the two’s-complement values are equal. However, because hexadecimal numbers are now treated as unsigned, the expression is true in MASM 6.1. To update, rewrite the affected code.

### **RET** Used with a Constant in Procedures with Epilogues

By default in MASM 6.1, the **RET** instruction followed by a constant suppresses automatic generation of epilogue code. MASM 5.1 ignores the operand and generates the epilogue. Remove the argument if necessary. See “Generating Prologue and Epilogue Code” in Chapter 7.

### Code Labels at Top of Procedures with Prologues

By default in MASM 5.1, a code label defined on the same line as the first procedure instruction refers to the first byte of the prologue.

In MASM 6.1, a code label defined at the beginning of a procedure refers to the first byte of the procedure after the prologue. If you need to label the start of the prologue code, place the label before the **PROC** statement. For more information, see “Generating Prologue and Epilogue Code” in Chapter 7.

### Use of **%** as an Identifier Character

MASM 5.1 allows **%** as an identifier character. This behavior leads to ambiguities when **%** is used as the expansion operator in macros. Since **%** is not allowed as a character in MASM 6.1 identifiers, you must change the names of any identifiers containing the **%** character. For a list of legal identifier characters, see “Identifiers” in Chapter 1.

### **ASSUME CS** Set to Wrong Value

With MASM 6.1 you do not need to use the **ASSUME** statement for the **CS** register. Instead, MASM 6.1 generates an automatic **ASSUME** statement for the code segment register to the current segment or group, as explained in “Setting the **ASSUME** Directive for Segment Registers” in Chapter 2. Additionally, MASM 6.1

does not allow explicit **ASSUME** statements for CS that contradict the automatically set **ASSUME** statement.

MASM 5.1 allows CS to be assumed to the current segment, even if that segment is a member of a group. With MASM 6.1, this results in warning A4004:

```
cannot ASSUME CS
```

To avoid this warning with MASM 6.1, delete the **ASSUME** statement for CS.

## Code Requiring Two-Pass Assembly

Unlike version 5.1, MASM 6.1 does most of its work on its first pass, then performs as many subsequent passes as necessary. In contrast, MASM 5.1 always assembles in two source passes. As a result, you may need to revise or delete some pass-dependent constructs under MASM 6.1.

### Two-Pass Directives

To assure compatibility, MASM 6.1 supports 5.1 directives referring to two passes. These include **.ERR1**, **.ERR2**, **IF1**, **IF2**, **ELSEIF1**, and **ELSEIF2**. For second-pass constructs, you must specify **OPTION SETIF2**, as discussed in “**OPTION SETIF2**,” page 377. Without **OPTION SETIF2**, the **IF2** and **.ERR2** directives cause error A2061:

```
[[ELSE]]IF2/.ERR2 not allowed : single-pass assembler
```

MASM 6.1 handles first-pass constructs differently. It treats the **.ERR1** directive as **.ERR**, and the **IF1** directive as **IF**.

The following examples show you how you can rewrite typical pass-sensitive code for MASM 6.1:

- Declare **var** external only if not defined in current module:

```
; MASM 5.1:
    IF2
        IFNDEF var
            EXTRN var:far
        ENDIF
    ENDIF

; MASM 6.1:
    EXTERNDEF var:far
```

- Include a file of definitions only once to speed assembly:

```
; MASM 5.1:
  IF1
    INCLUDE file1.inc
  ENDIF

; MASM 6.1:
  INCLUDE FILE1.INC
```

- Generate a %OUT or .ERR message only once:

```
; MASM 5.1:
  IF2
    %OUT This is my message
  ENDIF

  IF2
    .ERRNZ A NE B
  ENDIF

; MASM 6.1:
  ECHO This is my message

  .ERRNZ A NE B    <ASSERTION FAILURE: A NE B>
```

- Generate an error if a symbol is not defined but may be forward referenced:

```
; MASM 5.1:
  IF2
    .ERRNDEF    var
  ENDIF

; MASM 6.1:
    .ERRNDEF    var
```

For information on conditional directives, see “Conditional Directives,” Chapter 1.

### IFDEF and IFNDEF with Forward-Referenced Identifiers

If you use a symbol name that has not yet been defined in an **IFDEF** or **IFNDEF** expression, MASM 6.1 returns **FALSE** for the **IFDEF** expression and **TRUE** for the **IFNDEF** expression. When **OPTION M510** is enabled, the assembler generates warning A6005:

```
expression condition may be pass-dependent
```

To resolve the warning, place the symbol definition before the conditional test.



## Address Spans as Constants

The value of offsets calculated on the first assembly pass may not be the same as those calculated on later passes. Therefore, you should avoid comparisons with an address span, as in the following examples:

```
IF (OFFSET var1 - OFFSET var2) EQ 10
WHILE dx LT (OFFSET var1 - OFFSET var2)
REPEAT OFFSET var1 - OFFSET var2
```

However, the **DUP** operator allows such an expression as its count value. The assembler evaluates the **DUP** count on every pass, so even expressions involving forward references assemble correctly.

You can also use expressions containing span distances with the **.ERR** directives, since the assembler evaluates these directives after calculating all offsets:

```
.ERRE OFFSET var1 - OFFSET var2 - 10, <span incorrect>
```

## .TYPE with Forward References

MASM 5.1 evaluates **.TYPE** on both assembly passes. This means it yields zero on the first pass and nonzero on the second pass, if applied to an expression that forward-references a symbol.

MASM 6.1 evaluates **.TYPE** only on the first assembly pass. As a result, if the operand references a symbol that has not yet been defined, **.TYPE** yields a value of zero. This means that **.TYPE**, if used in a conditional-assembly construction, may yield different results in MASM 6.1 than in MASM 5.1.

## Obsolete Features No Longer Supported

The following two features are no longer supported by MASM 6.1. Because both are obscure features provided by early versions of the assembler, they probably do not affect your MASM 5.1 code.

### The ESC Instruction

MASM 6.1 no longer supports the **ESC** instruction, which was used to send hand-coded commands to the coprocessor. Because MASM 6.1 recognizes and assembles the full set of coprocessor mnemonics, the **ESC** instruction is not necessary. Using the **ESC** instruction generates error A2205:

```
ESC instruction is obsolete: ignored
```

To update MASM 5.1 code, use the coprocessor instructions instead of **ESC**.



If you do not have a **.MODEL** directive in your module, **OPTION M510** adds:

```
OPTION OFFSET:SEGMENT ; OFFSET operator defaults to
                      ; segment-relative
                      ; See "OPTION OFFSET," following
```

If you do not have a **.MODEL** directive with a language specifier in your module, **OPTION M510** also adds:

```
OPTION NOSCOPED      ; Code labels are not local inside
                      ; procedures
                      ; See "OPTION NOSCOPED," following
OPTION PROC:PRIVATE  ; Labels defined with PROC are not
                      ; public by default
                      ; See "OPTION PROC," following
```

If you want to remove **OPTION M510** from your code (or **/Zm** from the command line), add the **OPTION** directive arguments to your module according to the conditions stated earlier.

There may be compatibility issues affecting your code that are supported under **OPTION M510**, but are not covered by the other **OPTION** directive arguments. Once you have modified your source code so it no longer requires behavior supported by **OPTION M510**, you can replace **OPTION M510** with other **OPTION** directive arguments. These compatibility issues are discussed in following sections.

Once you have replaced **OPTION M510** with other forms of the **OPTION** directive and your code works correctly, try removing the **OPTION** directives, one at a time. Make appropriate source modifications as necessary, until your code uses only MASM 6.1 defaults.

### Reserved Keywords Dependent on CPU Mode with **OPTION M510**

With **OPTION M510**, keywords and instructions not available in the current CPU mode (such as **ENTER** under **.8086**) are not treated as keywords. This also means the **USE32**, **FLAT**, **FAR32**, and **NEAR32** segment types and the 80386/486 registers are not keywords with a processor selection less than **.386**.

If you remove **OPTION M510**, any reserved word used as an identifier generates a syntax error. You can either rename the identifiers or use **OPTION NOKEYWORD**. For more information on **OPTION NOKEYWORD**, see "OPTION NOKEYWORD," later in this appendix.

### Invalid Use of Instruction Prefixes with **OPTION M510**

Code without **OPTION M510** generates errors for all invalid uses of the instruction prefixes. **OPTION M510** suppresses some of these errors to match

MASM 5.1 behavior. MASM 5.1 does not check for illegal usage of the instruction prefixes **LOCK**, **REP**, **REPE**, **REPZ**, **REPNE**, and **REPNZ**.

Illegal usage of these prefixes results in error A2068:

```
instruction prefix not allowed
```

For more information on these instruction prefixes, see “Overview of String Instructions” in Chapter 5. See also “Bug Fixes from MASM 5.1,” earlier in this appendix.

### Size of Constant Operands with **OPTION M510**

In MASM 5.1, a large constant value that can fit only in the processor’s default word (4 bytes for **.386** and **.486**, 2 bytes otherwise) is assigned a size attribute of the default word size. The value of the constant affects the number of bytes changed by the instruction. For example,

```
; Legal only with OPTION M510
      mov     [bx], 0100h
```

is legal in **OPTION M510** mode. Since 0100h cannot fit in a byte, the assembler interprets the value as a word.

Without **OPTION M510**, the assembler never assigns a size automatically. You must state it explicitly with the **PTR** operator, as shown in the following example:

```
; Without OPTION M510
      mov     [bx], WORD PTR 0100h
```

### Code Labels when Defining Data with **OPTION M510**

MASM 5.1 allows a code label definition in a data definition statement if that statement does not also define a data label. MASM 6.1 also allows such definitions if **OPTION M510** is enabled; otherwise it is illegal.

```
; Legal only with OPTION M510
MyCodeLabel:  DW     0
```

### SEG Operator with **OPTION M510**

In MASM 5.1, the **SEG** operator returns a label’s segment address unless the frame is explicitly specified, in which case it returns the segment address of the frame. A statement such as **SEG DGROUP: var** always returns **DGROUP**, whereas **SEG var** always returns the segment address of **var**. **OPTION M510** forces this same behavior in MASM 6.1.

If you do not use **OPTION M510**, the behavior of the **SEG** operator is determined by the **OPTION OFFSET** directive, as described in “**OPTION OFFSET**,” later in this appendix.

In MASM 6.1, the value returned by the **SEG** operator applied to a nonexternal variable depends on compatibility mode:

- Without **OPTION M510**, **SEG** returns the address of the frame (the segment, group, or the value assumed to the segment register) if one has been explicitly set.
- With **OPTION M510**, **SEG** returns the group if one has been specified. In the absence of a defined group, **SEG** returns the segment where the variable is defined.

### Expression Evaluation with **OPTION M510**

By default, MASM 6.1 changes the way expressions are evaluated. In MASM 5.1,

```
var-2[bx]
```

is parsed as

```
(var-2)[bx]
```

Without **OPTION M510**, you must rewrite the statement, since the assembler parses it as

```
var-(2[bx])
```

which generates an error.

### Length and Size of Labels with **OPTION M510**

With **OPTION M510**, you can apply the **LENGTH** and **SIZE** operators to any label. For a code label, **SIZE** returns a value of 0FFFFh for **NEAR** and 0FFFEh for **FAR**. **LENGTH** always returns a value of 1. For strings, **SIZE** and **LENGTH** both return 1.

Without **OPTION M510**, **SIZE** returns values of 0FF01h, 0FF02h, 0FF04h, 0FF05h, and 0FF06h for **SHORT**, **NEAR16**, **NEAR32**, **FAR16**, and **FAR32** labels, respectively. **LENGTH** returns 1 except when used with **DUP**, in which case it returns the outermost count. For arrays initialized with **DUP**, **SIZE** returns the length multiplied by the size of the type.

The **LENGTHOF** and **SIZEOF** operators in MASM 6.1 handle arrays much more consistently. These operators return the number of data items and the number of bytes in an initializer. For a description of **SIZEOF** and **LENGTHOF**, see the following sections in Chapter 5: “Declaring and Referencing Arrays,” “Declaring and Initializing Strings,” “Defining Structure and Union Variables,” and “Defining Record Variables.”

## Comparing Types Using EQ and NE with OPTION M510

With **OPTION M510**, the assembler converts types to a constant value before comparisons with **EQ** and **NE**. Code types are converted to values of 0FFFFh (near) or 0FFFEh (far). If **OPTION M510** is not enabled, the assembler converts types to constants only when comparing them with constants. Thus, MASM 6.1 recognizes only equivalent qualified types as equal expressions.

For existing MASM 5.1 code, these distinctions affect only the use of the **TYPE** operator in conjunction with **EQ** and **NE**. The following example illustrates how the assembler compares types with and without compatibility mode:

```

MYSTRUCT          STRUC
    f1             DB      0
    f2             DB      0
MYSTRUCT          ENDS

; With OPTION M510

val = (TYPE MYSTRUCT) EQ WORD ; True: 2 EQ 2
val = 2 EQ WORD ; True: 2 EQ 2
val = WORD EQ WORD ; True: 2 EQ 2
val = SWORD EQ WORD ; True: 2 EQ 2

; Without OPTION M510

val = (TYPE MYSTRUCT) EQ WORD ; False: MyStruct NE WORD
val = 2 EQ WORD ; True: 2 EQ 2
val = WORD EQ WORD ; True: WORD EQ WORD
val = SWORD EQ WORD ; False: SWORD NE WORD

```

## Use of Constant and PTR as a Type with OPTION M510

You can use a constant as the left operand to **PTR** in compatibility mode. Otherwise, you must use a type expression. With **OPTION M510**, a constant must have a value of 1 (**BYTE**), 2 (**WORD**), 4 (**DWORD**), 6 (**FWORD**), 8 (**QWORD**) or 10 (**TBYTE**). The assembler treats the constant as the

parenthesized type. Note that the **TYPE** operator yields a type expression, but the **SIZE** operator yields a constant.

```

; With OPTION M510

MyData DW 0

        mov     WORD PTR [bx], 10      ; Legal
        mov     (TYPE MyData) PTR [bx], 10 ; Legal
        mov     (SIZE MyData) PTR [bx], 10 ; Legal
        mov     2 ptr [bx], 10        ; Legal

; Without OPTION M510

MyData WORD 0

        mov     WORD PTR [bx], 10      ; Legal
        mov     (TYPE MyData) PTR [bx], 10 ; Legal
;       mov     (SIZE MyData) PTR [bx], 10 ; Illegal
;       mov     2 PTR [bx], 10        ; Illegal

```

### Structure Type Cast on Expressions with OPTION M510

In compatibility mode, use the **PTR** operator to type-cast a constant to a structure type. This is most often done in data initializers to affect the CodeView information of the data label. Without **OPTION M510**, the assembler generates an error.

```

MYSTRC  STRUC
        f1  DB  0
MYSTRC  ENDS

MyPtr   DW     MYSTRC PTR 0    ; Illegal without OPTION M510

```

In MASM 6.1, the initializer type does not influence CodeView's type information.

### Hidden Coercion of OFFSET Expression Size with OPTION M510

When programming for the 80386 or 80486, the size of an **OFFSET** expression can be 2 bytes for a symbol in a **USE16** segment, or 4 bytes for a symbol in a **USE32** or **FLAT** segment. With **OPTION M510**, you can use a 32-bit **OFFSET** expression in a 16-bit context. Without **OPTION M510**, you must use the **LOWWORD** operator to convert the offset size.

```

.386

; With OPTION M510

seg32 SEGMENT USE32
MyLabel WORD 0
seg32 ENDS

seg16 SEGMENT USE16 'code' ; With OPTION M510:
      mov ax, OFFSET MyLabel ; Legal
      mov ax, LOWWORD OFFSET MyLabel ; Legal
      mov eax, OFFSET MyLabel ; Legal
seg16 ENDS

; Without OPTION M510

seg32 SEGMENT USE32
MyLabel WORD 0
seg32 ENDS

seg16 SEGMENT USE16 'code' ; Without OPTION M510:
;      mov ax, OFFSET MyLabel ; Illegal
      mov ax, LOWWORD offset MyLabel ; Legal
      mov eax, OFFSET MyLabel ; Legal
seg16 ENDS

```

### Specifying Radixes with OPTION M510

If the current radix in your code is greater than 10 decimal, MASM 6.1 allows the radix specifiers **B** (binary) and **D** (decimal) only in compatibility mode. You must change **B** to **Y** for binary, and **D** to **T** for decimal, since both **B** and **D** are legitimate hexadecimal values, making numbers such as 12D ambiguous. If you want to keep **B** and **D** as radix specifiers when the current radix is greater than 10, you must specify **OPTION M510**. For more information about radixes, see “Integer Constants and Constant Expressions” in Chapter 1.

### Naming Conventions with OPTION M510

By default, MASM 5.1 does not write the names of public variables in uppercase to the object file, even when a language type of **PASCAL**, **FORTTRAN**, or **BASIC** is specified.

Unless you use **OPTION M510**, these language types in MASM 6.1 write identifier names in uppercase, even with the **/Cp** or **/Cx** command-line options. When you link with **/NOI**, case must match in the object files to resolve externals.



## Length Significance of Symbol Names with OPTION M510

With MASM 5.1, only the first 31 characters of a symbol name are considered significant, and only the first 31 characters of a public or external symbol name are placed in the object file.

Without **OPTION M510**, the entire name is considered significant. The maximum number of characters placed in the object file is controlled with the */Hnumber* command-line option, with a default of 247 (the maximum length of an identifier in MASM 6.1).

## String Defaults in Structure Variables with OPTION M510

In compatibility mode, a constant initializer can override a structure field initialized with a string value. Without **OPTION M510**, only another string or a list can override a string initializer. To update your code, surround the constant override value with angle brackets or curly braces to indicate a list with one element.

```
MTSTRUCT      STRUCT
MyString      BYTE      "This is a string"
MTSTRUCT      ENDS
```

; With OPTION M510

```
MyInst        MTSTRUCT  <0>
```

; Without OPTION M510, either of these statements is correct

```
MyInst        MTSTRUCT  <<0>>
MyInst        MTSTRUCT  {<0>}
```

## Effects of the ? Initializer in Data Definitions with OPTION M510

As described in “Declaring and Initializing Strings” in Chapter 5, the assembler treats the ? initializer as either zero or as an unspecified value. In compatibility mode, however, the assembler always treats the ? initializer as zero unless it is used with the **DUP** operator. In this case, the assembler allocates space, but does not initialize it with any value.

## Current Address Operator with OPTION M510

In compatibility mode, the current address operator (\$) applied to a structure returns the offset of the first byte of the structure. When **OPTION M510** is not enabled, \$ returns the offset of the current field in the structure.

## Segment Association for FAR Externals with OPTION M510

In MASM 5.1, you must place an **EXTRN** directive for a variable in the same segment that holds the variable. For far data, this often entails opening and closing a segment just to place the **EXTRN** statement.

MASM 6.1 offers much greater flexibility in where **EXTERN** and **EXTERNDEF** statements can appear, as described in “Positioning External Declarations” in Chapter 8. However, in compatibility mode, MASM 6.1 emulates the behavior of MASM 5.1.

### Defining Aliases Using EQU with OPTION M510

In MASM 5.1, you can equate one symbol with another. These equates are called “aliases.”

Unless you specify **OPTION M510**, MASM 6.1 does not allow aliases defined with **EQU**. An immediate expression or text must appear as the right operand of an **EQU** directive. Change aliases to use the **TEXT EQU** directive, described in “Text Macros” in Chapter 9. This change may cause an expression to evaluate differently.

The following examples illustrate the differences between MASM 5.1 code, MASM 6.1 code with **OPTION M510**, and MASM 6.1 code without **OPTION M510**:

```
; MASM 5.1 code
var1    EQU    3
var2    EQU    var1    ; var2 taken as an alias
                        ; var2 references var1 anywhere var2 is
                        ; used as a symbol

; MASM 6.1 with OPTION M510
var1    EQU    3
var2    EQU    var1    ; var2 taken as a var2 EQU <var1>
                        ; var2 substituted for var1 whenever
                        ; text macros substituted

; MASM 6.1 without OPTION M510
var1    EQU    3
var2    EQU    var1    ; Treated as var2 EQU 3
```

## Difference in Text Macro Expansions with OPTION M510

MASM 6.1 recursively expands text macros used as values, whereas MASM 5.1 simply replaces the text macro with its value. The following example illustrates the difference:

```
; With OPTION M510

tm1    EQU    <contains tm2>
tm2    EQU    <value>

tm3    CATSTR tm1          ; == <contains tm2>

; Without OPTION M510

tm3    CATSTR tm1          ; == <contains value>
```

## Conditional Directives and Missing Operands with OPTION M510

MASM 5.1 considers a missing argument to be a zero. MASM 6.1 requires an argument unless **OPTION M510** is enabled.

## OPTION OLDSTRUCTS

This section describes changes in MASM 6.1 that apply to structures. With **OPTION OLDSTRUCTS** or **OPTION M510**:

- You can use plus operator (+) in structure field references.
- Labels and structure field names cannot have the same name with **OPTION OLDSTRUCTS**.

### Plus Operator Not Allowed with Structures

By default, each reference to structure member names must use the dot operator (.) to separate the structure variable name from the field name. You cannot use the dot operator as the plus operator (+) or vice versa.

To convert your code so that it does not need **OPTION OLDSTRUCTS**:

- Qualify all structure field references.
- Change all uses of the dot operator (.) that occur outside of structure references to use the plus operator (+).

If you remove **OPTION OLDSTRUCTS** from your code, the assembler generates errors for all lines requiring change. Using the dot operator in any context other than for a structure field results in error A2166:

```
structure field expected
```

Unqualified structure references result in error A2006:

```
undefined symbol : identifier
```

The following example illustrates how to change MASM 5.1 code from the old structure references to the new type in MASM 6.1:

```
; OPTION OLDSTRUCTS (simulates MASM 5.1)
structname      STRUC
a                BYTE ?
b                WORD ?
structname      ENDS

structinstance  structname <>

        mov     ax, [bx].b           ; This code assembles
        mov     al, structinstance.a ; correctly only with
        mov     ax, [bx].4           ; OPTION OLDSTRUCTS
                                        ; or OPTION M510

; OPTION NOOLDSTRUCTS (the MASM 6.1 default)
structname      STRUCT
a                BYTE ?
b                WORD ?
structname      ENDS

structinstance  structname <>

        mov     ax, [bx].structname.b ; Add qualifying type
        mov     al, structinstance.a   ; No change needed
        mov     ax, [bx]+4             ; Change dot to plus

; Alternative methods in MASM 6.1
; Either this:
        ASSUME bx:PTR structname
        mov     ax, [bx]
; or this:
        mov     ax, (structname PTR[bx]).b
```

## Duplicate Structure Field Names

With the default, **OPTION NOOLDSTRUCTS**, label and structure field names may have the same name. With **OPTION OLDSTRUCTS** (the MASM 5.1 default), labels and structure fields cannot have the same name. For more information, see “Structures and Unions” in Chapter 5.

## OPTION OLDMACROS

This section describes how MASM 5.1 and 6.1 differ in their handling of macros. Without **OPTION OLDMACROS** or **OPTION M510**, MASM 6.1 changes the behavior of macros in several ways. If you want the MASM 5.1 macro behavior, add **OPTION OLDMACROS** or **OPTION M510** to your MASM 5.1 code.

### Separating Macro Arguments with Commas

MASM 5.1 allows white spaces or commas to separate arguments to macros. MASM 6.1 with **OPTION NOOLDMACROS** (the default) requires commas between arguments. For example, in the macro call

```
MyMacro var1 var2 var3, var4
```

**OPTION OLDMACROS** causes the assembler to treat all four items as separate arguments. With **OPTION NOOLDMACROS**, the assembler treats

```
var1 var2 var3
```

as one argument, since the items are not separated with commas. To convert your macro code, replace spaces between macro arguments with a single comma.

### New Behavior with Ampersands in Macros

The default **OPTION NOOLDMACROS** causes the assembler to interpret ampersands (&) within a macro differently than does MASM 5.1. MASM 5.1 requires one ampersand for each level of macro nesting. **OPTION OLDMACROS** emulates this behavior.

Without **OPTION OLDMACROS**, MASM 6.1 removes ampersands only once no matter how deeply nested the macro. To update your MASM 5.1 macros, follow this simple rule: replace every sequence of ampersands with a single ampersand. The only exception is when macro parameters immediately precede and follow the ampersand, and both require substitution. In this case, use two ampersands. For a description of the new rules, see “Substitution Operator” in Chapter 9.

This example shows how to update a MASM 5.1 macro:

```
; OPTION OLDMACROS (emulates MASM 5.1 behavior)

createNames    macro    arg
    irp        tail, <Next, Last>
        irp    num, <1, 2>
            ; Define more names of the form: abcNext1?
arg&&tail&&&num&&&? label BYTE
        ENDM
    ENDM
ENDM

; OPTION NOOLDMACROS (the MASM 6.1 default)

createNames    macro    arg
    for        tail, <Next, Last> ; FOR is the MASM 6.1
        for    num, <1, 2>       ; synonym for irp
            ; Define more names of the form: abcNext1?
arg&&tail&&num&? label BYTE
        ENDM
    ENDM
ENDM
```

## OPTION DOTNAME

MASM 5.1 allows names of identifiers to begin with a period. The MASM 6.1 default is **OPTION NODOTNAME**. Adding **OPTION DOTNAME** to your code enables the MASM 5.1 behavior.

If you don't want to use this directive in your source code, rename the identifiers whose names begin with a period.

## OPTION EXPR16

MASM 5.1 treats expressions as 16-bit words if you do not specify **.386** or **.386P** directives. MASM 6.1 by default treats expressions as 32-bit words, regardless of the CPU type. You can force MASM 6.1 to use the smaller expression size with the **OPTION EXPR16** statement.

Unless your MASM 5.1 code specifies **.386** or **.386P**, **OPTION M510** also sets 16-bit expression size. You can selectively disable this by following **OPTION M510** with the **OPTION EXPR32** directive, which sets the size back to 32 bits. You cannot have both **OPTION EXPR32** and **OPTION EXPR16** in your program.

It may not be easy to determine the effect of changing from 16-bit internal expression size to 32-bit size. In most cases, the 32-bit word size does not affect the MASM 5.1 code. However, problems may arise because of differences in

intermediate values during evaluation of expressions. You can compare the files for differences by generating listing files with the /Fl and /Sa command-line options with and without **OPTION EXPR16**.

## OPTION OFFSET

The information in this section is relevant only if your MASM 5.1 code does not use the **.MODEL** directive. With no **.MODEL**, MASM 5.1 computes offsets from the start of the segment, whereas MASM 6.1 computes offsets from the start of the group. (With **.MODEL**, MASM 5.1 also computes offsets from the start of the group.)

To force MASM 6.1 to emulate 5.1 behavior, specify either **OFFSET:SEGMENT** or **OPTION M510**. Both directives cause the assembler to compute offsets relative to the segment if you do not include **.MODEL**.

To selectively enable MASM 6.1 behavior, place the directive **OPTION OFFSET:GROUP** after **OPTION M510**. In this case, you should ensure each **OFFSET** statement has a segment override where appropriate. The following example shows how **OPTION OFFSET:SEGMENT** affects code written for MASM 5.1:

```
OPTION  OFFSET:SEGMENT
MyGroup GROUP   MySeg

MySeg   SEGMENT 'data'
MyLabel LABEL   BYTE
          DW      OFFSET MyLabel           ; Relative to MySeg
          DW      OFFSET MyGroup:MyLabel   ; Relative to MyGroup
          DW      OFFSET MySeg:MyLabel     ; Relative to MySeg
MySeg   ENDS
```

In the preceding example, the first **OFFSET** statement computes the offset of **MyLabel** relative to **MySeg**. Without **OFFSET:SEGMENT**, MASM 6.1 returns the offset relative to **MyGroup**. To maintain the correct behavior with **OFFSET:GROUP**, specify a segment override, as shown in the following. The other two **OFFSET** statements already include overrides, and so do not require modification.

```
OPTION  OFFSET:GROUP
MyGroup GROUP   MySeg

MySeg   SEGMENT 'data'
MyLabel LABEL   BYTE
          DW      OFFSET MySeg:MyLabel     ; Relative to MySeg
          DW      OFFSET MyGroup:MyLabel   ; Relative to MyGroup
          DW      OFFSET MySeg:MyLabel     ; Relative to MySeg
MySeg   ENDS
```

When not in compatibility mode, the **OPTION OFFSET** directive determines whether the **SEG** operator returns a value relative to the group or segment. With **OPTION M510**, **SEG** is always segment-relative by default, regardless of the current value of **OPTION OFFSET**.

## OPTION NOSCOPED

The information in this section applies only if the **.MODEL** directive in your MASM 5.1 code does not specify a language type. Without a language type, MASM 5.1 assumes code labels in procedures have no “scope”—that is, the labels are not local to the procedure. When not in compatibility mode, MASM 6.1 always gives scope to code labels, even without a language type.

To force MASM 5.1 behavior, specify either **OPTION M510** or **OPTION NOSCOPED** in your code. To selectively enable MASM 6.1 behavior, place the directive **OPTION SCOPED** after **OPTION M510**.

To determine which labels require change, assemble the module without the **OPTION NOSCOPED** directive. For each reference to a label that is not local, the assembler generates error A2006:

```
undefined symbol : identifier
```

## OPTION PROC

The information in this section applies only if the **.MODEL** directive in your MASM 5.1 code does not specify a language type. Without a language type, MASM 5.1 makes procedures private to the module. By default, MASM 6.1 makes procedures public. You can explicitly change the default visibility to private with either **OPTION M510**, **OPTION PROC:PRIVATE**, or **OPTION PROC:EXPORT**.

To selectively enable MASM 6.1 behavior, place the directive **OPTION PROC:PUBLIC** after **OPTION M510**. You can override the default by adding the **PUBLIC** or **PRIVATE** keyword to selected procedures. The following example shows how to change MASM 5.1 code to keep a procedure private:

```
; MASM 5.1 (OPTION PROC:PRIVATE)  
MyProc PROC NEAR
```

```
; MASM 6.1 (OPTION PROC:PUBLIC)  
MyProc PROC NEAR PRIVATE
```

This is necessary only to avoid naming conflicts between public names in multiple modules or libraries. The symbol table in a listing file shows the visibility (public, private, or export) of each procedure.



## OPTION NOKEYWORD

MASM 6.1 has several new keywords that MASM 5.1 does not recognize as reserved. To resolve any conflicts, you can:

- Rename any offending symbols in your code.
- Selectively disable keywords with the **OPTION NOKEYWORD** directive.

The second option lets you retain the offending symbol names in your code by forcing MASM 6.1 to not recognize them as keywords. For example,

```
OPTION NOKEYWORD:<INVOKE STRUCT>
```

removes the keywords **INVOKE** and **STRUCT** from the assembler's list of reserved words. However, you cannot then use the keywords in their intended function, since the assembler no longer recognizes them.

The following list shows MASM 6.1 reserved words new since MASM 5.1:

<b>.BREAK</b>	<b>.UNTILCXZ</b>	<b>FRSTORD</b>
<b>.CONTINUE</b>	<b>.WHILE</b>	<b>FRSTORW</b>
<b>.DOSSEG</b>	<b>ADDR</b>	<b>FSAVED</b>
<b>.ELSE</b>	<b>ALIAS</b>	<b>FSAVEW</b>
<b>.ELSEIF</b>	<b>BSWAP</b>	<b>FSTENV D</b>
<b>.ENDIF</b>	<b>CARRY?</b>	<b>FSTENVW</b>
<b>.ENDW</b>	<b>CMPXCHG</b>	<b>GOTO</b>
<b>.EXIT</b>	<b>ECHO</b>	<b>HIGHWORD</b>
<b>.IF</b>	<b>EXTERN</b>	<b>INVD</b>
<b>.LISTALL</b>	<b>EXTERNDEF</b>	<b>INVLPG</b>
<b>.LISTIF</b>	<b>FAR16</b>	<b>INVOKE</b>
<b>.LISTMACRO</b>	<b>FAR32</b>	<b>IRETDF</b>
<b>.LISTMACROALL</b>	<b>FLAT</b>	<b>IRETF</b>
<b>.NO87</b>	<b>FLDENVD</b>	<b>LENGTHOF</b>
<b>.NOCREF</b>	<b>FLDENVW</b>	<b>LOOPD</b>
<b>.NOLIST</b>	<b>FNSAVED</b>	<b>LOOPED</b>
<b>.NOLISTIF</b>	<b>FNSAVEW</b>	<b>LOOPEW</b>
<b>.NOLISTMACRO</b>	<b>FNSTENV D</b>	<b>LOOPNED</b>
<b>.REPEAT</b>	<b>FNSTENVW</b>	<b>LOOPNEW</b>
<b>.STARTUP</b>	<b>FOR</b>	<b>LOOPNZD</b>
<b>.UNTIL</b>	<b>FORC</b>	<b>LOOPNZW</b>

<b>LOOPW</b>	<b>PUSHCONTEXT</b>	<b>SWORD</b>
<b>LOOPZW</b>	<b>PUSHD</b>	<b>SYSCALL</b>
<b>LOWWORD</b>	<b>PUSHW</b>	<b>TEXTEQU</b>
<b>LROFFSET</b>	<b>REAL10</b>	<b>TR3</b>
<b>NEAR16</b>	<b>REAL4</b>	<b>TR4</b>
<b>NEAR32</b>	<b>REAL8</b>	<b>TR5</b>
<b>OPATTR</b>	<b>REPEAT</b>	<b>TYPEDEF</b>
<b>OPTION</b>	<b>SBYTE</b>	<b>UNION</b>
<b>OVERFLOW?</b>	<b>SDWORD</b>	<b>VARARG</b>
<b>PARITY?</b>	<b>SIGN?</b>	<b>WBINVD</b>
<b>POPAW</b>	<b>SIZEOF</b>	<b>WHILE</b>
<b>POPCONTEXT</b>	<b>STDCALL</b>	<b>XADD</b>
<b>PROTO</b>	<b>STRUCT</b>	<b>ZERO?</b>
<b>PUSHAW</b>	<b>SUBTITLE</b>	

## OPTION SETIF2

By default, MASM 6.1 does not recognize pass-dependent constructs. Both the **OPTION M510** and **OPTION SETIF2** statements force MASM 6.1 to handle MASM 5.1 constructs that activate on the second assembly pass, such as **.ERR2**, **IF2**, and **ELSEIF2**.

Invoke the option like this:

```
OPTION SETIF2: {TRUE | FALSE}
```

When set to **TRUE**, **OPTION SETIF2** forces all second-pass constructs to activate on every assembly pass. When set to **FALSE**, second-pass constructs do not activate on any pass. **OPTION M510** implies **OPTION SETIF2:TRUE**.

## Changes to Instruction Encodings

MASM 6.1 contains changes to the encodings for several instructions. In some cases, the changes help optimize code size.

### Coprocessor Instructions

For the 8087 coprocessor, MASM 5.1 adds an extra **NOP** before the no-wait versions of coprocessor instructions. MASM 6.1 does not. In the rare case that the missing **NOP** affects timing, insert **NOP**.

For the 80287 coprocessor or better, MASM 5.1 inserts **FWAIT** before certain instructions. MASM 6.1 does not prefix any 80287, 80387, or 80486 coprocessor instruction with **FWAIT**, except for wait forms of instructions that have a no-wait form.

### RET Instruction

MASM 5.1 generates a 3-byte encoding for **RET**, **RETN**, or **RETF** instructions with an operand value of zero, unless the operand is an external absolute. In this case, MASM 5.1 ignores the parameter and generates a 1-byte encoding.

MASM 6.1 does the opposite. It ignores a zero operand for the return instructions and generates a 1-byte encoding, unless the operand is an external absolute. In this case, MASM 6.1 generates a 3-byte encoding.

Thus, you can suppress epilogue code in a procedure but still specify the default size for **RET** by coding the return as

```
ret    0
```

### Arithmetic Instructions

Versions 5.1 and 6.1 differ in the way they encode the arithmetic instructions **ADC**, **ADD**, **AND**, **CMP**, **OR**, **SUB**, **SBB**, and **XOR**, under the following conditions:

- The first operand is either **AX** or **EAX**.
- The second operand is a constant value between 0 and 127.

For the **AX** register, there is no size or speed difference between the two encodings. For the **EAX** register, the encoding in MASM 6.1 is 2 bytes smaller. The **OPTION NOSIGNEXTEND** directive forces the MASM 5.1 behavior for **AND**, **OR**, and **XOR**.

---

 APPENDIX B

# BNF Grammar

This appendix provides a complete description of symbols, operators, and directives for MASM 6.1. It uses the Backus-Naur Form (BNF) for grammar notation. You can use BNF grammar to determine the exact syntax for any language component and find all available options for any MASM command.

BNF definitions consist of “nonterminals” and “terminals.” Nonterminals are placeholders within a BNF definition, defined elsewhere in the BNF grammar. Terminals are endpoints in a BNF definition, consisting of MASM 6.1 keywords. In this Appendix, all nonterminals appear in *italic* type and all terminals appear in **bold** type.

## BNF Conventions

The conventions use different font attributes for different items in the BNF. The symbols and formats are as follows:

Attribute	Description
<i>nonterminal</i>	Italic type indicates nonterminals.
<b>RESERVED</b>	Terminals in boldface type are literal reserved words and symbols that must be entered as shown. Characters in this context are always case insensitive.
[ ]	Objects enclosed in double brackets ([ ]) are optional. The brackets do not actually appear in the source code.
	A vertical bar indicates a choice between the items on each side of the bar.
<u>8086</u>	Underlined items indicate the default option if one is given.
default typeface	Characters in the set described or listed can be used as terminals in MASM statements.

## How to Use the BNF Grammar

To illustrate the use of the BNF, Figure B.1 diagrams the definition of the **TYPEDEF** directive, starting with the nonterminal *typedefDir*.

The entries under each horizontal brace in Figure B.1 are terminals (such as **NEAR16**, **NEAR32**, **FAR16**, and **FAR32**) or nonterminals (such as *qualifier*, *qualifiedType*, *distance*, and *protoSpec*) that can be further defined. Each italicized nonterminal in the *typedefDir* definition is also an entry in the BNF. Three vertical dots indicate a branching definition for a nonterminal that, for the sake of simplicity, this figure does not illustrate.

The BNF grammar allows recursive definitions. For example, the grammar uses *qualifiedType* as a possible definition for *qualifiedType*, which is also a component of the definition for *qualifier*.

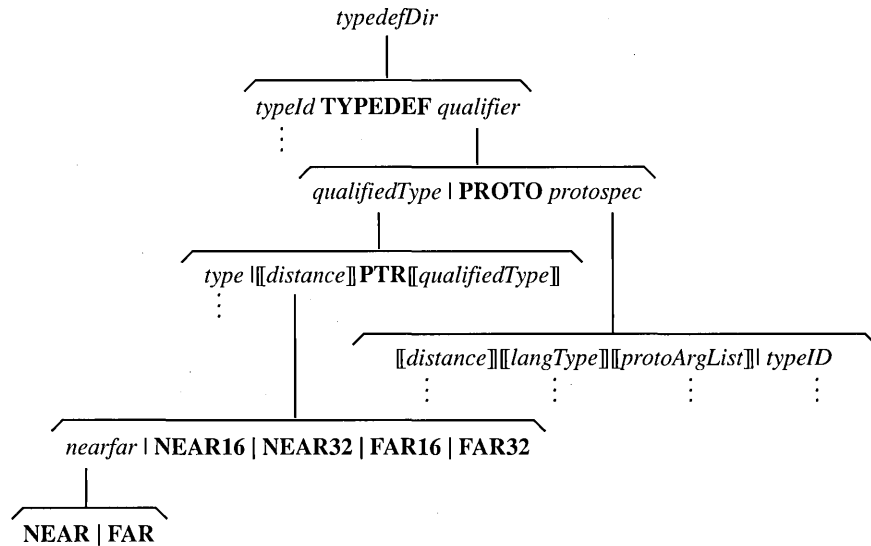

Figure B.1 BNF Definition of the **TYPEDEF** Directive

Nonterminal	Definition
<i>;;</i>	endOfLine   <i>comment</i>
<i>=Dir</i>	<i>id</i> = <i>immExpr</i> <i>;;</i>
<i>addOp</i>	+   -
<i>aExpr</i>	<i>term</i>   <i>aExpr</i> && <i>term</i>

Nonterminal	Definition
<i>altId</i>	<i>id</i>
<i>arbitraryText</i>	<i>charList</i>
<i>asmInstruction</i>	<i>mnemonic</i> [[ <i>exprList</i> ]]
<i>assumeDir</i>	<b>ASSUME</b> <i>assumeList</i> ;;   <b>ASSUME NOTHING</b> ;;
<i>assumeList</i>	<i>assumeRegister</i>   <i>assumeList</i> , <i>assumeRegister</i>
<i>assumeReg</i>	<i>register</i> : <i>assumeVal</i>
<i>assumeRegister</i>	<i>assumeSegReg</i>   <i>assumeReg</i>
<i>assumeSegReg</i>	<i>segmentRegister</i> : <i>assumeSegVal</i>
<i>assumeSegVal</i>	<i>frameExpr</i>   <b>NOTHING</b>   <b>ERROR</b>
<i>assumeVal</i>	<i>qualifiedType</i>   <b>NOTHING</b>   <b>ERROR</b>
<i>bcdConst</i>	[[ <i>sign</i> ]] <i>decNumber</i>
<i>binaryOp</i>	==   !=   >=   <=   >   <   &
<i>bitDef</i>	<i>bitFieldId</i> : <i>bitFieldSize</i> [[ = <i>constExpr</i> ]]
<i>bitDefList</i>	<i>bitDef</i>   <i>bitDefList</i> , [[ ;; ]] <i>bitDef</i>
<i>bitFieldId</i>	<i>id</i>
<i>bitFieldSize</i>	<i>constExpr</i>
<i>blockStatements</i>	<i>directiveList</i>   <b>.CONTINUE</b> [[ <b>.IF</b> <i>cExpr</i> ]]   <b>.BREAK</b> [[ <b>.IF</b> <i>cExpr</i> ]]
<i>bool</i>	<b>TRUE</b>   <b>FALSE</b>
<i>byteRegister</i>	AL   AH   BL   BH   CL   CH   DL   DH
<i>cExpr</i>	<i>aExpr</i>   <i>cExpr</i>    <i>aExpr</i>
<i>character</i>	Any character with ordinal in the range 0–255 except linefeed (10)
<i>charList</i>	<i>character</i>   <i>charList</i> <i>character</i>
<i>className</i>	<i>string</i>
<i>commDecl</i>	[[ <i>nearfar</i> ]] [[ <i>langType</i> ]] <i>id</i> : <i>commType</i> [[ : <i>constExpr</i> ]]
<i>commDir</i>	<b>COMM</b> <i>commList</i> ;;
<i>comment</i>	; <i>text</i> ;;

Nonterminal	Definition
<i>commentDir</i>	<b>COMMENT</b> <i>delimiter</i> <i>text</i> <i>text delimiter text</i> ;;
<i>commList</i>	<i>commDecl</i>   <i>commList</i> , <i>commDecl</i>
<i>commType</i>	<i>type</i>   <i>constExpr</i>
<i>constant</i>	<i>digits</i> [[ <i>radixOverride</i> ]]
<i>constExpr</i>	<i>expr</i>
<i>contextDir</i>	<b>PUSHCONTEXT</b> <i>contextItemList</i> ;;   <b>POPCONTEXT</b> <i>contextItemList</i> ;;
<i>contextItem</i>	<b>ASSUMES</b>   <b>RADIX</b>   <b>LISTING</b>   <b>CPU</b>   <b>ALL</b>
<i>contextItemList</i>	<i>contextItem</i>   <i>contextItemList</i> , <i>contextItem</i>
<i>controlBlock</i>	<i>whileBlock</i>   <i>repeatBlock</i>
<i>controlDir</i>	<i>controlIf</i>   <i>controlBlock</i>
<i>controlElseif</i>	<b>.ELSEIF</b> <i>cExpr</i> ;; <i>directiveList</i> [[ <i>controlElseif</i> ]]
<i>controlIf</i>	<b>.IF</b> <i>cExpr</i> ;; <i>directiveList</i> [[ <i>controlElseif</i> ]] [[ <b>.ELSE</b> ;; <i>directiveList</i> ]] <b>.ENDIF</b> ;;
<i>coprocessor</i>	<b>.8087</b>   <b>.287</b>   <b>.387</b>   <b>.NO87</b>
<i>crefDir</i>	<i>crefOption</i> ;;
<i>crefOption</i>	<b>.CREF</b>   <b>.XCREF</b> [[ <i>idList</i> ]]   <b>.NOCREF</b> [[ <i>idList</i> ]]
<i>cxzExpr</i>	<i>expr</i>   ! <i>expr</i>   <i>expr</i> == <i>expr</i>   <i>expr</i> != <i>expr</i>
<i>dataDecl</i>	<b>DB</b>   <b>DW</b>   <b>DD</b>   <b>DF</b>   <b>DQ</b>   <b>DT</b>   <i>dataType</i>   <i>typeId</i>
<i>dataDir</i>	[[ <i>id</i> ]] <i>dataItem</i> ;;

Nonterminal	Definition
<i>dataItem</i>	<i>dataDecl scalarInstList</i>   <i>structTag structInstList</i>   <i>typeId structInstList</i>   <i>unionTag structInstList</i>   <i>recordTag recordInstList</i>
<i>dataType</i>	<b>BYTE</b>   <b>SBYTE</b>   <b>WORD</b>   <b>SWORD</b>   <b>DWORD</b>   <b>SDWORD</b>   <b>FWORD</b>   <b>QWORD</b>   <b>TBYTE</b>   <b>REAL4</b>   <b>REAL8</b>   <b>REAL10</b>
<i>decdigit</i>	0   1   2   3   4   5   6   7   8   9
<i>decNumber</i>	<i>decdigit</i>   <i>decNumber decdigit</i>
<i>delimiter</i>	Any character except <i>whiteSpaceCharacter</i>
<i>digits</i>	<i>decdigit</i>   <i>digits decdigit</i>   <i>digits hexdigit</i>
<i>directive</i>	<i>generalDir</i>   <i>segmentDef</i>
<i>directiveList</i>	<i>directive</i>   <i>directiveList directive</i>
<i>distance</i>	<i>nearfar</i>   <b>NEAR16</b>   <b>NEAR32</b>   <b>FAR16</b>   <b>FAR32</b>
<i>e01</i>	<i>e01 orOp e02</i>   <i>e02</i>
<i>e02</i>	<i>e02 AND e03</i>   <i>e03</i>
<i>e03</i>	<b>NOT</b> <i>e04</i>   <i>e04</i>
<i>e04</i>	<i>e04 relOp e05</i>   <i>e05</i>
<i>e05</i>	<i>e05 addOp e06</i>   <i>e06</i>
<i>e06</i>	<i>e06 mulOp e07</i>   <i>e06 shiftOp e07</i>   <i>e07</i>
<i>e07</i>	<i>e07 addOp e08</i>   <i>e08</i>
<i>e08</i>	<b>HIGH</b> <i>e09</i>   <b>LOW</b> <i>e09</i>   <b>HIGHWORD</b> <i>e09</i>   <b>LOWWORD</b> <i>e09</i>   <i>e09</i>



Nonterminal	Definition
<i>e09</i>	<b>OFFSET</b> <i>e10</i>   <b>SEG</b> <i>e10</i>   <b>LROFFSET</b> <i>e10</i>   <b>TYPE</b> <i>e10</i>   <b>THIS</b> <i>e10</i>   <i>e09</i> <b>PTR</b> <i>e10</i>   <i>e09</i> : <i>e10</i>   <i>e10</i>
<i>e10</i>	<i>e10</i> . <i>e11</i>   <i>e10</i> [[ <i>expr</i> ]]   <i>e11</i>
<i>e11</i>	( <i>expr</i> )   [[ <i>expr</i> ]]   <b>WIDTH</b> <i>id</i>   <b>MASK</b> <i>id</i>   <b>SIZE</b> <i>sizeArg</i>   <b>SIZEOF</b> <i>sizeArg</i>   <b>LENGTH</b> <i>id</i>   <b>LENGTHOF</b> <i>id</i>   <i>recordConst</i>   <i>string</i>   <i>constant</i>   <i>type</i>   <i>id</i>   \$   <i>segmentRegister</i>   <i>register</i>   <b>ST</b>   <b>ST</b> ( <i>expr</i> )
<i>echoDir</i>	<b>ECHO</b> <i>arbitraryText</i> ;; <b>%OUT</b> <i>arbitraryText</i> ;;
<i>elseifBlock</i>	<i>elseifStatement</i> ;; <i>directiveList</i> [[ <i>elseifBlock</i> ]]
<i>elseifStatement</i>	<b>ELSEIF</b> <i>constExpr</i>   <b>ELSEIFE</b> <i>constExpr</i>   <b>ELSEIFB</b> <i>textItem</i>   <b>ELSEIFNB</b> <i>textItem</i>   <b>ELSEIFDEF</b> <i>id</i>   <b>ELSEIFNDEF</b> <i>id</i>   <b>ELSEIFDIF</b> <i>textItem</i> , <i>textItem</i>   <b>ELSEIFDIFI</b> <i>textItem</i> , <i>textItem</i>   <b>ELSEIFIDN</b> <i>textItem</i> , <i>textItem</i>   <b>ELSEIFIDNI</b> <i>textItem</i> , <i>textItem</i>   <b>ELSEIF1</b>   <b>ELSEIF2</b>

Nonterminal	Definition
<i>endDir</i>	<b>END</b> <i>[[ immExpr ]]</i> <b>;;</b>
<i>endpDir</i>	<i>proclId</i> <b>ENDP</b> <b>;;</b>
<i>endsDir</i>	<i>id</i> <b>ENDS</b> <b>;;</b>
<i>equDir</i>	<i>textMacroId</i> <b>EQU</b> <i>equType</i> <b>;;</b>
<i>equType</i>	<i>immExpr</i>   <i>textLiteral</i>
<i>errorDir</i>	<i>errorOpt</i> <b>;;</b>
<i>errorOpt</i>	<b>.ERR</b> <i>[[ textItem ]]</i>   <b>.ERRE</b> <i>constExpr</i> <i>[[ optText ]]</i>   <b>.ERRNZ</b> <i>constExpr</i> <i>[[ optText ]]</i>   <b>.ERRB</b> <i>textItem</i> <i>[[ optText ]]</i>   <b>.ERRNB</b> <i>textItem</i> <i>[[ optText ]]</i>   <b>.ERRDEF</b> <i>id</i> <i>[[ optText ]]</i>   <b>.ERRNDEF</b> <i>id</i> <i>[[ optText ]]</i>   <b>.ERRDIF</b> <i>textItem</i> , <i>textItem</i> <i>[[ optText ]]</i>   <b>.ERRDIFI</b> <i>textItem</i> , <i>textItem</i> <i>[[ optText ]]</i>   <b>.ERRIDN</b> <i>textItem</i> , <i>textItem</i> <i>[[ optText ]]</i>   <b>.ERRIDNI</b> <i>textItem</i> , <i>textItem</i> <i>[[ optText ]]</i>   <b>.ERR1</b> <i>[[ textItem ]]</i>   <b>.ERR2</b> <i>[[ textItem ]]</i>
<i>exitDir</i>	<b>.EXIT</b> <i>[[ expr ]]</i> <b>;;</b>
<i>exitmDir:</i>	<b>EXITM</b>   <b>EXITM</b> <i>textItem</i>
<i>exponent</i>	<b>E</b> <i>[[ sign ]]</i> <i>decNumber</i>
<i>expr</i>	<b>SHORT</b> <i>e05</i>   <b>.TYPE</b> <i>e01</i>   <b>OPATTR</b> <i>e01</i>   <i>e01</i>
<i>exprList</i>	<i>expr</i>   <i>exprList</i> , <i>expr</i>
<i>externDef</i>	<i>[[ langType ]]</i> <i>id</i> <i>[[ ( altId ) ]]</i> <b>:</b> <i>externType</i>
<i>externDir</i>	<i>externKey</i> <i>externList</i> <b>;;</b>
<i>externKey</i>	<b>EXTRN</b>   <b>EXTERN</b>   <b>EXTERNDEF</b>
<i>externList</i>	<i>externDef</i>   <i>externList</i> , <i>[[ ;; ]]</i> <i>externDef</i>
<i>externType</i>	<b>ABS</b>   <i>qualifiedType</i>
<i>fieldAlign</i>	<i>constExpr</i>
<i>fieldInit</i>	<i>[[ initValue ]]</i>   <i>structInstance</i>

Nonterminal	Definition
<i>fieldInitList</i>	<i>fieldInit</i>   <i>fieldInitList</i> , [ ; ] <i>fieldInit</i>
<i>fileChar</i>	<i>delimiter</i>
<i>fileCharList</i>	<i>fileChar</i>   <i>fileCharList fileChar</i>
<i>fileSpec</i>	<i>fileCharList</i>   <i>textLiteral</i>
<i>flagName</i>	<b>ZERO?</b>   <b>CARRY?</b>   <b>OVERFLOW?</b>   <b>SIGN?</b>   <b>PARITY?</b>
<i>floatNumber</i>	[ <i>sign</i> ] <i>decNumber</i> . [ <i>decNumber</i> ] [ <i>exponent</i> ]   <i>digits R</i>   <i>digits r</i>
<i>forcDir</i>	<b>FORC</b>   <b>IRPC</b>
<i>forDir</i>	<b>FOR</b>   <b>IRP</b>
<i>forParm</i>	<i>id</i> [ : <i>forParmType</i> ]
<i>forParmType</i>	<b>REQ</b>   = <i>textLiteral</i>
<i>frameExpr</i>	<b>SEG</b> <i>id</i>   <b>DGROUP</b> : <i>id</i>   <i>segmentRegister</i> : <i>id</i>   <i>id</i>
<i>generalDir</i>	<i>modelDir</i>   <i>segOrderDir</i>   <i>nameDir</i>   <i>includeLibDir</i>   <i>commentDir</i>   <i>groupDir</i>   <i>assumeDir</i>   <i>structDir</i>   <i>recordDir</i>   <i>typedefDir</i>   <i>externDir</i>   <i>publicDir</i>   <i>commDir</i>   <i>protoTypeDir</i>   <i>equDir</i>   = <i>Dir</i>   <i>textDir</i>   <i>contextDir</i>   <i>optionDir</i>   <i>processorDir</i>   <i>radixDir</i>   <i>titleDir</i>   <i>pageDir</i>   <i>listDir</i>   <i>crefDir</i>   <i>echoDir</i>   <i>ifDir</i>   <i>errorDir</i>   <i>includeDir</i>   <i>macroDir</i>   <i>macroCall</i>   <i>macroRepeat</i>   <i>purgeDir</i>   <i>macroWhile</i>   <i>macroFor</i>   <i>macroForc</i>   <i>aliasDir</i>
<i>gpRegister</i>	<b>AX</b>   <b>EAX</b>   <b>BX</b>   <b>EBX</b>   <b>CX</b>   <b>ECX</b>   <b>DX</b>   <b>EDX</b>   <b>BP</b>   <b>EBP</b>   <b>SP</b>   <b>ESP</b>   <b>DI</b>   <b>EDI</b>   <b>SI</b>   <b>ESI</b>
<i>groupDir</i>	<i>groupId</i> <b>GROUP</b> <i>segIdList</i>
<i>groupId</i>	<i>id</i>
<i>hexdigit</i>	a   b   c   d   e   f   A   B   C   D   E   F

Nonterminal	Definition
<i>id</i>	<i>alpha</i>   <i>id alpha</i>   <i>id decdigit</i>
<i>idList</i>	<i>id</i>   <i>idList , id</i>
<i>ifDir</i>	<i>ifStatement ;;</i> <i>directiveList</i> [[ <i>elseifBlock</i> ]] [[ <b>ELSE ;;</b> <i>directiveList</i> ]] <b>ENDIF ;;</b>
<i>ifStatement</i>	<b>IF</b> <i>constExpr</i>   <b>IFE</b> <i>constExpr</i>   <b>IFB</b> <i>textItem</i>   <b>IFNB</b> <i>textItem</i>   <b>IFDEF</b> <i>id</i>   <b>IFNDEF</b> <i>id</i>   <b>IFDIF</b> <i>textItem , textItem</i>   <b>IFDIFI</b> <i>textItem , textItem</i>   <b>IFIDN</b> <i>textItem , textItem</i>   <b>IFIDNI</b> <i>textItem , textItem</i>   <b>IF1</b>   <b>IF2</b>
<i>immExpr</i>	<i>expr</i>
<i>includeDir</i>	<b>INCLUDE</b> <i>fileSpec ;;</i>
<i>includeLibDir</i>	<b>INCLUDELIB</b> <i>fileSpec ;;</i>
<i>initValue</i>	<i>immExpr</i>   <i>string</i>   ?   <i>constExpr</i> <b>DUP</b> ( <i>scalarInstList</i> )   <i>floatNumber</i>   <i>bcdConst</i>
<i>inSegDir</i>	[[ <i>labelDef</i> ]] <i>inSegmentDir</i>
<i>inSegDirList</i>	<i>inSegDir</i>   <i>inSegDirList inSegDir</i>

Nonterminal	Definition
<i>inSegmentDir</i>	<i>instruction</i>   <i>dataDir</i>   <i>controlDir</i>   <i>startupDir</i>   <i>exitDir</i>   <i>offsetDir</i>   <i>labelDir</i>   <i>procDir</i> [[ <i>localDirList</i> ] ] [[ <i>inSegDirList</i> ] ] <i>endpDir</i>   <i>invokeDir</i>   <i>generalDir</i>
<i>instrPrefix</i>	<b>REP   REPE   REPZ   REPNE   REPNZ   LOCK</b>
<i>instruction</i>	[[ <i>instrPrefix</i> ] ] <i>asmInstruction</i>
<i>invokeArg</i>	<i>register</i> :: <i>register</i>   <i>expr</i>   <b>ADDR</b> <i>expr</i>
<i>invokeDir</i>	<b>INVOKE</b> <i>expr</i> [[ , [[ ;; ] ] <i>invokeList</i> ] ] ;;
<i>invokeList</i>	<i>invokeArg</i>   <i>invokeList</i> , [[ ;; ] ] <i>invokeArg</i>
<i>keyword</i>	Any reserved word
<i>keywordList</i>	<i>keyword</i>   <i>keyword</i> <i>keywordList</i>
<i>labelDef</i>	<i>id</i> :   <i>id</i> ::   @@:
<i>labelDir</i>	<i>id</i> <b>LABEL</b> <i>qualifiedType</i> ;;
<i>langType</i>	<b>C   PASCAL   FORTRAN   BASIC</b>   <b>SYSCALL   STDCALL</b>
<i>listDir</i>	<i>listOption</i> ;;
<i>listOption</i>	<b><u>.LIST</u></b>   <b>.NOLIST</b>   <b>.XLIST</b>   <b>.LISTALL</b>   <b>.LISTIF</b>   <b>.LFCOND</b>   <b><u>.NOLISTIF</u></b>   <b>.SFCOND</b>   <b>.TFCOND</b>   <b>.LISTMACROALL</b>   <b>.LALL</b>   <b>.NOLISTMACRO</b>   <b>.SALL</b>   <b><u>.LISTMACRO</u></b>   <b>.XALL</b>
<i>localDef</i>	<b>LOCAL</b> <i>idList</i> ;;
<i>localDir</i>	<b>LOCAL</b> <i>parmList</i> ;;
<i>localDirList</i>	<i>localDir</i>   <i>localDirList</i> <i>localDir</i>

Nonterminal	Definition
<i>localList</i>	<i>localDef</i>   <i>localList localDef</i>
<i>macroArg</i>	% <i>constExpr</i>   % <i>textMacroId</i>   % <i>macroFuncId</i> ( <i>macroArgList</i> )   <i>string</i>   <i>arbitraryText</i>   < <i>arbitraryText</i> >
<i>macroArgList</i>	<i>macroArg</i>   <i>macroArgList</i> , <i>macroArg</i>
<i>macroBody</i>	[[ <i>localList</i> ]] <i>macroStmtList</i>
<i>macroCall</i>	<i>id macroArgList</i> ;;   <i>id</i> ( <i>macroArgList</i> )
<i>macroDir</i>	<i>id MACRO</i> [[ <i>macroParmList</i> ]] ;; <i>macroBody</i> <b>ENDM</b> ;;
<i>macroFor</i>	<i>forDir forParm</i> , < <i>macroArgList</i> > ;; <i>macroBody</i> <b>ENDM</b> ;;
<i>macroForc</i>	<i>forcDir id</i> , <i>textLiteral</i> ;; <i>macroBody</i> <b>ENDM</b> ;;
<i>macroFuncId</i>	<i>id</i>
<i>macroId</i>	<i>macroProcId</i>   <i>macroFuncId</i>
<i>macroIdList</i>	<i>macroId</i>   <i>macroIdList</i> , <i>macroId</i>
<i>macroLabel</i>	<i>id</i>
<i>macroParm</i>	<i>id</i> [[ : <i>parmType</i> ]]
<i>macroParmList</i>	<i>macroParm</i>   <i>macroParmList</i> , [[ ;; ]] <i>macroParm</i>
<i>macroProcId</i>	<i>id</i>
<i>macroRepeat</i>	<i>repeatDir constExpr</i> ;; <i>macroBody</i> <b>ENDM</b> ;;
<i>macroStmt</i>	<i>directive</i>   <i>exitmDir</i>   : <i>macroLabel</i>   <b>GOTO</b> <i>macroLabel</i>

Nonterminal	Definition
<i>macroStmtList</i>	<i>macroStmt</i> ;;   <i>macroStmtList macroStmt</i> ;;
<i>macroWhile</i>	<b>WHILE</b> <i>constExpr</i> ;; <i>macroBody</i> <b>ENDM</b> ;;
<i>mapType</i>	<b>ALL</b>   <b>NONE</b>   <b><u>NOTPUBLIC</u></b>
<i>memOption</i>	<b>TINY</b>   <b>SMALL</b>   <b>MEDIUM</b>   <b>COMPACT</b>   <b>LARGE</b>   <b>HUGE</b>   <b>FLAT</b>
<i>mnemonic</i>	Instruction name
<i>modelDir</i>	<b>.MODEL</b> <i>memOption</i> [[ , <i>modelOptlist</i> ] ] ;;
<i>modelOpt</i>	<i>langType</i>   <i>stackOption</i>
<i>modelOptlist</i>	<i>modelOpt</i>   <i>modelOptlist</i> , <i>modelOpt</i>
<i>module</i>	[[ <i>directiveList</i> ] ] <i>endDir</i>
<i>mulOp</i>	*   /   <b>MOD</b>
<i>nameDir</i>	<b>NAME</b> <i>id</i> ;;
<i>nearfar</i>	<b>NEAR</b>   <b>FAR</b>
<i>nestedStruct</i>	<i>structHdr</i> [[ <i>id</i> ] ] ;; <i>structBody</i> <b>ENDS</b> ;;
<i>offsetDir</i>	<i>offsetDirType</i> ;;
<i>offsetDirType</i>	<b>EVEN</b>   <b>ORG</b> <i>immExpr</i>   <b>ALIGN</b> [[ <i>constExpr</i> ] ]
<i>offsetType</i>	<b><u>GROUP</u></b>   <b>SEGMENT</b>   <b>FLAT</b>
<i>oldRecordFieldList</i>	[[ <i>constExpr</i> ] ]   <i>oldRecordFieldList</i> , [[ <i>constExpr</i> ] ]
<i>optionDir</i>	<b>OPTION</b> <i>optionList</i> ;;

Nonterminal	Definition
<i>optionItem</i>	<b>CASEMAP</b> : <i>mapType</i>   <b>DOTNAME</b>   <b><u>NODOTNAME</u></b>   <b>EMULATOR</b>   <b><u>NOEMULATOR</u></b>   <b>EPILOGUE</b> : <i>macroId</i>   <b>EXPR16</b>   <b>EXPR32</b>   <b>LANGUAGE</b> : <i>langType</i>   <b><u>LJMP</u></b>   <b>NOLJMP</b>   <b>M510</b>   <b><u>NOM510</u></b>   <b>NOKEYWORD</b> : < <i>keywordList</i> >   <b>NOSIGNEXTEND</b>   <b>OFFSET</b> : <i>offsetType</i>   <b>OLDMACROS</b>   <b><u>NOOLDMACROS</u></b>   <b>OLDSTRUCTS</b>   <b><u>NOOLDSTRUCTS</u></b>   <b>PROC</b> : <i>oVisibility</i>   <b>PROLOGUE</b> : <i>macroId</i>   <b>READONLY</b>   <b><u>NOREADONLY</u></b>   <b><u>SCOPED</u></b>   <b>NOSCOPED</b>   <b>SEGMENT</b> : <i>segSize</i>   <b>SETIF2</b> : <i>bool</i>
<i>optionList</i>	<i>optionItem</i>   <i>optionList</i> , [ ; ] <i>optionItem</i>
<i>optText</i>	, <i>textItem</i>
<i>orOp</i>	<b>OR</b>   <b>XOR</b>
<i>oVisibility</i>	<b><u>PUBLIC</u></b>   <b>PRIVATE</b>   <b>EXPORT</b>
<i>pageDir</i>	<b>PAGE</b> [ [ <i>pageExpr</i> ] ] ;
<i>pageExpr</i>	+   [ [ <i>pageLength</i> ] [ , <i>pageWidth</i> ] ]
<i>pageLength</i>	<i>constExpr</i>
<i>pageWidth</i>	<i>constExpr</i>
<i>parm</i>	<i>parmlId</i> [ [ : <i>qualifiedType</i> ] ]   <i>parmlId</i> [ [ <i>constExpr</i> ] [ [ : <i>qualifiedType</i> ] ] ]
<i>parmlId</i>	<i>id</i>
<i>parmList</i>	<i>parm</i>   <i>parmList</i> , [ ; ] <i>parm</i>
<i>parmType</i>	<b>REQ</b>   = <i>textLiteral</i>   <b>VARARG</b>
<i>pOptions</i>	[ [ <i>distance</i> ] [ [ <i>langType</i> ] ] [ [ <i>oVisibility</i> ] ] ]
<i>primary</i>	<i>expr binaryOp expr</i>   <i>flagName</i>   <i>expr</i>



Nonterminal	Definition
<i>procDir</i>	<i>procId</i> <b>PROC</b> [[ <i>pOptions</i> ]] [[ < <i>macroArgList</i> > ]] [[ <i>usesRegs</i> ]] [[ <i>procParmList</i> ]]
<i>processor</i>	<b>.8086</b>   <b>.186</b>   <b>.286</b>   <b>.286C</b>   <b>.286P</b>   <b>.386</b>   <b>.386C</b>   <b>.386P</b>   <b>.486</b>   <b>.486P</b>
<i>processorDir</i>	<i>processor</i> ;;   <i>coprocessor</i> ;;
<i>procId</i>	<i>id</i>
<i>procParmList</i>	[[ , [[ ;; ]] <i>parmList</i> ]] [[ , [[ ;; ]] <i>parmId</i> : <b>VARARG</b> ]]
<i>protoArg</i>	[[ <i>id</i> ]] : <i>qualifiedType</i>
<i>protoArgList</i>	[[ , [[ ;; ]] <i>protoList</i> ]] [[ , [[ ;; ]] [[ <i>id</i> ]] : <b>VARARG</b> ]]
<i>protoList</i>	<i>protoArg</i>   <i>protoList</i> , [[ ;; ]] <i>protoArg</i>
<i>protoSpec</i>	[[ <i>distance</i> ]] [[ <i>langType</i> ]] [[ <i>protoArgList</i> ]]   <i>typeId</i>
<i>protoTypeDir</i>	<i>id</i> <b>PROTO</b> <i>protoSpec</i>
<i>pubDef</i>	[[ <i>langType</i> ]] <i>id</i>
<i>publicDir</i>	<b>PUBLIC</b> <i>pubList</i> ;;
<i>pubList</i>	<i>pubDef</i>   <i>pubList</i> , [[ ;; ]] <i>pubDef</i>
<i>purgeDir</i>	<b>PURGE</b> <i>macroIdList</i>
<i>qualifiedType</i>	<i>type</i>   [[ <i>distance</i> ]] <b>PTR</b> [[ <i>qualifiedType</i> ]]
<i>qualifier</i>	<i>qualifiedType</i>   <b>PROTO</b> <i>protoSpec</i>
<i>quote</i>	"   '
<i>radixDir</i>	<b>.RADIX</b> <i>constExpr</i> ;;
<i>radixOverride</i>	<b>h</b>   <b>l</b>   <b>q</b>   <b>t</b>   <b>y</b> <b>H</b>   <b>I</b>   <b>O</b>   <b>Q</b>   <b>T</b>   <b>Y</b>
<i>recordConst</i>	<i>recordTag</i> { <i>oldRecordFieldList</i> }   <i>recordTag</i> < <i>oldRecordFieldList</i> >
<i>recordDir</i>	<i>recordTag</i> <b>RECORD</b> <i>bitDefList</i> ;;
<i>recordFieldList</i>	[[ <i>constExpr</i> ]]   <i>recordFieldList</i> , [[ ;; ]] [[ <i>constExpr</i> ]]

Nonterminal	Definition
<i>recordInstance</i>	{ [[ ;; ]] <i>recordFieldList</i> [[ ;; ]] }   < <i>oldRecordFieldList</i> >   <i>constExpr</i> <b>DUP</b> ( <i>recordInstance</i> )
<i>recordInstList</i>	<i>recordInstance</i>   <i>recordInstList</i> , [[ ;; ]] <i>recordInstance</i>
<i>recordTag</i>	<i>id</i>
<i>register</i>	<i>specialRegister</i>   <i>gpRegister</i>   <i>byteRegister</i>
<i>regList</i>	<i>register</i>   <i>regList</i> <i>register</i>
<i>relOp</i>	<b>EQ</b>   <b>NE</b>   <b>LT</b>   <b>LE</b>   <b>GT</b>   <b>GE</b>
<i>repeatBlock</i>	<b>.REPEAT</b> ;; <i>blockStatements</i> ;; <i>untilDir</i> ;;
<i>repeatDir</i>	<b>REPEAT</b>   <b>REPT</b>
<i>scalarInstList</i>	<i>initValue</i>   <i>scalarInstList</i> , [[ ;; ]] <i>initValue</i>
<i>segAlign</i>	<b>BYTE</b>   <b>WORD</b>   <b>DWORD</b>   <b><u>PARA</u></b>   <b>PAGE</b>
<i>segAttrib</i>	<b>PUBLIC</b>   <b>STACK</b>   <b>COMMON</b>   <b>MEMORY</b>   <b>AT</b> <i>constExpr</i>   <b><u>PRIVATE</u></b>
<i>segDir</i>	<b>.CODE</b> [[ <i>segId</i> ]]   <b>.DATA</b>   <b>.DATA?</b>   <b>.CONST</b>   <b>.FARDATA</b> [[ <i>segId</i> ]]   <b>.FARDATA?</b> [[ <i>segId</i> ]]   <b>.STACK</b> [[ <i>constExpr</i> ]]
<i>segId</i>	<i>id</i>
<i>segIdList</i>	<i>segId</i>   <i>segIdList</i> , <i>segId</i>
<i>segmentDef</i>	<i>segmentDir</i> [[ <i>inSegDirList</i> ]] <i>endsDir</i>   <i>simpleSegDir</i> [[ <i>inSegDirList</i> ]] [[ <i>endsDir</i> ]]
<i>segmentDir</i>	<i>segId</i> <b>SEGMENT</b> [[ <i>segOptionList</i> ]] ;;
<i>segmentRegister</i>	<b>CS</b>   <b>DS</b>   <b>ES</b>   <b>FS</b>   <b>GS</b>   <b>SS</b>

Nonterminal	Definition
<i>segOption</i>	<i>segAlign</i>   <i>segRO</i>   <i>segAttrib</i>   <i>segSize</i>   <i>className</i>
<i>segOptionList</i>	<i>segOption</i>   <i>segOptionList segOption</i>
<i>segOrderDir</i>	<b>.ALPHA   .SEQ   .DOSSEG   DOSSEG</b>
<i>segRO</i>	<b>READONLY</b>
<i>segSize</i>	<b>USE16   USE32   FLAT</b>
<i>shiftOp</i>	<b>SHR   SHL</b>
<i>sign</i>	-   +
<i>simpleExpr</i>	( <i>cExpr</i> )   <i>primary</i>
<i>simpleSegDir</i>	<i>segDir</i> ;;
<i>sizeArg</i>	<i>id</i>   <i>type</i>   <i>e10</i>
<i>specialChars</i>	:   .   [   ]   (   )   <   >   {   }   +   -   /   *   &   %   !   '   \   =   ;   ,   "   <i>whiteSpaceCharacter</i>   <i>endOfLine</i>
<i>specialRegister</i>	CR0   CR2   CR3   DR0   DR1   DR2   DR3   DR6   DR7   TR3   TR4   TR5   TR6   TR7
<i>stackOption</i>	<b><u>NEARSTACK</u>   FARSTACK</b>
<i>startupDir</i>	<b>.STARTUP</b> ;;
<i>stext</i>	<i>stringChar</i>   <i>stext stringChar</i>
<i>string</i>	<i>quote</i> [ <i>stext</i> ] <i>quote</i>
<i>stringChar</i>	<i>quote quote</i>   Any character except <i>quote</i>
<i>structBody</i>	<i>structItem</i> ;;   <i>structBody structItem</i> ;;
<i>structDir</i>	<i>structTag structHdr</i> [ <i>fieldAlign</i> ] [ , NONUNIQUE ] ;; <i>structBody</i> <i>structTag ENDS</i> ;;
<i>structHdr</i>	<b>STRUC   STRUCT   UNION</b>

Nonterminal	Definition
<i>structInstance</i>	< [[ <i>fieldInitList</i> ] ] >   { [[ ;; ] ] [[ <i>fieldInitList</i> ] ] [[ ;; ] ] }   <i>constExpr</i> DUP ( <i>structInstList</i> )
<i>structInstList</i>	<i>structInstance</i>   <i>structInstList</i> , [[ ;; ] ] <i>structInstance</i>
<i>structItem</i>	<i>dataDir</i>   <i>generalDir</i>   <i>offsetDir</i>   <i>nestedStruct</i>
<i>structTag</i>	<i>id</i>
<i>term</i>	<i>simpleExpr</i>   ! <i>simpleExpr</i>
<i>text</i>	<i>textLiteral</i>   <i>text character</i>   ! <i>character text</i>   <i>character</i>   ! <i>character</i>
<i>textDir</i>	<i>id textMacroDir</i> ;;
<i>textItem</i>	<i>textLiteral</i>   <i>textMacroId</i>   % <i>constExpr</i>
<i>textLen</i>	<i>constExpr</i>
<i>textList</i>	<i>textItem</i>   <i>textList</i> , [[ ;; ] ] <i>textItem</i>
<i>textLiteral</i>	< <i>text</i> >;
<i>textMacroDir</i>	CATSTR [[ <i>textList</i> ] ]   TEXTEQU [[ <i>textList</i> ] ]   SIZESTR <i>textItem</i>   SUBSTR <i>textItem</i> , <i>textStart</i> [[ , <i>textLen</i> ] ]   INSTR [[ <i>textStart</i> , ] ] <i>textItem</i> , <i>textItem</i>
<i>textMacroId</i>	<i>id</i>
<i>textStart</i>	<i>constExpr</i>
<i>titleDir</i>	<i>titleType arbitraryText</i> ;;
<i>titleType</i>	TITLE   SUBTITLE   SUBTTL
<i>type</i>	<i>structTag</i>   <i>unionTag</i>   <i>recordTag</i>   <i>distance</i>   <i>dataType</i>   <i>typeId</i>
<i>typedefDir</i>	<i>typeId TYPEDEF qualifier</i>

<b>Nonterminal</b>	<b>Definition</b>
<i>typeId</i>	<i>id</i>
<i>unionTag</i>	<i>id</i>
<i>untilDir</i>	<b>.UNTIL</b> <i>cExpr</i> ;; <b>.UNTILCXZ</b> [[ <i>cxzExpr</i> ] ] ;;
<i>usesRegs</i>	<b>USES</b> <i>regList</i>
<i>whileBlock</i>	<b>.WHILE</b> <i>cExpr</i> ;; <i>blockStatements</i> ;; <b>.ENDW</b>
<i>whiteSpaceCharacter</i>	ASCII 8, 9, 11–13, 26, 32

# Generating and Reading Assembly Listings

A listing file shows precisely how the assembler translates your source file into machine code. The listing documents the assembler's assumptions, memory allocations, and optimizations.

MASM creates an assembly listing of your source file whenever you do one of the following:

- Select the appropriate option in PWB.
- Use one of the related source code directives.
- Specify the /Fl option on the MASM command line.

The assembly listing contains both the statements in the source file and the binary code (if any) generated for each statement. The listing also shows the names and values of all labels, variables, and symbols in your file.

The assembler creates tables for macros, structures, unions, records, segments, groups, and other symbols, and places the tables at the end of the assembly listing. Only the types of symbols encountered in the program are included. For example, if your program has no macros, the symbol table does not have a macros section.

## Generating Listing Files

To generate a listing file from within PWB, follow these steps:

1. From the Options menu, choose MASM Options.
2. In the MASM Options dialog box, choose Set Debug or Release Options.

The dialog box for Set Debug or Release Options lists the choices summarized in Table C.1. This table also shows the equivalent source code directives and command-line options.

Table C.1 Options for Generating or Modifying Listing Files

To generate this information:	In PWB <sup>1</sup> , select:	In source code, enter:	From command line, enter:
Default listing — includes all assembled lines	Generate Listing File	<b>.LIST</b> (default)	/Fl
Turn off all source listings (overrides all listing directives)	Generate Listing File (turn off)	<b>.NOLIST</b> (synonym = <b>.SFCOND</b> )	—
List all source lines, including false conditionals and generated code	Include All Source Lines	<b>.LISTALL</b>	/Fl /Sa
Show instruction timings	List Instruction Timings	—	/Fl /Sc
Show assembler-generated code	List Generated Instructions	—	/Fl /Sg
Include false conditionals <sup>2</sup>	List False Conditionals	<b>.LISTIF</b> (synonym = <b>.LFCOND</b> )	/Fl /Sx
Suppress listing of any subsequent conditional blocks whose condition is false	List False Conditionals (turn off)	<b>.NOLISTIF</b> (synonym = <b>.SFCOND</b> )	—
Toggle between <b>.LISTIF</b> and <b>.NOLISTIF</b>	—	<b>.TFCOND</b>	—
Suppress symbol table generation	Generate Symbol Table (turn off the default)	—	/Fl /Sn
List all processed macro statements	—	<b>.LISTMACROALL</b> (synonym = <b>.LALL</b> )	—
List only instructions, data, and segment directives in macros	—	<b>.LISTMACRO</b> (default) (synonym = <b>.XALL</b> )	—
Turn off all listing during macro expansion	—	<b>.NOLISTMACRO</b> (synonym = <b>.SALL</b> )	—
Specify title for each page (use only once per file)	—	<b>TITLE</b> <i>name</i>	/St <i>name</i>
Specify subtitle for page	—	<b>SUBTITLE</b> <i>name</i>	/Ss <i>name</i>
Designate page length and line width, increment section number, or generate page breaks	—	<b>PAGE</b> [[ <i>length,width</i> ]][[+]]	/Sp <i>length</i> /Sl <i>width</i>
Generate first-pass listing	—	—	/Ep

<sup>1</sup> Select MASM Options from the Options menu, then choose Set Dialog Options from the MASM Options dialog box.

<sup>2</sup> See “Conditional Directives” in Chapter 1

## Precedence of Command-Line Options and Listing Directives

Since command-line options and source code directives can specify opposite behavior for the same listing file option, the assembler interprets the commands according to the following precedence levels. Selecting PWB options is equivalent to specifying `/Fl /Sx` on the command line:

- `/Sa` overrides any source code directives that suppress listing.
- Source code directives override all command-line options except `/Sa`.
- `.NOLIST` overrides other listing directives such as `.NOLISTIF` and `.LISTMACROALL`.
- The `/Sx`, `/Ss`, `/Sp`, and `/Sl` options set initial values for their respective features. Directives in the source file can override these command-line options.

## Reading the Listing File

The first half of the listing shows macros from the include file `DOS.MAC`, structure declarations, and data. After the `.DATA` directive, the columns on the left show offsets and initialized byte values within the data segment.

Instructions begin after the `.CODE` directive. The three columns on the left show offsets, instruction timings, and binary code generated by the assembler. The columns on the right list the source statements exactly as they appear in the source file or as expanded by a macro. Various symbols and abbreviations in the middle column provide information about the code, as explained in the following section. The subsequent section, “Symbols and Abbreviations,” explains the meanings of listing symbols.

## Generated Code

The assembler lists the code generated from the statements of a source file. With the `/Sc` command-line switch, which generates instruction timings, each line has this syntax:

```
offset [timing] [code]
```

The *offset* is the offset from the beginning of the current code segment. The *timing* shows the number of cycles the processor needs to execute the instruction. The value of *timing* reflects the CPU type; for example, specifying the `.386` directive produces instruction timings for the 80386 processor. If the statement generates code or data, *code* shows the numeric value in hexadecimal notation if the value is known at assembly time. If the value is calculated at run time, the assembler indicates what action is necessary to compute the value.



When assembling under the default **.8086** directive, *timing* includes an effective address value if the instruction accesses memory. The 80186/486 processors do not use effective address values. For more information on effective address timing, see the “Processor” section in the *Reference* book.

## Error Messages

If any errors occur during assembly, each error message and error number appears directly below the statement where the error occurred. An example of an error line and message is:

```
mov     ax, [dx][di]
listst.asm(77): error A2031: must be index or base register
```

## Symbols and Abbreviations

The assembler uses the symbols and abbreviations shown in Table C.2 to indicate addresses that need to be resolved by the linker or values that were generated in a special way. The example in this section illustrates many of these symbols.

The example listing was produced using “List Generated Instructions” and “List Instruction Timings” in PWB. These options correspond to the ML command-line switches /Fl /Sg /Sc.

**Table C.2** Symbols and Abbreviations in Listings

Character	Meaning
C	Line from include file
=	EQU or equal-sign (=) directive
nn[xx]	DUP expression: nn copies of the value xx
----	Segment/group address (linker must resolve)
R	Relocatable address (linker must resolve)
*	Assembler-generated code
E	External address (linker must resolve)
n	Macro-expansion nesting level (+ if more than 9)
l	Operator size override
&	Address size override
nn:	Segment override in statement
nn/	REP or LOCK prefix instruction

Table C.3 explains the five symbols that may follow timing values in your listing. The *Reference* book will help you determine correct timings for those values marked with a symbol.

Table C.3 Symbols in Timing Column

Symbol	Meaning
m	Add cycles depending on next executed instruction.
n	Add cycles depending on number of iterations or size of data.
p	Different timing value in protected mode.
+	Add cycles depending on operands or combination of the preceding.
,	Separates two values for “jump taken” and “jump not taken.”

Microsoft (R) Macro Assembler Version 6.10 09/20/00 12:00:00  
listst.asm

Page 1 - 1

```

                                .MODEL small, c
                                .386
                                .DOSSEG
                                .STACK 256
                                INCLUDE dos.mac
C StrDef MACRO name1, text
C name1 BYTE &text
C       BYTE 13d, 10d, '$'
C l&name1 EQU LENGTHOF name1
C       ENDM
C
C Display MACRO string
C       mov ah, 09h
C       mov dx, OFFSET string
C       int 21h
C       ENDM
- 0020 num EQU 20h
COLOR RECORD b:1, r:3=1, i:1=1, f:3=7
value TEXTEQU %3 + num
tnum TEXTEQU %num
strpos TEXTEQU @InStr( , <person>,
<son> )

PutStr PROTO pMsg:PTR BYTE

0004 DATE STRUCT
0000 01 month BYTE 1
0001 01 day BYTE 1
0002 0000 year WORD ?
DATE ENDS

```

```

0002                                U1    UNION
0000 0028                            fsize WORD    40
                                       bsize BYTE    60
                                       U1    ENDS

0000                                .DATA

0000 00000000                        ddData  DWORD    ?
0004 1F                               text    COLOR   <>
0005 01 14 07C9                       today   DATE    <01, 20, 1993>
0009 00                               flag    BYTE    0
000A      001E [                       buffer  WORD    30 DUP (0)
      0000
      ]

                                StrDef  ending, "Finished."
0046 46 69 6E 69 73 68                1  ending  BYTE    "Finished."
      65 64 2E

004F 0D 0A 24                          1          BYTE    13d, 10d, '$'
= 0009                                1  ending  EQU    LENGTHOF ending
0052 54 68 69 73 20 69                Msg      BYTE    "This is a
string", "0"
      73 20 61 20
      73 74 72 69
      6E 67 30

                                float  TYPEDEF    REAL4
0063 ---- 0052 R                      FPBYTE  TYPEDEF  FAR    PTR BYTE
                                       FPMSG   FPBYTE
                                       PBYTE  TYPEDEF    PTR BYTE
                                       NPWORD  TYPEDEF  NEAR   PTR WORD
                                       PVOID  TYPEDEF    PTR
                                       PPBYTE  TYPEDEF    PTR PBYTE

0000                                .CODE
                                .STARTUP

0000                                *@Startup:
0000 2 B8 ---- R                       *      mov    ax, DGROUP
0003 2p 8E D8                          *      mov    ds, ax
0005 2 8C D3                            *      mov    bx, ss
0007 2 2B D8                            *      sub    bx, ax
0009 3 C1 E3 04                         *      shl   bx, 004h
000C 2p 8E D0                          *      mov    ss, ax
000E 2 03 E3                            *      add   sp, bx

                                EXTERNDEF  work:NEAR
0010 7m E8 0000 E                       call   work

```

```

                                INVOKE PutStr, ADDR msg
0013  2  68 0052 R  *      push  OFFSET Msg
0016  7m E8 0029  *      call  PutStr
0019  2  83 C4 02  *      add   sp, 00002h

001C  2  B8 ---- R      mov   ax, @data
001F  2p  8E C0      mov   es, ax
0021  2  B0 63      mov   al, 'c'
0023  4  26: 8B 0E      mov   cx, es:num
                                0020
0028  2  BF 0052      mov   di, 82
002B  7n F2/ AE      repne scasb
002D  4  66| A1 0000 R  mov   eax, ddData
0031  6  67& FE 03      inc   BYTE PTR [ebx]

                                EXTERNDEF      morework:NEAR
0034  7m E8 0000 E      call  morework

                                Display ending
0037  2  B4 09      1     mov   ah, 09h
0039  2  BA 0046 R  1     mov   dx, OFFSET ending
003C  37 CD 21      1     int   21h

                                .EXIT
003E  2  B4 4C      *     mov   ah, 04Ch
0040  37 CD 21      *     int   021h

0042                                PutStr PROC      pMsg:PTR BYTE

0042  2  55      *     push  bp
0043  4  8B EC      *     mov   bp, sp
0045  2  B4 02      mov   ah, 02H
0047  4  8B 7E 04      mov   di, pMsg
004A  4  8A 15      mov   dl, [di]
                                mov   ax, [dx][di]

listst.asm(77): error A2031: must be index or base register

                                .WHILE (dl)
004C  7m EB 10      *     jmp   @C0001
0059                                *@C0002:
0059  37 CD 21      int   21h
005B  2  47      inc   di
005C  4  8A 15      mov   dl, [di]
                                .ENDW
005E                                *@C0001:
005E  2  0A D2      *     or   dl, dl
0060  7m,3 75 F7      *     jne  @C0002

```

```

                                ret
0062  4  5D          *      pop   bp
0063  10m C3       *      ret   00000h
0064                                     PutStr ENDP

                                END

```

## Reading Tables in a Listing File

The tables at the end of a listing file list the macros, structures, unions, records, segments, groups, and symbols that appear in a source file. These tables are not printed in the previous sample listing, but are summarized as follows.

### Macro Table

Lists all macros in the main file or the include files. Differentiates between macro functions and macro procedures.

### Structures and Unions Table

Provides the size in bytes of the structure or union and the offset of each field. The type of each field is also given.

### Record Table

“Width” gives the number of bits of the entire record. “Shift” provides the offset in bits from the low-order bit of the record to the low-order bit of the field. “Width” for fields gives the number of bits in the field. “Mask” gives the maximum value of the field, expressed in hexadecimal notation. “Initial” gives the initial value supplied for the field.

### Type Table

The “Size” column in this table gives the size of the **TYPEDEF** type in bytes, and the “Attr” column gives the base type for the **TYPEDEF** definition.

### Segment and Group Table

“Size” specifies whether the segment is 16 bit or 32 bit. “Length” gives the size of the segment in bytes. “Align” gives the segment alignment (**WORD**, **PARA**, and so on). “Combine” gives the combine type (**PUBLIC**, **STACK**, and so on). “Class” gives the segment’s class (**CODE**, **DATA**, **STACK**, or **CONST**).

### Procedures, Parameters, and Locals

Gives the types and offsets from BP of all parameters and locals defined in each procedure, as well as the size and memory location of each procedure.

## Symbol Table

All symbols (except names for macros, structures, unions, records, and segments) are listed in a symbol table at the end of the listing. The “Name” column lists the names in alphabetical order. The “Type” column lists each symbol’s type.

The length of a multiple-element variable, such as an array or string, is the length of a single element, not the length of the entire variable.

If the symbol represents an absolute value defined with an **EQU** or equal sign (=) directive, the “Value” column shows the symbol’s value. The value may be another symbol, a string, or a constant numeric value (in hexadecimal), depending on the type. If the symbol represents a variable or label, the “Value” column shows the symbol’s hexadecimal offset from the beginning of the segment in which it is defined.

The “Attr” column shows the attributes of the symbol. The attributes include the name of the segment (if any) in which the symbol is defined, the scope of the symbol, and the code length. A symbol’s scope is given only if the symbol is defined using the **EXTERN** and **PUBLIC** directives. The scope can be external, global, or communal. The “Attr” column is blank if the symbol has no attribute.



# MASM Reserved Words

This appendix lists the reserved words recognized by MASM. They are divided primarily by their use in the language. The primary categories are:

- Operands and symbols
- Registers
- Operators and directives
- Processor instructions
- Coprocessor instructions

Reserved words in MASM 6.1 are reserved under all CPU modes. Words enabled in **.8086** mode, the default, can be used in all higher CPU modes. To use words from subcategories such as “Special Operands for the 80386” (later in this appendix) requires **.386** mode or higher.

You can disable the recognition of any reserved word specified in this appendix by setting the **NOKEYWORD** option for the **OPTION** directive. Once disabled, the word can be used in any way as a user-defined symbol (provided the word is a valid identifier). If you want to remove the **STR** instruction, the **MASK** operator, and the **NAME** directive, for instance, from the set of words MASM recognizes as reserved, add this statement to your program:

```
OPTION NOKEYWORD:<STR MASK NAME>
```

Words in this appendix identified with an asterisk (\*) are new since MASM 5.1.

## Operands and Symbols

The words on the two lists in this section are the operands to certain directives. They have special meaning to the assembler. The words on the first list are not reserved words. They can be used in every way as normal identifiers, without affecting their use as operands to directives. The assembler interprets their use from context.



Even though the words on the first list are not reserved, they should not be defined to be text macros or text macro functions. If they are, they will not be recognized in their special contexts. The assembler does not give a warning if such a redefinition occurs.

<b>ABS</b>	<b>LARGE</b>	<b>NOTHING</b>
<b>ALL</b>	<b>LISTING*</b>	<b>NOTPUBLIC*</b>
<b>ASSUMES</b>	<b>LJMP*</b>	<b>OLDMACROS*</b>
<b>AT</b>	<b>LOADDS*</b>	<b>OLDSTRUCTS*</b>
<b>CASEMAP*</b>	<b>M510*</b>	<b>OS_DOS*</b>
<b>COMMON</b>	<b>MEDIUM</b>	<b>PARA</b>
<b>COMPACT</b>	<b>MEMORY</b>	<b>PRIVATE*</b>
<b>CPU*</b>	<b>NEARSTACK*</b>	<b>PROLOGUE*</b>
<b>DOTNAME*</b>	<b>NODOTNAME*</b>	<b>RADIX*</b>
<b>EMULATOR*</b>	<b>NOEMULATOR*</b>	<b>READONLY*</b>
<b>EPILOGUE*</b>	<b>NOKEYWORD*</b>	<b>REQ*</b>
<b>ERROR*</b>	<b>NOLJMP*</b>	<b>SCOPED*</b>
<b>EXPORT*</b>	<b>NOM510*</b>	<b>SETIF2*</b>
<b>EXPR16*</b>	<b>NONE</b>	<b>SMALL</b>
<b>EXPR32*</b>	<b>NONUNIQUE*</b>	<b>STACK</b>
<b>FARSTACK*</b>	<b>NOOLDMACROS*</b>	<b>TINY</b>
<b>FLAT</b>	<b>NOOLDSTRUCTS*</b>	<b>USE16</b>
<b>FORCEFRAME</b>	<b>NOREADONLY*</b>	<b>USE32</b>
<b>HUGE</b>	<b>NOSCOPED*</b>	<b>USES</b>
<b>LANGUAGE*</b>	<b>NOSIGNEXTEND*</b>	

These operands are reserved words. Reserved words are not case sensitive.

<b>\$</b>	<b>DWORD</b>	<b>PASCAL</b>
<b>?</b>	<b>FAR</b>	<b>QWORD</b>
<b>@B</b>	<b>FAR16*</b>	<b>REAL4*</b>
<b>@F</b>	<b>FORTTRAN</b>	<b>REAL8*</b>
<b>ADDR*</b>	<b>FWORD</b>	<b>REAL10*</b>
<b>BASIC</b>	<b>NEAR</b>	<b>SBYTE*</b>
<b>BYTE</b>	<b>NEAR16*</b>	<b>SDWORD*</b>
<b>C</b>	<b>OVERFLOW?*</b>	<b>SIGN?*</b>
<b>CARRY?*</b>	<b>PARITY?*</b>	<b>STDCALL*</b>

<b>SWORD*</b>	<b>TBYTE</b>	<b>WORD</b>
<b>SYSCALL*</b>	<b>VARARG*</b>	<b>ZERO?*</b>

## Special Operands for the 80386/486

<b>FLAT*</b>	<b>NEAR32*</b>	<b>FAR32*</b>
--------------	----------------	---------------

## Predefined Symbols

Unlike most MASM reserved words, predefined symbols are case sensitive.

<b>@CatStr*</b>	<b>@Environ*</b>	<b>@Model*</b>
<b>@code</b>	<b>@fardata</b>	<b>@SizeStr*</b>
<b>@CodeSize</b>	<b>@fardata?</b>	<b>@stack*</b>
<b>@Cpu</b>	<b>@FileCur*</b>	<b>@SubStr*</b>
<b>@CurSeg</b>	<b>@FileName</b>	<b>@Time*</b>
<b>@data</b>	<b>@InStr*</b>	<b>@Version</b>
<b>@DataSize</b>	<b>@Interface*</b>	<b>@WordSize</b>
<b>@Date*</b>	<b>@Line*</b>	

## Registers

<b>AH</b>	<b>CS</b>	<b>DX</b>	<b>SI</b>
<b>AL</b>	<b>CX</b>	<b>EAX</b>	<b>SP</b>
<b>AX</b>	<b>DH</b>	<b>EBP</b>	<b>SS</b>
<b>BH</b>	<b>DI</b>	<b>EBX</b>	<b>ST</b>
<b>BL</b>	<b>DL</b>	<b>ECX</b>	<b>TR3*</b>
<b>BP</b>	<b>DR0</b>	<b>EDI</b>	<b>TR4*</b>
<b>BX</b>	<b>DR1</b>	<b>EDX</b>	<b>TR5*</b>
<b>CH</b>	<b>DR2</b>	<b>ES</b>	<b>TR6</b>
<b>CL</b>	<b>DR3</b>	<b>ESI</b>	<b>TR7</b>
<b>CR0</b>	<b>DR6</b>	<b>ESP</b>	
<b>CR2</b>	<b>DR7</b>	<b>FS</b>	
<b>CR3</b>	<b>DS</b>	<b>GS</b>	

## Operators and Directives

.186	.ERRDIFI	.TYPE
.286	.ERRE	.UNTIL*
.286C	.ERRIDN	.UNTILCXZ*
.286P	.ERRIDNI	.WHILE*
.287	.ERRNB	.XALL
.386	.ERRNDEF	.XCREF
.386C	.ERRNZ	.XLIST
.386P	.EXIT*	ALIAS*
.387	.FARDATA	ALIGN
.486*	.FARDATA?	ASSUME
.486P*	.IF*	CATSTR
.8086	.LALL	COMM
.8087	.LFCOND	COMMENT
.ALPHA	.LIST	DB
.BREAK*	.LISTALL*	DD
.CODE	.LISTIF*	DF
.CONST	.LISTMACRO*	DOSSEG
.CONTINUE*	.LISTMACROALL*	DQ
.CREF	.MODEL	DT
.DATA	.NO87*	DUP
.DATA?	.NOCREF*	DW
.DOSSEG*	.NOLIST*	ECHO*
.ELSE*	.NOLISTIF*	ELSE
.ELSEIF*	.NOLISTMACRO*	ELSEIF
.ENDIF*	.RADIX	ELSEIF1
.ENDW*	.REPEAT*	ELSEIF2
.ERR	.SALL	ELSEIFB
.ERR1	.SEQ	ELSEIFDEF
.ERR2	.SFCOND	ELSEIFDIF
.ERRB	.STACK	ELSEIFDIFI
.ERRDEF	.STARTUP*	ELSEIFE
.ERRDIF	.TFCOND	ELSEIFIDN

ELSEIFIDNI	IFIDN	POPCONTEXT*
ELSEIFNB	IFIDNI	PROC
ELSEIFNDEF	IFNB	PROTO*
END	IFNDEF	PTR
ENDIF	INCLUDE	PUBLIC
ENDM	INCLUDELIB	PURGE
ENDP	INSTR	PUSHCONTEXT*
ENDS	INVOKE*	RECORD
EQ	IRP	REPEAT*
EQU	IRPC	REPT
EVEN	LABEL	SEG
EXITM	LE	SEGMENT
EXTERN*	LENGTH	SHORT
EXTERNDEF*	LENGTHOF*	SIZE
EXTRN	LOCAL	SIZEOF*
FOR*	LOW	SIZESTR
FORC*	LOWWORD*	STRUC
GE	LROFFSET*	STRUCT*
GOTO*	LT	SUBSTR
GROUP	MACRO	SUBTITLE*
GT	MASK	SUBTTL
HIGH	MOD	TEXTEQU*
HIGHWORD*	.MSFLOAT	THIS
IF	NAME	TITLE
IF1	NE	TYPE
IF2	OFFSET	TYPEDEF*
IFB	OPATTR*	UNION*
IFDEF	OPTION*	WHILE*
IFDIF	ORG	WIDTH
IFDIFI	%OUT	
IFE	PAGE	

## Processor Instructions

Processor instructions are not case sensitive.

## 8086/8088 Processor Instructions

AAA	JB	LES
AAD	JBE	LODS
AAM	JC	LODSB
AAS	JCXZ	LODSW
ADC	JE	LOOP
ADD	JG	LOOPE
AND	JGE	LOOPEW*
CALL	JL	LOOPNE
CBW	JLE	LOOPNEW*
CLC	JMP	LOOPNZ
CLD	JNA	LOOPNZW*
CLI	JNAE	LOOPW*
CMC	JNB	LOOPZ
CMP	JNBE	LOOPZW*
CMPS	JNC	MOV
CMPSB	JNE	MOVS
CMPSW	JNG	MOVSB
CWD	JNGE	MOVSW
DAA	JNL	MUL
DAS	JNLE	NEG
DEC	JNO	NOP
DIV	JNP	NOT
ESC	JNS	OR
HLT	JNZ	OUT
IDIV	JO	POP
IMUL	JP	POPF
IN	JPE	PUSH
INC	JPO	PUSHF
INT	JS	RCL
INTO	JZ	RCR
IRET	LAHF	RET
JA	LDS	RETF
JAE	LEA	RETN

ROL	SCASW	STOSW
ROR	SHL	SUB
SAHF	SHR	TEST
SAL	STC	WAIT
SAR	STD	XCHG
SBB	STI	XLAT
SCAS	STOS	XLATB
SCASB	STOSB	XOR

### 80186 Processor Instructions

BOUND	INSW	OUTSW
ENTER	LEAVE	POPA
INS	OUTS	PUSHA
INSB	OUTSB	PUSHW*

### 80286 Processor Instructions

ARPL	SIDT	VERR
LAR	SLDT	VERW
LSL	SMSW	
SGDT	STR	

### 80286 and 80386 Privileged-Mode Instructions

CLTS	LIDT	LMSW
LGDT	LLDT	LTR

### 80386 Processor Instructions

BSF	CMPSD	LFS
BSR	CWDE	LGS
BT	INSD	LODSD
BTC	IRETD	LOOPD*
BTR	IRETDF*	LOOPED*
BTS	IRETF*	LOOPNED*
CDQ	JECXZ	LOOPNZD*

LOOPZD*	SETBE	SETNL
LSS	SETC	SETNLE
MOVSD	SETE	SETNO
MOVSX	SETG	SETNP
MOVZX	SETGE	SETNS
OUTSD	SETL	SETNZ
POPAD	SETLE	SETO
POPFD	SETNA	SETP
PUSHAD	SETNAE	SETPE
PUSHD*	SETNB	SETPO
PUSHFD	SETNBE	SETS
SCASD	SETNC	SETZ
SETA	SETNE	SHLD
SETAE	SETNG	SHRD
SETB	SETNGE	STOSD

## 80486 Processor Instructions

BSWAP*	INVD*	WBINVD*
CMPXCHG*	INVLPG*	XADD*

## Instruction Prefixes

LOCK	REPE	REPZ
REP	REPNE	REPZ

## Coprocessor Instructions

Coprocessor instructions are not case sensitive.

## 8087 Coprocessor Instructions

F2XM1	FBSTP	FCOMPP
FABS	FCHS	FDECSTP
FADD	FCLEX	FDISI
FADDP	FCOM	FDIV
FBLD	FCOMP	FDIVP

<b>FDIVR</b>	<b>FLDL2T</b>	<b>FRSTORW*</b>
<b>FDIVRP</b>	<b>FLDLG2</b>	<b>FSAVE</b>
<b>FENI</b>	<b>FLDLN2</b>	<b>FSAVEW*</b>
<b>FFREE</b>	<b>FLDPI</b>	<b>FSCALE</b>
<b>FIADD</b>	<b>FLDZ</b>	<b>FSQRT</b>
<b>FICOM</b>	<b>FMUL</b>	<b>FST</b>
<b>FICOMP</b>	<b>FMULP</b>	<b>FSTCW</b>
<b>FIDIV</b>	<b>FNCLEX</b>	<b>FSTENV</b>
<b>FIDIVR</b>	<b>FNDISI</b>	<b>FSTENVW*</b>
<b>FILD</b>	<b>FNENI</b>	<b>FSTP</b>
<b>FIMUL</b>	<b>FNINIT</b>	<b>FSTSW</b>
<b>FINCSTP</b>	<b>FNOP</b>	<b>FSUB</b>
<b>FINIT</b>	<b>FNSAVE</b>	<b>FSUBP</b>
<b>FIST</b>	<b>FNSAVEW*</b>	<b>FSUBR</b>
<b>FISTP</b>	<b>FNSTCW</b>	<b>FSUBRP</b>
<b>FISUB</b>	<b>FNSTENV</b>	<b>FTST</b>
<b>FISUBR</b>	<b>FNSTENVW*</b>	<b>FWAIT</b>
<b>FLD</b>	<b>FNSTSW</b>	<b>FXAM</b>
<b>FLD1</b>	<b>FPATAN</b>	<b>FXCH</b>
<b>FLDCW</b>	<b>FPREM</b>	<b>EXTRACT</b>
<b>FLDENV</b>	<b>FPTAN</b>	<b>FYL2X</b>
<b>FLDENVW*</b>	<b>FRNDINT</b>	<b>FYL2XP1</b>
<b>FLDL2E</b>	<b>FRSTOR</b>	

## 80287 Privileged-Mode Instruction

**FSETPM**

## 80387 Instructions

<b>FCOS</b>	<b>FRSTORD*</b>	<b>FUCOM</b>
<b>FLDENVD*</b>	<b>FSAVED*</b>	<b>FUCOMP</b>
<b>FNSAVED*</b>	<b>FSIN</b>	<b>FUCOMPP</b>
<b>FNSTENVVD*</b>	<b>FSINCOS</b>	
<b>FPREM1</b>	<b>FSTENVVD*</b>	





## Default Segment Names

If you use simplified segment directives by themselves, you do not need to know the names assigned for each segment. However, it is possible to mix full segment definitions with simplified segment directives, in which case you need to know the segment names.

Table E.1 shows the default segment names created by each directive.

If you use **.MODEL**, a **\_TEXT** segment is always defined, even if all **.CODE** directives specify a name. The default segment name used as part of far-code segment names is the filename of the module. The default name associated with the **.CODE** directive can be overridden, as can the default names for **.FARDATA** and **.FARDATA?**.

The segment and group table at the end of listings always shows the actual segment names. However, the **GROUP** and **ASSUME** statements generated by the **.MODEL** directive are not shown in listing files. For a program that uses all possible segments, group statements equivalent to the following would be generated:

```
DGROUP      GROUP      _DATA, CONST, _BSS, STACK
```

For the tiny model, these **ASSUME** statements would be generated:

```
ASSUME      cs:DGROUP, ds:DGROUP, ss:DGROUP
```

For small and compact models with **NEARSTACK**, these **ASSUME** statements would be generated:

```
ASSUME      cs: _TEXT, ds:DGROUP, ss:DGROUP
```

For medium, large, and huge models with **NEARSTACK**, these **ASSUME** statements would be generated:

```
ASSUME cs:name_TEXT, ds:DGROUP, ss:DGROUP
```

**Table E.1** Default Segments and Types for Standard Memory Models

Model	Directive	Name	Align	Combine	Class	Group
Tiny	.CODE	_TEXT	WORD	PUBLIC	'CODE'	DGROUP
	.FARDATA	FAR_DATA	PARA	PRIVATE	'FAR_DATA'	
	.FARDATA?	FAR_BSS	PARA	PRIVATE	'FAR_BSS'	
	.DATA	_DATA	WORD	PUBLIC	'DATA'	DGROUP
	.CONST	CONST	WORD	PUBLIC	'CONST'	DGROUP
	.DATA?	_BSS	WORD	PUBLIC	'BSS'	DGROUP
Small	.CODE	_TEXT	WORD	PUBLIC	'CODE'	
	.FARDATA	FAR_DATA	PARA	PRIVATE	'FAR_DATA'	
	.FARDATA?	FAR_BSS	PARA	PRIVATE	'FAR_BSS'	
	.DATA	_DATA	WORD	PUBLIC	'DATA'	DGROUP
	.CONST	CONST	WORD	PUBLIC	'CONST'	DGROUP
	.DATA?	_BSS	WORD	PUBLIC	'BSS'	DGROUP
	.STACK	STACK	PARA	STACK	'STACK'	DGROUP*
Medium	.CODE	<i>name_TEXT</i>	WORD	PUBLIC	'CODE'	
	.FARDATA	FAR_DATA	PARA	PRIVATE	'FAR_DATA'	
	.FARDATA?	FAR_BSS	PARA	PRIVATE	'FAR_BSS'	
	.DATA	_DATA	WORD	PUBLIC	'DATA'	DGROUP
	.CONST	CONST	WORD	PUBLIC	'CONST'	DGROUP
	.DATA?	_BSS	WORD	PUBLIC	'BSS'	DGROUP
	.STACK	STACK	PARA	STACK	'STACK'	DGROUP*
Compact	.CODE	_TEXT	WORD	PUBLIC	'CODE'	
	.FARDATA	FAR_DATA	PARA	PRIVATE	'FAR_DATA'	
	.FARDATA?	FAR_BSS	PARA	PRIVATE	'FAR_BSS'	
	.DATA	_DATA	WORD	PUBLIC	'DATA'	DGROUP
	.CONST	CONST	WORD	PUBLIC	'CONST'	DGROUP
	.DATA?	_BSS	WORD	PUBLIC	'BSS'	DGROUP
	.STACK	STACK	PARA	STACK	'STACK'	DGROUP*

Table E.1 (continued)

Model	Directive	Name	Align	Combine	Class	Group
Large or huge	.CODE	<i>name</i> _TEXT	WORD	PUBLIC	'CODE'	
	.FARDATA	FAR_DATA	PARA	PRIVATE	'FAR_DATA'	
	.FARDATA?	FAR_BSS	PARA	PRIVATE	'FAR_BSS'	
	.DATA	_DATA	WORD	PUBLIC	'DATA'	DGROUP
	.CONST	CONST	WORD	PUBLIC	'CONST'	DGROUP
	.DATA?	_BSS	WORD	PUBLIC	'BSS'	DGROUP
	.STACK	STACK	PARA	STACK	'STACK'	DGROUP*
Flat	.CODE	_TEXT	DWORD	PUBLIC	'CODE'	
	.FARDATA	_DATA	DWORD	PUBLIC	'DATA'	
	.FARDATA?	_BSS	DWORD	PUBLIC	'BSS'	
	.DATA	_DATA	DWORD	PUBLIC	'DATA'	
	.CONST	CONST	DWORD	PUBLIC	'CONST'	
	.DATA?	_BSS	DWORD	PUBLIC	'BSS'	
	.STACK	STACK	DWORD	PUBLIC	'STACK'	

\* unless the stack type is FARSTACK



# Glossary

**8087, 80287, or 80387 coprocessor** Intel chips that perform high-speed floating-point and binary coded decimal number processing. Also called math coprocessors. Floating-point instructions are supported directly by the 80486 processor.

## A

**address** The memory location of a data item or procedure. The expression can represent just the offset (in which case the default segment is assumed), or it can be in *segment:offset* format.

**address constant** In an assembly-language instruction, an immediate operand derived by applying the **SEG** or **OFFSET** operator to an identifier.

**address range** A range of memory bounded by two addresses.

**addressing modes** The various ways a memory address or device I/O address can be generated. See “far address,” “near address.”

**aggregate types** Data types containing more than one element, such as arrays, structures, and unions.

**animate** A debugging feature in which each line in a running program is highlighted as it executes. The Animate command from the CodeView debugger Run menu turns on animation.

**API (application programming interface)** A set of system-level routines that can be used in an application program for tasks such as basic input/output and file management. In a graphics-oriented operating environment like Microsoft Windows, high-level support for video graphics output is part of the Windows graphical API.

**arg** In PWB, a function modifier that introduces an argument or an editing function. The argument may be of any type and is passed to the next function as input. For example, the PWB command `Arg textarg Copy` passes the text argument `textarg` to the function `Copy`.

**argument** A value passed to a procedure or function. See “parameter.”

**array** An ordered set of continuous elements of the same type.

**ASCII (American Standard Code for Information Interchange)** A widely used coding scheme where 1-byte numeric values represent letters, numbers, symbols, and special characters. There are 256 possible codes. The first 128 codes are standardized; the remaining 128 are special characters defined by the computer manufacturer.

**assembler** A program that converts a text file containing mnemonically coded microprocessor instructions into the corresponding binary machine code. MASM is an assembler. See “compiler.”

**assembly language** A programming language in which each line of source code corresponds to a specific microprocessor instruction. Assembly language gives the programmer full access to the computer’s hardware and produces the most compact, fastest executing code. See “high-level language.”

**assembly mode** The mode in which the CodeView debugger displays the assembly-language equivalent of the high-level code being executed. CodeView obtains the assembly-language code by disassembling the executable file. See “source mode.”

**B**

**base address** The starting address of a stack frame. Base addresses are usually stored in the BP register.

**base name** The portion of the filename that precedes the extension. For example, SAMPLE is the base name of the file SAMPLE.ASM.

**BCD (binary coded decimal)** A way of representing decimal digits where 4 bits of 1 byte are a decimal digit, coded as the equivalent binary number.

**binary** Referring to the base-2 counting system, whose digits are 0 and 1.

**binary expression** A Boolean expression consisting of two operands joined by a binary operator and resolving to a binary number.

**binary file** A file that contains numbers in binary form (as opposed to ASCII characters representing the same numbers). For example, a program file is a binary file.

**binary operator** A Boolean operator that takes two arguments. The **AND** and **OR** operators in assembly language are examples of binary operators.

**BIOS (Basic Input/Output System)** The software in a computer's ROM which forms a hardware-independent interface between the CPU and its peripherals (for example, keyboard, disk drives, video display, I/O ports).

**bit** Short for **binary digit**. The basic unit of binary counting. Logically equivalent to decimal digits, except that bits can have a value of 0 or 1, whereas decimal digits can range from 0 through 9.

**breakpoint** A user-defined condition that pauses program execution while debugging. CodeView can set breakpoints at a specific line of code, for a

specific value of a variable, or for a combination of these two conditions.

**buffer** A reserved section of memory that holds data temporarily, most often during input/output operations.

**byte** The smallest unit of measure for computer memory and data storage. One byte consists of 8 bits and can store one 8-bit character (a letter, number, punctuation mark, or other symbol). It can represent unsigned values from 0 to 255 or signed values between -128 and +127.

**C**

**C calling convention** The convention that follows the C standard for calling a procedure—that is, pushing arguments onto the stack from right to left (in reverse order from the way they appear in the argument list). The C calling convention permits a variable number of arguments to be passed.

**chaining (to an interrupt)** Installing an interrupt handler that shares control of an interrupt with other handlers. Control passes from one handler to the next until a handler breaks the chain by terminating through an **IRET** instruction. See “interrupt handler,” “hooking (an interrupt).”

**character string** See “string.”

**clipboard** In PWB, a section of memory that holds text deleted with the Copy, Ldelete, or Sdelete functions. Any text attached to the clipboard deletes text already there. The Paste function inserts text from the clipboard at the current cursor position.

**.COM** The filename extension for executable files that have a single segment containing both code and data. Tiny model produces .COM files.

**combine type** The segment-declaration specifier (**AT**, **COMMON**, **MEMORY**, **PUBLIC**, or **STACK**) which tells the linker to combine all segments of the same type. Segments without a

combine type are private and are placed in separate physical segments.

**compact** A memory model with multiple data segments but only one code segment.

**compiler** A program that translates source code into machine language. Usually applied only to high-level languages such as Basic, FORTRAN, or C. See “assembler.”

**constant** A value that does not change during program execution. A variable, on the other hand, is a value that can—and usually does—change. See “symbolic constant.”

**constant expression** Any expression that evaluates to a constant. It may include integer constants, character constants, floating-point constants, or other constant expressions.

## D

**debugger** A utility program that allows the programmer to execute a program one line at a time and view the contents of registers and memory in order to help locate the source of bugs or other problems. Examples are CodeView and Symdeb.

**declaration** A construct that associates the name and the attributes of a variable, function, or type. See “variable declaration.”

**default** A setting or value that is assumed unless specified otherwise.

**definition** A construct that initializes and allocates storage for a variable, or that specifies either code labels or the name, formal parameters, body, and return type of a procedure. See “type definition.”

**description file** A text file used as input for the NMAKE utility.

**device driver** A program that transforms I/O requests into the operations necessary to make a specific piece of hardware fulfill that request.

**Dialog Command window** The window at the bottom of the CodeView screen where dialog commands can be entered, and previously entered dialog commands can be reviewed.

**direct memory operand** In an assembly-language instruction, a memory operand that refers to the contents of an explicitly specified memory location.

**directive** An instruction that controls the assembler’s state.

**displacement** In an assembly-language instruction, a constant value added to an effective address. This value often specifies the starting address of a variable, such as an array or multidimensional table.

**DLL** See “dynamic-link library.”

**double-click** To rapidly press and release a mouse button twice while pointing the mouse cursor at an object on the screen.

**double precision** A real (floating-point) value that occupies 8 bytes of memory (MASM type **REAL8**). Double-precision values are accurate to 15 or 16 digits.

**doubleword** A 4-byte word (MASM type **DWORD**).

**drag** To move the mouse while pointing at an object and holding down one of the mouse buttons.

**dump** To display or print the contents of memory in a specified memory range.

**dynamic linking** The resolution of external references at load time or run time (rather than link time). Dynamic linking allows the called subroutines to be packaged, distributed, and



maintained independently of their callers. Windows extends the dynamic-link mechanism to serve as the primary method by which all system and nonsystem services are obtained. See “linking.”

**dynamic-link library (DLL)** A library file that contains the executable code for a group of dynamically linked routines.

**dynamic-link routine** A routine in a dynamic-link library that can be linked at load time or run time.

## E

**element** A single member variable of an array of like variables.

**environment block** The section of memory containing the MS-DOS environment variables.

**errorlevel code** See “exit code.”

**.EXE** The filename extension for a program that can be loaded and executed by the computer. The small, compact, medium, large, huge, and flat models generate .EXE files. See “.COM,” “tiny.”

**exit code** A code returned by a program to the operating system. This usually indicates whether the program ran successfully.

**expanded memory** Increased memory available after adding an EMS (Expanded Memory Specification) board to an 8086 or 80286 machine. Expanded memory can be simulated in software. The EMS board can increase memory from 1 megabyte to 8 megabytes by swapping segments of high-end memory into lower memory. Applications must be written to the EMS standard in order to make use of expanded memory. See “extended memory.”

**expression** Any valid combination of mathematical or logical variables, constants, strings, and operators that yields a single value.

**extended memory** Physical memory above 1 megabyte that can be addressed by 80286–80486 machines in protected mode. Adding a memory card adds extended memory. On 80386-based machines, extended memory can be made to simulate expanded memory by using a memory-management program.

**extension** The part of a filename (of up to three characters) that follows the period (.). An extension is not required but is usually added to differentiate similar files. For example, the source-code file MYPROG.ASM is assembled into the object file MYPROG.OBJ, which is linked to produce the executable file MYPROG.EXE.

**external variable** A variable declared in one module and referenced in another module.

## F

**far address** A memory location specified with a segment value plus an offset from the start of that segment. Far addresses require 4 bytes—two for the segment and two for the offset. See “near address.”

**field** One of the components of a structure, union, or record variable.

**fixup** The linking process that supplies addresses for procedure calls and variable references.

**flags register** A register containing information about the status of the CPU and the results of the last arithmetic operation performed by the CPU.

**flat** A nonsegmented linear address space. Selectors in flat model can address the entire 4 gigabytes of addressable memory space. See “segment,” “selector.”

**formal parameters** The variables that receive values passed to a function when the function is called.

**forward declaration** A function declaration that establishes the attributes of a symbol so that it can be referenced before it is defined, or called from a different source file.

**frame** The segment, group, or segment register that specifies the segment portion of an address.

## G

**General-Protection (GP) fault** An error that occurs in protected mode when a program accesses invalid memory locations or accesses valid locations in an invalid way (such as writing into ROM areas).

**gigabyte** 1,024 megabytes, or 1,073,741,824 bytes.

**global** See “visibility.”

**global constant** A constant available throughout a module. Symbolic constants defined in the module-level code are global constants.

**global data segment** A data segment that is shared among all instances of a dynamic-link routine; in other words, a single segment that is accessible to all processes that call a particular dynamic-link routine.

**global variable** A variable that is available (visible) across multiple modules.

**granularity** The degree to which library procedures can be linked as individual blocks of code. In Microsoft libraries, granularity is at the object-file level. If a single object file containing three procedures is added to a library, all three procedures will be linked with the main program even if only one of them is actually called.

**group** A collection of individually defined segments that have the same segment base address.

## H

**handle** An arbitrary value that an operating system supplies to a program (or vice versa) so that the program can access system resources, files, peripherals, and so forth, in a controlled fashion.

**handler** See “interrupt handler.”

**hexadecimal** The base-16 numbering system whose digits are 0 through F (the letters A through F represent the decimal numbers 10 through 15). This is often used in computer programming because it is easily converted to and from the binary (base-2) numbering system the computer itself uses.

**high-level language** A programming language that expresses operations as mathematical or logical relationships, which the language’s compiler then converts into machine code. This contrasts with assembly language, in which the program is written directly as a sequence of explicit microprocessor instructions. Basic, C, COBOL, and FORTRAN are examples of high-level languages. See “assembly language,” “compiler.”

**hooking (an interrupt)** Replacing an address in the interrupt vector table with the address of another interrupt handler. See “interrupt handler,” “interrupt vector table,” “unhooking (an interrupt).”

**huge** A memory model (similar to large model) with more than one code segment and more than one data segment. However, individual data items can be larger than 64K, spanning more than one segment. See “large.”

## I

**identifier** A name that identifies a register or memory location.

**IEEE format** A standard created by the Institute of Electrical and Electronics Engineers for representing floating-point numbers, performing math with them, and handling underflow/overflow conditions. The 8087 family of coprocessors and the emulator package implement this format.

**immediate expression** An expression that evaluates to a number that can be either a component of an address or the entire address.

**immediate operand** In an assembly-language instruction, a constant operand that is specified at assembly time and stored in the program file as part of the instruction opcode.

**import library** A pseudo library that contains addresses rather than executable code. The linker reads the addresses from an import library to resolve references to external dynamic-link library routines.

**include file** A text file with the .INC extension whose contents are inserted into the source-code file and immediately assembled.

**indirect memory operand** In an assembly-language instruction, a memory operand whose value is treated as an address that points to the location of the desired data. See “pointer.”

**instruction** The unit of binary information that a CPU decodes and executes. In assembly language, instruction refers to the mnemonic (such as **LDS** or **SHL**) that the assembler converts into machine code.

**instruction prefix** See “prefix.”

**interrupt** A signal to the processor to halt its current operation and immediately transfer control to an interrupt handler. Interrupts are triggered either by hardware, as when the keyboard detects a keypress, or by software, as when a program executes the **INT** instruction. See “interrupt handler.”

**interrupt handler** A routine that receives processor control when a specific interrupt occurs.

**interrupt service routine** See “interrupt handler.”

**interrupt vector** An address that points to an interrupt handler.

**interrupt vector table** A table maintained by the operating system. It contains addresses (vectors) of current interrupt handlers. When an interrupt occurs, the CPU branches to the address in the table that corresponds to the interrupt’s number. See “interrupt handler.”

## K

**keyword** A word with a special, predefined meaning for the assembler. Keywords cannot be used as identifiers.

**kilobyte (K)** 1,024 bytes.

## L

**label** A symbol (identifier) representing the address of a code label or data objects.

**language type** The specifier that establishes the naming and calling conventions for a procedure. These are **BASIC**, **C**, **FORTRAN**, **PASCAL**, **STDCALL**, and **SYSCALL**.

**large** A memory model with more than one code segment and more than one data segment, but with no individual data item larger than 64K (a single segment). See “huge.”

**library** A file that contains modules of compiled code. MS-DOS programs use normal run-time libraries, from which the linker extracts modules and combines them with other object modules to create executable program files. Windows-based programs can use dynamic-link libraries (see), which the operating system loads and links to calling programs. See also “import library.”

**linked list** A data structure in which each entry includes a pointer to the location of the adjoining entries.

**linking** In normal static linking, the process in which the linker resolves all external references by searching run-time and user libraries, and then computes absolute offset addresses for these references. Static linking results in a single executable file. In dynamic linking (see), the operating system, rather than the linker, provides the addresses after loading the modules into separate parts of memory.

**local constant** A constant whose scope is limited to a procedure or a module.

**local variable** A variable whose scope is confined to a particular unit of code, such as module-level code, or a procedure. See “module-level code.”

**logical device** A symbolic name for a device that can be mapped to a physical (actual) device.

**logical line** A complete program statement in source code, including the initial line of code and any extension lines.

**logical segment** A memory area in which a program stores code, data, or stack information. See “physical segment.”

**low-level input and output routines** Run-time library routines that perform unbuffered, unformatted input/output operations.

**LSB (least-significant bit)** The bit lowest in memory in a binary number.

## M

**machine code** The binary numbers that a microprocessor interprets as program instructions. See “instruction.”

**macro** A block of text or instructions that has been assigned an identifier. When the assembler sees this identifier in the source code, it substitutes the related text or instructions and assembles them.

**main module** The module containing the point where program execution begins (the program’s entry point). See “module.”

**math coprocessor** See “8087, 80287, or 80387 coprocessor.”

**medium** A memory model with multiple code segments but only one data segment.

**megabyte** 1,024 kilobytes or 1,048,576 bytes.

**member** One of the elements of a structure or union; also called a field.

**memory address** A number through which a program can reference a location in memory.

**memory map** A representation of where in memory the computer expects to find certain types of information.

**memory model** A convention for specifying the number and types of code and data segments in a module. See “tiny,” “small,” “medium,” “compact,” “large,” “huge,” and “flat.”

**memory operand** An operand that specifies a memory location.

**meta** A prefix that modifies the subsequent PWB function.

**mnemonic** A word, abbreviation, or acronym that replaces something too complex to remember or type easily. For example, **ADC** is the mnemonic for the 8086’s add-with-carry instruction. The assembler converts it into machine (binary) code, so it is not necessary to remember or calculate the binary form.

**module** A discrete group of statements. Every program has at least one module (the main module). In most cases, a module is the same as a source file.

**module-definition file** A text file containing information that the linker uses to create a Windows-based program.

**module-level code** Program statements within any module that are outside procedure definitions.

**MSB (most-significant bit)** The bit farthest to the left in a binary number. It represents  $2^{(n-1)}$ , where  $n$  is the number of bits in the number.

**multitasking operating system** An operating system in which two or more programs, processes, or threads can execute simultaneously.

## N

**naming convention** The way the compiler or assembler alters the name of a routine before placing it into an object file.

**NAN** Acronym for “not a number.” Math coprocessors generate NANs when the result of an operation cannot be represented in IEEE format. For example, if two numbers being multiplied have a product larger than the maximum value permitted, the coprocessor returns a NAN instead of the product.

**near address** A memory location specified by the offset from the start of the value in a segment register. A near address requires only 2 bytes. See “far address.”

**nonreentrant** See “reentrant procedure.”

**null character** The ASCII character encoded as the value 0.

**null pointer** A pointer to nothing, expressed as the value 0.

## O

**.OBJ** Default filename extension for an object file.

**object file** A file (normally with the extension .OBJ) produced by assembling source code. It contains relocatable machine code. The linker combines object files with run-time and library code to create an executable file.

**offset** The number of bytes from the beginning of a segment to a particular byte within that segment.

**opcode** The binary number that represents a specific microprocessor instruction.

**operand** A constant or variable value that is manipulated in an expression or instruction.

**operator** One or more symbols that specify how the operand or operands of an expression are manipulated.

**option** A variable that modifies the way a program performs. Options can appear on the command line, or they can be part of an initialization file (such as TOOLS.INI). An option is sometimes called a switch.

**output screen** The CodeView screen that displays program output. Choosing the Output command from the View menu or pressing F4 switches to this screen.

**overflow** An error that occurs when the value assigned to a numeric variable is larger than the allowable limit for that variable’s type.

**overlay** A program component loaded into memory from disk only when needed. This technique reduces the amount of free RAM needed to run the program.

## P

**parameter** The name given in a procedure definition to a variable that is passed to the procedure. See “argument.”

**passing by reference** Transferring the address of an argument to a procedure. This allows the procedure to modify the argument's value.

**passing by value** Transferring the value (rather than the address) of an argument to a procedure. This prevents the procedure from changing the argument's original value.

**physical segment** The true memory address of a segment, referenced through a segment register.

**pointer** A variable containing the address of another variable. See "indirect memory operand."

**precedence** The relative position of an operator in the hierarchy that determines the order in which expression elements are evaluated.

**preemptive** Having the power to take precedence over another event.

**prefix** A keyword (**LOCK**, **REP**, **REPE**, **REPNE**, **REPNZ**, or **REPZ**) that modifies the behavior of an instruction. MASM 6.1 ensures the prefix is compatible with the instruction.

**private** Data items and routines local to the module in which they are defined. They cannot be accessed outside that module. See "public."

**privilege level** A hardware-supported feature of the 80286–80486 processors that allows the programmer to specify the exclusivity of a program or process. Programs running at low-numbered privilege levels can access data or resources at higher-numbered privilege levels, but the reverse is not true. This feature reduces the possibility that malfunctioning code will corrupt data or crash the operating system.

**privileged mode** The term applied to privilege level 0. This privilege level should be used only by a protected-mode operating system. Special privileged instructions are enabled by **.286P**, **.386P**, and **.486P**. Privileged mode should not be confused with protected mode.

**procedure call** An expression that invokes a procedure and passes actual arguments (if any) to the procedure.

**procedure definition** A definition that specifies a procedure's name, its formal parameters, the declarations and statements that define what it does, and (optionally) its return type and storage class.

**procedure prototype** A procedure declaration that includes a list of the names and types of formal parameters following the procedure name.

**process** Generally, any executing program or code unit. This term implies that the program or unit is one of a group of processes executing independently.

**Program Segment Prefix (PSP)** A 256-byte data structure at the base of the memory block allocated to a transient program. It contains data and addresses supplied by MS-DOS that a program can read during execution.

**protected mode** The 80286–80486 operating mode that permits multiple processes to run and not interfere with each other. This feature should not be confused with privileged mode.

**public** Data items and procedures that can be accessed outside the module in which they are defined. See "private."

## Q

**qualifiedtype** A user-defined type consisting of an existing MASM type (intrinsic, structure, union, or record), or a previously defined **TYPDEF** type, together with its language or distance attributes.

## R

**radix** The base of a number system. The default radix for MASM and CodeView is 10.

**RAM (random-access memory)** Computer memory that can be both written to and read from. RAM data is volatile; it is usually lost when the computer

is turned off. Programs are loaded into and executed from RAM. See “ROM.”

**real mode** The normal operating mode of the 8086 family of processors. Addresses correspond to physical (not mapped) memory locations, and there is no mechanism to keep one application from accessing or modifying the code or data of another. See “protected mode.”

**record** A MASM variable that consists of a sequence of bit values.

**reentrant procedure** A procedure that can be safely interrupted during execution and restarted from its beginning in response to a call from a preemptive process. After servicing the preemptive call, the procedure continues execution at the point at which it was interrupted.

**register operand** In an assembly-language instruction, an operand that is stored in the register specified by the instruction.

**register window** The optional CodeView window in which the CPU registers and the flag register bits are displayed.

**registers** Memory locations in the processor that temporarily store data, addresses, and processor flags.

**regular expression** A text expression that specifies a pattern of text to be matched (as opposed to matching specific characters).

**relocatable** Not having an absolute address. The assembler does not know where the label, data, or code will be located in memory, so it generates a fixup record. The linker provides the address.

**return value** The value returned by a function.

**ROM (read-only memory)** Computer memory that can only be read from and cannot be modified. ROM data is permanent; it is not lost when the machine is turned off. A computer’s ROM often

contains BIOS routines and parts of the operating system. See “RAM.”

**routine** A generic term for a procedure or function.

**run-time dynamic linking** The act of establishing a link when a process is running. See “dynamic linking.”

**run-time error** A math or logic error that can be detected only when the program runs. Examples of run-time errors are dividing by a variable whose value is zero or calling a DLL function that doesn’t exist.

## S

**scope** The range of statements over which a variable or constant can be referenced by name. See “global constant,” “global variable,” “local constant,” “local variable.”

**screen swapping** A screen-exchange method that uses buffers to store the debugging and output screens. When you request the other screen, the two buffers are exchanged. This method is slower than flipping (the other screen-exchange method), but it works with most adapters and most types of programs.

**scroll bars** The bars that appear at the right side and bottom of a window and some list boxes. Dragging the mouse on the scroll bars allows scrolling through the contents of a window or text box.

**segment** A section of memory, limited to 64K with 16-bit segments or 4 gigabytes with 32-bit segments, containing code or data. Also refers to the starting address of that memory area.

**sequential mode** The mode in CodeView in which no windows are available. Input and output scroll down the screen, and the old output scrolls off the top of the screen when the screen is full. You cannot examine previous commands after they

scroll off the top. This mode is required with computers that are not IBM compatible.

**selector** A value that indirectly references a segment address. A protected-mode operating system, such as Windows, assigns selector values to programs, which use them as segment addresses. If a program attempts to use an unassigned selector, it triggers a General-Protection fault (see).

**shared memory** A memory segment that can be accessed simultaneously by more than one process.

**shell escape** A method of gaining access to the operating system without leaving CodeView or losing the current debugging context. It is possible to execute MS-DOS commands, then return to the debugger.

**sign extended** The process of widening an integer (for example, going from a byte to a word, or a word to a doubleword) while retaining its correct value and sign.

**signed integer** An integer value that uses the most-significant bit to represent the value's sign. If the bit is one, the number is negative; if zero, the number is positive. See "two's complement," "unsigned integer," "MSB."

**single precision** A real (floating-point) value that occupies 4 bytes of memory. Single-precision values are accurate to six or seven decimal places.

**single-tasking environment** An environment in which only one program runs at a time. MS-DOS is a single-tasking environment.

**small** A memory model with only one code segment and only one data segment.

**source file** A text file containing symbols that define the program.

**source mode** The mode in which CodeView displays the assembly-language source code that

represents the machine code currently being executed.

**stack** An area of memory in which data items are consecutively stored and removed on a last-in, first-out basis. A stack can be used to pass parameters to procedures.

**stack frame** The portion of a stack containing a particular procedure's local variables and parameters.

**stack probe** A short routine called on entry to a function to verify that there is enough room in the program stack to allocate local variables required by the function.

**stack switching** Changing the stack pointers to point to another stack area.

**stack trace** A symbolic representation of the functions that are being executed to reach the current instruction address. As a function is executed, the function address and any function arguments are pushed on the stack. Therefore, tracing the stack shows the active functions and their arguments.

**standard error** The device to which a program can send error messages. The display is normally standard error.

**standard input** The device from which a program reads its input. The keyboard is normally standard input.

**standard output** The device to which a program can send its output. The display is normally standard output.

**statement** A combination of labels, data declarations, directives, or instructions that the assembler can convert into machine code.

**status bar** See "linking."



**static linking** The line at the bottom of the PWB or CodeView screen. The status bar displays text position, keyboard status, current context of execution, and other program information.

**STDCALL** A calling convention that uses caller stack cleanup if the **VARARG** keyword is specified. Otherwise the called routine must clean up the stack.

**string** A contiguous sequence of characters identified with a symbolic name.

**string literal** A string of characters and escape sequences delimited by single quotation marks ( ' ') or double quotation marks ( " ").

**structure** A set of variables that may be of different types, grouped under a single name.

**structure member** One of the elements of a structure. Also called a field.

**switch** See "option."

**symbol** A name that identifies a memory location (usually for data).

**symbolic constant** A constant represented by a symbol rather than the constant itself. Symbolic constants are defined with **EQU** statements. They make a program easier to read and modify.

**SYSCALL** A language type for a procedure. Its conventions are identical to C's, except no underscore is prefixed to the name.

## T

**tag** The name assigned to a structure, union, or enumeration type.

**task** See "process."

**text** Ordinary, readable characters, including the uppercase and lowercase letters of the alphabet, the numerals 0 through 9, and punctuation marks.

**text box** In PWB, a box where you type information needed to carry out a command. A text box appears within a dialog box. The text box may be blank or contain a default entry.

**tiny** Memory model with a single segment for both code and data. This limits the total program size to 64K. Tiny programs have the filename extension **.COM**.

**toggle** A function key or menu selection that turns a feature off if it is on, or on if it is off. Used as a verb, "toggle" means to reverse the status of a feature.

**TOOLS.INI** A file containing initialization information for many of the Microsoft utilities, including PWB.

**two's complement** A form of base-2 notation in which negative numbers are formed by inverting the bit values of the equivalent positive number and adding 1 to the result.

**type** A description of a set of values and a valid set of operations on items of that type. For example, a variable of type **BYTE** can have any of a set of integer values within the range specified for the type on a particular machine.

**type checking** An operation in which the assembler verifies that the operands of an operator are valid or that the actual arguments in a function call are of the same types as the function definition's parameters.

**type definition** The storage format and attributes for a data unit.

## U

**unary expression** An expression consisting of a single operand preceded or followed by a unary operator.

**unary operator** An operator that acts on a single operand, such as **NOT**.

**underflow** An error condition that occurs when a calculation produces a result too small for the computer to represent.

**unhooking (an interrupt)** The act of removing your interrupt handler and restoring the original vector. See “hooking (an interrupt).”

**union** A set of values (in fields) of different types that occupy the same storage space.

**unresolved external** See “unresolved reference.”

**unresolved reference** A reference to a global or external variable or function that cannot be found, either in the modules being linked or in the libraries linked with those modules. An unresolved reference causes a fatal link error.

**unsigned integer** An integer in which the most-significant bit serves as part of the number, rather than as an indication of sign. For example, an unsigned byte integer can have a value from 0 to 255. A signed byte integer, which reserves its eighth bit for the sign, can range from -127 to +128. See “signed integer,” “MSB.”

**user-defined type** A data type defined by the user. It is usually a structure, union, record, or pointer.

## V

**variable declaration** A statement that initializes and allocates storage for a variable of a given type.

**virtual disk** A portion of the computer’s random access memory reserved for use as a simulated disk drive. Also called an electronic disk or RAM disk. Unless saved to a physical disk, the contents of a virtual disk are lost when the computer is turned off.

**virtual memory** Memory space allocated on a disk, rather than in RAM. Virtual memory allows large data structures that would not fit in conventional memory, at the expense of slow access.

**visibility** The characteristic of a variable or function that describes the parts of the program in which it can be accessed. An item has global visibility if it can be referenced in every source file constituting the program. Otherwise, it has local visibility.

## W

**watch window** The window in CodeView that displays watch statements and their values. A variable or expression is watchable only while execution is occurring in the section of the program (context) in which the item is defined.

**window** A discrete area of the screen in PWB or CodeView used to display part of a file or to enter statements.

**window commands** Commands that work only in CodeView’s window mode. Window commands consist of function keys, mouse selections, CTRL and ALT key combinations, and selections from pop-up menus.

**window mode** The mode in which CodeView displays separate windows, which can change independently. CodeView has mouse support and a wide variety of window commands in window mode.

**word** A data unit containing 16 bits (2 bytes). It can store values from 0 to 65,535 (or -32,768 to +32,767).



# Index

! (literal-character operator) 235  
 != (not equal operator) 178  
 " (double quotation marks) 109, 353  
 \$ (current address operator) 368  
 % (expansion operator) 235, 248, 357  
 & (substitution operator) 238, 372  
 && (logical AND operator) 178  
 ' (single quotation mark) 109, 353  
 ( ) (parentheses) 106  
 + (plus operator) 63, 66, 352, 370  
 . (dot operator) 126  
 . (structure-member operator) 64, 67, 352, 370  
 .186 directive 38  
 .286 directive 38  
 .286P directive 38  
 .287 directive 38  
 .386 directive  
     FLAT, with 26, 36  
     processor mode, specifying 38, 336  
     segment mode, setting 46, 68  
 .386P directive 38  
 .387 directive 38  
 .486 directive  
     FLAT, with 36  
     processor mode, specifying 38  
     segment mode, setting 46, 68  
 .486P directive 38  
 .8087 directive 38  
 : (colon) 22, 352, 354  
 : (segment-override operator) 50, 59–60, 64  
 :: (double colon) 197, 215, 352–354  
 ; (semicolon) 21  
 ;; (double semicolon) 227  
 < (less than operator) 178  
 < > (angle brackets) *See* Angle brackets  
 == (equal operator) 178  
 > (greater than operator) 178  
 ? (question mark initializer)  
     array elements 109  
     described 368  
     variables 87  
 @ (at sign) 10  
 @@: (anonymous label) 170  
 [ ] (brackets) 107  
 [ ] (index operator) 63  
 \ (backslash character), MASM code 22  
 \ (line-continuation character) 121  
 { } (curly braces) 121, 131  
 || (logical OR operator) 178

32-bit programming 335  
 80186 processor 3  
 80188 processor 3  
 80286 processor 3  
 80287 math coprocessor 3, 135  
 80386 processor 3, 335  
 80387 math coprocessor 3, 135  
 80486 processor 3, 135  
 8086-based processors 2–3  
 8087 math coprocessor 3, 135  
 8088 processor 3

## A

AAD instruction 160  
 AAM instruction 160  
 ABS operand 220  
 Accessing data with pointers *See* Pointer variables  
 ADC instruction 92–94  
 ADD instruction 92–94  
 ADDR operator 197  
 Addresses  
     displacement of 65  
     dynamic 79  
     effective 65  
     errors in 54  
     far 57, 74, 80  
     near 57, 80  
     physical 7  
     registers, loading into 80  
     relocatable 57  
     segmented 7–8, 53  
 Addressing  
     direct registers, used in 62–63  
     indirect registers, used in 65, 68  
     scaling operands 70  
     specifying 60  
 Aliases 87, 369  
 ALIGN directive 3  
 Align types 45  
     *See also* individual entries  
 .ALPHA directive 47  
 AND instruction 27, 99, 100  
 Angle brackets (< >)  
     default parameters 230  
     epilogues 202  
     FOR loops 242  
     FORC loops 244

Angle brackets (<>) (*continued*)  
 macro text delimiters 234  
 prologues 202  
 records 131  
 structures and unions 121  
 Anonymous label (@@) 170

API (Application Programming Interface) 257

Architecture, segmented 2, 5

Architecture, unsegmented 5

Arguments  
 errors 196  
 macro 252  
 mixed-language programs, passing in 314  
 qualifiedtypes, with 16  
 stack, on 182

Arrays  
 accessing elements in 105  
 declaring 105  
 defined 105  
 defining 15  
 DUP, declaring with 106, 124  
 instructions for processing 110  
 length of 108  
 multiple-line declarations for 105  
 number of bytes in 108  
 referencing 108, 316  
 size of elements 108  
 with DUP operator *See* DUP operator  
 with SIZEOF operator *See* SIZEOF operator  
 with TYPE operator *See* TYPE operator

ASCIIZ 267

Assembly  
 actions during 23  
 conditional *See* Conditional assembly  
 INCLUDE files 212  
 language  
   book list xviii  
   mixed-language programs 312  
 listing files *See* Listing files  
 two-pass 358

Assembly pointers *See* Conditional assembly

Assembly-time variables 233

ASSUME directive  
 .MODEL, generated with 37  
 code segments, changing 357  
 enhancements 344  
 general-purpose registers 77  
 segment registers, setting 49–55, 58–59, 357

AT address combine type 46

/AT command-line option, ML 36

At sign (@) 10

## B

Backslash character (\) 22

Backus-Naur Form *See* BNF grammar

Base Pointer (BP) register 73

Basic calling conventions 308–310

Basic/MASM programs 328–332

Binary Coded Decimals  
 calculating with 156–160  
 defining 156  
 instructions for 156–160  
 packed 158  
 unpacked 159–160

Bits  
 mask 99–102  
 rotating 100  
 shifting 100

BNF grammar 16, 379–380

BOUND instruction 108, 204

BP (Base Pointer) register 73

Brackets ([ ]) 107

.BREAK directive 173, 176

BSF instruction 100

BSR instruction 100

BYTE  
 align type 45  
 directive 86

## C

C calling convention 309

C++/MASM programs 322–323

C/MASM programs 315–321

CALL instruction 180

Calling conventions 309  
 Basic 308–310  
 directives, specifying 37  
 FORTRAN 308–310  
 (list) 308  
 mixed-language programming 308–309  
 Pascal 310  
 STDCALL 311  
 SYSCALL 308–311

CARRY? flag as operand 178

Case sensitivity  
 enforcing 348  
 macro functions, predefined 245  
 MASM statements 22  
 radix specifiers 11  
 reserved words 9, 407  
 specifying  
   command-line options, in 25  
   language type 348  
   OPTION directive 25

Case sensitivity (*continued*)  
symbols, predefined 10

CASEMAP  
ALL argument, OPTION directive 25  
NONE argument, OPTION directive 25  
NOTPUBLIC argument, OPTION directive 25

CATSTR directive 245–247

CATSTR, compared with TEXTEQU directive *See* TEXTEQU directive

@CatStr predefined string function 245–247

CBW instruction 90

CDQ instruction 90

CLC instruction 104

Cleaning the stack 185

CLI instruction 5, 209

Client program 257, 266

CMC instruction 104

CMP instruction 166

CMPS instruction 110–114, 353

CMPSB instruction 114

.CODE directive 33, 40–42

Code segment *See* Segments, code

Code, near or far 57

@CodeSize predefined symbol 40

CodeView for Windows 264

Combine types  
(list) 46  
*See also* individual entries

.COM files  
relocatable segment expression, lacking 62  
starting address 56  
tiny model, using 36, 46–47

COMM directive 16, 211, 217–218

Command-line driver, ML xvi

Command-line options *See* ML command-line options

COMMENT directive 22

Comments  
extended lines, in 346  
macros, in 227  
source code 21–22

COMMON combine type 46

Communal variables 217

Compact model *See* Memory models, compact

Compatibility, MASM 5.1 *See* MASM 5.1 compatibility

Conditional assembly  
assembly behavior, changing 23  
conditions, testing for 28  
directives 28  
pointers 83, 187

Conditional-error directives (table) 29

Conditional jumps 164–170

Conditions, testing for conditional assembly *See* Conditional assembly

Constants  
defined 11  
expressions 12  
immediate 61  
integer 11–12  
size 363  
size of 12  
symbolic 12

.CONST directive 33, 39–40

.CONTINUE directive 173, 176

Coprocessors  
architecture 140–144  
control registers 156  
data format in registers 140  
defined 135  
described 3, 139  
instructions  
arithmetic 148–150  
data transfer 146  
described 146  
(list) 414  
overview 141  
program control 151–155  
memory access 145  
operand formats  
classical stack 141  
memory 142  
overview 141  
register 143  
register-pop 144  
specifying 37, 140  
status word register 156  
steps for using 145

/Cp command-line option, ML 10, 245

@Cpu predefined symbol 254

Curly braces ({} )  
records 131  
structures and unions 121

Current address operator (\$) 368

@CurSeg predefined symbol 39, 219

CWD instruction 90

CWDE instruction 90

/Cx command-line option, ML 158

## D

DAA instruction 162

DAS instruction 162

.DATA directive 33, 39–40

.DATA? directive 33, 39–40

@data predefined symbol 39

Data segment *See* Segments, data

@DataSize predefined symbol 39, 83

## Data types

- arrays *See* Arrays
  - attributes for 15
  - Binary Coded Decimals 159
  - defined 14
  - defining 87
  - directives 14
  - floating-point 136
  - initializers, as 14
  - integers, allocating memory for 85–86
  - new features, MASM 6.1 344
  - qualifiedtypes 15, 214
  - real 14, 136
  - signed 14, 86
  - strings *See* Strings
  - structures 117
  - unions 117
  - user-defined 15
- Data, near or far 57, 58
- Data-sharing methods 211
- Data-sharing methods, multiple-module programs *See*  
Multiple-module programs
- Date, system 11
- DB directive 86
- DD directive 86
- DEC instruction 92–94
- DF directive 86
- DGROUP group name
- .MODEL, defined by 34, 39, 51
  - DS registers, initializing to 56
  - MS-DOS programs, for 41–42
  - near data, accessing 57–58
  - segment 35–37, 51–52, 57
- Direct memory operands
- loading offset of 82
  - overview 60–64
- Directives
- .286P 38
  - .287 38
  - .386 *See* .386 directive
  - .386P 38
  - .387 38
  - .486P 38
  - .8087 38
  - .ALPHA 47
  - ALIGN 3
  - .BREAK 173, 176
  - BYTE 86
  - CATSTR 245–247
  - .CODE 33, 40–42
  - COMM 16, 211, 217–218
  - COMMENT 22
  - Conditional assembly 28
  - Conditional error 29, 358

Directives (*continued*)

- .CONST 33, 39–40
- .CONTINUE 173, 176
- .DATA 33, 39–40
- .DATA? 33, 39–40
- Data declarations, for 87
- Data types, for 14
- Data-sharing *See* EXTERN directive
- DB 86
- DD 86, 136
- Decision 171
- DF 86
- .DOSSEG 47
- DQ 86, 136
- DT 86, 136
- DW 86
- DWORD 86
- ECHO 236
- .ELSE 171
- ELSE 28
- .ELSEIF 171
- ELSEIF 28
- ELSEIF1 29, 358
- ELSEIF2 29, 358
- END 33, 56
- .ENDIF 171
- ENDIF 28
- ENDM 227–239
- ENDP 180–181, 206
- ENDS 44
- .ENDW 173
- EQU 12, 369
- .ERR 30
- .ERR1 30, 358
- .ERR2 30, 358
- .ERRB 30, 231
- .ERRDEF 30
- .ERRDIF 30
- .ERRE 30
- .ERRIDN 29
- .ERRNB 29, 231
- .ERRNDEF 29
- .ERRNZ 29
- EVEN 3
- .EXIT 33, 41–43
- EXITM 248
- EXTERN *See* EXTERN directive
- EXTERNDEF *See* EXTERNDEF directive
- FARDATA 33, 39–40
- .FARDATA 39–40
- .FARDATA? 33, 39–40
- Floating-point 136
- FOR 242–243, 249
- FORC 244

Directives (*continued*)

FWORD 86  
 GROUP 51–52  
 .IF 171  
 IF 28–29  
 IF1 29, 358  
 IF2 29, 358  
 IFB 29, 231  
 IFDEF 29, 359  
 IFDIF 29  
 IFE 29  
 IFIDN 29  
 IFNB 29, 231  
 IFNDEF 29, 359  
 INCLUDE 212  
 INCLUDELIB 222  
 INSTR 245–246  
 INVOKE *See* INVOKE directive  
 LABEL 16  
 LOCAL 188–191, 232  
 loop-generating 173  
 .MODEL *See* .MODEL directive  
 .MSFLOAT 361  
 Naming conventions 37  
 .NO87 38, 349  
 obsolete 361  
 OPTION *See* OPTION directive  
 ORG 56  
 POPCONTEXT 255, 349  
 PROC 180–184, 193, 206, 312  
 PUBLIC 185, 211, 220  
 PUSHCONTEXT 255, 349  
 QWORD 86  
 .RADIX 11  
 REAL4 136–137  
 REAL8 136–137  
 REAL10 136–137  
 RECORD 130–131  
 Renamed since MASM 5.1 350  
 .REPEAT 173–177  
 REPEAT 240  
 SBYTE 86  
 SDWORD 86  
 SEGMENT 44–47  
 Segment order, controlling 47  
 .SEQ 47  
 SIZESTR 245–246  
 STACK *See* STACK directive  
 .STARTUP *See* .STARTUP directive  
 STARTUP *See* .STARTUP directive  
 STRUCT 118–129  
 SUBSTR 245–246  
 SWORD 86  
 TBYTE 86, 159

Directives (*continued*)

TEXTEQU *See* TEXTEQU directive  
 UNION 118–119, 122, 125–129  
 .UNTIL 173  
 .UNTILCXZ 173  
 .WHILE 173–177  
 WHILE 241  
 WORD 86  
 Directives: 36–38, 46  
 Displacement 66  
 Distance attributes 15  
 DIV instruction 97–98  
 Division 97, 102  
 DLLs  
   client program 257, 266  
   data segment 265–269  
   defined 257, 266  
   example 267–268  
   extension name 266  
   heap 261–262, 265–267  
   IMPLIB utility 258  
   initialization 261–262, 268–269  
   loading 258–260  
   programming requirements 260–261, 267  
   prologue and epilogue 264–267  
   stacks in 46, 264–267  
   summary 266  
   termination 262–264, 270  
 Document conventions vii  
 DOS *See* MS-DOS  
 .DOSSEG directive 47  
 Dot (.) operator *See* Structure-member operator  
 DOTNAME argument, OPTION directive 25  
 Double colon (::) 197, 215  
 Double quotation marks (") 109  
 Double semicolon (;;) 227  
 Doublewords 86  
 DQ directive 86  
 DT directive 86  
 DUP operator  
   arrays, with 106, 124  
   record variables, with 131  
   structures and unions, with 121  
 DW directive 86  
 DWORD  
   align type 45  
   directive 86  
 Dynamic-link libraries *See* DLLs

**E**

ECHO directive 236  
 .ELSE directive 171  
 ELSE directive 28



.ELSEIF directive 171  
 ELSEIF directive 28  
 ELSEIF1 directive 358  
 ELSEIF2 directive 29, 358  
 EMULATOR argument, OPTION directive 27, 157  
 Emulator libraries 155–156  
 END directive 33, 56  
 .ENDIF directive 171  
 ENDF directive 28  
 ENDM directive 227–239  
 ENDP directive 180–181, 206  
 ENDS directive 44  
 .ENDW directive 173  
 ENTER instruction 183  
 Environment  
   target 4  
   variables  
     INCLUDE 213  
     LIB 222  
     returning values of 10  
 /EP command-line option, ML 342  
 EPILOGUE argument, OPTION directive 26, 201–203  
 Epilogue code  
   defined 198  
   macros 201–202, 264–265  
   PROC statement, specifying arguments in 185  
   procedures, with 26  
   RET instruction 357  
   standard 199  
   user-defined 201  
 EQ operator 365  
 EQU directive 12, 369  
 Equal directive (=) 12  
 Equates, predefined *See* Predefined symbols  
 .ERR directive 29  
 .ERR1 directive 30, 358  
 .ERR2 directive 30, 358  
 .ERRB directive 29, 231  
 .ERRDEF directive 29  
 .ERRDIF directive 29  
 .ERRE directive 29  
 .ERRIDN directive 29  
 .ERRNB directive 29, 231  
 .ERRNDEF directive 29  
 .ERRNZ directive 29  
 Error detection 196  
 ERROR operand 49–50  
 Errors, argument passing 196  
 ESC instruction 360  
 EVEN directive 3  
 Executable (.EXE) files, controlling size of 223  
 Exit codes, Windows operating system 263  
 .EXIT directive 33, 41–43  
 EXITM directive 248

Expansion operator (%) 235–236, 248, 357  
 Explicit loading 258  
 Exponent bias 139  
 EXPORT operand 185  
 EXPORTS statement 261, 270  
 EXPR16 argument, OPTION directive 13, 26, 361, 373  
 EXPR32 argument, OPTION directive 13, 26, 373  
 Expression operators 178  
 Expressions  
   assembly-time evaluation 23  
   constant 12  
   loop conditions, evaluating 179  
   OPTION M510 behavior 364, 373  
   order of evaluation 14  
   size 366, 373  
   word size 13, 26  
 Extension, filename 266  
 EXTERN directive  
   data-sharing 211  
   executable file size, limiting 223  
   module-specific 220  
   overview 16  
   positioning 218  
   procedure prototypes, declaring 193  
 External declarations 216–218  
 External variables 217, 369  
 EXTERNDEF directive  
   data-sharing 211  
   overview 16  
   positioning 218  
   procedure prototypes, declaring 193  
   symbols, declaring 214–215

## F

Far addresses, invoking 57, 74, 80–81, 197  
 Far code 57  
 Far data 58–60  
 .FARDATA directive 33, 39–40  
 .FARDATA? directive 39–40  
 FAR operator 169, 185  
 Far pointer 74, 80–81  
 FARSTACK operand  
   example 35  
   grouping 34  
   in Windows-based programs 266  
   MS-DOS program, initializing 43  
   special cases, setting for 37  
 Farwords 86  
 FCOM instruction 153  
 Fields, statements in 21–22  
 Files  
   .COM  
     relocatable segment expression, lacking 62

Files (*continued*).COM (*continued*)

- starting address 56
- tiny model, using 36, 46–47
- executable 24
- include 212–213, 348
- line numbers 11
- naming 11

## Flags

- CARRY? 178
- operands, as 178
- OVERFLOW? 178
- PARITY? 178
- SIGN? 178
- stack, saving on 73
- ZERO? 178

Flags register *See* Registers, flagsFlat model *See* Memory models, flat

FLAT operand 46, 49–50

FLDI instruction 147

FLDZ instruction 147

## Floating-point

- calculations 3
- constants
  - decimal form 137
  - encoded hexadecimal format 137
  - syntax for defining 136
- emulation 157–158
- IEEE format 139
- instructions
  - arithmetic 148–149
  - controlling 26
  - data transfer 147
  - not emulated (list) 158
  - program control 152–153, 156
- operations 146
- values
  - double precision 139
  - single precision 139
- variables
  - IEEE format 138
  - Microsoft binary format 138
  - .MSFLOAT format 138
  - ranges 136

FOR directive 242–243, 249

FORC directive 244

FORCEFRAME operand 200–201

FORTRAN calling convention 308–310

FORTRAN/MASM programs 323–326

/Fpi command-line option, ML 26, 157

Frame 62

FS register 17

FTST instruction 153

## Full segment definitions

- described 32
- segment registers, initializing 54–56
- using 44–51

Full segment definitions *See* .STARTUP directive

FWORD directive 86

FXCH instruction 144

**G**

Global variables 211

GROUP directive 51–52

## Groups

- defined 51
- DGROUP 51
- SEG operator, returned by 62

GS register 17

**H**

H2INC 318

Heap space 261–262, 265–267

HEAPSIZE statement 261, 271

Help, online *See* Microsoft Advisor

HIGH operator 356

HIGHWORD operator 346

Huge model *See* Memory models, huge**I**

/I command-line option, ML 213

## Identifiers

- ABS, using 220
- naming restrictions 9, 346, 353, 357, 368
- OPTION DOTNAME 373
- OPTION NOKEYWORD 376

IDIV instruction 97–98

IEEE format 139

.IF directive 171

IF directive 28–29

IF1 directive 29, 358

IF2 directive 29, 358

IFB directive 29, 231

IFDEF directive 29, 359

IFDIF directive 29

IFE directive 29

IFIDN directive 29

IFNB directive 29, 231

IFNDEF directive 29, 359

Immediate operands 60–62

IMPLIB utility 258

Implicit loading 258

Import libraries 258

IMPORTS statement 266  
IMUL instruction 95–96  
IN instruction 5  
INC instruction 92–94  
INCLUDE directive 212  
INCLUDE environment variable 213  
Include files  
    assembling 213  
    nested 213  
    overview 212, 348  
INCLUDELIB directive 222  
Index operator ([ ]) 63  
Indirect memory operands 60, 64–70  
Indirect procedure calls *See* INVOKE directive  
Initializers  
    allocating 87  
    directives for 15  
    multiple-line 346  
Instance 261, 266  
INSTR directive 245–246  
@InStr predefined string function 245–246  
Instruction Pointer (IP) register 20, 57, 161  
Instructions  
    ADC 92–94  
    ADD 92–94  
    AND 26, 99–100  
    arithmetic 378  
    bit-test 354  
    BOUND 108, 204  
    BSF 100  
    BSR 100  
    CALL 180  
    CBW 90  
    CDQ 90  
    CLC 104  
    CLI 5, 209  
    CMC 104  
    CMP 166  
    CMPS 110–114, 353  
    CMPSB 114  
    conditional-jump 165–167  
    coprocessor 377  
    CWD 90  
    CWDE 90  
    DAA 162  
    DAS 162  
    DEC 92–94  
    default segments, requiring 49  
    DIV 97–98  
    encodings, changes to 377–378  
    ENTER 183  
    ESC 360  
    FCOM 153  
    FLD1 147

Instructions (*continued*)

FLDZ 147  
floating-point *See* Floating-point instructions  
FTST 153  
FXCH 144  
IDIV 97–98  
IMUL 95–96  
IN 5  
INC 92–94  
INT 204–205  
INTO 207  
JCXZ 170–173  
JECXZ 170–173  
JMP 49, 162  
JO 165  
jump 165–167, 170, 173  
LAHF 73  
LDS 81  
LEA 82, 104  
LEAVE 183  
LES 81  
(list) 412  
LOCK 353, 363  
LODS 110–115, 353  
logical 99–102  
LOOP 172  
LOOPE 172  
LOOPNE 172  
LOOPNZ 172  
LOOPZ 172  
MOV 49, 82, 89  
MOVS 110–113, 353  
MOVSX 92  
MOVZX 92  
MUL 95–96  
NOP 377  
NOT 99–100  
obsolete 360  
operands for 60  
OR 26, 99–100, 168  
OUT 5  
POP 49, 71  
POPA 74  
POPAD 74  
POPF 73  
POPFD 73  
privileged 2, 38  
PUSH 49, 71  
PUSHA 74  
PUSHAD 74  
PUSHF 73  
PUSHFD 73  
RCL 101–104  
RCR 101–104

Instructions (*continued*)

REP 110–112, 363  
 REPE 110–112, 363  
 REPNE 110–112, 353, 363  
 REPNZ 110–112, 353, 363  
 REPZ 110–112, 363  
 RET 378  
 RETF 181, 378  
 RETN 181, 378  
 ROL 101–104  
 ROR 101–104  
 SAL 101–104  
 SAR 101–104  
 SBB 92–94  
 SCAS 110–115, 353  
 SHL 101–104  
 SHR 101–104  
 STC 104  
 STI 5, 209  
 STOS 110–113, 353  
 SUB 92–94  
 TEST 167–168  
 timing xvii, 399–400  
 XCHG 90  
 XLAT 116  
 XLATB 116  
 XOR 26, 99–100

## Integers

adding 92–94  
 allocating memory for 85–86  
 Binary Coded Decimal (BCD) 159  
 bit operations on 99  
 constants, defining 11–12  
 dividing 97–98  
 exchanging 90  
 hexadecimal 12  
 initializing 87  
 memory format 86  
 moving 89  
 multiplying 95–96  
 operations with 88  
 popping off stack 71  
 pushing onto stack 71  
 radix specifiers for 11  
 sign-extending 90  
 signed 86  
 size of 86  
 stack 71  
 subtracting 92–94  
 translating 116  
 types, defining 14, 86  
 value range 86

@Interface predefined symbol 37

Interrupt vector 205

Interrupt-enable flag 205

## Interrupts

CLI instruction 209  
 handlers 206–207  
 INT instruction 204–205  
 MS-DOS 204, 285  
 operation 206  
 overview 204  
 redefining 207  
 STI instruction 209  
 vector table 205

INTO instruction 207

## INVOKE directive

actions 194  
 ADDR, invoking 197  
 arguments, widening 196  
 error detection 196  
 far addresses, invoking 197  
 generated code, checking 198  
 indirect procedure calls 198  
 mixed-language programs 312–313  
 procedures, calling 193–197, 216  
 type conversions 194–195

**J**

JCXZ instruction 170–173

JECXZ instruction 170–173

JMP instruction 49, 162

JO instruction 165

## Jumps

anonymous 170  
 automatic 169  
 conditional  
   bit status 167  
   comparisons 166  
   extending 26, 169  
   flag status 165–166  
   instructions (list) 165–167  
   overview 164  
   zero value 168  
 directives for 171  
 extension, automatic 26, 169  
 instructions 165–167  
 optimization, automatic 162  
 overview 161  
 unconditional  
   indirect operands 163  
   jump tables 163  
   overview 162

**L**

LABEL directive 16

- Labels
    - anonymous 170
    - code
      - length 346
      - OPTION M510 behavior 363
      - OPTION NOSCOPEd 375
      - procedures, in 357
      - referencing 352
      - size 346
      - visibility 354
  - LAHF instruction 73
  - LANGUAGE
    - BASIC argument, OPTION directive 26
    - C argument, OPTION directive 26
    - FORTRAN argument, OPTION directive 26
    - PASCAL argument, OPTION directive 26
    - STDCALL argument, OPTION directive 26
    - SYSCALL argument, OPTION directive 26
  - LANGUAGE argument, OPTION directive 193
  - Language attributes
    - .MODEL directive, with 34, 37
    - OPATTR operator 253
    - OPTION directive, with 26
  - Large model *See* Memory models, large
  - LDS instruction 81
  - LEA instruction 82, 104
  - LEAVE instruction 183
  - Length of strings *See* LENGTHOF operator
  - LENGTH operator 356–357, 364
  - LENGTHOF operator
    - number of items, returning 110, 124, 132, 346
    - structures, defining 108
    - unions, with 125
  - LES instruction 81
  - Libraries
    - C run-time 271
    - emulator 155–156
    - overview 221
    - source files, specifying in 222
  - LIBRARY statement 270
  - Line-continuation character (\) 121
  - LINK, command-line options *See* individual entries
  - Linkage specification 322–323
  - Linking
    - actions during 24, 45
    - segment order in 48
  - Listing files
    - code generated 399
    - command-line options 397–399
    - error messages 400
    - examples 401
    - generating 397
    - PWB options 397–399
    - reading 399, 405
  - Listing files (*continued*)
    - symbols used in (list) 400
    - tables in 405–406
  - Literal-character operator (!) 235
  - LJMP argument, OPTION directive 27
  - LOADDS operand 200–201
  - Loading local address variables *See* Local variables
  - Loading, actions during 24
  - Local addresses, loading *See* Local variables
  - LOCAL directive 188–191, 232
  - Local variables
    - creating 188
    - loading addresses of 82
    - procedures, in 188
  - LOCK instruction 353, 363
  - LODS instruction 110–115, 353
  - Logical AND 178
  - Logical instruction 99–100
  - Logical line 22
  - Lookup tables 241
  - LOOP instruction 172
  - LOOPE instruction 172
  - LOOPNE instruction 172
  - LOOPNZ instruction 172
  - Loops
    - conditions
      - expression evaluation 179
      - precedence 179
      - PTR operator in 178
      - relational operators for (list) 178
      - signed operands 178
      - writing 178
    - controlling 176
    - directives
      - .REPEAT 173–177
      - .WHILE 173–177
    - instructions (list) 172
    - macros
      - FOR 242–243, 249
      - FORC 244
      - REPEAT 240
      - WHILE 241
  - LOOPZ instruction 172
  - LOW operator 356
  - LOWWORD operator 346, 366
  - LROFFSET operator 344
- ## M
- M510 argument, OPTION directive
    - compatibility with MASM 5.1 26, 353–370
    - expression word size, setting 13
    - structures, with 119

## Macros

- arguments
  - commas 352, 372
  - quotation marks 353
  - testing 29, 252
  - variable 242, 249
- calling 227
- checking argument types with 253
- comments (;) 227
- expansion 23
- functions
  - defined 248
  - epilogues 201
  - EXITM 248
  - prologues 201
  - returning values 248
- local symbols in 232
- loops
  - FOR 242–243, 249
  - FORC 244
  - REPEAT 240
  - WHILE 242–243
- MASM 5.1 behavior 25, 356, 372
- nested 251
- new features 351
- operators
  - behavior in macro functions 251
  - expansion (%) 235–236, 248, 357
  - (list) 234
  - literal-character (!) 235
  - substitution (&) 238, 352, 372
- OPTION OLDMACROS 372
- parameters
  - default values 230
  - procedure parameters, compared to 234
  - required 229
  - substitution 238
- passing arguments to 228, 235
- predefined string functions 11
- procedures
  - defined 226
  - functions, compared to 228
- recursive 255
- redefining 251
- text
  - defined 226
  - forward referencing 356
  - numeric equates, compared to 234
  - OPTION M510 behavior 370
  - syntax 226
- VARARG keyword 242, 249, 351
- writing 227

## Mask

- defined 99

Mask (*continued*)

- logic instructions, with 102
- record operators, with 133
- MASK operator 133
- MASM 5.1 compatibility
  - address fixups 26
  - macro behavior 25, 356, 372
  - OPTION directive, specifying 25
  - overview xvi
  - structures 25
  - updating code 353–360
- MASM utility xvi, 342
- Math coprocessor *See* Coprocessors
- Medium model *See* Memory models, medium
- Memory
  - access 64
  - allocation 24
  - virtual 5
- MEMORY combine type 46
- Memory models
  - attributes 35
  - compact 36
  - described 34
  - determining 10
  - far code segments 40
  - far data segments 40
  - flat 36, 58, 336
  - huge 36
  - large 36
  - medium 36
  - model-independent code 83
  - near code segments 40
  - small 36
  - specifying in PROC statement 185
  - tiny 36, 46–47
- Memory-resident programs *See* TSRs
- Microsoft Advisor xiii, 342
- Minus operator (–) 64
- Mixed-language programming
  - argument passing 314
  - assembly procedures 312
  - Basic/MASM programs 328–332
  - C prototypes, converting with H2INC 318
  - C++/MASM programs 322–323
  - C/MASM programs 315–321
  - calling conventions
    - Basic 308–310
    - FORTRAN 308–310
    - (list) 308
    - Pascal 310
    - STDCALL 311
    - SYSCALL 308–311
  - column-major order 315

Mixed-language programming (*continued*)

- compatible data types
  - Basic (list) 328
  - C (list) 315
  - FORTTRAN (list) 323
- external data 314
- FORTTRAN/MASM programs 323–326
- initialization code 313, 321
- INVOKE, using 312–313
- naming conventions 308–309
- overview 307
- register preservation 314
- row-major order 315

## ML command-line options

- /AT 36
- /Cp 10, 245
- described xvi
- /EP 342
- /Fpi 26, 157
- /I 213
- listing options (list) 397
- overview xvi
- /X 213
- /Zm 62, 119
- /Zp 119

Mode, real, protected *See* Real mode; Protected mode

## .MODEL directive

- attributes 34–35
- DGROUP 51
- language types, specifying 26, 308
- memory model, defining 35–36
- mode default 46
- overview 34
- positioning 46
- simplified segment directives 33

@Model predefined symbol 35, 83

## Module-definition file

- described 270
- statements
  - EXPORTS 261, 270
  - HEAPSIZE 261, 271
  - IMPORTS 266
  - LIBRARY 270
  - STUB 266

Module-specific EXTERN directive *See* EXTERN directive

MOV instruction 49, 82, 89

MOVS instruction 110–113, 353

MOVSB instruction 92

MOVZX instruction 92

MS-DOS interrupts 204, 285

MS-DOS operating system 2–6

MUL instruction 95–96

## Multiple-module programs

- alternatives to include files 219

Multiple-module programs (*continued*)

- COMM, using 217
- data-sharing methods 211
- declaring symbols public and external 214
- EXTERN with library routines 223
- external declarations, positioning 218
- EXTERNDEF, using 214
- include files 212–213
- libraries 221–222
- modules 212
- PROTO, using 216
- PUBLIC and EXTERN, using 220
- sharing symbols with include files 212

Multiplex interrupt 291, 304

## Multiplication

- instructions 95
- shift operations 102

## N

## Naming conventions

- directives 37
- (list) 308
- mixed-language programming 308–309

## Naming restrictions 9

Naming restrictions, identifiers *See* Identifiers

NE operator 365

Near address 57, 80

NEAR operator 169, 185

## NEARSTACK operand

- ASSUME statement 54
- default stack type 37, 42
- described 35

New features, MASM 6.1 xiv–xv, 342–351

NMAKE 270

.NO87 directive 38, 349

NODOTNAME argument, OPTION directive 25

NOEMULATOR argument, OPTION directive 27

NOKEYWORD argument, OPTION directive 9, 27, 353, 376

NOLJMP argument, OPTION directive 27, 170

NOM510 argument, OPTION directive 25

NONUNIQUE operand 118, 126

NOOLDMACROS argument, OPTION directive 26

NOOLDSTRUCTS argument, OPTION directive 26

NOP instruction 377

NOREADONLY argument, OPTION directive 27

NOSCOPE argument, OPTION directive 26, 362, 375

NOSIGNEXTEND argument, OPTION directive 27, 378

NOT instruction 99–100

NOTHING operand 49–50

Number of items with LENGTHOF operator *See* LENGTHOF operator

Numeric equates, compared to text macros 234

## O

## OFFSET

- FLAT argument, OPTION directive 27
- GROUP argument, OPTION directive 27
- SEGMENT argument, OPTION directive 27, 62

OFFSET operator 61, 82, 356, 374

## Offsets

- accessing data with 74
- addresses 7
- described 5–7
- determining 23–24, 360, 374
- fixups for 26

OLDMACROS argument, OPTION directive 25, 239, 361, 372

OLDSTRUCTS argument, OPTION directive

- MASM 5.1 compatibility 25, 361, 370–372
- structures, with 119, 126

Online help *See* Microsoft Advisor

OPATTR operator 252–253

## Operands

- ABS 220
- direct memory 60–64
- EXPORT 185
- FAR 15
- FARSTACK *See* FARSTACK operand
- FLAT 46, 49–50
- FORCEFRAME 244
- immediate 60–62
- indirect memory 60, 64–70
- NEAR 15
- PRIVATE READONLY 44–45
- registers 61
- size 66, 355
- USE16 44–46
- USE32 44–46

## Operating systems

- (list) 4
- .MODEL, specifying with 34
- multitasking 6
- types *See* MS-DOS, Windows operating systems

## Operators

- ADDR 197
- current address (\$) 368
- dot (.) 126, 352, 370
- EQ 365
- expansion (%) 235–236, 248, 357
- expressions, in 12–13
- FAR 169, 185
- HIGH 356
- HIGHWORD 346
- index ([ ]) 63
- instructions, compared to 13
- LENGTH 356–357, 364

LENGTHOF 346

Operators (*continued*)

- LOW 356
- LOWWORD 346, 366
- LROFFSET 344
- macro 251
- MASK 133
- minus (–) 64
- NE 365
- NEAR 169, 185
- OFFSET 61, 82, *See* OFFSET operator
- OPATTR 252–254
- plus (+) 63, 66
- precedence 14
- PTR *See* PTR operator
- PTR, example *See* PTR operator
- relational 357, 365
- relational (list) 178
- SEG 50, 62, 363
- segment-override (:) 59, 64
- SHORT 169
- SIZE 364–365
- size *See* PTR operator
- SIZEOF 86, 346
- structure-member (.) 64–67, 126, 352, 370
- substitution (&) 238
- .TYPE 252, 360
- TYPE 86
- WIDTH 133

## OPTION directive

- CASEMAP 25
- described 23
- DOTNAME 25, 361, 373
- emulation mode 157
- EMULATOR 26, 157
- EPILOGUE 26, 201–203
- EXPR16 OPTION directive 13, 26, 361, 373
- EXPR32 OPTION directive 13, 26, 373
- LANGUAGE 26, 193
- language types, specifying 308
- list of arguments for 25
- LJMP 26
- M510 *See* M510 argument, OPTION directive
- NODOTNAME 25
- NOEMULATOR 26
- NOKEYWORD *See* NOKEYWORD argument, OPTION directive
- NOLJMP 27, 170
- NOM510 25
- NOOLDMACROS 26
- NOOLDSTRUCTS 26
- NOREADONLY 27
- NOSCOPE 26, 362, 375
- NOSIGNEXTEND 27, 378



OPTION directive (*continued*)

- OFFSET 26, 62, 362, 374–375
- OLDMACROS 25, 237
- OLDSTRUCTS *See* OLDSTRUCTS argument, OPTION directive
- PROC 185, 375
- procedure use 26
- PROLOGUE 26, 201–203
- READONLY 26
- SCOPED 25
- SETIF2 25, 29–30
  - using 25, 361
- OR instruction 27, 99–100, 168
- ORG directive 56
- OUT instruction 5
- OVERFLOW? flag as operand 178

**P**

- PAGE align type 45
- PARA align type 45
- Parentheses [( )] 106
- PARITY? flag as operand 178
- Pascal convention 310
- Physical line 22
- Plus operator (+) 66, 352, 370
- Pointer variables 74–78
- Pointers
  - accessing data with 74
  - arguments, as 80
  - copying 79
  - far 74, 80–81
  - initializing 78
  - location 74
  - operations 78
  - TYPEDEF, defined with 15, 75–78
  - types, to 15
- Pointers and conditional Assembly *See* Conditional assembly
- Pointers defined by TYPEDEF *See* TYPEDEF directive
- POP instruction 49, 71
- POPA instruction 74
- POPAD instruction 74
- POPCONTEXT directive 255, 349
- POPF instruction 73
- POPFD instruction 73
- Positioning
  - EXTERN directive *See* EXTERN directive
  - EXTERNDEF directive *See* EXTERNDEF directive
- Precedence operators 14
- Predefined equates *See* Predefined symbols
- Predefined functions for macros 11
- Predefined string functions
  - @CatStr 245–247
  - @InStr 245–246

Predefined string functions (*continued*)

- @SizeStr 245–246
- @SubStr 245–246
- Predefined symbols 39, 83
  - @Codesize 40
  - @Cpu 254
  - @CurSeg 39, 219
  - @Data 39
  - @DataSize 39, 83
  - @Interface 37
    - (list) 10, 409
  - @Model 35, 83
  - @stack 37
  - @Wordsize 39
    - case sensitivity 9–10
    - new to MASM 6.1 (list) 343
- PRIVATE operand 185
- Privilege levels 5
- Problems, reporting xx
- PROC
  - EXPORT argument, OPTION directive 25
  - PRIVATE argument, OPTION directive 25, 362
  - PUBLIC argument, OPTION directive 25, 185
- PROC directive 180–184, 193, 206, 312
- PROC statements with visibility *See also* Visibility
- PROC with RET instruction *See* RET instruction
- Procedure prototypes
  - declaring *See* EXTERNDEF directive
  - defined with *See* PROTO directive
  - defined with PROTO directive *See* PROTO directive
  - writing *See* PROTO directive
- Procedures
  - arguments
    - far pointers 197
    - near addresses 197
    - passing 182
    - pointers 80
    - type conversions 195, 196
- CALL instruction 180
- calling *See* INVOKE directive
- calls
  - indirect 198
  - optimizing 181
- defining 180
- epilogues 26
- EXTERNDEF directive 214–215
  - See also* EXTERNDEF directive,
- include files 214
- INVOKE directive 193–197, 216
- libraries 221
- local variables 188–192
  - See also* Local variables
- Macro *See* Macros, procedures
- new features 347

Procedures (*continued*)

- OPTION PROC 375
- overview 180
- parameters
  - declaring 184–186
  - variable numbers of 186–188, 194
- PROC attributes, specifying 185
- prologues 26
- PROTO directive 193, 214, 216
  - See also* PROTO directive
- prototypes, writing 193
- RET instruction 180
- RETF instruction 181
- RETN instruction 181
- syntax description 184
- VARARG keyword 186–188, 194
- visibility 25, 375

## Processors

- See also* Real mode; Protected mode
- 8086-based 2–3
- .MODEL directive 37
- modes, determining 10
- target 2
- timing xvii, 399–400

## Product assistance xx

## Program Segment Prefix (PSP) 56

## Programming, MASM 6.1 practices 352

## Programs

- exiting 41
- mixed-language 307
- starting 41

## PROLOGUE argument, OPTION directive 25, 201–203

## Prologue code

- arguments, specifying 185
- code labels in 357
- defined 198
- macros for 201–203, 264–265
- standard 199
- user-defined 26, 201

## Protected mode

- described 2–7, 335
- flat model 335
- read-only segments 45

## PROTO directive

- include files 211, 214–216
- procedure prototypes, defined with 193
- procedure prototypes, writing 312

## Prototypes

- procedure
  - directives for 193
  - overview 193
- qualifiedtypes, defined with 15

## PTR operator

- example 92

PTR operator (*continued*)

- OPTION M510 behavior 365
  - pointer to type, as 15
  - signed number, specifying 178
  - size 66, 88
  - TYPEDF, used with 75
- PUBLIC combine type 45
- PUBLIC directive 185, 211, 220
- PUSH instruction 49, 71
- PUSHA instruction 74
- PUSHAD instruction 74
- PUSHCONTEXT directive 255, 349
- PUSHF instruction 73
- PUSHFD instruction 73

## Q

## Quadwords 86

## Qualifiedtypes

- BNF grammar 16
- defined 15
- pointers, defining 75–76
- prototypes, as 15
- rules for use 15–16

## Question mark initializer ( ? )

- array elements 109
- described 368
- variables 87

## Quotation marks (' or ") 109

## QWORD directive 86

## R

## .RADIX directive 11

## Radix specifiers

- (list) 11
- OPTION M510 behavior 367

## RCL instruction 101–104

## RCR instruction 101–104

## Read-only code 27

## READONLY argument, OPTION directive 26

## READONLY operand 44–45

## Real mode 2, 4, 7

Real numbers *See* Floating-point

## REAL4 directive 136–137

## REAL8 directive 136–137

## REAL10 directive 136–137

## RECORD directive 130–131

## Records

- defined 129
- field ranges 354
- LENGTH operator 357
- operators 133–134
- RECORD syntax 130–131

Records with SIZEOF operator *See* SIZEOF operator  
 Records with TYPE operator *See* TYPE operator  
 Recursive macros 255  
 Register operands 61  
 Registers  
   16-bit 16–17, 67  
   32-bit 335  
   base 65–70  
   coprocessor 140  
   copying pairs of 82  
   division (table) 98  
   Eflags 20  
   extended 17  
   flags 20  
   FS 17  
   general purpose 19  
   GS 17  
   index 65–69  
   indirect addressing 65  
   indirect operands 67–68  
   initializing 44  
   Instruction Pointer (IP) 20, 57, 161  
   (list) 409  
   loading addresses into 80  
   mixed 16-bit, 32-bit 70  
   pointers as 77  
   scaling 67–69  
   segment *See* Segment registers  
   Stack Pointer (SP) 19  
   Stack Segment (SS) 73  
   stacks, saving on 74  
   types, defined with ASSUME 77  
 Relational operators (list) 178  
 Relocatable  
   addresses 57  
   expressions 62, 65  
 REP instruction 110–112, 363  
 REPE instruction 110–112, 363  
 Repeat blocks 239  
 .REPEAT directive 173  
 REPEAT directive 240  
 REPNE instruction 110–112, 353, 363  
 REPNZ instruction 110–112, 353, 363  
 Reporting problems xx  
 REPZ instruction 110–112  
 Reserved words  
   described 8, 26  
   (list) 407  
   OPTION M510 behavior 362  
   OPTION NOKEYWORD 376  
 RET instruction  
   epilogue code, generating 200, 378  
   instruction encodings, changes to 357  
   PROC, with 180

RETF instruction 181, 378  
 RETN instruction 181, 378  
 ROL instruction 101–104  
 ROM-BIOS interrupts *See* Interrupts  
 ROR instruction 101–104  
 Rotate instructions 101  
 Routines, interrupt 206

## S

SAL instruction 101–104  
 SAR instruction 101–104  
 SBB instruction 92–94  
 SBYTE directive 86  
 Scaling factor 107  
 Scaling index registers 67–69  
 SCAS instruction 110–112, 115, 353  
 Scope within visibility *See also* Visibility  
 SCOPED argument, OPTION directive 26  
 SDWORD directive 86  
 SEG operator 49, 62, 363  
 SEGMENT  
   FLAT argument, OPTION directive 27  
   USE16 argument, OPTION directive 27  
   USE32 argument, OPTION directive 27  
 Segment arithmetic 7  
 SEGMENT directive 44–47  
 Segment mode, setting *See* .386 directive; .486 directive  
 Segment registers  
   32-bit 335  
   assigning 59, 62  
   ASSUME directive 49–55, 58–59, 357  
   changing 57  
   default 60, 64  
   described 18  
   FS 18  
   GS 18  
   initializing 43, 54–57  
   MS-DOS, under 24, 43  
   near code 57  
   restoring 59  
   segment-override operator (:) 50, 59–60, 64  
 Segment registers  
   initializing *See* STARTUP directive  
   setting *See* STACK directive  
 Segment selectors 5  
 Segment-override operator (:) 50, 59–60, 64  
 Segmented architecture 2, 5  
 Segments  
   32-bit 36, 335  
   accessing data 74  
   aligning 44–45  
   class types 44, 47–48

Segments (*continued*)

- code
  - creating 40
  - far 40
  - memory model support for 36
  - near 40
- combining 40, 44–46
- current 10
- data
  - creating 39
  - default 49, 54–55, 59
  - far 40
  - memory model support for 36
  - near 39
- defined 31
- described 5–7
- determining order of 47–48
- determining position of 23–24
- determining size of 44
- fixups for 26
- full segment definitions, defining 32
- groups, defining 51
- initializing 55
- location of 6
- naming 40
- ordering with the linker 48
- protection 6
- READONLY 45
- simplified segment directives 37–42
- size, determining 10
- types 44
- USE16 44
- USE32 44
- values 55
- word size, setting 46

Selector 335

Semicolon (;), comments 21

.SEQ directive 47

SETIF2 argument, OPTION directive 25, 29–30

Shift instructions 100

SHL instruction 101–104

SHORT operator 169

SHR instruction 101–104

Sign-extending integers 90

SIGN? flag as operand 178

Signed data 14, 91

Signed numbers, specifying *See* PTR operator

Significand 139

Simplified segment directives

- code segments 41
- code, starting and ending 42
- data segments 40
- described 32
- language convention 36

Simplified segment directives (*continued*)

- memory model 35
- .MODEL, defining with 34
- operating system 35
- processor 38
- segment registers, initializing 54–56
- stack 39
- stack distance 37
- using 33

Single quotation mark (') 109

Size attribute, segments

- FLAT 46
- USE16 46
- USE32 46

Size mismatch 355

Size of strings *See* SIZEOF operator

SIZE operator 364, 365

@SizeStr predefined string function 245–246

SIZEOF operator

- arrays, with 108
- described 346
- records, with 132
- strings, with 110
- structures, with 124
- types 86
- unions, with 125

SIZESTR directive 245–246

Small model *See* Memory models, small

Source code, statements in 21

SP (Stack Pointer) register 19, 71–73

SS (Stack Segment) register 73

STACK combine type 45

.STACK directive

- described 33
- segment registers, setting 56

Stack distance 37

Stack frame 73, 200, 264–265

Stack Pointer (SP) register 19

@stack predefined symbol 37

Stack Segment (SS) register 73

Stacks

- cleaning 185
- creating 38
- described 71
- distance 37
- far 10
- FARSTACK 35, 37
- in DLLs 264–267
- local variables on 188–191
- near 10
- NEARSTACK 33, 35–37
- operations with 72–74
- operators 71
- passing arguments 182

Stacks (*continued*)

- pointer 71–73
- POP instructions 71
- PUSH instructions 71
- saving flags 73
- saving registers 74
- segment register 18
- separate 46
- trace 264

.STARTUP directive

- described 33
- initializing segments 54–56
- program, starting 41–42
- segment address 37

Statements

- case sensitivity 22
- syntax 21

Status flags, saving 73

STC instruction 104

STDCALL calling convention 311, 336

STI instruction 5, 209

STOS instruction 110–113, 353

Strings

- declaring 109
- defined 105
- defining 15
- initializing 109
- instructions
  - processing, for 110
  - requirements (table) 112, 353
- length of 110
- multiple-line declarations for 109
- overview 111
- predefined functions for macros 11
  - See also* Predefined string functions
- size of 110
- type of 110

STRUCT directive 118–129

Structure-member operator (.) 64–67, 126, 352, 370

Structures

- alignment of fields 118–119
- array initializers 122
- arrays 124
- compatibility with MASM 5.1 25, 118
- current address operator (\$) 368
- default field values 122
- defined 117
- fields
  - accessing 64, 67, 371
  - initializing 118
  - naming 119, 352, 372
- initializers, as 123
- MASM 5.1 behavior 25, 355, 370
- memory allocation 117

Structures (*continued*)

- nested 128–129
- new features 345
- operators 124
- OPTION M510 behavior 366
- OPTION OLDSTRUCTS 370
- redeclaration 124, 355
- referencing fields in 126
- steps for using 118
- string initializers 122, 368
- syntax
  - types 118
  - variables 121

Structures with LENGTHOF operator *See* LENGTHOF operator

Structures with SIZEOF operator *See* SIZEOF operator

Structures with TYPE operator *See* TYPE operator

STUB statement 266

SUB instruction 92–94

Substitution operator (&) 238, 372

SUBSTR directive 245–246

@SubStr predefined string function 245–246

SWORD directive 86

Symbol table, listing files 405

Symbols

- declaring public and external 214, 220
- external 369
- naming 346, 368
- predefined 9–11

Symbols, declaring by EXTERNDEF directive *See* EXTERNDEF directive

Syntax, MASM 6.1 statements 21

SYSCALL calling convention 308–311

System date 11

System time 11

## T

Tables; lookup 241

Target environment 4

TBYTE directive 86, 159

Terminate-and-Stay-Resident programs *See* TSRs

TEST instruction 167–168

Testing for zero 168

Text delimiters *See* Angle brackets

Text macros *See* Macros, text

TEXT EQU directive

- aliases 369
- CATSTR, compared with 247
- syntax 226

Time, system 11

Timing (cycle/second) xvii, 399–400

Tiny model *See* Memory models, tiny

Trap flag 205

**TSRs**

- active
  - described 275
  - interrupt handlers in 275
  - MS-DOS functions, calling 285
  - MS-DOS functions, interrupting 286, 302
- deinstalling 292, 305
- described 273
- errors, trapping 288–289
- examples
  - ALARM.ASM 279–280, 284
  - SNAP.ASM 293–305
- existing data, preserving 290, 303
- hardware events, auditing 275–276, 299
- interrupt handlers 275
- monitoring
  - Critical Error flag 287
  - system status 277, 300
- MS-DOS internal stacks (lists) 286
- multiplex interrupt 290, 304
- passive 274

Type conversions *See* INVOKE directive

Type of strings *See* TYPE operator

**TYPE operator**

- and OPATTR 252–253
- arrays, with 108
- compatibility 360, 365
- records, with 132
- string, with 110
- structures, with 124
- types 86
- unions, with 125

**TYPEDEF directive**

- aliases, created by 87, 137
- BNF, from 380
- data types, defining 87
- indirect operands, defining 163
- pointers, defined by 15, 75–78
- procedure declarations 193
- procedure prototypes 193
- qualifiedtypes 16

TYPEDEF, used with PTR operator *See* PTR operator

Types, data *See* Data types

**U**

Unconditional jumps 162

UNION directive 118–119, 122, 125–129

**Unions**

- arrays as initializers 122
- arrays of 124
- defined 117
- fields 119, 127–129
- memory allocation 117

**Unions (continued)**

- nested 128–129
  - operators 125
  - referencing fields in 126
  - steps for using 118
  - strings as initializers 122
  - types 118
  - variables 121, 127
- Unpacked BCD numbers 160
- Unsegmented architecture 5
- Unsigned data 91
- .UNTIL directive 173
- .UNTILCXZ directive 173
- USE16 operand 44–46
- USE32 operand 44–46
- USES in PROC statement 184
- Utilities
- IMPLIB 258
  - MASM 342
  - ML xvi

**V****VARARG keyword**

- macros, used in 242, 249, 351
- procedures, used with 186–188, 194

**Variables**

- assembly-time 233
- communal 217
- environment 10, 213, 222
- external 217, 369
- floating-point 136–138
- global 211
- initializing 87
- integers, allocating memory for 85–86
- local address, loading 82
- naming restrictions 9

Virtual memory 5

Virtual-86 mode 2, 335

**Visibility**

- PROC statement 25, 185
- scope, within 9

**W**

WDEB386 debugger 264

WEP (Windows Exit Procedure) 263–264, 270

.WHILE directive 173

WHILE directive 241

WIDTH operator 133

**Windows operating system**

- API 257, 262
- applications 258, 261
- DLLs 261

Windows operating system (*continued*)

- exit codes 263
  - MS-DOS, compared 4
  - programming for 4
  - protected mode 2, 6
  - SDK 268
  - task header 265, 269
  - Windows NT 3–5
- WORD align type 45
- WORD directive 86
- Word size
- default 13, 363, 373
  - expressions, in 13, 26
- @WordSize predefined symbol 39
- Words, reserved *See* Reserved words

**X**

- XCHG instruction 90
- /X command-line option, ML 213
- XLAT instruction 116
- XLATB instruction 116
- XOR instruction 27, 99–100

**Z**

- ZERO? flag as operand 178
- /Zm command-line option, ML 62, 119
- /Zp command-line option, ML 119

# Documentation Feedback—Microsoft® Macro Assembler Version 6.1

Please help us improve our documentation. When you have used MASM 6.1 for a while, please complete and return this form. Use the back of the form for additional suggestions and comments. Suggestions and comments become the property of Microsoft Corporation.

## Rate each component of the document set:

Rate each from 1 (never use) to 5 (often use).

1 2 3 4 5 Getting Started

1 2 3 4 5 Programmer's Guide

1 2 3 4 5 Environment and Tools

1 2 3 4 5 Reference

1 2 3 4 5 Online Help

## List what stands out most about each component:

List the one or two things that you like, dislike, or both. Or, use the space to comment on the rating you gave the component in the previous section.

*Getting Started* \_\_\_\_\_  
\_\_\_\_\_  
\_\_\_\_\_

*Programmer's Guide* \_\_\_\_\_  
\_\_\_\_\_  
\_\_\_\_\_

*Environment and Tools* \_\_\_\_\_  
\_\_\_\_\_  
\_\_\_\_\_

*Reference* \_\_\_\_\_  
\_\_\_\_\_  
\_\_\_\_\_

*Online Help* \_\_\_\_\_  
\_\_\_\_\_  
\_\_\_\_\_

## What one thing would you like to see added to or removed from each component?

*Getting Started* \_\_\_\_\_  
\_\_\_\_\_  
\_\_\_\_\_

*Programmer's Guide* \_\_\_\_\_  
\_\_\_\_\_  
\_\_\_\_\_

*Environment and Tools* \_\_\_\_\_  
\_\_\_\_\_  
\_\_\_\_\_

*Reference* \_\_\_\_\_  
\_\_\_\_\_  
\_\_\_\_\_

*Online Help* \_\_\_\_\_  
\_\_\_\_\_  
\_\_\_\_\_

## How many years of programming experience do you have?

\_\_\_ With assembly language

\_\_\_ With other programming languages (including application macro languages)



Name \_\_\_\_\_

Address \_\_\_\_\_

City/State/Zip \_\_\_\_\_

Home Phone ( \_\_\_\_\_ ) \_\_\_\_\_

Work Phone ( \_\_\_\_\_ ) \_\_\_\_\_

May we contact you for additional information about your comments?  Yes  No

*Additional comments:*

.....Fold.....

Place stamp here. Post Office will not deliver without proper postage.
---

Microsoft Corporation  
Languages—MASM 6.1  
One Microsoft Way  
Redmond WA 98052-9953

Microsoft Corporation  
One Microsoft Way  
Redmond, WA 98052-6399

**Microsoft®**



Recyclable Paper



\* 3 5 7 4 7 \*