

MRX/40 and 50 Systems

Field Support Site Planning Manual

2610.002

MEMOREX

**Computer System
Products**

First Edition . . . September, 1972

**Memorex Corporation
Santa Clara, California 95052**

Requests for copies of Memorex publications should be made to your Memorex representative or to the Memorex branch office serving your locality.

A readers' comments form is provided at the back of this publication. If the form has been removed, comments may be addressed to the Memorex Corporation, Publications Dept., Santa Clara, California 95052.

© 1972, MEMOREX CORPORATION

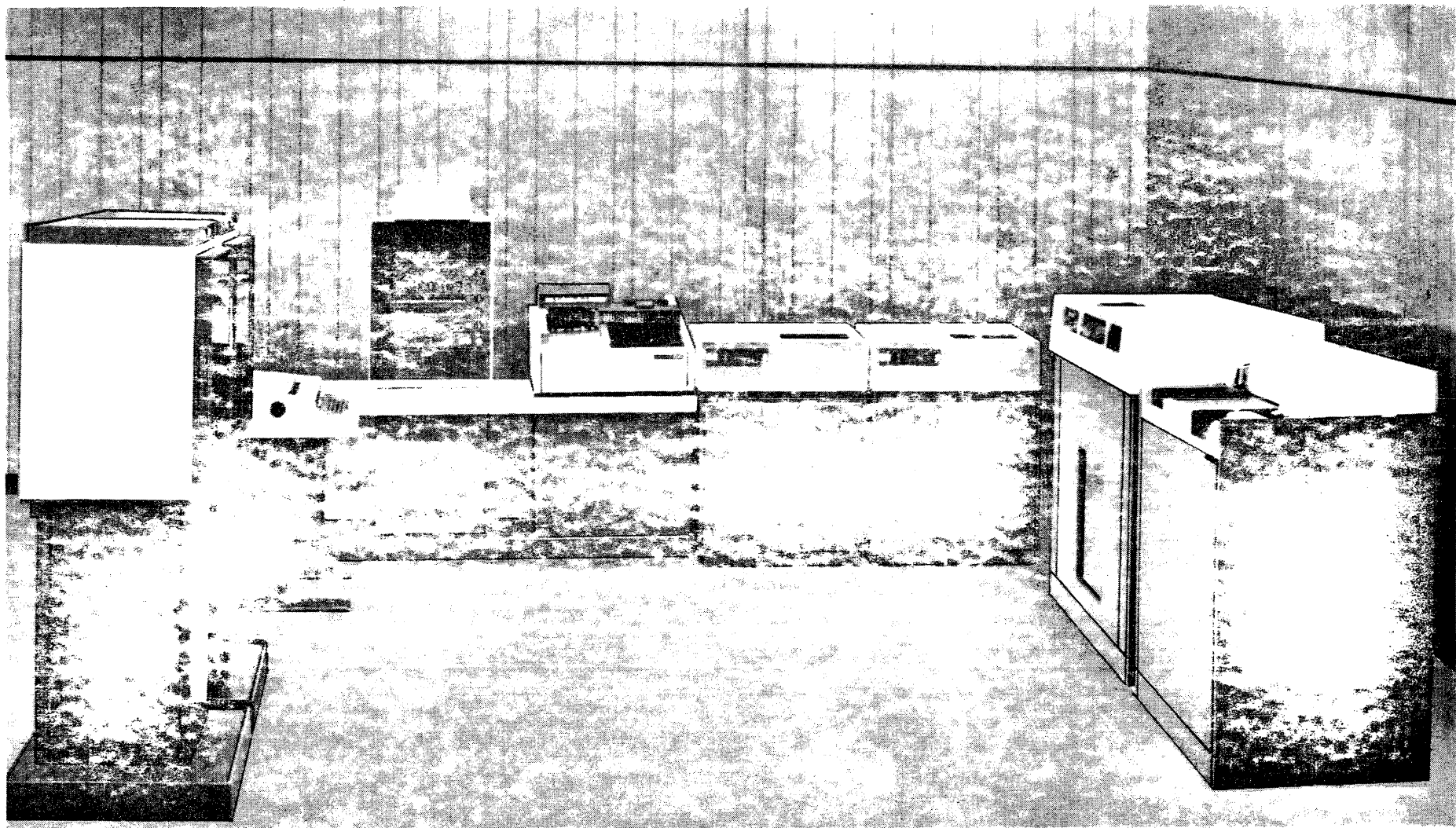

PREFACE

This manual is intended for use by Memorex field support personnel to facilitate the pre-installation planning of an MRX/40 or 50 computer system.

The purpose of this manual is to aid field support personnel in the site planning for the installation of an MRX/40 or 50 computer system. The manual comprises six sections providing general descriptions, planning, specific requirements, and equipment and cabling identification. Technical content is designed for experienced personnel familiar with similar types of planning.

TABLE OF CONTENTS

1.	GENERAL DESCRIPTION	1-1
	Introduction	1-1
	Planning	1-1
	Facility	1-1
	Power and Grounding	1-2
2.	PLANNING	2-1
	Introduction	2-1
	Scheduling	2-1
	Computer Site Layout	2-1
	Computer System Layout	2-1
	Site Selection and Preparation	2-2
	Cable Ordering	2-2
3.	FACILITY	3-1
	Introduction	3-1
	Site Area	3-1
	Computer System	3-1
	Storage Areas	3-1
	Field Support Representative	3-2
	Environment	3-2
	Air-conditioners	3-2
	Air Filtration	3-3
	Special Considerations	3-3
	Site Area Floors	3-3
	Site Area Lighting	3-3
	Site Area Emergency Lighting	3-3
	Site Area Fire Protection	3-4
	Local Codes and Insurance Regulations	3-4
	Planning for Communications Equipment	3-4
	Customer Responsibility	3-4
	Equipment Placement	3-4
	Equipment Environment and Power	3-4
	Fault Isolation	3-4
	Terminals	3-4
	Modems	3-5

TABLE OF CONTENTS (Continued)

4.	POWER	4-1
	Introduction	4-1
	Utility	4-1
	Computer System	4-1
	Power Limits	4-1
	Distribution	4-1
	Ground	4-2
	Transient Trap	4-2
	Phase Rotation	4-2
	Convenience Outlets	4-2
	Auxiliary Emergency Power	4-2
	Computer Power Distribution Facility	4-2
	System Power Calculations	4-3
5.	SYSTEM COMPONENT SPECIFICATIONS	5-1
	Introduction	5-1
	Specifications	5-1
6.	CABLING	6-1
	Introduction	6-1
	Cable Shipment	6-1
	Terminators	6-1
	Power Cords	6-8
	Special EPO Options	6-8
	Cable Length Measurement	6-8

LIST OF FIGURES

Figure 4-1	60 Hz Power Schematic	4-4
Figure 4-2	50 Hz Power Schematic	4-5
Figure 4-3	Power Distribution Facility	4-6
Figure 4-4	Power Distribution Facility Peripheral Interface	4-6
Figure 4-5	Power Phasing of Three PPLs	4-7
Figure 4-6	Equipment Phase Balance Form, Blank	4-7
Figure 4-7	Equipment Phase Balance Form, Completed	4-8
Figure 4-8	Peripheral Interface Load Calculation Example	4-9
Figure 6-1	Cabling Schematic	6-9

LIST OF TABLES

Table 4-1	Configuration Examples	4-6
Table 5-1	MRX/40 or /50 Devices	5-2
Table 6-1	Cable Groups	6-2
Table 6-2	Cable Part Numbers (60 Hz)	6-3
Table 6-3	Cable Part Numbers (50 Hz)	6-5
Table 6-4	60 Hz Power Connectors	6-8
Table 6-5	Cable Vertical Rise Dimensions	6-10

1. GENERAL DESCRIPTION

INTRODUCTION

This section describes the considerations which must be analyzed in arriving at the best planned scheme prior to actual accomplishment of a detailed plan. Only those areas directly affecting the computer system are considered. Areas such as telephone, water fountains, comfort stations, etc., are beyond the scope of this manual. Computer system equipment considerations are of course based on the proposed system configuration – the basis for this plan – and as such will not be discussed in this section. They are detailed elsewhere in this manual.

PLANNING

The design and scheme of planning a computer site is necessarily complex but when approached with an understanding and knowledge of an orderly sequence of events the total picture can be reduced to elementary functions and time-scales.

Specific areas of concern should include these:

1. Scheduling
2. Computer site layout
3. Site selection and preparation
4. Cable ordering

These areas of concern are described in detail within the Planning section of this manual.

FACILITY

The facility is defined herein as the environmental area where the computer system is to be installed and operated.

Specific areas of concern should include these:

1. Space for current and future (system expansion) needs.

2. Space free and clear of obstructions (air-conditioning ducts, false ceilings, etc.).
3. Access for equipment and personnel.
4. Floor space adequate for additional floor loading (installed equipment).
5. Acoustics.
6. Space free from unusual vibration.
7. Overhead clearance adequate for raised floor.
8. Space free from electromagnetic or radiation interference (motors, X-ray, etc.).
9. Three phase power available.
10. Air-conditioning with controlled humidity available.

POWER AND GROUNDING

Power and grounding is defined herein as that power and grounding dedicated exclusively to the computer system.

Specific areas of concern should include these:

1. Utility power supplied from an external source or internal transformer
2. Transient noise suppression insulation transformer
3. Emergency power (battery, engine-generator set)
4. Computer room distribution panel (208/230 VAC +10%, -15%, 60 Hz, three-phase or 200/345, 220/380, 230/400 or 240/415 VAC +10%, -15%, 50 Hz, three-phase. Service dependent on system configuration.
5. Equipment ground conductor (green, or green with yellow trace wire)
6. Neutral conductor (only required for local communication equipment)
7. Transient trap (high-frequency noise suppressor for grounding system)

These areas of concern are described in detail within the Power and Grounding section of this manual.

2. PLANNING

INTRODUCTION

This section describes the design and scheme of planning for the computer facility. Areas of concern are discussed relative to what must be accomplished but detailed accomplishment is left to the discretion of the reader. Included in the section are scheduling, computer site layout, site selection and modification and cable ordering.

SCHEDULING

Scheduling is herein defined as a program time table relative to the computer system site planning.

A typical time span from placement of an order for a computer system until delivery of equipment is three months. Scheduling will be based on this time span and an idealistic sequence of events. Neither is rigid and may be revised to fit the requirements of each customer but the events that are required must be accomplished. This schedule only reflects the computer system equipment planning.

Three months prior to delivery:

1. Review pertinent data and specifications relative to the equipment ordered. (Refer to Section 5 for equipment specs.)
2. Determine computer system layout as described in paragraph, "Computer Site Layout".
3. Select computer system site and plan any necessary modifications as described in paragraph, "Site Selection and Modification".
4. Determine cabling requirements based on equipment ordered, computer site layout, computer system site, and order as described in paragraph, "Cable Ordering".
5. Initiate an activity checkoff list of all functions being performed to enable follow up and confirmation of completion during succeeding months.

Two Months Prior To Delivery:

1. Review activity checkoff list for progress of all functions.
2. Reschedule any functions either not started or slow in progress.

One Month Prior To Delivery:

1. Review activity checkoff list for progress and completion of functions.
2. Initiate an inspection schedule of all functions for future use.

One Week Prior To Delivery:

1. Inspect all modifications of the computer system site for completeness and to see that site is clean.
2. Verify that items on checkoff sheet of previous months are completed.
3. Schedule customer representative for availability upon receipt of computer system equipment. Plan on either immediate placement of equipment or temporary storage space.

COMPUTER SITE LAYOUT

The layout of the computer site is determined by both the computer system equipment configuration and customer requirements. Only the computer system will be of concern in this discussion. Plans beyond this discussion must necessarily be determined by the customer.

COMPUTER SYSTEM LAYOUT

The layout of the computer system equipment is determined by many factors. The two most significant of these

are the equipment with their associated required clearances and interconnecting cabling (power, signal, etc.).

To make a layout it is necessary to have an accurate drawing of the proposed area. Templates, scaled at ¼ inch to 1 foot will be available from Memorex. Note that the plan views printed in this manual may not be exactly as scaled. The templates show the clearances required to allow working room for the customer's operator and for the field support representative to service the unit. Space is included for test or servicing equipment. The swinging radii of the unit gates covers and the caster and cable hole locations are shown. If the area layout scale is ¼ inch to 1 foot, these templates may be used to position the equipment on the area drawing; in some cases, clearances shown on the templates may be overlapped as long as the larger clearance is maintained. The gate swing of any unit must not interfere with the gate swing of another unit.

Equipment must be located so that the length of connecting cables will not exceed maximum limits. These limits vary for each type of unit, and charts showing the limits are in the cabling section of this manual.

To make a layout and order cables, it is necessary to consider the following information pertaining to the system configuration:

1. Devices to be assigned to each channel
2. Features on all units
3. Priority or logical sequence of control units on each channel
4. Number of input/output units or features attached to each control unit

The final layout must be reviewed to ensure that cable limitations have not been violated and that proper clearances have been maintained. Copies of this layout must accompany the cable order.

When a unit requires external cables which must be purchased by the customer and installed through walls and/or floors, the purchase of this cable and the arrangements for their installation should be made with sufficient lead time to permit the cabling to be available to the computer system at installation time.

Where telecommunications equipment requiring common-carrier facilities is to be installed, arrangement for these facilities should be made in advance to permit these facilities to be available at the time of installation of the computer equipment.

A checklist of all requirements should be formulated to ensure completeness.

SITE SELECTION AND PREPARATION

The selection and preparation of a site or area for the location of the computer system demands an understanding of the computer system requirements. The site must meet the requirements specified in subsequent discussions of a facility and power in the Facility and Power sections of this manual.

A checklist of activities or functions required should be formulated and checked periodically, as stated earlier.

CABLE ORDERING

The computer system equipment cabling is primarily determined by the computer system site and computer system equipment layout. Necessarily then, cable ordering must be planned in association with both of the aforementioned. A Memorex representative will actually do the ordering of all cables, but it will be based on customer requirements for equipment needs.

3. FACILITY

INTRODUCTION

This section describes the facility site area, environment, and special considerations necessary for the installation of an MRX/40 or /50 Computer System. Areas of accomplishment are indicated but no methods are included for their accomplishment. This is left to the discretion of the customer.

SITE AREA

The site area is defined herein as the total space required for the computer facility. The computer facility comprises all areas directly or indirectly supporting the computer system.

COMPUTER SYSTEM

The primary site area will be occupied by the previously determined computer system layout, allowing additional space for present customer requirements and future computer system expansion or customer requirements.

Some of the site area conditions which also must be considered follow:

1. Site area free and clear of obstruction such as air-conditioning or heating ducts, false ceilings, plumbing, building pillars, etc.
2. Site area access for equipment and personnel such as entryways, doors, windows, skylight, stairways, hallways, elevators, etc.
3. Site area floor loading (50 lbs/sq. ft.) capability for supporting computer system and any customer provided equipment weight load as oriented on computer system layout.
4. Site area acoustical soundness and free from unusual vibration, electromagnetic, or radiation interference.

STORAGE AREAS

Storage areas must be considered for two types of files, working and master. The working file storage area should be large enough to accommodate all of the supplies (disc pack, tape, cards, etc.) required to operate for one day. This area may be within the immediate area of the computer system.

The master file storage area should be located away from the computer system, preferably in a separate room where adequate security and fire protection can be provided. This area must be maintained within the specified environmental limits indicated below:

Magnetic Tape

Time	Temperature	Relative Humidity
Short Term	50° to 90°F	
Long Term	40° to 90°F	20% to 80%

Magnetic Tape exposed to temperature and humidity conditions outside the storage limits, must be reconditioned prior to use by placing the tape in the correct environment for a length of time equal to the time spent outside the correct environment (up to a maximum reconditioning time of 24 hours)

Disc Pack

Time	Temperature	Relative Humidity
Short Term	60° to 90°F	
Long Term	40° to 150°F	10% to 80%

Disc packs exposed to temperature and humidity conditions outside the storage limits, must be reconditioned prior to use. The same method as that employed for magnetic tape should be used, except reconditioning time is two hours minimum.

Punch Cards

Optimum Temperature	Relative Humidity
73°F	30% to 65%
Punch Card Reconditioning	
Variation From Computer Room Relative Humidity	Minimum Reconditioning Time*
+10%	1 day
+20%	10 days
+30%	15 days

*Times apply to cards packed in open containers.

FIELD SUPPORT REPRESENTATIVE

A maintenance area for both tools and test equipment storage and maintenance working area of approximately 70 square feet should be provided. It can be an open area but preferably should be an enclosed area or room outside of the immediate area of the computer system. Adequate lighting and power must also be available.

ENVIRONMENT

All MRX/40 or 50 system components with the exception of the 8010 Card Reader are designed to receive cooling air at or near floor level. Cooling air is circulated internally by fans or natural convection and exhausted at or near the top of the unit.

The design criteria optimum environment for MRX/40 or 50 system is 70°F and 50% relative humidity at altitudes up to 6000 feet. To ensure temperature and humidity conditions within the environmental limits, it is recommended that temperature and humidity monitoring and control instrumentation be installed which is accurate to within ± 2°F and ± 5% relative humidity. For those installations where continuous round-the-clock operation is essential, it is recommended that a temperature and humidity alarm system be installed in addition to the above equipment.

AIR-CONDITIONERS

A separate air-conditioning system is recommended for the computer facility. Because of the heat dissipated by the system while in operation, it may be necessary for the air-conditioner to maintain a cooling cycle year-round.

Consideration should also be given to the air-conditioner requirements for the computer facility, to provide for equipment room personnel, lighting, and other factors. In general, each 300 square feet of floor area will require one additional ton (12,000 BTU) of air-conditioning over and above the equipment requirements.

The following formula defines the computations for air-conditioning.

$$(A) \frac{\text{Total System BTU}}{12,000} = \text{Tons of Air-conditioning For System}$$

$$(B) \frac{\text{Total Floor Space}}{300 \text{ Sq. Ft.}} = \text{Tons of Air-conditioning For Facility}$$

A+B=Total Air-conditioning Requirements

The air-conditioner unit(s) should not be powered from the computer room distribution panel; however, local codes and fire regulations in many communities require that a means of disconnecting power to the air-conditioning system must be incorporated into the computer room distribution panel.

Three types of air-conditioning systems in general use that are suitable for cooling MRX/40 or 50 Computer Systems follow:

- single duct overhead system
- under floor system
- stand-alone system

In single duct overhead systems, all of the conditioned air is supplied either by a ceiling air plenum or a duct and diffuser arrangement. The total heat load generated within the room including the computer system is absorbed by the air supplied to the facilities. The return air is then picked up by return registers in the ceiling or walls. This type of system is generally part of the normal building air-conditioner system.

The under floor system utilizes the space between a raised floor and the regular building floor as an air plenum. Air is fed to the plenum and discharged into the computer facility by floor registers. The air return for this type of system is normally the same as in single-duct overhead systems.

NOTE

Cable entry holes in raised flooring are not a reliable means of discharging air into the room and should not be included in the calculation of discharge volume.

The stand-alone environmental control system is designed specifically for use in computer facilities. This system generally utilizes a raised floor as an air plenum (some systems are designed for floor venting when raised flooring is not used) to discharge air into the room. Stand-alone units range in size from 3 to 15 tons capacity and are self-contained.

Many computer facilities use a combination of two or more of the above systems. Because of the concentrated heat load produced by computer system equipment, the design selected for the computer facility is very important to year-round equipment use. For this reason, Memorex recommends that a professional air-conditioning engineer be consulted.

AIR FILTRATION

All air entering the computer facility should be filtered by the air-conditioning system to remove dirt, dust and other foreign contaminants. There are two types of air filters in common use suitable for filtering the air in computer facilities. The most efficient type, electrostatic plate filters, are designed to operate at 85% to 90% efficiency at a given air velocity. The efficiency of this type of filter decreases as the velocity increases. The second type, mechanical air filters are usually constructed of fiberglass. For computer room use, mechanical air filters must have a minimum efficiency of 20% based on a Bureau of Standards Discoloration Test with atmosphere dust.

SPECIAL CONSIDERATIONS

These considerations are some of the more significant ones and do not preclude others which a customer may decide are necessary.

SITE AREA FLOORS

Flooring in the site area due to cabling, air-conditioning, etc., will be one of two categories, primary floors or raised floors.

Primary floors will have to contain cable raceways either above or below the floor surface and must be adequate for the installation of a MRX/40 or 50 Computer System.

Raised Floors are not required for MRX/40 or 50 systems, however raised floors when installed offer the following advantages.

- Increased layout flexibility due to direct cabling

- Increased cabling protection and personnel safety
- Increased air-conditioner efficiency due to their use as an air plenum
- Decreased reconstruction cost in the event of layout change

Raised floors are of two types: free-access and raceway. Free-access raised floors are generally constructed of aluminum, steel or fire-resistant wood panels set in a metal frame and supported by pedestals at each corner of the panel. Raceway type raised floors, by contrast, are simply slots cut in a concrete floor in a prearranged pattern with a covering of metal or other material. A change to a raceway floor requires the cutting of a new raceway; and it therefore does not offer the freedom of change provided by free access-type floors. The minimum raised floor height should not be less than 6 inches.

Cutouts in the raised floors are required in the locations shown by the cable entry symbols on Memorex Installation Planning Templates. The cutouts should be located directly beneath the cable entry as shown on the Templates, and should be approximately the same size and shape as shown on the Template. All sharp edges must be removed or covered to protect the personnel and cables from injury.

The minimum and maximum resistance specifications for floor covering materials are as follows:

- Minimum – 5×10^5 ohms*
- Maximum – 2×10^{10} ohms*

Carpeting in a computer facility is not recommended unless it can meet the resistance specifications mentioned above.

SITE AREA LIGHTING

The average illumination level in the computer facility should be maintained at a minimum of 45 foot-candles measured 30 inches above the floor. If possible lighting should be sectionally controlled to allow a reduction in lighting level within the facility. Direct sunlight within the computer facility should be avoided.

SITE AREA EMERGENCY LIGHTING

A battery-powered emergency lighting system should be installed in the computer facility for the protection of personnel in the event of a power failure. As an added precaution in windowless rooms, the illuminated exit signs near each door should be tied into the emergency lighting system.

*Measured between the floor surface and applicable ground reference.

SITE AREA FIRE PROTECTION

Portable class ABC fire extinguishers of sufficient size and in sufficient numbers to satisfy local building and safety codes should be installed within the computer facility. In addition, a smoke detection or other approved system should be installed to protect the computer facility. This detection system should sound an audible alarm.

If an automatic sprinkler system is installed, the sprinkler head activation temperature should be set at 175°F or higher, if regulations permit. Sprinkler head guards to prevent accidental operation should also be installed.

Where a carbon dioxide (CO₂) total flooding fire protection system is installed or is contemplated, the customer is requested to forward the following information to Memorex:

- quantity and size of the carbon dioxide cylinders
- type of detection system
- type and location of the alarms
- timing sequence between the detection of a fire and the discharge of the carbon dioxide
- procedure to be followed by Memorex personnel whenever the detection system sounds the alarm

This information is required to ensure the safety of Memorex personnel

LOCAL CODES AND INSURANCE REGULATIONS

Local code and insurance regulation considerations of each customer will be different but should be analyzed based on their locality and requirements.

PLANNING FOR COMMUNICATIONS EQUIPMENT

CUSTOMER RESPONSIBILITY

Modems, Terminals and other special equipment (i.e., multiplexers, matrix switches, data communications lines and line conditioning) are required for a data communications system. This equipment is generally supplied in part or entirely by one or more outside vendors and, therefore, must be ordered independently of the computer system. If non-common-carrier modems are used for data transmission on telephone lines a Data

Access Arrangement must also be installed in combination with each modem. The customer is encouraged to contact each vendor well in advance of computer system delivery to ascertain lead times and prices.

EQUIPMENT PLACEMENT

Most modems used in the domestic and international market are designed to be placed on a table top or shelf. Some, however, require special rack mounting. Telephone company supplied modems are usually equipped with a telephone set for which space must be provided. Phone sets can often be omitted when non common carrier modems are used. Data Access Arrangements required by the Telephone company are normally installed on the wall of the facility. The placement or mounting of other special equipment will vary with each site. The customer should consult the vendor(s) for site planning information.

EQUIPMENT ENVIRONMENT AND POWER

The space environment and power requirements for each item of communications equipment is determined by the vendor. It remains the customer's responsibility to perform an inspection of each proposed Terminal/modem location to determine suitability. Domestic modems are generally designed to operate on 120 VAC 15 ampere 60 Hz service. Modems for the international market are generally designed to operate on 220 VAC, 15 ampere 50 Hz service.

FAULT ISOLATION AND TESTING

System layout should take into account accessibility for maintenance and testing. To facilitate fault isolation and testing the customer is encouraged to plan the communications subsystem so that it may be tested independently of the computer system. This may involve the use of modem testing devices and "patching" arrangements which allow the switching of modems and lines.

TERMINALS

The MRX/40 and 50 systems may include these terminals:

- MEMOREX 1240
- MEMOREX 1280
- MEMOREX 1250
- Teletype 33/35 KSR

- Teletype 33/35/37/38 ASR
- Binary synchronous terminals and processors attached to transmission control units having a synchronous line or data adapter.

Other terminals may be used if plug-to-plug compatibility is established. Terminals for specialized functions may require special engineering and programming support.

MODEMS

For general communications purposes, these modems may be used with the MRX/40 and 50 systems: (all have EIA-RS232C interface).

Asynchronous

WE103A	110-300 bits per second
WE103E	(2-wire)
WE103F	
WE113B	

WE202C	600-1200 bits per second
WE202D	(2-wire)
(both with reverse channel)	

Synchronous

WE202C	600-1200 bits per second
WE202D	(2-wire, operable in 201A mode only)
WE201A	2000-2400 bits per second
WE201B	(2-wire)
MRX1228-3	
WE203A	3600-7200 bits per second
	(4-wire)

Other modems may be used if electrically equivalent to these. It is the customer's responsibility to establish the compatibility of these modems to the Memorex system.

4. POWER

INTRODUCTION

This section contains the detailed power requirements and the grounding procedures for the MRX/40 or 50 Computer System comprised of the 7200/7300 computer and certain standard devices. If adhered to, these requirements and procedures will ensure proper power.

UTILITY

Utility power may be provided by either a transformer with usable voltages or higher voltage levels than required. When voltages that are usable exist, it may be advisable to install an isolation transformer to eliminate transient electrical noise and reduce the effects of power drops caused by other loads. For 60 Hz installations a delta wound secondary is required. A transformer with a wye wound secondary is required for 50 Hz installations.

When voltages that are too high are provided a step-down transformer will be required. An isolation transformer is not required.

COMPUTER SYSTEM

The primary power requirements of the computer system will vary dependent on the number and types of peripheral units used. Power is normally supplied to each computer subsystem directly from the computer Power Distribution Facility.

The 7200/7300 computer may be configured to accept either 30-ampere or 60-ampere service from a 208/230 VAC, 60 Hz, three-phase, 4-wire (three-phase conductors and 1 "green wire" equipment ground) power source or 30-ampere service from a 345, 380, 400, or 415 VAC, 50 Hz, three phase, 5-wire (three phase conductors, one neutral conductor and one "green wire" equipment ground) power source.

On those systems requiring in excess of 60-ampere service (60 Hz) or 30-ampere service (50 Hz), selected subsystems (3237, 5120 and 8025 only) may be configured to accept 15-ampere service from a 208/230 VAC, 60 Hz, three-phase, 4-wire (three-phase conductors and one "green wire" equipment ground) power source or 15-ampere service from a 345, 380, or 400 VAC, 50 Hz, three phase power source.

The 5120 and 8025 subsystems may also be configured to accept 15-ampere service from a 208/230 VAC, 60 Hz, single-phase, 3-wire (two-phase conductors and 1 "green wire" equipment ground) power source or 15-ampere service from a 200, 220, 230 or 240 VAC, 50 Hz, single-phase, 3-wire (two conductors and one "green wire" equipment ground) power source. The use of three-phase power permits subsystems to be "daisy-chained" (serial fashion) subject to the same rules as when the subsystems are powered directly from the computer (see Computer Power Distribution Facility). The 1603 subsystem when used with MRX/40 or 50 systems is configured for 15-ampere service from a 208/230 VAC, 60 Hz, single-phase, 3-wire (two phase conductors and one "green wire" equipment ground) power source or 15-ampere service from a 200, 220, 230 or 240 VAC, 50 Hz, single-phase 3-wire power source. The 1240 subsystem, when used as a local communications device, is configured for 15-ampere service from a 120 VAC, 60 Hz, single-phase, 3-wire (one phase conductor, one neutral conductor and one "green wire" ground) power source or 15-ampere service from a 200, 220, 230 or 240 VAC, 50 Hz, single-phase 3-wire power source. Customer supplied devices (including communications equipment) connected to the system must be powered (dependent on voltage requirements) in the same manner as described for Memorex subsystems.

POWER LIMITS

Voltage Limits – The line-to-line voltage tolerances must be maintained within +10%/-15% of the normal rated voltages, measured at the receptacle, when the system is operating.

Frequency Limits – The line frequency must be maintained at 60 Hz \pm 1 Hz, or 50 Hz \pm 1 Hz as applicable.

Line-To-Line Voltage Imbalance – The value of any of the three line-to-line equipment voltages in the three-phase system must not differ by more than 5% from the arithmetic average of the three voltages. All three line-to-line voltages shall be within the limits specified under "Voltage Limits".

Harmonic Content – The maximum total harmonic content of the power system voltage waveforms on the equipment feeder must not exceed 8% with the equipment not operating.

DISTRIBUTION

Primary power to the computer system should be supplied through a single feeder protected by a mainline circuit breaker (see Figures 4-1 and 4-2). The 7200/7300 computer power and individual 15-ampere circuits (if required) must be protected by circuit breakers suitable for motor load application and derated to manufacturers' specifications.

All customer supplied devices connected to the system must be supplied by a separately protected branch circuit interlocked with the main circuit breaker.

The power distribution panel should be located in an unobstructed and well lighted area within the computer room. As a safety precaution, an emergency switch (glass enclosed or recessed type) should be installed in the computer facility, capable of removing all power to the computer system and air-conditioning equipment. Local codes or insurance regulations may require that such a system be installed.

GROUND

Proper grounding of all equipment within the computer facility is vitally important for equipment operation and personnel safety. Conduit, plumbing, etc., are not acceptable means of grounding the computer system equipment. All Memorex supplied devices of a MRX/40 or 50 system are provided with an insulated non-current-carrying equipment ground wire (green or green with yellow trace). The grounding conductor at 60 Hz installations should not be mistaken for a neutral conductor – a neutral conductor is required only on 1240 subsystems when used as local communication devices. A neutral conductor in addition to a "green wire" ground is required for all Memorex 50 Hz devices. Customer supplied devices (including data sets) may require a neutral conductor; however, all such devices should also include a "green wire" equipment ground conductor.

The "green wire" equipment ground conductor for all branch circuits used to power devices connected to the system (including customer supplied devices) must be tied together in the computer room distribution panel and then carried back to the main building ground. The equipment grounding conductor must be the same size or larger than the phase conductors.

TRANSIENT TRAP

In some facilities, depending on structure, high frequency noise may be induced into the grounding system. Memorex recommends in this instance that a transient trap be installed to bleed off this type of noise. A recommended transient trap consists of a 10 square feet

piece of sheet metal 20 gauge or larger. The trap may be mounted either on the wall or floor of the facility and should be in contact with structural concrete. The trap must be connected to the computer power distribution panel ground bus using a 12 AWG or larger wire no more than 5 feet in length.

PHASE ROTATION

The three-phase power receptacles for use with the system must be wired for correct phase rotation. Correct phase rotation for the 30-ampere or 60-ampere receptacles feeding the computer may be determined by looking at the face of the receptacle; running counterclockwise from the ground pin, the sequence should be phase A, phase B and phase C. Correct phase rotation for supplementary 15-ampere receptacles will be dependent on the equipment configuration.

CONVENIENCE OUTLETS

The computer and each of the disc drives are provided with 120 VAC (60 Hz) or 220 VAC (50 Hz) service-convenience-outlets for use by Memorex Field Support Representatives. Under no circumstances are these service-convenience-outlets to be used for any other purpose. A minimum of two additional 15 ampere convenience outlets should be provided in the computer facility for use by building maintenance personnel. These outlets must be powered from other than the computer room distribution panel.

AUXILIARY EMERGENCY POWER

Consideration should be given to the installation of an Uninterruptable Power Source (UPS) on those systems requiring continuous operation during power disturbances or outages. A wide variety of engine-generator/battery-inverter devices are suitable for this purpose.

COMPUTER POWER DISTRIBUTION FACILITY

The Power Distribution Facility (PDF) incorporated into each 7200 or 7300 will allow most MRX/40 or 50 systems to be supplied from a single power line. The PDF is divided into two sections termed the Processing Unit Interface and the Peripheral Interface (See Figure 4-3). The Processing Unit Interface supplies power to the computer, the 1240 Console and the 8010 Card Reader (optional).

The Peripheral Interface supplied power to all those devices not serviced by the Processing Unit Interface and not demanding a separate 15-ampere power, power line

(See Figure 4-4). The Peripheral Interface may be used to power up to three Peripheral Power Lines (PPL's). A fuse in the Peripheral Interface, limits the power supplied to the PPL's. This fuse is rated at:

- 24 amperes when the computer is provided with 208/230, 60 ampere, three-phase service.
- 15 amperes when the computer is provided with 208/230, 30 ampere, three-phase service.

A separate 15 ampere peripheral power line will be required only when the aggregate current load of the devices attached to the PPL's exceeds the fuse rating in the Peripheral Interface.

The first step in calculation of power is to reference Table 5-1. The power requirements of each of the devices available on MRX systems (only MRX devices are included) are listed with their respective current loads. These current loads are rated in AMPS.

Figure 4-5 shows the equipment cabling method. The three phases are rotated between the 3 PPL's and between each device as power is passed through each peripheral. Because of this, the position of the peripheral in the cable sequence is important.

A single phase device in any given phase position loads a phase as follows: (Three phase devices load all phases.)

Phase Position	Phase Loading
A	C - A
B	A - B
C	B - C

Any equipment may be put in any position subject to the constraints listed above. Balancing of the phase loading may be accomplished by moving devices between phase positions.

NOTE

A separate 15-ampere power line may be configured in phase position A, B, or C depending on the requirements of the system.

The following rules apply when connecting peripheral devices on the PPL's or on separate 15-ampere power lines:

- Disc drives (3664 subsystem) may not be intermixed with other devices on a line.
- No more than three devices may be connected to a single power line with the exception of a tape subsystem (3237) which may consist of up to four tape transports.
- A tape subsystem must occupy the last position of the line which supplies it power.

The 120 VAC convenience outlets described under "Convenience Outlets" are not to be included in the computation of system power requirements.

SYSTEM POWER CALCULATIONS

Before calculating the system's power load, it should first be determined whether the configuration matches one of those shown in Table 4-1. Several of the most common configurations are included to eliminate the necessity of calculating power.

The first step in determining system power requirements is to record the devices that are to be used in the configuration and calculate their respective current loads. A form suitable for this purpose is shown in Figure 4-6. An attempt should be made to balance the loads on each peripheral power line (PPL) and, where possible, without upsetting this balance, place devices of approximately the same current load on the same PPL. Calculate each PPL load.

An example of a sample calculation using configuration 2B from Table 4-1 is shown in Figure 4-7.

The total line load should be less than the 16 AMP maximum per PPL. If not, an alternate power connection must be provided for.

The calculation of the total PPL line load must be performed for each Peripheral Power Line.

The next step is to insure that the aggregate power load of the three PPL's does not exceed the current rating of the Peripheral Interface. An example of this computation for the same equipments as in Figure 4-7 is shown in Figure 4-8.

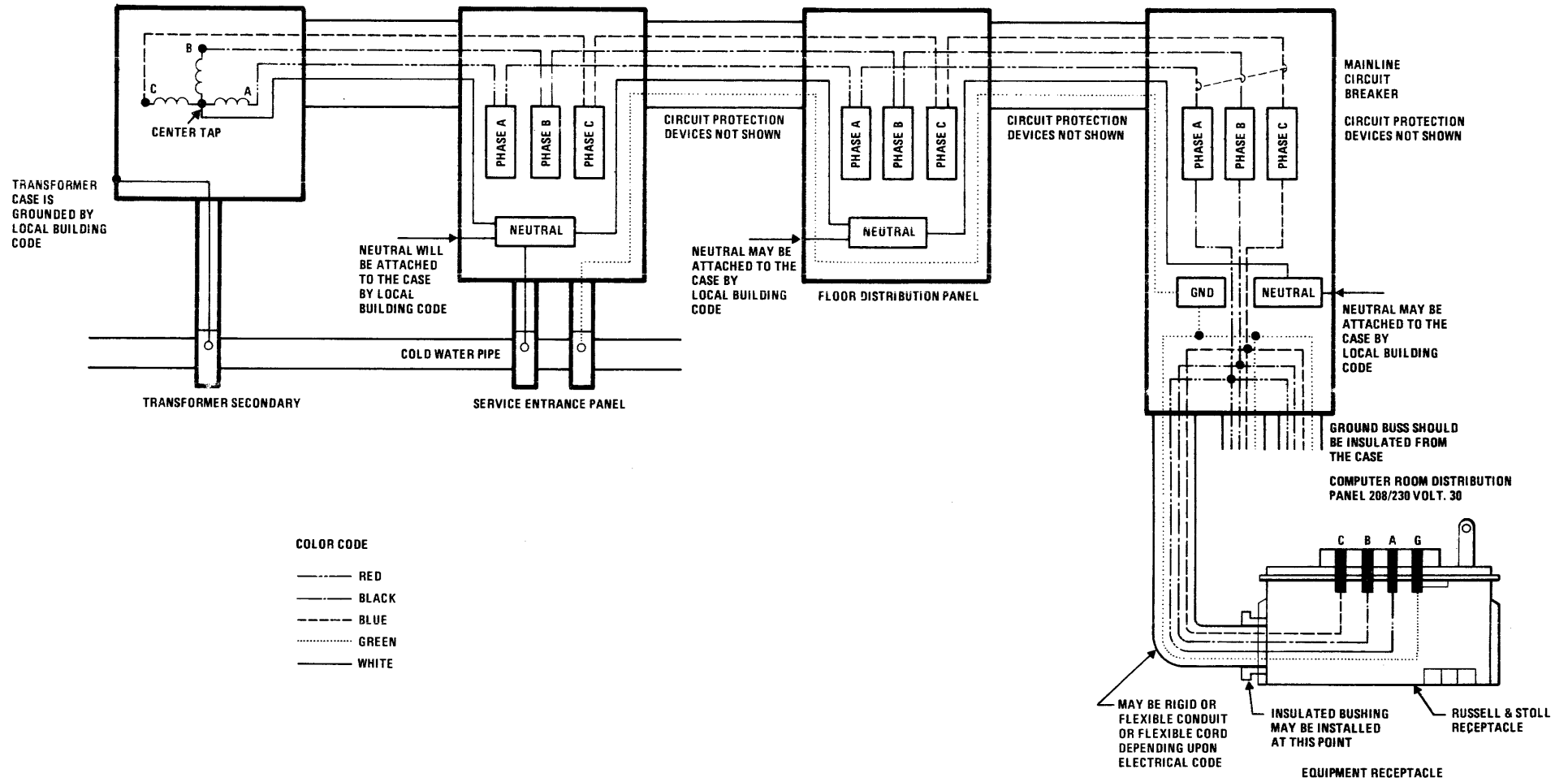

Figure 4-1. Power Schematic

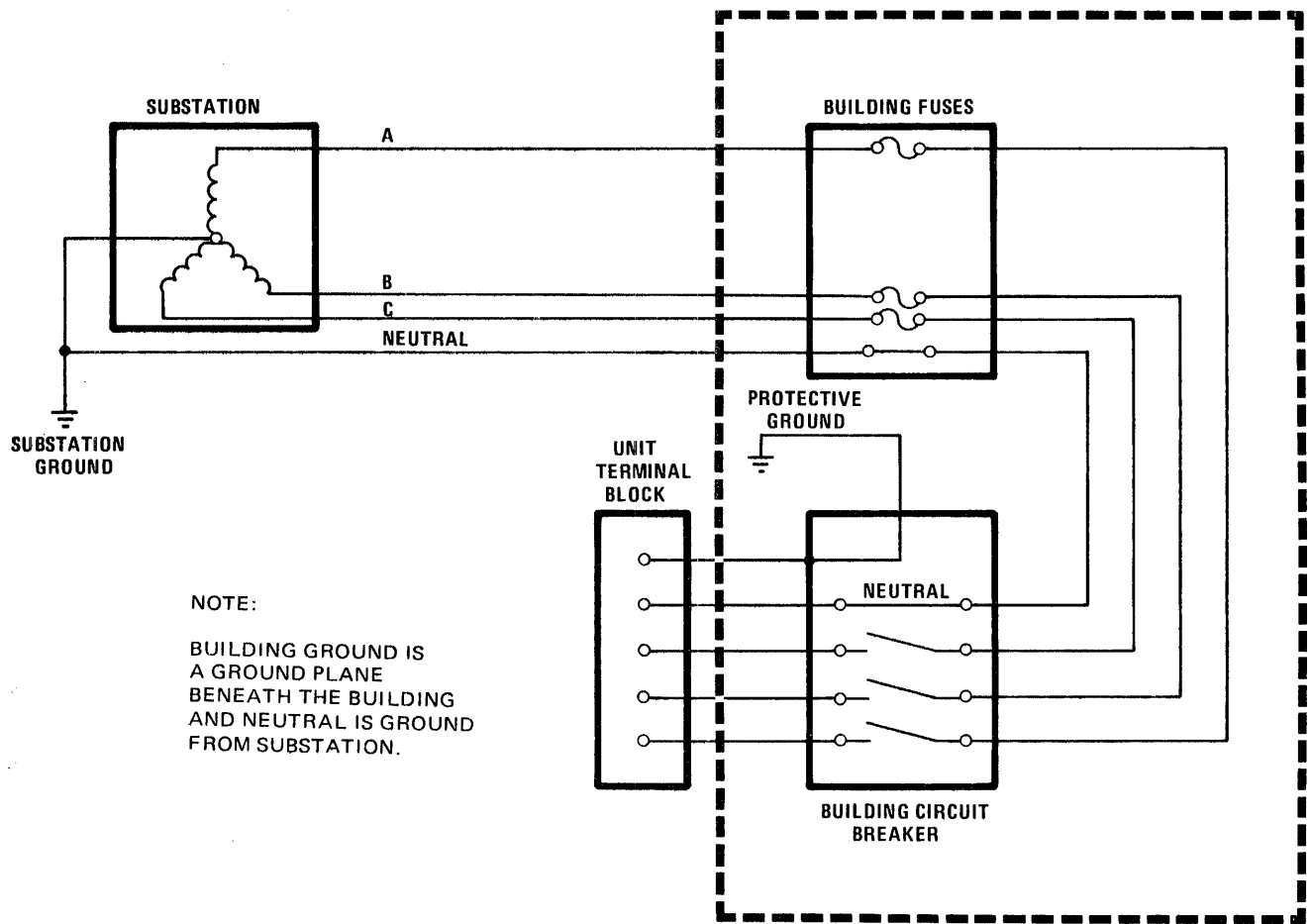

Figure 4-2. 50 Hz Power Schematic

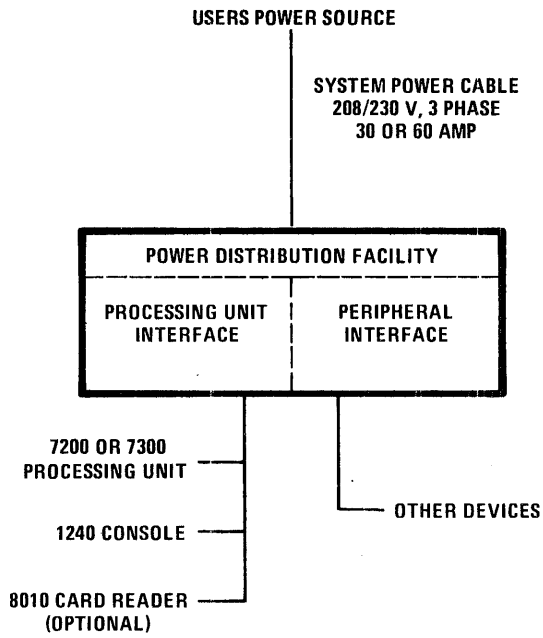

Figure 4-3. Power Distribution Facility

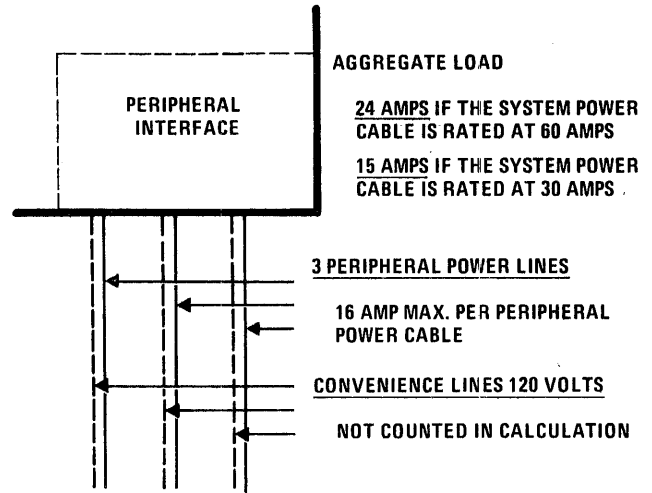

Figure 4-4. Power Distribution Facility Peripheral Interface

Table 4-1. Configuration Examples

7200 OR 7300, 1240 CONSOLE, AND 1 8010 CARD READER WITH 30 AMPERE SYSTEMS POWER CABLE

- CONFIGURATION 1A. UP TO 6 3664 DISC DRIVES.
- CONFIGURATION 1B. UP TO 2 3664 DISC DRIVES.
1 5120 LINE PRINTER
1 8025 CARD READER PUNCH
- CONFIGURATION 1C. UP TO 3 3664 DISC DRIVES
EITHER 1 5120 LINE PRINTER OR,
1 8025 CARD READER PUNCH

7200 OR 7300, 1240 CONSOLE, AND 1 8010 CARD READER WITH 60 AMPERE SYSTEMS POWER CABLE

- CONFIGURATION 2A. UP TO 9 3664 DISC DRIVES.
- CONFIGURATION 2B. UP TO 3 3664 DISC DRIVES.
1 5120 LINE PRINTER
1 8025 CARD READER PUNCH
1 3237 TAPE DRIVE
- CONFIGURATION 2C. UP TO 3 DISC DRIVES
1 5120 LINE PRINTER
1 8025 CARD READER PUNCH
4 3237 TAPE DRIVES

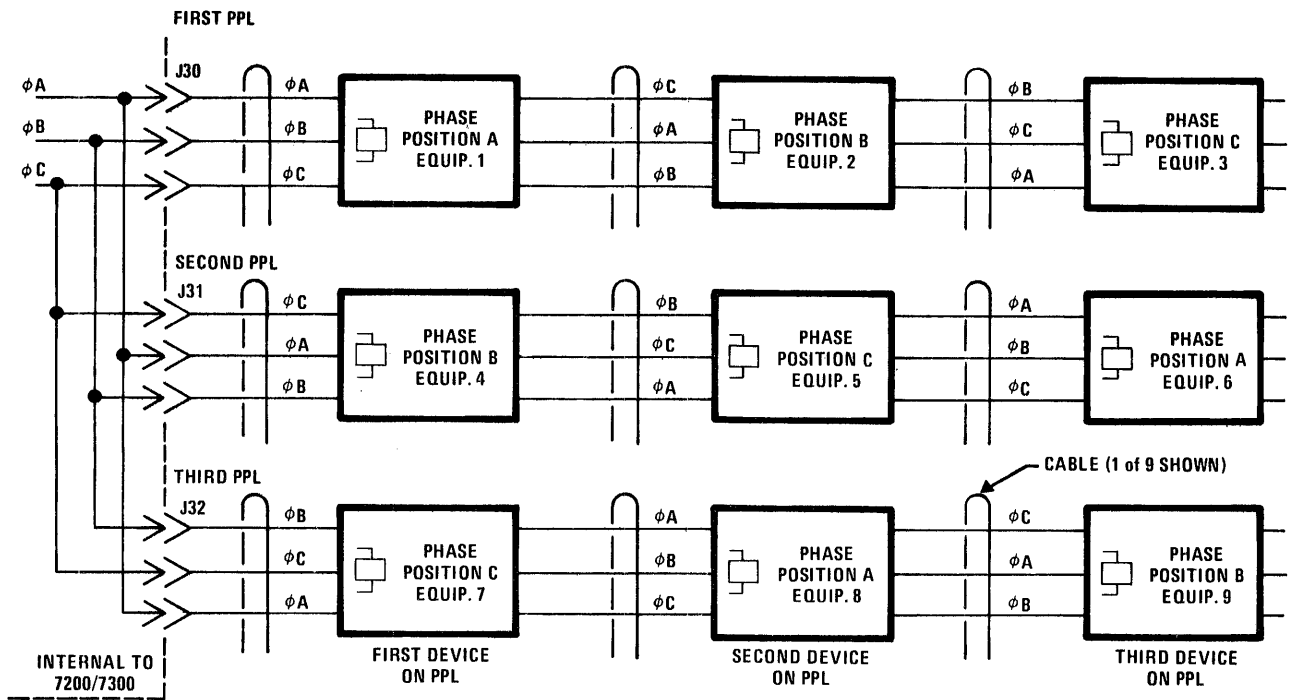

Figure 4-5. Power Phasing of Three PPLs

EQUIPMENT		PHASE POSITION		
		A	B	C
PPL1				
a				
b				
c				
d				
e	TOTAL			
f	IN BALANCE LOAD			
g	OUT OF BALANCE LOAD			
	TOTAL PPL LOAD			
PPL2				
a				
b				
c				
d				
e	TOTAL			
f	IN BALANCE LOAD			
g	OUT OF BALANCE LOAD			
	TOTAL PPL LOAD			
PPL3				
a				
b				
c				
d				
e	TOTAL			
f	IN BALANCE LOAD			
g	OUT OF BALANCE LOAD			
	TOTAL PPL LOAD			

Figure 4-6. Equipment Phase Balance Form, Blank

1. ENTER EQUIPMENT AND CURRENT LOAD ON LINES A, B AND C. SINGLE PHASE DEVICE LOADS SHOULD BE ENTERED IN ONE PHASE POSITION ONLY. 3 PHASE DEVICES SHOULD BE ENTERED IN ALL 3 PHASE POSITIONS.
2. CALCULATE THE PHASE POSITION LOADS. THESE 3 NUMBERS SHOULD BE AS NEARLY EQUALIZED AS POSSIBLE. ENTER ON LINE D.
3. IF MORE THAN ONE PHASE IS LOADED, MULTIPLY THE SMALLEST NON-ZERO TOTAL BY 1.73 AND ENTER ON LINE E. (IN BALANCE LOAD)
4. CALCULATE THE DIFFERENCE BETWEEN THE LARGEST AND SMALLEST NON-ZERO TOTAL ENTER ON LINE F. (OUT OF BALANCE LOAD.) WHERE ONLY ONE PHASE IS USED ENTER THAT TOTAL ON LINE F.
5. ADD LINES E AND F. (TOTAL PPL LOAD.) ENTER ON LINE G.
6. EACH PPL LOAD MUST BE LESS THAN 16 AMPS, OR AN ALTERNATE POWER CONNECTION MUST BE PROVIDED.

EQUIPMENT		PHASE POSITION		
		A	B	C
PPL 1				
a	3664 DISC DRIVE	3.6		
b	3664 DISC DRIVE		3.6	
c	3664 DISC DRIVE			3.6
d	TOTAL	3.6	3.6	3.6
e	3.6 X 1.73 =		6.2	
f	3.6 - 3.6 =		0	
g	TOTAL PPL LOAD		6.2	
PPL 2				
		B	C	A
a	5120-6 LINE PRINTER	7.5		
b	8025 CARD READER/PUNCH		5	
c				
d	TOTAL	7.5	5	0
e	5 X 1.73 =		8.7	
f	7.5 - 5 =		2.5	
g	TOTAL PPL LOAD		11.2	
PPL 3				
		C	A	B
a	1 - 3237 TAPE DRIVE	3.5	3.5	3.5
b				
c				
d	TOTAL	3.5	3.5	3.5
e	3.5 X 1.73 =		6.1	
f	3.5 - 3.5 =		0	
g	TOTAL PPL LOAD		6.1	

Figure 4-7. Equipment Phase Balance Form, Completed

(PPL 1)	EQUIPMENT TYPE	A	B	C
1	3664 DISC DRIVE	3.6		
2	3664 DISC DRIVE		3.6	
3	3664 DISC DRIVE			3.6
(PPL 2)				
4	5120-6 LINE PRINTER		7.5	
5	8025 CARD READER/PUNCH			5
6				
(PPL 3)				
7	1-3237 TAPE DRIVES	3.5	3.5	3.5
8				
9				
TOTAL		7.1	14.6	12.1

MULTIPLY SMALLEST NON-ZERO TOTAL BY 1.732

$$7.1 \times 1.73 = \text{IN BALANCE LOAD: } \underline{12.3}$$

CALCULATE DIFFERENCE BETWEEN SMALLEST AND LARGEST LOAD ON TOTAL LINE.

$$14.6 - 7.1 = \text{OUT OF BALANCE LOAD: } \underline{7.5}$$

ADD TOTAL LOAD: 19.8

IF THIS EXCEEDS 24 AMPS, SOME REDUCTION IN ATTACHED DEVICES OR REBALANCING IS REQUIRED.

IF LESS THAN 24 AMPS BUT MORE THAN 15 AMPS, THE CONFIGURATION IS USABLE WITH A 60 AMP SYSTEM POWER CORD.

IF LESS THAN 15 AMPS, A 30 AMP SYSTEM POWER CORD MAY BE USED.

Figure 4-8. Peripheral Interface Load Calculation Example

5. SYSTEM COMPONENT SPECIFICATIONS

INTRODUCTION

This section contains the physical, electrical and environmental specifications of each MRX/40 or 50 computer system. Individual specifications include physical, electrical and environmental data, data transfer rates, photograph of device and template size scale drawing (to assist in planning equipment layout when templates are not available).

SPECIFICATIONS

Table 5-1 is a condensed compilation of individual specifications which are provided for each device. Specifications for the following Memorex standard devices are included in this section:

- 7200/7300 Computer
- 1240 Console Writer
- 1240 Terminal
- 1603 Microfilm Printer
- 3237 Magnetic Tape Subsystem Models 11 and 12 (Master)
- 3237 Magnetic Tape Subsystem Models 21 and 22 (Slave)
- 3664 (660) Disc Drive
- 5120-6 Line Printer
- 5120-12 Line Printer
- 8010-Models 1,2 Card Reader
- 8010-Model 3 Card Reader
- 8025 Card Reader/Punch

Table 5-1. MRX/40 or /50 Devices

Device	Physical				Electrical Service					Environmental Range			
	Size Inches (cm)				Phases	60 Hz (50 Hz) VAC	Amps	KVA @208 VAC	BTU/ Hr (Kcal/hr)	Ambient Temp °F (C°)	Relative Hum. (%)	Temp. Rise/ Hr. °F (C°)	Cooling CFM (m ³ /min)
	H	W	D	Wt. lbs (Kg)									
7200/7300 Computer	60 (152.4)	76 (193)	75.5 (191.7)	1350 (612)	3	208/230 (200/345) (220/380) (230/400) (240/415)	7.5	2.70	9000 (2268)	50-104 (10-40)	10-90	12 (6.6)	700 (20.3)
1240 Console/Terminal	37.5 (95.2)	28 (70)	23 (58.4)	150 (67.5)	1	120 (220)	3	0.36	1250 (318)	50-110 (10-43)	8-80	12 (6.6)	N/A
1603 Microfilm Printer	60 (152.4)	30 (76.2)	30 (76.2)	560 (254)	1	208/230 (200) (220) (230) (240)	11	2.30	6800 (1730)	60-90 (16-32)	20-80	12 (6.6)	160 (4.65)
Console Card Readers													
8010-1	16 (40.6)	23 (58.4)	18 (45.7)	87 (39.4)	1	120 (220)	5	0.60	2000 (510)	50-100 (10-38)	30-90	12 (6.6)	120 (3.48)
8010-2	16 (40.6)	23 (58.4)	18 (45.7)	87 (39.4)	1	120 (220)	5	0.60	2000 (510)	50-100 (10-38)	30-90	12 (6.6)	120 (3.48)
8010-3	16 (40.6)	23 (58.4)	18 (45.7)	93 (42)	1	120 (220)	5	0.60	2000 (510)	50-100 (10-38)	30-90	12 (6.6)	120 (3.48)
Disc Drive 3664	39 (99)	30 (76.2)	24 (61)	430 (195)	3	208/230 (220)	3.6	0.77	2800 (710)	60-90 (16-32)	20-80	12 (6.6)	100 (2.8)
Card Rdr/Punch 8025	48.5 (123.2)	33 (83.8)	27.5 (69.8)	500 (225)	1/3	208/230 (200) (220) (230) (240)	5	1.04	3500 (890)	60-90 (16-32)	27-75	12 (6.6)	120 (3.48)
Line Printers													600
5120-6	48.5 (123.2)	50 (127)	42 (107)	800 (362.4)	1/3	208/230 (200) (220) (230) (240)	7.5	1.35	4800 (1220)	50-110 (10-43)	10-90	12 (6.6)	(16)
5120-12							9.0	1.87	6600 (1700)				
MASTER Magnetic Tape Sub- system 3237	62 (157.5)	24 (61)	24 (61)	325 (147.2) 250 (113)	3 1*	208/230 (200) (220) (230) (240)	** 3.5 3	1.22 0.62	4200 (1070) 2150 (547)	45-110 (7-43)	20-80	12 (6.6)	190 (5.5) 70 (2)

* Powered from Master 3237 Tape Unit

** Due to the relatively light phase loading of two of the three phases, power computations for tape subsystems should make use of the following current figures:

3237 Master Only	3.5 Amperes
Master +1 Slave	3.5 Amperes
Master +2 Slaves	3.5 Amperes
Master +3 Slaves	7.0 Amperes

MRX 7200/7300 Computer

Dimensions	Width	Height	Depth
Inches	76	60	75.5
Centimeters	193	152.4	191.7

Service Clearance	Overhead	Front	Rear
Inches	36	36	---
Centimeters	91.4	91.4	---

	Left	Right
Inches	36	40
Centimeters	91.4	101.6

Maximum Weight: 1350 Lbs. (612 Kg)

Heat Dissipation: 9000 BTU per hour (2268 Kcal/hr)

Unit Air Circulation: 700 CFM (20.3 m³/min)

Electrical Requirements – 60 Hz

- Voltage: 208 or 230 VAC + 10%, -15%
- Frequency: 60 Hz ± 1 Hz
- Current: 7.5 Amp
- KVA: 2.70
- Phases: 3
- Service: 30 Amp or 60 Amp

- 30 Amp Service
- Plug: Russell & Stoll FS 3760
- Connector: Russell & Stoll FS 3934
- Receptacle: Russell & Stoll FS 3754

- 60 Amp Service
- Plug: Russell & Stoll SC 3728
- Connector: Russell & Stoll SC 7428
- Receptacle: Russell & Stoll SC 7324

Electrical Requirements – 50 Hz

- Voltage: 200/345, 220/380, 230/400, 240/415 VAC + 10%, -15%
- Frequency: 50 Hz ± 1 Hz
- Current: } *
- KVA: } *
- Phases: 3
- Service: 30 Amp

Operating Environment

- Temperature: 50° to 104°F (10°C to 40°C)
- Relative Humidity: 10 to 90%
- Maximum Wet Bulb: 78°F (26°C)

Non-Operating Environment

- Temperature: -30° to 150°F (-35°C to 65°C)
- Relative Humidity: 5 to 95%
- Maximum Wet Bulb: 78°F (26°C)

Selector Channel Transfer Rate (Max.)

- 7200: 277 Kb @ 200 Ft.
- 7300: 555 Kb @ 200 Ft.

*To be supplied in next revision.

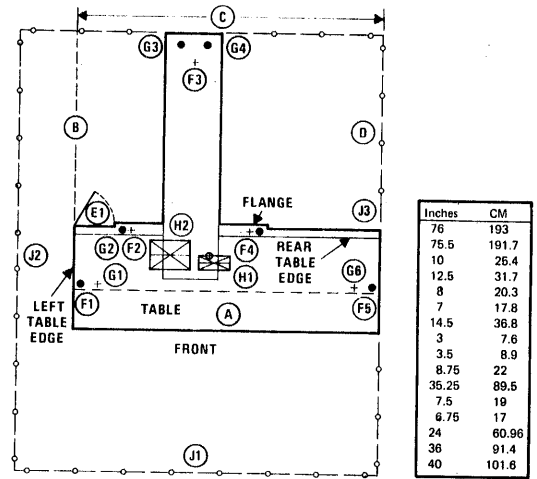
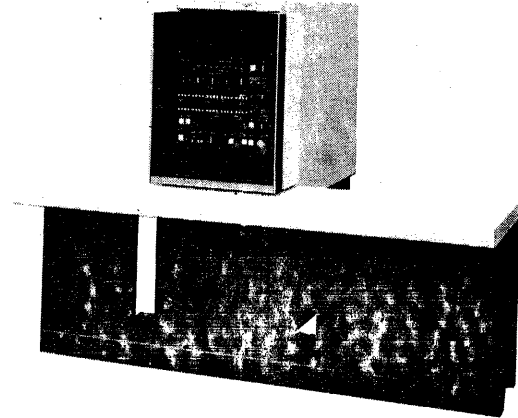

- DIMENSIONS:** A & C = 76"
- B & D = 75.5"
- GATE SWING:** E1 = 10"
- CASTERS:** F1 & F5 = 12.5" REAR TABLE EDGE/2.5" SIDE EDGE
- F2 & F4 = 8" CENTERED ON FLANGE
- F3 = 7" REAR/7" COMPUTER EDGE
- LEVELERS:** G1 & G6 = 14.5" REAR TABLE EDGE/6" SIDE TABLE EDGE
- G2 & G5 = 10" CENTERED ON FLANGE
- G3 & G4 = 3" REAR/3.5" SIDE
- CUTOUTS:** H1 = 8.75" REAR TABLE EDGE/35.25" LEFT TABLE EDGE TO CENTER OF CUTOUT
- CUTOUT DIMENSIONS = 3.5" X 7.5"
- H2 = 8.75" REAR TABLE EDGE/24" LEFT TABLE EDGE TO CENTER OF CUTOUT
- CUTOUT DIMENSIONS = 7.5" X 10"
- SERVICE CLEARANCES:** J1 = 36" J2 & J3 = 40"
- SLIDING DOOR – 86-INCHES HEIGHT CLEARANCE (PULL-OFF DOOR – NO CLEARANCE REQUIRED)

CODING FOR TEMPLATES

- FRONT = A
- LEFT = B
- REAR = C
- RIGHT = D

- GATE SWING E, 1, 2, 3, 4
- CASTERS F, 1, 2, 3, 4, 5
- LEVELERS G, 1, 2, 3, 4, 5
- CABLE CUTOUTS
- H1 = POWER / SIGNAL
- H2 = SIGNAL
- SERVICE CLEARANCES J, 1, 2, 3, 4

LETTER AND NUMBERS ARE CONSECUTIVE STARTING AT THE FRONT OF UNIT CLOCK-WISE.

LEGEND

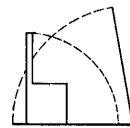

COVER AND GATE SWING



CABLE ENTRY



CASTERS



POWER CABLE EXIT



LEVELING PAD



SERVICE CLEARANCE BOUNDARY

MRX 1240 Console

Dimensions	Width	Height	Depth	
	Inches	28	37.5	23
	Centimeters	70	95.2	58.4
Service Clearance	Front	Rear	Right	Left
	Inches	36	36	2.5
	Centimeters	91.4	91.4	6.4

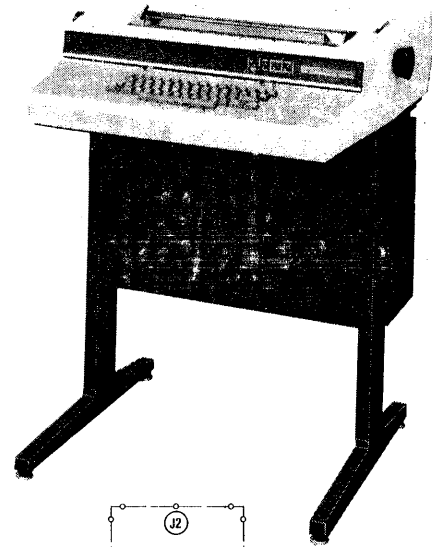

Maximum Weight: 150 Lbs. (67.5 Kg)

Heat Dissipation: 1250 BTU per hour (318 Kcal/hr)

Unit Air Circulation: N/A

Electrical Requirements – 60 Hz

- Voltage: 120 VAC + 10%, -15%
- Frequency: 60 Hz ± 1 Hz
- Current: 3 Amp
- KVA: 0.36
- Service: – Power supplied by 7200/7300 Computer

Electrical Requirements – 50 Hz

- Voltage: 200, 220, 230, 240 VAC + 10%, -15%
- Frequency: 50 Hz ± 1 Hz
- Current: } See footnote on page 5-3.
- KVA: }
- Service: – Power supplied by 7200/7300 Computer

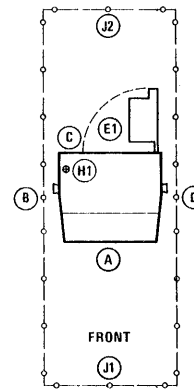

- DIMENSIONS:**
- (A) & (C) = 28"
 - (B) & (D) = 23"
- GATE SWING:**
- (E1) = 16.25"
- POWER RECEPTACLE:**
- (H1) = 4.25" FROM REAR/2.0" FROM SIDE
- SERVICE CLEARANCES:**
- (J1) & (J2) = 36"

Inches	CM
28	70
23	58.4
16.25	41.27
4.25	10.79
2	5.08
36	91.4

Operating Environment

- Temperature: 50° to 110°F (10°C to 43°C)
- Relative Humidity: 8 to 80%
- Maximum Wet Bulb: 78°F (26°C)

Non-Operating Environment

- Temperature: -30° to 150°F (-35°C to 65°C)
- Relative Humidity: 5 to 90%
- Maximum Wet Bulb: 78°F (26°C)

Character Transfer Rate:

60 per second

CODING FOR TEMPLATES

- FRONT = (A)
- LEFT = (B)
- REAR = (C)
- RIGHT = (D)

GATE SWING E, 1, 2, 3, 4

CASTERS F, 1, 2, 3, 4

LEVELERS G, 1, 2, 3, 4

CABLE CUTOUTS
H1 = POWER / SIGNAL
H2 = SIGNAL

SERVICE CLEARANCES J, 1, 2, 3, 4

LEGEND

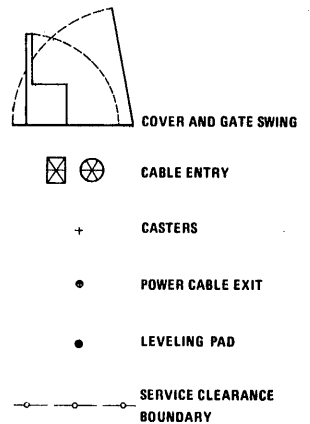

LETTER AND NUMBERS ARE CONSECUTIVE STARTING AT THE FRONT OF UNIT CLOCKWISE.

SCALE 1/2" = 1'

MRX 1240 Terminal

Dimensions	Width	Height	Depth	
	Inches	28	37.5	23
	Centimeters	70	95.2	58.4
Service Clearance	Front	Rear	Right	Left
	Inches	36	36	2.5
	Centimeters	91.4	91.4	6.4

Maximum Weight: 150 Lbs. (67.5 Kg)

Heat Dissipation: 1250 BTU per hour (318 Kcal/hr)

Unit Air Circulation: N/A

Electrical Requirements – 60 Hz

- Voltage: 120 VAC + 10%, -15%
- Frequency: 60 Hz ± 1 Hz
- Current: 3 Amp
- KVA: 0.36
- Phases: 1
- Service: 15 Amp – Wall receptacle

- Plug: Pass & Seymour or Hubbell 5266
- Connector: Pass & Seymour or Hubbell 5269
- Receptacle: Pass & Seymour or Hubbell 5261/5262

Electrical Requirements – 50 Hz

- Voltage: 200, 220, 230, 240 VAC + 10%, -15%
- Frequency: 50 Hz ± 1 Hz
- Current: } See footnote on page 5-3.
- KVA: }
- Phases: 1
- Service: 15 Amp – Terminal block

Operating Environment

- Temperature: 50° to 110°F (10°C to 43°C)
- Relative Humidity: 8 to 80%
- Maximum Wet Bulb: 78°F (26°C)

Non-Operating Environment

- Temperature: -30° to 150°F (-35°C to 65°C)
- Relative Humidity: 5 to 90%
- Maximum Wet Bulb: 78°F (26°C)

Character Transfer Rate

10, 15, 30, 60, or 120 per second
(Switch Selectable)

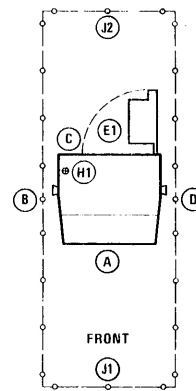
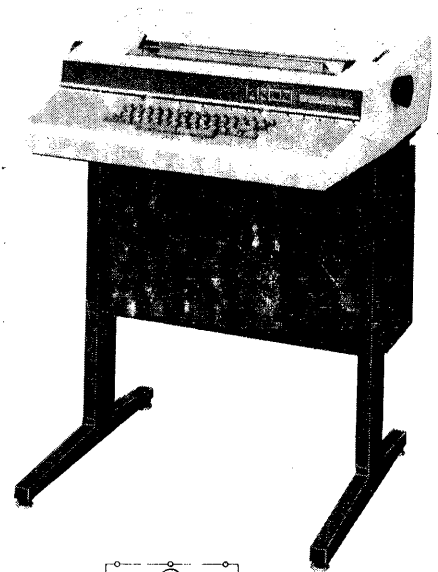

- DIMENSIONS:**
- (A) & (C) = 28"
 - (B) & (D) = 23"
 - (E1) = 16.25"
 - (H1) = 4.25" FROM REAR/2.0" FROM SIDE
 - (J1) & (J2) = 36"

Inches	CM
28	70
23	58.4
16.25	41.27
4.25	10.79
2	5.08
36	91.4

CODING FOR TEMPLATES

- FRONT = (A)
- LEFT = (B)
- REAR = (C)
- RIGHT = (D)

GATE SWING E, 1, 2, 3, 4

CASTERS F, 1, 2, 3, 4

LEVELERS G, 1, 2, 3, 4

CABLE CUTOUTS

H1 - POWER / SIGNAL
H2 - SIGNAL

SERVICE CLEARANCES J, 1, 2, 3, 4

LEGEND

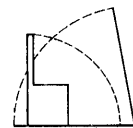

COVER AND GATE SWING



CABLE ENTRY

CASTERS

POWER CABLE EXIT

LEVELING PAD



SERVICE CLEARANCE BOUNDARY

LETTER AND NUMBERS ARE CONSECUTIVE STARTING AT THE FRONT OF UNIT CLOCKWISE.

SCALE 1/4" = 1'

MRX 1603 Microfilm Printer

Dimensions	Width	Height	Depth	
	Inches	30	60	30
	Centimeters	76.2	152.4	76.2
Service Clearance	Front	Rear	Right	Left
	Inches	36	36	---
	Centimeters	91.4	91.4	---

Maximum Weight: 560 Lbs. (244 Kg)

Heat Dissipation: 6800 BTU per hour (1730 Kcal/hr)

Unit Air Circulation: 160 CFM (4.65 m³/min)

Electrical Requirements – 60 Hz

- Voltage: 208 or 230 VAC + 10%, -15%
- Frequency: 60 Hz ± 1 Hz
- Current: 11 Amp
- KVA: 2.30
- Phases: 1
- Service: 15 Amp – Wall receptacle

- Plug: Russell & Stoll FS 3720
- Connector: Russell & Stoll FS 3913
- Receptacle: Russell & Stoll FS 3743

Electrical Requirements – 50 Hz

- Voltage: 200, 220, 230, 240 VAC + 10%, -15%
- Frequency: 50 Hz ± 1 Hz
- Current: } See footnote on page 5-3.
- KVA: }
- Phases: 1
- Service: 15 Amp – Terminal block

Operating Environment

- Temperature: 60°F to 90°F (16°C to 32°C)
- Relative Humidity: 20 to 80%
- Maximum Wet Bulb: 78°F (26°C)

Non-Operating Environment

- Temperature: 50° to 110°F (10°C to 40°C)
- Relative Humidity: 10 to 90%
- Maximum Wet Bulb: 78°F (26°C)

Basic Data Channel Transfer Rate (Max):
500 Kb – Buffered

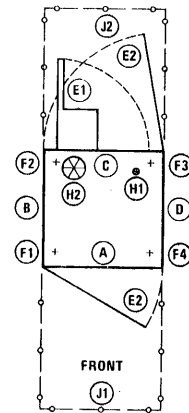
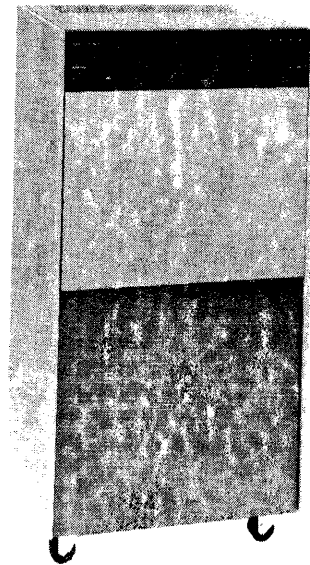

Inches	CM
30	76.2
23	58.4
4	10
3.25	8.25
5.25	13.3
6.75	17
4.75	12.56
7.75	19.68
6	15.24
36	91.4

- DIMENSIONS:** (A) & (C) = 30"
(B) & (D) = 30"
- GATE SWING:** (E1) = 23"
(E2) = 30"
- CASTERS:** (F1) & (F4) = 4" FROM REAR/3.25" FROM SIDE
(F2) & (F3) = 3.25" FROM REAR/3.25" FROM SIDE
- CABLE CUTOUTS:** (H1) = 5.25" FROM REAR/6.75" FROM RIGHT SIDE
(H2) = 4.75" FROM REAR TO CENTER OF CUTOUT/7.75" FROM LEFT SIDE
TO CENTER OF CUTOUT = 6" DIAMETER
- SERVICE CLEARANCES:** (J1) & (J2) = 36"

CODING FOR TEMPLATES

- FRONT = (A)
- LEFT = (B)
- REAR = (C)
- RIGHT = (D)

GATE SWING E, 1, 2, 3, 4

CASTERS F, 1, 2, 3, 4

LEVELERS G, 1, 2, 3, 4

CABLE CUTOUTS

H1 - POWER / SIGNAL
H2 - SIGNAL

SERVICE CLEARANCES J, 1, 2, 3, 4

LEGEND

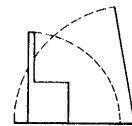

COVER AND GATE SWING



CABLE ENTRY



CASTERS



POWER CABLE EXIT



LEVELING PAD



SERVICE CLEARANCE BOUNDARY

LETTER AND NUMBERS ARE CONSECUTIVE STARTING AT THE FRONT OF UNIT CLOCK-WISE.

SCALE 1/4" = 1"

MRX 3237 Magnetic Tape Subsystem Models 11 and 12 (Master)

Dimensions	Width	Height	Depth
Inches	24	62	24
Centimeters	61	157.5	61

Service Clearance	Front	Rear	Right	Left
Inches	36	36	---	---
Centimeters	91.4	91.4	---	---

Maximum Weight: 325 Lbs. (147.2 Kg)

Heat Dissipation: 4200 BTU per hour (1070 Kcal/hr)

Unit Air Circulation: 190 CFM (5.5 m³/min)

Electrical Requirements - 60 Hz

- Voltage: 208 or 230 VAC + 10%, -15%
- Frequency: 60 Hz ± 1 Hz
- Current: 3.5 Amp
- KVA: 1.22
- Phases: 3
- Service: 15 Amp – Power may be supplied from wall receptacle or from 7200/7300 Computer

- Plug: Russell & Stoll FS 3730
- Connector: Russell & Stoll FS 3914
- Receptacle: Russell & Stoll FS 3744

Electrical Requirements – 50 Hz

- Voltage: 200/345, 220/380, 230/400, 240/415 VAC + 10%, -15%
- Frequency: 50 Hz ± 1 Hz
- Current: } See footnote on page 5-3.
- KVA: }
- Phases: 3
- Service: 15 Amp – Power may be supplied from terminal block or from 7200/7300 computer.

Operating Environment

- Temperature: 45° to 110°F (7°C to 43°C)
- Relative Humidity: 20 to 80%
- Maximum Wet Bulb: 78°F (26°C)

Non-Operating Environment

- Temperature: -30° to 150°F (-35°C to 65°C)
- Relative Humidity: 5 to 95%
- Maximum Wet Bulb: 78°F (26°C)

Basic Data Channel Transfer Rate (Max):

- 30 Kb (NRZI) or 60 Kb (Phase)
- High or low priority – Switch Selectable

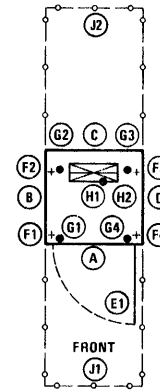
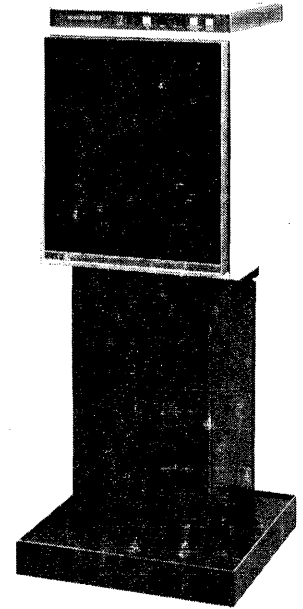

- DIMENSIONS:** (A & C) = 24"
 (B & D) = 24"
- GATE SWING:** (E1) = 20.83"
- CASTERS:** (F1 & F4) = 2.5" FROM FRONT/1.37" FROM SIDE
 (F2 & F3) = 5.5" FROM REAR/1.37" FROM SIDE
- LEVELERS:** (G1 & G4) = 1.37" FROM FRONT/3.75" FROM SIDE
 (G2 & G3) = 5.0" FROM REAR/3.75" FROM SIDE
- CABLE CUTOUTS:** (H1) = 5.75" FROM/12" FROM SIDE TO CENTER OF CUTOUT
 CUTOUT DIMENSIONS = 4.5" X 12"
- SERVICE CLEARANCES:** (J1 & J2) = 36"

Inches	CM
24	61
20.83	52.4
2.5	6.3
1.37	3.48
5.5	13.97
3.75	9.52
5	12.7
5.75	14.6
12	30.48
4.5	11.4
36	91.4

CODING FOR TEMPLATES

- FRONT = (A)
- LEFT = (B)
- REAR = (C)
- RIGHT = (D)

GATE SWING E, 1, 2, 3, 4

CASTERS F, 1, 2, 3, 4

LEVELERS G, 1, 2, 3, 4

CABLE CUTOUTS

H1 = POWER / SIGNAL
 H2 = SIGNAL

SERVICE CLEARANCES J, 1, 2, 3, 4

LEGEND

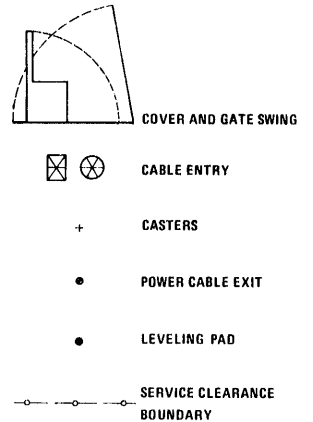

LETTER AND NUMBERS ARE CONSECUTIVE STARTING AT THE FRONT OF UNIT CLOCK-WISE.

SCALE 1/4" = 1'

MRX 3237 Magnetic Tape Subsystem Models 21 and 22 (Slave)

Dimensions	Width	Height	Depth
Inches	24	62	24
Centimeters	61	157.5	61

Service Clearance	Front	Rear	Right	Left
Inches	36	36	---	---
Centimeters	91.4	91.4	---	---

Maximum Weight: 250 Lbs. (113 Kg)

Heat Dissipation: 2150 BTU per hour (547 Kcal/hr)

Unit Air Circulation: 70 CFM (2 m³/min)

Electrical Requirements – 60 Hz

Voltage: 208 or 230 VAC + 10%, -15%
 Frequency: 60 Hz ± 1 Hz
 Current: 3 Amp
 KVA: 0.62

Electrical Requirements – 50 Hz

Voltage: 200, 220, 230, 240 VAC + 10%, -15%
 Frequency: 50 Hz ± 1 Hz
 Current: } See footnote on page 5-3.
 KVA: }

Operating Environment

Temperature: 45° to 110°F (7°C to 43°C)
 Relative Humidity: 20 to 80%
 Maximum Wet Bulb: 78°F (26°C)

Non-Operating Environment

Temperature: -30° to 150°F (-35°C to 55°C)
 Relative Humidity: 5 to 95%
 Maximum Wet Bulb: 78°F (26°C)

Transfer Rate (Max):

30 Kb (NRZI) or 60 Kb (Phase)

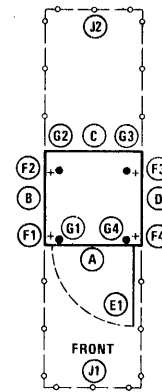
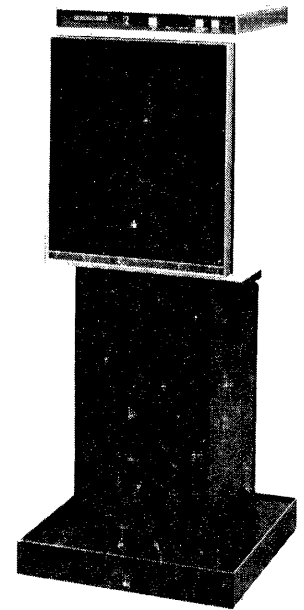

- DIMENSIONS:** (A) & (C) = 24"
 (B) & (D) = 24"
GATE SWING: (E1) = 20.83"
CASTERS: (F1) & (F4) = 2.5" FROM FRONT/1.37" FROM SIDE
 (F2) & (F3) = 5.5" FROM REAR/1.37" FROM SIDE
LEVELERS: (G1) & (G4) = 1.37" FROM FRONT/3.75" FROM SIDE
 (G2) & (G3) = 5.0" FROM REAR/3.75" FROM SIDE
CABLE CUTOUTS: (H1) = 5.75" FROM/12" FROM SIDE TO CENTER OF CUTOUT
 CUTOUT DIMENSIONS = 4.5" X 12"
SERVICE CLEARANCES: (J1) & (J2) = 36"

Inches	CM
24	61
20.63	52.4
2.5	6.3
1.37	3.48
5.6	13.97
3.75	9.52
5	12.7
5.75	14.6
12	30.48
4.6	11.4
36	91.4

CODING FOR TEMPLATES

- FRONT = (A)
 LEFT = (B)
 REAR = (C)
 RIGHT = (D)

GATE SWING E, 1, 2, 3, 4

CASTERS F, 1, 2, 3, 4

LEVELERS G, 1, 2, 3, 4

CABLE CUTOUTS
 H1 - POWER / SIGNAL
 H2 - SIGNAL

SERVICE CLEARANCES J, 1, 2, 3, 4

LEGEND

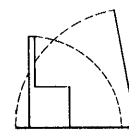

COVER AND GATE SWING



CABLE ENTRY



CASTERS



POWER CABLE EXIT



LEVELING PAD

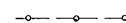

SERVICE CLEARANCE BOUNDARY

SCALE 1/4" = 1'

LETTER AND NUMBERS ARE CONSECUTIVE STARTING AT THE FRONT OF UNIT CLOCKWISE.

MRX 3664 Disc Drive

Dimensions	Width	Height	Depth
Inches	30	39	24
Centimeters	76.2	99	61

Service Clearance	Front	Rear	Right	Left
Inches	36	36	---	---
Centimeters	91.4	91.4	---	---

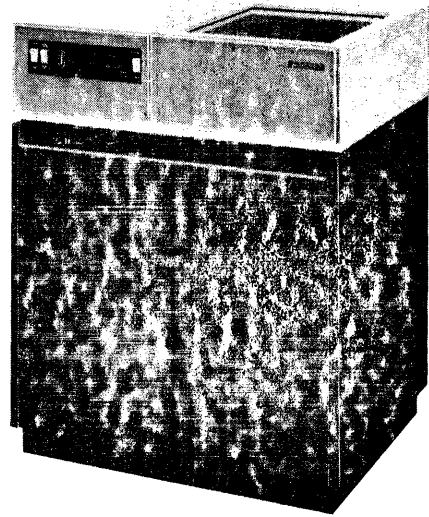

Maximum Weight: 430 Lbs. (195 Kg)
 Heat Dissipation: 2800 BTU per hour (710 Kcal/hr)
 Unit Air Circulation: 100 CFM (2.8 m³/min)

Electrical Requirements – 60 Hz

Voltage: 208 or 230 VAC + 10%, -15%
 Frequency: 60 Hz ± 1 Hz
 Current: 3.6 Amp
 KVA: 0.77
 Phases: 3
 Service: — Power supplied from 7200/7300 Computer

Electrical Requirements – 50 Hz

Voltage: 200, 220, 230, 240 VAC + 10%, -15%
 Frequency: 50 Hz ± 1 Hz
 Current: } See footnote on page 5-3.
 KVA: }
 Phases: 3
 Service: — Power supplied from 7200/7300 Computer

Operating Environment

Temperature: 60° to 90°F (16°C to 32°C)
 Relative Humidity: 20 to 80%
 Maximum Wet Bulb: 78°F (26°C)

Non-Operating Environment

Temperature: 50° to 110°F (10°C to 40°C)
 Relative Humidity: 10 to 90%
 Maximum Wet Bulb: 78°F (26°C)

Data Transfer Rate: 312 Kb

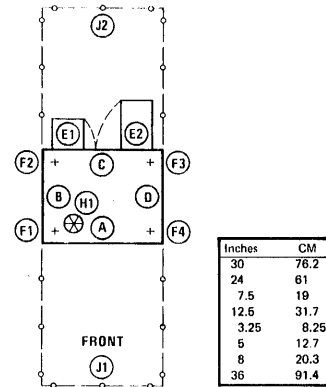

- DIMENSIONS:** (A) & (C) = 30"
 (B) & (D) = 24"
- GATE SWING:** (E1) = 7.5"
 (E2) = 12.5"
- CASTERS:** (F1) & (F2) & (F3) & (F4) = 3.25" FROM FRONT/3.25" FROM SIDE
- CABLE CUTOUTS:** (H1) = 5" FROM FRONT/8" FROM LEFT SIDE TO CENTER OF CUTOUT
 CUTOUT = 5" DIAMETER
- SERVICE CLEARANCES:** (J1) & (J2) = 36"

CODING FOR TEMPLATES

- FRONT = (A)
 LEFT = (B)
 REAR = (C)
 RIGHT = (D)

GATE SWING E, 1, 2, 3, 4

CASTERS F, 1, 2, 3, 4

LEVELERS G, 1, 2, 3, 4

CABLE CUTOUTS
 H1 = POWER / SIGNAL
 H2 = SIGNAL

SERVICE CLEARANCES J, 1, 2, 3, 4

LEGEND

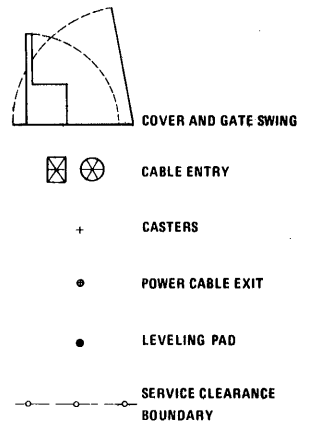

LETTER AND NUMBERS ARE CONSECUTIVE STARTING AT THE FRONT OF UNIT CLOCK-WISE.

SCALE 1/4" = 1'

MRX 5120 Model 6 Line Printer

Dimensions	Width	Height	Depth
Inches	50	48.5	42*
Centimeters	127	121.9	107

Service Clearance	Front	Rear	Right	Left
Inches	48	36	---	36
Centimeters	121.9	91.4	---	91.4

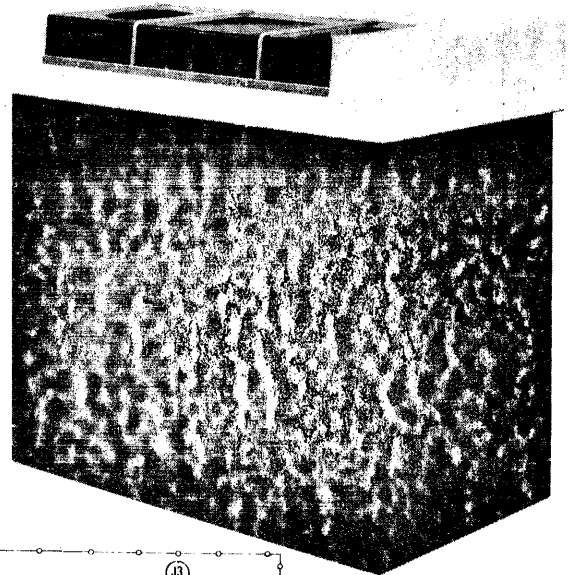

Maximum Weight: 800 Lbs. (362.4 Kg)
 Heat Dissipation: 4800 BTU per hour (1220 Kcal/hr)
 Unit Air Circulation: 600 CFM (16 m³/min)

Electrical Requirements – 60 Hz

Voltage: 208 or 230 VAC + 10%, -15%
 Frequency: 60 Hz ± 1 Hz
 Current: 7.5 Amp
 KVA: 1.35
 Phases: 1 or 3
 Service: 15 Amp – Power may be supplied from wall receptacle or from 7200/7300 Computer

Plug: Russell & Stoll FS 3730
 Connector: Russell & Stoll FS 3914
 Receptacle: Russell & Stoll FS 3744

Electrical Requirements – 50 Hz

Voltage: 200, 220, 230, 240 VAC + 10%, -15%
 Frequency: 50 Hz ± 1 Hz
 Current: } See footnote on page 5-3.
 KVA: }
 Phases: 1 or 3
 Service: 15 Amp – Power may be supplied from terminal block or from 7200/7300 Computer.

Operating Environment

Temperature: 50° to 110°F (10°C to 43°C)
 Relative Humidity: With Static Eliminator – 10 to 90%
 Maximum Wet Bulb: 78°F (26°C)

Non-Operating Environment

Temperature: 0° to 150°F (-18°C to 65°C)
 Relative Humidity: 5 to 95%
 Maximum Wet Bulb: 78°F (26°C)

Basic Data Channel Transfer Rate (Max):

300 Kb – Buffered

*with paper rack

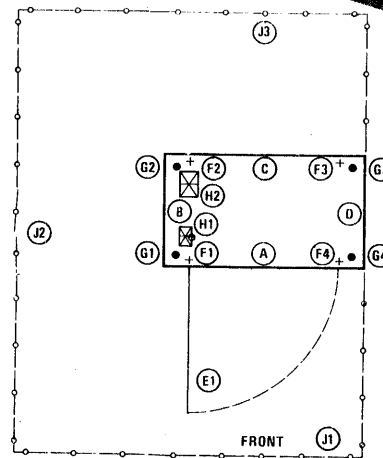

- DIMENSIONS:** (A) & (C) = 50"
 (B) & (D) = 29"
GATE SWING: (E1) = 37"
CASTERS: (F1) & (F2) & (F3) & (F4) = 2.03"
 FROM FRONT OR REAR 6.25" FROM SIDE
LEVELERS: (G1) & (G2) & (G3) & (G4) = 3.25"
 FROM FRONT OR REAR 3.25" FROM SIDE
CABLE CUTOUTS: (H1) = 11.0" FROM FRONT TO CENTER OF CUTOUT
 5.5" FROM LEFT SIDE TO CENTER OF CUTOUT
 CUTOUT DIMENSIONS = 3" X 5"
 (H2) = 7.75" FROM REAR TO CENTER OF CUTOUT
 = 6.25" FROM LEFT SIDE TO CENTER OF CUTOUT
 CUTOUT DIMENSIONS = 4.5" X 6.5"
SERVICE CLEARANCES: (J1) & (J3) = 36" (J2) = 36"

Inches	CM
50	127
29	73.7
37	94
2.03	5.15
3.25	8.25
11.0	27.9
5.5	13.97
3	7.62
5	12.7
7.75	19.7
6.25	15.87
4.5	11.4
6.5	16.5
36	91.4

CODING FOR TEMPLATES

- FRONT = (A)
 LEFT = (B)
 REAR = (C)
 RIGHT = (D)

GATE SWING E, 1, 2, 3, 4

CASTERS F, 1, 2, 3, 4

LEVELERS G, 1, 2, 3, 4

CABLE CUTOUTS
 H1 = POWER / SIGNAL
 H2 = SIGNAL

SERVICE CLEARANCES J, 1, 2, 3, 4

LETTER AND NUMBERS ARE CONSECUTIVE STARTING AT THE FRONT OF UNIT CLOCKWISE.

LEGEND

SCALE 1/4" = 1'

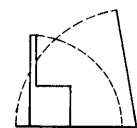

COVER AND GATE SWING



CABLE ENTRY



CASTERS



POWER CABLE EXIT



LEVELING PAD



SERVICE CLEARANCE BOUNDARY

MRX 5120 Model 12 Line Printer

Dimensions	Width	Height	Depth	
	Inches	50	48.5	42*
	Centimeters	127	121.9	107
Service Clearance	Front	Rear	Right	Left
	Inches	48	36	36
	Centimeters	121.9	91.4	91.4

Maximum Weight: 800 Lbs. (362.4 Kg)

Heat Dissipation: 6600 BTU per hour (1700 Kcal/hr)

Unit Air Circulation: 600 CFM (16 m³/min)

Electrical Requirements – 60 Hz

- Voltage: 208 or 230 VAC + 10%, -15%
- Frequency: 60 Hz ± 1 Hz
- Current: 9.0 Amp
- KVA: 1.87
- Phases: 1 or 3
- Service: 15 Amp – Power may be supplied from wall receptacle or from 7200/7300 Computer

- Plug: Russell & Stoll FS 3730
- Connector: Russell & Stoll FS 3914
- Receptacle: Russell & Stoll FS 3744

Electrical Requirements – 50 Hz

- Voltage: 200, 220, 230, 240 VAC + 10%, -15%
- Frequency: 50 Hz ± 1 Hz
- Current: } See footnote on page 5-3.
- KVA: }
- Phases: 1 or 3
- Service: 15 Amp – Power may be supplied from terminal block or from 7200/7300 Computer.

Operating Environment

- Temperature: 50° to 110°F (10°C to 43°C)
- Relative Humidity: With Static Eliminator – 10 to 90%
- Maximum Wet Bulb: 78°F (26°C)

Non-Operating Environment

- Temperature: 0° to 150°F (-18°C to 65°C)
- Relative Humidity: 5 to 95%
- Maximum Wet Bulb: 78°F (26°C)

Basic Data Channel Transfer Rate (Max):

300 Kb – Buffered

*with paper rack

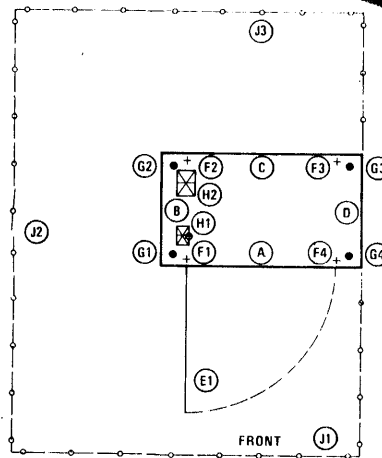
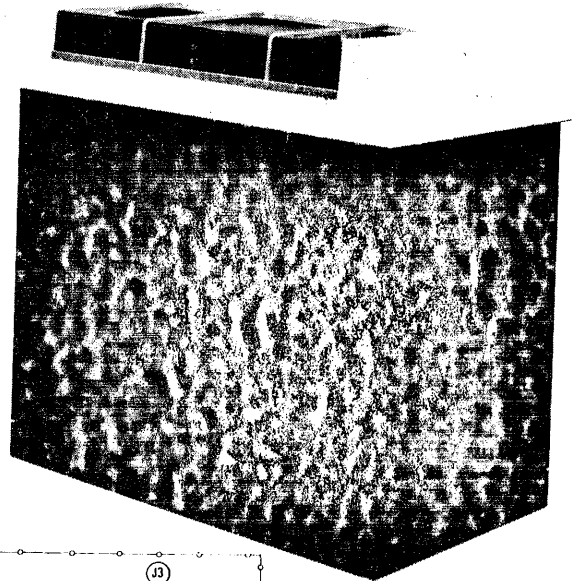

- DIMENSIONS:** (A) & (C) = 50"
 (B) & (D) = 29"
GATE SWING: (E1) = 37"
CASTERS: (F1) & (F2) & (F3) & (F4) = 2.03"
 FROM FRONT OR REAR 6.25" FROM SIDE
LEVELERS: (G1) & (G2) & (G3) & (G4) = 3.25"
 FROM FRONT OR REAR 3.25" FROM SIDE
CABLE CUTOUTS: (H1) = 11.0" FROM FRONT TO CENTER OF CUTOUT
 5.5" FROM LEFT SIDE TO CENTER OF CUTOUT
 CUTOUT DIMENSIONS = 3" X 5"
 (H2) = 7.75" FROM REAR TO CENTER OF CUTOUT
 = 6.25" FROM LEFT SIDE TO CENTER OF CUTOUT
 CUTOUT DIMENSIONS = 4.5" X 6.5"
SERVICE CLEARANCES: (J1) & (J3) = 36" (J2) = 36"

Inches	CM
50	127
29	73.7
37	94
2.03	5.15
3.25	8.25
11.0	27.9
5.5	13.97
3	7.62
5	12.7
7.75	19.7
6.25	15.87
4.5	11.4
6.5	16.5
36	91.4

CODING FOR TEMPLATES

- FRONT = (A)
- LEFT = (B)
- REAR = (C)
- RIGHT = (D)

GATE SWING E, 1, 2, 3, 4

CASTERS F, 1, 2, 3, 4

LEVELERS G, 1, 2, 3, 4

CABLE CUTOUTS
 H1 = POWER / SIGNAL
 H2 = SIGNAL

SERVICE CLEARANCES J, 1, 2, 3, 4

LETTER AND NUMBERS ARE CONSECUTIVE STARTING AT THE FRONT OF UNIT CLOCKWISE.

LEGEND

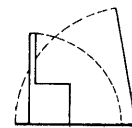

COVER AND GATE SWING



CABLE ENTRY



CASTERS



POWER CABLE EXIT



LEVELING PAD

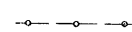

SERVICE CLEARANCE BOUNDARY

SCALE 3/4" = 1'

MRX 8010 – Models 1 and 2 Card Reader

Dimensions	Width	Height	Depth
Inches	23	16	18
Centimeters	58.4	40.6	45.7

Service Clearance	Front	Rear	Right	Left
Inches	36	36	---	---
Centimeters	91.4	91.4	---	---

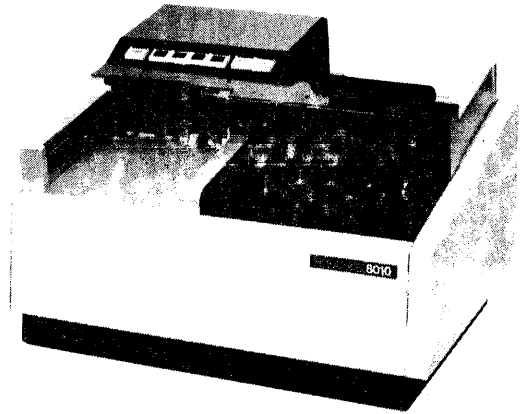

Maximum Weight: 87 Lbs. (39.4 Kg)

Heat Dissipation: 2000 BTU per hour (510 Kcal/hr)

Unit Air Circulation: 120 CFM (3.48 m³/min)

Electrical Requirements – 60 Hz

- Voltage: 120 VAC + 10%, -15%
- Frequency: 60 Hz ± 1 Hz
- Current: 5 Amp
- KVA: 0.60
- Service: — Power supplied by 7200/7300 Computer.

Electrical Requirements – 50 Hz

- Voltage: 200, 220, 230, 240 VAC + 10%, -15%
- Frequency: 50 Hz ± 1 Hz
- Current: } See footnote on page 5-3.
- KVA: }
- Service: — Power supplied by 7200/7300 Computer.

Operating Environment

- Temperature: 50^o to 100^oF (10^oC to 38^oC)
- Relative Humidity: 30 to 90%
- Maximum Wet Bulb: 78^oF (26^oC)

Non-Operating Environment

- Temperature: 0^o to 150^oF (-18^oC to 65^oC)
- Relative Humidity: 5 to 95%
- Maximum Wet Bulb: 78^oF (26^oC)

Data Transfer Rate (Max):

330 Kb – Buffered



DIMENSIONS:

- (A & C) 23"
- (B & D) 18"

SERVICE CLEARANCES:
REFER TO 7200&7300
SERVICE CLEARANCES

Inches	CM
23	58.4
18	45.7

CODING FOR TEMPLATES

- FRONT = (A)
- LEFT = (B)
- REAR = (C)
- RIGHT = (D)

GATE SWING E, 1, 2, 3, 4

CASTERS F, 1, 2, 3, 4

LEVELERS G, 1, 2, 3, 4

CABLE CUTOUTS

- H1 = POWER / SIGNAL
- H2 = SIGNAL

SERVICE CLEARANCES J, 1, 2, 3, 4

LEGEND

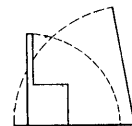

COVER AND GATE SWING

☒ ⊗ CABLE ENTRY

⊕ CASTERS

● POWER CABLE EXIT

● LEVELING PAD

—○— SERVICE CLEARANCE BOUNDARY

SCALE 1/4" = 1"

LETTER AND NUMBERS ARE CONSECUTIVE STARTING AT THE FRONT OF UNIT CLOCK WISE.

MRX 8010 – Model 3 Card Reader

Dimensions	Width	Height	Depth
Inches	23	16	18
Centimeters	58.4	40.6	45.7

Service Clearance	Front	Rear	Right	Left
Inches	36	36	---	---
Centimeters	91.4	91.4	---	---

Maximum Weight: 93 Lbs. (42 Kg)

Heat Dissipation: 2000 BTU per hour (510 Kcal/hr)

Unit Air Circulation: 120 CFM (3.48 m³/min)

Electrical Requirements – 60 Hz

Voltage: 120 VAC + 10%, -15%

Frequency: 60 Hz ± 1 Hz

Current: 5 Amp

KVA: 0.60

Service: – Power supplied by 7200/7300 Computer.

Electrical Requirements – 50 Hz

Voltage: 200, 220, 230, 240 VAC + 10%, -15%

Frequency: 50 Hz ± 1 Hz

Current: } See footnote on page 5-3.

KVA: }

Service: – Power supplied by 7200/7300 Computer

Operating Environment

Temperature: 50° to 100°F (10°C to 38°C)

Relative Humidity: 30 to 90%

Maximum Wet Bulb: 78°F (26°C)

Non-Operating Environment

Temperature: 0° to 150°F (-18°C to 65°C)

Relative Humidity: 5 to 95%

Maximum Wet Bulb: 78°F (26°C)

Data Transfer Rate (Max):

330 Kb – Buffered

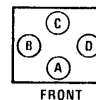
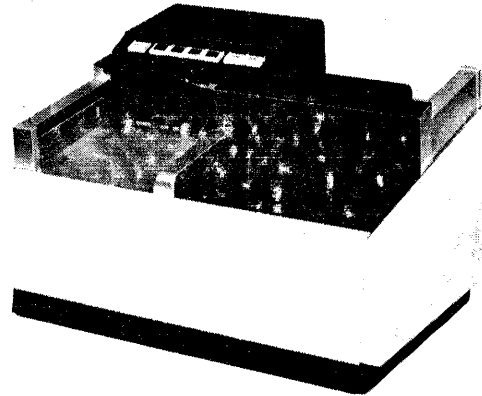

DIMENSIONS:

A & C 23"

B & D 18"

SERVICE CLEARANCES:
REFER TO 7200&7300
SERVICE CLEARANCES

Inches	CM
23	58.4
18	45.7

CODING FOR TEMPLATES

FRONT = (A)

LEFT = (B)

REAR = (C)

RIGHT = (D)

GATE SWING E, 1, 2, 3, 4

CASTERS F, 1, 2, 3, 4

LEVELERS G, 1, 2, 3, 4

CABLE CUTOUTS

H1 = POWER / SIGNAL

H2 = SIGNAL

SERVICE CLEARANCES J, 1, 2, 3, 4

LEGEND

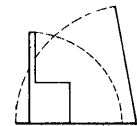

CABLE ENTRY



CASTERS



POWER CABLE EXIT



LEVELING PAD



SERVICE CLEARANCE
BOUNDARY

SCALE 1/2" = 1'

LETTER AND NUMBERS ARE CONSECUTIVE
STARTING AT THE FRONT OF UNIT CLOCK-
WISE.

MRX 8025 Card Reader/Punch

Dimensions	Width	Height	Depth	
	Inches	33	48.5	27.5
	Centimeters	83.8	123	69.8
Service Clearance	Front	Rear	Right	Left
	Inches	36	36	18
	Centimeters	91.4	91.4	45.7

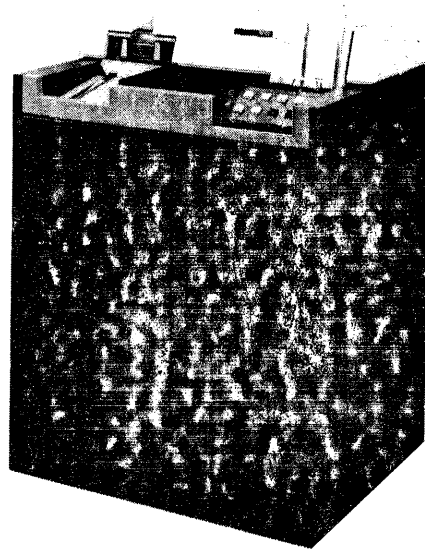

Maximum Weight: 500 Lbs. (225 Kg)

Heat Dissipation: 3500 BTU per hour (890 Kcal/hr)

Unit Air Circulation: 120 CFM (3.48 m³/min)

Electrical Requirements – 60 Hz

- Voltage: 208 or 230 VAC + 10%, -15%
- Frequency: 60 Hz ± 1 Hz
- Current: 5 Amp
- KVA: 1.04
- Phases: 1 or 3
- Service: 15 Amp – Power may be supplied from wall receptacle or from 7200/7300 Computer.

- Plug: Russell & Stoll FS 3730
- Connector: Russell & Stoll FS 3914
- Receptacle: Russell & Stoll FS 3744

Electrical Requirements – 50 Hz

- Voltage: 200, 220, 230, 240 VAC + 10%, -15%
- Frequency: 50 Hz ± 1 Hz
- Current: } See footnote on page 5-3.
- KVA: }
- Phases: 1 or 3
- Service: 15 Amp – Power may be supplied from terminal block or from 7200/7300 Computer.

Operating Environment

- Temperature: 60° to 90°F (16°C to 32°C)
- Relative Humidity: 30 to 80%
- Maximum Wet Bulb: 78°F (26°C)

Non-Operating Environment

- Temperature: -30° to 150°F (-35°C to 65°C)
- Relative Humidity: 5 to 95%
- Maximum Wet Bulb: 78°F (26°C)

Data Transfer Rate (Max):

330 Kb – Buffered

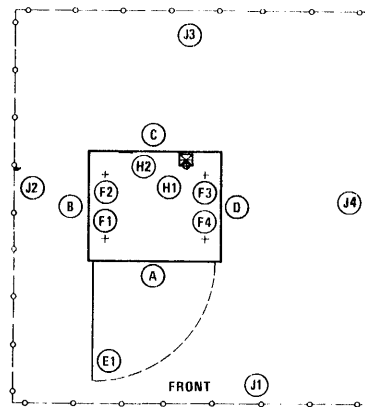

Inches	CM
33	83.8
27.5	69.8
30.5	77.7
5.75	14.6
4.25	10.79
2.25	5.7
9.5	24
3	7.62
36	91.4
18	45.7

- DIMENSIONS:** (A) & (C) = 33"
(B) & (D) = 27.5"
- GATE SWING:** (E1) = 30.5"
- CASTERS:** (F1) & (F2) & (F3) & (F4) = 5.75" FROM FRONT OR REAR/4.25" FROM SIDE
- CABLE CUTOUTS:** H1 = 2.25" FROM REAR/9.5" FROM LEFT SIDE TO CENTER OF CUTOUT
CUTOUT DIMENSIONS = 3" X 3"
- SERVICE CLEARANCES:** (J1) & (J3) & (J4) = 36" (J2) = 18"

CODING FOR TEMPLATES

- FRONT = (A)
- LEFT = (B)
- REAR = (C)
- RIGHT = (D)

GATE SWING E, 1, 2, 3, 4

CASTERS F, 1, 2, 3, 4

LEVELERS G, 1, 2, 3, 4

CABLE CUTOUTS

- H1 - POWER / SIGNAL
- H2 - SIGNAL

SERVICE CLEARANCES J, 1, 2, 3, 4

LEGEND

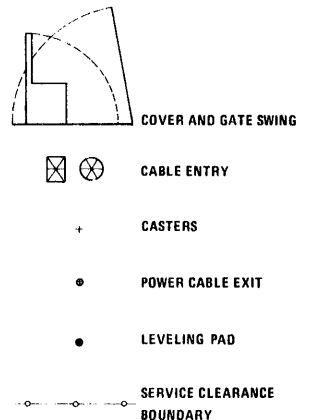

LETTER AND NUMBERS ARE CONSECUTIVE STARTING AT THE FRONT OF UNIT CLOCKWISE.

SCALE 1/4" = 1'

6. CABLING

INTRODUCTION

This section describes the cabling requirements for MRX/40 or 50 Computer Systems including the procedures to be used for compiling point-to-point cable lengths. Cables have been grouped according to device and coded by function to assist in determining the cables required to configure a system.

CABLE SHIPMENT

All cables required to install Memorex-supplied equipment and vendor-supplied local communications equipment (i.e., data sets) must be provided at the time of system installation (see Figure 6-1). Table 6-1 cable groups, lists these cables. The "FROM" heading in the

table establishes cable ownership for each device. By definition, the "FROM" unit is the most remote device by cabling from the controller or computer. This definition applies to all types of cabling except primary power cords and signal cabling for communications equipment. Communications signal cables are defined as running "FROM" the compute;"TO" the communications device. Power cords run "FROM" the device to the receptacle. Table 6-2 (60 Hz) and Table 6-3 (50 Hz) list all orderable cables and their part numbers.

TERMINATORS

The terminator required for the 3664 Subsystem Multiplex cable is furnished with the Integrated File Adapter (IFA) option. The Bus and Tag cable terminators are furnished with the Basic Data Channel (BDC) option.

Table 6-1. Cable Groups

Group or Alpha Number	Number of Cables	From	To	Frequency Application	Maximum Length Ft (M)	Notes
031	2	1603	—	50/60 Hz	200 Accum (61)	
032	1	1603	7200/7300	50/60 Hz	150 (45.7)	
033	1	1603	Receptacle	60 Hz	15 (4.57)	1
909	1	1603	Term. Block	50 Hz	14 (4.27)	1
202	1	7200/7300	—	50/60 Hz	100 (30.48)	
203	1	7200/7300	Receptacle	60 Hz	15 (4.57)	2
900	1	7200/7300	Term. Block	50 Hz	25 (7.62)	2
204	1	7200/7300	Receptacle	60 Hz	15 (4.57)	3
205	1	7200/7300	1240 Terminal or 202, 103 or 113 Data Sets	50/60 Hz	50 (15.24)	
206	1	7200/7300	201 Data Sets	50/60 Hz	50 (15.24)	
222	1	7200/7300	—	50/60 Hz	100 (30.48)	
225	1	7200/7300	DAA	50/60 Hz	50 (15.24)	
231	2	5120	—	50/60 Hz	200 Accum (61)	
232	1	5120	7200/7300	50/60 Hz	150 (45.7)	
233/234	1	5120	Receptacle	60 Hz	15 (4.57)	4
901	1	5120	Term. Block	50 Hz	25 (7.62)	1
902	1	5120	Term. Block	50 Hz	25 (7.62)	5
237	1	5120	—	50/60 Hz	100 Accum (30.48)	
242	1	8025	7200/7300	50/60 Hz	150 (45.7)	
243/244	1	8025	Receptacle	60 Hz	15 (4.57)	6
903	1	8025	Term. Block	50 Hz	25 (7.62)	1
904	1	8025	Term. Block	50 Hz	25 (7.62)	5
245	1	8025	7200/7300	50/60 Hz	200 (61)	
247	1	8025	—	50/60 Hz	100 Accum (30.48)	
251	2	3237 (M)	—	50/60 Hz	200 Accum (61)	
252	1	3237 (M)	7200/7300	50/60 Hz	150 (45.7)	
905	1	3237 (M)	Term. Block	50 Hz	25 (7.62)	5
254	1	3237 (M)	Receptacle	60 Hz	15 (4.57)	5
257	1	3237 (M)	7200/7300	50/60 Hz	100 Accum (30.48)	
265	1	3664	—	50/60 Hz	100 Accum (30.48)	
267	1	3664	7200/7300	50/60 Hz	100 Accum (30.48)	
268	1	3664	7200/7300	50/60 Hz	50 (15.24)	
269	1	3664	3664	50/60 Hz	100 Accum (30.48)	
906	1	7200/7300	Modem	50 Hz	40 (12.19)	7
907	1	7200/7300	Modem	50 Hz	40 (12.19)	8
908	1	7200/7300	Modem	50 Hz	—	9
A	1	8010	7200/7300	50/60 Hz	8 (2.4)	
B	1	8010	7200/7300	50/60 Hz	12 (3.66)	
C	2	3237 (S)	3237 (M)	50/60 Hz	7.5/6.35 (2.3/1.9)	10
D	1	1240	7200/7300	50/60 Hz	7.5 (2.3)	

NOTES:

1. Single phase cable -- 15 amp
2. Three phase cable -- 30 amp
3. Three phase cable -- 60 amp
4. 233 = single phase, 234 = three phase -- 15 amp
5. Three phase cable -- 15 amp
6. 243 = single phase, 244 = three phase -- 15 amp
7. Modem adapter isolater cable (UK only)
8. Modem adapter cable (Europe)
9. ICA to modem adapter cable
10. 7.5 = signal line, 6.35 = power line

Table 6-2. Cable Part Numbers

Group Number	Length in Feet	Part Number	Notes
031	-		Buss and tag cables between 1603 and one of the following devices: 5120, 3237 (Master), 1603, other vendor equipment or 7200/7300.
031	15	701501	
	20	700067	
	30	701502	
	50	701157	
	X	701503	- Specify Length
032	-		EPO cable between 1603 and 7200/7300
032	15	701504	
	20	701191	
	30	701505	
	50	700069	
	X	701506	- Specify Length
033	-		Power cord for 1603 (15 Amp, single phase)
033	6	701193	
	15	701192	
202	-		Two-system EPO cable
202	Plug	501220	
	15	502828	
	20	502829	
	30	502830	
	50	502831	
	X	502832	- Specify Length
203	-		Power cord for 7200/7300 (30 Amp, three phase)
203	6	504878	
	15	505113	
204	-		Power cord for 7200/7300 (60 Amp, three phase)
204	6	504881	
	15	504880	
205	-		Signal cable between 7200/7300 and local 202 data set or 1240 (console or terminal)
205	10	501580	
	15	501581	
	20	501582	
	30	501583	
	40	501584	
	50	501585	
206	-		Signal cable between 7200/7300 and local 201 data set
206	10	505092	
	15	505093	
	20	505094	
	30	505095	
	40	505096	
	50	505097	

Cable Group	Length in Feet	Part Number	Notes
222	-		Master system EPO cable
222	Plug	501220	
	15	701504	
	20	701191	
	30	701505	
	50	700069	
	X	701506	- Specify Length
225	-		Signal cable between 7200/7300 and DAA arrangement
225	10	501558	
	15	501559	
	20	501560	
	30	501561	
	40	501562	
	50	501563	
231	-		Buss and tag cables between 5120 and one of the following devices: 5120, 3237 (Master), 1603, other vendor equipment or 7200/7300.
231	15	701501	
	20	700067	
	30	701502	
	50	701157	
	X	701503	- Specify Length
232	-		EPO cable between 5120 and 7200/7300
232	15	701504	
	20	701191	
	30	701505	
	50	700069	
	X	701506	- Specify Length
233	-		Power cord for 5120 (15 Amp, single phase)
	6	506399	
	15	506398	
234	-		Power cord for 5120 (15 Amp, three phase)
234	6	505111	
	15	504090	
237	-		Power cable between 5120 and one of the following devices: 5120, 8025 or 7200/7300.
237	7	200388	
	10	200289	
	15	200390	
	20	200391	
	30	200392	
	40	200393	
	50	200394	
242	-		EPO cable between 8025 and 7200/7300
242	15	701504	
	20	701191	
	30	705505	
	50	700069	
	X	701506	- Specify Length

Table 6-2. Cable Part Numbers (Continued)

Cable Group	Length in Feet	Part Number	Notes
243		506398 506399	15 feet 6 feet
244	-- Power cord for 8025 (15 Amp, three phase)		
244	6 15	505111 504090	
245	-- Signal cable between 8025 and 7200/7300		
245	15 20 30 50 X	504529 504530 504531 504532 504533	-- Specify Length
247	-- Power cable between 8025 and one of the following devices: 5120, 8025 or 7200/7300.		
247	7 10 15 20 30 40 50	200388 200389 200390 200391 200392 200393 200394	
251	-- Buss and tag cables between 3237 (Master) and one of the following devices: 5120, 3237 (Master), 1603, other vendor equipment or 7200/7300		
251	15 20 30 50 X	701501 700067 701502 701157 701503	-- Specify Length
252	-- EPO cable between 3237 (Master) and 7200/7300		
252	15 20 30 50 X	701504 701191 701505 700069 701506	-- Specify Length
254	-- Power cord for 3237 (Master) -- (15 Amp, three phase)		
	6 15	505111 504990	
257	-- Power cable between 3237 (Master) and one of the following devices: 5120, 8025 or 7200/7300.		
257	7 10 15 20 30 40 50	200388 200889 200390 200391 200392 200393 200394	

- A -- Signal cable between 8010 and 7200/7300 (not orderable)
- B -- Power cable between 8010 and 7200/7300 (not orderable)
- C -- Signal and power cables between 3237 MASTER and 3237 SLAVE (not orderable)

Group Number	Length in Feet	Part Number	Notes
265	-- Signal cable between 3664 drives 7+6, or 4+3 or 1 and 7200/7300		
265	5 9 12 18 24 30 40 50	201719 201679 201680 201681 201801 202152 203043 203044	Note 1
267	-- Power cable between 3664 and 7200/7300		
267	7 10 15 20 30 40 50	200388 200389 200390 200391 200392 200393 200394	Note 2
268	-- Data (unit) cable between 3664 and 7200/7300		
268	7 9 12 18 24 32 40 50	200531 200532 200533 200534 200535 201800 202153 202154	Note 3
269	-- Power and signal (multiplex) cables between 3664 (660) disc drives		
269A	7 10 15 20 30 40 50	200388 200389 200390 200391 200392 200393 200394	Note 2
269B	5 9 12 18 24 30 40 50	201719 201679 201680 201581 201801 202152 203043 203044	Note 1 Note 4

D -- Power cable between 1240 console and 7200/7300 (not orderable)

NOTES

1. The maximum cable length for groups 265 and 269B is 100 feet. The first device must be within 50 feet.
2. No more than three (3) 3664's on a single cable. Maximum total cable length for groups 267 and 269A is 100 feet for three disc drives. The first device must be within 50 feet.
3. One (1) cable required for each 3664. Maximum cable length is 50 feet.
4. Group 269 is available in the following lengths only: 5, 9, 12, 18, 24, 30, 40, 50 ft.

Table 6-3. Cable Part Numbers – 50 Hz

Group Number	Length in Metres	Part Number	Notes	Cable Group	Length in Metres	Part Number	Notes
031	–		Buss and tag cables between 1603 and one of the following devices: 5120, 3237 (Master), 1603, other vendor equipment or 7200/7300.	222	–		Master system EPO cable
031	4.57	701501		222	Plug	501220	
	6.10	700067			4.57	701504	
	9.15	701502			6.10	701191	
	15.25	701157			9.15	701505	
	X	701503 – Specify Length			15.25	700069	
					*	701506 – Specify Length	
032	–		EPO cable between 1603 and 7200/7300	231	–		Buss and tag cables between 5120 and one of the following devices: 5120, 3237 (Master), 1603, other vendor equipment or 7200/7300.
032	4.57	701504		231	4.57	701501	
	6.10	701191			6.10	700067	
	9.15	701506			9.15	701502	
	15.25	700069			15.25	701157	
	X	701506 – Specify Length			X	701503 – Specify Length	
909	–		Power cord for 1603 (15 Amp, single phase)	232	–		EPO cable between 5120 and 7200/7300
909	4.57	701496		232	4.57	701504	
	7.62				6.10	701191	
202	–		Two-system EPO cable		9.15	701505	
202	Plug	501220			15.25	700069	
	4.57	502828			X	701506 – Specify Length	
	6.10	502829		901	–		Power cord for 5120 (15 Amp, single phase)
	9.15	502830		901	4.57	506346	
	15.25	502831			7.62	506347	
	X	502832 – Specify Length		902	–		Power cord for 5120 (15 Amp, three phase)
900	–		Power cord for 7200/7300 (30 Amp, three phase)	902	4.57	506349	
900	4.57	506395			7.62	506350	
	7.62	506396		237	–		Power cable between 5120 and one of the following devices: 5120, 8025 or 7200/7300.
205	–		Signal cable between 7200/7300 and local 202 data set or 1240 (console or terminal)	237	2.20	200388	
205	3.05	501530			3.05	200289	
	4.57	501581			4.57	200390	
	6.10	501582			6.10	200391	
	9.15	501583			9.15	200392	
	12.20	501584			12.20	200393	
	15.25	501585			15.25	200394	
206	–		Signal cable between 7200/7300 and local 201 data set	242	–		EPO cable between 8025 and 7200/7300
206	3.05	505092		242	4.57	701504	
	4.57	505093			6.10	701191	
	6.10	505094			9.15	705505	
	9.15	505095			15.25	700069	
	12.20	505096			X	701506 – Specify Length	
	15.25	505097					

Table 6-3. Cable Part Numbers – 50 Hz (Continued)

Cable Group	Length in Metres	Part Number	Notes	Group Number	Length in Metres	Part Number	Notes
903	--		Power cord for 8025 (15 Amp, single phase)	257	--		Power cable between 3237 (Master) and one of the following devices: 5120, 8025 or 7200/7300.
903	4.57	506346		257	2.20	200388	
	7.62	506347			3.05	200889	
904	--		Power cord for 8025 (15 Amp, three phase)		4.57	200390	
904	4.57	506349			9.15	200391	
	7.62	506350			12.20	200392	
					15.25	200393	
					6.10	200394	
245	--		Signal cable between 8025 and 7200/7300	265	--		Signal cable between 3664 drives 7+6, or 4+3 or 1 and 7200/7300
245	4.57	504529		265	1.52	201719	
	6.10	504530			3.00	201679	
	9.15	504531			4.10	201680	
	15.25	504532			6.00	201681	
	X	504533	Specify Length		7.50	201801	Note 1
					9.15	202152	
247			Power cable between 8025 and one of the following devices: 5120, 8025 or 7200/7300.		12.20	203043	
					15.25	202044	
247	2.20	200388		267	--		Power cable between 3664 and 7200/7200
	3.05	200389		267	2.20	200388	
	4.57	200390			3.50	200389	
	6.10	200391			4.57	200390	
	9.15	200392			6.10	200391	
	12.20	200393			9.15	200392	Note 2
	15.25	200394			12.20	200393	
					15.25	200394	
251	--		Buss and tag cables between 3237 (Master) and one of the following devices: 5120, 3237 (Master), 1603, other vendor equipment or 7200/7300	268	--		Data (unit) cable between 3664 and 7200/7300
251	4.57	701501		268	2.20	200531	
	6.10	700067			3.00	200532	
	9.15	701502			4.10	200533	
	15.25	701157			6.00	200534	
	X	701503	Specify Length		7.50	200535	Note 3
					9.30	201800	
252	--		EPO cable between 3237 (Master) and 7200/7300		12.20	202153	
					15.25	202154	
252	4.57	701504		269	--		Power and signal (multiplex) cables between 3664 (660) disc drives
	6.10	701191		269A	2.20	200388	
	9.15	701505			3.05	200389	
	15.25	700069			4.57	200390	Note 2
	X	701506	Specify Length		6.10	200391	
905	--		Power cord for 3237 (Master) – (15 Amp, three phase)		9.15	200392	
905	4.57	506349			12.20	200393	
	7.62	506350			15.25	200394	

Table 6-3. Cable Part Numbers – 50 Hz (Continued)

Cable Group	Length in Metres	Part Number	Notes
269B	1.52	201719	
	3.00	201679	
	4.10	201680	Note 1
	6.00	201581	Note 4
	7.50	201801	
	9.15	202152	
	12.20	203043	
	15.25	203044	
906	—	Modem adapter isolator cable — United Kingdom only	
906	3.05	506512	
	6.10	506513	
	9.15	506514	
	12.20	506519	
907	—	Modem adapter isolator cable — Europe	
907	3.05	506516	
	6.10	506517	
	9.15	506518	
	12.20	506520	
908	—	ICA to modem adapter cable	
908	X1	506521	Lines 1 to 7
	X2	506522	Lines 8 to 15 (7300 only)

- A — Signal cable between 8010 and 7200/7300 (not orderable)
- B — Power cable between 8010 and 7200/7300 (not orderable)
- C — Signal and power cables between 3237 MASTER and 3237 SLAVE (not orderable)
- D — Power cable between 1240 console and 7200/7300 (not orderable)

NOTES

1. The maximum cable length for groups 265 and 269B is 100 feet. The first device must be within 50 feet.
2. No more than three (3) 3664's on a single cable. Maximum total cable length for groups 267 and 269A is 100 feet for three disc drives. The first device must be within 50 feet.
3. One (1) cable required for each 3664. Maximum cable length is 50 feet.
4. Group 269 is available in the following lengths only: 5, 9, 12, 18, 24, 30, 40 50 ft.

POWER CORDS

Table 6-4 contains the recommended in-line connector or receptacle and service for power cords shown in Figure 6-1 and listed in Table 6-1. Device specifications in Section 5 of this manual define the plug number.

SPECIAL EPO OPTIONS

System Emergency Power Off (EPO) capability is provided by a switch (color coded red) mounted on the computer system control console which disconnects all power to the system. As an option MRX/40 or /50 systems may also be configured with either Two System EPO or Master System EPO capability. Two System EPO provides a remote

means of disconnecting power from the system. Master System EPO in addition to providing a means of disconnecting power from the system also provides a remote means of sequencing power to the system.

CABLE LENGTH MEASUREMENT

Cable lengths must be measured from receptacle to receptacle and, therefore, must include not only the horizontal distance between units but also the vertical distance from the cable surface to the point of connection in each unit. Table 6-5 shows the vertical dimensions for all devices. Where raised floors are installed, the total length of each cable must also take into account a distance equal to two times the depth of the raised floor.

Table 6-4. 60 Hz Power Connectors

Group Number	Plug	In-Line Connector	Receptacle	Recommended Service	Voltage
033 233 243	Russell & Stoll, FS 3720	FS 3913	FS 3743	15 Amp, 1 Phase, 3 Wire	208/230
234 244 254	Russell & Stoll, FS 3730	FS 3914	FS 3744	15 Amp, 3 Phase, 4 Wire	208/230
203	Russell & Stoll, FS 3760	FS 3934	FS 3754	30 Amp, 3 Phase, 4 Wire	208/230
204	Russell & Stoll, SC 7328	SC 7428	SC 7324	60 Amp, 3 Phase, 4 Wire	208/230
1240 Term	Pass & Seymour or Hubbell 5266	5269	5261/ 5262	15 Amp, 1 Phase, 3 Wire	120
1240 Terminal Power Cord not orderable, provided by Memorex.					

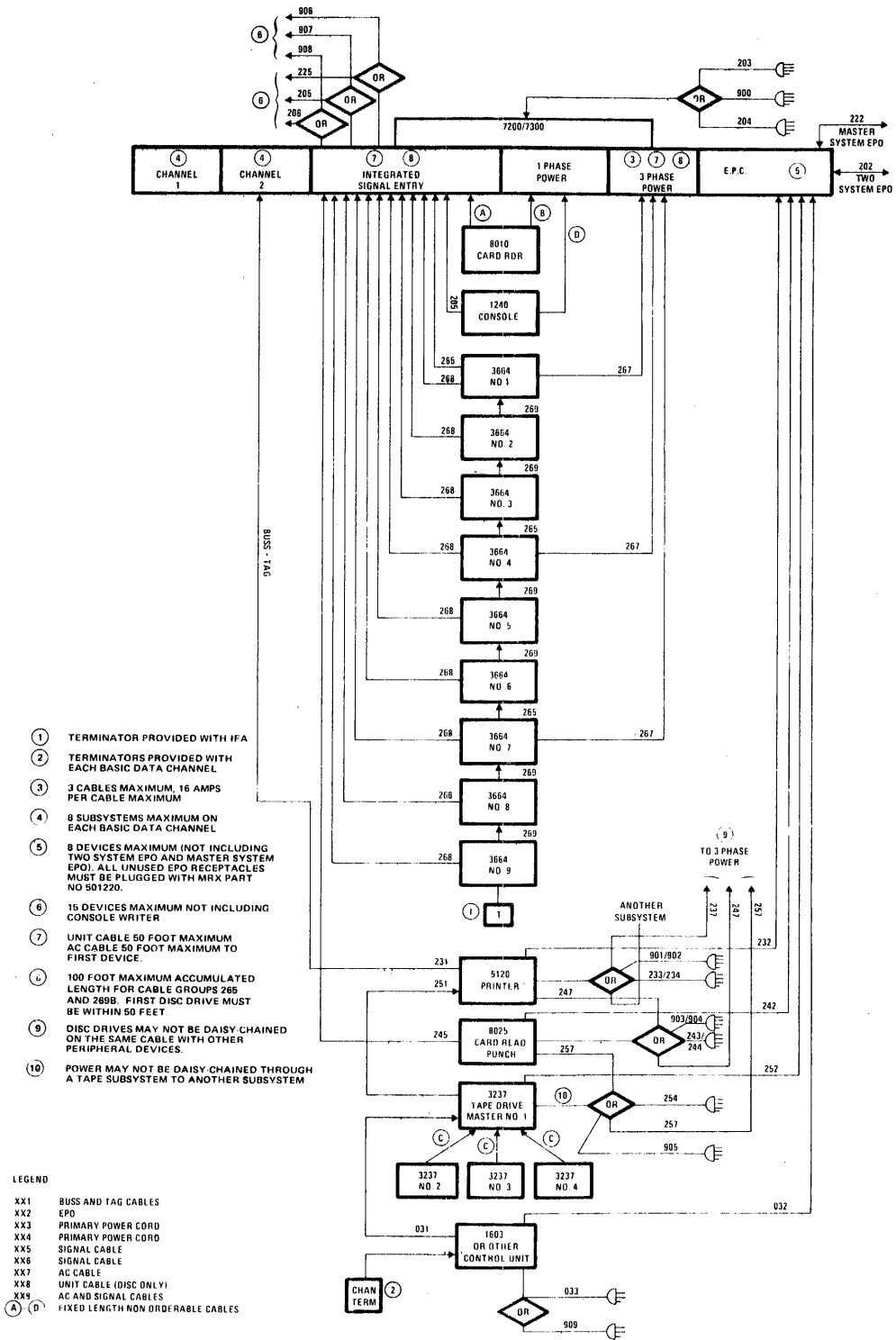

Figure 6-1. Cabling Diagram

Table 6-5. Cable Vertical Rise Dimensions

Group Number	From	To	From Z Dim.	To Y Dim.	Notes
031	1603	5120	12"	13"	
031	1603	3237(M)	12"	24"	
031	1603	1603	12"	12"	
031	1603	Vendor Equip	12"	—	1
031	1603	7200/7300	12"	12"	
032	1603	7200/7200	12"	27"	
202	7200/7300	—	27"	—	1
205	7200/7300	1240 Term	0-7=42"	12"	1,2
205	7200/7300	1240 Term	8-15=70"	12"	1,3
205	7200/7300	202 Data Set	0-7=42"	—	1,2
205	7200/7300	202 Data Set	8-15=70"	—	1,3
206	7200/7300	201 Data Set	0-7=42"	—	1,2
206	7200/7300	201 Data Set	8-15=70"	—	1,3
222	7200/7300	—	27"	—	1
225	7200/7300	DAA	0-7=42"	—	1,2
225	7200/7300	DAA	8-15=70"	—	1,3
231	5120	5120	13"	13"	
231	5120	3237(M)	13"	24"	
231	5120	1603	13"	12"	
231	5120	Vendor Equip	13"	—	1
231	5120	7200/7300	13"	12"	
232	5120	7200/7300	20"	27"	
237	5120	5120	22"	22"	
237	5120	3237(M)	22"	10"	
237	5120	8025	22"	12"	
237	5120	7200/7300	22"	24"	
242	8025	7200/7300	86"	27"	
245	8025	7200/7300	24"	62"	
247	8025	5120	12"	12"	
247	8025	3237(M)	12"	10"	
247	8025	8025	12"	12"	
247	8025	7200/7300	12"	24"	
251	3237(M)	5120	24"	13"	
251	3237(M)	3237(M)	24"	24"	
251	3237(M)	1603	24"	12"	
251	3237(M)	Vendor Equip	24"	—	1
251	3237(M)	7200/7300	24"	12"	
252	3237(M)	7200/7300	9"	27"	
257	3237(M)	7200/7300	10"	24"	
265	3664	7200/7300	18"	15"	
267	3664	7200/7300	12"	24"	
268	3664	7200/7300	18"	27"	

X = Distance from cable entry to cable entry between units including two times the raised floor depth (if raised floor is installed)

Y = Distance from floor to receptacle of the "TO" unit

Z = Distance from receptacle to floor of the "FROM" unit

Total length = X+Y+Z

Notes

1. Refer to appropriate vendor manual for requirement
2. Communications adapter positions 0 through 7
3. Communications adapter positions 8 through 15

MEMOREX

First Class
Permit No. 250
Santa Clara
California 95050

Business Reply Mail

No Postage Necessary if Mailed in the United States

Postage Will Be Paid By

Memorex Corporation

Santa Clara Publications
Department 9722 – M/S 00-21
1200 Memorex Drive
Santa Clara, California 95052

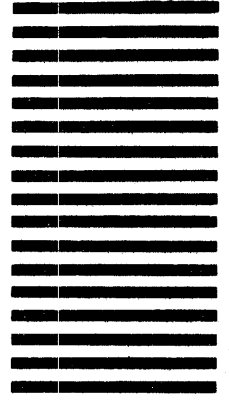

Thank you for your information.....

Our goal is to provide better, more useful manuals, and your comments will help us to do so.

.....Memorex Publications