



LM161/LM261/LM361 High Speed Differential Comparators

Voltage Comparators

General Description

The LM161/LM261/LM361 is a very high speed differential input, complementary TTL output voltage comparator with improved characteristics over the SE529/NE529 for which it is a pin-for-pin replacement. The device has been optimized for greater speed performance and lower input offset voltage. Typically delay varies only 3 ns for over-drive variations of 5 mV to 500 mV. It may be operated from op amp supplies ($\pm 15V$).

Complementary outputs having minimum skew are provided. Applications involve high speed analog to digital converters and zero-crossing detectors in disc file systems.

Features

- Independent strobes
- Guaranteed high speed 20 ns max
- Tight delay matching on both outputs
- Complementary TTL outputs
- Operates from op amp supplies $\pm 15V$
- Low speed variation with overdrive variation
- Low input offset voltage
- Versatile supply voltage range

Schematic and Connection Diagrams

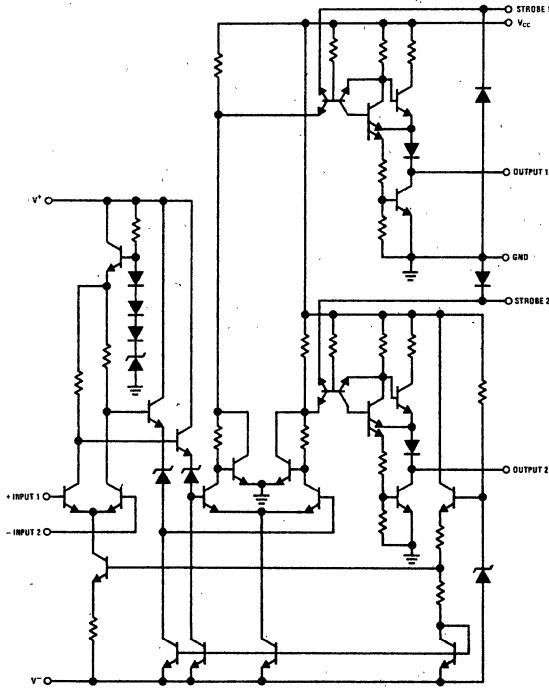

Logic Diagram

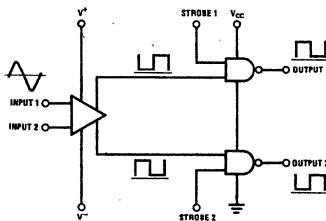

Dual-In-Line Package

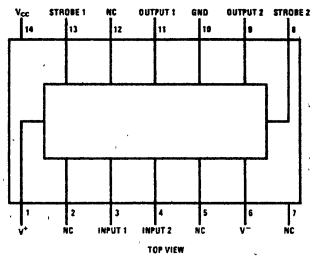

Order Number LM161J, LM261J
or LM361J
See NS Package J14A
Order Number LM361N
See NS Package N14A

Metal Can Package

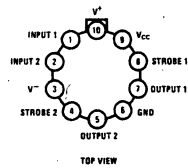

Order Number LM161H, LM261H
or LM361H
See NS Package H10C

Absolute Maximum Ratings

Positive Supply Voltage, V^+	+16V
Negative Supply Voltage, V^-	-16V
Gate Supply Voltage, V_{CC}	+7V
Output Voltage	+7V
Differential Input Voltage	±5V
Input Common Mode Voltage	±6V
Power Dissipation	600 mW
Storage Temperature Range	-65°C to +150°C
Operating Temperature Range	T_{MIN} T_{MAX}
LM161	-55°C to +125°C
LM261	-25°C to +85°C
LM361	0°C to +70°C
Lead Temperature (Soldering, 10 sec)	300°C

Operating Conditions

	MIN	TYP	MAX
Supply Voltage V^+			
LM161/LM261	5V		15V
LM361	5V		15V
Supply Voltage V^-			
LM161/LM261	-6V		-15V
LM361	-6V		-15V
Supply Voltage V_{CC}			
LM161/LM261	4.5V	5V	5.5V
LM361	4.75V	5V	5.25V

Electrical Characteristics ($V^+ = +10V, V_{CC} = +5V, V^- = -10V, T_{MIN} \leq T_A \leq T_{MAX}$, unless noted)

PARAMETER	CONDITIONS	LIMITS						UNITS
		LM161/LM261			LM361			
		MIN	TYP	MAX	MIN	TYP	MAX	
Input Offset Voltage			1	3		1	5	mV
Input Bias Current	$T_A = 25^\circ C$		5	20		10	30	μA
Input Offset Current	$T_A = 25^\circ C$		2	3		2	5	μA
Voltage Gain	$T_A = 25^\circ C$		3			3		V/mV
Input Resistance	$T_A = 25^\circ C, f = 1 \text{ kHz}$		20			20		k Ω
Logical "1" Output Voltage	$V_{CC} = 4.75V, I_{SOURCE} = -5 \text{ mA}$	2.4	3.3		2.4	3.3		V
Logical "0" Output Voltage	$V_{CC} = 4.75V, I_{SINK} = 6.4 \text{ mA}$.4			.4	V
Strobe Input "1" Current	$V_{CC} = 5.25V, V_{STROBE} = 2.4V$			200			200	μA
Strobe Input "0" Current	$V_{CC} = 5.25V, V_{STROBE} = .4V$			-1.6			-1.6	mA
Strobe Input "0" Voltage	$V_{CC} = 4.75V$.8			.8	V
Strobe Input "1" Voltage	$V_{CC} = 4.75V$	2			2			V
Output Short Circuit Current	$V_{CC} = 5.25V, V_{OUT} = 0V$	-18		55	-18		-55	mA
Supply Current I^+	$V^+ = 10V, V^- = -10V, V_{CC} = 5.25V, -55^\circ C \leq T_A \leq 125^\circ C$			4.5				mA
Supply Current I^+	$V^+ = 10V, V^- = -10V, V_{CC} = 5.25V, 0^\circ C \leq T_A \leq 70^\circ C$						5	mA
Supply Current I^-	$V^+ = 10V, V^- = -10V, V_{CC} = 5.25V, -55^\circ C \leq T_A \leq 125^\circ C$			10				mA
Supply Current I^-	$V^+ = 10V, V^- = -10V, V_{CC} = 5.25V, 0^\circ C \leq T_A \leq 70^\circ C$						10	mA
Supply Current I_{CC}	$V^+ = 10V, V^- = -10V, V_{CC} = 5.25V, -55^\circ C \leq T_A \leq 125^\circ C$			18				mA
Supply Current I_{CC}	$V^+ = 10V, V^- = -10V, V_{CC} = 5.25V, 0^\circ C \leq T_A \leq 70^\circ C$						20	mA
TRANSIENT RESPONSE		$V_{IN} = 50 \text{ mV Overdrive}$						
Propagation Delay Time ($t_{pd(0)}$)	$T_A = 25^\circ C$		14	20		14	20	ns
Propagation Delay Time ($t_{pd(1)}$)	$T_A = 25^\circ C$		14	20		14	20	ns
Delay Between Output A and B	$T_A = 25^\circ C$		2	5		2	5	ns
Strobe Delay Time ($t_{pd(0)}$)	$T_A = 25^\circ C$		8			8		ns
Strobe Delay Time ($t_{pd(1)}$)	$T_A = 25^\circ C$		8			8		ns

Typical Performance Characteristics

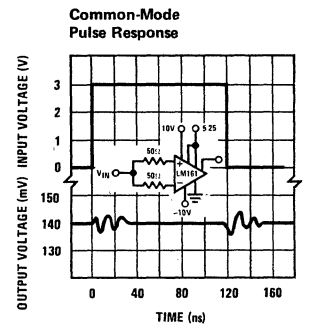
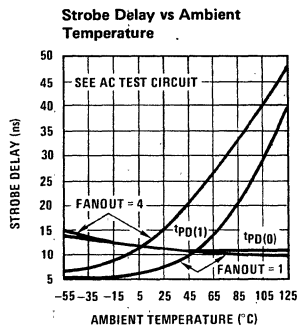
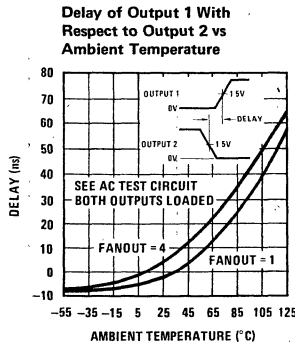
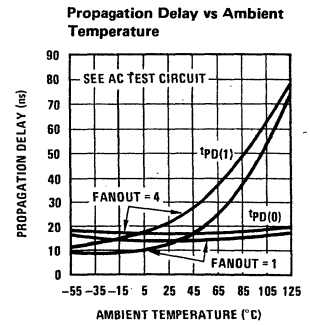
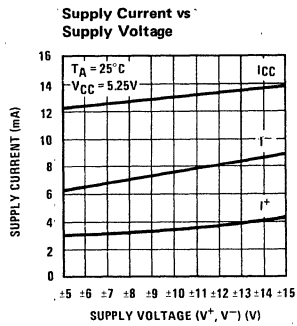
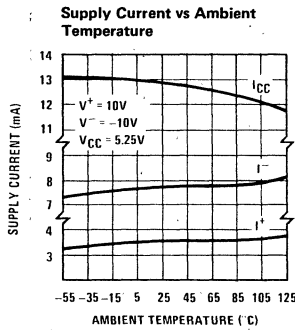
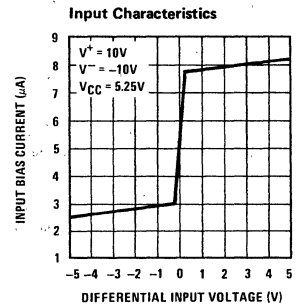
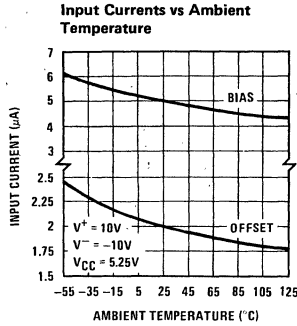
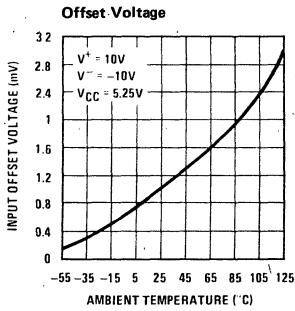

AC Test Circuit

