

# **iRMX 86™ DEBUGGER REFERENCE MANUAL**

Manual Order No. 143323-001

REV.	REVISION HISTORY	PRINT DATE
-001	Original Issue. Contains information formerly found in iRMX 86 NUCLEUS, TERMINAL HANDLER, AND DEBUGGER REFERENCE MANUAL and iRMX 86 SYSTEM PROGRAMMER'S REFERENCE MANUAL. This issue revises format, corrects technical and typographical errors, and describes the N and VA commands.	5/81

Additional copies of this manual or other Intel literature may be obtained from:

Literature Department  
Intel Corporation  
3065 Bowers Avenue  
Santa Clara, CA 95051

The information in this document is subject to change without notice.

Intel Corporation makes no warranty of any kind with regard to this material, including, but not limited to, the implied warranties of merchantability and fitness for a particular purpose. Intel Corporation assumes no responsibility for any errors that may appear in this document. Intel Corporation makes no commitment to update nor to keep current the information contained in this document.

Intel Corporation assumes no responsibility for the use of any circuitry other than circuitry embodied in an Intel product. No other circuit patent licenses are implied.

Intel software products are copyrighted by and shall remain the property of Intel Corporation. Use, duplication or disclosure is subject to restrictions stated in Intel's software license, or as defined in ASPR 7-104.9(a)(9).

No part of this document may be copied or reproduced in any form or by any means without the prior written consent of Intel Corporation.

The following are trademarks of Intel Corporation and its affiliates and may be used only to identify Intel products:

BXP	Intel	Megachassis
CREDIT	Intelelevision	Micromap
i	Inteltec	Multibus
ICE	iRMX	Multimodule
iCS	iSBC	PROMPT
im	iSBX	Promware
Insite	Library Manager	RMX/80
Intel	MCS	System 2000
		UPI
		μScope

and the combination of ICE, iCS, iRMX, iSBC, iSBX, MCS, or RMX and a numerical suffix.

## PREFACE

This manual documents the Debugger, a subsystem of the iRMX 86 Operating System that allows you to interactively examine your application system in order to find and correct errors. It contains introductory and overview material, as well as detailed descriptions of all Debugger commands.

### READER LEVEL

This manual is intended for both application and system programmers who are familiar with the concepts and terminology introduced in the iRMX 86 NUCLEUS REFERENCE MANUAL. System programmers should also be familiar with the concepts introduced in the iRMX 86 SYSTEM PROGRAMMER'S REFERENCE MANUAL.

### CONVENTIONS

This manual contains several examples of Debugger commands entered at a terminal. In these examples, user input is underscored to distinguish it from Debugger output.

### RELATED PUBLICATIONS

The following manuals provide additional background and reference information.

<u>Manual</u>	<u>Number</u>
Introduction to the iRMX 86 Operating System	9803124
iRMX 86 Nucleus Reference Manual	9803122
iRMX 86 Terminal Handler Reference Manual	143324
iRMX 86 System Programmer's Reference Manual	142721

## CONTENTS

	PAGE
CHAPTER 1	
INTRODUCTION	
Debugger Capabilities.....	1-1
Debugging Capabilities in the ICE-86 Emulator.....	1-2
Debugging Capabilities in the iSBC 957A Monitor.....	1-2
Reasons for Using the iRMX 86 Debugger.....	1-2
Invoking the Debugger.....	1-3
CHAPTER 2	
SPECIAL CHARACTERS	
End-of-Line Characters.....	2-1
Control-S.....	2-1
Control-Q.....	2-1
Control-O.....	2-1
Control-D.....	2-2
CHAPTER 3	
COMMAND SYNTAX	
Conventions.....	3-1
Pictorial Representation of Syntax.....	3-1
Special Symbols for the Debugger.....	3-2
CHAPTER 4	
DEBUGGER COMMANDS	
Command Dictionary.....	4-2
Symbolic Name Commands.....	4-4
Defining Numeric Variables--D.....	4-5
Listing Numeric and Breakpoint Variables--L.....	4-6
Changing Numeric Variables.....	4-8
Deleting Numeric Variables--Z.....	4-9
Breakpoint Commands.....	4-10
Execution Breakpoint Display.....	4-11
Exchange Breakpoint Display.....	4-12
Exception Breakpoint Display.....	4-13
Exception Breakpoint Differences.....	4-13
Defining a Breakpoint--DB.....	4-15
Examining a Breakpoint.....	4-17
Changing a Breakpoint.....	4-19
Deleting a Breakpoint--Z.....	4-21
Viewing a Breakpoint List--BL.....	4-22
Viewing Breakpoint Parameters--B.....	4-23
Resuming Task Execution--G.....	4-26
Establishing the Breakpoint Task--BT.....	4-27
Listing the Breakpoint Task--BT.....	4-28
Viewing the Breakpoint Task's Registers--R.....	4-29
Altering the Breakpoint Task's Registers--R.....	4-31

CONTENTS (continued)

	PAGE
CHAPTER 4 (continued)	
Viewing the Breakpoint Task's NDP Registers--N.....	4-33
Altering the Breakpoint Task's NDP Registers--N.....	4-35
Memory Commands.....	4-37
Setting the Current Display Mode--M.....	4-40
Examining Memory--M.....	4-41
Changing Memory--M.....	4-45
Commands to Inspect System Objects.....	4-53
Inspecting a Job--IJ.....	4-54
Inspecting a Task--IT.....	4-58
Inspecting an Exchange--IE.....	4-61
Inspecting a Segment--IG.....	4-66
Inspecting an Extension--IX.....	4-68
Inspecting a Composite--IC.....	4-70
Commands to View Object Lists.....	4-72
Viewing Jobs--VJ.....	4-73
Viewing Tasks--VT.....	4-74
Viewing Ready Tasks--VR.....	4-75
Viewing Suspended Tasks--VS.....	4-76
Viewing Asleep Tasks--VA.....	4-77
Viewing Exchanges--VE.....	4-78
Viewing Waiting Task Queues--VW.....	4-79
Viewing Mailbox Object Queues--VM.....	4-80
Viewing Segments--VG.....	4-81
Viewing Extensions--VX.....	4-82
Viewing Composites--VC.....	4-84
Commands to Exit the Debugger.....	4-85
Exiting the Debugger--Q.....	4-86

FIGURES

FIGURE	
3-1. Syntax Diagram for Term and Expression.....	3-4
3-2. Syntax Diagram for Item.....	3-4
4-1. Syntax Diagram for Memory Commands.....	4-37
4-2. Syntax Diagram for Inspecting System Objects.....	4-53
4-3. An iRMX 86 Job Report.....	4-55
4-4. An iRMX 86 Task Report.....	4-58
4-5. An iRMX 86 Mailbox Report.....	4-61
4-6. An iRMX 86 Semaphore Report.....	4-63
4-7. An iRMX 86 Region Report.....	4-64
4-8. An iRMX 86 Segment Report.....	4-66
4-9. An iRMX 86 Extension Report.....	4-68
4-10. An iRMX 86 Composite Report.....	4-70
4-11. Syntax Diagram for Viewing iRMX 86 Object Lists.....	4-72



## CHAPTER 1. INTRODUCTION

The development of almost every software application requires debugging. To aid in the development of iRMX 86 application systems, Intel provides three debugging tools. One, the iRMX 86 Debugger, is a powerful tool which is sensitive to the data structures that the Nucleus maintains. The other debugging tools are the ICE-86 In-Circuit Emulator and the iSBC 957A monitor.

The Debugger supplies its own Terminal Handler, which includes all of the capabilities described in the iRMX 86 TERMINAL HANDLER REFERENCE MANUAL. Your application software can make use of the Debugger's Terminal Handler, or you can include a separate version (or versions) of the Terminal Handler in your system configuration for application use. Refer to the iRMX 86 CONFIGURATION GUIDE for further configuration information.

### DEBUGGER CAPABILITIES

The iRMX 86 Debugger enables you to do the following:

- Use the Debugger as a task, job, or system exception handler.
- View iRMX 86 object lists, including the lists of jobs, tasks, ready tasks, suspended tasks, asleep tasks, task queues at exchanges, object queues at mailboxes, exchanges, and iRMX 86 segments.
- Inspect jobs, tasks, exchanges, segments composites, and extensions.
- Examine and/or alter the contents of absolute memory locations.
- Set, change, view, and delete breakpoints.
- View the list of tasks that have incurred breakpoints and remove tasks from it.
- Declare a task to be the breakpoint task.
- Examine and/or alter the breakpoint task's register values.
- Set, change, view, and delete special variables for debugging.
- Deactivate the Debugger.

## INTRODUCTION

### DEBUGGING CAPABILITIES IN THE ICE-86 EMULATOR

The ICE-86 In-Circuit Emulator provides several debugging capabilities. In particular, an ICE-86 emulator lets you:

- Get closer to the hardware level by examining the contents of input pins and input ports. You can also change the values at output ports.
- Set breakpoints.
- Use memory in your Intel Microcomputer Development System as if it were on your prototype board.
- Look at the most recent 80 to 150 assembly language instructions executed.

To learn more about the ICE-86 Emulator, consult the ICE-86 IN-CIRCUIT EMULATOR OPERATING INSTRUCTIONS FOR ISIS-II USERS.

### DEBUGGING CAPABILITIES IN THE iSBC 957A MONITOR

The iSBC 957A monitor is used with the iSBC 86/12A single board computer to provide several capabilities that can aid you in debugging. With the monitor, you can do the following:

- Examine and modify the contents of iAPX 86 registers and absolute memory locations.
- Set breakpoints.
- Single step program execution.
- Do I/O to and from ports.
- Move or compare blocks of memory.

To learn more about the iSBC 957A monitor, refer to the iSBC 957A INTELLEC -- iSBC 86/12A INTERFACE AND EXECUTION PACKAGE USER'S GUIDE.

### REASONS FOR USING THE iRMX 86 DEBUGGER

There are three important reasons for using the iRMX 86 Debugger instead of (or in addition to) the other available debuggers. They are:

- The iRMX 86 Debugger is aware of the data structures associated with the Nucleus and the Nucleus objects. The other debuggers can examine memory only as data. The iRMX 86 Debugger interprets some of that data so that it can provide lists of iRMX 86 objects, as well as detailed information about



## INTRODUCTION

individual objects. Because of this feature, you do not have to sort through complicated data structures in order to obtain information about objects.

- The iRMX 86 Debugger allows you to manipulate (or examine) one task while other tasks in the system continue to run. With the other debuggers, encountering a breakpoint stops the processor. With the iRMX 86 Debugger, encountering a breakpoint stops only a single task (or possibly the tasks in a single job). Other tasks can continue to run. This feature helps you debug in a multitask environment when the interactions between individual tasks are important.
- The iRMX 86 Debugger allows you to monitor system activity without interfering in the execution. You can, for example, set a breakpoint at a mailbox so that the Debugger displays information each time a task sends to or receives from the mailbox. You have the option of doing this without stopping the task or interfering with it in any way. This feature helps you verify that certain system activities do indeed occur.

### INVOKING THE DEBUGGER

You can invoke the Debugger from your iRMX 86 terminal by entering:

```
control-D
```

The Debugger responds with its sign-on message:

```
iRMX 86 DEBUGGER V3.0  
*
```

The asterisk is the prompt character for the Debugger. It indicates that the Debugger is ready to accept additional input from the terminal.

In addition to the functions the Debugger can perform when it has been invoked, there are two services it can perform at any time, even when not invoked. First, if a task encounters a breakpoint, the Debugger responds as described in Chapter 4.

Second, if a task has the Debugger as its exception handler and the task causes an exceptional condition, then the Debugger displays a message to that effect at the terminal. A task can get the Debugger as its exception handler in one of the following ways:

- By using the SET\$EXCEPTION\$HANDLER system call.
- By acquiring the Debugger as the default exception handler. You can use the %SYSTEM macro during configuration to specify the Debugger as the system default exception handler. Unless this default is overridden at job or task creation time, the Debugger automatically becomes the task's exception handler. Refer to the iRMX 86 CONFIGURATION GUIDE for a description of the %SYSTEM macro.

## INTRODUCTION

- By having the Debugger declared as the exception handler when the task is created with CREATE\$JOB or CREATE\$TASK. An example of code setting up one of these calls is the following:

```
RQ$DEBUGGER$EX: PROCEDURE (EX$CODE, PARAM$NO, RESERVED,  
                           NDP$STATUS, DUMMY$IF$COMPACT) EXTERNAL;
```

```
  DECLARE
```

```
    EX$CODE           WORD,  
    PARAM$NO         BYTE,  
    RESERVED         WORD,  
    NDP$STATUS       WORD,  
    DUMMY$IF$COMPACT WORD;
```

```
END RQ$DEBUGGER$EX;
```

```
  DECLARE EXCEPT$BLOCK STRUCTURE (  
    EXCEPT$PROC   POINTER,  
    EXCEPT$MODE   BYTE);
```

```
  .  
  .  
  .
```

```
EXCEPT$BLOCK.EXCEPT$PROC = @RQ$DEBUGGER$EX;  
EXCEPT$BLOCK.EXCEPT$MODE = ZERO$ONE$TWO$OR$THREE;
```

```
  .  
  .  
  .
```

```
RQ$CREATE$JOB(...,@EXCEPT$BLOCK,...);
```

```
  or
```

```
RQ$CREATE$TASK(...,@EXCEPT$BLOCK,...);
```

For this code to work, the task code must be linked to the CROOT.LIB library that is supplied with the Nucleus. The DUMMY\$IF\$COMPACT parameter in the RQ\$DEBUGGER\$EX declaration is a dummy parameter that you must include if your task is compiled using the PL/M-86 COMPACT control.

## CHAPTER 2. SPECIAL CHARACTERS

In addition to the Debugger commands listed in Chapter 4, the Debugger recognizes several special characters. This chapter lists these characters and describes their functions.

### END-OF-LINE CHARACTERS

The Debugger obtains input one line at a time from its Terminal Handler. The end-of-line characters separate individual input lines. The Debugger recognizes three end-of-line characters. They are:

- Carriage Return
- Line Feed
- ESCAPE

Both Carriage Return and Line Feed send the current input line to the Debugger for processing. ESCAPE causes the Debugger to discard the current input line and display a prompt.

### CONTROL-S

The Debugger generates display at the iRMX 86 terminal by sending output messages to its Terminal Handler. Application tasks can also send messages to the same terminal. To suppress output from application tasks during a debugging session, type control-S. The Debugger then stores the output from application tasks until you type control-Q. If you do not enter control-S, any output from tasks is interspersed with output from the Debugger. Control-S has no effect on output from the Debugger.

### CONTROL-Q

Control-Q negates the effect of a previously entered control-S character. To resume the output from tasks, type control-Q. Control-Q also causes the Debugger to display all output that was suppressed by control-S. Control-Q has no effect on output from the Debugger.

### CONTROL-O

Certain Debugger command responses are lengthy and can roll off the screen. To freeze the top part of such a display before it disappears, enter control-O. This discards all output including Debugger prompts until you enter another control-O. The discarded output cannot be retrieved.

## SPECIAL CHARACTERS

### CONTROL-D

Occasionally you will want to terminate a Debugger memory command function response before it is finished. For example, if you asked for a display of memory locations 0000H to 0FFFFH, it would be natural to change your mind. To abort the display and regain the Debugger prompt, enter control-D.

Note that control-O affects the display only, whereas control-D stops the function entirely.

## CHAPTER 3. COMMAND SYNTAX

When using the iRMX 86 Debugger, you sit at a terminal and type commands. This chapter describes the syntactical standards for commands to the Debugger, and it introduces notational conventions that are used throughout this manual.

### CONVENTIONS

The first one or two characters of a command constitute a key sequence for the command:

- Most Debugger commands are specified by one or two letters. The key letters or pairs of letters are BL, BT, D, DB, G, I, L, M, N, Q, R, V, and Z.
- In a few cases, a command is specified by beginning the command with a name. A name, for the Debugger, must consist of a period followed by a variable name.

After the key initial sequence, a command may be followed by one or more parameters or additional specifiers. Blanks are used as delimiters between elements of a command; they are mandatory except as follows:

- Immediately after a command key that is not a name.
- Between a letter or digit and a non-letter, non-digit. The legal characters of the latter type are the following: ; @ = / \ : ( ) \* + - ,

### PICTORIAL REPRESENTATION OF SYNTAX

In this manual, a schematic device illustrates the syntax of commands. The schematic consists of what looks like an aerial view of a model railroad setup, with syntactic entities scattered along the track. Imagine that a train enters the system at the upper left, drives around as much as it can or wants to (sharp turns and backing up are not allowed), and finally departs at the lower right. The command it generates in so doing consists, in order, of the syntactic entities that it encounters on its journey. For example, a string of A's and B's, in any order, would be depicted as:

## COMMAND SYNTAX

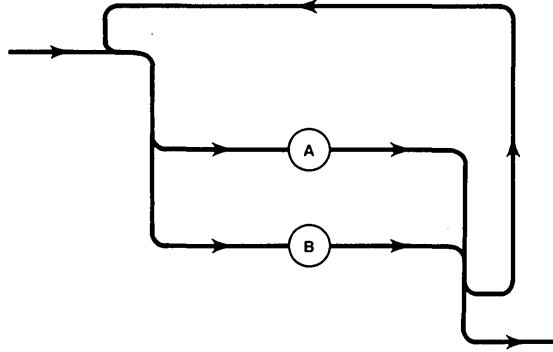

If such a string has to begin with an A, the schematic could be drawn as:

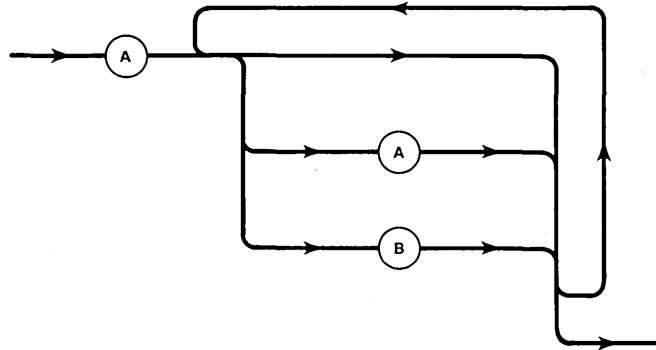

In the second drawing, it is necessary to represent the letter A twice because A is playing two roles. It is the first symbol (necessarily) and it is a symbol that may (optionally) be used after the first symbol. Note that a train could avoid the second A but cannot avoid the first A. The arrows are not necessary and henceforth are omitted.

### SPECIAL SYMBOLS FOR THE DEBUGGER

The entities that will be used in the remainder of this manual, as A and B were used in the previous paragraph, are the following:

- **CONSTANT.** Constants are always hexadecimal. Unlike such constants in PL/M-86, they do not require an H as the last character. H's may be used if desired. Leading zeroes are not necessary unless they help to distinguish between constants and other things. For example, AH is a register in the iAPX 86, but 0AH is a constant.
- **NAME.** A name is a period followed by up to 11 characters, the first of which must be alphabetic. The other characters can be alphabetic, numeric, question marks (?), or dollar signs (\$).

Examples:

.task

.mailbox\$7

## COMMAND SYNTAX

- **EXPRESSION.** As in algebra, an expression is either a term or is the result of adding and subtracting terms. Also as in algebra, a term is a product; each factor in the product is either a constant, a name, a parenthetical expression, or one of the registers AX, BX, CX, DX, DS, ES, SS, CS, IP, FL, SI, DI, BP, and SP. Graphically, term and expression are shown in Figure 3-1:

### NOTE

If the computed value of an expression is too large to fit into four hexadecimal digits, then only the low order four digits are used.

- **ITEM.** An item is either an expression or one of the segment registers of the iAPX 86 microprocessor. The values of items are used variously as tokens and as offsets in Debugger commands. Graphically, an item is defined in Figure 3-2.

COMMAND SYNTAX

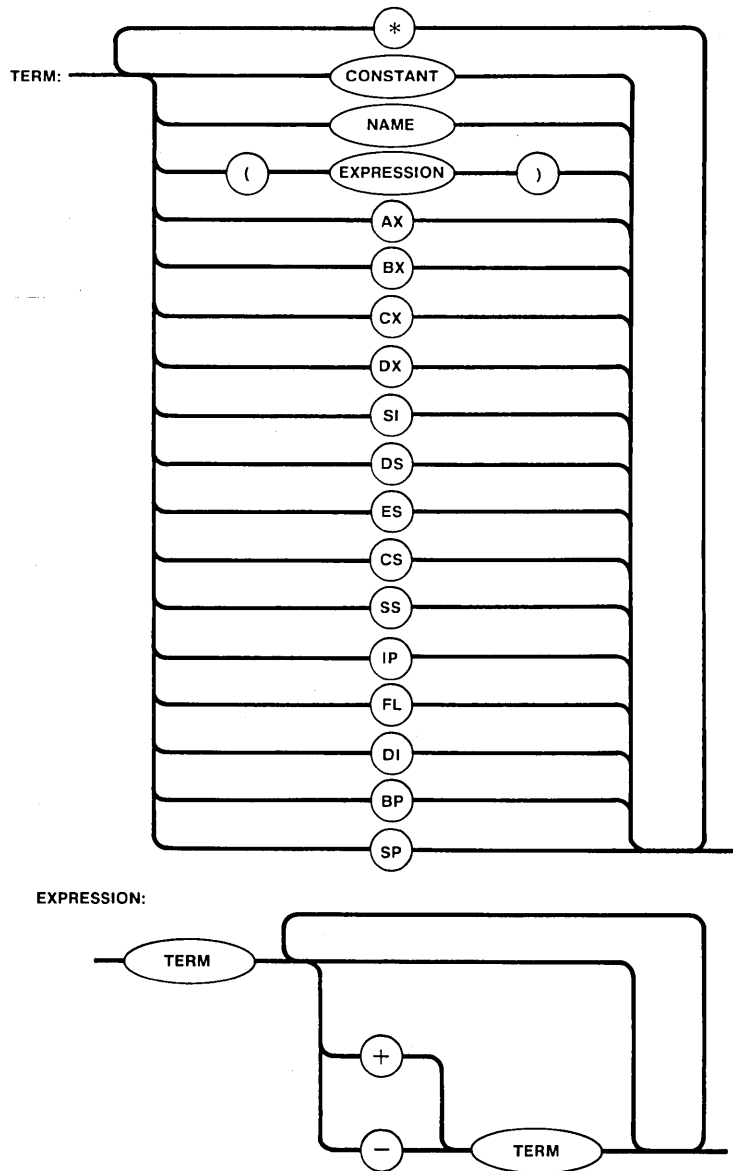

Figure 3-1. Syntax Diagrams for Term and Expression

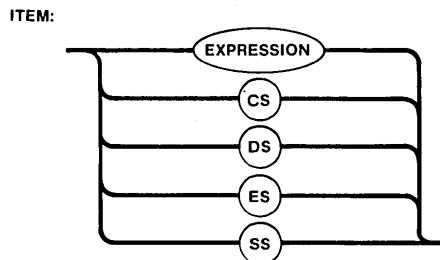

Figure 3-2. Syntax Diagram for Item



## CHAPTER 4. DEBUGGER COMMANDS

This chapter presents the details of the Debugger commands. It is divided into several sections, each of which describes a related group of commands. The command groupings are as follows:

- Symbolic Name Commands
- Breakpoint Commands
- Memory Commands
- Commands to Inspect iRMX 86 Objects
- Commands to View Object Lists
- Commands to Exit the Debugger

Each section contains a general information portion followed by detailed command descriptions.

Between this introduction and the discussions of the individual commands is a command dictionary. This dictionary, which lists the commands in alphabetical order, includes short descriptions and page numbers of the complete descriptions in this chapter. Those commands which are not associated with specific command letters are listed at the end of the dictionary.

# DEBUGGER COMMANDS

## COMMAND DICTIONARY

<u>Command</u>	<u>Page</u>
B -- Displays breakpoint parameters.....	4-23
BL -- Displays a breakpoint list.....	4-22
BT -- Establishes a breakpoint task.....	4-27
BT -- Inquires as to the breakpoint task.....	4-28
D -- Defines numeric variables.....	4-5
DB -- Defines a breakpoint.....	4-15
G -- Removes a task from the breakpoint list.....	4-26
IC -- Inspects a composite.....	4-69
IE -- Inspects an exchange.....	4-60
IG -- Inspects a segment.....	4-65
IJ -- Inspects a job.....	4-53
IT -- Inspects a task.....	4-57
IX -- Inspects an extension.....	4-67
L -- Displays numeric variables.....	4-6
M -- Changes memory.....	4-44
M -- Examines memory.....	4-40
M -- Sets the current display mode.....	4-39
N -- Alters the breakpoint task's NDP registers.....	4-34
N -- Displays the breakpoint task's NDP registers.....	4-32
Q -- Exits the Debugger.....	4-85
R -- Alters the breakpoint task's iAPX 86 registers.....	4-31
R -- Displays the breakpoint task's iAPX 86 registers.....	4-29
VA -- Displays a list of asleep tasks.....	4-76
VC -- Displays a list of composite objects.....	4-83
VE -- Displays a list of exchanges.....	4-77

DEBUGGER COMMANDS

<u>Command</u>	<u>Page</u>
VG -- Displays a list of segments.....	4-80
VJ -- Displays a list of jobs.....	4-72
VM -- Displays the mailbox object queues.....	4-79
VR -- Displays a list of ready tasks.....	4-74
VS -- Displays a list of suspended tasks.....	4-75
VT -- Displays a list of tasks.....	4-73
VW -- Displays the task queues at exchanges.....	4-78
VX -- Displays a list of extension objects.....	4-81
Z -- Deletes a breakpoint.....	4-21
Z -- Deletes a numeric variable.....	4-9
Changing a breakpoint.....	4-19
Changing numeric variables.....	4-8
Examining a breakpoint.....	4-17

SYMBOLIC NAME COMMANDS

For your convenience during debugging, the Debugger supports the use of alphanumeric variable names that stand for numerical quantities. The names and their associated values can be accessed by the Debugger from any of the following sources:

- A Debugger-maintained symbol table. The table contains name/value pairs that have been cataloged by the Debugger as numeric variables. This section describes commands for defining, changing, listing, and deleting numeric variables.
- The object directory of the current job. The current job is defined to be the job that contains the breakpoint task. (The command used to establish the breakpoint task is contained in the "Breakpoint Commands" section of this chapter.) If there is no breakpoint task, the current job is the root job.
- The object directory of the root job.

When you use a symbolic name that is not the name of a breakpoint variable, the Debugger searches these sources in the order just listed.

Suppose that you want to refer to a particular task by means of the name .TASK001. If the task is cataloged in the object directory of either the root job or the current job, then the Debugger will go to the appropriate directory and fetch a token for the task whenever the name .TASK001 is used in a Debugger command. If the task is not so cataloged, you can use VJ (view job), IJ (inspect job), VT (view task), and IT (inspect task) commands to deduce a token for the task. Then you can define .TASK001 to be a numeric variable whose value is that token.

SYMBOLIC NAME  
COMMANDS

DEFINING NUMERIC VARIABLES -- D

This command associates a variable name with a numeric value. The syntax for the D command is as follows:



PARAMETERS

- NAME            Name of the variable. This must be a period followed by up to 11 characters, the first of which must be alphabetic. The other characters can be alphabetic, numeric, question marks (?), or dollar signs (\$).
- ITEM            An expression or the name of an iAPX 86 segment register. The value of ITEM is associated with the variable name NAME.

DESCRIPTION

This command places NAME and the value of ITEM into the Debugger symbol table. You can use this command to create symbolic names for tokens, registers, or any other values. Then, you can use the symbolic names in other Debugger commands instead of entering the actual hexadecimal values.

EXAMPLES

```
D .TASKA = 2DC3
*
```

This command creates a symbol called .TASKA in the Debugger's local symbol table and assigns this symbol the hexadecimal value 2DC3.

SYMBOLIC NAME  
COMMANDS

LISTING NUMERIC AND BREAKPOINT VARIABLES -- L

This command lists numeric and breakpoint variable names and their associated values. The syntax for the L command is as follows:

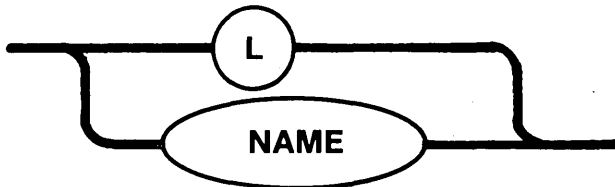

PARAMETER

**NAME** Name of an existing numeric or breakpoint variable. If entered, the Debugger lists the name and value of the indicated name only.

DESCRIPTION

The L command lists all numeric and breakpoint variable names and their associated values. (Breakpoint variables are described in the "Breakpoint Commands" section of this chapter.) Specifying NAME instead of L causes only one pair to be listed. In either case, one pair is listed per line in the format:

NAME=xxxx

where xxxx is the associated value.

EXAMPLES

```

L
BP=2DC3:00FF
MBOX          2F34
TASKA         2DC3
TASKB         2B8C
TASKC         2D8A
TASKD         2CEF
*
```

This command lists the names and values of all the numeric and breakpoint variables in the Debugger's local symbol table. It lists one breakpoint variable (.BP) and four numeric variables (.TASKA, .TASKB, .TASKC, and .TASKD).

## LISTING NUMERIC AND BREAKPOINT VARIABLES -- L (continued)

EXAMPLES (continued)

```
.TASKA  
TASKA=2DC3  
*
```

This command lists the value associated with the variable .TASKA.

## CHANGING NUMERIC VARIABLES

This command changes the value of an existing numeric variable. The syntax for this command is as follows:

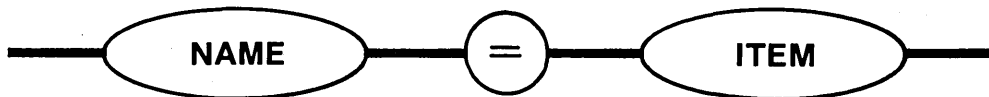

## PARAMETERS

NAME	Name of an existing numeric variable.
ITEM	An expression or the name of an iAPX 86 segment register. The value of ITEM is associated with the variable name NAME.

## DESCRIPTION

This command removes from the Debugger symbol table the value originally associated with NAME, and replaces it with the value of ITEM.

## EXAMPLES

```
.TASKA = 2F00  
*
```

This command changes the value of .TASKA to 2F00h.

```
.TASKA = .TASKB  
*
```

This command changes the value of .TASKA to that of .TASKB. In a previous example, .TASKB had a value of 2B8Ch. Therefore, this command changes the value of .TASKA to 2B8Ch.



DELETING NUMERIC VARIABLES -- Z

This command deletes a numeric variable. The syntax for the Z command is as follows:



PARAMETER

NAME                      Name of an existing numeric variable to be deleted.

DESCRIPTION

This command removes the NAME and associated value from the Debugger's symbol table.

EXAMPLE

Z .TASKA  
\*

This command deletes the numeric variable .TASKA.

SYMBOLIC NAME  
COMMANDS

BREAKPOINT COMMANDS

The Debugger provides you with the ability to set, change, view, or delete breakpoints. You set a breakpoint by defining an act which a task can perform. When a task performs the act, it incurs the breakpoint, causing its execution to cease. The Debugger supports three kinds of breakpoints:

- Execution breakpoint. A task incurs an execution breakpoint when it executes an instruction that is at a designated location in memory.
- Exchange breakpoint. A task incurs an exchange breakpoint when it performs a designated type of operation (send or receive) at a designated exchange.
- Exception breakpoint. A task incurs an exception breakpoint if its exception handler has been declared to be the Debugger and the task causes an exceptional condition of the type that invokes its exception handler.

When a task incurs a breakpoint (of any type), three things occur automatically:

- The task is placed in a pseudostate called "broken". Depending on the breakpoint options selected, the broken task and the tasks in the containing job might be suspended.
- If suspended, the broken task (and suspended tasks, if any) is (are) placed on a Debugger-maintained list called the breakpoint list. You can resume a task on the breakpoint list or you can remove it from the list.
- At the terminal, a display informs you that a breakpoint has been incurred. It also provides information about the event.

Each task on the breakpoint list is assigned a breakpoint state, which reflects the kind of breakpoint last incurred by the task. The states are as follows:

- X --- The task incurred an execution breakpoint.
- E --- The task incurred an exchange breakpoint.
- Z --- The task incurred an exception breakpoint.
- N --- The task was placed on the breakpoint list when another task in the same job incurred a breakpoint which had been set with the DB command (described later) using the J option.

BREAKPOINT COMMANDS

## DEBUGGER COMMANDS

You set an execution or exchange breakpoint with the DB command by defining a breakpoint variable and assigning it a breakpoint request. The request specifies to the Debugger the nature of the breakpoint, and the variable provides you with a convenient means of talking to the Debugger about the breakpoint. Using the breakpoint variable, you can cancel the breakpoint or replace it with a new one.

If you want to monitor a particular task that has not necessarily incurred a breakpoint, you can designate it to be the breakpoint task. If the task is not on the breakpoint list when you do this, the task is suspended. However, it is not placed on the breakpoint list. After designating a breakpoint task, you can examine and alter some of its registers. You can also ascertain the breakpoint state of the task. When ready, you can easily resume the task.

The Debugger displays information when a task incurs a breakpoint. The format of the display depends on the kind of breakpoint incurred.

### EXECUTION BREAKPOINT DISPLAY

The Debugger displays the following information when a task incurs an execution breakpoint.

```
bp-var: E, TASK=jjjjJ/ttttq, CS=cccc, IP=iiii
```

where:

bp-var	The name of the breakpoint variable.
jjjj	A token for the task's job.
tttt	A token for the task.
q	Either T (for task) or * (indicating that the task has overflowed its stack).
cccc	The base of the code segment in which the breakpoint was set.
iiii	The offset of the breakpoint within its code segment.

EXCHANGE BREAKPOINT DISPLAY

The Debugger displays the following information when a task incurs an exchange breakpoint:

bp-var: a, EXCH=jjjjJ/xxxxe, TASK=jjjjJ/ttttq, ITEM=item

where:

bp-var	The name of the breakpoint variable.
a	Indicates which kind of operation (S for send or R for receive) caused the breakpoint to be incurred.
jjjj	A token for the job containing the exchange whose token follows.
xxxx	A token for the exchange.
e	Indicates the type of the exchange (M for mailbox, S for semaphore, R for region).
tttt	A token for the task.
q	Either T (for task) or * (indicating that the task has overflowed its stack).
item	One of the following:  If the exchange is a mailbox, this field lists a pair of tokens, of the form:

jjjjJ/ooooo,

where:

jjjj	A token for the mailbox's containing job.
oooo	A token for the object being sent or received.
t	The type of the object being sent or received (J for job, T for task, M for mailbox, S for semaphore, G for segment, R for region, X for extension, and C for composite).

## DEBUGGER COMMANDS

If the kind of operation was receive, but no object was there to be received, item is 0000.

If the exchange is a semaphore, this field lists the number of units held by the exchange.

### EXCEPTION BREAKPOINT DISPLAY

The Debugger displays the following information when a task incurs an exception breakpoint:

```
EXCEPTION:  jjjjJ/ttttT, CS=cccc, IP=iiii, TYPE=www, PARAM=vvvv
```

where:

jjjj	A token for the job which contains the task that caused the exception condition.
tttt	A token for the task that caused the exceptional condition.
cccc and iiii	Respectively, the contents of the iAPX 86 CS and IP registers when the exceptional condition occurred.
www	The numerical value of the exception code; reflects the nature of the exceptional condition. Refer to the iRMX reference manuals for the mnemonic condition codes and their numerical equivalents.
vvv	The number (0001 for first, 0002 for second, etc.) of the parameter that caused the exceptional condition. If no parameter was at fault, vvv is 0000.

### EXCEPTION BREAKPOINT DIFFERENCES

Exception breakpoints differ from execution and exchange breakpoints in several respects:

- It is not possible to set, change, view, or delete exception breakpoints by using the commands of the Debugger. Instead, each task can set an exception breakpoint by declaring the Debugger to be its exception handler. The task can subsequently

delete the breakpoint by declaring a different exception handler. However, like the other kinds of breakpoints, once a task incurs an exception breakpoint and is placed on the breakpoint list, you can cause it to resume execution with the same command (the G command) that is used to resume other tasks on the breakpoint list.

- An exception breakpoint is set for a particular task. Execution and exchange breakpoints are set for no particular task; any task can incur such a breakpoint.
- An exception breakpoint is not known to the Debugger by a breakpoint variable name.

The handling of exception breakpoints is significantly different from that of execution and exchange breakpoints. For example, exception breakpoints cannot be viewed, but the other breakpoints can be. Wherever this distinction applies, this chapter points it out.

DEFINING A BREAKPOINT -- DB

This command defines an execution or exchange breakpoint. The syntax for the DB command is as follows:

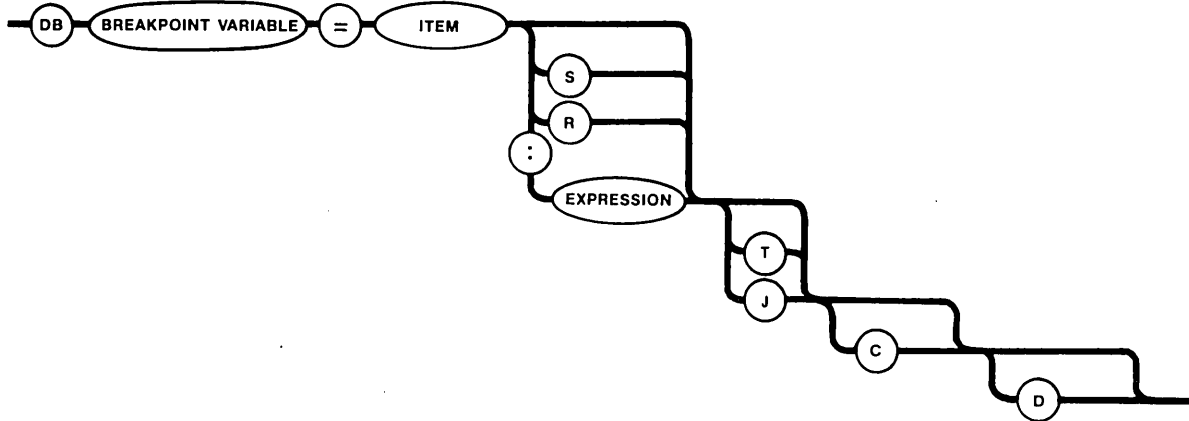

PARAMETERS

BREAKPOINT  
VARIABLE

A Debugger name by which to identify the breakpoint. This name must consist of a period followed by up to 11 characters, the first of which must be alphabetic. The other characters can be alphabetic, numeric, question marks (?), or dollar signs (\$). If the Debugger's symbol table already contains this name, an error message will appear on the terminal's display.

ITEM

If you are setting an execution breakpoint, ITEM is used in combination with EXPRESSION to specify the address of the breakpoint. ITEM must contain the base portion of the address. It must be followed by ":" and an EXPRESSION, which must contain the offset portion.

If you are setting an exchange breakpoint, ITEM must contain a token for an exchange.

S and R

To be used only when setting an exchange breakpoint. S means that the exchange breakpoint is for senders only, while R means that it is for receivers only. If you want to set an exchange breakpoint for both senders and receivers, omit both S and R, as well as both ":" and EXPRESSION.

BREAKPOINT COMMANDS

DEFINING A BREAKPOINT -- DB (continued)

PARAMETERS (continued)

- EXPRESSION      To be used only when setting an execution breakpoint. EXPRESSION must contain the offset portion of the address of the execution breakpoint.
- T and J          Indicate which tasks are to be put on the breakpoint list when a breakpoint is incurred. T indicates only the task that incurred the breakpoint, while J indicates all of the tasks in that task's job. The default is T.
- C                Continue task execution option. This option directs the Debugger not to "break" tasks that incur the breakpoint, and not to put them on the breakpoint list. When a task incurs such a breakpoint, the Debugger generates a breakpoint display, but the task continues to run.
- D                Delete breakpoint option. This option directs the Debugger to delete the breakpoint after it is first incurred by a task. The Debugger generates a breakpoint display and, unless the C option is also specified, places the task that incurred the breakpoint on the breakpoint list.

DESCRIPTION

The DB command sets a breakpoint of the type indicated in the remainder of the command line. The name designated as the breakpoint variable can be used when altering or deleting the breakpoint.

EXAMPLES

```
DB .BP = 2DC3:OFF  
*
```

This command defines an execution breakpoint at address 2DC3:OFF and assigns the name .BP to this breakpoint. When a task incurs this breakpoint, only the task itself is placed on the breakpoint list.

```
DB .BPOINT = .MBOX S C  
*
```

This command defines an exchange breakpoint at the mailbox whose token is specified by the numeric variable .MBOX. In a previous example, .MBOX had a value of 2F34; therefore the Debugger uses this value for the token.



## EXAMINING A BREAKPOINT

This command displays information about a particular breakpoint. The syntax for this command is as follows:



BREAKPOINT  
VARIABLE

## PARAMETER

BREAKPOINT VARIABLE	The name of an existing breakpoint to be examined.
------------------------	--

## DESCRIPTION

The Debugger displays two kinds of output, depending on whether the specified breakpoint variable represents an execution or an exchange breakpoint. Exception breakpoints cannot be examined.

## EXECUTION BREAKPOINT OUTPUT

If the designated breakpoint is an execution breakpoint, the Debugger sends the following display to the terminal:

```
bp-var=xxxx:yyyy z ops
```

where:

bp-var	The name of the breakpoint variable.
xxxx	Base portion of the breakpoint's address.
yyyy	Offset portion of the breakpoint's address.
z	Indicates whether a single task (T) is to be "broken" and placed on the breakpoint list or all tasks in a job (J) are to be suspended and placed on the breakpoint list, when the breakpoint is incurred.
ops	Indicates the breakpoint options. If any are present, they can be C (for Continue task) and/or D (for Delete breakpoint).

EXAMINING A BREAKPOINT (continued)

EXCHANGE BREAKPOINT OUTPUT

If the designated breakpoint is an exchange breakpoint, the Debugger sends the following display to the terminal:

```
bp-var=xxxx a z ops
```

where:

- bp-var        The name of the breakpoint variable.
- xxxx         A token for the exchange at which the breakpoint is set.
- a            Indicates the kind of breakpoint activity at the exchange, either S (for send), R (for receive), or SR (for both).
- z            Indicates whether a single task (T) is to be "broken" and placed on the breakpoint list or all tasks in a job (J) are to be suspended and placed on the breakpoint list, when the breakpoint is incurred.
- ops          Indicates the breakpoint options. If any are present, they can be C (for continue task) and/or D (for delete breakpoint).

EXAMPLES

```
.BP
BP=2DC3:00FF T
*
```

This command lists the address of the execution breakpoint associated with variable .BP. It also indicates that only the task is to be "broken" if a breakpoint is encountered.

```
.BPOINT
BPOINT=2F34 S T C
*
```

This command lists the address of the exchange breakpoint associated with variable .BPOINT. The S, T, and C indicate that only tasks which send messages to the exchange will incur the breakpoint, only the task that incurs the breakpoint will be "broken", and the task will continue processing after incurring the breakpoint.

CHANGING A BREAKPOINT

This command changes an existing breakpoint. The syntax for this command is as follows:

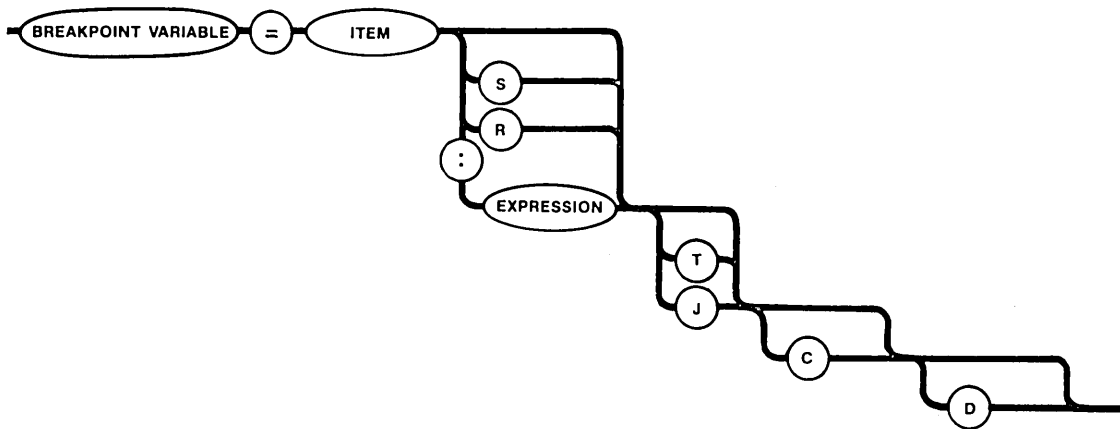

PARAMETERS

- BREAKPOINT VARIABLE      An existing Debugger breakpoint name. If the Debugger's symbol table does not already contain this name, an error message will appear on the terminal's display.
  
- ITEM                      If you are changing an execution breakpoint, ITEM is used in combination with EXPRESSION to specify the address of the breakpoint. ITEM must contain the base portion of the address. It must be followed by ":" and an EXPRESSION, which must contain the offset portion.  
  
                               If you are changing an exchange breakpoint, ITEM must contain a token for an exchange.
  
- S and R                    To be used only when changing an exchange breakpoint. S means that the exchange breakpoint is for senders only, while R means that it is for receivers only. If you want to set an exchange breakpoint for both senders and receivers, omit both S and R, as well as both ":" and EXPRESSION.

## CHANGING A BREAKPOINT (continued)

## PARAMETERS (continued)

- T and J        Indicate which tasks are to be put on the breakpoint list when a breakpoint is incurred. T indicates only the task that incurred the breakpoint, while J indicates all of the tasks in that task's job. If neither T nor J is present, T is assumed.
- C              Continue task execution option. This option directs the Debugger not to "break" tasks that incur the breakpoint, and not to put them on the breakpoint list. When a task incurs such a breakpoint, the Debugger generates a breakpoint display, but the task continues to run.
- D              Delete breakpoint option. This option directs the Debugger to delete the breakpoint after it is first incurred by a task. The Debugger generates a breakpoint display and, unless the C option is also specified, places the task that incurred the breakpoint on the breakpoint list.

## DESCRIPTION

This command deletes the breakpoint that was associated with the breakpoint variable name and replaces it with a new breakpoint, as specified in the command. The breakpoint variable name can be used when deleting or changing the breakpoint.

## EXAMPLE

```
.BPOINT  
BPOINT=2F34 S T C  
*  
.BPOINT = 2D2A S C  
*  
.BPOINT  
BPOINT=2D2A S C  
*
```

In this example, the user lists a breakpoint variable, changes it, and lists it again.

DELETING A BREAKPOINT -- Z

This command deletes a breakpoint. The syntax for the Z command is as follows:

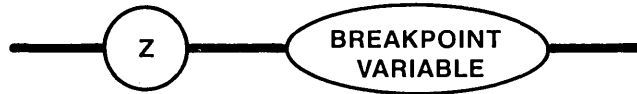

PARAMETER

BREAKPOINT VARIABLE	Name of an existing Debugger breakpoint to be deleted.
------------------------	--

DESCRIPTION

The Z command deletes the specified breakpoint and removes the breakpoint variable name from the Debugger's symbol table.

EXAMPLE

```
Z .BP
*
```

This command deletes the breakpoint associated with the variable .BP and removes .BP from the Debugger's symbol table.

VIEWING THE BREAKPOINT LIST -- BL

This command displays the breakpoint list. The syntax for the BL command is as follows:

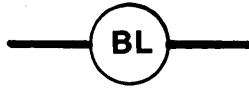

DESCRIPTION

The BL command displays the entire breakpoint list at the user terminal. This list appears as follows:

```
BL=jjjjJ/ttttT(s) jjjjJ/ttttT(s) ... jjjjJ/ttttT(s)
```

where:

- jjjj      A token for the job containing the task whose token follows.
- tttt      A token for a task.
- s         The breakpoint state of a task. Possible values are X (for execution), E (for exchange), Z (for exception), and N (for null).

## VIEWING BREAKPOINT PARAMETERS -- B

This command displays the breakpoint parameters. The syntax for the B command is as follows:

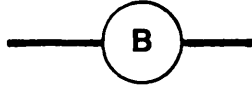

## DESCRIPTION

The B command performs the following three functions:

- o Displays the breakpoint list
- o Displays the breakpoint task
- o Displays the breakpoint variables

## Breakpoint List Display

The B command first displays the breakpoint list in the following format:

```
BL=jjjjJ/ttttT(s) jjjjJ/ttttT(s) ... jjjjJ/ttttT(s)
```

where:

- |      |   |
|------|---|
| jjjj | A token for the job containing the task whose token follows.  |
| tttt | A token for a task on the breakpoint list.  |
| s    | The breakpoint state of a task. Possible values are X (for execution), E (for exchange), Z (for exception), and N (for null). |

## VIEWING BREAKPOINT PARAMETERS -- B (continued)

## DESCRIPTION (continued)

## Breakpoint Task Display

The second effect of the B command is to display the breakpoint task originally selected with the BT command. The format of this display is as follows:

```
BT=jjjjJ/ttttT(s)
```

where:

jjjj	A token for the job containing the breakpoint task.
tttt	A token for the breakpoint task.
s	The breakpoint state of the breakpoint task. Possible values are X (for execute), E (for exchange), Z (for exception), and N (for null).

If there is no breakpoint task, the display is:

```
BT=0
```

## Breakpoint Variables Display

The third and final effect of the B command is to display the breakpoint variables. The format of the display depends on whether the variables are execution or exchange variables.

Execution breakpoints are displayed as:

```
bp-var = xxxx:yyyy z ops
```

where:

bp-var	The name of the breakpoint variable.
--------	--------------------------------------



## VIEWING BREAKPOINT PARAMETERS -- B (continued)

## DESCRIPTION

## Breakpoint Variables Display (continued)

xxxx	The base portion of the address at which the breakpoint is set.
yyyy	The offset portion of the address at which the breakpoint is set.
z	Indicates whether a task (T) or all the tasks in a job (J) are to be suspended and placed on the breakpoint list when the breakpoint is incurred.
ops	Indicates the breakpoint options. If any are present, they can be a C (for Continue task) and/or D (for Delete breakpoint).

Exchange breakpoints are displayed as:

bp-var = xxxx a z ops

where:

bp-var	The name of the breakpoint variable.
xxxx	A token for the exchange at which the breakpoint is set.
a	Indicates the kind of breakpoint activity at the exchange, either S (for Send), R (for Receive), or SR (for both).
z	Indicates whether a task (T) or all the tasks in a job (J) are to be suspended and placed on the breakpoint list when the breakpoint is incurred.
ops	Indicates the breakpoint options. If any are present, they can be C (for Continue task) and/or D (for Delete breakpoint).

## RESUMING TASK EXECUTION -- G

This command resumes execution of a task on the breakpoint list or the breakpoint task. The syntax for the G command is as follows:

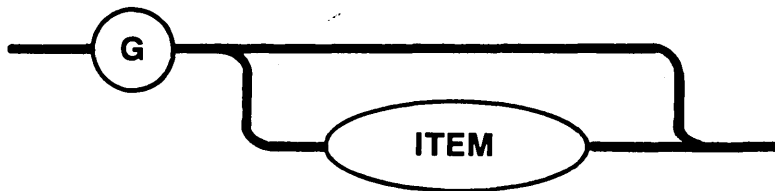

## PARAMETER

## ITEM

A token for a task on the breakpoint list or the breakpoint task. If the given token is not for a task on the breakpoint list or the breakpoint task, an error message will be displayed. If this parameter is omitted, the breakpoint task is assumed.

## DESCRIPTION

The G command applies to the breakpoint task if ITEM is not present. Otherwise, it applies to the task on the breakpoint list whose token is represented by ITEM.

The G command resumes execution of the designated task. If the task is in the broken state, it is made ready. If it is in the suspended state, its suspension depth is decreased by one.

If the G command is invoked without ITEM when there is no breakpoint task, an error message is displayed at the terminal.

## ESTABLISHING THE BREAKPOINT TASK -- BT

This command designates a task to be the breakpoint task. The syntax for the BT command is as follows:

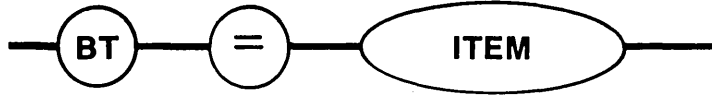

## PARAMETER

ITEM            A token for an existing task.

## DESCRIPTION

The task designated by ITEM becomes the breakpoint task. The Debugger suspends the task but does not place it on the breakpoint list.

LISTING THE BREAKPOINT TASK -- BT

This command lists the job and task tokens associated with the breakpoint task. The syntax for the BT command is as follows:

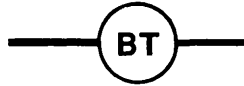

DESCRIPTION

This command displays the following information about the breakpoint task:

```
BT=jjjjJ/ttttT(s)
```

where:

- jjjj      A token for the job containing the breakpoint task.
- tttt      A token for the breakpoint task.
- s         The breakpoint state of the breakpoint task. Possible values are X (for execute), E (for exchange), Z (for exception), and N (for null).

If there is no breakpoint task, the Debugger displays the following:

```
BT=0
```

VIEWING THE BREAKPOINT TASK'S REGISTERS -- R

This command lists one or all of the breakpoint task's iAPX 86 registers. The syntax for the R command is as follows:

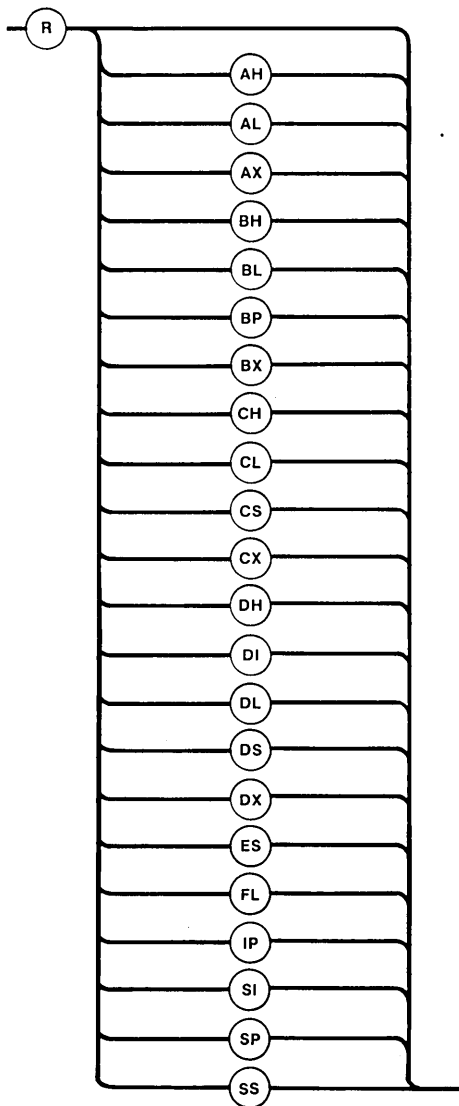

PARAMETERS

AH, AL, AX, Names of the breakpoint task's iAPX 86 registers.  
 BH, BL, BP, If no name is specified, the Debugger displays  
 BX, CH, CL, values for all registers.  
 CS, CX, DH,  
 DI, DL, DS,  
 DX, ES, FL,  
 IP, SI, SP, SS

VIEWING THE BREAKPOINT TASK'S REGISTERS -- R (continued)

DESCRIPTION

This command lists iAPX 86 register values for the breakpoint task. If the command is simply "R", then all of the breakpoint task's registers are displayed, in the following format:

RAX=xxxx	RSI=xxxx	RCS=xxxx	RIP=xxxx
RBX=xxxx	RDI=xxxx	RDS=xxxx	RFL=xxxx
RCX=xxxx	RBP=xxxx	RSS=xxxx	
RDX=xxxx	RSP=xxxx	RES=xxxx	

If the command has the form Ryy, where yy is the register name, then the contents of the specified register are displayed, either as:

Ryy=xxxx
----------

or as:

Ryy=xx
--------

depending on whether yy is a byte-size register (like AH) or a word-size register (like AX).

If the breakpoint task is in the null breakpoint state, only its BP, SP, CS, DS, SS, IP, and FL register contents are displayed. The remaining register displays consist of question marks.

In certain circumstances the breakpoint task, when suspended, is in a state which prevents the Debugger from obtaining its register contents. If this is the case, the Debugger displays question marks for all registers.

ALTERING THE BREAKPOINT TASK'S REGISTERS -- R

This command alters one of the breakpoint task's iAPX 86 register values. The syntax for this command is as follows:

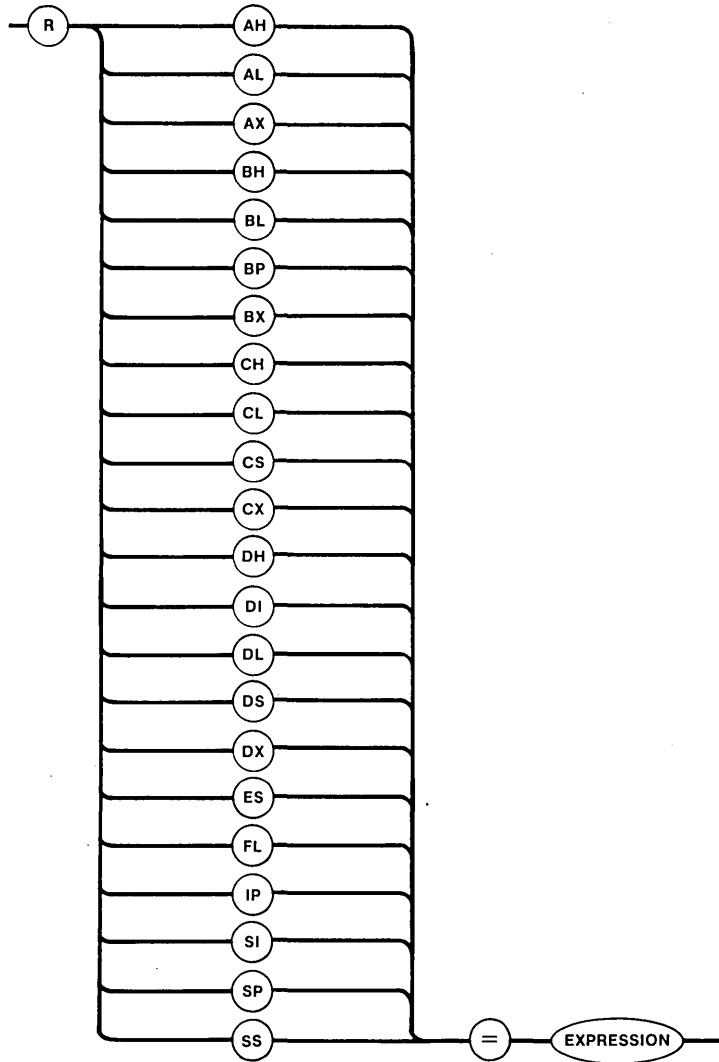

BREAKPOINT COMMANDS

PARAMETERS

- AH, AL, AX,     Names of the breakpoint task's iAPX 86 registers.
- BH, BL, BP,
- BX, CH, CL,
- CS, CX, DH,
- DI, DL, DS,
- DX, ES, FL,
- IP, SI, SP, SS

ALTERING THE BREAKPOINT TASK'S REGISTERS -- R (continued)

PARAMETERS (continued)

**EXPRESSION** A Debugger expression whose value is used for the new register value. If this value is too large to fit in the designated register, the Debugger fills the register with the low-order bytes of the value.

DESCRIPTION

This command requests that the breakpoint task's register, as specified in the command request, be updated with the value of the EXPRESSION. However, if the breakpoint task is in the null breakpoint state, its register values cannot be altered by the R command.



VIEWING THE BREAKPOINT TASK'S NDP REGISTERS -- N

This command displays the breakpoint task's 8087 Numeric Data Processor (NDP) register values. This command applies only to tasks that were specified at creation as having the ability to use the 8087 NDP. The syntax for this command is as follows:

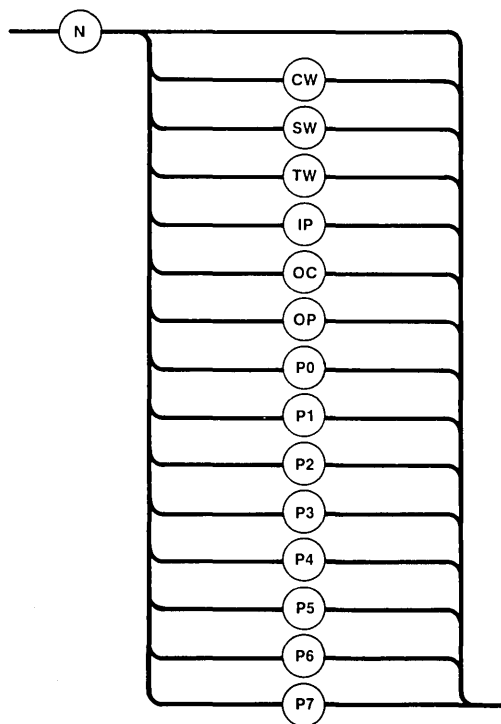

PARAMETERS

CW, SW, TW, Names of the breakpoint task's 8087 NDP registers,  
 IP, OC, OP, as follows:  
 P0 through P7

<u>Name</u>	<u>Description</u>
CW	Control Word
SW	Status Word
TW	Tag Word
IP	Instruction Pointer
OC	Operation Code
OP	Operand Pointer
P0-P7	Stack elements

If no name is specified, the Debugger displays values for all registers.

VIEWING THE BREAKPOINT TASK'S NDP REGISTERS -- N (continued)

DESCRIPTION

This command lists 8087 NDP register values for the breakpoint task. It applies only to tasks which were specified at creation as using the 8087 NDP. If the command is simply "N", then all of the breakpoint task's NDP registers are displayed, in the following format:

```

NCW = xxxx      NSW = xxxx      NTW = xxxx
NIP = xxxxxx    NOC = xxx       NOP = xxxxxx
NP0 = xxxxxxxxxxxxxxxxxxxxxxxx
NP1 = xxxxxxxxxxxxxxxxxxxxxxxx
NP2 = xxxxxxxxxxxxxxxxxxxxxxxx
NP3 = xxxxxxxxxxxxxxxxxxxxxxxx
NP4 = xxxxxxxxxxxxxxxxxxxxxxxx
NP5 = xxxxxxxxxxxxxxxxxxxxxxxx
NP6 = xxxxxxxxxxxxxxxxxxxxxxxx
NP7 = xxxxxxxxxxxxxxxxxxxxxxxx

```

The size of the field indicates the number of hexadecimal digits that the Debugger displays.

Registers P0 through P7 are 80-bit registers that the Debugger displays in temporary real format. Refer to the 8086 FAMILY USER'S MANUAL, NUMERICS SUPPLEMENT to translate fields of this format into actual real numbers.

If the breakpoint task does not use the NDP, the Debugger returns an error message in response to this command.

ALTERING THE BREAKPOINT TASK'S NDP REGISTERS -- N

This command modifies the breakpoint task's 8087 Numeric Data Processor (NDP) register values. This command applies only to tasks that were specified at creation as having the ability to use the 8087 NDP. The syntax for this command is as follows:

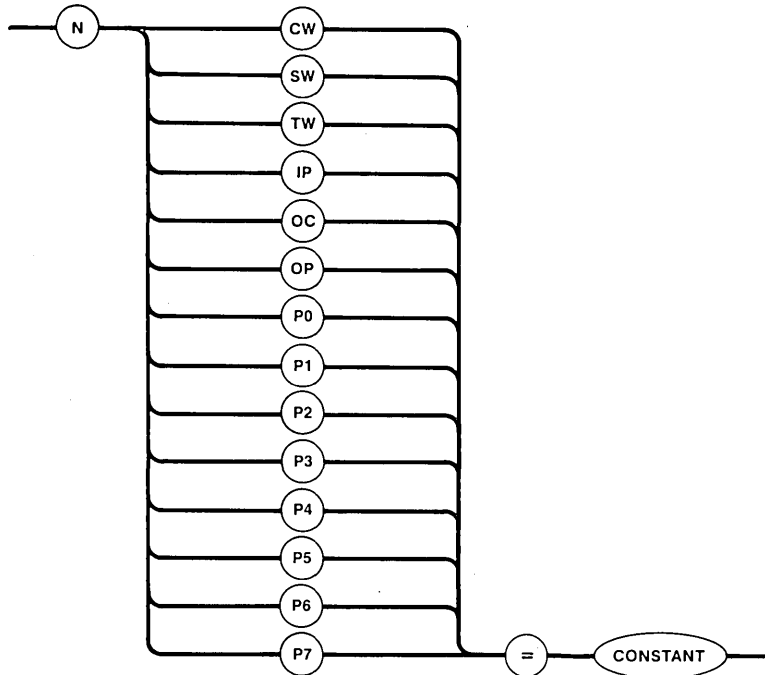

PARAMETERS

CW, SW, TW, Names of the breakpoint task's 8087 NDP  
IP, OC, OP, registers, as follows:  
P0 through P7

<u>Name</u>	<u>Description</u>
CW	Control Word
SW	Status Word
TW	Tag Word
IP	Instruction Pointer
OC	Operation Code
OP	Operand Pointer
P0-P7	Stack elements

ALTERING THE  
BREAKPOINT  
TASK'S NDP  
REGISTERS

DEBUGGER COMMANDS

ALTERING THE BREAKPOINT TASK'S NDP REGISTERS -- N (continued)

PARAMETERS (continued)

CONSTANT        A hexadecimal number which is used for the new register value. CONSTANT can specify an 80-bit value for registers P0 through P7, a 20-bit value for registers IP and OP, and a 16-bit value for the remaining registers. If this value is too large to fit in the specified register, the Debugger displays a SYNTAX ERROR message.

DESCRIPTION

This command requests that the breakpoint task's NDP register, as specified in the command request, be updated with the value of CONSTANT. This command applies only to tasks which were specified at creation as using the 8087 NDP.

DEBUGGER COMMANDS

MEMORY COMMANDS

The commands in this section enable you to inspect or modify the contents of absolute memory locations. Figure 4-1 illustrates the syntax for all commands in this section.

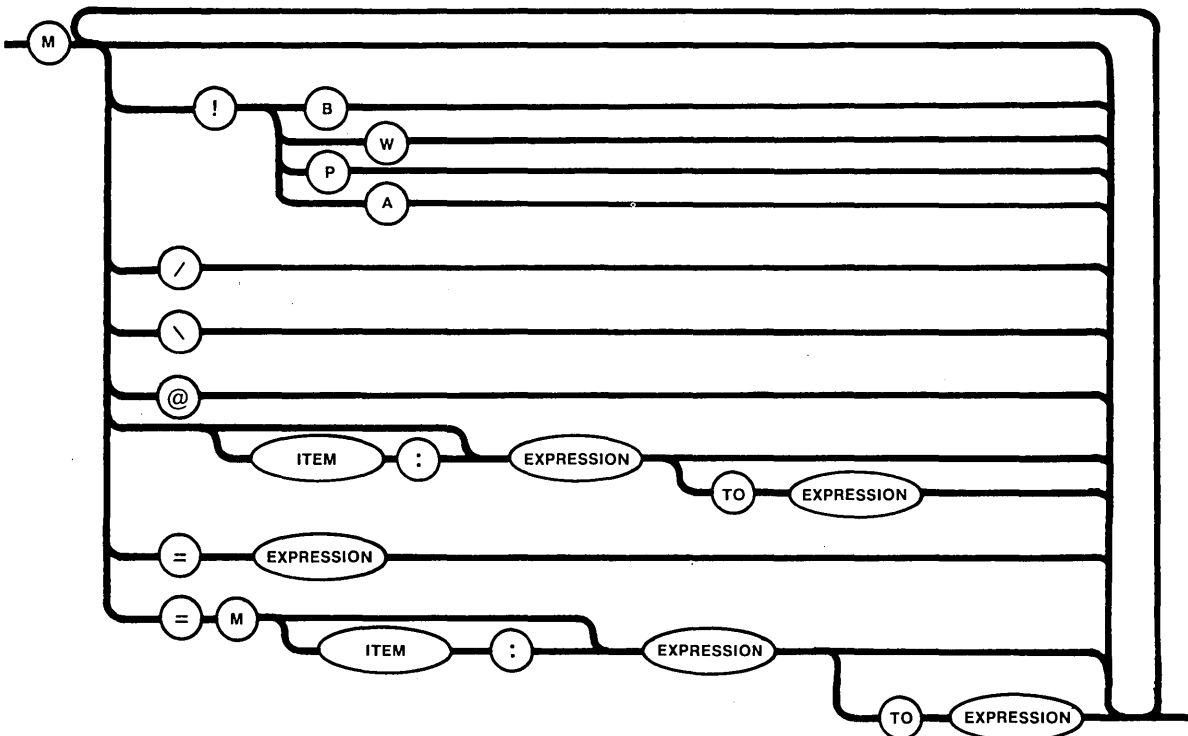

MEMORY COMMANDS

Figure 4-1. Syntax Diagram for Memory Commands

As Figure 4-1 illustrates, all memory commands begin with "M". There are a variety of parameters that can be specified with "M"; these parameters are grouped into the following basic options:

- o Setting current display mode. This option begins with "!".
- o Changing memory locations. This option includes the "=".
- o Displaying memory locations. This option consists of the remaining parameters.

## DEBUGGER COMMANDS

This section breaks up the description of the "M" command into these three groups and discusses the groups as separate commands. However, you can combine any number of "M" command options in a single command, as the syntax diagram in Figure 4-1 illustrates.

In the descriptions of these commands, frequent mention is made of the current display mode, the current segment base, the current offset, the current address, and the display of memory locations. This terminology is defined as follows:

- The current display mode determines the manner in which memory values are interpreted for display purposes. The possible modes are designated by the letters B, W, P, and A, and they stand, respectively, for byte, word, pointer, and ASCII. The effects of these modes are best explained in the context of an example. Suppose that memory locations 042B through 042E contain, respectively, the values 25, F3, 67, and 4C. If you ask for the display of the memory at location 042B, then the effects, which depend on the current display mode, are as follows:

Current Display Mode	Display
B	25
W	F325
P	4C67:F325
A	%

Observe that words and pointers are displayed from high-order (high address) to low-order (low address).

If a location contains a value which does not represent a printable ASCII character, and the current display mode is A, then the Debugger prints a period. The initial current display mode is B.

- The value of the current segment base is always the value of the most recently used iAPX 86 segment base. The initial value of the current segment base is 0.
- The current offset is a value the Debugger maintains and uses when reference is made to a memory location without explicitly citing an offset value. Except when the current offset has been modified by certain options of the M command, the current offset is always the value of the most recently used offset. The initial value of the current offset is 0.
- The current address is the iAPX 86 memory address computed from the combination of the current segment base and the current offset.

- When memory locations are displayed, the format is as follows:

```
xxxx:yyyy=value
```

where xxxx and yyyy are the current segment base and current offset, respectively, and value is a byte, word, pointer, or ASCII character, depending on the current display mode. If several contiguous memory locations are being requested in a single request, each line of display is as follows:

```
xxxx:yyyy=value value value ... value
```

where xxxx, yyyy, and value are as previously described, and xxxx:yyyy represent the address of the first value on that line.

The first such line begins with the first address in the request and continues to the end of that (16-byte) paragraph. If additional lines are required to satisfy the request, each of them begins at an offset which is a multiple of 16 (10 hexadecimal).

SETTING THE CURRENT DISPLAY MODE -- M

This command specifies the way in which the Debugger will display output. The syntax for the M command is as follows:

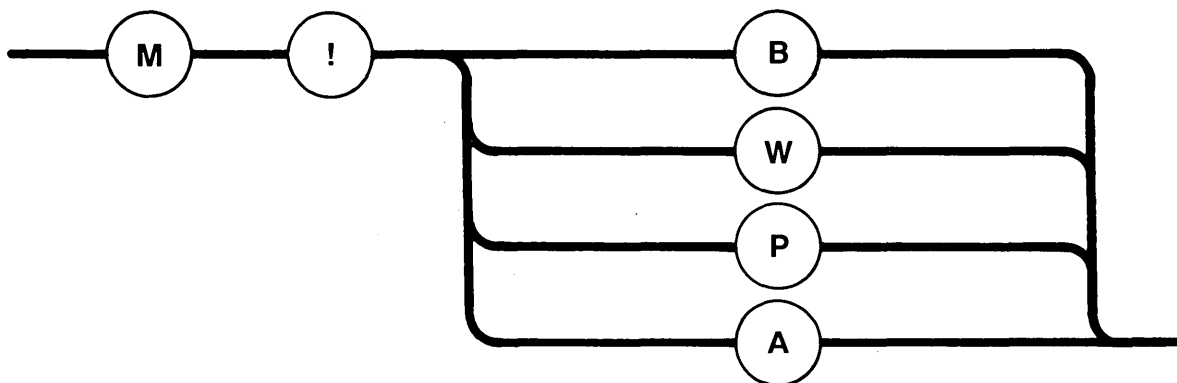

PARAMETERS

- |               |  |
|---------------|--|
| !             | Indicates that the display mode is being changed.  |
| B, W,<br>P, A | Specifies the mode of display. B indicates byte mode, W indicates word mode, P indicates pointer mode, and A indicates ASCII mode. |

DESCRIPTION

This command sets the display mode for further Debugger output. When the Debugger next displays memory, it will display the memory according to the mode specified with this command.

EXAMPLES

M!B  
\*

This command instructs the Debugger to display all further output in byte mode.

M!W  
\*

This command instructs the Debugger to display all further output in word mode.



This command displays memory locations without changing their contents. The syntax for this command is as follows:

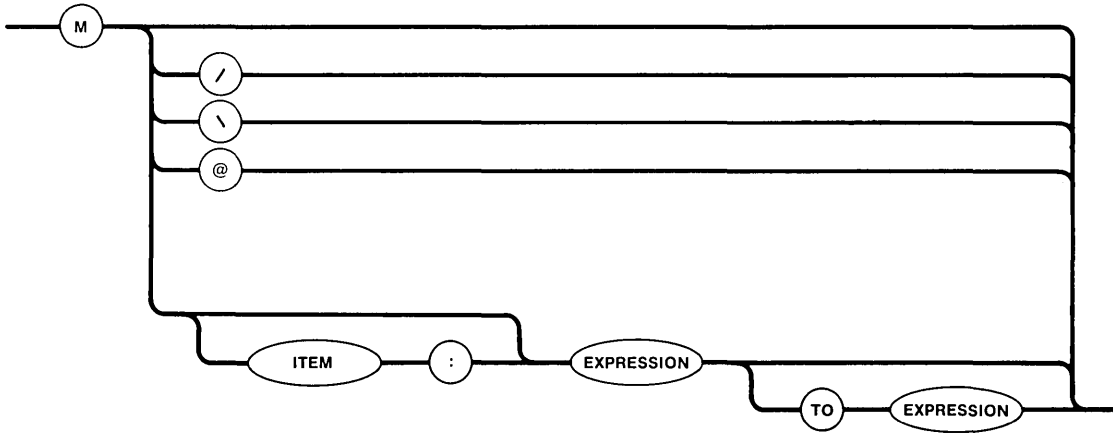

PARAMETERS

To avoid confusion, this section lists examples of complete commands in explaining the parameters.

M/ This option increments the current offset according to the current display mode: by one for byte or ASCII, by two for word, or by four for pointer. Then it displays the contents of the new current address.

Example:  $\frac{M/}{0400:0009} 0A$   
\*

This example increments the current offset and displays the address and contents of the location.

M\ This option is just like M/, except that the current offset is decremented.

Example:  $\frac{M}{0400:0008} 08$   
\*

This example decrements the current offset and displays the address and contents of the location.

EXAMINING MEMORY -- M (continued)

PARAMETERS (continued)

M When used by itself, M is an abbreviated way of specifying M/ or M\, whichever was used most recently. If neither has been used in the current Debugging session, M is interpreted as an M/ request.

```
Example:  M
          0400:0007 08
          *
          M
          0400:0006 07
          *
```

Since M\ was used most recently, these commands decrement the current offset before displaying the address and contents of memory.

M@ This option sets the current offset equal to the value of the word beginning at the current address. Then the value at the adjusted current address is displayed.

```
Example:  M!B
          *
          M@
          0400:0807 46
          *
```

Even though byte mode was selected, this example sets the current offset equal to contents of the word at offset 07. From the previous example you can see that this word is indeed 0807.

M EXPRESSION This option sets the current offset equal to the value of the EXPRESSION and displays the value at the new current address.

```
Example:  M 3
          0400:0003 04
          *
```

This example sets the current offset to 3 and displays the contents of that location.

M ITEM:EX-PRESSION This option is just like M EXPRESSION, except that ITEM is used as the base in the address calculation, and after the operation ITEM is the new current segment base.

MEMORY COMMANDS

EXAMINING MEMORY -- M (continued)

PARAMETERS

M ITEM:EXPRESSION (continued)

Example: M 300:2644  
0300:2644 47  
\*

This example sets the current base to 300 and the current offset to 2644. It also displays the contents of that location.

M EXPRESSION TO EXPRESSION This option displays the values of a series of consecutive locations. The EXPRESSIONs determine the beginning and ending offsets, respectively; the second EXPRESSION must be greater than the first. The current segment base is used as a base. After displaying the locations, the Debugger sets the current offset to the value of the second expression. If the specified range of locations is incompatible with the current display mode --- for example, an odd number of locations is not compatible with the word or pointer modes --- then all words or pointers that lie partially or totally inside the range are displayed.

Examples: (1) M 4 TO 6  
0300:0004 15 26 37  
\*  
(2) M!W  
\*  
M 4 TO 6  
0300:0004 2615 4837  
\*

These examples display a consecutive series of memory locations in both byte and word mode. Notice that the base set in the last example (300) is still used.

M ITEM:EXPRESSION TO EXPRESSION This option is just like M EXPRESSION TO EXPRESSION, except that ITEM is used as a base in the address calculation, and after the operation ITEM is the new segment base.

EXAMINING MEMORY -- M (continued)

PARAMETERS

M ITEM:EXPRESSION TO EXPRESSION (continued)

```

Example:  M!B
          *
          D .MEM = 100
          *
          M 400:.MEM TO .MEM +4
          0400:0100 FF A0 16 22 E1
          *

```

After setting the output mode to byte and defining a numeric variable .MEM, this example sets the base to 400 and displays five consecutive memory locations beginning with offset 100 (.MEM). Upon completion of this example, the current offset is 400 and the current base is 104.

DESCRIPTION

This command displays the contents of memory without disturbing those contents. Be aware, however that all of the options change the current offset, and some of them change the current segment base. None changes the current display mode.

MEMORY COMMANDS

This command changes the contents of designated RAM locations.

CAUTION

Because the Debugger is generally used during system development, while your tasks, the Nucleus, the Debugger, and possibly other iRMX 86 components are in RAM, you should use these M command options with extreme care.

The syntax for this command is as follows:

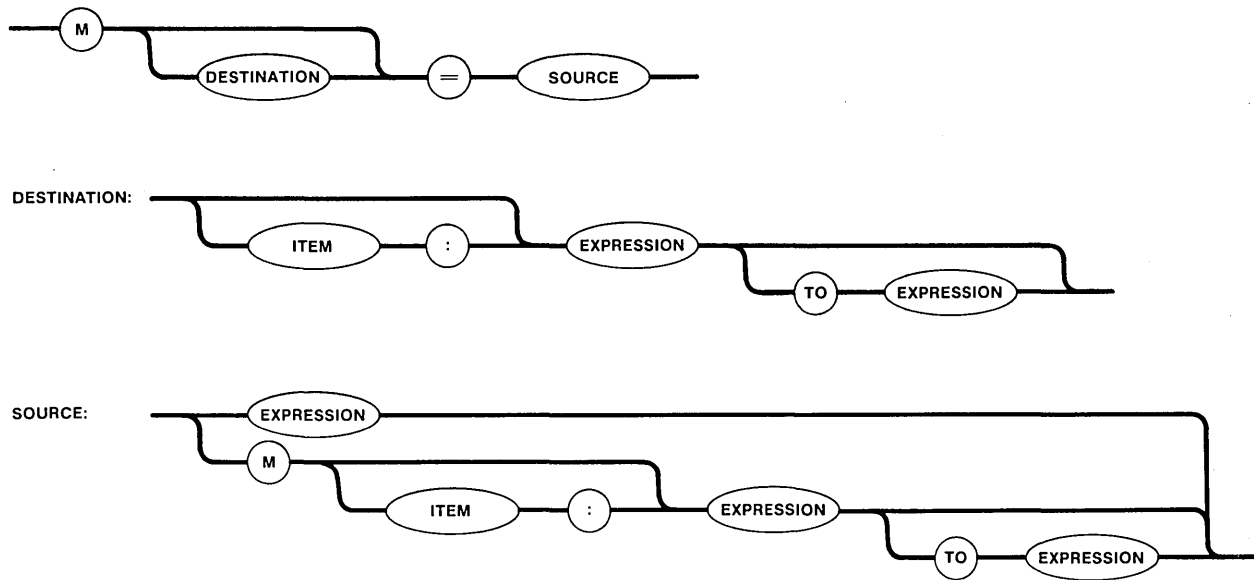

MEMORY COMMANDS

PARAMETERS

As shown in the syntax diagram, the parameters for this command are divided into DESTINATION and SOURCE parameters which are separated with an equal sign.

CHANGING MEMORY -- M (continued)

PARAMETERS (continued)

Destination Parameters

These parameters define the memory location or locations that are going to be changed. All parameters change the current offset, and some of them change the current base. The valid parameter combinations are as follows:

EXPRESSION            This form of the DESTINATION option implies that the address to be changed has the current base as its base value and the value of EXPRESSION as its offset.

ITEM:EX-  
PRESSION            This form of the DESTINATION option implies that the address to be changed has the value of ITEM as its base value and the value of EXPRESSION as its offset.

EXPRESSION TO  
EXPRESSION        This form of the DESTINATION option implies that a series of consecutive locations will be changed. The EXPRESSIONs determine the beginning and ending offsets, respectively. The current base is used as a base value. After memory has been changed, the current offset is set to the value of the second EXPRESSION.

ITEM:EX-  
PRESSION TO  
EXPRESSION        This form of the DESTINATION option is the same as the previous one, except that ITEM is used as the base value of the locations.

If no DESTINATION option is specified, the location specified by the current segment base and current offset is changed. However, if the previous command was a "Display Memory" command of the form:

M EXPRESSION TO EXPRESSION

the entire range of locations specified in that command is changed.

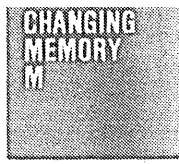

PARAMETERS (continued)

Source Parameters

These parameters define the information that will be placed into the DESTINATION memory. The valid parameter combinations are as follows:

**EXPRESSION** This form of the SOURCE option can be used only if the current display mode is byte or word. It implies that the value represented by EXPRESSION will be copied into the byte or word at the current address. However, if the DESTINATION option (supplied or default) specified a range of locations, this option instead copies the value of EXPRESSION into each byte or word in DESTINATION.

Examples:

(1) When the DESTINATION option did not specify a range of values:

```
M = 4C
0400:0008 09
0400:0008 4C
*
```

This example changes the contents of the current location (0400:0008) from 09 to 4C. Notice that the Debugger displays both the old and the new contents of memory.

(2) When the DESTINATION option specified a range of values:

```
M 1 TO 4
0400:0001 06 07 08 09
*
M = 4C
0400:0001 06 07 08 09
0400:0001 4C 4C 4C 4C
*
```

In this example, because the previous command was an examination of a range of memory, the command to change memory changes the entire range of memory.

**M EXPRESSION** This form of the SOURCE option uses the current segment base and the offset indicated by the value of EXPRESSION to compute an address. It copies the value at that computed address into the location specified by the current address.

MEMORY COMMANDS

CHANGING MEMORY -- M (continued)

PARAMETERS

Source Parameters

M EXPRESSION (continued)

However, if the DESTINATION option (supplied or default) specified a range of locations, the value at the computed address is instead copied to each of the locations in the destination field.

Examples:

(1) When the DESTINATION option did not specify a range of values:

```
M 9
0400:0009 11
*
M = M 6
0400:0009 11
0400:0009 4C
*
```

This example replaces the value in location 4000:0009 (11) with the value in location 4000:0006 (4C).

(2) When the DESTINATION option specified a range of values:

```
M 100
0400:0100 FF
*
M 100 TO 103 = M 6
0400:0100 FF A0 16
0400:0100 4C 4C 4C
*
```

In this example, the command to change memory included a DESTINATION option that specified a range of values. Thus the contents of location 0400:0006 (4C) are copied into each of the DESTINATION locations.

M ITEM:EX-PRESSION

This form of the SOURCE option uses ITEM and EXPRESSION as base and offset, respectively, to compute an address. It copies the value at that computed address into the location specified by the current address. However, if the DESTINATION option (supplied or default) specified a range of locations, the value at the computed address is instead copied to each of the locations in the destination field.





PARAMETERS

Source Parameters

M ITEM:EXPRESSION (continued)

Examples:

(1) When the DESTINATION option did not specify a range of values:

```

M 9
0400:0009 4C
*
M = M 300:2643
0400:0009 4C
0400:0009 21
*
    
```

This example takes the value in location 0300:2643 (21) and copies it into the current location (0400:0009).

(2) When the DESTINATION option specified a range of values:

```

M 100 TO 103 = M 300:2643
0400:0100 4C 4C 4C 22
0400:0100 21 21 21 21
*
    
```

This example copies the contents of location 0300:2643 (21) into each of the locations specified in the DESTINATION option.

M EXPRESSION TO EXPRESSION This form of the SOURCE option uses the current segment base and, in order, the offsets indicated by the EXPRESSIONS, to compute a beginning address and an ending address. It copies the sequence of values bounded by the computed addresses to the sequence of locations that begin at the current address. However, if the DESTINATION option (supplied or default) specified a range of locations, the sequence of values bounded by the computed addresses is copied to the destination field, with the source values being truncated or repeated as required.

MEMORY COMMANDS

CHANGING MEMORY -- M (continued)

PARAMETERS

Source Parameters

M EXPRESSION TO EXPRESSION (continued)

Examples:

(1) When the DESTINATION option did not specify a range of values:

```
M 400:104
0400:0104 E1
*
M = M A TO C
0400:0104 E1 F2 0A
0400:0104 0B 0C 0D
*
```

In this example, the contents of the range of locations specified in the SOURCE option (0400:000A - 0400:000C) are copied into the range of locations that begin with the current address (0400:0104).

(2) When the destination option specified a range of values:

```
M 1 TO 4 = M A TO C
0400:0001 4C 4C 4C 4C
0400:0001 0B 0C 0D 0B (first value
* repeated)
```

This example copies the contents of three locations (0400:000A - 0400:000C) into four locations (0400:0001 - 0400:0004). Notice that the values start repeating; 0400:0001 contains the same value as 0400:0004 (0B).

M ITEM:EX-  
PRESSION TO  
EXPRESSION

This form of the SOURCE option uses ITEM as a base and the EXPRESSIONs as offsets to compute a beginning and an ending address. The sequence of values bounded by the computed addresses is copied to the sequence of locations beginning at the current address. However, if the DESTINATION option (supplied or default) specified a range of values, the sequence of values bounded by the computed addresses is copied to the destination field, with the source values being truncated or repeated as required.

## CHANGING MEMORY -- M (continued)

## PARAMETERS

## Source Parameters

M ITEM:EXPRESSION TO EXPRESSION (continued)

## Examples:

(1) When the DESTINATION option did not specify a range of values:

D .VALUE = 2643

\*

M 1

0400:0001 0B

\*

M = M 300:.VALUE TO .VALUE + 4

0400:0001 0B 0C 0D 0B 4C

0400:0001 21 47 E2 C8 31

\*

In this example, the contents of the range of locations specified in the SOURCE option (0300:2643 - 0300:2647) are copied into the range of locations that begin with the current address (0400:0001).

(2) When the DESTINATION option specified a range of values:

M 101 TO 104

0400:0101 21 21 21 0B

\*

M = M 300:2643 TO 2647

0400:0101 21 21 21 0B

0400:0101 21 47 E2 C8 (last value

\*

truncated)

This example copies the contents of five locations (0300:2643 - 0300:2647) into four locations (0400:0101 - 0400:0104). Notice that the value of the fifth location (0300:2647) is not copied.

## DESCRIPTION

This command changes the contents of designated RAM locations. The DESTINATION options affect the current segment base and offset values. The SOURCE options do not affect these values.

## CHANGING MEMORY -- M (continued)

## DESCRIPTION (continued)

When executing this command, the Debugger displays the contents of the designated locations, then updates the contents, and finally displays the new contents. Thus, if you inadvertently destroy some important data, the information you need to restore it is available.

This command copies data in the byte mode. The current display mode is not affected by these copying options.

## NOTE

When using the M command, be aware of the following hazards:

- It is possible for you to modify memory within iRMX 86 components, such as the Nucleus and Debugger. Doing so can jeopardize the integrity of your application system, and should therefore be avoided.
- It is possible to request that non-RAM memory locations be modified. If you attempt to read or write to a non-RAM location, nothing happens to memory and the displays indicate that the specified locations contain zeros.
- A memory request might cross segment boundaries. In processing such a request, the Debugger ignores such boundaries, so don't assume that a boundary will terminate a request.

COMMANDS TO INSPECT SYSTEM OBJECTS

The commands in this section allow you to examine iRMX 86 objects in detail. They give specific information about the Nucleus object types. Figure 4-2 illustrates the general syntax for all the commands in this section.

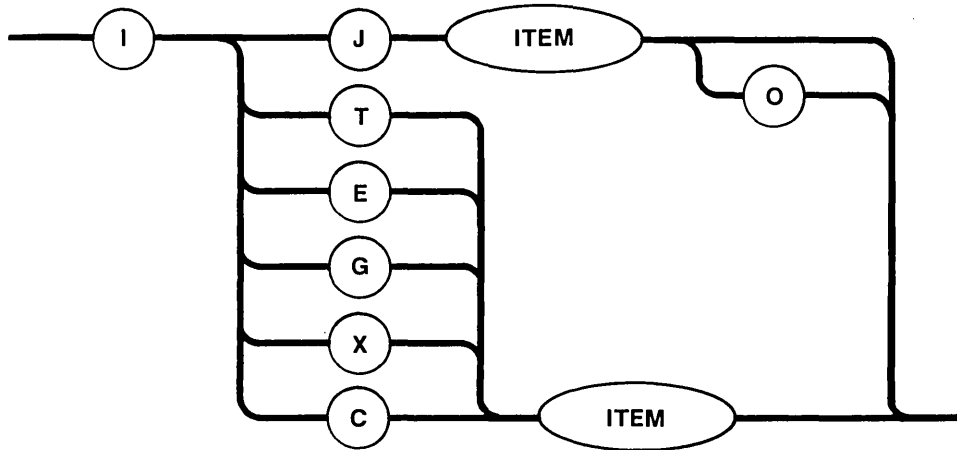

Figure 4-2. Syntax Diagram for Inspecting System Objects

The second letter of the command indicates the type of object to inspect, as follows:

- J Job
- T Task
- E Exchange
- G Segment
- C Composite
- X Extension

The remainder of this section describes the commands in detail.

INSPECT COMMANDS

INSPECTING A JOB -- IJ

This command lists the principal attributes of a specified job. The syntax for the IJ command is as follows:

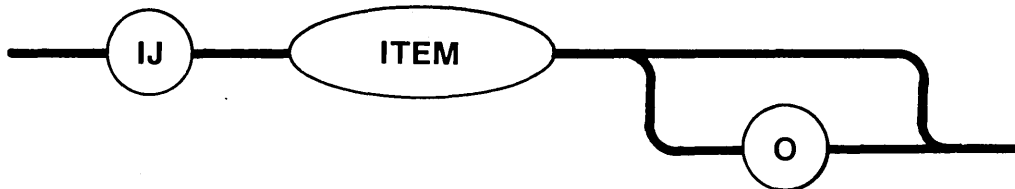

PARAMETERS

- ITEM            A token for the job to be inspected.
- 0                If this option is included, the job's object directory is also listed. If omitted, the object directory is not listed.

DESCRIPTION

The IJ command lists the principal attributes of a job whose token is represented by ITEM. It also lists the object directory if the 0 option is included. If there is a large number of entries in the object directory, the control-0 character can be used to prevent data from rolling off the screen. The control-0 special character is described in Chapter 2.

Figure 4-3 depicts the form of the display produced by the IJ command.

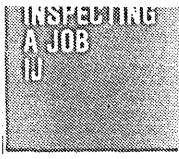

DESCRIPTION (continued)

```

----- iRMX86 JOB REPORT -----
JOB TOKEN          bbbb          PARENT JOB          jjjj
POOL MAXIMUM       cccc          POOL MINIMUM        kkkk
CURRENT ALLOCATED  dddd          CURRENT UNALLOCATED 1111
CURRENT # OBJECTS  eeee          CURRENT # TASKS      mmmm
MAXIMUM # OBJECTS  ffff          MAXIMUM # TASKS      nnnn
CURRENT # CHILD JOBS gggg          DELETION PENDING     ppp
EXCEPTION MODE     hhhh          EXCEPTION HANDLER    qqqq:rrrr
MAXIMUM PRIORITY   iiii

NAME(S)  aaaaaaaaaa  aaaaaaaaaa  aaaaaaaaaa  aaaaaaaaaa
         aaaaaaaaaa  aaaaaaaaaa  aaaaaaaaaa  aaaaaaaaaa

----- OBJECT DIRECTORY -----
MAXIMUM SIZE      uuuu          VALID ENTRIES       vvvv
NAME              TOKEN      NAME              TOKEN      NAME              TOKEN
ssssssssssss tttt    sssssssssssss tttt    sssssssssssss tttt
    
```

Figure 4-3. An iRMX 86™ Job Report

The following describes the fields in Figure 4-3:

<u>Field</u>	<u>Meaning</u>
aaaaaaaaaaaa	Each such field contains a name under which the job is cataloged in the object directory of either the job's parent job or the root job. If the job is not cataloged in either directory, "NONE FOUND" is printed here.
bbbb	Hexadecimal token for the job.
cccc	Maximum number, in hexadecimal, of 16-byte paragraphs that the job's pool can contain.
dddd	Number of paragraphs that have been either allocated to tasks in the job or lent to child jobs.
eeee	Number, in hexadecimal, of existing objects in job bbbb.
ffff	Maximum number, in hexadecimal, of objects that can exist simultaneously in job bbbb.
gggg	Number, in hexadecimal, of existing jobs that are offspring of job bbbb.

INSPECT COMMANDS



DEBUGGER COMMANDS

INSPECTING A JOB -- IJ (continued)

DESCRIPTION (continued)

<u>Field</u>	<u>Meaning</u>										
hhhh	Exception mode for the job's default exception handler. Possible values are as follows:										
	<table border="0"> <thead> <tr> <th><u>Value</u></th> <th><u>When to Pass Control To Exception Handler</u></th> </tr> </thead> <tbody> <tr> <td>0</td> <td>Never</td> </tr> <tr> <td>1</td> <td>On programmer errors only</td> </tr> <tr> <td>2</td> <td>On environmental conditions only</td> </tr> <tr> <td>3</td> <td>On all exceptional conditions</td> </tr> </tbody> </table>	<u>Value</u>	<u>When to Pass Control To Exception Handler</u>	0	Never	1	On programmer errors only	2	On environmental conditions only	3	On all exceptional conditions
<u>Value</u>	<u>When to Pass Control To Exception Handler</u>										
0	Never										
1	On programmer errors only										
2	On environmental conditions only										
3	On all exceptional conditions										
iiii	Hexadecimal value that indicates the maximum (numerically lowest) allowable priority for tasks in the job.										
jjjj	Hexadecimal token for the parent of job bbbb. If job bbbb is the root job, however, jjjj is "ROOT".										
kkkk	Minimum number, in hexadecimal, of 16-byte paragraphs that the job's pool can contain.										
llll	Number, in hexadecimal, of unused 16-byte paragraphs in the job's initial pool.										
mmmm	Number, in hexadecimal, of tasks currently in the job.										
nnnn	Maximum number, in hexadecimal, of tasks that can exist simultaneously in job bbbb.										
ppp	Indicator which tells whether a task has attempted to delete the job but was unsuccessful because the job has obtained protection from the DISABLE\$DELETION system call (which is described in the iRMX 86 SYSTEM PROGRAMMER'S REFERENCE MANUAL). The possible values of ppp are YES and NO.										
qqqq	Base, in hexadecimal, of the start address of the job's default exception handler.										
rrrr	Hexadecimal offset, relative to qqqq, of the start address of the job's default exception handler.										

INSPECT COMMANDS



## INSPECTING A JOB -- IJ (continued)

## DESCRIPTION (continued)

<u>Field</u>	<u>Meaning</u>
ssssssssss	Each such field contains the name under which an object is cataloged in the job's object directory. If there are no entries in the object directory, these fields are blank.
tttt	Each such field contains a token, in hexadecimal, of the object whose name (in the directory) appears next to it.
uuuu	Maximum allowable number, in hexadecimal, of entries in the job's object directory.
vvvv	Number, in hexadecimal, of entries currently in the job's object directory.

INSPECTING A TASK -- IT

This command lists the principal attributes of a specified task. The syntax for the IT command is as follows:



PARAMETER

ITEM                    Token for the task to be inspected.

DESCRIPTION

The IT command displays the principal attributes of the task whose token is represented by ITEM. Figure 4-4 depicts the form of display produced by IT.

```

----- iRMX86 TASK REPORT -----
TASK TOKEN          bbbb      CONTAINING JOB          kkkk
STACK SEGMENT BASE  cccc      STACK SEGMENT OFFSET    1111
STACK SEGMENT SIZE  dddd      STACK SEGMENT LEFT      mmmm
CODE SEGMENT BASE   eeee      DATA SEGMENT BASE      nnnn
INSTRUCTION POINTER ffff      TASK STATE              PPPPPPPP
STATIC PRIORITY     gggg      DYNAMIC PRIORITY        qqqq
SUSPENSION DEPTH    hhhh      SLEEP UNITS REQUESTED   rrrr
EXCEPTION MODE      iiiii     EXCEPTION HANDLER       ssss:tttt
NDP TASK            jjj
NAME(S)             aaaaaaaaaa aaaaaaaaaa aaaaaaaaaa aaaaaaaaaa
                   aaaaaaaaaa aaaaaaaaaa aaaaaaaaaa aaaaaaaaaa
  
```

Figure 4-4. An iRMX 86™ Task Report

The following describes the fields in Figure 4-4:

<u>Field</u>	<u>Meaning</u>
aaaaaaaaaaaa	Each such field contains a name under which the task is cataloged in the object directory of either the task's containing job or the root job. If the job is not cataloged in either directory, "NONE FOUND" is displayed here.

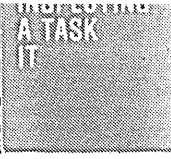

INSPECTING A TASK -- IT (continued)

DESCRIPTION (continued)

<u>Field</u>	<u>Meaning</u>										
bbbb	Hexadecimal token for the task.										
cccc	Base address, in hexadecimal, of the task's stack segment.										
dddd	Size, in bytes, of the task's stack segment.										
eeee	Base address, in hexadecimal, of the task's code segment.										
ffff	Current value, in hexadecimal, of the task's instruction pointer.										
gggg	Hexadecimal priority of the task.										
hhhh	Current number, in hexadecimal, of "suspends" against the task. Before the task can be made ready, each "suspend" must be countered with a "resume".										
iiii	Exception mode for the task's exception handler. Possible values are as follows:										
	<table border="0" style="margin-left: 40px;"> <thead> <tr> <th style="text-align: left;"><u>Value</u></th> <th style="text-align: left;"><u>When to Pass Control To Exception Handler</u></th> </tr> </thead> <tbody> <tr> <td>0</td> <td>Never</td> </tr> <tr> <td>1</td> <td>On programmer errors only</td> </tr> <tr> <td>2</td> <td>On environmental conditions only</td> </tr> <tr> <td>3</td> <td>On all exceptional conditions</td> </tr> </tbody> </table>	<u>Value</u>	<u>When to Pass Control To Exception Handler</u>	0	Never	1	On programmer errors only	2	On environmental conditions only	3	On all exceptional conditions
<u>Value</u>	<u>When to Pass Control To Exception Handler</u>										
0	Never										
1	On programmer errors only										
2	On environmental conditions only										
3	On all exceptional conditions										
jjj	Indicator which tells whether the task uses the 8087 NDP. The possible values of jjj are YES and NO.										
kkkk	Hexadecimal token for the task's containing job.										
llll	Hexadecimal offset, relative to cccc, of the task's stack segment.										
mmmm	Hexadecimal number of bytes currently available in the task's stack.										
nnnn	Base address, in hexadecimal, of the task's data segment.										
pppppppp	Current execution state of the task. Possible values are "READY", "ASLEEP", "SUSPENDED", "ASLEEP/SUSP", and "BROKEN".										

INSPECT COMMANDS



DEBUGGER COMMANDS

INSPECTING A TASK -- IT (continued)

DESCRIPTION (continued)

<u>Field</u>	<u>Meaning</u>
qqqq	A temporary, hexadecimal priority that is sometimes assigned to the task by the Nucleus. This is done to improve system performance.
rrrr	If the task is asleep or asleep/suspended, this is the number of 1/100 second sleep units that the task requested just prior to going to sleep. If the task is ready or suspended, qqqq is 0000.
ssss	Base, in hexadecimal, of the start address of the task's exception handler.
tttt	Hexadecimal offset, relative to ssss, of the start address of the task's exception handler.

INSPECT COMMANDS

This command displays the principal attributes of a mailbox, semaphore, or region whose token is specified. The syntax of the IE command is as follows:



PARAMETER

ITEM                   Token for the exchange to be inspected.

DESCRIPTION

The IE command displays the principal attributes of the mailbox, semaphore, or region whose token is represented by ITEM. It produces three kinds of output, one for each kind of exchange.

Mailbox Display

Figure 4-5 depicts the form of display produced by IE for a mailbox.

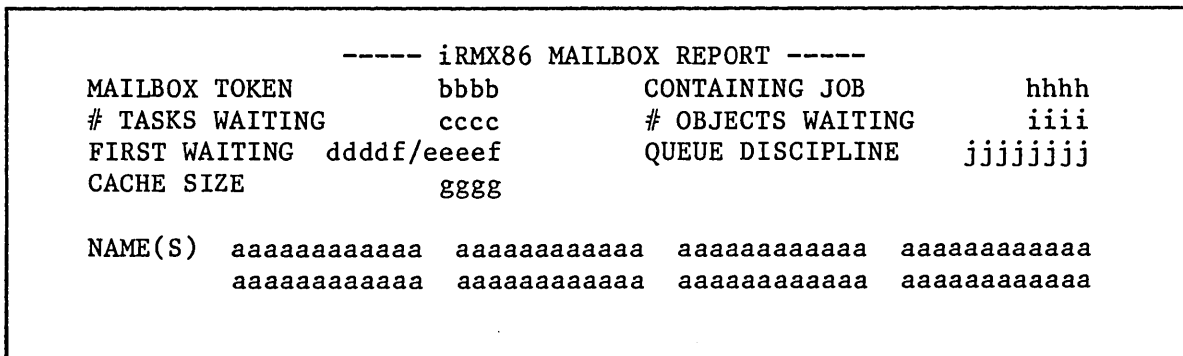

Figure 4-5. An iRMX 86™ Mailbox Report



DEBUGGER COMMANDS

INSPECTING AN EXCHANGE -- IE (continued)

DESCRIPTION

Mailbox Display (continued)

The following describes the fields in Figure 4-5:

<u>Field</u>	<u>Meaning</u>
aaaaaaaaaaaa	Each such field contains a name under which the mailbox is cataloged in the object directory of either the mailbox's containing job or the root job. If the mailbox is not cataloged in either directory, "NONE FOUND" is displayed here.
bbbb	Hexadecimal token for the mailbox.
cccc	Number, in hexadecimal, of tasks in the mailbox's task queue.
dddd	Token for the containing job of either the first task waiting in the task queue or the first object waiting in the object queue. Because at least one of these queues is empty, dddd is not ambiguous. If both queues are empty, dddd is absent.
eeee	Token for either the first task waiting in the task queue or the first object waiting in the object queue. Because at least one of these queues is empty, eeee is not ambiguous. If both queues are empty, eeee is 0000.
f	Single letter that indicates the type of the first task waiting in the task queue or the first object waiting in the object queue. Because at least one of these queues is empty, f is not ambiguous. If both queues are empty, f is blank. Otherwise, f has one of the following values:  C composite G segment J job M mailbox R region S semaphore T task X extension

INSPECT COMMANDS



INSPECTING AN EXCHANGE -- IE (continued)

DESCRIPTION

Mailbox Display (continued)

<u>Field</u>	<u>Meaning</u>
gggg	Number, in hexadecimal, of objects that the mailbox's high performance object queue is capable of holding.
hhhh	Hexadecimal token for the job containing the mailbox.
iiii	Number, in hexadecimal, of objects in the mailbox's object queue.
jjjjjjj	Description of the manner in which waiting tasks are queued in the mailbox's task queue. The possible values are FIFO and PRIORITY.

Semaphore Display

Figure 4-6 depicts the form of the display produced by IE for a semaphore.

```

----- iRMX86 SEMAPHORE REPORT -----
SEMAPHORE TOKEN      bbbb          CONTAINING JOB      gggg
# TASKS WAITING      cccc          QUEUE DISCIPLINE   hhhhhhhh
CURRENT VALUE        dddd          MAXIMUM VALUE      iiii
FIRST WAITING        eeeeJ/ffffT

NAME(S)  aaaaaaaaaa  aaaaaaaaaa  aaaaaaaaaa  aaaaaaaaaa
         aaaaaaaaaa  aaaaaaaaaa  aaaaaaaaaa  aaaaaaaaaa
    
```

Figure 4-6. An iRMX 86™ Semaphore Report

The following describes the fields in Figure 4-6:

<u>Field</u>	<u>Meaning</u>
aaaaaaaaaaaa	Each such field contains a name under which the semaphore is cataloged in the object directory of either the semaphore's containing job or the root job. If the semaphore is not cataloged in either directory, "NONE FOUND" is displayed here.
bbbb	Hexadecimal token for the semaphore.

INSPECT COMMANDS

INSPECTING AN EXCHANGE -- IE (continued)

Semaphore Display (continued)

<u>Field</u>	<u>Meaning</u>
cccc	Number, in hexadecimal, of tasks waiting in the queue.
dddd	Number, in hexadecimal, of units currently in the custody of the semaphore.
eeee	Hexadecimal token for the containing job of the first waiting task. It is absent if no tasks are waiting.
ffff	Hexadecimal token for the first waiting task. It is 0000 if no tasks are waiting.
gggg	Hexadecimal token for the semaphore's containing job.
hhhhhhh	Description of the manner in which waiting tasks are queued in the semaphore's task queue. The possible values are FIFO and PRIORITY.
iiii	Maximum allowable number, in hexadecimal, of units that the semaphore may have in its custody.

Region Display

Figure 4-7 depicts the form of display produced by IE for a region.

```

----- iRMX86 REGION REPORT -----
REGION TOKEN          bbbb          CONTAINING JOB          eeee
# TASKS WAITING      cccc          QUEUE DISCIPLINE      ffffffff
TASK IN REGION       dddd          FIRST WAITING          gggg

NAME(S)  aaaaaaaaaa  aaaaaaaaaa  aaaaaaaaaa  aaaaaaaaaa
         aaaaaaaaaa  aaaaaaaaaa  aaaaaaaaaa  aaaaaaaaaa
    
```

Figure 4-7. An iRMX 86™ Region Report





## INSPECTING AN EXCHANGE -- IE (continued)

## DESCRIPTION

## Region Display (continued)

The following describes the fields in Figure 4-7:

<u>Field</u>	<u>Meaning</u>
aaaaaaaaaaaa	Each such field contains a name under which the region is cataloged in the object directory of either the job containing the region or the root job. If the region is not cataloged in either directory, "NONE FOUND" is displayed here.
bbbb	Hexadecimal token for the region.
cccc	Number, in hexadecimal, of tasks awaiting access to the data protected by the region.
dddd	Hexadecimal token for the task that currently has access.
eeee	Hexadecimal token for the job that contains the region.
ffffff	Manner in which waiting tasks are queued at the region. Possible values are FIFO and PRIORITY.

INSPECTING A SEGMENT -- IG

This command displays the principal attributes of the specified segment. The syntax for the IG command is as follows:



PARAMETER

ITEM                   Token for the segment to be inspected.

DESCRIPTION

The IG command displays the principal attributes of the segment whose token is represented by ITEM. Figure 4-8 depicts the form of the display produced by IG.

----- iRMX86 SEGMENT REPORT -----				
SEGMENT TOKEN	bbbb	CONTAINING JOB	dddd	
SEGMENT BASE	cccc	SEGMENT LENGTH	eeee	
NAME(S)	aaaaaaaaaaaa	aaaaaaaaaaaa	aaaaaaaaaaaa	aaaaaaaaaaaa
	aaaaaaaaaaaa	aaaaaaaaaaaa	aaaaaaaaaaaa	aaaaaaaaaaaa

Figure 4-8. An iRMX 86™ Segment Report

The following describes the fields in Figure 4-8:

<u>Field</u>	<u>Meaning</u>
aaaaaaaaaaaa	Each such field contains a name under which the segment is cataloged in the object directory of either the segment's containing job or the root job. If the segment is not cataloged in either directory, "NONE FOUND" is displayed here.
bbbb	Hexadecimal token for the segment.

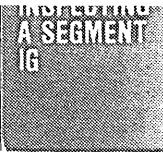

## INSPECTING A SEGMENT -- IG (continued)

## DESCRIPTION (continued)

<u>Field</u>	<u>Meaning</u>
cccc	Base address of the segment.
dddd	Hexadecimal token for the job that contains the segment.
eeee	Number, in hexadecimal, of bytes in the segment.

INSPECTING AN EXTENSION -- IX

This command displays the principal attributes of the specified extension object. The syntax for the IX command is as follows:



PARAMETER

ITEM                   Token for the extension object to be inspected.

DESCRIPTION

The IX command displays the principal attributes of the extension whose token is represented by ITEM. Figure 4-9 depicts the form of the display produced by IX.

----- iRMX86 EXTENSION REPORT -----				
EXTENSION TOKEN	bbbb	CONTAINING JOB	dddd	
TYPE CODE	cccc	DELETION MAILBOX	eeee	
NAME(S)	aaaaaaaaaaaa	aaaaaaaaaaaa	aaaaaaaaaaaa	aaaaaaaaaaaa
	aaaaaaaaaaaa	aaaaaaaaaaaa	aaaaaaaaaaaa	aaaaaaaaaaaa

Figure 4-9. An iRMX 86™ Extension Report

The following describes the fields in Figure 4-9:

<u>Field</u>	<u>Meaning</u>
aaaaaaaaaaaa	Each such field contains a name under which the extension is cataloged in the object directory of either the job containing the extension or the root job. If the extension is not cataloged in either directory, "NONE FOUND" is displayed here.
bbbb	Hexadecimal token for the extension.

## INSPECTING AN EXTENSION -- IX (continued)

## DESCRIPTION (continued)

<u>Field</u>	<u>Meaning</u>
cccc	Hexadecimal type code associated with composite objects licensed by this extension.
dddd	Hexadecimal token for the job containing this extension.
eeee	Hexadecimal token for the deletion mailbox associated with the extension. If there is no deletion mailbox for the extension, "NONE" is displayed here.

INSPECTING A COMPOSITE -- IC

This command displays the principal attributes of the specified composite. The syntax for the IC command is as follows:



PARAMETER

ITEM                    Token for the composite object to be inspected.

DESCRIPTION

The IC command displays the principal attributes of the composite object whose token is represented by ITEM. Figure 4-10 depicts the form of the display produced by IC.

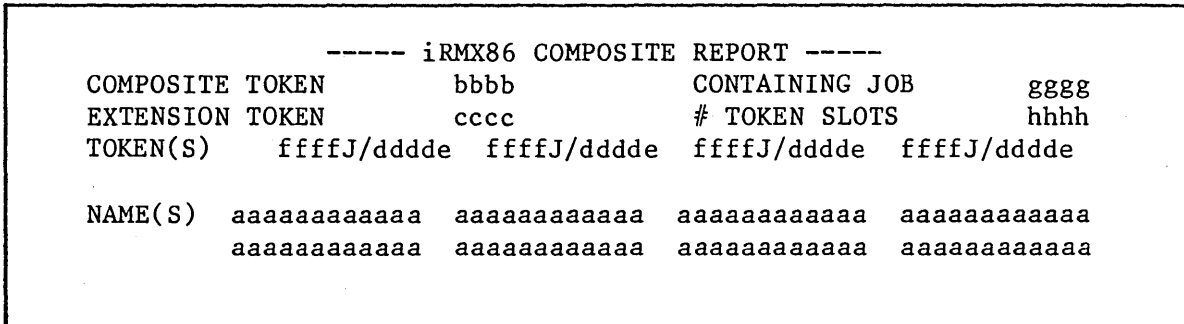
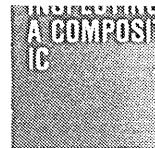

Figure 4-10. An iRMX 86™ Composite Report

The following describes the fields in Figure 4-10:

<u>Field</u>	<u>Meaning</u>
aaaaaaaaaaaa	Each such field contains a name under which the composite is cataloged in the object directory of either the job containing the composite or the root job. If the composite is not cataloged in either directory, "NONE FOUND" is displayed here.
bbbb	Hexadecimal token for the composite.



INSPECTING A COMPOSITE -- IC (continued)

DESCRIPTION (continued)

<u>Field</u>	<u>Meaning</u>
cccc	Hexadecimal token for the extension that represents license to create this type of composite.
dddd	Hexadecimal token for one of the components of the composite object.
e	Single letter that indicates the type of object dddd. This field can have any of the following values: <ul style="list-style-type: none"> <li>C composite</li> <li>G segment</li> <li>J job</li> <li>M mailbox</li> <li>R region</li> <li>S semaphore</li> <li>T task</li> <li>X extension</li> <li>* a task whose stack has overflowed or whose code was loaded by the iRMX 86 Application Loader</li> </ul>
ffff	Hexadecimal token for the job that contains object dddd.
gggg	Hexadecimal token for the job that contains composite object bbbb.
hhhh	Hexadecimal value specifying the maximum allowable number of component objects that the composite object can comprise.

UNOFFICIAL COPY

COMMANDS TO VIEW OBJECT LISTS

The commands in this section allow you to view lists of iRMX 86 objects. Figure 4-11 illustrates the general syntax for commands in this section.

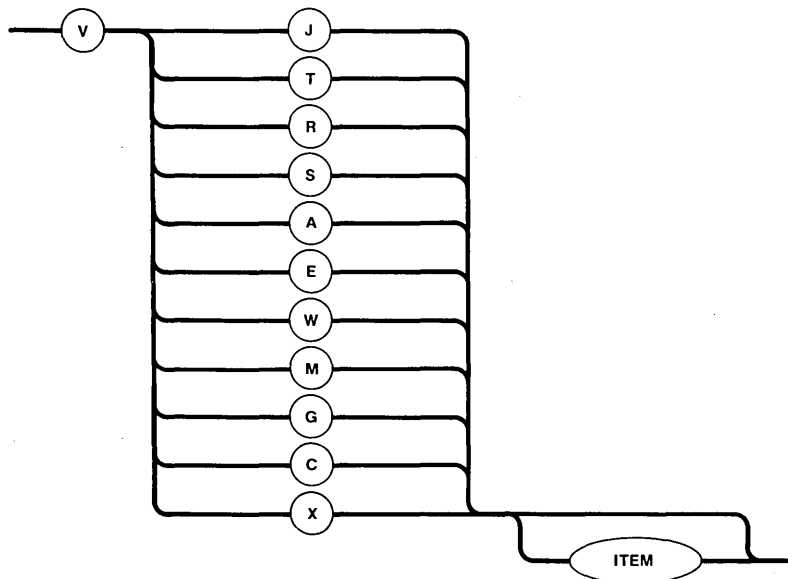

Figure 4-11. Syntax Diagram for Viewing iRMX 86™ Object Lists

The second letter of the command indicates the type of object list to display, as follows:

- J Jobs
- T Tasks
- R Ready tasks
- S Suspended tasks
- A Asleep tasks
- E Exchanges
- W Waiting Task queues
- M Mailbox queues
- G Segments
- C Composites
- X Extensions

The remainder of this section describes the commands in detail.



This command displays a list of jobs. The syntax for the VJ command is as follows:

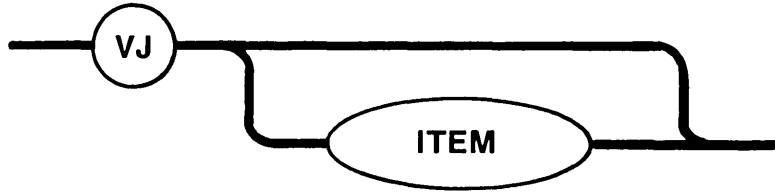

PARAMETER

**ITEM**                      Token for a job. If this option is included, the Debugger lists only those jobs that are children of the specified job. If this option is omitted, all jobs in the system are listed.

DESCRIPTION

The VJ command displays jobs as:

```
JL = ppppJ/jjjjJ ppppJ/jjjjJ ... ppppJ/jjjjJ
```

where:

- jjjj                      Job token.
- pppp                      Token of its parent job. If the job designated by jjjj is the root job, then "ROOT" replaces "ppppJ".

## VIEWING TASKS -- VT

This command displays a list of tasks. The syntax for the VT command is as follows:

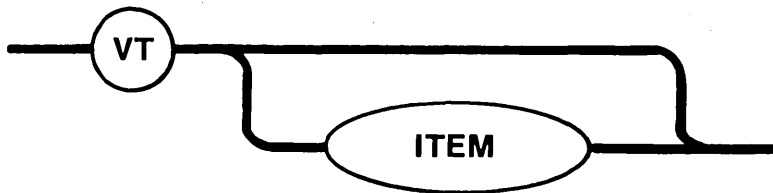

## PARAMETER

**ITEM** Token for a job. If this option is included, the Debugger lists only those tasks that are contained in the specified job. If this option is omitted, all tasks in the system are listed.

## DESCRIPTION

The VT command displays tasks as:

```
TL = jjjjJ/ttttT jjjjJ/ttttT ... jjjjJ/ttttT
```

where:

tttt	Task token.
jjjj	Token for the job that contains the task. An asterisk following a task token indicates that the task has overflowed its stack.

VIEWING READY TASKS -- VR

This command displays a list of ready tasks. The syntax for the VR command is as follows:

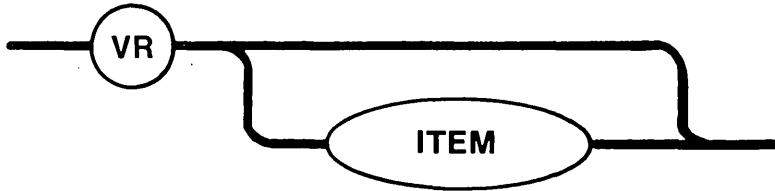

PARAMETER

ITEM           Token for a job. If this option is included, the Debugger lists, in priority order, the ready tasks that are contained in the specified job. If this option is omitted, all ready tasks in the system are listed in order of priority.

DESCRIPTION

The VR command displays ready tasks as:

```
RL = jjjjJ/ttttT jjjjJ/ttttT ... jjjjJ/ttttT
```

where:

tttt           Token of a ready task.

jjjj           Token for the job containing the task. An asterisk following a task token indicates that the task has overflowed its stack.

VIEWING SUSPENDED TASKS -- VS

This command displays a list of suspended tasks. The syntax for the VS command is as follows:

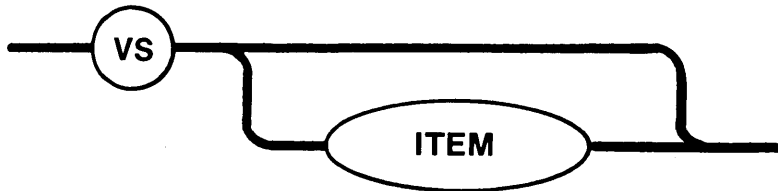

PARAMETER

ITEM	Token for a job. If this option is included, the Debugger lists only those suspended tasks that are contained in the specified job. If this option is omitted, all suspended tasks in the system are listed.
------	--

DESCRIPTION

The VS command displays suspended tasks as:

```
SL = jjjjJ/ttttT jjjjJ/ttttT ... jjjjJ/ttttT
```

where:

tttt	Token of a suspended task.
jjjj	Token for the job containing the task. An asterisk following a task token indicates that the task has overflowed its stack.

This command displays a list of asleep tasks. The syntax for the VA command is as follows:

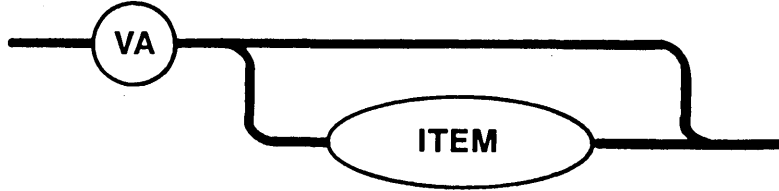

PARAMETER

**ITEM**                      Token for a job. If this option is included, the Debugger lists only those asleep tasks that are contained in the specified job. If this option is omitted, all asleep tasks in the system are listed.

DESCRIPTION

The VA command displays suspended tasks as:

```
SA = jjjjJ/ttttT  jjjjJ/ttttT  ...  jjjjJ/ttttT
```

where:

- tttt                      Token of an asleep task.
- jjjj                      Token for the job containing the task. An asterisk following the task token indicates that the task has overflowed its stack.

VIEWING EXCHANGES -- VE

This command displays a list of exchanges. The syntax for the VE command is as follows:

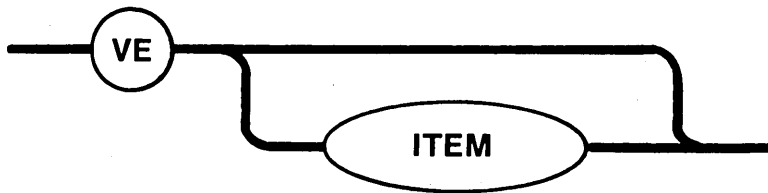

PARAMETER

ITEM                   Token for a job. If this option is included, the Debugger lists only those exchanges that are contained in the specified job. If this option is omitted, all exchanges in the system are listed.

DESCRIPTION

The VE command lists exchanges as:

```
EL = jjjjJ/xxxxt jjjjJ/xxxxt ... jjjjJ/xxxxt
```

where:

- xxxx           Token for an exchange.
- t              Type of the exchange (M for mailbox, S for semaphore, or R for region).
- jjjj           Token for the job containing the exchange.

VIEWING WAITING TASK QUEUES -- VW

This command displays the waiting task queues at exchanges. The syntax for the VW command is as follows:

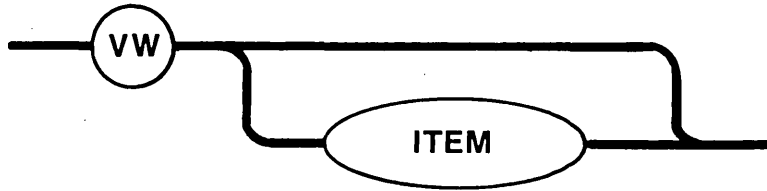

PARAMETER

**ITEM** Token for an exchange or a job. If you specify an exchange token for this option, the Debugger lists only the task queue associated with the specified exchange. If you specify a job token for this option, the Debugger lists all task queues in the specified job. If you omit this option, the Debugger displays task queues for all exchanges in the system.

DESCRIPTION

The VW command displays task queues at exchanges as:

```

WL jjjjJ/xxxxt = jjjjJ/ttttT jjjjJ/ttttT ... jjjjJ/ttttT
WL jjjjJ/xxxxt = jjjjJ/ttttT jjjjJ/ttttT ... jjjjJ/ttttT
.
.
.
WL jjjjJ/xxxxt = jjjjJ/ttttT jjjjJ/ttttT ... jjjjJ/ttttT
    
```

where:

- xxxx Token for an exchange.
- t Type of the exchange (M for mailbox, S for semaphore, or R for region).
- tttt Token for a task which is queued at that exchange.
- jjjj Token for the job containing the task. An asterisk indicates that either the task has overflowed its stack or the task was loaded by the Application Loader.

VIEWING MAILBOX OBJECT QUEUES -- VM

This command displays object queues at mailboxes. The syntax for the VM command is as follows:

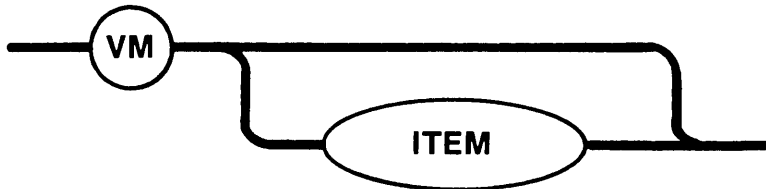

PARAMETER

ITEM	Token for a mailbox or a job. If you specify a mailbox token for this option, the Debugger lists only the object queue associated with the specified mailbox. If you specify a job token for this option, the Debugger lists all object queues in the specified job. If you omit this option, the Debugger displays object queues for all exchanges in the system.
------	--

DESCRIPTION

The VM command displays object queues at mailboxes as:

```

ML jjjjJ/MMMMM = jjjjJ/oooo jjjjJ/oooo ... jjjjJ/oooo
ML jjjjJ/MMMMM = jjjjJ/oooo jjjjJ/oooo ... jjjjJ/oooo
.
.
.
ML jjjjJ/MMMMM = jjjjJ/oooo jjjjJ/oooo ... jjjjJ/oooo

```

where:

- MMMM Token for a mailbox.
- oooo Token for an object in that mailbox's object queue.
- t Type of the object (J for job, T for task, M for mailbox, S for semaphore, and G for segment).
- jjjj Token for the job containing the mailbox or object.



This command displays a list of segments. The syntax for the VG command is as follows:

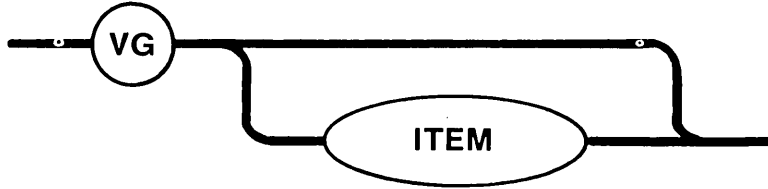

PARAMETER

ITEM           Token for a job. If this option is included, the Debugger lists only the segments contained in the specified job. If this option is omitted, all segments in the system are displayed.

DESCRIPTION

The VG command displays segments as:

```
GL = jjjjJ/ggggG jjjjJ/ggggG ... jjjjJ/ggggG
```

where:

gggg           Token for a segment.  
jjjj           Token for the job containing the segment.

## VIEWING EXTENSIONS -- VX

This command displays either a list of extension objects or a list of composite objects associated with a particular extension object. The syntax for the VX command is as follows:

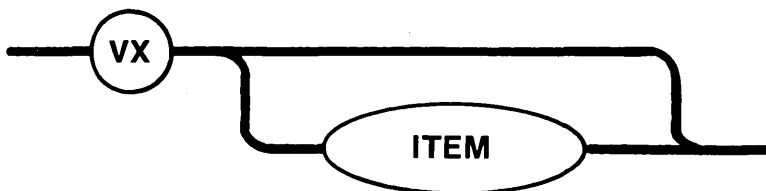

## PARAMETER

**ITEM**                   Token for an extension object. If this option is included, the Debugger lists all composite objects associated with the specified extension object. If this object is omitted, the Debugger lists all extension objects in the system.

## DESCRIPTION

If the ITEM parameter is omitted, the VX command displays extension objects as follows:

```
XL = jjjjJ/xxxxX jjjjJ/xxxxX ... jjjjJ/xxxxX
```

where:

xxxx                   Token for an extension object.  
jjjj                   Token for the job containing the extension.

If the ITEM option is included, the VX command lists the composite objects associated with a particular extension object as follows:

```
XL jjjjJ/xxxxX = kkkkJ/ccccC kkkkJ/ccccC ... kkkkJ/ccccC
```

where:

xxxx                   Token for the extension object.

## VIEWING EXTENSIONS -- VX (continued)

## DESCRIPTION (continued)

jjjj	Token for the job containing the extension.
cccc	Token for the composite object that is associated with the specified extension.
kkkk	Token for the job containing the composite object.

VIEWING COMPOSITES -- VC

This command displays a list of composite objects. The syntax for the VC command is as follows:

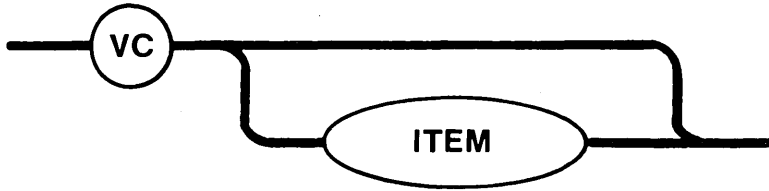

PARAMETER

ITEM	Token for a job. If this option is included, the Debugger lists only the composite objects contained in the specified job. If this option is omitted, all composite objects in the system are displayed.
------	--

DESCRIPTION

The VC command displays composite objects as:

```
CL = jjjjJ/ccccC jjjjJ/ccccC ... jjjjJ/ccccC
```

where:

cccc	Token for a composite object.
jjjj	Token for the job containing the composite object.

COMMANDS TO EXIT THE DEBUGGER

The Q command described in this section allows you to exit the Debugger and resume processing.

DEBUGGER COMMANDS

EXITING THE DEBUGGER -- Q

This command exits the Debugger. The syntax for the Q command is as follows:



DESCRIPTION

The Q command deactivates the Debugger. When a debugging session is terminated, the tables and lists the Debugger maintains are not destroyed. Q also displays the message "EXIT iRMX 86 DEBUGGER".

## APPENDIX A. ERROR MESSAGES

This appendix lists the error messages that can occur when you enter Debugger commands. Since the Debugger reads commands on a line-by-line basis, it will not issue an error message for a command until you terminate the command with an end-of-line character (carriage return or line feed). Then, if the Debugger detects an error, it generates a display of the following form:

```
command portion #  
error message
```

where command portion consists of the command up to the point where the Debugger detected the error, and error message consists of one of the following:

<u>Message</u>	<u>Description</u>
ATTEMPT TO MODIFY NON-RAM LOCATION	You tried to define a breakpoint at a non-RAM memory location.
BREAKPOINT TASK NOT AN NDP TASK	You specified the N command, but the breakpoint task was not designated as an 8087 task at its creation.
COMMAND TOO COMPLEX	In order to process your commands, the Debugger maintains a semantic stack, on which it places all the semantic entities of your command. Your command was too complex and overflowed this stack. To correct this problem, you should first define numeric variables for some of your more complex expressions, and then use these variables in your command in place of the expressions.
DEBUGGER POOL TOO SMALL	In order to process your command, the Debugger tried to create an iRMX 86 segment. However, there was not enough free space in the system to create this segment.
DUPLICATE SYMBOL	You attempted to define a numeric or breakpoint variable name that was already defined.

## ERROR MESSAGES

<u>Message</u>	<u>Description</u>
INVALID TASK STATE	The Nucleus-maintained task descriptor contains inconsistent information. You have probably overwritten this area of memory. It is unlikely that the task can continue to run.
INVALID TOKEN	You specified a token for a different kind of object than that required by the command.
ITEM NOT FOUND	You tried to delete or change a nonexistent numeric variable.
NO BREAKPOINT TASK	You entered the R or N command without first establishing a breakpoint task.
SYNTAX ERROR	The command is syntactically incorrect.
TASK NOT ON BREAKPOINT LIST	You tried to remove a task from the breakpoint list with the G command when the task was not on the list.
TASK NOT SUSPENDABLE. WILL BE BROKEN WHEN SUSPENDABLE	You entered the BT command to establish a breakpoint task, but the Debugger could not suspend the task in its current state (for example, the task currently has access to a region). The Debugger will suspend the task when it becomes possible to do this.
UNDEFINED SYMBOL	The Debugger was unable to find the specified symbol in the local symbol table, the object directory of the breakpoint task's job, or the root object directory.
UNKNOWN BREAKPOINT iSBC861 NOT CONFIGURED	The Debugger encountered a breakpoint for which it had no record. It tried to pass the breakpoint to the iSBC 957A monitor but could not because the iSBC 957A package is not included in your system.



## INDEX

8087 NDP 4-33, 4-35

address 4-38

altering

- breakpoint task's NDP registers 4-35
- breakpoint task's registers 4-31

asleep tasks 4-77

B command 4-32

BL command 4-22

breakpoint

- commands 4-10
- list 4-22
- parameters 4-23
- task 4-11, 4-27, 4-28
- variables 4-6

BT command 4-27, 4-28

capabilities of the Debugger 1-1

carriage return 2-1

changing

- breakpoints 4-19
- memory 4-45
- numeric variables 4-8

commands 4-1

- dictionary 4-2
- syntax 3-1

composites 4-70, 4-84

constant 3-2

control-D 1-3, 2-2

control-O 2-1

control-Q 2-1

control-S 2-1

conventions 3-1

CROOT.LIB library 1-4

current

- address 4-38
- display mode 4-38
- display mode 4-40
- offset 4-38
- segment base 4-38

D command 4-5

DB command 4-15

Debugger capabilities 1-1

defining

- breakpoints 4-15
- numeric variables 4-5

## INDEX (continued)

- deleting
  - breakpoints 4-21
  - numeric variables 4-9
- dictionary of commands 4-2
- display mode 4-38, 4-40
- displaying object lists 4-72
  
- end-of-line characters 2-1
- error messages A-1
- escape character 2-1
- establishing the breakpoint task 4-27
- examining
  - breakpoints 4-17
  - memory 4-41
- exception breakpoint 4-10
  - differences 4-13
  - display 4-12
- exchange breakpoint 4-10
  - display 4-12
- exchanges 4-61, 4-78
- execution breakpoint 4-10
  - display 4-11
- exiting the Debugger 4-85
- expression 3-3
- extensions 4-68, 4-82
  
- G command 4-26
  
- IC command 4-70
- ICE-86 capabilities 1-2
- IE command 4-61
- IG command 4-66
- IJ command 4-54
- in-circuit emulator 1-2
- inspecting
  - composites 4-70
  - exchanges 4-61
  - extensions 4-68
  - jobs 4-54
  - segments 4-66
  - tasks 4-58
- inspecting system objects 4-53
- invoking the Debugger 1-3
- iSBC 957A monitor capabilities 1-2
- IT command 4-58
- item 3-3
- IX command 4-68
  
- jobs 4-54, 4-74
  
- line feed 2-1
- listing
  - breakpoint task 4-28
  - numeric and breakpoint variables 4-6

## INDEX (continued)

- M command 4-40, 4-41, 4-45
- mailbox object queues 4-80
- memory,
  - commands 4-37
  - changing 4-45
  - examining 4-41
- messages A-1
- monitor 1-2
  
- name 3-2
- NDP registers 4-33, 4-35
- numeric variables
  - defining 4-5
  - changing 4-8
  - deleting 4-9
  
- object lists 4-72
- objects 4-53
- offset 4-38
  
- pictorial syntax representation 3-1
  
- Q command 4-85
  
- R command 4-29, 4-31
- ready tasks 4-75
- registers 4-29, 4-31
  - NDP 4-33, 4-35
- resuming
  - output from application tasks 2-1
  - task execution 4-26
  
- segment base 4-38
- segments 4-66, 4-81
- setting the current display mode 4-40
- special characters 2-1
- starting the Debugger 1-3
- supressing output from application tasks 2-1
- suspended tasks 4-76
- symbol table 4-4
- symbolic name commands 4-4
- symbols 3-2
- syntax 3-1
- system
  - exception handler 1-3
  - objects 4-53
  
- table of symbols 4-4
- tasks 4-58, 4-74
- terminating Debugger commands 2-2
  
- VA command 4-77
- VC command 4-85
- VE command 4-78
- VG command 4-81

INDEX (continued)

viewing

- asleep tasks 4-77
- breakpoint list 4-22
- breakpoint parameters 4-23
- breakpoint task's NDP registers 4-33
- breakpoint task's registers 4-29
- composites 4-84
- exchanges 4-78
- extensions 4-82
- jobs 4-73
- mailbox object queues 4-80
- object lists 4-72
- ready tasks 4-74
- segments 4-81
- suspended tasks 4-76
- tasks 4-74
- waiting tasks 4-79

waiting tasks 4-79

Z command 4-21



## REQUEST FOR READER'S COMMENTS

Intel Corporation attempts to provide documents that meet the needs of all Intel product users. This form lets you participate directly in the documentation process.

Please restrict your comments to the usability, accuracy, readability, organization, and completeness of this document.

1. Please specify by page any errors you found in this manual.

---

---

---

---

---

2. Does the document cover the information you expected or required? Please make suggestions for improvement.

---

---

---

---

---

3. Is this the right type of document for your needs? Is it at the right level? What other types of documents are needed?

---

---

---

---

---

---

4. Did you have any difficulty understanding descriptions or wording? Where?

---

---

---

---

5. Please rate this document on a scale of 1 to 10 with 10 being the best rating. \_\_\_\_\_

NAME \_\_\_\_\_ DATE \_\_\_\_\_

TITLE \_\_\_\_\_

COMPANY NAME/DEPARTMENT \_\_\_\_\_

ADDRESS \_\_\_\_\_

CITY \_\_\_\_\_ STATE \_\_\_\_\_ ZIP CODE \_\_\_\_\_

Please check here if you require a written reply.

**WE'D LIKE YOUR COMMENTS . . .**

This document is one of a series describing Intel products. Your comments on the back of this form will help us produce better manuals. Each reply will be carefully reviewed by the responsible person. All comments and suggestions become the property of Intel Corporation.



NO POSTAGE  
NECESSARY  
IF MAILED  
IN THE  
UNITED STATES

**BUSINESS REPLY MAIL**  
FIRST CLASS PERMIT NO.79 BEAVERTON, OR

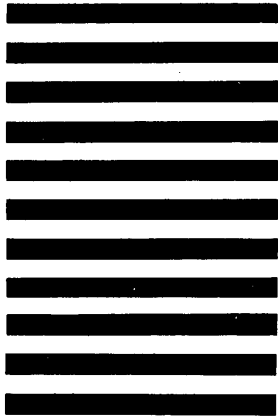

POSTAGE WILL BE PAID BY ADDRESSEE

**Intel Corporation**  
**5200 N.E. Elam Young Pkwy.**  
**Hillsboro, Oregon 97123**

**O.M.S. Technical Publications**





INTEL CORPORATION, 3065 Bowers Avenue, Santa Clara, California 95051 (408) 987-8080

Printed in U.S.A.