

**INTELLEC® SERIES II
MODEL 22X/23X
INSTALLATION MANUAL**

Order Number: 9800559-05

Additional copies of this manual or other Intel literature may be obtained from:

Literature Department
Intel Corporation
3065 Bowers Avenue
Santa Clara, CA 95051

The information in this document is subject to change without notice.

Intel Corporation makes no warranty of any kind with regard to this material, including, but not limited to, the implied warranties of merchantability and fitness for a particular purpose. Intel Corporation assumes no responsibility for any errors that may appear in this document. Intel Corporation makes no commitment to update nor to keep current the information contained in this document.

Intel Corporation assumes no responsibility for the use of any circuitry other than circuitry embodied in an Intel product. No other circuit patent licenses are implied.

Intel software products are copyrighted by and shall remain the property of Intel Corporation. Use, duplication or disclosure is subject to restrictions stated in Intel's software license, or as defined in ASPR 7-104.9(a)(9).

No part of this document may be copied or reproduced in any form or by any means without the prior written consent of Intel Corporation.

The following are trademarks of Intel Corporation and its affiliates and may be used only to identify Intel products:

BXP	Intel	Library Manager	Plug-A-Bubble
CREDIT	int _l	MCS	PROMPT
i	Intelevision	Megachassis	Promware
ICE	Intellec	Micromainframe	RMX/80
iCS	iRMX	Micromap	System 2000
i _m	iSBC	Multibus	UPI
Insite	iSBX	Multimodule	μScope

and the combination of ICE, iCS, iRMX, iSBC, iSBX, MCS, or RMX and a numerical suffix.

REV.	REVISION HISTORY	DATE
-01	Original issue.	5/78
-02	Diagnostic description expanded, appendix describing chassis-signal grounding added.	12/78
-03	Installation instructions expanded, Model 210 information deleted.	12/79
-04	Major reorganization of manual, Integrated Processor Card (IPC) information incorporated, appendix describing confidence test error messages added.	2/80
-05	Appendix describing diskette drive preventive maintenance added.	8/80



This manual, which is intended for the design engineer, programmer, or technician who will install and maintain the Intellec Series II Microcomputer Development System, is divided into five chapters and six appendixes as follows:

- Chapter 1, General Information, includes a functional description delineating the differences among the various system models. Also included are system specifications and power supply current capabilities.
- Chapter 2, Installation, provides step-by-step initial and preinstallation inspection procedures, system emplacement, and firmware diagnostics.
- Chapter 3, Confidence Test, provides a comprehensive test of the system and peripherals. Step-by-step instructions for this test, which runs under Version 4.0 (or later) of the ISIS-II Disk Operating System, are included.
- Chapter 4, Installing Options, provides detailed user instructions for installing system options.
- Chapter 5, Service Information, includes basic troubleshooting hints and instructions for obtaining service and repair assistance.
- Appendix A, Configuring the Serial Interfaces, describes the facilities available to customize the serial channel interfaces to specific devices.
- Appendix B, Modifying the Baud Rate, describes how to programatically change the baud rates for Serial Channel 1 and Serial Channel 2.
- Appendix C, Teletypewriter Modifications, describes how to modify and attach an ASR-33 Teletypewriter to the system.
- Appendix D, Chassis-Signal Ground, describes how to isolate chassis ground from signal ground.
- Appendix E, Confidence Test Error Messages, lists the error messages that can be encountered while running the Confidence Test described in Chapter 3.
- Appendix F, Diskette Drive Preventive Maintenance, provides a maintenance schedule and maintenance procedures for the integral single density diskette drive and the dual double density diskette drives.

Additional information on the system is provided in the following documents:

- *Intellec® Series II Hardware Reference Manual*, Order Number 9800556.
- *Intellec® Series II Hardware Interface Manual*, Order Number 9800555.
- *ISIS-II User's Guide*, Order Number 9800306.
- *8080/8085 Assembly Language Programming Manual*, Order Number 9800301.
- *Intellec® Series II Boot/Monitor*, Order Number 9800605.
- *Intellec® Series II Schematic Drawings*, Order Number 9800554.
- *Intel Component Data Catalog*
- *Intel System Data Catalog*



CONTENTS

PREFACE

PAGE

CHAPTER 1

GENERAL INFORMATION

PAGE

Introduction	1-1
Functional Description	1-1
Master CPU Card (IPB)	1-2
Master CPU Card (IPC)	1-2
Memory	1-2
Input/Output Subsystem	1-2
Keyboard and Integral CRT	1-2
Peripheral Interface	1-2
User Control	1-2
Diskette Subsystem (Model 22X)	1-3
Diskette Subsystem (Model 23X)	1-3
Cardcage Expansion	1-3
Multibus Capability	1-3
Specifications	1-3

CHAPTER 2

INSTALLATION

Introduction	2-1
Unpacking and Initial Inspection	2-1
Preinstallation Inspection	2-1
System Emplacement	2-7
Firmware Diagnostic Tests	2-8
Power-up/Reset Diagnostic	2-8
IPB/IPC Diagnostic	2-8
IOC Diagnostic	2-9
Integral Disk Drive Test	2-10
General Test	2-10
Keyboard Test	2-10

CHAPTER 3

CONFIDENCE TEST

Introduction	3-1
Test Description	3-1
Test 0 - Processor Test	3-1
Test 1 - CRT Character Set Test	3-1
Test 2 - Keyboard Character Set Test	3-1
Test 3 - CRT Write Test	3-1
Test 4 - CRT Cursor Test	3-1
Test 5 - TTY TEST	3-2
Test 6 - Line Printer Test	3-2
Test 7 - High Speed Punch Test	3-2
Test 8 - High Speed Reader Test	3-2
Test 9 - Front Panel Interrupt Test	3-2
Test A - Floppy Disk Test	3-2
Test B - Memory Test	3-2
Command Syntax Conventions	3-2

Test Manager Commands	3-3
TEST Command	3-3
Syntax	3-3
Description	3-3
Examples	3-3
DEBUG Command	3-4
Syntax	3-4
Description	3-4
Examples	3-4
LIST Command	3-4
Syntax	3-4
Description	3-4
Examples	3-4
SUMMARY Command	3-4
Syntax	3-4
Description	3-4
Examples	3-4
CLEAR Command	3-5
Syntax	3-5
Description	3-5
Examples	3-5
DESCRIBE Command	3-5
Syntax	3-5
Description	3-5
Examples	3-5
IGNORE Command	3-5
Syntax	3-5
Description	3-5
Examples	3-5
RECOGNIZE Command	3-5
Syntax	3-5
Description	3-5
Examples	3-5
EXIT Command	3-6
Syntax	3-6
Description	3-6
Examples	3-6
Memory Test Utility Commands	3-6
Running the Confidence Test	3-7

CHAPTER 4

INSTALLING OPTIONS

Introduction	4-1
Expansion Chassis Upgrade	4-1
Memory Upgrade	4-4
iSBC-032 32K RAM Board	4-4
iSBC-016 16K RAM Board	4-4
Double Density Diskette Upgrade	4-4
Diskette Controller	4-5
Dual Diskette Drive	4-7



CONTENTS (Cont'd.)

	PAGE
Integrated Processor Card (IPC) Upgrade	4-7
Adding Peripherals	4-7
Adding In-Circuit Emulators	4-9
Adding Multibus Modules	4-9

CHAPTER 5 SERVICE INFORMATION

Introduction	5-1
Basic Troubleshooting	5-1
Preventive Maintenance	5-1
Service and Repair Assistance	5-1

APPENDIX A CONFIGURING THE SERIAL INTERFACES

APPENDIX B MODIFYING THE BAUD RATE

APPENDIX C TELETYPEWRITER MODIFICATIONS

APPENDIX D CHASSIS-SIGNAL GROUND

APPENDIX E CONFIDENCE TEST ERROR MESSAGES

APPENDIX F DISKETTE DRIVE PREVENTIVE MAINTENANCE

INDEX



ILLUSTRATIONS

FIGURE	TITLE	PAGE	FIGURE	TITLE	PAGE
1-1	Intellec Series II Model 22X/23X Microcomputer Development System	1-1	4-1	Mainframe and Expansion Chassis Cable Ports	4-1
2-1	Chassis Top Cover Removal	2-2	4-2	Mainframe Cable Port Details	4-2
2-2	Model 23X Edge Connectors and Socket-Mounted Integrated Circuits	2-2	4-3	Expansion Chassis Cable Port Details	4-2
2-3	Model 22X Edge Connectors and Socket-Mounted Integrated Circuits	2-3	4-4	Expansion Chassis Ground Strip Installation	4-3
2-4	Keyboard Cable Connection	2-3	4-5	iSBC-032 32K RAM Board Jumper Post Locations	4-4
2-5	Rear Panel Keyboard Connection	2-4	4-6	iSBC-016 16K RAM Board Jumper Post Locations	4-5
2-6	Model 22X/23X System Front Panel	2-4	4-7	Channel Board and Interface Board Switch Settings	4-6
2-7	Model 22X/23X System Cardcage	2-5	4-8	Model 22X/23X System Rear Panel	4-6
2-8	Integrated Processor Assemblies	2-5	4-9	Double Density Diskette Controller Cable Routing	4-8
2-9	Dual Double Density Diskette Drive Controller	2-6	4-10	Dual Double Density Diskette Drive Installation Details	4-8
2-10	Dual Double Density Diskette Drive Installation	2-7			
2-11	Voltage Switching Card Orientation	2-8			



TABLES

TABLE	TITLE	PAGE	TABLE	TITLE	PAGE
1-1	Model 22X/23X System Specifications	1-3	2-2	IOC Firmware Diagnostic Errors/Error Messages	2-9
1-2	System Chassis and Optional Expansion Chassis Power Supply Current Capabilities	1-5	3-1	Command Syntax Conventions	3-2
2-1	IPB/IPC Firmware Diagnostic Error Messages	2-9	3-2	Memory Test Utility Commands	3-6
			3-3	Confidence Test Procedure	3-8

1-1. INTRODUCTION

This chapter provides a functional description and salient specifications of the Model 22X (220, 221, 222, 225, 226, and 227) and Model 23X (230, 231, and 232) Intellec Series II Microcomputer Development Systems. Except where stated otherwise, the information provided herein applies to both the Model 22X system and the Model 23X system.

1-2. FUNCTIONAL DESCRIPTION

The Model 22X/23X system (figure 1-1) consists of a CRT chassis with a six-slot cardcage, power supply, single density floppy diskette drive (Model 22X system only), fans, and cables. A separate ASCII keyboard connects to the CRT chassis by a single cable. The Model 23X system includes a second chassis containing two double density floppy diskette drives, a power supply, and fans.

The master CPU card, called the Integrated Processor Board (IPB) or Integrated Processor Card (IPC), is located in the topmost slot in the six-slot cardcage. The IPB/IPC contains its own microprocessor, memory, input/output, interrupt, and bus interface circuitry, and depending on the system model, employs an Intel 8080A-2 (IPB) or 8085A-2 (IPC) microprocessor. The IPC is the standard master CPU card on the Models 225, 226, and 227. The IPB is the standard master CPU card on all other models.

A second (slave) CPU card is responsible for all remaining I/O control including the CRT and keyboard interface. This card, mounted at the rear of the CRT chassis, also contains its own microprocessor, RAM and ROM memory, and I/O interface logic; thus, in effect, the master and slave CPU cards create a dual processor environment. Known as the I/O Controller (IOC), the slave CPU card communicates with the master CPU card over an 8-bit bidirectional data bus.

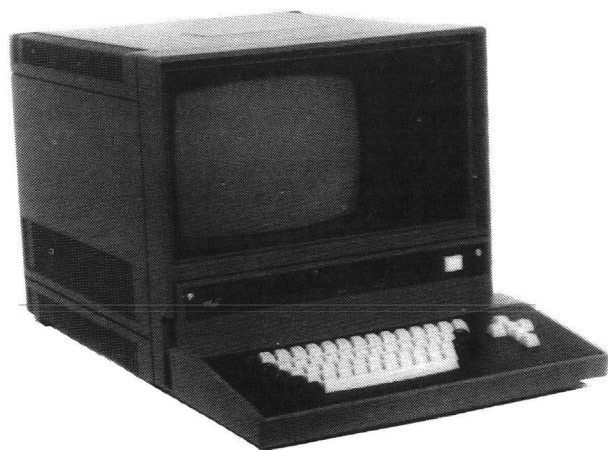

MODEL 22X SYSTEM

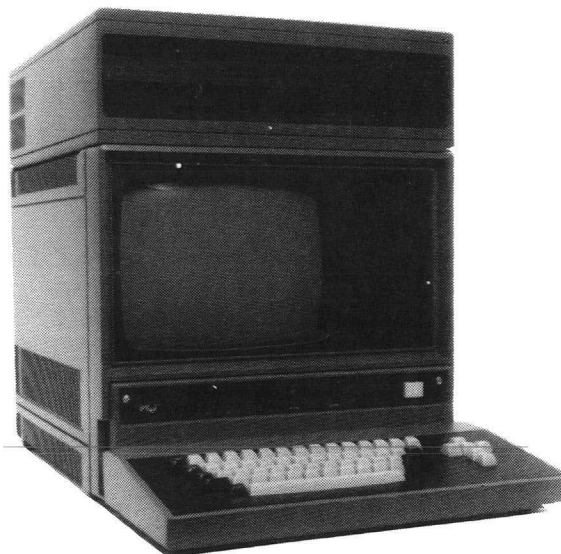

MODEL 23X SYSTEM

Figure 1-1. Intellec® Series II Model 22X/23X Microcomputer Development System

1-3. MASTER CPU CARD (IPB)

The master CPU card for the Models 220, 221, 222, 230, 231, and 232 is the Integrated Processor Board (IPB). The heart of the IPB is an Intel 8080A-2 8-bit NMOS microprocessor running at 2.6 MHz. Included on the card are 32k bytes of RAM and 4k bytes of ROM. The 4k bytes of ROM are preprogrammed with the system bootstrap “self-test” diagnostics and the Intellec Series II System Monitor. An eight-level vectored priority interrupt system is structured around a Programmable Interrupt Controller.

1-4. MASTER CPU CARD (IPC)

The master CPU card for the Models 225, 226, and 227 is the Integrated Processor Card (IPC). The heart of the IPC is an Intel 8085A-2 8-bit NMOS microprocessor running at 4.0 MHz. Included on the card are 64k bytes of RAM and 4k bytes of ROM. The 4k bytes of ROM are preprogrammed with the system bootstrap “self-test” diagnostics and the Intellec Series II System Monitor. An eight-level vectored priority interrupt system is structured around a Programmable Interrupt Controller.

1-5. MEMORY

Standard memory configuration for the system is as follows:

MODEL	RAM	ROM	LOCATION
220, 221, 222	32k	4k	IPB
225, 226, 227	64k	4k	IPC
230, 231, 232	32k	4k	IPB
	32k	—	RAM Board

As mentioned in paragraphs 1-3 and 1-4, the IPB and IPC contain 32k and 64k of RAM, respectively, and 4k of ROM. The Models 230, 231, and 232 also include 32k of RAM on a single board in the cardcage.

1-6. INPUT/OUTPUT SUBSYSTEM

The I/O subsystem consists of two parts: the IOC card and two serial channels on the IPB or IPC card. Each serial channel is RS232 compatible and capable of running asynchronously from 110 to 9600 baud, or synchronously from 150 to 56k baud. Each channel is implemented using an 8251A USART. Baud

rate selection is accomplished programmatically through an 8253 Programmable Interval Timer, which also serves as a real-time clock for the entire system. I/O activity through both serial channels is signaled to the system through a secondary Programmable Interrupt Controller operating in a polled mode and nested to the primary Programmable Interrupt Controller.

The remaining system I/O activity takes place in the IOC card. The IOC provides interface for the CRT, keyboard, and standard peripherals including a printer, high-speed paper tape reader/punch, and the Intel Universal PROM Programmer.

1-7. KEYBOARD AND INTEGRAL CRT

The keyboard interfaces directly to the IOC processor over an 8-bit data bus. The keyboard contains a UPI-41 Universal Peripheral Interface, which scans the keyboard, encodes the characters, and buffers the characters to provide N-key rollover.

The CRT is a 12-inch raster scan type monitor with a 50/60 Hz vertical scan rate and 15.5 kHz horizontal scan rate. The interface to the CRT is provided through an 8275 Programmable CRT Controller. Timing for the CRT control is provided by an 8253 Programmable Interval Timer.

1-8. PERIPHERAL INTERFACE

A UPI-41 Universal Peripheral Interface on the IOC card provides the interface for other standard Intellec peripherals including the printer, high-speed paper tape reader, high-speed paper tape punch, and Universal PROM Programmer mentioned in paragraph 1-6. Communication between the IPB or IPC card and the IOC card is maintained over a separate 8-bit bidirectional data bus. Connectors for the four devices named above, as well as the two serial channels, are mounted directly on the IOC card itself.

1-9. USER CONTROL

User control is maintained through the front panel, which consists of a power switch and indicator, reset/boot switch, run/ halt light, and eight interrupt switches and indicators. The front panel circuit board is attached directly to the IPB/IPC, allowing the eight interrupt switches to connect to the primary Programmable Interrupt Controller as well as to the system bus.

**1-10. DISKETTE SUBSYSTEM
(MODEL 22X)**

The Model 22X system includes an integral 250k byte, single density, floppy diskette drive controlled by an 8271 Programmable Floppy Disk Controller. The 8271 transfers data via an 8257 DMA Controller between an IOC RAM buffer and the diskette. The 8271 handles reading and writing of data, formatting diskettes, and reading status, all upon appropriate commands from the IOC microprocessor.

**1-11. DISKETTE SUBSYSTEM
(MODEL 23X)**

The Model 23X system includes two double density floppy diskette drives, each providing 500k bytes of storage. The diskette controller provides an interface to the system bus as well as supporting up to four diskette drives.

The diskette controller consists of two boards: the channel board and the interface board. These two PC boards reside in the cardcage. The channel board receives, decodes and responds to channel commands from the master CPU on the IPB/IPC. The interface board provides the diskette controller with a means of communication with the diskette drives and with the system bus.

1-12. CARDCAGE EXPANSION

The Model 22X has five slots in the cardcage available for system expansion. The Model 23X has two slots available for system expansion. Additional expansion of four slots can be achieved through the addition of an Intel Series II Expansion Chassis.

1-13. MULTIBUS CAPABILITY

The Model 22X/23X system implements Intel's Multibus architecture, which enables several bus masters, such as CPU and DMA devices, to share the bus and memory by operating at different priority levels. Resolution of bus exchanges is synchronized by a bus clock signal derived independently from processor clocks.

1-14. SPECIFICATIONS

Table 1-1 lists the salient specifications of the Model 22X/23X system. Except where noted otherwise, the specifications apply to all system models. Table 1-2 lists the system mainframe and expansion chassis power supply reserve versus system options.

Table 1-1. Model 22X/23X System Specifications

IPB Master Processor (Model 220, 221, 222, 230, 231, 232)	
Microprocessor:	8080A-2 operating at 2.600 MHz.
RAM:	32k (see note).
ROM:	4k (2k in monitor, 2k in boot/diagnostic).
Bus:	Multibus architecture; bus clock rate is 9.8304 MHz.
IPC Master Processor (Model 225, 226, 227)	
Microprocessor:	8085A-2 operating at 4.0 MHz.
RAM:	64k.
ROM:	4k (2k in monitor, 2k in boot/diagnostic).
Bus:	Multibus architecture; bus clock rate is 9.8304 MHz.
Interrupts:	8-level, maskable, nested priority interrupt network initiated from front panel or user selected devices.
I/O Interfaces	
Serial:	Two RS232 channels at 110-9600 baud (asynchronous) or 150-56,000 baud (synchronous); programmable baud rates and serial formats. Serial Channel 1 provided with 20 mA current loop.
Parallel:	Interface provided for paper tape punch, paper tape reader, printer, and UPP-103 Universal PROM Programmer.

Table 1-1. Model 22X/23X System Specifications (Cont'd.)

Direct Memory Access (DMA):	Standard capability of Multibus architecture; implemented for user-selected DMA devices through optional DMA module. Maximum transfer rate of 2 MHz.
Diskette Subsystem (Model 22X)	
No. of Drives:	One, single density.
Storage Capacity:	250k bytes (formatted).
Transfer Rate:	160k bytes/second.
Access Time:	Track-to-track: 10 ms. Head settling time: 10 ms.
Average Random Positioning:	260 ms.
Rotational Speed:	360 rpm.
Average Rotational Latency:	83 ms.
Recording Mode:	FM.
Diskette Subsystem (Model 23X)	
No. of Drives:	Two, double density.
Storage Capacity:	1M bytes (formatted) total.
Transfer Rate:	500k bytes/second.
Access Time:	Track-to-track: 10 ms. Head settling time: 10 ms.
Average Random Positioning:	260 ms.
Rotational Speed:	360 rpm.
Average Rotational Latency:	83 ms.
Recording Mode:	M ² FM.
AC Requirements:	
Input Voltage:	100/120/220/240 Vac ±10%, 47-63 Hz, single phase.
Input Current:	Model 220 and 225: 5.9A Model 221, 222, 226, and 227: 3.1A Model 230: 5.4A Model 231 and 232: 2.7A
Electrical Characteristics:	See table 1-2.
Environmental Characteristics	
Operating Temperature:	32° to 95°F (0° to 35°C).
Relative Humidity:	To 90% without condensation.
Physical Characteristics	
Model 22X Main Chassis:	Width: 17.37 in. (44.12 cm). Height: 15.81 in. (40.16 cm). Depth: 19.13 in. (48.59 cm). Weight: 86 lb (39 kg).
Model 23X Main Chassis:	Width: 17.37 in. (44.12 cm). Height: 15.81 in. (40.16 cm). Depth: 19.13 in. (48.59 cm). Weight: 73 lb (33 kg).
Dual Drive Chassis (Model 23X):	Width: 17.6 in. (44.7 cm). Height: 5.7 in. (14.7 cm). Depth: 19.4 in. (49.3 cm). Weight: 43.0 lb (19.5 kg).
Keyboard:	Width: 17.37 in. (44.12 cm). Height: 3.0 in. (7.62 cm). Depth: 9.0 in. (22.86 cm). Weight: 6.0 lb (2.72 kg).
Note: The IPB contains 32k of RAM. Model 23X provides 64k by including a 32K RAM board in cardcage.	

Table 1-2. System Chassis and Optional Expansion Chassis Power Supply Current Capabilities

System Component	Power Supply					
	+5V	+12V	-12V	-10V	+15V	+24V
MODEL 220, 221, 222						
Power Supply Capacity	30.0A	2.5A	0.3A	1.0A	1.5A	1.7A
IPB	4.0A	0.3A	0.1A	0.01A	—	—
IOC	2.8A	0.1A	—	0.01A	—	—
CRT	—	—	—	—	1.5A	—
Keyboard	0.4A	—	—	—	—	—
Diskette Drive	1.0A	—	—	—	—	1.7A
Total Current Drain	8.2A	0.4A	0.1A	0.02A	1.5A	1.7A
Available for Options	21.8A	2.1A	0.2A	0.98A	0	0
MODEL 225, 226, 227						
Power Supply Capacity	30.0A	2.5A	0.3A	1.0A	1.5A	1.7A
IPC	4.3A	1.4A	0.2A	0.02A	—	—
IOC	2.8A	0.1A	—	0.01A	—	—
CRT	—	—	—	—	1.5A	—
Keyboard	0.4A	—	—	—	—	—
Diskette Drive	1.0A	—	—	—	—	1.7A
Total Current Drain	8.5A	1.5A	0.2A	0.03A	1.5A	1.7A
Available for Options	21.5A	1.0A	0.1A	0.97A	0	0
MODEL 230, 231, 232						
Power Supply Capacity	30.0A	2.5A	0.3A	1.0A	1.5A	1.7A
IPB	4.0A	0.3A	0.1A	0.01A	—	—
IOC	2.8A	0.1A	—	0.01A	—	—
CRT	—	—	—	—	1.5A	—
Keyboard	0.4A	—	—	—	—	—
Diskette Controller	5.25A	—	—	0.1A	—	—
iSBC 032 32K RAM Board	2.0A	0.4A	—	0.05A	—	—
Total Current Drain	14.45A	0.8A	0.1A	0.17A	1.5A	0
Available for Options	15.55A	1.7A	0.2A	0.83A	0	1.7A
EXPANSION CHASSIS (OPTIONAL)						
Available for Options	20.0A	2.0A	0.3A	0.8A	N/A	N/A

2-1. INTRODUCTION

This chapter provides unpacking and initial inspection information, preinstallation inspection and system emplacement instructions, and firmware diagnostic procedures for the Intellec Series II Model 22X/23X Systems.

2-2. UNPACKING AND INITIAL INSPECTION

Inspect the shipping carton immediately upon receipt for evidence of mishandling during transit. If the shipping carton is severely damaged or waterstained, request that the carrier's agent be present when the carton is opened. If the carrier's agent is not present when the carton is opened and the contents of the carton are damaged, keep the carton and packing material for the agent's inspection.

For repairs to a product damaged in shipment, contact the Intel MCSD Technical Service Center (see Chapter 5) to obtain a Return Authorization Number and further instructions. A purchase order will be required to complete the repair. A copy of the purchase order should be submitted to the carrier with your claim.

It is suggested that salvageable shipping cartons and packing material be saved for future use in the event the product must be reshipped.

2-3. PREINSTALLATION INSPECTION

Before attempting to use the system, check the integrity of all cables, connectors, socket-mounted integrated circuits, ground straps, and voltage switching card as follows:

1. Place Intellec Series II on a surface that allows access to both front and back of chassis. Disconnect power cord (if connected) and check that three-position DIAGNOSTIC/LINE/LOCAL switch on rear panel is set to LINE (middle) position.
2. Loosen top cover of chassis by removing the two screws near front of cover and the two screws on rear of cover. (See figure 2-1.) Lift off top cover.
3. On Models 22X and 23X there are three edge connectors (J16, J15, and J14, from left to right) at top of IOC printed circuit board at rear of chassis. (See figure 2-2.) In addition to these three connectors, the Model 22X has two additional connectors (J17 and J18) to left of J16. (See figure 2-3.) Carefully disconnect attaching cable from each of these connectors, one at a time, and then push it firmly back on to ensure proper seating.
4. There are integrated circuits (two on Model 23X and three on Model 22X) mounted in sockets below connectors J16, J15, and J14. (Refer to figures 2-2 and 2-3.) Press firmly inward on these integrated circuits to ensure proper seating. Replace top cover.
5. Refer to figure 2-4 and disconnect keyboard cable at point of connection to keyboard assembly, and then push it firmly back on to ensure proper seating. Make certain that ground wire is attached to mounting screw next to keyboard cable plug. If ground wire is loose, turn keyboard assembly over and remove the two screws holding bottom cover in place. Remove bottom cover, attach ground wire, and replace bottom cover.
6. Insert free end of keyboard cable into KEYBOARD connector J1 on rear chassis panel. *Do not route keyboard cable underneath chassis.* Fasten keyboard cable ground wire to screw next to connector J1. (See figure 2-5.)
7. On front panel, rotate the two retaining screws counterclockwise and remove panel. (See figure 2-6.) Remove and discard foam packing material. Remove integrated processor assembly (IPB or IPC) mounted in top slot of cardcage by pulling outward on card extractors at each side of assembly. Refer to figures 2-7 and 2-8. Once IPB/IPC has been removed, press firmly inward on all integrated circuits mounted in sockets to ensure proper seating. Replace IPB/IPC *in the top slot* of cardcage; push firmly inward on card extractors to seat IPB/IPC fully into its backplane connector.
8. If you have a Model 22X, replace front panel and proceed with step 17. If you have a Model 23X, perform all remaining steps.

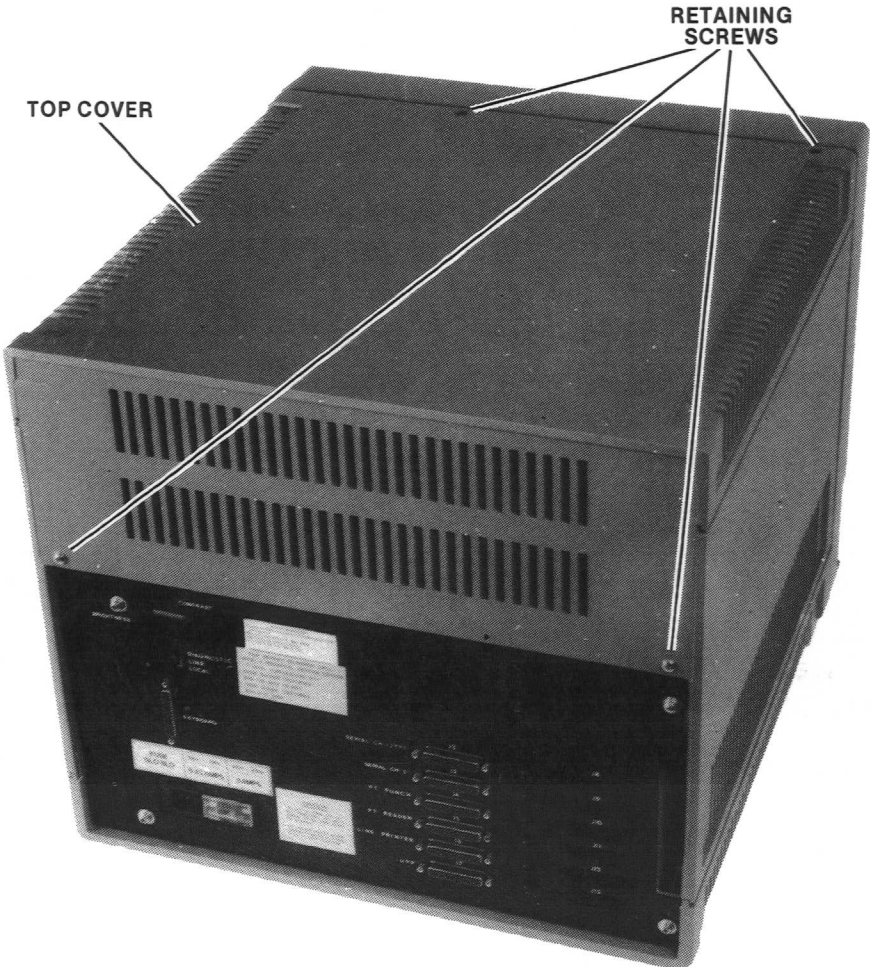

Figure 2-1. Chassis Top Cover Removal

559-46A

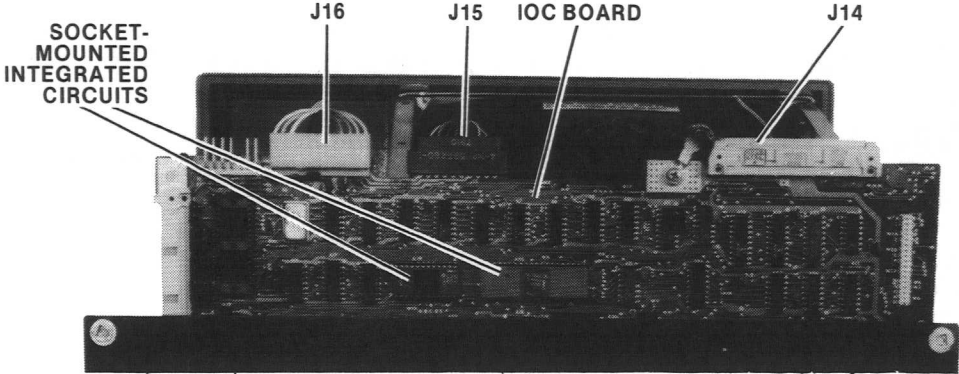

Figure 2-2. Model 23X Edge Connectors and Socket-Mounted Integrated Circuits

559-47A

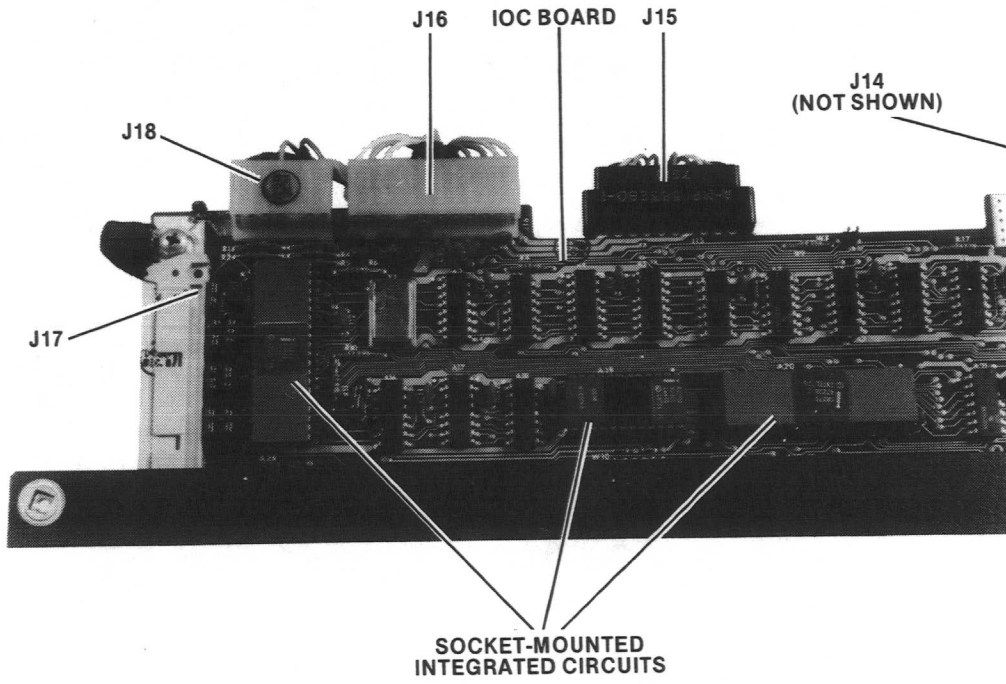

Figure 2-3. Model 22X Edge Connectors and Socket-Mounted Integrated Circuits

559-48A

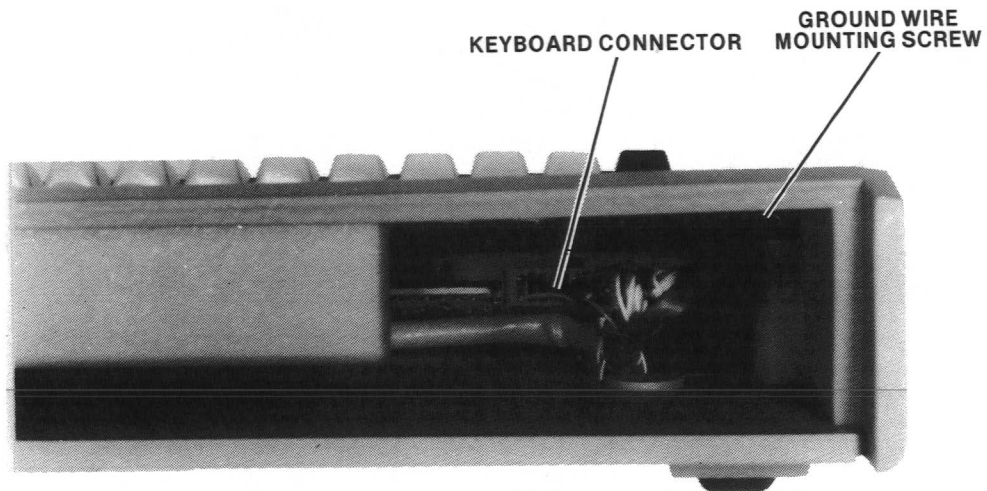

Figure 2-4. Keyboard Cable Connection

559-52

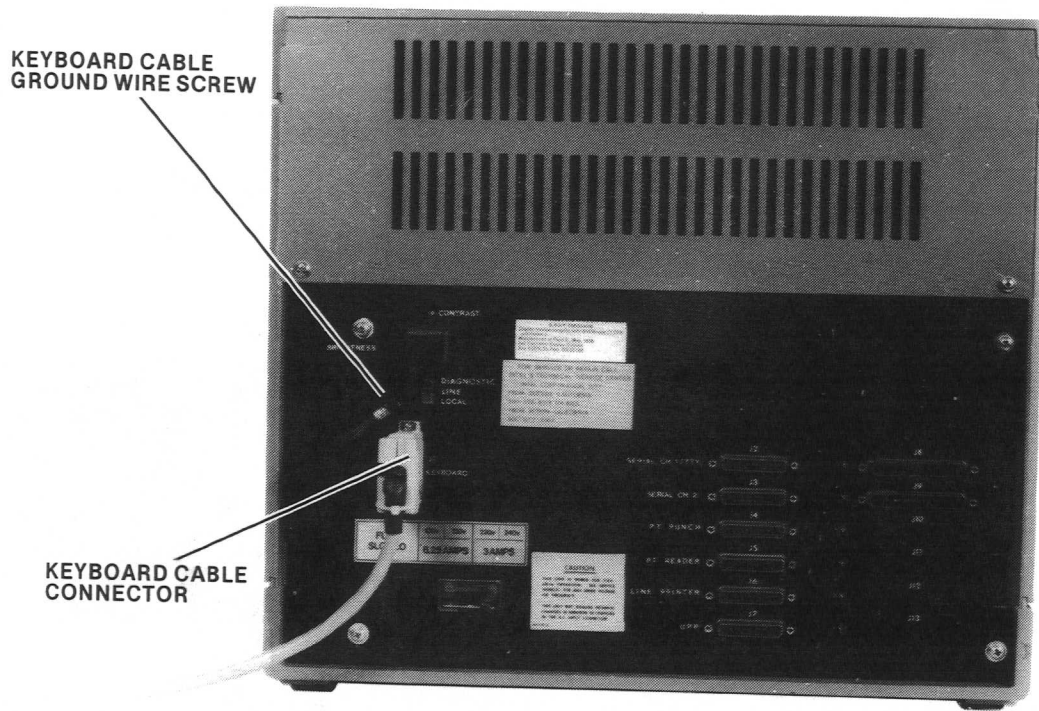

Figure 2-5. Rear Panel Keyboard Connection

559-53

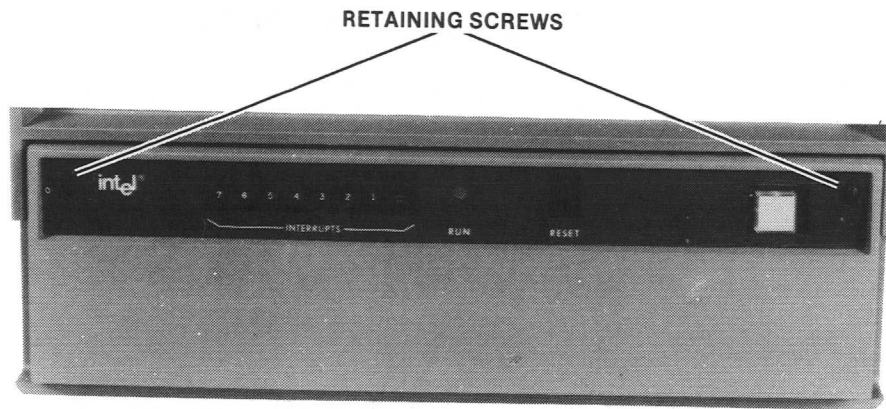

Figure 2-6. Model 22X/23X System Front Panel

559-54A

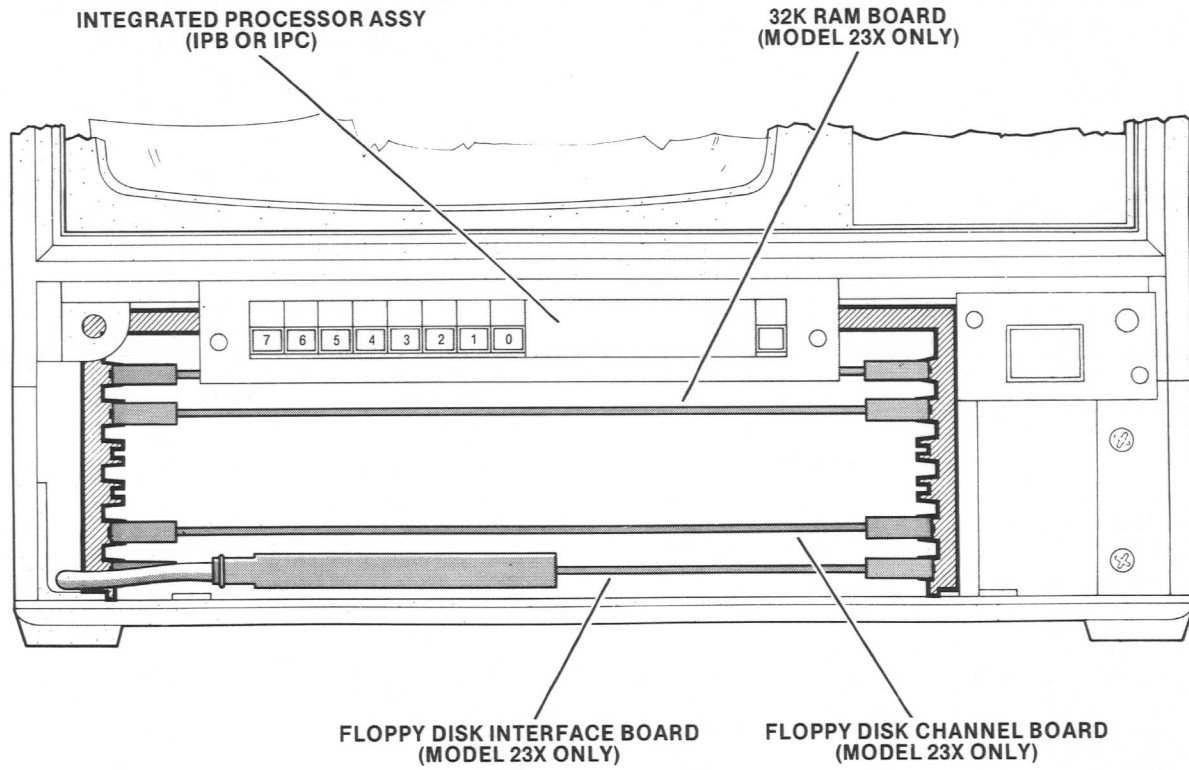

Figure 2-7. Model 22X/23X System Cardcage

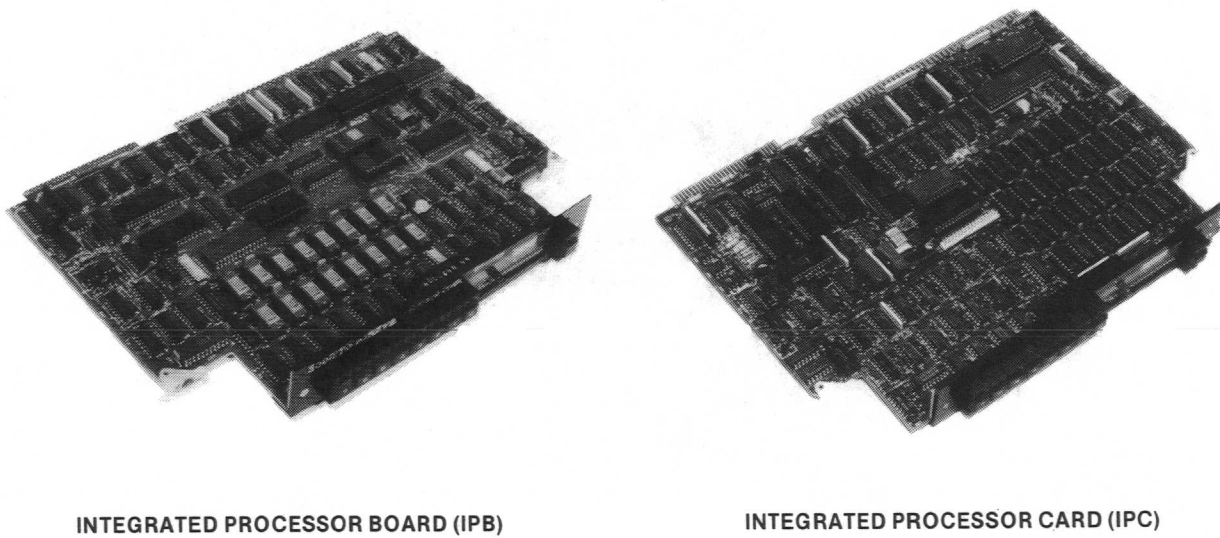

Figure 2-8. Integrated Processor Assemblies

559-56

9. Remove 32k RAM board directly below IPB/IPC assembly. Ensure that there are jumpers connected to and seated fully onto the following jumper posts:

E1 to E10	}	ADR SEL
E4 to E15		
E5 to E21		
E7 to E17		
E8 to E18		
E29 to E31		
T50 to L1		

Replace 32k RAM board in cardcage slot directly below IPB/IPC assembly; push firmly inward on card extractor to seat board into its backplane connector.

10. Examine the two printed circuit boards in the bottom two slots of cardcage. Remove large cable connector from interface board, and then remove *both* boards at once. A dual auxiliary connector is mounted on left rear, connecting both the interface board and channel board. (See figure 2-9.) Remove this connector.
11. Examine channel board switch S1, which is a light blue rectangular switch package with eight white switches. Switches 1, 2, 3, and 8 must be set to ON; 4, 5, 6, and 7 must be set to OFF. Push firmly inward on all integrated circuits mounted in sockets to ensure proper seating.
12. Examine interface board rotary switch S1. This switch must be set to position 3. Push firmly inward on integrated circuit mounted in socket to ensure proper seating.
13. Reinstall dual auxiliary connector. Be certain that connector is properly aligned with traces brought out to edge of boards. When you have verified this, replace the two boards in the bottom two slots of cardcage. Press firmly inward on all four card extractors to seat both boards into their backplane connectors.
14. Reinstall large cable connector on interface board. Reinstall front panel.

NOTE

Figure 2-9 shows the dual auxiliary connector installed such that the interface board will be mounted above the channel board when installed in the cardcage. As shown in figure 2-7, the positions of these boards can be reversed without affecting their operation.

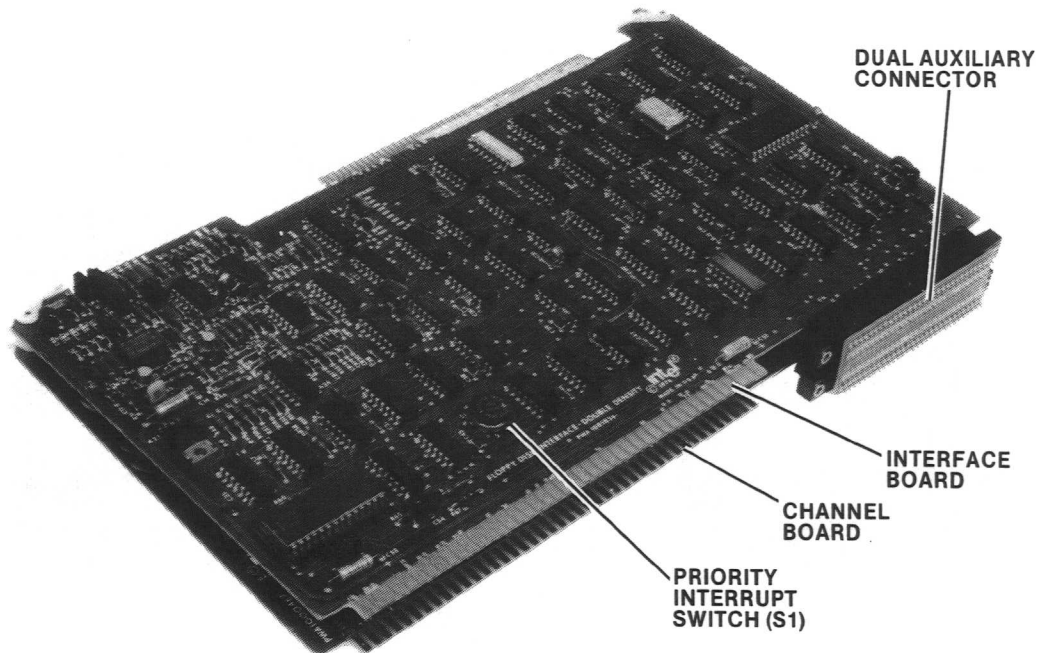

Figure 2-9. Dual Double Density Diskette Drive Controller

559-57A

15. Unpack disk drive and place on top of Model 23X chassis. (Refer to figure 2-10.) Fasten disk drive cable to the connector on rear panel of disk drive chassis and connect ground wire to adjacent screw. Fasten other end of disk drive cable to connector J8 on Model 23X rear chassis panel. Connect ground wire to screw adjacent to connector J8. Attach the two aluminum ground strips between rear panels of disk drive and Model 23X.

NOTE

The internal power supply for the double density diskette drive is configured *at the factory* for 110V or 220V ac. This power supply *cannot be reconfigured in the field* (i.e., 110V to 220V or vice versa).

16. Check voltage stickers on disk drive; voltage must match your available commercial power. On rear panel of disk drive, disconnect power cord (if connected) and slide fuse holder door on main power socket to left as shown in figure 2-11. Remove voltage switching card and reinstall it in position corresponding to your available commercial power. Verify that proper

fuse is installed: 2A slow-blow fuse for 100V or 120V; 1A slow-blow fuse for 220V or 240V. Close fuse holder door and install power cord.

17. On rear panel of Model 22X/23X, disconnect power cord (if connected) and slide fuse holder door on main power socket to left as shown in figure 2-11. Remove voltage switching card and reinstall it in position corresponding to your available commercial power. Verify that proper fuse is installed: 6.25A slow-blow fuse for 100V or 120V; 3A slow-blow fuse for 220V or 240V. Close fuse holder door and install power cord.

2-4. SYSTEM EMPLACEMENT

The physical characteristics of the Model 22X/23X are given in table 1-1. Ensure that the work surface and support capability of the bench, table, desk, or other structure will accommodate the system.

The power cord for the system plugs into a three-conductor power outlet. The round pin is safety power ground. If your facility does not have a three-conductor outlet, do not defeat the safety ground feature by using a three-prong to two-prong adapter. Have a qualified electrician rewire the system power outlet to accommodate the third wire.

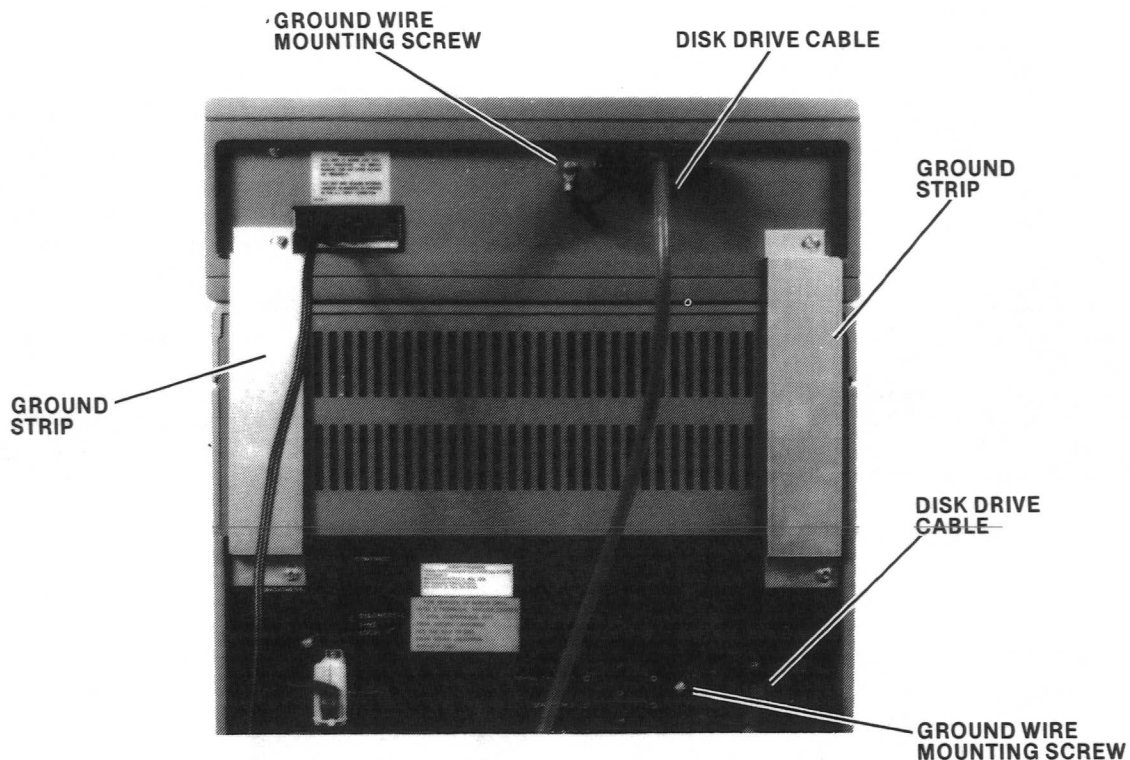

Figure 2-10. Dual Double Density Diskette Drive Installation

559-58A

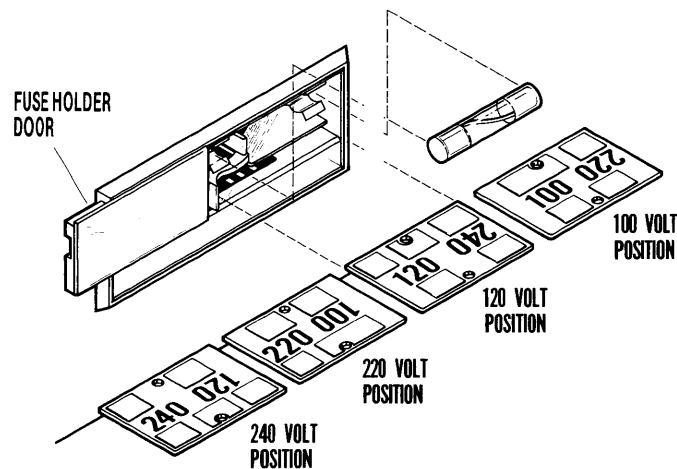

Figure 2-11. Voltage Switching Card Orientation

As with most sensitive electronic equipment, the Model 22X/23X system is not totally immune to its environment, in particular with respect to electrostatic discharge (ESD). To minimize performance problems related to ESD:

1. Maintain a relatively high (>60%) humidity environment.
2. Use antistatic mats in the work area.

If these precautionary steps are taken and you experience problems seemingly related to ESD, you can obtain service and repair assistance from Intel as directed in Chapter 5.

2-5. FIRMWARE DIAGNOSTIC TESTS

There are three firmware diagnostic tests and a Confidence Test for the Model 22X/23X system. Although each test will detect errors in the system, all four tests must be run to provide complete verification of system performance. The three firmware diagnostic tests are described in following paragraphs. The Confidence Test is presented in Chapter 3.

2-6. POWER-UP/RESET DIAGNOSTIC

The power-up/reset diagnostic runs automatically when power is first applied to the system or when the system is reset. This diagnostic verifies operation of the basic IPB/IPC and IOC circuits, but is not comprehensive. If there is any question about the

system's operation, perform the IPB/IPC and IOC diagnostics described in paragraphs 2-7 and 2-8 and the Confidence Test described in Chapter 3.

The system gives no indication that it has passed the power-up/reset diagnostic. If failures are detected, an error message or messages will be displayed on the CRT.

2-7. IPB/IPC DIAGNOSTIC

The IPB/IPC diagnostic tests circuits on both the IPB (or IPC) and the IOC. It is more comprehensive than the power-up/reset diagnostic and is easily called, but does not test all system functions. Specifically, this diagnostic checks (1) ROM and parallel input-output (PIO) checksums, (2) IOC interrupts and RAM, (3) PIO interrupts and RAM, and (4) system RAM.

To run the IPB/IPC diagnostic, proceed as follows:

1. Ensure that DIAGNOSTIC/LINE/LOCAL switch on rear panel is set to LINE (middle) position.
2. Turn power on and press RESET. The system responds with the monitor sign-on message

```
SERIES II MONITOR, Vx.y
```

where x.y indicates the version and release number of the monitor.

3. Call IPB/IPC diagnostic by typing

```
Z$ cr
```

where *cr* denotes a carriage return.

If your system has 64k of RAM memory and no errors are detected, the CRT will display:

```
INTELLEC SERIES II DIAGNOSTIC Vx.y
TESTING CHECKSUMS-PASSED
TESTING IOC-PASSED
TESTING PIO-PASSED
TESTING RAM-PASSED
END DIAGNOSTIC
```

If the diagnostic detects errors, error messages will be displayed under the TESTING CHECKSUMS, TESTING IOC, TESTING PIO, or TESTING RAM messages as appropriate. The error messages and probable failures are shown in table 2-1.

If your configuration has less than 64k of RAM memory, the memory test will produce an error message indicating a "failure" of the 32-48k memory bank and/or 48-62k memory bank as follows:

```
TESTING RAM
FAILURE-RAM BANK 32-48K
FAILURE-RAM BANK 48-62K
```

This does not indicate a real failure; it indicates only a recognition of the system configuration.

2-8. IOC DIAGNOSTIC

The IOC diagnostic tests circuits that (except for the reset) are exclusively located on the IOC. It is therefore a good test to use to isolate troubles to

either the IOC or the IPB/IPC. The IOC diagnostic also provides an audible indication of the test and can therefore be run as a starting point when the CRT is not providing correct indications.

In addition to testing the IOC, the IOC diagnostic also tests the keyboard, the CRT, and the integral disk drive on the Model 22X. Probable causes of failures encountered during execution of the IOC firmware diagnostic are listed in table 2-2.

Table 2-1. IPB/IPC Firmware Diagnostic Error Messages

Error Message	Probable Failure*
FAILURE—BOOT CHECKSUM	IPB/IPC
FAILURE—IOC CHECKSUM	IPB/IPC
FAILURE—IOC INTERRUPTS	IPB/IPC or IOC**
FAILURE—IOC NOT RESPONDING	IOC
FAILURE—IOC RAM	IOC
FAILURE—MONITOR CHECKSUM	IPB/IPC
FAILURE—PIO CHECKSUM	IOC
FAILURE—PIO INTERRUPTS	IPB/IPC or IOC**
FAILURE—PIO NOT RESPONDING	IOC
FAILURE—PIO RAM	IOC
FAILURE—RAM BANK mmK-nnK	0-32k : IPB/IPC 32-48k : IPC/RAM board 48-64k : IPC/RAM board

*Before replacing any board, run IOC diagnostic. Make decision based on results of all tests.
**Most probable cause is IPB/IPC, but may be IOC. Replace IPB/IPC first.

Table 2-2. IOC Firmware Diagnostic Errors/Error Messages

Errors/Error Message	Problem Failure
Failed Power-Up Reset Test	Faulty IPB/IPC or IOC. Analyze error message.
Failed Integral Disk (D) Test	Faulty IOC, disk, cable, or disk drive.
READ ERROR	Fields of result byte nnnnnnnn are:
ERROR nnnnnnnn	
Failed General (G) Test	Faulty IOC.
Failed Keyboard (K) Test	Single bad character indicates faulty keyboard or keyboard cable. Multiple bad characters indicate faulty IOC.

To run the IOC diagnostic, proceed as follows:

1. On rear panel, set DIAGNOSTIC/LINE/LOCAL switch to DIAGNOSTIC (up) position. Press RESET.
2. System runs a "five-beep" test automatically when RESET is pressed. If test executes correctly, you will hear the five beeps spaced as follows: two beeps, slight pause, three beeps. After fifth beep, system displays the following sign-on message:

```
INTELLEC SERIES II IOC DIAGNOSTIC Vx.y
TYPE CNTL-@, RUBOUT, 'U' AND '*'
```

```
REQUESTED      RECEIVED
```

3. Type

```
CNTL-@ (CNTL and @ keys simultaneously)
RUBOUT
U
*
```

4. System checks and displays each input and then displays the test menu as follows:

```
REQUESTED      RECEIVED

↑@ 00000000 ↑@ 00000000
RO 01111111 RO 01111111
U  01010101 U  01010101
*  00101010 *  00101010
```

```
D-DISK
G-GENERAL
K-KEYBOARD
```

If REQUESTED and RECEIVED data do not match, system will display ERROR and indicate faulty bits. For example:

```
REQUESTED      RECEIVED

↑@ 00000000 ↑@ 00000000
RO 01111111 W  01110111 ERROR 00001000
U  01010101 U  01010101
*  00101010 #  00100011 ERROR 00001001
```

2-9. INTEGRAL DISK DRIVE TEST. This test may be selected only when IOC diagnostic test menu is displayed. If system has an *integral* disk drive (e.g., Model 22X), proceed as follows:

1. Type

```
D
```

System prompts

```
DISK TEST
Insert SCRATCH disk and type '#'.
```

If system does not have an integral disk drive (i.e., Model 23X), disk test terminates after "D" is typed and system displays "NO DRIVE".

2. Insert scratch diskette; ensure that diskette is write enabled. Type

```
#
```

3. System runs test in approximately 40 seconds. Indicator on drive lights during test and you can hear drive operating. If system passes test, the test menu is displayed. If there is a failure, system displays

```
READ ERROR
```

or

```
ERROR nnnnnnnn (see table 2-2)
```

2-10. GENERAL TEST. To select and execute the general test from IOC diagnostic test menu:

1. Type

```
G
```

2. System displays

```
TEST PASSED
```

or

```
TEST FAILED
```

and menu.

2-11. KEYBOARD TEST. To select and execute the keyboard test from IOC diagnostic test menu:

1. Type

```
K
```

2. System displays full screen (25 lines, 80 characters per line) of characters.

3. Type each keyboard character. System displays full screen of each typed character. Note that pressing CNTL and any other key displays fx, where "x" is other key. Note that letters are displayed as capitals unless TPWR key is also pressed and latched. Letters follow SHIFT key when TPWR key is released.

4. On rear panel, set DIAGNOSTIC/LINE/LOCAL switch to LINE (middle) position. Press RESET. System displays

```
SERIES II MONITOR, Vx.y
```



3-1. INTRODUCTION

The Confidence Test, which runs under Version 4.0 (or later) of the ISIS-II Disk Operating System, provides a comprehensive test of the Intellec Series II system assemblies and peripherals. For each functional test, the Confidence Test outputs a PASS or FAIL message based on the expected and actual results, or prompts the operator to make a PASS or FAIL decision based on the displayed or printed output.

3-2. TEST DESCRIPTION

The Confidence Test is comprised of 12 functional tests, and is almost totally interactive in that all but two of the tests require some operator response. If the requested response is not received in a predetermined period of time, that particular functional test times out and is not executed.

There are two levels of test software: CONFID and CONFID.OVx. CONFID is the control module that selects which functional test is to be executed by accepting and interpreting the parameters passed to it by CONF (the test handler). CONFID.OVx, the overlay files, contains the functional tests to be executed (x is the overlay number).

The 12 functional tests performed by the Confidence Test are listed below and described in following paragraphs.

Test	Function
0	PROCESSOR TEST
1	CRT CHARACTER SET TEST
2	KEYBOARD CHARACTER SET TEST
3	CRT WRITE TEST
4	CRT CURSOR TEST
5	TTY TEST
6	LINE PRINTER TEST
7	HIGH SPEED PUNCH TEST
8	HIGH SPEED READER TEST
9	FRONT PANEL INTERRUPT TEST
A	FLOPPY DISK TEST
B	MEMORY TEST

3-3. TEST 0—PROCESSOR TEST

This test executes all IPB (8080) or IPC (8085) instructions and verifies the results. If a failure occurs, the test terminates and displays the address of the failure. (This address is a function of the Monitor and cannot be used to determine the exact failure). If a failure is encountered, control is passed to the Monitor. The remaining tests are not executed because further results are meaningless if the IPB or IPC is malfunctioning.

3-4. TEST 1—CRT CHARACTER SET TEST

This test outputs all the displayable characters to the integral CRT, and prompts the operator to examine the output and make a PASS or FAIL decision based on the quality of the displayed characters.

3-5. TEST 2—KEYBOARD CHARACTER SET TEST

This test checks the integral keyboard and prompts the operator to type each key. Any nonfunctioning key or bad keycode will be detected. If the test detects a failure, the test will continue checking the rest of the keyboard.

3-6. TEST 3—CRT WRITE TEST

This test outputs two screenfuls of characters to the integral CRT. The first screenful is filled with the numbers 0 through 9 repeatedly. Since no carriage returns are issued, the last line will show if any characters have been lost; the last line should be a full line of output. The second screenful is blank; i.e., the cursor moves through each position of the CRT screen without outputting characters. The operator is prompted to make a PASS or FAIL decision after each screenful.

3-7. TEST 4—CRT CURSOR TEST

This test, using cursor controls, outputs a rectangular pattern of asterisks (*) to the integral CRT. The operator is prompted to examine the screen at the end of the test and make a PASS or FAIL decision based on the display.

3-8. TEST 5—TTY TEST

This test checks the TTY keyboard and the TTY printer, punch, and reader. First, two lines of the standard ASCII character set are printed, after which the program echoes back to the TTY all keys that are pressed on the TTY keyboard.

The test then punches a null leader, two lines of the standard ASCII character set, and a null trailer, and prompts the operator to turn off the punch and load the paper tape that was just punched into the TTY reader. Finally, the tape is read and compared with correct data that should have been punched.

3-9. TEST 6—LINE PRINTER TEST

This test outputs the standard ASCII character set to the lineprinter and prompts the operator to examine the print quality and make a PASS or FAIL decision.

3-10. TEST 7—HIGH SPEED PUNCH TEST

This test punches a null header, two lines of the standard ASCII character set, and a null trailer. The punched tape may be examined for correct data or the tape can be used in the High Speed Reader Test described next.

3-11. TEST 8—HIGH SPEED READER TEST

This test prompts the operator to load the paper tape produced during the High Speed Punch Test into the high speed tape reader. The tape is read and compared with the correct data that should have been punched.

3-12. TEST 9—FRONT PANEL INTERRUPT TEST

This test checks the front panel interrupt switch operation. The operator is prompted to press each interrupt switch in any order. The test then services them in the selected order, making sure that the priority and jump addresses are correct.

3-13. TEST A—FLOPPY DISK TEST

This test exercises all installed floppy disk drives, starting with the external drive(s) and ending with the integral drive (if installed); the disk controller must be set at port address 78H or 88H. The disk(s) are formatted, then data is randomly written and read

from a variety of tracks and sectors, both in a single sector mode and multisector mode. Finally, the test performs a write, verify, and recalibrate on each drive.

3-14. TEST B—MEMORY TEST

This test checks all installed RAM memory, detects failures, and reports errors to aid in system diagnosis. This test allows the operator to select and run one of the following five types of tests:

1. A marching ones and zeros test to provide a quick, simple test to check for stuck cells and addressing problems.
2. A walking ones and zeros test to check for pattern sensitivity and access problems.
3. A galloping pattern (galpat) test to check for pattern sensitivity and access problems. This is an extended test sequence of the walking ones and zeros test.
4. A refresh test to locate RAM refresh failures not detectable by the other tests, which refresh RAM by reading and writing.
5. An address test to locate memory address errors.

The memory test has a set of utility commands to allow the operator to examine and optionally modify the parameters used by the selected type of memory test. These utility commands are described in paragraph 3-26.

3-15. COMMAND SYNTAX CONVENTIONS

Table 3-1 summarizes the syntax convention used in the Test Manager commands and the Memory Test utility commands.

Table 3-1. Command Syntax Conventions

Notation	Description
UPPERCASE Letters	Elements in uppercase are specific keywords that must be entered exactly as shown (or abbreviated as described in paragraph 3-16).
<i>lowercase italics</i>	Elements in lowercase italics identify tokens. From each set, select and enter a specific identifier.

Table 3-1. Command Syntax Conventions Cont'd)

Notation	Description
...	Elements followed by an ellipsis (...) may be repeated indefinitely.
[]	When only one element is enclosed in brackets, that element is optional. When two or more elements are enclosed in brackets, ALL elements are optional but only ONE element may be entered.
{ }	One, and <i>only</i> one, of the elements enclosed in braces must be entered.

3-16. TEST MANAGER COMMANDS

The Confidence Test includes nine Test Manager commands that allow the operator to specify the test sequence and report the result in an orderly manner. These test commands are described in following paragraphs. As shown below, any command consisting of four or more letters can be abbreviated to the first three letters of the command. Additionally, the letter T is accepted as an abbreviation for TEST.

Command	Abbreviation	Paragraph
TEST	T or TES	3-17
DEBUG	DEB	3-18
LIST	LIS	3-19
SUMMARY	SUM	3-20
CLEAR	CLE	3-21
DESCRIBE	DES	3-22
IGNORE	IGN	3-23
RECOGNIZE	REC	3-24
EXIT	EXI	3-25

The function and syntax of each command, including examples, are given in paragraphs 3-17 through 3-25. Test B (Memory Test) includes utility commands associated only with that specific test. These commands are described in paragraph 3-26.

3-17. TEST COMMAND

SYNTAX

```
TEST [ test# [, test#] ... [ ON ERROR
      test# TO test#      ON NOERROR
                        COUNT n
                        FOREVER ] ]
```

where

test# is a test number as listed and described in paragraphs 3-2 through 3-14, and

n is the number of times the test(s) is to run.

DESCRIPTION

The TEST command uses the operator-supplied elements to load and execute one or more software procedures (i.e., tests). The tests are executed in numerical order regardless of the order in which they are specified. If a *test#* (i.e., test number) is specified for which no test exists, an error results.

If ON ERROR is specified, the tests will execute in numerical order and loop only if one or more of the tests return an error condition.

If ON NOERROR is specified, the tests will execute in numerical order and loop only if all tests run without error.

If the COUNT element is included, the specified tests will execute in numerical order *n* times. If *n* = 0, or if *n* is omitted, the tests will not be executed, although the first test will be loaded into memory.

If FOREVER is specified, the tests will execute in numerical order, regardless of errors, and loop repeatedly until the operator hits the ESC key.

It should be noted that Test 0 (Processor Test) is the only test that does not require operator response. For all other tests, the COUNT, ON ERROR, ON NOERROR, or FOREVER element, when included in the TEST command, does not obviate the need for the usual operator response.

EXAMPLES

In the following examples, the asterisk (*) is the Confidence Test prompt for operator input; the *cr* denotes a carriage return.

- Run all tests (0-B) in numerical sequence.
*TEST *cr*
- Run a single test (e.g., Test 5).
*TEST 5 *cr*
- Run a sequence of tests (e.g., Tests 0 through 10).
*TEST 0 TO TEST 10 *cr*
- Run Tests 4, 9, 2, and 8 in numerical sequence.
*TEST 4, 9, 2, 8 *cr*

The TEST command will load and execute Tests 2, 4, 8, and 9 in numerical sequence.

5. Execute a single test (e.g., Test 0) and loop only if no error occurs.
*TEST 0 ON NOERROR *cr*
6. Beginning with Test 7, run and loop on Tests 7, 8, and 9 in sequence until an error occurs and then abort.
*TEST 7 TO 9 ON NOERROR *cr*
7. Loop on a single test (e.g., Test 7) only if an error occurs.
*TEST 7 ON ERROR *cr*
8. Beginning with Test 7, run and loop on Tests 7, 8, 9, and A only if at least one of the tests produces an error.
*TEST 7 TO A ON ERROR *cr*
9. Loop continuously on a single test (e.g., Test 5) regardless of error or no error.
*TEST 5 FOREVER *cr*
10. Beginning with Test 7, run and loop continuously on Tests 7, 8, 9, and A regardless of error or no error.
*TEST 7 TO A FOREVER *cr*
11. Run a single test (e.g., Test 7) a specified number of times (e.g., 10).
*TEST 7 COUNT 10 *cr*
12. Run a sequence of tests (e.g., Tests 7 through 9) five times.
*TEST 7 TO 9 COUNT 5 *cr*

3-18. DEBUG COMMAND

SYNTAX

```
DEBUG = 0
DEBUG = 1
```

DESCRIPTION

The DEBUG command is used to selectively suppress (DEBUG = 0) or display (DEBUG = 1) error messages. The debug switch is cleared during the Confidence Test initialization (i.e., the default condition is DEBUG = 0).

EXAMPLES

1. Run Test 0 through Test 4 and display error messages.
*DEBUG = 1 *cr*
*TEST 0 TO 4 *cr*

3-19. LIST COMMAND

SYNTAX

```
LIST pathname
```

DESCRIPTION

The LIST command causes a copy of all subsequent output, including prompts, input, line echo, and error messages, to be sent to the ISIS-II file *pathname*. If the *pathname* :CO: (the console display) is specified, there is effectively no list file (the initial setting).

EXAMPLES

1. Run Test A and print all output on line printer.
*DEBUG = 1 *cr*
*LIST :LP: *cr*
*TEST A *cr*

3-20. SUMMARY COMMAND

SYNTAX

```
SUMMARY [ test# [, test#] ... ] [ EO ]
```

DESCRIPTION

For each specified test, the following information is displayed by the SUMMARY command: the test number, the number of times executed, the number of times an error occurred, and whether the test was ignored or not. If no test(s) is specified, a summary of all tests will be included. If EO (Errors Only) is specified, only those tests with a non-zero error count will be displayed. The summary listing will be concluded with a statement as to whether any of the specified tests show a non-zero error count. Note that all error counts are given in hexadecimal.

EXAMPLES

1. Display summary of Tests 3, 4, and 5.
*SUMMARY 3 TO 5 *cr*
00003H CRT WRITE TEST
EXECUTE 00002H TIMES, 00000H FAILURES
00004H CRT CURSOR TEST
EXECUTE 00002H TIMES, 00001H FAILURES
00005H TTY TEST
EXECUTE 00002H TIMES, 00000H FAILURES

2. Display summary of Tests 3, 4, and 5 only if a non-zero error count exists.

```
*SUMMARY 3 TO 5 E0 cr
00004H CRT CURSOR TEST
EXECUTE 00002H TIMES, 00001H FAILURES
```

3-21. CLEAR COMMAND

SYNTAX

```
CLEAR [test# [, test#] ... ]
      [test# TO test#
```

DESCRIPTION

For each specified test, or for all tests if *test* range is missing, the execution count and the error count are set to zero. The CLEAR command does not affect the status (ignored or recognized) of a test, nor is the CLEAR command affected by the status of a test.

EXAMPLES

1. Clear execution count and error count on Tests 3, 4, and 5.
*CLEAR 3, 4, 5 cr

3-22. DESCRIBE COMMAND

SYNTAX

```
DESCRIBE [test# [, test#] ... ]
        [test# TO test#
```

DESCRIPTION

The DESCRIBE command displays the name, or description, of the specified test(s), and whether the test(s) would be ignored by the TEST command. If *test* range is missing, the descriptions of all tests will be displayed.

EXAMPLES

1. Describe Tests 3, 4, 5, and 6. (Assume that the IGNORE command has previously been specified for Test 5.)

```
*DESCRIBE 3 TO 6 cr
00003H CRT WRITE TEST
00004H CRT CURSOR TEST
00005H TTY TEST      ****IGNORED****
00006H LINE PRINTER TEST
```

3-23. IGNORE COMMAND

SYNTAX

```
IGNORE {test# [, test#] ... }
      {test# TO test#
```

DESCRIPTION

The IGNORE command allows the operator, at the beginning of the Confidence Test, to declare which test(s) is not to be run. The IGNORE command remains valid until negated, all or in part, by the RECOGNIZE command.

EXAMPLES

1. Run all Confidence Tests except Tests 5, 6, and 8.
*IGNORE 5, 6, 8 cr
*TEST cr

3-24. RECOGNIZE COMMAND

SYNTAX

```
RECOGNIZE {test# [, test#] ... }
          {test# TO test#
```

DESCRIPTION

The RECOGNIZE command allows the operator to negate all or part of a previously issued IGNORE command.

EXAMPLES

1. Assume that Tests 5, 6, and 8 are presently ignored and it is desired to run all tests except Test 6; i.e., Test 6 will remain ignored.
*RECOGNIZE 5, 8 cr
*TEST cr

3-25. EXIT COMMAND

SYNTAX

EXIT

DESCRIPTION

When at the Confidence Test prompt level (*), the EXIT command ends the Test session and returns control to the ISIS-II Disk Operating System.

EXAMPLES

```
*EXIT cr
-
```

3-26. MEMORY TEST UTILITY COMMANDS

The Memory Test (Test B) includes a set of utility commands to allow the operator to selectively run the five RAM memory tests described in paragraph 3-14. These utility commands, which are defined in table

3-2, also allow the operator to (1) examine and optionally modify the test patterns, (2) display or clear the pass and error counts, and (3) display or clear the error table. Any illegal character entered in response to the Memory Test prompt (>) causes the diagnostic to print a query (?) to indicate a syntax error.

NOTE

Loading Test B into memory destroys the Confidence Test code. To execute any test other than the Memory Test, the Confidence Test software must be reloaded.

The execution time for each of the five RAM tests depends on the memory configuration and the processor (IPB or IPC) employed. Typical execution times for a 64k configuration are as follows:

Test	IPB	IPC
Address (A)	25 sec	14.7 sec
Marching (M)	12 sec	7.1 sec
Refresh (R)	28 sec	16.5 sec
Walking (W)	4.0 hrs	2.4 hrs
Galpat (G)	7.5 hrs	4.4 hrs

Table 3-2. Memory Test Utility Commands

Command	Syntax	Description
A	A	Run address test to locate RAM address errors.
C	C	Clear error table.
E	E	Display current pass and error counts in the form PASS=nnnn ERRS=nnnn This message is also output during test after any key (other than ESC) is pressed. This feature gives interim test status and evidence that test is still running.
G	G[<i>pattern</i>]	Run standard galloping pattern (galpat) test on all installed RAM, starting from 0040H. Default pattern is FFH if no <i>pattern</i> is entered.
Kx	K $\left\{ \begin{matrix} A \\ M \\ R \\ W \\ G \end{matrix} \right\}$	Loop on specified test, where x is any one of five tests (A, M, R, W, or G).
KS	KS	Loop on short tests A, M, and R.
KL	KL	Loop on all five tests (A, M, R, W, and G).

Table 3-2. Memory Test Utility Commands (Cont'd.)

Command	Syntax	Description															
M	M[<i>pattern</i>]	Run marching ones and zeros test on all installed RAM, starting from 0040H. Default pattern is FFH if no <i>pattern</i> is entered.															
P	P [<i>new pattern</i>]	Examine and optionally modify foreground pattern used for galpat (G), marching ones and zeros (M), and walking ones and zeros (W) test.															
R	R	Test refresh circuits by writing a pattern, waiting beyond typical 2 ms refresh limit, and verifying pattern.															
S	S	Display error table (most recent 20 errors) in the form <table style="margin-left: auto; margin-right: auto;"> <thead> <tr> <th>ADDRESS</th> <th>EXPECTED</th> <th>RECEIVED</th> </tr> </thead> <tbody> <tr> <td>XX XX</td> <td>xx</td> <td>yy</td> </tr> <tr> <td>.</td> <td>.</td> <td>.</td> </tr> <tr> <td>.</td> <td>.</td> <td>.</td> </tr> <tr> <td>.</td> <td>.</td> <td>.</td> </tr> </tbody> </table>	ADDRESS	EXPECTED	RECEIVED	XX XX	xx	yy
ADDRESS	EXPECTED	RECEIVED															
XX XX	xx	yy															
.	.	.															
.	.	.															
.	.	.															
W	W[<i>pattern</i>]	Run walking ones and zeros test on all installed RAM, starting from 0040H. Default pattern is FFH if no <i>pattern</i> is entered.															
Z	Z	Clear pass and error counts and return to Memory Test prompt (>).															

3-27. RUNNING THE CONFIDENCE TEST

Step-by-step procedures for initializing the Confidence Test and running each individual test routine are provided in table 3-3. To simplify the procedure, the software DEBUG switch is turned off by default (see paragraph 3-18); however, a list of error messages that may occur with the DEBUG switch turned on is presented in Appendix E.

An individual test may be aborted by pressing the keyboard "ESC" key. (It may be necessary in some cases to press "ESC" several times to effect an

abort.) Aborting from Test 0 through Test A returns the program to the Confidence Test prompt (*) level; aborting from Test B returns the program to the Memory Test prompt (>) level.

In the test procedure given in table 3-3, all operator commands and responses are underlined for clarity. After you become familiar with each test routine, you will probably call for a sequence of tests using a single command as described in paragraph 3-17.

Table 3-3. Confidence Test Procedure

CONFIDENCE TEST INITIALIZATION
<p>Turn on Intellec Series II system power. Monitor signs on</p> <p>SERIES II MONITOR, Vx.y</p> <p>Turn on system drive, load ISIS-II system diskette, and press mainframe front panel RESET switch. After ISIS-II system signs on, initialize Confidence Test in one of the following ways.</p> <p>If your system does <i>not</i> include a hard disk subsystem, initialize Confidence Test as follows:</p> <pre> ISIS-II, Vx.y -CONF cr ISIS-II CONF, Vx.y *INIT CONFID cr SERIES II DIAGNOSTIC CONFIDENCE TEST, Vx.y USER RETURN *</pre> <p>If your system <i>includes</i> a hard disk subsystem, initialize Confidence Test as follows:</p> <pre> ISIS-II, Vx.y -:F4:CONF cr ISIS-II CONF, Vx.y *INIT:F4:CONFID cr SERIES II DIAGNOSTIC CONFIDENCE TEST, Vx.y USER RETURN *</pre> <p>Comment: Confidence Test is ready for execution. The following test procedure is run with error messages suppressed by default (i.e., DEBUG = 0). When finished with test session, return to ISIS-II system with EXIT command. (Refer to paragraph 3-25.) If you are unable to initialize Confidence Test, execute firmware diagnostics described in Chapter 2.</p>
TEST 0—PROCESSOR TEST
<pre> *TEST 0 cr PROCESSOR TEST 0000H PROCESSOR TEST "PASSED" *</pre> <p>Comment: If an error is detected, test terminates with four-digit hexadecimal address and passes control back to system Monitor. (The address is displayed as a function of the Monitor and cannot be used to isolate a malfunction.) Remaining Confidence Tests are not executed because further results will be meaningless. Replace IPB/IPC board and re-try test.</p>

Table 3-3. Confidence Test Procedure (Cont'd.)

TEST 1—CRT CHARACTER SET TEST
<p>*TEST 1 cr CRT CHARACTER SET TEST</p> <p>A B C D E F G H I J K L M N O P Q R S T U V W X Y Z 0 1 2 3 4 5 6 7 8 9 0 ! " # \$ % & () * = : - < > ? / + ; [] , .</p> <p style="text-align: center;">***** * EXAMINE OUTPUT—TYPE P(PASS)/F(FAIL) * *****</p> <p>P 0001H CRT CHARACTER SET TEST "PASSED" *</p> <p>Comment: If "F" is typed, or if neither "P" nor "F" is typed, test outputs "FAILED" instead of "PASSED". (If neither "P" nor "F" is typed, test times out and assumes that test failed.) If test fails, replace IOC board and re-try test.</p>
TEST 2—KEYBOARD CHARACTER SET TEST
<p>*TEST 2 cr KEYBOARD CHARACTER SET TEST</p> <p style="text-align: center;">***** * TYPE FOLLOWING CHARACTERS * *****</p> <p>Test outputs entire keyboard character set, one character at a time, and waits for you to type appropriate characters on keyboard. Assuming ALL keys test correctly, test outputs</p> <p>0002H KEYBOARD CHARACTER SET TEST "PASSED" *</p> <p>Test will detect any nonfunctioning key or bad keycode, in which case it outputs</p> <p>KEY INPUT ERROR EXPECTED=x RECEIVED=y</p> <p>and continues test. Upon completion, test will output</p> <p>0002H KEYBOARD CHARACTER SET TEST "FAILED" *</p> <p>If keyboard test fails badly, test terminates immediately with the message</p> <p>TEST ABORTED 0002H KEYBOARD CHARACTER SET TEST "FAILED" *</p> <p>Comment: If test fails, check or replace keyboard cable, keyboard, and IOC board, and re-try test.</p>

Table 3-3. Confidence Test Procedure (Cont'd.)

TEST 3—CRT WRITE TEST
<p>*<u>TEST 3</u> cr CRT WRITE TEST</p> <p>Test outputs 18 lines (80 characters per line) of the numerals 0 through 9. Since no carriage (cursor) returns are included, last line will show if any characters have been lost (last line should be equal in length to previous 17 lines). Test then prompts</p> <pre style="text-align: center;">***** * EXAMINE OUTPUT-TYPE P(PASS)/F(FAIL) * *****</pre> <p><u>P</u> Test moves cursor through each printable position on CRT screen without printing characters; i.e., screen is blank. Test then prompts</p> <pre style="text-align: center;">***** * EXAMINE OUTPUT-TYPE P(PASS)/F(FAIL) * *****</pre> <p><u>P</u> 0003H CRT WRITE TEST "PASSED"</p> <p>Comment: If "F" is typed, or if neither "P" nor "F" is typed, test outputs "FAILED" instead of "PASSED". (If neither "F" nor "P" is typed, test times out and assumes that test fails.) If test fails, replace IOC board and re-try test.</p>
TEST 4—CRT CURSOR TEST
<p>*<u>TEST 4</u> cr CRT WRITE TEST</p> <p>Test outputs a 2-inch by 3-inch rectangular pattern of asterisks (*) and prompts</p> <pre style="text-align: center;">***** * EXAMINE OUTPUT-TYPE P(PASS)/F(FAIL) * *****</pre> <p><u>P</u> 0004H CRT WRITE TEST "PASSED"</p> <p>Comment: If "F" is typed, or if neither "P" nor "F" is typed, test outputs "FAILED" instead of "PASSED". (If neither "F" nor "P" is typed, test times out and assumes that test failed.) If test fails, replace IOC board and re-try test.</p>

Table 3-3. Confidence Test Procedure (Cont'd.)

TEST 5—TTY TEST
<p>Set teletypewriter LINE/OFF/LOCAL to LINE position; ensure that printer paper and blank paper tape are in place.</p> <p>*TEST 5 cr TTY TEST DEPRESS ANY KEY ON TTY KEYBOARD</p> <p>On TTY keyboard, press any key. Teletypewriter prints two lines</p> <pre> ABCDEFGHIJKLMNOPQRSTUVWXYZ0123456789 !"#%&()*+,-./:;<=>?@[] ABCDEFGHIJKLMNOPQRSTUVWXYZ0123456789 !"#%&()*+,-./:;<=>?@[] </pre> <p>and test prompts (1)</p> <p>TYPE CHARACTERS FROM TTY KEYBOARD UNTIL ALTMODE KEY IS PRESSED</p> <p>Type in any key(s) and verify that proper character(s) is echoed back. When finished, press "ALT MODE" key. Test prompts (2)</p> <p>TURN ON TTY PUNCH WHEN READY DEPRESS P KEY ON CRT KEYBOARD</p> <p>Turn on teletypewriter tape punch. On CRT keyboard, press "P" key.</p> <p>Test punches null leader, two lines of standard ASCII character set, and null trailer. Test then prompts (3)</p> <p>TURN OFF TTY PUNCH LOAD PUNCHED TAPE IN TTY READER WHEN READY DEPRESS R KEY ON CRT KEYBOARD</p> <p>Turn off teletypewriter tape punch and turn on tape reader. On CRT keyboard, press "R" key. Test reads tape and outputs</p> <pre> 0005H TTY TEST "PASSED" * </pre> <p>Comment: Test outputs "FAILED" instead of "PASSED" if response to any of the three prompts are ignored. (Test times out and assumes that test failed.) If test fails (other than from an ignored prompt), replace IPB/IPC board and re-try test.</p>
TEST 6—LINE PRINTER TEST
<p>Turn on line printer; ensure that paper is loaded.</p> <p>*TEST 6 cr LINE PRINTER TEST</p> <p>Lineprinter prints ASCII character set on four lines as follows and then prompts</p> <pre> ABCDEFGHIJKLMNOPQRSTUVWXYZ 0123456789 abcdefghijklmnopqrstuvwxyz ! "# \$ % & () * = : - < > ? / + ; [] , . </pre>

Table 3-3. Confidence Test Procedure (Cont'd.)

<pre>***** * EXAMINE OUTPUT-TYPE (PASS) / F (FAIL) * * *****</pre>
<p><u>P</u> 0006H LINE PRINTER TEST "PASSED"</p> <p>Comment: If "F" is typed, or if neither "P" nor "F" is typed, test outputs "FAILED" instead of "PASSED". (If neither "P" nor "F" is typed, test times out and assumes that test failed.) If test fails, replace IOC board and re-try test.</p>
<p>TEST 7—HIGH SPEED PUNCH TEST</p>
<p>Turn on high speed punch; ensure that blank paper tape is in place.</p> <p>*TEST 7 cr HIGH SPEED PUNCH TEST</p> <p>Punch punches null leader, two lines of standard ASCII character set, and null trailer. Test then outputs</p> <p>0007H HIGH SPEED PUNCH TEST "PASSED" *</p> <p>Comment: Test checks only that punch accepted data; punched tape may be examined for correct data or verified in high speed reader test (Test 8). If test outputs "FAILED" instead of "PASSED", replace IOC board and re-try test.</p>
<p>TEST 8—HIGH SPEED READER TEST</p>
<p>Turn on high speed reader.</p> <p>*TEST 8 cr HIGH SPEED READER TEST</p> <p>LOAD HIGH SPEED READER WITH TAPE FROM PUNCH TEST AND DEPRESS R KEY WHEN READY TO READ TAPE</p> <p>Load prepunched tape in high speed reader. On CRT keyboard, press "R" key. Test reads tape and outputs</p> <p>0008H HIGH SPEED READER TEST "PASSED"</p> <p>Comment: Test reads data punched in Test 7. If bad data is read, test outputs "FAILED" instead of "PASSED". In this case, replace IOC board and re-try test.</p>

Table 3-3. Confidence Test Procedure (Cont'd.)

After executing the sequence eleven times, test outputs

```
***WARNING***
BEFORE PERFORMING ANY OTHER TEST THE ISIS
SYSTEM DISKETTE MUST BE PLACED IN ITS DRIVE
DEPRESS RETURN KEY WHEN READY TO CONTINUE
```

Remove scratch diskettes, place ISIS system diskette in system drive, and press "RETURN" key.

```
000BH FLOPPY DISK TEST    "PASSED"
```

Comment: Test outputs "FAILED" instead of "PASSED" if one or more of the drives are either not present or not ready. If test fails otherwise, replace appropriate board(s) and re-try test:

Integral Drive: IOC board

All Other Drives: Diskette Controller (Channel board and Interface board)

TEST B—MEMORY TEST

This procedure runs all five basic memory tests. Hitting "ESC" key while a memory test is running aborts test and returns program to Memory Test prompt level (>). Hitting any key (other than "ESC") gives interim test status as evidence that test is still running. The memory tests do not output a "passed" or "failed" message. If test runs without errors, it outputs an audible beep and a prompt (>). If test fails, it (1) tries to restore correct memory location so error message is not repetitively output for same error, and (2) returns to currently executing test to continue executing. A typical error message heading and error data would look like:

PASS	ADDR	EXPECTED	RECEIVED	ERRS
0000	5256	55	FF	0001
0001	5256	55	FF	0002
:	:	:	:	:
:	:	:	:	:

Loading Test B (Memory Test) into memory destroys all other Confidence Test code in memory. In order to execute any other test once Test B is loaded, ISIS-II system must be rebooted and Confidence Test reloaded.

```
*TEST B cr
MEMORY TEST
```

Immediately after test is initiated, the system memory size is computed. If during this process a memory failure is encountered, test outputs

```
RAM MEMORY SIZE, 32 OR 48 OR 64?_
```

Type 32 (for 32k), 48 (for 48k), or 64 (for 64k) and press "RETURN" key. Test defaults to 32k if any other number or character is entered.

```
>A cr
ADDRESS TEST

>M cr
MARCH TEST

>R cr
REFRESH TEST
```

} See paragraph 3-26 for execution times of these tests.

Table 3-3. Confidence Test Procedure (Cont'd.)

<pre>>W cr WALK TEST</pre>	}	See paragraph 3-26 for execution times of these tests.
<pre>>G cr GALPAT TEST</pre>		
<p>Comment: Depending on system configuration (IPB or IPC), memory failures are located as follows:</p>		
FAILING ADDRESS	IPB SYSTEM	IPC SYSTEM
0000-3FFF	IPB	IPC
4000-7FFF	IPB	IPC
8000-BFFF	RAM BOARD	IPC
C000-FFFF	RAM BOARD	IPC



4-1. INTRODUCTION

This chapter provides step-by-step procedures for installing options to the Intellec Series II system. Before adding any option to your system, refer to table 1-2 and ensure that the reserve capacity of the system power supply is adequate to support the additional current demand. Before starting to install a kit, unpack it and perform an initial inspection as described in Chapter 2 (paragraph 2-2).

4-2. EXPANSION CHASSIS UPGRADE

The expansion chassis, which includes an integral power supply, provides four additional card slots for the Model 22X/23X system. To install the expansion chassis, proceed as follows:

1. Turn off system power and disconnect mainframe power cord.
2. On rear panel, disconnect all peripheral cables. If system includes dual double density diskette drive(s), disconnect attaching hardware and remove drive(s) from top of mainframe.
3. Turn mainframe on its side as shown in figure 4-1. Remove cable port covers from mainframe and expansion chassis.
4. Refer to figure 4-2 and remove jumpers W1 and W2 from underneath connector J16 (accessible through mainframe cable port). Save port covers and jumpers in case expansion chassis is disconnected from mainframe in future.
5. Using supplied hardware, install ground strap on expansion chassis as shown in figure 4-3. Connect the two bus extension cables to connectors inside expansion chassis cable port.

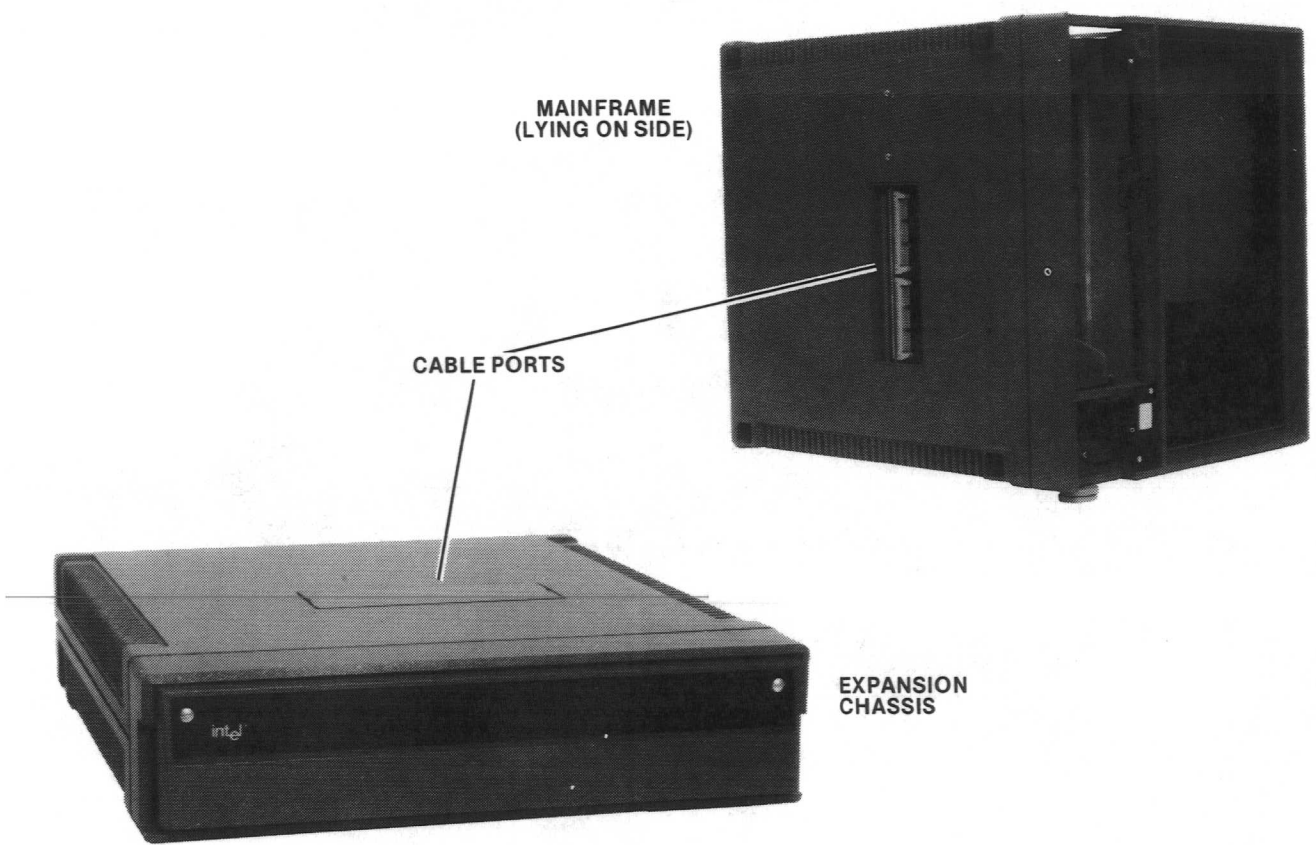

Figure 4-1. Mainframe and Expansion Chassis Cable Ports

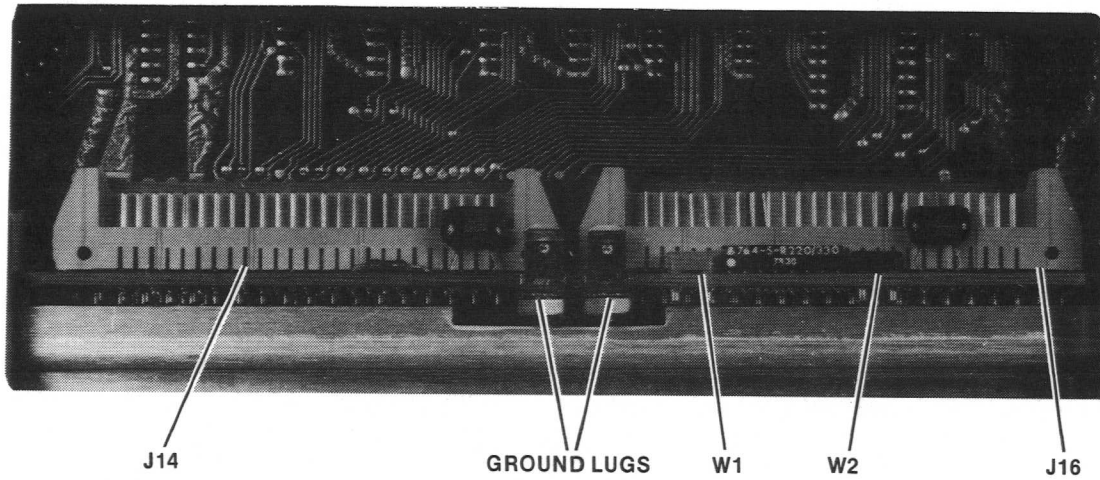

Figure 4-2. Mainframe Cable Port Details

559-75A

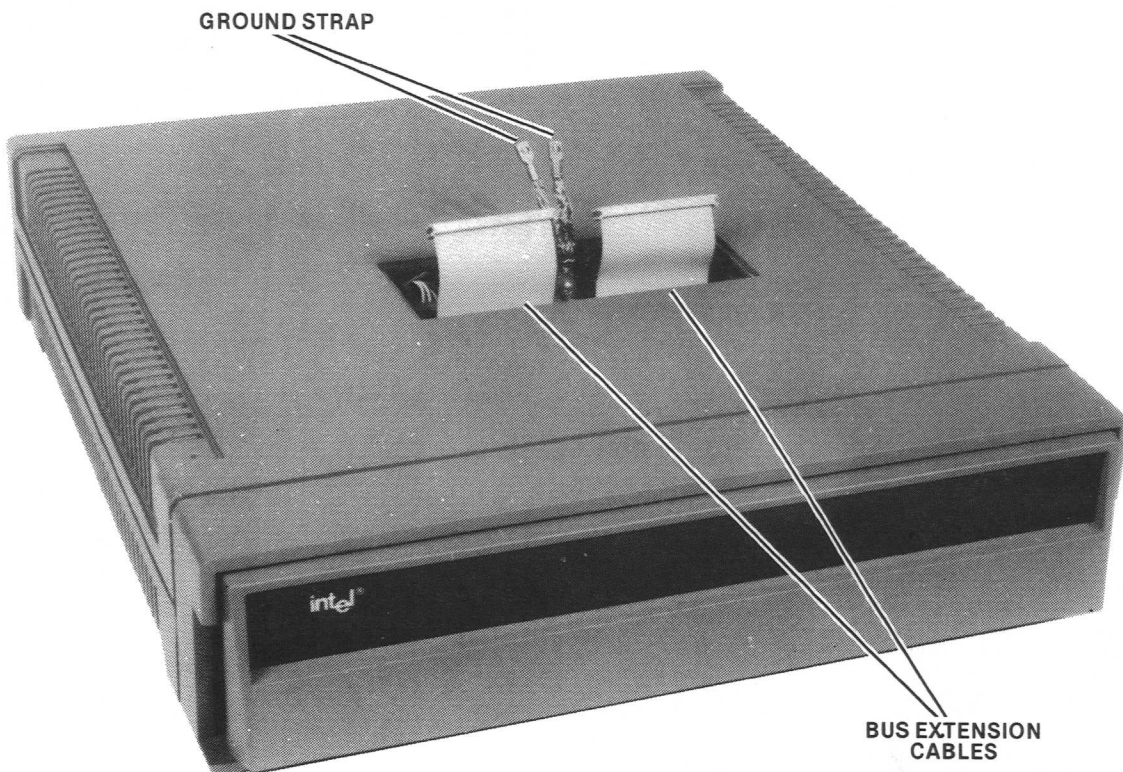

Figure 4-3. Expansion Chassis Cable Port Details

559-74A

6. Place mainframe on top of expansion chassis and tilt it backward.
7. Holding mainframe tilted backward, connect the other ends of the two bus extension cables to J14 and J16 inside mainframe cable port. Attach quick-disconnects on ground strap to the two ground lugs between J14 and J16.
8. Lower mainframe in place over expansion chassis. On rear panel of expansion chassis, disconnect power cord (if connected) and slide fuse holder door on main power socket to left. (Refer to figure 2-11.) Remove voltage switching card and reinstall it in position corresponding to your available commercial power. Verify that proper fuse is installed: 4A normal-blow fuse for 100V or 120V; 2A normal-blow fuse for 220V or 240V. Close fuse holder door and install power cord.
9. Attach aluminum ground strip between rear panels of mainframe and expansion chassis as shown in figure 4-4.
10. On rear panel of mainframe, reconnect all peripheral cables. Reinstall dual double density diskette drive(s) if removed for expansion chassis upgrade.
11. Reconnect mainframe power cord. Turn mainframe power on and verify that expansion chassis fans are operating.
12. Turn mainframe power off. Install a board (known to operate in mainframe) in any slot in expansion chassis cardcage.
13. Turn mainframe power on and execute firmware diagnostics (Chapter 2) and the appropriate test of the Confidence Test (Chapter 3).

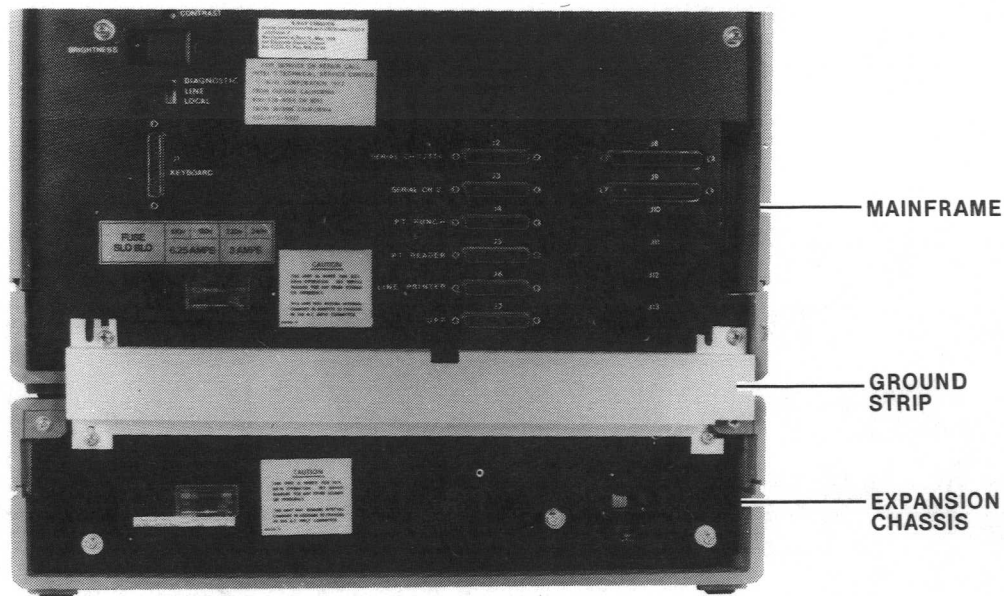

Figure 4-4. Expansion Chassis Ground Strip Installation

559-76A

4-3. MEMORY UPGRADE

The standard Model 220/221/222 includes 32k of RAM memory which can be increased to a maximum of 64k by the addition of one iSBC 032 RAM board or two iSBC 016 RAM boards.

4-4. iSBC-032 32K RAM BOARD

Configure the jumper post shorting plugs on the 32k RAM board and install it in the mainframe or expansion chassis as follows:

1. Refer to figure 4-5 and configure jumper post shorting plugs as follows to select proper address block and timing:

ADDRESS SELECT	TIMING SELECT
W3: E1 to E10	W8: E29 to E31
W4: E4 to E15	W11: T50 to L1
W5: E5 to E21	
W6: E7 to E17	
W7: E8 to E18	

2. Turn off system power and remove mainframe or expansion chassis front panel. Install RAM board in any vacant cardcage slot.
3. Replace front panel and turn on system power. Execute IPB/IPC firmware diagnostic (Chapter 2) and Test B of the Confidence Test (Chapter 3).

4-5. iSBC-016 16K RAM BOARD

Configure the jumper post shorting plugs on the 16k 016 RAM board and install it in the mainframe or expansion chassis as follows:

1. Refer to figure 4-6 and configure jumper post shorting plugs as follows to select desired address block and timing:

ADDRESS SELECT	TIMING SELECT
32-48K: 6 to 7	1 to 2
48-64K: 5 to 7	

2. Turn off system power and remove mainframe or expansion chassis front panel. Install RAM board in any vacant cardcage slot.
3. Replace front panel and turn on system power. Execute IPB/IPC firmware diagnostic (Chapter 2) and Test B if the Confidence Test (Chapter 3).

4-6. DOUBLE DENSITY DISKETTE UPGRADE

The Model 22X can be upgraded to double density diskette capability by the addition of a separate controller and one or two dual drives. The Model 23X, which includes a controller and one dual drive, can be upgraded to a four drive system by installing an additional dual drive.

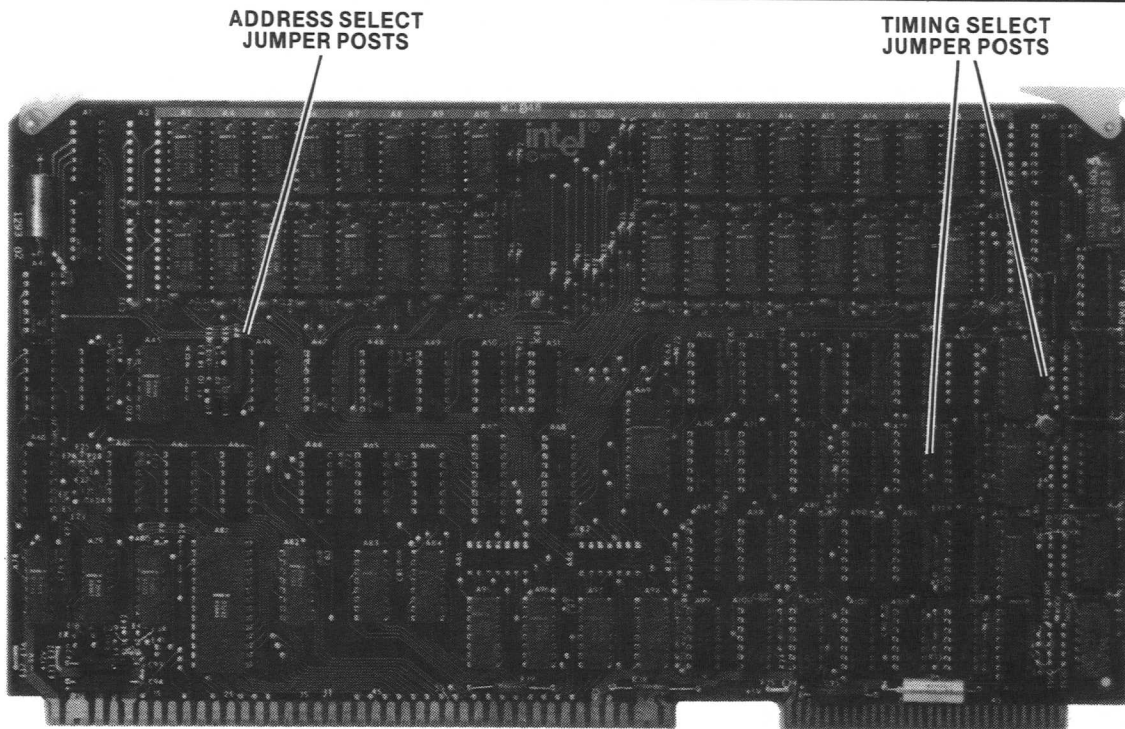

Figure 4-5. iSBC-032™ 32K RAM Board Jumper Post Locations

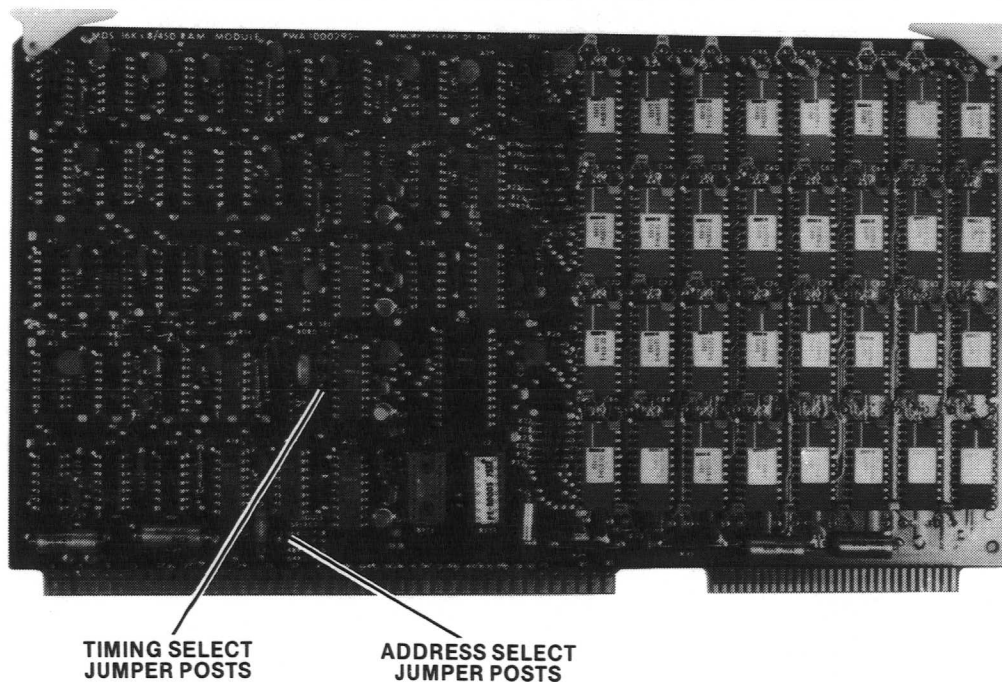

Figure 4-6. iSBC-016™ 16K RAM Board Jumper Post Locations

559-26A

The integral single density diskette in the Model 22X can also be upgraded to double density diskette capability by the installation of a Model 503 upgrade kit. Installation instructions for this kit are given in *Double Density Upgrade Kit Model 503 Installation Instructions*, Manual Order No. 121505.

4-7. DISKETTE CONTROLLER

Install the double density diskette controller (DDDC) in a Model 22X system as follows:

1. Turn off system power, disconnect power cord, and remove mainframe front panel. (See figure 2-6.)
2. The DDDC includes two printed circuit boards: a channel board and an interface board. On channel board, set address select switches to 78H as shown in figure 4-7.
3. On interface board, set interrupt select switch to position 3.

NOTE

Figure 2-9 shows the dual auxiliary connector installed such that the interface board will be mounted above the channel board when installed in the cardcage. As shown in figure 2-7, the positions of these two boards can be reversed without affecting their operation.

4. Install dual auxiliary connector on channel board and interface board edge connectors as shown in figure 2-9. Make certain that connector is properly aligned with traces brought out to edge of boards.
5. Refer to figure 2-7 and install these two boards in bottom two slots of mainframe. Press firmly inward on all four card extractors to seat both boards into their backplane connectors.
6. Loosen top cover of chassis by removing the two screws near front of cover and the two screws on rear of cover. (See figure 2-1.) Lift off top cover.
7. Refer to figure 4-8 and disconnect connectors J14 through J18 from mating connectors on top edge of IOC assembly. Remove the four rear panel retaining screws. Gently pull rear panel assembly slightly away from mainframe to access rear of connectors J8 and J9.
8. The controller cable has a 100-pin hooded connector on one end and two 37-pin connectors labeled "J8 DRIVE 0, 1" and "J9 DRIVE 2, 3" on the opposite end. Using supplied hardware, install 37-pin connector labeled "J8 DRIVE 0, 1" in hole marked "J8" on rear panel.
9. Install 37-pin connector labeled "J9 DRIVE 2, 3" in hold marked "J9" on rear panel.

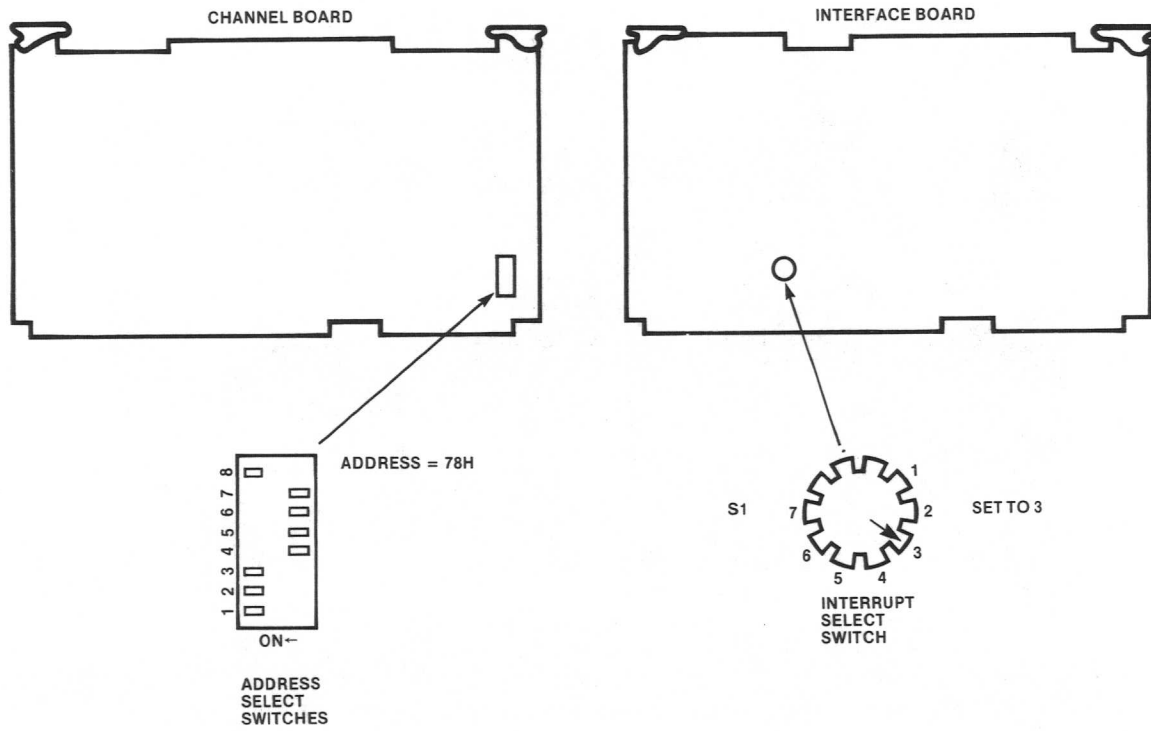

Figure 4-7. Channel Board and Interface Board Switch Settings

1505-3-1

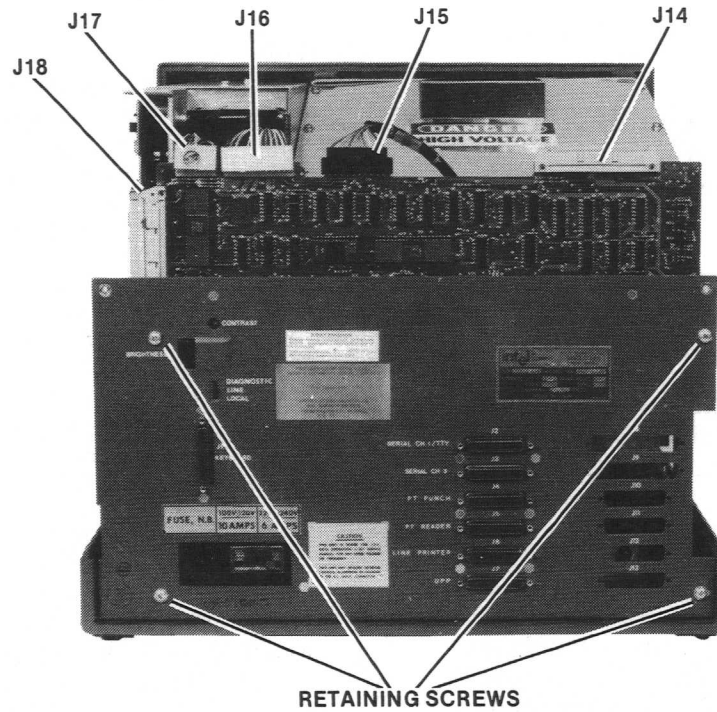

Figure 4-8. Model 22X/23X System Rear Panel

878-27A

10. Route controller cable along side of chassis as shown in figure 4-9. Install 100-pin hooded connector on interface board as shown in figure 2-7.
11. Reinstall and fasten rear panel assembly onto mainframe. Reinstall connectors J14 through J18 on appropriate mating connectors along top edge of IOC assembly.
12. Reinstall front panel and top cover. Install double density diskette drive(s) as described in the following paragraph.

4-8. DUAL DISKETTE DRIVE

Unpack drive(s), interface cable(s), and attaching hardware, and proceed as follows:

NOTE

To install second dual drive in a Model 22X or 23X system, proceed to step 8.

1. Place first dual drive (designated Drives 0 and 1) squarely on top of mainframe.
2. Install the two long aluminum ground strips between rear panels of first dual drive and mainframe. (See figure 4-10.)
3. Fasten interface cable to connector on rear panel of dual drive chassis; connect ground wire lead to adjacent screw.
4. Fasten other end of interface cable to connector J8 on rear panel of mainframe; connect ground wire lead to adjacent screw.

NOTE

The internal power supply for the double density diskette drive is configured *at the factory* for 110V or 220V ac. This power supply *cannot be reconfigured in the field* (i.e., 110V to 220V or vice versa).

5. Check voltage stickers on disk drive; voltage must match your available commercial power. On rear panel of dual drive, disconnect power cord (if connected) and slide fuse holder door on main power socket to left. (Refer to figure 2-11.) Remove voltage switching card and reinstall it in position corresponding to your available commercial power. Verify that proper fuse is installed: 2A slow-blow fuse for 110V or 120V; 1A slow-blow fuse for 220V or 240V. Close fuse holder door and install power cord.
6. This completes the installation of Drives 0 and 1 on a Model 22X system. The integral single density drive is redesignated Drive 4 by default. If installing a second dual drive, proceed with step 8.

7. Reinstall mainframe power cord and execute IOC firmware diagnostic (Chapter 2) and Test A of the Confidence Test (Chapter 2).
8. Place second dual drive (designated Drives 2 and 3) squarely on top of first dual drive. (Refer to figure 4-9.)
9. Install the two short aluminum ground strips between rear panels of first and second dual drives.
10. Fasten interface cable to connector on rear panel of second dual drive; connect ground wire lead to adjacent screw.
11. Fasten other end of interface cable to connector J9 on rear panel of mainframe; connect ground wire to adjacent screw.
12. Perform step 5 for second drive.
13. This completes the installation of Drives 2 and 3. Reinstall mainframe power cord and execute IOC firmware diagnostic (Chapter 2) and Test A of the Confidence Test (Chapter 3).

4-9. INTEGRATED PROCESSOR CARD UPGRADE

To install the integrated processor card (IPC), proceed as follows:

1. Turn off system power and remove mainframe front panel.
2. Refer to figure 2-7 and remove IPB assembly. Pack IPB assembly and store it for possible future use.
3. Install IPC in top slot of cardcage. Push firmly inward on IPC card extractors to seat board into its backplane connectors.
4. Turn on system power and execute IPB/IPC and IOC firmware diagnostics (Chapter 2) and Tests 0 and B of Confidence Test (Chapter 3).

4-10. ADDING PERIPHERALS

The rear panel includes connectors for the following peripheral devices:

- J2: Serial Channel 1/Teletypewriter (TTY)
- J3: Serial Channel 2
- J4: High-Speed Paper Tape Punch
- J5: High-Speed Paper Tape Reader
- J6: Line Printer
- J7: Universal PROM Programmer (UPP)

Interface circuitry for these peripheral devices is provided either on the IOC board or the IPB/IPC board; no additional boards are required in the Model 22X/23X mainframe.

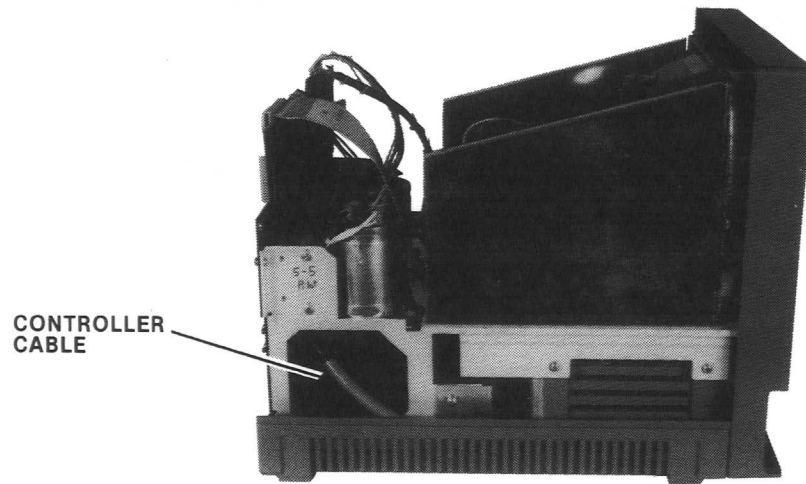

Figure 4-9. Double Density Diskette Controller Cable Routine

559-62A

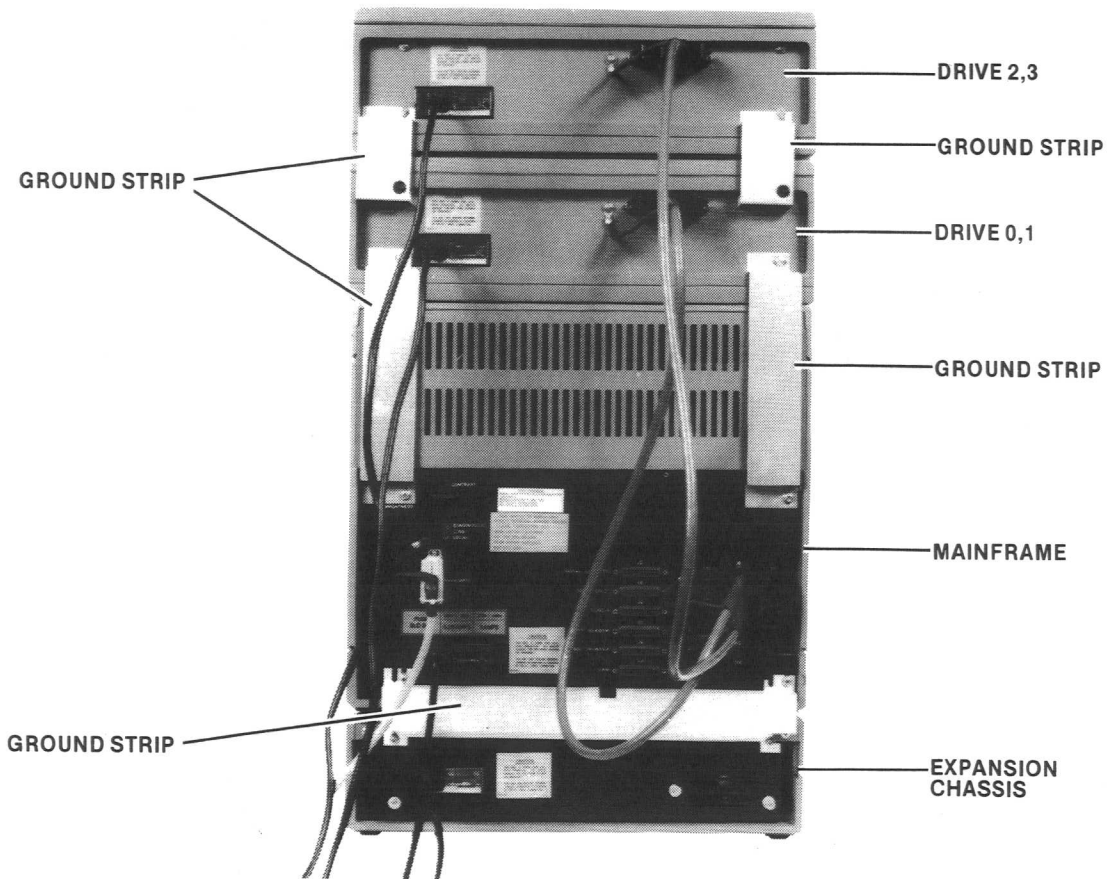

Figure 4-10. Dual Double Density Diskette Drive Installation Details

559-63A

Appendixes A and B provide configuration information for serial I/O interfacing. Appendix C provides instructions on how to modify an ASR-33 Teletypewriter for use in the Model 22X/23X system.

4-11. ADDING IN-CIRCUIT EMULATORS

Any of the currently available Intel Corporation in-circuit emulators may be installed in the Model 22X/23X system. Complete installation details are provided in the appropriate ICE™ module operating

instructions. Ensure that the power supply has ample reserve capacity to support the selected module. (Refer to Chapter 1, table 1-2.)

4-12. ADDING MULTIBUS™ MODULES

The Model 22X/23X will support most of the Intel Corporation single-board computer products described in the *System Data Catalog*. Ensure that the power supply has ample reserve capacity to support the selected module. (Refer to Chapter 1, table 1-2.)

5-1. INTRODUCTION

This chapter provides basic troubleshooting procedures and instructions on how to obtain service and repair assistance.

5-2. BASIC TROUBLESHOOTING

If the system will not power up and the fans are not operating, make the following simple checks:

1. Verify that facility power is available at main power outlet.
2. Ensure that power cord is firmly seated in mainframe power receptacle and main power outlet.
3. Disconnect power cord, open fuse holder door, and check fuse. (Refer to figure 2-11.)

If the system powers up but is failing otherwise, isolate the problem as follows:

1. Run IPB/IPC and IOC firmware diagnostics as described in Chapter 2.
2. Run Confidence Test as described in Chapter 3.

If any of these tests fails to execute properly, check the integrity of all connectors and socket-mounted IC's as described in Chapter 2 (Preinstallation Inspection). Also make certain that all boards in the cardcage are fully seated into the backplane connectors.

Try to re-run the failing diagnostic. If the diagnostic still doesn't execute properly, refer to table 2-2 or 2-3, as appropriate for the probable cause of failure.

5-3. PREVENTIVE MAINTENANCE

Preventive maintenance instructions for the integral single density diskette drive and the dual double density diskette drive are provided in Appendix F.

5-4. SERVICE AND REPAIR ASSISTANCE

The best service for your Intel product will be provided by an Intel Customer Engineer. These trained professionals will provide prompt, efficient on-site

installation, preventive maintenance, or corrective maintenance services that will keep your equipment in the best possible operating condition.

Your Intel Customer Engineer can provide the service you need through a prepaid service contract or on an hourly charge basis. For further information, contact your local Intel office.

When it is impossible for you to use the services of an Intel Customer Engineer or when Intel service is not available in your local area, you may contact the Intel Service Center directly at one of the following numbers:

Telephone:

From Alaska, Arizona, or Hawaii call—
(602) 869-4600

From all other U.S. locations call toll free—
(800) 528-0595

TWX: 910-951-1330

Never return equipment to Intel for service or repair before you contact an Intel Customer Engineer or the Intel Service Center.

If return of your equipment is necessary, you will be given a Repair Authorization Number, shipping instructions, and other important information that will help Intel provide you with fast, efficient service. If the product is being returned because of damage sustained during shipment, or if the product is out of warranty, a purchase order is necessary in order for the Intel Service Center to make the repair.

When preparing the product for shipment to the Service Center, use the original factory packaging material if available. If the original packaging is not available, wrap the product in a cushioning material such as Air Cap SD-240, manufactured by the Sealed Air Corporation, Hawthorne, N.J. (or equivalent) and enclose in a heavy-duty corrugated shipping carton. Seal the carton securely, mark it "FRAGILE" to ensure careful handling, and ship it to the address specified by the Intel Service Center.

NOTE

Customers outside of the United States should contact their sales source (Intel Sales Office or Authorized Intel Distributor) for directions on obtaining service or repair assistance.



APPENDIX A CONFIGURING THE SERIAL INTERFACES

The problems that sometimes occur when connecting devices from different manufacturers through an RS232C interface are usually due to different interpretations of the RS232C specification.

The Intellec Series II serial interfaces channels (SERIAL CH 1/SERIAL CH 2) are designed to be adaptable to any interpretation of the specification. The serial interfaces are implemented with extensive line jumpering capability.

As shipped, SERIAL CH 1 is jumpered for a standard TTY terminal configuration. SERIAL CH 2 is jumpered for modem or CRT terminal.

The jumpers are located at the top right corner of the IOC board and are accessible by removing the chassis top cover. Figure A-1 shows the lines and jumpers available for SERIAL CH 1, with the jumpers shown as shipped. Figure A-2 shows the lines and jumpers available for SERIAL CH 2, with the jumpers shown as shipped.

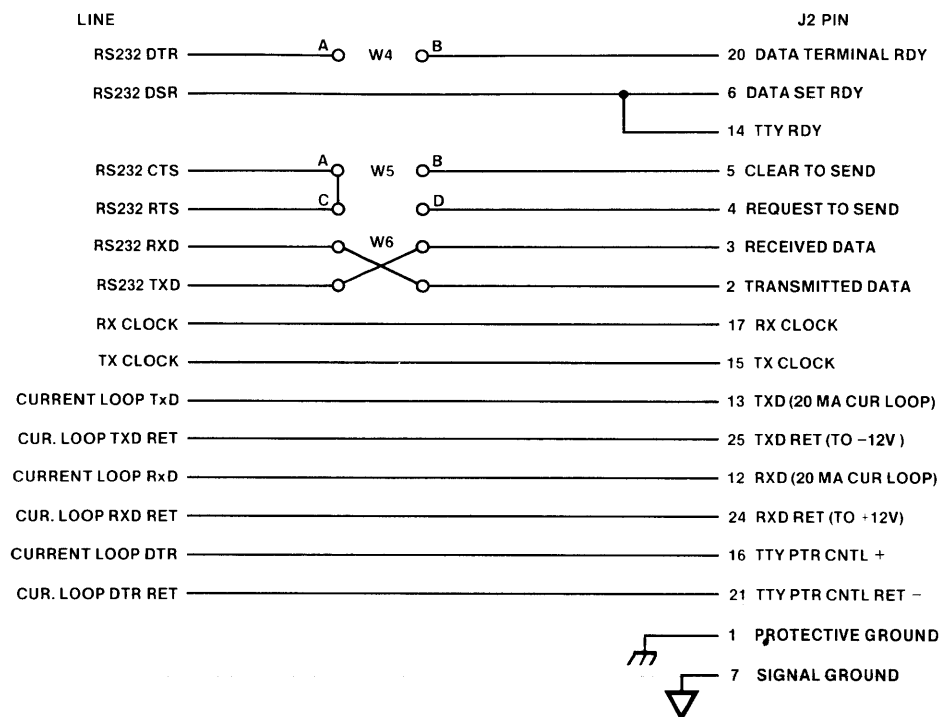

Figure A-1. SERIAL CH 1 Lines and Jumpers

559-10A

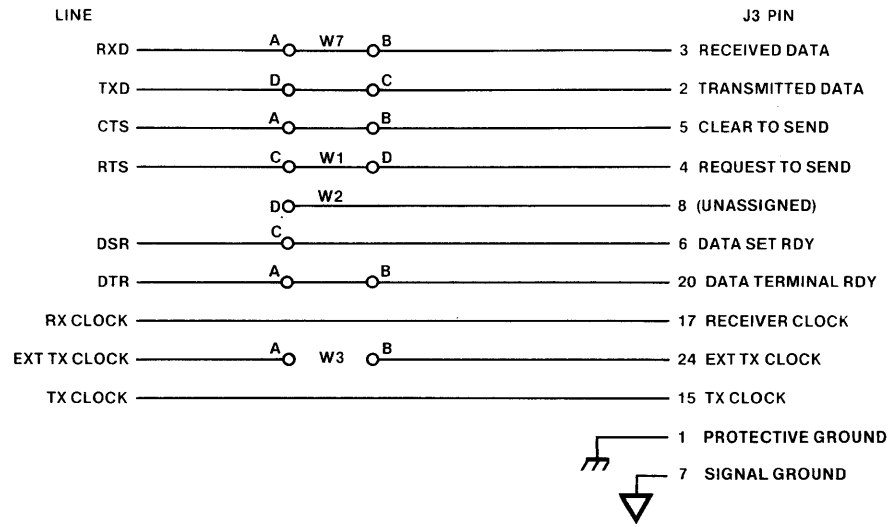

Figure A-2. SERIAL CH 2 Lines and Jumpers

559-11A



APPENDIX B MODIFYING THE BAUD RATE

```
;
; THIS PROGRAM MODIFIES THE BAUD RATES FOR THE SERIES-II
; SERIAL CHANNELS. SPECIFICALLY, AS IT IS WRITTEN, SERIAL
; CHANNEL 2 BAUD RATE WOULD BE MODIFIED. TO CHANGE THE
; BAUD RATE FOR SERIAL CHANNEL 1 (TTY), CHANGE THE THREE
; OCCURRENCES OF 'OUT 0F7H' TO 'OUT 0F5H', THE TWO
; OCCURRENCES OF 'OUT 0F1H' TO 'OUT 0F0H', THE ONE
; OCCURRENCE OF 'MVI A, 076H' TO 'MVI A, 036H', AND REASSEMBLE.
;
;
; BE SURE TO SUBSTITUTE THE PROPER BAUD CODE AND MULTIPLIER
; INTO THE ASSEMBLY LANGUAGE CODE PRIOR TO ASSEMBLING!
;
;
;
; CSEG
START: MVI     A,040H      ; RESET THE 8251 USART
       OUT     0F7H
       MVI     A,076H      ; PROGRAM THE 8253 COUNTER FOR
       OUT     0F3H      ; MODE 3 and LSB FOLLOWED BY MSB
;
;
;           BAUD RATE CODES
;
; RATE      CODE      MULTIPLIER
; 110       2BAH      0CEH
; 150       080H      0CFH
; 300       040H      0CFH
; 600       020H      0CFH
; 1200      010H      0CFH
; 2400      020H      0CEH
; 4800      010H      0CEH
; 9600      008H      0CEH
; 19200     004H      0CEH
;
; LXI       H, BAUD CODE ; LOAD 8253 WITH LSB OF BAUD
; MOV       A,L          ; CODE FIRST, FOLLOWED BY
; OUT       0F1H        ; MSB OF BAUD CODE
; MOV       A,H
; OUT       0F1H
;
;
; OBTAIN PROPER MULTIPLIER FROM BAUD RATE CODE TABLE ABOVE
;
; MVI       A, MULTIPLIER ; LOAD MULTIPLIER
; OUT       0F7H
; MVI       A,025H      ; ENABLE TRANSMITTER, RECEIVER AND RTS
; OUT       0F7H
; RST       01H
; END       START
```



APPENDIX C TELETYPEWRITER MODIFICATIONS

INTRODUCTION

This appendix provides information required to modify a Model ASR-33 Teletypewriter for use with the Intellec Series II system.

INTERNAL MODIFICATIONS

WARNING

Hazardous voltages are exposed when the top cover of the teletypewriter is removed. To prevent accidental shock, disconnect the teleprinter power cord before proceeding beyond this point.

Remove the top cover and modify the teletypewriter as follows:

1. Remove blue lead from 750-ohm tap on current source register; reconnect this lead to 1450-ohm tap. (Refer to figures C-1 and C-2.)
2. On terminal block, change two wires as follows to create an internal full-duplex loop (refer to figures C-1 and C-3):
 - a. Remove brown/yellow lead from terminal 3; reconnect this lead to terminal 5.
 - b. Remove white/blue lead from terminal 4; reconnect this lead to terminal 5.
3. On terminal block, remove violet lead from terminal 8; reconnect this lead to terminal 9. This changes the receiver current level from 60 mA to 20 mA.

A relay circuit card must be fabricated and connected to the paper tape reader driver circuit. The relay circuit card to be fabricated requires a relay, a diode, a thyrector, a small vector board for mounting the components, and suitable hardware for mounting the assembled relay card.

A circuit diagram of the relay circuit card is included in figure C-4; this diagram also includes the part numbers of the relay, diode, and thyrector. (Note that a 470-ohm resistor and a 0.1 μ F capacitor may be substituted for the thyrector.) After the relay circuit card has been assembled, mount it in position as shown in figure C-5. Secure the card to the base plate using two self-tapping screws. Connect the relay circuit to the distributor trip magnet and mode switch as follows:

1. Refer to figure C-4 and connect a wire (Wire A) from relay circuit card to terminal L2 on mode switch (see figure C-6).
2. Disconnect brown wire shown in figure C-7 from plastic connector. Connect this brown wire to terminal 12 on mode switch. (Brown wire will have to be extended.)
3. Refer to figure C-4 and connect a wire (Wire B) from relay circuit board to terminal L1 on mode switch.

EXTERNAL CONNECTIONS

Connect a two-wire receive loop, a two-wire send loop, and a two-wire tape reader control loop to the external device as shown in figure C-4. The external connector pin numbers shown in figure C-4 are for serial channel 1 on the Intellec Series II system.

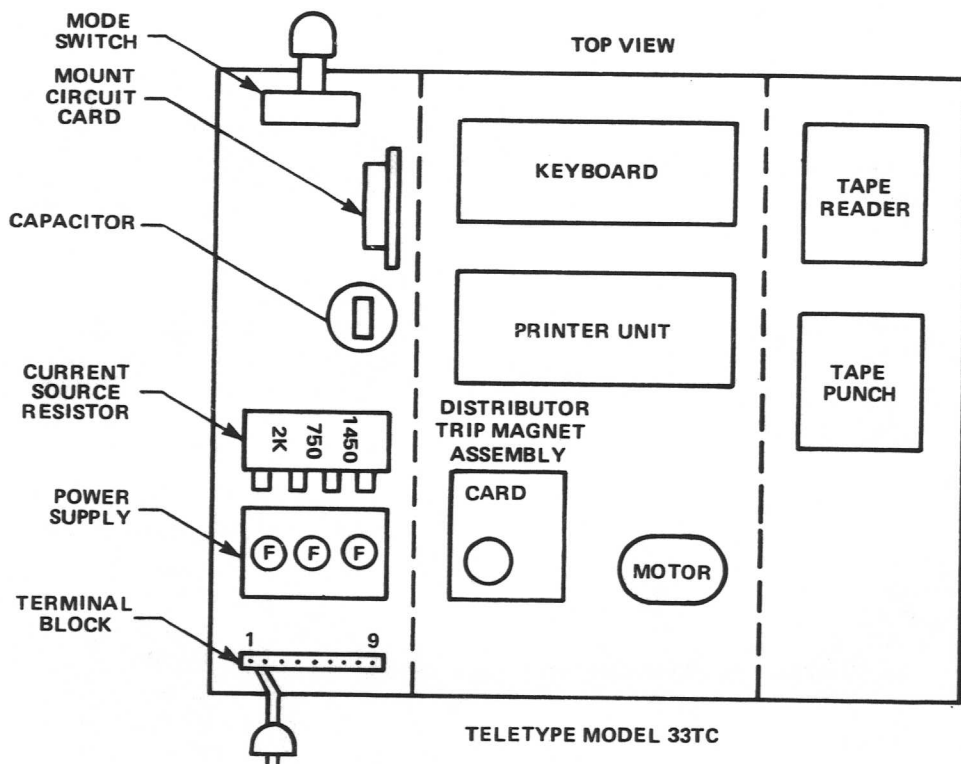

Figure C-1. Teletype Component Layout

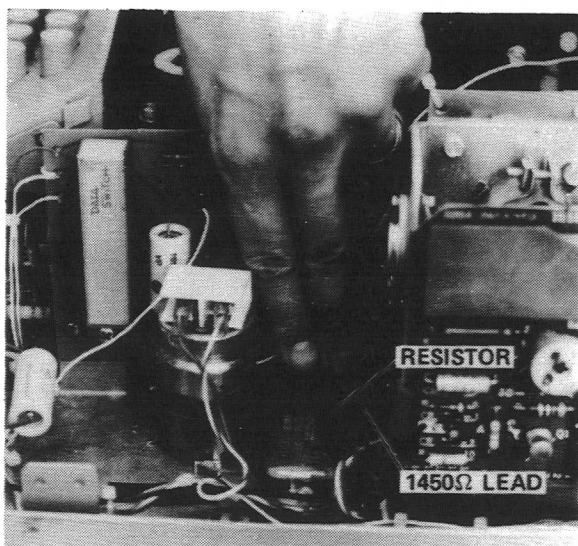

Figure C-2. Current Source Resistor

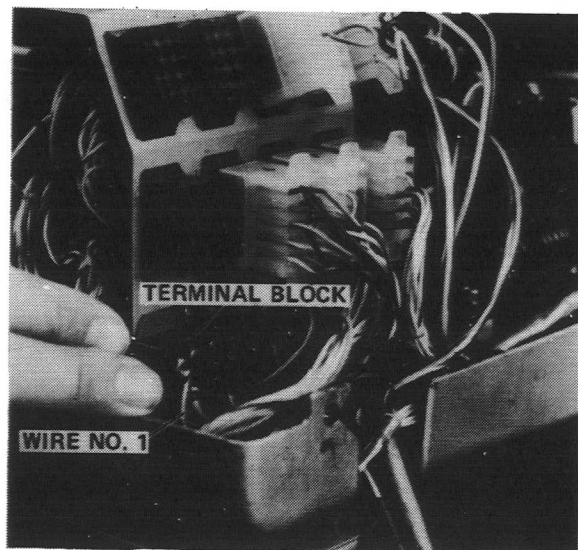

Figure C-3. Terminal Block

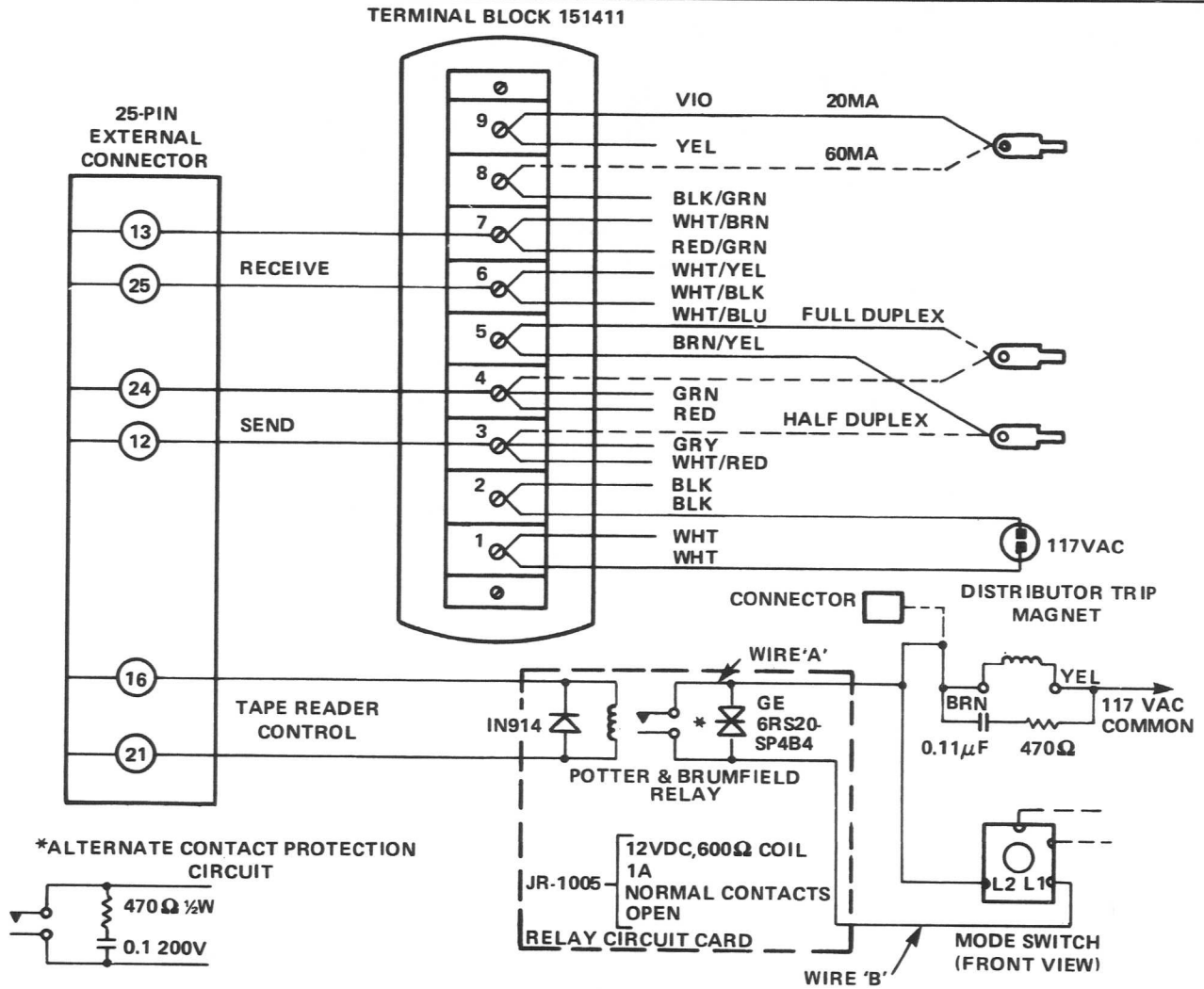

Figure C-4. Teletypewriter Modifications

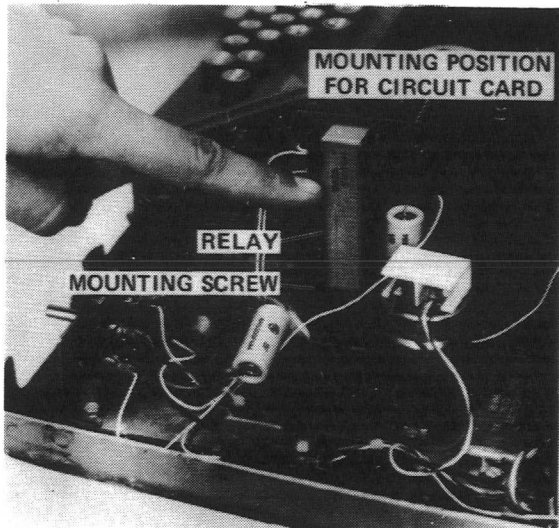

Figure C-5. Relay Circuit

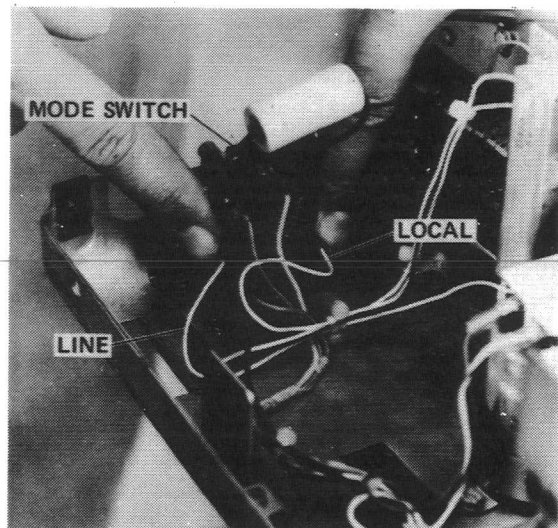

Figure C-6. Mode Switch

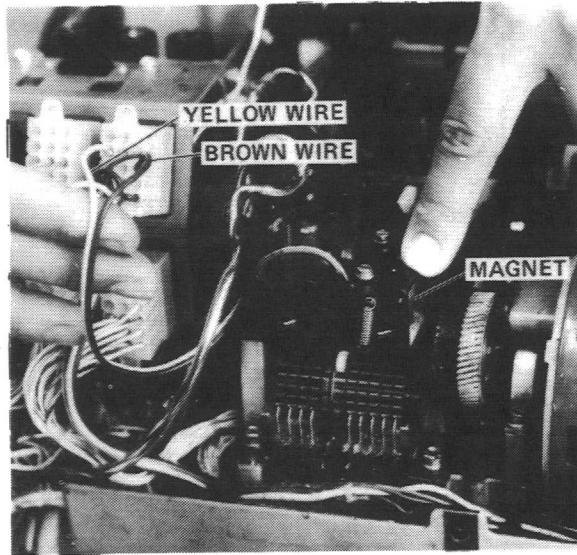

Figure C-7. Distributor Trip Magnet

To isolate the two grounds, you must first remove the top cover of the system. The ground connection is a yellow and green wire connected to the power supply. (Refer to figure D-1.)

The wire is connected to the power supply with a spade connector. Disconnect the wire and insulate the spade lug to prevent an accidental short. Replace the top cover and reconnect the system power cord to facility power.

In development work it is sometimes necessary to isolate chassis ground from signal ground. You can isolate these grounds in the Intellec Series II system by disconnecting a single wire from the power supply.

WARNING

Hazardous voltage is present in the vicinity of the power supply. Before proceeding, disconnect the system power cord from facility power.

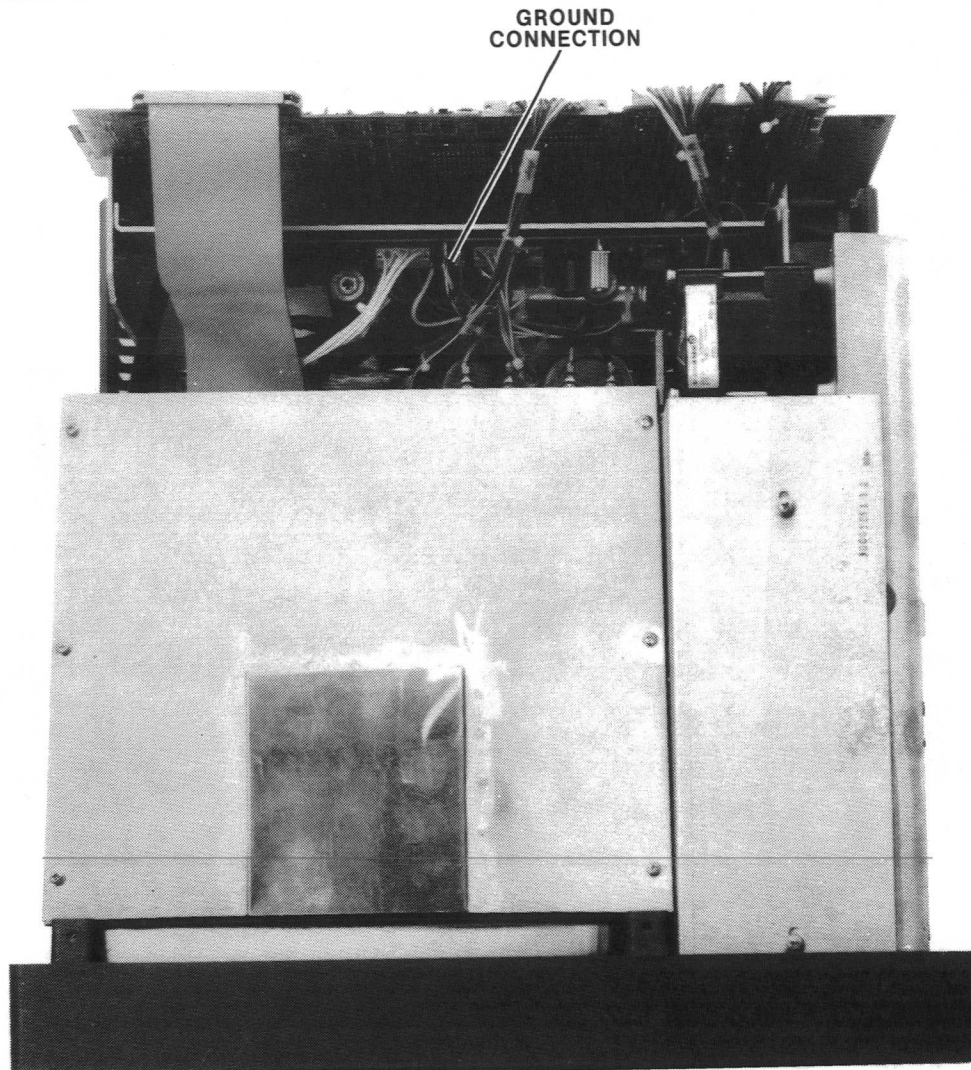

Figure D-1. Ground Connection



APPENDIX E CONFIDENCE TEST ERROR MESSAGES

Error Message	Probable Fault
ADDRESS ERROR	Note
CRT ILLEGAL COMMAND	IOC card
CRT ILLEGAL STATUS REQUEST	IOC card
CRT NOT PRESENT	IOC card
CRT OPERATION ERROR	CRT
DATA/ADDRESS MARK ERROR	Note
DATA CRC ERROR	Note
DATA OVERRUN	Note
DELETED RECORD ERROR	Note
DRIVE NOT READY	Note
DRIVE STATUS CHANGE	Note
FLOPPY OPERATION ERROR	Disk drive
HIGH SPEED READER DATA ERROR	Tape reader, IOC card
ID CRC ERROR	Note
INTERRUPT ERROR LEVEL X	IPB/IPC card
IOC DEVICE ERROR RCV	IOC card
IOC ILLEGAL COMMAND	IOC card
IOC ILL DATA RQST	IOC card
IOC INPUT ERROR	Peripheral device
IOC OPERATION ERROR XMIT	IOC card
IOC TIMEOUT	IOC card
IOC TIMEOUT RCV	IOC card
IOC TIMEOUT XMIT	IOC card
KEY INPUT ERROR	Keyboard, cable, IOC card
KEYBD ILL STATUS REQUEST	IOC card
KEYBOARD NOT PRESENT	Keyboard, cable, IOC card
KEYBD OPERATION ERROR	Keyboard, cable
KEYBD TIMEOUT	Operator response, keyboard, cable
LPT DEVICE ERROR	Line printer
LPT ILLEGAL COMMAND	IOC card
LPT ILLEGAL STATUS REQUEST	IOC card
LPT NOT PRESENT	Line printer, cable, IOC card
LPT NOT SELECTED	IOC card
LPT TIMEOUT XMIT	IOC card
NO DISKETTE CONTROLLER PRESENT	Interface board, channel board
PIO DEVICE ERROR RCV	IOC card
PIO OPERATION ERROR	IOC card
PIO TIMEOUT	IOC card
PIO TIMEOUT RCV	IOC card
PIO TIMEOUT XMIT	IOC card
SEEK ERROR	Note
SYNC ERROR	Note
TAPE PUNCH DEVICE ERROR	Tape punch, cable
TAPE PUNCH ILLEGAL COMMAND	IOC card
TAPE PUNCH ILL STATUS REQUEST	IOC card
TAPE PUNCH NOT PRESENT	Tape punch, cable, IOC card
TAPE PUNCH TIMEOUT	Tape punch, cable, IOC card
TAPE RDR DEVICE ERROR	Tape reader, cable

Error Message	Probable Fault
TAPE RDR NOT PRESENT TAPE READER TIMEOUT TEST ABORTED TIME OUT TTY READER DATA ERROR UNEXPECTED I/O COMPLETE USART 0 DEVICE ERROR USART 1 DEVICE ERROR USART 0 TIMEOUT RCV USART 1 TIMEOUT RCV WRITE ERROR WRITE PROTECTED	Tape reader, cable, IOC card Tape reader, cable, IOC card Operator request, keyboard Note TTY reader, IPB/IPC card Note TTY, cable, IPB/IPC card Device, cable, IPB/IPC card TTY, cable Device, cable Note Note Note: Internal Drive: Drive or IOC card External Drive: Drive, controller, cable, IPB/IPC card

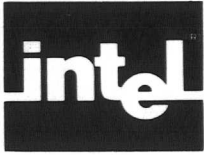

APPENDIX F DISKETTE DRIVE PREVENTIVE MAINTENANCE

F-1. MAINTENANCE SCHEDULE

The diskette drive or drives associated with the development system require periodic preventive maintenance. The recommended preventive maintenance schedule for normal (40 hours per week) operation is at 6-month intervals (shorter intervals are required for excessive operation and/or adverse environments). Table F-1 outlines the preventive maintenance requirements for diskette drives.

Table F-1. Preventive Maintenance Requirements

Inspect	Check For	Corrective Action
Read/Write head	Oxide build-up	Clean Read/Write head only if necessary
Head load pad	Wear, glazing	Replace head load pad
Drive belt	Fraying, cracks, loss of tension	Replace drive belt

In order to perform preventive maintenance on a drive, the drive must be removed from its chassis.

F-2. INTEGRAL DRIVE REMOVAL

Remove the integral drive from the mainframe as follows:

- Power down system and disconnect mainframe power cord.
- Remove mainframe top cover and disconnect the following cable connectors at the drive:
 - P25—controller interface connector
 - P24—ac power connector
 - P23—dc power connector
- Remove large braided ground strap (if present) between drive printed circuit board and mainframe chassis.
- Referring to figure F-1, remove the two screws securing drive to top mounting bracket, and remove the two screws securing side retainer plate to drive.
- Slide side retainer plate forward approximately ¼-inch to disengage “ears” and remove plate by raising it up and out of channel.
- Once side retainer plate is removed, pull rear of drive away from chassis.

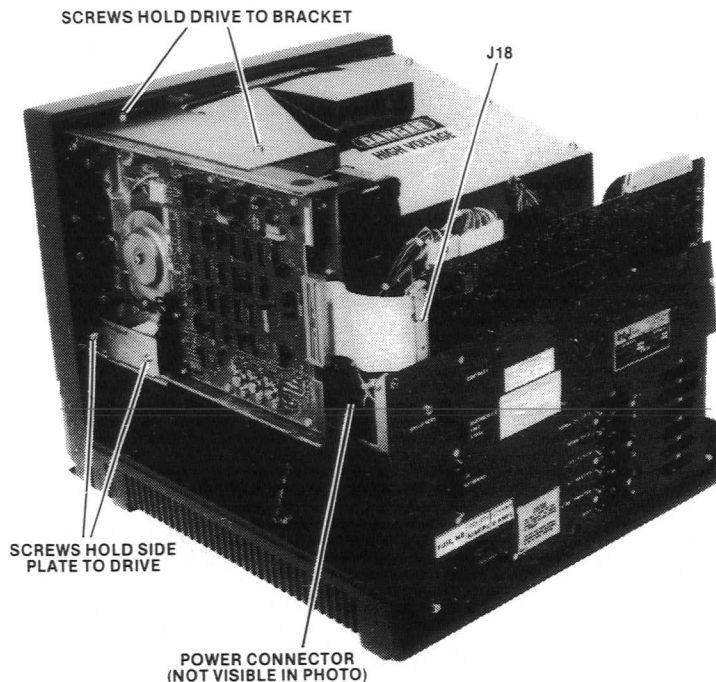

Figure F-1. Integral Drive Removal

878-34

F-3. DUAL DRIVE CHASSIS DRIVE REMOVAL

Remove the drives mounted in the dual drive chassis as follows:

- a. Power down both mainframe and dual drive chassis and disconnect power cords.
- b. Disconnect drive interface cable from rear panel of dual drive chassis.
- c. Place dual drive chassis on bench or suitable work surface capable of supporting chassis weight (approximately 43 pounds).
- d. Referring to figure F-2, remove the six Allen screws that secure top cover panel to drive chassis (a 7/64-inch angled Allen wrench is required) and remove top cover panel.
- e. Disconnect "daisy-chain" controller interface ribbon cable from top of each drive adapter printed circuit board; disconnect ac power connector (J3 and J4) and dc power connector (J1 and J2) from each drive.
- f. Each drive is secured to chassis by four screws accessible from bottom of drive chassis. Slide front of chassis over edge of work surface just

far enough to expose drive mounting screws. In the interest of safety, have someone hold chassis while screws are removed.

- g. Remove the four drive mounting screws from each drive, slide chassis back on work surface, and lift out drives.

F-4. MAINTENANCE PROCEDURES

F-5. READ/WRITE HEAD

Raise the spring-loaded head load arm and examine the head for oxide build-up. If, AND ONLY IF, oxide build-up is present (noted by a yellow-brown dull film visible on the clear surface of the head), clean the head using a cotton swab and isopropyl alcohol.

F-6. HEAD LOAD PAD

The head load pad, which is subject to wear and "glazing" (a hardening of the pad surface), is press-

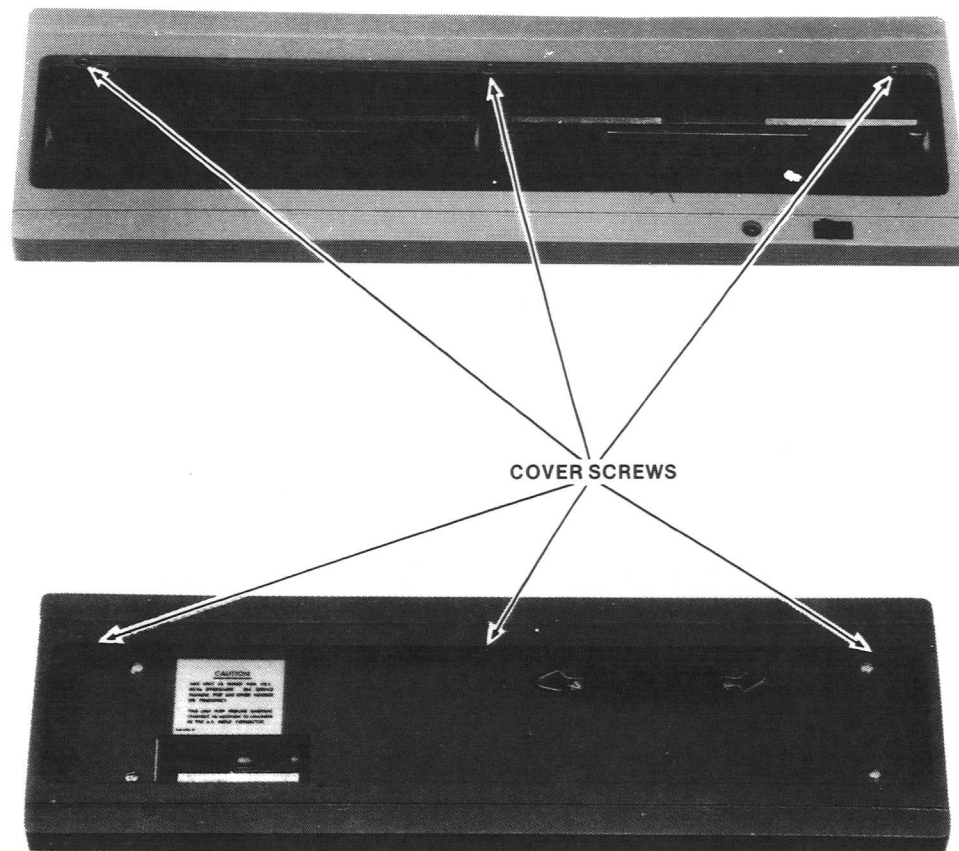

Figure F-2. Dual Drive Chassis Top Cover Removal

fit into the end of the head load arm. If the pad needs replacing, raise the head load arm (to avoid possibly damaging the read/write head) and, working from the back side of the pad with a small pair of needle-nose pliers, carefully pinch the pad halves together and push the halves down to clear the locking mechanism. Once clear of the locking mechanism, pry the pad out with a small screwdriver or fingernail. To install the new pad, simply press the pad into the head load arm until it locks in place.

F-7. DRIVE BELT

The drive belt is subject to fraying or cracking that can lead to loss of belt tension or breakage. To examine the drive belt, turn the drive over. The belt is located under the printed circuit board and only a portion of the belt is visible at the drive motor pulley. Slowly rotate the pulley to examine the entire belt. Note that if the belt must be replaced, the printed circuit board must first be removed from the drive.



REQUEST FOR READER'S COMMENTS

Intel's Technical Publications Departments attempt to provide publications that meet the needs of all Intel product users. This form lets you participate directly in the publication process. Your comments will help us correct and improve our publications. Please take a few minutes to respond.

Please restrict your comments to the usability, accuracy, readability, organization, and completeness of this publication. If you have any comments on the product that this publication describes, please contact your Intel representative. If you wish to order publications, contact the Intel Literature Department (see page ii of this manual).

1. Please describe any errors you found in this publication (include page number).

2. Does the publication cover the information you expected or required? Please make suggestions for improvement.

3. Is this the right type of publication for your needs? Is it at the right level? What other types of publications are needed?

4. Did you have any difficulty understanding descriptions or wording? Where?

5. Please rate this publication on a scale of 1 to 5 (5 being the best rating). _____

NAME _____ DATE _____

TITLE _____

COMPANY NAME/DEPARTMENT _____

ADDRESS _____

CITY _____ STATE _____ ZIP CODE _____
(COUNTRY)

Please check here if you require a written reply.

WE'D LIKE YOUR COMMENTS ...

This document is one of a series describing Intel products. Your comments on the back of this form will help us produce better manuals. Each reply will be carefully reviewed by the responsible person. All comments and suggestions become the property of Intel Corporation.



NO POSTAGE
NECESSARY
IF MAILED
IN U.S.A.

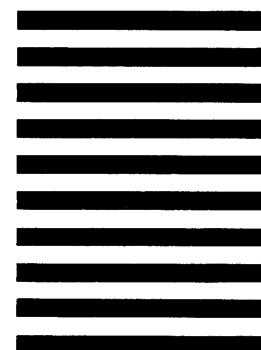

BUSINESS REPLY MAIL
FIRST CLASS PERMIT NO. 1040 SANTA CLARA, CA

POSTAGE WILL BE PAID BY ADDRESSEE

Intel Corporation
Attn: Technical Publications M/S 6-2000
3065 Bowers Avenue
Santa Clara, CA 95051



INTEL CORPORATION, 3065 Bowers Avenue, Santa Clara, California 95051 (408) 987-8080

Printed in U.S.A.