

IBM[®]

E T CUSTOMER ENGINEERING
B-1 ADJUSTMENT MANUAL

IBM

®

ETD CUSTOMER ENGINEERING



B - 1 ADJUSTMENT MANUAL

Form/Part no. 241-5141-1

Printed in U. S. A.

January 1, 1963

TABLE OF CONTENTS

BACKSPACE 19

CARRIAGE 9

CARRIAGE RETURN 32

ESCAPEMENT 4

KEYLEVERS AND CAMS 7

MARGIN RELEASE 13

MARGIN SET 12

MOTOR AND DRIVE 1

OPERATIONAL CAMS 18

PAPER FEED 14

RAILS 11

RIBBON 40

RIBBON LIFT 43

SHIFT 23

SPACEBAR 39

TABULATION 26

1. The ON-OFF SWITCH should function without hesitation and have even positive overthrow in both positions. (Fig. 1)

The switch requires equal overthrow in both directions in order to insure positive operation. Adjust the rear clevis on the switch operating link for this condition. The switch operating link must be held by its clamp and be free of all binds.

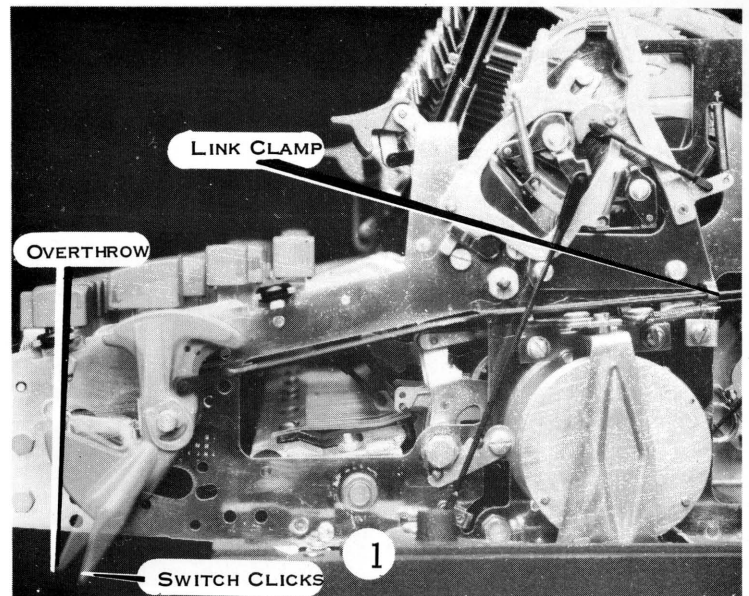

2. POWER ROLL END PLAY should be .002" to .010" (Fig. 2). Make the adjustment by positioning the power roll pulley on the shaft, then tightening the set screws.

The power roll must be held to the left while making this adjustment (Fig. 3). Excessive clearance will allow the power roll to drift left to right. As the power roll moves to the right, its shaft will contact the clutch plate and make noise.

Insufficient clearance will cause bearing to heat and expand, causing machine to lock up.

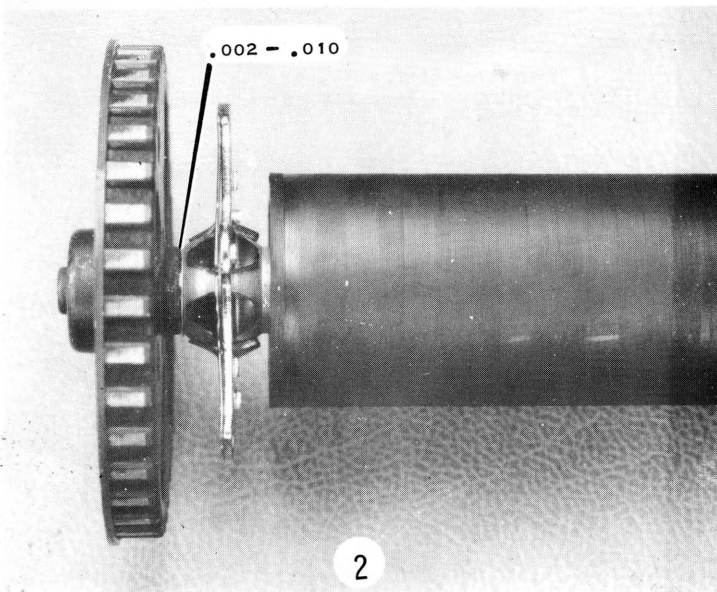

3. The SELF ALIGNING BEARINGS of the motor and power roll should be aligned to their shafts to eliminate binds.

If a bind should occur, a slight tapping action on the pulleys with the handle of a screwdriver should produce satisfactory results.

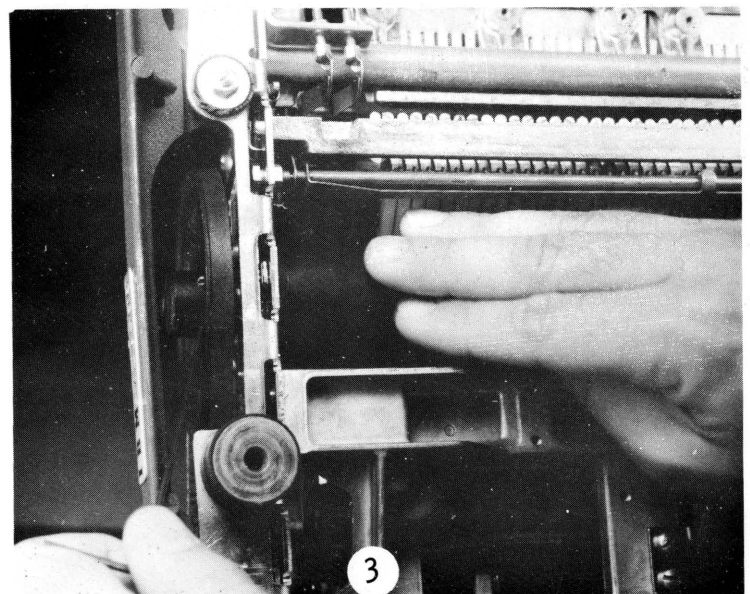

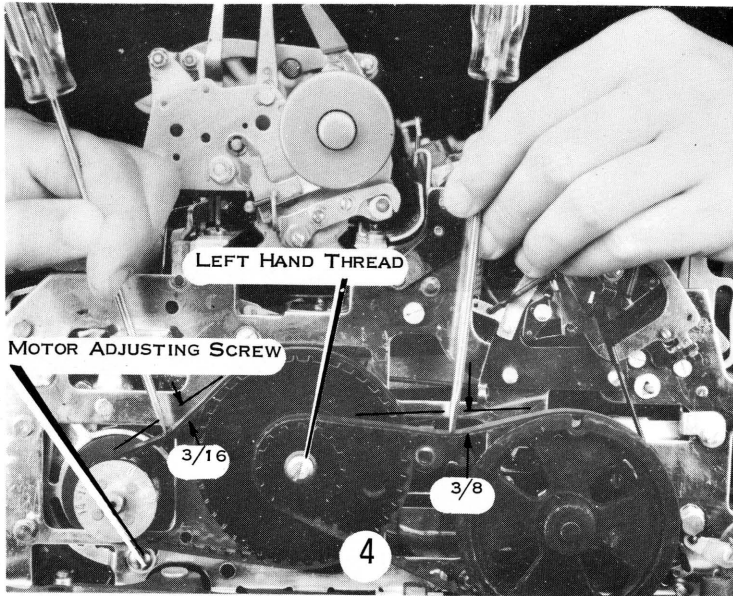

4. Adjust the DRIVEN BELT by positioning the intermediate pulley shaft. The shaft incorporates a left-hand thread so that pulley rotation tends to tighten the shaft. The deflection of the belt should be approximately $\frac{3}{8}$ " (Fig. 4).

5. POWER ROLL SPEED is adjusted by a two-step motor pulley. The motor pulley should be positioned on the motor shaft to align the belts and the pulleys (Fig. 5).

A 14-tooth pulley is generally used for the Elite or 12 pitch type styles, while the 15-tooth pulley is used for the larger Pica type styles or bold face type styles.

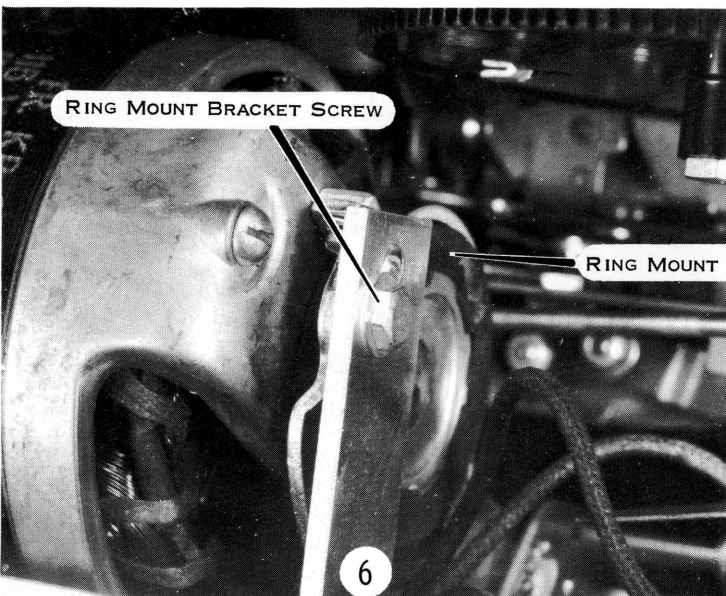
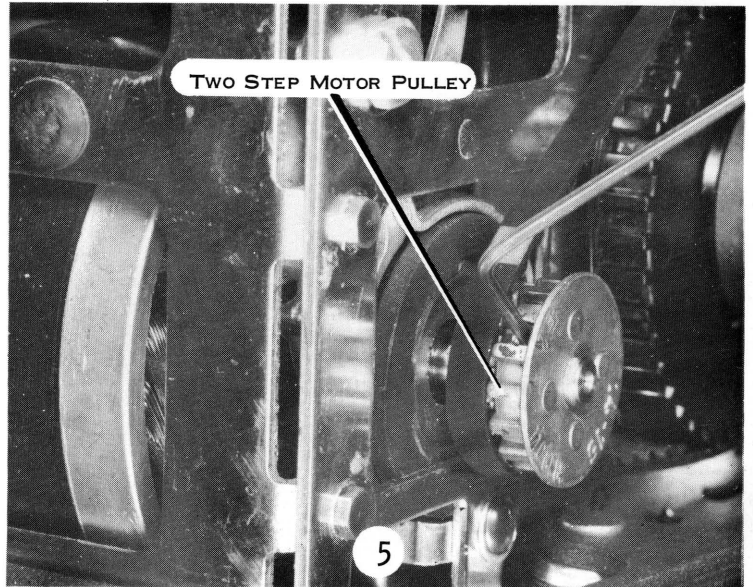

6. Adjust the DRIVE BELT for approximately $\frac{3}{16}$ " deflection by positioning the motor adjusting screw forward or back in its elongated mounting hole (Fig. 4).

To adjust the drive belt tension on ring mounted motors, loosen the motor adjusting screw and the ring mount bracket screw (Fig. 6). The motor may then be moved front to rear for proper belt tension. After tightening these screws, check the motor housing to be sure it is parallel to the frame and that the ring mount screws are tight. To adjust the drive belt tension on the shaft mounted motor, it is necessary only to loosen the motor adjusting screws.

The following are the effects of loose or tight belts:

LOOSE BELTS

1. Belt noise
2. Belt climbing on pulley
3. Uneven impression (due to momentary slowing of the power roll after shift or backspace operation).
4. Belt falling off when machine is moved

TIGHT BELTS

1. Belt noise
2. Motor vibration transmitted to machine
3. Failure of motor to start (extremely tight belts).

Properly adjusted belts should run quietly, bounce only slightly during a shift operation, and allow the drive mechanism to coast to a smooth stop as the switch is turned off.

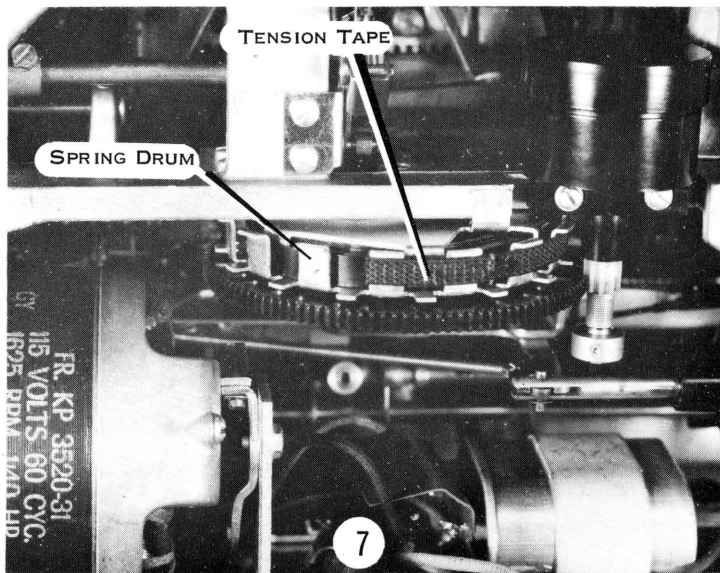

1. The MAIN SPRING tension is adjusted by placing the loop of the carriage tension tape on various lugs of the spring drum (Fig. 7).

Carriage tension should be checked from the full left to the full right position of the carriage (excluding air cylinder range). Tension is measured with the push pull scale and should measure as follows (Fig. 8).

<u>Carr. Length</u>	<u>Extreme Left</u>	<u>Extreme Right</u>
12"	2 1/2	3 3/8 lb
16"	2 1/2	3 1/2 lb
20"	2 3/4	3 5/8 lb
24"	2 3/4	3 7/8 lb
20"	3	4 1/8 lb

CAUTION: Use extreme care when removing tension tape loop from spring drum. Serious injury can result from fingers caught by spinning spring drum.

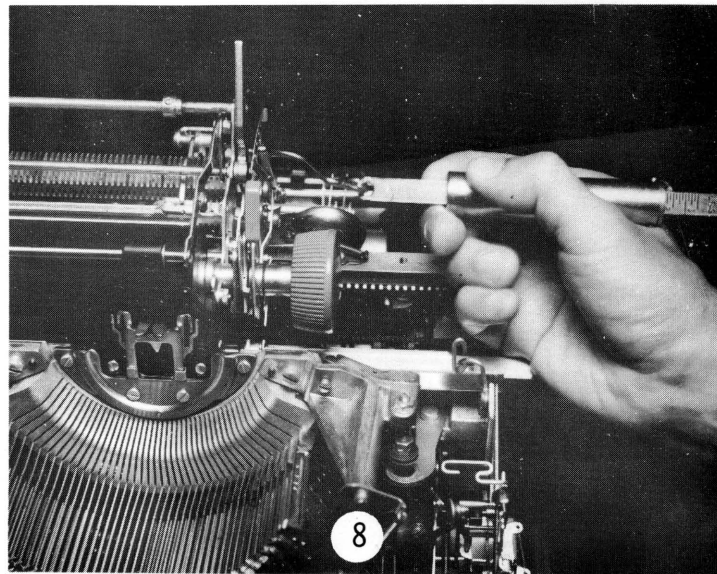

2. Adjust UNIVERSAL BAR so that all typebars trip the escapement pawl at the same distance from the PLATEN (Fig. 9).

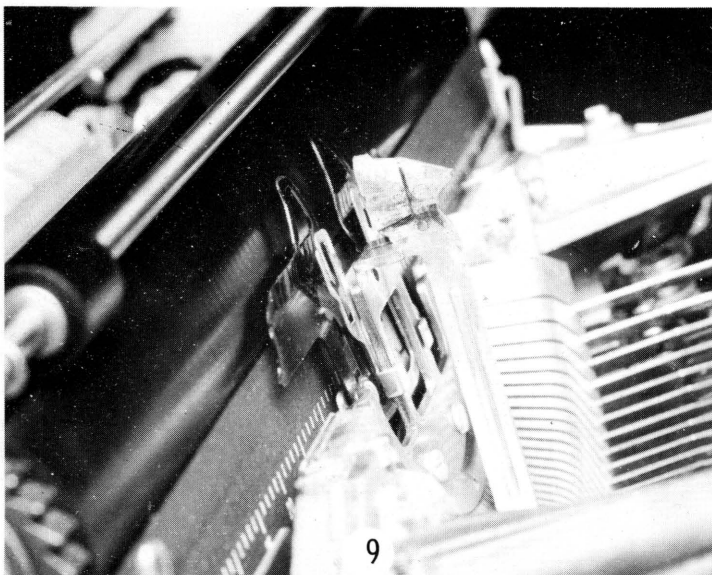

The rear spring of the universal bar is mounted to the support by a Hex screw (Fig. 10) through an enlarged hole in the spring. The off center mounting of the trip link on the universal bar would cause uneven tripping if the universal bar were adjusted square with the segment. To provide even tripping, the universal bar is adjusted slightly forward on the right. To adjust the universal bar for this condition; loosen hex screw, place #1, #22, and #42 typebars in front of the type guide as shown. The tension of the universal bar springs cause the universal bar to move against the staggered typebars (Fig. 10).

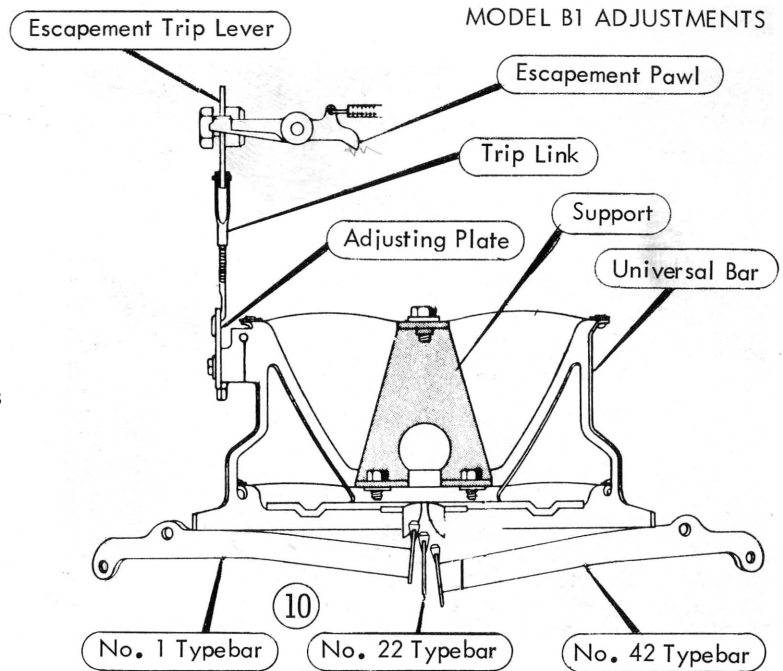

MODEL B1 ADJUSTMENTS

The hex screw is then tightened; holding the universal bar in this new position. The hex screw can be reached from the bottom of the machine with an open end wrench or from the rear with a spinner wrench through the rear frame (Fig. 11). Tripping should now be checked by moving typebars slowly toward the platen to insure even tripping. If tripping remains uneven, the process must be repeated with the 3 typebars staggered either more or less.

If the end typebars trip correctly with the center typebars either early or late, form the support up or down until all trip the same. Uneven tripping will cause type piling.

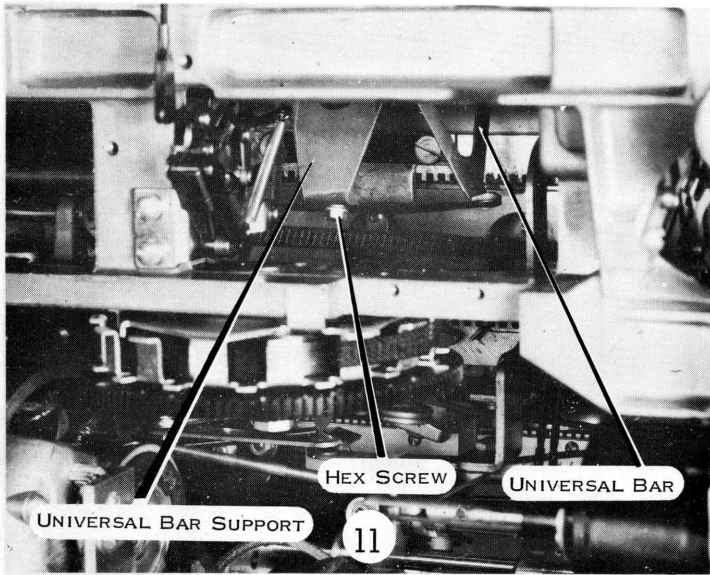

3. UNIVERSAL BAR ADJUSTING PLATE is positioned so that the escapement pawl will be tripped at the same point in both upper and lower case.

Reposition the adjusting plate by loosening the locking screw and sliding the plate up or down (Fig. 12). The locking screw is more accessible if the basket is in lower case and the universal bar held to the rear. Be sure to tighten locking screw after adjusting. Check by using the same typebar for both upper and lower case positions. Maladjustment will result in type piling or chcking off of typebar.

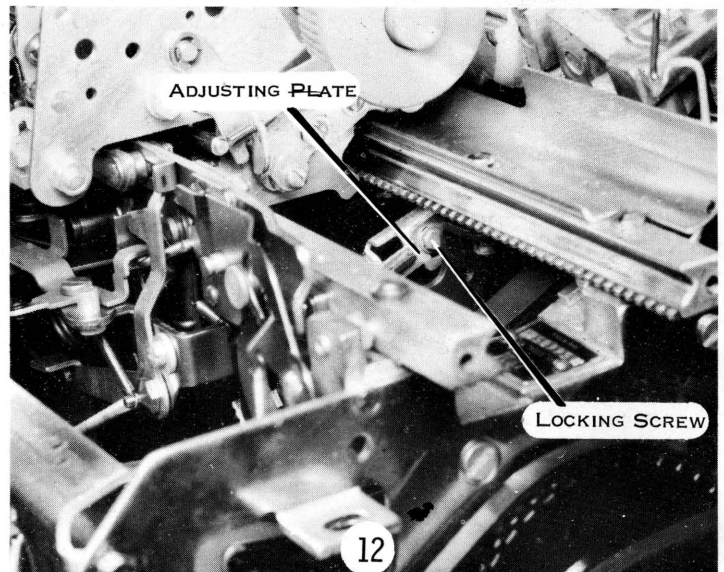

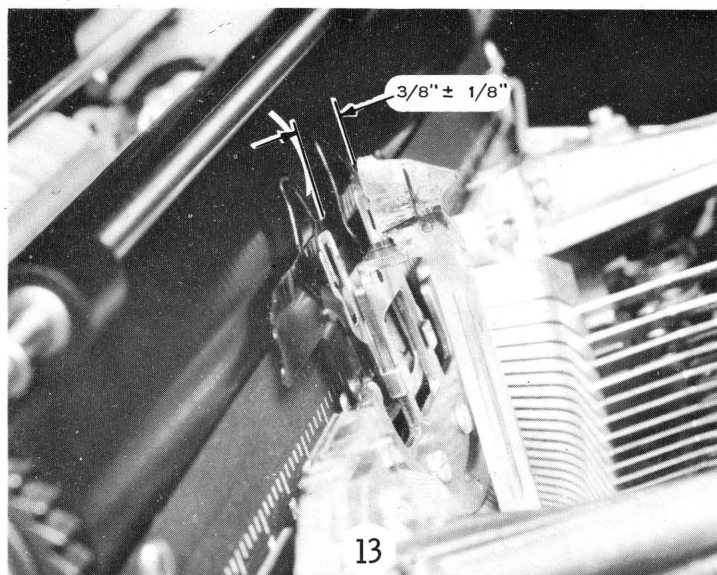

4. Adjust TRIP LINK to trip escapement pawl when any typeface is 3/8" + 1/8" from the platen (Fig. 13).

Early tripping will cause type piling due to late restoring of escapement pawl spacer.

1. Cam clearance is adjusted for .015" to .020" clearance between the nylon letter cams and power roll.

Adjust by loosening the upper screws on the cam lever bearing support and pivoting the support on its pivot screws (Fig. 14).

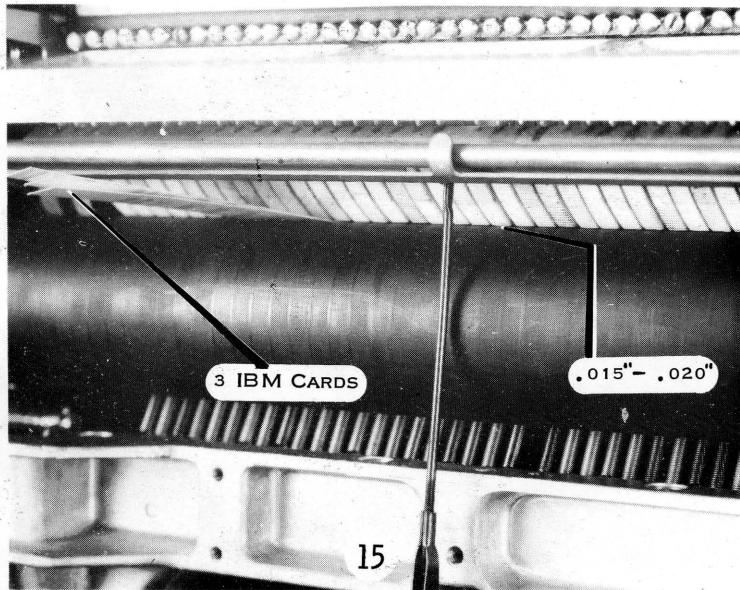
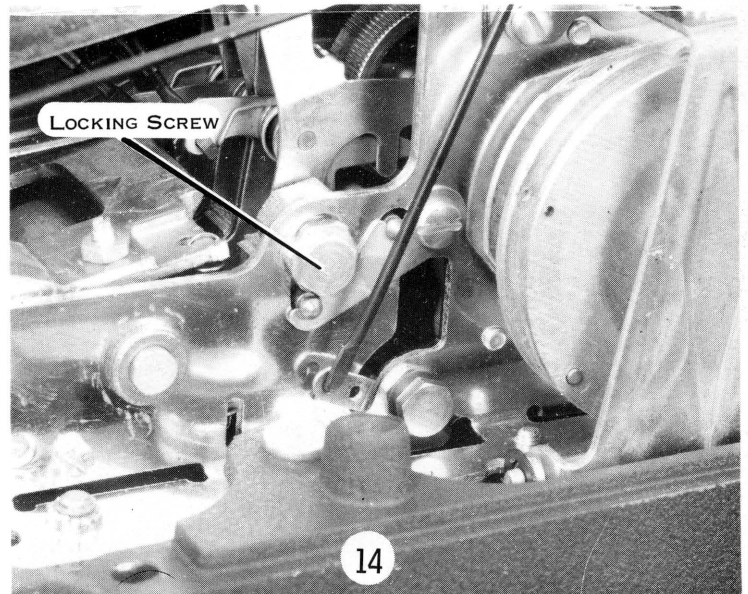

Check the adjustment by using tab cards (.007" thick as a guage. Three cards (.021") tight, two cards (.014) loose (Fig. 15). Cam clearance must be equal across all cams in order to have uniform impression and keyboard touch. Excessive clearance will cause failure of cams to engage power roll as keylever bottoms, or failure of trip lever to restore as keylever restores. Insufficient clearance will cause weak impression and repeating cams.

CAUTION: Any change in cam bearing support will affect functional cam clearances. Be sure to re-tighten locking screw after adjustment is correct.

2. Adjust the KEYLEVER BEARING SUPPORT up or down so that the keylevers will trip their respective cams when the keylevers are $1/32" + 1/64"$ from the bottom of the keylever guide comb.

Adjust by loosening either both front or both rear bearing support mounting screws slightly. *Tap the loose screw or the support, up or down with a screwdriver and hammer. This method allows the slight change which is necessary. *(Do not loosen both screws on either end, as this will allow the support to lose all adjustment). Check for proper tripping with several keylevers at both ends of the keyboard. If, with correct tripping, some trip levers do not restore, check adjustment #1 above.

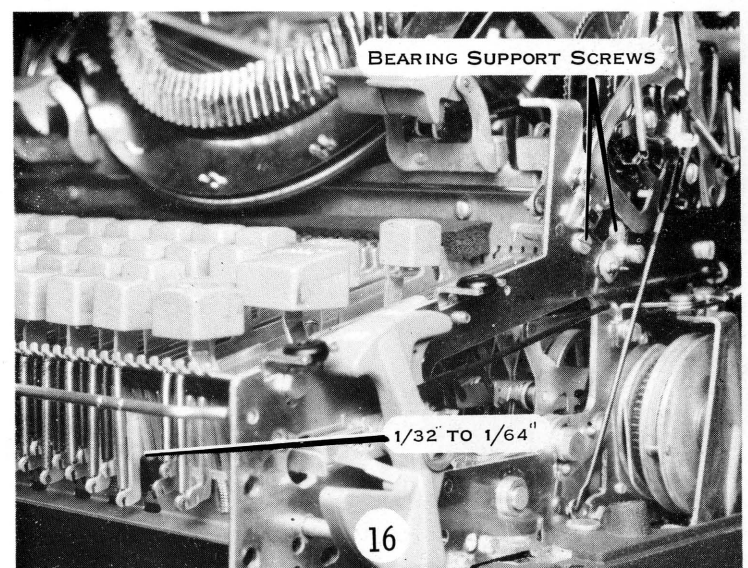

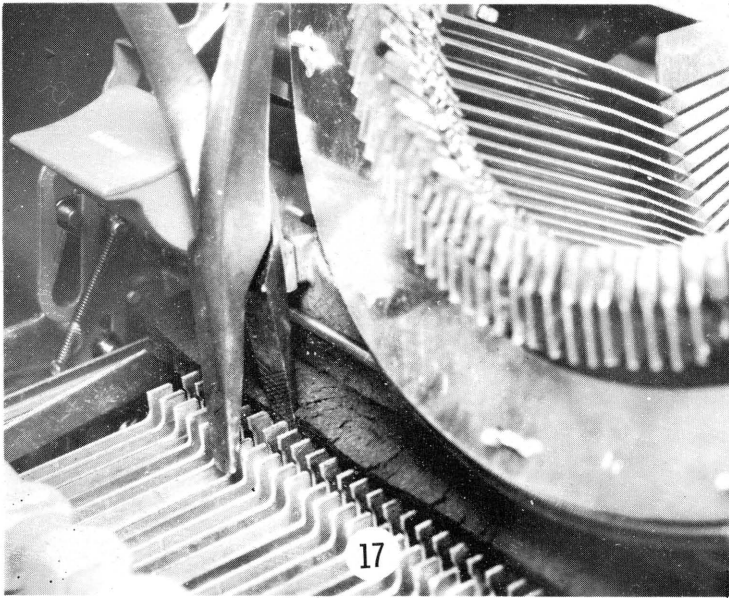

Individual keylevers are lowered by closing the gap between the adjusting lugs. This closing can be done with the duck-bill pliers (Fig. 17). Spreading the lugs with a screwdriver will raise the keylever (Fig. 18). Care must be taken when raising or lowering individual keylevers so as not to break or bind up the keylever.

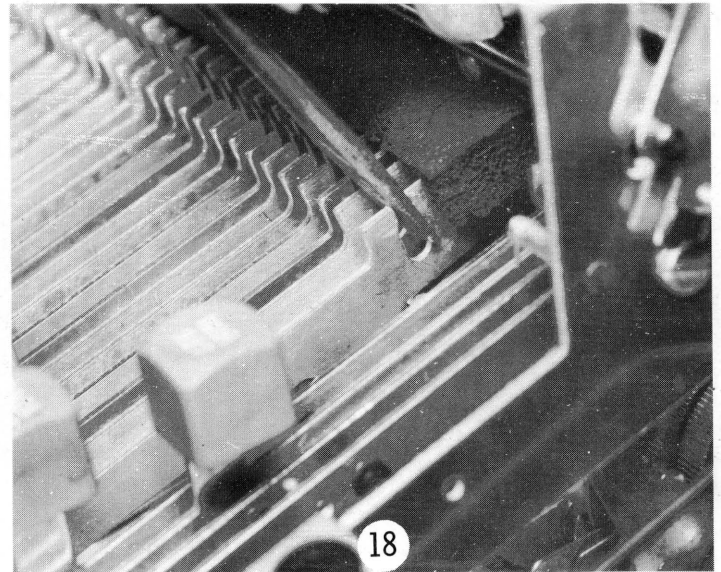

8. The KEYPLATE is positioned so that the keybuttons are free of binds and that $\frac{2}{3}$ to $\frac{3}{4}$ of each keybutton extends above it. (Fig. 19.)

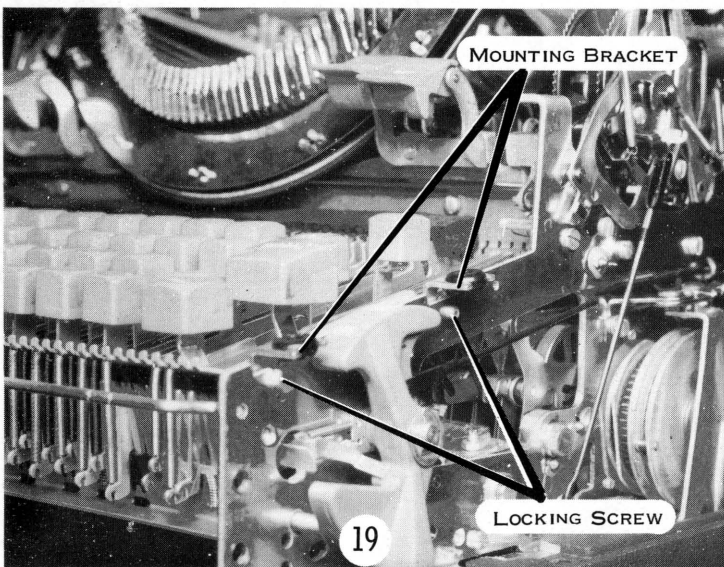

The keyplate is adjusted by repositioning its mounting brackets on the side frames. With the front cover off, the keyplate has a slight bow in the center. This bow is flattened as the top cover is screwed down and stops any vibration between the keyplate and cover. It should be noted that the keyplate positions the top cover when the cover is in place.

1. Adjust the PLATEN LATCH ECCENTRIC to just eliminate verticle movement of the platen. (Fig. 20.)

Loosen locking nut on the eccentric before attempting to adjust it. Excessive clearance will allow the platen to move, giving uneven writing line. Latches will work hard if adjusted too tight.

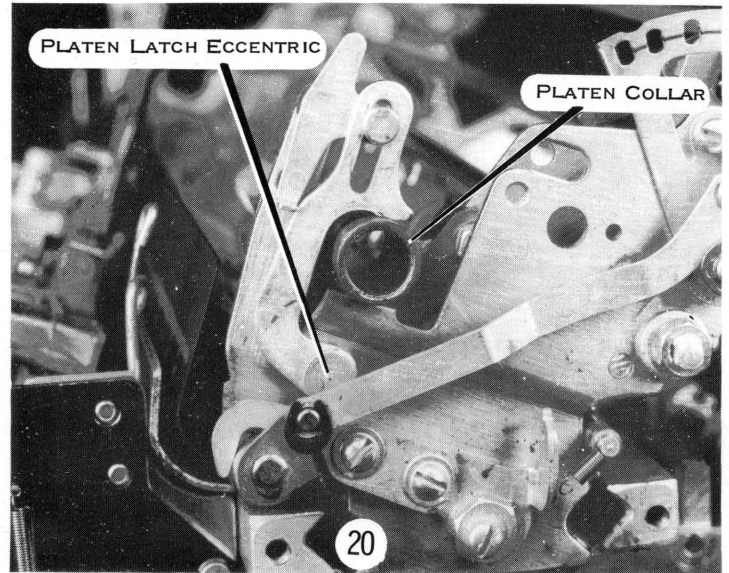

2. Adjust PLATEN CONTROL YOKES to remove front to back movement of Platen. (Fig. 21.)

Some machines will have locking screws and eccentrics; others only locking screws. With both types, loosen the locking screws and adjust. Correct adjustment insures a snug but easily removable platen.

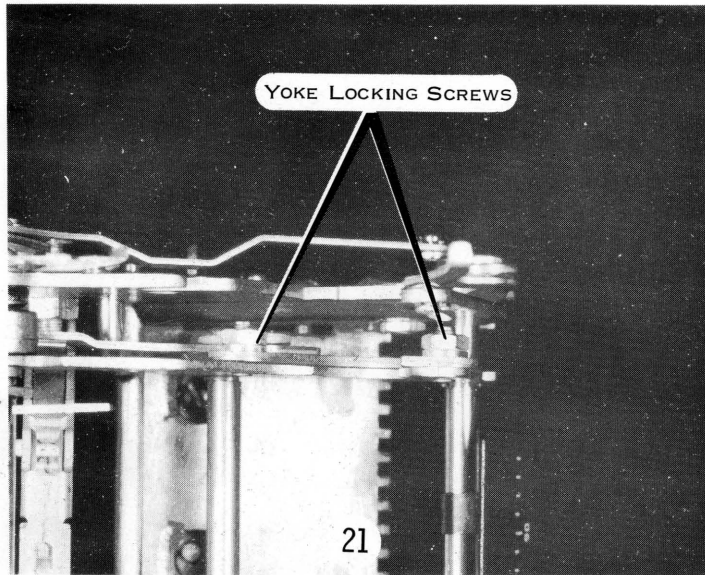

3. Position the PLATEN RETAINING PLATES to hold the platen guide shaft eccentrics tightly against the platen adjusting plates. (Fig. 22.)

The multiple copy control lever must be forward.

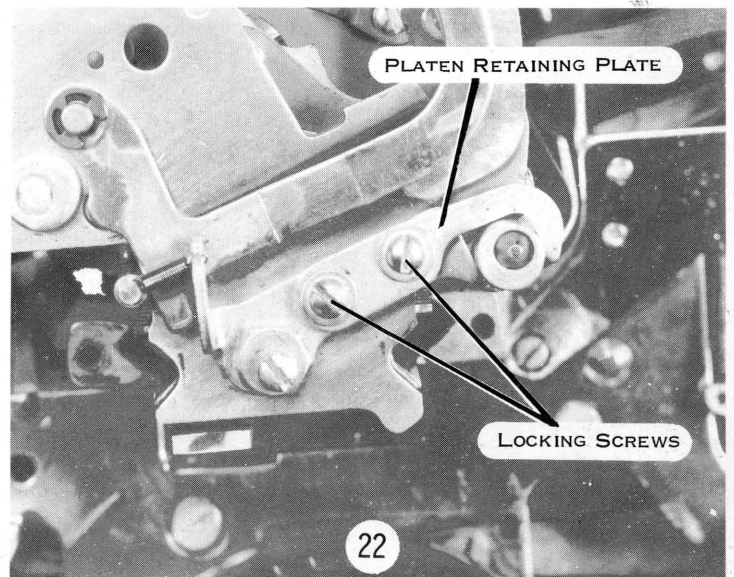

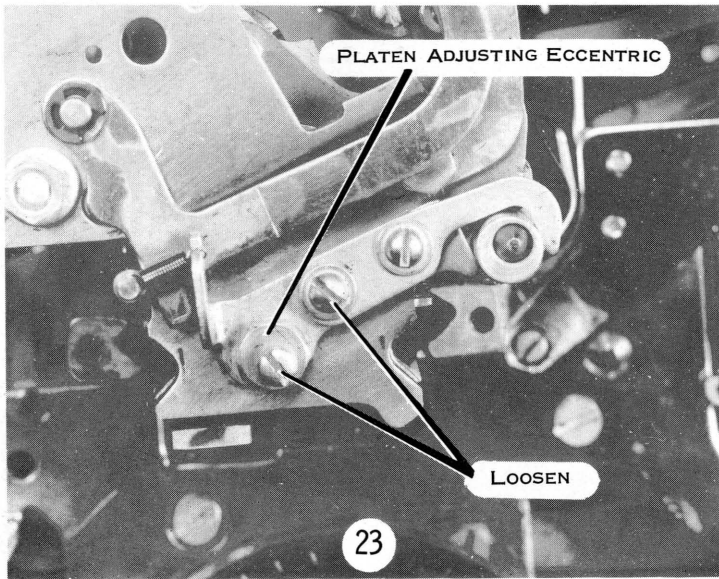

There should be a slight drag on the strip of paper as it is removed when the platen is in the proper position (Fig. 24).

Check this adjustment at both ends of the platen to insure ring and cylinder will not change across the platen.

Before adjusting the platen adjusting eccentrics, loosen the feed roll center support screws, (Fig. 25) and both rear platen retaining plate screws.

CARRIAGE

4. Adjust RING AND CYLINDER by moving inner carriage and platen front to rear with the platen adjusting eccentrics (Fig. 23).

Check RING AND CYLINDER with a single sheet of bond paper in the machine, and the ribbon in operating position. Hold a typebar in lower case position against the ring with a strip of bond paper used as a gauge between the ribbon and the sheet of bond paper.

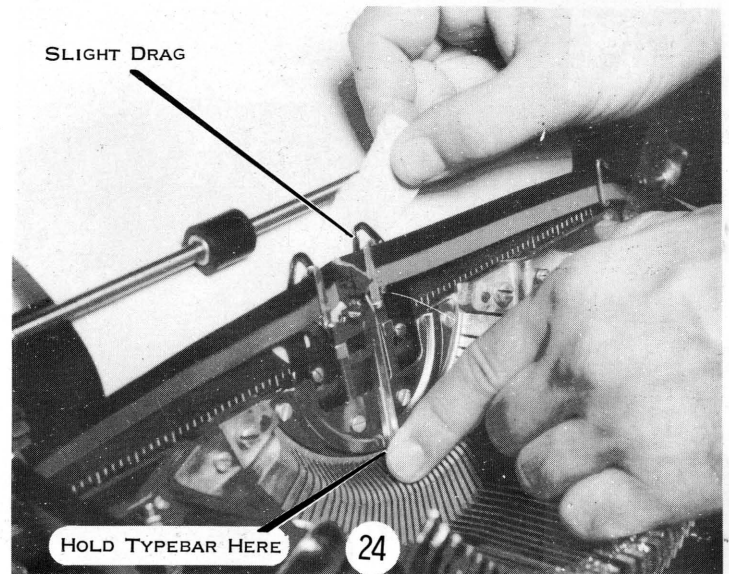

5. Adjust FEED ROLL CENTER SUPPORT to just touch the eccentric collar on the platen guide shaft. (Fig. 25.)

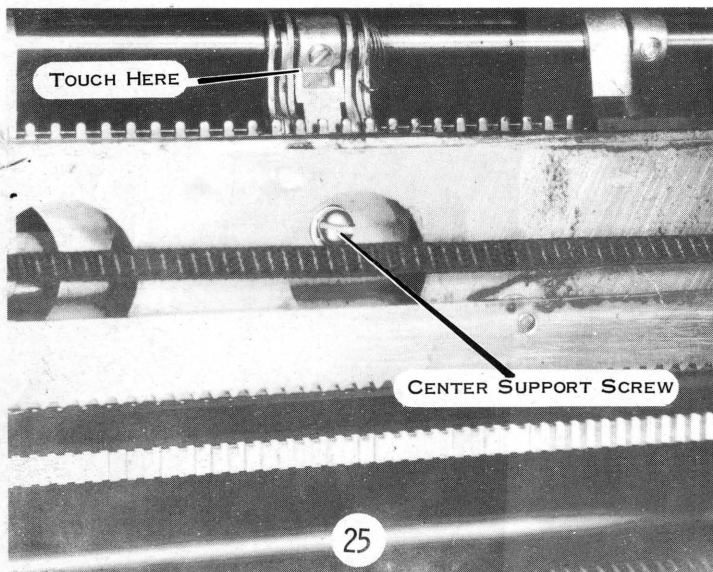

The center supports must be readjusted after any change in carriage ring and cylinder adjustment. On long carriage machines, it will be necessary to loosen the margin rack center support before adjusting the feed roll center support.

Correct support adjustment insures the proper relation between platen and feed rolls as the multiple copy control is adjusted.

1. The FRONT RAIL is positioned in the full forward position and locked in position with the rail clamping screw. (Fig. 26.)

The front rail is mounted to the power frame and maintains the correct relationship between the carriage and the type basket. The front rail is not adjustable and should remain in position during all rail adjustments.

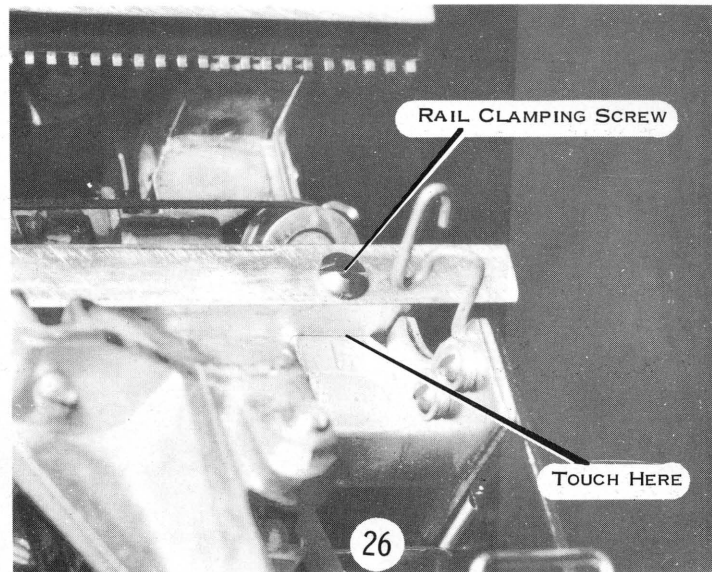

2. Adjust the RAIL SUPPORT ECCENTRICS to just remove front to rear movement of the carriage. The carriage is centered on the rails for the adjustment. (Fig. 27.)

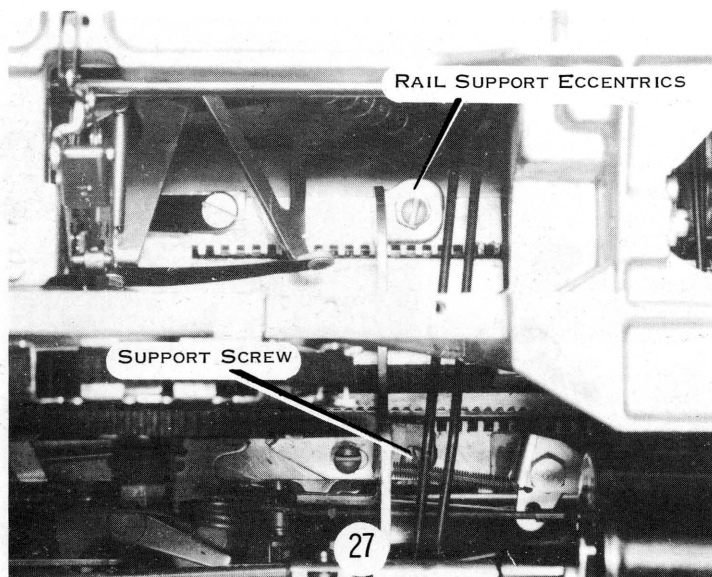

Before adjusting the rail support eccentrics, loosen both rear rail clamping screws and back off the rear rail adjusting screws (Fig. 28). If this is not done, adjusting the support eccentrics will bow the rails.

3. Adjust the REAR RAIL ADJUSTING SCREWS to just eliminate front to rear motion of the carriage. (Fig. 28.)

The carriage must be full right when adjusting the right adjusting screw, and full left when adjusting the left adjusting screw.

The rear rail is to be adjusted to just remove all front to back motion of the carriage with the carriage in any position. With the rails too tight, the carriage rollers will develop flat spots, the rails will wear more rapidly, and the carriage will bind or be sluggish. If the rails are loose, the carriage will move front to back causing uneven impression and writing line. When adjusting the rear rail, remove both carriage return and tension tape. With the tapes removed, the carriage should glide smoothly with no binds or front to rear motion.

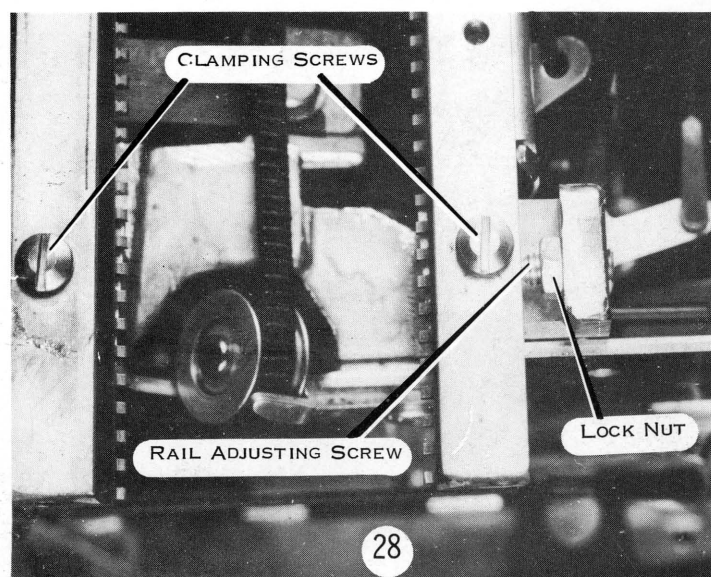

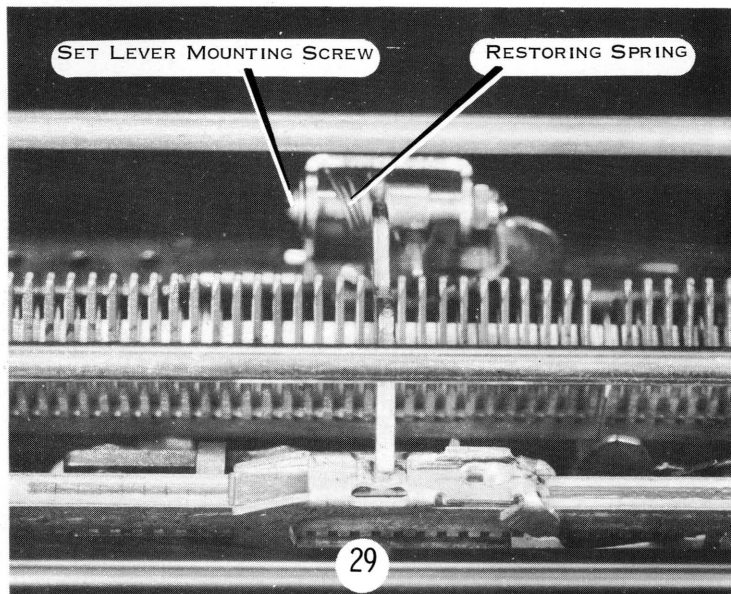

The margin stop is spring loaded to the left by the margin control lever. Therefore, it is necessary to adjust the margin set lever to contact the right side of the notch as it is operated. This slight off center adjustment compensates for the tension of the margin stop and the margin will set accurately. Do not form the margin set lever when making this adjustment. Move the bracket after loosening the mounting screws (Fig. 30). The margin set lever mounting screw and lock nut must be adjusted to remove all side movement of the set lever without binding the set lever. The hairpin spring must reliably restore the set lever (Fig. 29).

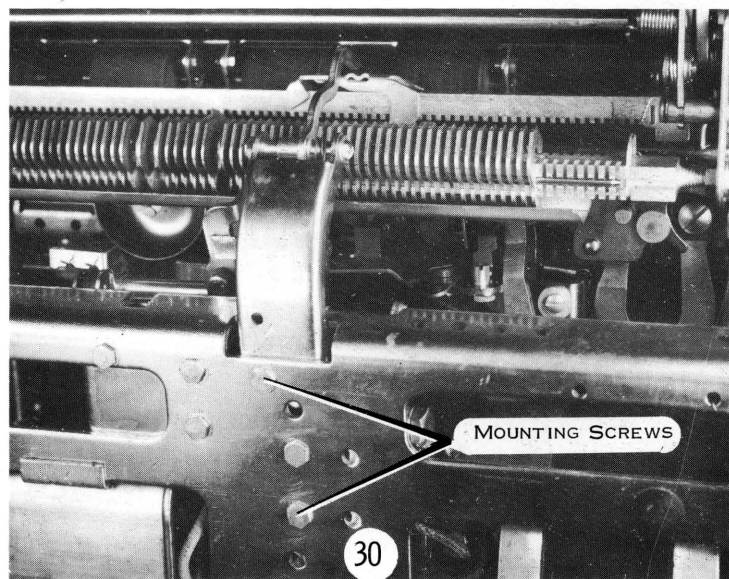

2. Adjust the MARGIN SET LINK so that the margin set lever just clears the margin rack with the margin set keybutton fully depressed.



If the margin set lever is set too high, it will not reliably release the margin stop from the margin rack. If the margin set lever is set too low, it will not cam over the margin stop as the set lever is incorrectly operated between the margins.

1. Adjust MARGIN RELEASE ECCENTRIC so that the margin control lever will clear the margin rack by .010" to .015". (Fig. 32.)

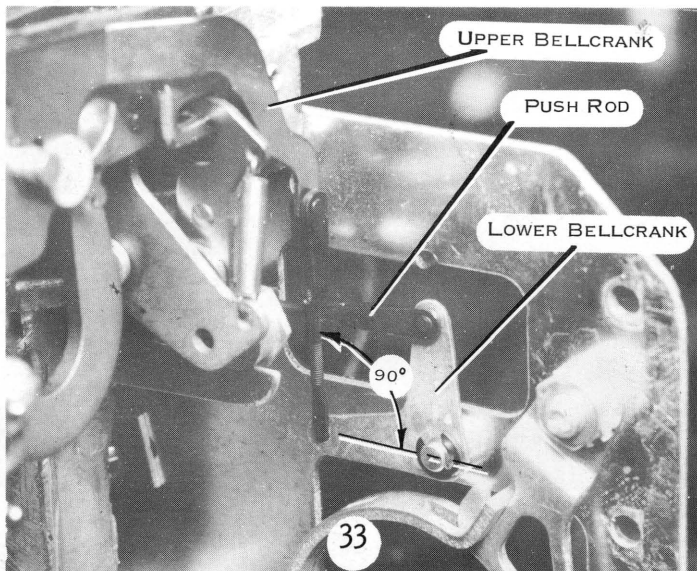
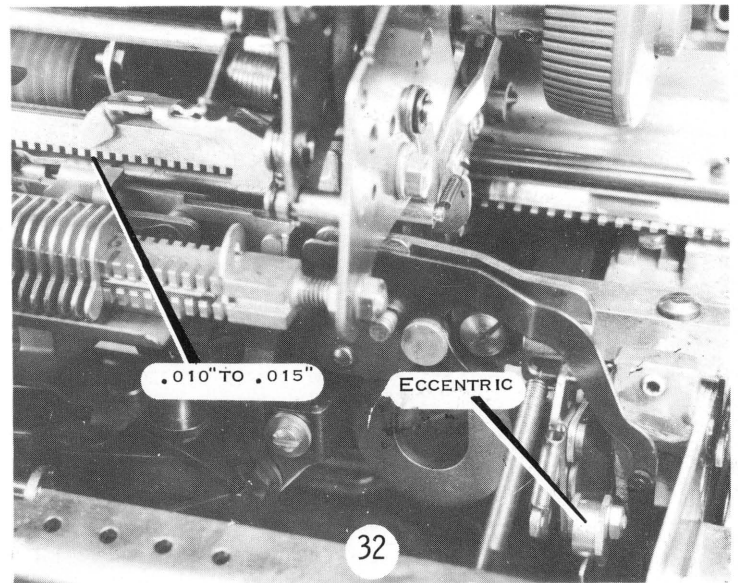

LINE LOCK

1. The VERTICAL LINK from the upper line lock bellcrank is adjusted so that the angle between the link and the arm of the lower bellcrank is approximately 90°. (Fig. 33.)

This adjustment insures maximum motion transmitted to line lock push rod.

2. Adjust the LINE LOCK PUSH ROD in the following manner:

- a. Unhook the push rod.
- b. Position the carriage at the right margin.
- c. Push the switch lever far enough to the rear to allow the linelock bracket to unlock the key lever.
- d. Push down and hold a letter keylever.
- e. Push forward on the push rod until it stops.
- f. Match the pin in the push rod clevis with the hole in the lower line lock bellcrank.

This adjustment insures maximum locking action without choking off.

MODEL B1 ADJUSTMENTS

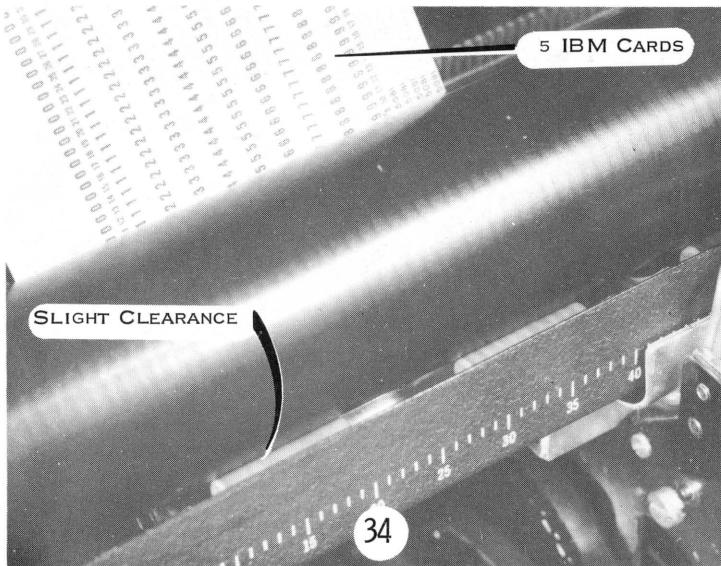

Too much clearance at the front feed rolls will decrease their tension and add greater tension to the rear feed rolls.

Check adjusting plate adjustment with the deflector out.

PAPER FEED

1. Position the ADJUSTING PLATES on the rear pressure levers (Fig. 35) so that when two IBM cards are inserted between the rear feed rolls and the platen, the front feed rolls have a slight amount of drag on the platen. If five IBM cards are inserted, the front feed rolls should be free to turn (Fig. 34).

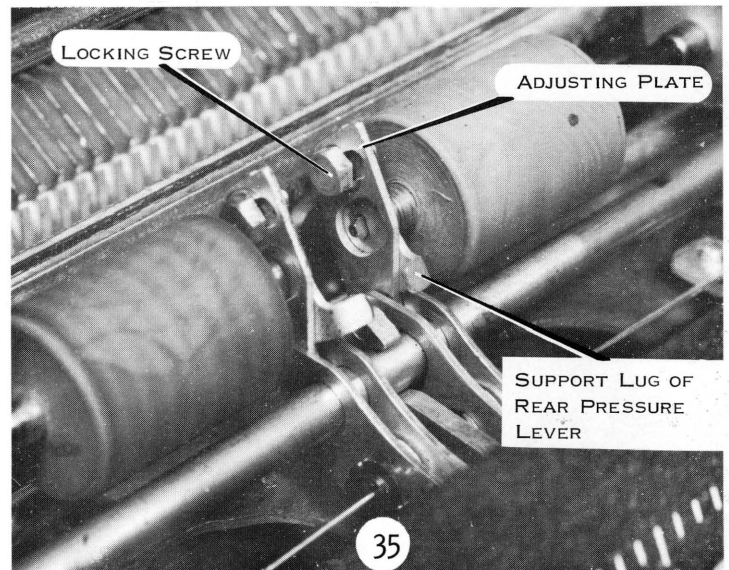

2. Support LUGS. Form the lugs on the rear pressure levels (Fig. 35) so that there is a clearance of .007" to .030" (one to four IBM cards) between the paper deflector and the platen.

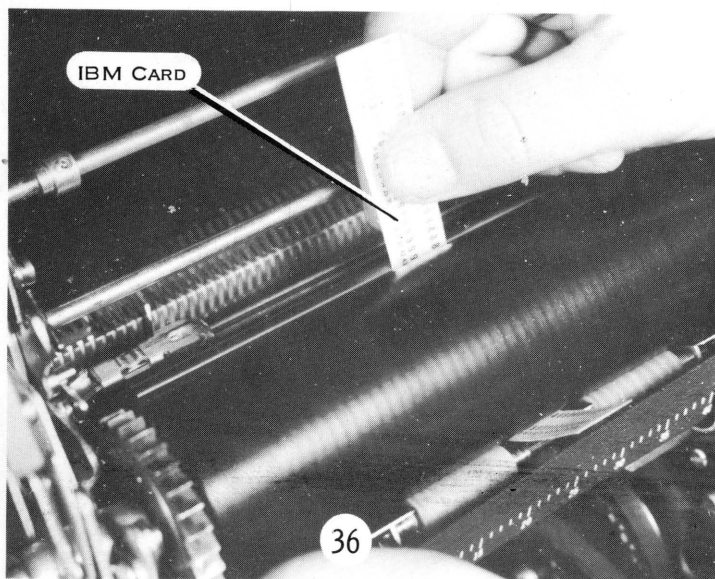

Card strips can be inserted at the ends of the deflector and between feed rolls to accurately check the clearance between the paper deflector and platen (Fig. 36). The deflector must not bind the platen or feed rolls.

3. FEED ROLL PRESSURE. Adjust by turning the feed roll pressure adjusting screws until a pressure of 12 to 16 ounces is necessary to deflect each feed roll pressure lever (Fig. 37).

A push scale may be applied at the ends of each feed roll shaft to make a reading of this adjustment. NOTE: Depress the front feed roll pressure levers when checking the pressure of the rear feed roll pressure levers, because with the platen out, the front pressure levers contact the adjusting plates. Pressure between two feed rolls on the same shaft, either front or rear, may be equalized by forming the feed roll tension spring. The screw plate should be centered before making this adjustment.

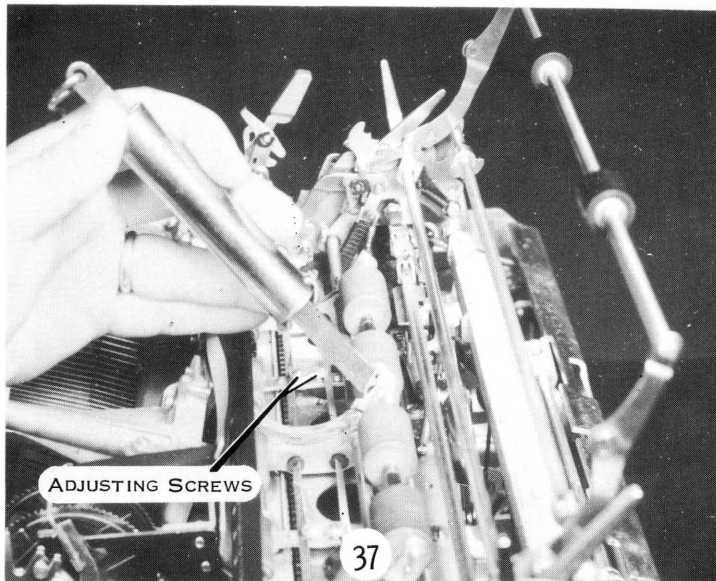

4. The LINE GAGE CARD HOLDERS should be adjusted in two ways:

- a. Up or down so when viewed from the operators position, a thick line of white shall be visible between the feet of the characters and the card holders. (Fig. 38.)
- b. Left or right by loosening the screws in the front rail dust cover and positioning the dust cover to align the marks on the card holder with the bottom of the V's typed on the paper (Fig. 38). Individual card holders can be moved left to right by loosening their mounting screws.

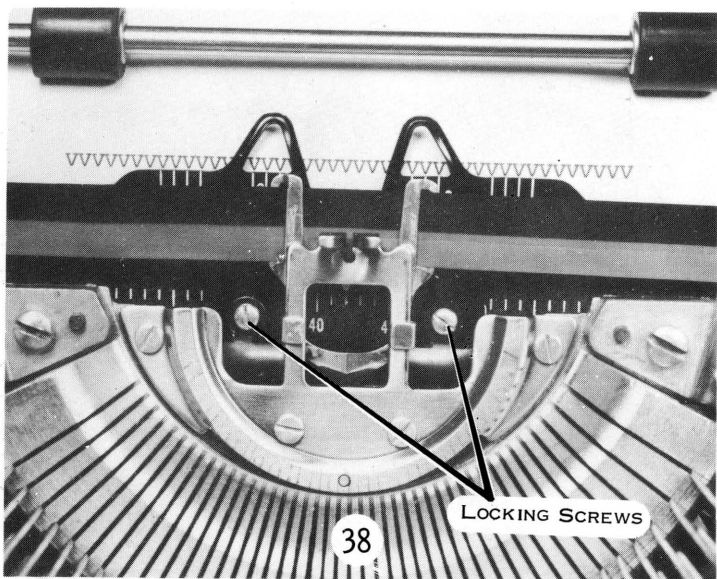

5. INDICATOR POINTER. Center the pointer with respect to the typebar guide throat. (Fig. 39.)

Do this by loosening the line gage card holder screws which secure the indicator pointer to the front rail dust cover.

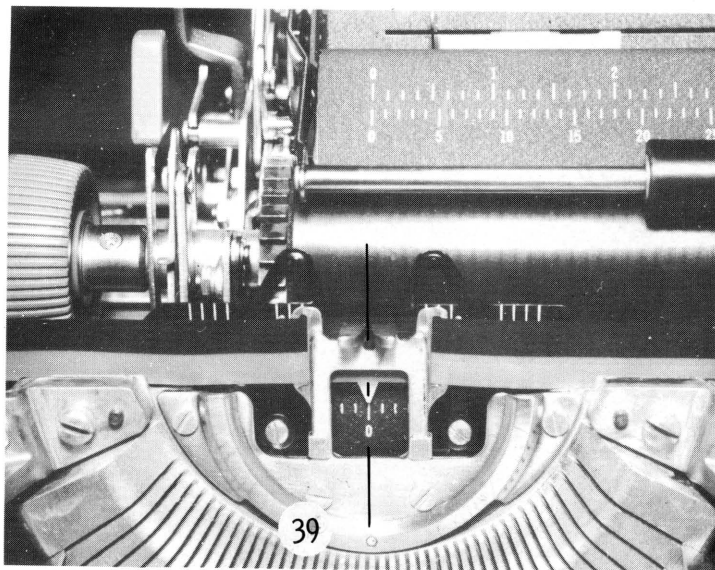

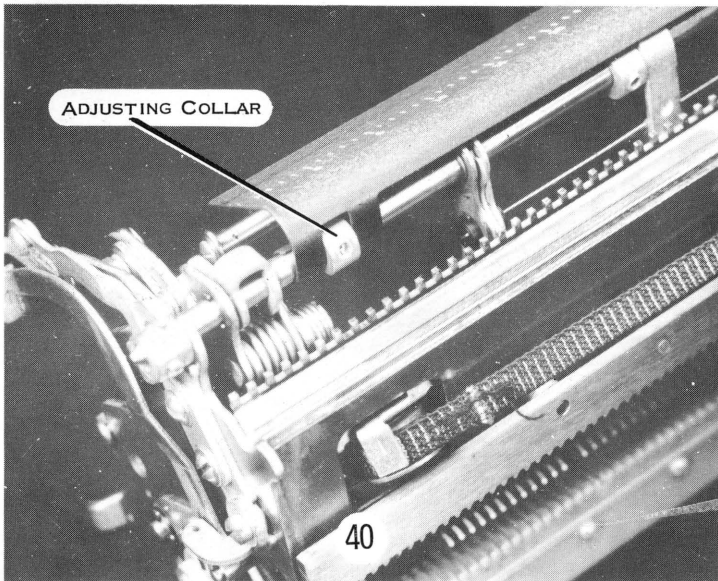

6. FRONT PAPER SCALE. Adjust in the following manner:

- a. Loosen the collar on the platen guide shaft which positions the front paper scale (Fig. 40).
- b. Position the left margin stop to its extreme left position.
- c. Move the carriage to the left margin.
- d. Position the front paper scale to align the zero with the indicator pointer and tighten the collar screw (Fig. 39).

Front scales must rest evenly across the platen. It must also be free to move front to rear as paper is inserted.

7. REAR PAPER TABLE. Adjust this so that the relationship between the deflector and the paper table will allow the paper to pass freely in either direction without catching (Fig. 41).

This is adjusted by the locking screws that clamp the adjusting plates to the paper table bracket (Fig. 42).

Check to be sure that the rear paper table is not touching the deflector.

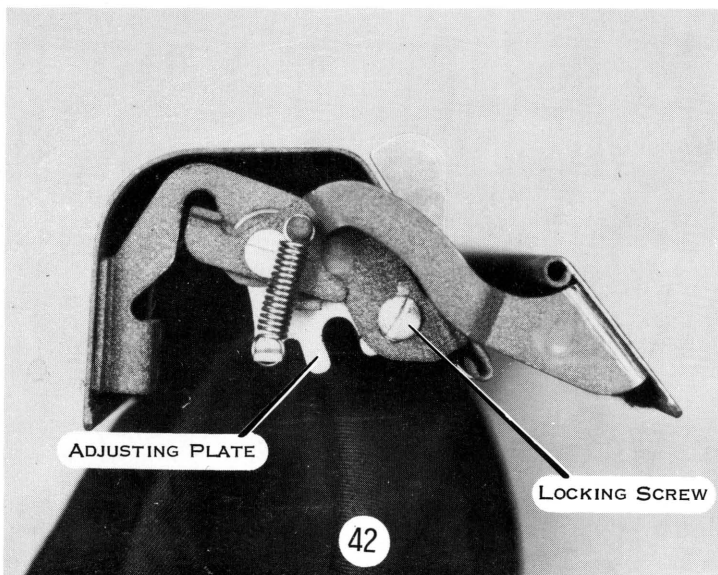
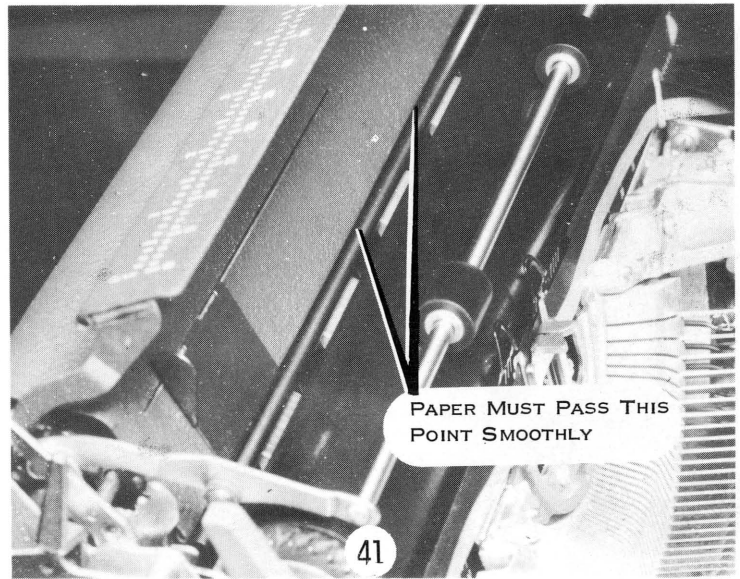

8. FRONT PAPER TABLE. Adjust this so that the graduations on the front paper table are in line with those on the front paper scale. (Fig. 43.)

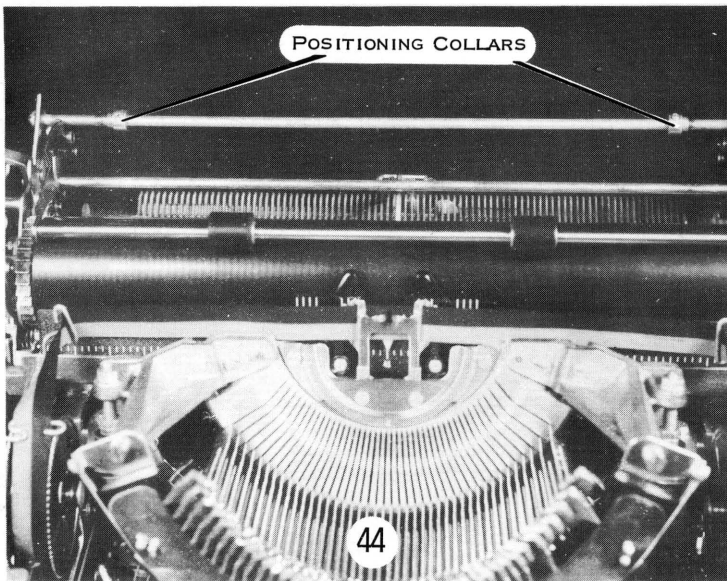
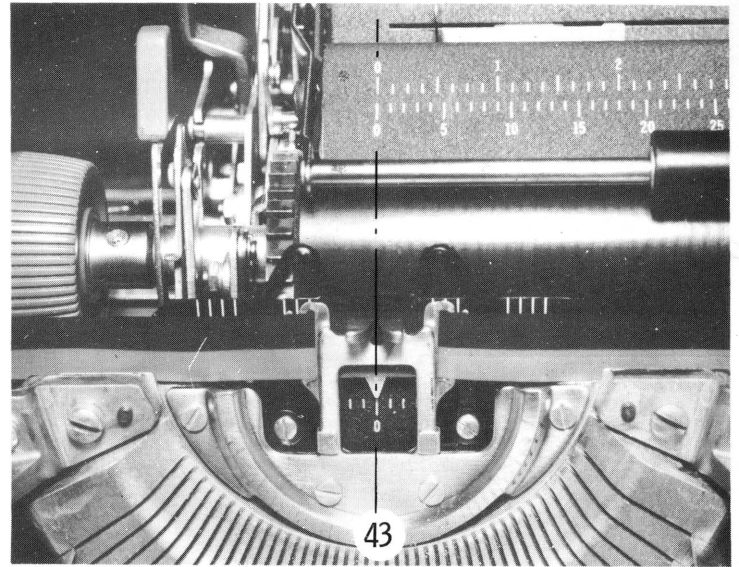

Adjust by loosening the positioning collars on the carriage tie rod and moving the rear paper table (Fig. 44). Also adjust the paper table to rest evenly on the platen throughout its entire length. This is accomplished by forming the stop lugs which contact the carriage tie rod.

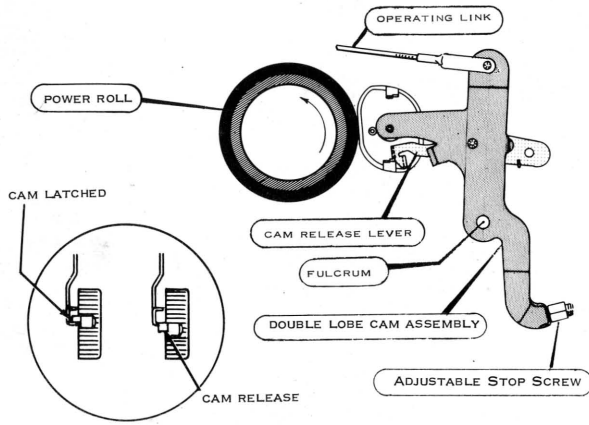

45

Operational cam clearance is checked by releasing the cam with the power off, and noting the position of the cam release lever with respect to the cam lug. The adjustment is correct when the release lever rests on the rear half of the cam lug. On the shift cam, the release lever should fall behind the cam lug by the thickness of the lug. Double lobed cams must be checked on both lobes.

1. Adjust OPERATIONAL CAM CLEARANCE for .010" to .015" from the power roll.

Adjustable stop screws are used to change operational cam clearance. Be sure to loosen lock nut before adjusting stop screws. (Fig. 45, 46, and 47).

The ribbon cam has an eccentric stop instead of a stop screw.

NOTE: All operational cams are adjusted in a similar manner for the .010" to .015" clearance. Therefore, the theory of adjustment will be given only in this section.

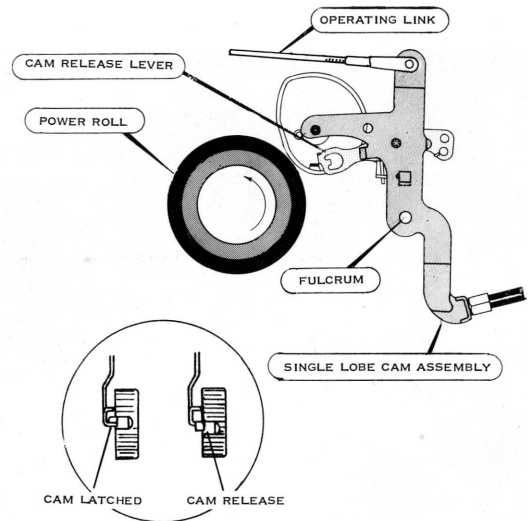

46

Insufficient cam clearance will cause the cam to ride on the power roll and make a buzzing sound. Excessive clearance reduces the effective rise of the cam.

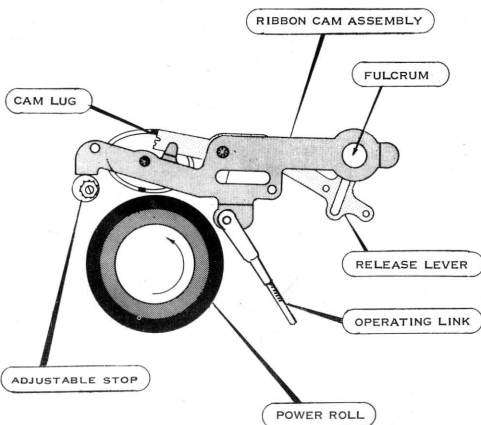

47

1. Adjust CAM CLEARANCE for .010" to .015". (Fig. 48.)

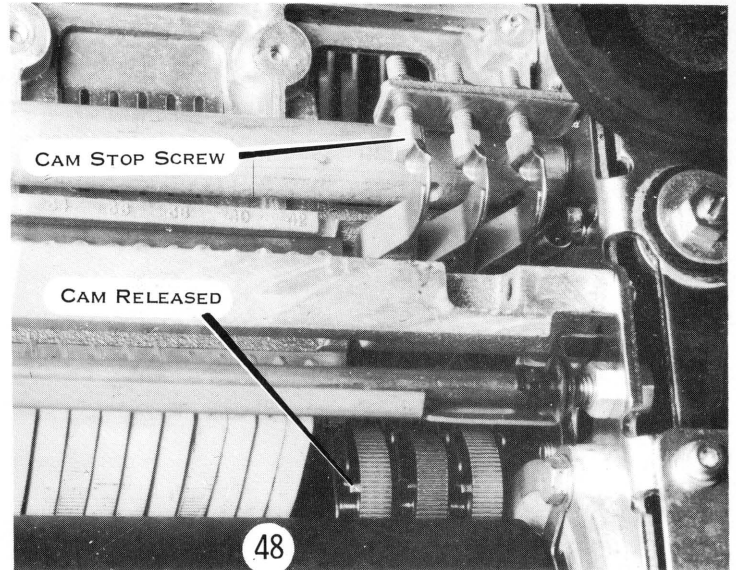

2. Adjust the CAM RELEASE LINK so that the cam is released when the keylever is depressed 1/2 to 2/3 of its travel. (Non-repeat cam). (Fig. 49.)

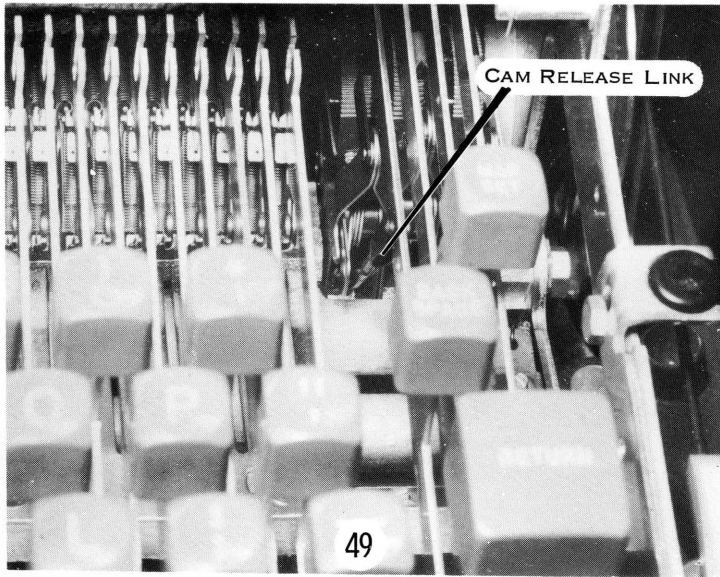

Adjust CAM RELEASE LINK so the cam repeats when the plunger is depressed 1/16". (Repeat cam). (Fig. 50.)

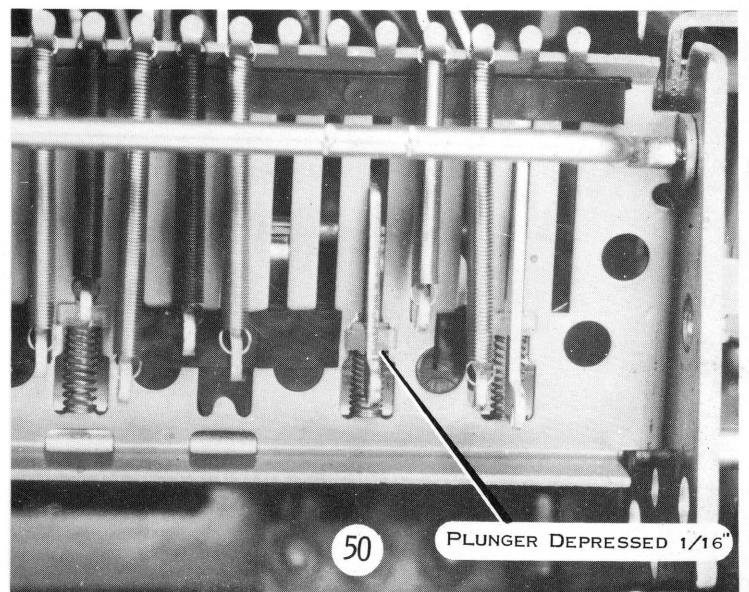

MODEL B1 ADJUSTMENTS

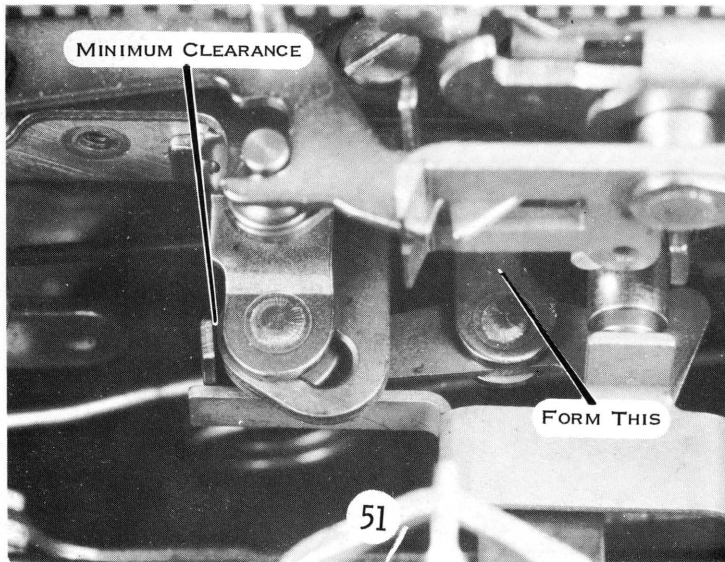

4. Form the PAWL RELEASE LEVER LUG so that with the interlock at rest, the backspace pawl will just clear the interlock as the pawl is operated. (Fig. 52.)

This adjustment insures positive interlocking.

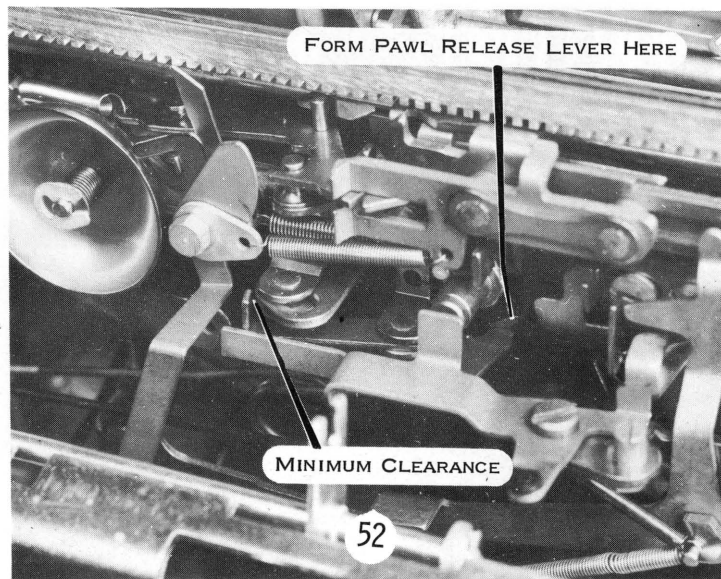

5. Form the BACKSPACE PAWL GUIDE LUG left or right so that it will guide the backspace pawl into the rack with $1/64$ " clearance between the right surface of the pawl tooth and an escapement rack tooth. (Fig. 53.)

Place the blade of a screwdriver against the forward portion of the lug and tap the screwdriver with the hammer.

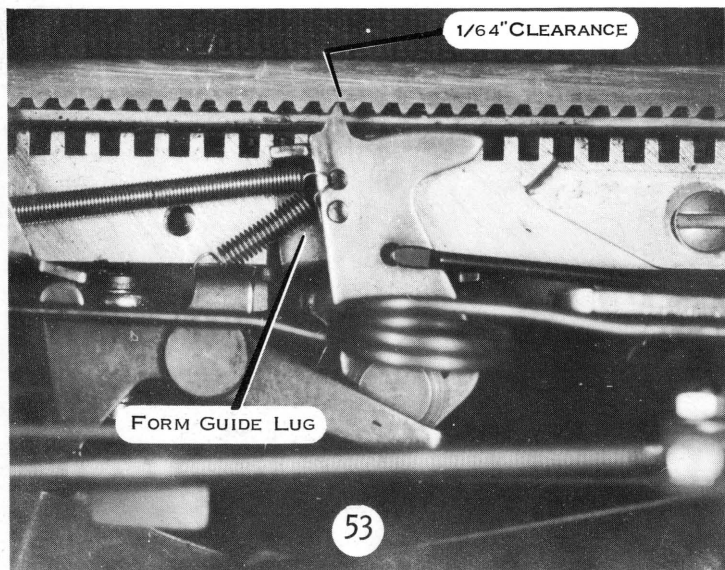

6. Adjust the BACKSPACE PAWL STOP so that it will stop the pawl just as the carriage has moved far enough for the escapement pawl to drop into the next tooth on the escapement rack. (Fig. 54.)

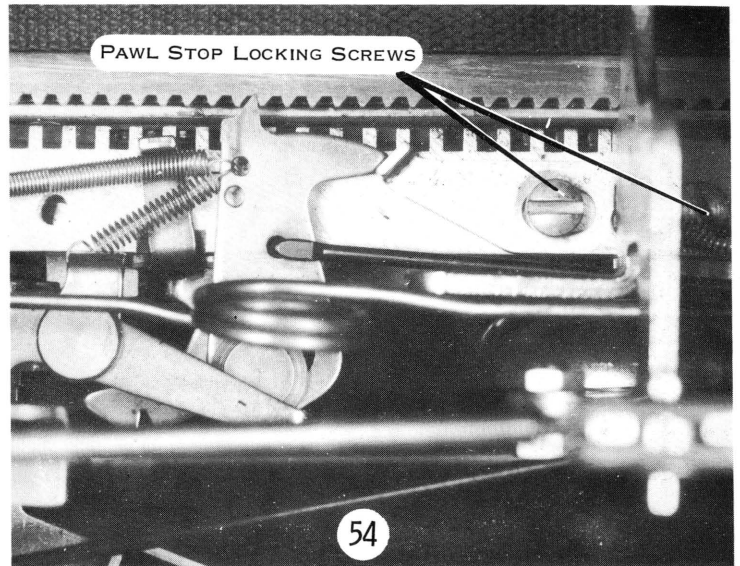

The pawl stop is also adjusted front to back so that when the backspace pawl is interlocked it will pass behind the stop. (Fig. 55.)

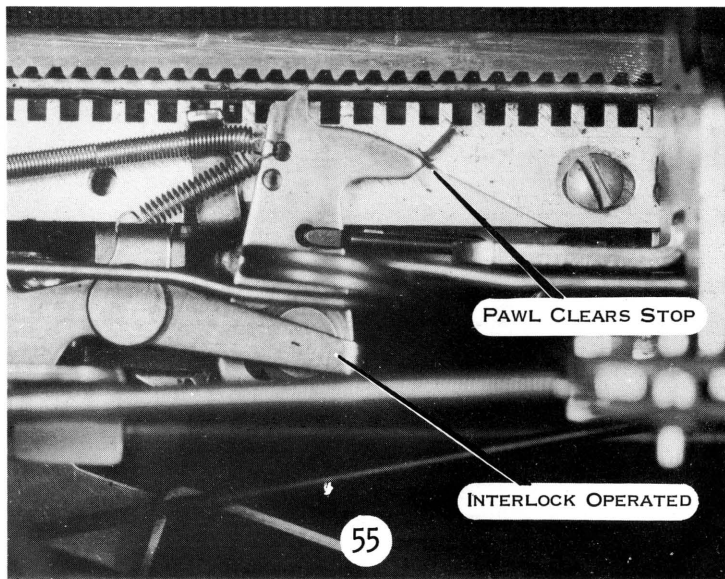

Observe this adjustment through the bottom of the machine. Release the cam and turn the power roll by hand. The backspace pawl must be stopped just as the escapement pawl clicks into the next rack tooth.

7. Adjust the OPERATING LINK so that there will be 1/4" of travel left on the cam when the backspace pawl is stopped by its stop. (Fig. 56.)

This 1/4 travel holds the backspace pawl in the escapement rack and against its stop. With the pawl so locked in position, the carriage will be stopped and will not coast back an extra space.

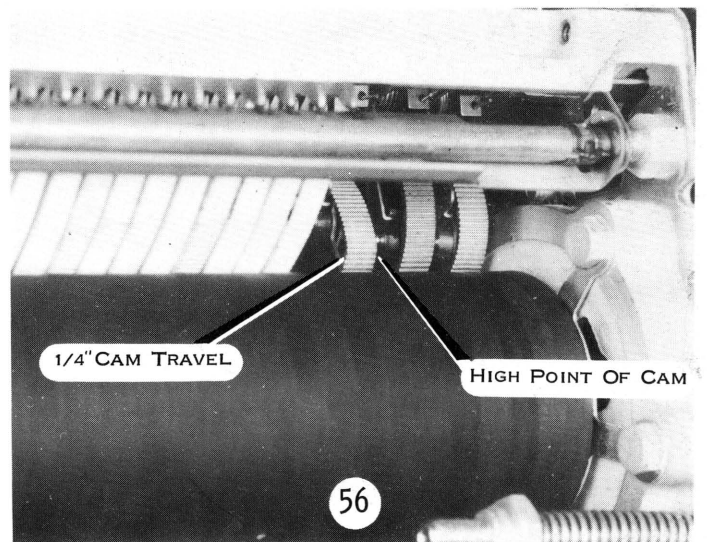

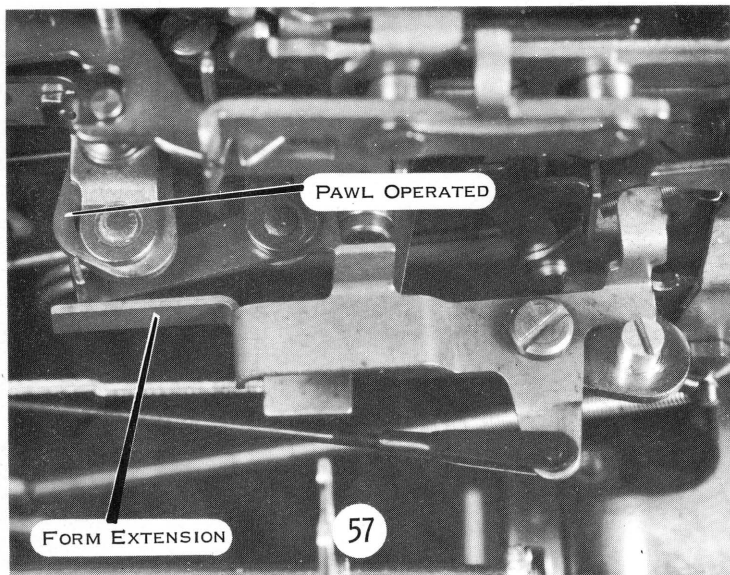

8. Form the CARRIAGE RETURN TAB INTERLOCK EXTENSION toward the front of the machine just far enough to prevent the clutch from latching during a simultaneous backspace and carriage return operation.

The clutch will not latch because the backspace interlock will prevent the carriage return tab interlock from rotating as shown (Fig. 57).

Before adjusting the shift mechanism, ring and cylinder adjustments must be correct. (See Carriage Adj. #4).

1. Adjust EVEN TOP AND BOTTOM of the lower case letters by screwing the shift stop screws up and down. (Fig. 58.)

Loosen lock nuts and adjust both stop screws. The heads of the stop screws must rest with equal pressure against the stop washers. Equal pressure is checked by placing a narrow strip of paper between the stop washer and the stop bracket. Slowly pull the paper out and note the amount of drag. Check both sides for equal drag. Unequal pressure will bend or break the stop bracket that is being used. Be sure to retighten the lock nuts.

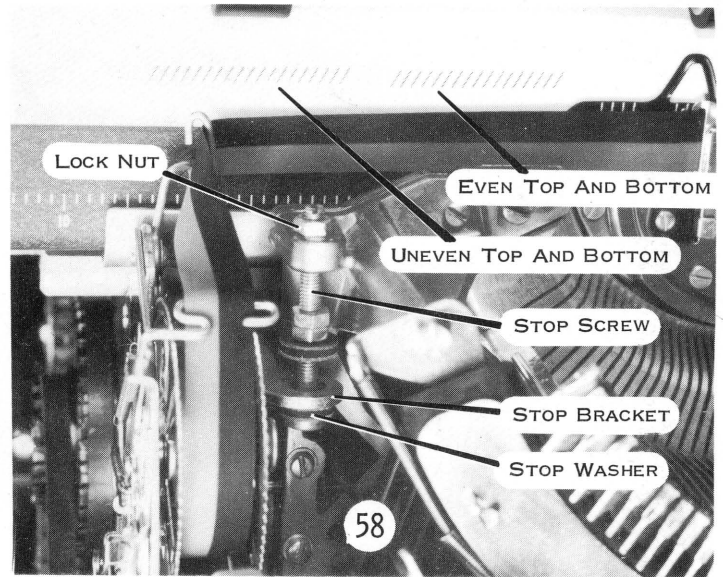

2. Adjust SHIFT MOTION by moving the lock nuts on each stop screw so that the upper case characters print on the same line as the lower case characters. (Fig. 59.)

The lock nuts must also rest with equal pressure on the stop bracket. Be careful not to turn the stop screws when adjusting the stop nuts.

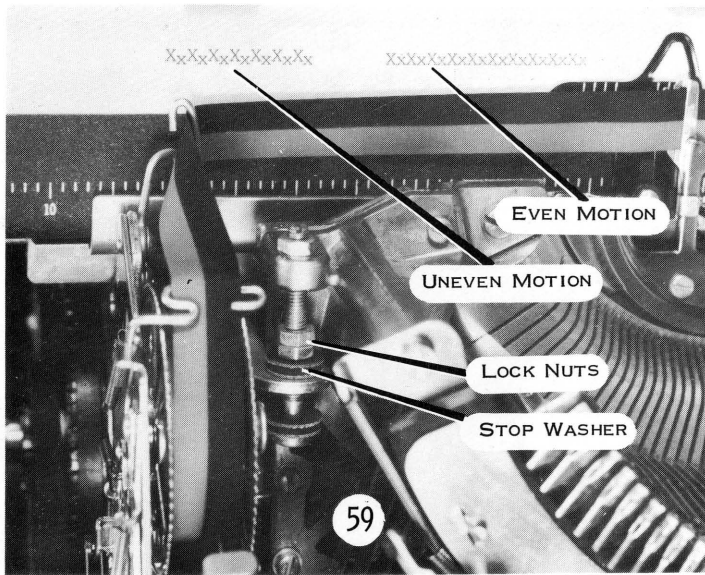

3. Adjust CAM CLEARANCE FOR .010" to .015" (Fig. 60).
4. Adjust CAM RELEASE LINK so that cam will be released when keylever is depressed 1/2 to 3/4 of its total travel.

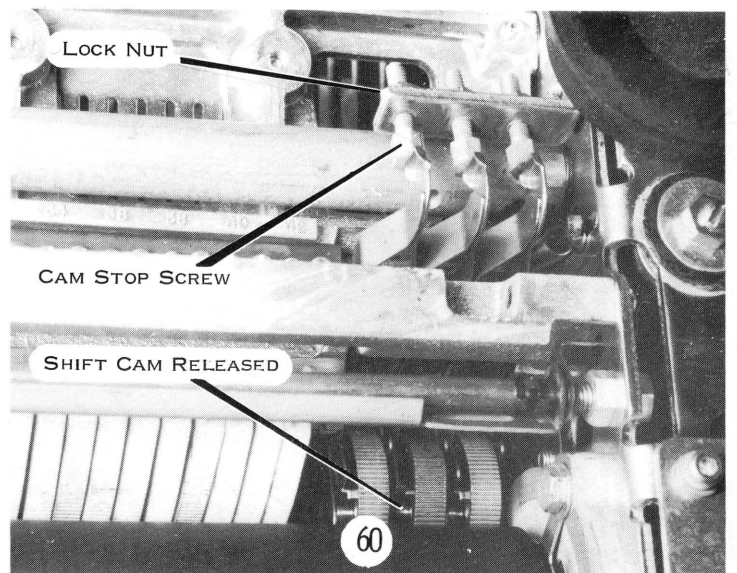

SHIFT

5. Adjust EQUAL PIN CLEARANCE by moving the toggle brackets up or down with the toggle bracket screws (Fig. 61).

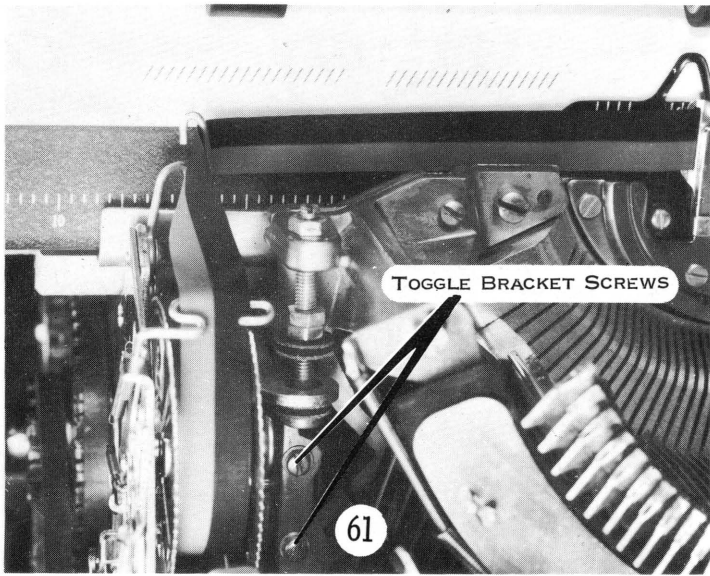

Equal pin clearance is checked in the following manner:

- a. With power OFF, place basket up in lower case.
- b. Depress shift keylever and observe the pusher to upper pin clearance (Fig. 62).
- c. Place basket down in upper case.
- d. Release keylever and observe pusher to lower pin clearance (Fig. 63).

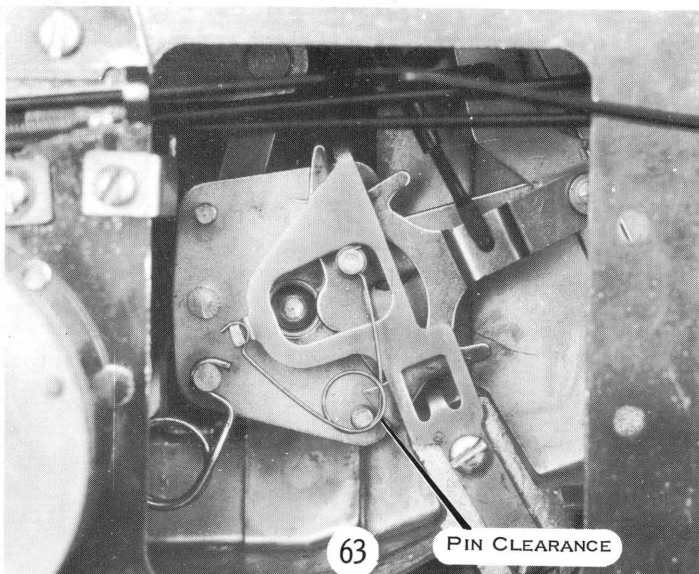
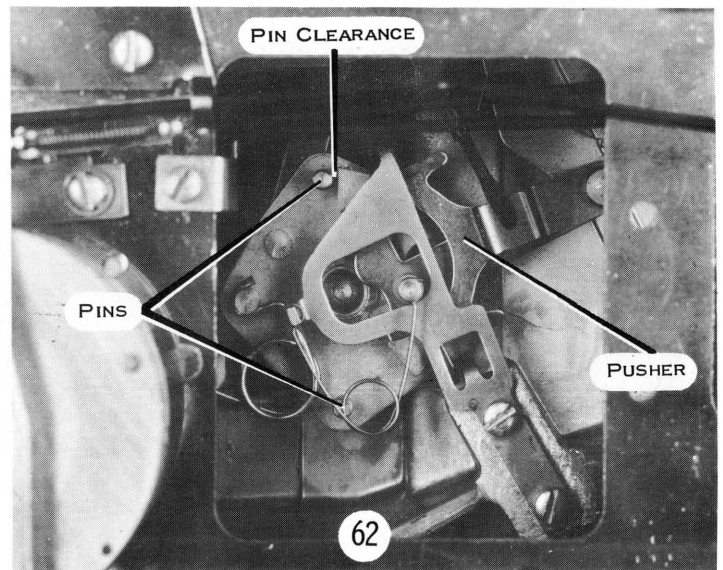

The pusher to pin clearance must be the same for both positions. The amount of pin clearance at this point is not important as long as it is equal (Fig. 62 & 63).

To adjust equal pin clearance, loosen both upper toggle bracket screws and tighten both lower screws to reduce lower pin clearance. Use the converse to reduce upper pin clearance. Unequal pin clearance will cause shift to vary in speed and action between upper and lower case (Fig. 61).

6. Adjust the **PUSHER LINK** so that the top of the pusher will be even with or slightly above the top of the upper pin when the cam is released (Fig. 64A.)

This adjustment is checked with the power ON. Slowly depress the shift keybutton while observing the rising pusher. Continue to observe as the cam operates and note the position of the pusher as it contacts with the pin.

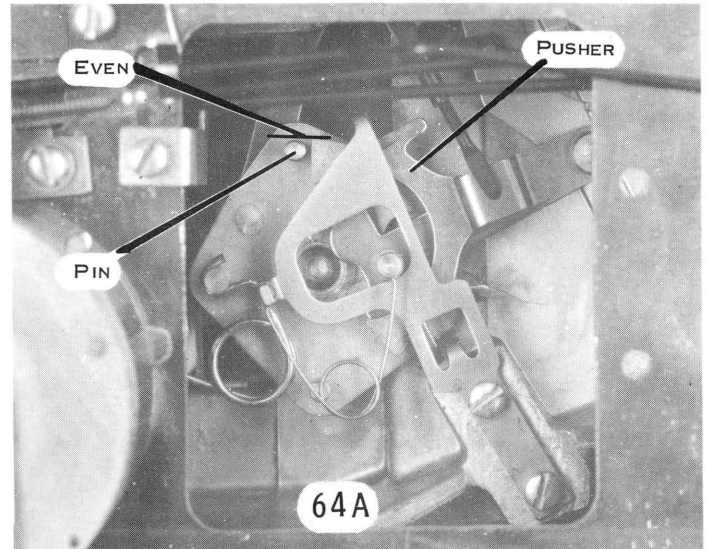

7. Adjust the **OPERATING LINK** so that the pusher clears the pin by $1/32''$ to $1/16''$. (Fig. 64B.)

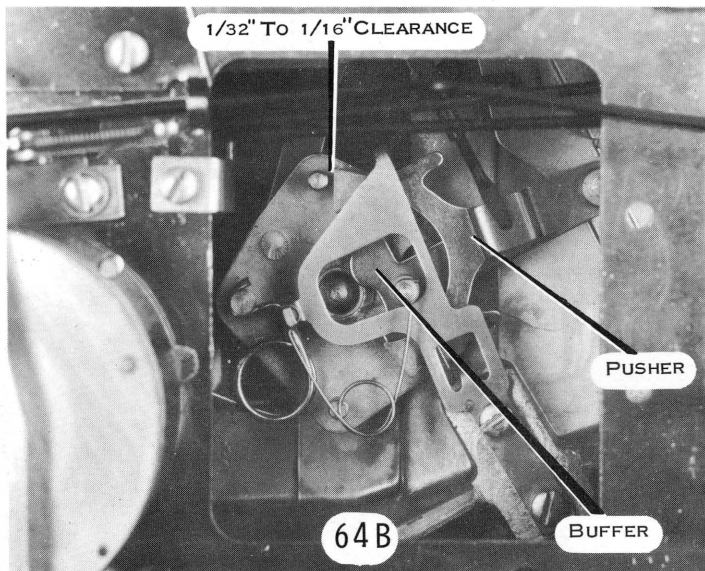

The shift buffer is mounted to the same stud as the shift pusher and any adjustment of the operating link will effect both buffer and pusher.

Insufficient pusher to pin clearance can cause the pusher to bind on pin, giving heavy touch on shift keybutton or hesitating shift action due to too much buffer action.

Excessive clearance can cause a noisy shift due to too little buffer action or shift failure due to pusher not rotating toggle plate far enough.

8. Adjust the **SHIFT LOCK BRACKET** so that the cam is released just as the lock engages. (Fig. 65.)

Check for easy unlocking with both shift keybuttons. Loosen locking stud only slightly when adjusting the bracket.

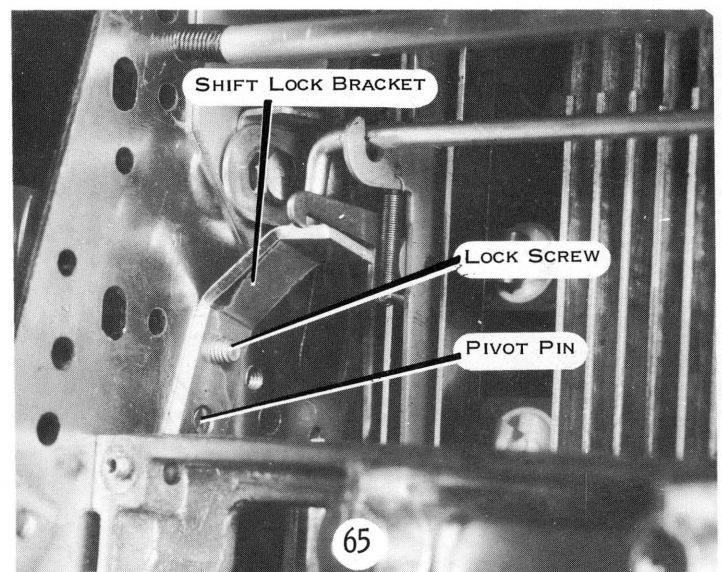

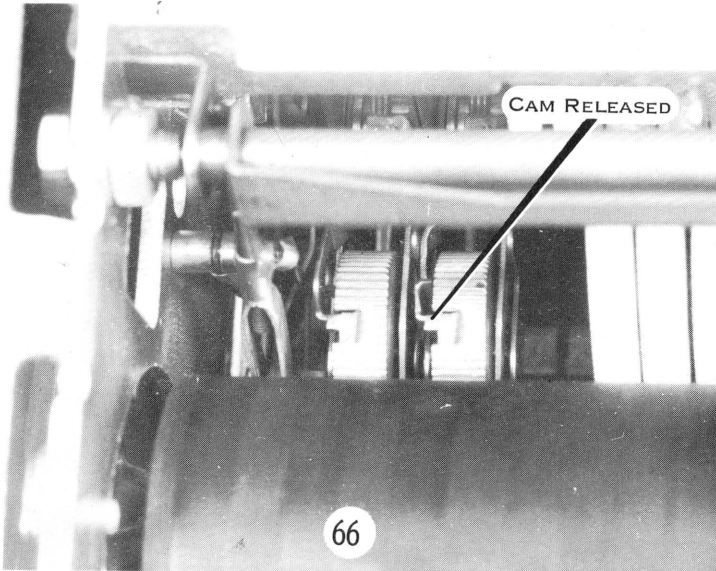

1. Adjust CAM CLEARANCE for .010" to .015". (Fig. 66.)
2. Adjust CAM RELEASE LINK so that the cam is released when the keylever is depressed 2/3 of its travel.

3. TAB LEVER HEIGHT. Adjust the margin release eccentric so that the margin control lever will clear the margin rack by .010" to .015". (Fig. 67.)

4. Adjust the TAB RACK left or right so that there is .002" to .015" clearance between the left face of any set tab stop and the engaging face of the tab lever (Fig. 68).

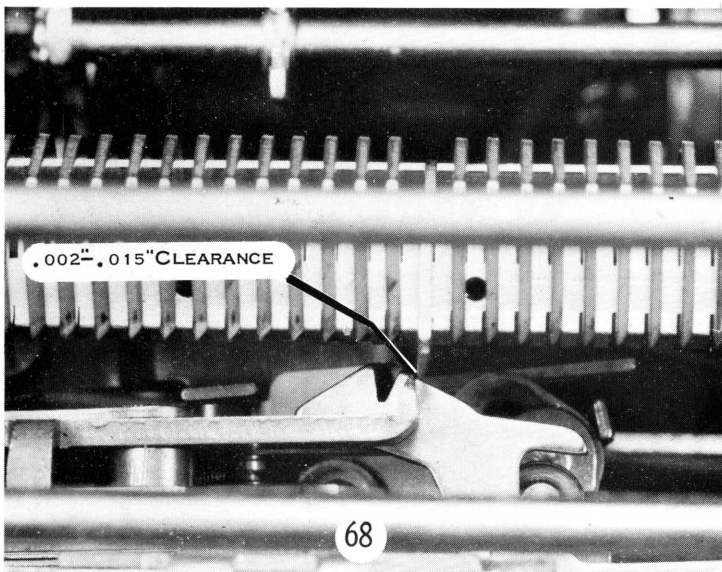
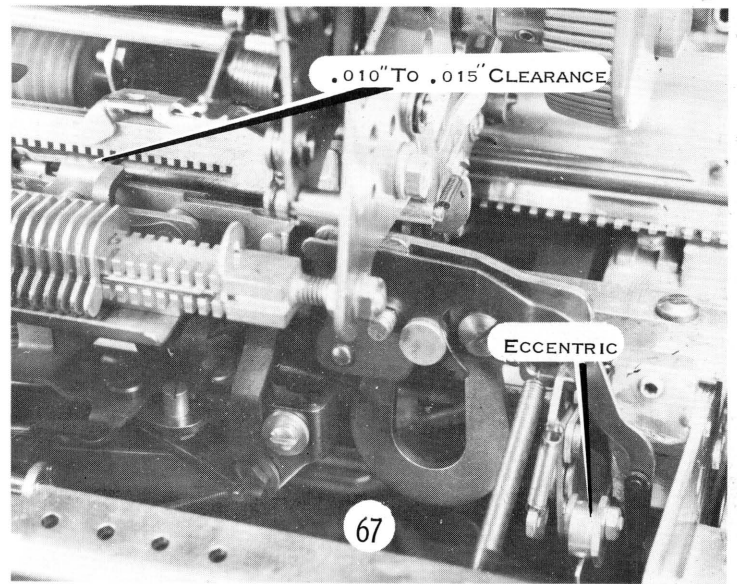

Check this adjustment by slowly moving the tab lever to the rear. The carriage must be held as the escapement pawl will be held out of the escapement rack. With the tab check lever just past the front edge of the tab stop (Fig. 68) observe the .002" to .015".

This adjustment insures that the carriage will be in the proper position when it is stopped by the check lever. It also allows tabbing to every other tab stop. Excessive clearance can cause carriage to stop one space past the tab stop.

Be sure to adjust both ends of the tab rack the same amount to prevent bowing the carriage and plates.

5. Adjust the TAB RACK PARALLEL to the rear rail and the front of a set tab stop parallel with the tip of the check lever. (Fig. 69.)

Adjust by moving the right end of the tab rack front to rear in its elongated mounting hole. Check this adjustment by noting the tab check lever bite on extreme left and right tab stops. Maintain the set tab stops parallel with the check lever when tightening the lock nuts.

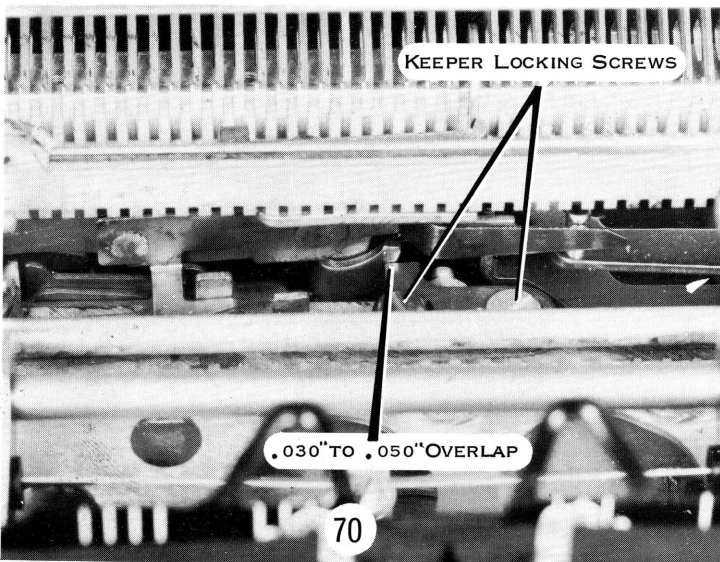
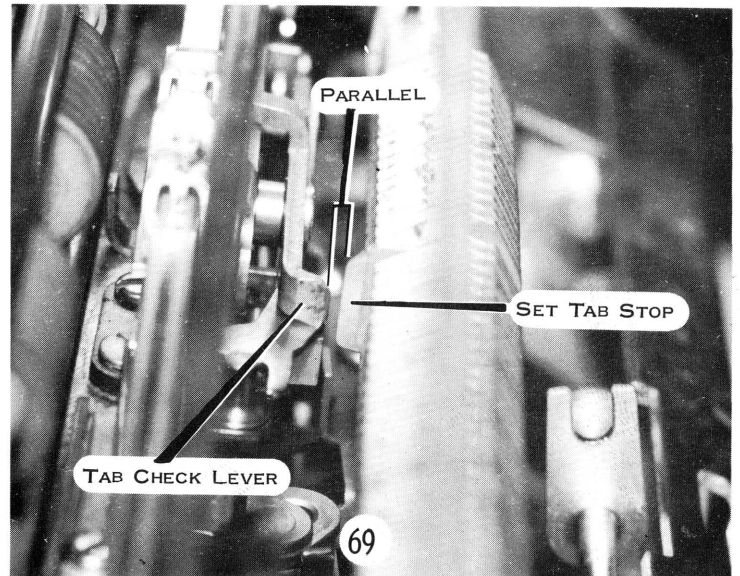

6. Adjust the TAB LATCH KEEPER front to back so that when latched, the check lever overlaps 1/2 to 2/3 of a set tab stop (Fig. 71). Adjust the keeper left to right so that there is .030" to .050" overlap of the tab latch on the keeper (Fig. 70).

This adjustment is checked by latching the tab lever by hand and holding the carriage so that a set tab stop just contacts the check lever. In this position, both adjustments can be checked.

Insufficient latch overthrow on the keeper can cause the carriage to stop one space too soon or be stopped by the escapement pawl due to early tab unlatching.

Excessive overthrow of the latch CAN cause failure of tab to unlatch or a bouncing sound as the check lever stops the carriage.

A correctly adjusted and operating tab will have a single solid sound as the carriage comes to rest at the tab stop.

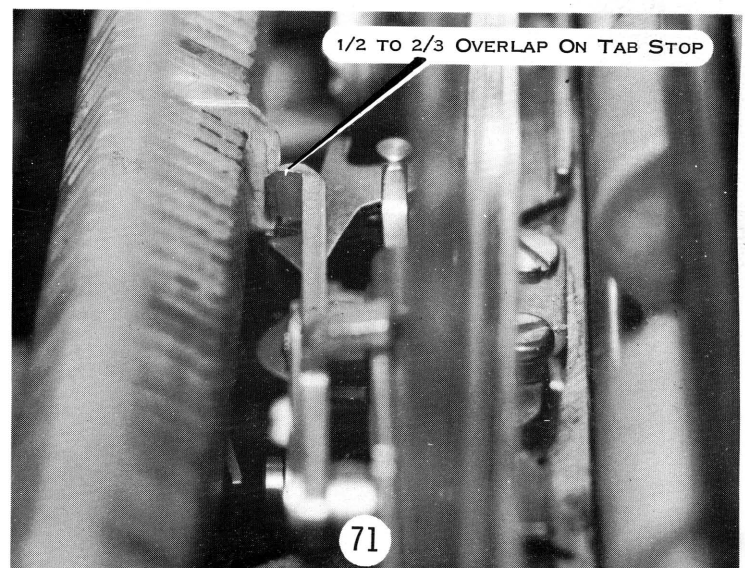

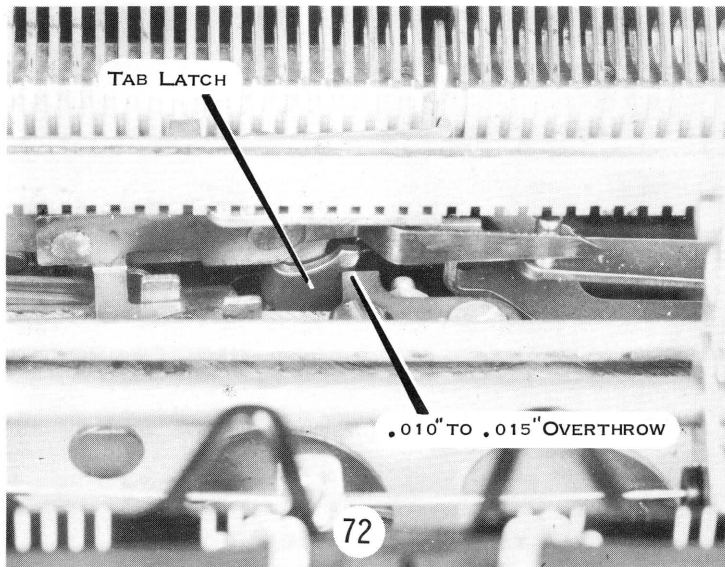

7. Adjust the TAB OPERATING LINK so that with the cam on its high point, there is .010" to .015" clearance between the tab latch and the keeper. (Fig. 72.)

Check this adjustment with the power OFF. Release the tab cam and turn power roll by hand until cam reaches its high point. Observe .010" to .015" overthrow. The operating link must not prevent tab lever from restoring against the rear rail. Be sure the overthrow stop does not limit the travel of the tab lever under hand operation. Excessive overthrow can cause the tab check lever to strike the tab rack. Insufficient overthrow can cause failure of the tab lever to latch.

8. Adjust PAWL CLEARANCE by forming the rear upright lug of the pawl release lever until the escapement pawl clears the escapement rack by 1/64" with the tab lever latched. (Fig. 73)

CAUTION: Do not form the hook on the tab lever. Form only the pawl release lever lug. Check the 1/64 clearance by latching out the tab lever and while holding the carriage, sight down the escapement rack.

Excessive clearance can cause late restoring of the escapement pawl and incorrect tabulation.

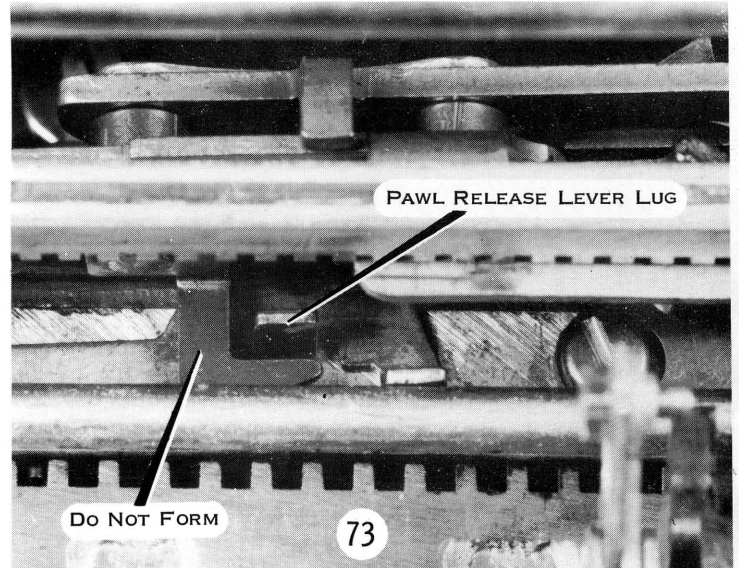

9. The REBOUND CHECK BRACKET is adjusted two ways: Position the bracket left or right so that the right edge of the V-slot of the rebound check lever clears the right hand of any set tab stop by .010" to .018" when the left hand face of the stop has pushed the tab check lever to the extreme left. At the same time, the bracket should be positioned front or rear so that, when the rebound check lever in its operated position against the pin in its bracket, the leading edge of the rebound check lever is even with the tip of the tab check lever or is .005" farther to the rear. The bracket can be conveniently adjusted for both conditions simultaneously.

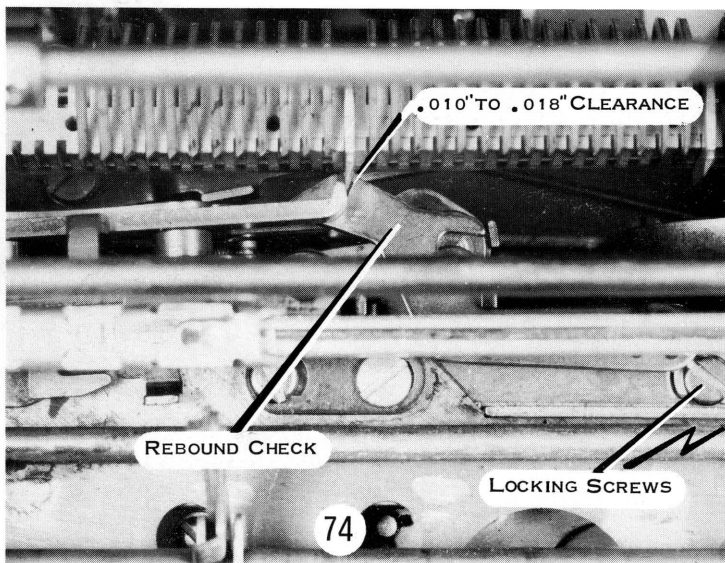

This adjustment is most rapidly made by releasing the tab cam, rotating the power roll until the cam is on its high point, allowing the carriage to rest with a tab stop against the check lever. The rebound check bracket can now be loosened and positioned in correct adjustment (Fig. 74).

Excessive clearance will allow the carriage to rebound and come to rest one space before the tab stop. Insufficient clearance can prevent tab lever from restoring and resulting in carriage lock-up.

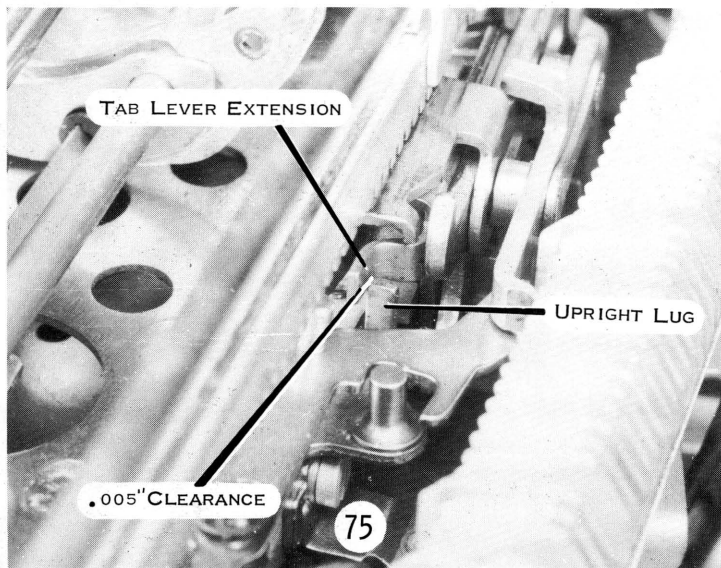

10. Adjust the TAB LEVER EXTENSION so that there is .005" clearance between the extension and the upright lug on the rebound check bracket with the cam on its high point. (Fig. 75.)

11. Form the TAB LEVER LEAF SPRING so that it contacts the upright stud on the rebound check with all parts at rest. (Fig. 76.)

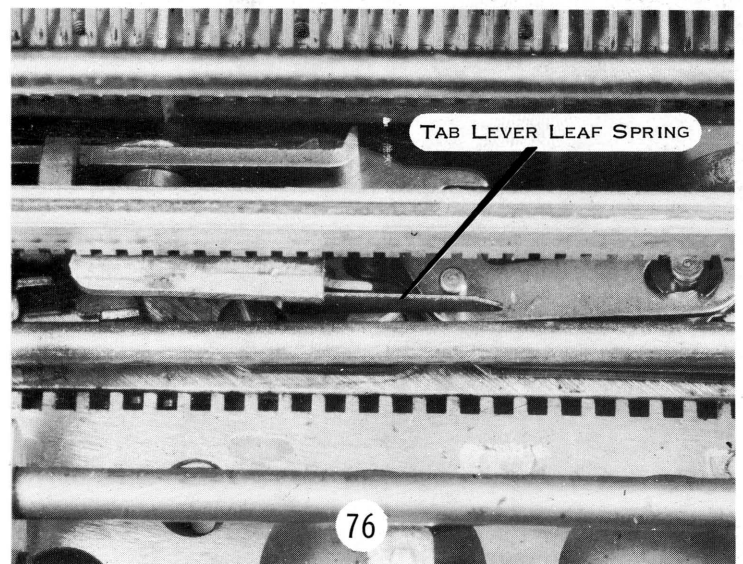

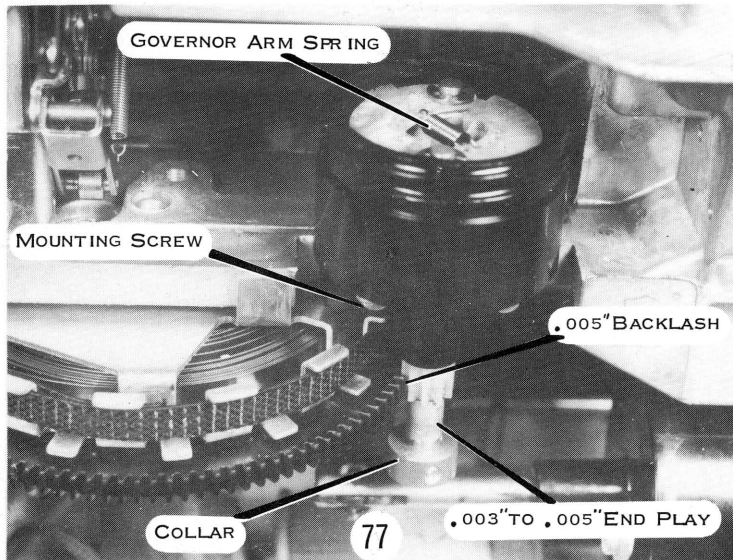

12. CENTRIFUGAL TAB GOVERNOR

- a. Position the governor by means of its mounting screws for a maximum of .005" backlash between the pinion gear and the main spring drum gear. Check full length of the carriage. (Fig. 77.)
- b. Adjust the collar on the governor shaft for .003" to .005" end play in the shaft.
- c. Speed of the carriage on tabulation is adjusted by moving the governor arm spring.

Move the spring closer to the governor arm pivots for more governor action. Move the spring away from the pivots for less governor action. (This spring must be in a corresponding hole in each governor arm).

13. Position the TAB SET AND CLEAR BRACKET right or left until the tab set lever strikes the center of the back of the tab stop which is second to the left of the tip of the tab check lever. (Fig. 78.)

Form the TAB SET AND CLEAR STOPS so that the levers will clear set and cleared stops by 1/32" with the levers at rest.

Loosen three mounting screws before positioning.

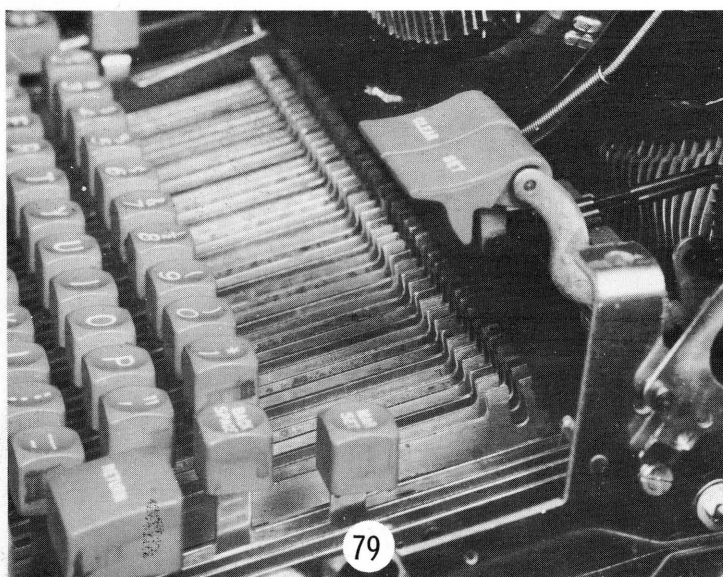
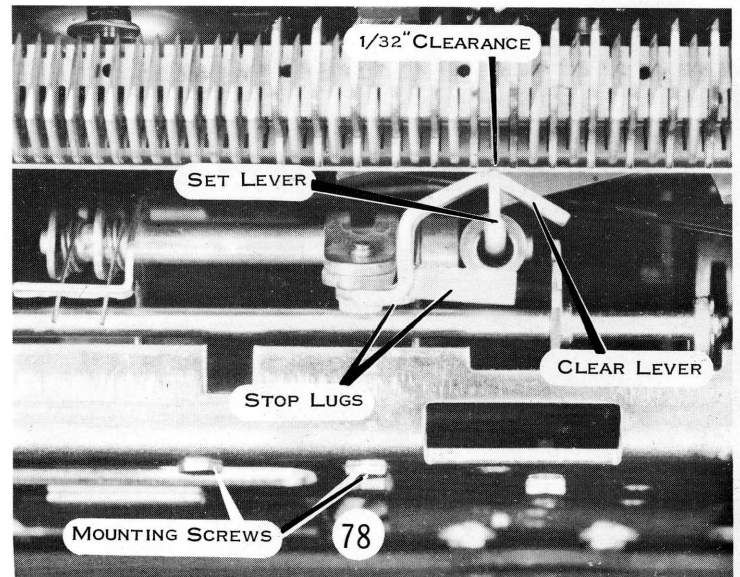

14. Adjust the TAB SET AND CLEAR LINKS so that when the set and clear buttons are at rest, the slope of their surfaces will be parallel to the slope of the keyboard. (Fig. 79.)

15. Adjust the FRICTION GOVERNOR PRESSURE by means of the two lock nuts on the hub of the main spring drum until the speed of tabulation approximates the speed of carriage return. (Fig. 80.)

Check the speed by clearing all tab stops except the last one on the right. Operate the carriage return and tab several times to determine this speed.

16. Adjust the TAB GOVERNOR PAWL LINK so that when the tab lever is latched, the governor pawl will engage the friction plate by the thickness of the pawl. (Fig. 80.)

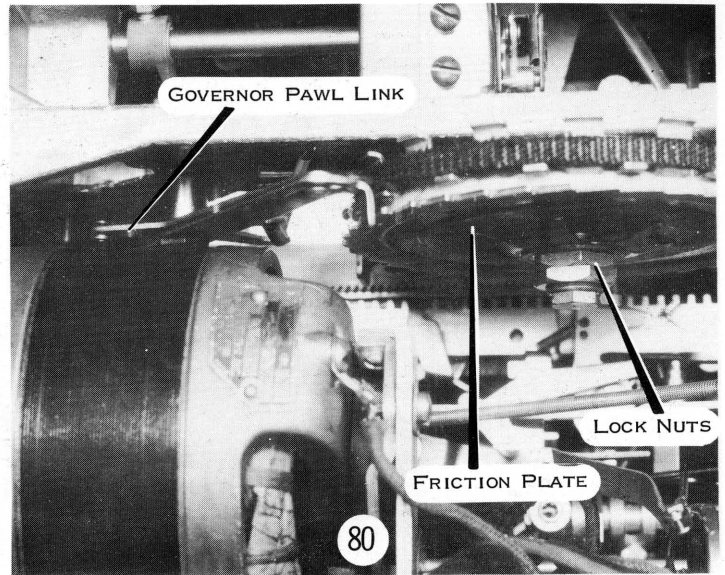

MODEL B1 ADJUSTMENTS

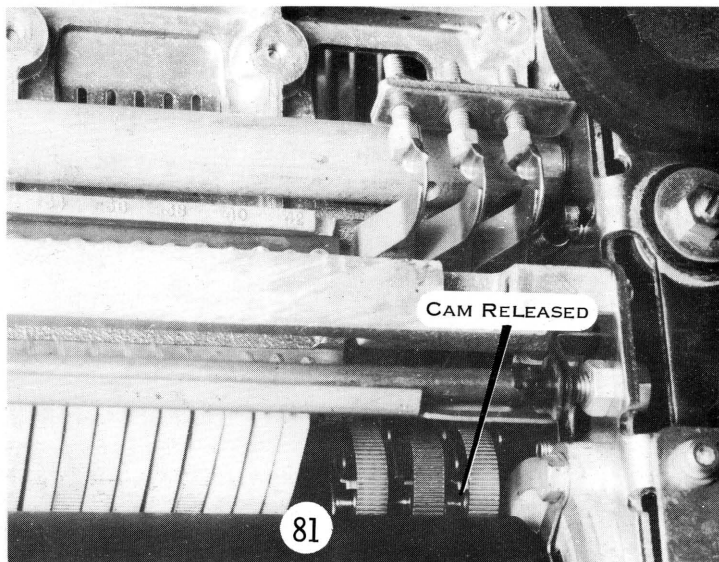

3. Adjust FRONT CLUTCH LEVER LINK so that with the cam on its high point, the clutch lever will clear the clutch latch by .020" to .025". (Fig. 82.)

This overthrow allows the latch to rotate to its latched position.

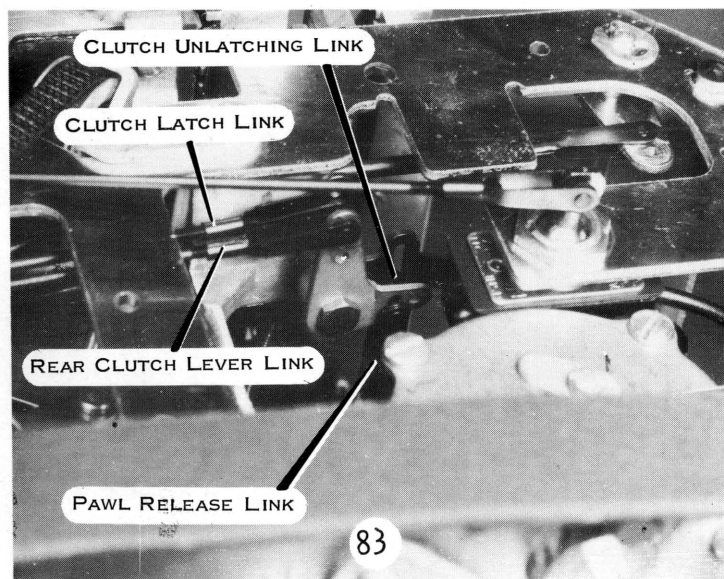
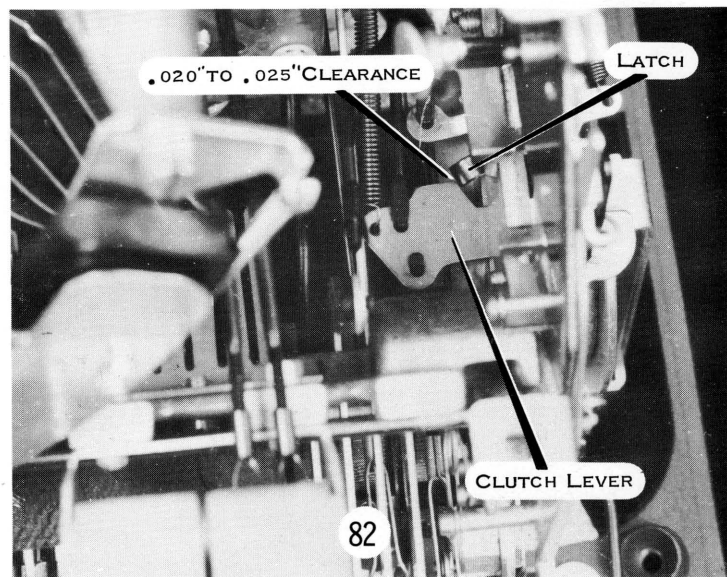

CARRIAGE RETURN

1. Adjust CAM CLEARANCE for .010" to .015". (Fig. 81.)
2. Adjust CAM RELEASE LINK so the cam will repeat when the plunger is depressed 1/16" (See Fig. 50).

The release link should be in the rear hole in the keylever and lower hole in the release lever.

4. Adjust the REAR CLUTCH LEVER LINK so that the slot in the clutch lever bellcrank is parallel to the rear rail, with all parts at rest. The link should be in the outer hole in the bellcrank. (Fig. 83.)

5. Adjust the CLUTCH LATCH LINK so that the slot in the clutch latch bellcrank is parallel to the rear rail. The link should be placed in the center hole of the bellcrank. (Fig. 83.)

All parts must be at rest with the latch resting against the clutch lever.

6. **OVERBANK** is the amount of play between the margin control lever and its final stop when the carriage is resting at the left margin.

Place the carriage one space from the left margin. Slowly move the carriage to the right and listen that the escapement pawl drops into an escapement rack tooth just as the margin control lever strikes its final stop (Fig. 84).

Excessive overbank can cause carriage to return one space to far. Insufficient overbank may prevent carriage from returning to margin.

Adjust both ends of margin rack. Do not bow the carriage end plates.

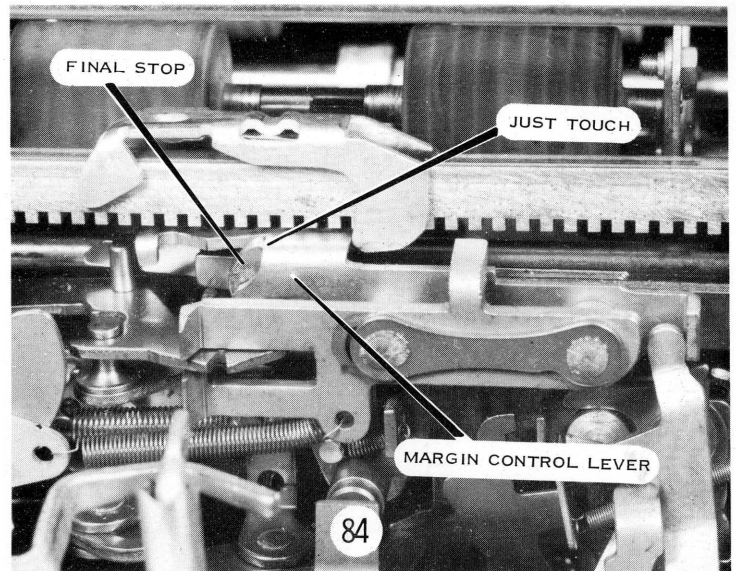

7. Form the **INTERMEDIATE PAWL RELEASE LEVER UPRIGHT LUG** to allow the intermediate pawl release lever to touch both the margin control bellcrank and pawl release bellcrank when the carriage is one space from the left margin. (Fig. 85.)

This adjustment insures the escapement pawl will not be released from the rack when the carriage is within one space of the margin and will remain in the rack during repeat line space.

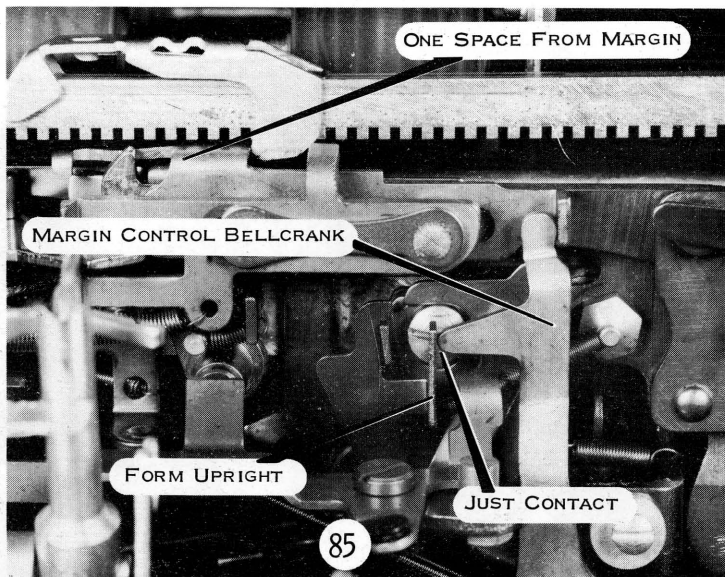

8. Adjust the **PAWL RELEASE LEVER ECCENTRIC** so that the right side of the ear on the pawl release lever just clears the intermediate pawl release lever when all parts are at rest. (Fig. 86.)

Keep the high point of the eccentric toward the front of the machine.

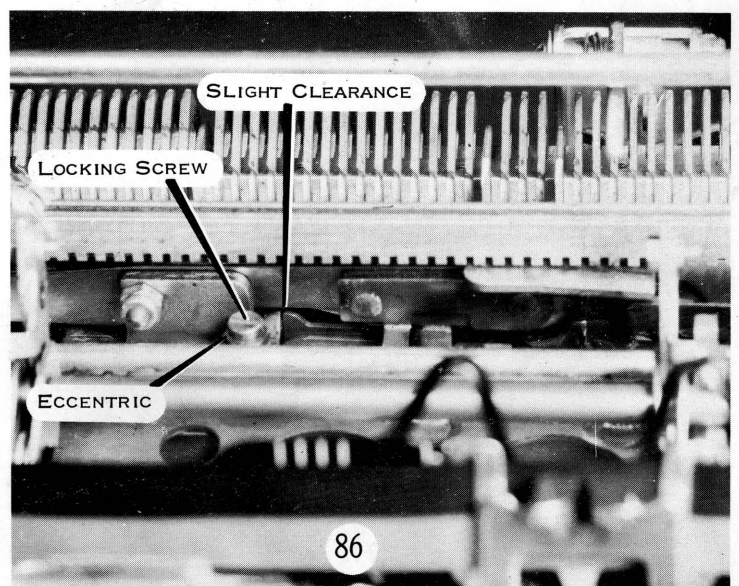

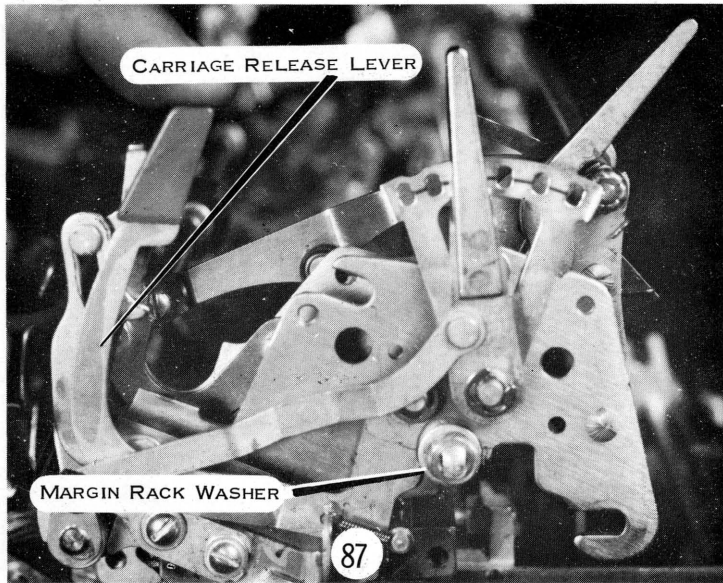

9. The MARGIN RACK WASHERS on the outside of the carriage and plates serve as adjustable overthrow stops for the carriage release levers. Position the washers front or rear so that when either carriage release lever is fully depressed, there will be a clearance of about .010" between the carriage universal bar and the pawl release lever eccentric. (See Fig. 88 for eccentric stud.)

10. Form PAWL RELEASE LEVER FRONT LUG so that it will clear the carriage universal bar by .005" with the both parts at rest. (Fig. 88.)

Check for positive pawl release for full carriage travel with either release button.

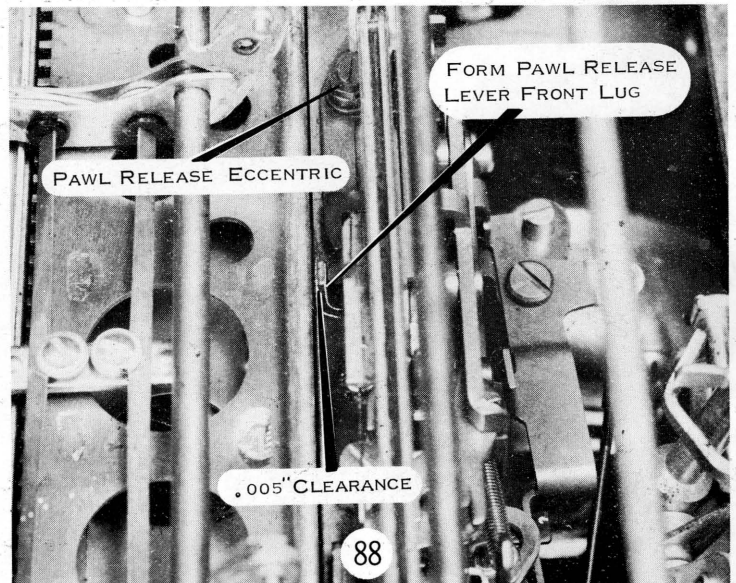

11. Adjust the MARGIN CONTROL BELLCRANK ECCENTRIC STOP so that the margin control lever has maximum travel without restricting movement of the tab check lever. (Fig. 89.)

Some machines have eccentric stops others have eccentric washers.

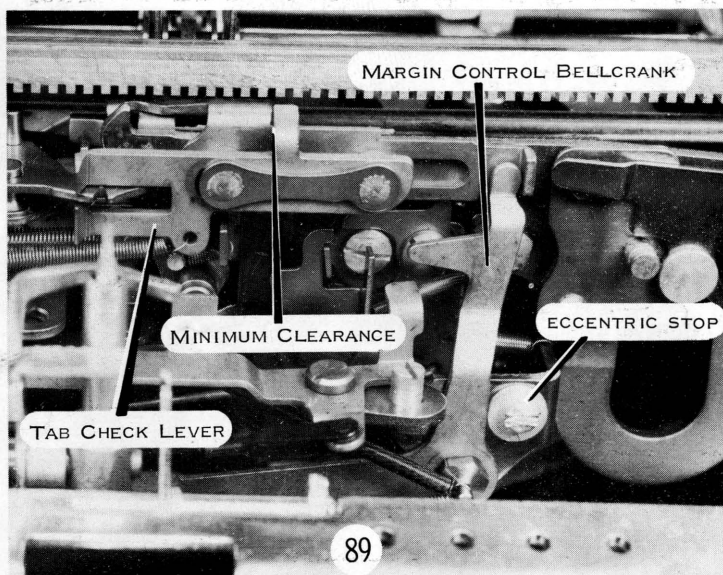

12. Adjust the CARRIAGE RETURN TAB INTERLOCK as follows: (Fig. 90.)

- a. Unhook the clutch unlatching link.
- b. Turn the high point of the interlock eccentric stop to the rear of the machine as a preliminary adjustment.
- c. With the carriage at the left margin, form the interlock so that it clears the tab latch stud by about 1/16" when the left-hand lug on the interlock is in contact with the margin control bellcrank.

This adjustment insures carriage return will be unlatched when the tab is operated.

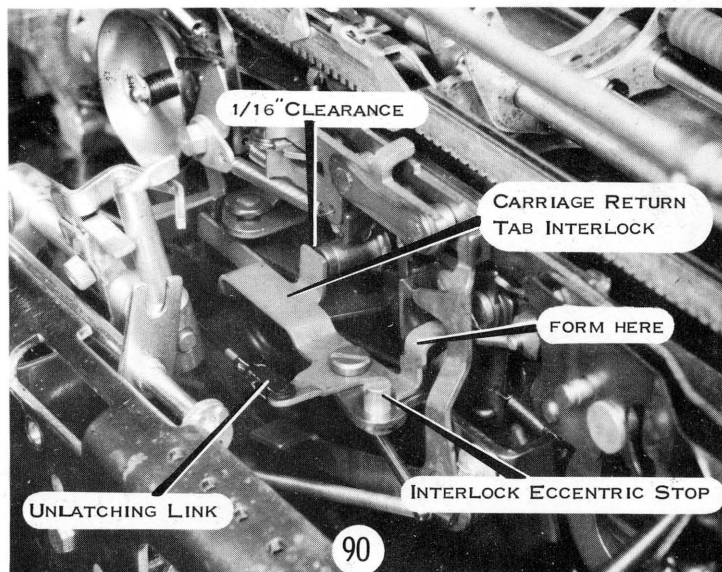

13. Adjust the CLUTCH UNLATCHING LINK so that the clutch unlatches when the carriage has pushed the margin control lever 1/64" to 1/32" from its final stop. (Fig. 91.)

Check this adjustment by holding the carriage while depressing the carriage return button with the power ON. Slowly allow the carriage to approach the left margin. Observe the margin control lever as it nears its final stop. The clutch should remain latched and continue to pull until the margin control lever comes to 1/32" to 1/64" of the stop.

Excessive clearance can cause the carriage to stop one space from margin.

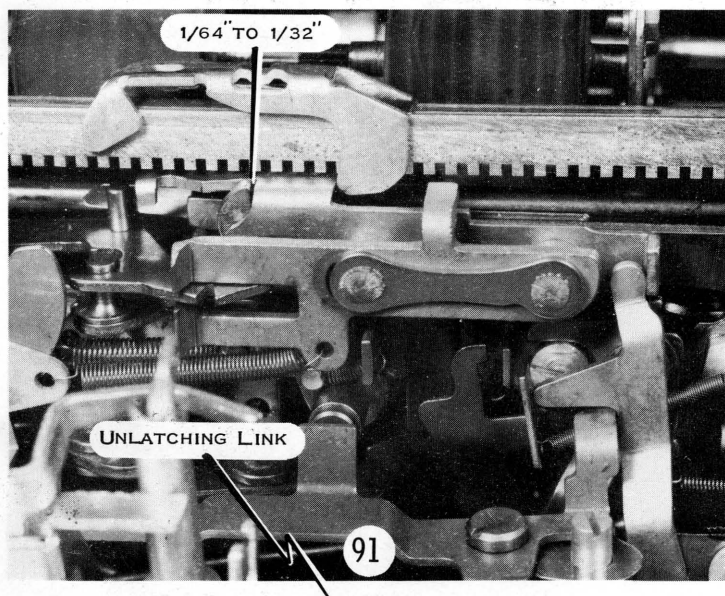

14. Adjust the CARRIAGE RETURN TAB INTERLOCK ECCENTRIC STOP (Fig. 90) so that the clutch latch engages the clutch lever by 1/3 to 1/2 of the clutch latch surface. (See adjustment #12 for picture of eccentric stop.)

15. Adjust the PAWL RELEASE LINK so that with the clutch latched, the escapement pawl will clear the escapement rack by 1/64". (See Fig. 83 for picture of pawl release link).

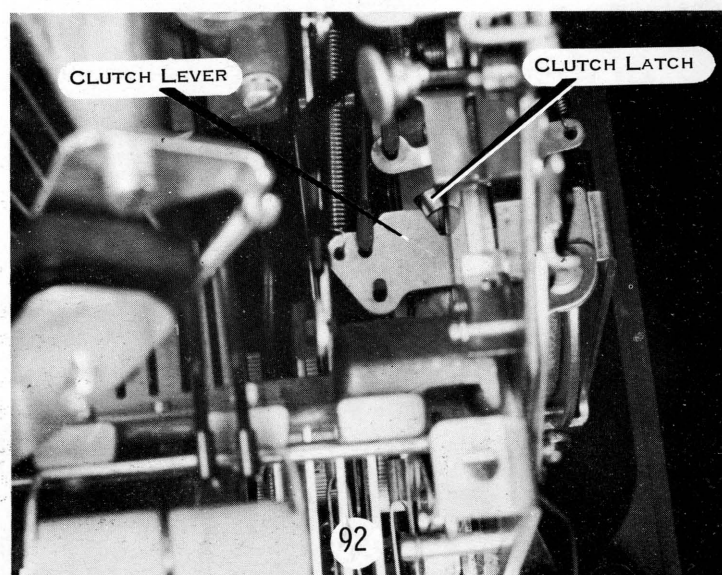

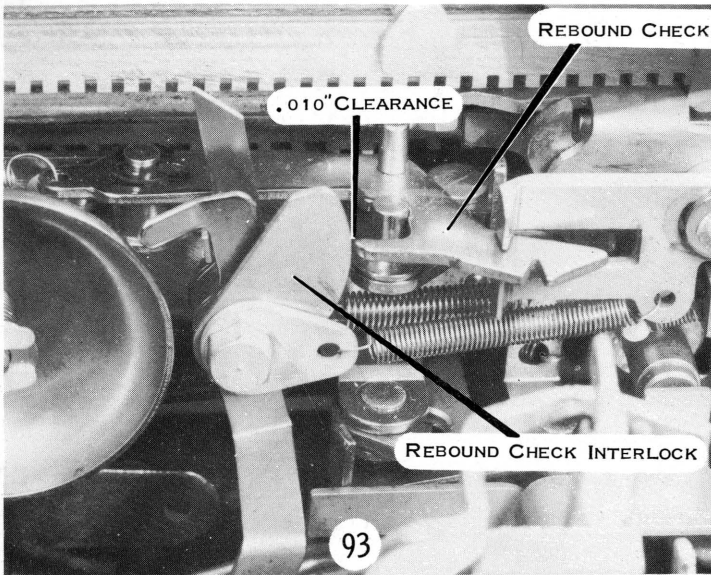

16. The REBOUND CHECK INTERLOCK LINK is adjusted so that the interlock lever clears the tab rebound check lever by about .010" when the rebound check lever is in its operated position. (Fig. 93.)

With the clutch unlatched, operate the tab lever by hand to observe this adjustment. Operate the carriage return cam by hand and observe that the rebound check interlock does not strike the rebound check lever at rest. Form the top of the interlock lever front to rear to provide a clearance of about .010". (Fig. 94.)

This adjustment prevents carriage lock-up if the rebound check remains to the rear and carriage return is operated.

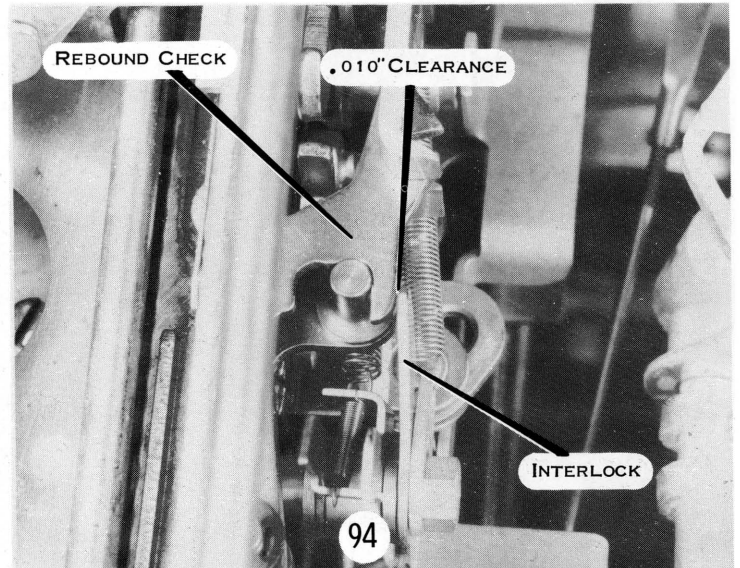

17. Adjust the CLUTCH PLATE CLEARANCE by positioning the clutch lever bracket on the side frame (Fig. 97). Obtain a clearance of .010" to .015" between the operating arm and the clutch plate with the clutch plate held tight against the friction disc. (Fig. 95.)

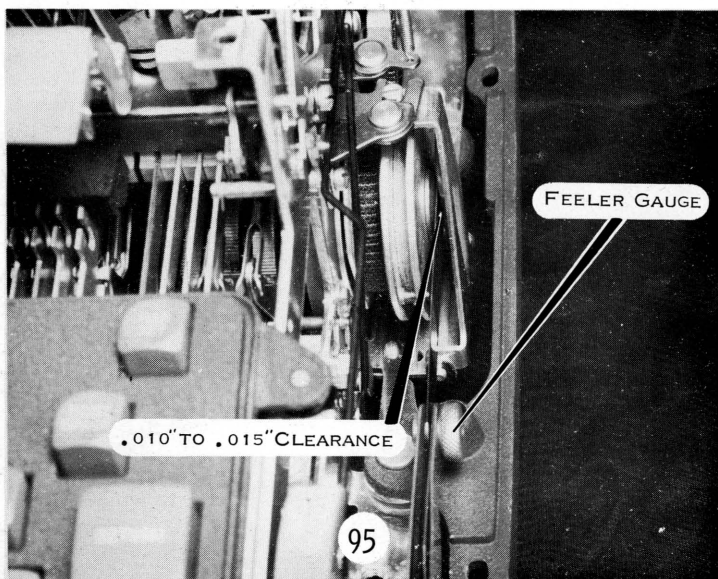

18. Position AIR CYLINDER front to rear on the side frame to permit the plunger to move freely (Fig. 96).

19. AIR CYLINDER PARTS AND CLUTCH COMPRESSION ADJUSTMENTS should be considered together. The air cylinder must reduce the impact of the carriage return as much as necessary without noticeably reducing speed.

The intake port on the air cylinder shell (Fig. 98) should be adjusted approximately half-way open.

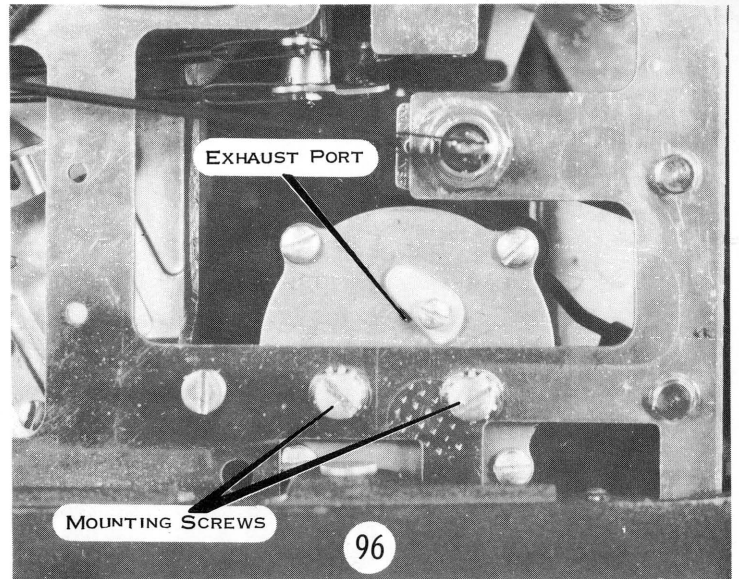

Open the exhaust port on the air cylinder cover (Fig. 96). With the line space lever set for triple spacing and the left margin stop moved to the extreme left, adjust the clutch compression spring to insure a positive return on short returns of one to two inches as well as on medium and long returns. Lack of sufficient tension can contribute to a slow carriage return. (Fig. 97.)

The compression spring must be adjusted so that if the carriage is stopped and held during a return, it will give a positive return when the carriage is released.

The clutch must slip and not stall the motor if the carriage is held during carriage return.

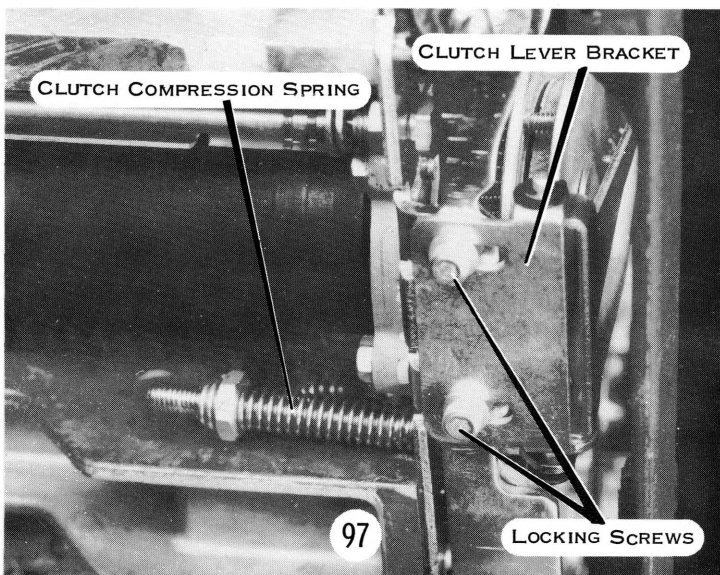

Adjust the exhaust port so that the shock of carriage return is reduced without noticeably slowing the carriage during the last half-inch of travel. Test this action on short, medium and full-length returns for positive and quiet operation.

If an operator finds excessive resistance in pushing the carriage back to the margin, recheck the air cylinder ports. It may be advantageous to open the exhaust port slightly.

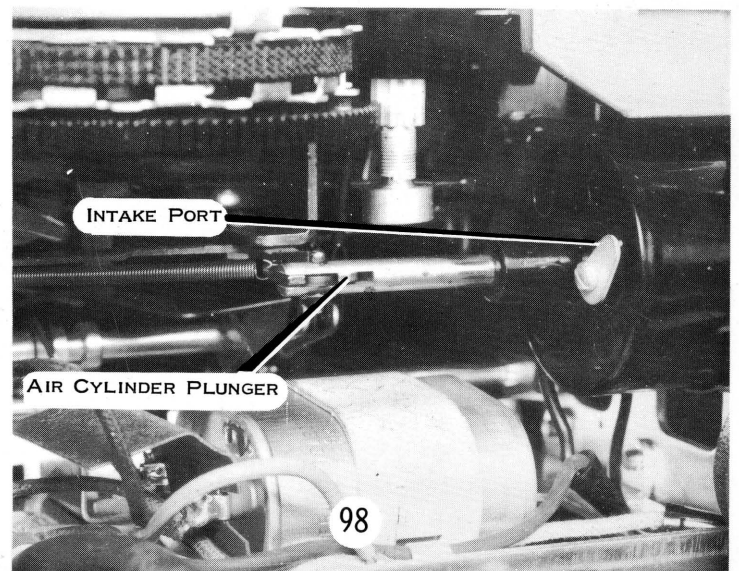

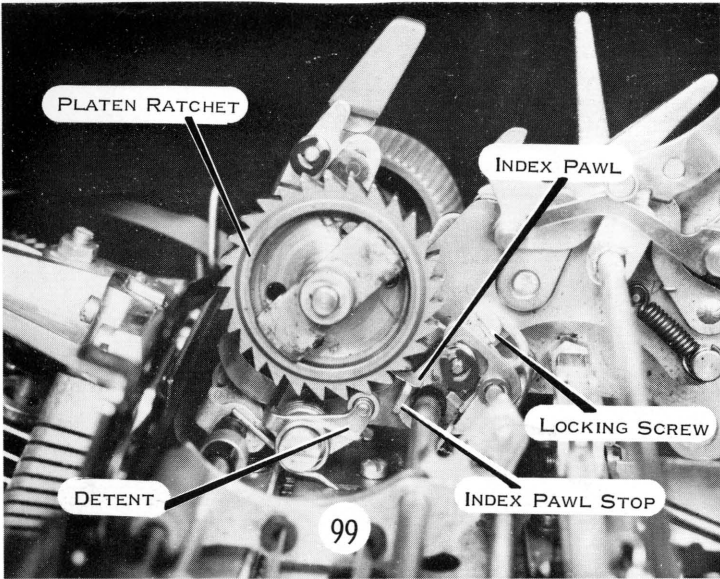

20. The LOWER INDEX PAWL STOP is adjusted to stop the downward movement of the line space mechanism when the detent roller is positioned between two teeth on the platen ratchet. (Fig. 99.)

Check this by pulling on the carriage return tape until the index pawl strikes the lower stop. Then slowly relax the tension. There should be no further rotation of the platen, either forward or backward.

1. Adjust CAM CLEARANCE for .010" to .015". (Fig. 100.)
2. Adjust the CAM RELEASE LINK so that the cam will repeat when the spring loaded plunger is depressed 1/16".

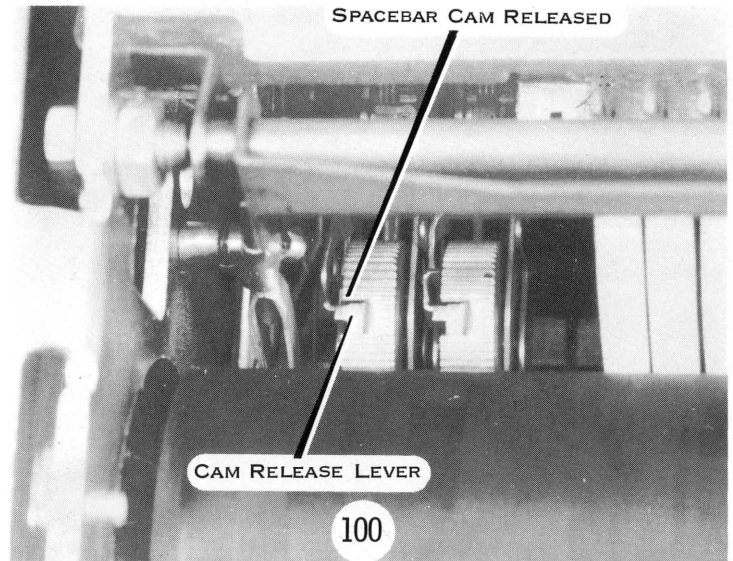

3. Adjust the UPPER SPACE BAR STOP BRACKET up or down so that the cam restores just before the keylever strikes the stop bracket. (Fig. 101.)

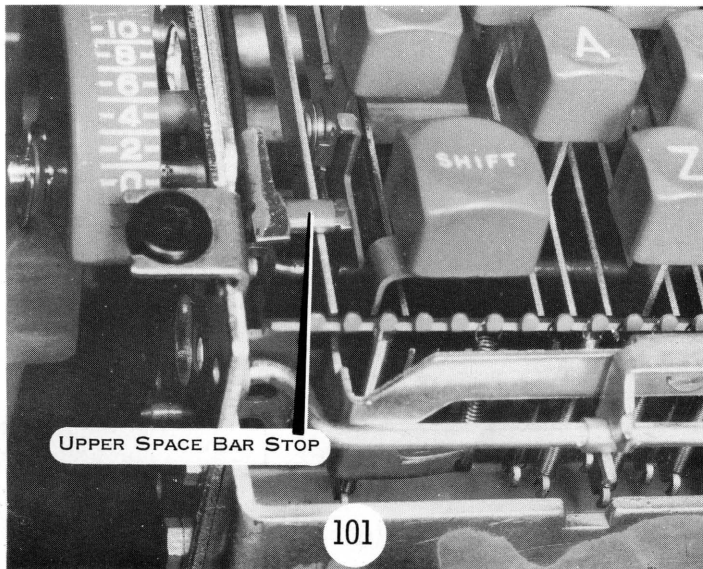

4. Adjust the OPERATING LINK so that the escapement pawl will be tripped out of the escapement rack just as the cam reaches its high point.

This adjustment MUST be checked on both lobes of the cam and can be done as follows:

With the power turned OFF, trip the space bar cam. Rotate the power roll by hand while observing the escapement lever moving toward the rear. The escapement pawl should be tripped just as the lever stops moving. Excessive overthrow can cause escapement failure because the escapement pawl spacer will restore late. (Fig. 102.)

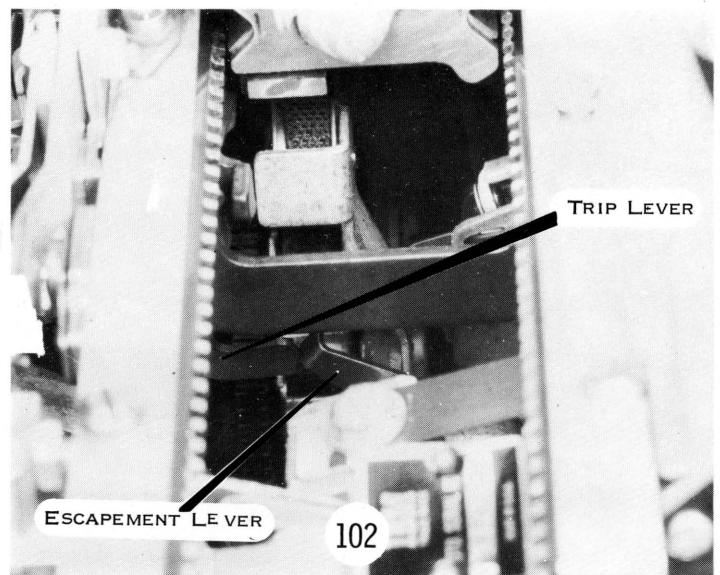

RIBBON

1. Adjust CAM CLEARANCE for .010" to .015". (Fig. 103.)

This adjustment is made by rotating the eccentric stop after loosening the lock nut. The stud and nut can be reached through the power roll pulley.

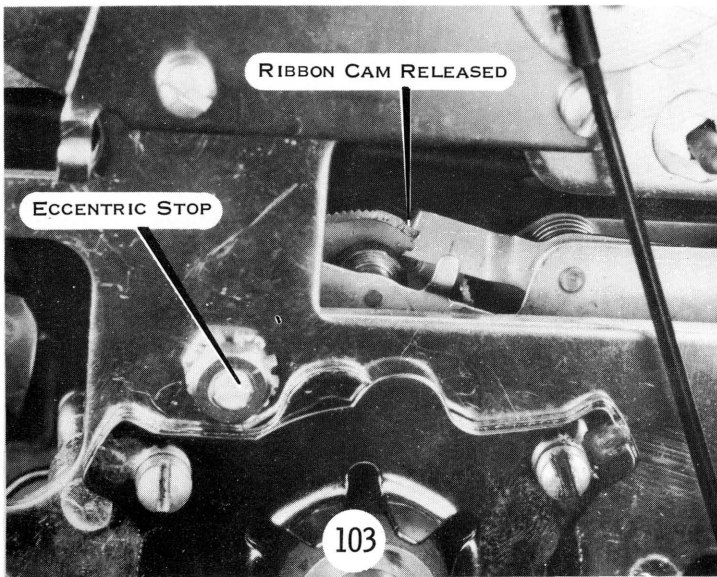

2. Adjust the CAM RELEASE LINK so that the ribbon cam is released when any typeface is $3/4" \pm 1/8"$ from the platen. (Fig. 104.)

The cam release link is more accessible if the ribbon lift bail is rotated down (Fig. 105). A variation in the tripping point between typebars may be caused by a bent or curved ribbon lift bail. A variation of $1/4"$ is acceptable.

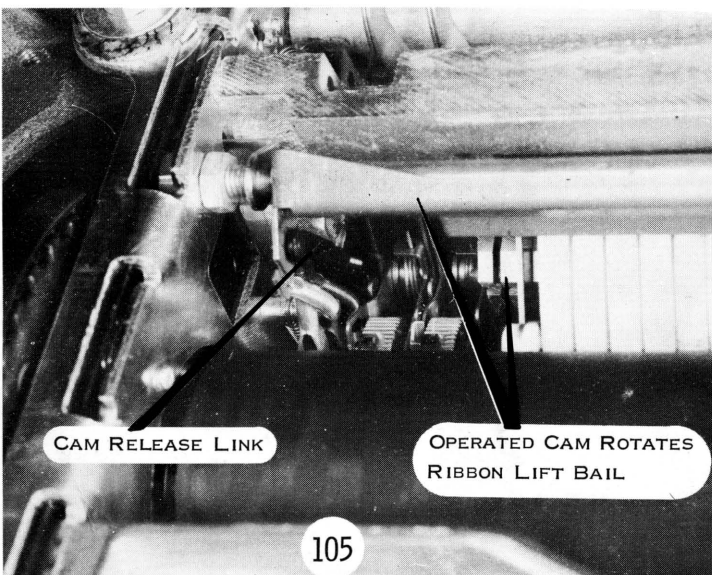
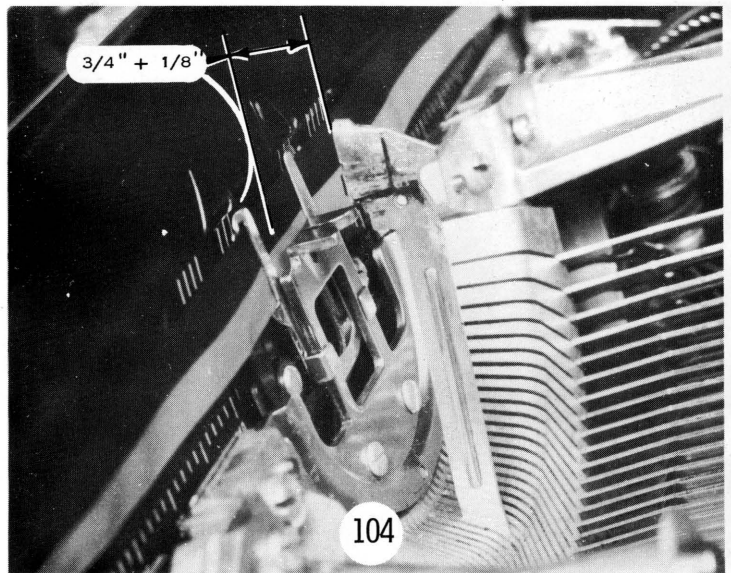

3. The OPERATING LINK is adjusted so that the bail end plate is $1/16$ " above the bottom of the slot in the side frame. (Fig. 106.)

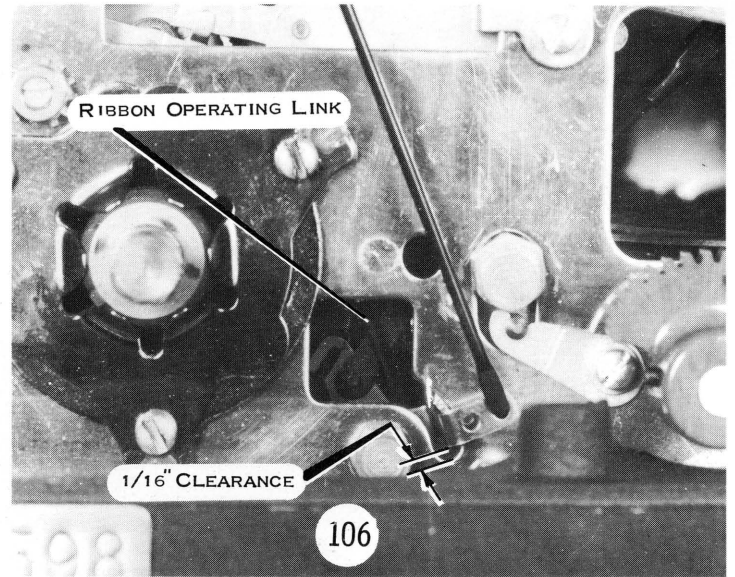

4. Adjust the RIBBON FEED LINKS so that the reversing latch will just clear the ribbon feed bellcrank as the latch moves to the rear with the cam on its high point. (Fig. 107.)

This must be checked on both feed links with the reversing plates up in the feed position as each side is checked. Excessive clearance will allow a reverse failure due to insufficient reversing plate movement.

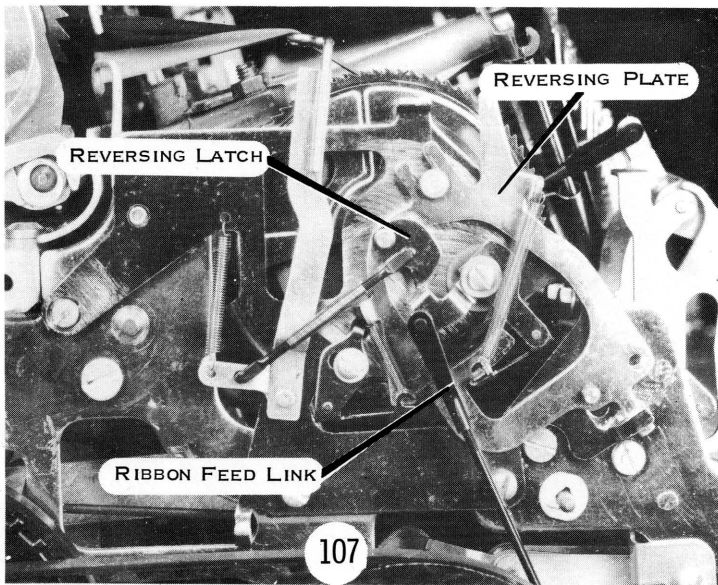

5. Adjust the SPRING LINKS so that the ribbon will reverse when the reversal lever has moved $1/4$ " to $3/8$ " toward the rear. (Fig. 108.)

Check with the power ON and the ribbon cam running. Slowly move the reversing arm to the rear and observe the reversing point.

Late reversing will cause excessive wear to ends of ribbon. Early reversing can cause the ribbon to reverse before the spool is empty.

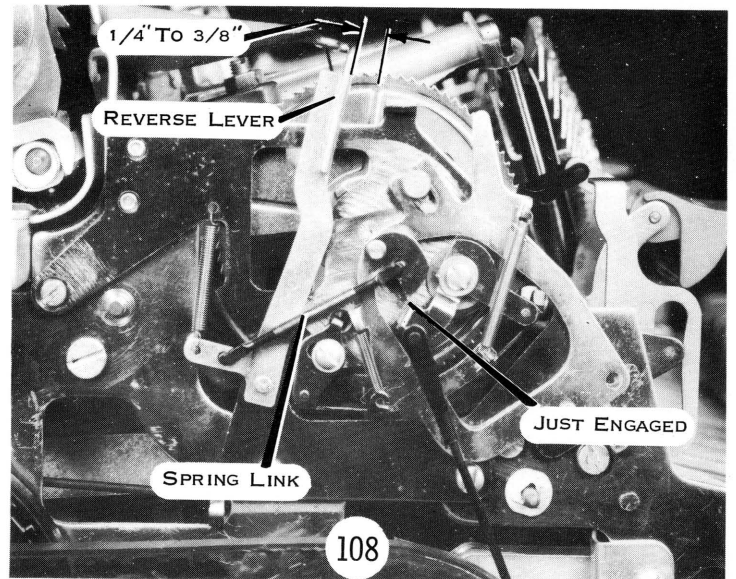

MODEL B1 ADJUSTMENTS

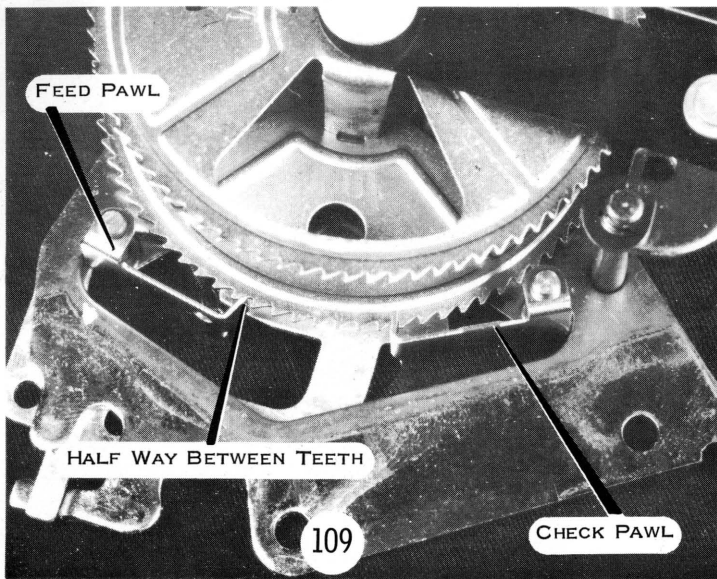

6. Adjust the CHECK PAWLS so that the feed pawl rests half-way between two teeth. (Fig. 109.)

RIBBON

Retighten the locking screw after making the adjustment. The ribbon feed mechanism shall, when properly adjusted, provide a two-tooth feed at each stroke.

Two tooth feed insures rapid reversing when a spool empties.

7. Adjust the RIBBON SPOOL RETAINING SPRINGS so that the teeth on the ribbon spool rides in the center of the feed and check pawls. Form the springs left to right so that they cause a slight drag to the spools. (Fig. 110.)

The ribbon spool plate must be removed to loosen the retaining spring screws.

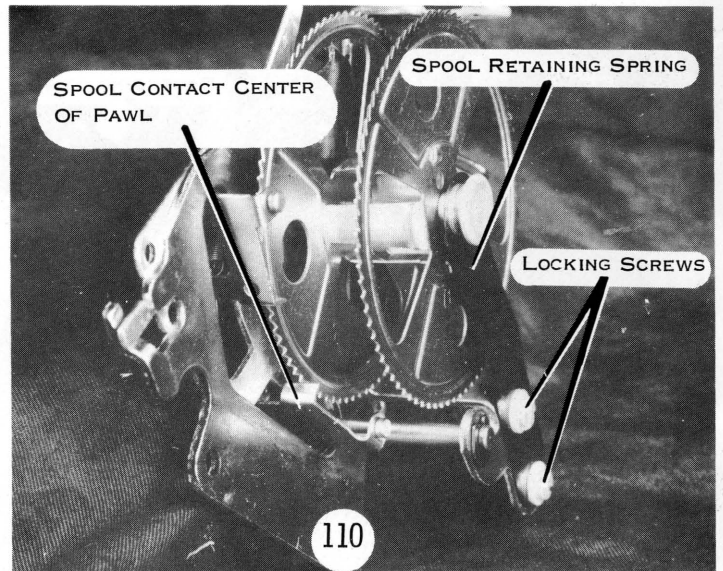

1. Adjust the RIBBON LIFT BAIL ASSEMBLY by the support screws so that there is .005" to .015" end play. (Fig. 111.)

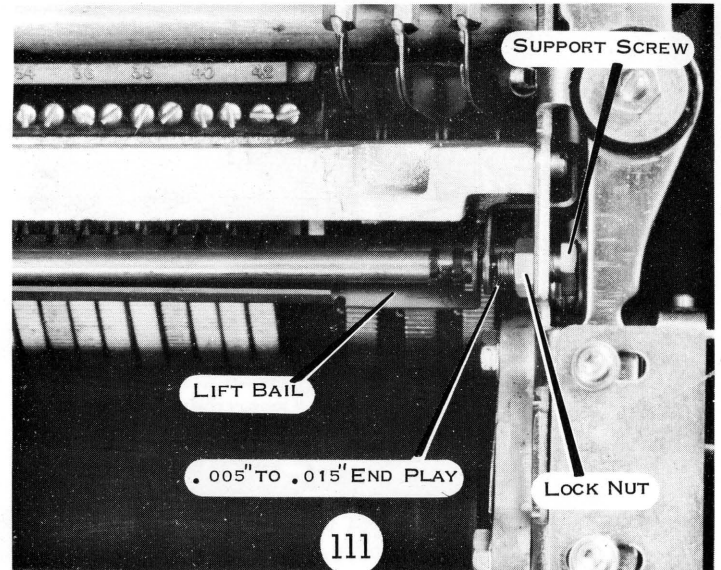

2. Adjust the RIBBON LIFT OPERATING LINK so that, with the bail at rest and the actuating lever held toward the front of the machine, the clevis pin matches the hole in the actuating lever. (Fig. 112.)

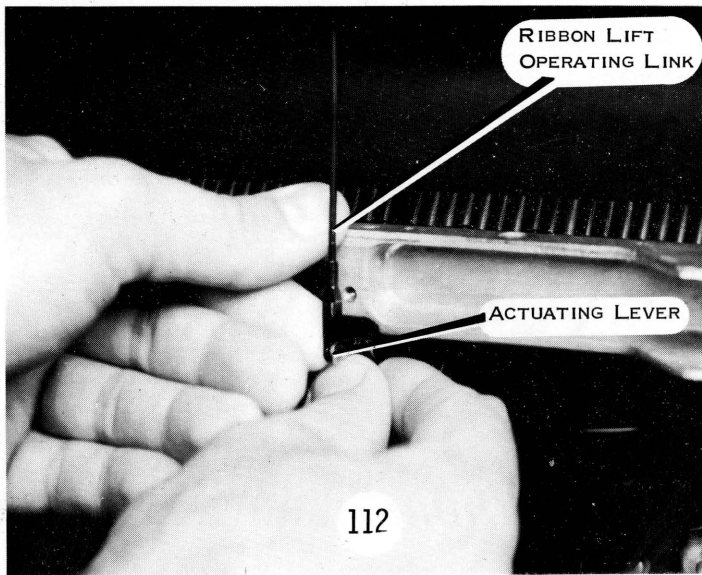

The purpose of this link is just to connect the bail to the actuating lever. This link should not be adjusted to correct ribbon lift failures.

3. Adjust the RIBBON CENTER GUIDE CLEVIS so that the top of the tallest characters strike 1/32" below the upper edge of the ribbon (Fig. 115).

Check this adjustment by typing several tall characters and noting on the ribbon where the type face struck. The lift mechanism should be set in the first lift or back position. Check at "0" through "10" impression setting.

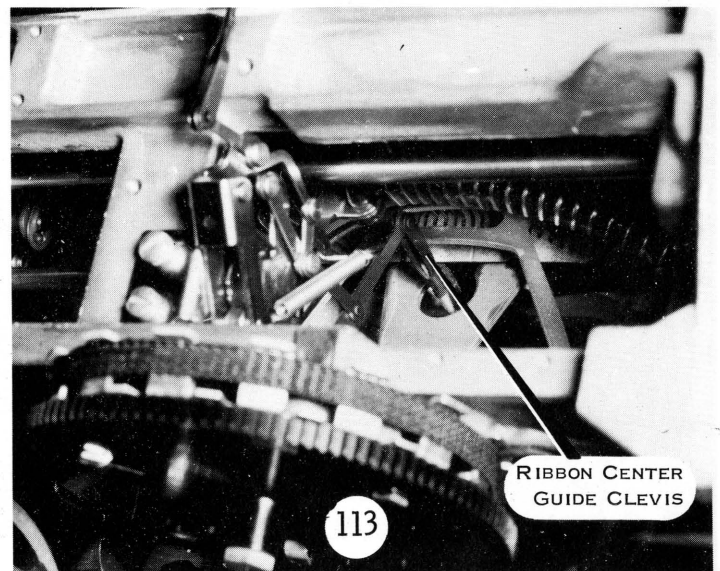

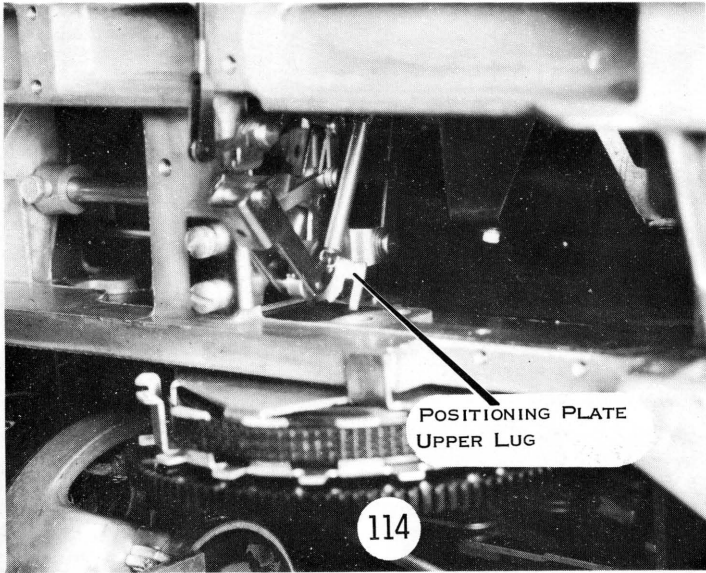

RIBBON LIFT

4. Form the UPPER LUG on the lift positioning plate so that the underscore prints $1/32$ " above the bottom edge of the ribbon (Fig. 115).

Type several underscores with the lift mechanism set at the highest lift or red position. Use the TKO tip bender to form the lug. Do not attempt to adjust the lug until adjustment #2 is correct as any change in center guide clevis will affect ALL ribbon positions.

NOTE: Any binds in the ribbon lift mechanism will cause erratic ribbon lift. The ribbon spools and guides must allow the ribbon to feed with just a slight drag or a ribbon lift failure will result.

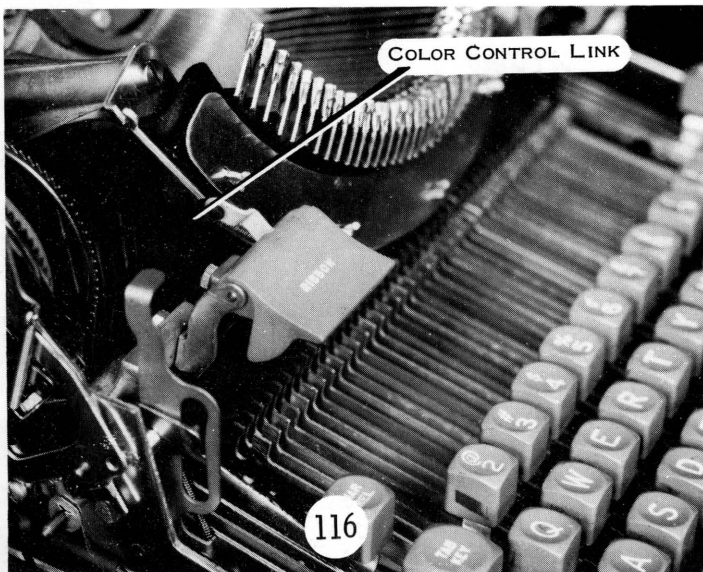
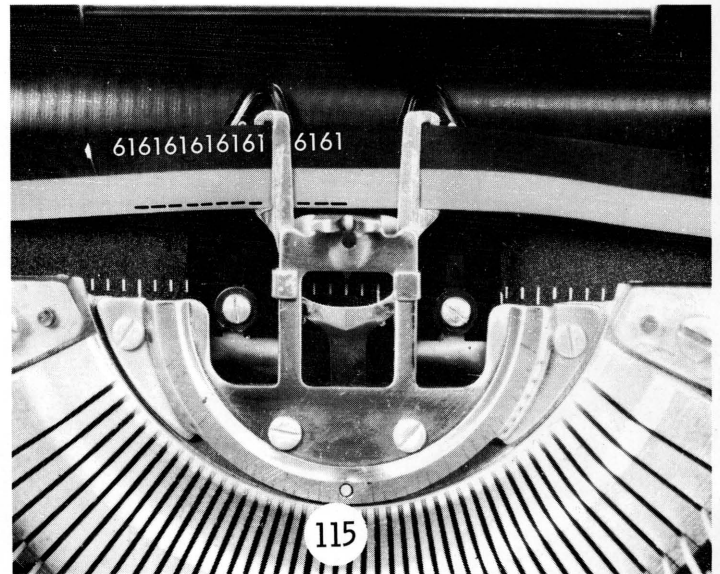

5. Adjust the COLOR CONTROL LINK so that the slope of the color control button is parallel to the keyboard with the button in the black ribbon position. (Fig. 116.)