



Systems Network Architecture Reference Summary

GA27-3136-4

File No. S370/8100-09

Fifth Edition (January 1981)

This is a major revision of, and obsoletes, GA27-3136-3. The manual has been completely reorganized. New and updated material has been added throughout; therefore, no vertical change bars have been used and the publication should be reviewed in its entirety. Information herein is extracted from GA27-3093, GC20-1868, GC30-3072, and SC30-3112.

Changes are made periodically to the information herein; before using this publication in connection with the operation of IBM systems, consult the latest **IBM System/370 and 4300 Processors Bibliography**, GC20-0001 and **IBM 8100 Information System Bibliography**, GC20-8100, for the editions that are applicable.

It is possible that this material may contain reference to, or information about, IBM products (machines and programs), programming, or services that are not announced in your country. Such references or information must not be construed to mean that IBM intends to announce such IBM products, programming, or services in your country.

Publications are not stocked at the address given below; requests for IBM publications should be made to your IBM representative or to the IBM branch office serving your locality.

A form for reader's comments is provided at the back of this publication. If the form has been removed, comments may be addressed to IBM Corporation, Publications Development, Department E02, PO Box 12195, Research Triangle Park, North Carolina U.S.A. 27709. IBM may use or distribute any of the information you supply in any way it believes appropriate without incurring any obligation whatever. You may, of course, continue to use the information you supply.

Preface

This handbook contains summary material about the structure and use of SNA and SDLC (Synchronous Data Link Control). The information included here is intended to supplement the information contained in various manuals on specific IBM SNA products.

A handbook binder for this publication may be purchased through your IBM representative (form number S229-4124 or part number 453559).

For further information on SNA, refer to:

- IBM Synchronous Data Link Control General Information (GA27-3093)
- Systems Network Architecture Concepts and Products (GC30-3072)
- Systems Network Architecture Format and Protocol Reference Manual: Architectural Logic (SC30-3112)

HOW TO USE THIS BOOK

The information in this manual is divided into two parts: "Part 1, The Basic Link Unit" and "Part 2, Diagnostic Aids."

Part 1 presents a Basic Link Unit, byte by byte, in the order it would appear on a link connection. The following figure, Organization of Part 1, shows how you can quickly find this information using the blind tabs on the page edges.

Part 2 is a collection of other diagnostic aids. Use chapter headings to locate the information you need.

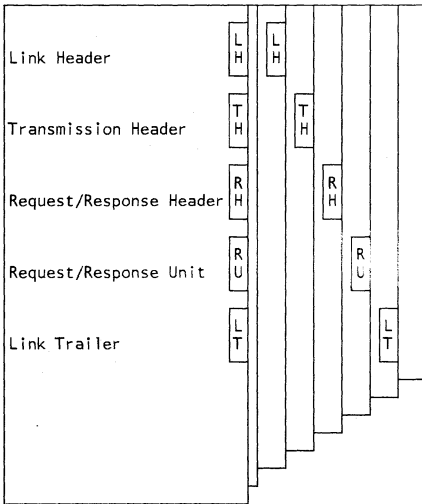

Organization of Part 1

Contents

Preface.....	iii
Organization of Part 1.....	iv
Data Units.....	vi
Part 1. The Basic Link Unit.....	vii
Chapter 1. Link Header.....	1-1
Flag.....	1-2
Address.....	1-3
Control.....	1-4
Chapter 2. Transmission Header.....	2-1
TH For FID Types 0-3.....	2-3
TH For FID Type 4.....	2-5
TH For FID Type F.....	2-10
Chapter 3. Request/Response Header...3-1	
Request Header.....	3-2
Response Header.....	3-5
Chapter 4. Request/Response Unit.....4-1	
Summary of Request RUs by Category..4-4	
Alphabetic List of Request RUs.....4-6	
Index of RUs by NS Headers and	
Request Codes.....	4-10
RU Formats.....	4-14
Index of RUs by NS Headers and	
Request Codes (foldout).....	4-161
Response RU Formats.....	4-163
Control Vectors.....	4-179
Control Lists.....	4-188
SDLC XID Information-Field Format...4-189	
RU Sizes Corresponding to X'ab'	
in BIND.....	4-199
Chapter 5. Link Trailer.....	5-1
Frame Check Sequence.....	5-2
Flag.....	5-3
Part 2. Diagnostic Aids	
Chapter 6. FM Profiles.....	6-1
Chapter 7. TS Profiles.....	7-1
Chapter 8. Sense Codes.....	8-1
Chapter 9. FM Headers.....	9-1
Chapter 10. LU-LU Session Types.....	10-1
Chapter 11. PU Node Types.....	11-1
Chapter 12. SNA Character Sets.....	12-1
Chapter 13. Products and SNA.....	13-1
Chapter 14. Common Sequences.....	14-1
Activation Sequences.....	14-3
Deactivation Sequences.....	14-4
Chapter 15. Other SNA Publications...15-1	
Chapter 16. SNA Acronym Glossary.....	16-1

This page left intentionally blank

DATA UNITS

As information passes through various layers of SNA, more information is added to it in the form of headers and trailers. The following figure illustrates this procedure.

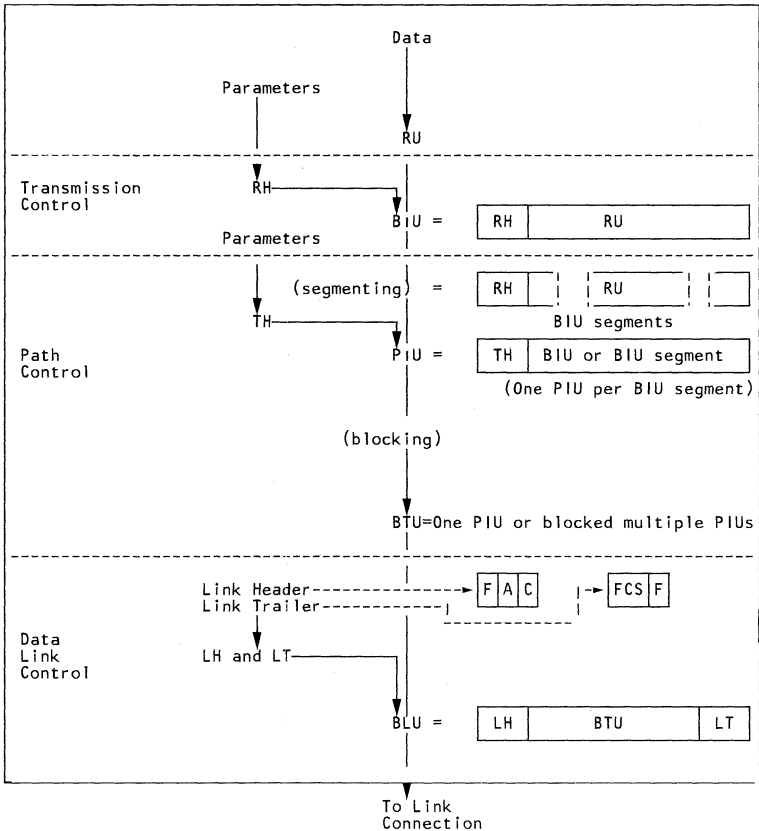

PART 1
The Basic Link Unit

Chapter 1 Link Header

Chapter 2 Transmission Header

Chapter 3 Request/Response Header

Chapter 4 Request/Response Unit

Chapter 5 Link Trailer

This page left intentionally blank

CHAPTER 1. LINK HEADER

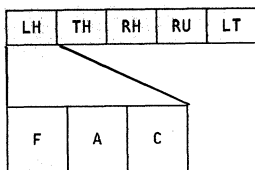

This chapter summarizes information from **Synchronous Data Link Control General Information (GA27-3093)**.

Because some transmissions contain no SDLC Information field (TH,RH,RU), you may wish to clip, mark, or otherwise identify Chapter 5 in order to easily refer between Chapter 1 and Chapter 5. As an alternative, you may move Chapter 5, in its entirety, to follow Chapter 1.

The link header described here is from IBM's Synchronous Data Link Control (SDLC).

The basic link unit (BLU) starts with the link header (LH), which has three fields: the flag, address, and control fields. Each is one byte long.

FLAG

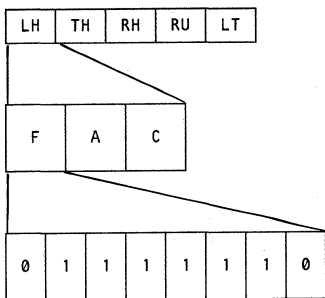

Flag (F) X'7E' B'01111110'

All BLUs begin with a flag. The configuration of the flag is always 01111110 (X'7E'). Because BLUs also end with flags, the trailing flag of one BLU may serve as the leading flag of the next BLU. Alternatively, the last 0 in the trailing flag may also be the first 0 in the next leading flag. See Figure 1-1.

```

                                |--leading flag--|
0 1 1 1 1 1 1 0 1 1 1 1 1 1 0
|-trailing flag--|

```

Figure 1-1. Shared Trailing/Leading 0 in SDLC Flags

ADDRESS

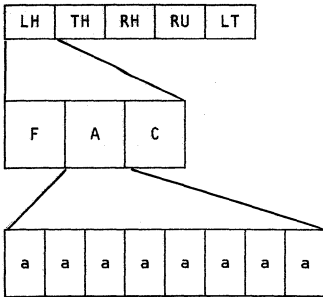

Address (A) B'aaaaaaaa'

The second byte of the link header is the address field. This address can be (1) a specific station address -- to only one station, (2) a group address -- to two or more stations but not all stations, (3) a broadcast address (X'FF', B'11111111') -- to all stations, or (4) a "no stations" address (X'00'). Note: The "no stations" address is reserved and should not be used for any station or group of stations.

This address is **always** the address of the secondary, regardless of whether the transmission is going from primary to secondary or secondary to primary.

CONTROL

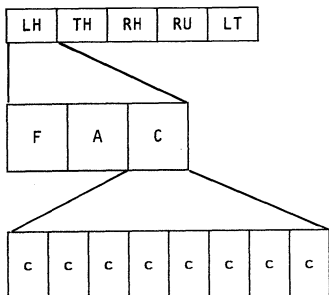

Control (C) B'cccccccc'

The third byte of the link header is the control field. This field contains any one of a number of SDLC commands or responses. There are three categories of SDLC commands and responses: unnumbered format, supervisory format, and information transfer format.

Each of the commands and responses in the **unnumbered format** has a poll/final bit that is set to 1 when it is in the last SDLC frame of a transmission. In a command, it is called a poll bit; in a response, a final bit. Therefore, each of the unnumbered commands and responses has two hex values: a value for when this poll/final bit is 0 and a value for when it is 1.

Each of the group of **supervisory format** commands and responses has a number of possible hex values corresponding to the receive sequence number assigned to the frame containing the command or response. These commands and responses also have a poll/final bit.

A command or response in the **information transfer format** similarly has a number of possible hex values depending on the send and receive sequence numbers assigned to the frame containing the command or response. These frames also have a poll/final bit.

Figure 1-2 contains a listing of the various SDLC commands and responses.



This page left intentionally blank

Format	Binary Configuration	Hex Equivalent P/F off,P/F on	Command Name	Acronym
Unnumbered Format	000 P/F 0011	X'03', X'13'	Unnumbered Information	UI
	000 F 0111	X'07', X'17'	Request Initialization Mode	RIM
	000 P 0111	X'07', X'17'	Set Initialization Mode	SIM
	000 F 1111	X'0F', X'1F'	Disconnect Mode	DM
	001 P 0011	X'23', X'33'	Unnumbered Poll	UP
	010 F 0011	X'43', X'53'	Request Disconnect	RD
	010 P 0011	X'43', X'53'	Disconnect	DISC
	011 F 0011	X'63', X'73'	Unnumbered Acknowledgment	UA
	100 P 0011	X'83', X'93'	Set Normal Response Mode	SNRM
	100 F 0111	X'87', X'97'	Frame Reject	FRMR
	101 P/F 1111	X'AF', X'BF'	Exchange Identification	XID
	110 P/F 0111	X'C7', X'D7'	Configure	CFGR
	111 P/F 0011	X'E3', X'F3'	Test	TEST
111 F 1111	X'EF', X'FF'	Beacon	BCN	
Supervisory Format	RRR P/F 0001	X'x1', X'x1'	Receive Ready	RR
	RRR P/F 0101	X'x5', X'x5'	Receive Not Ready	RNR
	RRR P/F 1001	X'x9', X'x9'	Reject	REJ
Information Transfer Format	RRR P/F SSS0	X'xx', X'xx'	Numbered Information Present	
Notes: P = poll bit F = final bit RRR = Nr (receive count) SSS = Ns (send count)				

Figure 1-2. SDLC Commands and Responses

CHAPTER 2. TRANSMISSION HEADER

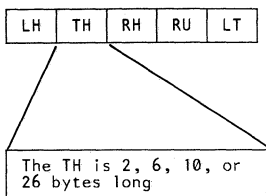

This chapter summarizes information from **Systems Network Architecture Format and Protocol Reference Manual: Architectural Logic** (SC30-3112).

The transmission header (TH) immediately follows the link header (LH). The TH consists of 2, 6, 10, or 26 bytes. There are six TH configurations, which vary according to Format Identifier type (FID type). The FID type depends on the type(s) of nodes involved in the transmission.

FID type 0 is used for traffic involving non-SNA devices between adjacent subarea nodes when either or both nodes do not support explicit route and virtual route protocols. (TH=10 bytes)

FID type 1 is used for traffic between adjacent subarea nodes when either or both nodes do not support explicit route and virtual route protocols. (TH=10 bytes)

FID type 2 is used for traffic between a subarea node and an adjacent PU type 2 peripheral node. (TH=6 bytes)

FID type 3 is used for traffic between a subarea node and an adjacent PU type 1 peripheral node. (TH=2 bytes)

FID type 4 is used for traffic between adjacent subarea nodes when both nodes support explicit

route and virtual route protocols. (TH=26 bytes)

FID type F is used for certain commands (for example, for transmission group control) sent between adjacent subarea nodes when both nodes support explicit route and virtual route protocols. (TH=26 bytes)

The following figures show the formats and meanings of the transmission header (TH) bytes.

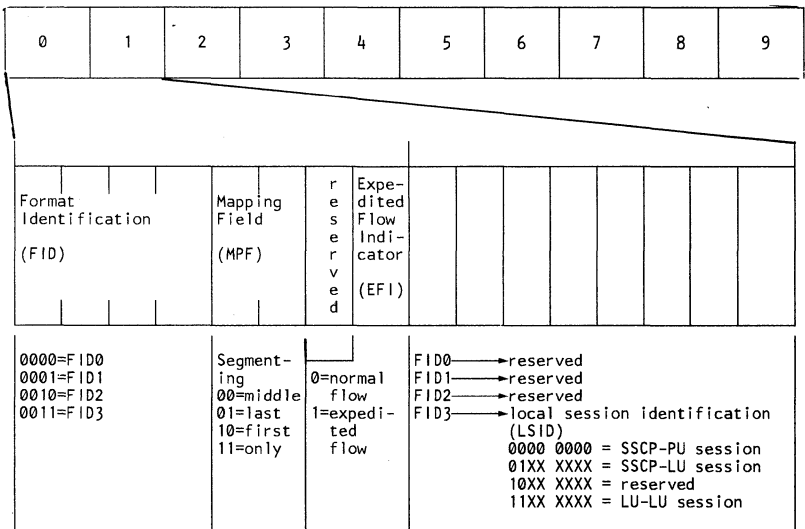

0	1	2	3	4	5	6	7	8	9
---	---	---	---	---	---	---	---	---	---

byte 2	byte 3	byte 4	byte 5	byte 6	byte 7	byte 8	byte 9
--------	--------	--------	--------	--------	--------	--------	--------

Destination Address Field (DAF)	Origin Address Field (OAF)	Sequence Number Field (SNF)	Data Count Field (DCF)	FID0 and FID1
---------------------------------	----------------------------	-----------------------------	------------------------	---------------

Destination Address Field (DAF')	Origin Address Field (OAF')	Sequence Number Field (SNF)
----------------------------------	-----------------------------	-----------------------------

-----FID2

FID3 is two bytes long

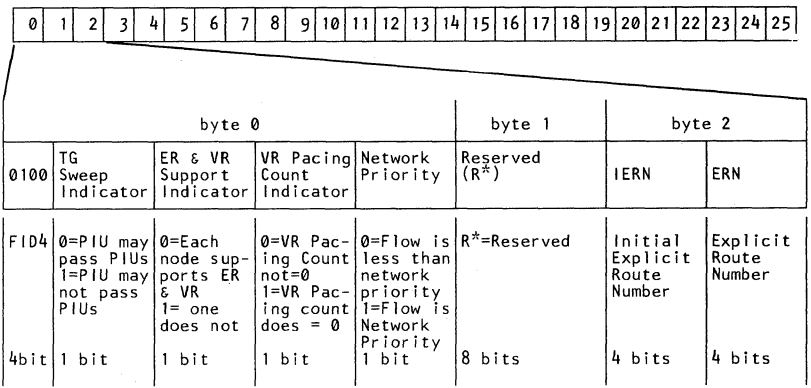

0	1	2	3	4	5	6	7	8	9	10	11	12	13	14	15	16	17	18	19	20	21	22	23	24	25
---	---	---	---	---	---	---	---	---	---	----	----	----	----	----	----	----	----	----	----	----	----	----	----	----	----

byte 3			byte 4			byte 5
V R N	RR*	TPF	VR Change Window Indicator	TG non-FIFO Indicator	VR Sequence & Type Indicator	Transmission Group Sequence Number Field
Virtual Route Number	Transmission Priority 00=Low 01=Medium 10=High	0=Increment Window Size 1=Decrement Window Size	0=TG FIFO Required 1=TG FIFO Not Required	00=Non-Sequenced 01=Non-Supervisory 11=Singly Sequenced	TGSNF	
4 bits	2 bits	1 bit	1 bit	2 bits	12 bits	

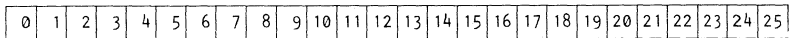

byte 6				byte 7	bytes 8-11	
VR Pacing Request (VRPRQ)	VR Pacing Response (VRPRS)	VR Change Window Reply Indicator	VR Reset Window Reply Indicator	VR Send Sequence Number	VR Send Sequence Number	Destination Subarea Field (DSAF)
0=No VR Pacing Response Requested 1=VR Pacing Response Requested 1 bit	0=No VR Pacing Response Sent 1=VR Pacing Response Sent 1 bit	Reserved 0=Increment Window Size by 1 1=Decrement Window Size by 1 1 bit	0=Do not Reset Window Size 1=Reset Window Size to Minimum 1 bit	First 4 bits of VRSSNF 4 bits	Last 8 bits of VRSSNF 8 bits	4 bytes



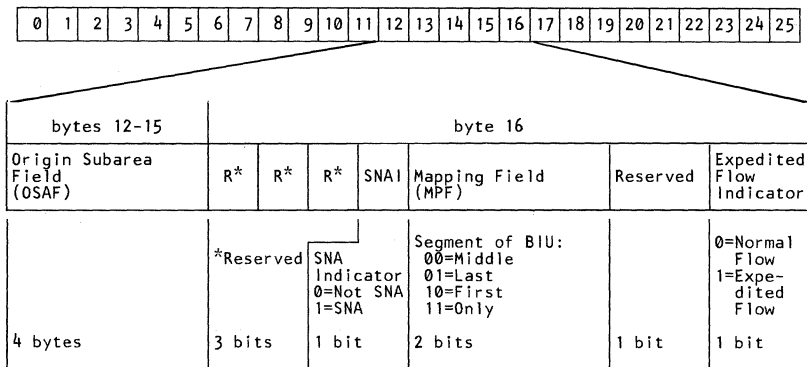

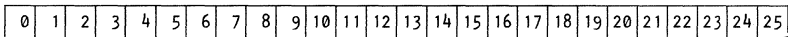

byte17	byte18-19	byte20-21	byte22-23	byte24-25
Reserved	DEF	OEF	SNF	DCF
1 byte	Destination Element Field 2 bytes	Origin Element Field 2 bytes	Sequence Number Field 2 bytes	Data Count Field 2 bytes



0	1	2	3	4	5	6	7	8	9	10	11	12	13	14	15	16	17	18	19	20	21	22	23	24	25
byte 0		byte 1		byte 2		byte 4		bytes 4-5		bytes 6-23						byte 24-25									
1111		R*		Reserved		Command Format		Command Type		Command Sequence Number		Reserved						Data Count Field							
Reserved				X'01'		X'01'																			
4bit		4bit		8 bits		8 bits		8 bits		2 bytes		18 bytes						2 bytes							

*TG SNF Wrap Acknowledgment (only value defined)

CHAPTER 3. REQUEST/RESPONSE HEADER

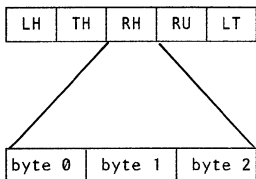

This chapter summarizes information from the **Systems Network Architecture Format and Protocol Reference Manual: Architectural Logic** (SC30-3112).

The request or response header (RH), when present, follows the transmission header (TH). In a request it is a request header; in a response, a response header. In either case, the RH is three bytes long.

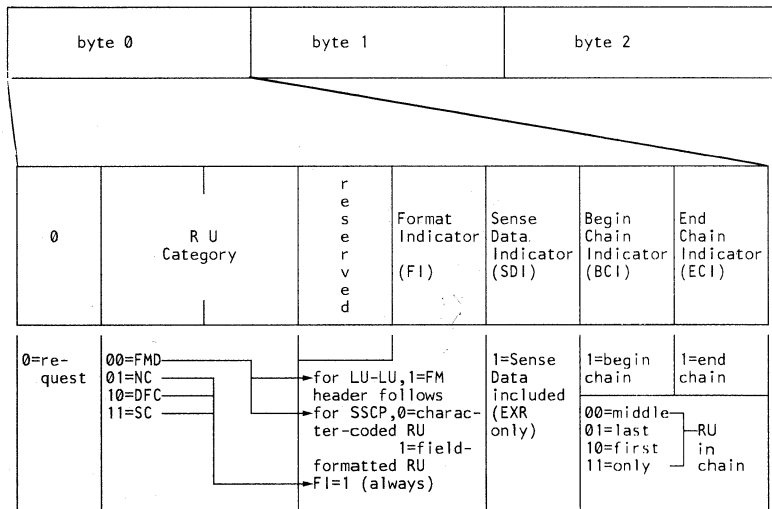

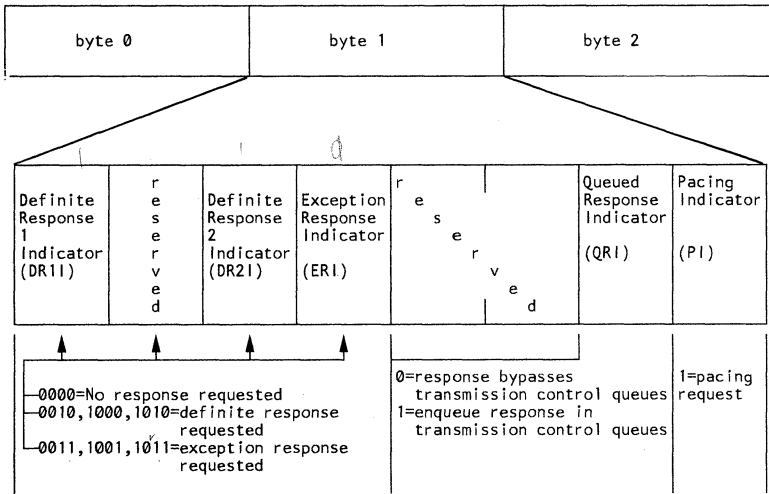

byte 0		byte 1		byte 2			
Begin Bracket Indicator (BBI)	End Bracket Indicator (EBI)	Change Direction Indicator (CDI)	reserved	Code Selection Indicator (CSI)	Enciphered Data Indicator (EDI)	Padded Data Indicator (PDI)	reserved
1=begin bracket	1=end bracket	1=change direction		0=code 0 1=code 1	1=RU is Enciphered	1=RU was padded before enchipherment	

RESPONSE HEADER

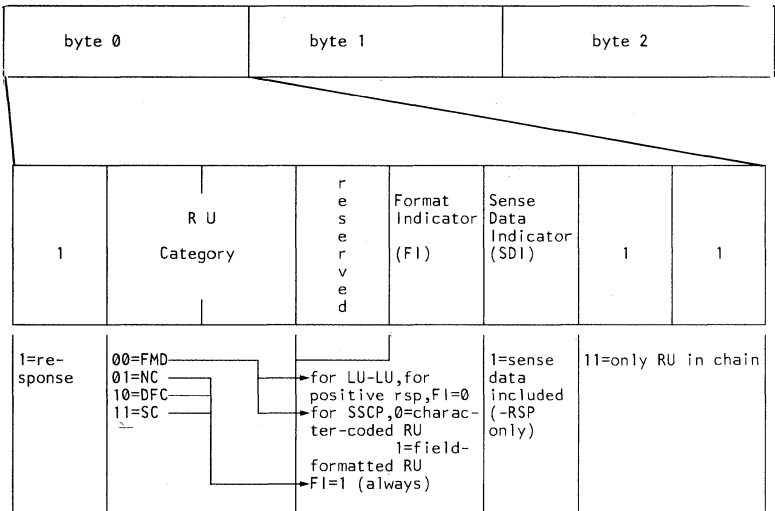

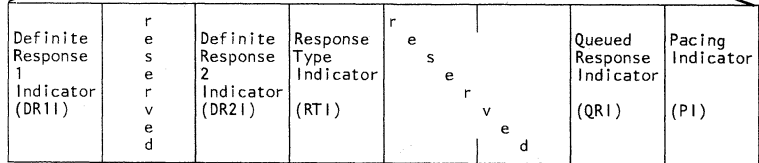
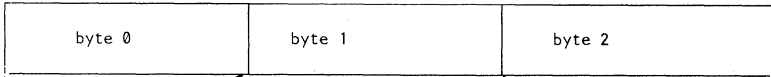

000=Reserved except in IPR (with RTI=0)
 100=DR1 response
 001=DR2 response
 101=DR1 and DR2 response (DR2 used with sync point)

0=+RSP
 1=-RSP

0=response bypasses TC queues
 1=enqueue response in TC queues

1=pacing response

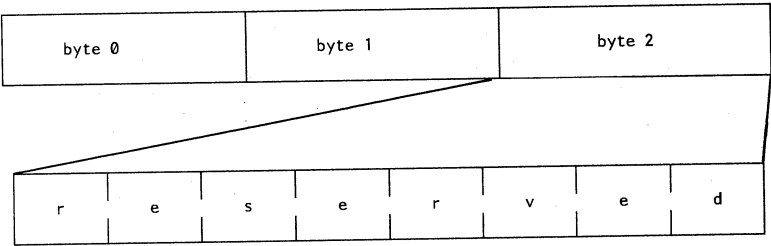

This page left intentionally blank

CHAPTER 4. REQUEST/RESPONSE UNIT

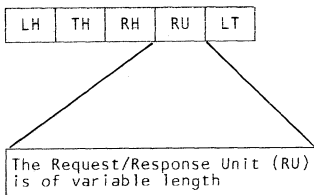

This chapter summarizes information from the **Systems Network Architecture Format and Protocol Reference Manual: Architectural Logic (SC30-3112)**.

The request/response unit (RU) follows the request/response header (RH). As with the RH, the RU can be either a request RU or a response RU. This chapter presents information in this order:

- A categorized list of abbreviated RU names
- An alphabetic index of request RUs
- An index of RUs by NS (Network Services) headers and request codes
- An alphabetic list of request RU format descriptions
- The RU NS header and request code index repeated (on a foldout page for the reader who is looking up a number of RUs)
- A summary of response RUs
- A list of response format descriptions for response RUs returning data
- A list of control vectors and control lists referred to in various RUs
- The XID command and response information-field formats

REQUEST-RESPONSE UNIT (RU) FORMATS

The initial line for each RU in the two RU format description lists is in one of the following formats:

Requests

"RU ABBREVIATION; Origin NAU-->Destination NAU, Normal (Norm) or Expedited (Exp) Flow; RU Category (RU NAME)"

Responses

"RSP(RU ABBREVIATION); Origin NAU-->Destination NAU, Norm or Exp Flow; RU Category"

Notes:

1. "RU Category" is abbreviated as follows:

DFC	data flow control
SC	session control
NC	network control
FMD NS(c)	function management data, network services, configuration services
FMD NS(ma)	function management data, network services, maintenance services
FMD NS(me)	function management data, network services, measurement services
FMD NS(mn)	function management data, network services, management services
FMD NS(no)	function management data, network services, network operator services
FMD NS(s)	function management data, network services, session services

2. The formats of character-coded FMD NS RUs are implementation dependent; LU-->LU FMD RUs (for example, FM headers) are described in SNA--Sessions Between Logical Units.
3. All values for field-formatted RUs that are not defined in this section are reserved.
4. The request code value X'FF' and the NS header values X'(3|7|B|F)F*****' and X'**(3|7|B|F)F**' are set aside for implementation internal use, and will not be otherwise defined in SNA.
5. Throughout this section, a "symbolic name in EBCDIC characters" is defined in general accordance with the System/360 or System/370 Assembler Language definition of an "ordinary symbol": the name must begin with any one of the EBCDIC letters--A through Z, \$, #, or @--and be followed by zero or more EBCDIC letters or numerics (0-9).

SUMMARY OF REQUEST RU'S BY CATEGORY

NC

+LSA	NC-ER-TEST
NC-ACTVR	NC-ER-TEST_REPLY
NC-DACTVR	NC-IPL_ABORT
NC-ER-ACT	NC-IPL_FINAL
NC-ER-ACT_REPLY	NC-IPL_INIT
NC-ER-INOP	NC-IPL_TEXT
NC-ER-OP	

SC

*ACTCDRM	DACTLU
*ACTLU	DACTPU
*ACTPU	RQR -
*BIND	*STSN -
CLEAR -	SDT -
CRV -	UNBIND
DACTCDRM	

DFC

BID	RELQ
BIS	RSHUTD
CANCEL	RTR
CHASE	SBI
LUSTAT	SHUTC
QC	SHUTD
QEC	SIG

FMD NS(c)

ABCONN	EXSLOW
ABCONNOUT	FNA
ACTCONNIN	INITPROC
ACTLINK	INOP
*ADDLINK	IPLFINAL
*ADDLINKSTA	IPLINIT
+ANA	IPLTEXT
CONNOUT	LCP
CONTACT	LDREQD
CONTACTED	NS-IPL-ABORT
DACTCONNIN	NS-IPL-FINAL
DACTLINK	NS-IPL-INIT
DISCONTACT	NS-IPL-TEXT
DELETENR	NS-LD-REQD
DUMPFINAL	+NS-LSA
*DUMPINIT	PROCSTAT
*DUMPTXT	REQACTLU
ER-INOP	REQCONT
ESLOW	REQDISCONT

REQFNA	SETCV
*RNAA	VR-INOP
RPO	
<u>FMD NS(ma)</u>	
ACTTRACE	RECTD
DACTTRACE	RECTR
DISPSTOR	RECTRD
ECHOTEST	REQECHO
ER-TESTED	REQMS
EXECTEST	REQTEST
REFCMS	*ROUTE-TEST
RECMS	SETCV
RECSTOR	TESTMODE
<u>FMD NS(mn)</u>	
DELIVER	FORWARD
<u>FMD NS(s)</u>	
BINDF	*DSRLST
CDCINIT	INIT-OTHER
*CDINIT	*INIT-OTHER-CD
*CDESSEND	INIT-SELF
CDESSSF	NOTIFY
CDESST	NSPE
CDESSTF	SESEND
CDTAKED	SESSST
CDTAKEDC	TERM-OTHER
*CDTERM	TERM-OTHER-CD
*CINIT	TERM-SELF
CLEANUP	UNBINDF
CTERM	

* These request RUs require response RUs that, if positive, may contain data in addition to the NS header or request code. See "Summary of Response RUs" and "Positive Response RUs with Extended Formats."

+ These RUs are supported only for subarea nodes that are not at the current level of SNA.

ACRONYM	FULL RU NAME	PAGE
ABCONN	ANBANDON CONNECTION	4-14
ABCONNOUT	ABANDON CONNECT OUT	4-14
ACTCDRM	ACTIVATE CROSS-DOMAIN RESOURCE MANAGER	4-14
ACTCONNIN	ACTIVATE CONNECT IN	4-15
ACTLINK	ACTIVATE LINK	4-15
ACTLU	ACTIVATE LOGICAL UNIT	4-16
ACTPU	ACTIVATE PHYSICAL UNIT	4-16
ACTTRACE	ACTIVATE TRACE	4-17
ADDLINK	ADD LINK	4-17
ADDLINKSTA	ADD LINK STATION	4-17
ANA	ASSIGN NETWORK ADDRESS	4-18
BID	BID	4-18
BIND	BIND SESSION	4-19
BINDF	BIND FAILURE	4-28
BIS	BRACKET INITIATION STOPPED	4-29
CANCEL	CANCEL	4-29
CDCINIT	CROSS-DOMAIN CONTROL INITIATE	4-29
CDINIT	CROSS-DOMAIN INITIATE	4-31
CDSSESEND	CROSS-DOMAIN SESSION ENDED	4-37
CDSSESSF	CROSS-DOMAIN SESSION SETUP FAILURE	4-40
CDSSESSST	CROSS-DOMAIN SESSION STARTED	4-41
CDSSESTF	CROSS-DOMAIN SESSION TAKEDOWN FAILURE	4-41
CDTAKED	CROSS-DOMAIN TAKEDOWN	4-42
CDTAKEDC	CROSS-DOMAIN TAKEDOWN COMPLETE	4-44
CDTERM	CROSS-DOMAIN TERMINATE	4-44
CHASE	CHASE	4-47
CINIT	CONTROL INITIATE	4-47
CLEANUP	CLEAN UP SESSION	4-52
CLEAR	CLEAR	4-53
CONNOUT	CONNECT OUT	4-54
CONTACT	CONTACT	4-54
CONTACTED	CONTACTED	4-54
CRV	CRYPTOGRAPHY VERIFICATION	4-56
CTERM	CONTROL TERMINATE	4-56
DACTCDRM	DEACTIVATE CROSS-DOMAIN RESOURCE MANAGER	4-58

DACTCONNIN	DEACTIVATE CONNECT IN	4-59
DACTLINK	DEACTIVATE LINK	4-60
DACTLU	DEACTIVATE LOGICAL UNIT	4-60
DACTPU	DEACTIVATE PHYSICAL UNIT	4-61
DACTTRACE	DEACTIVATE TRACE	4-62
DELETENR	DELETE NETWORK RESOURCE	4-63
DELIVER	DELIVER	4-63
DISCONTACT	DISCONTACT	4-65
DISPSTOR	DISPLAY STORAGE	4-65
DSRLST	DIRECT SEARCH LIST	4-66
DUMPFINAL	DUMP FINAL	4-66
DUMPINIT	DUMP INITIAL	4-66
DUMPTXT	DUMP TEXT	4-66
ECHOTEST	ECHO TEST	4-67
ER-INOP	EXPLICIT ROUTE INOPERATIVE	4-67
ER-TESTED	EXPLICIT ROUTE TESTED	4-68
ESLOW	ENTERING SLOWDOWN	4-70
EXECTEST	EXECUTE TEST	4-70
EXSLOW	EXITING SLOWDOWN	4-71
FNA	FREE NETWORK ADDRESSES	4-71
FORWARD	FORWARD	4-72
INIT-OTHER	INITIATE OTHER	4-73
INIT-OTHER-CD	INITIATE-OTHER CROSS-DOMAIN	4-79
INITPROC	INITIATE PROCEDURE	4-85
INIT-SELF	INITIATE-SELF (format 0)	4-86
INIT-SELF	INITIATE-SELF (format 1)	4-88
INOP	INOPERATIVE	4-92
IPLFINAL	IPL FINAL	4-94
IPLININT	IPL INITIAL	4-94
IPLTEXT	IPL TEXT	4-95
LCP	LOST CONTROL POINT	4-95
LDREQD	LOAD REQUIRED	4-96
LSA	LOST SUBAREA	4-96
LUSTAT	LOGICAL UNIT STATUS	4-97
NC-ACTVR	ACTIVATE VIRTUAL ROUTE	4-100
NC-DACTVR	DEACTIVATE VIRTUAL ROUTE	4-101
NC-ER-ACT	EXPLICIT ROUTE ACTIVATE	4-101
NC-ER-ACT-REPLY	EXPLICIT ROUTE ACTIVATE REPLY	4-102
NC-ER-INOP	EXPLICIT ROUTE INOPERATIVE	4-104
NC-ER-OP	EXPLICIT ROUTE OPERATIVE	4-105
NC-ER-TEST	EXPLICIT ROUTE TEST	4-106
NC-ER-TEST-REPLY	EXPLICIT ROUTE TEST REPLY	4-107
NC-IPL-ABORT	NC IPL ABORT	4-109
NC-IPL-FINAL	NC IPL FINAL	4-109
NC-IPL-INIT	NC IPL INITIAL	4-109

NC-IPL-TEXT	NC IPL TEXT	4-109
NOTIFY	NOTIFY	4-110
NS-IPL-ABORT	NS IPL ABORT	4-115
NS-IPL-FINAL	NS IPL FINAL	4-115
NS-IPL-INIT	NS IPL INITIAL	4-115
NS-IPL-TEXT	NS IPL TEXT	4-115
NS-LSA	NS LOST SUBAREA	4-115
NSPE	NS PROCEDURE ERROR	4-116
PROCSTAT	PROCEDURE STATUS	4-118
QC	QUIESCE COMPLETE	4-119
QEC	QUIESCE AT END OF CHAIN	4-119
RECFMS	RECORD FORMATTED	
	MAINTENANCE STATISTICS	4-119
RECMS	RECORD MAINTENANCE	
	STATISTICS	4-130
RECSTOR	RECORD STORAGE	4-130
RECTD	RECORD TEST DATA	4-131
RECTR	RECORD TEST RESULTS	4-131
RECTRD	RECORD TRACE DATA	4-132
RELQ	RELEASE QUIESCE	4-132
REACTLU	REQUEST ACTIVATE LOGICAL	
	UNIT	4-132
REQCONT	REQUEST CONTACT	4-133
REQDISCONT	REQUEST DISCONTACT	4-133
REQECHO	REQUEST ECHO TEST	4-133
REQFNA	REQUEST FREE NETWORK ADDRESS	4-134
REQMS	REQUEST MAINTENANCE	
	STATISTICS	4-134
REQTEST	REQUEST TEST PROCEDURE	4-135
RNAA	REQUEST NETWORK ADDRESS	
	ASSIGNMENT	4-136
ROUTE-TEST	ROUTE TEST	4-137
RPO	REMOTE POWER OFF	4-138
RQR	REQUEST RECOVERY	4-139
RSHUTD	REQUEST SHUTDOWN	4-139
RTR	READY TO RECEIVE	4-139
SBI	STOP BRACKET INITIATION	4-139
SDT	START DATA TRAFFIC	4-139
SESSEND	SESSION ENDED	4-139
SESSST	SESSION STARTED	4-141
SETCV	SET CONTROL VECTOR (NS(c))	4-141
SETCV	SET CONTROL VECTOR (NS(ma))	4-142
SHUTC	SHUTDOWN COMPLETE	4-142
SHUTD	SHUTDOWN	4-143
SIG	SIGNAL	4-143
STSN	SET AND TEST SEQUENCE	
	NUMBERS	4-143

TERM-OTHER	TERMINATE-OTHER	4-145
TERM-OTHER-CD	TERMINATE-OTHER CROSS-DOMAIN	4-148
TERM-SELF	TERMINATE-SELF (format 0)	4-150
TERM-SELF	TERMINATE-SELF (format 1)	4-152
TESTMODE	TEST MODE	4-155
UNBIND	UNBIND SESSION	4-156
UNBINDF	UNBIND FAILURE	4-158
VR-INOP	VIRTUAL ROUTE INOPERATIVE	4-158

INDEX OF RU'S BY NS HEADERS AND REQUEST CODES

Within DFC, NC, SC, or any specific FMD NS category, the request code is unique. However, while a request code has only one meaning in a specific category, a given code (for example, X'05') can represent different requests in separate categories (for example, DFC, NC, and configuration services). DSRLST, NOTIFY, and SETCV are exceptions: these three requests have request codes--X'27', X'20', and X'11', respectively--that are unique across all the FMD NS categories.

FMD NS Headers (Third byte is the request code)

X'010201'	CONTACT	4-54
X'010202'	DISCONTACT	4-65
X'010203'	IPLINIT	4-94
X'010204'	IPLTEXT	4-95
X'010205'	IPLFINAL	4-95
X'010206'	DUMPINIT	4-66
X'010207'	DUMPTXT	4-66
X'010208'	DUMPFINAL	4-66
X'010209'	RPO	4-138
X'01020A'	ACTLINK	4-15
X'01020B'	DACTLINK	4-60
X'01020E'	CONNOUT	4-53
X'01020F'	ABCONN	4-14
X'010211'	SETCV (FMD NS(c))	4-141
X'010214'	ESLOW	4-70
X'010215'	EXSLOW	4-71
X'010216'	ACTCONNIN	4-15
X'010217'	DACTCONNIN	4-59
X'010218'	ABCONNOUT	4-14
X'010219'	ANA	4-18
X'01021A'	FNA	4-71
X'01021B'	REQDISCONT	4-133
X'010280'	CONTACTED	4-54
X'010281'	INOP	4-91
X'010284'	REQCONT	4-133
X'010285	NS-LSA	4-115
X'010301'	EXECTEST	4-70
X'010302'	ACTTRACE	4-17
X'010303'	DACTTRACE	4-62
X'010311'	SETCV (FMD NS(ma))	4-142

X'010331'	DISPSTOR	4-65
X'010334'	RECSTOR	4-130
X'010380'	REQTEST	4-135
X'010381'	RECMS	4-130
X'010382'	RECTD	4-131
X'010383'	RECTRD	4-132
X'010604'	NSPE	4-116
X'010681'	INIT-SELF (Format 0)	4-86
X'010683'	TERM-SELF (Format 0)	4-150
X'410210'	RNAA	4-136
X'41021C'	DELETENR	4-63
X'41021D'	ER-INOP	4-67
X'41021E'	ADDLINK	4-17
X'410221'	ADDLINKSTA	4-17
X'410223'	VR-INOP	4-158
X'410235'	INITPROC	4-85
X'410236'	PROCSTAT	4-118
X'410237'	NS-LD-REQD	4-96
X'410240'	REQACTLU	4-132
X'410243'	NS-IPL-INIT	4-115
X'410244'	NS-IPL-TEXT	4-115
X'410245'	NS-IPL-FINAL	4-115
X'410246'	NS-IPL-ABORT	4-115
X'410286'	REQFNA	4-134
X'410287'	LCP	4-95
X'410304'	REQMS	4-134
X'410305'	TESTMODE	4-155
X'410306'	ROUTE-TEST	4-137
X'410384'	RECFMS	4-119
X'410385'	RECTR	4-131
X'410386'	ER-TESTED	4-68
X'810387'	REQECHO	4-133
X'810389'	ECHOTEST	4-67
X'810601'	CINIT	4-47
X'810602'	CTERM	4-56
X'810620'	NOTIFY (SSCP-->LU)	4-110
X'810629'	CLEANUP	4-52
X'810680'	INIT-OTHER	4-73
X'810681'	INIT-SELF (Format 1)	4-88
X'810682'	TERM-OTHER	4-145
X'810683'	TERM-SELF (Format 1)	4-152
X'810685'	BINDF	4-28
X'810686'	SESSST	4-141
X'810687'	UNBINDF	4-158
X'810688'	SESEND	4-139
X'810810'	FORWARD	4-72

X'810812'	DELIVER	4-63	
X'818620'	NOTIFY (SSCP-->SSCP)		4-110
X'818627'	DSRLST	4-66	
X'818640'	INIT-OTHER-CD		4-79
X'818641'	CDINIT	4-31	
X'818642'	TERM-OTHER-CD		4-148
X'818643'	CDTERM	4-44	
X'818645'	CDSESSF	4-40	
X'818646'	CDSESSST	4-41	
X'818647'	CDSESSTF	4-41	
X'818648'	CDSESEND	4-37	
X'818649'	CDTAKED	4-42	
X'81864A'	CDTAKEDC	4-44	
X'81864B'	CDCINIT	4-29	

DFC, NC, and SC Request Codes

X'02'	NC-IPL-FINAL
X'03'	NC-IPL-INIT
X'04'	NC-IPL-TEXT (NC)
X'04'	LUSTAT (DFC)
X'05'	RTR (DFC)
X'05'	LSA (NC)
X'06'	NC-ER-INOP
X'07'	ANSC
X'09'	NC-ER-TEST
X'0A'	NC-ER-TEST-REPLY
X'0B'	NC-ER-ACT
X'0C'	NC-ER-ACT-REPLY
X'0D'	ACTLU (SC)
X'0D'	NC-ACTVR (NC)
X'0E'	DACTLU (SC)
X'0E'	NC-DACTVR (NC)
X'0F'	NC-ER-OP
X'11'	ACTPU
X'12'	DACTPU
X'14'	ACTCDRM
X'15'	DACTCDRM
X'31'	BIND
X'32'	UNBIND
X'46'	NC-IPL-ABORT
X'70'	BIS
X'71'	SBI
X'80'	QEC
X'81'	QC
X'82'	RELQ
X'83'	CANCEL
X'84'	CHASE
X'A0'	SDT
X'A1'	CLEAR
X'A2'	STSN
X'A3'	RQR
X'CO'	CRV (SC)
X'CO'	SHUTD (DFC)
X'C1'	SHUTC
X'C2'	RSHUTD
X'C8'	BID
X'C9'	SIG

ABCONN ABCONNOUT ACTCDRM

REQUEST RU FORMATS

ABCONN; SSCP-->PU T4|5, PUCP-->PU, Norm; FMD
NS(c) (ABANDON CONNECTION)

ABCONN requests the PU to deactivate the link
connection for the specified link.

0-2 X'01020F' NS header
3-4 Network address of link

ABCONNOUT; SSCP-->PU T4|5, PUCP-->PU, Norm; FMD
NS(c) (ABANDON CONNECT OUT)

ABCONNOUT requests the PU to terminate a
connect-out procedure on the designated link.

0-2 X'010218' NS header
3-4 Network address of link

ACTCDRM; SSCP-->SSCP, Exp; SC (ACTIVATE
CROSS-DOMAIN RESOURCE MANAGER)

ACTCDRM is sent from one SSCP to another SSCP to
activate a session between them and to exchange
information about the SSCPs.

0 X'14' request code
1 bits 0-3, format: X'0' (only value
defined)
bits 4-7, type activation requested:
X'1' cold
X'2' ERP
2 FM profile
3 TS profile
4-11 Contents ID: eight-character EBCDIC
symbolic name that represents
implementation and installation
dependent information about the SSCP
issuing the ACTCDRM; eight space
(X'40') characters is the value used
if no information is to be conveyed
(This field could be used to provide a
check for a functional and
configurational match between the
SSCPs.)
12-17 SSCP ID: a six-byte field that
includes the ID of the SSCP issuing
the ACTCDRM; the first four bits
specify the format for the remaining
bits:
bits 0-3, format 0000 (only value

ACTCDRM ACTCONNIN ACTLINK

- defined)
- bits 4-7, physical unit type of the node containing the SSCP
- bits 8-47, implementation and installation dependent binary identification
- 18 TS Usage
 bits 0-1, reserved
 bits 2-7, primary CPMGR receive window size (0 means no pacing of requests flowing to the primary)
- 19-n One or more control vectors, as described in the section "Control Vectors and Control Lists," later in this section
- Note: The following vector keys may be used in ACTCDRM:
 X'06' CDRM control vector
 X'09' activation request/response sequence identifier control vector

ACTCONNIN; SSCP-->PU_T4|5, PUCP-->PU, Norm; FMD NS(c) (ACTIVATE CONNECT IN)

ACTCONNIN requests the PU to enable the specified link to accept incoming calls.

- 0-2 X'010216' NS header
 3-4 Network address of link
 5 bit 0, type: 0 (only value defined)
 bits 1-7, reserved

ACTLINK; SSCP-->PU_T4|5, PUCP-->PU, Norm; FMD NS(c) (ACTIVATE LINK)

ACTLINK initiates a procedure at the PU to activate the protocol boundary between a link station in the node (as specified by the link network address parameter in the request) and the link connection attached to it.

- 0-2 X'01020A' NS header
 3-4 Network address of link

ACTLU ACTPU

ACTLU; SSCP-->LU, Exp; SC (ACTIVATE LOGICAL UNIT)

ACTLU is sent from an SSCP to an LU to activate a session between the SSCP and the LU and to establish common session parameters.

- 0 X'0D' request code
- 1 Type activation requested:
 - X'01' cold
 - X'02' ERP
- 2 bits 0-3, FM profile
bits 4-7, TS profile

ACTPU; SSCP|PUCP-->PU, Exp; SC (ACTIVATE PHYSICAL UNIT)

ACTPU is sent by the SSCP to activate a session with the PU, and to obtain certain information about the PU.

- 0 X'11' request code
- 1 bits 0-3, format:
 - X'0' Format 0
 - X'3' Format 3; same as Format 0, except that it includes one or more control vectors in bytes 9-n (sent only to PU_T4|5s that support ERs and VRs)bits 4-7, type activation requested:
 - X'1' cold
 - X'2' ERP
- 2 bits 0-3, FM profile
bits 4-7, TS profile
- 3-8 A six-byte field that specifies the ID of the SSCP issuing ACTPU; the first four bits specify the format for the remaining bits:
 - bits 0-3, format: 0000 (only value defined)
 - bits 4-7, PU type of the node containing the SSCP
 - bits 8-47, implementation and installation dependent binary identification

Note: End of Format 0; Format 3 continues below
- 9-n One or more control vectors, as

ACTPU ACTTRACF ADDLINK ADDLINKSTA

described in the section "Control Vectors and Control Lists," later in this section

Note: The following vector keys may be used in ACTPU:

- X'09' activation request/response sequence identifier control vector
- X'0B' SSCP-PU session capabilities control vector

ACTTRACE; SSCP-->PU_T4|5, Norm; FMD NS(ma)
(ACTIVATE TRACE)

ACTTRACE requests the PU to activate the specified type of resource trace related to the specified network address.

- 0-2 X'010302' NS header
- 3-4 Network address of the resource to be traced
- 5 Selected trace:
 - bit 0, transmission group trace
 - bits 1-6, reserved
 - bit 7, link trace
- 6-n Data to support trace

ADDLINK; SSCP-->PU_T4|5, Norm; FMD NS(c) (ADD LINK)

ADDLINK is sent from the SSCP to the PU to obtain a link network address that will be mapped to the locally-used link identifier specified in the request.

- 0-2 X'41021E' NS header
- 3-4 Network address of target PU
- 5-6 Reserved
- 7 Length of local link identifier
- 8-n Local link identifier

ADDLINKSTA; SSCP-->PU_T4|5, Norm; FMD NS(c) (ADD LINK STATION)

ADDLINKSTA is sent from the SSCP to the PU to obtain an adjacent link station network address to be associated with the locally-used station identifier specified in the request.

- 0-2 X'410221' NS header
- 3-4 Network address of target
- 5 FID types supported:

81-11

ADDLINKSTA ANA BID

- bit 0, 1 FID0 support
- bit 1, 1 FID1 support
- bit 2, 1 FID2 support
- bit 3, 1 FID3 support
- bit 4, 1 FID4 support
- bits 5-7, Reserved
- 6 Reserved
- 7 Length of link station identifier
Note: When assigning an address for a link station on a point to point link, this field can be 0, the link station identifier is omitted, and the target network address in bytes 3 and 4 indicates the link to which the link station belongs.
- 8-n Link station identifier

ANA; SSCP-->PU T4|5, Norm; FMD NS(c) (ASSIGN NETWORK ADDRESSES)

ANA updates the path control routing algorithm in the PU_T4|5 node, such that PIUs with the specified LU network addresses (one or more) will be routed to the specified PU_T1|2 node.

- 0-2 X'010219' NS header
- 3-4 Network address of PU associated with the node to which LU network addresses are to be assigned
- 5 Number of network addresses to be assigned
- 6 Type: X'80' noncontiguous (only value defined)
- 7-8 First network address
- 9-n Any additional network addresses (two-byte multiples)

BID; LU-->LU, Norm; DFC (BID)

BID is used by the bidder to request permission to initiate a bracket, and is used only when using brackets.

- 0 X'C8' request code

BIND; PLU-->SLU, Exp; SC (BIND SESSION)

BIND is sent from a primary LU to a secondary LU to activate a session between the LUs. The secondary LU uses the BIND parameters to help determine whether it will respond positively or negatively to BIND.

- 0 X'31' request code
 - 1 bits 0-3, format: 0000 (only value defined)
bits 4-7, type:
 - 0000 negotiable
 - 0001 nonnegotiable
 - 2 FM profile
 - 3 TS profile
- FM Usage--Primary LU Protocols for FM Data
- 4 bit 0, chaining use selection:
 - 0 only single-RU chains allowed from primary LU half-session
 - 1 multiple-RU chains allowed from primary LU half-session
 - bit 1, request control mode selection:
 - 0 immediate request mode
 - 1 delayed request mode
 - bits 2-3, chain response protocol used by primary LU half-session for FMD requests; chains from primary will ask for:
 - 00 no response
 - 01 exception response
 - 10 definite response
 - 11 definite or exception response
 - bit 4, 2-phase commit for sync point (reserved if sync point protocol not used, that is, a TS profile other than 4 is used):
 - 0 2-phase commit not supported
 - 1 2-phase commit supported
 - bit 5, reserved
 - bit 6, compression indicator:
 - 0 compression will not be

BIND

used on requests from
primary
1 compression may be used
bit 7, send End Bracket indicator
0 primary will not send EB
1 primary may send EB

FM Usage--Secondary LU Protocols for
FM Data

5 bit 0, chaining use selection:
0 only single-RU chains
allowed from secondary LU
half-session
1 multiple-RU chains allowed
from secondary LU
half-session
bit 1, request control mode selection:
0 immediate request mode
1 delayed request mode
bits 2-3, chain response protocol used
by secondary LU half-session
for FMD requests; chains
from secondary will ask for:
00 no response
01 exception response
10 definite response
11 definite or exception
response
bit 4, 2-phase commit for sync point
(reserved if sync point
protocol not used, that is, a
TS profile other than 4 is
used):
0 2-phase commit not
supported
1 2-phase commit supported
bit 5, reserved
bit 6, compression indicator:
0 compression will not be
used on requests from
secondary
1 compression may be used
bit 7, send End Bracket indicator
0 secondary will not send EB
1 secondary may send EB

FM Usage--Common LU Protocols

6 bit 0, reserved

- bit 1, FM header usage:
 - 0 FM headers not allowed
 - 1 FM headers allowed
- bit 2, brackets usage and reset state:
 - 0 brackets not used if neither primary nor secondary will send EB, that is, if byte 4, bit 7 = 0 and byte 5, bit 7 = 0; brackets are used and bracket state managers' reset states are INB if either primary or secondary, or both, may send EB, that is, if byte 4, bit 7 = 1 or byte 5, bit 7 = 1
 - 1 brackets are used and bracket state managers' reset states are BETB
- bit 3, bracket termination rule selection (reserved if brackets not used, that is, if byte 6, bit 2 = 0, byte 4, bit 7 = 0, and byte 5, bit 7 = 0):
 - 0 Rule 2 (unconditional termination) will be used during this session
 - 1 Rule 1 (conditional termination) will be used during this session
- bit 4, alternate code set allowed indicator:
 - 0 alternate code set will not be used
 - 1 alternate code set may be used
- bit 5, sequence number availability for sync point resynchronization (reserved if sync point protocol not used, that is, a TS profile other than 4 is used):
 - 0 sequence numbers not available
 - 1 sequence numbers available

BIND

Note: Sequence numbers are transaction processing program sequence numbers from the previous activation of the session with the same session name; they are associated with the last acknowledged requests and any pending requests to commit a unit of work. If there was no previous activation, the numbers are 0, and this bit is set to 0.

bit 6, BIS sent (reserved if sync point protocol not used, that is, a TS profile other than 4 is used):

- 0 BIS not sent
- 1 BIS sent

bit 7, reserved

7

bits 0-1, normal-flow send/receive mode selection:

- 00 full-duplex
- 01 half-duplex contention
- 10 half-duplex flip-flop
- 11 reserved

bit 2, recovery responsibility (reserved if normal flow send/receive mode is FDX, that is, if byte 7, bits 0-1 = 00):

- 0 contention loser responsible for recovery (see byte 7, bit 3 for specification of which half-session is the contention loser)
- 1 symmetric responsibility for recovery

bit 3, contention winner/loser (reserved if normal flow send/receive mode is FDX, that is, if byte 7, bits 0-1 = 00; or if the normal flow send/receive mode is HDX-FF, brackets are not used, and symmetric responsibility for recovery is used, that is, if

byte 7, bits 0-1 = 10, byte 4,
bit 7 = 0, byte 5, bit 7 = 0,
byte 6, bit 2 = 0, and byte 7,
bit 2 = 1):

0 secondary is contention
winner and primary is
contention loser

1 primary is contention
winner and secondary is
contention loser

Note: Contention winner is
also brackets first speaker if
brackets are used.

bits 4-6, reserved

bit 7, half-duplex flip-flop reset
states (reserved unless (1)
normal-flow send/receive mode
is half-duplex flip-flop (byte
7, bits 0-1 = 10) and (2)
brackets are not used or
bracket state manager's reset
state is INB (byte 6, bit 2 =
0)):

0 HDX-FF reset state is
RECEIVE for the primary and
SEND for the secondary (for
example, the secondary
sends normal-flow requests
first after session
activation)

1 HDX-FF reset state is SEND
for the primary and RECEIVE
for the secondary (for
example, the primary sends
normal-flow requests first
after session activation)

TS Usage

8

bit 0, staging indicator for secondary
CPMGR to primary CPMGR normal flow:

0 pacing in this direction
occurs in one stage

1 pacing in this direction
occurs in two stages

Note: The meanings of 0 and 1
are reversed from the staging
indicator for primary CPMGR to

BIND

secondary CPMGR.

bit 1, reserved

bits 2-7, secondary CPMGR's send
window size: 0 means no
pacing of requests flowing
from the secondary

9 bits 0-1, reserved

bits 2-7, secondary CPMGR's receive
window size: a value of 0
causes the boundary function
to substitute the value set
by a system definition
pacing parameter (if the
system definition includes
such a parameter) before it
sends the BIND RU on to the
secondary half-session; a
value of 0 received at the
secondary is interpreted to
mean no pacing of requests
flowing to the secondary

10 Maximum RU size sent on the normal
flow by the secondary half-session: if
bit 0 is set to 0 then no maximum is
specified and the remaining bits 1-7
are ignored; if bit 0 is set to 1, the
byte is interpreted as $X'ab' = a \cdot 2^{**}b$
(Notice that, by definition, $a \geq 8$ and
therefore $X'ab'$ is a normalized
floating point representation.) See
RU Sizes Corresponding to Values $X'ab'$
in BIND. for all possible values.

11 Maximum RU size sent on the normal
flow by the primary half-session:
identical encoding as described for
byte 10

12 bit 0, staging indicator for primary
CPMGR to secondary CPMGR normal flow:

1 pacing in this direction
occurs in one stage

0 pacing in this direction
occurs in two stages

Note: The meanings of 0 and 1
are reversed from the staging
indicator for secondary to
primary CPMGR.

- bit 1, reserved
- bits 2-7, primary CPMGR's send window size: a value of 0 causes the value set by a system definition pacing parameter (if the system definition includes such a parameter) to be assumed for the session; if this is also 0, it means no pacing of requests flowing from the primary (For single-stage pacing in the primary-to-secondary direction, this field is redundant with, and will indicate the same value as, the secondary CPMGR's receive window size--see byte 9, bits 2-7, above.)
- 13 bits 0-1, reserved
- bits 2-7, primary CPMGR's receive window size: a value of 0 means no pacing of requests flowing to the primary (For single-stage pacing in the secondary-to-primary direction, this field is redundant with, and will indicate the same value as, the secondary CPMGR's send window size--see byte 8, bits 2-7, above.)
- PS Profile
- 14 bit 0, PS Usage field format:
 0 basic format
 1 reserved
- bits 1-7, LU-LU session type
- PS Usage
- 15-25 PS characteristics
Note: For information on PS usage, see SNA--Sessions Between Logical Units.
- End of PS Usage Field
- 26-k Cryptography Options
- 26 bits 0-1, private cryptography

BIND

options:

- 00 no private cryptography supported
- 01 private cryptography supported: the session cryptography key and cryptography protocols are privately supplied by the end user

bits 2-3, session-level cryptography options:

- 00 no session-level cryptography supported
- 01 session-level selective cryptography supported; all cryptography key management is supported by SSCP.SVC_MGR and LU.SVC_MGR; exchange (via +RSP(BIND)) and verification (via CRV) of the cryptography session-seed value is supported by the LU.SVC_MGRs for the session; all FMD requests carrying ED are enciphered/deciphered by the CPMGRs
- 10 reserved
- 11 session-level mandatory cryptography supported; same as session-level selective cryptography except all FMD requests are enciphered/deciphered by the CPMGRs

bits 4-7, session-level cryptography options field length:

- X'0' no session-level cryptography specified; following additional cryptography options

fields (bytes 27-k)
omitted
X'9' session-level
cryptography speci-
fied; additional
options follow in
next nine bytes

27 bits 0-1, session cryptography key
encipherment method:
00 session cryptography
key enciphered under
SLU master cryptography
key using a seed value
of 0 (only value
defined)

bits 2-4, reserved

bits 5-7, cryptography cipher method:
000 block chaining with
seed and cipher text
feedback, using the
Data Encryption
Standard (DES)
algorithm (only value
defined)

28-k Session cryptography key enciphered
under secondary LU master cryptography
key; an eight-byte value that, when
deciphered, yields the session
cryptography key used for enciphering
and deciphering FMD requests

k+1 Length of primary LU name--see Note,
below, concerning the BIND RU length

k+2-m Primary LU network name or, if the
secondary LU issued the INITIATE(-SELF
or -OTHER), the uninterpreted name as
carried in that RU (and also in CDINIT
for a cross-domain session)

m+1 Length of user data (X'00' = no user
data field present)--see Note, below,
concerning the BIND RU length

m+2-n User data

m+2 User data key
X'00' structured subfields follow
~X'00' first byte of unstructured
user data
Note: Individual structured

BIND BINDF

subfields may be omitted entirely. When present, they appear in ascending field number order.

- For unstructured user data
- m+3-n Remainder of unstructured user data
- For structured user data
- m+3-n Structured subfields (For detailed definitions, see the structured user data section on page 4-162.)
- n+1 Length of user request correlation (URC) field
Note: X'00' = no URC present
- n+2-p URC: end user defined identifier (present only if carried in INIT from SLU)
- p+1 Length of secondary LU network name--see Note, below, concerning the BIND RU length
Note: X'00' = no secondary LU name present
- p+2-r Secondary LU network name (present only in negotiable BIND)
Note: The length of the BIND RU cannot exceed 256 bytes, lest a negative response be returned.

BINDF; PLU-->SSCP, Norm; FMD NS(s) (BIND FAILURE)

BINDF is sent, with no-response requested, by the PLU to notify the SSCP that the attempt to activate the session between the specified LUs has failed.

- 0-2 X'810685' NS header
- 3-6 Sense data
- 7 Reason
 - bit 0, reserved
 - bit 1, 1 BIND error in reaching SLU
 - bit 2, 1 setup reject at PLU
 - bit 3, 1 setup reject at SLU
 - bits 4-7, reserved
- 8 Session key
 - X'06' uninterpreted name pair
 - X'07' network address pair
- 9-m Session Key Content
 - For session key X'06': uninterpreted

BINDF BIS CANCEL CDCINIT

name pair
 9 Type: X'F3' logical unit
 10 Length, in binary, of symbolic name of PLU
 11-k Symbolic name in EBCDIC characters
 k+1 Type: X'F3' logical unit
 k+2 Length, in binary, of symbolic name of SLU
 k+3-m Symbolic name, in EBCDIC characters
 • For session key X'07': network address pair
 9-10 Network address of PLU
 11-12(=m) Network address of SLU

BIS; LU-->LU, Norm; DFC (BRACKET INITIATION STOPPED)

BIS is sent by the half-session that received SBI to acknowledge its agreement not to sent BB or BID. It is used only when using brackets.

0 X'70' request code

CANCEL; LU-->LU, Norm; DFC (CANCEL)

CANCEL may be sent by a half-session to terminate a partially sent chain of FMD requests. CANCEL may be sent only when a chain is in process. The sending half-session may send CANCEL to end a partially sent chain if a negative response is received for a request in the chain, or for some other reason.

0 X'83' request code

CDCINIT; SSCP-->SSCP, Norm; FMD NS(s)
 (CROSS-DOMAIN CONTROL INITIATE)

CDCINIT passes information about the SLU from the SSCP(SLU) to the SSCP(PLU) and requests that the SSCP(PLU) send CINIT to the PLU.

0-2 X'81864B' NS header
 3 Format
 bits 0-3, 0000 Format 0 (only value defined)

bits 4-7, reserved

4 Reserved

5-12 PCID

5-6 The network address of SSCP(ILU)

7-12 A unique 6-byte value, generated by the SSCP(ILU), that is retained and

CDCINIT

used in all cross-domain requests dealing with the same procedure until it is completed. The SSCP(ILU) maintains correlation between PCID and the URC, if one has been provided by the INIT-SELF or INIT-OTHER request.

13-14	Network address of PLU
15-16	Network address of SLU
17-18	Length, in binary, of BIND image
19-n	BIND image: bytes 1-p of the BIND RU (see BIND format description), that is, through the URC field
	<u>Notes on BIND image:</u>
	<ul style="list-style-type: none"> • If the length of the URC field is 0, the length field itself is excluded from the BIND image. • For SLUs not in the sending SSCP's node, the session cryptography key is enciphered under the SLU master cryptography key; for SLUs in the SSCP's node, the sending SSCP enciphers the session cryptography key under a dummy SLU master cryptography key.
n+1-n+2	Length, in binary, of LU or non-SNA device characteristics field and format--that is, bytes n+3 - p (X'00' = no characteristics/format field)
n+3	LU or non-SNA device characteristics format: X'01' Format 1: access method unique device characteristics (only value defined)
n+4-p	LU or non-SNA device specifications (See CINIT for the format of this field.)
p+1	Length, in binary, of session cryptography key <u>Note:</u> X'00' = no Session Cryptography Key field is present
p+2-q	Session cryptography key for primary: the session cryptography key, enciphered under the cross-domain cryptography key defined for the SSCP(SLU) to SSCP(PLU) direction (a different cross-domain cryptography

key is defined for the opposite direction) and using a seed value of 0

CDINIT; SSCP-->SSCP, Norm; FMD NS(s)
(CROSS-DOMAIN INITIATE)

CDINIT from the SSCP(OLU) requests that the SSCP(DLU) assist in initiating an LU-LU session for the specified (OLU,DLU) pair.

0-2 X'818641' NS header

3 Format

bits 0-3, 0000 Format 0: used when Type = I, I/Q, or Q; bytes 17-18 are reserved and no COS fields are specified for Format 0; Format 0 includes bytes 0 through s
0001 Format 1: used when Type = DQ and specifies a subset of the parameters; Format 1 includes bytes 0 through 18
0010 Format 2: specifies COS fields and an additional OLU status (byte 6, bit 5) in addition to the parameters in Format 0; Format 2 includes bytes 0 through s+9

bits 4-7, reserved

4-(s|s+9) Formats 0 and 2 Continue (See Format 1 continuation below.)

4 Type:

bits 0-1, 00 reserved
01 initiate only (I)
10 queue only (Q)
11 initiate or queue (I/Q)

bits 2-5, reserved

bit 6, 0 DLU is PLU
1 OLU is PLU

bit 7, reserved

5 Queuing Conditions For DLU

bit 0, 0 do not queue if session

CDINIT

- limit exceeded
- 1 queue if session limit exceeded
- bit 1, 0 do not queue if DLU is not currently able to comply with the PLU/SLU specification (as given in byte 4, bit 6)
- 1 queue if DLU is not currently able to comply with the PLU/SLU specification
- bit 2, 0 do not queue if CDINIT loses contention
- 1 queue if CDINIT loses contention
- bit 3, 0 do not queue if no SSCP(DLU)-DLU path
- 1 queue if no SSCP(DLU)-DLU path
- bit 4, reserved
- bits 5-6, queuing position/service
 - 00 put this request on the bottom of the queue (this request is put at the bottom of the queue and serviced last)
 - 01 enqueue this request FIFO
 - 10 enqueue this request LIFO
 - 11 reserved
- bit 7, 0 do not queue for recovery retry
- 1 queue for recovery retry (The element will be maintained on the recovery retry queue even after the activation of the session so that the session can be retried in the event of a session failure.)

Note: Queuing will not be done if the DLU is unknown, or the domain of the DLU is in takedown status.

6	<p>OLU status</p> <p>bit 0, reserved</p> <p>bit 1, 0 LU is not available 1 LU is available</p> <p>bits 2-3, (used if LU is not available; otherwise, reserved)</p> <p>00 LU session limit exceeded</p> <p>01 reserved</p> <p>10 LU is not currently able to comply with the PLU/SLU specification</p> <p>11 reserved</p> <p>bit 4, 0 existing SSCP to LU path 1 no existing SSCP to LU path (connectivity is lost)</p> <p>bit 5, (reserved in format 0)</p> <p>0 UNBIND and SESSEND cannot be sent by the LU or by its boundary function (if any)</p> <p>1 UNBIND and SESSEND may be sent by the LU or by its boundary function (if any)</p> <p>bits 6-7, 01 OLU is PLU 10 OLU is SLU</p>
7-14	<u>PCID</u>
7-8	The network address of SSCP(ILU)
9-14	A unique 6-byte value, generated by the SSCP (ILU), that is retained and used in all cross-domain requests dealing with the same procedure until it is completed
15-16	Network address of OLU
17-18	Reserved
19	INITIATE origin:
	bit 0, 0 OLU is origin 1 third party is origin
	bits 1-2, reserved
	bit 3, 0 network user is the initiator 1 network manager is the initiator
	bits 4-7, reserved
20	NOTIFY specification:
	bits 0-1, 00 do not send NOTIFY to

CDINIT

		01	send NOTIFY to all LUs in session with DLU
		10	send NOTIFY to all LUs in session with DLU only if the CDINIT request is queued
		11	reserved
	bits 2-7, reserved		
21-28	Mode name: an eight-character symbolic name (implementation and installation dependent) that identifies the set of rules and protocols to be used for the session; used by the SSCP(SLU) to select the BIND image to be used by the SSCP(PLU) to build the CINIT request		
29-m	<u>Network Name of DLU</u>		
29	Type: X'F3' logical unit		
30	Length, in binary, of symbolic name		
31-m	Symbolic name, in EBCDIC characters		
m+1-n	<u>Requester ID</u>		
m+1	Length, in binary, of requester ID		
	Note: X'00' = no requester ID is present		
m+2-n	Requester ID: the ID, in EBCDIC characters, of the end user initiating the request (May be used to establish the authority of the end user to access a particular resource.)		
n+1-p	<u>Password</u>		
n+1	Length, in binary, of password		
	Note: X'00' = no password is present		
n+2-p	Password used to verify the identity of the end user		
p+1-q	<u>User Field</u>		
p+1	Length, in binary, of user data		
	Note: X'00' = no user data is present		
p+2-q	User data: user-specific data that is passed to the primary LU on the CINIT request		
p+2	User data key		
	X'00'	structured subfields follow	
	¬X'00'	first byte of unstructured user data	
		Note: Individual structured	

subfields may be omitted entirely. When present, they appear in ascending field number order.

- For unstructured user data
 - For structured user data
- p+3-q Remainder of unstructured user data
- p+3-q Structured subfields (For detailed definitions, see the structured user data section on page 4-162.)
- q+1-r Network Name of OLU
- q+1 Type: X'F3' logical unit
- q+2 Length, in binary, of symbolic name
- q+3-r Symbolic name in EBCDIC characters
- r+1-s Uninterpreted Name of DLU
- r+1 Type: X'F3' logical unit
- r+2 Length, in binary, of DLU name
- Note: X'00' = no uninterpreted name is present.
- r+3-s EBCDIC character string; when present, this name is obtained from the preceding INIT-SELF or INIT-OTHER (when ILU=OLU)
- Note: End of Format 0; Format 2 continues below.
- s+1 COS name initialization indicators:
- bit 0, 0 COS name not received from ILU (see bits 1-2)
- 1 COS name received from ILU
- bits 1-2, (reserved if byte s+1, bit 0 = 1)
- 01 SSCP(DLU) is to initialize COS name (DLU is SLU)
- 10 SSCP(OLU) has initialized COS name (OLU is SLU)
- bits 3-7, reserved
- s+2-s+9 COS name (this field reserved if byte s+1, bits 1-2 = 01): symbolic name of class of service in EBCDIC characters
- 4-18 Format 1
- 4 Type
- bits 0-1, 00 dequeue (DQ)
- bits 2-3, 00 leave on queue if dequeue retry is

CDINIT

- 01 unsuccessful
- 01 remove from queue if dequeue retry is unsuccessful
- 10 do not retry--remove from queue
- 11 reserved
- bit 4, reserved
- bits 5-6, 00 LU2 is PLU
- 01 LU2 is SLU
- 10 reserved
- 11 reserved
- bit 7, reserved
- 5 Queuing Status (For LU associated with SSCP sending CDINIT(DQ))
- bits 0-4, reserved
- bits 5-6, 00 request on bottom of queue
- 01 enqueued request FIFO
- 10 enqueued request LIFO
- 11 reserved
- bit 7, reserved
- 6 LU Status (For LU associated with SSCP sending CDINIT(DQ))
- bit 0, reserved
- bit 1, 0 LU is unavailable
- 1 LU is available
- bits 2-3, (if LU is unavailable)
- 00 LU session limit exceeded
- 01 reserved
- 10 LU is not currently able to comply with the PLU/SLU specification
- 11 reserved
- bit 4, 0 existing SSCP to LU path
- 1 no existing SSCP to LU path
- bit 5, reserved
- bits 6-7, 01 LU is PLU
- 10 LU is SLU
- 7-14 PCID
- 7-8 The network address of SSCP(ILU)
- 9-14 A unique 6-byte value, generated by the SSCP(ILU), that is retained and used in all cross-domain requests dealing with the same procedure until

it is completed. (This PCID must be the same as in the original CDINIT request.)

15-16 Network address of LU1
17-18 Network address of LU2

CDESSEND; SSCP(PLU)<-->SSCP(SLU), Norm; FMD
NS(s) (CROSS-DOMAIN SESSION ENDED)

CDESSEND notifies the SSCP that the LU-LU session identified by the Session Key Content field and the specified PCID for the termination procedure has been successfully deactivated.

0-2 X'818648' NS header

3-10 PCID

3-4 Network address of SSCP(TLU)

Note: A network address value of 0 indicates that no PCID is present in bytes 5 through 10; bytes 5-10 are reserved when bytes 3-4 are 0.

5-10 A unique 6-byte value, generated by the SSCP(TLU), that is retained and used in all cross-domain requests dealing with the same procedure until it is completed.

11 bits 0-3, format:

0000 Format 0

0010 Format 2

bits 4-7, reserved

12-n Format 0

12 Session key

X'06' network name pair

X'07' network address pair

13-n Session Key Content

- For session key X'06': network name pair

13 Type: X'F3' logical unit

14 Length, in binary, of symbolic name of PLU

15-m Symbolic name in EBCDIC characters

m+1 Type: X'F3' logical unit

m+2 Length, in binary, of symbolic name of SLU

m+3-n Symbolic name in EBCDIC characters

- For session key X'07': network address pair

13-14 Network address of PLU

CDSSESEND

- 15-16(=n) Network address of SLU
12-n Format 2
12 Cause: indicates the reason for deactivation of the identified LU-LU session
- X'01' normal deactivation
 - X'02' BIND forthcoming; retain the node resources allocated to this session, if possible
 - X'04' restart mismatch; synch point records do not match; operator intervention is needed before the session can be activated
 - X'05' LU not authorized: the secondary half-session has failed to supply an acceptable password or other authorization information in the User Data field
 - X'06' invalid session parameters: the BIND negotiation has failed due to an inability of the primary half-session to support parameters specified by the secondary
 - X'07' virtual route inoperative: the virtual route used by the (LU,LU) session has become inoperative, thus forcing the deactivation of the identified (LU,LU) session
 - X'08' route extension inoperative: the route extension used by the (LU,LU) session has become inoperative thus forcing the deactivation of the identified (LU,LU) session
 - X'09' hierarchical reset: the identified (LU,LU) session had to be deactivated because of a +RSP(ACTPU|ACTLU,cold)
 - X'0A' SSCP gone: the identified (LU,LU) session had to be deactivated because of a forced deactivation of the (SSCP,PU) or (SSCP,LU) session

	(for example, DACTPU, DACTLU, or DISCONTACT)
X'0B'	virtual route deactivated: the identified (LU,LU) session had to be deactivated because of a forced deactivation of the virtual route being used by the (LU,LU) session
X'0C'	PLU failure: the identified (LU,LU) session had to be deactivated because of an abnormal termination of the PLU
13	Action (reserved for cause codes X'01' through X'06'):
X'01'	normal, no resultant automatic action
X'02'	primary half-session will restart
X'03'	secondary half-session will restart
14-15	Reserved
16	Session key:
X'06'	network name pair
X'07'	network address pair
17-n	<u>Session Key Content</u>
	• For session key X'06': network name pair
17	Type: X'F3' logical unit
18	Length, in binary, of symbolic name of PLU
19-m	Symbolic name in EBCDIC characters
m+1	Type: X'F3' logical unit
m+2	Length, in binary, of symbolic name of SLU
m+3-n	Symbolic name in EBCDIC characters
	• For session key X'07': network address pair
17-18	Network address of PLU
19-20(=n)	Network address of SLU

CDSESSSF

CDSESSSF; SSCP(PLU)-->SSCP(SLU), Norm; FMD NS(s)
(CROSS-DOMAIN SESSION SETUP FAILURE)

CDSESSSF notifies the SSCP(SLU) that the LU-LU session initiation identified by the Session Key Content field and the specified PCID for the initiation procedure has failed.

0-2	X'818645' NS header
3-10	<u>PCID</u>
3-4	The network address of SSCP (ILU)
5-10	A unique 6-byte value, generated by the SSCP(ILU), that is retained and used in all cross-domain requests dealing with the same procedure until it is completed
11-14	Sense data
15	Reason
	bit 0, 1 CINIT error in reaching PLU
	bit 1, 1 BIND error in reaching SLU
	bit 2, 1 setup reject at PLU
	bit 3, 1 setup reject at SLU
	bits 4-7, reserved
16	Session key
	X'06' network name pair
	X'07' network address pair
17-n	<u>Session Key Content</u>
	• For session key X'06': network name pair
17	Type: X'F3' logical unit
18	Length, in binary, of symbolic name of PLU
19-m	Symbolic name in EBCDIC characters
m+1	Type: X'F3' logical unit
m+2	Length, in binary, of symbolic name of SLU
m+3-n	Symbolic name in EBCDIC characters
	• For session key X'07': network address pair
17-18	Network address of PLU
19-20(=n)	Network address of SLU

CDESST; SSCP(PLU)-->SSCP(SLU), Norm; FMD NS(s)
 (CROSS-DOMAIN SESSION STARTED)

CDESST notifies the SSCP(SLU) that the LU-LU session identified by the Session Key Content field and the specified PCID for the initiation procedure has been successfully activated.

- 0-2 X'818646' NS header
- 3-10 PCID
- 3-4 The network address of SSCP(ILU)
- 5-10 A unique 6-byte value, generated by the SSCP(ILU), which is retained and used in all cross-domain requests dealing with the same procedure until it is completed
- 11 Reserved
- 12 Session key
 - X'06' network name pair
 - X'07' network address pair
- 13-n Session Key Content
 - For session key X'06': network name pair
- 13 Type: X'F3' logical unit
- 14 Length, in binary, of symbolic name of PLU
- 15-m Symbolic name in EBCDIC characters
- m+1 Type: X'F3' logical unit
- m+2 Length, in binary, of symbolic name of SLU
- m+3-n Symbolic name in EBCDIC characters
 - For session key X'07': network address pair
- 13-14 Network address of PLU
- 15-16(=n) Network address of SLU

CDESSTF; SSCP(PLU)-->SSCP(SLU), Norm; FMD NS(s)
 (CROSS-DOMAIN SESSION TAKEDOWN FAILURE)

CDESSTF notifies the SSCP(SLU) that the LU-LU session identified by the Session Key Content field and the specified PCID for the termination procedure has failed.

- 0-2 X'818647' NS header
- 3-10 PCID
- 3-4 The network address of SSCP(TLU)
- Note: A network address value of 0 indicates that no PCID is present; bytes 5-10 are reserved when bytes 3-4

CDSESSTF CDTAKED

- are 0.
- 5-10 A unique 6-byte value, generated by the SSCP(TLU), that is retained and used in all cross-domain requests dealing with the same procedure until it is completed
- 11-14 Sense data
- 15 Reason:
 bit 0, 1 CTERM error in reaching PLU
 bit 1, 1 UNBIND error in reaching SLU
 bit 2, 1 takedown reject at PLU
 bits 3-7, reserved
- 16 Session key:
 X'06' network name pair
 X'07' network address pair
- 17-n Session Key Content
 • For session key X'06': network name pair
- 17 Type: X'F3' logical unit
- 18 Length, in binary, of symbolic name of PLU
- 19-m Symbolic name in EBCDIC characters
- m+1 Type: X'F3' logical unit
- m+2 Length, in binary, of symbolic name of SLU
- m+3-n Symbolic name in EBCDIC characters
 • For session key X'07': network address pair
- 17-18 Network address of PLU
- 19-20(=n) Network address of SLU

CDTAKED; SSCP-->SSCP, Norm; FMD NS(s)
 (CROSS-DOMAIN TAKEDOWN)

CDTAKED initiates a procedure to cause the takedown of all cross-domain LU-LU sessions (active, pending-active, and queued) involving the domains of both the sending and receiving SSCP. It also prevents the initiation of new LU-LU sessions between these domains.

- 0-2 X'818649' NS header
- 3-10 PCID
- 3-4 The network address of the SSCP sending the request
- 5-10 A unique 6-byte value generated by the sending SSCP and retained and used in

- all cross-domain requests dealing with the same procedure until it is completed
- 11 Type:
- | | | |
|-----------|----|---|
| bits 0-1, | 00 | active and pending-active sessions |
| | 01 | active, pending-active, and queued sessions |
| | 10 | queued only sessions |
| | 11 | reserved |
| bits 2-3, | 00 | quiesce |
| | 01 | orderly |
| | 10 | forced |
| | 11 | cleanup (mutual procedure) |
| bits 4-7, | | reserved |
- 12 Reason:
- | | | |
|--------|---|-----------------|
| bit 0, | 0 | network user |
| | 1 | network manager |
| bit 1, | 0 | normal |
| | 1 | abnormal |
- bits 2-7, detailed reason (dependent upon bits 0-1):
- For bits 0-1, 00 user and normal:

bits 2-7,	000000	general category (only value defined)
-----------	--------	---------------------------------------
 - For bits 0-1, 01 user and abnormal:

bits 2-7,	000000	general category (only value defined)
-----------	--------	---------------------------------------
 - For bits 0-1, 10 manager and normal:

bits 2-7,	000000	general category
	000011	operator command--domain is going away
 - For bits 0-1, 11 manager and abnormal:

bits 2-7,	000000	general category
	000001	operator command
	000010	restart procedure

CDTAKEDC CDTERM

CDTAKEDC; SSCP-->SSCP, Norm; FMD NS(s)
(CROSS-DOMAIN TAKEDOWN COMPLETE)

Except when the Cleanup option was specified, the SSCP that received CDTAKED (and responded positively to it) sends CDTAKEDC upon completion of its domain takedown procedure. The other SSCP, after completing its domain takedown procedure and receiving a CDTAKEDC, also sends a CDTAKEDC.

- 0-2 X'81864A' NS header
- 3-10 PCID.
- 3-4 The network address of the SSCP that initiated the takedown procedure
- 5-10 A unique 6-byte value, generated by the SSCP initiating the takedown procedure, that is retained and used in all cross-domain requests dealing with the same procedure until it is completed
- 11 Type:
 - X'01' summary (only value defined)
- 12 Status:
 - For Type X'01': summary
 - X'01' all sessions successfully taken down
 - X'02' takedown failures occurred

CDTERM; SSCP(OLU)-->SSCP(DLU), Norm; FMD NS(s)
(CROSS-DOMAIN TERMINATE)

CDTERM from the SSCP(OLU) requests that the SSCP(DLU) assist in the termination of the cross-domain LU-LU session identified by the Session Key Content field and the Type byte of the RU. Each SSCP executes that portion of termination processing that relates to the LU in its domain.

- 0-2 X'818643' NS header
- 3 bits 0-3, 0000 Format 0 (only value defined)
- bits 4-7, reserved
- 4 Type:
 - bits 0-1, 00 request applies to active and pending-active sessions
 - 01 request applies to active, pending-active,

- and queued sessions
 - 10 request applies to queued sessions only
 - 11 reserved
- bit 2, reserved if byte 4, bit 7 = 1; otherwise:
 - 0 forced termination, session to be deactivated immediately and unconditionally
 - 1 orderly termination, permitting an end-of-session procedure to be executed at the PLU before the session is deactivated
- bit 3,
 - 0 do not send DACTLU to DLU; another session initiation request will be sent for DLU
 - 1 send DACTLU to DLU when appropriate; no further session initiation request will be sent (from this sender) for DLU
- bits 4-6, reserved
- bit 7,
 - 0 orderly or forced (see byte 4, bit 2)
 - 1 cleanup
- 5-12 PCID
- 5-6 The network address of the SSCP(TLU)
- 7-12 A unique 6-byte value, generated by the SSCP(TLU), that is retained and used in all cross-domain requests dealing with the same procedure until it is completed
- 13 Reason:
 - bit 0,
 - 0 network user
 - 1 network manager
 - bit 1,
 - 0 normal
 - 1 abnormal
 - bits 2-7, detailed reason (dependent upon bits 0-1):
 - For bits 0-1, 00 user and normal:
 - bits 2-7, 000000 general category
 - 000001 self, 0LU=PLU

CDTERM

- 000010 self, OLU=SLU
- 000011 other
- For bits 0-1, 01 user and abnormal:
 - bits 2-7, 000000 general category
- For bits 0-1, 10 manager and normal:
 - bits 2-7, 000000 general category
 - 000001 operator
 - command--session
 - 000010 operator
 - command--LU
 - 000011 operator
 - command--domain
- For bits 0-1, 11 manager and abnormal:
 - bits 2-7, 000000 general category
 - 000001 operator command
 - 000010 restart procedure
 - 000011 preempt procedure
 - 000100 unrecoverable path error
 - 000101 unrecoverable destination error
- 14-15 Reserved
- 16 Session key:
 - X'05' PCID
 - X'06' network name pair
 - X'07' network address pair
 - X'08' network address-network name
- 17-n Session Key Content
- For session key X'05': PCID
- 17-18 Network address of the SSCP(ILU)
- 19-24(=n) A unique six-byte value, generated by the SSCP(ILU), which is retained and used in all cross-domain requests dealing with the same procedure until it is completed
- Note: This PCID is different from the one in bytes 5-12, which is generated by the SSCP(TLU).
- For session key X'06': network name pair
- 17 Type: X'F3' logical unit
- 18 Length, in binary, of symbolic name of OLU
- 19-m Symbolic name in EBCDIC characters
- m+1 Type: X'F3' logical unit
- m+2 Length, in binary, of symbolic name of

	DLU
m+3-n	Symbolic name in EBCDIC characters <ul style="list-style-type: none"> • For session key X'07': network address pair
17-18	Network address of PLU
19-20(=n)	Network address of SLU <ul style="list-style-type: none"> • For session key X'08': network address-network name
17-18	Network address of OLU
19	Type: X'F3' logical unit
20	Length, in binary, of symbolic name of DLU
21-n	Symbolic name in EBCDIC characters
n+1-p	<u>Requester ID</u>
n+1	Length, in binary, of requester ID <ul style="list-style-type: none"> <u>Note:</u> X'00' = no requester ID
n+2-p	Requester ID: the ID, in EBCDIC characters, of the end user initiating the request
p+1-q	<u>Password</u>
p+1	Length, in binary, of password <ul style="list-style-type: none"> <u>Note:</u> X'00' = no password is present
p+2-q	Password used to verify the identity of the end user

CHASE; LU-->LU, Norm; DFC (CHASE)

CHASE is sent by a half-session to request the receiving half-session to return all outstanding normal-flow responses to requests previously received from the issuer of CHASE. The receiver of CHASE sends the response to CHASE after processing (and sending any necessary responses to) all requests received before the CHASE.

0 X'84' request code

CINIT; SSCP-->PLU, Norm; FMD NS(s) (CONTROL INITIATE)

CINIT requests the PLU to attempt to activate, via a BIND request, a session with the specified SLU.

0-2 X'810601' NS header

3 Format

bits 0-3, 0000 Format 0 (only value defined)

Note: CINIT format 0 may carry control vectors at the

CINIT

end of the basic RU (which ends with the Session Cryptography Key field).

- 4 bits 4-7, reserved
INITIATE Origin:
bit 0, 0 ILU is OLU
 1 ILU is not OLU
bit 1, reserved
bit 2, 0 SLU is OLU
 1 PLU is OLU
bit 3, 0 network user is the initiator
 1 network manager is the initiator
bits 4-5, reserved
bit 6, 0 no recovery retry
 1 recovery retry to be used
bit 7, reserved
- 5 Session key:
 X'07' network address pair
- 6-7 Network address of PLU
- 8-9 Network address of SLU
- 10-11 Length of BIND Image field
- 12-m BIND image: bytes 1-p of the BIND RU, that is, through the URC field (see BIND format description)
Note: If the length of the URC field is 0, the Length field itself is excluded from the BIND image.
- m+1-n Name of SLU
- m+1 Type: X'F3' logical unit
- m+2 Length, in binary, of symbolic name
- m+3-n Symbolic name, in EBCDIC characters
- n+1-p Requester ID
- n+1 Length, in binary, of requester ID
Note: X'00' = no requester ID
- n+2-p Requester ID: the ID, in EBCDIC characters, of the end user initiating the session activation request (May be used to establish the authority of the end user to access a particular resource.)
- p+1-q Password
- p+1 Length, in binary, of password
Note: X'00' = no password is present
- p+2-q Password used to verify the identity

	of the end user
q+1-r	<u>User Field</u> (from INITIATE RU)
q+1	Length, in binary, of user data
	<u>Note:</u> X'00' = no user data is present
q+2-r	User data: user-specific data
q+2	User data key
	X'00' structured subfields follow
	-X'00' first byte of unstructured user data
	<u>Note:</u> Individual structured subfields may be omitted entirely. When present, they appear in ascending field number order.
	• For unstructured user data
q+3-r	Remainder of unstructured user data
	• For structured user data
q+3-r	Structured subfields (For detailed definitions, see the structured user data section on page 4-162.)
r+1-s	<u>LU or Non-SNA Device Specifications</u>
r+1-r+2	Length of characteristics field, including both format and characteristics fields--that is, bytes r+4 - s
	<u>Note:</u> X'0000' = no Format and no Characteristics fields are present.
r+3	Characteristics format:
	X'01' device characteristics (only value defined)
r+4-s	<u>LU or Non-SNA Device Characteristics</u>
	• Format X'01': (This format represents an access-method-unique LU/device characteristics definition. For more specific information refer to access method implementation documentation.)
r+4	Scheduling information:
	X'80' input device
	X'40' output device
	X'20' conversational mode
	X'10' reserved
	x'08' start print sensitive
	X'04' reserved
	X'02' additional information provided (always :hp1.on)
	X'01' specific poll= :hp1.on general

CINIT

```

                                poll= :hpl.off
r+5      Device type:
          X'00' undefined device type
          X'04' 2741
          X'08' WTTY
          X'10' 115A
          X'20' TWX (33-35)
          X'30' 83B3
          X'40' 2740
          X'80' 1050
          X'90' 2780
          X'19' 3277
          X'1A' 3284
          X'1B' 3286/3288
          X'1C' 3275
          X'91' 3780
          X'6D' SNA logical unit
r+6      Model information:
          X'00' Model 1
          X'01' Model 2
r+7      Feature information:
          bits 0-1, 00 SLDC
                                01 start/stop
                                10 BSC
                                11 reserved
          bits 2-7, X'20' XMIT interrupt
                                feature
          X'10' SWITCHED LINE = ON;
                                LEASED LINE = OFF
          X'08' attention
          X'04' checking
          X'02' station control
          X'01' selector pen
r+8      Physical device address
r+9      Miscellaneous flags:
          X'80' SNA compatible application
                                program interface (always )
          X'40' non-SNA application program
                                interface (always )
          X'20' buffered
          X'10' continue mode
          X'08' contention mode
          X'04' inhibit mode (text timeout)
          X'02' end-to-end control
          X'01' 3270 extended data stream
                                requiring BSC transparency

```

r+10	Device data stream compatibility characteristics: (This field is used in conjunction with the Device Type field, r+5, when that field is set to X'6D': SNA logical unit; otherwise, it is reserved.)
	X'00' no data stream characteristics defined here
	X'04' 2741
	X'08' WTTY
	X'10' 115A
	X'20' TWX (33-35)
	X'30' 83B3
	X'40' 2740
	X'80' 1050
	X'90' 2780
	X'19' 3277
	X'1A' 3284
	X'1B' 3286/3288
	X'1C' 3275
	X'91' 3780
	X'A0'-X'FF' available for installation-defined use
r+11	Reserved
r+12-r+16	Screen size (see the PS Usage field in the BIND RU for format)
r+17-s	<u>Work Area</u> (This field is optional if not present, s = r+16.)
r+17	Work area format:
	X'00' unformatted
	X'01' TCAM format
r+18-s	Work area excluding format
s+1	Length of Session Cryptography Key field
	<u>Note:</u> X'00' = no Session Cryptography Key field present
s+2-t	Session Cryptography Key field: session cryptography key enciphered under PLU master cryptography key
	<u>Note:</u> End of base RU
t+1-u	Control vector, as described in the section, "Control Vectors and Control lists," later in this section
	<u>Note:</u> The following vector key is used in CINIT:
	X'0D' Mode/Class of Service/Virtual

CLEANUP

Route List

CLEANUP; SSCP-->SLU, Norm; FMD NS(s) (CLEAN UP SESSION)

CLEANUP is sent by the SSCP to the SLU (in a subarea node only) requesting that the SLU attempt to deactivate the session for the specified (PLU,SLU) network address pair.

0-2 X'810629' NS header

3 bits 0-3, 0000 Format 0 (only value defined)

bits 4-7, reserved

4 Reserved

5 Reason:

bit 0, 0 network user

1 network manager

bit 1, 0 normal

1 abnormal

bits 2-7, detailed reason (dependent upon bits 0-1):

- For bits 0-1, 00 user and normal

bits 2-7, 000000 general category

000001 self, 0LU=PLU

000010 self, 0LU=SLU

000011 other

- For bits 0-1, 01 user and abnormal

bits 2-7, 000000 general category
(only value defined)

- For bits 0-1, 10 manager and normal

bits 2-7, 000000 general category

000001 operator

command--clean up
the session

000010 operator

command--clean up
all sessions for LU

000011 operator

command--clean up
all LU-LU sessions
for LUs in the
domain

- For bits 0-1, 11 manager and abnormal

bits 2-7, 000000 general category

000001 operator command

000010 restart procedure

CLEANUP CLEAR CONNOUT

	000011	preempt procedure
	000100	unrecoverable path error
	000101	unrecoverable destination error
6	Session key	
	X'06'	uninterpreted name pair
	X'07'	network address pair
7-n	<u>Session Key Content</u>	
	•	For session key X'06': uninterpreted name pair
7	Type: X'F3'	logical unit
8	Length, in binary, of PLU name	
9-m	EBCDIC character string	
m+1	Type: X'F3'	logical unit
m+2	Length, in binary, of SLU name	
m+3-n	EBCDIC character string	
	•	For session key X'07': network address pair
7-8	Network address of PLU	
9-10(=n)	Network address of SLU	

CLEAR; PLU-->SLU, SSCP-->SSCP, Exp; SC (CLEAR)
 CLEAR is sent by primary session control to reset the data traffic FSMs and subtrees (for example, brackets, pacing, sequence numbers) in the primary and secondary half-sessions (and boundary function, if any).

0 X'A1' request code

CONNOUT; SSCP-->PU T4|5, PUCP-->PU, Norm; FMD
 NS(c) (CONNECT OUT)

CONNOUT requests the PU to initiate a connect-out procedure on the specified link.

0-2	X'01020E'	NS header
3-4	Network address of link	
5	SDLC link station identifier	
6	bit 0, type: 0 (only value defined)	
	bits 1-2, connect-out feature:	
	00	automatic connect out (dial digits are provided)
	01	reserved
	10	manual connect out (no dial digits are provided); this bit

CONNOUT CONTACT CONTACTED

- setting does not apply
to CCITT X.21
connections
- 11 CCITT X.21 direct
connect out (no dial
digits are provided)
- bits 3-7, reserved
- Note: Bytes 7-n are not
included on manual connect
calls (bits 1-2 = 10).
- 7 Retry limit: number of times the
connect-out procedure is to be retried
- 8 Number of dial digits (for X.21
direct connect out)
- 9-n Dial digits: EBCDIC characters
representing decimal digits and
control information, as appropriate to
the link connection

CONTACT; SSCP-->PU_T4|5, PUCP-->PU, Norm; FMD
NS(c) (CONTACT)

CONTACT requests the initiation of a procedure
at the PU to activate DLC-level contact with the
adjacent link station specified in the request.
The DLC-level contact must be activated before
any PIUs can be exchanged with the adjacent node
over the link.

- 0-2 X'010201' NS header
- 3-4 Network address of adjacent link
station of the node to be contacted

CONTACTED; PU T4|5-->SSCP, PU-->PUCP, Norm; FMD
NS(c) (CONTACTED)

CONTACTED is issued by the PU to indicate to the
SSCP the completion of the DLC contact
procedure. A status parameter conveyed by this
request informs SSCP configuration services
whether or not the contact procedure was
successful; if not successful, the status
indicates whether an adjacent node load is
required or whether an error occurred on the
contact procedure.

- 0-2 X'010280' NS header
- 3-4 Network address of adjacent link
station of the node being contacted
- 5 Status of adjacent link station or

node associated with adjacent link station:

	X'01'	loaded (no field follows)
	X'02'	load required (no field follows)
	X'03'	error on CONTACT (no field follows)
	X'04'	loaded (additional field, bytes 6-p, follows)
	X'05'	exchanged parameters in XID Format 2 l-field not compatible (additional field, bytes 6-p, follows)
	X'07'	no routing capability to adjacent node (additional field, bytes 6-p, follows)
	X'08'	incompatible parameters in XID Format 2 l-field for addition of link station to currently active TG (additional field, bytes 6-p, follows)
6-p		Additional fields for status bytes X'04', X'05', X'07', and X'08'
		• For status byte X'04'
6		Resolved TG number
7-10		Adjacent node subarea address (right-justified with leading 0's.)
11-18		IPL load module ID received from the adjacent node: an eight-character EBCDIC symbolic name of the IPL load module currently operating in the adjacent node
		<u>Note:</u> X'40...40' = no information conveyed.
		• For status bytes X'05', X'07', and X'08'
6		Length, in binary, of XID Format 2 l-field received
7-n		XID Format 2 l-field received (See the later section, "DLC XID Information-Field Format," for format details.)
n+1		Length, in binary, of XID Format 2 l-field sent
n+2-p		XID Format 2 l-field sent (See the later section, "DLC XID

CRV CTERM

Information-Field Format," for format details.)

CRV; PLU-->SLU, Exp; SC (CRYPTOGRAPHY VERIFICATION)

CRV, a valid request only when session-level cryptography was selected in BIND, is sent by the primary LU session control to verify cryptography security and thereby enable sending and receiving of FMD requests by both half-sessions.

0 X'CO' request code
1-8 A transform of the (deciphered) cryptography session-seed value received (enciphered) in bytes 28-k of +RSP(BIND), re-enciphered under the session cryptography key using a seed value of 0 the transform is the cryptography session-seed value with the first four bytes inverted
Note: The cryptography session-seed is used as the seed for all session-level cryptography encipherment and decipherment provided for FMD RUs.

CTERM; SSCP-->PLU, Norm; FMD NS(s) (CONTROL TERMINATE)

CTERM requests that the PLU attempt to deactivate a session identified by the specified (PLU,SLU) network address pair.

0-2 X'810602' NS header
3 bits 0-3, 0000 Format 0 (only value defined)
bits 4-7, reserved
4 Type:
bits 0-1, reserved
bits 2-3, 00 reserved
01 orderly
10 forced
11 cleanup
bits 4-7, reserved
5 Reason:
bit 0, 0 network user
1 network manager
bit 1, 0 normal

	1	abnormal
	bits 2-7,	detailed reason (dependent upon bits 0-1):
	• For bits 0-1, 00	user and normal
	bits 2-7,	000000 general category
		000001 self, OLU = PLU
		000010 self, OLU = SLU
		000011 other
	• For bits 0-1, 01	user and abnormal
	bits 2-7,	000000 general category
		(only value defined)
	• For bits 0-1, 10	manager and normal
	bits 2-7,	000000 general category
		000001 operator
		command--session
		000010 operator
		command--LU
		000011 operator
		command--domain
	• For bits 0-1, 11	manager and abnormal
	bits 2-7,	000000 general category
		000001 operator command
		000010 restart procedure
		000011 preempt procedure
		000100 unrecoverable path error
		000101 unrecoverable destination error
6-7		Reserved
8		Session key:
		X'07' network address pair
9-10		Network address of PLU
11-12		Network address of SLU
13-n		<u>Requester ID</u>
13		Length, in binary, of requester ID
		Note: X'00' = no requester ID
14-n		Requester ID: the ID, in EBCDIC characters, of the end user initiating the session deactivation request (May be used to establish the authority of the end user to access a particular resource or service.)
n+1-p		<u>Password</u>
n+1		Length, in binary, of password
		Note: X'00' = no password is present

CTERM DACTCDRM

n+2-p Password used to verify the identity of the end user

DACTCDRM; SSCP-->SSCP, Exp; SC (DEACTIVATE CROSS-DOMAIN RESOURCE MANAGER)

DACTCDRM is sent to deactivate an SSCP-SSCP session.

- 0 X'15' request code
- 1 bits 0-3, format: X'0' (only value defined)
- bits 4-7, type deactivation requested:
- X'1' normal end of session
 - X'2' invalid activation parameter, sent by the primary half-session to deactivate the session and to indicate to the secondary that the response to ACTCDRM contained an invalid parameter
 - X'3' session outage notification (SON)
- 2-5
- End of Type 1; Type 2 Continues Reason code (included only if type deactivation requested is invalid activation parameter, that is, byte 1, bits 4-7 = X'2'): sense data (see Chapter 8) corresponding to the error
 - Type 3 Continues
- 2 Cause of session outage notification:
- X'07' virtual route inoperative: the virtual route being used by the SSCP-SSCP session has become inoperative, thus forcing the deactivation of the SSCP-SSCP session
 - X'0B' virtual route deactivated: the identified SSCP-SSCP session is being deactivated because of a forced deactivation of the virtual route being used by the session
 - X'0C' SSCP failure--unrecoverable:

- the identified (SSCP,SSCP) session had to be deactivated because of an abnormal termination of one of the SSCPs of the session; recovery from the failure was not possible
- X'0D' session override: the subject session has to be deactivated because of a more recent session activation request for the same session over a different virtual route
- X'0E' SSCP failure--recoverable: the identified (SSCP,SSCP) session had to be deactivated because of an abnormal termination of one of the SSCPs of the session; recovery from the failure may be possible
- X'0F' cleanup: the SSCP is resetting its half-session before it receives the response from the partner SSCP receiving the DACTCDRM
- X'10' SSCP contention: two SSCPs have sent each other an ACTCDRM request over different virtual routes; the SSCP receiving the ACTCDRM from the SSCP with the greater SSCP ID sends DACTCDRM, with this SON code, to the other SSCP over the same virtual route on which the contention-losing ACTCDRM was sent

3 Reserved

DACTCONNIN; SSCP-->PU T4|5, PUCP-->PU, Norm; FMD NS(c) (DEACTIVATE CONNECT IN)

DACTCONNIN requests the PU to disable the specified link from accepting incoming calls.

0-2 X'010217' NS header

3-4 Network address of link

DACTLINK DACTLU

DACTLINK; SSCP-->PU_T4|5, PUCP-->PU, Norm; FMD
NS(c) (DEACTIVATE LINK)

DACTLINK initiates a procedure at the PU to deactivate the protocol boundary between a link station in the node (as specified by the link network address parameter in the request) and the link connection attached to it. It is used after all adjacent link stations on the specified link have been disconnected.

0-2 X'01020B' NS header
3-4 Network address of link

DACTLU; SSCP<-->LU, Exp; SC (DEACTIVATE LOGICAL UNIT)

DACTLU is sent to deactivate the session between the SSCP and the LU.

0 X'0E' request code
Note: End of short (one-byte) request

1 Type of deactivation requested:
X'01' normal deactivation
X'03' session outage notification (SON)

2 Cause (reserved if byte 1 = X'03'):
X'07' virtual route inoperative: the virtual route serving the (SSCP,LU) session has become inoperative, thus forcing the deactivation of the session
X'08' route extension inoperative: the route extension serving the (SSCP,LU) session has become inoperative, thus forcing the deactivation of the session
X'09' hierarchical reset: the identified session is being deactivated because of a +RSP(ACTPU, Cold)
X'0B' virtual route deactivated: the identified (SSCP,LU) session is being deactivated because of a forced deactivation of the virtual route being used by the session
X'0C' SSCP or LU failure--unrecoverable: the

subject session had to be reset because of an abnormal termination; recovery from the failure was not possible

X'0E' SSCP or LU failure--recoverable: the identified (SSCP,LU) session had to be deactivated because of an abnormal termination of the SSCP or LU of the session; recovery from the failure may be possible

X'0F' cleanup: the SSCP is resetting its half-session before receiving the response from the LU being deactivated

DACTPU; SSCP|PUCP-->PU, PU-->SSCP, Exp; SC
(DEACTIVATE PHYSICAL UNIT)

DACTPU is sent to deactivate the session between the SSCP and the PU.

0 X'12' request code

1 Type deactivation requested:

X'01' final use, physical connection may be broken

X'02' not final use, physical connection should not be broken

X'03' session outage notification (SON)

2 Cause (not present if byte 1 = X'03'):

X'07' virtual route inoperative: the virtual route for the (SSCP,PU) session has become inoperative, thus forcing the deactivation of the (SSCP,PU) session

X'08' route extension inoperative: the route extension serving the (SSCP,PU) session has become inoperative, thus forcing the deactivation of the (SSCP,PU) session

X'09' hierarchical reset: the identified session is being

DACTPU DACTTRACE

- deactivated because of a +RSP(ACTPU, Cold)
- X'0B' virtual route deactivated: the identified (SSCP,PU) session is being deactivated because of a forced deactivation of the virtual route being used by the session
- X'0C' SSCP or PU failure--unrecoverable: the identified (SSCP,PU) session had to be deactivated because of an abnormal termination of the SSCP or PU of the session; recovery from the failure was not possible
- X'0D' session override: the subject session has to be deactivated because of a more recent session activation request for the same session over a different virtual route
- X'0E' SSCP or PU failure--recoverable: the identified (SSCP,PU) session had to be deactivated because of an abnormal termination of the SSCP or PU of the session; recovery from the failure may be possible
- X'0F' cleanup: the SSCP is resetting its half-session before receiving the response from the PU that is being deactivated.

DACTTRACE; SSCP-->PU_T4|5, Norm; FMD NS(ma)
(DEACTIVATE TRACE)

DACTTRACE requests that the specified trace be deactivated.

- 0-2 X'010303' NS header
3-4 Network address of resource to be traced
5 Selected trace
bit 0, transmission group trace
bits 1-6, reserved

DACTTRACE DELETENR DELIVER

6-n bit 7, link trace
 Data to support trace deactivation

DELETENR; SSCP-->PU_T4|5, Norm; FMD NS(c)
 (DELETE NETWORK RESOURCE)

DELETENR is sent to free a network address assigned to a link or adjacent link station.

0-2 X'41021C' NS header

3-4 Network address of resource being deleted

DELIVER; SSCP-->LU, Norm; FMD NS(mn) (DELIVER)

DELIVER contains an embedded NS RU. A flag in the DELIVER RU indicates whether the NS RU contains a CNM header. An embedded NS RU is either a reply request corresponding to an NS RU embedded in a FORWARD request, or it is an unsolicited request.

0-2 X'810812' NS header

3 Format: X'00' format 0 (only value defined)

4 Flags:

bits 0-6, reserved

bit 7, format of embedded NS RU:

0 embedded NS RU contains a CNM header

1 embedded NS RU does not contain a CNM header

5 Reserved

6-7 Length, in binary, of embedded NS RU

8-n Embedded NS RU

n+1-p Network Name of Origin PU

n+1 Type:

X'F1' PU

n+2 Length, in binary, of symbolic name

n+3-p Symbolic name in EBCDIC characters

p+1-q Network Name of Target PU, LU, Adjacent Link Station, or Link

p+1 Type:

X'F1' PU

X'F3' LU

X'F7' adjacent link station

X'F9' link

p+2 Length, in binary, of symbolic name

p+3-q Symbolic name in EBCDIC characters

- If the target is a PU in a PU_T1|2

DELIVER

node or is an adjacent link station attached to a PU_T4|5 node

q+1-s+1 Configuration Hierarchy Network Name List

q+1 Type: X'F9' link connecting the PU_T1|2 node to the PU_T4|5 node containing the boundary function for the target PU or connecting the adjacent link station to the PU_T4|5 node

q+2 Length, in binary, of symbolic name

q+3-r Symbolic name in EBCDIC characters

r+1 Type: X'F1' PU in the PU_T4|5 node containing the boundary function for the target PU or attaching the target adjacent link station

r+2 Length, in binary, of symbolic name

r+3-s Symbolic name in EBCDIC characters

s+1 X'00' (end of configuration hierarchy network name list)

- If the target is an LU in a PU_T1|2 node:

q+1-t+1 Configuration Hierarchy Network Name List

q+1 Type: X'F1' PU in the PU_T1|2 node containing the target L U

q+2 Length, in binary, of symbolic name

q+3-r Symbolic name in EBCDIC characters

r+1 Type: X'F9' link connecting the PU_T1|2 node to the PU_T4|5 node containing the boundary function for the target LU

r+2 Length, in binary, of symbolic name

r+3-s Symbolic name in EBCDIC characters

s+1 Type: X'F1' PU in the PU_T4|5 node containing the boundary function for the target LU

s+2 Length, in binary, of symbolic name

s+3-t Symbolic name in EBCDIC characters

t+1 X'00' (end of configuration hierarchy network name list)

- If the target is a link attached to, or a PU or LU in, a PU_T4|5 node:

q+1-q+1 Configuration Hierarchy Network Name List

q+1 X'00' (end of configuration hierarchy network name list)

network name list)

DISCONTACT; SSCP-->PU_T4|5, PUCP-->PU, Norm; FMD NS(c) (DISCONTACT)

DISCONTACT requests the PU to deactivate DLC-level contact with the specified adjacent node. The discontact procedure is DLC-dependent; if applicable, polling is stopped. DISCONTACT may be used to terminate contact, IPL, or dump procedures before their completion. The PU responds negatively to DISCONTACT if an uninterruptible link-level procedure is in progress at the primary link station of the specified link.

0-2 X'010202' NS header

3-4 Network address of adjacent link station to be discontacted

DISPSTOR; SSCP-->PU_T4|5, Norm; FMD NS(ma) (DISPLAY STORAGE)

DISPSTOR requests the PU to send a RECSTOR RU containing a specified number of bytes of storage beginning at a specified location.

0-2 X'010331' NS header

3-4 Network address of resource to be displayed

5 Display target and type:
bits 0-3, target address space to be displayed

Note: Refer to implementation documentation for description of these values.

bits 4-7, display type:
0001 nonstatic storage display
0010 static snapshot display

6 Reserved

7-8 Number of bytes to be displayed

9-12 Beginning location of display

DSRLST DUMPFINAL DUMPINIT DUMPTXT

DSRLST; SSCP-->SSCP, Norm; FMD NS(s) (DIRECT SEARCH LIST)

DSRLST identifies a control list type and specifies a list search argument to be used at the receiving SSCP:

- 0-2 X'818627' NS header
- 3 Control list type : X'01' (only value defined)
- 4-m Control list search argument: network name of LU (only value defined)
- 4 Type: X'F3' logical unit
- 5 Length, in binary, of symbolic name
- 6-m Symbolic name in EBCDIC characters

DUMPFINAL; SSCP-->PU_T4|5, Norm; FMD NS(c) (DUMP FINAL)

DUMPFINAL terminates the dump sequence, whether DUMPTXT is used or not. A positive response to DUMPFINAL indicates that the dump sequence is complete.

- 0-2 X'010208' NS header
- 3-4 Network address of adjacent link station of the node being dumped

DUMPINIT; SSCP-->PU_T4|5, Norm; FMD NS(c) (DUMP INITIAL)

DUMPINIT requests the PU_T4|5 to initiate a DLC-level dump from an adjacent PU_T4 node to the PU_T4|5, for eventual transmission to the SSCP. The node to be dumped is identified by the adjacent link station address contained in the request.

- 0-2 X'010206' NS header
- 3-4 Network address of adjacent link station of the node to be dumped

DUMPTXT; SSCP-->PU_T4|5, Norm; FMD NS(c) (DUMP TEXT)

If further dump data is required, DUMPINIT may be followed by DUMPTXT. DUMPTXT causes the dump data specified by the starting-address parameter to be returned to the SSCP on the response. The PU_T4|5 obtains the dump data from the PU_T4 ndoe, using a DLC-level interchange.

- 0-2 X'010207' NS header

DUMPTXT ECHOTEST ER-INOP

- 3-4 Network address of adjacent link station of the node to be dumped
- 5-8 Starting address where dump data is to begin
- 9-10 Length of text: two-byte binary count of the number of bytes of dump data to be returned

ECHOTEST; SSCP-->LU, Norm; FMD NS(ma) (ECHO TEST)

ECHOTEST carries test data to the target LU; the test data is the same as that carried in the corresponding REQECHO.

- 0-2 X'810389' NS header
- 3-n Echo data field: same as bytes 4-m in the soliciting REQECHO
- 3 Number of data bytes
- 4-n Data

ER-INOP; PU T4|5-->SSCP, PU T4-->PUCP, Norm; FMD NS(c) (EXPLICIT ROUTE INOPERATIVE)

ER-INOP notifies the CP when an explicit route has become inoperative as the result of a transmission group having become inoperative somewhere in the network.

- 0-2 X'41021D' NS header
- 3 Format: X'01' (only value defined)
- 4 Reason code for INOP:
 - X'01' unexpected routing interruption over a transmission group, for example, the last active link on a TG has failed
 - X'02' controlled routing interruption such as the result of a DISCONTACT
- 5-8 Address of the subarea that originated the corresponding NC-ER-INOP
- 9-12 Subarea address on the other end of the transmission group that had the routing interruption
- 13 TGN of the transmission group that had routing interruption
- 14 Number of destination subareas that are on the ERs using the above TG
- 15-20 Inoperative ER Field

ER-INOP ER-TESTED

- 15-18 Subarea address of a destination that is routed to over an ER using the above TG
- 19-20 Inoperative explicit route mask: a bit is on if the ER of the corresponding ERN is inoperative (Bit 0 corresponds to ERN 0, bit 1 to ERN 1, and so forth.)
- 21-n Any additional six-byte entries in the same format as bytes 15-20

ER-TESTED; PU T4|5-->SSCP, Norm; FMD NS(ma)
(EXPLICIT ROUTE TESTED)

ER-TESTED is sent by a subarea node to one or more SSCPs to provide the status of an ER as determined by explicit route test procedures.

0-2 X'410386' NS header

3 Format:

X'1' Format 1

X'2' Format 2; same as Format 1, except that it includes bytes 48-52

4

Type:

X'00' the corresponding NC-ER-TEST reached its destination subarea

X'02' ER not reversible since there is no reverse ERN defined

X'03' encountered a PU that does not support ER and VR protocols

X'04' ER length exceeded that specified in the NC-ER-TEST request

X'05' ER requires a TG that is not active

X'06' ER is not defined in the NC-ER-TEST-REPLY originating node

5

Explicit route length, in terms of the number of transmission groups in the explicit route, as accumulated in NC-ER-TEST

6

Maximum ER length, as specified in the NC-ER-TEST request

7-10

Subarea address of the destination PU of the corresponding NC-ER-TEST

11	Reserved
12	bits 0-3, reserved bits 4-7, ERN of the ER tested
13-16	Subarea address of the originating PU of the corresponding NC-ER-TEST
17-18	Reverse ERN mask: A bit is <u>on</u> if the corresponding ERN can be used to route from the NC-ER-TEST-REPLY originating subarea to the NC-ER-TEST originating subarea (Bit 0 corresponds to ERN 0, bit 1 to ERN 1, and so forth.)
19-20	Maximum PIU length allowed on the reverse ERN specified in byte 17-18: X'00' no restriction (only value defined)
21-22	Maximum PIU size accumulated by the corresponding NC-ER-TEST: X'00' no restriction (only value defined)
23-28	Network address of the SSCP originating the test request
29-38	Request Correlation field, as specified in the corresponding ROUTE-TEST
39-42	Subarea address of the PU that originated the corresponding NC-ER-TEST-REPLY
43-46	Subarea address depending on the Type field (Byte 4) as follows:

<u>Type</u>	<u>Contents of this field</u>
X'00'	reserved
X'02'	subarea on the ER prior to that with no reverse ERN defined
X'03'	subarea that does not support ER and VR protocols
X'04'	subarea on the ER preceding the subarea where the explicit route length (byte 5 of NC-ER-TEST) is incremented to a value one more than the maximum ER length limit (byte 6)
X'05'	subarea on the other end of

ER-TESTED ESLOW EXECTEST

X'06' the TG that is not active subarea on the ER from which the PU (that does not have the ER defined) received the corresponding NC-ER-TEST

- 47 TGN of the TG between the subareas specified in bytes 39-42 and 43-46; reserved if Type is X'00'.
Note: End of Format 1; Format 2 continues below
- 48-51 Subarea address of the adjacent node through which the tested explicit route flows from this node
- 52 Transmission group number of the TG (to the node identified in bytes 48-51) over which the tested explicit route flows from this node

ESLOW; PU_T4-->SSCP, Norm; FMD NS(c) (ENTERING SLOWDOWN)

ESLOW informs the SSCP that the node of the sending PU has entered a slowdown state. This state is generally associated with buffer depletion, and requires traffic through the node to be selectively reduced or suspended.

- 0-2 X'010214' NS header
3-4 Network address of PU

EXECTEST; SSCP-->PU_T4|5, Norm; FMD NS(ma) (EXECUTE TEST)

EXECTEST requests the PU to activate the specified test type related to the specified network address. The test code specifies the test type and defines the contents of the test data field. The test may be for the PU, or for the LUs or links supported by the PU.

- 0-2 X'010301' NS header
3-4 Network address of resource to be tested
5-8 Binary code selecting the test
9-n Data to support the selected test

EXSLOW; PU_T4-->SSCP, Norm; FMD NS(c) (EXITING SLOWDOWN)

EXSLOW informs the SSCP that the node of the sending PU is no longer in the slowdown state and regular traffic can resume.

0-2 X'010215' NS header

3-4 Network address of PU

FNA; SSCP-->PU_T4|5, Norm; FMD NS(c) (FREE NETWORK ADDRESSES)

FNA is sent from an SSCP to request the PU_T4|5 to remove the appropriate entries from the node resource list, thereby freeing the network addresses associated with the corresponding resources in the node.

0-2 X'01021A' NS header

3-4 Network address of target link, SPU, or LU (X'0000' indicates that the network addresses in bytes 7-n are to be freed without verification of their attachment to a specific target link, SPU, or LU.)

5 Number of SPU (if bytes 3-4 specify a link), BF.LU (if bytes 3-4 specify an SPU), or LU (if bytes 3-4 specify an LU network address used for the SSCP-LU session) network addresses to be freed (X'00' = all--and bytes 7-n not present)

6 Type: X'80' noncontiguous

7-8 First network address to be freed

9-n Any additional network addresses (two-byte multiples)

Note: All the network addresses specified in bytes 7-n are associated with the same target link, SPU, or LU. See the following table for the relation of target resources to resources to free.

FNA FORWARD

<u>Target resource</u>	<u>Resources to free</u>
PU	LUs identified by network addresses associated with SSCP-LU sessions
LU (identified by the network address associated with an SSCP-LU session)	LU network addresses used as <u>primary</u> network addresses in parallel sessions
Link	BF.PUs and adjacent link stations
BF.PU	BF.LUs
<p>FORWARD; LU-->SSCP, Norm; FMD NS(mn) (FORWARD) FORWARD requests the SSCP to send the embedded NS RU to the named destination PU LU, using the corresponding SSCP-PU LU session. The FORWARD RU contains a flag that specifies whether the embedded NS RU contains a partially initialized CNM header or no CNM header at all.</p>	
0-2	X'810810' NS header
3	Format: X'00' format 0 (only value defined)
4	Flags: bits 0-5, reserved bit 6, solicitation indicator: 0 embedded NS RU solicits a reply request 1 embedded NS RU does not solicit a reply request bit 7, format of embedded NS RU: 0 embedded NS RU contains a (partially initialized) CNM header 1 embedded NS RU does not contain a CNM header
5	Reserved
6-7	Length, in binary, of embedded NS RU
8-n	Embedded NS RU
n+1-p	<u>Network Name of Destination PU</u>
n+1	Type: X'F1' PU

FORWARD INIT-OTHER

n+2 Length, in binary, of symbolic name
 n+3-p Symbolic name in EBCDIC characters
 p+1-q Network Name of Target PU, LU,
Adjacent Link Station, or Link
 p+1 Type:
 X'F1' PU
 X'F3' LU
 X'F7' adjacent link station
 X'F9' link
 p+2 Length, in binary, of symbolic name
 p+3-q Symbolic name in EBCDIC characters

INIT-OTHER; ILU-->SSCP, Norm; FMD NS(s)
 (INITIATE-OTHER)

INIT-OTHER from the ILU requests the initiation of a session between the two LUs named in the RU. The requester may be a third-party LU or one of the two named LUs.

0-2 X'810680' NS header
 3 Format:
 bits 0-3, 0001 Format 1
 0010 Format 2: specifies
 the COS name field in
 addition to the
 parameters in Format
 1
 bits 4-7, reserved
 4 Type:
 bits 0-1, 00 dequeue (DQ) a
 previously enqueued
 initiate request (See
 bits 2-3 for further
 specification of
 dequeue actions.)
 01 initiate only (I); do
 not enqueue
 10 enqueue only (Q) (See
 bytes 5-6 for further
 specification of
 queuing conditions.)
 11 initiate/enqueue (I/Q):
 enqueue the request if
 it cannot be satisfied
 immediately
 bits 2-3, (used for DQ; otherwise,
 reserved)

INIT-OTHER

- 00 leave on queue if dequeuing attempt is unsuccessful
- 01 remove from queue if dequeuing attempt is unsuccessful
- 10 remove from queue; do not attempt initiation
- 11 reserved

bit 4, reserved

bits 5-6, PLU/SLU specification:

- 00 LU1 is PLU
- 01 LU2 is PLU

bit 7, reserved

5 Queuing conditions for LU1 (when Type = DQ, bits 0-7 are reserved):

- bit 0, 0 do not enqueue if session limit will be exceeded
- 1 enqueue if session limit will be exceeded
- bit 1, 0 do not enqueue if the LU is not currently able to comply with the PLU/SLU specification (as given in byte 4, bits 5-6)
- 1 enqueue even though the LU might not be currently able to comply with the PLU/SLU specification
- bit 2, 0 do not enqueue if CDINIT loses contention
- 1 enqueue if CDINIT loses contention
- bit 3, 0 do not enqueue if there are no SSCP-LU paths
- 1 enqueue if there are no SSCP-LU paths

bit 4, reserved

bits 5-6, queuing position/service

- 00 enqueue this request at the bottom of the queue (the request is put at the bottom of the queue and serviced last)
- 01 enqueue this request FIFO

- 10 enqueue this request LIFO
- 11 reserved
- bit 7, 0 do not enqueue for recovery retry
 - 1 enqueue for recovery retry (This is a queue that is used for recovery-reactivating an LU-LU session when the session, though it had been successfully activated, fails for some reason. Elements on this queue are not dequeued when a session activation is successfully completed; explicit session deactivation requests are needed to dequeue elements from this queue.)
- 6 Queuing conditions for LU2 (When Type = DQ, bits 0-7 are reserved):
 - bit 0, 0 do not enqueue if session limit will be exceeded
 - 1 enqueue if session limit will be exceeded
 - bit 1, 0 do not enqueue if the LU is not currently able to comply with the PLU/SLU specification (as given in byte 4, bits 5-6)
 - 1 enqueue even though the LU might not be currently able to comply with the PLU/SLU specification
 - bit 2, 0 do not enqueue if CDINIT loses contention
 - 1 enqueue if CDINIT loses contention
 - bit 3, 0 do not enqueue if there are no SSCP-LU paths
 - 1 enqueue if there are no SSCP-LU paths
 - bit 4, reserved
 - bits 5-6, queuing position/service
 - 00 enqueue this request at

INIT-OTHER

- the bottom of the queue
(the request is put at
the bottom of the queue
and serviced last)
- 01 enqueue this request
FIFO
- 10 enqueue this request
LIFO
- 11 reserved
- bit 7, 0 do not queue for recovery
retry
- 1 enqueue for recovery retry
(This is a queue that is
used for
recovery-reactivating an
LU-LU session when the
session, though it had been
successfully activated,
fails for some reason.
Elements on this queue are
not dequeued when a session
activation is successfully
completed; explicit session
deactivation requests are
needed to dequeue elements
from this queue.)

Notes on Bytes 5-6:

- If enqueueing for recovery is desired, it must be indicated in both LU1 and LU2 Queuing Conditions bytes (bit 7 = '1').
- Bit 2 (CDINIT contention) must have the same setting for both LU1 and LU2. (Contention occurs when both SSCPs try to set up a session between the same LUs at the same time.)
- Enqueueing is not performed if the DLU is unknown, or if the domain of either LU is in takedown status.

7

INITIATE origin:

bits 0-2, reserved

bit 3, (when Type = DQ, bit 3 is reserved)

- 0 network user is the initiator

- 1 network manager is the initiator
- bits 4-7, reserved
- 8 NOTIFY
- bits 0-1, (when Type = DQ, bits 0 and 1 are reserved)
- 00 do not send NOTIFY to LUs in session with LU1
 - 01 send NOTIFY to all LUs in session with LU1
 - 10 send NOTIFY to all LUs in session with LU1 only if the request is queued
 - 11 reserved
- bits 2-3, (when Type = DQ, bits 2 and 3 are reserved)
- 00 do not send NOTIFY to LUs in session with LU2
 - 01 send NOTIFY to all LUs in session with LU2
 - 10 send NOTIFY to all LUs in session with LU2 only if the request is enqueued
 - 11 reserved
- bit 4, 0 do not send NOTIFY to the ILU when INIT is dequeued
- 1 send NOTIFY to the ILU when INIT is dequeued
- bit 5, 0 do not send NOTIFY to the ILU when the requested session is set up
- 1 send NOTIFY to the ILU when the requested session is set up
- bits 6-7, reserved
- 9-16 Mode name: an eight-character symbolic name (implementation and installation dependent) that identifies the set of rules and protocols to be used for the session; used by the SSCP(SLU) to select the BIND image that will be used by the SSCP(PLU) to build the CINIT request (When Type = DQ, the Mode Name field is reserved.)

INIT-OTHER

17-m	<u>Uninterpreted name of LU1</u>
17	Type: X'F3' logical unit
18	Length, in binary, of LU1 name
19-m	EBCDIC character string
m+1-n	<u>Uninterpreted name of LU2</u>
m+1	Type: X'F3' logical unit
m+2	Length, in binary, of LU2 name
m+3-n	EBCDIC character string
n+1-p	<u>Requester ID</u>
n+1	Length, in binary, of requester ID
	Note: X'00' = no requester ID
n+2-p	Requester ID: the ID, in EBCDIC characters, of the end user initiating the request (May be used to establish the authority of the end user to access a particular resource.)
p+1-q	<u>Password</u>
p+1	Length, in binary, of password
	Note: X'00' = no password is present
p+2-q	Password used to verify the identity of the end user
q+1-r	<u>User Field</u> (When Type = DQ, user field is reserved)
q+1	Length, in binary, of user data
	Note: X'00' = no user data is present
q+2-r	<u>User data</u>
q+2	User data key
	X'00' structured subfields follow
	¬X'00' first byte of unstructured user data
	Note: Individual structured subfields may be omitted entirely. When present, they appear in ascending field number order.
q+3-r	• For unstructured user data Remainder of unstructured user data
q+3-r	• For structured user data Structured subfields (For detailed definitions, see the structured user data section on page 4-162.)
r+1-s	<u>User Request Correlation (URC) field</u> (When Type = DQ, the URC must be the same as on the original INIT-OTHER request.)
r+1	Length, in binary, of URC

Note: X'00' = no URC

r+2-s URC: end-user defined identifier; this value can be returned by the SSCP in a subsequent NOTIFY to correlate a given session to the initiating request

s+1-s+8 End of Format 1; Format 2 Continues
 COS name: symbolic name of class of service in EBCDIC characters (A value of eight space (X'40') characters may be specified; in this case, the COS name is derived from the mode name table, using the mode name received in bytes 9-16.)

INIT-OTHER-CD; SSCP-->SSCP, Norm; FMD NS(s)
 (INITIATE-OTHER CROSS-DOMAIN)

INIT-OTHER-CD from the SSCP(ILU) requests that a session be initiated between the two LUs named in the RU. The INIT-OTHER-CD request simply transports an INIT-OTHER from the SSCP(ILU) (a third party SSCP in this case) to the SSCP(OLU).

0-2 X'818640' NS header

3 Format:

bits 0-3,	0000	Format 0
	0010	Format 2: specifies COS name field in addition to the parameters in Format 0

bits 4-7, reserved

4 Type:

bits 0-1,	00	dequeue (DQ) a previously enqueued initiate request. (See bits 2-3 for further specification of dequeue actions.)
	01	initiate only (I); do not enqueue
	10	enqueue only (Q): (See bytes 5-6 for further specification of queuing conditions.)
	11	initiate/enqueue (I/Q): enqueue the request if

INIT-OTHER-CD

it cannot be satisfied immediately

bits 2-3, (used for DQ; otherwise, reserved)

00 leave on queue if dequeuing attempt is unsuccessful

01 remove from queue if dequeuing attempt is unsuccessful

10 remove from queue, do not attempt initiation

11 reserved

bit 4, reserved

bits 5-6, PLU/SLU specification:

00 LU1 is PLU

01 LU2 is PLU

5 bit 7, reserved

Queuing conditions for LU1 (When Type = DQ, bits 0-7, are reserved.):

bit 0, 0 do not enqueue if session limit will be exceeded

1 enqueue if session limit will be exceeded

bit 1, 0 do not enqueue if the LU is not currently able to comply with the PLU/SLU specification (as given in byte 4, bits 5-6)

1 enqueue if the LU is not currently able to comply with the PLU/SLU specification

bit 2, 0 do not enqueue if CDINIT loses contention

1 enqueue if CDINIT loses contention

bit 3, 0 do not enqueue if there are no SSCP-LU paths

1 enqueue if there are no SSCP-LU paths

bit 4, reserved

bits 5-6, 00 enqueue this request at the bottom of the queue (the request is put at

- the bottom of the queue and serviced last)
- 01 enqueue this request FIFO
 - 10 enqueue this request LIFO
 - 11 reserved
- bit 7, 0 do not enqueue for recovery retry
- 1 enqueue for recovery retry (This is a queue that is used for recovery-reactivating an LU-LU session when the session, though it had been successfully activated, fails for some reason. Elements on this queue are not dequeued when a session activation is successfully completed. Explicit session deactivation requests are needed to dequeue elements from this queue.)
- 6 Queuing conditions for LU2 (When Type = DQ, bits 0-7 are reserved.):
- bit 0, 0 do not enqueue if session limit will be exceeded
 - 1 enqueue if session limit will be exceeded
 - bit 1, 0 do not enqueue if the LU is not currently able to comply with the PLU/SLU specification (as given in byte 4, bits 5-6)
 - 1 enqueue even though the LU might not be currently able to comply with the PLU/SLU specification
 - bit 2, 0 do not enqueue if CDINIT loses contention
 - 1 enqueue if CDINIT loses contention
 - bit 3, 0 do not enqueue if there are no SSCP-LU paths

INIT-OTHER-CD

- 1 enqueue even if there are no SSCP-LU paths
- bit 4, reserved
- bits 5-6, queuing position/service:
 - 00 enqueue this request at the bottom of the queue (the request at the bottom of the queue and is serviced last)
 - 01 enqueue this request FIFO
 - 10 enqueue this request LIFO
 - 11 reserved
- bit 7, 0 do not enqueue for recovery retry
 - 1 enqueue for recovery retry (This is a queue that is used for recovery-reactivating an LU-LU session when the session, though it had been successfully activated, fails for some reason. Elements on this queue are not dequeued when a session activation is successfully completed; explicit session deactivation requests are needed to dequeue elements from this queue.)

Notes on Bytes 5-6:

- If enqueueing for recovery is desired, it is indicated in both LU1 and LU2 Queuing Conditions bytes (bit 7 = 1).
- Bit 2 (CDINIT contention) has the same setting for both LU1 and LU2. (Contention occurs when both SSCPs try to set up a session between the same LUs at the same time.)
- Enqueueing is not performed if the DLU is unknown, or if the domain of either LU is in takedown status.

7-14

PCID (When Type = DQ, the PCID is the same as in the original INIT-OTHER-CD)

	request.)
7-8	Network address of SSCP(ILU)
9-14	A unique 6-byte value, generated by the SSCP(ILU), that is retained and used in all cross-domain requests dealing with the same procedure until it is completed; an SSCP maintains correlation between PCID and the URC, if a URC has been provided by the INIT-OTHER request
15	INITIATE origin
	bits 0-2, reserved
	bit 3, (reserved when Type = DQ.)
	0 network user is the initiator
	1 network manager is the initiator
	bits 4-7, reserved
16	NOTIFY
	bits 0-1 (When Type = DQ, bits 0-1 are reserved.)
	00 do not send NOTIFY to LUs in session with LU1
	01 send NOTIFY to all LUs in session with LU1
	10 send NOTIFY to all LUs in session with LU1 only if the request is enqueued
	11 reserved
	bits 2-3, (When Type = DQ, bits 2-3 are reserved.)
	00 do not send NOTIFY to LUs in session with LU2
	01 send NOTIFY to all LUs in session with LU2
	10 send NOTIFY to all LUs in session with LU2 only if the request is enqueued.
	11 reserved
	bit 4, 0 do not send NOTIFY to the SSCP(ILU) when INIT is dequeued
	1 send NOTIFY to the SSCP(ILU) when INIT is

INIT-OTHER-CD

	dequeued
	bits 5-7, reserved
17-24	Mode name: an eight-character symbolic name (implementation and installation dependent) that identifies the set of rules and protocols to be used for the session; used by the SSCP(SLU) to select the BIND image that will be used by the SSCP(PLU) to build the CINIT request (When Type = DQ, the Mode Name field is reserved.)
25-m	<u>Network Name of LU1</u>
25	Type: X'F3' logical unit
26	Length, in binary, of symbolic name
27-m	Symbolic name, in EBCDIC characters
m+1-n	<u>Network Name of LU2</u>
m+1	Type: X'F3' logical unit
m+2	Length, in binary, of symbolic name
m+3-n	Symbolic name, in EBCDIC characters
n+1-p	<u>Requester ID</u>
n+1	Length, in binary, of requester ID
	Note: X'00' = no requester ID is present
n+2-p	Requester ID: the ID, in EBCDIC characters, of the end user initiating the request (May be used to establish the authority of the end user to access a particular resource.)
p+1-q	<u>Password</u>
p+1	Length, in binary, of password
	Note: X'00' = no password is present
p+2-q	Password used to verify the identity of the end user
q+1-r	<u>User Field</u> (When Type = DQ, this field is reserved.)
q+1	Length, in binary, of user data
	Note: X'00' = no user data is present
q+2-r	User data: user-specific data that is passed to the primary LU on the CINIT request
q+2	User data key
	X'00' structured subfields follow
	-X'00' first byte of unstructured user data
	Note: Individual structured subfields may be omitted

INIT-OTHER-CD INITPROC

entirely. When present, they appear in ascending field number order.

- For unstructured user data
- q+3-r Remainder of unstructured user data
- For structured user data
- q+3-r Structured subfields (For detailed definitions, see the structured user data section on page 4-162.)
- Note: With the exception of the NS header and PCID, all the fields in the INIT-OTHER-CD RU are derived from its corresponding INIT-OTHER RU.
- End of Format 0; Format 2 Continues
- r+1 COS name field initialization indicator:
 - bit 0, 0 ILU did not specify COS name
 - 1 ILU did specify COS name
 - bits 1-7, reserved
- r+2-r+9 COS name (reserved if byte r+1, bit 0 = 0): symbolic name of class of service in EBCDIC characters (A value of eight space (X'40') characters may be specified; in this case, the COS name is derived from the mode name table using the mode name received in bytes 17-24.)

INITPROC; SSCP-->PU T4|5, Norm; FMD NS(c)
(INITIATE PROCEDURE)

INITPROC is sent to the subarea PU adjacent to a PU_T2 in order to initiate a PU_T4|5-PU_T2 load operation.

- 0-2 X'410235' NS header
- 3-6 Reserved
- 7-8 Network address of PU_T2 for which the procedure is to be initiated
- 9 Procedure type:
 - X'00' load (only value defined)
- For procedure type = load
- 10-17 IPL load module: an eight-character EBCDIC symbolic name of the IPL load module to be sent to the PU identified in bytes 7-8

INIT-SELF (format 0)

INIT-SELF; ILU-->SSCP, Norm; FMD NS(s)
(INITIATE-SELF)

INIT-SELF from the ILU requests that the SSCP authorize and assist in the initiation of a session between the LU sending the request (that is, the ILU, which also becomes the OLU) and the LU named in the request (the DLU).

0-2 X'010681' NS header

3 bits 0-3, format:

0000 Format 0: specifies a subset of the parameters shown in Format 1 of INIT-SELF (described separately, because the NS header differs in the first byte), with the receiver supplying default values

bit 4, reserved

bits 5-6, 00 DLU is PLU

01 DLU is SLU

bit 7, 0 initiate only (I); do not enqueue.

1 initiate/enqueue (I/Q):
enqueue the request if it cannot be satisfied immediately

4-11 Mode name: an eight-character symbolic name (implementation and installation dependent) that identifies the set of rules and protocols to be used for the session; used by the SSCP(SLU) to select the BIND image that will be used by the SSCP(PLU) to build the CINIT request

12-m Uninterpreted Name of DLU

12 Type: X'F3' logical unit

13 Length, in binary, of DLU name

14-m EBCDIC character string

m+1-p Requester ID

m+1 Length, in binary, of requester ID

Note: X'00' = no requester ID

m+2-p Requester ID: the ID, in EBCDIC characters, of the end user initiating

- the request (May be used to establish the authority of the end user to access a particular resource.)
- p+1-q Password
- p+1 Length, in binary, of password
Note: X'00' = no password is present
- p+2-q Password used to verify the identity of the end user
- q+1-r User Field
- q+1 Length, in binary, of user data
Note: X'00' = no user data is present
- q+2-r User data: user-specific data that is passed to the primary LU on the CINIT request
- q+2 User data key
 X'00' structured subfields follow
 -X'00' first byte of unstructured user data
Note: Individual structured subfields may be omitted entirely. When present, they appear in ascending field number order.
- For unstructured user data
- q+3-r Remainder of unstructured user data
- For structured user data
- q+3-r Structured subfields (For detailed definitions, see the structured user data section on page 4-162.)
Note: The following default values are supplied by the SSCP(ILU) receiving the Format 0 INIT-SELF request:
- Queuing conditions (if queuing is specified):
 - Enqueue if session count exceeded.
 - Enqueue this request FIFO.
 - Initiate origin: network user is the initiator.
 - NOTIFY: do not notify

INIT-SELF (format 1)

INIT-SELF; ILU-->SSCP, Norm; FMD NS(s)
(INITIATE-SELF)

INIT-SELF from the ILU requests that the SSCP authorize and assist in the initiation of a session between the LU sending the request (that is, the ILU, which also becomes the OLU) and the LU named in the request (the DLU).

0-2 X'810681' NS header

3 bits 0-3, format:

0001 Format 1: specifies queuing, initiate origin, NOTIFY, and URC in addition to the parameters in Format 0

0010 Format 2: specifies the COS name field in addition to the parameters in Format 1

bits 4-7, reserved

4

Type:

bits 0-1, 00 dequeue (DQ) a previously enqueued initiate request (Note: Value 00 is reserved if not Format 1.) (See bits 2-3 for further specification of setup actions.)

01 initiate only(I); do not enqueue

10 enqueue only (Q) (See byte 5 for further specification of queuing conditions.)

11 initiate/enqueue (I/Q): enqueue the request if it cannot be satisfied immediately

bits 2-3, (used for DQ; otherwise, reserved)

00 leave on queue if setup attempt is unsuccessful

01 remove from queue if setup attempt is

INIT-SELF (format 1)

- unsuccessful
- 10 remove from queue; do not attempt setup
- 11 reserved
- bit 4, reserved
- bits 5-6, PLU/SLU specification:
 - 00 DLU is PLU
 - 01 DLU is SLU
- bit 7, reserved
- 5 Queuing conditions for DLU (When Type = DQ, bits 0-7 are reserved.):
- bit 0, 0 do not enqueue if session limit exceeded
- 1 enqueue if session limit exceeded
- bit 1, 0 do not enqueue if DLU is not currently able to comply with the PLU/SLU specification (as given in byte 4, bits 5-6)
- 1 enqueue if DLU is not currently able to comply with the PLU/SLU specification
- bit 2, 0 do not enqueue if CDINIT loses contention
- 1 enqueue if CDINIT loses contention
- bit 3, 0 do not enqueue if no SSCP(DLU)-DLU path
- 1 enqueue if no SSCP(DLU)-DLU path
- bit 4, reserved
- bits 5-6, queuing position/service:
 - 00 put this request at the bottom of the queue (the request is put at the bottom of the queue and serviced last)
 - 01 enqueue this request FIFO
 - 10 enqueue this request LIFO
 - 11 reserved
- bit 7, 0 do not enqueue for recovery retry

INIT-SELF (format 1)

- 1 enqueue for recovery retry
(The element is maintained on the recovery retry queue even after the activation of the session, so that the session can be retried in the event of a session failure.)

Note: Since queuing conditions are specified for the DLU only, the following default values are used by SSCP(OLU) for the OLU:

- Enqueue if session limit exceeded.
- Enqueue this request at the foot of the queue (FIFO).
- For "CDINIT contention" and "recovery retry," the default values are the same as those specified for the DLU (see bits 2 and 7 above).

- 6 INITIATE Origin:
bits 0-2, reserved
bit 3, (bit 3 is reserved when Type = DQ)

- 0 network user is the initiator
- 1 network manager is the initiator

bits 4-7, reserved

- 7 NOTIFY specifications:
bits 0-1, (bits 0 and 1 are reserved when Type = DQ)

- 00 do not notify LUs in session with DLU
- 01 notify all LUs in session with DLU that the ILU/OLU has requested a session with the DLU
- 10 notify LUs in session with DLU only if request is queued
- 11 reserved

INIT-SELF (format 1)

	bits 2-3, reserved
	bit 4, 0 do not notify the ILU when the request is dequeued
	1 notify the ILU when the request is dequeued
	bits 5-7, reserved
8-15	Mode name: an eight-character symbolic name (implementation and installation dependent) that identifies the set of rules and protocols to be used for the session; used by the SSCP(SLU) to select the BIND image that will be used by the SSCP(PLU) to build the CINIT request (When Type = DQ, the Mode Name field is reserved.)
16-n	<u>Uninterpreted Name of DLU</u>
16	Type: X'F3' logical unit
17	Length, in binary, of DLU name
18-n	EBCDIC character string
n+1-p	<u>Requester ID</u>
n+1	Length, in binary, of requester ID
	Note: X'00' = no requester ID
n+2-p	Requester ID: the ID, in EBCDIC characters, of the end user initiating the request (May be used to establish the authority of the end user to access a particular resource.)
p+1-q	<u>Password</u>
p+1	Length, in binary, of password
	Note: X'00' = no password is present
p+2-q	Password used to verify the identity of the end user
q+1-r	<u>User Field</u> (When Type = DQ, User field is reserved)
q+1	Length, in binary, of user data
	Note: X'00' = no user data is present
q+2-r	User data: user-specific data that is passed to the primary LU on the CINIT request
q+2	User data key
	X'00' structured subfields follow
	-X'00' first byte of unstructured user data
	Note: Individual structured subfields may be omitted entirely. When present, they

INIT-SELF (format 1) INOP

appear in ascending field number order.

- For unstructured user data
 - For structured user data
- q+3-r Remainder of unstructured user data
- q+3-r Structured subfields (For detailed definitions, see the structured user data section on page 4-162.)
- r+1-s User Request Correlation (URC) Field (When Type = DQ, the URC must be the same as in the original INIT-SELF request.)
- r+1 Length, in binary, of URC
 Note: X'00' = no URC
- r+2-s URC: end-user defined identifier; this value can be returned by the SSCP in a subsequent NOTIFY to correlate a given session to this initiating request
- s+1-s+8 End of Format 1; Format 2 Continues
 COS name: symbolic name of class of service in EBCDIC characters (A value of eight space characters may be specified; in this case, the COS name is derived from the mode name table using the mode name received in bytes 8-15.)

INOP; PU T4|5-->SSCP, PU-->PUCP, Norm; FMD NS(c)
 (INOPERATIVE)

INOP is sent to the SSCP by the PU to report a link-related connection or contact failure involving one or more nodes.

- 0-2 X'010281' NS header
- 3-4 Network address of an inoperative (1) link or (2) adjacent link station
- 5 bits 0-3, format: X'0' (only value defined)

Note: The value X'F' is set aside for implementation use and will not be further defined in SNA.

bits 4-7, reason:

- X'1' adjacent link station: loss of contact, unexpected loss of connection,

or connection
 establishment failure
 X'2' link: link failure
 X'3' adjacent link
 station:
 discontact--loss of
 synchronization
 X'4' adjacent link
 station: incomplete
 discontact--loss of
 synchronization
 X'5' adjacent link
 station: request
 resynchronization --
 unexpected request
 for resynchronization
 X'6' adjacent link station
 (IPL or DUMP in
 progress)
 X'7' adjacent link station
 (RPO in progress)
 X'A' link: CCITT X.21 call
 establishment
 failure; X.21 call
 progress signals were
 received but are not
 included in bytes 6-7
 X'B' link: CCITT X.21
 outgoing call
 establishment failure
 because of DCE
 signalling DCE clear
 condition
 X'C' link: CCITT X.21
 outgoing call
 establishment failure
 because of expiration
 of time-out on
 changing DCE
 conditions
 X'D' link: unexpected loss
 of connection during
 the CCITT X.21 call
 phase
 X'E' link: failure during
 the CCITT X.21 call

INOP IPLFINAL IPLINIT

X'F' clearing phase
link: CCITT X.21
outgoing call
establishment
failure; X.21 call
progress signals were
received--the signal
is included in bytes
6-7

6-7 The CCITT X.21 call progress signal last received--included only if byte 5, bits 4-7 = X'F'; otherwise, these bytes are omitted (The codes and meanings of these X.21 call progress signals are as described in the CCITT recommendation X.21.)

IPLFINAL; SSCP-->PU_T4|5, Norm; FMD NS(c) (IPL FINAL)

IPLFINAL completes an IPL sequence and supplies the load-module entry point to the PU_T4 node. A positive response to IPLFINAL indicates that the PU_T4 node is successfully loaded.

0-2 X'010205' NS header

3-4 Network address of adjacent link station associated with the node being loaded

5-8 Entry point location within load module

IPLINIT; SSCP-->PU_T4|5, Norm; FMD NS(c) (IPL INITIAL)

IPLINIT initiates a DLC-level load of an adjacent PU_T4 node from the PU_T4|5 node. The node to be loaded is identified by the adjacent link station address contained in the request.

0-2 X'010203' NS header

3-4 Network address of adjacent link station associated with the node to be loaded

IPLTEXT; SSCP-->PU_T4|5, Norm; FMD NS(c) (IPLTEXT)

IPLTEXT transfers load module information to the PU_T4|5, which passes it in a DLC-level load to the PU_T4 node. Following an IPLINIT, any number of IPLTEXT commands are valid.

- 0-2 X'010204' NS header
- 3-4 Network address of adjacent link station associated with the node to be loaded
- 5-n Text: a variable-length byte-string in the form required by the node being loaded

LCP; PU_T4|5-->SSCP, PU_T4-->PUCP, Norm; FMD NS(c) (LOST CONTROL POINT)

LCP notifies the SSCP that a subarea PU's session with another SSCP has failed. The SSCP displays this information for the network operator.

- 0-2 X'410287' NS header
- 3 Reason code, specifying why LCP was generated:
 - X'07' virtual route inoperative: VR-INOP received for the virtual route used by the (SSCP,PU) session (where the SSCP is the lost control point identified later, and the PU is the originator of the LCP)
 - X'0A' forced deactivation of the (SSCP,PU) session (DACTPU(=SON) received by the PU)
 - X'0B' virtual route deactivated: NC-DACTVR(Forced) received for the virtual route used by the (SSCP,PU) session (where the SSCP is the lost control point identified later and the PU is the originator of the LCP)
 - X'0C' SSCP failure: the session between this PU and the identified SSCP was reset because of an abnormal termination of the SSCP

LCP LDREQD LSA

(DACTPU(SON,Cause = X'0C') was received by the PU)

- 4 Reserved
- 5-10 Network address of the lost control point (SSCP)
- 5-8 Subarea address of the lost control point
- 9-10 Element address of the lost control point

LDREQD; PU_T2-->SSCP, Norm; FMD NS(c) (LOAD REQUIRED)

The LDREQD request enables the PU_T2 to request a specific load module be moved to its node.

- 0-2 X'410237' NS header
- 3-10 IPL load module: an eight-character EBCDIC symbolic name of the IPL load module requested:
 - X'4040...40' any load module will be accepted
 - X'4040...40' specific load module specified
- 11 bits 0-6, reserved
- bit 7, adjacent PU load capability (initialized to 0 by the PU_T2):
 - 0 the adjacent PU is unable to load the PU_T2
 - 1 the adjacent PU can load the PU_T2 (set by the boundary function in the adjacent subarea node)

LSA; PU_T4|5-->PU_T4|5, Exp; NC (LOST SUBAREA)

When LSA is received from a node that does not support ER-VR protocols, the ER manager converts it to an NC-ER-INOP and processes it accordingly. If the node to which an NC-ER-INOP is to be sent does not support ER-VR protocols, the ER manager transforms the NC-ER-INOP into LSA. The LSA includes the list of destination subarea addresses included in the NC-ER-INOP, but no ERN values.

- 0 X'05' request code
- 1-2 Reserved
- 3 Reason code, specifying why LSA was

	originated:
	X'01' unexpected routing interruption
	X'02' controlled routing interruption
4	Format: X'01' (only value defined)
5-8	<u>Origination Address</u>
5-6	Reserved
7-8	Network address of the PU that originated the LSA
9-12	<u>Lost Subarea Address Field</u>
9-10	Reserved
11	Subarea address (left-justified) for a lost subarea
12	Reserved
13-n	Additional 4-byte fields in the form of bytes 9-12, corresponding to additional lost subareas

LUSTAT; LU-->LU|SSCP, Norm; DFC (LOGICAL UNIT STATUS)

LUSTAT is used by one half-session to send four bytes of status information to its paired half-session. The RU format allows the sending of either end-user information or LU status information. If the high-order two bytes of the status information are 0, the low-order two bytes carry end-user information and may be set to any value. In general, LUSTAT is used to report about failures and error recovery conditions for a local device of an LU.

0	X'04' request code
1-4	Status value + status extension field (two bytes each):
	X'0000'+ 'uuuu' user status (no system-defined status) + user-defined field
	X'0001'+ 'ccdd' component now available + component identification (see Note)
	X'0002'+ 'rrrr' sender will have no (more) FMD requests to transmit during the time that this

LUSTAT

	session remains active + reserved field
X'0003'+ 'ccdd'	component entering attended mode of operation + component identification (see Note)
X'0004'+ 'ccdd'	component entering unattended mode of operation + component identification (see Note)
X'0005'+ 'iiii'	prepare to commit all resources required for the unit of work + information field: X'0001' request End Bracket be sent on next chain (only value defined)
X'0006'+ 'rrrr'	no-op (used to allow an RH to be sent when no other request is available or allowed) + reserved field
X'0007'+ 'rrrr'	sender currently has no FMD requests to transmit (but may have later during the time that this session remains active) + reserved field
X'0801'+ 'ccdd'	component not available (for example, not configured) + component identification (see Note)
X'0802'+ 'ccdd'	component failure (intervention required) + component

	identification (see Note)
X'081C'+ 'ccdd'	component failure (permanent error) + component identification (see Note)
X'0824'+ 'rrrr'	function canceled + reserved field
X'082B'+ 'ccdd'	component available, but presentation space integrity lost + component identification (see Note)
X'0831'+ 'ccdd'	component disconnected (power off or some other disconnecting condition) + component identification (see Note)
X'0848'+ 'rrrr'	cryptography component failure + reserved field
X'400A'+ 'ssss'	no-response mode not allowed + sequence number of the request specifying no-response

Note: Values for cc byte are:

X'00'	LU itself rather than a specific LU component (For this cc value, dd=X'00'.)
X'FF'	The dd byte specifies the LU component medium class and device address. (See <u>SNA--Sessions Between Logical Units</u> for definitions of these terms and usage of the values according to LU-LU session type.)
¬X'(00 FF)'	LU component medium class

LUSTAT NC-ACTVR

and device address (For these cc values, dd=X'00'.)

NC-ACTVR; PU_T4|5-->PU_T4|5, Exp; NC (ACTIVATE VIRTUAL ROUTE)

NC-ACTVR initializes the state and attributes of the VR at each of its end nodes.

- 0 X'0D' request code
- 1-2 Reserved
- 3 Format: X'01' (only value defined)
- 4 Reserved
- 5-6 Receive ERN mask: a bit is on if that ERN can be used to send PIUs to NC-ACTVR originator; multiple bits may be set to 1 (bit 0 corresponds to reverse ERN 0, bit 1 to reverse ERN 1, and so forth)
- 7-8 Send ERN mask: a bit is on if that ERN can be used to send PIUs from the NC-ACTVR originator: exactly one bit is set to 1 (bit 0 corresponds to ERN 0, bit 1 to ERN 1, and so forth)
- 9-10 bits 0-3, reserved
bits 4-15, initial VR send sequence number
- 11 Reserved
- 12 Maximum window size permitted on the VR
- 13 Reserved
- 14 Minimum window size permitted on the VR
- 15-16 Maximum PIU size permitted to be sent by the NC-ACTVR originator:
X'0000' no restriction (only value defined)
- 17-18 Maximum PIU length permitted to be received by the NC-ACTVR originator:
X'0000' no restriction (only value defined)

Note: The NC-ER-ACT and NC-ER-ACT-REPLY RUs accumulate the maximum PIU size permitted to flow in each direction of the ER. NC-ACTVR communicates these limits to the other end of the VR.

NC-DACTVR; PU_T4|5-->PU_T4|5, Exp, NC
(DEACTIVATE VIRTUAL ROUTE)

NC-DACTVR deactivates a virtual route.

0	X'0E'	request code
1-2		Reserved
3		Format: X'01'
4	Type	
	X'01'	orderly: receiver of NC-DACTVR to deactivate the VR if there are no sessions on the VR
	X'02'	forced: receiver of NC-DACTVR to deactivate the VR even if there are sessions on the VR; it also results in session outage notification for sessions using the VR

NC-ER-ACT; PU_T4|5-->PU_T4|5, Exp; NC (EXPLICIT ROUTE ACTIVATE)

NC-ER-ACT is sent by the ER manager in a subarea node in order to activate an explicit route.

0	X'0B'	request code
1-2		Reserved
3		Format: X'01' (only value defined)
4		Reserved
5		Explicit route length: initially set to 0 at the originating PU, incremented by 1 at each receiver of the original or propagated NC-ER-ACT
6		Maximum ER length, as specified by the request originator
7-10		Subarea address of the destination PU corresponding to the ERN specified in byte 12, bits 4-7
11		bit 0, route definition capability of RU sender:
	0	RU sender does not allow route usage except by explicit installation definition
	1	RU sender allows route usage without requiring explicit installation definition
		bits 1-7, reserved

NC-ER-ACT NC-ER-ACT-REPLY

- 12 bits 0-3, reserved
bits 4-7, ERN of the explicit route
being activated
- 13-16 Subarea address of the PU that
originated the NC-ER-ACT request
- 17-18 Reverse ERN mask: a bit is on if the
corresponding ERN can be used to route
to the originating subarea (bit 0
corresponds to ERN 0, bit 1 to ERN 1
and so forth)
- 19-20 Maximum PIU length allowed on the ER
in the direction of flow of this
NC-ER-ACT:
X'0000' no restriction (only value
defined)
- 21-28 Reserved
- 29-36 Activation request sequence
identifier: an 8-byte binary value,
generated by the originator of
NC-ER-ACT, and included by the
destination node in NC-ER-ACT-REPLY to
correlate an NC-ER-ACT with its
corresponding NC-ER-ACT-REPLY (The
8-byte field has the following
characteristic: If n1 was generated
at time t1, and n2 was generated at
time t2, then t1 < t2 implies n1 <
n2.)

NC-ER-ACT-REPLY; PU T4|5-->PU T4|5, Exp; NC
(EXPLICIT ROUTE ACTIVATE REPLY)

NC-ER-ACT-REPLY is returned to signal the
successful or unsuccessful completion of the
NC-ER-ACT.

- 0 X'0C' request code
- 1-2 Reserved
- 3 Format: X'01' (only value defined)
- 4 Type
 - X'00' explicit route activated
 - X'01' race condition resulting from
NC-ER-ACT being sent by both
nodes, each of which allows
routing usage without
requiring explicit
installation definition; this
condition is resolved in favor

	of the NC-ER-ACT from the PU having the greater subarea address (thus, this Type code is sent by the PU having the larger subarea address)
X'02'	ER is not reversible since there is no reverse ERN defined
X'03'	encountered a PU that does not support ER and VR protocols
X'04'	ER length exceeded the maximum specified in NC-ER-ACT
X'05'	ER requires a TG that is not active
X'06'	ER is not defined in the NC-ER-ACT-REPLY originating node
5	Explicit route length, in terms of the number of transmission groups in the explicit route as accumulated by NC-ER-ACT
6	Maximum ER length, as specified in NC-ER-ACT request
7-10	Subarea address of the destination PU of corresponding NC-ER-ACT
11	Reserved
12	bits 0-3, reserved bits 4-7, ERN of the ER being activated
13-16	Subarea address of the PU originating the corresponding NC-ER-ACT
17-18	Reverse ERN mask: a bit is <u>on</u> if the corresponding ERN can be used to route to the NC-ER-ACT originating subarea (bit 0 corresponds to ERN 0, bit 1 to ERN 1, and so forth)
19-20	Maximum size of PIU allowed to flow on the reverse ERNs specified in bytes 17-18: X'0000' no restriction (only value defined)
21-22	Maximum PIU length accumulated by the NC-ER-ACT: X'0000' no restriction (only value defined)
23-28	Reserved

NC-ER-ACT-REPLY NC-ER-INOP

- 29-36 Activation request sequence
 identifier: same value as specified
 in the corresponding NC-ER-ACT
- 37-38 Reserved
- 39-42 Subarea address of the node that
 originated this NC-ER-ACT-REPLY
- 43-46 Subarea address depending on the Type
 field (byte 4), as follows:

<u>Type</u>	<u>Contents of this field</u>
X'00'	reserved
X'01'	reserved
X'02'	subarea on the ER prior to that with no reverse ERN defined
X'03'	subarea that does not support ER and VR protocols
X'04'	subarea on the ER preceding the subarea where the explicit route length (byte 5 of NC-ER-ACT) is incremented to a value one more than the maximum ER length limit (byte 6)
X'05'	subarea on the other end of the TG that is not active
X'06'	subarea on the ER from which the PU (that does not have the ER defined) received the corresponding NC-ER-ACT

- 47 TGN of the TG between the subareas
 specified in bytes 39-42 and 43-46;
 reserved if Type is X'00' or X'01'
- 48 Reserved

NC-ER-INOP; PU T4|5-->PU T4|5, Exp; NC
 (EXPLICIT ROUTE INOPERATIVE)

NC-ER-INOP is initiated when the last remaining
 link of the transmission group has failed or is
 disconnected via a link-level procedure.

- 0 X'06' request code
- 1-2 Reserved
- 3 Format: X'01' (only value defined)
- 4 Reason code:

	X'01'	unexpected routing interruption over a transmission group, such as the failure of the last active link in the TG
	X'02'	controlled routing interruption, such as the result of a DISCONTACT
5-8		Subarea address of the PU that originated the NC-ER-INOP
9-12		Subarea address on other end of the transmission group that had the routing interruption
13		TG number of the transmission group that had the routing interruption
14		Number of destination subareas that are on the ERs using the above TG
15-20		<u>Inoperative ER Field</u>
15-18		Subarea address of a destination that is routed to using an ER requiring the TG that had the routing interruption
19-20		Inoperative explicit route mask: a bit is <u>on</u> if the ER of the corresponding ERN is inoperative (bit 0 corresponds to ERN 0, bit 1 corresponds to ERN 1, and so forth)
21-n		Any additional six-byte entries in the same format as bytes 15-20

NC-ER-OP; PU_T4|5-->PU_T4|5, Exp; NC (EXPLICIT ROUTE OPERATIVE)

NC-ER-OP is generated when a link of an inoperative transmission group becomes operative.

0	X'0F'	request code
1-2		Reserved
3		Format: X'01' (Only value defined)
4		Reserved
5-8		Subarea address of the PU that originated the NC-ER-OP
9-12		Subarea address on other end of the operational TG
13		TG number of the operational TG
14		Number of destination subareas that are routed to using the ERs requiring the above TG

NC-ER-OP NC-ER-TEST

- 15-20 Operative ER Field
Note: This field is included if at least one operative ER exists for the subarea in bytes 15-18.
- 15-18 Subarea address of a destination that is routed to using an ER requiring the above TG
- 19-20 Operative explicit route mask: a bit is on if the ER for the corresponding ERN is operative (bit 0 corresponds to ERN 0, bit 1 to ERN 1, and so forth)
- 21-n Any additional six-byte field entries in the same format as bytes 15-20

NC-ER-TEST; PU T4|5-->PU_T4|5, Exp; NC
(EXPLICIT ROUTE TEST)

NC-ER-TEST is sent by a subarea node that requires testing of an explicit route to a specified destination subarea.

- 0 X'09' request code
- 1-2 Reserved
- 3 Format: X'01' (only value defined)
- 4 Reserved
- 5 Explicit route length: initially set to by the PU that originated the NC-ER-TEST, incremented by at each receiver of the original or propagated NC-ER-TEST
- 6 Maximum ER length (number of TGs comprising the ER), specified by the request originator
- 7-10 Subarea address of the destination of ER corresponding to the ERN specified in byte 12, bits 4-7
- 11 Reserved
- 12 bits 0-3, reserved
bits 4-7, ERN of the explicit route being tested
- 13-16 Subarea address of the PU that originated the NC-ER-TEST
- 17-18 Reverse ERN mask: a bit is on if the corresponding ERN can be used to route to the originating subarea (Bit 0 corresponds to ERN 0, bit 1, to ERN 1 and so forth.)
- 19-20 Maximum size of PIU allowed on the ERN

- specified in byte 12, bits 4-7:
 X'00' no restriction (only value defined)
- 21-22 Reserved
- 23-28 Network address of the SSCP that originated the corresponding NS request
- 29-38 Request correlation field: an implementation defined value, which is returned in NC-ER-TEST-REPLY for correlation of reply to request

NC-ER-TEST-REPLY; PU_T415-->PU_T415, EXP; NC (EXPLICIT ROUTE TEST REPLY)

NC-ER-TEST-REPLY is returned to signal the successful or unsuccessful completion of the NC-ER-TEST.

- 0 X'0A' request code
- 1-2 Reserved
- 3 Format: X'01' (only value defined)
- 4 Type:
 X'00' The corresponding NC-ER-TEST reached its destination subarea
 X'02' ER not reversible since there is no reverse ERN defined
 X'03' encountered a PU that does not support ER and VR protocols
 X'04' ER length exceeded the limit specified in the NC-ER-TEST request
 X'05' ER requires a TG that is not active
 X'06' ER is not defined in the NC-ER-TEST-REPLY originating node
- 5 Explicit route length, in terms of number of the transmission groups in the explicit route as accumulated in NC-ER-TEST.
- 6 Maximum ER length, as specified in the NC-ER-TEST request
- 7-10 Subarea address of the destination PU for corresponding NC-ER-TEST
- 11 Reserved
- 12 bits 0-3, reserved

NC-ER-TEST-REPLY

- 13-16 bits 4-7, ERN of the ER being tested
Subarea address of the PU that originated the corresponding NC-ER-TEST
- 17-18 Reverse ERN mask: a bit is on if the corresponding ERN can be used to route to the originating subarea
- 19-20 Maximum PIU size permitted on the reverse ERN specified in bytes 17-18:
X'0000' no restriction (only value defined)
- 21-22 Maximum PIU size accumulated by the NC-ER-TEST:
X'0000' no restriction (only value defined)
- 23-28 Network address of the SSCP originating the corresponding NS test request
- 29-38 Request correlation field: same value as specified in the corresponding NC-ER-TEST
- 39-42 Subarea address of the PU that originated this NC-ER-TEST-REPLY
- 43-46 Subarea address depending on the type field (byte 4) as follows:

<u>Type</u>	<u>Contents of this field</u>
X'00'	reserved
X'02'	subarea on the ER prior to that with no reverse ERN defined
X'03'	subarea that does not support ER and VR protocols
X'04'	subarea on the ER preceding the subarea where the explicit route length (byte 5 of NC-ER-TEST) is incremented to a value one more than the maximum ER length limit (byte 6)
X'05'	subarea on the other end of the TG that is not active
X'06'	subarea on the ER from which the PU (that does not have the ER defined), received the

corresponding NC-ER-TEST

- 47 TGN of the TG between the subareas specified in bytes 39-42 and 43-46; reserved if Type is X'00'

NC-IPL-ABORT; PU_T4|5-->PU_T2, Exp; NC (NC IPL ABORT)

NC-IPL-ABORT contains sense data indicating the reason for a failure during IPL.

- 0 X'46' request code
1-4 Sense data

NC-IPL-FINAL; PU_T4|5-->PU_T2, Exp; NC (NC IPL FINAL)

NC-IPL-FINAL contains the entry point location of the IPL module.

- 0 X'02' request code
1-4 Entry point location (hexadecimal address) within load module

NC-IPL-INIT; PU_T4|5-->PU_T2, Exp; NC (NC IPL INITIAL)

NC-IPL-INIT is sent from a PU_T5|4 to a PU_T4|2 after the PU_T5|4 processes an INITPROC(Type=IPL) RU.

- 0 X'03' request code
1 Reserved
2-9 IPL load module: an eight-character EBCDIC symbolic name of the IPL load module to be transmitted

NC-IPL-TEXT; PU_T4|5-->PU_T2, Exp; NC (NC IPL TEXT)

NC-IPL-TEXT contains the IPL data.

- 0 X'04' request code
1-n Text: a variable-length byte-string of IPL data, where the maximum value of n is 255

NOTIFY

NOTIFY; SSCP-->SSCP|LU, LU-->SSCP, Norm; FMD
NS(s) (NOTIFY)

NOTIFY is used to send information from an SSCP to another SSCP or to an LU, or from an LU to an SSCP. Notify carries information in the form of a (vector key, vector data) pair.

0-2 X'810620' NS header (for SSCP-->LU and LU-->SSCP)

0-2 X'818620' NS header (for SSCP-->SSCP)

3 NOTIFY vector key:

X'01' resource requested: used to send NOTIFY to the current users (LUs) of a resource (LU) to inform them that another LU wishes to use the resource

X'03' ILU/TLU or third-party SSCP notification:

- ILU/TLU notification: used to send NOTIFY to the issuer of an INIT or TERM request to give the status of the session
- third-party SSCP notification: used to send NOTIFY to a third-party SSCP (the SSCP whose LU issued an INIT-OTHER or TERM-OTHER request) to give the status of the setup/takedown procedure

X'04' LU notification: used to send NOTIFY to an LU informing it of the completed deactivation of the identified LU-LU session

X'0C' LU-LU session services capabilities: used to send NOTIFY to the SSCP having an active session with the sending LU, to convey the current LU-LU session services capability of that LU

4-p NOTIFY Vector Data

- For NOTIFY vector key X'01':

4-m Network name of requested LU

4 Type: X'F3' logical unit

5	Length, in binary, of symbolic name of LU
6-m	Symbolic name in EBCDIC characters
m+1-p	<u>Network name of requesting LU</u>
m+1	Type: X'F3' logical unit
m+2	Length, in binary, of symbolic name
m+3-p	Symbolic name in EBCDIC characters
	• For NOTIFY vector key X'03':
4	Status: <ul style="list-style-type: none"> X'01' session terminated X'02' session initiated X'03' procedure error X'04' setup process started
5-12	<u>PCID</u>
5-6	Network address of the SSCP(ILU) or SSCP(TLU)
7-12	A unique 6-byte value, generated by the SSCP(ILU) or SSCP(TLU), that is used in all cross-domain requests dealing with the same setup or takedown procedure until it is completed
13	Reason (defined for Status value of X'03' only) <u>Note:</u> There are two encodings of the Reason byte: <ul style="list-style-type: none"> • If bit 4 = 0, then the Reason byte is encoded for a setup procedure error. • If bit 4 = 1, then the Reason byte is encoded for a takedown procedure error.
	<u>Setup Procedure Error</u>
	bit 0, 1 CINIT error in reaching the PLU
	bit 1, 1 BIND error in reaching the SLU
	bit 2, 1 setup reject at the PLU
	bit 3, 1 setup reject at the SLU
	bit 4, 0 setup procedure error
	bit 5, reserved
	bit 6, 1 setup reject at SSCP
	bit 7, reserved
	<u>Takedown Procedure Error</u>
	bit 0, 1 CTERM error in reaching the PLU

NOTIFY

- bit 1, 1 UNBIND error in reaching the SLU
- bit 2, 1 takedown reject at the PLU
- bit 3, 1 takedown reject at the SLU
- bit 4, 1 takedown procedure error
- bit 5, 1 takedown reject at the SSCP
- bit 6, 0 see following Note
- bit 7, reserved

Note: The bit combination of 11 for bits 4 and 6 is set aside for implementation internal use and will not be otherwise defined.

- 14-17 Sense data (defined for Status value of X'03' only)
- 18 Session key:
 - X'05' PCID
 - X'06' network name pair
 - X'07' network address pair
 - X'0A' URC
- 19-n Session Key Content
 - For session key X'05': PCID
- 19-20 Network address of the SSCP(ILU)
- 21-26(=n) A unique 6-byte value, generated by the SSCP(ILU), that is retained and used in all cross-domain requests dealing with the same procedure until it is completed

Note: This session key is applicable within a NOTIFY only for SSCP-to-SSCP(TLU); it differs from the PCID carried in the NOTIFY Vector Data field (bytes 5-12) for NOTIFY vector key X'03'.

 - For session key X'06': network name pair
- 19 Type: X'F3' logical unit
- 20 Length, in binary, of symbolic name of PLU (or OLU or LU1)
- 21-m Symbolic name in EBCDIC characters
- m+1 Type: X'F3' logical unit
- m+2 Length, in binary, of symbolic name of SLU (or DLU or LU2)
- m+3-n Symbolic name in EBCDIC characters
 - For session key X'07': network address pair

19-20	Network address of PLU
21-22(=n)	Network address of SLU
	• For session key X'0A': URC
19	Length, in binary, of the URC
20-n	URC: end user defined identifier
	<u>Note:</u> This session key is applicable within a NOTIFY only for SSCP-to-TLU; it is the URC carried as the session key in TERM, and differs from the URC in bytes n+1 through p.
n+1-p	<u>User Request Correlation (URC) Field</u>
n+1	Length, in binary, of the URC
n+2-p	URC: end user defined identifier, specified in an INIT or TERM request; used to correlate the given session to the initiating or terminating requests
	<u>Note:</u> The URC length is :hpl.0 for SSCP-to-SSCP.
	• For NOTIFY Vector key X'04'
4	Type:
	X'01' session count decremented; no corresponding INIT-SELF
	X'02' session count decremented; corresponding INIT-SELF
5	Cause: cause of deactivating the (LU,LU) session, as specified in byte 4 of SESSEND
6	Action: any reactivation of the (LU,LU) session to be performed by either the PLU or SLU as specified in SESSEND or CDESSEND
7	Session key:
	X'06' network name pair
	X'07' network address pair
8-n	<u>Session Key Content</u>
	• For session key X'06': network name pair
8	Type: X'F3' logical unit
9	Length, in binary, of symbolic name of PLU (or OLU or LU1)
10-m	Symbolic name in EBCDIC characters
m+1	Type: X'F3' logical unit
m+2	Length, in binary, of symbolic name of SLU (or DLU or LU2)
m+3-n	Symbolic name in EBCDIC characters
	• For session key X'07': network address

NOTIFY

- pair
- 8-9 Network address of PLU
- 10-11(=n) Network address of SLU
- n+1-p User Request Correlation (URC) Field
- n+1 Length, in binary, of the URC
- n+2-p URC (from INIT-SELF, if Type = X'02'; otherwise, not included)
- For NOTIFY Vector Key X'0C':
- 4 Length, in binary, of vector data field
- 5 bits 0-3, primary LU capability:
- 0000 cannot ever act as primary LU
 - 0001 cannot currently act as primary LU
 - 0010 reserved
 - 0011 can now act as primary LU
- bits 4-7, secondary LU capability:
- 0000 cannot ever act as secondary LU
 - 0001 cannot currently act as secondary LU
 - 0010 reserved
 - 0011 can now act as secondary LU
- 6-7 LU-LU session limit (where a value of means that no session limit is specified)
- 8-9 LU-LU session count: the number of LU-LU sessions that are not reset, for this LU, and for which SESSEND will be sent to the SSCP
- 10 bit 0, parallel session capability:
- 0 parallel sessions not supported
 - 1 parallel sessions supported
- bits 1-7, reserved
- 11-18(=p) Mode table name: a symbolic name in EBCDIC characters
- Note: A value of all space (X'40') characters means that the mode table name is to be selected by the SSCP.

NS-IPL-ABORT NS-IPL-FINAL NS-IPL-INIT
NS-IPL-TEXT NS-LSA

NS-IPL-ABORT; SSCP-->PU_T2, Norm; FMD NS(c) (NS IPL ABORT)

NS-IPL-ABORT indicates to the PU_T2 that the load operation has been halted. Sense data is included in NS-IPL-ABORT indicating the cause of the failure.

0-2 X'410246' NS header

3-6 Sense data

NS-IPL-FINAL; SSCP-->PU_T2, Norm; FMD NS(c) (NS IPL FINAL)

NS-IPL-FINAL contains the entry-point location for the PU_T2 node to begin execution of the load module.

0-2 X'410245' NS header

3-6 Entry point location (hexadecimal address) within load module

NS-IPL-INIT; SSCP-->PU_T2, Norm; FMD NS(c) (NS IPL INITIAL)

NS-IPL-INIT is sent from the SSCP to the PU_T2 to indicate that a particular load module is about to be transmitted to the PU_T2's node.

0-2 X'410243' NS header

3 Reserved

4-11 IPL load module: eight-character EBCDIC symbolic name of the IPL load module to be transmitted

NS-IPL-TEXT; SSCP-->PU_T2, Norm; FMD NS(c) (NS IPL TEXT)

NS-IPL-TEXT contains the IPL data.

0-2 X'410244' NS header

3-n Text: a variable-length byte-string of IPL data

NS-LSA; PU_T4|5-->SSCP, Norm; FMD NS(c) (NS LOST SUBAREA)

NS-LSA is sent by a PU_T4|5 (after originating or propagating an LSA) to every SSCP with which it has an active session to report the interruption of routing capability to a set of subareas. The list of subareas in the NS-LSA request is identical to the list sent by the PU_T4|5 in the LSA request.

0-2 X'010285' NS header

NS-LSA NSPE

Note: Bytes 3-n are identical to those in the originated or propagated LSA.

- 3 Reason code, specifying why LSA was originated:
 X'01' unexpected routing interruption
 X'02' controlled routing interruption
- 4 Format: X'01' (only value defined)
- 5-8 Origination Address
- 5-6 Reserved
- 7-8 Network address of the PU that originated the LSA
- 9-12 Lost Subarea Address Field
- 9-10 Reserved
- 11 Subarea address (left-justified) for a lost subarea
- 12 Reserved
- 13-n Additional 4-byte fields in the form of bytes 9-12, corresponding to additional lost subareas

NSPE; SSCP-->ILU or TLU, Norm; FMD NS(s) (NS PROCEDURE ERROR)

NSPE is used by the SSCP to inform an ILU or TLU that a session initiation or termination attempt has failed after a positive response has been sent to the corresponding initiation or termination request. (NSPE is used only if Format 0 of INIT-SELF or TERM-SELF was issued. Otherwise, NOTIFY is used.)

- 0-2 X'010604' NS header
- Note: The remainder of this RU has two formats: a comprehensive form and a condensed form, based upon the setting of bit 7 of the Reason byte (byte 3). The choice is implementation-dependent.
- Comprehensive Format

- 3 Reason
- Note: There are two encodings of the Reason byte in the comprehensive format:
- If bit 4 = 0, then the Reason byte is encoded for a setup procedure

error.

- If bit 4 = 1, then the Reason byte is encoded for a takedown procedure error.

Setup Procedure Error

bit 0, 1 CINIT error in reaching the PLU
 bit 1, 1 BIND error in reaching the SLU
 bit 2, 1 setup reject at the PLU
 bit 3, 1 setup reject at the SLU
 bit 4, 0 setup procedure error
 bit 5, reserved
 bit 6, 1 setup reject at SSCP
 bit 7, 1 comprehensive format of Reason byte

Takedown Procedure Error

bit 0, 1 CTERM error in reaching the PLU
 bit 1, 1 UNBIND error in reaching the SLU
 bit 2, 1 takedown reject at the PLU
 bit 3, 1 takedown reject at the SLU
 bit 4, 1 takedown procedure error
 bit 5, 1 takedown reject at SSCP
 bit 6, 0 see following Note
 bit 7, 1 comprehensive format of Reason byte

Note: The bit combination of 11 for bits 4 and 6 is set aside for implementation internal use and will not be otherwise defined.

4-7

Sense data

8

Session key:

X'06' uninterpreted name pair

9-n

Session Key Content

- For session key X'06': uninterpreted name pair

9

Type: X'F3' logical unit

10

Length, in binary, of the PLU name

11-m

EBCDIC character string

m+1

Type: X'F3' logical unit

m+2

Length, in binary, of the SLU name

m+3-n

EBCDIC character string

Condensed Format

3

Reason:

NSPE PROCSTAT

	bit 0,	1	CINIT error in reaching the PLU
	bit 1,	1	BIND error in reaching the SLU
	bit 2,	1	setup reject at the PLU
	bit 3,	1	setup reject at the SLU
	bit 4,	1	takedown failure
	bit 5,	1	takedown reject at SSCP
	bit 6,	1	setup reject at SSCP
	bit 7,	0	condensed format
4-m			Uninterpreted name of PLU
4			Type: X'F3' logical unit
5			Length, in binary, of PLU name
6-m			EBCDIC character string
m+1-n			Uninterpreted name of SLU
m+1			Type: X'F3' logical unit
m+2			Length, in binary, of SLU name
m+3-n			EBCDIC character string

PROCSTAT; PU T4|5-->SSCP, Norm; FMD NS(c)
(PROCEDURE STATUS)

PROCSTAT reports to the SSCP either the successful completion or the failure of the load operation. If the procedure failed, the request code of the failing RU and sense data are included as parameters in the PROCSTAT RU.

0-2	X'410236'	NS header
3-6		Reserved
7-8		Network address of PU for which the procedure was initiated
9		Procedure type X'00' load (only value defined)
10		Procedure status: X'00' successful (bytes 13-17 set to 0's) X'01' reserved X'02' failure occurred--procedure failure; bytes 13-17 contain additional information
11-12		Reserved
13-17		<u>Status Qualifier</u>
13		Request code of failing NC RU
14-17		Sense data returned in the -RSP for the failing NC RU

QC; LU-->LU, Norm; DFC (QUIESCE COMPLETE)
 QC is sent by a half-session after receiving
 QEC, to indicate that it has quiesced.
 0 X'81' request code

QEC; LU-->LU, Exp; DFC (QUIESCE AT END OF CHAIN)
 QEC is sent by a half-session to quiesce its
 partner half-session after it (the partner)
 finishes sending the current chain (if any).
 0 X'80' request code

RECFMS; PU-->SSCP|PUCP, Norm; FMD NS(ma) (RECORD
 FORMATTED MAINTENANCE STATISTICS)

RECFMS permits the passing of maintenance
 related information from a PU to maintenance
 services at the SSCP.

0-2 X'410384' NS header
 7-n Alert
 7 bit 0, reserved
 bit 1, not last request indicator (see
 above)
 bits 2-7, type code: 000000; any
 defined CNM target id is
 valid
 8-13 Node Identification
 bits 0-11, block number
 bits 12-31, ID number
 12-13 Reserved
 14-19 Alert Classification
 14 bits 0-1, reserved
 bits 2-7, alert classification code:
 valid values are the same as
 the valid Type codes for
 RECFMS (byte 7, bits 2-7),
 with the exception of 000000
 15 Subclassification identifier: the
 subclassification for the
 classification indicated in byte 14;
 if the RECFMS type identified by byte
 14, bits 2-7, has a further
 qualification (for example, RECFMS
 types 000011 and 000110 have
 qualifiers in byte 14 of their
 formats), this byte contains the
 qualifying value; if not, the byte is
 reserved

RECFMS

- 16-19 Alert reason mask: a mask field selecting the item(s) that caused the alert event to be originated; a bit value of 1 indicates that the corresponding data item was a reason for the alert event; if the RECFMS type identified by byte 14, bits 2-7, and byte 15 has a validity mask field, the format of the Alert Reason Mask field is the same as the format of the Validity Mask field (for example, RECFMS 000011 bytes 15-17); if the identified RECFMS does not contain a validity mask, the i'th bit of this field corresponds to the i'th data item in the identified RECFMS
- 20-n Appended RECFMS vector(s): zero or more RECFMS vectors may be appended to the request to convey data available to the CNMS when the alert event was originated, including data represented in RECFMS types; inclusion of RECFMS vectors is optional; appended vectors must be ordered according to the binary value of the Vector Type field (lowest value first)
- 20 Vector length: a binary count of the length in bytes of this RECFMS vector (bytes 21-m)
- 21 bit 0, criticality indicator: for certain vector types, an indication of the urgency of the event being reported; if bits 2-7 of this byte are not 000000, this bit is reserved; if bits 2-7 of this byte are 000000, the bit has the following values:
- 0 the event cited is noncritical
 - 1 the event cited is potentially terminal; if the CNMA is unavailable, the SSCP will display this text
- Note: When the criticality indicator is set to 1 in an appended vector, the appended

vector (vector type 000000) contains a message formatted for display at an operator console and must occur as the first appended vector. Only one vector of type 000000 with the criticality indicator equal to 1 may be appended.

bit 1, reserved

bits 2-7, vector type: an identifier of the information contained in this RECFMS vector; valid values are:

000000 the vector contains a text message, composed of SCS characters

-000000 any valid type code for RECFMS (byte 7, bits 2-7), with the exception of 000000; these values indicate that the balance of the vector contains the information specified in bytes 14-n for the identified RECFMS type

Note: The sending of information in appended RECFMS vectors does not cause reset of any counters.

- 22-m Bytes 14-n of the indicated RECFMS type or the SCS text message
- m+1-(n-1) Additional vectors (if required) having the same format as bytes 20-m
- n X'00' indicating end of appended vectors
- 7-17 SDLC Test Command/Response Statistics
- 7 bit 0, solicitation indicator (see above)
- bit 1, not last request indicator (see above)
- bits 2-7, type code: 000001; the CNM

RECFMS

- target ID identifies a
PU T1|2
- 8-13 Node identification:
bits 0-11, block number
bits 12-31, ID number
- 12-13 Reserved
- 14-15 Counter: the number of times the
secondary SDLC station has received an
SDLC Test command with or without a
valid FCS
- 16-17 Counter: the number of times the
secondary SDLC station has received an
SDLC Test command with a valid FCS and
has transmitted an SDLC Test response
Note: All counters are in binary.
- 7-22 Summary error data
- 7 bit 0, solicitation indicator (see
above)
bit 1, not last request indicator (see
above)
bits 2-7, type code: 000010; the CNM
target ID identifies a PU
- 8-13 Node identification:
bits 0-11, block number
bits 12-31, ID number
- 12-13 Reserved
- 14-16 Summary counter validity mask:
- 14 bit 0, set to 1 if product error
counter is valid
bit 1, set to 1 if communication
adapter error counter is valid
bit 2, set to 1 if SNA negative
response counter is valid
bits 3-7, reserved
- 15-16 Reserved
- 17-18 Product error counter: a count for the
product identified by the Node
Identification field (bytes 8-13) of
certain product-detected hardware
errors whose origins are failures
designated as internal by that
product's own logic capability (The
identified product has the
responsibility for further isolation
of these failures using its own
product-specific problem determination

- and maintenance procedures.)
- 19-20 Communication adapter error counter for communication adapter errors whose source is either external or internal to the product identified by the block number
- 21-22 Count of SNA negative responses originating at this node
Note: All counters are in binary.
- 7-30|31 Communication Adapter Error Statistics: counts of selected errors, useful for problem determination, that have been supplied by the communication adapter (For these errors, the RECFMS Type 000010 communication adapter error counter is always incremented; the RECFMS Type 000010 product error counter is also incremented for those errors classified as internal errors by the product identified by the block number.)
- 7 bit 0, solicitation indicator (see above)
 bit 1, not last request indicator (see above)
 bits 2-7, type code: 000011; the CNM target ID identifies a PU T1|2
- 8-13 Node identification:
 bits 0-11, block number
 bits 12-31, ID number
- 12-13 Reserved
- 14 Communication adapter error counter sets:
 X'01' counter set 1
 X'02' counter set 2
 X'03' counter set 3
- 15-30 Data for Counter Sets 1 and 2
- 15-17 Communication adapter counter validity mask bytes
- 15 Mask byte 1:
 bit 0, set to 1 if nonproductive time-out or receive overrun counter is valid
 bit 1, set to 1 if idle time-out

RECFMS

- counter is valid
- bit 2, set to 1 if write retry counter is valid
- bit 3, set to 1 if overrun counter is valid
- bit 4, set to 1 if underrun counter is valid
- bit 5, set to 1 if connection problem counter is valid
- bit 6, set to 1 if FCS error counter is valid
- bit 7, set to 1 if primary station abort counter is valid
- 16 Mask byte 2:
 - bit 0, set to 1 if command reject counter is valid
 - bit 1, set to 1 if DCE error counter is valid
 - bit 2, set to 1 if write time-out counter is valid
 - bit 3, set to 1 if invalid status counter is valid
 - bit 4, set to 1 if communication adapter machine check counter is valid
 - bits 5-7, reserved
- 17 Reserved
- 18 Nonproductive time-out counter: no valid SDLC frames have been received within the time interval specified by the communication adapter; or receive overrun counter: the line is "hung" or insufficient buffer space has been allocated
 - Note: Receive overrun applies only to counter set 2.
- 19 Idle time-out counter: no SDLC Flag octets received for n seconds, where n is specified by the communication adapter
- 20 Write retry counter: the number of retransmissions of one or more SDLC I-frames
- 21 Overrun counter: the number of times one or more received characters have been overlaid

- 22 Underrun counter: the number of times one or more characters have been transmitted more than once
- 23 Connection problem counter: incremented by 1 for every n retries of commands that establish connection with a station, when RLSD drops, or whenever write retry is updated-- n is specified by the communication adapter
- 24 FCS error counter: the number of times a received SDLC frame had an invalid FCS
- 25 Primary station abort counter: number of times eight or more consecutive one bits have been received
- 26 SDLC command reject counter
- 27 DCE error counter: number of DCE interrupts or other unexpected conditions (for example, "data set ready" drops)
- 28 Write time-out counter: number of time-outs during write operations, for example, because of transmit clock failures
- 29 Invalid status counter: number of times status generated by the adapter was not meaningful
- 30 Communication adapter machine check counter: number of times the communication adapter has been identified as causing a machine check
- 15-31 Note: All counters are in binary.
- 15-17 Data for Counter Set 3
- 15-17 Communication adapter counter validity mask:
- 15 bit 0, set to 1 if total transmitted frames counter is valid
- bit 1, set to 1 if write retry counter is valid
- bit 2, set to 1 if total received frames counter is valid
- bit 3, set to 1 if FCS error counter is valid
- bit 4, set to 1 if command reject counter is valid

RECFMS

- bit 5, set to 1 if DCE error counter is valid
 - bit 6, set to 1 if nonproductive time-out counter is valid
 - bit 7, reserved
 - 16-17 Reserved
 - 18-19 Total transmitted frames counter: the total number of SDLC I-frames transmitted successfully
 - 20-21 Write retry counter: the number of retransmissions of one or more SDLC I-frames
 - 22-23 Total received frames counter: the number of SDLC I-frames successfully received
 - 24-25 FCS error counter: the number of SDLC frames received with FCS errors
 - 26-27 SDLC command reject counter
 - 28-29 DCE error counter: the number of DCE interrupts and other unexpected conditions (for example, "data set ready" drops)
 - 30-31 Nonproductive time-out counter: the number of times an SDLC frame has not been received within the time interval specified by the adapter
- Note: All counters are in binary.
- 15-33 Data for Counter Set 4 (Note: For a definition of adapter, control unit, and System/370 channel commands, and orders see implementation documentation.)
- 15-17 Adapter counter validity mask bytes
 - 15 Mask byte 1: bit is set to 1 if the counter is valid
 - bit 0, command-reject-while-not-initialized counter
 - bit 1, command-not-recognized counter
 - bit 2, sense-while-not-initialized counter
 - bit 3, channel-parity-check-during-selection-sequence counter
 - bit 4, channel-parity-check-during-data-write-sequence counter
 - bit 5, output-parity-check-at-control-unit counter

- bit 6, input-parity-check-at-control-unit counter
- bit 7, input-parity-check-at-adapter counter
- 16 Mask byte 2:
 - bit 0, data-error-at-adapter counter
 - bit 1, data-stop-sequence counter
 - bit 2, short-frame-or-length-check counter
 - bit 3, connect-received-when-already-connected counter
 - bit 4, disconnect-received-while-PU-active counter
 - bit 5, long-RU counter
 - bit 6, connect-parameter-error counter
 - bit 7, Read-Start-Old-received counter
- 17 Reserved
- 18 Command-reject-when-not-initialized counter: an initial Control command containing a valid Connect order was not received prior to a Restart Reset, Read Start 0/1, Write Start 0/1, Read, Write, or Write Break command
- 19 Command-not-recognized counter: control unit channel adapter received a command code that it did not recognize (invalid or not supported)
- 20 Sense-when-not-initialized counter: Sense command was received in response to the initial asynchronous interrupt (device-end,unit check), or Sense command was received without a preceding unit check ending status
- 21 Channel-parity-check-during-selection-sequence counter: control unit channel adapter detected a parity error from the channel during the selection sequence from the channel
- 22 Channel-parity-check-during-data-write-sequence counter: control unit channel adapter detected a parity error on channel bus-out during a channel Write operation
- 23 Output-parity-check-at-control-unit counter: control unit channel adapter detected a control unit parity error

RECFMS

- 24 during a channel Write operation
Input-parity-check-at-control-unit
counter: control unit detected a
control unit parity error during a
channel Read operation
- 25 Input-parity-check-at-adapter counter:
control unit channel adapter detected
that it transmitted bad parity on
channel bus-in during a channel Read
operation
- 26 Data-error-at-adapter counter:
control unit detected a channel
adapter error during an internal
channel adapter cycle-steal operation
- 27 Data-stop-sequence counter: the
number of data bytes accepted by the
System/370's Read command was less
than that specified in Connect
- 28 Short-frame-or-length-check counter:
a minimum four bytes have not been
transferred as a link header; or the
byte count specified in the first two
bytes of the header did not equal the
number of bytes received during a
Control, Write, or Write Break
operation
- 29 Connect-received-when-already-connected
counter: a Connect was received when
the control unit was already
connected; this is an error condition
and the PU is deactivated
- 30 Disconnect-received-while-PU-active
counter: a Disconnect order was
received from the System/370 while the
PU is active (that is, with no DACTPU
preceding the Disconnect); this is an
error condition
- 31 Long-RU counter: primary link station
has sent an RU greater than the
secondary link station can accept
- 32 Connect-parameter-error counter: the
Connect was rejected because it
specified an odd-number buffer length,
or it specified a buffer size
insufficient to hold the link header,
TH, RH, and at least a 64-byte RU

- 33 Read-Start-Old-received counter: the secondary link station received a Read Start Old command
 Note: All counters are in binary.
- 7-n PU/LU Dependent Data
- 7 bit 0, solicitation indicator (see above)
 bit 1, not last request indicator (see above)
 bits 2-7, type code: 000100; the CNM target ID identifies a PU/LU
- 8-13 Node identification
 bits 0-11, block number
 bits 12-31, ID number
- 12-13 Reserved
- 14-n PU/LU dependent data
- 7-n Engineering Change Levels
- 7 bit 0, solicitation indicator (see above)
 bit 1, not last request indicator (see above)
 bits 2-7, type code: 000101; the CNM target ID identifies a PU
- 8-13 Node identification
 bits 0-11, block number
 bits 12-31, ID number
- 12-13 Reserved
- 14-n Implementation defined data describing hardware, microcode, and programming levels
- 7-n Link Connection Subsystem Data
- 7 bit 0, solicitation indicator (see above)
 bit 1, not last request indicator (see above)
 bits 2-7, type code: 000110; the CNM target ID identifies an adjacent link station in the origin subarea
- 8-13 Node identification
 bits 0-11, block number
 bits 12-31, ID number
- 12-13 Reserved
- 14 Data selection:
 X'01' available data (only value defined)

RECFMS RECMS RECSTOR

- 15 Link connection subsystem type:
 X'01' IBM 3863, 3864, or 3865 modem
 (only value defined)
- 16-n Link connection subsystem data:
 product defined data

RECMS; PU T415-->SSCP, Norm; FMD NS(ma) (RECORD MAINTENANCE STATISTICS)

RECMS permits the passing of maintenance statistics from a PU to a centralized recording facility at the SSCP. A PU may send statistics for itself, for its node, for supported links, or for adjacent link stations, as indicated by the network address in the request.

- 0-2 X'010381' NS header
 3-4 Network address of resource
 5-n Maintenance statistics

RECSTOR; PU T415-->SSCP, Norm; FMD NS(ma) (RECORD STORAGE)

RECSTOR carries the storage dump as requested by a DISPSTOR RU.

- 0-2 X'010334' NS header
 3-4 Network address of resource to be displayed
- 5 Display source and type:
 bits 0-3, source (address space) of storage display
Note: Refer to implementation documentation for description of these values.
 bits 4-7, display type:
 0001 nonstatic storage display
 0010 static snapshot display
- 6 Reserved
 7-8 Number of bytes of program storage following in this record
 9-12 Beginning location
 13-n Storage display

RECTD; PU T4|5-->SSCP, Norm; FMD NS(ma) (RECORD TEST DATA)

RECTD returns the status and results of a test requested by EXECTEST to SSCP maintenance services.

0-2	X'010382' NS header
3-4	Network address of resource under test
5-8	Binary code selecting the test
9-n	Test status and results

RECTR; PU T4|5-->SSCP, Norm; FMD NS(ma) (RECORD TEST RESULTS)

RECTR is the reply request corresponding to a TESTMODE request. It returns the results and status for the test. Multiple reply requests may be sent in answer to a single soliciting TESTMODE request. When TESTMODE initiates a continuous test, the RECTR(s) is sent in reply to the TESTMODE request that terminates the test. However, the PRID that is echoed in the CNM header of the replying RECTR is the PRID received in the TESTMODE that initiated the test.

0-2	X'410385' NS header
7	<u>Link Level 2 Test Statistics</u> bit 0, solicitation indicator (see above)
	bit 1, not last request indicator (see above)
	bits 2-7, type code: 000001; the CNM target ID specifies an adjacent link station attached to a PU T4 5 node (<u>Note</u> : When the attached adjacent link station is in a PU T1 2 node, the PU CNM ID is used as the adjacent link station CNM ID.)
8	Reserved
9-10	Number of DLC link test frames transmitted
11-12	Number of DLC link test frames received with or without link errors
13-14	Number of DLC link test frames received without link errors
15-16	Reason for test termination:

RECTR RECTRD RELQ REQACTLU

X'0000' test completed without error
 X'0001' test completed with error--see bytes 9-14
 X'0002' test ended because of link inoperative condition
 X'0003' test initialization failure; bytes 9-14 contain 0's

RECTRD; PU T415-->SSCP, Norm; FMD NS(ma) (RECORD TRACE DATA)

RECTRD returns data collected during a trace of the specified resource.

0-2 X'010383' NS header
 3-4 Network address of resource under trace
 5 Trace data type
 bit 0, transmission group trace
 bits 1-4, reserved
 bits 5-6, trace data format
 10 fixed-length data segments
 11 variable-length data segments
 bit 7, link trace
 6-n Trace data

RELQ; LU-->LU, Exp; DFC (RELEASE QUIESCE)

RELQ is used to release a half-session from a quiesced state.

0 X'82' request code

REQACTLU; PU T415-->SSCP, Norm; FMD NS(c) (REQUEST ACTIVATE LOGICAL UNIT)

REQACTLU is sent from the PU to an SSCP to request that ACTLU be sent to the LU named in the RU.

0-2 X'410240' NS header
 3-4 Network address of LU to be sent ACTLU
 5-m Network Name of LU
 5 Type: X'F3' logical unit
 6 Length, in binary, of network name
 7-m Symbolic name in EBCDIC characters

REQCONT REQDISCONT REQECHO

REQCONT; PU T4|5-->SSCP, PU-->PUCP, Norm; FMD NS(c) (REQUEST CONTACT)

REQCONT notifies the SSCP that a connection with an adjacent secondary link station (in a PU_T1|2 node) has been activated via a successful connect-in or connect-out procedure. A DLC-level identification exchange (XID) is required before issuing REQCONT.

0-2 X'010284' NS header
 3-4 Network address of link
 5-n XID I-field image: the bytes received in the information field of the SDLC XID response; see the later section, "DLC XID Information-Field Formats," for format details

REQDISCONT; PU T1|2-->SSCP, Norm; FMD NS(c) (REQUEST DISCONTACT)

With REQDISCONT, the PU_T1|2 requests the SSCP to start a procedure that will ultimately discontact the secondary station in the PU_T1|2 node.

0-2 X'01021B' NS header
 3 bits 0-3, type:
 X'0' normal
 X'8' immediate
 bits 4-7, CONTACT information:
 X'0' do not send CONTACT immediately
 X'1' send CONTACT immediately

REQECHO; LU-->SSCP, Norm; FMD NS(ma) (REQUEST ECHO TEST)

REQECHO requests that the SSCP return to the LU via ECHOTEST the data included in REQECHO.

0-2 X'810387' NS header
 3 Repetition factor: number of times the test data is to be echoed to the target LU
Note: X'00' is not a valid repetition factor.
 4-m Echoed Data Field
 4 Number of data bytes to be echoed
 5-m Echoed data

REQFNA REQMS

REQFNA; PU_T4|5-->SSCP, Norm; FMD NS(c) (REQUEST FREE NETWORK ADDRESS)

REQFNA is sent from a PU_T4|5 to an SSCP to request the SSCP to send FNA to the PU_T4|5 in order to free all addresses for the specified LU.

0-2	X'410286' NS header
3-4	Network address of LU to be deleted
5	Reserved
6	Type of request: X'01' request X'02' normal X'03' forced X'04' cleanup

REQMS; SSCP|PUCP-->PU, Norm; FMD NS(ma) (REQUEST MAINTENANCE STATISTICS)

REQMS requests the CNM services associated with the PU to provide maintenance statistics for the resource indicated by the CNM target ID in the CNM header.

0-2	X'410304' NS header
7	<u>SDLC Test Command/Response Statistics</u> bit 0, reset indicator bit 1, reserved bits 2-7, type code: 000001; the CNM target ID identifies a PU_T1 2
7	<u>Summary Error Data</u> bit 0, reset indicator bit 1, reserved bits 2-7, type code: 000010; the CNM target ID identifies a PU
7	<u>Communication Adapter Data</u> bits 0-1, reserved bits 2-7, type code: 000011; the CNM target ID identifies a PU_T1 2
7-n	<u>PU- or LU-Dependent Data</u>
7	bit 0, reset indicator bit 1, reserved bits 2-7, type code: 000100; the CNM target ID identifies a PU LU
8-n	PU- or LU-dependent request parameters: implementation dependent information (See CNM application

- product specifications for details.)
- 7 Engineering Change Levels
 bits 0-1, reserved
 bits 2-7, type code: 000101; the CNM
 target ID identifies a PU
- 7-8 Link Connection Subsystem Data
- 7 bit 0, reset indicator
 bit 1, reserved
 bits 2-7, type code: 000110; the CNM
 target ID identifies an
 adjacent link station in the
 destination subarea
- 8 Data selection requested:
 X'01' available data (only value
 defined)

REQTEST; LU-->SSCP, PU T4|5-->SSCP, Norm; FMD
 NS(ma) (REQUEST TEST PROCEDURE)

REQTEST requests that the specified test
 procedure be executed for network name 2 and be
 controlled by network name 1.

- 0-2 X'010380' NS header
 Network Name 1
- 3 Type: X'F3' logical unit
- 4 Length: binary number of bytes in
 symbolic name (X'00' = no symbolic
 name present)
- 5-m Symbolic name, in EBCDIC characters,
 of LU controlling the test
 Network Name 2
- m+1 Type: X'F1' physical unit
 X'F3' logical unit
 X'F9' link
- m+2 Length: binary number of bytes in
 symbolic name (X'00' = no symbolic
 name present)
- m+3-n Symbolic name, in EBCDIC characters,
 of resource to be tested
- n+1-p Procedure Name
- n+1 Type: X'F5' test procedure name
- n+2 Length: binary number of bytes in
 symbolic name (X'00' = no symbolic
 name present)
- n+3-p Symbolic name, in EBCDIC characters,
 of test procedure to be executed
- p+1-q Requester ID

REQUEST RNAA

p+1	Length: binary number of bytes in requester ID (X'00' = no requester ID present)
p+2-q	Requester ID, in EBCDIC characters, of the end user initiating the request (May be used to verify end user's authority to access a particular resource.)
q+1-r	<u>Password</u>
q+1	Length: binary number of bytes in password (X'00' = no password present)
q+2-r	Password, field used to verify the identity of an end user
r+1-s	<u>User Field</u>
r+1	Length: binary number of bytes of user data (X'00' = no user data present)
r+1-s	User data

RNAA; SSCP-->PU_T4|5, Norm; FMD NS(c) (REQUEST NETWORK ADDRESS ASSIGNMENT)

RNAA requests the PU to update its path control routing table and to assign network addresses: (1) to one or more adjacent link stations and their BF.PUs, as identified in the RNAA request by a link network address and secondary link station link-level addresses (2) to one or more BF.LUs, where the BF.LUs are identified in the RNAA request by an adjacent link station network address and the LU local addresses (3) to an LU that supports parallel sessions, where the LU is identified in the RNAA request by the LU network address used for the SSCP-LU session, in order to assign an additional network address. The PU returns the network addresses in the RNAA response.

0-2	X'410210' NS header
3-4	Network address of target link, adjacent link station, or LU
5	Assignment type:
	X'00' request is for network address assignment of adjacent link station(s) associated with target link
	X'01' request is for network address assignment of BF.LU(s) associated with the target

	adjacent link station
	X'02' request is for an additional network address assignment for the target LU; bytes 3-4 contain the LU network address used in the SSCP-LU session
6	Number of network addresses to be assigned
7-8	<u>DLC Header Link Station Address, LU Local Address, or LU Network Address Entry</u>
	• For Assignment Type 0
7	Reserved
8	DLC header link station address associated with the adjacent link station for which a network address is requested
	• For Assignment Type 1
7	Reserved
8	Local address of a BF.LU for which a network address is requested, where the local address has either the one-byte format of FID2 or the six-bit local address format of FID3 (in which case, bits 0-1 of byte 8 are reserved)
	• For Assignment Type 2
7-8	Reserved
9-n	Any additional two-byte entries in the same format as bytes 7-8 for assignment types 0 and 1 (not present for assignment type 2)

ROUTE-TEST; SSCP-->PU_T4|5, Norm; FMD NS(ma)
(ROUTE TEST)

ROUTE-TEST requests the PC_ROUTE_MGR component of PU.SVC_MGR to return the status (for example, active, operative, not defined), as known in the control blocks in the node, of various explicit and/or virtual routes.

0-2	X'410306' NS header
3	Format: X'01' (only value defined)
4	Test code:
	X'01' test regardless of the states of ERs
	X'02' test each ER that is not inoperative

ROUTE-TEST RPO

- X'03' test each ER that is inoperative
- X'04' do not test the ER; respond with the current ER state (See RSP(ROUTE-TEST))
- 5 Type of route to be tested:
 - X'01' test the ERs corresponding to the ERNs specified in bytes 11-12
 - X'02' test the VRs corresponding to the VRNs specified in bytes 11-12; Byte 4 applies to the underlying ERs for the VRs
 - X'03' test the ERs corresponding to the defined TG for the ERNs specified in bytes 11-12
- 6 Maximum expected ER length of any ER being tested
- 7-10 Subarea address of destination PU for the NC-ER-TEST request
- 11-12 A bit is on if the corresponding ERN or VRN (depending on the route type specified in byte 5) is to be tested (Bit 0 corresponds to ERN or VRN 0, bit 1 to ERN or VRN 1, and so forth.)
- 13-22 Request correlation field: an implementation defined value that is returned in ER-TESTED for correlation of reply to request

RPO; SSCP-->PU_T4|5, Norm; FMD NS(c) (REMOTE POWER OFF)

RPO causes the receiving PU_T4|5 to initiate a DLC-level power-off sequence to the PU_T4 node specified by the adjacent link station address conveyed in the request. The PU_T4|5 node being powered off does not need to have an active SSCP-PU half-session nor be contacted.

0-2 X'010209' NS header

3-4 Network address of adjacent link station associated with the node to be powered off

RQR RSHUTD RTR SBI SDT SESSEND

RQR; SLU-->PLU, SSCP-->SSCP, Exp; SC (REQUEST RECOVERY)

RQR is sent by the secondary to request the primary to initiate recovery for the session by sending CLEAR or to deactivate the session.

0 X'A3' request code

RSHUTD; SLU-->PLU, Exp; DFC (REQUEST SHUTDOWN)

RSHUTD is sent from the secondary to the primary to indicate that the secondary is ready to have the session deactivated. RSHUTD does not request a shutdown; therefore, SHUTD is not a proper reply; RSHUTD requests an UNBIND.

0 X'C2' request code

RTR; LU-->LU, Norm; DFC (READY TO RECEIVE)

RTR indicates to the bidder that it is now allowed to initiate a bracket. RTR is issued by the first speaker, and is used only when using brackets.

0 X'05' request code

SBI; LU-->LU, Exp; DFC (STOP BRACKET INITIATION)

SBI is sent by either half-session to request that the receiving half-session stop initiating brackets by continued sending of BB and the BID request.

0 X'71' request code

SDT; PLU-->SLU, SSCP-->PU|SSCP, Exp; SC (START DATA TRAFFIC)

SDT is sent by the primary session control to the secondary session control to enable the sending and receiving of FMD and DFC requests and responses by both half-sessions.

0 X'A0' request code

SESEND; LU-->SSCP, Norm; FMD NS(s) (SESSION ENDED)

SESEND is sent, with no-response requested, to notify the SSCP that the session between the specified LUs has been successfully deactivated.

Note: SESEND is generated by the BF.LU.SVC_MGR on behalf of the SLU in a PU_T1|2 node.

0-2 X'810688' NS header

SESSEND

- 3 bits 0-3, format:
 0000 format 0
 0010 format 2
 bits 4-7, reserved
Format 0
- 4 Session key:
 X'06' uninterpreted name pair
 X'07' network address pair
- 5-n Session Key Content
- For session key X'06': Uninterpreted name pair
- 5 Type: X'F3' logical unit
 6 Length, in binary, of PLU name
 7-m EBCDIC character string
 m+1 Type: X'F3' logical unit
 m+2 Length, in binary, of SLU name
 m+3-n EBCDIC character string
- For session key X'07': network address pair
- 5-6 Network address of PLU
 7-8(=n) Network address of SLU
Format 2
- 4 Cause: indicates the reason for the deactivation of the identified (LU,LU) session (see UNBIND for values)
- 5 Action: indicates if any resultant action is to be taken and by whom:
 X'01' normal, no resultant automatic action
 X'02' primary half-session will restart
 X'03' secondary half-session will restart
- 6 Session key:
 X'06' network name pair
 X'07' network address pair
- 7-n Session Key Content
- For session key X'06': network name pair
- 7 Type: X'F3' logical unit
 8 Length, in binary, of symbolic name of PLU
 9-m Symbolic name in EBCDIC characters
 m+1 Type: X'F3' logical unit
 m+2 Length, in binary, of symbolic name of SLU

SESSEND SESST SETCV (NS(c))

- m+3-n Symbolic name in EBCDIC characters
 - For session key X'07': network address pair
- 7-8 Network address of PLU
- 9-10(=n) Network address of SLU

SESST; PLU-->SSCP, Norm; FMD NS(s) (SESSION STARTED)

SESST is sent, with no-response requested, by the PLU to notify the SSCP that the session between the specified LUs has been successfully activated.

- 0-2 X'810686' NS header
- 3 Reserved
- 4 Session key:
 - X'06' uninterpreted name pair
 - X'07' network address pair
- 5-n Session Key Content
 - For session key X'06': Uninterpreted name pair
- 5 Type: X'F3' logical unit
- 6 Length, in binary, of PLU name
- 7-m EBCDIC character string
- m+1 Type: X'F3' logical unit
- m+2 Length, in binary, of SLU name
- m+3-n EBCDIC character string
 - For session key X'07': network address pair
- 5-6 Network address of PLU
- 7-8(=n) Network address of SLU

SETCV; SSCP-->PU_T4|5, Norm; FMD NS(c) (SET CONTROL VECTOR)

SETCV sets a control vector that is maintained by the PU receiving the request and that is associated with the network address specified in the RU.

- 0-2 X'010211' NS header
- 3-4 Network address of resource to which control vector applies, as described in the Note below
- 5-n Control vector, as described in the section "Control Vectors and Control Lists," later in this section

Note: The following combinations are used in SETCV (configuration

SETCV (NS(c)) SETCV (NS(ma)) SHUTC

services):

<u>Vector</u>	<u>Key</u> (<u>Byte</u> <u>5</u>)	<u>Resource</u> (<u>Bytes</u> <u>3-4</u>)
X'01'		PU
X'02'		Link to be used for routing to the subarea specified in byte 6
X'03'		SPU
X'04'		LU
X'05'		Link (S/370 channel)

SETCV; SSCP-->PU_T4|5, Norm; FMD NS(ma) (SET CONTROL VECTOR)

SETCV sets the intensive mode (X'08') control vector that is maintained by the PU receiving the request and that is associated with the network address specified in the RU.

0-2 X'010311' NS header

3-4 Network address of resource to which control vector applies, as described in the Note below

5-n Control vector, as described in the section "Control Vectors and Control Lists," later in this section

Note: The following combination is used in SETCV (maintenance services):

<u>Vector</u>	<u>Key</u> (<u>Byte</u> <u>5</u>)	<u>Resource</u> (<u>Bytes</u> <u>3-4</u>)
X'08'		Adjacent link station

SHUTC; SLU-->PLU, Exp; DFC (SHUTDOWN COMPLETE)
SHUTC is sent by a secondary to indicate that it is in the shutdown (quiesced) state.

0 X'C1' request code

SHUTD; PLU-->SLU, Exp; DFC (SHUTDOWN)

SHUTD is sent by the primary to request that the secondary shut down (quiesce) as soon as convenient.

0 X'CO' request code

SIG; LU-->LU, Exp; DFC (SIGNAL)

SIG is an expedited request that can be sent between half-sessions, regardless of the status of the normal flows. It carries a four-byte value, of which the first two bytes are the signal code and the last two bytes are the signal extension value. These values are used in higher level protocols.

0 X'C9' request code

1-4 Signal code + signal extension field (2 bytes each), set by the sending end user or NAU services manager; has meaning only to the NAU services level or above:

X'0000'+ 'uuuu'	no-op (no system-defined code) + user-defined field
X'0001'+ 'uuuu'	request to send + user-defined field
X'0002'+ 'uuuu'	assistance requested + user defined field
X'0003'+ 'uuuu'	intervention required (no data loss) + user-defined field

STSN; PLU-->SLU, Exp; SC (SET AND TEST SEQUENCE NUMBERS)

STSN is sent by the primary half-session sync point manager to resynchronize the values of the half-session sequence numbers, for one or both of the normal flows at both ends of the session.

0 X'A2' request code

1 bits 0-1, action code for S-->P flow (related data in bytes 2-3)

bits 2-3, action code for P-->S flow (related data in bytes 4-5)

Note: Each action code is set and processed independently. Values for either action code are:

00 ignore; this flow not

STSN

- 01 affected by this STSN set; the half-session value is set to the value in bytes 2-3 or 4-5, as appropriate
- 10 sense; secondary half-session's sync point manager returns the transaction processing program's sequence number for this flow in the response RU
- 11 set and test; the half-session value is set to the value in appropriate bytes 2-3 or 4-5, and the secondary half-session's sync point manager compares that value against the transaction processing program's number and responds accordingly
- bits 4-7, reserved
- 2-3 Secondary-to-primary sequence number data to support S-->P action code
- 4-5 Primary-to-secondary sequence number data to support P-->S action code
- Note: For action codes 01 and 11, the appropriate bytes 2-3 or 4-5 contain the value to which the half-session value is set and against which the secondary half-session's sync point manager tests the transaction processing program's value for the respective flow. For action codes 00 and 10, the appropriate bytes 2-3 or 4-5 are reserved.

TERM-OTHER; TLU-->SSCP, Norm; FMD

NS(s)(TERMINATE-OTHER)

TERM-OTHER from the TLU requests that the SSCP assist in terminating session(s) between the two LUs named in the RU. The requester may be a third party LU or one of the two named LUs.

0-2 X'810682' NS header

3 bits 0-3, Format:

0001 Format 1 (Only value defined)

bits 4-7, reserved

4 Type

bits 0-1, 00 the request applies to active and pending-active sessions
 01 the request applies to active, pending-active, and queued sessions
 10 the request applies to queued sessions only
 11 available only for implementation use

bit 2, reserved if byte 4, bit 7 = 1; otherwise:

0 forced termination--session to be deactivated immediately and unconditionally

1 orderly termination--permitting an end-of-session procedure to be executed at the PLU before the session is deactivated

bit 3, 0 do not send DACTLU to LU1; another session initiation request will be sent for LU1

1 send DACTLU to LU1 when appropriate; no further session initiation request will be sent (from this sender) for LU1

bit 4, 0 do not send DACTLU to LU2; another session initiation request will be sent for

TERM-OTHER

- LU2
- 1 send DACTLU to LU2 when appropriate; no further session initiation request will be sent (from this sender) for LU2
- bits 5-6, 00 select session(s) for which LU1 is PLU
01 select session(s) for which LU2 is PLU
10 select session(s) regardless of whether LU is PLU or SLU
11 reserved
- bit 7, 0 orderly or forced (see byte 4, bit 2)
1 cleanup
- 5 Reason
bits 0-2, reserved
bit 3, 0 network user requested the termination
1 network manager requested the termination
bit 4, reserved
bit 5, 0 normal termination
1 abnormal termination
bits 6-7, reserved
- 6 NOTIFY specifications:
bits 0-5, reserved
bit 6, 0 do not notify TLU when the session takedown procedure is complete
1 notify the TLU when the session takedown procedure is complete.
bit 7, reserved
- 7 Reserved
- 8 Session key:
X'06' uninterpreted name pair
X'07' network address pair
X'0A' URC
- 9-n Session Key Content
• For session key X'06': uninterpreted name pair
- 9 Type: X'F3' logical unit
- 10 Length, in binary, of LU1 name

11-m	EBCDIC character string
m+1	Type: X'F3' logical unit
m+2	Length, in binary, of LU2 name
m+3-n	EBCDIC character string
	<u>Note:</u> If the length of one of the uninterpreted names (LU1 or LU2, but not both) is 0 then all sessions for the named LU, as specified by the Type byte, are terminated as a result of this TERM-OTHER request.
	• For session key X'07': network address pair
9-10	Network address of PLU
11-12(=n)	Network address of SLU
	• For session key X'0A': URC
9	Length, in binary, of the URC
10-n	URC: end user defined identifier
	<u>Note:</u> This URC is the one carried in the INIT issued previously by the same LU (that is, ILU = TLU), and differs from the one in bytes q+1 through r.
n+1-p	<u>Requester ID</u>
n+1	Length, in binary, of requester ID
	<u>Note:</u> X'00' = no requester ID
n+2-p	<u>Requester ID:</u> the ID, in EBCDIC characters, of the end user initiating the request
p+1-q	<u>Password</u>
p+1	Length, in binary, of password
	<u>Note:</u> X'00' = no password is present
p+2-q	<u>Password used to verify the identity of the end user</u>
q+1-r	<u>User Request Correlation (URC) Field</u>
q+1	Length, in binary, of the URC
	<u>Note:</u> X'00' = no URC
q+2-r	URC: end-user defined identifier; this value can be returned by the SSCP in a subsequent NOTIFY or NSPE to correlate a given session to this terminating request

TERM-OTHER-CD

TERM-OTHER-CD; SSCP(TLU)-->SSCP(OLU), Norm; FMD
 NS(s) (TERMINATE-OTHER CROSS-DOMAIN)

TERM-OTHER-CD transports a TERM-OTHER request from the SSCP(TLU) where it was received, to the SSCP(OLU), which manages at least one of the (LU1,LU2) pair participating in the session(s) to be terminated.

- 0-2 X'818642' NS header
- 3 bits 0-3, 0000 Format 0 (only value defined)
 bits 4-7, reserved
- 4 Type:
 - bits 0-1, 00 the request applies to active and pending-active sessions
 - 01 the request applies to active, pending-active, and queued sessions
 - 10 the request applies to queued sessions only
 - 11 reserved
- bit 2, reserved if byte 4, bit 7 = 1; otherwise:
 - 0 forced termination--session to be deactivated immediately and unconditionally
 - 1 orderly termination--permitting an end-of-session procedure to be executed at the PLU before the session is deactivated
- bit 3, 0 do not send DACTLU to LU1; another session initiation request will be sent for LU1
 - 1 send DACTLU to LU1 when appropriate; no further session initiation request will be sent (from this sender) for LU1
- bit 4, 0 do not send DACTLU to LU2; another session initiation request will be sent for LU2

- 1 send DACTLU to LU2 when appropriate; no further session initiation request will be sent (from this sender) for LU2
- bits 5-6, 00 select session(s) for which LU1 is PLU
 01 select session(s) for which LU2 is PLU
 10 select session(s) regardless of whether LU is SLU or PLU
 11 reserved
- bit 7, 0 orderly or forced (see byte 4, bit 2)
 1 cleanup
- 5-12 PCID
 5-6 Network address of the SSCP(TLU)
 7-12 A unique 6-byte value, generated by the SSCP(TLU), that is retained and used in all cross-domain requests dealing with the same procedure until it is completed
- 13 Reason:
 bits 0-2, reserved
 bit 3, 0 network user requested the termination
 1 network manager requested the termination
 bit 4, reserved
 bit 5, 0 normal termination
 1 abnormal termination
 bits 6-7, reserved
- 14-15 Reserved
- 16 Session key:
 X'05' PCID
 X'06' network name pair
 X'07' network address pair
- 17-n Session Key Content
 • For session key X'05': PCID
- 17-18 Network address of the SSCP(ILU)
- 19-24(=n) A unique six-byte value, generated by the SSCP(ILU), that is retained and used in all cross-domain requests dealing with the same procedure until it is completed

TERM-OTHER-CD TERM-SELF (format 0)

Note: This is a PCID generated by the SSCP(ILU), and differs from the one in bytes 5-12.

- For session key X'06': network name pair
 - 17 Type: X'F3' logical unit
 - 18 Length, in binary, of symbolic name of LU1
 - 19-m Symbolic name in EBCDIC characters
 - m+1 Type: X'F3' logical unit
 - m+2 Length, in binary, of symbolic name of LU2
 - m+3-n Symbolic name in EBCDIC characters
- Note: If the length of one of the network names, but not both, is zero then all sessions specified by the Type byte are terminated as a result of this TERM-OTHER-CD request
- For session key X'07': network address pair
 - 17-18 Network address of PLU
 - 19-20(=n) Network address of SLU
 - n+1-p Requester ID
 - n+1 Length, in binary, of requester ID
 - Note: X'00' = no requester ID
 - n+2-p Requester ID: the ID, in EBCDIC characters, of the end-user initiating the request
 - p+1-q Password
 - p+1 Length, in binary, of password
 - Note: X'00' = no password is present
 - p+2-q Password used to verify the identity of the end-user

TERM-SELF; TLU-->SSCP, Norm; FMD NS(s)
(TERMINATE-SELF)

TERM-SELF from the TLU requests that the SSCP assist in the termination of one or more sessions between the sender of the request (TLU = OLU) and the DLU.

- 0-2 X'010683' NS header
- 3 Type:
 - bits 0-1, 00 the request applies to active and pending-active sessions
 - 01 the request applies to

TERM-SELF (format 0)

- active, pending-active,
and queued sessions
- 10 the request applies to
queued only sessions
- 11 reserved
- bit 2, reserved if byte 3, bit 4 = 1;
otherwise:
 - 0 forced termination--session
to be deactivated
immediately and
unconditionally
 - 1 orderly
termination--permitting an
end-of-session procedure to
be executed at the PLU
before the session is
deactivated
- bit 3, 0 do not send DACTLU to OLU;
another session initiation
request will be sent for
OLU
 - 1 send DACTLU to OLU when
appropriate; no further
session initiation request
will be sent (from this
sender) for OLU
- bit 4, 0 orderly or forced (see byte
3, bit 2)
 - 1 clean up
- bits 5-6, 00 select session(s) for
which DLU is PLU
 - 01 select session(s) for
which DLU is SLU
 - 10 select session(s)
regardless of whether
LU is SLU or PLU
 - 11 reserved
- bit 7, 0 indicates that the format
of the RU is Format 0 and
that byte 3 is the Type
byte.

4-m

4

5

Uninterpreted Name of DLU

Type: X'F3' logical unit

Length, in binary, of DLU name

Note: If the length value of the DLU
name is 0, then the TERM-SELF applies

TERM-SELF (format 0) TERM-SELF (format 1)

6-m to all sessions, as specified in the Type byte, where the TLU is a partner.
EBCDIC character string

Note: The following defaults are supplied by the SSCP receiving a Format 0 TERM-SELF:

- Reason: network user, normal
- Notify: do not notify
- Requester ID, URC, and password are not used in mapping to subsequent requests.

TERM-SELF; TLU-->SSCP, Norm; FMD NS(s)
(TERMINATE-SELF)

TERM-SELF from the TLU requests that the SSCP assist in the termination of one or more sessions between the sender of the request (TLU = OLU) and the DLU.

0-2 X'810683' NS header

3 bits 0-3, format:

0001 Format 1 (only value defined)

bits 4-6, reserved

bit 7, 1 indicates that byte 3, bits 0-3, contain the format value

4 Type:

bits 0-1, 00 the request applies to active and pending-active sessions

01 the request applies to active, pending-active, and queued sessions

10 the request applies to queued sessions only

11 available only for implementation use

bit 2, reserved if byte 4, bit 7 = 1; otherwise:

0 forced termination--session to be deactivated immediately and unconditionally

1 orderly termination--permitting an end-of-session procedure to

TERM-SELF (format 1)

- be executed at the PLU before the session is deactivated
- bit 3, 0 do not send DACTLU to OLU; another session initiation request will be sent for OLU
- 1 send DACTLU to OLU when appropriate; no further session initiation request will be sent (from this sender) for OLU
- bit 4, reserved
- bits 5-6, 00 select session(s) for which DLU is PLU
- 01 select session(s) for which DLU is SLU
- 10 select session(s) regardless of whether LU is SLU or PLU
- 11 reserved
- bit 7, 0 orderly or forced (see byte 4, bit 2)
- 1 clean up
- 5 Reason:
- bits 0-2, reserved
- bit 3, 0 network user requested the termination
- 1 network manager requested the termination
- bit 4, reserved
- bit 5, 0 normal termination
- 1 abnormal termination
- bits 6-7, reserved
- 6 NOTIFY specifications:
- bits 0-5, reserved
- bit 6, 0 do not notify TLU when the session takedown procedure is complete
- 1 notify the TLU when the session takedown procedure is complete
- bit 7, reserved
- 7 Reserved
- 8 Session key:
- X'01' uninterpreted name

TERM-SELF (format 1)

	X'07'	network address pair
	X'0A'	URC
9-n		<u>Session Key Content</u>
		• For session key X'01': uninterpreted name
9		Type: X'F3' logical unit
10		Length, in binary, of name
11-n		EBCDIC character string
		<u>Note:</u> If the length value is 0, then the TERM-SELF applies to all sessions specified in the Type byte where the TLU is a partner.
		• For session key X'07': network address pair
9-10		Network address of PLU
11-12(=n)		Network address of SLU
		• For session key X'0A': URC
9		Length, in binary, of the URC
10-n		URC: end user defined identifier
		<u>Note:</u> This URC is the one carried in the INIT issued previously by the same LU (that is, ILU = TLU), and differs from the one in bytes q+1 through r.
n+1-p		<u>Requester ID</u>
n+1		Length, in binary, of requester ID
		<u>Note:</u> X'00' = no requester ID
n+2-p		Requester ID: the ID, in EBCDIC characters, of the end user initiating the request
p+1-q		<u>Password</u>
p+1		Length, in binary, of password
		<u>Note:</u> X'00' = no password is present
p+2-q		Password used to verify the identity of the end user
q+1-r		<u>User Request Correlation (URC) Field</u>
q+1		Length, in binary, of URC field
		<u>Note:</u> X'00' = no URC
q+2-r		URC: end-user defined identifier; this value can be returned by the SSCP in a subsequent NOTIFY to correlate a given session to this terminating request

TESTMODE; SSCP-->PU_T4|5, Norm; FMD NS(ma) (TEST MODE)

TESTMODE requests the CNM services associated with the PU to manage a test procedure. The test procedure begins with the TESTMODE request that initiates a test and ends when the test results and status are returned in a RECTR reply request corresponding to the initial TESTMODE request.

0-2	X'410305' NS header
7-n	<u>Link Level 2 Test Statistics</u>
7	bits 0-1, reserved
	bits 2-7, type code: 000001; the CNM target ID specifies an adjacent link station attached to a PU_T4 5 node (:hpl.Note : When the attached adjacent link station is in a PU_T1 2 node, the PU CNM ID is used as the adjacent link station CNM ID.)
8	Reserved
9-10	Test initiation/termination code: X'0000'(=n1) terminate an ongoing link test previously initiated X'FFFF'(=n2) initiate a link test and run it continuously n=¬(n1 n2) initiate a link test and transmit <u>n</u> test frames
11-12	For point-to-point links this field is reserved; for multipoint links, this field specifies the number of test frame transmissions to be sent each time the secondary link station is serviced, for example, in SDLC the time interval during which frames are being sent and received from a single secondary link station without another secondary link station on the link being polled or being sent frames
13-n	Data to be sent in the data field of the link test frame

UNBIND

UNBIND; LU-->LU, Exp; SC (UNBIND SESSION)

UNBIND is sent to deactivate an active session between the two LUs.

0 X'32' request code

1 Type UNBIND:

- X'01' normal end of session
- X'02' BIND forthcoming; retain the node resources allocated to this session, if possible
- X'03' talk: the session will be resumed by the sender of UNBIND after alternate use of the physical connection
- X'04' restart mismatch: sync point records do not match; operator intervention is needed before the session can be established
- X'05' LU not authorized: the secondary half-session has failed to supply an acceptable password or other authorization information in the User Data field
- X'06' invalid session parameters: the BIND negotiation has failed due to an inability of the primary half-session to support parameters specified by the secondary
- X'07' virtual route inoperative: the virtual route used by the (LU,LU) session has become inoperative, thus forcing the deactivation of the identified (LU,LU) session
- X'08' route extension inoperative: the route extension used by the (LU,LU) session has become inoperative, thus forcing the deactivation of the identified (LU,LU) session
- X'09' hierarchical reset: the identified (LU,LU) session is being deactivated because of a +RSP((ACTPU | ACTLU), Cold)
- X'0A' SSCP gone: the identified

- (LU,LU) session had to be deactivated because of a forced deactivation of the (SSCP,PU) or (SSCP,LU) session (for example, DACTPU, DACTLU, or DISCONTACT)
- X'OB' virtual route deactivated: the identified (LU,LU) session had to be deactivated because of a forced deactivation of the virtual route being used by the (LU,LU) session
- X'OC' LU failure--unrecoverable: the identified (LU,LU) session had to be deactivated because of an abnormal termination of the PLU or SLU; recovery from the failure was not possible
- X'OE' LU failure--recoverable: the identified (LU,LU) session had to be deactivated because of an abnormal termination of one of the LUs of the session; recovery from the failure may be possible
- X'OF' cleanup: the LU sending UNBIND is resetting its half-session before receiving the response from the partner LU
- X'FE' invalid session protocol: the session has failed because a protocol violation has been detected

2-5

Sense data (included only when Type = X'FE'; otherwise, this field is omitted): same value as generated at the time the error was originally detected (for example, for a negative response, receive check, or EXR)

UNBINDF VR-INOP

UNBINDF; PLU-->SSCP, Norm; FMD NS(s) (UNBIND FAILURE)

UNBINDF is sent, with no-response requested, by the PLU to notify the SSCP that the attempt to deactivate the session between the specified LUs has failed (for example, because of a path failure).

0-2	X'810687' NS header
3-6	Sense data
7	Reason: bit 0, reserved bit 1, 1 UNBIND error in reaching SLU bit 2, 1 takedown reject at PLU bits 3-7, reserved
8	Session key: X'06' uninterpreted name pair X'07' network address pair
9-n	<u>Session Key Content</u> <ul style="list-style-type: none">• For session key X'06': uninterpreted name pair
9	Type: X'F3' logical unit
10	Length, in binary, of PLU name
11-m	EBCDIC character string
m+1	Type: X'F3' logical unit
m+2	Length, in binary, of SLU name
m+3-n	EBCDIC character string <ul style="list-style-type: none">• For session key X'07': network address pair
9-10	Network address of PLU
11-12(=n)	Network address of SLU

VR-INOP; PU T4|5-->SSCP, PU T4-->PUCP, Norm; FMD NS(c) (VIRTUAL ROUTE INOPERATIVE)

VR-INOP notifies the CP when a virtual route has become inoperative as the result of a transmission group having become inoperative somewhere in the network.

0-2	X'410223' NS header
3	Format: X'01' (only value defined)
4	Reason code: X'01' unexpected routing interruption over a transmission group, for example, the last active link in a TG has failed

	X'02'	controlled routing interruption such as the result of DISCONTACT
5-8		Subarea address of the PU that originated the NC-ER-INOP
9-12		Subarea address on other end of the transmission group that had the routing interruption
13		TGN of the transmission group that had the routing interruption
14		Number of VRs that map to an ER using the above TG
15-22		<u>VR Field</u>
15-18		Subarea address of a destination that is routed to over the VR that uses the failed TG
19		Reserved
20		Virtual route identifier: bits 0-3, VRN bits 4-5, reserved bits 6-7, transmission priority field
21-22		ER INOP mask: a bit is <u>on</u> for the ER used by the VRID (Bit 0 corresponds to ERN 0, bit 1 to ERN 1, and so forth.)
23-n		Any additional eight-byte entries in the same format as bytes 15-22

This page left intentionally blank

FMD NS Headers

X'010201'	CONTACT 4-54	X'41021D'	ER-INOP 4-67	X'818646'	CDESSSST 4-41	DFC, NC, and SC Request Cod
X'010202'	DISCONTACT 4-65	X'41021E'	ADDLINK 4-17	X'818647'	CDESSSTF 4-41	X'02' NC-IPL-FINAL 4-109
X'010203'	IPLINIT 4-94	X'410221'	ADDLINKSTA 4-17	X'818648'	CDESSSEND 4-37	X'03' NC-IPL-INIT 4-109
X'010204'	IPLTEXT 4-95	X'410223'	VR-INOP 4-158	X'818649'	CDTAKED 4-42	X'04' NC-IPL-TEXT (NC) 4-109
X'010205'	IPLFINAL 4-95	X'410235'	INITPROC 4-85	X'81864A'	CDTAKEDC 4-44	X'04' LUSTAT (DFC) 4-97
X'010206'	DUMPINIT 4-66	X'410236'	PROCSTAT 4-118	X'81864B'	CDCCINIT 4-29	X'05' RTR (DFC) 4-139
X'010207'	DUMPTXT 4-66	X'410237'	NS-LD-REQD 4-96			X'05' LSA (NC) 4-96
X'010208'	DUMPFINAL 4-66	X'410240'	REQACTLU 4-132			X'06' NC-ER-INOP 4-104
X'010209'	RPO 4-138	X'410243'	NS-IPL-INIT 4-115			X'09' NC-ER-TEST 4-106
X'01020A'	ACTLINK 4-15	X'410244'	NS-IPL-TEXT 4-115			X'0A' NC-ER-TEST-REPLY 4-107
X'01020B'	DACTLINK 4-60	X'410245'	NS-IPL-FINAL 4-115			X'0B' NC-ER-ACT 4-101
X'01020E'	CONNOUT 4-53	X'410246'	NS-IPL-ABORT 4-115			X'0C' NC-ER-ACT-REPLY 4-102
X'01020F'	ABCONN 4-14	X'410286'	REQFNA 4-134			X'0D' ACTLU (SC) 4-16
X'010211'	SETCV (FMD NS(c)) 4-141	X'410287'	LCP 4-95			X'0D' NC-ACTVR (NC) 4-100
X'010214'	ESLOW 4-70	X'410304'	REQMS 4-134			X'0E' DACTLU (SC) 4-60
X'010215'	EXSLOW 4-71	X'410305'	TESTMODE 4-155			X'0E' NC-DACTVR (NC) 4-101
X'010216'	ACTCONNIN 4-15	X'410306'	ROUTE-TEST 4-137			X'0F' NC-ER-OP 4-105
X'010217'	DACTCONNIN 4-59	X'410384'	RECFMS 4-119			X'11' ACTPU 4-16
X'010218'	ABCONNOUT 4-14	X'410385'	RECTR 4-131			X'12' DACTPU 4-61
X'010219'	ANA 4-18	X'410386'	ER-TESTED 4-68			X'14' ACTCDRM 4-14
X'01021A'	FNA 4-71	X'810387'	REQECHO 4-133			X'15' DACTCDRM 4-58
X'01021B'	REQDISCONT 4-133	X'810389'	ECHOTEST 4-67			X'31' BIND 4-19
X'010280'	CONTACTED 4-54	X'810601'	CINIT 4-47			X'32' UNBIND 4-156
X'010281'	INOP 4-91	X'810602'	CTERM 4-56			X'46' NC-IPL-ABORT 4-109
X'010284'	REQCONT 4-133	X'810620'	NOTIFY (SSCP-->LU) 4-110			X'70' BIS 4-29
X'010285'	NS-LSA 4-115	X'810629'	CLEANUP 4-52			X'71' SBI 4-139
X'010301'	EXECTEST 4-70	X'810680'	INIT-OTHER 4-73			X'80' QEC 4-119
X'010302'	ACTTRACE 4-17	X'810681'	INIT-SELF (Format 1) 4-88			X'81' QC 4-119
X'010303'	DACTTRACE 4-62	X'810682'	TERM-OTHER 4-145			X'82' RELQ 4-132
X'010311'	SETCV (FMD NS(ma)) 4-142	X'810683'	TERM-SELF (Format 1) 4-152			X'83' CANCEL 4-29
X'010331'	DISPSTOR 4-65	X'810685'	BINDF 4-28			X'84' CHASE 4-47
X'010334'	RECTOR 4-130	X'810686'	SESSST 4-141			X'A0' SDT 4-139
X'010380'	REQTEST 4-135	X'810687'	UNBINDF 4-158			X'A1' CLEAR 4-53
X'010381'	RECMS 4-130	X'810688'	SESSEND 4-139			X'A2' STSN 4-143
X'010382'	RECTD 4-131	X'810810'	FORWARD 4-72			X'A3' RQR 4-139
X'010383'	RECTRD 4-132	X'810812'	DFLIVER 4-63			X'CO' CRV (SC) 4-56
X'010604'	NSPE 4-116	X'818620'	NOTIFY (SSCP-->SSCP) 4-110			X'CO' SHUTD (DFC) 4-143
X'010681'	INIT-SELF (Format 0) 4-86	X'818627'	DSRLST 4-66			X'C1' SHUTC 4-142
X'010683'	TERM-SELF (Format 0) 4-150	X'818640'	INIT-OTHER-CD 4-79			X'C2' RSHUTD 4-139
X'410210'	RNAA 4-136	X'818641'	CDINIT 4-31			X'C8' BID 4-18
X'41021C'	DELETENR 4-63	X'818642'	TERM-OTHER-CD 4-148			X'C9' SIG 4-143
		X'818643'	CDTERM 4-44			
		X'818645'	CDESSSSF 4-40			

SUMMARY OF RESPONSE RU'S

Apart from the exceptions cited below, response RUs return the number of bytes specified in the following table; only enough of the request RU is returned to include the field-formatted request code.

RU Category or Response	Number of Bytes in RU
NC	1
SC	1
DFC	1
FMD NS (FI=1) (field-formatted)	3
FMD NS (FI=0) (character-coded)	0
FMD (LU-LU)	0

Various positive response RUs return additional data. See "Positive Response RUs with Extended Formats."

All negative responses return four bytes of sense data in the RU, followed by either (1) the number of bytes specified in the table above or (2) three bytes (or the entire request RU, if shorter than three bytes). The second option applies to PU.SVC_MGR.CSC_MGR and PC (where a sensitivity to SSCP-based sessions versus LU-LU sessions does not necessarily exist) and can be chosen for other layers for implementation simplicity. Refer to Chapter 8 for sense data values and their corresponding meanings.

RSP(ACTCDRM)

POSITIVE RESPONSE RU'S WITH EXTENDED FORMATS

RSP(ACTCDRM); SSCP-->SSCP, Exp; SC

- 0 X'14' request code
- 1 bits 0-3, format: X'0' (only value defined)
bits 4-7, type activation performed:
 - X'1' cold
 - X'2' ERP
- 2 FM profile
- 3 TS profile
- 4-11 Contents ID: eight-character EBCDIC symbolic name that represents implementation and installation dependent information about the SSCP issuing the response to ACTCDRM; eight space (X'40') characters is the value used if no information is to be conveyed (This field could be used to provide a check for a functional and configurational match between the SSCPs.)
- 12-17 SSCP ID: a six-byte field that includes the ID of the SSCP issuing the ACTCDRM response; the first four bits specify the format for the remaining bits:
 - bits 0-3, 0000
 - bits 4-7, physical unit type of the node containing the SSCP
 - bits 8-47, implementation and installation dependent binary identification
- 18 TS Usage
 - bits 0-1, reserved
 - bits 2-7, secondary CPMGR receive window size (0 means no pacing of requests flowing to the secondary)
- 19-n Control vector, as described in the section "Control Vectors and Control lists," later in this section
Note: The following vector keys may be used in RSP(ACTCDRM):

RSP(ACTCDRM) RSP(ACTLU) RSP(ACTPU)

X'06' CDRM control vector
 X'09' activation request/response
 sequence identifier
 X'FE' one or more control vector
 keys not recognized in the
 corresponding request

RSP(ACTLU); LU-->SSCP, Exp; SC

0 X'0D' request code
 1 Type activation selected:
 X'01' cold
 X'02' ERP
 2 bits 0-3, FM profile: same as the
 corresponding request
 bits 4-7, TS profile: same as the
 corresponding request
 3-7 SSCP-LU session capabilities control
 vector (See the section, "Control
 Vectors and Control Lists," later in
 this section, for control vector
 X'00'.)
 8-23 LU-LU session services capabilities
 control vector (See the section
 "Control Vectors and Control Lists,"
 later in this section, for control
 vector X'0C'.)
Note: A two-byte response can be
 sent; it means maximum RU size = 256
 bytes, LU-LU session limit = 1, LU can
 act as a secondary LU, and all other
 fields in control vectors X'00' and
 X'0C' are defaulted to 0's. except
 Mode Table Name in control vector
 X'0C', which is defaulted to eight
 space (X'40') characters.

RSP(ACTPU); PU-->SSCP|PUCP, Exp; SC

0 X'11' request code
 1 bits 0-1, reserved
 bits 2-3, format of response:
 00 format 0
 01 format 1 (defined only
 for PU_T1s and PU_T2s)
 10 format 2 (this format

RSP(ACTPU)

requires that bits 4-7
be set to X'3')

11 format 3 (only for
PU T4|5s)

Note: If format 0 is used on a
RSP(ACTPU) from a PU_T1|2, it implies
that the PU cannot receive FMD
requests from the SSCP; for format 1,
a control vector specifies this
capability--see the control vector
with Key = X'07'. A PU_T4|5 does not
use format 1, since it can receive FMD
requests.

bits 4-7, type activation selected:

X'1' cold, IPL not
required

X'2' ERP

X'3' cold, IPL required

2-9 Contents ID: eight-character EBCDIC
symbolic name of the load module
currently operating in the node; eight
space (X'40') characters is the
default value

Note: End of Format 0; Formats 1-3
continue below.

10-n Format 1 Continues

10-11 Reserved

12-n Control vector as described in the
section "Control Vectors and Control
Lists," later in this section

Note: The following control vectors
may be used in RSP(ACTPU):

X'07' PU FMD-RU-Usage

X'FE' vector key not recognized in
the corresponding request

10-n Format 2 Continues

10-17 Load module ID: an eight-character
EBCDIC symbolic name of the requested
IPL load module:

X'4040...40' any load module will be
accepted

-X'4040...40' identifies specific
load module name

18-19 Reserved

20-n Control vector as described in the
section "Control Vectors and Control

RSP(ACTPU) RSP(ADLINK) RSP(ADLINKSTA)
RSP(BIND)

lists," later in this section

Note: The following control vectors may be used in RSP(ACTPU):

X'07' PU FMD-RU-Usage

X'FE' vector key not recognized in the corresponding request

10-n Format 3 Continues

10-n Control vector as described in the section "Control Vectors and Control Lists," later in this section

Note: The following control vectors may be used in RSP(ACTPU):

X'09' activation request/response sequence identifier

X'FE' vector keys not recognized in the corresponding request

RSP(ADLINK); PU_T4|5-->SSCP, Norm; FMD NS(c)

0-2 X'41021E' NS header

3-4 Link network address

RSP(ADLINKSTA); PU_T4|5-->SSCP, Norm; FMD NS(C)

0-2 X'410220' NS header

3-4 Adjacent link station network address

RSP(BIND); SLU-->PLU, Exp; SC

0 X'31' request code

Note: The following bytes are returned for the extended nonnegotiable BIND response or for the negotiable BIND response. (The request code alone is sent if a nonnegotiable BIND request specifies no session-level cryptography.)

1 bits 0-3, format: 0000 (only value defined)

bits 4-7, type:

0000 negotiable

0001 nonnegotiable

2-25 Bytes as received on BIND request, for nonnegotiable response; or bytes having the same format, but possibly with values changed from those

RSP(BIND)

- received on the BIND request, for negotiable response
- 26-k Cryptography Options
- 26 bits 0-1, private cryptography options: for nonnegotiable case, same value returned as received in the request, if present--see Note 3
- bits 2-3, session-level cryptography options: for nonnegotiable case, same value returned as received in the request, if present--see Note 3
- bits 4-7, session-level cryptography options field length: same value returned as received in the request, if present--see Note 3 (Bytes 27-k are omitted if this length field is omitted or set to 0.)
- 27 bits 0-1, session cryptography key encipherment method: same value returned as received in the request, if present--see Note 3
- bits 2-4, reserved
- bits 5-7, cryptography cipher method: same value returned as received in the request, if present--see Note 3
- 28-k An eight-byte implementation-chosen, nonzero, pseudo random session-seed cryptography value enciphered under the session cryptography key, if session-level cryptography is specified; otherwise, same value as in BIND, if present--see Note 3
- k+1-r Bytes as received on BIND request, for nonnegotiable response; or bytes having the same format, but possibly with values changed from those received on the BIND request, for negotiable response
- Note 1: The extended format is required for the negotiable BIND response or if session-level

cryptography is specified in the BIND request; otherwise, only the short form (request code) is used.

Note 2: On a response, if the last byte of a response is a length field and that field is 0, that byte may be dropped from the response. This applies also to byte 26 (where the count occupies only bits 4-7) if bits 0-3 are also 0--the entire byte may be dropped if no bytes follow.

Note 3: The Cryptography Options field is returned on the response for a nonnegotiable BIND only when session-level cryptography was specified, or for a negotiable BIND.

RSP(CDINIT); SSCP-->SSCP, Norm; FMD NS(s)

- | | |
|-----|---|
| 0-2 | X'818641' NS header |
| 3 | Format: same value as received in corresponding request
bits 4-7, reserved |
| 4 | Procedure Status:
bits 0-3, reserved
bits 4-7, Status at SSCP receiving CDINIT:
0000 reserved
0001 initiate
successful--proceed
0010 initiate
successful--queued
0011 dequeued--successful
0100 dequeued--unsuccessful |
| 5-6 | Network address of DLU for CDINIT; for CDINIT(DQ), it is the network address of the LU associated with the SSCP receiving the CDINIT(DQ) request |
| 7 | LU status for LU associated with the SSCP receiving the CDINIT request:
bit 0, reserved
bit 1, 0 LU is unavailable
1 LU is available
bits 2-3, (reserved if LU is available)
00 LU session limit |

RSP(CDINIT)

- exceeded
- 01 reserved
- 10 LU is not currently able to comply with the PLU/SLU specification
- 11 reserved
- bit 4, 0 existing SSCP to LU path
- 1 no existing SSCP to LU path
- bit 5, (reserved in formats 0 and 1)
- 0 UNBIND and SESSEND cannot be sent by the LU or by its boundary function (if any)
- 1 UNBIND and SESSEND will be sent by the LU or by its boundary function (if any)
- bits 6-7, 00 reserved
- 01 LU is PLU
- 10 LU is SLU
- 11 reserved

End of Formats 0 and 1; Format 2 continues below

8

COS origin:

- bit 0, 0 no COS name from ILU
- 1 COS name from ILU
- bits 1-2, (reserved if byte 8, bit 0 = 0)
- 01 SSCP(DLU) chose COS name (DLU is SLU)
- 10 SSCP(OLU) chose COS name (OLU is SLU)

bits 3-7, reserved

9-16

COS name (if byte 8, bits 1-2 = 01, this field carries unpredictable values and is not used): symbolic name of class of service in EBCDIC characters

17-24

Mode name (if byte 8, bits 1-2 = 01, this field carries unpredictable values and is not used): an eight-byte symbolic name (implementation and installation dependent) that identifies the set of rules and protocols to be used for the session (included here for use in reactivating the (LU,LU) session, if necessary; see CINIT and SESSEND for

RSP(CDSESEND) RSP(CDTERM) RSP(CINIT)

other details)

RSP(CDSESEND); SSCP-->SSCP, Norm; FMD NS(s)

- 0-2 X'818648' NS header
- 3 bits 0-3, format: 0010 Format 2 (only value defined)
Note: The extended form of RSP(CDSESEND,Format 2) is used only in conjunction with CDSESEND(Format 2). For CDSESEND(Format 0), RSP(CDSESEND,Format 0) includes only bytes 0-2.
bits 4-7, reserved
- 4 Cause: cause of deactivation the (LU,LU) session, as specified in byte 12 of CDSESEND
- 5 Action: any reactivation of the (LU,LU) session to be performed by either the PLU or SLU, as specified in SESEND and CDSESEND and resolved by the SSCPs

RSP(CDTERM); SSCP(DLU)-->SSCP(OLU), Norm; NS(s)

- 0-2 X'818643' NS header
- 3 bits 0-3, 0000 Format 0 (only value defined)
bits 4-7, reserved
- 4 Reserved
- 5-6 Network address of DLU

RSP(CINIT); PLU-->SSCP, Norm; FMD NS(s)

- 0-2 X'810601' NS header
- 3-n Control vectors as described in the section "Control Vectors and Control Lists," later in this appendix
Note: The following control vector key is used in RSP(CINIT):
X'FE' control vector keys not recognized

RSP(DSRLST) RSP(DUMPINIT) RSP(DUMPTTEXT)
RSP(INIT-OTHER-CD)

RSP(DSRLST); SSCP-->SSCP, Norm; NS(s)

0-2 X'818627' NS header
3-n Control list entry data for list type:
X'01' (only value defined) See the
section "Control Vectors and
Control Lists" for the format
of the control list.

RSP(DUMPINIT); PU_T4|5-->SSCP, Norm; FMD NS(c)

0-2 X'010206' NS header
3-n Dump data

RSP(DUMPTTEXT); PU_T4|5-->SSCP, Norm; FMD NS(c)

0-2 X'010207' NS header
3-n Dump data

RSP(INIT-OTHER-CD); SSCP-->SSCP, Norm: FMD NS(s)

0-2 X'818640' NS header
3 Format
bits 0-3, 0000 Format 0 (only value
defined)
bits 4-7, reserved
4 Procedure Status:
bits 0-3, Status for SSCP(LU1)
0000 reserved
0001 initiate
successful--proceed
0010 initiate
successful--queued
0011 dequeued--successful
0100 dequeued--unsuccessful
bits 4-7, Status for SSCP(LU2)
0000 reserved
0001 initiate
successful--proceed
0010 initiate
successful--queued
0011 dequeued--successful
0100 dequeued--unsuccessful
5 LU1 Status
bit 0, reserved
bit 1, 0 LU1 is unavailable

RSP(INIT-OTHER-CD) RSP(RNAA)

- 1 LU1 is available
 - bits 2-3, (reserved if LU1 is available)
 - 00 LU1 session limit exceeded
 - 01 reserved
 - 10 LU1 is not currently able to comply with the PLU/SLU specification
 - 11 reserved
 - bit 4, 0 existing SSCP to LU path
 - 1 no existing SSCP to LU path
 - bit 5, reserved
 - bits 6-7, 00 reserved
 - 01 LU1 is PLU
 - 10 LU1 is SLU
 - 11 reserved
- 6 LU2 Status:
- bit 0, reserved
 - bit 1, 0 LU2 is unavailable
 - 1 LU2 is available
 - bits 2-3, (reserved if LU2 is available)
 - 00 LU2 session limit exceeded
 - 01 reserved
 - 10 LU2 is not currently able to comply with the PLU/SLU specification
 - 11 reserved
 - bit 4, 0 existing SSCP to LU path
 - 1 no existing SSCP to LU path
 - bit 5, reserved
 - bits 6-7, 00 reserved
 - 01 LU2 is PLU
 - 10 LU2 is SLU
 - 11 reserved

RSP(RNAA); PU_T4|5-->SSCP, Norm; FMD NS(c)

- 0-2 X'410210' NS header
- 3-5 Set to same value as bytes 3-5 in RNAA request:
- 3-4 Network address of target link, adjacent link station, or LU
- 5 Assignment type

RSP(RNAA) RSP(ROUTE-TEST)

- 6 Number of network addresses returned
- 7-8 Network address assigned: adjacent link station address for assignment type 0; BF.LU network address for assignment type 1; LU address for assignment type 2
- 9-n Any additional network addresses assigned (two-byte multiples), in the same format as bytes 7-8; the order of the network addresses returned corresponds to the order of the entries (bytes 7-n) in the RNAA request

RSP(ROUTE-TEST); PU_T4|5-->SSCP, Norm; FMD
NS(ma)

- 0-2 X'410306' NS header
- 3 Format: X'01'
- 4 Count of the number of Route Data fields
- 5-13 Route Data: information about the ERs or VRs that were tested.
- 5 Virtual route identifier:
bits 0-3, VRN of the VR tested
bits 4-5, reserved
bits 6-7, transmission priority field of the VR tested
- 6 VR status:
X'00' VR is not defined
X'01' VR is in reset state
X'02' activation of the VR is pending notification of the activation of the underlying ER
X'03' an NC-ACTVR was sent to activate the VR, but no RSP(NC-ACTVR) has been received
X'04' an NC-ACTVR was received to activate the VR, but no RSP(NC-ACTVR) has been sent
X'05' an NC-DACTVR(Orderly) has been sent, but no RSP(NC-DACTVR) has been received
X'06' an NC-DACTVR(Orderly) was

received, but no
 X'07' RSP(NC-DACTVR) has been sent
 an NC-DACTVR(Forced) was
 received, but no
 X'08' RSP(NC-DACTVR) has been sent
 an NC-DACTVR(Forced) was sent
 but no RSP(NC-DACTVR) has been
 received
 X'09' VR is active
 7 bits 0-3, reserved
 bits 4-7, ERN of the ER tested
 8 ER status:
 X'00' ER is not defined and not
 currently operative
 X'01' ER is defined but not
 currently operative
 X'02' ER is defined and operative,
 but not currently active
 X'03' an NC-ER-ACT was sent, but no
 NC-ER-ACT-REPLY has been
 received
 X'04' an NC-ER-ACT was received, but
 no NC-ER-ACT-REPLY has been
 sent
 X'05' an NC-ER-ACT was received and
 an NC-ER-ACT-REPLY was sent;
 an NC-ER-ACT was sent, but no
 NC-ER-ACT-REPLY has been
 received
 X'06' an NC-ER-ACT was received but
 no ER is defined; should the
 ER subsequently become
 defined, an NC-ER-ACT will be
 sent
 X'07' an NC-ER-ACT was received and
 an NC-ER-ACT-REPLY was sent
 (no NC-ER-ACT has been sent
 from this end)
 X'08' ER is active and each node on
 the ER supports ER-VR
 protocols
 X'09' ER is operative but not
 currently defined
 X'0A' ER is active and traverses a
 node that does not support
 ER-VR protocols

RSP(ROUTE-TEST) RSP(STSN)

- 9-12 Subarea address of the adjacent node through which the ER being tested flows from this node
- 13 Transmission group number of the TG (to the node identified in bytes 9-12) over which the ER being tested flows from this node
- 14-n Any additional 9-byte entries in the same format as bytes 5-13

RSP(STSN); SLU-->PLU, Exp; SC

- 0 X'A2' request code
 - 1 bits 0-1, result code for S-->P action code in the request (related data in bytes 2-3)
bits 2-3, result code for P-->S action code in the request (related data in bytes 4-5)
- Note 1: Values for either result code are:
- For set or ignore action code:
 - 01 ignore (other values reserved); appropriate bytes 2-3 or 4-5 reserved
 - For sense action code:
 - 00 for LU-LU session type 0: user-defined meaning; for all other LU-LU session types: reserved (appropriate bytes 2-3 or 4-5 reserved)
 - 01 reserved
 - 10 secondary half-session's sync point manager does not maintain or cannot return a valid transaction processing program sequence number (appropriate bytes 2-3 or 4-5 reserved)
 - 11 transaction processing

program sequence number, as known at the secondary, is returned in bytes 2-3 or 4-5, as appropriate

- For set and test action code:
 - 00 for LU-LU session type 0: user-defined meaning; for all other LU-LU session types: invalid sequence numbers have been detected by the secondary (appropriate bytes 2-3 or 4-5 return the secondary transaction processing program sequence number)

Note 2: invalid determination results when the sequence number indicated could not have occurred. For example, the mounting of an incorrect sync point log tape by the operator at one of the LUs would cause this condition.

- 01 value received in STSN request equals the transaction processing program sequence number value as known at the secondary (appropriate bytes 2-3 or 4-5 return the secondary's value for the transaction processing program sequence number)
- 10 secondary half-session's sync point manager does not maintain or cannot return a valid transaction processing

RSP(STSN)

- program sequence number
(appropriate bytes 2-3
or 4-5 reserved)
- 11 value received in STSN
request does not equal
the transaction
processing program
sequence number value
as known at the
secondary (appropriate
bytes 2-3 or 4-5 return
the secondary's value
for the transaction
processing program
sequence number)
- bits 4-7, reserved
- 2-3 Secondary-to-primary normal-flow
sequence number data to support S-->P
result code, or reserved (see Note 1
above)
- 4-5 Primary-to-secondary normal-flow
sequence number data to support P-->S
result code or reserved (see Note 1
above)

Note 2: Where the STSN request
specified as action codes two "sets,"
two "ignores," or a combination of
"set" and "ignore," the positive
response RU optionally may consist of
one byte--X'A2' (the STSN request
code)--rather than all six bytes.

Control Vectors and Control Lists

CONTROL VECTORS AND CONTROL LISTS

The following table shows, by key value, the requests and responses that carry the specific control vector:

<u>Control Vector Key</u>	<u>Requests or Responses Carrying the Vector</u>
X'00'	RSP(ACTLU)
X'01'	SETCV (NS(c))
X'02'	SETCV (NS(c))
X'03'	SETCV (NS(c))
X'04'	SETCV (NS(c))
X'05'	SETCV (NS(c))
X'06'	ACTCDRM, RSP(ACTCDRM)
X'07'	RSP(ACTPU)
X'08'	SETCV (NS(ma))
X'09'	ACTCDRM, ACTPU, RSP(ACTCDRM ACTPU)
X'0B'	ACTPU
X'0C'	RSP(ACTLU)
X'0D'	CINIT
X'FE'	RSP(ACTCDRM ACTPU ACTLU CINIT)

The following table shows, by list type, the requests and responses that carry the specific control list:

<u>Control List Type</u>	<u>Requests or Responses Carrying the List</u>
X'01'	+RSP(DSRLST)

The control vectors are defined as follows (with zero-origin indexing of the vector bytes--see the individual RU description for the actual displacement within the RU):

Control Vectors

SSCP-LU Session Capabilities Control Vector

- 0 Key: X'00'
- 1 Maximum RU size sent on the normal flow by either half-session: if bit 0 is set to 0, then no maximum is specified and the remaining bits 1-7 are ignored; if bit 0 is set to 1, then the byte is interpreted as X'ab' = $a \cdot 2^b$ (Notice that, by definition, $a \geq 8$ and therefore X'ab' is a normalized floating point representation.) See RU Sizes Corresponding to X'ab' in BIND for all possible values.
- 2-3 LU Capabilities
- 2 bit 0, character-coded capability:
 - 0 the SSCP may not send unsolicited character-coded requests; a solicited request is a reply request or a request that carries additional error information to supplement a previously sent negative response or error information after a positive response has already been sent
 - 1 the SSCP may send unsolicited character-coded requests
- bit 1, field-formatted capability:
 - 0 the SSCP may not send unsolicited field-formatted requests
 - 1 the SSCP may send unsolicited field-formatted requests
- 2-3 bits 2-15, reserved
- 4 Reserved

Date-Time Control Vector

- 0 Key: X'01'
- 1-12 Date, in EBCDIC: MM/DD/YY.ddd (MM = month; DD = day of month; YY = year; ddd = Nth day of year, 1-366)
- 13-20 Time, in EBCDIC: HH.MM.SS (HH = hours; MM = minutes; SS = seconds)

Subarea Routing Control Vector

- 0 Key: X'02'
- 1 Subarea address (left-justified)

SDLC Secondary Station Control Vector

- 0 Key: X'03'
- 1 Reserved
- 2 PU type identifier for SPU:
 - bits 0-4, reserved
 - bits 5-6, 01 PU_T2
10 PU_T1
 - bit 7, reserved
- 3 Type modifier:
 - bit 0, (reserved except when byte 2 identifies PU_T1)
 - 0 TS Profile 2
 - 1 TS Profile 2
 - bit 1, 0 discontinue link-level contact with adjacent PU_T1|2 node if the PU_T4 initiates an auto network shutdown procedure for the SSCP controlling that PU_T1|2 node
 - 1 continue link-level contact with adjacent PU_T1|2 node if the PU_T4 initiates an auto network shutdown procedure for the SSCP controlling that PU_T1|2 node
- bits 2-7, reserved
- 4 SDLC BTU send limit
- 5 Maximum consecutive BTUs sent from the primary station to the specified secondary station without another secondary station on the link being polled or being sent BTUs

Control Vectors

- 6 Error retry indicator
- 7-8 Link error recovery control information
- 9-10 Byte count of maximum BTU size permitted to be sent to the adjacent link station represented by the specified SPU

LU Control Vector

- 0 Key: X'04'
- 1 Local address form of LU network address
- 2 bits 0-1, reserved
bits 2-7, secondary CPMGR's receive pacing count
- 3 Reserved, set to a value of 1
- 4 Scheduling priority to be used for the BF.TCs supporting secondary half-sessions involving the specified LU:
 - X'01' low priority (batch)
 - X'02' high priority (interactive)

Channel Control Vector

- 0 Key: X'05'
- 1-2 Channel delay: minimum interval between successive inbound transmissions (binary, in tenths of a second)

CDRM Control Vector (Carries information on the capabilities of the SSCP sending the control vector.)

- 0 Key: X'06'
- 1 Length, in binary, of Description field (X'00' = no Description field present)
- 2-n Description Field
- 2 CDRM profile: X'00' (only value defined)
- 3 CDRM usage:
 - bit 0, 0 name pair session key (X'06') supported
 - 1 name pair session key not supported
 - bit 1, 0 address pair session key

- (X'07') not supported
- 1 address pair session key supported
- bit 2, 0 parallel sessions not supported
- 1 parallel sessions supported
- bit 3, 0 URC not supported by SSCP (and all PLUs within its domain) in cross-domain session initiation
- 1 URC supported by SSCP (and all PLUs within its domain) in cross-domain session initiation
- bit 4, reserved
- bit 5, 0 PCID session key (X'05') not supported
- 1 PCID session key supported
- bit 6, 0 CDESSEND from SSCP(SLU) and CDINIT(Format 2) not supported; requires NS-LSA to reset session knowledge; therefore, all sessions managed by the SSCP use virtual routes mapping to ERO from the subarea of the SLU to the subarea of the PLU
- 1 CDESSEND from SSCP(SLU) and CDINIT(Format 2) supported; NS-LSA is not used to reset session knowledge; therefore, no ER restrictions exist for sessions managed by this SSCP
- bit 7, 0 Format 2 CDESSEND not supported
- 1 Format 2 CDESSEND supported

Note: If the control vector is omitted or the length is 0, the corresponding request or response implicitly specifies that the name pair session key is supported and the others are not.

Control Vectors

4-n Reserved

PU FMD-RU-Usage Control Vector

0 Key: X'07'

1 bits 0-5, reserved

bit 6, adjacent PU load capability
(initialized to 0 by the
PU_T2):

0 adjacent PU cannot load the
PU_T2 node

1 adjacent PU can load the
PU_T2 node (set by the
boundary function in the
adjacent subarea node)

bit 7, FMD request capability of the
node:

0 PU cannot receive FMD
requests from the SSCP

1 PU can receive FMD requests
from the SSCP

2-7 Reserved

Intensive Mode Control Vector

0 Key X'08'

1 bit 0, 0 reset intensive mode

1 set intensive mode

bits 1-7, reserved

2-3 Maximum number of intensive mode
records (IMRs)

Activation Request/Response Sequence Identifier Control Vector

0 Key: X'09'

1 Length, in binary, of Vector Data
field

2-9 Vector Data Field

2-9 Activation request/response sequence
identifier: an eight-byte binary
value, generated by the sender of
ACTCDRM, RSP(ACTCDRM), ACTPU, and
echoed in RSP(ACTPU), and used by the
receiver to determine whether the
current RU supersedes a previously
received RU from the same sender (If
the current RU has an activation
request/response sequence identifier

Control Vectors

value greater than the corresponding activation request/response sequence identifier value of the earlier ACTPU, ACTCDRM, or RSP(ACTCDRM), the current RU is accepted and processed, while the earlier RU is superseded. The eight-byte field has the following characteristic: If n1 was generated at time t1, and n2 was generated at time t2, and $t1 < t2$, then $n1 < n2$.)

SSCP-PU Session Capabilities Control Vector

0 Key: X'0B'
 1 Length, in binary, of Vector Data field
 2 Vector Data Field
 2 bit 0, 0 NS-LSA required
 1 NS-LSA not required
 bit 1, 0 adjacent link station network address not supported
 1 adjacent link station network address supported
 bits 2-7, reserved

LU-LU Session Services Capabilities Control Vector

0 Key: X'0C'
 1 Length, in binary, of vector data field
 2-15 Vector Data Field
 2 bits 0-3, primary LU capability:
 0000 cannot ever act as primary LU
 0001 cannot currently act as primary LU
 0010 reserved
 0011 can now act as primary LU
 bits 4-7, secondary LU capability:
 0000 cannot ever act as secondary LU
 0001 cannot currently act as secondary LU
 0010 reserved
 0011 can now act as

Control Vectors

- secondary LU
- 3-4 LU-LU session limit (where a value of 0 means that no session limit is specified)
- 5-6 LU-LU session count: the number of LU-LU sessions that are not reset, for this LU, and for which SESSEND will be sent to the SSCP
- 7 bit 0, parallel session capability:
 0 parallel sessions not supported
 1 parallel sessions supported
bit 1, 0 do not send NOTIFY at the completion of (LU,LU) session deactivation
 1 send NOTIFY at the completion of the (LU,LU) session deactivation
- bits 2-7, reserved
- 8-15 Mode table name: an eight-character symbolic name (implementation and installation dependent) that identifies the mode table that contains the mode name (A value of eight space (X'40') characters means that the mode table name is to be selected by the SSCP.)

Mode/Class-of-Service/Virtual-Route-Identifier-List Control Vector

- 0 Key: X'0D'
- 1 Length, in binary, of vector data field
- 2-n Vector Data Field
- 2-9 Mode name: an eight-character symbolic name (implementation and installation dependent) that identifies the set of rules and protocols to be used for the session; used by the SSCP(SLU) to select the BIND image that will be used by the SSCP(PLU) to build the CINIT request
- 10-17 COS name: symbolic name of class of service in EBCDIC characters
- 18-n Virtual Route Information
- 18 Length (in bytes)--including format,

Control Vectors

- type, number of entries, and entries of Virtual Route Information field
- 19 Format of virtual route identifier list:
X'00' format 0 (only value defined)
- 20 Type of virtual route required:
X'00' only virtual routes mapping to ERO from the subarea of the SLU to the subarea of the PLU may be used
X'01' virtual routes mapping to any ERN may be used
- 21 Number of entries in the virtual route identifier list
- 22-n Virtual route identifier list:
two-byte (VRN, TPF) entries where VRN is one byte and TPF is one byte

Control Vector Keys Not Recognized Control Vector

- 0 Key: X'FE'
- 1 Length, in binary, of vector data field
- 2-n Vector Data Field
- 2 Control vector key value not recognized in corresponding request
- 3-n Any additional unrecognized control vector keys

Control Lists

control lists are defined, by type, as follows (with zero-origin indexing of the list bytes; see the individual RU description for the actual displacement within the RU):

Type X'01': LU Status Control List Entry

- 0 LU status
 - bit 0, reserved
 - bit 1, 0 LU is unavailable
 - 1 LU is available
 - bits 2-3, (if LU is unavailable)
 - 00 LU session count exceeded
 - 01 LU is being taken down (not accepting new sessions)
 - 10 LU is not currently able to comply with the PLU/SLU specification
 - 11 reserved
 - bit 4, 0 existing SSCP to LU path
 - 1 no existing SSCP to LU path
 - bits 5-7, reserved
- 1 LU information:
 - bit 0, 0 LU does not reside in a PU_T5 node
 - 1 LU resides in a PU_T5 node
 - bits 1-6, reserved
 - bit 7, 0 LU is accepting INITIATES/logons
 - 1 LU is temporarily not accepting INITIATES/logons
- 2-3 Session count (range: 0-65535)

DLC XID INFORMATION-FIELD FORMATS

This section describes the formats of the information field of the XID command (sent by a primary link station) and response (sent by a secondary link station); XID Formats 0, 1, and 2 apply to SDLC, and Format 2 applies also to the System/370 channel DLC. The response format for Formats 0 and 1 is also carried in the REQCONT request RU, which is sent from the PPU to the SSCP or PUCP. The contents of XID Format 2 sent and received are also included in the CONTACTED RU, which is sent from the PU to the SSCP or PUCP.

- 0 bits 0-3, format of XID I-field:
- X'0' fixed format: only bytes 0-5 are included
 - X'1' variable format (for PU_T1|2 to PU_T4|5 node exchanges): bytes 0-p are included
 - X'2' variable format (for PU_T4|5 to PU_T4|5 node exchanges): bytes 0-p are included
- bits 4-7, type of the XID-sending node:
- X'1' PU_T1
 - X'2' PU_T2
 - X'3' reserved
 - X'4' subarea node (PU_T4 or PU_T5)
- 1 Length, in binary, of variable-format XID I-field; reserved for fixed-format XID I-field
- 2-5|7 Node Identification
- 2-5 bits 0-11, Block number: an IBM product specific number; see the individual product specifications for

XID I-Field

the specific values used
bits 12-31, ID number: a binary value that, together with the block number, identifies a specific station uniquely within a customer network installation; the ID number can be assigned in various ways, depending on the product; see the individual product specifications for details

- End of Format 0

6-p Format 1 Continuation

6-7 Reserved

8 Link Station and Connection Protocol
Flags

8 bits 0-1, reserved

bit 2, link-station role of XID

sender:

0 sender is a secondary link station

1 sender is a primary link station

bit 3, reserved

bits 4-7, link-station

transmit-receive capability:

X'0' two-way alternating

X'1' two-way simultaneous

9 Characteristics of the node of the XID sender:

bits 0-1, reserved

bits 2-3, segment assembly capability of the path control element of the node:

00 the Mapping field is ignored and PIUs are forwarded unchanged

01 segments are assembled on a link-station basis

10 segments are assembled on a session basis

11 only whole BIUs are allowed

bits 4-7, reserved

10-11 Maximum I-field length that the XID

sender can receive:
 bit 0, format flag:
 0 bits 1-15 contain the
 maximum I-field length
 (only value defined)
 bits 1-15, maximum I-field length, in
 binary
 12 bits 0-3, reserved
 bits 4-7, SDLC command/response
 profile:
 X'0' SNA link profile
 (only value defined)
Note: This profile refers
 to the mandatory
 command/response support on
 a SDLC link, as follows:

- For an SDLC link, having a point-to-point or multipoint configuration, the support required is:

Commands

Responses

I-frames	I-frames
RR	RR
RNR	RNR
Test	Test
XID	XID
SNRM	UA
Disconnect	DM
-	RD (Note 1)
-	Frame Reject
Reject (Note 2)	Reject (Note 2)

Note 1: The RD response is sent by the secondary station if and only if the SPU in its node receives a DISCONTACT request from its SSCP or PUCP.

XID I-Field

Note 2: Reject is required only if both sender and receiver have two-way simultaneous transmit-receive capability.

- For an SDLC link having a loop configuration, the support required is:

Commands

Responses

I-frames	I-frames
RR	RR
RNR	RNR
Test	Test
XID	XID
SNRM	UA
Disconnect	DM
UP	-
-	Frame
-	Reject
Configure	Configure
-	Beacon
-	RD
-	(Note)

Note: The RD response is sent by the secondary station if and only if the SPU in its node receives a DISCONTACT request from its SSCP or PUCP.

- 13 bits 0-1, reserved
bit 2, SDLC initialization mode options:
 0 SIM and RIM not supported
 1 SIM and RIM supported
- 14-15 bits 3-7, reserved
Reserved
- 16 bit 0, reserved
bits 1-7, maximum number of I-frames that can be received by the

XID sender before an acknowledgment is sent, with an implied modulus for the send and receive sequence counts--less than 8 implies a modulus of 8, 8 or greater implies a modulus of 128

17	Reserved
18-m	<u>SDLC Address Assignment Field</u>
18	Length in bytes (or octets) of the SDLC address to be assigned (bytes 19-m)
19-m	Secondary station address to be assigned
m+1-p	<u>Dial Digits of XID Sender</u>
m+1	Number of dial digits
m+2-p	Dial digits: any byte value of the form X'Fn' ($0 \leq n \leq F$) is valid
	• End of Format 1
8-p	<u>Format 2 Continuation</u>
8	bit 0, TG status:
	0 TG inactive
	1 TG active
	bit 1, multiple-link TG support:
	0 multiple-link TG not supported
	1 multiple-link TG supported
	bits 2-3, segment assembly capability of the path control element of the node:
	00 segments are ignored and passed through
	01 segments are assembled on a link station basis
	10 segments are assembled on a session basis
	11 segments are not allowed
	bits 4-7, reserved
9	FID types supported:
	bit 0, 0 FID 0 not supported
	1 FID 0 supported
	bit 1, 0 FID 1 not supported
	1 FID 1 supported
	<u>Note:</u> Neither bit 0 nor bit 1 is set to 1 when XID Format 2

XID 1-Field

is exchanged, but can be set by PU.SVC_MGR when the contents of XID Format 2 is carried in the CONTACTED RU.

- bits 2-3, reserved
- bit 4, 0 FID 4 not supported
1 FID 4 supported
- bits 5-7, reserved
- 10 Reserved
- 11-12 Length, in binary, of maximum PIU that the XID sender can receive
- 13 Transmission group number (TGN)
- 14-17 Subarea address of the XID sender (right-justified with leading 0's)
- 18 bit 0, reserved
bits 1-4, error status (set in reply to a previously received XID):
 - X'8' exchanged parameters in the XIDs are not compatible
 - X'9' incompatible parameters in the XID received for addition of the link station to currently active multiple-link TG (for example, maximum PIU length)
 - X'A' TG is not defined (that is, no routing found)
 - X'C' multiple-link TG support (byte 8, bit 1) or DLC type (byte 30) specified in the XIDs is incompatible with a link in the associated active TG
- bits 5-7, reserved
- 19 CONTACT or load status of XID sender:
 - X'00' CONTACT has been received by an XID command sender
 - X'07' XID response sender is already loaded
- 20-27 IPL load module name: an 8-character

	EBCDIC symbolic name of the IPL load module of the XID sender
	<u>Note:</u> X'40...40' = no information conveyed
28-29	Reserved
30	DLC type: X'01' SDLC X'02' System/370 channel--communication controller is the secondary
31-p	<u>DLC-Dependent Parameters</u>
	• For SDLC
31	bits 0-1, reserved bits 2-3, link-station role of XID sender: bit 2, 0 XID sender cannot be secondary 1 XID sender can be secondary bit 3, 0 XID sender cannot be primary 1 XID sender can be primary <u>Note:</u> A combination of 00 in bits 2-3 is reserved. bits 4-5, reserved bits 6-7, link station transmit-receive capability: 00 two-way alternating 01 two-way simultaneous
32-33	Maximum 1-field length, in binary, that the XID sender can receive
34	bits 0-3, reserved bits 4-7, SDLC command/response profile: X'0' SNA link profile (only value defined) <u>Note:</u> See the Notes described in Format 1, byte 12, for this profile.
35	bits 0-1, reserved bits 2-3, SDLC initialization mode options: bit 2, 0 XID sender cannot send SIM nor receive RIM (or RQI) 1 XID sender can send SIM and receive RIM (or RQI) bit 3, 0 XID sender cannot receive

XID 1-Field

- SIM nor send RIM (or RQI)
1 XID sender can receive SIM
and send RIM (or RQI)
bits 4-7, reserved
- 36-37 Reserved
38 bit 0, reserved
bits 1-7, maximum number of 1-frames
that can be received by the
XID sender before an
acknowledgment is sent, with
an implied modulus for the
send and receive sequence
counts--less than 8 implies
a modulus of 8, 8 or greater
implies a modulus of 128
- 39-43(=p) Reserved
- 31-p For System/370 Channel DLC
31 Number of initial buffers suggested by
the primary link station for the
secondary link station to use for data
transfer from primary to secondary
(primary sets and secondary echoes)
Note: X'00' = no suggestion made. If
byte 31 = X'00' in the XID received,
secondary uses the value defined by
optional implementation and
installation specific parameters and
sends it to the primary
- 32-33 Number of Read channel command words
that primary issues to secondary in a
channel program (primary sets and
secondary echoes)
Note: If secondary does not agree
with the received value, secondary
sends the value defined by
implementation- and
installation-specific parameters; byte
18, bit 1, is set to 1.
- 34-35 Number of data bytes allocated per
Read channel command at primary
(primary sets and secondary echoes)
Note: If secondary does not agree
with the received value, secondary
sends the value defined by
implementation- and
installation-specific parameters; byte

- 18, bit 1, is set to 1.
- 36 Number of pad (X'00') characters secondary transmits to primary immediately preceding each PIU to be sent (primary sets and secondary echoes)
Note: If secondary does not agree with the received value, secondary sends the value defined by implementation- and installation-specific parameters; byte 18, bit 1, is set to 1.
- 37 bit 0, reserved for primary; for secondary:
- 0 secondary does not use the status modifier option for data transfer to primary
 - 1 secondary uses the status modifier option for data transfer to primary
- bit 1, reserved
- bit 2, reserved for secondary; for primary:
- 0 if the TG specified in this XID is active, the secondary is to send an XID response with error status X'C' in byte 18
 - 1 if the TG specified in this XID is active and associated with another System/370 channel, INOP is to be sent for the previously activated System/370 channel and the requested System/370 channel is to be activated
- bits 3-7, reserved
- 38-39 Reserved for primary; for secondary: the maximum interval (in tenths of a second) that the secondary delays between the time it has a PIU for the primary and the time it presents an Attention signal to the primary
- 40-41(=p) Reserved for primary; for secondary: the maximum interval (in tenths of a

XID I-Field

second) that the secondary awaits a response to an Attention signal that has been sent to the primary before initiating inoperative link processing

User Data Structured Subfield Formats

The structured subfields of the User Data field are defined as follows (shown with zero-origin indexing of the subfield bytes--see the individual RU description for the actual displacement within the RU):

- Structured subfield X'00':
unstructured data
 - 0 Length of unstructured data field (if 0, this field may be omitted entirely)
 - 1 X'00'
 - 2-n Unstructured data
- Structured subfield X'01': session qualifier
 - 0 Length of session qualifier field (if 0, this field may be omitted entirely)
 - 1 X'01'
 - 2 Length of primary resource qualifier (X'00' means no primary resource qualifier is present: values 0 to 8 are valid)
 - 3-n Primary resource qualifier
 - n+1 Length of secondary resource qualifier (X'00' means no secondary resource qualifier is present: values 0 to 8 are valid)
 - n+2-m Secondary resource qualifier

Exponent (b)	Mantissa (a)							
	8	9	A (10)	B (11)	C (12)	D (13)	E (14)	F (15)
0	8	9	10	11	12	13	14	15
1	16	18	20	22	24	26	28	30
2	32	36	40	44	48	52	56	60
3	64	72	80	88	96	104	112	120
4	128	144	160	176	192	208	224	240
5	256	288	320	352	384	416	448	480
6	512	576	640	704	768	832	896	960
7	1024	1152	1280	1408	1536	1664	1792	1920
8	2048	2304	2560	2816	3072	3328	3584	3840
9	4096	4608	5120	5632	6144	6656	7168	7680
A (10)	8192	9216	10240	11264	12288	13312	14336	15360
B (11)	16384	18432	20480	22528	24576	26624	28672	30720
C (12)	32768	36864	40960	45056	49152	53248	57344	61440
D (13)	65536	73728	81920	90112	98304	106496	114688	122880
E (14)	131072	147456	163840	180224	196608	212992	229376	245760
F (15)	262144	294912	327680	360448	393216	425984	458752	491520

Note: A value of X'ab' in byte 10 or byte 11 of BIND represents $a \cdot 2^{**b}$. For example, X'C5' represents (in decimal)
 $12 \cdot 2^{**5} = 384$.

CHAPTER 5. LINK TRAILER

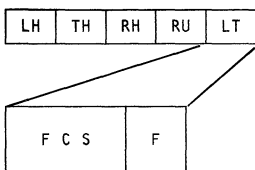

This chapter summarizes information from **Synchronous Data Link Control General Information (GA27-3093)**.

The link trailer described here is from IBM's **Synchronous Data Link Control (SDLC)**.

The link trailer (LT) follows the request/response unit (RU) and is three bytes long. The first two bytes make up the frame check sequence; the last byte, the closing flag.

FRAME CHECK SEQUENCE

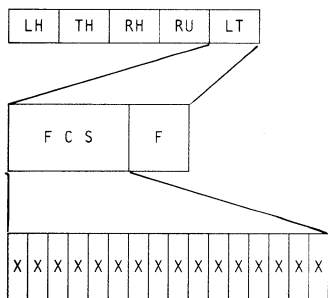

Frame Check Sequence (FCS)

The frame check sequence carries information that the receiver uses to check the received BLU for errors that may have been introduced by the communication channel. This field contains a 16-bit check sequence that is the result of a computation on the contents of the LH (with the exception of the flag), TH, RH, and RU fields at the transmitter. cyclic redundancy checking (CRC) is used to perform this calculation.

The receiver performs a similar computation and checks its results.

FLAG

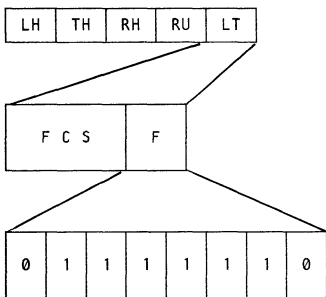

Flag (F) X'7E' B'01111110'

All BLUs end with a flag. The configuration of the ending (trailing) flag is the same as that of the beginning (leading) flag: 01111110 (X'7E'). See Chapter 1, "Link Header," for information on shared leading/trailing flags.

This page left intentionally blank

PART 2

Diagnostic Aids

Chapter 6	FM Profiles
Chapter 7	TS Profiles
Chapter 8	Sense Codes
Chapter 9	FM Headers
Chapter 10	Logical Unit To Logical Unit Session Types
Chapter 11	Physical Unit and Node Types
Chapter 12	SNA Character Sets
Chapter 13	Products and SNA
Chapter 14	Common Sequences
Chapter 15	Other SNA Publications
Chapter 16	SNA Acronym Glossary

CHAPTER 6. FM PROFILES

This chapter summarizes information from **Systems Network Architecture Format and Protocol Reference Manual: Architectural Logic** (SC30-3112).

This chapter describes the function management (FM) profiles and their use by the various sessions defined in SNA. Profile numbers not shown are reserved.

Note: If the FM Usage field specifies a value for a parameter, that value is used unless it conflicts with a value specified by the FM profile. The FM profile overrides the FM Usage field.

FM PROFILE 0

Profile 0 specifies the following session rules:

- Primary and secondary half-sessions use immediate request mode and immediate response mode.
- Only single-RU chains allowed.
- Primary and secondary half-session chains indicate definite response.
- No compression.
- Primary half-session sends no DFC RUs.
- Secondary half-session may send LUSTAT.
- No FM headers.
- No brackets.
- No alternate code.
- Normal-flow send/receive mode is HDX-CONT.
- Secondary half-session wins contention.
- Primary half-session is responsible for recovery.

FM PROFILE 2

Profile 2 specifies the following session rules:

- Secondary LU half-session uses delayed request mode.
- Secondary LU half-session uses immediate response mode.
- Only single-RU chains allowed.
- Secondary LU half-session requests indicate no-response.
- No compression.
- No DFC RUs.
- No FM headers.
- Secondary LU half-session is first speaker if brackets are used.
- Bracket termination rule 2 is used if brackets are used.
- Primary LU half-session will send EB.
- Secondary LU half-session will not send EB.
- Normal-flow send/receive mode is FDX.
- Primary LU half-session is responsible for recovery.

The FM Usage fields defining the options for Profile 2 are:

- Primary request control mode selection
- Primary chain response protocol
(no-response may not be used)
- Brackets usage and reset state
- Alternate code

FM PROFILE 3

Profile 3 specifies the following session rules:

- Primary LU half-session and secondary LU half-session use immediate response mode.
- Primary LU half-session and secondary LU half-session support the

following DFC functions:

CANCEL
SIG
LUSTAT (allowed
secondary-to-primary only)
CHASE
SHUTD
SHUTC
RSHUTD
BID and RTR (allowed only if
brackets are used)

The FM usage fields defining the options for
Profile 3 are:

Chaining use (primary and secondary)
Request control mode selection
(primary and secondary)
Chain response protocol (primary and
secondary)
Compression indicator (primary and
secondary)
Send EB indicator (primary and
secondary)
FM header usage
Brackets usage and reset state
Bracket termination rule
Alternate Code Set Allowed indicator
Normal-flow send/receive mode
Recovery responsibility
Contention winner/loser
Half-duplex flip-flop reset states

FM PROFILE 4

Profile 4 specifies the following session rules:

Primary LU half-session and secondary
LU half-session use immediate
response mode.
Primary LU half-session and secondary
LU half-session support the
following DFC functions:

CANCEL
SIG
LUSTAT
QEC
QC
RELQ
SHUTD
SHUTC
RSHUTD
CHASE
BID and RTR (allowed only if
brackets are used)

The FM Usage fields defining the options for
Profile 4 are:

Chaining use (primary and
secondary)
Request control mode selection
(primary and secondary)
Chain response protocol (primary
and secondary)
Compression indicator (primary
and secondary)
Send EB indicator (primary and
secondary)
FM header usage
Brackets usage and reset state
Bracket termination rule
Alternate Code Set Allowed
indicator
Normal-flow send/receive mode
Recovery responsibility
Contention winner/loser
Half-duplex flip-flop reset
states

FM PROFILE 5

Profile 5 specifies the following session rules:

Only single-RU chains allowed.
Primary half-session uses delayed
request mode.
Secondary half-session uses delayed

- request mode and delayed response mode.
- Primary half-session chains indicate definite response.
- Secondary half-session chains indicate no-response or definite response.
- No compression.
- No DFC RUs.
- No FM headers.
- No brackets.
- No alternate code.
- Normal-flow send/receive mode is FDX.

FM PROFILE 6

Profile 6 specifies the following session rules:

- Only single-RU chains allowed.
- Primary and secondary half-sessions use delayed request mode and delayed response mode.
- Primary and secondary half-session chains may indicate definite response, exception response, or no response.
- Primary half-session sends no DFC RUs.
- Secondary half-session may send LUSTAT.
- No FM headers.
- No compression.
- No brackets.
- No alternate code.
- Normal-flow send/receive mode is FDX.

FM PROFILE 7

Profile 7 specifies the following session rules:

- Primary LU half-session and secondary LU half-session use immediate response mode.

Primary LU half-session and secondary LU half-session support the following DFC functions:

CANCEL
SIG
LUSTAT
RSHUTD

The FM Usage fields defining the options for Profile 7 are:

Chaining use (primary and secondary)
Request control mode selection
(primary and secondary)
Chain response protocol (primary and secondary)
Compression indicator (primary and secondary)
Send EB indicator (primary and secondary)
FM header usage
Brackets usage and reset state
Bracket termination rule
Alternate Code Set Allowed indicator
Normal-flow send/receive mode
Recovery responsibility
Contention winner/loser
Half-duplex flip-flop reset rules

FM PROFILE 17

Profile 17 specifies the following session rules:

Only single-RU chains allowed.
Primary and secondary half-sessions use delayed request mode and delayed response mode.
Primary and secondary half-session chains indicate definite response.
No DFC RUs.
No FM headers.
No compression.
No brackets.

No alternate code.
Normal-flow send/receive mode is FDX.

FM PROFILE 18

Profile 18 specifies the following session rules:

Primary LU half-session and secondary LU half-session use immediate response mode.

Primary LU half-session and secondary LU half-session support the following DFC functions:

CANCEL
SIG
LUSTAT
BIS and SBI (allowed only if brackets are used)
RSHUTD
CHASE
BID and RTR (allowed only if brackets are used)

The FM Usage fields defining the options for Profile 18 are:

Chaining use (primary and secondary)
Request control mode selection (primary and secondary)
Chain response protocol (primary and secondary)
Compression indicator (primary and secondary)
Send EB indicator (primary and secondary)
FM header usage
Brackets usage and reset state
Bracket termination rule
Alternate Code Set Allowed indicator
Normal-flow send/receive mode
Recovery responsibility

Contention winner/loser
Half-duplex flip-flop reset
states

FM Profile	Session Type(s)
0	SSCP-PU, SSCP-LU
2	LU-LU
3	LU-LU
4	LU-LU
5	SSCP-PU
6	SSCP-LU
7	LU-LU
17	SSCP-SSCP
18	LU-LU

Figure 6-1. FM Profiles and Session Types

CHAPTER 7. TS PROFILES

This chapter summarizes information from **Systems Network Architecture Format and Protocol Reference Manual: Architectural Logic (SC30-3112)**.

This chapter describes the transmission services (TS) profiles and their uses for the various sessions defined in SNA. Profile numbers not shown are reserved.

Note: If the TS Usage field specifies a value for a parameter, that value is used unless it conflicts with a value specified by the TS profile. The TS profile overrides the TS Usage field.

TS PROFILE 1

Profile 1 specifies the following session rules:

- No pacing.

- Identifiers rather than sequence numbers are used on the normal flows (whenever the TH format used includes a sequence number field).

- SDT, CLEAR, RQR, STSN, and CRV are not supported.

- Maximum RU size on the normal flow for either half-session is 256, unless a different value is specified in RSP(ACTLU).

This profile does not require the use of the TS Usage field.

TS PROFILE 2

Profile 2 specifies the following session rules:

- Primary-to-secondary and secondary-to-primary normal flows are paced.
- Sequence numbers are used on the normal flows (whenever the TH format used includes a sequence number field).
- CLEAR is supported.
- SDT, RQR, STSN, and CRV are not supported.

The TS Usage subfields defining the options for this profile are:

- Pacing counts
- Maximum RU sizes on the normal flows

TS PROFILE 3

Profile 3 specifies the following session rules:

- Primary-to-secondary and secondary-to-primary normal flows are paced.
- Sequence numbers are used on the normal flows (whenever the TH format used includes a sequence number field).
- CLEAR and SDT are supported.
- RQR and STSN are not supported.
- CRV is supported when session-level cryptography is selected (via a BIND parameter).

The TS Usage subfields defining the options for this profile are:

- Pacing counts
- Maximum RU sizes on the normal flows

TS PROFILE 4

Profile 4 specifies the following session rules:

- Primary-to-secondary and secondary-to-primary normal flows are paced.

- Sequence numbers are used on the normal flows (whenever the TH format used includes a sequence number field).

- SDT, CLEAR, RQR, and STSN are supported.

- CRV is supported when session-level cryptography is selected (via a BIND parameter).

The TS Usage subfields defining the options for this profile are:

- Pacing counts

- Maximum RU sizes on the normal flows

TS PROFILE 5

Profile 5 specifies the following session rules:

- No pacing.

- Sequence numbers are used on normal flows.

- SDT is supported.

- CLEAR, RQR, STSN, and CRV are not supported.

- No maximum RU sizes for the normal flows are specified.

This profile does not require the use of the TS Usage field.

TS PROFILE 7

Profile 7 specifies the following session rules:

- Primary-to-secondary and secondary-to-primary normal flows are paced.
- Sequence numbers are used on the normal flows (whenever the TH format used includes a sequence number field).
- SDT, CLEAR, RQR, and STSN are not supported.
- CRV is supported when session-level cryptography is selected (via a BIND parameter).

The TS Usage subfields defining the options for this profile are:

- Pacing counts
- Maximum RU sizes on the normal flows

TS PROFILE 17

Profile 17 specifies the following session rules:

- Primary-to-secondary and secondary-to-primary normal flows are paced.
- Identifiers rather than sequence numbers are used on the normal flows.
- SDT, CLEAR, and RQR are supported.
- STSN and CRV are not supported.
- No maximum RU sizes for the normal flow are specified.

The TS Usage subfields defining the options for this profile are:

- Pacing counts

TS Profile	Session Type(s)
1	SSCP-PU, SSCP-LU
2	LU-LU
3	LU-LU
4	LU-LU
5	SSCP-PU
7	LU-LU
17	SSCP-SSCP

Figure 7-1. TS Profiles and Session Types

This page left intentionally blank

CHAPTER 8. SENSE CODES

This chapter summarizes information from *Systems Network Architecture Format and Protocol Reference Manual: Architectural Logic* (SC30-3112).

The sense data included with an EXCEPTION REQUEST (EXR), a negative response, or a send or receive check is a four-byte field (see Figure 8-1) that generally includes a one-byte category value, a one-byte modifier value, and two bytes of implementation- or end-user-defined data (hereafter referred to as user-defined data). For certain sense codes, user-defined data cannot be included in the sense data (it is never carried in send-check sense data); in its place is sense code specific information, whose format is defined along with the sense code definition, below.

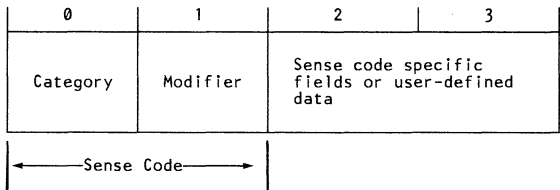

Figure 8-1. Sense Code and Sense Data

Together, the category and modifier bytes hold the sense code (SNC) defined for the exception condition that has occurred.

The following categories are defined; all others are reserved:

Value	Category
X'00'	User Sense Data Only
X'08'	Request Reject
X'10'	Request Error
X'20'	State Error
X'40'	RH Usage Error
X'80'	Path Error

The category User Sense Data Only (X'00') allows the end users to exchange sense data in bytes 2-3 for conditions not defined by SNA within the other categories (and perhaps unique to the end users involved). The modifier value is also X'00'.

The sense codes for the other categories are discussed below. For these categories, a modifier value of X'00' can be used (as an implementation option) when no definition of the exception condition beyond the major category is to be identified.

REQUEST REJECT (CATEGORY CODE = X'08')

This category indicates that the request was delivered to the intended half-session component and was understood and supported, but not executed.

- 08 01 Resource Not Available: The LU, PU, or link specified in an RU is not available.
- 08 02 Intervention Required: Forms or cards are required at an output device, or a device is temporarily in local mode, or other conditions require intervention.
- 08 03 Missing Password: The required password was not supplied.
- 08 04 Invalid Password: Password was not valid.
- 08 05 Session Limit Exceeded: The requested session cannot be activated, as one of the NAUs is at its session limit. Applies to ACTCDRM, INIT, BIND, and CINIT requests.
- 08 06 Resource Unknown: The request contained a name or address not identifying a PU, LU, link, or link station known to the receiver.
- 08 07 Resource Not Available--LUSTAT Forthcoming: A subsidiary device will be unavailable for an indeterminate period of time. LUSTAT will be sent when the device becomes available.
- 08 08 Invalid Contents ID: The contents ID contained on the ACTCDRM request was found to be invalid.
- 08 09 Mode Inconsistency: The requested function cannot be performed in the present state of the receiver.
- 08 0A Permission Rejected: The receiver has

denied an implicit or explicit request of the sender; when sent in response to BIND, it implies either that the secondary LU will not notify the SSCP when a BIND can be accepted, or that the SSCP does not recognize the NOTIFY vector key X'0C'. (See the X'0845' sense code for a contrasting response.)

- 08 0B Bracket Race Error: Loss of contention within the bracket protocol. Arises when bracket initiation/termination by both NAUs is allowed.
- 08 0C Procedure Not Supported: A procedure (Test, Trace, IPL, REQMS type) specified in an RU is not supported by the receiver.
- 08 0D NAU Contention: A request to activate a session was received while the receiving half-session was awaiting a response to a previously sent activation request for the same session; for example, the SSCP receives an ACTCDRM from the other SSCP before it receives the response for an ACTCDRM that it sent to the other SSCP and the SSCP ID in the received ACTCDRM was less than or equal to the SSCP ID in the ACTCDRM previously sent.
- 08 0E NAU Not Authorized: The requesting NAU does not have access to the requested resource.
- 08 0F End User Not Authorized: The requesting end user does not have access to the requested resource.
- 08 10 Missing Requester ID: The required requester ID was missing.
- 08 11 Break: Asks the receiver of this sense code to terminate the present chain with CANCEL or with an FMD request carrying EC. The half-session sending the Break sense code enters chain-purge state when Break is sent.
- 08 12 Insufficient Resource: Receiver cannot

act on the request because of a temporary lack of resources.

- 08 13 Bracket Bid Reject--No RTR
Forthcoming: BID (or BB) was received while the first speaker was in the in-bracket state, or while the first speaker was in the between-brackets state and the first speaker denied permission. RTR will not be sent.
- 08 14 Bracket Bid Reject--RTR Forthcoming:
BID (or BB) was received while the first speaker was in the in-bracket state, or while the first speaker was in the between-brackets state and the first speaker denied permission. RTR will be sent.
- 08 15 Function Active: A request to activate a network element or procedure was received, but the element or procedure was already active.
- 08 16 Function Inactive: A request to deactivate a network element or procedure was received, but the element or procedure was not active.
- 08 17 Link Inactive: A request requires the use of a link, but the link is not active.
- 08 18 Link Procedure in Process: CONTACT, DISCONTACT, IPL, or other link procedure in progress when a conflicting request was received.
- 08 19 RTR Not Required: Receiver of READY TO RECEIVE has nothing to send.
- 08 1A Request Sequence Error: Invalid sequence of requests.
- 08 1B Receiver in Transmit Mode: A race condition: normal-flow request received while the half-duplex contention state was not-receive, (*S,-R), or while resources (such as buffers) necessary for handling normal-flow data were unavailable.

(Contrast this sense code with X'2004', which signals a protocol violation.)

- 08 1C Request Not Executable: The requested function cannot be executed, because of a permanent error condition in the receiver.
- 08 1D Invalid Station/SSCP ID: The Station ID or SSCP ID in the request was found to be invalid.
- 08 1E Session Reference Error: The request contained reference to a half-session that was neither active nor in the process of being activated (generally applies to network services requests).
- 08 1F Reserved.
- 08 20 Control Vector Error: Invalid data for the control vector specified by the target network address and key.
- 08 21 Invalid Session Parameters: Session parameters were not valid or not supported by the half-session whose activation was requested.
- 08 22 Link Procedure Failure: A link-level procedure has failed due to link equipment failure, loss of contact with a link station, or an invalid response to a link command. (This is not a path error, since the request being rejected was delivered to its destination.)
- 08 23 Unknown Control Vector: The control vector specified by a network address and key is not known to the receiver.
- 08 24 Unit of Work Aborted: The current unit of work has been aborted; when sync point protocols are in use, both sync point managers are to revert to the previously committed sync point.
- 08 25 Component Not Available: The LU component (a device indicated by an FM header) is not available.

- 08 26 FM Function Not Supported: A function requested in an FMD RU is not supported by the receiver.
- 08 27 Intermittent Error--Retry Requested: An error at the receiver caused an RU to be lost. The error is not permanent, and retry of the RU (or chain) is requested.
- 08 28 Reply Not Allowed: A request requires a normal-flow reply, but the outbound data flow for this half-session is quiesced or shut down, and there is no delayed reply capability.
- 08 29 Change Direction Required: ▲ request requires a normal-flow reply, but the half-duplex flip-flop state is not-send, (-S,*R), CD was not set on the request, and there is no delayed reply capability.
- 08 2A Presentation Space Alteration: Presentation space altered by the end user while the half-duplex state was not-send, (-S,*R); request executed.
- 08 2B Presentation Space Integrity Lost: Presentation space integrity lost (for example, cleared or changed) because of a transient condition--for example, because of a transient hardware error or an end user action such as allowing presentation services to be used by the SSCP. (Note: The end-user action described under X'082A' and X'084A' is excluded here.)
- 08 2C Resource-Sharing Limit Reached: The request received from an SSCP was to activate a half-session, a link, or a procedure, when that resource was at its share limit.
- 08 2D LU Busy: The LU resources needed to process the request are being used; for example, the LU resources needed to process the request received from the SSCP are being used for the LU-LU session.

- 08 2E Intervention Required at LU Subsidiary Device: A condition requiring intervention, such as out of paper, or power-off, or cover interlock open, exists at a subsidiary device.
- 08 2F Request Not Executable because of LU Subsidiary Device: The requested function cannot be executed, due to a permanent error condition in one or more of the receiver's subsidiary devices.
- 08 30 Reserved
- 08 31 LU Component Disconnected: An LU component is not available because of power off or some other disconnecting condition.
- 08 32 Invalid Count Field: A count field contained in the request indicates a value too long or too short to be interpreted by the receiver, or the count field is inconsistent with the length of the remaining fields. Bytes 2 and 3 following the sense code are not used for user-defined data; they contain a binary count that indexes (zero-origin) the first byte of the invalid count field.
- 08 33 Invalid Parameter (with Pointer and Complemented Byte): one or more parameters contained in fixed- or variable-length fields of the request are invalid or not supported by the NAU that received the request. Bytes 2 and 3 following the sense code are not used for user-defined data. Byte 2 contains a binary value that indexes (zero-origin) the first byte that contained an invalid parameter. Byte 3 contains a transform of the first byte that contained an invalid parameter: the bits that constitute the one or more invalid parameters are complemented, and all other bits are copied.

- 08 34 RPO Not Initiated: A power-off procedure for the specified node was not initiated because one or more other SSCPs have contacted the node, or because a CONTACT, DUMP, IPL, or DISCONTACT procedure is in progress for that node.
- 08 35 Invalid Parameter (with Pointer Only): The request contained a fixed- or variable-length field whose contents are invalid or not supported by the NAU that received the request. Bytes 2 and 3 following the sense code are not used for user-defined data; they contain a two-byte binary count that indexes (zero-origin) the first byte of the fixed- or variable-length field having invalid contents.
- 08 36 PLU/SLU Specification Mismatch: For a specified LU-LU session, both the origin LU (OLU) and the destination LU (DLU) have only the primary capability or have only the secondary capability.
- 08 37 Queuing Limit Exceeded: For an LU-LU session initiation request (INIT, CDINIT, or INIT-OTHER-CD) specifying (1) Initiate or Queue (if Initiate not possible) or (2) Queue Only, the queuing limit of either the OLU or the DLU, or both, was exceeded.
- 08 38 Reserved
- 08 39 LU-LU or SSCP-LU Session Being Taken Down: At the time an LU-LU session initiation or termination request is received, the SSCP of at least one of the LUs is either processing a CDTAKED request or is in the process of deactivating the associated SSCP-LU session.
- 08 3A LU Not Enabled: At the time an LU-LU session initiation request is received at the SSCP, at least one of the two LUs, although having an active session with its SSCP, is not ready to accept CINIT or BIND requests.

- 08 3B Invalid PCID: An invalid PCID (procedure correlation identifier) was received, for example, one containing an invalid network address of the SSCP of the initiating LU (ILU) or terminating LU (TLU), has been received in CDINIT, INIT-OTHER-CD, CDTERM, or TERM-OTHER-CD; or a PCID that does not identify a previously queued request has been received in CDINIT (Dequeue) or INIT-OTHER-CD (Dequeue); or, a PCID that cannot be associated with the PCID of any previously processed CDINIT has been received on CDCINIT
- 08 3C Domain Takedown Contention: While waiting for a response to a CDTAKED, a CDTAKED request is received by the SSCP containing the SSCP-SSCP primary half-session. Contention is resolved by giving preference to the CDTAKED sent by the primary half-session.
- 08 3D Dequeue Retry Unsuccessful--Removed from Queue: The SSCP cannot successfully honor a CDINIT(Dequeue) request (which specifies "leave on queue if dequeue-retry is unsuccessful") to dequeue and process a previously queued CDINIT request (for example, because the LU in its domain is still not available for the specified session), and removes the queued CDINIT request from its queue.
- 08 3E Reserved
- 08 3F Terminate Contention: While waiting for a response to a CDTERM, a CDTERM is received by the SSCP of the SLU. Contention is resolved by giving preference to the CDTERM sent by the SSCP of the SLU.
- 08 40 Procedure Invalid for Resource: The named procedure is not supported in the receiver for this type of resource (for example, (1) SETCV specifies boundary function support for a type 1 node but the capability is not supported by the

receiving node, or (2) the PU receiving an EXECTEST or TESTMODE is not the primary PU for the target link.)

- 08 41 Duplicate Network Address: In a cross-domain LU-LU session initiation request, the SSCP of the DLU determines that the OLU network address specified in the CDINIT request is a duplicate of an LU network address assigned to a different LU name.
- 08 42 SSCP-SSCP Session Not Active: The SSCP-SSCP session, which is required for the processing of a network services request, is not active; for example, at the time an LU-LU session initiation or termination request is received, at least one of the following conditions exists:
- The SSCP of the ILU and the SSCP of the OLU do not have an active session with each other, and therefore INIT-OTHER-CD cannot flow.
 - The SSCP of the TLU and the SSCP of the OLU do not have an active session with each other, and therefore TERM-OTHER-CD cannot flow.
 - The SSCP of the OLU and the SSCP of the DLU do not have an active session with each other, and therefore CDINIT or CDTERM cannot flow.
- 08 43 Required FMDS Synchronization Not Supplied: For example, a secondary LU (LU-LU session type 2 or 3) received a request with Write Control Code = Start Print, along with RQE and -CD.
- 08 44 Initiation Dequeue Contention: While waiting for a response to a CDINIT(Dequeue), a CDINIT(Dequeue) is received by the SSCP of the SLU. Contention is resolved by giving preference to the CDINIT(Dequeue) sent by the SSCP of the SLU.

- 08 45 Permission Rejected--SSCP Will Be
Notified: The receiver has denied an
implicit or explicit request of the sender;
when sent in response to BIND, it implies
that the secondary LU will notify the SSCP
(via NOTIFY vector key X'0C') when a BIND
can be accepted, and the SSCP of the SLU
supports the notification. (See the
X'080A' sense code for a contrasting
response.)
- 08 46 ERP Message Forthcoming: The received
request was rejected for a reason to be
specified in a forthcoming request.
- 08 47 Restart Mismatch: Sent in response to
STSN or SDT or BIND to indicate that the
secondary half-session is trying to execute
a resynchronizing restart but has received
insufficient or incorrect information.
- 08 48 Cryptography Function Inoperative: The
receiver of a request was not able to
decipher the request because of a
malfunction in its cryptography facility.
- 08 49 Reserved
- 08 4A Presentation Space Alteration: The
presentation space was altered by the end
user while the half-duplex state was
not-send, (-S,*R); request not executed.
- 08 4B Requested Resources Not Available:
Resources named in the request, and
required to honor it, are not currently
available. It is not known when the
resources will be made available.

Bytes 2 and 3 following the sense code are
not used for user-defined data; they
contain sense-code specific information.
Settings allowed are:

- 0000 Requested resources are not
 available.
- 6002 The resource identified by the
 destination program name (DPN) is not

supported.

- 6003 The resource identified by the primary resource name (PRN) is not supported.
- 08 4C Permanent Insufficient Resource: Receiver cannot act on the request because resources required to honor the request are permanently unavailable.
- 08 4D Invalid Session Parameters--BF: Session parameters were not valid or were unacceptable by the boundary function. Bytes 2 and 3 following the sense code contain a binary count that indexes (zero origin) the first byte of the fixed- or variable-length field having invalid contents.
- 08 4E Invalid Session Parameters--PRI: A positive response to an activation request (for example, BIND) was received and was changed to a negative response due to invalid session parameters carried in the response. The services manager receiving the response will send a deactivation request for the corresponding session.
- 08 4F through 08 50 Reserved
- 08 51 Session Busy: Another session that is needed to complete the function being requested on this session (for example, to forward an NS RU embedded in a FORWARD request) is temporarily unavailable.
- 08 52 Session with Larger Activation Request Sequence Identifier Already Active: A session has already been activated for the subject destination-origin pair by a session activation request that carried a larger activation request identifier than the current request; the current request (ACTPU or ACTCDRM) is refused.

08 53 TERMINATE(Cleanup) Required: The SSCP cannot process the termination request, as it requires cross-domain SSCP-SSCP services that are not available. (The corresponding SSCP-SSCP session is not active.)
TERMINATE(Cleanup) is required.

08 54
through Reserved
08 55

08 56 SSCP-SSCP Session Lost: Carried in the Sense Data field in a NOTIFY or NSPE sent to an ILU or SSCP(ILU) to indicate that the activation of the LU-LU session either cannot be completed or is uncertain because the SSCP-SSCP session between the two domains has been lost. (This sense code appears only in NOTIFY or NSPE, not in a negative response. Another sense code, X'0842', is used on a negative response to signal the condition when the condition is known at the time the response, for example, to INIT, is prepared.)

08 57 SSCP-LU Session Not Active: The SSCP-LU session, required for the processing of a request, is not active; for example, in processing REQECHO, the SSCP did not have an active session with the target LU named in the REQECHO RU.

08 58 Reserved

08 59 REQECHO Data Length Error: The specified length of data to be echoed (in REQECHO) violates the maximum RU size limit for the target LU.

08 5A
through Reserved
08 5F

08 60 Function Not Supported--Continue Session: The function requested is not supported; the function may have been specified by a request code or some other field, control character, or graphic

character in an RU. Bytes 2-3 following the sense code are not used for user defined data; they contain a two-byte binary count that indexes (zero-origin) the first byte in which an error was detected. This sense code is used to request that the session continue, thereby ignoring the error.

- 08 61 Invalid COS Name: The class of service (COS) name, either specified by the ILU or generated by the SSCP of the SLU from the mode table is not in the "COS name to VR identifier list" table used by the SSCP of the PLU. Bytes 2 and 3 following the sense code contain X'0000' if the COS name was generated by the SSCP or X'0001' if specified by the ILU.
- 08 62 Medium Presentation Space Recovery: An error has occurred on the current presentation space. Recovery consists of restarting at the top of the current presentation space. The sequence number returned is of the RU in effect at the top of the current presentation space. Bytes 2 and 3 following the sense code contain the byte offset from the beginning of the RU to the first byte of the RU that is displayed at the top of the current presentation space.
- 08 63 Referenced Local Character Set Identifier (LCID) Not Found: A referenced character set does not exist.
- 08 64 Function Abort: A loop will occur upon reexecution; the request sender should not send the same data.
- 08 65 Function Abort: Sender is responsible to detect the loop.
- 08 66 Function Abort: Receiver is responsible to detect the loop.
- 08 67 Sync Event Response: Indicates a negative response to a sync event.

- 08 68 No Panels Loaded: Referenced format not found because no panels are loaded for the display.
- 08 69 Panel Not Loaded: The referenced panel is not loaded for the display.
- 08 70 Reserved
- 08 71 Read Partition State Error: A Read Partition structured field was received while the display was in the retry state.
- 08 72 Orderly Deactivation Refused: An NC-DACTVR(Orderly) request has been received, but sessions are assigned to the VR and it will not be deactivated.
- 08 73 Virtual Route Not Defined: There is no ERN designated to support this VRN.
- 08 74 ER Not in a Valid State: The ER supporting the requested VR is not in a state allowing VR activation.
- 08 75 Incorrect or Undefined Explicit Route Requested: The reverse ERNs specified in the NC-ACTVR do not contain the ERN defined to be used for the VR requested, or the ERN designated to be used for the VR is not defined.
- 08 76 Nonreversible Explicit Route Requested: The ERN used by the NC-ACTVR does not use the same sequence of transmission groups (in reverse order) as the ERN that should be used for the RSP(NC-ACTVR).
- 08 77 Reserved
- 08 78 Insufficient Storage: The storage resource required for a data format is not available.
- 08 79 Storage Medium Error: A permanent error has occurred involving a storage medium.

08 7A Format Processing Error: A processing
error occurred during data formatting.

REQUEST ERROR (CATEGORY CODE = X'10')

This category indicates that the RU was delivered to the intended half-session component, but could not be interpreted or processed. This condition represents a mismatch of half-session capabilities.

- 10 01 RU Data Error: Data in the request RU is not acceptable to the receiving FMDS component; for example, a character code is not in the set supported, a formatted data field is not acceptable to presentation services, or a required name in the request has been omitted.
- 10 02 RU Length Error: The request RU was too long or too short.
- 10 03 Function Not Supported: The function requested is not supported. The function may have been specified by a formatted request code, a field in an RU, or a control character.

(Note: This code can also be used instead of sense code X'0826'.)

Bytes 2 and 3 following the sense code are not used for user-defined data; they contain sense-code specific information. Settings allowed are:

- 0000 Function requested is not supported.
 - 6002 The resource identified by the destination program name (DPN) is not supported.
 - 6003 The resource identified by the primary resource name (PRN) is not supported.
- 10 04 Reserved.

- 10 05 Parameter Error: A parameter modifying a control function is invalid, or outside the range allowed by the receiver.
- 10 06 Reserved.
- 10 07 Category Not Supported: DFC, SC, NC, or FMD request was received by a half-session not supporting any requests in that category; or an NS request with byte 0 was not set to a defined value, or byte 1 was not set to an NS category supported by the receiver.
- 10 08 Invalid FM Header: The FM header was not understood or translatable by the receiver, or an FM header was expected but not present.
Bytes 2 and 3 following the sense code are not used for user-defined data; they contain sense-code specific information, as described in chapter 9.
- 10 09 Format Group Not Selected: No format group was selected before issuing a Present Absolute or Present Relative Format structured field to a display.

100A UNKNOWN USER NAME
 100B FORMS EXCEPTION
 100C UNRECOGNIZED
 100D REQUEST INCONSISTENCY
 100E DIRECTING EXCEPTION
 100F IMPROPER SNA/DS G.2
 1010 RNAA REQUEST FROM
 1012 SNA/DS REV EXC
 1013 UNKNOWN SERVER PARAMS
 1018 NO SNA EXC
 1019 INV RESTART BYTE POS

STATE ERROR (CATEGORY CODE = X'20')

This category indicates a sequence number error, or an RH or RU that is not allowed for the receiver's current session control or data flow control state. These errors prevent delivery of the request to the intended half-session component.

- 20 01 Sequence Number: Sequence number received on normal-flow request was not 1 greater than the last.
- 20 02 Chaining: Error in the sequence of the chain indicator settings (BCI, ECI), such as first, middle, first.
- 20 03 Bracket: Error resulting from failure of sender to enforce bracket rules for session. (This error does not apply to contention or race conditions.)
- 20 04 Direction: Error resulting from a normal-flow request received while the half-duplex flip-flop state was not-receive, (*S,-R). (Contrast this sense code with X'081B', which signals a race condition.)
- 20 05 Data Traffic Reset: An FMD or normal-flow DFC request received by a half-session whose session activation state was active, but whose data traffic state was not active
- 20 06 Data Traffic Quiesced: An FMD or DFC request received from a half-session that has sent QUIESCE COMPLETE or SHUTDOWN COMPLETE and has not responded to RELEASE QUIESCE.
- 20 07 Data Traffic Not Reset: A session control request (for example, STSN), allowed only while the data traffic state is reset, was received while the data traffic state was not reset.

- 20 08 No Begin Bracket: A BID or an FMD request specifying BBI=BB was received after the receiver had previously sent a positive response to BRACKET INITIATION STOPPED.
- 20 09 Session Control Protocol Violation: An SC protocol has been violated; a request, allowed only after a successful exchange of an SC request and its associated positive response, has been received before such successful exchange has occurred (for example, an FMD request has preceded a required CRYPTOGRAPHY VERIFICATION request). The request code of the particular SC request or response required, or X'00' if undetermined, appears in the fourth byte of the sense data. There is no user data associated with this sense code.
- 20 0A Immediate Request Mode Error: The immediate request mode protocol has been violated by the request.
- 20 0B Queued Response Error: The Queued Response protocol has been violated by a request, that is, QRI=-QR when an outstanding request had QRI=QR.
- 20 0C ERP Sync Event Error: The ERP sync event protocol has been violated.
- 20 0D Response Owed Before Sending Request: An attempt has been made in half-duplex (flip-flop or contention) send/receive mode to send a normal-flow request when a response to a previously received request has not yet been sent.

2010 BIS Protocol Error
 2011 PACING Protocol Error
 2012

RH USAGE ERROR (CATEGORY CODE = X'40')

This category indicates that the value of a field or combination of fields in the RH violates architectural rules or previously selected BIND options. These errors prevent delivery of the request to the intended half-session component and are independent of the current states of the session. They may result from the failure of the sender to enforce session rules. Detection by the receiver of each of these errors is optional.

- 40 01 Invalid SC or NC RH: The RH of a session control (SC) or network control (NC) request was invalid. For example, an SC RH with pacing request indicator set to 1 is invalid.
- 40 02 Reserved.
- 40 03 BB Not Allowed: The Begin Bracket indicator (BBI) was specified incorrectly, for example, BBI=BB with BCI=-EC.
- 40 04 EB Not Allowed: The End Bracket indicator (EBI) was specified incorrectly, for example, EBI=EB with BCI=-BC, or by the primary half-session when only the secondary may send EB, or by the secondary when only the primary may send EB.
- 40 05 Incomplete RH: Transmission shorter than full TH-RH.
- 40 06 Exception Response Not Allowed: Exception response was requested when not permitted.
- 40 07 Definite Response Not Allowed: Definite response was requested when not permitted.
- 40 08 Pacing Not Supported: The Pacing indicator was set on a request, but the receiving half-session or boundary function

half-session does not support pacing for this session.

- 40 09 CD Not Allowed: The Change Direction indicator (CDI) was specified incorrectly, for example, CDI=CD with ECI=-EC, or CDI=CD with EBI=EB.
- 40 0A No-Response Not Allowed: No-response was specified on a request when not permitted. (Used only on EXR.)
- 40 0B Chaining Not Supported: The chaining indicators (BCI and ECI) were specified incorrectly, for example, chaining bits indicated other than (BC,EC), but multiple-request chains are not supported for the session or for the category specified in the request header.
- 40 0C Brackets Not Supported: The bracket indicators (BBI and EBI) were specified incorrectly, for example, a bracket indicator was set (BBI=BB or EBI=EB), but brackets are not used for the session.
- 40 0D CD Not Supported: The Change-Direction indicator was set, but is not supported.
- 40 0E Reserved.
- 40 0F Incorrect Use of Format Indicator: The Format indicator (FI) was specified incorrectly, for example, FI was set with BCI=-BC, or FI was not set on a DFC request.
- 40 10 Alternate Code Not Supported: The Code Selection indicator (CSI) was set when not supported for the session.
- 40 11 Incorrect Specification of RU Category: The RU Category indicator was specified incorrectly, for example, an expedited-flow request or response was specified with RU Category indicator = FMD.
- 40 12 Incorrect Specification of Request Code: The request code on a response does

not match the request code on its corresponding request.

- 40 13 Incorrect Specification of (SDI, RTI): The Sense Data Included indicator (SDI) and the Response Type indicator (RTI) were not specified properly on a response. The proper value pairs are (SDI=SD, RTI=negative) and (SDI=-SD, RTI=positive).
- 40 14 Incorrect Use of (DR1I, DR2I, ERI): The Definite Response 1 indicator (DR1I), Definite Response 2 indicator (DR2I), and Exception Response indicator (ERI) were specified incorrectly, for example, a CANCEL request was not specified with DR1I=DR1, DR2I=-DR2, and ERI=-ER.
- 40 15 Incorrect Use of QRI: The Queued Response indicator (QRI) was specified incorrectly, for example, QRI=QR on an expedited-flow request.
- 40 16 Incorrect Use of EDI: The Enciphered Data indicator (EDI) was specified incorrectly, for example, EDI=ED on a DFC request.
- 40 17 Incorrect Use of PDI: The Padded Data indicator (PDI) was specified incorrectly, for example, PDI=PD on a DFC request.

4018 INCORRECT QRT WITH
BIDDER BB

4019 INCORRECT INDICATOR IN LBC

4021 QRT RSP DIFF FROM
REQUEST

PATH ERROR (CATEGORY CODE = X'80')

This category indicates that the request could not be delivered to the intended receiver, because of a path outage, an invalid sequence of activation requests, or one of the listed path information unit (PIU) errors. (Some PIU errors fall into other categories, for example, sequence number errors are category X'20'.) A path error received while the session is active generally indicates that the path to the session partner has been lost. In this case, the NAU services manager receiving the -RSP(Path Error) may deactivate the affected half-session.

- 80 01 Intermediate Node Failure: Machine or program check in a node providing intermediate function. A response may or may not be possible.
- 80 02 Link Failure: Data link failure.
- 80 03 NAU Inoperative: The NAU is unable to process requests or responses, for example, the NAU has been disrupted by an abnormal termination.
- 80 04 Unrecognized Destination Address: A node in the path has no routing information for the destination specified by the TH.
- 80 05 No Session: No half-session is active in the receiving end node for the indicated origination-destination pair, or no boundary function half-session component is active for the origin-destination pair in a node providing the boundary function. A session activation request is needed.
- 80 06 Invalid FID: Invalid FID for the receiving node. (Note 1)
- 80 07 Segmenting Error: First BIU segment had less than 10 bytes; or mapping field sequencing error, such as first, last, middle; or segmenting not supported and MPF

not set to 11. (Note 2)

- 80 08 PU Not Active: The SSCP-PU secondary half-session in the receiving node has not been activated and the request was not ACTPU for this half-session; for example, the request was ACTLU from an SSCP that does not have an active SSCP-PU session with the PU associated with the addressed LU.
- 80 09 LU Not Active: The destination address specifies an LU for which the SSCP-LU secondary half-session has not been activated and the request was not ACTLU.
- 80 0A Too-Long PIU: Transmission was truncated by a receiving node because the PIU exceeded a maximum length or sufficient buffering was not available.
- 80 0B Incomplete TH: Transmission received was shorter than a TH. (Note 1)
- 80 0C DCF Error: Data Count field inconsistent with transmission length.
- 80 0D Lost Contact: Contact with the link station for which the transmission was intended has been lost, but the link has not failed. If the difference between link failure and loss of contact is not detectable, link failure (X'8002') is sent.
- 80 0E Unrecognized Origin: The origin address specified in the TH was not recognized.
- 80 0F Invalid Address Combination: The (DAF',OAF') (FID2) combination or the LSID (FID3) specified an invalid type of session, for example, a PU-LU combination.
- 80 10 Segmented RU Length Error: An RU was found to exceed a maximum length, or required buffer allocation that might cause future buffer depletion.

- 80 11 ER Inoperative or Undefined: A PIU was received from a subarea node that does not support ER and VR protocols, and the explicit route to the destination is inoperative or undefined.
- 80 12 Subarea PU Not Active or Invalid Virtual Route: A session activation request for a peripheral PU or LU cannot be satisfied because there is no active SSCP-PU session for the subarea node providing boundary function support, or the virtual route for the specified SSCP-PU_T1|2 or SSCP-LU session is not the same as that used for the SSCP-PU session of the PU_T1|2's or LU's subarea PU.
- 80 13 COS Not Available: A session activation request cannot be satisfied because none of the virtual routes requested for the session is available. This condition may arise because each of the specified virtual routes cannot be activated for one of the following reasons:
- oThe specified virtual route cannot be mapped to an explicit route to the destination subarea, or the explicit route it is mapped to is not defined.
 - oThe underlying explicit route is not operative.
 - oThe underlying explicit route is operative but cannot be activated.
 - oThe underlying explicit route is active but the virtual route cannot be activated.
 - oThe session must be assigned to a virtual route with an underlying reverse explicit route number of 0, but the virtual route does not meet this criterion.

Notes:

1. It is generally not possible to send a response for this exception condition, since information (FID, addresses) required

to generate a response is not available. It is logged as an error if this capability exists in the receiver.

2. If segmenting is not supported, a negative response is returned for the first segment only, since this contains the RH. Subsequent segments are discarded.

The following figure shows some instances where FM headers are used.

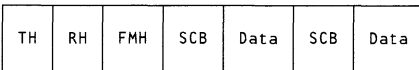
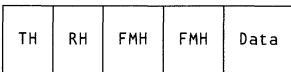
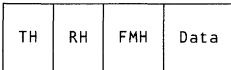
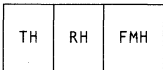

Note: SCB = String Control Byte

FMH-1 - This header is used to select a destination within an LU. A destination may be represented by a device, a data set residing on a device, or merely a data stream. The LU initiates, interrupts, resumes, and concludes data traffic for the half-session using the FMH-1.

FMH-2 - Once a destination has been selected using an FMH-1, this header handles the data management tasks for that destination.

FMH-3 - This header handles data management tasks that are common to all destinations in the LU-LU session.

FMH-4 - This header carries a logical block command and its parameters, together with information, that applies to a logical block within a logical message as defined for Logical Message Service.

FMH-5 - This header flows from the program using the sending half-session to the attach manager of the receiving half-session. This header identifies the program at the receiving LU that it wishes to have attached. An FMH-5 can be followed by other FMHs (for example, FMH-6, FMH-8, and FMH-4), a logical record header (LRH), and FM data. Optionally it can be sent with CD or EB.

FMH-6 - This header flows with an architected command from a currently active transaction program using a sending half-session to a currently active transaction program using a receiving half-session.

FMH-7 - This header is sent after a negative response (0846) to provide further information about an error.

FMH-10 - This header is sent to prepare the session for a sync point. It may be sent with data. The RU chain must have CD set on so that the receiver may, on the next flow, request a sync point or abort the unit of work.

FORMATS OF FM HEADERS

FM Header Type 1

BYTE	BIT	CONTENT	MEANING
0		Length	Length of header including length byte
1	0	FMHC	FMH Concatenation. B'0' No FMH follows this FMH-1 B'1' Another FMH follows this FMH-1
2	1-7 0-3	B'0000001' Medium Select X'0' X'1' X'2' X'3' X'4' X'5' X'6' X'7'	FMH-1 Identifier Desired medium for data: Console Exchange Card Document Nonexchange disk Extended Document Extended Card Data Set Name Selects Destination (see Note 3)
		X'8' X'9' X'A' X'B' X'C'	WP Media 1 WP Media 2 WP Media 3 Reserved WP Media 4 All other values reserved.
	4-7	X'0'...X'E' X'F'	Logical Subaddress Specific device in medium class Any device in medium class

NOTE 1:

The DSP defaults for the Medium Select field are:

FMH-1 MEDIUM SELECT	DEFAULT DSP
Console, X'0'	Base
Exchange, X'1'	DST field of FMH-1
Card, X'2'	SCS (IRS, TRN)
Document, X'3'	Subset 2 (RJE)
Nonexchange Disk, X'4'	DST field of FMH-1
Extended Document, X'5'	Subset 2 (RJE)
Extended Card, X'6'	SCS (IRS, TRN)
WP Medium 1, X'8'	WP Raw Form
WP Medium 2, X'9'	WP Raw Form
WP Medium 3, X'A'	WP Raw Form
WP Medium 4, X'C'	WP Raw Form

An LU requiring any other DSP value associated with Medium Select must do so by specifying the desired DSP in byte 3, bits 4-7 of the FMH-1. This selection must adhere to those DSPs allowed on the session as specified in the BIND parameters.

NOTE 2: Media and logical subaddress values are reserved when DSSEL field is set to B'110' (Continue Destination Selection), B'001' (End), B'100' (Suspend), or B'101' (End Abort).

NOTE 3: If Medium = X'7' and Logical Subaddress = X'F', DSNAME field is used to select destination.

BYTE	BIT	CONTENT	MEANING	
3	0	SRI	Stack Reference Indicator	
		B'0'	Stack to be used is the sender's send stack.	
		B'1'	Stack to be used is the receiver's send stack.	
	1		Demand Select	Receiver may direct data to alternate medium/subaddress.
		B'0'		Receiver must
		B'1'		

		direct data to specified medium/subaddress (spooling is prohibited).
2-3		Reserved
4-7	DSP Select	Data Stream Profile
		Profiles are:
	X'0'	Default DSP
	X'1'	Base DSP
	X'2'	General DSP
	X'3'	Job DSP
	X'4'	WP Raw-Form Text DSP
	X'5'	WP Exchange Diskette DSP
	X'6'	Reserved
	X'7'	OLL Level 2 DSP
	X'8'	Reserved
	X'9'	Reserved
	X'A'	Document Interchange DSP
	X'B'	Structured Field DSP
		All other values reserved.

Note: If DSP select is X'0', the DSP is implied by the Medium Select field.

BYTE	BIT	CONTENT	MEANING
4			FMH-1 Properties
	0-2	DSSEL	Destination Selection
		B'000'	Resume Destination Selection
		B'001'	End Destination Selection
		B'010'	Begin Destination Selection
		B'011'	Begin/End Destination Selection
		B'100'	Suspend Destination Selection
		B'101'	End-Abort Destination Selection

	B'110'	Continue Destination Selection
	B'111'	Reserved
	DST B'0'	Data Set Transmission Transmission Exchange Format
	B'1'	Basic Exchange Format
		When Medium Select ≠ Exchange Medium, this field is reserved. Receiver may do spooling and exchange-medium creation locally.
		When Medium Select = Exchange Medium (see byte 2), specifying B'0' preserves chain boundaries while spooling, but nonsequential allocation techniques may be used. Specifying B'1' does not preserve chain boundaries, but uses sequential medium allocation. See "Field Definitions" below.
4		Reserved
5	CMI B'0' B'1'	Compression Indicator (see "Notes" below) No compression Compression
6	CPI B'0'	Compaction Indicator (see "Notes" below) No compaction

		B'1'	Compaction
	7		Reserved
5	0-7	ERCL	Exchange Record Length if Medium = Exchange Medium or Card; otherwise reserved. For Medium = Card, a hexadecimal value indicates maximum card length. The value X'00' indicates an 80-column length.
6-7			Reserved (Optional)
8		DSLEN	Length of Destination Name (Optional)
9-n		DSNAME	Destination Name (Optional) (Reserved when DSSEL = Continue)

NOTES:

1. CMI/CPI/ERCL information received when DSSEL = Continue overlays the settings of the BEGIN FMH-1 or the last-received CONTINUE FMH-1.
2. CMI, CPI, and ERCL indicators are meaningful and valid only when specified in a BEGIN, BEGIN/END, or CONTINUE FMH-1.
3. If CMI or CPI is on, the first byte following the FMH (or FMHs) is a string control byte (SCB).

FM Header Type 2

(General Format)

BYTE	BIT	CONTENT	MEANING
0		Length	Length of header including length byte
1	0	FMHC B'0'	FMH Concatenation. No FMH follows this FMH-2
		B'1'	Another FMH follows this FMH-2
	1-7	B'0000010'	FMH-2 Identifier
2	0	SRI B'0'	Stack reference indicator. FMH-2 pertains to the active destination of the sending half-session's send stack and the receiving half-session's receive stack.
		B'1'	FMH-2 pertains to the active destination of the receiving half-session's send stack and the sending half-session's receive stack.
	1-7	Function	FMH-2 function to be performed.
		B'nnnnnn'	Identifies the function that this FMH-2 is to perform.

Note: The FMH-2s listed in Figure 9-1 combine the SRI

and function settings, and show valid settings for these fields.

3-n	Parms	Parameter fields. These fields provide the information needed to perform the selected function. They are different for each FMH-2 function, and are described in <u>SNA -- Sessions Between Logical Units.</u>
-----	-------	--

FUNCTION CODE	FUNCTION
X'01'	Peripheral Data Information Record (PDIR)
X'02'	Compaction Table
X'04'	Prime Compression Character
X'07'	Execute Program Offline
X'20'	Create Data Set
X'21'	Scratch Data Set
X'22'	Erase Data Set
X'23'	Password
X'24'	Add
X'25'	Replace
X'26'	Add Replicate
X'27'	Replace Replicate
X'28'	Query for Data Set
X'29'	Note
X'2B'	Record ID
X'2C'	Erase Record
X'2D'	Scratch All Data Sets
X'2E'	Volume ID
X'AA'	Note Reply (SRI is always on)

Figure 9-1. FMH-2 functions and their function codes.

FM Header Type 3

(General Format)

The FMH-3 format is identical to the FMH-2 format except that FMH-3s do not have a stack reference indicator (SRI) in byte 2.

An FMH-3 is used when information is needed or used by all destinations managed by the half-session. By contrast, an FMH-2 is used for a specific destination.

Two functions, the COMPACTION TABLE FMH and the PRIME COMPRESSION CHARACTER FMH, can be sent as FMH-2s or FMH-3s. They should be sent as FMH-2s when they apply to a specific destination at the half-session and as FMH-3s when they apply to all destinations at the half-session.

Figure 9-2 shows the FMH-3 functions.

FUNCTION CODE	FUNCTION
X'02'	Compaction Table
X'03'	Query for Compaction Table
X'04'	Prime Compression Character
X'05'	Status
X'06'	Series ID

Figure 9-2. FMH-3 functions and their function codes.

FM Header Type 4

BYTE	BIT	CONTENT	MEANING
------	-----	---------	---------

0		Length	Length of header including length byte
1	0	FMHC	FMH Concatenation (must be B'0').
	1-7	B'0000100'	FMH-4 Identifier
2		FMH4FXCT	Length of fixed length parameters excluding the length of FMH4FXCT. The first nonfixed parameter position is FMH4LBN. The minimum value of FMH4FXCT is 3, the maximum is 4.
3		FMH4TT1	Block transmission type
		X'00'	Inherit code (from MM-TT register)
		X'00'-X'3F'	Reserved
		X'40'	FFR-FNI Record
		X'41'	FFR-FS Record
		X'42'	FFR-FS2 Record
		X'42'-X'4F'	Reserved
		X'50'-X'FE'	Reserved
		X'FF'	Derivative code
Note: FFR=Field Formatted Record, FNI=Fixed Fields without field separators, FS=Fixed Fields with field separators, FS2=Fixed Fields with or without field separators			
4		FMH4TT2	Block transmission type qualifier. Reserved except for FMH4TT1=X'41' or X'42', in which case it holds the separator value.
5		FMH4CMD	Command
		X'00'	CRT-NU-BLK
		X'02'	CRT-SU-BLK
		X'03'	CRT-SN-BLK
		X'10'	CONT-NU-BLK
		X'12'	CONT-SU-BLK

X'13'	CONT-SN-BLK
X'23'	DEL-SN-BLK
X'32'	UPD-SU-BLK
X'33'	UPD-SN-BLK
X'42'	RPL-SU-BLK
X'43'	RPL-SN-BLK
Other	Reserved

Note: NU=Nonshared, Unnamed; SU=Shared, Unnamed; SN=Shared, Named; NN=Nonshared, Named

6	FMH4FLAG	Flags. If omitted, X'00' is assumed.
0-1		Reserved
2-3	F4RDESCR	Record Descriptor Flag
	B'00'	No LRHs in transmission block
	B'01'	LRHs present, with implicit lengths
	B'10'	Reserved
	B'11'	Reserved
Note:	LRH=Logical Record Header	
4-5		Reserved
6	FMH4BDTF	Block Data Transform Flag
	B'0'	FMH4BDT absent
	B'1'	FMH4BDT present
7	FMH4RDTF	Reserved
m	FMH4LBN	Length of FMH4BN. 0, or omitted, if unnamed block.
m+1	FMH4BN	Name of Block
n	FMH4LBDT	Length of FMH4BDT. 0 if FMH4BDTF is B'0'.
n+1	FMH4BDT	Block Data Transform
p	FMH4LVID	Length of FMH4VID
p+1	FMH4VID	Version Identifier

FM Header Type 5

(General Format)

BYTE	BIT	CONTENT	MEANING
0		Length	Length of header including length byte
1	0	FMHC B'0'	FMH Concatenation. No FMH follows
		B'1'	Another FMH follows
	1-7	B'0000101'	FMH-5 Identifier
2-3		FMH5CMD X'0202'	Command Code Attach Transaction Program
		X'0204'	RAP
		X'0206'	Data Descriptor
4		FMH5MOD	Modifier
5		FMH5FXCT	Fixed-length parameters X'00' for RAP X'02' for ATT, DD
6		ATTDSP	
7		ATTDBA	
8-n		Resource Names	
Note: If bytes 2-3 = X'0204' (Reset Attached Process), bytes n-m are omitted.			

FM Header Type 6

BYTE	BIT	CONTENT	MEANING
0		Length	Length of header

			including length byte
1	0	FMHC B'0' B'1'	FMH Concatenation. No FMH follows Another FMH follows
	1-7	B'0000110'	FMH-6 Identifier
2-3		Code	Command Code (CC2)
			For architected transaction programs, the first byte of the command code identifies a transaction program and the second byte identifies a function within a transaction program.
4	0	FMH6MOD FMH6LNSZ B'0' B'1'	Modifier Length of parameter length fields One-byte parameter length field Two-byte parameter length field
	1-7		Reserved
5-n		Fixed	Total Length of fixed length parameters (LF). This field contains the sum of the lengths of all fixed length parameters which are mandatory for the particular command code located in bytes 2 and 3. This field is either one byte or two bytes in length based on the

		setting of FMH6LNSZ (0 = one byte, 1 = two bytes).
n+1-m		Fixed Length Parameters (FDy). The fixed length parameters are positional by command code.
m+1-p	Variable	Length field of first, positional variable-length parameter (LV1). This field is either one byte or two bytes in length based on the setting of FMH6LNSZ (0 = one byte, 1 = two bytes). If the Length Field (LVx) is equal to 0, then the variable parameter is omitted. The next positional variable-length parameter length (LV2) occurs in byte q+1.
p+1-q		Variable-Length Positional Parameter (VD). The LV and VD fields are replicated to represent x number of variable-length parameters according to command code.

FM Header Type 7

BYTE	BIT	CONTENT	MEANING
0		Length	Length of header including length byte
1	0	FMHC B'0' B'1'	FMH Concatenation. No FMH follows Reserved
	1-7	B'0000111'	FMH-7 Identifier
2-5		ERPSENSE	SNA sense code, which would appear on error response
6-7		ERPSEQ	Sequence number of RU chain in which error was detected

FM Header Type 10

BYTE	BIT	CONTENT	MEANING
0		Length	Length of header including length byte
1	0	FMHC B'0' B'1'	FMH Concatenation. No FMH follows Another FMH follows
	1-7	B'0001010'	FMH-10 Identifier
2-3		SPCCMD X'0202'	Prepare command (other values reserved)
4-5		SPCMOD	Modifier. For a Prepare command

	(FMH-10), the modifier indicates DFC settings to be returned on the first RU chain sent by the FMH-10 receiver.
X'0000'	*CD,*EB. The sender of FMH-10 does not care what DFC settings are returned on the reply.
X'0001'	EB. The sender of FMH-10 requires an EB on the reply.
X'0002'	CD,¬EB. The sender of FMH-10 requires a CD on the reply.

SENSE DATA TO ACCOMPANY SENSE CODE X'1008'

The sense code X'1008' (Invalid FM Header) may carry with it two bytes of sense data. The following list gives the reasons for the error and the assigned sense data.

DATA PROCESSING ERRORS (X'100808XX')

0801	Invalid Function Code Parameters
0803	Forms Function Cannot Be Performed
0805	Unable to Perform Copy Function
0806	Compaction Table Outside Supported Set
0807	Invalid PDIR (Peripheral Data Information Record) Identifier
0808	Printer Train Function Cannot Be Performed
0809	FCB (Forms Control Block) Load Function Cannot Be Performed
080A	FCB (Forms Control Block) Load Function Not Supported
080B	Invalid Compaction Table Name
080C	Invalid ACCESS

080D	Invalid RECLEN
080E	Invalid NUMRECS
080F	Data Set In Use
0810	Data Set Not Found
0811	Invalid Password
0812	Function Not Allowed For Destination
0813	Record Too Long
0814	Data Set Full
0815	Invalid RECID
0817	Invalid VOLID Format
0818	Number of Logical Records Per Chain Exceeded
0819	Data Set Exists
081A	No Space Available
081B	Invalid VOLID
081C	Invalid DSACCESS
081D	Invalid RECTYPE
081E	Insufficient Resolution Space
081F	Invalid Key Technique
0820	Invalid Key Displacement
0821	Invalid Key
0822	Invalid N (number of records)
0823	Invalid KEYIND
0824	Invalid SERID
0826	Invalid RECID Format
0827	Password Not Supplied
0828	Record ID Not Supplied
0829	Volume ID Not Supplied
082A	Invalid PGMNAME

FM HEADER PROTOCOL ERRORS (X'100820XX')

2001	Invalid Destination -- Active
2002	Invalid Destination -- Inactive
2003	Invalid Destination -- Suspended
2004	Invalid Suspend-Resume Sequence
2005	Interruption Level Violation
2006	Invalid Resume Properties
2007	Destination Not Available
2008	Invalid End Sequence
2009	Invalid FM Header Length
200A	Invalid Field Setting -- Reserved Field Set to One or Setting Not Defined
200B	Invalid Destination -- Destination Does Not Exist

200C	Invalid ERCL
200D	Invalid DST
200E	Invalid Concatenation -- Header Cannot Be Concatenated
200F	FM Data Not Allowed For Header
2010	BIND FM Header Set Violation
2014	FM Header Not Sent Concatenated
2019	Stack Reference Indicator Invalidly Set To One For Begin, Suspend, Resume, Or End FMH-1 Or For FMH-2
201A	Unable To Accept CMI Modification
201B	Unable To Accept CPI Modification
201C	Unable To Accept ERCL Modification

SESSION ERRORS (X'100840XX')

4001	Invalid FMH Type
4002	Invalid FMH Code
4003	Compression Not Supported
4004	Compaction Not Supported
4005	Basic Exchange Not Supported
4006	Only Basic Exchange Supported
4007	Medium Not Supported
4008	Code Selection Compression Violation
4009	FMHC Not Supported
400A	Demand Select Not Supported
400B	DSNAME Not Supported
400C	Invalid Medium Subaddress Field
400D	Insufficient Resources To Perform FMH Function
400E	DSP Select not supported

FMH PROTOCOL ERRORS UNIQUE TO LU-LU SESSION TYPE 6 (X'100860XX')

6001	Invalid Deblocking Algorithm (DBA)
6004	Invalid Queue Name Length
6006	Invalid Data Stream Profile (DSP)
6007	FMH-7 not preceded by -RSP 0846
6008	Invalid Attach access code.
6009	FMH-5 fixed length parm count not equal to 2
600A	Not first FMH-5 and the Interchange

Unit Type is not the same as the old
and the Interchange Unit End indicator
is not on

600B	FMH-5 command invalid
600C	Null Sequence field required
600D	User to user program not allowed.
600E	User to architected program not allowed
600F	FMH-5 Reset Attached Program (RAP) not sent properly
6010	FMH-5 RAP sent with inactive Attach register

NOTE: The words that are in all capital letters
(except BIND) are Type 1, 2, or 3 FM header
parameters.

CHAPTER 10. LU-LU SESSION TYPES

LU-LU SESSION TYPE DESCRIPTIONS

- 0 A type of session between two LU half-sessions using SNA-defined protocols for transmission control and data flow control, but using end-user or product-defined protocols to augment or replace FMD services protocols: for example, a session that involves an application program using IMS/VS and an IBM 3600 Finance Communication System, in which the operator of the 3600 terminal is updating the passbook balance for a customer's savings account.
- 1 A type of session between an application program and single- or multiple-device data processing terminals, in an interactive, batch data transfer, or distributed processing environment. For example, a session involving an application program using IMS/VS and an IBM 3767 Communication Terminal in which the 3767 operator is correcting a data base that is maintained using the application program. The data stream is the SNA character string (SCS).
- 2 A type of session between an application program and a single display terminal in an interactive environment, using the SNA 3270 data stream; for example, an application program using IMS/VS and an IBM 3277 Display Station, in which the 3277 operator is creating data and sending it to the application program.
- 3 A type of session between an application program and a single printer, using the SNA 3270 data stream; for example, an application program using CICS/VS to send data to an IBM 3284 Printer attached to an IBM 3791 Controller.

- 4 A type of session between: (1) an application program and a single- or multiple-device data processing or word processing terminal in an interactive batch data transfer, or distributed processing environment; for example, a session between an application program using CICS/VS and an IBM 6670 Information Distributor; or (2) logical units (LUs) in peripheral nodes; for example, two 6670s. The data stream is the SNA character string (SCS) for data processing environments and Office Information Interchange (OII) Level-2 for word processing environments.
- 6 A type of session between two application programs in a distributed processing environment, using the SNA character string (SCS), a structured-field data stream, an SNA 3270 data stream, a Logical Messages Services (LMS) data stream, or a user-defined data stream; for example, an application program using CICS/VS communicating with an application program using IMS/VS.
- 7 A type of session between an application program and a single display terminal in an interactive environment; for example, a session involving an application program in a System/34 and an IBM 5251 Display Station, where the 5251 operator is creating data and sending it to the application program. The data stream is the 5250 data stream.

Session partners must use the same LU-LU session type. SNA does not permit, for example, one half-session to use session type 1 and the other to use session type 4.

LU-LU SESSION CHARACTERISTICS

LU-LU Session Type 0

Half-Session Characteristics

TS Profile 2, 3, 4, 7

FM Profile 2, 3, 4, 7, 18

PS Characteristics: Any option desired

Sense Codes: Any SNA sense codes plus codes defined by session partners

LU-LU Session Type 1

Half-Session Characteristics

TS Profile 3, 4

FM Profile 3, 4

PS Characteristics: SNA character string, FM headers (none, or one or more of FMH-1, FMH-2, FMH-3), Data processing media support

Sense Codes

Request Reject (X'08xx')

0802 Intervention Required

0805 Session Limit Exceeded

080A Permission Rejected

080B Bracket Race Error

0811 Break

0812 Insufficient Resource

0813 Bracket Bid Reject -- No RTR
Forthcoming

0814 Bracket Bid Reject -- RTR
Forthcoming

081B Receiver in Transmit Mode

081C Request Not Executable

0821 Invalid Session Parameters

0825 Component Not Available

082B Presentation Space Integrity Lost

0831 LU Component Disconnected

0845 Permission Rejected -- SSCP Will
Be Notified

0860 Function Not Supported --
Continue Session

0862 Medium Presentation Space
Recovery

0863 Referenced LCID Not Found

0871 Read Partition State Error

Request Error (X'10xx')

- 1001 RU Data Error
- 1002 RU Length Error
- 1003 Function Not Supported
- 1005 Parameter Error
- 1008 Invalid FM Header

State Error (X'20xx')

- 2001 Sequence Number
- 2002 Chaining
- 2003 Bracket
- 2004 Direction
- 2005 Data Traffic Reset
- 2006 Data Traffic Quiesced
- 2007 Data Traffic Not Reset
- 2008 No Begin Bracket
- 2009 Session Control or Data Flow
Control Protocol Violation

LU-LU Session Type 2

Half-Session Characteristics

TS Profile 3

FM Profile 3

PS Characteristics: SNA 3270 data stream,
No FM Headers, Display support

Sense Codes

Request Reject (X'08xx')

- 0801 Resource Not Available
- 0802 Intervention Required
- 0807 Resource Not Available -- LUSTAT
Forthcoming
- 080A Permission Rejected
- 080B Bracket Race Error
- 0813 Bracket Bid Reject -- No RTR
Forthcoming
- 0814 Bracket Bid Reject -- RTR
Forthcoming
- 081B Receiver in Transmit Mode
- 081C Request Not Executable
- 0821 Invalid Session Parameter
- 0829 Change Direction Required
- 082A Presentation Space Alteration
- 082B Presentation Space Integrity Lost
- 082D LU Busy
- 082E Intervention Required at LU
Subsidiary Device
- 082F Request Not Executable because of
LU Subsidiary Device

0831 LU Component Disconnected
 0833 Invalid Parameter (with pointer
 and complemented byte)
 0843 Required FMD Synchronization Not
 Supplied
 0845 Permission Rejected -- SSCP Will
 Be Notified
 084A Presentation Space Alteration
 084C Permanent Insufficient Resource
 0863 Referenced LCID Not Found
 0868 No Panels Loaded
 0869 Panel Not Loaded
 0871 Read Partition State Error
 Request Error (X'10xx')
 1001 RU Data Error
 1003 Function Not Supported
 1005 Parameter Error
 1007 Category Not Supported
 1009 Format Group Not Selected
 State Error (X'20xx')
 2001 Sequence Number
 2002 Chaining
 2003 Bracket
 2004 Direction
 2005 Data Traffic Reset
 2006 Data Traffic Quiesced
 2007 Data Traffic Not Reset
 2008 No Begin Bracket
 2009 Session Control or Data Flow
 Control Protocol Violation

LU-LU Session Type 3

Half-Session Characteristics

TS Profile 3

FM Profile 3

PS Characteristics: SNA 3270 data stream,
 No FM headers, Display Support

Sense Codes

Request Reject (X'08xx')
 0801 Resource Not Available
 0802 Intervention Required
 080A Permission Rejected
 0814 Bracket Bid Reject -- RTR
 Forthcoming
 081B Receiver in Transmit Mode
 081C Request Not Executable
 0821 Invalid Session Parameters

082B Presentation Space Integrity Lost
 082D LU Busy
 0831 LU Component Disconnected
 0843 Required FMD Synchronization Not
 Supplied
 0845 Permission Rejected -- SSCP Will
 Be Notified
 084C Permanent Insufficient Resource
 0863 Referenced LCID Not Found
 Request Error (X'10xx')
 1001 RU Data Error
 1003 Function Not Supported
 1005 Parameter Error
 1007 Category Not Supported
 State Error (X'20xx')
 2001 Sequence Number
 2002 Chaining
 2003 Bracket
 2004 Direction
 2005 Data Traffic Reset
 2006 Data Traffic Quiesced
 2007 Data Traffic Not Reset
 2008 No Begin Bracket
 2009 Session Control or Data Flow
 Control Protocol Violation

LU-LU Session Type 4

Half-Session Characteristics

TS Profile 7

FM Profile 7

PS Characteristics: SNA character string or
 OII Level-2, FM headers (none, or one or
 more of FMH-1, FMH-2, FMH-3), Data
 processing and word processing media
 support

Sense Codes

Request Reject (X'08xx')
 0801 Resource Not Available
 0802 Intervention Required
 0809 Mode Inconsistency
 080A Permission Rejected
 080D NAU Contention
 080E NAU Not Authorized
 080F End User Not Authorized
 0811 Break
 0812 Insufficient Resource
 0813 Bracket Bid Reject -- No RTR
 Forthcoming

0815	Function Active
081C	Request Not Executable
0821	Invalid Session Parameter
0824	Component Aborted
0825	Component Not Available
0827	Intermittent Error -- Retry Requested
0829	Change Direction Required
082D	LU Busy
Request Error (X'10xx')	
1001	RU Data Error
1002	RU Length Error
1005	Parameter Error
1008	Invalid FM Header
State Error (X'20xx')	
2001	Sequence Number
2002	Chaining
2003	Bracket
2004	Direction
2005	Data Traffic Reset
2006	Data Traffic Quiesced
2007	Data Traffic Not Reset
2008	No Begin Bracket
2009	Session Control or Data Flow Control Protocol Violation

LU-LU Session Type 6

Half-Session Characteristics

TS Profile 4

FM Profile 18

PS Characteristics: SNA character string, SNA 3270 data stream, structured fields, Logical Message Services data stream, or user-defined data stream; FM headers (FMH-4 through FMH-8 and FMH-10); Program-to-program support for programs, queues, files, and data bases

Sense Codes

Request Reject ('08xx')	
080F	End User Not Authorized
0812	Insufficient Resource
0813	Bracket Bid Reject
0814	Bracket Bid Reject -- RTR Forthcoming
0819	RTR Not Required
081C	Request Not Executable
0824	Component Aborted

0826 FM Function Not Supported
 0829 Change Direction Required
 0846 ERP Message Forthcoming
 084B Requested Resources Not Available
 0864 Function Abort: Loop will occur
 upon re-execution
 0865 Function Abort: Sender
 responsible to detect loop
 0866 Function Abort: Receiver
 responsible to detect loop
 Request Error (X'10xx')
 1003 Function Not Supported
 1008 Invalid FM Header
 State Error (X'20xx')
 2001 Sequence Number
 2002 Chaining
 2003 Bracket
 2004 Direction
 2005 Data Traffic Reset
 2006 Data Traffic Quiesced
 2007 Data Traffic Not Reset
 2008 No Begin Bracket
 2009 Session Control or Data Flow
 Control Protocol Violation

LU-LU Session Type 7

Half Session Characteristics

TS Profile 7

FM Profile 7

Sense Codes

Request Reject (X'08xx')
 0801 Resource Not Available
 0813 Bracket Bid Reject -- No RTR
 Forthcoming
 0815 Function Active
 081C Request Not Executable
 0821 Invalid Session Parameters
 0829 Change Direction Required
 082D LU Busy
 0831 LU Component Disconnected
 Request Error (X'10xx')
 1003 Function Not Supported
 1005 Parameter Error
 State Error (X'20xx')
 2001 Sequence Number
 2002 Chaining
 2003 Bracket

2004	Direction
2005	Data Traffic Reset
2006	Data Traffic Quiesced
2007	Data Traffic Not Reset
2008	No Begin Bracket
2009	Session Control or Data Flow Control Protocol Violation

This page left intentionally blank

CHAPTER 11. PU AND NODE TYPES

This chapter summarizes information from **Systems Network Architecture Format and Protocol Reference Manual: Architectural Logic** (SC30-3112).

Node types correspond to the PU type used in the node.

Peripheral Node Types

PU Type 1 (PU_T1)

For all PIUs sent to and received from a PU_T1 node, the transmission header (TH) format is FID3.

PU Type 2 (PU_T2)

For all PIUs sent to and received from a PU_T2 node, the transmission header (TH) format is FID2.

Subarea Node Types

PU Type 4 (PU_T4)

A PU_T4 node has intermediate function, boundary function, or both.

The TH format is either:

- FID0 or FID1 for all PIUs transmitted between the PU_T4 and adjacent PU_T4|5 node, if either or both nodes do not support ER and VR protocols.
- FID2 for all PIUs transmitted between the PU_T4 and an adjacent PU_T2 node.
- FID3 for all PIUs transmitted between the PU_T4 and an adjacent PU_T1 node.
- FID4 or FIDF for all PIUs transmitted between the PU_T4 and adjacent PU_T4|5 node, if both nodes support ER and VR

protocols.

PU Type 5 (PU_T5)

A PU_T5 is at a node that has intermediate function, boundary function, or both, and also contains an SSCP.



The TH format is either:

- FID0 or FID1 for all PIUs transmitted between the PU_T5 and adjacent PU_T4|5 node, if either or both nodes do not support ER and VR protocols.
- FID2 for all PIUs transmitted between the PU_T5 and an adjacent PU_T2 node.
- FID3 for all PIUs transmitted between the PU_T5 and an adjacent PU_T1 node.
- FID4 or FIDF for all PIUs transmitted between the PU_T5 and an adjacent PU_T4|5 node, if both nodes support ER and VR protocols.

CHAPTER 12. SNA CHARACTER SETS

Column Row Pat.	00		01		10		11		F
	0	1	0	1	0	1	0	1	
	00	01	10	11	00	01	10	11	
0 0000			SP	&	-				
1 0001					/				
2 0010						a	j		
3 0011						b	k	s	
4 0100						c	l	t	
5 0101						d	m	u	
6 0110						e	n	v	
7 0111						f	o	w	
8 1000						g	p	x	
9 1001						h	q	y	
A 1010						i	r	z	
B 1011						,	:		
C 1100						\$	'	#	
D 1101						%	@		
E 1110						^	=	"	
F 1111						~	?		

Column (high-order), Row (low order); for example, A = "C1"

-  94-character set, only
-  63- or 94-character set
-  48-, 63-, or 94-character set

Note: This table applies only to US EBCDIC character sets; international sets may vary.

This page left intentionally blank

CHAPTER 13. PRODUCTS AND SNA

This chapter summarizes information from Systems Network Architecture Concepts and Products (GC30-3072). It also contains additional information to assist people interested in a specific SNA product.





HARDWARE

Product	PU/ Node Type	LU-LU Session Type
Series/1	2	0,1,2
S/32	2	1
S/34	2	0,1,2,3,4,7
S/38	1,2	1,4,7
3270	1	0,1,2,3
3600	2,3	0,1,2
3614	2	0
3624	2	0
3630	2	0,1
3640	1,2	0,1
3650	2	0
3660	2	0
3767	1	1
3770	2	1
3790	1,2	0,1,2,3
5250	1	4,7
6670	1	4
8775	2	2

SOFTWARE

Product	PU/ Node Type	LU-LU Session Type
ACP	5	0,1,2,3,6
CICS/VS	5	0,1,2,3,4,6
DPCX	2	0,1,2,3,4
DPPX	2	0,1,2
IMS/VS	5	0,1,2,4,6
JES2	5	0,1
JES3	5	0,1
NCCF	5	0,1,2
POWER/VS	5	1
RES	5	1,4
TCAM	5	0,1,2,3,4
TSO	5	1,2
VM/370	5	1,2
VSPC	5	1,2

CHAPTER 14. COMMON SEQUENCES

Key	
	Request Unit
	Response Unit
	SDLC Command or Response
	Channel
	SDLC Link
(XXX)	Network Resource Associated With the RU
ER	Explicit Route
Host	Host Processor
Link	Data Link
LS	Link Station
LU	Logical Unit
NCP	Network Control Program
PNODE	Peripheral Node
PU	Physical Unit
PUCP	Physical Unit Control Point
SA	Subarea
SSCP	Systems Services Control Point
TG	Transmission Group
VR	Virtual Route

This page left intentionally blank

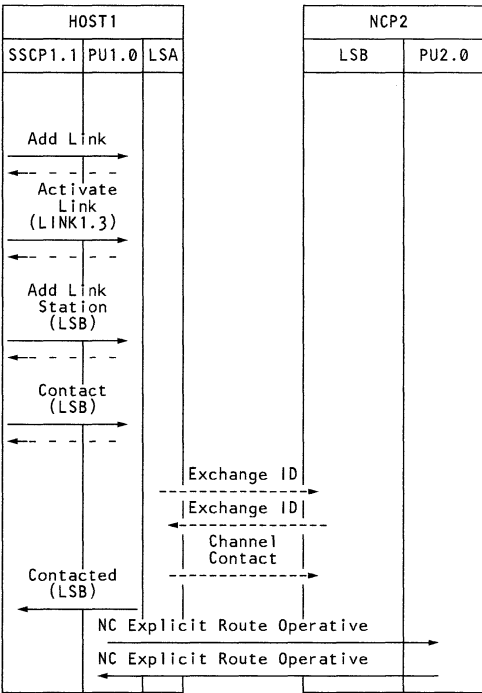
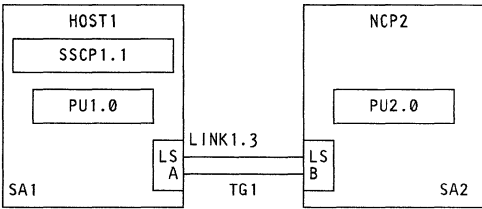

Activating a Host Node, a Channel-Attached Subarea Node, and the Channel Between Them
Figure 14-1.

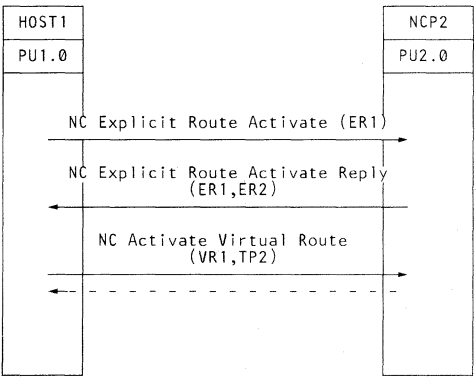
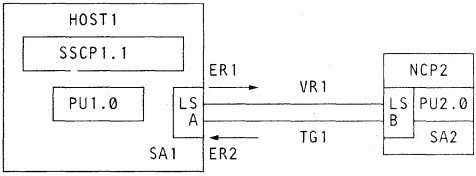

Activating Explicit and Virtual Routes Between Adjacent Subarea Nodes

Figure 14-2.

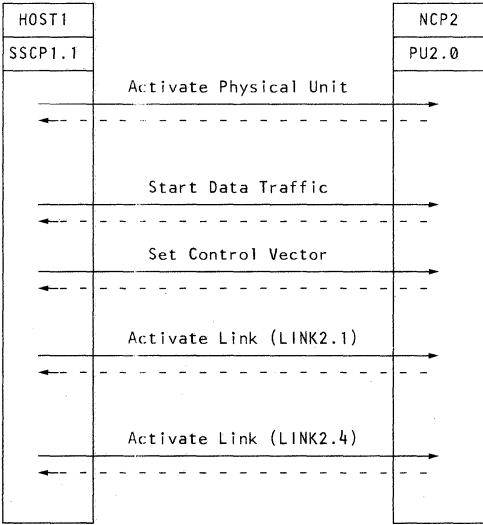
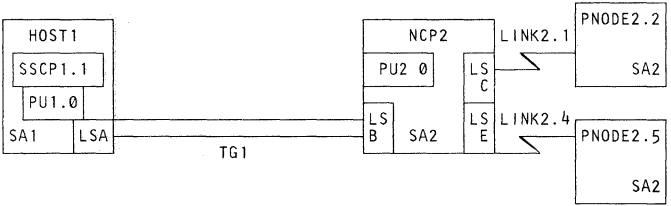

Activating a Channel-Attached Subarea Node and Attached Links

Figure 14-3.

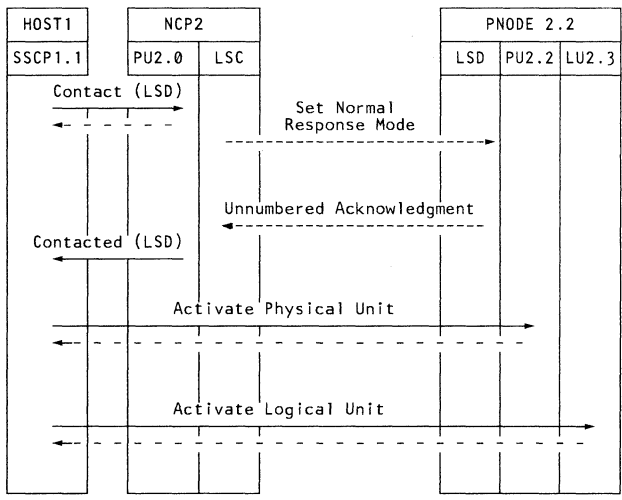
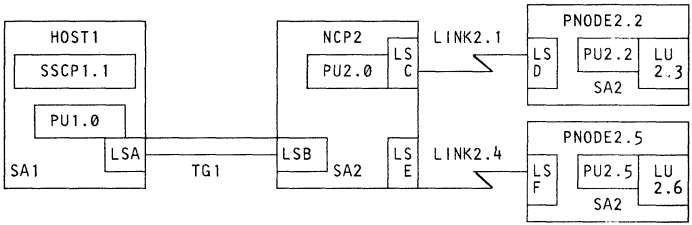

Activating a Peripheral Node Attached via a Nonswitched SDLC Link

Figure 14-4.

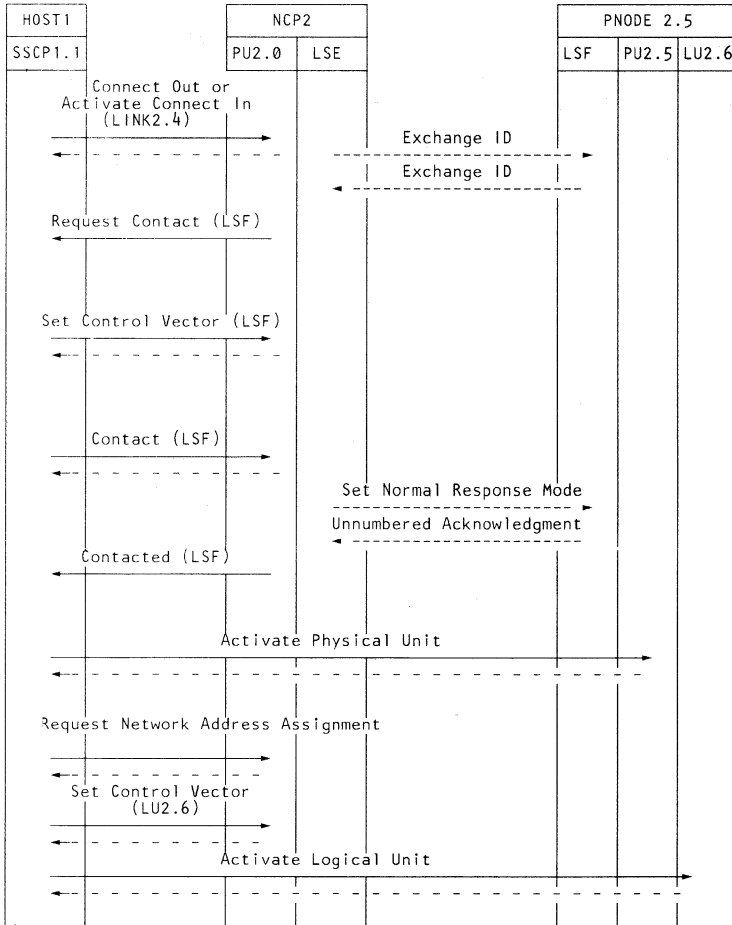
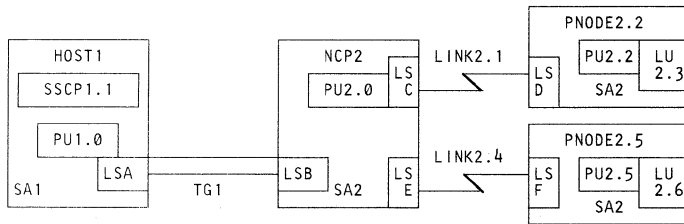

Activating a Peripheral Node Attached to a Switched SDLC Link
 Figure 14-5.

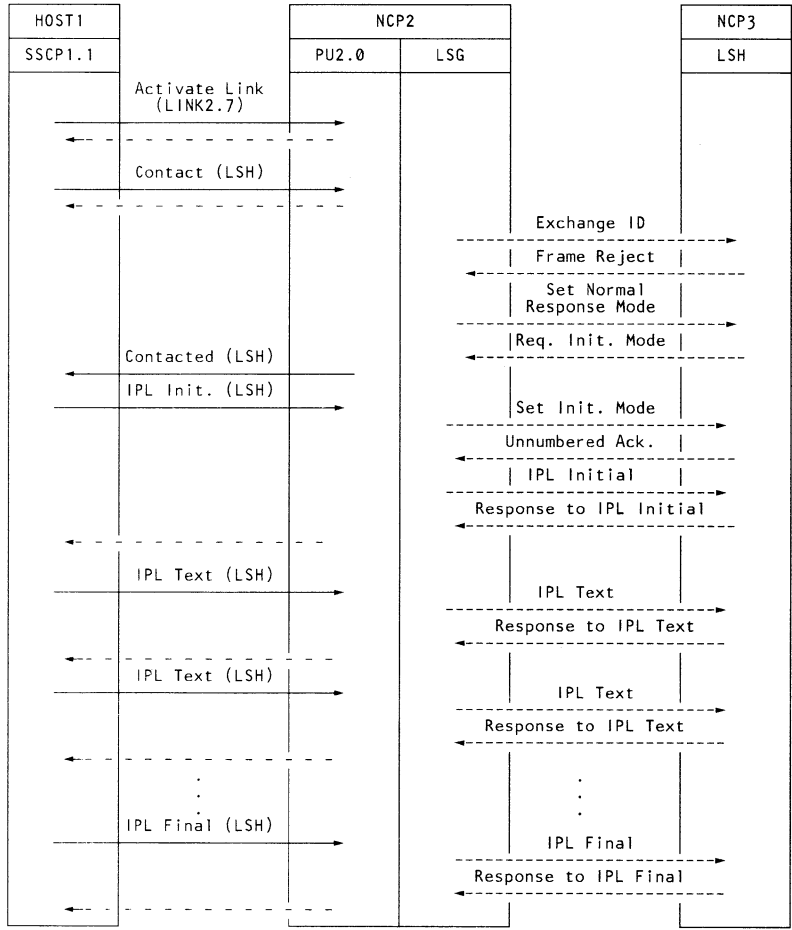
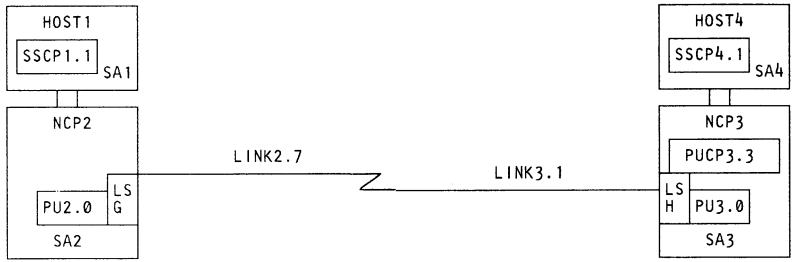

Loading a 3705 Communications Controller with an NCP
 Figure 14-6.

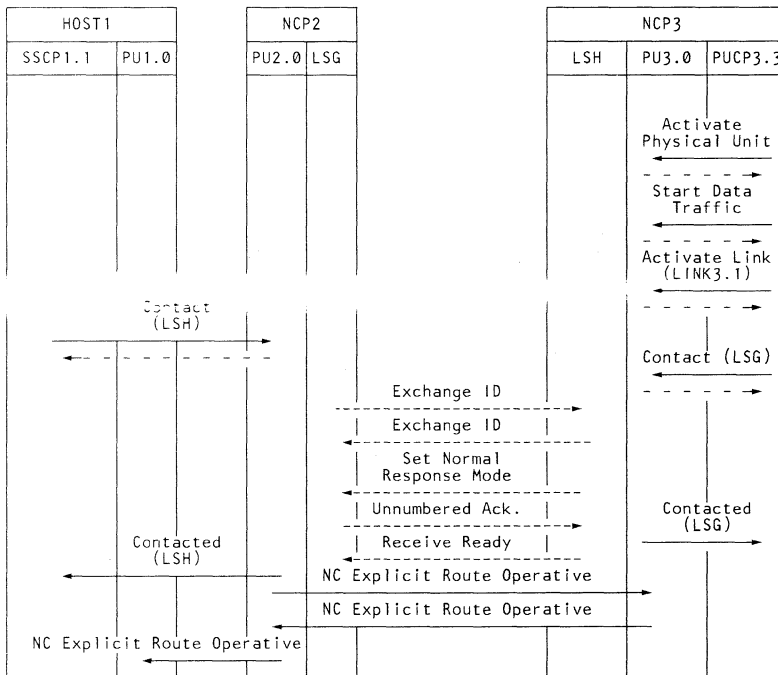
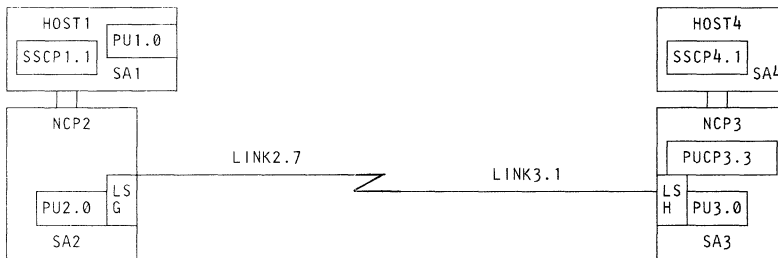

SSCP4.1 activates NCP3.
(See Figs. 1, 2, and 3.)

Activating and SDLC Link Between Subarea Nodes

Figure 14-7.

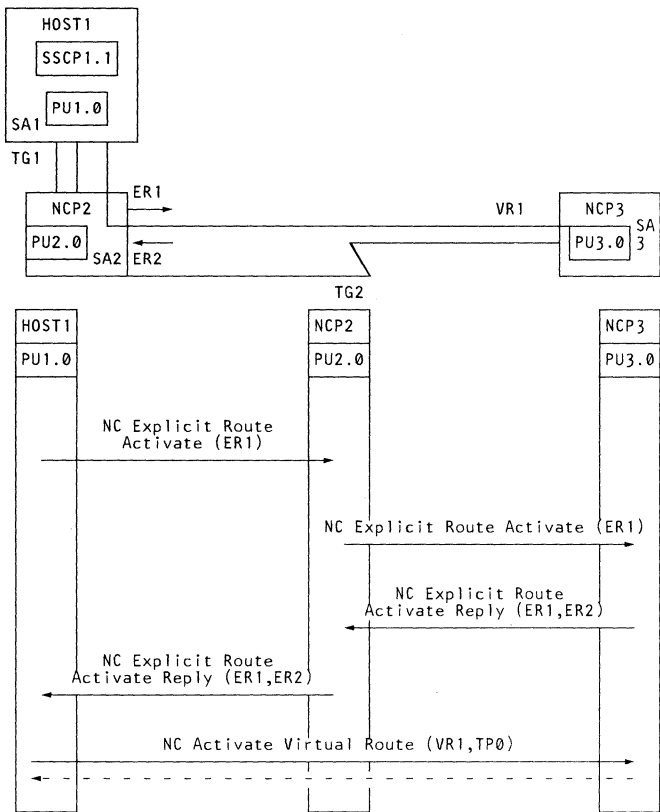

Activating Explicit and Virtual Routes Between Non-Adjacent Subarea Nodes

Figure 14-8.

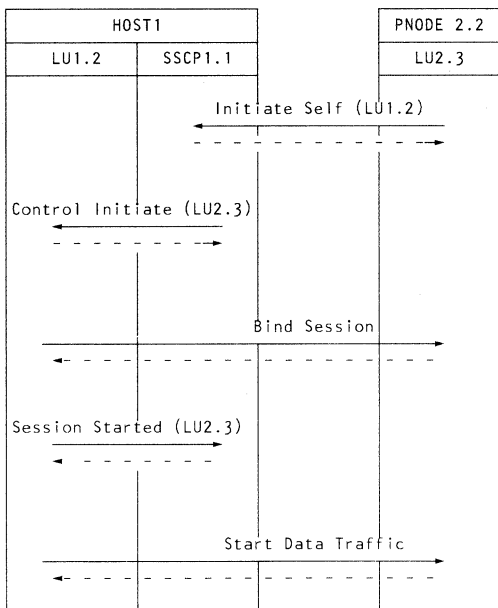
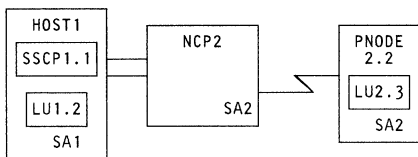

Establishing a Same-Domain LU-LU Session
Figure 14-9.

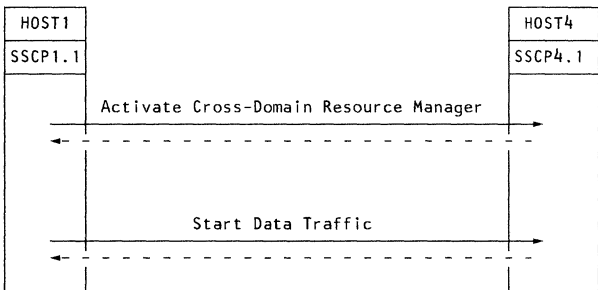
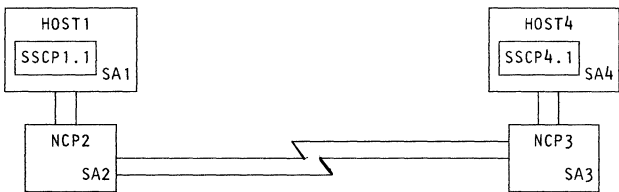

Establishing an SSCP-SSCP Session

Figure 14-10.

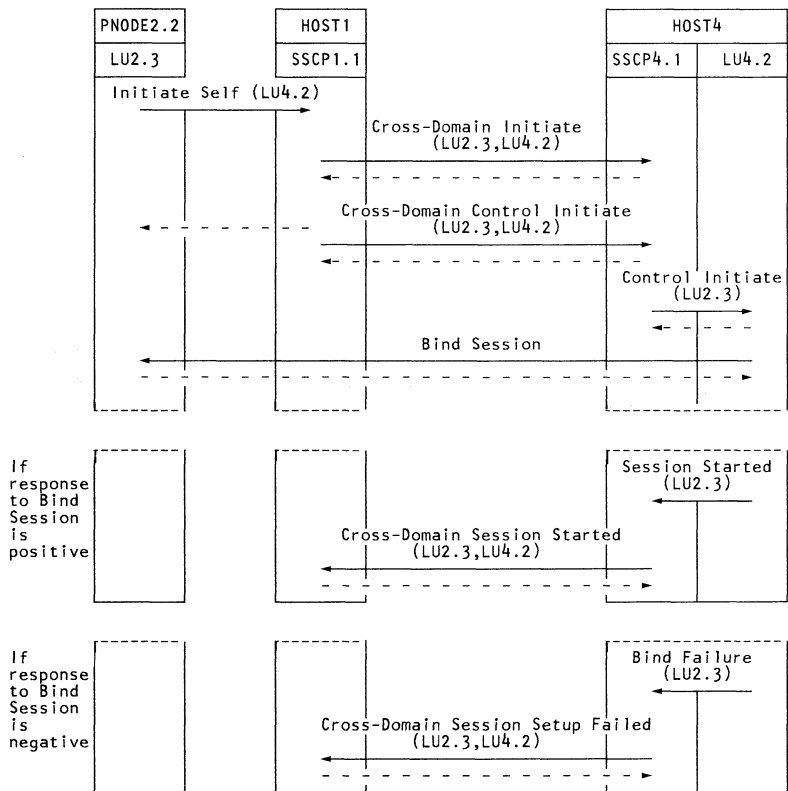
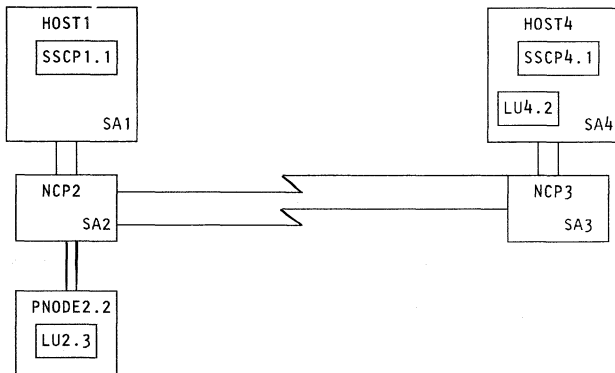

Establishing a Cross-Domain LU-LU Session

Figure 14-11.

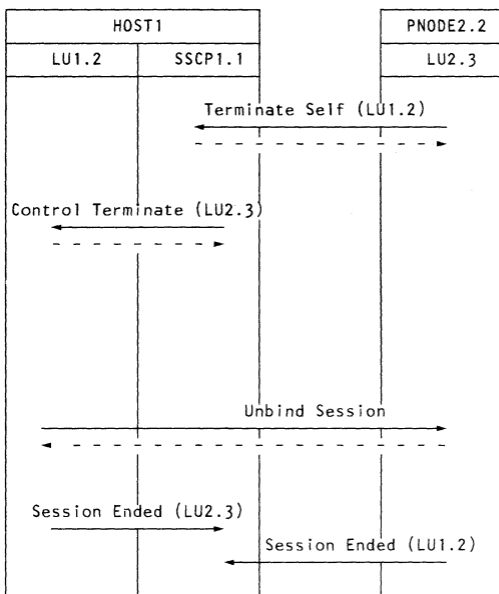
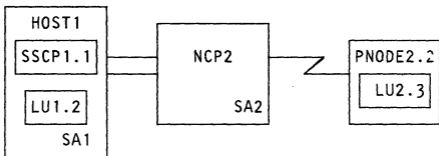

Terminating a Same-Domain LU-LU Session
Figure 14-12.

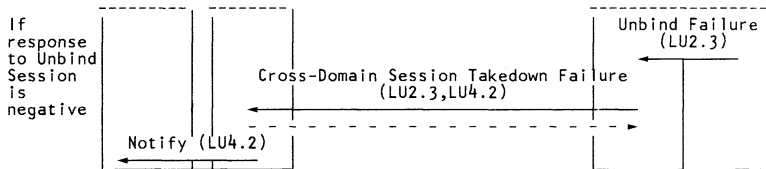
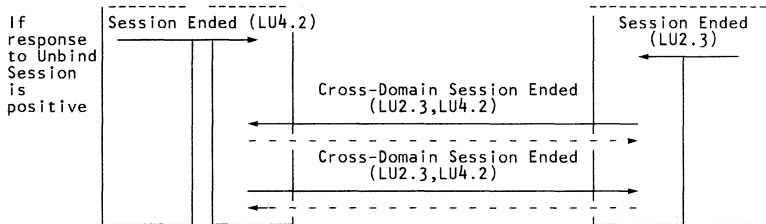
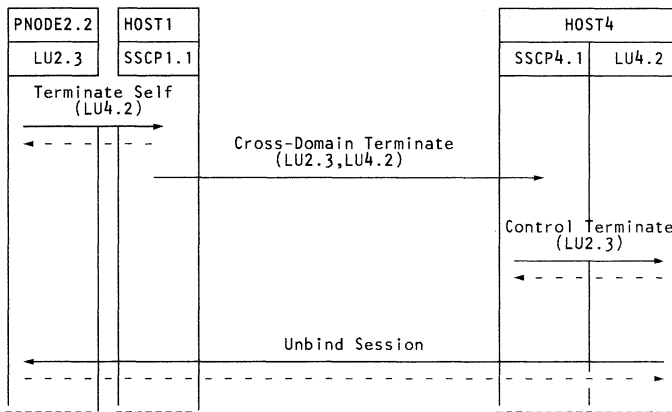
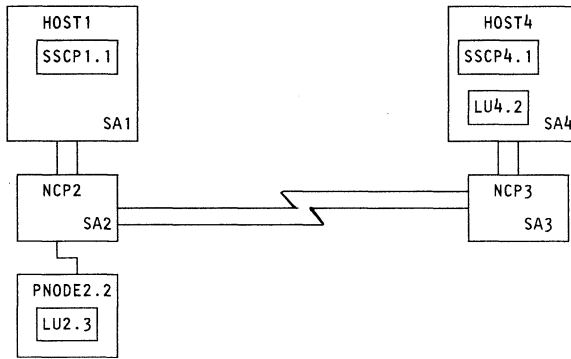

Deactivating a Cross-Domain LU-LU Session
Figure 14-13.

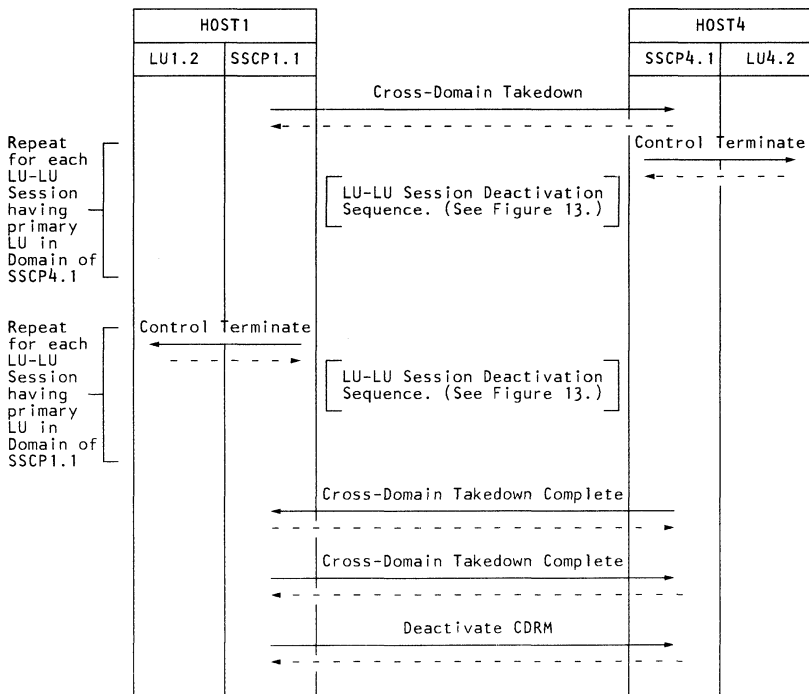
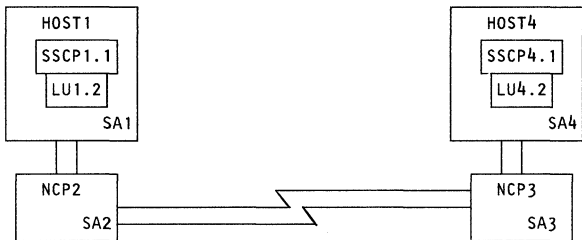

Cross-Domain Takedown Sequence
 Figure 14-14.

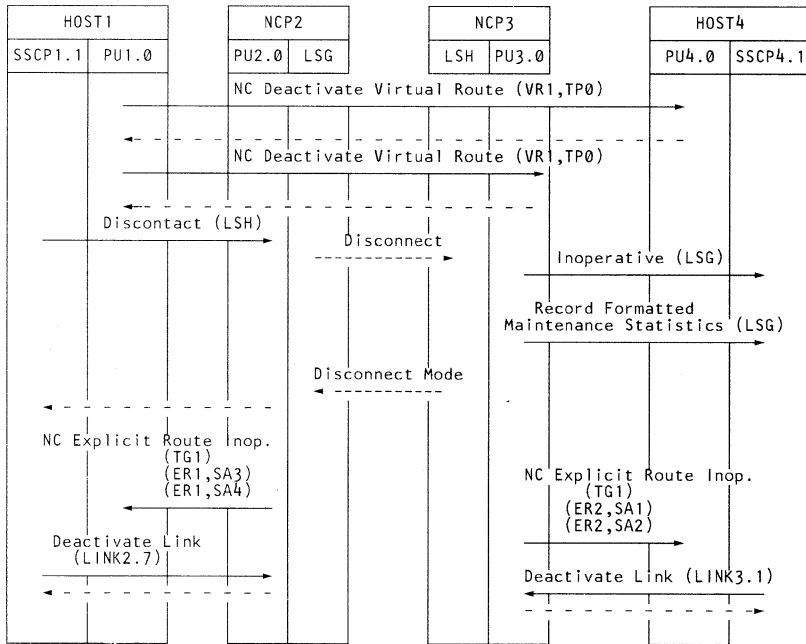
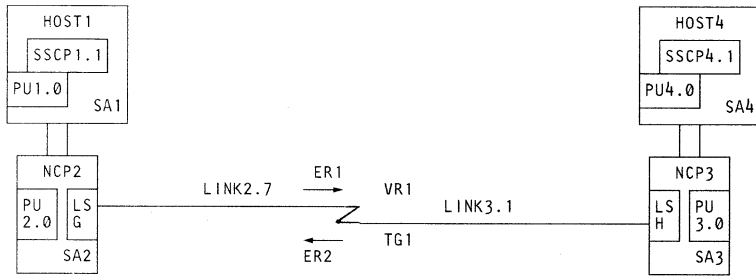

Deactivating Virtual Routes, Explicit Routes, and SDLC Links
 Figure 14-15.

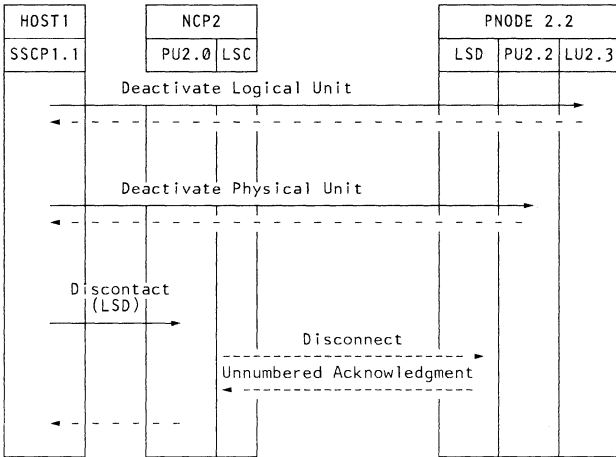
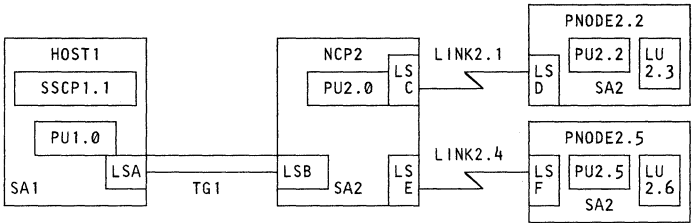

Deactivating a Peripheral Node Attached via a Nonswitched SDLC Link

Figure 14-16.

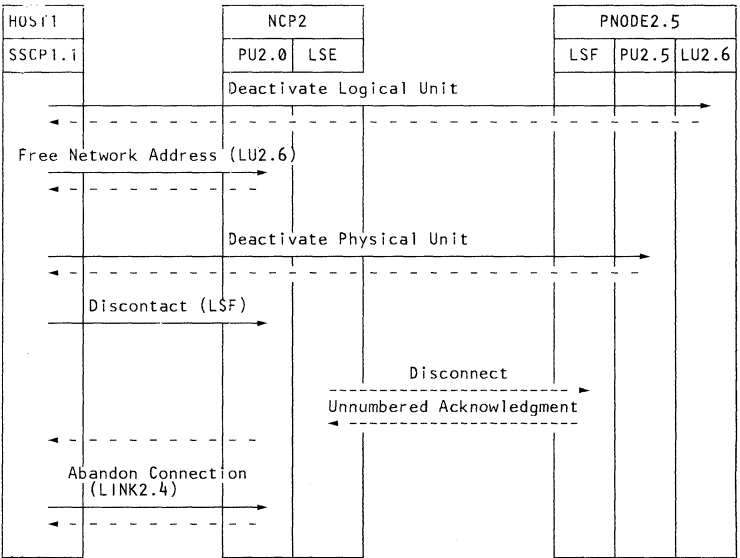
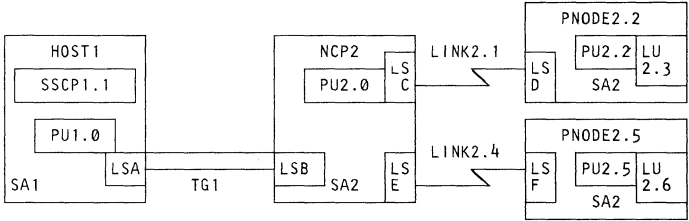

Deactivating a Peripheral Node Attached to a Switched SDLC Link
Figure 14-17.

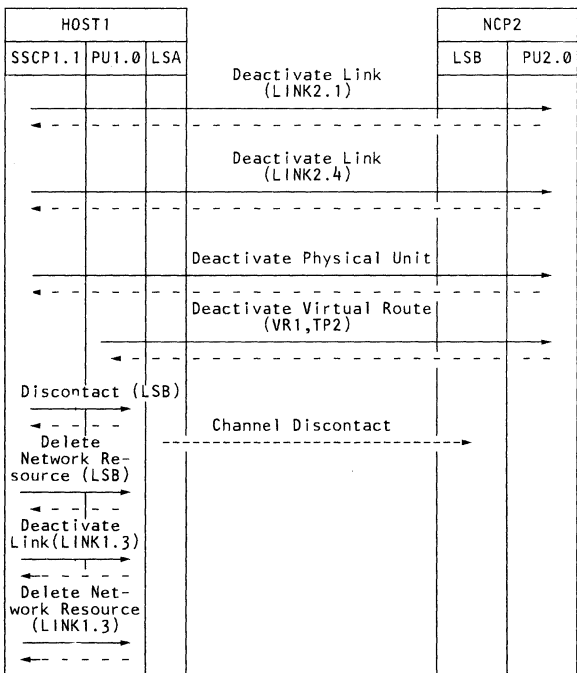
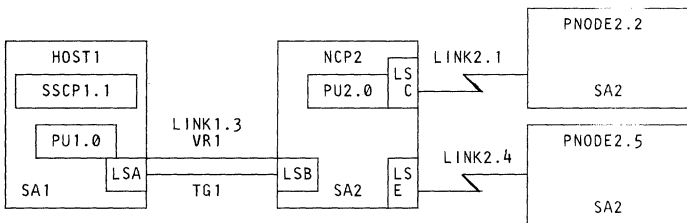

Deactivating a Channel-Attached Subarea Node and Associated Resources

Figure 14-18.

CHAPTER 15. OTHER SNA PUBLICATIONS

This chapter lists other IBM SNA publications that you may find useful. These publications supplied information for various parts of the chapters in this book.

IBM Synchronous Data Link Control General Information (GA27-3093)

This manual, written for technical people interested in data communication, presents in simple terms the concepts and operation of SDLC. **IBM Synchronous Data Link Control** assumes the reader has no prior knowledge of data communication.

The chapters in **Systems Network Architecture Reference Summary** that contain information from **IBM Synchronous Data Link Control** are: 1, 5, and 16.

Systems Network Architecture Concepts and Products (GC30-3072)

This manual, written for DP Managers and other decision-makers, briefly presents the basic concepts of SNA and briefly describes each of the SNA-based hardware and software products that IBM offers. **Systems Network Architecture Concepts and Products** assumes that the reader has no prior knowledge of SNA.

The chapters in **Systems Network Architecture Reference Summary** that contain information from **Systems Network Architecture Concepts and Products** are: 13 and 14.

**Systems Network Architecture Format and Protocol
Reference Manual: Architectural Logic
(SC30-3112)**

This manual, written for System Programmers and Maintenance People, provides a formal and detailed definition of all portions of SNA except for LU presentation services. In this manual, each functional layer of SNA consists of one or more protocol machines, which in turn consist of one or more procedures or finite-state machines, which are presented as routines or matrices written in a PL/I-like language called FAPL. **Systems Network Architecture Format and Protocol Reference Manual: Architectural Logic** assumes that the reader has basic programming knowledge.

The chapters of **Systems Network Architecture Reference Summary** that contain information from the **Systems Network Architecture Format and Protocol Reference Manual: Architectural Logic** are: 2, 3, 4, 6, 7, 8, 11, and 16.

CHAPTER 16. SNA ACRONYM GLOSSARY

A

A address (SDLC)
 ACT active, activate

B

B 'nnnn' binary digits
 BB Begin Bracket
 BBI Begin Bracket Indicator
 BC Begin Chain
 BCI Begin Chain Indicator
 BETB Between Brackets
 BF boundary function
 BIU basic information unit
 BLU basic link unit
 BSC Binary Synchronous Communication
 BTU basic transmission unit

C

(c) configuration services
 C control (SDLC)
 CCA communication controller adapter
 CCITT Comite Consultatif International
 Telegraphique et Telephonique
 (International Telegraph and Telephone
 Consultative Committee)
 CD cross-domain, Change Direction
 CDI Change Direction indicator
 CDRM cross-domain resource manager
 CNM communication network management
 CNMA communication network management
 application
 CNMS communication network management
 services
 CONT contention
 COS class of service
 CPMGR connection point manager
 CSC common session control
 CSI Code Selection indicator
 CSP Control Sequence Prefix

D

DAF	destination address field
DCE	Data Communication Equipment, Data Circuit-terminating Equipment
DCF	data count field
DD	day of month
ddd	day of year
DEF	Destination Element Address Field
DES	Date Encryption Standard
DFC	data flow control
DISC	Disconnect (SDLC)
DLC	data link control
DLU	destination logic unit
DM	Disconnected Mode (SDLC)
DPN	Destination Program Name
DQ	dequeue
DR11	Definite Response 1 indicator
DR21	Definite Response 2 indicator
DSAF	Destination Subarea Address Field

E

EB	End Bracket
EBCDIC	extended binary coded decimal interchange code
EBI	End Bracket indicator
EC	End Chain
ECI	End Chain indicator
ED	enciphered data
EDI	Enciphered Data indicator
EFI	Expedited Flow indicator
ENP	Enable Presentation
ER	Explicit Route
ERI	Exception Response indicator
ERN	Explicit Route Number
ERP	error recovery procedures
Exp	expedited flow
EXR	Exception Request

F

F	flag (SDLC)
FCS	frame check sequence (SDLC)
FDX	full duplex data flow
FF	flip-flop direction control
FI	Format indicator
FID	format identification
FIFO	first-in, first-out

FM function management
 FMD function management data
 FMDS function management data services
 FMH function management header
 FRMR Frame Reject (SDLC)
 FSM finite-state machine

H

HDX half-duplex data flow
 HH hours
 HSID half-session identification

I

I information (SDLC)
 I initiate only
 ID identification
 IERN Initial Explicit Route Number
 ILU initiating logical unit
 INB in bracket
 INIT initiate
 INOP inoperative
 INP Inhibit Presentation
 IPL initial program load
 I/Q initiate or queue
 ISO International Organization for Standardization

L

LCID local coded graphic character set identifier
 LH link header
 LIFO last-in, first-out
 LT link trailer
 LSID local session identification
 LU logical unit

M

(ma) maintenance services
 (me) measurement services
 MGR manager
 MM month, minutes
 (mn) management services
 MPC maximum presentation column
 MPF mapping field (BIU segments)
 MPL maximum presentation line

N

NA network address
 NAU network addressable unit
 NC network control
 (no) network operator services
 Norm normal flow
 NS network services
 NTWK network

O

OAF Origin Address field
 OEF Origin Element field
 OLU originating logical unit
 OSAF Origin Subarea field

P

P primary
 PC path control
 PCID procedure correlation identifier
 PD Padded Data
 PDI Padded Data indicator
 PEND pending
 PI Pacing indicator
 PIU path information unit
 PLU primary logical unit
 POC Program Operator Communication
 PPU primary physical unit
 PRI primary
 PRID procedure related identifier
 PRN Primary Resource Name
 PRTY Priority
 PS presentation services
 PU physical unit
 PUCP physical unit control point

Q

Q queue
 QR Queued Response
 QRI Queued Response indicator

R

RCV receive
 RD Request Disconnect (SDLC)
 REC receive

REJ	Reject (SDLC)
RES	resource
RH	request/response header
RIM	Request Initialization Mode (SDLC)
RLSD	released
RNR	Receive Not-Ready (SDLC)
RQ	request
RR	Receive Ready (SDLC)
RR1	Request/Response Indicator
RSP	response
RTI	Response Type indicator (+/-)
RU	request/response unit

S

S	secondary
(s)	session services
SC	session control
SCS	SNA Character String
SDI	Sense Data Included indicator
SDLC	Synchronous Data Link Control
SEC	secondary
SESS	session
SIM	Set Initialization Mode (SDLC)
SLU	secondary logical unit
SNA	Systems Network Architecture
SNC	sense code
SNF	sequence number field
SNRM	Set Normal Response Mode (SDLC)
SPU	secondary physical unit
SQN	sequence number
SS	seconds
SSCP	system services control point
SVC	services

T

TC	transmission control
TERM	terminate
TEST	Test (SDLC)
TG	transmission group
TGN	transmission group number
TH	transmission header
TLU	terminating logical unit
TPF	Transmission Priority Field
TS	transmission services
TWX	teletypewriter exchange service

U

UA Unnumbered Acknowledgment (SDLC)
UI Unnumbered Information (SDLC)
UNAVL unavailable
UP Unnumbered Poll (SDLC)
URC user request correlation

V

VR virtual route
VRID Virtual Route identifier
VRN virtual route number
VRPRQ Virtual Route Pacing Request
VRPRS Virtual Route Pacing Response
VT Vertical Tab

X

XID Exchange Identification (SDLC)
X'n...n' hexadecimal digits
XMIT transmit

Y

YY year

| or
* any value
¬ not
** exponential operator

Systems Network Architecture
Reference Summary

READER'S
COMMENT
FORM

Order No. GA27-3136-4

This form may be used to communicate your views about this publication. They will be sent to the author's department for whatever review and action, if any, is deemed appropriate.

IBM may use or distribute any of the information you supply in any way it believes appropriate without incurring any obligation whatever. You may, of course, continue to use the information you supply.

Note: *Copies of IBM publications are not stocked at the location to which this form is addressed. Please direct any requests for copies of publications, or for assistance in using your IBM system, to your IBM representative or to the IBM branch office serving your locality.*

If you desire a reply by the group that prepared this manual, include your name and address.

FROM

NAME _____ DATE _____

COMPANY _____ OFFICE/DEPT NO. _____

CITY/STATE _____ ZIP CODE _____

Yes No <input type="checkbox"/> <input type="checkbox"/> Did you receive this guide in time?	Yes No <input type="checkbox"/> <input type="checkbox"/> Are the illustrations clear?
<input type="checkbox"/> <input type="checkbox"/> Do you find this guide useful?	<input type="checkbox"/> <input type="checkbox"/> Were the instructions accurate?
<input type="checkbox"/> <input type="checkbox"/> Is the guide too technical?	<input type="checkbox"/> <input type="checkbox"/> Were the instructions clear?
<input type="checkbox"/> <input type="checkbox"/> Is the guide well organized?	<input type="checkbox"/> <input type="checkbox"/> Are the instructions complete?

please use the space provided to comment further

Thank you for your cooperation. No postage stamp is necessary if mailed in the U.S.A. (Elsewhere, an IBM office or representative will be happy to forward your comments)



NO POSTAGE
NECESSARY
IF MAILED
IN THE
UNITED STATES

BUSINESS REPLY MAIL

FIRST CLASS PERMIT NO. 40 ARMONK, N.Y.

POSTAGE WILL BE PAID BY ADDRESSEE

International Business Machines Corporation
Dept. E02
P.O. Box 12195
Research Triangle Park
North Carolina 27709

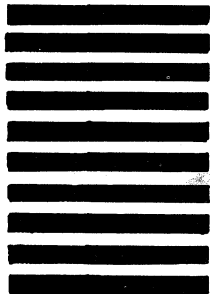

GA27-3136-4



**International Business Machines Corporation
Data Processing Division
1133 Westchester Avenue, White Plains, N.Y. 10604**

**IBM World Trade Americas/Far East Corporation
Town of Mount Pleasant, Route 9, North Tarrytown, N.Y., U.S.A. 10591**

**IBM World Trade Europe/Middle East/Africa Corporation
360 Hamilton Avenue, White Plains, N.Y., U.S.A. 10601**

Printed in U.S.A.