

GA21-9409-2

File No. S5250/S34/S36/S38-06

**IBM 5291 Models 1 and 2
Display Station
Operator's Guide**

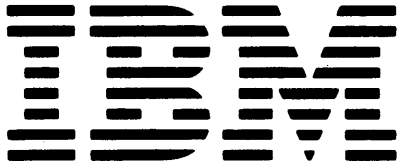

GA21-9409-2

File No. S5250/S34/S36/S38-06

**IBM 5291 Models 1 and 2
Display Station
Operator's Guide**

Federal Communications Commission (FCC) Statement

WARNING: *This equipment generates, uses, and can radiate radio frequency energy and if not installed and used in accordance with the instructions manual, may cause interference to radio communications. It has been tested and found to comply with the limits for a Class A computing device pursuant to Subpart J of Part 15 of FCC Rules, which are designed to provide reasonable protection against such interference when operated in a commercial environment. Operation of this equipment in a residential area is likely to cause interference in which case the user, at his own expense, will be required to take whatever measures may be required to correct the interference.*

Third Edition (May 1984)

This major revision makes obsolete GA21-9409-1. Additions were made to include information about the 5291 Model 2. Changes or additions to the text and illustrations are indicated by a vertical line to the left of the change or addition.

Changes are periodically made to the information herein; any such changes will be reported in subsequent revisions or Technical Newsletters.

Use this publication only for the purposes stated in the *Preface*.

Publications are not stocked at the address below. Requests for copies of IBM publications and for technical information about the system should be made to your IBM representative or to the branch office serving your locality.

This publication could contain technical inaccuracies or typographical errors. A form for readers' comments is provided at the back of this publication. If the form has been removed, comments may be addressed to IBM Corporation, Information Development, Rochester, Minnesota, U.S.A. 55901. IBM may use or distribute whatever information you supply in any way it believes appropriate without incurring any obligation to you.

This operator's guide provides three types of information about the IBM 5291 Models 1 and 2 Display Stations:

1. How to operate the display stations
2. Reference information about the display stations
3. What to do when things appear wrong

This guide is for the IBM 5291 Models 1 and 2 operator and supervisory personnel. It can be used as a learning tool as well as a source of reference information. The operator does not need to know any programming but should be familiar with typing.

Note: The term *host system* refers to the controlling or highest level system in a configuration; some system publications might use the term *system unit*.

The term *remote work station controller* refers to a controlling device at a remote location, such as a 5294 or a 5251 Model 2 or 12 that coordinates work station operation with system operation.

The term *display station* refers to the IBM 5291 Models 1 and 2.

Chapter 1 contains information that the operator needs to operate the display stations.

Chapter 2 contains reference information about the keyboard.

Chapter 3 explains the error codes and the recovery procedures.

Chapter 4 contains the problem determination procedures.

Chapter 5 contains the matrix printer verification test (5256 Printer).

A glossary is included at the back of this manual.

Note: This manual follows the convention that *he* means *he* or *she*.

Related Publications

- *IBM 5250 Information Display System Introduction*, GA21-9246, describes the work stations that make up the 5250 and their available functions and features.
- *IBM 5250 Information Display System Planning and Site Preparation Guide*, GA21-9337, provides environment, electrical, communications, space, furniture, and cable specifications to assist in planning for the setup of the IBM 5250 Information Display System. This manual also provides information to help the system programmer configure the system and prepare instructions for setup personnel at remote sites.
- *IBM 5291 Display Station Setup Procedures*, GA21-9408, provides step-by-step instructions for the setup and checkout of the IBM 5291 Display Station. This manual is used after the display station has been unpacked and placed in position.
- *IBM 5291 Model 2 Display Station Setup Procedure*, GA21-9802, provides step-by-step instructions for the setup and checkout of the IBM 5291 Model 2 Display Station. This manual is used after the display station has been unpacked and placed in position.
- *IBM 5251 Display Station Models 2 and 12 Operator's Guide*, GA21-9323, describes the procedures required to operate the 5251 Models 2 and 12 and to correct situations when the 5251 does not operate as expected.
- *IBM 5250 Information Display System Functions Reference Manual*, SA21-9247, describes the programming requirements for communicating with the 5250 Information Display System. This manual also describes how to determine problem-causing areas within the remote link to that system.

- *IBM 5250 Information Display System Keyboard Template Assignment Sheet and Display Screen Layout Sheet, GX21-9271*, provides row and column layout of the display screen. The sheet can also be filled out for use by the key/data operator as a run sheet.
- *IBM 5291 Keyboard Template, GX21-9410*, or the *IBM 5291 Model 2 Keyboard Template, GX21-9501*, provides forms that when filled out by the customer, identify 24 additional functions that can be assigned to the top row of keyboard keys. The template also contains customer problem determination procedures for the IBM 5291 Display Station.
- *IBM 5250 Information Display System Typewriter-Like Keytop Graphics, GX21-9397*, is an adhesive material form providing examples of keytops for use in customer developed documentation such as run books. The form contains keytop graphics from the typewriter-like keyboard on the IBM 5251 Display Station and the IBM 5252 Dual Display Station.

Contents

CHAPTER 1. LEARNING TO OPERATE THE DISPLAY STATION	1-1
General Information	1-1
Host System	1-3
Cleaning	1-3
Basic Operation	1-4
Power Switch	1-4
Brightness Control	1-6
Contrast Control (Model 2 Only)	1-7
Alarm Control	1-8
Rotating the Display Unit (Model 2 Only)	1-9
Adjusting the Slope of the Keyboard	1-10
Adjusting the Viewing Angle of the Display Screen	1-12
The Display Screen	1-13
Display Status Indicators	1-14
Cursor Location Information	1-16
Choosing the Cursor	1-17
Display Highlighting and Formatting	1-18
The Keyboard	1-19
Typematic Keys	1-20
Command Function Keys	1-21
CHAPTER 2. KEYBOARD	2-1
Function Control Keys	2-1
Command Key	2-2
Test Request	2-4
Reversing the Display Image (Display Mode)	2-4
Clear	2-5
System Request/Attention Key	2-6
Delete Key	2-7
Insert Key	2-8
Erase Input Key	2-9
Home Key	2-9
Print Key	2-10
Help Key	2-10
Roll Keys	2-11
Error Reset Key	2-11
Enter/Record Advance Key	2-12
Duplicate Key	2-12
Field Exit Key	2-13
Field + Key	2-14
Field - Key	2-14
Cursor Movement Keys	2-15
Moving the Cursor to the Beginning of a Field or New Line	2-18
Shift, Spacebar, and Special Symbol Keys	2-20
Shift Keys	2-20
Shift Lock Key	2-20
Spacebar	2-21
Special Symbol Keys	2-21
CHAPTER 3. ERROR CODES AND RECOVERY PROCEDURES	3-1
Help Key Function	3-1
Additional Information	3-1
Error Codes	3-2
CHAPTER 4. PROBLEM DETERMINATION PROCEDURES	4-1
CHAPTER 5. RUNNING THE VERIFICATION TESTS	5-1
GLOSSARY	G-1
INDEX	X-1

Chapter 1. Learning to Operate the Display Station

This chapter describes the Power switch, the Brightness and Alarm controls, the display screen, and the keyboard, as well as some common operator tasks.

GENERAL INFORMATION

The IBM 5291 Models 1 and 2 Display Stations are tabletop display units connected to movable keyboards by flexible cables. The display stations are compatible with the IBM 5251 Models 1 and 11.

The display stations have 83-key typewriter-like keyboards that provide the following:

- Function control keys that are used to insert, delete, or move data, and to position the cursor
- A Cmd (Command) key that permits selection of programmable command functions
- Typematic keys that repeat their function when held down
- A 10-key numeric cluster that allows you to enter numeric data as on an adding machine

The Model 1 has three major parts: the display unit, the keyboard unit, and the lower unit. The Model 2 has four major parts: the display unit, the lower unit, the keyboard, and the pedestal. (See the following illustrations.) These names will be used throughout the manual to help locate switches and indicators on the display stations.

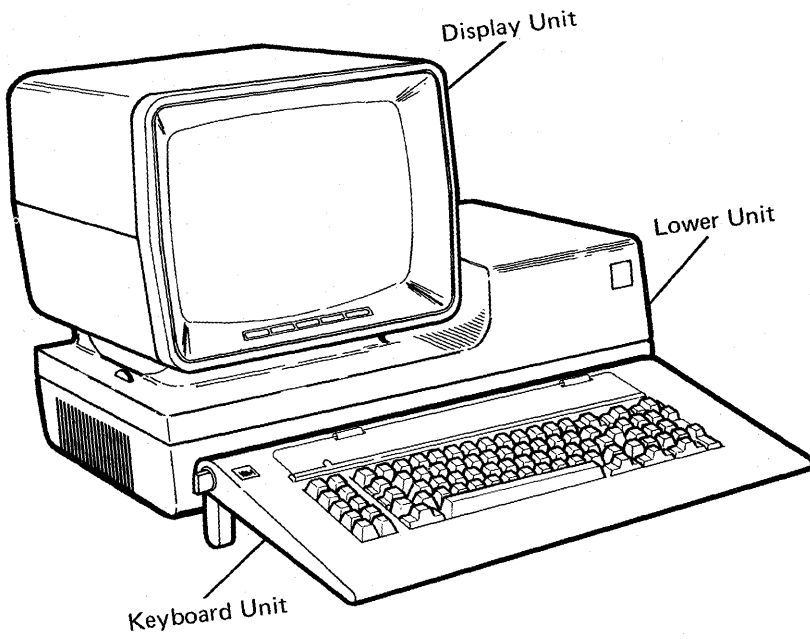

The Three Units of the Model 1 Display Station

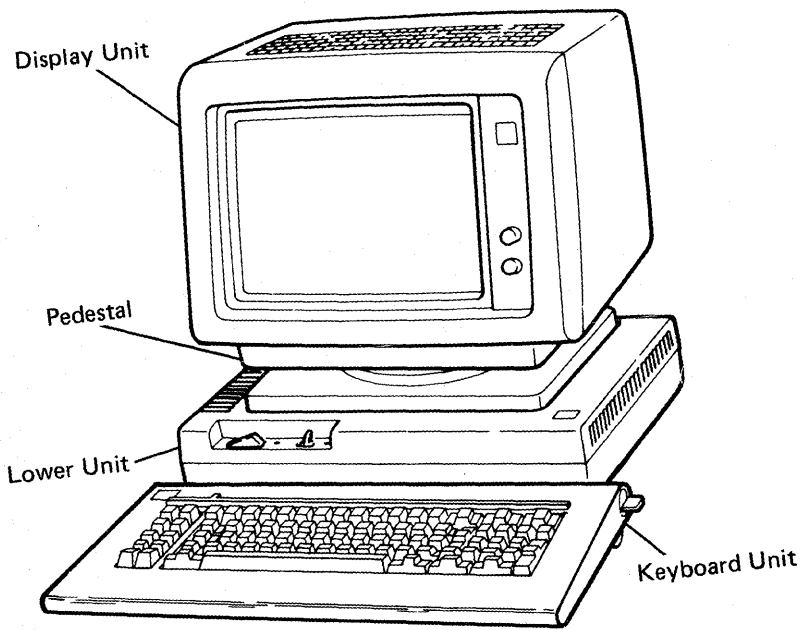

The Four Units of the Model 2 Display Station

Host System

In this manual, the term *system* refers to any host system that your display station is connected to. If you are working in a data communications environment, then the host system is the controlling or highest-level system in the configuration. The system can receive, process, and send back information entered by display station operators.

- | The term *display station* refers to the IBM 5291 Models 1 and 2.

Cleaning

CAUTION

Do not use spray cleaners on the keys or near the keyboard. Do not use IBM cleaning fluid (methyl chloroform) or isopropyl alcohol for cleaning.

Use a cloth dampened with mild soap and water to clean the covers, keyboard, display screen, and display screen filter.

BASIC OPERATION

Once your display station is properly set up and checked out, you can learn how to operate it. For information on how to set up your display station, refer to the *Display Station Setup Procedures* shipped with your display.

The best way to learn to operate the display station is to use the switches, controls, and keys as you read about them.

Power Switch

Model 1

The Power switch is on the right side of the lower unit near the rear corner. To turn the display station on, set the Power switch to On (I) by lifting upward. To turn the display station off, set the Power switch to Off (O) by pressing downward.

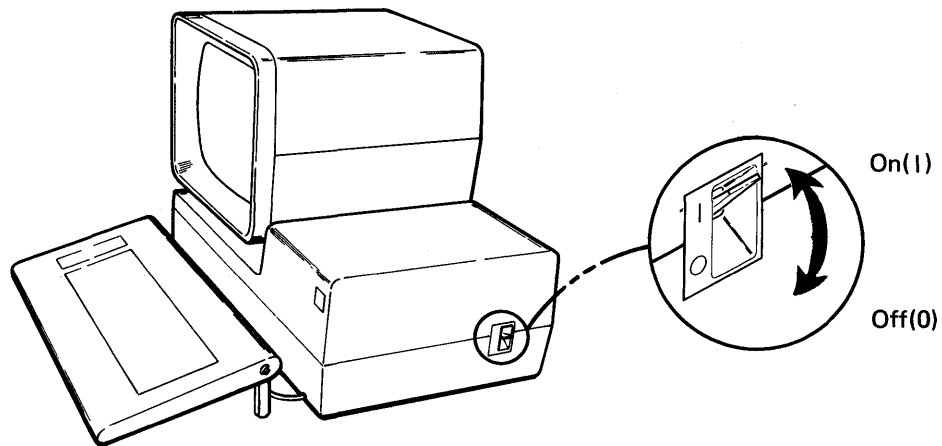

Model 2

The Power switch is on the front of the lower unit. To turn the display station on, set the Power switch to On (I). To turn the display station off, set the Power switch to Off (O).

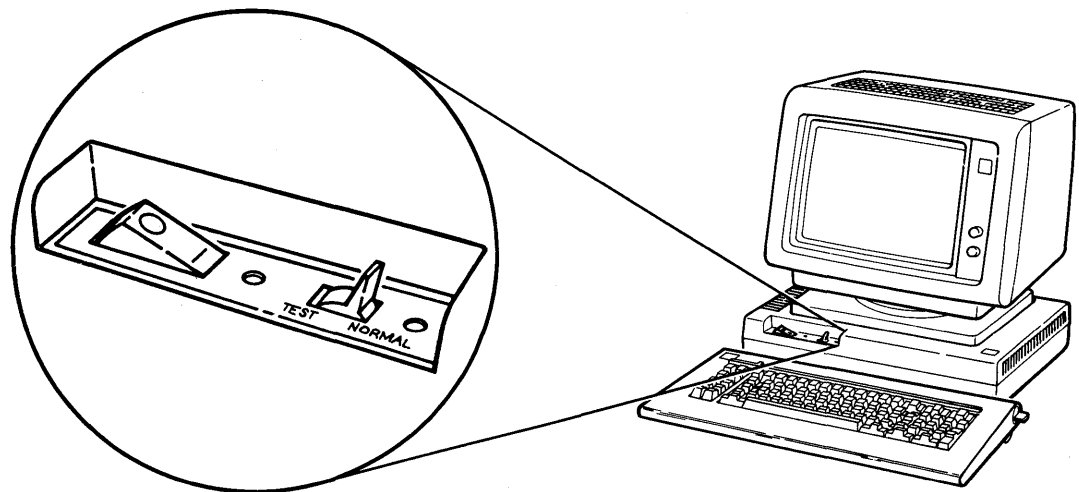

Whenever you set the Power switch to the On position, tests are automatically performed to tell you whether the display station is operating correctly. An alarm will sound when the tests have successfully been completed. If your display station is attached to the system, a sign-on display or the display that follows should appear.

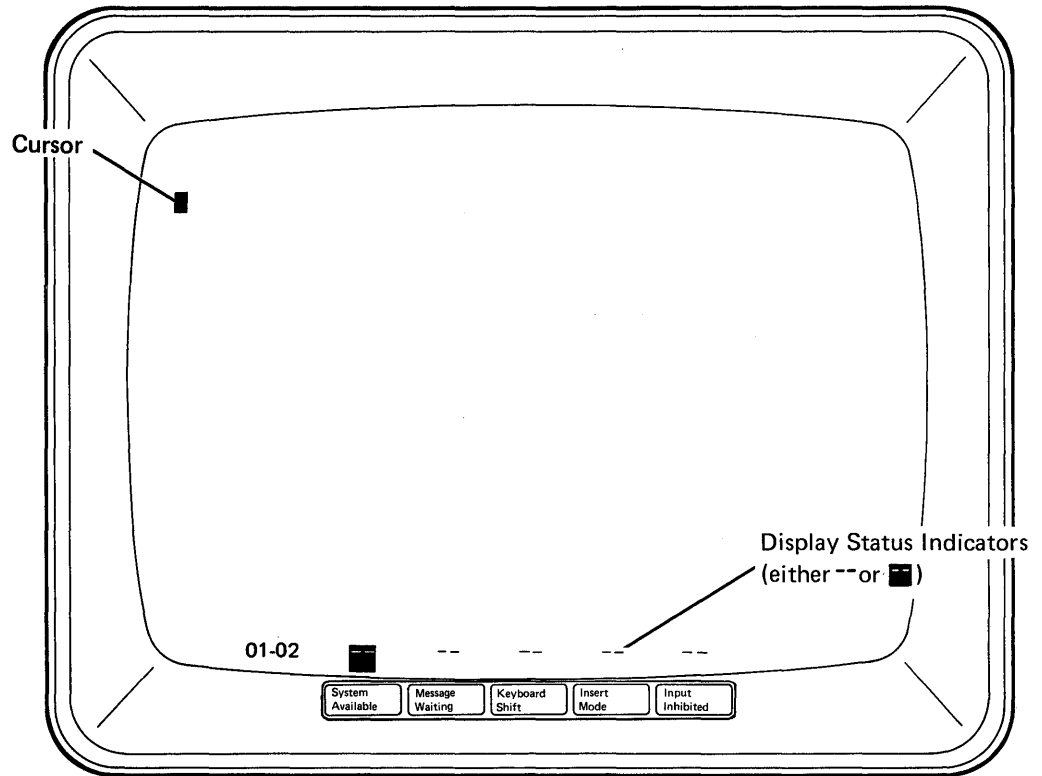

Note: Your display station must be connected to the system and the system must be operating. Otherwise, the display will be different from the illustration.

If a problem is encountered during this testing, see the *Problem Determination Procedures* in Chapter 4 of this manual or refer to the *IBM 5291 Keyboard Template, GX21-9410* for the Model 1 or the *IBM 5291 Model 2 Keyboard Template, GX21-9501*.

Brightness Control

Model 1

The brightness of the data on the display is controlled by the Brightness control on the left underside of the display unit. Turn the control while watching the display and adjust to the level of brightness you desire.

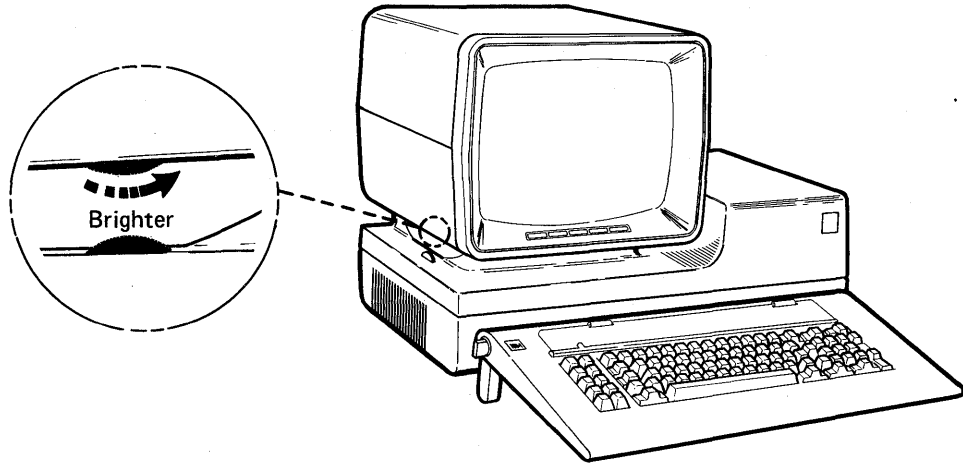

Model 2

The Brightness control is on the right side of the display unit. Turn the Brightness knob clockwise to make the data on the display brighter.

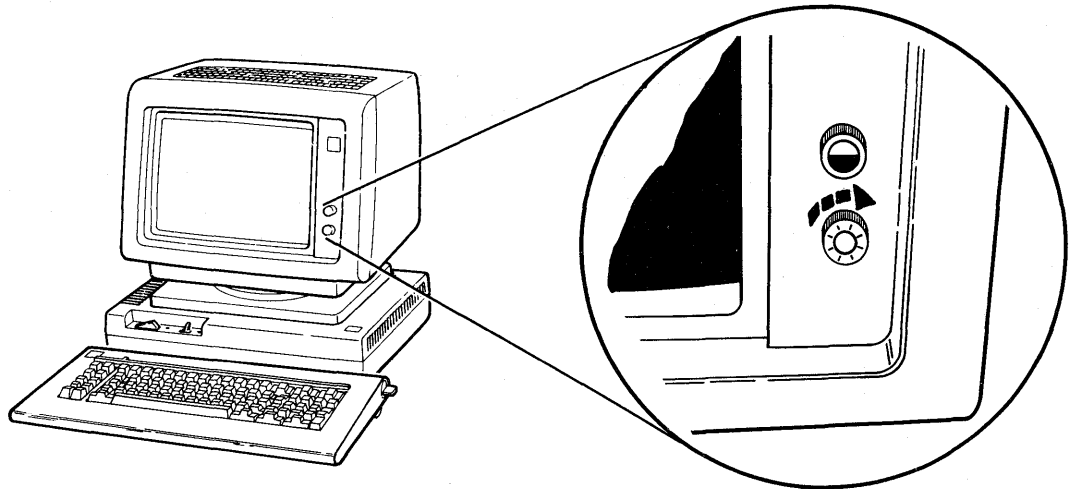

Contrast Control (Model 2 Only)

The Contrast control is on the right side of the display unit and is used to adjust the display contrast (the difference in brightness between fields that are highlighted and the fields not highlighted).

Turn the Contrast knob clockwise to decrease the contrast between fields.

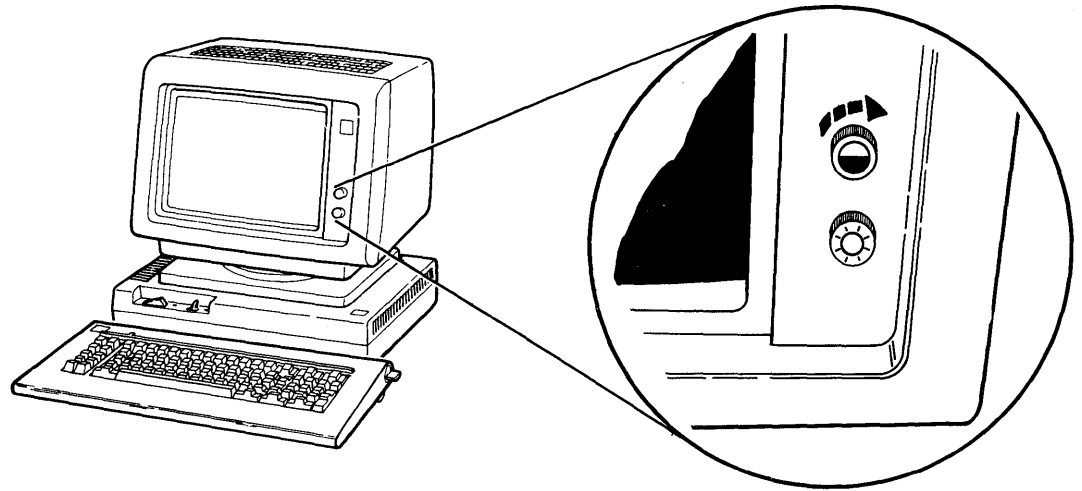

Alarm Control

Model 1

The loudness of the display station alarm is controlled by the Alarm control. The Alarm control is located on the left side of the lower unit. Adjust this control to the loudness level you prefer.

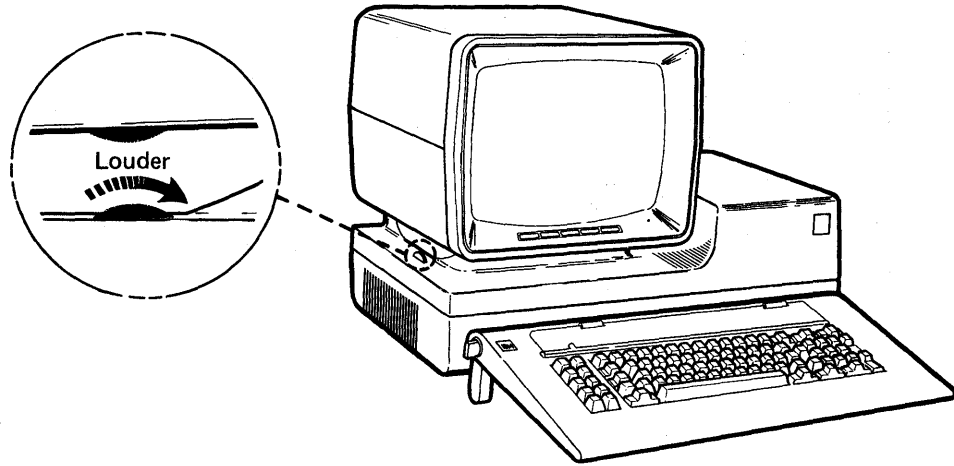

Model 2

The Alarm control is located on the back of the lower unit. Turn the Alarm control clockwise to increase the volume.

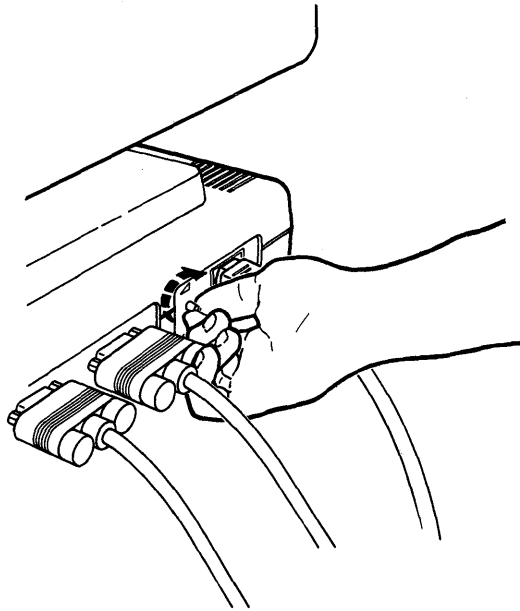

Rotating the Display Unit (Model 2 Only)

The Display Unit can be rotated without moving the lower unit.

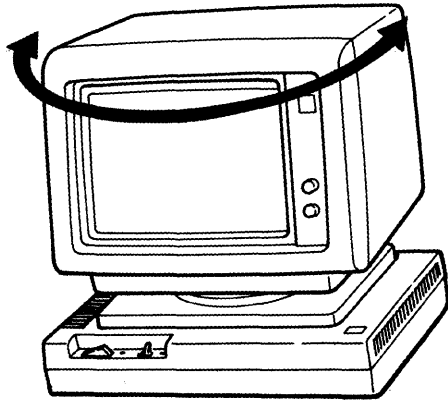

Rotate

Adjusting the Slope of the Keyboard

The keyboard can be adjusted so that the slope of the keys is most comfortable for you. The keyboard can be used flat, or sloped approximately 10 degrees, 15 degrees, or 20 degrees.

Using the Keyboard at 20 Degrees

1. Rotate the left adjustment knob until the longest leg is locked into place (see the following illustration).
2. Rotate the right adjustment knob until the longest leg is locked into place.

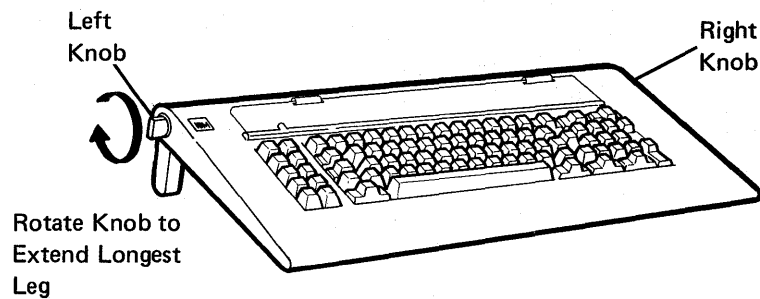

Using the Keyboard at 15 Degrees

1. Rotate the left and right adjustment knobs as described in *Using the Keyboard at 20 Degrees*.
2. Rotate the left and right adjustment knobs in the opposite direction from that in step 1 (see the following illustration). The longest leg will go back into the keyboard and a shorter leg (the middle-length leg) will remain extended.

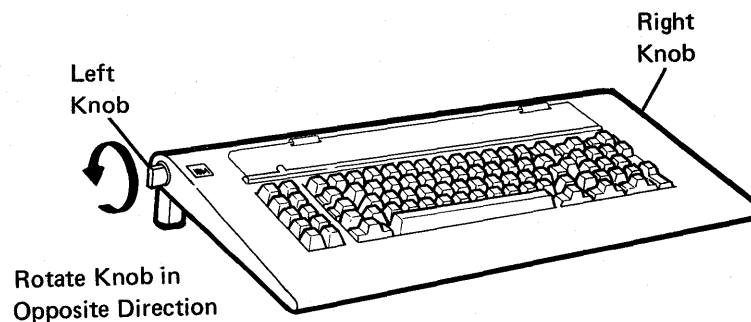

Using the Keyboard at 10 Degrees

1. Adjust the slope of the keyboard as described in *Using the Keyboard at 10 Degrees*. The middle-length legs should be extended.
2. Use your fingers to push the middle-length legs up into the keyboard (see the following illustration). The shortest legs will remain extended.

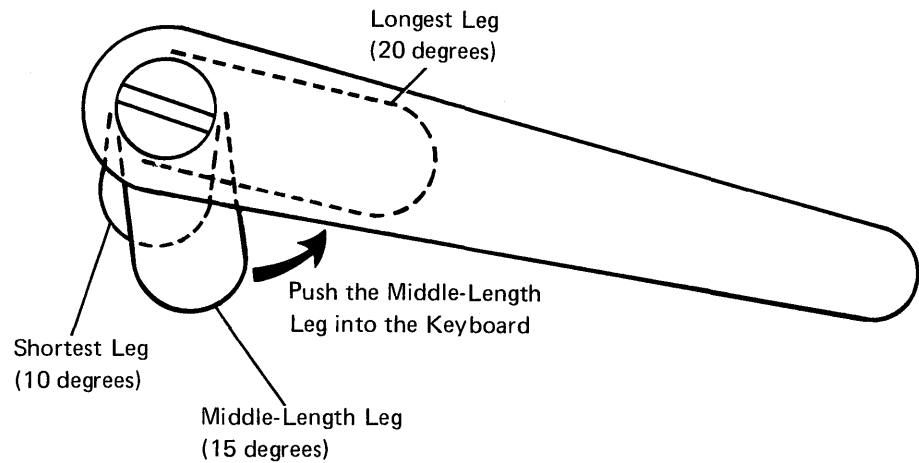

Using the Keyboard in the Flat Position

When all the legs are locked in the underside of the keyboard, the keyboard is in the flat position.

Adjusting the Viewing Angle of the Display Screen

The display unit tilts upward and downward so you can adjust the screen to a comfortable viewing position. To tilt the screen upward, pull upward and towards you; to tilt the display unit downward, push downward and away from you.

Model 1

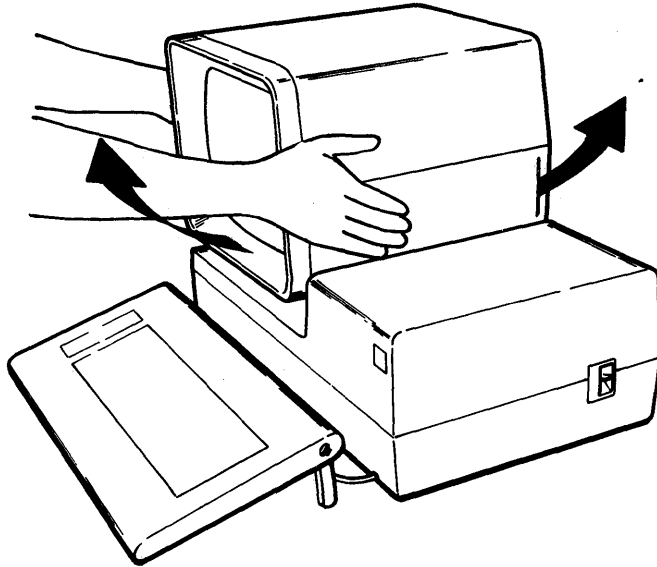

Model 2

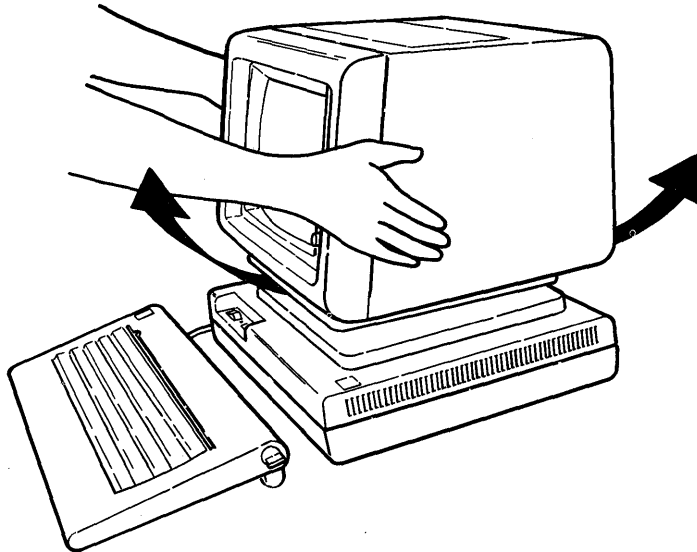

THE DISPLAY SCREEN

The display screen can display 24 lines of data with up to 80 characters on each line (a maximum of 1920 characters). A status line at the bottom of the display is reserved for system and display station status information.

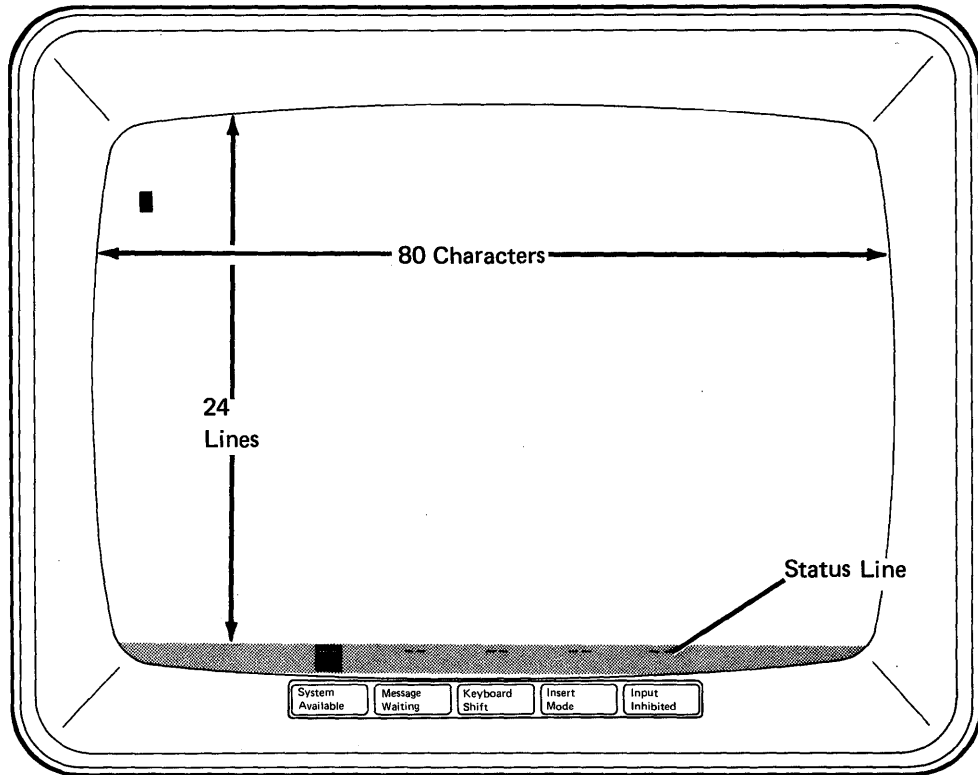

Display Status Indicators

Display status indicators are located at the bottom of the display screen in an area known as the status line. These indicators show the operating status of both the display station and the system or remote work station controller.

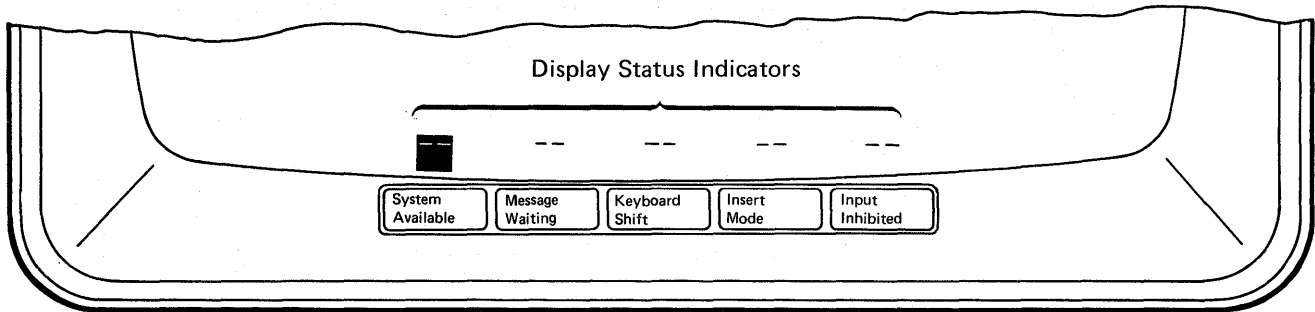

When the Power switch is set to the On position and the display station has warmed up, each of the display status indicators will appear either on or off. The indicator is on when a square block (■) appears on the status line above the name of the indicator. The indicator is off when two dashes (--) appear on the status line above the name of the indicator.

The display status indicators and their meanings are as follows:

System Available

- = The system or remote work station controller is operating and is available to the display station.
- = The system or remote work station controller is not available to the display station.

If the System Available indicator does not come on, see the *Problem Determination Procedures* in Chapter 4 of this manual or the *IBM 5291 Keyboard Template, GX21-9410* for the Model 1 or the *IBM 5291 Model 2 Keyboard Template, GX21-9501*.

Message Waiting

- = The system has one or more messages for you.
(An alarm may also sound when the Message Waiting indicator is on.)
- = The system does not have a message for you.

Refer to the host system operating manual for information on how to obtain your messages.

Keyboard Shift

- = The keyboard is in uppershift.
- = The keyboard is in lowershift.

Refer to *Shift, Spacebar, and Special Symbol Keys* in Chapter 2 for information on how to change the keyboard shift.

Insert Mode

- = Characters can be inserted into an existing field (from the keyboard) without destroying existing data.
- = Characters cannot be inserted into an existing field without destroying data.

Refer to *Insert Key* in Chapter 2 for an explanation.

Input Inhibited

- = Keyboard input will not be accepted by the system or remote work station controller.
- = Keyboard input will be accepted by the system or remote work station controller.

When the Input Inhibited indicator is turned on, the alarm will sound when most keys are pressed. The alarm indicates that the system is not accepting your keystrokes.

The Input Inhibited indicator is turned on by the system or by the remote work station controller while it is processing your data and requests. The Input Inhibited indicator is also turned on by error conditions; see Chapter 3, *Error Codes and Recovery Procedures*. If the condition is not an error and persists for an abnormal length of time, contact your supervisor for recovery instructions.

Cursor Location Information

The status line of the display station describes the screen row and column location of the cursor.

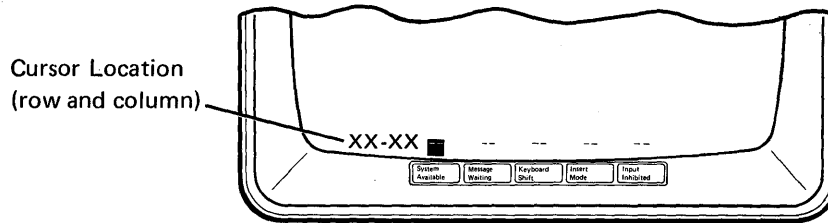

The cursor location is displayed as a four-digit number separated by a dash (the first two digits represent the row that the cursor is in and the second two digits represent the column). The display screen contains 24 rows (lines) of data with a maximum of 80 columns (characters) per row. The following illustration shows how the display screen is divided into rows and columns:

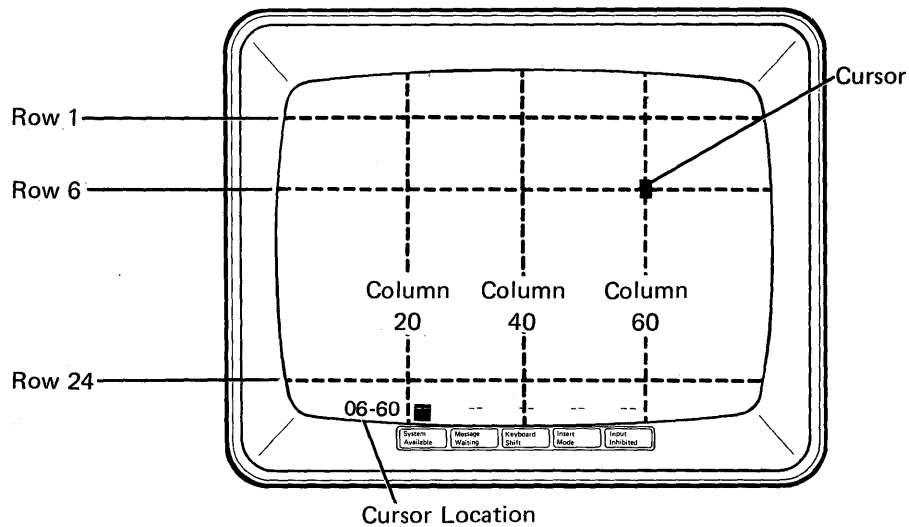



For example, the cursor in the illustration is in row 6 and column 60. This would be displayed on your status line as 06-60.

Choosing the Cursor

The cursor appears on the display screen to show where the next character entered from the keyboard will appear. The cursor normally appears as a rectangular block (■), however, you can change the cursor to appear as an underscore (_).

To change the cursor:

1. Press and hold down the  (Command) key.
2. Press the  key.

If you want to change the cursor back to the rectangular block, repeat the above steps.

Display Highlighting and Formatting

The display station has several field highlighting characteristics to help draw attention to a certain display screen location or field, or to show any place you must enter data (input areas). These characteristics may appear in any combination.

This display formatting is accomplished through programming in the system. You might see one or more of the following display highlighting characteristics (attributes):

- **Reverse Image:** If light green characters are ordinarily displayed on a dark background, a reverse image field has dark characters on a light green background.

Name: **James Rothey**

- **Column Separator:** Characters in this field are separated by dots. The dots appear below the character.

Name: J.a.m.e.s .R.o.t.h.e.y.

- **Underscore:** Characters in this field have a continuous horizontal line below them.

Name: James Rothey

- **Blink:** Characters in this field blink repeatedly.
- **High Intensity:** Characters in this field are brighter than those with normal intensity.
- **Nondisplay:** Characters in this field are not displayed. For example, security codes or passwords used for signing on to the system are often entered in nondisplay fields.

THE KEYBOARD

The following illustration shows the typewriter-like keyboard. The dark keys are the function control keys. (See Chapter 2 of this manual for detailed information about each function control key.) The function control keys are used to insert, delete, and move data, and to position the cursor. The dotted keys in the illustration are data keys. Data keys are used in the same manner as the keys on a typewriter.

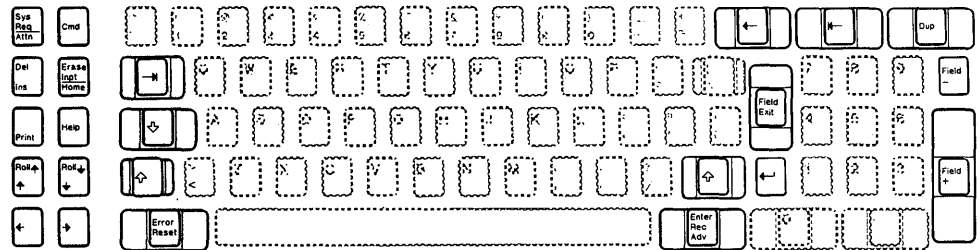

Typematic Keys

All of the data keys and many of the function control keys are typematic. This means that if the key is held down, it repeats its character or function until it is released. In the following illustration, the dark keys are the typematic keys.

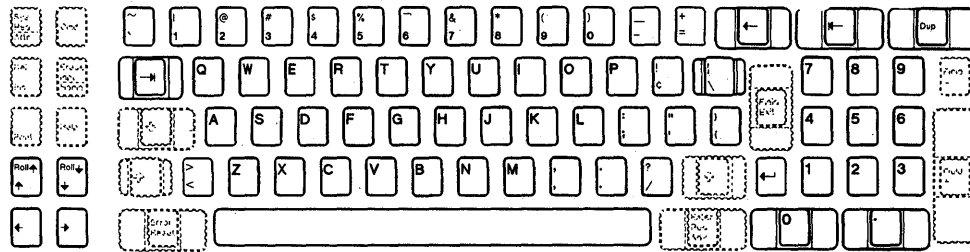

For an example of a typematic function, press and hold the J key for a few seconds while observing the display screen. Notice that the letter J appears continuously on the display screen until you release the key.

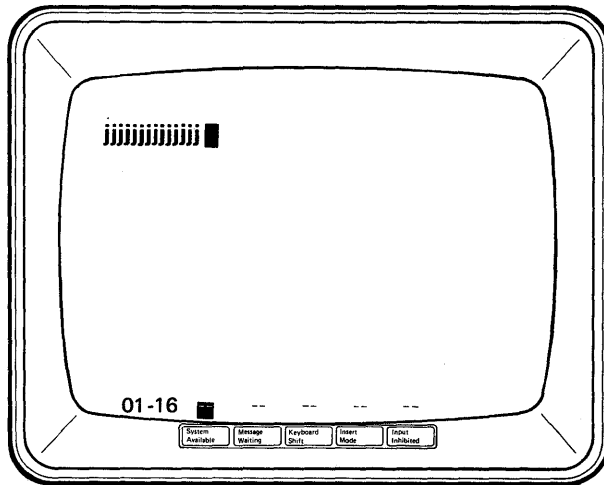

Command Function Keys

The top row of data keys and the Character Backspace key, when used with the Command key, are known as the command function keys. Command function keys are used to communicate with the system program. The dark keys in the following illustration are the command function keys.

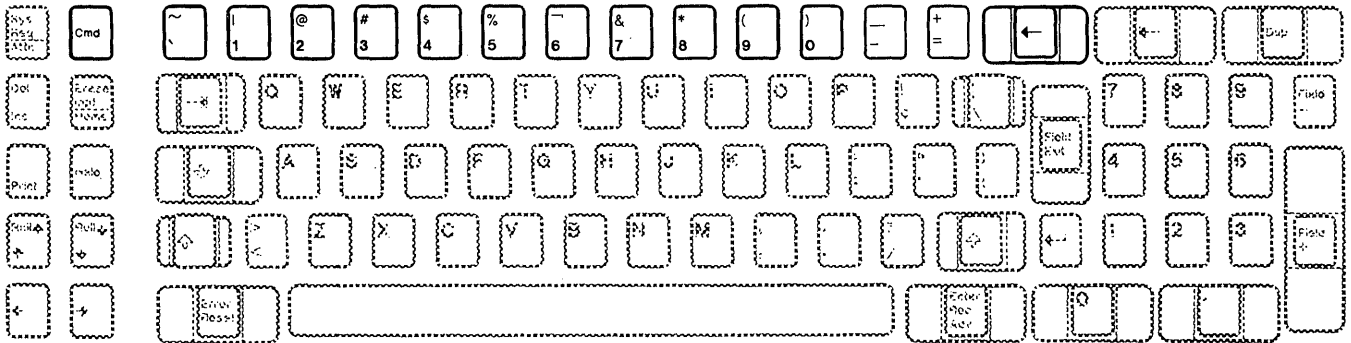

The Command key is used to select the command functions that are described on the *IBM 5291 Keyboard Template, GX21-9410* for the Model 1 or the *IBM 5291 Model 2 Keyboard Template, GX21-9501*. The command functions are assigned by the system programmer and permit the display station operator to communicate with the system program.

Each template has 24 spaces that correspond to the upper row of data keys on the keyboard. Your programmer can label the template to describe the functions of these keys. The template should then be placed in the area just above the top row of the keyboard keys as shown. Refer to *Command Key* in Chapter 2 for more detailed information.

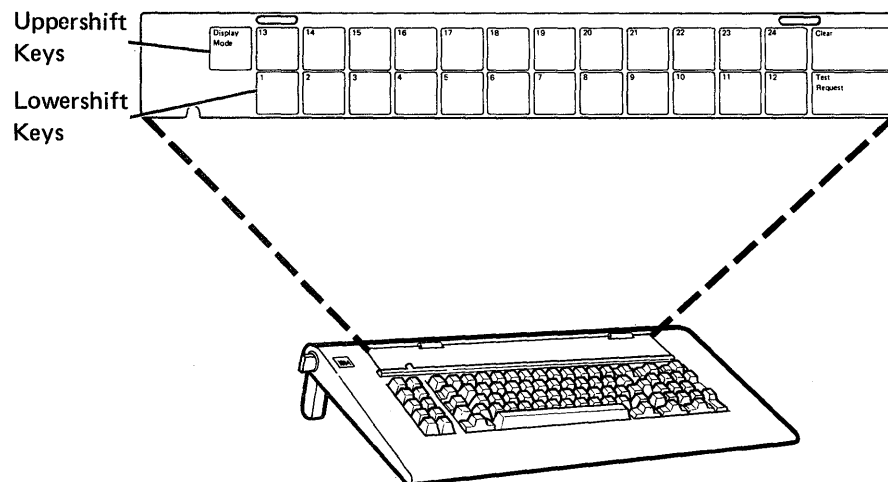

Chapter 2. Keyboard

This chapter explains the function control keys, cursor movement keys, and special symbol keys. Usage of these keys can vary depending on what system your display station is connected to. For more information, refer to your system operating manual.

FUNCTION CONTROL KEYS

The function control keys perform system-related functions as well as operations on the display station. The function control keys are shown as the darkened keys in the illustration below.

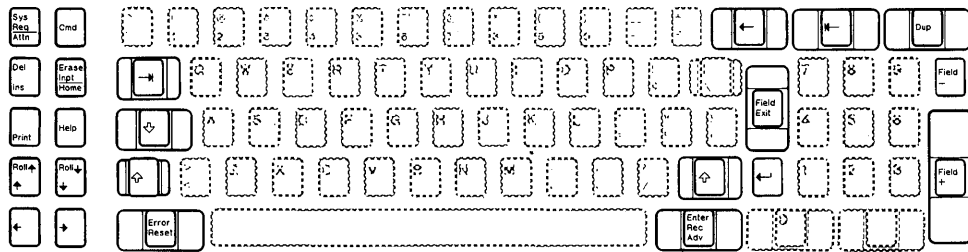

Command Key

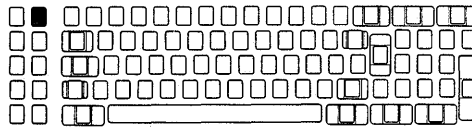

When the Command key is pressed the system disregards the normal function shown on the top row key and instead performs the function assigned to that key in the system program. The keyboard template fits in the recessed area just above the top row of keys. It can be used to indicate to the operator the command functions assigned to the top row of keys (called command function keys).

The illustration below shows how the keyboard template corresponds with the top row of keys. Note that each key can be used to select either of two command functions.

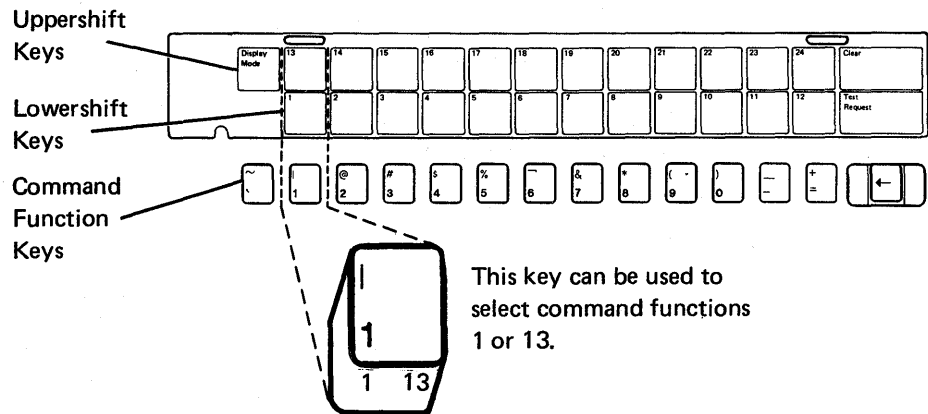

Selecting Functions on the Bottom Row of the Keyboard Template

To select the command functions shown on the bottom row of the keyboard template (1 through 12 and Test Request):



1. Press the  (Command) key.
2. Press the top row key that is directly below the keyboard template indicating the program function desired. Pressing any other key causes an error.

To cancel the selection procedure after you have pressed the Cmd key, press the Error Reset key.

Note: If you press the Cmd key and the Error Reset key at the same time, the cursor changes from an underscore to a solid rectangular block. This is explained in *Choosing the Cursor* in Chapter 1.

Selecting Functions on the Top Row of the Keyboard Template

To select the command functions shown on the top row of the keyboard template (Display Mode, 13 through 24, and Clear):

1. Press the  (Command) key.
2. Press and hold an  (Uppershift) key. (The Uppershift key must be used even if the Keyboard Shift indicator is on.)
3. Press the top row key that is directly below the keyboard template indicating the program function desired. Pressing any other key causes an error.

To cancel the selection procedure after you have pressed the Cmd key, press the Error Reset key.

Test Request

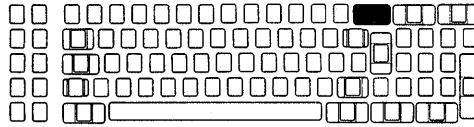
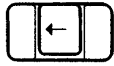

The test request command starts the test routines for your display station. (See Chapter 5, *Running the Verification Tests*.)

To start the testing routines:

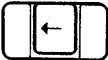

1. Press the  (Command) key.
2. Press the  (Character Backspace) key. (The key located directly below the words Test Request on the keyboard template.)

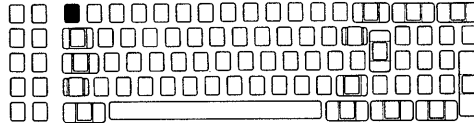
Reversing the Display Image (Display Mode)



This key allows you to choose the most suitable display screen image. By using this key, you can switch back and forth from light green characters on a dark background to dark characters on a light green background.

To reverse the display image:

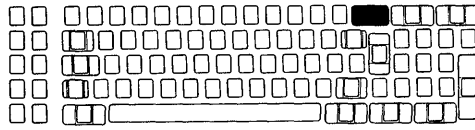
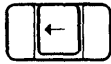

1. Press the  (Command) key.
2. Press and hold an  (Uppershift) key.
3. Press the  (Grave Accent) key. (The key located directly below the words Display Mode on the keyboard template.)

Clear



The Clear command erases the display (with the exception of the cursor and the display indicators) when the display station is not under program control (that is, with an unformatted display). A system program can change the way this command operates, so you can recover if you accidentally press the Clear key. On some systems, you may have to set the Power switch to the Off position to blank the display because some system programs ignore the Clear command.

To use the Clear command:

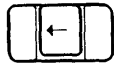
1. Press the  (Command) key.
2. Press and hold an  (Uppershift) key.
3. Press the  (Character Backspace) key. (The key located directly below the word Clear on the keyboard template.)

System Request/Attention Key

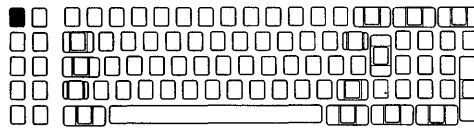

Use of the Sys Req/Attn key can vary depending on the system. With most systems, the Sys Req/Attn key can be used to:

- Start sign on to the system
- Start and select an alternate job
- Temporarily stop the present display station activity and allow selection of a new activity
- Notify the system that the display station is ready to select a new program or activity
- Request that the keyboard be unlocked (after normal error recovery action has failed) so you can continue to enter data

To use the system request function:

1. Press and hold an (Uppershift) key.
2. Press the key.
3. Press the key.

To cancel the Sys Req/Attn key function, press the Error Reset key. Pressing any other key before pressing the Enter/Rec Adv key causes an error. However, if your display station is connected to a remote work station controller, you can press data keys before pressing the Enter key.

To use the Attention function, press the key.

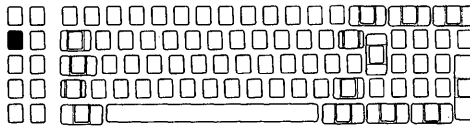

Delete Key



The Del/Ins key deletes data from the display screen. When you do this, the character that the cursor is positioned at is deleted and all characters to the right of the cursor (in the same field) are shifted to the left one position. Nulls (hex '00' characters in the buffer displayed as blanks) are inserted at the end of the field as the characters are shifted left.

Note: The delete key is accepted only in *input* fields.

To use the delete key:

1. Position the cursor at the character to be deleted.
2. Press and hold an  (Uppershift) key.
3. Press the  key.

Insert Key

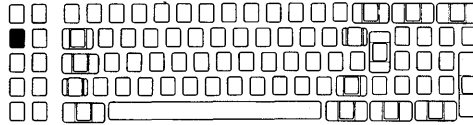

The Del/Ins key allows you to insert a character or characters, at the cursor position, into an existing input field on your screen without destroying data already there. (There must be nulls [hex '00' characters in the buffer displayed as blanks] in the rightmost positions of the field where the insert or inserts will be done. Use the Delete key to insert nulls.) When you insert data, the existing characters are shifted to the right one position for each character inserted. The cursor also shifts to the right one position. If you attempt to insert more characters than there are nulls, the Input Inhibited indicator comes on, the keyboard locks, and an error message is displayed.

The insert function is not accepted in the last position of an input field.

To use the insert mode:

1. Position the cursor at the location where the data is to be inserted.
2. Press the  key.

The Insert Mode indicator (■) at the bottom of the display screen comes on when the function is accepted.

3. Enter the data to be inserted.
4. To leave the insert mode, press the Error Reset key.

Note: If the Error Reset key is pressed during a system recovery procedure, the display station leaves insert mode. To reenter insert mode, press the Del/Ins key.

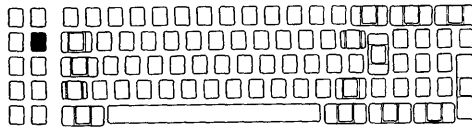

Erase Input Key



The Erase Input/Home key erases data from all input fields and the cursor moves to the home position on the screen (usually the first input position of the first input field).

When the display station is in free key mode, this key erases everything on the display screen and the cursor moves to the first input position on line 1.

To use the erase input function:

1. Press and hold an  (Uppershift) key.
2. Press the  key.

Home Key

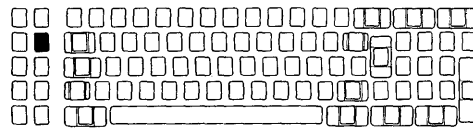

When the display screen is under format control, the Erase Input/Home key moves the cursor to the system designated home position.

When the display station is in free key mode, this key moves the cursor to the first input position on line 1.

When supported by the host system program, this key displays a previous record. If the cursor is in the home position and you press this key, the previous record is displayed.

To use the Home key:

Press the  key.

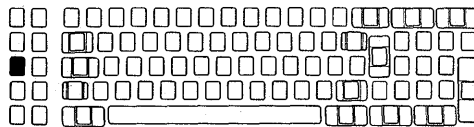

Print Key



The Print key gives you a printed copy of the current information on your display screen. The system program selects the printer that will print the data being displayed.

To use the Print key:

Press the  key.

Note: On some host systems, a print request can be canceled when you press an  (Uppershift) key and the  key. For more information, contact the host system operator.

Help Key

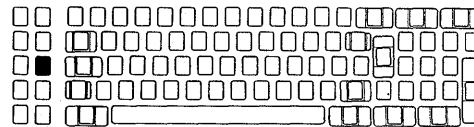

The Help key gives you further assistance or a description of a current error condition. (You must be signed on to the system and the system must be programmed to provide help.) For more information about the error condition see Chapter 3, *Error Codes and Recovery Procedures*.

To use the Help key:

Press the  key

If you press the Help key during an error condition, a message might be displayed that describes the error unless the error resulted in a loss of communications with the host system. To continue entering data, press the Error Reset key. This will reset the help message, reset the error condition, restore the display screen, and unlock the keyboard.

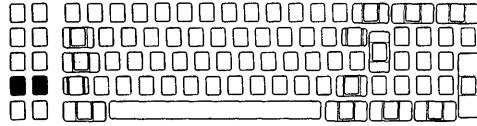
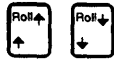

Roll Keys



A Roll key moves the information on the display screen up or down. This movement repositions the information on the screen and allows you to view data either above or below what is normally viewed.

The system program controls the use of these keys for each individual job.

To use the Roll keys:

Press and hold an  (Uppershift) key; then press the  key or the  key.

Error Reset Key

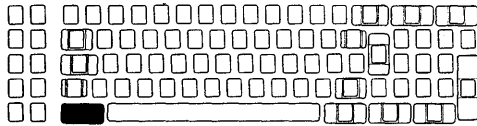
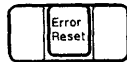

The Error Reset key unlocks the keyboard when it is locked because of an error condition. It also resets the help, insert, system request, and command modes.

To use the Error Reset key:

Press the  key.

Enter/Record Advance Key

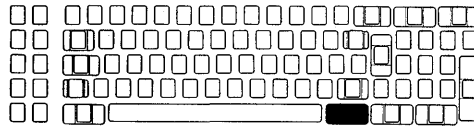
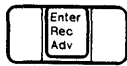

The Enter/Rec Adv key indicates that the entered data is ready to be sent to the system.

If an error code appears on the display screen, see Chapter 3, *Error Codes and Recovery Procedures* for the meaning of the error and do the recovery procedure listed.

To use the Enter/Rec Adv key:

Press the  key.

Duplicate Key

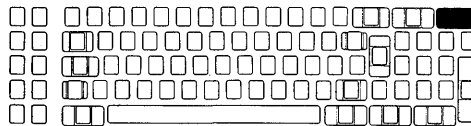
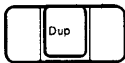

The Dup key requests the program to duplicate the information in the same field of the previous record into this record. An asterisk with an overscore ($\bar{*}$) is placed in the cursor position and all the following positions of that field to indicate that duplication will occur.

If you press the key in a field not programmed to accept duplication, an error is displayed.

To use the Dup key:

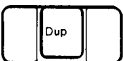
Press the  key.

Field Exit Key

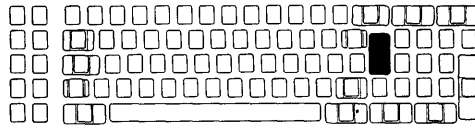

The Field Exit key exits an input field. When you press this key, blanks are inserted from the present cursor location to the end of the field. When you press this key in a right-adjust field, the data to the left of the cursor is shifted to the right. The vacated positions are filled with zeros or blanks as specified by the format and the cursor advances to the next input field. When you press this key in a signed numeric field, a blank is inserted in the last position of the field.

Press the Field Exit key to exit input fields that are specified by a program as right-adjust or field exit required fields. If an error code appears on the display, see Chapter 3 *Error Codes and Recovery Procedures* for the meaning of the error and do the recovery procedure listed.

To use the Field Exit key:

Press the  key.

Field + Key

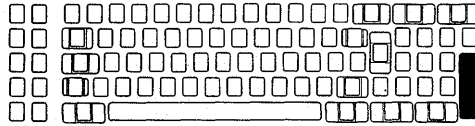

The Field + key operates as a Field Exit key in all fields.

To use the Field + key:

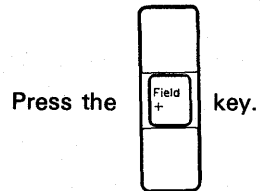

Field - Key

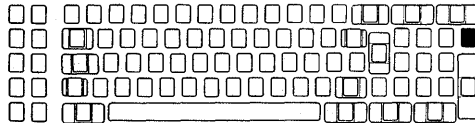

Use of the Field - key can vary depending on the system. However, with most systems the Field - key operates the same as the Field + and Field Exit keys except that it is allowed only in signed numeric and numeric only fields. Pressing this key inserts a - (minus) sign in the last position of a signed numeric field or it changes the last position of a numeric only field to an alphabetic character.

Note: The Field - key causes an error if used with any field not programmed to accept negative input.

To use the Field - key:



CURSOR MOVEMENT KEYS

The cursor movement keys move the cursor in the direction of the arrow on the keytop. All cursor movement keys are typematic, and cursor movement does not affect data already entered.

If an error code appears on the display, see Chapter 3 *Error Codes and Recovery Procedures* for the meaning of the error and do the recovery procedure listed.

The dark keys in the following illustration show the location of the cursor movement keys.

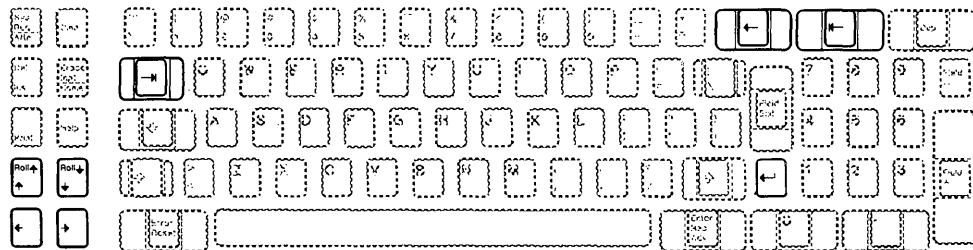

Right Cursor Movement Key

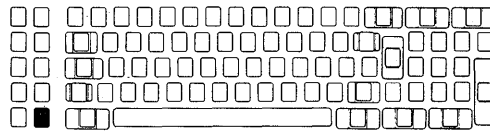

The Right Cursor Movement key moves the cursor from left to right. When the cursor reaches the end of a line, it moves to the first position of the next line. When the cursor moves past the last position on the bottom line, the cursor moves back to the first position of the top line.

Left Cursor Movement Key

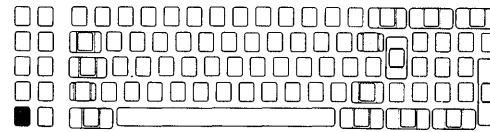

The Left Cursor Movement key moves the cursor from right to left. When the cursor reaches the leftmost position of a line, it moves up one line to the rightmost position of the screen. When the cursor moves past the first position on the top line (upper left corner), the cursor moves to the last position on the bottom line (lower right corner).

Note: To move the cursor to the left or right approximately

three times faster, press and hold down an  (Uppershift) key and the Left or Right Cursor Movement key.

Up Cursor Movement Key

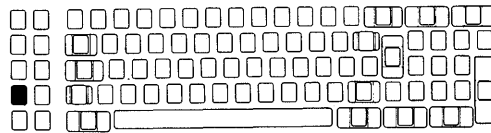

The Up Cursor Movement key moves the cursor up one line. When the cursor is on the top line, it moves to the same vertical column on the bottom line.

Down Cursor Movement Key

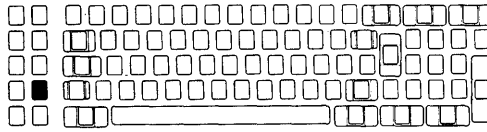

The Down Cursor Movement key moves the cursor down one line. When the cursor is on the bottom line, it moves to the same vertical column on the top line.

Character Backspace Key

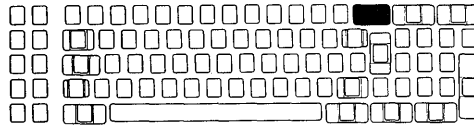
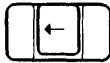

The Character Backspace key moves the cursor back to the previous position in which data could be entered (not necessarily the last position) when the display screen is under format control.

For example, if the cursor is in the first position of an input field when the Character Backspace key is pressed, the cursor moves back to the last position of the previous *input* field.

Note: If you press this key after pressing the Command key, the function is different. See the descriptions of the Test Request command and Clear command in this chapter for more information.

Moving the Cursor to the Beginning of a Field or New Line

Field Advance Key

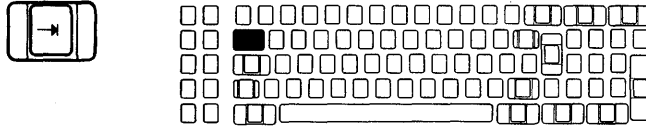

The Field Advance key moves the cursor forward (right) to the first character position of the next input field.

In fields specified as automatic enter, the auto enter function is not performed when you move the cursor through that field using the Field Advance key.

If you press this key when the cursor is in the last field on the screen, the cursor moves to the first position of the first field on the screen.

Field Backspace Key

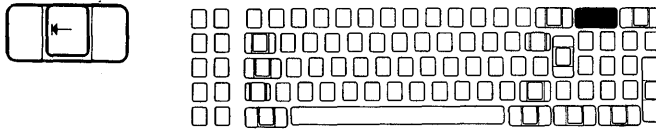

The Field Backspace key moves the cursor back (left) to the first character position of the field it is in. If the cursor is already in the first position of a field, it moves back to the first position of the preceding input field.

New Line Key

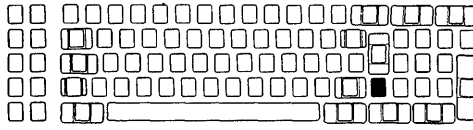

The New Line key moves the cursor to the first input position of the first input field of a new line. If the cursor is on the last input line, the cursor moves to the first input position.

SHIFT, SPACEBAR, AND SPECIAL SYMBOL KEYS

Shift Keys

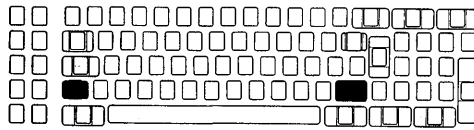

When you press and hold an Uppershift key:

- The alphabetic characters (A through Z) are entered as uppercase letters.
- The special characters identified on the tops of the numeric and symbol keys can be entered.
- The function control keys perform the function shown on the top half of the key.
- The command function keys perform the function shown on the top row of the keyboard template (Display Mode, 13 through 24, and Clear).

Shift Lock Key

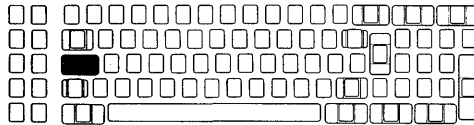
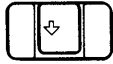

When you press the Shift Lock key:

- The keyboard locks in uppershift.
- The alphabetic characters (A through Z) are entered as uppercase letters.
- The special characters identified on the tops of the numeric and symbol keys can be entered.
- The function control keys perform the function shown on the top half of the key.
- The command function keys perform the function shown on the bottom row of the keyboard template (1 through 12 and Test Request).

To return the keyboard to lowershift, press and release either of the Uppershift keys.

Spacebar

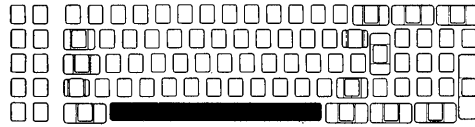
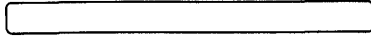

The Spacebar moves the cursor to the right one position at a time. Unlike the cursor movement keys, the Spacebar destroys all data in the positions where it is used. A blank is entered each time you press the Spacebar.

Special Symbol Keys

Some symbols and punctuation marks are on the upper half of the numeric keys (on the top row). Other symbols and punctuation marks are on keys with special symbols on both upper and lower positions. To display the upper

symbol, press the  (Shift Lock) key or press and hold an

 (Uppershift) key and the desired key.

Chapter 3. Error Codes and Recovery Procedures

If a keying error occurs while you are entering information:

- The cursor blinks (marking the location of the error)
- The display station ignores any additional data entered from the keyboard
- The display station alarm sounds each time you press a key
- A four- or six-digit error code is displayed.

You should find the four- or six-digit error code in this chapter and attempt the recovery procedure.

Note: The following system error codes are communications or controller type errors and must be corrected at the remote work station controller:

0040 through 0054
0080 through 0087
10xxxx through 1Fxxxx
D0xxxx through DFxxxx
E0xxxx
F0xxxx through FFxxxx

HELP KEY FUNCTION

A Help key function is provided on some systems to aid in error recovery. If an error code is displayed after you sign on to the system, press the Help key. A message will be displayed describing the error condition. After you finish reading the message, press the Error Reset key. You should correct your error and then continue entering data to your display station.

ADDITIONAL INFORMATION

Additional error information can be found in the system messages manual. If you are not able to recover from an error, refer to the *Problem Determination Procedures* in Chapter 4 of this manual or to the *IBM 5291 Keyboard Template, GX21-9410* for the Model 1 or the *IBM 5291 Model 2 Keyboard Template, GX21-9501*.

ERROR CODES

The error codes, their meanings, and the recovery procedures are as follows:

Error Code	Meaning
0000	<p>You have pressed the Help key; however, either no error code was displayed or the error was issued by a program that does not support the Help key.</p> <p>To recover, press the Error Reset key. Then continue entering information or refer to the meaning for the previous error code displayed and do the recovery procedure listed.</p>
I 0001	<p>The host system or a remote work station controller could not keep up with the rate at which you entered information and the last characters you entered were not recognized.</p> <p>To recover, press the Error Reset key and continue entering information.</p>
I 0002	<p>The system or a remote work station controller received a key code that is not valid and therefore does not recognize which key you pressed.</p> <p>To recover, press the Error Reset key and try to continue entering data. If the error cannot be reset or still occurs, contact the IBM 5291 service representative and report the problem.</p>
0003	<p>You have pressed the Cmd key, but the next key you pressed was not one of the command function keys.</p> <p>To recover, press the Error Reset key and continue by using the correct keys.</p>
0004	<p>You have attempted to enter data into a field that does not allow input. This field is defined as an I/O feature field.</p> <p>To recover, press the Error Reset key.</p>
0005	<p>You have attempted to enter data; however, the cursor is not in an input field. Data cannot be entered in a protected area of the display.</p> <p>To recover, press the Error Reset key and move the cursor to a valid input field.</p>
0006	<p>After pressing the Sys Req/Attn key and prior to pressing the Enter/Rec Adv key or the Error Reset key, you pressed a key that is not valid.</p> <p>To recover, press the Error Reset key and use a valid key sequence.</p>

- 0007 There is at least one mandatory enter field on the display that you must enter data into before the display can be changed or moved. (The cursor goes to the first character position of the first mandatory entry field requiring data.)
- To recover, press the Error Reset key and enter the required data.
- 0008 The field you are now trying to enter data into will take only alphabetic data and you have pressed a nonalphabetic key.
- Valid characters are A through Z, blank, comma, period, and hyphen.
- To recover, press the Error Reset key and continue by using valid characters.
- 0009 The field you are now trying to enter data into will take only numeric data and you have pressed a nonnumeric key.
- Valid characters are 0 through 9, blank, comma, period, plus, and minus.
- To recover, press the Error Reset key and continue by using valid characters.
- 0010 The field you are now trying to enter data into will take only signed numeric data and you have pressed some other key.
- Valid characters are 0 through 9.
- To recover, press the Error Reset key and continue by using valid characters.
- 0011 You have attempted to enter data into the last position of a signed numeric field.
- To recover, press the Error Reset key. Make sure that the data is correct and exit the field by using the Field -, Field +, or Field Exit key.
- 0012 There is no room to insert data into this field. Either there is no more room in the field or the cursor is in the last position of the field.
- Do not use insert mode to change data or to enter the last character into this field.
- To recover, press the Error Reset key. Then, correct the field, if necessary, and continue.
- 0013 You attempted to leave a field while the display station was still in the insert mode.
- To recover, press the Error Reset key and exit the field normally.

0014 You have pressed a function key that would move the cursor out of this field; however, the requirements of this mandatory fill field have not been met. A mandatory fill field must be completely filled or left blank.

To recover, press the Error Reset key. Then enter data to fill the entire field or move the cursor to the start of the field and then use the Field -, Field +, or Field Exit key to blank all of the field.

0015 You have entered data into a self-check field and the number you just entered and the check digit do not compare.

To recover, press the Error Reset key. Check that you have correctly entered the number and check digit. If you have entered them correctly, check that the number is valid for a self-check field. If the numbers you are using are valid but this error still occurs, contact your service representative and report the problem.

0016 You have pressed the Field - key, but the field you are in is not a signed numeric field or (for some systems) a numeric only field.

To recover, press the Error Reset key. You can now continue to enter data or press the Field Exit key to leave the field.

0017 You have pressed the Field -, Field +, or Field Exit key; however, the requirements for this mandatory fill field have not been met. A mandatory fill field must be completely filled unless you exit it from the first position of the field.

To recover, press the Error Reset key. Then enter data to the end of the field or move the cursor to the start of the field and use the Field -, Field +, or Field Exit key to blank all of the field.

0018 You must use a nondata key such as the Field Exit key or a cursor movement key, to leave this field.

To recover, press the Error Reset key. Then use a nondata key to leave this field.

0019 You have pressed the Dup key; however, the Dup key is not permitted in this field.

To recover, press the Error Reset key and continue without using the Dup key in this field.

0020 You have pressed a key that is not allowed in this field. This is either a right-adjust or a signed numeric field and you must exit the field before pressing the following keys: command function keys, Character Backspace key, Enter/Rec Adv key, Print key, Help key, Roll keys, Clear key, and the Home key (when the cursor is in the home position).

To recover, press the Error Reset key. The cursor is in the same position it was when you pressed the invalid key. Continue by pressing the Field +, Field -, or Field Exit key.

0021 The cursor is positioned in a mandatory enter field that must have data entered in it before you can exit the field by pressing the Field +, Field -, or Field Exit key.

To recover, press the Error Reset key and enter the required data.

0022 A system error has occurred. The status of the present field is not known. This error can occur during an insert or delete operation.

To recover, press the Error Reset key. Check the display screen to determine if the insert or delete function was completed properly. If not completed properly, correct the field.

0023 You are in hexadecimal mode but the first key pressed was not a character A through F or 4 through 9; or the second key pressed was not a character A through F or 0 through 9.

This error also occurs when a hexadecimal code is used in a numeric only, signed numeric, alpha only, or I/O field.

To recover, press the Error Reset key. Continue by using the correct keys.

0026 You pressed the Field - key to exit a numeric only field but the last position of the field was not a character 0 through 9.

To recover, press the Error Reset key. Correct the last position of the field or exit the field by using the Field + or Field Exit key.

0027 You pressed a key that is not used by this display station.

To recover, press the Error Reset key and continue by using valid keys.

0028 You pressed a key that is not used by this display station.

To recover, press the Error Reset key and continue by using valid keys.

0029 The second key pressed during a diacritic key function did not result in a valid combination.

To recover, press the Error Reset key and enter a valid combination.

- 0040 Communications type errors.
through
0054 Recovery – Refer to your remote work station controller operator's guide.
- 0080 Recovery – Refer to your remote work station controller operator's guide.
through
0087
- 0097 Online verification tests are not possible. The host system does not have the programming to support these tests.
- To recover, press the Error Reset key. Then continue to use the display station without performing the verification tests.
- 0099 To recover, determine when the error occurred (before, during, or after sign-on) and then refer to the following for the meaning and recovery procedure:

Error Occurred Before Sign-On

The function key you pressed is not valid at this time.

To recover, press the Error Reset key. Then use the correct procedure to sign on. (On some systems, press the Sys Req/Attn key if the sign-on screen is not displayed.)

Error Occurred During Sign-On

Either the host system is not operating or the remote work station controller is not communicating with the host system.

To recover, press the Error Reset key. Then use the correct procedure to sign-on. If the error persists, contact the host system operator and ensure that the host system is operating.

If the display station is attached to a remote work station controller, contact that operator and ensure that the remote work station controller is communicating with the host system.

Error Occurred After Sign-On

The program or utility did not recognize the key you pressed.

If the display station is attached to a remote work station controller, this error can be caused by a loss of communication between the remote work station controller and the host system.

To recover, press the Error Reset key, then try to do a different type of job or procedure. If the error does not occur again, there is a system programming problem or a keying error. If the error does occur again and the display station is attached to a remote work station controller, contact that operator to determine if communications with the host system have been lost. If the display station is not attached to a remote work station controller, contact the host system operator to determine if there is a problem with the system.

For additional error code information, contact the host system operator.

If you are not able to recover from an error, refer to the *Problem Determination Procedures* in Chapter 4 of this manual or to the *IBM 5291 Keyboard Template, GX21-9410* for the Model 1 or the *IBM 5291 Model 2 Keyboard Template, GX21-9501*.

10xxxx through 1Fxxxx	Recovery – Refer to your remote work station controller operator's guide.
D0xxxx through DFxxxx	Recovery – Refer to your remote work station controller operator's guide.
E0xxxx	Recovery – Refer to your remote work station controller operator's guide.
F0xxxx through FFxxxx	Recovery – Refer to your remote work station controller operator's guide.

Chapter 4. Problem Determination Procedures

SAFETY PRECAUTION: If you detect smoke, excessive heat, or unusual odors coming from your display station, immediately set the Power switch to Off, disconnect the power cord, and call a service representative.

This chapter can help you solve a problem with your display station. Check to see if any of the following six symptoms describe your problem, and attempt the corrective actions. (The symptoms are numbered **1** through **6**.) Your service representative should be called if you cannot correct the problem. *Examine all six symptoms before calling your service representative.*

1 SYMPTOM:

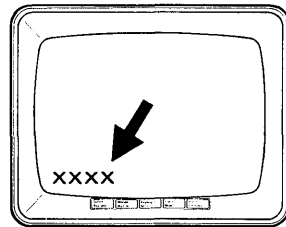

A four-digit system error code is displayed. (This error code is displayed in the lower left corner of the display.)

CORRECTIVE ACTION:

Find the error code in Chapter 3 of this manual and take the corrective action.

2 SYMPTOM:

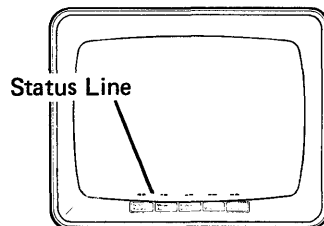

Error information is displayed on the bottom (status) line and the alarm may sound.

CORRECTIVE ACTION:

Model 1

Make sure the CSR switch is set to N (Normal). (See the illustration under Symptom 6 later in this chapter.)

Model 2

Make sure the Test/Normal switch is set to Normal. (See the illustration under Symptom 6 later in this chapter.)

Turn to the next page.

CORRECTIVE ACTION:

The following illustration shows the position of error information on the status line. Try to determine the type of information you have and go to the correct symbol (A, B, C, D, or E). (If you cannot determine the type of error you have, refer to the *IBM 5291 Display Station Keyboard Template, GX21-9410* for the Model 1 or the *IBM 5291 Model 2 Keyboard Template, GX21-9501*. The template can be held up to the screen and used as a guide in determining what types of error information are displayed.)

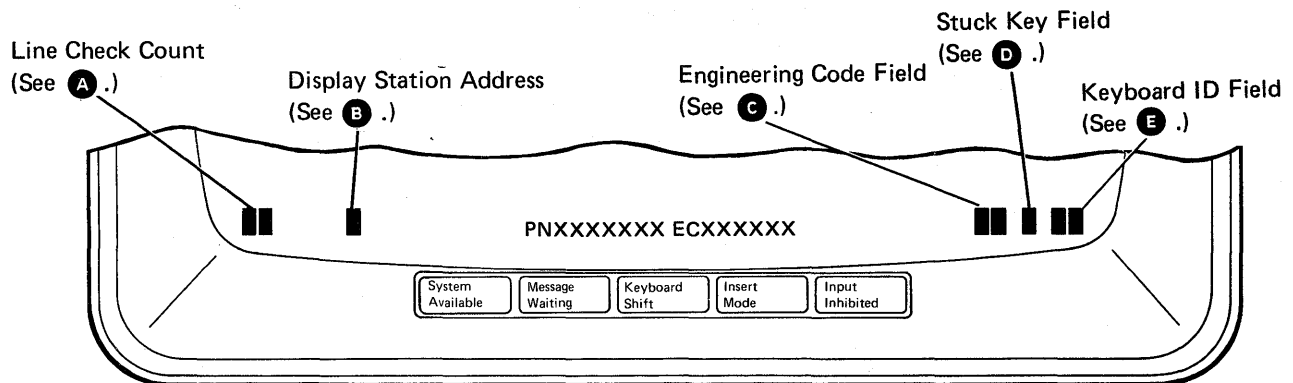

- A** **00-05: Normal operation.** Ignore this position.
06-99: Verify Terminator switch setting and check work station cables. Contact your system operator and check the Terminator switch setting on your display station and all other work stations on your cable. (Refer to the *IBM 5291 Display Station Setup Procedure, GA21-9408* for the Model 1 or the *IBM 5291 Model 2 Display Station Setup Procedure, GA21-9802*.) Also check that all work station cables are tight. Then set the Power switch to Off, wait 10 seconds, then set the Power switch to On.
- B** **0-6: Address switch setting.** Normal operation. This number should match the address of your display station. Contact your system operator for your display station address and reset the Address switches on your display station if these numbers do not match. (Refer to the *IBM 5291 Display Station Setup Procedure, GA21-9408* for the Model 1 or the *IBM 5291 Model 2 Display Station Setup Procedure, GA21-9802*.) After resetting the Address switches, set the Power switch to Off, wait 10 seconds, then set the Power switch to On.
7: Invalid Address switch setting. Contact your system operator and ask for assistance in resetting the Address switches on your display station. (Refer to the *IBM 5291 Display Station Setup Procedure, GA21-9408* for the Model 1 or the *IBM 5291 Model 2 Display Station Setup Procedure, GA21-9802*.) After resetting the Address switches, set the Power switch to Off, wait 10 seconds, then set the Power switch to On.

C **E0-E6: Machine error.** Set the Power switch to Off, wait 10 seconds, then set the Power switch to On. If the problem persists, report this error to your service representative.

E7: If you have a **0, 1, 2, 3, 4, 5, or 6** displayed in position **B**, report the **E7** error to your service representative. If you have a **7** displayed in position **B**, contact your system operator and ask for assistance in resetting the Address switches on your display station. (Refer to the *IBM 5291 Display Station Setup Procedure, GA21-9408* for the Model 1 or the *IBM 5291 Model 2 Display Station Setup Procedure, GA21-9802*.) After resetting the Address switches, set the Power switch to Off, wait 10 seconds, then set the Power switch to On.

D **1: Stuck key.** Examine the display station keyboard and remove any objects that may be holding a key down. Report a **stuck key** to your service representative if this problem persists.

E **00-31: Normal operation.** Ignore this position.
KU, LU, LV, LW, or any other letters:

Model 1

Set the Power switch to Off, wait 10 seconds, then set the Power switch to On. If the problem persists, report this error to your service representative.

Model 2

Set the Power switch to Off, make sure that the keyboard connector is fastened securely to the lower unit, then set the Power switch to On. If the problem persists, report this error to your service representative.

3 SYMPTOM:

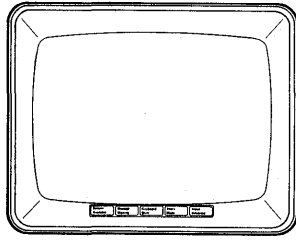

BLANK SCREEN

The display screen is blank. (No status indicators can be seen and the cursor is missing.)

CORRECTIVE ACTIONS:

1. Adjust the Brightness control.
2. Adjust the Contrast control (Model 2 only)
3. Set the Power switch to Off.
4. Make sure that you have power at the wall outlet.
5. Make sure that the display station power cord is securely plugged into the rear of the display station and securely plugged into the wall outlet.
6. Make sure that the cable from the display unit is tightly fastened in its socket on the rear of the lower unit. (The thumbscrews should be turned clockwise until tight.)

Model 1

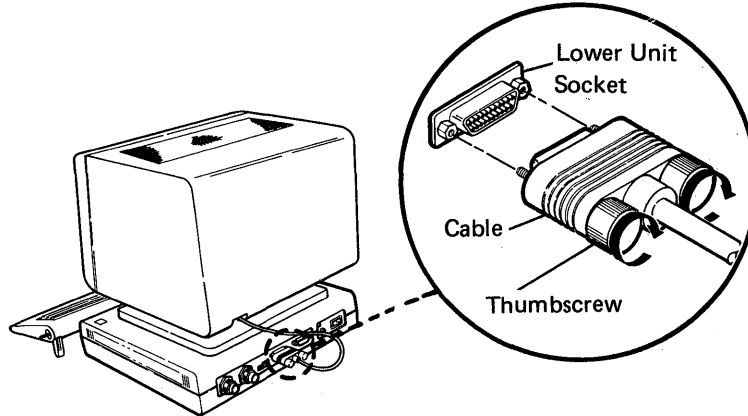

Model 2

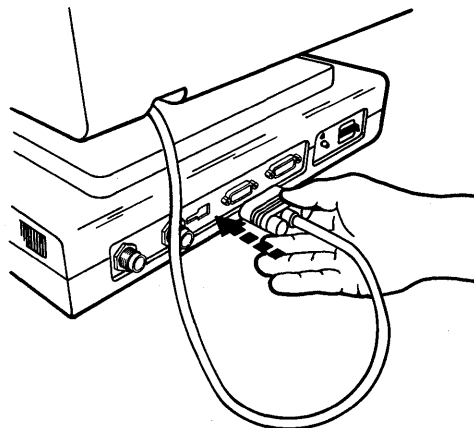

7. Set the Power switch to On and listen for the alarm.

8. Model 1

If the screen is still blank, call your service representative and report a **blank screen**. Also report whether or not you heard the alarm.

Model 2

If the screen is still blank, call your service representative and report a blank screen. Also report whether or not you heard the alarm and if the Power-on light is on.

4 SYMPTOM:

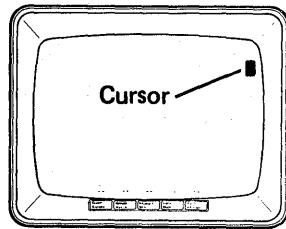

The cursor is in the upper right corner of the display screen.

CORRECTIVE ACTIONS:

1. Contact your system operator and make sure the system is operating correctly.
2. Make sure that the work station cable between your display station and the system is securely fastened and is not physically damaged.
3. Make sure that the Address switches on your display station are set to the proper address. Ask your system operator for assistance. (Refer to the *IBM 5291 Display Station Setup Procedure, GA21-9408* for the Model 1 or the *IBM 5291 Model 2 Display Station Setup Procedure, GA21-9802.*)
4. Make sure that the Terminator switch on your display station, and the Terminator switches on all other display stations on your cable, are set properly. Ask your system operator for assistance.
5. Call your service representative if the problem persists and report that **your display station is not communicating with the system.**

5 SYMPTOM:

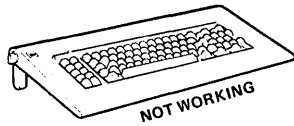

The keyboard is not working. (When you press keys, no data appears on the display screen.)

CORRECTIVE ACTIONS:

1. Model 1

Set the Power switch to Off, wait 10 seconds, then set the Power switch to On.

Model 2

Set the Power switch to Off, make sure the keyboard connector is fastened securely to the lower unit (refer to the *IBM 5291 Model 2 Display Station Setup Procedure, GA21-9802*), then set the Power switch to On.

2. Models 1 and 2

Test the keyboard by pressing a few data keys. If the screen remains blank, call your service representative and report a **keyboard problem**. If characters are displayed on the screen, contact your system operator and ask if the system is operating correctly.

6 SYMPTOM:

You still have a problem. (Your display station is not operating as expected and you have none of the previous five symptoms.)

CORRECTIVE ACTIONS:

1. Contact your system operator and make sure that the system is operating correctly.
2. Make sure that the work station cable between your display station and the system is securely fastened and is not physically damaged.
3. Make sure that the Address switches on your display station are set to the proper address. Ask your system operator for assistance. (Refer to the *IBM 5291 Display Station Setup Procedure, GA21-9408.*)
4. Model 1

Make sure that the CSR switch on the back of your display station is set to N (Normal).

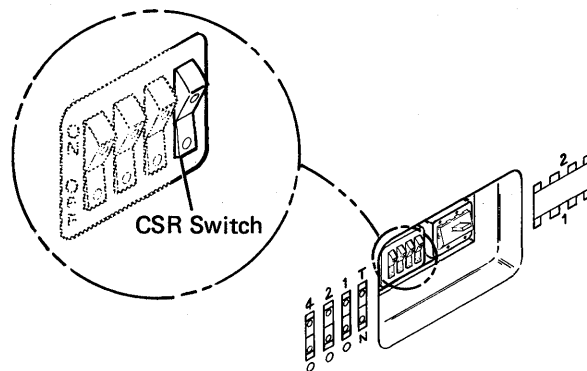

Model 2

Make sure the Test/Normal switch is set to Normal.

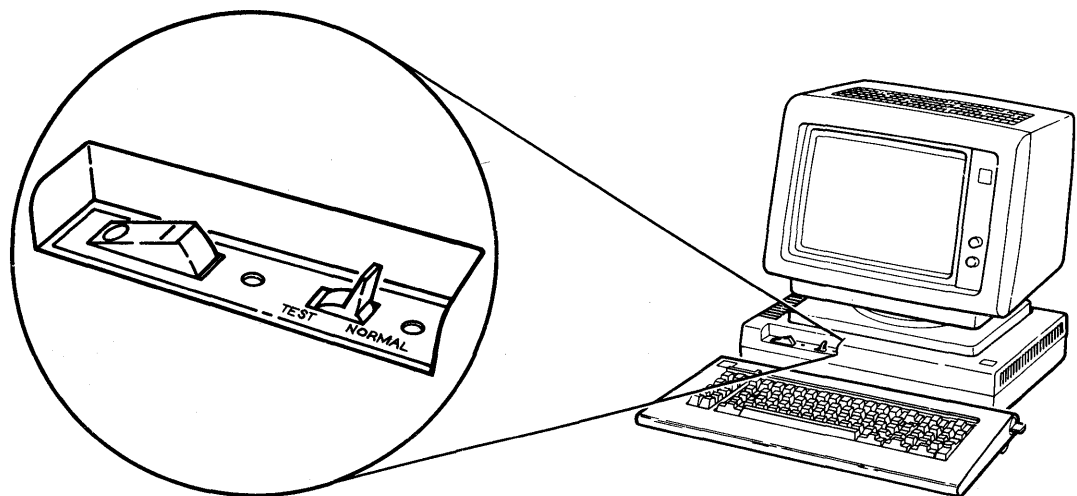

5. Call your service representative if you still have a problem.

Chapter 5. Running the Verification Tests

The verification tests check out the functions of work stations.

Throughout these tests, you are required to make selections from a menu. If you make a selection error, the tests will not proceed. To recover from a selection error, you can:

- Backspace and enter the correct selection over the incorrect one (if you have not yet pressed the Enter/Rec Adv key).
- Press the C and Enter/Rec Adv keys. This will return you to the Prime Option Menu, where you can make another selection.

Do the following to run the verification tests:

1. If necessary, start communications with the host system.
2. When the sign-on screen is displayed, press the Cmd key.
3. Press the Test Request (Character Backspace) key.

The following Prime Option Menu is displayed.

Note: The exact format of the display screens might vary from host system to host system.

```
PRIME OPTION MENU          SELECT OPTION          DISPLAY A8
C END                      3 CONFIGURATION DATA
1 DISPLAY VERIFICATION     4 ERAP
2 WORK STATION PRINTER VERIFICATION

USE THE FOLLOWING LINES TO VERIFY CORRECT OPERATION OF KEYBOARD DATA KEYS
```

4. Select desired option:

C END—This option returns you to the Prime Option Menu.

1 DISPLAY VERIFICATION—This option provides test patterns that show various character display capabilities; a test is also performed on the function keys.

2 WORK STATION PRINTER VERIFICATION—This option checks out a printer. A printed report shows print patterns for analysis.

3 CONFIGURATION DATA—This option displays descriptive information, including addresses, on system devices.

4 ERAP—This option displays or prints the errors that are stored in the host system for the attached work stations.

5. Press the Enter/Rec Adv key.

Follow the instructions and prompts provided with each option.

Note: See the appropriate work station Operator's Guide for operational requirements and meaning of error codes.

address switches: Switches on the access panel of a work station that has Cable Thru capability. These switches are set to the assigned work station address.

allocate: To assign a resource (such as a disk file or a diskette file) to perform a specific task.

automatic enter field: A format control that is used to specify that after the operator has entered information in the field, the information is automatically entered in the host system (without the operator pressing the Enter key).

blank character: A character that does not display but occupies a position on the display screen.

buffer: A temporary storage unit, especially one that accepts information at one rate and delivers it at another rate.

character location: A location on the display screen at which one character can be displayed.

command: An instruction that directs the system to perform an operation.

command function keys: The 14 keys in the top row of the display station keyboard that are used with the Cmd key to request functions of program products and user programs.

configuration: The arrangement of interconnected machines forming a computer system.

controller: A remote work station controller is a device used to coordinate and control operations of one or more attached work stations and to synchronize their operation with that of the system.

cursor: A movable marker on the screen that may appear as an underscore or as a rectangular block. The cursor indicates where the next character entered from the keyboard will appear.

diacritic: A modifying mark that changes the phonetic value of a character when entered in combination with that character.

display: An electronic vacuum tube, similar to a TV display tube, used to display characters.

display field: See *field*.

display station: An input/output device containing a display unit and an attached keyboard.

display station operator: A person who uses the keyboard to perform operations at a display station.

display system: A family of display stations and printers that are attached to a system.

field: One or more consecutive positions on the display screen set up for a specific type of data.

field exit required: A format control used to prohibit exiting from the field unless a certain key is pressed. For example: for the 5251 Display Station, any key except a character key can be pressed to exit from a field exit required field.

format control: The field edit and controls that the host system provides to control the type of characters that can be entered and the appearance of the information for a formatted display. For the 5291 Display Station, the format controls are alpha only, alphameric entry, auto enter, bypass, duplicate enable, field exit required, mandatory entry, mandatory fill, monospace, numeric only, right adjust, and signed numeric.

formatted display: A display screen with fields established for specific information.

free key mode: An operating mode that allows the entering of data without control by a system program (unformatted).

function control keys: Keys that are used to insert, delete, or move data, and to position the cursor.

home position: The first input position of the first input field.

host system: The controlling or highest level system in a data communications configuration.

image: The characters or attributes displayed on a display screen.

input field: An area on the display in which an operator enters data. Input fields are blank on the display and can be preceded by a prompt.

keyboard buzzer: A short buzzing sound, controlled by the system, used to remind or warn the operator of a certain condition.

mandatory enter field: A format control used to specify that at least one character must be entered in the field.

mandatory fill field: A format control used to specify that if one character is entered in the field, the entire field must be filled.

null: A blank that is displayed as the result of hex '00' occupying character positions in the buffer.

numeric only: A format control used to specify that only the numeric characters, comma, hyphen, period, plus, and blank can be entered in the field.

power cord: A cord that plugs into a wall outlet supplying electrical power.

printer: A device that provides printed output.

program: A computer program written to perform a specific job; for example, order entry or payroll. The program is stored in the system and can be accessed by the display station using the Cmd key procedure.

right-adjust field: Pertains to the placement of data in a field, or the shifting of the contents of a field, so that the last significant byte at the end of the data is placed in the rightmost position of the field.

self-check field: A field (such as an account number) that consists of a base number and a self-check digit. For example: An operator enters data and a self-check digit, which is compared to the self-check digit computed by the system. If the operator made a mistake when entering the data in the self-check field, an error message is displayed.

signed numeric field: A format control used to specify that the units position of the field is reserved for the sign (usually, blank for positive and minus for negative).

system: The main computer and the programming necessary to execute customer jobs. The system can have numerous display stations or printers attached.

system cable: A cable that carries commands and data between the system and the display stations or printers.

system console: An I/O device (such as a display station) designed to actuate certain system functions, and control and monitor system operation, in addition to functioning as an I/O device.

system operator: A person who uses a display station that is designated as the system console, to activate certain system functions, and control and monitor system operation.

typematic keys: Keyboard keys that repeat their function when pressed and held down.

unformatted display: See *free key mode*.

unit: One of the three major assemblies that make up the 5291 (display unit, lower unit, and keyboard unit).



2-17

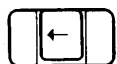

2-5



2-4



2-18



2-18



2-16



2-19



2-20

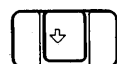

2-20

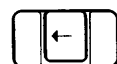

2-4

A

address switches 4-2
 adjusting 1-6
 alarm 1-8
 brightness of display screen 1-6
 contrast 1-7
 slope of keyboard 1-10
 viewing angle of display screen 1-12
 attention function 2-6

B

blink field 1-18
 brightness control 1-6

C

character backspace key 2-17
 cleaning 1-3
 clear key 2-5
 column separator field 1-18
 command function keys 1-1, 1-21
 command key 1-1, 2-2
 contrast control 1-7
 control, Alarm 1-8
 control, Brightness 1-6
 control, contrast 1-7
 controls
 alarm 1-8
 brightness 1-6
 contrast 1-7
 cursor
 block 1-17
 location 1-16
 movement keys 2-15
 underline 1-17

D

delete key 2-7
 display formatting 1-18
 display highlighting 1-18
 display mode key 2-4
 display screen 1-13
 adjusting brightness 1-6
 adjusting contrast 1-7
 adjusting viewing angle 1-12
 formatting 1-18
 highlighting 1-18
 indicators 1-14
 size 1-13
 status line 1-14
 display status indicators 1-14
 display unit 1-1, 1-2
 display unit, rotating 1-9
 duplicate key 2-12

E

enter record advance key 2-12
 erase input key 2-9
 error codes 3-1
 error reset key 2-11

F

field - key 2-14
field + key 2-14
field advance key 2-18
field backspace key 2-18
field exit key 2-13
formatting, display 1-18
function control keys 1-1, 2-1

G

general information 1-1
glossary G-1

H

help key 2-10
help key function 3-1
high intensity field 1-18
highlighting
 blink 1-18
 column separator 1-18
 high intensity 1-18
 nondisplay 1-18
 reverse image 1-18
 underscore 1-18
highlighting, display 1-18
home key 2-9
host system 1-3

I

indicators
 input inhibited 1-15
 insert mode 1-15
 keyboard shift 1-15
 message waiting 1-14
 system available 1-14
input inhibited indicator 1-15
insert key 2-8
insert mode indicator 1-15

K

keyboard
 adjustment knobs 1-10
 description 1-1, 1-19
 keys 2-1
 slope adjustment 1-10
 template 1-21, 2-2
keyboard shift indicator 1-15
keyboard template 1-21, 2-2
keyboard unit 1-1, 1-2

keys

attention 2-6
character backspace 2-17
clear 2-5
Cmd 2-2
command 2-2
command function 1-21
cursor movement 2-15
delete 2-7
display mode 2-4
down cursor movement 2-17
duplicate 2-12
enter/record advance 2-12
erase input 2-9
error reset 2-11
field - 2-14
field + 2-14
field advance 2-18
field backspace 2-18
field exit 2-13
function control 2-1
help 2-10
home 2-9
horizontal movement 2-16
insert 2-8
left cursor movement 2-16
new line 2-19
print 2-10
reverse display image 2-4
right cursor movement 2-16
roll 2-11
shift 2-20
shift lock 2-20
spacebar 2-21
special symbol 2-21
system request/attention 2-6
test request 2-4
typematic 1-20
up cursor movement 2-16
vertical movement 2-16

L

lower unit 1-1, 1-2

M

message waiting indicator 1-14

N

new line key 2-19
nondisplay field 1-18

P

power switch 1-4
print key 2-10
problem determination procedures 4-1

R

recovery procedures 3-1
reverse image 1-18, 2-4
reverse image field 1-18, 2-4
roll keys 2-11
rotating display unit 1-9

S

shift keys 2-20
shift lock key 2-20
spacebar key 2-21
special symbol keys 2-21
status indicators 1-14
status line 1-14
switches
 address 4-2
 Power 1-4
 terminator 4-2
system available indicator 1-14
system request/attention key 2-6
system request function 2-6
system, host 1-3

T

template, keyboard 1-21, 2-2
terminator switch 4-2
test request key 2-4
tests, verification 5-1
typematic keys 1-20

U

underscore field 1-18

V

verification test 5-1
vertical movement keys 2-16, 2-17

10-key numeric cluster 1-1
5291
 display unit 1-1
 keyboard unit 1-1
 lower unit 1-1

READER'S COMMENT FORM

Please use this form only to identify publication errors or to request changes in publications. Direct any requests for additional publications, technical questions about IBM systems, changes in IBM programming support, and so on, to your IBM representative or to your nearest IBM branch office. You may use this form to communicate your comments about this publication, its organization, or subject matter, with the understanding that IBM may use or distribute whatever information you supply in any way it believes appropriate without incurring any obligation to you.

If your comment does not need a reply (for example, pointing out a typing error) check this box and do not include your name and address below. If your comment is applicable, we will include it in the next revision of the manual.

If you would like a reply, check this box. Be sure to print your name and address below.

Page number(s):

Comment(s):

Please contact your nearest IBM branch office to request additional publications.

Name _____

Company or
Organization _____

Address _____

No postage necessary if mailed in the U.S.A.

City _____ State _____ Zip Code _____

Phone No. (_____) _____

Area Code

Cut Along Line

IBM 5291 Models 1 and 2 Display Station Operator's Guide (File No. S5250/S34/S36/S38-06) Printed in U.S.A. GA21-9409-2

Fold and tape

Please do not staple

Fold and tape



NO POSTAGE
NECESSARY IF
MAILED IN THE
UNITED STATES

BUSINESS REPLY MAIL
FIRST CLASS PERMIT NO. 40 ARMONK, N. Y.

POSTAGE WILL BE PAID BY ADDRESSEE:

International Business Machines Corporation
Information Development
Department 245
Rochester, Minnesota, U.S.A. 55901

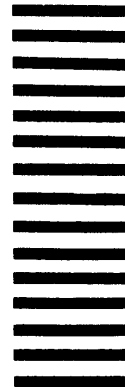

Fold and tape

Please do not staple

Fold and tape





International Business Machines Corporation

IBM 5291 Models 1 and 2 Display Station Operator's Guide (File No. S5250/S34/S36/S38-06) Printed in U.S.A. GA21-9409-2