



---

Virtual Machine/  
System Product

## Operator's Guide

Release 5

SC19-6202-4

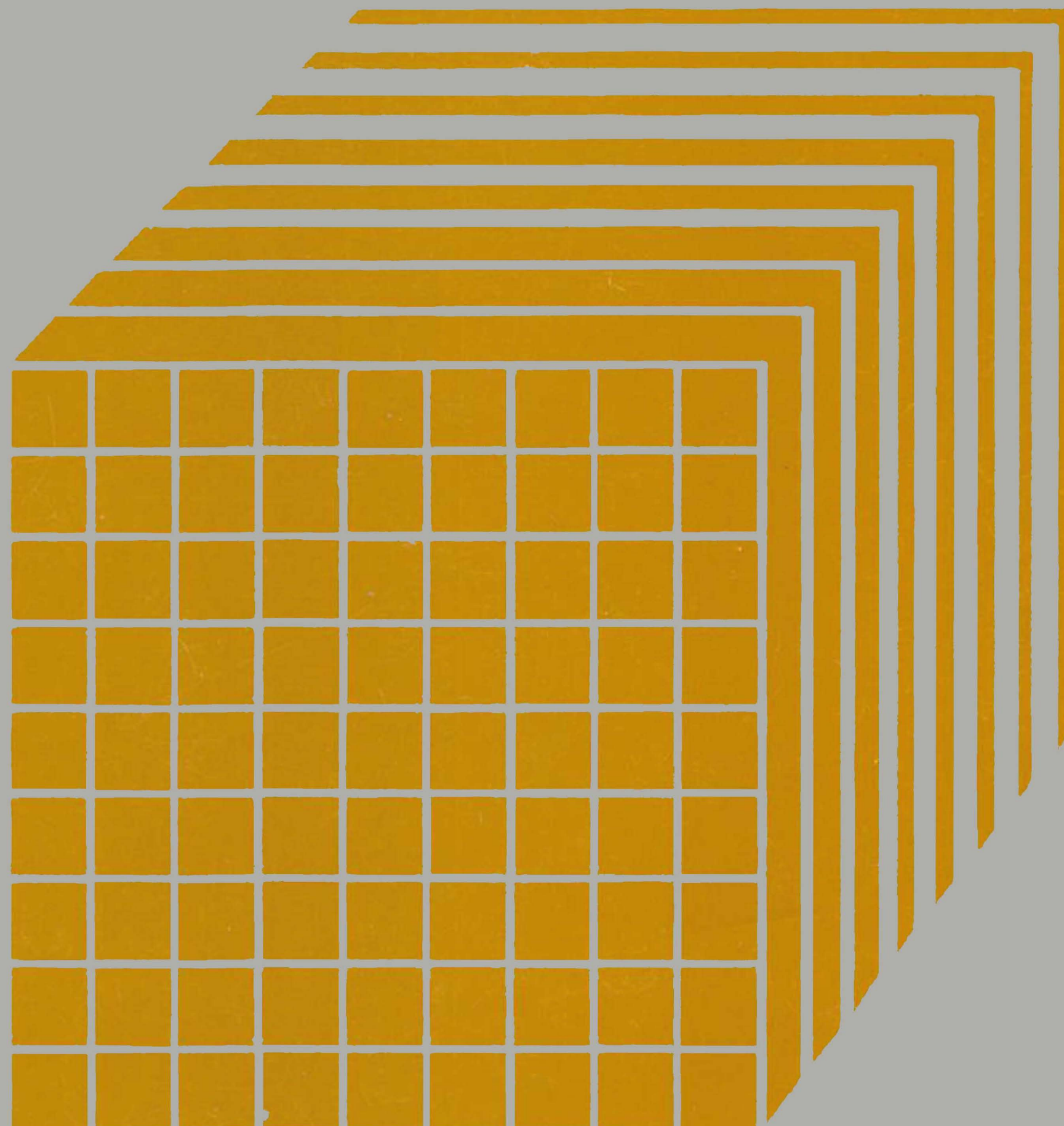



---

# Virtual Machine/ System Product

## **Operator's Guide**

Release 5

SC19-6202-4

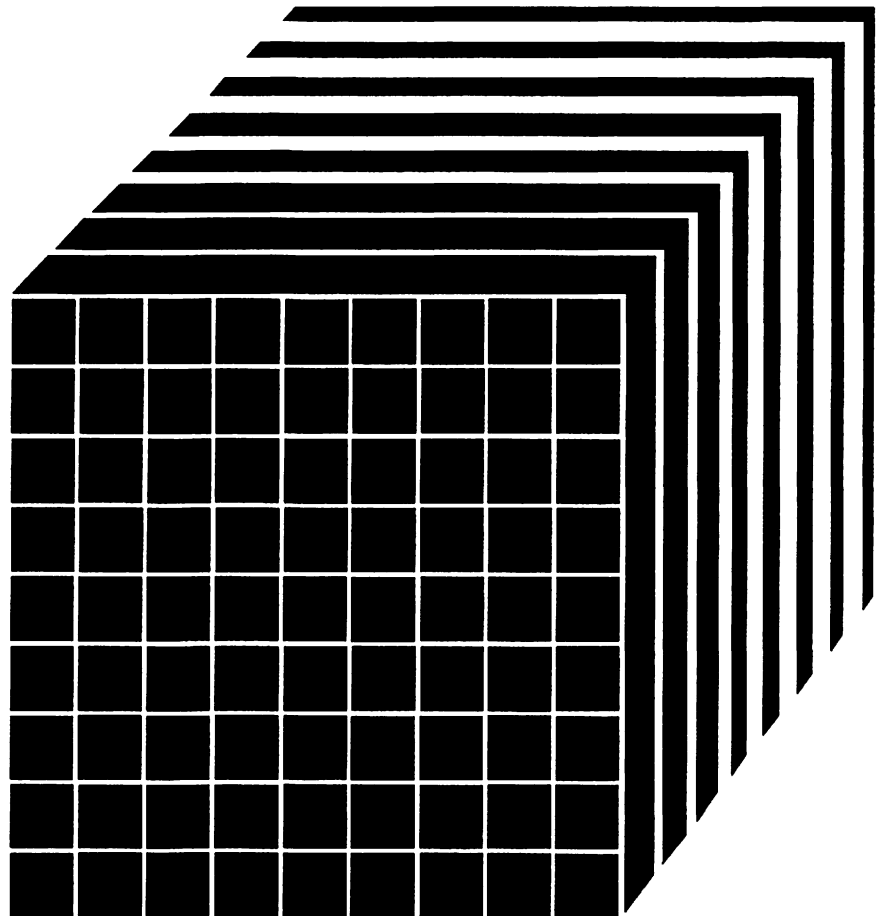

## **Fifth Edition (December 1986)**

This edition, SC19-6202-4, is a major revision of SC19-6202-3, and applies to Release 5 of Virtual Machine/System Product (VM/SP), program number 5664-167, and to all subsequent releases and modifications until otherwise indicated in new editions or Technical Newsletters. Changes are made periodically to the information herein; before using this publication in connection with the operation of IBM systems, consult the latest *IBM System/370, 30xx and 4300 Processors Bibliography*, GC20-0001, for the editions that are applicable and current.

### **Summary of Changes**

For a list of changes, see "Summary of Changes" on page 83.

Changes or additions to text and illustrations are indicated by a vertical line to the left of the change.

References in this publication to IBM products, programs, or services do not imply that IBM intends to make these available in all countries in which IBM operates. Any reference to an IBM licensed program in this publication is not intended to state or imply that only IBM's licensed program may be used. Any functionally equivalent program may be used instead.

### **Ordering Publications**

Publications are not stocked at the address given below. Requests for IBM publications should be made to your IBM representative or to the IBM branch office serving your locality.

A form for readers' comments is provided at the back of this publication. If the form has been removed, comments may be addressed to IBM Corporation, Information Development, Dept. G60, P.O. Box 6, Endicott, NY, U.S.A. 13760. IBM may use or distribute whatever information you supply in any way it believes appropriate without incurring any obligation to you.

## Preface

This book is for those persons responsible for the operation and administration of a Virtual Machine/System Product (VM/SP) system. This book contains the following chapters:

- Chapter 1, “Introduction to Operational Control of the VM/SP System” on page 1 – Briefly describes the recovery features of VM/SP and how to control VM/SP under normal and adverse conditions.
- Chapter 2, “Starting VM/SP Operation” on page 9 – Describes how to initialize the system, various hardware and performance considerations, and how to terminate the system.
- Chapter 3, “Commands that You May Use” on page 51 – Lists some of the CMS commands that you, as the operator, may find helpful. This chapter also contains a complete list of the CP commands and their associate function types, privilege classes, and uses.
- Chapter 4, “The Programmable Operator Facility” on page 63 – Introduces the Programmable Operator Facility and describes what it can do in a single system, in a distributed VM environment, and in a mixed environment. You can find more detail about this facility in the *VM System Facilities for Programming*.
- Chapter 5, “Operator Spooling Functions” on page 67 – Describes the various spooling commands and how to use the CMS Batch Facility.

The CP privilege-class command descriptions, formerly in this manual as Chapter 3, have been moved to the *VM/SP CP Command Reference*. The VM/SP service program descriptions, formerly in this manual as Chapter 4, have been moved to other manuals in the VM/SP library. Refer to “Summary of Changes” on page 83 for further detail on where this information has moved.

The following manuals may also be helpful to you:

*VM/SP Introduction,*  
SC19-6200

To help you understand virtual machine concepts and capabilities. This book briefly discusses virtual storage, virtual machine features and facilities of VM/SP.

*VM Diagnosis*  
*Guide, LY24-5241*

For details on the Interactive Problem Control System (IPCS) component of VM/SP to help you report, diagnose, and manage problems. Also, refer to this book for operator commands and related tasks for the Group Control System (GCS) component of VM/SP.

*RSCS Networking*  
*Version 2 Operation*  
*and Use, SH24-5058*

For details on how to operate the Remote Spooling Communications Subsystem (RSCS) virtual machine. If your installation uses RSCS networking, you, as the system operator, may also be the operator of the RSCS virtual machine as well as of the real machine at the installation.

*Note:* For more effective use of RSCS in VM/SP, the RSCS Networking Program Product (5748-XP1) is recommended.

*Running Guest*  
*Operating Systems,*  
GC19-6212

For general information on how to run batch jobs in VM/SP virtual machines (other than CMS).

Refer to “Prerequisite Publications” on page 91 and “Corequisite Publications” on page 92 for a complete listing of the manuals that you may find helpful.

# Contents

<b>Chapter 1. Introduction to Operational Control of the VM/SP</b>	
System	1
System/370 Recovery Management Support	3
Machine Check Handler (MCH)	3
Channel Check Handler (CCH)	4
Missing Interrupt Handler	4
I/O Error Recording and SVC 76	5
VM/SP Recovery Features	5
Recording Facilities	5
VM/SP Repair Facilities	6
VM/SP Restart Facilities	6
<b>Chapter 2. Starting VM/SP Operation</b>	<b>9</b>
Console Procedures	10
Privileged Operations	11
Page Frame Availability	12
Initializing the System	12
Using the Time-of-Day Clock	16
Specifying a Warm Start	18
Specifying a Checkpoint Start	19
Specifying a Force Start	19
Specifying a Cold Start	20
Specifying a Shutdown Start	20
Automatically IPLing the System	21
Automatically Logging On the System Operator	21
Manually Logging on the System Operator	21
Starting the Unit Record Devices	23
Enabling 37xx Resources	23
Messages On Startup and Initialization	24
Initializing a Mass Storage System	24
Initializing a Multiprocessor	26
Initializing an Attached Processor	27
Interval Timer	27
Console Definition	28
Disabling the VM/SP Primary Console	29
Selecting a VM/SP Alternate Console during VM/SP Initialization	30
Control Messages after Startup	31
System Operation Status Messages	31
Messages from Virtual Machine Users	31
Hardware and Program Status Messages	31
Important Hardware Considerations	33
Controlling the 3704/3705/3725 Communications Controller	33
3480 Magnetic Tape Subsystem Support	35
3800 Printing Subsystem Support	36
Assigning Performance Options	37
Reserved Page Frames Option	38

Favored Execution Option	39
Virtual = Real Option	40
Locked Pages Option	42
Priority Option	43
VM/370 Assistance - Hardware Assist	43
Affinity Option	46
Queue Drop Elimination Option	47
Terminating the System	47
System Abend Dumps	49
<b>Chapter 3. Commands that You May Use</b>	<b>51</b>
Using CP and CMS	51
Using CMS To Alter VM/SP Files	52
Using CP to Perform Operations	52
Privilege Classes for CP Commands	53
Summary of CP Commands	55
<b>Chapter 4. The Programmable Operator Facility</b>	<b>63</b>
Use in a Single System	64
Use in a Distributed VM Environment	64
Use in a Mixed Environment	65
<b>Chapter 5. Operator Spooling Functions</b>	<b>67</b>
Spooling	67
Spooling Considerations	67
Spooling Functions	68
Spool Buffers	71
Spool Files	71
Output Classes	72
Output Forms	73
Spooling Commands	74
Spooled Card Input	75
Spool Files for Virtual Machines Running Batch Jobs	79
Using the CMS Batch Facility	79
Starting the Batch Virtual Machine	80
CMS Batch Output	81
Purging, Reordering, and Restarting Batch Jobs	81
Stopping the Batch Virtual Machine	82
<b>Summary of Changes</b>	<b>83</b>
Structural Changes	83
Technical Changes	85
<b>Glossary of Terms and Abbreviations</b>	<b>89</b>
Terminology	89
<b>Bibliography</b>	<b>91</b>
Prerequisite Publications	91
Corequisite Publications	92
<b>Index</b>	<b>97</b>

## Figures

1. DOS 160K Virtual=Real Storage Assignments .....	42
2. Command Control of VM/370 Hardware Assist .....	46
3. CP Privilege Classes .....	54
4. CP Commands .....	55
5. Example of a Programmable Operator Facility Configuration. ...	65
6. A single system with NCCF or NetView .....	66
7. CP Spooling Commands .....	74
8. Changes to the Operator's Guide for Release 5 .....	84



# Chapter 1. Introduction to Operational Control of the VM/SP System

System operators, in almost all large System/370 installations, serve in an apprentice capacity until they have acquired the skill and knowledge to maintain the installation's operating system, be it DOS, OS, or VM/SP.

In an apprentice capacity, an operator acquires a basic proficiency in mounting, making ready, and loading tape, DASD, line control, and other hardware devices. Novice operators also learn the address designations of all hardware devices attached to the system. They become aware of those system resources that can be switched or patched via alternate channel or telecommunication path to expedite system operations. The operator becomes aware of system console terminal operation as well as the function of most of the indicators, switches, buttons, and alarms that are part of the processor control. All of this knowledge is basic and must be acquired before considering the operational control of any system control program (SCP).

The second phase of an operator's training is to be knowledgeable about the SCP that is controlling the data processing operations; he must be aware of its capability and its operating philosophy. The operator must also be aware of the priorities and the demands placed upon the system.

Much of this basic knowledge of VM/SP is described in the *VM/SP Introduction*. In that document there is discussion on virtual machines; how they are built, identified, and used. Each facet of the virtual machine is described: the virtual processor, virtual storage, virtual I/O devices, and the virtual system console. Concurrent virtual machine usage and spooling operations are also described.

With an understanding of VM/SP concepts, the power and versatility of VM/SP is soon realized. The system operator is not just controlling one process and its related storage and I/O with control and application programs; the operator is exercising control over the resources of multiple systems (virtual systems). Each virtual system with its own system operation, in turn, is being controlled by a user via a terminal console. When additional facilities and resources or priorities are needed by the virtual system, the virtual system operator must request these services from the VM/SP system operator. The system operator then delegates additional system resources to the virtual machine, if feasible.

# Operational Control

---

Some of the operations that are exclusive functions performed by the VM/SP system operator are as follows:

- Reorder, purge, or copy any closed spool files
- Issue warning and high priority messages
- Attach and dedicate devices to specified virtual machines
- Automatically logon virtual machines
- Force users off the system when warranted
- Change any virtual machine's dispatch priority and operating characteristics.

For details on how many of these and other functions are accomplished, see the *VM/SP CP Command Reference*.

Depending on the system installation, the system operator may also be the operator of a large DOS/VSE, OS/MVS, or OS/VS1 batch processing system that is run in the virtual machine environment. Another duty of the system operator is to control the data traffic from remote work stations. Information on VM/SP control of such data transfer is detailed in the *RSCS Networking Version 2 Operation and Use*.

Regardless of the real system resources and the tasks and procedures used, systems are subject to hardware and program malfunction. The Interactive Problem Control System (IPCS) component of VM/SP provides a method of recording and maintaining a history of VM/370 and virtual machine program problems. The *VM Diagnosis Guide* provides the details on how to use IPCS.

Problems that are a result of a hardware fault are usually detected by the hardware itself and trigger the recording of register contents and sense values (related to the occurrence of the error) in VM/SP's error recording area.

Regardless of whether the malfunction origin is hardware or software, the system operator (in most cases) is notified of the seriousness of the situations by means of console indicators/alarms or by console diagnostic messages. These all serve to inform the operator that:

- The system operation can continue as before.
- The system operation can continue with reduced power/resource.
- System restart and recovery is commencing.
- System operation is terminated.

The type of recovery that is attempted is described in "System/370 Recovery Management Support" on page 3.

## System/370 Recovery Management Support

IBM System/370 attempts correction of most machine errors without program assistance. CP is notified, via an interruption, of both intermittent and permanent machine errors to allow error recording and recovery procedures to start.

The following recovery features are implemented in the IBM System/370 hardware:

- Retry of the failing processor operations
- Validity checking on processor and control storage to correct all single-bit errors
- I/O operation retry facilities including an extended channel status word (ECSW), which provides channel retry data to channel and control unit retry procedures
- Expanded machine check interruption facilities to improve error recording and recovery procedures.

### Machine Check Handler (MCH)

You can set the recording mode to record errors corrected by processor retry (logically termed as processor retry) and Error Correction Code (ECC) with the SET MODE command. In attached processor or multiprocessor applications, recording mode can be set for either or both processors. For processor retry, the default setting is record mode.

*Note:* The SET MODE MAIN command is invalid for 3031, 3032, 3033, and 308X processors.

When processor retry or ECC succeed in correcting errors and the processor is in record mode, the machine check handler records the error. When processor retry or ECC fail, the machine check handler:

- Attempts to isolate the failure to one page frame and makes that page frame invalid or unavailable for paging.
- Attempts to isolate the failure to one virtual machine and logs off or resets that virtual machine.
- Attempts to isolate the failure to portions of the system and to continue system operation in degraded mode.
- Abnormally terminates the system when recovery is not possible; or, if VM/SP is operating in attached processor mode and the malfunction is isolated to the attached processor and to a particular virtual machine, then, system operation continues in uniprocessor mode.

# Operational Control

---

*Note:* If VM/SP is operating in multiprocessor mode and the following conditions exist:

- The malfunction can be isolated to one processor and one virtual machine.
- No system-owned device has its only online path on the failing processor.

The system can continue operation in uniprocessor mode.

MCH records an error whenever any of the following conditions occur:

- Processor retry occurred<sup>1</sup>
- ECC corrected data<sup>1</sup>
- Hardware reported a buffer or DLAT (Data Look Aside Table) error
- Multiple-bit storage failure
- External damage
- Storage protection feature damage
- Timer error
- System damage
- Instruction processor damage.

## Channel Check Handler (CCH)

Whenever a channel control check, channel data check, or interface control check occurs, the channel check handler (CCH) constructs an error record and records the results in an IOERBLOK. The error recovery procedures use this IOERBLOK to retry the error. Recovery is not attempted for channel errors associated with virtual machine I/O events.

## Missing Interrupt Handler

The missing interrupt handler monitors system I/O activity on specific device classes for interruptions that do not occur within a specified period of time. When a missing interruption is detected, the control program attempts corrective action, then notifies the system operator of the condition (either cleared or pending), and writes a record to the error recording area. The operator is notified so that he can take manual action if the control program's corrective action was unsuccessful.

---

<sup>1</sup> VM/SP records these errors only under specific conditions. The conditions for recording these errors are detailed in the *EREP User's Guide and Reference*.

## I/O Error Recording and SVC 76

VM/SP maintains an error recording area that captures I/O, CCH, and MCH error records. Device and control unit detected unit checks during VM/SP spooling, paging, and virtual machine I/O errors generate the I/O records.

VM/SP and the virtual machine's SYS1.LOGREC data set contain recorded I/O errors; this double recording occurs when the virtual machine's operating system does not invoke SVC 76.

If the virtual machine operating system invokes SVC 76 and passes the correct parameters to VM/SP, VM/SP records the error in its own error recording area. VM/SP then passes control back to the virtual machine operating system, thus bypassing virtual machine error recording facilities.

## VM/SP Recovery Features

### Recording Facilities

The Environmental Recording Editing and Printing (EREP) program is executed when the CMS CPEREP command is invoked. The output of the CPEREP command consists of printed reports whose content depends upon the specified (or defaulted) CPEREP operands and upon the input system error records. The reports generated by CPEREP have the same format as those generated on an MVS system. The input system error records may be from the VM/SP error recording area or from a history tape. The history tape may have been produced earlier by CPEREP from the VM/SP error recording area data or by an OS/VS system from SYS1.LOGREC data. Unlabeled tapes produced on OS/VS systems by EREP and on VM/SP systems by CPEREP are compatible and can be transported between systems. Data from both systems can also be accumulated on the same tape. For more details on CPEREP, refer to the *EREP User's Guide and Reference*.

If the facilities of an IBM 3850 Mass Storage System (MSS) are used with VM/SP virtual machine operations and MSS errors are reflected to VM/SP's error recording area, CPEREP must be invoked so that MSS-related errors recorded in the error recording area can be collected on an accumulation (ACC = YES) tape for further processing by the VS System Data Analyzer Program (SDA). Because MSS logged-out data is voluminous and the interrelationships of MSS components are complex, it is imperative that this service program be used to effectively diagnose and isolate mass storage problems.

# Operational Control

---

## VM/SP Repair Facilities

The Online Test Standalone Executive Program (OLTSEP) and associated Online Tests (OLT) execute in a virtual machine that can run concurrently with normal system operations. These programs provide online diagnosis of I/O errors for most devices that connect to the System/370.

The service representative (with a CP command privilege class of F) can execute online tests from a terminal as a user of the system; CP console functions, including the ability to display or alter virtual machine storage, are available when these tests are run. Those tests that violate VM/SP restrictions may not run correctly in a virtual machine environment.

## VM/SP Restart Facilities

VM/SP tries to reload CP when a system failure causes:

1. An abnormal termination that does not result in a disabled WAIT state.
2. The Dump to be directed to DASD.

Often, the operator does not need to do anything. The system attempts to execute a warm start, thus allowing user's terminals to be reconnected (for logon reinitialization by users) and completed spool files as well as open console spool files to be maintained. In the event of a warm start, device reconfiguration (such as varying a device off-line) that was performed by the real computing system operator is remembered by CP for system spooling devices only. Storage reconfiguration data acquired during the process of recovering from real storage errors is lost. After a VM/SP system failure, each user must re-access VM/SP (LOGON), and each virtual machine must be reloaded (IPLed).

If the operator was logged off, running disconnected, or logged on to a machine other than the primary system console, the operator will be restored as disconnected with the console spooled; CP issues the message:

```
DMKOPE967I Disconnect userid - system restarted (mmmmnnn)
and system console not VM operator console:
```

Otherwise, the operator will be logged on to the system console.

Termination of a virtual machine, whether caused by a real computing system malfunction or a virtual machine program error, normally does not affect the execution of other virtual machines unless the error involves shared segments.

With virtual storage preservation, the system programmer can tell VM/SP to automatically save the contents of up to a 16M byte virtual machine (main storage and registers) if:

- VM/SP terminates the virtual machine.
- VM/SP itself terminates.

The system programmer must specify at system generation time which virtual machines are going to be saved. The contents of the virtual machine or virtual machines are saved on DASD space that the VM/SP system programmer has previously allocated; users can then restore the contents via the IPL command. Normal recovery procedures for the virtual machines can then be initiated by their respective owners.

Virtual storage preservation is designed to make the automatically-saved virtual machine available only to one or both of two previously specified users. This is for the privacy and security of the virtual machine. The saved virtual machine can be loaded into either a V = R or normal non-V = R area. A system generation macro instruction (NAMESYS) enables the system programmer to assign priorities which indicate the order in which multiple virtual machines should be saved. To create an environment for saved systems requires both the use of the NAMESYS macro instruction and enabling the VMSAVE function via the CP SET command or the directory OPTION statement.

*Note:* VM/SP restart operations on systems employing virtual storage preservation can consume more time than is usual because the system must sequentially page out the contents of the saved virtual storage to the previously allocated DASD space. If an I/O malfunction prevents the saving of a VMSAVE system, the system operator is notified.

In VM/SP attached processor operations, the priorities and restart activities are similar to a uniprocessor mode of operation. However, if system damage assessment indicates an unrecoverable operation on the attached processor and the error can be isolated to a virtual machine, VM/SP will be continued in uniprocessor mode on the main processor. All virtual machines with an AFFINITY setting to the attached processor are automatically reset to AFFINITY OFF for subsequent virtual machine processing. (Note, the affected virtual machines are placed in console function mode.) If a virtual machine was running when the malfunction occurred, its operation will be terminated.

*Note:* See the VARY command description in the *VM/SP CP Command Reference* for instructions on how to vary the attached processor and multiprocessor back online.

If a similar malfunction occurred on the main processor while VM/SP was operating in attached processor mode, VM/SP terminates. VM/SP cannot switch to uniprocessor operation on the attached processor unit because the attached processor unit has no hardware interface for input/output capabilities.

# Operational Control

---

*Note:* In certain 303x attached processor environments the channel set switching facility is present. In the case of a malfunction on the main processor in these environments, VM/SP can continue system operation in uniprocessor mode by switching the channel set from the failing processor to the remaining processor.

In VM/SP multiprocessor operations, if an unrecoverable error occurs on one processor and the error can be isolated to one virtual machine, it may be possible for VM/SP to continue operation in uniprocessor mode on the nonfailing processor. System operation can continue if all system-owned devices have online paths from the nonfailing processor. Virtual machines with affinity set to the failing processor have their affinity set off and are placed in console function mode.

A MESSAGE or WARNING appearing on the screen during restart, puts the screen in MORE status. Normally, this would put the screen in HOLDING status. However, if the screen is in MORE status during restart operations, pressing the ENTER key will put the screen in HOLDING status.



## Chapter 2. Starting VM/SP Operation

This chapter contains information related to the tasks that you, as the system operator, will need to perform. This chapter contains the following sections:

- “Console Procedures” talks about using your console and how an operator’s console differs from a user’s console.
- “Privileged Operations” talks about what disks you should label and other functions that privilege class users may perform.
- “Page Frame Availability” explains how many page frames must be available at certain times.
- “Initializing the System” introduces the steps involved in starting the system, discusses the types of starts, and how the operator will be logged on. Also, this section describes how to start the unit record devices and how to enable 37xx resources.
- “Initializing a Mass Storage System” describes how to set up your system to run with full MSS support.
- “Initializing a Multiprocessor” describes what you must do to set up your system to run with a multiprocessor.
- “Initializing an Attached Processor” describes what you must do to set up your system to run with an attached processor.
- “Interval Timer” introduces the messages you may receive if the interval timer is not running.
- “Console Definition” lists a number of different console configurations.
- “Disabling the VM/SP Primary Console” describes what happens when the primary system console is disabled.
- “Selecting a VM/SP Alternate Console during VM/SP Initialization” describes how to enable an alternate console.
- “Control Messages after Startup” describes the different types of system console messages that you may receive.
- “Important Hardware Considerations” discusses the 37xx communications controller, the 3480 magnetic tape subsystem, and the 3800 printing subsystem.

# Starting Operation

---

- “Assigning Performance Options” discusses the different performance options that are available to add to the efficiency of particular virtual machines.
- “Terminating the System” talks about the different ways of shutting down the system.

## Console Procedures

You, as the VM/SP system operator, are like other system users, but with some important differences:

- You are allowed to perform certain console functions that the normal user is not.
- Your terminal normally stays in CP mode and is usually ready to receive messages from the VM/SP system and other users.

When the VM operator is logged off, the system routes console messages to the first class ‘A’ user to log on. To recover, both the “acting” system operator (class ‘A’ user) and the VM operator must be logged off. Then, if the VM operator is the next class ‘A’ user to log on, he or she will become the system operator once again.

Unless you are using a 3270 terminal, before you can type a command, you must press the REQUEST key (or its equivalent) on the designated VM/SP system console. VM/SP responds with the time, and sets up to read data from the console keyboard. You can then enter CP commands into the system.

You can enter all CP commands in lowercase or uppercase, or a mixture of both. All system responses, that are less than 72 characters in length, are prefixed with the clock time at which you entered the command from the primary console. Full descriptions of CP commands with a class of A through F are in the *VM/SP CP Command Reference*.

Enter commands into the VM/SP system by pressing the end-of-line function key on the console to terminate the command line. To cancel a miskeyed or inappropriate VM/SP command that you partially or totally entered on the console, enter the designated logical line delete character (normally, the  $\text{¢}$  symbol) or press the CANCEL key (or its equivalent).

*Note:* The CANCEL key on the 3215 cannot cancel lines of input until you finish defining the VM/SP system during system generation. Also, the PA2 key or the CANCEL key on the 3270 and 3066 cannot cancel input lines.

For details on supported VM/SP typewriter-like terminal consoles, display terminal consoles and the associated keys that manage the display screen, signal attention, and process line records, consult the *VM/SP Terminal Reference*.

## Privileged Operations

*Labeling Disks:* CP and CMS, with the exception of the special CP service programs and certain frequently used CP functions, get all of their system functions from disk. Each of the disks may or may not be labeled. If the disks are for CMS file residence, or CP paging and spooling (temporary use), you must label each pack (count-key-data pack) with a six-character label in real cylinder 0 track 0 record 3 by using the CP Format/Allocate program. For FB-512 devices, this label is placed in block 1.

The VM/SP system is device-independent; each of the volumes that have CP labels can reside on any available and defined 2314, 2319, 3330, 3333, 3340, 3375, 3380, 3344, 3350, 2305 or FB-512 direct access storage device. This definition occurs at system generation time. The CP system residence (SYSRES) volume must be mounted on an available IPL device; then use the normal IPL procedure for your processor. If you are using CP-owned volumes, they should be mounted and ready at this time. All other resident volumes should be mounted and ready when the system is started, although they can be added later (via the CP ATTACH command) to the system, while it is in operation.

*Assignment of Special Performance Options to Logged-On Users:* FAVORED, AFFINITY, SASSIST, CPASSIST, RESERVE, PRIORITY, LOCK, and UNLOCK commands can be assigned only by an operator with privilege class A.

*Handling of Spooled Input and Output:* Card decks for users must be fed into the real card reader, printed and punched output properly distributed, and the unit record equipment and spool data files controlled. The control functions for the system's unit record equipment and spool data files can be performed only by a class D operator. For 3800 virtual printers, the operator must mount the designated paper stock if directed to do so.

*Attaching and Detaching of User and System Volumes:* Devices used by virtual machines in dedicated mode must be attached and detached as appropriate. Control over the real System/370 computing system's I/O can be performed by an operator with privilege class B.

Operators with these privilege classes must be logged on to perform these functions. An example of a directory entry that allows an operator to perform all of these functions is:

```
USER OPERATOR OPASS 512 1M ABDG
```

The system and spooling operators do not require virtual devices or options in their VM/SP directory entries unless CMS is used. Multiple virtual machines for operators may be set up, each with all or some of the associated privilege classes. The primary system operator must have class A assigned in the directory to properly initiate VM/SP operation.

# Starting Operation

---

## Page Frame Availability

If you intend to define or attach more than 64 virtual devices for a single virtual machine, be aware that any single request for free storage in excess of 512 doublewords (a full page) may cause the VM/SP system to issue an appropriate error message if the extra storage is not available on a contiguous page. Therefore, two contiguous page frames of free storage must be available in order to log on to a virtual machine with more than 64 virtual devices (three contiguous page frames for a virtual machine with more than 128 virtual devices, etc.). Contiguous page frames of free storage are sure to be available only immediately after IPL, before other virtual machines have logged on. Therefore, as a system operator you can inhibit the logon of many virtual machines until the virtual machine or machines with many I/O devices have accomplished logon and are operating.

## Initializing the System

Before you invoke any type of start:

- The following devices must be powered up and ready:
  - The processor
  - Processor storage
  - All necessary devices (and disk volumes) for a minimum VM/SP system with system residence, paging, and spooling requirements.
- The system cannot encounter any unrecoverable hardware errors in the initialization and startup phase of bringing the VM/SP system online.
- The generated VM/SP SCP and the System/370 hardware and its attached features must have matching compatibility. If they are not compatible you will get an error message in addition to VM/SP performance degradation.

To simplify system initialization, be sure that:

1. All VM/SP resident volumes (specified in the SYSOWN list for paging and spooling) are mounted and ready at IPL time.

If the volumes specified in SYSOWN are not mounted when you IPL VM/SP, they are not available to you. If you need the volumes, use the VARY ONLINE command and the ATTACH command (described in the *VM/SP CP Command Reference*) to mount and attach them. The SYSOWN macro is described in the *VM/SP Planning Guide and Reference*.

2. Volumes that have user minidisks (such as the CMS system residence volume) are mounted and ready at IPL time. You can, however, vary online and attach volumes not required for startup after the VM/SP program is up and running.

The steps involved with system initialization follow.

## Step 1 - Begin Initialization

To start the operation of the VM/SP system, load the CP system residence volume.

*Note:* When you turn system power on, you may need to run a CS (control storage) patch routine. This is a System/370 operating procedure and is not discussed further in this book.

CP calculates the real machine's storage size. If a real machine has more storage than what you specified on SYSCOR, the system does not use the extra storage. For example, if a real machine's storage size is 1 megabyte and you set SYSCOR to 768K, the system uses 768K of real storage. If less storage is available in the real machine than what you specified on SYSCOR, the system uses the lesser figure. The SYSCOR macro is described in the *VM/SP Planning Guide and Reference*.

The system checks for a valid microcode level. If the microcode level is invalid, the system disables the microcode assists and stores an error message for display later. Also, CP searches for the devices defined during system generation and checks to make sure the volume labels on each DASD are correct. CP varies the devices online.

*Note:* If the configuration differs from that specified during system generation (SYSOWN volumes not mounted or storage size not equal to SYSCOR), the system stores the message for display later and continues to operate. Label errors also cause the system to store an error message for later display, and the system startup may abnormally end.

CP starts the segment, page, core, and swap tables. It also checks to see if VM assist and the 370E facility are available.

## Step 2 - Locate the Operator's Console

CP locates the operator's console. During VM/SP system generation, your installation will assign a console or terminal as the primary operator's system console. Your installation can specify more than one alternate console in the RIOGEN macro instruction during system generation. (The RIOGEN macro is described in the *VM/SP Planning Guide and Reference*.) If the specified primary system console is not operational, CP will use the first designated alternate console. If the first alternate console is not operational and your installation specified more than one alternate console, CP will use the next alternate console.

The primary and alternate consoles must be one of the following devices:

- A real primary or alternate system console.
- A locally attached 3270.
- In addition, the alternate console can be any VM/SP supported remote terminal on a leased line connected to a 270x transmission control unit.

# Starting Operation

---

The system does not support, as primary or alternate VM/SP consoles, terminals on switched lines or leased line terminals connected to 3704/3705/3725s.

Next, the following message tells you what release and service level of VM/SP you are using, and when it was created:

```
VM/SP Release x, Service Level xxxx; created on mm/dd/yy at hh:mm:ss
```

## Step 3 - Check the Time-of-Day Clock

CP then checks the status of the time of day (TOD) clock. If the clock is not set, CP requests that you set it. Refer to “Using the Time-of-Day Clock” on page 16 and “Setting the Clock (Uniprocessor Application)” on page 17. If the clock is set, CP lets you change the clock. The following is an example of the message you would get:

```
It is now 08:28:00 EST Thursday 01/26/86
Change TOD clock (YES|NO):
```

If you enter “YES”, CP responds with prompts like those explained in “Setting the Clock (Uniprocessor Application)” on page 17. If you press the ENTER key, CP assumes the response is “NO”.

For AP/MP, if the other processor is available, CP begins prefixing and synchronizes the TOD clocks.

*Note:* If the SYSCOR macro had specified AP= YES or MP= YES and the second processor is unavailable for startup, the system operates in uniprocessor mode instead of attached processor or multiprocessor mode.

CP initializes the user directory and verifies that the interval timer is running. If the interval timer is not running, CP requests that you start it.

At this point, the system displays any delayed messages. Also, if any CP owned volumes are malfunctioning or not mounted, the system displays one or more messages. This lets you select a shutdown start in the next step of the IPL process if you need to.

## Step 4 - Select the Type of Start

The system then prompts you for the type of system start you want:

```
Start ((WARM|CKPT|FORCE|COLD) (DRAIN))|(SHUTDOWN) :
```

You can respond in the following ways:

COLD or COLD DRAIN (described in “Specifying a Cold Start” on page 20)

WARM or WARM DRAIN (described in “Specifying a Warm Start” on page 18)

CKPT or CKPT DRAIN (described in “Specifying a Checkpoint Start” on page 19)

FORCE or FORCE DRAIN (described in “Specifying a Force Start” on page 19)

DRAIN (described in the *VM/SP CP Command Reference*)

SHUTDOWN (described in “Specifying a Shutdown Start” on page 20)

WARM is the default. Specify DRAIN if you do not want the system to automatically start the real unit record devices during initialization.

CP then allocates DASD dump space. If CP cannot allocate the dump space, it issues the following message:

```
DMKIDU953I Unable to allocate system auto dump
```

## Step 5 - Log on the System Operator

Next, the system automatically logs on the system operator.

The system operator’s userid, password, and command privilege class or classes are usually stored on the CP system residence volume during system installation. The primary system operator must have class A command privileges. CP compares the userid supplied by the SYSOPR macro (used in system generation) with the user directory. If the userids do not match, CP stops the automatic operator logon process and gives system operational control to the first privilege class A user who logs onto the system.

If the primary or alternate devices do not exist or are not ready, automatic logon stops, and the VM/SP system enters the disabled wait state. If the primary or alternate consoles are operational, but some processing error occurs, you must intervene to bring up the VM/SP system. CP considers the first user to log on VM/SP with privilege class A as the primary system operator. For more information see “Manually Logging on the System Operator” on page 21. The system does not accept any users until the primary system operator logs on.

The following message is then displayed:

```
DMKCPJ957I STORAGE SIZE = xxxxx K,      NUCLEUS SIZE = xxx K,  
DYNAMIC PAGING SIZE = xxxxx K, TRACE TABLE SIZE = xxx K,  
FREE STORAGE SIZE = xxxx K,    VIRTUAL=REAL SIZE = xxxxx K
```

If MONITOR is enabled, the system starts MONITOR. Also, the system logs on the AUTOLOG1 virtual machine.

Finally, CP displays the following message:

```
DMKCPI966I Initialization complete
```

# Starting Operation

---

At this point, the system is ready for normal use. You can now:

- Write a message of the day for the system to issue when users log on.
- Enable communications lines so users can log on.

## Using the Time-of-Day Clock

The Time-of-Day (TOD) clock provides an accurate measure of time, independent of system events or activities. It makes accurate measurements available for programming applications. When system power is turned off, the clock value is lost on some System/370 models. Once CP uses the set clock instructions and you use the TOD ENABLE SET switch to make the time-of-day (TOD) clock operational, the system increments the clock at a constant rate. The following do not affect the timing operation:

- Any normal activity or event in the system
- Wait state
- Stopped state
- Instruction-step mode
- Single-cycle mode
- Test mode<sup>2</sup>
- System reset
- Initial program load procedure.

If TOD clock hardware errors occur, the System/370 hardware posts a machine check and CP enters a disabled WAIT state.

Virtual machines may use the System/370 STORE CLOCK instruction to find the current clock value. This instruction causes VM/SP to store the current clock value in the storage location specified in the instruction. Thus, virtual machine users can use the value of the TOD clock for any purpose. However, virtual machine users cannot set or change the TOD clock.

VM/SP uses the TOD clock to establish:

- Certain accounting records for the virtual machines.
- Queueing and prioritizing tasks for CP and virtual machine operations.

The privileged System/370 instruction, SET CLOCK, sets the clock to a specific value. If certain operating or program conditions exist, CP executes SET CLOCK when the system is initialized. SET CLOCK replaces the current clock value with the value you specified. The SET CLOCK instruction changes the clock value only when the TOD ENABLE SET switch is enabled.

If your installation has a second processor, you may need to synchronize the TOD clocks in the initialization procedure. The system may request

---

<sup>2</sup> The current clock value is lost when the time-of-day microdiagnostic tests are being run, or when system power is turned off.



that you ready the TOD ENABLE SET key twice: once to set the clock on the main processor and once to SET and SYNC the clock on the second processor. If the clock value has previously been established for the main processor, the system will only issue one prompt message.

Note that the TOD ENABLE SET key is ORed to the other processors' TOD ENABLE SET key. This lets you set the clock from either processor. If the low-order 32 bits of the TOD clock are not synchronized, a TOD Sync check will be received. Again, the system will request that you synchronize the TOD clocks by pressing the TOD ENABLE SET key.

4361 processors are offered with an Auto Start feature. Using a battery operated clock, this feature maintains the time while the power is off. For these processors, if you shut down the system using the SHUTDOWN command with the POWEROFF parameter, during the next IPL, you will not be prompted to set the time-of-day clock.

Details on the parts of VM/SP initialization that are unique to the attached processor or multiprocessor applications are explained later in this chapter.

## Setting the Clock (Uniprocessor Application)

If the clock is not set, CP issues the following message to prompt you to enter the date:

```
Set date (MM/DD/YY) :
```

Enter the date.

*Note:* If the two digit number for the year is less than 50, the system assumes the century is 2000. If the number is equal to or greater than 50, the system assumes the century is 1900. Do not use the numbers 41 through 49, because they do not represent anything.

CP then requests the time:

```
Set time (HH:MM:SS OR HH.MM.SS) :
```

Enter the time. Note that this is a 24 hour clock.

### Notes:

1. Enter data immediately following the colon (:). If you are using a 3270 or a VM/SP supported processor display console, enter the data in the user input area. The data then appears in the output display area on the line following the SET TIME request.
2. Because CP requests that you press the TOD ENABLE SET key to set the clock, enter a time value that is 30 to 60 seconds ahead of the current time.

# Starting Operation

---

For example, if the date is 10/24/86, and the time will soon be 08:28 (EST), the exchange on a printing terminal looks like this:

```
VM/SP Release 5,Service Level 0000; created on 10/01/86 at 11:15:00
Set date (MM/DD/YY) :10/24/86
Set time (HH:MM:SS OR HH.MM.SS) :08.28.00
Press 'TOD ENABLE SET' key at designated instant
```

When you press the TOD ENABLE SET key, CP responds with:

```
It is now 08:28:00 EST Friday 10/24/86
Change TOD clock (YES|NO):
```

*Note:* The previous example run on a display terminal would show your responses on separate lines.

You can now change the clock's value. If you enter "yes," another series of prompting messages let you enter a new date and time. If you enter "no," or press the END function key on the console, clock initialization ends.

*Programming Note:* To VM/SP users, the epoch clock value of all zeros is the beginning of the day January 1, 1900. To OS and MVS users, the epoch clock value of all zeros is the beginning of the day January 1, 1980. Thus, OS virtual machine users will find that stored clock values differ by 80 years. You can, however, use 1900 in OS as the base epoch clock value.

## Specifying a Warm Start

Warm start means that the previous VM/SP session ended with an orderly shutdown procedure. Use a warm start procedure to recover accounting data and access previously closed spooled output files. CP tells you when a warm start cannot be done and requests an alternate recovery method.

Begin a warm start for the following situations:

1. If you are not alerted by console messages or visual signs that a checkpoint or cold start is required.
2. After VM/SP has abnormally stopped and a system dump operation has completed.
3. After an orderly shutdown has been performed.

Warm start restores previous spool controls and files. Accounting records remain valid and are to be kept as a base for continuing operations. Spool files being processed by logical printers at SHUTDOWN will be recovered at warm start.

Key in WARM or simply press the END, ENTER, or RETURN key (depending on the console device) when the following message appears at the console:

```
Start ((WARM|CKPT|FORCE|COLD)(DRAIN))|(SHUTDOWN) :
```

(You can also specify `WARM DRAIN` to warm start the system and drain all unit record devices.)

If you try a warm start, but the system has not saved any warm start data, the system will enter a wait state PSW (code 009). In this case, try a checkpoint start.

In many cases, VM/SP recovers from system failures and restarts itself. When this occurs, you will see the following message at the console:

```
VM/SP system restart due to system failure
```

When you enter the `SHUTDOWN REIPL` command, you will see the following message at the console:

```
VM/SP system restart due to shutdown REIPL
```

## Specifying a Checkpoint Start

If the system could not do a warm start because of I/O errors or invalid data in the warm start area, you can request a checkpoint start.

This option tries to start the system using the information that has been dynamically checkpointed during system operation and stored in the checkpoint area. Checkpoint start reconstructs the spool file chains, but the original order of the files is lost. Spool files being processed by logical printers will be recovered at checkpoint start. Accounting and system message data, recovered under a warm start, is lost under a checkpoint start. Also, because the system must read each spool buffer to reconstruct the record allocation blocks, a checkpoint start takes longer than a warm start.

To begin a checkpoint start, respond with `CKPT` to the following message:

```
Start ((WARM|CKPT|FORCE|COLD)(DRAIN))|(SHUTDOWN) :
```

## Specifying a Force Start

If the system cannot do a checkpoint start because of I/O errors or invalid data in the checkpoint area, you can request a force start. This option operates like the checkpoint start, except that any spool file that has unreadable or invalid data is dropped from the system.

To begin a force start, respond with `FORCE` to the following message:

```
Start ((WARM|CKPT|FORCE|COLD)(DRAIN))|(SHUTDOWN) :
```

# Starting Operation

---

## Specifying a Cold Start

You may want to use cold start procedures if you have tried a warm start, a checkpoint start, and a force start, and all have failed. This may happen when:

- You migrate to a new release of VM/SP.
- All closed spool files and accounting records are lost or unreadable because of a hardware error that prevented valid system recovery and continuation.

VM/SP issues a message telling you to do cold start procedures when it recognizes that unrecoverable errors have occurred. You may have failures in system component power, building power, hardware logic, or the CP program. Also, some (rare) kinds of user programs can be classified as system operating procedure errors. All these types of failures can require that you start the system with a cold start.

VM/SP cold start procedures start after the condition, which caused the System/370 or the operator to abnormally stop VM/SP, has been corrected.

To start a cold start, respond with `COLD` to the following message:

```
Start ((WARM|CKPT|FORCE|COLD)(DRAIN))|(SHUTDOWN) :
```

After the cold start procedure is complete, enter into the LOGMSG the time of the unplanned shutdown and that a cold start was done. This tells the user that his spooled files were lost, and that he may need to reconstruct some of his other files.

## Specifying a Shutdown Start

A shutdown start stops the initialization process. You may want to do a shutdown start if you receive a message that one or more vital CP owned volumes are not mounted or malfunctioning. For a shutdown start, the system does not process warm start or checkpoint data. Following a shutdown start, previously saved warm start and checkpoint data is still valid.

To begin a shutdown start, respond with `SHUTDOWN` to the following message:

```
Start ((WARM|CKPT|FORCE|COLD)(DRAIN))|(SHUTDOWN) :
```

If you cannot key in the SHUTDOWN command, press the LOAD button on the System/370 console without clearing storage. After you see the shutdown message, press the LOAD button a second time to reload the system with VM/SP.

## Automatically IPLing the System

This feature is supported for 4361 processors only. 4361 processors are available with an Auto Start feature. Using a battery operated clock, this feature maintains the time while the processor is powered off and sets the system time-of-day clock after power on.

The 4361 processor with the Auto Start feature can be set to automatically power on at a specified time, or it can be powered on by telephone from a remote location.

Once the processor has been powered on, if you previously shut down the system using the SHUTDOWN command with the POWEROFF parameter, you will not be prompted to set the time-of-day clock. In fact, you do not need to be present for the IPL to occur.

## Automatically Logging On the System Operator

Automatic logon is normally part of an IPL. When the system operator is logged on, the following message shows the date and the time of the last LOGMSG setting:

```
hh:mm:ss LOGMSG- hh:mm:ss EST FRIDAY mm/dd/yy
```

The following message is displayed next only if queued, closed spool files exist:

```
hh:mm:ss FILES: xxx RDR xxx PRT xxx PUN
```

### Notes:

1. A MESSAGE or WARNING on the screen during system IPL puts the screen in MORE status. Normally, this would put the screen in HOLDING status. If the screen is in MORE status during system IPL operations, you may press ENTER to put the screen in HOLDING status.
2. If the automatic logon fails, the user (privilege class A) will have to explicitly log onto the system. If the system console is either a 3210 or 3215 (or a 3138, 3148, or 3158 console in printer keyboard mode), the user must protect the security of his password because there are no print-masking or print-inhibiting features on these devices.

## Manually Logging on the System Operator

If the automatic logon of the primary system operator fails because the VM/SP directory defines no system operator, the following message occurs:

```
DMKOPE950A Operator not logged on; explicit LOGON required
```

# Starting Operation

---

Check your directory entry to confirm your userid and password. A logon prompt will not be displayed. Log on with your userid:

```
LOGON userid
```

In the above response, you enter the CP LOGON command, followed by a blank and your identifier name (userid), followed by pressing the end function key. CP checks this entry with the values in the VM/SP directory. If the userid is valid and you have class A command privileges, the following message on the console prompts you for the next response:

```
hh:mm:ss Enter password
```

You then key in your password, which is checked against the password stored in your VM/SP directory entry. The system is not accessible to other users until you log on and enable the necessary teleprocessing lines. Maintaining password security on real printer-keyboard system consoles is your responsibility because password inhibiting or masking is not possible on these devices.

If the password is valid, the VM/SP system can be started.

If you enter an invalid password more than 'n' times (n is specified by your installation in the LOGLOC operand of the SYSJRL in DMKSYS), you will get this message:

```
DMKLOG780E Maximum password attempts exceeded, try again later
```

You must then wait 'm' minutes (m is also specified in the LOGLOC operand of SYSJRL in DMKSYS) before you logon again. If you try to logon before 'm' minutes have passed, DMKLOG780E will be re-issued. Both the userid and terminal will be locked out, until the time (m minutes) has expired. After that, the userid and terminal will be unlocked. The default for the LOGLOC operand is 10 LOGON attempts. If the user exceeds this limit, the user and the terminal are locked out for 60 minutes.

*Note:* If the system operator as defined in SYSOP in DMKSYS logs off, the next class A user who logs on will become the system operator. That is, the system will send operator messages to this class A user, even if the userid originally specified in SYSOP logs back on. The class A user will continue to receive any operator messages that the system sends until he logs off.

When this class A user logs off, then there is no operator. A user sending a message to the operator will get the message, DMKMSG045E 'OPERATOR NOT LOGGED ON'. The next class A user to log on will become the system operator.

## Starting the Unit Record Devices

After starting the VM/SP system, the system responds with the status of the system spool files:

```
hh:mm:ss FILES: 031 RDR, 039 PRT, 001 PUN
```

The response indicates that a total of 31 spooled reader files, 39 spooled print files (which also includes closed spooled console files), and 1 spooled punch file were saved at the last system shutdown.

If the unit record devices are drained as a result of the DRAIN option during IPL, then you should start the unit record devices at this time. For example, the CP command

```
START ALL
```

starts all real unit record equipment. The system then responds with the status of each unit record device.

## Enabling 37xx Resources

At this point, if the following conditions are met:

- 3705 control units are part of the VM/SP system support of remote terminals
- The automatic load function for the 3705 was not generated into the VM/SP system
- The 370x control program was generated under VM/SP

invoke the NETWORK LOAD command as follows:

```
NETWORK LOAD raddr ncpname
```

Raddr is the base address of the 3705 and ncpname is the desired copy of the 3705 Emulator Program. For a description of the NETWORK command, see the *VM/SP CP Command Reference*. If you are using 3725 communication control units, use the ACF/NCP-SSP loader.

You can then enable any or all of the EP teleprocessing lines and 3705/3725 resources for VM/SP users by issuing the CP ENABLE command and NETWORK ENABLE command, respectively. For example, pressing the REQUEST function key and entering:

```
hh:mm:ss ENABLE 50
```

enables only line 50, while:

```
hh:mm:ss EN ALL
```

enables all 3270 and 270x lines. CP responds with:

```
hh:mm:ss COMMAND COMPLETE
```

# Starting Operation

---

when the requested command has been serviced.

*Note:* The same message occurs even if no lines connect to the machine. If a patch panel is in use, make sure that all desired lines connect to the system.

The VM/SP system is now operational and waits for users to log on. Similarly, if:

NETWORK ENABLE ALL

is invoked, the total resources of all VM/SP controlled 3705 control units are enabled if the system is equipped with the devices.

For more information on 37xx control units refer to “Controlling the 3704/3705/3725 Communications Controller” on page 33.

## Messages On Startup and Initialization

In the course of VM/SP initialization or startup, in addition to the normal expected messages that are a part of loading the system, you may see other messages to which you must respond. These messages relate to functions of initialization, checkpoint, warm start, and automatic checkpoint requirements. These messages and the recommended course of action are described in the *VM/SP System Messages and Codes*.

*Note:* Some of the messages that you receive are always in English, even if your virtual machine is set to another language. Refer to the *VM/SP System Messages and Codes* for more information.

## Initializing a Mass Storage System

If an MSS port is attached to a virtual machine running MVS with MSS support and the MSS communicator program is running in the virtual machine, the control program can cause automatic 3330V volume mount and demount in response to any of the following:

- A virtual machine logs on with a minidisk defined on a system disk that is not mounted. The control program attempts to mount an MSS volume with the correct volume label.
- A virtual machine logs on having a dedicate directory statement specifying a volid for a volume that is not mounted. The control program again attempts to mount an MSS volume with the specified volume label.
- An operator ATTACH command is issued specifying a device address that is an MSS 3330V address and volid. The control program attempts to mount the volid on the device address as part of the ATTACH processing.



- The operator DEFINE command is used to change the feature (SYSVIRT or VIRTUAL) of a 3330V containing a mounted volume. The control program demounts the volume before completing the DEFINE process.
- A virtual machine issues a LINK command to link to a virtual device that is all or part of a 3330V volume. The control program attempts to mount the volume as part of the LINK process.

The VM/SP control program does not issue orders directly to the mass storage control (MSC). Rather, it passes requests to an MVS system with MSS support that is operating in a virtual machine with an MSC port dedicated to it. The MVS system then issues orders to the MSC and passes response information back to the control program.

In order for the installation to run with full MSS support, an MVS system must be IPLed in a virtual machine. An MSC port must be dedicated to this virtual machine. There are no special requirements for this IPL. The standard installation procedures for IPLing MVS in a virtual machine should be followed. After the system is IPLed, the VM/SP communicator program must be started. If the standard MSS installation procedures as documented in the *VM/SP Planning Guide and Reference* have been followed, the communicator program is started in the virtual machine through the MVS operator command:

```
START DMKMSS [.pn]
```

The [.pn] operand is used only in OS/VS1 systems to specify the partition in which the program is to be started.

The absence of error messages received from DMKMSS indicates that MSS support is initialized. The communicator virtual machine may now be disconnected if the installation desires.

There are two error messages that the DMKMSS program can produce. If either of these messages is received, then the VM/SP control program will not be able to communicate with the MSS. The first possible message is:

```
DMKMSS ENDING ERROR - MSS NOT INITIALIZED
```

*Explanation:* The MSS did not get initialized as it should during the MVS IPL process. Either the virtual machine does not have access to the MSC, or there was an MSS error.

*Operator response:* Correct the problem, use the MVS VARY command to initialize the MSS, then reissue the START DMKMSS command.

The second possible error message is:

```
DMKMSS ENDING ERROR - DCB FOR COMM. DEVICE NOT OPENED
```

# Starting Operation

---

*Explanation:* The DMKMSS program was not able to establish communication with the VM/SP control program because the MVS DCB control block could not be opened. The probable cause is the definition of the communicator device for the virtual machine.

*Operator response:* Contact the system programmer. After the problem has been corrected, reissue the START DMKMSS command.

## Initializing a Multiprocessor

In order for the installation to run with a multiprocessor, it must do the following:

- Specify MP = YES in the SYSCOR macro during VM/SP system generation (The SYSCOR macro is described in the *VM/SP Planning Guide and Reference*.)
- Have the second processor online during system IPL.

If the second processor was generated as part of the system but was not online, and the multiprocessing feature is installed, the following message is issued:

```
DMKCPI963W  Second processor not online
```

If the second processor is not required, processing can continue. However, if the second processor is required, the operator should ready the unit and reload the system.

Assuming MP = YES and the second processor was online the following message is issued:

```
DMKCPI964I  Processor xx IPLed; processor yy initialized
```

No operator action is required; the system will now utilize the second processor.

If the installation is running with a second or an attached processor, the system operator will receive the following message if the clocks are to be synchronized:

```
CLOCK SYNCHRONIZATION-PRESS 'TOD ENABLE SET'
```

From this message on, see “Initializing an Attached Processor” on page 27 because the procedure is the same.

## Initializing an Attached Processor

In order for the installation to run with an attached processor, it must do the following:

- Specify AP = YES in the SYSCOR macro during VM/SP system generation (The SYSCOR macro is described in the *VM/SP Planning Guide and Reference*.)
- Have the attached processor online during system IPL.

If the attached processor was generated as part of the system but was not online, the following message is issued if the multiprocessing feature is installed:

```
DMKCPI959W Attached processor not online
```

If the attached processor is not required, processing can continue. However, if the attached processor is required, the operator should ready the unit and reload the system.

The operator will then press the TOD ENABLE SET key on either processor to synchronize the TOD clocks. Note that once the clocks are synchronized, it will not be necessary to resynchronize the clocks on subsequent IPL operations unless:

- FE diagnostics are run.
- Power is turned off on either processor.
- The clocks are running but not synchronized.
- A clock's error is encountered during initialization.

If the clocks should run out of low-order synchronization, after the clocks are synchronized (during or after system initialization), you will receive the following message:

```
DMKCLK970W TOD CLOCK SYNC CHECK RECEIVED  
CLOCK SYNCHRONIZATION-PRESS 'TOD ENABLE SET'
```

As before, press the TOD Enable SET Key to synchronize the clocks.

## Interval Timer

VM/SP uses the interval timer to support time slicing; therefore, during initialization, the system verifies that the interval timer is running before virtual machine logon operations are performed. The system initialization routine will loop issuing the following message if the interval timer is found not running when tested:

```
Turn on the interval timer  
Turn on the interval timer  
.  
.  
.  
.
```

# Starting Operation

---

The messages cease when the operator complies by enabling the interval timer and the system initialization process continues.

In attached processor application the text of the message indicates the processor owning the disabled interval timer. This message reads as follows:

```
Turn on the {  main  } processor's interval timer
            {attached}
```

To continue, the interval timer must be enabled on the requested processor. Refer to the *VM/SP CP for System Programming* for more information on interval timers.

## Console Definition

The terms “system console,” “primary system console,” and “alternate system console” apply to those console devices that exercise primary control of the processor.

The VM/SP primary system console can be a real system console, a real alternate system console, or a local 3270.

The VM/SP alternate system console can be a real system console, a real alternate system console, a local 3270, or any VM/SP supported remote terminal on a leased line connected to a 270x transmission control unit (TCU). The VM/SP alternate system console cannot be a remote terminal connected to a 37xx TCU.

*Note:* If the 37xx is loaded with the 270x Emulation Program (EP) prior to initializing VM/SP, any line defined by EP will appear to VM/SP as 270x TCU.

The following examples show the various configurations that can control VM/SP operations:

- First Configuration:

```
Real system console = VM/SP system console
Real alternate system console = VM/SP alternate system console
```

- Second Configuration:

```
Real system console = Batch virtual machine
Real alternate system console = VM/SP system console
Remote terminal = VM/SP alternate system console
```

- Third Configuration:

```
Real system console = VM/SP system console
```

Remote terminal = VM/SP alternate system console

- Fourth Configuration:

Real system console = Batch virtual machine

Two locally attached 3277 Display Stations = VM/SP system console and alternate system console

- Fifth Configuration:

Enabled remote terminal (not 3270) = VM/SP alternate system console (No valid VM/SP primary system console is designated in SYSGEN)

*Note:* The real system consoles must be turned off to prevent VM/SP from using them.

- Sixth Configuration:

System console = VM/SP system console (No VM/SP alternate console designated in SYSGEN)

The first four configurations allow disabling of the VM/SP primary console and selection of an alternate VM/SP console; or, conversely, reselection of the VM/SP primary console and disabling of the alternate console.

Configurations five and six indicate that VM/SP system generation specified no console substitution. Therefore, if the designated VM/SP system console is inoperative at VM/SP startup, the system enters the wait state and cannot continue. After the console becomes operative again, VM/SP must be reloaded into the real system.

## Disabling the VM/SP Primary Console

If the VM/SP primary system console is inoperative, VM/SP automatically selects the first alternate console (specified in the RIOGEN macro instruction) as the console for primary system operation. If the first alternate console specified is not operational, an attempt will be made to start the next alternate console. If an operational console is found, it will be used as the VM/SP system operator's console.

*Note:* The RIOGEN macro is described in the *VM/SP Planning Guide and Reference*.

If intermittent errors occur at the VM/SP console, and all alternate consoles are unavailable (or not specified in the RIOGEN macro instruction), issue the DISCONN command and log on again at some other terminal.

If the VM/SP system console becomes inoperative to the point where you cannot log off, press the System/370 external INTERRUPT button to

## Starting Operation

---

disconnect you from the failing system console (or alternate console if that console is currently controlling the system.) This allows you to log on and reconnect to a terminal with a communications line that has already been enabled. This terminal can be another system console (VM/SP supported device) or a remote terminal attached to a 270x TCU. When the primary console is again operative, control can be regained from the alternate console by pressing the INTERRUPT button and reconnecting using the primary console.

When the device specified as the alternate console is a communication line VM/SP enables the line. You can then establish a link with the processor through a terminal connected to the line. Once the line is established, VM/SP proceeds with the normal system initiation. The alternate console must not be a telecommunications line on a real IBM 37xx Communications Controller. If the alternate console is an IBM 2741 Communication Terminal, it must use the EBCDIC transmission code.

*Note:* VM/SP 37xx supports multiple alternate console selection only in 270x emulator mode.

## Selecting a VM/SP Alternate Console during VM/SP Initialization

If the VM/SP system console is inoperative, a VM/SP alternate system console can start VM/SP. To do this, place the primary VM/SP system console in a not-ready status.

Load VM/SP in the normal way (i.e., the appropriate way for your processor). When the primary system console (assuming it was generated as the VM/SP system console) indicates “not ready”, VM/SP rings the console alarm bell and enables the alternate system console (such as a 3210 Model 2, 1052 Model 7, or local 3270 if one is specified) or one 2701, 2702, or 2703 transmission control unit (TCU) line that has a leased line terminal attached, to allow the system operator to log on. The TCU line address must be defined in the DMKRIO module (Real I/O Configuration file) during VM/SP system generation. See the *VM/SP Planning Guide and Reference* for more details on DMKRIO. If the real system consoles are dedicated to virtual machine use only, the system can be generated with a fictitious VM/SP primary system console address and the same results occur as the load operation with the not ready console described above.

You can now establish a link with VM/SP by using the designated device. Once CP identifies the terminal in the normal procedure, the operator presses the BREAK, ATTN, RESET, or ENTER key, depending on the terminal type. The VM/SP system then performs automatic or manual logon procedures, as previously discussed.

## Control Messages after Startup

System console messages are in three categories:

- System operation status messages
- Virtual machine user messages
- Hardware and program status messages.

The operator action required depends on the type and content of the message.

## System Operation Status Messages

These messages inform the system operator of the logging on and logging off of users, number of spooled files, output printer or punch accounting data, device attention conditions, and command completion indications. Some of these messages require operator action, while others do not.

## Messages from Virtual Machine Users

These messages include requests and inquiries from virtual machine users on the system; a sampling of these user messages follows:

```
MSG FROM JONES: CAN YOU GIVE ME A TAPE
MSG FROM SMITH: CAN YOU PUT UP A SCRATCH 181
MSG FROM SMITH: PLEASE TAKE RING OUT OF 181 NOW
MSG FROM BROWN: PLS ATTACH 382
```

## Hardware and Program Status Messages

These messages include VM/SP error recording messages, VM/SP system error information, and I/O error messages related to users of virtual machines who have invoked SVC 76. SVC 76 causes VM/SP to send a message to the system operator (for I/O error records only) and to record the error data in VM/SP's error recording area. The *VM/SP System Messages and Codes* manual describes these messages.

For more information about error detection and the recording and editing of errors, refer to the *EREP User's Guide and Reference*.

The following summarizes the action that the operator must take in response to an error message:

1. Determine the severity of the error.
2. Take a storage dump if the automatic dump routine failed.
3. Try to preserve spooling and accounting data by issuing the SHUTDOWN command if it has not been done automatically.
4. Try to force error recording if it did not occur.

## Starting Operation

---

5. Attempt to analyze the problem by whatever means at his disposal and if necessary, reallocate resources and priorities.
6. Call for technical assistance if necessary.

Whenever there are indications that I/O errors require further analysis or that basic integrity of a device needs to be determined, other service programs may be invoked to help make such an assessment. For example, to test the operational 3344 or 3350 DASD devices, the operator may invoke the OS/VS and DOS/VS Analysis Program-1 (AP-1). This utility program, if resident in the OS/VS or DOS/VS library of a virtual machine, can be used to check the proper operation of the device. The use of this program along with error messages and user action is detailed in the *OS/VS and DOS/VSE Analysis Program-1 (AP-1) User's Guide*, GC26-3855.

In the event that technical assistance is required, it can be obtained from the following sources:

- The customer's own system programmer(s)
- The service representative, who has special test equipment for hardware problem isolation
- The IBM Program Support Representative, who can also assist with VM/SP system problem diagnosis.

You can assist with problem diagnosis by being alert for the following error recording messages:

```
DMKIOF550E  Error recording area 90 percent full; run CPEREP
DMKIOF551E  Error recording area full; run CPEREP
```

You should then dump the error recording data to some other device (usually a tape drive) and clear the error recording area to insure enough space to record additional error records. Additional information on EREP, the program to which CPEREP passes control, is detailed in *EREP User's Guide and Reference*.

Other errors may not be severe enough to cause VM/SP system failure, but might cause a specific virtual machine to abnormally terminate. In most cases, the user can IPL the virtual machine again.

Should the VM/SP machine enter an unexpected WAIT state or loop, see the *VM Diagnosis Guide* for information about debugging.



## Important Hardware Considerations

### Controlling the 3704/3705/3725 Communications Controller

This section only applies to EP gens as defined, created and loaded with VM/SP. VM/SP does not provide loading or dumping facilities for the 3725. If you have a 3725 communication controller or a 3705 that has been loaded by ACF/NCP-SSP, refer to the manuals listed in the Bibliography for control information.

The *EP/3725 Installation and Resource Definition Guide and Reference*, SC30-3172, provides the information necessary to:

- Define and generate an Emulator Program for the IBM 3725.
- Load the control program into the controller.
- Dump the contents of the controller storage.

You can control the 3704/3705 communication controller (hereinafter referred to as 3705) with the CP NETWORK command. How the 3705 device operates depends on the communications control program that loaded it. The communication control programs are created, assembled, or modified by the following CMS commands specifically designed for this purpose:

- ASM3705 (described in the *VM/SP Installation Guide*)
- GEN3705 (described in the *VM/SP Installation Guide*)
- LKED (described in the *VM/SP Installation Guide*)
- SAVENCP (described in the *VM/SP Installation Guide*)
- ZAP (described in the *VM Diagnosis Guide*).

Your system programmer is responsible for using these commands. However, the 3705 NETWORK command is your responsibility.

The 3704/3705 Dynamic Trace Facility is supported for virtual machine operation. However, if the 3704/3705 in emulator mode is not dedicated to the user invoking the trace, the user is required to have in his directory a privilege class other than, or in addition to, G.

### Loading the 3704 and 3705 Communications Controllers

The 3704 and 3705 Communications Controllers are programmable devices; to be controlled by VM/SP, they must be loaded with an appropriate control program before VM/SP uses them for system telecommunications. An automatic function of VM/SP system initialization usually loads the devices, but you can load them manually.

To load a 370x program into the 370x (either manually or automatically), you must have previously saved the 370x program on one of the VM/SP

# Starting Operation

---

system volumes. Specifications in the VM/SP configuration module, DMKRIO, describe whether the load process is automatic or manual. For more information on saving or loading a 370x control program, see the *VM/SP Planning Guide and Reference* and the *VM/SP Installation Guide*.

If you want to manually load a 370x control program, use the NETWORK LOAD command as follows:

```
NETWORK LOAD raddr ncpname
```

where raddr specifies the physical device address of the 370x, and ncpname is the name of a 370x control program image.

When you use the NETWORK LOAD command to load EP for the 370x, the system does the following:

- Disconnects active users
- Resets active I/O operations
- Detaches and releases dedicated devices
- Releases dialed lines
- Resets devices that are enabled but not dedicated
- Resets Binary Synchronous Communication (BSC).

On the other hand, if the specified 370x Communications Controller does not require loading (that is, it already has an active control program loaded), you will get this message on your console:

```
DMKNLD461R  CTLR rdev IPL NOT REQUIRED;  
            ENTER YES TO CONTINUE
```

Verify that you specified the correct 370x, and reply "YES" only if the load is to be attempted. (Note that execution of the NETWORK LOAD command causes the 370x to be reset, thus discontinuing any current teleprocessing activity.)

Other messages relating to the operation of the 370x can appear on your console. These messages are described in the *VM/SP System Messages and Codes*. For more information about the facilities of the NETWORK command, refer to the *VM/SP CP Command Reference*. For more information about NCPDUMP, refer to the *VM Diagnosis Guide*.

## Special Considerations for Loading the EP 370x Control Program

If the system automatically reloads a 370x Emulation Program (EP) after a 370x failure, the system may loop after the restart. The message

```
DMKRNH463I  CTLR rdev unit check; restart in progress
```

and two responses

```
CTLR xxx DUMP COMPLETE
```

```
CTLR xxx ncpname LOAD COMPLETE
```

indicate that the 370x has been reloaded. If the system loops after the second response, you must reset all emulator lines from the 370x control panel.

If the automatic dump feature is not enabled, one of the messages

```
DMKRNH462I  CTLR rdev unit check; IPL required
```

```
DMKRNH464I  CTLR rdev CC=3; press 3705 'LOAD' button
```

indicates a 370x abnormal termination. You must reload the 370x Emulation Program with the NETWORK LOAD command. If the system loops when an attempt is made to enable the lines, you must reset all emulator lines from the 370x control panel.

The *Guide to Using the IBM 3704 Communications Controller Control Panel* and the *Guide to Using the 3705 Control Panel* describe the procedure for resetting emulator lines from the 370x control panel in their “Generating Channel End/Device End with Emulator Program” section.

## 3480 Magnetic Tape Subsystem Support

VM/SP supports the 3480 magnetic tape subsystem with the following restrictions:

- If you IPL a standalone program from a 3480, the 3480 is not assigned to the processor that IPLed the 3480. Because of this, do not IPL any other processor that has a path to the 3480, since the other processor might steal the 3480 by assigning it to itself.
- When a 3480 is assigned to one processor, another processor’s attempt to perform I/O to the device (for example, write, read, forward space file) will receive an assigned Elsewhere Unit Check. The processor that owns the device assignment will not be able to perform I/O to the device until the other processor clears the contingent connection that the Unit Check established (for example, issuing a SENSE command or Signal System Reset). This problem can occur if a processor tries to IPL a 3480 device that is assigned to another system, but fails to clear the resulting unit check.
- When running Single Processor Mode, the MVS MP system can perform its I/O to a 3480 device from only one of its processors, either the V=R processor or the MVS native processor. Before the MVS native processor can use a 3480 device, VARY OFF the device from the CP system if the device is not already offline.

# Starting Operation

---

## 3800 Printing Subsystem Support

The 3800 models 1 and 3 are supported as dedicated, spooled, and virtual devices. The 3800 model 8 is supported in CP as a dedicated device or as a system printer. In dedicated support, the real printer is owned by CP but acts like one virtual machine owns it. While the printer is dedicated to a virtual machine, only that machine may issue commands to the printer. CP handles the passing of information between the device and the virtual machine.

System printer support includes handling the writing of the spool output. The 3800-8 is supported as a system printer by specifying the device type and model on the RDEVICE macro. RDEVICE is described in the *VM/SP Planning Guide and Reference*. The virtual output provided by the 3800-3 virtual device is compatible to the 3800-8. The 3800 models 3 and 8 are supported in 3800 model 1 compatibility mode and provide the following:

- An improved pel density of 240 x 240 pels
- A 10 line per inch vertical spacing.

Following is a list of features for the 3800 printers:

- FORMS CONTROL lets the user select the amount of vertical space between printed lines. Lines can be vertically spaced at 6, 8, or 12 lines per inch. Users of the 3800 Model 3 printer have an additional option of 10 lines per inch. You can also mix different spacings on the same page.
- FORMS OVERLAY permits photographing of predefined data (forms) on one or more pages. The 3800 printer supports the creation of a form on a page and the immediate printing of data on that form.
- PREDEFINED CHARACTER SETS lets the user select previously designated character sets that have up to 64 characters each. Different character sets provide varied character types, sizes, and horizontal spacings between the characters. The 3800 supports the simultaneous use of two character sets and optionally supports the use of two additional character sets. The user can mix characters from the different character sets on a single page. Use the translate tables to reference the characters within the 3800. You can load up to four translate tables at any one time.
- CHARACTER SET MODIFICATION lets users modify and extend character sets.

*Note:* Due to the change in pel density, customized 3800 Model 1 character sets are not interchangeable with the 3800 Model 3 character sets. To convert 3800 Model 1 character sets, you can:

- Recode the customized character sets in the 3800 Model 3 pel resolution, and use the CMS GENIMAGE command to build new modules.

- Use the MVS Character Conversion Aid to convert customized character sets to the 3800 Model 3 pel density. Then use the CMS GENIMAGE command to build new modules.
- COPY MODIFICATION permits printing of predefined data (for example, printing the same header on each page) or the suppression of printing for selected data.
- MULTIPLE COPIES permits numerous copies of files and datasets to be printed without the use of multiple-ply paper. Numerous copies of a single 3800 buffer can also be printed.

The formatting of 3800 output is controlled by character arrangement tables, library character sets, graphic character modification modules, and forms control buffers. These are stored in an image library and are loaded into the 3800 before it prints a spool file. They may also be imbedded directly in the spool file. Use the START command to control information (including the default character set and FCB) for the 3800.

## Dedicated 3800 Printing Subsystem Support

VM/SP lets virtual machines, including virtual VM/SP, attach the 3800 printer as a dedicated I/O device. When attached, the full capability of the 3800 is available to the virtual machine. All of the functions previously described are available when the 3800 is used as a dedicated device, provided the device is specified in the RDEVICE macro instruction at system generation. See the *VM/SP Planning Guide and Reference*.

## Assigning Performance Options

VM/SP offers a number of performance options to enhance the operating efficiency of one or more virtual machines. This enhancement is normally at the expense of the performance of other virtual machines. In certain instances, enhancements to a specific virtual machine (or multiple virtual machines) are detrimental to the operating efficiency of other virtual machines. The performance options are:

- Reserved page frames
- Favored execution
- Virtual = real
- Locked pages
- Priority
- Virtual machine assist
- Extended Control-Program Support: VM/370
- Affinity in an attached processor environment
- Queue drop elimination.

You can dynamically assign or withdraw any of these options except for the virtual = real option (it can only be dynamically withdrawn) from virtual machine users during system operations. You can assign to one virtual machine a “mix” of performance options, or the options may be assigned to

# Starting Operation

---

separate virtual machines. Efficient use of these options depends upon the characteristics of the program applications; the number, size, and complexity of the virtual machines being run; and the size, I/O configuration, and processor model of the real computer being used.

In addition to using these performance options, you can also use the SET PRIORITY command to change a virtual machine's execution priority and, thereby, change its performance.

For example, you could assign the following mix of options.

- One virtual machine:

Reserved Pages = 10  
Favored Execution = 80%  
Virtual Machine Assist

- Another virtual machine:

Virtual = Real  
Priority = 1

- A third virtual machine:

Locked Pages = 2

The VIRT = REAL and reserved page options are unique in that both options cannot be applied to multiple virtual machines at the same time. However, no such restrictions apply to the locked pages, virtual machine assist, Extended Control-Program Support: VM/370, priority, or favored execution options; they can be applied to multiple virtual machines.

## Reserved Page Frames Option

The CP paging routine uses chained lists of available and pageable pages to control real storage use. CP assigns pages for users from the available list, which it replenishes from the pageable list.

Pages that are temporarily locked in real storage are not available or pageable. Paging proceeds using demand paging to select the best page for swapping. The reserved page option gives a particular virtual machine an essentially private set of pages. The pages are not locked; they can be swapped, but normally only for the virtual machine for which they are reserved. You specify the number of reserved pages for the virtual machine as a maximum. When the page selection routine selects an available page for a reserved user, it marks that page reserved if the maximum specified for the user has not previously been reached. If CP encounters an available (idle) reserved page for the reserved user during page selection, it is used whether or not the maximum has been reached.

Only an operator with privilege class A can specify the number of reserved pages. Issue the CP SET RESERVE command in the following format:

**SET RESERVE** *userid xx*

*userid*

is the name of the VM/SP user to whose virtual machine you are to assign the reserved page option.

*xx*

is the maximum number of pages you assign.

If the CP page selection routine cannot locate an available page for other users because they are all reserved, the routine uses one of the reserved pages as a last resort.

## Favored Execution Option

The favored execution option guarantees that the specified virtual machine gets up to a fixed percentage of processor time. Favored in this sense means that CP provides execution time up to the specified percentage to that virtual machine, provided that virtual machine can use that much processor time. At regular time intervals, the CP dispatcher checks the processor time used by the favored virtual machine. If the guaranteed percentage is exceeded, the machine gets its normal priority for the remainder of the time interval. If the percentage used is less than the guaranteed value, the favored virtual machine has the highest execution priority until it reaches that threshold. You, as the system operator with privilege class A, specify the percentage of processor time assured by the favored option in the CP SET command. The format of the command is:

```
SET FAVORED userid [ xxx ]  
                        [ OFF ]
```

*userid*

is the name of the VM/SP user whose virtual machine is to be assigned the favored option.

*xxx*

is any percentage value from 1 to 100.

**OFF**

operand stops favored operation.

You can assign multiple virtual machines the favored execution option with, and/or without a percentage value.

### Example:

```
set favored operatns 75  
set favored payroll 25  
set favored revenue  
set favored hotjobs  
set favored hotjobs 10
```

# Starting Operation

---

Although the SET FAVORED command will prevent the specifying of more than 100% for a particular virtual machine, nothing is done to prevent more than 100% being allocated to a number of virtual machines. In situations where more than 100% has been allocated, the individual favored virtual machines will compete for the available resources on a pro-rata basis: an individual virtual machine's allocation will be roughly proportional to the percentage allocated to it divided by the total percentage allocated to all virtual machines. The effect that allocating more than 100% of the system has on interactive (Q1) response is unpredictable.

## Virtual = Real Option

The virtual = real option permanently relocates the CP nucleus (except for real page 0) to provide space in real lower storage to contain the largest virtual = real machine. For the virtual machine, each page from page 1 to its last or *n*th page is in its true real storage location; only its page zero is relocated. The virtual machine still runs in relocate mode, but because each virtual page frame address is the same as the real page frame address, the virtual machine requires no CCW translation for the virtual machine. Because no CCW translation is performed, no check is made of the I/O data addresses. The virtual machine must ensure that no I/O data transfer occurs into real page zero or beyond the upper boundary of the virtual machine's storage. Failure to observe these limits can cause damage to the VM/SP system or to other virtual machines.

Initial program loading of a named or shared system is not allowed in the virtual = real machine; the hexadecimal device address must be used.

Several aspects of the operation of the virtual = real option can affect overall system operation:

1. The area of contiguous storage built for the virtual = real machine must be large enough to contain the entire addressing space of the largest virtual = real machine.
2. Only virtual machines with the virtual = real option can use the real storage reserved for virtual = real machines. Only one virtual = real virtual machine can run at a time. The storage is not available for other users, nor for VM/SP use, unless the virtual = real machine is not logged on and you issue an UNLOCK command with the VIRT = REAL option. When you issue this command, all page frames previously reserved for the virtual = real machine are permanently relinquished to the available-page pool. Once these virtual = real page frames are available to the page pool, no virtual = real machine can run until you load VM/SP again (via IPL). For this reason, it is suggested that the virtual = real machine should be a machine with high availability and heavy workload demands. It is not possible to relinquish only some of the virtual = real page frames (if, for example, a smaller virtual = real machine is to be run). All virtual = real page frames are locked until all are released to the pool.



3. The virtual=real machine operates in its allocated storage area with normal CCW translation in effect until the virtual machine operator issues the CP command:

```
SET NOTRANS ON
```

At this time, all subsequent I/O operations occur from the virtual CCWs in the virtual=real machine without translation. With NOTRANS on, the virtual machine must not perform I/O operations into page zero or beyond its addressable limit. As mentioned previously, violation of this requirement can cause damage to the VM/SP system or to other virtual machines.

4. If the virtual=real machine performs a reset or IPL, the normal CCW translation routine regains control until the virtual machine operator again issues the SET NOTRANS ON command. Only the virtual=real machine operator can use the command. An operator message occurs if the virtual machine enters normal translation mode.

The virtual=real option is used with programs or operating systems that dynamically modify channel programs, or that wish to avoid CP virtual channel program translation and paging degradation. If virtual=real operation is desired, it must be specified at VM/SP system generation time. Virtual=real assigns the same real storage locations to the virtual machine that exist on the real machine (except for page zero, which is relocated).

For example, in Figure 1 on page 42, if a DOS system needs 160K bytes to run virtual=real, CP puts all but the first 4096 bytes of the program at the real storage address locations. Page 0 of the DOS supervisor is the only part of the DOS virtual machine that can be relocated, and it follows the last real page frame of the DOS machine. Figure 1 on page 42 also shows that the major portion of the CP nucleus is permanently relocated into upper storage (except for page zero) whether the virtual=real system is operating or not. The real page frame zero remains under control of VM/SP. CP dedicates 160K nonpageable bytes to the DOS machine.

# Starting Operation

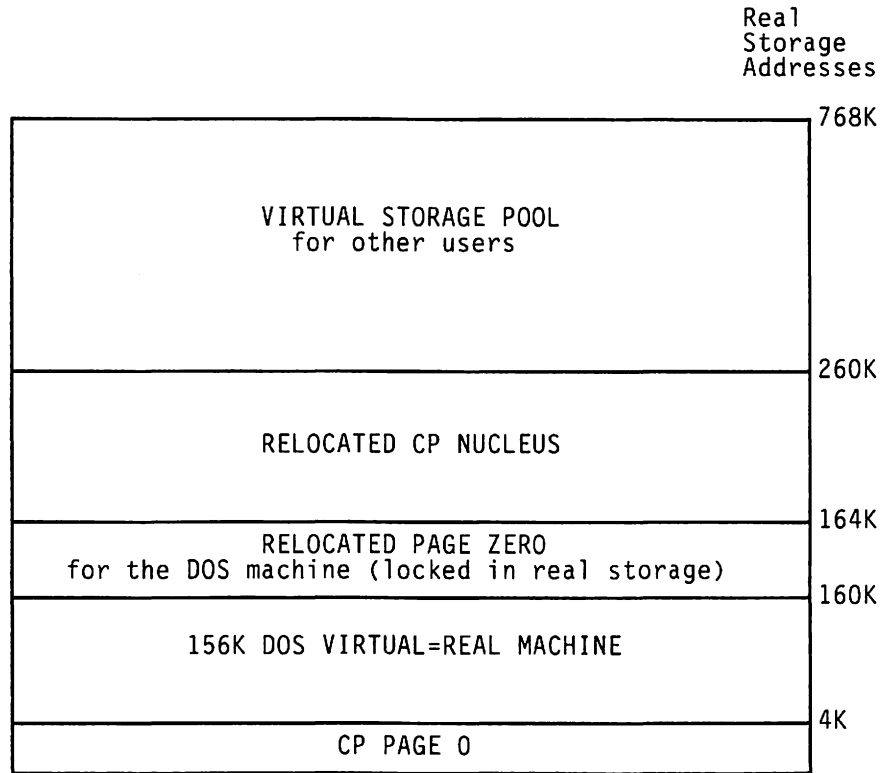

**Figure 1. DOS 160K Virtual=Real Storage Assignments**

However, when the user no longer needs the virtual=real machine performance option and he logs off, the assigned virtual=real storage can be reallocated as available pageable storage for use by other virtual machines (assuming that no other users with the VIRT=REAL directory have need of the area). The reallocation of virtual=real storage as usable and available storage for other virtual machines is controlled by the UNLOCK command and the VIRT=REAL operand. Once the pages are released, no virtual=real machine can be run unless VM/SP itself is reloaded. If more than one virtual machine needs the capabilities of running virtual=real (at different times), VM/SP system generation parameters must specify the largest virtual machine that is to run in the virtual=real environment. A more practical approach may be to generate a different version of VM/SP for each virtual=real machine, if the storage sizes are substantially different.

## Locked Pages Option

If sufficient page frames are available for other users, you can choose to lock (fix) one or more specific pages of a virtual machine or the pageable CP nucleus in real storage. This performance option differs from the other options in that the LOCK command can apply to several virtual machines. It is also possible to have the reserved page frames option apply to one user's virtual machine, and then have the lock option apply to another user's virtual machine. A locked page is effective from the time you invoke the lock option until the user logs off the system, or until you issue the

UNLOCK command. If the page or pages that are locked have a high frequency of reference or change activity, the lock option, like the reserved option, can cause an improvement in the user's virtual machine performance or overall system performance because of the reduction in paging activity.

## Notes:

1. If a named system currently has the locked pages option in effect, reloading of the same named system, loading of another named system, or a system reset does not affect the locked pages option of a virtual machine. The loading of named systems over other named systems without using the UNLOCK command beforehand results in pages being made unavailable for use if the first named system has locked pages in effect.
2. In systems generated for AP and MP operation, shared pages cannot be locked.
3. You should always prefer the reserved page frames option to the locked pages option, if it is not already in use. The LOCK command locks specific pages into real storage regardless of activity, while the reserved page frames option keeps all the currently most active pages in real storage.

## Priority Option

You can assign specific (dispatch) priority values to different virtual machines to override the assigned or default priority value for each user in the VM/SP directory. In doing so, the virtual machine with a lower *nn* value is considered for dispatching before a virtual machine with a higher *nn* value. You set user priorities by using the following class A console function:

**SET PRIORITY** *userid nn*

*userid*

is the user's identification.

*nn*

is an integer value from 0 to 99. The higher the *nn* value, the lower the dispatching priority. The default is 64.

## VM/370 Assistance - Hardware Assist

The overhead associated with CP's handling of virtual machines and their collective I/O resources is extensive and time consuming. To reduce this overhead, CP is assisted by System/370 processor hardware that duplicates some of the functions provided by CP routines. This hardware assistance to program function is called VM/370 hardware assist. Some form of VM/370 hardware assist is available on most, but not all VM/SP-supported

# Starting Operation

---

processors. VM/370 hardware assist on certain processors can consist of virtual machine assist; on other processors VM/370 hardware assistance is composed of virtual machine assist and VM/370 Extended Control Program Support (ECPS:VM/370).

VM/370 hardware assist is activated when VM/SP is loaded or by the use of CP commands, and it is deactivated by CP commands. For the command that activates/deactivates the VM/370 hardware assist process, refer to the SET command described in the *VM/SP CP Command Reference*. The status of VM/370 hardware assist may be determined by the use of the QUERY command also described in the *VM/SP CP Command Reference*.

## Virtual Machine Assist Option

The virtual machine assist facility can be ordered via feature number, it is available as an RPQ (Request for Price Quotation), and is standard on some processors. On attached processor or multiprocessor systems, virtual machine assist may be installed on one or both processors. Virtual machine assist relieves CP of some of the processing overhead caused by the simulated execution of certain instructions, privileged operation instructions, and interrupts of virtual machines. On/off system control of virtual machine assist is provided by the privilege class A command:

```
SET SASSIST { ON } [[PROC] nn]
             { OFF }
```

Users of virtual machines, in turn, have discrete control over the functions of virtual machine assist by means of directory entry options or by command. For control of this function on a virtual machine level, refer to the privilege class G command SET ASSIST, described in *VM/SP CP Command Reference*.

## Extended Control-Program Support:VM/370 Option

Extended Control-Program Support:VM/370 is an expansion of the function provided by virtual machine assist and consists of three major parts:

- Expanded virtual machine assist
- CP assist
- Virtual interval timer assist.

Expanded virtual machine assist is an expansion of function provided by virtual machine assist in that, via hardware, CP is relieved of processing some conditions of CP simulated instruction execution that were not covered by the virtual machine assist process. Expanded virtual machine assist also assists CP in the processing of other instructions and privileged operations not emulated by virtual machine assist.

Expanded virtual machine assist is activated for all virtual machines when VM/SP is loaded. It is also activated when both class A commands are invoked as shown:

**SET SASSIST ON**

**SET CPASSIST ON**

Expanded virtual machine assist is deactivated when either SET SASSIST OFF or SET CPASSIST OFF is invoked.

The CP assist portion of the Extended Control-Program:VM/370 Support duplicates via hardware the function provided by various high-usage significant overhead portions of CP routines. CP assist is activated upon system initialization or by invoking the privilege class A command:

**SET CPASSIST** { **ON** } [[ **PROC** ] *nn*]  
                  { **OFF** }

When the OFF operand of CPASSIST is invoked, CP assist is deactivated (as well as expanded virtual machine assist portion of ECPS, if previously active).

For attached processor applications, specify PROC *nn* to activate or deactivate CP assist on the desired main or attached processor. If you desire the same setting for both processors, omit the PROC *nn* option and use the ON or OFF options to activate or deactivate CP assist for both the main and attached processor at the same time.

The third function provided by ECPS:VM/370 is virtual interval timer assist. This hardware assist provides virtual machines with a more accurate method of updating the virtual machine's interval timer (location X'50'). Overall system control of this function is by the class A commands SET SASSIST ON and SET SASSIST OFF. Control of this facility on the individual virtual machine level is by the class G command SET ASSIST TMR and SET ASSIST NOTMR. For more details on this, refer to the *VM/SP CP Command Reference*.

The following figure summarizes the use of the SET CPASSIST and SET SASSIST in relationship to virtual machine assist and Extended Control-Program Support:VM/370. In this figure, X means that the function is activated.

# Starting Operation

VM/370: Hardware Assist	SET SASSIST ON SET CPASSIST OFF	SET SASSIST ON SET CPASSIST ON	SET SASSIST OFF SET CPASSIST ON	SET SASSIST OFF SET CPASSIST OFF
Virtual Machine Assist	X	X		
Virtual Interval Timer Assist	X	X		
Extended Virtual Machine Assist		X		
CP Assist		X	X	

**Figure 2. Command Control of VM/370 Hardware Assist**

*Note:* When you install the CPFRET Trap, CP disables CP Assists DSP1, DSP2, UNTFR, FREE, and FRET. This causes performance to lower for systems that use CP Assists. However, this lowering in performance is not expected to be a problem when CP traps suspected free storage problems. When the trap is not installed, system performance remains the same.

## VM/370 Hardware Assist Restrictions

A virtual machine running in certain virtual machine modes or running certain operations cannot use certain facilities provided by VM/370 hardware assist. When these modes or operations are encountered, the action taken is dependent upon the processor facilities of either virtual machine assist or Extended Control-Program Support:VM/370.

For all VM/SP supported processors that have VM/370 hardware assist active when the CP ADSTOP or certain CP TRACE command functions are encountered, the virtual machine assist is deactivated during the interval of their use.

For System/370 Models 135-3, 138, 145-3, and 148, the use of the DOS emulator or PER (Program Event Recording) curtails some of the function provided by Extended Control-Program Support:VM/370. For more details on VM/370 hardware assist, see the *VM/SP CP for System Programming*.

## Affinity Option

In attached processor or multiprocessor systems a virtual machine may be designated to execute only on one specified processor. This may be advantageous for performance or functional requirements. Performance gains might be realized with affinity because of the nature of the workload or the availability of performance assists on one processor. Functional requirements could be the existence of required operation codes on one processor. In either case, CP code executed on behalf of the virtual machine may execute on either processor.

## Queue Drop Elimination Option

VM/SP attempts to optimize system throughput by monitoring the execution status of virtual machines. When a virtual machine becomes idle, VM/SP drops it from the active queue. The virtual machine's page and segment tables are scanned, and resident pages are invalidated and put on the flush list.

In certain cases, where cycle of queue dropping and reactivation is repeatedly executed, there is a significant increase in the overhead involved in invalidating and revalidating pages. One example of this is the SNA service virtual machine processing IUCV messages.

The SET QDROP userid ON/OFF class A command allows an installation to control this situation. If SET QDROP OFF is in effect for a virtual machine, that virtual machine's pages are not scanned or flushed when the machine becomes idle. Specifying SET QDROP OFF for a service virtual machine can improve system performance and throughput when queue dropping would otherwise occur frequently. Specifying SET QDROP OFF USERS allows the QDROP OFF status to be extended to any virtual machine communicating via VMCF or IUCV to a (server) virtual machine for which SET QDROP OFF has been specified. Thus, performance gains can be realized in systems with heavy usage of products such as IFS or PVM (invoked via the CMS PASSTHRU command). Note, however, that indiscriminate use of the SET QDROP OFF command could degrade system throughput by forcing page stealing to take place.

## Terminating the System

The VM/SP system may be shut down in one of two ways:

1. By an operator initiated shutdown
2. By an abnormal termination of operation.

The normal shutdown is initiated by a class A operator entering the SHUTDOWN command from the operator's console. The format of the SHUTDOWN command is:

```
SHUTDOWN [ REIPL          ] [raddr]
          [ POWEROFF      ]
```

You can also use this command to IPL an alternate nucleus. If more than one version or copy of the nucleus is installed on your system, your operating procedures should describe the nucleus on each real device and have instructions for selecting the nucleus to IPL. Get this information from the person who installed your system. The format of the SHUTDOWN command is described in the *VM/SP CP Command Reference*.

If the SHUTDOWN command is ineffective, press the LOAD button on the system console once to shut down the system (a second pressing of the load button reloads VM/SP).

# Starting Operation

---

*Note:* When the LOAD button on the system console is used, spooling and accounting files can be lost because the files are not closed properly.

The POWEROFF option is valid only for 4361 processors. When you specify this option for a 4361 processor, the system shuts down normally, and the processor is powered off. If the 4361 processor has the Auto Start feature, you will not be prompted to set the time-of-day clock when the next IPL takes place.

The shutdown operation checkpoints spooling and accounting functions; in addition, user activity is terminated by automatically logging off all virtual machines and disabling communication lines. Open and active files on the spool unit record devices are purged and, if applicable the SUSPEND order is issued to all 3851 device addresses (suspends MSC interface activity to the host virtual machine). Note that the SUSPEND order issued to a Mass Storage Control interface may cause the SHUTDOWN command to run longer than usual.

*Note:* Before issuing the SHUTDOWN command, a message or warning should be sent to all logged-on users so that they can quickly bring their virtual machines to an orderly halt. Time should also be allotted to the class D (spooling) operator so that he too can terminate in an orderly manner the active files being processed on the unit record devices.

When you specify the REIPL option with the SHUTDOWN command, the system shuts down and does an automatic warm start. For this type of automatic restart, you do not need to set the time-of-day clock or choose the type of start you want the system to do. In fact, you do not need to be present for the automatic warm start to occur. You can also use the REIPL option on the SHUTDOWN command to IPL an alternate nucleus.

The raddr parameter lets you specify the real device address (rdev) of the CP-owned volume where an alternate nucleus has been installed. When you specify raddr, the nucleus installed on the device at the specified real address is IPLed. For example, SHUTDOWN REIPL 241 starts the IPL process for device 241. If you specify REIPL without 'raddr', the current nucleus is loaded and started again. The raddr parameter can be the address of any DASD available to the system that contains a CP nucleus.

The dump unit for VM/SP system failures is specified in the SYSDUMP operand of the SYSOPER macro during VM/SP system generation, but can be changed by a privilege class A or class B system operator.

If the dump unit is set to disk (by default or via the SET DUMP AUTO command) at the time of system failure, the system dumps all or parts of real storage to the specified disk and automatically restarts the VM/SP system.

When automatically restarted, the system preserves all accounting information and spool file data on disk, performs an automatic logon of the primary system operator, restores the system LOGMSG, and continues system operation. It is not necessary to re-enable the lines, since dump and



re-IPL automatically re-enable them. The VM/SP online message is sent to the terminal users, indicating that they must log on again.

When the system is automatically restarted after a system failure, the system operator is automatically logged on only if he was logged on the primary system console at system failure time. If logged off, disconnected or logged on elsewhere, the operator must explicitly log on.

If, at the time of the system failure, the dump unit is set to a printer or tape, the VM/SP system writes the dump on the specified unit, preserves the spooling and accounting data, and stops. The operator must then re-IPL the VM/SP system as for normal system start up, specifying a WARM START to preserve the accounting and spooling file data. The operator must re-enable the communication lines to permit users to log on again.

## System Abend Dumps

Conditions can occur within the CP program that may force an abnormal ending condition (ABEND) and cause the dumping of system registers and storage. The device that receives these records can be a tape, printer, or disk device.

Dumping operations are caused by any program interruptions or system restart condition. These interruptions cause routines to gather data from registers and storage and place this data on a previously defined device. The system CP command SET DUMP defines the quantity of data to be dumped. For example:

```
SET DUMP AUTO
SET DUMP raddr
SET DUMP raddr ALL
SET DUMP AUTO ALL
```

SET DUMP AUTO places the VM/SP system dump on a preselected file device. (The disk dump area is automatically selected at system initialization time if sufficient contiguous space is available.) You can verify the device type and address by entering the QUERY DUMP command.

Use SET DUMP raddr when the dump device is to be a high speed printer or tape device. Substitute the real hexadecimal address for raddr.

The ALL operand used with SET DUMP AUTO or SET DUMP raddr dumps all of storage onto to the DUMP device. If the ALL operand is not specified, the system defaults to dumping only those areas that pertain to CP, and not those areas that pertain to virtual machine operations.

If you dump to a disk file, an additional operation is necessary to transform these records into readable output for programmers or system analysts. You can do this with the CMS IPCSDUMP program.

## Starting Operation

---

Note that expanded function is available to the IPCSDUMP command as generated for the IPCS virtual machine.

If the records are dumped onto a tape drive, other CMS command options must be invoked for printout.

Only abend dumps that are a result of using the SET DUMP AUTO command are spooled as a special virtual card reader file. This card reader file is assigned during system generation to a specific virtual machine user via the SYSOPR macro. The CMS IPCSDUMP command formats and prints these CP abend dumps.

The IPCSDUMP command creates a CMS file from the CP disk dump data and prints the dump from the CMS file.

VM/SP Interactive Problem Control System (IPCS) provides installations with expanded facilities for reporting and diagnosing software failure. The VMDUMP command allows the user to dump a virtual machine's storage area. The VM/SP IPCS component or a user written program must process the file created by the VMDUMP command. For additional information, see the *VM Diagnosis Guide*.

## Chapter 3. Commands that You May Use

There are a number of CMS and CP commands available to you as the system operator. This chapter contains a brief introduction to these commands.

### Using CP and CMS

CP and CMS commands are eight characters or less, and you can truncate the commands to the minimum size indicated in the command format description. The operands, if any, follow the command on the same input data line. Most CP and CMS commands may not extend beyond one line except on the 3270. Generally, the operands are positional, but some commands have keywords to assist in the translation of the command line. One or more blanks must separate the command from any operands (except for some EDIT subcommands).

You will get the CMS READY message (Ready;) when CMS commands complete successfully. You will receive error messages for invalid commands and/or operands.

CP does not recognize CMS commands. On the other hand, a CMS user can issue CP commands without leaving the CMS environment. Although not required, you should prefix CP commands entered while in the CMS environment with "CP" or "#CP" to decrease VM/SP table and disk search time. CP then handles the command and passes control back to CMS. If you are in CMS and want to enter CP mode, you can do so by keying in "CP" or "#CP" with no operands (that is, no CP commands) or with an attention interruption. For details, refer to "Attention Handling" in the *VM/SP Terminal Reference*.

If you want to communicate with CP before responding to specific error messages issued by some virtual machine operating systems, enter CP mode by keying in "#CP" with one or more CP command lines separated by a logical line end character, or by signalling attention. Then perform the necessary console functions. When returning to the virtual machine environment, the virtual machine read will have been canceled by a unit exception, and the virtual operating system normally responds by reissuing the read. You can then enter the required virtual machine response.

# Commands that You May Use

---

## Using CMS To Alter VM/SP Files

You, as the VM/SP system operator, are usually assigned a virtual machine with a large DASD storage allotment. You can assign this DASD storage to other users as a temporary work area or for short-term DASD storage. In addition, your virtual machine can record system statistical data, or create and maintain directory files and other system files.

For whatever reason you use the system, you will probably need to modify some files at some time. One of the easiest ways to modify such system files is to use the VM/SP System Product Editor (XEDIT) facilities.

VM/SP XEDIT facilities provide ways to create and modify all types of CMS files. For a complete description of VM/SP XEDIT facilities and commands, see the *VM/SP System Product Editor User's Guide* and the *VM/SP System Product Editor Command and Macro Reference*.

## Other CMS Commands

You may need to invoke other CMS facilities to comply with user requests. For example, you may need to create punched output of a file for another system to use or create a history file. You may need to use any of the following CMS commands:

CMSBATCH	LISTFILE	STATE
COMPARE	MOVEFILE	TAPE
COPYFILE	PRINT	TAPEMAC
ERASE	PUNCH	TAPPDS
FORMAT	QUERY	TYPE
LABELDEF	READCARD	UPDATE
LISTDS	SET	

A complete description of these and other commands and their usage is contained in the *VM/SP CMS User's Guide* and the *VM/SP CMS Command Reference*.

## Using CP to Perform Operations

CP commands let you control your virtual machine. The commands that you may issue depend on your assigned privilege class(es).

Each CP command has one or more of the following function types:

- Operations
- Resource
- Programmer
- Spooling
- Analyst
- CE (Customer Engineer - Service)
- General.

## Privilege Classes for CP Commands

The IBM-defined class structure is based on the seven function types. A command keeps its function type even if your installation establishes its own class structure. The *VM/SP CP for System Programming* contains information on how to change the privilege classes associated with the various CP commands. In most cases, each command class (A-G) has a corresponding function type (O,R,P,S,A,C or G). Some commands fall into more than one class. “Summary of CP Commands” on page 55 has a list of each CP command, its IBM-defined privilege class, function type, and a description of what each command does.

Your installation will assign to you, as part of your entry in the directory, one or more privilege classes. If you try to issue a command that does not have your command class, CP does not execute the command and issues an error message. For descriptions of the CP commands refer to the *VM/SP CP Command Reference*.

*Note:* If your installation adds or removes any commands from the general user class (IBM-defined class G), your installation should update the HELP files to show these changes. See the *VM/SP CMS User's Guide* for more information.

Users with a password of NOLOG have no privilege class and can only:

- Send messages.
- Receive spooled output as punched cards or printed forms.

The NOLOG password identifies them to receive spooled output when a virtual machine user spools output for them.

This table shows the different privilege classes, the function codes, and the major tasks that can be performed for each privilege class.

## Commands that You May Use

IBM-Defined Class	Function Type	Function, Primary User, and Use
A	O	<p><b>Operations</b> - <i>Primary system operator</i>            The system assigns class A to the user at the VM/SP console during IPL. The class A user is responsible for VM/SP's availability and its communication lines and resources. These commands control system accounting, broadcast messages, run virtual machine performance options and affect VM/SP performance.</p> <p>Note: The Class A system operator who is automatically logged on during CP initialization is designated as the primary system operator.</p>
B	R	<p><b>Resource</b> - <i>System Resource Operator</i>            These commands control allocation and deallocation of real resources of the VM/SP system, except those that the primary system operator and the spooling operator control.</p>
C	P	<p><b>Programming</b> - <i>System programmer</i>            These commands update functions of the VM/SP system and change real storage in the real machine.</p>
D	S	<p><b>Spooling</b> - <i>Spooling operator</i>            These commands control spool data files and specific functions of the system's unit record equipment.</p>
E	A	<p><b>Analyzing</b> - <i>System analyst</i>            These commands examine and save certain data in the VM/SP storage area.</p>
F	C	<p><b>CE</b> - <i>Service Representative (Customer Engineer)</i>            These commands get and examine data about input and output devices connected to the VM/SP system.</p>
G	G	<p><b>General</b> - <i>General User</i>            These commands control functions to run users' virtual machines.</p>
Any	None	<p>These CP commands are available to any user. These are to gain and take away access to the VM/SP system.</p>

Figure 3. CP Privilege Classes

## Summary of CP Commands

The following table lists all the CP commands in VM/SP. You will use many of these commands in your system operations. The table includes:

- The CP commands in alphabetical order.
- The IBM-defined privilege classes that can execute the command.
- The corresponding function type.
- A blank column for you to record the user-defined classes (The *VM/SP CP for System Programming* contains information on how to change the privilege classes associated with the various CP commands.).
- A brief description of each command.

*Note:* Brackets indicate type is optional in the `OVERRIDE` statement. The `OVERRIDE` command lets you change the privilege classes associated with the commands, and is described in the *VM/SP CP for System Programming*.

COMMAND	FUNCTION TYPE*	IBM-DEFINED PRIVILEGE CLASS	USER-DEFINED CLASS	Usage
*	N/A	Any	None	Annotate the console sheet.
#CP	N/A	Any	None	Execute a CP command while remaining in the virtual machine environment.
ACNT	<O>	A		Create accounting records for logged on users, and reset accounting data. ACNT also closes the spool file that is accumulating accounting records.
ADSTOP	<G>	G		Halt execution at a specific virtual machine instruction address.
ATTACH	<R>	B		Logically connect a real device to a virtual machine for that machine's exclusive use or logically connect a DASD device for CP access and control. With CHANNEL operand, dedicate all devices on a particular channel to a specific user.
ATTN	<G>	G		Make an attention interruption pending for the virtual machine console.
AUTOLOG	<O>	A,B		Log on any virtual machine defined in the directory.
BACKSPAC	<S>	D		Restart or reposition the current output on a real punch or printer.

Figure 4 (Part 1 of 8). CP Commands

## Commands that You May Use

COMMAND	FUNCTION TYPE*	IBM-DEFINED PRIVILEGE CLASS	USER-DEFINED CLASS	Usage
BEGIN	< G >	G		Continue or resume execution of the virtual machine at either a specific storage location or at the address in the current PSW.
CHANGE	S	D		Alter one or more external attributes of a closed spool file or files.
	G	G		Alter one or more attributes of a closed spool file.
CLOSE	< G >	G		Terminate spooling operations on a virtual card reader, punch, printer, or console.
COMMANDS	N/A	Any	None	Display the commands and diagnose codes you are authorized to use.
COUPLE	< G >	G		Connect channel-to-channel devices.
CP	N/A	Any	None	Execute a CP command while remaining in the CMS virtual machine environment.
CPTRAP	< P >	C		Create a reader file of selected trace table, CP interface, and virtual machine interface entries for problem determination.
DCP	< P >	C,E		Display the contents of real storage locations at the terminal.
DEFINE	R	B		Redefine the status of a 3330V volume.
	G	G		Reconfigure your virtual machine.
DETACH	R	B		Remove a real device from the CP system. With the CHANNEL operand, remove a dedicated channel from a user.
	G	G		Detach a virtual device from a virtual machine. Detach a channel from your virtual machine.
DIAL	N/A	Any	None	Connect a terminal or display device to the virtual machine's virtual communication line.
DISABLE	< R >	A, B		Prevent low-speed communication lines from accessing the system.

Figure 4 (Part 2 of 8). CP Commands



## Commands that You May Use

COMMAND	FUNCTION TYPE*	IBM-DEFINED PRIVILEGE CLASS	USER-DEFINED CLASS	Usage
DISCONN	N/A	Any	None	Disconnect your terminal from your virtual machine.
DISPLAY	<G>	G		Display virtual storage on your terminal.
DMCP	<P>	C,E		Print the contents of real storage locations on a user's virtual spooled printer.
DRAIN	<S>	D		Stop spooling operations on a specified real unit record devices after the file currently being processed has been completed.
DUMP	<G>	G		Print the following on the virtual printer: Virtual PSW, general registers, floating-point registers, storage keys, and contents of specified virtual storage locations.
ECHO	<G>	G		Test terminal hardware by redisplaying data entered at the terminal.
ENABLE	<R>	A,B		Enable the previously disabled or nonenabled devices so users may access the system.
EXTERNAL	<G>	G		Simulate an external interruption for a virtual machine and return control to that machine.
FLUSH	<S>	D		Halt and immediately purge or hold the current output on a specified real unit record device.
FORCE	<O>	A		Force a logoff of any user on the system.
FREE	<S>	D		Remove a set of spool files belonging to a specified user from a system hold status.
HALT	<O>	A		Terminate any active channel program on a specified real device.
HOLD	<S>	D		Place user spool files in a system hold status.
INDICATE	O	A		Provides a list of statistics for all users who have the favored execution option.
	A	E		Display, at the console, the use of and contention for system processor and storage.

Figure 4 (Part 3 of 8). CP Commands

## Commands that You May Use

COMMAND	FUNCTION TYPE*	IBM-DEFINED PRIVILEGE CLASS	USER-DEFINED CLASS	Usage
	G	G		Indicate resource utilization and contention.
IPL	<G>	G		Simulate IPL for a virtual machine.
LINK	<G>	G		Provide access to a specific DASD by a virtual machine.
LOADBUF	<S>	D		On a 1403 printer load the Universal Character Set(UCS) with a specified print chain/train image. On 3203, 3211, 3262, 4245, or 4248 printers, load UCS or Forms Control Buffer(FCB) with a specified image. On 3289 Model 4 printer, load the Font Offset Buffer (FOB) with the image print belt and FCB.
LOADVFCB	<G>	G		Load virtual forms control buffer for a virtual 3203, 3262, 3289E, 3211, 4245, or 4248 printer.
LOCATE	<P>	C,E		Find the addresses of CP control blocks associated with a particular user, a user's virtual device, or a real system device.
LOCK	<O>	A		Permanently locks in selected pages of real storage.
LOGOFF	N/A	Any	None	Disable access to CP.
LOGON	N/A	Any	None	Provide access to CP.
MESSAGE	N/A	Any	None	Transmit messages to other users.
	<O>	A,B		Send message text to a specified user, to primary system operator, or to one or all logged-on users.
MIGRATE	<O>	A		Activate the normal page/swap table migration routines or force a particular user's pages to the secondary device even if that user is currently active.
MONITOR	<O>	A,E		Initiate or override the system-generated monitor function or terminate the recording of events occurring in the real machine.

Figure 4 (Part 4 of 8). CP Commands

## Commands that You May Use

COMMAND	FUNCTION TYPE*	IBM-DEFINED PRIVILEGE CLASS	USER-DEFINED CLASS	Usage
MSGNOH	< R >	B		Allow a service virtual machine to send messages to specified users without the standard header associated with the MESSAGE command.
NETWORK	O	A		Load, dump, and control operation of a 3704/3705 and control operation of a 3725 control program operating in 270x emulation mode (EP). Also control remote 3270 devices via binary synchronous lines.
	R	B		Load, dump, and control operation of a 3704/3705 and control operation of a 3725 control program operating in 270x emulation mode (EP).
NOTREADY	< G >	G		Simulate "not ready" for a device to a virtual machine.
ORDER	S	D		Place closed spool files (of a specified device type) in a different order.
	G	G		Rearrange closed spool files in a specific order.
PER	< G >	A, B, C, D, E, F, G		Monitors certain events in the user's virtual machine as they occur during program execution.
PURGE	S	D		Remove closed spool files from the system before they are printed or punched by the spooling devices or before they are read by a user.
	G	G		Remove closed spool file from the system.
QUERY	O	A		Provide status information on the real or virtual machine and miscellaneous CP functions. Also displays the status of MVS/System Extensions Support.
	R	B		Provide status information on the real or virtual machine and miscellaneous CP functions. Displays the status of the various devices.

Figure 4 (Part 5 of 8). CP Commands

## Commands that You May Use

COMMAND	FUNCTION TYPE*	IBM-DEFINED PRIVILEGE CLASS	USER-DEFINED CLASS	Usage
	P	C		Provide system log messages and information about system users and processors.
	S	D		Provide system spooling information.
	A	E		Provide status information on the real or virtual machine and miscellaneous CP functions.
	C	F		Provide system log messages and information about system users.
	G	G		Request information about machine configuration and system status.
QVM	<O>	A		Request the transition from VM/SP environment to native mode for a particular virtual machine.
READY	<G>	G		Simulate device end interruption for a virtual device.
REPEAT	<S>	D		Increase the number of copies of an output file or place the current output file in a HOLD status increasing or not increasing the number of copies to be created.
REQUEST	<G>	G		Make an attention interruption pending for the virtual machine console.
RESET	<G>	G		Clear and reset all pending interruptions for a specified virtual device and reset all error conditions.
REWIND	<G>	G		Rewind (to load point) a tape and ready a tape unit.
SAVESYS	<A>	E		Save a virtual machine storage space with registers and PSW as they currently exist. Used in the process of creating named systems.
SCREEN	<G>	G		Allows the user to change or alter the color and extended highlighting values for his virtual machine.

Figure 4 (Part 6 of 8). CP Commands

## Commands that You May Use

COMMAND	FUNCTION TYPE*	IBM-DEFINED PRIVILEGE CLASS	USER-DEFINED CLASS	Usage
SEND	< G >	G		Pass commands and message replies to disconnected virtual machine for processing.
SET	O	A		Establish system parameters and perform various functions to control the CP system and virtual machine options.
	R	B		Change log message, designate the unit to receive system abend dump, change time interval for a specific device class, set off monitoring for a specified class, or terminate all monitoring of missing interruptions.
	A	E		Sets paging and sets the system resource management function.
	C	F		Set the recording mode for a device and for soft errors.
	G	G		Control various functions within the virtual machine.
SHUTDOWN	< O >	A		Systematically end all virtual machine functions and checkpoint the system for an eventual warm start.
SLEEP	< G >	G		Place the virtual machine in a dormant state but allow messages to be displayed.
SMSG	< G >	G		Send special messages to specified virtual machine.
SPACE	< S >	D		Force the output on the specified printer to be single spaced for the current active spool file, regardless of the carriage control commands the actual file.
SPMODE	< O >	A		Establish or reset the single processor mode environment.
SPOOL	< G >	G		Alter spooling control options; direct a file to another virtual machine or to a remote location via the RSCS virtual machine.
SPTAPE	< S >	D		Dump spool files to tape or load spool files from tape.

Figure 4 (Part 7 of 8). CP Commands

## Commands that You May Use

COMMAND	FUNCTION TYPE*	IBM-DEFINED PRIVILEGE CLASS	USER-DEFINED CLASS	Usage
START	<S>	D		Restart a spooling device after it has been drained or to change the output class that it may service.
STCP	<P>	C		Alter the contents of real storage but not real PSW or real registers.
STORE	<G>	G		Alter specified virtual storage locations and registers.
SYSTEM	<G>	G		Simulate RESET, CLEAR STORAGE, and RESTART buttons on a real system console.
TAG	<G>	G		Specify variable information to be associated with a spool file or output unit record device. Interrogate the current TAG text setting of a given spool file or output unit record device.
TERMINAL	<G>	G		Define or redefine the input and attention handling characteristics of your virtual console.
TRACE	<G>	G		Trace specified virtual machine activity at your terminal, spooled printer, or both.
TRANSFER	S	D		Direct one or more spool files to a specified user or reclaim reader spool files previously sent to one or more users.
	G	G		Transfer input files or reclaim input files from a specified user's virtual card reader.
UNLOCK	<O>	A		Unlock page frames previously locked by a LOCK command.
VARY	<R>	B		Mark a device available or unavailable for use by a user or the control program.
VMDUMP	<G>	G		Dump virtual machine (use VM/SP IPCS to view dump.)
WARNING	<O>	A,B		Transmit high-priority messages to a specified user or to all users.

Figure 4 (Part 8 of 8). CP Commands

For the command formats and descriptions of these commands, refer to the *VM/SP CP Command Reference*.

## Chapter 4. The Programmable Operator Facility

The Programmable Operator Facility is designed to increase the efficiency of system operation and to allow remote operation of systems in a distributed data processing environment. It does this by intercepting messages and responses that are sent to the operator, converting the messages to uppercase (using English uppercasing tables), and comparing the text against a list of entries in a CMS file called a "routing table." If the message matches an entry in the routing table, the programmable operator performs the appropriate action.

The tasks that can be performed by the programmable operator facility include:

- Logging messages
- Suppressing message display and routing messages to a logical (real) operator
- Executing commands
- Responding with preprogrammed message responses.

Informational messages, such as those appearing on the CP system console as a result of the LOGON and LOGOFF commands, can be filtered out by the programmable operator facility and not clutter the real operator's display.

Messages with requests that cannot be handled by the programmable operator facility either because they require physical intervention, because the user is not authorized to issue the programmable operator facility command, or because the request does not match an entry in the routing table are routed to a real operator (the logical operator) at another virtual machine for consideration and/or appropriate action. These requests may include tasks such as mounting tapes and loading paper into the printer or may be messages to the operator from CMS users. Refer also to "Flow of Operation" under the description of the programmable operator facility in the *VM System Facilities for Programming*.

**Note:** Messages to the programmable operator should always be in English to ensure that the uppercasing and routing table comparisons are handled correctly. If you send a message to the programmable operator that is not in English the message is routed to the real operator for appropriate action.

The logical operator may or may not be located on the same physical system as the programmable operator facility. When the logical operator and the programmable operator facility are not on the same VM system, the communications are handled through RSCS networking. Several different physical systems may be connected by an RSCS network and controlled by

# Programmable Operator Facility

---

one logical operator from a single console. When the logical operator is an NCCF (Network Communication Control Facility) or NetView operator, the communications are handled primarily by the Programmable Operator/NCCF Message Exchange (PMX) portion of the programmable operator facility.

## Use in a Single System

When the programmable operator facility is operational in a single-system environment, it can:

- Ease message traffic to the system operator, by:
  - Filtering (logging) non-essential, information-only messages.
  - Routing messages (for example, I/O intervention requests) to someone else for specialized action.
- Increase productivity, by freeing the system operator from certain routine responses or tasks. Such responses (whether they consist of one or a series of commands, whether VM/SP or guest operating system) may be programmed to execute automatically upon receipt of a given message.

Thus, only essential, non-routine messages (that is, those requiring the skill and experience of a system operator to handle) are sent on to the operator for response or action.

## Use in a Distributed VM Environment

The capabilities of the programmable operator, outlined above, also allow for the remote operation of systems in a distributed environment. When the programmable operator facility is operational in a distributed system, it can:

- Issue responses and perform tasks that do not require an on-site operator.
- Filter (log) non-essential, information-only messages.
- Route messages requiring on-site (that is, manual) intervention to someone, not necessarily an operator, at the distributed site for action.
- Route messages that require the skill and experience of a system operator to handle to the operator at the host system. The operator at the host site also has the capability to send commands to the programmable operator facility to control its operation, as well as commands to execute on the distributed system to control the system itself.



# Programmable Operator Facility

By running the programmable operator facility on VM/SP systems distributed at several different locations (network nodes), one operator at a host site can control a network of systems.

Figure 5 shows a simplified configuration of the logical operator controlling a distributed system through RSCS networking. Communications between the programmable operator facility running in the system operator virtual machine (OPERATOR) at the remote site and the logical operator virtual machine (LGLOPR) at the host site are handled through the RSCS network that connects the two VM systems.

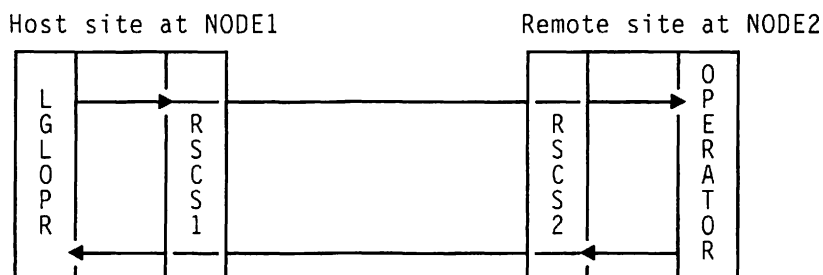

Figure 5. Example of a Programmable Operator Facility Configuration.

## Use in a Mixed Environment

The programmable operator facility also provides for distributed data processing in an SNA environment with mixed VM, OS/VS, and VSE distributed systems and host systems, called a "mixed environment". The Programmable Operator/NCCF Message Exchange (PMX) provides an interface with NCCF or NetView so that an operator on an OS/VS or VSE system can operate a VM distributed system from an NCCF or NetView operator station. This means that an NCCF or NetView operator can be the logical operator for a programmable operator facility. Also, an NCCF or NetView operator (not necessarily the logical operator) can issue programmable operator commands, including the ability to run any VM command that the programmable operator virtual machine is authorized to run.

### Notes:

1. The programmable operator facility does not let a user logged onto VM issue NCCF or NetView commands.
2. VM/SP Group Control System (GCS) is a requirement for this support. The Programmable Operator/NCCF Message Exchange (PMX) uses facilities unique to GCS, and cannot run on any other supervisor. For more information on GCS, see the *VM/SP Group Control System Command and Macro Reference*, SC24-5249.

# Programmable Operator Facility

When the logical operator is an NCCF or NetView operator, the programmable operator does not use RSCS to route messages to the logical operator; instead, the programmable operator passes the messages to NCCF or NetView through the NCCF Message Queueing Service, so NCCF or NetView displays the messages at the appropriate NCCF operator console.

Figure 6 shows a single system environment, VM-only, where NCCF or NetView has been added. In this configuration, if you log on to an NCCF or NetView operator station you can operate the VM system. You can extend this idea to multiple unconnected systems which can be controlled by different NCCF or NetView operator stations centralized at the same location. This, however, requires one operator station for each of the systems being controlled.

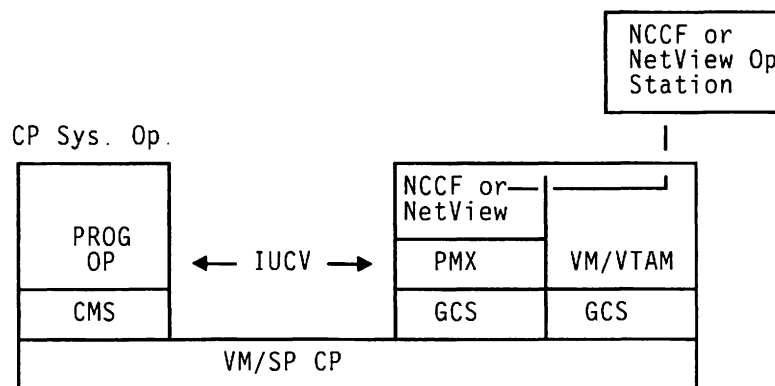

**Figure 6. A single system with NCCF or NetView**

The *VM System Facilities for Programming* contains more information on the programmable operator facility, such as:

- The logical operator
- The routing table
- Action routines
- The log file
- The feedback file
- Installing the programmable operator
- Invoking the programmable operator
- Invoking programmable operator commands
- Programmable operator commands
- Stopping the programmable operator
- Running the programmable operator from NCCF or NetView
- The Programmable Operator/NCCF Message Exchange (PMX).

## Chapter 5. Operator Spooling Functions

### Spooling

Input and output files for use and access by virtual machines through unit record devices are maintained by CP as disk data files using a mechanism called spooling. Individual files can be identified and manipulated using various console functions. The disk records are chained to form a logical file from dynamically assigned areas on specially formatted CP disk areas. Data records from disk are read into available page space obtained through the CP paging mechanism. The data records contain the actual data to be used and the CCWs to properly control the format. These CCWs are directly executed to perform the actual unit record operations on the real hardware. CP can support any number of virtual and real unit record devices given sufficient system resources.

The data is placed in the spool buffers through the virtual machine unit record simulation routines in CP. Certain spool files have a special data format (system dumps, for example) and are accessed using a special interface.

### Spooling Considerations

VM/SP spooling facilities allow several virtual machines to share one or more unit record devices. Since virtual machines controlled by CMS ordinarily have modest requirements for unit record I/O, such device sharing is quite advantageous, and it is the standard mode of system operation.

Each user has, as a general rule, a virtual reader, a virtual punch, and a virtual printer as his spooling devices. In addition, the virtual console can also be classified as a spool file generator as all input and output to the console can be logged on a spool file. This console log, and the files created by the user's virtual spooling devices, can be processed by the real unit record devices that attach to the system.

CP controls and schedules the operation of the real unit record devices via spooling techniques. Virtual machine SIO instructions directed to those unit record devices designated as spool devices in the user directory entry are intercepted and modified by CP. CP generates another I/O operation, transparent to the virtual machine, which replaces the one specified. The new operation is directed to a CP spooling disk area which acts as intermediate storage between the real unit record device and the virtual

# Spooling Functions

---

machine. The data transfer operation between a spooled unit record device and the virtual machine is, in reality, between a CP spool file and the virtual machine. Spool file records are page size (that is, 4096 byte blocks), and are transferred between storage media via the CP paging mechanism.

When the system informs you that the spooling space is full or nearly full of spool files, you can use the SPTAPE command to write those unit record files to tape to relieve the situation. Then, when spool space is more plentiful you can use the SPTAPE command to read the spool files back to the system for eventual spool file output. See the description of the SPTAPE command in the *VM/SP CP Command Reference*.

## Spooling Functions

CP spooling support performs the following five functions for virtual machines:

1. It simulates, with software routines, the operation of the virtual unit record devices that are attached to each user's virtual machine. The simulation makes it appear that the program in the virtual machine controls real unit record devices. Unit record device simulation involves the interception and interpretation of user Start I/O (SIO) instructions, the movement of data to and from the user's virtual storage space, and the reflection of interruption codes and ending conditions in the virtual machine.
2. It operates the real unit record equipment attached to the real machine. Spooling moves print-image and punch-card-image files to a real printer and card punch, and creates spool files from data read in from the real card reader.
3. It provides an easy-to-use interface between the virtual machine users, the system operator, and the spooling system to allow flexible and easy switching of system resources between many users. A set of general user and operator commands can request these functions.
4. It allows keyed-in CP commands and responses as well as virtual machine console input and output to be placed on disk instead of, or in addition to, being displayed at the terminal. You can initiate or terminate virtual console spooling at any time during a terminal session.
5. It provides the ability to spool files across the RSCS teleprocessing network.

Spooling commands can be separated by type into those that affect virtual devices, those that affect real devices, and those that affect queued spool files within the system. The commands that affect virtual devices are available to all general users; a user may affect the status of devices that attach to only his virtual machine. For a discussion of the Class G spooling commands, see the *VM/SP CP Command Reference*.

Only the spooling or resource operator can use commands that affect the status of the real spooling devices. Commands affecting the user's virtual machine closed spool files that are awaiting processing are available to all users, with some additional capabilities available to the spooling operator. For example, a user can alter characteristics of only those files that have the same userid as his, but the spooling operator can change the status of any spool file in the system. These commands are described in the *VM/SP CP Command Reference*.

You can create input spool files (that is, data available at a specific user's virtual card reader), when you place cards in the real card reader that are preceded by a special VM/SP card that identifies the virtual machine userid of the user requesting spool files.

When the virtual machine operating system writes to a virtual printer or card punch, it creates output spool files and stores them on direct access devices. Real output is scheduled for a real printer or card punch, or for remote output, whenever a user logs off the system or issues a CP spooling command to close the file.

You can transfer specific files from the spooled printer or card punch of a virtual machine to the card reader of the same or another virtual machine. (A virtual card reader is not limited to 80-character records.) Files are not physically printed or punched when transferred between virtual unit record devices by the spooling routines. With this method, you can make files available to multiple virtual machines, or to different operating systems executing at different times in the same virtual machine.

The Remote Spooling Communications Subsystem Networking, with the CP spooling system, provides support for spooling across a teleprocessing network. For detailed information about RSCS, see the *RSCS Networking Version 2 Operation and Use*.

VM/SP spooling includes many options for the virtual machine user and the real machine operator. These options include printing multiple copies of a single spool file and defining or reordering spooling classes and forms for real output scheduling.

Real printers with the Universal Character Set feature must have the block data check set when using VM/SP spooling. The `LOADBUF` command automatically sets the block data check. For more details on spooling, see "Spooling Considerations" on page 67.

## Virtual Console Spooling

The terminal user can spool virtual console output and virtual console input keyed in by him in addition to typing or displaying it at the terminal. Furthermore, if the virtual console is disconnected and the virtual machine is active, the console spool file acquires all console output that would normally print or display at the terminal. Virtual console I/O consists of all initiated CP commands and responses, as well as the communication to and from the operating system running in the virtual machine.

# Spooling Functions

---

You start virtual console spooling when you issue the command:

`SPOOL CONSOLE START`

You close the console spool file at logoff time or when you stop and close the file. When you close the console spool file, it goes on the printer spool file and then the operator can manipulate it in the same way as any other printer spool file.

The display output of local or remote 3270s in DISPLAY mode (every 16 lines) is written automatically on the spool file if the operator is the system operator and the device was specified as a graphic device supported as a virtual machine operator's console.

Console spooling for the system operator continues even if the operator disconnects from one terminal and logs onto another. To stop the automatic console spooling, the operator must issue the `SPOOL CONSOLE STOP` command. If the system fails, up to 16 lines of output may be lost from the system operator's spool file, but the system closes the console spool file when the failure occurs. However, virtual machine operators may lose up to one page of spooling data in a system failure because their spooling buffer is one page (4096 bytes) in size. In regard to DASD I/O, errors occurring on spool and paging devices produce error messages that appear on the system operator's terminal.

A user can start or stop virtual console spooling any time during a terminal session with the `SPOOL CONSOLE` command. For a description of the `CP SPOOL` and `CLOSE` commands, see the *VM/SP CP Command Reference*.

*Note:* The user cannot use console spooling to stack commands for subsequent execution. The console spool file is for historical purposes only. In addition, the following types of data will not be placed in the console spool file for the indicated conditions:

- CP command output - if this is being received in a buffer via `DIAGNOSE 8`
- Messages and Warnings - if they are being trapped via the IUCV and MSG System Service.

## I/O Error Handling

If a permanent I/O error occurs during a real I/O operation, you restart the spooled files as follows:

- Printer files - from the beginning of the current page (the last skip to channel 1).
- Punch files - from the beginning of the spool file.
- Reader files - from the beginning of the real deck (the operator must normally place the card deck back in the reader).

- Console files - do not restart. CP ends console spooling and purges the console file. The virtual machine continues without further console spooling.

*Note:* If an I/O error occurs while punching accounting cards, CP will repunch only the error card and not the whole file as in the case of normal punch spool files.

## Spool Buffers

The buffers used in virtual machines while collecting and writing spool data are each one page (4096 bytes) long, and contain both the data to be transcribed and all CCWs necessary for operating the unit record devices that perform the transcription. System failures that end system operation can cause virtual machine operators to lose up to one page of spooling data.

Buffers used for the temporary storage of spool data on its way between auxiliary storage and the user's virtual machine are allocated from a pool of virtual pages that belong to CP. Direct access devices provide the auxiliary storage necessary for CP spool buffering.

CP uses unit record devices to spool input and output operations. However, certain features or functions that pertain to this group of machines are not supported. Consult the VM/SP restrictions listed in the *VM/SP Planning Guide and Reference*.

## Spool Files

Each spool file in the system has a number of attributes that are assigned to it, either explicitly or by default, at the time that it is created. These attributes and their values are as follows:

*Filename and Filetype:* Each of these consist of alphameric fields of up to eight characters. The CHANGE or CLOSE command can change these fields.

*Spoolid:* This is a system-assigned number between 1 and 9,900. It is automatically assigned when the file is closed, and is unique to that spooled file. To identify a given file, it is necessary to specify the userid of the file's owner, the device type, and the spoolid number. In most instances, the userid defaults to the ID of the user issuing the given command. Since the ID number, rather than the filename and filetype, is used as an identifier, duplicate user-assigned names do not present an identification problem.

*Owner's User ID:* This is the ID of the current owner of the file.

*Originating User ID:* This is the ID of the file's creator. This is the same as the current owner, unless the originator has used the SPOOL or TRANSFER commands to send the file to another user.

# Spooling Functions

---

*Number of Copies:* This is the number requested for an output spool file; it is a number between 1 and 255. Unless specified by the user or operator, it defaults to 1.

*Date and Time:* This is the date and time that the file was created. Users create most files from virtual spool devices and the date and time indicate when the originator of the file closed the device.

*Number of Records:* This is an eight-digit number indicating the number of logical record (printer or card images) in the file and is an indication of the size of the file.

*Distribution Code:* This is an eight-character value that is normally assigned to each user by the system administrator, although users may alter their assigned value. It is printed in large block letters on the separator pages, and punched in the separator cards. It may assist you in distributing output to users.

*Hold Status:* A spool file may be in “user hold,” “system hold,” or both. User hold can be removed by the user, but only the operator can remove system hold. Either hold status prevents a spool file from being printed or punched.

*3800 Status:* There are several attributes that apply only to printer files on the 3800 Printing Subsystem. See the discussion of the SPOOL command and the START command in the *VM/SP CP Command Reference* for more information.

## Output Classes

In addition to the attributes described above, a file queued for output on a real unit record device always has an output class associated with it. A single alphanumeric character (A through Z, 0 through 9, and the special character \*) controls what real device the file is to be printed or punched on, and the relative priority and sequence of output on the device. Although each file is assigned a single class, you can designate each real spooling output device to handle from one to four classes. The device processes only files that have a class code that corresponds to one of its own, and processes these files in the order you specify. For example, if you assign a printer the classes A, D, and 2, it always processes any printer file with class A before it searches the printer output queue for a file with class D, and all class D files are printed before any file with class 2. You can assign a class of \* to a real output unit record device to allow that device to process any class spool file.

The output class for a file is assigned at the time of the file's creation and is the class that is associated with the virtual device that created it. When a user logs on to the system, the class associated with the device is the one defined in his user directory entry for that device; however, he may alter this class at any time with the SPOOL command. After files are closed and are awaiting output, their class can be altered with the CHANGE command either by the file's owner or by the spooling operator. The spooling



operator can alter the standard assignments of output classes of a real output device with the `START` command.

Output priorities can also be rearranged by altering the hold status of a file. The system operator can hold or release the files of specific users, all files of a given type, or all files in the system. The hold function can ensure the immediate processing of high priority output files, while allowing high volume or low priority jobs to be deferred for output until periods of low system usage.

## Output Forms

An output file has two form numbers associated with it - the user form and the operator form. Each form is one to eight characters long. Any combination of letters, numbers, or special characters may be used.

The user form is assigned by the user when he creates the spool file. He can later change it.

The operator form is assigned by the system when the spool file is created. The system looks in a table for the file's user form. The table provides the corresponding operator form. If the user form is not found in the table, the operator form is set equal to the user form. The table is created by your installation's system programmer using the `SYSFORM` macro. You can change the operator form of any spool file with the `CHANGE` command.

When you start a real spooling printer or punch, you can specify the form number that device is to process. Spool files with the specified operator form number will be processed if the class matches and they are not held. This is called `MANUAL` mode.

You can also specify `AUTO` move when you start the real spooling printer or punch. In this mode, the system will process files with any form number. The system will send you the following message and sound the audible alarm each time a new form is selected:

```
{ PRT } raddr MOUNT REQ CLASS A... FORM form AUTO { SEP }  
{ PUN }                               { NOSEP }
```

`RADDR`

is the real address of the printer or punch.

`A...`

are the classes that the device is processing.

`FORM`

is the form number for which a mount is requested.

The system then waits for you to make any necessary manual device adjustments (such as mounting new forms). You then press `START` on the device, or enter the command "`START raddr`" at the console. The printer or punch device will then print or punch the file.

# Spooling Functions

---

All other files with the same form number will be printed or punched without further intervention.

Some special printer forms require careful alignment on the printer (pre-printed forms, for example). SETUP mode is provided to assist you in performing this alignment. If you start the printer in SETUP mode, all of the steps described above for AUTO mode are followed. However, when you press START on the printer, only the first page of the file prints, with letters replaced by X's and numbers replaced by 9's. You can then manually adjust and align the printer. Each time you press the START button, another page of the file is printed, and you can further adjust the forms. When the forms are properly aligned, enter the command "START raddr" at the console. The file will then print in its entirety.

At any time during the SETUP process, you may use the FLUSH command to terminate the process, or you can use a BACKSPAC command to return to the previous page of output.

## Spooling Commands

The commands shown in the following figure control VM/SP spooling operations. This figure shows what commands have general user and/or spooling operator classes.

CP Command	General User Class	Spooling Operator Class
BACKSPAC		X
CHANGE	X	X
CLOSE	X	
DRAIN		X
FLUSH		X
FREE		X
HOLD		X
LOADBUF		X
ORDER	X	X
PURGE	X	X
REPEAT		X
SPACE		X
SPOOL	X	
SPTAPE		X
START		X
TAG	X	

Figure 7 (Part 1 of 2). CP Spooling Commands

CP Command	General User Class	Spooling Operator Class
TRANSFER	X	X

**Figure 7 (Part 2 of 2). CP Spooling Commands**

This list represents all the CP commands that pertain to spooling operations. Users having privilege classes D (the spooling operator) and G (the general user) can issue these commands. Users with only the G privilege class cannot invoke class D commands.

The spooling operator has responsibility for the following unit record spooling operations. He must:

1. Verify that the special VM/SP user identification (ID) card precedes a user's physical deck of cards to associate the cards with the correct user's virtual machine (See "Spooled Card Input.").
2. Make sure that sufficient blank cards are available for the punch unit, and that the paper in the printer is the proper size, width, and number of copies, and that the proper print train is mounted and the print buffer is properly loaded.
3. Separate punched and printed output by user identification (userid) code.
4. Start, stop, restart, or rearrange the sequence schedules of spool files to be printed or punched.

The spooling commands are discussed (along with other operator commands) in the *VM/SP CP Command Reference*.

## **NOLOG Password**

The NOLOG password is reserved for users who are not assigned any privilege class. These users cannot log on to a virtual machine. The user with the NOLOG password can submit jobs to the CMS Batch facility via the real card reader. The user with the NOLOG password can also be the recipient of spool files sent by any other logged-on user only if the other user issued a SPOOL FOR command to the userid having the NOLOG password.

## **Spooled Card Input**

Spooled input from a real card reader requires a CP ID (identification) card before the VM/SP system can accept it for processing.

*Note:* Load cards for only one user at a time. VM/SP does not look for ID cards in the middle of the card deck.

# Spooling Functions

---

The CP ID card must be inserted in front of the card deck. Then place the deck in the empty feed hopper. Then ready the reader device and push the EOF button. The reader immediately processes the cards (if no errors are encountered) and places the file on a direct access device. The file now resides in the virtual machine card reader that was identified by the CP ID card. Note that a file is transferred from the real reader to the virtual reader regardless of whether that user is logged on or off. The user may log on at any time to read the file.

## CP ID Card Format

ID USERID	userid [CLASS n] [NAME {filename filetype } dsname ]]
--------------	--

1. Begin punching in column 1.
2. The first field must be one of the following:  
  
ID  
USERID
3. Separate all fields by one or more blanks.
4. The second field must be the user's identification (userid), limited to eight characters.
5. The third field (optional) is CLASS n (if class is assigned); one or more spaces must separate the word CLASS and the class designation (n). (A through Z and 0 through 9 are valid class designations.) If the class option is not coded, the file defaults to class A. If the class option is coded, it must immediately follow userid.
6. The fourth field (optional) is the keyword NAME, followed by filename and filetype (or dsname alone). If only a dsname is specified, it can be 24 characters long. If both filename and filetype are coded, they are each restricted to a maximum of eight characters and must be separated by a blank.

An invalid or missing user CP ID card on the front of a card deck, when read, causes an error message on the system console.

## Spool Printer and Punch Output

Printed and punched output from virtual machine users is directed to the appropriate real unit record device. The operator (class D) can control this spooling output by combinations of output class, form number, hold status, and other spool command operands as discussed earlier.

# Spooling Functions

---

Unless you used the NOSEP option to “START” a device, VM/SP prints a two-page header and a one-page trailer between all output on printers and punches a four-card separator between all output on punch devices.

The printer header gives the pertinent spool file characteristics as well as real device data. The header prints the owner userid and distribution code in block letters on two pages. The header does not print between multiple copies of the file.

The card separator gives the owner’s userid and the distribution code. The distribution code is expanded to punch each character in four columns with two separating blanks so that visual interpretation of the punched data is easier.

The printer trailer prints the sequence number in large block letters. The sequence number is maintained for each printer in the system. It starts at 1 and increases by 1 for each file printed on that real printer. When it reaches 999, it recycles to 1 again. The sequence number is also printed on the header pages. It will assist you in separating and distributing output.

The SYSPCLAS macro instruction is available to classify printed output with a classification title. This classification title is printed on the output separator page and optionally at the top or bottom of each page of output.

Because output for a user file starts on a real device, the following message occurs:

```
{ PRT } raddr { PRINTING } USERID FILE CLASS RECORDS RECLEFT CPY DIST SEQ  
{ PUN }      { PUNCHING }  userid file a typ norecs  recleft nnn dist sss  
{ REPEATED }
```

RADDR  
is the real device address.

USERID  
is the identification of the owner of the spool file.

FILE  
is the spool file spoolid number.

A  
is the spool file class.

# Spooling Functions

---

## TYP

is the originating device typ (PRT, PUN or CON).

## NORECS

is the logical record count (lines or cards) for the file.

## RECLEFT

is the number of records left to be printed or punched. This number is initially the same as “norecs” but decreases as the file is printed or punched.

## NNN

is the current copy number being produced where 001 is the last copy.

## DIST

is the spool file distribution code.

## SSS

is the sequence number of this file on this device. It is printed in large block letters on the header and trailer pages.

The PRINTING/PUNCHING message occurs when the file output first starts and the REPEATED message occurs for subsequent copies of the same file as they start.

When the card deck is read in, the operator receives the following message:

```
RDR raddr { READING      } USERID FILE CLASS RECORDS  
           { HAS READ... } userid file c RDR norecs
```

## RADDR

is the real address of the card reader.

## USERID

is the user identification of the owner of the file from the ID card at the front of the deck.

## FILE

is the spool file spoolid number assigned.

## C

is the spool file class from the ID card at the front of the deck.

## NORECS

is the number of cards read. Initially zero, this number increases as the file is read.

The READING message occurs when the ID card is successfully read. The HAS READ message occurs when the entire file is read and the reader stops.

An invalid or missing user identification card on the front of a card deck, when read, causes an error message on the system console.

When the last file for an output device is processed and the device becomes idle, the following message is produced:

```
{ PRT } raddr WAITING CLASS c... FORM form { MANUAL } { SEP }  
{ PUN }                                     { AUTO  } { NOSEP }  
                                     { SETUP }
```

RADDR  
is the address of the device.

C...  
is the class(es) the device will process.

FORM  
is the form number the device will process.

## Spool Files for Virtual Machines Running Batch Jobs

Usually, when an installation has only one real reader, printer, or punch, the unit record devices must be shared by all virtual machines. Before VM/SP can process any virtual machine CP spool files and direct them to a real device, those files must be closed. For virtual machines executing batch jobs and using operating systems other than CMS, usually the operator who initially program loaded the virtual machine operating system must intervene to issue the CP CLOSE command.

A feature that automatically closes CP spool files is available for OS/VS1 and DOS/VSE with VSE/AF. Once output files are closed, they can be processed by VM/SP without operator intervention.

Without this feature, CP spool files are not sent to the real printer or punch until the virtual machine operator intervenes.

## Using the CMS Batch Facility

The batch facility is a VM/SP programming facility that runs under CMS. It allows a VM/SP user to run jobs in batch mode by sending jobs from either his own virtual machine or the real card reader to a virtual machine dedicated to running batch jobs under the batch facility. This dedicated machine is generally set up at a terminal in the installation's computer room and is controlled by the system operator.

The batch facility virtual machine runs continuously, executing all jobs spooled to its virtual card reader from other virtual machines or from the real card reader. The batch operator need pay no attention to the batch machine once he has started, and disconnected it.

# Spooling Functions

---

## Starting the Batch Virtual Machine

The system operator starts the batch virtual machine by logging on with a batch userid and loading CMS using the CP IPL command.

### The Batch Userid

Every installation in which the CMS batch facility is available should establish one or more userids for the CMS Batch virtual machines. Users can then spool their files for execution to the card reader for that batch userid.

It is the operator's responsibility to log on the VM/SP system using the batch userid that has been established for his installation.

The userid established for the batch facility virtual machine must have a read/write disk in its directory at virtual address 195. The 195 disk is erased when it is accessed as the A-disk at the beginning of each job.

### Invoking the Batch Facility

The batch facility virtual machine is invoked by the batch operator when he issues the CP IPL command with PARM BATCH or CP IPL followed by the CMSBATCH command. The latter method follows:

```
ipl cms parm nosprof
CMS mm/dd/yy WED 17.58.48

cmsbatch

Y/S (19E) R/O
The following names are undefined:
  BATEXIT1 BATEXIT2
Ready; T=0.14/0.39 08:47:40
Waiting for the reader
```

The operator may now disconnect the batch machine terminal, if he wishes, using the CP DISCONN command. The batch facility will IPL itself after each job is executed.

All virtual machine (CMS) console output is automatically spooled to a file to be printed after the program output at the real system printer. All commands entered through the virtual reader are displayed on the console to allow them to appear in the console output file. If the batch terminal is disconnected, only CP and batch initialization messages are displayed at the terminal.

If an installation wishes to use a saved system in running batch jobs, the operator must enter the name of the saved system in the CMSBATCH command line.



## CMS Batch Output

The batch virtual machine spools output resulting from program execution to the system printer. Output is printed under the submitting userid, with the submitting userid's distribution code, a spool filename of CMSBATCH, and a spool filetype of JOB (unless a job name was specified on the /JOB card).

The console output is always spooled. Therefore, if the console is disconnected, the CMS console output is spooled to a file that is printed following the user's program execution output at the real system printer, with the submitting userid as distribution code, a spool filename of BATCH, and a spool filetype of CONSOLE.

If the CP TAG command has been used to identify spool files or to direct these files to other virtual machines or remote work stations, BATCH resets the spooling devices for the next job.

A more complete description regarding control of the CMS Batch virtual machine is contained in the *VM/SP CMS User's Guide*. It describes the user control cards and suggests control techniques as well as how to control the batch machine using EXEC procedures.

## Purging, Reordering, and Restarting Batch Jobs

When required, the spooling operator can control the execution of batch virtual machine jobs by purging, reordering, and restarting them; by the same token, because all the closed printer files are queued for system output under the submitting userid, the submitting user can change, purge, or reorder these files prior to processing on the system printer.

To purge a job executing under CMS Batch, follow the procedure below:

1. Signal attention and enter the virtual machine environment.
2. Enter the HX (halt execution) immediate command.
3. Disconnect the virtual machine using the CP DISCONN command.

The HX command causes the CMSBATCH to abnormally terminate. This provides the user with an error message and a CP dump of the CMSBATCH virtual machine. The CMSBATCH machine then loads itself again and starts the next job (if any).

To purge an individual input spool file that is not yet executing, issue the CP PURGE command:

```
PURGE READER spoolid
```

In the format above, spoolid is the spool file number of the job to be purged from the batch virtual machine's job queue. For example, the statement:

```
PURGE READER 123
```

# Spooling Functions

---

would purge 123 from the batch virtual machine's job queue.

To reorder individual spool files in the CMSBATCH's job queue, use the CP ORDER command:

```
ORDER READER spoolid1 spoolid2...
```

In this format, spoolid1 and spoolid2 is the assigned spool file identification of the jobs to be reordered.

The operator can determine which jobs are in the queue by using the CP QUERY command:

```
QUERY READER ALL
```

This QUERY command lists the filenames and filetypes of all the jobs in the batch virtual machine's job queue. The operator can then reorder them, using the ORDER command.

## Stopping the Batch Virtual Machine

To stop batch virtual machine execution after completion of the current job, issue the HB immediate command and press the attention key or equivalent to cause an attention interruption at any time during the job. This causes the batch virtual machine to be logged off at job completion.

When batch facility virtual machine execution is to be stopped immediately, but current files must be saved, you can use the CP SPOOL command, in the form SPOOL READER HOLD, and then issue the CP LOGOFF command.

The HOLD option causes CP to retain the virtual machine's current card reader file, so that when the batch machine is logged on again, execution resumes at the beginning of the held reader file.

If an emergency should occur, all jobs in the batch reader and all spool files are saved.

# Summary of Changes

## Structural Changes

This book has been restructured and much of the reference information has been moved to other books. The CP privilege class command descriptions, formerly Chapter 3 in the Release 4 *Operator's Guide*, are now in the *VM/SP CP Command Reference*, SC19-6211. Chapter 3 of this manual now contains a summary of the commands available to the operator.

The Release 4 *Operator's Guide* also contained a section devoted to service programs, Chapter 4. VM/SP Service Programs. This information, with the exception of a small description of the Programmable Operator Facility, is no longer in this book and has moved in the following way:

## Release 4

## Release 5

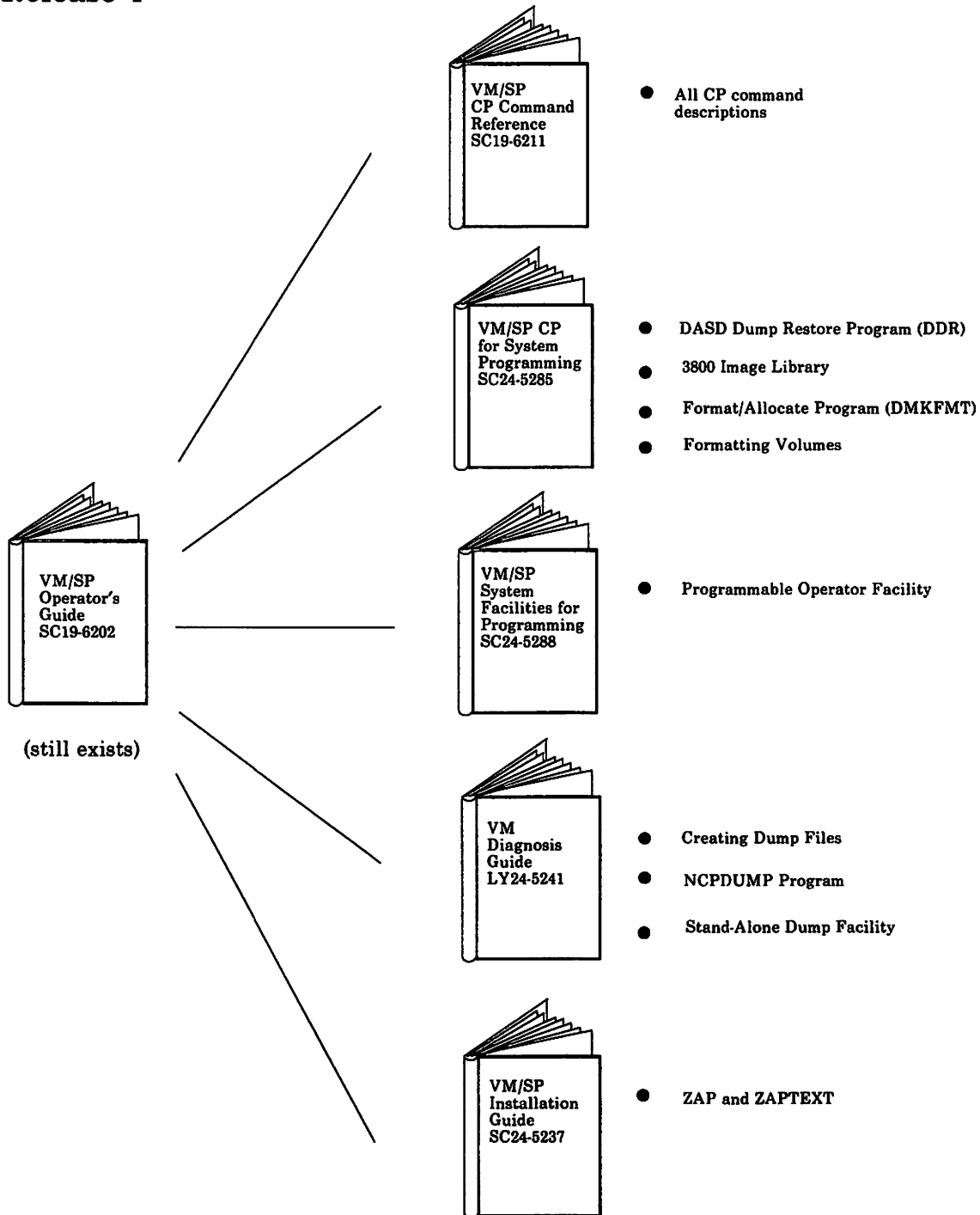

**Figure 8. Changes to the Operator's Guide for Release 5**

## Technical Changes

### Summary of Changes for SC19-6202-4 for VM/SP Release 5

To obtain editions of this publication that pertain to earlier releases of VM/SP, you must order using the pseudo-number assigned to the respective edition. For:

- Release 4, order ST00-1577
- Release 3, order ST00-1351

### *Hardware Support*

#### *Advanced Printer Subsystem Support*

*Changed:* VM/SP can now interface with a logical printer subsystem. Spool files being processed by logical printers can now be recovered for warm starts and checkpoint starts.

### *Program Support*

#### *Security Improvements*

*Changed:* If you enter an invalid password a specified number of times you must wait a specified amount of time before reattempting logon.

#### *National Language Support*

*New:* Depending on the language your terminal is set to, some messages will appear in that language, while others will remain in English.

#### *Alternate Nucleus Support*

*New:* You can now specify a real device address (raddr) as part of REIPL to IPL an alternate nucleus immediately after SHUTDOWN.

### Summary of Changes for SC19-6202-3 for VM/SP Release 4

### *Hardware Support*

Information was added for the support of:

- The 3290 Information Panel.
- The 4361 Model Group 4 and 5 Processors.
- The 4381 Model Group 1 and 2 Processors.

- The 3370 Direct Access Storage Models A2 and B2.
- The 4248 Printer.
- The 3800 Model 3 Printing Subsystem - Existing programs designed to produce 3800 Model 1 printer output may produce output for the 3800 Model 3 printer with little or no program change. Use of this support provides improved print quality (240 x 240 pel resolution) and the addition of a 10 line-per-inch (LPI) vertical space option.
- The 3480 Magnetic Tape Subsystem.

### ***Program Support***

#### ***Saved System 8 M Byte Limit Removal***

*Changed:* SAVESYS, VMSAVE and IPL functions have been modified to let a page image copy of up to a 16 M byte virtual machine be saved and restored. Also, the NAMESYS MACRO was changed to enforce the 16 M byte limit.

#### ***Shared/Nonshared Restriction***

*Changed:* Any attempt to construct a virtual device configuration that would mix SHARED and NONSHARED device types on the same virtual control unit is rejected. To permit migration of data on 3420 tapes (a shared device) to the 3480 (a nonshared device), this restriction will not be enforced.

#### ***VM/SP Interactive Problem Control System***

*Changed:* The base VM/IPCS component is enhanced to include the functional equivalent to the VM/IPCS Extension licensed program.

#### ***System Initialization***

*Changed:* A new operand was added to the SHUTDOWN command.

#### ***Stand-Alone Dump***

*New:* This facility enhances serviceability by letting support personnel dump up to 16 M of real storage.

#### ***Programmable Operator***

*Changed:* This facility can now be used in a mixed environment and the commands can be used from an NCCF operator station. Slight changes were added to the LOADTBL and QUERY commands, and a new command, LGLOPR, was added.

#### ***CPTRAP Command***

*Changed:* Two new operands were added to the CPTRAP command: Groupid and Wrap.

## ***Miscellaneous***

***Changed Format:*** The format of the command descriptions in Chapter 3. CP Commands changed to include a “When to Use” section. Former usage notes have now become a part of the operand description or have been included in a “Things You Should Know” section. This new organization is not marked with revision bars since it effects all of Chapter 3.

## **Summary of Changes for SC19-6202-2 for VM/SP Release 3**

### ***Program Support***

***New:*** A “text” option was added to the SET command to enhance the capability of the LOGMSG operand.

Information was added for using the MSGNOH command.

Improved functions for the programmable operator facility are explained.

### ***Hardware Support***

***New:*** Information was added for the support of the 3262, 3289-E, and 4245 printers and the 3430 tape drive.

The IBM 3088 Multisystem Communication Unit interconnects multiple systems using block multiplexer channels. The 3088 uses an unshared subchannel for each unique address and is fully compatible with existing channel-to-channel protocol.

## ***Miscellaneous***

***Changed:*** The information for the INDICATE, NETWORK, QUERY, and SET commands was reorganized to make it easier to determine the operands that can be issued by each privilege class user and to locate information about the command operands and system responses.

Various minor technical and editorial changes have been made throughout the publication.

# Glossary of Terms and Abbreviations

## Terminology

The following terms in this publication refer to the indicated support devices:

- “2305” – IBM 2305 Fixed Head Storage, Models 1 and 2.
- “270x”
  - IBM 2701, 2702, and 2703 Transmission Control Units
  - The Integrated Communications Adapter (ICA) on some IBM CPUs.
- “2741” – IBM 2741 and the 3767, unless otherwise specified.
- “3033” – all 3033 processor models including the IBM 3033 Model Group S processors. Information about the IBM 3033 Model Group S processors is for planning purposes only until the availability of the product.
- “3081” – IBM 3081 Processor complex.
- “3262” – IBM 3262 Printer, Models 1 and 11.
- “3270” – A series of display devices, namely the IBM 3275, 3276, 3277, 3278 and 3279 Display Stations, and the 3290 Information Panel. A specific device type is named only when a distinction is needed among device types.
- “3289” – IBM 3289 Model 4 Printer.
- “3330”
  - IBM 3330 Disk Storage, Models 1, 2, or 11
  - IBM 3333 Disk Storage and Control, Models 1 or 11
  - 3350 Direct Access Storage operating in 3330/3333 Model 1 or 3330/3333 Model 11 compatibility mode.
- “3340”
  - IBM 3340 Disk Storage, Models A2, B1, and B2.
  - IBM 3344 Direct Access Storage Model B2.
- “3350” – IBM 3350 Direct Access Storage Models A2 and B2 in native mode.
- “3370” – IBM 3370 Direct Access Storage Models A1, A2, B1, and B2.
- “3375” – IBM 3375 Direct Access Storage Device.
- “3380” – IBM 3380 Direct Access Storage Device.



If the 3380 attached to the 3880 Controller Model 3 with Speed Matching Buffer (Feature #6550) is part of your installation, CP will permit execution of extended count-key-data channel programs.

*Note:* The speed matching buffer is not supported for 3380 Models AD4/BD4 or AE4/BE4.

- “3480” — IBM 3480 Magnetic Tape Subsystem.
- “3704,” “3705,” “3725,” or “37xx” — IBM 3704, 3705, and 3725 Communications Controllers.
- “3705” — 3705 I and the 3705 II, unless otherwise noted.
- “3800” — IBM 3800 Printing Subsystems, Models 1, 3, and 8. A specific device type is named only when a distinction is required between device types.
  - “3800 Model 3” — IBM 3800 Models 3 and 8, unless otherwise stated. (The IBM 3800 Model 8 is available only in selected world trade countries.)
- “3850” — IBM 3850 Mass Storage System.
- “3880” — IBM 3880 Storage Control Unit.
- “4248” — IBM 4248 printer.
- “Attached processors” also refers to multiprocessors unless otherwise indicated.
- “FB-512” or “FBA” — IBM 3310 and 3370 Direct Access Devices.
- “VSM” refers to the VTAM service machine, a service virtual machine that lets SNA (Systems Network Architecture) terminals access the VM/SP system.
- “VSE” refers to the combination of the DOS/VSE system control program and the VSE/Advanced Functions licensed program. Also includes the VSE/System Product.
- “DOS,” in certain cases, is still used as a generic term. For example, disk packs initialized for use with VSE or any predecessor DOS or DOS/VS system may be referred to as DOS disks.
- “CMS/DOS” continues to be used when referring to the DOS-like simulation environment provided under the CMS component of the VM/System Product.

Information about display terminal usage also applies to the IBM 3138, 3148, and 3158 Display Consoles when used in display mode, unless otherwise noted.

Any information pertaining to the IBM 3284 or 3286 also pertains to the IBM 3287, 3288 and the 3289 printers, unless otherwise noted.

## Prerequisite Publications

*Virtual Machine/System Product:*

*Introduction*, GC19-6200

*Terminal Reference*, GC19-6206

*CMS User's Guide*, SC19-6210

(This book is a prerequisite only if you edit files used for system control or accounting purposes.)

If the 3767 Communications Terminal is used as the alternate system console, the *IBM 3767 Operator's Guide*, GA18-2000, is also a prerequisite.

If the VTAM Communications Network Application (VM/VCNA) product is used, the following publications are prerequisites:

*Communication Network Application General Information Manual*, GC27-0501

*Communication Network Application Installation, Operation, and Terminal Use*, SC27-0502.

If the ACF/VTAM Release 3 (ACF/VTAM Version 3 for VM/SP with VM SNA Console Support (VSCS)) product is used, the following publications are prerequisites:

*ACF/VTAM VTAM General Information (for VM)*, GC30-3246

*ACF/VTAM Network Program Products Planning*, SC23-0110

*ACF/VTAM VTAM Installation and Resource Definition*, SC23-0111

*ACF/VTAM VTAM Customization*, SC23-0112

*ACF/VTAM VTAM Operation*, SC23-0113.

## Corequisite Publications

### *Virtual Machine/System Product:*

*System Product Editor User's Guide, SC24-5220*

*System Product Editor Command and Macro Reference, SC24-5221*

*Installation Guide, SC24-5237*

*System Product Interpreter User's Guide, SC24-5238*

*System Product Interpreter Reference, SC24-5239*

*Distributed Data Processing Guide, SC24-5241*

*Group Control System Command and Macro Reference, SC24-5250*

*CP for System Programming, SC24-5285*

*CMS for System Programming, SC24-5286*

*Transparent Services Access Facility Reference, SC24-5287*

*System Facilities for Programming, SC24-5288*

*Release 5 Guide, SC24-5290*

*Planning Guide and Reference, SC19-6201*

*System Messages and Codes, SC19-6204*

*Library Guide, Glossary, and Master Index, GC19-6207*

*CMS Command Reference, SC19-6209*

*CP Command Reference, SC19-6211*

*System Logic and Problem Determination Guide Volume 1 (CP), LY20-0892*

*Data Areas and Control Block Logic Volume 1 (CP), LY24-5220*

*Data Areas and Control Block Logic Volume 2 (CMS), LY24-5221*

### *Virtual Machine:*

*Diagnosis Guide, LY24-5241*

*System Facilities for Programming, SC24-5288*

If your installation has a 3850 Mass Storage System, the following are corequisite publications:

*IBM 3850 Mass Storage System (MSS): Principles of Operation: Theory, GA32-0035*

*IBM 3850 Mass Storage System (MSS): Principles of Operation, GA32-0036*

*IBM 3850 Mass Storage System (MSS): Introduction and Preinstallation Planning, GA32-0038*

*Operators Library: IBM 3850 Mass Storage System (MSS) Under OS/VS, GC35-0014*

*OS/VS Message Library: Mass Storage System (MSS) Messages, GC38-1000.*

Other corequisite publications include:

*Device Support Facility User's Guide and Reference, GC35-0033*

*EREP User's Guide and Reference, GC28-1378.*

*2821 Control Unit Component Description, GA24-3312*

*IBM 3211 Printer 3216 Interchangeable Train Cartridge & 3811 Printer Control Unit Comp. Desc. and Operator's Guide, GA24-3543*

*3262 Printer Models 1 and 11 Component Description, GA24-3733*

*3800 Printing Subsystem Programmer's Guide, GC26-3846*

*OS/VS and DOS/VSE Analysis Program-1 (AP-1) User's Guide, GC26-3855*

The following are corequisite publications if your installation has a 3704, 3705 or 3725:

*Guide to Using the IBM 3704 Communications Controller Control Panel, GA27-3086*

*Guide to Using the 3705 Control Panel, GA27-3087.*

*ACP/NCP-SSP, V3 Installation and Resource Definition Guide, SC30-3253.*

*EP/3725 Installation and Resource Definition Guide and Reference, SC30-3172.*

*EP/3705 Generation and Utilities Guide and Reference, GC30-3242.*

*ACF/NCP V4, ACF/SSP V3 Diagnosis Guide, SC30-3255.*

For the relationship of the *Virtual Machine/System Product: Operator's Guide* to other VM/SP prerequisite and corequisite publications, refer to "The VM/SP Library."

## The VM/SP Library (Part 1 of 3)

### Evaluation

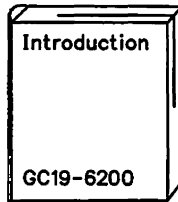
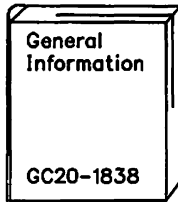

### Index

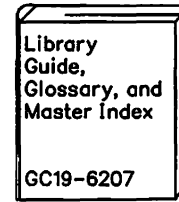

### Planning

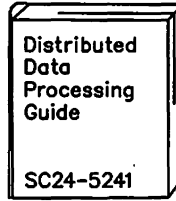
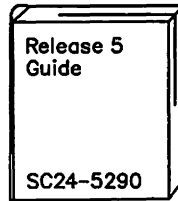
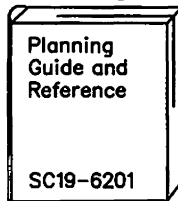

### Installation



### Applications

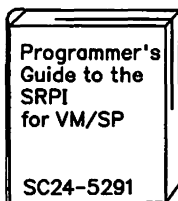
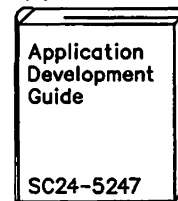

### Operation

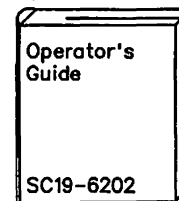

### Reference Summaries

To order all of the Reference Summaries, use order number SBOF-3242

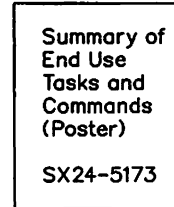
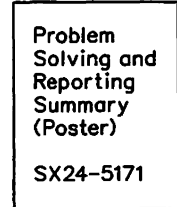
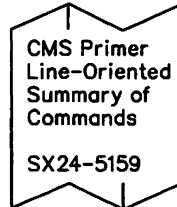
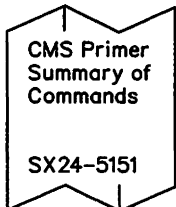
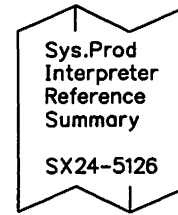
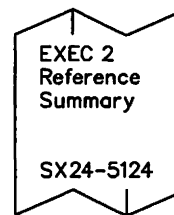
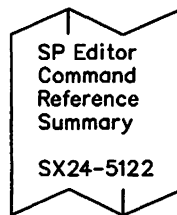
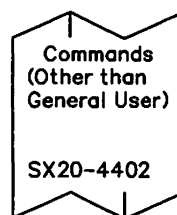
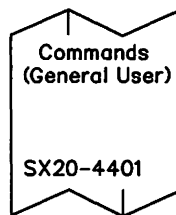

## The VM/SP Library (Part 2 of 3)

### End Use

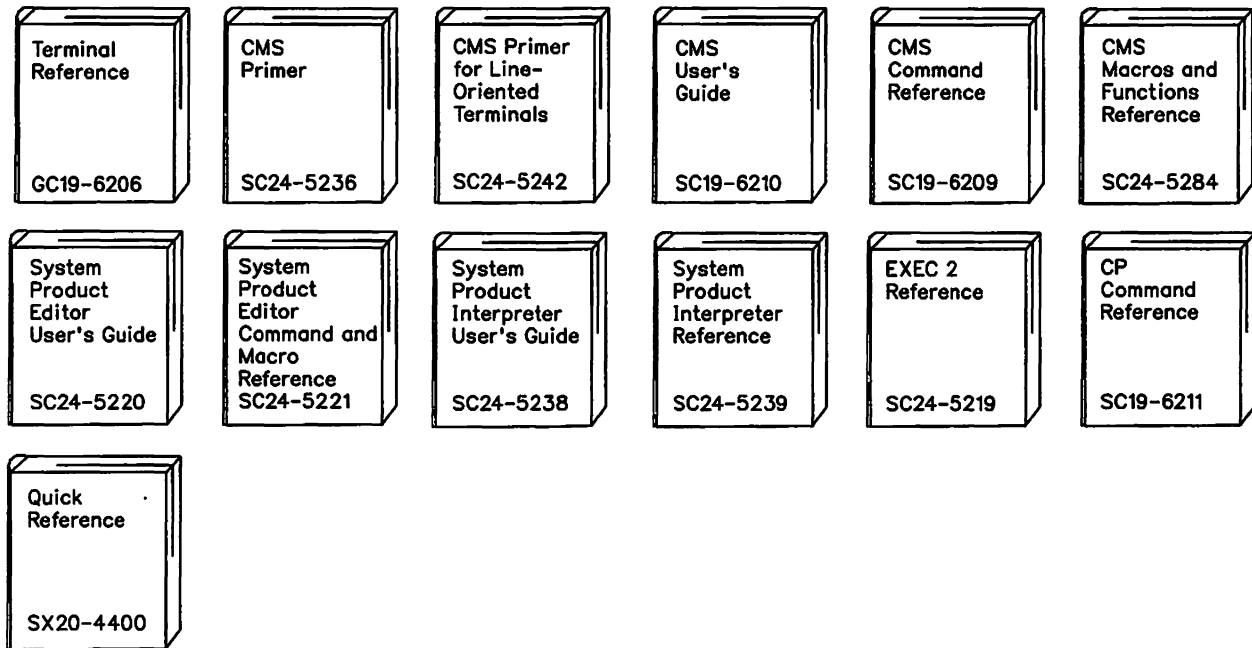

### Diagnosis

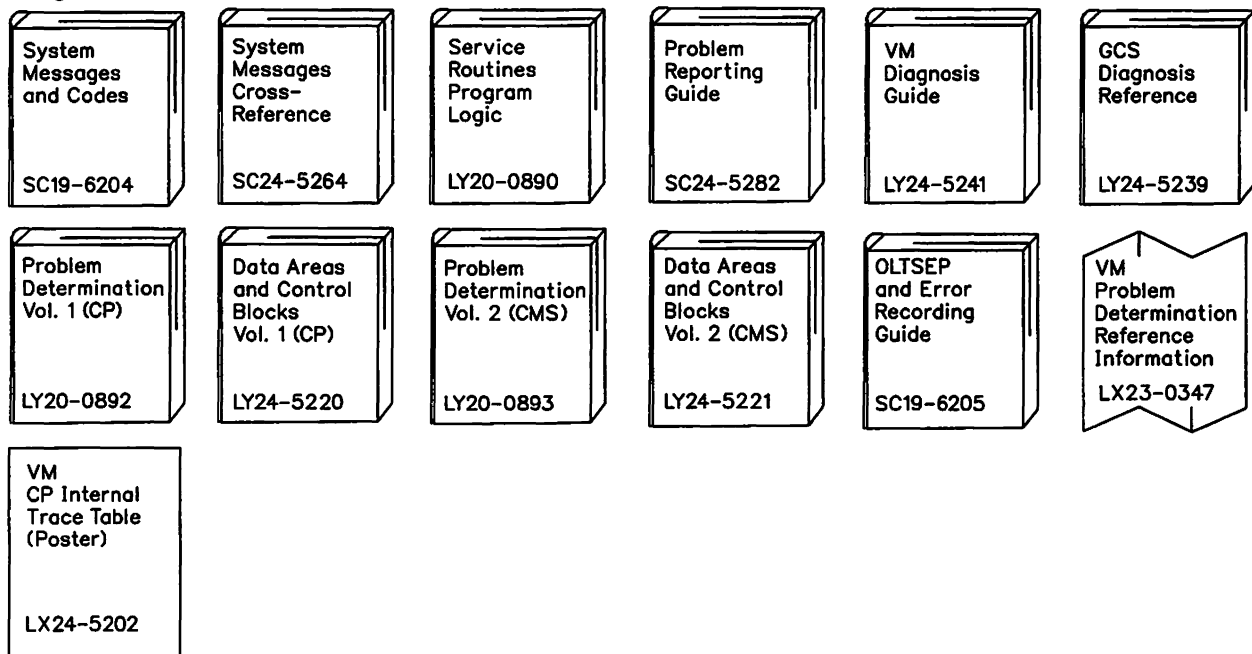

## The VM/SP Library (Part 3 of 3)

### Administration

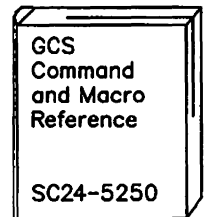
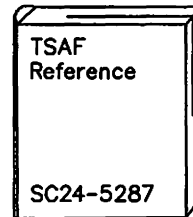
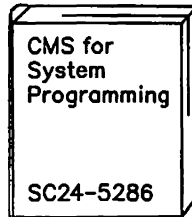
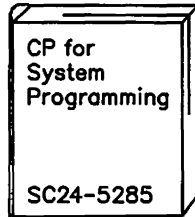

### Auxiliary Communication Support

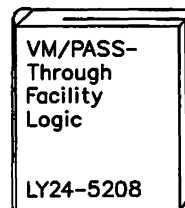
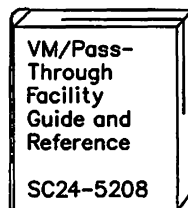
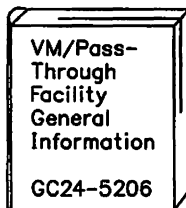
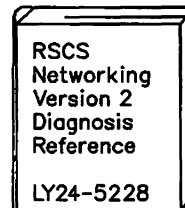
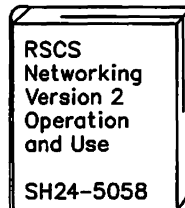
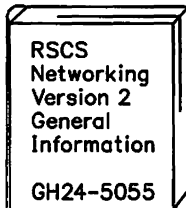
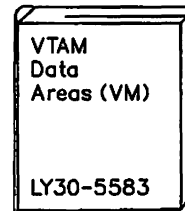
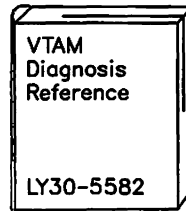
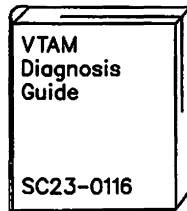
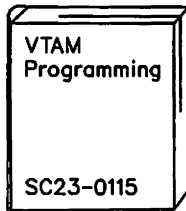
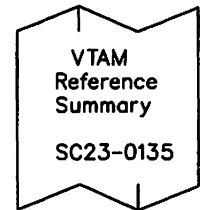
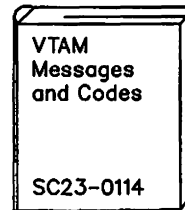
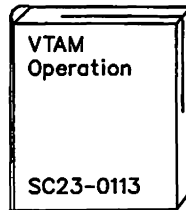
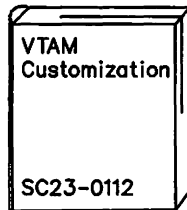
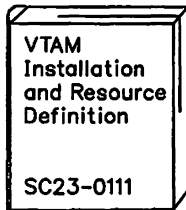

## Special Characters

#CP command 55

### A

abend dump by system 49  
 ACNT command 55  
 ADSTOP command 55  
 affinity  
   automatic reset 6  
   usage with attached processor 46  
 alternate console  
   at system generation 13  
   automatic logon 13  
   disconnecting 28  
   multiple 28  
   selecting (during initialization) 30  
   specifying 13  
   valid terminal designations 13, 28  
 analyst function type 52, 53  
 ATTACH command 55  
 attached processor system  
   affinity command usage 46  
   initialization 27  
   restarting 6  
   restrictions for locked shared pages 42  
   specifying one processor 45  
 attaching and detaching volumes 11  
 ATTN command 55  
 attributes, spool file 71  
 AUTOLOG command 55  
 automatic ipl 21  
 automatic logon, operator 21  
 automatic volume mount and demount  
   causes 24  
   3330V 24

### B

BACKSPAC command 55  
 batch facility  
   invoking 80  
   using 79  
 batch jobs  
   purging 81  
   reordering 81  
   restarting 81  
 batch virtual machine  
   starting 80  
   stopping 82  
 BEGIN command 56  
 Bibliography 91  
 buffers, spool 71

### C

CANCEL key 10  
 card input  
   spooled 75  
 card separator for spool punch output 77  
 CCH (channel check handler) 4  
 CE function type 52, 53  
 CHANGE command 56  
 channel check handler (CCH) 4  
 channel control check 4  
 character set for 3800 printer  
   modified 36  
   predefined 36  
 checkpoint (CKPT) start 19  
 CKPT (checkpoint) start 19  
 classes of output for spooling 72  
 clock  
   setting uniprocessor application 17  
   time-of-day (TOD) 16  
 CLOSE command 56  
 CMS (Conversational Monitor System)  
   commands 51  
   system operator 52  
 CMS used to alter VM/SP files 52  
 cold start 20  
 commands  
   CP (Control Program)  
     command privilege classes 52

---

These symbols are used in the index to refer to other VM and VM/SP books:

CPPROG—VM/SP CP for System Programming  
 DIAG—VM Diagnosis Guide

CPREF—VM/SP CP Command Reference  
 SFPROG—VM/SP System Facilities for Programming  
 Index 97



- privilege class assignments 52
  - privilege class description 53
  - spooling 67
- function types 52
- privilege class 52
- 3704/3705/3725 control program 33
- COMMANDS command 56
- Communications Control program
  - controlling 33
- communications controller
  - See also 3704/3705 Communications Controller
  - loading considerations 33
- considerations
  - for virtual = real performance option 40
  - spooling 67
- console 10
  - alternate 28
    - description 28
    - selecting 30
  - definition 28
  - input 10
    - procedures 10
  - messages after VM/SP initialization 24
  - primary
    - description 28
    - disabling 29
  - spooling 69
  - system description 28
  - virtual 69
- Control Program (CP)
  - commands 51, 53-62
  - CP assist 45
    - attached processor application 45
    - supported processors 45
  - disk areas 67
  - dispatcher 39
  - ID card
    - description of 75
    - fields 76
    - format 76
    - message to operator 78
  - paging routine 38
  - prefixing with 51
  - SYSRES volume 11
  - system functions from disk 11
  - using 51
- controlling
  - 3704/3705 Communications Controller 33
  - 3704/3705/3725 Communications Controller 33
- conventions of environment 10
- Conversational Monitor System (CMS)
  - commands 51
    - system operator 52
- conversion to 3800 Model 3 pel density 37
- copy modification for 3800 printer 37
- count-key-data DASD

- label requirements 11
- COUPLE command 56
- CP (Control Program)
  - commands 51, 53-62
  - CP assist 45
    - attached processor application 45
    - supported processors 45
  - disk areas 67
  - dispatcher 39
  - ID card
    - description of 75
    - fields 76
    - format 76
    - message to operator 78
  - paging routine 38
  - prefixing with 51
  - SYSRES volume 11
  - system functions from disk 11
  - using 51
- CP command 56
- CPEREP program, I/O error recording 5
- CPTRAP command 56

## D

- DASD (Direct Access Storage Device)
  - for spool buffering 71
- DCP command 56
- dedicated device, 3800 printer subsystem
  - support 37
- DEFINE command 56
- defining the console 28
- DETACH command 56
- detaching and attaching volumes 11
- diagnosing software failure 50
- DIAL command 56
- Direct Access Storage Device (DASD)
  - for spool buffering 71
- DISABLE command 56
- disabling the primary VM/SP console 29
- DISCONN command 57
- disks
  - for spool buffering 71
  - labeling 11
- DISPLAY 57
- DMCP command 57
- DMKMSS (mass storage system) error messages 25
- DOS virtual = real storage assignments 40
  - VIRT = REAL option 40
- DRAIN command 57
- DUMP 57
- dumps
  - system abend 49
- dynamic trace facility 33

## E

ECHO command 57  
ECPS (Extended Control-Program Support:VM/370) 44  
    attached processor application 45  
    supported processors 45  
edit error records 5  
editor, system product 52  
elimination, queue drop 47  
Emulation Program (EP)  
    See also 3704/3705 Communications Controller  
    special considerations for loading 34  
ENABLE command 57  
entering CP commands 10  
environment conventions 10  
EP (Emulation Program)  
    See 3704/3705 Communications Controller  
epoch clock value 18  
EREP with the CPEREP command 5  
error handling, I/O 70  
error messages  
    See messages  
error recording  
    CPEREP program 5  
    editing error records 5  
    I/O 5  
    IOERBLOK, recording in 4  
execution, favored 39  
Extended Control-Program Support  
    See ECPS (Extended Control-Program Support:VM/370)  
extended virtual machine assist 44  
EXTERNAL command 57

## F

facilities  
    repair 6  
    restart 6  
failure, recovery from 18  
favored execution option 39  
FBA DASD  
    label requirements 11  
features  
    defining for a 3330V 25  
    sysvirt 25  
    virtual 25  
filename of spool files 71  
filetype of spool files 71  
fixed-block DASD  
    See FBA DASD  
fixed-block mode  
    See FBA DASD

FLUSH command 57  
FORCE command 57  
force start 19  
format of user identification card 76  
forms control described for 3800 printer 36  
forms overlay described for 3800 printer 36  
FREE command 57  
function types of CP command 53

## G

general function type 52, 53

## H

HALT command 57  
handling I/O errors 70  
hardware assist  
    See also ECPS (Extended Control-Program Support:VM/370)  
    description 43  
hardware status messages 31  
HOLD command 57

## I

I/O (input/output)  
    error handling 70  
    error recording 5  
INDICATE command 57  
initialization  
    attached processor 27  
    mass storage system (MSS) 24  
    messages 24  
    multiprocessor system 26  
    selecting an alternate console during 30  
    system 12  
        logging on the system operator 15  
        operator's console, locating 13  
        simplifying 12  
        starting 13  
        time-of-day clock 14  
        type of start, selecting 14  
initialization procedures  
    checkpoint start 19  
    clock, setting 17  
    cold start 20  
    force start 19  
    lines and resources, enabling 23  
    logon

---

These symbols are used in the index to refer to other VM and VM/SP books:

CPPROG—VM/SP CP for System Programming  
DIAG—VM Diagnosis Guide

CPREF—VM/SP CP Command Reference  
SFPROG—VM/SP System Facilities for Programming  
Index 99

- automatic 21
  - manual 21
  - shutdown start 20
  - time-of-day clock 16
  - warm start 18
- initiating VM/SP operation 51
- input
  - spooled card 75
- input/output (I/O)
  - error handling 70
  - error recording 5
- Interactive Problem Control System (IPCS) 50
  - IPCSDUMP command 50
- interface control check 4
- interval timer 27
  - at initialization 27
- interval timer assist, part of ECPS 45
- invoking the CMS batch facility 80
- IPCS (Interactive Problem Control System) 50
  - IPCSDUMP command 50
- IPCSDUMP command (IPCS) 50
- IPL command 58
- IPL, automatic 21

## K

keywords

- CMS 51
- CP 51

## L

- label requirements for FB-512 DASD 11
- labeling
  - disks 11
- LINK command 58
- LOADBUF command 58
- loading
  - 3704/3705 Communications Controller 33
  - 3704/3705 control program 23, 34
    - EP considerations 34
  - 3704/3705/3725 control program 33
- LOADVFCB command 58
- LOCATE command 58
- LOCK command 58
- locked pages option 42
- locked shared pages, attached processor
  - restriction 42
- LOGOFF command 58
- logon
  - automatic 21
  - manual 21

- message 21
- LOGON command 58

## M

- machine check handler (MCH) 3
- manual logon, operator 21
- map storage allocations 41
- mass storage control (MSC), communicating
  - with 25
- mass storage system
  - See MSS (mass storage system)
- MCH (machine check handler) 3
- MESSAGE command 58
- messages
  - after startup 31
  - DMKMSS (mass storage system) 25
  - during VM/SP initialization 24
  - from virtual machine users 31
  - hardware and program status 31
  - logon 21
    - status to system operator 31
    - to system operator, SVC 76 31
- MIGRATE command 58
- missing interrupt handler (MIH) 4
  - description 4
- MONITOR command 58
- MSC (mass storage control), communicating
  - with 25
- MSGNOH command 59
- MSS (mass storage system)
  - CP automatic volume mount and demount 24
  - error messages 25
  - initializing 24
    - specifying a partition 24
  - multiple alternate consoles selection 28
  - multiprocessor mode, recovery management 5
  - multiprocessor system
    - initialization 26
    - restarting 6

## N

- NCCF interface with Programmable Operator
  - Facility
    - in a single system 66
    - Message Exchange (PMX) 65
    - operator 65
- NETWORK command 59
- nolog password 75
- NOTREADY command 59
- number of copies of an output spool file 72

## O

- operating the system
  - installation requirements 1
  - program requirements 1
- operations function type 53
- operator
  - commands, CMS 52
  - commands, CP 55-62
  - duties 1
  - function type 52
  - initialization procedures 12-27
  - NCCF or NetView 65
  - primary system 53
  - procedures 10
  - responsibilities for spooling 74
  - spooling 53
  - spooling functions 68
  - system 1
  - system resource 53
  - tasks
    - disks, labeling 11
    - system, initializing 12
    - virtual devices, defining 12
  - termination procedures 47-50
  - training 1
- options, performance
  - assignment of 11
  - avored execution 39
  - locked pages 42
  - priority 43
  - reserved page frames 38
  - virtual = real 40
  - VM/SP 37
- ORDER command 59
- output
  - spool files 72, 76
    - classes 72
  - rearranging priorities 73
- output forms 79

## P

- partition in OS/VS1 system 25
- password, nolog 75
- PER command 59
- performance options
  - affinity 46
  - assignment 11
  - Extended Control-Program Support 44
  - avored execution 39
  - hardware assist 43
  - locked pages 42
  - priority 43

- reserved page frames 38
- virtual machine assist 44
- virtual = real 40
- primary system operator
  - See also operator
  - description of 2
- primary VM/SP console, disabling 29
- printer separator for spool printer output 77
- printing subsystem support for 3800 36
- priority, performance option 43
- privilege class of user and function 53
- procedures, operating 10
- program interrupts 49
- program status messages 31
- programmable operator facility
  - description of 63
  - environments
    - distributed VM 64
    - mixed 65
    - single system 64
  - NCCF or NetView operator as the logical operator 65
  - sample configuration 65
  - single system with NCCF or NetView 66
  - tasks 63
- programmer function type 52, 53
- PURGE command 59
- purging the batch facility 81

## Q

- QUERY command 59
- queue drop elimination 47
- QVM command 60

## R

- READY command 60
- recording I/O errors with CPEREP program 5
- recording mode (MCH) 3
- recovery
  - EREP 5
  - features of VM/SP 5
  - using different starts 18-20
- Recovery Management Support (RMS)
  - See RMS (Recovery Management Support)
- Remote Spooling Communication Subsystem (RSCS) 69
  - spooling to remote locations 69
- reordering the batch facility 81
- repair facilities 6
- REPEAT command 60
- reporting software failure 50

---

These symbols are used in the index to refer to other VM and VM/SP books:

CPPROG—VM/SP CP for System Programming  
DIAG—VM Diagnosis Guide

CPREF—VM/SP CP Command Reference  
SFPROG—VM/SP System Facilities for Programming  
Index 101

- REQUEST command 60
- reserved page frames option 38
- RESET command 60
- resource function type 52, 53
- responsibilities for spooling operator 75
- restart facilities
  - in attached processor operations 6
  - VM/SP 6
- restarting the batch facility 81
- restrictions
  - locked pages 42
  - virtual = real performance option 40
  - VM/370 hardware assist 46
  - 3066/3215/3270 terminal console (CANCEL key) 10
- REWIND command 60
- RMS (Recovery Management Support)
  - channel check handler (CCH) 4
  - machine check handler (MCH) 3
  - missing interrupt handler (MIH) 4
  - System/370 3
  - VM/SP (Virtual Machine/System Product) 3
- RSCS (Remote Spooling Communication Subsystem) 69
  - spooling to remote locations 69

## S

- saved virtual storage 7
- SAVESYS command 60
- SCREEN command 60
- selecting an alternate VM/SP console 30
- SEND command 61
- separator
  - spool printer 77
  - spool punch output 77
- service function type 52, 53
- service virtual machine 47
- SET command 61
  - CPASSIST use with ECPS 45
  - DUMP subcommand 49
  - MODE MAIN, invalid processors for 3
  - NOTRANS subcommand 41
  - QDROP subcommand 47
  - SASSIST subcommand
    - use with ECPS 45
    - use with hardware assist 44
    - use with virtual machine assist 44
  - use with ECPS 45
- shared pages in attached processor system 43
- sharing devices, spooling 67
- SHUTDOWN command 61
- SHUTDOWN command to terminate system 47
- shutdown start 20
- single processor mode 35
- SLEEP command 61
- SMSG command 61

- software failure 50
- SPACE command 61
- SPMODE command 61
- spool buffers 71
- SPOOL COMMAND 61
- SPOOL command to spool virtual console
  - output 70
- spool file
  - attributes
    - date 72
    - filename 71
    - filetype 71
    - number of copies 72
    - number of records 72
    - spoolid 71
    - time 72
    - userid 71
  - VM/SP unit record 23
- spooled
  - card input 75
  - input handling 11
  - output handling 11
  - printer output 73
  - punch output 73
- spooling
  - across a teleprocessing network 69
  - commands 75
  - considerations 67
  - devices 69
  - function type 52
  - I/O error handling 70
  - input spool files 69
  - operator functions 68
  - operator responsibilities 75
  - options 68
  - output spool files 69
  - real 68
  - support 68
  - virtual console 69
  - with RSCS 69
- spooling function type 53
- SPTAPE command 61
- start
  - checkpoint (CKPT) 19
  - cold 20
  - force 19
  - shutdown 20
  - warm start to initiate VM/SP) 18
- START command 62
- starting VM/SP operation 51
- status messages
  - hardware and program 31
  - system operation 31
- STCP command 62
- stopping the batch virtual machine 82
- storage allocations, map 41
- STORE command 62
- SVC 76
  - error recording 5

- messages to system operator 31
- SYSCOR macro instruction with AP operand 27
- SYSOPT macro to specify virtual card reader file 48
- system
  - abend dumps 49
  - console 28
  - definition 12
  - failure dump unit 48
  - initialization 12
  - messages during initialization 24
  - termination 47
- SYSTEM command 62
- system operation
  - installation requirements 1
  - program requirements 1
- system operator 2
  - See also operator
  - alerted to error conditions 2
  - description of 2
  - functions performed by 3
- system product editor 52

## T

- TAG command 62
- TERMINAL command 62
- terminals
  - for VM/SP control 28
  - input procedures 10
- termination
  - system 47
  - virtual machine 6
- time slicing supported by the interval timer 27
- time-of-day (TOD) clock
  - obtaining current value 16
  - setting 20
  - System/370 16
- TOD clock
  - See time-of-day (TOD) clock
- TRACE command 62
- TRANSFER command 62
- translate tables, description for 3800 printer 37

## U

- unit record spool files 23
- universal character set feature 69
- UNLOCK command 62
- user identification (userid), spool file attribute 71
- user identification card
  - for spooled card input 75
  - format 76

- user messages to the operator (virtual machine) 31
- userid, spool file attribute 71

## V

- VARY command 62
- virtual console spooling 69
- virtual devices, defining 12
- virtual interval timer assist 45
- virtual machine assist
- Virtual Machine/System Product (VM/SP)
  - components, brief description 1
  - concepts, brief description referral 1
  - initiating 51
  - messages, initialization and status 24
  - operating procedures 10
  - operator
    - See also operator
    - alerted to error conditions 3
    - functions performed by 3
    - performance options 37
    - recovery features 5
    - recovery from system failures 18
    - recovery management support 3
    - repair facilities 6
    - restart facilities 6
  - start
    - checkpoint (CKPT) start 19
    - cold start 20
    - force start 19
    - shutdown start 20
    - warm start 18
  - system console 28
  - unit record spool files 23
- virtual machines
  - assist 44
  - console 69
  - restoring of contents 7
  - spooling
    - considerations 67
    - functions 68
  - termination 6
  - user messages 31
- virtual storage preservation 7
- virtual = real
  - performance option 40
  - storage assignments in DOS system 41
- VM/SP (Virtual Machine/System Product)
  - components, brief description 1
  - concepts, brief description referral 1
  - initiating 51
  - messages, initialization and status 24
  - operating procedures 10
  - operator
    - See also operator

These symbols are used in the index to refer to other VM and VM/SP books:

CPPROG—VM/SP CP for System Programming  
 DIAG—VM Diagnosis Guide

CPREF—VM/SP CP Command Reference  
 SFPROG—VM/SP System Facilities for Programming  
 Index 103

- alerted to error conditions 3
  - functions performed by 3
- performance options 37
- recovery features 5
- recovery from system failures 18
- recovery management support 3
- repair facilities 6
- restart facilities 6
- start
  - checkpoint (CKPT) start 19
  - cold start 20
  - force start 19
  - shutdown start 20
  - warm start 18
- system console 28
- system operator 18
- unit record spool files 23
- VM/370
  - Extended Control-Program Support 44
  - hardware assist 43
  - hardware assist restrictions 46
- VMDUMP command 62
- VMSAVE function 7
- volume mount and demount, 3330V 24
- volumes
  - user and system, attaching and detaching 11

## W

- warm start 18
- WARNING command 62

## X

- XEDIT (System Product Editor) 52

## Numerics

- 3031 set mode main invalid 3
- 3032 set mode main invalid 3
- 3033 set mode main invalid 3
- 3066/3215/3270 terminal console, CANCEL key restrictions 10
- 3081 set mode main invalid 3
- 3270
  - primary/alternate console 13, 28, 30
- 3330V
  - automatic volume mount and demount 24
  - features 25
  - sysvirt feature 25
  - virtual feature 25
- 3480 magnetic tape subsystem
  - restrictions in single processor 35
  - restrictions under VM/SP 35
- 3704/3705 Communications Controller
  - CMS commands 33
  - controlling 33
  - Emulation Program (EP), loading considerations 34
  - loading considerations 34
  - network load command usage 34
- 3800 printing subsystem
  - dedicated device support 36
  - features 36
  - translate tables 36
- 3850 mass storage system (MSS) 24
  - error messages 25
  - installation 25
  - partitioning 25

Is there anything you especially like or dislike about this book? Feel free to comment on specific errors or omissions, accuracy, organization, or completeness of this book.

If you use this form to comment on the online HELP facility, please copy the top line of the HELP screen.

\_\_\_\_\_ Help Information line \_\_\_\_ of \_\_\_\_

IBM may use or distribute whatever information you supply in any way it believes appropriate without incurring any obligation to you, and all such information will be considered nonconfidential.

**Note:** Do not use this form to report system problems or to request copies of publications. Instead, contact your IBM representative or the IBM branch office serving you.

Would you like a reply?  YES  NO

Please print your name, company name, and address:

---

---

---

---

IBM Branch Office serving you: \_\_\_\_\_

Thank you for your cooperation. You can either mail this form directly to us or give this form to an IBM representative who will forward it to us.



SC19-6202-4

**Reader's Comment Form**

CUT  
OR  
FOLD  
ALONG  
LINE

Fold and tape

Please Do Not Staple

Fold and tape



**BUSINESS REPLY MAIL**  
FIRST-CLASS MAIL PERMIT NO. 40 ARMONK, NY

POSTAGE WILL BE PAID BY ADDRESSEE:

NO POSTAGE  
NECESSARY  
IF MAILED  
IN THE  
UNITED STATES



INTERNATIONAL BUSINESS MACHINES CORPORATION  
DEPARTMENT G60  
PO BOX 6  
ENDICOTT NY 13760-9987



Fold and tape

Please Do Not Staple

Fold and tape



International Business  
Machines Corporation  
P.O. Box 6  
Endicott, New York 13760

File No. S370/4300-40  
Printed in U.S.A.

SC19-6202-4



SC19-6202-04

