

MVS Software Manufacturing Offerings

GC23-0351-05

MVS Custom-Built Installation Process Offering  
MVS Custom-Built Product Delivery Offering  
System Modification Program Extended  
Process Aids -- Drivers

**General Information**

Release 6





## MVS Software Manufacturing Offerings

GC23-0351-05

MVS Custom-Built Installation Process Offering  
MVS Custom-Built Product Delivery Offering  
System Modification Program Extended  
Process Aids – Drivers

### **General Information**

Release 6

---

**Note!**

Before using this information and the product it supports, be sure to read the general information under "Notices" on page vii.

**Sixth Edition (June 1991)**

This book replaces the previous edition, GC23-0351-4, which is now obsolete. Changes or additions to the text and illustrations are indicated by a vertical line to the left of the change.

This edition applies to the following licensed program and program offerings, and to all subsequent releases and modifications until otherwise indicated in new editions:

- MVS Custom-Built Installation Process Offering (CBIPO), program number 5751-CS1
- MVS Custom-Built Product Delivery Offering (CBPDO), program number 5751-CS3
- System Modification Program Extended (SMP/E) Release 6, licensed program number 5668-949, which is applicable to Release 3.8 of OS/VS2 (MVS) and all subsequent releases, unless otherwise indicated
- MVS Custom-Built Installation Process Offering Process Aids, program number 5751-CS2
- MVS Custom-Built Installation Process Offering Drivers, program number 5665-343.

Consult the latest edition of *IBM System/370, 30xx, 4300, and 9370 Processors Bibliography*, GC20-0001, for current information on these offerings.

Order IBM publications through your IBM representative or the IBM branch office serving your locality. Publications are not stocked at the address given below.

A form for reader's comments appears at the back of this publication. If the form has been removed, address your comments to:

IBM Corporation  
Information Development  
Department 52QA/MS 911  
Neighborhood Road  
Kingston, NY 12401-0000  
USA

When you send information to IBM, you grant IBM a nonexclusive right to use or distribute the information in any way it believes appropriate without incurring any obligation to you.

© Copyright International Business Machines Corporation 1986, 1991. All rights reserved.

Note to U.S. Government Users — Documentation related to restricted rights — Use, duplication or disclosure is subject to restrictions set forth in GSA ADP Schedule Contract with IBM Corp.

---

# Contents

<b>Notices</b> . . . . .	vii
Trademarks . . . . .	vii
 <b>Preface</b> . . . . .	 ix
 <b>Summary of Changes</b> . . . . .	 xi
Revision GC23-0351-05 (June 1991) . . . . .	xi
 <b>Chapter 1. MVS Software Manufacturing Offerings</b> . . . . .	 1
Introduction . . . . .	1
CBIPOs . . . . .	1
CBPDOs . . . . .	2
Which Should You Choose: a CBIPO or a CBPDO? . . . . .	3
SMP/E . . . . .	5
 <b>Chapter 2. CBIPO Summary</b> . . . . .	 7
What Is a CBIPO? . . . . .	7
CBIPO Features . . . . .	8
Contents of a CBIPO . . . . .	8
The DLIB Tapes . . . . .	9
The RIM Tape . . . . .	9
The SERV Tapes . . . . .	10
Ordering a CBIPO . . . . .	10
Getting Information about CBIPOs . . . . .	11
Placing Your Order . . . . .	11
Some Points to Remember . . . . .	12
How a CBIPO Is Created . . . . .	12
CBIPO Requirements . . . . .	13
Programming Requirements . . . . .	14
Hardware Requirements . . . . .	15
Education Requirements . . . . .	15
Installing a CBIPO . . . . .	16
Which to Use: the CBIPO Dialogs or the CBIPO Batch Jobs? . . . . .	17
The SMP/E GENERATE Command . . . . .	18
 <b>Chapter 3. CBPDO Summary</b> . . . . .	 19
What Is a CBPDO? . . . . .	19
CBPDO Features . . . . .	19
Contents of a CBPDO . . . . .	20
The CBPDO Tapes . . . . .	20
Ordering a CBPDO . . . . .	21
Getting Information about CBPDOs . . . . .	21
Placing Your Order . . . . .	21
Some Points to Remember . . . . .	22
How a CBPDO Is Created . . . . .	23
CBPDO Requirements . . . . .	24
Programming Requirements . . . . .	24
Hardware Requirements . . . . .	24
Education Requirements . . . . .	25
Installing a CBPDO . . . . .	25

---

<b>Chapter 4. SMP/E Summary</b>	27
What Is SMP/E?	27
System Modifications (SYSMODs)	29
Data Sets Used by SMP/E	29
The SMPCSI Data Set	30
Using SMP/E to Install Products and Service	31
SMP/E Requirements and Considerations	32
Programming Requirements	32
Hardware Requirements	33
Education Requirements	33
Compatibility	33
Performance	33
Migration	34
SMP/E Data Integrity	35
Security	35
<b>Chapter 5. CBIPO Process Aids Summary</b>	37
Contents of the Process Aids	37
Ordering the Process Aids	37
<b>Chapter 6. MVS CBIPO Drivers Summary</b>	39
Contents of a Driver	39
Ordering a Driver	39
Hardware Requirements	39
<b>Appendix A. Education and Related Documentation</b>	41
CBIPO Documentation	42
Common Documents	42
MVS Feature Documents	43
NCP Feature Documents	45
DBS Feature Documents	45
CICS Feature Documents	46
CBPDO Documentation	46
SMP/E Documentation	47
<b>Appendix B. Acronyms and Abbreviations</b>	49

---

## Figures

1.	Tapes for a CBIPO Feature	9
2.	How a CBIPO Is Created	13
3.	How a CBPDO Is Created	23
4.	Summary of Zone Relationships	31
5.	Types of Information Provided for CBIPOs	44
6.	Types of Information Provided for CBPDOs	47

---

## Tables

1.	Comparison of a CBIPO with a CBPDO	3
2.	Using the CBIPO Dialogs versus Using the CBIPO Batch Jobs	17
3.	What You Can Do with the CBIPO Dialogs and the SMP/E Dialogs	28
4.	Migrating to SMP/E Release 6	34
5.	Classes and Self-Study Courses	41
6.	Common CBIPO Documents	42
7.	MVS Feature Documents	43
8.	NCP Feature Documents	45
9.	DBS Feature Documents	45
10.	CICS Feature Documents	46
11.	Common CBPDO Documents	46
12.	Publications for SMP/E Release 6	47



---

## Notices

References in this publication to IBM products, programs, or services do not imply that IBM intends to make them available in all countries in which IBM operates. Any reference to an IBM product, program, or service is not intended to state or imply that only IBM's product, program, or service may be used. Any functionally equivalent product, program, or service that does not infringe any of IBM's intellectual property rights or other legally protected rights may be used instead of the IBM product, program, or service. Evaluation and verification of operation in conjunction with other products, programs, or services, except those expressly designated by IBM, are the user's responsibility.

IBM may have patents or pending patent applications covering subject matter in this document. The furnishing of this document does not give you any license to these patents. You can send license inquiries, in writing, to the IBM Director of Commercial Relations, IBM Corporation, Purchase, NY 10577.

---

## Trademarks

The following terms, denoted by an asterisk (\*) in this publication, are trademarks of the IBM Corporation in the United States and/or in other countries:

- BookManager
- DATABASE 2
- DB2
- IBM
- MVS/DFP
- MVS/ESA
- MVS/SP
- MVS/XA
- System/370





---

## Preface

IBM provides a variety of support to help you order, install, and service software:

- **MVS Custom-Built Installation Process Offering (CBIPO).** This is a software package for creating or replacing an MVS system or subsystem.
- **MVS Custom-Built Product Delivery Offering (CBPDO).** This is a software package for adding or upgrading products or service (or both) on an existing MVS system or subsystem.
- **System Modification Program Extended (SMP/E).** This is a tool for installing and maintaining software, and for managing the inventory of software that has been installed. This software includes CBIPOs and CBPDOs, separately orderable products and service, and user-written software.
- **CBIPO Process Aids.** This consists of documentation and jobs for a CBIPO feature, without any product code, and can be used to plan the installation of a CBIPO.
- **MVS CBIPO Drivers.** A driver is a load-and-go MVS/XA<sup>®</sup> or MVS/370 system to help you install a CBIPO system if you do not already have an MVS system.

This book will help you select the offering that is right for you. You should already have a working knowledge of how to install products and service on an MVS system. For a list of related publications, see Appendix A.

### What Is New?

SMP/E Release 6 provides new dialogs for installing CBIPOs.

For a quick comparison of using the new CBIPO dialogs versus using the batch installation process, see Table 2 on page 17.



---

## Summary of Changes

---

### Revision GC23-0351-05 (June 1991)

This revision documents SMP/E Release 6, which provides the following new support:

- **CBIPO Dialogs**

SMP/E now includes dialogs that can be used to install CBIPO packages. These dialogs can be used instead of the existing batch installation process.

With the CBIPO dialogs you can:

- Install a system or subsystem from a CBIPO or redistribution tape.
- Reinstall existing user application programs and user data while installing a new system or subsystem from a CBIPO or redistribution tape.
- Redistribute a system or subsystem by either:
  - Copying the complete system or subsystem to DASD at the same location. This is called *local redistribution*.
  - Copying the complete system or subsystem to tape, transporting it, and installing the copied system or subsystem from the tape onto DASD at either the same location or at a different location. This is called *remote redistribution*.

For both types of redistribution, the data set, DASD, and catalog configuration of the copied system or subsystem need not be the same as the configuration of the original system or subsystem.

- Process I/O definitions for an MVS system that was installed using the CBIPO dialogs:
  - Process an MVSCP deck
  - Include existing IODFs (I/O definition files) for use during IPL and to be copied during reinstall or redistribution processing.
- Connect a previously installed subsystem to another MVS system.

- **Online Books**

Online books will be provided for SMP/E Release 6. These online books can be viewed using IBM® BookManager® READ Release 2.

- **New Packaging for SMP/E Release 6**

SMP/E Release 6 is packaged using data elements. As a result, you can only install SMP/E Release 6 using SMP/E Release 5 or higher. You cannot install SMP/E Release 6 using SMP4 or a release of SMP/E before Release 5.

---

- **SYSMOD Status Report Accuracy**

The accuracy of the SYSMOD Status report has been improved when listing unsatisfied requisite SYSMOD and hold conditions. SMP/E has been enhanced to search beyond the initial point of SYSMOD termination and report on additional requisite SYSMOD and hold conditions that are unresolved for the failing SYSMOD. These conditions, identified with a dash (-) in the SYSMOD Status report, are also identified with additional GIM359xx messages. This enhancement can improve system programmer productivity by reducing the number of times a mass APPLY CHECK or ACCEPT CHECK must be run in order to resolve all conditions required to install the desired SYSMODs.

- **REPLACE Operand on GENERATE Command**

The GENERATE command now provides a new operand, REPLACE, to create copy and link-edit jobs that replace existing members and load modules.

---

Change for Root Cause SPE

- **Root Cause Analysis**

To simplify the process of determining the errors that caused SYSMODs to fail, SMP/E will provide a new report called the Causer SYSMOD Summary report. This report summarizes the messages describing the errors that actually caused the SYSMODs to fail and that must be fixed in order to resolve the problem. The report filters out subsequent messages that are generated because of these initial errors.

The SYSMOD Status report has also been improved:

- For each SYSMOD that failed, the report indicates the ID of the SYSMOD that caused this failure.
- A new statistics section summarizes the number of SYSMODs that were successfully processed and the number of SYSMODs that were not successful.

In addition, messages have been added, reworded, and deleted to provide better information for determining the cause of SYSMOD failure.

The changes for root cause analysis will be available later in a small programming enhancement (SPE). (See the announcement letter for details.) Information about root cause analysis is, however, currently included in the SMP/E manuals. It is clearly marked to indicate that it only applies to the root cause SPE.

---

End of Change for Root Cause SPE

Vertical bars to the left of the text mark all these changes.

---

## Chapter 1. MVS Software Manufacturing Offerings

This chapter introduces the following MVS software manufacturing offerings. It briefly describes the offerings and suggests when to use each one.

- **MVS Custom-Built Installation Process Offering (CBIPO).** This is a software package for creating or replacing an MVS system or subsystem.
- **MVS Custom-Built Product Delivery Offering (CBPDO).** This is a software package for adding or upgrading products or service (or both) on an existing MVS system or subsystem.
- **System Modification Program Extended (SMP/E).** This is a tool for installing and maintaining software, and for managing the inventory of software that has been installed. This software includes CBIPOs and CBPDOs, separately orderable products and service, and user-written software.

### What Is New?

SMP/E Release 6 provides new dialogs for installing CBIPOs.

For a quick comparison of using the new CBIPO dialogs versus using the batch installation process, see Table 2 on page 17.

---

## Introduction

In recent years, the software programs available to MVS users have increased dramatically in number, function, and flexibility. The availability of such a wide variety of offerings and options has increased the complexity of ordering, distributing, installing, customizing, and servicing MVS systems and subsystems.

To make the task of installing and servicing MVS-based systems easier, CBIPOs, CBPDOs, and SMP/E provide the following:

- Wide-ranging product support
- Software packages and tools to support a variety of installation processes such as system replacement, incremental product and service installation, and service-only installation
- Software packages, installation tools, and installation processes that are designed to be used together
- A level of service that is appropriate for the installation package
- Record-keeping and process-control mechanisms to describe software contents precisely and to make sure the correct levels of products and service are installed.

---

## CBIPOs

A CBIPO is a package that helps you create or replace an MVS system or subsystem. For example, you might use a CBIPO to install products that have significant service and function prerequisites, or you might use it if the service level of your system has fallen behind.

CBIPOs are available for MVS, NCP, Data Base Systems (DBS), and CICS. A CBIPO consists of distribution libraries that are customized to the licensed programs you select, as well as related installation materials (RIMs), which are task-oriented documentation, jobs, sample exit routines, procedures, parameters, and examples developed by IBM. The RIMs are designed to help you install, generate, and use your MVS system.

In a CBIPO, all of the products and service you order are in a single integrated set of distribution libraries at a predetermined service level. This service level has been IPL-tested on a number of CBIPO systems with a variety of products before it is made available.

IBM also provides the following installation tools for CBIPOs:

- **CBIPO dialogs.** SMP/E Release 6 contains dialogs for installing and redistributing CBIPO orders, and for optionally reinstalling user application programs and user data from an existing system or subsystem.

**Notes:**

1. If you have SMP/E Release 6, you can use the CBIPO dialogs instead of the batch jobs contained on the RIM tape to install a CBIPO order. However, you cannot use both the RIM batch jobs and the CBIPO dialogs in combination to install the same order; you must use one or the other.
  2. If you do not have SMP/E Release 6, you must use the batch jobs on the RIM tape to install a CBIPO order.
- **CBIPO Process Aids.** These are RIMs for a CBIPO feature, without any product code. You can use the documentation in the Process Aids to plan the installation of a CBIPO, and wait until you are ready to install it before ordering the system itself. This way, the system you install is the latest CBIPO level.  
**Note:** When you order a CBIPO, you automatically get the associated RIMs. Therefore, you do not have to order the Process Aids to get the RIMs for the features you order. You would order the Process Aids only if you want RIMs without the associated product code.
  - **MVS CBIPO Drivers.** A driver is a load-and-go MVS/XA\* or MVS/370 system designed to help you install a CBIPO if you do not already have an MVS system to use as a driver.

---

## CBPDOs

A CBPDO is a package that helps you add or upgrade products or service (or both) on an existing MVS system. (This system may have been created by installing products individually or by installing a CBIPO.) For example, you might use a CBPDO to install a few additional products, or to add new versions or releases of currently installed products, or you might use it to periodically update the service level of your system.

CBPDOs are available for MVS, NCP, DBS, and CICS. A CBPDO may consist of both products and service, or just service. For example, a CBPDO may contain

---

MVS/XA is a trademark of the IBM Corporation.

new products that you are ordering, service for those new products, and service for products you ordered previously and for which you are licensed under a single customer number. It also includes the basic machine-readable documentation that is needed to install the products on your MVS system. Because the level of service in a CBPDO is appropriate for a specific installation package, CBPDOs are recommended instead of program update tapes (PUTs) as the preferred method for maintaining an MVS system.

In a CBPDO, the individual products and service you order are not integrated, but are packaged on a single logical tape (there may be more than one physical reel of tape). The service includes program temporary fixes (PTFs) that are currently available, as well as PTFs that have been approved for distribution but are not yet available on a program update tape (PUT). Because the service is not integrated, it can be removed if a problem occurs after the service is installed. In addition, you can install the CBPDO on a copy of your system (for example, a backup or test system) to protect your running system in the event a problem occurs.

## Which Should You Choose: a CBIPO or a CBPDO?

There may be times when you are not sure whether to use a CBIPO or a CBPDO to update your system. Table 1 briefly compares these two offerings.

CBIPO	CBPDO
Adds a new system or replaces an existing system.	Adds to or upgrades an existing system.
A predetermined service level is integrated in the product distribution libraries.	Service is not integrated.
Provides installation assistance (CBIPO dialogs and RIMs) for system generation, IPL, system installation verification procedures (IVPs), and customization.	Provides assistance (RIMs) through the SMP/E RECEIVE step only.

In deciding whether to replace your system with a CBIPO or upgrade it with a CBPDO, you should also consider the following:

- **Service level of your current system**

The older the service level of your current system, the more you should consider replacing the system, using a CBIPO to minimize time and DASD requirements. Because CBPDO service goes back only two years, it is unsuitable for upgrading a zone or system with a service level that is more than two years old.

- **Number of products to be added or updated**

If the number of products being added or updated is minimal (for example, one or two products) and the change is not complex, you should consider using a CBPDO. If, however, the number of products is large or the change



is complex (for example, migration from MVS/370 to MVS/ESA\*, or from one release of IMS to another), then you should use a CBIPO. The time required to install a large number of products using a CBIPO is usually considerably less than the time required to install the products using a CBPDO or traditional methods.

Because of your unique requirements, you may have to use a CBPDO to install a major system change (rather than use a CBIPO to replace your system). In addition, if your system service level is not reasonably current, you should do the following to minimize requirements for time, DASD resources, and virtual storage:

1. Order and install a service-only CBPDO to bring the service on your system up to the required level.
2. Order and install a CBPDO for the new products to be installed on the system.

- **System programming resources**

If you are new to MVS (or NCP, DBS, or CICS) or have a small staff, then a CBIPO might be your preference because of the CBIPO dialogs, the RIMs and the “cookbook” approach to installation. If, on the other hand, you have a large system programming staff or are very experienced with MVS, the subsystems, and SMP/E, then the choice of offerings should be based on other factors.

Installing a CBPDO requires the same skills and experience traditionally required to install individual products and service. With respect to installation, a CBIPO requires less expertise than a CBPDO.

- **Change control at your installation**

If you are implementing a new change control system at your site or change control in the past has been weak, then a CBIPO is again the better choice because it offers a known starting point. On the other hand, if you already have effective change control procedures in place, make your choice based on other factors.

- **Availability of products**

Products are generally supported sooner through a CBPDO than through a CBIPO. Therefore, if you want to add a particular product to your system as soon as possible, you may choose to order it on a CBPDO rather than wait to order it on a CBIPO.

- **Products or changes not available in a CBIPO**

If your system has a large number of user modifications or contains a large number of products that are not available in a CBIPO, then a CBPDO is probably the better choice. Remember, because a CBPDO updates your existing system instead of replacing it, your user modifications and other products may be preserved.

Each offering has different strengths and, for a given situation, one of the offerings will be the better choice. Each time you order products, review the consid-

---

MVS/ESA is a trademark of the IBM Corporation.

---

erations above along with any that are unique to your site, then order the offering best suited to your needs at that time.

---

## SMP/E

SMP/E is a tool that helps you install and maintain products and service by selecting the correct level of change, calling the utility programs to install the changes, and recording the changes that were made. SMP/E can also be used to manage the inventory of software that has been installed. It is an integral part of the installation, service, and maintenance processes for CBIPOs and CBPDOs. In addition, SMP/E can be used to install and service any software that is packaged in SMP/E system modification (SYSMOD) format.

SMP/E can be run using either batch jobs or using dialogs under ISPF/PDF. Two types of dialogs are provided by SMP/E:

- **CBIPO dialogs.** These are new dialogs for installing and redistributing CBIPO orders (instead of using the batch jobs provided in the CBIPO RIMs). The CBIPO dialogs are available only in SMP/E Release 6.
- **SMP/E dialogs.** These are dialogs that help you interactively query the SMP/E data base, as well as create and submit jobs to process SMP/E commands. The SMP/E dialogs are available in SMP/E Release 6, as well as in previous releases.



---

## Chapter 2. CBIPO Summary

This chapter provides a summary of CBIPOs. It briefly describes:

- What a CBIPO is
- CBIPO features
- Contents of a CBIPO
- How to order a CBIPO
- How a CBIPO is created
- Installation requirements for CBIPOs
- How to install a CBIPO.

---

### What Is a CBIPO?

A CBIPO is a software package for creating or replacing an MVS system or subsystem. It makes software installation easier by helping you to:

- Order a selection of products that reflects your installation's unique requirements
- Receive your selected products with PTF service already integrated
- Design, install, and maintain your system and subsystems using the documentation and examples in the related installation materials (RIMs).

CBIPO are designed to:

- Offer you flexibility in selecting the product set to support your MVS installation
- Deliver your selected IBM\* licensed programs with PTF service already integrated, reducing the need for you to research and apply a large volume of PTF service as part of your installation process
- Help your system programmers make decisions regarding system design and configuration that will make subsequent additions to your installation easier
- Provide an installation approach that will make future reinstallations of MVS and its subsystems easier
- Reduce the stand-alone machine time required to install your systems, and to use, wherever possible, your existing system and tools
- Help you choose the number of DASD volumes required to install your system or subsystem
- Isolate the installation activities associated with MVS and each of its subsystems, while allowing the installation tasks for each feature to proceed in parallel
- Provide a documented, step-by-step approach to building your system
- Reduce the number of non-installation-dependent options and parameter decisions you have to research, implement, and test

---

IBM is a trademark of the IBM Corporation.

- Provide installation JCL and a process that makes it easy to modify and use
- Provide a functional system, generated from your CBIPO distribution libraries, that you can tune and customize to your installation's requirements
- Provide procedures to verify that your basic system or subsystem is operational
- Provide guidance in the additional post-installation steps you will need to perform to customize your system or subsystem following the CBIPO installation process.

---

### CBIPO Features

CBIPO consists of four separately orderable features. These features parallel four of the system release identifiers (SRELs) used by SMP/E to install products and service in the MVS environment.

- **MVS.** This includes MVS/Enterprise Systems Architecture (MVS/ESA), MVS/Extended Architecture (MVS/XA), or MVS/370, and the associated IBM system control program (SCP) and licensed programs.
- **Network Control Program (NCP).** This includes Advanced Communications Function for NCP (ACF/NCP) and associated IBM licensed programs.
- **Data Base Systems (DBS).** This includes Information Management System (IMS), DATABASE 2\* (DB2\*), and associated IBM licensed programs.
- **Customer Information Control System (CICS).** This includes CICS and associated IBM licensed programs.

For each feature, you select from a large number of SMP/E-installable IBM licensed programs that run in the MVS environment. You receive them integrated with their PTF service in a distribution library (DLIB) customized to the products you select. There are advantages to grouping products into these features:

- Related IBM SCP and licensed programs can be installed and managed as a group.
- Related IBM SCP and licensed programs can be serviced together.
- The features correspond to the management structure of many current installations.
- The activities required to install a complete system are divided into manageable units.

---

### Contents of a CBIPO

When you order a CBIPO feature, you receive a hard-copy *MVS CBIPO Memo to Users*, a *Programming Shipping Request* (packing list), and three or more tapes:

- The DLIB tapes
- The RIM tape
- The SERV tapes.

---

DATABASE 2 and DB2 are trademarks of the IBM Corporation.

The *Memo to Users* describes how to start the CBIPO installation process. The *Programming Shipping Request* describes the tapes, their standard internal labels or volume serial numbers, and external labels.

Figure 1 briefly reviews the contents of the tapes you receive for a CBIPO feature.

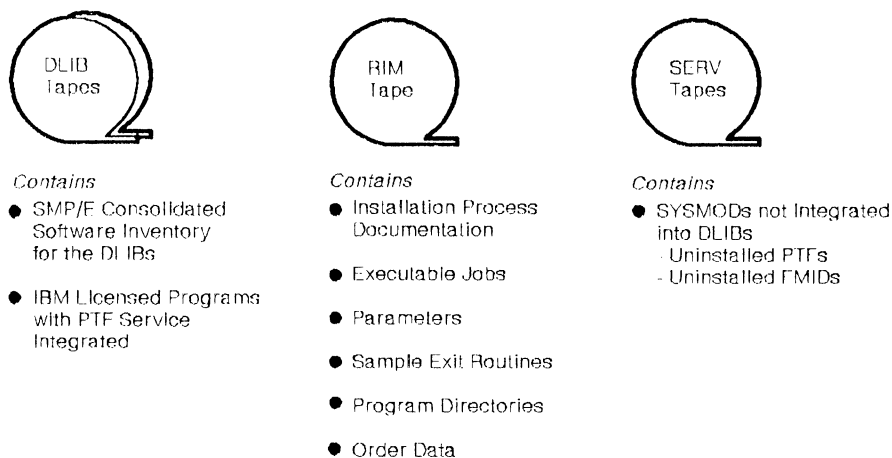

Figure 1. Tapes for a CBIPO Feature

## The DLIB Tapes

The DLIB tapes contain the following data sets, customized to the products you select:

- Distribution libraries (DLIBs) for the specified products, with the PTF service integrated
- The SMPCSI data set for the DLIBs.

## The RIM Tape

The RIM tape contains installation-process documentation, as well as jobs, parameters, and sample exit routines. More specifically, it provides the following:

- An *MVS CBIPO Memo to Users Extension* containing a customized description of the contents of your CBIPO order.
  - Note:** The *Memo to Users Extension* is the only CBIPO document that is customized to the contents of your CBIPO order.
- A job to print selected documents on the RIM tape.
- Jobs to allocate and load selected files from the RIM tape.
- Jobs to allocate space on the target system volumes.
- The softcopy program directories associated with the products you selected.
- Cover letters for selected PTFs.
- The publication *MVS CBIPO System Design Reference* and the installation guide for the feature.
- The CBIPO print program.

- The jobs and additional documents needed to install and customize the CBIPO feature.
- *Order data*, which describes the contents of your CBIPO order. This data is used by the CBIPO dialogs in SMP/E Release 6. It consists of:
  - The names of the products in the order.
  - The FMIDs that make up the products in the order.
  - The name of the feature to which the order applies.
  - Descriptions of one or more default configurations on which the order may be installed.

A *configuration* describes the DASD layout on which a CBIPO order may be installed. It defines data set names and space allocations, the volumes where the data sets reside, and the catalogs where the data sets are defined. User-defined configurations for actual customer systems are created based on default configurations shipped with the order.

### The SERV Tapes

The SERV tapes contain functions and service that were not integrated into the DLIBs. (There may be more than one physical SERV tape.) Specifically, SERV tapes provide:

- **Uninstalled function SYSMODs.** These SYSMODs are parts of a licensed program you selected that your particular product mix does not require. For example, the SERV tapes would include function SYSMODs that require unavailable prerequisite licensed programs not included in your product mix, or function SYSMODs that are mutually exclusive with other function SYSMODs in your product mix.
- **PTF SYSMODs**, such as:
  - PTFs with unresolved error holds (PTFs-in-error, or PEs)
  - PTFs with unresolved system holds
  - PTFs in PE chains and system hold chains
  - PTFs from PUT tapes more current than those integrated into your CBIPO DLIBs
  - PTFs not yet available on a PUT but approved for distribution.

For more information on using the SERV tapes, see the publication *MVS Custom-Built Offerings Planning and Installation*.

---

### Ordering a CBIPO

The CBIPO ordering process is designed to accommodate the wide variety of options available to you in the CBIPO features. It also makes it easy for you to select specific products.

---

## Getting Information about CBIPOs

One source of information about a CBIPO feature is the order checklist. The checklist identifies the IBM products and release levels currently available for each feature. There is also a HONE NEWS file that identifies products added since the last CBIPO release and the PTF service level. It should be used for information and planning purposes.

The order checklist is updated as new products and service become available. Likewise, the HONE NEWS file is updated as RIMs, enhancements to the CBIPO features, and changes to the supported product set become available. Copies of the order checklist and the NEWS file are available from your IBM representative.

## Placing Your Order

When you are ready to place an order, your IBM representative will provide you with a current order checklist that identifies the IBM licensed programs and release levels currently available for the feature (MVS, NCP, DBS, or CICS) you wish to install. Available programs are identified within the order checklist by their program and feature numbers.

When you have completed the checklist for a feature, return it to your IBM representative for processing.

Each CBIPO feature must be ordered separately. Orders for each CBIPO feature must include certain specific products:

- **MVS feature for MVS/ESA.** Orders for a CBIPO MVS feature for MVS/ESA must include the currently supported level of MVS/SP Version 3 or MVS/ESA SP Version 4, MVS/ESA DFP, and SMP/E.
- **MVS feature for MVS/XA.** Orders for a CBIPO MVS feature for MVS/XA must include the currently supported level of MVS/SP Version 2, MVS/XA DFP, and SMP/E.
- **MVS feature for MVS/370.** Orders for a CBIPO MVS feature for MVS/370 must include the currently supported level of MVS/SP\* Version 1, MVS/370 Data Facilities Product (DFP), and SMP/E.
- **NCP feature.** Orders for a CBIPO NCP feature must include a currently supported level of ACF/SSP and the appropriate corresponding level of ACF/NCP.
- **DBS feature.** Orders for a CBIPO DBS feature must include (as a minimum) a currently supported level of IMS or DB2.
- **CICS feature.** Orders for a CBIPO CICS feature must include a currently supported level of CICS.

**Note:** All the CBIPO features except the MVS feature for MVS/370 can be installed using either the CBIPO dialogs or the CBIPO batch installation process. The MVS feature for MVS/370 can be installed only with the CBIPO batch installation process.

---

MVS/SP is a trademark of the IBM Corporation.



## Some Points to Remember

- When you place an order for a CBIPO feature, make sure you are using a current order checklist. This ensures that the products you order match the products currently available in a CBIPO.
- If you wish to install the most current PTF service available in a CBIPO, avoid ordering your CBIPO too far in advance of your planned installation date.
- To receive any of the IBM licensed programs available in a CBIPO, you must be licensed for those programs and applicable features under the same customer number for which you are ordering the CBIPO. Licensing can be done at the time you place your CBIPO order, by marking a field on the CBIPO order checklist. The marked and signed checklist informs your IBM representative that you wish to be licensed for a particular licensed program.

---

## How a CBIPO Is Created

Each CBIPO is produced in response to a specific customer order. The DLIBs contain the products that were selected, and the RIMs are tailored to support those products. For example, jobs to allocate and load the DLIBs will correspond to the products that were ordered.

IBM uses a software manufacturing process to build and package your CBIPO according to information you have provided on an order checklist. Figure 2 on page 13 shows this process.

To produce CBIPOs, IBM maintains a data base that contains:

- The IBM SCP and licensed programs supported for MVS systems and sub-systems.
- PTF service for the products. The service level of your CBIPO is identified by a PUT service level.
- The IBM-developed materials that are delivered to assist you in the installation and use of your system or subsystem.

These materials include installation procedures, sample JCL, job streams, and order data. All of these installation materials can easily be modified to meet your particular needs by using either:

- The CBIPO dialogs in SMP/E Release 6

With the CBIPO dialogs you can change information such as data set names, space allocations, DASD volumes, and catalogs. Extensive options are available for tailoring data as necessary.

- A CBIPO-supplied program called IPOUPDTE.

With IPOUPDTE you can change parameters such as volume names and types.

The CBIPO-developed materials for MVS features are based on an integrated system known as the model installation. The model installation system is an MVS/ESA SP Version 4 JES2 system at the current CBIPO level. It is used by IBM to carry out, document, and package the processes used to install MVS and related licensed programs available in a CBIPO. The IBM CBIPO development group's experience in customizing and using this system provides

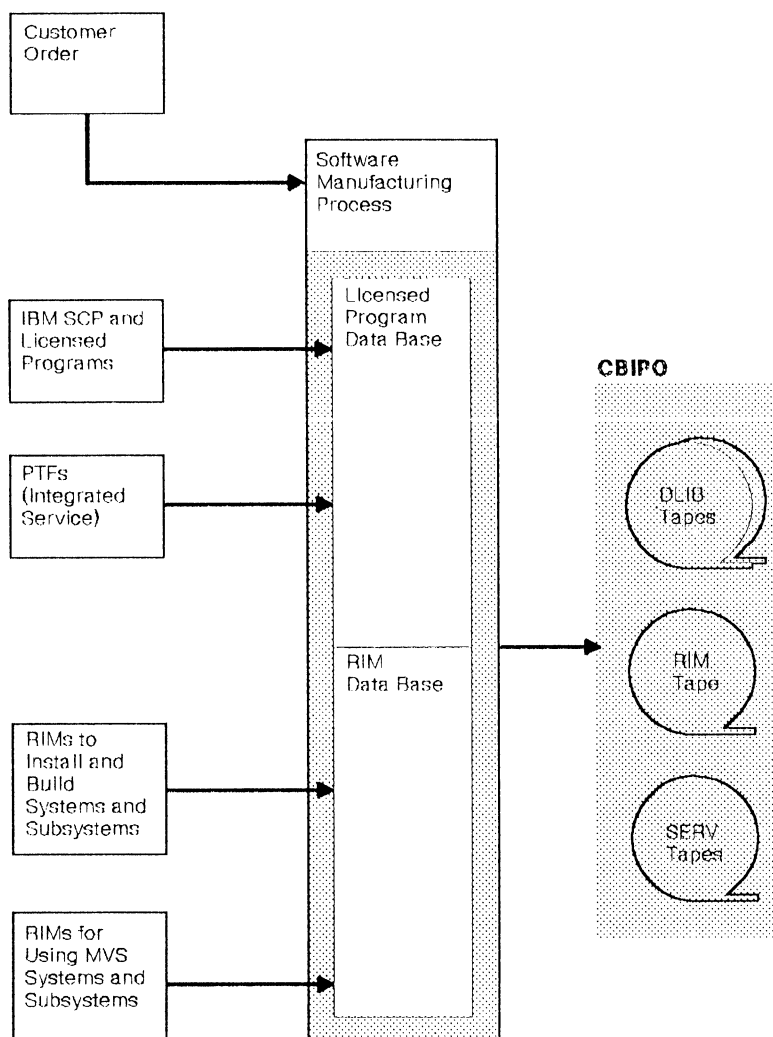

Figure 2. How a CBIPO Is Created

the basis for the system installation and maintenance philosophy of the CBIPO offerings. In addition, the model installation is used to create the CBIPO Process Aids for the MVS feature. The Process Aids are described on page 37.

IBM uses SMP/E as it fills each CBIPO order by building DLIBs containing the requested set of products with their PTF service integrated. RIMs for each order are built from the RIM data base. Certain SYSMODs are identified in the data base and may be shipped as part of your order, but are not integrated into your DLIBs. Instead, they are shipped on the SERV tape, which is described on page 10.

## CBIPO Requirements

Before installing a CBIPO, you should be aware of the requirements for:

- Programming
- Hardware
- Education.

## Programming Requirements

You must be licensed for SMP/E to order a CBIPO.

The following products must be installed on the driving system used to install a custom-built offering:

- One of the following: MVS/System Extensions Release 1 or 2, MVS/370 (MVS/SP Version 1), MVS/XA (MVS/SP Version 2), or MVS/ESA (MVS/SP Version 3 or MVS/ESA SP Version 4).
- JES2 or JES3 as the job entry subsystem.
- The Device Support Facilities program. This is used by the CBIPO dialogs contained in SMP/E Release 6 and the CBIPO RIM batch jobs to initialize DASD, create VTOCs, and perform other utility functions during system installation.
- To install integrated catalog facility (ICF) catalogs on your new system, the driving system must include either MVS/370 DFP, MVS/XA DFP, MVS/DFP\*, or data facility extended function (DFEF).

**Note:** You do not need to convert all the catalogs on your driving system to ICF. However, you **should** try to convert your catalogs to ICF. Jobs are supplied on the MVS RIM tape to help you do this.

- To use the IODF option when installing an order containing MVS/ESA SP Version 4, the driving system must contain DFP Version 2 Release 3 (MVS/XA DFP) or higher.
- SMP/E. The specific level of SMP/E required on your driving system depends on the type of feature you are installing:
  - For MVS features, any supported level of SMP/E is allowed. This is because a CBIPO order for an MVS feature must always include SMP/E. The installation process for the MVS feature makes batch SMP/E (without any dialogs) available to the driving system as part of the installation process.
  - For subsystem features, the minimum required level of SMP/E is Release 5.

### Notes:

1. SMP/E Release 6 is required on your driving system if you plan to use the CBIPO dialogs to install CBIPO orders. To install SMP/E Release 6 on your driving system, you can do one of the following:
  - Order SMP/E Release 6 in a CBPDO and install it using the SMP/E dialogs or SMP/E batch jobs. (You must use SMP/E Release 5 or later to install SMP/E Release 6.)
  - Order SMP/E Release 6 when it is available in a CBIPO and install the entire order using the RIM batch jobs.
  - Order and install a CBIPO driver when SMP/E Release 6 is available in a CBIPO.

---

MVS/DFP is a trademark of the IBM Corporation.

Additional programs are required in order to use the CBIPO dialogs in SMP/E Release 6. See "Programming Requirements" on page 32 for details.

2. Subsystem orders can be installed using the CBIPO dialogs regardless of whether the driving system was installed using the CBIPO dialogs.
  3. All the CBIPO features except the MVS feature for MVS/370 can be installed using either the CBIPO dialogs or the CBIPO batch installation process. The MVS feature for MVS/370 can be installed only with the CBIPO batch installation process.
- The installation process makes Assembler H and the MVS/XA linkage editor available to the driving system when installing MVS/XA or MVS/ESA.

For information about any additional requirements for the products in a CBIPO order, see the announcement material for those products.

## Hardware Requirements

You can run the CBIPO installation process on any hardware configuration capable of running MVS, provided the configuration has at least the following:

- One 6250-bpi tape drive or one 3480 tape drive.
- Sufficient 3350, 3375, 3380, or 3390 DASDs to hold the MVS system, RIM data sets, DLIB, and catalog volume data sets used in the installation process. These CBIPO volumes are in addition to those required to run your driving MVS (including DASD storage required for MVS work data sets and other temporary storage) on your configuration.

**Note:** The CBIPO DASD requirements may vary depending on your DASD types, your mix of products, and your performance criteria.

*MVS CBIPO System Design Reference* discusses this topic in detail, and the *MVS CBIPO Memo to Users Extension* provides estimates of the DASD space requirements for your particular order. (These documents are provided in the CBIPO RIMs.)

- One or more terminals. The CBIPO jobs are designed to be edited and submitted from TSO or another online interactive system. A terminal can be used to view the CBIPO documentation online.
- One printer. Since the CBIPO documentation is distributed in mixed case, your printer should have the capability to print both uppercase and lowercase. The documentation can, however, be printed in uppercase only.

## Education Requirements

The person responsible for planning and installing a CBIPO feature should be familiar with:

- The MVS area of responsibility (for example, MVS, NCP, IMS, DB2, CICS, JES)
- Job control language
- SMP/E concepts
- MVS utilities
- ISPF (if used)

- ISPF/PDF (if used).

For more information about recommended education for CBIPOs, CBPDOs, and SMP/E, see Table 5 on page 41.

---

## Installing a CBIPO

### What Is New?

SMP/E Release 6 provides new dialogs for installing CBIPOs.

For a quick comparison of using the new CBIPO dialogs versus using the batch installation process, see Table 2 on page 17.

The CBIPO installation process is designed to provide you with a system or subsystem that is capable of running an installation verification procedure (IVP).

There are several sources of information to help you install your order:

- The publication *MVS Custom-Built Offerings Planning and Installation* and the RIMs provide planning information to help you design your system, as well as documentation and jobs to guide you step-by-step through the installation process.
- The CBIPO dialogs in SMP/E Release 6 contain an online tutorial that briefly describes how to use the CBIPO dialogs in SMP/E Release 6 to install, reinstall, and redistribute CBIPO orders.
- The *SMP/E CBIPO Dialogs User's Guide* explains in greater detail how to use the CBIPO dialogs in SMP/E Release 6 to install, reinstall, and redistribute CBIPO orders. For beginning dialog users, it describes concepts unique to the CBIPO dialogs, as well as scenarios, dialog functions, and hints and tips. It also covers advanced topics for experienced dialog users.

Sometimes, you will have to customize specific products to make those products ready to use and to meet your installation's specific requirements. The RIMs for many of those products include customization and use guides to help you tailor your system.

You can install CBIPO orders with either:

- The CBIPO dialogs in SMP/E Release 6
- The CBIPO batch installation RIMs using SMP/E Release 5 or higher.

### Notes:

1. If you have SMP/E Release 6, you can use either the CBIPO dialogs or the batch jobs contained on the RIM tape to install a CBIPO order. However, you cannot use both the RIM batch jobs and the CBIPO dialogs in combination to install the same order; you must use one or the other.
2. If you do not have SMP/E Release 6, you must use the batch jobs contained on the RIM tape to install a CBIPO order.

Both the CBIPO dialogs and the batch jobs use the SMP/E GENERATE command to improve installation processing. See the following sections for more information on the SMP/E GENERATE command.

## Which to Use: the CBIPO Dialogs or the CBIPO Batch Jobs?

The CBIPO installation process is designed to reduce the system programmer effort required to install systems and subsystems. The assistance provided by the CBIPO batch jobs is further enhanced by the CBIPO dialogs. Table 2 compares the advantages of using the CBIPO dialogs over using the CBIPO batch installation process supported by the RIMs. For more information about what you can do with the CBIPO dialogs, see Table 3 on page 28.

Table 2 (Page 1 of 2). Using the CBIPO Dialogs versus Using the CBIPO Batch Jobs

Category	Using the CBIPO Dialogs	Using the CBIPO Batch Jobs
Installation options	<p>With the CBIPO dialogs you can:</p> <ul style="list-style-type: none"> <li>• Install a system or subsystem from a CBIPO or redistribution tape.</li> <li>• Reinstall existing user application programs and user data while installing a new system or subsystem from a CBIPO or redistribution tape.</li> <li>• Redistribute a system or subsystem by either:               <ul style="list-style-type: none"> <li>– Copying the complete system or subsystem to DASD at the same location. This is called <i>local redistribution</i>.</li> <li>– Copying the complete system or subsystem to tape, transporting it, and installing the copied system or subsystem from the tape onto DASD at either the same location or at a different location. This is called <i>remote redistribution</i>.</li> </ul> </li> </ul> <p>For both types of redistribution, the data set, DASD, and catalog configuration of the copied system or subsystem need not be the same as the configuration of the original system or subsystem.</p> <ul style="list-style-type: none"> <li>• Process an MVSCP deck or IODF (I/O definition file) for an MVS system that was installed using the CBIPO dialogs.</li> <li>• Connect a previously installed subsystem to another MVS system.</li> </ul>	<p>With the CBIPO batch jobs you can:</p> <ul style="list-style-type: none"> <li>• Install a system or subsystem from a CBIPO tape.</li> <li>• Process an IOGEN deck, MVSCP deck, or IODF (I/O definition file) for an MVS system.</li> </ul> <p>In addition, you can copy a system by tailoring the JCL sample provided in the RIMs.</p>

Table 2 (Page 2 of 2). Using the CBIPO Dialogs versus Using the CBIPO Batch Jobs

Category	Using the CBIPO Dialogs	Using the CBIPO Batch Jobs
Customization	<ul style="list-style-type: none"> <li>• The dialogs are used to customize the configuration on which an order is to be installed.</li> </ul> <p>Users can change information about data set names, space allocations, volumes on which data sets reside, and catalogs where data sets are defined.</p> <p>Extensive options are available for tailoring as generally or as specifically as necessary.</p> <ul style="list-style-type: none"> <li>• Input is validated as it is entered, which helps eliminate JCL errors.</li> </ul>	<ul style="list-style-type: none"> <li>• IPOUPDTE can be used to change certain parameters in the RIM jobs (such as volume names and types), or the JCL can be changed directly.</li> <li>• Input is not validated by IPOUPDTE. Input errors may result in JCL errors.</li> </ul>
System programmer effort	<ul style="list-style-type: none"> <li>• Most job streams can be automatically submitted. The user does not have to be there to submit them.</li> <li>• The dialogs save the configurations, so they can be used across orders. Users do not need to respecify input for each CBIPO order.</li> <li>• The dialogs can merge user data when a new system or subsystem is installed. For example, it can include user data sets and generate JCL to reinstall user modifications.</li> </ul>	<ul style="list-style-type: none"> <li>• Job streams must be manually submitted. The user must be there to submit them.</li> <li>• Users need to respecify input for each CBIPO order.</li> <li>• Users must manually process user data when a new system or subsystem is installed. For example, they must import catalogs and reinstall user modifications.</li> </ul>

## The SMP/E GENERATE Command

The SMP/E GENERATE command is used to install the products in a CBIPO order. The GENERATE command uses product-specific JCLIN that was generated for your order by the software manufacturing process to install all of the programs in your CBIPO (including those that do not have SYSGEN support) into your target libraries. Using the GENERATE command provides a number of advantages:

- You no longer need to run many product-specific post-SYSGEN installation jobs.
- The installation process generally takes less time than running SYSGEN and post-SYSGEN jobs. This is because the GENERATE command tailors the job stream it creates for maximum efficiency by eliminating duplicate or unnecessary steps that sometimes occur in normal SYSGEN processing.
- You no longer need to edit product-supplied Stage 2 job streams to match your installation's data set names or unit and volume serial numbers. GENERATE uses the information supplied to either the CBIPO dialogs or the IPOUPDTE program to create a job stream.
- The GENERATE command produces a summary report that lists the utilities and libraries used in the job stream, which elements go in which libraries, and which modules are included in each load module.

---

## Chapter 3. CBPDO Summary

This chapter provides a summary of CBPDOs. It briefly describes:

- What a CBPDO is
- CBPDO features
- Contents of a CBPDO
- How to order a CBPDO
- How a CBPDO is created
- Installation requirements for CBPDOs
- How to install a CBPDO.

---

### What Is a CBPDO?

A CBPDO is a software package for adding to or updating an existing MVS system or subsystem. It makes software installation easier by helping you to:

- Order a selection of products to extend the function of your existing MVS system
- Order service for all the products for which you are licensed under a single customer number
- Obtain the basic machine-readable material needed to install the products and service onto your MVS system.

CBPDOs are designed to:

- Provide the basic machine-readable material necessary to install products and PTF service on your MVS system
- Offer you a choice in selecting and installing the products and PTF service level to support your MVS installation
- Allow you to incrementally upgrade your MVS system with products and PTF service
- Deliver your selected IBM licensed programs with currently available PTF service unintegrated, reducing the need for you to research and separately obtain a large volume of PTF service as part of your installation process
- Deliver service approved for distribution but not yet available on a PUT.

---

### CBPDO Features

CBPDO consists of four separately orderable features:

- **MVS.** This includes MVS/Enterprise Systems Architecture (MVS/ESA), MVS/Extended Architecture (MVS/XA), or MVS/370, and the associated IBM system control program (SCP) and licensed programs.
- **NCP.** This includes ACF/NCP and associated IBM licensed programs.
- **DBS.** This includes IMS, DB2, and associated IBM licensed programs.
- **CICS.** This includes CICS and associated IBM licensed programs.



For each feature, you select from a large number of SMP/E-installable IBM licensed programs that run in the MVS environment. There are advantages to grouping products into these features:

- Related IBM SCP and licensed programs can be shipped together.
- The PTF service for the related IBM SCP and licensed programs can be shipped with the associated programs.
- The features correspond to the management structure of many current installations. This allows the installation tasks for each feature to proceed in parallel.

---

### Contents of a CBPDO

When you order a CBPDO feature, you receive an *MVS CBPDO Memo to Users*, a *Programming Shipping Request* (packing list), and one or more CBPDO tapes.

The *Memo to Users* describes how to start the CBPDO installation process. The *Programming Shipping Request* describes the tapes, their standard internal labels or volume serial numbers, and external labels.

**Note:** Other product materials, such as basic publications, are shipped to you just as they are when you order an individual product. However, they are delivered separately from your CBPDO tapes.

### The CBPDO Tapes

The CBPDO tapes contain:

- A *Memo to Users Extension*, with a customized description of the contents of your CBPDO.
- A sample job to receive products and PTF service.
- The softcopy program directories associated with the products you selected.
- Preventive service planning (PSP) information. This includes the following:
  - An individual PSP upgrade file for each PUT service level on the CBPDO tape
  - The available PSP upgrade and subset files for each product on the CBPDO tape
  - PSP information for upgrade CORPE
  - A cross-reference of PTFs referred to in the upgrades
- The SMP/E modification control statements (MCS) for products and PTF service on the CBPDO tapes.
- A customer-specified set of IBM SCP and licensed programs for a single feature, with currently available PTF service for all licensed programs within that feature for which you are licensed, in SMP/E relative file format.

**Note:** The service is not integrated into the products.

The *Memo to Users Extension* is the only CBPDO document that is customized to the contents of your CBPDO. It contains a complete list of the contents of the package, including:

- A list of products by name, order number, and feature code
- A list of the copyrighted licensed programs in the package
- Volume serial numbers of the tapes contained in the package
- A list of the FMIDs contained in the package
- The PTF service levels contained in the package
- Driving system dependencies for the installation process
- Instructions for installing and servicing SMP/E in an established SMP/E environment.

---

## Ordering a CBPDO

The CBPDO ordering process is designed to accommodate the wide variety of options available to you in the CBPDO features. It also makes it easy for you to select specific products and service.

## Getting Information about CBPDOs

One source of information about a CBPDO feature is the order checklist. The checklist identifies the IBM products and release levels currently available for each feature and is updated as new products and service become available. There is also a HONE NEWS file that identifies additional products being supported and products that are deleted. It should be used for information and planning purposes.

The order checklist is updated as new products and releases become available. Likewise, the HONE NEWS file is updated as new enhancements to the CBPDO features and changes to the supported product set become available. Copies of the NEWS file and the order checklist are available from your IBM representative.

## Placing Your Order

When you are ready to place an order, your IBM representative will provide you with a current order checklist that identifies the IBM licensed programs and release levels currently available for the feature (MVS, NCP, DBS, or CICS) you wish to install. Available programs are identified within the order checklist by their program and feature numbers.

You have two options when ordering a CBPDO: you can get products plus service, or service only. With both of these options, you automatically receive service for the products for which you are already licensed under a single customer number for a single feature—**you do not have to check off these products to get service for them.**

The amount of service you receive in your CBPDO depends on whether you select a service level and whether this is your first CBPDO order:

- If you select a PUT service level on the order checklist, you will get all service from that level to the current level.
- If you do not select a service level and this is your first CBPDO order, you will get all the service shown on the order checklist.
- If you do not select a service level and you have ordered a CBPDO before, you will get service following the PUT service level that was shipped in your previous CBPDO.

**Note:** The service level of your system must not be more than two years behind the currently available PUT. (Service in a CBPDO does not go back more than two years.)

If you order products and service, the level of service provided for the new products you order will be the earliest of the following:

- The level of service integrated into the product (the SUP level of the product) in the software manufacturing data base
- The service level you specified on the order checklist.

**Note:** A CBPDO order is based on the total set of products for which you are licensed under a single customer number. It does not reflect the contents of any specific system within the establishment defined by that customer number. For example, the same establishment may have MVS/XA on one system and MVS/370 on another system, and be licensed for both under the same customer number. In this case, service for both MVS/XA and MVS/370 will be included in the CBPDO order.

When you have completed the checklist for a feature, return the checklist to your IBM representative for processing.

**Note:** In the United States, you can place your order for a service-only CBPDO by calling the IBM Support Center (1-800-237-5511).

Each CBPDO feature must be ordered separately. You can order products and service, or service only, for any of these features:

- MVS
- NCP
- DBS
- CICS.

## Some Points to Remember

- When you place an order for a CBPDO feature, make sure that you are using a current order checklist. This ensures that your order content matches the current CBPDO-supported product set.
- If you wish to install the most current PTF service level available in a CBPDO, avoid ordering your CBPDO too far in advance of your planned installation date.
- To receive any of the IBM licensed programs available in a CBPDO, you must be licensed for those programs and applicable features under the same customer number for which you are ordering the CBPDO. Licensing can be done at the time you place your CBPDO order by marking a field on the

CBPDO order checklist. The marked and signed checklist informs your IBM representative that you wish to be licensed for a particular licensed program.

## How a CBPDO Is Created

Each CBPDO is produced in response to a specific customer order. The products, service, program directories, and *Memo to Users Extension* are tailored to the products that were selected, as well as to products for which you are already licensed under a single customer number.

IBM uses a software manufacturing process to build and package your CBPDO according to information you have provided on an order checklist. Figure 3 shows this process.

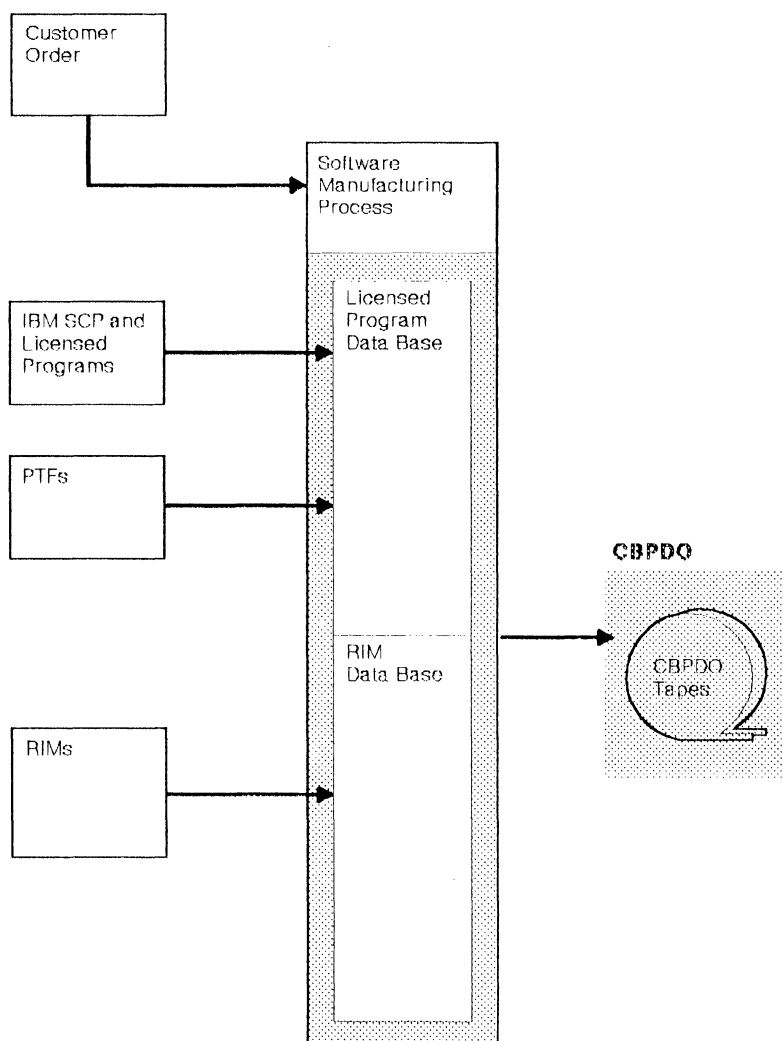

Figure 3. How a CBPDO Is Created

To produce CBPDOs, IBM maintains a data base that contains:

- The IBM SCP and licensed programs supported for MVS systems and sub-systems.

- PTF service for the products. This service is not integrated into the products in your CBPDO. The service level of your CBPDO is identified by the PUT service levels included.
- The year plus the week number. This indicates when the service was added to the CBPDO data base (for example, 9002 for the second week of 1990). The year and week number, together with the PUT service level, identifies the service level of the CBPDO.
- The IBM-developed materials that are delivered to assist you in receiving your products and PTF service.

---

### CBPDO Requirements

Before installing a CBPDO, you should be aware of the requirements for:

- Programming
- Hardware
- Education.

### Programming Requirements

You must be licensed for SMP/E to order a CBPDO.

The following products must be installed on the driving system used to install a CBPDO:

- MVS Release 3.8 or above. This includes MVS/System Extensions Release 1 or 2, MVS/370 (MVS/SP Version 1), MVS/XA (MVS/SP Version 2), or MVS/ESA (MVS/SP Version 3 or MVS/ESA SP Version 4).
- SMP/E. The minimum required level of SMP/E is Release 5.

**Note:** If your driving system has an earlier release of SMP/E, you can do one of the following:

- Order SMP/E as part of a CBIPO MVS feature.
- Order and install a CBIPO driver.

You must have an established SMP/E environment to install a CBPDO. There are no CBPDO jobs or documentation to help you migrate from SMP4 to SMP/E.

If you plan to use the SMP/E dialogs to install a CBPDO, additional programs are required. See "Programming Requirements" on page 32 for details.

### Hardware Requirements

To install a CBPDO, you must have the following:

- One 6250-bpi tape drive or one 3480 tape drive.
- DASD and other devices (such as a terminal or printer) as required by the products in your CBPDO.

## Education Requirements

Installing a CBPDO requires the same skills and experience required to install individual products and service. The person responsible for planning and installing a CBPDO feature should be familiar with:

- The MVS area of responsibility (for example, MVS, NCP, IMS, DB2, CICS, JES)
- Job control language
- SMP/E concepts related to the installation of individual products and service
- MVS utilities
- ISPF (if used)
- ISPF/PDF (if used).

For more information about recommended education for CBIPOs, CBPDOs, and SMP/E, see Table 5 on page 41.

---

## Installing a CBPDO

The CBPDO installation process is designed to help you receive products and service into your SMPPTS data set. From that point on, you can use standard SMP/E methods to install the products and service. There are SMP/E dialogs to help you install CBPDO tapes. The publication *MVS Custom-Built Offerings Planning and Installation* provides information to help you plan for installing a CBPDO.



---

## Chapter 4. SMP/E Summary

This chapter provides a summary of SMP/E. It briefly describes:

- What SMP/E is
- What system modifications are
- The data sets used by SMP/E
- The basic ways of using SMP/E processes
- Installation requirements and considerations for SMP/E.

### What Is New?

SMP/E Release 6 provides new dialogs for installing CBIPO orders.

For a quick comparison of using the new CBIPO dialogs versus using the batch installation process, see Table 2 on page 17.

---

### What Is SMP/E?

SMP/E is the basic tool for installing and maintaining software in MVS systems and subsystems. It controls these changes at the element level by:

- Selecting the proper levels of elements to be installed from a large number of potential changes
- Calling system utility programs to install the changes
- Keeping records of the installed changes.

SMP/E can be run using either batch jobs or using dialogs under ISPF/PDF. Two types of dialogs are provided by SMP/E:

- **CBIPO dialogs.** These are new dialogs for installing and redistributing CBIPO orders (instead of using the batch jobs provided in the CBIPO RIMs). The CBIPO dialogs are available only in SMP/E Release 6.
- **SMP/E dialogs.** These are dialogs that help you interactively query the SMP/E data base, as well as create and submit jobs to process SMP/E commands. The SMP/E dialogs are available in SMP/E Release 6, as well as in previous releases of SMP/E.

Table 3 on page 28 summarizes what you can do with the CBIPO dialogs and the SMP/E dialogs.



Table 3. What You Can Do with the CBIPO Dialogs and the SMP/E Dialogs

With the CBIPO Dialogs You Can:	With the SMP/E Dialogs You Can:
<ul style="list-style-type: none"> <li>• Read in RIMs and order data from CBIPO and redistribution tapes</li> <li>• Print documents on CBIPO and redistribution tapes</li> <li>• Create and customize layouts of the data set, catalog, and DASD configurations upon which a CBIPO order can be installed</li> <li>• Install a system or subsystem from a CBIPO or redistribution tape</li> <li>• Reinstall existing user application programs and user data while installing a new system or subsystem from a CBIPO or redistribution tape</li> <li>• Redistribute a system or subsystem by either:               <ul style="list-style-type: none"> <li>– Copying the complete system or subsystem to DASD at the same location (<i>local redistribution</i>)</li> <li>– Copying the complete system or subsystem to tape, transporting it, and installing the copied system or subsystem from the tape onto DASD at either the same location or at a different location (<i>remote redistribution</i>)</li> </ul> </li> <li>• Process an MVSCP deck or IODF (I/O definition file) for an MVS system that was installed using the CBIPO dialogs</li> <li>• Connect a previously installed subsystem to another MVS system</li> <li>• Customize how your display panels will appear when you are running the CBIPO dialogs</li> <li>• Customize the CBIPO dialog defaults used for:               <ul style="list-style-type: none"> <li>– Job card conventions</li> <li>– Tape expiration date for tape data sets</li> <li>– Write-to-operator messages for mounting tapes</li> </ul> </li> <li>• Learn how to use the CBIPO dialogs</li> </ul>	<ul style="list-style-type: none"> <li>• Define the contents of the system</li> <li>• Install products and service from a variety of sources by following a guided step-by-step process</li> <li>• Run individual SMP/E commands</li> <li>• Display information from the SMP/E data base about the contents and status of the system</li> <li>• Learn how to use the SMP/E dialogs</li> </ul>

By providing support for the tasks shown in Table 3, SMP/E reduces the amount of work the system programmer must do to install and maintain system changes. For this reason, IBM products and service are packaged so they can be installed using SMP/E. These are some of the types of software that may be installed by SMP/E:

- Products and service provided in CBPDOs
- Products and service from IBM Software Distribution Centers not provided in CBIPOs or CBPDOs
- Service provided on program update tapes (PUTs)
- Other products and service.

SMP/E can install software from any of these sources, provided it is packaged as a system modification, or **SYSMOD**.

---

## System Modifications (SYSMODs)

Software, whether it is a product or service, consists of **elements** such as macros, modules, source, and other types of data (such as CLISTs or sample procedures). For software to be installed by SMP/E, it must include control information for the elements. This information describes the elements and any relationships the software has with other products or service that may also be installed on the same MVS system. The combination of elements and control information is called a system modification, or **SYSMOD**. There are four types of SYSMODs, which are defined by how they affect the system on which they are installed. A SYSMOD may:

- Introduce a new product or a new release of a product. This is called a **function**.
- Correct a problem that may affect many users. This is called a **program temporary fix (PTF)**.
- Correct a problem that affects a specific user. This is called an **APAR fix**.
- Make authorized changes to IBM products or to user-written products. This is called a **user modification**.

SMP/E processes SYSMODs using a variety of data sets.

---

## Data Sets Used by SMP/E

SMP/E installs SYSMOD elements into two types of libraries:

- **Target libraries**, which contain the executable code that makes up the running system.
- **Distribution libraries**, which contain the master copy of all elements for a system. The distribution libraries (DLIBs) are used as input to the system generation process that builds target libraries for a new system. They are also used by SMP/E for backup if it is necessary to replace or update elements in the target libraries.

To install SYSMOD elements in these libraries, SMP/E uses several types of data sets:

- Data sets for temporary storage of SYSMODs waiting to be installed
- Various utility and work data sets
- VSAM data sets containing various types of control information:
  - System content and structure
  - Function and service levels of system elements
  - Control information from individual SYSMODs.

SMP/E uses the control information to (1) select proper element levels for installation, (2) determine which libraries should contain which elements, and (3) identify which system utilities are to be called for the installation.

In addition to directing SMP/E processing, the control information is also used by system programmers, who must have current information available on system structures, content, and status. SMP/E provides this information in reports, listings, and dialogs that help the programmer do the following:

- Research function and service levels
- Understand intersections and relationships of SYSMODs (either installed or waiting to be installed)
- Build job streams for SMP/E processing.

The SMP/E data set containing this control information is the SMP/E consolidated software inventory data set (SMPCSI).

## The SMPCSI Data Set

The SMPCSI (or CSI) is a keyed VSAM data set that is logically divided into “zones.” These zones describe the various subsystems and products in the system. There are three types of zones:

- **Global zone**, which describes the following:
  - Associated target and distribution zones
  - SYSMODs waiting to be installed (stored in the SMP/E PTF temporary storage data set, or **SMPPTS**)
  - Names of, and information used by, system utilities SMP/E calls to install SYSMODs
- **Target zone**, which describes the structure and contents of a set of target libraries, and names the related distribution zone
- **Distribution zone**, which describes the structure and contents of a set of distribution libraries, and names the related target zone.

Figure 4 on page 31 shows the relationships between SMP/E zones and libraries.

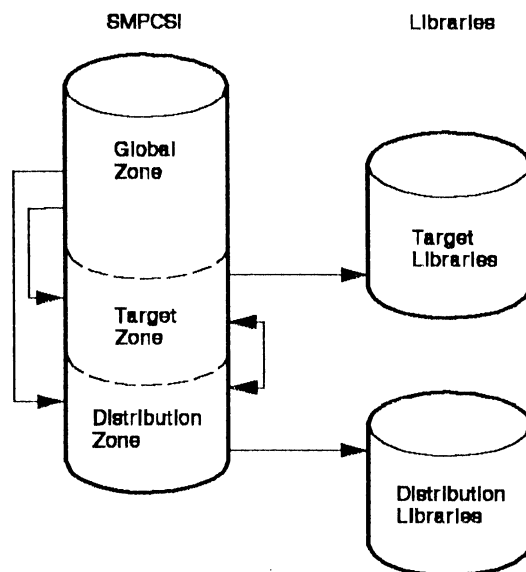

Figure 4. Summary of Zone Relationships

There can be more than one zone in an SMPCSI data set. For example, an SMPCSI data set could contain a global zone, several target zones, and several distribution zones. The zones could also be in separate SMPCSI data sets. One SMPCSI data set could contain just the global zone, a second SMPCSI data set the target zones, and a third SMPCSI data set the distribution zones. For more information on ways to structure SMPCSI data sets, see the *SMP/E Program Directory for Installation Planning* and the publication *MVS Custom-Built Offerings Planning and Installation*.

## Using SMP/E to Install Products and Service

Whether you use the CBIPO dialogs, the SMP/E dialogs, or batch SMP/E jobs, there are basically two methods of using SMP/E to install software:

- The **standard method**, which uses the RECEIVE, APPLY, and ACCEPT commands. The standard method is generally used to add products and service to an existing system or subsystem. You would typically use the standard RECEIVE-APPLY-ACCEPT method to install:
  - Products and service provided in CBPDOs
  - Products and service from IBM Software Distribution Centers not provided in CBIPO or CBPDO
  - Service provided on PUTs
  - User modifications

---

With this method, the RECEIVE command is used to read SYSMODs into the SMPPTS, or temporary storage data set. The APPLY command is then used to install the SYSMODs in the target libraries. Once the changes have been tested, the ACCEPT command is used to install the SYSMODs in the distribution libraries. Generally, there is no special processing required outside of SMP/E to install the SYSMODs.

- The **generation method**, which uses the GENERATE command. The generation method can be used to create or replace a system or subsystem, or it can be used to add to an existing system or subsystem. For example, the GENERATE command is used by the CBIPO dialogs to install products and service contained in CBIPO orders. (For more information, see “Installing a CBIPO” on page 16.)

With this method, either the SMP/E GENERATE command or system, subsystem, or product generation procedures are used in addition to SMP/E commands to install functions onto a system or subsystem.

There are variations on these methods to accommodate installation processes needed for specific products or offerings. See the *SMP/E User's Guide*, the publication *MVS Custom-Built Offerings Planning and Installation*, or the *SMP/E Program Packaging Guide* for more information.

---

## SMP/E Requirements and Considerations

Before installing SMP/E, you should be aware of the requirements and considerations for:

- Programming
- Hardware
- Education
- Compatibility with SMP Release 4 (SMP4) and prior releases of SMP/E
- Performance
- Migration
- SMP/E data integrity
- Security.

### Programming Requirements

SMP/E operates with Release 3.8 of OS/VS2 (MVS), and with MVS/370 (MVS/SP Version 1), MVS/XA (MVS/SP Version 2), and MVS/ESA (MVS/SP Version 3 or MVS/ESA SP Version 4).

Use of the CBIPO and SMP/E dialogs is optional. If the dialogs are to be used, the following programs are also required:

- Interactive System Productivity Facility (ISPF). Use one of the following:
  - Version 2 Release 3 (Program No. 5665-319), or later, plus service PTF UY14417 (for FMID HIF2302)
  - Version 3 (Program No. 5685-054), or later
- Interactive System Productivity Facility/Program Development Facility (ISPF/PDF). Use one of the following:
  - Version 2 Release 3 (Program No. 5665-317), or later, plus service PTF UY15941 (for FMID HDV2302)

- Version 3 (Program No. 5665-402), or later
- Time Sharing Option/Extensions (TSO/E) Version 1 Release 2 (Program No. 5665-285), or later.

## Hardware Requirements

SMP/E runs on all hardware supported by the operating systems listed above.

The input and output devices used must support uppercase English characters, plus any other languages (such as Japanese) that are being processed. If the dialogs for the English feature are being used, then a terminal that processes both uppercase and lowercase English characters must be used.

## Education Requirements

The person responsible for using SMP/E to install products and service should be familiar with:

- The MVS area of responsibility (for example, MVS, NCP, IMS, DB2, CICS, JES)
- Job control language
- SMP/E concepts
- MVS utilities
- ISPF (if used)
- ISPF/PDF (if used).

For more information about recommended education for CBIPOs, CBPDOs, and SMP/E, see Table 5 on page 41.

## Compatibility

For compatibility, all SYSMOD input acceptable to SMP Release 4 (SMP4) and previous releases of SMP/E is acceptable to SMP/E Release 6.

## Performance

The batch processing characteristics of SMP/E can be tuned using VSAM allocation parameters and VSAM index and data buffer specifications. The performance of SMP/E dialogs is similar to that of other applications running under ISPF.

When running on MVS/ESA systems, SMP/E Release 6 automatically takes advantage of the local shared resource (LSR) feature of VSAM. This reduces the number of times SMP/E must access data when it is reading CSI data sets. As a result, SMP/E performance is improved for commands such as APPLY, APPLY CHECK, ACCEPT, ACCEPT CHECK, and especially, LIST.

### Notes:

1. This performance improvement also occurs automatically on MVS/XA systems if the Data Facility Product (DFP) is at or beyond the minimum required service level (DFP 2.3 with PTFs UY22823, UY27311, UY28559, UY28999, and UY35924).
2. The improvement does not occur on MVS/370 systems, or on MVS/XA systems where DFP is not at or beyond the minimum required service level.
3. You will not experience any noticeable improvement in performance if you are currently implementing batch LSR through JCL, as described in APAR

OY24097. However, because SMP/E Release 6 makes use of this function through normal processing, you can remove the JCL references once SMP/E Release 6 is in production.

## Migration

This section discusses migrating to SMP/E Release 6 from a previous release of SMP/E. Table 4 shows the possible migration paths.

Current Release	To SMP/E Release 6?
SMP/E Release 5.1	Yes
SMP/E Release 5	Yes
SMP/E Release 4 or earlier	No
SMP4	No

This section also offers a suggestion for VS1 users migrating to MVS.

### Migrating to SMP/E Release 6

You can migrate to SMP/E Release 6 from either SMP/E Release 5.1 or SMP/E Release 5. The migration process consists of running the SMP/E RECEIVE, APPLY, and ACCEPT commands to install SMP/E Release 6. This deletes the previous release of SMP/E from the system. No conversion is needed.

**Note:** SMP/E Release 6 is packaged using data elements. As a result, you can only install SMP/E Release 6 using SMP/E Release 5 or later. You cannot install SMP/E Release 6 using SMP4 or SMP/E Release 4 (or earlier).

However, you can wait until SMP/E Release 6 is available in an MVS CBIPO, then order a CBIPO MVS feature that includes SMP/E Release 6. Install the CBIPO feature. Then convert any data sets from your previous release that will be used with SMP/E Release 6. (This is done with the SMP/E CONVERT command.)

### Migrating from VS1 to MVS

The enhanced change-management capabilities of SMP/E provide a migration aid for VS1 users planning to move to MVS. Here is a possible migration path for VS1 users planning to migrate to MVS:

1. Install SMP/E Release 2, which supports VS1, on VS1 to gain experience using SMP/E.

Major subsystems can be converted to SMP/E format and managed using SMPCSI data sets before the MVS migration, providing an additional option for staging the migration workload.

2. Install an MVS CBIPO feature containing SMP/E Release 6.

Install SMP/E Release 6, as described under "Migrating to SMP/E Release 6" in the note for users of SMP/E Release 4 or earlier.

3. Convert existing SMPCSI data sets.

Once SMP/E Release 6 has been installed, you can convert existing SMPCSI and SMPSCDS data sets from SMP/E Release 2 format to the required format. (This is done with the SMP/E CONVERT command.)

## SMP/E Data Integrity

SMP/E uses VSAM functions to maintain the integrity of SMP/E data sets. SMP/E defines the CSI with VSAM SHAREOPTIONS(2 3), which allows many users to read the same CSI data set at one time. WRITE operations, however, are serialized, which prevents more than one user from updating a CSI at the same time.

## Security

SMP/E runs as an authorized program under MVS. Use of this program can be controlled by the Resource Access Control Facility (RACF) (Program No. 5740-XXH) or password protection of the SMP/E data sets (for example, the CSI). Customers are responsible for the selection, adequacy, and implementation of these controls for the protection of their data.

RACF can also be used to permit read-only access to CSI data sets. This allows users to run commands that only read the CSI (such as LIST or REPORT), while preventing those users from updating the CSI.





---

## Chapter 5. CBIPO Process Aids Summary

The CBIPO Process Aids consist of related installation materials (RIMs) for each of the CBIPO features. The Process Aids for the MVS feature are based on the IBM model installation system. (The model installation system is an MVS/ESA SP Version 4 JES2 system at the current CBIPO level. It is used by IBM to carry out, document, and package the processes used to install MVS and related licensed programs available in a CBIPO.) These RIMs reflect the installation process defined by CBIPO and can be used to plan for installing a CBIPO. However, they do not correspond to any specific CBIPO you may order.

---

### Contents of the Process Aids

The Process Aids are RIMs only, without associated product code. (For the MVS feature, these RIMs correspond to the CBIPO for the IBM model installation system.) There are four separately orderable features:

- **MVS.** This includes RIMs for MVS/Enterprise Systems Architecture (MVS/ESA) and associated IBM licensed programs.
- **NCP.** This includes RIMs for ACF/NCP and associated IBM licensed programs.
- **DBS.** This includes RIMs for IMS, DB2, and associated IBM licensed programs.
- **CICS.** This includes RIMs for CICS and associated IBM licensed programs.

The Process Aids also include RIMs for installing a CBIPO using either the CBIPO dialogs contained in SMP/E Release 6 or the CBIPO batch installation jobs.

---

### Ordering the Process Aids

Your IBM representative can provide you with information about ordering the CBIPO Process Aids. Because the Process Aids do not include any product code, there are no licensing requirements for placing an order.



---

## Chapter 6. MVS CBIPO Drivers Summary

The MVS CBIPO drivers are for customers who do not have an MVS system they can use to install a CBIPO MVS feature. A driver is a pregenerated MVS/XA or MVS/370 system in dump/restore format. It can be used only as an initial MVS system to install a CBIPO MVS feature. It is not intended for any other purpose and cannot be used as a conventional MVS/XA or MVS/370 system.

---

### Contents of a Driver

An MVS CBIPO driver contains the products needed to support the installation of a CBIPO MVS feature. Along with the driver, you also get stand-alone copies of utility programs to initialize DASD and restore the driver.

When SMP/E Release 6 is available in a CBIPO, it will also be available in the drivers. SMP/E Release 6 contains dialogs that can be used to install a CBIPO feature.

A *Memo to Users and Installation Guide* is provided with each driver.

---

### Ordering a Driver

Your IBM representative can provide you with an order checklist for an MVS CBIPO driver.

---

### Hardware Requirements

The MVS/XA CBIPO driver supports 3380 and 3390 DASDs. The MVS/370 CBIPO driver supports 3350, 3375, 3380, and 3390 DASDs. To install an MVS CBIPO driver, you need:

- Two DASDs of the same type, such as two 3350s, two 3375s, two 3380s, or two 3390s
- One 6250-bpi tape drive or one 3480 tape drive
- One local terminal for TSO and ISPF
- One printer
- A processor and system console capable of supporting an MVS system.

The publication *MVS Custom-Built Offerings Planning and Installation* lists the I/O device addresses generated for the drivers.



## Appendix A. Education and Related Documentation

This appendix indicates where you can find additional information about CBIPOs, CBPDOs, and SMP/E.

Table 5 shows the recommended education on CBIPOs, CBPDOs, and SMP/E that is offered through the various IBM locations.

*Table 5 (Page 1 of 2). Classes and Self-Study Courses*

Location	Recommended Education	Catalog of Courses	Phone Number for More Information
Australia	<ul style="list-style-type: none"> <li>• "SMP/E: A Guide for the New SMP/E User" (Self-Study Course 32186)</li> <li>• "SMP/E Fundamentals" (Course H3765)</li> <li>• "Integrated System Maintenance Using SMP/E" (Course H3763)</li> <li>• "MVS Installation and Tailoring" (Course H3903)</li> </ul> and all prerequisites or equivalent experience.	Contact your local branch office.	Contact your local branch office.
Canada	<ul style="list-style-type: none"> <li>• "SMP/E: A Guide for the New SMP/E User" (Self-Study Course 32186)</li> <li>• "New SMP Users" (Course S4716)</li> <li>• "MVS Installation and Tailoring" (Course S6375)</li> </ul> and all prerequisites or equivalent experience.	<i>Education Course Catalogue</i> , G209-0073 (bilingual version) or G209-0062 (English version)	IBM Direct-Education at 1-800-465-1234
EMEA	<ul style="list-style-type: none"> <li>• "SMP/E: A Guide for the New SMP/E User" (Self-Study Course 32186)</li> <li>• "System Installation and Maintenance with SMP/E"</li> <li>• "MVS/XA Installation Practice and Procedure" or "MVS/ESA Installation and Implementation"</li> <li>• "MVS/ESA Customization"</li> </ul> and all prerequisites or equivalent experience.	See your country's education course catalog.	See your country's education course catalog for enrollment procedures.
Japan	<ul style="list-style-type: none"> <li>• "How to Use SMP/E" (Self-Study Course 25024)</li> <li>• "MVS Installation and Tailoring" (Course H3903)</li> <li>• "MVS/ESA Installation" (Course 24226)</li> <li>• "MVS/ESA Customization" (Course 24228)</li> </ul> and all prerequisites or equivalent experience.	<i>Catalog of IBM Education</i> , GR18-5200	IBM DIRECT at 03-865-5748

*Table 5 (Page 2 of 2). Classes and Self-Study Courses*

Location	Recommended Education	Catalog of Courses	Phone Number for More Information
United States	<ul style="list-style-type: none"> <li>• "SMP/E: A Guide for the New SMP/E User" (Self-Study Course 32186)</li> <li>• "SMP/E Fundamentals" (Course H3765)</li> <li>• "Integrated System Maintenance Using SMP/E" (Course H3763)</li> <li>• "MVS Installation and Tailoring" (Course H3903)</li> </ul> and all prerequisites or equivalent experience.	<i>Catalog of IBM Education</i> , G320-1244	IBM DIRECT at 1-800-IBM-TEACH

### CBIPO Documentation

Figure 5 on page 44 briefly reviews the types of documents in the CBIPO library and their relationship to each other. In this figure, the documents are grouped into three major categories (planning, installation, and customization) for each of the four features. The specific documents are described in the following tables:

- Common CBIPO documents: Table 6
- MVS feature documents: Table 7 on page 43
- NCP feature documents: Table 8 on page 45
- DBS feature documents: Table 9 on page 45
- CICS feature documents: Table 10 on page 46

All of the CBIPO documentation is on a RIM tape, except for the publication *MVS Custom-Built Offerings Planning and Installation*, and the memo to users. Documents on the RIM tape can be printed using either the CBIPO dialogs or jobs that are included on the RIM tape.

**Note:** The only CBIPO document that is customized to the specific products you ordered is the memo to users extension. The other documents are based on the CBIPO model installation and are only customized to the particular feature you ordered.

### Common Documents

*Table 6 (Page 1 of 2). Common CBIPO Documents*

Title	Description
<i>MVS Custom-Built Offerings Planning and Installation</i> , SC23-0352	Provides a summary of how to plan for installing products and service from a CBIPO or CBPDO.
<i>MVS CBIPO System Design Reference</i>	Helps in designing a system. It shows the system that results when you follow the installation procedures described in the installation guides and other RIM data sets, or when you use the CBIPO dialogs. <b>This document is part of the CBIPO package and does not have an order number.</b>

<i>Table 6 (Page 2 of 2). Common CBIPO Documents</i>	
<b>Title</b>	<b>Description</b>
<i>MVS CBIPO Security Guide</i>	Discusses the security features of various products, focusing on how to customize RACF. <b>This document is part of the CBIPO package and does not have an order number.</b>
<b>Note:</b> For a description of <i>SMP/E CBIPO Dialogs User's Guide</i> , see "SMP/E Documentation" on page 47.	

## MVS Feature Documents

<i>Table 7. MVS Feature Documents</i>	
<b>Title</b>	<b>Description</b>
<i>MVS CBIPO Memo to Users Extension</i>	Describes the order as a whole, as well as individual licensed programs in the order. There is a separate memo to users extension for each feature, which is customized to the specific order.
<i>CBIPO Dialogs Installation Guide for MVS/XA and MVS/ESA</i> <i>MVS CBIPO Installation Guide for MVS/XA and MVS/ESA</i>	Describe how to install a new MVS/XA or MVS/ESA system from a CBIPO-customized DLIB. One guide is for using the CBIPO dialogs. The other is for using the CBIPO batch installation process. Both guides are shipped with each feature.
<i>MVS CBIPO Installation Guide for MVS/370</i>	Describes how to install a new MVS/370 system from a CBIPO-customized DLIB using the CBIPO batch installation process.
<i>MVS CBIPO Customization and Use Guide</i>	Describes how to customize and use the MVS system control program and selected other products.
<i>MVS CBIPO Communication Customization and Use Guide</i>	Contains information needed for customizing and managing a communication network.
<i>MVS CBIPO JES2 Customization and Use Guide for MVS/XA and MVS/ESA</i> <i>MVS CBIPO JES2 Customization and Use Guide for MVS/370</i>	Provides step-by-step procedures for migrating to a new level of JES2 and describes how to define and use JES2 network job entry (NJE).
<i>MVS CBIPO JES3 Customization and Use Guide for MVS/XA and MVS/ESA</i> <i>MVS CBIPO JES3 Customization and Use Guide for MVS/370</i>	Provides step-by-step procedures for migrating to a new level of JES3 in an MVS/SP environment.
<i>CBIPO MVS System Problem Determination Guide</i>	Contains information to help users with system-level problem determination.
<b>Note:</b> These documents are part of the CBIPO package and do not have order numbers.	



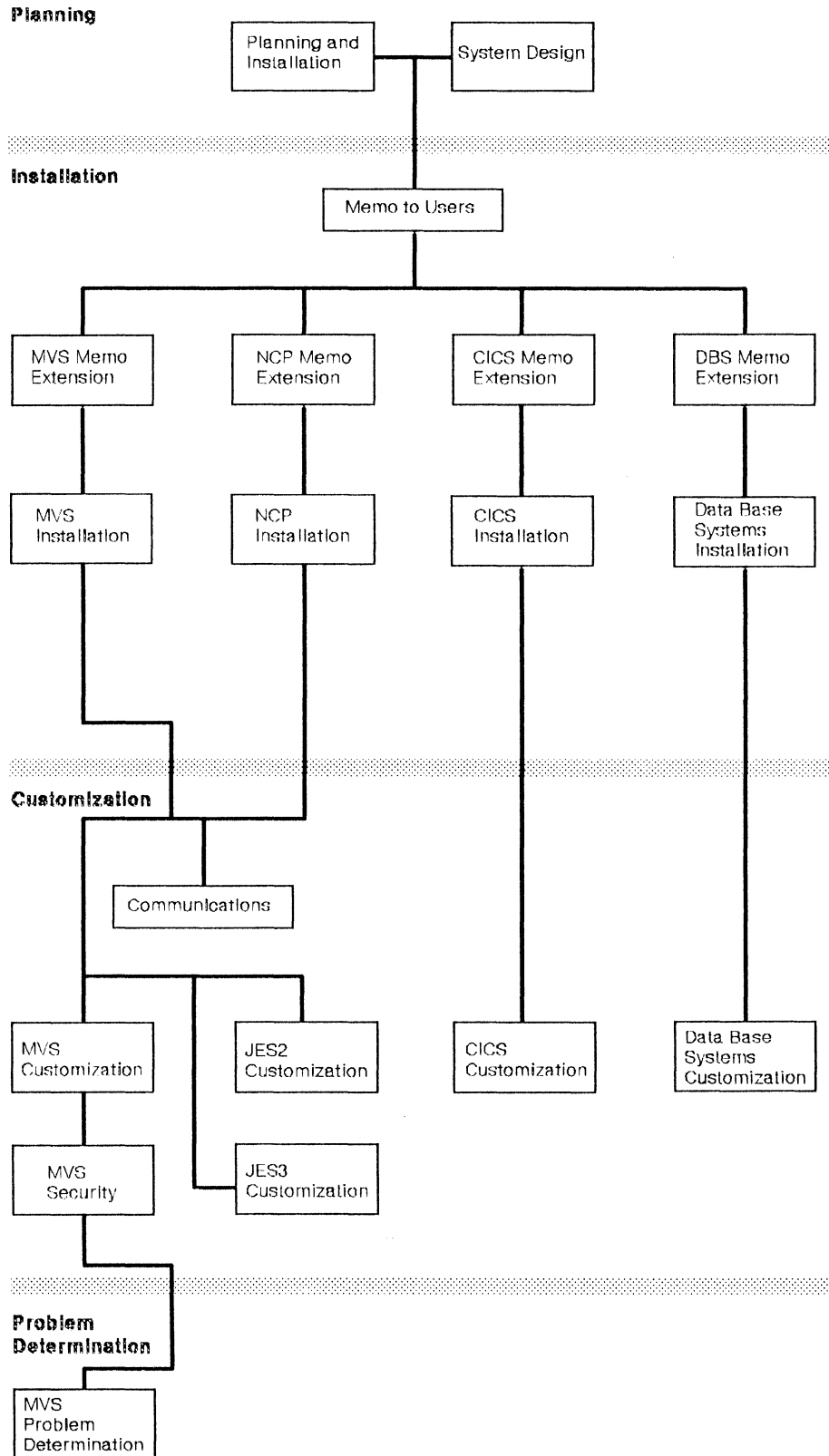

Figure 5. Types of Information Provided for CBIPOs

## NCP Feature Documents

<i>Table 8. NCP Feature Documents</i>	
<b>Title</b>	<b>Description</b>
<i>MVS CBIPO Memo to Users Extension</i>	Describes the order as a whole, as well as individual licensed programs in the order. There is a separate memo to users extension for each feature, which is customized to the specific order.
<i>CBIPO Dialogs Installation Guide for NCP</i> <i>MVS CBIPO NCP Installation Guide</i>	Provide step-by-step procedures for installing the CBIPO NCP feature. It also describes other aspects of ACF/NCP that you may want to review, such as NCPGEN. One guide is for using the CBIPO dialogs. The other guide is for using the CBIPO batch installation process. Both guides are shipped with each feature.
<i>MVS CBIPO Communication Customization and Use Guide</i>	Contains information needed for customizing and managing a communication network.
<b>Note:</b> These documents are part of the CBIPO package and do not have order numbers.	

## DBS Feature Documents

<i>Table 9. DBS Feature Documents</i>	
<b>Title</b>	<b>Description</b>
<i>MVS CBIPO Memo to Users Extension</i>	Describes the order as a whole, as well as individual licensed programs in the order. There is a separate memo to users extension for each feature, which is customized to the specific order.
<i>CBIPO Dialogs Installation Guide for Data Base Systems</i> <i>MVS CBIPO Data Base Systems Installation Guide</i>	Describe step-by-step procedures for installing the CBIPO Data Base Systems feature. One guide is for using the CBIPO dialogs. The other is for using the CBIPO batch installation process. Both guides are shipped with each feature.
<i>MVS CBIPO Data Base Systems Customization and Use Guide</i>	Describes how to customize IMS-related products and includes hints and tips for dialogs provided by DB2 and other related products.
<b>Note:</b> These documents are part of the CBIPO package and do not have order numbers.	

## CICS Feature Documents

<i>Table 10. CICS Feature Documents</i>	
<b>Title</b>	<b>Description</b>
<i>MVS CBIPO Memo to Users Extension</i>	Describes the order as a whole, as well as individual licensed programs in the order. There is a separate memo to users extension for each feature, which is customized to the specific order.
<i>CBIPO Dialogs Installation Guide for CICS</i> <i>MVS CBIPO CICS Installation Guide</i>	Describes how to install a CICS/OS/VS system from a CBIPO-customized DLIB. One guide is for using the CBIPO dialogs. The other guide is for using the CBIPO batch installation process. Both guides are shipped with each feature.
<i>MVS CBIPO CICS Customization and Use Guide</i>	Describes how to customize and use CICS, and provides guidance on using CICS together with its related products.
<b>Note:</b> These documents are part of the CBIPO package and do not have order numbers.	

## CBPDO Documentation

Figure 6 on page 47 briefly shows the types of documents in the CBPDO library and their relationship to each other. In this figure, the documents are grouped into two categories: planning and installation. The specific documents are described in Table 11. The memo to users extension can be printed using directions in the memo to users.

<i>Table 11. Common CBPDO Documents</i>	
<b>Title</b>	<b>Description</b>
<i>MVS Custom-Built Offerings Planning and Installation, SC23-0352</i>	Provides a summary of how to plan for installing products and service from a CBIPO or CBPDO.
<i>MVS CBPDO Memo to Users Extension</i>	Describes the order as a whole, as well as individual licensed programs in the order. There is a separate memo to users extension for each feature, which is customized to the specific order. <b>This document is part of the CBPDO package and does not have an order number.</b>

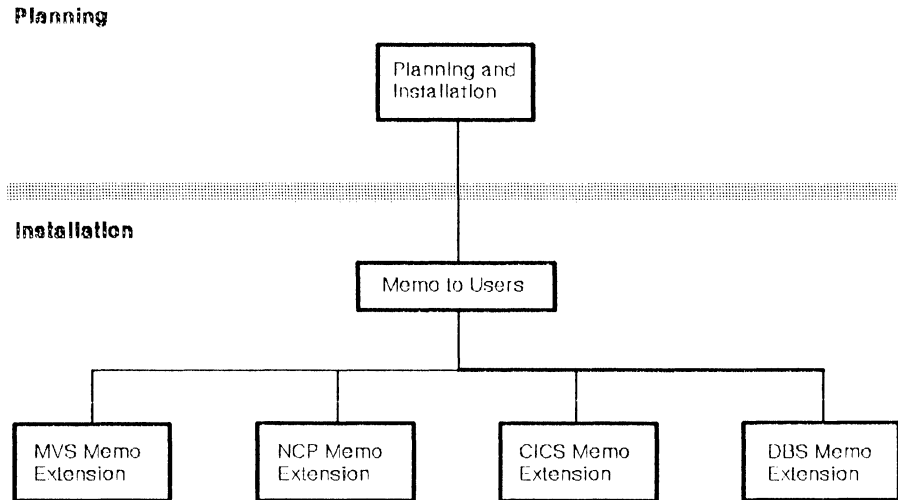

Figure 6. Types of Information Provided for CBPDOs

## SMP/E Documentation

Table 12 lists the SMP/E Release 6 publications and briefly describes each one.

Table 12. Publications for SMP/E Release 6	
Title	Description
<i>MVS Software Manufacturing Offerings General Information</i> , GC23-0351 Online book: GIM9MST	Provides a summary of SMP/E, CBIPO, and CBPDO.
<i>SMP/E Program Directory for Installation Planning (English Feature)</i> , GC23-0130 Online book: GIM1MST	Explains how to plan for installing SMP/E Release 6 using SMP/E Release 5 or higher.
<i>SMP/E Program Directory for Installation Planning (Japanese Feature)</i> , GC23-0469 Online book: GIMJMST	
<i>SMP/E User's Guide</i> , SC28-1302 Online book: GIM8MST	Describes how to use SMP/E to install programs and service.
<i>SMP/E Messages and Codes</i> , SC28-1108 Online book: GIM4MST	Explains SMP/E messages and return codes and the actions to take for each message and code.
<i>SMP/E Reference</i> , SC28-1107 Online book: GIM6MST	Explains SMP/E commands and processing in detail.
<i>SMP/E Reference Summary</i> , SX22-0006 Online book: GIM7MST	Reviews the SMP/E commands in a convenient form.
<i>SMP/E Program Packaging Guide</i> , SC23-0221 Online book: GIM5MST	Explains how to package programs for installation by SMP/E.
<i>SMP/E CBIPO Dialogs User's Guide</i> , SC23-0538 Online book: GIMIMST	Explains how to use the CBIPO dialogs to install, reinstall, and redistribute CBIPO orders.
<i>SMP/E Diagnosis Guide</i> , LY27-8047 (no online book)	Explains how to handle suspected SMP/E problems.

### Notes:

1. You can order hardcopy versions of individual SMP/E Release 6 publications or use a Bill of Forms number to order the complete set of unlicensed publications. (Because *SMP/E Diagnosis Guide* is a licensed publication, it must be ordered separately and is only available if you are licensed for SMP/E Release 6.)
  - For the English feature of SMP/E, use **SBOF-1587**.
  - For the Japanese feature of SMP/E, use **SBOF-3161**.
2. Online versions of the SMP/E Release 6 books (except for *SMP/E Diagnosis Guide*) will be available on the MVS CD-ROM update following general availability of SMP/E Release 6.
  - For JES2 systems, order **SK2T-1200**.
  - For JES3 systems, order **SK2T-1201**.

See the latest MVS/ESA\* SP Version 4 announcement letter for details.

3. You can order binders and inserts for the SMP/E library. Here are the order numbers:
  - For *SMP/E Reference*:
    - Binder plus inserts: **SBOF-2136**
    - Inserts only: **SX23-0442**
  - For the rest of the SMP/E library:
    - Binder plus inserts: **SBOF-2137**
    - Inserts only: **SX23-0443**.

**Note:** You will probably need two binders for the rest of the library.

## Appendix B. Acronyms and Abbreviations

<b>ACDS</b>	Alternate control data set.	<b>ISPF/PDF</b>	Interactive System Productivity Facility/Program Development Facility.
<b>ACRQ</b>	Alternate conditional requisite queue.	<b>IVP</b>	Installation verification procedure.
<b>APAR</b>	Authorized program analysis report.	<b>JES</b>	Job entry subsystem.
<b>CBIPO</b>	Custom-Built Installation Process Offering.	<b>MCS</b>	Modification control statement.
<b>CBPDO</b>	Custom-Built Product Delivery Offering.	<b>MVS</b>	Multiple Virtual Storage.
<b>CDS</b>	Control data set.	<b>MVS/ESA</b>	Multiple Virtual Storage/Enterprise Systems Architecture (MVS/SP Version 3 or MVS/ESA SP Version 4).
<b>CICS</b>	Customer Information Control System.	<b>MVS/SP</b>	Multiple Virtual Storage/System Product.
<b>CORPE</b>	PSP UPGRADE for PE-PTFs available correctively but not yet available on a PUT.	<b>MVS/XA</b>	Multiple Virtual Storage/Extended Architecture (MVS/SP Version 2).
<b>CRQ</b>	Conditional requisite queue.	<b>MVS/370</b>	Multiple Virtual Storage for System/370* (MVS/SP Version 1).
<b>CSI</b>	Consolidated software inventory.	<b>NCP</b>	Network Control Program.
<b>CVOL</b>	Control volume.	<b>NJE</b>	Network job entry.
<b>DASD</b>	Direct access storage device.	<b>OS/VS1</b>	Operating System/Virtual Storage 1.
<b>DBS</b>	Data Base Systems.	<b>OS/VS2</b>	Operating System/Virtual Storage 2.
<b>DB2</b>	DATABASE 2.	<b>PDF</b>	Program Development Facility.
<b>DFEF</b>	Data Facility Extended Function.	<b>PE-PTF</b>	PTF in error.
<b>DFP</b>	Data Facility Product.	<b>PSP</b>	Preventive service planning.
<b>DLIB</b>	Distribution library.	<b>PTF</b>	Program temporary fix.
<b>EMEA</b>	IBM World Trade E/ME/A (Europe/Middle East/Africa).	<b>PTS</b>	PTF temporary store.
<b>HIPER</b>	High impact or pervasive APAR.	<b>PUT</b>	Program update tape.
<b>ICF</b>	Integrated catalog facility.	<b>RACF</b>	Resource Access Control Facility.
<b>IMS</b>	Information Management System.	<b>RIM</b>	Related installation material.
<b>I/O</b>	Input or output.	<b>SCP</b>	System control program.
<b>IODF</b>	I/O definition file.	<b>SERV</b>	CBIPO service tape.
<b>IPL</b>	Initial program load.	<b>SMP</b>	System Modification Program.
<b>ISPF</b>	Interactive System Productivity Facility.		

\* System/370 is a trademark of the IBM Corporation.

## Abbreviations

---

**SMPCSI** System Modification Program consolidated software inventory.

**SMP/E** System Modification Program Extended.

**SMPPTS** System Modification Program PTF temporary store.

| **SREL** System release.

**SSP** System Support Program.

**SYSMOD** System modification.

**USERMOD** User modification.

**VSAM** Virtual Sequential Access Method.

**VTOC** Volume table of contents.

---

# Readers' Comments

## MVS Software Manufacturing Offerings

### MVS Custom-Built Installation Process Offering

### MVS Custom-Built Product Delivery Offering

### System Modification Program Extended

### Process Aids – Drivers

### General Information

### Release 6

**Publication No. GC23-0351-05**

You may use this form to communicate your comments about this publication, its organization, or subject matter, with the understanding that IBM may use or distribute whatever information you supply in any way it believes appropriate without incurring any obligation to you. Your comments will be sent to the author's department for whatever review and action, if any, are deemed appropriate.

**Note:** Copies of IBM publications are not stocked at the location to which this form is addressed. Please direct any requests for copies of publications, or for assistance in using your IBM system, to your IBM representative or to the IBM branch office serving your locality.

What is your occupation?

Newsletter number of latest Technical Newsletter (if any) concerning this publication:

How did you use this publication?

- |                          |                               |                          |                        |
|--------------------------|-------------------------------|--------------------------|------------------------|
| <input type="checkbox"/> | As an introduction            | <input type="checkbox"/> | As a text (student)    |
| <input type="checkbox"/> | As a reference manual         | <input type="checkbox"/> | As a text (instructor) |
| <input type="checkbox"/> | For another purpose (explain) |                          |                        |

---

Is there anything you especially like or dislike about the organization, presentation, or writing in this manual? Helpful comments include general usefulness of the book; possible additions, deletions, and clarifications; specific errors and omissions.

Page Number:

Comment:

---

Name

---

Address

---

Company or Organization

---

Phone No.





Fold and Tape

Please do not staple

Fold and Tape



NO POSTAGE  
NECESSARY  
IF MAILED IN THE  
UNITED STATES

# BUSINESS REPLY MAIL

FIRST CLASS MAIL PERMIT NO. 40 ARMONK, NEW YORK

POSTAGE WILL BE PAID BY ADDRESSEE

International Business Machines Corporation  
Information Development  
Department 52QA MS 911  
NEIGHBORHOOD ROAD  
KINGSTON NY 12401-0000

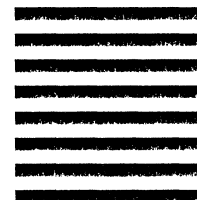

Fold and Tape

Please do not staple

Fold and Tape



File Number: S370-20  
Program Number: 5751-CS1  
5751-CS2  
5751-CS3  
5665-343  
5668-949

Printed in USA



GC23-0351-05

