

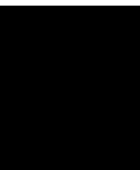

Systems Reference Library

**IBM System/360 Operating System:
Programmer's Guide to Debugging
OS Release 21.7**

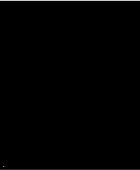
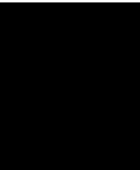
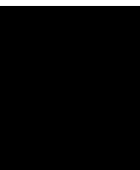
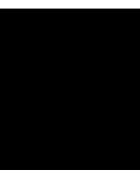
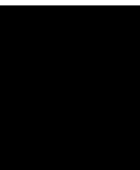
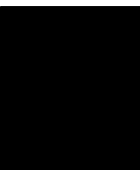

Seventh Edition (November, 1972)

This is a reprint of GC28-6670-5 incorporating changes released in the following Technical Newsletter:

GN28-2520 (dated April 15, 1972)

This edition with Technical Newsletter GN28-2545 applies to release 21.7 and component release 360S-OS-586 of IBM System/360 Operating System, and to all subsequent releases until otherwise indicated in new editions or Technical Newsletters. Changes are continually made to the information herein; before using this publication in connection with the operation of IBM systems, consult the latest IBM System/360 and System/370 Bibliography, GA22-6822, for the editions that are applicable and current.

Requests for copies of IBM publications should be made to your IBM representative or to the IBM branch office serving your locality.

A form for readers' comments is provided at the back of this publication. If the form has been removed, comments may be addressed to IBM Corporation, Publications Development, Department D58, Building 706-2, PO Box 390, Poughkeepsie, N.Y. 12602. Comments become the property of IBM.

This publication is intended to help you use the debugging facilities provided with the IBM System/360 Operating System. It describes, in assembler language terms, the major debugging facilities provided with the System/360 Operating System, and is directed towards the programmer who deals with system and application program problems.

The publication is divided into three principal parts: "Section 1: Operating System Concepts;" "Section 2: Interpreting Dumps;" and "Section 3: Tracing Aids," plus an Introduction and a set of Appendixes that provide specific debugging information.

The Introduction provides a brief survey of the material presented in the balance of the publication.

Section 1 deals with internal aspects of the operating system that are pertinent to debugging. A working knowledge of this information will provide you with the means of determining the status of the system at the time of failure, and the course of events which led up to that failure. The general procedure for debugging with an operating system dump (Appendix A) assumes knowledge of this control flow.

Section 2 includes instructions for invoking, reading, and interpreting storage dumps of systems with MFT or MVT control programs. The material is intended to aid you in interpreting dumps and isolating errors.

Section 3 deals with the save area chain, the Trace Option, and the Generalized Trace Facility. Output from the Generalized Trace Facility is discussed.

Before reading this publication, you should have a general knowledge of operating system features and concepts as presented in the prerequisite publications. Occasionally, the text refers you to other publications for detailed discussions beyond the scope of this book.

For information on debugging facilities provided within higher languages, consult the programmers' guides associated with the respective languages. Other System/360 Operating System publications, such as Messages and Codes, describe additional debugging aids provided for the assembler language programmer.

Notice: Coding level information presented in this publication must not be used for coding purposes or exposure to changes in implementation may result. The information is presented for debugging purposes only.

PREREQUISITE PUBLICATIONS

IBM System/360: Principles of Operation, GA22-6821

IBM System/360 Operating System:

Supervisor Services and Macro Instructions, GC28-6646

Data Management Services, GC26-3746

REFERENCE PUBLICATIONS

IBM System/360 Operating System:

System Control Blocks, GC28-6628

Messages and Codes, GC28-6631

Data Management Macro Instructions, GC26-3794

Service Aids, GC28-6719

TCAM Programmer's Guide and Reference, GC30-2024.

TCAM Serviceability Aids, GY30-2027.

TCAM, GY30-2029.

TSO Control Program, GY27-7199.

Contents

| | | | |
|---|----|---|-----|
| SUMMARY OF AMENDMENTS FOR GC28-6670-5 OS RELEASE 21 | 9 | Guide to Using an Indicative Dump | 67 |
| SUMMARY OF AMENDMENTS FOR GC28-6670-4 AS UPDATED BY GN28-2457 AND GN28-2472 OS RELEASE 20.1 | 10 | Storage Dumps | 68 |
| SUMMARY OF AMENDMENTS FOR GC28-6670-3 OS RELEASE 20 | 10 | Damage Assessment Routine (DAR) | 68 |
| INTRODUCTION | 11 | Console Dump | 68 |
| SECTION 1: OPERATING SYSTEM CONCEPTS | 13 | IMDSADMP Service Aid | 68 |
| Task Management | 13 | System Failure | 68 |
| Task Control Block | 13 | The SYS1.DUMP Data Set | 68 |
| Request Blocks | 13 | Tape | 68 |
| Active RB Queue | 16 | Direct Access | 69 |
| Load List | 16 | IMDPRDMP Output | 70 |
| Job Pack Area Queue (MFT With Subtasking Only) | 17 | Queue Control Block Traces | 70 |
| Effects of LINK, ATTACH, XCTL, and LOAD | 18 | Link Pack Area Maps | 71 |
| System Task Control Differences | 19 | Major System Control Block Formats | 75 |
| Systems With MFT (Without Subtasking) | 19 | MVT Control Block Formatting | 75 |
| Main Storage Supervision | 21 | MFT Control Block Formatting | 92 |
| Storage Control in Systems with MFT (Without Subtasking) | 21 | TSO System Block Formatting | 108 |
| Storage Control in Systems with MFT (With Subtasking) | 22 | Task Control Block Summaries | 124 |
| Storage Control for a Region in Systems with MVT | 22 | The General Format | 128 |
| Storage Control for a Subpool in Systems with MVT | 24 | Output Comments | 130 |
| Storage Control for a Load Module in Systems With MVT | 25 | Guide to Storage Dumps | 137 |
| System Control Blocks and Tables | 26 | Determining the Cause of the Dump | 138 |
| Communications Vector Table (CVT) | 26 | Task Structure | 138 |
| Task Input/Output Table (TIOT) | 26 | MFT System (Without Subtasking) | 138 |
| Unit Control Block (UCB) | 27 | MFT System (With Subtasking) | 139 |
| Event Control Block (ECB) | 27 | MVT System | 139 |
| Input/Output Block (IOB) | 27 | Task Status - Active RB Queue | 141 |
| Data Control Block (DCB) | 27 | Main Storage Contents | 142 |
| Data Extent Block (DEB) | 27 | Load List (MFT) | 142 |
| Summary of Control Block Relationships | 27 | Load List (MVT) | 142 |
| SECTION 2: INTERPRETING DUMPS | 29 | Job Pack Area Queue (MFT With Subtasking, MVT) | 142 |
| ABEND/SNAP Dump (MFT) | 29 | Main Storage Supervision | 143 |
| Invoking an ABEND/SNAP Dump (MFT) | 29 | Free Areas in MFT Systems | 143 |
| Contents of an ABEND/SNAP Dump (MFT) | 32 | Gotten Subtask Areas (MFT) | 143 |
| Guide to Using an ABEND/SNAP Dump (MFT) | 44 | Region Structure in MVT System | 143 |
| ABEND/SNAP Dump (MVT) | 46 | I/O Control Blocks | 143 |
| Invoking an ABEND/SNAP Dump (MVT) | 46 | Queue of DEBs | 143 |
| Contents of an ABEND/SNAP Dump (MVT) | 46 | UCBs | 144 |
| Guide to Using an ABEND/SNAP Dump (MVT) | 63 | DCB and TIOT | 144 |
| Indicative Dump | 65 | IOB | 144 |
| Contents of an Indicative Dump | 65 | ECB | 145 |
| | | TSO Control Blocks | 145 |
| | | TSCVT | 145 |
| | | RCB | 146 |
| | | UMSM | 146 |
| | | SWAP DCB | 146 |
| | | TJB | 146 |
| | | TSB | 146 |
| | | TJBX | 146 |
| | | PSCB | 146 |
| | | TAXE | 146 |
| | | SECTION 3: TRACING AIDS | 147 |
| | | Save Area Chain | 147 |
| | | Trace Option | 148 |
| | | Interpreting Trace Table Entries | 148 |
| | | Generalized Trace Facility | 150 |
| | | GTF Minimal Trace Records | 150 |
| | | IO and PCI/IO Minimal Trace Record | 151 |
| | | SIO Minimal Trace Record | 152 |
| | | DSP Minimal Trace Record | 153 |
| | | EXT Minimal Trace Record | 154 |

| | | | |
|---|------|--|------|
| PGM Minimal Trace Record | .155 | IMDPRDMP Output Comments - GTF | |
| SVC Minimal Trace Record | .156 | Processing | .203 |
| SSM Minimal Trace Record | .157 | | |
| GTF Comprehensive Trace Records | .158 | APPENDIX A: DEBUGGING WITH AN | |
| IO and PCI/IO Comprehensive Trace | | OPERATING SYSTEM DUMP | .205 |
| Record | .159 | Specialized Program Checks | .206 |
| SIO Comprehensive Trace Record | .161 | Debugging Procedure Summary | .207 |
| DSP Comprehensive Trace Record | .162 | | |
| EXT Comprehensive Trace Record | .163 | APPENDIX B: SVCs | .209 |
| PGM Comprehensive Trace Records | .165 | APPENDIX C: COMPLETION CODES | .215 |
| SSM Comprehensive Trace Record | .166 | APPENDIX D: SYSTEM MODULE NAME | |
| Time and Lost Event Records | .167 | PREFIXES | .219 |
| Hexadecimal Format Record | .168 | APPENDIX E: LIST OF ABBREVIATIONS | .221 |
| GTF SVC Comprehensive Trace Records | .169 | APPENDIX F: ECB COMPLETION CODES | .223 |
| SVC Comprehensive Trace Records | | APPENDIX G: UCB SENSE BYTES | .225 |
| Group 1 -- Basic Fields | .170 | APPENDIX H: SERVICE AIDS | .229 |
| SVC Comprehensive Trace Records | | APPENDIX J: TCAM DEBUGGING AIDS | .231 |
| Group 1 -- Basic Fields | .170 | APPENDIX K: CONTROL BLOCK POINTERS | .233 |
| SVC Comprehensive Trace Records | | APPENDIX L: OPEN/CLOSE/EOV DEBUGGING | |
| Group 2 - Basic Fields Plus DDNAME | | AIDS | .241 |
| Field | .181 | INDEX. | .243 |
| SVC Comprehensive Trace Records; | | | |
| Group 3 - Basic Fields Plus | | | |
| Parameter List Field | .182 | | |
| SVC Comprehensive Trace Records; | | | |
| Group 4 - Basic Fields Plus | | | |
| Variable Fields | .190 | | |

Figures

| | | | |
|---|------|--|------|
| Figure 1. Control Information Available Through the TCB | 13 | Figure 27. Sample of General Format Dump | .129 |
| Figure 2. RB Formats | 15 | Figure 28. Permanently Assigned Hardware Control Words | .138 |
| Figure 3. Active RB Queue | 16 | Figure 29. Finding the Partition TCBs in MFT | .139 |
| Figure 4. Load List (MFT) | 16 | Figure 30. Finding the TCB | .140 |
| Figure 5. Job Pack Area Queue | 18 | Figure 31. IMDPRDMP TCB Summary | .141 |
| Figure 6. Main Storage Snapshot (MFT Without Subtasking) | 19 | Figure 32. Determining Module From CDE in MVT | .142 |
| Figure 7. Partition (MFT Without Subtasking) | 19 | Figure 33. Subpool Descriptions in MVT - IMDPRDMP Storage Print | .144 |
| Figure 8. Main Storage Snapshot (MFT With Subtasking) | 20 | Figure 34. I/O Control Blocks | .145 |
| Figure 9. Main Storage Snapshot (MVT) | 21 | Figure 35. Save Area Trace | .147 |
| Figure 10. Storage Control for a Partition (MFT Without Subtasking) | 22 | Figure 36. Trace Table Entries (MFT) | .148 |
| Figure 11. Storage Control for Subtask Storage (MFT With Subtasking) | 22 | Figure 37. Trace Table Entries (MVT) | .148 |
| Figure 12. Storage Control for a Region (MVT) | 24 | Figure 38. Trace Table Entries (MVT with Model 65 multiprocessing) | .149 |
| Figure 13. Storage Control for a Subpool (MVT) | 25 | Figure 39. Sample Trace Table Entries (MFT) | .150 |
| Figure 14. Storage Control for a Load Module (MVT) | 26 | Figure 40. Sample Trace Table Entries (MVT) | .150 |
| Figure 15. Control Block Relationships | 27 | Figure 41. IO and PCI/IO Minimal Trace Record | .151 |
| Figure 16. Sample of an ABEND Dump (MFT) (Part 1 of 2) | 30 | Figure 42. SIO Minimal Trace Record | .152 |
| Figure 17. SYSABEND DD Statements | 33 | Figure 43. DSP Minimal Trace Record | .153 |
| Figure 18. Sample of Complete ABEND Dump (MVT) (Part 1 of 2) | 47 | Figure 44. EXT Minimal Trace Record | .154 |
| Figure 19. Contents of an Indicative Dump | 65 | Figure 45. PGM Minimal Trace Record | .155 |
| Figure 20. Queue Control Block Trace Sample | 71 | Figure 46. SVC Minimal Trace Record | .156 |
| Figure 21. Link Pack Area Map Sample | 73 | Figure 47. SSM Minimal Trace Record | .157 |
| Figure 22. Sample of MVT Major Control Block Format | 74 | Figure 48. IO and PCI/IO Comprehensive Trace Record | .159 |
| Figure 23. Sample of MFT Control Block Format | 93 | Figure 49. SIO Comprehensive Trace Record | .161 |
| Figure 24. Sample of TSO Control Block Format (Part 1 of 3) | .109 | Figure 50. DSP Comprehensive Trace Record | .162 |
| Figure 25. TSB Summary Sample for System That Operated Under MVT or MFT With Subtasking | .126 | Figure 51. EXT Comprehensive Trace Record | .163 |
| Figure 26. TCB Summary Sample for Systems that Operated Under MFT Without Subtasking | .127 | Figure 52. PGM Comprehensive Trace Record | .165 |
| | | Figure 53. SSM Comprehensive Trace Record | .166 |
| | | Figure 54. Hexadecimal Format Record | .168 |
| | | Figure 55. Basic SVC Comprehensive Trace Record | .170 |
| | | Figure 56. Control Block Flow | .237 |
| | | Figure 57. MVT Storage Control Flow | .239 |

Summary of Amendments

Summary of Amendments for GC28-6670-5,-6 as Updated by GN28-2545 OS Release 21.7

Model 91 or 195 Imprecise Interruption

An explanation of the bits set by an imprecise interruption on the Model 91 or 195 has been added.

AMDPRDMP Format Changes

Some additional fields have been added to the JOB information and the TCB.

AMDPRDMP Messages

Several new messages can be put out by AMDPRDMP to aid in debugging.

GTF Records

The DSP, EXT, PRM, and SVC comprehensive trace records have had a parameter added to the MODN field.

The explanation for SVC 79 (STATUS) has been changed.

New Emulator

The 7074 emulator can be run on the Model 155.

New I/O Devices

Sense byte information has been added for the 3213, 3215, 3272, 3277, and 3333 as well as additional support for the 3410/3411.

Miscellaneous Corrections

Several additional changes have been made to correct errors.

Summary of Amendments for GC28-6670-5 OS Release 21

PCP REMOVAL

References to the PCP version of Operating System/360 have been deleted from the publication.

TESTRAN REMOVAL

References to the TESTRAN testing facility of Operating System/360 have been deleted from the publication.

IMDPRDMP SERVICE AID OUTPUT

Storage dumps as formatted and displayed by the IMDPRDMP service aid are now discussed in this publication. This material was formerly in the Service Aids publication, GC28-6719.

GENERALIZED TRACE FACILITY (GTF) OUTPUT

GTF trace records, as processed by the EDIT function of the IMDPRDMP service aid are illustrated and discussed in Section 3 of the publication.

DEVICE SUPPORT

The sense byte information given in Appendix G is updated to include information for the:

IBM 3420 Magnetic Tape Unit and 3803 Tape Control

IBM 2596 Card Read Punch
IBM 3505 Card Reader
IBM 3525 Card Punch
IBM 3410 Magnetic Tape Unit
IBM 3411 Magnetic Tape Unit and Control

PROBLEM DETERMINATION

Addition of an Appendix discussing problem determination aids for OPEN/CLOSE/EOV processing.

Updating of the completion codes and service aids Appendixes to reflect release 21 changes.

The Console Dump facility, used to obtain a storage dump for later processing by IMDPRDMP, is briefly described in the storage dump and IMDPRDMP formatting section of the publication.

MISCELLANEOUS

Editorial improvements and corrections to existing material have been made throughout the publication.

Summary of Amendments
for GC28-6670-4
as Updated by GN28-2457 and GN28-2472
OS Release 20.1

TCAM

Section 2: ABEND/SNAP Dump (PCP and MFT)
ABEND/SNAP Dump (MVT)

Appendix A
Appendix H

A brief description of TCAM debugging
Aids and a new SVC.

TSO

Section 2: TSO Control Blocks
Appendix A

The addition of new SVCs and a summary
of the control blocks formatted by
IMDPRDMP.

Summary of Amendments
for GC28-6670-3
OS Release 20

IMDPRDMP

"Guide to Using a Storage Image Dump"

IMDPRDMP is used instead of IEAPRINT to
print MFT and MVT dumps.

3330, 2305, 2319

Appendix F

Additional of sense byte information fo
new devices.

MISCELLANEOUS

Appendix C

1. Addition of module name prefixes
for emulator programs.

Appendix G

2. New features of service aid program
IMAPTFLE.

TSO

Appendix A

New SVCs in Appendix A. This
information is for planning purposes
only.

To debug efficiently, you should be familiar with the system control information reflected in dumps. This control information, in the form of control blocks and traces, tells you what has happened up to the point of error and where key information related to the program is located. To provide an insight into the IBM System/360 Operating System and its complex aspects of task management and storage supervision, Section 1 of this publication provides an orientation in the control functions of the operating system.

The IBM System/360 Operating System provides extensive debugging facilities to aid you in locating errors and determining the system state quickly. Some debugging aids, such as console messages, provide limited information that may not always help you identify the error. This manual discusses those debugging facilities that provide you with the most extensive information:

- a. Abnormal termination (ABEND) and snapshot (SNAP) dumps.
- b. Indicative dumps.
- c. Storage image dumps.
- d. Tracing facilities.

Dumps are discussed in Section 2 and tracing facilities in Section 3.

ABEND and SNAP Dumps are invoked by ABEND and SNAP macro instructions, respectively. They are grouped in a single category because they provide identical information. In addition to a hexadecimal dump of main storage, they can contain conveniently edited control information and displays of the operating system nucleus and trace table.

Indicative dumps contain control information useful in isolating the instruction that caused an abnormal end of task situation. The information is similar to that given in an ABEND/SNAP dump, but does not include a dump of main storage.

Storage dumps are produced by either the system dump facility at the time of a system failure, or by a dump program created through use of the IMDSADMP service aid. IMDSADMP programs must be loaded into

storage through use of the IPL facilities and are intended for use in situations in which the system is not operative, e.g., a disabled wait state or an unending system loop.

The system dump facility writes to the SYS1.DUMP data set. The IMDPRDMP service aid is used to format and print the SYS1.DUMP data set. IMDPRDMP output is described in this publication. The IMDSADMP programs write to tape (high-speed dump) or to tape or printer (low-speed dump). The output tape produced by the high-speed dump must be processed by the IMDPRDMP program; low-speed output to tape may be processed by IMDPRDMP, IEBTPCH or the IEBGENER utility program.

Storage dumps taken by the system dump facility consist of control information followed by a display of printable storage from location 00 to the capacity of storage. Storage words are displayed in both hexadecimal and EBCDIC notation. Storage dumps taken by an IMDSADMP program consist of register contents followed by a display of storage from location 00 to the capacity of storage. Notation is in both hexadecimal and EBCDIC.

Tracing facilities consist of the save area chain trace, the Trace Option and the Generalized Trace Facility.

The save area chain enables tracing of the save areas for each level of load module in a task. The save area trace is displayed in ABEND/SNAP and storage dumps.

The Trace Option, if installed in the system, provides records of system interruptions (IO, SIO, etc.) that are displayed in ABEND/SNAP and storage dumps.

The Generalized Trace Facility (GTF) enables selective tracing of system and application program events and records the information internally, in a table which is displayed in printouts of ABEND dumps and storage dumps, or externally in a data set which is processed by the IMDPRDMP service aid to provide edited and formatted GTF trace records. (For complete information on GTF see the Service Aids publication.) The GTF output, as processed by IMDPRDMP, is discussed in Section 3 of this publication.

General Notes:

- Displacements and addresses shown in the text and illustrations of this publication are given in decimal numbers, followed by the corresponding hexadecimal number in parentheses, e.g., TCB+14(E); location 28(1C); SVC 42(2A). All other numbers in the text are decimal, e.g., the seventeenth word of the TCB; a 4-word control block; 15 job steps.
- Control block field names referred to are those used in the IBM System/360 Operating System: System Control Blocks manual, GC28-6628.
- Wherever possible, diagrams, and reproductions of dumps have been included to aid you during the debugging process.

Section 1: Operating System Concepts

This section introduces you to the control information that you must know to interpret dumps. It is divided into three topics:

- task management
- main storage supervision
- system control blocks and tables

The first two topics deal with those aspects of task management and main storage management, respectively, that are represented in dumps. The third topic describes the remaining system control blocks and tables helpful in pinpointing errors.

Note: The descriptions of system control blocks and tables in this section emphasize function rather than byte-by-byte contents. Appendix K summarizes the contents of those control blocks most useful in debugging.

For a more detailed description of system control blocks and tables, refer to the System Control Blocks publication, GC28-6628.

Task Management

The task management control information most useful in debugging with a dump includes the task control block and its associated request blocks and elements.

The functions, interactions, and relationships to other system features of these items are discussed in this topic. A summary of how task supervision differs at each system level concludes the topic.

Task Control Block

The operating system keeps pointers to all information related to a task in a task control block (TCB). For the most part, the TCB contains pointers to other system control blocks. By using these pointers, you can learn such facts as what I/O devices were allocated to the task, which data sets were open, and which load modules were requested.

Figure 1 shows some of the control information that can be located by using the pointers in the TCB. Later, in the discussion of system control blocks and tables, Figure 1 is expanded to show the actual block names and pointer addresses.

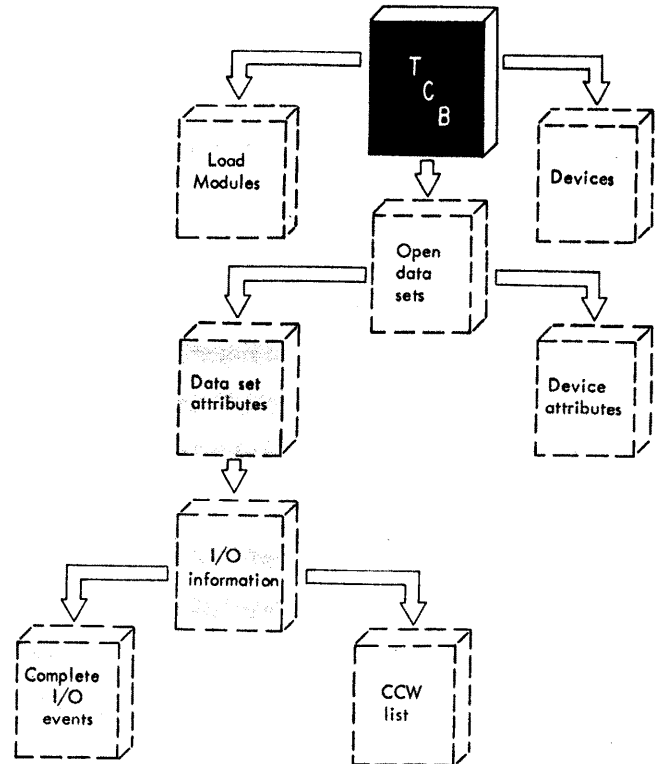

Figure 1. Control Information Available Through the TCB

Request Blocks

Frequently, the routines that comprise a task are not all brought into main storage with the first load module. Instead, they are requested by the task as it requires them. This dynamic loading capability necessitates another type of control block to describe each load module associated with a task -- a request block (RB). An RB is created by the control program when it receives a request from the system or from a problem program to fetch a load module for execution, and at other times, such as when a type II supervisor call (SVC) is issued. By looking at RBs, you can determine which load modules have been executed, why each lost control, and, in most cases, which one was the source of an error condition.

There are seven types of RBs created by the control program:

- Program request block (PRB)
- Supervisor request block (SVRB)
- Interrupt request block (IRB)

- Supervisor interrupt request block (SIRB)
- Loaded program request block (LPRB)
- Loaded request block (LRB)
- Finch request block (FRB)

Of these, you will most often encounter the PRB and SVRB in dumps. The type of RB created depends on the routine or load module with which it is associated.

PRB (Systems with MFT): A PRB is created whenever an XCTL, LINK, or ATTACH macro instruction is issued. It is located immediately before the load module with which it is associated.

PRB (Systems with MVT): A PRB is created whenever an XCTL or LINK macro instruction is issued. It is located in a fixed area of the operating system.

SVRB: An SVRB is created each time a type II, III, or IV supervisor call is issued. (Type I SVC routines are resident, but run disabled; they do not require a request block.) This block is used to store information if an interruption occurs during execution of these SVC routines. A list of SVCs, including their numbers and types, appears in Appendix A.

IRB: An IRB is created each time an asynchronous exit routine is executed. It is associated with an event that can occur at an unpredictable time during program execution, such as a timing routine initiated by an STIMER macro instruction. The IRB is filled at the time the event occurs, just before control is given to the exit routine.

SIRB: An SIRB is similar to an IRB, except that it is associated only with IBM-supplied input/output error routines. Its associated error routine is fetched from the SYS1.SVCLIB data set.

LPRB (MFT only): An LPRB is created when a LOAD macro instruction is issued unless the LOAD macro instruction specifies:

- A routine that has already been loaded.
- A routine that is being loaded in response to a LOAD macro instruction previously issued by a task in the partition (MFT with subtasking).
- A routine that is "only loadable" (see LRB).

An LPRB is located immediately before the load module with which it is associated. Routines for which an LPRB is created can also be invoked by XCTL, LINK, and ATTACH macro instructions.

LRB (MFT only): The LRB is a shortened form of an LPRB. Routines associated with LRBs can be invoked only by a LOAD macro instruction. This attribute is assigned to a routine through the OL (only loadable) subparameter in the PARM parameter of the EXEC statement that executes the linkage editor. The most common reason for assigning this attribute is that linkage conventions for XCTL, LINK, and ATTACH are not followed. This request block is located immediately before the load module with which it is associated.

FRB (MFT with subtasking only): An FRB is created and attached to the job pack area queue, during LOAD macro instruction processing, if the requested module is not already in the job pack area. The FRB describes a module being loaded in response to a LOAD macro instruction. Any subsequent requests for the same module, received while it is still being loaded, are deferred by means of wait list elements (WLEs) queued to the FRB. When the module is fully loaded, an LRB or an LPRB is created, the FRB is removed from the job pack area queue, and any requests, represented by wait list elements, are reinitiated.

Figure 2 shows the relative size of the seven types of RBs and the significant fields in each.

In Figure 2, the "size" field tells the number of doublewords in both the RB and its associated load module. The PSW contained in the "resume PSW" field reflects the reason that the associated load module lost control. Other fields are discussed in succeeding topics.

This far, the characteristics of the TCB and its associated RBs have been discussed. With the possibility of many RBs subordinate to one task, it is necessary that queues of RBs be maintained. In systems with MFT without subtasking, two queues are maintained by the system -- the active RB queue and the load list. In MFT systems with subtasking, a job pack area queue, containing FRBs, and LRBs and LPRBs that represent reenterable modules is also maintained. MVT systems maintain an active RB queue and a contents directory. The contents directory is made up of three separate queues: the link pack area control queue (LPAQ); the job pack area control queue (JPAQ); and the load list.

LPRB

| | | | |
|--|---|--|--|
| -12 | | Major RB address (MFT with subtasking) | |
| -8 | | Load list pointers (MFT) | |
| -4 | | Absent (MVT) | |
| 0 | | | |
| Module name (MFT) Last half of user's PSW (MVT) | | | |
| 8 | | Size Flags | |
| 12(C) Use Ct | ↑ | Entry point (MFT); CDE (MVT) | |
| 16 (10) | | | |
| Resume PSW | | | |
| | | | |
| 28(1C) Wait Ct | ↑ | Next RB | |

LRB

| | | | |
|--|---|---------------------------------|--|
| -8 | | Load list pointers (MFT) | |
| -4 | | Absent (MVT) | |
| 0 | | | |
| Module name (MFT) Last half of user's PSW (MVT) | | | |
| 8 | | Size Flags | |
| 12(C) Use Ct | ↑ | Entry point (MFT); CDE (MVT) | |

PRB

| | | | |
|--|---|---------------------------------|--|
| -8 | | Load list pointers (MFT) | |
| -4 | | Absent (MVT) | |
| 0 | | | |
| Module name (MFT) Last half of user's PSW (MVT) | | | |
| 8 | | Size Flags | |
| 12(C) Use Ct | ↑ | Entry point (MFT); CDE (MVT) | |
| 16 (10) | | | |
| Resume PSW | | | |
| | | | |
| 28(1C) Wait Ct | ↑ | Next RB | |

FRB

| | | | |
|-----------------|--|--------------------|--|
| -8 | | Load list pointers | |
| -4 | | Load list pointers | |
| 0 | | | |
| Module name | | | |
| 8 | | Size Flags | |
| 12 (C) | | | |
| Address of WLE | | | |
| 16 (10) | | | |
| Address of TCB | | | |
| 20 (14) | | | |
| Address of LPRB | | | |

Program Extent List

| | |
|---------|----------------------------------|
| + 0 | Length of extent in hierarchy 0 |
| + 4 | Length of extent in hierarchy 1 |
| + 8 | Address of extent in hierarchy 0 |
| + 12(C) | Address of extent in hierarchy 1 |

Note: Program extent list is added to LPRB, LRB, or PRB if the program described was hierarchy block loaded.

SVRB

| | | | |
|--------------------|---|--|--|
| 0 | | Module name (MFT) Last half of user's PSW (MVT) | |
| 8 | | Size Flags | |
| 12(C) Use Ct | ↑ | Entry point (MFT); CDE (MVT) | |
| 16 (10) | | | |
| Resume PSW | | | |
| | | | |
| 28(1C) Wait Ct | ↑ | Next RB | |
| 32 (20) | | | |
| Register Save Area | | | |
| 96 (60) | | | |
| Extended Save Area | | | |

IRB

| | | | |
|--------------------|---|--|--|
| 0 | | Module name (MFT) Last half of user's PSW (MVT) | |
| 8 | | Size Flags | |
| 12(C) Use Ct | ↑ | Entry point (MFT); CDE (MVT) | |
| 16 (10) | | | |
| Resume PSW | | | |
| | | | |
| 28(1C) Wait Ct | ↑ | Next RB | |
| 32 (20) | | | |
| Register Save Area | | | |

SIRB

| | | | |
|--------------------|---|--|--|
| 0 | | Module name (MFT) Last half of user's PSW (MVT) | |
| 8 | | Size Flags | |
| 12(C) Use Ct | ↑ | Entry point (MFT); CDE (MVT) | |
| 16 (10) | | | |
| Resume PSW | | | |
| | | | |
| 28(1C) Wait Ct | ↑ | Next RB | |
| 32 (20) | | | |
| Register Save Area | | | |

Figure 2. RB Formats

Active RB Queue

The active RB queue is a chain of request blocks associated with active load modules and SVC routines. This queue can contain PRBs, SVRBs, IRBs, SIRBs, and under certain circumstances, LPRBs. Figure 3 illustrates how the active RB queue links together the TCB and its associated RBs.

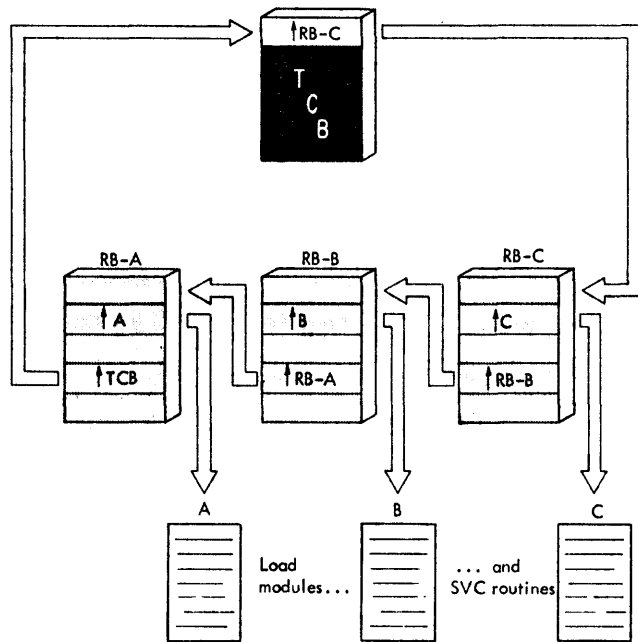

Figure 3. Active RB Queue

The request blocks in the active RB queue in Figure 3 represent three load modules. Load module A invokes load module B, and B, in turn, invokes C. When execution of A began, only one RB existed. When the first invoking request was encountered, a second RB was created, the TCB field that points to the most recent RB was changed, and A's status information was stored in RB-A. A similar set of actions occurred when the second invoking request was encountered. As each load module is executed and control is returned to the next higher level module, its RB is removed from the chain and pointers are updated accordingly.

Load List

The load list is a chain of request blocks or elements associated with load modules invoked by a LOAD macro instruction. The load list differs from the active RB queue in that RBs and associated load modules are not deleted automatically. They remain intact until they are deleted with a DELETE macro instruction or job step termination occurs. By looking at the load list, you can determine which system and problem

program routines were loaded before the dump was taken. The format of the load list differs with control program levels.

Systems with MFT (without subtasking): At this control program level, the load list associated with a TCB contains LRBs and LPRBs. RBs on the load list are linked together somewhat differently from those on the active RB queue because of the characteristics of the LOAD macro instruction. Because RBs may be deleted from a load list in a different order than they were created (depending on the order of DELETE macro instructions), they must have both forward and backward pointers. Figure 4 illustrates how a load list links together a TCB and three RBs.

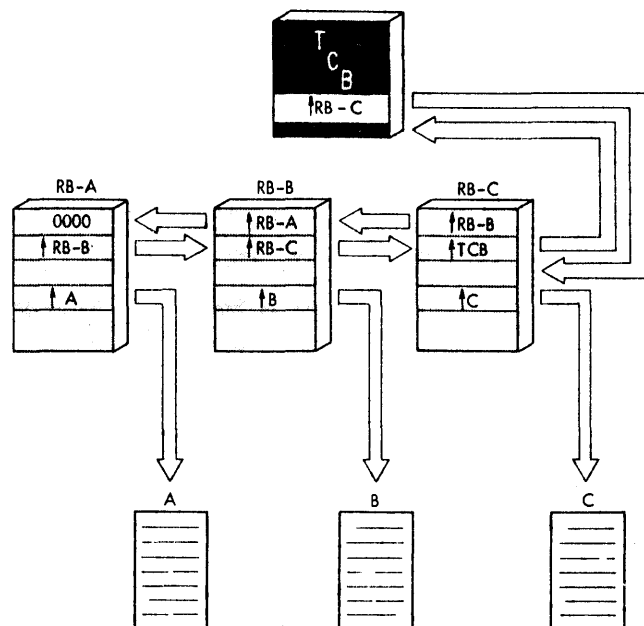

Figure 4. Load List (MFT)

Here, each RB contains a pointer both to the previous RB and the next most recent RB in the list. If there is no previous or more recent RB, these fields contain zeros and a pointer to the TCB, respectively.

Another field of a load list RB that merits consideration is the use count. Whenever a LOAD macro instruction is issued, the load list is searched to see if the routine is already loaded. If it is loaded, the system increments the use count by one and passes the entry point address to the requesting routine.

Each time a DELETE macro instruction is issued for the routine, the use count is decremented by one. When it reaches zero, the RB is removed from the load list and storage occupied by the associated routine is freed.

Systems With MFT (With Subtasking): At this control program level, the load list is used as described for MFT without subtasking, with the following exceptions:

1. The LRBs and LPRBs queued on the load list represent modules that are not reenterable. LRBs and LPRBs representing reenterable modules are queued on the job pack area queue.
2. When a LOAD macro instruction is issued, the system searches the job pack area queue before searching the load list.

Systems With MVT: Instead of LRBs and LPRBs created as a result of LOAD macro instructions, the load list maintained by a system with MVT contains elements representing load modules. Load list elements (LLEs) are associated with load modules through another control medium called the contents directory.

The contents directory is made up of three separate queues: the link pack area control queue (LPAQ), the job pack area control queue (JPAQ), and the load list.

The LPAQ is a record of every program in the system link pack area. This area contains reenterable routines specified by the control program or by the user. The routines in the system link pack area can be used repeatedly to perform any task of any job step in the system. The entries in the LPAQ are contents directory entries (CDEs).

There is a JPAQ for each job step in the system that uses a program not in the link pack area. The JPAQ, like the LPAQ, is made up of CDEs. It describes routines in a job step region. The routines in the job pack area can be either reenterable or not reenterable. These routines however, cannot be used to perform a task that is not part of the job step.

The load list represents routines that are brought into a job pack area or found in the link pack area by the routines that perform the Load function. The entries in the load list are load list elements, not CDEs. Each load list element is associated with a CDE in the JPAQ or the LPAQ; the programs represented in the load list are thus also represented in one of the other contents directory queues.

Load list elements also contain a count field that corresponds to the use count in a LPRB or LRB. Each time a LOAD macro instruction is issued for a load module already represented on the load list, the count is incremented by one. As corresponding DELETE macro instructions are issued, the count is decremented until it

reaches zero. An LLE has the following format:

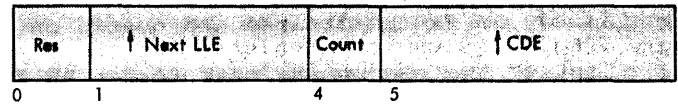

Byte 0: Reserved (RES).

Bytes 1-3: Pointer to the next more recent LLE on the load list.

Byte 4: Count.

Bytes 5-7: Pointer to the corresponding CDE.

More will be said about CDEs in the next topic of Section 1, titled "Main Storage Supervision."

Job Pack Area Queue (MFT With Subtasking Only)

In an MFT system with subtasking, the job pack area queue is a chain of request blocks associated with load modules invoked by a LOAD macro instruction. The queue contains FRBs, and those LRBs and LPRBs that represent reenterable modules. FRBs are queued on the job pack area queue until the requested module is completely loaded. When the module is completely loaded into main storage, the FRB is removed from the job pack area queue and replaced with an LBR or an LPR queue on the job pack area queue if the loaded module is reenterable, and on the load list if it is not.

In the MFT with subtasking configuration, the load list represents non-reenterable modules, while the job pack area queue represents only reenterable modules within the partition. These RBs on the job pack area queue are not deleted automatically, but remain intact until they are deleted by a DELETE macro instruction, or until job step termination occurs. Reenterable load modules are therefore retained in the partition for use by the job step task or any subtasks which may be created.

Whenever a LOAD macro instruction is issued, the job pack area queue is searched. If the routine is already fully loaded and represented by an LRB or an LPRB on the JPAQ (the routine is reenterable), the system increments the use count by one and passes the module entry point address to the requesting routine. If an FRB for the requested module is found, a wait list element (WLE) representing the deferred request is queued to the FRB, and the request is placed in a wait. When the

requested routine is fully loaded, the system releases the request from the wait condition, and the request is re-initiated. If no RB for the requested routine is found, an FRB is created and queued on the JPAQ. The system then searches the load list of the requesting task for an RB for the requested routine. If an RB for that routine is found on the load list (the routine is not reenterable), the use count is incremented by one, the entry point address of the module is passed to the requesting routine, and the FRB is dequeued from the JPAQ. If no RB is found on the load list, the FRB remains on the JPAQ and the system begins loading the requested module.

Each time a DELETE macro instruction is issued for the routine, the use count is decremented by one (the DELETE routine ignores FRBs). When the use count reaches zero, the RB is removed from the queue.

Figure 5 illustrates how the job pack area queue is chained to a TCB.

In Figure 5, each RB contains a pointer to the previous RB and a pointer to the next RB on the queue. If there is no previous RB on the queue, that pointer will contain zero; if there is no next RB on the queue (this RB is the most recent on the JPAQ), the next RB pointer will point back to the job pack area queue pointer in the PIB.

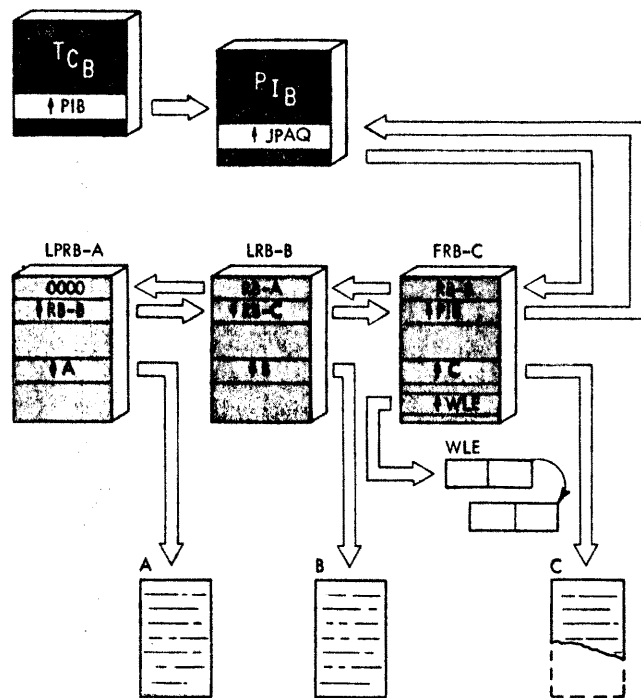

Figure 5. Job Pack Area Queue

Two wait list elements (WLEs) are queued to FRB-C representing deferred requests waiting until the initial loading of the module is completed. The last WLE contains zero in its forward pointer, indicating that it is the last element on the WLE queue.

Effects of LINK, ATTACH, XCTL, and LOAD

LINK, ATTACH, XCTL, and LOAD, though similar, have some distinguishing characteristics and system dependencies worth mentioning. By knowing what happens when these macro instructions are issued, you can make more effective use of the active RB queue and the load list.

LINK: A LINK results in the creation of a PRB chained to the active RB queue. Upon completion of the invoked routine, control is returned to the invoking routine. In systems with MFT, the RB is removed from the queue. The storage occupied by the invoked routine is freed unless the routine is also represented on the load list, or on the job pack area queue in MFT systems with subtasking. In systems with MVT, the use count in the CDE is decremented by one; if it is then zero, the RB and the storage occupied by the routine are marked for deletion. A LINK macro instruction generates an SVC 6.

ATTACH: An ATTACH is similar to the other three macro instructions in systems with MFT without subtasking. In systems with MFT with subtasking or MVT, ATTACH is the means for dynamically creating a separate but related task -- a subtask.

At the MFT without subtasking level, ATTACH effectively performs the same functions as LINK with two notable additions:

1. You can request an exit routine to be given control upon normal completion of the attached routine.
2. You can request the posting of an event control block upon the routine's completion.

Exit routines are represented by additional RBs on the active RB queue. The ATTACH macro instruction generates an SVC 42(2A).

XCTL: An XCTL also results in the creation of a PRB and immediate transfer of control to the invoked routine. However, XCTL differs from the other macro instructions in that, upon completion of the invoked routine, control is passed to a routine other than the invoking routine. In fact, an XCTL does not result in the creation of a lower level RB. Instead, the invoking routine and its associated RBs are deleted when the XCTL is issued. In effect, the RB

for the invoked routine replaces the invoking routine's RB. The XCTL macro instruction generates an SVC 7.

LOAD: The LOAD macro instruction was treated previously in the discussion of the load list. To summarize: the system responds to a LOAD by fetching the routine into main storage and passing the entry point address to the requesting routine in register 0. Because the system does not have an indication of when the routine is no longer needed, a LOAD must be accompanied by a corresponding DELETE macro instruction. If not, the routine and its RB remain intact until the job step is terminated. The LOAD macro instruction generates an SVC 8.

System Task Control Differences

Thus far, this topic has dealt with the aspects of task supervision that are similar for MFT and MVT. There are, however, some major differences:

1. The number of tasks that can be known to the system concurrently.
2. The layout of main storage.
3. The additional main storage control information in systems with MVT.

The first two subjects are discussed here, by system. The third subject, because of its volume, is discussed in the next topic of Section 1.

Systems With MFT (Without Subtasking)

Figure 6 is a snapshot of main storage in a system with MFT without subtasking.

The fixed area contains the nucleus (including TCB queue, transient area loading task, communications task, and master scheduler task), and the system queue area. Optionally it may contain access methods and SVC routine which are normally nonresident, a list of absolute addresses for routines which reside on direct access devices, and a reenterable load module area.

One TCB exists for each task. All TCBs are linked by dispatching priority in a TCB queue, beginning with the three resident tasks.

The dynamic area is divided into a maximum of 52 partitions. Each partition contains one task. The dynamic area can contain as many as 3 reading tasks, 36 writing tasks, and 15 job step tasks, providing that the total number of tasks does not exceed 52. Partition sizes and attributes are defined during system generation. Figure 7 shows the contents of an MFT partition.

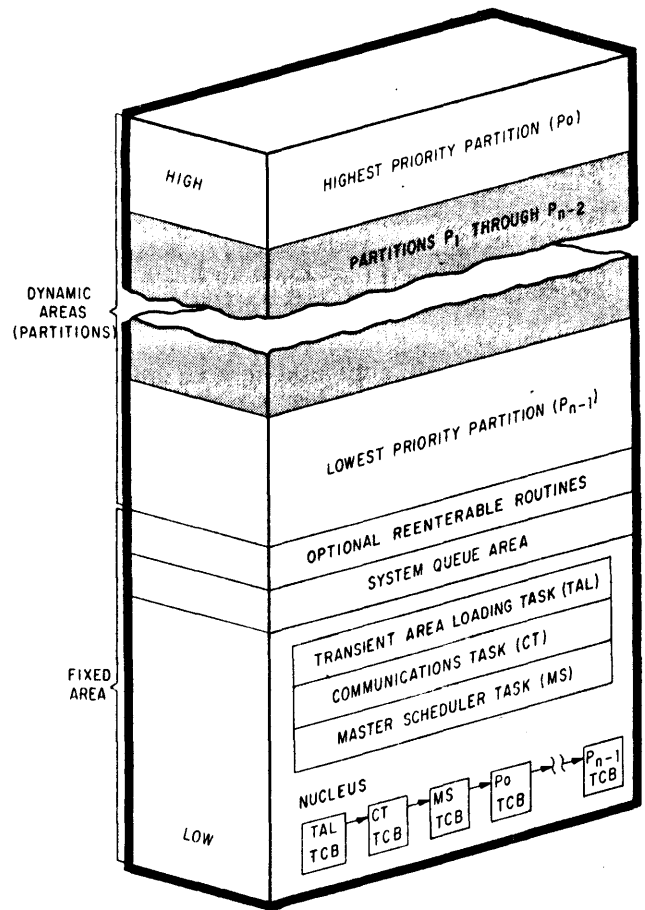

Figure 6. Main Storage Snapshot (MFT Without Subtasking)

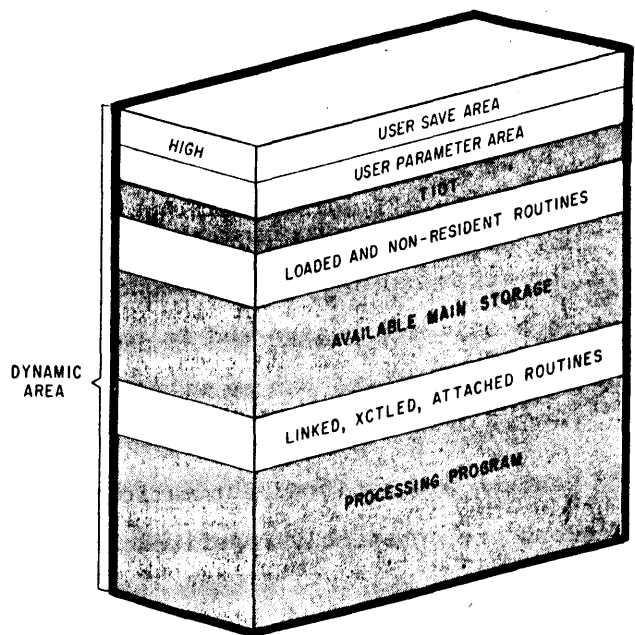

Figure 7. Partition (MFT Without Subtasking)

Jobs are processed sequentially in a partition, one job step at a time. An ATTACH macro instruction does not create a subtask.

Systems with MFT (With Subtasking):

Operating Systems that provide multiprogramming with a fixed number of tasks with the subtasking option (MFT with subtasking) differ from MFT systems without subtasking in the following major areas:

1. MFT with subtasking has an ATTACH facility similar to the ATTACH facility in MVT. While the number of job step TCBS still may not exceed 15, the number of tasks in any partition, and therefore the total number of tasks in the system, is now variable. Job step task TCBS reside in the nucleus. They are queued, following the system task TCBS, in the same manner as in MFT without subtasking. When subtasks are created, however, the subtask TCBS are placed in the system queue area and queued to the job step TCBS according to dispatching priority (TCBTCB field), and according to subtask relationships (TCBNTC, TCBOTC, TCBLTC fields).
2. MFT with subtasking provides the ability to change the dispatching priority of any task within a partition through the use of the CHAP macro instruction.

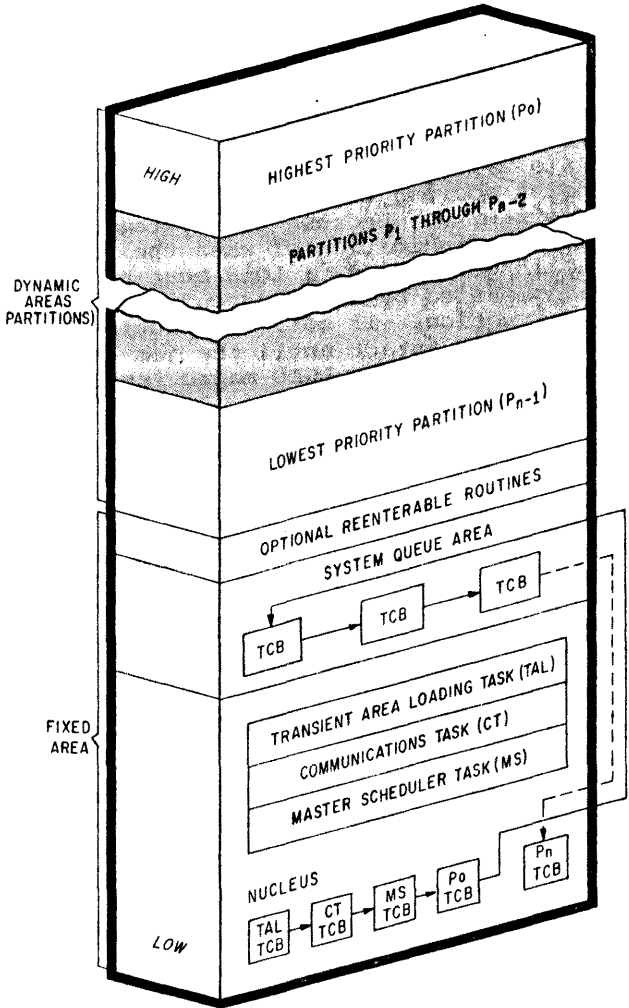

Figure 8. Main Storage Snapshot (MFT With Subtasking)

With the facility of attaching subtasks available to each task through the ATTACH macro instruction, the number of TCBS in the system is variable. Tasks gain control of the CPU by priority. To keep track of the priority and status of each task in the system, TCBS are linked together in a TCB queue.

Figure 8 is a snapshot of main storage in an MFT system with subtasking. Note here that the TCBS in the nucleus are all job step TCBS, while those residing in the system queue area are the subtask TCBS.

Systems with MVT: In Operating Systems that provide multiprogramming with a variable number of tasks (MVT), as many as 15 job steps can be executed concurrently. Each job step requests an area of main storage called a region and is executed as a job step task. In addition, system tasks request regions and can be executed concurrently with job step tasks.

Figure 9 is a snapshot of main storage in a system with MVT. The fixed area is occupied by the resident portion of the control program loaded at IPL. The system queue space is reserved for control blocks and tables built by the control program. The dynamic area is divided into variable-sized regions, each of which is allocated to a job step task or a system task. Finally, the link pack area contains selected reenterable routines, loaded at IPL. If an IBM 2361 Core Storage device and Main Storage Hierarchy Support are included in the system, a secondary link

Regions are assigned automatically from the dynamic area when tasks are initiated. Regions are constantly redefined according to the main storage requirements of each new task.

pack area may be created in hierarchy 1 to contain other reenterable routines.

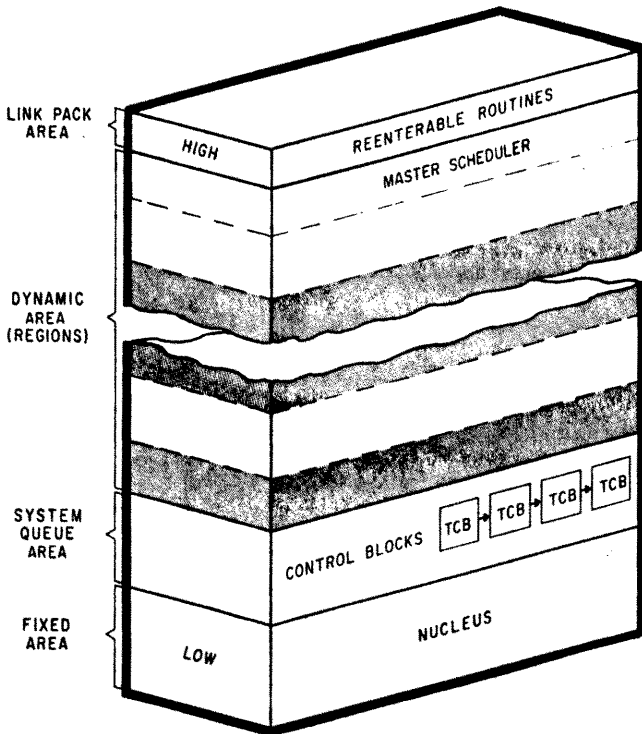

Figure 9. Main Storage Snapshot (MVT)

Main Storage Supervision

Storage control information is kept in a series of control blocks called queue elements. In systems with MFT without subtasking, queue elements reflect areas of main storage that are unassigned. In MFT systems with subtasking, a gotten subtask area queue element (GQE) is introduced to record storage obtained for a subtask by a supervisor issued GETMAIN macro instruction. In systems with MVT, more elaborate storage control is maintained; at any given time, queue elements reflect the distribution of main storage in regions, subpools, and load modules.

The dynamic area may be significantly expanded by including IBM 2361 Core Storage in the system. Main Storage Hierarchy Support for IBM 2361 Models 1 and 2 permits selective access to either processor storage (hierarchy 0) or 2361 Core Storage (hierarchy 1). If IBM 2361 Core Storage is not included, requests for storage from hierarchy 1 are obtained from hierarchy 0. If 2361 Core Storage is not present in an MVT system and a region is defined to exist in two hierarchies, a two-part region is established within processor storage. The two parts are not necessarily contiguous.

Storage Control in Systems with MFT (Without Subtasking)

The chain of storage control information in an MFT system without subtasking begins at a table called the main storage supervisor (MSS) boundary box, located in the system nucleus. There is one MSS boundary box for each partition. It is pointed to by the TCB (TCBMSS field) for the partition.

Each boundary box contains 3 words. The first word points to the Free Queue Element (FQE) associated with the highest free area in the partition. The second word points to the lowest limit of the partition. The third word contains the highest address in the partition plus 1.

If Main Storage Hierarchy Support is included, the first half of each expanded boundary box describes the processor storage (hierarchy 0) partition segment, and the second half describes the 2361 Core Storage (hierarchy 1) partition segment. Any partition segment not currently assigned storage in the system has the applicable boundary box pointers set to zero. If the partition is established entirely within hierarchy 0, or if 2361 Core Storage is not included in the system, the hierarchy 1 pointers in the second half of the expanded boundary box are set to zero. If a partition is established entirely within hierarchy 1, the hierarchy 0 pointers in the first half of the expanded boundary box are set to zero.

FQE: Each free area in a partition is described by an FQE. FQEs are chained beginning with the FQE associated with the free area having the highest address in the partition. If Main Storage Hierarchy Support is present, one FQE chain exists for each hierarchy specified. Each FQE occupies the first 8 bytes of the area it describes. It has the following format:

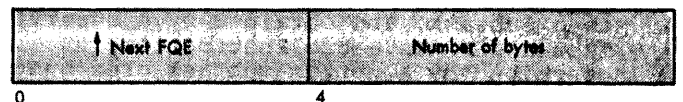

Bytes 0-3: Pointer to FQE associated with next lower free area or, if this is the last FQE, zeros.

Bytes 4-7: Number of bytes in the free area.

Figure 10 summarizes storage control in systems with MFT without subtasking.

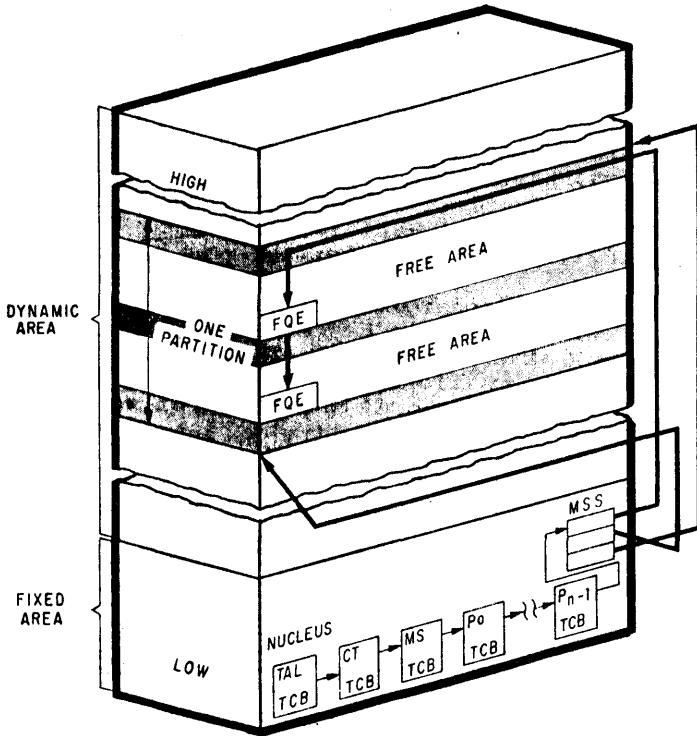

Figure 10. Storage Control for a Partition (MFT Without Subtasking)

Storage Control in Systems with MFT (With Subtasking)

Storage control information for the job step or partition TCB in MFT systems with subtasking is handled in the same way as in MFT systems without subtasking. However, when subtasks are created, the supervisor builds another control block, the gotten subtask area queue element (GQE). The GQEs associated with each subtask originate from a one word pointer addressed by the TCBMSS field of the subtask TCB.

GQE: Each area in main storage belonging to a subtask, and obtained by a supervisor issued GETMAIN macro instruction, is described by a gotten subtask area queue element (GQE). GQEs are chained in the order they are created. The TCBMSS field of the subtask TCB contains the address of a word which points to the most recently created GQE.

If Main Storage Hierarchy Support is present in the system, the GQE chain can span from hierarchy 0 to hierarchy 1 and back in any order. Each GQE occupies the first eight bytes of the area it describes, and has the following format:

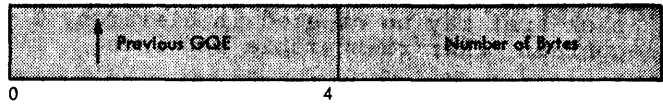

Bytes 0-3: Pointer to the Previous GQE or, if zero, this is the last GQE on the chain.

Bytes 4-7: Number of bytes in the gotten subtask area.

Figure 11 summarizes the chaining of GQEs to a subtask TCB.

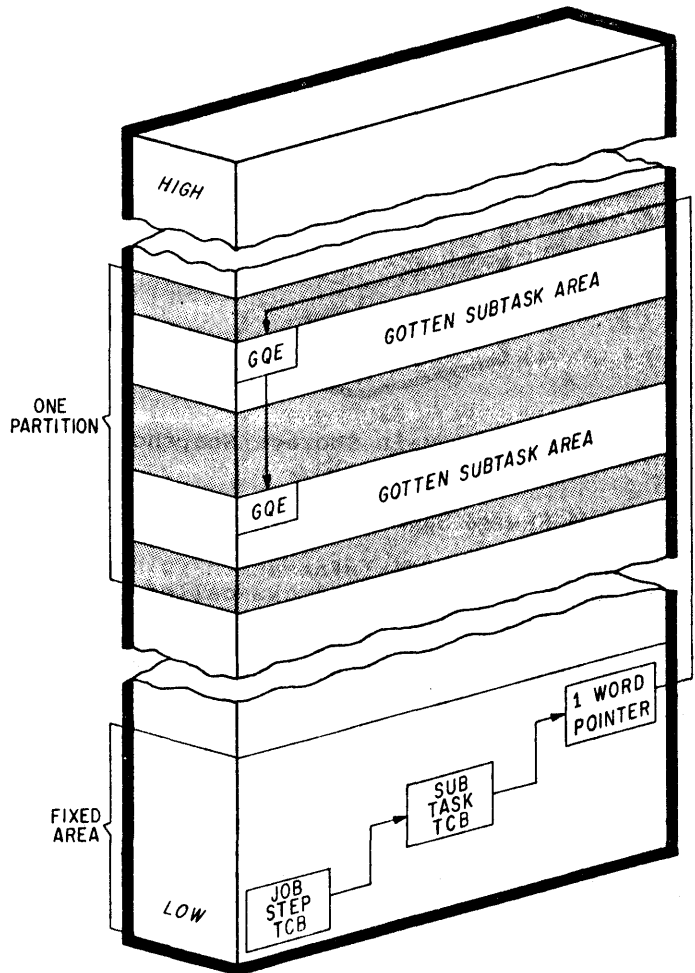

Figure 11. Storage Control for Subtask Storage (MFT With Subtasking)

Storage Control for a Region in Systems with MVT

Unassigned areas of main storage within each region of a system with MVT are reflected in a queue of partition queue elements (PQEs) and a series of free block queue elements (FBQEs).

PQE: The partition queue associated with a region resides in the system queue space. It is connected to the TCBS for all tasks in the job step through a dummy PQE located in the system queue space. A dummy PQE has the following format:



Bytes 0-3: Pointer to the first PQE in the partition queue.

Bytes 4-7: Pointer to the last PQE in the partition queue.

In systems that do not include the rollout/rollin feature or Main Storage Hierarchy Support for IBM 2361 Models 1 and 2, there is one PQE for each job step. If the rollout feature is used, additional PQEs are added each time a job step borrows storage space from existing steps or acquires unassigned free space to satisfy an unconditional GETMAIN request. These additional PQEs are removed from the queue as the rollin feature is used. If Main Storage Hierarchy Support is present, one PQE exists for each hierarchy used by the job step. A PQE has the following format:

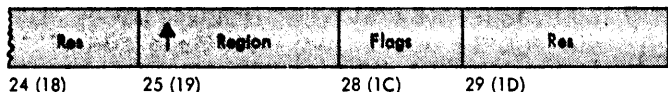
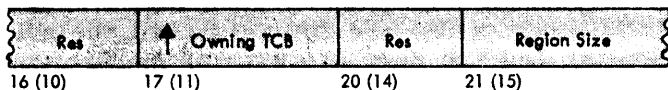
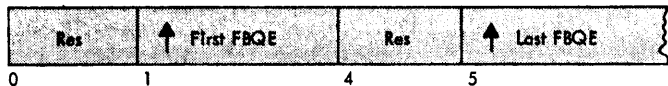

Bytes 1-3: Pointer to the first FBQE or, if there are no FBQEs, a pointer to the PQE itself.

Bytes 5-7: Pointer to the last FBQE or, if there are no FBQEs, a pointer to the PQE itself.

Bytes 9-11(B): Pointer to the next PQE or, if this is the last PQE, zeros.

Bytes 13-15(D-F): Pointer to the previous PQE or, if this is the first PQE, zeros.

Bytes 17-19(11-13): Pointer to the TCB of the owning job step.

Bytes 21-23(15-17): Size of the region, in 2K (2048) bytes.

Bytes 25-27(19-1B): Pointer to the first byte of the region.

Byte 28(1C): Rollout flags.

FBQE: The FBQEs chained to a PQE reflect the total amount of free space in a region. Each FBQE is associated with one or more contiguous 2K blocks of free storage area. FBQEs reside in the lowest part of their associated area. As area distribution within the region changes, FBQEs are added to and deleted from the free block queue.

An FBQE has the following format:

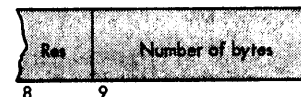
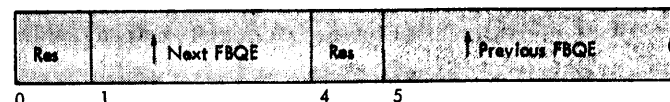

Bytes 1-3: Pointer to the next lower FBQE or, if this is the last FBQE, a pointer to the PQE.

Bytes 5-7: Pointer to the preceding FBQE, or, if this is the first FBQE, a pointer to the PQE.

Bytes 8-11(B): Number of bytes in the free block.

The remaining main storage in a region is used by problem programs and system programs. For convenience in referring to storage areas, the total amount of space assigned to a task represents one or more numbered subpools. (Subpools can also be shared by tasks.) Subpools are designated by a number assigned to the area through a GETMAIN macro instruction. Subpool numbers available for problem program use range from 0 through 127. Subpool numbers 128 through 255 are either unavailable or used by system programs.

Storage control elements and queues for a region are summarized in Figure 12.

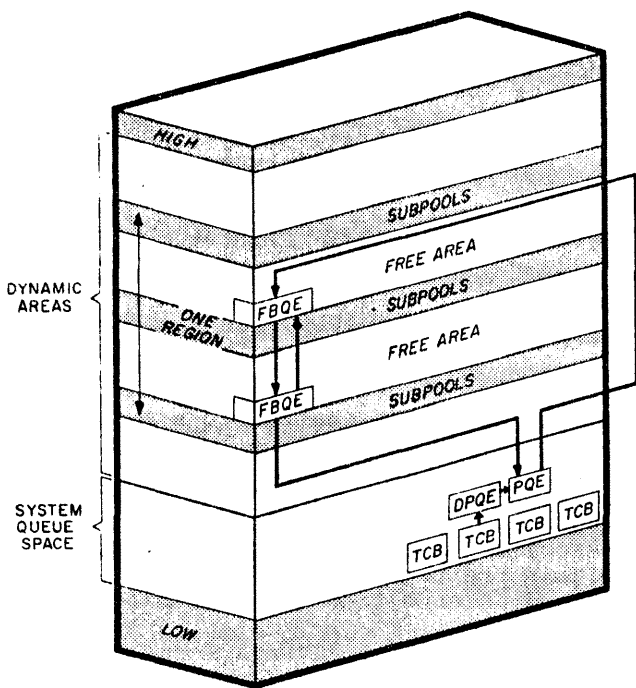
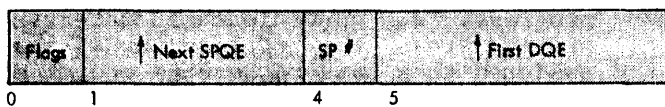

Figure 12. Storage Control for a Region (MVT)

Storage Control for a Subpool in Systems with MVT

Main storage distribution within each subpool is reflected in a subpool queue element (SPQE) and queues of descriptor queue elements (DQEs) and free queue elements (FQEs).

SPQE: SPQEs are associated with the subpools created for a task. SPQEs reside in the system queue space and are chained to the TCB(s) that use the subpool. They serve as a link between the TCB and the descriptor queue, and may be part of a subpool queue if the task uses more than one subpool. If a subpool is used by more than one task, only one SPQE is created. An SPQE has the following format:



- Byte 0:
- Bit 0 - Subpool is owned by this task if zero; shared, and owned by another task, if one.
 - Bit 1 - This SPQE is the last on the queue, if one.
 - Bit 2 - Subpool is shared and owned by this task, if one.
 - Bits 3-7 - Reserved.

Bytes 1-3: Pointer to next SPQE or, in last SPQE, zero.

Byte 4: Subpool number.

Bytes 5-7: Pointer to first DQE or, if the subpool is shared, a pointer to the "owning" SPQE.

DQE: DQEs associated with each SPQE reflect the total amount of space assigned to a subpool. Each DQE is associated with one or more 2K blocks of main storage set aside as a result of a GETMAIN macro instruction. Each DQE is also the starting point for the free queue. A DQE has the following format:

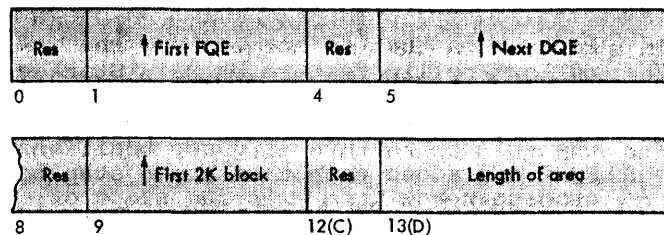

Bytes 1-3: Pointer to the FQE associated with the first free area.

Bytes 5-7: Pointer to the next DQE or, if this is the last DQE, zeros.

Bytes 9-11(B): Pointer to first 2K block described by this DQE.

Bytes 13-15(D-F): Length in bytes of area described by this DQE.

FQE: The FQE describes a free area within a set of 2K blocks described by a DQE. It occupies the first eight bytes of that free area. Since the FQE is within the subpool, it has the same protect key as the task active within that subpool. Extreme care should be exercised to see that FQEs are not destroyed by the problem program. If an FQE is destroyed, the free space that it describes is lost to the system and cannot be assigned through a GETMAIN. As area distribution within the set of blocks changes, FQEs are added to and deleted from the free queue. An FQE has the following format:

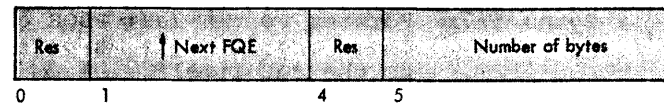

Bytes 1-3: Pointer to the next lower FQE or, if this is the last FQE, zeros.

Bytes 5-7: Number of bytes in the free area.

Storage control for a subpool is summarized in Figure 13.

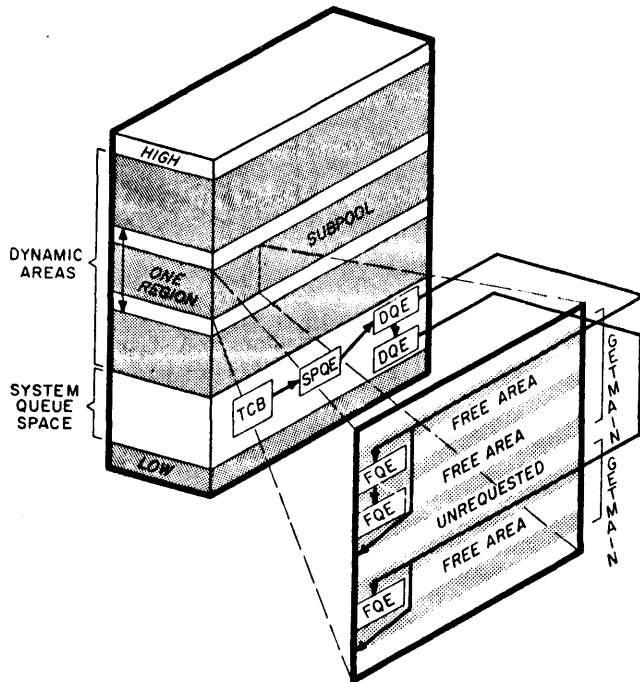
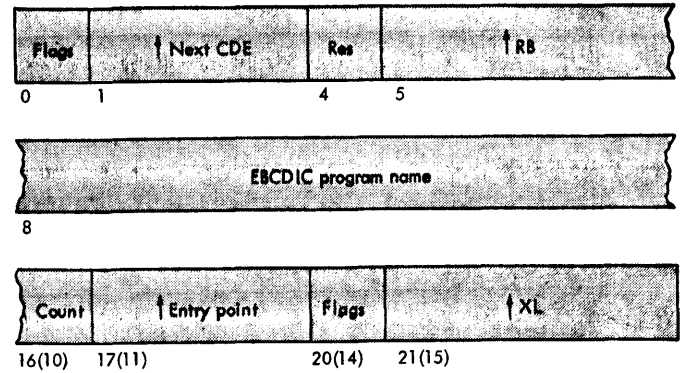

Figure 13. Storage Control for a Subpool (MVT)

Storage Control for a Load Module in Systems With MVT

Each load module in main storage is described by a contents directory entry (CDE) and an extent list (XL) that tells how much space it occupies.

CDE: The contents directory is a group of queues, each of which is associated with an area of main storage. The CDEs in each queue represent the load modules residing in the associated area. There is a CDE queue for the link pack area and one for each region, or job pack area. The TCB for the job step task that requested the region contents directory queues reside in the system queue space. A CDE has the following format:



Byte 0: Flag bits, when set to one, indicate:
 Bit 0 - Module was loaded by NIP.
 Bit 1 - Module is in process of being loaded.
 Bit 2 - Module is reenterable.
 Bit 3 - Module is serially reusable.
 Bit 4 - Module may not be reused.
 Bit 5 - This CDE reflects an alias name (a minor CDE).
 Bit 6 - Module is in job pack area.
 Bit 7 - Module is not only-loadable.

Bytes 1-3: Pointer to next CDE.

Bytes 5-7: Pointer to the RB.

Bytes 8-15(F): EBCDIC name of load module.

Byte 16(10): Use count.

Bytes 17-19(11-13): Entry point address of load module.

Byte 20: Flag bits, when set to one, indicate:
 Bit 0 - Reserved.
 Bit 1 - Module is inactive.
 Bit 2 - An extent list has been built for the module.
 Bit 3 - This CDE contains a relocated alias entry point address.
 Bit 4 - The module is refreshable.
 Bits 5, 6, 7 - Reserved.

Bytes 21-23(15-17): Pointer to the XL for this module or, if this is a minor CDE, pointer to the major CDE.

XL: The total amount of main storage occupied by a load module is reflected in an extent list (XL). XLs are located in the system queue space. An XL has the following format:

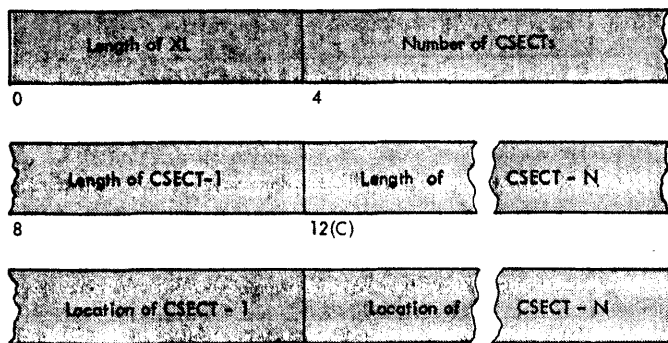

Bytes 0-3: Length of XL in bytes.

Bytes 4-7: Number of scattered control sections. If the control sections are block-loaded, 1.

Remaining bytes: Length in bytes of each control section in the module (4 bytes for each control section) and starting location of each control section (4 bytes for each control section).

Storage control elements and queues for load modules are summarized in Figure 14.

System Control Blocks and Tables

In addition to the key task management control blocks (TCB and RB), several other control blocks containing essential debugging information are built and maintained by data management and job management routines. Although some of these blocks are not readily identifiable on a storage dump, they can be located by following chains of pointers that begin at the TCB.

The control blocks discussed here have the same basic functions at each control program level. The precise byte-by-byte contents of the blocks can be found in the publication System Control Blocks. Block contents useful in debugging are listed in Appendix K.

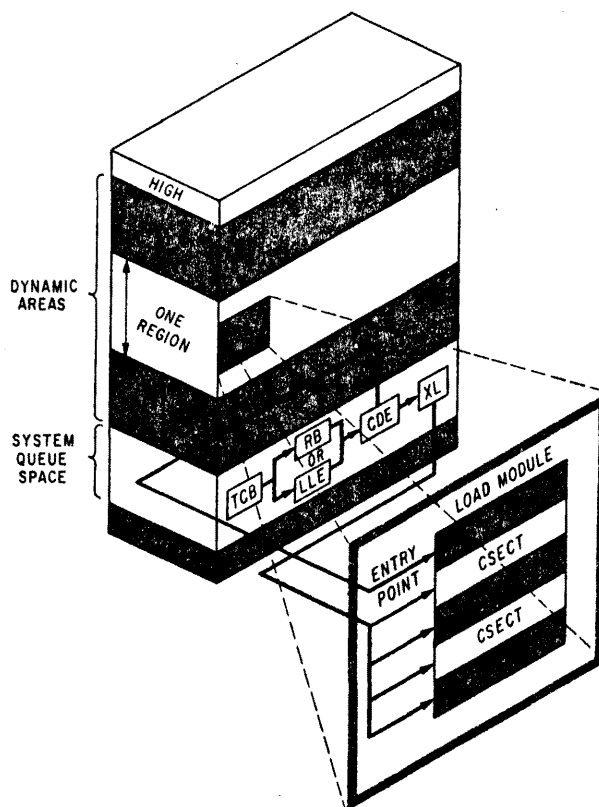

Figure 14. Storage Control for a Load Module (MVT)

Communications Vector Table (CVT)

The CVT provides a means of communication between nonresident routines and the control program nucleus. Its most important role in debugging is its pointer to two words of TCB addresses. These words enable you to locate the TCB of the active task, and from there to find other essential control information. Storage locations 16(10) and 76(4c) contain a pointer to the CVT.

Task Input/Output Table (TIOT)

A TIOT is constructed by job management for each task in the system. It contains primarily pointers to control blocks used by I/O support routines. It is usually located in the highest part of the main storage area occupied by the associated task (in systems with MVT, TIOTs are in the system queue space.) Through the TIOT, you can obtain addresses of unit control blocks allocated to the task, the job and step name, the ddnames associated with the step, and the status of each device and volume used by the data sets.

Unit Control Block (UCB)

The UCB describes the characteristics of an I/O device. One UCB is associated with each I/O device configured into a system. The UCB's most useful debugging aid is the sense information returned by the last sense command issued to the associated device.

Event Control Block (ECB)

The ECB is a 1-word control block created when a READ or WRITE macro instruction is issued, initiating an asynchronous I/O operation. At the completion of the I/O operation, the access method routine posts the ECB. By checking this ECB, the completion status of an I/O operation can be determined. In all access methods but QTAM, the ECB is the first word of a larger block, the data event control block.

Input/Output Block (IOB)

The IOB is the source of information required by the I/O supervisor. It is filled in with information taken from an I/O operation request. In debugging, it is useful as a source of pointers to the DCB associated with the I/O operation and the channel commands associated with a particular device.

Data Control Block (DCB)

The DCB is the place where the operating system and the problem program store all pertinent information about a data set. It may be completely filled by operands in the DCB macro instruction, or partially filled in and completed when the data set is opened, with subparameters in a DD statement and/or information from the data set label. The format of DCBs differs slightly for each of the various access methods and device types. The DCB's primary debugging aids are its pointers to the DEB and current IOB associated with its data set, and the offset value of the ddname in the TIOT.

Data Extent Block (DEB)

A DEB describes a data set's auxiliary storage assignments and contains pointers

to some other control blocks. The DEB is created and queued to the TCB at the time a data set is opened. Each TCB contains a pointer to the first DEB on its chain. Through this pointer you can find out which data sets are opened for the task at a given time, what extents are occupied by open data sets, and where the DCB and UCB are located.

Summary of Control Block Relationships

Figure 15, an expansion of Figure 1, shows the relationships among the principal control blocks and tables in the System/360 Operating System.

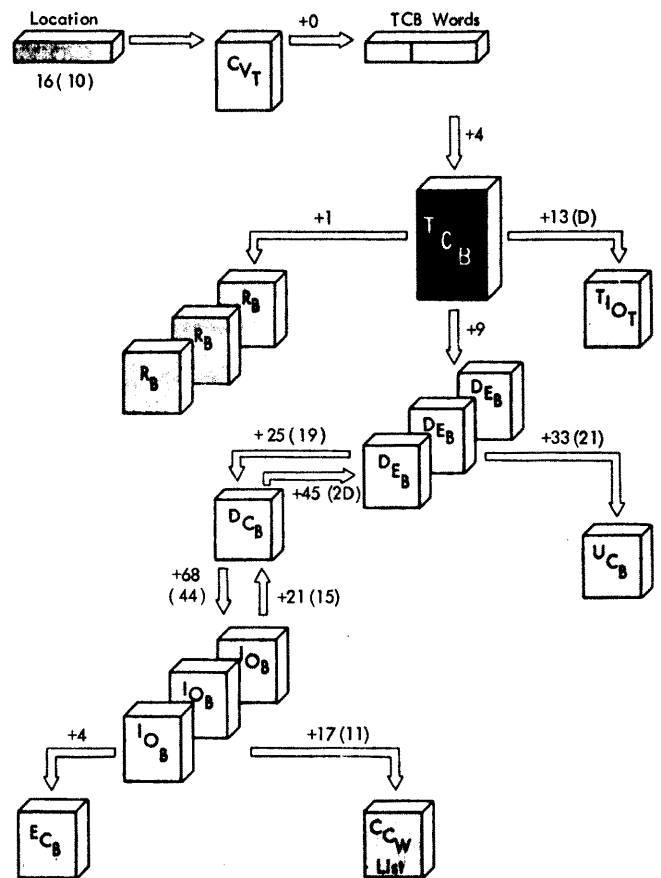

Figure 15. Control Block Relationships

Section 2: Interpreting Dumps

Topics composing Section 2 are:

- ABEND/SNAP dumps issued by systems with MFT.
- ABEND/SNAP dumps issued by systems with MVT.
- Indicative dumps.
- Storage dumps.

Each topic includes instructions for invoking the dump, a detailed description of the dump's contents, and a guide to using the dump.

ABEND/SNAP Dump (MFT)

ABEND/SNAP storage dumps are issued whenever the control program or problem program issues an ABEND or SNAP macro instruction, or the operator issues a CANCEL command requesting a dump, and proper dump data sets have been defined. However, in the event of a system failure, if a SYS1.DUMP data set has been defined and is available, a full storage dump will be provided, as explained in the section "Storage Dumps."

Since, in an MFT with subtasking system, subtasks may be created, you may receive one or more partial dumps in addition to the complete dump of the task that caused the abnormal termination. A complete dump includes a printout of all control information related to the terminating task, and the nucleus and all allocated storage within the partition in which the abending task resided. A partial dump of a task related to the terminating task includes only control information. The partial dump is identified by either ID=001 or ID=002 printed in the first line of the dump. Figure 16 is a copy of the first few pages of a complete ABEND dump of an MFT system with subtasking. It illustrates some of the key areas on an ABEND dump, as issued by systems with MFT. Those portions of the dump that would only appear on a dump of a subtasking system are noted in the later discussions as appearing only in a dump of an MFT with subtasking system.

For a discussion of a formatted ABEND dump using the telecommunications access method (TCAM) in an MFT environment, see IBM System/360 Operating System: TCAM Program Logic Manual, GY30-2029. References to other TCAM debugging aids are found in Appendix J.

Invoking an ABEND/SNAP Dump (MFT)

ABEND dumps are produced as a result of an ABEND macro instruction, issued either by a processing program or an operating system routine. The macro instruction requires a DD statement in the input stream for each job step that is subject to abnormal termination. This DD statement must be identified by one of the special ddnames SYSABEND or SYSUDUMP. SYSABEND results in edited control information, the system nucleus, the trace table, and a dump of main storage; SYSUDUMP excludes the nucleus and the trace table. In the event of a system failure, the Damage Assessment routine (DAR) attempts to write a storage image dump to the SYS1.DUMP data set. A full explanation of storage dumps may be found in the section "Storage Dumps."

SNAP Dumps result from a problem program issuing a SNAP macro instruction. The contents of a SNAP dump vary according to the operands specified in the SNAP macro instruction. SNAP dumps also require a DD statement in the input stream. This DD statement has no special characteristics except that its ddname must not be SYSABEND or SYSUDUMP. The processing program must define a DCB for the snapshot data set. The DCB macro instruction must contain, in addition to the usual DCB requirements, the operands DSORG=PS, RECFM=VBA, MACRF=(W), BLKSIZE=882 or 1632, and LRECL=125. In addition, the DCB must be opened before the first SNAP macro instruction is issued.

Main Storage Considerations: Three BSAM modules (IGG019BA, IGG019BB, and the device-dependent EOB module) are required to process dumps. These modules should be made resident in the Resident Access Method (RAM) area by specifying RESIDENT=ACSMETH in the SUPRVSOR macro instruction during system generation. If these modules are not resident, as much as 1352 bytes of main storage within the partition are required to contain them.

In addition to the area required for the BSAM modules, 2784 bytes must be available in the partition. 1344 of these bytes are required for EOVS processing should the initial space specification for a direct access device be exceeded by the dump requirements.

* ABDUMP REQUESTED *

JOB ATHEOT24 STEP STEP TIME 000737 DATE 99366 PAGE 0001

COMPLETION CODE USER = 0123

INTERRUPT AT C6EF5A

PSW AT ENTRY TO ABEND 00150000 4006EF5A

| | | | | | | | | | | | | | |
|-----|--------|------|----------|--------|----------|------|----------|------|----------|------|----------|------|----------|
| TCB | 01C820 | RB | 0007FC58 | PIE | 00000000 | DEB | 0007F78C | TLOT | 0007FD80 | CMP | 8000007B | TRN | 00000000 |
| | | MSS | 0001CC58 | PK/FLG | 10810408 | FLG | 000001F8 | LLS | 00000000 | JLB | 0007FFF8 | JST | 00005508 |
| | | FSA | 1506EF58 | TCB | 0001D0A0 | IME | 0001C808 | PIB | E0012420 | NTC | 00000000 | OTC | 0001CDE0 |
| | | STAE | 00000000 | TCT | 00000000 | USER | 00000000 | DAR | 00000000 | RESV | 00000000 | JSCB | 00000000 |

ACTIVE RBS

| | | | | | | | | | | | | | | |
|------|--------|--------|----------|----------|----------|----------|----------|----------|----------|----------|---|--------|----------|----------|
| PRB | 06EE28 | NM | TATHB10G | SZ/STAB | 003020D0 | USE/EP | 0106EE48 | PSW | 00150000 | 4006EF5A | Q | 000700 | WT/LNK | 0001C820 |
| SVRB | 07FD20 | NM | SVC-601C | SZ/STAB | 0012D062 | USE/EP | 00007B78 | PSW | FF040033 | 50007D20 | Q | 900390 | WT/LNK | 0006EE28 |
| | | RG | 0-7 | 000002A0 | 8000007B | 00000000 | 00080000 | 0007FE48 | 00000098 | 00005508 | | | 0007FC30 | 00000000 |
| | | 8-15-7 | 0006EE60 | 0007FF78 | 0007FF80 | 0007FFF8 | 4006EE4E | 0006EE60 | 00009848 | 00000000 | | | | |
| SVRB | 07FC58 | NM | SVC-A05A | SZ/STAB | 000CD062 | USE/EP | 00007B78 | PSW | FF04000E | 8001E7EC | Q | F803F8 | WT/LNK | 0007FD20 |
| | | RG | 0-7 | 0007F7E8 | 0007FD80 | 40007B7A | 000097F8 | 0001C820 | 0007FD20 | 0006F230 | | | 00005508 | 00000000 |
| | | 8-15-7 | 0007F7E8 | 0006F296 | 0001CC56 | 0000225C | 0001C820 | 0006F230 | 90007C8C | 0001E7C8 | | | | |

| | | | | | | | | | | | | | | |
|-----|--------|------|----------|----------|----------|----------|----------|----------|----------|----------|----------|----------|----------|----------|
| JOB | PAC | AREA | 00000000 | 00000000 | 00000000 | 00000000 | 00000000 | 00000000 | 00000000 | 00000000 | 00000000 | 00000000 | 00000000 | 00000000 |
| LP | 06BCAD | NM | TATHB10G | SZ/STAB | 002F20D0 | USE/EP | 0106EE48 | PSW | FF19000E | 8006E09C | Q | 000000 | WT/LNK | 0101CDE0 |
| LP | 06EE28 | NM | TATHB10G | SZ/STAB | 003020D0 | USE/EP | 0106EE48 | PSW | 00150000 | 4006EF5A | Q | 000000 | WT/LNK | 0001C820 |
| LP | 06F810 | NM | TATHB10G | SZ/STAB | 00122090 | USE/EP | 0106F038 | PSW | 00040000 | 4006AE4 | Q | 000000 | WT/LNK | 0001CC80 |
| LP | 0A0050 | NM | TATHB10G | SZ/STAB | 00182090 | USE/EP | 0106F000 | PSW | 881E0001 | 4006F10E | Q | 000000 | WT/LNK | 0101D0A0 |
| LP | 0A0050 | NM | TATHB10G | SZ/STAB | 00182090 | USE/EP | 0106F100 | PSW | 881E0001 | 4006F21E | Q | 000000 | WT/LNK | 0101CF40 |

P/P STORAGE BOUNDARIES 0006E800 TO 00080000

| FREE AREAS | SIZE |
|------------|----------|
| 06E890 | 00000060 |
| 06EC50 | 00000050 |
| 06F588 | 0000FC58 |
| 07F668 | C0000098 |
| 07F708 | 00000010 |
| 07F840 | C0000228 |
| 07FB90 | 000000C0 |
| 07FEE8 | 0000C018 |

| BOTTEN CORE | SIZE |
|-------------|----------|
| 07F218 | 00000380 |
| 06F310 | 000002A8 |
| 07FC50 | 00000088 |
| 06F228 | 000000E8 |
| 07E390 | 00000008 |
| 07E3F0 | 00000008 |
| 07E418 | 00000098 |
| 07F700 | 00000060 |
| 07F760 | 00000078 |
| 07FA68 | 00000060 |
| 07FAC8 | 00000078 |

Figure 16. Sample of an ABEND Dump (MFT) (Part 1 of 2)

SAVE AREA TRACE

PAGE 0002

TATHBLOG WAS ENTERED

```

SA 06EBF8 WD1 0606EAC8 HSA 00000100 LSA 0006EE60 RET 00009848 EPA 4006EE48 R0 000099CE
           R1 0001CC80 R2 00000000 R3 00080000 R4 0007FE48 R5 00000098 R6 000055D8
           R7 0007FC30 R8 0006ECE0 R9 0007FF78 R10 0007FFB0 R11 0007FFF8 R12 4006ECCE

SA 06EE60 WD1 00000000 HSA 0006EBF8 LSA 00000000 RET 00000000 EPA 00000000 R0 00000000
           R1 00000000 R2 00000000 R3 00000000 R4 00000000 R5 00000000 R6 00000000
           R7 00000000 R8 00000000 R9 00000000 R10 00000000 R11 00000000 R12 00000000

```

PROCEEDING BACK VIA REG 13

```

SA 06EE60 WD1 00000000 HSA 0006EBF8 LSA 00000000 RET 00000000 EPA 00000000 R0 00000000
           R1 00000000 R2 00000000 R3 00000000 R4 00000000 R5 00000000 R6 00000000
           R7 00000000 R8 00000000 R9 00000000 R10 00000000 R11 00000000 R12 00000000

```

TATHBLOG WAS ENTERED

```

SA 06EBF8 WD1 0606EAC8 HSA 00000100 LSA 0006EE60 RET 00009848 EPA 4006EE48 R0 000099CE
           R1 0001CC80 R2 00000000 R3 00080000 R4 0007FE48 R5 00000098 R6 000055D8
           R7 0007FC30 R8 0006ECE0 R9 0007FF78 R10 0007FFB0 R11 0007FFF8 R12 4006ECCE

```

DATA SETS

```

SNAP2      UCB 192 00225C      DEB 07F78C      DCB 06EF84
DUMDCB     UCB 192 00225C      DEB 07FAF4      DCB 06EF5C
JOB LIB    UCB 190 00218C
SYS PRINT  UCB 192 00225C
SYS ABEND  UCB 192 00225C
SNAP1     UCB 190 00218C

```

REGS AT ENTRY TO ABEND

```

FL.PT.REGS 0-6      00.000000 00000000      00.000000 00000000      00.000000 00000000      00.000000 00000000
REGS 0-7           00000240 80000078 00000000 00080000      0007FE48 00000098 000055D8 0007FC30
REGS 8-15         0006EE60 0007FF78 0007FFB0 0007FFF8      4006EE4E 0006EE60 00009848 00000000

```

NUCLEUS

```

000000 00000000 0000051C F0F0F5C1 00000000      000097F8 00013440 01040080 8003ACD4 *.....005A.....8... ..M*
000020 0004000A 50006846 00000000 00000000      0000FF00 00000000 FF04000E A0007E2A *.....*
000040 1007F5E8 50000000 00001480 000097F8      60C85D00 00000000 00040000 00000282 *..5Y.....8.H.....*
000060 00040000 0000033A 00040000 000002DE      00000000 0000B278 00040000 00000226 *.....*
000080 0001538C 00000000 00000000 00003000      00000000 00000000 00000000 00000000 *.....*
0000A0 00000000 00000000 00000000 00000000      00000000 00000000 00000000 00000000 *.....*
LINES
000160 00000000 00000000 00000000 82000170      00040000 0003A7A0 00000000 00000000 *.....*
000180 0001C820 00007E91 0006F465 80007D16      00000080 0006F491 00000001 0006F4A8 *.....4.....*
0001A0 00000000 00000000 00000000 00000000      00000000 00000000 00000000 C0000000 *.....*
LINE
0001E0 000079F0 00006888 0000A43A 00000001      40007720 0000A042 90001520 00000000 *..0.....*
000200 0000846C 000083E4 00006780 00006942      00001000 00000F28 00009730 0001335C *.....U.....*
000220 00013340 00234700 024C96F0 02279029      01805830 06C45840 30004700 025CD207 *..0.....O.....D.....K*
000240 40100038 94FD0111 90A13030 5890021C      05895850 02105890 021407F9 90A1010E *.....9.....*
000260 02070440 003847F0 024C940F 02279829      018091F0 02384780 044898A1 01E08200 *K...0.....*
000280 04409029 018091F0 02384780 029C90A1      01E0D207 04400018 47F00282 589006C4 *.....0.....K...0...D*
0002A0 90A1903C 58990000 02079010 001894FD      90119140 00184780 02C05820 02D40522 *.....K.....M.....*
0002C0 9180001B 478002CE 582002D8 052247F0      026A0000 00015388 0000870A 0A0390A9 *.....Q...0.....*
0002E0 01A098CD 00285880 02189101 00290788      58A006C4 58A0A004 12AA07CB 188A58AA *.....D.....*
000300 000012AA 47C00332 90C28004 18185880      02189280 100098F0 A0008900 C0001200 *.....P.....0.....*
000320 078B50F0 002C41E0 02DC98AD 01A08200      00281818 58800218 07FB900F 04005890 *..0.....*

```

Figure 16. Sample of an ABEND Dump (MFT) (Part 2 of 2)

Device and Space Considerations: DD statements for ABEND/SNAP dumps, must contain parameters appropriate for a basic sequential (BSAM) data set. Data sets can be allocated to any device supported by the basic sequential access method. There are several ways to code these DD statements depending on what type of device you choose and when you want the dump printed.

If you wish to have the dump printed immediately, code a DD statement defining a printer data set.

```
-----  
//SYSABEND DD UNIT=1443,DCB=(...  
-----
```

A printer is associated with the SYSOUT class, you can also obtain immediate printing by routing the data set through the output stream.

```
-----  
//SNAPDUMP DD SYSOUT=A,DCB=(...  
-----
```

This type of request is the easiest, most economical way to provide for a dump. All other DD statements result in the tying up of an output unit or delayed printing of the dump.

If you wish to retain the dump, you can keep or catalog it on a direct access or tape unit. The last step in the pertinent job can serve several functions: to print out key data sets in steps that have been abnormally terminated, to print an ABEND or SNAP dump stored in an earlier step, or to release a tape volume or direct access space acquired for dump data sets. Conditional execution of the last step can be established through proper use of the COND parameter and its subparameters, EVEN and ONLY, on the EXEC statement.

Direct access space should be requested in units of average block size rather than in cylinders (CYL) or tracks (TRK). If abnormal termination occurs and the data set is retained, the tape volume or direct access space should be released (DELETE in the DISP parameter) at the time the data set is printed.

Sample DD Statements: Figure 17 shows a set of job steps that include DD statements for ABEND dump data sets.

The SYSABEND DD statement in STEP2 takes advantage of the direct access space acquired in STEP1 by indicating MOD in the DISP parameter. Note that the space request in STEP1 is large so that the dumping operation is not inhibited due to insufficient space. The final SYSABEND DD statement in the job should indicate a disposition of DELETE to free the space acquired for dumping.

Contents of an ABEND/SNAP Dump (MFT)

This explanation of the contents of ABEND/SNAP dumps for systems with MFT is interspersed with sample sections taken from an ABEND dump. Capital letters represent the headings found in all dumps, and lowercase letters, information that varies with each dump. The lowercase letter used indicates the mode of the information, and the number of letters indicates its length:

- h represents 1/2 byte of hexadecimal information
- d represents 1 byte of decimal information
- c represents a 1-byte character

You may prefer to follow the explanation on your own ABEND or SNAP dump.

```

//STEP1 EXEC PGM=PROGRAM1
//SYSABEND DD DSN=SYSABEND.DUMP,UNIT=2311,DISP=(,KEEP,KEEP), X
//          VOLUME=SER=1234,SPACE=(TRK,(110,10))
          other DD statements

//STEP2 EXEC PGM=PROGRAM2
//SYSABEND DD DSN=*.STEP1.SYSABEND,DISP=(MOD,DELETE,KEEP), X
//          VOL=REF=*.STEP1.SYSABEND

```

Figure 17. SYSABEND DD Statements

```

*** ABDUMP REQUESTED ***
*cccccc...
JOB cccccccc      STEP cccccccc      TIME dddddd      DATE dddd      PAGE dddd
COMPLETION CODE    SYSTEM = hhh (or USER = dddd)
cccccc...
INTERRUPT AT hhhhhh
PSW AT ENTRY TO ABEND (SNAP) hhhhhhhh hhhhhhhh

```

*** ABDUMP REQUESTED *** identifies the dump as an ABEND or SNAP dump.

in the free area specified by an MSS element.

*cccccc..... is omitted or is one or more of the following:

*CORE NOT AVAILABLE, LOC. hhhhhhhhhhhh TAKEN... indicates that the ABDUMP routine confiscated storage locations hhhhhh through hhhhhh because not enough storage was available. This area is printed under P/P STORAGE, but can be ignored because the problem program originally in it was overlaid during the dumping process.

*MODIFIED, /SIRB/DEB/LLS/ARB/MSS... indicates that the one or more queues listed were destroyed or their elements dequeued during abnormal termination:

- SIRB -- system interruption request block queue. One or more SIRB elements were found in the active RB queue: these elements are always dequeued during dumping.
- DEB -- DEB queue. If the first message also appeared, either a DEB or an associated DCB was overlaid.
- LLS -- load list. If the first message also appeared, one or more loaded RBs were overlaid.
- ARB -- active RB queue. If the first message also appeared, one or more RBs were overlaid.
- MSS -- boundary box queue. One or more MSS elements were dequeued, but an otherwise valid control block was found

*FOUND ERROR IN /DEB/LLS/ARB/MSS... indicates that one or more of the following contained an error:

- DEB: data extent block
- LLS: load list
- ARB: active RB
- MSS: boundary box

This message appears with either the first or second message above. The error could be: improper boundary alignment, control block not within storage assigned to the program being dumped, or an infinite loop (300 times is the maximum for this test). For an MSS block, 4 other errors could also be found: incorrect descending sequence (omitting loop count), overlapping free areas, free area not entirely within the storage assigned to the program being dumped, or count in count field not a multiple of 8.

JOB cccccccc is the job name specified in the JOB statement.

STEP cccccccc is the step name specified in the EXEC statement for the problem program being dumped.

TIME dddddd is the hour (first 2 digits), minute (second 2 digits), and second (last 2 digits) when the ABDUMP routine began processing.

DATE dddd is the year (first 2 digits) and day of the year (last 3 digits). For example, 67352 would be December 18, 1967.

PAGE dddd
is the page number. Appears at the top of each page.

COMPLETION CODE SYSTEM=hhh or COMPLETION CODE USER=dddd
is the completion code supplied by the control program (SYSTEM=hhh) or the problem program (USER=dddd). Either SYSTEM=hhh or USER=dddd is printed, but not both. Common completion codes are explained in Appendix B.

cccccc...
explains the completion code or, if a program interruption occurred:
PROGRAM INTERRUPTION ccccc... AT LOCATION hhhhhh,

where ccccc is the program interruption cause -- OPERATION, PRIVILEGED OPERATION, EXECUTE, PROTECTION, ADDRESSING, SPECIFICATION,

DATA, FIXED-POINT OVERFLOW, FIXED-POINT DIVIDE, DECIMAL OVERFLOW, DECIMAL DIVIDE, EXPONENT OVERFLOW, EXPONENT UNDERFLOW, SIGNIFICANCE, or FLOATING-POINT DIVIDE; and hhhhhh is the starting address of the instruction being executed when the interruption occurred.

INTERRUPT AT hhhhhh
is the address of next instruction to be executed in the problem program. It is obtained from the resume PSW of the PRB or LPRB in the active RB queue at the time abnormal termination was requested.

PSW AT ENTRY TO ABEND hhhhhhhh hhhhhhhh or PSW AT ENTRY TO SNAP hhhhhhhh hhhhhhhh
is the PSW for the problem or control program that had control when abnormal termination was requested or when the SNAP macro instruction was executed.

| | | | | | | | | | | | | | |
|---------|----------|----------|----------|----------|----------|----------|----------|----------|----------|----------|----------|----------|----------|
| TCB | hhhhhh | RB | hhhhhhhh | PIE | hhhhhhhh | DEB | hhhhhhhh | TIOT | hhhhhhhh | CMP | hhhhhhhh | TRN | hhhhhhhh |
| MSS | hhhhhhhh | PK/FLG | hhhhhhhh | FLG | hhhhhhhh | LLS | hhhhhhhh | JLB | hhhhhhhh | JST | hhhhhhhh | hhhhhhhh | hhhhhhhh |
| RG 0-7 | hhhhhhhh | hhhhhhhh | hhhhhhhh | hhhhhhhh | hhhhhhhh | hhhhhhhh | hhhhhhhh | hhhhhhhh | hhhhhhhh | hhhhhhhh | hhhhhhhh | hhhhhhhh | hhhhhhhh |
| RG 8-15 | hhhhhhhh | hhhhhhhh | hhhhhhhh | hhhhhhhh | hhhhhhhh | hhhhhhhh | hhhhhhhh | hhhhhhhh | hhhhhhhh | hhhhhhhh | hhhhhhhh | hhhhhhhh | hhhhhhhh |
| FSA | hhhhhhhh | TCB | hhhhhhhh | TME | hhhhhhhh | PIB | hhhhhhhh | NTC | hhhhhhhh | OTC | hhhhhhhh | hhhhhhhh | hhhhhhhh |
| LTC | hhhhhhhh | IQE | hhhhhhhh | ECB | hhhhhhhh | XTCB | hhhhhhhh | LP/FL | hhhhhhhh | RESV | hhhhhhhh | hhhhhhhh | hhhhhhhh |
| STAE | hhhhhhhh | TCT | hhhhhhhh | USER | hhhhhhhh | DAR | hhhhhhhh | RESV | hhhhhhhh | JSCB | hhhhhhhh | hhhhhhhh | hhhhhhhh |

TCB hhhhhh
is the starting address of the TCB.

in the third through fifth digits and user codes in the sixth through eighth.

RB hhhhhhhh
is the TCBRBP field (bytes 0 through 3): starting address of the active RB queue and, consequently, the most recent RB on the queue (usually ABEND's RB).

TRN hhhhhhhh
is the TCBTRN field (bytes 20 through 23): starting address of control core (table) for controlling testing of the task by TESTRAN.

PIE hhhhhhhh
is the TCBPIE field (bytes 4 through 7): starting address of the program interruption element (PIE) for the task.

MSS hhhhhhhh
is the TCBMSS field (bytes 24 through 27): starting address of the main storage supervisor's boundary box.

DEB hhhhhhhh
is the TCBDEB field (bytes 8 through 11): starting address of the DEB queue.

PK/FLG hhhhhhhh
contains, in the first 2 digits, the TCBPKF field (byte 28): protection key.

TIOT hhhhhhhh
is the TCBTIO field (bytes 12 through 15): starting address of the TIOT.

FLG hhhhhhhh
contains, in the first 4 digits, the last 2 bytes of the TCBFLGS field (bytes 32 and 33): last 2 flag bytes.

CMP hhhhhhhh
is the TCBCMP field (bytes 16 through 19): task completion code in hexadecimal. System codes are shown

contains, in the next 2 digits, the TCBLMP field (byte 34): number of resources on which the task is queued.

contains, in the last 2 digits, the TCBDSP field (byte 35):

- Reserved in MFT without subtasking; both digits are zero.
- In MFT with subtasking, this field contains the dispatching priority of the TCB.

LLS hhhhhhhh
is the TCBLLS field (bytes 36 through 39): starting address of the RB most recently added to the load list.

JLB hhhhhhhh
is the TCBJLB field (bytes 40 through 43): starting address of the DCB for the JOBLIB data set.

JST hhhhhhhh
is the TCBJST field (bytes 44 through 47). Not currently used in MFT without subtasking. In MFT with subtasking - the starting address of the TCB for the job step task.

RG 0-7 and RG 8-15
is the TCBGRS field (bytes 48 through 111): contents of general registers 0 through 7 and 8 through 15, as stored in the save area of the TCB when a task switch occurred. These 2 lines appear only in TCBS of tasks other than the task in control when the dump was requested.

FSA hhhhhhhh
contains, in the first 2 digits, the TCBIDF field (byte 112): TCB identifier field.

contains, in the last 6 digits, the TCBFSA field (bytes 113 through 115): starting address of the first problem program save area. This save area was set up by the control program when the job step was initiated.

TCB hhhhhhhh
is the TCBTCB field (bytes 116 through 119): starting address of the next TCB of lower priority or, if this is the last TCB, zeros.

TME hhhhhhhh
is the TCBTME field (bytes 120 through 123): starting address of the timer element created when an STIMER macro instruction is issued by the task. This field is not printed if the computer does not contain the timer option.

PIB hhhhhhhh
is the TCBPIB field (bytes 124 through 127): starting address of the program information block.

NTC hhhhhhhh
is the TCBNTC field (bytes 128 through 131):

MFT without subtasking: zeros.

MFT with subtasking: the starting address of the TCB for the previous subtask on this subtask TCB queue. This field is zero both in the job step task, and in the TCB for the first subtask created by a parent task.

OTC hhhhhhhh
is the TCBOTC field (bytes 132 through 135): starting address of the TCB for the parent task. Both in the TCB for the job step task, and in MFT systems without subtasking this field is zero.

LTC hhhhhhhh
is the TCBLTC field (bytes 136 through 139): starting address of the TCB for the most recent subtask created by this task. This field is zero in the TCB for the last subtask of a job step, or in the TCB for a task that does not create subtasks. This field is always zero in an MFT system without subtasking.

hhhhhhhhh
is the TCBIQE field (bytes 140 through 143).

MFT without subtasking: zero.

MFT with subtasking: starting address of the interruption queue element (IQE) for the ETXR exit routine. This routine is specified by the ETXR operand of the ATTACH macro instruction that created the TCB being dumped. The routine is to be entered when the task terminates.

ECB hhhhhhhh
is the TCBECEB field (bytes 144 through 147).

MFT without subtasking: zero.

MFT with subtasking: starting address of the ECB field to be posted by the control program at task termination. This field is zero if the task was attached without an ECB operand.

XTCB hhhhhhhh reserved for future use.

LP/FL hhhhhhhh MFT without subtasking: reserved.

MFT with subtasking: contains in the first byte, the limit priority of the task (byte 152). contains, in the last three bytes the field TCBFTFIG (bytes 153 through 155) - flag bytes.

RESV hhhhhhhh reserved for future use.

STAE hhhhhhhh contains, in the first 2 digits, STAE flags (byte 160).

contains, in the last 6 digits, the TCBNSTAE field (bytes 161 through 163): starting address of the current STAE control block for the task. This field is zero if STAE has not been issued.

TCT hhhhhhhh is the TCBTCT field (bytes 164 through 167):

Address of the Timing Control Table (TCT): zeros if the System Management Facilities option is not present in the system.

USER hhhhhhhh is the TCBUSER field (bytes 168 through 171): to be used as the user chooses.

DAR hhhhhhhh contains, in the first 2 digits, Damage Assessment Routine (DAR) flags (byte 172);

contains, in the last 6 digits, the secondary non-dispatchability bits (bytes 173 through 175).

RESV hhhhhhhh reserved for future use.

JSCB hhhhhhhh is the TCBJSCB field (bytes 180 through 183): the last three bytes contain the address of the Job Step Control Block.

| ACTIVE RBS | | | | | | | | | | | | | | |
|------------|--------|----|----------|----------|----------|----------|----------|----------|----------|----------|----------|----------|----------|----------|
| cccc | hhhhhh | NM | cccccccc | SZ/STAB | hhhhhhhh | USE/EP | hhhhhhhh | PSW | hhhhhhhh | hhhhhhhh | Q | hhhhhh | WT/LNK | hhhhhhhh |
| | | RG | 0-7 | hhhhhhhh | hhhhhhhh | hhhhhhhh | hhhhhhhh | hhhhhhhh | hhhhhhhh | hhhhhhhh | hhhhhhhh | hhhhhhhh | hhhhhhhh | hhhhhhhh |
| | | RG | 8-15 | hhhhhhhh | hhhhhhhh | hhhhhhhh | hhhhhhhh | hhhhhhhh | hhhhhhhh | hhhhhhhh | hhhhhhhh | hhhhhhhh | hhhhhhhh | hhhhhhhh |

ACTIVE RBS identifies the next lines as the contents of the active RBs queued to the TCB.

cccc hhhhhh indicates the RB type and its starting address.

The RB types are:

- PRB Program request block
- SIRB Supervisor interrupt request block
- LPRB Loaded program request block
- IRB Interruption request block
- SVRB Supervisor request block

Note: Three SVRBs for ABEND processing exist in the nucleus. They are used when there is insufficient space in the partition to create an SVRB.

NM xxxxxxxx is the XRBNM field (bytes 0 through 7): in PRB, LRB, and LPRB, the program name; in IRB, the first byte contains flags for the timer or, if the timer is not being used, contains no meaningful information; in SVRB for a type 2 SVC routine, the first 4 bytes contain the TTR of the load module in the SVC library, and the last 4 bytes contain the SVC number in signed, unpacked decimal.

SZ/STAB hhhhhhhh
contains in the first 4 digits, the XRBSZ field (bytes 8 and 9): number of contiguous doublewords in the RB, the program (if applicable), and associated supervisor work areas.

contains in the last 4 digits, the XSTAB field (bytes 10 and 11): flag bytes.

USE/EP hhhhhhhh
contains, in the first 2 digits, the XRBUSE field (byte 12): use count.

contains, in the last 6 digits, the XRBEP field (bytes 13 through 15): address of entry point in the associated program.

PSW hhhhhhhh hhhhhhhh
is the XRBPSW field (bytes 16 through 23): resume PSW.

Q hhhhhh
is the last 3 bytes of the XRBQ field

(bytes 25 through 27): in PRB and LPRB, starting address of an LPRB for an entry identified by an IDENTIFY macro instruction; in IRB, starting address of a request element; in SVRB for a type 3 or 4 SVC, size of the program in bytes.

WT/LNK hhhhhhhh
contains, in the first 2 digits, the XRBWT field (byte 28): wait count.

contains, in the last 6 digits, the XRBLENK field (bytes 29 through 31): primary queuing field. It is the starting address of the previous RB for the task or, in the first RB to be placed on the queue, the starting address of the TCB.

RG 0-7 and RG 8-15
is the XRBREB field (bytes 32 through 95 in IRBs and SVRBs): contents of general registers 0 through 15 stored in the RB. These 2 lines do not appear for PRBs, LPRBs, and LRBs.

```
LOAD LIST
cccc hhhhhh  NM ccccccc  SZ/STAB hhhhhhhh  USE/EP hhhhhhhh  PSW hhhhhhhh hhhhhhhh  Q hhhhhh  WT/LNK hhhhhhhh
```

LOAD LIST
identifies the next lines as the contents of the load list queued to the TCB.

cccc hhhhhh
indicates the RB type and its starting address.

The RB types are:

- LRB** Loaded request block
- LPRB** Loaded program request block
- D-LPRB** Dummy loaded program request block. (Present if the resident reenterable load module option was selected).

NM ccccccc
is the XRBNM field (bytes 0 through 7): program name.

SZ/STAB hhhhhhhh
contains, in the first 4 digits, the XRBSZ field (bytes 8 and 9): number of contiguous doublewords for the RB, the program (if applicable), and associated supervisor work areas.

contains, in the last 4 digits, the XSTAB field (bytes 10 and 11): flag bytes.

USE/EP hhhhhhhh
contains, in the first 2 digits, the XRBUSE field (byte 12): use count.

contains, in the last 6 digits, the XRBEP field (bytes 12 through 15): address of entry point in the program.

PSW hhhhhhhh hhhhhhhh
is the XRBPSW field (bytes 16 through 23): resume PSW.

Q hhhhhh
is the last 3 bytes of the XRBQ field (bytes 25 through 27): in LPRB, starting address of an LPRB for an entry identified by an IDENTIFY macro instruction; in LRB, unused.

WT/LNK hhhhhhhh
contains, in the first 2 digits, the XRBWT field (byte 28): wait count.

contains, in the last 6 digits, the XRBLENK field (bytes 29 through 31):

primary queuing field for LRBs and LPRBs also on the active RB queue. It points to the previous RB for the task or, in the oldest RB in the queue, back to the TCB.

JOB PACK AREA QUEUE

| | | | | | | | | | | | | | | |
|------|-------|----|---------|---------|---------|--------|---------|-----|---------|---------|---------|-------|--------|---------|
| cccc | hhhhh | NM | ccccccc | SZ/STAB | hhhhhhh | USE/EP | hhhhhhh | PSW | hhhhhhh | hhhhhhh | Q | hhhhh | WT/LNK | hhhhhhh |
| cccc | hhhhh | NM | ccccccc | SZ/STAB | hhhhhhh | WTL | hhhhhhh | REQ | hhhhhhh | TLPRB | hhhhhhh | | | |
| cccc | hhhhh | NM | ccccccc | SZ/STAB | hhhhhhh | USE/EP | hhhhhhh | PSW | hhhhhhh | hhhhhhh | Q | hhhhh | WT/LNK | hhhhhhh |

JOB PACK AREA QUEUE (MFT with subtasking only)

identifies the next lines as the contents of the job pack area queue originating in the partition information block (PIB).

cccc hhhhhh indicates the RB type and its starting address.

The RB types are:

- FRB Finch request block
- LRB Loaded request block
- LPRB Loaded program request block

NM ccccccc is the XRBNM field (bytes 0 through 7): Program name.

SZ/STAB hhhhhhhh contains, in the first 4 digits, the XRBSZ field (bytes 8 and 9): number of contiguous doublewords for the RB, the program (if applicable), and associated supervisor work areas.

contains, in the last 4 digits, the XSTAB field (bytes 10 and 11): flag bytes.

USE/EP hhhhhhhh (LPRB, LRB Only) contains, in the first 2 digits, the XRBUSE field (byte 12): use count.

contains, in the last 6 digits, the XRBEP field (bytes 13 through 15): address of entry point in the program.

WTL hhhhhhhh (FRB Only) is the XRWTL field of the FRB (bytes

12 through 15): address of the most recent wait list element (WLE) on the WLE queue.

PSW hhhhhhhh hhhhhhhh (LPRB, LRB Only) is the XRBPSW field (bytes 16 through 23): resume PSW.

REQ hhhhhhhh (FRB Only) is the XRREQ field of the FRB (bytes 16 through 19): address of the TCB of the requesting task.

TLPRB hhhhhhhh (FRB Only) is the XRTPRB field of the FRB (bytes 20 through 23): address of the LPRB built by the Finch routine for the requested program.

Q hhhhhh (LRB, LPRB Only) is the last 3 bytes of the XRBQ field (bytes 25 through 27):

- in an LPRB, the starting address of an LPRB for an entry identified by an IDENTIFY macro instruction.
- in an LRB, unused.

WT/LNK hhhhhhhh (LRB, LPRB Only) contains, in the first 2 digits, the XRBWT field (byte 28): wait count.

contains, in the last 6 digits (bytes 29 through 31): primary queuing field for RBs. These RBs may be queued either on the job pack area queue or on the active RB queue. It points to the previous RB for the task or, in the oldest RB on the queue, back to the TCB.

```

P/P STORAGE BOUNDARIES hhhhhhhh TO hhhhhhhh

FREE AREAS      SIZE
  hhhhhh      hhhhhhhh

GOTTEN CORE    SIZE
  hhhhhh      hhhhhhhh

SAVE AREA TRACE

cccccccc WAS ENTERED VIA LINK (CALL) ddddd AT EP ccccc...

SA  hhhhhh  WD1 hhhhhhhh  HSA hhhhhhhh  LSA hhhhhhhh  RET hhhhhhhh  EPA hhhhhhhh  R0 hhhhhhhh
    hhhhhh  R1 hhhhhhhh  R2 hhhhhhhh  R3 hhhhhhhh  R4 hhhhhhhh  R5 hhhhhhhh  R6 hhhhhhhh
    hhhhhh  R7 hhhhhhhh  R8 hhhhhhhh  R9 hhhhhhhh  R10 hhhhhhhh  R11 hhhhhhhh  R12 hhhhhhhh

INCORRECT BACK CHAIN

PROCEEDING BACK VIA REG 13

```

P/P STORAGE BOUNDARIES hhhhhhhh TO hhhhhhhh gives the addresses of the lower and upper boundaries of a main storage area assigned to the task. This heading is repeated for every noncontiguous block of storage owned by the task.

```

FREE AREAS      SIZE
  hhhhhh      hhhhhh
  .           .
  .           .
  .           .
  hhhhhh      hhhhhh

```

are the starting addresses of free areas and the size, in bytes, of each area contained within the P/P STORAGE BOUNDARIES field listed above.

```

GOTTEN CORE    SIZE
  hhhhhh      hhhhhhhh
  .           .
  .           .
  .           .
  hhhhhh      hhhhhhhh

```

(Printed only in a dump of a system with the MFT with subtasking option). These figures represent the starting addresses of the gotten areas (those areas obtained for a subtask through a supervisor issued GETMAIN macro instruction), and the size, in bytes, of each area contained within the P/P STORAGE BOUNDARIES field listed above. If main storage hierarchy support is included in the system, the values in this field can address storage in either hierarchy 0 or hierarchy 1, or both.

SAVE AREA TRACE identifies the next lines as a trace of the save areas for the program.

cccccccc WAS ENTERED is the name of the program that stored register contents in the save area. This name is obtained from the RB.

VIA LINK (CALL) ddddd indicates the macro instruction (LINK or CALL) used to give control to the next lower level module, and is the ID operand, if it was specified, of the LINK or CALL macro instruction.

AT EP ccccc... is the entry point identified, which appears only if it was specified in the SAVE macro instruction that filled the save area.

SA hhhhhh is the starting address of the save area.

WD1 hhhhhhhh is the first word of the save area: use of this word is optional.

HSA hhhhhhhh is the second word of the save area: starting address of the save area in the next higher level module. In the first save area in a job step, this word contains zeros. In all other save areas, this word must be filled.

LSA hhhhhhhh is the third word of the save area (register 13): starting address of the save area in the next lower level module.

RET hhhhhhhh is the fourth word of the save area (register 14): return address. Optional.

EPA hhhhhhhh
is the fifth word of the save area
(register 15): entry point to the
invoked module. Optional.

word in this area does not point back
to the previous save area in the
chain.

R0 hhhhhhhh R1 hhhhhhhh ... R12 hhhhhhhh
are words 6 through 18 of the save
area (registers 0 through 12):
contents of registers 0 through 12
immediately after the linkage for the
module containing the save area.

PROCEEDING BACK VIA REG 13
indicates that the next 2 save areas
are (1) the save area in the lowest
level module, followed by (2) the save
area in the next higher level module.
The lowest save area is assumed to be
the save area pointed to by register
13. These 2 save areas appear only if
register 13 points to a full word
boundary and does not contain zeros.

INCORRECT BACK CHAIN
indicates that the following lines may
not be a save area because the second

DATA SETS

***** NOT FORMATTED *****

cccccccc UCB ddd hhhhhh DEB hhhhhh DCB hhhhhh

D/S FORMATTING TERMINATED

DATA SETS
indicates that the next lines present
information about the data sets for
the task. For unopened data sets,
only the ddname and UCB information
are printed.

assigned, and the starting address of
the UCB for that unit. If the data
set was assigned to several units, the
additional units are identified on
following lines.

NOT FORMATTED
indicates that the abnormal
termination dump routine confiscated
storage (indicated by *CORE NOT
AVAILABLE, LOC. hhhhhh-hhhhhh TAKEN);
because DCBs may have been overlaid,
or that the dump is for an OLTEP task.
Data set information is not presented.

DEB hhhhhh
is the starting address of the DEB for
the data set. Appears only for open
data sets.

DCB hhhhhh
is the starting address of the DCB for
the data set. Appears only for open
data sets.

cccccccc
is the name field (ddname) of the DD
statement.

D/S FORMATTING TERMINATED
indicates that no more data set
information is presented because a DCB
is incorrect, possibly because a
program incorrectly modified it.

UCB ddd hhhhhh
is the unit to which the data set was

TRACE TABLE - STARTING WITH OLDEST ENTRY

| | | | | | |
|------|---------|-----------------------|---------------|---------|---------------------------------------|
| dddd | I/O ddd | PSW hhhhhhhh hhhhhhhh | | CSW | hhhhhhh hhhhhhhh |
| dddd | SIO ddd | CC = d | CAW hhhhhhhh | OLD CSW | hhhhhhh hhhhhhhh (or CSW STATUS hhhh) |
| dddd | SVC ddd | PSW hhhhhhhh hhhhhhhh | RG 0 hhhhhhhh | RG 1 | hhhhhhh |

TRACE TABLE -- STARTING WITH OLDEST ENTRY identifies the next lines as the contents of the trace table. Each entry is presented on one line. The types of entries are:

I/O Input/output interruption entry

SIO Start input/output (SIO) entry

SVC Supervisor call (SVC) interruption entry

dddd is the number assigned to each entry. The oldest entry receives the number 0001.

I/O ddd is the channel and unit that caused the input/output interruption.

PSW hhhhhhhh hhhhhhhh is the program status word that was stored when the input/output interruption occurred.

CSW hhhhhhhh hhhhhhhh is the channel status word that was stored when the input/output interruption occurred.

SIO ddd is the device specified in the SIO instruction.

CC=d is the condition code resulting from execution of the SIO instruction. Zero indicates a successful start.

CAW hhhhhhhh is the channel address word used by the SIO instruction.

OLD CSW hhhhhhhh hhhhhhhh is the channel status word stored during execution of an SIO operation. It appears when CC is not equal to 1.

CSW STATUS hhhh is the status portion of the channel status word stored during execution of an SIO instruction. Appears when CC is equal to 1.

SVC ddd is the SVC instruction's operand.

PSW hhhhhhhh hhhhhhhh is the PSW stored during the SVC interruption. An F in the fifth digit of the first word identifies the entry as representing a task switch.

RG 0 hhhhhhhh is the contents of register 0 as passed to the SVC routine.

RG 1 hhhhhhhh is the contents of register 1 as passed to the SVC routine.

| REGS AT ENTRY TO ABEND (SNAP) | | | | | | | |
|-------------------------------|------------------|------------------|------------------|------------------|------------------|------------------|------------------|
| FLTR 0-6 | hhhhhhhhhhhhhhhh | hhhhhhhhhhhhhhhh | hhhhhhhhhhhhhhhh | hhhhhhhhhhhhhhhh | hhhhhhhhhhhhhhhh | hhhhhhhhhhhhhhhh | hhhhhhhhhhhhhhhh |
| REGS 0-7 | hhhhhhhh | hhhhhhhh | hhhhhhhh | hhhhhhhh | hhhhhhhh | hhhhhhhh | hhhhhhhh |
| REGS 8-15 | hhhhhhhh | hhhhhhhh | hhhhhhhh | hhhhhhhh | hhhhhhhh | hhhhhhhh | hhhhhhhh |

REGS AT ENTRY TO ABEND or REGS AT ENTRY TO SNAP

identifies the next 3 lines as the contents of the floating point and general registers when the abnormal termination routine received control in response to an ABEND macro instruction or when the SNAP routine received control in response to a SNAP macro instruction.

FLTR 0-6

is the contents of floating point registers 0, 2, 4, and 6.

REGS 0-7

is the contents of general registers 0 through 7.

REGS 8-15

is the contents of general registers 8 through 15.

| NUCLEUS | | | | | | | |
|-------------|-------------|---------------|----------|----------|----------|----------|----------|
| hhhhh | hhhhhhhh | hhhhhhhh | hhhhhhhh | hhhhhhhh | hhhhhhhh | hhhhhhhh | hhhhhhhh |
| hhhhh | hhhhhhhh | hhhhhhhh | hhhhhhhh | hhhhhhhh | hhhhhhhh | hhhhhhhh | hhhhhhhh |
| LINE | hhhhh | SAME AS ABOVE | | hhhhh | hhhhh | hhhhh | hhhhh |
| hhhhh | hhhhhhhh | hhhhhhhh | hhhhhhhh | hhhhhhhh | hhhhhhhh | hhhhhhhh | hhhhhhhh |
| LINES | hhhhh-hhhh | SAME AS ABOVE | | hhhhh | hhhhh | hhhhh | hhhhh |
| hhhhh | hhhhhhhh | hhhhhhhh | hhhhhhhh | hhhhhhhh | hhhhhhhh | hhhhhhhh | hhhhhhhh |
| P/P STORAGE | | | | | | | |
| hhhhh | hhhhhhhh | hhhhhhhh | hhhhhhhh | hhhhhhhh | hhhhhhhh | hhhhhhhh | hhhhhhhh |
| hhhhh | hhhhhhhh | hhhhhhhh | hhhhhhhh | hhhhhhhh | hhhhhhhh | hhhhhhhh | hhhhhhhh |
| hhhhh | hhhhhhhh | hhhhhhhh | hhhhhhhh | hhhhhhhh | hhhhhhhh | hhhhhhhh | hhhhhhhh |
| LINES | hhhhh-hhhh | SAME AS ABOVE | | hhhhh | hhhhh | hhhhh | hhhhh |
| hhhhh | hhhhhhhh | hhhhhhhh | hhhhhhhh | hhhhhhhh | hhhhhhhh | hhhhhhhh | hhhhhhhh |
| | END OF DUMP | | | | | | |

The content of main storage is given under 2 headings: NUCLEUS and P/P STORAGE. Under these headings, the lines have the following format:

- First entry: the address of the initial byte of main storage contents presented on the line.
- Next 8 entries: 8 full words (32 bytes) of main storage in hexadecimal.
- Last entry (surrounded by asterisks): the same 8 full words of main storage in EBCDIC. Only A through Z, 0 through 9, and blanks are printed; a period is printed for anything else. An exception occurs in the printed lines representing the ABDUMP work area. The contents of the ABDUMP work area during the printing of EBCDIC characters

differs from the contents during printing of the hexadecimal characters because a portion of the work area is used to write lines to the printer. This exception should not create any problems since the contents of the ABDUMP work area is of little use in debugging.

The following lines may also appear:

- LINES** hhhhhhh-hhhhhhh SAME AS ABOVE are the starting addresses of the first and last line of a group of lines that are identical to the line immediately preceding.
- LINE** hhhhhh SAME AS ABOVE is the starting address of a line that is identical to the line immediately preceding.

NUCLEUS

identifies the next lines as the contents of the control program nucleus.

P/P STORAGE

identifies the next lines as the contents of the main storage area assigned to the task (problem program).

END OF DUMP

indicates that the dump or snapshot is completed.

Guide to Using an ABEND/SNAP Dump (MFT)

Cause of Abnormal Termination: Evaluate the user (USER Decimal code) or system (SYSTEM=hex code) completion code using Appendix C or the publication Messages and Codes.

Active RB Queue: The first RB shown on the dump represents the oldest RB on the queue. The RB representing the load module that had control when the dump was taken is third from the bottom. The last RB represents the ABDUMP routine, and the second from last, the ABEND routine. The names of load modules represented in the active RB queue are given in the RB field labeled NM in the dump. Names of load modules in SVC routines are presented in the format:

```
-----
NM   SVC-mnnn
-----
```

where m is the load module number (minus 1) in the routine and nnn is the signed decimal SVC number. The last two RBs on an ABEND/SNAP dump will always be SVRBs with edited names SVC-105A (ABDUMP--SVC 51) and SVC-401C (ABEND--SVC 13).

Resume PSW: The resume PSW field is the fourth entry in the first line of each RB printout. It is identified by the subheading PSW. For debugging purposes, the resume PSW of the third RB from the bottom, on the dump, is most useful. The last three characters of the first word give the SVC number or the I/O device address, depending on which type of interruption caused the associated routine to lose control. It also provides the CPU state at the time of the interruption (bit 15), the length of the last instruction executed in the program (bits 32,33), and the address of the next instruction to be executed (bytes 5-8).

Load List and Job Pack Area Queue: The load module that had control at the time of abnormal termination may not contain the instruction address pointed to by the resume PSW. In that case, look at the RBs on the load list and on the job pack area queue (MFT with subtasking). Compare the instruction address with the entry points of each load module (shown in the last 3 bytes of the field labeled USE/EP). The module which contains the instruction pointed to by the resume PSW is the one in which abnormal termination occurred. The name of the load module is indicated in the field labeled NM.

Trace Table: Entries in the trace table reflect SIO, I/O, and SVC interruptions and task switching. SIO entries can be used to locate the CCW (through the CAW), which reflects the operation initiated by an SIO instruction. If the SIO operation was not successful, the CSW STATUS portion of the entry will show you why it failed.

I/O entries reflect the I/O old PSW and the CSW that was stored when the interruption occurred. From the PSW, you can learn the address of the device on which the interruption occurred (bytes 2 and 3), the CPU state at the time of interruption (bit 15), and the instruction address where the interruption occurred (bytes 5-8). The CSW provides you with the unit status (byte 4), the channel status (byte 5), and the address of the previous CCW plus 8 (bytes 0-3).

SVC entries provide the SVC old PSW and the contents of registers 0 and 1. The PSW offers you the hexadecimal SVC number (bits 20-31), the CPU mode (bit 15), and the address of the SVC instruction (bytes 5-8). The contents of registers 0 and 1 are useful in that many system macro instructions use these registers for parameter information. Contents of registers 0 and 1 for each SVC interruption are given in Appendix A.

A task switch entry is similar to an SVC entry, except that words 3 and 4 of the entry contain the address of the TCBs for the "new" and "old" tasks being performed, respectively. The trace table entries for one particular task are contained between sets of two task switch entries. Word 3 of the beginning task switch entry and word 4 of the ending task switch entry point to the TCB for that task. Task switch entries are identified by a fifth digit of 'F'.

Notes: If an ABEND macro instruction is issued by the system when a program check interruption causes abnormal termination, an SVC entry does not appear in the trace table, but is reflected in the PSW at entry to ABEND.

Dumps issued by systems with MFT contain only the last four characters of the module name in the RB APSW field. You cannot distinguish between IFG0xxxx and IGG0xxxx. After an SVC 19 has been issued, the OPEN where-to-go table should be checked for the module name.

Free Areas: ABEND/SNAP dumps do not print out areas of main storage that are available for allocation. Since the ABEND routine uses some available main storage, the only way you can determine the amount of free storage available when abnormal termination occurred is to re-create the situation and take a stand-alone dump.

ABEND/SNAP Dump (MVT)

MVT dumps differ from PCP and MFT dumps in the addition of detailed main storage control information, the omission of a complete main storage dump, and the omission of a trace table in ABEND dumps. MVT dumps occur immediately after an abnormal termination, provided an ABEND or SNAP macro instruction was issued and proper dump data sets were defined. However, if a system failure has occurred and a SYS1.DUMP data set has been defined and is available, a full storage image dump is provided, as explained in the section headed "Storage Image Dump."

With MVT's subtask creating capability, you may receive one or more partial dumps in addition to a complete dump of the task that caused abnormal termination. A complete dump includes all control information associated with the terminating task and a printout of the load modules and subpools used by the task. A partial dump of a task related to the terminating task includes only control information. A partial dump is identified by either ID=001 or ID=002 printed in the first line of the dump. Figure 18 shows the key areas of a complete dump.

In systems with MVT, you can effect termination of a job step task upon abnormal termination of a lower level task. To do this, you must either terminate each task upon finding an abnormal termination completion code issued by its subtask or pass the completion code on to the next higher level task.

For a discussion of a formatted ABEND dump using the telecommunications access method (TCAM) in an MVT environment, see IBM System/360 Operating System: TCAM Program Logic Manual, GY30-2029. References to other TCAM debugging aids are found in Appendix J.

Invoking an ABEND/SNAP Dump (MVT)

ABEND/SNAP dumps issued by systems with MVT are invoked in the same manner as those under systems with PCP and MFT. They result from an ABEND or SNAP macro instruction in a system or user program, accompanied by a properly defined data set. In the case of a system failure, the damage assessment routine (DAR) attempts to write a storage image dump to the SYS1.DUMP data set. A full explanation of storage image dumps may be found in the section headed "Storage Image Dump." The instructions that invoke an ABEND/SNAP dump in MVT

environment are the same as those given in the preceding topic for systems with MFT. However, some additional considerations must be made in requesting main storage and direct access space.

MVT Considerations: In specifying a region size for a job step subject to abnormal termination, you must consider the space requirements for opening a SYSABEND or SYSUDUMP data set (if there is one), and loading the ABDUMP routine and required data management routines. This space requirement can run as high as 6000 bytes.

Direct access devices are used frequently for intermediate storage of dump data sets in systems with MVT. To use direct access space efficiently, the space for the dump data set should be varied, depending on whether or not abnormal termination is likely. A small quantity should be requested if normal termination is expected. To prevent termination of the dump due to a lack of direct access space, always specify an incremental (secondary) quantity when coding a SPACE parameter for a dump data set. You can obtain a reasonable estimate of the direct access space required for an ABEND/SNAP dump by adding, (1) the number of bytes in the nucleus, (2) the part of the system queue space required by the task (9150 bytes is a sufficient estimate), and (3) the amount of region space occupied by the task. Multiply the sum by 4, and request this amount of space in 1024-byte blocks.

This formula gives the space requirements for one task. Request additional space if partial dumps of subtasks and invoking tasks will be included.

Contents of an ABEND/SNAP Dump (MVT)

This explanation of the contents of ABEND/SNAP dumps issued by systems with MVT is interspersed with sample sections from an ABEND dump. Capital letters represent the headings found in all dumps, and lowercase letters, information that varies with each dump. The lowercase letter used indicates the mode of the information and the number of letters indicates its length:

- h represents 1/2 byte of hexadecimal information
- d represents 1 byte of decimal information
- c represents a 1-byte character

You may prefer to follow the explanation on your own ABEND or SNAP dump.

```

JOB IPCT41          STEP FXSTEP          TIME 007409  DATE 99366          PAGE 0001
COMPLETION CODE    SYSTEM = B37
PSW AT ENTRY TO ABEND FF040000 5000C408

TCB 02F028  RRP 0002EC78  PIF 00000000  DER 0002ED34  TIN 000302F0  CMP 00037000  TRN 00000000
          M55 0103173A  PK-FLG F0850409  FLG 00000000  LLS 00030980  JLB 00000000  JPK 000301E8
          FSA 01060768  TCB 00000000  TME 00000000  JST 0002F028  NTC 00000000  OTC 00030508
          LTC 00000000  IOE 00000000  FCA 00030484  STA 00000000  D-PQF 00032668  SOS 0002EAA0
          NSTAF 00000000  TCT 00030268  USER 00000000  DAR 00000000  RFSV 00000000  JSCB 0003146C

ACTIVE PWS
PRB 0300F8  RESV 00000000  APSW 00000000  WC-SZ-STAR 00040082  FL-CDE 00031290  PSW FFF50006 7003553E
          Q/TTR 00000000  WT-LNK 0002F028
PRB 030988  RESV 00000000  APSW 00000000  WC-SZ-STAR 00040002  FL-CDE 00030E40  PSW FFF50037 5207EC4A
          Q/TTR 00000000  WT-LNK 00030DF8

SVRR 02F0F0  TAB-LN 00980400  APSW F5F5F0F2  WC-SZ-STAR 00120002  TQN 00000000  PSW FF040000 5000C408
          Q/TTR 000030DF  WT-LNK 00030988
          RG 0-7 00000F09 000396F4 00000003 00000006 00000073 0003BC00 00036F88 0003CC33
          RG 8-15 00009100 000396F4 000696C0 0003A158 0003ACE1 000395C0 5207F434 0007EC10
          FXTSA E2E8E2F5 F306C340 0006DDE0 0002FFF4 0002FFF4 0006DF88 00000837 0003036C
          00007648 00000001 0006DFE0 C3C45004

SVRR 02F170  TAB-LN 008803C8  APSW F2F0F1C3  WC-SZ-STAR 00120002  TQN 00000000  PSW 00040033 5000C0CE
          Q/TTR 00006109  WT-LNK 0002F0E0
          RG 0-7 00000000 80B37000 000396F4 4000C1A2 0006DDE0 0002EED4 0002EFC4 0006DF88
          RG 8-15 00000837 0003036C 00007648 00000001 0006DFE0 00002648 0000DR68 00000001
          FXTSA 0000298F 000AD088 2000FFFF 000AD0F0 FF030000 0002F1FC 0002F1F4 E2E8F2C9
          C5C1F0F1 C9F5C128 C1C2C5D5 C4078386

SVRR 02F078  TAB-LN 00C803C8  APSW F1F0F5C1  WC-SZ-STAR 00120002  TQN 00000000  PSW FF040001 4007F8A4
          Q/TTR 00006201  WT-LNK 0002F170
          RG 0-7 00000000 0002F100 000080CA 0000DR68 0002F028 0002F170 00031290 00000000
          RG 8-15 0002F028 4000803A 0002F028 00008088 00030320 0002F1F4 4000D594 00000000
          FXTSA 00620300 00090040 0008000A 18002648 00000040 00090041 00028460 00000018
          0012C002 00000000 00000000 00000000

LOAD LIST
          NE 00030AF8  RSP-CDE 020301F8          NE 00030DF0  RSP-CDE 01032390          NE 00031078  RSP-CDE 01092290
          NE 00031080  RSP-CDE 01032240          NE 000310C8  RSP-CDE 01032390          NE 00031170  RSP-CDE 01032200
          NE 000311C0  RSP-CDE 010323C0          NE 00000000  RSP-CDE 010308F0

CDE
031290  ATR1 08  NCDE 000000  ROC-RB 00030DF8  NM GO  USE 01  EPA 035508  ATR2 20  XL/MJ 031280
030E80  ATR1 08  NCDE 011290  ROC-RB 00030988  NM IEKAA00  USE 01  EPA 036240  ATR2 20  XL/MJ 02F398
0301F8  ATR1 31  NCDE 0308F0  ROC-RB 00000000  NM 1GCA0A5A  USE 02  EPA 04C980  ATR2 28  XL/MJ 030A80
032390  ATR1 88  NCDE 0323C0  ROC-RB 07030000  NM 1GG019CD  USE 06  EPA 07EA00  ATR2 20  XL/MJ 032380
032290  ATR1 88  NCDE 0322C0  ROC-RB 00000000  NM 1GG0198A  USE 05  EPA 07E4A0  ATR2 20  XL/MJ 032280
032260  ATR1 88  NCDE 032290  ROC-RB 00000000  NM 1GG0198B  USE 05  EPA 07E8A0  ATR2 20  XL/MJ 032250
032390  ATR1 88  NCDE 0323C0  ROC-RB 00000000  NM 1GG019CD  USE 06  EPA 07EA00  ATR2 20  XL/MJ 032380
032200  ATR1 88  NCDE 032230  ROC-RB 00000000  NM 1GG019AJ  USE 03  EPA 07E3A0  ATR2 20  XL/MJ 0321F0
0323C0  ATR1 88  NCDE 0323F0  ROC-RB 00000000  NM 1GG019AR  USE 04  EPA 07FC10  ATR2 20  XL/MJ 032380
0303F0  ATR1 39  NCDE 0308F0  ROC-RB 00000000  NM 1EWSZ0VR  USE 01  EPA 06C480  ATR2 20  XL/MJ 030888

XL
          LN          ADR          LN          ADR          LN          ADR
031280  S2 00000010  N0 00000001  800002F8  00035508
02F398  S2 0000004C  N0 00000001  80016E3A  000359C8  000359C8  00030800  010A0400  01000500
          011C0300  01100300  011E0200  01290400  012E0500  01300500
          01320300  013A0100  01460600  01480400  014D0500

030A80  S2 00000010  N0 00000001  80000680  0006F980
0323A0  S2 00000010  N0 00000001  80000210  0007FA00
032280  S2 00000010  N0 00000001  80000180  0007FA40
032250  S2 00000010  N0 00000001  80000058  0007F880
032380  S2 00000010  N0 00000001  80000210  0007FA00
0321F0  S2 00000010  N0 00000001  80000100  0007E3A0
032390  S2 00000010  N0 00000001  80000090  0007EC10
030888  S2 00000010  N0 00000001  80000350  0006C480

DFB
02F000
02ED20 00000050 00000000 0003020A 000078E0 00000050 00000050 00000050 00000050 *.....*
02FD40 8F000000 01000000 00000000 FF060888 0402ED10 18002648 00000031 00010032 *.....0.....M.....*
02EDA0 00010008 00010001 C2C2C2C1 C3C40000 00000000 00000000 00000000 C3C40000 *.....BBBACD.....CD..*

```

Figure 18. Sample of Complete ABEND Dump (MVT) (Part 1 of 2)

```

02FEA0 00000050 00000000 0000020F 00011AF0 00000050 00000050 00000050 *..P.....*
02FEC0 00000050 00000000 0000020F 00011AF0 2A000000 0302F02F 04000000 88000000 *.....0.....*
02FFE0 0F000000 10000000 00000000 FF0396F4 0402F0E0 18002648 00000039 0009003E *.....*
02FF00 00080032 18002648 0000003E 0009003F 0008000A 18002648 0000003F 00090040 *.....*
02FF20 0008000A 18002648 00000040 00090041 0008000A 18002648 00000041 00090042 *.....*
02FF40 0009000A 18002648 00000042 00090043 0008000A 18002648 00000043 00090044 *.....*
02FF60 0008000A 18002648 00000044 00090045 0008000A 18002648 00000045 00090046 *.....*
02FF80 0008000A 18002648 00000046 00090047 0008000A 18002648 00000047 00090048 *.....*
02FFA0 0009000A 18002648 00000048 00090049 0008000A 18002648 00000049 0009004A *.....*
02FFC0 0008000A 18002648 0000004A 0009004B 0008000A 18002648 0000004B 0009004C *.....*
02FFED 0009000A 18002648 0000004C 0009004D 0008000A 00010001 C109C1D1 C3C4F6C0 *.....ARAJCD6..*

```

```

TIDT JOB IPCT41 STFP EXSTEP
DN 14040101 PGM**DN 00230F00 80002648
DD 14040100 SYSABEND 00240900 80002648
DP 14040180 FT06F001 00240C00 80002648
DQ 14040100 FTNL IN 00250100 8000199A
DD 14000000 SYSPUNCH 00250800 00000000
DD 14040100 SYSPRINT 00240F00 80002648
DD 14040101 SYSIN 00250A00 80002648

```

```

MSS ***** SPJF ***** DQF *****
      FLGS  MSPQE  SPID  DQF      BLK  FQE  LN  NDQE  NFQE  FQE  LN
031738 00 031740 251 031250 00035000 00035800 00000800 000310F0 00000000 00000508
031740 00 031488 252 0314C0 00035800 00035800 00017000 00000000 00000000 000001C8
0006D800 0006D800 00000800 00030878 00000000 00000588
0006C000 0006C000 00000800 00030308 00000000 00000480
0006C400 0006C400 00000800 0002F388 00000000 00000180
0006B800 0006B800 00000800 00000000 00000000 000001A0
031488 00 000000 000 031400 0006D000 0006D748 00000800 00000000 0006D000 00000020
031400 60 000000 000 031488 00000000 00000000 00000000 00000518

```

```

D-PQE 00032668 FIRST 00031460 LAST 00031460
POF 031460 FFB 0004C800 LFR 0004C800 NPQ 00000000 PPQ 00000000
      TCB 00030508 RSI 00039000 RAD 00035000 FLG 0000

```

```
FRQF 04C800 NFR 00031460 PFR 00031460 SZ 0001F000
```

QCR TRACE

```

MAJ 0311C8 NMAJ 000301D0 PMAJ 0001C6A0 FMIN 00031088 NM SYS05N
MIN 031098 FQEL 00031698 PMIN 000311C8 NMIN 00000000 NM FF SYS1.MACLIB
      NQEL 00000000 PQEL 80031088 TCR 00030508 SVRB 000301D0
MAJ 0301D0 NMAJ 00000000 PMAJ 000311C8 FMIN 000301A0 NM SYSEAD01
MIN 0301A0 FQEL 00030190 PMIN 000301D0 NMIN 00000000 NM FO IEA
      NQEL 00000000 PQEL 000301A0 TCB 0002F028 SVRB 0002ERE8

```

SAVE AREA TRACE

```

SA 06D768 W01 00000000 HSA 00000000 LSA 00000000 RET 00000000 EPA 00000000 R0 00000000
      R1 00000000 R2 00000000 R3 00000000 R4 00000000 R5 00000000 R6 00000000
      R7 00000000 R8 00000000 R9 00000000 R10 00000000 R11 00000000 R12 00000000

```

INTERRUPT AT 07EC44

PROCEEDING BACK VIA RFG 13

```

SA 0395C0 W01 957095FF HSA 70004780 LSA 95789180 REFJ 80064710 EPA 958C1811 R0 5203936E
      R1 9207F3A0 R2 0006D570 R3 000396F4 R4 000396F4 R5 0006D570 R6 7F06D5CC
      R7 0006D688 RA 0006D78C R9 00000F09 R10 0007EC10 R11 5207F434 R12 0007EC10
SA 004780 W01 47900000 HSA FF000000 LSA 00000000 RET 00000000 EPA 47A00000 R0 FF000000
      R1 00000000 R2 00000000 R3 47800000 R4 FF000000 R5 00000000 R6 00000000
      R7 47C00000 R8 FF000000 R9 00000000 R10 00000000 R11 47D00000 R12 FF000000

```

NUCLEUS

```

000000 00000000 00000000 00000000 00000000 0000D868 00000000 FF040080 8003B724 *.....*
000020 FF050001 4007EC3C FFF50001 02036CF2 0000FF00 00000000 FF060336 80000000 *...5.....2.....*
000040 0000A7C8 0C000000 000725A0 0000D868 0R36E8BC 0001389C 00040000 0000F678 *...H.....Y.....6..*

```

Figure 18. Sample of Complete ABEND Dump (MVT) (Part 2 of 2)

| | | | | | |
|------------------------------|-------------------------------|-------------|-------------|----------|-----------|
| JOB ccccccc | STEP ccccccc | TIME dddddd | DATE dddddd | ID = ddd | PAGE dddd |
| COMPLETION CODE | SYSTEM = hhh (or USER = dddd) | | | | |
| PSW AT ENTRY TO ABEND (SNAP) | hhhhhhhh hhhhhhhh | | | | |

JOB ccccccc
is the job name specified in the JOB statement.

task being abnormally terminated, up to and including the job step task.

STEP ccccccc
is the step name specified in the EXEC statement for the problem program associated with the task being dumped.

PAGE dddd
is the page number. Appears at the top of each page. Page numbers begin at 0001 for each task or subtask dumped.

TIME dddddd
is the hour (first 2 digits), minute (next 2 digits), and second (last 2 digits) when the abnormal termination dump routine began processing.

COMPLETION CODE SYSTEM=hhh or COMPLETION CODE USER=dddd
is the completion code supplied by the control program (SYSTEM=hhh) or the problem program (USER=dddd). For a system completion code of 0C0, denoting an imprecise interruption on a Model 91 or Model 195, bits 20 through 29 of the CMP field of the TCB are significant for a Model 91, while all the bits (20 through 31) are used by a Model 195. For further discussion on interpreting the imprecise interruption configuration refer to the publication IBM System/360 Operating System: Supervisor Services, Order No. GC28-6646.

DATE dddddd
is the year (first 2 digits) and day of the year (last 3 digits). For example, 67352 would be December 18, 1967.

ID=ddd
is an identification of the dump. For dumps requested by an ABEND macro instruction, this identification is:

- Absent if the dump is of the task being abnormally terminated.
- 001 if the dump is of a subtask of the task being abnormally terminated. (Note that, when a task is abnormally terminated, its subtasks are also abnormally terminated.)
- 002 if the dump is of a task that directly or indirectly created the

PSW AT ENTRY TO ABEND hhhhhhhh hhhhhhhh or
PSW AT ENTRY TO SNAP hhhhhhhh hhhhhhhh
is the PSW for the problem program or control program routine that had control when abnormal termination was requested, or when the SNAP macro instruction was executed. It is not necessarily the PSW at the time the error condition occurred.

| | | | | | | | | | | | | | |
|-----|--------|---------|----------|----------|----------|----------|----------|----------|----------|----------|----------|----------|----------|
| TCB | hhhhhh | RBP | hhhhhhhh | PIE | hhhhhhhh | DEB | hhhhhhhh | TIO | hhhhhhhh | CMP | hhhhhhhh | TRN | hhhhhhhh |
| | | MSS | hhhhhhhh | PK-FLG | hhhhhhhh | FLG | hhhhhhhh | LLG | hhhhhhhh | JLB | hhhhhhhh | JPQ | hhhhhhhh |
| | | RG 0-7 | hhhhhhhh | hhhhhhhh | hhhhhhhh | hhhhhhhh | hhhhhhhh | hhhhhhhh | hhhhhhhh | hhhhhhhh | hhhhhhhh | hhhhhhhh | hhhhhhhh |
| | | RG 8-15 | hhhhhhhh | hhhhhhhh | hhhhhhhh | hhhhhhhh | hhhhhhhh | hhhhhhhh | hhhhhhhh | hhhhhhhh | hhhhhhhh | hhhhhhhh | hhhhhhhh |
| | | FSA | hhhhhhhh | TCB | hhhhhhhh | TME | hhhhhhhh | JST | hhhhhhhh | NTC | hhhhhhhh | OTC | hhhhhhhh |
| | | LTC | hhhhhhhh | IQE | hhhhhhhh | ECB | hhhhhhhh | STA | hhhhhhhh | D-PQE | hhhhhhhh | SQS | hhhhhhhh |
| | | NSTAE | hhhhhhhh | TCT | hhhhhhhh | USER | hhhhhhhh | DAR | hhhhhhhh | RESV | hhhhhhhh | JSCB | hhhhhhhh |

TCB hhhhhh
is the starting address of the TCB.

RBP hhhhhhhh
is the TCBRBP field (bytes 0 through 3): starting address of the active RB queue and, consequently, the most recent RB on the queue.

PIE hhhhhhhh
is the TCBPIE field (bytes 4 through 7): starting address of the program interruption element (PIE) for the task; however, in an abnormal termination dump for the task causing the abnormal termination, zeros. The field is zeroed by the ABEND routine to prevent interruptions during dumping.

DEB hhhhhhhh
is the TCBDEB field (bytes 8 through 11): starting address of the DEB queue. Under the heading DEB in the dump, the prefix section for the first DEB in the queue is presented in the first 8-digit entry on the first line. The 6-digit entry at the left of each line under DEB is the address of the second column on the line, whether or not the column is filled. The contents of the TCBDEB field may differ in the main storage printout from what appears in the TCBDEB field of the formatted section. This occurs when the number of extents specified in the DEB for the dump data set is not sufficient to complete ABDUMP processing. When the dump of main storage is given, the END OF VOLUME routine may have built another DEB having additional extents for the dump data set and dequeued the original DEB. Therefore, the TCBDEB field in the main storage printout may contain the address of the new DEB built by END OF VOLUME.

TIO hhhhhhhh
is the TCBTIO field (bytes 12 through 15): starting address of the TIOT.

CMP hhhhhhhh
is the TCBCMP field (bytes 16 through 19): task completion code or contents of register 1 when the dump was requested. System codes are given in the third through fifth digits and user codes in the sixth through eight digits.

For a system completion code of 0C0, denoting an imprecise interruption on a Model 91 or Model 195, digits six through eight contain the imprecise interruption configuration. These bit settings represent bits 16 to 27 of the program old PSW (location X'28') at the time of the program exception. Therefore, in the TCB CMP field, bits 20 to 29 are significant for a Model 91 while a Model 195 makes use of all the bits (20 to 31). For further discussion on interpreting the imprecise interruption configuration refer to the publication IBM System/360 Operating System: Supervisor Services, Order No. GC28-6646.

TRN hhhhhhhh
is the TCBTRN field (bytes 20 through 23): starting address of the control core (table) for controlling testing of the task by TESTRAN.

MSS hhhhhhhh
is the TCBMSS field (bytes 24 through 27): starting address of SPQE most recently added to the SPQE queue.

PK-FLG hhhhhhhh
contains, in the first 2 digits, the TCBPKF field (byte 28): protection key.

contains, in the last 6 digits, the first 3 bytes of the TCBFLGS field (bytes 29 through 31): first 3 flag bytes.

FLG hhhhhhhh
contains, in the first 4 digits, the last 2 bytes of the TCBFLGS (bytes 32 and 33): last 2 flag bytes.

contains, in the next 2 digits, the TCBLMP field (byte 34): limit priority (converted to an internal priority, 0 to 255).

contains, in the last 2 digits, the TCBDSP field (byte 35): dispatching priority (converted to an internal priority, 0 to 255).

LLS hhhhhhhh
is the TCBLLS field (bytes 36 through 39): starting address of the load list element most recently added to the load list.

JLB hhhhhhhh
is the TCBJLB field (bytes 40 through 43): starting address of the DCB for the JOBLIB data set.

JPQ hhhhhhhh
is the TCBJPQ field (bytes 41 through 47): when translated into binary bits:

- Bit 0 is the purge flag.
- Bits 1 through 7 are reserved for future use and are zeros.
- Bits 8 through 31 are the starting address of the queue of CDEs for the job pack area control queue, which is for programs acquired by the job step.

The TCBJPQ field is used only in the first TCB in the job step; it is zeros for all other TCBS.

RG 0-7 and RG 8-15
is the TCBGRS field (bytes 48 through 111): contents of general registers 0 through 7 and 8 through 15, as stored in the save area of the TCB when a task switch occurred. These 2 lines appear only in dumps of tasks other than the task in control when the dump was requested.

FSA hhhhhhhh
contains, in the first 2 digits, the TCBQEL field (byte 112): count of enqueue elements.

contains, in the last 6 digits, the TCBFSA field (bytes 113 through 115): starting address of the first problem program save area. This save area was set up by the control program when the job step was initiated.

TCB hhhhhhhh
is the TCBTCB field (bytes 116 through 119): starting address of the next lower priority TCB on the TCB queue or, if this is the lowest priority TCB, zeros.

- TME** hhhhhhhh
is the TCBTME field (bytes 120 through 123): starting address of the timer element created when an STIMER macro instruction is issued by the task.
- JST** hhhhhhhh
is the TCBJSTCB field (bytes 124 through 127): starting address of the TCB for the job step task. For tasks with a protection key of zero, this field contains the starting address of the TCB.
- NTC** hhhhhhhh
is the TCBNTC field (bytes 128 through 131): the starting address of the TCB for the previous subtask on this subtask queue. This field is zero in the job step task, and in the TCB for the first subtask created by a parent task.
- OTC** hhhhhhhh
is the TCBOTC field (bytes 132 through 135): starting address of TCB for the parent task. In the TCB for the job step task, this field contains the address of the initiator.
- LTC** hhhhhhhh
is the TCBLTC field (bytes 136 through 139): starting address of the TCB for the most recent subtask created by this task. This field is zero in the TCB for the last subtask of a job step, or in a TCB for a task that does not create subtasks.
- IQE** hhhhhhhh
is the TCBIQE field (bytes 140 through 143): starting address of the interruption queue element (IQE) for the ETXR exit routine. This routine is specified by the ETXR operand of the ATTACH macro instruction that created the TCB being dumped. The routine is to be entered when the task terminates.
- ECB** hhhhhhhh
is the TCBECEB field (bytes 144 through 147): starting address of the ECB to be posted by the control program at task termination. This field is zero if the task was attached without an ECB operand.
- TSF** hhhhhhhh
is the TCBSFLG field (bytes 94 through 97). The first two digits, byte 94, contain internal TSO flags, the next two digits, byte 95, contain the stop count, and the last two bytes, 96 and 97, contain the limit and dispatching priority of the TSO task.
- D-PQE** hhhhhhhh
is the TCBPQE field (bytes 152 through 155): starting address minus 8 bytes of the dummy PQE. This field is passed by the ATTACH macro instruction to each TCB in a job step.
- SQS** hhhhhhhh
is the TCBAQE field (bytes 156 through 159): starting address of the allocation queue element (AQE).
- NSTAE** hhhhhhhh
contains, in the first 2 digits, STAE flags (byte 160).

contains, in the last 6 digits, the TCBNSTAE field (bytes 161 through 163): starting address of the current STAE control block for the task. This field is zero if STAE has not been issued.
- TCT** hhhhhhhh
is the TCBTCT field (bytes 164 through 167): address of the Timing Control Table (TCT).
- USER** hhhhhhhh
is the TCBUSER field (bytes 168 through 171): to be used as the user chooses.
- DAR** hhhhhhhh
contains, in the first two digits, Damage Assessment Routine (DAR) flags (byte 172).
- RESV** hhhhhhhh
reserved for future use.
- JSCB** hhhhhhhh
is the TCBJSCB field (bytes 180 through 183): the last three bytes contain the address of the Job Step Control Block.

| ACTIVE RBS | | | | | | | | | | | | |
|------------|---------|----------|----------|----------|----------|------------|----------|----------|----------|----------|----------|----------|
| cccc | hhhhh | cccccc | hhhhhhhh | APSW | hhhhhhhh | WC-SZ-STAB | hhhhhhhh | cccccc | hhhhhhhh | PSW | hhhhhhhh | hhhhhhhh |
| | Q/TTR | hhhhhhhh | WT-LNK | hhhhhhhh | | | | | | | | |
| | RG 0-7 | hhhhhhhh | hhhhhhhh | hhhhhhhh | hhhhhhhh | hhhhhhhh | hhhhhhhh | hhhhhhhh | hhhhhhhh | hhhhhhhh | hhhhhhhh | hhhhhhhh |
| | RG 8-15 | hhhhhhhh | hhhhhhhh | hhhhhhhh | hhhhhhhh | hhhhhhhh | hhhhhhhh | hhhhhhhh | hhhhhhhh | hhhhhhhh | hhhhhhhh | hhhhhhhh |
| | EXTSA | hhhhhhhh | hhhhhhhh | hhhhhhhh | hhhhhhhh | hhhhhhhh | hhhhhhhh | hhhhhhhh | hhhhhhhh | hhhhhhhh | hhhhhhhh | hhhhhhhh |
| | | hhhhhhhh | hhhhhhhh | hhhhhhhh | hhhhhhhh | hhhhhhhh | hhhhhhhh | hhhhhhhh | hhhhhhhh | hhhhhhhh | hhhhhhhh | hhhhhhhh |

ACTIVE RBS

identifies the next lines as the contents of the active RBS queued to the TCB, beginning with the oldest RB first.

cccc hhhhhh

indicates the RB type (cccc) and starting address (hhhhh).

The RB types are:

- PRB program request block
- IRB interruption request block
- SVRB supervisor request block

cccccc hhhhhhhh

indicates the RB's function (cccccc) and bytes 0 through 3 of the RB (hhhhhhhh):

- RESV hhhhhhhh indicates PRB or SVRB for resident routines. Bytes 0 through 3 are reserved for later use and contain zeros.
- TAB-LN hhhhhhhh indicates SVRB for transient routines. The first 4 digits contain the RBTAENO field (bytes 0 and 1): displacement from the beginning of the transient area control table (TACT) to the entry for the module represented by the RB. The last 4 digits contain the RBRTLNTH field (bytes 2 and 3): length of the SVC routine.
- FL-PSA hhhhhhhh indicates IRB. The first 2 digits contain the RBTMFLD field (byte 0): indicators for the timer routines. This byte contains zeros when the IRB does not represent a timer routine. The last 6 digits contain the RBPSAV field (bytes 1 through 3): starting address of the problem program register save area (PSA).

APSW hhhhhhhh

is the RBABOPSW field (bytes 4 through 7):

- In PRB, right half of the problem program's PSW when the interruption occurred.
- In IRB or SVRB for type II SVC routines, right half of routine's PSW during execution of ABEND or ABTERM, or zeros.
- In SVRB for type III or IV SVC routines, right half of routine's PSW during execution of ABEND or ABTERM, or the last four characters of the name of the requested routine. (The last two characters give the SVC number.)

WC-SZ-STAB hhhhhhhh

contains, in the first 2 digits, the RBWCSA field (byte 8): wait count in effect at time of abnormal termination of the program.

contains, in the second 2 digits, the RBSIZE field (byte 9): size of the RB in doublewords.

contains, in the last 4 digits, the RBSTAB field (bytes 10 and 11): status and attribute bits.

cccccc hhhhhhhh

indicates the RB's function (cccccc) and bytes 12 through 15 of the RB (hhhhhhhh):

- FL-CDE hhhhhhhh indicates SVRB for resident routines, or PRB. The first 2 digits contain the RBCDFLGS field (byte 12): control flags.

The last 6 digits contain the RBCDE field (bytes 13 through 15): starting address of the CDE for the module associated with this RB.

- EPA hhhhhhhh is the RBEP field of an IRB (bytes 12 through 15): entry-point address of asynchronously executed routine.
- TQN hhhhhhhh indicates SVRB for transient routines. Is the RBSVTQN field (bytes 12 through 15): address of the next RB in the transient control queue.

PSW hhhhhhhh hhhhhhhh
is the RBOPSW field (bytes 16 through 23): resume PSW.

Q/TTR hhhhhhhh

- In PRBs and SVRBs for resident routines, contains zeros in the first 2 digits. The last 6 digits contain the RBPGMQ field (bytes 25 through 27): queue field for serially reusable programs (also called the secondary queue).
- In IRBs, contains the RBUSE field in the first 2 digits (byte 24): count of requests for the same exit (ETXR). The RBIQE field in last 6 digits (bytes 25 through 27): starting address of the queue of interruption queue elements (IQE), or zeros in the first 4 digits and the RBIQE field in the last 4 digits (bytes 26 and 27): starting address of the request queue elements.

- In SVRBs for transient routines the first 2 digits contain the RBTAWCSA field (byte 24): number of requests (used if transient routine is overlaid) and the last 6 digits, the RBSVTTR field (bytes 25 through 27): relative track address for the SVC routine.

WT-LNK hhhhhhhh

contains, in the first 2 digits, the RBWCF field (byte 28): wait count.

contains, in the last 6 digits, the RBLINK field (bytes 29 through 31): starting address of the previous RB on the active RB queue (primary queuing field) or, if this is the first or only RB, the starting address of the TCB.

RG 0-7 and RG 8-15

is the RBGRSAVE field (bytes 32 through 95): in SVRBs and IRBs, contents of registers 0 through 15.

EXTSA

- In IRBs, contains the RBNEXAV field in the first 8 digits (bytes 96 through 99): address of next available interruption queue element (IQE), and in the remaining digits, the interruption queue element work space (up to 1948 bytes).
- In SVRBs, contains the RBEXSAVE field (bytes 96 through 143): extended save area for SVC routine.

| LOAD LIST | | | | | |
|-------------|------------------|-------------|------------------|-------------|------------------|
| NE hhhhhhhh | RSP-CDE hhhhhhhh | NE hhhhhhhh | RSP-CDE hhhhhhhh | NE hhhhhhhh | RSP-CDE hhhhhhhh |

LOAD LIST

identifies the next lines as the contents of the load list elements (LLEs) queued to the TCB by its TCBLLS field. The contents of 3 load list elements are presented per line until all elements in the queue are shown.

NE hhhhhhhh

contains, in the first 2 digits, LLE byte 0: zeros.

contains, in the last 6 digits, LLE bytes 1 through 3: starting address of the next element in the load list.

RSP-CDE hhhhhhhh

contains, in the first 2 digits, LLE byte 4: the count of the number of requests made by LOAD macro instructions for the indicated load module. This count is decremented by DELETE macro instructions.

contains, in the last 6 digits, LLE bytes 5 through 7: starting address of the CDE for the load module.

CDE

hhhhhhhh ATR1 hh NCDE hhhhhh ROC-RB hhhhhhhh NM cccccccc USE hh EPA hhhhhh ATR2 hh XL/MJ hhhhhh

CDE

identifies the next lines as the contents directory addressed by an LLE or RB. One entry is presented per line.

hhhhhhhh

is the starting address of the entry given on the line.

ATR1 hh

is the attribute flags.

NCDE hhhhhh

is the starting address of the next entry in the contents directory.

ROC-RB hhhhhhhh

contains, in the first 2 digits, zeros.

contains, in the last 6 digits, the starting address of the RB for the load module represented by this entry.

NM cccccccc

is the name of the entry point to the load module represented by this entry.

USE hh

is the count of the uses (through ATTACH, LINK, and XCTL macro instructions) of the load module, and of the number of LOAD macro instructions executed for the module.

EPA hhhhhh

is the entry point address associated with the name in the NM field.

ATR2 hh

is the attribute flags.

XL/MJ hhhhhh

is the starting address of the extent list (XL) for a major CDE, or the starting address of the major CDE for a minor CDE. (Minor CDEs are for aliases.)

XL

hhhhhh SZ hhhhhhhh NO hhhhhhhh hhhhhhhh hhhhhhhh hhhhhhhh hhhhhhhh

LN

ADR

LN

ADR

LN

ADR

XL

indicates the next lines are entries in the extent list, which is queued to the major contents directory entry. Each extent list entry is given in one or more lines. Only the first line for an entry contains the left 3 columns; additional lines for an entry contain information only in the right 6 columns.

hhhhhh

is the starting address of the entry.

SZ hhhhhhhh

is the total length, in bytes, of the entry.

NO hhhhhhhh

is the number of scattered control sections in the load module described by this entry. If this number is 1, the load module was loaded as one block.

LN hhhhhhhh

gives the length, in bytes, of the control sections in the load module described by this entry. Bit 0 is set to 1 in the last, or only, LN field to signal the end of the list of lengths.

ADR hhhhhhhh

gives the starting addresses of the control sections. Each ADR field is paired with the LN field to its left.

| | | | | | | | | | |
|-------|-------|---------|---------|---------|-------|---------|-------|-------|-------|
| DEB | | | | | | | | | |
| hhhhh | hhhhh | hhhhh | hhhhh | hhhhh | hhhhh | hhhhh | hhhhh | hhhhh | hhhhh |
| hhhhh | hhhhh | hhhhh | hhhhh | hhhhh | hhhhh | hhhhh | hhhhh | hhhhh | hhhhh |
| hhhhh | hhhhh | hhhhh | hhhhh | hhhhh | hhhhh | hhhhh | hhhhh | hhhhh | hhhhh |
| hhhhh | hhhhh | hhhhh | hhhhh | hhhhh | hhhhh | hhhhh | hhhhh | hhhhh | hhhhh |
| TIOT | JOB | ccccccc | STEP | ccccccc | PROC | ccccccc | | | |
| DD | | hhhhh | ccccccc | hhhhh | hhhhh | hhhhh | | | |

DEB identifies the next lines as the contents of the DEBs and their prefix sections. The first 6 digits in each line give the address of the DEB contents shown on the line, beginning with the second column. The first six digits of the first line contains the prefix section for the first DEB on the queue.

Note: DEBs are not formatted if the dump is for an OLTEP task. If a dump of the DEB chain is desired, use a SYSABEND DD card so that the nucleus will be dumped.

TIOT identifies the next lines as the contents of the TIOT.

JOB ccccccc
is the name of the job whose task is being dumped.

STEP ccccccc
is the name of the step whose task is being dumped.

PROC ccccccc
is the name for the job step that called the cataloged procedure. This field appears if the job step whose task is being dumped was part of a cataloged procedure.

DD identifies the line as the contents of the DD entry in the TIOT.

| | | | | | | | | | |
|-------|-------|------------|----------|-----------|----------|-----------|----------|-----------|----------|
| MSS | ***** | SPQE ***** | ***** | DQE ***** | ***** | FQE ***** | ***** | FQE ***** | ***** |
| | FLGS | NSPQE | SPID | DQE | BLK | FQE | LN | NDQE | NPQE LN |
| hhhhh | hh | hhhhh | ddd | hhhhh | hhhhh | hhhhh | hhhhh | hhhhh | hhhhh |
| D-PQE | hhhhh | FIRST | hhhhhhhh | LAST | hhhhhhhh | | | | |
| PQE | hhhhh | FFB | hhhhhhhh | LFB | hhhhhhhh | NPO | hhhhhhhh | PPO | hhhhhhhh |
| | | TCB | hhhhhhhh | RSI | hhhhhhhh | RAD | hhhhhhhh | FLC | hhhhhhhh |
| FBQE | hhhhh | NFB | hhhhhhhh | PFB | hhhhhhhh | SZ | hhhhhhhh | | |
| . | . | . | . | . | . | . | . | . | . |
| PQE | hhhhh | FFB | hhhhhhhh | LFB | hhhhhhhh | NPO | hhhhhhhh | PPO | hhhhhhhh |
| | | TCB | hhhhhhhh | RSI | hhhhhhhh | RAD | hhhhhhhh | FLC | hhhhhhhh |
| FBQE | hhhhh | NFB | hhhhhhhh | PFB | hhhhhhhh | SZ | hhhhhhhh | | |

MSS identifies the next lines as the contents of the main storage supervisor queue. This queue includes subpool queue elements (SPQE), descriptor queue elements (DQE), and free queue elements (FQE).

hhhhh is the starting address of the first element shown on the line.

SPQE identifies the 4 columns beneath it as the contents of SPQEs.

FLGS hh
 is the SPQE flag byte.

NSPQE hhhhhh
 is the starting address of the next SPQE in the queue.

SPID ddd
 is the subpool number.

DQE hhhhhh
 for a subpool owned by the task being dumped: the starting address of the first DQE for the subpool.

 for a subpool that is shared: the starting address of the SPQE for the task that owns the subpool.

DQE
 identifies the 4 columns beneath it as the contents of DQEs.

BLK hhhhhh
 is the starting address of the allocated 2K block of main storage or set of 2K blocks.

FQE hhhhhh
 is the starting address of the first FQE within the allocated blocks.

LN hhhhhh
 is the length, in bytes, of the allocated blocks.

NDQE hhhhhh
 is the starting address of the next DQE.

FQE
 identifies the 2 columns beneath it as the contents of FQEs.

NFQE hhhhhhhh
 is the starting address of the next FQE.

LN hhhhhhhh
 indicates the number of bytes in the free area.

D-PQE hhhhhh
 is the TCBPQE field (bytes 152 through 155): starting address minus 8 bytes of the dummy PQE shown on the line.

FIRST hhhhhhhh
 is the starting address of the first PQE.

LAST hhhhhhhh
 is the starting address of the last PQE.

PQE hhhhhh
 is the starting address of the PQE shown on the line.

FFB hhhhhhhh
 is bytes 0 through 3 of the PQE: starting address of the first FBQE. If no FBQEs exist, this field is the starting address of this PQE

LFB hhhhhhhh
 is bytes 4 through 7 of the PQE: starting address of the last FBQE. If no FBQEs exist, this field is the starting address of this PQE.

NPQ hhhhhhhh
 is bytes 8 through 11 of the element: starting address of the next PQE or, if this is the last PQE, zeros.

PPQ hhhhhhhh
 is bytes 12 through 15 of the element: starting address of the preceding PQE or, if this is the first PQE, zeros.

TCB hhhhhhhh
 is bytes 16 through 19 of the element: starting address of the TCB for the job step to which the space belongs or, if the space was obtained from unassigned free space, zeros.

RSI hhhhhhhh
 is bytes 20 through 23 of the element: size of the region described by this PQE (a multiple of 2048).

RAD hhhhhhhh
 is bytes 24 through 27 of the element: starting address of the region described by this PQE.

FLG hhhhhhhh
 is byte 28 of the element:

- bit 0 when 0, indicates space described by this PQE is owned;
- when 1, indicates space is borrowed.
- bit 1 when 1, indicates region has been rolled out (meaningful only when bit 0 is 0).
- bit 2 when 1, indicates region has been borrowed.
- bit 3-7, reserved for future use.

Note: PQE information is contained in two lines on the dump. When the rollout/rollin feature or Main Storage Hierarchy Support is included in the system, PQE information (with associated FBQEs) appears once in the dump for each region segment of the job step. (Each PQE on the partition queue defines a region segment. A job step's region contains more than one segment only when the step has rolled out another step or steps, or Main Storage Hierarchy Support is present.)

FBQE hhhhhh
is the starting address of the FBQE
shown on the line.

NFB hhhhhhhh
is bytes 0 through 3 of the element:
starting address of the next FBQE. In
the highest or only FBQE, this field
contains the address of the PQE.

PFB hhhhhhhh
is bytes 4 through 7 of the element:
starting address of the previous FBQE.
In the lowest or only FBQE, the field
contains the address of the PQE.

SZ hhhhhhhh
is bytes 8 through 11 of the element:
size, in bytes, of the free area.

| | | | | | |
|------------|---------------|---------------|---------------|----------------|--|
| QCB TRACE | | | | | |
| MAJ hhhhhh | NMAJ hhhhhhhh | PMAJ hhhhhhhh | FMIN hhhhhhhh | NM cccccccc | |
| MIN hhhhhh | PQEL hhhhhhhh | PMIN hhhhhhhh | NMIN hhhhhhhh | NM xx xxxxxxxx | |
| | NQEL hhhhhhhh | PQEL hhhhhhhh | TCB hhhhhhhh | SVRB hhhhhhhh | |

QCB TRACE
identifies the next lines as a trace
of the queue control blocks (QCB)
associated with the job step. Lines
beginning with MAJ show major QCBs,
lines beginning with MIN show minor
QCBs, and lines beginning with NQEL
show queue elements (QEL).

MAJ hhhhhh
is the starting address of the major
QCB whose contents are given on the
line.

NMAJ hhhhhhhh
is the starting address of the next
major QCB for the job step.

PMAJ hhhhhhhh
is the starting address of the
previous major QCB for the job step.

FMIN hhhhhhhh
is the starting address of the first
minor QCB associated with the major
QCB given on the line.

NM cccccccc
is the name of the serially reusable
resource represented by the major QCB.

MIN hhhhhh
is the starting address of the minor
QCB whose contents are given on the
line.

PQEL hhhhhhhh
is the starting address of the first
queue element (QEL), which represents
a request to gain access to a serially
reusable resource or set of resources.

PMIN hhhhhhhh
is the starting address of the
previous minor QCB.

NMIN hhhhhhhh
is the starting address of the next
minor QCB.

NM xx xxxxxxxx
indicates, in the first 2 digits, the
scope of the name or address of the
minor QCB being dumped. If the scope
is hexadecimal FF, the name is known
to the entire operating system. If
the scope is hexadecimal 00 or 10
through FO, the name is known only to
the job step; in this case, the scope
is the protection key of the TCB
enqueueing the minor QCB.

Also contains, in the last 8 digits,
the name or the starting address of
the minor QCB.

NQEL hhhhhhhh
indicates, by hexadecimal 10 in the
first 2 digits, that the queue element
on the line represents a request for
step-must-complete; by 00, ordinary
request; and by 20, a
set-must-complete request.

Also contains, in the last 6 digits,
the starting address of the next queue
element in the queue, or for the last
queue element in the queue, zeros.

PQEL hhhhhhhh
indicates, by hexadecimal 80 in the
first 2 digits, that the queue element
represents a shared request or, by
hexadecimal 00, that the element
represents an exclusive request. (If

the shared DASD option was selected, hexadecimal 40 in the first 2 digits indicates an exclusive RESERVE request and 00 indicates a shared RESERVE request.)

SVRB hhhhhhhh
is the starting address, of the SVRB under which the routine for the ENQ macro instruction is executed, or, after the requesting task receives control of the resource, the UCB address of a device being reserved through a RESERVE macro instruction (the latter value occurs only when the shared DASD option was selected).

TCB hhhhhhhh
is the starting address of the TCB under which the ENQ macro instruction was issued.

```

SAVE AREA TRACE

cccccccc WAS ENTERED VIA LINK (CALL) ddddd AT EP ccccc...

SA  hhhhhh  WDI hhhhhhhh  HSA hhhhhhhh  LSA hhhhhhhh  RET hhhhhhhh  EPA hhhhhhhh  R0  hhhhhhhh
      R1 hhhhhhhh  R2 hhhhhhhh  R3 hhhhhhhh  R4 hhhhhhhh  R5 hhhhhhhh  R6  hhhhhhhh
      R7 hhhhhhhh  R8 hhhhhhhh  R9 hhhhhhhh  R10 hhhhhhhh  R11 hhhhhhhh  R12 hhhhhhhh

INCORRECT BACK CHAIN

INTERRUPT AT hhhhhh

PROCEEDING BACK VIA REG 13

```

SAVE AREA TRACE identifies the next lines as a trace of the save areas for the program. Each save area is presented in 3 or 4 lines. The first line gives information about the linkage that last used the save area. This line will not appear when the RB for the linkage cannot be found. The second line gives the contents of words 0 through 5 of the save area. The third and fourth lines give the contents of words 6 through 18 of the save area; these words are the contents of registers 0 through 12. Save areas are presented in the following order:

1. The save area pointed to in the TCBFSA field of the TCB. This save area is the first one for the problem program; it was set up by the control program when the job step was initiated.
2. If the third word of the first save area was filled by the problem program, then the second save area shown is that of the next lower level module of the task. However, if the third word of the first area points to a location whose second word does not point back to the first area, the message INCORRECT BACK CHAIN appears, followed by possible contents of the second save area.

3. The third, fourth, etc. save areas are then shown, provided the third word in each higher save area was filled and the second word of each lower save area points back to the next higher save area. This process is continued until the end of the chain is reached (the third word in a save area contains zeros) or INCORRECT BACK CHAIN appears.

Following the forward trace, the message INTERRUPT AT hhhhhh appears, followed by the message PROCEEDING BACK VIA REG 13. Then, the save area in the lowest level module is presented, followed by the save area in the next higher level. The lowest save area is assumed to be the 76 bytes beginning with the byte addressed by register 13. These two save areas appear only if register 13 points to a full word boundary and does not contain zeros.

cccccccc WAS ENTERED
is the name of the module that stored register contents in the save area. This name is obtained from the RB.

VIA LINK ddddd or VIA CALL ddddd
indicates the macro instruction (LINK or CALL) used to give control to the next lower level module, and is the ID

operand, if it was specified, of the LINK or CALL macro instruction.

AT EP ccccc...

is the entry point identifier, which appears only if it was specified in the SAVE macro instruction that filled the save area.

SA hhhhhh

is the starting address of the save area.

WD1 hhhhhhhh

is the first word of the save area (optional).

HSA hhhhhhhh

is the second word of the save area: starting address of the save area in the next higher level module. In the first save area in a job step, this word contains zeros. In all other save areas, this word must be filled.

LSA hhhhhhhh

is the third word of the save area (register 13): starting address of the save area in the next lower level (called) module. If the module containing this save area did not fill the word, it contains zeros.

RET hhhhhhhh

is the fourth word of the save area (register 14): return address (optional); if the called module did not fill the word, it contains zeros.

EPA hhhhhhhh

is the fifth word of the save area

(register 15): entry point to the called module. Use of this word is optional; if the called module did not fill the word, it contains zeros.

RO hhhhhhhh R1 hhhhhhhh ... R12 hhhhhhhh

are words 6 through 18 of the save area (registers 0 through 12): contents of registers 0 through 12 for the module containing the save area immediately after the linkage. Use of these words is optional; if the called module did not fill these words, they contain zeros.

INCORRECT BACK CHAIN

indicates that the following lines may not be a save area because the second word in this area does not point back to the previous save area in the trace.

INTERRUPT AT hhhhhh

is the address of the next instruction to be executed in the problem program. It is obtained from the resume PSW word of the last PRB or LPRB in the active RB queue.

PROCEEDING BACK VIA REG 13

indicates that the next 2 save areas are (1) the save area in the lowest level module, followed by (2) the save area in the next higher level module. The lowest save area is the save area pointed to by register 13. These 2 save areas appear only if register 13 points to a fullword boundary and does not contain zero.

```

CPUx PSA
hhhhhh hhhhhhhh hhhhhhhh hhhhhhhh hhhhhhhh hhhhhhhh hhhhhhhh hhhhhhhh *cccccccccccccccccccccccccccccccc*
hhhhhh hhhhhhhh hhhhhhhh hhhhhhhh hhhhhhhh hhhhhhhh hhhhhhhh hhhhhhhh *cccccccccccccccccccccccccccccccc*

NUCLEUS
hhhhhh hhhhhhhh hhhhhhhh hhhhhhhh hhhhhhhh hhhhhhhh hhhhhhhh hhhhhhhh *cccccccccccccccccccccccccccccccc*
hhhhhh hhhhhhhh hhhhhhhh hhhhhhhh hhhhhhhh hhhhhhhh hhhhhhhh hhhhhhhh *cccccccccccccccccccccccccccccccc*

NUCLEUS CONT.
hhhhhh hhhhhhhh hhhhhhhh hhhhhhhh hhhhhhhh hhhhhhhh hhhhhhhh hhhhhhhh *cccccccccccccccccccccccccccccccc*
hhhhhh hhhhhhhh hhhhhhhh hhhhhhhh hhhhhhhh hhhhhhhh hhhhhhhh hhhhhhhh *cccccccccccccccccccccccccccccccc*

REGS AT ENTRY TO ABEND (SNAP)
      FLTR 0-6      hhhhhhhhhhhhhhhhh      hhhhhhhhhhhhhhhhh      hhhhhhhhhhhhhhhhh      hhhhhhhhhhhhhhhhh
      REGS 0-7      hhhhhhhh      hhhhhhhh      hhhhhhhh      hhhhhhhh      hhhhhhhh      hhhhhhhh      hhhhhhhh      hhhhhhhh
      REGS 8-15     hhhhhhhh      hhhhhhhh      hhhhhhhh      hhhhhhhh      hhhhhhhh      hhhhhhhh      hhhhhhhh      hhhhhhhh

LOAD MODULE cccccccc
hhhhhh hhhhhhhh hhhhhhhh hhhhhhhh hhhhhhhh hhhhhhhh hhhhhhhh hhhhhhhh *cccccccccccccccccccccccccccccccc*
hhhhhh hhhhhhhh hhhhhhhh hhhhhhhh hhhhhhhh hhhhhhhh hhhhhhhh hhhhhhhh *cccccccccccccccccccccccccccccccc*
      LINES hhhhhh-hhhhhh SAME AS ABOVE
hhhhhh hhhhhhhh hhhhhhhh hhhhhhhh hhhhhhhh hhhhhhhh hhhhhhhh hhhhhhhh *cccccccccccccccccccccccccccccccc*
hhhhhh hhhhhhhh hhhhhhhh hhhhhhhh hhhhhhhh hhhhhhhh hhhhhhhh hhhhhhhh *cccccccccccccccccccccccccccccccc*
      LINE hhhhhh SAME AS ABOVE

CSECT dd OF cccccccc
hhhhhh hhhhhhhh hhhhhhhh hhhhhhhh hhhhhhhh hhhhhhhh hhhhhhhh hhhhhhhh *cccccccccccccccccccccccccccccccc*
hhhhhh hhhhhhhh hhhhhhhh hhhhhhhh hhhhhhhh hhhhhhhh hhhhhhhh hhhhhhhh *cccccccccccccccccccccccccccccccc*

```

The contents of main storage are given under 6 headings: CPUx PSA, NUCLEUS, NUCLEUS CONT., LOAD MODULE cccccccc, CSECT dd OF cccccccc, and in the trace table, SP ddd BLK hh. Under these headings, the lines have the following format:

- First entry: the address of the initial bytes of the main storage presented on the line.
- Next 8 entries: 8 full words (32 bytes) of main storage in hexadecimal.
- Last entry (surrounded by asterisks): the same 8 full words of main storage in EBCDIC. Only A through Z, 0 through 9, and blanks are printed; a period is printed for anything else.

The following lines may also appear:

LINES hhhhhh-hhhhhh SAME AS ABOVE
are the starting addresses of the first and last lines for a group of lines that are identical to the line immediately preceding.

LINE hhhhhh SAME AS ABOVE
is the starting address of a line that is identical to the line immediately preceding.

CPUx PSA (Model 65 Multiprocessing dumps only)
identifies the next lines as the contents of the prefixed storage area (PSA) -- 0 through 4095 (FFF). If the system is operating in partitioned mode (1 CPU), x is the CPU identification. If the system is operating in a 2 CPU multisystem mode, both PSAs are printed, the first under the heading CPUA PSA and the second under CPUB PSA.

NUCLEUS
identifies the next lines as the contents of the nucleus of the control program.

NUCLEUS CONT.
identifies the next lines as the contents of the part of the nucleus that lies above the trace table.

REGS AT ENTRY TO ABEND or REGS AT ENTRY TO SNAP
identifies the next 3 lines as the contents of the floating point and general registers when the abnormal termination routine received control in response to an ABEND macro instruction or when the SNAP routine received control in response to a SNAP

macro instruction. These are not the registers for the problem program when the error occurred.

FLTR 0-6 indicates the contents of floating point registers 0, 2, 4, and 6.

REGS 0-7 indicates the contents of general registers 0 through 7.

REGS 8-15 indicates the contents of general registers 8 through 15.

LOAD MODULE ccccccc identifies the next lines as the contents of the main storage area occupied by the load module ccccccc addressed by an LLE or RB. All the modules for the job step are dumped under this type of heading. Partial dumps do not contain this information.

CSECT hhhh OF ccccccc identifies the next lines as the contents of the main storage area occupied by the control section (CSECT) indicated by hhhh. This control section belongs to the scatter-loaded load module ccccccc.

| TRACE TABLE | | | | | | | | | | | | | | |
|-------------|------------|----------|----------|--------|----------|----------|-----|----------|-----|----------|-----|----------|-----|----------|
| DSP | NEW PSW | hhhhhhhh | hhhhhhhh | R15/RO | hhhhhhhh | hhhhhhhh | R1 | hhhhhhhh | SW | hhhhhhhh | TCB | hhhhhhhh | TME | hhhhhhhh |
| I/O | OLD PSW | hhhhhhhh | hhhhhhhh | R15/RO | hhhhhhhh | hhhhhhhh | R1 | hhhhhhhh | PES | hhhhhhhh | TCB | hhhhhhhh | TME | hhhhhhhh |
| SIO | CC/DEV/CAW | hhhhhhhh | hhhhhhhh | CSW | hhhhhhhh | hhhhhhhh | RES | hhhhhhhh | RES | hhhhhhhh | TCB | hhhhhhhh | TME | hhhhhhhh |
| SVC | OLD PSW | hhhhhhhh | hhhhhhhh | R15/RO | hhhhhhhh | hhhhhhhh | R1 | hhhhhhhh | RES | hhhhhhhh | TCB | hhhhhhhh | TME | hhhhhhhh |
| PGM | OLD PSW | hhhhhhhh | hhhhhhhh | R15/RO | hhhhhhhh | hhhhhhhh | R1 | hhhhhhhh | PES | hhhhhhhh | TCB | hhhhhhhh | TME | hhhhhhhh |
| EXT | OLD PSW | hhhhhhhh | hhhhhhhh | R15/RO | hhhhhhhh | hhhhhhhh | R1 | hhhhhhhh | RES | hhhhhhhh | TCB | hhhhhhhh | TME | hhhhhhhh |

TRACE TABLE (SNAP dumps only) identifies the next lines as the contents of the trace table. Each trace table entry is presented on one line; the name at the beginning of each line identifies the type of entry on the line:

- DSP Dispatcher entry
- I/O Input/output interruption entry
- SIO Start input-output (SIO) entry
- SVC Supervisor call (SVC) interruption entry
- PGM Program interruption entry
- EXT External interruption entry

OLD PSW hhhhhhhh hhhhhhhh is the PSW stored when the interruption represented by the entry occurred.

NEW PSW hhhhhhhh hhhhhhhh is the new PSW stored in the entry.

CC/DEV/CAW hhhhhhhh hhhhhhhh contains, in the first 2 digits: completion code.

contains, in the next 6 digits: device type.

contains, in the last 8 digits: address of the channel address word (CAW) stored in the entry.

R15/RO hhhhhhhh hhhhhhhh contains, in the first 8 digits: contents of register 15 stored in the entry.

contains, in the last 8 digits: contents of register 0 stored in the entry.

CSW hhhhhhhh hhhhhhhh is the channel status word (CSW) stored in the entry.

R1 hhhhhhhh is the contents of register 1 stored in the entry.

RES hhhhhhhh is reserved for future use; all digits are zeros.

SW hhhhhhhh is reserved for future use; all digits are zeros.

TCB hhhhhhhh is the starting address of the TCB associated with the entry.

TME hhhhhhhh is a representation of the timer element associated with the entry.

TRT

| | | | | | | | | | | | | | | |
|-------|------------|----------|----------|--------|----------|----------|-----|----------|-----|----------|-----|----------|-----|--------|
| X DSP | NEW PSW | hhhhhhhh | hhhhhhhh | R15/R0 | hhhhhhhh | hhhhhhhh | R1 | hhhhhhhh | NUA | hhhhhhhh | NUB | hhhhhhhh | TME | hhhhhh |
| X I/O | OLD PSW | hhhhhhhh | hhhhhhhh | CSW | hhhhhhhh | hhhhhhhh | R1 | hhhhhhhh | OLA | hhhhhhhh | OLB | hhhhhhhh | TME | hhhhhh |
| X SIO | CC/DEV/CAW | hhhhhhhh | hhhhhhhh | CSW | hhhhhhhh | hhhhhhhh | TCB | hhhhhhhh | OLA | hhhhhhhh | OLB | hhhhhhhh | TME | hhhhhh |
| X SVC | OLD PSW | hhhhhhhh | hhhhhhhh | R15/R0 | hhhhhhhh | hhhhhhhh | R1 | hhhhhhhh | OLA | hhhhhhhh | OLB | hhhhhhhh | TME | hhhhhh |
| X PGM | OLD PSW | hhhhhhhh | hhhhhhhh | R15/R0 | hhhhhhhh | hhhhhhhh | R1 | hhhhhhhh | OLA | hhhhhhhh | OLB | hhhhhhhh | TME | hhhhhh |
| X EXT | OLD PSW | hhhhhhhh | hhhhhhhh | R15/R0 | hhhhhhhh | hhhhhhhh | R1 | hhhhhhhh | MSK | hhhhhhhh | TQE | hhhhhhhh | TME | hhhhhh |
| X SSM | OLD PSW | hhhhhhhh | hhhhhhhh | R15/R0 | hhhhhhhh | hhhhhhhh | R1 | hhhhhhhh | AFF | yyhhhhhh | OLB | hhhhhhhh | TME | hhhhhh |

TRT (MVT with Model 65 multiprocessing dumps only) identifies the next lines as the contents of the trace table. Each trace table entry is presented on one line; the letter and name at the beginning of each line identify the CPU and the type of entry, respectively:

- DSP Dispatcher entry.
- I/O Input/output interruption entry.
- SIO Start input/output entry.
- SVC Supervisor call interruption entry.
- PGM Program interruption entry.
- EXT External interruption entry.
- SSM Set system mask entry.

OLD PSW hhhhhhhh hhhhhhhh
is the PSW stored when the interruption represented by the entry occurred.

NEW PSW hhhhhhhh hhhhhhhh
is the new PSW stored in the entry.

CC/DEV/CAW hhhhhhhh hhhhhhhh
contains, in the first 2 digits: completion code; in the next 6 digits: device type; in the last 8 digits: address of the channel address word stored in the entry.

R15/R0 hhhhhhhh hhhhhhhh
contains, in the first 8 digits: contents of register 15; in the last 8 digits: contents of register 0, both as stored in the entry.

CSW hhhhhhhh hhhhhhhh
is the channel status word stored in the entry.

R1 hhhhhhhh
is the contents of register 1 as stored in the entry.

TCB hhhhhhhh
is the starting address of the TCB associated with the entry.

NUA hhhhhhhh
is the starting address of the new TCB for CPU A, as stored in the entry.

OLA hhhhhhhh
is the starting address of the old TCB for CPU A, as stored in the entry.

MSK hhhhhhhh
is the STMASK of the other CPU as stored in the entry.

NUB hhhhhhhh
is the starting address of the new TCB for CPU B, as stored in the entry.

OLB hhhhhhhh
is the starting address of the old TCB for CPU B, as stored in the entry.

TQE hhhhhhhh
is the first word of the timer queue element stored in the entry, provided a timer interrupt occurred.

TME hhhhhhhh
is a representation of the timer element associated with the entry.

AFF yyhhhhhh
contains, in the first 2 digits: the ID of the locking CPU at the time of the interrupt; in the last 6 digits: starting address of the old TCB for CPU A, as stored in the entry.

```

SP ddd
hhhhh  hhhhhhh  hhhhhhh  hhhhhhh  hhhhhhh  hhhhhhh  hhhhhhh  hhhhhhh  *cccccccccccccccccccccccccccccccccc*
hhhhh  hhhhhhh  hhhhhhh  hhhhhhh  hhhhhhh  hhhhhhh  hhhhhhh  hhhhhhh  *cccccccccccccccccccccccccccccccccc*
END OF DUMP

```

SP ddd
 identifies the next lines as the contents of a block of main storage obtained through a GETMAIN macro instruction, and indicates the subpool number (ddd). The part of subpool 252 that is the supervisor work area is presented first, followed by the entire contents of any problem program subpools (0 through 127) in existence during the dumping.

END OF DUMP
 indicates that the dump or snapshot is completed. If this line does not appear, the ABDUMP routine was abnormally terminated before the dump was completed, possibly because enough space was not allocated for the dump data set.

Guide to Using an ABEND/SNAP Dump (MVT)

Cause of Abnormal Termination: Evaluate the user (USER=decimal code) or system (SYSTEM=hex code) completion code using Appendix B or the publication Messages and Codes.

Dumped Task: Check the ID field for an indication of which task is being dumped in relation to the task that was abnormally terminated:

- 001 indicates a partial dump of a subtask
- 002 indicates a partial dump of the invoking task

If the ID field is absent, the dump contains a full dump of the task that was abnormally terminated.

Active RB Queue: The first RB shown on the dump represents the oldest RB on the queue. The RB representing the load module that had control when the dump was taken is third from the bottom. The last RB represents the ABDUMP routine and the second from last, the ABEND routine. The load module name and entry point (for a PRB) are given in a contents directory entry, the address of which is shown in the last 3 bytes of the FL/CDE field.

Program Check PSW: The program check old PSW is the fifth entry in the first line of each RB printout. It is identified by the subheading APSW. For debugging purposes, the APSW of the third RB from the bottom of the dump is most useful. It provides the length of the last instruction executed in the program (bits 32,33), and the address of the next instruction to be executed (bytes 5-8).

Load List: Does the resume PSW indicate an instruction address outside the limits of the load module that had control at the time of abnormal termination? If so, look at the LLEs on the load list. Each LLE contains the CDE address in the dump field labeled RSP-CDE.

CDEs: The entries in the contents directory for the region are listed under the dump heading CDE. The printouts for each CDE include the load module and its entry point. If you have a complete dump, each load module represented in a CDE is printed in its entirety following the NUCLEUS section of the dump.

Trace Table (SNAP dumps only): Entries on an MVT SNAP dump, if valid, represent occurrences of SIO, external, SVC, program, I/O, and dispatcher interruptions. SIO entries can be used to locate the CCW (through the CAW), which reflects the operation initiated by an SIO instruction. If the SIO operation was not successful, the CSW STATUS portion of the entry will show you why it failed. EXT and PGM entries are useful for locating the instruction where the interruption occurred (bytes 5-8 of the PSW).

SVC trace table entries provide the SVC old PSW and the contents of registers 0, 1, and 15. The PSW offers you the hexadecimal SVC number (bits 20-31), the CPU mode (bit 15), and the address of the SVC instruction (bytes 5-8). The contents of registers 0 and 1 are especially useful in that many system macro instructions pass key information in these registers. (See Appendix A.)

I/O entries reflect the I/O old PSW and the CSW that was stored when the interruption occurred. From the PSW, you can learn the

address of the device that caused the interruption (bytes 2 and 3), the CPU state at the time of interruption (bit 15), and the instruction address where the interruption occurred (bytes 5-8). The CSW provides you with the unit status (byte 4), the channel status (byte 5), and the address of the previous CCW plus 8 (bytes 0-3).

You can use the DSP entry to delimit the entries in the trace table. To find all entries for the terminated task, scan word 7 of each trace table entry for the TCB address in a DSP entry. The lines between this and the next DSP entry represent interruptions that occurred in the task.

Region Contents: Free areas for the region occupied by the dumped task are identified under headings PQE and FBQE. The field

labeled SZ gives the number of bytes in the free area represented by the FBQE.

Subpool Contents: Free and requested areas of the subpools used by the dumped task are described under the dump heading MSS. Subpool numbers are given under the SPID column in the list of SPQEs. If a GETMAIN macro instruction was issued without a subpool specification, space is assigned from subpool 0. Thus, two SPQEs may exist for subpool 0. The sizes of the requested areas and free areas are given under the LN column in the lists of DQEs and FQEs, respectively.

Load Module Contents: The contents of each load module used by the job step are given under the heading XL. Each entry includes the sizes (LN) and starting addresses (ADR) of the control sections in the load module.

Indicative Dump

An indicative dump is issued when a task is abnormally terminated by an ABEND macro instruction, and a dump is requested, but a dump data set is not available, due either to omission or incorrect specification of a SYSABEND or SYSUDUMP DD statement. An indicative dump is issued automatically on the system output (SYSOUT) device.

Systems with MVT do not issue indicative dumps.

Contents of an Indicative Dump

This explanation of indicative dumps utilizes capital letters for the headings found in all dumps, and lowercase letters for information that varies with each dump. The lowercase letter used indicates the mode of the information, and the number of letters indicates its length:

- h represents 1/2 byte of hexadecimal information
- d represents 1 byte of decimal information
- c represents a 1-byte character

Figure 19 shows the contents of an indicative dump. You may prefer to follow the explanation on your own indicative dump.

CONTROL BYTE=hh
describes the contents of the indicative dump.

First digit:

| Bit | Setting | Meaning |
|-----|---------|--------------------------------------|
| 0 | 0 | Instruction image not present |
| | 1 | Instruction image present |
| 1 | 0 | Floating-point registers not present |
| | 1 | Floating-point registers present |
| 2 | 0 | One general register set present |
| | 1 | Two general register sets present |
| 3 | 0 | All active RBs present |
| | 1 | All active RBs not present |

Last digit:

| Digit in Hexadecimal | Meaning |
|----------------------|----------------------------|
| 0 | All loaded RBs present |
| 8 | All loaded RBs not present |

TCB FLAGS=hh

is the first byte of TCBFLGS field (byte 29 in the TCB for the program being dumped): task end flag byte:

| Bit | Setting | Meaning |
|-----|---------|---|
| 0 | 1 | Abnormal termination in process |
| 1 | 1 | Normal termination in process |
| 2 | 1 | Abnormal termination was initiated by the resident ABTERM routine |

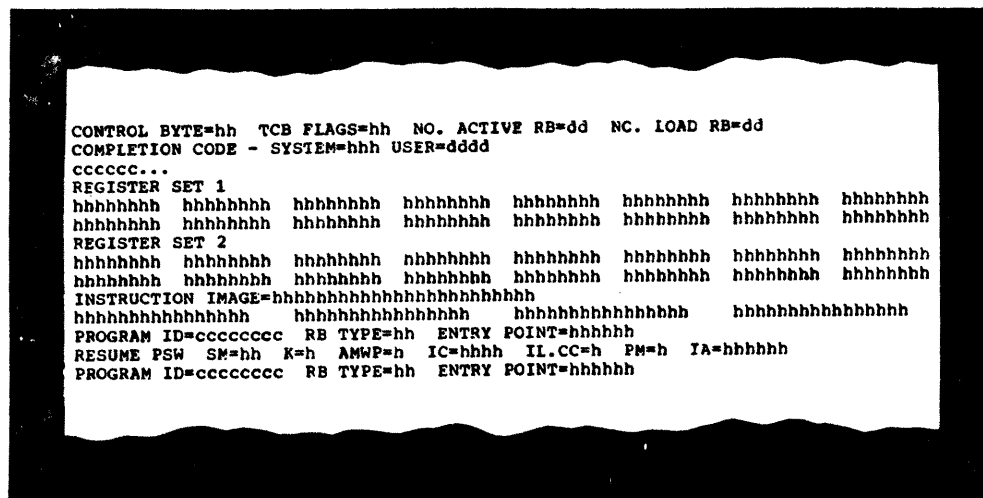

Figure 19. Contents of an Indicative Dump

- 3 1 ABTERM routine entered because of program interruption
- 4 1 Reserved for future use
- 5 1 Data set closing initiated by the ABTERM routine
- 6 1 The ABTERM routine overlaid some or all of the problem program
- 7 1 The system prohibited queuing of asynchronous exit routines for this task

- Lost control to the input/output interruption handler, which subsequently terminated abnormally.
- Was abnormally terminated by the control program because of a program interruption.
- Issued an ABEND macro instruction to request an abnormal termination.

If REGISTER SET 2 also appears in the dump, the lines under REGISTER SET 1 give the general register contents for a type II, III, or IV SVC routine operating under an SVRB.

NO. ACTIVE RB=dd is the number of active RBs presented in the dump.

NO. LOAD RB=dd is the number of RBs in the load list presented in the dump.

COMPLETION CODE SYSTEM=hhh USER=dddd is the completion code supplied by the control program (SYSTEM=hhh) or the problem program (USER=dddd). Both SYSTEM=hhh and USER=dddd are printed; however, one of them is always zero.

REGISTER SET 2 indicates that the next 2 lines give the contents of general registers 0 through 7 and 8 through 15 for a program being executed under control of an RB other than an SVRB when the program last passed control to a type II, III, or IV SVC routine.

INSTRUCTION IMAGE=hhhhhhhhhhhhhhhhhhhhhhhh is 12 bytes of main storage, with the instruction that caused a program interruption in the right part of the printout. This field appears only if a program interruption occurred and is also valid when the instruction length in the resume PSW is 0.

cccccc... explains the completion code or, if a program interruption occurred:

PROGRAM INTERRUPTION ccccc... AT LOCATION hhhhhh where ccccc is the program interruption cause: OPERATION, PRIVILEGED OPERATION, EXECUTE, PROTECTION, ADDRESSING, SPECIFICATION, DATA, FIXED-POINT OVERFLOW, FIXED-POINT DIVIDE, DECIMAL OVERFLOW, DECIMAL DIVIDE, EXPONENT OVERFLOW, DECIMAL DIVIDE, EXPONENT UNDERFLOW, SIGNIFICANCE, or FLOATING-POINT DIVIDE; and hhhhhh is the address of the instruction being executed when the interruption occurred.

hhhhhhhhhhhhhhhh hhhhhhhhhhhhhhhhh hhhhhhhhhhhhhhhhh hhhhhhhhhhhhhhhhh are the contents of floating-point registers 0, 2, 4, and 6 when the abnormal termination occurred. This field appears only if the floating point option is present. The first 2 digits of each register are the characteristic of the floating point number. The last 14 digits are the mantissa.

PROGRAM ID=cccccccc is the XRBNM field (bytes 0 through 7): in PRB, LRBS, and LPRBS, the program name; in IRBS, the first character contains flags for the timer or, if the timer is not being used, contains no meaningful information; in SVRBs for a type II SVC routine, contains no meaningful information; in SVRBs for a type III or IV SVC routine, the first 4 bytes contain the relative track address (TTR) of the load module in the SVC library and the last 4 bytes contain the SVC number in signed, unpacked decimal; in SIRBS, the name of the error routine currently occupying the 400-byte input/output supervisor transient area.

REGISTER SET 1 indicates that the next 2 lines give the contents of general registers 0 through 7 and 8 through 15 for a program being executed under control of an RB when it:
• Passed control to a type I SVC routine through an SVC instruction and the routine terminated abnormally.

RB TYPE=hh
 indicates the type of active RB

| hh | Type of RB |
|----|---|
| 00 | PRB that does not contain entry points identified by IDENTIFY macro instructions |
| 10 | PRB that contains one or more entry points identified by IDENTIFY macro instructions |
| 20 | LPRB that does not contain entry points identified by IDENTIFY macro instructions |
| 30 | LPRB that contains one or more entry points identified by IDENTIFY macro instructions |
| 40 | IRB |
| 80 | SIRB |
| C0 | SVRB for a type II SVC routine |
| D0 | SVRB for a type III or IV SVC routine |
| E0 | LPRB for an entry point identified by an IDENTIFY macro instruction |
| F0 | LRB |

ENTRY POINT=hhhhhh
 is the XRBEP field (bytes 13 through 15): address of entry point in the program.

RESUME PSW
 XRBPSW field (bytes 16 through 23):
 is the contents of the resume PSW.

SM=hh
 is bits 0 through 7 of PSW: system mask.

K=h
 is bits 8 through 11 of PSW: protection key.

AMWP=h
 is bits 12 through 15 of PSW: indicators.

IC=hhhh
 is bits 16 through 31 of PSW: interruption code.

IL.CC=h
 is bits 32 through 35 of PSW: instruction length code (bits 32 and 33) and condition code (bits 34 and 35).

PM=h
 is bits 36 through 39 of PSW: program mask.

IA=hhhhhh
 is bits 40 through 63 of PSW: instruction address.

PROGRAM ID=cccccccc
 is the XRBNM field (bytes 0 through 7): program name.

RB TYPE=hh
 indicates the type of RB:

| hh | Type of RB |
|----|--|
| 20 | LPRB that does not contain entry points identified by IDENTIFY macro instructions. |
| 30 | LPRB that contains one or more entry points identified by IDENTIFY macro instructions. |
| E0 | LPRB for an entry point identified by an IDENTIFY macro instruction. |
| F0 | LRB. |

ENTRY POINT=hhhhhh
 is the XRBEP field (bytes 13 through 15): address of entry point in the program.

Guide to Using an Indicative Dump

Completion Code: Evaluate the user (USER=decimal code) or system (SYSTEM=hex code) completion code using either Appendix C of this publication or the publication Messages and Codes. The line under the completion code gives a capsule explanation of the code or the type of program interruption that occurred.

Instruction Address: If a program interruption occurred, get the address of the erroneous instruction in the last 3 bytes of the field labeled INSTRUCTION IMAGE.

Active RB Queue: RBs are shown in the first group of two-line printouts labeled PROGRAM ID and RESUME PSW, with the most recent RB shown first. There are two lines for as many RBs indicated by NO. ACTIVE RB=dd.

Register Contents: General register contents at the time a program last had control are given under the heading REGISTER SET 2 or, if this heading is not present, under REGISTER SET 1. Register contents, particularly those of register 14, may aid you in locating the last instruction executed in your program.

Storage Dumps

Storage dumps record the contents of main storage from location 00 to the end of printable storage.

Storage dumps are produced by the damage assessment routine (DAR) or other system recovery routines, the Console Dump facility, or the stand-alone service aid program IMDSADMP.

DAMAGE ASSESSMENT ROUTINE (DAR)

The damage assessment routine produces a storage dump when a system task fails and is designed to provide increased system availability in the event of system failure. The storage dump is written to the SYS1.DUMP data set.

If a system routine fails, DAR attempts to reinitialize the failing task, thereby permitting the system to continue operation without interruption. DAR permits the system to continue processing in a degraded condition if it encounters a system failure that does not permit total reinstatement of the affected task or region. The operator will be informed, via a WTO, that the system is in an unpredictable state; he then must decide whether or not already-scheduled jobs should be allowed to attempt completion.

Note: If TSO is installed in the system and a failure occurs in the TSO subsystem or in the operating system the TSO SWAP data set must be recorded for use in diagnosis if needed. The system recovery routines do not do this. The IMDPRDMP service aid can be used as a high-performance dumping program for this purpose by directing its output to tape. Refer to the Service Aids publication for details of this usage of the IMDPRDMP program.

CONSOLE DUMP

The Console Dump function is designed to meet the requirements for a dynamic main storage dumping tool in the operating system. The operator initiates the Console Dump from the primary console via a DUMP command. Execution of the function allows a dump to be taken to the SYS1.DUMP data set of all or selective portions of main storage. The dump operation is performed during system operation and requires no IPL. The storage dump may then be formatted and printed by the IMDPRDMP Service Aid program. Refer to the Operator's Guide publication for details of the DUMP command.

IMDSADMP SERVICE AID

In situations where the system is not operative, an IMDSADMP program is loaded into storage through use of the IPL facilities. The storage dump taken may be written in a high-speed version to tape or disk, and in a low speed version to tape or printer. The high-speed IMDSADMP dump must be processed by the IMDPRDMP program. The low-speed tape output may be processed by a program such as the IEBGENER utility program. The format of the low-speed IMDSADMP output is similar to the general format listing produced by the IMDPRDMP program and therefore is not illustrated in this publication. A sample IMDSADMP listing and a discussion of the program are contained in the Service Aids publication.

SYSTEM FAILURE

If a system failure occurs, the damage assessment routine immediately attempts to write a storage dump to the SYS1.DUMP data set. A system failure may be caused by a failure in any of the following system tasks:

MFT:

- Communications Task
- Master Scheduler Task
- Log Task

MVT:

- System Error Task
- Rollout/Rollin Task
- Communications Task
- Master Scheduler Task
- Transient Area Fetch Task

A system failure is also caused by an ABEND recursion in other than OPEN, CLOSE, ABDUMP, or STAE; by a failure of a task in 'must complete' status; or, in MFT only, by a failure in the scheduler if no SYSABEND or SYSUDUMP DD card is provided.

THE SYS1.DUMP DATA SET

The SYS1.DUMP data set may reside on tape or on a direct access device.

Tape

If you wish to have the SYS1.DUMP data set reside on tape, you may specify the tape drive during IPL. If the drive has not been made ready prior to IPL, a MOUNT message is issued to the console, specifying the selected device. The device should be mounted with an unlabeled tape.

After writing a storage image dump, the damage assessment routine writes a tape mark and will position the tape to the next file. The tape drive will remain in a ready state to receive another storage image dump.

Direct Access

If you wish to have the SYS1.DUMP data set placed on a direct access device, you may preallocate the data set at system generation or prior to any IPL of the system. The following restrictions apply:

- The data set name must be SYS1.DUMP.
- The data set must be cataloged on the IPL volume.

- The data set may be preallocated on any volume that will be online during system operation.
- The data set must be sequential.
- Sufficient space must be allocated to receive a storage image dump for all of main storage.

When a direct access device is used for the SYS1.DUMP data set, the data set can hold only one storage dump. If additional failures occur, and if the SYS1.DUMP data set is occupied, DAR does not attempt to write another storage image dump.

Use the IMDPRDMP service aid to format and list the SYS1.DUMP data set.

IMDPRDMP Output

Main storage information processed by the IMDPRDMP program is presented in six different output formats. The output format used is determined by the function of the particular area of the dumped system's main storage that is being printed. Two of these formats, the queue control block trace and the link pack area map, are invoked by specific format statements. A third format is used to print the major system control blocks. Two formats are used for TSO; one for system control blocks and the other for user control blocks. Any areas of the dumped system's main storage that do not fall into any of the aforementioned functional categories are processed in the general format.

Dump List Headings: Each page of output listing contains a heading. This heading has the optional user specified title, the name of the module that invoked the dump, the date and the time the dump was taken except when processing Generalized Trace Facility output when the heading will be "EXTERNAL TRACE - DD dname." **Note:** If the dump was produced by IMDSADMP on a system with the time-of-day (TOD) clock, IMDPRDMP can not determine the time at which the dump was taken; the time is replaced by "TOD CLK."

Dump Header: If the dump was produced by SVC DUMP, IMDPRDMP will print the title taken from the dump header record. A maximum of 100 characters are printed on the second line of the first page of the output listing.

Output Comments: While formatting the dump, the IMDPRDMP program occasionally is unable to locate, format and print a control block. On those occasions IMDPRDMP prints a comment explaining why the control block could not be formatted and printed. These comments are printed within the body of the formatted dump and are part of the IMDPRDMP output. A complete list of these output comments along with further explanations is contained at the end of this chapter.

Summary Information: In addition to formats, the following summary information is printed at the end of each execution of IMDPRDMP:

- The number of entries to the read routine;
- The number of times that the required address was not found in a buffer;
- The number of blocks read from the dump data set;

- The number of permanent I/O errors encountered during the execution;
- The average number of buffers used for each operation performed during this execution;
- The number of blocks read from the TSO swap data sets;
- The ratio of the number of times the read routine was called to the number of times the requested address was not in a buffer.
- When processing Generalized Trace Facility output, the number of trace records processed.

QUEUE CONTROL BLOCK TRACES

In a multiprogramming environment, requests for system resources are enqueued. This process is accomplished through the use of queue control blocks (QCBs).

Certain system failures, such as task contention deadlocks, become evident to the user upon examination of a queue control block trace. When requested through the use of the QCBTRACE statement, the QCB trace appears on a separate page of the IMDPRDMP program dump listing. The trace, a sample of which appears in Figure 20, contains a listing of all queue control blocks that were present in the dumped system, and is available to users who are processing main storage information gathered from an MVT or MFT system.

(For more information on system resource queuing, see IBM System/360 Operating System: MVT Supervisor, GY28-6659.)

The page of the IMDPRDMP listing containing the Queue Control Block trace is identified by two heading lines. The first line contains an optional title, the name of the module that invoked the dump, and the date and time that the information was gathered from the dumped system. The second line of the heading identifies the page as containing a Queue Control Block trace. The individual QCBs are then listed for each Task Control Block. Each Queue Control Block is formatted as follows:

MAJOR hhhhhh

The starting address of a major queue control block, the contents of which are given, indented, on the line or lines below.

NAME ccccccc

The name of the system resource represented by the major QCB.

```

SAMPLE QCB TRACE      MODULE IMDSADMP    DATE 7/04/70    TIME 0.10    PAGE 2
* * * *  Q U E U E  C O N T R O L  B L O C K  T R A C E  * * * *

MAJOR 024100  NAME SYSDN

MINOR 0239AO      NAME FF  SYS1.LINKLIB
QEL 024068      TCB 023488  SHARED

MINOR 023838      NAME FF  SYS1.MACLIB
QEL 023ED8      TCB 023448  SHARED

MAJOR 0235E8  NAME SYSIEFSD

MINOR 0235C8  NAME FF  Q5
QEL 023208      TCB 023480  EXCLUSIVE
QEL 023C10      TCB 0238E0  EXCLUSIVE

```

Figure 20. Queue Control Block Trace Sample

MINOR hhhhhh

The starting address of the minor queue control block. Contents are given on this line or the lines below.

NAME hh ccccccc

The first two characters appearing after the NAME field identifier indicate the scope of the minor QCB being dumped. If the scope is given as hexadecimal FF, the name of the QCB is known to the entire operating system. If the scope indicator is hexadecimal 00 or 10 through F0, the name of the QCB is known only to the job step. The scope indicator shows the storage protection key of the TCB that enqueued this minor QCB. The NAME field also contains the name of the specific system resource represented by the minor QCB.

QEL hhhhhh

The address of a queue element (QEL) associated with the minor QCB described on the line above. A QEL line appears for each resource requested by the task associated with the minor QCB.

TCB hhhhhh

The starting address of the task control block of the requesting task. This task requests a specific system resource through the use of the QEL indicated on this line.

SHARED or EXCLUSIVE

This indicator tells whether the system resource is available to one task (EXCLUSIVE) or several tasks (SHARED).

LINK PACK AREA MAPS

Information on routines residing in either the MVT link pack area or the MFT resident reenterable load module area of the dump system is available to the user through use of the LPAMAP (link pack area map) format statement.

For users who are processing an MVT dump, the IMDPRDMP program produces a listing of all routines loaded into the link pack area by the nucleus initialization program (NIP). For MFT dumps, this list contains information pertaining to all resident reentrant routines loaded into the reenterable load module area by NIP.

The IMDPRDMP user will find the link pack area map, for MVT, or the reenterable load module area map, for MFT, to be a useful tool in isolating system failures that occurred in program modules that reside outside the user's partition or region. If requested, the applicable map appears on a separate page of the IMDPRDMP program dump listing. A sample Link Pack Area map is shown in Figure 21.

The dump listing page containing the link pack area map is identified by two heading lines. The first line contains the optional title supplied by the user, the name of the module that invoked the dump, and the date and time that the information was gathered from the dumped system. The second line of the heading identifies the page as containing a link pack area map. Information on each module contained in the

link pack area or reenterable load module area, is given in the following format:

NAME ccccccc
The name of the load module represented by this entry.

EPA hhhhhh
The entry point address of the module identified on the corresponding line in the NAME column.

STA hhhhhh
The starting address of the named module's control section.

LNGH hhhhhh
The length, in bytes, of the control sections in the load module described on this line.

TYPE ccccc
The attributes of the control block associated with the module being described on this line. Under MVT, the type of the contents directory entry (CDE) associated with the module is given. The type may be either MAJOR or MINOR. Under MFT, the type is shown as either a loaded request block (LRB) or a loaded program request block (LPRB).

*** LINK PACK AREA MAP ***

| NAME | EPA | STA | LNGH | TYPE |
|----------|--------|--------|--------|-------|
| IEELWAIT | 072418 | 072418 | 0003F8 | MAJOR |
| IGGO209Z | C748C0 | C74800 | C00400 | MAJOR |
| IGGO201Z | C74C00 | C74C00 | 000400 | MAJOR |
| IGGO201Y | C75000 | C75000 | 000400 | MAJOR |
| IGGC200Z | C75400 | C75400 | 000400 | MAJOR |
| IGGO200Y | C75800 | C75800 | 000400 | MAJOR |
| IGGO200H | C75C00 | C75C00 | 000400 | MAJOR |
| IGGO200G | 076000 | C760C0 | 000400 | MAJOR |
| IGGO200F | 076400 | 0764C0 | 000400 | MAJOR |
| IGGO200A | C76800 | 076800 | 000400 | MAJOR |
| IGGO199M | 076C00 | 076C00 | 000400 | MAJOR |
| IGGO196B | C77000 | 077000 | 000400 | MAJOR |
| IGGO196A | C77400 | C77400 | C00400 | MAJOR |
| IGGO1917 | C77800 | C778C0 | 000400 | MAJOR |
| IGGO1911 | C77C00 | 077C00 | C00400 | MAJOR |
| IGGO1910 | C78000 | 078000 | C00400 | MAJOR |
| IGGO1910 | C78400 | C78400 | 000400 | MAJOR |
| IGGO191G | C78800 | C78800 | 000400 | MAJOR |
| IGGO191D | C78C00 | C78C00 | 000400 | MAJOR |
| IGGC191B | C79000 | C790C0 | 000400 | MAJOR |
| IGGC191A | C79400 | C79400 | 000400 | MAJOR |
| IGGO190S | C79800 | C79800 | 000400 | MAJOR |
| IGGO190N | 079C00 | C79C00 | 000400 | MAJOR |
| IGGO190M | C7A000 | C7A000 | 000400 | MAJOR |
| IGGO190L | C7A400 | C7A400 | 000400 | MAJOR |
| IGCO005E | C7A800 | C7A800 | 000400 | MAJOR |
| IGCC002 | C7AC00 | C7AC00 | 000400 | MAJOR |
| IGCC001I | C7B360 | C7B360 | C00400 | MAJOR |
| IGGO19CK | C7CA00 | C7CA00 | 000060 | MAJOR |
| IGGO19BC | C7CA60 | C7CA60 | 0000E8 | MAJOR |
| IGGO19BD | C7CB48 | C7CB48 | 000128 | MAJOR |
| IGGO19AD | C7CC70 | C7CC70 | 0000C0 | MAJOR |
| IGGO19AL | C7CD30 | C7CD30 | 000158 | MAJOR |
| IGGO19AC | C7D848 | 07D848 | 0000E8 | MAJOR |
| IGGO19CA | C7D930 | C7D930 | 000088 | MAJOR |
| IGGC19CB | C7D988 | C7D988 | 000098 | MAJOR |
| IGGO19AG | C7DA50 | C7DA50 | 000090 | MAJOR |
| IGGO19BE | C7DAE0 | C7DAE0 | 000188 | MAJOR |
| IGGO19AM | C7DC68 | 07DC68 | 000078 | MAJOR |
| IGGO19AN | C7DCE0 | C7DCE0 | 0000D8 | MAJOR |
| IGGO19AV | C7DD88 | C7DD88 | 000058 | MAJOR |
| IGGO19MO | 07DE10 | C7DE10 | 0000F0 | MAJOR |
| IGGC19MB | 07B760 | 07B760 | 0010A0 | MAJOR |
| IGGC19MA | C7CE88 | 07CE88 | 000978 | MAJOR |
| IGGO19CL | C7E820 | 07E820 | 000040 | MAJOR |
| IGGO19CF | C7DF00 | C7DF00 | 000100 | MAJOR |
| IGGO19CE | 07E038 | 07E038 | 000088 | MAJOR |
| IGGC19AJ | C7E0C0 | 07E0C0 | 000120 | MAJOR |
| IGGO19AI | C7E1E0 | C7E1E0 | 000080 | MAJOR |
| IGGO19BB | C7E86C | C7E860 | 000058 | MAJOR |
| IGGO19BA | C7E260 | C7E260 | 000180 | MAJOR |

IMDPRDMP Output Formatting: Link Pack Area Maps

Figure 21. Link Pack Area Map Sample

| MODULE MDSADMP DATE 11/12/70 TIME 00.15 PAGE 002° | | | | | | | | | | | | | |
|---|----------|------------|------------|----------|-----------|--------------------------|----------|----------|----------|----------|----------|----------|-----------------------|
| JOB | JOB4 | STEP | GO | PROCSTEP | STEP1 | ***** CURRENT TASK ***** | | | | | | | |
| TCB | 02D400 | RBP | 0002E410 | PIE | 0J0C00000 | DEB | 0002DABC | TIO | 0002E1F0 | CMP | 00000000 | TRN | 00000000 |
| | | MSS | 0002E770 | PK-FLG | F0000000 | FLG | 00001B1B | LLS | 0002E3E0 | JLB | 00000000 | JPQ | 0002E3E8 |
| | | RG | 0-7 | 0C0000C0 | C000C066 | 0002DFBC | 00000000 | 0002D660 | 0002D1E8 | 0002E234 | 0002D8A8 | | |
| | | RG | 8-15 | 0C02CFA0 | 0J0C0000 | 0002DFC8 | 0005DF08 | 4005DE56 | 0005DF08 | 6007F060 | 60J08342 | | |
| | | FSA | 0006BF68 | TCB | C0000000 | TME | 00000000 | JST | 0002D400 | NTC | 00000000 | OTC | 0002D1E8 |
| | | LTC | 00000000 | IQE | 0000C000 | ECB | 0002DFC4 | TSPR | 0C000000 | D-PQE | 0002E770 | SQS | 0002DA90 |
| | | STA | CCCCC000 | TCT | 0002CF28 | USR | 00000000 | DAR | 00000000 | RES | 00000000 | JSCB | 0002E33C |
| ACTIVE RBS | | | | | | | | | | | | | |
| PRB | 02E410 | RESV | 0C0000C0 | APSW | 000000C0 | WC-SZ-STAB | C0040082 | FL-CDE | 0002E5E8 | PSW | FFF50009 | AC05DEF9 | |
| | | Q/TTR | 000C0000 | WT-LNK | 0002D400 | NM GO | | EPA | 05DE50 | STA | 05DE50 | LN | 0001B0 ATR1 0B |
| MAIN STORAGE | | | | | | | | | | | | | |
| D-PQE | 0002E770 | FIRST | 0002E688 | LAST | 0002E688 | | | | | | | | |
| PQE | 02E688 | FFB | 00C5ECC0 | LFB | 00C5E000 | NPQ | 00000000 | PPQ | 00000000 | | | | |
| | | TCB | 0002D1E8 | RSI | C000F000 | RAD | 0005D800 | FLG | 0000 | | | | |
| LOAD LIST | | | | | | | | | | | | | |
| CDE | 02E3E8 | NM | RETURNS | USE | 01 | RESP | 01 | ATR1 | 0B | EPA | 05DDC8 | STA | 05DDC8 LN 000088 |
| CDE | 02BB50 | NM | IGG019CC | USE | 03 | RESP | 01 | ATR1 | 80 | EPA | 07E928 | STA | 07E928 LN C00008 |
| CDE | 02BB20 | NM | IGG019CH | USE | 03 | RESP | 01 | ATR1 | 80 | EPA | 07E888 | STA | 07E888 LN 000070 |
| CDE | 02B730 | NM | IGG019AC | USE | 02 | RESP | 01 | ATR1 | 80 | EPA | 07D848 | STA | 07D848 LN 0000E8 |
| CDE | 02BBF0 | NM | IGG019AQ | USE | 03 | RESP | 01 | ATR1 | 80 | EPA | 07F020 | STA | 07F020 LN 000078 |
| JOB PACK QUEUE | | | | | | | | | | | | | |
| CDE | 02E3E8 | NM | RETURNS | USE | 01 | RESP | NA | ATR1 | 0B | EPA | 05DDC8 | STA | 05DDC8 LN 000088 |
| CDE | 02E5E8 | NM | GO | USE | 01 | RESP | NA | ATR1 | 0B | EPA | 05DE50 | STA | 05DE50 LN 00018C |
| JEB | 02DABC | APPENDAGES | END OF EXT | 07E8B8 | SIO | 000D72 | PCI | 000D72 | CH END | 000D72 | AB END | 000D72 | |
| | | PFX | 00000000 | C5000006 | 000108E0 | 1100C000 | | | | | | | |
| | | TCB | 0402D400 | NDEB | 1CC00000 | ASYN | F8000000 | SPRG | 00000000 | UPRG | 01068E18 | PLST | 18000000 DCB FF05DFA0 |
| | | AVT | 0402CA98 | | | | | | | | | | |
| | | FM-UCB | START | END | TRKS | | | | | | | | |
| | | 580026AC | 0002C003 | C0C20003 | 0001 | | | | | | | | |
| TIOT | 02E1F0 | JOB | JOB4 | STEP | GO | PROC | STEP1 | | | | | | |
| | | OFFSET | LN-STA | DCNAME | TTR-STC | STB-UCB | | | | | | | |
| | | 0018 | 140401C1 | PGM=*.DD | 00271500 | 8C0026AC | | | | | | | |
| | | 002C | 140401C1 | DUMMY | C0271900 | 8C0026AC | | | | | | | |

Figure 22. Sample of MVT Major Control Block Format

MAJOR SYSTEM CONTROL BLOCK FORMATS

Formatting of the major system control blocks associated with a task is a function of either a FORMAT control statement, or one of the several noted parameters associated with the PRINT control statement. The control blocks of several tasks may be printed during one execution of IMDPRDMP. When more than one task is printed, the associated task control blocks (TCBs) are grouped into a TCB summary, listed following the printing of all requested tasks. This summary provides an index to the formatted TCBs by jobname. See the discussion "Task Control Block Summaries."

For ease of identifying various dump printouts, specific headings are printed on each dump; such as FORMAT, DAR AND F03 TASKS, PRINT CURRENT, and PRINT JOBNAME.

Each task being printed begins on a new page, identified by two heading lines. The first heading line contains the optional title supplied by the user, the name of the module that invoked the dump, and the date and time that the information was gathered from the dumped system, and a page number. The second line of the heading identifies the particular task being printed. This task information is broken down into the following named fields:

UNKNOWN
JOB ccccccc
The JOB field displays the eight-character name that was specified in the label field of the JOB statement.

UNKNOWN indicates that the job name is unavailable.

STEP ccccccc
The STEP field shows the eight-character step name of the problem program associated with the task being dumped. This name was supplied in the label field of the EXEC statement.

PROCSTEP ccccccc
If the job step being displayed was invoked from a cataloged procedure, the step name of the cataloged procedure, as contained in the cataloged procedure's EXEC statement, is displayed in this field.

If the task being printed was in control at the time the dump was taken, a third

heading line follows the two previously described. The line "**** CURRENT TASK ****" identifies the TCB associated with the task in control when the dump was taken.

While formatting the dumped control blocks, IMDPRDMP may issue various output comments to assist the person who analyzes the printout. The output comments are discussed following the control block discussion.

Specific formatting of the major system control blocks is dependent upon the operating system option under which the dumped system was operating. To allow the reader to concentrate on the particular operating system with which he is concerned, the discussion of control block formatting is divided into three parts: MVT, MFT, and the TSO option of MVT.

MVT Control Block Formatting

The formats described below are repeated for each requested task that is printed. A sample of the major system control blocks, as formatted from an MVT dump, is shown in Figure 22.

MVT TASK CONTROL BLOCK (TCB) FORMATTING:
The task control block (TCB) contains information that pertains to the specific task named in the heading lines that appear at the top of the page. Each TCB is formatted as follows:

TCB hhhhhh
The address of the task control block being displayed is given in this first field.

RBP hhhhhhhh
The address of the request block (RB) that was currently associated with the task represented by this TCB.

PIE hhhhhhhh
The address of the first program interrupt element (PIE) enqueued by this TCB.

DEB hhhhhhhh
The address of the beginning of the data extent block (DEB) queue that was associated with this task. Information on the contents of each DEB in the queue is given in a separate portion of this MVT dump listing.

TIO hhhhhhhh

The address of the task input output table (TIOT) that was constructed during device allocation for the task represented by this TCB. The contents of this table are displayed in a later portion of this task's display.

...1

belonged to either a graphics foreground or the graphic job processor.

Bit 3 set indicates that the TCB being displayed was associated with a 7094 emulator task that was being run on a System/360 Model 85 machine.

CMP hhhhhhhh

This word contains ABEND indicators and user and system completion codes. The usage of this field is as follows:

.... x...

Bit 4 is reserved for future use.

byte 0

- 1... Bit 0 indicates that a dump had been requested.
- .1.. Bit 1 set indicates that a step ABEND had been requested.
- ..xx xxxx Bits 2 through 7 are reserved for future use.

.... .1..

Bit 5 set indicates that this is a time shared task under control of the TEST command processor.

.... ..1.

Bit 6 set indicates that the OLTEP functions require cleanup before abnormal termination can be invoked.

.... ...x

Bit 7 is reserved for future use.

bytes 1-3

The first 12 bits contain a system completion code. These codes and their meanings are explained in the publication IBM System/360 Operating System: Messages and Codes, GC28-6631 under the heading "System Completion Codes." A user completion code is contained in the last 12 bits.

bytes 1-3

The address of the control core table that was used by TESTRAN.

For a system completion code of 0C0, denoting an imprecise interruption on a Model 91 or Model 195, digits six through eight contain the imprecise interruption configuration. These bit settings represent bits 16 through 27 of the program old PSW (location X'28') at the time of the program exception. Therefore, in the TCB CMP field, bits 20 through 29 are significant for a Model 91, while a Model 195 makes use of all the bits (20 through 31). For further discussion on interpreting the imprecise interruption configuration refer to the publication IBM System/360 Operating System: Supervisor Services, Order No. GC28-6646.

MSS hhhhhhhh

Main storage supervision information as follows:

byte 0

This byte determined roll-out eligibility for the job step associated with this TCB.

00 in this byte indicated that the job step may be rolled out.

nz (nonzero) in this byte indicated that the job step may not be rolled out.

bytes 1-3

These bytes contain the starting address of the last subpool queue element (SPQE).

TRN hhhhhhhh

Contains flags and TESTRAN indicators as follows:

byte 0

- 1... Bit 0 set indicates that both TESTRAN and decimal simulator programs were being used on a System/360 Model 91 machine.
- .1.. Bit 1 set indicates that checkpoints were not taken for this step.
- ..1. Bit 2 set indicates that the TCB being displayed

PK-FIG hhhhhhhh

The storage protection key of the task and a series of flags. This word is divided into several subfields. These are:

byte 0

xxxx The storage protection key of the task represented by this TCB. Always contain zeros.

byte 1

1... Bit 0 set indicates that an abnormal termination was in progress at the time the

dump was taken.
.1. Bit 1 set indicates that
a normal termination was
in progress at the time
the dump was taken.
..1. Bit 2 set causes the
Erase routine in ABEND
to enter when ABEND is
in control again.

...1 Bit 3 set causes the
Purge routine in ABEND
to enter when ABEND is
in control again.
.... 1... Bit 4 set indicates that
the Graphics Abnormal
Termination routine was
in control of the task
associated with this TCB

| | | | |
|-----------|---|-----------|---|
| | at the time the dump was taken. Bit 7 in byte 3 of this word must also be on. | byte 3 | |
|1.. | Bit 5 set indicates that the top task in the TCB chain (usually the job step TCB) was in the process of being terminated when the dump was taken. | 1... | Bit 0 set indicates that a PSW associated with the task represented by this TCB was in the supervisor state. |
|1. | Bit 6 set indicates that an abnormal dump has been completed. | .1.. | Bit 1 set is applicable to job step TCBs. Setting of this bit indicates that the job step had invoked rollouts that were still in effect at the time the dump was taken. |
|1 | Bit 7 indicates that asynchronous exits could not be scheduled. | ..1. | Bit 2 set indicates that ABEND was processing in such a manner as to prevent multiple ABENDS from occurring in the dumped system. |
| byte 2 | | ...1 ...x | Bit 3 set indicates that the SYSABEND (or SYSUDUMP) data set is being opened by this task. (See also bit 7.) |
| 1... | Bit 0 set indicates that the SYSABEND (or SYSUDUMP) data set for the job step is being opened. Operands of ABEND macro instruction have been saved in TCBCMP field. | 1..x | Bit 4 set indicates that an ABDUMP was in process for the task associated with this TCB at the time the dump was taken. (See bit 7 of this byte.) |
| .1.. | Bit 1 set indicates that if this is an initiator TCB, the second job step interval has expired. |1.. | Bit 5 set is applicable only for job step TCBs. With this bit set, no abnormal termination dumps could have been provided within the job step represented by this TCB. |
| ..1. | Bit 2 set indicates that for a job step TCB, the job step can cause rollout. |1x | Bit 6 set indicates that a CLOSE had been issued during ABEND processing. (See bit 7 of this byte.) |
| ...1 | Bit 3 set indicates that the current task had a forced completion imposed upon it. Other tasks in the system could not have been performed until the current task had been completed. | ...x x.x1 | Bit 7 set, in conjunction with bits 3, 4, or 6 of this byte or bit 4 in byte 1 of this word indicates that, had the dumped system been allowed to continue processing without interruption by the IMDSADMP dump program, a valid reentry to ABEND would have been effected. |
| 1... | Bit 4 set indicates that the job step had a forced completion imposed upon it. Other tasks in the job step could not have been performed until the present job step had been completed. | | |
|1.. | Bit 5 set indicates that the SYSABEND (or SYSUDUMP) data set has been opened for the job step. | | |
|1. | Bit 6 set indicates that an EXTR exit was requested by an attaching task. | | |
|1 | Bit 7 set indicates that the task associated with this TCB was a member of a time-sliced group. | | |

FLG hhhhhhhh
This field displays a further series of flags and certain priority indicators. This word is divided into subfields as follows:

byte 0

If any one of the flags comprising this byte were set at the time the dump was taken, the task represented by this TCB was considered to be non-dispatchable.

- 1... Bit 0 was set by ABDUMP
- .x.. Bit 1 is reserved for future use.
- ..1. Bit 2 set indicates that the supply of I/O request queue elements (RQEs) had been exhausted.
- ...x xx.. Bits 3 through 5 are reserved for future use.
-1. Bit 6 is applicable only to M65 multiprocessing situations. The setting of this bit indicates that the task represented by this TCB had been flagged non-dispatchable by one CPU to prevent any CPU from working on it.
-1 Bit 7 set indicates that the task associated with this TCB entered the ABEND routine while the data control block representing the SYSABEND data set was being opened for another task.

byte 1

If any one of the flags comprising this byte were set at the time the dump was taken, the task represented by this TCB was considered to be non-dispatchable.

- 1... Bit 0 set indicates that the task represented by this TCB was terminated prior to the time the dump was taken.
- .1.. Bit 1 set indicates that the task represented by this TCB was a candidate for termination by ABEND.
- ..1. Bit 2 set indicates that a routine of the task represented by this TCB issued an unconditional GETMAIN that could only have been satisfied by the rolling out of another job step.
- ...1 Bit 3 indicates that the job step associated with this TCB was rolled out.
- 1... Bit 4 set indicates that another task was in system-must-complete status.

-1.. Bit 5 set indicates that another task in this job step was in step-must-complete status at the time the dump was taken.
-1. Bit 6 is applicable only for an initiator task. Setting of this bit indicates that a request for a region could not be satisfied.
-1 Bit 7 is the primary non-dispatchability indicator. Setting of this bit indicates that one or more of the secondary non-dispatchability bits (bytes 1-3 of the DAR field) was set at the time the dump was taken.

byte 2

The dispatching priority limit for the task represented by this TCB.

byte 3

The dispatching priority of the task represented by this TCB.

LLS hhhhhhhh

The load list element (LLE) for the program that was loaded by means of the LOAD macro instruction.

JLB hhhhhhhh

The address of the data control block associated with the JOBLIB associated with the task.

JPQ hhhhhhhh

Contains information pertaining to a job step TCB as follows:

byte 0

- 1... Bit 0 set indicates that if the associated job step had been allowed to continue processing without being interrupted by the dump program, the job step would have been purged.
- .xxx xxxx Bits 1 through 7 are reserved for future use.

bytes 1-3

The address of the last contents directory entry for a job pack area (JPA) control queue.

RG 0-7 and RG 8-15

The register save area of the TCB being displayed. The general registers were stored in this area upon entry to the first routine invoked in the task. On entry to any

task, register 13 points to this TCB's register save area. This pointer is useful in locating the entry points of first routines and in tracing the save area chains.

FSA hhhhhhhh
The address of the first problem program save area.

TCB hhhhhhhh
The address of the TCB that had the next lowest priority on the ready queue at the time the dump was taken.

TME hhhhhhhh
The address of the timer element.

JST hhhhhhhh
The address of the first TCB for a job step. For tasks with a storage protection key of zero (as shown in the first byte of the PK-FLG field), this word contains the address of this TCB.

NTC hhhhhhhh
The address of the previous TCB that existed on the originating task's queue of subtask TCBs (sister). If this TCB was the first on the queue, this field contains zeros.

OTC hhhhhhhh
The address of the TCB representing the originating task (mother).

LTC hhhhhhhh
The address of the last TCB that existed on the originating task's queue of subtask TCBs at the time the dump was taken (daughter). If this TCB was the last on the queue, this field contains zeros.

IQE hhhhhhhh
The address of the interruption queue element (IQE) that was used in scheduling the EXTR routine on the originating task.

ECB hhhhhhhh
The address of the event control block (ECB) that would have been posted by the supervisor's task termination routines had either normal or abnormal task termination been allowed to occur.

TSPR hhhhhhhh
byte 0
This field contains flags that indicate the status of the time sharing (TSO). Without TSO or when TSO has not been started, this field contains zeros.

1... Bit 0 set indicates that this task is a time sharing task.

.1.. Bit 1 set indicates that the time sharing task should be set non-dispatchable. This bit was set by the TCBSTP routine while the routine was not executing as a privileged program.

..1. Bit 2 set indicates that the system is executing and requires that the time sharing task must not be interrupted by the attention exit or by the STATUS SVC.

...1 Bit 3 set indicates that a terminal I/O purge is required.

.... xxxx Bits 4 through 7 are reserved for future use.

byte 1
This field contains the number of SET STATUS starts required to make this time sharing task dispatchable.

byte 2
This field contains the limit priority of the time sharing task.

byte 3
This field contains the dispatching priority of the time sharing task.

D-PQE hhhhhhhh
The address of the region dummy partition queue element minus 8 (DPQE-8).

SQS hhhhhhhh
The address of an allocated queue element (AQE) which contains the amount of available bytes assigned to this task in the system queue area (SQA), and a pointer to the next AQE for this task.

STA hhhhhhhh
Internal STAE routine flags and the address of the STAE control block that was in effect at the time the dump was taken.

TCT hhhhhhhh
This word contains information pertaining to the dumped system's timing control table (TCT). The TCT field is divided into the following two subfields:
byte 0
Reserved for future use.

bytes 1-3

If the system management facilities option was present in the dumped system, these bytes contain the address of the dumped system's timing control table.

USR hhhhhhhh

This word is available to the user of the dumped system. It contains any information placed in it by the user.

DAR hhhhhhhh

The contents of this field were used by the damage assessment routines (DAR). Certain subfields displayed in this word were also used to control the dispatchability of the dumped task. The DAR field is divided into the following subfields:

byte 0

The first byte of the DAR field contains DAR flags. These flags are as follows:

- 1... Bit 0 set indicates that primary DAR recursion occurred in the dumped system. The damage assessment routine failed while writing a main storage image dump.
- .1.. Bit 1 set indicates that secondary DAR recursion occurred in the dumped system. The damage assessment routine failed while attempting to reinstate a failing region or partition.
- ..xx Bits 2 and 3 are reserved for future use.
- 1... Bit 4 set indicates that the system error task is failing. The DAR dump should not request any error recovery procedure (ERP) processing.
-xx. Bits 5 and 6 are reserved for future use.
-1 Bit 7 set indicates that an SVC dump is executing for this task.

byte 1

Bytes 1 through 3 of the DAR field are used to store secondary non-dispatchability flags. If any of the flag bits in this subfield were set, the primary non-dispatchability bit (the last bit in the FLG field) will also have been non-dispatchable. The bit settings that may appear in byte 1 are as follows:

- xx.. Bits 0 and 1 are set by the damage assessment routines. Their meanings are:

- 1... Bit 0 set indicates that the task represented by this TCB is temporarily non-dispatchable.
- .1.. Bit 1 set indicates that the task represented by this TCB is permanently non-dispatchable.
- ..xx Bits 2 and 3 are recovery management support and system error recovery flags. Their meanings are:
 - ..1. Bit 2 set indicates that the task represented by this TCB is temporarily non-dispatchable.
 - ...1 Bit 3 set indicates that the task represented by the TCB is permanently non-dispatchable.
- x... Bit 4 is reserved for future use.
-1.. Bit 5 set indicates that this task is temporarily non-dispatchable. Timer services have been requested and the time-of-day clock is still inoperative.
-xx Bits 6 and 7 are reserved for future use.

byte 2

The bit settings for byte 2 are as follows:

- x... Bit 0 is reserved for future use.
- .1.. Bit 1 set indicates that this task has been stopped by a STATUS stop.
- ..1. ... Bit 2 set indicates that task is non-dispatchable. An SVC dump is executing for another task.
- ...1 Bit 3 set indicates that this task is being swapped out by the time sharing (TSO).
- 1... Bit 4 set indicates that this task is in an input wait state.
-1.. Bit 5 set indicates that this task is in an output wait state.
-xx Bits 6 and 7 are reserved for future use.

byte 3

Reserved for future use.

RES hhhhhhhh

Reserved for future use.

JSCB hhhhhhhh
The address of the job step control block.

resident routines. The first word of these particular RBs is reserved for future use and contains zeros.

RES hhhhhhhh
Reserved for future use.

TAB-LN

IOBRC hhhhhhhh
Contains the address of the IOB restore chain for I/O quiesced by end-of-task.

indicates that the request block being displayed is used as an SVRB for transient routines. The value field is divided into two subfields of two bytes each. The first two bytes show the displacement of the entry point of the module represented by this SVRB from the beginning of the transient area control table (TACT). The second subfield shows the length, in bytes, of the SVC routine.

MVT ACTIVE REQUEST BLOCK (RB) FORMATTING:
Request blocks (RBs) were used by the lines at the top of the dump page and in the preceding TCB display, are listed in the portion of the dump listing labeled "ACTIVE RBS." Information on each RB associated with the task is formatted as shown below:

PRB
IRB hhhhhh
SVRB
SIRB

FL-PSA

Each RB display is preceded by a field that indicates the type and address of the RB being displayed. The four types of RBs that may be displayed under an MVT task are:

indicates that the RB being displayed is an IRB. The value portion of this field is divided into two subfields. The first subfield has a length of one byte and contains indicators for the timer routines. When there were no timer routines, this field contains zeros. The timer routine indicators set at the time the dump was taken are shown as:

PRB program request block
IRB interruption request block
SVRB supervisor request block (SVRBs may be divided into two categories; type 2 for resident routines and type 3 or 4 for transient routines)
SIRB system interruption request block.

1... indicates that the timer element was not on queue.
.1.. indicates that the local time-of-day option was used.
..00 indicates that the time interval was requested in timer units.
..01 indicates that the time interval was requested in binary units.
..11 indicates that the time interval was requested in decimal form.
.... 1... indicates that the time interval had expired.
.... .000 indicates a task request
.... .100 indicates a task request with an exit specified.
.... .001 indicates a wait request.
.... .011 indicates a real request.
.... .111 indicates a real request with an exit specified.

The type acronym for each RB is displayed in the first portion of the field. The starting address of the indicated request block appears in the last portion of the field. The contents of certain fields in the body of the formatted display are dependent upon the type of RB being displayed. Variations in display field usage are noted in the descriptions of the fields in which they occur.

RESV
TAB-LN hhhhhhhh
FL-PSA

This field shows both the function and the first word of the request block being displayed. The meanings of the function indicators and the values that follow them are:

RESV indicates that the request block is either a PRB or an SVRB for

The second subfield is three bytes long and contains the starting address of the problem program register save area (PSA).

APSW hhhhhhhh

The APSW field displays information pertaining to the program status word that was active at the time the dump was taken. The functional variations associated with the usage of this field are:

- PRBs being formatted contain the right half (bytes 4 through 7) of the problem program's PSW when an ABTERM interruption occurred.
- IRBs, SIRBs, and SVRBs for resident routines use this field to display the right half (bytes 4 through 7) of the PSW that was active, in the dumped system, during the execution of an ABEND or ABTERM routine. If no ABEND or ABTERM routine was evoked in the dumped system, this field contains zeros.
- SVRBs for transient routines use this field in much the same way as SVRBs for resident routines. If an ABEND or ABTERM routine was invoked in the dumped system, bytes 4 through 7 of the associated PSW are displayed in this field. If an ABEND or ABTERM routine was not invoked, this field contains the last four characters of the name of the requested routine. (The last two characters of the name represent the SVC number.)

WC-SZ-STAB hhhhhhhh

This field contains information pertaining to wait conditions, request block sizes, and RB status and attribute characteristics. This field is divided into three subfields, as follows:

byte 0

The wait count that was in effect at the time of the dump.

byte 1

The size of this request block. This RB size is expressed as the number of doublewords comprising the block.

byte 2

The last two bytes of the WC-SZ-STAB field contain bit settings that reflect the status and attributes of the request block. The settings that may appear in byte 2 are:

xx.. Bits 0 and 1 indicate the type of RB being displayed. The possible

settings for these two bits and their meanings are:

- 00.. This is a program request block (PRB).
- 01.. This is an interrupt request block (IRB).
- 10.. This is a system interrupt request block (SIRB).
- 11.. This is a supervisor request block (SVRB).
- ..x. x.xx Bits 2, 4, 6 and 7 are reserved for future use.
- ...1 Bit 3 set indicates that this request block is an SVRB for a transient routine.
-1.. Bit 5 is applicable only if the request block being displayed is an SVRB. If this bit is set, a checkpoint could have been taken in a user exit from the SVC routine associated with this RB.

byte 3

The last byte of the WC-SZ-STAB field contains more status and attribute flags. The possible settings for this subfield and their meanings are:

- 1... Bit 0 set indicates that the WT-LNK field in this RB display, contains in its last three bytes, the address of the TCB to which this request block is linked.
- .1.. Bit 1 applies only to IRBs and SIRBs. If this bit is set, the indication is that at the time the dump was taken, the program associated with this RB was active.
- ..x. Bit 2 is reserved for future use.
- ...1 Bit 3 is applicable only to IRBs. The setting of this bit is an indication that the IRB was associated with an ETRX exit routine.
- xx.. Bits 4 and 5 concern interruption queue elements (IQEs) and request queue elements (RQEs). This flag is used as follows:
- 00.. This setting indicates that the request queue element was not to be returned to the free list when the exit was taken.

.... 01.. This setting indicates that the IRB had queue elements for asynchronously executed routines that were RQEs. This setting is applicable only if the RB being displayed is an IRB.

.... 10.. This setting indicates that the IQE was not to have been returned at EXIT.

.... 11.. This setting is applicable only to IRBs. If this setting appears, the indication is that the IRB had queue elements for asynchronously executed routines that were IQEs.

.... ..1. Bit 6 set indicates that request block storage could be freed at the time of exit.

.... ...x Bit 7 indicates request wait conditions. The meanings of the two possible settings for this bit are:

.... ...0 Bit 7 not set indicates that the request had to wait for a single event or all of a number of events.

.... ...1 Bit 7 set indicates that the request had to wait for a number of events. This number of events was less than the total number of events that were waiting.

.... -1.. indicates that a SYNC macro instruction was requested.

.... ..1. indicates that an XCTL macro instruction was requested.

.... ...1 indicates that a LOAD macro instruction was requested.

The second subfield is three bytes long and contains the address of the contents directory entry (CDE) representing the module that this request block was associated with.

EPA

The request block being displayed is an IRB. The value field contains the entry point address of a routine that was asynchronously executed.

TQN

The request block being displayed represents a transient routine SVRB. The value field contains the address of the next request block that was on the queue of transient routines.

PSW hhhhhhhh hhhhhhhh

The resume program status word. This PSW represents the status of the program represented by the RB being displayed when a new RB was created. Had the dumped system been allowed to continue processing without being interrupted by the dump program, operation would have resumed on this PSW.

Q/TTR hhhhhhhh

This word is used to display various data, depending upon the type of request block being displayed. Usage of the Q/TTR value field is used by each type of request block as follows:

- PRBs and SVRBs that represented resident routines do not use this field; the first byte always contains zeros. Bytes 1 through 3 of the field show the address of a request block that requested the use of the same serially reusable program.
- IRBs utilize this field in one of two ways, to show either the three-byte link-field segment or the two-byte link-field segment, depending upon the IRB usage. The three-byte link-field segment appears in the Q/TTR value field as follows:

FL-CDE

EPA hhhhhhhh

TQN

This field shows both the function and the fourth word of the request block being displayed. The meaning of the function indicator and the value following it is given below:

FL-CDE

the request block being displayed is either a PRB or an SVRB for a resident routine. The value field is divided into two elements. The first subfield has a length of one byte and contains control flag settings.

These control flags are as follows:

xxxx x... Bits 0 through 4 are reserved for future use.

byte 0

Contains a count of the number of requests for the same exit (ETXR). This use count is utilized by the ATTACH macro instruction.

byte 1-3

Contains the starting address of the queue of interruption queue elements (IQEs).

Alternately, the Q/TTR value field may be formatted to show the two-byte link-field segment. In this instance, the field is used thusly:

byte 0-1

Reserved for future use.

bytes 2-3

The starting address of the queue of request queue elements (RQEs).

- SVRBs that represented transient routines display two data elements in this field. The first subfield has a length of one byte and shows the number of requests if the transient routine was overlaid. The last three bytes of the Q/TTR field contain the relative direct access device address for the associated supervisor routine in the form TTR.

WT-LNK hhhhhhhh

This field displays information pertaining to wait counts and request block linkages. In the case of a transient SVC, if this field contains x'FF', either the routine represented by the SVRB is currently being brought into the transient area, or this routine has been displaced in the transient area by a routine requested by a higher priority task. To tell what has happened, compare the APSW and NM field contents as described under NM below. This field is divided into two subfields, one with a length of one byte and the other with a length of three bytes. These subfields show the following:

byte 0

The number of requests that were pending at the time the dump was taken (wait count).

byte 1-3

The address of the next request block on the RB queue. In the last RB on the queue, this field contains the address of the task control block (TCB).

NM cccccccc

The eight character name of the load module represented by the request block being displayed with a possible exception for transient SVRBs.

If byte 0 of the WT-LNK field contains x'FF', it is possible that the module represented by this SVRB has been overlaid in the transient area by a module requested by a higher priority task. Compare the APSW field, (providing it contains the four low-order bytes of a module name) with the last four characters (the hexadecimal should be translated to EBCDIC) of the module name in the NM field. No match indicates the user of the transient area has been pre-empted by a higher priority task. NM therefore represents the module currently in the transient area, not the module represented by this SVRB.

If a match results, NM correctly identifies the module name requested by this SVRB.

EPA hhhhhh

The address of the entry point of the module named in the NM field of this RB display.

STA hhhhhh

The starting address of the module identified in the NM field of this RB's display.

LN hhhhhh

The length, in bytes, of the load module that is represented by this request block.

ATRI hh

This one byte field displays the attributes of the described module. These attributes are taken from the contents directory entry associated with the module. The meanings of the attribute flag settings are given below:

- 1... Bit 0 set indicates that the module was resident in the link pack area.
- .1.. Bit 1 set indicates that at the time the dump was taken, the module represented by this request block was in the process of being fetched.
- ..1. Bit 2 set indicates that the module was reenterable.
- ...1 Bit 3 set indicates that the module was serially reusable.

- 1... Bit 4 set indicates that the module could not have been reused. This flag setting is not applicable if either bit 2 or 3 is set.
-1.. Bit 5 set indicates that the contents directory entry associated with this module reflects the use of an alias name. This information applies only to minor CDEs.
-1. Bit 6 set indicates that the module was in the job pack area.
-1 Bit 7 set indicates that the module was considered not only-loadable.

If no FBQEs exist, this field contains the address of the PQE being displayed

LFB hhhhhhhh
The starting address of the last free block queue element (FBQE) on the free block queue associated with this PQE. If no FBQEs exist, this field shows the starting address of this PQE.

NPQ hhhhhhhh
The starting address of the next partition queue element on the partition queue. If the PQE being displayed was the last PQE on the queue, this field contains zeros.

PPQ hhhhhhhh
The starting address of the partition queue element on the partition queue that preceded this PQE. If this PQE was the first on the queue, this field contains zeros.

MVT MAIN STORAGE INFORMATION: Each task operating under the MVT option of the operating system was dynamically assigned a region of main storage that consisted of one or more 2K-byte subpool areas. To keep track of main storage allocations, the MVT supervisor maintained a partition queue associated with each region. Composed of partition queue elements (PQEs), and residing in the system queue area, this partition queue was connected to the TCBs for each task in a job step through a dummy partition queue element (DPQE).

TCB hhhhhhhh
The starting address of the TCB of the job step to which the described region is assigned. If this field contains zeros, the indication is that the area of main storage was obtained from unassigned free space.

RSI hhhhhhhh
The size of the region being described. This number is a multiple of 2K (2048).

Information on the areas of main storage allocated to each task, is presented to the user in a separate portion of each task's dump listing headed "MAIN STORAGE." This main storage information is formatted as shown below:

RAD hhhhhhhh
The starting address of the region being described by this PQE.

FLG hhh
The FLG field shows the settings of several PQE flags whose meanings are given below:

- x... Bit 0 indicates region ownership. The meanings of the settings are:
- 0... indicates that the space described by this PQE was owned by the associated task.
- 1... indicates that the space described by this PQE was borrowed.
- .1.. The setting of bit 1 is meaningful only if bit 0 was not set. If this bit is set and bit 0 is not set, the indication is that the region had been rolled out.
- ..1. Bit 2 set indicates that the region described by this PQE was borrowed by another task.
- ...x xxxx Bits 3 through 7 are reserved for future use.

D-PQE hhhhhhhh
The address minus eight bytes of the dummy partition queue element (DPQE-8) connecting the partition queue to this task's TCB.

FIRST hhhhhhhh
The starting address of the first partition queue element (PQE) on this region's partition queue.

LAST hhhhhhhh
The starting address of the last PQE on the partition queue.

PQE hhhhhh
The starting address of one of the partition queue elements on the partition queue bounded by the addresses given on the line above.

FFB hhhhhhhh
The starting address of the first free block queue element (FBQE) on the free block queue associated with this PQE.

MVT LOAD LIST FORMATTING: A load list was maintained by the dumped system's supervisor in order to keep track of the load modules that were in main storage and the area of main storage each occupied. The load list maintained by a system operating under the MVT option of the operating system contained a series of load list elements (LLEs), each of which was associated with a particular load module through the use of a control block called a contents directory entry (CDE). A formatted listing of the dumped system's MVT load list appears as follows:

CDE hhhhhh
 The starting address of the contents directory entry associated with this load list item.

NM ccccccc
 The eight-character name of the entry point to the load module represented by this entry.

USE hh
 The count of the number of uses (through the ATTACH, LINK and XCTL macro instructions) of the load module, and the number of times a LOAD macro instruction was issued for the module.

RESP hh
 The responsibility count contained in the load list entry associated with the load module. This count indicates the number of requests made by the LOAD macro instruction for the indicated load module. This count was decremented by one for each occurrence of the DELETE macro instruction.

ATR1 hh
 The attributes of the load module described in this load list entry. These attributes are taken from the contents directory entry associated with the module. The meanings of the attribute flag settings are given below:

- 1... Bit 0 set indicates that the module was resident in the link pack area.
- .1.. Bit 1 set indicates that at the time the dump was taken, the load module represented by this load list element was in the process of being loaded.
- ..1. Bit 2 set indicates that the load module was reenterable.
- ...1 Bit 3 set indicates that the load module was serially reusable.

.... 1... Bit 4 set indicates that the load module could not have been reused. This flag setting is not applicable if either bit 2 or 3 is set.

.... .1.. Bit 5 set indicates that the contents directory entry associated with this load module reflects the use of an alias name. If this bit is set, this line of the load list display reflects information taken from a minor CDE.

.... ..1. Bit 6 set indicates that the load module was in the job pack area.

.... ...1 Bit 7 set indicates that the load module was considered not only-loadable.

EPA hhhhhh
 The address of the entry point of the load module named in the NM field of this load list display line.

STA hhhhhh
 This field contains the starting address of the load module identified in the NM field of this load list display line.

LN hhhhhh
 The LN field supplies the user with the length, in bytes, of the load module represented by this load list entry (LLE).

MVT JOB PACK QUEUE FORMAT: A job pack area control queue (JPACQ) exists for each job step in the dumped system that used a program not in the link pack area. The job pack queue, like the link pack area, is made up of contents directory entries (CDEs). This area describes routines in a job step region that were brought into main storage by contents supervision routines to perform a task in the job step. The IMDPRDMP program displays the contents of the dumped MVT system's job pack queue as follows:

CDE hhhhhh
 The starting address of the contents directory entry associated with this job pack queue element.

NM ccccccc
 The eight-character name of the entry point to the load module represented by this entry.

USE hh
The count of the number of uses (through the ATTACH, LINK and XCTL macro instructions) of the load module, and the number of times a LOAD macro instruction was issued for the module.

RESP NA
This responsibility count field is flagged 'NA' to indicate that the information is not applicable to modules displayed in the job pack queue.

ATRI hh
The attributes of the load module described in this job pack queue entry. These attributes are taken from the contents directory entry associated with the module. The meanings of the attribute flag settings are:

- 1... Bit 0 set indicates that the module was resident in the link pack area.
- .1... Bit 1 set indicates that at the time the dump was taken, the load module represented by this job pack queue entry was in the process of being loaded.
- ..1. Bit 2 set indicates that the load module was reenterable.
- ...1 Bit 3 set indicates that the load module was serially reusable.
- 1... Bit 4 set indicates that the load module could not have been reused. This flag setting is not applicable if either bit 2 or 3 is set.
-1.. Bit 5 set indicates that the contents directory entry associated with this load module reflects the use of an alias name. If this bit is set, this line of the job pack queue display reflects information taken from a minor CDE.
-1. Bit 6 set indicates that the load module was in the job pack queue area.
-1 Bit 7 set indicates that the load module was considered not only-loadable.

EPA hhhhhh
The address of the entry point of the load module named in the NM field of this job pack queue entry display line.

STA hhhhhh
This field contains the starting address of the load module identified in the NM field of this job pack queue entry display line.

LN hhhhhh
The LN field supplies the user with the length, in bytes, of the load module represented by this job pack queue entry.

MVT DATA EXTENT BLOCK (DEB) FORMATTING:
Data extent blocks (DEBs), describing a data set's external storage requirements, were queued to those task control blocks (TCBs) that represented tasks requiring auxiliary storage input/output processing. External storage information, taken from each DEB, is formatted as shown below:

DEB hhhhhh
The starting address of the basic section of the DEB being displayed.

APPENDAGES
The word "appendages" informs the user that the five named fields on this line contain information taken from the appendage vector table preceding the DEB being displayed. The named fields appearing on the rest of this line are:

END OF EXT hhhhhh
The entry point of the end-of-extent appendage routine.

SIO hhhhhh
The entry point of the start I/O appendage routine.

PCI hhhhhh
The entry point of the program-controlled-interruption appendage routine.

CH END hhhhhh
The entry point of the channel-end appendage routine.

AB END hhhhhh
The entry point of the abnormal-end appendage routine.

PFX hhhhhhhh hhhhhhhh hhhhhhhh
The second line of a DEB display contains information taken from the prefix section of the DEB being displayed. The area is subdivided as follows:

byte 0
The first byte of the prefix area contain the contents of the I/O support work area. This area is used only by DEBs dealing with direct access storage devices.

bytes 1-7

The next seven bytes of the DEB prefix section are used by DEBs associated with direct access storage device functions. This subfield displays the data set control block's (DSCB) address used by I/O support. The address is expressed in the following format:

- bytes 1 and 2 the bin (cell) number.
- bytes 3 and 4 the cylinder address.
- bytes 5 and 6 the track address.
- byte 7 the record number.

bytes 8-11

The third word of the PFX field contains the data control block (DCB) modification mask that was used by I/O support.

byte 12

The length of the DEB in doublewords .

bytes 13-15

The remainder of the DEB prefix section is reserved for future use.

TCB hhhhhh

This field marks the beginning of the basic section of the data extent block. The TCB field is divided into two subfields as follows:

byte 0

The number of subroutines for which a LOAD macro instruction was issued during the execution of the OPEN executor routines.

bytes 1-3

The starting address of the task control block to which this DEB was enqueued.

NDEB hhhhhh

The NDEB field is also used to display two data elements. It is subfielded as follows:

byte 0

The overall length of a data extent block includes the length of a variable length access method dependent section. The first byte of the NDEB field, expresses the length of the access method dependent section in bytes. If the access method was BDAM, this indicator is expressed as a number of fullwords.

bytes 1-3

The last portion of the NDEB field displays the starting address of the basic section of the next DEB on the task's queue. If this DEB was the last on the queue, the contents of this field are the starting address of the TCB that enqueued this DEB.

ASYN hhhhhhhh

This field contains data set status flags and the address of the associated IRB. This field is used as follows:

byte 0

The first byte of the ASYN field contains data set status flags. These flags have the following meanings:

- xx.. Bits 0 and 1 indicate the data set's disposition. The possible settings are:
- 01.. This setting indicates that the disposition was OLD.
- 10.. This setting indicates that the disposition of the data set was MOD (modify).
- 11.. This setting indicates that the disposition was NEW.
- ..1. Bit 2 set indicates that an end-of-volume (EOV) or end-of-file (EOF) condition had been encountered.
- ...1 The setting of bit 3 has one of two meanings depending upon the external storage medium. For disk this indicator reflects a release of unused external storage. For tape, the meaning of this indicator is that an emulator tape with second generation format was being used.
- 1... Bit 4 set is a data control block (DCB) modification indicator.
-1.. Bit 5 set has two meanings, depending upon the auxiliary storage recording medium. For disk, the setting of bit 5 indicates that a split cylinder was encountered. For tape, this flag indicates that an emulator tape with possible mixed parity records was used.
-1. Bit 6 set indicates the use of nonstandard labels.
-1 Bit 7 set indicates that reduced error recovery procedures were used on magnetic tapes containing the data set represented by this DEB.

bytes 1-3

The last portion of the ASYN field shows the starting address of the IRB that was associated with asynchronous appendage exit scheduling.

SPRG hhhhhhhh

This field contains information on I/O processing methods and the system PURGE routine. The usage of this field is as follows:

byte 0

The first byte of this field contain flags that indicate the method of input/output processing and the disposition of the data set that was to have been performed when an end-of-volume condition occurred. These flag settings are:

- 1... Bit 0 was set by ABEND. The setting of this bit indicates that the data set associated with this DEB was a SYSABEND or SYSUDUMP data set.
- .0.. Bit 1 is always zero.
- ...x Bits 2 and 3 show the end-of-volume disposition procedure. The values for this flag are:
 - ..01 REREAD
 - ..11 LEAVE
 - xxxx The last half of this byte contains flags that indicate the type of input/output processing that was performed on the data set represented by this DEB. The values for this flag are:
 - 0000 INPUT
 - 1111 OUTPUT
 - 0011 INOUT
 - 0111 OUTIN
 - 0001 RDBACK
 - 0i00 UPDAT

byte 1

The quiesce count. The byte is associated with the system PURGE routines (SVC 16) and indicates the number of auxiliary storage devices that were executing the user's channel programs.

bytes 2-3

Reserved for future use.

UPRG hhhhhhhh

The UPRG field contains extent information and data used by the user's purge routines. This field is divided into the following two subfields:

byte 0

The number of extents that were specified in the DSCBs associated with this DEB.

bytes 1-3

The address of the first input/output block (IOB) in the user's purge chain.

PLST hhhhhhhh

Task priority and supervisor purge information are contained in this field. This field is formatted as follows:

byte 0

The priority of the task under which this DEB was enqueued.

bytes 1-3

The starting address of a parameter list that was used to locate the purge event control block (ECB) for a supervisor purge request.

DCB hhhhhhhh

The DCB field contains three data elements. These are displayed in the format given below:

byte 0

xxxx The storage protection key that was associated with the task under which this DEB was enqueued.

.... 1111 A hexadecimal 'F' in bits 4 through 7 of this field identify this control block as a data extent block (DEB).

bytes 1-3

The starting address of the data control block (DCB) that was associated with this DEB.

AVT hhhhhhhh

The AVT field displays two DEB data elements and is subfielded as follows:

byte 0

The DEB extent scale that is used to determine the size of the device dependent section of this DEB. For direct access devices, a 4 is displayed in this subfield. For a nondirect access device or a communication device, a 2 is displayed.

bytes 1-3

In most cases the last portion of the AVT field shows the starting address of the appendage vector table preceding this DEB. This table of appendage routine addresses appears on the first line of this DEB's display.

OP-UCB hhhhhhh

The contents of this field have meaning only when the DEB being displayed describes a data set that was assigned to a unit record or magnetic tape device. This information is formatted from the device dependent section of the DEB. The OP-UCB field is subfielded as follows:

byte 0

This first subfield is applicable only to data sets assigned to magnetic tape devices and shows the SET MODE operation code. For a data set that was assigned to a unit record device, this subfield is reserved.

bytes 1-3

The starting address of the unit control block (UCB) associated with the data set described by the DEB being displayed.

The following four fields are present only for data sets assigned to the IBM 3525 Card Punch for multi-function. The information is formatted as shown below:

UCB hhhhhhhh

byte 0

The device modifier field (not used for the 3525).

bytes 1-3

The starting address of the unit control block (UCB) associated with the data set described by the DEB being displayed.

RDRDCB hhhhhhhh

The starting address of the data control block (DCB) for the read associated data set.

PCHDCB hhhhhhhh

The starting address of the data control block (DCB) for the punch associated data set.

WTRDCB hhhhhhhh

The starting address of the data control block (DCB) for the print associated data set.

The final portion of a DEB display shows information pertaining to a data set that was assigned to a direct access device. This information, taken from the DEB's device dependent section, is arranged in columnar format with a line for each extent. The information is formatted as shown below:

FM-UCB hhhhhhhh

The first column displays two data elements and is formatted as follows:

byte 0

The device modifier showing the file mask.

bytes 1-3

The starting address of the unit control block (UCB) that was associated with the data extent.

START hhhhhhhh

The address of the beginning of the direct access device extent. The first four characters represent the cylinder address and the last four characters represent the track address.

END hhhhhhhh

The address of the end of the data extent. Cylinder and track references are formatted as in the extent beginning address, described above.

TRKS hhhh

The number of direct access tracks bounded by the starting and ending addresses shown in the previous two columns.

MVT TASK INPUT/OUTPUT TABLE (TIOT)

FORMATTING: A task input output table (TIOT) was constructed for each task in the dumped system by MVT job management routines. Residing in the system queue area, this table contained primary pointers to control blocks used by I/O support routines. As the functions of several TIOT fields were dependent upon the state of associated external storage devices, multiple definitions may apply. The TIOT that was constructed in an MVT system is formatted as shown.

TIOT hhhhhh

The starting address of the task input/output table being displayed.

JOB ccccccc

The eight-character name of the job for which this TIOT was constructed.

STEP ccccccc

The eight-character name specified in the label field of the EXEC JCL statement associated with this job step.

PROC ccccccc

If the job step for which this TIOT was constructed was invoked from a cataloged procedure, the procedure name, as contained in the EXEC JCL statement, is displayed in this field.

Each data set associated with the indicated task is represented by a separate DD entry that is included in the TIOT. Each TIOT entry is displayed on a separate line in

columnar format. The use and meaning of each column is given below:

OFFSET hhhh

The offset of this DD entry from the beginning of the TIOT in hexadecimal.

LN-STA hhhhhhhh

Four bytes of length and status information, described below:

byte 0

The total length (including all device entries) in bytes of the DD entry being displayed on this line.

byte 1

Status byte A, one of three status bytes in a TIOT entry. The meanings of the status byte settings are:

- x... .x.. Bits 0 and 5 indicate the tape label processing that was to have been performed. The meanings of the settings are:
 - 0... .0.. Nonlabeled tape or an indication to bypass label processing.
 - 0... .1.. Standard labels and standard user labels.
 - 1... .0.. Nonstandard labels.
 - .1.. The setting of status bit 1 has two meanings, depending upon the processing phase that had been reached at the time the system was dumped. During allocation processing, the setting of this bit indicates that this entry represents a split cylinder primary space allocation DD. If the dump was taken during step termination processing, the setting of this bit indicated that no unallocation of space was necessary.
- ..1. The setting of status bit 2 works under the same philosophy as status bit 1. During allocation processing, the setting of this bit indicates that this entry represents a split cylinder secondary space allocation DD. If the dump was taken during step termination processing, the indication was one of rewinding with no unload.

- ...1 Bit 3 set indicates that this DD entry represents a JOBLIB.
- 1... Bit 4 set indicates that direct access device space management was deemed necessary.
-1. The setting of bit 6 specifies that the tape volume was to have been rewound and unloaded.
-1 The setting of bit 7 specifies that the tape volume was to have been rewound.

byte 2

The third byte of this column has meaning only during the allocation phase. This displays the number of devices that were requested by the data set represented by the TIOT entry displayed on this line.

byte 3

The last byte of the LN-STA field displays a TIOT field that had meaning at two points during the processing of this task. During the allocation process, this field contained a link to the appropriate prime split, unit affinity, volume affinity or suballocate TIOT entry. After CLOSE processing, this byte was used thusly:

- 1... The setting of bit 0 indicates that the data set represented by this DD entry was a SYSOUT data set that contained data.
- ...xxx xxxx Bits 1 through 7 are reserved for future use.

DDNAME cccccccc

The eight-character DD name associated with the TIOT entry being displayed.

TTR-STC hhhhhhhh

The first three bytes of this column display the relative track address (TTR) of the job file control block (JFCB) associated with this entry.

STB-UCB hhhhhhhh

The last column in a TIOT display contains information taken from the one-word device entries that are appended to each TIOT entry. One TIOT device entry exists for each allocated device. This display field shows this information in the following format:

byte 0

Status byte B. The status bits have the following meanings:

- 1... Bit 0 set indicates that the data set associated with this line of the TIOT display was present on the device represented by this TIOT device entry.
- .1.. Bit 1 set indicates that the data set associated with this line of the TIOT display would have used the device represented by this TIOT device entry.
- ..1. Bit 2 set indicates that the device represented by this device entry violated separation.
- ...1 Bit 3 set indicates that a volume serial number was present.
- 1... Bit 4 set indicates that a setup message was required.
-x.. Bit 5 indicates the device disposition that would have taken place had the dumped system been allowed to continue processing this task. The settings for this bit are:
 -0.. Indicates that if the volume was required to be unloaded, the volume was to have been deleted.
 -1.. Indicates that if the volume was requires to be unloaded, the unloaded volume was to have been retained.
-1. Bit 6 indicates that an unload requirement had been made.
-1 Bit 7 set indicates that a load or label verification requirement had been made.

bytes 1-3

The address of the UCB that was used in all cases except when the device was a 2321 data cell drive. For a 2321, this address is that of the description in the UCB of the cell in the bin.

MFT Control Block Formatting

The formats described below are repeated for each requested task that is printed. A sample of the major system control blocks, as formatted from an MFT dump, is shown in Figure 23.

MFT TASK CONTROL BLOCK (TCB) FORMATTING:

The task control block (TCB) contains information pertaining to the specific task identified in the heading lines at the top of the dump listing page. It is formatted as follows:

TCB hhhhhh
The address of the task control block being displayed is given in this first display field.

RBP hhhhhhhh
The starting address of the request block (RB) that was currently associated with the task represented by this TCB.

PIE hhhhhhhh
The address of the first program interrupt element (PIE) enqueued by this TCB.

DEB hhhhhhhh
The address of the beginning of the data extent block (DEB) queue that was associated with this task. Information on the contents of each DEB in the queue is given in a separate portion of this MFT task's dump listing.

TIO hhhhhhhh
The starting address of the task input/output table (TIOT) that was constructed during device allocation for the task represented by this TCB. The contents of this table are displayed in a later portion of this task's display.

CMP hhhhhhhh
This word contains ABEND indicators and user and system completion codes as follows:

byte 0

- 1... ... Bit 0 set indicates that a dump had been requested.
- .1.. Bit 1 is reserved for future use but is set for MVT compatibility.
- ..1. Bit 2 set indicates that a portion of the problem program's main storage area was overlaid by a second load of ABEND. A first load overlay is indicated by the setting of bit 14 of the PK-FLG field.
- ...x Bit 3 is reserved for future use.
- 1... Bit 4 set indicates that a double ABEND occurred in the dumped task.

JOB JOBS STEP GO PROCSTEP STEPI

***** CURRENT TASK *****

TGB 009148 RBP 00009228 PIE 00000000 DEB 00071634 TIO 00071728 CMP 00000000 TRN 00000000
 MSS 00009210 PK-FLG 10000008 FLG 000001E3 LLS 000712F8 JLB 00000000 JST 00009148
 RG 10-1 00071780 0002A910 5002A826 98C71280 4002A896 50007FD2 CCC00000 0000011A
 RG 2-9 00000000 0002C304 0007176C 0000004C 00009148 000717F8 00071778 00000000
 FSA 08071730 TCB 00009348 TME 00009228 PIB 00019A88 NTC 00000000 GTC 00000000
 LTC 00000000 IQE 00000000 ECB 00000000 XTCB 00000000 LP/FL E3000000 RES 00000000
 STA 00000000 TCT 000209A8 USR 00000000 CAR 00000000 RES 00000000 JSCB 00021284

ACTIVE RBS

PRB 02A800 NM GO SZ/STAB 00200000 USE/EP 0002A820 PSW FF150G80 9002A87A Q 00000000 WT-LNK 00009148
 IRB 009228 NM 5GKJ AKY SZ/STAB 000E404C USE/EP 0002A87E PSW FF150193 8002A8AA Q 00009288 WT-LNK 0002A800
 RG 10-1 FA000048 00009228 00000000 0002C304 0007176C 0000004C 00009148 000717F8
 RG 2-9 00071778 00000000 00071780 0002A910 5002A826 0002A510 13000000 400122EA
 EXTSA 00000000 00071280 00009228 00009148

P/P BOUNDRIES

HIER 0 0002A800 TO 00071800 HIER 1 00000000 TO 00000000

LOAD LIST

LRB 071300 NM DUMMYGL SZ 000088 USE/EP 01071310
 LPRB 071390 NM RETURNS SZ 0000A8 USE/EP 01071380

JOB PACK QUEUE

NOTHING IN JOB PACK

DEB 07163+ APPENDAGES END OF EXT 0229C0 SIG 003FF4 PCI 003FF4 CH END 003FF4 AB END 003FF4
 PFX 00000000 05000005 00010BEO 11000000
 TCB 04009148 NDEB 1007150C ASYN F8000000 SPRG 00000000 UPRG 0107144C PLST E3000000 CCB 1F02A88C
 AVT 04071610
 FM-UCB START END TRKS
 5800156C 00020003 00020003 0001

DEB 07150C APPENDAGES END OF EXT 0138F0 SIG 013922 PCI 0136F8 CH END 013864 AB END 013922
 PFX 00000000 05000007 000007E0 0F000000
 TCB 00009148 NDEB 00000000 ASYN A8000000 SPRG 00000000 UPRG 01000000 PLST E3000000 CCB 0F071778
 AVT 040136E4
 FM-UCB START END TRKS
 580015EC 00040003 00050009 0011

TIO 071728 JOB JOBS STEP GO PROC STEP1
 OFFSET LN-STA DDNAME TTR-STC STB-UCB
 0018 14040100 PGM=*.DD 00700000 800015EC
 002C 14040100 DUMMY 007F0300 8000156C

IMDPRDMP Output Formatting: MFT -- TCB

Figure 23. Sample of MFT Control Block Format

CMP hhhhhhhh -- byte 0 -- (continued)

| | |
|-----------|--|
|1.. | Bit 5 set indicates that a dump message (WTO) was to have been issued. |
|1. | Bit 6 set indicates that the dumped system's scheduler was to have printed an indicative dump. |
|1 | Bit 7 set indicates that an ABEND message, to be printed by the ABDUMP routine, was provided. |

bytes 1-3
 The first 12 bits contain a system completion code. These codes and their meanings are explained in the publication IBM System/360 Operating System: Messages and Codes, GC28-6631 under the heading "System Completion Messages." A user completion code is contained in the last 12 bits.

TRN hhhhhhhh
 Contains flags as follows:

byte 0

| | |
|------------|--|
| 1... | Bit 0 set indicates that decimal simulator programs were being used on a System/360 model 91 machine. |
| .1.. | Bit 1 set indicates that checkpoints were not taken for this step. |
| ..1. | Bit 2 set indicates that the TCB being displayed was associated with either a graphics foreground job or the graphic job processor. |
| ...1 | Bit 3 set indicates that the TCB being displayed was associated with a 7094 emulator task that was being run on a System/360 model 85 machine. |
| xxxxx | Bits 4 through 7 are reserved for future use. |

bytes 1-3
 Reserved.

MSS hhhhhhhh
 Main storage supervision as follows:

byte 0
 This byte is reserved for future use.

bytes 1-3
 This subfield displays one of two addresses. If the TCB being displayed represents a job step, this subfield contains the address of the boundary box. If this TCB represents a

subtask, this field displays the address of the gotten queue element (GQE). GQEs are preset only if the dumped system issued a GETMAIN macro instruction for the space.

PK-FIG hhhhhhhh
 The storage protection key and a series of flags associated with the task being displayed. This field is divided into several subfields. These are:

byte 0

| | |
|-----------|--|
| xxxx | The storage protection key associated with the task represented by this TCB. |
| 0000 | Always contain zeros. |

byte 1

| | |
|------------|---|
| 1... | Bit 0 set indicates that an abnormal termination was in progress at the time the dump was taken. |
| .1.. | Bit 1 set indicates that a normal termination was in progress at the time the dump was taken. |
| ..1. | Bit 2 set indicates that ABEND was initiated by the resident abnormal termination routine. |
| ...1 | Bit 3 set indicates that recursion through ABEND was permitted. |
| 1... | Bit 4 set indicates that the graphics abnormal termination routine had been entered for the task represented by the TCB being displayed. |
|1.. | Bit 5 set indicates that the CLOSE routine was initiated by ABEND. |
|1. | Bit 6 set indicates that a portion of the problem program's main storage area was overlaid in order to process ABEND routines. (See also bit 2 of the CMP display field.) |
|1 | Bit 7 set indicates that the queueing of asynchronous exits for the task represented by the TCB being displayed, was prohibited. |

byte 2

| | |
|------------|--|
| 1... | Bit 0 set indicates that ABEND was prohibited for this task. The setting of this bit has meaning only if the TCB being displayed represents a system task. |
|------------|--|

| | |
|---|---|
| <p>.xx. .x. Bits 1, 2 and 6 are reserved for future use.</p> <p>...1 Bit 3 set indicates that the task represented by the TCB being displayed had a forced completion imposed upon it. Other tasks in the dumped system could not have been performed until this task had been completed.</p> <p>.... 1... Bit 4 set indicates that the job step had a forced completion imposed upon it. Other tasks in the dumped system could not have been performed until this job step had been completed.</p> <p>.... .1.. Bit 5 indicates that dump processing had been initiated in ABEND.</p> <p>.... ...1 Bit 7 set indicates that the task represented by the TCB being displayed was a member of a time sliced group.</p> <p>byte 3</p> <p>xx.x ...x Bits 0, 1, 3 and 7 are reserved for future use.</p> <p>..1. Bit 2 is an exit effector indicator. The setting of this bit indicates that at the time the dump was taken, system error routines were operating on this task.</p> <p>.... 1... Bit 4 set indicates that floating point registers existed in the dumped system.</p> <p>.... .1.. Bit 5 set indicates that at the time the dump was taken, job scheduler routines were processing.</p> <p>.... ..1. Bit 6 set indicates that at the time the dump was taken, an XCTL routine was changing the storage protection key in the PSW from zero to the one used by the problem program.</p> <p>FLG hhhhhhhh</p> <p>This field displays a further series of flags and certain priority indicators. This word is formatted as follows:</p> <p>byte 0</p> <p>Reserved for future use.</p> | <p>byte 1</p> <p>xxxx xxx. Bits 0 through 6 are reserved for future use.</p> <p>.... ...1 Bit 7 is the primary non-dispatchability indicator. Setting of this bit indicates that one or more of the secondary non-dispatchability bits (bytes 1-3 of the DAR field) was set at the time the dump was taken. If this bit is set, the task represented by this TCB was considered to be non-dispatchable.</p> <p>byte 2</p> <p>This byte contains the number of resources for which the task represented by this TCB was enqueued.</p> <p>byte 3</p> <p>This byte displays the dispatching priority of the task represented by this TCB.</p> <p>LLS hhhhhhhh</p> <p>The address of the last request block (RB) that was created by the loading of a module that used the LOAD macro instruction.</p> <p>JLB hhhhhhhh</p> <p>The address of the data control block (DCB) representing the JOBLIB associated with this task.</p> <p>JST hhhhhhhh</p> <p>Job step information. The contents of this field have meaning only when the dumped MFT system was operating with the subtasking option. If this was the case, this field shows the address of the first TCB for a job step.</p> <p>RG 0-7 and RG 8-15</p> <p>The register save area of the TCB being displayed. This pointer is useful in locating the entry points of first routines and in tracing the save area chains.</p> <p>FSA hhhhhhhh</p> <p>This field displays two data elements and is formatted as follows:</p> <p>byte 0</p> <p>The TCB identification code.</p> <p>byte 1-3</p> <p>The address of the first problem program save area.</p> |
|---|---|

TCB hhhhhhhh
The address of the TCB that had the next lowest priority on the ready queue at the time the dump was taken.

TME hhhhhhhh
The address of the timer element.

PIB hhhhhhhh
The PIB field displays two items of information in the following format:

byte 0

This byte contains flags that identify the partition attributes. These flags are:

| | |
|-----------|--|
| xx.. | Bits 0 and 1 indicate the function of the partition. The possible functions are given below: |
| 00.. | System task partition. |
| 01.. | Reader partition. |
| 10.. | Writer partition. |
| 11.. | Processing program partition. |
| ..x. | Bit 2 gives the partition size. The meanings of the possible settings are: |
| ..0. | Small partition. |
| ..1. | Large partition. |
| ...1 | Bit 3 set indicates that CPU timing was stopped by FINCH until a transient routine was loaded. |
| xx.. | Bits 4 and 5 are reserved for future use. |
|1. | Bit 6 set indicates that the partition associated with this task was a writer partition. This bit is used by ABEND, transient writers and resident writers. |
|1. | Bit 7 set indicates that at the time the system was dumped, the scheduler was in control. Had this task's TIOT been written to SYS1.SYSJOBQE, this bit would not be set. |

bytes 1-3

The last portion of the PIB field shows the address of the partition information block (PIB) that was associated with this task's partition.

NTC hhhhhhhh
The address of the previous TCB that existed on the originating task's queue of subtask TCBs (sister). If the TCB was the first on the queue, this field contains zeros. The contents of the NTC field have meaning

only if the dumped system was operating with the MFT subtasking option.

OTC hhhhhhhh
The OTC field is applicable only when the dumped system was operating under MFT subtasking option. If this was the case, this field displays the address of the TCB representing the originating task (mother).

LTC hhhhhhhh
The address of the last TCB that existed on the originating task's queue of subtask TCBs (daughter) at the time the dump was taken. If this TCB was the last on the queue, this field contains zeros. This field is applicable only if the dumped system was operating under the MFT subtasking option.

IQE hhhhhhhh
The address of the interruption queue element (IQE) that was used in scheduling the ETXR routine on the originating task. The contents of this field have no meaning unless the dumped system was operating under the MFT subtasking option.

ECB hhhhhhhh
If the dumped system was operating under the MFT subtasking option, this field displays the address of the event control block (ECB) that would have been posted by the supervisor's task termination routines had either normal or abnormal task termination been allowed to occur.

XTCB hhhhhhhh
The XTCB field in this TCB display is reserved for future use.

LP/FL hh hhhhhh
Priority and dump information on tasks that were operating under the subtasking option of MFT. The LP/FL field displays its data as follows:

byte 0

The limit priority of the task represented by the TCB being displayed.

byte 1

Dump information flags.

| | |
|-----------|--|
| xxxx x... | Bits 0 through 4 are reserved for future use. |
|1.. | Bit 5 set indicates that the task represented by the TCB being displayed was the top task in the tree of abnormally terminating tasks. |

-1. Bit 6 set indicates that an abnormal termination dump had been completed.
-1 Bit 7 set indicates that the task represented by this TCB was enqueued on a dump data set.

byte 2

This byte contains more dump information flag bits. The meanings of these bits are:

- 1... Bit 0 set indicates that at the time the system was dumped, an OPEN was in process for the dump data set.
- ...x x..x Bits 1 through 4 and bit 7 are reserved for future use.
-1.. Bit 5 set indicates that the dump data set was open for the job step.
-x. Bit 6 indicates the type of dump data set. The possible settings are:
-0. SYSUDUMP data set.
-1. SYSABEND data set.

byte 3

This last byte of the LP/FL field shows abnormal termination flags as follows:

- xxx. x.xx Bits 0, 1, 2, 4, 6 and 7 are reserved for future use.
- ...1 Bit 3 set indicates that a valid message recursion occurred in ABEND.
-1.. Bit 5 set indicates that no abnormal termination dumps could be provided within the job step associated with the TCB being displayed.

RES hhhhhhhh

This field is reserved for future use.

STA hhhhhhhh

Internal STAE routine flags and the address of the STAE control block that was in effect at the time the dump was taken.

TCT hhhhhhhh

Information pertaining to the dumped system's timing control table (TCT). The TCT field is divided into the following two subfields:

byte 0

This byte is reserved for future use.

byte 1-3

If the system management facilities option was presented in the dumped

system, these bytes contain the address of the dumped system's timing control table (TCT).

USR hhhhhhhh

This word is available to the user of the dumped system. It contains any information placed in it by the user.

DAR hhhhhhhh

The contents of this field were used by the damage assessment routine (DAR). Certain subfields displayed in this word were also used to control the dispatchability of the dumped task. The DAR field is divided into the following subfields.

byte 0

The first byte of the DAR field contains DAR flags. The flags are as follows:

- 1... Bit 0 set indicates that primary DAR recursion occurred in the dumped system. The damage assessment routine failed while writing a main storage image dump.
- ..1. Bit 1 set indicates that secondary DAR recursion occurred in the dumped system. The damage assessment routine failed while attempting to reinstate a failing partition.
- ...x Bit 2 set indicates that only the dump capability of the damage assessment routine was requested.
- 1... Bit 3 is reserved for future use.
-xx. Bit 4 set indicates that the system error task is failing. The DAR dump should not request any error recovery procedure (ERP) processing.
-1 Bit 5 and 6 are reserved for future use.
-1 Bit 7 set indicates that an SVC dump is executing for this task.

byte 1

Bytes 1 through 3 of the DAR display field are used to show the settings of secondary non-dispatchability flags bits. If any of the flags in this subfield were set, the primary non-dispatchability flag (the last bit in the FLG field) will also have been set and the task represented by this TCB will have been non-dispatchable. The bit settings that may appear in byte 1 and their meanings are:

xx.. Bits 0 and 1 were set by the damage assessment routines. Their meanings are:
 1... Bit 0 set indicates that the task represented by the TCB being displayed was flagged temporarily non-dispatchable.
 .1.. Bit 1 set indicates that the task represented by this TCB was deemed permanently non-dispatchable.
 ..xx Bits 2 and 3 are recovery management support and system error recovery flags. Their meanings are:
 ..1. Bit 2 set indicates that the task represented by this TCB was flagged temporarily non-dispatchable.
 ...1 Bit 3 set indicates that the task represented by the TCB being displayed was deemed permanently non-dispatchable.
 x... Bit 4 is reserved for future use.
1.. Bit 5 set indicates that this task is temporarily non-dispatchable. Time services have been requested and the time-of-day clock is still inoperative.
xx Bits 6 and 7 are reserved for future use.

byte 2

1... Bit 0 indicates that at the time the dumped system was active, ABDUMP was processing. The setting of this flag bit has meaning only if the dumped system was operating with the subtasking option of MFT.
 .x.. Bit 1 is reserved for future use.
 ..1. Bit 2 set indicates that this task is non-dispatchable. An SVC dump is executing for another task.
 ..x xxx. Bits 3 through 6 are reserved for future use.
1 Bit 7 set indicates that at the time the system was dumped, the dump data set was in the process of being opened.

byte 3

1... The setting of this first bit has meaning only if the dumped system was operating with the MFT subtasking option. If this bit is set, the indication is that the task represented by the TCB being displayed was terminated.
 .1.. Bit 1 set indicates that had the dumped MFT system, operating with the subtasking option, been allowed to continue processing without intervention by the dump program, the task represented by this TCB would have been terminated by ABEND.
 ..xx xxxx Bits 2 through 7 are reserved for future use.

RES hhhhhhhh Reserved for future use.
 JSCB hhhhhhhh Contains the address of the job step control block.
 RES hhhhhhhh Reserved for future use.
 IOBRC hhhhhhhh Contains the address of the IOB restore chain for I/O quiesced by end-of-task.

MFT ACTIVE REQUEST BLOCK (RB) FORMATTING:

Request blocks (RBs) were used by the dumped system's supervisor to maintain information concerning a task. RBs associated with the task identified in the heading lines at the top of the dump page and in the preceding TCB display, are listed in the portion of the dump listing labeled "ACTIVE RBS". Information on each RB associated with the task is formatted as shown below:

PRB
 LPRB
 SVRB hhhhhh
 SIRB
 IRB

Each RB display is preceded by a field that indicates the type and starting address of the RB being displayed. The five types of RBs that may be displayed under an MFT task are:

PRB program request block
 LPRB loaded program request block

SVRB
supervisor request block (SVRBs may be divided into two categories; type 2 for resident routines and type 3 or 4 for transient routines).

SIRB
system interrupt request block

IRB
interruption request block

The type acronym for each RB is displayed in the first portion of the field. The starting address of the indicated request block appears in the last portion of the field. The contents of certain fields in the body of the formatted RB display are dependent upon the type of RB being displayed. Variations in display field usage are noted in the descriptions of the fields in which they occur.

NM cccccccc

The variations associated with the usage of this field are:

- PRBs and LPRBs use this field to display the name of the program they represented.
- SVRBs display the SVRB type in this field.
- SIRBs use this field to present the eight-character name of the error routine that was occupying the supervisor transient area at the time the dump was taken.
- IRBs display meaningful information in this field only if the timer was being used. If this was the case, the first character in this field represents the setting of the timer flags. The remainder of the NM field is meaningless.

SZ/STAB hhhhhhhh

This field displays two data elements; RB size information and STAB flag bit settings. This field is subfielded as follows:

bytes 0-1

The number of contiguous doublewords that were occupied by the request block, the associated program (if applicable), and associated supervisor work areas. If a program extent list was present, the program size is not included in this figure.

byte 2

STAB flag bit settings. The meaning of these flags are depends upon the type of request block being displayed. These flags are presented, by RB type, below:

PRB

The following bit settings are applicable to program request block displays:

- 0000 indicates that the program represented by this PRB was not loaded by a LOAD macro instruction; nor did it have minor entries identified by an IDENTIFY macro instruction.
- 0001 indicate that the program represented by this PRB was not loaded by a LOAD macro instruction but did have minor entries identified by an IDENTIFY macro instruction.
- xx.. Bit 4 and 5 have no meaning in PRB displays.
-1. indicates that the program represented by this PRB was hierarchy block loaded and that a program extent list existed.
-1 indicates that the program module represented by this PRB was refreshable.

LPRB

Loaded program request blocks being displayed may have the following bit settings in this byte:

- 0010 indicates that the program represented by this LPRB was not loaded by a LOAD macro instruction; nor did it have minor entries identified by an IDENTIFY macro instruction.
- 0011 indicates that the program represented by this LPRB was not loaded by a LOAD macro instruction but did have minor entries identified by an IDENTIFY macro instruction.

1110 indicates that this LPRB describes a minor entry identified by an IDENTIFY macro instruction.

.... xx.. Bits 4 and 5 have no meaning in LPRB displays.

.... ..1. indicates that the program represented by this LPRB was hierarchy block loaded and that a program extent list existed.

.... ...1 indicates that the program module represented by this LPRB was refreshable.

SVRB

Supervisor request blocks display the following bit settings in this subfield:

1100 indicates that the program represented by this SVRB is a type 2 SVC routine that had not been loaded at the time the dump was taken.

1101 indicates that the program represented by this SVRB is a type 3 or SVC routine that had been loaded.

.... 1... indicates that the type 3 or 4 SVC routine was resident.

.... .1.. indicates that while the dumped system was active, a checkpoint could have been taken in a user exit from the SVC routine represented by this SVRB.

.... ..xx bits 6 and 7 have no meaning in SVRB displays.

SIRB

The flag bit setting applicable to supervisor interrupt request block displays is as follows:

1000 indicates that the RB being displayed is a supervisor interrupt request block (SIRB).

.... xxxx bits 4 through 7 have no meaning in SIRB displays.

IRB

Interrupt request block displays use these flag bits in the following manner.

0100 indicates that the RB being displayed is an interrupt request block (IRB).

.... xxxx bits 4 through 7 have no meaning in IRB displays.

byte 3

The last byte of the SZ/STAB field displays more status and attribute flags. The possible settings for this subfield and their meanings are:

1... Bit 0 set indicates that the WT-LNK field in this RB display contains, in its last three bytes, the address of the TCB to which this request block is linked.

.1.. Bit 1 set indicates that at the time the dumped system was active, the program associated with the RB being displayed was active.

..1. Bit 2 set indicates that had the dumped system been allowed to continue processing without intervention by the dump program, general registers 2 through 14 would have been restored from this RB's general register save area, displayed on the following two lines. The setting of this bit is valid only for IRB, SIRB and SVRB displays.

...1 Bit 3 set indicates that the program module represented by this request block was reenterable or reusable.

.... xx.. Bits 4 and 5 are used only in IRB or LPRB displays. The settings of these bits and their meanings are:

.... 00.. This setting indicates that the IRB being displayed had no interrupt queue elements (IQEs) associated with it.

- 01.. This setting indicates that the IRB being displayed had associated with it interrupt queue elements that were request queue elements (RQEs).
- 10.. This setting indicates that the request block being displayed is a dummy LPRB, in a partition that represents a program in the reenterable load module area. The LPRB for the program is in the reenterable load module area.
- 11.. This setting indicates that the IRB being displayed had interrupt queue elements associated with it that were not request queue elements (RQEs).
-1. Bit 6 set indicates that when the dumped system was active, request block storage was to have been freed when the program returned.
-x Bit 3 indicates wait request conditions. The meanings of the two possible settings for this bit are:
-0 Bit 7 not set indicates that the request had to wait for a single event or for all of a number of events.
-1 Bit 7 set indicates that the request had to wait for a number of events. This number of events was less than the total number of events that were waiting.

USE/EP hhhhhhhh

The USE/EP field, as indicated by the field identifier, displays two data elements. These are shown in the following format:

byte 0

The first byte of this field contains the use count that was applied to the program module represented by the request block being displayed. This use count was calculated by subtracting the number of invocations of the DELETE macro instruction from the number of times the LOAD macro instruction was used.

byte 1-3

The second portion of the USE/EP field displays the address of the entry point of the module represented by this request block.

PSW hhhhhhhh hhhhhhhh

The two words of the PSW field display to the user the dumped system's old program status word. If the dumped system had been allowed to continue processing without interruption by the dump program, operation would have resumed on this PSW.

Q hhhhhhhh

The information displayed in this field depends upon type of RB being displayed. The contents of this display field are described below, by RB type:

- PRBs and LPRBs use this field to display the address of an LPRB describing an entry that was identified via the IDENTIFY macro instruction.
- SVRBs representing type 3 or 4 SVCs use this field to indicate the size of the program they represent in bytes.
- SIRBs and IRBs display in this field the address of a 12- or 16-byte request element.

WT-LNK hhhhhhhh

This field displays information pertaining to wait counts and request block linkages. The field is divided into the following two subfields:

byte 0

The number of requests that were pending at the time the dump was taken (wait count).

byte 1-3

The address of the next request block on the RB queue. If the RB being displayed was the last request block on the queue, this field shows the address of the task control block (TCB) that enqueued this RB.

RG 0-7 and RG 8-15

The sixteen-word register save area appears only after IRB, SIRB or SVRB displays. These two lines display the contents of general registers 0 through 15 as they were stored in the request block.

MFT PROBLEM PROGRAM BOUNDARIES INFORMATION:

Each task operating under the MFT option of the operating system was assigned a main storage partition in which to operate. If

the system configuration included 2361 Large Core Storage, partitions may have included area from both hierarchy 0 (main storage) and hierarchy 1 (low speed main storage). If 2361 Large Core Storage was not available or was not used, hierarchy 1 pointers were set to zero. Each MFT task displays in its dump listing the limits of the partition in which it operated. This display is presented under the heading "P/P BOUNDARIES" (problem program boundaries) in the following format:

HIER 0 hhhhhhhh
The starting address of the problem program's hierarchy 0 partition.

TO hhhhhhhh
The ending address of the problem program's hierarchy 0 main storage partition.

HIER 1 hhhhhhhh
The starting address of the problem program's hierarchy 1 partition. If this field contains zeros, the indication is that 2361 Large Core Storage was either not available or not utilized by this task.

TO hhhhhhhh
This last field indicates the high limit of the problem program's hierarchy 1 partition if one was used. If this field contains zeros, either 2361 Large Core Storage was not available or it was not used by this task.

MFT LOAD LIST FORMATTING: A load list was maintained by the dumped system's supervisor in order to keep track of the load modules that were in main storage and the area of main storage each occupied. A load list created by an MFT supervisor is composed of loaded request blocks (LRBs) and loaded program request blocks (LPRBs). A formatted listing of the dumped MFT system's load list appears as follows:

LRB
LPRB hhhhhhhh
The type of request block being displayed and its starting address.

NM cccccccc
The eight-character name of the program module represented by the request block being displayed.

SZ hhhhhh
The number of contiguous double words that were occupied by the request block, the associated program (if applicable) and associated supervisor work areas. If a program extent list was present, the program size is not included.

USE/EP hhhhhhhh
Use count and entry point address as follows:

byte 0
The use count that was applied to the program module represented by the request block being displayed. This use count was calculated by subtracting the number of times the DELETE macro instruction was issued from the number of times the LOAD macro instruction was used.

byte 1-3
The address of the entry point of the program module named in the NM field of this RB display line.

MFT JOB PACK QUEUE FORMATTING: A job pack area queue was maintained by the dumped system's supervisor for each job step that used a program not in the resident reenterable load module area. A job pack queue created by an MFT supervisor consists of loaded request blocks (LRBs), loaded program request blocks (LPRBs) and FINCH request blocks (FRBs). A formatted job pack area queue display appears as follows:

LRB
LPRB hhhhhh
FRB
The type of request block being displayed and its starting address.

NM cccccccc
The eight-character name of the module represented by the request block being displayed.

SZ hhhhhh
The number of contiguous doublewords that were occupied by the request block, the associated program (if applicable) and associated supervisor work areas. If a program extent list was present, the program size is not included.

USE/EP hhhhhhhh
XRWTL
The usage of this display field is dependent upon the type of request block being displayed:

USE/EP
is used for LRBs and LPRBs and displays the use count and entry point address as follows:

byte 0
The use count that was applied to the program module represented by the request block being displayed. This use count was calculated by subtracting the number of times the DELETE macro

instruction was issued from the number of times the LOAD macro instruction was used.

bytes 1-3

The address of the entry point of the program module named in the NM field of this display line.

XRWTL

is used for FRBs and shows the starting address of the wait list element.

XRREQ hhhhhhhh

This field appears only in FRB displays, and shows the address of the TCB representing the task on whose behalf this FRB was constructed.

XRTLPRB hhhhhhhh

This field appears only in FRB displays and shows the starting address of the area of main storage that was acquired by the FETCH routine for the module identified by the NM field of this line.

MFT DATA EXTENT BLOCK (DEB) FORMATTING:

Data extent blocks (DEBs), describing a data set's external storage requirements, were queued to those task control blocks (TCBs) that represented tasks requiring auxiliary storage input/output processing. External storage information, taken from each DEB, is formatted as shown below:

DEB hhhhhh

The starting address of the basic section of the DEB being displayed.

APPENDAGES

The word "appendages" informs the user that the five named fields on this line contain information taken from the appendage vector table preceding the DEB being displayed. The named fields appearing on the rest of this line are:

END OF EXT hhhhhh

The entry point of the end-of-extent appendage routine.

SIO hhhhhh

The entry point of the start I/O appendage routine.

PCI hhhhhh

The entry point of the program-controlled-interruption appendage routine.

CH END hhhhhh

The entry point of the channel-end appendage routine.

AB END hhhhhh

The entry point of the abnormal-end appendage routine.

PFX hhhhhhhh hhhhhhhh hhhhhhhh

The second line of a DEB display contains information taken from the prefix section of the DEB being displayed. The area is subdivided as follows:

byte 0

The first byte of the prefix area contains the contents of the I/O support work area. This area is used only by DEBs dealing with direct access storage devices.

bytes 1-7

The next seven bytes of the DEB prefix section are used by DEBs associated with direct access storage device functions. This subfield displays the data set control block's (DSCB) address used by I/O support. The address is expressed in the following format:

bytes 1 and 2 the bin (cell) number.

bytes 3 and 4 the cylinder address.

bytes 5 and 6 the track address.

byte 7 the record number.

bytes 8-11

The third word of the PFX field contains the data control block (DCB) modification mask that was used by I/O support.

byte 12

The length of the DEB in double words.

bytes 13-15

The remainder of the DEB prefix section is reserved for future use.

TCB hhhhhhhh

This field marks the beginning of the basic section of the data extent block. The TCB field is divided into two subfields as follows:

byte 0

The number of subroutines for which a LOAD macro instruction was issued during the execution of the OPEN executor routines.

bytes 1-3

The starting address of the task control block to which this DEB was enqueued.

NDEB hhhhhhhh

byte 0

The overall length of a data extent block includes the length of a

variable length access method dependent section. The first byte of the NDEB field expresses the length of the access method dependent section in bytes. If the access method was BDAM, this indicator is expressed as a number of full words.

bytes 1-3

The last portion of the NDEB field displays the starting address of the basic section of the next DEB on the task's queue. If this DEB was the last on the queue, the content of this field is the starting address of the TCB that enqueued this DEB.

ASYN hhhhhhhh

This field contains data set status flags and the address of the associated IRB:

byte 0

The first byte of the ASYN field contains data set status flags. These flags have the following meanings:

- xx.. Bits 0 and 1 indicate the data set's disposition. The possible settings are:
- 01.. This setting indicates that the disposition was OLD.
- 10.. This setting indicates that the disposition of the data set was MOD (modify).
- 11.. This setting indicates that the disposition was NEW.
- ..1. Bit 2 set indicates that an end-of-volume (EOV) or end-of-file (EOF) condition had been encountered.
- ...1 The setting of bit 3 has one of two meanings depending upon the external storage medium. For disk, this indicator reflects a release of unused external storage. For tape, this indicator means that an emulator tape with second generation format was being used.
- 1... Bit 4 set is a data control block (DCB) modification indicator.
-1.. Bit 5 set has two meanings, depending upon the auxiliary storage recording medium. For disk, the setting of bit 5 indicates that a split cylinder was

encountered. For tape, this flag indicates that an emulator tape with possible mixed parity records was used.

.... ..1.

Bit 6 set indicates the use of nonstandard labels.

.... ...1

Bit 7 set indicates that reduced error recovery procedures were used on magnetic tapes containing the data set represented by this DEB.

bytes 1-3

The last portion of the ASYN field shows the starting address of the IRB that was associated with asynchronous appendage exit scheduling.

SPRG hhhhhhhh

This field contains information on I/O processing methods and the system PURGE routine.

byte 0

The first byte of this field contains flags that indicate the method of input/output processing and the disposition of the data set that was to have been performed when an end-of-volume condition occurred. These flag settings are:

- 1... Bit 0 was set by ABEND. The setting of this bit indicates that the data set associated with this DEB was a SYSABEND or SYSUDUMP data set.
- .0.. Bit 1 is always zero.
- ..xx Bit 2 and 3 show the end-of-volume disposition procedure. The values for this flag are:
- ..01 REREAD
- ..11 LEAVE
- xxxx The last half of this byte contains flags that indicate the type of input/output processing that was performed on the data set represented by this DEB. The values for this flag are:
- 0000 INPUT
- 1111 OUTPUT
- 0011 INOUT
- 0111 OUTIN
- 0001 RDBACK
- 0100 UPDAT

byte 1

The quiesce count. The byte is associated with the system PURGE routines (SVC 16), and indicates the

number of auxiliary storage devices that were executing the user's channel programs.

bytes 2-3
Reserved for future use.

UPRG hhhhhhhh
The UPRG field contains extent information and data used by the user's purge routines. This field is divided into the following two subfields:

byte 0
The number of extents that were specified in the DSCBs associated with this DEB.

bytes 1-3
The address of the first input/output block (IOB) in the user's purge chain.

PLST hhhhhhhh
Task priority and supervisor purge information are contained in this field. This field is formatted as follows:

byte 0
The priority of the task under which this DEB was enqueued.

bytes 1-3
The starting address of a parameter list that was used to locate the purge event control block (ECB) for a supervisor purge request.

DCB hhhhhhhh
The DCB field contains three data elements. These are displayed in the format given below:

byte 0
xxxx The storage protection key that was associated with the task under which this DEB was enqueued.
.... 1111 A hexadecimal "F" in bits 4 through 7 of this field identify this control block as a data extent block (DEB).

bytes 1-3
The starting address of the data control block (DCB) that was associated with this DEB.

AVT hhhhhhhh
The AVT field displays two DEB data elements and is subfielded as follows:

byte 0
The DEB extent scale that is used to determine the size of the device

dependent section of this DEB. For direct access devices, a 4 is displayed in this subfield. For a nondirect access device or a communication device, a 2 is displayed.

bytes 1-3
In most cases, the last portion of the AVT field shows the starting address of the appendage vector table preceding this DEB. This table of appendage routine addresses appears on the first line of this DEB's display.

OP-UCB hhhhhhhh
The contents of this field have meaning only when the DEB being displayed describes a data set that was assigned to a unit record or magnetic tape device. This information is formatted from the device dependent section of the DEB. The OP-UCB field is subfielded as follows:

byte 0
This first subfield is applicable only to data sets assigned to magnetic tape devices, and shows the SET MODE operation code. For a data set that was assigned to a unit record device, this subfield is reserved.

bytes 1-3
The starting address of the unit control block (UCB) associated with the data set described by the DEB being displayed.

The following four fields are present only for data sets assigned to the IBM 3525 Card Punch for multi-function. The information is formatted as shown below:

UCB hhhhhhhh
byte 0
The device modifier field (not used for the 3525).
bytes 1-3
The starting address of the unit control block (UCB) associated with the data set described by the DEB being displayed.

RDRDCB hhhhhhhh
The starting address of the data control block (DCB) for the read associated data set.

PCHDCB hhhhhhhh
The starting address of the data control block (DCB) for the punch associated data set.

WTRDCB hhhhhhhh

The starting address of the data control block (DCB) for the print associated data set.

The final portion of a DEB display shows information pertaining to a data set that was assigned to a direct access device. This information, taken from the DEB's device dependent section, is arranged in columnar format with a line for each extent. The information is formatted as shown below:

FM-UCB hhhhhhhh

The first column displays two data elements and is formatted as follows:

byte 0

The device modifier showing the file mask.

bytes 1-3

The starting address of the unit control block (UCB) that was associated with the data extent.

START hhhhhhhh

The address of the beginning of the direct access device extent. The first four characters represent the cylinder address and the last four characters represent the track address.

END hhhhhhhh

The address of the end of the data extent. Cylinder and track references are formatted as in the extent beginning address, described above.

TRKS hhhh

The number of direct access tracks bounded by the starting and ending addresses shown in the previous two columns.

MFT TASK INPUT/OUTPUT TABLE (TIOT)

FORMATTING: A task input/output table (TIOT) was constructed for each task in the dumped system by MFT job management routines. This table contained primary pointers to control blocks used by I/O support routines. As the functions of several TIOT fields were dependent upon the state of associated external storage devices, multiple definitions may apply. The TIOT that was constructed in the dumped MFT system is formatted as shown.

TIOT hhhhhh

The starting address of the task input/output table being displayed.

JOB cccccccc

The eight-character name of the job for which this TIOT was constructed.

STEP cccccccc

The eight-character name specified in the label field of the EXEC JCL statement associated with this job step.

PROC cccccccc

If the job step for which this TIOT was constructed was invoked from a cataloged procedure, the procedure name, as contained in the EXEC JCL statement, is displayed in this field.

Each data set associated with the indicated task is represented by a separate DD entry that is included in the TIOT. Each TIOT entry is displayed on a separate line in columnar format. The use and meaning of each column is given below:

OFFSET hhhh

The offset of this DD entry from the beginning of the TIOT in hexadecimal.

LN-STA hhhhhhhh

byte 0

The total length (including all device entries) in bytes of the DD entry being displayed on this line.

byte 1

Status byte A, one of three status bytes in a TIOT entry. The meanings of the status byte settings are:

| | |
|-----------|--|
| x... .x.. | Bits 0 and 5 indicate the tape label processing that was to have been performed. The meanings of the settings are: |
| 0... .0.. | Nonlabeled tape or an indication to bypass label processing. |
| 0... .1.. | Standard labels or standard user labels. |
| 1... .0.. | Nonstandard labels. |
| .1.. | The setting of status bit 1 has two meanings, depending upon the processing phase that had been reached at the time the system was dumped. During allocation processing, the setting of this bit indicates that this entry represents a split cylinder primary space allocation DD. If the dump was taken during step termination processing, the setting of this bit indicates that no unallocation of space was necessary. |

- ..1. The setting of status bit 2 works under the same philosophy as status bit 1. During allocation processing, the setting of this bit indicates that this entry represents a split cylinder secondary space allocation DD. If the dump was taken during step termination processing, the indication was one of rewinding with no unload.
- ...1 Bit 3 set indicates that this DD entry represents a JOBLIB.
- 1... Bit 4 set indicates that direct access device space management was deemed necessary.
-1. The setting of bit 6 specifies that the tape volume was to have been rewound and unloaded.
-1 The setting of bit 7 specifies that the tape volume was to have been rewound.

byte 2

The third byte of this column has meaning only during the allocation phase. This displays the number of devices that were requested by the data set represented by the TIOT entry displayed on this line.

byte 3

The last byte of the LN-STA field displays a TIOT field that had meaning at two points during the processing of this task. During the allocation process, this field contained a link to the appropriate prime split, unit affinity, volume affinity or suballocate TIOT entry. After CLOSE processing, this byte was used as follows:

- 1... The setting of bit 0 indicates that the data set represented by this DD entry was a SYSOUT data set that contained data.
- ..xxx xxxx Bits 1 through 7 are reserved for future use.

DDNAME ccccccc

The eight character DD name associated with the TIOT entry being displayed.

TTR-STC hhhhhhhh

The first three bytes of this column display the relative track address (TTR) of the job file control block (JFCB) associated with this entry.

STB-UCB hhhhhhhh

The last column in a TIOT display contains information taken from the one-word device entries that are appended to each TIOT entry. One TIOT device entry exists for each allocated device. This display field shows this information in the following format:

byte 0

Status byte B. The status bits have the following meanings:

- 1... ... Bit 0 set indicates that the data set associated with this line of the TIOT display was present on the device represented by this TIOT device entry.
- .1.. Bit 1 set indicates that the data set associated with this line of the TIOT display would have used the device represented by this TIOT device entry.
- ..1. Bit 2 set indicates that the device represented by this device entry violated separation.
- ...1 Bit 3 set indicates that a volume serial number was present.
- 1... Bit 4 set indicates that a setup message was required.
-x.. Bit 5 indicates the device disposition that would have taken place had the dumped system been allowed to continue processing this task. The settings for this bit are:
 -0.. Indicates that if the volume was required to be unloaded, the volume was to have been deleted.
 -1.. Indicates that if the volume was required to be unloaded, the unloaded volume was to have been retained.
-1. Bit 6 indicates that an unload requirement had been made.
-1 Bit 7 set indicates that a load or label verification requirement had been made.

bytes 1-3

The address of the UCB that was used in all cases except when the device was a 2321 data cell drive. For a 2321, this address is that of the description in the UCB of the cell in the bin.

TSO System Block Formatting

The TSO control blocks are divided into two groups: system and user. The control blocks are discussed in the order in which they appear when both groups are requested. Some control blocks are formatted and printed when either group is requested.

An example of a TSO system and user dump listing is shown in Figure 24.

TIME SHARING COMMUNICATIONS VECTOR TABLE

(TSCVT) FORMATTING: The time sharing communications vector table is a secondary CVT to meet the time sharing requirements. The time sharing CVT resides in the time sharing region; therefore, it exists only while the time sharing region is active. When time sharing does not exist in the system, the MVT CVT pointer to the TSCVT is zero.

TSCVT hhhhhh

The address of this time sharing communications vector table.

TJB hhhhhhhh

The address of the time-sharing job block (TJB) table. This table contains all of the TJBs allowed TSO users. The first TJB is for the terminal job identification (TJID) equal to zero.

RCB hhhhhhhh

The address of the region control block (RCB) table. It is an indexed table containing one RCB for each possible time sharing region; therefore, the table contains the maximum number of RCBs that may be used by time sharing. The first RCB is for region one.

RPT hhhhhhhh

The address of the reference point table (RPT). It is used by the terminal input output coordinator (TIOC).

FLG hhhh

These flags indicate functions requested from the time sharing control task (TSC).

byte 0

1... TSCSWPND: Bit 0 set indicates that a swap has ended.

.1.. TSCSWPBG: Bit 1 set indicates that a swap should be started.

..1. TSCLOGON: Bit 2 set indicates that a logon is required.

...1 TSCDISC: Bit 3 set indicates that a disconnect is required.

.... xxxx Bits 4 through 7 are reserved for future use.

byte 1

Reserved for future use.

FL1 hhhh

These flags indicate atypical functions required by the time sharing control task (TSC).

byte 0

1... TSCSSTOP: Bit 0 indicates that a system stop has been requested and the time sharing system is in the process of stopping.

.1.. TSCRSTOP: Bit 1 indicates that a region stop has been requested.

..1. TSCASTOP: Bit 2 is the ABEND-STOP flag. When set, it indicates to the time sharing control task (TSC) that time sharing should be stopped. This flag is set by (1) the TSO/RMS interface return when a machine check occurs in TCAM or (2) the TCAM STAE exit when TCAM abnormally terminates.

...x xxxx Bits 3 through 7 are reserved for future use.

byte 1

Reserved for future use.

SDC hhhhhhhh

The address of the first data control block (DCB) for swap data sets.

CUS hhhh

A count of the current TSO users logged onto the system. For additional users to be logged onto the system, this number must be less than the value in LUS.

```

MODULE IMDSADMP  DATE 11/12/70  TIME 00.12  PAGE 0004

TSCVT ODDA90  TJB 0G0EDCE8  RCB 000DDFB8  RPT 000D9D00  FLG 0000  FL1 0000  SDC 00000000
CUS 0C04  LUS 000A  NTJ 000A  SZU 0030  CTR 0001  MUS 000A
SAV 0G0DDDB20  ECB 000DD814  SIA 000DDC8C  ICB 000DDC34  IO1 000D38C4  TQE 00014674
IO2 000D3B50  IO3 000D3E46  D02 000D28C8  LCQ 00000000  TRB 00000000  LPA 00000000
SLF 0G0CDF10  TSC 0001ACD0  SPL 0001B4E8  RSZ 0028  RSV 0000  SVT 00000000
SVQ CCCC0000  ABN 000D1C20  D03 000DE880  FLM 000DF040  QTP 000DFD40  T08 000DEAD8
DMP 0C0DD998  T06 0001A5D8

RCB 0DDFB8  RCT 0001A7B8  ECB C0000001  DIECB 00000000  TJID 0004  RSIZE 0048  LSQSZ 0005
NMBR 01  PKEY EO  UMSMN 04  FLG 40  FLG2 20  FBQE 01
UTTMQ 0000  CUSE 0004  EXTNT 000A7F69  UMSM 000DDFA8  SDCB 000DE120  PQE 0001AC20
PRG 0E000000  PRG1 000A79D0  PRG2 000A7F1C  QPL 000A7F10  STECB 00000000  RCDVR 0B00FF00
CONID 00  RESV 000000

UMSM 0DDFA8  ADDR-LN CA580G60  ADDR-LN 0CB80020  ADDR-LN 00000000  ADDR-LN 000000C0

SWAP DCB 000000

CA5800  STORAGE KEY 0
0A5800 0 00000000 000A58C8 00CA7260 00000000 000A5800 00J02800 00CA5820 000A5820 *.....#
0A5820 0 00000000 00CAF000 00000000 00000000 0001A7B8 00028000 000A5800 00000000 *.....0.....#
0A5840 0 00000000 000C1468 00000000 00000000 00000000 00000000 00000000 *.....#
0A5860 0 00000000 00000000 00000000 00000000 00000000 00000000 00000000 *.....#
0A5880 0 TO NEXT LINE ADDRESS SAME AS ABOVE
0A6C20 0 0012CC02 00000000 00000000 00000000 00000000 000A7700 00000000 00000000 *.....8.....#
0A6C40 0 000CFA3 0000C28C 000A6D68 000A7700 4000A4B6 00000001 000DD018 00009D00 *.....B.....#
0A6C60 0 000A7788 0001C1C0 000D9DF4 00000000 A000A5F8 9000A60C 00000000 00000000 *.....A.....4.....8.....#
0A6C80 0 00000000 00000000 00000000 00000000 00000000 00000000 00000000 *.....#
0A6CA0 0 00000000 00000000 000A7478 00000098 000CD710 00000000 00124034 0000B834 *.....P.....#
0A6CC0 0 00040C00 00000000 00000000 00000000 00000000 00000000 00000000 *.....#
0A6CE0 0 00000000 00000000 00000000 00000000 00000000 00000000 00000000 *.....#

```

Figure 24. Sample of TSO Control Block Format (Part 1 of 3)

***** TSO USER CONTROL BLOCKS *****

***** USER KGN01 TJID=0001 *****

TJB 00DD18 TSB 000D9DF4 ATTN 00 STAX 01 STAT 00 STAT2 00 EXTNT 000A7F68
 RCB 000DCFB8 UMSM 000DDF08 SDCB 000DE120 UTTMQ 0002 RSTOR 48 UMSMN 04
 USER KGN01 IPPB 00000000 NEWID 00 FLUSL 00 TJID 0001 MONI 00
 RSV 0C0000

UMSM 0DDF08 ADDR-LN 0A580C38 ADDR-LN 0A980058 ADDR-LN 0CB00028 ADDR-LN 00000000

TSB 0D9DF4 STAT 81 TJB 0DCD18 FLG1 00 WTSB 000000 LNSZ 78 OTBFP 000000
 NOBF 00 CBFP 000000 BPKFL 00 ITBFP 000000 NITR 01 IBFP 0DA0F0
 CLEAR 00 QCB 0E1CC0 ECB 00000000 TJID 0001 STCC 0000 ATNLC 0016
 ATNTC 0000 LNNO 00 BLNK 00 ASRCE 0000 ATNCC 0003 AUTOS 00000000
 AUTOI 00000000 ERSDS 00000000

**** THE FOLLOWING TJBX, TAXE, PSCB, TCB'S AND STORAGE ARE FROM THE SWAPPED DATA SET ****

TJBX 0A7F68 XFST 000A7DAC XLAST 000A6D68 XDSE 000A7320 XSVRB 000A7700 XRQE 00000000 XIQE 00000000
 TAXE 000A6C80 XLECB 00000000 XPSWD RSV 00000000 XAIQE 00000000 XQPL 000A7F10
 XNQPE 000A XNTCB 0002 XLQPL 0054 HBFL 0000 XACT 00000000 XAECB 0001A534
 XKEYA 00CA7FB0

JJB KGN01 STEP KGN01 PROCSTEP STARTING

TCB 0A7DA0 RBP 000A7D18 FIE 00000000 DEB 00000000 TIO 000A7864 CMP 00000000 TRN 00000000
 MSS 030A79A0 PK-FLG E0000000 FLG 00018888 LLS 000A7EAO JLB 00000000 JPQ 000A7E80
 RG 0-7 00000001 FFF58C74 0001A534 0001A500 000A7510 000A7DA0 00000000 00000001
 RG 8-15 000A7370 FFFFFFF9 000A7564 000A6D68 600FEAB2 000A7534 400FE930 600062FA
 FSA 030000C0 TCB 000A6D68 TME 00000000 JST 000A7DA0 NTC 00000000 OTC 0001A788
 LTC 000A6D68 IQE 00000000 ECB 000DDFBC TSPR 8000B828 D-PQE 000A5810 SQS 000A6D40
 STA 200CC498 TCT 00CA73D8 USR 00000000 DAR 00001000 RES 00000000 JSCB 000A7E00

ACTIVE RBS

PRB 0A7D18 RESV 00000000 APSW 00000000 WC-SZ-STAB 00040083 FL-CDE 0001D580 PSW FF050001 500FEC8A
 Q/TTR 0C0C0000 WT-LNK 010A7DA0 NM IEFSD263 EPA 0FEAB0 STA 0FEAB0 LN 000550 ATRI B9

MAIN STORAGE

D-PQE 000A5810 FIRST 000A5820 LAST 000A5820

PQE 0A5820 FFB 0CCCC000 LFB 000AF000 NPQ 00000000 PPQ 00000000
 TCB 0001A788 RSI 00028000 RAD 000A5800 FLG 0000

Figure 24. Sample of TSO Control Block Format (Part 2 of 3)

DEB 0A74A4 APPENDAGES END OF EXT 01516E SIO 01516C PCI 0151DC CH END 0151A0 AB END 01516C
 PFX 00000000 C2C00C0B 00003FE2 11000000
 TCB 050A6D68 NDEB 01000000 ASYN 69000000 SPRG 00000000 UPRG 02000000 PLST B8000000 DCB EFOCCE64
 AVT 04015158
 FM-UCB START END TRKS
 50002AF0 0C61C000 0C920013 03E8
 50002AB0 009F0000 00C60013 0320

TIOT 0A6E28 JOB KGN01 STEP TMP PROC KGNP01

| OFFSET | LN-STA | DDNAME | TTR-STC | STB-UCB |
|--------|----------|----------|----------|----------|
| 0018 | 140401C0 | S\SPRINT | 00491600 | 80002570 |
| 002C | 14040140 | SYSCCMD | 00480A00 | 80002AF0 |
| 0040 | 140401C0 | | 00481000 | 80002AB0 |
| 0054 | 14040100 | SYSUDUMP | 00491800 | 80002530 |
| 0068 | 14040100 | SYSUT1 | 00481200 | 80002530 |
| 007C | 14040100 | SYSUT2 | 00480600 | 80002570 |
| 0090 | 14040100 | BSLOUT | 00491A00 | 800025F0 |
| 00A4 | 14040100 | SNAPTAPE | 004C1100 | 80002530 |
| 00B8 | 140C0010 | DD1 | 004B0800 | 00000000 |
| 00CC | 14000010 | DD2 | 004B0C00 | 00000000 |
| 00E0 | 14000010 | DD3 | 004B0E00 | 00000000 |
| 00F4 | 140C0010 | DD4 | 004E0100 | 00000000 |
| 0108 | 140C0010 | DD5 | 004E0300 | 00000000 |
| 011C | 140C0010 | DD6 | 004E0500 | 00000000 |
| 0130 | 140C0010 | DD7 | 004E0900 | 00000000 |
| 0144 | 140C0010 | DD8 | 004E0B00 | 00000000 |

PSCB 0A7B88 USER KGN01 USRL 05 GPNM SYSDA ATR1 E000 ATR2 0000 CPU 00018800
 SWP 004C33FD LTIM 008A0560 TCPU 00000000 TSWP 00000000 TCON 00000000 TCO1 00000000
 RLGB 00CA8700 UPT 000A86F0 UPTL 0010 PSV1 0000 RSV2 00000000 USE1 00000000
 USE2 00000000

TAXE 0A6CB0 TMFLD 00 PPSAV 0CD710 ABOPSW 00000000 WCSA 00 SIZE 12 STAB 4034
 EP 00008834 LCPSW 00040000 ROPSW 000003C2 USE 00 IQE 000000 WCF 00
 LINK 000000 GR0 00000000 GR1 00000000 GR2 00000000 GR3 00000000 GR4 00000000
 GR5 00000000 GR6 00000000 GR7 00000000 GR8 00000000 GR9 00000000 GR10 00000000
 GR11 00000000 GR12 00000000 GR13 00000000 GR14 00000000 GR15 00000000 NIQE 00000000
 LNK 000A6D14 PRM1 00000000 IRB 000A6CB0 TCB 000A6CB0 TLNK 000A6D68 XPSW 00000000
 EXIT 00000000 STAT 00000000 PARM 000A8BF8 TAIE 000CCF7C IRUF 00000000 USER 000CCDB4

IMDPRDMP Output Formatting: TSO -- TSCVT 111

Figure 24. Sample of TSO Control Block Format (Part 3 of 3)

LUS hhhh
The maximum number of TSO users that may be logged onto the system. For additional users to be logged onto the system, the value of LUS must be greater than the value in CUS. LUS cannot exceed the value in NTJ. LUS is set by the time sharing control task (TSC). This field is initially set to the same value as MUS; however, if TSO encounters I/O errors while swapping users in and out, the time sharing control task reduces this value to limit the number of TSO users.

NTJ hhhh
The number of time-sharing job blocks (TJBs) and terminal status blocks (TSBs) allocated when TSO was started. The dummy TJB for the terminal job identification (TJID) equal zero is not included. The value of LUS cannot exceed this number.

SZU hhhh
The number of bytes in the time sharing job block (TJB).

CTR hhhh
Contains the number of region control blocks (RCBs) allocated when TSO was started. This number cannot be increased after the TSO system is started.

MUS hhhh
The maximum number of users that may be logged onto a TSO system. This field is set by the START and MODIFY commands issued by the operator.

SAV hhhhhhhh
The beginning address of three 18-word save areas used by the time sharing control task (TSC), the time sharing interface program (TSIP), and the time sharing dispatcher.

ECB hhhhhhhh
The address of the table control block (TSECBTAB) which contains the event control blocks (ECBs) used to post the time sharing control task (TSC), the region control tasks (RCTs), and the terminal input output coordinator (TIOC).

SIA hhhhhhhh
The address of the time sharing interface area (TSIA).

ICB hhhhhhhh
The address of the time sharing interface control block (TSICB).

I01 hhhhhhhh
The address of the branch entry point IKJEAI01 in the time sharing interface program (TSIP).

TQE hhhhhhhh
The address of the timer queue element (TQE) used by TSO for time slicing.

I02 hhhhhhhh
The address of the entry point IKJEAI02 in the time sharing dispatcher.

I03 hhhhhhhh
The address of the entry point IKJEAI03 in the time sharing dispatcher.

D02 hhhhhhhh
The address of the entry point to the TSO driver routine (IKJEAD02), or the equivalent entry in a user written routine.

LCQ hhhhhhhh
The address of the first element in the logon communications queue.

TRB hhhhhhhh
The first address in the trace control block chain. This address is established and used by the statistics collection routine. It is set to zero by the time sharing control task (TSC).

LPA hhhhhhhh
The address of the first contents directory entry (CDE) in the time sharing link pack area.

SLF hhhhhhhh
The address of the system-initiated logoff routine.

TSC hhhhhhhh
The address of the task control block (TCB) for the time sharing control task (TSC).

SPL hhhhhhhh
The address of the start parameter list.

RSZ hhhh
The minimum number of 2K blocks for a region during logon.

RSV hhhh
Reserved for future use.

SVT hhhhhhhh
The contents of the SVC table entry used by the time sharing interface program (TSIP).

SVQ hhhhhhhh
The contents of the SVC table entry used by the TCAM/TIOC interface program.

ABN hhhhhhhh
The address of the out-of-main storage abnormal termination routine (IKJEAT07). The routine is resident in main storage.

D03 hhhhhhhh
The entry point address to the TSO driver MODIFY routine (IKJEAD03), or the equivalent entry point address in a user written routine.

FLM hhhhhhhh
The entry point address IKJEFILM for the system initiated logoff routine.

QTP hhhhhhhh
The entry point address IKJGGQT1 for the branch entry to the TCAM interface program (QTIP).

T08 hhhhhhhh
The entry point address to the TSO command routine (IJEAT08) for TSO dumps taken by the time sharing control task (TSC) TSO dumps.

DMP hhhhhhhh
The address of the TSO dump control block.

T06 hhhhhhhh
The TCB address of the TSO dump routine (IKJEAT06) for the time sharing control task (TSC) modify routine.

TIME SHARING REGION CONTROL BLOCK (RCB)

FORMATTING: A region control block (RCB) contains information that is unique to a time sharing region. There is one RCB for each time sharing region. The RCBs reside in the time sharing control tasks region, they are contiguous, and they are created during initialization of the time sharing controller.

RCB hhhhhh
The address of the RCB.

RCT hhhhhhhh
The address of the task control block (TCB) for this region control task (RCT). The TCB contains the address of the partition queue element (PQE) that defines the region.

ECB hhhhhhhh
The event control block (ECB) on which this region control block (RCB) waits. This ECB must be posted before this region control task (RCT) can perform one of its functions.

DIECB hhhhhhhh
The event control block (ECB) that is posted upon completion of this region control task (RCT). The time sharing control task (TSC) waits for this ECB to be posted.

TJID hhhh
The terminal job identification (TJID) for the time sharing job currently executing in this region.

RSIZE hhhh
The number of 2K blocks in this region. It is set by the time sharing control task (TSC) when the time sharing system is started.

LSQSZ hhhh
The number of 2K blocks in the local system queue space (LSQS) for this region. It is set by the time sharing control task (TSC) when the time sharing system is started.

NMBR hh
The identification number assigned to this region.

PKEY hh
The protect key (PKEY) for the time sharing job currently executing in this region.

UMSMN hh
The number of entries in the main storage map which describes the main storage image that was initialized during logon.

FLG hh
This field contains the first byte of the region control block (RCB) flags. The flags indicate various functions to be performed by the region control task (RCT) and time sharing control task (TSC). These flags are set by the time sharing interface program (TSIP), the time sharing control task (TSC), and the terminal input/output coordinator (TIOC). These flags are tested and reset by the region control task (RCT) and the time sharing control task (TSC).

1... RCBFQ0: Bit 0 is the quiesce flag. When set, this flag indicates that the current user of this region should be quiesced.

.1.. RCBFSO: Bit 1 is the swap out flag. When set, this flag indicates that the current user should be swapped out.

..1. RCBFSI: Bit 2 is the swap in flag. When set, this flag indicates that the current user of this region should be swapped in. The user's terminal job identification (TJID) is in the region control block (RCB).

...1 RCBFRS: Bit 3 is the restore flag. When set, this flag indicates that the user, whose terminal job identification (TJID) is in the region control block (RCB), should be restored by the region control task (RCT).

.... 1... RCBOCAB: Bit 4 set indicates that the out-of-main storage abnormal termination routine was invoked.

.... .x.. Bit 5 is reserved for future use.

.... ..1. RCBFAT: Bit 6 is the attention exit flag. When set, this flag indicates that an attention exit has been requested for one or more users.

.... ...1 RCBFND: Bit 7 is the END region control task (RCT) flag. When set, this flag indicates that the region control task (RCT) should terminate normally and return control to the time sharing control task (TSC).

FLG2 hh

This field contains the second byte of the region control block (RCB) flags. See FLG.

1... RCBFSE: Bit 0 is the swap end flag. When set, this flag indicates that the swap-in operation for the current user of this region is complete.

.1.. RCBSTOP: Bit 1 is the region stop flag. When set, this flag indicates that a request has been made to stop the region. Every user of this region will be logged off.

..1. RCBACTV: Bit 2 indicates the active status of the region control task (RCT).

The flag is set to one when the region control task is initialized; it is set to zero when the region control task is terminated.

...1 RCBSTR1: Bit 3 indicates that a region start has been requested, and the region control task should be attached.

.... 1... RCBSTR2: Bit 4 indicates that a region start has been requested, and a swap logon image should be created.

.... .xxx Bits 5 through 7 are reserved for future use.

FBQE hh

The number of free block queue elements (FBQEs) for this region.

UTTMQ hhhh

The relative track address (TT) of the map queue pointer. The map queue pointer describes the location of the region's initialized logon image on the swap data set.

CUSE hhhh

The number of users logged on to use this region. The time sharing control task (TSC) increments the count before disconnect (DISC) and decrements the count during logon.

EXTNT hhhhhhhh

The address of the initialized time sharing job block extension (TJBX). The TJBX is created during the logon initialization for this region.

UMSM hhhhhhhh

The address of the user main storage map. This map describes the initialized logon main storage image for this region.

SDCB hhhhhhhh

The address of the swap data set control block (SDCB). This block points to the location of the initialized logon image on the swap data set for this region.

PQE hhhhhhhh

The address of the partition queue element (PQE) pointer in the system queue space (SQS). The PQE describes the main storage space assigned to this region. The PQE pointer is used to manipulate main storage when (1) this region control task's (RCT's) region is obtained during start time sharing initialization and (2) this region control task's (RCT's) region

is freed during region control task termination.

PRG hhhhhhhh
PRG1 hhhhhhhh
PRG2 hhhhhhhh

These three words constitute the SVC I/O purge parameter list. For further information, see the "Purge Macro Instruction" in the publication IBM System/360: System Programmer's Guide, GC28-6550.

QPL hhhhhhhh

The address of the quiesce I/O parameter list.

STECB hhhhhhhh

An event control block (ECB). During a subsystem recovery, the time sharing control task (TSC) waits for this ECB to be posted by the region control task (RCT). The posting is done during end processing.

RCOVR hhhhhhhh

These bits indicate the current recovery status of the region control task (RCT) in the event of a subsystem failure.

byte 0

1... RCBRCOVR: Bit 0 set indicates that the status bits in the following 3 bytes are valid.

.xxx xx.. Reserved for future use.

.... ..x. RCBWTOR: WTOR restore processing complete.

.... ..x RCBTACMP: Transient area restore processing complete.

byte 1 -- RCBRSFLG

1... RCBRSTRT: Bit 0 set indicates a restore.

.1.. RCBTCBDN: Bit 1 set indicates that the task control blocks (TCBs) have been requeued.

..1. RCBQELCM: Bit 2 set indicates that the queue element (QEL) restore processing is complete.

...1 RCBTQECM: Bit 3 set indicates that the timer queue element (TQE) restore processing is complete.

.... 1... RCBRQIQC: Bit 4 set indicates that both the request queue element (RQE) and the interrupt queue element (IQE) restore processing is complete.

.... .1.. RCBIORSC: Bit 5 set indicates that the I/O restore processing is complete.

.... ..xx Bits 6 and 7 are reserved for future use.

byte 2 -- RCBQUFLG

1... RCBQUSTR: Bit 0 set indicates that quiesce has started.

.1.. RCBIOSTR: Bit 1 set indicates that the first entry into the I/O purge routine is complete.

..1. RCBTADON: Bit 2 set indicates that the transient area quiesce is complete.

...1 RCBWTORD: Bit 3 set indicates that the write to operator with reply (WTOR) quiesce is complete.

.... 1... RCBQELDN: Bit 4 set indicates that the queue element (QEL) quiesce is complete.

.... .1.. RCBIODON: Bit 5 set indicates that the second entry I/O purge is complete.

.... ..1. RCBTQEDN: Bit 6 set indicates that the timer queue element (TQE) quiesce is complete.

.... ...1 RCBRQIQD: Bit 7 set indicates that both the request queue element (RQE) and the interrupt queue element (IQE) are complete.

byte 3

1... RCBSWTCH: Bit 0 indicates the method of search used by various subroutines in IKJEAT07. When equal to zero, all system users are purged according to the terminal job identification (TJID). When equal to one, all users in this region are purged as indicated by the region control block addresses.

.1.. RCBSWTON: When bit 1 is set along with bit 0 being set, all system users are purged. A search is made according to the terminal job identification (TJID) and the request control block (RCB).

..xx xxxx Bits 2 through 7 are reserved for future use.

CONID hh

The routing code of the console that issued the last START, MODIFY, or STOP command.

RESV hhhhhh

Reserved for future use.

3 MAIN STORAGE MAP (UMSM) FORMATTING:

UMSM is used in the swap operation. One user main storage map exists for each possible time sharing user. The UMSM contains a series of consecutive one-word extent fields (ADDR-LN). Each one-word extent contains a halfword address field (ADDR) and a halfword length field (LN) that describe the main storage space allocated to the time sharing user. The number of UMSM extents has established defaults that can be modified by the operator when he starts the time sharing system. The number of extent entries is stored in the time sharing job block (TJB) at TJBUMSMN. Unused extent fields contain zeros.

UMSM hhhhhh

The address of the user main storage map.

ADDR-LN hhhhhhhh

bytes 0 and 1

Begin Address: This field contains the two high order bytes of the beginning address of the main storage segment allocated to the time sharing user. Since main storage is allocated in 2K blocks, the low order byte is always zero and, therefore, need not be kept in a control block.

bytes 2 and 3

This field contains the two high-order bytes designating the length of the main storage space allocated to the time sharing user. Since main storage is allocated in 2K blocks, the low-order byte is always zero and, therefore, need not be kept in a control block.

SWAP DATA CONTROL BLOCK (SWAP DCB)

FORMATTING: The swap data control block (SWAP DCB) is used whenever a time sharing user's region is swapped into or out of main storage. Each region control task (RCT) has one swap data control block. Following the address of the swap data control block is the contents of the main storage data that was written on the swap data set.

SWAP DCB hhhhhhhh

The address of the swap data control block.

TIME SHARING JOB BLOCK (TJB) FORMATTING:

The time sharing job block (TJB) contains status information about the time sharing user. The TJB is retained in main storage while the user is swapped out. One time sharing job block exists for each possible simultaneous time sharing user. The space for the TJB is obtained from the time sharing control task (TSC) region during time sharing initialization. Status information about terminals related to this TJB is contained in the terminal status block (TSB). The address of the terminal status block is the first word of the TJB.

TJB hhhhhh

The address of this TJB.

TSB hhhhhhhh

The address of the terminal status block (TSB) that owns this terminal job. If zero, this job was started by an operator command.

ATTN hh

A count of the unprocessed attention interrupts for this job.

STAX hh

The number of scheduled specify terminal attention exits (STAXs).

STAT hh

This field contains flags that indicate the status of the time sharing job.

1... TJB NJB: Bit 0 set indicates that this TJB is currently unused.

.1.. TJB INCOR: Bit 1 set indicates that this user is currently in main storage.

..1. TJB LOGON: Bit 2 set indicates that the logon start has been set by the terminal input output coordinator (TIOC) during a dialup to request a logon. This bit is reset by the time sharing control task (TSC).

...1 TJB IWAIT: Bit 3 set indicates that the terminal job is in an input wait state.

.... 1... TJB OWAIT: Bit 4 set indicates that the terminal job is in an output wait state.

.... .1.. TJBSILF: Bit 5 set indicates that the user is to be logged off the system. This bit is set by the IKJSILF subroutine and tested by the region control task (RCT) restore routine that posts the logon ECB. This bit is tested and reset by the logon/logoff routine.

.... ..1. TJBDISC: Bit 6 set indicates that a request has been made to the terminal input output coordinator (TIOC) to disconnect the line.

.... ...x Bit 7 is reserved for future use.

STAT2 hh

These flags indicate the status of the time sharing job.

1... TJBHUNG: Bit 0 set indicates that the user's communication line disconnected.

.1.. TJBHOLD: Bit 1 set indicates that an output wait (OWAIT) exists because of a hold option.

..1. TJBOCAB: Bit 2 set indicates an out-of-main storage abnormal termination has occurred for this user.

...1 TJBRNAV: Bit 3 set indicates that the user cannot be logged onto the time sharing system because (1) a machine check occurred in the user's region or (2) the region is too small for the user.

.... 1... TJBSURSV: Bit 4 set indicates that on the next swap in the swap unit is not marked as available for the user.

.... .xxx Bits 5 through 7 are reserved for future use.

EXTNT hhhhhhhh

The address of the terminal job block extension (TJBX) when it is in main storage.

RCB hhhhhhhh

The address of the region control block (RCB) for this job.

UMSM hhhhhhhh

The address of the user main storage map (UMSM) for this job.

SDCB hhhhhhhh

The address of the swap data control block (DCB) for this job.

UTTMQ hhhh

1... TJBUTTMP: Bit 0 of byte 0 set indicates a parallel swap.

.111 1111 Bits 1 through 7 of byte 0 along with byte 1 contain the offset into the map queue. The map queue contains a chain of allocation units for this user on the swap data set. The address of the queue is in the UTTMQ field of the TSO region control block (RCB).

RSTOR hh

This field contains the status flags used by the region control task (RCT) restore operation.

1... TJBOWP: Bit 0 set indicates to the terminal input output coordinator (TIOC) to end the output wait (OWAIT) condition.

.1.. TJBIWP: Bit 1 set indicates to the terminal input output coordinator (TIOC) to end the input wait (IWAIT) condition.

..x. Bit 2 is reserved for future use.

...1 TJBLOGP: Bit 3 set indicates that the event control block (ECB) waited for by the logon image should be posted. This flag is set by the time sharing control task (TSC) logon routine and by the IKJSILF subroutine.

.... 1... TJBLWAIT: Bit 4 set indicates that if the user is not made ready by restore processing, he should be swapped out again.

.... .x.. Bit 5 is reserved for future use.

.... ..1. TJB FAT: Bit 6 set indicates that an attention exit is requested for this user's job.

.... ..x Bit 7 is reserved for future use.

UMSMN hh
The number of entries in the user main storage map (UMSM).

USER ccccccc
The userid of the user who owns this job. This field may have trailing blanks when the user identification contains less than eight characters.

IPPB hhhhhhhh
An address pointer to the beginning of a chain of inter-partition post blocks that indicate the event control blocks (ECBs) to be posted by the restore operation.

NEWID hh
Identifies the region where the user should be logged on. When this field is zero, the TSO driver should select the region. When this field is set by the end-of-routine for logon/logoff, it identifies the new region to which the user will be shifted.

FLUSL hh
Reserved for future use.

TJID hhhh
This field contains the terminal job identification (TJID) for this time sharing job.

MONI hh
These flags indicate various processing functions that cause operator messages to be sent to this terminal. The flags are set and reset when the terminal user issues the MONITOR subcommand of the OPERATOR command.

1... .. TJBMSN: Bit 0 set indicates that the first non-temporary data set allocated to a new volume should be displayed as part of the mount and keep messages.

.1... .. TJBMBN: Bit 1 set indicates that the name of each job is to be displayed on the console when each job is initiated and terminated, and that the unit record allocations are to be displayed when a job step is initiated.

..1. TJBMSSES: Bit 2 set indicates that, when a terminal session is initiated or terminated a message is displayed on the operator console.

...1 TJBMSPA: Bit 3 set indicates that the available space on a direct access device is to be displayed on the operator console as part of the demount message.

.... 1... TJBMSSTA: Bit 4 set indicates that, at the end of a job or job step, certain data set disposition information should be printed with the demount messages. These dispositions are: KEEP, CATLG, or UNCATLG.

.... .xxx Bits 5 through 7 are reserved for future use.

RSV hhhhhh
Reserved for future use.

TERMINAL STATUS BLOCK (TSB) FORMATTING:
Each terminal status block (TSB) contains status information about one terminal user. The terminal input output coordinator (TIOC) uses this information. During system initialization, one TSB is created for each possible user. The main storage space is obtained in one contiguous block for all of the TSBs in the region of the time sharing control task (TSC); this contiguous string of TSBs is called the TSB table. The origin pointer to the TSB table is the TIOCTSB field in the TIOCRPT.

TSB hhhhhh
The address of this terminal status block (TSB).

STAT hh
This field contains the terminal status indicator flags.

1... .. TSBINUSE: Bit 0 set indicates that this TSB is being used.

.1... .. TSBLWAIT: Bit 1 set indicates that the terminal keyboard is locked due to a lack of input buffer space.

..1. TSBDSPLY: Bit 2 set indicates that this TSB represents a terminal which is a graphic device.

....1 TSBNOBUF: Bit 3 set indicates that TPUT found no time sharing buffers.

.... 1... TSBITOFF: Bit 4 set indicates that this user wishes to prevent inter-terminal communications.

.... .1.. TSBDISC: Bit 5 set indicates that this TSB has been processed by logoff.

.... ..x. Bit 6 is reserved for future use.

.... ...1 TSBATNLD: Bit 7 set indicates an attention for an input line deletion.

TJB hhhhhh
 The address of the time sharing job block (TJB) currently used by this terminal. This field contains zeros when this terminal is not associated with a time sharing job block.

FLG1 hh
 This field contains terminal status flags.

1... TSBANSR: Bit 0 set indicates that an attention simulation is requested.

.1.. TSBFLSH: Bit 1 set indicates that the output trailer queue is to be flushed. This bit is set by TCLEARQ.

..1. TSBOWIP: Bit 2 set indicates that a TPUT operation is in progress.

...1 TSBWOWIP: Bit 3 set indicates that a task is waiting for another task to complete a TPUT operation.

.... 1... TSBIFLSH: Bit 4 set indicates that an input queue flush is in progress.

.... .1.. TSBTJOW: Bit 5 set indicates that this user is already using the maximum number of output buffers that can be allocated. This TSB waits on event control block (ECB) for this TCB. This bit is set by a TPUT macro instruction with a terminal job identification (TJID).

.... ..x. Bit 6 is reserved for future use.

.... ...1 TSBTJBF: Bit 7 set indicates that no time sharing buffers were available when the SVC for TPUT with the terminal job identification (TJID) was issued. The system waits for the TJB event control block (ECB) to be posted.

WTSB hhhhhh
 Reserved for future use.

LNSZ hh
 The number of characters that can be printed on one line for this terminal. This field is set by either logon or STSIZE.

OTBFP hhhhhh
 The address of the trailer buffer if the heading buffer for a message has been removed from the message queue. This field is reset to zeros when the message has been completely moved to the TCAM buffers.

NOBF hh
 The number of buffers on the output queue.

OBFP hhhhhh
 The address of the first buffer on the output buffer queue.

BRKFL hh
 These flags indicate the status of the communication line.

1... TSBBIPI: Bit 0 set indicates to the TSINPUT that a partial line exists for prompting. Set by TSOUTPUT.

.1.. TSBAUTON: Bit 1 set indicates that automatic input line numbering is requested.

..1. TSBBRKIN: Bit 2 set indicates that TPUT is using the breakin option and a partial line was assigned to this function. This bit is set by TSINPUT. TSINPUT is a TCAM subtask.

...1 TSBALST: Bit 3 set indicates that automatic line numbering has started.

.... 1... TSBAUTOC: Bit 4 set indicates that automatic character prompting is used.

.... .1.. TBSTAUT: Bit 5 set indicates that the user is being prompted with the next line number.

.... ..11 TSBSATN1: Bits 6 and 7 contain a count of the number of characters used to simulate attention.

ITBFP hhhhhh
The address of the first buffer in the trailer input buffer chain.

NIBF
The number of buffers on the input queue.

IBFP hhhhhh
The address of the first buffer in the input buffer queue chain.

CLEAR hh
This field contains terminal status flags.

1... TSBATTN: Bit 0 set indicates that an attention from this terminal has been ignored.

.1.. TSBTJMSG: Bit 1 set indicates that TSOUTPUT is processing a terminal job identification (TJID) message.

..1. TSBSPIT: Bit 2 set indicates that breakin prompt and automatic prompt are suppressed.

...1 TSBNBKSP: Bit 3 set indicates that the next character in the user's buffer is a backspace character.

.... xxxx Bits 4 through 7 are reserved for future use.

QCB hhhhhh
The address of the queue control block (QCB) that contains the destination for the message being sent.

ECB hhhhhhhh
The event control block (ECB) at which the inter-terminal communication (TPUT with TJID) waits (1) when there are no time sharing buffers, (2) when the TSBOWIP bit is set, or (3) when the TSBOQHL D bit is set.

TJID hhhh
The terminal job identification (TJID) of the task waiting on this TCB's event control block (ECB).

STCC hhhh
These two bytes define special purpose characters that may be redefined by the terminal user.

byte 0
TSBLNDCC: This byte contains the line delete character.

byte 1
TSBKSPCC: This byte contains the character delete character.

ATNLC hhhh
The number of successive lines of printed output between attention simulation reads.

ATNTC hhhh
The number of seconds between attention simulation reads.

LNNO hh
When a graphic terminal device is used, this is the number of line that can be displayed.

BLNK hh
Reserved for future use.

ASRCE hhhh
This field contains the same information as the PRFSRCE field in the TCAM buffer prefix.

ATNCC cccc
This field contains from one to four characters that are used to simulate attention. Some of the character positions may contain blanks.

AUTOS hhhhhhhh
This field initially contains the starting line number for the first input line. While the line of input information is being received from the terminal user, this field is updated to contain the value of the current line number.

AUTOI hhhhhhhh
This field contains the value that is used to automatically increment the value of the input line numbers. This field can be modified by the terminal user.

ERSDS cccc
When a graphic terminal device is used, this word contains the characters used to erase the display screen.

TIME SHARING JOB BLOCK EXTENSION (TJBX) FORMATTING: The time sharing job block extension (TJBX) contains user job information that can be rolled out to the swap data set with the user's job. The

TJBX resides in the local system queue space (ISQS) for the region. The TJBX location is pointed to by the third word of the time sharing job block (TJB). The space for the TJBX is obtained by the region control task (RCT) during initialization.

TJBX hhhhhh
The address of the TJBX.

XFST hhhhhhhh
The address of the logon TCB. The logon TCB is the first TCB on the user's ready queue.

XLAST hhhhhhhh
The address of the last TCB on the user's ready queue.

XDSE hhhhhhhh
The address of the data set extension (DSE) used by TSO dynamic allocation.

XSVRB hhhhhhhh
The address of the first supervisor request block (SVRB) purged from the transient area queue.

XRQE hhhhhhhh
The address of the first request queue element (RQE) purged from the asynchronous exit queue.

XIQE hhhhhhhh
The address of the first interrupt queue element (IQE) purged from the asynchronous exit queue.

TAXE hhhhhhhh
The address of the queue of terminal attention exit elements (TAXEs) used to schedule the attention exits.

XLECB hhhhhhhh
The logon event control block (ECB) that was posted by the region control task (RCT) to activate logon/logoff.

XPSWD ccccccc
The password entered by the terminal user during logon. If the password contains less than eight characters, the field is padded to the right with blanks. The entire field contains blanks when the user is not required to enter a password.

XATTR hhhhhhhh
The address of the chain of attribute control blocks (ATRCBs).

XAIQE hhhhhhhh
The address of the attention interrupt queue element (IQE) currently being processed by the attention prologue.

XQPL hhhhhhhh
The address of the quiesce parameter list (QPL).

XNQPE hhhh
The number of entries in the quiesce parameter list (QPL).

XNTCB hhhh
The number of task control blocks (TCBs) active in the user's job step. When the value in XNTCB exceeds XNQPE, the quiesce parameter list is enlarged.

XLQPL hhhh
The number of bytes in the quiesce parameter list.

RSV hhhh
Reserved for future use.

XACT hhhhhhhh
The relative track and record address (TTR) for the account control table (ACT) on SYSJOBQE.

XAECB hhhhhhhh
This field contains either: (1) The address of the logon/logoff event control block (ECB) when logon processing begins. (2) The address of the command scheduling block (CSCB's) cancel event control block (ECB) after the CSCB is created.

XKEYA hhhhhhhh
The address of the storage key save area.

PROTECTED STEP CONTROL BLOCK (PSCB): The protected step control block (PSCB) contains accounting information related to a single user. All timing information is in software timer units. A software timer unit is equal to 26.04166 microseconds.

PSCB hhhhhh
The address of this PSCB.

USER ccccccc
These seven bytes contain the userid entered by the terminal user during logon. If necessary, it is padded to the right with blanks. This field uniquely identifies each terminal user in the time sharing system.

USRL hh
The number of nonblank characters in the userid.

GPNM ccccccc
An eight-byte group name initialized by logon from the user attribute data set (UADS). When a name is not available from UADS, the unit name used by the dynamic allocation

interface routine (DAIR) is used, if a name is required.

ATR1 hhhh
Sixteen bits used to define terminal user attributes.

byte 0

- 1... PSCBCTRL: Bit 0 set indicates that the user may use the OPERATOR command.
- .1.. PSCBACCT: Bit 1 set indicates that the user may use the ACCOUNT command.
- ..1. PSCBJCL: Bit 2 set indicates that the user may use the SUBMIT, STATUS, CANCEL, and OUTPUT commands.
- ...x xxxx Bits 3 through 7 are reserved for future use.

byte 1
Reserved for future use.

ATR2 hhhh

bytes 0 and 1
Reserved for use by IBM customers.

CPU hhhhhhhh
The cumulative CPU time used by this terminal user during this session. The CPU field is set to zero during logon.

SWP hhhhhhhh
The cumulative time that this terminal user has been resident in the region. The SWP field is set to zero during logon.

LTIM hhhhhhhh
The actual time of day that this user logged on to the time sharing system for this session.

TCPU hhhhhhhh
The total CPU time used by this terminal user, excluding the current session.

TSWP hhhhhhhh
The total time that the terminal user has been resident in the region during this accounting period, excluding the current session.

TCON hhhhhhhh

TCO1 hhhhhhhh
TCON and TCO1 are a single eight byte field. This field contains the total connect time for this terminal user during this accounting period, excluding the current session.

RLGB hhhhhhhh
The address of the re-logon buffer block used by logon as a pointer to the re-logon command buffer.

UPT hhhhhhhh
The address of the user profile table (UPT).

UPTL hhhh
The number of bytes in the user profile table.

RSV1 hhhh
RSV2 hhhhhhhh
RSV1 and RSV2 are a single six byte field that is reserved for future use.

USE1 hhhhhhhh
USE2 hhhhhhhh
USE1 and USE2 are a single eight byte field reserved for use by IBM customers.

TERMINAL ATTENTION EXIT ELEMENT (TAXE) FORMATTING: The TSO terminal attention exit element (TAXE) consists of a regular 24 word interrupt request block (IRB) plus a TSO addendum. It is used to schedule an attention exit resulting from a terminal attention interruption. It is created, queued, and dequeued by the specify terminal attention exit (STAX) macro instruction. The main storage space for the TAXE is obtained in the local system queue space (LSQS) of the terminal user's region.

TAXE hhhhhh
The address of this TAXE when it is in main storage.

TMFLD hh
This field contains indicators for the time routines.

- 1... Bit 0 set indicates that the timer element was not queued.
- .1.. Bit 1 set indicates that the local time-of-day option is used.
- ..00 Bits 2 and 3 set to zero-zero indicate that the time interval was requested in timer units (26.04166 microseconds).
- ..01 Bits 2 and 3 set to zero-one indicate that the time interval was requested in binary units.
- ..10 Reserved for future use.

..11 Bit 2 and 3 set to one-one indicate that the time interval was requested in decimal digits.
 1... Bit 4 set indicates that the time interval has expired.
000 Bits 5 through 7 set to zero-zero-zero indicate an STIMER task time request.
001 Bits 5 through 7 set to zero-zero-one indicate an STIMER wait request.
011 Bits 5 through 7 set to zero-one-one indicate an STIMER REAL time request.
100 Bits 5 through 7 set to one-zero-zero indicate an STIMER task time request with a specified exit.
111 Bits 5 through 7 set to one-one-one indicate an STIMER REAL time request with a specified exit.
 Other combinations of bits 5 through 7 are reserved for future use.

PPSAV hhhhhh
 The starting address of the register save area for the problem program.

ABOPSW hhhhhhhh
 This field displays the right half (bytes 4 through 7) of the program status word (PSW) that was active in the dump system during the execution of an ABEND or ABTERM routine. If these routines have not been invoked, then this field contains zeros.

WCSA hh
 The number of requests waiting when termination occurred.

SIZE hh
 The number of doublewords in this request block.

STAB hhhh
 This field contains two bytes of status and attribute information.

byte 0
 The TAXE is a type of interrupt request block (IRB). Byte zero identifies the type of request block; however, for the TAXE, only the IRB identification is used.
 01.. Bits 0 and 1 set to zero-one indicate that this is an interrupt request block (IRB).

byte 1
 This byte contains various request block indicators.

1... Bit 0 set indicates that the RBLINK field points to the task control block (TCB).
 .1.. Bit 1 set indicates that the program related to the interrupt request block (IRB) is active.
 ..1. Bit 2 set indicates that this interrupt request block (IRB) is for an exit routine (ETXR).
 ...x Bit 3 is reserved for future use.
 00.. Bits 4 and 5 set to zero-zero indicate that the request queue element (IQE) is not to be returned.
 01.. Bits 4 and 5 set to zero-one indicate that the interrupt request block (IRB) has queue elements for asynchronously executed routines that are request queue elements (RQEs).
 10.. Bits 4 and 5 set to one-zero indicate that an interrupt queue element (IQE) is not to be returned at EXIT.
 11.. Bits 4 and 5 set to one-one indicate that the interrupt request block (IRB) has queue elements for asynchronously executed routines that are interrupt queue elements (IQEs).
1. Bit 6 set indicates that the request block storage can be freed at exit.
0 Bit 7 set to zero indicates a wait for a single event or all of a number of events.
1 Bit 7 set to one indicates a wait for a number of events that is less than the total number of events that are waiting.

EP hhhhhhhh
 The address of the routine that was asynchronously executed.

LOPSW hhhhhhhh (Left half of PSW)
 ROPSW hhhhhhhh (Right half of PSW)
 This program status word (PSW) contains the status of the program represented by the request block being displayed when a new request block was created. Had the dumped system been allowed to continue processing normally, the operation would have been resumed with this PSW.

USE hh
 This field contains the use count as used by ATTACH.

IQE hhhhhh
 The address of the list origin for the interrupt queue element (IQE).

WCF hh
 The number of requests that were pending when this dump was taken.

LINK hhhhhh
 The address of the next request block (RB) on this RB queue. If this is the last request block on the queue, then this field contains the address of the task control block (TCB).

GRO hhhhhhhh

.
 .
 .

GR15 hhhhhhhh
 The general register save area used by the supervisor.

NIQE hhhhhhhh
 The address of the next available interrupt queue element (IQE).

LNK hhhhhhhh
 The address of the next interrupt queue element (IQE).

PRM1 hhhhhhhh
 The address of the parameter list for the asynchronous exit routine.

IRB hhhhhhhh
 The address of the interrupt request block (IRB) to be scheduled next.

TCB hhhhhhhh
 The address of the task control block (TCB) for this TAXE.

TLNK hhhhhhhh
 The address of the next TAXE on this queue.

XPSW hhhhhhhh
 The left half (bytes 0 through 3) of the program status word (PSW) for the user attention exit routine.

EXIT hhhhhhhh
 The address of the user attention exit routine.

STAT hhhhhhhh
 This field contains status flags for this TAXE.

byte 0

1... TAXEFKEY: Bit 0 set indicates that the task issuing the specify terminal attention exit (STAX) macro instruction is a problem program.

.1.. TAXEMOD: Bit 1 set indicates that the task issuing the specify terminal attention exit (STAX) macro instruction is in problem program mode.

..1. TAXEFFREQ: Bit 2 set indicates that the requested TAXE is not available for scheduling.

...x xxxx Bits 3 through 7 are reserved for future use.

bytes 1-3

Reserved for future use.

PARM hhhhhhhh
 The address of the parameter list for the specify terminal attention exit (STAX) macro instruction.

TAIE hhhhhhhh
 The address of the terminal attention interrupt element.

IBUF hhhhhhhh
 The address of the user input buffer.

USER hhhhhhhh
 The address of the user parameter list from the specify terminal attention exit (STAX) macro instruction.

Task Control Block Summaries

If, during the course of program execution, the IMDPRDMP program formatted the major system control blocks of more than one MVT or MFT task, a summary of each displayed task's TCB is presented at the end of the control block portion of the dump listing. Depending upon the operating system option under which the dumped task was operating, either the MVT/MFT-with-subtasking TCB summary format (Figure 25), or the abridged MFT-without-subtasking TCB summary format (Figure 26) is presented.

Both summary formats are identified by two lines of heading information. The

first heading line displays the optional dump listing title, the name of the module that invoked the dump, and the date and time that the information was captured from the dumped system. The second line of heading displays the identifying phrase "**** TCB SUMMARY ****."

The individual TCB summaries contain the following information:

MVT or MFT with Subtasking TCBs: Are summarized in the two-line array illustrated in Figure PROUT-9 and described below:

JOB ccccccc
The JOB field in the first line of each task control block array displays to the user the eight-character name of the job associated with the TCB.

STEP ccccccc
The STEP field shows the eight-character name of the job step as it appeared on the label field of the EXEC JCL statement associated with the step.

TCB hhhhhh
The starting address of the task control block.

CMP hhhhhhhh
This field shows the ABEND indicators and user and system completion codes associated with this TCB. (See the relevant TCB discussion for the contents of this field.)

NTC hhhhhhhh
This word contains the address of the TCB that occurred previous to this one on the originating task's subtask queue. If the TCB being summarized was the first on the queue, this field displays zeros.

OTC hhhhhhhh
The OTC field displays the address of the TCB representing the originating task.

LTC hhhhhhhh
This field contains the address of the TCB that occurred last on the originating task's subtask queue at the time the dump was taken. If the TCB being summarized was the last on the subtask queue, this field contains zeros.

PAGE ddd
The page of the dump listing on which the formatted control blocks associated with this TCB, may be found.

MFT Without Subtasking TCBs: Are summarized in the two line abridged array illustrated in Figure PROUT-10 and described below:

JOB ccccccc
The JOB field in the first line of each task control block array, displays to the user the eight-character name of the job associated with the TCB being summarized.

STEP ccccccc
The STEP field shows the eight-character name of the job step as it appeared in the label field of the EXEC JCL statement associated with the step.

TCB hhhhhh
The starting address of the task control block being summarized is given in the first field of this second line.

CMP hhhhhhhh
This field shows the ABEND indicators and user and system completion codes associated with the TCB. (See the MFT TCB discussion for a description of the contents of this field.)

PAGE ddd
The page of the dump listing on which the formatted control blocks associated with this TCB, are found.

```

                                MODULE IMDSADMP  DATE 11/12/70  TIME 00.15      PAGE 0032
                                * * * *  T C B  S U M M A R Y  * * * *

JOB      STEP
TCB 0085E8  CMP 00000000  NTC 00000000  DTC 00009CA0  LTC 00000000  PAGE 0004

JOB      STEP
TCB 008728  CMP 00000000  NTC 00000000  DTC 00009CA0  LTC 00000000  PAGE 0005

JOB      STEP
TCB 008868  CMP 00000000  NTC 00000000  DTC 00009CA0  LTC 00000000  PAGE 0006

JOB      STEP
TCB 0089A8  CMP 00000000  NTC 00000000  DTC 00009CA0  LTC 00000000  PAGE 0007

JOB      STEP
TCB 008AE8  CMP 00000000  NTC 00000000  DTC 00009CA0  LTC 00000000  PAGE 0008

JOB      STEP
TCB 008C28  CMP 00000000  NTC 00000000  DTC 00009CA0  LTC 00000000  PAGE 0009

JOB      STEP
TCB 008D68  CMP 00000000  NTC 00000000  DTC 00009CA0  LTC 00000000  PAGE 0010

JOB      STEP
TCB 008EA8  CMP 00000000  NTC 00000000  DTC 00009CA0  LTC 00000000  PAGE 0011

JOB      STEP
TCB 008FE8  CMP 00000000  NTC 00000000  DTC 00009CA0  LTC 00000000  PAGE 0012

```

```

                                MODULE IMDSADMP  DATE 11/12/70  TIME 00.15      PAGE 0033
                                * * * *  T C B  S U M M A R Y  * * * *

JOB  MASTER  STEP SCHEDULR
TCB 009CA0  CMP 00000000  NTC 00000000  DTC 00000000  LTC 0002E268  PAGE 0022

JOB  MASTER  STEP SCHEDULR
TCB 0288C8  CMP 00000000  NTC 00009BA8  DTC 00009CA0  LTC 00000000  PAGE 0025

JOB  JOB4    STEP GO
TCB 02E0F8  CMP 00000000  NTC 000288C8  DTC 00009CA0  LTC 0002D1E8  PAGE 0027
TCB 02D1E8  CMP 00000000  NTC 00000000  DTC 0002E0F8  LTC 0002D400  PAGE 0028
TCB 02D400  CMP 00000000  NTC 00000000  DTC 0002D1E8  LTC 00000000  PAGE 0029

JOB  WTR     STEP CCE
TCB 02E268  CMP 00000000  NTC 0002E0F8  DTC 00009CA0  LTC 0002D108  PAGE 0030
TCB 02D108  CMP 00000000  NTC 00000000  DTC 0002E268  LTC 00000000  PAGE 0031

```

Figure 25. TSB Summary Sample for System That Operated Under MVT or MFT With Subtasking

* * * * T C B S U M M A R Y * * * *

| | | | |
|-----|----------------------|-------------------------------|-----------|
| JOB | TCB 00877d | STEP CMP 0000CC0C | PAGE 0001 |
| JOB | MASTER TCB 00835d | STEP SCHEDULR CMP 00000000 | PAGE 0002 |
| JOB | TCB 00893d | STEP CMP 0000CC0C | PAGE 0004 |
| JOB | TCB 008A1d | STEP CMP 0000CC0C | PAGE 0005 |
| JOB | MASTER TCB 00836d | STEP SCHEDULR CMP 0000CC0C | PAGE 0006 |
| JOB | MASTER TCB 008C4d | STEP SCHEDULR CMP 0000CC0C | PAGE 0007 |
| JOB | WTR TCB 00874d | STEP PU CMP 0000CC0C | PAGE 0009 |
| JOB | TCB 008F4d | STEP CMP 0000CC0C | PAGE 0010 |
| JOB | JOB5 TCB 00914d | STEP GJ CMP 00000000 | PAGE 0011 |
| JOB | TCB 00934d | STEP CMP 0000CC0C | PAGE 0013 |
| JOB | TCB 00954d | STEP CMP 0000CC0C | PAGE 0014 |
| JOB | TCB 00974d | STEP CMP 0000CC0C | PAGE 0015 |
| JOB | TCB 00954d | STEP CMP 0000CC0C | PAGE 0016 |
| JOB | TCB 00934d | STEP CMP 0000CC0C | PAGE 0017 |
| JOB | TCB 009D4d | STEP CMP 00000000 | PAGE 0018 |
| JOB | TCB 009F4d | STEP CMP 0000CC0C | PAGE 0019 |
| JOB | TCB 00A14d | STEP CMP 0000000C | PAGE 0020 |
| JOB | TCB 00A34d | STEP CMP 0000CC0C | PAGE 0021 |

Figure 26. TCB Summary Sample for Systems that Operated Under MFT Without Subtasking

THE GENERAL FORMAT

The IMDPRDMP program uses a general format to display the hexadecimal contents of main storage. The particular areas of main storage displayed are determined by the parameters entered after the PRINT user control verb.

To identify various dump printouts, IMDPRDMP prints specific headings on each dump, such as ALLOCATED STORAGE, PRINT STORAGE, and NUCLEUS and SQA PRINT. A sample of a general format dump is shown in Figure 27.

The IMDPRDMP program also reverts to the general format if it is unable to format control block information because it encountered either a control block error or one of several user control statement format errors.

Each page of an IMDPRDMP program dump listing containing information displayed in the general format is identified by a heading line. This heading line shows the optional title supplied by the user followed by the date and time that the information was taken from the dumped system. A sequential page number also appears in each heading line.

Listings being produced under control of the PRINT ALL, PRINT CURRENT, or PRINT STORAGE (no operands) format control statement display the contents of the

sixteen general purpose registers. If the dump was obtained from a multiprocessing system and both sets of registers were obtained, then the contents of both sets of registers are displayed. Where applicable, the beginning of each main storage region is noted by a line that gives the job, step and procedure step name of the owning task, followed by the status of the region (BORROWED, ROLL-OUT, OWNED).

Then, starting at an address requested by the user, as specified in a PRINT user control statement, (or location zero if no address was specified) the contents of main storage are displayed. Each line of the general format displays eight words of main storage. Preceding each line of information is the address of the first byte displayed followed by a one-character storage protection key indicator representing the key associated with the area of main storage being displayed on this line. Following each line of information, a 32-character translation field is printed. This field gives the EBCDIC translation of the translatable characters in the eight hexadecimal words. Untranslatable bytes are represented by positional periods.

Printing of any line that duplicates the contents of the line printed previously, is suppressed. Duplicate lines are indicated by the phrase "TO NEXT LINE ADDRESS SAME AS ABOVE" following the line duplicated.

```

R 0-7 000G0000 000022C8 00000000 8000214A 00002280 0000000A 00000000 00000000 *.....H.....*
R 8-15 00000000 00000000 00000000 00000000 00000000 00000000 00000000 400020B4 *.....*
000000 00000191 00001C00 400020B4 6000002B 08000080 40000001 FFE50000 900432B6 *.....V.....*
000020 FFC40C01 5000BBB2 FFF50C04 A006E7C2 0000FF00 00000000 FF060009 80000000 *.....5.....XB.....*
000040 000022E8 0C000000 00002280 00005E08 5A64336D 48100002 412000C0 50200048 *...Y.....S.....*
000060 982400C8 9D001000 00020000 00000003 9D001000 47700070 91030044 4750007C *...H.....*
000080 310000A6 4CC0C005 08000080 40000001 05001C00 40000500 06001C00 00000480 *.....*
0000A0 00000000 00000000 00000450 00D20650 44500088 47F0006C D2002000 00D84040 *.....K.....O..K...Q *
0000C0 020000C8 2C000048 C2C5D5C4 40404040 40404040 40404040 40404040 *...H.....END
0000E0 40404040 40404040 40404040 404040C6 40404040 40404040 F0F8C1D7 D9F7F040 F0F048F1 F140F1F4 *
* F08APR70 00.11 14*
000100 61F0F161 F9F94040 40404040 40404040 00000000 00000000 00000000 00000000 *.01.99
000120 00000000 00000000 00000000 00000000 00000000 00000000 00000000 *.....*
000160 00000000 00000000 00000000 82000170 00040000 00036D18 00000000 00002000 *.....*
000180 FF060C09 80C00000 C000018A 018A018A FF000190 FF000190 00000001 FFFF6528 *.....*
0001A0 00009A00 00009AF4 00009968 000099B4 00009AF0 80009B74 00009AD0 4000BB62 *.....4.....0.....*
0001C0 000117E0 000098B4 C0000340 00009874 50008CA4 6000A57A 00000030 0006F9F4 *.....94*
0001E0 000000CC 000729C0 00000000 0006F000 5006E596 000729B8 A006E740 00000001 *.....0.....V.....X.....*
000200 000726D0 00067594 00065D40 00072798 4006E7AE 0001828C 00000000 00000000 *.....X.....*
000220 00004E98 00000000 41500800 1A551821 92825098 1B114010 50881804 58420014 *.....*
000240 5834002C D5022015 30194770 0ED491F0 00214780 025A45E0 0E681B99 18A991FE *...N.....M.O.....*
000260 30104770 02724873 00229170 70124780 02824393 001C43A2 002099A0 9000487A *.....*
000280 302291FF 700247E0 0ED491A0 50984790 029E58F0 0FC445EF C00041C0 02B258B2 *.....M.....O.D.....*
0002A0 000418AA 43A7C00A 89A00003 41DA52FC 07FC4012 001ED708 20082008 D4032000 *.....P.....M.....*
0002C0 5084927F 2004501B 000094FD 50984580 02F647F0 02E247F0 02EA4700 000045E0 *.....6.O.S.O.....*
0002E0 071C1812 58E00FC8 07FE4180 02D245C0 02A247F0 03444810 0F9C1211 4740035C *.....H.....K.....0.....*
000300 91011001 47100352 4C710002 902310C4 5001000C 92001004 D300100C 0021D201 *.....L.....K.....*
000320 0F9C1000 401050E8 18A09200 1008A023 45E00AD0 91EF7006 47708008 91F0FB0 *.....K.....*
000340 47500E2A 91107C06 47100DE6 48AD0006 07FAD502 20150FD1 47800308 58A00024 *.....W.....N.....J.....*
000360 48A0508C 50A0C024 18B09620 802092F0 09771899 058A00FB 5090A000 47FC02E2 *.....O.....O.....*
000380 91102000 471003E6 41A05020 D200A000 302045C0 05E407BC 48A00044 54A05058 *.....W.....K.....U.....*
0003A0 4770065C 58AC7030 91042001 471003C0 58A20010 91012000 478003C0 58A2C018 *.....*
0003C0 91082000 478003DA 50A05030 92085030 41A05028 D200502D 701850A0 004841C0 *.....K.....*
0003E0 066447F0 06249104 20014780 05D647F0 03889140 702C4710 C5929101 70064770 *...O.....D.O.....*
000400 040694E7 20019110 20014710 05709102 70064710 04D241A0 703140A0 503AD203 *...X.....K.....K.....*
000420 50007031 91012000 47100432 02077030 20201BAA 43A70030 89A00004 41AA3020 *.....K.....*
000440 91082001 47100490 D5037033 A0064740 053ED503 7033A00A 4720053E 91027013 *.....N.....N.....*
000460 471004D2 D5017031 A0044770 053E9104 30084780 0490D501 7035A008 4740048A *...KN.....N.....*
000480 D5017035 A00C47C0 0490D201 7035A008 41A05038 41800578 45C005E8 4770C688 *N.....K.....Y.....*
0004A0 9D006C00 47B004A0 48A00044 54A05058 477006A8 96A27006 D2062009 00419104 *.....K.....*
0004C0 00444780 8008945F 700691A0 50984790 80081886 88B00008 89B00002 48CB52D4 *.....M.....*
0004E0 48C05096 41AC7031 40A0C002 43B07030 89B00004 439B3020 4290C00D D202C011 *.....K.....*
000500 20119101 20004780 051C2020 C0112019 91082001 4780051C 9618C00D 50C00048 *.....K.....*
000520 91027013 47800530 58A00048 47F005E0 45C00624 077C96A6 700647F0 066C58F3 *.....O.....O.....O.....*
000540 001C58FF 000005EF 47F0055C 47F00554 47F00432 41E00960 47F00564 92422004 *.....O.....O.....O.....*
000560 41E00DA2 94FE7C06 94DF2000 47F00752 58C20018 47F0051C D5037031 50004770 *.....O.....B.....O.N.....*
000580 06249602 70064060 70044010 701447F0 04CA4910 702A4770 CDD69148 702C4710 *.....O.....O.....*
0005A0 05AE9101 70064780 0DD247F0 040E9407 702C94DF 200047F0 C40E9110 20004710 *.....K.O.....O.....*
0005C0 05D658A2 00189101 20004710 05D258A2 001047F0 05E0D200 50082018 41A05008 *...O.....K.....O..K.....*
0005E0 41C00664 41B00624 50A00048 91202000 47800604 910C402C 47800624 943F402C *.....*
000600 94DF2000 58F3001C 58FF0004 50B05074 05EF47F0 061E41E0 096447F0 075258B0 *...3.....O.....O.....*
000620 507407FB 92000048 91017006 47800638 91102001 4710063E C3000048 10C09C00 *.....L.....*
000640 600005A0 88A00018 42A20010 58900FC0 05B91899 40607004 40107014 58A02010 *.....*
000660 04A005CC 4770068E 96A07006 43907004 1A994079 52F0D600 700C509A D7C0700C *.....O.....P.....*
000680 509A45E0 075207F8 D2C37031 50004720 070C58A0 004841A0 A00850A0 0040D206 *.....8K.....K.....*
0006A0 20090041 471006E4 18E096A0 70069106 00454770 0F8C9110 00444780 0714945F *.....U.....*
0006C0 70069120 00444710 80C49608 70069140 0044071E 91840044 47808008 41808004 *.....*

```

IMDRDMP Output Formatting: Output Comments 129

Figure 27. Sample of General Format Dump

OUTPUT COMMENTS

The following output comments are printed within the body of a formatted dump whenever IMDPRDMP is unable to locate, format and print a control block. These comments explain why the referenced control block is not printed within the dump listing, these output comments are separated from the main storage information by a blank line both before and after each output comment. Note: Output Comments produced when IMDPRDMP is processing GTF output are shown in Section 3 of this publication under the heading 'IMDPRDMP Output Comments - GTF Processing'.

DUPLICATE PREFIX FOLLOWS - ID 'A'

Explanation: While processing a dump from a Model 65 multiprocessing system, IMDPRDMP has determined that the CPU prefixes (CPUIDs) are the same. If the task that performs the dump is initiated on one CPU, interrupted, dispatched to the second CPU, and completed the rest of the processing on the second CPU, then the prefix shown in this output comment is that of the first CPU to which the task was assigned. Processing continues.

END OF FILE ON DUMP TAPE

Explanation: While trying to locate a block of main storage on the dump tape, IMDPRDMP reached the end of the tape. This message is printed only if IMDPRDMP is either trying to extract the CVT pointer or trying to extract an area of storage for printing.

Processing terminates. If IMDPRDMP did no formatting and the tape does not contain a low-speed dump produced by IMDSADMP, the job may be rerun using the CVT control statement to direct IMDPRDMP to the CVT in this dump. Low-speed dumps produced by IMDSADMP can not be formatted by IMDPRDMP.

ERROR FINDING PARTITION BOUNDARIES FOR TCB aaaaaa

Explanation: IMDPRDMP found (1) a TCB family chain pointer, (2) a partition boundary box pointer, or (3) a pointer within the partition boundary box that was one of the following:
1. Addressed an area that was not on a full-word boundary.
2. Addressed an area that was

higher than the highest address in the dump.

3. Could not be extracted from the dump because either an I/O error was encountered while attempting to read the block containing the pointer or the block containing the pointer was missing from the dump. A possible cause for a missing block is that the routine that produced the dump encountered an I/O error while attempting to write the block.
Processing continues.

ERROR FINDING REGION BOUNDARIES FOR TCB aaaaaa.

Explanation: While attempting to determine the region boundaries for the family of TCBs attached to the job step TCB at address aaaaaa, one of the following conditions occurred:

- IMDPRDMP found a chain with more than fifty partition queue elements (PQEs); or,
- IMDPRDMP found (1) a TCB family chain pointer, (2) a partition queue element (PQE) pointer (TCB + X'98'), or (3) a pointer within a PQE that:
1. Addressed an area that was not on a word boundary; or,
2. Addressed an area that was higher than the highest address in the dump; or,
3. Could not be extracted from the dump because either an I/O error was encountered while attempting to read the block containing the pointer or the block containing the pointer was missing from the dump; a possible cause for a missing block is that the routine that produced the dump encountered an I/O error while attempting to write the block.

Processing continues.

ERROR FORMATTING TCB

Explanation: One of the fields in the TCB required for formatting could not be extracted from the dump because:

- IMDPRDMP encountered an I/O error while attempting to read the block that contains the required data; or,

- The block containing the required data was missing from the dump; a possible cause is that the routine that produced the dump encountered an I/O error while attempting to write the block.

Processing continues.

ERROR IN DEB CHAIN

Explanation: The routine that formats the data extent block (DEB) found one of the following errors:

- A DEB chain pointer:
 1. Was not on a word boundary; or,
 2. Addressed an area of main storage higher than the highest address in the dump; or,
- The address of the DEB was invalid causing the address of the DEB prefix (DEB - 16) to be zero or negative; or,
- A DEB chain pointer or one of the fields necessary to format the DEB could not be extracted from the dump because:
 1. IMDPRDMP encountered an I/O error attempting to read the block that contained the data; or,
 2. The block containing the data was missing from the dump; a possible cause is that the routine that produced the dump encountered an I/O error while attempting to write the block.

Processing continues.

ERROR IN EXTENT LIST

Explanation: While formatting the load list or job pack area of an MVT dump, IMDPRDMP encountered a contents directory entry (CDE) that had a block extent list with a relocation factor (extent list + 4) of zero or greater than twenty-five. A relocation factor of zero is an error; however, a value greater than twenty-five can be valid. The value of twenty-five was established by IMDPRDMP as a reasonable limit; it is improbable that a normal task would have a program that has more than twenty-five CSECTs causing it to get an extent list with a relocation factor greater than twenty-five. Processing continues with the next CDE.

ERROR IN JOB PACK QUEUE

Explanation: The routine that formats the job pack area encountered one of the following errors:

- A job pack queue chain pointer addressed an area that:
 1. Was not on a word boundary, or,
 2. Was greater than the highest address in the dump.
- A job pack queue chain pointer or one of the fields in a job pack area control block could not be extracted from the dump because:
 1. IMDPRDMP encountered an I/O error attempting to read the block containing the needed data, or,
 2. The block containing the needed data was missing from the dump; a possible cause is that the routine that produced the dump encountered an I/O error while attempting to write the block.

Processing continues.

ERROR IN LOAD LIST

Explanation: The load list print routine encountered one of the following errors:

- A pointer in the load list control block chain referenced an area of main storage that:
 1. Was not on a word boundary, or
 2. Was greater than the highest address in the dump.
- A field in a load list queue control block could not be extracted from the dump because:
 1. IMDPRDMP encountered an I/O error attempting to read the block that contained the data needed to format the load list; or,
 2. The block containing the data was missing from the dump; a possible cause is that the routine that produced the dump encountered an I/O error while attempting to write the block.

Processing continues.

ERROR IN TCB CHAIN DURING PRINT ALL
FUNCTION

Explanation: The PRINT ALL routine encountered a TCB chain pointer that was not on a full-word boundary or addressed an area that could not be extracted from the dump because:

1. The pointer addressed an area higher than the highest address in th dump.
2. IMDPRDMP encountered an I/O error while trying to read the record that contained the area addressed by the pointer.
3. The record containing the addressed area was missing from the dump, possibly because the routine that produced the dump encountered an I/O error while attempting to write the record.

No more TCBs are processed, but all tasks encountered up to the point are printed. The last TCB printed may contain the error described in 1 above or point to the unavailable area described in 2 and 3 above.

ERROR IN TCB CHAIN TCB aaaaaa

Explanation: The routine that formats the TCBs encountered one of the errors given below; the address of the TCB associated with the error replaces the aaaaaa field of the output comment.

- A TCB pointer for one of the TCBs in the TCB family chain addressed an area not on a word boundary; or,
- A TCB pointer or the TIOT pointer in the TCB at location aaaaaa points to an area that could not be extracted from the dump because:
 1. IMDPRDMP encountered an I/O error while attempting to read the block that contains the pointer; or,
 2. The routine that produced the dump encountered an I/O error while writing the block that contains the pointer; therefore, the block is missing from

the dump.

ERROR IN TIOT

Explanation: The format routine found one of the following errors:

- The task input output table (TIOT) pointer (TCB + X'C') was not on a word boundary; or,
- One of the fields required to format the TIOT could not be extracted from the dump because:
 1. IMDPRDMP encountered an I/O error while attempting to read the block that contains the required data, or,
 2. The block containing the required data was missing from the dump; a possible cause is that the routine that produced the dump encountered an I/O error while attempting to write the block.

ERROR WHILE FORMATTING CONTROL BLOCKS
CONTINUING

Explanation: While building a list of job step TCB's for all partition regions in the dump data set, PRDMP encountered one of the following conditions:

1. One of the TCB chain pointers was greater than the highest address in the dump.
2. One of the TCB chain pointers addressed an area that was missing from the dump data set.

PRDMP will attempt to use the partial list and continue with its formatting.

ERROR WHILE FORMATTING PSCB

Explanation: One of the following errors occurred while IMDPRDMP was formatting the protected step control block (PSCB):

- The address of the PSCB in the time sharing job block extension (TJEX) was greater than the highest main storage address in dump; or,
- An I/O error occurred while reading the block of dump information that contained the needed data; or,
- A block of dump information containing part of the PSCB was not found on either the dump or swap data sets.

Processing continues. IMDPRDMP attempts to format the control blocks for the next TSO user.

ERROR WHILE FORMATTING RCB

Explanation: One of the following errors occurred while IMDPRDMP was formatting the time sharing region control blocks (RCBs):

- The address of the RCB table in the time sharing

communication vector table (TSCVT) was greater than the highest main storage address in the dump; or,

- An I/O error occurred while reading the block of dump information that contained the needed data; or,
- A block of dump information containing part of an RCB was not found on the dump data set. This happens when an I/O error occurred while the dump routine was writing the data onto the dump data set. Processing continues. IMDPRDMP attempts to format the next entry in the RCB table.

ERROR WHILE FORMATTING SWAP CONTROL BLOCK

Explanation: One of the following errors occurred while IMDPRDMP was formatting the swap control block (SWAP DCB):

- The address of the SWAP DCB in the time sharing communication vector table (TSCVT) was greater than the highest main storage address in the dump; or,

- An I/O error occurred while reading the block of dump information that contained the data; or,
- A block of dump information containing part of the SWAP DCB was not found on the dump data set. This happens when an I/O error occurred while the dump routine was writing the data onto the dump data set.

Processing continues. IMDPRDMP attempts to continue formatting the time sharing job block (TJB).

ERROR WHILE FORMATTING TAXE

Explanation: One of the following errors occurred while IMDPRDMP was formatting the terminal attention exit element (TAXE):

- The address of the TAXE in the time sharing job block extension (TJBX) was not aligned in a fullword boundary; or,
- The address of the TAXE in the TJBX was greater than the highest main storage address in the dump; or,
- An I/O error occurred while reading the block of dump information that contained the needed data; or,
- A block of dump information containing part of the TJBX was not found on the dump or swap data sets.

Processing continues. IMDPRDMP attempts to format the control blocks for the next TSO user.

ERROR WHILE FORMATTING TJB

Explanation: One of the following errors occurred while IMDPRDMP was formatting the time sharing job block (TJB):

- The address of the TJB table in the time sharing communication vector table (TSCVT) was greater than the highest main storage address in the dump; or,
- An I/O error occurred while reading the block of dump information that contained the needed data; or,

- A block of dump information containing part of the TJB was not found on the dump data set. This happens when an I/O error occurred while the dump routine was writing the data onto the dump data set.

Processing continues. IMDPRDMP attempts to format the next active TJB.

ERROR WHILE FORMATTING TJBX

Explanation: One of the following errors occurred while formatting the time sharing job block extension (TJBX):

- The terminal job block (TJB), that contained the address of the TJB was not aligned on a fullword boundary; or,
- The address of the TJBX in the TJB was greater than the highest address in the system dump; or,
- An I/O error occurred while reading the block of dump information that contained the needed data; or,
- A block of dump information containing part of the TJBX was not found on either the dump or swap data sets.

Processing continues. IMDPRDMP attempts to format the control blocks associated with the next TSO user.

ERROR WHILE FORMATTING TSB

Explanation: One of the following errors occurred while IMDPRDMP was formatting the terminal status block (TSB):

- The address of the TSB table in the time sharing communication vector table (TSCVT) was greater than the highest main storage address in the dump; or,
- An I/O error occurred while reading the block of dump information that contained the needed data; or,
- A block of dump information containing part of the TSB was not found on the dump data set. This happens when an I/O error occurred while the dump routine was writing the data onto the dump data set.

Processing continues. IMDPRDMP attempts to format the associated time sharing job block extension (TJBX).

Processing continues. IMDPRDMP attempts to continue formatting with the terminal status block (TSB).

ERROR WHILE FORMATTING TSCVT

FORMAT ERROR DURING TCB SUMMARY

Explanation: One of the following errors occurred while IMDPRDMP was formatting the time sharing communication vector table (TSCVT):

- The address of the TSCVT in the communication vector table (CVT) was greater than the highest main storage address in the dump; or,
- An I/O error occurred while reading the block of dump information that contained the needed data; or,
- A block of the dump information containing part of the TSCVT was not found on the dump data set. This happens when a I/O error occurred while the dump routine was writing the data onto the dump data set.

Explanation: The routine that prints the TCB summary must extract a TCB completion code (TCB + X'16') or a TCB family chain pointer from the dump. In this case, IMDPRDMP was unable to do so because:

- IMDPRDMP encountered an I/O error while attempting to read the block containing the completion code or pointer; or,
- The block containing the completion code or pointer was missing from the dump; a possible cause is that the routine that produced the dump encountered an I/O error while attempting to write the block.

Processing for the current control statement is terminated.

Processing continues. IMDPRDMP attempts to format the time sharing region control blocks (RCBs).

FORMAT ERROR IN MAIN STORAGE BLOCKS

Explanation: While formatting main storage control blocks, IMDPRDMP encountered one of the following errors:

- A pointer in a main storage control block addressed an area that:
 1. Was not on a word boundary; or,
 2. Was higher than the maximum address in the dump; or,
- One of the fields in a main storage control block could not be extracted from the dump because:
 1. IMDPRDMP encountered an I/O error while attempting to read the block that contains the required field; or,
 2. The block containing the required field is missing from the dump; a possible cause is that the routine that produced the dump encountered an I/O error while attempting to write the block.

Processing continues.

ERROR WHILE FORMATTING USER MAIN STORAGE MAP

Explanation: One of the following errors occurred while IMDPRDMP was formatting the user main storage map (UMSM):

- The address of the UMSM associated with the region control task (RCT) or time sharing job block (TJB) was greater than the highest main storage address in the dump; or,
- An I/O error occurred while reading the block of dump information that contained needed data; or,
- A block of dump information containing part of the UMSM was not found in the dump data set. This happens when an I/O error occurred while the dump routine was writing the data onto the dump data set.

INFINITE LOOP IN DEB CHAIN

Explanation: While formatting the data extent blocks (DEBs), IMDPRDMP found more than 200 DEBs chained to the TCB. The limit of 200 DEBs prevents IMDPRDMP from looping. When the limit is exceeded, a loop is assumed which causes this comment to be printed. Processing continues after the first 200 DEBs are printed.

INFINITE LOOP IN JOB PACK QUEUE

Explanation: In MVT, IMDPRDMP found more than 255 CDEs on the job pack queue associated with the TCB. In MFT, IMDPRDMP found more than 255 RBs on the job pack queue associated with the TCB. A limit of 255 job pack queue control blocks has been established by IMDPRDMP to prevent a possible looping condition. When the limit is exceeded, a loop is assumed and this comment is issued. The first 255 job pack queue control blocks are printed and then processing continues.

INFINITE LOOP IN LOAD LIST

Explanation: In MVT, IMDPRDMP found more than 255 load list elements (LLEs) on the load list chained to the TCB. In MFT, IMDPRDMP found more than 255 RBs on the load list. A limit of 255 elements on the load list has been established by IMDPRDMP to prevent a possible looping condition. When the limit is exceeded, a loop is assumed and this comment is issued. The first 255 load list elements are printed and then processing continues.

INFINITE LOOP IN PQES

Explanation: The main storage print routine found more than 50 partition queue elements (PQEs) chained to the TCB. A limit of 50 PQEs has been established by IMDPRDMP to prevent a possible looping condition. When the limit is exceeded, a loop is assumed and this comment is issued. The first 50 PQEs are printed and then processing continues.

INFINITE LOOP IN QCB CHAIN

Explanation: The QCB print routine found more than 100 queue control blocks (QCBs) on the major QCB chain or more than 100 QCBs on a minor QCB chain. A limit of 100 QCBs has been established within IMDPRDMP to prevent a possible looping condition. When the limit is exceeded, a loop is assumed and this comment is issued. The first 100 QCBs are printed and then processing continues.

INFINITE LOOP IN QEL CHAIN

Explanation: The QCB print routine found more than 100 queue elements (QELs) on a QEL chain. A limit of 100 QELs has been established within IMDPRDMP to prevent a possible looping condition. When the limit is exceeded, a loop is assumed and this comment is issued. The first 100 QELs are printed and then processing continues.

INFINITE LOOP IN RB CHAIN

Explanation: The RB print routine found more than 50 request blocks (RBs) on the RB chain. A limit of 50 RBs has been established within IMDPRDMP to prevent a possible looping condition. When the limit is exceeded, a loop is assumed and this comment is issued. The first 50 RBs are printed and then processing continues.

INFINITE LOOP IN TIOT

Explanation: While formatting the TIOT, IMDPRDMP found more than 255 DD entries in the TIOT. Since only 255 DD statements are allowed per job step, a valid TIOT cannot have more than 255 DD entries. A loop is assumed because the limit was exceeded and the TIOT end indicator could not be found. Processing continues.

INVALID TIOT

Explanation: While formatting the task input output table (TIOT), the FORMAT routine found an invalid job name in the TIOT. To be valid, the first character of the job name must be A through Z, or \$, #, @ or a blank (X'40'). Processing continues.

NO ELEMENTS ON LOAD LIST

Explanation: The load list pointer in the TCB (displacement X'24') is zero. The zero pointer indicates that (1) no programs were loaded by the LOAD macro instruction or (2) the load list pointer was overlaid with zero. Processing continues.

partition information block (PIB) field (TCB + X'7C') or the job pack queue pointer (PIB + X'24') is zero. PCP does not have a job pack pointer; therefore, this comment does not appear in a PCP dump. A zero job pack queue pointer is usually a normal condition, especially for a system task. Processing continues.

NO EXTENT LIST

Explanation: While formatting the load list and job pack queue for an MVT dump, IMDPRDMP encountered zeros in the extent list pointer (CDE + '20') in a major contents directory entry (CDE). This zero pointer usually indicates an error condition in which the extent list pointer was overlaid with zeros. Processing continues with the next CDE.

RB FORMAT ERROR

Explanation: While formatting a request block (RB), the RB print routine found that the request block (RB) chain pointer addressed an area of main storage that:

- Was not on a word boundary; or,
- Was higher than the highest address in main storage; or,
- Could not be extracted from the dump because:
 1. IMDPRDMP encountered an I/O error while attempting to read the block that contained the pointer; or,
 2. The block that contained the pointer was missing from the dump. One possible cause for this is that the program that produced the dump may have encountered an I/O error while writing the block.

NO LINK PACK AREA QUEUE

Explanation: In MFT, an LPAMAP was requested but the link pack area queue pointer (CVT + X'BC') was zero. Processing continues.

NO MAJOR QCBS

Explanation: The QCB TRACE routine found zeros as the pointer to the first major queue control block (QCB). This indicates that no resources have been enqueued at the time of the dump or that the pointer to the QCB queue has been overlaid with zeros. Processing continues.

- A field in the RB, or a contents directory entry (CDE) associated with the RB, necessary to formatting the RB could not be extracted from the dump. Either IMDPRDMP encountered an I/O error while trying to read the block, or the block that contained the pointer is missing from the dump.

NO RSVC MODULES IN LPA RAM

Explanation: In MVT, either the CDE or LLE chain, pointing to the modules in the link pack area, was empty. RSVC modules are found by following the LLE pointer in the master scheduler TCB (TCBLLEP). Rprocessing continues.

RAM modules are found by following the CDE chain from the CVT (CVTQLPAQ). Processing for this IMDPRDMP verb ends.

REGISTERS FROM OTHER CPU ARE INVALID-NOT FORMATTED

Explanation: Multiprocessing systems only. Only the registers for the CPU in which the dump program was executed will be displayed on the dump listing. This can occur when the dump is taken on a multiprocessing system either when the NOMP option of IMDSADMP is used or when the direct control feature is not operational.

NOTHING IN JOB PACK

Explanation: In MVT, the job pack queue field of the TCB (TCB + X'2C') is zero. In MFT, the

TASK HAS NO OPEN DATA SETS

Explanation: IMDPRDMP found the data extent block (DEB) pointer in the TCB (TCB + X'8') to be zero. This situation indicates that there were actually no open data sets or the DEB pointer in the TCB was overlaid with zeros. Processing continues.

TASK HAS NO TIOT

Explanation: While attempting to format the task input output table (TIOT), IMDPRDMP found that the TIOT pointer (TCB + T'C') was either zero or larger than the highest address in the dump. The zero TIOT pointer could be a normal condition for a system communication task, but for a problem program task this is an error condition. Processing continues.

TASK HAS TERMINATED

Explanation: After formatting a TCB, this comment is printed below the TCB if the first bit (the terminated bit) of the flag byte at X'21' of the TCB is set. Processing continues with the next TCB.

TCB CHAIN ERROR IN F03 PRINT ROUTINE
TCB aaaaaa...CONTINUING WITH NEXT TCB

Explanation: The Print F03 routine encountered a TCB chain pointer that:

- Was not on a word boundary; or,
- Addressed an area that could not be extracted from the dump because:
 1. The pointer addressed an area higher than the maximum address in the dump; or,

2. IMDPRDMP encountered an I/O error trying to read the record containing the area addressed by the pointer; or,
3. The block containing the addressed area was missing from the dump, probably because the routine that produced the dump encountered an I/O error while attempting to write the block.

The address of the TCB associated with the error replaces the aaaaaa field in the message. Processing continues with the next TCB.

UNABLE TO OBTAIN JOB STEP TCB FOR CURRENT TASK

Explanation: In an MFT system with ATTACH, the job step TCB is used to get the partition boundaries. If the address of this TCB is zero in the current TCB, then the above comment is issued. Processing continues.

xxxxxx THROUGH xxxxxx COULD NOT BE PRINTED

Explanation: The block(s) of storage between the two addresses could not be printed because IMDPRDMP encountered an I/O error while attempting to read the block(s) or the block(s) that were missing from the dump. Processing continues.

Guide to Storage Dumps

The purpose of this section is to suggest debugging procedures that you may use with a storage dump. This discussion applies to the output of the following programs:

- IMDSADMP- The low speed version that creates an unformatted dump of main storage.
- IMDPRDMP- Reads, formats, and prints storage dumps from MFT or MVT systems and the high speed version of IMDSADMP.

These programs produce hexadecimal dumps of the contents of main storage from location zero to the highest machine address.

The IMDPRDMP program provides formatting capabilities which can be used to display the important system control blocks for easy examination. The IMDPRDMP program does most of the procedures described in this section automatically. The cases in which the IMDPRDMP program does not provide formatting are identified. A complete description of the services provided by the IMDPRDMP program is found in the publication, IBM System/360 Operating System: Service Aids, GC28-6719.

Since the formatting for the IMDPRDMP program depends on the contents of the dump, it is not always possible to provide complete formatting. For example, if the CVT of the system to be dumped has been overlaid, the IMDPRDMP program can provide only a hexadecimal dump of main storage.

DETERMINING THE CAUSE OF THE DUMP

Main storage dumps are invoked by system routines and these routines can be identified by module names appearing in the most recent request block (RB) for the failing task. The main storage dump is invoked by SVC 51. This SVC PSW appears as the resume PSW in the second most recent RB of some task in the system. The module name in the current RB for that task must be 201C.

Main storage locations from zero to 128 (hexadecimal 80) are permanently assigned and contain hardware control words. Figure 28 shows these fields, their location, their length, and their purpose.

| Address Dec Hex | Length In Bytes | Purpose |
|--------------------|--------------------|-------------------------|
| 0 0 | 8 | IPL PSW |
| 8 8 | 8 | IPL CCW1 |
| 16 10 | 8 | IPL CCW2 |
| 24 18 | 8 | External old PSW |
| 32 20 | 8 | Supervisor call old PSW |
| 40 28 | 8 | Program old PSW |
| 48 30 | 8 | Machine check old PSW |
| 56 38 | 8 | I/O old PSW |
| 64 40 | 8 | Channel Status Word |
| 72 48 | 4 | Channel Address Word |
| 76 4C | 4 | Unused |
| 80 50 | 4 | Timer |
| 84 54 | 4 | Unused |
| 88 58 | 8 | External new PSW |
| 96 60 | 8 | Supervisor call new PSW |
| 104 68 | 8 | Program new PSW |
| 112 70 | 8 | Machine check new PSW |
| 120 78 | 8 | I/O new PSW |

Figure 28. Permanently Assigned Hardware Control Words

Cause of the Dump: Evaluate the PSWs that appear in the formatted section of the dump (the first four lines) to find the cause of

the dump. The PSW has the following format:

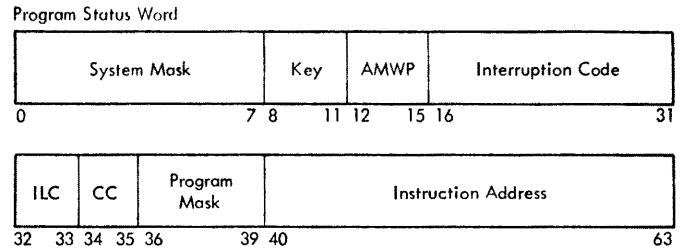

- Does the instruction address field of the old machine check PSW show either the value E2 or E02? If so, a hardware error has occurred.
- Does the instruction address field of the old program check PSW have a value other than zero? If so, a program check at the instruction preceding that address caused the interruption.

TASK STRUCTURE

MFT System (Without Subtasking)

There is a TCB associated with each partition of main storage there are also TCBs for critical system tasks such as the master scheduler task and the transient area loading task. Figure 28 shows location 76 (4C) unused for hardware control words. The control program uses this word to contain a pointer to the CVT. Use this CVT pointer to locate the first byte of the CVT, then the CVTIXAVL field (offset 124) in the CVT. The address contained at CVTIXAVL is a pointer to the IOS freelist. At offset 4 in the IOS freelist is a pointer to the first address in a list of TCB addresses. You can look through this list of TCB addresses, and, keeping your system options in mind, find the TCBs for each partition. The TCB addresses are listed in the following order:

- Transient area loading task.
- System error task (MFT with subtasking).
- Multiple console support write-to-log task (optional).
- I/O recovery management support task (optional).
- Communications task.
- Master scheduler task.
- System management facilities task (optional).
- Partition 0 task.

- Partition 1 task.
- :
- :
- Partition n task.

Figure 29 shows how to locate the partition TCBs in sample output from the IMDPRDMP program.

MFT System (With Subtasking)

For MFT with subtasking (and for MVT), a task may create a subtask. The partition TCBs for MFT with subtasking are referred to as job step TCBs. The task structure for a job step may be reconstructed in a main storage dump by using the information in Figure 30.

For MFT with subtasking, the job step TCB may be found using the method described for MFT without subtasking or by a more direct method. CVT offset 245 (F5) contains a pointer to the partition 0 job step TCB address in this address table.

To recreate the task structure within any partition, simply locate the job step TCB, and follow the TCB pointers - as explained in the previous section.

MVT System

To find the current TCB, look at location 76 (4C) for a pointer to the CVT. The first word of the CVT contains a pointer to a doubleword of TCB addresses, which contains pointers to the next TCB to be dispatched (first word) and the current TCB (second word). Beginning with the current TCB, you can recreate the task structure for the job step using the methods in Figure 30.

If the first word of the current TCB points to itself, there are no ready tasks to be dispatched, and the system has been placed in an enabled wait state. This TCB, now in control, is called the system wait TCB.

All TCBs in the system are maintained in a queue called the CVT ready queue. These TCBs are queued according to their dispatching priority. The CVTHEAD field, offset +160 (A0) in the CVT, contains the address of the highest priority TCB in the system. Offset +116 (74) in the TCB points to the TCB with the next lowest priority. Figure 30 shows how to locate all of the TCBs in the system.

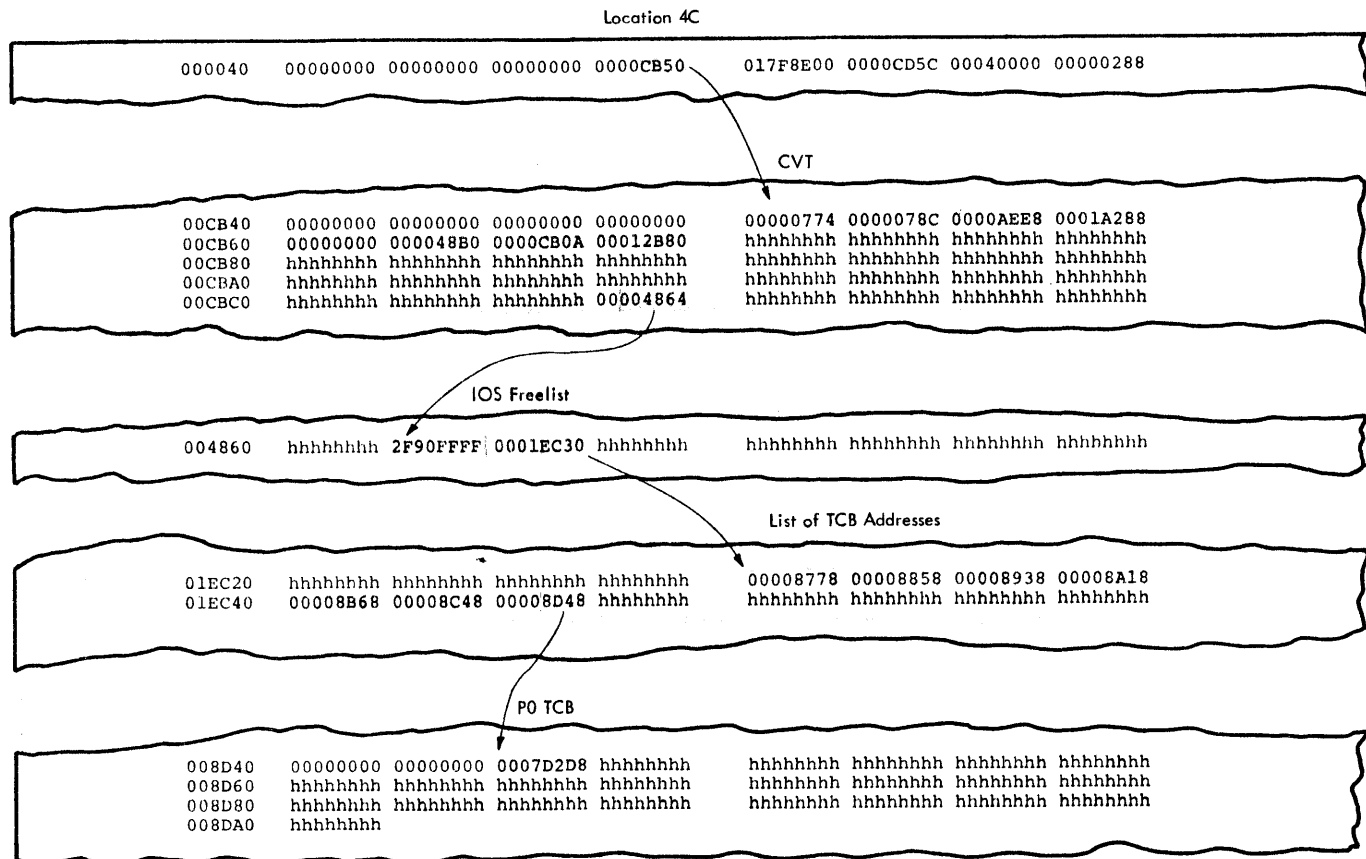

Figure 29. Finding the Partition TCBs in MFT

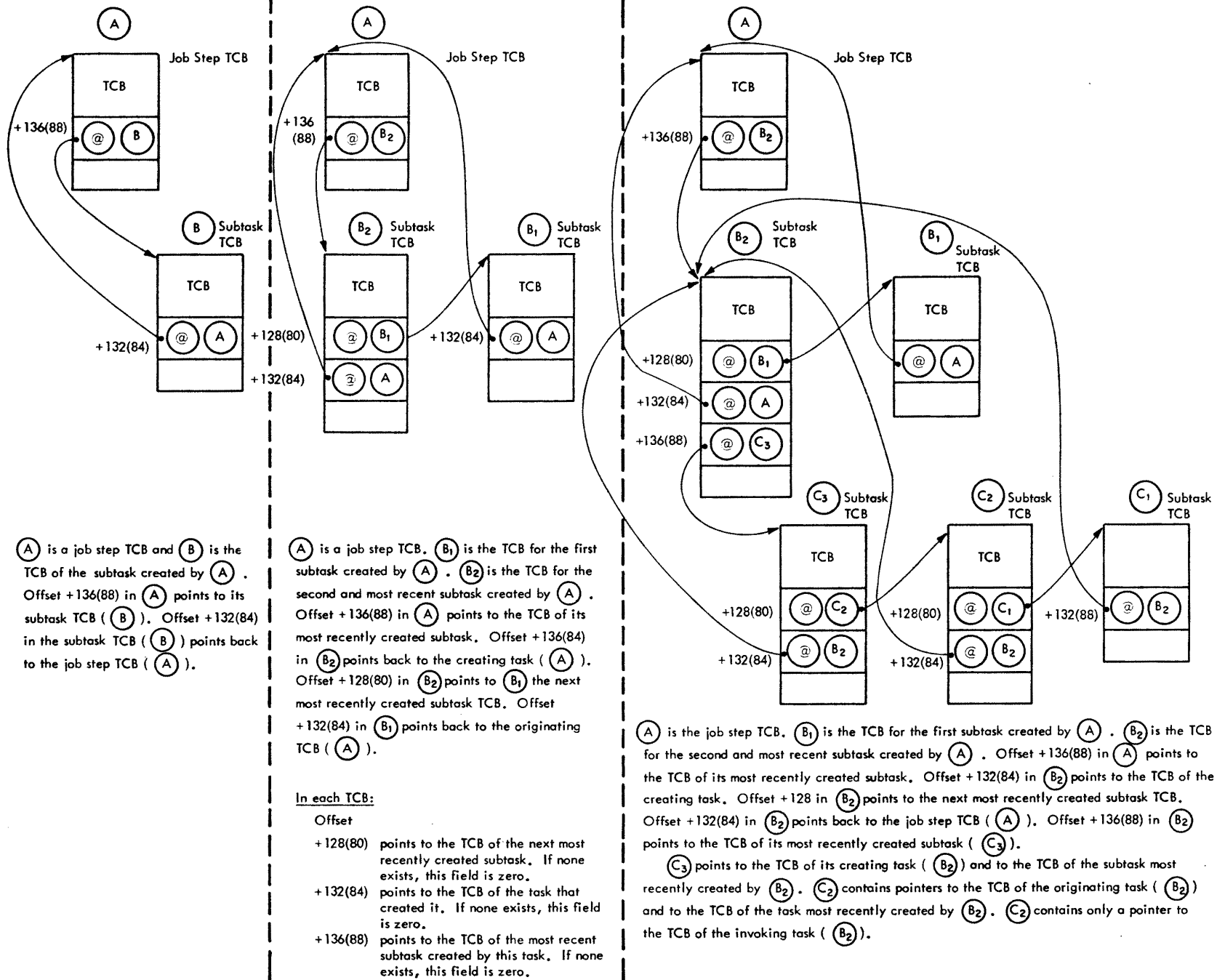

Figure 30. Finding the TCB

Keep in mind that all TCBs in the system appear on this queue. Therefore, not only does a particular job step TCB appear on the ready queue, but all of its subtask TCBs also appear.

You can find the job step TCB associated with any TCB by using the TCBJSTCB field of the TCB, offset +124 (7C). This field contains the address of the job step TCB for the TCB you are examining.

In response to the FORMAT control statement, the IMDPRDMP program will do most of this work for you. It will recreate the task structure, format all TCBs in the system, and provide a TCB summary. The TCB summary shows the task structure. Figure 31 shows a portion of the TCB summary information from an MVT system. TCBs associated with a particular job are grouped together under the job name and step name. The TCB summary contains the TCB address, the completion code, and, when applicable, the address of the originating TCB and the addresses of created TCBs.

TASK STATUS - ACTIVE RB QUEUE

The first word of the TCB contains a one-word pointer to the first word of the most recent RB added to the queue. In its eighth word, RB+28(1C), each RB contains a pointer to the next most recent RB. The last RB points back to the TCB.

You can determine the identity of the load module by looking either in the first

and/or second words of the RB for its EBCDIC name or in the last 3 digits of the resume PSW in the previous RB for its SVC number. The entry point to the module is in the last 3 bytes of the fourth word in the RB, RB-13(D).

In an MVT system, the name and entry point of the associated load module are not always contained in the RB associated with the module. Instead, they are found in a contents directory entry (CDE).

The address of the contents directory entry for a particular load module is given in the fourth word of the RB, RB+12(C). The CDE gives the address of the next entry in the directory (bytes 1-3), the name of the load module, bytes 8-15(F); the entry points of the module, bytes 17-19(11-13).

Figure 31 shows the formatting that the IMDPRDMP program does for a task in an MVT system. Notice the connection between the RB and the CDE. The IMDPRDMP program extracts the CDE information and displays this information with the RB.

The wait-count field of the RB is particularly important when locating the TCB by using the CVT ready queue (CVTHEAD). The high-order byte of the RB link field, RB-28(1C), of the most recent RB for a TCB contains a count of the number of events for which the task is waiting. Tasks that have a zero wait count are ready to be dispatched (unless marked non-dispatchable). Such a task will be dispatched or become the current task when all TCBs of higher priority are waiting for

| * * * * T C B S U M M A R Y * * * * | | | | | | |
|-------------------------------------|------------|----------------|-------------|-------------|-------------|-----------|
| JOB | MASTER | STEP SCHEDULER | NTChhhhhhhh | OTChhhhhhhh | LTChhhhhhhh | PAGE hhhh |
| | TCBhhhhhhh | CMPhhhhhhhh | | | | |
| JOB | MASTER | STEP SCHEDULER | NTChhhhhhhh | OTChhhhhhhh | LTChhhhhhhh | PAGE hhhh |
| | TCBhhhhhhh | CMPhhhhhhhh | | | | |
| JOB | WTR | STEP OOE | NTChhhhhhhh | OTChhhhhhhh | LTChhhhhhhh | PAGE hhhh |
| | TCBhhhhhhh | CMPhhhhhhhh | NTChhhhhhhh | OTChhhhhhhh | LTChhhhhhhh | PAGE hhhh |
| JOB | JOB11 | STEP GO | NTChhhhhhhh | OTChhhhhhhh | LTChhhhhhhh | PAGE hhhh |
| | TCBhhhhhhh | CMPhhhhhhhh | NTChhhhhhhh | OTChhhhhhhh | LTChhhhhhhh | PAGE hhhh |
| | TCBhhhhhhh | CMPhhhhhhhh | NTChhhhhhhh | OTChhhhhhhh | LTChhhhhhhh | PAGE hhhh |
| JOB | JOB12 | STEP GO | NTChhhhhhhh | OTChhhhhhhh | LTChhhhhhhh | PAGE hhhh |
| | TCBhhhhhhh | CMPhhhhhhhh | | | | |

Figure 31. IMDPRDMP TCB Summary

the completion of an event. To determine the events for which a task is waiting, use the instruction address field in the resume PSW to locate the WAIT macro instruction in the source program. This will point you to the operation being executed at the time of the dump.

MAIN STORAGE CONTENTS

Load List (MFT)

The load list is a chain of request blocks associated with load modules invoked by a LOAD macro instruction. By looking at the load list, and at the job pack area queue described below, you can determine which system and problem program routines were loaded before the dump was taken. To construct the load list associated with the task in control, look at the tenth word in the TCB, TCB+36(24), for a pointer to the most recent RB entry on the load list, minus 8 bytes (RB-8). This word, in turn, points to the next most recent entry (minus 8), and so on. If this is the last RB, RB-8 will contain zeroes. The word preceding the most recent RB on the list (RB-4) points back to the TCB's load list pointer.

Load List (MVT)

To construct the load list associated with the task in control, look at the tenth word in the TCB, TCB+36(24), for a pointer to the most recent load list entry (LLE). Each LLE contains the address of the next most recent entry (bytes 0-3), the count (byte 4), and the address of the CDE for the associated load module (bytes 5-7). If

this is the last LLE in the list, TCB+36(24) will contain zeroes.

Job Pack Area Queue (MFT With Subtasking, MVT)

In systems with MFT with subtasking or MVT control programs, the job pack area queue is used to maintain reenterable modules within a partition or region. The complete description of this queue is found under the topic "Task Status-Active RB Queue".

MFT System: To reconstruct the job pack area queue in an MFT system with subtasking, look at TCB+125(7D) for a three byte pointer to the partition information block (PIB). The twelfth word of the PIB, PIB+44(2C), points to the most recent RB on the job pack area queue minus 8 bytes (RB-8). This word in turn points to the next most recent RB minus 8, and so on. The last RB will have zero in this field. The word preceding the most recent RB on the queue (RB-4) points back to the job pack area queue pointer in the PIB. You can determine the identity of the load module by looking either in the first and/or second word of the RB for its EBCDIC name, or in the last three digits of the resume PSW in the previous RB for the SVC number. The entry point of the module is given in the last three bytes of the fourth word in the RB, RB+29(1D), unless it is an FRB.

The first five words of an FRB (beginning at offset minus 8) are identical in content to those of other RBs. The XRWTL field, offset 12(C), contains the address of a wait list element. The first word of the WLE points to the next WLE, or

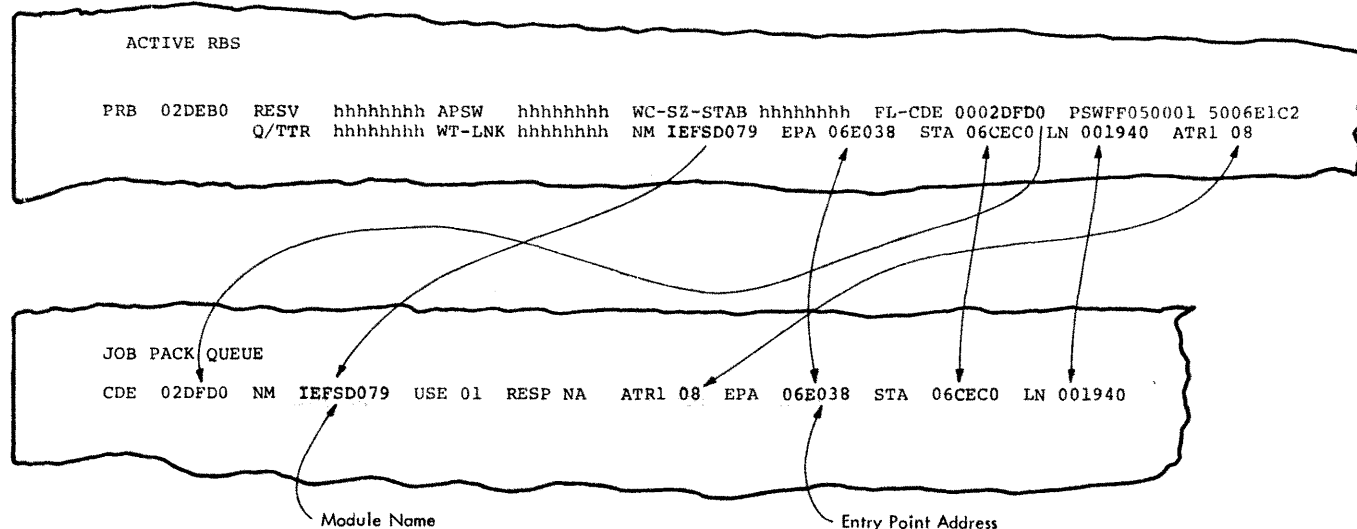

Figure 32. Determining Module From CDE in MVT

contains zeros if the WLE is the last one. The second word points to the waiting SVRB. You can determine the number of deferred requests for the module by tracing the chain of WLEs.

The XRREQ field of an FRB, offset 16(10), contains a pointer to the TCB of the requesting task. The next word, CRTLPRB, offset 20(14), points to an LPRB built by the Finch routine for the requested program. The FRB for the requested program is removed from the job pack area queue by the Finch routine when the program is fully loaded.

MVT System: In MVT, the job pack area queue is maintained in the same manner as the load list. The distinction between the two queues is that the job pack area queue contains reenterable programs. There are no FRBs in MVT.

MAIN STORAGE SUPERVISION

Free Areas in MFT Systems

Areas of main storage that are available for allocation at the time the dump was taken are described by the MSS boundary box and a series of free queue elements (FQEs). The seventh word of the TCB for the task, TCB+24(18), points to a six-word MSS boundary box. The first word of the MSS boundary box points to the FQE with the highest processor storage address in the partition (hierarchy 0), and the fourth word, to the highest 2361 Core Storage address in the partition (hierarchy 1). The first word of each FQE points to the next lower FQE; the second word of the FQE gives the length of the area it describes. FQEs occupy the first 8 bytes of the area they describe.

Gotten Subtask Areas (MFT)

In MFT with subtasking, areas of a partition allocated by the system to a subtask within the partition are described by gotten subtask area queue elements (GQEs). The seventh word of the subtask TCB, TCB+24(18), points to a one word pointer to the most recently created GQE on the GQE queue. Bytes 0 through 3 of the GQE contain a pointer to the previous GQE or, if zero, indicate that the GQE is the last one on the queue. Bytes 4 through 7 of the GQE contain the length of the gotten subtask area. Each GQE occupies the first eight bytes of the gotten subtask area it describes.

Region Structure in MVT System

The region associated with a particular task in an MVT system is described by

partition queue elements (PQEs). The thirty-ninth word of the TCB, offset +152 (98) contains a pointer to the dummy PQE (D-PQE) for the region. The first word of the dummy PQE points to the first PQE and the second word, to the last PQE. The first and second words of each PQE point to the first and last free block queue elements (FBQEs), respectively, associated with the PQE. Separate PQEs are used to describe parts of a region in different storage hierarchies or part of a region that was obtained by another task which has been rolled out.

FBQEs describe free areas in the region that have a length which is a multiple of 2048 bytes. These free areas are available for allocation to a specific subpool.

Subpool Descriptions (SPQEs) (MVT): The seventh word of the TCB, TCB+24(18), points to the SPQE representing the first subpool used by the task. Each SPQE contains the address of the next SPQE (bytes 1-3), the subpool number (byte 4), and the address of the first descriptor queue element (DQE) for the subpool (bytes 5-7) or, if the subpool is owned by another task (bit 0 is 1), the address of the SPQE that describes it (bytes 5-7).

Storage within a subpool is described by a descriptor queue element. Each DQE contains the number of bytes of main storage in the subpool. This count is always a multiple of 2048 bytes. If a request for space from a subpool cannot be satisfied with the space described by an existing DQE the GETMAIN routine builds another DQE and links the new DQE to the chain of existing DQE's. Each DQE contains a pointer to the FQE that represents the free area with the highest main storage address in the subpool (bytes 1-3), a pointer to the next DQE (bytes 5-7), and the length of the area described by the DQE, bytes 13-15(D-F).

Figure 33 shows the control blocks used to describe the subpools for a task in an MVT system.

I/O CONTROL BLOCKS

Queue of DEBs

To find the queue of DEBs for the task, look at the third word in the TCB (TCB+8). The address given here points to the first word of the most recent entry on the DEB queue. There is a DEB on this queue for each data set opened to the task at the time of the dump. DEBs are enqueued in the same order as the data sets are opened. The last three bytes of the second word in each DEB (DEB+5) points to the next most

recent DEB on the queue. The queue contains one DEB for each open data set.

UCBs

You can find unit information for each device in your system in the unit control block (UCB) for that device. The address of the UCB is contained in the last 3 bytes of the ninth word of the DEB, DEB+33(21). If the DEB queue is empty, scan the dump around location 4096(1000) for words whose fifth and sixth digits are FF. These are the first words of the UCBs for the system; UCBs are arranged in numerical order by device address. (You may find it easier to locate UCBs by looking for the device address in the EBCDIC printout to the right of each page.) The first two bytes of the second word of each UCB give the device address. The device type and class are given in the third and fourth bytes of the fifth word, UCB+18(12), respectively. The sense bytes, with the exception of those for devices with extended sense, begin in the last two bytes of the sixth UCB word, UCB+22(16), and continue from 1 to 6 bytes depending on the device type. For the extended sense devices, UCB+22 and UCB+23 are ignored. UCB+24(18) in this case contains the number of bytes of sense

information to be found starting at the address specified in UCB+25(19). Sense bytes are given in Appendix G of this publication.

DCB and TIOT

The address of the DCB, a control block that describes the attributes of an open data set, is located in the last 3 bytes of the seventh DEB word, DEB+25(19). The first two bytes of the ninth word of the DCB, offset 40(28), contains the offset in the task input/output table (TIOT) of the DD name entered for the data set. Therefore, the address of the DD name for a particular data set may be found by adding the TIOT offset in the DCB to the TIOT address in the TCB (TCB+12), plus 24(16) bytes for the TIOT header.

IOB

If a data set is being accessed by a sequential access method with normal scheduling, the address of the input/output block (IOB) prefix (IOB-8) is located in the seventeenth word of the DCB, DCB-68(44). The first word of the IOB prefix points to the next IOB (if more than one IOB exists for the data set). Each IOB

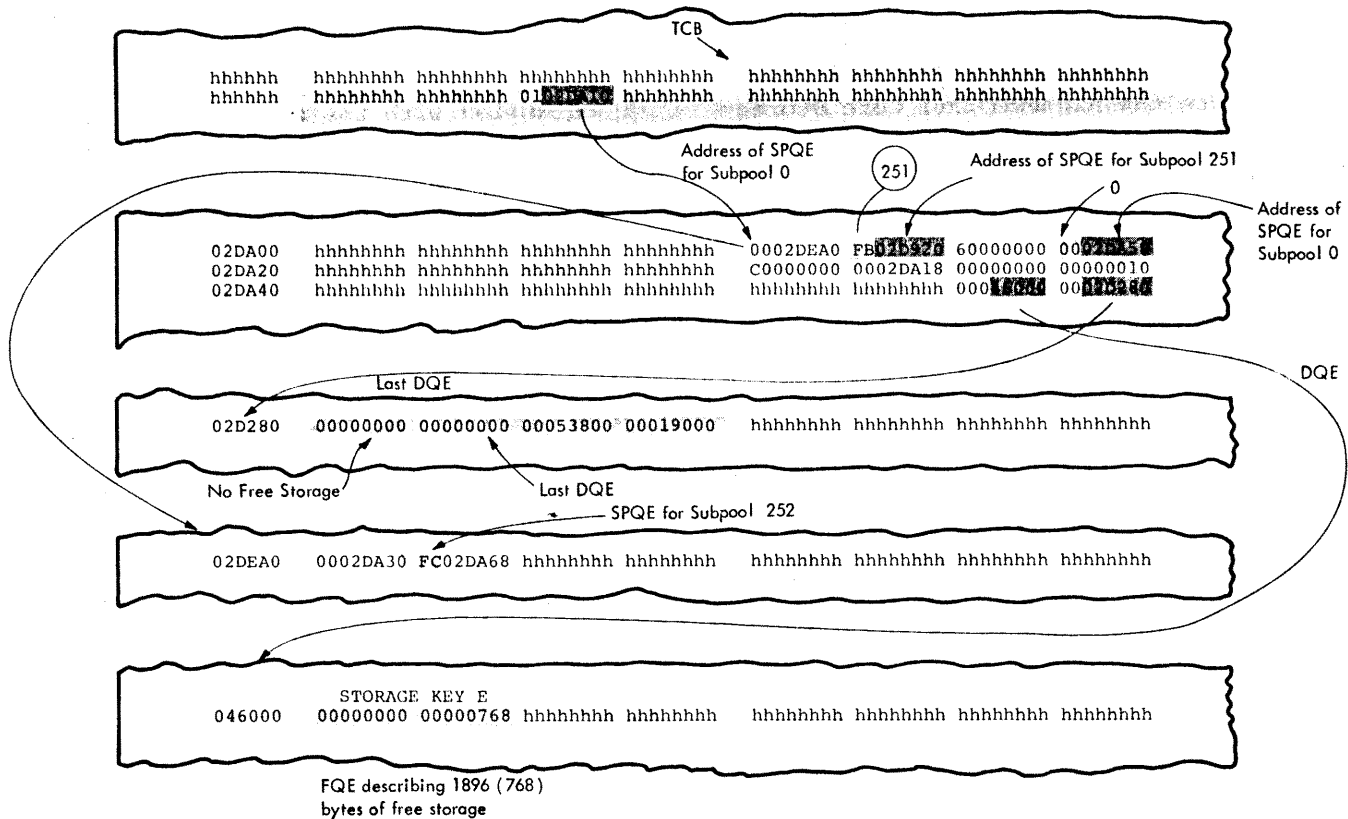

Figure 33. Subpool Descriptions in MVT - IMDPRDMP Storage Print

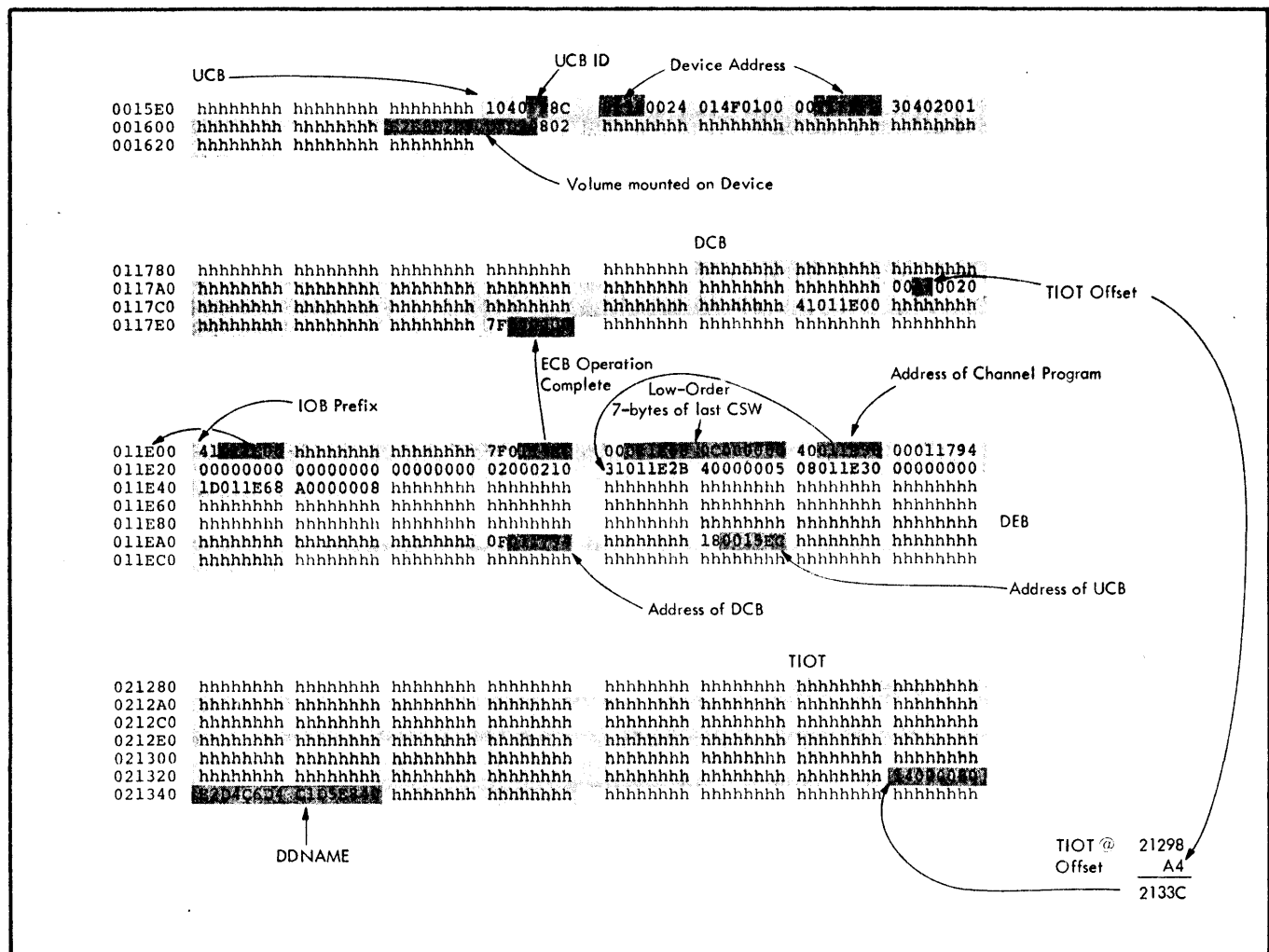

Figure 34. I/O Control Blocks

for an open data set contains a pointer to the CCW list in the last three bytes of the fifth word, IOB+17(11).

ECB

The Completion code for an I/O operation is posted in the first byte of the event control block (ECB). ECB completion codes are explained in Appendix F. If the I/O event is not complete and an SVC I (WAIT) has been issued, the high-order bit of the ECB is on, and bytes one through three contain the address of the associated RB. For the sequential and basic partition access methods the second word of an IOB points to its associated ECB.

Figure 34 shows the DEB, UCB, DCB, and IOB for a BSAM data set.

TSO CONTROL BLOCKS

The time sharing (TSO) control blocks are obtained from the IMDPRDMP service aid program by specifying the TSO control statement in the input stream. The first part of the TSO dump is the same as the normal MVT dump. The control blocks that IMDPRDMP formats are divided into two group: system and user.

TSCVT

The time sharing communications vector table (TSCVT) is a secondary CVT for the MVT CVT. The time sharing CVT resides in the time sharing region; therefore, it exists only while the time sharing region is active. When time sharing does not exist in the system, the MVT CVT pointer to the TSCVT (CVT+229) is zero.

RCB

A region control block (RCB) contains information that is unique to a time sharing region. There is one RCB for each time sharing region. The RCBs reside in the time sharing controller's region, they are contiguous, and they are created during initialization of the time sharing controller.

The TSCVT points to a region control block table. The RCB table is an indexed table containing one RCB address for each possible time sharing region, therefore, the table contains the maximum number of RCBs that may be used by time sharing. The first RCB is for region one, the second for region two, etc. The time sharing job block (TJB) of a job points to the RCB associated with that job.

UMSM

One user main storage map (UMSM) exists for each possible time sharing user. The UMSM contains a series of consecutive one-word extent fields (ADDR-LN). Each one-word extent contains a halfword address field (ADDR) and a halfword length field (LN) that describes the main storage allocated to the time sharing user. The UMSM contains the address and length of a storage block (a multiple of 2K bytes) that has been allocated to the user; only this allocated storage will be swapped out for the user. The time sharing job block (TJB) points to the UMSM.

SWAP DCB

The swap data control block (SWAP DCB) is used whenever a time sharing user's region is swapped into or out of main storage. It describes a swap data set that contains an IOB, area for channel programs, and the track map queue. The TJB points to the swap DCB.

TJB

The time sharing job block (TJB) contains status information about a time sharing user. The TJB is retained in main storage while the user is swapped out. One time sharing job block exists for each possible simultaneous time sharing user. The space for the TJB is obtained from the time sharing control task (TSC) region during time sharing initialization. Status information about the terminal related to this TJB is contained in the terminal

status block (TSB). The address of the terminal status block is the first word of the TJB. The first word of the TSCVT points to the TJB.

TSB

Each terminal status block (TSB) contains status information about one terminal. The terminal input/output coordinator (TIOC) uses this information. During system initialization, one TSB is created for each possible user. The main storage space is obtained in one contiguous block for all of the TSBs in the region of the time sharing control task (TSC); this contiguous string of TSBs is called the TSB table. The origin pointer to the TSB table is the TIOCTSB field of the TIOCRPT.

TJBX

The time sharing job block extension (TJBX) contains user job information that can be rolled out to the swap data set with the user's job. The TJBX resides in the local system queue space (LSQS) for the region. The TJBX location is pointed to by the third word of the time sharing job block (TJB). The space for the TJBX is obtained by the region control task (RCT) during initialization.

PSCB

The protected step control block (PSCB) contains accounting information related to a single user. All timing information is in software timer units. A software timer unit is equal to 26.04166 micro seconds. The job step control block (JSCB), offset 268, points to the PSCB.

TAXE

The TSO terminal attention exit element (TAXE) is a physical addendum to a regular 24 word interrupt request block (IRB). It is used to schedule an attention exit resulting from a terminal attention interruption. It is created, queued, and dequeued by the specify terminal attention exit (STAX) macro instruction. The main storage space for the TAXE is obtained in the local system queue space (LSQS) of the terminal user's region.

For a more detailed description of the TSO control blocks formatted by the IMDPRDMP program, see the Control Block and/or TSO Control Program PLM publications.

Section 3: Tracing Aids

Tracing aids available are the save area chain, trace option, and Generalized Trace Facility (GTF). This section provides a description of each tracing aid, and, for GTF, describes its output after processing by the IMDPRDMP service aid.

Save Area Chain

The save area chain is edited and clearly identified in ABEND/SNAP dumps, and can be located easily in storage dumps produced by system dump facilities or the IMDSADMP service aid.

A save area is a block of 72 bytes containing chain pointers and register contents. It has the following format:

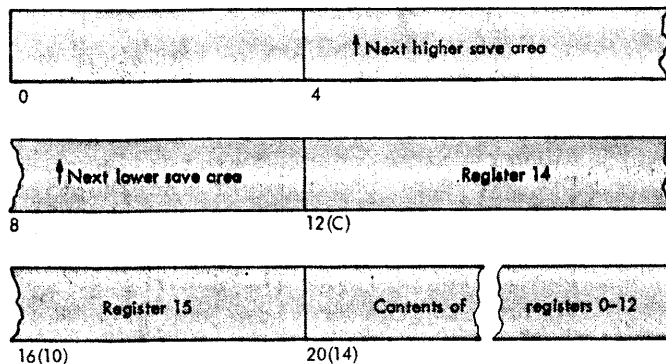

Bytes 4-7: Pointer to the next higher level save area or, if this is the highest level save area, zeros.

Bytes 8-11(B): Pointer to the next lower level save area or, if this is the lowest level save area, unused.

Bytes 12-15(C-F): Contents of register 14 (optional)

Bytes 16-19(10-13): Contents of register 15 (optional)

Bytes 20-71(14-3F): Contents of registers 0 to 12

The save area for the first or highest level load module in a task (save area 1) is provided by the control program. The address of this area is contained in register 13 when the load module is first entered. It is the responsibility of the highest level module to:

1. Save registers 0-12 in bytes 20-71(14-3F) of save area 1 when it is entered.
2. Establish a new save area (save area 2).
3. Place the contents of register 13 into bytes 4-7 of save area 2.
4. Place the address of save area 2 into register 13.
5. Place the address of save area 2 into bytes 8-11(B) of save area 1.

At this point, the save areas appear as shown in Figure 35.

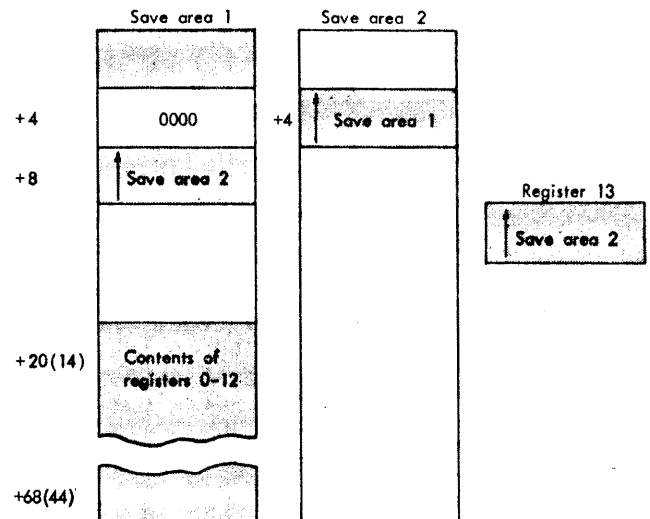

Figure 35. Save Area Trace

If a module requests a lower level module, it must perform actions 1 through 4 to ensure proper restoration of registers when it regains control. (Action 5 is not required, but must be performed if the dump printout of the field is desired.) A module that does not request a lower level module need only perform the first action.

ABEND and SNAP dumps include edited information from all save areas associated with the dumped task under the heading "SAVE AREA TRACE". In a stand-alone dump, the highest level save area can be located through a field of the TCB. Subsequent save areas can be located through the save area chain.

TRACE OPTION

The tracing routine is an optional feature specified during system generation. This routine places entries, each of which is associated with a certain type of event, into a trace table. When the table is filled, the routine overlays old entries with new entries, beginning at the top of the table (the entry having the lowest storage address). The contents and size of a trace table are highly system-dependent.

Systems With MFT: Trace table entries for systems with MFT are 4 words long and represent SIO, I/O, SVC and dispatcher task-switching interruptions. Figure 36 shows the word contents of each type of entry.

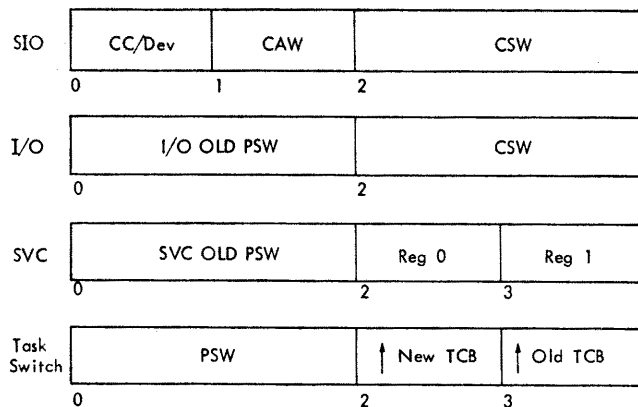

Figure 36. Trace Table Entries (MFT)

Systems with MVT: The trace table in a system with MVT is expanded to include more entries and more information in each entry. Trace table printouts occur only on SNAP dumps and stand-alone dumps. Entries are eight words long and represent occurrences of SIO, external, SVC, program, and I/O interruptions, and dispatcher loaded PSWs.

Figure 37 shows the word contents of trace table entries for SNAP dumps and stand-alone dumps. Figure 38 shows the contents of trace table entries as filled by MVT with Model 65 multiprocessing. (SSM -- set system mask -- entries are optional.)

INTERPRETING TRACE TABLE ENTRIES

Location 84(54) in main storage contains the address of the first word of the three word trace table control block. The trace table control block immediately precedes the table. The trace table control block describes the bounds of the table and the most recent entry at the time of the dump.

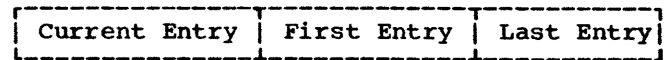

You can locate the trace table by scanning the contents of main storage between locations 16,384(4000) and 32,768(8000) for trace table entries. Entries are four words long and begin at addresses ending with zero. To find the table boundaries and current entry, scan the table in reverse until you reach the trace table control block.

Trace Table Entries in MFT: Trace table entries for systems with MFT are 4 words long and represent occurrences of SIO, I/O, SVC, and task-switching interruptions. Figure 39 gives some sample entries and their contents.

SIO entries can be used to locate the CCW (through the CAW), which reflects the operation initiated by an SIO instruction. If the SIO operation was not successful, the CSW STATUS portion of the entry will show you why it failed.

I/O entries reflect the I/O old PSW and the CSW that was stored when the interruption occurred. From the PSW, you can learn the address of the device on which the interruption occurred (bytes 2 and 3), the CPU state at the time of interruption (bit 15), and the instruction address where the interruption occurred (bytes 5-8). The CSW provides you with the unit status (byte 4), the channel status (byte 5), and the address of the previous CCW plus 8 (bytes 0-3).

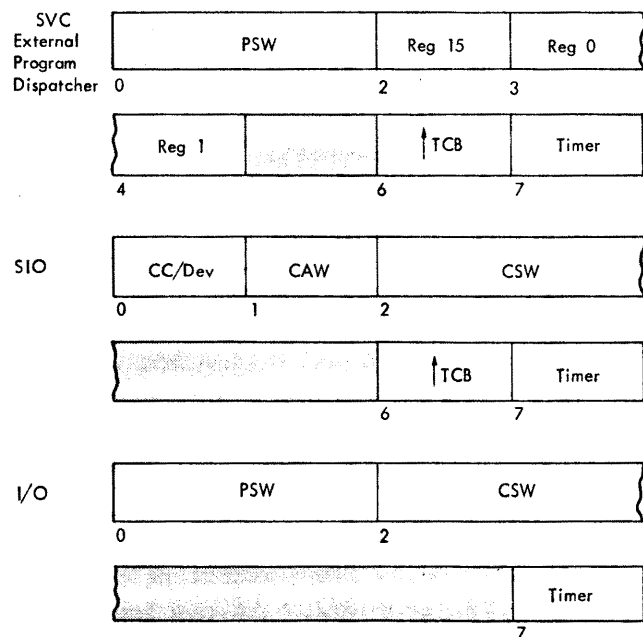

Figure 37. Trace Table Entries (MVT)

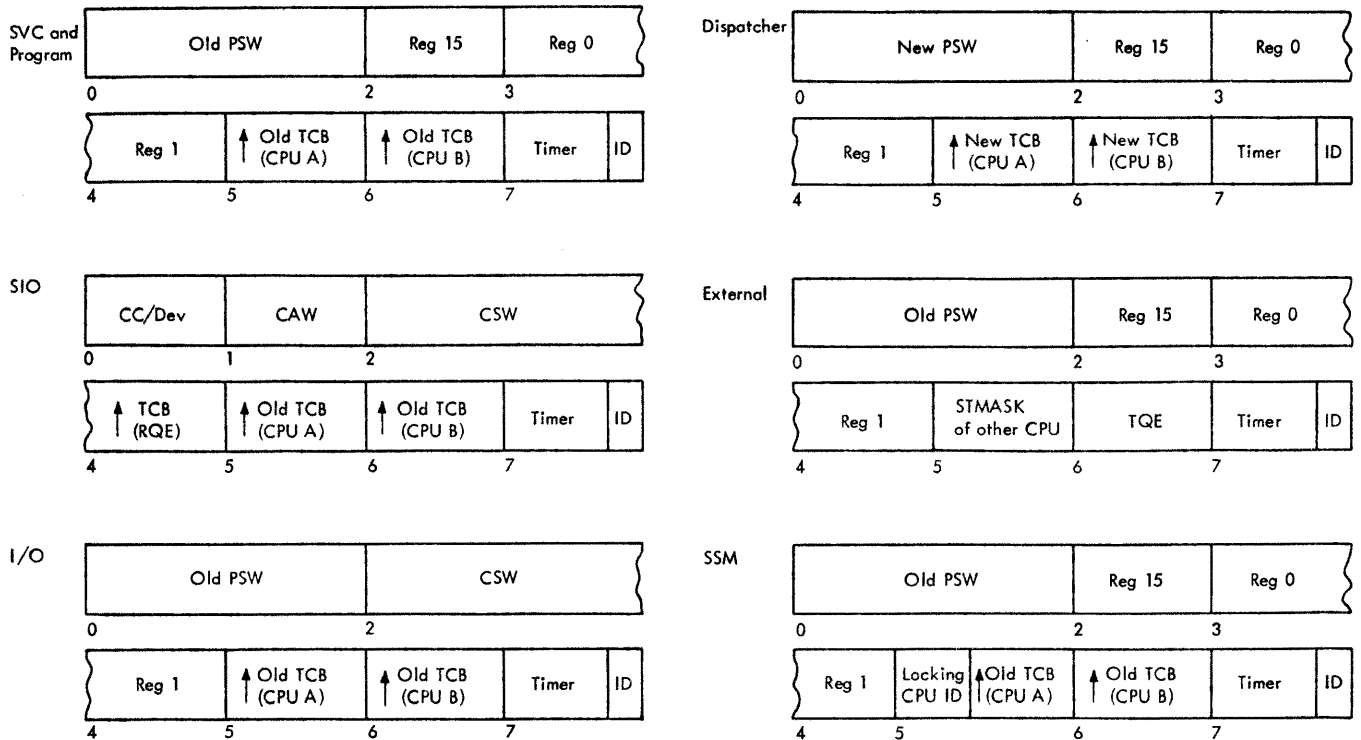

Figure 38. Trace Table Entries (MVT with Model 65 multiprocessing)

SVC entries provide the SVC old PSW and the contents of registers 0 and 1. The PSW offers you the hexadecimal SVC number (bits 20-31), the CPU mode (bit 15), and the address of the SVC instruction (bytes 5-8). The contents of registers 0 and 1 are useful in that many system macro instructions use these registers for parameter information. Contents of registers 0 and 1 for each SVC interruption are given in Appendix B.

Trace Table Entries in MVT and M65MP:

Entries in an MVT trace table are 8 words long and represent occurrences of SIO, external, SVC, program, I/O, and dispatcher interruptions. You can identify what type of interruption caused an entry by looking at the fifth digit:

- 0 = SIO
- 1 = External
- 2 = SVC
- 3 = Program
- 5 = I/O
- D = Dispatcher

Figure 40 gives some sample entries and their contents.

In dumps of Model 65 Multiprocessing system, trace table entries differ as follows:

- SIO
 - 5th word: address of TCB.
 - 6th word: address of old TCB for CPU A.
 - 7th word: address of old TCB for CPU B.
 - 8th word: CPU identification (last byte).
- I/O
 - 3rd word: contents of register 15.
 - 4th word: contents of register 0.
 - 8th word: CPU identification (last byte).
- SVC and Program
 - 6th word: address of old TCB for CPU A.
 - 7th word: address of old TCB for CPU B.
 - 8th word: CPU identification (last byte).
- Dispatcher
 - 6th word: address of new TCB for CPU A.
 - 7th word: address of new TCB for CPU B.
 - 8th word: CPU identification (last byte).
- External
 - 6th word: STMASK of other CPU.
 - 7th word: TQE if timer interrupt occurred.
 - 8th word: CPU identification (last byte). If so, a program check at the instruction preceding that address caused the interruption.

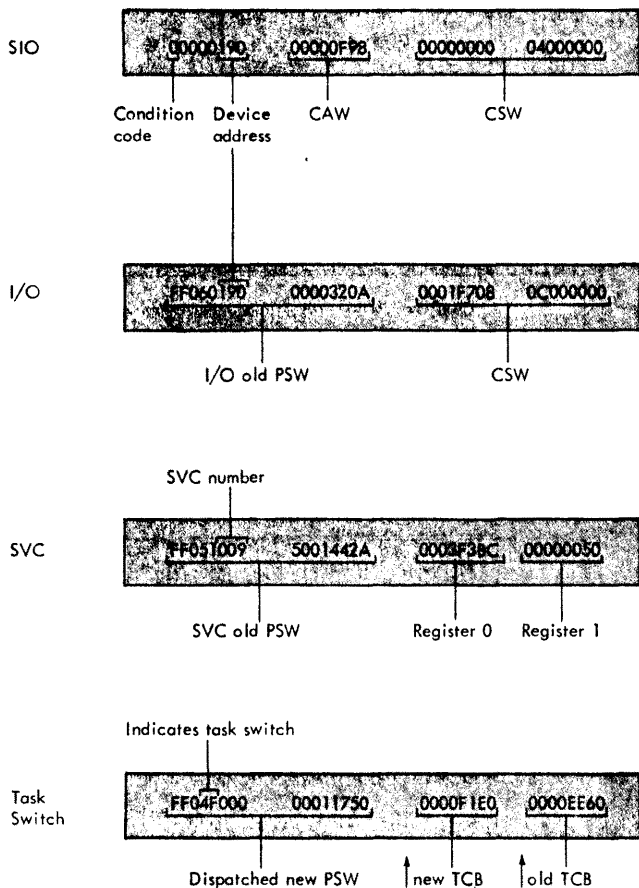

Figure 39. Sample Trace Table Entries (MFT)

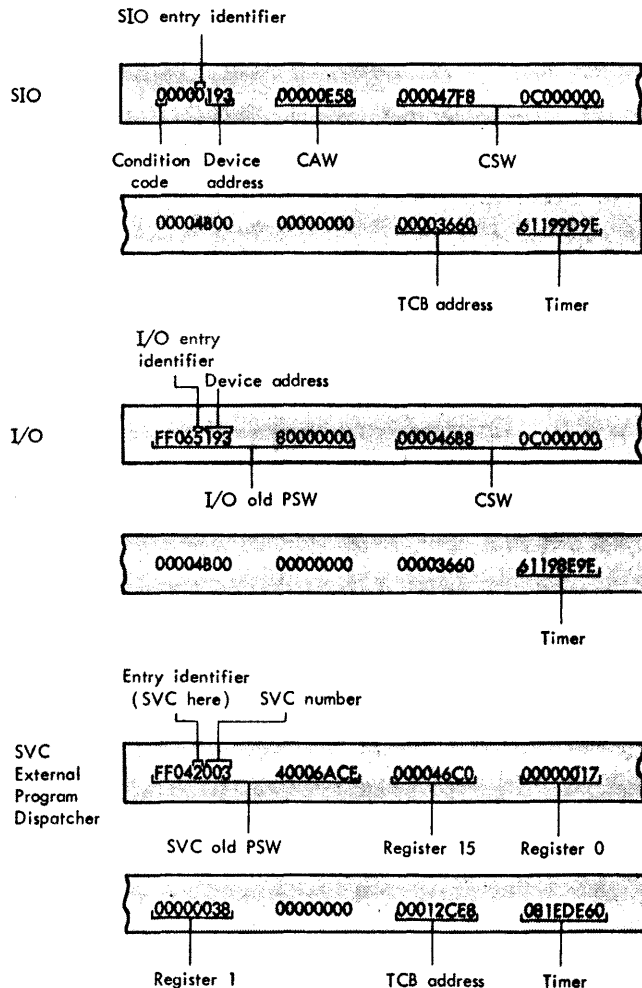

Figure 40. Sample Trace Table Entries (MVT)

System events traced by GTF in MFT, MVT, and MVT-M65MP systems are:

- IO interrupts
- SIO operations
- SVC interrupts
- Program interrupts
- External interrupts
- Task Switches by the system dispatcher
- SSM interrupts in multi-processing systems

GTF MINIMAL TRACE RECORDS

The following material describes the records produced under the minimal trace option (SYSM) of GTF. The formats described appear in both ABEND/SNAP dumps (under the heading GTF TRACE TABLE) and in IMDPRDMP output. Minimal trace records are produced for IO and PCI/IO, SIO, SVC, PGM, EXT, DSP, and SSM events.

Generalized Trace Facility

The Generalized Trace Facility (GTF) traces system and application program events and records information about these events. Trace records can be stored internally -- in a table similar to the trace table of the Trace Option -- or they can be recorded externally in a data set that becomes input to the IMDPRDMP service aid program. (When stored internally the trace table is formatted in ABEND/SNAP dumps.) The IMDPRDMP service aid edits and formats the GTF external trace records as specified in an EDIT control statement.

This section describes the output of GTF; it does not tell how to use GTF. For a description of the functions performed by GTF and IMDPRDMP refer to the Service Aids publication.

IO and PCI/IO Minimal Trace Record

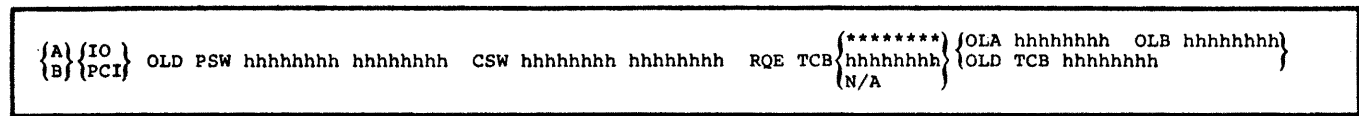

Figure 41. IO and PCI/IO Minimal Trace Record

| | |
|---|--|
| <pre> {A } {B } </pre> <p>appears in MVT-M65MP system records; identifies the CPU associated with the event.</p> | <pre> hhhhhhh </pre> <p>is the address of the TCB of the task for which this I/O operation is being performed.</p> |
| <pre> IO } PCI} </pre> <p>identifies the type of trace record.</p> | <pre> N/A </pre> <p>indicates the interrupt was unsolicited: either the I/O supervisor did not issue an SIO instruction to the device; or there is no valid UCB for the device.</p> |
| <pre> OLD PSW hhhhhhhh hhhhhhhh </pre> <p>the program status word that was current at the time the IO or PCI/IO interrupt occurred.</p> | |
| <pre> CSW hhhhhhhh hhhhhhhh </pre> <p>the channel status word associated with the IO or PCI/IO interrupt being traced.</p> | <pre> OLD TCB hhhhhhhh </pre> <p>in MFT and MVT system trace records, the address of the TCB for the task that was in control when the interrupt occurred.</p> |
| <pre> RQE TCB {*****} {hhhhhhh} {N/A} </pre> <p>***** indicates that an error occurred while gathering the information.</p> | <p>in MVT-M65MP systems the OLA and OLB fields replace the OLD TCB field and contain the address of the TCB for the task in control of CPU A and CPU B respectively, at the time the interrupt occurred.</p> |

SIO Minimal Trace Record

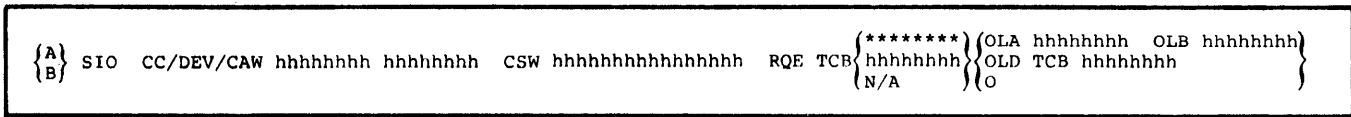

Figure 42. SIO Minimal Trace Record

| | |
|--|--|
| <p>{A}</p> <p>{B}</p> <p>appears in MVT-M65MP system records; identifies the CPU associated with the event.</p> <p>SIO identifies the type of trace record.</p> <p>CC/DEV/CAW hhhhhhhh hhhhhhhh displays the SIO condition code, the device address, and the CAW (channel address word) for the I/O operation just initiated.</p> <p>The first four digits represent the condition code returned from the SIO operation; the next four digits represent the device address; and the last eight digits represent the CAW.</p> <p>CSW hhhhhhhh hhhhhhhh the channel status word associated with this event.</p> <p>RQE TCB {*****} {hhhhhhh} {N/A}</p> | <p>***** indicates that an error occurred while gathering the information.</p> <p>hhhhhhh is the address of the TCB of the task for which this I/O operation is being performed.</p> <p>N/A indicates the interrupt was unsolicited, i.e., the I/O supervisor did not issue an SIO instruction to the device; or, there is no valid UCB for the device.</p> <p>OLD TCB hhhhhhhh in MFT and MVT system trace records, the address of the TCB for the task that was in control when the interrupt occurred.</p> <p>In MVT-M65MP systems the OLA and OLB fields replace the OLD TCB field and contain the address of the TCB for the task in control of CPU A and CPU B respectively, at the time the interrupt occurred.</p> |
|--|--|

DSP Minimal Trace Record

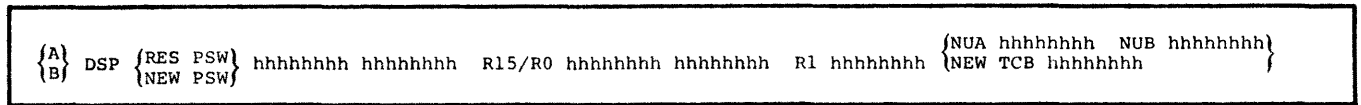

Figure 43. DSP Minimal Trace Record

| | | |
|--|--|--|
| $\left\{ \begin{array}{l} A \\ B \end{array} \right\}$ | appears in MVT-M65MP records; identifies the CPU associated with the event. | registers 15 and 0 as they will be when the task being dispatched is given control. |
| DSP | identifies the type of record. | R1 hhhhhhhh the contents of general purpose register 1 as it will be when the task being dispatched is given control. |
| NEW PSW hhhhhhhh hhhhhhhh | the PSW for the task about to be dispatched. | NEW TCB hhhhhhhh the address of the TCB for the task about to be dispatched. |
| | In a record obtained from a MVT-M65MP system this field will be labeled RES PSW. | In a record obtained from a MVT-M65MP system this field is replaced by the NUA and NUB fields containing the addresses of the tasks to be dispatched on CPU A and CPU B when processing resumes. |
| R15/R0 hhhhhhhh hhhhhhhh | the contents of general purpose | |

EXT Minimal Trace Record

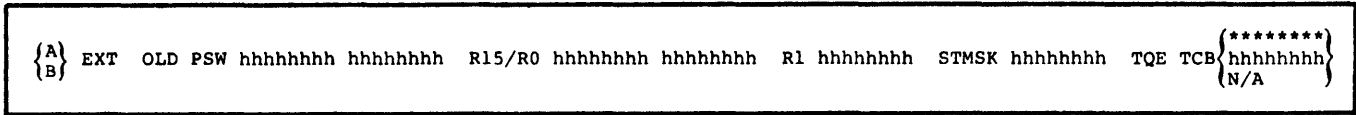

Figure 44. EXT Minimal Trace Record

| | | | | | | | | | | | | | | | | | |
|---|---|---|----------|-----|---|-------|--|---|--|--|----------|---|--|--|--|-----|--|
| <table border="0"> <tr> <td style="border: none;">{A}</td> <td style="border: none;">}</td> <td style="border: none;"></td> </tr> <tr> <td style="border: none;">{B}</td> <td style="border: none;">}</td> <td style="border: none;"></td> </tr> </table> | {A} | } | | {B} | } | | <p>appears in MVT-M65MP records; identifies the CPU associated with the event.</p> | <p>STMSK hhhhhhhh appears in MVT-M65MP records only; displays the SHOULDER TAP MASK at the time the interrupt occurred.</p> | | | | | | | | | |
| {A} | } | | | | | | | | | | | | | | | | |
| {B} | } | | | | | | | | | | | | | | | | |
| EXT | identifies the type of trace record. | <table border="0"> <tr> <td style="border: none;">TQE</td> <td style="border: none;">TCB</td> <td style="border: none;">{</td> <td style="border: none;">*****</td> <td style="border: none;">}</td> </tr> <tr> <td style="border: none;"></td> <td style="border: none;"></td> <td style="border: none;"></td> <td style="border: none;">hhhhhhhh</td> <td style="border: none;">}</td> </tr> <tr> <td style="border: none;"></td> <td style="border: none;"></td> <td style="border: none;"></td> <td style="border: none;">N/A</td> <td style="border: none;"></td> </tr> </table> | TQE | TCB | { | ***** | } | | | | hhhhhhhh | } | | | | N/A | |
| TQE | TCB | { | ***** | } | | | | | | | | | | | | | |
| | | | hhhhhhhh | } | | | | | | | | | | | | | |
| | | | N/A | | | | | | | | | | | | | | |
| OLD PSW | <p>hhhhhhhh hhhhhhhh the program status word that was current at the time the external interrupt occurred.</p> | <p>***** indicates that an error occurred while gathering the information.</p> | | | | | | | | | | | | | | | |
| R15/R0 | <p>hhhhhhhh hhhhhhhh the contents of general purpose registers 15 and 0 at the time the interrupt occurred.</p> | <p>hhhhhhhh is the address of the TCB of the task that requested this timer interrupt.</p> | | | | | | | | | | | | | | | |
| R1 | <p>hhhhhhhh the contents of general purpose register 1 at the time the interrupt occurred.</p> | <p>N/A indicates the interrupt was other than a timer interrupt.</p> | | | | | | | | | | | | | | | |

PGM Minimal Trace Record

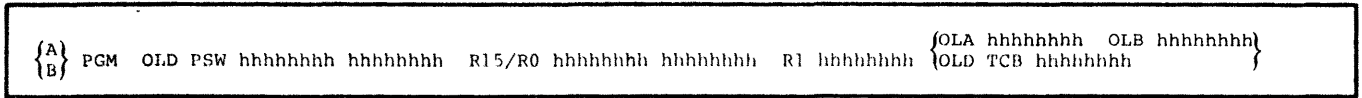

Figure 45. PGM Minimal Trace Record

- | | | | | | |
|--|--|----------|--|--|--|
| $\left. \begin{matrix} \{A\} \\ \{B\} \end{matrix} \right\}$ | appears in MVT-M65MP system records; identifies the CPU associated with the event. | R1 | hhhhhhhh | the contents of general purpose register 1 at the time the interrupt occurred. | |
| PGM | identifies the type of trace record. | OLD | TCB | hhhhhhhh | the address of the TCB for the task that was in control when the interrupt occurred. |
| OLD | PSW | hhhhhhhh | hhhhhhhh | the program status word that was current at the time the program interrupt occurred. | In MVT-M65MP trace records this field is replaced by the OLA and OLB fields that contain, respectively, the address of the TCB for the tasks in control of CPU A and CPU B at the time the interrupt occurred. |
| R15/R0 | hhhhhhhh | hhhhhhhh | the contents of general purpose registers 15 and 0 at the time the interrupt occurred. | | |

SVC Minimal Trace Record

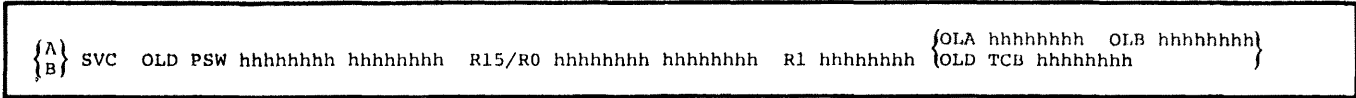

Figure 46. SVC Minimal Trace Record

| | | |
|--|---|---|
| $\left. \begin{matrix} \{A\} \\ \{B\} \end{matrix} \right\}$ | appears in MVT-M65MP system records; identifies the CPU associated with the event. | registers 15 and 0 at the time the interrupt occurred. |
| SVC | identifies the type of trace record. | R1 hhhhhhhh the contents of general purpose register 1 at the time the interrupt occurred. |
| OLD PSW hhhhhhhh hhhhhhhh | the program status word that was current at the time the interrupt occurred. The SVC number, e.g., SVC 51, is represented by the last two hexadecimal digits in the first word. | OLD TCB hhhhhhhh the address of the TCB for the task that issued the SVC. |
| R15/R0 hhhhhhhh hhhhhhhh | the contents of general purpose | In MVT-M65MP systems the OLA and OLB fields replace the OLD TCB field and contain the address of the TCB for the task in control of CPU A and CPU B respectively, at the time the interrupt occurred. |

SSM Minimal Trace Record

| |
|---|
| $\left. \begin{matrix} \{A\} \\ \{B\} \end{matrix} \right\}$ SSM LK C OPSW hhhhhhhh hhhhhhhh R15/R0 hhhhhhhh hhhhhhhh R1 hhhhhhhh OLA hhhhhhhh OLB hhhhhhhh |
|---|

Figure 47. SSM Minimal Trace Record

| | | |
|--|---|--|
| $\left. \begin{matrix} \{A\} \\ \{B\} \end{matrix} \right\}$ | indicates the CPU associated with the event. | OPSW hhhhhhhh hhhhhhhh the program status word that was current at the time the interrupt occurred. Obtained from the CPU on which the interrupt occurred. |
| SSM | identifies the type of trace record. | R15/R0 hhhhhhhh hhhhhhhh R1 hhhhhhhh The contents of general purpose registers 15, 0, and 1 from the CPU on which the interrupt occurred, at the time the interrupt occurred. |
| IK c | CPU affinity byte: A indicates CPU A executing disabled. B indicates CPU B executing disabled. 0 Neither CPU executing disabled. | OLA hhhhhhhh OLB hhhhhhhh the addresses of the TCBs of the tasks in control in CPU A and CPU B respectively at the time the interrupt occurred. |

GTF COMPREHENSIVE TRACE RECORDS

The following material describes the records produced when comprehensive tracing is specified at the invoking of GTF (MODE=EXT). The formats described appear

in the output from IMDPRDMP service aid processing of the data recorded by GTF.

Comprehensive trace records are produced for IO, PCI/IO, SIO, DSP, EXT, PGM, SSM, and SVC events.

IO and PCI/IO Comprehensive Trace Record

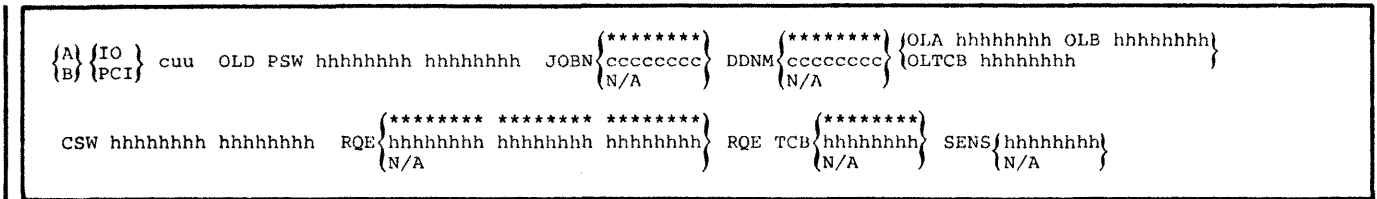

Figure 48. IO and PCI/IO Comprehensive Trace Record

{A}
{B}

This field appears only in MVT-M65MP system I/O or PCI trace records and identifies the computer associated with the event.

UCB for the device issuing the interrupt.

DDNM {cccccccc

N/A}

{IO
PCI}

This field identifies the type of trace record -- input/output (IO) or program controlled interrupt (PCI).

This field has three possible entries, as follows:

cuu

This field displays the device address for the device associated with the interrupt in channel/unit form.

cccccccc

is the name of the DD statement associated with the interrupt being traced.

OLD PSW hhhhhhhh hhhhhhhh

This field displays the program status word that was current at the time the IO or PCI interrupt being traced, occurred.

asterisk indicate that a bad control block chain prevented the data definition name from being obtained.

JOBN {cccccccc

N/A}

This field has three possible entries, as follows:

N/A

N/A appears in the DDNM field for one of the following reasons:

cccccccc

is the one to eight character name of the job associated with the interrupt being traced.

- An interrupt was issued without a valid UCB for the device issuing the interrupt.
- The post bit in the UCB is 'off.'
- The data event block (DEB) pointer to the TCB is set to 0.
- The DCB is not opened.
- The DCB TIOT offset is outside the valid range.
- The TCB TIOT pointer is set to 0.
- The DDNAME in the TIOT is not recorded in EBCDIC characters.

asterisks indicate that a bad control block chain prevented the jobname from being obtained.

N/A

in PCI trace records N/A indicates that the interrupt was issued by the system and there is no associated jobname; in IO interrupt trace records N/A indicates either a system issued interrupt as for PCI or an interrupt issued without a valid

OLTCB hhhhhhhh

In MFT and MVT system trace records this field displays the address of the TCB that was current at the time the IO or PCI interrupt being traced, occurred.

In MVT-M65MP system IO and PCI trace records the following fields replace the OLTCB field:

OLA hhhhhhhh
This field displays the address of the A computer TCB that was current when the IO or PCI interrupt occurred.

RQE TCB { hhhhhhhh }
 { ***** }
 { N/A }
}

This field has three possible entries as follows:

OLB hhhhhhhh
This field displays the address of the B computer TCB that was current when the IO or PCI interrupt occurred.

hhhhhhhh
is the address of the TCB associated with the Request Queue Element

CSW hhhhhhhh hhhhhhhh
This field displays the channel status word from permanent storage location 64.

asterisks indicate that a bad control block chain prevented the TCB address from being obtained.

RQE { hhhhhhhh hhhhhhhh hhhhhhhh }
 { ***** ***** ***** }
 { N/A }
}

N/A
indicates that the interrupt was issued without a valid UCB for the device issuing the interrupt.

This field has three possible entries as follows:

SENS { hhhhhhhh }
 { N/A }
}

hhhhhhhh hhhhhhhh hhhhhhhh
is the content of the first three words of the Request Queue Element associated with the IO or PCI interrupt.

This field has two possible entries as follows:

asterisks indicate that a bad control block chain prevented the RQE information from being obtained.

hhhhhhhh
is the content of the four sense bytes in the UCB beginning at UCB + 22 which describe the IO or PCI interrupt being traced. For more information about the sense bytes see Appendix G.

N/A
indicates that the interrupt was issued without a valid UCB for the device issuing the interrupt.

N/A
indicates that the interrupt was issued without a valid UCB for the device issuing the interrupt.

SIO Comprehensive Trace Record

```

{A} SIO cuu CC hh CAW hhhhhhhh JOBN{cccccccc} {OLA hhhhhhhh OLB hhhhhhhh}
{B}                               {N/A}   {OLTCB hhhhhhhh}

CSW hhhhhhhh hhhhhhhh RQE hhhhhhhh hhhhhhhh hhhhhhhh RQE TCB hhhhhhhh

```

Figure 49. SIO Comprehensive Trace Record

| | |
|--|--|
| <p>{A} {B}</p> <p>appears in MVT-M65MP system trace records; identifies the computer associated with the event.</p> | <p>OLTCB hhhhhhhh in MFT/MVT systems the address of the TCB that was current when the SIO was issued.</p> |
| <p>SIO</p> <p>the type of trace record.</p> | <p>in MVT-M65MP systems the OLA and OLB fields replace the OLTCB field.</p> |
| <p>cuu</p> <p>the device address in channel/unit form for the device associated with the record.</p> | <p>OLA hhhhhhhh is the A computer address of the TCB that was current when the SIO was issued.</p> |
| <p>CC hh</p> <p>hh - is the condition code set by the SIO event.</p> | <p>OLB hhhhhhhh is the B computer address of the TCB that was current when the SIO was issued.</p> |
| <p>CAW hhhhhhhh</p> <p>the channel address word associated with this event -- taken from permanent storage location 72.</p> | <p>CSW hhhhhhhh hhhhhhhh the channel status word associated with this event -- taken from permanent storage location 64.</p> |
| <p>JOBN {cccccccc} { N/A }</p> <p>cccccccc</p> <p>is the one to eight character jobname of the job associated with this event.</p> | <p>RQE hhhhhhhh hhhhhhhh hhhhhhhh the first three words of the Request Queue Element associated with the SIO operation.</p> |
| <p>N/A</p> <p>indicates the SIO was issued by the system and there is no associated jobname.</p> | <p>RQE TCB hhhhhhhh the address of the TCB associated with the request queue element.</p> |

DSP Comprehensive Trace Record

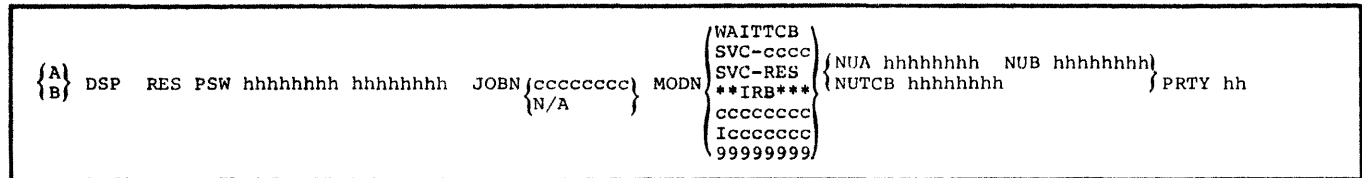

Figure 50. DSP Comprehensive Trace Record

| | | |
|---|--|--|
| <p>{A} {B}</p> <p>MVT-M65MP systems only. Identifies the computer associated with the event.</p> <p>DSP the type of trace record.</p> <p>RES PSW hhhhhhhh hhhhhhhh the PSW for the task about to be dispatched. If this task was interrupted at some previous point in time, then this was the current PSW at the interrupt.</p> <p>JOBN {cccccccc} { N/A }</p> <p>cccccccc is the eight character name of the job associated with the task being dispatched.</p> <p>N/A indicates the task switch is for a system task; no jobname is available.</p> <p>MODN (WAITTCB SVC-cccc SVC-RES **IRB** cccccccc Iccccccc 99999999)</p> <p>WAITTCB the WAIT task is about to be given control.</p> <p>SVC-cccc indicates a type 3 or 4 SVC is about to get control; cccc is the last four characters in the module name.</p> <p>SVC-RES indicates a resident type SVC routine is about to be given control.</p> | | <p>**IRB** an asynchronous routine is about to be dispatched and the module name is not available.</p> <p>cccccccc in MVT systems the eight character module name from the CDE associated with the task to be dispatched; or, the name of an error exit routine from the SIRB associated with the task.</p> <p>in MFT systems the eight character name from the LRB, LPRB, PRB or FRB associated with the task being dispatched; or an error exit routine name from the SIRB associated with the task.</p> <p>Iccccccc indicates that error fetch is in the process of loading an error recovery module. The last seven characters of the module name are shown.</p> <p>99999999 In MFT (with subtasking) an ATTACH was issued, but the module requested did not receive control.</p> <p>NUTCB hhhhhhhh the address of the new TCB -- the TCB of the next-to-be-dispatched task.</p> <p>in MVT-M65MP systems the following fields replace the NUTCB field: NUA hhhhhhhh the address of the TCB of the next-to-be-dispatched task in the A computer. NUB hhhhhhhh the address of the TCB of the next-to-be-dispatched task in the B computer.</p> <p>PRTY hh hh the dispatching priority of the next-to-be-dispatched task.</p> |
|---|--|--|

EXT Comprehensive Trace Record

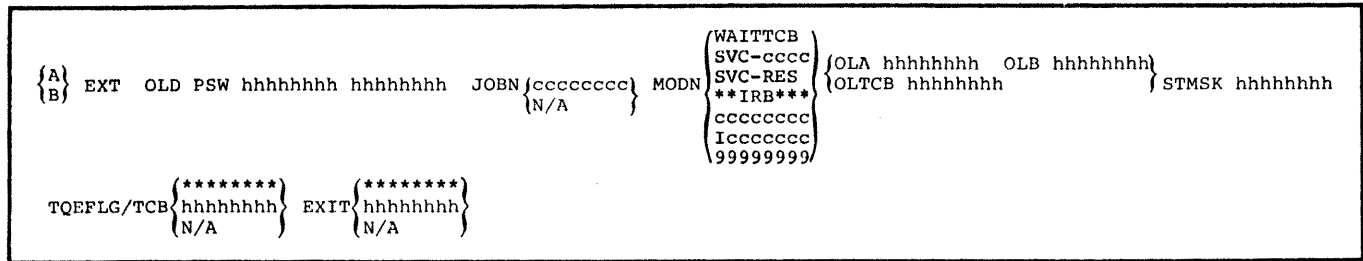

Figure 51. EXT Comprehensive Trace Record

| | | | | | | | | | |
|--|---|---|---------|---------|----------|----------|----------|--|--|
| {A} {B} | This field appears only in MVT-M65MP system EXT trace records and identifies the computer associated with the event. | SVC-RES a resident SVC routine was interrupted. | | | | | | | |
| EXT | This field identifies the trace record as an EXT trace record. | **IRB** the EXT interrupt occurred during execution of an asynchronous routine with an associated IRB. | | | | | | | |
| OLD PSW hhhhhhhh hhhhhhhh | This field displays the program status word that was current at the time the external interrupt occurred. | cccccccc in MVT systems the eight character name of the module that was interrupted - taken from the CDE associated with the task; or the name of an error routine - taken from the SIRB associated with the task. | | | | | | | |
| JOBN {cccccccc} { N/A } | This field has two possible entries as follows: cccccccc is the one to eight character name of the job associated with the event. N/A indicates that the interrupt was issued by the system and there is not associated job name. | in MFT systems the eight character name of the module that was interrupted - taken from either the LRB, LPRB, PRB, or FRB; or the name of an error routine - taken from the SIRB associated with the task. Iccccccc indicates that error fetch was in the process of loading an error recovery routine when the interrupt occurred. The last seven characters of the module name are shown. | | | | | | | |
| MODN { <table style="border: none; padding: 0;"> <tr><td style="border-left: 1px solid black; padding-left: 5px;">WAITTCB</td></tr> <tr><td style="border-left: 1px solid black; padding-left: 5px;">SVC-cccc</td></tr> <tr><td style="border-left: 1px solid black; padding-left: 5px;">SVC-RES</td></tr> <tr><td style="border-left: 1px solid black; padding-left: 5px;">**IRB**</td></tr> <tr><td style="border-left: 1px solid black; padding-left: 5px;">cccccccc</td></tr> <tr><td style="border-left: 1px solid black; padding-left: 5px;">Iccccccc</td></tr> <tr><td style="border-left: 1px solid black; padding-left: 5px;">99999999</td></tr> </table> | WAITTCB | SVC-cccc | SVC-RES | **IRB** | cccccccc | Iccccccc | 99999999 | 99999999 In MFT (with subtasking) an ATTACH was issued, but the module requested did not receive control. | |
| WAITTCB | | | | | | | | | |
| SVC-cccc | | | | | | | | | |
| SVC-RES | | | | | | | | | |
| **IRB** | | | | | | | | | |
| cccccccc | | | | | | | | | |
| Iccccccc | | | | | | | | | |
| 99999999 | | | | | | | | | |
| WAITTCB | The WAIT task was interrupted. | OLTCB hhhhhhhh In MFT/MVT systems the address of the TCB that was current when the interrupt occurred. In MVT-M65MP systems the OLA and OLB fields replace the OLTCB field. | | | | | | | |
| SVC-cccc | A type 3 or 4 SVC routine was interrupted; cccc is the last four characters of the routine name. | | | | | | | | |

OLA hhhhhhhh
is the address of the TCB in the
A computer that was current when
the interrupt occurred.

OLB hhhhhhhh
is the address of the TCB in the
B computer that was current when
the interrupt occurred.

STMSK hhhhhhhh
In MVT-M65MP systems only - the
'shoulder tap' mask from location
X'2BC' in the other computers prefix.

TQEFLG/TCB { N/A
 ***** }
 (hhhhhhhh)

hhhhhhhh
is the first word of the timer
queue element (TQE). The first
byte of the word is the TQEFLGS
and the remaining three bytes the
TQETCB, which is the address of
the TCB for the task in which
this timer element is being used.

asterisks indicate that a bad
control block chain prevented the
information from being obtained.

N/A
indicates that this EXT interrupt
was not caused by the timer.

EXIT { hhhhhhhh }
 { N/A }
 { ***** }

hhhhhhhh
is the address of the exit
routine - taken from the eighth
word of the TQE.

N/A
indicates that this EXT interrupt
was not caused by the timer.

asterisks indicate that a bad
control block chain prevented the
information from being obtained.

PGM Comprehensive Trace Records

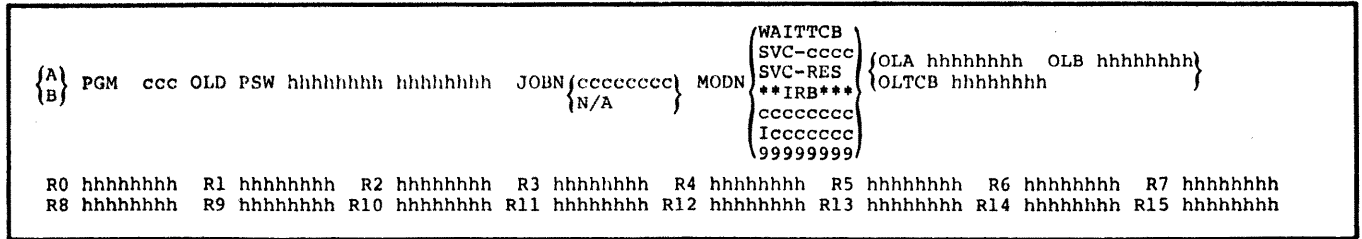

Figure 52. PGM Comprehensive Trace Record

| | |
|---|--|
| <p>{A} {B}</p> <p>MVT-M65MP systems only; identifies the computer associated with the interrupt.</p> <p>PGM the type of trace record.</p> <p>ccc the completion code for the program interrupt.</p> <p>OLD PSW hhhhhhhh hhhhhhhh the program status word that was current at the time the program interrupt occurred.</p> <p>JOBN {cccccccc} {N/A}</p> <p>cccccccc is the one to eight character jobname of the job associated with this event.</p> <p>N/A indicates a system task program checked and no jobname is available.</p> <p>MODN { WAITTCB SVC-cccc SVC-RES **IRB*** cccccccc Iccccccc 99999999</p> <p>SVC-ccc A type 3 or 4 SVC routine was interrupted; cccc is the last four characters of the routine name.</p> <p>SVC-RES a resident SVC routine was interrupted.</p> | <p>**IRB*** the program check interrupt occurred in an asynchronous routine with an associated IRB.</p> <p>cccccccc in MVT systems the eight character name of the module that was interrupted - taken from the CDE associated with the task; or, the name of an error routine - taken from the SIRB associated with the task.</p> <p>Iccccccc indicates that error fetch was in the process of loading an error recovery routine when the interrupt occurred. The last seven characters of the module name are shown.</p> <p>99999999 In MFT (with subtasking) an ATTACH was issued, but the module requested did not receive control.</p> <p>OLTCB hhhhhhhh in MFT/MVT systems the address of the TCB that was current when the interrupt occurred.</p> <p>In MVT-M65MP systems the OLA and OLB fields replace the OLTCB field.</p> <p>OLA hhhhhhhh is the A computer address of the TCB that was current when the interrupt occurred.</p> <p>OLB hhhhhhhh is the B computer address of the TCB that was current when the interrupt occurred.</p> <p>R0 hhhhhhhh to R15 hhhhhhhh the content of general purpose registers zero through fifteen at the time of the interrupt.</p> |
|---|--|

SSM Comprehensive Trace Record

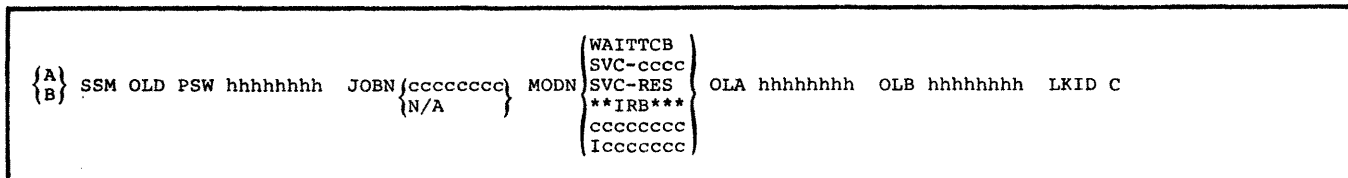

Figure 53. SSM Comprehensive Trace Record

| | | |
|--|---|--|
| <p>{A} {B}</p> | <p>identifies the computer associated with the SSM interrupt.</p> | <p>**IRB*** the SSM interrupt occurred during execution of an asynchronous routine with an associated IRB.</p> |
| <p>SSM</p> | <p>identifies this trace record as an SSM trace record.</p> | <p>cccccccc the eight character name of the module that was interrupted - taken from the content directory element (CDE) for the task; or the name of an error routine - taken from the SIRB associated with the task.</p> |
| <p>OLD PSW hhhhhhhh hhhhhhhh</p> | <p>the program status word that was current at the time the set system mask instruction was issued.</p> | <p>Iccccccc indicates that error fetch was in the process of loading an error recovery routine when the interrupt occurred. The last seven characters of the module name are shown.</p> |
| <p>JOBN {cccccccc} {N/A}</p> | <p>cccccccc is the one to eight character name of the job associated with SSM interrupt.</p> <p>N/A indicates that the system originated the interrupt and there is no associated jobname.</p> | <p>OLA hhhhhhhh is the A computer address of the TCB that was current when the interrupt occurred.</p> |
| <p>MODN {WAITTCB SVC-cccc SVC-RES **IRB*** Iccccccc}</p> | <p>WAITTCB the WAIT task was interrupted.</p> <p>SVC-cccc a type 3 or 4 SVC routine was interrupted; cccc is the last four characters of the routine name.</p> <p>SVC-RES a resident SVC routine was interrupted.</p> | <p>OLB hhhhhhhh is the B computer address of the TCB that was current when the interrupt occurred.</p> <p>LKID c CPU affinity byte:</p> <p>A indicates CPU A executing disabled. B indicates CPU B executing disabled. 0 Neither CPU executing disabled.</p> |

TIME AND LOST EVENT RECORDS

GTF produces two types of time records and a lost event record as follows:

TIME dddd.dddddd

appears on the last line of every event record if TIME=YES was specified in the GTF start command, and designates in decimal the number of seconds and microseconds since the last midnight.

***DATE: DAY ddd YEAR dddd TIME dd.dd.dd

This timestamp record appears at the beginning of the printout of each buffer filled by GTF and represents the time the first record was placed in the buffer.

DAY ddd
is the Julian date.

YEAR dddd
is the year.

TIME dd.dd.dd

is the time since midnight in a twenty-four hour format (hours.minutes.seconds).

*** LOST EVENTS: NUM dddddddddd TIME dd.dd.dd [GTF DISABLED]

The lost event record appears whenever GTF loses records, whether it is because the GTF buffers overflowed or because GTF was temporarily disabled by ABEND. The record is not produced if GTF terminates when the buffers are full.

NUM dddddddddd

is the number of records that were lost; one to ten decimal digits.

TIME dd.dd.dd

is the time GTF resumed recording; 24-hour format starting at midnight.

GTF DISABLED

appears only if the events were lost because GTF was temporarily disabled, e.g., ABEND temporarily disables GTF in order to format GTF output for an ABEND dump.

HEXADECIMAL FORMAT RECORD

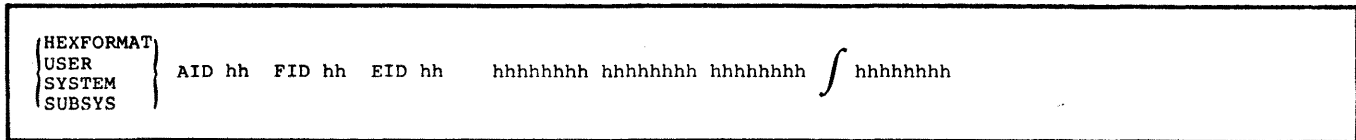

Figure 54. Hexadecimal Format Record

Under some circumstances IMDPRDMP formats and prints GTF records in hexadecimal notation. The conditions under which GTF records are formatted and printed in hexadecimal format by IMDPRDMP are presented in the discussion of the hexformat record that follows:

HEXFORMAT

This label identifies a record dumped in hex format at the request of the user on a GTRACE macro. This request was made by not specifying a format appendage, that is FID=00.

USR

This label identifies this record as dumped in hexformat because the user requested a format appendage on the GTRACE macro that could not be found. This format appendage was identified by FID=hh, and therefore its name is IMDUSR hh.

SYSTEM

This label identifies a record that was dumped in hex format because either it is a GTF error record or the format appendage for it has been scratched by the user. If relative bytes 0, 1 or 8, 9 contain X'EEEE', then this is an error record produced by GTF. This error record was produced as a result of an unrecoverable error in a GTF data gathering routine. When the error was encountered message IHL118I was written on the master system console identifying the error and the action taken. This message is not issued if the error occurred while building a comprehensive SVC trace record.

Except for comprehensive SVC records, this was the last record of its type produced during the run of GTF that produced it. If the X'EEEE' were not in the record, then it was dumped in hexformat because the IMDPRDMP format appendage that formats this type of record was not found by IMDPRDMP.

SUBSYS

This label identifies this record as dumped in hexformat because the subsystem format appendage requested by the subsystem on a GTRACE was not found by IMDPRDMP. The request was made via FID=hh, and therefore, it's name is IMDUSRhh.

AID hh

This field contains the AID of this record, and should always be X'FF'. The AID is the application identifier, and GTF's is always X'FF'.

FID hh

This field contains the FID, or format identifier. It is appended to 'IMDSYS' or 'IMDUSR' to obtain the name of the format appendage that was to have formatted this record.

EID hhhh

This field contains the EID, or event identifier, for this record. The EID uniquely identifies the event that produced this record.

hhhhhhhhh hhhhhhhh hhhhhhhh hhhhhhhh
 up to 64 words (256 bytes) of record in the GTF internal format. The internal format of GTF records is available in the Service Aids PLM.

GTF SVC COMPREHENSIVE TRACE RECORDS

There are four groups of GTF SVC Comprehensive Trace records.

- Group 1 -- Those with Basic Fields
- Group 2 -- Those with Basic Fields plus a DDNAME Field
- Group 3 -- Those with Basic Fields plus a Parameter List Field
- Group 4 -- Those with Basic Fields plus Variable Field(s)

The following sub-index lists the SVCs in sequence, identifies the group to which they belong, and gives the page where register contents and other variable fields are noted.

| <u>SVC #</u> | <u>Group</u> | <u>Page</u> | <u>SVC #</u> | <u>Group</u> | <u>Page</u> |
|--------------|--------------|-------------|--------------|--------------|-------------|
| 0 | 4 | 190 | 45 | 3 | 185 |
| 1 | 3 | 182 | 46 | 1 | 172 |
| 2 | 1 | 170 | 47 | 3 | 185 |
| 3 | 1 | 171 | 48 | 3 | 185 |
| 4 | 3 | 182 | 49 | 1 | 172 |
| 5 | 3 | 183 | 50 | null | |
| 6 | 4 | 190 | 51 | 4 | 197 |
| 7 | 4 | 190 | 52 | 1 | 172 |
| 8 | 4 | 190 | 53 | 2 | 181 |
| 9 | 4 | 191 | 54 | 4 | 198 |
| 10 | 3 | 171 | 55 | 2 | 181 |
| 11 | 1 | 171 | 56 | 3 | 186 |
| 12 | 1 | 171 | 57 | 2 | 181 |
| 13 | 4 | 191 | 58 | 2 | 181 |
| 14 | 4 | 191 | 59 | 1 | 172 |
| 15 | 4 | 191 | 60 | 3 | 186 |
| 16 | 4 | 191 | 61 | 1 | 172 |
| 17 | 4 | 192 | 62 | 4 | 198 |
| 18 | 3 | 183 | 63 | 3 | 187 |
| 19 | 3 | 183 | 64 | 3 | 187 |
| 20 | 3 | 183 | 65 | 4 | 198 |
| 21 | 4 | 192 | 66 | 4 | 199 |
| 22 | 3 | 183 | 67 | 4 | 199 |
| 23 | 3 | 183 | 68 | 1 | 172 |
| 24 | 2 | 181 | 69 | 2 | 181 |
| 25 | 4 | 192 | 70 | 3 | 187 |
| 26 | 4 | 193 | 71 | 4 | 199 |
| 27 | 4 | 194 | 72 | 1 | 173 |
| 28 | 4 | 195 | 73 | 3 | 187 |
| 29 | 4 | 195 | 74 | 3 | 187 |
| 30 | 4 | 195 | 75 | 4 | 199 |
| 31 | 2 | 181 | 76 | 1 | 173 |
| 32 | 4 | 195 | 77 | 3 | 187 |
| 33 | 4 | 195 | 78 | 4 | 200 |
| 34 | 1 | 171 | 79 | 1 | 173 |
| 35 | 3 | 183 | 80 | 3 | 188 |
| 36 | 1 | 171 | 81 | 4 | 200 |
| 37 | 3 | 184 | 82 | 4 | 200 |
| 38 | 1 | 171 | 83 | 1 | 173 |
| 39 | 3 | 184 | 84 | 1 | 173 |
| 40 | 3 | 184 | 85 | 1 | 173 |
| 41 | 4 | 196 | 86 | 4 | 201 |
| 42 | 4 | 196 | 87 | 3 | 188 |
| 43 | 1 | 171 | 88 | 4 | 202 |
| 44 | 4 | 197 | 89 | 4 | 202 |
| | | | 90 | 3 | 188 |
| | | | 91 | 1 | 173 |
| | | | 92 | 1 | 173 |
| | | | 93 | 1 | 174 |
| | | | 94 | 1 | 175 |
| | | | 95 | 1 | 177 |
| | | | 96 | 3 | 188 |
| | | | 97 | 1 | 178 |
| | | | 98 | 4 | 202 |
| | | | 99 | 3 | 189 |
| | | | 100 | 1 | 178 |
| | | | 101 | 1 | 179 |
| | | | 102 | 3 | 189 |
| | | | 103 | 1 | 179 |
| | | | 104 | 1 | 179 |
| | | | 105 | 1 | 180 |
| | | | 109 | 1 | 180 |
| | | | 116 | 1 | 180 |
| | | | 117 | 1 | 180 |

SVC Comprehensive Trace Records Group 1 -- Basic Fields

```

{A} SVC ddd OLD PSW hhhhhhhh hhhhhhhh JOBN cccccccc MODN cccccccc {OLA hhhhhhhh OLB hhhhhhhh}
{B}                                {OLTCB hhhhhhhh}

R15/R0 hhhhhhhh hhhhhhhh RI hhhhhhhh
    
```

Figure 55. Basic SVC Comprehensive Trace Record

| | |
|---|--|
| <p>{A} {B}</p> <p>this field appears only in MVT-M65MP records and identifies the CPU associated with the event.</p> <p>SVC ddd the decimal number of the SVC</p> <p>OLD PSW hhhhhhhh hhhhhhhh the program status word that was current at the time the SVC interrupt occurred. When SVC processing is completed, operation is resumed under control of this PSW.</p> <p>JOBN {***** cccccccc N/A}</p> <p>***** indicate an error occurred while attempting to retrieve the jobname, e.g., an incorrect TIOT address in the TCB could result in asterisks being placed in this field.</p> <p>cccccccc is the eight character jobname of the job issuing the SVC.</p> <p>N/A indicates that the SVC was issued by the system and there is no associated jobname.</p> <p>MODN {**IRB** SVC-RES SVC-nnnn *ccccccc cccccccc N/A ***** 99999999}</p> <p>**IRB** indicates the SVC was issued by an asynchronously executed routine with an associated IRB.</p> | <p>SVC-RES indicates the SVC was issued by a resident SVC with an associated SVRB.</p> <p>SVC-nnn indicates the SVC was issued by a transient SVC module with an associated SVRB. nnnn denotes the last four characters of the module name.</p> <p>*ccccccc indicates that error fetch is in the process of loading an error recovery module. ccccccc is the last seven characters of the module name.</p> <p>cccccccc is, in MVT systems, the eight character name of the module issuing the SVC -- taken from the CDE associated with the task; or the name of an error routine -- taken from the SIRB associated with the task.</p> <p>In MFT systems the module name is taken from the LRB, LPRB, PRB, or FRB and the error routine name is taken from the SIRB associated with the task.</p> <p>N/A indicates the RB CDE pointer was zero.</p> <p>***** indicates that an error occurred while attempting to retrieve the module name.</p> <p>99999999 In MFT (with subtasking) an ATTACH was issued, but the module requested did not receive control.</p> |
|---|--|

OLTCB hhhhhhh
the address of the TCB that was
current when the SVC was issued.

In MVT-M65MP systems the OLA and OLB
fields replace the OLTCB field and
indicate the addresses of the TCBs
that were current in CPU A and CPU B
when the SVC was issued.

R15/R0 hhhhhhhh hhhhhhhh R1 hhhhhhhh
the contents of registers 15, 0, and 1
when the SVC was issued.

SVC Comprehensive Trace Records Group 1 --
Basic Fields

SVC 2 (POST)

R15 contains no applicable
information.

R0 contains the completion code to be
placed in the ECB.

R1 contains the address of the ECB to
be posted.

SVC 3 (EXIT)

registers contain no applicable information.

If R1 is negative and R0 is zero, then R1 contains a pointer to the CSCB that is to be either added to the chain or deleted from the chain.

SVC 10 (REGMAIN)

R15 contains no applicable information.
R0 contains the number of the subpool requested in the high order byte, and the number of bytes requested in the low order three bytes.
R1 contains any negative value if the request is for a GETMAIN; contains the address of the storage to be freed if the request is for a FREEMAIN; contains zero value if the request is for a FREEMAIN for an entire subpool.

If R1 is negative and R0 is positive, then R1 contains a pointer to the CIB that is to be added to or deleted from the chain. R0 contains a pointer to the beginning of the chain.

If R1 is negative and R0 is negative, then R0 contains a pointer to the CIB in which the CIB count is to be set and R1 contains the value to which the CIB count is to be set.

SVC 11 (TIME)

R15 contains no applicable information.
R0 contains no applicable information.
R1 contains flag bits in the low order byte that designate how the time is to be returned in Register 0.

If the low order byte is:

x'00'
register 0 is to contain a 32 bit unsigned binary number representing the number of timer units that have elapsed. (A timer unit is 26.04 micro-seconds).

x'01'
register 0 is to contain elapsed time in hundredths of a second.

x'02'
register 0 is to contain packed decimal digits representing elapsed time in hours, minutes, seconds, tenths of a second, and hundredths of a second (HHMMSSth).

SVC 12 (SYNCH)

R15 contains the address of the entry point for the processing program that is to be given control.
R0 contains no applicable information.
R1 contains no applicable information.

SVC 34 (MGCR)

R15 contains no applicable information.

R0 and R1 contents are as follows:
R1, if positive, contains a pointer to the command buffer of the command to be processed. R0 is not used in this case.

SVC 36 (WTL)

R15 contains no applicable information.
R0 contains no applicable information.
R1 if positive, contains a pointer to the user record that is to be written to the system log dataset.

If negative, contains a pointer to the LCA indicating either initialization, (both data sets have to be opened), or data set switching is required.

SVC 38 (TTROUTER)

Registers 15, 0, and 1 do not contain any applicable information.

SVC 43 (CIRB)

R15 contains no applicable information.
R0 contains the entry point address of the user's asynchronous exit routine.
R1 contains option bit flags in the high order halfword and the size of the work area requested (in double words) in the low order halfword.

Flag settings are:

| | |
|--------------------|-----------------------------------|
| <u>flag byte 1</u> | |
| 1..... | DIRB |
| 0..... | CIRB |
| .1000.. | bits 1-4 always set as shown |
|1.. | problem program key |
|0.. | supervisor key |
|1. | problem program state |
|0. | supervisor state |
|1 | save area for registers requested |
|0 | no save area requested |

| | |
|--------------------|----------------------------|
| <u>flag byte 2</u> | |
| xxxx.xx | reserved |
|1.. | do not return IQEs at exit |
|1.. | return IQEs at exit |

SVC 46 (TTIMER)

R15 contains no applicable information.
R0 contains no applicable information.
R1 the low order three bytes carry code determining how TTIMER should work, as follows:

x'00'
the time remaining in the current tasks time interval is to be returned in register 0; the interval timer is not to be canceled.

x'01'
the current task's time interval is to be canceled.

x'02'
the time interval of a related task is to be canceled.

SVC 49 (TTOPEN)

Registers 15, 0, and 1 do not contain any applicable information.

SVC 52 (Restart/SMB Reader)

Registers 15 and 0 have no applicable information.

R1 contents are as follows:
If SVC 52 is issued by the Initiator for the purpose of reading SMBs (containing JCL) for an automatic step or checkpoint restart, register 1 points to a job queue DCB, SMB buffer, and general work space.

If SVC 52 is issued from module IEFRSTRT to initiate a checkpoint restart, register 1 contains a pointer to a parameter list.

SVC 59 (OLTEP)

R15 contains no applicable information.
R0 contains a pointer to a three word parameter list, which, in turn contains pointers as follows:

- Word 1 -- pointer to UCB
- Word 2 -- pointer to DEB
- Word 3 -- pointer to IECIOLTS (I/O interrupt handler).

R1 contains a call code used to locate the particular OLTEP function requested. The value will be greater than x'00' and equal or less than x'94'.

SVC 61 (TSAV)

Registers 15 and 0 have no applicable information.

R1 contains zeroes if the routine is being entered from the Overlay Supervisor.

R1 contains the address of the DCB used to fetch the module (set to a negative value) if the routine is being entered from the Contents Supervisor.

SVC 68 (SYNADAF/SYNADRLS)

Entry from SYNADAF:

R15 contains a flag byte in the high-order position and three bytes of user data or an address of an entry point to the SYNAD routine.

The flag byte contains codes as follows:

- 00 EXCP request
- 01 BPAM request
- 02 BSAM request
- 03 QSAM request
- 04 BDAM request
- 05 BISAM request
- 06 QISAM request
- 07 BTAM request
- 08 QTAM request
- 09 GAM request

R0 contains, in the three low order bytes, the address of the DECB (BSAM, BPAM, BDAM) or the address of the IOB (BISAM, QISAM, QSAM).

Additionally, when a QSAM request is made, the high-order byte contains the offset of the first CCW in the IOB.

R1 contains a flag byte and the address of the DCB in the high-order byte and the three low-order bytes respectively.

The flag byte bit settings are:

- 00000000 BISAM and QISAM
- 1..... error caused by input
- .1..... error caused by output
- ..1..... error caused by BSP, CNTRL, or POINT
- ...1.... record had been successfully read
-1... INVALID request
-1.. PT conversion - invalid character
-1. BDAM only - hardware error
-1 BDAM only - no space for record

Entry from SYNADRLS:

Registers 0 and 1 have no applicable information.

R15 contains x'FF' in the high-order byte, indicating the SVC routine is being entered from the SYNADRLS macro instruction and three bytes of user data.

SVC 72 (CHATR)

Registers 15 and 0 have no applicable information.

R1 contains the address of a parameter list with the following structure:

Offset

| | |
|----|--|
| 0 | address of parameter list+8 |
| 4 | address of DCB |
| 8 | module name for XCTL |
| 16 | code for OPEN/CLOSE (1 byte); address of UCM entry (3 bytes) |
| 20 | address of UCM |
| 24 | address of return |

SVC 76 (IFBSTAT)

R15 contains no applicable information.

The content and applicability of Registers 0 and 1 vary with the presence or absence of RDE (Reliability Data Extractor) routines in the control program.

If RDE is present:

R0 contains a positive 0 or 8.
R1 has no applicable information.

A positive 0 in R0 indicates that EOD recording is requested; a positive 8 indicates that IPL recording is requested.

If RDE is not present:

R0 contains a negative number representing the length in bytes of a record to be placed in the SYS1.LOGREC data set.
R1 contains the address of the record to be written.

SVC 79 (STATUS)

R15 has no applicable information.

R0 If ND was specified, the two high-order bytes contain the bits indicating dispatchability.

The two low-order bytes contain the function code:

| | |
|---|---------------------------|
| 0 | cannot be rolled out |
| 1 | must complete - step |
| 2 | must complete - system |
| 3 | non-dispatchable - step |
| 4 | non-dispatchable - system |

5 non-dispatchable - TCB address
6 stop non-dispatchable
7 start dispatchable

R1 the high-order bit indicates SET or RESET:

0 SET(SS)
1 RESET(RS)

The three low-order bytes contain the TCB address if it was specified, or, if not, zero.

SVC 83 (SMFWTM)

Registers 15 and 0 contain no applicable information.

R1 contains a pointer as follows:

If positive a pointer to the record that is to be written to the SMF data set.

if negative a pointer to the SMCA indicating either initialization or processing for a SWITCH command to switch SMF data sets.

SVC 84 (Restart Address Routine)

SVC 84 is issued by the GPS Graphic I/O Control Routine to have the buffer restart address stored in the UCB associated with the display unit for which the routine builds a channel program.

R15 contains no applicable information.

R0 contains the buffer restart address to be stored in the UCB in the high order two bytes. The low order two bytes point to the UCB.
R1 contains a zero

SVC 85 (SWAP)

Registers 15, 0, and 1 do not contain any applicable information.

SVC 91 (VOLSTAT)

R15 contains no applicable information.

R0 when negative, contains the address of the UCB. Note: If device type is disk go to SVC 91 load 2.

R0 when positive, contains the address of the DCB.

R1 contents are as follows:

if zero, the SVC was issued by CLOSE
if X'32', the SVC was issued by DDR
if X'33' the SVC was issued by EOD
if X'63', the SVC was issued by EOV
if any other than the above, the SVC was issued by UNALLOCATION

SVC 92 (TCBEXCP)

R15 contains no applicable information
R0 contains the address of the TCB for the issuers task.

R1 contains the address of the IOB.

SVC 93 (TGET/TPUT)

Entry from TGET

R15 contains no applicable information

R0 the two high-order bytes are reserved. The two low-order bytes contain the buffer size in bytes.

R1 contains a flag byte and an address as follows:

the high order byte is a flag byte with these bit settings.

| | |
|----------|--|
| 1..... | Denotes "TGET" specified |
| 0..... | Denotes "TPUT" specified |
| .1..... | Reserved. |
| ..1..... | Reserved for TPUT |
| ...1.... | Denotes "NOWAIT" specified means that control should be returned to the program that issued the TGET whether or not an input line is available from the terminal if no input line is obtained, a return code of 4 will be found in register 15. |
| ...0.... | Denotes "WAIT" specified means that control will not be returned to the program that issued the TGET until an input line has been put into the program's buffer if an input line is not available from the terminal, the issuing program is put into a wait state until a line does become available and is placed in the program's buffer |
|1... | Reserved for TPUT |
|1.. | Reserved for TPUT |
|10 | Reserved for TPUT |
|01 | Denotes "ASIS" specified means that normal or minimal editing will be performed. |
|00 | Denotes "EDIT" specified means that in addition to the normal ("ASIS") editing, further editing will be performed. |

the low-order three bytes contain the address of the buffer that is to receive the input line.

Entry from TPUT

R15 contains no applicable information.

R0 the two high-order bytes contain the Terminal Job Identifier number; the two low-order bytes contain the size of the input buffer in bytes.

R1 contains a flag byte and an address as follows:

| | |
|---|---|
| the high-order byte is a flag byte with these bit settings: | |
| 1..... | Denotes "TGET" specified |
| 0..... | Denotes "TPUT" specified |
| .1..... | Reserved |
| ..1..... | Denotes "LOWP" specified means that the terminal will not receive any inter-terminal messages if TSBITOFF is on even if a key-zero task is sending the messages may only be specified on a TPUT with TJID. |
| ..0..... | Denotes "HIGHP" specified means that the terminal will receive inter-terminal messages even if TSBITOFF is on if a key-zero task is sending the messages may only be specified on a TPUT with TJID. |
| ...1.... | Denotes "NOWAIT" specified means that control should be returned to the program that issued the TPUT whether or not system output buffers are available for the output line if no buffers are available, a return code of 4 will be found in register 15. |
| ...0.... | Denotes "WAIT" specified means that control will not be returned to the program that issued the TPUT until the output line has been placed in a system output buffer if no buffers are |

available, the issuing program will be put into a wait state until buffers do become available and the output line is placed in them.

.....1... Denotes "HOLD" specified means that the program that issued the TPUT cannot continue its processing until this output line has been either written to the terminal or deleted.

.....0... Denotes "NOHOLD" specified means that control should be returned to the program that issued the TPUT as soon as the output line has been placed on the output queue.

.....1.. Denotes "BREAKIN" specified means that output has precedence over input; that is, if the user at the terminal is transmitting, he is interrupted, and this output line is sent any data that was received before the interruption is kept and displayed at the terminal following this output line.

.....0.. Denotes "NOBREAK" specified means that input has precedence over output; that is, the output message will be placed on the output queue to be printed at some future time when the terminal user is not entering a line.

.....10 Denotes "CONTROL" specified means that this line is composed of terminal control characters and will not print or move the carriage on the terminal.

.....01 Denotes "ASIS" specified; means that normal or minimal editing will be performed.

.....00 Denotes "EDIT" specified; means that in addition to the normal ("ASIS")

editing, further editing will be performed.

the low-order three bytes contain the address of the buffer that is to hold the line of output.

SVC 94 (TERMCTL)

Entry from TCLEARQ:

R15 contains no applicable information.

R0 Contents:

| <u>Bytes</u> | |
|--------------|------------------|
| 0 | 01 -- Entry code |
| 1-3 | 0 -- Reserved |

R1 Contents:

| <u>Bytes</u> | |
|--------------|--------------------------|
| 0 | 80 -- "INPUT" specified |
| | 00 -- "OUTPUT" specified |
| 1-3 | 0 -- Reserved |

Entry from STBREAK:

R15 contains no applicable information.

R0 Contents:

| <u>Bytes</u> | |
|--------------|------------------|
| 0 | 04 -- Entry code |
| 1-3 | 0 -- Reserved |

R1 Contents:

| <u>Bytes</u> | |
|--------------|-----------------------|
| 0 | 80 -- "YES" specified |
| | 00 -- "NO" specified |
| 1-3 | 0 -- Reserved |

Entry from STCOM:

R15 contains no applicable information.

R0 Contents:

| <u>Bytes</u> | |
|--------------|------------------|
| 0 | 05 -- Entry code |
| 1-3 | 0 -- Reserved |

R1 Contents:

| <u>Bytes</u> | |
|--------------|---------------------|
| 0 | 80 -- YES specified |
| | 00 -- NO specified |
| 1-3 | 0 -- Reserved |

Entry from STTIMEOU:

R15 contains no applicable information.

R0 Contents:

| | |
|--------------|------------------|
| <u>Bytes</u> | |
| 0 | 06 -- Entry code |
| 1-3 | 0 -- Reserved |

R1 Contents:

| | |
|--------------|-----------------------|
| <u>Bytes</u> | |
| 0 | 80 -- "YES" specified |
| | 00 -- "NO" specified |
| 1-3 | 0 -- Reserved |

Entry from STCC:

R15 contains no applicable information.

R0 Contents:

| | |
|--------------|------------------|
| <u>Bytes</u> | |
| 0 | 07 -- Entry code |
| 1-3 | 0 -- Reserved |

R1 Contents:

| | |
|--------------|---|
| <u>Bytes</u> | |
| 0 | Flag byte as follows: |
| | 1..... first operand specified |
| | .1..... ATTN specified |
| | ..1..... LD specified |
| | ...1..... CD specified |
| | 00000000 no operands specified, retain previously-used characters. |
| 1 | 0 -- Reserved |
| 2 | hh -- line delete control character. The hexadecimal representation of any EBCDIC character on the terminal keyboard except the new line (NL) and carriage return (CR) control characters. c -- the character representation of any EBCDIC character on the terminal keyboard. |
| 3 | hh -- character delete control character. The hexadecimal representation of any EBCDIC character on the terminal keyboard except the new line (NL) and carriage return (CR) characters. c -- the character representation of any EBCDIC character on the terminal keyboard. |

Entry from STATN:

R15 contains no applicable information.

R0 Contents:

| | |
|--------------|--|
| <u>Bytes</u> | |
| 0 | 08 -- Entry code |
| 1 | 00 -- Reserved |
| 2 | hh -- Lines byte. The number of consecutive lines of output that can be directed to the terminal before the keyboard will unlock. 00 -- Output line counting is not used. |
| 3 | hh -- Tens byte. The tens of seconds that can elapse before the keyboard will unlock. 00 -- Locked keyboard timing is not used. |

R1 Contents:

| | |
|--------------|--|
| <u>Bytes</u> | |
| 0 | Flag byte as follows: |
| | 1..... LINES specified |
| | .1..... TENS specified |
| | ..1..... input address specified |
| | 00000000 no operands specified, results in a NOP instruction. |
| 1-3 | hhhhh -- Character string address. 000000 -- no character string was specified. |

Entry from STAUTOLN:

R15 contains no applicable information.

R0 Contents

| | |
|--------------|--|
| <u>Bytes</u> | |
| 0 | 09 -- Entry code |
| 1-3 | hhhhh -- the address of a fullword containing the number to be assigned to the first line of terminal input. |

R1 Contents:

| | |
|--------------|---|
| <u>Bytes</u> | |
| 0 | 00 -- Reserved |
| 1-3 | hhhhh -- the address of a fullword containing the increment value used in assigning line numbers. |

Entry from STSIZE:

R15 contains no applicable information.

R0 Contents:

| | |
|--------------|--|
| <u>Bytes</u> | |
| 0 | 0A -- Entry code |
| 1,2 | 0000 -- Reserved. |
| 3 | hh -- lines byte. The number of lines (depth) that can appear on the screen. |

R1 Contents:

| | |
|--------------|---|
| <u>Bytes</u> | |
| 0-2 | 000000 -- Reserved |
| 3 | hh -- size byte. The logical line size (width) in characters of the terminal. |

Entry from GTSIZE, STAUTOCP, SPAUTOPT, RTAUTOPT

R15 contains no applicable information.

R0 Contents:

| | |
|--------------|-------------------------|
| <u>Bytes</u> | |
| 0 | Entry codes as follows: |
| | 0B -- GTSIZE |
| | 0C -- STAUTOCP |
| | 0D -- SPAUTOPT |
| | 0E -- RTAUTOPT |
| 1-3 | 000000 -- Reserved |

R1 Contents:

No applicable information, will be zeroed.

Entry from STCLEAR:

R15 contains no applicable information.

R0 Contents:

| | |
|--------------|--------------------|
| <u>Bytes</u> | |
| 0 | 10 -- Entry code |
| 1-3 | 000000 -- Reserved |

R1 Contents:

| | |
|--------------|--|
| <u>Bytes</u> | |
| 0 | 00 -- Reserved. |
| 1-3 | hhhhh -- erasure character string address. |

Entry from TCABEND

R15 contains no applicable information.

R0 Contents:

| | |
|--------------|------------------|
| <u>Bytes</u> | |
| 0 | 00 -- Entry code |
| 1-3 | 0 -- Reserved |

R1 Contents:

No applicable information will be zeroed.

Entry from TSABEND

R15 contains no applicable information.

R0 Contents:

| | |
|--------------|------------------|
| <u>Bytes</u> | |
| 0 | 0F -- Entry code |
| 1-3 | 0 -- Reserved |

R1 Contents:

No applicable information will be zeroed.

SVC 95 (TSIP)

R15 contains no applicable information.

R0 Contents:

| | |
|--------------|---|
| <u>Bytes</u> | |
| 0,1 | zero or Terminal Job Identifier (TJID) or not applicable. |
| 2 | 00 -- Reserved |
| 3 | Entry code as follows: |

Entry Code

Calling Routine

| | |
|----|--|
| 00 | Problem Program (TMP) |
| 01 | Timer Second - Level Interruption Handler |
| 02 | TGET/TPUT |
| 03 | Region Control Task |
| 04 | Dequeue, TIOC (Attention, TSINPUT, TSOUTPUT), Timer SLIH, WTOR |
| 05 | Region Control Task |
| 06 | Enqueue |
| 07 | Dequeue |
| 08 | TSO Dispatcher |
| 09 | TSO Dispatcher |
| 0A | TSO Dispatcher |
| 0B | TSO Dispatcher |
| 0C | Region Control Task (Quiesce) |

0D Region Control Task (Quiesce)
 0E Time Sharing Control Task (Swap)
 0F Time Sharing Control Task (Swap)
 10 Time Sharing Control Task (Swap)
 11 Time Sharing Control Task (Swap)
 12 Region Control Task (Restore)
 13 Region Control Task (Restore)
 14-18 Reserved

R1 Contents:

Bytes
 0,1,2,3 variable as follows:

| <u>Entry Code</u> | <u>Content</u> |
|-------------------|--|
| 00 | Address of 8-character command name sign-bit: 0-ended 1-beginning |
| 01 | not applicable |
| 02 | Sign-bit: 0-Input 1-Output Bytes 3&4: Number of free buffers |
| 03-05 | not applicable |
| 06 | Estimated must complete time |
| 07-0C | not applicable |
| 0D | Number of FBQEs |
| 0E | Byte 0: Swap Units Byte 1: Swap device code (0,4,8,c) Bytes 2&3: Swap size in 2K blocks |
| 0F-13 | not applicable |

SVC 97 (TEST(TSO))

Entered from:

Any module of the tested program, when used as a breakpoint handler. If used as a breakpoint handler the TCBTCP bit is '1' in the current TCB and registers 15, 0, and 1 contain no applicable information.

Any module of the TSO Test Command Processor when used as a subroutine of TSO TEST. In this case the current TCBTCP bit is '0' and registers are as follows:

R15 contains no applicable information.

R0 Contents:

Bytes

0 Entry code as follows:
 40 -- Set TCBTCP bit to '1'
 20 -- Set TCBTCP bit to '0'
 10 -- Alter TCBTRN field
 08 -- Alter second word of RBOPSW field
 04 -- Alter specific register in SVC 97's SVRB register save area
 04 -- Alter all registers in SVC 97's SVRB register save area
 02 -- Alter floating-point register in TCB save area
 01 -- Set RB wait count to 0 (zero).
 1-3 Address of target TCB, PRB, or IRB

R1 Contents:

Register 1 contents are variable as follows:

| <u>Entry code</u> | <u>Bytes</u> | <u>Content</u> |
|-------------------|--------------|---|
| 0123 | | not applicable |
| 40 | | not applicable |
| 0123 | | not applicable |
| 20 | | not applicable |
| 0 | 1,2,3 | TCBTRN value |
| 0 | 08 | instruction length, completion code program mask |
| 08 | 1,2,3 | address of value for second word of RBOPSW field. |
| 0 | | register number |
| 07 | 1,2,3 | address of new value |
| 0 | | x'FF' |
| 04 | 1,2,3 | address of 64-byte value |
| 0 | | floating-point |
| 02 | 1,2,3 | register number address of new value for register |
| 0,1, | | not applicable |
| 01 | 2,3 | |

SVC 100

SVC 100 is used by the SUBMIT, OUTPUT, OPERATOR, and CANCEL/STATUS processors.

Contact your FE programming representative for information concerning the content of General Purpose Registers 15, 0, and 1 upon entry to SVC 100.

R1 Content:

SVC 101 (QTIP)

SVC 101 is used only by the TSO sub-system and the MCP and provides an interface between them for inter-region communication and data movement.

R15 Contents:

| <u>Bytes</u> | |
|--------------|---|
| 0 | 0 -- zeroed. by entry code in R0 |
| 1-3 | hhhhh -- variable by entry code in R0 as follows: |
| | 00 -- not applicable |
| | 03 -- entry address of QTIP0030 within IEDAYAA |
| | 04-0D -- not applicable |
| | 0E -- (with savearea address in R1) not applicable. (Without savearea address in R1) entry address of QTIP0140 within IEDAYOO |
| | 0F-11 -- not applicable |
| | 12-16 -- entry address of IKJGGQT1, branch entry to QTIP SVC |
| | 17 -- address of TSB being logged off |
| | 18 -- (same as 12-16) |
| | 19-1A -- not applicable |
| | 1C -- entry address of QTIP0280 within IEDAYII |
| | 1D -- not applicable. |

R0 Content:

| <u>Bytes</u> | |
|--------------|------------------------------|
| 0 | 0 -- zeroed. |
| 1-3 | hh -- entry codes as follows |
| | 00 -- invokes IEDAYAA |
| | 03 -- invokes IEDAYAA |
| | 04 -- invokes IEDAYHH |
| | 05-09 -- invokes IEDAYII; |
| | 0A -- invokes IEDAYLL; |
| | 0B-11 -- invokes IEDAYOO |
| | 12-14 -- invokes IEDAYGP |
| | 15-16 -- invokes IEDAYAA; |
| | 17 -- invokes IKJGG088 |
| | 18 -- invokes IEDAYOO; |
| | 19-1A -- IEDAYZZ invoked |
| | 1C -- invokes IEDAYII |
| | 1D -- IEDAYGP invoked; |

Bytes

| | |
|-----|--|
| 0 | 0 -- zeroed. |
| 1-3 | hhhhh -- variable by entry code in R0 as follows: |
| | 00 -- address of savearea within AVT |
| | 03 -- not applicable |
| | 04-0D -- address of savearea within AVT |
| | 0E -- (without entry address in R15; address of savearea in AVT) (with entry address in R15; not applicable) |
| | 0F-11 -- address of savearea within AVT |
| | 12-16 -- not applicable |
| | 17 -- zeroed; indicates no savearea is being passed |
| | 18 -- not applicable |
| | 19-1A -- address of savearea within AVT |
| | 1C -- not applicable |
| | 1D -- address of savearea within TIOCRPT |

SVC 103 (XLATE)

R15 contains no applicable information.

R0 contains the length of the field to be translated.

R1 Contents:

Bytes

| | | |
|-----|-------|-----------------------------------|
| 0 | hh | action byte as follows: |
| | | 80-translate from EBCDIC to ASCII |
| | | 00-translate from ASCII to EBCDIC |
| 1-3 | hhhhh | address of field to be translated |

SVC 104 (TCAM)

R15 contains no applicable information

R0 indicates the subroutine to be executed as follows:

Bytes

0-3 00000001 IGC0010D entry
point routine
00000002 GTFIELDA decode
routine
00000003 STTNME operator
command addressing
routine
00000004 IEDQCA02 scan
routine

R1 contains the address of the
operator control work area

SVC 105 (IMGLIB)

R15 contains no applicable information

R0 contains no applicable information

R1 indicates actions to be taken as
follows:

Bytes

0-3 00000000 construct a DCB
and DEB for
SYS1.IMGLIB
hhhhhhhh delete DCB at this
address and also
the DEB pointed to
by the DCB.

SVC 109

Type 3 and type 4 SVC routing routine.

R15 contains an index value, converted
to 3 digit EBCDIC number and appended
to name IGC00. This routine is then
called.

R0/R1 contain no applicable
information for SVC 109, contents are
to be used by called routine IGX00.

SVC 116

Type 1 SVC routing routine.

R15 contains an index value, used in
binary form to index into a table to
call other SVC routines.

R0/R1 contain no applicable
information for SVC 116, contents are
to be used by called routines.

SVC 117

Type 2 SVC routing routine.

R15 contains an index value, used in
binary form to index into a table to
call other SVC routines.

R0/R1 contain no applicable
information for SVC 117, contents are
to be used by called routines.

SVC Comprehensive Trace Records Group 2 -
Basic Fields Plus DDNAME Field

Group 2 SVC comprehensive trace records add a DDNAME field to the fields composing the basic record. The format is:

```
DDNAME { *****
        cccccccc
        N/A }
```

asterisks indicate an error occurred while gathering the information.

cccccccc

the name of the associated DD statement.

N/A

indicates that the DD name could not be obtained for the following reasons:

- The DCB was not opened
- The DCB TIOT offset was outside the valid range
- The DEB TCB pointer was set to 0
- The TCB TIOT pointer was set to 0
- The DD name in the TIOT was not in EBCDIC notation

Following are descriptions of register 15, 0, and 1 content for the Group 2 SVCs.

SVC 24 (DEVTYPE)

R15 contains no applicable information.

R0 contains the address of the output area or the two's complement of the output area address.

R1 contains the address of the DD name, or the two's complement of the DD name address.

When control returns from the DEVTYPE SVC routine, the output area will contain 8, 20, or 24 bytes of device data, depending on the value (+ or -) of R0 and R1, and the device type associated with the DDNAME as follows.

| | <u>Output Area Size (Bytes)</u> | | |
|-----------------------------|---------------------------------|-----------|---------------|
| | <u>RPS-DA</u> | <u>DA</u> | <u>Non-DA</u> |
| R0 and R1 positive | 20 | 20 | 8 |
| R0 negative and R1 positive | 20 | 20 | 8 |
| R0 and R1 negative | 24 | 20 | 8 |

SVC 31 (FEOV)

R15 and R0 contain no applicable information

R1 contains the address of the DCB

SVC 53 (RELEX)

R15 contains no applicable information

R0 contains the address of a parameter list which contains either:

hhhhhhh relative block or TTR
MBBCHHR actual address

R1 contains the address of the DCB

SVC 55 (EOV)

R15 contains no applicable information

R0 contains the IOB address if the following are true:

DCBOFLAGS = ...1....
DCBMACRF = 0.....
and R0 is not equal to x'00001000'

R1 contains the DCB address

SVC 57 (FREEDBUF)

R15 contains no applicable information

R0 contains the address of the DECB

R1 contains the address of the DCB

SVC 58 (REQBUF/RELBUF)

R15 contains no applicable information

R0 contains the request count or release address

R1 contains the DCB address

SVC 69 (BSP)

R15 and R0 contain no applicable information

R1 contains the address of the DCB

SVC Comprehensive Trace Records; Group 3 - Basic Fields Plus Parameter List Field

Group 3 SVC comprehensive trace records add a parameter list field to the fields composing the basic record. The parameter list field displays all or a portion of the parameter list being passed to the SVC routine by the caller. The format is:

```
PLIST { N/A
        hhhhhhhh hhhhhhhh hhhhhhhh ... }
        ***** ***** *****
```

N/A indicates that there is no applicable information

hhhhhhh ... parameter list display. Content and amount varies with the SVC being traced.

***** indicates that an error occurred while gathering the information.

Following are descriptions of register 15, 0, and 1 content, and PLIST content for the Group 3 SVCs.

SVC 1 (WAIT)

R15 contains no applicable information

R0 contains the count of the events being waited on. If zero the wait is treated as a NOP.

R1 if positive, contains the address of the ECB being waited on. If negative, contains the address of a list of ECBs, in two's complement form.

PLIST may contain up to 40 bytes of information. It consists of a list of ECB addresses up to a maximum of 10.

SVC 4 (GETMAIN)

R15 and R0 contain no applicable information.

R1 contains the address of the parameter list passed when the SVC was called. (If R1 is zero there is no parameter list and the PLIST field will not be present.)

PLIST is ten bytes in length and breaks down as follows:

Bytes
0-3 hhhhhhhh

- a. For a single area request - the length requested.
- b. For a variable request - the address of a doubleword containing the minimum and maximum length requested as shown below:

Bytes
0 zero
1,2,3 minimum length
4 zero
5,6,7 maximum length

- c. For a list request - the address of a list of GETMAIN length requests (1 word per request) the last word containing x'80' in byte 0.

4 hh

Hierarchy identifier (optional)

5-7 hhhhhhhh

- a. For a single area request - the address of a word GETMAIN will initialize as the beginning allocated core area.

- b. For a variable area request - the address of a doubleword which GETMAIN will initialize with the address of the GETMAINED area and the actual length allocated.

- c. For a list area request - the address of a list of words which GETMAIN will initialize with the address of allocated areas.

8 hh Flag byte as follows:

00 unconditional single area request
20 conditional single area request
C0 unconditional variable request
E0 conditional variable request

80 unconditional list request
A0 conditional list request

9 hh Subpool identification

SVC 5 (FREEMAIN)

R15 and R0 contains no applicable information.

R1 contains the address of the parameter list passed when the SVC was called. (If R1 is zero, no list passed, and PLIST will not appear.)

PLIST is 10 bytes in length and breaks down as follows:

Bytes

- 0-3 a. For a single area request the length to be freed.
b. For a list area request -- the address of a list of FREEMAIN length requests (1 word per request), the list word containing x'80' in byte 0.
- 4-7 a. For a single area request -- the address of an area to be freed.
b. For a list area request -- the address of a list of addresses of the areas to be freed.

8 hh Flag byte as follows:

- 00 unconditional single area request
20 conditional single area request
80 unconditional list area request
A0 conditional list area request

9 hh Subpool identification.

SVC 18 (BLDL/FIND - Type D)

R15 contains no applicable information.

R0 contains the address of the parameter list.

R1 contains the address of the DCB and indicates the macro instruction that issued the SVC call; if R1 is positive -- BLDL; if R1 is negative -- FIND.

PLIST

The BLDL parameter list is 12 bytes in length:

Bytes

- 0,1 the numbering entries
2,3 entry length

4-11 the hexadecimal representation of the member name for which the BLDL was issued.

The FIND parameter list is 8 bytes in length:

Bytes

- 0-7 the hexadecimal representation of the member name for which the FIND was issued.

SVC 19,20,22,23 (OPEN,CLOSE,OPENJ,TCLOSE)

R15 and R0 contain no applicable data.

R1 contains the address of the parameter list.

PLIST is up to 40 bytes in length and consists of a series of 4-byte entries (up to 10). Each entry breaks down as follows:

Bytes

- 0 hh Option byte as shown below:

Bits

- 1... Last Entry indicator
.011 LEAVE
.001 REREAD
.100 REWIND
.010 IDLE
.000 DISP
.... 0000 INPUT
.... 1111 OUTPUT
.... 0011 INOUT
.... 0111 OUTIN
.... 0100 UPDAT
.... 0001 RDBACK

1-3 hhhhhh DCB address

SVC 35 (WTO/WTOR)

R15 contains no applicable information.

R0 contains console source ID.

R1 contains the address of the parameter list being passed to the SVC.

PLIST is 12 bytes in length for WTO and 20 bytes in length for WTOR.

The PLIST field for WTO breaks down as follows:

Bytes

- 0 00-- indicates WTO parameter list.

1 hh-- message length plus four.
 2,3 hhhh-- MCS flag bytes; bit settings as follows:

Byte 2

1..... Invalid entry
 .1..... Message is to be queued to the console whose source ID is passed in Register 0.
 ..1..... the WTO is an immediate command response.
1... the WTO macro instruction is a reply to a WTOR macro instruction.
1. Message should be broadcast to all active consoles.
1 Message queued for hard copy only.
1 Message queued unconditionally to the console whose source ID is passed in register 0.

Byte 3

1..... time is not appended to the message.
 .1111... Invalid entry
1.. message is not queued for hard copy
11 invalid entry

4-11 First eight bytes of message

The PLIST field for WTOR breaks down as follows:

Bytes

0 hh--length of reply
 1-3 hhhhhh--address of reply buffer
 4-7 hhhhhhhh--address of reply ECB
 8 00--zeroed
 9 hh--message length plus four
 10,11 hhhh--MCS flag bytes, see WTO PLIST
 12-19 first eight bytes of message.

SVC 37 (SEGLD/SEGWT)

R15 contains no applicable information.

R0 if zero, entry was from SEGLD; non-zero indicates entry from SEGWT.

R1 contains the address of the parameter list.

PLIST is 12 bytes in length and breaks down as follows:

Bytes

0-3 hhhhhhhh branch instruction (to SVC 45)
 4-7 hhhhhhhh address of Referred-to Symbol
 8 hh "To" segment number
 9-11 hhhhhh Previous caller or 0

SVC 39 (LABEL)

R15 and R0 contain no applicable information.

R1 contains the address of the parameter list.

PLIST is 20 bytes in length and breaks down as follows:

Bytes

0-2 c00004 -- REWIND option
 c00006 -- UNLOAD option
 3 hh relative UCB in TIOT to use for mounting purposes.
 4-7 hhhhhhhh address of 8 byte DDNAME for DD card that allocates devices for mounting tapes.
 8-11 hhhhhhhh--address of volume label set.
 12,13 hhhh-- length of one volume label.
 14 hh-- number of labels in volume label set
 15 hh-- command byte of control CCW
 16-19 hhhhhhhh-- address of the first 10 bytes of volume header label.

SVC 40 (Extract)

R15 and R0 contain no applicable information.

R1 contains the address of the parameter list.

PLIST is 12 bytes in length and breaks down as follows:

Bytes

0 -- Reserved
 1-3 hhhhhh address of list area in which the extracted information will be stored.
 4 00 Reserved

5-7 0^0000 EXTRACT will obtain information from the current TCB and/or its related control blocks.
 hhhhhh address of TCB from which EXTRACT is to get requested information.
 8 hh flags byte; indicates the fields to be extracted as follows:

Bits
 1..... address of the general register save area
 .1..... address of floating point register save area
 ..1..... reserved
 ...1.... address of end-of-task exit routine
1... limit priority & dispatching priority
1.. task completion code
1. address of TIOT
1 address of the command scheduler communication list in the CSCB

9 hh TSO only flags byte; indicates the TSO fields to be extracted as follows:

Bits
 1..... address of time-sharing flags in TCB
 .1..... address of protected storage control block
 ..1..... terminal job identifier for task
 ...xxxx reserved

10,11 0000 reserved

SVC 45 (OVLVBRCH)

R15 contains the address of the Entry Table entry which caused the SVC to be issued.

R0 and R1 contain no applicable information.

PLIST is 12 bytes in length and breaks down as follows:

0-3 hhhhhhhh Branch (inst. to SVC 45)
 4-7 hhhhhhhh address of Referred-to-Symbol
 8 hh "To" segment number
 9-11 hhhhhh Previous caller or 0

SVC 47 (STIMER)

R15 contains no applicable information

R0 contents:

Bytes
 0 hh STIMER option byte as follows:
 x'40' TOD option
 x'30' DINTVL option
 x'10' BINTVL option
 x'00' TUINTVL option
 1-3 hhhhhh exit address

R15 contains the address of the time value

PLIST is four or eight bytes in length depending on the option in force:
 a. For the DINTVL and TOD options PLIST is eight bytes in length and represents the time value.
 b. For the BINTVL and TUINTVL options PLIST is 4 bytes in length and represents the time value.

SVC 48 (DEQ)

R15 and R0 contain no applicable information.

R1 contains the address of the parameter list.

PLIST is 16 bytes in length and breaks down as follows:

Bytes
 0 hh if set to x'FF' indicates the last element in the parameter list. Otherwise no meaning.
 1 hh the length of the minor name whose address is in bytes 8, 9, 10 and 11 of this element.
 00 the length of the minor name is in the first byte of the minor name field whose address is in bytes 8, 9, 10, and 11 of this element (does not include length byte itself).
 2 hh DEQ parameters byte as follows:

Bit Settings
 0..... Exclusive request
 1..... Shared request
 .0..... MINOR name is known only to job step

.1..... the scope of minor name is SYSTEM
 ..1..... Set must complete equal to SYSTEM
 ...1.... Set must complete equal to STEP
000 RET=NONE
001 RET=HAVE
010 RET=CHNGE
011 RET=USE
111 RET=TEST
1... RELEASE
 3 hh return code field for codes returned to the issuer by DEQ
 4-7 hhhhhhh address of major resource name (QNAME)
 8-11 hhhhhhh address of minor resource name (RNAME)
 12-15 hhhhhhhh if the DEQ parameters byte bit 4 (RELEASE) is set on this word contains the UCB address; otherwise the content of this word is unpredictable.

.0..... MINOR name is known only to job step
 .1..... the scope of minor name is SYSTEM
 ..1..... Set must complete equal to SYSTEM
 ...1.... Set must complete equal to STEP
000 RET=NONE
001 RET=HAVE
010 RET=CHNGE
011 RET=USE
111 RET=TEST
1... RESERVE
 3 hh return code field for codes returned to the issuer by ENQ
 4-7 hhhhhhh address of major resource name (QNAME)
 8-11 hhhhhhh address of minor resource name (RNAME)
 12-15 hhhhhhhh if the ENQ parameters byte bit 4 (RESERVE) is set on, this word contains the UCB address; otherwise the content of this word is unpredictable.

SVC 56 (ENQ)

R15 and R0 contain no applicable information

R1 contains the address of the parameter list

PLIST is 16 bytes in length and breaks down as follows:

Bytes

0 hh if set to x'FF' indicate the last element in the parameter list. Otherwise no meaning.
 1 hh the length of the minor name whose address is in bytes 8, 9, 10, and 11 of this element.
 00 the length of the minor name is in the first byte of the minor name field whose address is in bytes 5, 9, 10, and 11 of this element (does not include length byte itself).
 2 hh ENQ parameters byte as follows:

Bit Settings

0..... Exclusive request
 1..... shared request

SVC 60 (STAE/STAI)

R15 contains no applicable information

R0 contents:

00 -- Create
 04 -- Cancel
 08 -- Overlay

R1 contains the address of the parameter list. The high-order bit is set to one if the XCTL=YES parameter was coded.

PLIST is eight bytes in length and breaks down as follows:

Bytes

0 flag byte as follows:
 x '80' for STAI processing
 x '20' for STAE processing
 1-3 hhhhh If zero, the 'CAMCE:' operand is in effect; otherwise this is the address of the STAE/STAI exit routine.
 4-7 hhhhhhh address of the exit routine parameter list; if zero no exit routine parameter list exists.

SVC 63 (CHKPT)

R15 and R0 contain no applicable info.

R1 contents:

- a. the address of the parameter list
- b. Zero if a CANCEL request

PLIST is eight bytes in length and breaks down as follows:

| <u>Bytes</u> | | |
|--------------|----------|--|
| 0 | 00 | check ID address provided via the second parameter of CHKPT macro instruction |
| | 80 | No check ID address provided |
| 1-3 | hhhhhh | address of checkpoint DCB |
| 4 | 00 | check ID address not provided |
| | 01 to 10 | check ID length provided via third parameter of the CHKPT macro instruction |
| | FF | "S" specified as third parameter of CHKPT macro instruction; the system generated check ID is to be placed at the address specified in bytes 5-7 |
| 5-7 | hhhhhh | address for storing system generated check ID or address of user provided check ID |

SVC 64 (RDJFCB)

R15 and R0 contain no applicable information

R1 contains the address of the parameter list

PLIST is up to forty bytes in length and consists of a series of 4-byte entries containing the DCB address. The high-order byte has bit 0 set to one to indicate the last entry.

SVC 70 (GSERV)

R15 and R0 contain no applicable information.

R1 contents:

| <u>Bytes</u> | | |
|--------------|--------|---|
| 0 | hh | is a mask indicating which bits in the Graphic Control Byte (GCB) should be reset. |
| 1-3 | hhhhhh | the address of a fullword field that identifies the DCB related to the GCB in which bits are to be reset. |

PLIST is four bytes in length and displays the fullword pointed to by R1. Byte 0 is a unit index factor used to locate the UCB address in the DEB associated with the DCB. (The GCB to be reset is in the UCB).

SVC 73 (SPAR)

R15 and R0 contain no applicable information

R1 contains the address of the parameter list

PLIST is up to 40 bytes in length and consists of a series of 4-byte entries. The first entry breaks down as follows:

| <u>Bytes</u> | | |
|--------------|------|---|
| 0 | hh | the priority specified for the attention routine by the SPAR macro instruction. |
| 1 | hh | Reserved |
| 2,3 | hhhh | the number of words in the parameter list. |

Each additional entry contains a GACB address as specified by the SPAR macro.

SVC 74 (DAR)

R15 and R0 contain no applicable information.

R1 contains the address of the parameter list.

PLIST is up to forty bytes in length, consisting of 4-byte entries. The first entry breaks down as follows:

| <u>Bytes</u> | | |
|--------------|----|--|
| 0,1 | hh | Reserved |
| 2,3 | hh | the number of words in the parameter list. |

Each additional entry contains a GACB address specified by the DAR macro.

SVC 77 (ONLT)

R15 contains the address of the UCB of the line for the terminal being tested.

R0 contains the address of the first of five '9's in the test request buffer for ONLT (five '9's' indicate a request for an online test).

R1 contains the address of the parameter list.

PLIST is 14 bytes in length and breaks down as follows:

| <u>Bytes</u> | | |
|--------------|----------|--|
| 0-3 | hhhhhhhh | address of the ECB and the prefix of the request buffer. |
| 4-7 | hhhhhhhh | address of the GETMAIN parameters and terminal test pattern table. |
| 8-11 | hhhhhhhh | address of special line control characters |
| 12 | hh | 00 means test is valid 01 means test is invalid and not set up |
| 13 | hh | 00 means no answer on dial line 01 means answer on dial line |

SVC 80 (GJP/GFX)

(The SVC 80 Processing Routine serves as a communication link between GJP routines and the GFX Task, and between the GFX task and ABEND Hook routine.)

R15 contains no applicable information.

R0 contains the address of the parameter list.

R1 contains the address of the console control table.

PLIST is eight bytes in length and breaks down as follows:

| <u>Bytes</u> | | |
|--------------|----------|---|
| 0-3 | cccc | indicates which routine passed to SVC 80 as follows: PLOG -- Log Off PBEG -- Begin Job Processor ABDH -- Abend Hook Routine IERR -- Internal Error Routine NPRO -- Initial Processor |
| 4-7 | hhhhhhhh | the 2250 unit address that indicates which graphic job processor is using the SVC 80 routine. |

SVC 87 (DOM)

R15 contains no applicable information.

R0 the value (positive or negative) of R0 determines the content of R1.

R1 If R0 is not negative, R1 contains a message ID word (which is also displayed in the PLIST field).

If R0 is negative, R1 contains the address of a list of message ID words.

PLIST is up to 40 bytes in length, consisting of 4-byte entries. Each entry is a message ID word. The last entry is identified by the 0 bit in the high-order byte being set to 1.

SVC 90 (XQMNGR)

R15 and R0 contain no applicable information.

R1 contains the address of the QMPA.

PLIST is 36 bytes in length and contains the QMPA fields. The QMPA and its associated control blocks are described in the MVT Job Management PLM, Order No. GY28-6660.

SVC 96 (STAX)

R15 and R0 contain no applicable information.

R1 contains the address of the parameter list.

PLIST is 20 bytes in length and breaks down as follows:

| <u>Bytes</u> | | |
|--------------|----------|--|
| 0-3 | hhhhhhhh | address of user program to get control at attention interrupt. |
| 4,5 | hhhh | size of input buffer (max 4095) |
| 6,7 | hhhh | size of output buffer (max 4095) |
| 8-11 | hhhhhhhh | address of output buffer |
| 12-15 | hhhhhhhh | address of input buffer |
| 16 | hh | STAX option flag byte as follows: <u>Bits</u> 1.....Reserved .0.....replace=YES .1.....replace=NO ..1.....defer=YES ...1....defer=NO1111Reserved |
| 17-19 | hhhhhh | address of user parameters for user program. |

SVC 99 (TSO Dynamic Allocation)

R15 and R0 contain no applicable information.

R1 contains the address of the parameter list.

PLIST is up to 40 bytes in length. Consult your FE programming representative for information concerning the data displayed in this field.

SVC 102 (TCAM)

R15 and R0 contain no applicable information.

R1 contains the address of the parameter list.

PLIST is up to 12 bytes in length depending on the function and breaks down as follows:

Bytes

| | | |
|---|----|---|
| 0 | hh | Action code byte for SVC 102 as follows: |
| | | 1... Flag issuing task not eligible for rollout |
| | | .1.. Post rollout/rollin ECB complete |
| | | ..1. Post standard or TSO ECB complete |
| | | ...1 Flag issuing task not eligible for swap |
| | | 1... Move data across partition boundary |
| | |1.. Enqueue element on disabled ready queue and post MCP ECB complete |
| | |1. Flag issuing task eligible for swap |
| | |1 Flag issuing task eligible for rollout |

1-3 hhhhhh varies by action code as follows:

Action Code
 80,40,01 ECB address
 20,02,10
 08,04 Data Address

4 hh varies by action code as follows:

20 x'80', last four bytes
 80,40,01,
 08,04,02,
 10 x'00' reserved

5-7 hhhhhh varies by action code as follows:

Action Code
 20,02,10 TSO job ID address
 80,40,01, TCB address
 08,04 Target address (for enqueueing an element the target address is the address of the disabled ready queue in the TCAM AVT).

8 hh varies with action code as follows:

Action Code
 80,40,20,10,08,
 04,02,01 x'80', last four bytes

9-11 hhhhhh varies with action code as follows:

Action Code
 80,40,01 DEB address
 08,04 Length address
 10,20,02 TCB address

SVC Comprehensive Trace Records; Group 4 -
Basic Fields Plus Variable Fields

GTF Group 4 SVC comprehensive trace records have a variety of fields -- differing from SVC to SVC -- added to the fields composing the basic SVC record (Group 1). Format and content of the additional fields for each SVC are discussed in the following material.

SVC 0 (EXCP)

Additional fields -- DDNAME, DCB, DEB.

Register 15, 0, and 1 content, and DDNAME DCB, and DEB format and content follow:

R15 and R0 contain no applicable information.

R1 contains the address of the IOB associated with this request.

DDNAME cccccccc
N/A

See explanation of DDNAME field under Group 2.

DCB hhhhhhhh

address of the DCB associated with this I/O request.

DEB hhhhhhhh

address of the DEB associated with this I/O request.

SVC 6 (LINK)

Additional fields -- PLIST, NAME

Register 15, 0, and 1 content, and PLIST and NAME format and content follow:

R15 contains the address of the parameter list.

R0 and R1 contain no applicable information.

PLIST hhhhhhhh hhhhhhhh
is eight bytes in length and breaks down as follows:

| | | |
|--------------|----|---|
| <u>Bytes</u> | hh | flag byte as follows: |
| 0 | | 80 DE form of macro instruction |
| | | 00 EP and EPLOC form of macro instruction |

1-3 hhhhhh If byte 0 is 80; the address of the directory entry list.

If byte 0 is 00; the address of the entry point name.

4 hh hierarchy ID as follows:

00 -- no hierarchy
01 -- hierarchy 0
02 -- hierarchy 1

5 hhhhhh address of DCB or zero.

NAME cccccccc
is the entry point/directory entry (EP/DE) name of the module to be linked to or control transferred to.

SVC 7 (XCTL)

(Same as SVC 6)

SVC 8 (LOAD)

Additional field -- NAME

R15 contains no applicable information.

R0 Content:

If byte 0 contains x'00', bytes 1, 2, and 3 contain the address of the entry point name.

If byte 0 contains x'80', bytes 1, 2, and 3 contain the address of the directory entry list.

R1 Content:

In LCS systems, byte 0 contains the hierarchy ID as follows:

00 -- no hierarchy
01 -- hierarchy 0
02 -- hierarchy 1

In systems without LCS byte 0 contains no significant information.

Bytes 1, 2, and 3 contain the DCB address or zero if the default for DCB was specified.

NAME cccccccc
is the entry point/directory entry name of the module to be loaded.

SVC 9 (Delete)

Additional field -- NAME

R15 and R1 contain no applicable information.

R0 contains the address of the entry point name.

NAME ccccccc
is the entry point name of the module to be deleted.

SVC 13 (ABEND)

Additional field -- CMP CODE

R15 and R0 contain no applicable information.

R1 contains significant information only if SVC 13 was not called by the ABTERM routines. In this case R1 contains the following:

Bytes
0 hh Flag byte as follows:

Bits
1... DUMP option
.1.. STEP option
..xx xxxx reserved

1-3 hhhhhh ABEND completion code

CMP CODE hhhhhhhh
is the ABEND completion code if SVC 13 was called by the ABTERM routines. It is the content of the TCBCMP field of the current TCB at the time the SVC interrupt occurred. If ABEND recursion has occurred this field will contain the recursive completion code.

SVC 14 (SPIE)

Additional field -- PICA

R15 and R0 contain no applicable information.

R1 contains the address of the program interrupt control area (PICA).

PICA hhhhhhhh hhhh
displays the program interrupt control area from the associated SPIE macro instruction.

SVC 15 (ERREXCP)

Additional fields -- DDNAME, RQE, RQE TCB, CUU hhhh

R15 and R0 contain no applicable information.

R1 contains the address of the Request Queue Element (RQE) which was assigned to this I/O request by IOS.

DDNAME ccccccc
is the name of the DD statement associated with this I/O request.

RQE hhhhhhhh hhhhhhhh hhhhhhhh
is the first 12 bytes of the RQE assigned to this request by IOS. The breakdown is:

Bytes
0,1 hhhh not applicable
2,3 hhhh address of the UCB
4 hh TCB ID for MFT
5,6,7 hhhhhh address of IOB
8 hh priority byte
9 hhhhhh address of DEB

RQE TCB hhhhhhhh
is the address of the TCB associated with the I/O request.

CUU hhhh
device address in channel-unit form of the device associated with this I/O request.

SVC 16 (PURGE)

Additional fields -- DDNAME, DCB, PLIST

R15 and R0 contain no applicable information.

R1 address of the purge parameter list.

DDNAME { N/A
ccccccc
***** }

ccccccc
is the name of the DD statement associated with the requests being purged.

DCB hhhhhhhh
is the address of the DCB associated with the purge request.

PLIST hhhhhhhh hhhhhhhh hhhhhhhh
displays the PURGE parameter list which breaks down as follows:

Bytes
0 hh option byte as follows:
0... Purge request elements in complete DEB chain starting with DEB specified in address field.

1... .. Purge the requests associated with the DEB specified in address field.
 .1.. Post the purge requests with x'48'.
 ..0. Allow the active request to quiesce.
 ..1. Halt the I/O operations.
 ...0 Purge all requests.
 ...1 Purge only related requests.
0.. Purge AEQ, RB and IOS logical channel queue.
1.. Purge AEQ and IOS logical channel queue.
0. Purge by DEB
1. Purge by TCB

1-3 hhhhhh address of DEB.
 4 hh completion code
 5-7 hhhhhh address of TCB
 8 hh quiesce indicator:
 01 if one or more requests are quiescing.
 9-13 hhhhhh address of IOB.

SVC 17 (RESTORE)

Additional fields -- DDNAME, DCB, DEB

R15 and R0 contain no applicable information.

R1 contains the address of a pointer to the chain of IOBs to be restarted.

DDNAME { N/A
 ccccccc
 ***** }

ccccccc is the name of the DD statement associated with this IOB.

DCB hhhhhhhh is the address of the DCB associated with the IOB.

DEB hhhhhhhh is the address of the DEB associated with the IOB.

SVC 21 (STOW)

Additional fields -- DDNAME, PLIST

R15 contains no applicable information.

R0 contains the address of the parameter list.

R1 contains the address of the associated DCB.

The values, positive or negative, of R0 and R1, indicate the directory action STOW is to take as follows:

| R0 | R1 | Action |
|----|----|---------|
| + | + | ADD |
| + | - | REPLACE |
| - | + | DELETE |
| - | - | CHANGE |

N/A
 DDNAME ccccccc

ccccccc is the name of the associated DD statement.

PLIST

hhhhhhh ... (2 or 4 words)

is eight or 16 bytes in length, depending on the directory action being performed:

For ADD, REPLACE, or DELETE actions the PLIST field is eight bytes long and contains, the member name or alias of the PDS directory entry being acted upon.

For CHANGE the PLIST field is 16 bytes long, the first eight bytes containing the old member name or alias, and the second eight bytes contain the new member name or alias.

SVC 25 (TRKBAI)

Additional fields -- DDNAME, DCBFDAD, DCBTRBAL

R15 and R0 contain no applicable information.

R1 contains the address of the associated DCB. Note: If R1 is negative, the address is in complement form and the DCBFDAD and DCBTRBAL fields are meaningless.

DDNAME { N/A
 ccccccc
 ***** }

is the name of the associated DD statement.

DCBFDAD hhhhhhhh hhhhhhhh is the full direct access address (MBBCHHR) from the DCB pointed to by R1.

DCBTRBAL hhhh
 is the track balance -- the number of bytes remaining on the current track after a write. The field is negative if no bytes remain.

2 00
 3 00
 4 00 Reserved
 5-7 hhhhhh address of the area that contains the data set name
 8 00 Reserved
 9-11 hhhhhh the address of the CVOL ID, or zeroed.
 12 00
 13-15 hhhhhh address of the volume list

SVC 26 (CATALOG/INDEX/LOCATE)

Additional fields -- PLIST, DSN

R15 and R0 contain no applicable information.

R1 contains the address of the parameter list when CATALOG or INDEX issue the SVC call.

R1 contains the address of CAMLST as generated by the CAMLST macro instruction when LOCATE issues the SVC call.

DSN ccccccc...
 is the data set name.

PLIST hhhhhhhh ... (4 words)

is the parameter list passed to the SVC routine by the calling macro instruction. Its content varies, depending on the macro instruction issuing the call.

Entry from CATALOG:

Bytes
 0 hh option byte as follows:

Bits
 1... Search is to start on specified CVOL
 0... Search is to start on SYS.RES
 ..1. Catalog a data set
 ...1 Recatalog a data set
 1... Uncatalog a data set

1 hh option bytes as follows:

Bits
 .1.. Build all missing index levels
 1... Delete all unneeded index levels except the high level
1. Indicate presence of DSCB TIR

Entry from INDEX:

Bytes
 0 hh option byte as follows:

Bits
 1... Search is to start on specified CVOL
 0... Search is to start on SYS.RES

1 hh option byte as follows:

Bits
 .1.. Build an index
 ..1. Build a generation index
 ...1 Build an alias
 1... Connect CVOLs
1.. Delete an index
1 Delete an alias

2 hh option byte as follows:

Bits
 1... Disconnect CVOLs
 .1.. Indicate DELETE option
 1... Indicate EMPTY option

3 hh size of generation data group

4 00

5-7 hhhhhh a. address of the index name.
 b. address of an eight byte area that contains a high-level index name.

c. address of an area that contains an alias to be deleted.

8 00

9-11 hhhhhh the address of the area that contains the CVOL ID, or zeroed.

12 00

13-15 hhhhh a. address of an eight-byte area that contains an alias for a high-level index.
 b. address of a ten-byte area that contains the 4-byte device code of the CVOL to be connected followed by its 6-byte volume serial number.

Entry from LOCATE:

Bytes
 0 hh option byte as follows:

Bits
 1... Search is to start on specified CVOL
 0... Search is to start on SYS.RES
1. Read a block by TTR.
 ..00 0.0. LOCATE a name

1 hh option byte as follows:

Bits
 .000 0000 LOCATE a name

2 hh option byte as follows:

Bits
 0... LOCATE a name

3 00

4 00

5-7 hhhhhh address of the data set name or the relative track address (TTR) of the desired block in the catalog.

8 00

9-11 hhhhhh address of the CVOL ID or zeroes.

12 00

13-15, hhhhhh address of a 265 byte workarea which must be on a doubleword boundary. If the issuer of LOCATE has a non-zero protect key, then the workarea must have a matching storage protect key.

SVC 27 (OBTAIN)

Additional fields -- PLIST, VOLSER, DSN/CCHHR

R15 and R0 contain no applicable information.

R1 contains the address of the parameter list.

PLIST hhhhhhhh ... (4 words)
 displays the OBTAIN parameter list which breaks down as follows:

Bytes
 0-3 hhhhhhhh operation code as follows:

C1000000 SEARCH for DSNAME
 C1800000 SEEK for track address

4-7 hhhhhhhh address of data set name or address of track address of DSCB, CCHHR depending on operation code.

8-11 hhhhhhhh address of the volume serial number

12-15 hhhhhhhh address of 14-byte workarea.

VOLSER { N/A
 ccccc }

cccccc is the volume serial number of the associated volume.

N/A indicates that the volser pointer in the parameter list was zero.

DSN/CCHHR { nnnnn
 ccccccccc ... }

nnnnn is the track address in EBCDIC notation and is displayed when the operation code in Word 1 of the parameter list indicates SEEK.

cccccc ... is the data set name and is displayed when the operation code in word 1 of the parameter list indicates SEARCH. N/A if the name is unavailable.

SVC 28 (OPENEXT)

Additional fields -- content of R13

R15 contains no applicable information.

R0 contains zeroes, or the DCB address of the SYSCTLG to be processed.

R1 contains the UCB address of the volume whose SYSTCLG is to be opened, if R0 contains zeroes.

SVC 29 (SCRATCH)

Additional fields -- PLIST, DSN

R15 contains no applicable information.

R0 contains zeroes; or, the address of a UCB or a SUBUCB (for a 2321 device) for the device upon which unmounted volumes may be mounted.

PLIST hhhhhhhh ... (4 words)
displays the SCRATCH parameter list which breaks-down as follows:

| <u>Bytes</u> | |
|--------------|---|
| 0-3 | hhhhhhh operation code as follows: 41004000 -- check purge date 41005000 -- override purge date |
| 4-7 | hhhhhhh address of data set name |
| 8-11 | not used |
| 12-15 | address of the volume list |

DSN cccccccc ...
is the data set name. N/A if the name is unavailable.

SVC 30 (RENAME)

Additional fields -- PLIST, OLD DSN, NEW DSN

R15 contains no applicable information.

R0 contains the address of the UCB for the device on which unmounted volumes should be mounted, or zero.

R1 contains the address of the parameter list.

PLIST hhhhhhhh ... (4 words)

displays the RENAME parameter list which breaks-down as follows:

| <u>Bytes</u> | |
|--------------|--------------------------------------|
| 0-3 | x'41002000' |
| 5-7 | hhhhhhh address of old data set name |
| 8-11 | hhhhhhh address of new |
| 12-15 | hhhhhhh address of the volume list |

OLD DSN ccccc ...
is the fully qualified name of the data set to be renamed. N/A if the name is unavailable.

NEW DSN ccccc ...
is the new name for the data set being renamed. N/A if the name is unavailable.

SVC 32 (ALLOCATE)

Additional fields -- CUU, DSN

R15 contains no applicable information

R0 when positive, contains the address of the associated job file control block; when negative (not complemented--high-order bit is set on), contains the address of the associated model DSCB.

R1 contains the address of the UCB list.

CUU ccc
is the unit address from the UCB pointed to by R1.

DSN cccccccc ...
is the data set name from the DSN field of the JFCB or DSCB pointed to by R0. N/A if the DSN field was blank.

SVC 33 (IOHALT)

Additional fields -- CUU

R15 and R0 contain no applicable information

R1 contains the address of the UCB associated with the request to be halted.

CUU hhhh
 is the device address associated
 with the device being halted.

01 -- bytes 13-15
 contain the
 address of a
 listing of subpool
 numbers.

SVC 41 (IDENTIFY)

Additional fields -- EPNAME

R15 contains no applicable
 information.

R0 contains the entry point name
 address

R1 contains the main storage address
 for the entry point name being added.

EPNAME ccccccc
 is the entry point name being
 added.

13-15 hhhhhh

a subpool number
 or address of
 subpool list
 (determined by
 byte 12)

16 hh

SHSP flag byte:
 00 -- bytes 17-19
 contain a subpool
 number
 01 -- bytes 17-19
 contain the
 address of a list
 of subpool
 numbers.

17-19 hhhhhh

a subpool number
 or address of a
 subpool list
 (determined by
 byte 16)

SVC 42 (ATTACH)

Additional fields -- SUPRVLIST, PPLIST

R15 contains the address of the
 parameter list being passed to the SVC
 routine.

R0 contains no significant
 information.

R1 contains the address of the
 parameter list being passed to the
 called program, or zero (no parameter
 list being passed).

SUPRVLIST hhhhhhhh ... (36 bytes)
 is the parameter list being
 passed to the SVC routine and
 breakdown as follows:

20 hh

Roll-In/Roll-Out
 flag:
 00 -- new task may
 not be rolled-out
 and cannot invoke
 roll-out.

01 -- new task may
 not be rolled-out
 but can invoke
 roll-out
 02 -- new task may
 be rolled-out but
 cannot invoke
 roll-out
 03 -- new task may
 be rolled-out and
 can invoke
 roll-out

Bytes

0 hh EP/DE flag byte:
 00 -- EP or EPLOC
 specified
 80 -- DE specified
 1-3 hhhhhh address of the EP
 name or directory
 entry (determined
 by byte 0).
 4 hh hierarchy flag
 (used if option
 chosen):
 00 -- no hierarchy
 specified
 01 -- hierarchy 0
 02 -- hierarchy 1
 5-7 hhhhhh address of the
 DCB; or zero.
 8 hh Reserved.
 9-11 hhhhhh address of the ECB
 12 hh GSP flag byte:
 00 -- bytes 13-15
 contain subpool
 number

21-23 hhhhhh

address of the
 end-of-task exit
 routine

24,25 hhhh

dispatching
 priority number

26 hh

limit priority
 number

27 hh

Key Flags byte as
 follows:

Bits

x... Reserved
 .0.. Propagate the
 JSCB field from
 the originating
 task
 .1.. If the origina-
 ting task has a
 protect key of
 0, move the
 specified JSCB
 address into the

attached TCB;
otherwise,
propagate the
originating
task's TCBJSCB
field

- ..0. Subpools 251 and 252 and the job pack queue pointer of the originating task are not given to the attached task.
- ..1. Subpools 251 and 252 of the job pack queue pointer are given to the attached task.
- ...1 the attached task is to have a protect key of 0.
- 0... Subpool zero is to be shared with other tasks.
- 1... Subpool zero is not to be shared
-0.. A save area of 72 bytes is to be obtained for the task.
-1.. No save area is to be obtained.
-0. Propagate the TCBJSTCB field from the originating task.
-1. The TCBJSTCB of the new task is to point to the new task.
-0 The new task is to operate in problem program mode.
-1 The new task is to operate in supervisor mode.
- 28-35 hhhh the entry point name for EP; or blank for EPLOC or DE specification.

PPLIST hhhhhhhh hhhhhhhh hhhhhhhh
... (up to 40 bytes)
is the parameter list being passed to the called program and consists of a series of four-byte entries, each entry having it's high-order byte reserved, and an address in the low-order three bytes.

SVC 44 (CHAP)

Additional fields -- CHAP TCB

- R15 contains no applicable information.
- R0 contains a signed value to be added to the dispatching priority of the specified task. A negative value will be in two's-complement form.
- R1 contains the address of an area containing the address of the TCB whose priority is to be changed; or zero. If zero, it indicates that the active task's priority is to be changed.
- CHAP TCB hhhhhhhh
is the address of the TCB of the active task at the time the SVC interrupt occurred.

SVC 51 (SNAP)

Additional fields -- PLIST, MODN

- R15 and R0 contain no applicable information.
- R1 contains the address of the parameter list.
- PLIST:
The PLIST field when SVC 51 is called by the SNAP macro instruction is 12 bytes in length and breakdown as follows:
PLIST hhhhhhhh hhhhhhhh hhhhhhhh displays three words of the parameter list passed to SVC 51 by SNAP.

Bytes

- 0 hh ID number to be printed in the identification heading of the dump.
- 1 00
- 2 hh option flag bytes as follows:

Bits

- 0... ABEND request
- 1... SNAP request
- .1.. TCB address given
- ..1. Display all supervisor data
- ...1 Display trace table
- 1... Display nucleus
-1.. Snapshot list is given

.... ..1. ID given
1 Display QCBs

DDNAME { N/A
 CCCCCCCC
 ***** }

is the name of the DD statement associated with this request.

3 hh option flag byte as follows:

DCB hhhhhhhh

is the address of the associated DCB.

Bits

1... Save area (see next flags)
 .0.. Display entire save area
 .1.. Display heading only
 ..1. Display registers on entry to ABEND or SNAP
 ...1 Display link pack area
 1... Display job pack area
1.. Display PSW on entry to ABEND or SNAP
1. Display all subpools less than subpool 128
x Reserved

DEB hhhhhhhh

is the address of the associated DEB.

SVC 62 (DETACH)

Additional fields -- DETACH TCB

R15 and R0 contain no applicable information.

R1 contains the address of an area containing the address of the TCB to be detached.

Note: If R1 contains zero the DETACH TCB field is meaningless.

DETACH TCB hhhhhhhh

is the address of the TCB to be detached.

SVC 65 (QWAIT)

Additional fields -- R2, QCB

R15, R0 and R1 contain no applicable information.

R2 contains the address of the QCB for the element being waited on.

QCB hhhhhhhh hhhhhhhh hhhhhhhh

is the queue control block pointed to by R2, and breakdown as follows:

Bytes

0 hh queue status:
 01 -- not on ready queue
 02 -- not waiting
 03 -- waiting

1-3 hhhhhh address of first element on the queue.

4 hh priority of the queue when linked onto the ready queue.

5-7 hhhhhh address of the next item on the ready queue.

8 hh reserved.

9-11 hhhhhh address of the STCB for the subtask to be activated.

4 00

5-7 hhhhhh address of DCB

8 00

9-11 hhhhhh address of the TCB specified in the SNAP macro instruction; or zero. If zero, the dump is for the current task.

Certain calls for SVC 51 may result in a 16 byte PLIST field being recorded. If there is a problem in this area please contact your FE programming representative for programming support.

MODN { N/A
 CCCCCCCC }

cccccccc is the name of the module calling SVC 51.

N/A appears if no module name is available.

SVC 54 (DISABLE)

Additional fields -- DDNAME, DCB, DEB

R15 and R0 contain no applicable information.

R1 contains the address of the associated DCB

SVC 66 (BTAM TEST)

Additional fields -- IOBERINF

R15 and R0 contain no applicable information.

R1 contains the address of the IOB pointed to when the SVC was issued.

IOBERINF hhhhhhhh ... (4 words) is the error information field used by BTAM error recovery routines.

SVC 67 (QPOST)

Additional fields -- R2, QCB

R15 and R0 contain no applicable information.

R1 contains the address of the element being posted.

R2 contains the address of the QCB to which the element is being posted.

QCB hhhhhhhh hhhhhhhh hhhhhhhh is the queue control block pointed to by R2 and breakdown as follows:

| <u>Bytes</u> | | |
|--------------|-------|---|
| 0 | hh | queue status: 01 -- not on Ready queue 02 -- not waiting 03 -- waiting |
| 1-3 | hhhhh | address of first element on the queue. |
| 4 | hh | priority of the queue when linked onto the ready queue. |
| 5-7 | hhhhh | address of the next item on the ready queue. |
| 8 | hh | reserved. |
| 9-11 | hhhhh | address of the STCB for the subtask to be activated. |

SVC 71 (ASGNBFR/RLSEBFR/BUFINQ)

Additional fields -- DDNAME, PLIST

R15 and R0 contain no applicable information

R1 contains the address of the parameter list.

DDNAME ccccccc is the name of the DD statement associated with the DCB specified by the macro instruction.

PLIST hhhhhhhh hhhh ... (up to 12 bytes)

displays the parameter list pointed to by R1. The content varies according to the macro instruction calling the SVC.

Entry from ASGNBFR:

| <u>Bytes</u> | | |
|--------------|---------|---|
| 0 | 04 | request byte, 04 indicates ASGNBFR |
| 1-3 | hhhhh | the DCB address |
| 4-7 | hhhhhhh | the address of a half-word field containing the number of bytes of buffer to be assigned. |

Entry from RLSEBFR:

| <u>Bytes</u> | | |
|--------------|---------|---|
| 0 | hh | request byte: 08 indicates RLSEBFR 0C indicates RLSEBFR ALL |
| 1-3 | hhhhh | the DCB address |
| 4-7 | hhhhhhh | the address of a half-word field containing the number of bytes of buffer to be released. |

Entry from BUFINQ:

| <u>Bytes</u> | | |
|--------------|---------|---|
| 0 | 10 | request byte, 10 indicates BUFINQ |
| 1-3 | hhhhh | the DCB address |
| 4-7 | hhhhh | address of the table of buffer addresses (must be on a fullword boundary) |
| 8-11 | hhhhhhh | the number of bytes specified to be available for the table of buffer addresses |

SVC 75 (Dequeue Routine)

Additional fields -- IQE

R15 contains no applicable information

R0 contains the address of the next IQE on the IRB active list for the attention routine when ATTNINQ has specified clear mode; otherwise, contains zero.

R1 Content:

Bytes
 0 hh is a unit index to identify a particular 2260 display station; or 00 for a 2250 station.
 1-3 hhhhhh the GACB address

N/A
 IQE hhhhhhhh hhhhhhhh hhhhhhhh
 when ATTNINQ specifies clear mode this field displays the first 3 words of the IQE pointed to by R0:

Bytes
 0-3 hhhhhhhh the address of the next IQE in the chain, or zero
 4-7 hhhhhhhh not meaningful
 8-11 hhhhhhhh the address of the hhhhhhhh IRB associated with the IQE.

N/A
 will appear in this field whenever the ATTNINQ macro instruction did not specify clear mode.

SVC 78 (LSPACE)

Additional fields -- CUU
 R15 and R1 contain no applicable information
 R0 contains the address of the associated UCB
 CUU hhhh is the unit address

SVC 81 (SETPRT)

Additional fields -- DDNAME, PLIST
 R15 and R0 contain no applicable information
 R1 contains the address of the parameter list.
 DDNAME ccccccc
 is the name of the DD statement associated with the data set being printed.
 PLIST hhhhhhhh .. (four words)
 is four words of the parameter list being passed to SVC 81 and breaks down as follows:

Bytes
 0-3 hhhhhhhh address of the DCB
 4-7 hhhhhhhh EBCDIC character set image ID
 8 hh LOAD MODE indicator:
 .0.. no fold
 .1.. fold
 x.xx xxxx reserved
 9 hh verification indicator:
1 verify
 ...0 don't verify
 xxx. xxxx reserved
 10 hh data check indicator:
 1... block
 .1.. unblock
 00.. as DCB specifies
 1... unfold UCS 3211
1.. fold UCS 3211
 ..xx ..xx reserved
 11-14 hhhhhhhh EBCDIC FCB image ID
 15 hh FCB parameter options:
 1... verify FCB
1 align
 .xxx xxx. reserved

SVC 82 (DISKANAL) Entered from modules: IEHDANAL, IEHOGETA, IEHDCELL, IEHDLABL, IEHDREST, IEHDDUMP

Additional fields -- VOLSER, DA-ADDR, PLIST
 R15 and R0 contain no applicable information
 R1 contains the address of the parameter list.
 VOLSER ccccc
 is the volume serial number
 DA-ADDR N/A
 hhhhhhhh hhhhhhhh
 displays a six or eight byte track address or N/A, dependent on the options in effect for the SVC routine. The breakdown is:

| <u>Option</u> | <u>DA-ADDR Content</u> |
|-------------------|--------------------------|
| analyze or format | six-byte track address |
| post UCB | eight-byte track address |

| | | | | |
|---------------------------------|--------------------------|-------|---------|---|
| address of alternate track CCHH | N/A | 8-11 | hhhhhhh | address of VTOC flag byte -- last element |
| unlabeled volume | eight-byte track address | 12 | 80 | |
| new volume | N/A | 13-15 | hhhhh | address of DEB |

SVC 86 (ATLAS)

PLIST hhhhhhhh ... (16 bytes maximum) is either 8, 12, or 16 bytes of the parameter list pointed to by R1. The first four bytes always consist of a flag byte, defining the function to be performed, and a 3-byte UCB address. The fifth, ninth, and thirteenth bytes, when present, will contain a flag indicating the last element (4-bytes) in the list. The breakdown is as follows:

| <u>Bytes</u> | | | |
|---------------|---------|--|--|
| 0 | hh | function byte as follows: | |
| | | 8F -- new volume | |
| | | 1F -- address of alternate track CCHH | |
| | | 00 -- ANALYZE or FORMAT | |
| | | 08 -- POST UCB | |
| | | 88 -- unlabeled volume | |
| 1-3 | hhhhh | address of UCB | |
| (function 8F) | | | |
| 4 | 80 | flag byte -- last element | |
| 5-7 | hhhhh | address of DCB | |
| (function 1F) | | | |
| 4 | 80 | flag byte -- last element | |
| 5-7 | hhhhh | address of alternate track CCHH | |
| (function 00) | | | |
| 4-70 | hhhhhhh | address of alternate track CCHH | |
| 8 | 80 | flag byte -- last element | |
| 9-11 | hhhhh | address of alternate track information | |
| (function 08) | | | |
| 4-7 | hhhhhhh | address of serial number | |
| 8 | 80 | flag byte -- last element | |
| 9-11 | hhhhh | address of VTOC address of VTOC | |
| (function 88) | | | |
| 4-7 | hhhhhhh | address of serial number | |

Additional fields -- PLIST, CCHHR

R15 and R0 contain no applicable information

R1 contains the address of the parameter list

PLIST hhhhhhhh hhhhhhhh is the parameter list passed to SVC 86 and breaks down as follows:

| <u>Bytes</u> | | | |
|--------------|-----------|--|--|
| 0 | hh | flag byte as follows: | |
| 1... .. | | User's channel program can not be re-executed. | |
| | .xxx xxxx | reserved | |
| 1-3 | hhhhh | address of IOB | |
| 4 | hh | flag byte as follows: | |
| 1... .. | | IEHATLAS is the calling program | |
| .1.. .. | | a partial count (CCHH only) has been passed by the calling program | |
| ..1. | | a write special CCW is required for a track overflow record | |
| ...1 | | a write special CCW is not required | |
| | xxxx | reserved | |
| 5-7 | hhhhh | address of count (CCHHR) or partial count (CCHH) field | |

CCHHR hhhhhhhh is the five-byte track address of the complete (CCHHR) or partial count (CCHH) field passed by the calling program.
 Note: If entry to SVC 86 is from the IEHATLAS program (byte 4, bit 0 in parameter list) this address points to the CCHH part of the count field.

SVC 88 (MOD 88)

Additional fields -- DEB, DSSTAT FLGS, DEVMOD

R15 and R0 contain no applicable information.

R1 contains the address of the DCB associated with the current task at the time the SVC was issued.

DEB hhhhhhhh
is the address of the data extent block (taken from DCB pointed to by R1)

DSSTAT hh
the data set status flags field (taken from the DEB)

DEVMOD hh
the device modifier field (taken from the DEB)

SVC 89 (EMSERV)

Additional fields -- PLIST, RESMCW

R15 and R0 contain no applicable information

R1 contains the address of the parameter list

PLIST hhhhhhhh
displays four bytes from the parameter list being passed to the SVC routine. The breakdown is:

| <u>Bytes</u> | | flag byte: |
|--------------|----|---------------------------|
| 0 | hh | |
| | | C0 -- enter emulator mode |
| | | A0 -- leave emulator mode |

1-3 hhhhhh address of control storage lead name

RESMCW hhhhhhhh hhhhhhhh
displays eight bytes of the RESMCW field from the RMS common area.

SVC 98 (TSO PROTECT)

Additional fields -- PLIST, DSN

R15 and R0 contain no applicable information

R1 contains the address of the parameter list

PLIST hhhhhhhh
displays the first four bytes of the parameter list as follows:

| <u>Byte</u> | | |
|-------------|----|-------------------------------------|
| 0 | 01 | entry code for the add function |
| | 02 | entry code for the replace function |
| | 03 | entry code for the delete function |
| | 04 | entry code for the list function |

1-3 hhhhhh varies by function as follows:

| | |
|--------|---------------------------|
| 000000 | -- add function |
| 000000 | -- replace function |
| 000000 | -- delete function |
| hhhhhh | -- 80 byte buffer address |

DSN ccccccc ...
is the data set name

IMDPRDMP OUTPUT COMMENTS - GTF PROCESSING

The following comments may appear in the listing of GTF trace records.

I/O ERROR ON ddname - CONTINUE

Explanation: The EDIT function of IMDPRDMP is being used to process a GTF external trace data set. An I/O error was encountered while attempting to read the trace data set identified by ddname. Fewer than three consecutive I/O errors have occurred for this data set, so EDIT continues processing, ignoring the current block that caused the I/O error.

I/O ERROR ON ddname - EDIT PROCESSING TERMINATED

Explanation: The EDIT function of IMDPRDMP is being used to process a GTF external trace data set. Three consecutive I/O errors have been encountered while attempting to read the trace data set identified by ddname. EDIT processing terminates.

ERROR IN GTF BUFFER CHAIN

Explanation: The EDIT function of IMDPRDMP is being used to process an internal (dump) trace data set. While attempting to locate the GTF trace buffers, IMDPRDMP encountered one of the following errors:

- A buffer pointer was not on a word boundary.
- A buffer pointer addressed an area of main storage that could not be extracted from the dump for one of the following reasons:
 1. The pointer addressed an area higher than the highest address in the dump.
 2. IMDPRDMP encountered an I/O error while attempting to read the record containing the area addressed by the pointer.
 3. The block containing the addressed area was missing from the dump, perhaps because the program that produced the dump encountered an I/O error while attempting to write the block. EDIT processing is terminated.

ERROR IN GTF BUFFER - CONTINUING WITH NEXT BUFFER

Explanation: The EDIT function of IMDPRDMP is being used to process an internal (dump) trace data set. EDIT has encountered a GTF trace record with a length that does not lie within the acceptable range of 4 to 272 bytes. EDIT continues processing with the next GTF buffer.

GTF NOT ACTIVE AT TIME OF DUMP

Explanation: The Edit function of IMDPRDMP is being used to process an internal (dump) trace data set. EDIT has determined that GTF was not active at the time that the dump was taken. EDIT processing is terminated.

TRACE RECORD LL INVALID, DD ddname BLOCK NO xxxyyy - EDIT PROCESSING TERMINATED

Explanation: The EDIT function of IMDPRDMP is being used to process a GTF external trace data set. EDIT has encountered a GTF trace record with a length that does not lie within the acceptable range of 4 to 272 bytes. Ddname identifies the GTF external data set being processed; xxxyyy identifies the number of the block containing the faulty record. EDIT processing is terminated.

EDIT TERMINATED UPON USER'S REQUEST

Explanation: A user exit has requested EDIT termination by returning to EDIT with a return code of 24.

EXIT DELETED UPON USER'S REQUEST

Explanation: A user exit has requested that it no longer be invoked during the current EDIT execution. This is the result of a user exit routine return code of 16 or 20.

GTF OPTIONS IN EFFECT - option

Explanation: The input trace data set was created by GTF with trace options in effect as indicated by 'option'. The Service Aids publication describes the options available.

Appendix A: Debugging With an Operating System Dump

The first facts you must determine in debugging with an operating system dump are the cause of the abnormal termination and whether it occurred in a system routine or a problem program. To aid you in making these determinations, ABEND, SNAP, and indicative dumps provide two vital pieces of information -- the completion code and the active RB queue. Similar information can be obtained from a storage image dump or a stand-alone dump by analyzing PSWs and re-creating an active RB queue.

A completion code is printed at the top of ABEND, SNAP, and indicative dumps. It consists of a system code and a user code. The system code is supplied by the control program and is printed as a 3-digit hexadecimal number. The user code is the code you supplied when you issued your own ABEND macro instruction; it is printed as a 4-digit decimal number. If the dump shows a user code, the error is in your program, and the completion code should lead you directly to the source of error. Normally, however, a system code will be listed; this indicates that the operating system issued the ABEND. Often the system completion code gives enough information for you to determine the cause of the error. The explanations of system completion codes, along with a short explanation of the action to be taken by the programmer to correct the error, are contained in the publication IBM System/360 Operating System: Messages and Codes, GC28-6631.

To locate the load module that had control at the time the dump was issued, find the RB associated with the module. If the dump resulted from an ABEND or SNAP macro instruction, the third most recent RB on the queue represents the load module that had control. The most recent and second most recent RBs represent the ABDUMP and ABEND routines, respectively. Storage image dumps and stand-alone dumps contain PSW information that can be used to identify the load module in control.

Once you have located the RB or load module, look at its name. If it does not have a name, it is probably an SVRB for an SVC routine, such as one resulting from a LINK, ATTACH, XCTL or LOAD macro instruction. To find the SVC number, look at the last three digits of the resume PSW in the previous RB on the queue. If a previous RB does not exist, the RB in question is an SVRB for a routine invoked

by an XCTL macro instruction. Register 15 in the extended save area of the RB gives a pointer to a parameter list containing the name of the routine that issued the XCTL.

If the RB does not bear the name of one of your load modules, either an RB was overlaid or termination occurred during execution of a system routine. The first three characters of the name identify the system components.

If the RB bears the name of one of your load modules, you can be reasonably certain that the source of the abnormal termination lies in your object code. However, an access method routine may be at fault. This possibility arises because your program branches to access method routines instead of invoking them through a supervisor-assisted linkage. Thus, an access method routine is not represented on the active RB queue. To ascertain whether an access method routine was the source of the abnormal termination, you must examine the resume PSW field in the RB. If the last 3 bytes in this field point to a main storage address outside your program, check the load list to see if an access method routine is loaded at that address. If it is, you can assume that it, and not your program, was the source of abnormal termination.

Abnormal Termination in System Routines:

By analyzing the RB's name field or the SVC number in the previous RB, you can determine which system load module requested the termination. If the RB has a system module name, the first three characters tell you the name of the system component. The remaining characters in the name identify the load module in error.

Remember, although a system routine had control when the dump was taken, a problem program error may indirectly have been at fault. Such a situation might result from an incorrectly specified macro instruction, an FQE modified inadvertently, a request for too much storage space, a branch to an invalid storage address, etc. To determine the function of the load module that had control, consult Appendix C. With its function in mind, the completion code together with an examination of the trace table may help you to uncover which instruction in the problem program incorrectly requested a system function.

Program Check Interruptions in Problem

Programs: If you have determined from the completion code or PSWs and evaluation of the RB queue that the dump resulted from a program check in your problem program, examine the status of your program in main storage. (If you have received only an indicative dump, you must obtain either an ABEND/SNAP dump or a stand-alone dump at this point.) Locate your program using pointers in the RB. If its entry point does not coincide with the lower boundary of the program, you can find the lower boundary by adding 32(20) to the address of the RB (systems with MFT). The RB's size field gives the number of doublewords occupied by the RB, the program, and associated supervisor work areas. ABEND/SNAP dumps with MFT have the storage boundaries of the problem program calculated and printed.

Next, locate the area within your program that was executed immediately prior to the dump. To do this, you must examine the program check old PSW. Pertinent information in this PSW includes:

Bits 12-15: AMWP bits
Bits 32,33: Instruction length in halfwords.
Bits 40-63: Instruction address

A useful item of information in the PSW is the P bit of the AMWP bits (bits 12-15). If the P bit is on, the PSW was stored while the CPU was operating in the problem program state. If it is off, the CPU was operating in the supervisor state.

Find the last instruction executed before the dump was taken by subtracting the instruction length from the instruction address. This gives you the address of the instruction that caused the termination. If the source program was written in a higher level language, you must evaluate the instructions that precede and follow the instruction at fault to determine their function. You can then relate the function to a statement in the source program.

Other Interruptions in Problem Programs:

If the completion code or PSWs and the active RB queue indicate a machine check interruption, a hardware error has occurred. Call your IBM Field Engineering representative and show him the dump.

If an external interruption is indicated, with no other type of interruption, the dump probably was taken by the operator. Check with him to find out why the dump was taken at this point. The most likely reasons are an unexpected

wait or a program loop. If a trace table exists, examine it for the events preceding the trouble or, if the trace table was made ineffectual by a program loop, resubmit the job and take a dump at an earlier point in the program.

The remaining causes of a dump are an error during either execution of an SVC or an I/O interruption. In either case, examine the trace table. Entries in the table tell you what events occurred leading up to termination. From the sequence of events, you should be able to determine what caused a dump to be taken. From here, you can turn to system control blocks and save areas to get specific information. For example, you can find the sense information issued as a result of a unit check in the UCB, a list of the open data sets from the DEB chain, the CCW list from the IOB, the reason for an I/O interrupt in the status portion of the CSW, etc.

Specialized Program Checks

In addition to the error program checks (1-15), other system events cause program checks which are normally transparent to the user. They could, however, if seen in a dump (except ABEND dumps where they do not appear, result in some confusion. One such event is the monitor call interrupt. On 360 CPU's, the monitor call appears as a 01 (operation) interrupt code in the program old PSW. To verify that a simulated monitor call occurred, check the address in the program old PSW. A monitor call occurred if:

1. The address (-4) points to an execution instruction ('44');
2. The execute is operating on an x'AF00' in low core;
3. A NOP (x'470') follows the execute.

370 CPU's support the real monitor call interrupt. The code in the program old PSW is a x'40', and the PSW address (-4) points directly at an x'AF' instruction.

On 360 CPU's, the x'AF' opcode is simulated as follows:

1. The first time an x'AF' instruction is encountered, an execute instruction is substituted for the x'AF'.
2. The execute is of an instruction in a low-core table (Class Mask Table).
3. If the monitor call should occur, the instruction in the Class Mask Table is an x'AF00'; if it should not occur, the instruction is a x'0700' (NOP).

4. Required class and ID information for the monitor call are contained in the x'470' NOP following the execute.

On 370 CPU's, the monitor call occurs under control of a mask in Control Register 8.

The Generalized Trace Facility (GTF) is a user of the monitor call interrupt. For more detailed information, refer to the Service Aids Logic PLM, GY28-6721.

Debugging Procedure Summary

1. Look at the completion code or PSW printouts to find out what type of error occurred. Common completion codes and causes are explained in Appendix C.
2. Check the name of the load module that had control at the time the dump was taken by looking at the active RB's.
3. If the name identifies a system routine, proceed to step 4. If the name identifies a problem program and the completion code or PSW indicates a program check, proceed to step 6. If the name identifies a problem program, and the completion code or PSW indicates other than a program check, proceed to step 10.
4. Find the function of the system routine using Appendix D.
5. If the dump contains a trace table, begin at the most recent entry and proceed backward to locate the most recent SVC entry indicating the problem state. From this entry, proceed forward in the table, examining each entry for an error that could have caused the system routine to be terminated.
6. If the name identifies one of your load modules, check the instruction address and the load list to see if an access method routine last had control. If so, return to step 4.
7. Locate your program in the dump.
8. Locate the last instruction executed before the dump.
9. Examine the instruction and, if the program was written in a high-level language, the instructions around it for a possible error in object code.
10. If a machine check interruption is indicated, call your IBM Field Engineering representative.
11. If only an external interruption is indicated, ask the operator why he took the dump. Resubmit the job and take a dump at the point where trouble first occurred.
12. Examine the trace table, if one is present, for events leading up to the termination. Use trace table entries and/or information in system control blocks and save areas to isolate the cause of the error.

Appendix B: SVCs

Register contents at entry to an SVC routine are often helpful in finding pointers and control information. The table below lists SVC numbers in decimal and hexadecimal, and gives the type, associated macro instruction, and significant contents of registers 0 and 1 at entry to each SVC routine.

| Decimal No. | Hex. No. | Type | Macro | Register 0 | Register 1 |
|-------------|----------|---------|---------------------------------|---|----------------------------------|
| 0 | 0 | I | EXCP | | IOB address |
| 0 | 0 | I | XDAP | | |
| 1 | 1 | I | WAIT | Event count | ECB address |
| 1 | 1 | I | WAITR | Event count | 2's complement of ECB address |
| 1 | 1 | I | PRTOV | | |
| 2 | 2 | I | POST | Completion code | ECB address |
| 3 | 3 | I | EXIT | | |
| 4 | 4 | I | GETMAIN | | Parameter list address |
| 5 | 5 | I | FREEMAIN | | Parameter list address |
| 6 | 6 | II | LINK | | Parameter list address |
| 7 | 7 | II | XCTL | | Parameter list address |
| 8 | 8 | II | LOAD | Address of entry point address | DCB address |
| 9 | 9 | I, II | DELETE | Address of program name | |
| 10 | A | I | GETMAIN or FREEMAIN (R Operand) | Subpool number (byte 0) Length (bytes 1-3) | Address of area to be freed |
| 10 | A | I | FREEPOOL | | |
| 11 | B | I, III | TIME | | Time units code |
| 12 | C | II | SYNCH | | |
| 13 | D | IV | ABEND | | Completion code |
| 14 | E | II, III | SPIE | | PICA address |
| 15 | F | I | ERREXCP | | Address of request queue element |

(Part 1 of 5)

| Decimal No. | Hex. No. | Type | Macro | Register 0 | Register 1 |
|-------------|----------|---------|-------------------------|------------------------|--|
| 16 | 10 | III | PURGE | | |
| 17 | 11 | III | RESTORE | | IOB chain address |
| 18 | 12 | II | BLDL | Address of build list | DCB address |
| 18 | 12 | II | FIND | | |
| 19 | 13 | IV | OPEN | | Address of parameter list of DCB addresses |
| 20 | 14 | IV | CLOSE | | Address of parameter list of DCB addresses |
| 21 | 15 | III | STOW | Parameter list address | DCB address |
| 22 | 16 | IV | OPEN TYPE=J | | Address of parameter list of DCB addresses |
| 23 | 17 | IV | CLOSE TYPE=T | | Address of parameter list of DCB addresses |
| 24 | 18 | III | DEVTYPE | | ddname address |
| 25 | 19 | III | TRKBAL | | DCB address |
| 26 | 1A | IV | CATALOG | | Parameter list address |
| 26 | 1A | IV | INDEX | | Parameter list address |
| 26 | 1A | III | LOCATE | | Parameter list address |
| 27 | 1B | III | OBTAIN | | Parameter list address |
| 28 | 1C | IV | CVOL | | |
| 29 | 1D | IV | SCRATCH | UCB address | Parameter list address |
| 30 | 1E | IV | RENAME | UCB address | Parameter list address |
| 31 | 1F | IV | FEOV | | DCB address |
| 32 | 20 | IV | ALLOC | | Address of UCB list |
| 33 | 21 | III | IOHALT | | UCB address |
| 34 | 22 | IV | MGCR (MAST CMD EXCP) | | |
| 35 | 23 | IV | WTO | | Message address |
| 35 | 23 | IV | WTOR | | Message address |
| 36 | 24 | IV | WTL | | Address of message |
| 37 | 25 | II | SEGLD | | Segment name address |
| 37 | 25 | II | SEGWT | | Segment name address |
| 38 | 26 | II | TTROUTER | | |
| 39 | 27 | III, IV | LABEL | | Parameter list address |

(Part 2 of 5)

| Decimal No. | Hex. No. | Type | Macro | Register 0 | Register 1 |
|-------------|----------|------------|----------|--|--|
| 40 | 28 | I, II, III | EXTRACT | | Parameter list address |
| 41 | 29 | II, III | IDENTIFY | Entry point name address | Entry point address |
| 42 | 2A | II, III | ATTACH | | |
| 43 | 2B | II, III | CIRB | Entry point address | Size of work area in doublewords |
| 44 | 2C | I | CHAP | + Increase priority - Decrease priority | TCB address |
| 45 | 2D | II | OVLVBRCH | | |
| 46 | 2E | I | TTIMER | | 1: Cancel |
| 47 | 2F | II | STIMER | Exit address | Timer interval address |
| 48 | 30 | I, II | DEQ | | QCB address |
| 49 | 31 | III | TEST | | |
| 50 | 32 | | | | |
| 51 | 33 | IV | SNAP | | Parameter list address |
| 52 | 34 | IV | RESTART | | DCB address |
| 53 | 35 | III | RELEX | Key address | DCB address |
| 54 | 36 | II | DISABLE | | |
| 55 | 37 | IV | EOV | EOB address | DCB address |
| 56 | 38 | I, II | ENQ | QEL address | QCB address |
| 56 | 38 | I, II | RESERVE | | |
| 57 | 39 | III | FREEDBUF | DECB address | DCB address |
| 58 | 3A | I | RELBUF | | DCB address |
| 58 | 3A | I | REQBUF | | DCB address |
| 59 | 3B | III | OLTEP | | |
| 60 | 3C | III | STAE | 0 Create SCB 4 Cancel SCB 8 0 | Parameter list address |
| 61 | 3D | III | TTSAV | | Parameter list address |
| 62 | 3E | II | DETACH | | TCB address |
| 63 | 3F | IV | CHKPT | | DCB address |
| 64 | 40 | III | RDJFCB | | Address of parameter list of DCB addresses |
| 65 | 41 | II | QWAIT | | Parameter list address |
| 66 | 42 | IV | BTAMTEST | | |

(Part 3 of 5)

| Decimal No. | Hex. No. | Type | Macro | Register 0 | Register 1 |
|-------------|----------|------|----------|--|---|
| 67 | 43 | II | ENDREADY | | QPOST |
| 68 | 44 | IV | SYNADAF | Same as register 0 on entry to SYNAD | Same as register 1 on entry to SYNAD |
| 68 | 44 | IV | SYNADRLS | | |
| 69 | 45 | III | BSP | | DCB address |
| 70 | 46 | II | GSERV | | Parameter list address |
| 71 | 47 | III | RLSEBFR | | Parameter list address |
| 71 | 47 | III | ASGNBFR | | Parameter list address |
| 71 | 47 | III | BUFINQ | | Parameter list address |
| 72 | 48 | IV | CHATR | | Parameter list address |
| 73 | 49 | III | SPAR | | Parameter list address |
| 74 | 4A | III | DAR | | Parameter list address |
| 75 | 4B | III | DQUEUE | | Parameter list address |
| 76 | 4C | IV | IFBSTAT | | |
| 77 | 4D | IV | QTAMTEST | | |
| 78 | 4E | III | WSCAN | | |
| 79 | 4F | I | STATUS | | |
| 80 | 50 | III | IKASVC | | |
| 81 | 51 | IV | SETPRT | | |
| 82 | 52 | IV | DASDR | | |
| 83 | 53 | III | SMFWM | | Message address |
| 84 | 54 | I | GRAPHICS | UCB address and buffer restart address | |
| 85 | 55 | IV | DDRSWAP | | |
| 86 | 56 | IV | ATLAS | | Parameter list address |
| 87 | 57 | III | DOM | If zero If negative | A DOM message I.D. A pointer to a list of DOM message I.Ds |
| 88 | 58 | III | MOD88 | Routine code | DCB address |
| 89 | 59 | III | EMSRV | | Parameter list address |
| 90 | 5A | IV | XQMNGR | Address of list of ECB/IOB pointers (optional) | QMPA address |
| 91 | 5B | III | VOLSTAT | DCB address | zero: issued by CLOSE Non-zero: issued by EOVS |

(Part 4 of 5)

| Decimal No. | Hex. No. | Type | Macro | Register 0 | Register 1 |
|-------------|----------|------|------------------|--|---------------------------------------|
| 92 | 5C | I | TCBEXCP | | |
| 93 | 5D | IV | TGET/TPUT | TJID & buffer Size | Address of User's Buffer |
| 94 | 5E | IV | STERMINAL STATUS | Entry code | |
| 95 | 5F | I | TSEVENT | TJID/Entry Code or 0 | Not Always Applicable |
| 96 | 60 | III | STAX | | Parameter List Address |
| 97 | 61 | III | TEST-TSO | | |
| 98 | 62 | IV | PROTECT | | Parameter List Address |
| 99 | 63 | IV | none | | |
| 100 | 64 | III | FIB | | |
| 101 | 65 | I | QTIP | Entry code | Parameter List Address |
| 102 | 66 | I | AQCTL | | Parameter List Address |
| 103 | 67 | | XLATE | Field length | Action byte and field address |
| 104 | 68 | IV | TOPCTL | Subroutine indicator | Address of operator control word area |
| 105 | 69 | III | IMAGLIB | | Action indication |
| 109 | 6D | IV | | -- contents used by called routine -- | |
| 116 | 74 | I | AT | -- contents used by called routines -- | |
| 117 | 75 | II | | -- contents used by called routines -- | |

(Part 5 of 5)

Appendix C: Completion Codes

Completion codes issued by operating system routines are often caused by problem program errors. This appendix includes the most common system completion codes, their probable causes, and how to correct the error or locate related information using a dump. For a more comprehensive coverage of completion codes, see the publication Messages and Codes.

0Cx A program check occurred without a recovery routine. If bit 15 of the old program PSW (PSW at entry to ABEND) is on, the problem program had control when the interruption occurred; "x" reflects the type of error that causes the interruption:

| x | Cause |
|---|----------------------|
| 1 | Operation |
| 2 | Privileged operation |
| 3 | Execute |
| 4 | Protection |
| 5 | Addressing |
| 6 | Specification |
| 7 | Data |
| 8 | Fixed-point overflow |
| 9 | Fixed-point divide |
| A | Decimal overflow |
| B | Decimal divide |
| C | Exponent overflow |
| D | Exponent underflow |
| E | Significance |
| F | Floating-point |

The correct register contents are reflected under the heading "REGS AT ENTRY TO ABEND" in an ABEND/SNAP dump. In a stand-alone dump, register contents can be found in the register save area for ABEND'S SVRB.

0F1 A program check occurred in the interruption handling part of the input/output supervisor. The applicable program check PSW can be found at location 40(28). (In systems with MFT, this PSW is valid only if the first four digits are 0004).

The problem program can be responsible for this code if:

1. An access method routine in the problem program storage area has been overlaid.
2. An IOB, DCB, or DEB has been modified after an EXCP has been issued, but prior to the completion of an event.

If a trace table exists (trace option was specified at system generation), the instruction address in the new program check PSW, location 104(68), contains the address of a field of register contents. This field includes registers 10 through 9 on an ABEND/SNAP dump, or 10 through 1 on a stand-alone dump.

If no trace table exists, the above field contains registers 10 through 1 on both ABEND/SNAP (MFT only) and stand-alone dumps.

0F2 Most frequently caused by incorrect parameters passed to a type I SVC routine.

100 A device has been taken off-line without informing the system, or a device is not operational.

If a trace table exists, the most current entry is an SIO entry beginning with 30. The last 3 digits of the first word give the device address.

If a trace table does not exist, register 1 (in the SVRB for the ABEND routine) contains a pointer to the IOB associated with the device.

101 The wait count, contained in register 0 when a WAIT macro instruction was issued, is greater than the number of ECBs being waited upon.

102 An invalid ECB address has been given in a POST macro instruction.

If a POST macro instruction has been issued by the problem program, the ECB address is given in register 1 of either the trace table entry or the SVRB for the ABEND routine.

If the POST was issued by an I/O interruption handler, the ECB address can be found in the IOB associated with the event.

106 During a transient area load or a dynamic load resulting from a LINK, LOAD, XCTL, or ATTACH macro instruction, the fetch routine found an error. A description of the error is contained in register 15 of ABEND'S SVRB register save area:

- OD The control program found an invalid record type.
- OE The control program found an invalid address. The problem program may contain a relocatable expression that specifies a location outside the partition boundaries.
- OF A permanent I/O error has occurred. This error can probably be found in the trace table prior to the ABEND entry.

Register 6 of ABEND's SVRB register save area points to the work area used by the fetch routine. This area contains the IOB, channel program, RLD buffer, and the BLDL directory entry associated with the program being loaded.

- 122 The operator cancelled the job and requested a dump.
- 155 An unauthorized user (a user other than dynamic device reconfiguration) has issued SVC 85. The user's task has been abnormally terminated by dynamic device recognition.
- 200 The error was detected when an I/O operation was requested and the storage protection keys of the IOB, ECB, and DCB were not the same as the key in the DEB. (checked for MVT only)
- 201 This completion code is identical to 102, but applies to the WAIT macro instruction instead of POST.
- 202 An invalid RB address was found in an ECB. The RB address is placed in the ECB when a WAIT macro instruction is issued.
- 213 The error occurred during execution of an OPEN macro instruction for a data set on a direct-access device. Either:
1. The data set control block (DSCB) could not be found on the direct access device.
 2. An uncorrectable input/output error occurred in reading or writing the data set control block.

Register 4 contains the address of a combined work and control block area. This address plus x'64' is the address of the data set name in the JFCBDSNM field of the job file control block (JFCB).

- 222 The operator cancelled the job without requesting a dump. The cancellation was probably the result of a wait state or loop.
- 301 A WAIT macro instruction was issued, specifying an ECB which has not been posted complete from a previous event. Either:
1. The ECB has been reinitialized by the problem program prior to a second WAIT on the same ECB, or
 2. The high order bit of the ECB has been inadvertently turned on.

- 308 The problem program requested the loading of a module using an entry point given to the control program by an IDENTIFY macro instruction.

Register 0 of LOAD's SVRB register save area contains the address (or its complement) of the name of the module being loaded.

- 400 The control program found an invalid IOB, DCB, or DEB. Check the following blocks for the indicated information:
- IOB - a valid DCB address.
 - DCB - a valid DEB address.
 - DEB - ID of 0F and a valid UCB address.
 - UCB - a valid identification of FF.

Note: In systems with MVT, this code may appear instead of a 200 code, for the reasons given under 200.

- 406 A program has the "only loadable" attribute or has an entry point given to the control program by an IDENTIFY macro instruction. In either case, the program was invoked by a LINK, XCTL, or ATTACH macro instruction.

Register 15 of the LINK, XCTL, or ATTACH SVRB register save area contains the address of the name of the program being loaded.

- 506 The error occurred during execution of a LINK, XCTL, ATTACH, or LOAD macro instruction in an overlay program or in a program that was being tested using the TESTRAN interpreter.

The program name can be found as follows:

1. If a LOAD macro instruction was issued, register 0 in the trace table SVC entry or in the SVRB

register save area contains the address (or its complement) of the program name.

2. If a LINK, XCTL, or ATTACH was issued, register 15 of the associated SVRB register save area contains the address of a pointer to the program name.

Note: Programs written in an overlay structure or using TESTRAN should not reside in the SVC library.

604 During execution of a GETMAIN macro instruction, the control program found one of the following:

1. A free area exceeds the boundaries of the main storage assigned to the task. This can result from a modified FQE.
2. The A-operand of the macro instruction specified an address outside the main storage boundaries assigned to the task.

605 During execution of a FREEMAIN macro instruction, the control program found that part of the area to be freed is outside the main storage boundaries assigned to the task, possibly resulting from a modified FQE.

Item 1 under the 604 completion code is also applicable to 605.

606 During execution of a LINK, XCTL, ATTACH, or LOAD macro instruction, a conditional GETMAIN request was not satisfied because of a lack of available main storage for a fetch routine work area. Consequently, the request was not satisfied.

The name of the load module can be found as described under completion code 506.

60A Results from the same situations described under 604 and 605 for R-form GETMAIN and FREEMAIN macro instructions.

613 The error occurred during execution of an OPEN macro instruction for a data set on magnetic tape. An uncorrectable input/output error occurred in tape positioning or in label processing.

700 A unit check resulted from an SIO issued to initiate a sense command.

The defective device can be determined from the SIO trace table entry that

reflects a unit check in the CSW status.

704 A GETMAIN macro instruction requested a list of areas to be allocated. This type of request is valid only for systems with MVT.

The applicable SVC can be found in a trace table entry or in the PSW at entry to ABEND.

705 Results from the same situations described under 704 for FREEMAIN macro instructions.

706 During execution of a LINK, LOAD, XCTL, or ATTACH macro instruction, the requested load module was found to be not executable.

The name of the module can be found as described under the completion code 506.

804 The error occurred during execution of a GETMAIN macro instruction with a mode operand of EU or VU. More main storage was requested than was available.

806 The error occurred during execution of a LINK, XCTL, ATTACH, or LOAD macro instruction.

An error was detected by the control program routing for the BLDL macro instruction. This routine is executed as a result of these macro instructions if the problem program names the requested program in an EP or EPLOC operand. The contents of register 15 indicate the nature of the error:

X'04' The requested program was not found in the indicated source.

X'08' An uncorrectable input/output error occurred when the BLDL control program routine attempted to search the directory of the library indicated as containing the requested program.

Register 12 contains the address of the BLDL list used by the routine. In systems with MFT this address plus 4 is the location of the 8-byte name of the requested program that could not be loaded. In systems with MVT, registers 2 and 3 contain the name of the requested module.

- 80A The error occurred during execution of an R-form GETMAIN macro instruction. More main storage was requested than was available.
- 905 The address of the area to be freed (given in a FREEMAIN macro instruction) is not a multiple of eight. The contents of register one in either the trace table entry or ABEND's SVRB register save area reflect the invalid address.
- 90A Results from the same situations described under 905 for R-form FREEMAIN macro instructions.
- A05 The error occurred during execution of a FREEMAIN macro instruction. The area to be freed overlaps an already existing free area. This error can occur if the address or the size of the area to be freed were incorrect or modified.
- The contents of registers 0 and 1 in either the SVC trace table entry or ABEND's SVRB register save area reflect the size and address.
- A0A Results from the same situations described under A05 for R-form of GETMAIN and FREEMAIN macro instructions.
- B04 This error occurred during execution of a GETMAIN macro instruction. A subpool number greater than 127 was specified. The problem program is restricted to using subpools 0-127. This error can occur if the subpool number was either incorrectly specified or modified.
- A displacement of nine bytes from the list address passed to GETMAIN in register 1 contains the subpool number. Register 1 can be found in either the SVC trace table entry or ABEND's SVRB register save area.
- B05 Results from the same situation described under B04 for FREEMAIN macro instructions.
- B0A Results from the same situations described under B04 and B05 for R-form of GETMAIN and FREEMAIN macro instructions.
- The subpool number can be found in the high order bytes of register 0 in either the SVC trace table entry or ABEND's SVRB register save area.
- B37 The error occurred at an end of volume. The control program found that all space on the currently mounted volumes was allocated, that more space was required, and that no volume was available for demounting.
- Either allocate more devices or change the program so that a device will be free when a volume must be mounted.
- Fnn An SVC instruction contained an invalid operand; nn is the hexadecimal value of the SVC.
- This error can occur if either an invalid instruction was issued by the problem program or an operand referring to an optional function was not included during system generation.

Appendix D: System Module Name Prefixes

All load modules associated with a specific operating system component have a common prefix on their module names. This appendix lists the module name prefixes and the associated system component(s).

| <u>Prefix</u> | <u>Component</u> | <u>Prefix</u> | <u>Component</u> |
|---------------|---|---------------|---|
| IBC | Independent utility programs | IFF | Graphic programming support |
| IEA | Supervisor, I/O supervisor, and NIP | IFG | Close, open, and related routines |
| IEB | Data set utility programs | IGC | Transient SVC routines |
| IEC | Input/output supervisor | IGE | I/O error routines |
| IEE | Master scheduler | IGF | Machine check handler program |
| IEF | Job scheduler | IHA | System control blocks |
| IEG | TESTRAN | IHB | Assembler during expansion of supervisor and data management macro instructions |
| IEH | System utility programs | IHC | FORTRAN library subroutines |
| IEI | Assembler program during system generation | IHD | COBOL library subroutines |
| IEJ | FORTRAN IV E compiler | IHE | PL/I library subroutines |
| IEK | FORTRAN IV H compiler | IHF | PL/I library subroutines |
| IEM | PL/I F compiler | IHG | Update analysis program |
| IEP | COBOL E compiler | IHI | Object program originally coded in ALGOL language |
| IEQ | COBOL F compiler | IHJ | Checkpoint/restart |
| IER | Sort/Merge program | IHL | Generalized Trace Facility |
| IES | Report program generator | IHK | Remote job entry |
| IET | Assembler E | IIN | 7094 emulator program for the Model 85 |
| IEU | Assembler F | IIO | 7074 emulator program on the Models 155 and 165 |
| IEW | Linkage editor/overlay supervisor/program fetch | IIP | 7080 emulator program on the Model 165 |
| IEX | ALGOL compiler | IIQ | 1401/1440/1460 emulator program on Models 135, 145, and 155 |
| IEY | FORTRAN IV G compiler | IIR | 1440/7010 emulator program on Models 145 and 155 |
| IEZ | System Interfaces | IIT | 709/7090/7094/7094 II emulator program on the Model 165 |
| IFB | Environment recording routines | | |
| IFC | Environment recording and print routines | | |
| IFD | Online test executive program | | |

| | | | |
|-----|---|-----|------------------------|
| IIU | 7074 emulator program on the Model 155 | IKF | USAS COBOL compiler |
| IKA | Graphic Job Processor | IKJ | Time Sharing |
| IKD | Satellite graphic job processor messages | ILB | USAS COBOL subroutines |

Appendix E: List of Abbreviations

| | | | |
|-------|-----------------------------------|--------|--|
| ABEND | abnormal end-of-task | MFT | multiprogramming with a fixed number of tasks |
| APR | alternate path retry | | |
| CCW | channel command word | MVT | multiprogramming with a variable number of tasks |
| CDE | contents directory entry | NIP | nucleus initialization program |
| CPU | central processing unit | PIB | partition information block |
| CSW | channel status word | PQE | partition queue element |
| CVT | communications vector table | PRB | program request block |
| DAR | damage assessment routine | PSA | prefixed storage area |
| DCB | data control block | PSW | program status word |
| DD | data definition | QCB | queue control block |
| DDR | dynamic device reconfiguration | QEL | queue element |
| DEB | data extent block | RB | request block |
| DPQE | dummy partition queue element | SCB | STAE control block |
| DQE | descriptor queue element | SIO | start input/output |
| ECB | event control block | SIRB | supervisor interrupt request block |
| FBQE | free block queue element | SPQE | subpool queue element |
| FQE | free queue element | SVC | supervisor call |
| FRB | finch request block | SVRB | supervisor request block |
| GQE | gotten subtask area queue element | SYSOUT | system output |
| IOB | input/output block | TCB | task control block |
| IPL | initial program loading | TIOT | task input/output table |
| IRB | interrupt request block | UCB | unit control block |
| LLE | load list element | WLE | wait list element |
| LPRB | loaded program request block | XCTL | transfer control |
| LRB | loaded request block | XL | extent list |

Appendix F: ECB Completion Codes

| Hexadecimal Code | Meaning |
|------------------|---|
| 7F000000 | Channel program has terminated without error. (CSW contents can be useful.) |
| 41000000 | Channel program has terminated with permanent error. (CSW contents can be useful.) |
| 42000000 | Channel program has terminated because a direct access extent address has been violated. (CSW contents do not apply.) |
| 44000000 | Channel program has been intercepted because of permanent error associated with device end of previous request. You may reissue the intercepted request. (CSW contents do not apply.) |
| 48000000 | Request element for channel program has been made available after it has been purged. (CSW contents do not apply.) |
| 4F000000 | Error recovery routines have been entered because of direct access error but are unable to read home address of record 0. (CSW contents do not apply.) |

Appendix G: UCB Sense Bytes

| BYTE 0 | | | | | | | | | BYTE 1 | | | | | | | |
|--|---------|------------------|---------|------------------|------------------|-------------------|------------------------|-------------------------------|-------------------|--|----------------------|------------------------------|--------------------------|--------------------|---------------------|----------------------|
| DEVICE | BIT | | | | | | | | BIT | | | | | | | |
| | 0 | 1 | 2 | 3 | 4 | 5 | 6 | 7 | 0 | 1 | 2 | 3 | 4 | 5 | 6 | 7 |
| 2400 | CMD REJ | INT REQ | BUS OUT | EQ CHK | DATA CHK | OVER-RUN | WORD CNT ZERO | DATA CNVTT CHK | NOISE | 00-NON-XST TU 01-NOT READY 10-RDY & NO RWD 11-RDY & RWDNG | 7 TRK | AT LOAD POINT | WRT STATUS | FILE PROT-ECT | NOT CAP-ABLE | |
| 2311, 2841 | CMD REJ | INT REQ | BUS OUT | EQ CHK | DATA CHK | OVER-RUN | TRK CCND CHK | SEEK CHK | DATA CHK FLD | TRK OVER-RUN | END OF CYL | IN-VALID SEQ | NO REC FOUND | FILE PROT | MISSING ADM MRKR | OVER-FLOW INL |
| 2301, 2302 2303, 2314 2319, 2820 | CMD REJ | INT REQ | BUS OUT | EQ CHK | DATA CHK | OVER-RUN | | INVAL ADDR | DATA CHK IN COUNT | TRK OVER-RUN | END OF CYL | INVAL SEQ | NO REC FOUND | FILE PROT | SERVICE OVER-RUN | OVER-FLOW INL |
| 2250 | CMD REJ | SHOULD NOT OCCUR | BUS OUT | SHOULD NOT OCCUR | DATA CHK | SHOULD NOT OCCUR | BUFFER RUN-NING | SHOULD NOT OCCUR | LIGHT PEN DETECT | END ORDER SEQ | CHAR MODE | | | | | |
| 2280 | CMD REJ | INT REQ | BUS OUT | EQ CHK | DATA CHK | SHOULD NOT OCCUR | SHOULD NOT OCCUR | ILLGL SEG | READ COUNT CHK | FILM LOW | RECRDR FORCED GAP | SHOULD NOT OCCUR | SHOULD NOT OCCUR | 2840 OUTPUT CHK | 2840 INPUT CHK | GRAPH-IC CHK |
| 2282 | CMD REJ | INT REQ | BUS OUT | EQ CHK | DATA CHK | SHOULD NOT OCCUR | SHOULD NOT OCCUR | ILLGL SEGN | READ COUNT CHK | FILM LOW | RECRDR FORCED GAP | FILM MOTION LIMIT | SHOULD NOT OCCUR | 2840 OUTPUT CHK | 2840 INPUT CHK | GRAPH-IC CHK |
| 1052, 2150 | CMD REJ | INT REQ | BUS OUT | EQ CHK | | | | | | | | | | | | |
| 1285 | CMD REJ | INT REQ | BUS OUT | EQ CHK | DATA CHK | OVER-RUN | NON RCVY | KYBD CORR | | | | | | | | |
| 1287 | CMD REJ | INT REQ | BUS OUT | EQ CHK | DATA CHK | OVER-RUN | NON RCVY | KYBD CORR | TAPE MODE | LATE STKR SELECT | NO DOC FOUND | SHOULD NOT OCCUR | INVAL OP | SHOULD NOT OCCUR | SHOULD NOT OCCUR | SHOULD NOT OCCUR |
| 1288 | CMD REJ | INT REQ | BUS OUT | EQ CHK | DATA CHK | OVER-RUN | NON RCVY | SHOULD NOT OCCUR | SHOULD NOT OCCUR | END OF PAGE | NO DOC FOUND | SHOULD NOT OCCUR | INVAL OP | SHOULD NOT OCCUR | SHOULD NOT OCCUR | SHOULD NOT OCCUR |
| 2495 | CMD REJ | INT REQ | BUS OUT | EQ CHK | DATA CHK | SHOULD NOT OCCUR | POSN CHK | SHOULD NOT OCCUR | | | | | | | | |
| 2540, 2021 | CMD REJ | INT REQ | BUS OUT | EQ CHK | DATA CHK | | UN-USUAL CMD | | | | | | | | | |
| 3505, 3525 | CMD REJ | INT REQ | BUS OUT | EQ CHK | DATA CHK | NOT USED | ABNOR-MAL FORMAT RESET | PERMAN-ENT ERROR (BYPASS KEY) | PERM-ANENT ERROR | AUTO-MATIC RETRY | MOTION MAL-FUNCT-ION | RETRY AFTER INT REQ COMPLETE | | | | |
| 3211 | CMD REJ | INT REQ | BUS OUT | EQ CHK | DATA CHK | BUFFER PARITY CHK | LOAD CHK | CH 9 | CMD RETRY | PRINT CHK | PRINT QUAL-ITY | LINE POS | FORMS CHK | CMD SUP | MECHAN-ICAL MOTION | |
| 1403, 1443 | CMD REJ | INT REQ | BUS OUT | EQ CHK | TYPE BAR | TYPE BAR | | CH 9 | | | | | | | | |
| 1442, 2596 2501, 2520 | CMD REJ | INT REQ | BUS OUT | EQ CHK | DATA CHK | OVER-RUN | | | | | | | | | | |
| 2671, 2822 | CMD REJ | INT REQ | BUS OUT | EQ CHK | DATA CHK | | | | | | | | | | | |
| 2260 | CMD REJ | INT REQ | BUS OUT | EQ CHK | SHOULD NOT OCCUR | SHOULD NOT OCCUR | SHOULD NOT OCCUR | SHOULD NOT OCCUR | | | | | | | | |
| 2701, 2702 | CMD REJ | INT REQ | BUS OUT | EQ CHK | DATA CHK | OVER-RUN | LOST DATA | TIME OUT | | | | | | | | |
| 1419/1275 PCU | CMD REJ | INT REQ | BUS OUT | NOT USED | DATA CHK | OVER-RUN | AUTO SELECT | NOT USED | NOT USED | NOT USED | DOC UNDER READ HEAD | AMT FIELD VALID | PROCES CNTRL FIELD VALID | ACCT # FIELD VALID | TRANSIT FIELD VALID | SERIAL # FIELD VALID |
| 1419/1275 SCU | CMD REJ | INT REQ | BUS OUT | NOT USED | NOT USED | LATE STKR SELECT | AUTO SELECT | OP ATT | | | | | | | | |
| 3330, 3333 | CMD REJ | INT REQ | BUS OUT | EQ CHK | DATA CHK | OVER-RUN | | | PERM ERR | INVL TRK FORMAT | END OF CYL | STATE VAR PRES | NO REC FOUND | FILE PROT | WRITE INHIBIT | OPERATION INL |
| 3410/3411 | CMD REJ | INT REQ | BUS OUT | EQ CHK | DATA CHK | OVER-RUN | WORD CNT ZERO | DATA CNVTT CHK | NOISE | TU STATUS A | TU STATUS B | 7 TRK TU | AT LOAD POINT | WRT STATUS | FILE PROT-ECT | NOT CAP-ABLE |
| 2305 | CMD REJ | INT REQ | BUS OUT | EQ CHK | DATA CHK | OVER-RUN | | | PERM ERR | INVL TRK FORMAT | END OF CYL | | NO REC FOUND | FILE PROT | | OPERATION INL |
| 3420/3803 | CMD REJ | INT REQ | BUS OUT | EQ CHK | DATA CHK | OVER-RUN | WORD CNT ZERO | DATA CNVTT CHK | NOISE | TU STATUS A | TU STATUS B | 7 TRK TU | LOAD POINT | WRT STATUS | FILE PROT-ECT | NOT CAP-ABLE |

BYTE 2

| BIT | 0 | 1 | 2 | 3 | 4 | 5 | 6 | 7 |
|--|---------------------------------------|---------------|----------------|----------------------|--------------------------|--------------|--|----------------|
| 2400 | BITS 0-7 INDICATE A TRACK IS IN ERROR | | | | | | 6 & 7 INDICATE NO ERROR OR MULTI-ERROR | |
| 2311, 2841 | UN-SAFE | | SERIALIZER CHK | TAG LINE CHK | ALU CHK | UNSEL STATUS | | |
| 2301, 2302 2303, 2314 2319, 2820 | UN-SAFE | SHIFT REG CHK | SKEW FAIL | CTR CHK | COMP CHK | | | |
| 2250 | BUFFER ADDRESS REGISTER | | | | | | | |
| | BIT 15 | BIT 14 | BIT 13 | BIT 12 | BIT 11 | BIT 10 | BIT 9 | |
| 2280 | BUFFER ADDRESS REGISTER | | | | | | | |
| | BIT 15 | BIT 14 | BIT 13 | BIT 12 | BIT 11 | BIT 10 | BIT 9 | |
| 2282 | BUFFER ADDRESS REGISTER | | | | | | | |
| | BIT 15 | BIT 14 | BIT 13 | BIT 12 | BIT 11 | BIT 10 | BIT 9 | |
| 3211 | CARR FAILED TO MOVE | CARR SEQ CHK | CARR STOP CHK | PLATEN FAILED TO ADV | PLATEN FAILED TO RETRACT | FORMS JAM | RIBBON MOTION | TRAIN OVERLOAD |
| 3330, 3333 | | CORRECTABLE | | ENV DATA PRESENT | | | | |
| 2305 | BUF LOG FULL | CORRECTABLE | | | | | | |
| 3505, 3525 | USED FOR DIAGNOSTIC PURPOSES ONLY | | | | | | | |
| 3410/3411 | TRACK IN ERROR | | | | | | | |
| 3420/3803 | TRACK IN ERROR | | | | | | | |

BYTE 3

| | 0 | 1 | 2 | 3 | 4 | 5 | 6 | 7 |
|-----------------------------------|------------|-------------|------------------|--------------|--------------------|----------------|--------------|---|
| R/W VRC | LRCR | SKEW | CRC | SKEW REQ VRC | 0-800 0-1600 | BKWD STATUS | COM-PARE | |
| READY | ON LINE | READ SAFETY | WRITE SAFETY | | END OF CYL | | SEEK INCMPL | |
| LRC BIT 0 | LRC BIT 1 | LRC BIT 2 | LRC BIT 3 | | | | | |
| BUFFER ADDRESS REGISTER | | | | | | | | |
| BIT 8 | BIT 7 | BIT 6 | BIT 5 | BIT 4 | BIT 3 | BIT 2 | BIT 1 | |
| BUFFER ADDRESS REGISTER | | | | | | | | |
| BIT 8 | BIT 7 | BIT 6 | BIT 5 | BIT 4 | BIT 3 | BIT 2 | BIT 1 | |
| BUFFER ADDRESS REGISTER | | | | | | | | |
| BIT 8 | BIT 7 | BIT 6 | BIT 5 | BIT 4 | BIT 3 | BIT 2 | BIT 1 | |
| UCSB PARITY | PLB PARITY | FCB PARITY | COIL PROT CHK | HAMMER FIRE | FIELD ENG | USCAR SYNC CHK | SEP SYNC CHK | |
| RESTART COMMAND | | | | | | | | |
| RESTART COMMAND | | | | | | | | |
| USED FOR DIAGNOSTIC PURPOSES ONLY | | | | | | | | |
| VRC | MTE/LRCR | SKEW | END DATA CHK/CRC | ENV CHK | 1600 BPI SET IN TU | BKWD | | |
| R/W VRC | MTE/LRCR | SKEW | END DATA CHK/CRC | VRC ENV CHK | 1600 BPI SET IN TU | BKWD | C COM-PARE | |

BYTE 4

| | | | | | | | | |
|--|-------------------------------|---------------|----------------|-----------------|-------------------------|---------------|---------------|-----------|
| 2400 | ECHO ERR | RES TAPE UNIT | READ CLOCK ERR | WRITE CLOCK ERR | DELAY CNTR ERR | SEQ IND C | SEQ IND B | SEQ IND A |
| 2311, 2841 | | | | | | | | |
| 2301, 2302 2303, 2314 2319, 2820 | SEQ IND 0 | SEQ IND 1 | SEQ IND 2 | SEQ IND 3 | SEQ IND 4 | SEQ IND 5 | SEQ IND 6 | SEQ IND 7 |
| 3330, 3333 | PHYSICAL DRIVE IDENTIFICATION | | | | | | | |
| 2305 | | | | | | | | |
| 3410/3411 | TAPE UNIT POS CHK | TAPE UNIT REJ | EOT | | DIAG TRK CHK | TAPE UNIT CHK | SPARE | |
| 3420/3803 | ALU HARDWARE ERROR | REJ TAPE UNIT | TAPE INDICATE | WRITE TGR VRC | MICRO-PRGM DETECT ERROR | LWR ERROR | TAPE UNIT CHK | |

BYTE 5

| | | | | | | | |
|--|----------------|-------------------|-------------|-----------------|----------------|----------------------------|-----|
| COMMAND IN PROGRESS WHEN OVERFLOW INCOMPLETE OCCURS OR ZERO | | | | | | | |
| COMMAND IN PROGRESS WHEN OVERFLOW INCOMPLETE OCCURS WRITE = X'05' OR READ = X'06' ZERO | | | | | | | |
| CYLINDER ADDRESS | | | | | | | |
| CYLINDER ADDRESS | | | | | | | |
| NEW SUB-SYSTEM | NEW SUB-SYSTEM | WRT TAPE MARK CHK | PE ID BURST | PARITY COM-PARE | TACHOMETER CHK | FALSE END MARK | RPQ |
| NEW SUB-SYSTEM | NEW SUB-SYSTEM | WRT TAPE MARK CHK | PE ID BURST | START READ CHK | PARTIAL RECORD | EXCESSIVE POST-AMPLE OR TM | RPQ |

BYTE 6

| | | | | | | | | |
|----------------|-------------------|---------------------|---------------|---------------------|-------------------------|--|--|--|
| 3330,* 3333 | RE-VERSE | CYL HIGH | DIFFER HIGH | HEAD ADDR | | | | |
| 2305* | CURRENT HEAD ADDR | | | | | | | |
| 3410/3411 | 7 TRK TU | SHORT GAP MODE | DUAL DEN-SITY | ALTER-NATE DEN-SITY | TU MODEL | | | |
| 3420/3803 | 7 TRK | WRT CURRENT FAILURE | DUAL DEN-SITY | NRZI DEN-SITY | TAPE UNIT MODEL DEFINED | | | |

BYTE 7

| | | | | | | | |
|--|------------------------------|-------------------------------|-----------|-------------------------|------------|-----------------------|--------------|
| FORMAT OF REMAINING SENSE BYTES (8-23) | | | | ENCODED ERROR MESSAGE | | | |
| ENCODED ERROR MESSAGE | | | | | | | |
| LAMP FAILURE CHK | TAPE BOT-TOM LEFT COLUMN CHK | TAPE BOT-TOM RIGHT COLUMN CHK | RESET KEY | DATA SECURITY ERASE CHK | | | |
| LAMP FAILURE | TAPE BOT-TOM LEFT | TAPE BOT-TOM RIGHT | RESET KEY | DATA SECURITY ERASE | ERASE HEAD | AIR BEARING PRES-SURE | LOAD FAILURE |

BYTE 8

| BIT | 0 | 1 | 2 | 3 | 4 | 5 | 6 | 7 |
|-----------|--------------------|----------------------|---|----------------------|--------------------|---------------------|-------------------|-------------------|
| 3410/3411 | | WRT FEED-THROUGH CHK | | END VELOCITY CHK | NO READ-BACK DATA | START VELOCITY CHK | | MARGINAL VELOCITY |
| 3420/3803 | IBG DROP WHILE WRT | FEED THRU | | EARLY BEGIN RDBK CHK | EARLY END RDBK CHK | SLOW BEGIN RDBK CHK | SLOW END RDBK CHK | VELOCITY RETRY |

BYTE 9

| 0 | 1 | 2 | 3 | 4 | 5 | 6 | 7 | |
|------------|--------------------------|-----------|---|---|---|------------|---|----|
| [REDACTED] | | | | | | | | |
| SDR CNT | VELOCITY CHGE WHILE WRNG | SDR CNTRS | | | | [REDACTED] | | CU |

BYTE 10

| | | | | | | | | |
|-----------|----------------|--|----------------|----------------------------|----------------|-----------------------|--|----------|
| 3420/3803 | CMD STATUS REJ | | CNTRL UNIT REJ | NO BLK ON RECORD RD BK CHK | WTM NOT DETECT | TACHOMETER START FAIL | | VELOCITY |
|-----------|----------------|--|----------------|----------------------------|----------------|-----------------------|--|----------|

BYTE 11

| | | | | | | | |
|-------------------------|--------------|------------------|---------------------|-------------------------------|-----------------|--|-----------|
| B1 BUS PAR/LSR ADDR ERR | ROSI PAR ERR | XFR/LOW IC 1 ERR | INSTRUC-TION DECODE | ALU 1 MICRO-PRGM DETECT HRDWR | D BUS PAR ALU 1 | | BOC ALU 2 |
|-------------------------|--------------|------------------|---------------------|-------------------------------|-----------------|--|-----------|

BYTE 12

| | | | | | | | | |
|-----------|----------------------------|------------------|------------------|----------------|-------------------------------|--------------------|--|-----------|
| 3420/3803 | B2 BUS PARITY LSR ADDR ERR | ROS 2 PARITY ERR | XFR/LOW IC 2 ERR | INSTR DECODE 4 | ALU 2 MICRO-PRGM DETECT HRDWR | D BUS PARITY ALU 2 | | BOC ALU 2 |
|-----------|----------------------------|------------------|------------------|----------------|-------------------------------|--------------------|--|-----------|

BYTE 13

| | | | | | | | |
|----------------------|-----------------------------|--|--|--|--|--|--|
| CONTROL UNIT DENSITY | CONTROL UNIT UNIQUE ID HIGH | | | | | | |
|----------------------|-----------------------------|--|--|--|--|--|--|

BYTE 14

| | | | | | | | | |
|-----------|----------------------------|--|--|--|--|--|--|--|
| 3420/3803 | CONTROL UNIT UNIQUE ID LOW | | | | | | | |
|-----------|----------------------------|--|--|--|--|--|--|--|

BYTE 15

| | | | | | | | |
|---------------------|--|--|--|--|--|--|--|
| TAPE UNIT UNIQUE ID | | | | | | | |
|---------------------|--|--|--|--|--|--|--|

BYTE 16

| | | | | | | | | |
|-----------|---------------------|--|--|--|--|--|--|--|
| 3420/3803 | TAPE UNIT UNIQUE ID | | | | | | | |
|-----------|---------------------|--|--|--|--|--|--|--|

BYTE 17

| | | | | | | | |
|-----------------------|-------------------------------------|--------------------------|--|--|--|--|--|
| TWO CHAN-NEL SW (MIS) | CONTROL UNIT DEVICE SWITCH FEATURES | EC LEVEL OF CONTROL UNIT | | | | | |
|-----------------------|-------------------------------------|--------------------------|--|--|--|--|--|

BYTE 18

| | | | | | | | | |
|-----------|-------------------------------|--|-----------------------|--|--|--|--|--|
| 3420/3803 | POWER CHK / OVER-TEMPER-ATURE | | EC LEVEL OF TAPE UNIT | | | | | |
|-----------|-------------------------------|--|-----------------------|--|--|--|--|--|

BYTE 19

| PRIMED FOR DEVICE END | | | | | | | |
|-----------------------|------|------|------|------|------|------|------|
| TU 7 | TU 6 | TU 5 | TU 4 | TU 3 | TU 2 | TU 1 | TU 0 |
| [REDACTED] | | | | | | | |

BYTE 20

| PRIMED FOR DEVICE END | | | | | | | |
|-----------------------|------|------|------|------|------|------|------|
| TU F | TU E | TU D | TU C | TU B | TU A | TU 9 | TU 8 |
| [REDACTED] | | | | | | | |

BYTE 21

| | | | | | | | |
|---------------------|--------------------|---------------------|---------------|--------------|-------------|---------------|------------|
| LOAD BUTTON DEPRESS | LEFT REEL TURN-ING | RIGHT REEL TURN-ING | TAPE PRE-SENT | REELS LOADED | LOAD REWIND | LOAD COM-LETE | LOAD CHECK |
|---------------------|--------------------|---------------------|---------------|--------------|-------------|---------------|------------|

BYTE 22

| | | | | | | | | |
|-----------|----------------------------------|--|--|--|--|--|--|--|
| 3420/3803 | FRU IDENTIFIERS FOR CONTROL UNIT | | | | | | | |
|-----------|----------------------------------|--|--|--|--|--|--|--|

BYTE 23

| | | | | | | | |
|----------------------------------|--|--|--|--|--|--|--|
| FRU IDENTIFIERS FOR CONTROL UNIT | | | | | | | |
|----------------------------------|--|--|--|--|--|--|--|

Appendix H: Service Aids

In addition to the debugging facilities discussed in this manual, IBM provides the following service aid programs to aid you in debugging. A complete description of each of these service aids and instructions for their use are found in the publication IBM System/360 Operating System Service Aids, GC28-6719.

| <u>Program Name</u> | <u>Functional Description</u> |
|---------------------|--|
| IMDSADMP | <p>A stand-alone program, assembled with user-selected options, that dumps the contents of main storage onto a tape or a printer. The program has two versions:</p> <ul style="list-style-type: none">• A high speed version that dumps the contents of main storage to a tape.• A low speed version that formats and dumps the contents of main storage either to a tape or directly to a printer. |
| IMDPRDMP | <p>A problem program that allows the user to format and print IMSADMP output data sets, the SYS1.DUMP data set, the TSO dump data set and its associated swap data sets, and Generalized Trace Facility output data sets. IMDPRDMP can also be used to transfer a system dump from a SYS1.DUMP data set on a direct access device to another data set for later formatting and printing.</p> |
| IMCJQDMP | <p>A stand-alone program that reads, formats, and prints either the entire operating system data set SYS1.SYSJOBQE, or selects and prints information related to a specific job in that data set. Because it operates independently of the operating system, IMCJQDMP can print the contents of the job queue as it appeared at the time of abnormal termination.</p> |
| IMCOSJQD | <p>A problem program that reads, formats, and prints the contents of the system job queue data set (SYS1.SYSJOBQE). Either the entire job queue or information related to a specific job may be printed.</p> <p>Because the program can be run under OS, it is not necessary to re-IPL the operating system as with IMCJQDMP.</p> |
| IMBLIST | <p>A problem program that produces formatted listings of object modules, load modules, module cross references, CSECT identification records (IDRs), and PTFs.</p> |
| IMBMDMAP | <p>A problem program that produces a map of the system nucleus, any load module, the resident reenterable load module area of an MFT system, or the link pack area of an MVT system. The listing produced by this program shows the locations of CSECTS, external references, and entry points within a load module.</p> |
| IMASPZAP | <p>A problem program that can inspect and modify either data records or load modules located on a direct access storage device.</p> |

IMAPTFLE A problem program that generates job control language (JCL) statements necessary to add a PTF to the Operating System in a later step, or applies PTFs to the Operating System by dynamically invoking the linkage editor.

IFCDIP00 A problem program that initializes the SYS1.LOGREC data set.

IFCEREPO A problem program that edits, writes, and accumulates environment records on the SYS1.LOGREC data set.

Appendix J: TCAM Debugging Aids

In addition to the debugging facilities described in this publication, the telecommunications access method provides the following aids to debugging:

- I/O error recording procedures.
- I/O interrupt trace table (line trace).
- A dispatcher subtask trace table (STCB trace).
- Sequential listings of buffers and message queue data sets.

Optional formatted listings of the line and STCB traces are available with TCAM. These debugging aids are described in the publications IBM System/360 Operating System: TCAM Programmer's Guide and Reference Manual, GC30-2024, and IBM System/360 Operating System: TCAM Serviceability Aids Program Logic Manual, GY30-2027. A discussion of the TCAM formatted ABEND dump is given in the publication IBM System/360 Operating System: TCAM Program Logic Manual, GY30-2029.

Appendix K: Control Block Pointers

This appendix summarizes the contents of the control blocks that are most useful in debugging. Control blocks are presented in alphabetical order, with displacements in decimal, followed by the hexadecimal counterpart in parentheses. Figure 56 illustrates control block relationships in the System/360 Operating System. Figure 57 shows relationships between storage control elements in a system with MVT.

CVT - Communications Vector Table

+0 Address of TCB control words
 +53(35) Address of entry point of ABTERM
 +193(C1) Address of secondary CVT (used only with Model 65 Multiprocessing systems and TSO)

DCB - Data Control Block

+40(28) ddname (before open); offset to ddname in TIOT (after open)
 +45(2D) DEB address
 +69(45) IOB address

DEB - Data Extent Block

+1 TCB address
 +5 Address of next DEB
 +25(19) DCB address
 +33(21) UCB address
 +38(26) Address of start of extent
 +42(2A) Address of end of extent

ECB - Event Control Block

+1 RB address or completion code

IOB - Input/Output Block

-7 Address of next IOB (BSAM, QSAM, and BPAM)
 +2 Sense bytes
 +5 ECB address
 +9 CSW
 +17(11) CCW list address
 +21(15) DCB address

RB - Request Block (PCP and MFT)

-8 Address of previous RB on load list
 -4 Address of next RB on load list
 +0 Module name
 +13(D) Entry point address
 +16(10) Resume PSW
 +29(1D) Address of previous RB

RB - Request Block (MVT)

+4 Last half of user's PSW
 +13(D) CDE address
 +16(10) Resume PSW
 +29(1D) Address of previous RB

TIOT - Task Input/Output Table

+0 Job name
 +8 Step name
 +24(18) DD entries begin (one variable-length entry for each DD statement)
 +0 Length of DD entry
 +4 ddname
 +16(10) Device entries begin (one 4-byte entry for each device)
 +20(14) Next device entry (if there is one)
 :
 :
 (Next DD entry begins at 24(18) plus length of first DD entry)

TCB - Task Control Block (PCP and MFT)

+1 Address of most recent RB
 +9 Address of most recent DEB
 +13(D) TIOT address
 +16(10) Completion code
 +25(19) MSS boundary box address
 +37(25) Address of most recent RB on load list
 +113(71) Address of first save area
 +161(A1) Address of STAE control block
 +181(B5) Address of the job step control block

TCB - Task Control Block (MFT) with Subtasking

+45(2D) Address of TCB for job step task
 +129(81) Address of TCB for next subtask attached by same parent task
 +133(85) Address of TCB for parent task
 +137(89) Address of TCB for most recent subtask
 +145(91) Address of ECB to be posted at task completion
 +181(B5) Address of the job step control block

TCB - Task Control Block (MVT)

+1 Address of most recent RB
+9 Address of most recent DEB
+13(D) TIOT address
+16(10) Completion code
+25(19) Address of most recent SPQE
+33(21) Bit 7 -- Non-dispatchability bit
+37(25) Address of most recent LLE
+113(71) Address of first save area
+125(7D) Address of TCB for job step task
+129(81) Address of TCB for next subtask
attached by same parent task
+133(85) Address of TCB for parent task
+137(89) Address of TCB for most recent
subtask
+145(91) Address of ECB to be posted at
task completion
+153(99) Address of dummy PQE minus 8
bytes
+161(A1) Address of STAE control block

+181(B5) Address of the job step control
block

UCB - Unit Control Block

-4 CPU ID (used only with Model 65
Multiprocessing systems)
+2 FF (UCB identification)
+4 Device address
+13(D) Unit name
+18(12) Device class
+19(13) Device type
+22(16) Sense bytes (except devices with
extended sense)
+24(18) Number of sense bytes (devices
with extended sense)
+25(19) Address of sense bytes (devices
with extended sense)
+40(28) Number of outstanding RESERVE
requests (shared DASD only)

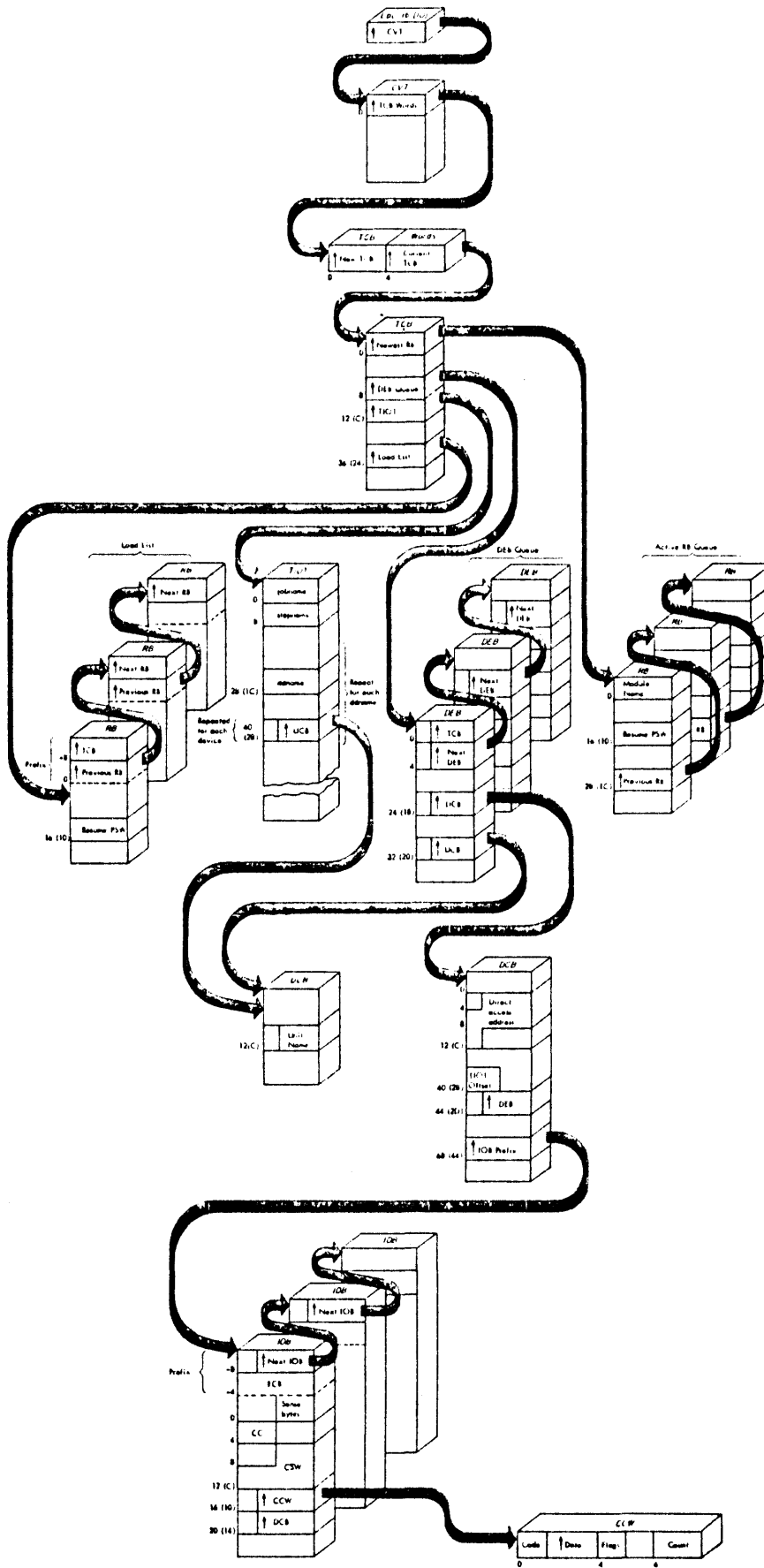

Figure 56. Control Block Flow

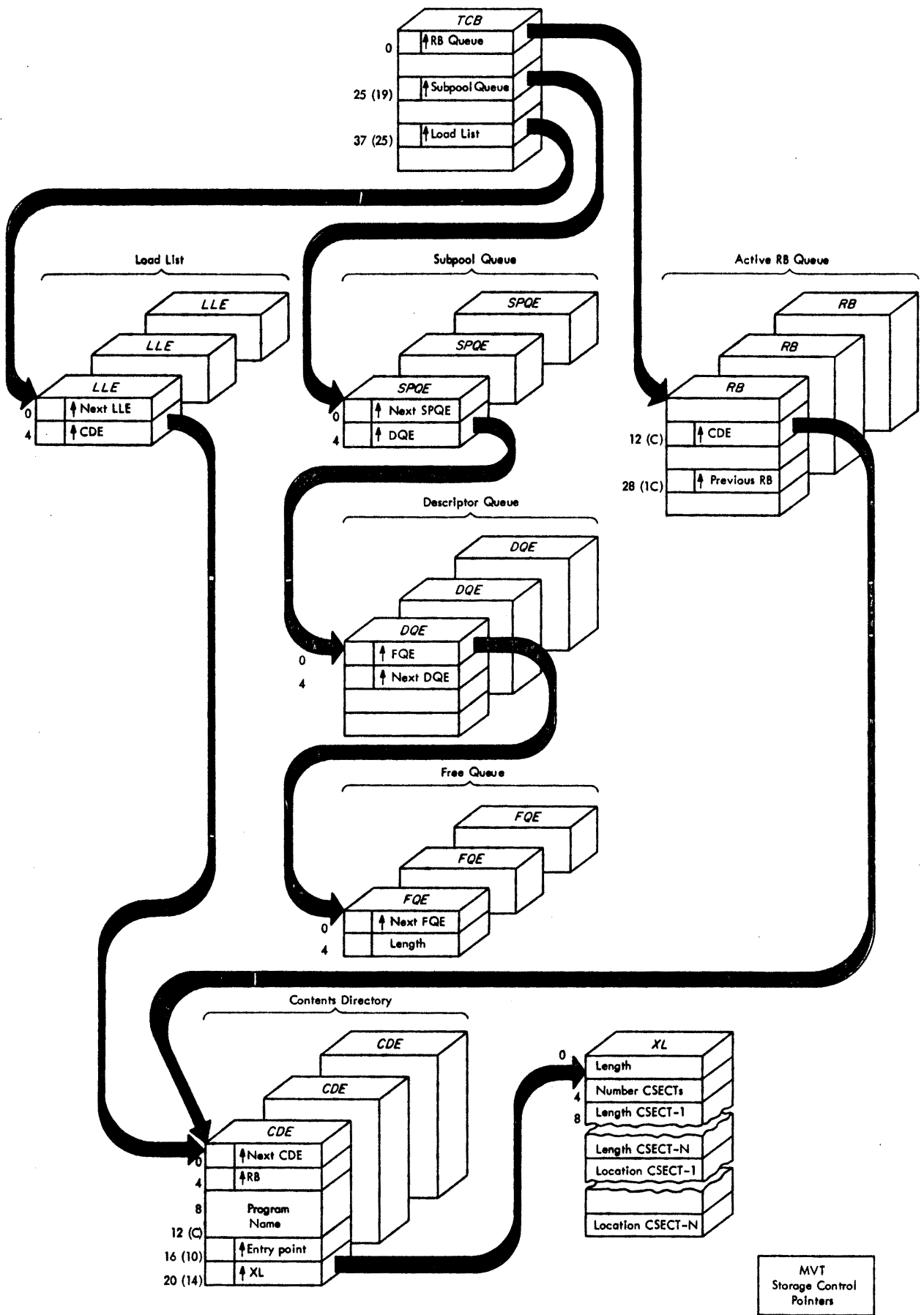

Figure 57. MVT Storage Control Flow

Appendix L: OPEN/CLOSE/EOV Debugging Aids

There are two types of traces that may be performed during OPEN/CLOSE/EOV processing, provided that GTF is active.

- ABEND trace - A trace performed before an OPEN/CLOSE/EOV problem determination module calls an ABEND routine.
- Optional work area trace - A trace performed when an OPEN/CLOSE/EOV module has finished execution. This trace is made only if DCB=DIAGNS=TRACE is specified in the DD statement of the data set for which the trace is desired.

Further information on requesting these traces is contained in IBM System/360 Operating System: Data Management Services, GC26-3746.

The format of both types of OPEN/CLOSE/EOV trace output is as follows:

```
-----  
|USRFF FFF ccc control block fields|  
-----
```

USRFF

is the name (excluding the IMD prefix) of the IMDPRDMP appendage which formats the control block and work area information collected by OPEN/CLOSE/EOV and included in the GTF output data set. FF is the format ID for OPEN/CLOSE/EOV.

FFF

is the event ID which defines the event which caused the trace entry. Everything traced by OPEN/CLOSE/EOV has an event ID of FF.

ccc

is the control block that was traced to provide the problem program with OPEN/CLOSE/EOV data for debugging purposes.

When the OPEN/CLOSE/EOV ABEND trace occurs, only those control blocks meaningful to an ABEND condition will be traced. The selection of these control blocks is described in IBM System/360 Input/Output Support (OPEN/CLOSE/EOV) PLM, GY28-6609.

If the optional work area trace has been requested, the OPEN/CLOSE/EOV work area and the user's DCB will be traced after the execution of each OPEN/CLOSE/EOV module.

control block fields

are the contents of fields in control block ccc. For descriptions of the fields shown, refer to IBM System/360 Operating System: System Control Blocks, GC28-6628 or IBM System/360 Operating System: Input/Output Support (OPEN/CLOSE/EOV) PLM, GY28-6609.

Index

Indexes to systems reference library manuals are consolidated in the publication IBM System/360 Operating System: Systems Reference Library Master Index, GC28-6644. For additional information about any subject listed below, refer to other publications listed for the same subject in the Master Index.

When more than one page reference is given, the major reference is first.

- ABEND dumps
 - contents of (MVT) 46-64
 - contents of (MFT) 29-45
 - guide to using (MVT) 63-64
 - guide to using (MFT) 44-45
 - how to invoke (MVT) 46
 - how to invoke (MFT) 29
 - introduction to 11
 - samples of (MVT) 47-48
 - samples of (MFT) 30-31
- Abnormal termination, cause of
 - in an ABEND/SNAP dump (MVT) 63
 - in an ABEND/SNAP dump (MFT) 44
- Abnormal termination dumps (see ABEND dumps)
- Active RB queue
 - description of 16
 - instructions for using 205
 - in a storage dump 141
 - in an ABEND/SNAP dump (MVT) 52,63
 - in an ABEND/SNAP dump (MFT) 37,44
 - in an indicative dump 67
- AMWP bits
 - in an indicative dump 67
 - meaning of 206
- APSW field, in an ABEND/SNAP dump (MVT) 52,63
- ATTACH macro instruction, effects of 18
- Attaching subtasks 20
- Boundary
 - problem program 40,206
- Catalog dump 32
- CDE
 - as used with the load list 17
 - format of 25
 - in an ABEND/SNAP dump 54
 - in a storage dump 141
- Communications vector table (see CVT)
- Complete dump (MVT)
 - description of 46
 - sample of 47,48
- Completion codes
 - description of common 215
 - explanation of 205
 - in an ABEND/SNAP dump (MVT) 49
 - in an ABEND/SNAP dump (MFT) 35
 - in an indicative dump 67
- Console dump facility 68
- COND parameter,
 - to regulate job step execution 32
- Contents directory
 - description of 17,25
 - entries (see CDE)
- Control blocks
 - descriptions of 26,27
 - pointers in 233
 - relationships between 27
 - use in debugging 205
- Control block displays (IMDPRDMP output) 74-122
 - MFT DEB format 103
 - MFT job pack queue format 102
 - MFT load list format 102
 - MFT problem program boundaries 101-102
 - MFT RB format 98
 - MFT TCB format 92-98
 - MFT TIOT format 107
 - MVT DEB format 87-90
 - MVT job pack queue format 86-87
 - MVT load list format 86
 - MVT main storage information 85
 - MVT RB format 81-85
 - MVT TCB format 75-80
 - MVT TIOT format 90-92
 - TSO PSCB format 121
 - TSO RCB format 113
 - TSO SWAP DCB format 116
 - TSO TAXE format 123
 - TSO TJB format 116
 - TSO TJBX format 120-121
 - TSO TSB format 118
 - TSO TSCVT format 108
 - TSO UMSM format 116
- Control information 13
- Control program nucleus
 - ABEND/SNAP (MVT) 60
 - ABEND/SNAP (MFT) 43-44
- CVT
 - description of 26
 - in a storage image dump 138,139
 - pointers in 233
- Data control block (see DCB)
- Data event control block 27
- Data extent block (see DEB)
- Damage assessment routine (DAR) 68
- DCB
 - description of 27
 - in a storage dump 144
 - pointers in 233
- DD statements
 - required with ABEND/SNAP dumps 29,32
 - sample of SYSABEND 32
- DEB
 - description of 27
 - in a storage dump 143
 - in an ABEND/SNAP dump (MVT) 55
 - in an ABEND/SNAP dump (MFT) 41
 - pointers in 233

DEB queue
 in a storage dump 143
 in an ABEND/SNAP dump (MVT) 50
 in an ANDED/SNAP dump (MFT) 35

Debugging procedure
 description of 205
 summary 207

DELETE macro instruction 16

Dequeued elements 34

Descriptor queue element (see DQE)

Destroyed queues 32

Device considerations,
 for ABEND/SNAP dumps 29, 32

Dispatcher trace table entry (MVT)
 format of 148, 149
 in a SNAP dump 61, 64
 in a storage image dump 146

Dispatching priority 19, 20

DQE
 format of 24
 in a storage dump 143
 in an ABEND/SNAP dump 56, 64

Dump (see individual type of dump, e.g.,
 ABEND, indicative)

Dump data set
 MVT 46
 MFT 29

Dump list heading (IMDPRDMP output) 70

Dynamic area
 in systems with MVT 20
 in systems with MFT 19

ECB
 completion codes, list of 223
 description of 27
 in a storage dump 145
 pointers in 233
 posting of, using ATTACH 18

Event control block (see ECB)

Extent list (see XL)

External interruption 206

External trace table entry
 format of 148
 in a SNAP dump 61, 63, 64
 in a storage dump 148, 149

FBQE
 format of 22-23
 in a storage dump 146
 in an ABEND/SNAP dump 57, 64

FINCH request block 14

Finding the partition TCB 141

FRB 14

Fixed area
 in systems with MFT 19
 in systems with MVT 20

FQE
 format of (MFT) 21
 format of (MVT) 24

Free areas
 in an ABEND/SNAP dump (MFT) 44

Free block queue element (see FBQE)

Free queue element (see FQE)

General debugging procedure
 description of 205-207
 summary 207

General format (IMDPRDMP output) 128

Generalized trace facility (GTF) 150-203
 comprehensive trace records
 158-166, 169-202
 DSP 162
 EXT 163
 IO 159
 PCI/IO 159
 PGM 165
 SIO 161
 SSM 166
 SVC 170
 description of 15
 hexadecimal format record 168
 lost event record 167
 minimal trace records 150-157
 DSP 153
 EXT 154
 IO 151
 PCI/IO 151
 PGM 155
 SIO 152
 SSM 157
 SVC 156
 SVC comprehensive trace records 169-202
 sub-index 169
 time record 167

GETMAIN macro instruction 21-22

Gotten subtask area queue element 21-22

GQE 21-22

GTF (see Generalized Trace Facility)

GTF trace table
 in ABEND/SNAP dumps 150
 in IMDPRDMP output 150

Guide to using storage image dump 137

Hardware error 205, 206

Hierarchy, main storage 20-22

IFCDIP00 230

IFCEREPO 230

IMAPTFL 230

IMASPZAP 229

IMBLIST 229

IMBMDMAP 229

IMCJQDMP 229

IMCOSJQD 229

IMDPRDMP 229

IMDSADMP 229

Indicative dumps
 contents of 65-67
 description of 65
 guide to using 67
 introduction 11

Input/output block (see IOB)

Interrupt request block 14

Interruptions 205, 206

IOB
 description of 27
 in a storage dump 144-145
 pointers in 233

I/O trace table entry
 format of 148
 in a storage dump (MFT) 148-149
 in a storage dump (MVT) 148
 in a SNAP dump (MVT) 61, 63-64
 in an ABEND/SNAP dump (MFT) 42, 44
 IRB 14

Job pack area 14, 17
 Job pack area queue 17
 Job step 19
 Job step task (MVT) 20, 46
 JPAQ 17

LINK macro instruction, effects of 18
 Link pack area (MVT) 20-21
 Link pack area maps (IMDPRDMP output)
 71-73
 LLE
 count field 17
 description of 17
 in an ABEND/SNAP dump (MVT) 50
 Load list
 description of 16
 instruction for using 205, 207
 in a storage dump 142
 in an ABEND/SNAP dump (MVT) 53, 63
 in an ABEND/SNAP dump (MFT) 38, 44
 in an indicative dump 66
 in systems with MVT 17
 in systems with MFT 16-17
 Load list element (see LLE)
 LOAD macro instruction, effects of 18-19
 Load module, storage control for
 in an ABEND/SNAP dump (MVT) 53-54, 64
 in systems with MVT 25-26
 Loaded program request block 14
 LPRB 14
 LRB 14

Main storage hierarchy support
 inclusion of 20-22
 effects on MSS boundary box 21
 effects on partition queue 21
 Main storage layout
 in systems with MFT with subtasking
 19-20
 in systems with MFT without subtasking
 19
 in the systems with MVT 20
 Main storage supervisor's boundary box
 (see MSS)
 Machine check interruption 205-207
 MFT, systems with
 considerations in using an ABEND/SNAP
 dump of 44-45
 contents of an ABEND/SNAP dump of 34-45
 guide to using a storage
 dump of 137
 how to invoke an ABEND/SNAP
 dump of 29
 main storage layout in 20
 storage control in 21-23
 task control characteristics of 19-20
 trace table entries in 148

Model 65 Multiprocessing system
 trace table formats 149
 prefixed storage area, as shown in an
 ABEND/SNAP dump (MVT) 60
 trace table entries in a SNAP dump 62
 Module name prefixes, list of 219
 description of (MFT) 21-22
 in an ABEND/SNAP dump (MVT) 55-56
 starting address (MFT) 35
 Multiprogramming with a fixed number of
 tasks (see MFT, systems with)
 Multiprogramming with a variable number of
 tasks (see MVT, system with)
 MVT, systems with
 complete ABEND/SNAP dump of 47-48
 contents of an ABEND/SNAP dump 46-64
 guide to using a storage image dump of
 137-146
 guide to using an ABEND/SNAP dump
 of 63-64
 how to invoke an ABEND/SNAP dump of 46
 load list 16
 main storage layout in 20
 storage control in 22-26
 task control characteristics in 20
 trace table entries in 148

Nucleus
 contents of 19-20
 in an ABEND/SNAP dump (MVT) 60
 in an ABEND/SNAP dump (MFT) 44

Only loadable (OL) 14
 OPEN/CLOSE/EOV debugging 241
 Output comments (IMDPRDMP output) 130-136
 from GTF processing 203
 Overlaid problem program 34

Partition (MFT) 19-20
 Partition queue element (see PQE)
 Partition TCBS 138-141
 PIE 35, 49
 Pointers, control block 231
 PQE
 format of 23
 in a storage dump 143
 in an ABEND/SNAP dump 56-64
 PRB 14
 Priority 19-20
 Problem program, how to locate in a
 dump 205-207
 Problem program storage boundaries, in an
 ABEND/SNAP dump (MFT) 40
 Program check interruption 205, 206
 Program check old PSW
 in an ABEND/SNAP dump (MVT) 52, 63
 information in 205, 206
 Program check trace table entry
 format of 148
 in a SNAP dump 61-62
 in a storage dump 145-146
 Program interruption element (see PIE)
 Program request block 14
 Protection key 35
 PSCB 146

- PSW at entry to ABEND
 - in an ABEND/SNAP dump (MVT) 49
 - in an ABEND/SNAP dump nMFT) 35
- PSW, program check old (see program check old PSW)
- PSW, resume (see resume PSW)
- QCB 57
- Queue control block trace (IMDPRDMP output) 70-71
- Queue elements (MVT) 21,22-26
- Queues destroyed 34
- RB
 - as affected by LINK, ATTACH, XCTL and LOAD 18
 - formats of 13-16
 - in an ABEND/SNAP dump (MVT) 52-54
 - in an ABEND/SNAP dump (MFT) 37,38,44
 - in an indicative dump 66
 - most recent 35,49
 - name field, in a dump 205
 - purpose of 13
 - pointers in 233
 - pointers to, in a storage dump 141-142
 - queue (see active RB queue)
 - sizes of 15
 - types of 13-14
 - when created 13
 - which ones appear in a dump 205
- RCB 145
- Re-creating the task structure
 - MFT with subtasking 139
 - MVT 139
- Reenterable load module area (MFT) 19
- Region (MVT)
 - contents of, in an ABEND/SNAP dump 64
 - description of 20
 - storage control for 22-24
- Register contents
 - in a save area 147
 - in an ABEND/SNAP dump (MVT) 60-61
 - in an ABEND/SNAP dump (MFT) 43
 - in an indicative dump 66
- Request block (see RB)
- Resume PSW
 - in an ABEND/SNAP dump (MVT) 53,62
 - in an ABEND/SNAP dump (MFT) 38,44
 - in an indicative dump 67
- Retain dump 32
- Rollout/rollin
 - effects on partition queue 22-23
- Save areas
 - format of 147
 - in an ABEND/SNAP dump (MVT) 58
 - in an ABEND/SNAP dump (MFT) 40
- Save area chain 147
- Sense bytes, UCB
 - table of 225
- Sequential partitioned system (see MFT, systems with)
- Service aids 229
- Set system mask trace table entry
 - format of 149
 - in an ABEND/SNAP dump 62
- SIO trace table entry
 - format of (MFT) 148
 - format of (MVT) 148
 - in a SNAP dump (MVT) 62-63
 - in an ABEND-SNAP dump (MFT) 42,44-45
- SIRB 14
- SNAP dumps
 - contents of (MVT) 46-63
 - contents of (MFT) 32-44
 - guide to using (MVT) 63-64
 - guide to using (MFT) 44-45
 - how to invoke (MVT) 46
 - how to invoke 5MFT) 29
 - introduction to 11
- Snapshot dumps (see SNAP dumps)
- Space considerations, for ABEND/SNAP dumps 32
- SPQE
 - format of 24
 - in a storage dump 143
 - in an ABEND/SNAP dump 55,64
- SQS (see system queue space)
- SSM (see set system mask trace table entry)
- Storage control
 - in systems with MFT with subtasking 22
 - in systems with MFT without subtasking 21
 - in systems with MVT 25,26
- Storage dumps
 - discussion of 68
 - guide to using 137
 - introduction to 11
- Subpool
 - definition of 24
 - in a storage dump 143
 - in an ABEND/SNAP dump 55,64
 - queue elements (see SPQE)
- Subtask, as created by ATTACH 18
- Supervisor calls, list of 209
- Supervisor interrupt request block 14
- Supervisor request block 14
- SVC trace table entries
 - format of (MFT) 148
 - format of (MVT) 148
 - in a SNAP dump (MVT) 61-62
 - in an ABEND/SNAP dump (MFT) 42-44
- SVCs, list of 209
- SVRB 14
- SYSABEND DD statement
 - description of 32
 - samples of 33
- SYSOUT, as a dump data set 32
- System control blocks (see control blocks)
- System differences in task control 18-20
- System failure 68
- System queue space (MVT) 20
- System tasks 18-20
- System wait TCB 75
- SYS1.DUMP data set 68,29
- SYSUDUMP DD statement 29
- Task completion code (see completion codes)
- Task control block (see TCB)
- Task control differences, by system 18-20
- Task dispatching priority 20
- Task input/output table (see TIOT)

Task management 13-21
 Task supervision 13-21
 Task structure, recreating the, using a storage dump (MVT) 139
 Task switch trace table entry (MFT)
 format of 148
 in an ABEND/SNAP dump 44
 Task switching (MFT) 20
 TAXE 146
 TCAM Debugging Aids 231
 TCB
 description of 13
 in an ABEND/SNAP dump (MVT) 49-51
 in an ABEND/SNAP dump (MFT) 35-37
 information available through 13
 locating, in a storage dump 138-141
 pointers in 233
 pointers to, in a storage dump (MFT) 138-139
 queue (MFT) 19,20
 queue (MVT) 20
 relationships 19-20
 summary display (IMDPRDMP output) 124-127
 MFT without subtask TCBS 125
 MFT or MVT with subtask TCBS 125
 TCBLCT 51,233
 TCBNTC 51,233
 TCBOTC 51,233
 TCBTCB 50,233
 Telecommunications Access Method (see TCAM)
 Termination, abnormal (see abnormal termination)
 TIOT
 description 26
 in ABEND dump (MVT) 55
 in IMDPRDMP output (MVT) 90
 pointers in 233
 TJB 146
 TJBX 146
 Traces 147-150
 Trace table
 control block 148
 delimiting entries, in an ABEND/SNAP dump (MFT) 44
 description of 148
 format of entries (MFT) 148
 format of entries (MVT) 149
 format of entries (Mod 65 multiprocessing systems) 149
 in a SNAP dump (MVT) 61-62
 in a storage dump 148-149
 in an ABEND/SNAP dump (MFT) 42
 samples of entries 148-149
 usefulness in debugging 206
 TSB 146
 TSCVT 145
 TSO Control Blocks 145-146
 UCB
 description of 27
 in a storage dump 144
 in an ABEND/SNAP dump (MFT) 41
 pointers in 234
 UMSM 146
 Unit control block (see UCB)
 Use count 17
 Wait list 17
 Wait list element 17,18
 WLE 17
 XCTL macro instruction, effects of 18
 XL
 description of 25
 in a ABEND/SNAP dumps 54,64

IBM

**International Business Machines Corporation
Data Processing Division
1133 Westchester Avenue, White Plains, New York 10604
(U.S.A. only)**

**IBM World Trade Corporation
821 United Nations Plaza, New York, New York 10017
(International)**