

GA18-2041-2  
File No. S360/S370/S3-09

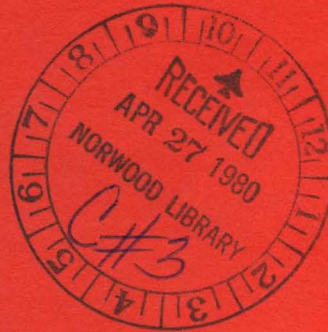

**Systems**

**IBM 3270  
Information Display System  
3276 Control Unit Display Station  
Planning and Setup Guide**



**IBM**

GA18-2041-2  
File No. S360/S370/S3-09

**Systems**

**IBM 3270  
Information Display System  
3276 Control Unit Display Station  
Planning and Setup Guide**



### **Third Edition (December 1979)**

Information concerning the 3276 Control Unit Display Station was formerly contained in *IBM 3270 Information Display System: Planning and Setup Guide*; *IBM 3274 Control Unit*, *IBM 3276 Control Unit Display*, *IBM 3278 Display Station*, *IBM 3279 Color Display Station*, *IBM 3287 Printer*, *IBM 3289 Line Printer*, GA27-2827. The 3276 information in this manual is a revision of 3276 information contained in GA27-2827-3. For planning and setup information about the 3274 Control Unit, see *IBM Information Display System: IBM 3274 Control Unit Planning, Setup, and Customizing Guide*, GA27-2827.

This publication is for planning only. Changes are periodically made to the information herein. Before using this publication in connection with the operation of IBM systems or equipment, consult the latest *IBM System/360 Bibliography*, GC20-0360, and *IBM System/370 Bibliography*, GC20-0001, for the editions that are applicable and current.

Requests for the latest copies of IBM publications should be made to your IBM representative or to the IBM Branch Office serving your locality.

Some of the devices, options, and features listed in this publication may not be available in every locale. Consult your local IBM marketing representative for information about product availability.

A form for readers' comments is provided at the back of this publication. If the form has been removed, address comments to International Business Machines Corporation, Dept. 825, 1133 Westchester Avenue, White Plains, New York 10604. IBM may use or distribute any of the information you supply in any way it believes appropriate without incurring any obligation whatever. You may, of course, continue to use the information you supply.

## Preface

This guide is written for customers, planners, and IBM representatives who may be responsible for planning the installation and setup of the IBM 3276 Control Unit Display Station and of the following 3270 Information Display System units:

- IBM 3278 Display Station
- IBM 3279 Color Display Station
- IBM 3287 Printer
- IBM 3289 Line Printer

This guide contains planning information. For detailed information about the functions and features of the above 3270 Information Display System units, see the latest editions of the following publications:

*An Introduction to the IBM 3270 Information Display System*, GA27-2739

*IBM 3270 Information Display System: Component Description*, GA27-2749

*IBM 3270 Information Display System: Installation Manual – Physical Planning*, GA27-2787

*IBM 3270 Information Display System: Configurator*, GA27-2849

*IBM 3270 Information Display System: IBM 3276 Control Unit Display Station Operator's Guide*, GA18-2040

*IBM 3270 Information Display System: IBM 3278 Display Station Operator's Guide*, GA27-2890

*IBM 3270 Information Display System: IBM 3279 Color Display Station Operator's Guide*, GA33-3057

*IBM 3270 Information Display System: IBM 3287 Printer Models 1 and 2 Operator's Guide*, GA27-3150

*IBM 3270 Information Display System: IBM 3287 Printer Models 1C and 2C Operator's Guide*, GA27-3230

*IBM 3270 Information Display System: IBM 3289 Line Printer Operator's Guide*, GA27-3147

See Figures P-1 through P-5 for other manuals that may help you plan your installation.

IBM 3270 Information Display System and Associated Manuals

General Information and Installation Manuals

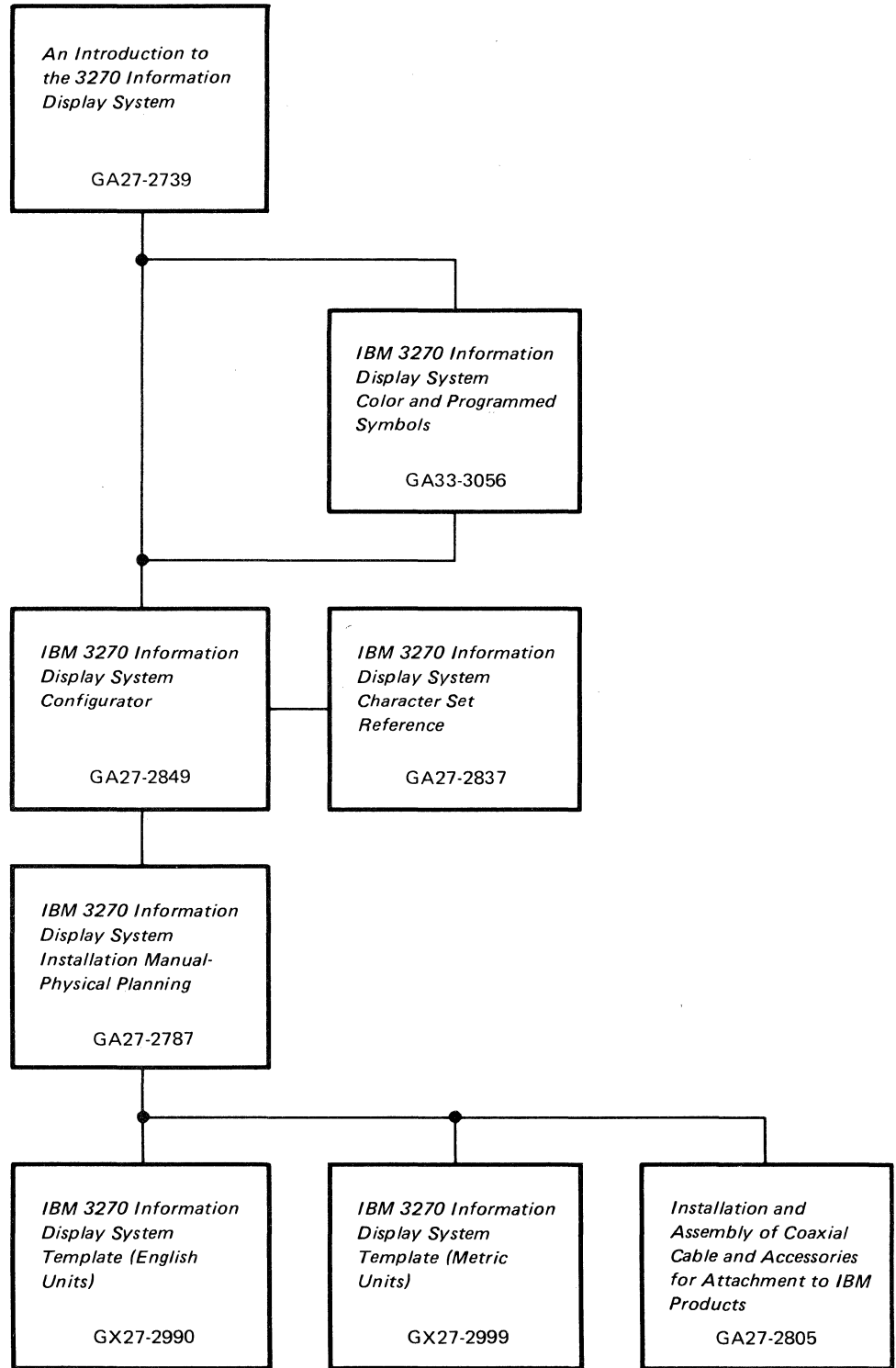
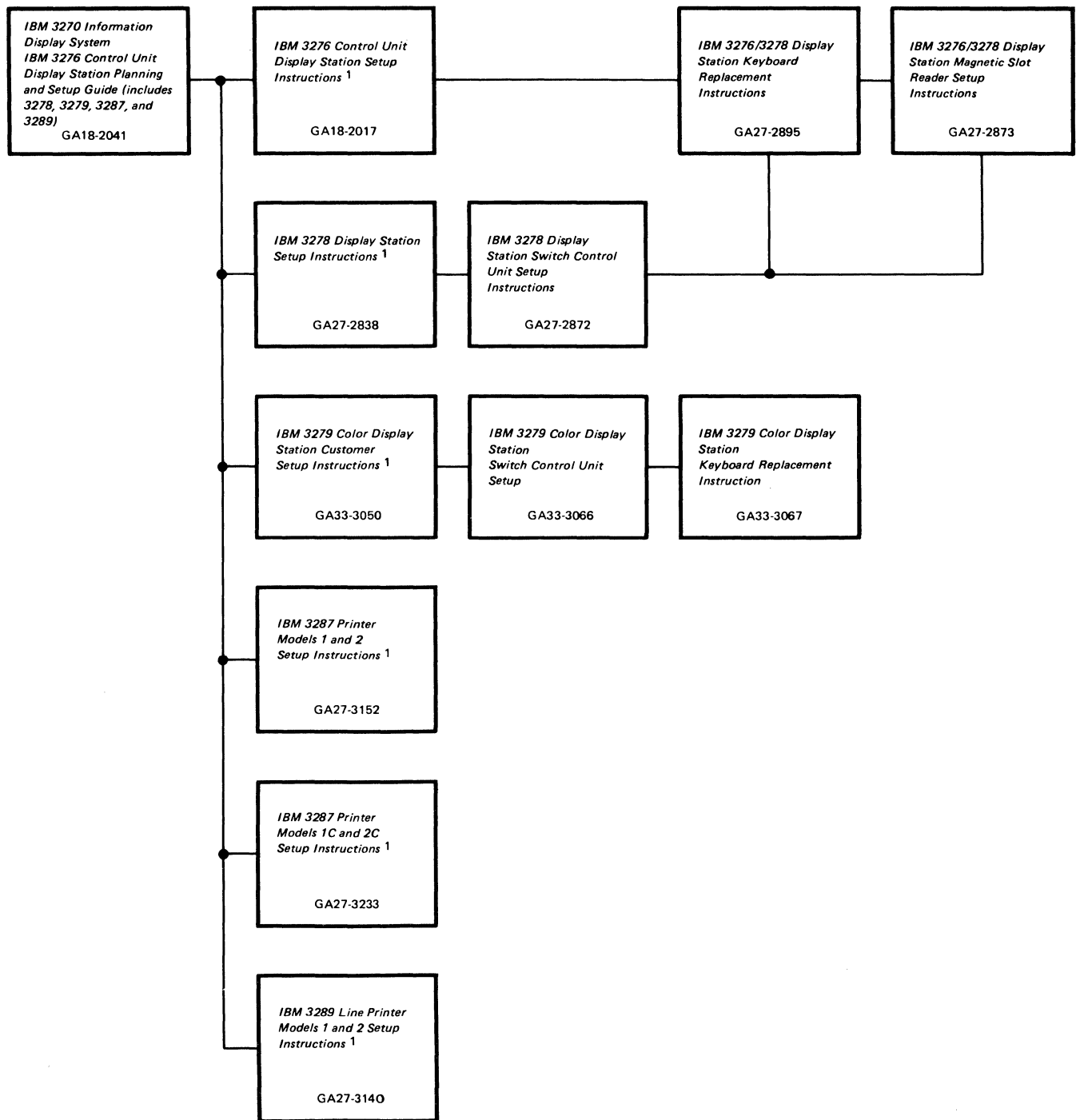

Figure P-1. General Information and Installation Manuals

Customer Setup Manuals



<sup>1</sup> will be delivered with the indicated machine.

Figure P-2. Customer Setup Manuals

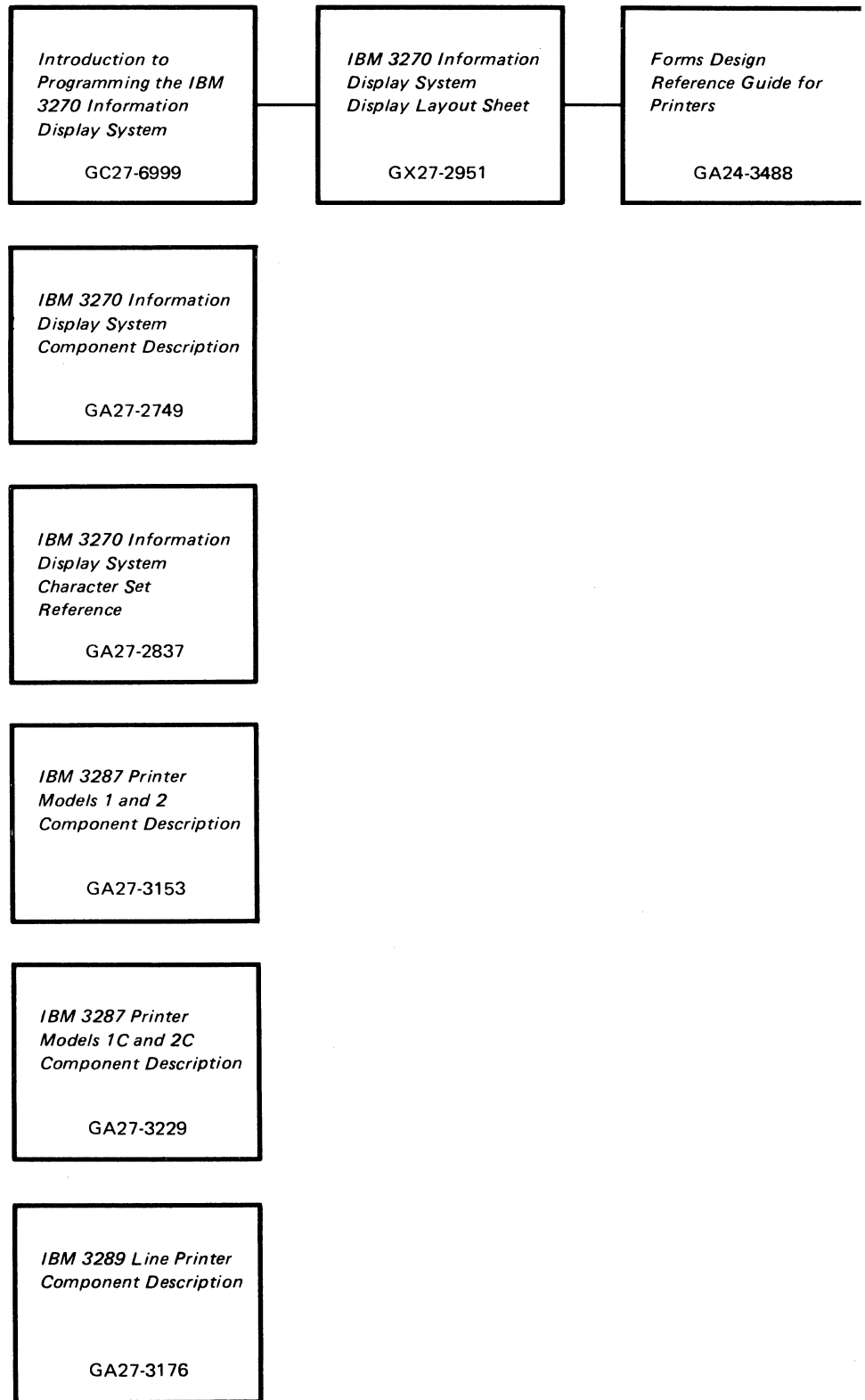

Figure P-3. Programming Manuals

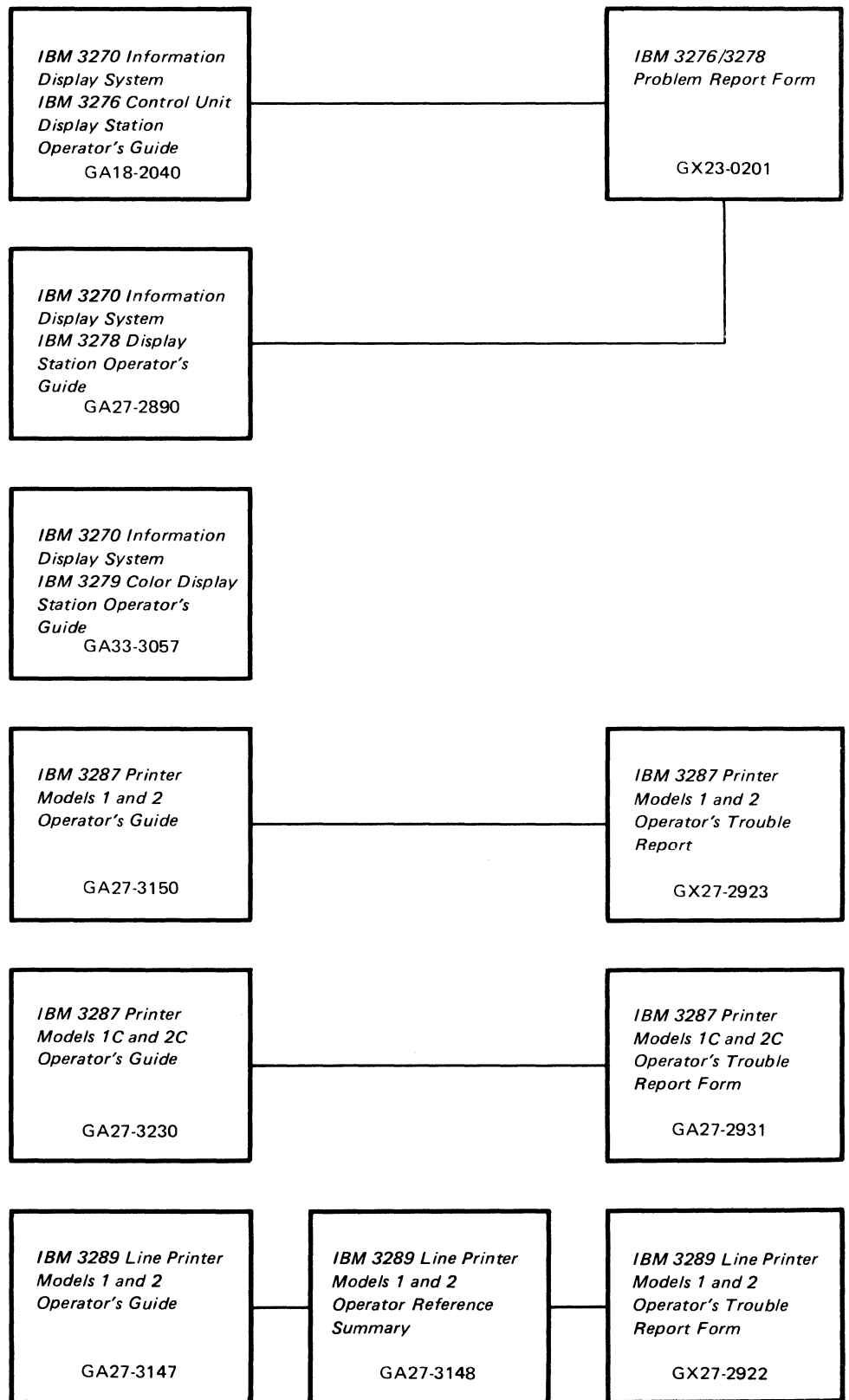
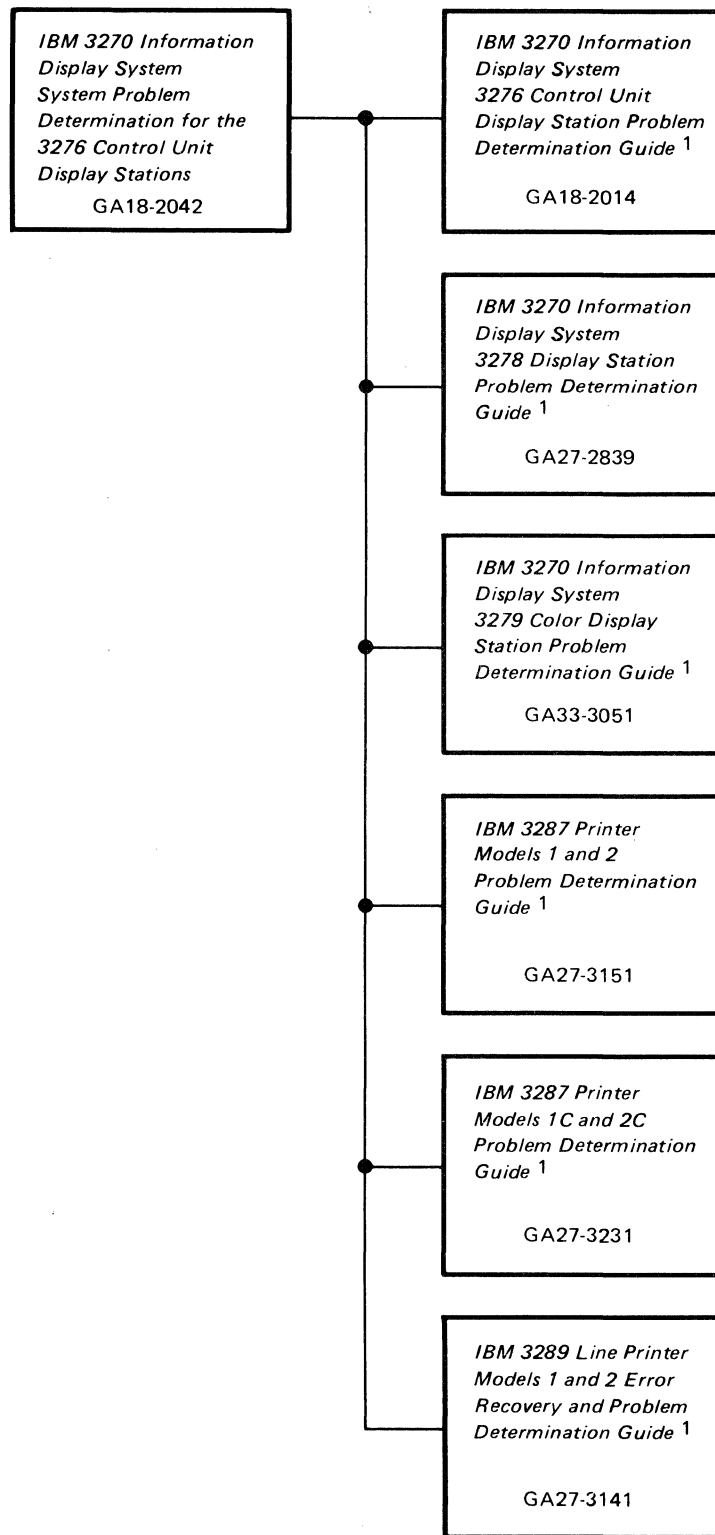

Figure P-4. Operations Manuals





<sup>1</sup> will be delivered with the indicated machine.

Figure P-5. Problem Determination Manuals

# Contents

<b>Introduction</b>	1
<b>3276 Cluster Unit Descriptions</b>	1
<b>Configuration Planning</b>	2
<b>System Planning</b>	2
Site Preparation	2
Communication Services	3
Programming Support	3
3270 Exchange Station Identification (SDLC Only)	4
3276 Terminal Identification	4
3276 SDLC Station Address	4
Encrypt/Decrypt Feature (Models 11, 12, 13, and 14)	5
Pre-Delivery Planning	5
3276 Device Cables	5
3276 Cluster Network Address Labels	6
3276 Communication Cable	6
Modem Considerations	7
3276 Switches	8
<b>Setup Procedures</b>	8
3276 Setup Procedures	8
3278 Setup Procedures	9
3279 Setup Procedures	9
3287 and 3289 Setup Procedures	9
<b>Replacing Other 3270 Units with 3276s and Attached Units</b>	9
Replacing a 3271 with One or More 3276s	9
Device Addresses	9
Power	10
Cables	10
Modems	10
Replacing a 3275 with a 3276	10
<b>Problem Determination Procedures</b>	11
<b>Relocation/Removal</b>	11
<b>Progress Review</b>	12
<b>IBM Americas/Far East and IBM Europe/Middle East/Africa</b>	13
<b>Supplemental Information</b>	13
Safety	13
Security	13
Personnel Training	14
Supplies	14
Voice Communication between 3276 Cluster Operators and Host System Operators	14
Reference Manuals	14
<b>Appendix A. Planning Checklist</b>	17
<b>Appendix B. 3276 Device Cable Attachment</b>	21
<b>Appendix C. 3276 Communication Cable Connection Instructions</b>	23
3276 with an Integrated Modem Attached to a Nonswitched Line (U.S. and Canada only)	23
3276 with an Integrated Modem Attached to a Nonswitched Line (Japan only)	24
3276 with an Integrated Modem Attached to a Switched Line with Manual Answer (U.S. and Canada Only)	26
3276 with an Integrated Modem Attached to a Nonswitched Line with Switched Network Backup (SNBU) and Manual Answer (U.S. and Canada Only)	27
3276 with an Integrated Modem Attached to a Nonswitched Line with Switched Network Backup (SNBU) and Auto-Answer (U.S. and Canada Only)	28
3276 with an Integrated Modem Attached to a Switched Line with Auto-Answer (U.S. and Canada Only)	29
3276 with an External Modem Attached to a Switched or Nonswitched Line (All Countries except United Kingdom Datel Modem)	30
3276 with an External Modem Attached to a Switched or Nonswitched Line (United Kingdom Datel Modem)	32
3276 with an Integrated Modem Attached to a Switched Line with Auto-Answer (All Countries except U.S. and Canada)	34
3276 with an Integrated Modem Attached to a Nonswitched Line with Switched Network Backup (SNBU) and Auto-Answer (All Countries except U.S. and Canada)	35
3276 with an Integrated Modem Attached to a Nonswitched Line (All Countries except U.S., Canada, and Japan)	36
3276 with a Digital Data Service Adapter (DDSA) Attached to A.T.&T. Channel Service Unit (U.S. Only)	37
3276 with a Loop Adapter Attached to a Loop (All Countries)	38
<b>Appendix D. 3276 Switches</b>	39
Switches A1–A8: SDLC Address Switches	39
Switches B1–B5: BSC Control Unit Address Switches (Except Loop Adapter Feature Machines)	39
Switches B6: Full-Duplex (FDX)/Half-Duplex (HDX) Switch (Except Loop Adapter Feature Machines)	40
Switch B7: (Except Loop Adapter Feature Machines)	42
Switch B8: NRZ/NRZI Switch (Except Loop Adapter Feature Machines)	42
Switches B1–B5: (Loop Adapter Feature Machines Only)	42
Switches B6–B8: Line Speed Switches (Loop Adapter Feature Machines Only)	42
Transmit Level Switches (U.S. and Canada Only)	43
Primary Line Speed/Secondary Line Speed Switch	45
SNBU/Non-Switched Line Switch	45
SDLC/BSC Switch	45
Communicate/Local Switch (Loop Adapter Feature Machines Only)	45
3276 Switch Settings Form	46
<b>Abbreviations</b>	49

## Figures

- Figure P-1. General Information and Installation Manuals ii
- Figure P-2. Customer Setup Manuals iii
- Figure P-3. Programming Manuals iv
- Figure P-4. Operations Manuals v
- Figure P-5. Problem Determination Manuals vi
- Figure A-1. Planning Checklist, Sample Plan (3 parts) 17
- Figure D-1. SDLC Address Switch Setting  
(Switches A1–A8) 40
- Figure D-2. BSC Control Unit Address Switch Setting  
(Switches B1–B5) 41
- Figure D-3. FDX/HDX Switch Setting Summary 42
- Figure D-3a. Loop Line Speed Switch Setting (Switches B6–B8) 43
- Figure D-4. 3276 Transmit Level Switches 44
- Figure D-5. Integrated Modem Transmit Level Settings by  
Country 44
- Figure D-6. Example of a Completed 3276 Switch Settings  
Form 46

# Introduction

This planning and setup guide will help you plan the installation of the IBM 3276 Control Unit Display Station and of the following 3270 Information Display System units:

- IBM 3278 Display Station
- IBM 3279 Color Display Station
- IBM 3287 Printer
- IBM 3289 Line Printer

These units have convenient customer access areas to which your personnel can attach the device cables and the keyboard and feature cables.

The 3276, 3278, 3279, 3287, and 3289 units are delivered with unpacking instructions attached to an outside surface of the shipping carton. In addition to the unpacking instructions, the 3276, 3278, 3279, 3287, and 3289 units have setup instructions inside the shipping carton. The unpacking instructions and the setup instructions are step-by-step procedures that describe the unpacking and setup tasks for the unit.

Using the planning information in this publication will help you to ensure that your personnel can (1) unpack, position, set up, and check out the 3276, 3278, 3279, 3287, and 3289 units, and (2) unpack, position, and attach the device cables. As a result, you will be able to use your new display/printer cluster at an early date. If, later, you choose to improve the work flow by relocating these units within the site, your personnel should be able to accomplish the relocation quickly and easily.

## 3276 Cluster Unit Descriptions

The 3276 cluster consists of an IBM 3276 Control Unit/Display Station with attached display stations and/or printers.

For detailed information about the functions and features of the 3276 and the units that can be attached to the 3276, see the latest editions of:

*An Introduction to the IBM 3270 Information Display System, GA27-2739*

*IBM 3270 Information Display System: Component Description, GA27-2749*

*IBM 3270 Information Display System: Installation Manual – Physical Planning, GA27-2787*

*IBM 3270 Information Display System: Configurator, GA27-2849*

## Configuration Planning

To plan the configuration of the 3276 and the attached units, use the appropriate (U.S., Americas/Far East, or Europe/Middle East/Africa) Configuration Tables in *IBM 3270 Information Display System: Configurator*, GA27-2849. These tables will help you determine which feature codes are needed to:

- Connect the 3276 to a host system through communication facilities or through an IBM 3704 or 3705 Communications Controller.
- Connect the 3276 to the IBM 81XX Processor through the loop.
- Provide the required quantity of 3276 terminal adapters.
- Provide feature compatibility among the individual units.

The tables also indicate necessary features, optional features, prerequisite features, and features that cannot coexist.

If you intend to use 3276 cluster copy operations, it is recommended that you consider the effect that the cluster configuration has on the Printer Default matrix. A Printer Default matrix in the 3276 directs the cluster copy operations. Default source-destination relationships are generated at power-on time; the default values are determined by the physical configuration of the cluster units. For additional information regarding this function, refer to the *IBM 3270 Information Display System: Component Description*, GA27-2749.

## System Planning

The following tasks should be planned so they can be accomplished in a timely manner:

- Site preparation for the 3276 clusters
- Communication facilities preparation for the 3276
- Programming support preparation
- 3276 pre-delivery planning activities

It may be useful to designate a person in your organization to be responsible for ensuring that all these tasks are planned. The Planning Checklist in Appendix A of this guide contains the events, in a suggested sequence, that should be planned in order to set up a 3276 and the attached units for the first time; it therefore contains more detail than is required for adding to or replacing an existing display/printer system. In either case, each event should be carefully considered so that setting up the 3276 and the attached units is problem-free.

## Site Preparation

The specifications for all physical requirements of the 3276, 3278, 3279, 3287, and 3289 units are given in *IBM 3270 Information Display System: Installation Manual – Physical Planning*, GA27-2787.

This guide will help you provide compatibility between these units and the following:

- Work space considerations
- Electrical requirements
- Cable requirements and their installation
- Power cord plug requirements and their installation.
- Environmental requirements

## Communication Services

Arrangements need to be made for the installation of the communication facilities between the 3276 and the host system communication unit/adaptor. There must be compatibility between the 3276, the modems, the communication line, and the communication unit/adaptor; for example, line speed, duplex or half-duplex facilities, and non-return to zero (NRZ) or non-return to zero inverted (NRZI).

When a 3276 is attached directly to an IBM 3704/3705 Communications Controller, there are no modems or communication lines. However, the 3704/3705 and the 3276 must be compatible. It is recommended that you request assistance from your IBM representative to determine whether the 3704/3705 and the 3276 are compatible.

When the 3276 has a Loop Adapter feature (and is attached to the loop), no modem is used. The 3276 has a communication cable, called the Loop Station Connector (LSC) cable, which connects the 3276 to the loop. The same line speed on the loop must be selected and set in the 3276 operator panel drawer to perform the communicate operation.

Compatibility among these components is a major consideration in new installations. To reduce delays caused by incompatibility, it is recommended that you request assistance from your communications representative and from your IBM representative to determine whether the 3276, modems, communication line, and communication unit/adaptor are compatible. In addition, schedules should be established to ensure that the modems, communication line, and communication unit/adaptor are installed and tested before delivery of the 3276 and the attached units.

## Programming Support

It is important to plan for proper programming support at the host system. The 3276 clusters can be added to most 3270 display/printer systems with minimal impact on the existing programs. In certain cases, however, host system definition (SYSGEN) parameters will have to be changed to accommodate attachment of a 3276 cluster. Information concerning programming requirements is included in the following publications:

- *An Introduction to the IBM 3270 Information Display System*, GA27-2739
- *Introduction to Programming the IBM 3270*, GC27-6999
- *IBM 3270 Information Display System: Component Description*, GA27-2749

In addition, it is recommended that for 3276 clusters you enhance your system availability and serviceability by installing the Online Test Executive Program (OLTEP) at the host system. Call your IBM representative for information about OLTEP.

### 3270 Exchange Station Identification (SDLC Only)

The Exchange Station Identification (XID) number described below should be added to the host programs for a 3276 attached to a switched network, but the XID is not critical when the 3276 is attached to a nonswitched network.

Bits	Meaning
0-3	ID format B'0000'
4-7	PU type B'0010'
8-15	Self-description X'00'
16-27	X'018'
28-47	Terminal ID number

### 3276 Terminal Identification

Each terminal operating under synchronous data link control (SDLC) has a permanent, unique, 6-byte identification that it will transmit in response to a request for its ID (XID command). This identification, described below, is fixed at the time of manufacture and is not selectable.

Bits 28-47 of the Exchange Station Identification are a unique Terminal ID that can be obtained from the seven digits either shown in the Machine History list supplied with the 3276 or engraved on the side frame of the 3276. These seven digits are the machine serial number and should be converted into the proper Station ID as follows:

1. The first two digits of the machine serial number should be 00, 23, 55, or 82. Each number should be converted into the following bits:

#### Bits 28-31

00, 23	B'0000' or X'0'
55	B'1100' or X'C'
82	B'1111' or X'F'

2. The remaining five digits can be converted into bits 32-47 by use of the *IBM System Reference Card*, GX20-1850 or GX20-1703.

Example: If the seven digits of your machine are 00-15623.

#### Bits

28-31	B'0000' or X'0'
32-47	B'0011110100000111' or X'3D07'

Complete Terminal ID is X'020001803D07'  
Fixed Variable

### 3276 SDLC Station Address

The SDLC station address is a 1-byte address that must be selected by the customer at setup time.

An SDLC Station address of either X'00' or X'FF' should not be assigned.

**Note:** The SDLC station address must correspond to the address selected by Host Programming Support (NCP generation).

### ***Encrypt/Decrypt Feature (Models 11, 12, 13, and 14)***

It is the customer's responsibility to install a copy of the secondary logical unit (LU) key (the terminal master key) in the 3276 equipped with the Encrypt/Decrypt feature (#3680). This should be done by someone in a position of trust, such as a security officer. Once the terminal master key has been installed in the 3276, the 3276 generates a verification value based on the terminal master key. A master-key verification procedure can be performed by any operator without compromising the security of the Encrypt/Decrypt feature. A mercury battery, IBM Part 1743456, is installed in the 3276 to sustain the terminal master key when the 3276 power is off. Replacing this battery, or its equivalent, is also a customer responsibility. Procedures to install and verify the terminal master key, and to replace the mercury battery, are described in *IBM 3276 Control Unit Display Station Operator's Guide*, GA18-2040.

Refer also to *IBM Cryptographic Subsystem Concepts and Facilities*, GC22-9063, for background information, and to *IBM 3270 Information Display System Component Description*, GA27-2749, for programming information.

### **Pre-Delivery Planning**

Some of the 3276 setup tasks require your personnel to set configuration switches and connect cluster cables. To prevent delays and help ensure a smooth installation/setup, it is recommended that a designated person in your organization:

1. Compile the installation-dependent information described in this section
2. Distribute the installation-dependent information to the appropriate personnel
3. Coordinate the activities of your personnel

### ***3276 Device Cables***

The device cables are the coaxial cables that connect the 3276 to its display stations and printers. These cables should be procured and installed before delivery of the 3276 and of the units that will be attached to the 3276. The setup personnel will connect these cables to the 3276 and to the attached units.

**Note:** *If you are replacing a 3271 and its attached units with a 3276 and its attached units, you can use the existing 3271 device cables. However, the 3271 device cables must be connected/disconnected by an IBM service representative, because the 3271 and its attached units do not have customer access areas. Before the IBM service representative disconnects these cables, you should have the cables marked as described below.*

To reduce delays associated with connecting these cables to the 3276, it is recommended that each cable be marked at both ends to identify the 3276 port (1 to 7) to which it is to be connected and the unit type to be attached.

For additional information concerning device cables, refer to *IBM 3270 Information Display System: Installation Manual – Physical Planning*, GA27-2787.

A 3276 Device Cable Attachment form is provided in Appendix B of this guide to help simplify marking and connecting the cables. (For completing the Network Address portion of the form, refer to “3276 Cluster Network Address Labels.”) A form should be completed for each 3276 you order. Copies of the completed form should be given to the personnel who will install and mark the cables and to the setup personnel who will connect the cables to the 3276. In addition, a copy of the form should be available at the 3276 for future reference.

**Note:** *Port 0 must be the 3276 Integral Display.*



### 3276 Cluster Network Address Labels

Hexadecimal address labels (IBM Part 1743290) are delivered with the 3276. After each cluster unit is set up, the labels that specify the unit's network address should be attached to the unit's address label holder (if present).

It is recommended that a designated person in your organization (1) obtain the cluster network addresses from the system programmer, (2) enter the addresses in the Network Address column of the 3276 Device Cable Attachment form in Appendix B, and (3) distribute the network addresses information to the person who will attach the address labels.

For information about systems network architecture (SNA) network addresses, see *Systems Network Architecture General Information: Network Addresses*, GA27-3102; for information concerning BSC network addresses, see *IBM 3270 Information Display System: Component Description*, GA27-2749.

### 3276 Communication Cable

The communication cable that connects the 3276 to the modem, to the communication facility, to the 3704/3705 (local attachment), or to the loop is delivered with the 3276. The standard cable length is 6.1 metres (20 feet), or in the case of the loop 1.8 metres (6 feet); optional cable lengths of 3.1 metres (10 feet), 9.1 metres (30 feet), and 12.2 metres (40 feet), or in the case of the loop 4.3 metres (14 feet) may be specified. The location of the 3276's modem or communication facility termination, of the 3704/3705, or of the LSC receptacle for the loop, may require the communication cable to be routed through floors, walls, or ceilings. If the communication cable must be routed through floors, walls, or ceilings, you should arrange to have your maintenance personnel or a contractor route the cable and connect the cable to the communication facilities. Instructions for connecting a communication cable to the 3276 are provided in the *IBM 3276 Setup Instructions*, GA18-2017, delivered with the 3276.

#### Notes:

1. When the 3276 local attachment to a 3704/3705 is used, the total cable length between the 3704/3705 and the 3276 must not exceed 30.5 metres (100 feet). For information concerning attachments longer than 12.2 metres (40 feet), call your IBM representative.
2. When the 3276 EIA/CCITT direct attachment to a 81xx is used, the total cable length must not exceed 12.2 metres (40 feet).

Connection instructions and diagrams for this cable are given in Appendix C of this guide. It is recommended that a designated person in your organization determine which of the configurations listed below applies to the cluster, then copy or remove the applicable cable connection instructions in Appendix C, and give them to the appropriate person.

#### *U.S., Canada, and Japan*

- 3276 with an integrated modem attached to a nonswitched line

#### *U.S. and Canada Only*

- 3276 with an integrated modem attached to a switched line with manual answer
- 3276 with an integrated modem attached to a nonswitched line with switched network backup (SNBU) and manual answer
- 3276 with an integrated modem attached to a nonswitched line with SNBU and auto-answer
- 3276 with an integrated modem attached to a switched line with auto-answer

*All Countries except United Kingdom Datel Modem*

- 3276 with an external modem attached to a switched or nonswitched line

*United Kingdom Datel Modem*

- 3276 with an external modem attached to a switched or nonswitched line

*All Countries except U.S. and Canada*

- 3276 with an integrated modem attached to a switched line with auto-answer
- 3276 with an integrated modem attached to a nonswitched line with SNBU and auto-answer

*All Countries except U.S., Canada, and Japan*

- 3276 with an integrated modem attached to a nonswitched line

*U.S. Only*

- 3276 with a Digital Data Service Adapter (DDSA) attached to the A. T. & T. Channel Service Unit<sup>\*</sup>

*All Countries*

- 3276 with a Loop Adapter attached to a Loop

In countries served by IBM Americas/Far East (except Canada) and IBM Europe/Middle East/Africa where it is permissible, your personnel (or contractor) will connect the communication cable to the external modem, communication facilities termination, or Loop Station connector. Where the local (country) regulations require a manufacturer's representative to make the connection to the communication facility, the local IBM branch office should be called for assistance.

## ***Modem Considerations***

**Wrap Feature:** Determine whether the modem permits data from the 3276 to be wrapped under control of the 3276 or whether the modem has a switch to control the wrap function. If the modem has the wrap capability and wrapping can be controlled from the switch on the modem, it is recommended that this method be used.

**Primary Line Speed/Secondary Line Speed Option:** If the modem has a secondary line speed option, determine whether this option can be controlled externally (by the 3276) or by a switch on the modem. If the option can be controlled by a switch, it is recommended that the switch be used to control this option rather than controlling it externally by the 3276.

When the 3276 provides clocking, primary line speed/secondary line speed must be controlled by a switch on the 3276. This switch is located on the operator panel drawer to the right of the display screen. See the 3276 Switch Settings Form in Appendix D.

**Switched Network Backup (SNBU) Feature:** If the modem has this feature, determine whether this feature can be controlled externally (by the 3276) or at the modem. It is recommended that this feature be controlled by the 3276 by setting the SNBU/Non-switched Line switch to SNBU. The switch is located on the operator panel drawer to the right of the display screen. See the 3276 Switch Settings Form in Appendix D.

**Note:** *In the U.S. and Canada a switched network attachment requires the use of a protective device. This must be ordered from an original equipment manufacturer (OEM) communication equipment supplier and installed separately.*

---

\* Trademark of American Telephone & Telegraph Co.

## 3276 Switches

The 3276 has configuration switches that the setup personnel must set before the 3276 can be put online to communicate with the host system. To simplify setting these switches, it is recommended that a designated person in your organization determine the correct switch settings for the cluster configuration, record the settings on the 3276 Switch Settings Form in Appendix D in this guide, and supply the completed form to the 3276 setup personnel. Included in Appendix D are (1) descriptions of all the 3276 configuration switches, (2) instructions for completing the form, and (3) an example of a completed form. A form should be completed for each 3276 ordered. In addition, a copy of the form should be available at the 3276 for future reference.

## Setup Procedures

Each 3276, 3278, 3279, 3287, and 3289 unit is delivered with its own:

- Unpacking instructions attached to an outside surface of the shipping carton
- Setup instructions
- Problem Determination Guide (PDG)

Before each unit is unpacked and placed in its prepared location, the personnel who will unpack and place the units should read the unpacking instructions.

After the unit is unpacked and put in place, the setup personnel should perform the step-by-step procedures in the setup instructions. If problems occur during setup, the setup instructions provide assistance in resolving them.

The following information on setup procedures is included for planning purposes only and to give you a general idea of what is involved. It is *not* intended to replace the setup instructions delivered with the individual units.

It is recommended that the setup instructions be obtained and read before the units are delivered. These instructions may be ordered as Forms GA18-2017 (3276), GA27-2838 (3278), GA33-3050 (3279), GA27-3152 (3287), and GA27-3140 (3289).

## 3276 Setup Procedures

After the 3276 is unpacked and placed in its prepared location, the 3276 setup involves:

- Connecting the 3276 keyboard cable and the communication cable to the 3276 front connector panel, or
- Connecting the communication cable to the loop (for 3276 with Loop Adapter).
- Connecting the device cables from the 3278s/3279s/3287s/3289s to the 3276 rear connector panel.
- Connecting the magnetic slot reader (if present) to the 3276.
- Setting the 3276 switches.
- Plugging in the power cord and switching on the 3276 power.
- Performing the 3276 checkout procedures.

## 3278 Setup Procedures

After the 3278 is unpacked and placed in its prepared location, the 3278 setup involves:

- Connecting the keyboard cable to the 3278.
- Connecting the device cable(s) (coaxial cable from the control unit) to the 3278 or to the Switch Control Unit feature.
- Connecting the magnetic slot reader (if present) to the 3278.
- Plugging in the power cord and switching on the 3278 power.
- Performing the 3278 checkout procedures.

## 3279 Setup Procedures

After the 3279 is unpacked and placed in its prepared location, the 3279 setup involves:

- Connecting the keyboard cable to the 3279.
- Connecting the device cable(s) (coaxial cable from the control unit) to the 3279 or to the Switch Control Unit feature.
- Connecting the magnetic slot reader (if present) to the 3279.
- Plugging in the power cord and switching on the 3279 power.
- Performing the 3279 checkout procedures.

After completing the 3279 setup procedure, it may be necessary to adjust the color convergence.

## 3287 and 3289 Setup Procedures

After the 3287 or 3289 is unpacked and placed in its prepared location, the setup involves:

- Plugging in the power cord and switching power on.
- Performing the 3287 or 3289 checkout procedures.
- Connecting the device cable (coaxial cable from the control unit) to the 3287 or 3289.

## Replacing Other 3270 Units with 3276s and Attached Units

### Replacing a 3271 with One or More 3276s

When a 3271 and its attached units (3277s/3284s/3286s/3287s/3288s) are replaced by one or more 3276s with attached 3278s/3279s/3287s/3289s, special consideration should be given to planning in order to minimize changes to the existing device addresses, power, cables, and modems. Replacing a 3284 or a 3286 with a 3287 requires physical planning, because the 3287 is a table-top unit, whereas the 3284 and the 3286 are floor-standing units.

**Note:** *The 3277 keyboards, keys, and operator ID card readers cannot be used with the 3276/3278/3279.*

### Device Addresses

Both the 3271 and the 3276 can control a cluster of display/printer units. The 3271 can control up to 32 attached units; the control unit portion of the 3276 can control up to 8 units (7 attached units and the 3276 Display Station). Both the 3271 and the 3276 have ports to which the units attach. For problem determination, the 3276 Display Station must be connected to 3276 port 0.

If the configuration of the 3276, of its ports, and of its attached units differs in any way from the configuration of the replaced 3271, its ports, and attached units, the device (program) addresses are affected. For example, the device addresses may be affected when:

- More than one 3276 is required to replace a 3271.
- The 3276 is located at the site of a unit other than the 3277 that was attached to 3271 port 0.

## **Power**

The 3276 is not available with a 208/230 volt power option for the U.S. and Canada. If the 3271 uses these voltages, you may have to arrange to have the power and power receptacles changed. Refer to *IBM 3270 Information Display System: Installation Manual – Physical Planning*, GA27-2787, for power requirements.

## **Cables**

The least amount of change to existing cables occurs when the 3276 is placed at the location of the replaced 3271, because all cluster cables originate from that location. The 3271 is a control unit, whereas the 3276 is both a control unit and a display station that may replace both the 3271 and one of the attached 3277s. It may be necessary, therefore, to locate the 3276 at the site of one of the replaced 3277s, because the location of the replaced 3271 may not be suitable for an operator. When this is the case, the cluster cables have to be rerouted, replaced, or extended to accommodate the new cluster configuration. In addition, it is recommended that the existing device cables (coaxial cables between the 3271 and its attached units) be marked as described under “3276 Device Cables.”

The communication cable that connects the 3271 to its modem cannot be used with the 3276. A new communication cable is delivered with the 3276. The standard cable length is 6.1 metres (20 feet); optional cable lengths of 3.1 metres (10 feet), 9.1 metres (30 feet), and 12.2 metres (40 feet) may be specified. If the 3276 has the loop adapter, the standard cable length is 1.8 metres (6 feet); optional cable length of 4.3 metres (14 feet) may be specified.

**Note:** *All the 3271 cluster cables must be connected/disconnected by an IBM service representative, because the 3271 and its attached units do not have customer access areas.*

## **Modems**

When the 3276 is located at the site of one of the replaced 3277s rather than at the site of the replaced 3271, it may be necessary to relocate the modem, because it can be no more than 12.2 metres (40 feet) from the 3276.

If more than one 3276 is required to replace a 3271, additional modems may be required.

## **Replacing a 3275 with a 3276**

When a 3275 is replaced by a 3276, the 3276 can use the external modem (if applicable) and the device address that were used with the 3275. However, the communication cable that connects the 3275 to its modem or communication facility termination cannot be used with the 3276. A new communication cable is delivered with the 3276. The standard cable length is 6.1 metres (20 feet); optional cable lengths of 3.1 metres (10 feet), 9.1 metres (30 feet), and 12.2 metres (40 feet) may be specified.

**Notes:**

1. *The 3275 keyboards, keys, and operator ID card reader cannot be used with the 3276.*
2. *The 3276, when operating in BSC mode, functions as a 3271 Control Unit, but is not compatible with a 3275. See IBM 3270 Information Display System: Component Description, GA27-2749, for differences.*

When a 3275 with an attached 3284-3 is replaced by a 3276 with an attached 3287 or 3289, the communication cable and the device addresses have to be changed. If a 3284-3 is replaced with a 3287, physical planning is also necessary, because the 3287 is a table-top unit, whereas the 3284-3 is a floor-standing unit. The device addresses have to be changed because a 3284-3 that is attached to a 3275 does not have a unique device address, whereas a 3287 or 3289 that is attached to a 3276 must be assigned a unique device address.

**Note:** *The 3275 and 3284-3 units must be connected/disconnected by an IBM service representative, because these units do not have customer access areas.*

## Problem Determination Procedures

The problem determination procedures will help you perform problem determination with minimal reliance on the host system. These procedures use tests contained in the 3276, 3278, 3279, 3287, and 3289 units and are described in the Problem Determination Guides, one guide for each unit type. See Figure P-5, "Problem Determination Manuals" in the Preface.

The procedures enable you to determine whether a problem is being caused by a cluster unit, a system unit or function outside the 3276 cluster, or an operator error. You will also be able to determine whether:

- Operation in a degraded mode is possible.
- Useful work can be done until the problem is corrected.
- The repair action can be scheduled for deferred maintenance.

If you require the help of an IBM service representative, the error message and error condition information should be recorded on a Problem Report Form for the failing unit before the service representative is called. This information will help the service representative resolve the problem as soon as possible.

## Relocation/Removal

To ensure proper handling and/or shipping of the 3276 and the attached 3278s/3279s/3287s/3289s when the units are removed or relocated to a different room, building, or mailing address, it is recommended that you call your local IBM branch office. Your IBM representative will supply you with the necessary information and can order the required materials.

## Progress Review

To ensure a smooth setup of the 3276 and its attached units, it is recommended that approximately two months before delivery of the units you and your IBM representative review (1) the progress (or the schedule associated with the changes) at the host system site, (2) the communication network and modems, (3) the physical changes needed at the cluster site, and (4) the progress of the pre-delivery planning tasks. At the same time, you can review the cluster configuration to determine whether the feature mix is adequate.

It is also recommended that about two weeks before delivery of the units the project leader and the setup personnel review the setup instructions with the IBM representative.

## IBM Americas/Far East and IBM Europe/Middle East/Africa

The pre-delivery/setup responsibilities and procedures for a 3276 with an *external* modem, the 3278, the 3279, the 3287, and the 3289 are the same for U.S. installations and for countries served by IBM A/FE and IBM E/ME/A. The pre-delivery/setup responsibilities and procedures for a 3276 with an *integrated* modem for A/FE and E/ME/A countries are the same as those for the U.S., with the following exceptions:

- Connection of the 3276 communication cable to the communication facilities. In countries where it is permissible, you can connect the 3276 to the communication facilities. Where the local (country) regulations require a manufacturer's representative to make the connection, it is recommended that arrangements be made to have an IBM service representative make the connection. If you do not know whether it is permissible for you to make this connection, ask your IBM representative for guidance.
- Communications checks. If communications checks are experienced when attempting to communicate with the host system, ask your IBM service representative for guidance.

If you need IBM publications in languages other than English, consult your IBM representative. The IBM representative can provide information concerning the availability of translated IBM publications.

## Supplemental Information

### Safety

The 3276 cluster units are listed by the Underwriters' Laboratory. Exposed hazardous voltages are not present at the designated customer access areas of the 3274, 3276, 3278, 3279, 3287, and 3289 units.

#### **DANGER**

**Your personnel should be warned not to go beyond the customer access areas, because hazardous voltages are present within the areas designated for trained personnel only.**

Electrical grounding of the 3276 and all the attached units is essential for safety; be sure that all the facility power receptacles are properly grounded and will accept a grounding type plug (3-prong or equivalent). If you have any questions about the grounding of power receptacles, ask an electrician. For information about power cord plugs, power receptacles, and other safety considerations, refer to *IBM 3270 Information Display System: Installation Manual – Physical Planning*, GA27-2787.

### Security

If the 3276 and the attached units may have access to proprietary records or personnel records, it is recommended that you implement appropriate safeguards for the security of the information and the units. IBM makes available some basic functions, but you should decide which ones to use. In addition to safeguards that you may develop, the Security Keylock and Magnetic Reader Control features, and the Magnetic Slot Reader accessory, may be ordered for 3276s, 3278s, and 3279s. In addition, the 3276 Address Keylock feature is available to enable you to control access to the 3276 SDLC/BSC address



switches. Also available with certain models of the 3276 is an Encrypt/Decrypt feature that enhances data security in an SNA-communications environment.

## Personnel Training

If you intend to provide formal training for your operators, you can use the following operator's guides as texts:

*IBM 3276 Control Unit Display Station Operator's Guide, GA18-2040*

*IBM 3278 Display Station Operator's Guide, GA27-2890*

*IBM 3279 Color Display Station Operator's Guide, GA33-3057*

*IBM 3287 Printer Models 1 and 2 Operator's Guide, GA27-3150*

*IBM 3287 Printer Models 1C and 2C Operator's Guide, G27-3230*

*IBM 3289 Line Printer Models 1 and 2 Operator's Guide, GA27-3147*

The operator's guides describe the basic capabilities of the 3270 units. It is recommended that you use this information to prepare operating procedures for your unique operations. Problem Determination Guides for the 3276, 3278, 3279, 3287, and 3289 are delivered with these units to assist operators in determining when an error has been made or when the equipment is not performing properly.

## Supplies

The following supplies may be required, depending upon the types of terminals, devices, and features installed.

- Ribbon: Black, IBM Part 1136653 or a customer-selected equivalent, used by the 3287-1 and 2.
- Ribbon: Black, IBM Part 7032482 or customer selected equivalent, used by 3287-1C and 2C for all black printing.
- Ribbon: Multi-colored, IBM Part 7032483 or customer selected equivalent, used by 3287-1C and 2C for multi-color printing.
- Ribbon: Black, IBM Part 1136634 or a customer-selected equivalent, used by the 3289-1.
- Ribbon: Black, IBM Part 1136670 or a customer-selected equivalent, used by the 3289-2.
- Paper: Single-part continuous or multipart (six-part maximum) for the 3287s and 3289s. See *Forms Design Reference Guide for Printers*, GA24-3488.
- Spare magnetic stripe cards.
- Hexadecimal address labels: IBM Part 1743290.
- Mercury Battery: IBM Part 1743456.

## **Voice Communication between 3276 Cluster Operators and Host System Operators**

It is recommended that a telephone be available at each location to allow the 3274/3276 cluster operators to talk with the host system operators or network coordinators. This will assist the operators in performing the problem determination procedures as well as the daily work.

### **Reference Manuals**

See Figure P-1 through P-5 in the Preface for publications that may help you to plan the installation of your equipment.

**This page is intentionally left blank**

## Appendix A. Planning Checklist

This planning checklist (Figure A-1) is provided as a sample plan. The plan may have to be modified to accommodate your unique system/cluster configuration.

Weeks Before Delivery	Schedule Date	Responsibility		✓	Event
		Customer	IBM		
16	_____	X			Designate a person in your organization who will be responsible for all phases of the cluster installation.
		X	X		Review this planning guide with the person designated above.
		X			Decide who will install (1) the device cables between the 3276 and the attached units and (2) the power receptacles, wiring, etc. (your maintenance personnel or a contractor).
		X	X		Determine the schedule dates with the IBM representative. <sup>1</sup> Fill in the dates on this form and give a copy to the IBM representative.
		X			Identify and schedule data communication needs. Identify the source for communication line (call telephone company). Order modems as required.
14	_____	X			Lay out the floor plan. Show locations of modems and cluster units.
		X			Order supplies (refer to "Supplies" list).
		X	X		Review the overall installation plan with IBM representative.
		X			Place order for device cables (coaxial cables between 3276 and attached units) from IBM or a contractor, or order the materials to make the cables yourself. Refer to <i>Installation and Assembly of Coaxial Cable and Accessories for Attachment to IBM Products</i> , GA27-2805.
12	_____	X			Determine whether changes are required to the existing programs (system control program, network control program, program products, and application programs. (Refer to <i>Introduction to Programming the IBM 3270</i> , GC27-6999, and <i>3270 Component Description</i> , GA27-2749.) If so, schedule the required changes.
		X			Determine whether changes are required to the existing data processing units (host system computer, 2701, 2703, 3704, and 3705). If so, schedule the required changes.

<sup>1</sup>If you have purchased the Magnetic Slot Reader feature, be aware that it may not arrive at the same time as your 3276, 3278, or 3279.

Figure A-1 (Part 1 of 3). Planning Checklist, Sample Plan

Weeks Before Delivery	Schedule Date	Responsibility		✓	Event
		Customer	IBM		
12		X			Arrange for the installation of (1) the device cables between the 3276 and the attached units and (2) the power receptacles, wiring, etc.
		X			Define a training program for employees.
		X			Order the required 3276, 3278, 3279, 3287, and 3289 manuals.
10	_____	X			Review the progress of the data communication plan. Identify and resolve any schedule conflicts.
9	_____	X	X		Review the cluster configuration to make sure the configuration meets your requirements. Make any necessary changes to your order.
8	_____	X	X		Review the installation plan to define any exposure to schedule.
		X	X		Confirm the arrival of package containing cluster cables.
		X			Start installing and labeling cluster cables and power receptacles.
6	_____	X			Start employee training.
			X		IBM representative checks progress of site preparation.
4	_____	X			Receive supplies (magnetic stripe cards, forms, etc.).
		X			Complete the installation of cables and power receptacles.
2	_____	X			Complete the checkout of the cables and power: continuity and polarity tests of cluster cables, power receptacles, and safety considerations.
		X			Complete the required changes to the existing programs and data processing units.
		X			Complete the site preparation.
		X			Install communication facilities (telephone line and modems).
		X			Make sure all the necessary information is available for the setup personnel (switch settings, configuration information, customizing form, etc.).
		X			Review setup instructions with the setup personnel.

Figure A-1 (Part 2 of 3). Planning Checklist, Sample Plan

Weeks Before Delivery	Schedule Date	Responsibility		✓	Event
		Customer	IBM		
Arrival of Units	_____	X			Move the units to locations. Unpack per unpacking instructions.
		X			Read the setup instructions.
		X			Complete setup of the 3276, 3278s, 3279s, 3287s, and 3289s using the setup instructions in- cluded in the shipping cartons.

Figure A-1 (Part 3 of 3). Planning Checklist, Sample Plan

This page is intentionally left blank

## Appendix B. 3276 Device Cable Attachment

Use the table and the figure below to connect the device cables to the 3276 ports.

1. Use a push-and-twist motion to the right to connect and lock the device cables to the port sockets.
2. Connect the device cable identified for port 1 to the port 1 socket, port 2 to the port 2 socket, and so on. Connect the cables in numeric order, starting at port 1.

**Note:** Port 0 must be the 3276 Integral Display.

### CAUTION

**Do not connect or disconnect device cables during an electrical storm.**

3276 Port	BSC Device No.	SNA LU Address	Cable Identification	Unit Type	Unit Location	Telephone Nearest the Unit
0	0	02	Integrated Cable	3276 Integral Display		
1	1	03				
2	2	04				
3	3	05				
4	4	06				
5	5	07				
6	6	08				
7	7	09				

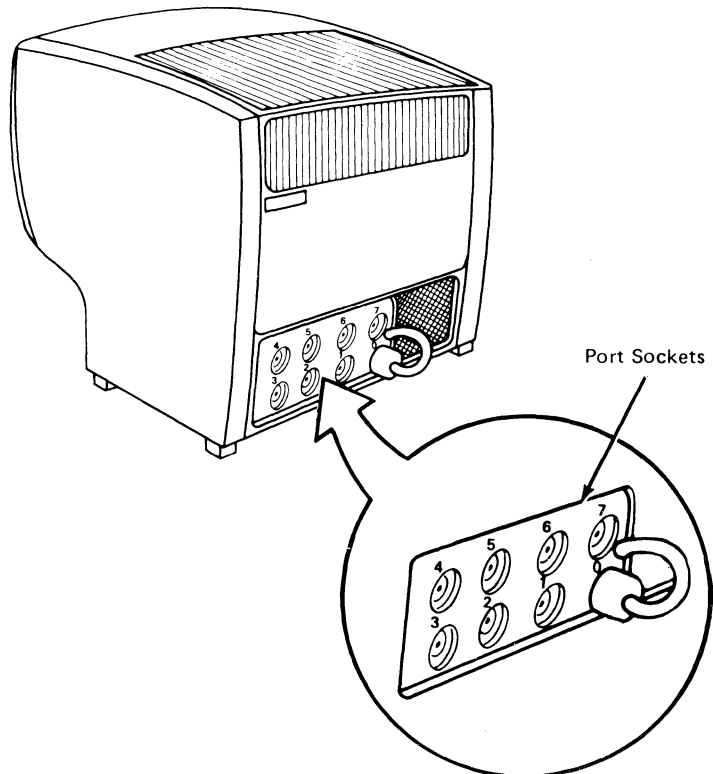



This page is intentionally left blank

## Appendix C. 3276 Communication Cable Connection Instructions

### 3276 Communication Cable Connection Instructions 3276 with an Integrated Modem Attached to a Nonswitched Line (U.S. and Canada only)

- Plug the four-prong plug attached to the communication cable marked **NONSWITCHED** into the four-pin receptacle connected to the nonswitched line.

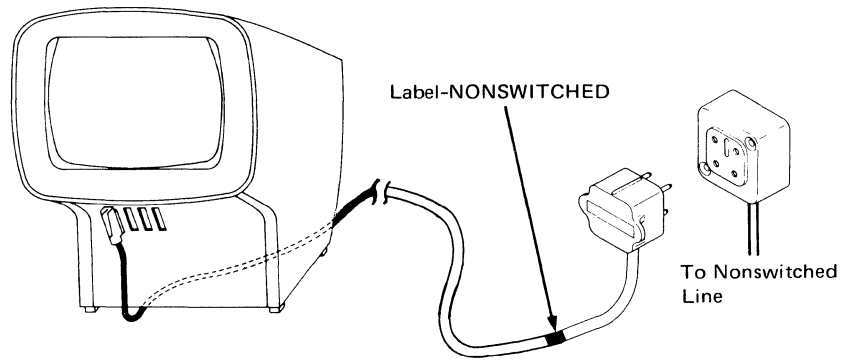

**3276 Communication Cable Connection Instructions**  
**3276 with an Integrated Modem Attached to a Nonswitched Line**  
*(Japan only)*

You will receive the following parts in the customer envelope when the 3276 is delivered to your site.

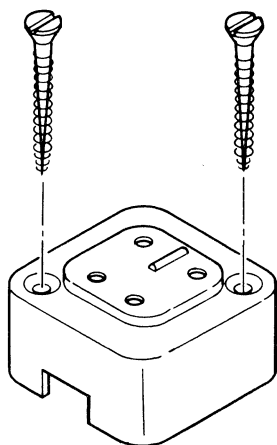

**1** Four-pin Receptacle  
(with two screws)

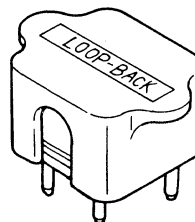

**2** LOOP-BACK Plug

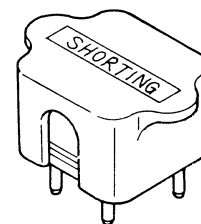

**3** SHORTING Plug

- Keep the LOOP-BACK plug **2** and SHORTING plug **3** in a convenient place for future use. (When required, the NTT may ask you to use them for testing the communication lines or associated equipment.)

The four-pin receptacle **1** is for the 3276 communication cable connection, and should be connected to the NTT non-switched line through the NTT-provided device, PD-1A, according to the following instructions:

- Connect one end of a pair cable to the R and GN terminals of the four-pin receptacle **1**. Connect the opposite end to the DS terminals of the PD-1A.
- Connect one end of another pair cable to the Y and BK terminals of the four-pin receptacle **1** and the opposite end to the DR terminals of the PD-1A.

Four-pin Receptacle **1**

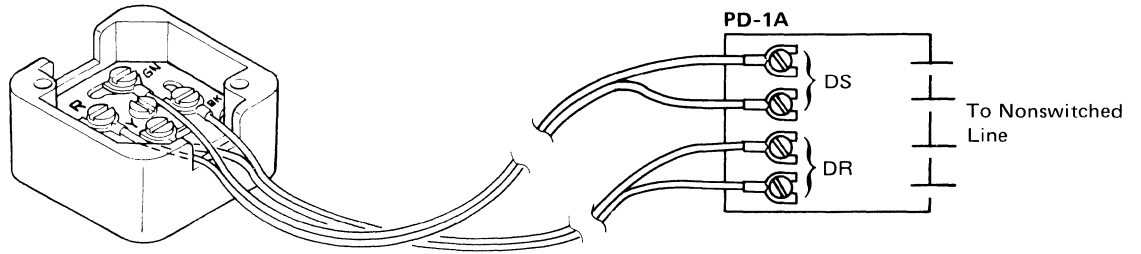

- Attach the four-pin receptacle **1**, using the two screws supplied, to a place that is convenient to connect the communication cable from the 3276.
- Plug the four-prong plug attached to the communication cable marked NON-SWITCHED into the four-pin receptacle connected to the nonswitched line.

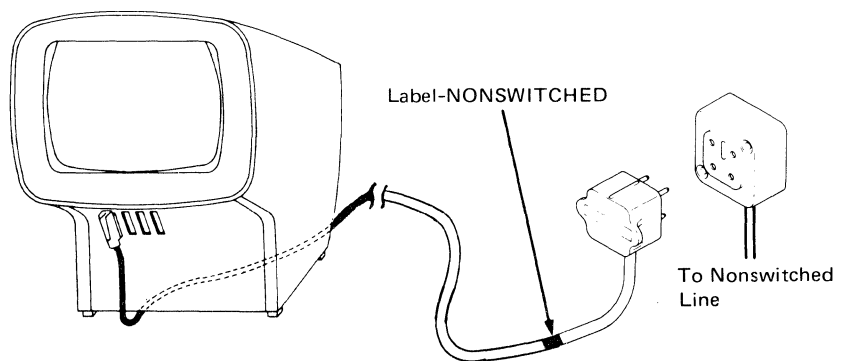

## 3276 Communication Cable Connection Instructions

### 3276 with an Integrated Modem Attached to a Switched Line with Manual Answer

*(U.S. and Canada Only)*

- Plug the four-prong plug attached to the communication cable marked SWITCHED into the four-pin receptacle connected to the data coupler.

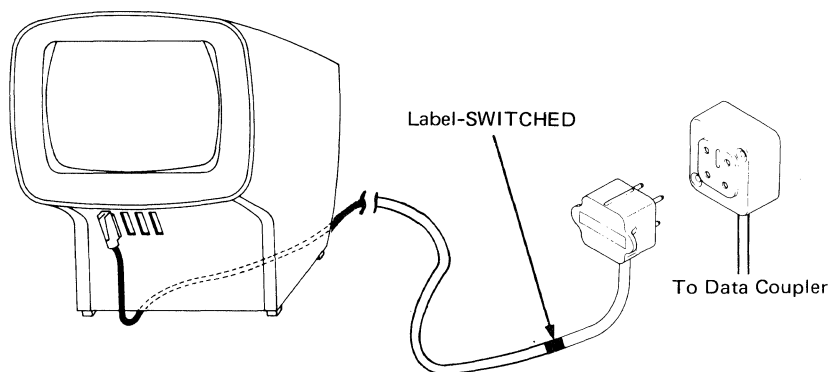

**3276 Communication Cable Connection Instructions**  
**3276 with an Integrated Modem Attached to a Nonswitched Line with Switched**  
**Network Backup (SNBU) and Manual Answer**  
*(U.S. and Canada Only)*

- Plug the four-prong plug attached to the communication cable marked **NONSWITCHED** into the four-pin receptacle connected to the nonswitched line.
- Plug the four-prong plug attached to the communication cable marked **SWITCHED** into the four-pin receptacle connected to the data coupler.

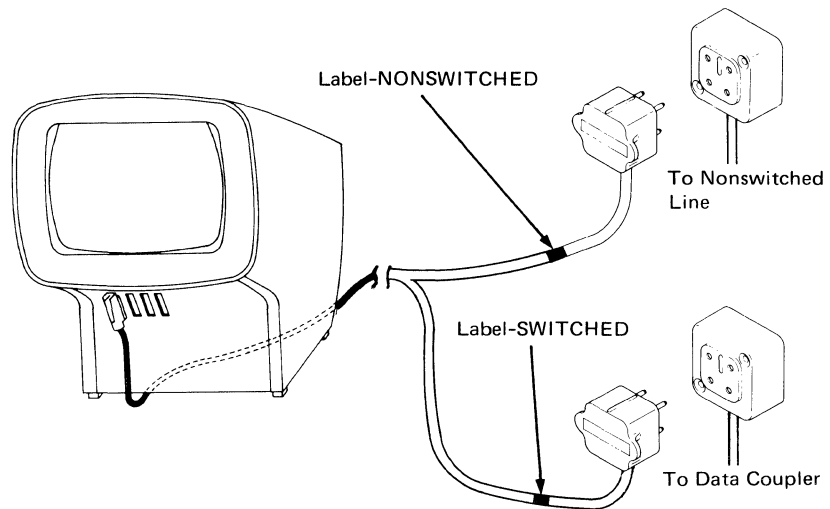

**Note:** *It is recommended that:*

- *The four-pin receptacle from the data coupler (Type CBS or CDT, or FCC-certified equivalent) be labeled SWITCHED LINE.*
- *The four-pin receptacle from the nonswitched line be labeled NONSWITCHED LINE.*

### 3276 Communication Cable Connection Instructions

### 3276 with an Integrated Modem Attached to a Nonswitched Line with Switched Network Backup (SNBU) and Auto-Answer

(U.S. and Canada Only)

- Plug the four-prong plug attached to the communication cable marked NONSWITCHED into the four-pin receptacle connected to the nonswitched line.
- Attach the communication cable's color-coded wires to the data coupler, as shown in the following table and diagram.

Coupler Terminal	Wire Color
DR	Black
DT	White
RI	Violet
OH	Blue
CCT	Brown
DA	Yellow
SG	Gray
SH	Red

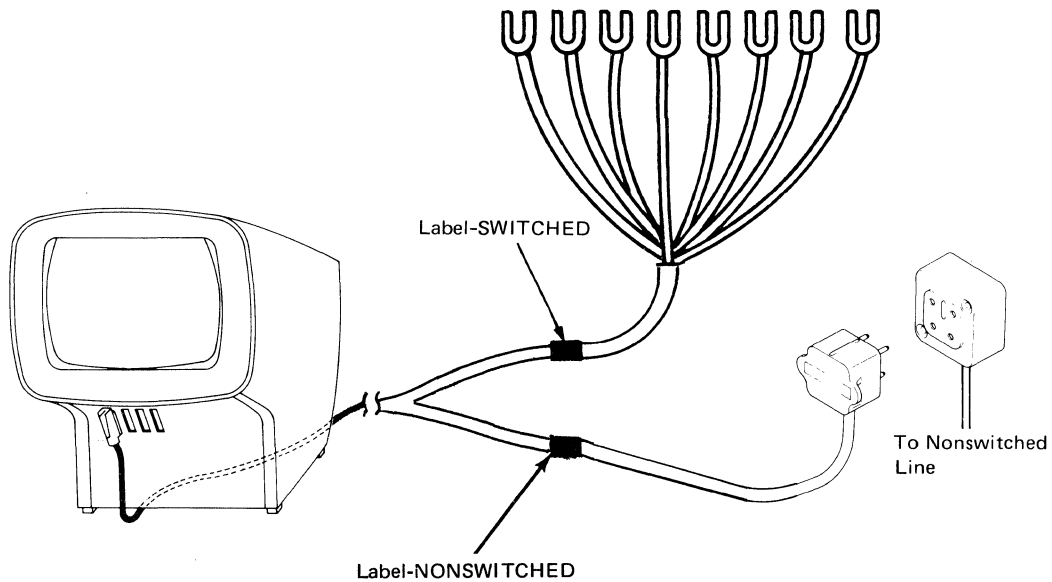
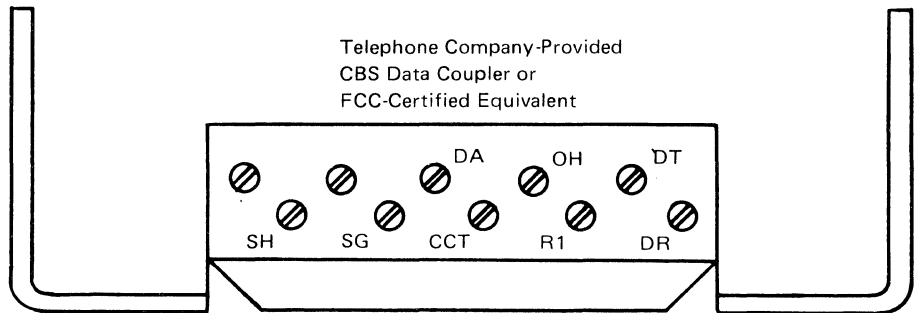

**3276 Communication Cable Connection Instructions**  
**3276 with an Integrated Modem Attached to a Switched Line with Auto-Answer**  
*(U.S. and Canada Only)*

- Attach the communication cable's color-coded wires to the data coupler as shown in the following table and diagram.

Coupler Terminal	Wire Color
DR	Black
DT	White
R1	Violet
OH	Blue
CCT	Brown
DA	Yellow
SG	Gray
SH	Red

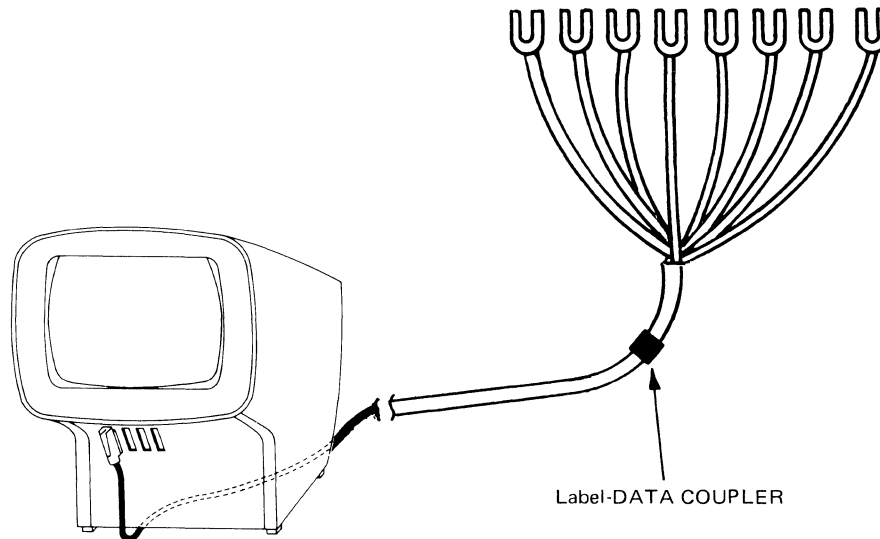
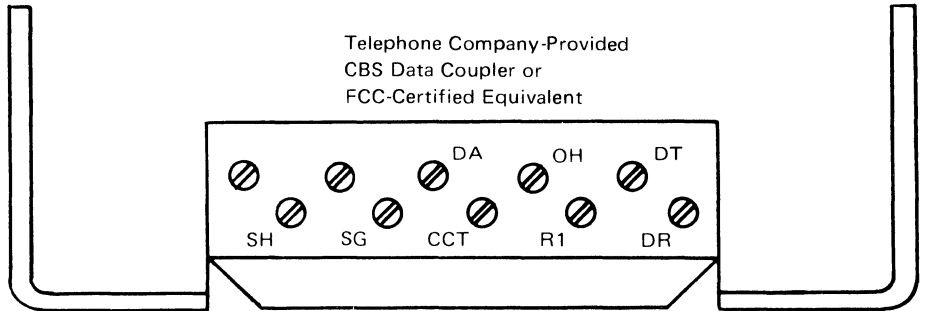



**3276 Communication Cable Connection Instructions**  
**3276 with an External Modem Attached to a Switched or Nonswitched Line**  
*(All Countries Except United Kingdom Datel modem)*

You have received either a single or a dual (two cable sections joined by a connector) communication cable with your 3276. Follow the instructions that apply to the cable you received.

**Single Cable:**

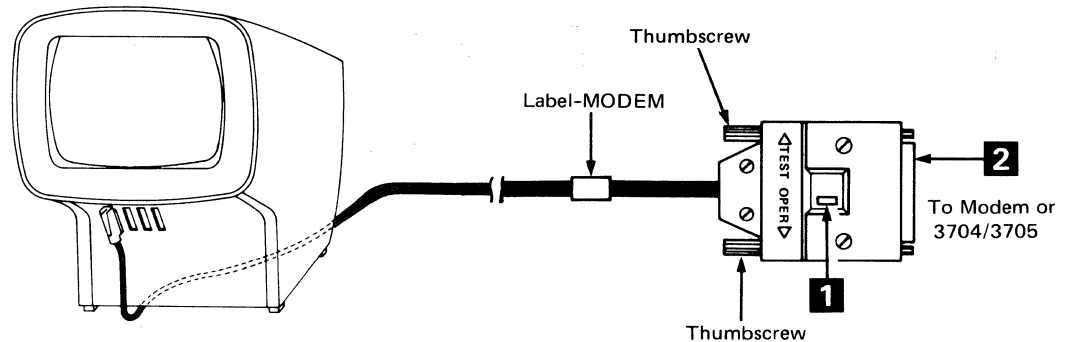

- Set the TEST/OPER switch **1** to the OPER position. If you are in Japan, read the Note: on this page first, then continue with "Thumbscrew Replacement Instructions"
- Connect the cable plug **2** to the modem or to the 3704/3705 Line Set 1F Interface Cable connector (for 3276 direct attachment to a 3704/3705). Tighten the thumbscrews of the cable plug securely with your fingers.

**Note (If you are in Japan):** *The black thumbscrews on the communication cable shipped to you are made with metric threads and are attachable to NTT modems or their equivalents. If your modem is an IBM 3872 or 3874, or any other modem using an English-unit connector, the black thumbscrews must be replaced with the silver thumbscrews (made with English threads) provided in the customer envelope.*

**Thumbscrew Replacement Instructions:**

1. Remove the black thumbscrews **A** by pulling them in the direction of the arrows. (Don't be afraid to apply necessary force.)

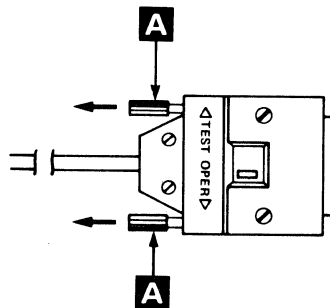

2. Insert the silver thumbscrews provided in the customer envelope by pushing them in the reverse direction of the arrows until the end of each thumbscrew appears outside of the hood.

**Note:** *You should keep the removed thumbscrews in the customer envelope for later use; the modem may be changed or the terminal may be relocated.*

**Dual Cable:**

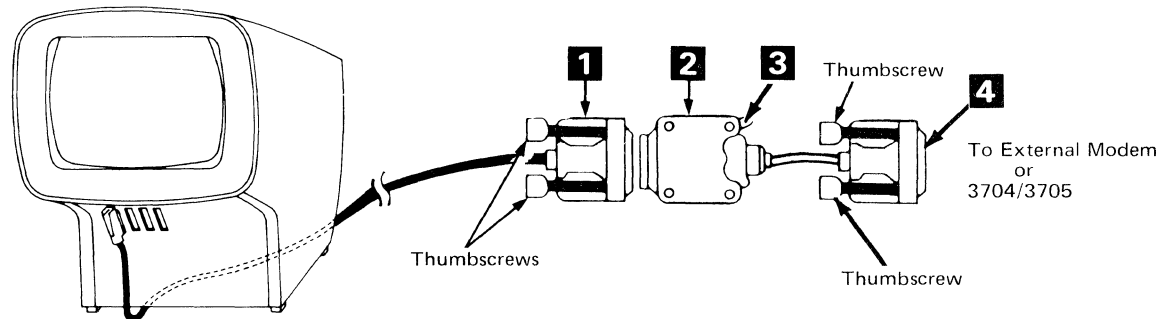

- Connect the cable plug **1** (on the long section of the communication cable) to the socket **2** on the short section of the communication cable. Tighten the thumbscrews of the cable plug **1** securely with your fingers.
- Set the TEST/OPER switch **3** to OPER.
- Connect the cable plug **4** to the modem or to the 3704/3705 Line Set 1F Interface Cable connector (for 3276 direct attachment to a 3704/3705). Tighten the thumbscrews of the cable plug **4** securely with your fingers.

**3276 Communication Cable Connection Instructions**  
**3276 with an External Modem Attached to a Switched or Nonswitched Line**  
( *United Kingdom Datel Modem* )

You have received either a Version 1 or Version 2 communication cable with your 3276. Follow the instructions that apply to the version you received.

Version 1 Cable

- Connect the cable plug **1** attached to the long communication cable to the socket **2** of the 0.4-metre (15-in.) communication cable. Tighten the thumbscrews of the cable plug **1** securely with your fingers.
- Set the TEST/OPER switch **3** to OPER.
- Connect the cable plug **4** on the other end of the 0.4-metre (15-in.) cable to the modem.

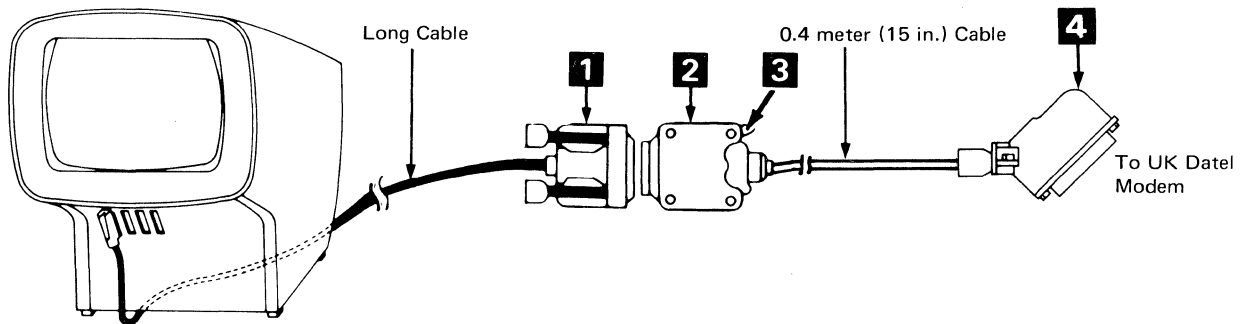

Version 2 Cable

- Connect the cable plug **1** attached to the long communication cable labeled MODEM to the socket **2** of the 0.4-metre (15-in.) communication cable. Tighten the thumbscrews of cable plug **1** securely with your fingers.
- Set the TEST/OPER switch **3** to the OPER position.
- Connect the cable plug **4** on the other end of the 0.4-metre (15-in.) cable to the modem.

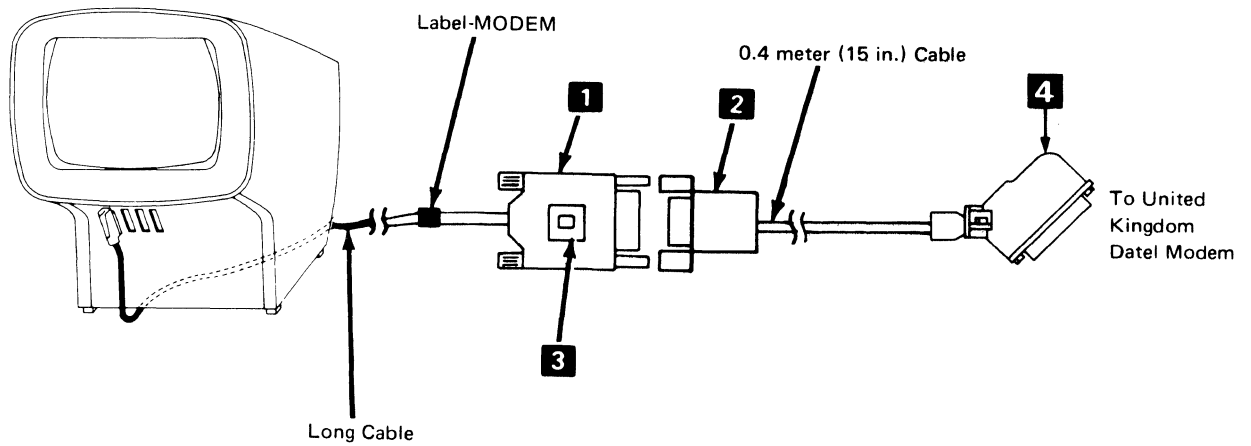

## 3276 Communication Cable Connection Instructions

### 3276 with an Integrated Modem Attached to a Switched Line with Auto-Answer

(All Countries except U.S. and Canada)

**Note:** The communication cable labeled NONSWITCHED-A is not used in this configuration.

- Connect the Switched Lines (White and Red) wires of the section of the communication cable labeled SWITCHED-B to the Telephone Line terminals of the PTT connection block. Either wire may be connected to either terminal.
- Connect the Telephone Set (Black and Yellow) wires of the section of the communication cable labeled SWITCHED-B to the Telephone Set terminals of the PTT connection block. Either wire may be connected to either terminal.

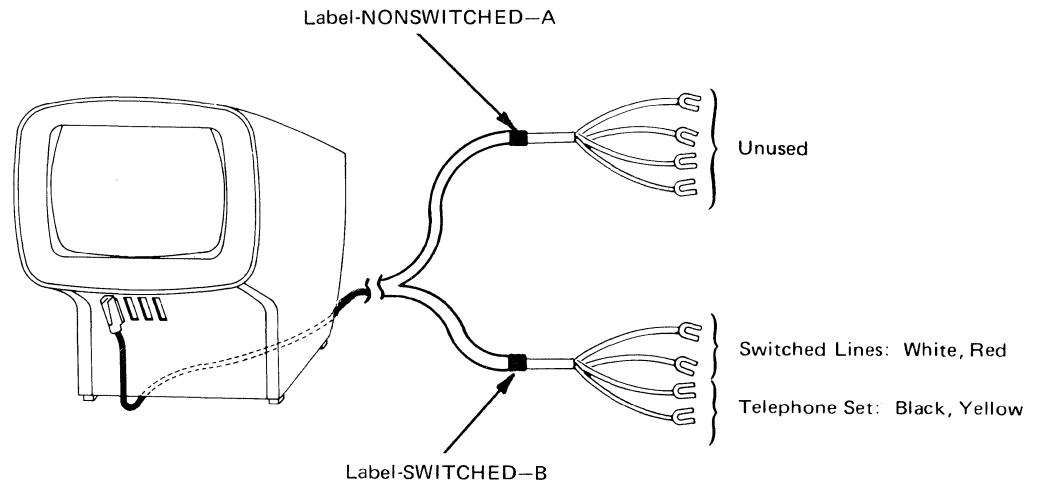

**3276 Communication Cable Connection Instructions**  
**3276 with an Integrated Modem Attached to a Nonswitched Line**  
**with Switched Network Backup (SNBU) and Auto-Answer**  
*(All Countries except U.S. and Canada)*

- Connect the Transmit Pair (White and Red) wires of the cable labeled NONSWITCHED—A communication cable to the communication facility termination as follows:
  - White wire to -XMIT terminal
  - Red wire to +XMIT terminal
- Connect the Receive Pair (Black and Yellow) wires of the cable labeled NONSWITCHED—A communication cable to the communication facility termination as follows:
  - Black wire to +REC terminal
  - Yellow wire to -REC terminal
- Connect the Switched Lines (White and Red) wires of the cable labeled SWITCHED—B communication cable to the Telephone Line terminals of the PTT connection block. Either wire may be connected to either terminal.
- Connect the Telephone Set (Black and Yellow) wires of the cable labeled SWITCHED—B communication cable to the Telephone Set terminals of the PTT connection block. Either wire may be connected to either terminal.

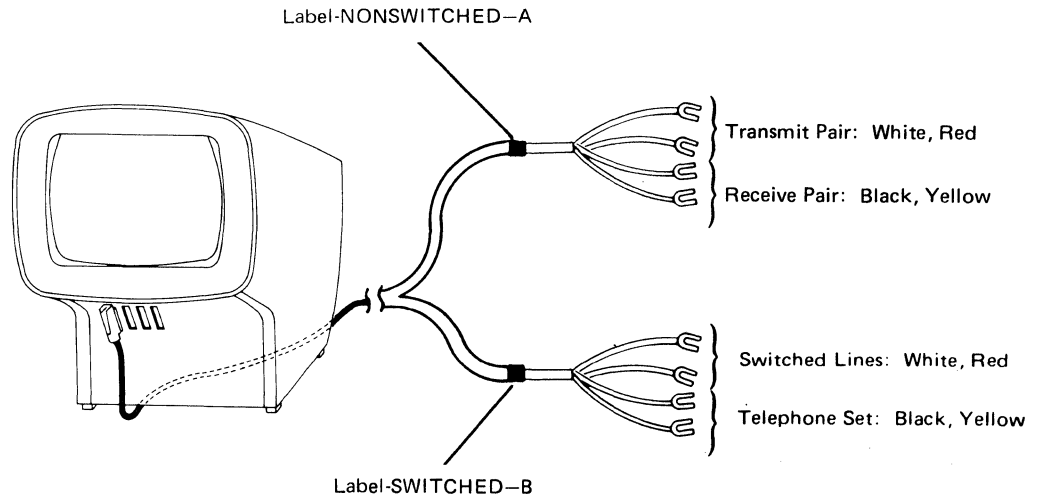

**3276 Communication Cable Connection Instructions**  
**3276 with an Integrated Modem Attached to a Nonswitched Line**  
*(All Countries except U.S., Canada, and Japan)*

- Connect the Transmit Pair (White and Red) wires of the communication cable labeled NONSWITCHED to the communication facility termination as follows:
  - White wire to -XMIT terminal
  - Red wire to +XMIT terminal
- Connect the Receive Pair (Black and Yellow) wires of the communication cable labeled NONSWITCHED to the communication facility termination as follows:
  - Black wire to +REC terminal
  - Yellow wire to -REC terminal

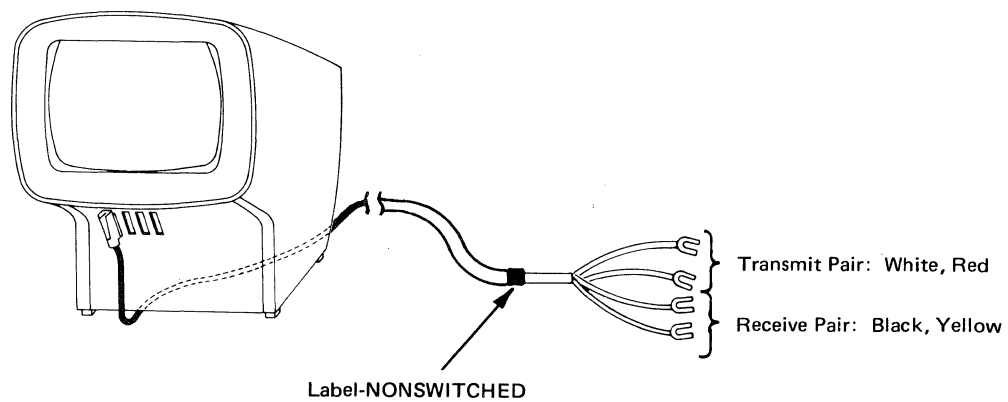

**3276 Communication Cable Connection Instructions**  
**3276 with Digital Data Service Adapter (DDSA) Attached to**  
**A.T.&T. Channel Service Unit**  
*(U.S. only)*

- Set the TEST/OPER switch **1** to the OPER position.
- Connect the cable plug **2** on the end of the cable labeled CSU to the channel service unit. Tighten the thumbscrews of the cable plug **3** securely with your fingers.

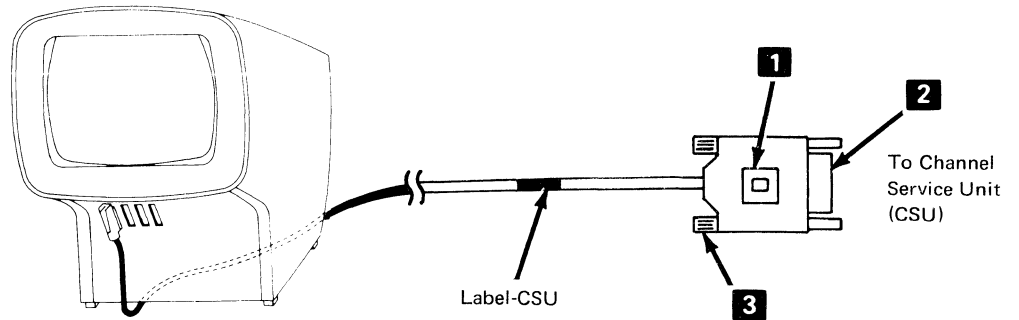



**3276 Communication Cable Connection Instructions**  
**3276 with a Loop Adapter Attached to a Loop**  
*( All Countries )*

The 3276 communication cable that attaches to the loop is called the Loop Station Connector (LSC) cable.

- Plug the LSC cable connector **3** into the LSC receptacle **2** from the loop. Push the connector until it snaps into the receptacle.

**Note:** *To disconnect the LSC cable from its receptacle, press the locking button **1** on the LSC connector as far as it will go and pull the connector from the receptacle.*

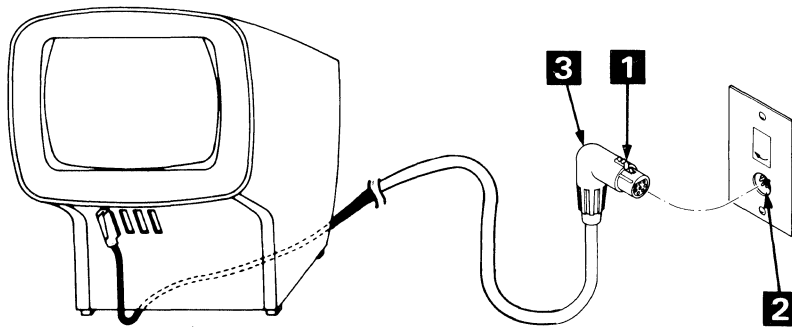

## Appendix D. 3276 Switches

**Note:** *To be effective, switches must be set when 3276 power is off. Changing a switch position when power is on has no effect. Exceptions: Primary Line Speed/Secondary Line Speed and SNBU switches may be changed while power is on.*

This appendix describes only the switches associated with matching the 3276 to the host system and to the communication facilities; operational switches are not included. Instructions for completing the 3276 Switch Settings Form (at the end of this appendix) are included in each description. It is recommended that the planner:

1. Review all switch descriptions and determine the correct setting for all applicable switches.
2. Enter the switch settings on the form.
3. Cross out all form entries that are not needed.
4. Supply the completed form to the 3276 setup personnel.

### Switches A1 – A8: SDLC Address Switches

These eight switches (labeled “A” on the control panel) are set to correspond to the SDLC control unit address of the 3276. When the 3276 has the SDLC/BSC Switch feature, the “A” switches are effective when the SDLC/BSC switch is set to SDLC; the settings of the “A” switches are therefore important if SDLC line control is used. However, if you wish to switch alternately between SDLC and BSC line control, both the “A” and “B” switches must be set to correspond to the correct addresses.

To determine the “A” switch settings, first obtain the control unit address (in hexadecimal) from the system programmer. Then use the chart in Figure D-1 to find the “A” switch (SDLC Address switch) settings. A “1” in the figure represents a switch set to ON; a “0” represents a switch set to OFF. For example, a control unit address of hexadecimal 02 requires that switches A1 through A6 and switch A8 be set to OFF and switch A7 to ON.

In Figure D-1, note that hexadecimal addresses 30 through E0 are bracketed. To determine the switch settings for control unit address C8, for example, first find address C0. Address C0 requires that switches A1 and A2 be set to ON and switches A3 and A4 to OFF. Next, find address 08. Address 08 requires that switch A5 be set to ON and switches A6, A7, and A8 to OFF.

Item 1 in the example of a completed 3276 Switch Settings Form (Figure D-6, at the end of this appendix) shows how the form should be filled in for SDLC address C8. Fill in item 1 on the form.

### Switches B1 – B5: BSC Control Unit Address Switches (Except Loop Adapter Feature Machines)

These five switches (labeled “B” on the control panel) are set to correspond to the BSC control unit address of the 3276. When the 3276 has the SDLC/BSC Switch feature, the “B” switches are effective when the SDLC/BSC switch is set to BSC; the settings of the “B” switches are therefore important if BSC line control is used. However, if you wish to switch alternately between SDLC and BSC line control, both the “A” and “B” switches must be set to correspond to the correct addresses.

Control Unit Hex Address	SDLC Address Switches <sup>1</sup> 12345678	Control Unit Hex Address	SDLC Address Switches <sup>1</sup> 12345678	Control Unit Hex Address	SDLC Address Switches <sup>1</sup> 12345678
01	00000001	1A	00011010	60	01100000
02	00000010	1B	00011011	70	01110000
03	00000011	1C	00011100	80	10000000
04	00000100	1D	00011101	90	10010000
05	00000101	1E	00011110	A0	10100000
06	00000110	1F	00011111	B0	10110000
07	00000111	20	00100000	C0	11000000
08	00001000	21	00100001	D0	11010000
09	00001001	22	00100010	E0	11100000
0A	00001010	23	00100011	F0	11110000
0B	00001011	24	00100100	F1	11110001
0C	00001100	25	00100101	F2	11110010
0D	00001101	26	00100110	F3	11110011
0E	00001110	27	00100111	F4	11110100
0F	00001111	28	00101000	F5	11110101
10	00010000	29	00101001	F6	11110110
11	00010001	2A	00101010	F7	11110111
12	00010010	2B	00101011	F8	11111000
13	00010011	2C	00101100	F9	11111001
14	00010100	2D	00101101	FA	11111010
15	00010101	2E	00101110	FB	11111011
16	00010110	2F	00101111	FC	11111100
17	00010111	30	00110000	FD	11111101
18	00011000	40	01000000	FE	11111110
19	00011001	50	01010000		

<sup>1</sup> "A" Switches  
 1 = Switch ON  
 0 = Switch OFF

<sup>2</sup> Use addresses 01 - 0F as necessary.  
 Ex: Address AD = A0 10100000  
 + 0D 00001101  
 AD 10101101

Figure D-1. SDLC Address Switch Setting (Switches A1-A8)

To determine the "B" switch settings, first obtain the control unit *number* (decimal 0-31) or the control unit *address* (in EBCDIC hexadecimal) from the system programmer. Using either address designation, look up the "B" switch settings in Figure D-2. For example, a control unit address of hexadecimal 5A (control unit number of decimal 26) requires that switches B1, B2, and B4 be set to ON and switches B3 and B5 to OFF.

Item 2 in the example of the 3276 Switch Settings Form (Figure D-6, at the end of this appendix) shows how the form should be filled in for control unit address 5A (control unit 26). Fill in B1-B5 of item 2 on the form.

### Switch B6: Full-Duplex (FDX)/Half-Duplex (HDX) Switch (Except Loop Adapter Feature Machines)

In the HDX (OFF) position, this switch causes noncontinuous carrier operation. That is, the Request to Send lead to the modem is on only when the 3276 wants to transmit. The switch should be set to HDX when:

- BSC or SDLC protocol is being used in 2-wire operation.
- SDLC protocol is being used in 4-wire, leased-line, multipoint operation.

When the host modem has the NEWSYNC feature and the required host program support, the HDX(OFF) position *must* be selected.

Control Unit Address					
EBCDIC Poll Address (Hex)	EBCDIC Selection Address (Hex)	ASCII Poll Address (Hex)	ASCII Selection Address (Hex)	CU No. (Decimal)	BSC Address Switches 12345
40	60	20	2D	0	00000
C1	61	41	2F	1	00001
C2	E2	42	53	2	00010
C3	E3	43	54	3	00011
C4	E4	44	55	4	00100
C5	E5	45	56	5	00101
C6	E6	46	57	6	00110
C7	E7	47	58	7	00111
C8	E8	48	59	8	01000
C9	E9	49	5A	9	01001
4A	6A	5B	7C	10	01010
4B	6B	2E	2C	11	01011
4C	6C	3C	25	12	01100
4D	6D	28	5F	13	01101
4E	6E	2B	3E	14	01110
4F	6F	21	3F	15	01111

Control Unit Address					
EBCDIC Poll Address (Hex)	EBCDIC Selection Address (Hex)	ASCII Poll Address (Hex)	ASCII Selection Address (Hex)	CU No. (Decimal)	BSC Address Switches 12345
50	F0	26	30	16	10000
D1	F1	4A	31	17	10001
D2	F2	4B	32	18	10010
D3	F3	4C	33	19	10011
D4	F4	4D	34	20	10100
D5	F5	4E	35	21	10101
D6	F6	4F	36	22	10110
D7	F7	50	37	23	10111
D8	F8	51	38	24	11000
D9	F9	52	39	25	11001
5A	7A	5D	3A	26	11010
5B	7B	24	23	27	11011
5C	7C	2A	40	28	11100
5D	7D	29	27	29	11101
5E	7E	3B	3D	30	11110
5F	7F	5E	22	31	11111

<sup>1</sup> "B" Switches  
1 = Switch ON  
0 = Switch OFF

Figure D-2. BSC Control Unit Address Switch Setting (Switches B1-B5)

In the FDX (ON) position and

- When SDLC protocol is being used, this switch causes continuous carrier operation by keeping Request to Send on continuously.
- When BSC protocol is being used, this switch causes continuous carrier operation only when the 3276 is selected (to avoid turnaround time). When EOT is detected (sent from either end of the line), carrier operation is turned off.

The switch should be set to FDX (ON) when:

- BSC protocol is being used in 4-wire, point-to-point operation.
- SDLC protocol is being used in 4-wire, point-to-point operation.

In addition,

- If the 3276 is configured for leased-line operation (for example, by Special Feature 3701, External Modem Interface, and Specify Feature 9491, for operation on private nonswitched communication facilities), a jumper wire is installed at the plant of manufacture. The jumper permits switch B6 to be used on a leased line, selecting either continuous carrier or noncontinuous carrier as described above. However, if the leased line goes down, and the terminal is to operate in switched network backup (SNBU) mode, setting the SNBU switch in the SNBU (UP) position forces noncontinuous carrier operation (that is, switch B6 is not operative).
- If the 3276 is configured for full-time switched network operation (that is by Special Feature 3701, External Modem Interface, and Specify Feature 9490, for SDLC operation on public switched network), the jumper wire is omitted. Switch B6 is disabled, and half-duplex (noncontinuous carrier operation) is forced.

The switch should be set as summarized in Figure D-3.

The example (Figure D-6) shows how the 3276 Switch Settings Form should be filled in to set the switch for FDX. Fill in the switch B6 portion of item 2 on the form.

Mode	BSC	SDLC
Switched (3276 only)	N/S	HDX
Nonswitched, 2-wire	HDX	HDX
Nonswitched, 4-wire, point-to-point	FDX	FDX
Nonswitched, 4-wire, multipoint	FDX	HDX
Host modem with NEWSYNC feature	HDX	HDX

N/S = Not supported

Figure D-3. FDX/HDX Switch Setting Summary

### Switch B7: (Except Loop Adapter Feature Machines)

This switch is not used.

### Switch B8: NRZ/NRZI Switch (Except Loop Adapter Feature Machines)

The NRZ (non-return to zero)/NRZI (non-return to zero inverted) switch should be set to define whether your modem uses NRZ or NRZI encoding when the 3276 is using SDLC protocol; no setting is needed if the 3276 uses only BSC protocol. The switch must be set ON for NRZ, and OFF for NRZI.

The setting of this switch is determined by the communication line speed and the type of modem. If the 3276 is attached to an IBM 3872 modem and SDLC is used, this switch should be set to the NRZI (OFF) position. If the 3276 is attached to another modem, it is recommended that you consult the modem manufacturer's representative to determine the correct setting of this switch.

If the 3276 has an integrated modem, NRZI encoding is automatically used and the switch setting has no effect. Neither does the switch setting have an effect when the 3276 is using BSC line control.

Figure D-6 shows how the 3276 Switch Settings Form should be filled in to set the switch for NRZ.

Fill in the switch B8 portion of item 2 on the form.

### Switches B1 – B5: (Loop Adapter Feature Machines Only)

These switch settings are ignored.

### Switches B6 – B8: Line Speed Switches (Loop Adapter Feature Machines Only)

These three switches (labeled B on the control panel) are set to select the primary and secondary line speed. The selection of the primary line speed or secondary line speed is made by setting the Primary Line Speed/Secondary Line Speed switch on the operator panel.

Line Speed (bps) Primary/Secondary	B Switch Position		
	6	7	8
9600/4800	0	0	0
9600/2400	0	1	0
4800/2400	0	0	1
2400/1200	1	0	0
1200/ 600	1	0	1

1 = Switch ON  
0 = Switch OFF

Figure D-3a. Loop Line Speed Switch Settings (Switches B6-B8)

To determine the switch settings, find, in Figure D-3a, the primary and secondary line speeds that your system is going to use. The switch settings will be on the same line in the B Switch Position column.

For your convenience, the B switch setting table is affixed below the B switches, where the Transmit Level switches are shown in Figure D-6.

In Figure D-6, the right half of item 2 shows how the 3276 Switch Settings Form should be completed to set the switches for a primary line speed of 4800 bps and a secondary line speed of 2400 bps. Fill in the switch settings for B6–B8 in the right half of item 2 on the form.

### Transmit Level Switches (U.S. and Canada Only)

These four switches are installed only in 3276s used in the U.S. and Canada that have an integrated modem that attaches to a switched network. These switches are used to match the 3276 Transmit Level to the data coupler (Type CDT, CBS, or FCC-certified equivalent) that is attached to the termination of the communication line. You should consult the data coupler manufacturer's representative to determine the proper dBm<sup>1</sup> level for the data coupler. Use Figure D-4 to determine the correct setting of the Transmit Level switches for the dBm level obtained from the manufacturer's representative; then enter this information in item 3 of the 3276 Switch Settings Form. Figure D-6 shows how the form should be filled in for a Transmit Level of – 5dBm.

In countries other than the U.S. and Canada, the Transmit Level switches are not installed in a 3276 with an integrated modem that attaches to a switched network. In these countries, the transmit level is set at the plant of manufacture in accordance with PTT specifications for the country in which the 3276 is to be installed. (See Figure D-5.) If the transmit levels are suspected of causing a problem, notify your IBM service representative.

<sup>1</sup> Same as decibel (dB), but comparison is to an absolute value of power, 1 milliwatt.

dBm Level	Transmit Level Switches			
	-1dB	-2dB	-4dB	-8dB
0	OFF	OFF	OFF	OFF
-1	ON	OFF	OFF	OFF
-2	OFF	ON	OFF	OFF
-3	ON	ON	OFF	OFF
-4	OFF	OFF	ON	OFF
-5	ON	OFF	ON	OFF
-6	OFF	ON	ON	OFF
-7	ON	ON	ON	OFF
-8	OFF	OFF	OFF	ON
-9	ON	OFF	OFF	ON
-10	OFF	ON	OFF	ON
-11	ON	ON	OFF	ON
-12	OFF	OFF	ON	ON
-13	ON	OFF	ON	ON
-14	OFF	ON	ON	ON
-15	ON	ON	ON	ON

Figure D-4. 3276 Transmit Level Switches

Country <sup>1</sup>	Maximum Transmit Level for a Standard (600 ohms) Load	
	Nonswitched	Switched <sup>2</sup>
Argentina	0 dBm	0 dBm
Austria	- 6 dBm	Not applicable
Belgium	- 6 dBm	Not applicable
Brazil	0 dBm	Not applicable
Canada	- 8 dBm	-12 dBm
Chile	0 dBm	Not applicable
Columbia	0 dBm	0 dBm
Costa Rica	0 dBm	0 dBm
Ecuador	0 dBm	0 dBm
Finland	- 6 dBm	- 6 dBm
France	-13 dBm	-10 dBm
Germany	- 6 dBm	Not applicable
Guatemala	0 dBm	0 dBm
Iceland	- 6 dBm	- 6 dBm
Iran	- 6 dBm	- 6 dBm
Israel	- 6 dBm	- 6 dBm
Italy <sup>3</sup>	-10 dBm (4-wire)	0 dBm
	-13 dBm (2-wire)	0 dBm
Japan	0 dBm	Not applicable
Mexico	0 dBm	Not applicable
Netherlands	- 6 dBm	- 6 dBm
Panama	0 dBm	0 dBm
Switzerland	- 6 dBm (2-wire)	Not applicable
	- 9 dBm (4-wire)	Not applicable
U. K.	-13 dBm	Not applicable
Uruguay	0 dBm	0 dBm
Venezuela	0 dBm	0 dBm

- <sup>1</sup> For countries not listed, set level to that specified by country PTT.
- <sup>2</sup> For switched line -- if line plate is installed -- add -1 dBm to compensate for insertion loss.
- <sup>3</sup> Italy-integrated modems are generally not allowed. Exceptions can be obtained on a case-by-case basis.

Figure D-5. Integrated Modem Transmit Level Settings by Country

## Primary Line Speed/Secondary Line Speed Switch

This switch is installed on all 3276s, except those with the DDSA feature and is normally set to the Primary (up) position. When the switch is in the Primary (up) position, the primary communication line speed is selected; when the switch is in the Secondary (down) position, the secondary (half-speed backup) speed is selected. Fill in item 4 of the 3276 Switch Setting Form.

## SNBU/Non-Switched Line Switch

This switch is installed if the 3276 (1) has an integrated modem with Switched Network Backup (SNBU) feature and is attached to a nonswitched line or (2) has an external modem and is connected to a nonswitched line. The switch is normally set in the Non-Switched Line (down) position. To select the switched network backup, place the switch in the SNBU (up) position. Fill in item 5 of the 3276 Switch Settings Form.

## SDLC/BSC Switch

This switch is installed if the 3276 has the SDLC/BSC Switch feature. The function of the switch is to select either SDLC or BSC line control. Fill in item 6 of the 3276 Switch Settings Form.

**Note:** *This switch is interrelated with switch B6, the FDX/HDX switch. See Figure D-3.*

## Communicate/Local Switch (Loop Adapter Feature Machines Only)

This switch is installed if the 3276 has the loop Adapter feature. Set the switch to the Communicate (up) position to perform the communicate operation as a unit attached to the loop. Fill in item 7 of the 3276 Switch Settings Form.

**Note:** *When the switch is in the Local (down) position, the 3276 is electrically disconnected from the loop. Changing the setting of the I/O switch (Power On/Off switch) or performing the 3276 local operation, such as the Subsystem test, does not interfere with the communicate operation of the other units that are attached to the loop.*



# 3276 Switch Settings Form

The operator panel drawer is located to the right of the display screen. To gain access to the switches, grasp the top of the drawer in the recess. Push it slightly to the right, and pull it toward you. The drawer will stop and latch at the first stop. (If the 3276 has the Address Keylock feature, insert the key into the lock and turn the key clockwise until it stops.) Press spring (located on the lower left side of the door), and continue to pull until the drawer stops again. After you have set the switches according to the chart below, push the drawer back to its closed position. (If the 3276 has the Address Keylock feature, turn the key counter-clockwise and remove the key.)

- Switch off the 3276 power.
- Set the 3276 Operator Panel Drawer switches to the positions that are checked in the tables on this page.
- DO NOT** Set any switches that are associated with any tables that are crossed out.
- Switch on the 3276 power.
- DO NOT** Change the position of switches while power is on. Changing a switch position while power is on has no effect.  
 Exceptions: The Primary Line Speed/Secondary Line Speed and the SNBU switches can be changed while power is on.

**1**

Set the A switches to the ON or OFF positions checked in the table below.

		SDLC							
		1	2	3	4	5	6	7	8
ON ↑	OFF ↓	✓	✓			✓			
ON ↑	OFF ↓	✓	✓			✓	✓	✓	✓

**2**

Set the B switches to the ON or OFF positions checked in the table below.

		BSC								$E_0$	$N_{1/2}$
		1	2	3	4	5	6	7	8		
ON ↑	OFF ↓	✓	✓			✓				✓	✓
ON ↑	OFF ↓	✓	✓			✓	✓	✓	✓	✓	✓

**For Loop Adapter feature machine only**

Set the B switch positions 6, 7, and 8 to the ON or OFF positions checked in the table below.

		6	7	8
ON ↑	OFF ↓	✓	✓	✓
ON ↑	OFF ↓	✓	✓	✓

Quick reference of switch settings for line speed selection is located below the B switch in the Operator Panel Drawer.

**(U.S. and Canada Only)**

**3**

Set the Transmit Level switches (-1dB, -2dB, -4dB, and -8dB) to the ON or OFF positions checked in the tables below.

		-1	-2
OFF	ON		✓
OFF	ON	✓	✓

		-4	-8
OFF	ON		✓
OFF	ON	✓	✓

**4**

PRI	
SEC	

Set the Primary/Secondary Line Speed switch to the Primary (up) or the Secondary (down) position checked in the table above.

**5**

SNBU	
Non-Switched Line	

Set the SNBU/Non-switched Line switch to the SNBU (up) or the Non-Switched Line (down) position checked in the table above.

**6**

SDLC	
BSC	

Set the SDLC/BSC switch to the SDLC (up) or the BSC (down) position checked in the table above.

**7 For Loop Adapter feature machine only**

Communicate	✓
Local	

Set the Communicate/Local switch to the Communicate (up) or Local (down) position checked in the table above.

Figure D-6. Example of a Completed 3276 Switch Settings Form

# 3276 Switch Settings Form

The operator panel drawer is located to the right of the display screen. To gain access to the switches, grasp the top of the drawer in the recess. Push it slightly to the right, and pull it toward you. The drawer will stop and latch at the first stop. (If the 3276 has the Address Keylock feature, insert the key into the lock and turn the key clockwise until it stops.) Press spring (located on the lower left side of the door), and continue to pull until the drawer stops again. After you have set the switches according to the chart below, push the drawer back to its closed position. (If the 3276 has the Address Keylock feature, turn the key counter-clockwise and remove the key.)

- Switch off the 3276 power.
- Set the 3276 Operator Panel Drawer switches to the positions that are checked in the tables on this page.
- DO NOT** Set any switches that are associated with any tables that are crossed out.
- Switch on the 3276 power.
- DO NOT** Change the position of switches while power is on. Changing a switch position while power is on has no effect.  
 Exceptions: The Primary Line Speed/Secondary Line Speed and the SNBU switches can be changed while power is on.

**1**

Set the A switches to the ON or OFF positions checked in the table below.

SDLC							
1	2	3	4	5	6	7	8

**2**

Set the B switches to the ON or OFF positions checked in the table below.

BSC								F <sub>0x</sub>	M <sub>1/2</sub>
1	2	3	4	5	6	7	8		

**For Loop Adapter feature machine only**

Set the B switch positions 6, 7, and 8 to the ON or OFF positions checked in the table below.

6	7	8
---	---	---

**(U.S. and Canada Only)**

**3**

Set the Transmit Level switches (-1dB, -2dB, -4dB, and -8dB) to the ON or OFF positions checked in the tables below.

	-1	-2
OFF	<input type="checkbox"/>	<input type="checkbox"/>
ON	<input type="checkbox"/>	<input type="checkbox"/>

	-4	-8
OFF	<input type="checkbox"/>	<input type="checkbox"/>
ON	<input type="checkbox"/>	<input type="checkbox"/>

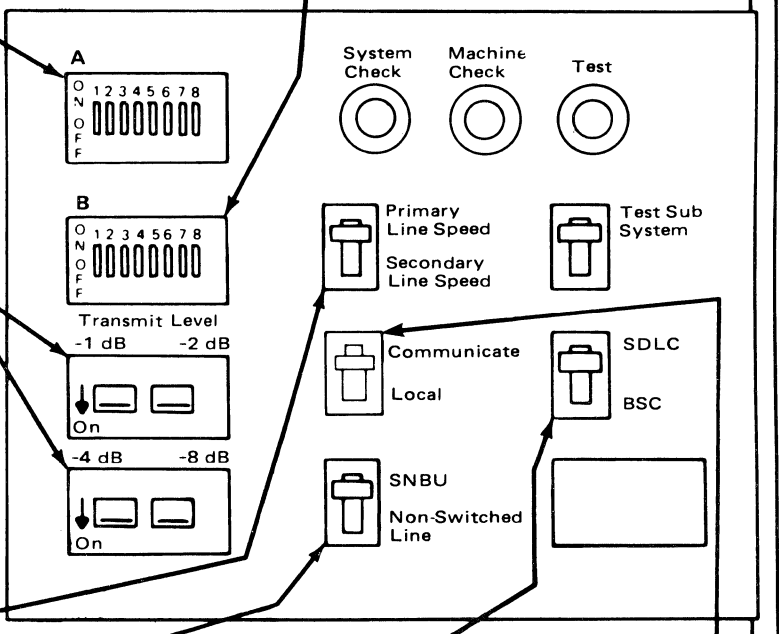

**4**

PRI	
SEC	

Set the Primary/Secondary Line Speed switch to the Primary (up) or the Secondary (down) position checked in the table above.

**5**

SNBU	
Non-Switched Line	

Set the SNBU/Non-switched Line switch to the SNBU (up) or the Non-Switched Line (down) position checked in the table above.

**6**

SDLC	
BSC	

Set the SDLC/BSC switch to the SDLC (up) or the BSC (down) position checked in the table above.

**7 For Loop Adapter feature machine only**

Communicate	
Local	

Set the Communicate/Local switch to the Communicate (up) or Local (down) position checked in the table above.

# 3276 Switch Settings Form

The operator panel drawer is located to the right of the display screen. To gain access to the switches, grasp the top of the drawer in the recess. Push it slightly to the right, and pull it toward you. The drawer will stop and latch at the first stop. (If the 3276 has the Address Keylock feature, insert the key into the lock and turn the key clockwise until it stops.) Press spring (located on the lower left side of the door), and continue to pull until the drawer stops again. After you have set the switches according to the chart below, push the drawer back to its closed position. (If the 3276 has the Address Keylock feature, turn the key counter-clockwise and remove the key.)

- Switch off the 3276 power.
- Set the 3276 Operator Panel Drawer switches to the positions that are checked in the tables on this page.

**DO NOT** Set any switches that are associated with any tables that are crossed out.

- Switch on the 3276 power.

**DO NOT** Change the position of switches while power is on. Changing a switch position while power is on has no effect.  
 Exceptions: The Primary Line Speed/Secondary Line Speed and the SNBU switches can be changed while power is on.

**1**

Set the A switches to the ON or OFF positions checked in the table below.

SDLC								
1	2	3	4	5	6	7	8	
ON ↑	ON →							
OFF ↓	OFF →							

**2**

Set the B switches to the ON or OFF positions checked in the table below.

BSC								$E_{0x}$	$N_{1/2}$
1	2	3	4	5	6	7	8		
ON ↑	ON →								
OFF ↓	OFF →								

**For Loop Adapter feature machine only**

Set the B switch positions 6, 7, and 8 to the ON or OFF positions checked in the table below.

					6	7	8
ON ↑	ON →						
OFF ↓	OFF →						

Quick reference of switch settings for line speed selection is located below the B switch in the Operator Panel Drawer.

**3**

Set the Transmit Level switches (-1dB, -2dB, -4dB, and -8dB) to the ON or OFF positions checked in the tables below.

-1 -2	
OFF	
ON	

-4 -8	
OFF	
ON	

**4**

PRI	
SEC	

Set the Primary/Secondary Line Speed switch to the Primary (up) or the Secondary (down) position checked in the table above.

**5**

SNBU	
Non-Switched Line	

Set the SNBU/Non-switched Line switch to the SNBU (up) or the Non-Switched Line (down) position checked in the table above.

**6**

SDLC	
BSC	

Set the SDLC/BSC switch to the SDLC (up) or the BSC (down) position checked in the table above.

**7 For Loop Adapter feature machine only**

Communicate	
Local	

Set the Communicate/Local switch to the Communicate (up) or Local (down) position checked in the table above.

## Abbreviations

**A/FE.** Americas/Far East.

**BSC.** Binary synchronous control.

**CSU.** Customer setup.

**CU.** Control unit.

**dB.** Decibel.

**dBm.** Decibel/milliwatt.

**DDSA.** Digital Data Service Adapter.

**EBCDIC.** Extended binary-coded decimal interchange code.

**EOT.** End of transmission.

**E/ME/A.** Europe/Middle East/Asia.

**FDX.** Full duplex.

**Hex.** Hexadecimal.

**HDX.** Half-duplex.

**ID.** Identification.

**LSC.** Loop Station Connector.

**LU.** Logical unit.

**NCP.** Network control program.

**NRZ.** Non-return to zero.

**NRZI.** Non-return to zero inverted.

**OEM.** Original equipment manufacturer.

**OLTEP.** Online Test Executive Program.

**OPER.** Operate.

**PDG.** Problem Determination Guide.

**PTT.** Post Telephone and Telegraph Administration.

**REC.** Receive.

**SDLC.** Synchronous data link control.

**SNA.** Systems network architecture.

**SNBU.** Switched network backup.

**U.S.** United States.

**XID.** Exchange station identification.

**XMIT.** Transmit.

This page is intentionally left blank

IBM 3270 Information Display System  
3276 Control Unit Display Station  
Planning and Setup Guide

**READER'S  
COMMENT  
FORM**

Order No. GA18-2041-2

This manual is part of a library that serves as a reference source for systems analysts, programmers, and operators of IBM systems. This form may be used to communicate your views about this publication. They will be sent to the author's department for whatever review and action, if any, is deemed appropriate. Comments may be written in your own language; use of English is not required.

IBM may use or distribute any of the information you supply in any way it believes appropriate without incurring any obligation whatever. You may, of course, continue to use the information you supply.

**Note:** *Copies of IBM publications are not stocked at the location to which this form is addressed.*

*Please direct any requests for copies of publications, or for assistance in using your IBM system, to your IBM representative or to the IBM branch office serving your locality.*

Possible topics for comment are:

Clarity      Accuracy      Completeness      Organization      Coding      Retrieval      Legibility

If you wish a reply, give your name and mailing address:

Please use pressure sensitive or other gummed tape to seal this form.

Cut or Fold Along Line

What is your occupation? \_\_\_\_\_

Number of latest Technical Newsletter (if any) concerning this publication: \_\_\_\_\_

Thank you for your cooperation. No postage stamp necessary if mailed in the U.S.A. (Elsewhere, an IBM office or representative will be happy to forward your comments.)

**Reader's Comment Form**

Cut or Fold Along Line

IBM 2470 IBM 2470 CONTINUOUS FORM DISPLAY STATISTICAL FORMING AND SCRAP GUIDE (FORM NO. 3000/3070/3075) FINISHED IN U.S.A. GA18-2041-2

Fold and tape

**Please Do Not Staple**

Fold and tape



**BUSINESS REPLY MAIL**

FIRST CLASS    PERMIT NO. 40    ARMONK, N.Y. U.S.A.

POSTAGE WILL BE PAID BY ADDRESSEE

NO POSTAGE  
NECESSARY  
IF MAILED  
IN THE  
UNITED STATES

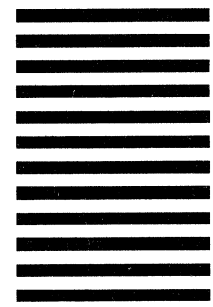

INTERNATIONAL BUSINESS MACHINES CORPORATION  
DEPARTMENT 825  
1133 WESTCHESTER AVENUE  
WHITE PLAINS, NEW YORK 10604

Fold and tape

**Please Do Not Staple**

Fold and tape



**International Business Machines Corporation**  
Data Processing Division  
1133 Westchester Avenue, White Plains, N.Y., 10604 U.S.A.

**IBM World Trade Americas/Far East Corporation**  
Town of Mount Pleasant, Route 9, North Tarrytown, N.Y., 10591 U.S.A.

**IBM World Trade Europe/Middle East/Africa Corporation**  
360 Hamilton Avenue, White Plains, N.Y., 10601 U.S.A.

IBM3270 IDS 3276 Control Unit Display Station Planning and Setup Guide (File No. S360/S370/S3-09) Printed in U.S.A. GA18-2041-2



International Business Machines Corporation  
Data Processing Division  
1133 Westchester Avenue, White Plains, New York 10604

IBM World Trade Americas/Far East Corporation  
Town of Mount Pleasant, Route 9, North Tarrytown, N.Y., U.S.A. 10591

IBM World Trade Europe/Middle East/Africa Corporation  
360 Hamilton Avenue, White Plains, N.Y., U.S.A. 10601