



HP700/60

HP700/60ES

USER'S MANUAL



HEWLETT
PACKARD

HP 700/60 and HP 700/60ES User's Manual



**HEWLETT
PACKARD**

**HP Part No. C1080-90009
Printed in Singapore 3rd Edition, March, 1992**

Notice

The information contained in this document is subject to change without notice. **Hewlett-Packard makes no warranty of any kind with regard to this material including, but not limited to, the implied warranties of merchantability and fitness for a particular purpose.** Hewlett-Packard shall not be liable for errors contained herein or for incidental or consequential damages in connection with the furnishing, performance, or use of this material.

The VT320, VT100 and VT52 are products of Digital Equipment Corporation. The IBM PC/AT2 is a product of International Business Machines Corporation. The WY-60 is a product of Wyse Technology. DEC is a registered trademark of Digital Equipment Corporation.

Hewlett-Packard Company
CSY Roseville Terminals Division
8000 Foothills Boulevard
Roseville, California, 95678-6502

Warranty Information

This terminal is warranted by Hewlett-Packard against defects in materials and workmanship for one year from date of original purchase. If you transfer ownership, this warranty is automatically transferred to the new owner and remains in effect for the original one year period.

During the warranty period we will repair or, at our option, replace at no charge any unit that proves to be defective, provided it is returned, shipping prepaid, to an identified Hewlett-Packard repair facility. You are responsible for all customs duties in connection with the return of the unit.

This warranty does not apply if the product has been damaged by accident or misuse, or as a result of service or modification by other than an authorized HP repair facility, or by hardware, software interfacing, or peripherals not provided by Hewlett-Packard. Hewlett-Packard shall have no obligation to modify or update products once manufactured.

No other expressed warranty is given. The repair or replacement of a product is your exclusive remedy. Any implied warranty of merchantability or fitness is limited to the one year duration of this written warranty. Some states or provinces do not allow limitations on how long an implied warranty lasts, so the above limitation or exclusion may not apply to you. In no event shall Hewlett-Packard Company be liable for consequential damages. Some states or provinces do not allow the exclusion or limitations of incidental or consequential damages, so the above limitation or exclusion may not apply to you.

This warranty gives you specific legal rights, and you may also have other rights which vary according to the state or province in which you reside. Retain this warranty for your records.

If your hardware should fail during the warranty period, return the failed piece of equipment to an HP Field Repair Center in your area. When sending equipment to a Field Repair Center, use the original shipping container if possible. Insure the equipment.

Call Hewlett-Packard Sales and Services Offices to learn more about the support services available to you.

Regulatory Information

For USA

FCC RFI Statement

This equipment generates, uses, and can radiate radio frequency energy and, if not installed and used in strict accordance with the instruction manual, may cause interference to radio communications. It has been tested and found to comply with the limits of a Class A computing device pursuant to Subpart J of Part 15 of FCC Rules, which are designed to provide reasonable protections against such interference when operated in a commercial environment.

Operation of this equipment in a residential area is likely to cause interference, in which case the user, at his own expense, will be required to take whatever steps may be required to correct the interference.

For Canada

This apparatus complies with the CLASS "A" limits for radio interference as specified in the Canadian Department of Communications Radio Interference Regulations.

Cet appareil est conforme aux normes CLASS "A" D'Interference radio tel que specifier par le Ministere Canadien des communications dans les reglements D'Interference Radio.

For Germany

Ergonomics Statement

This equipment has been tested in accordance with the requirements of the Equipment Safety Law and carries the GS Safety Mark.

The following characteristics:

- ZH 1/618 Font Set
- Refresh Rate
- Positive and Negative Polarity
- Column Width

may be software influenced. Therefore, it was only possible to verify the basic capabilities of these ergonomics requirements.

The user will have to assure that the characteristics stated above meet with the individually-used software.

Acoustics

LpA < 25 db	LpA < 25 db
Operator position	am Arbeitsplatz
Normal position	normaler Betrieb
Per ISO 7779	nach DIN 45635 T. 19
No Fan installed	Kein Ventilator eingebaut

United Kingdom Telecom Statement

Interconnection directly, or by way of other apparatus of ports marked "WARNING. CONNECT ONLY APPARATUS COMPLYING WITH BS6301 TO THIS (THESE) PORT(S)" with ports not so marked, may produce hazardous conditions on the network, and advice should be obtained from a competent engineer before such a connection is made. Connection to the network must not be handwired. This apparatus complies with BS6301. Connect only apparatus complying with BS6301 to the ports of this apparatus.

DECLARATION OF CONFORMITY

(according to ISO/IEC Guide 22 and EN 45014)

Manufacturer's Name Hewlett-Packard Co.

Manufacturer's Address 8000 Foothills Blvd.
Roseville, CA 95678
U.S.A.

declares, that the product

Product Name: Data Terminal

Model Numbers: HP700/60 and HP700/60ES

conforms to the following product specifications:

Safety: EN 60950 and IEC 950

EMI: EN 55022 Class B

EMC: prEN 55101-2: 4 kV Contact Discharge
8 kV Air Discharge

prEN 55101-3: 3 V/m

Other Emissions: HP700/60ES only - MPR 1990:10 Clauses 2.01
through 2.04

Ergonomics: ZH1/618

Supplementary Information: With or Without the Following Keyboards:
C1400A, C1401A, C1402A, C1403A, C1008A,
C1409A, C1411A, C1417A, C1421A, C1422A,
C1424A, or C1425A.

Roseville, California

Location

2/28/92

Date



Signature / QA Manager

For Japan

この装置は、第二種情報装置（住宅地域又はその隣接した地域において使用されるべき情報装置）で住宅地域での電波障害防止を目的とした情報処理装置等電波障害自主規制協議会（VCCI）基準に適合しております。

しかし、本装置をラジオ、テレビジョン受信機に近接してご使用になると、受信障害の原因となることがあります。

取扱説明書に従って正しい取り扱いをして下さい。

Preface

The HP 700/60 and HP 700/60ES Display Terminals are versatile, high-performance display terminals that support various ASCII, ANSI and PC terminal operations. Like all HP terminals, the HP 700/60 and HP 700/60ES offers ergonomic features, powerful functionality and superior display quality.

Multiple operating mode support makes the HP 700/60 and HP 700/60ES compatible with a wide variety of terminals including the DEC VT320 (with both 7- and 8-bit controls), VT100, VT52, the Wyse WY-60 and PCTERM terminals.

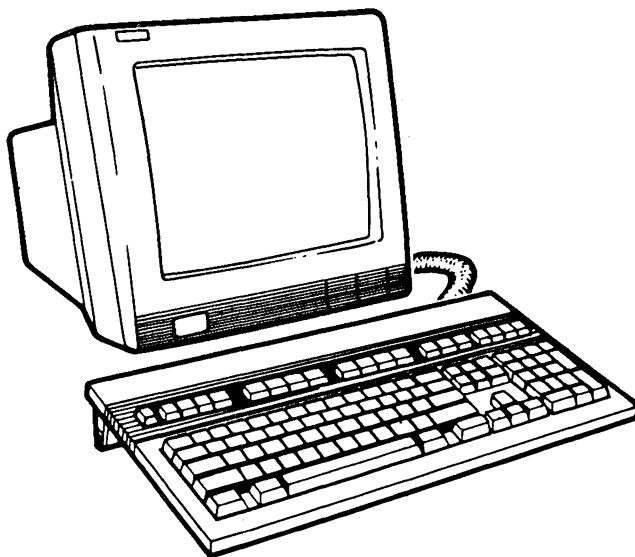

Finally, the HP 700/60 terminals meet the most stringent regulatory and safety standards. In addition, the HP 700/60ES terminal complies with the MPR 1990:10 standard for reduced low frequency electrostatic and electromagnetic emissions.

Ergonomics

- Tilt and swivel display unit
- Etched/dark anti-glare display screen
- High resolution characters
- Full overscan display screen (page white CRT)
- Brightness and contrast controls on the front panel
- Detached, slant adjustable, low-profile keyboard with sculptured keys and tactile feedback
- Small footprint

Display Screen

- 14 inch; choice of page white (with full overscan), green or amber phosphor
- User area of the screen configurable from 27 to 44 lines
- User selectable 0, 1, 2 or 3 lines for terminal status, host messages and soft key labels
- 80 or 132 columns
- Superior character formation: 7 x 13 characters in 10 x 16 cells (24 line user area)
- Block or underline cursor, blinking or nonblinking
- Display enhancements: bold and normal intensity, blinking, inverse, underline and secret
- Single and double height/width characters
- CRT screen saver
- Dark or light display background
- Refresh rates: 72 Hz, 60 Hz or 50 Hz

Memory

- 3 pages of display memory with 24 line/80 column display
- 2 pages of display memory with 24 line/132 column display

Terminal Compatibility

- ASCII Terminal:
 - Wyse WY-60
- ANSI Terminal:
 - DEC VT320 (both 7-and 8-bit controls)
 - DEC VT100
 - DEC VT52
- PC Terminal:
 - PC TERM (Wyse PC TERM)

Keyboard

- All Keyboards
 - 68 programmable keys in Wyse WY-60 emulation.
 - Keyboard available in national layouts
- ANSI Keyboard
 - 105-key, VT 320 compatible keyboard
- PC-AT Keyboard
 - 105-key, IBM-PC/AT2 compatible keyboard

Communication

- Ports 1 and 3:
 - RS-232C/422A (423 Port 1 only)ports with:
 - 25-pin connector (Port 1)
 - 9-pin connector (Port 3)
 - Bidirectional serial communications
 - Support baud rates from 300 to 38,400
 - Support HP, DEC and ASCII printer control sequences
- Port 2:
 - Buffered parallel port; 25-pin connector (Centronics interface)

Character Sets

- ANSI Terminal:
 - ASCII
 - DEC Supplemental
 - ISO 8859 Latin-1
 - DEC Special Graphics
 - 12 national 7-bit character sets
- ASCII Terminal:
 - WY-60 Native Mode
 - Multinational
 - Standard ASCII
 - Graphics 1
 - Graphics 2
 - Graphics 3
 - Standard ANSI
 - PC Equivalent
 - 12 national 7-bit character sets
- PCTERM Terminal:
 - IBM 437
 - IBM 850
 - IBM 860
 - IBM 863
 - IBM 865

Other Features

- Easy to use Setup menus
- Non-volatile RAM for saving setup specifications
- Smooth scroll
- Keyclick enable/disable
- Compose characters
- Copy and transparent print modes
- Time-of-day clock available in all compatibility modes

Contents

1. Installation	
Getting Ready	1-2
Visual Inspection	1-2
Power Requirements	1-5
Datacomm Information	1-5
Connecting the Cables	1-6
Turning the Terminal On and Off	1-7
Adjusting for Comfort	1-8
Identifying the Keyboard	1-9
Setup Requirements	1-9
2. Terminal Setup	
Introduction	2-1
Entering and Exiting Setup Mode	2-2
Using Setup Menus	2-3
Going From One Setup Menu to Another	2-3
Changing Field Values	2-4
Restoring Previous Setup Menu Values	2-5
Changing Setup Menu Values Temporarily	2-5
Saving Setup Menu Values	2-5
Using Setup Menu Functions	2-6
Global Setup Menu	2-7
User Setup Menu	2-11
System Setup Menu	2-16
Port 1 and Port 3 Setup Menus	2-25
Keyboard Setup Menu	2-30
Program Setup Menu	2-38
Programming a Key	2-39
Notes	2-40

3. Using the Terminal	
The Display Screen	3-1
The Screen Areas and Cursor	3-2
Status Line Messages	3-3
Status Line (ANSI Mode)	3-3
Status Line (ASCII Mode)	3-5
The Keyboard	3-10
Special Keys on the Keyboard	3-12
Other Special Keys on the PC-AT Keyboard	3-15
Composing Characters	3-17
Locating the Characters You Want	3-17
Multinational Character Set Mode	3-17
National Character Set Mode	3-17
Composing Character Sequences	3-18
Composing Three-Key Sequences	3-18
Composing Two-Key Sequences	3-19
Completing or Canceling a Sequence	3-19
Printing	3-29
Printing the Screen Contents	3-29
Using Auto Print Mode (ANSI Mode Only)	3-29
Using Copy Print Mode (ASCII Mode Only)	3-30
Using Controller Print Mode (ASCII Mode Only)	3-30
Using Bidirectional Print Mode (ASCII Mode Only)	3-30
Using Serial Input Devices	3-31
Resetting the Terminal	3-31
4. Troubleshooting and Maintaining the Terminal	
Problems and Solutions	4-1
Preventive Maintenance	4-4
A. ANSI-Mode Terminal Commands	
C0 Codes and C1 Codes	A-2
Key Codes	A-4
Terminal Configuration	A-7
Terminal Operating Modes	A-9
Screen Control	A-11
Character Sets	A-15
Soft Character Sets (VT320 Mode Only)	A-19

Programmable Function Keys (VT320 Mode Only)	A-21
Print and Aux to Host Modes	A-23
Reports	A-25
B. PCTERM-Mode Terminal Commands	
C. Wyse 60-Mode Terminal Commands	
D. Character Sets	
E. International Keyboards	
ANSI Keyboards	E-1
PC-AT Keyboards	E-8
Index	

Figures

1-1. Shipping Container Contents	1-1
1-2. Terminal Controls	1-3
1-3. Terminal Rear Panel Connections	1-4
1-4. Keyboard Cord Attachment and Angle Adjustment	1-8
2-1. Format of Setup Menus	2-3
2-2. Global Setup Menu	2-7
2-3. User Setup Menu under ANSI Mode	2-11
2-4. User Setup Menu under ASCII Mode	2-13
2-5. System Setup Menu under ANSI Mode	2-16
2-6. System Setup Menu under ASCII Mode	2-21
2-7. Port 1 Setup Menu	2-25
2-8. Keyboard Setup Menu, ANSI Mode with an ANSI Keyboard	2-30
2-9. Keyboard Setup Menu, ANSI Mode with a PC-AT Keyboard	2-30
2-10. Keyboard Setup Menu under ASCII Mode	2-34
2-11. Program Setup Menu	2-38
3-1. The HP 700/60 and HP 700/60ES Display Screen	3-2
3-2. The ANSI Keyboard Layout	3-10
3-3. The PC-AT Keyboard Layout	3-11
C-1. Graphics Characters	C-18
D-1. ASCII Character Set (same as Wyse Standard ASCII)	D-1
D-2. DEC Supplemental Character Set	D-2
D-3. ISO 8859 Latin-1 Character Set	D-3
D-4. DEC Special Graphics Character Set	D-4
D-5. 7-Bit National Character Set	D-5
D-6. Wyse Native Mode Character Set	D-6
D-7. Wyse Graphics 1 Character Set	D-7
D-8. Wyse Graphics 2 Character Set	D-8
D-9. Wyse Graphics 3 Character Set	D-9
D-10. Wyse Standard ANSI Character Set	D-10
D-11. IBM 437 Character Set	D-11

D-12. IBM 850 Character Set	D-12
D-13. IBM 860 Character Set	D-13
D-14. IBM 863 Character Set	D-14
D-15. IBM 865 Character Set	D-15
D-16. HP Line Drawing Character Set	D-16
D-17. HP Roman 8 Character Set	D-17
E-1. Danish	E-1
E-2. Dutch	E-2
E-3. Finnish	E-2
E-4. French	E-3
E-5. German (DIN)	E-3
E-6. Italian	E-4
E-7. Norwegian	E-4
E-8. Spanish	E-5
E-9. Swedish	E-5
E-10. Swiss—French	E-6
E-11. Swiss—German	E-6
E-12. United States	E-7
E-13. Danish	E-8
E-14. Belgian	E-8
E-15. French	E-9
E-16. German	E-9
E-17. Italian	E-10
E-18. Norwegian	E-10
E-19. Spanish	E-11
E-20. Swedish	E-11
E-21. Swiss	E-12
E-22. United Kingdom	E-12
E-23. United States	E-13

Tables

2-1. Setup Labels and Corresponding Function Keys	2-6
2-2. Fields in the Global Setup Menu	2-8
2-3. Fields in the User Setup Menu under ANSI Mode	2-12
2-4. Fields in the User Setup Menu under ASCII Mode	2-13
2-5. Fields in the System Setup Menus under ANSI Mode	2-17
2-6. Fields in the System Setup Menus under ASCII Mode	2-21
2-7. Fields in the Port 1 and Port 3 Setup Menus	2-26
2-8. Fields in the Keyboard Setup Menu	2-31
2-9. Fields in the Keyboard Setup Menu	2-34
2-10. Fields in the Program Setup Menu	2-39
3-1. Status Line Message Locations	3-4
3-2. Descriptions of the Status Line Messages	3-4
3-3. Status Line Message Locations	3-5
3-4. Descriptions of the Standard Status Line Messages	3-6
3-5. Combined Status and Message Locations	3-7
3-6. Descriptions of Combined Status and Message	3-7
3-7. Combined Extended Status and Message Locations	3-8
3-8. Descriptions of Combined Extended Status and Message	3-9
3-9. Special Keys on the Keyboard	3-12
3-10. Remapping When Using a PC Keyboard	3-16
3-11. Compose Character Sequences: Multinational Character Set Mode	3-20
3-12. Compose Character Sequences: National Character Set Mode	3-24

Installation

This chapter tells you how to install the terminal and prepare it for use.

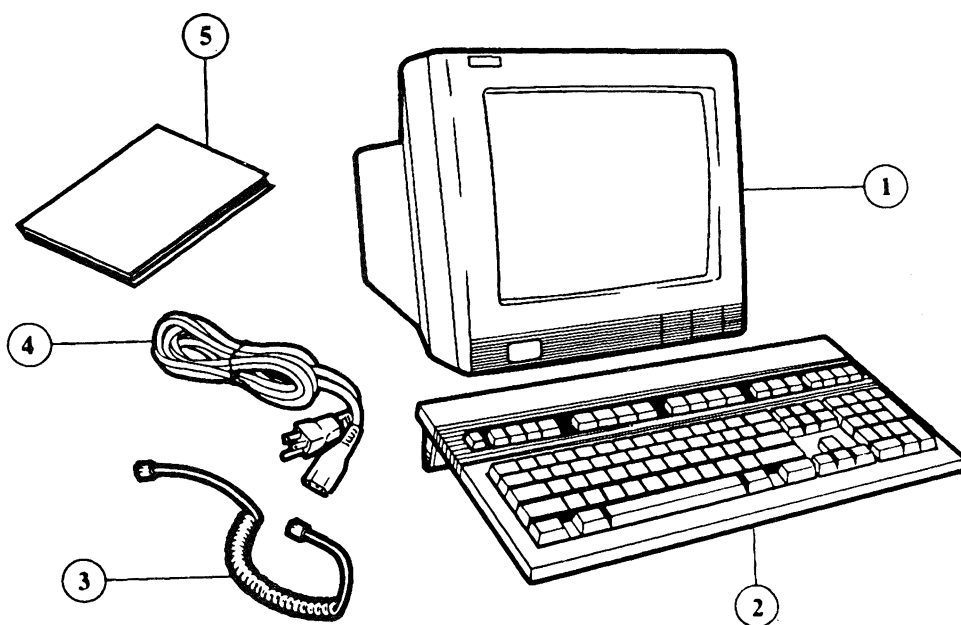

Figure 1-1. Shipping Container Contents

- 1) Display Unit 2) Keyboard 3) Keyboard Cable 4) Power Cable
5) User's Manual

Getting Ready

Visual Inspection

If the terminal is still in the shipping container, unpack it; then, visually inspect the items. As Figure 1-1 indicates, you should have the display unit, keyboard, keyboard cable, power cord and this manual (the *HP 700/60 and HP 700/60ES User's Manual*).

Keep the container and other packing material in case the terminal has to be repacked at a later date.

If any of the items are missing or appear damaged in any way, do not install the terminal. Instead, contact an HP Sales and Service Office.

Caution



Under no circumstances should you open your terminal to expose its internal circuitry. Only a qualified service engineer should perform maintenance procedures that require opening the terminal case.

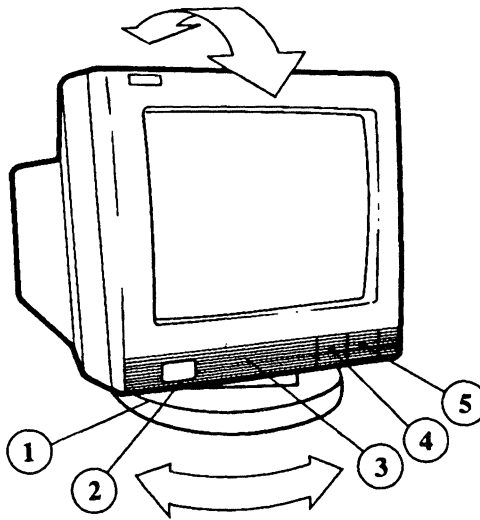

Figure 1-2. Terminal Controls

- 1) Tilt and Swivel Pedestal
- 2) Power Switch
- 3) Service Door
- 4) Contrast Control
- 5) Brightness Control

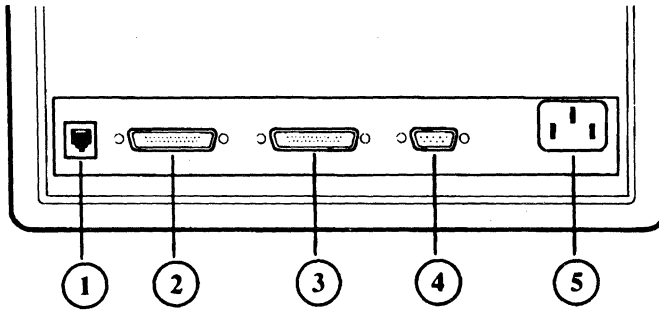

Figure 1-3. Terminal Rear Panel Connections

- 1) Keyboard connector 2) Port 1: RS-232C connector 3) Port 2: Parallel port
4) Port 3: RS-232C connector 5) Power cord connector

Power Requirements

The power cord plugs into a grounded power outlet. The HP 700/60 and HP 700/60ES works with any voltage rating from 100 to 240 VAC. There is no voltage setting for you to adjust on the terminal.

Make sure you use a power cord that bears the mark of the safety agency in your country that defines the regulations for power cords. That is your assurance that the power cord can be used safely with the terminal.

Datacomm Information

The datacomm cable links your terminal to the host computer. The cable that you use to make the connection depends on the communications protocol that you use. In its standard configuration, the terminal communicates through Port 1 over a 25-pin, RS232C datacomm cable. The terminal also supports datacomm through Port 3 over a 9-pin, RS232C cable. *Only one of these interfaces can be used as the host computer port.*

You can use either of the two serial ports as an auxiliary port. The auxiliary port can be connected to a serial printer or to a serial input device (such as a bar code reader). Refer to the instructions that came with the serial device for details about communication requirements.

Port 2 is a parallel, output-only port that can be used to connect the terminal to a printer.

Connecting the Cables

To connect the cables:

1. Place the terminal on a sturdy, level surface such as a desk, table or stand.
2. Make sure the power cord is not yet connected to the terminal. Make sure the power switch is in the OFF position (pushed in is ON, flush with the panel is OFF). The power switch is located on the lower left front of the display unit (Figure 1-2).
3. Connect the keyboard cable. Both ends are identical. Plug one end into the rear of the terminal (Figure 1-3). Plug the other end into the connector located on the back of the keyboard (Figure 1-4).
4. Connect the datacomm cable to your terminal or modem. Insert the RS232C connector into the socket provided at the back of the terminal and tighten the two screws to secure the connector. Use Port 1 for a 25-pin cable; use Port 3 for a 9-pin cable. (If you are connecting the cable to a modem, follow the instructions given in the manual provided with the modem.)

Note



Only one of the ports can be used as the main port. See Chapter 2 for port setup information.

5. Connect any auxiliary devices.
 - a. If you have an auxiliary device that requires RS232C communication (such as a barcode reader), connect its cable to the serial port that *is not* connected to the host. Connect the printer or serial input device according to the instructions given in the manual that comes with that device.
 - b. If you have a parallel printer, connect the cable to Port 2. Then, tighten the screws to secure the connector.

6. Connect the power cord. Plug the slotted end of the power cord into the AC socket on the right rear of the terminal (Figure 1-3). Plug the three-pronged end of the power cord into the electrical outlet. The outlet should be properly wired and grounded.

Caution

Don't block the terminal's air vents by setting objects on top of it or near its rear panel.

Turning the Terminal On and Off

To turn on the terminal, press the power switch on the left front of the terminal. The button remains in while the terminal is on. (You'll hear a beep when you turn on the terminal. If the terminal doesn't turn on, make sure it is plugged into a power outlet.)

To turn off the terminal, press the power switch so that it is flush with the front panel.

Caution

When turning the terminal off and on in rapid succession, wait at least five seconds for the terminal to completely power down before turning the terminal back on again.

Adjacent to the power switch is an entry door to the front of the display unit. This door is used to service and repair the terminal. Pushing down lightly on the door opens it. Moving it gently back into place closes it.

Adjusting for Comfort

To adjust the *tilt*, move the top of the terminal gently up or down until the angle is most comfortable for you (Figure 1-2). The terminal remains tilted at the angle in which you leave it.

The base of the terminal allows you to swivel it freely to the right and left (Figure 1-2).

The keyboard can lie flat or be raised at an angle. To raise the keyboard at an angle, flip down the bar on the rear underside of the keyboard (Figure 1-4).

The brightness and contrast controls are slide switches under the front right corner of the terminal (Figure 1-2). Sliding these switches adjusts the brightness and contrast.

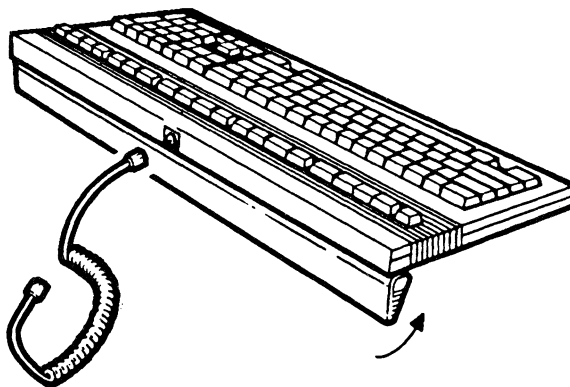

Figure 1-4. Keyboard Cord Attachment and Angle Adjustment

Identifying the Keyboard

The terminal comes with either an ANSI or a PC-AT keyboard. The first time you turn on the terminal, it displays the following message:

Press [Set-Up] to identify keyboard.

When you press **[Set-Up]**, the terminal identifies the type of keyboard that you are using.

To change the keyboard or to reset all of the terminal's nonvolatile memory to the default settings, press and hold down **[D]** and turn on the terminal. Hold down **[D]** until the terminal beeps (after about 5 seconds), then release it.

For details about the ANSI and PC-AT keyboards, see Chapter 3.

Setup Requirements

The terminal's default setup specifications are correct for many, but not all, situations. Depending on the requirements of the host computer system, applications and peripherals, you may have to change some of the terminal's setup specifications. The terminal's setup specifications are explained in Chapter 2.

Terminal Setup

Introduction

This chapter tells you how to use the HP 700/60 and HP 700/60ES Display Terminal's Setup mode.

Setup mode consists of a series of menus which let you:

- configure the terminal so that it can communicate properly with your computer, application programs and peripherals,
- set some of the terminal's features for your convenience, and
- program the terminal's programmable keys.

You won't use Setup mode very often. For instance, you'll use Setup mode when you first set up your terminal to work with a computer or printer. And occasionally you may want to use Setup mode to make minor adjustments to specific features of the terminal. Also, you'll use Setup mode if you want to program or reprogram any of the terminal's programmable keys.

Use Setup mode to configure your HP 700/60 or HP 700/60ES communications port to match the host computer port. If there's a printer or serial input device connected to the terminal, refer to the manual for that device for its communication requirements.

In general, you use the following procedure to change Setup specifications.

- Enter Setup. See the next section in this chapter for details.
- Select the Setup menu that contains the fields you want to change.
- Make the changes. Unless you save the changes you make to a Setup menu, they will last only until you turn off or reset the terminal.
- Continue to another Setup menu and make more changes as needed.
- Exit Setup mode when you are finished changing Setup values.

Entering and Exiting Setup Mode

To enter Setup mode, press **Setup**. The Global Setup menu appears on the screen.

The computer can send data to the terminal while you are in Setup mode. This data may be lost unless the terminal's receive *handshaking* is enabled. Handshaking refers to a data communications protocol that ensures that the computer and the terminal are sending and receiving information in the same format. The default setting for receive handshaking is *enabled*. For more information on enabling and disabling handshaking, refer to Recv Pace and XPC Handshaking in Table 2-7.

Caution



If you disable the terminal's receive handshaking and then enter Setup mode, the terminal's input buffer will store up to 255 characters and any data received beyond this limit will be lost.

To exit Setup mode, press **Setup**. The data that was on the screen when you entered Setup is redisplayed (unless you changed the compatibility mode from ANSI to ASCII or vice versa, in which case the screen will be blank). Any Setup changes you made are put into effect.

Using Setup Menus

Although each Setup menu is different, all of the Setup menus have the same format (Figure 2-1).

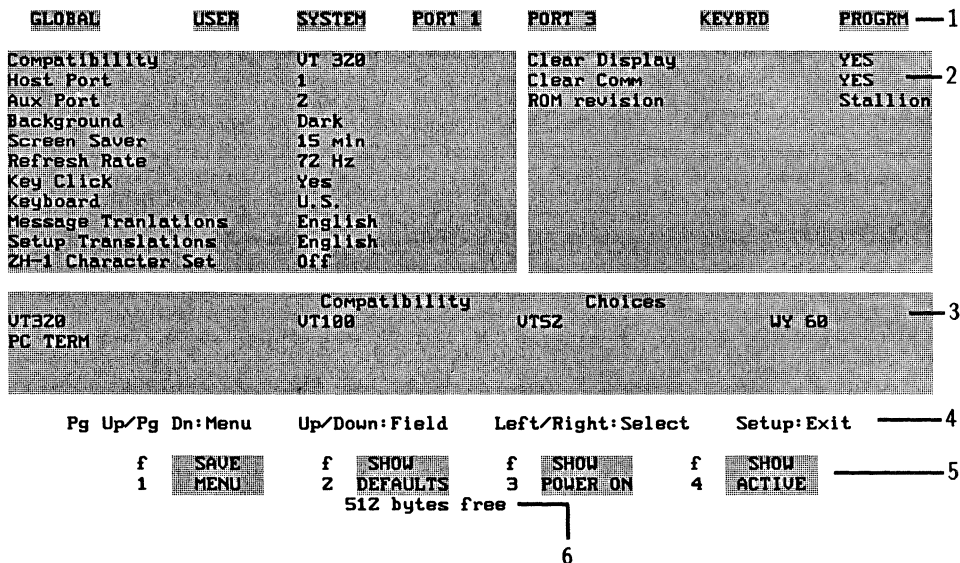

Figure 2-1. Format of Setup Menu

- 1) Menu titles
- 2) Fields
- 3) Choices
- 4) Reminder line
- 5) Setup labels
- 6) Memory available

Going From One Setup Menu to Another

The names of the Setup menus are at the top of the screen. The name of the current menu is highlighted. To move to a different menu, press

Page Up / **Prev Screen** OR **Page Down** / **Next Screen**.

There are seven Setup menus under the Setup mode:

- Global Setup menu
- User Setup menu
- System Setup menu

- Port 1 Setup menu
- Port 3 Setup menu
- Keyboard Setup menu
- Program Setup menu

Each of these menus is described in this chapter.

Changing Field Values

To change a value on a menu:

1. Select the Setup menu containing the field you want to change.
2. Select the field by pressing the up or down arrow keys (▲ or ▼).
3. Select a choice by pressing ► (or the Space bar) for the next choice, or ◀ for the previous choice.

Note



The fields in some of the Setup menus are different depending on the mode (ANSI or ASCII) the terminal is operating in. The mode is selected on the Global Setup menu.

Restoring Previous Setup Menu Values

To abandon any changes made to a Setup menu, press **SHOW ACTIVE**. The values in the fields are reset to those that were active when you entered the menu. For more information on the Setup mode function keys, see “Using the Setup Menu Functions” later in this chapter.

Changing Setup Menu Values Temporarily

To make temporary changes to values on Setup menus, simply change the value on the menu. The changed values will be active until you turn off or reset the terminal. For more information on the Setup mode function keys, see “Using the Setup Menu Functions” later in this chapter.

Saving Setup Menu Values

To save changes to a Setup menu press **SAVE MENU** before you exit the menu.

SAVE MENU stores the values of the current Setup menu only in nonvolatile memory (NV RAM) and will be active for the current session and the next time the terminal is turned on or reset. For more information on the Setup mode function keys, see the next section in this chapter.

Using Setup Menu Functions

The actions performed by the four Setup function keys are described below. To perform a Setup function, press the corresponding function key as shown.

Table 2-1. Setup Labels and Corresponding Function Keys

Key Labels	SAVE MENU	SHOW DEFAULTS	SHOW POWER ON	SHOW ACTIVE
PC-AT	F1	F2	F3	F4
ANSI	F6	F7	F8	F9

SAVE MENU

Values on the current Setup menu only are saved in non-volatile memory. The values are active immediately and when the terminal is turned on or reset.

SHOW DEFAULTS

Displays the factory default values for all of the menu's fields.

SHOW POWER ON

Shows the values which are now stored in non-volatile memory and will be in effect when the terminal is turned on or reset.

SHOW ACTIVE

Displays the currently active settings.

Note



If you use a **SHOW** key to display menu values and then exit the menu, the choices displayed in the menu fields will become active until you reset or turn off the terminal.

Global Setup Menu

Table 2-2 lists the fields on the Global Setup menu and describes the possible values for each field. These values are the same whether the terminal operates under ANSI or ASCII mode. The Default values are listed first.

GLOBAL	USER	SYSTEM	PORT 1	PORT 2	KEYBRD	PROGRM
Compatibility		UT 320				
Host Port		1				
Aux Port		2				
Background		Dark				
Screen Saver		15 min				
Refresh Rate		72 Hz				
Key Click		Yes				
Keyboard		U.S.				
Message Tranlations		English				
Setup Translations		English				
ZH-1 Character Set		Off				
					Clear Display	
					Clear Comm	
					ROM revision	(number)
UT320		Compatibility		Choices		uy 60
PC TERM		UT100		UT52		

Pg Up/Pg Dn: Menu Up/Down: Field Left/Right: Select Setup: Exit

Figure 2-2. Global Setup Menu

Table 2-2. Fields in the Global Setup Menu

Field	Choices	Description
Compatibility	VT320 ¹ VT100- VT52 WY-60 PCTERM	Determines the field set (or compatibility mode) that the terminal will use. Some fields are available only in certain modes. VT320 , VT100 and VT52 operate in ANSI mode. WY-60 and PCTERM operate in ASCII mode. For a list of the commands available in each mode, refer to Appendices A, B and C.
Host Port	1 3	1 sets Port 1 for communication with the computer. 3 sets Port 3 for communication with the computer.
Aux Port	2 3 1	Specifies port used for printer output and auxiliary input (if needed) for bidirectional or "Aux to Host" operations. (If the same port is selected as Host and Aux Port, the terminal beeps and the next valid port is automatically selected as Aux.)
Background	Dark Light	<i>For green and amber CRT's:</i> Dark (default) sets the display for light characters on a dark display background. Light sets for dark characters on a light display background. <i>For page white CRT's:</i> Same except that Light is the default.
Screen Saver	15 min 10 min 5 min Off	Off disables the screen saver feature so that the display remains on while the terminal is on. The time settings indicate how long the display remains on before the screen saver feature is enabled. If the screen saver feature is enabled, any keystroke or data from the computer will turn the display back on with no loss of data.
<p>¹If you use VT320 compatibility with a PC-AT keyboard, refer to Table 3-10 which shows the keys that can be remapped.</p>		

Table 2-2. Fields in the Global Setup Menu (continued)

Field	Choices	Description
Refresh Rate	72 Hz 50 Hz 60 Hz	Specifies the screen refresh rate. Select the rate that provides the clearest display quality for your environment.
Key Click	Yes No	Yes enables, No disables the audible click sound when the keys are pressed.
Keyboard	US UK Danish Belgian ¹ Dutch ² Finnish ² French German Italian Norwegian Spanish Swedish Swiss Fr. Swiss Ger.	Tells the terminal which keyboard version you're using. This allows the terminal to use the characters that match the characters on the keyboard.
Message Translations	English Danish Dutch Finnish French German Italian Spanish Swedish Norwegian	Specifies the language in which to display the terminal's message labels.
¹ Available with PC-AT keyboard only.		
² Available with ANSI keyboard only.		

Table 2-2. Fields in the Global Setup Menu (continued)

Field	Choices	Description
Setup Translations	English French German Spanish Italian	Specifies the language in which to display the terminal's Setup menus.
ZH-1 Char Set	Off On	When Off , display height of capital letters depends upon ascenders. When On , capital letters with or without ascenders are the same height.
Clear Display	-	Tells the terminal to clear user data in all pages when Setup menus are exited.
Clear Comm.	-	Clears keyboard, receive and transmit buffers. Sends Xon signal to host and resets Xoff received flags at printer and at host.
ROM Revision	(number)	Shows the terminal's firmware version number.

User Setup Menu

There are two command sets for the User Setup menu. The one that is displayed depends on the value in the Compatibility field on the Global Setup menu. Tables 2-3 and 2-4 list the command fields and describe the possible values for the System Setup menu under ANSI (Compatibility field values VT320, VT100 and VT52) and ASCII (Compatibility field values WY-60 and PCTERM) modes. The default values are listed first.

GLOBAL	USER	SYSTEM	PORT 1	PORT 3	KEYBOARD	PROGRAM
Scroll		Jump				
Cursor Type		Blink Box				
Cursor		On				
Message Line		Off				
Status Line		Off				
On Line		Yes				
Auto Wrap		Off				
Auto Linefeed		Off				
Display Width		80				
		Scroll				
Jump		Smooth 1			Choices	
Smooth 4		Smooth 10			Smooth 2	Smooth 3

Pg Up/Pg Dn: Menu Up/Down: Field Left/Right: Select Setup: Exit

Figure 2-3. User Setup Menu under ANSI Mode

Table 2-3. Fields in the User Setup Menu under ANSI Mode

Field	Choices	Description
Scroll	Jump Smooth 1 Smooth 2 Smooth 3 Smooth 4 Smooth 10	Jump causes rapid scrolling at the speed in which data is received from the computer. Smooth n causes smooth scrolling at speeds of <i>n</i> lines per second.
Cursor Type	Blink Line Blink Box Steady Line Steady Box	Displays cursor as either a blinking underline, blinking rectangle, unblinking underline or unblinking rectangle.
Cursor	On Off	Selects whether or not to display the cursor.
Message Line	Off/On	Selects whether or not to display the status line.
Status Line	Off On	Selects whether or not to display the status line.
On Line	Yes No	Yes enables, No disables communication with the computer.
Auto Wrap	Off On	On specifies that when the cursor reaches the right margin and a new character is received, the cursor automatically wraps to the beginning of the next line. Off does not allow the cursor to wrap, thereby causing the last character on the line to be overwritten.
Auto Linefeed	Off On	Determines whether or not a line feed is sent in addition to a carriage return when Return or Enter (on the numeric key pad) is pressed. Also determines whether or not a CR is performed when the terminal receives a linefeed.
Display Width	80 132	Sets the screen display at 80 or 132 columns.

GLOBAL	USER	SYSTEM	PORT 1	PORT 3	KEYBRD	PROGRAM
Scroll		Jump			Clr on Width Change	No
Cursor Type		Blink Box			Logical Page Size	24
Cursor		On			Number of Pages	1
Save Label		No			CR=	CR
Label Line		Off				
Status Line		Off				
Extended Status Line		Off				
On Line		Yes				
Auto Wrap		On				
Display Width		80				
Disp. Width Allowed		80 or 132				
		Scroll		Choices		
Jump		Smooth 1		Smooth 2		Smooth 3
Smooth 4		Smooth 10				

Pg Up/Pg Dn: Menu Up/Down: Field Left/Right: Select Setup: Exit

Figure 2-4. User Setup Menu under ASCII Mode

Table 2-4. Fields in the User Setup Menu under ASCII Mode

Field	Choices	Description
Scroll	Jump Smooth 1 Smooth 2 Smooth 3 Smooth 4 Smooth 10	Jump causes rapid scrolling at the speed in which data is received from the computer. Smooth n causes smooth scrolling speeds of <i>n</i> lines per second.

Table 2-4.
Fields in the User Setup Menu under ASCII Mode (continued)

Field	Choices	Description
Cursor Type	Blink Line Blink Box Steady Line Steady Box	Displays the cursor as either a blinking underline, blinking rectangle, unblinking underline or unblinking rectangle.
Cursor	On Off	Selects whether or not to display the cursor.
Save Label	No Yes	When No , the function keys are not saved in volatile memory. When Yes , the function keys are saved.
Label Line	Off On	Selects whether or not to display the label line.
Status Line	On Off	Selects whether or not to display the status line.
Extended Status Line	Off On	When Off , terminal status is not displayed. When On , terminal status is displayed.
On Line	Yes No	Yes enables, No disables communication with the computer.
Auto Wrap	On Off	On specifies that when the cursor reaches the right margin and a new character is received, the cursor automatically wraps to the beginning of the next line. Off does not allow the cursor to wrap, thereby causing the last character on the line to be overwritten.
Display Width	80 132	Sets the screen display at 80 or 132 columns. (If Width Allowed is set to 80 , this field is limited to 80 columns.)
Display Width Allowed	80 or 132 80	Sets the maximum display width.

Table 2-4.
Fields in the User Setup Menu under ASCII Mode (continued)

Field	Choices	Description
Clr on Width Change	No	No, the screen will not clear data displayed when the screen width is changed. Yes, the screen will clear data displayed when the screen width is changed (between 80 and 132 columns). This field is active only when the value in the Display Width Allowed field is set to 80 or 132 .
	Yes	
Logical Page Size	24	Specifies the number of lines to be used for a logical page. Caution: Changing the setting in this field clears the terminal's display memory.
	25	
	42	
	43	
	49	
Number of Pages	50	Specifies the number of logical pages to be used. Caution: Changing this setting in this field clears the terminal's display memory.
	1	
	2	
CR =	3	Determines action to be taken when the terminal receives a CR character. If it receives a CR , the cursor moves to column 1 of same line. If it receives a CRLF , the cursor moves to column 1 of the next line.
	CR	
	CRLF	

System Setup Menu

There are two command sets for the System Setup menu. The one that is displayed depends on the value in the Compatibility field on the Global Setup menu. Tables 2-5 and 2-6 list the command fields and describe the possible values for the System Setup menu under ANSI (Compatibility field values VT320, VT100 and VT52) and ASCII (Compatibility field values WY- 60 and PCTERM) modes. The default values are listed first.

GLOBAL	USER	SYSTEM	PORT 1	PORT 3	KEYBRD	PROGRM
Terminal Id		UT320		Print Scroll Region		OFF
Display Ctrl Codes		Off		Aux Mode		Normal
Control Codes		7-bit		Aux To Host		No
Characters Mode		8-bit		Print Terminator=FF		No
Local Echo		Off		Printer Char Set		HP
Preferred Char Set		DEC Supplemental				
Keypad Mode		Numeric				
Cursor Keys		Normal				
User Features Locked		No				
User Keys Locked		No				
Data Processing Keys		No				

Terminal Id	Choices
UT320	UT100
UT220	UT101
	UT102

Pg Up/Pg Dn: Menu Up/Down: Field Left/Right: Select Setup: Exit

Figure 2-5. System Setup Menu under ANSI Mode

Table 2-5. Fields in the System Setup Menus under ANSI Mode

Field	Choices	Description
Terminal ID	VT320 VT100 VT101 VT102 VT220	Specifies which terminal ID is sent in response to a device attributes request. Refer to "Reports" in Appendix A for more information about primary and secondary device attributes requests.
Display Ctrl Codes	Off On	When On , control characters are displayed instead of executed. If the terminal is turned on or reset, the value in this field reverts to the default value.
Control Codes	7-bit 8-bit	8-bit causes the terminal to generate 8-bit codes when transmitting to the host computer. 7-bit causes the terminal to use 7-bit equivalent control codes. This field is automatically set to 7-bit when the value in the Compatibility field on the Global Setup menu is set to any mode other than VT320.
Characters Mode	8-bit 7-bit	7-bit selects the character set that is appropriate for the current setting in the Keyboard field on the Global Setup menu. The 7-bit mode value is available only if the Keyboard field is <i>not</i> set to U.S. 8-bit sets the terminal to use either the DEC Multinational or ISO 8859 Latin-1 character set depending on the setting in the Preferred Char Set field on the System Setup menu.
Local Echo	Off On	When On , input from the keyboard is directed to the display screen and the host system (via the host port). When Off , the input is sent to the host system only.
Preferred Character Set	DEC Supple- mental ISO 8859-1	This field specifies the preferred supplemental character set.

Table 2-5.
Fields in the System Setup Menus under ANSI Mode (continued)

Field	Choices	Description
Keypad Mode	Numeric Application	Numeric specifies auxiliary keypad functions in Numeric Mode, sending the ASCII characters that match its keycaps. Application specifies auxiliary keypad sends escape sequences which application can use to assign customized functions.
Cursor Keys	Normal Application	Normal specifies that cursor (arrow) keys send escape sequences that move the cursor. Application specifies that cursor keys send escape sequences that can be assigned customized functions by applications.
User Features Locked	No Yes	Yes specifies that settings for the following Setup fields cannot be altered by the host computer: Tab Stops (Keyboard Setup menu), Background (Global Setup menu), Scroll (User Setup menu), Auto Repeat (Keyboard Setup menu) and Lock Key (Keyboard Setup menu). If your applications require control of these features, set this field to No .
User Keys Locked	No Yes	Yes specifies that host computer cannot reprogram the terminal's function keys. No specifies that host computer can reprogram the terminal's function keys.
Data Processing Keys	No Yes	No specifies that characters on the left side of the keycaps will be used. Yes specifies that characters on the right side of the keycaps will be used.
Print Scroll Region	Off On	Off specifies that the entire display contents is printed when the terminal receives a print screen command or when Shift + Print Screen is pressed. On specifies that only the region between the top and bottom scrolling margins is printed.

**Table 2-5.
Fields in the System Setup Menu under ANSI Mode (continued)**

Field	Choices	Description
Aux Mode	Normal	Normal turns off the Aux Mode and sets the terminal for normal printing (printing that can be invoked from the keyboard or by escape sequences).
	Controller	Controller causes data received at the main port to be transmitted to the auxiliary port without being displayed on the screen.
	Auto	Auto causes all data to be sent to the display screen; then, after a VT, LF or FF is received, the data is copied to the auxiliary port. (This mode is offered for VT320 compatibility.) If the terminal is turned off or reset, the value in this field reverts to the default value.
Aux to Host	No	No specifies that data coming into the auxiliary port is to be ignored. (Exception: In Bidirectional Mode, this field is ignored.) Yes specifies that all data coming from the auxiliary port is to be sent directly to the host without being displayed on the screen.
	Yes	
Print Terminator = FF	No Yes	No specifies that print page operations are terminated with no character. Yes specifies that print page operations are terminated by a form feed character.
Printer Char Set		Selects the protocol and character set to be used when performing local print operations using the auxiliary port.
	HP	Supports HP ROMAN8 and HP Line Drawing character sets. HP PCL commands are sent for selecting character sets and reproducing character attributes such as underline).

Table 2-5.
Fields in the System Setup Menus under ANSI Mode (continued)

Field	Choices	Description
	DEC 7-Bit	Supports the ASCII set and the 7-bit mode National character sets, and DEC special graphics. No character attribute commands are sent. Available in ANSI mode only.
	DEC 8-Bit	Supports ISO 8859-1, DEC Supplemental, 7-bit mode National character sets, and the DEC Special Graphics character sets. DEC commands are sent to select character sets and reproduce character attributes. Available in ANSI mode only.
	ASCII	Supports the ASCII set and the 7-bit mode National character sets. No character attribute commands are sent.
	IBM437	Supports the United States PC character set. No character attribute commands are sent.
	IBM850	Supports the Multilingual PC character set. No character attribute commands are sent.
	IBM860	Supports the Portugal PC character set. No character attribute commands are sent.
	IBM863	Supports the Canada-French PC character set. No character attribute commands are sent.
	IBM865	Supports the Norway PC character set. No character attribute commands are sent.
	ISO 8859-1	Supports the ISO 8859 Latin-1 character set. No character attribute commands are sent.

GLOBAL	USER	SYSTEM	PORT 1	PORT 3	KEYBRD	PROGRM
Block Mode		Off		Aux Mode		Off
Display Ctrl Codes		Off		Printer Char Set		HP
Preferred Char Set		WY 60				
Background Attr		Dim				
Attr Extent		Char				
Auto Page		Off				
Page Edit		Off				
Auto Scroll		On				
Auto Font Load		Yes				
Send Ack		Yes				
Block Term		Us / Cr				
		Block Moded		Choices		
Off		On				

Pg Up/Pg Dn:Menu Up/Down:Field Left/Right:Select Setup:Exit

Figure 2-6. System Setup Menu under ASCII Mode

Table 2-6. Fields in the System Setup Menus under ASCII Mode

Field	Choices	Description
Block Mode	Off On	Turns Block Mode on and off. The Interactive or Conversation Mode is selected when the field is set to Off .
Display Ctrl Codes	Off On	When On , control characters will be displayed instead of executed. If the terminal is turned on or reset, the value in this field reverts to the default value.

Table 2-6.
Fields in the System Setup Menus under ASCII Mode (continued)

Field	Choices	Description
Preferred Char Set	WY 60 IBM437 IBM850 IBM860 IBM863 IBM865 ISO 8859-1	This field specifies the preferred supplemental character set.
Background Attr	Dim Dim/Rv Dim/UL Dim/UL/Rv Normal Reverse Underline UL/Rv Secret Sec/Rv Sec/UL Sec/UL/Rv	Sets video attribute for all write-protected fields. Attribute abbreviations are: Dim (Dim), Blk (Blinking), UL (Underline), Sec (Secret or Security; that is, not displayed). The combinations can be up to 32 characters.
Attr Extent	Char Line Page	Determines the extent of the attribute (highlighting, underlining, and so on) for a character, a line or a page.
Auto Page	Off On	On causes cursor movement across page boundaries to automatically position cursor at next line of next page. A command to move <i>above</i> the top line of the current page moves the cursor to the bottom line of the previous page; a command to move <i>below</i> the bottom line of the current page moves the cursor to the top line of the next page. In both cases, that entire next or previous page moves into the user area. (Scrolling status is ignored and page changes are made in jumps.)

Table 2-6.
Fields in the System Setup Menus under ASCII Mode (continued)

Field	Choices	Description
Page Edit	Off On	On causes insert and delete instructions to operate on the entire page, rather than just the current line. In this case: inserting a character shifts all characters in the current logical page to the right and wraps the last character on each line down to the next line; deleting a character shifts all characters in the current logical page to the left and wraps the first character on each line up to the next line.
Auto Scroll	On Off	When set to On , a line feed with the cursor at the bottom of the screen causes the rows in the window to scroll up. (Exception: When Protect Mode is on, this field is ignored.) When set to Off , the cursor moves from the bottom of the screen to the top.
Auto Font Load	Yes No	Yes automatically loads character font information whenever the value in the Compatibility field is changed or when the screen width or number of scan lines is changed.
Send Ack	Yes No	Yes transmits an ACK character after certain commands, including: print page sequences, sequences that load or clear character sets, sequences that change the datacomm port configuration, terminal receipt of a <i>Ctrl E</i> character, and commands that split the display into "Wyse-Windows".
Block Term	Us/Cr CrLf/Etx	Characters used to separate lines and terminate block transfers. A line is terminated with Us (Unit Separator) or CR and LF ; a block is terminated with CR or EXT (End Of Text).

Table 2-6.
Fields in the System Setup Menus under ASCII Mode (continued)

Field	Choices	Description
Aux Mode		Four choices are available for Aux mode: Off, Controller, BiDirect, and Copy. If the terminal is turned off or reset, the value in the field reverts to the default.
	Off	Off turns off the Aux Mode and sets the terminal for normal printing (printing that is invoked from the keyboard or by escape sequences).
	Controller	Controller causes data received at the main port to be transmitted to the auxiliary port without being displayed on the screen.
	BiDirect	BiDirect causes all data received at the main port to be displayed on the screen and transmitted to the the auxiliary port.
	Copy	Copy causes every character from the main port to be sent to the display screen and the auxiliary port.
Printer Char Set	HP	Selects the protocol and character set to be used when performing local print operations via the auxiliary port. For more details on the description of the choices, refer to the Printer Char Set field in Table 2-5.
	DEC 7-Bit	
	DEC 8-Bit	
	ASCII	
	IBM437	
	IBM850	
	IBM860	
	IBM863	
	IBM865	
ISO 8859-1		

Port 1 and Port 3 Setup Menus

These menus specify how the terminal will communicate with the host computer and with a serial peripheral device.

By default, Port 1 is dedicated to the host computer and Port 3 to any optional peripheral device that may be connected to the terminal. However, these port designations can be switched using the Host Port field in the Global Setup menu. Both ports are bidirectional.

Table 2-7 list the command fields and describes the possible values for the Port 1 and Port 3 Setup menus. The default values are listed first.

GLOBAL	USER	SYSTEM	PORT 1	PORT 3	KEYBRD	PRGRM
Communication		Full Duplex		Limited Transmit		None
Data Length		8 bits		Search Duration		170 ms
Parity		None		Disconnect Delay		2 Sec
Stop Bits		1				
Xmit Baud		9600				
Recv Baud		=Xmit				
Xmit Pace		Xon/Xoff				
Recv Pace		Xoff at 128				
XPC Handshaking		No				
Monitor Line		Off				
Modem /Data Ctrl		Data				
			Communication	Choices		
Full Duplex			Half Duplex			

Pg Up/Pg Dn: Menu Up/Down: Field Left/Right: Select Setup: Exit

Figure 2-7. Port 1 Setup Menu

Table 2-7. Fields in the Port 1 and Port 3 Setup Menus

Field	Choices	Description
Communication		Only available in ASCII mode.
	Full Duplex	Data sent to the computer by the terminal is echoed by the computer to the terminal before the terminal displays it on the screen. Data is not sent directly to the screen by the terminal. The RTS (Request to Send) signal is always high.
	Half Duplex	Terminal sends data to the computer and the screen simultaneously.
Data Length	8 bits 7 bits	Selects the data length. Each port may send and receive 7-bit or 8-bit characters. (In ASCII mode, the 8th bit is ignored.) The value chosen must agree with what the value of the host computer.
Parity	None Odd Even 0 1	Parity may be set separately for each port and must agree with the value of the host computer.
Stop Bits	1 2	Selects the number of stop bits sent and expected by the terminal. The value chosen must agree with the value of the host computer.
Xmit Baud	9600 19200 38400 300 600 1200 2400 4800	The transmit baud rate (from the terminal to the computer) is listed in bits per second. The terminal's transmit baud rate should be set to match the host computer's receive baud rate. The terminal can be set at different transmit and receive baud rates (so long as the rates match those of the host computer). Baud rates for Port 1 and Port 3 do not have to match.

Table 2-7.
Fields in the Port 1 and Port 3 Setup Menus (continued)

Field	Choices	Description
Recv Baud	= Xmit	The receive baud rate (incoming to the terminal from the computer) is listed in bits per second. The terminal's receive baud rate should be set to match the host computer's transmit baud rate. = Xmit sets the terminal's receive baud rate to match the terminal's transmit baud rate.
	300	
	600	
	1200	
	2400	
	4800	
	9600	
	19200	
Xmit Pace	Xon/Xoff	Xon/Xoff sets the terminal to stop transmitting when an Xoff is received and resume transmitting when an Xon is received.
	DSR	DSR causes the terminal to send or receive data. (DSR set high)
	None	None sets the terminal for no transmit pacing.
Recv Pace	Xoff at 128	Xoff at 128 causes an Xoff to be sent when the buffer reaches 128 characters and an Xon to be sent when the buffer has emptied to 32 characters.

**Table 2-7.
Fields in the Port 1 and Port 3 Setup Menus (continued)**

Field	Choices	Description
	DTR	DTR (Data Terminal Ready) causes the DTR control line to lower when the receive buffer fills to 128 characters; the DTR line is raised when the buffer empties to 32 characters.
	DTR/Xoff/64 DTR/Xoff/128	These selections combines the following forms of handshaking: DTR, Xoff at 128, and Xoff at 64 (Xoff sent/DTR lowered at 64 (or 128); Xon sent/DTR raised at 32). Xon and Xoff are not sent in PCTERM mode.
	None	None sets the terminal for no receive pacing. The other parameters for this field involve the port's receive buffer which can hold up to 255 characters.
	Xoff at 64	Xoff at 64 causes an Xoff to be sent when the buffer reaches 128 characters and an Xon to be sent when the buffer has emptied to 32 characters.
XPC Handshaking	No Yes	No deactivates handshaking regulation in PCTERM mode. Yes activates handshaking regulation in PCTERM mode. Only available in PCTERM mode.
Monitor Line	Off CTS DSR CD	Off specifies no monitoring. CTS (Clear To Send) enables the terminal to transmit data. DSR (Data Set Ready) enables the terminal to transmit or receive data. CD (Carrier Detect) enables the terminal to receive data.
Modem/Data Ctrl	Data Modem	Data has no control. Modem controls the active communications port signals.

Table 2-7.
Fields in the Port 1 and Port 3 Setup Menus (continued)

Field	Choices	Description
Limited Transmit	Off	Off and On are available in ANSI mode. None , 150 cps and 60 cps are available in ASCII mode. None or Off allows unlimited transmit speed. 150CPS and 60 cps or On limits data transmission to no more than 150 or 60 characters per second.
	On	
	None	
	150 cps 60 cps	
Break Duration	170 ms	Specifies in milliseconds the duration of the break signal generated by the Break key.
	250 ms	
Disconnect Delay	2 Sec	Specifies the length of time (if any) that the CD signal must be low before the terminal automatically disconnects the datacomm line. 2 Sec (default) specifies that the terminal will initiate a disconnect if the CD signal drops for 2 seconds. 60 ms specifies that the terminal will initiate a disconnect if the CD signal drops for 60 milliseconds. Set the value at 60 ms only if your terminal is in the United Kingdom. For any of these settings, a modem disconnect can be caused by an escape sequence for that purpose or by typing Shift + Ctrl + Break .
	60 ms	

Keyboard Setup Menu

The fields shown on the Keyboard Setup menu depend on whether the terminal operates under ANSI or ASCII mode. Tables 2-8 and 2-9 list the fields and describe the possible values for the Keyboard Setup menu for ANSI (using either an ANSI or a PC-AT keyboard) and ASCII modes. The default values are listed first.

GLOBAL	USER	SYSTEM	PORT 1	PORT 3	KEYBRD	PROGRAM
Lock Key		Caps Lock			< X J	Delete
Auto Repeat		Yes			< > Key Sends	< >
Margin Bell		Yes			' ~ Key Sends	' ~
Warning Bell		Yes			.. and .. Keys Send	.. & ..
Char Access		Compose				
Auto Answerback		No				
Conceal Answerback		No				
Answerback =						
Clear All Tabs						
Set 8 Column Tabs						
Tab Setting						
		Lock Key			Choices	
Caps Lock		Shift Lock			Reverse Lock	
Pg Up/Pg Dn:Menu Up/Down:Field Left/Right>Select Setup:Exit						

Figure 2-8. Keyboard Setup Menu, ANSI Mode with an ANSI Keyboard

Figure 2-9 shows a partial screen of the Keyboard Setup menu that appears when a PC-AT keyboard is attached to the terminal. Notice that *Keypad Mode* appears in the upper right corner of the menu instead of the three values that appear on the Keyboard Setup menu in ANSI mode with an attached ANSI keyboard.

GLOBAL	USER	SYSTEM	PORT 1	PORT 3	KEYBRD	PROGRAM
Lock Key		Caps Lock			< X J	Delete
Auto Repeat		Yes			Keypad Mode	UT
Margin Bell		Yes				

Figure 2-9. Keyboard Setup Menu, ANSI Mode with a PC-AT Keyboard

Table 2-8. Fields in the Keyboard Setup Menu

Field	Choices	Description
Lock Key		Specifies the function of the Lock key. Pressing Lock toggles the Lock Mode on and off.
	Caps Lock	When Caps Lock is active, all alphabetic keys send uppercase characters.
	Shift Lock	When Shift Lock is active, all alphabetic keys send uppercase characters, and the numeric/symbol keys send the characters at the top of their keycaps. (Pressing Shift while in Shift Lock mode turns off Shift Lock mode.)
	Reverse Lock	When Reverse Lock is active, holding Shift down while pressing an alphabetic key causes the lowercase character to be sent.
Auto Repeat	Yes	<p>Yes enables, No disables Auto Repeat. When enabled, most keys will repeat automatically if held down longer than 1/2 second. (The following keys do not auto repeat: Return/Enter, Setup, Hold Screen/Scroll Lock, Break/Pause, Print Screen, Lock/Caps Lock and Compose Character/Alt.)</p>
	No	
Margin Bell	Yes	Yes specifies that the terminal bell sound when the cursor nears the right margin and No disables the terminal's bell.
	No	
Warning Bell	Yes	Yes specifies that the terminal's bell sound for operator errors and Ctrl-G. No disables the warning bell.
	No	
Char Access	Compose	Specifies the mode for accessing the extended character set.
	Alt	
	None	
Auto Answerback	No	If Yes , the answerback message (if one has been created) is automatically sent to the computer after a communications line is established. No disables this function.
	Yes	

Table 2-8. Fields in the Keyboard Setup Menu (continued)

Field	Choices	Description
Conceal Answerback	No Yes	No specifies that Answerback message be displayed in the Program Setup menu. Yes specifies that the Answerback message not be displayed. Once set to Yes , you cannot change this feature except by filling in the Answerback field again.
Answerback =	(fill-in)	Lets you specify a message of up to 30 characters. Any of the following three conditions can cause this message to be sent to the computer: when Ctrl + Break is typed at the keyboard, when an ENQ character is received from the computer, or when the communications line is established and the Auto Answerback field is set to Yes . The first character typed in this field clears the old message and starts a new message.
Clear All Tabs	—	Pressing Enter (on the numeric key pad) or the Space bar while this field is highlighted erases all saved tabs.
Set 8 Column Tabs	—	Pressing Enter (on the numeric key pad) or the Space bar while this field is highlighted sets tabs at every eighth column. This is the default tab setting.
Tab Setting	—	Specifies the location of tab stops. The top ruler line is for columns 1-80; the bottom line is for columns 81-132. Use the arrow keys to highlight a column. Press ▶ or ◀ to move the highlight. Press Enter (on the numeric key pad) or the Space bar to set a tab stop (marked by a T) or clear a tab stop.
<X]	Delete Backspace	Specifies whether the <X] sends a delete (DEL) character or a backspace (BS) character. For more information on ← , see Table 3-9.

Table 2-8. Fields in the Keyboard Setup Menu (continued)

Field	Choices	Description
<> Key Sends	< > , ~	In ANSI mode with an ANSI keyboard, specifies which characters the angle bracket key sends. If < >, the angle bracket key sends a < when unshifted and a > when shifted. If ', ~, the angle bracket key sends a ' when unshifted and a ~ when shifted.
'~ Key Sends	'~ Esc	In ANSI mode with an ANSI keyboard, specifies which character the tilde key sends. If '~', the tilde key sends a ' when unshifted and a ~ when shifted. If Esc, the tilde key sends an escape (ESC) character.
,, & .. Keys Send	,, & .. ,< & .>	In ANSI mode with an ANSI keyboard, specified which characters the comma and period keys send. If ,, & .., the comma key sends a comma when shifted or unshifted. The period key sends a period when shifted or unshifted. If ,< & .>, the comma key sends a comma when unshifted and a < character when shifted. The period key sends a period when unshifted and a > character when shifted.
Keypad Mode	VT PC	In ANSI mode with a PC-AT keyboard, specifies whether the numeric keypad functions as an ANSI or as a PC-AT numeric keypad. The setting PC is effective only if the Keypad mode field on the System menu is set to Numeric . (If the Keypad mode field on the System menu is set to Application , the setting in the Keypad mode field on the Keyboard Setup menu is ignored and the numeric keypad emulates DEC Application mode.) VT is the default setting.

GLOBAL	USER	SYSTEM	PORT 1	PORT 3	KEYBRD	PROGRM
Lock Key		Caps Lock			Hold Key	Hold
Auto Repeat		Yes			Return =	CR
Margin Bell		Yes			Enter =	CR
Warning Bell		Yes				
Char Access		Compose				
Auto Answerback		No				
Conceal Answerback		No				
Answerback =						
Clear All Tabs						
Set 8 Column Tabs						
Tab Setting						
		Lock Key			Choices	
Caps Lock		Shift Lock			Reverse Lock	

Pg Up/Pg Dn:Menu Up/Down:Field Left/Right:Select Setup:Exit

Figure 2-10. Keyboard Setup Menu under ASCII Mode

Table 2-9. Fields in the Keyboard Setup Menu

Field	Choices	Description
Lock Key		This field specifies the function of the Lock key. Pressing Lock toggles the Lock mode on and off.
	Caps Lock	When Caps Lock is active, all alphabetic keys send uppercase characters.
	Shift Lock	When Shift Lock is active, all alphabetic keys send uppercase characters, and the numeric/symbol keys send the characters at top of their keycaps. (Pressing Shift when Shift Lock mode is active turns off Lock mode.)
	Reverse Lock	When Reverse Lock is active, holding Shift down while pressing an alphabetic key causes the lowercase character to be sent.

Table 2-9. Fields in the Keyboard Setup Menu (continued)

Field	Choices	Description
Auto Repeat	Yes No	Yes enables, No disables Auto Repeat. When enabled, most keys will repeat automatically if held down longer than 1/2 second. (The following keys do not auto repeat: Return/Enter , Setup , Hold Screen/Scroll Lock , Break/Pause , Print Screen , Lock/Caps Lock and Compose Character/Alt .)
Margin Bell	Yes No	Yes specifies that the terminal bell sound when the cursor nears the right margin. No disables the margin bell.
Warning Bell	Yes No	Yes specifies that the terminal's bell sound for operator errors and Ctrl-G. No disables the warning bell.
Char Access	Compose Alt None	Specifies the mode for accessing the extended character set.
Auto Answerback	No Yes	If Yes , the answerback message (if one has been created) is automatically sent to the computer after a communications line is established. No disables this function.
Conceal Answerback	No Yes	If set to No , the Answerback message will be displayed in the Program Setup menu. Yes specifies that the Answerback message not be displayed. Once set to Yes , you cannot change this feature except by filling in the Answerback field again.

Table 2-9. Fields in the Keyboard Setup Menu (continued)

Field	Choices	Description
Answerback =	(fill-in)	This field lets you enter a message of up to 30 characters. Any of the following three conditions can cause this message to be sent to computer: when (Ctrl) + (Break) is typed at the keyboard, when an ENQ character is received from the computer, or when the communications line is established and the Auto Answerback field is set to Yes . The first character typed in this field clears the old message and starts a new message.
Clear All Tabs	—	Pressing (Enter) (on the numeric key pad) or the Space bar while this field is highlighted erases all saved tabs.
Set 8 Column Tabs	—	Pressing (Enter) (on the numeric key pad) or the Space bar while this field is highlighted sets tabs at every eighth column. This is the default tab setting.
Tab Setting	—	Specifies the location of tab stops. The top ruler line is for columns 1-80; the bottom line is for columns 81-132. Use the arrow keys to highlight a column. Press (▶) or (◀) to move the highlight. Press (Enter) (on the numeric key pad) or the Space bar to set a tab stop (marked by a T) or clear a tab stop.
Hold Key	Hold Function	Specifies the function of the (Hold) key. If set to Hold , the (Hold) key, when pressed once, stops the computer from sending data to the terminal; when pressed again resumes sending data. If set to Function , the (Hold) key, when pressed with an alphanumeric key, sends a SOH character, the other key's code, and a carriage return (CR) character.

Table 2-9. Fields in the Keyboard Setup Menu (continued)

Field	Choices	Description
Return=	CR CRLF TAB	Specifies the function of the Return key. CR , the Return key sends a carriage return (Carriage Return) character; CRLF , sends carriage return (CR) and linefeed (LF) characters; TAB , sends a horizontal tab (HT) character.
Enter=	CR CRLF TAB	Specifies the function of the Enter key. CR , the Enter key sends a carriage return (Carriage Return) character; CRLF , sends carriage return (CR) and linefeed (LF) characters; TAB , sends a horizontal tab (HT) character.

Program Setup Menu

This menu, only accessible in ASCII mode, lets you program (that is, define special functions for) some of the terminal's keys. Table 2-10 lists the fields and describes the possible values for the Program Setup menu.

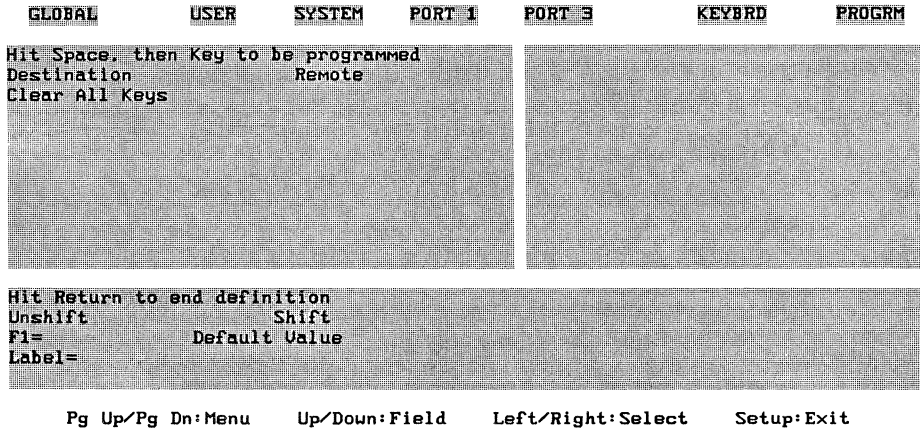

Figure 2-11. Program Setup Menu

In all, 15 function keys and 27 other keys are programmable.

You can also program a combination of keys: each of the function keys can be combined with **Ctrl**, **Shift**, or **Ctrl+Shift**. The total number of programs you can write using a key or a key combination is 60

Table 2-10. Fields in the Program Setup Menu

Field	Choices	Description
Hit space, then Key to be programmed	-	<p>Selecting this field enables key programming. Each function key may be programmed in four states:</p> <ul style="list-style-type: none"> ■ Unshift (the key pressed by itself). ■ Shift (the key pressed while the Shift is held down). ■ Control (the key pressed while the Ctrl is held down). ■ Control + Shift (the key pressed while the Ctrl + Shift are held down).
Destination		This field specifies the destination of where the definition string will be sent.
	Local	string sent to display screen.
	Remote	string sent to the computer (default).
	Printer	string sent to the printer.
	Rem & Loc	string sent both to the computer and display screen.
Clear All Keys	-	Press Enter on the numeric key pad or Return .
Hit Return to end definition	-	This field is not active in the menu. Rather, it reminds you to mark an end to a definition by pressing Return .

Programming a Key

To program a key:

1. Enter Setup mode and display the Program Setup menu.
2. Select the **Hit Space, then key to be programmed** field. A field is selected when it is highlighted. (To select a different field, use **▲** or **▼**.)
3. Select a key to program:
 - a. Press the Space bar.
 - b. Press the key (or key combination) you want to program.
4. Type the program (definition) for the key.

5. Press **Return**.

The definition stays in the Fill-in field until you begin to program another key by pressing the Space bar (step 3 above).

To save definitions in non-volatile RAM for future use, press **SAVE MENU** before exiting Setup. Otherwise, the definitions are saved only temporarily until the terminal is turned off or reset.

If you want to delete all the stored key definitions, select the Clear All Keys field and press **Enter** on the numeric key pad.

Caution



If you select the Clear All Keys field and press **Enter** on the numeric key pad, all the definitions are erased.

Notes

- A maximum of 512 bytes can be stored in NV RAM for all the programmed keys. You cannot enter characters beyond the 512- byte limit.
- Up to 80 characters can be included in each definition.
- The escape sequence for programming function keys (summarized in Appendix B) does not limit each string to 80 bytes.
- Control characters and escape sequences can be included in the definitions.
- Each control character counts as one character. Each space character counts as one character.
- To remove characters in a definition, press **< X** or **←**.
- Storage of the Answerback message takes up part of 512 bytes of non-volatile memory available for programmed keys. The Answerback message can be up to 30 characters long. The Answerback message is treated the same as any other definition string.
- Keeping the definition strings as short as possible lets you save more definitions for future use.

Using the Terminal

This chapter describes how to use the keyboard and display. It also describes how the terminal can be used with a printer.

The Display Screen

The appearance of the display screen may vary depending on the applications that you run and the screen features that you select in the Setup menus. This section lists the standard selectable features (by the menu in which they appear), describes the basic parts of the screen, and discusses how to use the display.

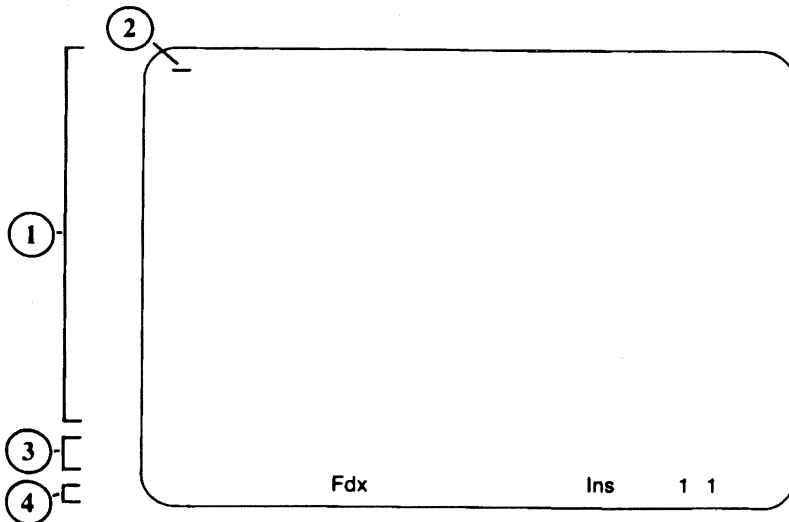

Figure 3-1. The HP 700/60 and HP 700/60ES Display Screen

1) User area: 80 or 132 columns 2) Cursor 3) User Message line 4) Status line

The Screen Areas and Cursor

1. User area

By default, the user area consists of one, 24-line by 80-column page of display memory. (Logical page size and display width are selectable in Setup mode and may be altered by different application programs when the terminal operates under ASCII mode).

2. Cursor

The cursor indicates where the next character you type will appear on the screen. The cursor style is selectable in Setup mode.

3. User Message line

This line may be blank, or it may consist of one message line, depending upon Setup settings and the application program.

4. Status line

The status line displays brief messages regarding the operating status of the terminal. This line, too, can be disabled in Setup mode or by the application, thereby adding another line to the user area. When enabled, the line is always the bottom line of the display.

Status Line Messages

Specific fields on the status line, which appear at the bottom of the screen, are reserved for messages. The messages are different depending on the mode the terminal is in, ANSI or ASCII. Only one status message can be displayed at each position at any given time.

Status Line (ANSI Mode)

Table 3-1 lists the possible status messages and in which fields the message will appear. Table 3-2 describes what these status messages mean. (In Table 3-1, **Fld** stands for “Field”. Field numbers do not appear on the Status Line, only the messages.)

Table 3-1. Status Line Message Locations

Fld 1	Fld 2	Fld 3	Fld 4	Fld 5	Fld 6	Fld 7	Fld 8
*	(1,1)	HdScrn	Caps	Comp	Wait	Printer:None Printer:Not Ready Printer:Ready Printer:Auto Printer:Controller	Modem:No DSR Modem: DSR

Table 3-2. Descriptions of the Status Line Messages

Field	Message	Description
1	*	* appears when the Monitor Line field in Setup is set to CTS, DSR or CD.
2	(1,1)	Indicates where the cursor position is; that is, the line (1 to 24) and the column (1 to 80 or 132).
3	HdScrn	The Hold Screen or Scroll Lock key has been pressed preventing data from reaching the screen. Press Hold Screen or Scroll Lock again to clear.
4	Caps	The terminal is in Caps Lock mode. Press the Caps Lock key to clear.
5	Comp	Indicates you have started a compose character sequence.
6	Wait	The keyboard is locked by the application through the active communication port.
7	None	The printer is not connected.
	Not Ready	The printer is disconnected.
	Ready	The printer is ready.
	Auto	Auto Print mode is on.
	Controller	Controller Print mode is on.
8	No DSR	The modem is not ready to transmit data.
	DSR	The modem is ready to transmit data.
		No message will be displayed if the Modem/Data Ctrl field in the Port 1/3 Setup menu is set to Data.

Status Line (ASCII Mode)

In ASCII mode there are two types of status lines, standard and extended, which can be selected in the User Setup menu. The status line appears as one line when the Logical Page Size field on the User Setup menu is set to 24, 25, 48, or 50. The status line and the user message line are combined into a single line when the Logical Page Size field on the User Setup menu is set to 42 or 43.

The status line appears at the bottom of the screen.

Table 3-3 shows the location of status line fields and lists the messages that may appear in those field. Table 3-4 explains what each status line message means.

Table 3-3. Status Line Message Locations

Fld 1	Fld 2	Fld 3	Fld 4	Fld 5	Fld 6	Fld 7	Fld 8	Fld 9	Fld 10	Fld 11	Fld 12	Fld 13	Fld 14	Fld 15
*	Num	Comp	10:30a	>	Fdx	Blk	<	Cop	Prot	LocE	Mon	Ins	1	12 35
	Lock			<	HDx		<	Trn	Wprt				2	
	Caps													
	Loc													
	BDx					3								
					HLD			Aut						
								SRv						

Table 3-4. Descriptions of the Standard Status Line Messages

Field	Message	Description
1	*	* appears when the Monitor Line field in Setup is set to CTS, DSR or CR.
2	Lock	The keyboard is locked.
	Num	The key "Num Lock" is enabled.
	Caps	The keyboard is in Caps Lock mode.
3	Comp	The Compose Character key is enabled.
4	10:30a	The current time is displayed (hh:mmx) with an a.m. or p.m indicator.
5	(blank)	No datacomm activity.
	>	There is data in the host port input buffer.
	<	There is data in the host port output buffer.
	=	There is data in both of the host port buffers.
6	FDx	The terminal is in Full Duplex mode.
	HDx	The terminal is in Half Duplex mode.
	Loc	The terminal is operating in Local mode (not in communication with the computer).
	HLD	The <u>Hold Screen</u> key is enabled.
7	Blk	The terminal is in Block or Half Duplex mode.
8	<	There is data in the auxiliary port input buffer.
	>	There is data in the auxiliary port output buffer.
	=	There is data in both of the host port buffers.
9	Cop	Copy Print mode is on. Refer also to Aux mode in Table 2-6.
	Trn	Controller (or Transparent) Print mode is on.
	BDx	BiDirect Print mode is on.
	Aut	Auto Print mode is on.
	SVr	Secondary Receive mode is on.
10	Prot	Protect mode is on.
	Wprt	Write-protect mode is on (displayed only when Protect Mode is also on).
11	LocE	Local edit commands are enabled.
12	Mon	Monitor mode is on.
13	Ins	The terminal is in Insert Character mode. Any characters to the right of the cursor are moved right.
14	1	The indicated page is displayed.
	2	
	3	
15	12 35	Indicates cursor position by row (from 1 to 43) and column (1 to 80 or 132).

Table 3-5 shows the location of fields when the status line and the user message line appear on the same line. The lines appear on one line when the setting in the Logical Page Size field on the User Setup menu is set to 42 or 43. Table 3-6 explains what each message on the combined line means.

Table 3-5. Combined Status and Message Locations

Fld 1	Fld 2	Fld 3	Fld 4	Fld 5	Fld 6	Fld 7	Fld 8
*	Lock	*	FDx	10:30a	1	012 35	(Message Line)
	Num		HDx		2		
	Caps		Blk		3		

Table 3-6. Descriptions of Combined Status and Message

Field	Message	Description
1	*	* appears when the Monitor Line field in Setup is set to CTS, DSR or CR.
2	Lock	The keyboard is locked.
	Num	The keyboard is in Num Lock mode.
	Caps	The keyboard is in Caps Lock mode.
3	*	Monitor is on.
4	FDx	The terminal is in Full Duplex mode.
	HDx	The terminal is in Half Duplex mode.
	Blk	The terminal is operating in Local mode (not in communication with the computer).
5	10:30a	The current time is displayed (hh:mmx) with an a.m. or p.m indicator.
6	1	The indicated page is displayed.
	2	
	3	
7	012 35	Indicates cursor position by row (from 1 to 43) and column (1 to 80 or 132).
8	Application message	This area is reserved for message sent from the application. The message length can be from 48 to 100 characters depending on the display width (80 or 132 columns) set in the User Setup menu.

Table 3-7 shows the location of fields when the extended status line and the user message line appear on the same line. The lines appear on one line when the setting in the Logical Page Size field on the User Setup menu is set to 42 or 43. Table 3-8 explains what each message on the combined line means.

Table 3-7. Combined Extended Status and Message Locations

Fld 1	Fld 2	Fld 3	Fld 4	Fld 5	Fld 6	Fld 7	Fld 8	Fld 9
*	Lock Num Caps	*	FDx HDx Blk	Prot	Wprt	Ins	1 2 3	(Message Line)

**Table 3-8.
Descriptions of Combined Extended Status and Message**

Field	Message	Description
1	*	* appears when the Monitor Line field in Setup is set to CTS, DSR or CR.
2	Lock	The keyboard is locked.
	Num	The Num Lock key is enabled.
	Caps	The keyboard is in Caps Lock mode.
3	*	Monitor is on.
4	FDx	The terminal is in Full Duplex mode.
	HDx	The terminal is in Half Duplex mode.
	Blk	The terminal is operating in Local mode (not in communication with the computer).
5	Prot	Protect mode is enabled.
6	Wprt	Write Protect mode is enabled.
7	Ins	The terminal is in Insert Character mode. Inserts characters you type. Any characters to the right of the cursor are moved right.
8	1	The indicated page is displayed.
	2	
	3	
9	Application message	This area is reserved for message sent from the application. The message length can be from 48 to 100 characters depending on the display width (80 or 132 columns) set in the User Setup menu.

The Keyboard

Your terminal came with either a ANSI or PC-AT keyboard.

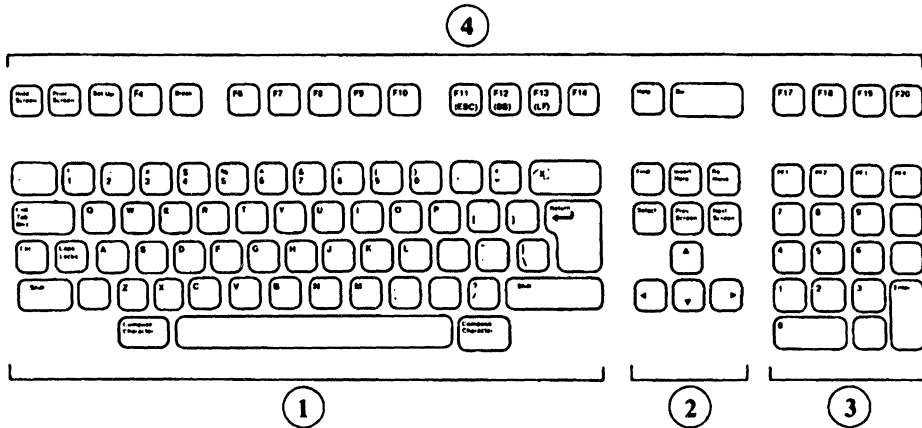

Figure 3-2. The ANSI Keyboard Layout

1) Typewriter Keypad 2) Middle Keypad 3) Numeric Keypad 4) Top Row Keypad

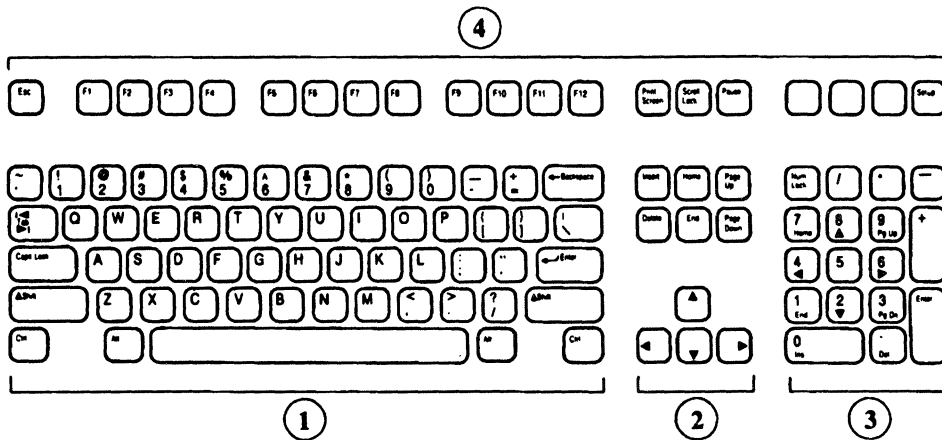

Figure 3-3. The PC-AT Keyboard Layout

1) Typewriter Keypad 2) Middle Keypad 3) Numeric Keypad 4) Top Row Keypad

Special Keys on the Keyboard

This section lists (by keyboard type) the special keys on the keyboard and describes the function of each.

Table 3-9. Special Keys on the Keyboard











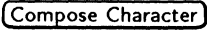

ANSI Key	PC-AT Key	Description
		The effect this key has depends upon the application program. For most applications, pressing this key moves the cursor left one space, erasing the character at that space.
		Lets you create characters that are not on the keyboard's keycaps. Refer to "Compose Character" later in this chapter for detailed information.
		Used with certain keys to provide application-dependent or predefined functions. Press the indicated key while holding down  .
		Toggles on and off Caps mode, which can be either Caps Lock, Shift Lock or Reverse Lock, as specified in the Keyboard Setup menu. All Caps modes set the alphabetic keys to uppercase. Shift Lock also sets the numeric/symbol keys to uppercase. In Reverse Lock, pressing an alphabetic key while holding down  displays the letter in lowercase. When any of the Caps modes is on, Lock is displayed on the Status Line (if that line is enabled). Press  again to turn the Caps mode off. Shift Lock mode can be turned off by pressing  .
		Moves the cursor to the beginning of the next line. On ANSI keyboards, the cursor moves to the beginning of the next line if the value in the Auto Linefeed field on the User Setup menu is set to On; to the beginning of the same line if the value in the field is set to Off.

Table 3-9. Special Keys on the Keyboard (continued)

ANSI Key	PC-AT Key	Description
Shift	Shift	Selects a key's upper symbol and capitalizes alphabetic keys. Turns off Shift Lock mode. Is used in conjunction with some keys for additional functions. To use, press Shift and the key together.
Tab	Tab	Moves the cursor to the next tab stop or to the right margin if no tabs are encountered. The effect of this key, however, depends on the application.
Find	Home	In ASCII mode, moves the cursor to the top left corner on the screen. Application specific in ANSI mode.
Insert Here	Insert	In ASCII mode, inserts a space at the cursor position. Shift + Insert Here inserts a line. Application specific in ANSI mode.
Next Screen	Page Down	Display next page. In most cases, the key transmits a command to the host computer only, so its action is application dependent. The exception is in ASCII mode where Ctrl + Page Down or Ctrl + Next Screen display the next page to the terminal only and no command is transmitted to the host computer.
Prev Screen	Page Up	Display previous page. In most cases, the key transmits a command to the host computer only, so its action is application dependent. The exception is in ASCII mode where Ctrl + Page Up or Ctrl + Prev Screen display the previous page to the terminal only and no command is transmitted to the host computer.
Remove	Delete	In ASCII mode, clears the character at cursor position. Shift + Remove clears the current line. Application specific in ANSI mode.

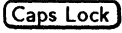
Table 3-9. Special Keys on the Keyboard (continued)

ANSI Key	PC-AT Key	Description
Select	End	In ASCII mode, transmits the current line to the host system if Text mode in the System Setup menu is set to On. Shift + Select transmits the current page to the host system if Text mode in the System menu is on. Application specific in ANSI mode.
PF1 PF2 PF3 PF4	Num Lock / * -	In ASCII mode, keys are programmable by application programs for specialized functions. In ASCII mode, the upper symbols on the numeric keypad are enabled when the Num Lock key is On; the lower symbols on the numeric keypad are enabled when the Num Lock key is Off.
Break	Pause	Key sends a break signal out the main port, the effect of which depends upon your computer's programming. The break signal can last for 170 milliseconds, 250 ms. or 500 ms., selectable in Setup's Break Duration field. Pressing Break while holding down Shift and Ctrl causes a modem disconnect (if applicable). Pressing Break while holding down Ctrl sends the answerback message (if there is one).
Do		In ASCII mode, turns Insert mode on or off. F15 in ANSI mode.
Help		In ASCII mode, replaces characters not protected in a line with spaces. Shift + help replaces characters not protected in a page with spaces. F15 in ANSI mode.
Hold Screen	Scroll Lock	when pressed once, tells the computer to stop sending data to the terminal (scrolling stops). When pressed again, tells the computer to resume sending data (scrolling resumes). When active, HldScr is displayed on the status line. This key has no effect if Xon/Xoff and DTR handshaking are disabled.

Table 3-9. Special Keys on the Keyboard (continued)

ANSI Key	PC-AT Key	Description
Print Screen	Print Screen	Effect of pressing this key alone is application-dependent. Pressed while holding down Shift , it initiates a local print screen operation; either the entire display memory contents or the scrolling region (as per Setup's Print Scroll Region field) is sent to the Aux port. Pressed while holding down Shift and Ctrl cancels a local print screen operation. Pressed while holding down Ctrl toggles Auto Print mode on and off. Pressed when the terminal is in Setup mode, prints the current menu.
Setup	Setup	Used to enter and exit Setup mode. Press Setup while holding down Ctrl to soft reset the terminal. Press Setup while holding down Shift and Ctrl to hard reset the terminal. Caution: Hard reset clears the display memory.
F11 ESC		In VT100 and VT52 modes, sends an escape character.
F12 BS		In VT100 and VT52 modes, sends the backspace (BS) character, which moves the cursor back one space.
F13 LF		In VT100 and VT52 modes, sends the line feed (LF) character, which moves the cursor down one line in the same column.

Other Special Keys on the PC-AT Keyboard

This section lists the special keys on a PC-AT keyboard that can be used when the terminal is in VT320 emulation mode.

Table 3-10. Remapping When Using a PC Keyboard

HP700/60 and HP 700/60ES	VT320 Equivalent
keypad +	,
keypad , (some languages)	-
Shift +	-
keypad numlock	PF1
keypad /	PF2
keypad *	PF3
keypad -	PF4
F1	F6
F2	F7
F3	F8
F4	F9
F5	F10
F6	F11
F7	F12
F8	F13
F9	F14
F10	Help
F11	Do
F12	F17
first blank key between Pause and Setup	F18
second blank key between Pause and Setup	F19
third blank key between Pause and Setup	F20

Composing Characters

The HP 700/60 and HP 700/60ES Display Terminal's compose character feature lets you generate characters that are not on the keyboard. Tables 3-10 and 3-11 list the extra characters available with this feature.

Locating the Characters You Want

The terminal's compose characters are listed in Tables 3-10 and 3-11. Which of these tables you use depends upon the current settings of following fields on the System Setup menu:

- Characters Mode
- Preferred Char Set
- Keyboard
- Data Processing Keys

Multinational Character Set Mode

When the Characters Mode field on the ANSI System Setup menu is set to 8-bit, use Table 3-10 as a compose character guide.

The 8-bit setting of the Characters Mode field puts your terminal in Multinational Character Set mode.

There are two multinational character sets. The one that is displayed depends upon the current setting in the Preferred Char Set field on System Setup menu. The two character sets are:

- ISO Latin-1
- DEC Supplemental

Most of the characters are common to both character sets. Some are different. The characters in Table 3-10 apply to both sets, except where noted.

National Character Set Mode

If the Characters Mode field on the System Setup menu is set to 7-bit, refer to Table 3-11 for compose character sequences.

The 7-bit setting for the Characters Mode field puts your terminal in National Character Set mode.

Table 3-11 contains sections for each of the keyboard languages supported by the terminal, plus a section for data processing keys. The section of Table 3-11 you use depends on information in the Data Processing Keys field on the System Setup menu and the Keyboard field in the Global Setup menu.

If the Data Processing Keys field on the System Setup menu is set to Yes, then refer to “Data Processing Keys” at the end of Table 3-11.

If the Data Processing Keys field is set to No, then use the section within Table 3-11 that matches the language specified in the Keyboard field on the Global Setup menu. For example, if the Keyboard field is set to Swedish, then refer to the Swedish section of Table 3-11.

Composing Character Sequences

There are two ways to compose characters: the three-key sequence and the two-key sequence. The two-key sequence is the faster method of the two, but more characters are available to you using the three-key sequence.

If your keyboard language is set to U.S., the only compose character method you can use is the three-key sequence method. All other keyboard languages let you to use either the three-key sequence or two-key sequence method.

Composing Three-Key Sequences

To compose characters using a three-key sequence:

1. Locate the character you want to compose in the left-hand column of Table 3-10 or 3-11.
2. Press **Compose Character**. Compose is displayed in the Status Line (if the Status Line is enabled).
3. Type the two corresponding characters from the middle (“Three-Key Sequence”) column.

For example, to generate the cent sign, press **Compose Character**, then type c and / (lowercase c and the slash character).

You can enter the two characters in step 3 in any order unless the table states “this order only”.

Composing Two-Key Sequences

To compose characters using a two-key sequence:

1. Locate the character you want to compose.
2. Type the corresponding two characters in the right-hand column.

In the two-key sequence, the first character typed is a diacritical character. These are the grave accent, acute accent, circumflex, tilde, umlaut and ring mark. When you type a diacritical character, the word **Compose** is displayed on the Status Line (if the Status Line is enabled). The second character completes the sequence. You must type the diacritical character first.

Completing or Canceling a Sequence

When you successfully complete a compose sequence, the composed character is displayed, and **Compose** is erased from the Status Line. If you enter an invalid sequence, the terminal's warning bell sounds (if it has been enabled using the Keyboard Setup menu) and the sequence is canceled.

If you accidentally begin a compose sequence, you can cancel it by pressing



In Tables 3-10 and Table 3-11, “or” indicates two or more possible sequences for the same character, and “(space)” indicates a space character.

Table 3-11.
Compose Character Sequences: Multinational Character Set
Mode

Compose Character	Description	Three-Key Sequence	Two-Key Sequence
"	quotation mark	" (space)	" (space)
#	number sign	++	
'	apostrophe	' (space)	' (space)
@	commercial at sign	aa <i>or</i> AA	
[opening bracket	((
\	backslash	/< <i>or</i> </ <i>or</i> //	
]	closing bracket))	
^	circumflex	^ (space)	^ (space)
`	single quote mark	'(space)	' (space)
{	opening brace	(-	
	vertical line	/^ <i>or</i> ^/	
}	closing brace)-	
~	tilde	~ (space)	~ (space)
!	inverted !	!!	
¢	cent sign	C/ <i>or</i> C <i>or</i> c/ <i>or</i> c	
¥	yen sign	Y- <i>or</i> Y= <i>or</i> y- <i>or</i> y=	
§	section	S0 <i>or</i> SO; <i>or</i> S! <i>or</i> s0 <i>or</i> so <i>or</i> s!	
¤	currency sign	xo <i>or</i> XO <i>or</i> x0 <i>or</i> X0	
©	copyright sign	co <i>or</i> CO <i>or</i> c0 <i>or</i> C0	
♀	female ordinal indicator	a_ <i>or</i> A_	
“	open angle quotation	<<	
•	degree sign	0^ <i>or</i> (space) *	
±	plus minus sign	+_	
¹	superscript 1	1^	
²	superscript 2	2^	
³	superscript 3	3^	
µ	micro sign	u <i>or</i> /U (<i>this order only</i>)	

Table 3-11.
Compose Character Sequences: Multinational Character Set
Mode (continued)

Compose Character	Description	Three-Key Sequence	Two-Key Sequence
¶	paragraph sign	p! or P!	
·	middle dot	.^ or ^.	
£	pound sign	L- or L= or l- or l=	
º	male ordinal indicator	_O or _o	
»	close angle quotation	>>	
¼	fraction one-quarter	14 (<i>this order only</i>)	
½	fraction one-half	12 (<i>this order only</i>)	
¿	inverted ?	??	
À	A grave	A'	'A
Á	A acute	A'	'A
Â	A circumflex	A^	^A
Ã	A tilde	A~	~A
Ä	A umlaut	A"	"A
Å	A ring	A* or A°	°A
Æ	AE	A E (<i>this order only</i>)	
Ç	C cedilla	C,	
È	E grave	E'	'E
É	E acute	E'	'E
Ê	E circumflex	E^	^E
Ë	E umlaut	E"	"E
Ì	I grave	I'	'I
Í	I acute	I'	'I
Î	I circumflex	I^	^I
Ï	I umlaut	I"	"I
Ñ	N tilde	N~	~N
Ò	O grave	O'	'O
Ó	O acute	O'	'O
Ô	O circumflex	O^	^O
Õ	O tilde	O~	~O
Ö	O umlaut	O"	"O

Table 3-11.
Compose Character Sequences: Multinational Character Set
Mode (continued)

Compose Character	Description	Three-Key Sequence	Two-Key Sequence
Œ	OE ligature ¹	OE (<i>this order only</i>)	
ø	O slash	O/	
ù	U grave	U'	'U
ú	U acute	U'	'U
û	U circumflex	U^	^U
ü	U umlaut	U"	"U
ÿ	Y umlaut	Y"	"Y
à	a grave	a'	'a
á	a acute	a'	'a
â	a circumflex	a^	^a
ã	a tilde	a~	~a
ä	a umlaut	a"	"a
å	a ring	a* or a°	°a
æ	ae	ae (<i>this order only</i>)	
ç	c cedilla	c,	
è	e grave	e'	'e
é	e acute	e'	'e
ê	e circumflex	e^	^e
ë	e umlaut	e"	"e
ì	i grave	i'	'i
í	i acute	i'	'i
î	i circumflex	i^	^i
ï	i umlaut	i"	"i
ñ	n tilde	n~	~n
ò	o grave	o'	'o
ó	o acute	o'	'o
ô	o circumflex	o^	^o
õ	o tilde	o~	~o
ö	o umlaut	o"	"o
œ	oe ligature	oe (<i>this order only</i>)	
ù	u grave	u'	'u

¹Only in the DEC supplemental character set.

**Table 3-11.
Compose Character Sequences: Multinational Character Set
Mode (continued)**

Compose Character	Description	Three-Key Sequence	Two-Key Sequence
ú	u acute	u'	'u
û	u circumflex	u^	^u
ü	u umlaut	u"	"u
ß	German small sharp s	ss	
ø	o slash (small)	o/	
ÿ	y umlaut (small)	y" or y"	"y
	no break space@	sp sp	
	broken vertical bar@	or !	
¬	logical not@	- or , or *	
-	soft (syllable) hyphen@	--	
®	registered trademark@	R O	
—	macron@	- ^	
¾	three quarters@	3 4 *	
+	division sign@	- :	
×	multiplication sign	x x	
´	acute accent@	' '	
¸	cedilla@	' '	
¨	diaeresis@	" "	␣ (sp)
Ý	Y acute@	Y'	Y'
ý	y acute@	y'	y'
Þ	capital Icelandic thorn@	T H	
þ	small Icelandic thorn@	t h	
Ð	capital Icelandic Eth@	- D	
ð	small Icelandic Eth@	- d	

* Only in the DEC supplemental character set.
@ Only in the ISO Latin-1 character set.

Table 3-12.
Compose Character Sequences: National Character Set Mode

Compose Character	Description	Three-Key Sequence	Two-Key Sequence
BRITISH KEYBOARD			
£	pound sign	-l or -L or =l or L=	
\	backslash	/<	
"	quotation mark	"(space)	
'	apostrophe	'(space)	
~	tilde	~(space)	
}	right brace)-	
{	left brace	(-	
	vertical bar	~/	
@	commercial at sign	aa or AA or aA	
[left bracket	((
]	right bracket	^^)	
GERMAN KEYBOARD			
Ä	A umlaut	"A	
Ü	U umlaut	"U	
ä	a umlaut	"a	
ü	u umlaut	"u	
§	section sign	so or OS or !s or !S or OS or OS	
ö	O umlaut	O"	
o	o umlaut	o"	
^	circumflex accent	^(space)	
`	grave accent	`(space)	
#	number sign	++	
ß	German small sharp s	ss	
"	quotation mark	"(space)	
'	apostrophe	'(space)	

Table 3-12.
Compose Character Sequences: National Character Set Mode
(continued)

Compose Character	Description	Three-Key Sequence	Two-Key Sequence
DANISH and NORWEGIAN KEYBOARDS			
Æ	AE	A E <i>(this order only)</i>	
æ	ae	a e <i>(this order only)</i>	
#	number sign	++	
À	A ring	A*	
Ø	O slash	O/	
Å	a ring	a*	
ø	o slash	o/	
"	quotation mark	"(space)	
`	grave accent	`(space)	
~	tilde	~(space)	
"	quotation mark	"(space)	
@	commercial at sign	aa <i>or</i> AA <i>or</i> aA	
SWISS KEYBOARD			
à	a grave	a'	'a
ç	c cedilla	c,	
ê	e circumflex	e^	^e
é	e acute	e'	'e
è	e grave	e'	^i
î	i circumflex	i^	^i
ô	o circumflex	o^	^o
û	u circumflex	u^	^u
ù	u grave	u'	'u
ä	a umlaut		a
ö	o umlaut		o
ü	u umlaut		u
<	less than sign	.)	
>	greater than sign	(.	
"	umlaut	"(space)	
'	apostrophe	'(space)	
â	a circumflex	a^	^a

**Table 3-12.
Compose Character Sequences: National Character Set Mode
(continued)**

Compose Character	Description	Three-Key Sequence	Two-Key Sequence
SWEDISH KEYBOARD			
#	number sign	++	
Å	Å ring	A*	
É	E acute	E'	
U	U umlaut	U"	
å	a ring	a*	
é	e acute	e'	
ü	u umlaut	u"	
ö	O umlaut	O"	
ä	A umlaut	A"	
o	o umlaut	o"	
ä	a umlaut	a"	
"	quotation mark	"(space)	
'	apostrophe	'(space)	
FRENCH KEYBOARD			
£	pound sign	L- or l- or L@ or l@	
§	section	s! or S! or so or So or Os or OS or 0s or 0S	
è	e grave	e'	'e
ù	u grave	u'	'u
`	grave accent	'(space)	'(space)
à	a grave	a'	'a
ç	c cedilla	c,	
é	e acute	e'	
^	circumflex	^(space)	^(space)

Table 3-12.
Compose Character Sequences: National Character Set Mode
(continued)

Compose Character	Description	Three-Key Sequence	Two-Key Sequence
SPANISH KEYBOARD			
£	pound sign	L- or l- or L@ or l@	
§	section	s! or S! or so or So or Os or OS or 0s or 0S	
¡	inverted !	!!	
¿	inverted ?	??	
°	degree sign	(space)*	
~	tilde mark	(space)~	
Ñ	N tilde	N~	
ñ	n tilde	n~	
^	circumflex accent	^(space)	^(space)
`	grave accent	‘(space)	‘(space)
ç	c cedilla	c,	
"	quotation mark	"(space)	
'	apostrophe	'(space)	
FLEMISH KEYBOARD			
£	pound sign	L- or l- or L@ or l@	
§	section	s! or S! or so or So or Os or OS or 0s or 0S	
è	e grave	e‘	‘e
ù	u grave	u‘	‘u
`	grave accent	‘(space)	‘(space)
à	a grave	a‘	‘a
ç	c cedilla	c,	
é	e acute	e’	
^	circumflex	^(space)	^(space)
"	quotation mark	(space)	
°	degree sign	(space)	

Table 3-12.
Compose Character Sequences: National Character Set Mode
(continued)

Compose Character	Description	Three-Key Sequence	Two-Key Sequence
ITALIAN KEYBOARD			
£	pound sign	L- or l- or L@ or l@	
§	section	s! or S! or so or So or Os or OS or 0s or 0S	
è	e grave	e'	'e
ù	u grave	u'	'u
`	grave accent	' (space)	'(space)
à	a grave	a'	'a
ç	c cedilla	c,	
é	e acute	e'	
^	circumflex	^ (space)	^(space)
ì	i grave	i'	'i
ò	o grave	o'	'o
"	quotation mark	(space)	
°	degree sign	(space)*	
DATA PROCESSING KEYS			
"	quotation mark	”(space)	
#	number sign	++	
@	commercial at sign	aa or AA or aA	
[left bracket	((
\	backslash	/<	
]	right bracket)	
'	apostrophe	'(space)	
{	left brace	(-	
	vertical bar	~/	
}	right brace)-	
~	tilde	~(space)	

Printing

If you have a printer connected to your terminal, you can print data using the methods described in this section. Make sure the printer is ready for operation and properly connected to the terminal and that the terminal's setup matches the printer's requirements.

Printing the Screen Contents

To send the display contents to the printer, press **Print Screen**

Note



If the terminal is operating in an ANSI compatibility mode, the current value of the Print Scroll Region field on the System Setup menu determines whether the entire screen is printed or just the scrolling region. (The scrolling region is the area between the top and bottom margins as set by an application program.)

Using Auto Print Mode (ANSI Mode Only)

In Auto Print mode, all data received from the computer is displayed on the screen. Then, after a LF, VT or FF character is received, the data also is sent to the printer attached to the terminal.

There are two ways to turn on Auto Print mode.

1. Press **Print Screen** while holding down the **Ctrl** key.
2. Select Auto in the Aux Mode field on the System Setup menu. **Aut** is displayed on the Status Line (if enabled) when Auto Print mode is on.

There are two ways to turn off Auto Print mode.

- Press **Print Screen** again while holding down **Ctrl**.
- Select **Off** in the Aux Mode field on the System Setup menu.

Using Copy Print Mode (ASCII Mode Only)

In contrast to Auto Print mode, Copy Print mode sends every character received from the computer to the display screen and to the printer attached to the terminal.

To turn on Copy Print mode, select Copy in the Aux Mode field on the System Setup menu. See “Aux Mode” in Table 2-6 for more information. The message, Cop, is displayed on the Status Line (if enabled) when Copy Print mode is on. To turn Copy Print mode off, select Off.

Using Controller Print Mode (ASCII Mode Only)

In Controller Print mode, all data received from the computer is sent to the printer without being displayed on the screen.

You can turn on Controller Print mode by selecting Controller in the Aux Mode field on System Setup menu. Trn is displayed on the Status Line (if enabled) when Controller Print mode is on. To turn off Controller Print mode, select Off. For more information on the Controller setting, see “Aux Mode” in Table 2-6.

Using Bidirectional Print Mode (ASCII Mode Only)

Bidirectional Print mode causes all data received from the computer to be displayed, printed, and transmitted back to the computer. Data sent to the terminal from the auxiliary device is transmitted to the computer without being displayed. BDx is displayed on the status line when this mode is on.

Data can be entered from the keyboard while the terminal is receiving data from the computer without losing or corrupting the data. In Block mode, transfer of a block of data to the computer can be initiated while data is being received from the computer.

To turn Bidirectional mode on, select *Bidirect* in the Aux Mode field on the System Setup menu.

To turn Bidirectional mode off, select Off in the Aux Mode field on the System Setup menu. For more information on the BiDirect setting, see “Aux Mode” in Table 2-6.

Using Serial Input Devices

If you have connected a serial input device to one of the terminal's serial ports and you want to direct data from the auxiliary port to the host computer, you must set the value in the Aux to Host field on the System Setup menu to Yes. When the value is Yes, the data from the auxiliary port is routed to the host computer without being displayed on the terminal's screen. To turn off Aux to Host mode, set the Aux to Host field to No.

Resetting the Terminal

There are two terminal resets: a soft reset and hard reset.

Soft Reset:

To perform a soft reset of the terminal, press **Setup** + **Ctrl**.

A soft reset resets many of the terminal's operating parameters to the default settings. It does not alter the terminal's nonvolatile memory, character set selection or user-programmed keys. It does not cause a host disconnect.

Hard Reset:

To perform a hard reset of the terminal, press **Setup** + **Shift** + **Ctrl**.

A hard reset restores the Setup values last saved in the terminal's non-volatile memory. It causes a communications disconnect. It also clears the terminals' volatile memory; that is, it erases the display screen contents. It has the same effect as turning the terminal on and off again.

Troubleshooting and Maintaining the Terminal

Problems and Solutions

If you encounter a problem in using the HP 700/60 and HP 700/60ES Display Terminal, you may be able to easily fix yourself. This chapter contains possible problems and solutions. If your terminal does require repair service, contact an HP Sales and Service Office.

Caution



Do not open your terminal to expose its internal circuitry. Only a qualified customer representative should perform maintenance procedures that require opening the terminal case.

In the following sections, the problems are in bold type followed by possible solutions.

The power button is pushed in, but the display is blank.

- Press any key. If the screen saver feature has blanked the screen, this will restore the display.
- Brightness may be turned down. Adjust the brightness control.
- Turn the power off and on again. If you didn't hear a beep, make sure the power cord is plugged securely into the terminal and power outlet. Make sure the power outlet is on.

The screen goes blank while the terminal is on.

- The screen saver feature is probably on. This feature blanks the screen after a specified period of inactivity. Press any key to cause the display screen to come back on without any loss of data.

There is no response on the display when you press keys.

- If the message, Lock, is displayed on the status line, then the keyboard is locked. Press **Setup** while holding down [Ctrl] (soft reset).
- If the DSR, CTS or CD signal is required, but is not currently active, this may lock the keyboard. If this has locked the keyboard, change the Port 1 Setup menu so that the signal is ignored and/or DSR handshaking is not used. For more information, refer to “Port 1 and Port 3 Setup Menus.”
- If the message, HdScr, is displayed on the Status Line, press **Hold Screen**.
- Press the **Setup** key. The first menu of Setup mode should appear. If it doesn't, then make sure that the keyboard cable is securely connected to the keyboard and terminal.
- Change the Online field on the User Setup menu to No. Exit Setup mode and press keys to see if characters display on the screen. If the terminal doesn't display alphabetic characters in local mode, and it is correctly installed (as described in Chapter 1), then the terminal requires repair service.
- Make sure the data communications cable to the host port is securely connected to the rear of the terminal.
- Change the Online field on the User Setup menu to Yes. Exit Setup mode and try typing characters again.
- Press **Break** to send a break signal to the host.
- Make sure that all the Setup fields involving communications with the computer are set properly.
- If you are using a modem, make sure it is working properly.
- The host computer system may not be working.

The Characters you type are displayed twice.

- On the Port Setup menu for the port you are using to communicate (port 1 by default), set the value in the Communication field to Full Duplex.
- Also make sure that the Local Echo field on the System Setup menu is set to Off

The screen displays nonsense characters.

- Make sure that all the fields on the Port Setup menu for the port you are using for communicating with the computer (port 1 by default) are set correctly.

The printer attached to your terminal is not printing correctly.

- Make sure the printer is plugged in and turned on. If the printer doesn't turn on, make sure the power outlet has power. (For instance, connect a lamp to the outlet and turn the lamp on.)
- Make sure the printer cable is connected securely to the terminal and the printer.
- Go into Port Setup menu and make sure all the Setup fields for communicating with the printer are set correctly.
- Ask a technician to determine if the pin assignments for the printer cable are correct.

Error codes are displayed at the bottom of the screen when the terminal is turned on.

- Try turning on the terminal again while pressing **D**. If the condition persists, the terminal requires service by a qualified technician.

The message, **Defaults used. Press Return to continue.**, appears at the bottom of the screen when the terminal is on.

- Non-volatile memory could not be accessed, so the terminal's default Setup values were invoked. Try turning the terminal off and then on again. If the condition persists, the terminal requires service by a qualified technician.

Preventive Maintenance

Clean the terminal and keyboard regularly to remove dust and grease. Unplug the power cord, then dust lightly using a damp, lint-free cloth. (Paper towels are fine.) The cloth should be just damp enough to pick up dust. Avoid wiping dust or lint into the keyboard.

If smudges or fingerprints persist, use a mild solution of soap and water. Remember to wring the cloth thoroughly; otherwise, rubbing the dirty areas will drip water over the terminal. Avoid getting any liquid between the keys.

Caution



Never use petroleum-based cleaners such as lighter fluid, or cleaners containing benzene, trichloroethylene, dilute ammonia, ammonia, or acetone. These cleaners may harm the terminal's plastic surface.

A

ANSI-Mode Terminal Commands

This appendix lists the terminal commands that are available when the terminal is used in various ANSI modes.

Note

Spaces are used between command elements in this appendix for readability. Do not use spaces when you enter the commands. For instance, ESC H is printed here with a space between the elements; don't include a space between the ESC and H when you enter the command.

C0 Codes and C1 Codes

Supported ASCII C0 Control Codes

Mnemonic	Hex	Description
NU	00	Null Ignored
EQ	05	Enquiry. The answerback message is sent.
BL	07	Bell. Sounds the bell if enabled.
BS	08	Backspace. Moves the cursor one position to the left; no action if the cursor is at the left margin.
HT	09	Horizontal Tab. Moves the cursor to the next tab stop or to the right margin if no further tab stops are in the line. No auto wrap.
LF	0A	Line Feed. Executes a line feed or a new line operation. (For more information, refer to "Auto Linefeed" in Table 2-3.)
VT	0A	Vertical Tab. Interpreted as LF.
FF	0C	Form Feed. Interpreted as LF.
CR	0D	Carriage Return. Moves cursor to column 1 of the current line.
SO	0E	Shift Out. Character set currently designated as G1 is invoked into GL.
SI	0F	Shift In. Character set currently designated as G0 is invoked into GL.
D1	11	Device Control 1 (Xon). Causes the terminal to resume transmission if Xon/Xoff handshaking is enabled.
D3	13	Device Control 3 (Xoff). If Xon/Xoff is enabled, causes the terminal to stop transmission of all codes except Xon and Xoff.
CN	18	Cancel. Aborts current escape sequence or device control string; the Cancel character is not displayed.
SB	1A	Substitute. Aborts current escape sequence or device control string; displays reverse question mark.
EC	1B	Escape. Escape sequence introducer.
DEL	7F	Delete. Ignored.

Supported C1 Control Codes

Mnemonic	Hex	7-Bit Code Extension Equivalent	Description
IND	84	ESC D	Index. Moves cursor down a line in the same column; scroll up if cursor is at bottom margin.
NEL	85	ESC E	Next line. Moves cursor to beginning of next line; scroll up if cursor is at bottom margin.
HTS	88	ESC H	Horizontal Tab Set. Sets a tab stop in the column currently occupied by the cursor.
RI	8D	ESC M	Reverse Index. Moves cursor up a line in the same column; scrolls down if cursor is at top margin.
SS2	8E	ESC N	Single Shift G2. The character set designated as G2 is temporarily invoked into GL for the next graphic character received.
SS3	8F	ESC O	Single Shift G3. The character set designated as G3 is temporarily invoked into GL for the next graphic character received.
DCS	90	ESC P	Device Control String. Introducer of a device control string.
CSI	9B	ESC [Control Sequence Introducer. Introduces a control sequence.
ST	9C	ESC \	String terminator. Close of a string opened by DCS
OSC	9D	ESC]	Operating System Command Introducer. Ignored until ST is received.
PM	9E	ESC ^	Privacy Message Introducer. Ignored until ST is received.
APC	9F	ESC _	Application Program Command Introducer. Ignored until ST is received.

Key Codes

Codes Sent By Edit Keys (VT300 Mode Only)

ANSI	PC-AT	Code Sent
Find	Home	CSI 1~
Insert Here	Insert	CSI 2~
Remove	Delete	CSI 3~
Select	End	CSI 4~
Prev Screen	Page Up	CSI 5~
Next Screen	Page Down	CSI 6~

Codes Sent By the Unshifted Top Row Keys¹

ANSI	PC-AT	Code Sent in VT320 Mode	Code Sent in VT100/VT52 Modes
F6	F1	CSI 17~	
F7	F2	CSI 18~	
F8	F3	CSI 19~	
F9	F4	CSI 20~	
F10	F5	CSI 21~	
F11	F6	CSI 23~	ESC
F12	F7	CSI 24~	BS
F13	F8	CSI 25~	LF
F14	F9	CSI 26~	
Help	F10	CSI 28~	
Do	F11	CSI 29~	
F17	F12	CSI 31~	
F18		CSI 32~	
F19		CSI 33~	
F20		CSI 34~	

¹Hold Screen, Print Screen, Set-Up, and Break do not send codes to the host.

Codes Sent By Numeric Keypad Keys

ANSI	PC-AT	Numeric Mode	Application Mode sVT320/VT100	Application Mode VT52
0	0	0	SS3 p	ESC ? p
1	1	1	SS3 q	ESC ? q
2	2	2	SS3 r	ESC ? r
3	3	3	SS3 s	ESC ? s
4	4	4	SS3 t	ESC ? t
5	5	5	SS3 u	ESC ? u
6	6	6	SS3 v	ESC ? v
7	7	7	SS3 w	ESC ? w
8	8	8	SS3 x	ESC ? x
9	9	9	SS3 y	ESC ? y
,	+	, (comma)	SS3 l	ESC ? l
-	(Shift)+	- (minus)	SS3 m	ESC ? m
.	.	. (period)	SS3 n	ESC ? n
Enter ¹	Enter	CR or CR LF	SS3 M	ESC ? M
PF1	Num Lock	SS3 P	SS3 P	ESC P
PF2	/	SS3 Q	SS3 Q	ESC Q
PF3	*	SS3 R	SS3 R	ESC R
PF4	-	SS3 S	SS3 S	ESC S

¹Enter sends CR. When the Auto Linefeed field on the User Setup Menu is set to On, Enter sends CR LF.

Codes Sent By Cursor Keys

Key Symbol	VT320/VT100 Normal	VT320/VT100 Application Mode	VT52
▲	CSI A	SS3 A	ESC A
▼	CSI B	SS3 B	ESC B
▶	CSI C	SS3 C	ESC C
◀	CSI D	SS3 D	ESC D

Keyboard Generated Control Characters¹

Name	Key + Ctrl	Key + Shift + Ctrl	Name	Key + Ctrl	Key + Shift + Ctrl
2 or space bar	NU		P	DL	DCS
A	SH		Q	D1	PU1
B	SX		R	D2	PU2
C	EX		S	D3	
D	ET	IND	T	D4	CCH
E	EQ	NEL	U	NK	MW
F	AK	SSA	V	SY	SPA
G	BL	ESA	W	EB	EPA
H	BS	HTS	X	CN	
I	HT	HTJ	Y	EM	
J	LF	VTS	Z	SB	
K	VT	PLD	3 or [EC	CSI
L	FF	PLU	4 or /	FS	ST
M	CR	RI	5 or]	GS	OSC
N	SO	SS2	6	RS	PM
O	SI	SS3	7	US	APC
P	DL	DCS	8	DEL	

¹Codes sent when the key is pressed while holding down **Ctrl**. Holding down **Ctrl** and **Shift** together will generate 8-bit version.

Terminal Configuration

Set Compatibility Mode (DECSCL)

Mode	Command
WY 60	CSI 42h ¹
VT 52 mode	CSI ? 2l ²
VT 100 mode	CSI 61 " p
VT 320 mode, 8-bit controls	CSI 62 " p <i>or</i> CSI 62 ; 0 " p <i>or</i> CSI 62 ; 2 " p <i>or</i> CSI 63 " p <i>or</i> CSI 63 ; 0 " p <i>or</i> CSI 63 ; 2 " p
VT320 mode, 7-bit controls	CSI 62 ; 1 " p <i>or</i> CSI 63 ; 1 " p

¹ CSI is equivalent to ESC [. See "Supported C1 Control Codes" in this appendix.
² The character "l" in this command is a lowercase L.

The following C1 Control Transmission commands determine whether or not the terminal will translate C1 codes into their 7-bit extension equivalents for transmission to the host.

Set C1 Control Transmission (VT320 Mode only)

Control Transmission	Command
7-Bit (C1 Codes translated into their 7-bit extension equivalents)	ESC <space>F
8-Bit (No translation)	ESC <space>G

Resets, Display Test

Reset Type	Command	Mnemonic
Soft Reset	CSI ! p	DECSTR
Hard Reset	ESC c	RIS
Screen Alignment Patter	ESC #8	DECALN

Terminal Operating Modes

Terminal Operating Modes

Mode	Description	Command	Mnemonic
Cursor Keys	Set to Application	CSI ? 1 h	DECCKM
	Reset to Cursor	CSI ? 1 l	
ANSI	Reset to VT52 mode	CSI ? 2 l	DECANM
Columns	Set Columns to 132	CSI ? 3 h	DECCOLM
	Reset Columns to 80	CSI ? 3 l	
Scrolling ¹	Set to Smooth Scrolling	CSI ? 4 h	DECSCLM
	Reset to Jump Scrolling	CSI ? 4 l	
Screen ¹	Set to Reverse Video	CSI ? 5 h	DECSCNM
	Reset to Normal Video	CSI ? 5 l	
Cursor Origin Mode	Set to Origin	CSI ? 6 h	DECOM
	Reset to Absolute	CSI ? 6 l	
Auto Wrap	Set Auto Wrap Mode On	CSI ? 7 h	DECAWM
	Reset Auto Wrap Mode Off	CSI ? 7 l	
Auto Repeat ¹	Set Auto Repeat Mode On	CSI ? 8 h	DECARM
	Reset Auto Repeat Mode	CSI ? 8 l	
	Off		
Print Form Feed	Set to On	CSI ? 18 h	DECPFF
	Reset to Off	CSI ? 18 l	
Print Extent	Set to Full Screen	CSI ? 19 h	DECPEX
	Reset to Scrolling Region	CSI ? 19 l	
Cursor Visibility (Text Cursor Enable)	Set to On (Enable)	CSI ? 25 h	DECTCEM
	Reset to Off (Disable)	CSI ? 25 l	

¹The host can be prevented from changing this mode by setting the User Features Locked field in the System Setup Menu to Yes.

Terminal Operating Modes (continued)

Mode	Description	Command	Mnemonic
National Replacement Character Set	Set to 7-Bit Reset to 8-Bit	CSI ? 42 h CSI ? 42 l	DECNRCM
Numeric Keypad	Set to Application Reset to Numeric	CSI ? 66 h CSI ? 66 l	DECNKM
Numeric Keypad	Set to Application Reset to Numeric	ESC = ESC >	DECKPAM DECKPNM
Destructive Backspace	Set to On Reset to Off	CSI ? 67 h CSI ? 67 l	DECBKM
Data Processing Keys (Keyboard Usage)	Set to On Reset to Off	CSI ? 68 h CSI ? 68 l	DECKBUM
Keyboard Action ¹	Set to Lock Reset to Unlock	CSI 2 h CSI 2 l	KAM
Control Representation ²	Set Reset	CSI 3 h CSI 3 l	CRM
Insert/Replace	Set to Insert Mode Reset to Replace Mode	CSI 4 h CSI 4 l	IRM
Horizontal Editing ³	Set Reset	CSI 10 h CSI 10 l	HEM
Send/Receive	Set to Local Echo Off Reset to Local Echo On	CSI 12 h CSI 12 l	SRM
Line Feed/New Line	Set to New Line Mode Set to Line Feed Mode	CSI 20 h CSI 20 l	LNM
¹ Mode can be locked using the Keyboard Setup menu. ² The host can not change CRM. It can only be changed in the Setup Menus. ³ HEM is permanently reset.			

Screen Control

Cursor Control

Description	Command ¹	Mnemonic
Move cursor up <i>n</i> line(s); no scroll up	CSI <i>n</i> A	CUU
Move cursor down <i>n</i> line(s); no scroll down	CSI <i>n</i> B	CUD
Move cursor forward <i>n</i> column(s); no auto wrap	CSI <i>n</i> C	CUF
Move cursor backward <i>n</i> column(s); no auto wrap	CSI <i>n</i> D	CUB
Cursor position (depends on setting of Origin Mode)	CSI <i>l</i> ; <i>c</i> H	CUP
Horizontal and vertical position	CSI <i>l</i> ; <i>c</i> f	HVP
Index: move cursor down a line in same column; scroll up if at bottom margin	ESC D	IND
Reverse Index: move cursor up a line in same column; scroll down if at top margin	ESC M	RI
Next Line: move cursor to beginning of next line; scroll up if at bottom margin	ESC E	NEL
Save cursor-related attributes	ESC 7	DECSC
Restore cursor-related attributes	ESC 8	DECRC
Cursor displayed	CSI ? 25 h	DECTCEM
Cursor not displayed	CSI ? 25 l	

¹*n* = number; *l* = line number; *c*=column number; *pn* = page number

Editing

Action ¹	Command	Mnemonic
Insert <i>n</i> blank lines	CSI <i>n</i> L	IL
Delete <i>n</i> blank lines	CSI <i>n</i> M	DL
Insert <i>n</i> blank characters (VT320 only)	CSI <i>n</i> @	ICH
Delete <i>n</i> characters	CSI <i>n</i> P	DCH

¹These actions begin at the cursor's current position.

Setting Margins

Margins	Command ¹	Mnemonic
Top and Bottom Margins	CSI <i>t</i> ; <i>b</i> r	DECSTBM
¹ <i>t</i> = line number of top margin; <i>b</i> = line number of bottom margin; <i>t</i> and <i>b</i> are included in the scrolling region.		

Using Tabs

Action	Command	Mnemonic
Set Tab Stop at Cursor Column	ESC H	HTS
Clear Tab Stop at Cursor Column	CSI <i>g</i>	
	<i>or</i>	
Clear All Tab Stops	CSI 0 <i>g</i>	TBC
	CSI 3 <i>g</i>	TBC
Move Cursor to Next Tab Stop	CTRL I	TAB

The Message Area

Action	Command/Parameters	Mnemonic
Select Destination for Received Data	Command: CSI <i>s</i> \$ }	DECSASD
Selects Main Display	If <i>s</i> = 0	
Selects Message Line 1	If <i>s</i> = 1	
Set Status and Message Lines On/Off	Command: CSI <i>s</i> \$ ~	DECSSDT
Status and Message Lines Off	If <i>s</i> = 0	
Status Line On; Message Line Off	If <i>s</i> = 1	
Message Line On	If <i>s</i> = 2	

Graphic Renditions

Action	Command/Parameters
Set Graphic Renditions (SGR)	Command: CSI <i>s</i> ;;.. <i>s</i> <i>m</i>
Turn Off All Attributes	If <i>s</i> = 0
Bold	If <i>s</i> = 1
Underscored	If <i>s</i> = 4
Blinking	If <i>s</i> = 5
Inverse (Reverse) Video	If <i>s</i> = 7
Normal Intensity	If <i>s</i> = 22
No Underline	If <i>s</i> = 24
No Blinking	If <i>s</i> = 25
Normal Video (Reverse Off)	If <i>s</i> = 27

Line Attributes

Line/Action	Command	Mnemonic
Cursor Line Becomes:		
Top Half of a Double-Width/Double-Height Line	ESC # 3	DECDHL
Bottom Half of a Double-Width/Double-Height Line	ESC # 4	DECDHL
Single-Width/Single-Height (Normal) Line	ESC # 5	DECSWL
Single-Width/Double-Height Line	ESC # 6	DECDWL

Erasing Characters (includes beginning and ending characters)

Action	Command	Mnemonic
Erase <i>n</i> Characters Starting at Cursor ¹	CSI <i>n</i> X	ECH
Erase in Display	CSI <i>n</i> J	ED
Erase cursor to end	If <i>n</i> = 0	
Erase beginning to cursor	If <i>n</i> = 1	
Erase complete display	If <i>n</i> = 2	
Erase in Line	CSI <i>n</i> K	EL
Erase cursor to end	If <i>n</i> = 0	
Erase beginning to cursor	If <i>n</i> = 1	
Erase complete line	If <i>n</i> = 2	
Select Character Erase Attribute	CSI <i>n</i> "	DECSCA
Erasable	If <i>n</i> = 0	
Not erasable	If <i>n</i> = 1	
Erasable	If <i>n</i> = 2	
Selective Erase in Display	CSI ? <i>n</i> J	DECSED
Erase cursor to end	If <i>n</i> = 0	
Erase beginning to cursor	If <i>n</i> = 1	
Erase complete display	If <i>n</i> = 2	
Selective Erase in Line	CSI ? <i>n</i> K	DECSEL
Erase cursor to end	If <i>n</i> = 0	
Erase beginning to cursor	If <i>n</i> = 1	
Erase complete line	If <i>n</i> = 2	
¹ Command may be used only in VT320 mode.		

Character Sets

Assign User-Preferred Character Set (VT320 Mode Only) (DECAUPSS)

Action	Command
Select DEC Supplemental Character Set	DCS 0 ! u % 5 ST
Select ISO Latin-1 Character Set	DCS 1 ! u A ST

National Replacement Character Set (VT320 Mode Only) (DECNRCM)

Action	Command
Set for 7-Bit Characters	CSI ? 42 h
Reset for 8-Bit Characters	CSI ? 42 l

Designating the 94 Character Set (SCS)

Designation	Command		
G0	ESC (<i>s</i>		
G1	ESC) <i>s</i>		
G2	ESC * <i>s</i>		
G3	ESC + <i>s</i>		
	where <i>s</i> =	B	ASCII
		%5	Supplemental
		0	Special Graphics
		<	User Preferred
		NRC Sets ¹	
		A	United Kingdom
		R	French
		K	German
		E or 6 or ‘	Danish/Norwegian
		Z	Spanish
		H or 7	Swedish
		=	Swiss
		4	Dutch
		C or 5	Finnish
		Y	Italian
		<i>name</i>	Soft Character Set

¹Must be in 7-bit Character mode.

Designating the 96 Character Set

Designation	Command		
G1	ESC - <i>s</i>		
G2	ESC . <i>s</i>		
G3	ESC / <i>s</i>		
	where <i>s</i> =	A	ISO Latin-1
		<	User Preferred
		<i>name</i>	Name of Soft Character Set) ¹

¹The name of the soft character set can consist of 0, 1 or 2 immediate characters in Hex range of 20 through 2F and a final character in the Hex range of 30 through 7E; this can also be a 94 character set.



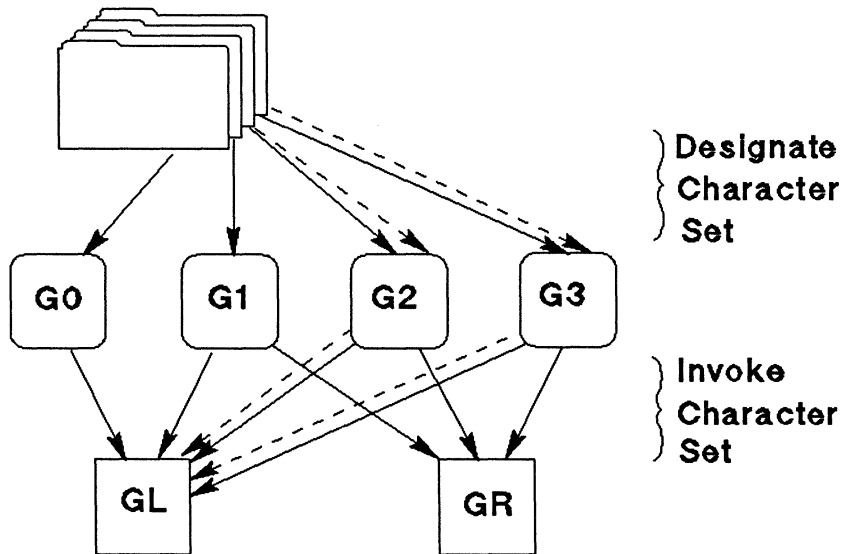

Invoking Character Sets

Mnemonic	Sequence	Description
LS0	SI	Lock Shift G0, Left: invoke G0 into GL
LS1	SO	Lock Shift G1, Left: invoke G1 into GL
LS1R ¹	ESC ~	Lock Shift G1, Right: invoke G1 into GR
LS2 ¹	ESC n	Lock Shift G2, Left: invoke G2 into GL
LS2R ¹	ESC }	Lock Shift G2, Right: invoke G2 into GR
LS3 ¹	ESC o	Lock Shift G3, Left: invoke G3 into GL
LS3R ¹	ESC	Lock Shift G3, Right: invoke G3 into GR
SS2	SS2 <i>or</i> ESC N	Single Shift G2, Left; invoke G2 into GL for only the next received graphic character
SS3	SS3 <i>or</i> ESC O	Single Shift G3, Left; invoke G3 into GL for only the next received graphic character

¹VT320 mode only.



Legend

-  Character Set Fonts
-  Font Buffers
-  GL and GR (Fonts Available for Use)
-  Single Shift
-  Lock Shift

Soft Character Sets (VT320 Mode Only)

In VT320 mode, you can download a soft character set by using the following command:

DCS *fn; cn; e; ccw; sw; t; cch; ss; {name *szbp1; szbp2; ... szbpn* ST*

The command string can contain up to 94 characters. For a list of allowable parameter values refer to the following table.

Downloading Soft Character Sets (VT320 Mode Only) (DECDLD)

Parameter	Description/Value
DCS	Device Control String Introducer
<i>fn</i>	Font number 0 or 1
<i>cn</i>	First Usable Position in Buffer (0-94 or 95)
<i>e</i>	Erase Control, where: 0 = erase all characters in set 1 = erase only characters being loaded 2 = erase all character in set
<i>ccw</i>	Cell Width (Pixels), where: 0 = 15 for 80 columns; 9 for 132 columns (default) 1 = not used 2 = 5w x 10h (VT220 compatible) 3 = 6w x 10h (VT220 compatible) 4 = 7w x 10h (VT220 compatible) 5 = 5w 6 = 6w : 14 = 14w 15 = 15w
<i>sw</i>	Screen Width, where: 0 = 80 columns (default) 1 = 8 columns 2 = 132 columns

Downloading Soft Character Sets (VT320 Mode Only) (DECCLD)
(continued)

Parameter	Description/Value
<i>t</i>	Text or Full-Cell, where: 0 = Text (default) 1 = Text 2 = Full-Cell
<i>cch</i>	Character Cell Height (Pixels), where: 0 = 12 (default) 1 = 1 2 3 12 = 12 <i>cch</i> is ignored if <i>ccw</i> is 2,3, or 4.
<i>ss</i>	Size of Set, where: 0 = 94 Characters (default) 1 = 96 Characters
<i>name</i>	Name of Soft Character Set, for example: <i>II F</i> where: <i>II</i> = 0 - 2 Intermediate Character (fm 2/0 to 2/15 in ASCII Character Set) <i>F</i> = Final Character (fm 3/0 to 7/14 in ASCII Character Set)
<i>szbpn</i>	Sixel Bit Patterns, for example, <i>S..S/S..S</i> where: 1st <i>S..S</i> = ASCII Characters for Upper Columns / = Required Separator 2nd <i>S..S</i> = ASCII Characters for Lower Columns
ST	String Terminator

Clearing a Soft Character Set

Action	Command
Clear Downloaded Soft Character Set ¹	DCS 1; 1; 2; { <i>sp</i> @ ST where <i>sp</i> =the space character
¹ Starting a power cycle or resetting (RIS) ESC c can also clear the Soft Character Set.	

Programmable Function Keys (VT320 Mode Only)

You can use the following command to program the function keys. (Up to 512 bytes are available for the user key strings.)

DCS *pc; pl | kyn/stn ;.;* *kyn/stn*; ST

The command string can contain up to 94 characters. Parameter values are listed in the following table.

Assigning Programs to Function Keys (VT320 Mode Only) (DECUDK)

Parameter	Description/Value
DCS	Device Control String Introducer
<i>pc</i>	Clear Parameter, where: 0 = clear all keys (default) 1 = clear only redefined keys
<i>pl</i>	Lock Parameter, where: 0 = lock keys to prevent redefinition (default) 1 = don't lock keys
<i>kyn</i>	Key Number; key number codes are listed in "VT300 Mode Function Key <i>kyn</i> Codes."
<i>stn</i>	Definition String; Hex Pairs for Each Character in the String
ST	String Terminator

VT300 Mode Function Key *kyn* Codes

Key Combination	<i>kyn</i> Code	Key Combination	<i>kyn</i> Code
Shift + F6	17	Ctrl + F6	37
Shift + F7	18	Ctrl + F7	38
Shift + F8	19	Ctrl + F8	39
Shift + F9	20	Ctrl + F9	40
Shift + F10	21	Ctrl + F10	41
Shift + F11	23	Ctrl + F11	43
Shift + F12	24	Ctrl + F12	44
Shift + F13	25	Ctrl + F13	45
Shift + F14	26	Ctrl + F14	46
Shift + Help	28	Ctrl + Help	48
Shift + Do	29	Ctrl + Do	49
Shift + F17	31	Ctrl + F17	51
Shift + F18	32	Ctrl + F18	52
Shift + F19	33	Ctrl + F19	53
Shift + F20	34	Ctrl + F20	54

Print and Aux to Host Modes

Printing

Action	Command	Mnemonics
Auto Print Mode On	CSI ? 5 i	MC
Auto Print Mode Off	CSI ? 4 i	
Printer Controller Mode On	CSI 5 i	MC
Print Controller Mode Off	CSI 4 i	
Print Display Screen	CSI i <i>or</i> CSI 0 i	
Print the Cursor Line	CSI ? 1 i	
Printer Extent Mode		
Set to full screen	CSI ? 19 h	DECPEX
Set to scrolling region	CSI ? 19 l	
Print Form Feed Mode On	CSI ? 18 h	DECPFF
Print Form Feed Mode Off	CSI ? 18 l	

Auxiliary to Host Mode

Action	Command
Turn on Bi-Directional mode. (Data may be sent and received over the printer port.)	CSI ? 9 i
Turn off Bi-Directional mode. (Data cannot be received by the printer port.)	CSI ? 8 i

VT52 Mode Escape Sequences

Description	Sequence
Cursor Up	ESC A
Cursor Down	ESC B
Cursor Right	ESC C
Cursor Left	ESC D
Select and enable alternate character set	ESC F
Select and enable base character set	ESC G
Home Cursor	ESC H
Reverse linefeed	ESC I
Erase to end of screen	ESC J
Erase to end of line	ESC K
Direct cursor address ¹	ESC Y <i>r c</i>
Enter Alternate Keypad mode	ESC =
Exit Alternate Keypad mode	ESC >
Enter VT52 mode	ESC [? 21
Enter VT100 mode	ESC <
Identify (request from host)	ESC Z
Identify (request from terminal)	ESC / Z
Enter AutoPrint mode	ESC ^
Exit AutoPrint mode	ESC _
Enter Print Transparent mode	ESC W
Exit Print Transparent mode	ESC X
Print the screen	ESC]
Print the cursor line	ESC V

¹ Use ASCII values for row and column. For example, 20H is 1, 21H is 2, and so on.

Reports

Reports

Request = Host to terminal; Primary device attributes request: (product type)	Response = Terminal to host CSI c <i>or</i> CSI 0 c <i>or</i> ESC Z	Mnemonic DA
Responses:		
ID Emulation		
VT300, VT320	CSI ? 63; 1; 2; 6; 7; 8; 9 c	
VT300, VT220	CSI ? 62; 1; 2; 6; 7; 8; 9 c	
VT100, VT100	CSI ? 1; 2 c	
VT101, VT101	CSI ? 1; 0 c	
VT102, VT102	CSI ? 6 c	
	<i>where</i>	
	63 = VT320 mode	
	62 = VT220 mode	
	1 = 132 columns	
	2 = printer port	
	6 = selective erase	
	7 = soft character set	
	8 = user-defined keys	
	9 = NRC sets	
Secondary device attributes request: (firmware and options)	CSI > c <i>or</i> CSI > 0 c	DA
Response: (VT300 mode only)	CSI > 24; 12; 0 c	DA
	<i>where</i>	
	24 = VT320 terminal	
	12 = firmware version	
	0 = no options	

Reports (continued)

Terminal status request:	CSI 5 n	DSR
Responses:		DSR
working properly	CSI 0 n	
malfunction	CSI 3 n	
Cursor position request:	CSI 6 n	DSR
Response:	CSI <i>r</i> ; <i>c</i> R	CPR
(<i>r</i> = row; <i>c</i> = column)		
Printer status request:	CSI ? 15 n	DSR
Responses:		DSR
Printer is ready	CSI ? 10 n	
Printer is not ready	CSI ? 11 n	
Printer is not connected	CSI ? 13 n	
Function key status request:	CSI ? 25 n	DSR
Responses:		DSR
Function keys unlocked	CSI ? 20 n	
Function keys locked	CSI ? 21 n	

Reports (continued)

Keyboard language request	CSI ? 26 n	DSR
Responses:	CSI ? 27; l n where l = 1 US 2 U.K. 3 Flemish 4 Canadian (French) 5 Danish 6 Finnish 7 German 8 Dutch 9 Italian 10 Swiss (French) 11 Swiss (German) 12 Swedish 13 Norwegian 14 French/Belgian 15 Spanish 16 Portuguese	DSR
Terminal state request:	CSI 1 \$ u	DECRQTSR
Responses:	DCS 1 \$ s d..d c ST where: c = 2-byte checksums d..d = data strings	DECTSR
Host restores terminal state:	DCS 1 \$ p d..d ST	DECRSTS
Cursor information request:	CSI 1 \$ w	DECRQPSR
Response:	DCS 1 \$ u d; ... ;d ST where: d = data strings	DECUR
Host restores presentation style:	DCS 1 \$ t d; ... ;d ST	DECRSPS

Reports (continued)

Tab stop information request:	CSI 2 \$ w	DECRQPSR
Responses:	DCS 2 \$ u d/./d ST <i>where: d = tab stop column number</i>	DECTABSR
Host restores tab stops:	DCS 2 \$ t d/./d ST	DECRSPS
User-preferred character set request:	CSI & u	DECRQUPSS
Response for DEC Supplemental:	DCS 0 ! u %5 ST	DECAUPSS
Response for ISO Latin-1:	DCS 1 ! u A ST	DECAUPSS
ANSI Set/Reset Mode request:	CSI s \$ p <i>where: s =</i> 2 keyboard action 3 display controls 4 insert/replace 12 send/receive 20 line feed/new line	DECRQM
Responses:	CSI s ; x \$ y <i>where: x =</i> 0 unrecognized mode 1 set 2 reset 3 permanently set 4 permanently reset	DECRPM
Set ANSI states:	CSI s ;,; s h	SM
Reset ANSI states:	CSI s ;,; s l	RM

Reports (continued)

DEC Private Set/Reset Mode request:	CSI ? s \$ p <i>where: s =</i> 1 cursor keys 2 ANSI 3 columns 4 scrolling 5 screen 6 origin 7 autowrap 8 autorepeat 18 print form feed 19 printer extent 25 cursor enable 42 Character Set Mode 66 auxiliary keypad 67 backarrow key 68 data processing keys	DEC RQM
Response:	CSI ? s ; x \$ y <i>where: x =</i> 0 unrecognized mode 1 set 2 reset 3 permanently set 4 permanently reset	DEC RPM
Set DEC private states:	CSI ? s ;..; s h	SM
Reset DEC private states:	CSI ? s ;..; s l	RM

Reports (continued)

Control functions request:	DCS \$ q s ST	DECRQSS
	<i>where: s =</i>	
	\$ } data destination	
	" q Selective Erase Mode (on/off)	
	" p erase all/part of line	
	\$ ~ status line: status/ message	
	r scroll region boundaries	
	m selected character attributes	

Response:	DCS v \$ r s..s ST	DECRPSS
	<i>where:</i>	
	<i>v =</i>	
	0 request invalid	
	1 request valid	
	<i>s = state of control functions</i>	
	\$ } parameters associated with DECSASD	
	" q parameters associated with DECSA	
	" p parameters associated with DECSCL	
	\$ ~ parameters associated with DECSSDT	
	r parameters associated with DECSTBM	
	m parameters associated with SGR	
	<i>example: DCS 1 \$ r 0 \$~ ST =</i> message lines off	

PCTERM-Mode Terminal Commands

This appendix lists the terminal commands that are available when the terminal is used in PCTERM mode.

Note



Spaces are used between command elements in this appendix for readability. Do not use spaces, though, when you enter the commands. For instance, ESC H is printed here with a space between the elements; don't include a space between the ESC and H when you enter the command.

Data Entry Forms—PCTERM Mode

Action	Command
Protect mode on	ESC &
Protect mode off	ESC '
Background mode on	ESC)
Background mode off	ESC (
Protect cursor column	ESC V

Clearing Data—PCTERM Mode

Action	Command
Home cursor, turn off Protect and Background modes, and clear entire window/page to foreground nulls	ESC *
Home cursor to first unprotected cell; clear all unprotected characters to:	
Foreground nulls	ESC :
Foreground spaces ¹	ESC ; or ESC +
Background spaces	ESC ,
Clear unprotected characters from cursor to end of line (Protect mode off) or end of field (Protect mode on). If Background mode is off, ¹ clear to:	
Foreground spaces	ESC T
Foreground nulls	ESC t
Clear unprotected characters from cursor to end of window/page. If Background mode is off, ¹ clear to:	
Foreground spaces	ESC Y
Foreground nulls	ESC y
Clear entire window/page to character 'H'	ESC F
¹ If Background mode is on, background spaces/nulls are used. If Foreground mode is off, foreground spaces/nulls are used.	

Editing—PCTERM Mode

Action	Command
Turn Insert mode on	ESC Z
Turn Insert mode off	ESC r
Insert line of foreground space characters if Protect mode is off	ESC E ¹
Insert one foreground space character	ESC Q
Delete line if Protect mode is off	ESC R ¹
Delete cursor character	ESC W

¹This command is ignored when Protect mode is on.

Display Attributes—PCTERM Mode

Action	Command
Set and propagate screen attribute	ESC G <attr> ¹
Set screen attribute to normal	ESC d
Set screen attribute to reverse	ESC b

¹Refer to PCTERM Attribute Codes for character attribute codes.

PCTERM Attribute Codes

<attr>	attributes				
0	none				
1					blank
2				blink	
3				blink	blank
4			reverse		
5			reverse		blank
6			reverse	blink	
7			reverse	blink	blank
8	underline				
9	underline				blank
:	underline			blink	
;	underline			blink	blank
<	underline	reverse			
=	underline	reverse			blank
>	underline	reverse		blink	
?	underline	reverse		blink	blank
p	dim				
q	dim				blank
r	dim			blink	
s	dim			blink	blank
t	dim		reverse		
u	dim		reverse		blank
v	dim		reverse	blink	
w	dim		reverse	blink	blank
x	dim	underline			
y	dim	underline			blank
z	dim	underline		blink	
{	dim	underline		blink	blank

PCTERM Attribute Codes (continued)

<attr>	attributes				
	dim	underline	reverse		
}	dim	underline	reverse		blank
-	dim	underline	reverse	blink	
Del	dim	underliine	reverse	blink	blank

Cursor Control—PCTERM Mode

Action	Command
Backspace, cursor left	Ctrl H <i>or</i> [BS]
Linefeed, cursor down	Ctrl J <i>or</i> [LF]
Cursor up	Ctrl K <i>or</i> [VT]
Cursor right	Ctrl L <i>or</i> [FF]
Carriage return	Ctrl M <i>or</i> [CR]
Cursor down, no scroll or wrap	Ctrl V <i>or</i> [SY]
Cursor home	Ctrl ^ <i>or</i> [RS]
Move cursor to column 1 of next line; scroll	Ctrl _ <i>or</i> [US]
Move cursor to page <P>, line <l>, column <c>	ESC - <P> <l> <c> ¹
Move cursor to line <l>, column <c>	ESC = <l> <c> ¹
Reverse linefeed	ESC j
Read active window number and cursor address	ESC /
Read cursor address (80 Column mode)	ESC ?
Switch to previous page	ESC J
Switch to next page	ESC K

¹Refer to "Line and Column Codes" detailed information.

Line and Column Codes

Line	Code	Line	Code	Line	Code	Line	Code
1	Space	25	8	49	P	73	h
2	!	26	9	50	Q	74	i
3	"	27	:	51	R	75	j
4	#	28	;	52	S	76	k
5	\$	29	<	53	T	77	l
6	%	30	=	54	U	78	m
7	&	31	>	55	V	79	n
8	'	32	?	56	W	80	o
9	(33	@	57	X	81	p
10)	34	A	58	Y	82	q
11	*	35	B	59	Z	83	r
12	+	36	C	60	[84	s
13	,	37	D	61	\	85	t
14	-	38	E	62]	86	u
15	.	39	F	63	^	87	v
16	/	40	G	64	_	88	w
17	0	41	H	65	`	89	x
18	1	42	I	66	a	90	y
19	2	43	J	67	b	91	z
20	3	44	K	68	c	92	{
21	4	45	L	69	d	93	
22	5	46	M	70	e	94	}
23	6	47	N	71	f	95	~
24	7	48	O	72	g	96	DEL

Line and Column Codes (continued)

Line	Code	Line	Code	Line	Code	Line	Code
97	80H	121	98H	145	B0H	169	C8H
98	81H	122	99H	146	B1H	170	C9H
99	82H	123	9AH	147	B2H	171	CAH
100	83H	124	9BH	148	B3H	172	CBH
101	84H	125	9CH	149	B4H	173	CCH
102	85H	126	9DH	150	B5H	174	CDH
103	86H	127	9EH	151	B6H	175	CEH
104	87H	128	9FH	152	B7H	176	CFH
195	88H	129	A0H	153	B8H	177	D0H
106	89H	130	A1H	154	B9H	178	D1H
107	8AH	131	A2H	155	BAH	179	D2H
108	8BH	132	A3H	156	BBH	180	D3H
109	8CH	133	A4H	157	BCH	181	D4H
110	8DH	134	A5H	158	BDH	182	D5H
111	8EH	135	A6H	159	BEH	183	D6H
112	8FH	136	A7H	160	BFH	184	D7H
113	90H	137	A8H	161	C0H	185	D8H
114	91H	138	A9H	162	C1H	186	D9H
115	92H	139	AAH	163	C2H	187	DAH
116	93H	140	ABH	164	C3H	188	DBH
117	94H	141	ACH	165	C4H	189	DCH
118	95H	142	ADH	166	C5H	190	DDH
119	96H	143	AEH	167	C6H	191	DEH
120	97H	144	AFH	168	C7H	192	DFH

Tabs—PCTERM Mode

Action	Command
Tab cursor	ESC i <i>or</i> Ctrl I
Backtab	ESC I
Clear all tabs	ESC 3
Set tab at cursor column; enable	ESC 1
Clear tab at cursor column	ESC 2

Monitor Mode—PCTERM Mode

Action	Command
Turn Monitor mode on	ESC U
Turn Monitor mode off	ESC X <i>or</i> ESC u

Keyboard Controls—PCTERM Mode

Action	Command
Unlock keyboard	ESC "
Lock keyboard	ESC #
Local Edit mode on	ESC k
Local Edit mode off	ESC l
Application Key mode on	ESC v 3
Application Key mode off	ESC v 2
Keyclick on (default)	ESC >
Keyclick off	ESC <

Display Control—PCTERM Mode

Action	Command
Set cursor attributes	ESC . <c> where <c> = 0 Cursor off 1 Cursor on (default) 2 Steady box cursor 3 Blinking line cursor 4 Steady line cursor 5 Blinking box cursor
Margin bell off	ESC n
Set margin bell at cursor position	ESC o
Turn display on	ESC N
Turn display off	ESC O
Display 25 data lines	ESC ^
Display 43 data lines	ESC _
Autowrap on (default)	ESC ~
Autowrap off	ESC 0
Received CR mode on	ESC 8
Received CR mode off	ESC 9

Function Key Label Control—PCTERM Mode

Action	Command
Write on unshifted label line	ESC f <s> CR ¹
Disable the display of the label line	ESC e
Enable the display of the label line	ESC g
¹ The label line programming is not supported when the Logical Page Size field on the User Setup menu is set to 25 or 43.	

Data Communications—PCTERM Mode

Action	Command
Full Duplex mode on	ESC }
Half Duplex mode on	ESC {
Switch to Block mode	ESC B
Leave Block mode	ESC C
Enable DTR handshaking	Ctrl N <i>or</i> [SO]
Read status	ESC [

Sending Data—PCTERM Mode

Action	Command
Send unprotected line	ESC 4
Send unprotected page	ESC 5
Send line	ESC 6
Send page	ESC 7
Send block of unprotected characters from [SX] to [EX]	ESC S
Send block of data	ESC s
Set page terminator	ESC x 4 <cc> ¹
Set line terminator	ESC x 1 <cc> ¹
Report attribute under cursor	ESC D ²

¹<cc> = 2 characters to be sent at end of any transmission which is initiated by a SEND command.

²Response is <attr> a, where <attr> is replaced by the attribute code shown in the table, "Attribute Codes Used with ESC D" later in this appendix.

Printing—PCTERM Mode

Action	Command
Copy Print mode on	ESC @
Copy Print mode off	ESC A
Print formatted page	ESC P
Enable Bidirectional Aux Port mode	[D2]
Disable Bidirectional Aux Port mode	[D4]
Transparent Print mode on	ESC ‘
Transparent Print mode off	ESC a
Print all unprotected	ESC L
Set page print terminator to character <c>	ESC p <c>

Graphics Characters—PCTERM Mode

Action	Command
Turn Graphics mode on; load WY-multinational character set	ESC \$
Turn Graphics mode off	ESC %

Attribute Codes Used with ESC D

<attr>	attributes			
[NU]	none			
[SH]				blank
SPACE			blink	
!			blink	blank
[DL]		reverse		
[D1]		reverse		blank
0		reverse	blink	
1		reverse	blink	blank
[BS]	underline			
[HT]	underline			blank
(underline		blink	
)	underline		blink	blank
[CN]	underline	reverse		
[EM]	underline	reverse		blank
8	underline	reverse	blink	
9	underline	reverse	blink	blank
[SX]	dim			
[EX]	dim			blank
"	dim		blink	
#	dim		blink	blank
[D2]	dim	reverse		
[D3]	dim	reverse		blank
2	dim	reverse	blink	
3	dim	reverse	blink	blank
[LF]	dim	underline		
[VT]	dim	underline		blank
*	dim	underline	blink	
+	dim	underline	blink	blank

Attribute Codes Used with ESC D (continued)

<attr>	attributes				
[SB]	dim	underline	reverse		
[EC]	dim	underline	reverse		blank
:	dim	underline	reverse	blink	
;	dim	underline	reverse	blink	blank

Terminal Commands—PCTERM Mode

Action	Command
Set active values to defaults	ESC m
Set time of day clock	ESC 1 <m> <HH> <MM> where: <m> = A (for AM) or P (for PM) <HH> = Hours; 01-12 (two ASCII digits) <MM> = Minutes, 00-59 (two ASCII digits)
Enhance mode on	ESC v !
Enhance mode off	ESC v <sp> where <sp> = space character
Switch Compatibility mode	ESC ~ <n> where <n> = - VT100 4 WYSE60 5 PC Term 6 VT52 ; VT300

Control Characters—PCTERM Mode

Action	Command
Reply with [AK]	Ctrl E <i>or</i> [EQ]
Bell	Ctrl G <i>or</i> [BL]
Backspace, cursor left	Ctrl H <i>or</i> [BS]
Move to next tab stop	Ctrl I <i>or</i> [HT]
Line feed, cursor down	Ctrl J <i>or</i> [LF]
Cursor up	Ctrl K <i>or</i> [VT]
Cursor right	Ctrl L <i>or</i> [FF]
Carriage return	Ctrl M <i>or</i> [CR]
DTR handshake	Ctrl N <i>or</i> [SO]
Xon/Xoff handshake	Ctrl O <i>or</i> [SI]
Xon handshaking enable	Ctrl Q <i>or</i> [D1]
Bidirection Print mode on	Ctrl R <i>or</i> [D2]
Xoff handshaking enable	Ctrl S <i>or</i> [D3]
Bidirection Print mode off	Ctrl T <i>or</i> [D4]
Cursor down	Ctrl V <i>or</i> [SY]
Clear unprotected page to foreground spaces	Ctrl Z <i>or</i> [SB]
Escape sequence leading char	Ctrl [<i>or</i> [EC]
Home cursor	Ctrl ^ <i>or</i> [RS]
Move to column 1 of next line	Ctrl - <i>or</i> [US]

Wyse 60-Mode Terminal Commands

This appendix lists the terminal commands that are available when the terminal is used in WY-60 mode.

Note

Spaces are used between command elements in this appendix for readability. Do not use spaces, though, when you enter the commands. For instance, ESC H is printed here with a space between the elements. Do not include a space between the ESC and H when you enter the command.

Data Entry Forms—WY-60 Mode

Action	Command
Protect mode on	ESC &
Protect mode off	ESC '
Background mode on	ESC)
Background mode off	ESC (
Protect cursor column	ESC V

Clearing Data—WY-60 Mode

Action	Command
Home cursor; replace all unprotected data with character $\langle c \rangle$ ¹	ESC . $\langle c \rangle$
Home cursor, turn off Protect and Background modes, and clear entire window/page to:	
Foreground nulls	ESC *
Foreground spaces	ESC +
Background spaces	ESC ,
Home cursor to first unprotected cell; clear all unprotected characters to foreground nulls	ESC :
Home cursor to first unprotected cell; clear unprotected characters to foreground spaces ¹	ESC ;
Clear unprotected characters from cursor to end of line (Protect mode off) or end of field (Protect mode on). If Background mode is off, ¹ clear to:	
Foreground spaces	ESC T
Foreground nulls	ESC t
¹ If Background mode is on, background spaces/nulls are used. If Background mode is off, foreground spaces/nulls are used.	

Clearing Data—WY-60 Mode (continued)

Action	Command
Clear unprotected characters from cursor to end of window/page If Background mode is off, ¹ clear to: Foreground spaces Foreground nulls	ESC Y ESC y
Clear unprotected to end of page with nulls	ESC c Q
Clear unprotected to end of page with spaces	ESC c P
Clear unprotected line to end of field with spaces	ESC c R
Clear unprotected to end of line with nulls	ESC c L
Clear unprotected to end of line with spaces	ESC c O
Clear unprotected to end of field with spaces	ESC c S
Clear unprotected column to nulls	ESC c K
Clear unprotected column to character specified in <c>	ESC c I <c>

¹If Background mode is on, background spaces/nulls are used. If Background mode is off, foreground spaces/nulls are used.

Editing—WY-60 Mode

Action	Command
Turn Insert mode on	ESC q
Turn Insert mode off	ESC r
Insert line of foreground space characters if Protect mode is off	ESC E ¹
Insert one foreground space character	ESC Q
Delete line if Protect mode is off	ESC R ¹
Delete cursor character	ESC W
Delete cursor column	ESC c J
Insert column of nulls at cursor	ESC c M

¹This command is ignored if Protect mode is on.

Monitor Mode—WY-60 Mode

Action	Command
Turn Monitor mode on	ESC U
Turn Monitor mode off	ESC X <i>or</i> ESC u

Display Attributes—WY-60 Mode

Action	Command
Set attribute for field <f>	ESC A <f> <attr> ¹ where <f> = 0 User data area 1 Label line 2 Status Line 3 Message line
Set screen attribute ¹	ESC ^ <n> where <n> = 0 normal 1 reverse
Set attribute to all background characters received ¹	ESC ' <c> where <c> = 7 Dim only (default) 6 Reverse only A Normal only B Add Blinking C Add Secret E Add Underline F Add Reverse G Add Dim
Character Attribute mode on	ESC e 1
Character Attribute mode off	ESC e 0
Line Attribute mode on	ESC e 3
Page Attribute mode on	ESC e 2
Set and propagate screen attribute	ESC G <attr> ¹
Set and propagate line attribute	ESC G <latr> ²
¹ Refer to "PCTERM Attribute Codes" in Appendix B for character attribute codes. ² Refer to "PCTERM Attribute Codes" in Appendix B for character attribute codes. ESC ' G, ESC ' H, ESC ' I, and ESC ' J are not supported.	

Cursor Control—WY-60 Mode

Action	Command
Backspace, cursor left	Ctrl H <i>or</i> [BS]
Linefeed, cursor down	Ctrl J <i>or</i> [LF]
Cursor up	Ctrl K <i>or</i> [VT]
Cursor right	Ctrl L <i>or</i> [FF]
Carriage return	Ctrl M <i>or</i> [CR]
Cursor down, no scroll or wrap	Ctrl V <i>or</i> [SY]
Home cursor	Ctrl ^ <i>or</i> [RS]
Move cursor to column 1 of next line; scroll	Ctrl _ <i>or</i> [US]
Cursor home	ESC {
Move cursor to window <w>, line <l>, column <c>	ESC - <w> <l> <c> ¹
Move cursor to page <P>, line <l>, column <c>	ESC - <P> <l> <c> ¹
Move cursor to column <c>	ESC _ <c> ¹
Move cursor to line <l>, column <c>	ESC = <l> <c> ¹
Move cursor to line <l>	ESC [<l> ¹
Move cursor to page <P>, line <l>, column <c>	ESC w @ <P> <l> <c> ¹
Move cursor to line <lll>, column <ccc> ¹	ESC a <lll>R <ccc>C ²
Reverse linefeed	ESC j
Read page number and cursor position	ESC /
Response: <w> <l> <c> [CR] <i>or</i>	ESC w '
<P> <l> <c> [CR]	ESC w l
	ESC w m
	ESC w n
	ESC w o
Read cursor address (80 Column mode)	ESC ?
Response: <l> <c> [CR]	
Read cursor address in 80/132 Column modes	ESC b
Response: <lll>R<ccc>C	

¹Refer to "Line and Column Codes" in Appendix B for line and column number codes.

²<lll> and <ccc> are decimal ASCII strings. They can be up to 3 digits excluding leading zeros.

Tabs—WY-60 Mode

Action	Command
Tab cursor	ESC i <i>or</i> Ctrl I
Backtab	ESC I
Clear all tabs	ESC 0 <i>or</i> ESC 3
Set tab at cursor column; enable	ESC 1
Clear tab at cursor column	ESC 2
Initialize tabs off	ESC e :
Initialize tabs on	ESC e ;

Keyboard Controls—WY-60 Mode

Action	Command
Unlock keyboard	ESC " <i>or</i> Ctrl N
Lock keyboard	ESC # <i>or</i> Ctrl O
Local Edit mode on	ESC k
Local Edit mode off	ESC l
Keyclick on (default)	ESC >
Keyclick off	ESC <
Key repeat on	ESC e -
Key repeat off	ESC e ,
Keyclick on	ESC e %
Keyclick off	ESC e \$
CAPS lock on	ESC e &
CAPS lock off	ESC e '
Margin bell on	ESC e M
Margin bell off	ESC e L
Set margin bell at cursor position	ESC ' J
Define CAPS LOCK key = CAPS LOCK	ESC e T
Define CAPS LOCK key = REV	ESC e U
Application Key mode on	ESC ~ 3
Application Key mode off	ESC ~ 2

Display and Wyse-Window Control

Action	Command
Autoscrolling mode on	ESC O
Autoscrolling mode off	ESC N
Split screen horizontally at line <l> ¹	ESC x 1 <l>
Split screen horizontally at line <l> ¹	ESC x 3 <l> ²
Split screen horizontally at line <l> ³	ESC x A <l> or ESC x C <l> ²
Split screen horizontally at line <l> ³	ESC x a <l> or ESC x c <l> ²
Redefine screen as one window ⁴	ESC x 0
Redefine screen as one window ⁴	ESC x @
Switch to other window/page	ESC J or ESC K
Activate upper window	ESC }
Activate lower window	ESC }
Autopage mode on	ESC d + or ESC v
Autopage mode off	ESC d *
Screen saver on	ESC e Q
Screen saver off	ESC e P
80 Column mode on	ESC e G
80/132 Column mode on	ESC e F

¹ESC x 1 <l> and ESC x 3 <l> both clear screen. The difference between these two commands is that the first one splits window within one page; the second one, within multiple pages.

²Refer to "Line and Column Codes" in Appendix B for line codes.

³ESC x A <l> or ESC x C <l>, and ESC x a <l> or ESC x c <l> both do not clear screen. The difference between these two is that the first one splits window within one page; the second one, within multiple pages.

⁴The difference between ESC x 0 and ESC x @ is that the first one clears screen while the second does not.

Display and Wyse-Window Control (continued)

Action	Command
Set logical page size	ESC e <n> where <n> = (24 rows)) (25 rows) * (42 rows) + (43 rows)
Set to one page of 1 x logical page size	ESC w G
Set to one page of 2 x logical page size	ESC w H or ESC w J
Set to one page of 4 x logical page size	ESC w I
Display specified page	ESC w <P> or ESC h <P> where <P> = page number
Display previous page	ESC w B
Display next page	ESC w C
Enlarge upper window	ESC x P or ESC x p
Enlarge lower window	ESC x R or ESC x r
Roll the active window up	ESC w E
Roll the active window down	ESC w F
Autowrap mode on	ESC d /
Autowrap mode off	ESC d .
Received Carriage Return mode on	ESC e 5
Received Carriage Return mode off	ESC e 4
Page Edit mode on	ESC e "
Page Edit mode off	ESC e #
Width-Change-Clear mode on	ESC e /
Width-Change-Clear mode off	ESC e .

Display and Wyse-Window Control (continued)

Action	Command
Set screen feature	ESC ' <c> where <c> = 0 Cursor off 1 Cursor on (default) 2 Steady box cursor 3 Blinking line cursor 4 Steady line cursor 5 Blinking box cursor a Extended status line on b Standard status line on c Turn status line off 9 Screen on (default) 8 Screen off : 80 column screen width (default) ; 132 column screen with < smooth scroll at rate of 1 line/second = smooth scroll at rate of 2 lines > smooth scroll at rate of 4 lines/second ? smooth scroll at rate of 8 lines/second @ jump scroll (default)
Screen on	ESC n
Screen off	ESC o

Message Line—WY-60 Mode

Action	Command
Write <s> string to message line	ESC F <s> [CR]

Function Key Label Control—WY-60 Mode

Action	Command
Write on unshifted label line	ESC z (< <i>s</i> > CR <i>or</i> ESC f < <i>s</i> > CR where < <i>s</i> > = string ≤ 80 characters (80 col mode) ¹ string ≤ 132 characters (132 col mode) ¹
Write on shifted label line	ESC f) < <i>s</i> > CR where < <i>s</i> > = string ≤ 80 characters (80 col mode) ¹ string ≤ 132 characters (132 col mode) ¹
Disable shifted label line	ESC z DEL
Write a function key label	ESC z < <i>l</i> > < <i>s</i> > CR where < <i>l</i> > = label code. Refer to “Programmable Key Codes (Function Keys)” later in this appendix. where < <i>s</i> > = string ²
Save Function Key Labels mode on	ESC e K
Save Function Key Labels mode off	ESC e J
¹ The string is written into one of the two levels of label lines. The string fills all columns, starting at column 1 and is ended by the 80th or 132th character or a CR, whichever comes first.	
² The label string is terminated after 9 characters (for an 80-column screen), 7 characters (for a 132-column screen) or CR, whichever occurs first.	

Programmable Keys—WY-60 Mode

Action	Command
Define programmable key	ESC z <f> <s>DEL where <f> = function key code ¹ where <s> = string up to 64 characters long ³
Clear programmed key	ESC z <f>DEL where <f> = function key code ¹
Program direction and definition of key	ESC Z <d> <k> <s> DEL where <d> = 0 Normal (default) 1 Remote 2 Local where <k> = programmable key code ²
Set maximum function key transmission speed	ESC c 7 <spd> where <spd> = 1 60 character per second 2 None (default) 3 150 character per second
Sense programmable key	ESC Z ~ <k> where <k> = programmable key code ²
Set default function keys	ESC c U
¹ Refer to “Programmable Key Codes (Function Keys)” later in this appendix for key code information. ² Refer to “Programmable Key Codes (Function Keys)” and “Programmable Key Codes (Non-Function Keys)” which follow for key code information. ³ The string is terminated by the 64th character or DEL, whichever occurs first. The DEL character is not included in the key definition string.	

Programmable Key Codes (Function Keys)

Key Only				Key + Shift			
Key ID	Key Code	Label Code	Default String	Key ID	Key Code	Label Code	Default String
f1	@	0	[SH]@[CR]	sf1	‘	P	[SH]‘[CR]
f2	A	1	[SH]A[CR]	sf2	a	Q	[SH]a[CR]
f3	B	2	[SH]B[CR]	sf3	b	R	[SH]b[CR]
f4	C	3	[SH]C[CR]	sf4	c	S	[SH]c[CR]
f5	D	4	[SH]D[CR]	sf5	d	T	[SH]d[CR]
f6	E	5	[SH]E[CR]	sf6	e	U	[SH]e[CR]
f7	F	6	[SH]F[CR]	sf7	f	V	[SH]f[CR]
f8	G	7	[SH]G[CR]	sf8	g	W	[SH]g[CR]
f9	H	8	[SH]H[CR]	sf9	h	X	[SH]h[CR]
f10	I	9	[SH]I[CR]	sf10	i	Y	[SH]i[CR]
f11	J	:	[SH]J[CR]	sf11	j	Z	[SH]j[CR]
f12	K	;	[SH]K[CR]	sf12	k	[[SH]k[CR]
f13	L	<	[SH]L[CR]	sf13	l	\	[SH]l[CR]
f14	M	=	[SH]M[CR]	sf14	m]	[SH]m[CR]
f15	N	>	[SH]N[CR]	sf15	n	^	[SH]n[CR]

Programmable Key Codes (Non-Function Keys)

Key ID	Default String	Key Code
Esc	EC	SP
Tab	HT	!
←	BS	"
Delete	DEL	#
Return	CR	\$
Shift+Esc	EC	%
Shift+Tab	EC I	&
Shift+←	BS	'
Shift+Delete	DEL	(
Shift+Return	CR)
▶	RS	*
▲	VT	+
▼	LF	,
◀	BS	-
▶	FF	.
Shift+▼	EC {	/
Shift+▲	VT	0
Shift+▼	LF	1
Shift+◀	BS	2
Shift+▶	FF	3
Shift+Enter	1	4
Page Dn	EC K	r
Enter	CR	s
Print Screen	EC P	t
Page Up	EC J	w
End	EC T	}
Shift+End	EC Y	z

¹Toggles keyclick

Data Communications—WY-60 Mode

Action	Command
[AK] mode on	ESC e 7
[AK] mode off	ESC e 6
Redefine Modem/Aux port	ESC e 8
Redefine Aux/Modem port	ESC e 9
Switch to Block mode	ESC B
Full Duplex mode on	ESC C ESC D F
Half Duplex mode on	ESC C ESC D H
Half Duplex Block mode off	ESC C ESC D B
Set main port configuration	ESC c 0 <s> <P> <w>
where = Baud rate code	where <s> = Stop bit code
0 38400	0 1 (default)
1 19200	1 2
2 9600 (default)	
3 4800	where <P> = Parity bit code
4 2400	0 None (default)
7 1200	1 Odd
8 600	2 Mark
9 300	3 Even
	where <w> = Data word code
	0 7 bits
	1 8 bits (default)
Set aux port configuration	ESC c 1 <s> <P> <w>
where = Baud rate code	where <s> = Stop bit code
0 19200	0 1 (default)
1 9600 (default)	1 2
3 4800	
5 2400	where <P> = Parity bit code
8 1200	0 None (default)
9 600	1 Odd
: 300	2 Mark
	3 Even
	where <s> = Data word code
	0 7 bits
	1 8 bits (default)

Sending Data—WY-60 Mode

Action	Command
Xon Handshaking enabled	Ctrl Q <i>or</i> [D1]
Xoff Handshaking enabled	Ctrl S <i>or</i> [D3]
Send unprotected line	ESC 4
Send unprotected page	ESC 5
Send line	ESC 6
Send page	ESC 7
Send character at cursor position	ESC M
Place STX character at cursor position	ESC 8
Place ETX character at cursor position	ESC 9
Send block of unprotected characters from STX to ETX	ESC S
Send block of data	ESC s
Send terminal ID	ESC <space>
Begin send/print at top of split window/screen	ESC d &
Begin send/print at top of page	ESC d '
Program answerback message	ESC c ; <ans> [EM] where <ans> = answer back string
Send answer back message	ESC c <
Conceal answerback message in menu	ESC c =
Answerback mode off	ESC e <space>
Answerback mode on	ESC e !

Printing—WY-60 Mode

Action	Command
Copy Print mode on	Ctrl R <i>or</i> [D2] <i>or</i> ESC d c <i>or</i> ESC d C
All Print modes off	Ctrl T <i>or</i> [D4]
Print formatted unprotected page	ESC @
Print unformatted page	ESC L <i>or</i> ESC p
Print formatted page	ESC P
Bidirectional Print mode on	ESC d %
Bidirectional Aux Port mode on	ESC d e <i>or</i> ESC d E <i>or</i> ESC d u <i>or</i> ESC d U
Bidirectional Print mode off	ESC d \$
Transparent Print mode on	ESC d s <i>or</i> ESC d S <i>or</i> ESC d #
Secondary Receive mode on	ESC d q <i>or</i> ESC d Q <i>or</i> ESC d ! <i>or</i> ESC d a <i>or</i> ESC d A
Secondary Receive mode off	ESC d <space>

Graphics Characters—WY-60 Mode

Action	Command
Turn graphics mode on	ESC H [SX]
Turn graphics mode off	ESC H [EX]
Place a graphic character at cursor	ESC H <x> ¹
Draw rectangle	ESC c G <l> <c> ²
Draw rectangle; fill with character <char>	ESC c F <l> <c> <char> ² or ESC c H <l> <c> <char>
Box rectangle relative to cursor position	ESC c N <w> <h> ²

¹For box drawing codes, see Figure C-1.

²For <l>, line and <c>, column number codes, see Figure B-2 or B-3.













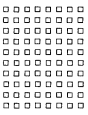

ASCII char	Graphics char	ASCII char	Graphics char	ASCII char	Graphics char	ASCII char	Graphics char
0		1		2		3	
4		5		6		7	
8		9		:		;	
<		=		>		?	

Figure C-1. Graphics Characters

Terminal Commands—WY-60 Mode

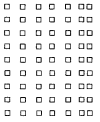
Action	Command
Set time of day	ESC c 8 <HH> <MM> where <HH> = Hours; 00-23 where <MM> = Minutes; 0-59
Hard reset	ESC c X
Send copyright message	ESC d b <i>or</i> ESC d B <i>or</i> ESC d r <i>or</i> ESC d R
Enhance mode on ¹	ESC ~ !
Enhance mode off	ESC ~ <sp> where <sp> = Space character
Switch Compatibility mode	ESC ~ <n> where <n> = - (VT100) 4 (WYSE60) 5 (PC Term) 6 (VT52) ; (VT300)
¹ Has no effect on the HP 700/60 or HP 700/60ES Display Terminal.	

Font Characters—WY-60 Mode

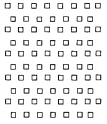
Action	Command
Autofontload on	ESC e O
Autofontload off	ESC e N
Define and load character	<p>ESC c A <P> <s> (Ctrl) Y</p> <p>where = Bank number</p> <p style="margin-left: 2em;">0 (26-line font bank)</p> <p style="margin-left: 2em;">1 (26-line font bank)</p> <p style="margin-left: 2em;">2 (44-line font bank)</p> <p style="margin-left: 2em;">3 (44-line font bank)</p> <p>where <P> = Position (hexadecimal address) of character in set</p> <p>where <s> = String of hexadecimal bytes that define character</p>
Select primary character set	ESC c D
Select secondary character set	ESC c E
Load font bank	<p>ESC c @ <f></p> <p>where = Bank number</p> <p style="margin-left: 2em;">0-3, see above.</p> <p>where <f> = Font name code</p> <p style="margin-left: 2em;">@ (26-line Native mode) See Figure D-6.</p> <p style="margin-left: 2em;">A (26-line Multinational) See Figure D-11.</p> <p style="margin-left: 2em;">B (26-line Standard ASCII) See Figure D-1.</p> <p style="margin-left: 2em;">C (Graphics 1) See Figure D-7.</p> <p style="margin-left: 2em;">D (26-line PC Equivalent) See Figure D-11.</p> <p style="margin-left: 2em;">E (Graphics 2) See Figure D-8.</p> <p style="margin-left: 2em;">F (Graphics 3) See Figure D-9.</p> <p style="margin-left: 2em;">G (26-line ANSI) See Figure D-10.</p> <p style="margin-left: 2em;">' (44-line Native mode) See Figure D-6.</p> <p style="margin-left: 2em;">a (44-line Multinational) See Figure D-11.</p> <p style="margin-left: 2em;">b (44-line PC Equivalent) See Figure D-11.</p> <p style="margin-left: 2em;">g (44-line ANSI) See Figure D-10.</p>
Clear font bank	<p>ESC c ? </p> <p>where = Bank number</p> <p style="margin-left: 2em;">0-3, see above.</p>

Font Characters—WY-60 Mode (continued)

Action	Command
Define primary character set bank	ESC c B where = Bank number 0 (26-line font bank) 1 (26-line font bank) 2 (44-line font bank) 3 (44-line font bank)
Define secondary character set bank	ESC c C where = Bank number 0-3, see above.

Control Characters—WY-60 Mode

Action	Command
Reply with [ACK]	Ctrl E or [EQ]
Bell	Ctrl G or [BL]
Backspace, cursor left	Ctrl H or [BS]
Move to next tab stop	Ctrl I or [HT]
Line feed, cursor down	Ctrl J or [LF]
Cursor up	Ctrl K or [VT]
Cursor right	Ctrl L or [FF]
Carriage return	Ctrl M or [CR]
DTR handshake	Ctrl N or [SO]
Xon/Xoff handshake	Ctrl O or [SI]
Xon handshaking enable	Ctrl Q or [D1]
Bidirection Print mode on	Ctrl R or [D2]
Xoff handshaking enable	Ctrl S or [D3]
Bidirection Print mode off	Ctrl T or [D4]
Cursor down	Ctrl V or [SY]
Clear unprotected page to foreground spaces	Ctrl Z or [SB]
Escape sequence leading char	Ctrl [or [EC]
Home cursor	Ctrl ^ or [RS]
Move to column 1 of next line	Ctrl - or [US]

D

Character Sets

This appendix lists the character sets supported by the 700/60 Display Terminal in ANSI, ASCII and PCTERM modes.

Dec	→	0	16	32	48	64	80	96	112
↓	Hex	0	1	2	3	4	5	6	7
0	0	NUL	DLE		0	@	P	`	p
1	1	SOH	DC1	!	1	A	Q	a	q
2	2	STX	DC2	"	2	B	R	b	r
3	3	ETX	DC3	#	3	C	S	c	s
4	4	EOF	DC4	\$	4	D	T	d	t
5	5	ENQ	NAK	%	5	E	U	e	u
6	6	ACK	SYN	&	6	F	V	f	v
7	7	BEL	ETB	'	7	G	W	g	w
8	8	BS	CAN	(8	H	X	h	x
9	9	HT	EM)	9	I	Y	i	y
10	A	LF	SUB	*	:	J	Z	j	z
11	B	VT	ESC	+	;	K	[k	{
12	C	FF	FS	,	<	L	\	l	
13	D	CR	GS	-	=	M]	m	}
14	E	SO	RS	.	>	N	^	n	~
15	F	SI	US	/	?	O	_	o	

Figure D-1. ASCII Character Set (same as Wyse Standard ASCII)

Dec	→	128	144	160	176	192	208	224	240
↓	Hex	8	9	A	B	C	D	E	F
0	0		DCS		°	À		à	
1	1		PU1	¡	±	Á	Ñ	á	ñ
2	2		PU2	ç	²	Â	Ò	â	ò
3	3		STS	£	³	Ã	Ó	ã	ó
4	4	IND	CCH			Ä	Ô	ä	ô
5	5	NEL	MW	¥	μ	Å	Õ	å	õ
6	6	SSA	SPA		¶	Æ	Ö	æ	ö
7	7	ESA	EPA	§	·	Ç	È	ç	è
8	8	HTS		¤		È	Ø	è	ø
9	9	HTJ		©	¹	É	Ù	é	ù
10	A	VTS		ª	º	Ê	Ú	ê	ú
11	B	PLD	CSI	«	»	Ë	Û	ë	û
12	C	PLU	ST		¼	Ì	Ü	ì	ü
13	D	RI	OMC		½	Í	Ý	í	ý
14	E	SS2	PM			Î		î	
15	F	SS3	APC		¿	Ï	ß	ï	

Figure D-2. DEC Supplemental Character Set

Dec	→	128	144	160	176	192	208	224	240
↓	Hex	8	9	A	B	C	D	E	F
0	0		DCS		°	À	Ð	à	ð
1	1		PU1	¡	±	Á	Ñ	á	ñ
2	2		PU2	¢	²	Â	Ò	â	ò
3	3		STS	£	³	Ã	Ó	ã	ó
4	4	IND	CCH	¤	´	Ä	Ô	ä	ô
5	5	NEL	MW	¥	µ	Å	Ö	å	ö
6	6	SSA	SPA	¦	¶	Æ	Û	æ	Û
7	7	ESA	EPA	§	·	Ç	×	ç	÷
8	8	HTS		"	,	È	Ø	è	ø
9	9	HTJ		©	¹	É	Ù	é	ù
10	A	VTS		ª	º	Ê	Ú	ê	ú
11	B	PLD	CSI	«	»	Ë	Û	ë	û
12	C	PLU	ST	¬	¼	Ì	Ü	ì	ü
13	D	RI	OMC	½	½	Í	Ý	í	ý
14	E	SS2	PM	¾	¾	Î	Þ	î	þ
15	F	SS3	APC	¯	¿	Ï	ß	ï	ÿ

Figure D-3. ISO 8859 Latin-1 Character Set

Dec	→	0	16	32	48	64	80	96	112
↓	Hex	0	1	2	3	4	5	6	7
0	0	NUL	DLE		0	@	P	◆	—
1	1	SOH	DC1	!	1	A	Q	⋮	—
2	2	STX	DC2	"	2	B	R	H _T	—
3	3	ETX	DC3	#	3	C	S	F _F	—
4	4	EOT	DC4	\$	4	D	T	C _R	
5	5	ENQ	NAK	%	5	E	U	L _F	
6	6	ACK	SYN	&	6	F	V	o	⊥
7	7	BEL	ETB	'	7	G	W	±	⊥
8	8	BS	CAN	(8	H	X	N _L	
9	9	HT	EM)	9	I	Y	V _T	≤
10	A	LF	SUB	*	:	J	Z	J	≥
11	B	VT	ESC	+	;	K	[⌈	π
12	C	FF	FS	,	<	L	\	⌈	*
13	D	CR	GS	-	=	M]	L	£
14	E	SO	RS	.	>	N	^	+	·
15	F	SI	US	/	?	O	_	-	

Figure D-4. DEC Special Graphics Character Set

Keyboards	Characters											
Hexadecimal Value	23	40	5B	5C	5D	5E	5F	60	7B	7C	7D	7E
ASCII	#	@	[\]	^	_	'	{		}	~
Swedish	#	É	Ä	Ö	Å	Ü	_	é	ä	ö	å	ü
French	£	à	°	ç	§	^	_	'	é	ù	è	¨
German	#	§	Ä	Ö	Ü	^	_	'	ä	ö	ü	ß
United Kingdom	£	@	[\]	^	_	'	{		}	~
Spanish	£	§	ı	Ñ	ı	^	_	'	°	ñ	ç	~
French Canadian	#	à	â	ç	ê	î	_	ô	é	ù	è	û
Italian	£	§	°	ç	é	^	_	ù	à	ò	è	ì
Dutch	#	@	[\]	^	_	'	{		}	~
Finnish	#	@	Ä	Ö	Å	Ü	_	é	ä	ö	å	ü
Norwegian/Danish	#	@	Æ	Ø	Å	^	_	'	æ	ø	å	~
Swiss	ù	à	é	ç	ê	î	è	ô	ä	ö	ü	û
Belgian	£	à	°	ç	§	^	_	'	é	ù	è	¨
Portuguese	#	@	Á	Ç	Õ	^	_	'	ã	ç	õ	~

Figure D-5. 7-Bit National Character Set

Dec	→	0	16	32	48	64	80	96	112
↓	Hex	0	1	2	3	4	5	6	7
0	0		T		0	@	P	'	p
1	1	S _H	L	!	1	A	Q	a	q
2	2	S _X	r	"	2	B	R	b	r
3	3	E _X	γ	#	3	C	S	c	s
4	4	E _T	†	\$	4	D	T	d	t
5	5	E _Q	J	%	5	E	U	e	u
6	6	A _K		&	6	F	V	f	v
7	7	B _L	■	'	7	G	W	g	w
8	8	B _S	+	(8	H	X	h	x
9	9	H _T	†)	9	I	Y	i	y
10	A	L _F	-	*	:	J	Z	j	z
11	B	V _T	⊗	+	;	K	[k	{
12	C	F _F	=	,	<	L	\	l	
13	D	C _R	⊥	-	=	M]	m	}
14	E	S _O		.	>	N	^	n	~
15	F	S _I	⊞	/	?	O	_	o	

Figure D-6. Wyse Native Mode Character Set

Dec	→	0	16	32	48	64	80	96	112
↓	Hex	0	1	2	3	4	5	6	7
0	0				0			0	▮
1	1				1			1	-
2	2				2			2	■
3	3				3			3	■
4	4				4			4	†
5	5				5			5	†
6	6				6			6	⊥
7	7				7			7	T
8	8				8			8	
9	9				9			9	
10	A							J	γ
11	B							γ	⋈
12	C				▶			r	⋈
13	D				◀			L	r
14	E				▲			†	■
15	F				▼			▮	

Figure D-7. Wyse Graphics 1 Character Set

Dec	→	0	16	32	48	64	80	96	112
↓	Hex	0	1	2	3	4	5	6	7
0	0					┌	┐	—	
1	1								
2	2								
3	3								
4	4					└	┘		
5	5								
6	6								
7	7								
8	8					└	┘	+	
9	9								
10	A								
11	B								
12	C					└	┘		
13	D								
14	E								
15	F								

**Figure D-8. Wyse Graphics 2
Character Set**

Dec	→	0	16	32	48	64	80	96	112
↓	Hex	0	1	2	3	4	5	6	7
0	0						—		
1	1					└	—		
2	2					└	◆		
3	3					└	■		
4	4					└	■		
5	5					└	■		
6	6					└	■		
7	7					└	■		
8	8					└	■		
9	9					└	■		
10	A					└	■		
11	B					—	■		
12	C					└	■		
13	D					└	■		
14	E					└	■		
15	F					└	■		

**Figure D-9. Wyse Graphics 3
Character Set**

Dec	→	0	16	32	48	64	80	96	112
↓	Hex	0	1	2	3	4	5	6	7
0	0		-		0	@	P	`	p
1	1	♦	-	!	1	A	Q	a	q
2	2	⊠	-	"	2	B	R	b	r
3	3	^H T	-	#	3	C	S	c	s
4	4	^F F	-	\$	4	D	T	d	t
5	5	^C R		%	5	E	U	e	u
6	6	^L F		&	6	F	V	f	v
7	7	o	⊥	'	7	G	W	g	w
8	8	±	⊥	(8	H	X	h	x
9	9	^N L)	9	I	Y	i	y
10	A	^V T	≤	*	:	J	Z	j	z
11	B	J	≥	+	;	K	[k	{
12	C	γ	π	,	<	L	\	l	
13	D	Γ	*	-	=	M]	m	}
14	E	L	£	.	>	N	^	n	~
15	F	†	·	/	?	O	_	o	

Figure D-10. Wyse Standard ANSI Character Set

Wyse PC Equivalent

Wyse Multinational

Decimal Value	→	0	16	32	48	64	80	96	112	128	144	160	176	192	208	224	240
↓	Hex Value	0	1	2	3	4	5	6	7	8	9	A	B	C	D	E	F
0	0		▶		0	@	P	˘	p	Ç	É	á	⋮	L	⌌	α	≡
1	1	☺	◀	!	1	A	Q	a	q	ü	œ	í	⋮	⌌	⌌	β	±
2	2	☹	↕	"	2	B	R	b	r	é	Æ	ó	⋮	⌌	⌌	Γ	≥
3	3	♥	!!	#	3	C	S	c	s	â	ô	ú	⌌	⌌	⌌	π	≤
4	4	♦	¶	\$	4	D	T	d	t	ä	ö	ñ	⌌	⌌	⌌	Σ	í
5	5	♣	§	%	5	E	U	e	u	ä	ö	Ñ	⌌	⌌	⌌	σ	ı
6	6	♠	—	&	6	F	V	f	v	ä	ü	°	⌌	⌌	⌌	μ	+
7	7	●	↕	'	7	G	W	g	w	ç	ù	°	⌌	⌌	⌌	τ	≈
8	8	◐	↑	(8	H	X	h	x	ê	ÿ	¿	⌌	⌌	⌌	Φ	°
9	9	◑	↓)	9	I	Y	i	y	ë	Ö	˘	⌌	⌌	⌌	Θ	•
10	A	◒	→	*	:	J	Z	j	z	è	Ü	˘	⌌	⌌	⌌	Ω	•
11	B	♂	←	+	:	K	(k	{	ï	é	½	⌌	⌌	■	δ	√
12	C	♀	⌌	.	<	L	\	l	l	î	£	¼	⌌	⌌	■	∞	n
13	D	♪	↔	-	=	M)	m	}	ï	¥	ı	⌌	⌌	■	∅	²
14	E	♫	▲	.	>	N	^	n	~	Ä	Pt	«	⌌	⌌	■	ε	■
15	F	☼	▼	/	?	O	-	o	⌌	Å	f	»	⌌	⌌	■	n	

Figure D-11. IBM 437 Character Set

Decimal Value	→	0	16	32	48	64	80	96	112	128	144	160	176	192	208	224	240
↓	Hex Value	0	1	2	3	4	5	6	7	8	9	A	B	C	D		
0	0		▶		0	@	P	˘	p	Ç	É	á	⋮	⊥	ƒ	Ó	-
1	1	☺	◀	!	1	A	Q	a	q	ü	œ	í	⋮	⊥	Ð	ß	±
2	2	☹	↕	"	2	B	R	b	r	é	Æ	ó	⋮	⊥	Ê	Ô	=
3	3	♥	!!	#	3	C	S	c	s	â	ô	ú		⊥	Ë	Ö	³ / ₄
4	4	♦	¶	\$	4	D	T	d	t	ä	ö	ñ	⊥	—	È	ø	¶
5	5	♣	§	%	5	E	U	e	u	à	ò	Ñ	Á	+	ı	Û	§
6	6	♠	—	&	6	F	V	f	v	ä	ü	°	Â	ã	î	μ	+
7	7	●	±	'	7	G	W	g	w	ç	ù	°	À	Ä	ï	þ	·
8	8	◼	↑	(8	H	X	h	x	ê	ÿ	ı	©	⊥	İ	Þ	°
9	9	○	↓)	9	I	Y	i	y	è	ö	®	⊥	⊥	⊥	Ú	••
10	A	◼	→	*	:	J	Z	j	z	è	ü	˘	⊥	⊥	⊥	Û	•
11	B	♂	←	+	:	K	(k	(ï	ø	½	⊥	⊥	⊥	Ü	ı
12	C	♀	⊥	,	<	L	\	l	l	î	£	¼	⊥	⊥	⊥	Ý	3
13	D	♪	↔	-	=	M)	m)	ï	∅	ı	¢	==	ı	Ÿ	2
14	E	♪	▲		>	N	^	n	~	Ä	×	«	¥	⊥	ı	-	◼
15	F	☀	▼	/	?	○	-	o	🏠	Ä	f	»	⊥	◻	◼	'	

Figure D-12. IBM 850 Character Set

Decimal Value	→	0	16	32	48	64	80	96	112	128	144	160	176	192	208	224	240
↓	Hex Value	0	1	2	3	4	5	6	7	8	9	A	B	C	D	E	F
0	0		▶		0	@	P	`	p	Ç	É	á	▤	⊥	⊥	α	≡
1	1	☺	◀	!	1	A	Q	a	q	ü	Â	í	▤	⊥	⊥	β	±
2	2	☹	↕	"	2	B	R	b	r	é	Ê	ó	▤	⊥	⊥	γ	≥
3	3	♥	!!	#	3	C	S	c	s	â	ô	ú		⊥	⊥	π	≤
4	4	♦	¶	\$	4	D	T	d	t	ä	ö	ñ	⊥	—	⊥	Σ	∫
5	5	♣	§	%	5	E	U	e	u	à	ò	Ñ	⊥	+	⊥	σ	∫
6	6	♠	—	&	6	F	V	f	v	Á	Ú	º	⊥	⊥	⊥	μ	±
7	7	●	±	'	7	G	W	g	w	ç	ù	º	⊥	⊥	⊥	τ	≈
8	8	◼	↑	(8	H	X	h	x	ê	ï	ç	⊥	⊥	⊥	Φ	°
9	9	◯	↓)	9	I	Y	i	y	Ê	Ö	Ö	⊥	⊥	⊥	Θ	•
10	A	◼	•	:	J	Z	j	z	è	Ü	¬		⊥	⊥	⊥	Ω	•
11	B	♂	←	+	:	K	(k	{	í	º	½	⊥	⊥	◼	δ	√
12	C	♀	⊥	,	<	L	\	l	l	Ô	£	¼	⊥	⊥	◼	∞	n
13	D	♪	◀▶	-	=	M)	m	}	í	Û	ı	⊥	==	◼	∅	2
14	E	♪	▲	.	>	N	^	n	~	Â	P†	«	⊥	⊥	◼	ε	◼
15	F	☀	▼	/	?	◊	_	◊	🏠	Â	Ó	»	⊥	⊥	◼	∩	

Figure D-13. IBM 860 Character Set

Decimal Value	→	0	16	32	48	64	80	96	112	128	144	160	176	192	208	224	240
↓	Hex Value	0	1	2	3	4	5	6	7	8	9	A	B	C	D	E	F
0	0		▶		0	@	P	`	p	Ç	É	ı	⋮	L	⋮	α	≡
1	1	☺	◀	!	1	A	Q	a	q	ü	Ë	˘	⋮	⊥	⊥	β	±
2	2	☹	↕	"	2	B	R	b	r	é	Ê	ó	⋮	⊥	⊥	Γ	≥
3	3	♥	!!	#	3	C	S	c	s	à	ô	ú	ı	⊥	⊥	π	≤
4	4	♦	¶	\$	4	D	T	d	t	Â	Ë	"	⊥	⊥	⊥	Σ	ı
5	5	♣	§	%	5	E	U	e	u	à	ï	˘	⊥	⊥	⊥	σ	ı
6	6	♠	—	&	6	F	V	f	v	¶	û	3	⊥	⊥	⊥	μ	+
7	7	●	±	'	7	G	W	g	w	ç	ù	-	⊥	⊥	⊥	τ	≈
8	8	◼	↑	(8	H	X	h	x	ê	o	î	⊥	⊥	⊥	Φ	°
9	9	◯	↓)	9	I	Y	i	y	è	Ô	ı	⊥	⊥	⊥	Θ	•
10	A	◼	→	*	:	J	Z	j	z	è	Ü	ı	⊥	⊥	⊥	Ω	•
11	B	♂	←	+	:	K	(k	{	ı	ç	½	⊥	⊥	◼	δ	√
12	C	♀	└	,	<	L	\	l	l	ı	ç	¼	⊥	⊥	◼	∞	∞
13	D	♪	↔	-	=	M)	m	}	=	Ù	¾	⊥	⊥	◼	∅	2
14	E	♪	▲	.	>	N	^	n	~	Â	Û	«	⊥	⊥	◼	ε	◼
15	F	☼	▼	/	?	O	_	o	⏠	§	f	»	⊥	⊥	◼	n	

Figure D-14. IBM 863 Character Set

Decimal Value	→	0	16	32	48	64	80	96	112	128	144	160	176	192	208	224	240
↓	Hex Value	0	1	2	3	4	5	6	7	8	9	A	B	C	D	E	F
0	0		▶		0	@	P	`	p	Ç	É	á	⋮	⊥	⊥	α	≡
1	1	☺	◀	!	1	A	Q	a	q	ü	œ	í	⋮	⊥	⊥	β	±
2	2	☺	↕	"	2	B	R	b	r	é	Æ	ó	⋮	⊥	⊥	γ	≥
3	3	♥	!!	#	3	C	S	c	s	ä	ô	ú		⊥	⊥	π	≤
4	4	♦	¶	\$	4	D	T	d	t	ä	ö	ñ	⊥	—	⊥	Σ	∫
5	5	♣	§	%	5	E	U	e	u	ä	ò	Ñ	⊥	+	⊥	σ	∫
6	6	♠	—	&	6	F	V	f	v	ä	ü	°	⊥	⊥	⊥	μ	+
7	7	●	±	'	7	G	W	g	w	ç	ù	°	⊥	⊥	⊥	τ	≈
8	8	◐	↑	(8	H	X	h	x	ê	ÿ	¿	⊥	⊥	⊥	Φ	°
9	9	○	↓)	9	I	Y	i	y	è	Ö	ˆ	⊥	⊥	⊥	Θ	•
10	A	◑	→	*	:	J	Z	j	z	è	Ü	ˆ	⊥	⊥	⊥	Ω	•
11	B	♂	←	+	:	K	(k	{	ï	ø	½	⊥	⊥	■	δ	√
12	C	♀	⊥	,	<	L	\	l	l	î	£	¼	⊥	⊥	■	∞	∞
13	D	♪	↔	-	=	M)	m	}	ï	∅	l	⊥	⊥	■	∅	2
14	E	♪	▲	.	>	N	^	n	~	Ä	P†	«	⊥	⊥	■	ε	■
15	F	☼	▼	/	?	O	-	o	⏏	Å	f	œ	⊥	⊥	■	n	

Figure D-15. IBM 865 Character Set

DEC	32	48	64	80	96	112
0		†	‡	‡	‡	‡
1	†	†	‡	‡	‡	‡
2	†	†	‡	‡	‡	‡
3	†	†	‡	‡	‡	‡
4	†	†	‡	‡	‡	‡
5	†	†	‡	‡	‡	‡
6	†	†	‡	‡	‡	‡
7	†	†	‡	‡	‡	‡
8	†	†	‡	‡	‡	‡
9	†	†	‡	‡	‡	‡
10	†	†	‡	‡	‡	‡
11	†	†	‡	‡	‡	‡
12	†	†	‡	‡	‡	‡
13	†	†	‡	‡	‡	‡
14	†	†	‡	‡	‡	‡
15	†	†	‡	‡	‡	‡

Figure D-16. HP Line Drawing Character Set

DEC	32	48	64	80	96	112	160	176	192	208	224	240
0		0	@	P	`	p		-	â	Å	Á	þ
1	!	1	A	Q	a	q	À	Ý	ê	î	Ã	Þ
2	"	2	B	R	b	r	Â	ý	ô	ø	ä	·
3	#	3	C	S	c	s	È	°	û	Æ	Ð	μ
4	\$	4	D	T	d	t	Ê	Ç	á	à	ð	¶
5	%	5	E	U	e	u	Ë	ç	é	í	Í	¾
6	&	6	F	V	f	v	Î	Ñ	ó	ø	Ì	-
7	'	7	G	W	g	w	Ï	ñ	ú	æ	Ó	¼
8	(8	H	X	h	x	ˆ	ı	à	Ä	Ò	½
9)	9	I	Y	i	y	˘	ı	è	ì	Õ	á
10	*	:	J	Z	j	z	˙	α	ò	Ö	ö	°
11	+	;	K	[k	{	˚	£	ù	Ü	Š	«
12	,	<	L	\	l		˛	¥	ä	É	š	■
13	-	=	M]	m	}	Û	§	ë	ï	Û	»
14	.	>	N	^	n	~	Û	f	ö	ß	ÿ	±
15	/	?	O	_	o	¸	£	ç	ü	Ô	ÿ	

Figure D-17. HP Roman 8 Character Set

E

International Keyboards

This appendix lists each version of the ANSI and PC-AT keyboards.

ANSI Keyboards

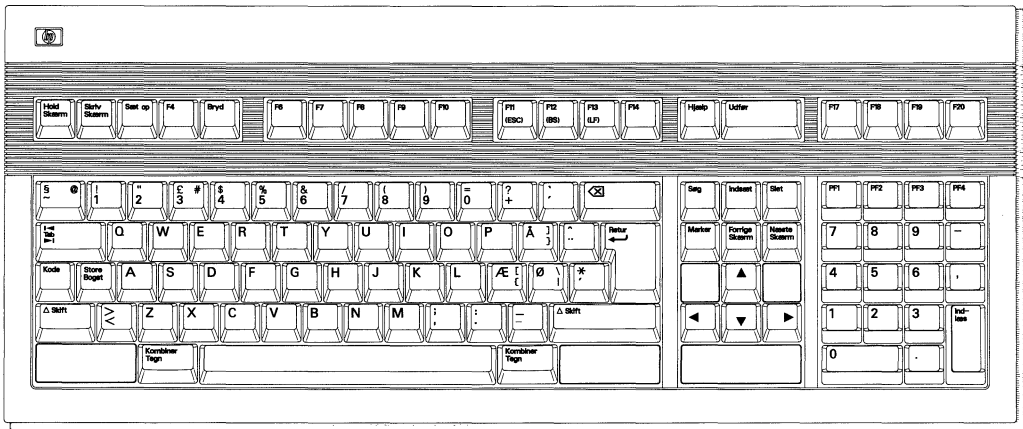

Figure E-1. Danish

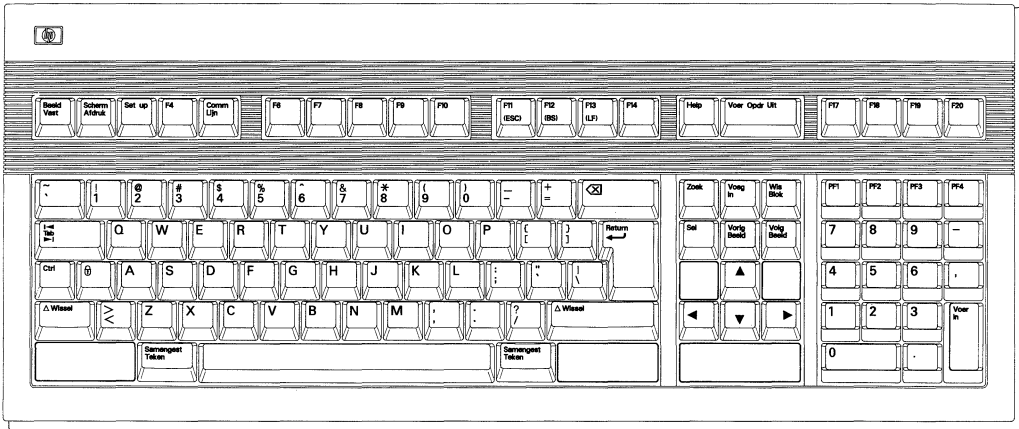

Figure E-2. Dutch

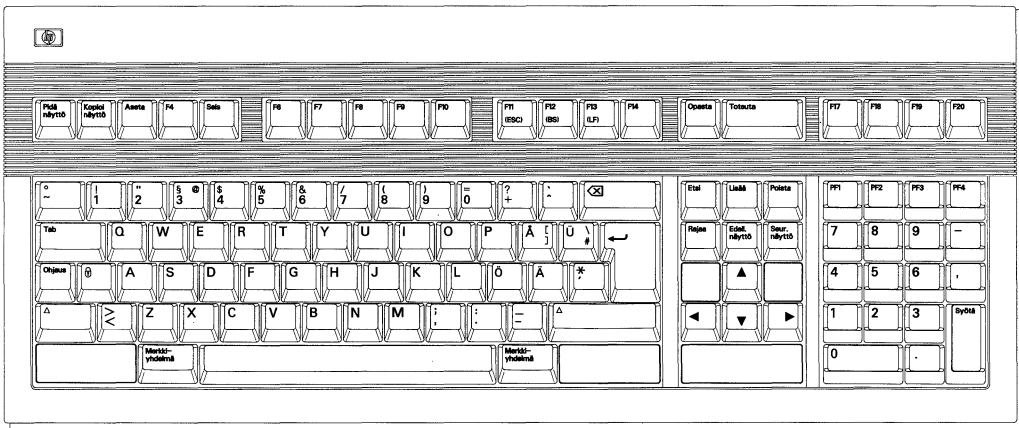

Figure E-3. Finnish

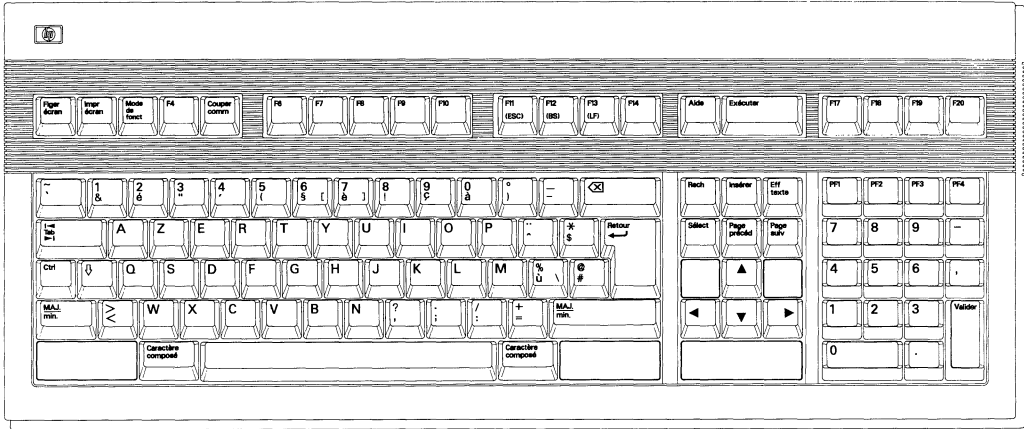

Figure E-4. French

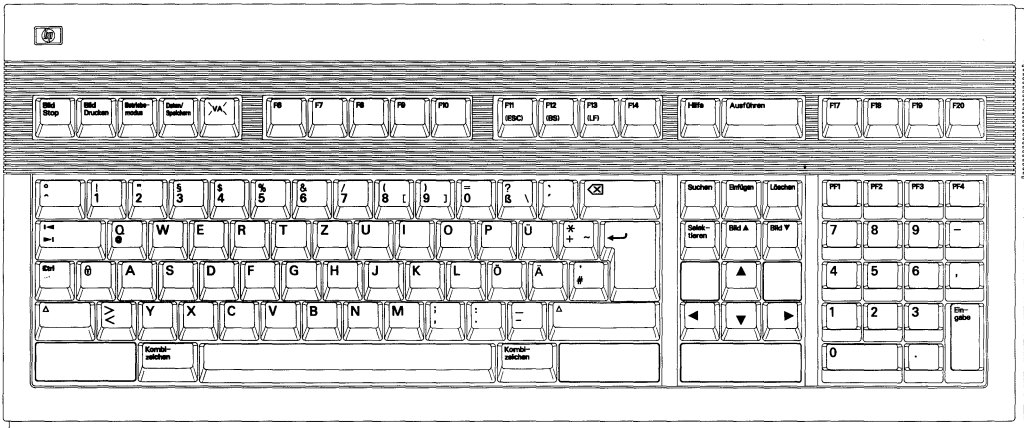

Figure E-5. German (DIN)

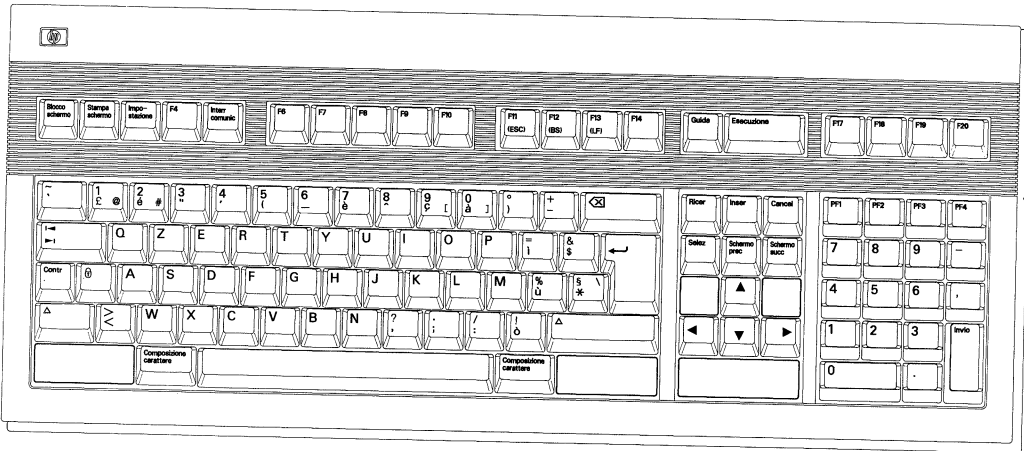

Figure E-6. Italian

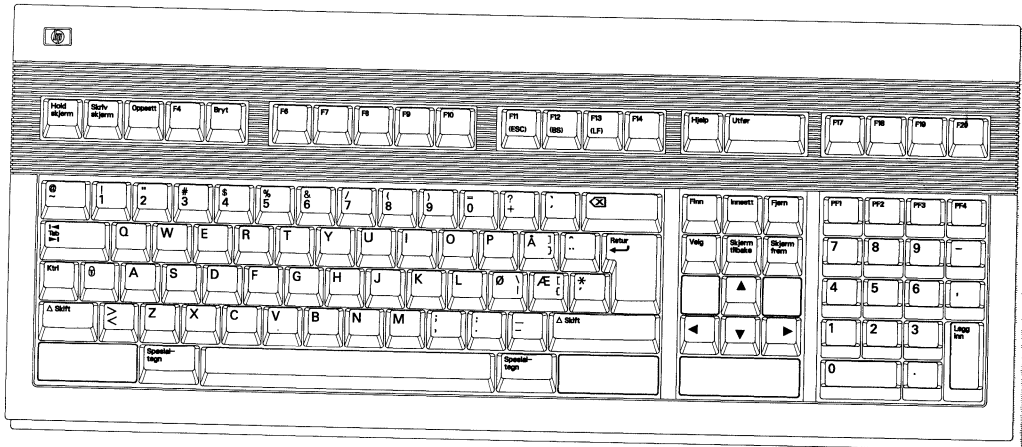

Figure E-7. Norwegian

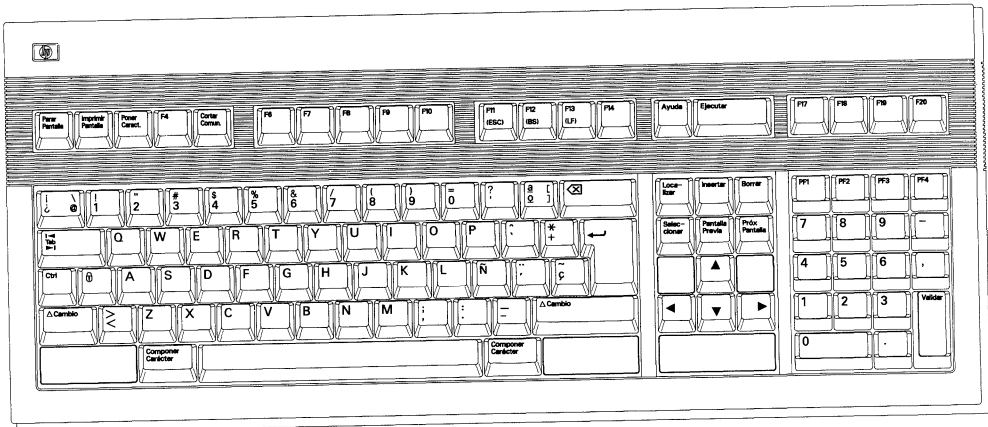

Figure E-8. Spanish

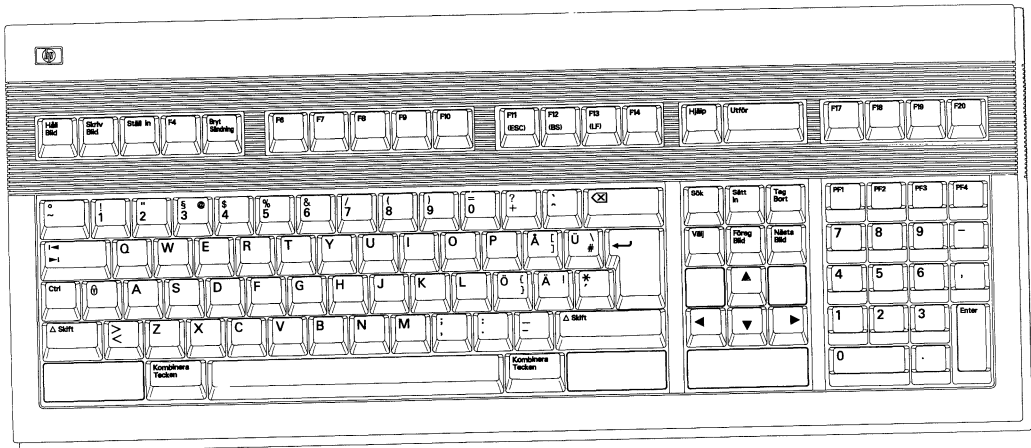

Figure E-9. Swedish

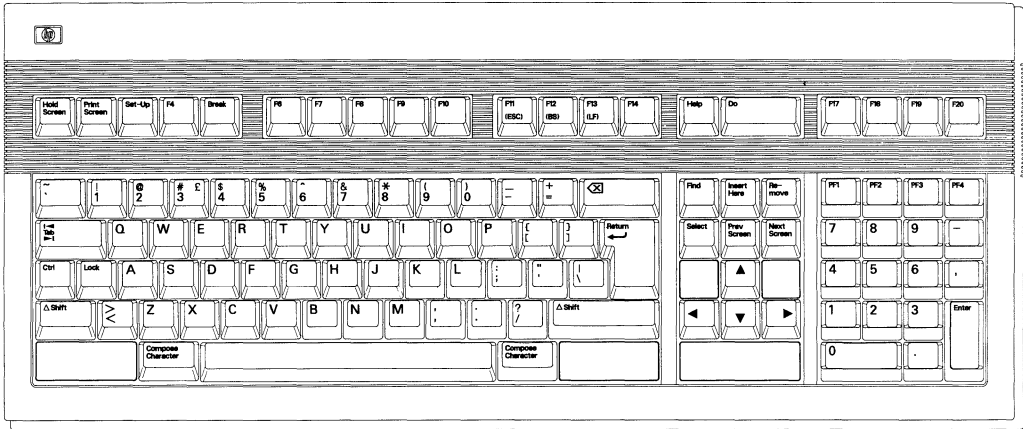

Figure E-12. United States

PC-AT Keyboards

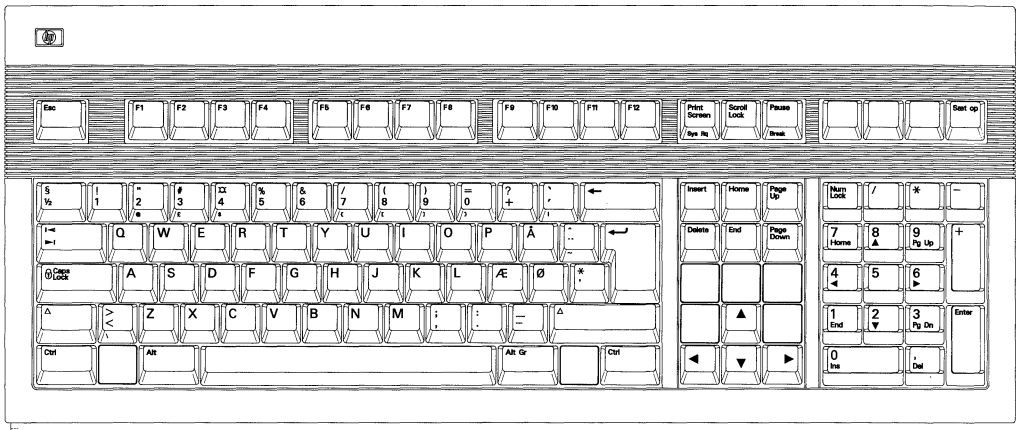

Figure E-13. Danish

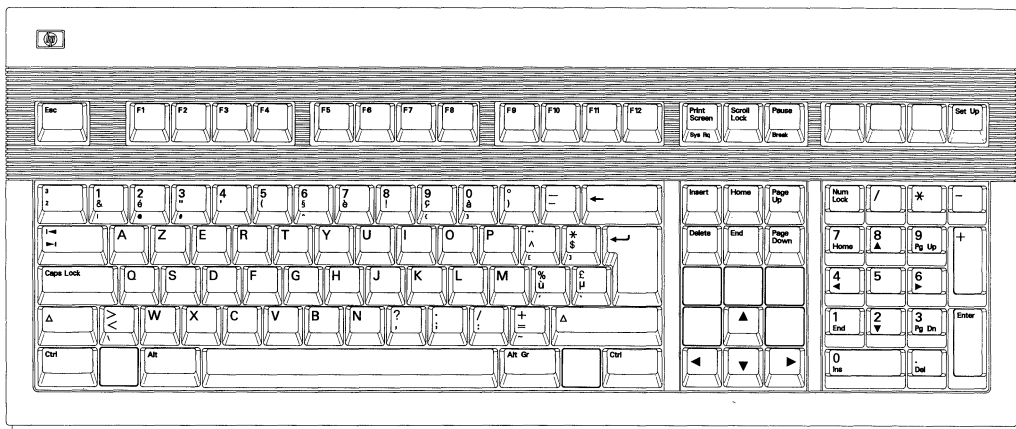

Figure E-14. Belgian

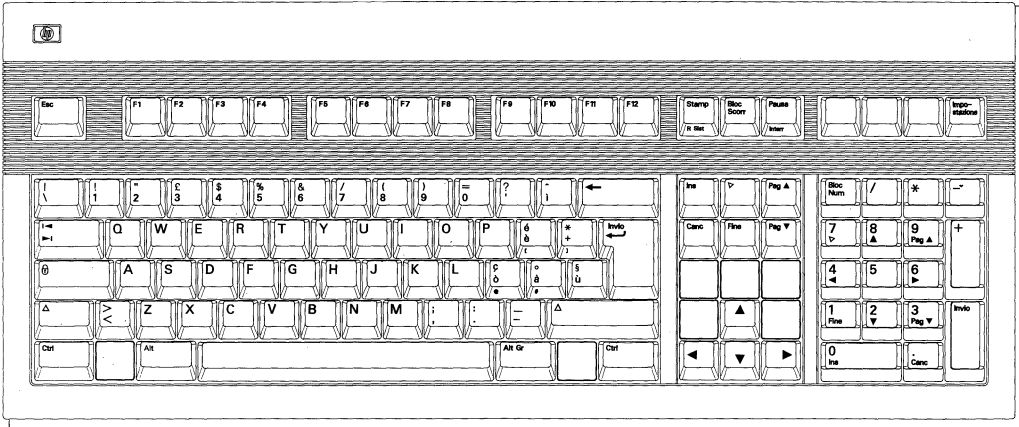

Figure E-17. Italian

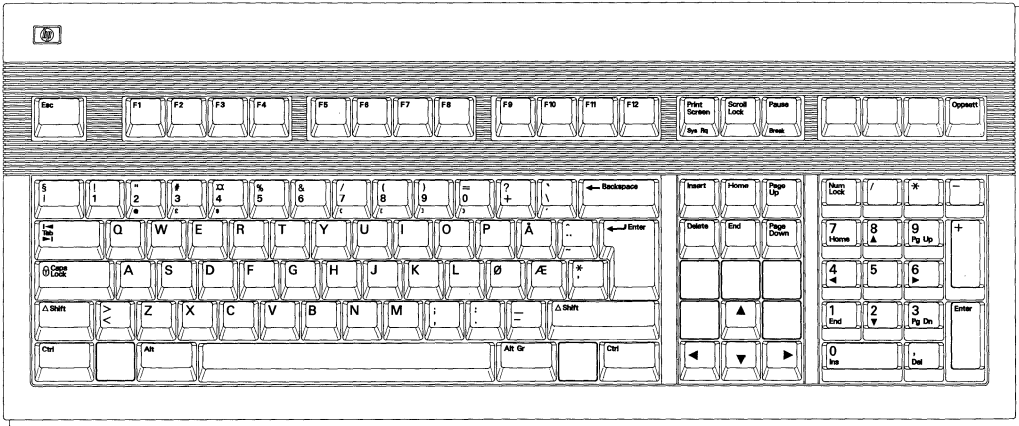

Figure E-18. Norwegian

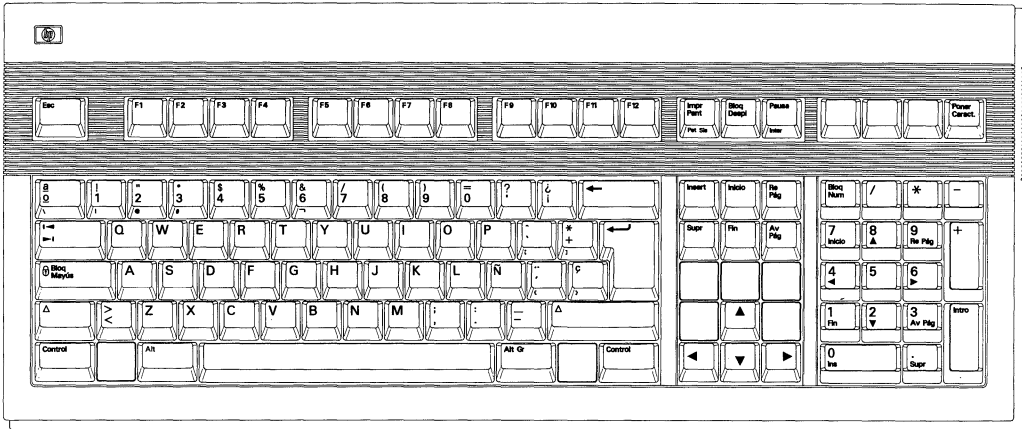

Figure E-19. Spanish

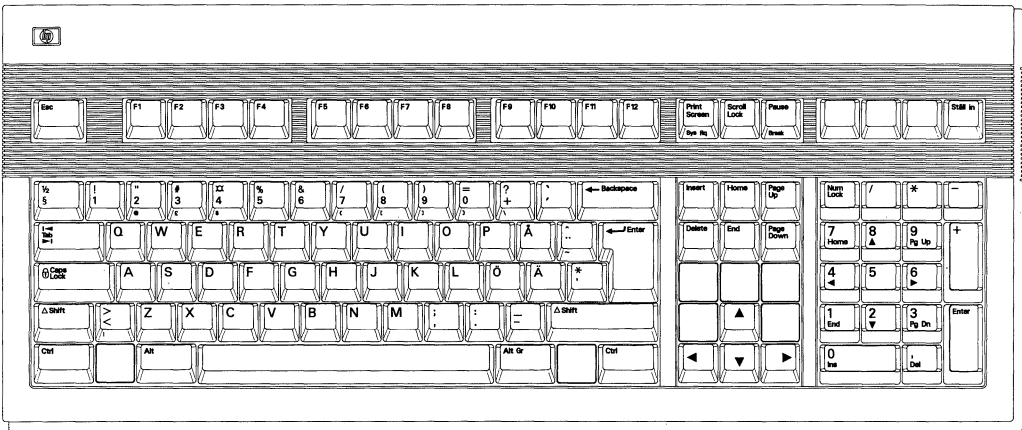

Figure E-20. Swedish

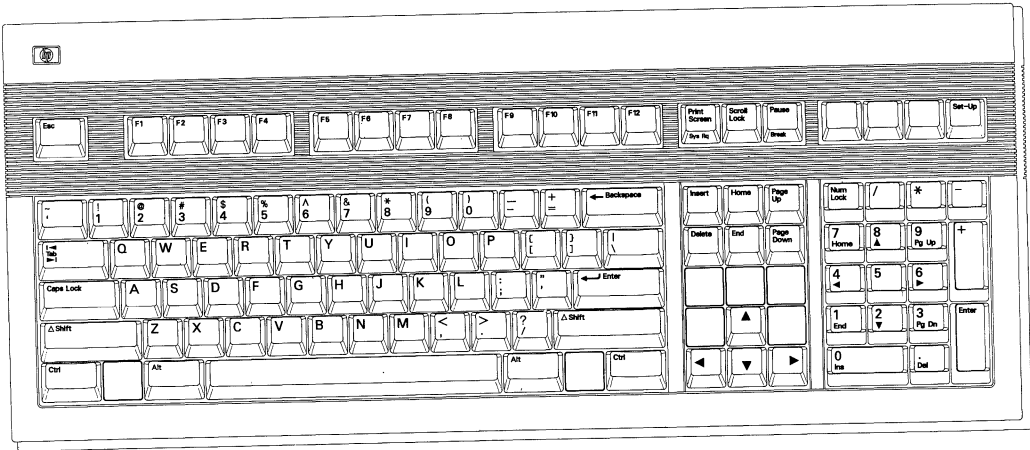

Figure E-23. United States



Index

A

Alt key, 3-12
Answerback field, 2-32, 2-36
answerback message, 2-31, 2-32, 2-35,
2-36, 3-15
Application mode, A-9, A-10
Attr Extent field, 2-22
Aut message, 3-5
Auto Answerback field, 2-31, 2-35
Auto Font Load field, 2-23
Auto Linefeed field, 2-12
Auto Page field, 2-22
Auto Print mode, 3-29
Auto Print Mode, 2-19
Auto Repeat field, 2-31, 2-35
Auto Scroll field, 2-23
Auto Wrap field, 2-12, 2-14
auxiliary input, 2-8
auxiliary port cable, 1-5
Aux mode, 3-29
Aux Mode field, 2-19
Aux Port, 2-8
Aux to Host, 2-8
Aux to Host field, 2-19
Aux to Host mode, 3-31

B

Backarrow Key field, 2-32
Background Attr field, 2-22
Background field, 2-8
Backspace key, 3-12
BDx message, 3-5

BiDirect, 3-30
bidirectional, 2-8
Bidirectional Print mode, 3-30
Bidirect Print Mode, 2-24
Blk message, 3-5
Block Mode field, 2-21
Block Term field, 2-23
Break Duration field, 2-29
Break key, 2-29, 3-14
brightness control, 1-8, 4-1

C

Caps Lock key, 3-12
Caps Lock Mode, 2-31, 2-34
CD, 2-28
Centronics interface , 1-5
Char Access field, 2-31, 2-35
Characters Mode field, 2-17, 3-17
cleaning the terminal, 4-4
Clear All Keys field, 2-39
Clear All Tabs field, 2-32, 2-36
Clear Comm. field, 2-10
Clear Display field, 2-10
Clr on Width Change field, 2-15
Communication field, 2-26
Comp message, 3-4
Compose Character, 3-17
Compose Character key, 3-12
Conceal Answerback field, 2-32, 2-35
contrast control, 1-8
Control Codes field, 2-17
Controller Print mode, 3-30

Controller Print Mode, 2-19
Cop message, 3-5
Copy Print mode, 3-30
Copy Print Mode, 2-24
Ctrl key, 3-12
CTS, 2-28
Cursor field, 2-12, 2-14
Cursor Keys field, 2-18
cursor position, 3-3
Cursor Type field, 2-12, 2-14

D

Data Length field, 2-26
Data Processing Keys field, 2-18, 3-17
DEC Supplemental, 2-17, 3-17
Destination field, 2-39
Disconnect Delay field, 2-29
display screen, 3-1
Display Width Allowed field, 2-14
Display Width field, 2-12, 2-14
DSR, 2-27, 2-28
DSR message, 3-4
DTR, 2-28

E

Enter= field, 2-37
Enter key, 3-12
Extended Status Line field, 2-14

F

Fdx message, 3-5
firmware version, 2-10
Full Duplex, 2-26

H

Half Duplex, 2-26
hard reset, 3-31
HdScr message, 3-4
HDx message, 3-5
Hit Return to end definition field, 2-39

Hit space, then Key to be programmed
field, 2-39
Hold Key field, 2-36
Hold Screen key, 3-14
Host Port field, 2-8

I

input buffer, 2-2
Ins message, 3-5
ISO Latin, 2-17
ISO Latin-1, 3-17

K

keyboard angle, 1-8
Keyboard field, 2-9, 3-17
Key Click field, 2-9
Keypad mode, 2-33
Keypad Mode field, 2-18

L

Limited Transmit field, 2-29
Local Echo field, 2-17
local paging, 3-13
LocE message, 3-5
Lock key, 3-12
Lock Key field, 2-31, 2-34
Lock message, 3-4
Loc message, 3-5
Logical Page field, 2-15

M

Margin Bell field, 2-31, 2-35
Message Line, 3-3
Message Line field, 2-12, 2-14
Message Translations field, 2-9
Modem/Data Ctrl field, 2-28
Modem disconnect, 2-29
Monitor Line field, 2-28
Mon message, 3-5
Multinational Character Set mode, 3-17

N

National Character Set mode, 3-17
Normal Print Mode, 2-19
NoScrl message, 3-5
Number of Pages field, 2-15

O

On Line field , 2-12, 2-14

P

Page Edit field, 2-23
parallel port , 1-5
Parity field, 2-26
Port 1, 1-5
Port 2, 1-5
Port 3, 1-5
power cord, 1-5
Preferred Character Set field, 2-17
Preferred Char Set field, 3-17
Printer Char Set field, 2-20, 2-24
printer output, 2-8
Printer Terminator field, 2-19
Print Screen key, 3-15
Print Scroll field, 2-18
Print Scroll Region, 3-29
programmable keys, 2-38, C-14
Prot message, 3-5

R

Recv Baud rate field, 2-27
Refresh Rate field, 2-9
reset the terminal, 3-31, 4-2
Return= field, 2-37
Return key, 3-12
Reverse Lock Mode, 2-31, 2-34
RS-232C, 1-5

S

Save Label field, 2-14
Save Menu label, 2-6
screen saver, 4-1

Screen Saver field, 2-8
Send ACK field, 2-23
serial port, 1-5
Set 8 Column Tabs field, 2-32, 2-36
Setup Functions, 2-6
Setup key, 3-15
Setup mode, 2-1
Setup Translations field, 2-10
Shift, 3-13
Shift Lock Mode, 2-31, 2-34
shipping container, 1-2
Show Active label, 2-6
Show Defaults label, 2-6
Show Power On label, 2-6
Smooth Scroll field, 2-12, 2-13
soft reset, 3-31
(space), 3-19
SRv message, 3-5
Status Line, 3-3
Status Line field, 2-12, 2-14
Status Line messages, 3-3
Stop Bits field, 2-26
swivel, display unit, 1-8

T

Tab key, 3-13
Tab Setting field, 2-32, 2-36
Terminal ID field, 2-17
tilt, terminal, 1-8
Trn message, 3-5
troubleshooting, 4-1

U

User Features Locked field, 2-18
User Keys Locked field, 2-18
User Preferred Character Set, 2-17

V

voltage, 1-5

W

Wait message, 3-4

Warning Bell field, 2-31, 2-35

Wprt message, 3-5

X

Xmit Baud rate field, 2-26

Xmit Pace field, 2-27

Xon/Off, 2-27, 2-29

XPC Handshaking field, 2-28

Z

ZH-1 Char Set field, 2-10



**HEWLETT
PACKARD**



Manual Part Number C1080-90009
Printed in Singapore
April 1992