

Display Terminal Application Software Catalog

Summer, 1981

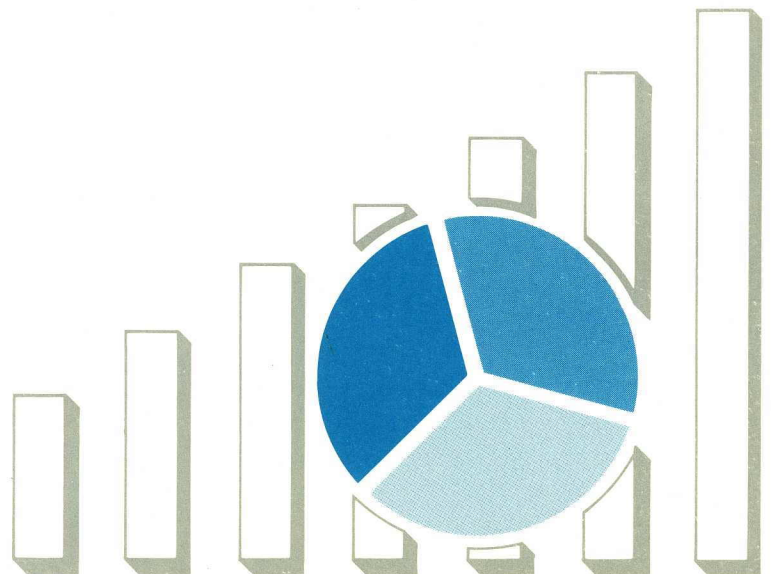

HP DISPLAY TERMINAL APPLICATION SOFTWARE CATALOG

USE THIS CATALOG . . .

- TO LOCATE SOFTWARE THAT GETS THE MOST OUT OF YOUR HP DISPLAY TERMINAL'S ADVANCED FEATURES IN THE FOLLOWING APPLICATIONS:
 - Graphics
 - Data Entry and Capture
 - Text Preparation
 - Data Analysis and Display

- TO FIND OUT ABOUT NEW SOFTWARE UPDATES AVAILABLE FOR YOUR HP 2647A TERMINAL.

- TO ORDER HP 2647A TERMINAL RESIDENT APPLICATION SOFTWARE, AND SOFTWARE UPDATES.

THIS CATALOG SUMMARIZES SOFTWARE FROM TWO SOURCES . . .

1. Developed by Hewlett-Packard to get the most from HP terminals and computer systems.

2. Developed by independent software suppliers for HP terminals. Software suppliers are software professionals whose business is developing, selling and supporting software. They bring application expertise to areas that complement HP's terminal software and hardware.

This catalog describes various types of software, including programs developed by independent software suppliers as well as by Hewlett-Packard. HP makes no express or implied warranty of any kind, including but not limited to, the implied warranties of merchantability and fitness for a particular purpose, with regard to the program material contained herein. HP shall not be liable for incidental or consequential damages in connection with or arising out of the furnishing, performance or use of this program material.

NEW PRODUCTS IN THIS EDITION



APPLICATION SOFTWARE PACKAGES FOR THE HP 2647A, Pages 3, 25, 27, 29

- Graphics Presentation
- Project Management — Financial Analysis
- Statistics
- Mathematics



MULTILOT SOFTWARE UPDATED TO SUPPORT NEW PLOTTERS — REV. F, Page 35

- 8-Color HP 9872 “C” and “T” Plotters
- HP 7580A Large Format Plotter



2647/1351 BASIC FOR HP 2647A AND 1351A TERMINALS, Page 11



CSC/PLOT AND DIAGRAPH GRAPHICS PACKAGES FOR HP 2647A, Pages 5 and 13



HP 3075 and 3076 DATA CAPTURE TERMINALS SUPPORTED BY V PLUS/3000, Page 15

DON'T FORGET . . . TO GET YOUR NEXT ISSUE OF THIS CATALOG, COMPLETE THE READER COMMENT SHEET ON PAGE 43!

CONTENTS

APPLICATION SOFTWARE INDEX	v
SOFTWARE SUMMARIES	1-32
OBTAINING APPLICATION SOFTWARE	33
SUPPORT, SERVICE AND WARRANTY	34
UPDATING TERMINAL-RESIDENT SOFTWARE	35
ORDERING INFORMATION	37
HOW TO BECOME A SOFTWARE SUPPLIER	41
READER COMMENT SHEET	43
HP SALES OFFICES	45

APPLICATION SOFTWARE INDEX

Ref. No.	Application Software Title	Executes in Terminal	Executes in Computer	Terminal/Software Selection Chart										See Page	
				2621A/P	2622A	2624A	2626A	2640B	2642A	2645A	2647A	2648A	3075A 3076A		
1.0	Graphics														
1.01	MULTILOT/SLIDE	Yes	No									•			1
1.02	Graphics Presentation Resource Pac	Yes	No									•			3
1.03	CSC/PLOT	Yes	No									•			5
1.04	GRAPHICS/1000-II (HP 1000)	No	Yes									•	•		7
1.05	DSG/3000 (HP 3000)	No	Yes		◦ 1.	◦ 1.	◦ 1.	◦ 1.	◦ 1.	◦ 1.		•	•		9
1.06	2647/1351 BASIC	Yes	No									•			11
1.07	CSC DIAGRAPH	Yes	No									•			13
2.0	Data Entry and Data Capture														
2.01	VPLUS/3000 (HP 3000)	No	Yes		•	•	•	◦	◦	◦	◦	◦	◦	•	15
2.02	DATA CAP 1000-II (HP 1000)	No	Yes											•	17
3.0	Text Preparation														
3.01	2642A Page Formatter	Yes	No							•					19
3.02	TDP/3000 (HP 3000)	No	Yes	•	◦ 2.	• 2.	◦ 2.	◦ 2.	• 2.	◦ 2.	◦ 2.	◦ 2.	◦ 2.		21
3.03	IFS/3000 (HP 3000)	No	Yes		◦	◦	◦	◦	◦	◦		•	•		23
3.04	IDS/3000 (HP 3000)	No	Yes									•	•		23
4.0	Data Analysis and Display														
4.01	Project Management Resource Pac	Yes	No									•			25
4.02	Statistical Analysis Resource Pac	Yes	No									•			27
4.03	Mathematical Analysis Resource Pac	Yes	No									•			29
5.0	Miscellaneous														
5.01	Terminal BASIC	Yes	No									•			31

◦ = Compatible

• = Recommended/Compatible

1. = For chart definition only

2. = SCREEN command can be used

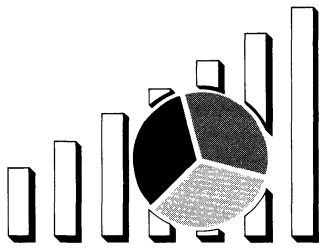

HEWLETT-PACKARD PROGRAM SUMMARY

REFERENCE NO. 1.01

GRAPHICS

TERMINAL	COMPUTER	PROGRAM TITLE
2647A	Not Required	MULTILOT/SLIDE

DESCRIPTION

Multiple automatic plotting, MULTILOT is a set of terminal-resident graphics plotting programs for the HP2647A Intelligent Graphics Terminal which allows the user to quickly and easily plot numeric data and produce slides in the form of Pie charts, Bar charts, Linear charts or Logarithmic charts. The SLIDE program allows the user to produce textual slides and to append charts.

MULTILOT helps the user, who has no programming experience, to design, preview and plot graphs and slides for analysis and presentations. The user produces the various charts and slides by filling the blanks on a menu form which appears on the screen. While designing a chart, the user can preview the chart on the terminal's screen and make modifications interactively on the menu to make adjustments to the chart. MULTILOT can use the 9872 series of multicolor plotters to produce quality hardcopy output on paper or overhead transparency film. Large format plots can be provided with the HP 7580A plotter.

FEATURES

Pie Chart Program — allows the user to shade segments of the pie, to pull-out or "explode" segments, and to label up to 10 pie segments. Example:

SALES BY MARKET AREAS
MODEL YEAR 1977

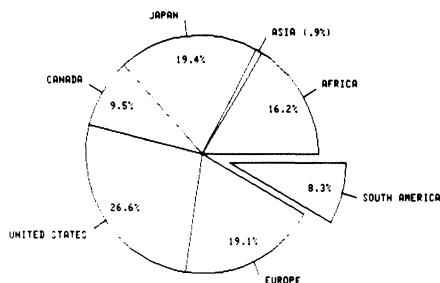

Bar Chart Program — provides various shade patterns on bars, legends and labels. The user can specify the y-axis scaling or use the program's automatic scaling feature. Three types of bar charts are available: normal, stacked or comparative formats. An example of a comparative chart is below:

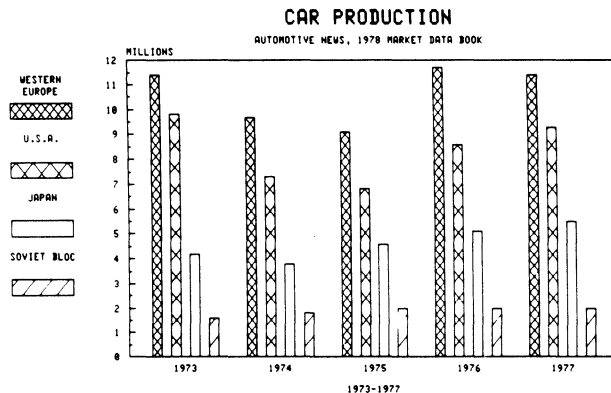

DESCRIPTION *(Continued)*

Linear Chart Program — provides linear or logarithmic x and y scales with an optional grid. In specifying the legends and labels, the user has the option of specifying the x-axis labels as time in months or days. In addition to providing various line types to connect data points, the program can also produce scattergrams of unconnected points. Example:

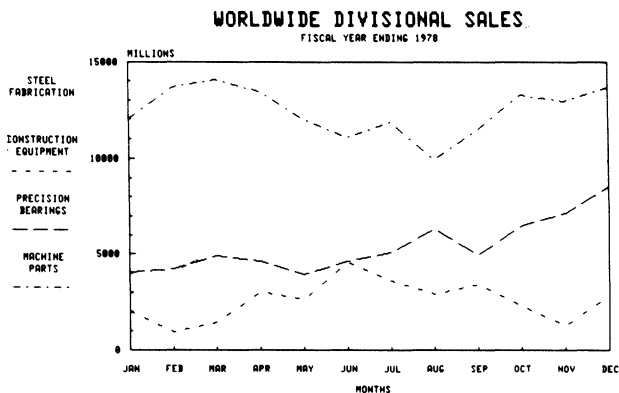

Slide Program — allows the user to design textual slides and add graphs to the slides. Characters are available in normal, slanted, Roman, or Italic fonts. The user can edit slides with insert and delete of characters and lines. The program will center or left or right justify lines of text, automatically annotate a series of slides, and frame the slide with a box. Additionally, vector lines can be drawn directly on the slides.

HARDWARE CONFIGURATION REQUIRED:

TERMINAL AND/OR HOST MAINFRAME: 2647A Terminal

MEMORY (TERMINAL AND/OR HOST): Standard with 2647A

TERMINAL OPTIONS: Graphics hardcopy requires option 096 — shared peripheral interface

PERIPHERALS: Any HP-IB compatible plotter or raster printer; 2631G, 7225A, 7245B, 7310A, 7580A, 9872 series multicolor plotters.

ORDERING INFORMATION:

HP MULTILOT Software is included with each HP 2647A Intelligent Graphics Terminal.

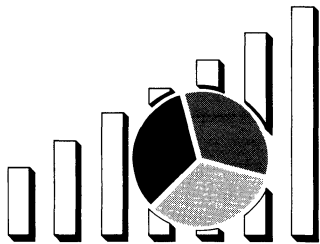

APPLICATION RESOURCE PAC PROGRAM SUMMARY

REFERENCE NO. 1.02

GRAPHICS

TERMINAL	COMPUTER	PROGRAM TITLE
2647A	Not Required	Graphics Presentation Resource Pac

DESCRIPTION

The 2647A Graphics Presentation Resource Pac offers a variety of programs which can be used to generate graphical presentation of data. By completing an easy-to-use menu, users without programming experience can design, preview and plot charts from numerical data. Included in the pac are three program tapes, a documentation tape, a printed listing of the documentation tape and a Quick Reference Guide.

The pac contains the following software programs:

MULTILOT PLUS/SLIDE

MULTILOT PLUS/SLIDE is an enhanced version of the standard MULTILOT/SLIDE software package which is included with each HP 2647A Intelligent Graphics Terminal. A summary of the standard MULTILOT package is also contained in this catalog, (see page 1, reference number 1.01).

The following enhancements to MULTILOT have been incorporated into MULTILOT PLUS.

- Pie Charts** — 1. Plots pie slice based on either percentages or actual numeric values.
— 2. Adds 5 new shades: rays, circular fill, dense circular fill, circular fill with rays, and dense circular fill with rays.
- Bar Charts** — 1. Three dimensional bars.
2. Prints numbers on top of bars.
3. Draws top lines of bars only (stepladder effect).

- Linear Charts** — 1. Optional larger letters in title.
2. Label y axis on left and right side.

In addition, several new programs have been added:

- Planning Chart** — A 12-month planning tool which can display on the same linear chart historical, forecasted and present actual values for comparison purposes.

- Label Program** — A utility, which provides a method to label graphs and diagrams with variable character size, colors and justification.

Note: LOG/LOG, Y-LOG, and X-LOG plotting functions are not included in MULTILOT PLUS. No changes have been made to the SLIDE program.

REPEAT-A-PLOT

REPEAT-A-PLOT operates in the same manner as the programs used on the HP 2647A MULTILOT tape. In addition, REPEAT-A-PLOT will plot multiple Pie charts, Bar charts, and Linear charts using the HP 9872S Color Plotter and the HP 2647A terminal in an UNATTENDED mode. REPEAT-A-PLOT formats data from the menu, stores the data on tape, and reads the data to plot multiple charts continuously. The SLIDE program is not included with REPEAT-A-PLOT.

DESCRIPTION (Continued)

FLOWCHART

The flowchart program can be used effectively to create flowcharts, organizational charts, and any other diagrams which represent a systematic flow of activities or processes. A set of flowchart symbols or "shapes" are employed to define a chart i.e., input/output, decision, process, display, line connectors, arrows, etc., which can be labeled with text. Extensive user instructions and editing features have been designed into the program to simplify text entry, text editing and symbol selection. The flowchart program can be used with the HP 9872 series of multicolor plotters. Example:

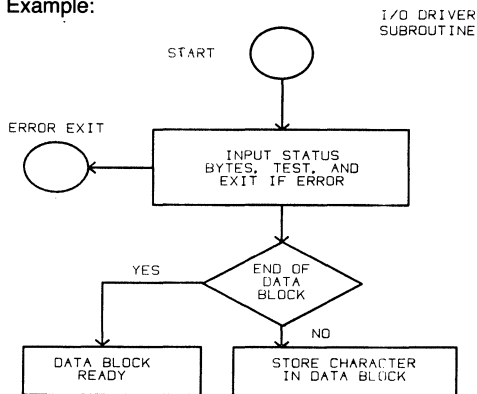

ELECTRONIC SYMBOL TEMPLATE

The Electronic Symbol Template is a program that allows the user to graphically display (draw) electronic circuits employing symbols commonly used in the electronics industry, e.g., AND gates, OR gates, resistors, etc. The user determines where to place the symbol on the terminal screen, and optionally, can output the circuit drawing to a HP 9872 series plotter for presentation purposes. Example:

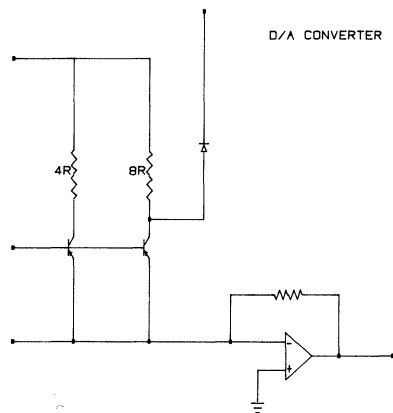

HARDWARE CONFIGURATION REQUIRED:

TERMINAL AND/OR HOST MAINFRAME: 2647A Terminal

MEMORY (TERMINAL AND/OR HOST): Standard with 2647A

TERMINAL OPTIONS: Graphics hardcopy requires option 096 — shared peripheral interface

PERIPHERALS: Any HP-IB compatible plotter or raster printer; 2631G, 7225A, 7245B, 7310A, 7580A, 9872 series multicolor plotters.

ORDERING INFORMATION:

Contact your local HP sales office; or use the ordering form in this catalog, order number 13257B.

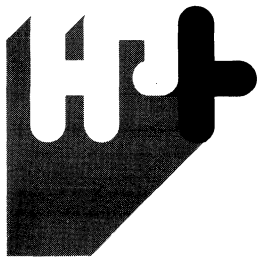

SOFTWARE SUPPLIER APPLICATION PROGRAM SUMMARY

REFERENCE NO. 1.03

GRAPHICS

TERMINAL	COMPUTER	PROGRAM TITLE
2647A	Not Required	CSC/PLOT

DESCRIPTION

CSC/PLOT is a set of terminal resident, menu driven graphics programs which allow the non-technical user to design, preview and plot graphs and slides. The user can interactively adjust the program parameters and produce quality hardcopy output using the 9872 or 7580 series of multipen plotters.

The significant features of **CSC/PLOT** include: extensive provisions for annotation, shading and labeling of graphs, a single screen/one-pass linear program and the real-time menu design capability of **CSC/COMPLEX**. Features common to all programs are: automatic setting of P1 and P2 based on paper size, variable margins, frame option, **BOLD** lettering and a multiple copies option.

CSC/PIE has provisions for a main title line, 2 subtitles and 2 footnote lines with variable character sizes. Each pie piece can be separated or exploded and labeled with 2 lines of annotation in 5 different character sizes and 2 character fonts. The placement of the pie piece label is determined by the user. There are 8 shading patterns.

CSC/BAR and **CSC/HORIZONTAL** allow for variable character sizes for the main title, subtitle, X and Y axis labels. Two lines of

annotation are provided for each bar with additional annotation placed in the margin. 12 shading patterns are available. The numeric value for each bar can be placed at the end of the bar. Should the value of a bar exceed the limits of the axis, the bar is "broken" to depict an extreme value.

CSC/COMPLEX is used to create complex bar charts. **COMPLEX** prompts the user to define general parameters of the chart and then designs an input screen to fit those requirements. The user can adjust certain parameters that are static in **CSC/BAR**, such as bar width, bar spacing, location of bar values and axis labeling. **COMPLEX** allows for extensive annotation, concurrent stacked and comparative bars with positive and negative values.

CSC/LINEAR is a single screen/one pass program with provisions for 2 independent numeric Y axes and a numeric or user annotated X axis. The program accommodates missing data points, symbols at plotted points, 9 line types, annotation at the line or in a legend. Highlighting specific points with annotation, actual values and placing annotation anywhere on the chart aids in designing a meaningful graph. Additional features include: variable character sizes and colors, grid patterns and read from tape operations for use with large data bases.

Price: \$1750 Licensed product, multiple site discount available, individual programs available as separate products.

COMPANY NAME	Computer Support Corporation	TELEPHONE	(214) 661-8960
ADDRESS	4215 Beltwood Parkway Dallas, Texas 75234	OFFICE HOURS	8:30a.m.-6:00p.m. CST
CONTACT	Mike Kallet, Fred Schoeller	CONTINUED ON OTHER SIDE	

DESCRIPTION (Continued)

CSC/PLOT Chart Examples:

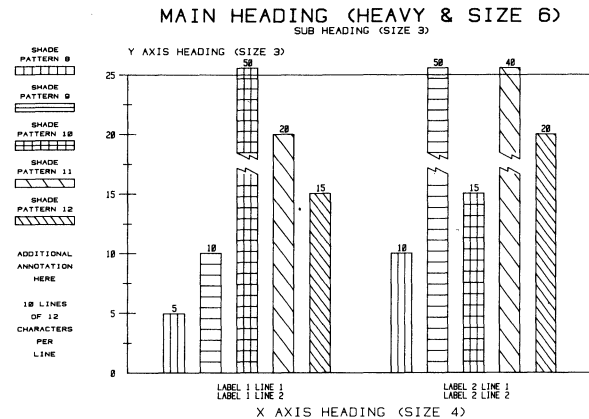
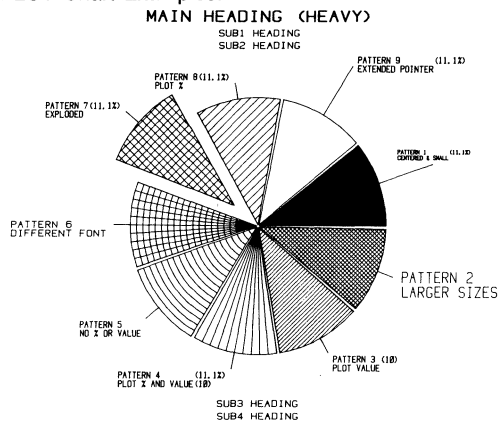

HARDWARE CONFIGURATION REQUIRED:

TERMINAL AND/OR HOST MAINFRAME: Standard 2647A

MEMORY (TERMINAL AND/OR HOST): Standard with 2647A

TERMINAL OPTIONS: Graphics hardcopy requires option 096 — shared peripheral interface

PERIPHERALS: Any HP-IB compatible plotter or raster printer; 2631G, 7225A, 7245B, 7310, 7580, and 9872 series multicolor plotters.

SUPPORT AVAILABLE:

MANUALS DOCUMENTATION: User's Reference Manual

CONSULTATION: Phone MAIL CUSTOMER SITE

PROGRAM CUSTOMIZATION SERVICE: Available

CUSTOMER TRAINING: Available one day training on-site at no charge within 100 miles of New York City, Chicago, Dallas, Houston, San Francisco, Los Angeles. Travel and lodging charges may apply if training site is other than the above specified areas.

GEOGRAPHICAL AREA SUPPORTED: Continental United States.

Disclaimer: This software has been developed by Computer Support Corporation for operation on Hewlett Packard equipment. Computer Support Corporation is solely responsible for its software and support services. Hewlett Packard is not the manufacturer or co-developer of such software or support. Hewlett Packard disclaims any and all liability for and makes no warranties with respect to this software. Buyer's sole recourse against Hewlett Packard is set forth in Hewlett Packard's warranty statement provided with the Hewlett Packard manufactured equipment. Distribution of Software Summaries by HP does not constitute endorsement of Computer Support Corporation software or support services.

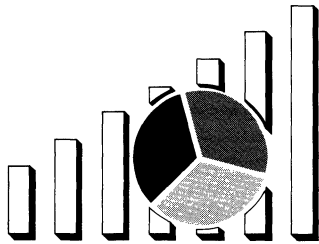

HEWLETT-PACKARD PROGRAM SUMMARY

REFERENCE NO. 1.04

GRAPHICS

TERMINAL	COMPUTER	PROGRAM TITLE
2647A, 2648A	HP 1000	GRAPHICS 1000-II

DESCRIPTION

GRAPHICS 1000-II is a family of computer graphics software for the entire line of HP 1000 computers. GRAPHICS 1000-II consists of two sets of easy to use subroutines called from the application program — the 92841A Device-independent Graphics Library, DGL, and the 92842A Advanced Graphics Package-3D (AGP-3). DGL is a powerful tool for developing 2D high-performance graphics applications. AGP-3 is a sophisticated interactive 3D graphics tool based on the SIGGRAPH committee "CORE" proposal, and is designed for anyone developing interactive graphics applications on the HP 1000.

The device-independence feature of GRAPHICS 1000-II lets an application program operate any supported device without changing the program. This feature reduces the application development time to support multiple graphics devices or to change devices. It also produces simpler applications software for reduced software maintenance and documentation costs.

92841A Device-independent graphics library

If you would like to take advantage of fast, memory-efficient, general purpose 2D computer graphics, 92841A Device-independent Graphics Library (DGL) is the answer. DGL is particularly useful in data display and dynamic display applications. Data display applications include the development of line-graphs, histograms, bar graphs, and pie charts. Dynamic display applications can benefit from DGL's high-speed, low overhead processing, where the display must show the dynamics of changing phenomena. These applications include process control, system monitoring, and testing. DGL is used to provide the device-independent 2D interface for AGP-3.

92842A Advanced graphics package-3D

The 92842A Advanced Graphics Package-3D (AGP-3) is especially suited for interactive graphics applications requiring either 2D or 3D capabilities. Since AGP-3 handles all the interactive graphics processing, the application program becomes much simpler, reducing the development and maintenance costs of software.

AGP-3 viewing operations easily generate 2D images of 3D objects viewed from any angle or position. Viewing parameters are specified by the application program to correspond to the position, angle, and type of projection to be used. Using this approach, developing standard three-view drawings is simple. Only the viewing parameters are changed three times to develop the front, top, and side projections of a 3D object. The 3D object coordinates need not be altered. Full perspective projections from any position are just as easy. Special views, such as oblique projections, are easily accomplished by manipulating the AGP-3 viewing parameters.

AGP-3 uses an efficient design that separates graphics processing into two programs, the user's program and the AGP-3 workstation program. Each program executes concurrently using the HP 1000 multi-tasking operating system, all transparent to the application programmer. By separating the tasks, the user gets the power of a large graphics package with a fraction of the memory utilization and the performance of multi-task processing.

DESCRIPTION (Continued)**Device Support**

Currently, the GRAPHICS/1000-II family will support several HP graphics devices:

1350S, 1351S	Vector Refresh Displays
2647A, 2648A	Graphics Terminals
9111A/T	Graphics Tablets (Digitizers)
9872A/B/S/C/T	Four-Pen Plotters
7580A	Large Format Plotter

Additional device support will be added as standard enhancements.

Systems compatibility

AGP-3 will operate on the HP 1000 L, M, E, and F series processors with RTE-IVB and RTE-XL operating systems. AGP-3 also requires 92841A DGL to operate. DGL runs on the entire line of HP 1000 computers with RTE-IVB, RTE-IVE, RTE-XL, and RTE-L.

HARDWARE CONFIGURATION REQUIRED:

TERMINAL AND/OR HOST MAINFRAME:

MEMORY (TERMINAL AND/OR HOST):

TERMINAL OPTIONS: 032 Extended
Asynchronous communications

PERIPHERALS: N/A

Required Interface in		Required Driver in	
HP 1000 L-Series	HP 1000 M/E/F-Series	RTE-L/XL	RTE-IVB/ RTE-IVE
12005A +005	12966A +001 or 12966A +002	ID.00 & DD.00	DVR05 or DVA05
	12792A		PVM00, DVM00, & DDV05

ORDERING INFORMATION:

Contact your local HP sales office for more information.

92841A Device-independent
Graphics Library (DGL)

92842A Advanced Graphics
Package-3D (AGP-3)
Prerequisite: Previous or concurrent purchase of 92841A DGL

92843X Skeleton Device Handler

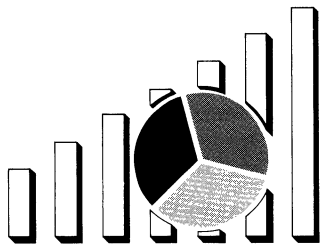

HEWLETT-PACKARD PROGRAM SUMMARY

REFERENCE NO. 1.05

GRAPHICS

TERMINAL	COMPUTER	PROGRAM TITLE
HP 2648A, HP 2647A See "Hardware Environment"	HP 3000	HP Decision Support Graphics/3000 DSG/3000

DESCRIPTION

HP Decision Support Graphics/3000 (HP DSG/3000) is a data display system that helps you design, produce, and save business graphs drawn from numerical information kept in any data file on the HP 3000 computer system. The graphs can be displayed on any HP graphics terminal or a printed copy can be made on one of the HP multi-color plotters.

HP DSG/3000 is highly interactive and was designed for the periodic or one-time user. Chart design is guided by simple "fill in the blanks" menus presented in logical sequence. A "Help" facility which is built into the system, assists the user upon request. It requires little knowledge of graphics design and the non-computer professional can obtain business graphics without waiting for the development of application programs.

HP DSG/3000 also offers a powerful capability for program development. Both the interactive user and the programmatic user have access to the full capabilities of the product.

HP DSG/3000 facilitates the creation of line graphs, horizontal and vertical bar charts, pie charts, and scattergrams. All charts can be annotated with symbols and text.

Features

- The one-time user can explore data and easily produce charts.
- The periodic-user can design, modify and save charts to be used again on changing data.

- Data can come from any tabular file on the system which was created by the EDITOR, V/3000, QUERY, any user-written application program, or was entered through the terminal keyboard.
- Since chart design is independent of the data, data can be updated or modified without changing the chart specifications.
- Data can be automatically scaled but flexible design options let the user change any standards provided.
- Data transformation and subsetting capabilities will help you to mathematically reshape your data to be graphed.
- Annotations are provided to enhance and customize charts with symbols and text.
- Chart boundaries can be set by the user. This provides for multiple charts to be placed on one page for easy comparison.
- Chart design is device independent.
- Provides a comprehensive set of program procedures which can be called from COBOL, BASIC, FORTRAN, and SPL.

DESCRIPTION *(Continued)*

Hardware Environment

- The minimum hardware system recommended to implement HP DSG/3000 is an HP 3000 Series II, III, 30, 33 or 44 with 512Kb of memory. However, the amount of memory actually needed is dependent on the overall system load and customer's expectations regarding performance and terminal response time. Consultation with your local sales office is recommended.
- Terminals supported by HP DSG/3000.
 - for chart definition only: 2622A, 2624A, 2626A, 2642A, 2645A
 - for chart definition and previewing graphs: 2647A, 2648A
- Plotters supported by HP DSG/3000:

High-Resolution Vector Pen Plotters:

- RS-232 7220 A/C/S/T (4-color)
7221 A/B/C/S/T (4-color)
7225A (with 17604A personality module)
7580A (4-color)
7240A Printer/Plotter
- HP-IB 9872 A/B/C/S/T (4-color)
7580A (4-color)
7225A (with 17601A personality module)
7245A/B Printer/Plotter

*Check with your local HP representative to determine when 8-color support is available.

Software Environment

HP DSG/3000 requires current version of the MPE operating system. VPLUS/3000 run-time library which is a standard part of the fundamental operating software, is required for chart definition.

ORDERING INFORMATION:

Contact your local HP sales office. Product No. 32250A

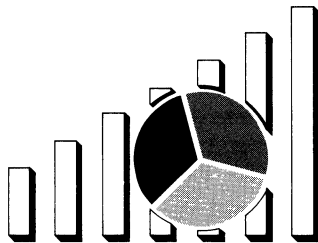

HEWLETT-PACKARD PROGRAM SUMMARY

REFERENCE NO. 1.06

GRAPHICS

TERMINAL	COMPUTER	PROGRAM TITLE
2647A	Not Required	2647/1351 BASIC

DESCRIPTION

2647/1351 BASIC is a special version of HP Terminal BASIC which sends its graphics output to the large screen, high resolution HP 1310B Graphics Display when used with the HP 1351A Graphics Translator.

FEATURES

- Plots AGL Graphics Program output on 19" HP 1310B Display (instead of 2647A Display)
- Same BASIC/AGL commands and syntax as HP Terminal BASIC except for functions not supported on 1310S/1351A*
- Supports HP's new multicolor 8-pen and large format plotters.

An attractive and flexible design graphics workstation is made possible using the 2647/1351 BASIC/AGL with the 2647A intelligent terminal, the HP 1351A Graphics Translator and the HP 1310B Large Screen Display. This workstation features a 19"

high resolution, high quality display for graphics with 1000 × 1000 addressable resolution, Terminal BASIC, and cartridge tape local mass storage. HP's Shared Peripheral Interface, 2647A #096, allows local hardcopy through a variety of HP peripherals including the multicolor 8-pen and large format plotters.

DOCUMENTATION

For further information, consult the following manuals:

02647-90005	Terminal Basic Manual
5955-6312	BASIC Manual Supplement

*AGL functions not supported by the 1351A/1310B are cursor control functions: POINT, CURSOR, and DIGITIZE; LINE, and LDIR for PI/2 and 3PI/4.

NOTE: The slide program from MULTILOT/SLIDE is incompatible with the 2647/1351 BASIC/AGL.

DESCRIPTION (Continued)

2647/1351 BASIC offers the following commands and statements to the user:

COMMANDS					STATEMENTS					FUNCTIONS					
COMMENTS							Numeric	String	Print	Input/Output	Other				
AUTO	MERGE	ASSIGN	INTEGER	PRINT USING	ABS	CHR\$	LIN	GETKBD	ERRL						
CSAVE	REMOVE	CALL	KEYCODE	READ	CSENA	LEN	SPA	DSPIN\$	ERRN						
DELETE	RENUM	COMMAND	LET	READ#	CSENS	NUM	TAB	GETDCM	FRE						
EXIT	RUN	DATA	LINPUT	REMARK	EXP	POS	MOVCS	PUTDCM							
GET	SAVE	DIM	LINPUT#	RESTORE	INT	VAL	MOVCA								
GO	SCRATCH	END	LONG	RESTORE#	LOG	VAL\$	MOVCR								
LIST	SET	ERROR	OFF KEY#	RESUME	LONG	RPT\$									
		FOR...NEXT	ON END#	RETURN	RND	TRIM\$									
		GETDCM ON/OFF	ON...GOSUB	SHORT	SGM	UPC\$									
		GETKBD ON/OFF	ON...GOTO	SLEEP	SHORT	PROC\$									
		GOSUB	ON ERROR	STOP	SQR										
		GOTO	ON KEY#	SUB	ATN										
		IF...THEN...ELSE	ON KEY#	SUBEND	COS										
		IMAGE	PRINT	WAKE UP	SIN										
		INPUT	PRINT#		TAN										

AGL FUNCTIONS			
Interactive	Set-Up	Plotting	Axis Labeling
WHERE	PLOTR	PENUP/PENDN	XAXIS
GPM	GPON	PEN	YAXIS
DSIZE	SETAR	PLOT	LXAXIS
DSTAT	LIMIT	MOVE	LYAXIS
GSTAT	GCLP	DRAW	AXES
	LOCATE	RPLLOT	LAXES
	MARGIN	IPLOT	GRID
	SCALE	PDIR	LGRID
	SHOW	PDRG	FRAME
	MSCALE		FXD
	CLIP		LORG
	CLIPOFF		LDIR
	CLIPON		Csize
	SETGU/SETUU		

HARDWARE CONFIGURATION REQUIRED:

TERMINAL AND/OR HOST MAINFRAME: 2647A.

MEMORY (TERMINAL AND/OR HOST): Standard 2647A.

TERMINAL OPTIONS: Shared Peripheral Interface: 2647A #096

PERIPHERALS: HP 1351A Graphics Translator
 HP 1310B Large Screen Display
 Optional: 9872C,T 8-Pen Plotters; 7580A Large Format Plotter

ORDERING INFORMATION:

Contact your local HP sales office; or use the ordering form in this catalog, order number 13257K.

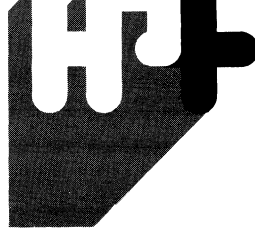

SOFTWARE SUPPLIER APPLICATION PROGRAM SUMMARY

REFERENCE NO. 1.07

GRAPHICS

TERMINAL	COMPUTER	PROGRAM TITLE
2647A	Not Required	CSC DIAGRAPH

DESCRIPTION

DIAGRAPH utilizes the extensive graphics capabilities of the 2647A Intelligent Terminal to produce organization charts, flow diagrams and presentation aids. Combinations of a variety of symbols, line types, tokens and text can be used to produce diagrams for diverse applications.

DIAGRAPH is User Oriented: The interactive mode of operation allows precise control in the placement, size and color of symbols, lines and text. Connection of the symbols and the drawing of lines is controlled by the graphics cursor and utilizes the zoom and pan features of the terminal.

DIAGRAPH is Function Key Controlled: Primary and secondary functions (move, size, create, delete) are displayed with prompt messages on the screen to lead the user through the preparation of the diagram.

DIAGRAPH Remembers: Connections between symbols are automatically redrawn when the symbols are moved or the size of a symbol is changed. When a symbol is deleted, its connections and annotations are removed.

DIAGRAPH is Versatile: Provisions for connecting symbols include specification of the line type, color and tokens which can be used in combination to clarify the connection between symbols. Symbols can be created, deleted, moved, connected, detached, increased in size, decreased in size and the symbol changed: i.e., square to circle. Text can be placed in and around any symbol. The color and line type of the symbol may be varied and the color and size of the text is controlled by the user. The diagram or chart can be stored on tape as a file and retrieved at a later time for modification or additional copies. Specification of the paper size, margins and an optional border permit the user to scale the diagram to the desired shape and size.

Price: \$350 Licensed product, multiple site discount available.

COMPANY NAME	Computer Support Corporation	TELEPHONE	(214) 661-8960
ADDRESS	4215 Beltwood Parkway Dallas, Texas 75234	OFFICE HOURS	8:30a.m.-6:00p.m. CST Monday-Friday
CONTACT	Mike Kallet, Fred Schoeller, Vicki Huyge	CONTINUED ON OTHER SIDE	

DESCRIPTION (Continued)

CSC DIAGRAPH Chart Examples:

CLASSICAL MANAGEMENT THEORY

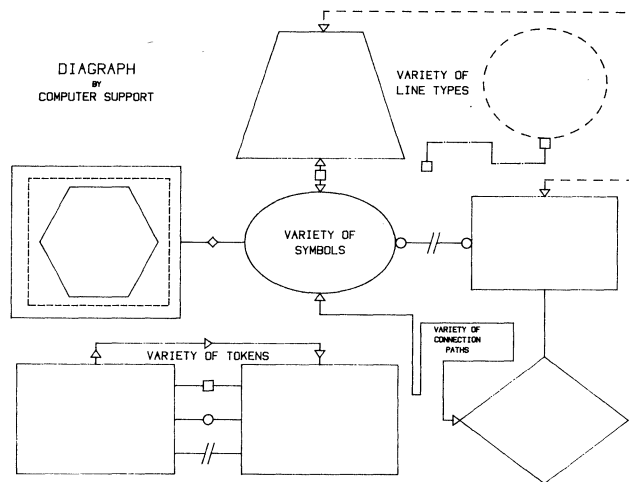
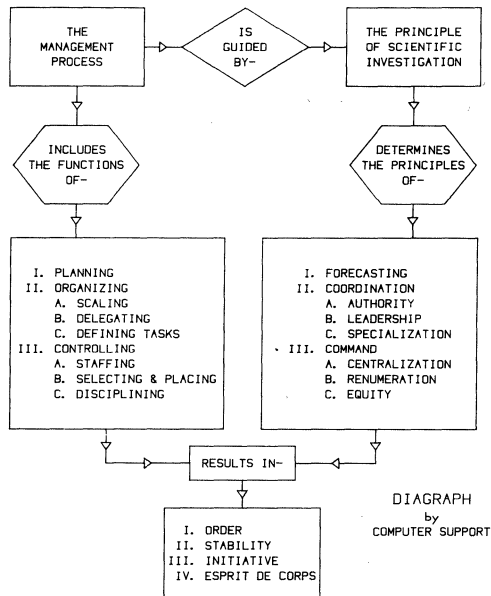

HARDWARE CONFIGURATION REQUIRED:

TERMINAL AND/OR HOST MAINFRAME: Standard 2647A

MEMORY (TERMINAL AND/OR HOST): Standard with 2647A

TERMINAL OPTIONS: Graphics hardcopy requires option 096 — shared peripheral interface.

PERIPHERALS: Any HP-IB compatible plotter or raster printer; 2631G, 7225A, 7245B, 7310, 7580 and 9872 series multicolor plotters.

SUPPORT AVAILABLE:

MANUALS DOCUMENTATION: User's Reference Manual

CONSULTATION: Phone MAIL CUSTOMER SITE

PROGRAM CUSTOMIZATION SERVICE: Available upon request.

CUSTOMER TRAINING: Not available. Training manual provided with program.

GEOGRAPHICAL AREA SUPPORTED: Continental United States.

Disclaimer: This software has been developed by Computer Support Corporation for operation on Hewlett Packard equipment. Computer Support Corporation is solely responsible for its software and support services. Hewlett Packard is not the manufacturer or co-developer of such software or support. Hewlett Packard disclaims any and all liability for and makes no warranties with respect to this software. Buyer's sole recourse against Hewlett Packard is set forth in Hewlett Packard's warranty statement provided with the Hewlett Packard manufactured equipment. Distribution of Software Summaries by HP does not constitute endorsement of Computer Support Corporation software or support services.

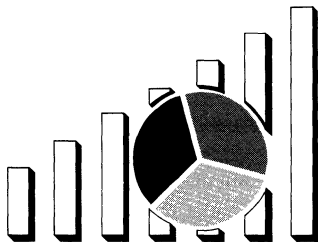

HEWLETT-PACKARD PROGRAM SUMMARY

REFERENCE NO. 2.01

DATA ENTRY AND CAPTURE

TERMINAL	COMPUTER	PROGRAM TITLE
HP Block/Format Mode Display and Data Capture Terminals	HP 3000	VPLUS/3000

DESCRIPTION

HP VPLUS/3000 is a data entry and forms management software product for use with HP block/Format mode and data capture terminals on an HP 3000 computer system. HP VPLUS/3000 can help users implement straightforward interactive data entry tasks easily and efficiently, and can facilitate the development of more complex terminal-oriented applications through the use of a high-level program interface. It is designed both as a stand-alone source data entry facility that can be implemented without programming effort and as "front-end" to transaction processing applications.

FEATURES

- **A forms design facility** utilizing HP 262X and HP 264X terminals, allows the creation of interactive screens from "fill-in-the-blanks" menus and the use of function keys. Simple edits are accepted by standard defaults and comprehensive data editing and validation can be specified by the use of a free-form field definition language.
- **Support of data capture.** The same forms Design Forms Design Facility that utilizes HP block/format CRT terminals, can be used to configure HP 3075 and 3076 data capture terminals. Multiple input/output devices (e.g., printer, keyboard, bar code readers) and up to 17 prompting lights can be specified through the simple menu approach. Data editing and customized messages for operator interaction can easily be defined. A choice of three data communication modes is available to accommodate the data collection environment: 1) point-to-point, 2) multipoint (daisy-chained), 3) DSN/data link.

- **A source data entry facility** allows immediate on-line entry and modification of data through forms created with the Forms Design Facility or through input from data capture terminals. For CRT's, this facility controls the sequence of forms displayed on a terminal screen, edits and validates the input data, and records that data in a special file. The same facility allows the terminal operator to "browse" through this file and to modify already entered data as desired. For Data Capture terminals, the data entry facility aids in managing the interface to the data collection devices, and offers simple data collection without programming.

- **A data reformatting facility** to change the format of entered data to meet the input requirements of existing application programs.
- **A program interface** which aids efficient and easy implementation of source data entry to transaction processing applications. This library of high-level procedures is available to provide a simple programmatic interface between an application program on the HP 3000 computer system, the terminal, the forms and edits created by the forms design facility, the entered data, and the data file.

With VPLUS/3000 screen formats are created by simply drawing them in an interactive fashion on the CRT and selecting edit routines from a standard set. Implementation does not require programming effort or extensive training.

DESCRIPTION *(Continued)*

HARDWARE ENVIRONMENT

The minimum system required for VPLUS/3000 is an HP 3000 Series 30 with 256KB of memory. The amount of memory actually needed above 256KB will depend on a customer's expectations regarding terminal response time and transaction volume.

The Data Entry terminals must be HP 2622A, 2624A, 2626A, 2640B, 2641A, 2644A, 2645A, or 2648A CRT units. Terminals may operate in either point-to-point, or multipoint mode (multipoint is not available on the HP 2622A and 2624A).

The Data Capture terminals, HP 3075 and 3076 support three data communication alternatives: point-to-point, multi-point, and the DSN/data link. The DSN/data link is a data communications link used to interface a computer and a large number of terminals. HP Data Capture terminals can be connected directly to the data link, and the HP 3074A Data Link Adapter is available to plug in other CRT-type terminals. This provides great flexibility for terminal-oriented applications throughout the company.

VPLUS/3000 integrates the following 262X terminals features into your data entry application:

- **Modified Data Tag on the HP 2624A:**
allows the transmission of only modified data fields. Only corrected fields need to be sent back to the computer.
- **Extended Local Edits on the HP 2624A:**
provides first level data checks in the terminal giving instant operator feedback, and reduces system overhead.
- **Relabeling Function Keys on the HP 2622A, 2624A, and 2626A:**
allows a VPLUS form to be customized to meet specific application needs during data entry.
- **Security Display Enhancements on the HP 2624A and 2626A:**
allows forms to have fields which will not display entered data.
- **Local Form Storage on the HP 2626A:**
allows subsequent forms to be preloaded into off-screen workspaces in the terminal; reduces time between displayed forms.

ORDERING INFORMATION:

Contact your local HP sales office. Product No. 32209B (VPLUS/3000).

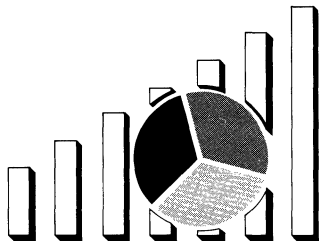

HEWLETT-PACKARD PROGRAM SUMMARY

REFERENCE NO. 2.02

DATA CAPTURE

TERMINAL	COMPUTER	PROGRAM TITLE
3075A, 3076A, 3077A	HP 1000	DATA CAP/1000-II

DESCRIPTION

FEATURES

- Simple configuration and management of multiple data capture transactions running on multiple HP Data Capture Terminals
- Easy creation and modification of transaction specifications, using menu form guidance on 264x CRT display terminal
- Direct recording of data onto mag tape or disc files
- Data entry direct to data sets in data base with optional IMAGE/1000 Data Base Management System as well as retrieval and updating from data capture terminals
- Automatic transaction logging and IMAGE data base recovery from a transaction file of data base modifications
- Support of user subroutines for special display, input validation, data entry, or storage procedures
- Security code can be used to protect data integrity and prevent unauthorized system access through the data capture terminals
- Automatic detection and recovery from data transmission error or power failure at any of the data capture terminals
- HP-IB and RS-232 devices can be dropped off the Data Capture Terminals and accessed directly by the HP 1000 via user-written subroutines
- Time schedulable start-up and shut-down

HP 92080A DATA CAP/1000-II is a real-time data capture support package used with HP 3075A and 3076A Data Capture Terminals and the HP 3077A Time Reporting Terminal in HP 1000 Computer Systems managed by HP's disc-based RTE-IVB real-time executive operating system.

Use of a DATA CAP/1000-II system bypasses the slow costly, error-prone process of filling out handwritten forms, keypunching and reading cards into the computer. The result is lower overall information processing costs and improved timeliness and accuracy.

DATA CAP/1000-II provides software support for entry of information (e.g., employee numbers, clock-in time, part numbers, work orders, test results, etc.) from multiple HP Data Capture and/or time reporting terminals directly into computer-readable storage media or an IMAGE 1000 data base.

A completely operational DATA CAP/1000-II system tailored to the user's application can be established with a minimum of programming. DATA CAP/1000-II is a complete package that manages multiple HP Data Capture Terminals in accordance with user-defined transaction specifications.

DATA CAP/1000-II functions include creation of transaction specifications, set-up of a data capture subsystem, on-line management of multiple HP Data Capture Terminals, data entry validation checking, and serial recording of transactions and/or entry of data into an IMAGE 1000 data base. This includes checking and validation of entered data. For users with special display, input validation data entry, and/or data recording requirements. DATA CAP/1000-II provides linkage to user-written subroutines.

DESCRIPTION *(Continued)*

HARDWARE CONFIGURATION REQUIRED:

TERMINAL AND/OR HOST MAINFRAME: HP 1000 with 92068A RTE-IVB operating system.

MEMORY (TERMINAL AND/OR HOST): High performance memory in the HP 1000 is mandatory for performance critical applications. All published performance data assumes high performance memory.

TERMINAL OPTIONS: None

PERIPHERALS:

NOTE: Please see HP 1000 Computer Systems Software Technical Data Manual (P/N 5953-4282) for more detailed configuration information.

ORDERING INFORMATION:

Contact your local HP sales office; product no. 92080A.

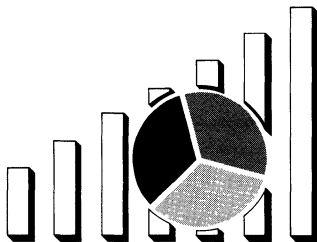

HEWLETT-PACKARD PROGRAM SUMMARY

REFERENCE NO. 3.01

TEXT PREPARATION

TERMINAL	HOST MAINFRAME	PROGRAM TITLE
2642A	Not Required	2642A Page Formatter

DESCRIPTION

The HP 13257A Page Formatter is a terminal-resident program for the 2642A that allows you to output prepared text from the display, disc file, or cartridge tape file in a paged format to a printer, disc file, cartridge tape file, or display.

The formatter program is obtainable on either diskette or cartridge tape to match the media capabilities of your HP 2642A terminal. It is menu-driven, and allows you to embed formatter *commands* into your text file for additional control.

FEATURES

The HP 13257A extends the realm of the HP 2642A's off-line text processing power from memos and letters to that of lengthy multi-page documents with these features:

- Automatic page breaks
- Alternate offsetting (for staples or punched holes)
- Footing/heading text with flexible positioning
- Menu and/or command driven
- Automatic page numbering
- Display preview
- File merging

DESCRIPTION *(Continued)***HARDWARE CONFIGURATION REQUIRED:**

TERMINAL AND/OR HOST MAINFRAME: 2642A (with mini-disc) or 2642A-070 (with cartridge tapes).

MEMORY (TERMINAL AND/OR HOST): Required memory standard with 2642A terminal.

TERMINAL OPTIONS: None

PERIPHERALS: Compatible with RS232 printers, i.e., HP 2601; 8-bit parallel printers, i.e., HP 9871A, and HP-IB printers, i.e., HP 7310, HP 2631A/B and HP 9876.

ORDERING INFORMATION:

Contact your local HP sales office; or use the ordering form in this catalog. Order number 13257A for use with HP 2642 terminal with mini-disc; or order number 13257A-001 for use with HP 2642A terminal (2642A-070) with cartridge tapes. Includes manual.

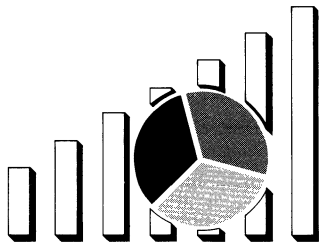

HEWLETT-PACKARD PROGRAM SUMMARY

REFERENCE NO. 3.02

TEXT PREPARATION

TERMINAL	COMPUTER	PROGRAM TITLE
All HP Terminals except see * below	HP 3000	Text and Document Processor/3000 TDP/3000

DESCRIPTION

Text and Document Processor/3000 (TDP/3000) is a text editing and document formatting system. By using easy-to-understand commands, documents can be typed in, errors corrected, text rearranged, and formatted, and final reports, generated. TDP/3000 can be used to create letters, memos, manuals, tabular reports, and computer programs. The command-driven TDP/3000 system provides users with the capability for comprehensive text editing and document formatting on the HP 3000 with standard HP terminals.

FEATURES

- Text editing
- Document formatting
- Mathematical expression handling
- Table creation
- Built-in calculator
- Command files
- Form letters
- Automatic hyphenation
- Security
- MPE command execution

TEXT EDITING

You can move, copy, modify, insert or delete words, phrases, lines or paragraphs at any location in your file. Global searches and replacements can be done on all or any portion of your file.

Parts of other documents such as boilerplate information can be inserted in your document during editing or just before printing.

TDP/3000's editing capabilities are also complemented by the text editing features of HP terminals such as the HP 2642A and 2645A.* With the TDP/3000 command, SCREEN, a requested section of a document is displayed on the terminal. Full screen editing using the terminal's text preparation capabilities can be accomplished. For example, the cursor can be positioned to any character and characters added or removed using the character insert/delete keys. When all changes have been inserted, the SCREEN command is completed by pressing the ENTER key.

DOCUMENT FORMATTING

Using imbedded commands, TDP/3000 offers print enhancement features such as underlining, subscripts, and superscripts, and user control over margin and tab settings.

Multiple column output is achieved through a single command. Output page size can be modified or the automatic pagination feature can be used.

Titles can be centered or right or left justified. Multiple line headings and footings can be inserted and changed for every page. Footnotes can be inserted after the line containing the reference. TDP/3000 takes care of placing the footnote on the correct page. A table of contents can be created by TDP/3000 by specifying the sections to be included.

*Terminal text editing features require an HP block mode terminal and are not available on the character mode HP 2621A/P, and HP 2635A/B terminals.

DESCRIPTION *(Continued)***HARDWARE ENVIRONMENT**

HP 3000 Systems

Series 30
Series 33
Series 44
Series III

Terminals

All HP terminals which connect to the HP 3000 may be used except when using the SCREEN command which requires an HP block-mode terminal.

Supported Printers

HP 2608A	HP 2631B
HP 2613A	HP 2635A
HP 2617A	HP 2635B
HP 2619A	HP 9871A
HP 2631A	

SOFTWARE ENVIRONMENT

MPE operating system. No other software is required.

ORDERING INFORMATION:

Contact your local HP sales office. Product no. 36578A (TDP/3000).

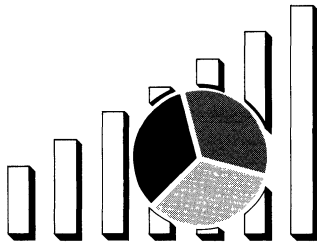

HEWLETT-PACKARD PROGRAM SUMMARY

REFERENCE NO. 3.03, 3.04

TEXT PREPARATION

TERMINAL	COMPUTER	PROGRAM TITLE
2647A, 2648A see "Operating Requirements"	HP 3000	Interactive Design System (IDS/3000) Interactive Formatting System (IFS/3000)

DESCRIPTION

DESCRIPTION

As part of the 2680A Laser Printing System, IDS/3000 and IFS/3000 allow users throughout an organization to easily take advantage of the unique print quality and flexibility of the HP 2680A Intelligent Page Printer.

The HP 2680 Laser Printing System produces high quality printed output that is easily tailored to each user's needs. Several unique capabilities provide cost-effective solutions to a wide range of printing applications that have traditionally required retyping, re-formatting, copying, and photoreduction of computer generated output.

The Interactive Design System (IDS/3000) is used for design of characters, symbols, and forms, at a graphics terminal, with simple cursor movements. This easy to use, menu-driven software interacts with an HP 2647A or HP 2648A graphics terminal to create any desired image. Optionally, an HP 9874A or HP 9111A digitizer can be used to facilitate creation of characters, logos, or symbols.

The Interactive Formatting System (IFS/3000) is used to configure output tailored to each user's needs. Character fonts, logos, symbols, forms, and even signatures designed with IDS/3000 can be selected for use in any printing application. In addition, more than 40 predefined character fonts are supplied with the formatting software. The IFS/3000 software allows users to specify which character fonts and forms are to be used in a printing application, and how they are to be positioned on each page.

IDS/3000 Operating Requirements

- IDS/3000 operates *only* on the HP 2647A or 2648A graphics terminals.
- Interactive Formatting System (IFS/3000) is required to format characters and forms developed on IDS/3000 for printing on the HP 2680A Intelligent Page Printer.

DESCRIPTION *(Continued)***IFS/3000 Operating Requirements**

- IFS/3000 operates on HP block/FORMAT mode terminals that support VPLUS/3000. However, if you plan to use IFS/3000 in conjunction with IDS/3000, the HP 2647A and 2648A graphics terminals are compatible with both IFS/3000 and IDS/3000.
- IFS/3000 is required to format characters and forms produced with IDS/3000 that are to be printed on the HP 2680A Laser Printer. If IDS/3000 is not purchased, only standard character fonts provided with IFS/3000 can be used for output.

ORDERING INFORMATION:

Contact your local HP sales office.

Product no. 36581A (IDS/3000)

Product no. 36580A (IFS/3000)

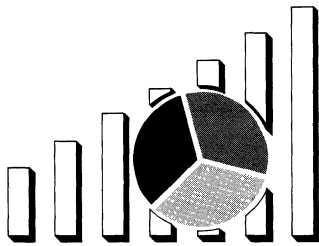

APPLICATION RESOURCE PAC PROGRAM SUMMARY

REFERENCE NO. 4.01

DATA ANALYSIS AND DISPLAY

TERMINAL	COMPUTER	PAC TITLE
2647A	Not Required	Project Management Resource Pac

DESCRIPTION

The 2647A Project Management Resource Pac offers a variety of programs to assist project managers and planners to improve planning, control, and overall decision-making of their projects. Optional graphic display and color plotter output are included to produce an easy-to-communicate visual representation of project status and organization. Each pac includes two program tapes, a documentation tape, a printed listing of the documentation tape, and a Quick Reference Guide.

The following programs are contained in the pac:

CPM: CRITICAL PATH METHOD CHART

The CPM program will perform a critical path analysis on small to medium projects which can be represented as a network of up to 30 individual events. It assists the users to develop and maintain project schedules, thus giving continuous management control for the project duration. Some of the many outputs which are provided include full project completion time, earliest start and latest start times, tracing of a critical path plus optional graphic display and output to the HP 9872 series of multicolor plotters.

Example Chart: ABC PROJECT CPM CHART

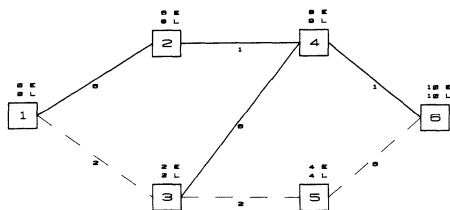

TIME TO PROJECT COMPLETION IS 10 WEEKS
 --- CRITICAL PATH
 E -- EARLIEST START TIME
 L -- LATEST START TIME
 J. DOE

TEC: TIME-EVENT CHART

The time-events chart program provides the capabilities to create events and time-related charts (commonly referred to as BAR charts). These charts can be used to lay out a detailed action plan for developing target objectives and measuring them against their progress. This program uses the menu-driven features and users can easily enter and edit input data simply by answering questions in the menu. Optional output to the HP 9872 series of multicolor plotters, is available for both instant viewing, future reference and presentation.

The Project Management Resource Pac also contains a variety of financial decision programs which will assist managers and professionals to evaluate financial alternatives.

PROGRAM NAME	DESCRIPTION
INTRSI	NOMINAL INTEREST RATE — Given a known present and known future value of an investment, this program calculates the nominal rate (or stated annual rate when compounded more than once per year).
FUTR1	FUTURE VALUE — Given initial value, number of compounding periods per year, and the number of years, this program calculates the future value of the investment. Graphics output is optional.
FUTR2	INVESTMENT FOR FUTURE VALUE — Calculates the initial investment needed to generate a specified future value after a stated period of time. Graphics output is optional.

DESCRIPTION *(Continued)*

MORT	MORTGAGE AMORTIZATION — Calculates an amortization table based on user inputs on loan amounts, regular payments, loan rate, etc. Table includes remaining balance on the loan, amount of each payment that goes to interest and balance amortization for each payment.	INVES	MINIMUM INVESTMENT — Calculates the initial investment necessary to accommodate a specified number of withdrawals over a given number of years. Graphics output is optional.
LOAN1	REMAINING BALANCE OF LOAN — This program gives you the balance remaining on a loan given the number and amounts of regular payments, interest rate and principal.	SALV	SALVAGE VALUE — Calculates the salvage value at yearly intervals for an asset of given value. User inputs include depreciation rate and those years of the asset's life for which salvage value is to be calculated. Graphics output is optional.
LOAN2	TERM OF LOAN — Given user provided information on amount and number of regular payments per year, initial loan and applicable interest rate, this program calculates the time needed to repay the loan.	DEPRI	DEPRECIATION RATE — Calculates rate of depreciation given original price, resale price, and age in years of asset.
LOAN3	PRINCIPAL OF LOAN — This program calculates the initial principal of a loan given the amount and number of payments per year, the number of years of the loan, and applicable interest rates.	DEPR2	DEPRECIATION AMOUNT — Calculates the depreciation amount at yearly intervals for an asset of given value. User inputs include depreciation rate and those years of the asset's life for which depreciation is to be calculated. Graphics output is optional.
LOAN4	PAYMENT OF LOAN — Calculates the amount of regular payments needed to pay back a given loan with specified number of payments per year, term in years and interest rate.	INTRS2	EARNED INTEREST TABLE — Inputs to the program are initial investment, interest rate, number and amount of deposits or withdrawals per year, number of compounding periods per year, and start and end year. The program will then return a table consisting of interest accumulated per period, total interest accumulated to date and total balance. Graphics output is optional.

HARDWARE CONFIGURATION REQUIRED:

TERMINAL AND/OR HOST MAINFRAME: 2647A

MEMORY (TERMINAL AND/OR HOST): Standard with 2647A

TERMINAL OPTIONS: Graphics hardcopy requires option 096 — shared peripheral interface

PERIPHERALS OPTIONAL: Any HP-IB compatible plotter or raster printer: 2631G, 7225A, 7245B, 7310A, 7580A, 9872 series multicolor plotters.

ORDERING INFORMATION:

Contact your local HP sales office or use the ordering form in this catalog. Order No. 13257F.

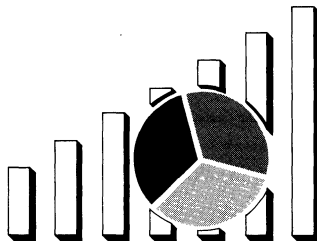

APPLICATION RESOURCE PAC PROGRAM SUMMARY

REFERENCE NO. 4.02

DATA ANALYSIS AND DISPLAY

TERMINAL	COMPUTER	PAC TITLE
2647A	Not Required	Statistical Analysis Resource Pac

DESCRIPTION

The 2647A Statistical Analysis Resource Pac offers a variety of programs that provide solutions to the most frequently used statistical operations: basic statistics, curve fitting, regressions, analysis of variance, confidence limits, etc. In addition, many programs offer optional graphical output to display the results of your computation. Each pac includes one program tape, a documentation tape, a printed listing of the documentation tape, and a Quick Reference Guide.

The following programs are contained in the pac:

PROGRAM NAME	DESCRIPTION
CONLM1	Computes confidence limits for an unknown population mean, based on the random sample data entered.
CONLM2	Computes confidence limits for the difference between two samples, based on data supplied for two samples, one from each population.
BICONF	Determines the confidence limits for a population proportion based on the exact binomial distribution.

GEOMSD	Computes the geometric mean and standard deviation of a data set.
STAT	Calculates the arithmetic mean, variance and standard deviation of grouped or ungrouped data. The data may represent just a sample, or the entire population.
PERM	Calculates the number of permutations and combinations of N objects taken D at a time.
HISTO	Draws and labels histogram, plots data, calculates mean and standard deviation of data displayed.
LINRG	Linear regression; fits a straight line to an array of points on a given set of coordinates using the method of least squares; prints coefficients of determination and correlation and standard error of estimation; includes graphical output.
MULRG	Multiple regression; calculates a least squares regression for multiple variables; prints equation coefficients, coefficients of determination and multiple correlation; and standard error of estimation. Specific values of "Y" may be calculated by inputting specific values of "X".

DESCRIPTION *(Continued)*

NTHRG	This program will best fit a line or curve to an Nth order equation, and print out the equation coefficients, the coefficient of determination, the coefficient of correlation, and the standard error of estimation; graphical output is available from the program if desired.		standard deviations for the individual groups as input. An analysis of variance table will be printed containing sum of squares, degrees of freedom, mean square, a comparison with F distribution.
EXPRG	Calculates the coefficients of an equation for an exponential curve. Calculates specific values of "Y" for given values of "X"; prints coefficients of determination and correlation, and standard error of estimation; provides graphical output.	CHISQ	Computes exact probability of a chi-square value with specified degrees of freedom.
GRPRJ	Calculates historical average growth rate; projects future value; and provides graphical output.	TZTEST	Calculates the mean and standard deviation for each of two samples by comparing the means using equal variance, unequal variance or pairing of data.
ANVAR	One-way analysis of variance for up to 30 groups using sample sizes, means, and	CURFT	Determines least squares curve fit to the following seven functions: (1) $y = A + B(x)$, (2) $y = A \exp(B * X)$, (3) $y = A (X^B)$, (4) $y = A + B * X$, (5) $y = 1/(A + B * X)$, (6) $y = X (A + B * X)$, (7) $y = A + B * \text{Log}(X)$. Provides optional graphical output.

HARDWARE CONFIGURATION REQUIRED:

TERMINAL AND/OR HOST MAINFRAME: 2647A Terminal

MEMORY (TERMINAL AND/OR HOST): Standard with 2647A

TERMINAL OPTIONS: Graphics hardcopy requires option 096 — shared peripheral interface

PERIPHERALS OPTIONAL: Any HP-IB compatible plotter or raster printer: 2631G, 7225A, 7245B, 7310A, 7580A, 9872 series multicolor plotters.

ORDERING INFORMATION:

Contact your local HP sales office; or use the ordering form in this catalog. Order No. 13257D.

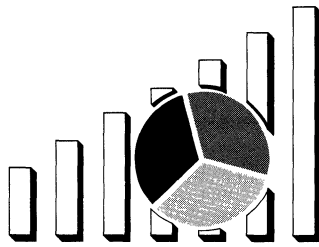

APPLICATION RESOURCE PAC PROGRAM SUMMARY

REFERENCE NO. 4.03

DATA ANALYSIS AND DISPLAY

TERMINAL	HOST MAINFRAME	PAC TITLE
2647A	Not Required	Mathematical Analysis Resource Pac

DESCRIPTION

The 2647A Mathematical Analysis Resource Pac offers a variety of programs that provide solutions to the most frequently used mathematical operations: differentiation, integration, finding roots of polynomials, interpolation, etc.

Each pac includes a program tape, and a Quick Reference Guide. Instructions are available when executing each program.

The following programs are contained in the pac:

PROGRAM NAME	DESCRIPTION		
1ORDER	Solves the initial value problem for a first order differential equation by the second order Runge-Kutta method.		
2ORDER	Solves the initial value problem for a second order differential equation by the second order Runge-Kutta method.		
INTEGRAL	Computes a definite integral by means of the three point Gaussian integration formula.		
ROOTS	Finds the roots of a polynomial using Barstow's method.		
INTEGRAT	Computes the area under a curve, its movement, its center of gravity along the y-axis, and its center of gravity along the		
			x-axis, using Simpson's rule for numerical integration.
		SIMULEQU	Solves a system of linear equations. The number of unknown coefficients in each equation must equal the number of equations being solved. The coefficients of each equation must be entered.
		BESSEL	Calculates the Bessel functions of the first kind. It uses an integration routine based on Simpson's rule to integrate the function. The program will request the order, the argument and the acceptable error, in return for the computed value.
		POLYGON	Calculates the area of any polygon when given the coordinates of all vertices.
		QUADEQU	Calculates the real and/or complex roots of a quadratic equation. The equation must be in the form $Ax + By + C = 0$ whereas A, B, and C are real coefficients.
		LININTER	Interpolates values for a given linear function between two specified x-y coordinates.
		LAGRANGE	Computes any y-coordinate on a curve given you input the x and y coordinates of the known points on the curve. The Lagrange method of interpolation is used.

DESCRIPTION *(Continued)*

MATRIX	Adds and subtracts two matrices, or multiplies a matrix by a given scalar.	ANGDEG	Converts an angle given in degrees, minutes and seconds to radians.
MATINV	Inverts a square matrix. The inversion is performed by a modified Gauss-Jordan elimination method.	CONVERS	Converts variables from anglo to metric and metro to anglo. There are 17 conversion factors in total.
GCD	Calculates the greatest common denominator of two integers based on the Euclidean Algorithm for finding the GCD.	CARPOLAR	Converts Cartesian coordinates to polar coordinates and vice versa.
OPERVEC	Performs four operations listed below, on two vectors given in three dimensional space. 1. addition 2. subtraction 3. scalar (dot) product 4. cross product	COORPLOT	Plots the x, y coordinates of data points on a Cartesian grid.
ANGRAD	Converts an angle given in radians to degrees, minutes and seconds.	TABLE	Allows you to enter twelve months of data for three different values. The data will then be plotted while the numerical data will be presented in a table below the corresponding plotted points.

HARDWARE CONFIGURATION REQUIRED:

TERMINAL AND/OR HOST MAINFRAME: 2647A

MEMORY (TERMINAL AND/OR HOST): Standard with 2647A

TERMINAL OPTIONS: Graphics hardcopy requires option 096 — shared peripheral interface

PERIPHERALS OPTIONAL: Any HP-IB compatible plotter or raster printer; 2631G, 7225A, 7245B, 7310A, 9872 series multicolor plotters.

ORDERING INFORMATION:

Contact your local HP sales office or use the ordering form in this catalog. Order No. 13257C.

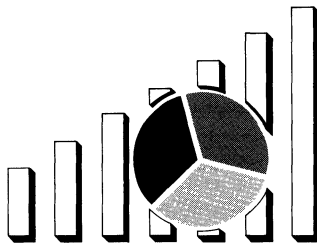

HEWLETT-PACKARD PROGRAM SUMMARY

REFERENCE NO. 5.01

MISCELLANEOUS

TERMINAL	HOST MAINFRAME	TITLE
2647A	Not Required	Terminal BASIC

DESCRIPTION

The Terminal BASIC Interpreter provides local programming capability on the HP 2647A Intelligent Graphics Terminal. Terminal BASIC is designed to enhance the flexibility of the terminal when used with a host computer system or in off-line graphic workstation applications. Terminal BASIC provides programmatic control over the functions of the 2647A, so that the user can customize the operation of the terminal to his exact requirements.

A Graphics Language (AGL) extension to terminal BASIC allows the user to control the graphics features of the 2647A with high level English-like commands. Included are graphics set-up functions, axes and labeling, plotting and interactive functions.

Terminal BASIC offers the following commands and statements to the user.

COMMANDS		STATEMENTS			FUNCTIONS				
					Numeric	String	Print	Input/Output	Other
AUTO	MERGE	ASSIGN	INTEGER	PRINT USING	ABS	CHR*	LIN	GETKBD	ERRL
CSAVE	REMOVE	CALL	KEYCDE	READ	CEENA	LEN	SPA	DSPIN*	ERRN
DELETE	RENUM	COMMAND	LET	READ*	CESENS	NUM	TAB	GETDCM	FRE
EXIT	RUN	DATA	LINPUT	REMARK	EXP	POS	MOVCS	PUTDCM	
GET	SAVE	DIM	LINPUT*	RESTORE	INT	VAL	MOVCA		
GO	SCRATCH	END	LONG	RESTORE*	LOG	VAL*	MOVCR		
LIST	SET	ERROR	OFF KEY*	RESUME	LONG	RPT*			
		FOR...NEXT	ON END*	RETURN	RND	TRIM*			
		GETDCM ON/OFF	ON...GOSUB	SHORT	SGN	UPC*			
		GETKBD ON/OFF	ON...GOTO	SLEEP	SHDRT	PRDC*			
		GOSUB	ON ERROR	STOP	SQR				
		GOTO	ON KEY*	SUB	ATN				
		IF...THEN...ELSE	PRINT	SUBEND	COS				
		IMAGE	PRINT*	WAKE UP	SIN				
		INPUT			TAN				

DESCRIPTION (Continued)

AGL FUNCTIONS			
Interactive	Set-Up	Plotting	Axis Labeling
WHERE	PLDTR	PENUP/PENDN	XAXIS
POINT	GPDN	PEN	YAXIS
CURSOR	SETAR	LINE	LXAXIS
DIGITIZE	LIMIT	PLOT	LYAXIS
GPMM	GCLR	MOVE	AXES
DSIZE	LOCATE	DRAW	LAXES
DSTAT	MARGIN	RPLOT	GRID
GSTAT	SCALE	IPLOT	LGRID
	SHOW	PDIR	FRAME
	MSCALE	PDRG	FXD
	CLIP		LORG
	CLIPDFF		LDIR
	CLIPDN		CSIZE
	SETGU/SETUU		

HARDWARE CONFIGURATION REQUIRED:

TERMINAL AND/OR HOST MAINFRAME: 2647A

MEMORY (TERMINAL AND/OR HOST): Standard 2647A

TERMINAL OPTIONS: Not Applicable.

PERIPHERALS: Not Applicable.

ORDERING INFORMATION:

HP Terminal BASIC is included with each HP 2647A Intelligent Graphics Terminal.

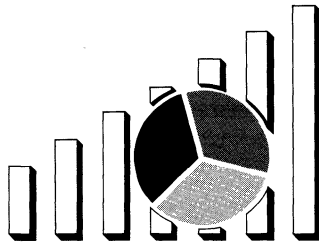

OBTAINING APPLICATION SOFTWARE

FOR HEWLETT-PACKARD DEVELOPED APPLICATION PRODUCTS AND FOR APPLICATION RESOURCE PACS

Programs developed by HP computer systems divisions specifically for HP computer systems (e.g., HP 1000 and 3000) are ordered by contacting your local HP sales representative. Application Resource Pacs can be ordered directly from this catalog or ordered from your local HP sales representative.

The ordering instructions at the bottom of each Software Summary will indicate whether to order directly from this catalog or to contact your local HP sales representative. To contact your HP sales representative, consult the listing at the back of this catalog for the HP sales office nearest you.

FOR SOFTWARE SUPPLIER PRODUCTS*

To obtain a program offered by a software supplier, contact the supplier listed on the Software Summary for more information. Hewlett-Packard sales and service representatives have no demonstration material on these programs.

*If you are interested in becoming a software supplier and wish to have your HP terminal application software listed for sale in this catalog, see the section titled "How to Become a Software Supplier" in the back of this catalog.

NOTE: This catalog is regularly updated. Prices and procedures for obtaining programs are subject to change at any time without prior notice. HP reserves the right to withdraw any program from its catalog at any time.

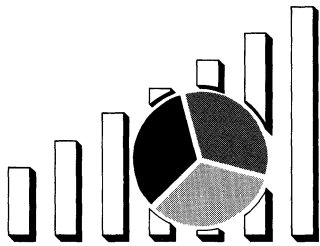

SUPPORT, SERVICE AND WARRANTY

FOR HEWLETT-PACKARD APPLICATION PRODUCTS

Hewlett-Packard offers a broad range of software and hardware support services to help insure customer satisfaction with HP computer systems, peripherals and terminals. Depending upon the type of equipment and software offered, different services are available allowing each customer to have an appropriate support plan. Support services are arranged through HP's worldwide sales and service offices; consult the listing on page 45 for the office nearest you.

HP warrants that its software and firmware designed by HP for use with a HP computer or terminal will execute its programming instructions when properly installed on that computer or terminal. HP does not warrant that the operation of the computer, or terminal, or software, or firmware will be uninterrupted or error free. NO OTHER WARRANTY IS EXPRESSED OR IMPLIED. HP SPECIFICALLY DISCLAIMS THE IMPLIED WARRANTIES OF MERCHANTABILITY AND FITNESS FOR A PARTICULAR PURPOSE. HP SHALL NOT BE LIABLE FOR ANY DIRECT, INDIRECT, SPECIAL, INCIDENTAL, OR CONSEQUENTIAL DAMAGES, WHETHER BASED ON CONTRACT, TORT OR ANY OTHER LEGAL THEORY.

With regard to Application Resource Pacs, warranty service is limited to the replacement of defective media. No support services are available from Hewlett-Packard. However, HP will make

software corrections or enhancements to Application Resource Pac programs on a best effort basis as time allows. After corrections or enhancements are made, software updates for each pac will be announced in an updated edition of the software catalog. Customers can purchase software updates directly from the catalog.

NOTE: To receive the next issue of the catalog, please complete the reader comment sheet.

FOR SOFTWARE SUPPLIER PRODUCTS

Software suppliers are responsible for the support of their products. To help you evaluate the support services provided by the supplier, each Software Summary for supplier programs lists the support capability of the supplier. All questions and problems regarding their products and support services should be directed to the supplier.

Hewlett-Packard is not the manufacturer or co-developer of the software or support developed by software suppliers. Hewlett-Packard disclaims any and all liability for and makes no express or implied warranties of any kind with respect to software suppliers' products. The responsibilities of Hewlett-Packard to the buyer are limited to those set forth in the warranty statement provided by HP with Hewlett-Packard manufactured equipment. Distribution of Software Summaries by HP does not constitute endorsement of supplier's software products or support services.

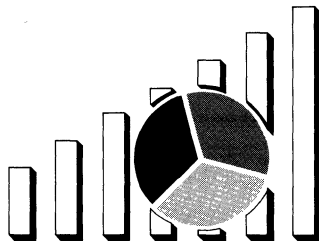

UPDATING TERMINAL-RESIDENT SOFTWARE

The latest software releases (i.e., software updates) to terminal resident software products, such as HP MULTIPLY/SIDE, Terminal BASIC and the Application Resource Pacs, can be ordered from HP using the procedures found in the "Ordering

Information" section of this catalog. These releases include code changes to correct known problems and/or to enhance capabilities. Use the order number listed below.

Terminal Model No.	Software	Revision	Cartridge Tape Media	Flexible Disc Media
			Order No.	Order No.

2647A	MULTIPLY and SLIDE with Terminal BASIC	Rev F	Cartridge Tape Media	Flexible Disc Media
			02647-13301	None

DESCRIPTION:

Terminal BASIC with MULTIPLY and SLIDE has been revised to accommodate HP's new exciting plotting products.

Specifically:

1. BASIC and MULTIPLY and SLIDE Rev. F. can now access the eight pens of the HP 9872 "C" or "T" plotters, and the large format plotter, the HP 7580A.

2. Slide parameters, P1 and P2, can be set independently which enables the user to create slides of any size. With this enhancement, D-size flipcharts can be made using the 7580A.

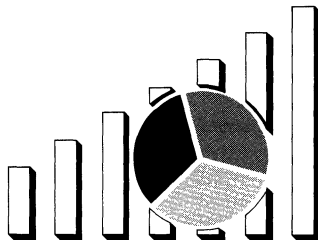

ORDERING INFORMATION DOMESTIC CUSTOMERS

Use this ordering information to order the following terminal software products:

- | | | | |
|---|-------|--|-------|
| • Graphics Presentation Resource Pac (13257B) | \$195 | • 2642A Page Formatter (13257A, Disc; 13257A-001 Tape) | \$160 |
| • Project Management Resource Pac (13257F) | \$195 | • 2647/1351 BASIC (13257K) | \$150 |
| • Mathematical Analysis Resource Pac (13257C) | \$195 | • MULTIPLOT/SLIDE with BASIC Update (02647-13301) | \$ 48 |
| • Statistical Analysis Resource Pac (13257D) | \$195 | | |

Order by Phone Directly from Our Supplies Distribution Center

Direct Phone Ordering is available in the 48 contiguous states to all U.S. customers having an open account with HP. Your Visa, MasterCard and American Express credit cards can also be used.

When you call us between 9:00 A.M. and 5:00 P.M. (in your local time zone), we'll give you an immediate confirmation of supply item availability — and we'll usually be able to ship your order within 24 hours of your phone call.

As with HP field office orders, a minimum of \$20 per order applies.

In *all states except California*, call toll-free: **800-538-8787**
In *California*, call collect: **(408) 738-4133**

Order from Your Nearby HP Office

If it is more convenient for you, the Hewlett-Packard office serving your area (see page 45) will be pleased to confirm current prices and to accept your order for supplies. The HP office will then forward your order to our supplies distribution center for prompt shipment.

As with Direct Phone orders, a minimum of \$20 per order applies.

Or By Mail Using Your Credit Card

Using your credit card, all supplies are available through the mail. You may prefer to order this way — especially if your total order will not meet the \$20.00 minimum required on orders placed via the Direct Phone Service or through a local HP office. Although there is a \$3.00 handling charge, there is no minimum order size when you use your credit card. Please note that state and local

taxes need to be added to your order total in addition to the \$3.00 handling charge. Extra freight charges may be applied to items weighing over 30 lbs., such as furniture and large quantities of paper products. We will ship by premium transportation methods upon your request, but the cost will be applied to your order.

Use the convenient Credit Card Order Form in this catalog. If it is missing, call us for details.

Terms of Sale

Inside the USA: Terms **net 30 days** from invoice date if credit with Hewlett-Packard has already been established. Otherwise shipments will be made COD or on receipt of cash in advance. **Minimum of \$20 per order** applies.

When **ordering by mail**, receipt of valid credit card number and expiration date is necessary. **No minimum applies.** A \$3.00 handling charge will be applied to all credit card mail orders.

Outside the USA: Terms are determined by the Hewlett-Packard international sales subsidiary or authorized representative/distributor.

Prices

Prices, included in this catalog for your budgetary guidance, are **F.O.B. USA shipping point** — and they apply only to domestic USA customers.

They are net prices which prevailed at the time of printing. HP reserves the right to change prices, and only those prices officially listed on the HP corporate price list and prevailing at the time an order is received will apply.

We will be pleased to confirm by telephone the current price of any HP computer supply item, delivered to your location.

Shipping Methods

Shipments to destinations in the USA are made directly from HP computer supplies distribution centers (F.O.B. shipping point) — typically within 24 hours of the receipt of your order.

Unless specifically requested otherwise, UPS or truck transportation is used, whichever is less expensive and most serviceable to you.

We will gladly ship by premium transportation methods when specified on your order, at prevailing rates.

Warranty

HP terminal application software products as listed in this catalog for use with HP terminal products are warranted against defects in materials and workmanship for 90 days from date of shipment.

HP will replace any such supply item which proves to be defective. Please call HP first for shipping instructions, and then return the defective item, freight prepaid.

This warranty does not apply to damage resulting from misuse, and no other warranty is expressed or implied. HP specifically disclaims the implied warranties of merchantability and fitness for a particular purpose. HP shall not be liable for any direct, indirect, special, incidental or consequential damages.

OLD
HERE

FOLD
HERE

From: _____

Place
Postage
Here

HEWLETT-PACKARD
Computer Supplies Operation
P.O. Box 60008
Sunnyvale, California 94088

(STAPLE)

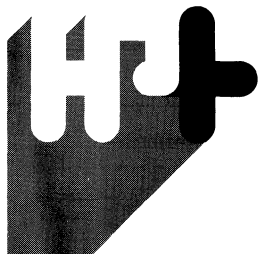

HP PLUS SOFTWARE SUPPLIER PROGRAM FOR HP DISPLAY TERMINALS

If your business is developing and marketing software for intelligent and/or graphics terminals, Hewlett-Packard has a program to assist your marketing efforts. The purpose of this program is to provide existing and prospective HP customers with a full range of solutions using your software and HP terminals.

BE A PART OF OUR APPLICATIONS CATALOG AND BE VISIBLE TO HP CUSTOMERS

Under the HP PLUS Software Supplier Program, HP places a description, prepared by you, along with your name, address and ordering information in the Hewlett-Packard Display Terminal Application Software Catalog. This catalog is regularly updated, and lists software developed and marketed by HP as well as supplier software. This catalog is distributed to HP terminal customers, and HP sales and support representatives.

ENJOY THE BENEFITS OF A SUCCESSFUL PRODUCT DEVELOPMENT AND MARKETING PROGRAM

Every year, thousands of HP terminals are sold worldwide for sophisticated data entry, graphic display, data analysis, and programming applications. As a result, our experience indicates HP terminal customers are interested in application software packages in the following areas:

- Graphics, data entry, data capture and text editing software packages that reside and execute on HP or other computer systems, or execute locally on HP intelligent terminals.
- Decision support, data analysis and display software packages which execute locally on HP intelligent terminals.

If you currently offer or plan to offer software in these areas that take advantage of HP's high performance terminal features, the HP PLUS Software Supplier Program could be an important part of your marketing effort.

In recognition of the contribution your software provides towards solving the customer's problem, the program offers you the following benefits:

1. More sales by making your software visible to HP's customer base through the Software Catalog.
2. Sales leads by HP sales representatives.
3. There is no cost to you for participation in the Software Supplier Program.
4. You retain complete control over your software because you know your software best. Arrangements for brochures, demo's, installations, training, support and modifications of your software should be handled by you without HP's direct involvement.

FOR MORE INFORMATION

Contact your local HP representative or, write or call:

Data Terminal Application Software Manager
Hewlett-Packard Company
Data Terminals Division
974 East Arques Avenue
Sunnyvale, CA 94086

Telephone: 408-735-1550

5953-2066D

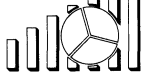

KEEPING INFORMED HEWLETT-PACKARD LISTENS

We'll automatically mail you a free copy of our next HP Display Terminal Application Software Catalog when it's available.

Just complete and return this comment sheet.

Name _____

Title/Position _____

Company _____

Mail Station _____

Address _____

City _____ State _____ Zip _____

1. Name of software package you ordered to support your Hewlett-Packard terminal:

2. How important was the availability of this software in making your decision to buy a Hewlett-Packard terminal?

Would not buy without it. Important. Not important.

3. Model number(s) of HP terminal(s) you plan to use with this software:

4. What is the major application area for which you purchased this software?

5. Please list the most useful features of this software:

6. What additions or changes would you make to this software?

7. What additional application software packages would you like to see developed for HP terminals?

8. Would you like to receive literature about new HP terminals as they are introduced? YES NO

Thank you for your time and cooperation.

Tear along dotted line.

From: _____

PLACE
POSTAGE
HERE

Application Software Manager
Hewlett-Packard Company
Data Terminals Division
974 East Arques Avenue
Sunnyvale, CA 94086

(FOLD)

Additional Comments:

