

IDSCHAR

Character Font and Logo Design, Reference Guide

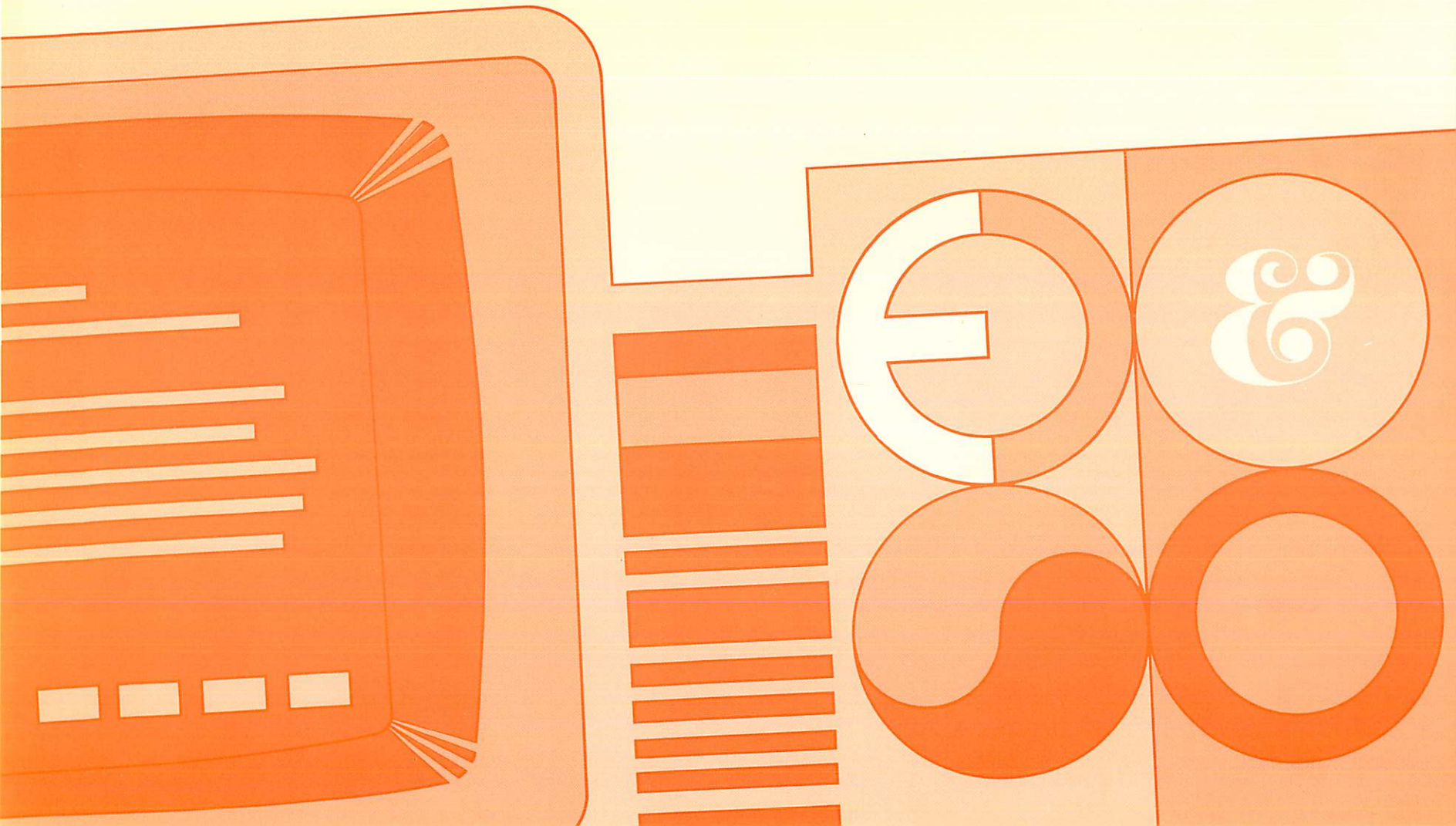

HP 3000 Computer Systems

CHARACTER FONT AND LOGO DESIGN

Reference Guide



11311 CHINDEN BOULEVARD, BOISE, IDAHO 83707

Part No. 36581-90001

Product No. E1083

Printed in U.S.A. 10/83

NOTICE

The information contained in this document is subject to change without notice.

HEWLETT-PACKARD MAKES NO WARRANTY OF ANY KIND WITH REGARD TO THIS MATERIAL, INCLUDING, BUT NOT LIMITED TO, THE IMPLIED WARRANTIES OF MERCHANTABILITY AND FITNESS FOR A PARTICULAR PURPOSE. Hewlett-Packard shall not be liable for errors contained herein or for incidental or consequential damages in connection with the furnishing, performance or use of this material.

Hewlett-Packard assumes no responsibility for the use or reliability of its software on equipment that is not furnished by Hewlett-Packard.

This document contains proprietary information which is protected by copyright. All rights are reserved. No part of this document may be photocopied, reproduced or translated to another language without the prior written consent of Hewlett-Packard Company.

PRINTING HISTORY

New editions are complete revisions of the manual. Update packages, which are issued between editions, contain additional and replacement pages to be merged into the manual by the customer. The dates on the title page change only when a new edition or a new update is published. No information is incorporated into a reprinting unless it appears as a prior update; the edition does not change when an update is incorporated.

The software code printed alongside the date indicates the version level of the software product at the time the manual or update was issued. Many product updates and fixes do not require manual changes and, conversely, manual corrections may be done without accompanying product changes. Therefore, do not expect a one to one correspondence between product updates and manual updates.

First Edition.....	Aug 1981.....	36581A.00.00
Second Edition.....	Oct 1983.....	36581A.01.00

THIS PAGE SHOULD BE BLANK

LIST OF EFFECTIVE PAGES

The List of Effective Pages gives the date of the most recent version of each page in the manual. To verify that your manual contains the most current information, check the dates printed at the bottom of each page with those listed below. The date on the bottom of each page reflects the edition or subsequent update in which that page was printed.

Effective Pages	Date
all.....	Oct 1983

THIS PAGE SHOULD BE BLANK

PREFACE

Hello, and welcome.

Please take a moment to read this information.

The IDSCHAR Reference Guide is one of a set of documents defining the Interactive Design System, IDS/3000. It is written primarily for graphics designers and others who have a basic understanding of typesetting terminology. Computer terminology has been kept to a minimum to insure that you can do your job as quickly and efficiently as possible. Instructions unique to IDSCHAR are defined and illustrated where needed.

With IDSCHAR you can perform the following functions:

- Create a character font, logo, or other artwork.
- Modify/add logos or character fonts.
- Provide documentation for the logo or character font file to describe the contents of a file.
- Use the HP 9811A or 9874A Digitizer to create outlines for logos, characters, or artwork.

Additional Information

The following is a list of part numbers for terminal and digitizer overlays. Also included are part numbers for documents which can give you further information on printers, plotters and digitizers. Use these part numbers when you need to order additional reference guides or overlays.

Overlays

Extra IDS/3000 Templates for the HP 2647A or HP 2647F.....	P/N 36581-60001
Extra IDS/3000 Templates for the HP 2648A.....	P/N 36581-60002
Extra Overlays for HP 9111A Digitizer (Pkg. of 3).....	P/N 7121-0988
Extra Overlay Blanks for HP 9874A Digitizer (Pkg. of 5).....	P/N 7120-7105

PREFACE (continued)

Reference Guides

IDSCHAR Reference Guide.....	P/N 36581-90001
IDSFORM Reference Guide.....	P/N 36581-90002
IFS/3000 Reference Guide.....	P/N 36580-90001
HP 2631G Printer Reference Manual.....	P/N 02631-90911
HP 9872A Plotter Reference Manual.....	P/N 09872-90003
HP 2647A Graphics Terminal User's Manual.....	P/N 02647-90001
HP 2647F User's Manual.....	P/N 02647-90036
HP 2647F User's Supplement.....	P/N 02647-90052
HP 2648A Graphics Terminal User's Manual.....	P/N 02648-90001
HP 7245A Plotter/Printer Reference Manual.....	P/N 07245-90001
HP 9111A Graphics Tablet User's Manual.....	P/N 09111-90000
HP 9874A Digitizer Reference Manual.....	P/N 09874-90000

Ordering Information

Consumable supplies and accessories may be ordered directly from the Hewlett-Packard Computer Supplies Operation (CSO). Direct phone service is available to HP customers within the continental U.S. Orders may be taken from 9 a.m. to 5 p.m. in all time zones. If it is more convenient, orders may be placed with the local HP Sales and Service Office. In Europe, orders may also be placed with the local HP Sales and Service Office.

800-538-8787 Toll Free
California (408) 738-4133 Collect

CONVENTIONS USED IN THIS MANUAL

NOTATION

DESCRIPTION



May be used to illustrate specific keys on the terminal keyboard corresponding to the label within the symbol, such as the **ENTER** key. On some terminal keyboards, abbreviated key labels may differ.

**Function
Label**

May be used to illustrate specific function labels currently assigned to the special function keys labeled f1 through f8 on the terminal keyboard.

OR,

Function

nonitalics

Words in syntax or format statements which are not in italics must be entered exactly as shown. Punctuation characters other than brackets, braces and ellipses must also be entered exactly as shown. For example:

EXIT;

italics

Words in syntax in lowercase italics denote a parameter which must be replaced by a user-supplied variable. For example:

CLOSE *filename*

[]

Within syntax, an element inside brackets is optional. Several elements stacked inside brackets means the user may select any one or none of these elements. For example:

$\left[\begin{array}{l} A \\ B \end{array} \right]$ User *may* select A or B or neither.

{ }

Within syntax, when elements are stacked within braces the user must select one of those elements. For example:

$\left\{ \begin{array}{l} A \\ B \end{array} \right\}$ User *must* select A or B.

CONVENTIONS (continued)

() Elements *within* parentheses *within* a word or a parameter in syntax or format statements are not entered by the user and appear for identification purposes only. For example:

C(O M MAND)	User enters C <i>only</i> .
Y(e s)	User enters Y <i>only</i> .

... Within syntax, a horizontal ellipsis indicates that a previous element may be repeated. For example:

[*,itemname*]...;

underlining

When necessary for clarity in an example, user input may be underlined. For example:

NEW NAME? ALPHA

In addition, brackets, braces or ellipses appearing in syntax or format statements which must be entered as shown will be underlined. For example:

LET *var*[[subscript]] = *value*

Δ When necessary for clarity, the symbol Δ may be used to indicate a required blank or an exact number of blanks. For example:

SET[(*modifier*)]Δ(*variable*);

TABLE OF CONTENTS

Additional Information.....	9
Overlays.....	9
Reference Guides.....	10
Ordering Information.....	10

Section 1

Introduction.....	1-1
IDSCHAR in the IDS/3000 System.....	1-1
The Cell.....	1-2
Cell Files.....	1-2
Character Font File.....	1-2
Logo File.....	1-4
Outlines.....	1-4
Converting Cell Files to New IDSCHAR Format.....	1-4
Logging-On.....	1-5
Using a Remote Computer.....	1-5
IDSCHAR Operation.....	1-6

Section 2

Equipment Use.....	2-1
Introduction.....	2-1
The HP Graphics Terminal.....	2-1
Terminal Control Group Keys.....	2-3
Terminal Keys.....	2-4
Optional Equipment.....	2-6
The HP 9872A Plotter.....	2-7
Manually Selecting Pens.....	2-8
The HP 2631G Printer.....	2-8
The HP 7245A Plotter/Printer.....	2-8

CONTENTS (continued)

Using Digitizers.....	2-9
The HP 9111A Digitizer.....	2-9
HP 9111A Back Panel.....	2-10
HP 9111A Keyboard.....	2-11
HP 9111A Stylus.....	2-11
The HP 9111A Digitizer Keys.....	2-11
The HP 9874A Digitizer.....	2-13
HP 9874A Back Panel.....	2-14
HP 9874A Keyboard.....	2-14
HP 9874A Keys and Lights.....	2-15
HP 9874A Digitizer Cursor and Stylus.....	2-16
Getting Ready to Digitize.....	2-17
Step 1 - Preparing the Artwork.....	2-19
Step 2 - Logging on to the Terminal.....	2-20
Step 3 - Creating the File and Cell.....	2-20
Step 4 - The Display Area.....	2-21
Continue Digitizing with the HP 9111A.....	2-23
Step 5A - Defining the Cell With the HP 9111A.....	2-23
Step 6A - Tracing the Artwork.....	2-24
Step 7A - Digitizing Separate Lines.....	2-26
Step 8A - Stopping.....	2-27
Step 9A - Saving the Outline.....	2-28
Step 10A - Filling the Outline.....	2-29
Step 11A - Saving the Character.....	2-30

CONTENTS (continued)

Continue Digitizing with the HP 9874A.....	2-32
Step 5B - Align Axis on the HP 9874A.....	2-32
Step 6B - Defining the Cell.....	2-33
Step 7B - Tracing the Artwork.....	2-34
Step 8B - Digitizing Separate Lines.....	2-36
Step 9B - Continuous Drawing.....	2-37
Step 10B - Stopping.....	2-38
Step 11B - Saving the Outline.....	2-39
Step 12B - Filling the Outline.....	2-41
Step 13B - Saving the Character.....	2-42
Correcting Digitizing Errors.....	2-44
Using an Outline for More Than One Cell Size.....	2-45
Digitizing a Complex Logo.....	2-46

Section 3

Using IDSCHAR.....	3-1
Introduction.....	3-1
Menu Format.....	3-2
Main Menu.....	3-2
Main Menu Selections.....	3-3

CONTENTS (continued)

Creating a Cell File.....	3-5
Cell File Discription.....	3-7
Character Font File.....	3-7
Logo File.....	3-7
Making Your Selection.....	3-7
Proportionally Spaced? Y/N.....	3-9
Serifs? Y/N.....	3-10
Changing the Default Spacing.....	3-10
Creating a Character.....	3-11
Character Font Size.....	3-13
Optional Fields.....	3-15
Grid Lines.....	3-15
Vertical and Horizontal Line Spacing.....	3-16
Creating a Logo.....	3-17
Logo Size.....	3-19
Positioning Logos Using the Baseline.....	3-20
Modifying a Cell File.....	3-21
Modifying a Character.....	3-23
Selecting a Cell Size.....	3-24
List of Character Font Sizes.....	3-25
Character Font Size.....	3-27
Changing Cell Size Parameters.....	3-28
Grid Lines.....	3-28
Vertical and Horizontal Line Spacing.....	3-28
Adding a New Cell Size.....	3-28

CONTENTS (continued)

Modifying a Logo.....	3-29
List of Logo Sizes.....	3-31
Logo Size.....	3-33
Adding a New Logo Size.....	3-34
Using The Display Area Functions.....	3-35
The Cell.....	3-35
IDSCHAR Design and Function Keys.....	3-36
IDSCHAR Design Keyboard Layout.....	3-38
Keys that Perform a Function.....	3-39
Drawing and Cursor Control Keys.....	3-43
Display Area Menus.....	3-55
Saving a Cell.....	3-56
Getting a Cell.....	3-62
Placing a Character or Logo in the Temporary Hold Area.....	3-63
Retrieving a Character or Logo from the Temporary Hold Area.....	3-65
Saving an Outline.....	3-66
Getting an Outline.....	3-68
Making a Hardcopy.....	3-70
Using the Cell Graphics Function.....	3-72
Two-Letter Commands.....	3-74
Using the Cell Magnification Function.....	3-75
Using the Simulating a Device Function	3-79
Using the Simulating a Cell Function.....	3-81

CONTENTS (continued)

Using the Cell Bounds Function.....	3-83
Using the Transform Outline Function.....	3-86
Using the Zoom Feature of the HP Graphics Terminal.....	3-87
Using the Main Menu/Display Key.....	3-89
Documenting a Character Font or Logo File.....	3-90
Describing a Cell File.....	3-94
Character Font Description.....	3-97
Logo Cell File Additional Comments.....	3-99
Cell File Additional Comments.....	3-101
Reviewing Documentation About an Existing Character Font or Logo File.....	3-102
Target Device Information.....	3-103
Character Font Information.....	3-104
Cell File Descriptive Comments.....	3-105
Deleting Character Font and Logo Cells.....	3-106
Deleting Character Fonts.....	3-107
Delete a Character Font Size.....	3-109
Delete an Individual Character.....	3-111
Delete an Outline Size.....	3-113
Delete an Individual Outline.....	3-115
Delete Logo Menu.....	3-117
Delete a Logo Size.....	3-119
Delete an Individual Logo.....	3-121
Delete a Logo Outline.....	3-123

CONTENTS (continued)

Appendix A

Glossary.....	A-1
----------------------	------------

Appendix B

IDSCHAR

Maintenance.....	B-1
Recover/Refresh.....	B-1
Accidental/Intentional Break.....	B-2
Break and Abort.....	B-3
Listing the Cell Files.....	B-4
Enlarging a Cell File.....	B-6
Building a New File.....	B-7
Purging Old Cell Files.....	B-8

Appendix C

Characters and

ASCII Characters Codes.....	C-1
------------------------------------	------------

Appendix D

IDSCHAR Messages.....	D-1
------------------------------	------------

INDEX.....	I-1
-------------------	------------

TABLE OF FIGURES

1-1. IDSCHAR in the Laser Printing System	1-3
2-1. 2647A/F and 2648A Keyboards and Overlays	2-2
2-2. Terminal Control Group Keys	2-3
2-3. HP 9111A Digitizer	2-10
2-4. HP 9874A Digitizer	2-13
2-5. HP 9874A Digitizer Keyboard	2-14
2-6. HP 9874A Digitizer Cursor and Stylus	2-17
2-7. Sample B for Digitizing	2-19
2-8. Display Area with 12 Point Cell	2-21
2-9. Defining the Parameters of the Cell	2-24
2-10. Tracing the Outline	2-25
2-11. Digitizing Separate Lines	2-26
2-12. Cell Showing Digitized Outline	2-27
2-13. Save Outline Menu	2-28
2-14. Cell with Outline and Dots	2-29
2-15. Save Cell Menu	2-31
2-16. Aligning the Horizontal Axis	2-32
2-17. Defining the Parameters of the Artwork	2-34
2-18. Tracing the Outline	2-35
2-19. Digitizing Separate Lines	2-36
2-20. Using the Continuous Mode	2-38
2-21. Cell Showing Digitized Outline	2-39
2-22. Save Outline Menu	2-40
2-23. Cell with Outline and Dots	2-41
2-24. Save Cell Menu	2-43

FIGURES (continued)

2-25. Complex Logo Digitizing.....	2-47
3-1. Main Menu.....	3-3
3-2. Menu Path for Creating a Cell File.....	3-5
3-3. Selection to Create a Cell File.....	3-6
3-4. Cell File Description Menu.....	3-8
3-5. Proportional and Non-Proportional	3-9
3-6. Modification Menu (Characters).....	3-11
3-7. Character Font Size Menu.....	3-13
3-8. Character Cell Showing Grid Lines	3-15
3-9. Vertical and Horizontal Text Spacing	3-16
3-10. Modification Menu (Logo).....	3-17
3-11. Logo Size Menu.....	3-19
3-12. Using the Baseline to Position Logos	3-20
3-13. Menu Path for Modifying a Cell File	3-21
3-14. Modification Menu (Character File).....	3-23
3-15. List of Character Font Sizes Menu.....	3-25
3-16. Character Font Size Menu.....	3-27
3-17. Modification Menu (Logo File).....	3-29
3-18. List of Logo Sizes Menu.....	3-31
3-19. Logo Size Menu.....	3-33
3-20. DISPLAY AREA Showing 10 Point Cell	3-35
3-21. Display Area Design and Function Keys.....	3-36
3-22. Keys Used in the Design Area	3-38
3-23. Moving a Cell in the DISPLAY AREA	3-41
3-24. Creating a Cell on the Display	3-42

FIGURES (continued)

3-25. Cursor Control Keys	3-43
3-26. Drawing and Erasing a Dot	3-44
3-27. Drawing a Line	3-45
3-28. Erasing a Line	3-47
3-29. Drawing an Arc	3-48
3-30. Erasing an Arc	3-50
3-31. Drawing a Circle	3-51
3-32. Filling a Rectangle	3-52
3-33. Erasing a Filled Rectangle	3-54
3-34. Filling an Outline	3-55
3-35. Save Cell Menu.....	3-56
3-36. Two Orientations of the Letter B.....	3-59
3-37. Orientation Distortion	3-60
3-38. Characters Designed at 0 and 90 Degrees	3-61
3-39. Get Cell Menu.....	3-62
3-40. Save Outline Menu.....	3-66
3-41. Get Outline Menu.....	3-68
3-42. Make Hardcopy Menu.....	3-70
3-43. Cell Graphics Menu.....	3-72
3-44. Magnification Menu.....	3-75
3-45. Terminal Screen with Cell	3-77
3-46. Characters Designed in a Line	3-78
3-47. Target Device Simulation Menu.....	3-79
3-48. Cell Simulation Menu.....	3-81
3-49. Set Bounds Menu.....	3-83
3-50. Cell Showing Bounds	3-85
3-51. Transform Outline Menu.....	3-86
3-52. Using the ZOOM feature	3-88
3-53. Menu Path for Documenting a Cell File.....	3-90
3-54. Documentation Menu.....	3-92
3-55. Cell File Description Menu.....	3-94
3-56. Target Device Description Menu.....	3-95
3-57. Grid Width and Grid Height	3-96
3-58. Character Font Description Menu.....	3-97
3-59. Additional Comments Menu (Logo File).....	3-99

FIGURES (continued)

3-60. Additional Comments Menu.....	3-101
3-61. Target Device Information Menu.....	3-103
3-62. Character Font Information Menu.....	3-104
3-63. Descriptive Comments Menu.....	3-105
3-64. Menu Path for Deleting Cell Parts.....	3-106
3-65. Delete Character Menu.....	3-107
3-66. Delete Character Size Menu.....	3-109
3-67. Delete Individual Character Menu.....	3-111
3-68. Delete Outline Size Menu.....	3-113
3-69. Delete Individual Outline Menu	3-115
3-70. Delete Logo Menu.....	3-117
3-71. Delete Logo Size Menu.....	3-119
3-72. Delete Individual Logo Menu.....	3-121
3-73. Delete Logo Outline Menu.....	3-123
A-1. Display with Sample Cell	A-1
A-2. Proportional Bounds Calculations	A-5
A-3. Letter Showing Serifs	A-6

THIS PAGE SHOULD BE BLANK

This manual is intended to familiarize you with the features and processes involved in using IDSCHAR.

Section 1 presents a brief overview of IDSCHAR. Section 2 is intended to familiarize you with the equipment (digitizers, plotters, printers, etc.) you are likely to use when designing characters and logos. Section 3 contains in-depth descriptions of the processes involved in using IDSCHAR and gives detailed instructions along with the menus involved to fully utilize IDSCHAR.

The Appendices are provided for your convenience and contain the following information: **Appendix A** contains a glossary of the terms unique to IDSCHAR. **Appendix B** contains information on the maintenance of IDSCHAR. **Appendix C** provides you with a list of characters and their ASCII codes. **Appendix D** lists the error messages and informational messages unique to IDSCHAR.

IDSCHAR in the IDS/3000 System

Character Font and Logo Design (IDSCHAR) is a subsystem of the Interactive Design System, IDS/3000. By using IDSCHAR, you can design your own character fonts, logos, and other artwork. In Forms Design (IDSFORM), you can specify that text contained in the form is to be printed using a previously designed character font or logo. With the Interactive Formatting System (IFS/3000), you can specify which character fonts are to be used to print information associated with an IFS/3000 environment file. Figure 1-1 shows the relationship of IDSCHAR to the other subsystems of IDS/3000.

NOTE

Previous versions of IDSCHAR differ from this version of IDSCHAR. Cell files created with the new version will not be compatible and should not be used with an earlier version. (Refer to "Converting Cell Files to New IDSCHAR Format" in this section).

IDSCHAR automates as much of the character and logo design process as possible by filling in outlines of characters or logos, and by generating curves and rectangles. This lets you concentrate on the details and subtleties of the design.

INTRODUCTION

IDSCHAR also gives you an accurate simulation of the printing device, which lets you preview what the character or logo will look like when it is printed.

These characteristics make IDSCHAR an effective way to create high-quality artwork (such as company logos and signatures) for later use with your printed output on letterheads and forms.

The Cell

The Cell is the basic unit of IDSCHAR in which a character or logo is designed. A cell is a simulation of a single character cell of the target printing device. Cells or groups of cells are stored in a cell file for later use on a target printing device. The background of a cell can be white so that dots appear black or you can reverse the colors. Cells or groups of cells are stored in a CELL FILE for later use on a target printing device.

Cell Files

There are two kinds of cell files: Character Font Files and Logo Files. To effectively use IDSCHAR for complex character and logo design, you should work from a drawing or photograph of the ideal result. Cell Files may also contain the vector outline for the logo or type font represented by the file.

Character Font File

A Character Font File contains a character font in varying sizes. The file can contain up to 128 different characters. All sizes of the character font in a single file are of the same typeface, so that an "A" chosen from one size appears nearly identical to an "A" from another size except for its size. The character font file may contain several versions of the character or logo and also may contain different versions created for multiple devices.

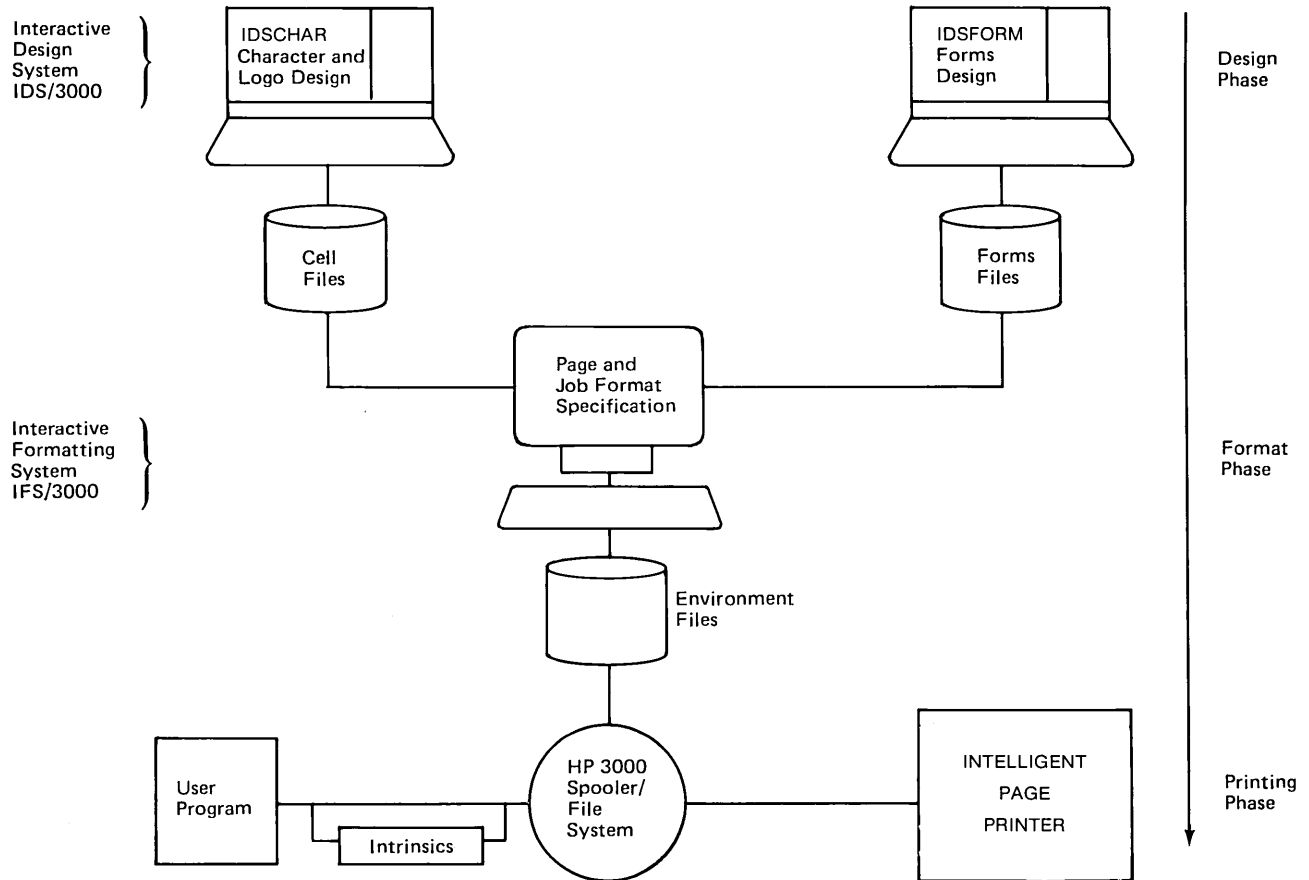

Figure 1-1. IDSCCHAR in the Laser Printing System

INTRODUCTION

Logo File

A Logo File contains one or more sizes of a single logo or other artwork. There is only one logo design per logo file, but there can be different versions and sizes.

Outlines

There can be an outline for each logo in a Logo File and one outline for each character in a Character Font File. You can use an outline of one size to design a character or a logo of another size. These outlines can be displayed on the cell size being designed, and then automatically filled in with dots where appropriate. Guided by this initial outline, you can apply your artistic eye to the placement of dots within a cell to produce the most accurate and pleasing representation possible, given the limitations of the target printing device.

Any Cell File can contain cells created for more than one target device and in addition, a Cell File can contain multiple versions of a character or logo in that file. This lets you experiment with various ways of placing dots to represent a particular character or logo and compare the results. Cells can also be designed for different printing directions. This is important for devices which are not symmetrical in the horizontal and vertical directions, but which are capable of printing in either direction. Versions can be ranked so that it is possible for a computer program (such as IFS/3000) using a Cell File to pick the best version for the orientation needed.

Converting Cell Files to New IDSCHAR Format

Since the file format of the new IDSCHAR differs from the old format, cell files created using the previous version must be converted to the new format before they can be used. Old cell files are converted automatically the first time they are accessed using the new IDSCHAR. That is, if you perform any of the functions on the old cell file, such as looking at sizes, modifying existing sizes, adding new sizes, deleting a size, or documenting the file, the file will be converted to the new format. After the file has been converted successfully, the message "The file has been updated to the new PCELL format" will be displayed.

NOTE

Once an old cell file is converted to the new cell file format, or a new cell is created using the new IDSCHAR, it should not be used with previous versions.

A merge utility is available to facilitate the combination of like character sets in a single file. Refer to the IFS/3000 Reference Guide for information on how to use this utility.

Logging-On

To use the Character Font and Logo Design feature of IDS/3000, log on to your computer system, then type:

```
:RUN IDSCHAR.PUB.SYS
```

After you press the **RETURN** key, the Main Menu appears on your terminal screen. Choose which feature you want and begin work.

NOTE

Once in the program use the **ENTER** key to communicate with the menus.

Using a Remote Computer

Using a modem: to access a remote computer, you must specify the terminal type to be 10 with the LOG ON command.

```
:HELLO user.account;term=10
```

Using a DS line: you must also enter the following statement before you run IDSCHAR on another computer system through a DSLINE.

INTRODUCTION

:DSLIN *dsdevice*;LINEBUF=4048

Your System Manager can give you additional information about the DS feature (the *dsdevice* number, etc.).

NOTE

You cannot use IDSCHAR with Multiple Terminal Software/3000 (MTS/3000).

IDSCHAR Operation

There are two basic operations involved in the creation of characters or logos;

1. Menu Communications
2. Graphics Capabilities

IDSCHAR provides you with a series of menus and graphics capabilities for use in designing characters and logos. Some menus are presented in response to a specific request from you, while other menus follow predefined menu paths.

The graphics capabilities are performed on the DISPLAY AREA using terminal keys specifically identified by IDSCHAR.

These menus and keys are explained in detail in section 3 of this manual.

Introduction

This section will familiarize you with the equipment you may want to use with the IDSCHAR software. An HP 2647A/F or 2648A Graphics Terminal is the only required piece of equipment necessary to use IDSCHAR. (Of course, you also need an HP/3000 computer system). However, a graphics terminal used with an HP digitizer, printer, and plotter can make your work much easier and faster.

This section is concerned with special features of the equipment that you need to know to do your job. Consult the appropriate device's reference guide for information such as maintenance, device parameters, operating instructions, and configuration.

You can use the following HP terminals to **REVIEW** the menu screens for IDSCHAR:

2640B, 2645A, 2641A, 2647A/F, 2648A, 2623A, 2624A, 2626A, 2642A

You **CANNOT**, however, use any of the graphics features of IDSCHAR unless you use a terminal with graphics supported (i.e., 2647A/F or 2648A).

The HP Graphics Terminal

An HP 2647A/F or HP 2648A Graphics Terminal is required for the design of characters, logos, and artwork. Only those features of the terminal necessary for you to use IDSCHAR are presented here. Since some of the keys are in different positions on the terminals, special overlays are available with the appropriate IDSCHAR keys labeled.

Figure 2-1 shows the keyboards and overlays for the graphics terminals. The keys that you will need to use are illustrated and explained below.

EQUIPMENT USE

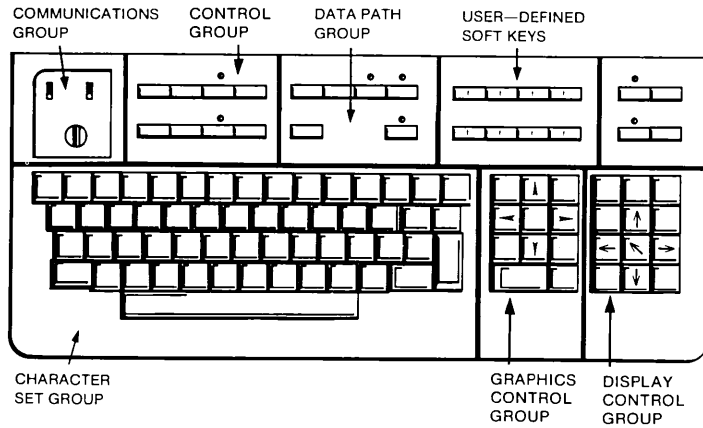

2648A OVERLAY

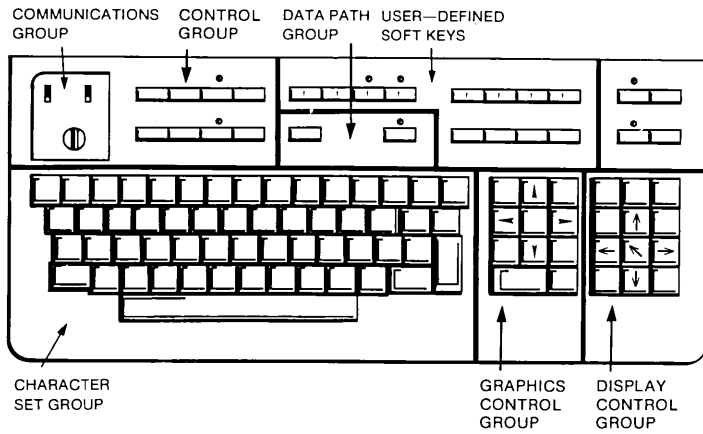
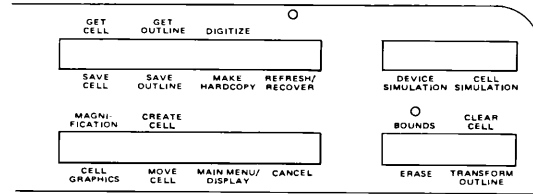

2647A/F OVERLAY

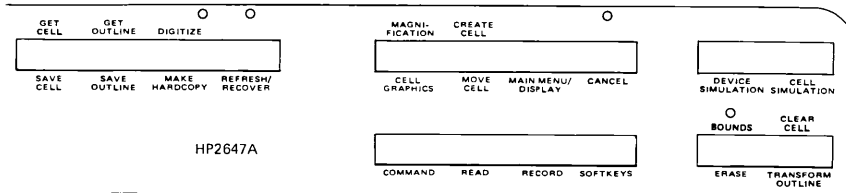

CONTROL KEY CHART

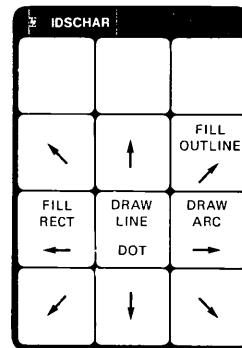

Figure 2-1. 2647A/F and 2648A Keyboards and Overlays

Terminal Control Group Keys

The keys illustrated in figure 2-2 should already be set to the proper positions. However, before you begin, check to make sure that the settings are correct.

- The REMOTE key is always pressed down when you communicate with the system.
- The CAPS LOCK key can be either up or down. With the key in UP position, the terminal will print upper and lower case letters. With the key in the DOWN position, the terminal will print capital letters only.
- All other keys in this group should be in the up position.

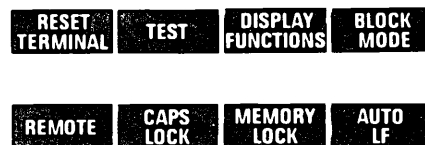

Figure 2-2. Terminal Control Group Keys

EQUIPMENT USE

Terminal Keys

Most of the keys on the keyboard work like those on a typewriter. For example, if you press the BACK SPACE key, the cursor (the blinking dash on the terminal screen) moves back one space. Hitting the SPACE BAR moves the cursor ahead one space. If you continue to hold either key down, the cursor moves until you remove your finger. Also, pressing down the space bar erases any characters as the cursor passes them. These keys will be especially helpful when you add comments about a character font or logo.

KEY SELECTION

EFFECT

CLEAR
DSPLY



Clears all fields on the menu from the cursor to the last field.

CNTL
CLEAR DSPLY



Hold down the **CONTROL** key then press the CLEAR DSPLY key and the remaining characters on the display are deleted.

HOME
CURSOR



This is the HOME CURSOR key. If you are at a menu and press this key, the cursor is moved to the first field on the menu.

CNTL
HOME CURSOR



If you press **CONTROL** HOME CURSOR while you are at a menu, the cursor moves to the last field on the menu. (See also HOME CURSOR.)

TAB



Moves the cursor to the next field (white box on the menu). If the cursor is at the last field, **TAB** returns the cursor to the first field.

CNTL TAB



By holding down the **CONTROL** key then pressing **TAB**, you return to the previous field on a menu. (See also TAB.)

DISPLAY
CONTROL GROUP

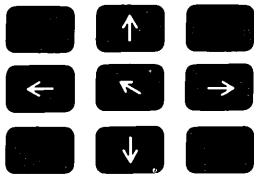

By pressing these keys you can move to any position on the menu. Pressing **TAB** moves you to the next field to the right or below the cursor.

NOTE

These keys are redefined when you are in the DISPLAY area of IDSCHAR. They become the primary drawing keys. Refer to "IDSCHAR Design and Function Keys" in section 3.

FUNCTION AND EDIT GROUP KEYS

You use these keys in IDSCHAR to go to different menus and perform certain functions. For some functions you use a combination of the key and the **CONTROL** key (refer to figure 3-21).

These keys perform the same functions whether you are using the HP 2647A/F or HP 2648A Graphics Terminal. However, they are located at different locations on the keyboards.



DELETE
CHAR 

On all menus you can use this key to delete characters or words in a line. Position the cursor under the first character you want to delete. Press the DELETE CHAR key. Each time you press this key, a character, including spaces, is deleted. (Redefined in Graphics Mode).

INSERT
CHAR 

On any menu, you can use this key to insert characters or words in a line. Position the cursor to where you want to insert the material. Press the INSERT CHAR key (red indicator LED illuminates), Type in the character or words you want to insert. Press the INSERT CHAR key again to stop inserting characters. (Redefined in Graphics Mode).

GRAPHICS CONTROL GROUP

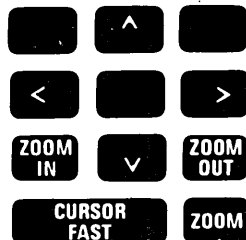

You can use the ZOOM feature of the graphics terminal to help you in the design of large character font and logo cell sizes.

This feature is explained in detail in section 3.

EQUIPMENT USE

REMOTE 

This key puts your terminal in contact with the computer. The normal position is pressed down except when you use the ZOOM feature. See ZOOM in section 3.

RESET
TERMINAL 

Used in conjunction with the **BREAK** key to correct problems. See Appendix B for use of this key.

ENTER 

After you have filled in the necessary information on a menu, press the **ENTER** key and that information is kept in IDSCHAR.

BREAK 

Used in conjunction with the RESET key to correct problems. See Appendix B for use of this key.

RETURN 

When you are not running IDSCHAR, you use the **RETURN** key to transmit information to the computer system. This key can also be used while you are at a menu to move the cursor to the beginning of the current line.

Optional Equipment

Although the HP 2647A/F or 2648A Graphics terminal is all that is required to use IDSCHAR, the recommended configuration for highest quality and ease of use is a 9111A or 9874A Digitizer, a 2631G Printer, and a 9872A Plotter. IDSCHAR also supports the 7245A Plotter/Printer in place of the 9872A Plotter and 2631G Printer.

Each of the devices has its own unique address code. Before using any device verify that the address switches are in the correct positions. The address codes and switch positions for the devices described can be found in table 2-1.

TABLE 2-1. ADDRESS CODES AND SWITCH POSITIONS

DEVICE	ADDRESS	SWITCH POSITIONS
HP 9872A PLOTTER	5	<p>16 8 4 2 1</p> <p>0</p> <p>1</p>
HP 2631G PRINTER	6	<p>16 8 4 2 1</p> <p>0</p> <p>1</p>
HP 7245A PLOTTER/ PRINTER	5	<p>16 8 4 2 1</p> <p>0</p> <p>1</p>
HP 9111A DIGITIZER	7	<p>16 8 4 2 1</p> <p>0</p> <p>1</p>
HP 9874A DIGITIZER	7	<p>16 8 4 2 1</p> <p>0</p> <p>1</p>

Detailed operating instructions for a specific piece of equipment can be obtained in the appropriate reference guide. Certain features of this equipment pertain to IDSCHAR and are described on the following pages.

The HP 9872A Plotter

When you specify the coordinates for the plotter, the plotter will print the character or logo at the approximate size it will appear on the target device. The HP 9872A Plotter is described in detail in the HP 9872A Plotter Reference guide. However, one area you should be aware of when using the plotter with IDSCHAR is the method of manually selecting pens.

EQUIPMENT USE

Manually Selecting Pens

IDSCHAR selects pen #1 by default. You might want to use a different pen because of pen styles, color differences, or pen tip wear. To select a different pen, wait until IDSCHAR has caused the plotter to pick up the pen to plot a character. Press **ENTER** on the plotter, then press the pen number on the plotter corresponding to the current pen. Next press **ENTER** again and press the pen number corresponding to the pen you want to use. IDSCHAR now uses that pen.

The HP 2631G Printer

The HP 2631G printer prints everything that is on the terminal screen. The printout can be used for comparing different versions of a character or logo, or for keeping a record of each cell. Select PR, for printer, on the MAKE HARDCOPY menu. For specific instructions see the HP 2631G Reference Manual.

NOTE

The printer reverses the color scheme that you are using when the cell is printed. Use the two letter command IN (refer to Two-Letter Commands in section 3) to invert the color scheme.

The HP 7245A Plotter/Printer

The HP 7245A Plotter/Printer can be used instead of the HP 2631G Printer and the HP 9872A Plotter. When you "print" from IDSCHAR, the HP 7245A acts like the HP 2631G. When you "plot" from IDSCHAR, the HP 7245A acts like the HP 9872A. You can use either plot or print when you run IDSCHAR. You make your choice for plot or print on the MAKE HARDCOPY menu.

Using Digitizers

Characters can be designed in a number of ways. You can use the Graphics terminal in a variety of configurations, including the HP 9111A or HP 9874A Digitizer. The following pages will describe the features of the HP 9111A and HP 9874A digitizers and provide you with a step-by-step approach for designing a character using a digitizer.

Once you understand the basic tools available to you, how your characters and logos look will depend on your own artistic skills.

The HP 9111A Digitizer

Figure 2-3 illustrates the features of the HP 9111A digitizer. You need to become familiar with the features to use it with IDSCHAR. For additional information about the HP 9111A, consult the 9111A Graphics Tablet User's Manual.

EQUIPMENT USE

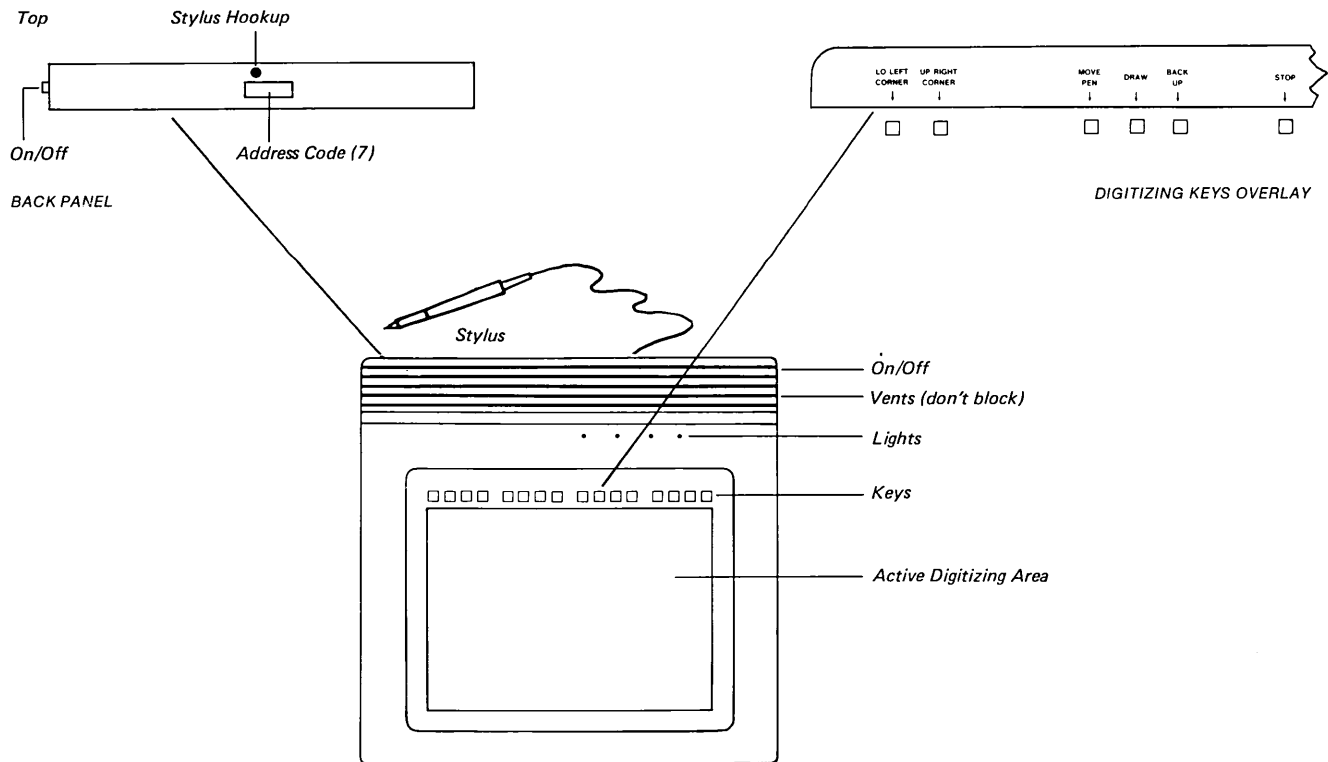

Figure 2-3. HP 9111A Digitizer

HP 9111A Back Panel

You need to be concerned that the digitizer is plugged in and connected to the terminal with an HP-IB cable, and that the Address Code is set at 7. (Refer to table 2-1).

HP 9111A Keyboard

The HP 9111A has sixteen keys. Six of the keys are used when digitizing. Figure 2-3 shows the keys you will be using.

HP 9111A Stylus

To operate the HP 9111A keys, you use the STYLUS. The Stylus is the pen-shaped tool that you use to digitize (refer to figure 2-3). To use the stylus, press down on the tip until you hear the tone. You do not have to press very hard. This activates the process that the key represents. For example, to stop the digitizing process, you press the stylus tip down in the key marked STOP. You then press the stylus tip down anywhere in the ACTIVE DIGITIZING AREA (refer to figure 2-3). The digitizing is stopped.

NOTE

The stylus tip can be replaced with a ball point pen filler. If this is done, use tracing paper to protect your artwork.

The HP 9111A Digitizer Keys

The digitizer has a keyboard overlay that is especially designed for IDSCHAR. The function of each key is defined below. The use of the keys is explained in greater detail later on in this section.

KEY	EXPLANATION
LO LEFT CORNER	You use this key to mark the border for the area that surrounds your artwork. First, press the stylus tip on the LO LEFT CORNER key. Next, press the stylus tip on the lower left corner of your artwork border. The lower left corner of the border is defined.
UPPER RT CORNER	After you define the lower left corner, press the UPPER RT CORNER key with the stylus tip. Next, press the stylus tip on a point that is the upper right corner of the artwork border. IDSCHAR calculates the entire border and you are ready to begin digitizing your outline.

EQUIPMENT USE

- BACKUP** Press the **BACKUP** key with the stylus tip. Then press the stylus tip on a point within the border of your artwork. The previous line is erased. Each time you press the stylus tip another line is erased. Press **DRAW** to resume tracing.
- DRAW** Press the **DRAW** key to put the digitizer in "Draw" mode. Then, digitize points as appropriate. The digitizer remains in "Draw" mode until another selection is made.
- MOVE
PEN** If you are just beginning to digitize your artwork or if you want to end the previous line and move to a different point to start a new line, press the **MOVE PEN** key. Next, press the stylus tip on a point where you want the new line to begin. Press **DRAW** to continue.
- STOP** When you are finished, press the **STOP** key, then press the stylus tip on a point anywhere in the active digitizing area. This returns the cursor to your terminal screen.

The HP 9874A Digitizer

Figure 2-4 illustrates the features of the HP 9874A Digitizer. You need to become familiar with these features to use it with IDSCHAR. For additional information, consult the HP 9874A Digitizer Reference Manual.

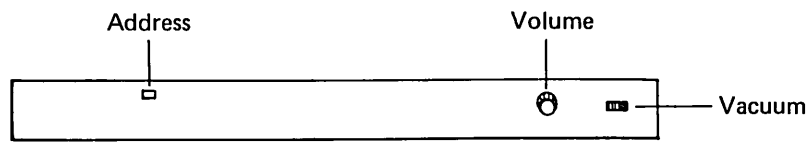

BACK PANEL

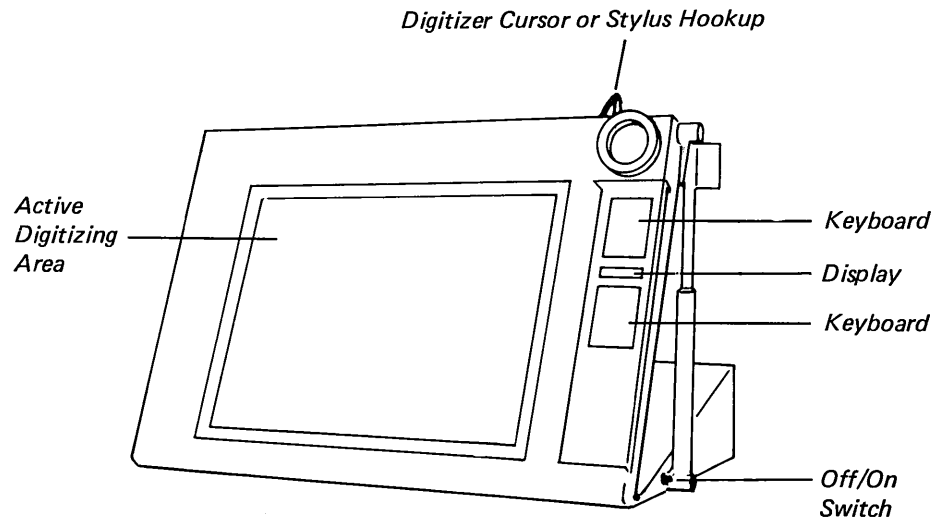

Figure 2-4. HP 9874A Digitizer

EQUIPMENT USE

HP 9874A Back Panel

The following switches are on the back panel of the digitizer.

- Vacuum Switch - The main ON/OFF switch for the vacuum system. The vacuum is used with the digitizer cursor to hold the digitizer cursor to the digitizing area.
- Volume Control - Lets you control the volume of the internal tone that you hear when you digitize a point.
- Address Code Switch - Signals the location of digitizer to the terminal (refer to table 2-1).

HP 9874A Keyboard

You do not use all the keys on the digitizer keyboard. The keys you use are illustrated in figure 2-5 below. The MOVE PEN, DRAW, BACKUP and STOP keys are not labeled on the digitizer, but are defined by IDSCHAR. A keyboard overlay is available for the 9874A digitizer.

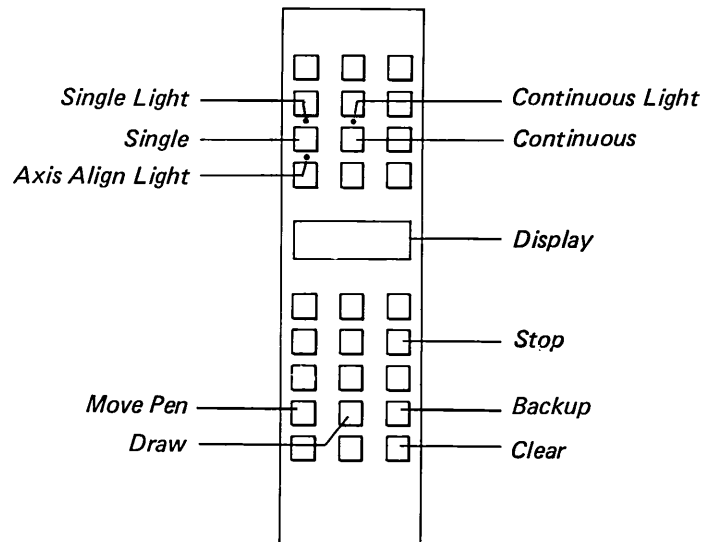

Figure 2-5. HP 9874A Digitizer Keyboard

HP 9874A Keys and Lights

The use of the digitizer keys, display, and lights is explained in greater detail later in this section (Refer to "Continue Digitizing with the 9874A). You need to be familiar with the following keys and lights:

KEY OR LIGHT	EXPLANATION
AXIS ALIGN LIGHT	The AXIS ALIGN LIGHT comes on as the first step in defining the parameters of the artwork on the digitizer.
BACKUP	You use this key to erase the last digitized line drawn. If you use this key, each time you press the digitizer cursor switch or press down on the stylus, the previous line is erased. Press DRAW to resume.
CLEAR	If you accidentally press the wrong key or change your mind about a key, pressing the CLEAR key cancels your request and clears the digitizer display. You can then continue.
CONTINUOUS	Pressing this key illuminates the light above the key and puts the digitizer cursor or stylus in a CONTINUOUS point mode. Each time you press down on the digitizer cursor or stylus, and hold it down, digitized points are made at a set time interval. This mode is especially useful for drawing curved lines since you can keep the digitizer cursor or stylus pressed down as your trace over your artwork
DRAW	Press the DRAW key to start the drawing process after you press the MOVE PEN key to start a new line or if you used the BACKUP key to erase a line.
MOVE PEN	If you are just beginning to digitize your artwork or if you want to end the previous line and move to a different point and start a new line, press the MOVE PEN key. Next, digitize a point where you want the new line to begin.
SINGLE	Pressing this key illuminates the light above the key and puts the digitizer cursor or stylus in the SINGLE point mode. Each time you press down on the digitizer cursor switch or stylus, you digitize one point.

EQUIPMENT USE

STOP

When you are finished, press the STOP key, then digitize a point anywhere inside the parameter of your artwork. Cursor will return to your terminal screen.

HP 9874A Digitizer Cursor and Stylus

The DIGITIZER CURSOR and STYLUS are the two drawing instruments you use to digitize points. Two switches (A and D) and a light are located on the digitizer cursor ring (refer to figure 2-6). The left-hand switch (A) controls the vacuum. If you want to use the vacuum feature, make sure the vacuum is turned on. (See HP 9874A Back Panel) Press A and the digitizer cursor is fixed to the digitizer board. Press A again and the digitizer cursor is released.

To digitize a point, align the cross hairs in the digitizer cursor ring on a point you want to digitize. Press switch D. Move to another point to be digitized. Press switch D. When you hear the tone, another point is digitized and is connected on your terminal screen with a line. For CONTINUOUS mode, press switch D and hold it down. As you trace your artwork, points are digitized at set time intervals. Release switch D to stop.

The STYLUS works like a pen. In fact, the tip is a ball point pen for writing. If you use the stylus, press down on the tip until you hear the tone. You do not have to press very hard.

NOTE

Since the tip of the stylus is a ball point pen, you might want to cover your artwork with tracing paper.

If you are using the CONTINUOUS mode, press the tip down and hold it down as you trace your artwork. Points are digitized at set time intervals. Lift up the tip from the board and the digitizing stops.

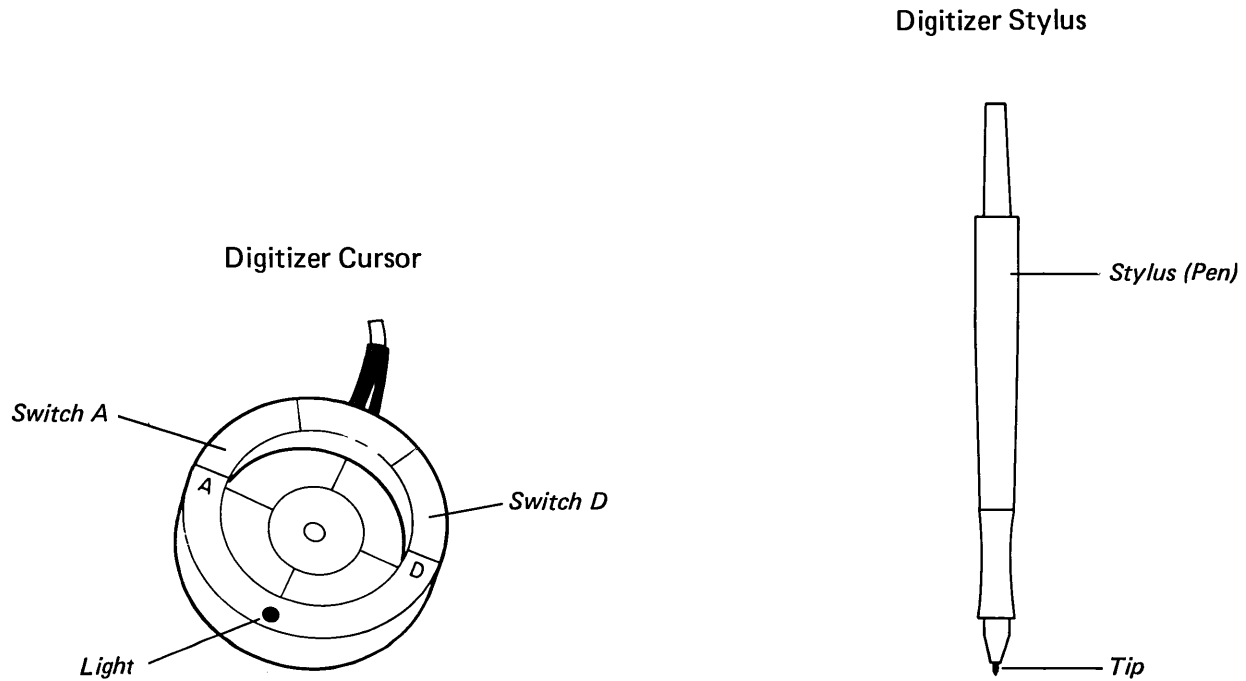

Figure 2-6. HP 9874A Digitizer Cursor and Stylus

Getting Ready to Digitize

The most effective way to use IDSCHAR for designing complex characters and logos is to have a drawing or photograph of the ideal result to work from. In general, the drawing or photograph should occupy as much of the active digitizing area (either vertically or horizontally) as possible, especially when working with a small character (1/4 inch or less).

EQUIPMENT USE

For characters or logos greater than 18 point (1/4 inch), make sure that the artwork does not exceed the digitizing area. This allows easier comparison between the drawing and the magnified version on the screen. The larger size also makes it easier to trace with the digitizer cursor or stylus.

NOTE

Do not use a lead pencil drawing for digitizing since the graphite in the pencil can cause problems with the digitizer.

NOTE

You may experience some static difficulties when using extremely thin artpaper. Use of a heavier artpaper or a reproduction from a copier will eliminate this problem.

The following is a step-by-step approach for designing a 12 point letter "B" using a digitizer. The first four steps listed below are common to both the HP 9111A and HP 9874A Digitizers. Step 5 and on presents the step-by-step approach unique to each digitizer. The HP 9111A is documented first, (Steps 5A - 11A); followed by the HP 9874A (Steps 5B - 13B.)

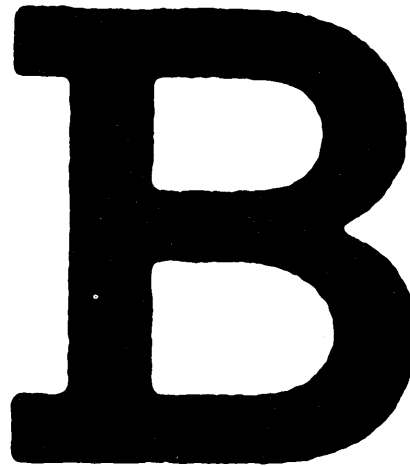

Figure 2-7. Sample B for Digitizing

Step 1 – Preparing the Artwork

Prepare the artwork you want to digitize. Draw a border around the artwork. The border should be proportional to the cell or the digitized outline will appear distorted. IDSCHAR scales the artwork to fit within the border of the cell.

Tape the artwork to the digitizing area so it will not move during the digitizing process. Make sure that the character outline will be properly aligned within the border you have drawn around your artwork. IDSCHAR lets you scale or shift your digitized artwork but not rotate it. Since this is the case, the bottom of your character or logo artwork should be parallel with the bottom of the active digitizing area, especially on the HP 9111A. Straight, horizontal lines may staircase if the bottom is not parallel.

NOTE

For best results on the HP 9111A, tape your artwork in the lower left corner.

Step 2 - Logging on to the Terminal

Turn on the terminal, digitizer, and any other optional equipment. Make sure the digitizer is connected to the terminal with an HP-IB cable and the digitizer address is 7. Log on.

After you have logged on, type in the following command after the colon prompt.

```
:RUN IDSCHAR.PUB.SYS
```

Press **RETURN** key.

After a few seconds, the terminal screen goes blank and the MAIN menu for IDSCHAR is displayed.

Step 3 - Creating the File and Cell

Create a character font file with proportional spacing and serifs. Define a 12 point cell on the MODIFICATION menu. IDSCHAR will ask you to provide the cell width. For this example, use 15 for the width, 26 for the top of uppercase, 21 for top of lowercase, 8 for the baseline, and 3 for bottom of descenders. The DISPLAY AREA is then presented with the 12 point cell displayed (see figure 2-8).

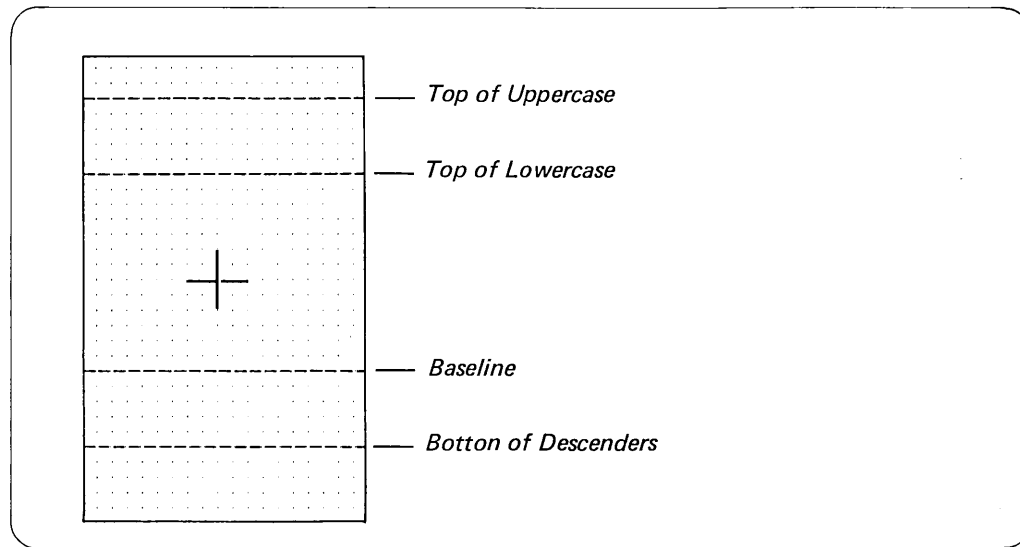

Figure 2-8. Display Area with 12 Point Cell

Step 4 - The Display Area

When the DISPLAY AREA appears you can type in the following two letter commands: GR and LI. (See Two-Letter Commands in section 3.) The Grid Lines appear with all grid points (see figure 2-8).

You are now ready to begin digitizing your outline. If you want, you can also move the cell to a different position, reduce or increase the magnification, change the background to black and use white dots, or even

EQUIPMENT USE

change the grid lines by using the CELL SIMULATION menu (refer to "Using the Simulating a Cell Function" in section 3).

Experiment with these features until you feel comfortable with them. You can't hurt IDSCHAR so test your design keys and design features. After you have experimented all you want, press **CONTROL** CLEAR CELL. The cell is cleared of everything but the grid lines and grid points.

Continue Digitizing with the HP 9111A

Once you have completed steps 1 through 4, press the **CONTROL** DIGITIZE keys. The cursor disappears from your screen and you should hear a series of tones coming from the digitizer.

Step 5A - Defining the Cell With the HP 9111A

You must first define the parameters of the border around the artwork so that it corresponds to the cell size on the DISPLAY AREA of the terminal (see figure 2-9).

First press the LO LEFT CORNER key with the stylus tip. Then press the stylus tip on the point which is the lower left corner of the border drawn around the artwork. A tone indicates that you have digitized the lower left corner.

Second, press the UP RIGHT CORNER key with the stylus tip. Then press the stylus tip on the point which is the upper right corner of the border drawn around the artwork. A tone indicates that you have digitized the upper right corner. IDSCHAR uses these coordinates to scale the artwork with the size of the cell in the Display area on your terminal screen.

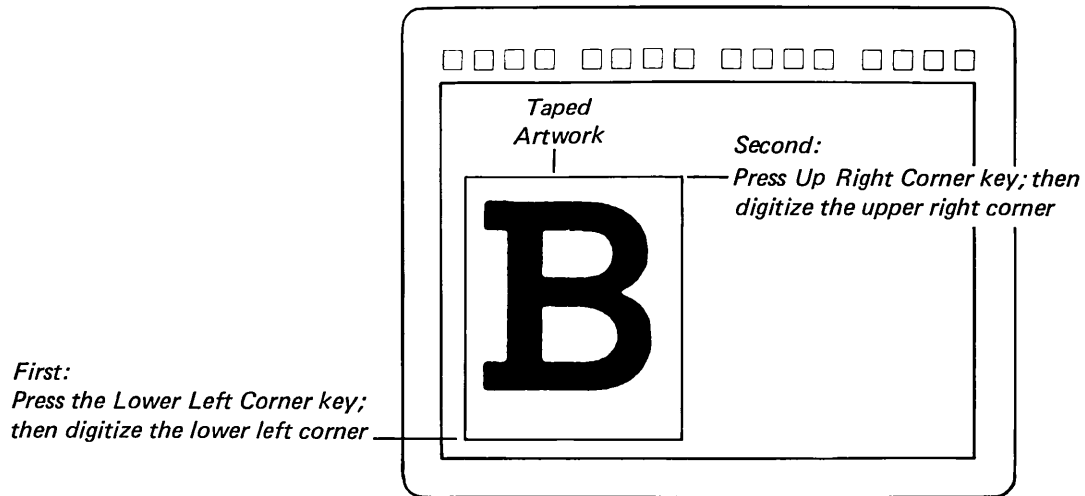

Figure 2-9. Defining the Parameters of the Cell

Step 6A - Tracing the Artwork

You are now ready to begin tracing the artwork (see figure 2-10). Press the MOVE PEN key with your stylus tip. Then press the DRAW key with the stylus tip. Digitize a point where you want to start tracing. You can then digitize points on your artwork. For each point you digitize, you hear a tone and a line is connected in the cell on your terminal screen.

HINTS: For long straight lines you only have to digitize the beginning and the end of the line. For curves, you digitize many points close together. The more points, the smoother the curve.

NOTE

Be sure to complete the outline so it meets. Otherwise your outline will not fill properly.

Erasing a Line

In order to erase a digitized line, press the BACKUP key with the stylus tip. Next, press the stylus tip on a point ANYWHERE inside the active digitizing area. The last line drawn is erased from the cell on your terminal screen. Each time you press down on the stylus you hear a tone and another line is erased.

To resume drawing from the last point erased, press the DRAW key with your stylus tip and continue tracing.

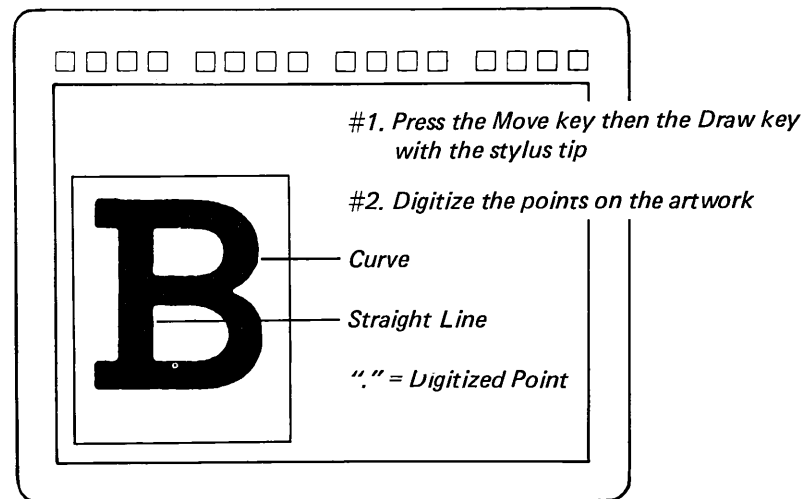

Figure 2-10. Tracing the Outline

Step 7A - Digitizing Separate Lines

You might want to stop digitizing at one point and start digitizing another line that is not connected to the current line you are drawing.

In the example in figure 2-11, the center part on the "B" is separate from the outer part. To trace this part, first press the MOVE PEN key with the stylus tip. Next, digitize a point where you want the new line to start. Finally, press the DRAW key with the stylus tip. You can now digitize the separate line.

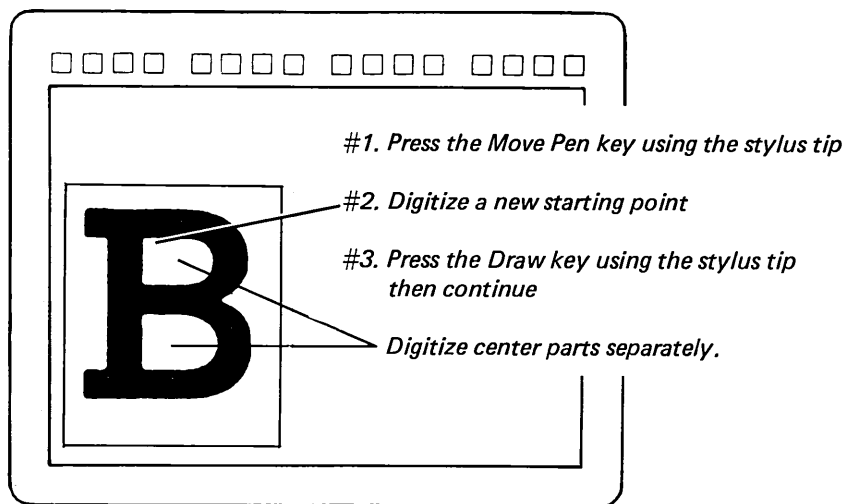

Figure 2-11. Digitizing Separate Lines

Step 8A - Stopping

When you are finished with the outline, use the stylus tip to press the STOP key. Then press the stylus tip on a point ANYWHERE in the border around your artwork. The digitizing process is stopped. You can stop digitizing and return to the DISPLAY at any time, but once you stop you cannot go back to make changes or add to the outline. Refer to "Digitizing a Complex Logo" in this section. Once you stop, The cursor should reappear in the cell on the DISPLAY AREA of the terminal.

There are a number of functions you can perform to position the outline and enlarge or reduce it. The outline in figure 2-12 needs to be enlarged and moved to the left. Experiment with the TRANSFORM OUTLINE menu (see figure 3-51) until you have the outline resting on the baseline and as close to the top of caps line as you can get it. It doesn't have to be exact since you can remove or add dots as needed.

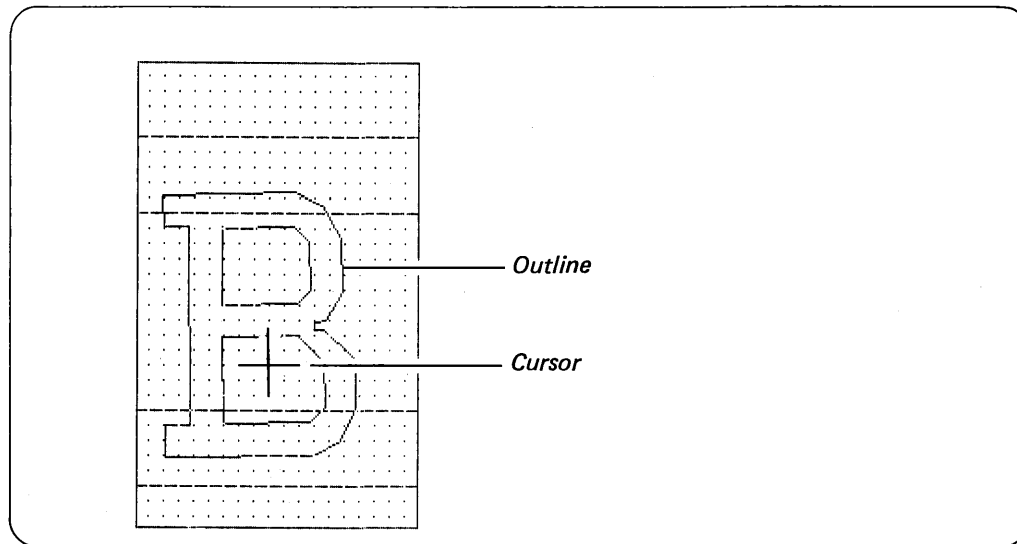

Figure 2-12. Cell Showing Digitized Outline

Step 9A - Saving the Outline

Once the outline is complete you will want to save it for future use. You can do so with the SAVE OUTLINE menu (see figure 2-13).

It is not necessary to save the outline before you fill the character, however, you are less likely to forget to save it at this point.

IDSCHAR Save Outline

Character
- OR -
Character code number

Cell file

Point size
- OR -
Cell size
Height
Width

Figure 2-13. Save Outline Menu

Step 10A – Filling the Outline

Once you have the outline in the approximate position you desire, press the **CONTROL** FILL OUTLINE keys to fill the outline with dots.

In figure 2-14, you can see that the outline is not filled in perfectly. IDSCHAR fills in the majority of the dots to save you time, but you must do the final touch up until the letter is acceptable to you.

NOTE

Remember that you can use the two letter command CO to turn the outline ON or OFF.

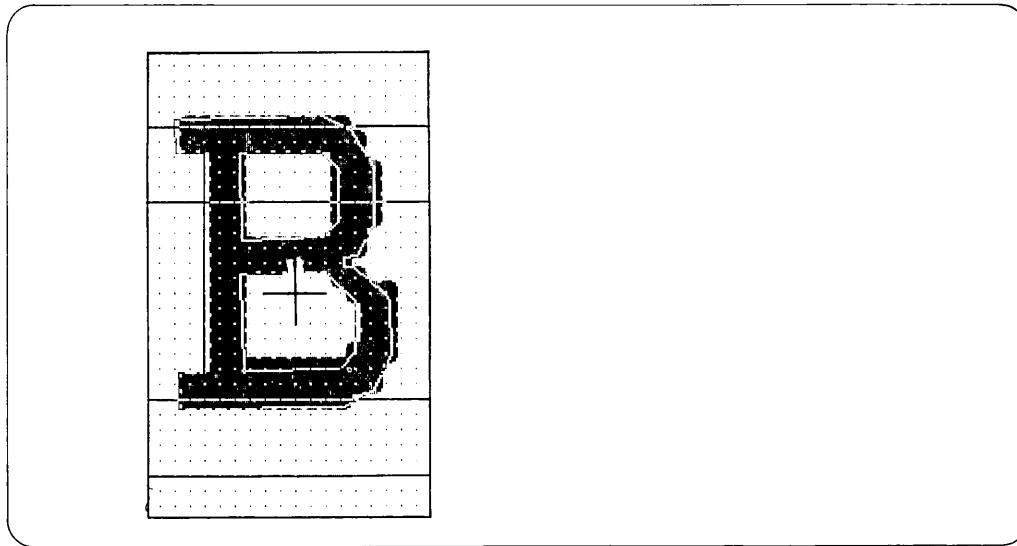

Figure 2-14. Cell with Outline and Dots

EQUIPMENT USE

Step 11A - Saving the Character

Once you are satisfied with the character, you can save it with the SAVE CELL menu (see figure 2-15).

After you save the character, clear the cell with the **CONTROL** CLEAR CELL keys. You are now ready to digitize another outline.

NOTE

It is not necessary to complete the character before you save it. You may save the partially finished character and retrieve it with the GET CELL menu for completion at a later time. Once complete you can resave the cell. IDSCHAR will issue a warning that the previously saved cell will be replaced by the current cell.

IDSCHAR	Save Cell
Character	
- OR -	
Character code number	
Version number	
Ranking (1 is best, 999 is worst)	
Orientation (0, 90, 180 or 270 degrees)	
Destination	
H - Temporary hold	
S - Stored in file	
Cell file	
Point size	
- OR -	
Cell size	
Height	
Width	

Figure 2-15. Save Cell Menu

EQUIPMENT USE

Continue Digitizing with the HP 9874A

Once you have completed step 1 through 4, press the **CONTROL** DIGITIZE keys. The cursor disappears from your screen and you can begin digitizing.

Step 5B – Align Axis on the HP 9874A

When the AXIS ALIGN light on the Digitizer keyboard comes on, digitize two points: First digitize a point below and to the left of the artwork you are going to digitize. Second, digitize a point on the same horizontal line with the first point you digitized. If the first point was the lower left hand corner of the border drawn around the artwork, then this point should be on the line which forms the bottom side of this border. Think of this as an invisible line on which the border rests (see figure 2-16).

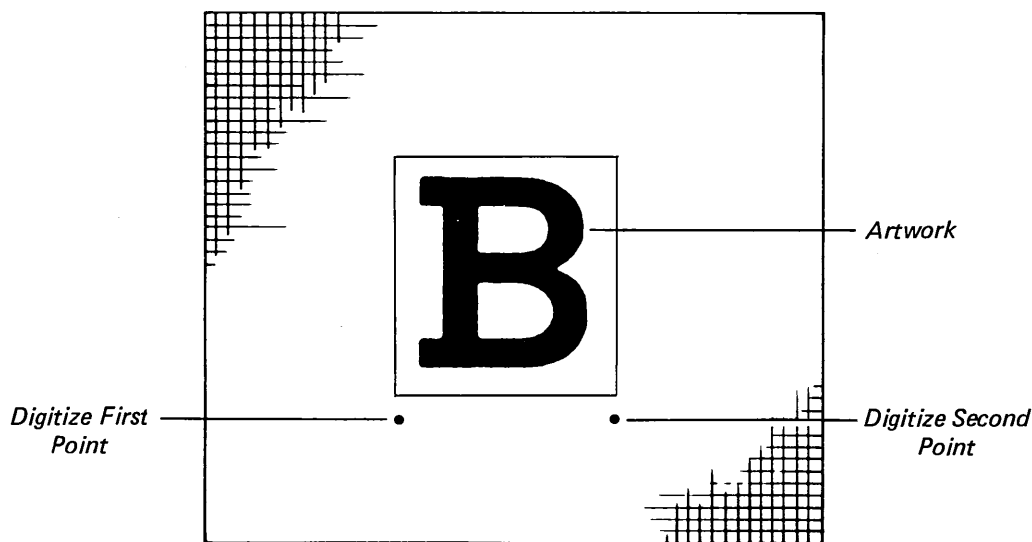

Figure 2-16. Aligning the Horizontal Axis

Step 6B - Defining the Cell

You must next define the parameters of the border around the artwork so that it corresponds to the cell size on the Display area of the terminal (see figure 2-17).

First, press the SINGLE key on the Digitizer keyboard. This lets you digitize one point each time you press down on the cursor or stylus.

Second, digitize the point which is the lower left hand corner of the border drawn around the artwork. The "Lo Left Corner" message disappears from the digitizer display.

When the message "Upper Rt Corner" is displayed, digitize the point which is the upper right hand corner of the rectangle drawn around the artwork. IDSCHAR uses these coordinates to scale the artwork with the size of the cell in the DISPLAY AREA of your terminal.

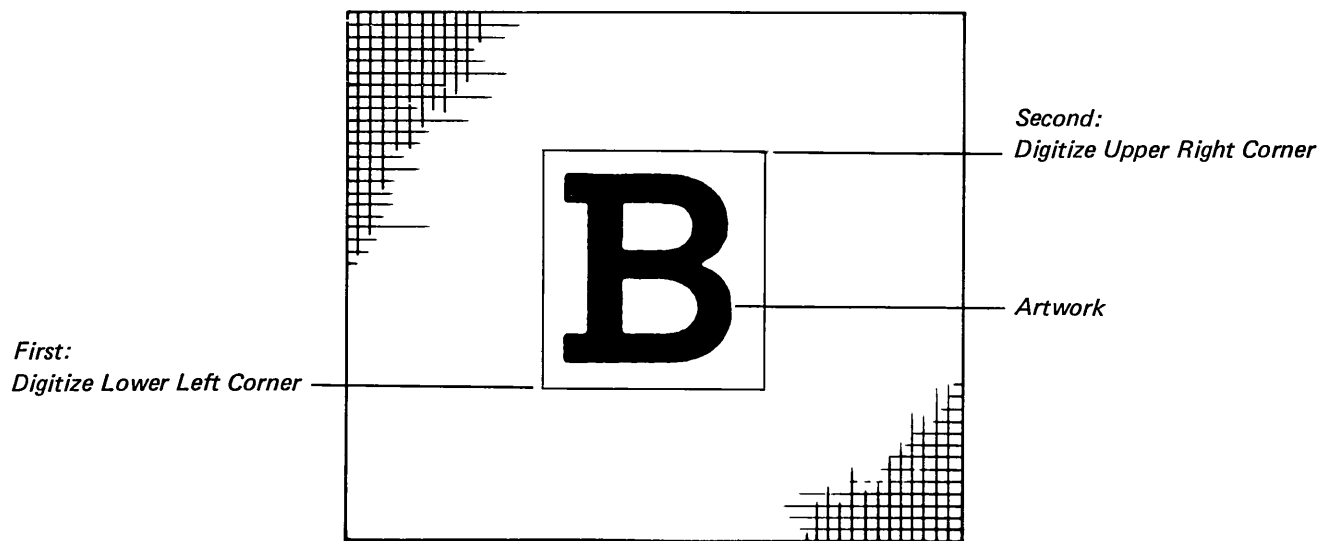

Figure 2-17. Defining the Parameters of the Artwork

Step 7B - Tracing the Artwork

You are now ready to begin tracing the outline (see figure 2-18). Press 1 on the digitizer keyboard. This is the MOVE PEN key. Digitize a point where you want to start tracing.

Press 2 on the digitizer's numeric keyboard. This is the DRAW key. Now begin digitizing points, making a continuous line. For each point you digitize, a line is connected in the cell on your terminal screen.

HINTS: For long straight lines you only have to digitize the beginning and the end of the line. For curves, you can digitize many points close together. The more points the smoother the curve. Be sure to complete the outline so it meets. Otherwise your outline will not fill properly.

Erasing A Line

In order to erase a digitized line drawn, press the **BACKUP** key (3) on the Digitizer's keyboard. Digitize a point anywhere inside the border drawn around your artwork. The last line drawn is erased. Each time you digitize another point, another line will erase.

To resume drawing from the last point, press the **DRAW** key (2) and continue digitizing points.

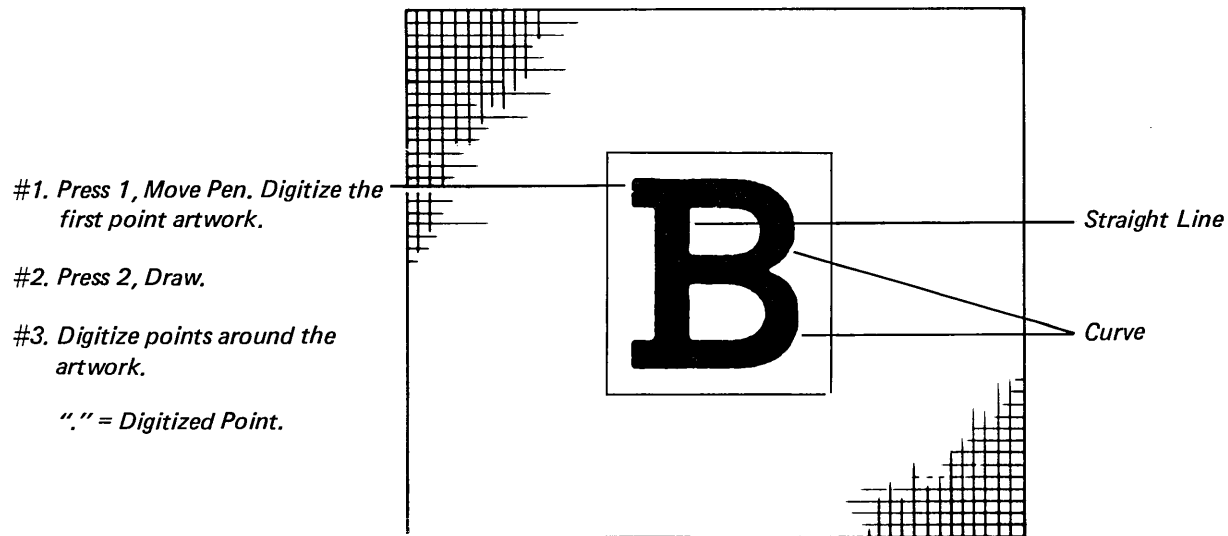

Figure 2-18. Tracing the Outline

EQUIPMENT USE

Step 8B – Digitizing Separate Lines

You might want to stop digitizing at one point and digitize a line that is not connected to the line you are drawing. In figure 2-19, the center portion in the "B" is separate from the outer portion. To trace this section, first press the MOVE PEN key (1). Digitize the new starting point then press the DRAW key (2). You can then begin digitizing from the new point.

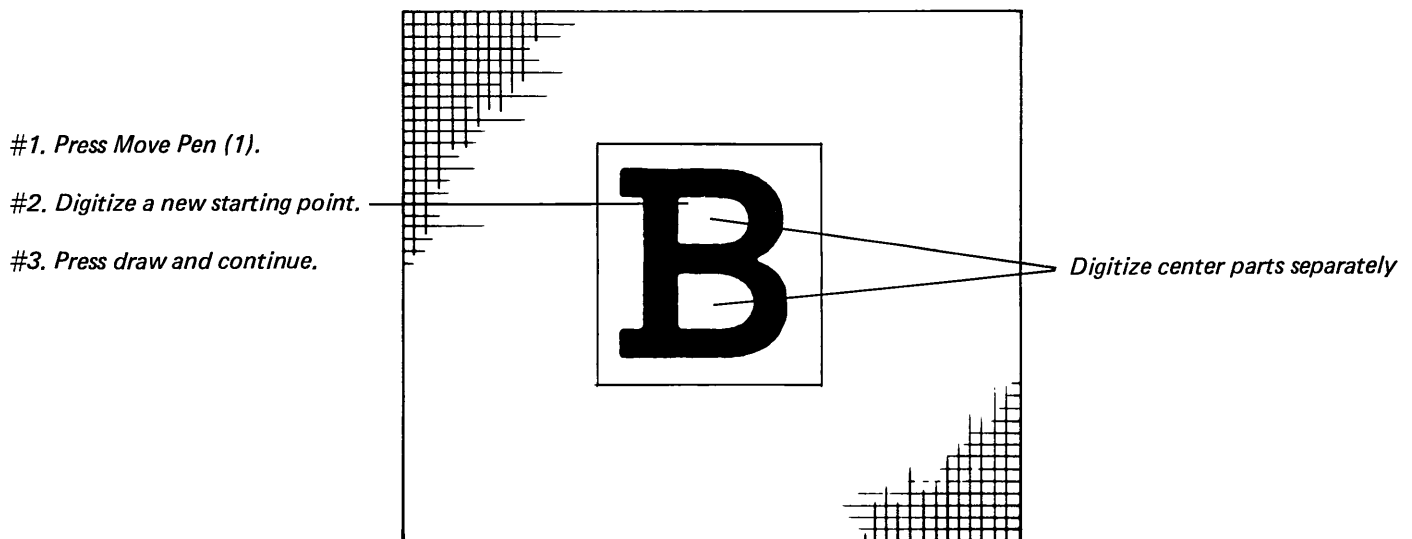

Figure 2-19. Digitizing Separate Lines

Step 9B – Continuous Drawing

You could digitize all the points while in the SINGLE mode. However, for curves you can use the CONTINUOUS mode key.

NOTE

The maximum number of digitized lines you can have in a cell is 1001. A digitized line is the line between two digitized points. For very complex outlines, you could use up the number of digitized lines if you use continuous mode since continuous mode digitizes points rapidly and close together.

In figure 2-20, when you come to the first large curve on the letter, press the CONTINUOUS key. From that point on as long as you keep the cursor switch D pressed down or hold the stylus tip down, points are digitized at regular intervals. In this way you trace the outline as you would if you were using a pen or pencil. The slower you move the digitizer cursor or stylus, more points will be digitized and the smoother the curve will be.

NOTE

If you use the stylus, remember that the point is a ball point pen and will leave the ink impressions on your artwork. If you do not want the artwork marked, you can use tracing paper over the artwork.

NOTE

The set time intervals depend on the speed with which the computer responds. If your computer is especially busy, you could be moving your stylus faster than the points will be digitized. In that case, slow down your tracing.

EQUIPMENT USE

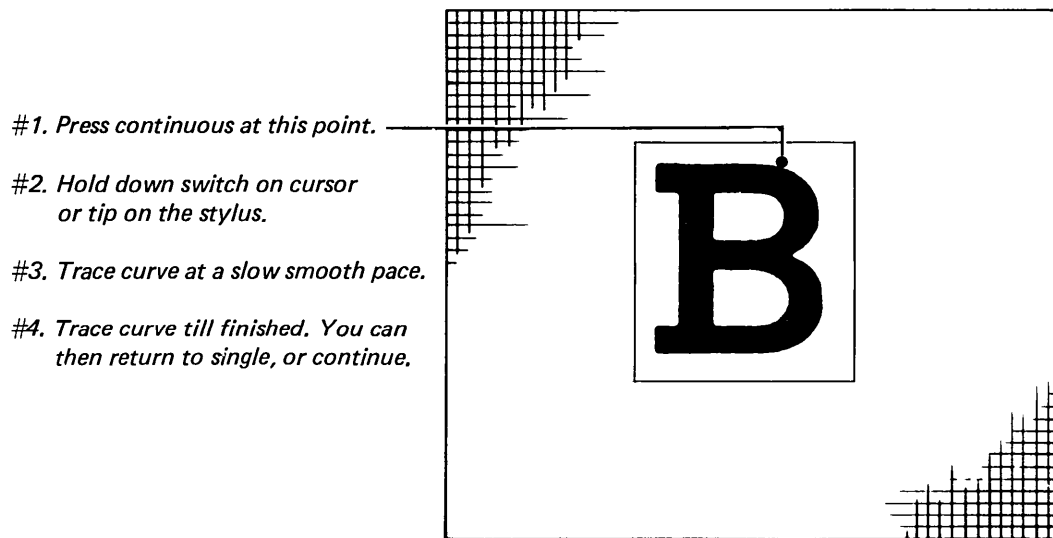

Figure 2-20. Using the Continuous Mode

Step 10B - Stopping

When you are finished with the outline, press the STOP key (9) on the digitizer keyboard. Then digitize a point anywhere in the border around the artwork. The digitizing process is stopped. Once you stop digitizing an outline you cannot go back to make changes or to add to the outline. Refer to "Digitizing a Complex Logo" in this section.

Once you stop, the cursor should reappear in the cell on the DISPLAY AREA of the terminal

There are a number of maintenance functions you can perform to position the outline and enlarge or reduce it.

The outline in figure 2-21 needs to be enlarged and moved to the left. Experiment with the TRANSFORM OUTLINE menu (refer to figure 3-51) until you have the outline resting on the baseline and as close to the top of caps line that you can get it. It doesn't have to be exact, since you can remove or add dots as needed.

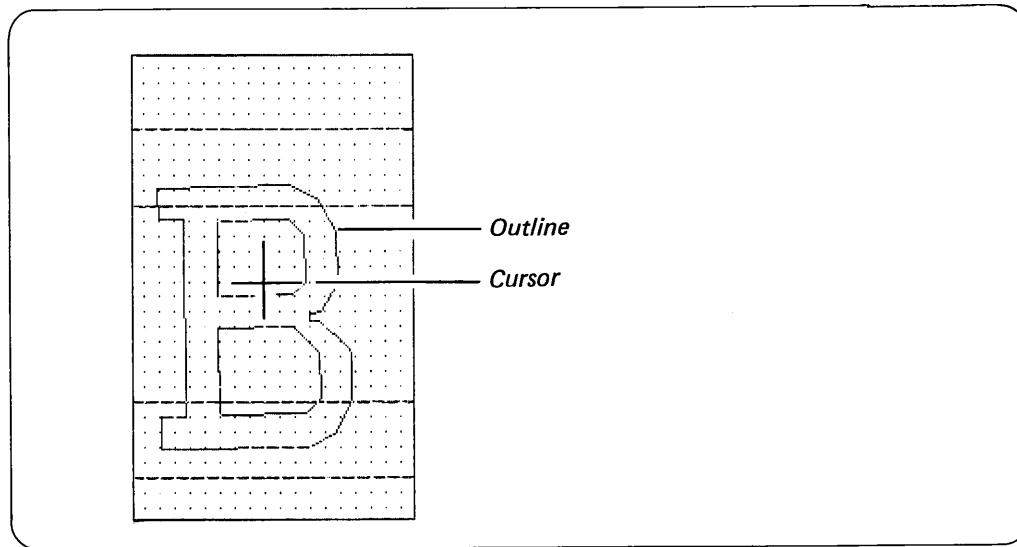

Figure 2-21. Cell Showing Digitized Outline

Step 11B - Saving the Outline

Once the outline is complete you will want to save it for future use. You can do so with the SAVE OUTLINE menu (see figure 2-22).

It is not necessary to save the outline before you fill the character. However, you are less likely to forget to save it at this point.

EQUIPMENT USE

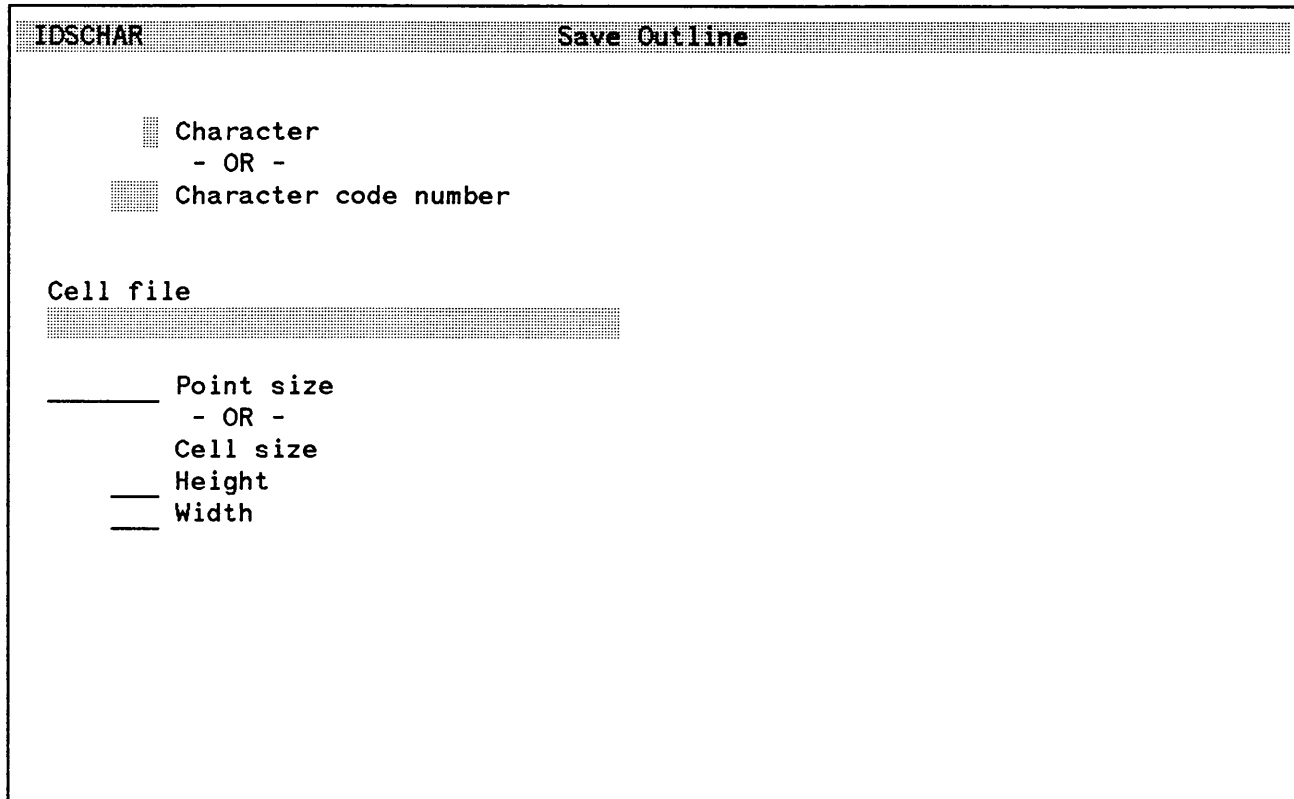

Figure 2-22. Save Outline Menu

Step 12B - Filling the Outline

Once you have the outline in the approximate position and size you desire, press the **CONTROL** FILL OUTLINE keys to fill the outline with dots.

In figure 2-23, you can see that the outline is not filled in perfectly. IDSCHAR fills in the majority of the dots to save you time, but you must do the final touch up until the letter is acceptable to you.

NOTE

Remember that you can use the two letter command CO to turn the outline ON or OFF.

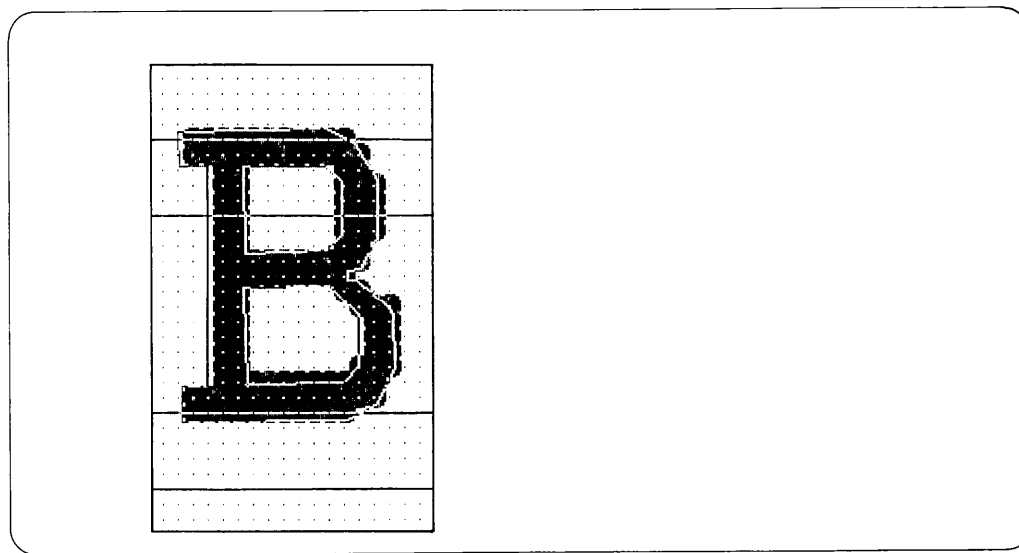

Figure 2-23. Cell with Outline and Dots

EQUIPMENT USE

Step 13B - Saving the Character

Once you are satisfied with the character, you can save it with the SAVE CELL menu (see figure 2-24).

After you save the character, clear the cell with the **CONTROL** CLEAR CELL keys. You are now ready to digitize another outline.

NOTE

It is not necessary to complete the character before you save it. You may save the partially finished character and retrieve it with the GET CELL menu for completion at a later time. Once complete you can resave the cell. IDSCHAR will issue a warning that the previously saved cell will be replaced by the current cell.

IDSCHAR	Save Cell
Character	
- OR -	
Character code number	
Version number	
Ranking (1 is best, 999 is worst)	
Orientation (0, 90, 180 or 270 degrees)	
Destination	
H - Temporary hold	
S - Stored in file	
Cell file	
Point size	
- OR -	
Cell size	
Height	
Width	

Figure 2-24. Save Cell Menu

Correcting Digitizing Errors

The following lists possible mistakes you might make while you are digitizing an outline and how you can correct them.

1. Accidentally pressing the DIGITIZE key.

If you press the DIGITIZE key when the digitizer is not powered on, or the address code is incorrect, or the cable is not hooked up, wait 20-30 seconds, IDSCHAR returns to the MAIN menu with an IDSCHAR message informing you of the problem. You can then continue working.

For the HP 2648A terminal, if you accidentally power off in the middle of digitizing, wait 20-30 second. IDSCHAR returns you to the MAIN menu. However, if you are using the HP 2647A/F terminal and accidentally power off while you are digitizing, you have to abort IDSCHAR. See Appendix B for a discussion on the abort procedure.

2. Axis align is incorrect (HP 9874A only).

If you have not yet digitized the lower left corner, press the axis align key (the light should come on) and try again. If you have already digitized the lower left corner, press STOP, digitize a point above the axis, and start over.

3. Wrong lower left and/or upper right corners digitized.

Press STOP and digitize a point in the border. Start over.

4. Wrong key is pressed before digitizing a point.

Press the CLEAR key, then press the key you want (HP 9874A only). For the HP 9111A, just select the key you really wanted.

5. Specified an undefined key then accidentally digitized a point.

Don't worry. IDSCHAR didn't do anything. Press CLEAR then choose the right key (HP 9874A only). For the HP 9111A, just select the right key and try again.

6. For axis align (HP 9874A), you specified two points on top of each other.

If you haven't digitized the lower left corner, press the AXIS ALIGN key (the light should illuminate) and try again.

Using an Outline for More Than One Cell Size

After you have digitized and saved an outline, it is not necessary to digitize the outline each time you want a different point size or cell size.

The following steps show you how to use an outline to create characters (or logos) of different point sizes.

Creating an Outline for a New Point Size or Cell Size:

1. First create the cell in the point size or cell size in grid points that you want to work with.
2. When the cell appears in the DISPLAY AREA, press the GET OUTLINE key.
3. On the GET OUTLINE menu specify the character, the file that the outline is in, and the size of the outline. Press **ENTER**.

For a logo, on the GET OUTLINE menu, specify the file name the logo outline is in and the logo outline size. Press **ENTER**.

4. The DISPLAY appears with the size you want to work with. The outline is scaled by IDSCHAR and is drawn to fit that cell.

If the Point Size or Cell Size Already Exists:

1. When the cell for that point size or cell size appears in the DISPLAY AREA, go to the GET OUTLINE menu. Enter the character, file name, and size of the outline. Press **ENTER**.

For a logo, on the GET OUTLINE menu, specify the file name and size of the logo outline. Press **ENTER**.

2. The DISPLAY appears with the cell you want to work with. The outline is scaled by IDSCHAR and drawn in the cell.

Digitizing a Complex Logo

You cannot use the digitizer to modify or add to a previously created outline. If you have a complex logo you may want to consider digitizing a complete portion of the logo and then another. The following example shows an application where this might be the preferred method.

The logo in figure 2-25 needs only a portion of the outline filled. Since **FILL OUTLINE** fills the entire outline, you might want to digitize this in two parts.

1. Create a Logo File (refer to section 3).
2. Digitize the outline around the unfilled portion of the logo and **SAVE OUTLINE** as character "A".
3. Clear cell and digitize the outline around the filled portion of the logo and **SAVE OUTLINE** as character "B".
4. Fill outline "B".
5. Now **GET OUTLINE "A"**.
6. Since "outlines" do not print, it is necessary to "trace" the portion of the outline you do not intend to fill. Trace the outline "A" using draw line and draw arc as described in section 3.
7. Now **SAVE CELL**. Since this is a logo file, **IDSFORM** automatically saves the cell as character "L".

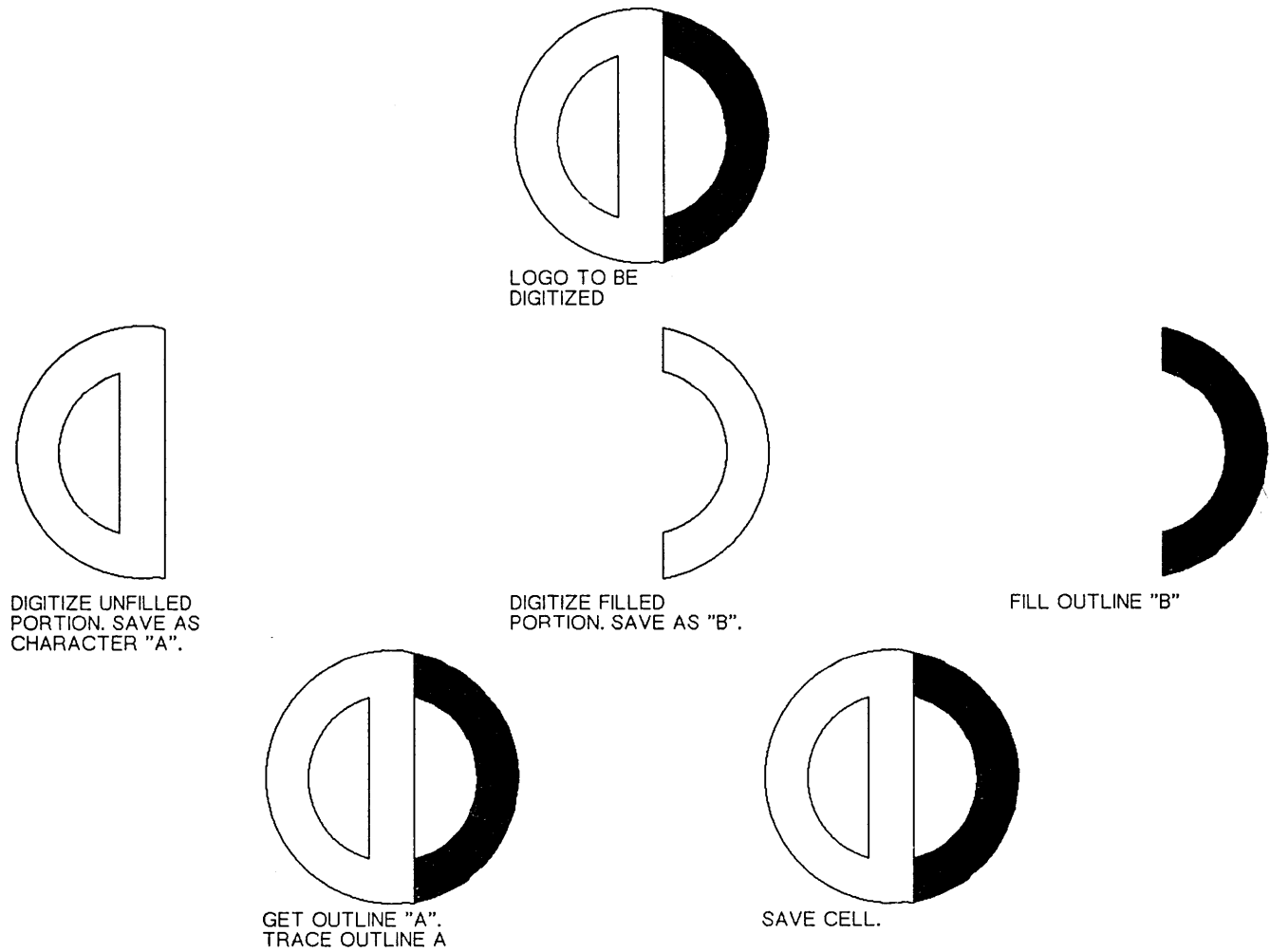

Figure 2-25. Complex Logo Digitizing

THIS PAGE SHOULD BE BLANK

Introduction

IDSCHAR uses menus to communicate with you. Some menus are presented in response to a specific request from you, while other menus follow predefined menu paths. This section will step you through the menus and processes involved to complete the following procedures:

- Creating a Cell File (C)
- Modifying a Cell File (M)
- Using The Display Area Functions
- Documenting a Cell File (DO)
- Deleting Character Font and Logo Cells (D)

NOTE

Previous versions of IDSCHAR differ from this version of IDSCHAR. Cell files created with the new version will not be compatible and should not be used with an earlier version (Refer to "Converting Cell Files to New IDSCHAR Format" in section 1.)

Menu Format

Information located on menus is either variable or non-changing. Menus in IDSCHAR use the following format:

- Fields (highlighted in white on the terminal screen) in which you can enter information.
- Display-only fields (underlined but not highlighted) in which variable information known by IDSCHAR, but not changeable, is displayed.
- Textual information which describes or explains what is on the menu. This information never changes.

NOTE

At any time in the menu path, you can press the CANCEL function key (**F8**) and be returned to the previous menu.

You can also refresh the terminal screen at any time by pressing the REFRESH/RECOVER function key (**F4**).

Main Menu

The menu illustrated in figure 3-1 is the MAIN menu and is the first menu you see when you run IDSCHAR. From this menu you can get to any of IDSCHAR's functions by selecting the function you want to perform. Type the one or two letter code in the Selection field and the cell file name in the CELL File field, then press **ENTER**.

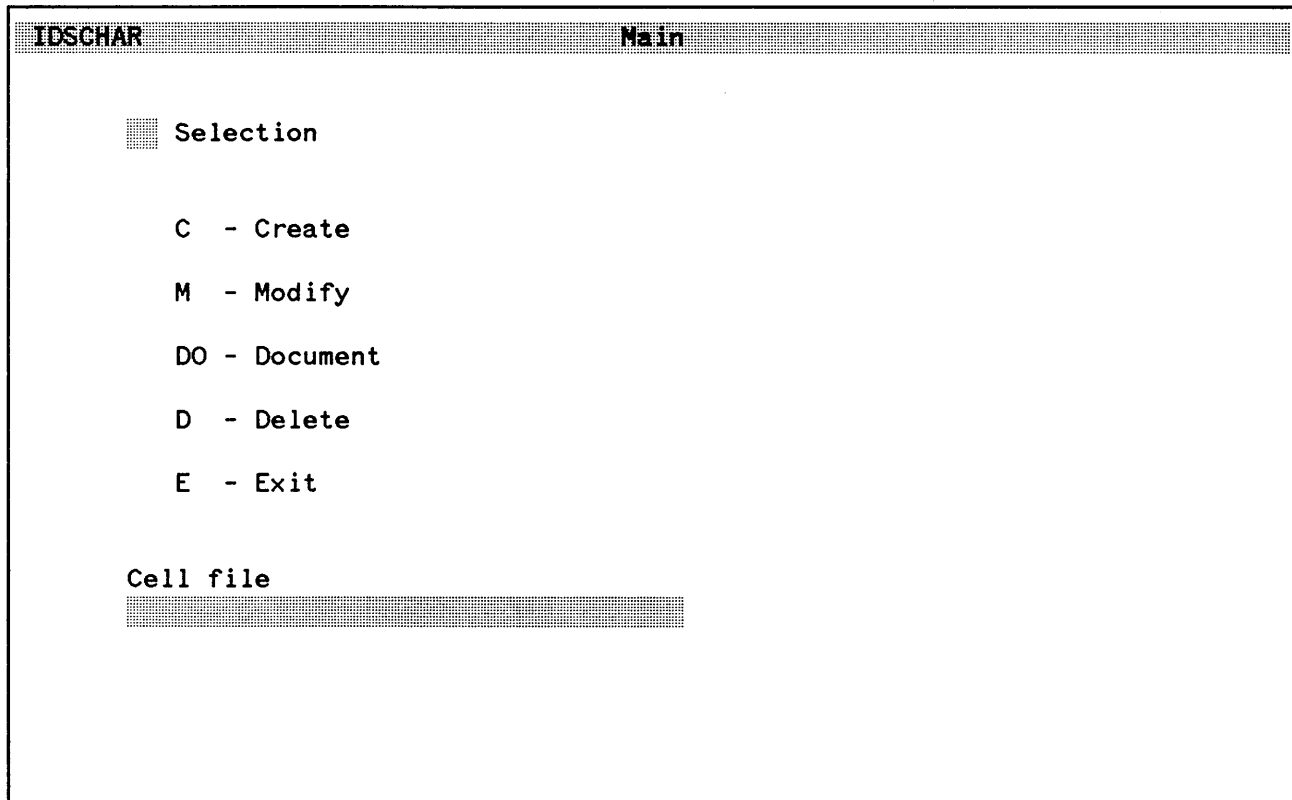

Figure 3-1. Main Menu

Main Menu Selections

Each selection you make on the MAIN menu results in another menu being displayed where you can describe in more detail what you want to do. For example, if you want to create a new cell file, you first select the Create function. The next menu to appear is the CELL FILE DESCRIPTION menu. On this menu you can then designate whether your new file is to be a character file or logo file. The following choices are made on the MAIN Menu:

USING IDSCHAR

- **Create (C):** This function creates a new cell file. Type C in the Selection field and the new file name in the CELL File field.
- **Modify (M):** This function lets you make a variety of changes to an existing cell file. Or you can add new sizes to an existing cell file. Type an M in the Selection field and the file name in the CELL File field.
- **Document (DO):** With this function you can describe a cell file by filling in the series of menus that follow. These comments become part of the file and can be referred to by selecting this function. To select the documentation function, type DO in the Selection field and the file name in the CELL File field. You can also change target device information on the appropriate document menu screen.
- **Delete (D):** This function lets you delete one or more versions of characters, logos, or outlines from an existing cell file. Type D in the Selection field and the file name in the CELL File field.
- **Exit (E):** This function exits you from IDSCHAR. Type E in the Selection field and you are returned to the operating system.

ILLUSTRATION HERE

NOTE

If you do not save your work, it will be lost to you when you exit from IDSCHAR.
Refer to "Saving a Cell" in this section.

Creating a Cell File

Figure 3-2 shows the menu path (from bottom to top) involved in creating a cell file. The selections you make on each menu determines the menu flow through the process.

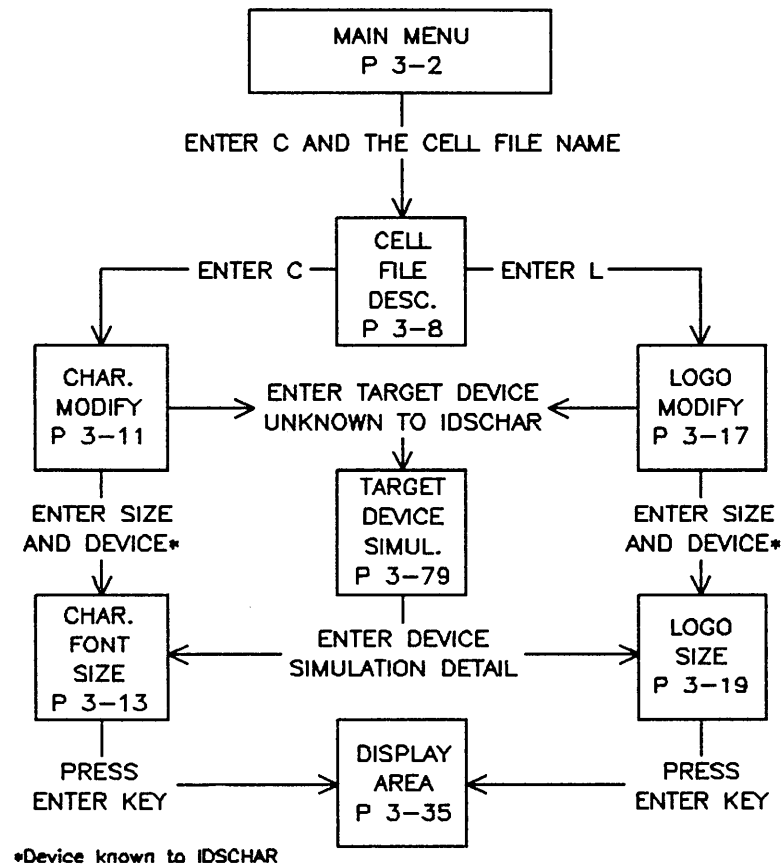
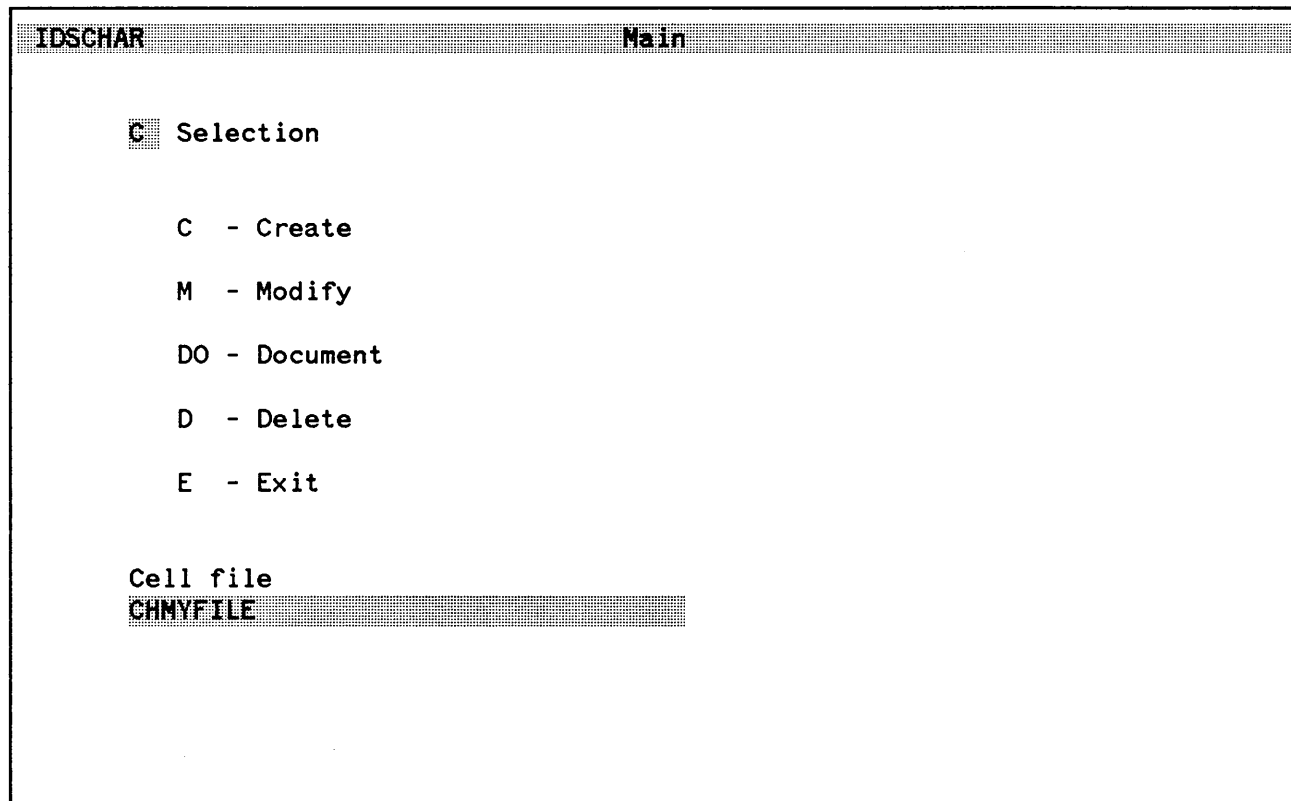

Figure 3-2. Menu Path for Creating a Cell File

USING IDSCHAR

To design a new character font or logo, you must first create a new cell file. When the IDSCHAR MAIN menu is displayed on your terminal screen, type C in the Selection field and the new Cell File Name in the CELL File field (see figure 3-3). The cell file name can be eight characters or less in length and must begin with a letter. Once you type the file name in the CELL File field and press **ENTER**, the file is created. If you were to exit at that point, IDSCHAR designates the file as a character font by default. Once created, additions and modifications can only be accomplished by using the MODIFY function.



```
IDSCHAR                               Main

C Selection

C - Create

M - Modify

DO - Document

D - Delete

E - Exit

Cell file
CHMYFILE
```

Figure 3-3. Selection to Create a Cell File

Cell File Discription

IDSCHAR needs to know what kind of file, character font or logo, that you want to create.

Character Font File

Character Font Files contain a character font in varying sizes. The file can contain up to 128 different characters. All sizes of the character font in a single file are of the same typeface, so that an "A" chosen from one size should appear nearly identical to an "A" from another size in the same file except for its size. In addition, information about the typeface represented by a particular font file is also kept in the file.

Logo File

A Logo File, which is typically a large, complicated cell, contains one or more sizes of a single logo or other artwork. There is only one logo design per logo file, but there can be different versions and sizes.

Making Your Selection

When the CELL FILE DESCRIPTION menu appears on the screen type L (logo file) or C (character font file) in the Selection field and press **ENTER** (see figure 3-4).

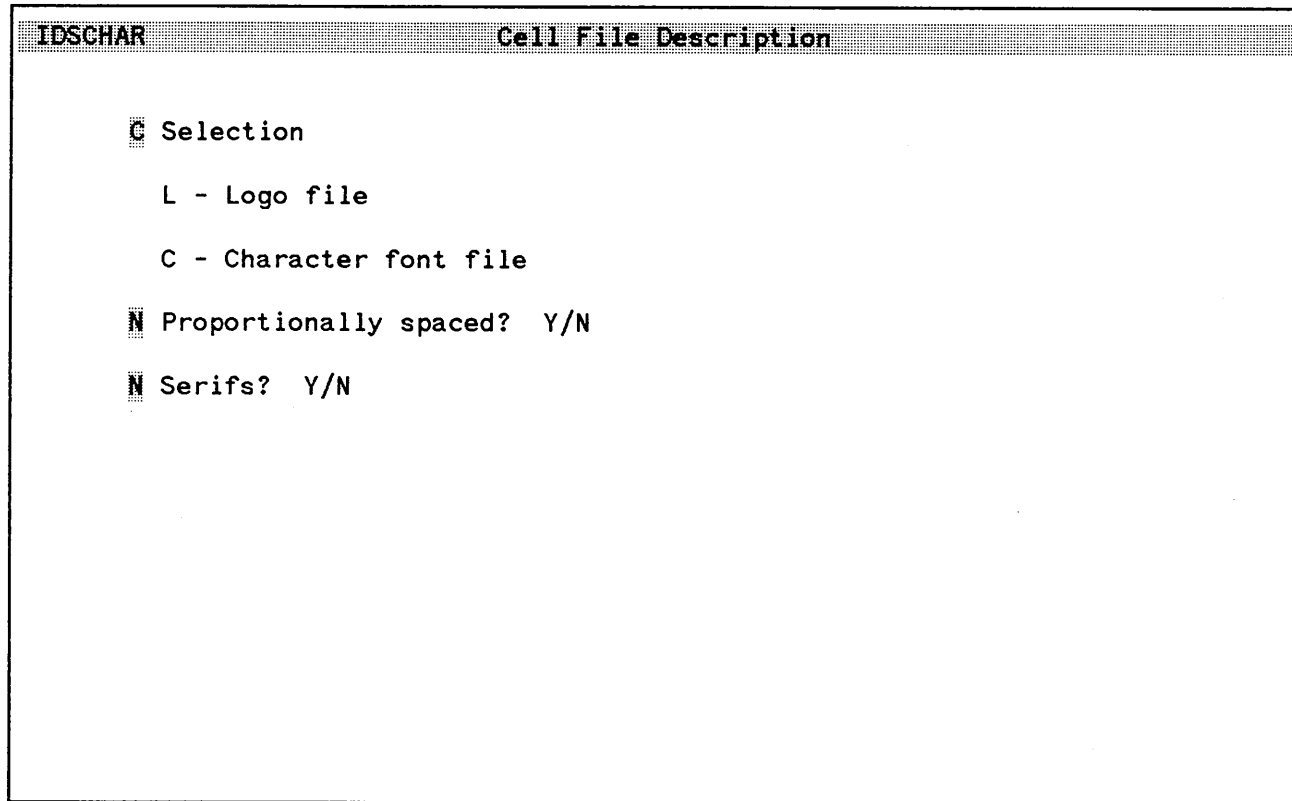

Figure 3-4. Cell File Description Menu

Proportionally Spaced? Y/N

You can also indicate if a character font file is to be proportionally spaced by entering a Y (yes) or N (no) in the appropriate field. A proportionally spaced character font is one whose individual characters occupy only the amount of space they need within the cell. For example, typewriter characters are not proportionally spaced. An "i" uses as much space as a "W". In a proportionally spaced font, "i" takes much less space than a "W". Entering a Y in the field indicates to IDSCHAR that you want the characters proportionally spaced. When they are printed, IDSCHAR then determines the correct proportions for each character. The SET BOUNDS menu (Refer to "Using The Display Area Functions") allows you to override the proportional bounds calculated by IDSCHAR for individual characters in a font.

NOTE

Even if you do not choose to use proportional spacing, IDSCHAR calculates it. You can see the proportional spacing bounds at any time for the cell you are in by typing the two-letter command PB.

THIS IS A PROPORTIONALLY SPACED SENTENCE

THIS IS NOT A PROPORTIONALLY SPACED SENTENCE.

Figure 3-5. Proportional and Non-Proportional

USING IDSCHAR

Serifs? Y/N

A serif is a short cross line at the end of the main strokes of a character (refer to appendix A).

If your characters will have serifs, type Y (yes) in the Serif? Y/N field. IDSCHAR uses this information when calculating proportional spacing.

NOTE

To change from proportional spacing to non-proportional spacing, non-proportional spacing to proportional spacing, or to change from serif to sans-serif see CELL FILE DESCRIPTION menu in this section.

Changing the Default Spacing

For proportionally spaced character fonts, IFS/3000 computes the width of blank spaces to be some percentage of the cell height (refer to appendix A). If you don't want to use this default, you can design your own blank space in the following way:

- Start with a blank character cell that has the same dimensions as the character font size in question.
- Move the cursor to the left most column, then set the left bound.
- Move the cursor to the column you want to be the new right bound, then set the right bound.
- On the SAVE CELL menu, save this cell using the character code number 32.

Refer to "Using The Display Area Functions - SET BOUNDS menu" for additional information.

Creating a Character

If you select C (character font file) on the CELL FILE DESCRIPTION menu, the MODIFICATION Menu for characters is displayed. (See also "Creating a Logo" in this section).

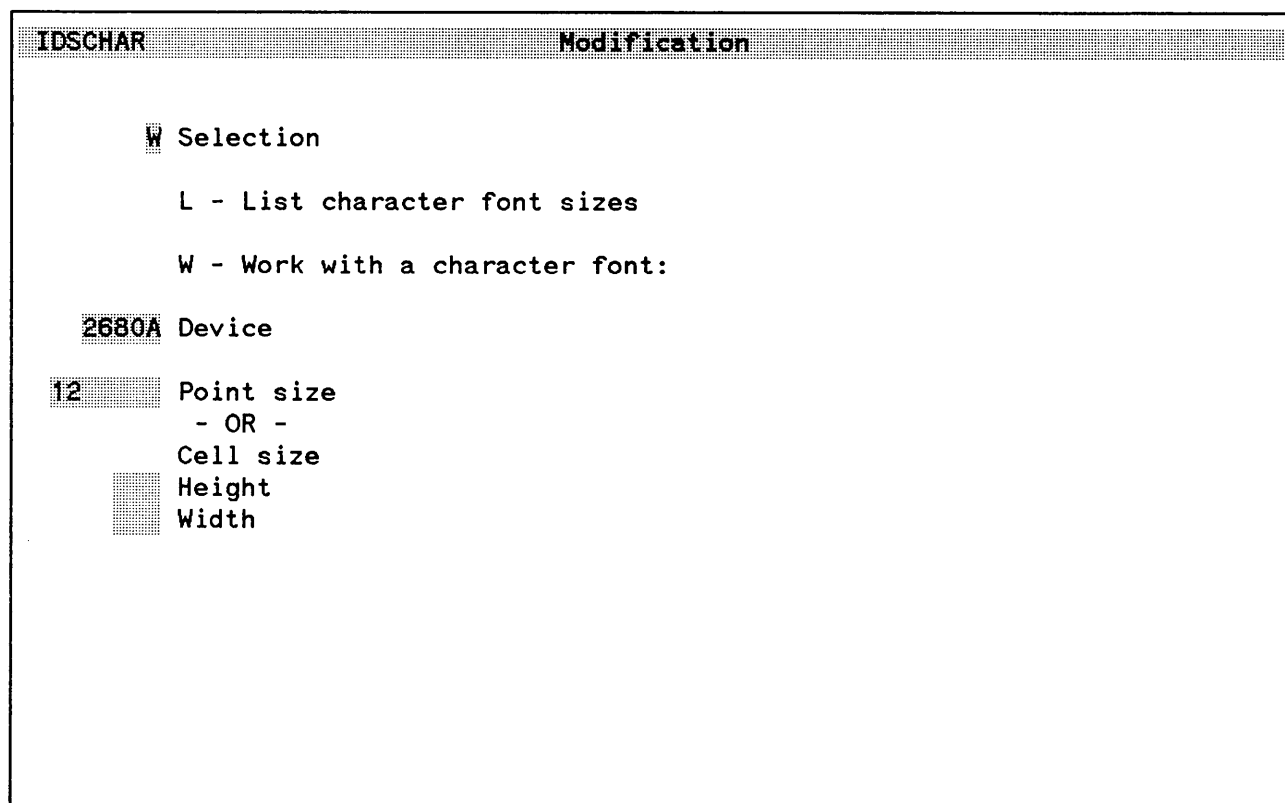

Figure 3-6. Modification Menu (Characters)

USING IDSCHAR

In the Create function of IDSCHAR, the MODIFICATION menu is where you choose the target device and the point size or cell size in grid points that you want to work with.

If you want to work with point size, type a W in the Selection field, type a device in the Device field, and a point size in the Point Size field (point sizes must be greater than 0 and less than or equal to 200). Press **ENTER**. The nearest cell height for the target device and point size selected is calculated for you and appears on the CHARACTER FONT SIZE menu.

You may also choose to work with the cell size in grid points. Type a W in the Selection field, type a device in the Device field, and the height and width you want to work with in the Cell Size fields (cell sizes must be 1 dot by 1 dot minimum and 255 dots by 255 dots maximum). Press **ENTER**. The nearest point size is calculated for you and appears on the CHARACTER FONT SIZE menu.

The L (list font size) option does not apply for the Create Function since no font sizes have been specified.

NOTE

If the device specified is a device that is not known to IDSCHAR the TARGET DEVICE SIMULATION menu will appear for additional input prior to displaying the CHARACTER FONT SIZE menu. Refer to "Documenting a Cell File - TARGET DEVICE SIMULATION menu" (figure 3-47) for additional information.

Character Font Size

IDSCHAR		Character Font Size	
12.	Point size		
	Cell size		
30	Height		
	Width		
	Top of uppercase		
	Top of lowercase		
1	Baseline		
	Bottom of descenders		
<hr/>			
	Text printed horizontally		
0.0	Grid points between cells		
0.0	Grid points between lines		
	Text printed vertically		
0.0	Grid points between cells		
0.0	Grid points between lines		

Figure 3-7. Character Font Size Menu

After you have determined the point size or cell size in grid points on the MODIFICATION menu, the CHARACTER FONT SIZE menu appears (see figure 3-7). If you specified point size, the cell height was calculated for you and is displayed in the Height field. If you specify a cell size, then the point size is automatically calculated for you and is displayed in the Point Size field. In either case, you must enter a width.

USING IDSCHAR

At this point you can change the point size or cell height value that was calculated for you. However, once you press **ENTER** on this menu, these values cannot be changed.

After you have typed in the required information, you can press **ENTER** or fill in the optional fields. Once you press **ENTER**, the DISPLAY AREA appears on your terminal screen and you can begin designing.

NOTE

The largest cell size possible is 255 dots by 255 dots.

NOTE

Once the cell size has been calculated you cannot create another cell of a different width for the same height and device within the same cell file. IDSCHAR will respond with a message disallowing the size selection.

Optional Fields

You can specify options on the CHARACTER FONT SIZE menu. These options are explained and illustrated on the following pages. You can change the optional information at a later time if you want. These optional features include grid lines and line spacing information.

Grid Lines

Grid lines are displayed when you use the two-letter command LI (see figure 3-8). The grid lines may be changed by using the CELL SIMULATION menu (refer to "Using The Display Area Functions"). Grid lines can also be turned on or off by using the CELL GRAPHICS menu.

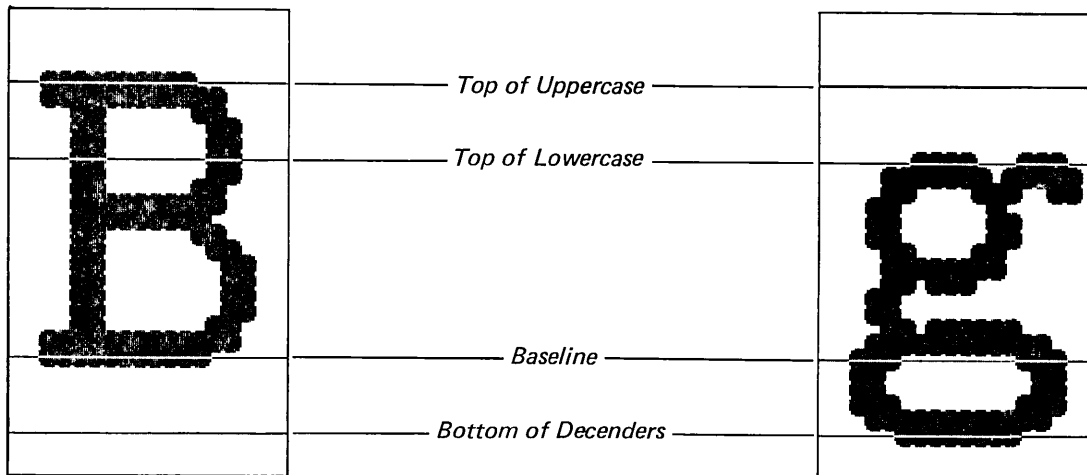

Figure 3-8. Character Cell Showing Grid Lines

Vertical and Horizontal Line Spacing

If the default spacing values are used, character cells are printed side-by-side. The CHARACTER FONT SIZE menu provides fields for you to change the amount of space between lines and characters for characters that are printed horizontally or vertically.

Supplying a positive number causes characters to be printed with more spacing, while supplying a negative spacing value causes characters to be printed closer together. Figure 3-9. shows where these spaces are determined.

Spacing between lines is meaningful only if you do not override the line spacing calculated for you in IFS/3000 (refer to IFS/3000 Reference Guide - Logical Page menu).

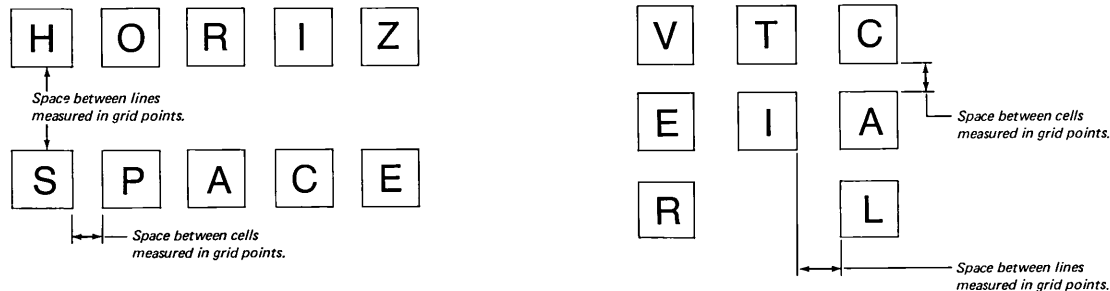

Figure 3-9. Vertical and Horizontal Text Spacing

After you type in the necessary information and press **ENTER** the DISPLAY AREA appears on your terminal screen and you can begin your design work on a new character. Refer to "Using The Display Area Functions" in this section for additional information.

Creating a Logo

If you select L (logo) on the CELL FILE DESCRIPTION menu, the LOGO MODIFICATION menu for logos is displayed. (See also "Creating a Character" in this section).

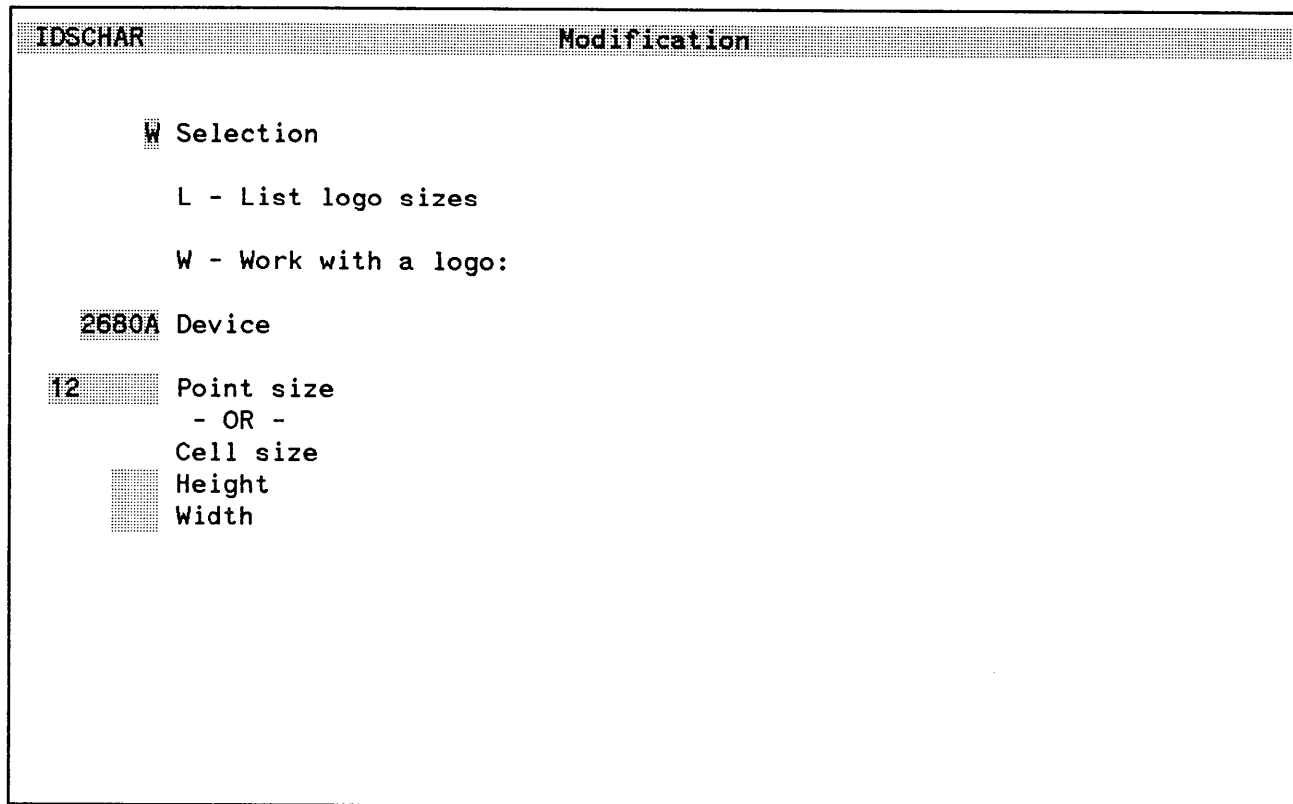

Figure 3-10. Modification Menu (Logo)

USING IDSCHAR

When this menu is displayed, type in the logo size that you want to work with. You have the choice of using a point size or a cell size measured in grid points.

To use a point size, type W in the Selection field, the target device in the Device field, and the point size in the Point Size field (point size must be greater than 0 and less than or equal to 200 depending on the target device). Press **ENTER**. The nearest cell height for the target device and point size selected is calculated for you and appears on the LOGO SIZE menu.

You may also choose to work with the cell size in grid points. Type a W in the Selection field, type a device in the Device field, and the height and width you want to work with in the Cell Size fields (cell sizes must be 1 dot by 1 dot minimum and 255 dots by 255 dots maximum). Press **ENTER**. The nearest point size is calculated for you and appears on the LOGO SIZE menu.

The L (list logo size) option does not apply for the create function since no logo sizes have been specified.

NOTE

If the device specified is a device not known to IDSCHAR the TARGET DEVICE SIMULATION menu will appear for additional input prior to displaying the LOGO SIZE menu. Different printing devices can use a different size and shape of dot to print. If you are designing a character font or logo for a device not known to IDSCHAR you might also have to define the width and height and general shape of the dot that the device uses. Refer to the Reference Manual for the specific device parameters. For information regarding simulation refer to "Documenting a Cell File - TARGET DEVICE SIMULATION menu" in this section.

Logo Size

IDSCHAR	Logo Size
12	Point size
	Cell size
30	Height
	Width
1	Baseline

Figure 3-11. Logo Size Menu

After you have determined the point size or cell size in grid points on the MODIFICATION menu, the LOGO SIZE menu appears (see Figure 3-11). If you specified point size, the cell height was calculated for you and is displayed in the Height field. If you specify a cell size, then the point size is automatically calculated for you and is displayed in the Point Size field. In either case, you must enter a width.

USING IDSCHAR

At this point you can change the point size or cell height value that was calculated for you. However, once you press **ENTER** on this menu, these values cannot be changed.

After you have typed in the required information and pressed **ENTER**, the DISPLAY AREA appears on your terminal screen and you can begin your design work on a new logo.

Refer to "Using The Display Area Functions" in this section for additional information.

Positioning Logos Using the Baseline

You can also change the baseline from the default (1). The baseline can aid you in positioning a logo relative to surrounding text because all symbols that are printed are aligned according to the baseline.

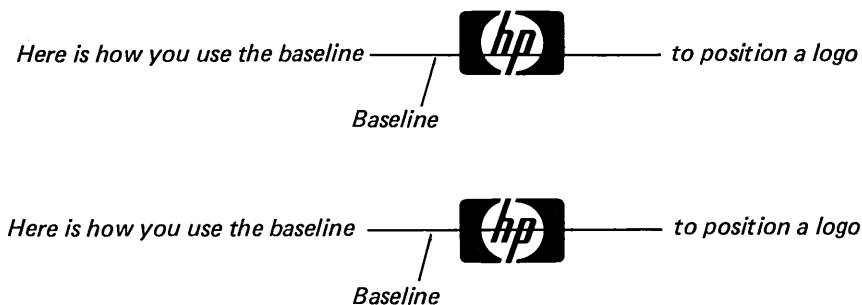

Figure 3-12. Using the Baseline to Position Logos

Modifying a Cell File

Figure 3-13 shows the menu path (bottom to top) involved in modifying or adding a cell file. The selections you make on each menu determines the menu flow through the process.

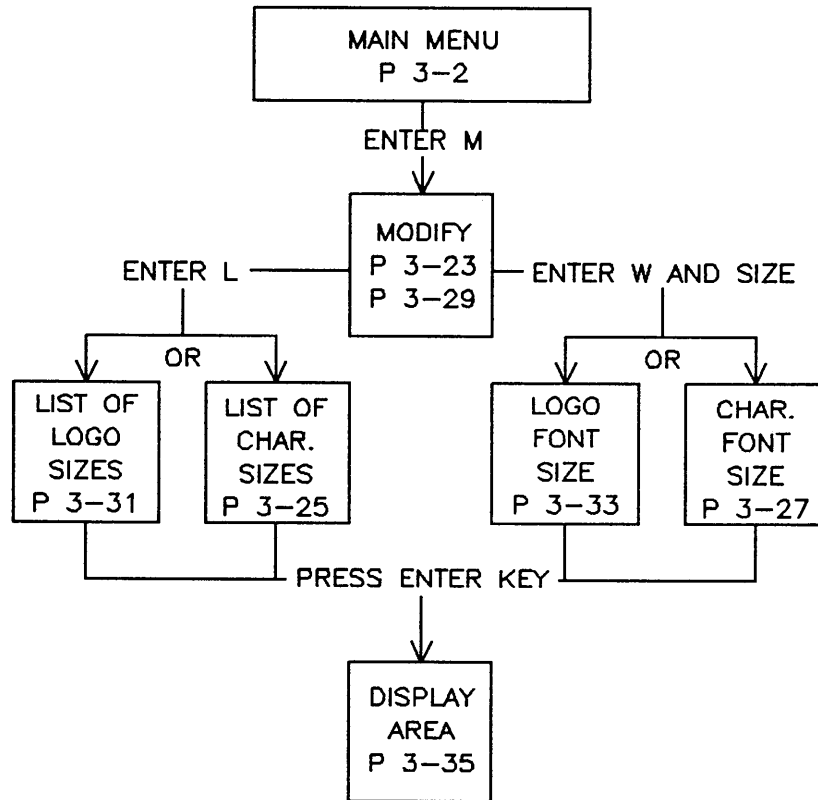

Figure 3-13. Menu Path for modifying or adding a cell file

USING IDSCHAR

After you have designed a character font or logo, you might want to go back at some later time and make changes. Or you might want to add a new character font or logo size. On the MAIN menu, type M in the Selection field and the file name in the CELL File field, then press **ENTER**.

IDSCHAR recognizes the file name you entered on the MAIN menu as either a Character Font file or a Logo file.

Modifying a Character

IDSCHAR	Modification
<input type="checkbox"/>	Selection
	L - List character font sizes
	W - Work with a character font:
<input type="checkbox"/>	Device
<input type="checkbox"/>	Point size
	- OR -
	Cell size
<input type="checkbox"/>	Height
<input type="checkbox"/>	Width

Figure 3-14. Modification Menu (Character File)

The MODIFICATION menu (figure 3-14) is where you choose the point size or cell size in grid points you want to work with or elect to see a list of all available sizes. Type L in the Selection field and press **(ENTER)**. The List of CHARACTER FONT SIZES menu appears (see figure 3-15). If you do not specify a device the

USING IDSCHAR

list will show all sizes for all target devices in the Cell File. If you select a specific target device the CHARACTER FONT SIZES menu will display only those character font sizes resident for the device selected.

Selecting a Cell Size

If you know what point size you want to work with, type W in the Selection field, the target device in the Device field, and the point size in the Point Size field on the MODIFICATION menu. Press **ENTER**.

If you know what cell size in grid points you want to work with, type W in the Selection field, the target device in the Device field, and the cell size in the Height and Width fields on the MODIFICATION menu. Press **ENTER**. The CHARACTER FONT SIZE menu is displayed.

List of Character Font Sizes

IDSCHAR		List Of Character Font Sizes		
Press ENTER to see next size on list				
Display this size?	Point Size	Cell Width	Cell Height	Target Device
N	6.	7	15	2680A
N	8.	10	20	2680A
N	12.	15	30	2680A
N	8.	17	34	2688A
N	10.	20	42	2688A

Figure 3-15. List of Character Font Sizes Menu

If you choose the L (list character font sizes) option on the MODIFICATION menu, the LIST OF CHARACTER FONT SIZES menu (figure 3-15) is displayed. Each time you press **ENTER**, the next size is presented. They are presented from the smallest size to the largest size by target device. When all sizes for

USING IDSCHAR

all target devices have been listed, the MODIFICATION menu returns. Then you can type in the size you want to work with. You may also select a size while in the LIST OF CHARACTER FONT SIZES menu by placing a Y in the Display this size? field and pressing **(ENTER)**. The DISPLAY AREA will present the cell size you select.

NOTE

At any time in the menu path, you can press the CANCEL function key (**F8**) and be returned to the previous menu.

Character Font Size

IDSCHAR	Character Font Size
<u>12.</u>	Point size
	Cell size
<u>30</u>	Height
<u>15</u>	Width
<input type="checkbox"/>	Top of uppercase
<input type="checkbox"/>	Top of lowercase
<input type="checkbox"/>	Baseline
<input type="checkbox"/>	Bottom of descenders
<hr/>	
	Text printed horizontally
<input type="checkbox"/>	Grid points between cells
<input type="checkbox"/>	Grid points between lines
	Text printed vertically
<input type="checkbox"/>	Grid points between cells
<input type="checkbox"/>	Grid points between lines

Figure 3-16. Character Font Size Menu

USING IDSCHAR

Changing Cell Size Parameters

This menu appears if you chose **W** on the **MODIFICATION** menu and specified a device and point or cell size. On this menu, you can change any of the values that are entered except cell size and point size. These features include grid lines and line spacing information.

Grid Lines

The grid lines are displayed when you use the **CELL GRAPHICS** menu (refer to figure 3-43) or use the two-letter command **LI** while in Display mode. Refer to figure 3-8 to see a sample character font cell with the grid lines turned on.

Vertical and Horizontal Line Spacing

The **CHARACTER FONT SIZE** menu also provides fields for you to change the amount of space between lines and characters for characters that are printed horizontally or vertically. Refer to figure 3-9 to see how this space is defined.

Adding a New Cell Size

If you have specified a new point size or cell size in grid points on the **MODIFICATION** menu, the **CHARACTER FONT SIZE** menu appears. If you specified point size, the cell height is calculated for you and is displayed in the Height field. If you specified cell size in grid points, then the point size is automatically calculated for you and is displayed in the Point Size field. In either case, you must enter a width. After you type in the necessary information and press **(ENTER)**, the **DISPLAY AREA** appears on your screen and you can begin to design work on a new character.

Refer to "Using The Display Area Functions" in this section.

Modifying a Logo

IDSCHAR	Modification
<p>L Selection</p> <p>L - List logo sizes</p> <p>W - Work with a logo:</p> <p>Device</p> <p>Point size - OR - Cell size</p> <p>Height</p> <p>Width</p>	

Figure 3-17. Modification Menu (Logo File)

The MODIFICATION menu is where you choose the point size or cell size in grid points you want to work with. To see a list of all available sizes, type L in the Selection field and press **ENTER**. The LIST OF LOGO SIZES menu appears (see figure 3-18).

USING IDSCHAR

If you know what point size you want to work with, type a *W* in the Selection field, the target device in the Device field, and the point size in the Point Size field. Press **ENTER**.

If you are working with the cell size in grid points, type *W* in the Selection field, the target device in the Device field, and the cell size in the Height and Width fields on the MODIFICATION menu. Press **ENTER**. The LOGO SIZE menu is displayed.

List of Logo Sizes

IDSCHAR		List Of Logo Sizes		
Press ENTER to see next size on list				
Display this size?	Point Size	Cell Width	Cell Height	Target Device
N	12.	15	30	2680A
N	26.	255	65	2680A

Figure 3-18. List of Logo Sizes Menu

If you choose the L (list logo sizes) option of the MODIFICATION menu, the LIST OF LOGO SIZES menu is displayed. Each time you press **ENTER**, the next size is presented. When all sizes for all target devices have been listed, the MODIFICATION menu returns. Then you can type in the size you want to work with. You

USING IDSCHAR

may also select the size by placing a Y in the Display this size? field on the LOGO SIZES menu when the size you want appears. Press **ENTER** and the DISPLAY AREA is presented.

NOTE

At any time in the menu path, you can press the CANCEL function key (**F8**) and be returned to the previous menu.

Logo Size

If you choose W on the MODIFICATION menu and enter an existing cell size or point size, this menu is displayed. You can change the baseline default.

IDSCHAR	Logo Size
<u>12.</u>	Point size
	Cell size
<u>30</u>	Height
<u>15</u>	Width
<u>1</u>	Baseline

Figure 3-19. Logo Size Menu

USING IDSCHAR

Adding a New Logo Size

If you entered a new point size or cell size in grid points on the MODIFICATION menu, the LOGO SIZE menu is displayed. If you specified a cell size in grid points on the MODIFICATION menu, the point size is calculated automatically by IDSCHAR and appears in the appropriate field on the LOGO SIZE menu. If you specified the point size on the MODIFICATION menu, the cell height is calculated, but you must enter the cell width. You can also change the baseline from the default (1).

At this point you can change the point size or cell height values that were calculated for you. However, once you press **ENTER** on this menu, the values cannot be changed.

After you type in the necessary information and press **ENTER**, the DISPLAY AREA appears on your terminal screen and you can begin your design work on a new logo. Refer to the "Using The Display Area Functions" in this section for additional information.

Using The Display Area Functions

After you have specified whether you are creating or modifying a cell file, and have defined the necessary parameters, the DISPLAY AREA appears.

The DISPLAY AREA is where you do the actual design of a character or logo cell. You can add or erase dots at any position in the cell, plus you can produce lines, arcs, and rectangles. In addition, if you use a digitizer, you can transfer an outline of a character or logo to the cell and fill the outline.

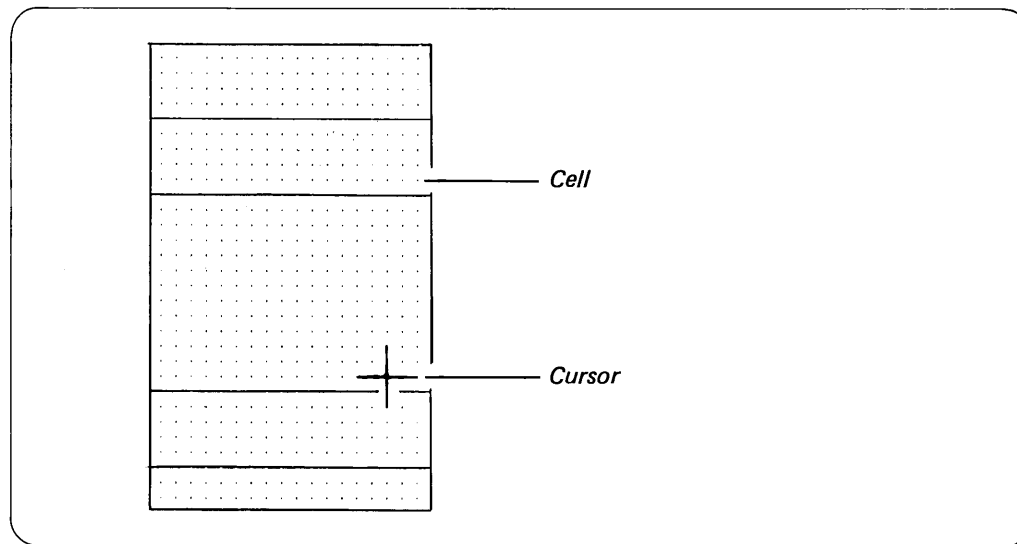

Figure 3-20. DISPLAY AREA Showing 10 Point Cell

The Cell

A cell is the area displayed on the terminal screen where a simulation of a single cell of a target device is presented.

IDSCHAR Design and Function Keys

Many keys are activated only when you reach the DISPLAY AREA of IDSCHAR. Figure 3-21 shows these keys and the menus or functions they produce.

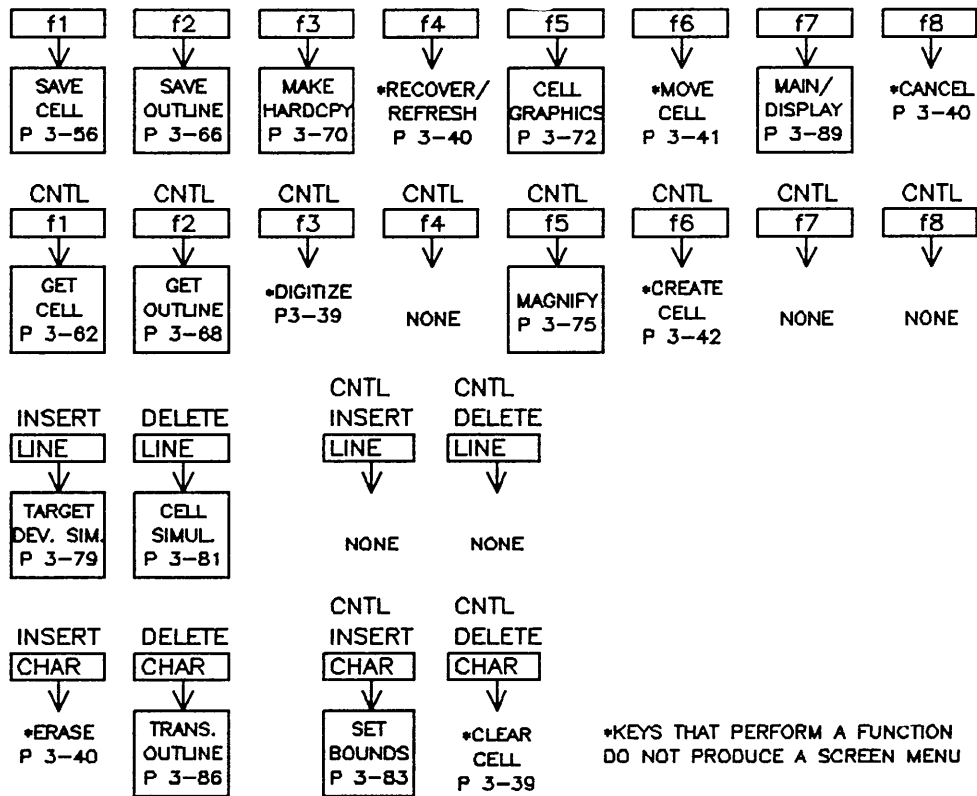
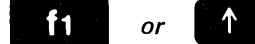

Figure 3-21. Display Area Design and Function Keys

To use a design function or display a menu, press the appropriate key or a combination of the **CONTROL** key with another key by holding down the **CONTROL** key then pressing the design or function key.



Hold down the CNTL key.

Then press the function or design key.

After you press the function or design key, release the **CONTROL** key. The menu is displayed or the design function takes place.

NOTE

Accidentally pressing the **ENTER** key while you are in the DISPLAY AREA will present a randomly selected menu. Press the CANCEL key (**ESC**) and you are returned to the DISPLAY AREA.

IDSCHAR Design Keyboard Layout

Figure 3-22 shows the position of the function and design keys you need to do design work.

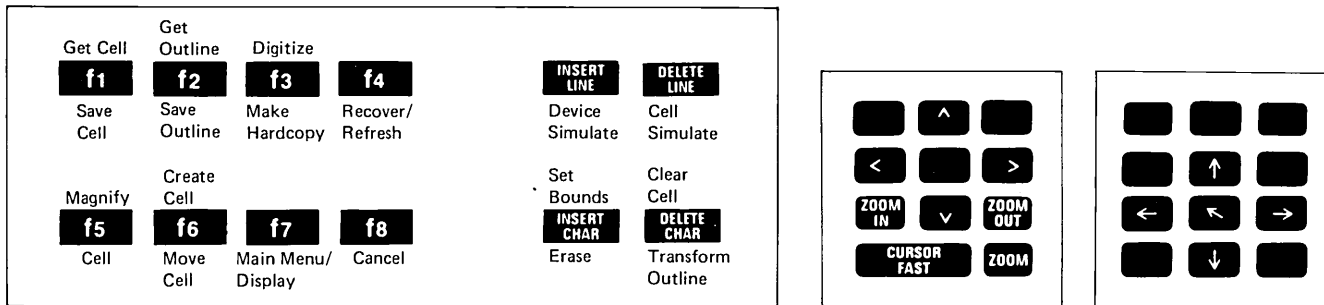

Figure 3-22. Keys Used in the Design Area

Keys that Perform a Function

CLEARING A CELL

CONTROL CLEAR CELL

The entire cell is erased and the empty cell is redrawn along with all current design aids, except the character outline (if using). However the outline still exists and can be turned back on.

USING THE HP DIGITIZER

CONTROL DIGITIZE (**CONTROL** )

Pressing this combination signals IDSCHAR that you want to use the HP Digitizer to design an outline. After you press this combination, the cursor disappears from the cell. By following the instructions for digitizing an outline in section 2 you can now have the outline you draw with the digitizer appear in your cell.

STOPPING A PROCESS

CONTROL Y

Hold down the **CONTROL** key and press the Y key when you want to stop IDSCHAR from redrawing the entire cell, filling a rectangle, filling an outline, plotting, or drawing grid points. For example, if you used the GET CELL menu to retrieve a logo, and you discovered while the logo is being drawn on your terminal screen that it is the wrong one, press Y^C. The process is stopped.

IDSCHAR tries to erase all grid points. However, some might remain. In that case, press the RECOVER/REFRESH key and the cell is redrawn. Y^C also stops Fill Outline and Fill Rectangle and plotting. For these functions the cell is cleared and what you had before you started is redrawn. For a GET CELL, the cell is cleared and an empty one is drawn.

USING IDSCHAR

ADDITIONAL KEYS

RECOVER/REFRESH ()

Pressing this key clears your terminal screen of everything except for what is in the cell, then re-displays the material in the cell in its proper form. Sometimes when you use the Y^C combination to stop a process, the cell is not completely cleared of grid points. The REFRESH key restores the cell to the correct format. Refer to appendix B for additional information concerning the RECOVER/REFRESH key.

MAIN MENU/DISPLAY ()

If you are in the DISPLAY AREA and press this key, the MAIN menu appears. If you are at the MAIN menu and press this key, the DISPLAY AREA appears. If you are at any other menu and press this key, the MAIN menu appears. If you went directly to the DISPLAY AREA from the MAIN menu and did not create a file, you must create a file before you can save anything you have designed in the DISPLAY. Refer to "IDSCHAR Design Keyboard Layout - Using the Main Menu/Display Key" in this section.

CANCEL ()

If you are at a menu accessed from the DISPLAY area, pressing this key quickly returns you to the DISPLAY AREA. (This is helpful if you accidentally go to the wrong menu.) If you are in a menu path, you are "backed-up" in IDSCHAR to the previous menu.

ERASE

By first pressing this key (the light above the key illuminates), and following the same steps as you would to draw a line, rectangle, or arc, the structure is erased.

MOVING THE CURRENT CELL IN THE DISPLAY AREA

MOVE CELL ( **6**)

To move a cell to a different position in the DISPLAY AREA, move the cursor so that it is positioned at the lower left corner of where you want to move the cell. Press the MOVE CELL key. The cell is erased and then redrawn in its new location. If you move a cell to an area where there is not enough room for the cell, the cell is drawn at a magnification that fits that area. If you move that cell to an area where there is enough space, then the cell is drawn at its original size.

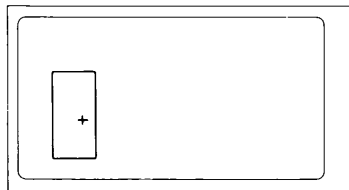

#1. Present position of cell

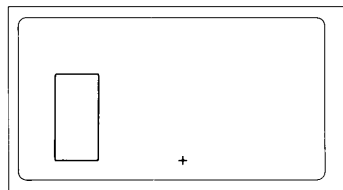

#2. Position the cursor to the bottom left corner
Press Move Cell

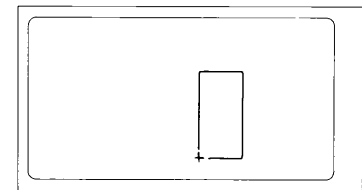

#3. New position of cell

Figure 3-23. Moving a Cell in the DISPLAY AREA

USING IDSCHAR

CREATING A NEW CELL ON THE DISPLAY

CONTROL CREATE CELL

You can create a new cell while leaving the old cell on the screen. However, once you create the new cell, you cannot work in the old cell. Using this feature, you could design a line of characters on your screen, or you could use it to compare different designs of the same character. Move the cursor to the lower left corner of where you want to create the new cell. Press **CONTROL** CREATE CELL. A new empty cell is drawn at the new location. To get rid of the old cell, press REFRESH (**F4**). The screen is redrawn and only the new cell remains.

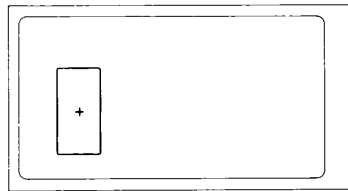

#1. Current position of cell

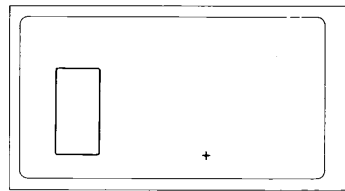

#2. Position the cursor to the bottom left corner
Press CNTL/Create Cell

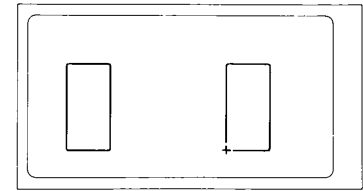

#3. New current cell is drawn

NOTE: Remember to save the old cell (if you want) before you create a cell.

Figure 3-24. Creating a Cell on the Display

Drawing and Cursor Control Keys

Certain keys are redefined by IDSCHAR to be used only when you design the character or logo in the cell. These keys are used for drawing a character or logo and moving the cursor to any position in the cell. Some keys can move you to any position outside the cell; however, you cannot perform a drawing function unless you are in the cell.

CURSOR CONTROL KEYS

These keys are the same as the DISPLAY GROUP described earlier in the guide. When you reach the DISPLAY AREA, IDSCHAR redefines them to be used for drawing functions. Along with the vertical and horizontal movement keys, other keys are defined for diagonal movement within the cell.

Each time you press a cursor control key, the cursor moves one grid point. If you hold the key down, the cursor moves in that direction until you release the key.

NOTE

You can also use the GRAPHICS CONTROL GROUP arrow keys to move the graphic's cursor.

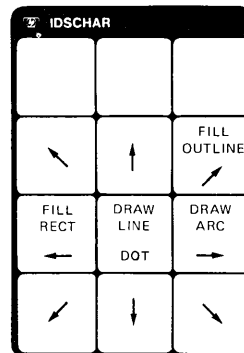

Figure 3-25. Cursor Control Keys

DRAWING AND ERASING A DOT

DRAW DOT KEY

After you have defined all the parameters for the cell and are ready to start drawing the character or logo, by using the cursor control keys, position the cursor in the cell where you want to begin working. Press the DRAW DOT key and IDSCHAR draws the dot at the position you indicated. Continue placing dots in the cell until you are satisfied with your results. To erase one dot, position the cursor over the dot and press DRAW DOT. That dot is erased.

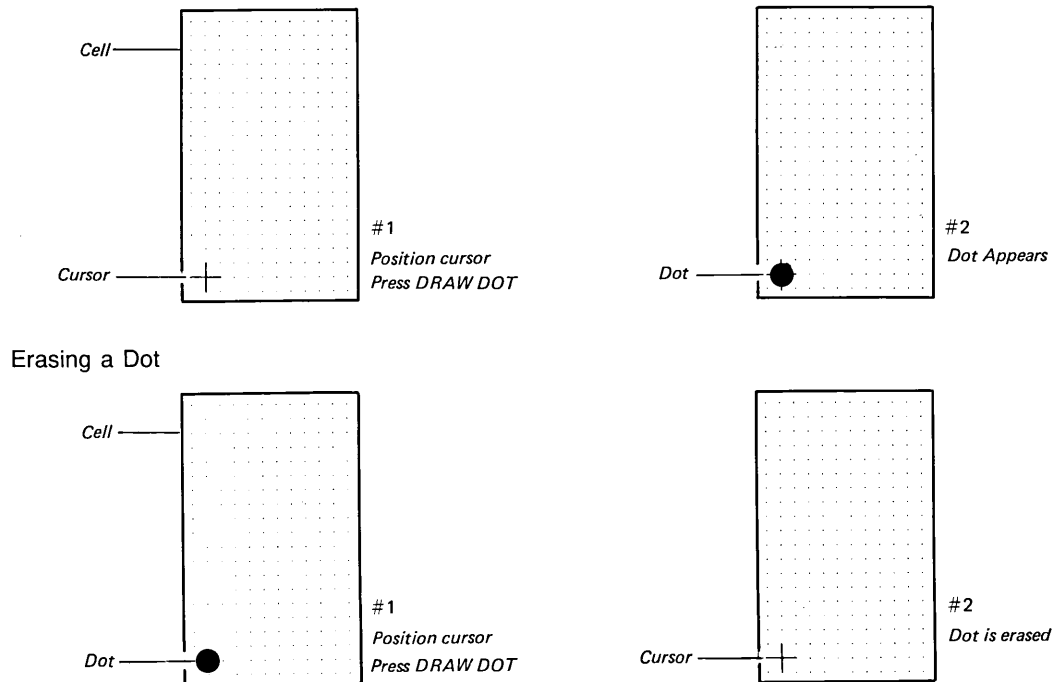

Figure 3-26. Drawing and Erasing a Dot

DRAWING A LINE

CONTROL DRAW LINE

Instead of drawing a continuous line of dots using the DRAW DOT key, you can draw one dot then move the cursor to the end of the line. Hold down the **CONTROL** key and press the DRAW LINE key. IDSCHAR then draws all the dots to make as straight a line as possible between the two points.

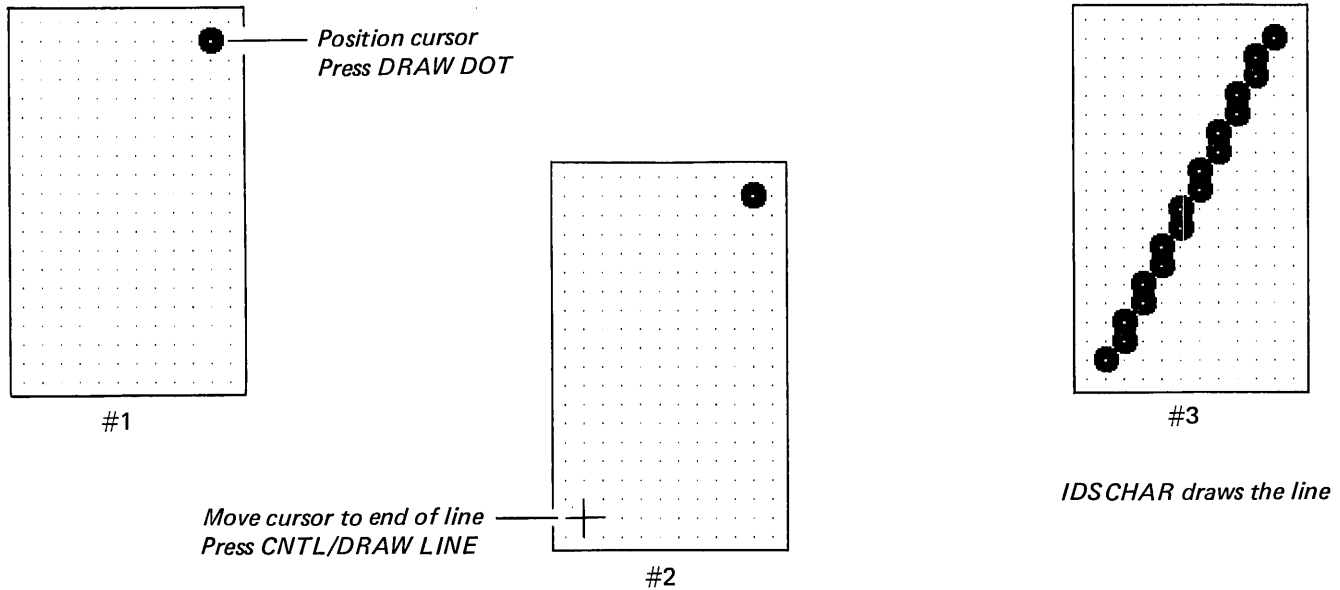

Figure 3-27. Drawing a Line

USING IDSCHAR

ERASING A LINE

ERASE

Erasing a line involves the use of the ERASE key and the **CONTROL** DRAW LINE combination. To erase a line, press the ERASE key. The red light above the ERASE key illuminates, letting you know you are in the erase mode. Next, position the cursor at the beginning of the line and press DRAW DOT. That dot is erased and the beginning of the line is marked. Position the cursor at the end of the line you want to erase and press **CONTROL** DRAW LINE. The line is erased and the ERASE key light is turned off.

NOTE

The erase line function relies on two dots. Once you press the ERASE key, followed by the **CONTROL** DRAW LINE key, IDSCHAR erases from where you are to the previous dot that was drawn. If you are at the last position of a line you've just drawn and you want to erase it, press the ERASE key and then the **CONTROL** DRAW LINE key. The line is erased.

If you press the ERASE key, then change your mind, press the key again. The light goes off and you are out of the erase mode.

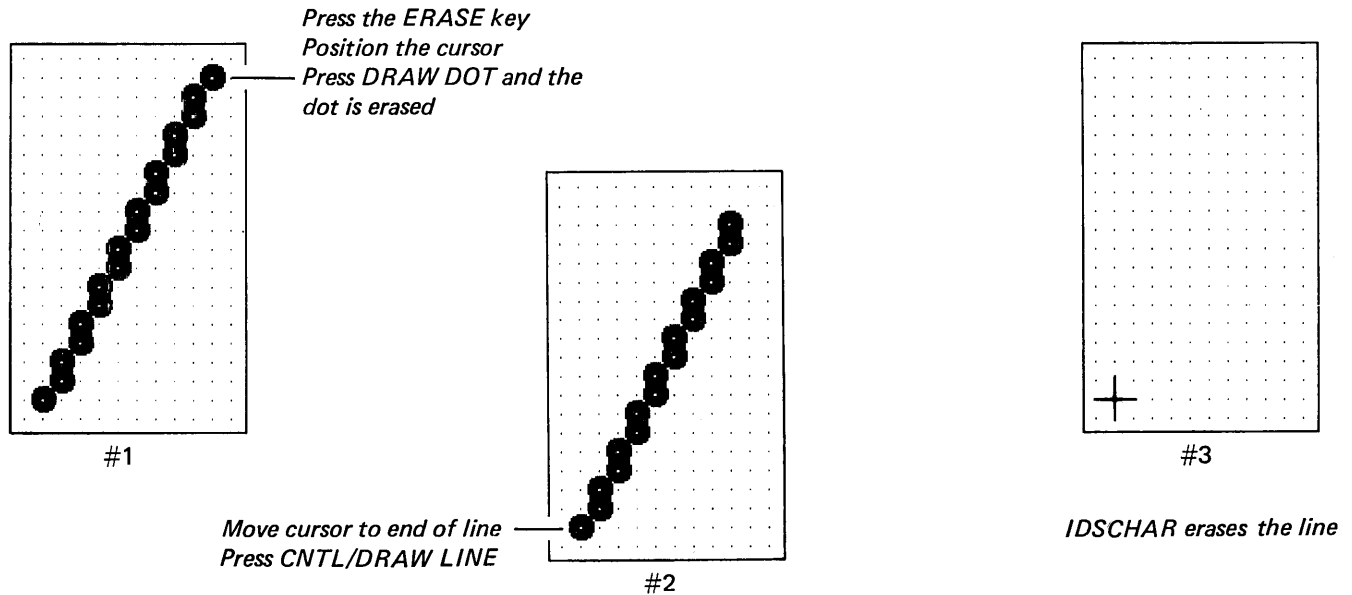

Figure 3-28. Erasing a Line

DRAWING AN ARC

CONTROL DRAW ARC

The DRAW ARC function works by taking three dots that you specify and drawing an arc through those points. IDSCHAR computes the circle that passes through all three points and draws the appropriate arc. Draw Arc works on the LAST three positions that you specified. For example: If you want to draw an arc, position two dots in the cell. Move to the third position and hold down the **CONTROL** key then press the DRAW ARC key. An arc connects the three points.

NOTE

Experimenting with the DRAW ARC feature before you begin designing will improve your skill. Placing the dots at equal distances from each other will produce a more uniform arc.

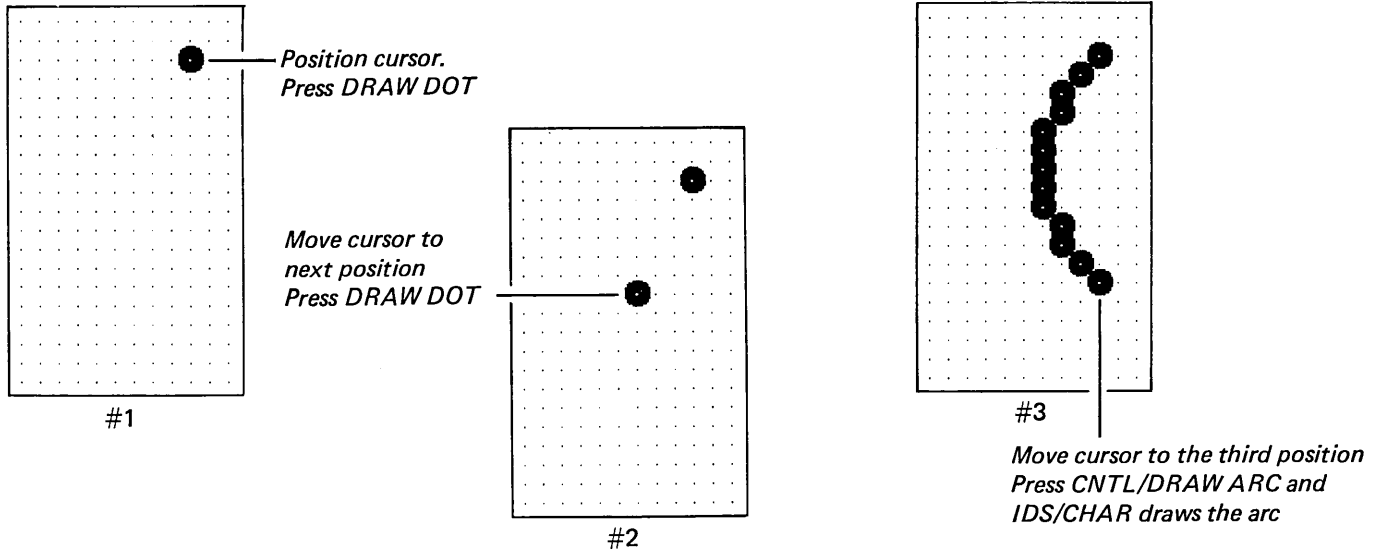

Figure 3-29. Drawing an Arc

ERASING AN ARC

ERASE

Drawing an arc depends a lot on your skill. If you make a mistake or do not like the arc you have drawn, you can erase it.

Press the ERASE key. The red light above the key illuminates, indicating you are in the erase mode. Position the cursor at the beginning of the arc you have drawn and press DRAW DOT. That dot is erased and the beginning of the arc marked. Move to the middle position and press DRAW DOT. That dot is erased and the middle position of the arc is marked. Move to the last position of the arc and press **CONTROL** DRAW ARC. The arc is erased and the ERASE key light is turned off.

NOTE

If you have just drawn an arc and do not like it, you only have to turn on the ERASE key and press **CONTROL** DRAW ARC. The arc is erased.

The erase function works by using the LAST three points of the arc you have drawn, so that you can turn the erase function on at any time while you are specifying the three dots.

To insure that you erase the entire arc, the middle dot should be the same dot used to create the arc. If all the dots are not erased they can be removed by the ERASE DOT method.

USING IDSCHAR

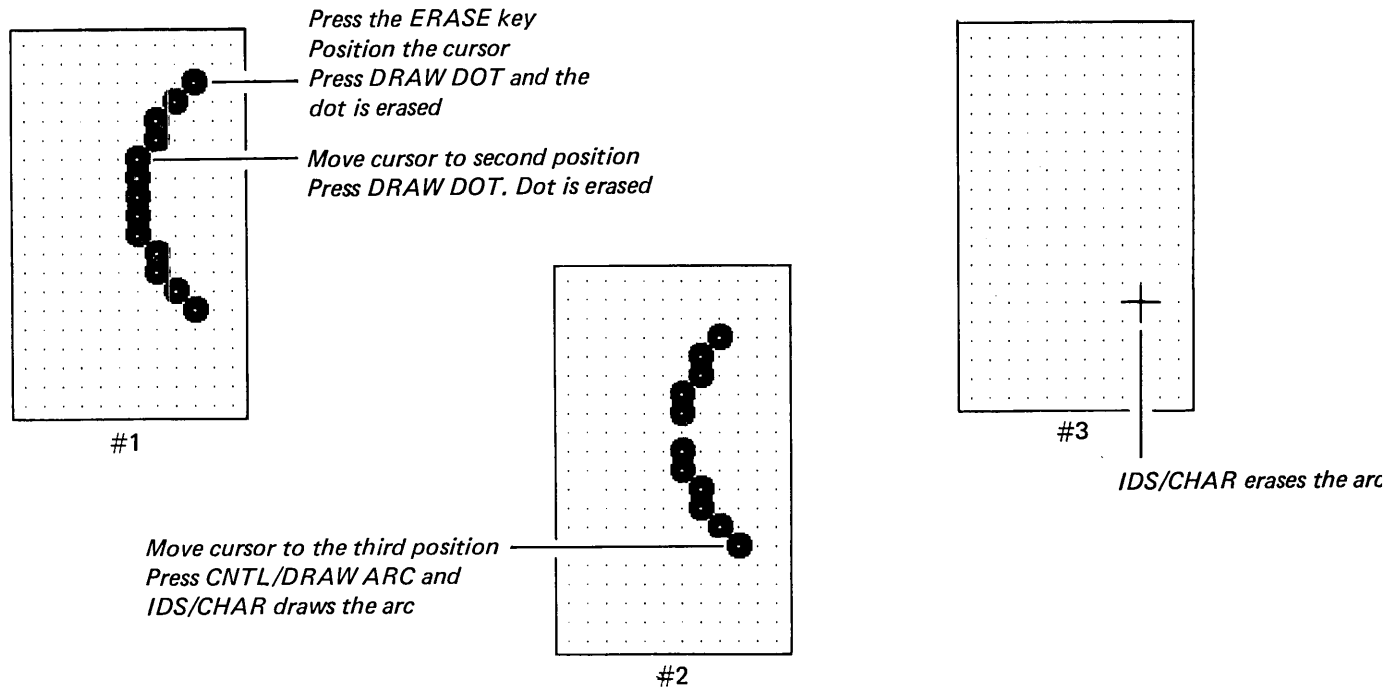

Figure 3-30. Erasing an Arc

DRAWING A CIRCLE

CONTROL DRAW ARC

To draw a complete circle, you use the DRAW ARC key. Specify a point of the circle in the cell and press DRAW DOT. Next, specify a point directly below the first dot on the opposite side of the circle and press DRAW DOT. Then position your cursor directly to the right of the dot you first drew and press **CONTROL** DRAW ARC. Your circle is drawn.

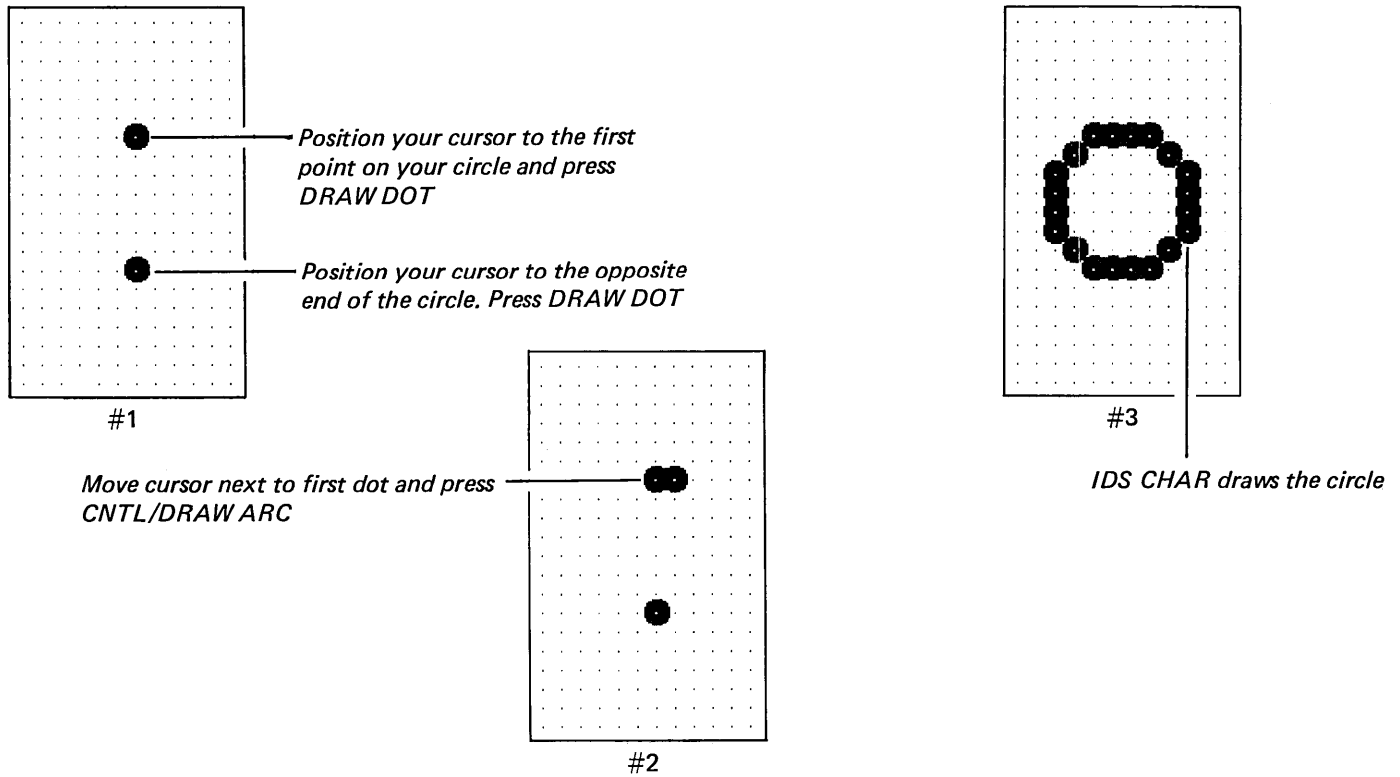

Figure 3-31. Drawing a Circle

USING IDSCHAR

FILLING A RECTANGLE

(CONTROL) FILL RECTANGLE

To save time, you can fill in a rectangle without having to draw each dot by using this key combination. Move the cursor to one corner of the rectangle and press DRAW DOT. Position the cursor at what is the diagonally opposite corner and press **(CONTROL)** FILL RECTANGLE. IDSCHAR completely fills in the rectangle with dots.

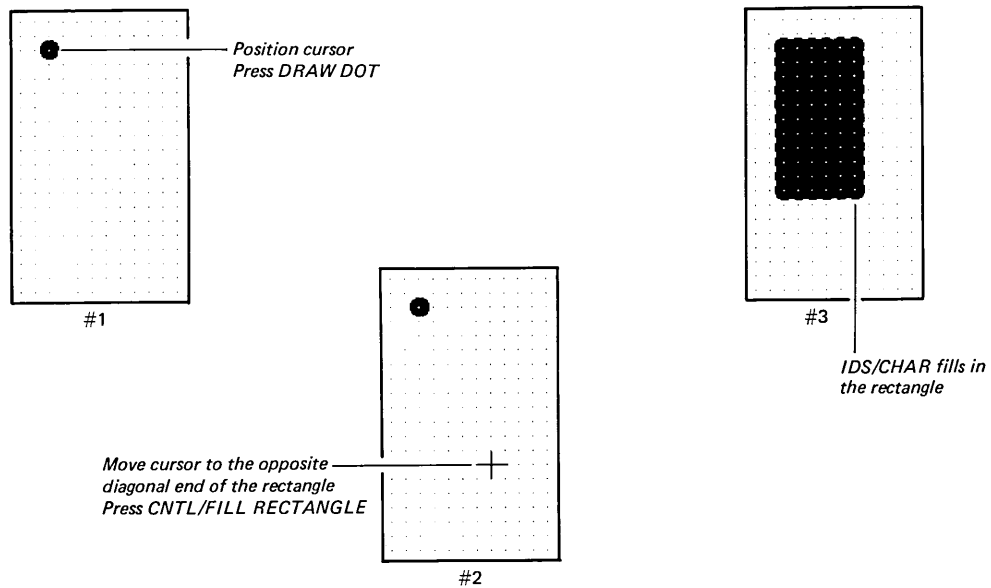

Figure 3-32. Filling a Rectangle

ERASING A FILLED RECTANGLE

ERASE

Erasing a rectangle works basically the same as filling one. Press the ERASE key. The red light above the erase key illuminates, indicating you are in the erase mode. Position the cursor at one corner of the rectangle you want to erase. Press DRAW DOT. That dot is erased. Move the cursor to the diagonally opposite corner and press **CONTROL** FILL RECTANGLE and the rectangle is erased. The ERASE key light is turned off.

NOTE

If you just filled a rectangle and are in the last position, you can erase the rectangle. Turn on the ERASE key, then press **CONTROL** FILL RECTANGLE. The rectangle you drew is erased

USING IDSCHAR

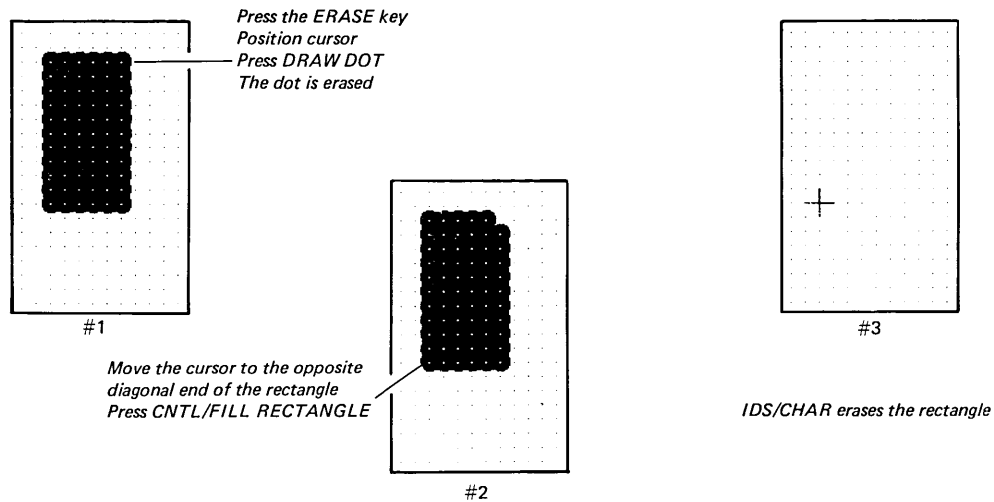

Figure 3-33. Erasing a Filled Rectangle

FILLING AN OUTLINE

CONTROL FILL OUTLINE

After you have drawn an outline by using the digitizer, press this combination and the outline in the cell on the DISPLAY AREA is filled with dots. You can then do the detail work, if necessary, to finish the character or logo. To turn the outline on and off, type CO.

To erase all the dots in a filled outline, press **CONTROL** CLEAR CELL.

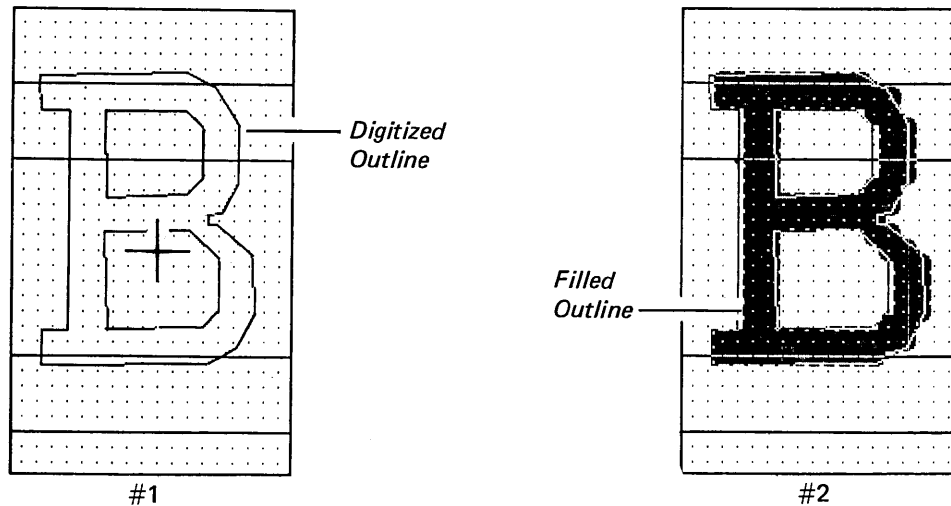

Press CNTL/FILL OUTLINE

IDS/CHAR fills the outline

Figure 3-34. Filling an Outline

Display Area Menus

All the menus available to you from the DISPLAY AREA are presented on the following pages. You choose the menu you want by pressing the appropriate function key or a combination of the **CONTROL** key and function keys.

USING IDSCHAR

Saving a Cell

SAVE CELL (F1)

When you press this key, the SAVE CELL menu appears.

IDSCHAR	Save Cell
Character	
- OR -	
Character code number	
1 Version number	
Ranking (1 is best, 999 is worst)	
0 Orientation (0, 90, 180 or 270 degrees)	
§ Destination	
H - Temporary hold	
S - Stored in file	
Cell file	
12. _____ Point size	
- OR -	
Cell size	
_____ Height	
_____ Width	

Figure 3-35. Save Cell Menu

The SAVE CELL menu has two options: save the character or logo in a cell file, or put the character or logo in a hold cell. When you have finished designing a character or logo, or if you quit in the middle, the cell must be saved in a cell file or all your work on that cell is lost.

Saving a Character

Type in the character representation for which you wish to save your cell (or enter the ASCII Character Code Number from appendix C). You can also enter the version number, ranking, and orientation of the character if you desire.

Saving a Logo

You only have to press **ENTER** since "character" is meaningless for logo files. A logo is the one and only "character" in that file and will be saved under "L". You can also enter the version number, ranking and orientation of the logo. Logos are saved according to size.

NOTE

Normally, the cell will be saved in the current cell file, but you can save the cell in a cell file other than the current one by specifying another file name in the SAVE CELL menu. If another file is specified, you should make sure that the device you are working with is also in the specified file, otherwise, the cell will not be saved. A warning message will be displayed at the top of the menu to advise you.

The menu will display the point size or cell size in grid points, and the default values for version number, ranking, and orientation. You may change the default values as necessary.

Version Number

To save more than one version of a character or logo, you must enter a version number. Each version number you enter must be a unique number. If you do not specify a new version number, IDSCHAR saves the cell in version 1. If the cell version specified in the menu already exists, a message appears before this happens and you can cancel the save if you want. Otherwise the predefined version is deleted before the new one is saved.

USING IDSCHAR

Ranking

If you have a number of versions you want to save, you can rank them according to which ones you like best. 1=the best version; 999=the least favorite. When the character is used for printing by the target device, the best ranked version is selected.

NOTE

When reviewing a character the default version (1) will be displayed unless you select another version. The best ranked version might be version 2 but unless you specifically request version 2 you will see version 1 on the terminal screen.

Orientation

A character or logo can be printed using four orientations (0, 90, 180, or 270 degrees) on a target device. If a character font or logo has not been designed for the orientation you desire, IFS/3000 tries to use the opposite (0 and 180 are opposites; 90 and 270 are opposites) orientation. As a last resort, IFS/3000 uses the 0 orientation.

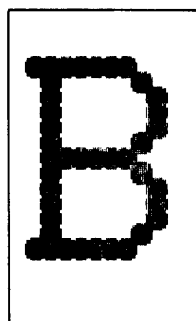

0 Degrees

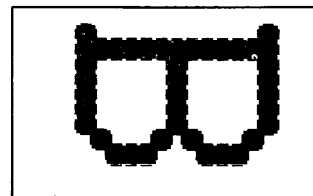

90 Degrees

Figure 3-36. Two Orientations of the Letter B

USING IDSCHAR

Some target devices might have dots that are longer than wide (or vice versa) or grids that are not square. For those devices you should design a character for each orientation that you want to use. (Or at least 0 and 90.)

Figure 3-37 shows a character that has been designed for one orientation - 0 degrees. The grid is 5.5 high by 3.5 wide (A). Therefore, if you specify an orientation of 90 degrees for the target device, and have not designed a character for that orientation, the character will appear distorted (B). C shows the character as printed on a target device which uses a perfect circle for a dot and a square grid.

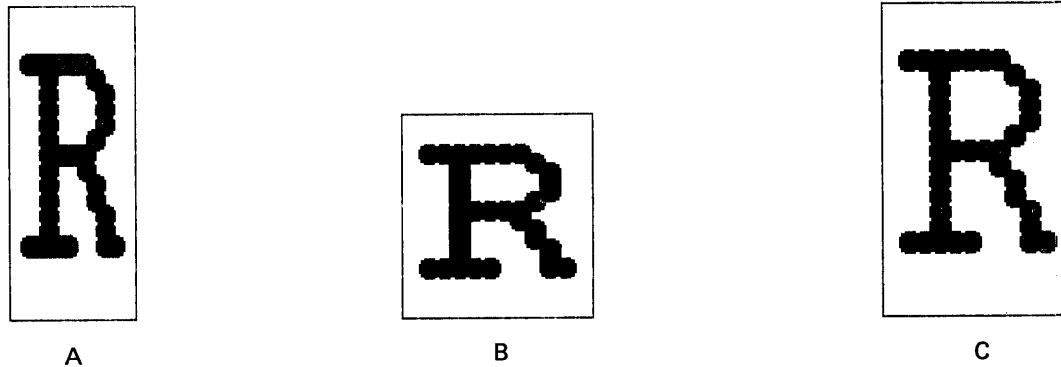

Figure 3-37. Orientation Distortion

To design a cell so that it is not distorted for different orientations, you first display the CELL SIMULATION menu. Type in the orientation (90, 180, 270) for the cell you want to design (0 is default). Press **ENTER** and the cell will be drawn to the correct dimensions for that orientation and displayed on the DISPLAY AREA. You can then begin drawing or getting an outline (if one exists) to design that orientation. When you are satisfied with the design, save the cell using that orientation.

Figure 3-38 shows a letter designed and saved at 0 and 90 degrees orientation for a printing device that has 10 by 8 millimeter dots.

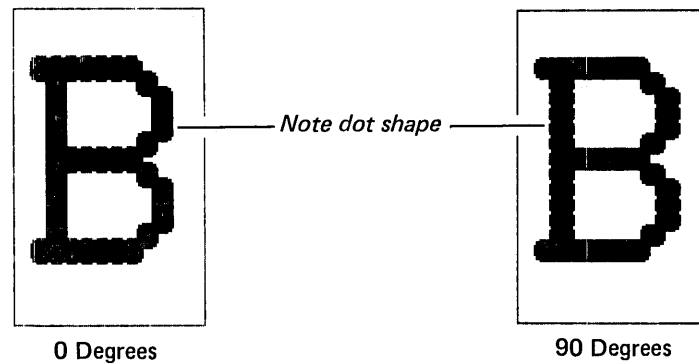

Figure 3-38. Characters Designed at 0 and 90 Degrees

Getting a Cell

CONTROL GET CELL (**CONTROL** **F1**)

This combination displays the GET CELL menu.

IDSCHAR	Get Cell
<input type="checkbox"/>	Character
	- OR -
<input type="checkbox"/>	Character code number
<input checked="" type="checkbox"/>	Version number <u> </u>
	Ranking <u> </u>
<input checked="" type="checkbox"/>	Orientation (0, 90, 180 or 270 degrees)
<input type="checkbox"/>	Source
	H - Temporary hold
	S - Stored in file
Cell file	
CHMYCELL	
<input type="checkbox"/>	Point size
	- OR -
	Cell size
<input checked="" type="checkbox"/>	Height
<input checked="" type="checkbox"/>	Width

Figure 3-39. Get Cell Menu

To retrieve characters that were saved in a cell file, press **CONTROL** GET CELL. When the GET CELL menu appears, type in the character or character code number and press **ENTER**.

If more than one version exists for the device, you also have to enter the version number. This also applies to the orientation (if necessary), otherwise the defaults (version 1, orientation 0) will be displayed. After you press **ENTER**, information about that character, including ranking, is displayed on the GET CELL menu. If it is the character you want, press **ENTER** again. The character appears on the DISPLAY.

To retrieve logos that were saved press **CONTROL** GET CELL. When the GET CELL menu appears press **ENTER**. If more than one version exists, you also have to enter the version number. Ranking and version information for that logo is displayed. If it is the logo you want, press **ENTER** again and that logo appears in the DISPLAY.

Normally, you indicate what character you want to work with and press **ENTER**. As with the SAVE CELL, it is possible to get a character font or logo size from another file. Type in the character (or character code), the file name, and the point size or cell size in grid points. Press **ENTER**. Make sure that the device for the cell you are getting is in the file you are working in, otherwise IDSCHAR will display a warning message at the top of the menu.

NOTE

If you retrieve a logo or character and discover while it is being drawn that it is the wrong one, press Y^C. IDSCHAR stops drawing the cell and clears it.

**Placing a Character or Logo
in the Temporary Hold Area**

The temporary hold area is a special off-screen place to keep a cell while the space it was occupying in the DISPLAY is used for another cell.

Any changes you make to the cell remaining on the DISPLAY does not affect what you have in the hold cell. You can even save that version if you want, plus the one in the holding area.

If you went directly to the DISPLAY AREA from the MAIN menu and did not create a file, you must create a file before you can save anything you have designed in the DISPLAY. Before you create the new file, you should save the cell in the temporary hold area. This prevents the accidental loss of your character or logo while you are creating a file. Refer to "IDSCHAR Design Keyboard Layout - Using the Main Menu/Display Key" in this section.

USING IDSCHAR

NOTE

Each time you put a character or logo in the hold area, whatever was there previously is deleted. Only ONE character or logo can be in the holding area at any one time.

Placing a Character or Logo in the Holding Area:

Press SAVE CELL. When the SAVE CELL menu is displayed, type H (for hold) in the Destination field. Press **ENTER**. The character or logo is placed in the hold area and the DISPLAY returns.

NOTE

Once you EXIT from IDSCHAR, whatever is in the temporary hold area is lost unless you save it.

Retrieving a Character or Logo from the Temporary Hold Area

To retrieve a character or logo placed in the HOLD area you use the GET CELL menu. When the menu appears, type H (for hold) in the Source field and press **ENTER**. The character or logo appears in the DISPLAY AREA.

NOTE

Remember that to keep the cell that was in the hold cell, you must first go to the GET CELL menu to retrieve the cell from the hold area. Next go to the SAVE CELL menu and use the save option. Otherwise, if you exit IDSCHAR, all your work on that character or logo in the temporary hold area is lost.

Saving an Outline

SAVE OUTLINE (F2)

When you press this key, the SAVE OUTLINE menu appears.

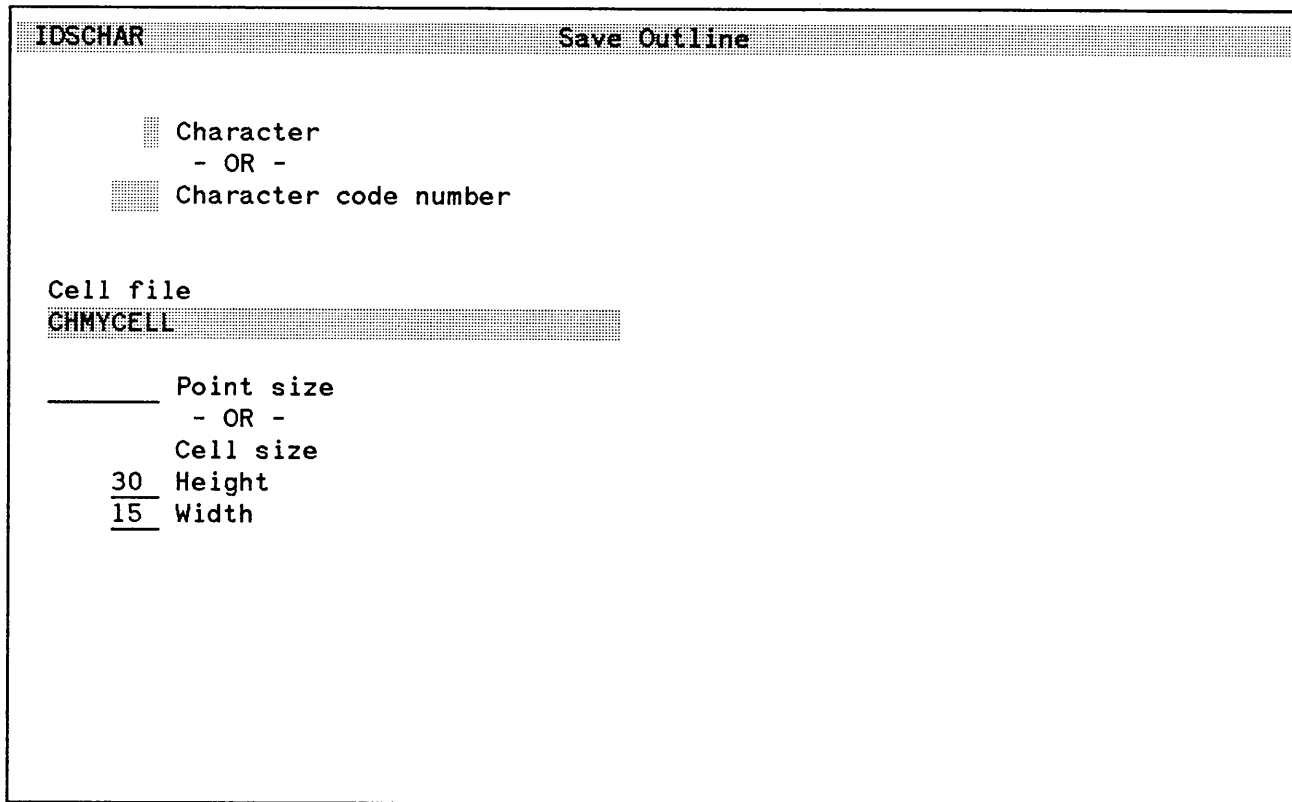

Figure 3-40. Save Outline Menu

Saving a Character Outline

Once you have drawn an outline of a character using the digitizer, you can save the outline with the SAVE OUTLINE menu. When the menu appears, type in the character (or character code number) of the outline. Press **ENTER** and the outline is saved for future use.

Saving a Logo Outline

When the SAVE OUTLINE menu appears, press **ENTER**. The logo outline is saved.

NOTE

Saved outlines don't have version numbers or rankings. Only one outline is associated with each character or logo for a particular use. Outlines can be transformed by using the TRANSFORM OUTLINE menu (see figure 3-51).

You can save the outline in any file by specifying the character (or character code) and the file name (as long as the file name you select already exists) Be sure the target device you are working with is in the file you specify, or your outline will not be saved.

Getting an Outline

CONTROL GET OUTLINE (**CONTROL** **F2**)

This combination causes the GET OUTLINE menu to be displayed.

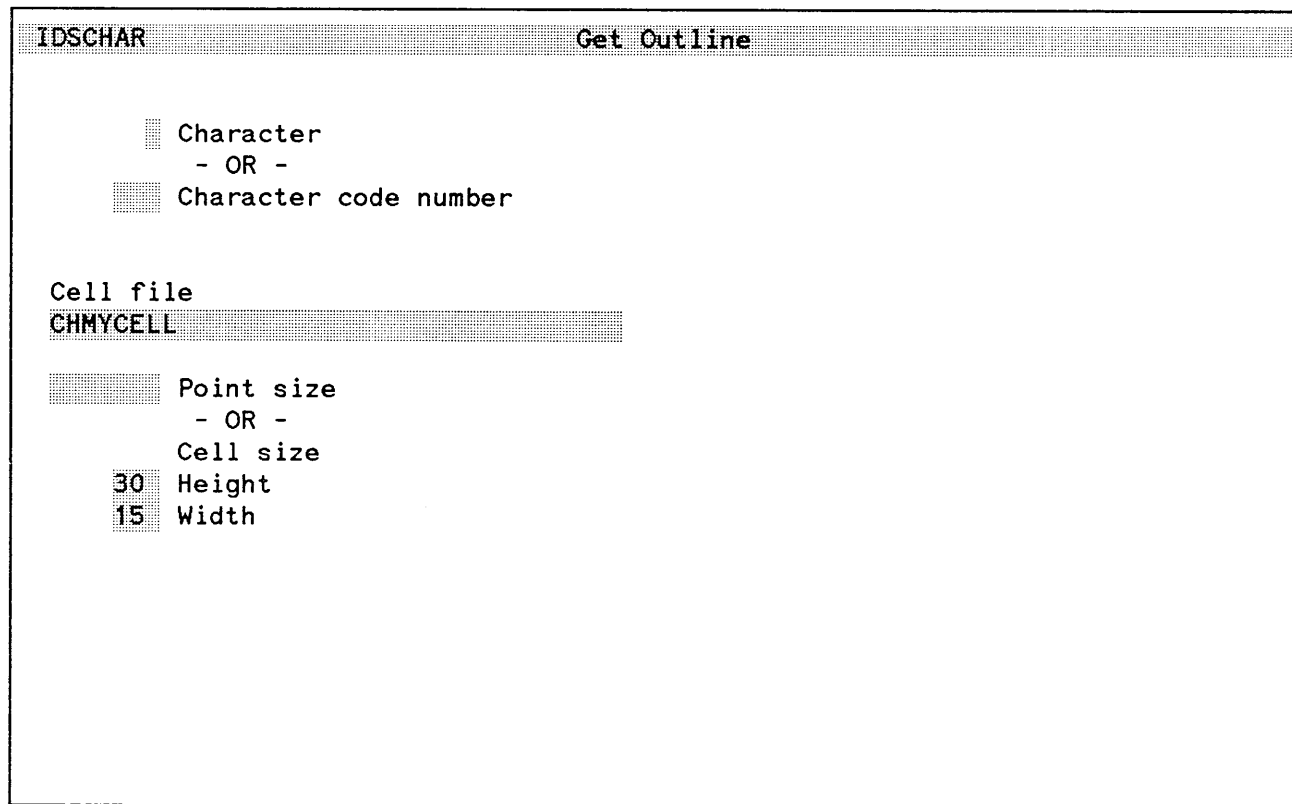

Figure 3-41. Get Outline Menu

Retrieving a Character Outline

To retrieve a character outline, press **CONTROL** GET OUTLINE. When the GET OUTLINE menu appears, type in the character (or character code number). Press **ENTER** and the outline is drawn in the cell on the DISPLAY AREA.

Retrieving a Logo Outline

To retrieve a logo, when the GET OUTLINE menu appears, press **ENTER**. The outline for that logo appears on the DISPLAY.

If the character or logo outline you want is in a different file, you need to enter that file name and the point or cell size. Be sure the target device you are working with is in the specified file.

NOTE

The outline can be moved or expanded by using the TRANSFORM OUTLINE menu.

Making a Hardcopy

MAKE HARDCOPY ()

Pressing this key displays the MAKE HARDCOPY menu.

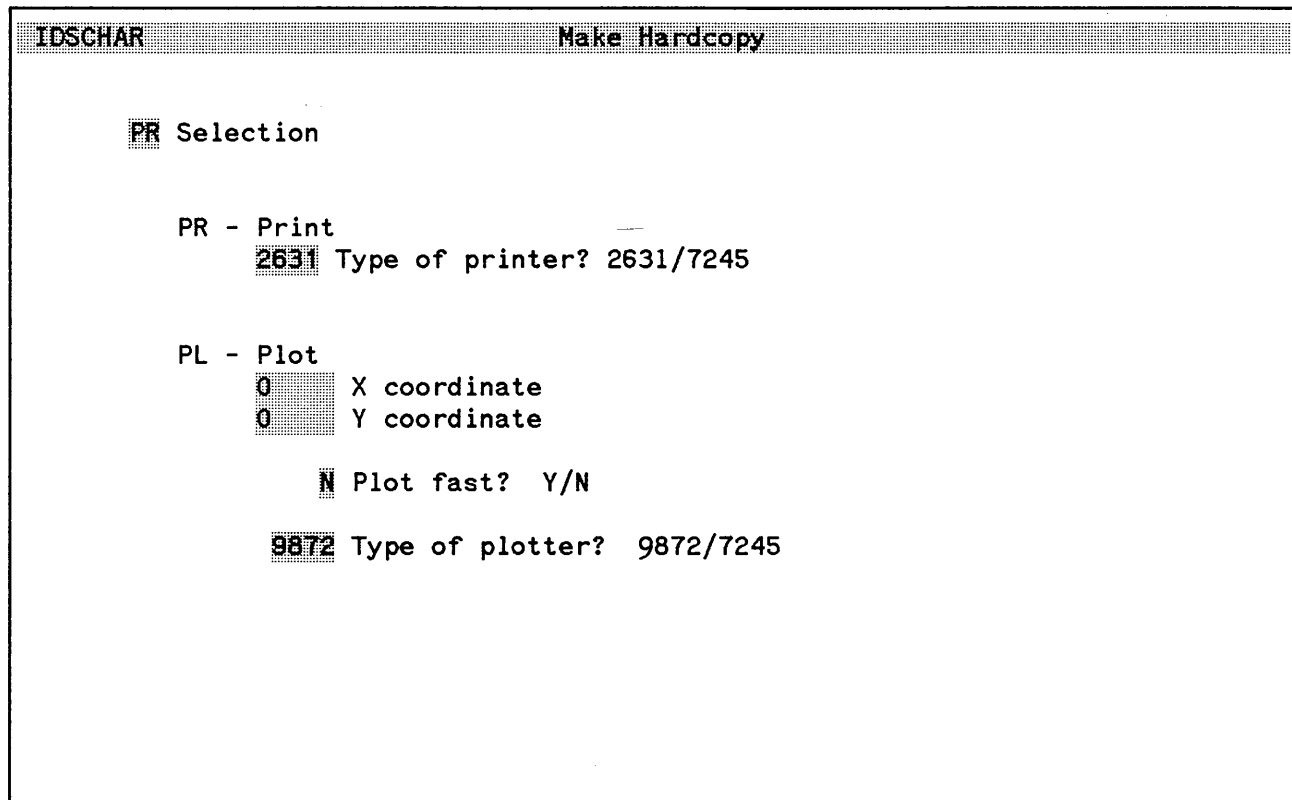

Figure 3-42. Make Hardcopy Menu

The **MAKE HARDCOPY** menu gives you the choice of making a copy of the character or logo on an attached printer or plotter. The printer reproduces exactly what is on the terminal screen (except that the color scheme is reversed by the printer), including magnified dots, grid points, grid lines, and character outlines.

The plotter simulates the target device. Thus, the character or logo that is plotted will be close to the actual size that would appear on the target device.

If you have a printer attached, select **PR**, the printer name, and press **ENTER**. Whatever is in the cell on the **DISPLAY** is printed. If you use a plotter, select **PL**, the plotter name, and enter the coordinates where you want the character or logo to be printed on the device.

For a plotter, you can also choose whether you want **Full** or **Fast** plotting. **Full** plotting draws every dot that makes up the character. **Fast** plotting uses only the first and last dot in a straight line and draws a line between the dots.

Refer to the appropriate device reference guide for instructions on the operation of the printer or plotter.

NOTE

The attached printing/plotting device is **NOT** the same as the target device.

You might be using an **HP 7245A Printer/Plotter**. This device is both a printer and a plotter; however, you use the **MAKE HARDCOPY** menu to select which feature of the **HP 7245A** you want to use.

Using the Cell Graphics Function

CELL GRAPHICS (F5)

Pressing this key causes the CELL GRAPHICS menu to be displayed.

IDSCHAR	Cell Graphics
Indicate with an X which design aids should be displayed.	
<input type="checkbox"/>	Grid lines (LI)
<input type="checkbox"/>	Character or logo outline (CO)
<input type="checkbox"/>	Proportional spacing bounds display (PB)
<input checked="" type="checkbox"/>	Cell border display (CB)
Select one from each of the following two groups:	
<input type="checkbox"/>	All grid points (GR)
<input type="checkbox"/>	Only points which have dots printed over them (PG)
<input checked="" type="checkbox"/>	No grid points (GR)
<input checked="" type="checkbox"/>	Black dots on a white background (IN)
<input type="checkbox"/>	White dots on a black background (IN)
(Corresponding two-letter commands are in parenthesis.)	

Figure 3-43. Cell Graphics Menu

Before you begin working in the DISPLAY AREA and using the design keys, you might want to use certain graphics tools available to you. Make your selection on the CELL GRAPHICS menu by placing an X in the field for each tool you want (in some sections you can choose only one option).

The following choices can be made:

DISPLAY GRID

By placing an X in one of the fields in this category, you can have all grid points displayed, only those displayed which have dots printed on them, or no grid points.

CELL LINES

You can choose any or all of these design aids to be turned on or off as desired.

Grid Lines - all designated grid lines are turned on or off (baseline, top of uppercase, bottom of descenders, top of To change, see Cell Simulation.

Character or logo outline - displays or turns off the character outline that is current.

Proportional spacing - displays or turns off the vertical and horizontal lines which indicate which bounds will be used for a proportionally spaced character. After proportional spacing bounds are displayed, as soon as you do something that will potentially change their value (i.e., drawing a dot), they are turned off. To change, see Set Bounds.

Cell border display - turns the thin line bordering a cell on all four sides on or off.

COLOR SCHEME

You can choose either black dots on a white background (the default) or white dots on a black background.

NOTE

At any time you want you can turn any of the design aids on or off. If you do make a change, each time you return to the DISPLAY, the cell is updated with the design aids you requested.

USING IDSCHAR

Two-Letter Commands

The design aids available on the CELL GRAPHICS menu can also be turned on and off with two letter commands. After you have become familiar with the CELL GRAPHICS menu, you can use the commands to activate these features. The two letter commands let you make changes to the design aids directly from the DISPLAY AREA without having to go to the CELL GRAPHICS menu.

While you are at the DISPLAY, all you have to do is type in the two letter command for the function you want to use. This feature is then turned on or off. The two letter command is not displayed on the terminal screen. If you type in a wrong command, press **RETURN** then type in the correct command.

The following is a list of the available two-letter commands:

GR - Shows the grid points, unless they are already displayed. If grid points are already displayed, then this command removes them. If a different grid point display option is currently in effect (i.e., printed points are drawn), typing this command causes all grid points to be shown.

PG - Shows only the grid points where dots are drawn. If printed grid points are already displayed, then this command removes them. If a different grid point option is currently in effect (i.e., grid points are shown), typing this command causes grid points to be shown only where dots are printed.

LI - Shows the grid lines if they are not already displayed. If they are already displayed, it removes them.

IN - Changes the cell's current color scheme to the opposite of what is currently being displayed.

CB - Turns the cell border on or off.

CO - Turns the character outline display on or off (if an outline exists).

PB - Turns the proportional spacing bounds display option on or off. This also shows you any bounds calculated automatically by IDSCHAR.

Using the Cell Magnification Function

CONTROL MAGNIFICATION (**CONTROL** **5**)

The MAGNIFICATION menu is displayed when you press this combination.

```

IDSCHAR                               Magnification
-----
New magnification

35.0000 Horizontal magnification
35.0000 Vertical magnification

5.555556 Apparent grid width
5.555556 Apparent grid height

7.936509 Apparent dot width
7.936509 Apparent dot height

mils Unit of measurement
      mils ( 1 mil = .001 inch )
      mm  ( 10 millimeters = 1 centimeter )
  
```

Figure 3-44. Magnification Menu

USING IDSCHAR

The **MAGNIFICATION** menu lets you change the magnification of the cell in the **DISPLAY AREA** and obtain information about the simulation accuracy at the current magnification. If the current magnification is 30, the cell size will be 30 times the size the character or logo will be printed on the target device. Available magnifications are limited by the resolution of the terminal.

To increase or reduce magnification, type the magnification number in the New Magnification field, then press **ENTER**. **IDSCHAR** then computes the closest available magnification in both the horizontal and vertical directions and displays those values. Information about the target device dimensions that are actually being simulated at that magnification is also computed and displayed.

These values include the apparent grid width and height, and the apparent dot width and height that the character or logo on the **DISPLAY** is using at that magnification. You can check these values against the apparent values at different magnifications for any distortion. The unit of measurement used is also given.

If the values are acceptable to you, press **ENTER** again and the cell, at that magnification, appears in the **DISPLAY AREA**.

NOTE

When you originally create the cell, the cell appears in the **DISPLAY** at the maximum magnification. If for some reason you have changed the magnification to something less than the maximum value and you want to redisplay the cell at its maximum magnification, select a very large magnification (2000, 3000) for the cell. **IDSCHAR** will compute the largest available magnification.

You can also use the **ZOOM** feature (see "Using the **ZOOM** Feature of the HP Graphics Terminal") to enlarge a cell. However, the magnification feature improves the target device simulation.

Uses for the Magnification Feature

When a cell is first created, it is at its largest magnification. The larger the dots in a cell, the longer **IDSCHAR** takes to draw a letter or logo, If you reduce the cell by using the **MAGNIFICATION** feature, the speed with which the cell is drawn is increased. This is especially helpful for large point sizes that use many dots. You can reduce the cell to a magnification that you find easiest to work with.

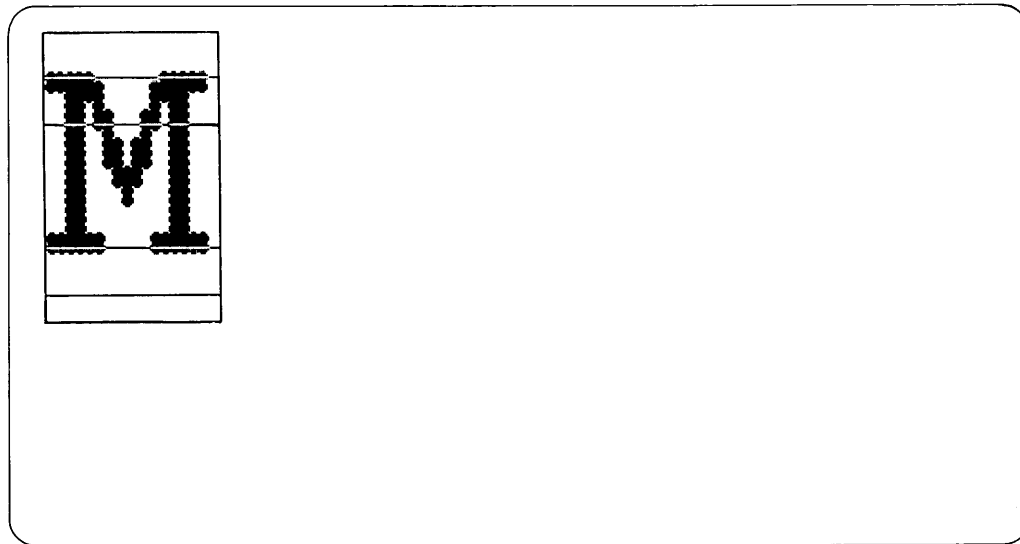

Figure 3-45. Terminal Screen with Cell

USING IDSCHAR

Creating Lines of Characters on the Terminal Screen

By using a combination of the magnification, move cell, and create cell features, you can design a line of characters on your terminal screen.

First, design and save all your characters at the maximum magnification. Then reduce the cell to a workable magnification. CLEAR CELL and MOVE the cell to the upper left corner. Next, do a GET CELL for your character. If you want to set proportional spacing bounds, set them.

Create a new cell next to the cell you have just retrieved. You can now do a GET CELL for another character. The BASELINES of the two cells, depending on your creating skill, should be approximately in line with each other.

This way you can see how the characters will look together when printed by the target device. Continue this process until you are finished or you run out of space.

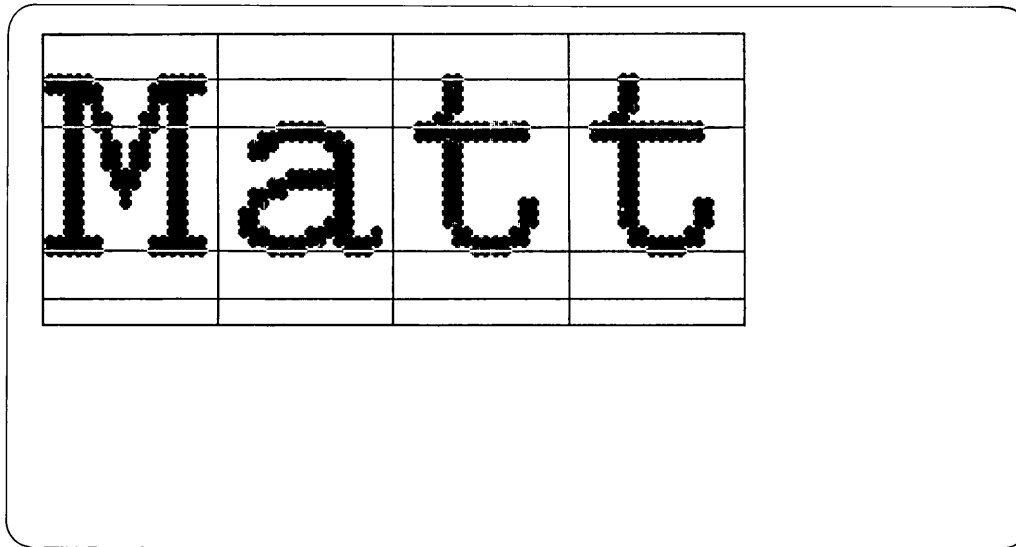

Figure 3-46. Characters Designed in a Line

Using the Simulating a Device Function

DEVICE SIMULATION

Pressing this key displays the TARGET DEVICE SIMULATION menu.

IDSCHAR	Target Device Simulation
<input type="checkbox"/>	Dot width
<input type="checkbox"/>	Dot height
<input type="checkbox"/>	Grid width
<input type="checkbox"/>	Grid height
<input type="checkbox"/>	Unit of measurement
	mils (1 mil = .001 inch)
	mm (10 millimeters = 1 centimeter)
<input type="checkbox"/>	Dot shape
	C - Circular
	R - Rectangular
<input type="checkbox"/>	Update current file? Y/N
Current file:	

Figure 3-47. Target Device Simulation Menu

USING IDSCHAR

Here you can change parameters describing the target device, such as grid size, dot size, and dot shape. The default parameters describing the target device are given to the user for devices that are known to IDSCHAR. To change the parameters for other target devices you simply type in the parameters which describe the target device you wish to use. Refer to the individual target device reference manual.

NOTE

The DEVICE SIMULATION function should be used only to change device parameters for devices that are not known to IDSCHAR. It is possible to change parameters for known devices but it is not recommended.

The parameters you may wish to change include the dot height and width, the grid width and height, the unit of measurement you are using for these parameters and the dot shape.

When you have typed these parameters on this menu, press **(ENTER)**, the cell is redrawn reflecting that device. You can then design the character or logo using that device's characteristics. Type Y (yes) in the Update Current File? field if you want to keep these parameters as the new target device. Those parameters become the new target device's parameters.

Using the Simulating a Cell Function

CELL SIMULATION

Pressing this key displays the CELL SIMULATION menu.

```

IDSCHAR                               Cell Simulation

15 Cell height
7  Cell width

14 Top of uppercase
11 Top of lowercase
5  Baseline
2  Bottom of descenders

N Update current file? Y/N

Current file:
NEWELITE
_____

0 Orientation (0, 90, 180 or 270 degrees)
    
```

Figure 3-48. Cell Simulation Menu

USING IDSCHAR

The CELL SIMULATION menu lets you change the cell dimensions and/or the grid lines of the cell you are working with. This change is visible in the current cell you are working in. If you want to make these changes permanent, in the Update Current File? field, type a Y (yes). The file is updated to reflect the grid line changes.

You also can use the CELL SIMULATION menu to define a new cell size. When the CELL SIMULATION menu appears, define the parameters of the cell. Press **ENTER** and IDSCHAR draws that cell on the DISPLAY.

NOTE

Whatever is in the previously displayed cell is lost when you change cell size.

If you want to save the new cell size, after the SAVE CELL menu is displayed and you save the cell, the CHARACTER FONT SIZE or LOGO SIZE menu is displayed. Check the values entered in the fields to be sure they are the ones you want, then press **ENTER**. The new cell size is created and the character or logo is saved.

Using the Cell Bounds Function

CONTROL BOUNDS

This combination causes the SET BOUNDS menu to appear.

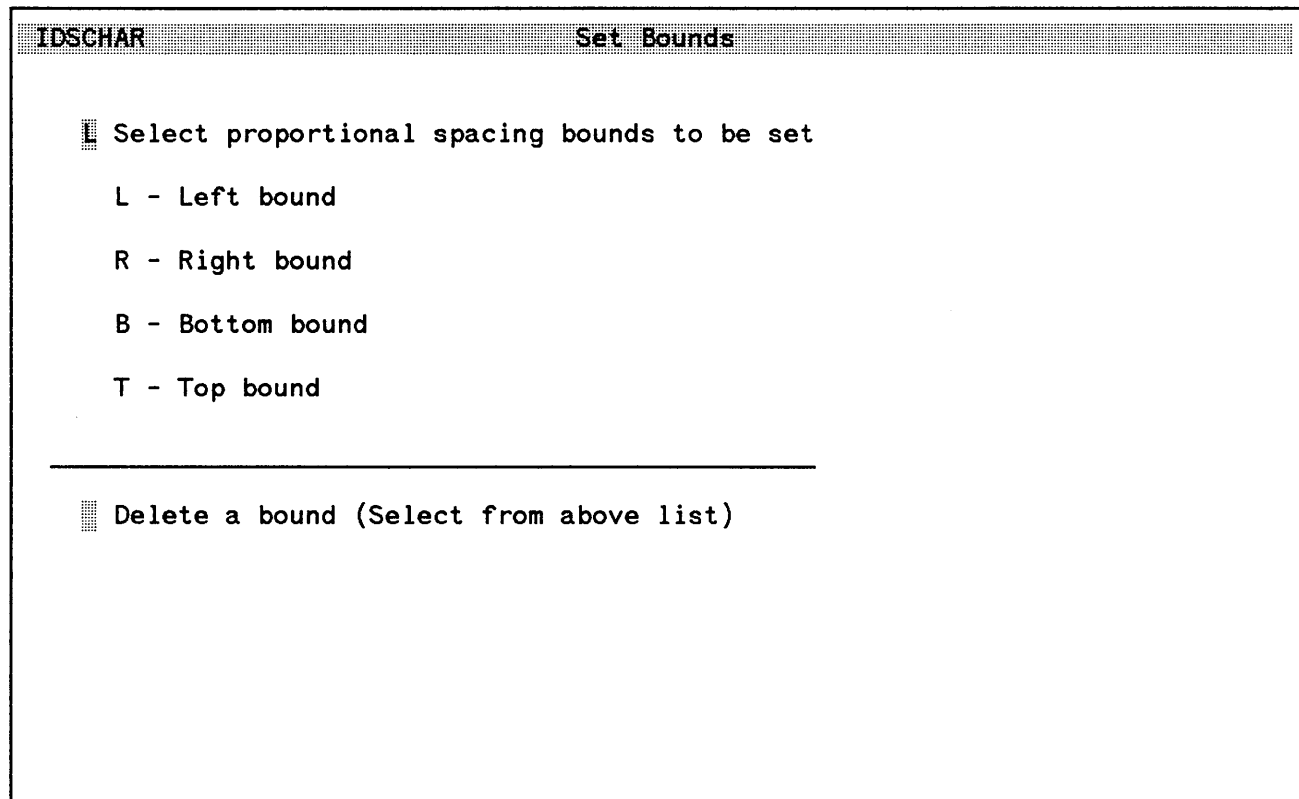

Figure 3-49. Set Bounds Menu

USING IDSCHAR

This menu lets you specify or delete a right, left, top and/or bottom bound for a character font. If this is a proportionally spaced character font, the bounds values you specified are used in place of those computed by IDSCHAR. For example, you might want more or less space between certain letters that you design.

To use this feature, position the cursor to where you want the bound to be and press **(CONTROL) BOUNDS** and the **SET BOUNDS** menu is displayed. Type in the letter for the type of bound you want, then press **(ENTER)**. When the Display appears, all computed bounds are displayed.

If you specified a bound, that bound is displayed instead of the computed bounds. When the character font is used in printing, your specified bound is recognized. You can specify as many of the bounds as you need by repeating the procedure.

Top and bottom bounds can be set to override proportional spacing for characters printed vertically. Left and right bounds override proportional spacing for characters printed horizontally.

DELETING BOUNDS

Press **CONTROL** BOUNDS. When the SET BOUNDS menu appears, type the letter for the bound you want deleted in the "Delete a bound" field. Press **ENTER** and that bound is no longer recognized by IDSCHAR. The IDSCHAR computed bound is used instead.

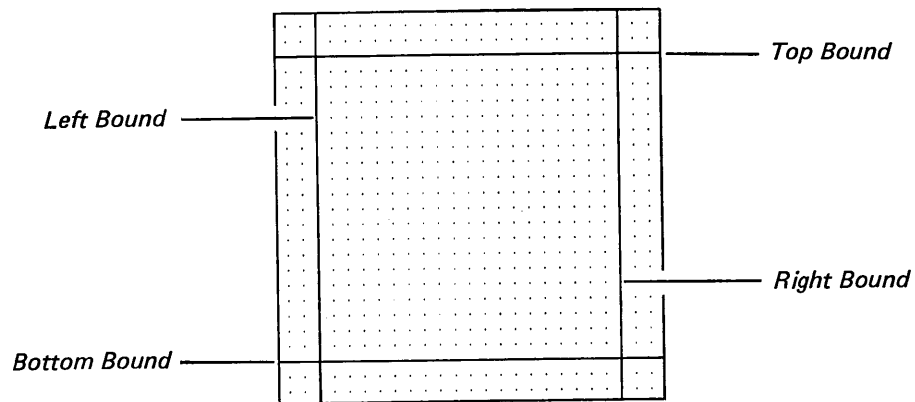

Figure 3-50. Cell Showing Bounds

Using the Transform Outline Function

TRANSFORM OUTLINE

Pressing this key displays the TRANSFORM OUTLINE menu.

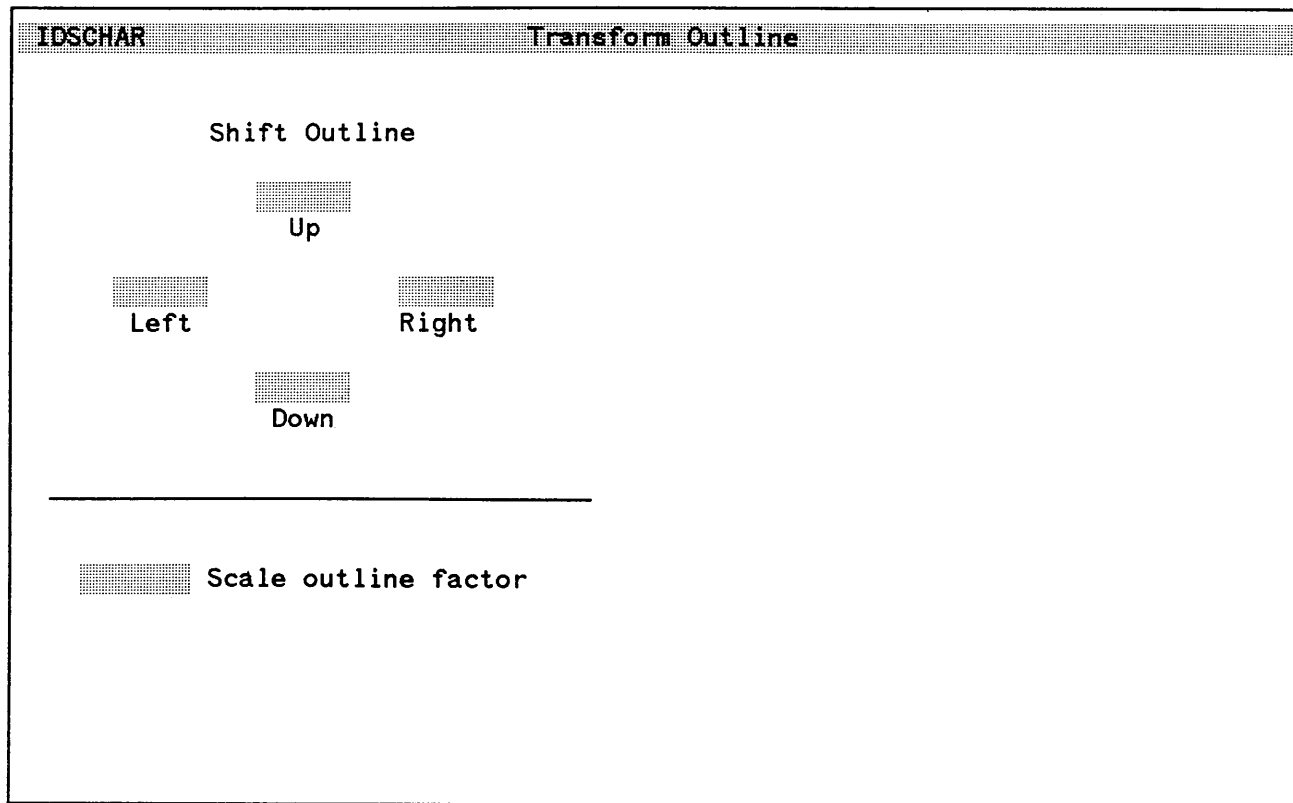

Figure 3-51. Transform Outline Menu

Once you have digitized an outline in your cell there might be a need to move it around, or enlarge or reduce it. The TRANSFORM OUTLINE menu lets you move the outline up, down, right, and left. You can also enlarge or reduce the outline by using the Scale feature.

Outlines can be moved by grid points or fractions of grid points. For example, to move an outline up 1.1 grid point, type 1.1 in the UP field on the TRANSFORM OUTLINE menu. Press **ENTER**. The DISPLAY appears and the cell is redrawn with the outline moved up 1.1 grid points. The outline can be adjusted in two directions at once, for example: up and right.

The size of the outline can also be changed by using a scaling factor. The scale of the outline in the cell always equals 1. If you type 1.5 in the Scale field then press **ENTER**, the outline in the cell is redrawn at one and a half times the size. That outline is then scaled at a factor of 1.

If you decide that the outline is too big, use a number smaller than 1. For example, .9 makes the outline nine tenths the size of the current outline.

Using the Zoom Feature of the HP Graphics Terminal

Character font and logo cells can range from very small to very large. When you design a very large cell, dots appear very small on your terminal screen. To increase the size of the cell so that you can see the dots better you can increase the magnification by using the MAGNIFICATION menu, or you can use the ZOOM feature of the graphics terminal.

To use the ZOOM feature:

- Put the REMOTE key in the UP position.
- Press the ZOOM key on the Graphics Control Group.
- You can now use the ZOOM IN or ZOOM OUT key.

Once you have the cell at the size you want to work with, press the REMOTE key down. You can now use the design features of IDSCHAR with the cell magnified. The cursor directional keys on the Graphics Control Group can be used to move the character or logo in the cell to the part you want to work with. You can also use the directional keys to move the cursor.

USING IDSCHAR

When you are finished using the ZOOM feature and want to see the cell returned to the original size, put the REMOTE key in the UP position. Press ZOOM. The cell returns to the original size. Press the REMOTE key down and you can continue with IDSCHAR.

Figure 3-52 shows an "R" at the original cell size and a portion of the "R" magnified after using the ZOOM feature.

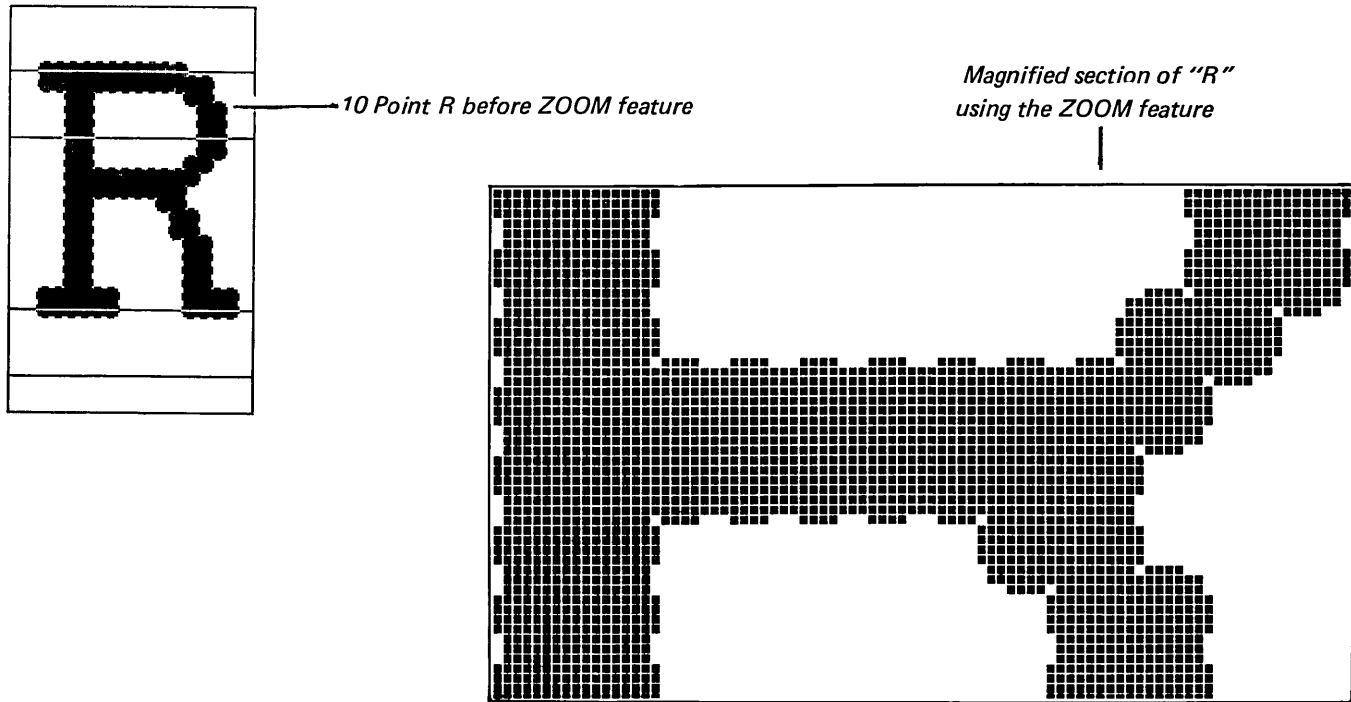

Figure 3-52. Using the ZOOM feature

Using the Main Menu/Display Key

You can go directly from the MAIN Menu to the DISPLAY AREA by pressing the MAIN MENU/DISPLAY key **(F7)**. Three possible situations exist for which you might want to do this.

1. You might not be interested in working with a specific character font or logo, but you might want to experiment with the DISPLAY AREA functions. If you press the MAIN MENU/DISPLAY key. In this instance, the TARGET DEVICE SIMULATION menu is displayed, followed by the CELL SIMULATION menu. You can choose the special characteristics or use the defaults. The DISPLAY AREA is then presented for you to begin working.

However, before you can save the cell, you must create the file. Press MAIN MENU/DISPLAY and create the file. (You might want to put the cell in the temporary hold area before you do this.) You must also define whether the file is a character font or logo on the CELL FILE DESCRIPTION menu. Go back to the MAIN menu and return to the DISPLAY.

Save the character or logo. After you save the cell, the CHARACTER FONT SIZE or LOGO SIZE menu is displayed. Check to be sure the values in the fields are the ones you want, then press **(ENTER)**. Your character or logo is now saved and a new size is defined.

2. You might be working with a specific character font or logo (that is, you have created and/or modified it), but you haven't indicated to IDSCHAR what cell size or point size you want to design. In this instance, if you press the MAIN MENU/DISPLAY key, the CELL SIMULATION menu is displayed, letting you specify the dimensions of the cell you want simulated. The DISPLAY AREA is presented.
3. If you are already at the DISPLAY AREA, designing a specific size in a defined cell, pressing the MAIN MENU/DISPLAY key returns you to the MAIN menu where you can perform another function. Once you have finished, you can return to the MAIN menu and press the MAIN MENU/DISPLAY key and the DISPLAY AREA, with the work you were doing, is re-displayed.

Documenting a Character Font or Logo File

Figure 3-53 shows the menu path (from bottom to top) involved in documenting a character font or logo file. Since the cell file can contain multiple sizes of a given character font or logo designed for more than one target device, the TARGET DEVICE DESCRIPTION menu will appear as many times as there are devices in the cell file. Each TARGET DEVICE DESCRIPTION menu describes information about each specific device.

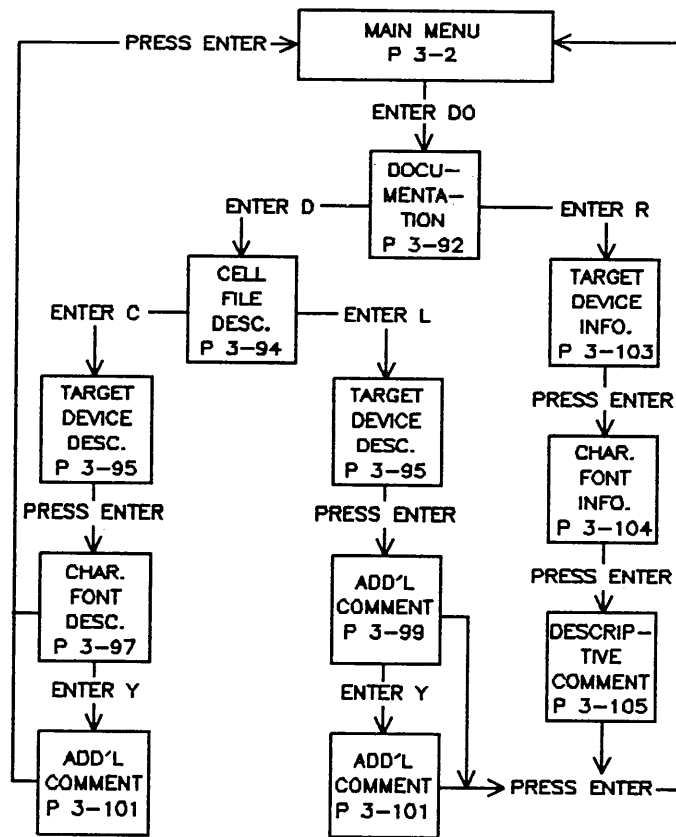

Figure 3-53. Menu Path for Documenting a Cell File

Selecting the "Document" function in the MAIN menu allows you to either describe the cell file by entering information via a series of menus, or reading a summary of the documentation about the cell file that has previously been entered.

You can specify instructions and information about character fonts and logos that you have designed. This information is stored in the cell file, and you can review it by making the "Document" selection on the MAIN menu. Included is information on type styles, written comments about any aspect of a file, and other cell file information. You can also use these menus to change or delete information that describes a cell file.

Since the "Document" function allows you to perform two procedures, there are two sets of menus. One set is for adding or modifying cell file information, and the other set is for reading information about an existing character font or logo. The following pages show the menus available to you for documenting character fonts and logos and how you use them.

When the MAIN menu appears on your terminal, type in DO (for document a logo or character cell file), and the cell file name, then press ENTER. The next menu to appear is the DOCUMENTATION menu.

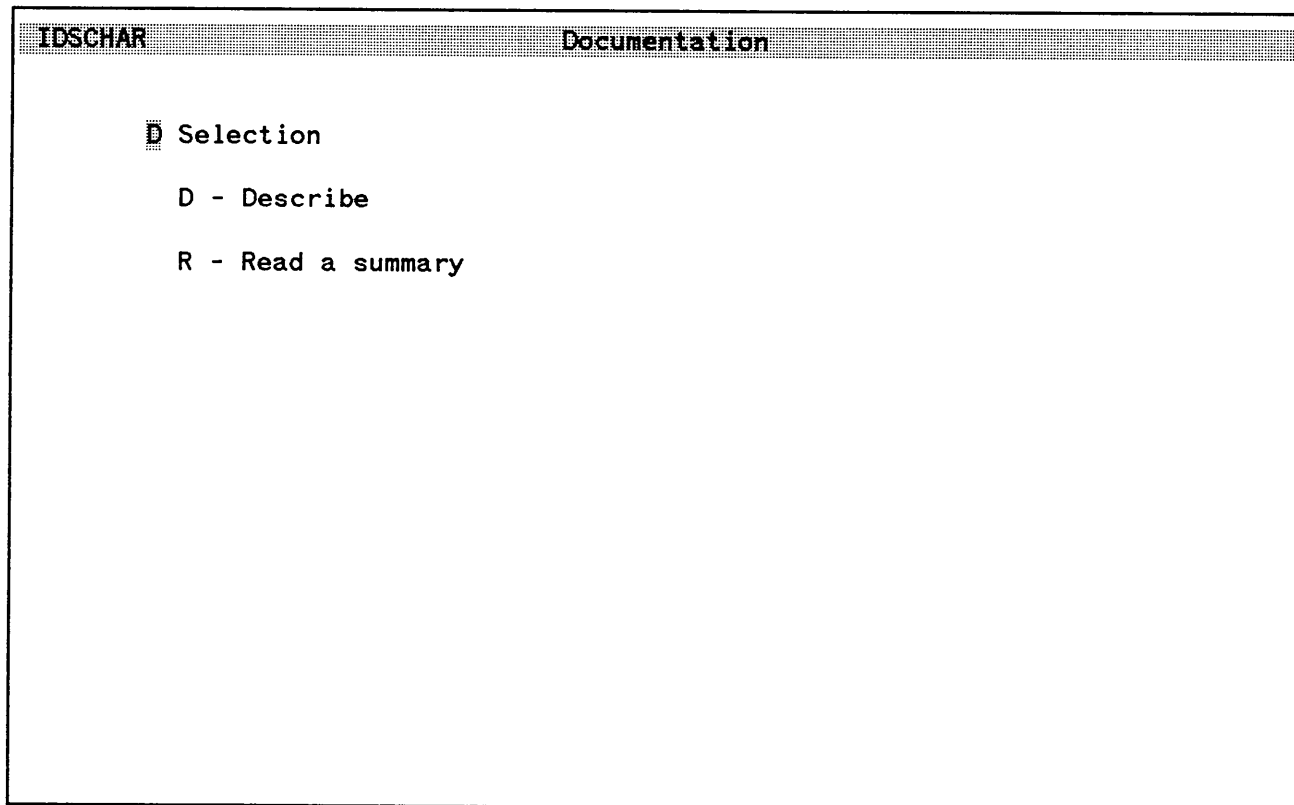

Figure 3-54. Documentation Menu

Enter a D (describe) or R (read) on the DOCUMENTATION menu, then press **ENTER**. The next menu that appears depends on which choice you make.

D - Describe: With this function you can produce documentation that is stored in the cell file. This information is entered on a series of menus. The first two menus affect the design process. The remaining menus are for documenting the character font or logo and do not affect the design process or the final appearance.

Changing the values displayed on the CELL FILE DESCRIPTION menu will change the file type (i.e., from a logo file to a character font file), and changing the values displayed on the TARGET DEVICE DESCRIPTION menu will change the actual device parameters.

The TARGET DEVICE DESCRIPTION menu cannot be used to add a new device, since new devices can be added when the user specifies a new device name on the MODIFICATION menu. Therefore, if a device is entered which is not already in the cell file on the TARGET DEVICE DESCRIPTION menu, IDSCHAR will not accept the information.

R - Read: You can read a summary of what has been previously entered documenting a character font or logo. Documentation cannot be changed on these menus; the menus are for review only.

Describing a Cell File

IDSCHAR	Cell File Description
<input type="checkbox"/> C	Selection
	L - Logo file
	C - Character font file
<input type="checkbox"/> N	Proportionally spaced? Y/N
<input type="checkbox"/> N	Serifs? Y/N

Figure 3-55. Cell File Description Menu

If you choose D on the DOCUMENTATION menu, the CELL FILE DESCRIPTION menu appears on your terminal screen. Enter L (logo file) or C (character file) for the type of cell file you want to document.

You can also indicate if a character font file is proportionally spaced and if serifs are used.

Each type of file (character font or logo) has its own unique menu path. The menus that appear on your terminal depend on which file you choose to document.

IDSCHAR	Target Device Description
█	Target device
█	Dot width
█	Dot Height
█	Grid width
█	Grid height
█	Unit of measurement
	mils (1 mil = .001 inch)
	mm (10 millimeters = 1 centimeter)
█	Dot shape
	C - Circular
	r - Rectangular

Figure 3-56. Target Device Description Menu

When the TARGET DEVICE DESCRIPTION menu appears, type the target device name in the selection field. You can also enter the unit of measure to be used for the target device. Press **ENTER**.

USING IDSCHAR

A variety of devices exist that the character font or logo might be printed with. IDSCHAR has knowledge of certain devices built into it, if you are using a device other than those known, IDSCHAR will ask for additional information to be defined.

Change the Parameters for a Target Device

You design characters and logos in IDSCHAR by using an arrangement of dots (called a dot matrix). Different printing devices can use a different size and shape of dot to print. If you are designing a character font or logo for a device not known to IDSCHAR you might also have to define the width and height and general shape of the dot that the device uses. You can get this information from the device's reference guide.

Grid Width and Grid Height

The grid width and grid height determine how much space is between the dots and will also have to be specified. Where the grid lines intersect is called a Grid Point. This is where a dot is printed. Grid lines are not shown on the display (refer to figure 3-57).

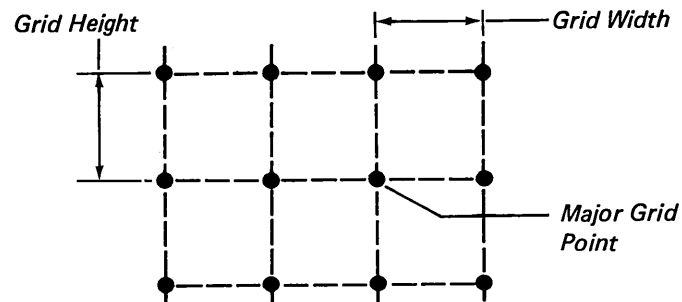

Figure 3-57. Grid Width and Grid Height

You will also have to specify whether the printing device prints a rectangular or circular dot. Select the shape that is nearest to the shape of the dot printed by the target device. You can describe oval dots by specifying a dot width different than the dot height and by specifying circular for the shape.

Character Font Description

IDSCHAR		Character Font Description	
TYPEFACE		EXAMPLE:	
<input type="checkbox"/>	Family	Helvetica	
<input type="checkbox"/>	Style	Upright or Italic	
<input type="checkbox"/>	Weight	Bold	
<input type="checkbox"/>	Width	Extended	
<input type="checkbox"/>	Other Variation	Outline	
LANGUAGE			
<input type="checkbox"/>		English	
<input type="checkbox"/>	Additional comments? Y/N		

Figure 3-58. Character Font Description Menu

USING IDSCHAR

This menu is displayed only if the cell file is a character font file. The menu is for information only and does not affect the printing of the character. The information on this menu includes the type family, style, character width and any special variations. Plus you can specify if the font is in a special language. If you design your own unique character font, you can also document it by entering the information in the blank fields.

If you want to add any particular comments about the cell file, type Y (yes) in answer to the question at the bottom of the menu. Press **ENTER** and the ADDITIONAL COMMENTS menu is displayed.

After you type in the necessary information, press **ENTER**. That information is stored in the cell file.

Logo Cell File Additional Comments

IDSCHAR	Additional Comments
■	Additional comments about this logo file? Y/N

Figure 3-59. Additional Comments Menu (Logo File)

This menu appears if you are documenting a logo cell file. If you want to enter additional comments about a logo file, type Y in the field and press **(ENTER)**. The cell file **ADDITIONAL COMMENTS** menu then appears on your terminal screen.

USING IDSCHAR

If you do not want to enter any additional comments, leave the N (default) in the field and press **ENTER**. The MAIN menu then returns to your terminal screen. Pressing the MAIN MENU/DISPLAY (**F7**) key also returns you to the MAIN menu.

NOTE

If you press any key other than **ENTER**, your comments are lost and will have to be re-entered.

If you do not want to add any comments to the file, leave the ADDITIONAL COMMENT menu blank and press the MAIN MENU/DISPLAY key (**f7**) and you are returned to the MAIN menu. Pressing **ENTER** when the menu is blank also returns you to the MAIN menu.

Deleting a Page of Comments

To delete a page of comments from the cell file, when the page appears that you want to delete, type a Y in the delete field on the bottom of the page. Press **ENTER** and that page is deleted. You can then type in new comments or you can return to the MAIN menu by pressing key f7.

Reviewing Documentation About an Existing Character Font or Logo File

Information about existing character fonts or logos in a cell file can be reviewed by selecting the Document function on the MAIN menu. When the DOCUMENTATION menu appears, select R (read) on the menu and press **ENTER**.

IDSCHAR determines automatically if the cell file is a character font or logo file. The following pages present the menus for reviewing information about a character font or logo file.

NOTE

The CANCEL key (**f8**) returns you to the previous menu and the MAIN MENU/DISPLAY key (**f7**) returns you to the MAIN menu.

Target Device Information

IDSCHAR	Target Device Information
Target device	<u>2688A</u>
Unit of measurement	<u>MILS</u>
Dot width	<u>4.133800</u>
Dot height	<u>4.133800</u>
Grid width	<u>3.300000</u>
Grid height	<u>3.300000</u>
Dot shape	<u>CIRCULAR</u>
<hr/>	
File type	<u>CHARACTER FONT</u>

Figure 3-61. Target Device Information Menu

This menu shows information pertaining to the target printing device. Included is information about the dot and grid sizes. The dot shape whether it is circular or rectangular, is also included. This menu will be displayed once for each target device resident in the cell file.

Character Font Information

IDSCHAR		Character Font Information	
Proportionally spaces? ...	<u>NO</u>		
Serifs?	<u>YES</u>		
Typeface			
Family	<u>ELITE</u>		
Style	<u>UPRIGHT</u>		
Weight	<u>REGULAR</u>		
Width	<u>REGULAR</u>		
Other Variation	_____		
Language	<u>ENGLISH</u>		

Figure 3-62. Character Font Information Menu

This menu is displayed if you are reading information about a character font. The specific characteristics of the cell file are listed. Much of the information from the documentation menus has been condensed and listed on this menu. Included are specific typesetting terms defining the character font.

Cell File Descriptive Comments

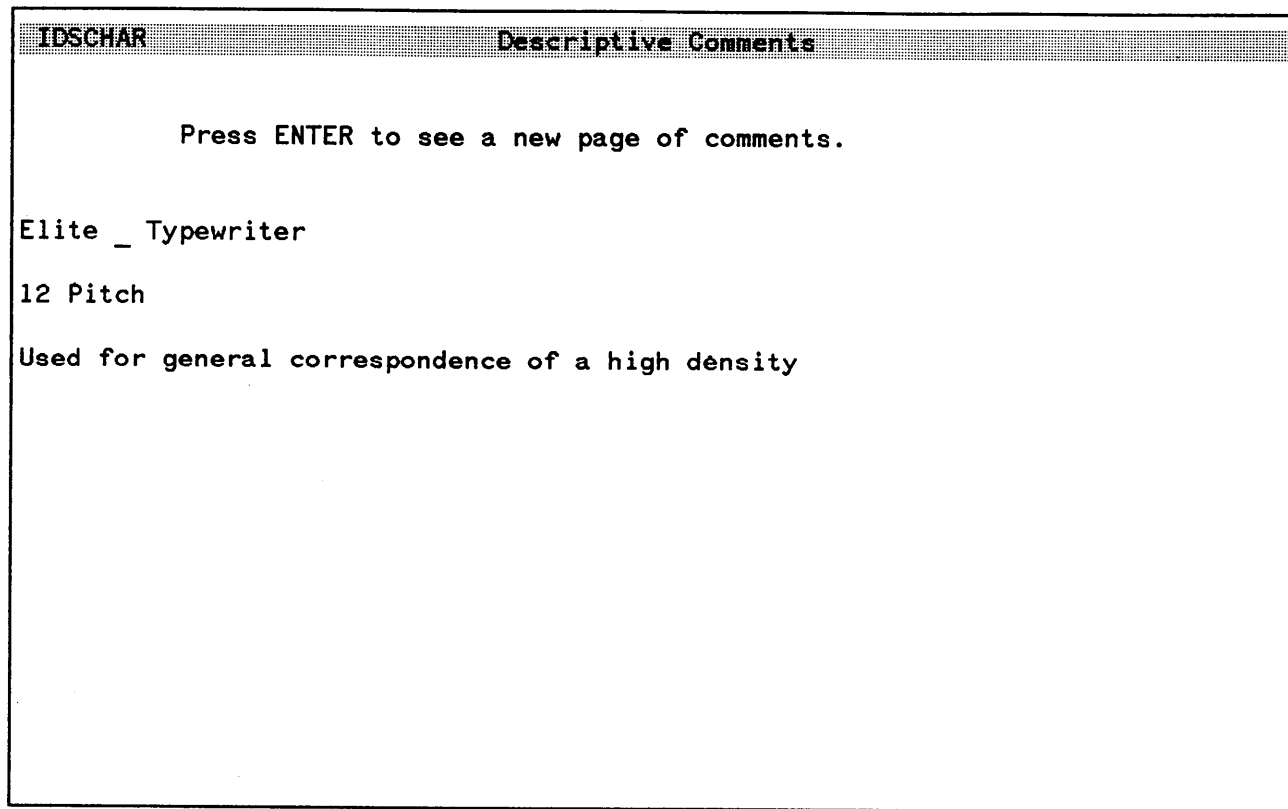

Figure 3-63. Descriptive Comments Menu

All textual comments describing a character font or logo cell file are displayed on this menu. To view additional comment pages, press **(ENTER)** for each additional page until all pages have been shown.

This menu is not displayed if there are no comment pages. You are returned to the MAIN menu.

Deleting Character Font and Logo Cells

The following illustration shows the menu path involved in deleting portions of a cell file. The selections you make on each menu determines the flow through the process.

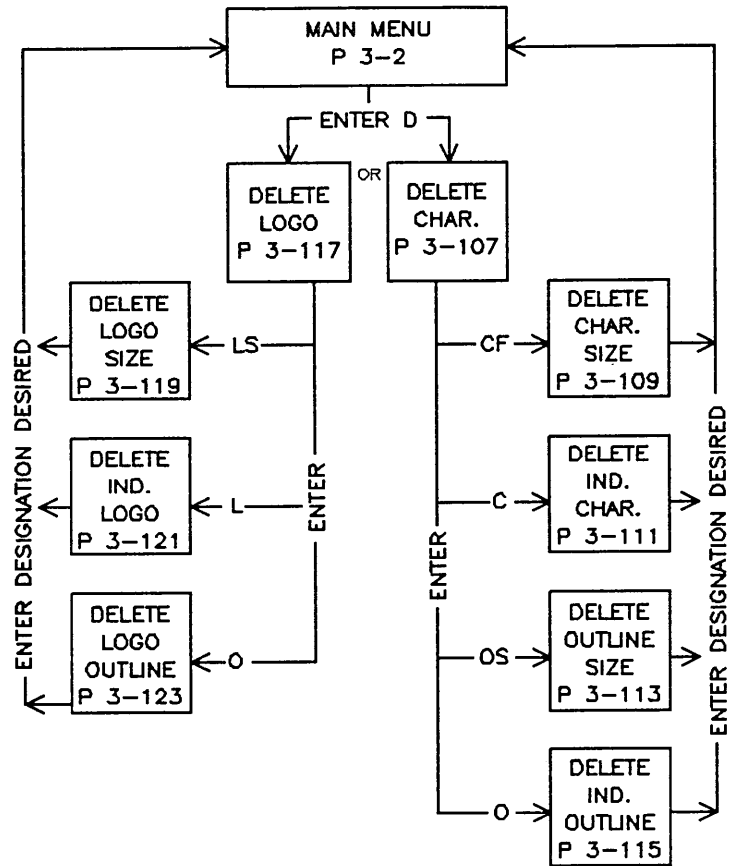

Figure 3-64. Menu Path for Deleting Cell Parts

Deleting Character Fonts

The DELETE CHARACTER menu is where you select which delete function you want to perform. Type the appropriate delete function code in the Selection field and press **ENTER**. The delete menu for that function is then displayed on your terminal screen.

```
IDSCHAR                               Delete Character

CF Selection

CF - Entire character font size
C  - Individual character
OS - Entire outline size
O  - Individual outline

2688A Target Device
```

Figure 3-65. Delete Character Menu

USING IDSCHAR

The acceptable codes are:

CF - Entire character font size. Displays the **DELETE CHARACTER SIZE** menu where you can enter the appropriate information for deleting any font size in point size or cell size.

C - Individual character. Displays the **DELETE INDIVIDUAL CHARACTER** menu where you can delete any character in a character font.

OS - Entire outline size. Displays the **DELETE OUTLINE SIZE** menu where you can delete any outline size.

O - Individual outline. Displays the **DELETE INDIVIDUAL OUTLINE** menu where you can delete the outline for a particular character.

Delete a Character Font Size

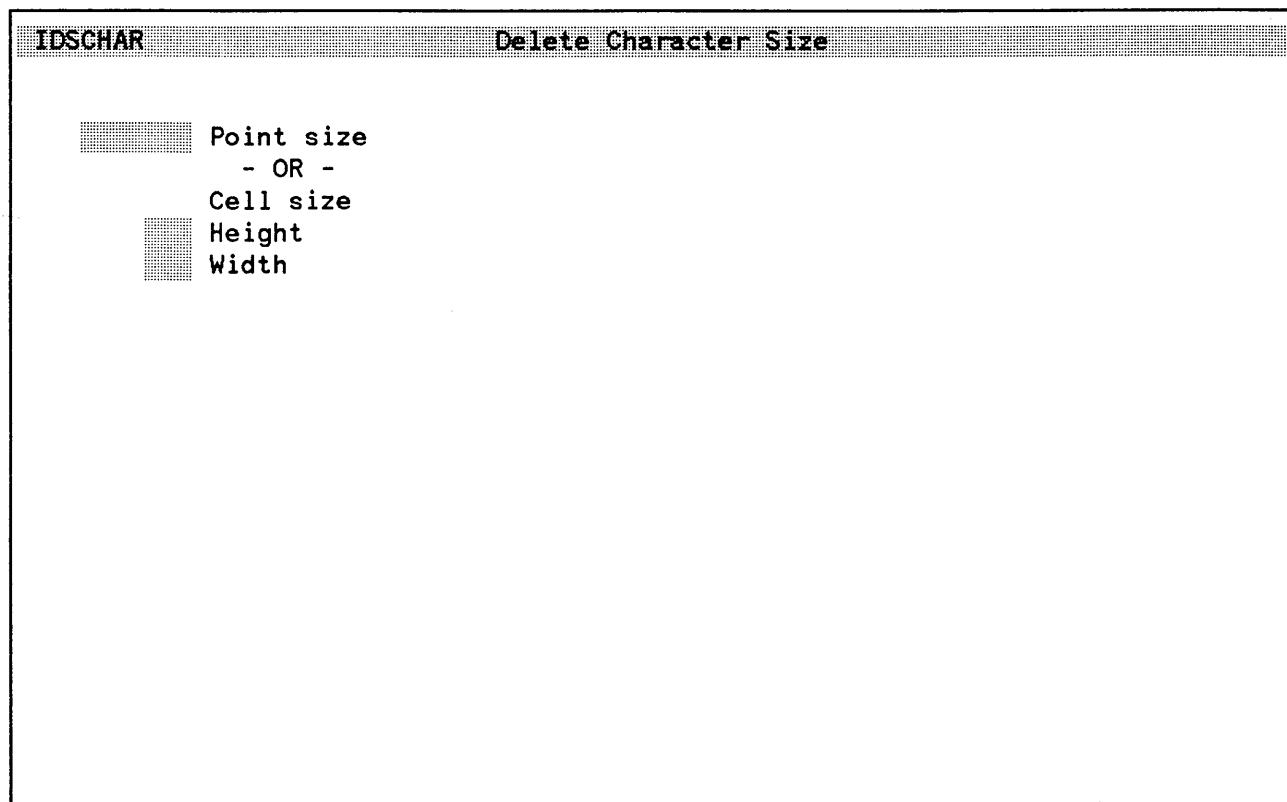

Figure 3-66. Delete Character Size Menu

To delete all characters in a particular size, type in the point size or the cell size (measured by grid points). Press **ENTER**. A message appears asking you to press **ENTER** again if you really want to delete the entire size. Press CANCEL (**^B**) to prevent the deletion.

USING IDSCHAR

NOTE

Be sure that all the information entered in the fields for the DELETE CHARACTER FONT SIZE is correct since after you press **ENTER** the second time that font size is no longer in IDSCHAR.

CAUTION

If a device name is specified on the DELETE CHARACTER or DELETE LOGO menu, ALL the specified sizes designed for that particular device named in the file will be deleted. If NO device name is specified, ALL the specified sizes designed for ALL devices contained in the file will be deleted

Delete an Individual Character

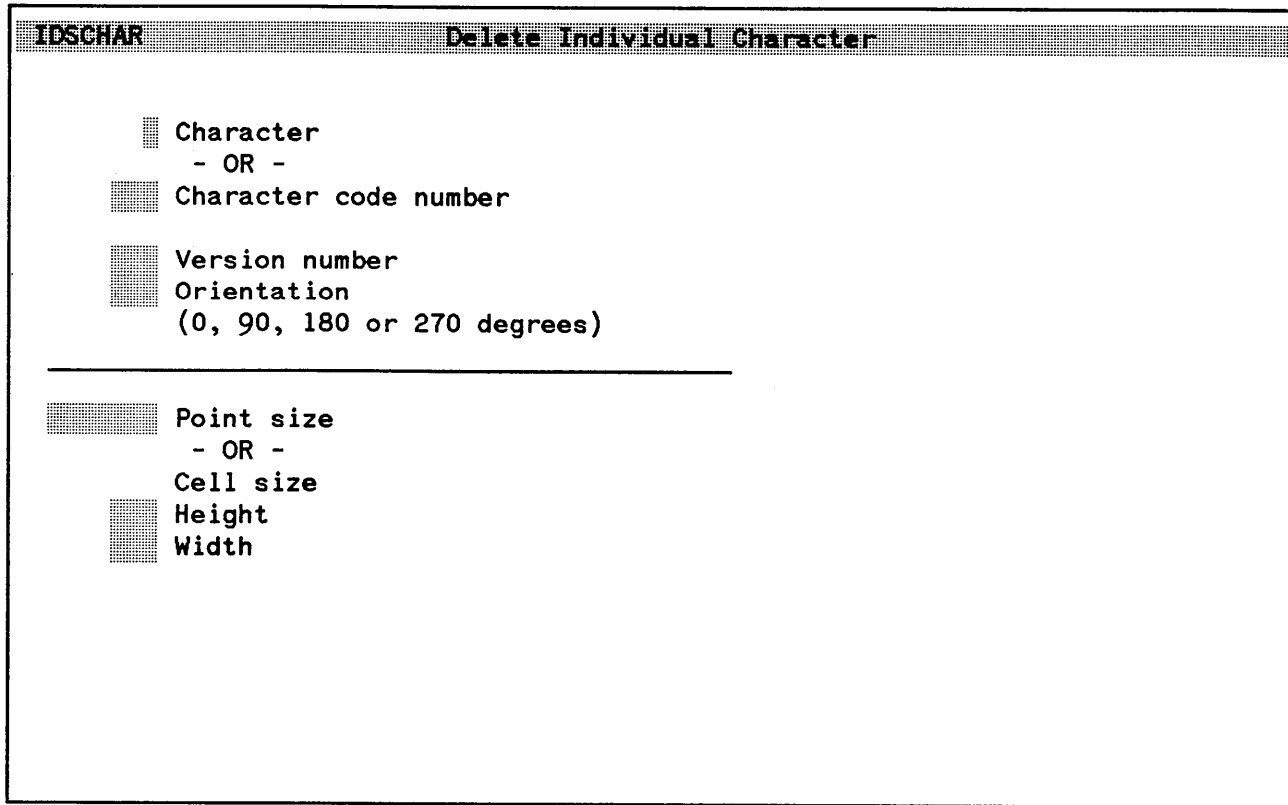

Figure 3-67. Delete Individual Character Menu

In the design process you might have designed many different versions of a character and saved them in the file. When you are finished, you can delete the individual characters that you do not plan to use from IDSCHAR.

USING IDSCHAR

To delete an individual character, type in the point size or cell size in grid points. You will also have to type in the character or the Character Code Number. It is also important that you enter the version number for the character if there is more than one version and the orientation of the character, if applicable. If there is only one version and you want to delete it, then you only have to enter the size and character (or character code number). Press **ENTER**. A message appears asking you to press **ENTER** again if you really want to delete that character. Press **CANCEL** (**↵**) to prevent the deletion.

NOTE

After you press **ENTER** twice, the character is deleted from IDSCHAR. Be sure that you entered all the correct information, especially if more than one version exists for the character.

Delete an Outline Size

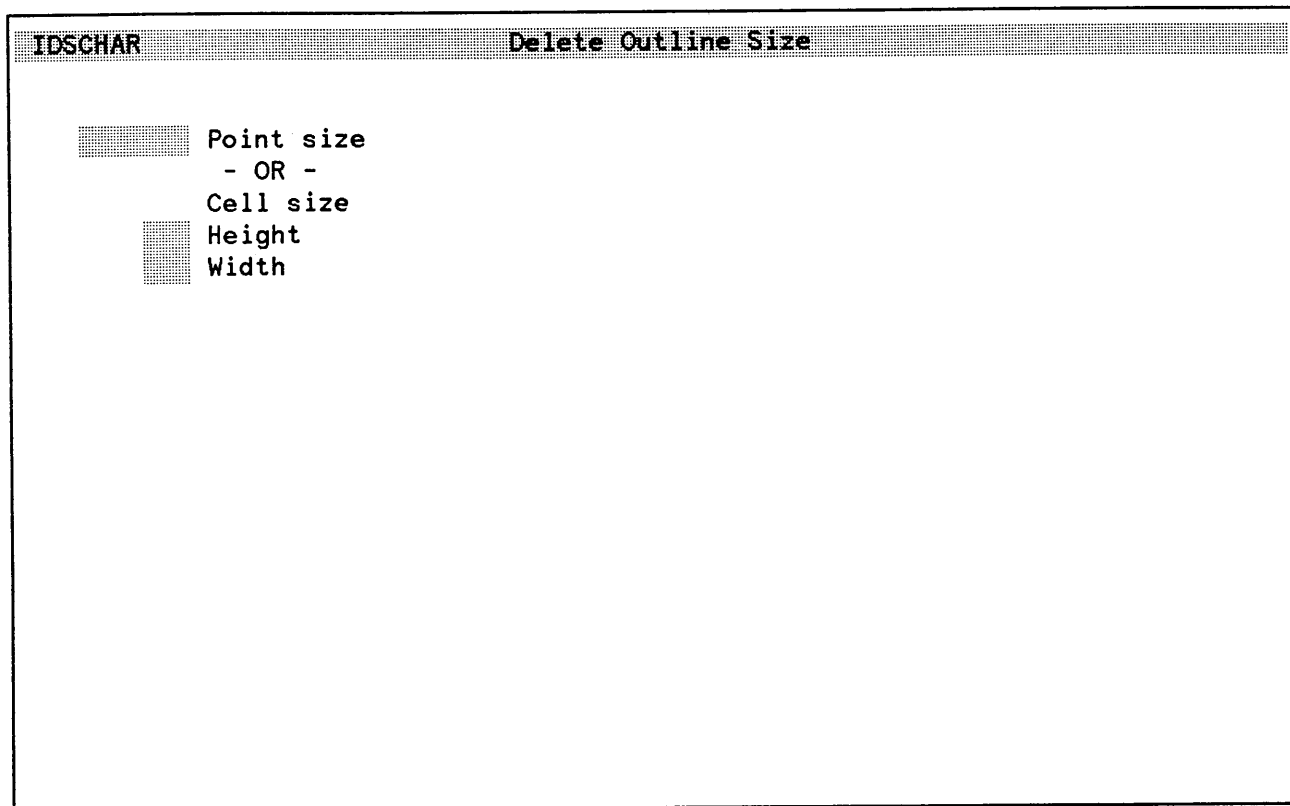

Figure 3-68. Delete Outline Size Menu

To delete the outline size, type in the outline point size or the outline cell size in grid points, then press **ENTER**. A message appears asking you to press **ENTER** again if you really want to delete all the outlines for that size. All outlines for that size will be deleted and you will be returned to the MAIN menu. Press CANCEL (**fg**) to prevent the deletion.

USING IDSCHAR

NOTE

After you press **ENTER** twice the outline size is deleted from IDSCHAR. Be sure to check that you have entered the correct size **BEFORE** you press **ENTER**.

Delete an Individual Outline

IDSCHAR	Delete Individual Outline
<input type="checkbox"/>	Character
	- OR -
<input type="checkbox"/>	Character code number
<hr/>	
<input type="checkbox"/>	Point size
	- OR -
<input type="checkbox"/>	Cell size
<input type="checkbox"/>	Height
<input type="checkbox"/>	Width

Figure 3-69. Delete Individual Outline Menu

To eliminate unneeded character outlines or clean up your character font file, you can delete individual character outlines. Type in the point size or cell size in grid points. You must also enter the character or Character Code Number. Press **ENTER**. A message appears asking you to press **ENTER** again if you really want to delete the outline. Press CANCEL (**FB**) to prevent the deletion.

USING IDSCHAR

NOTE

After you press **ENTER** twice the outline size is deleted from IDSCHAR. Be sure to check that you have entered the correct information for the outline **BEFORE** you press **ENTER**.

Delete Logo Menu

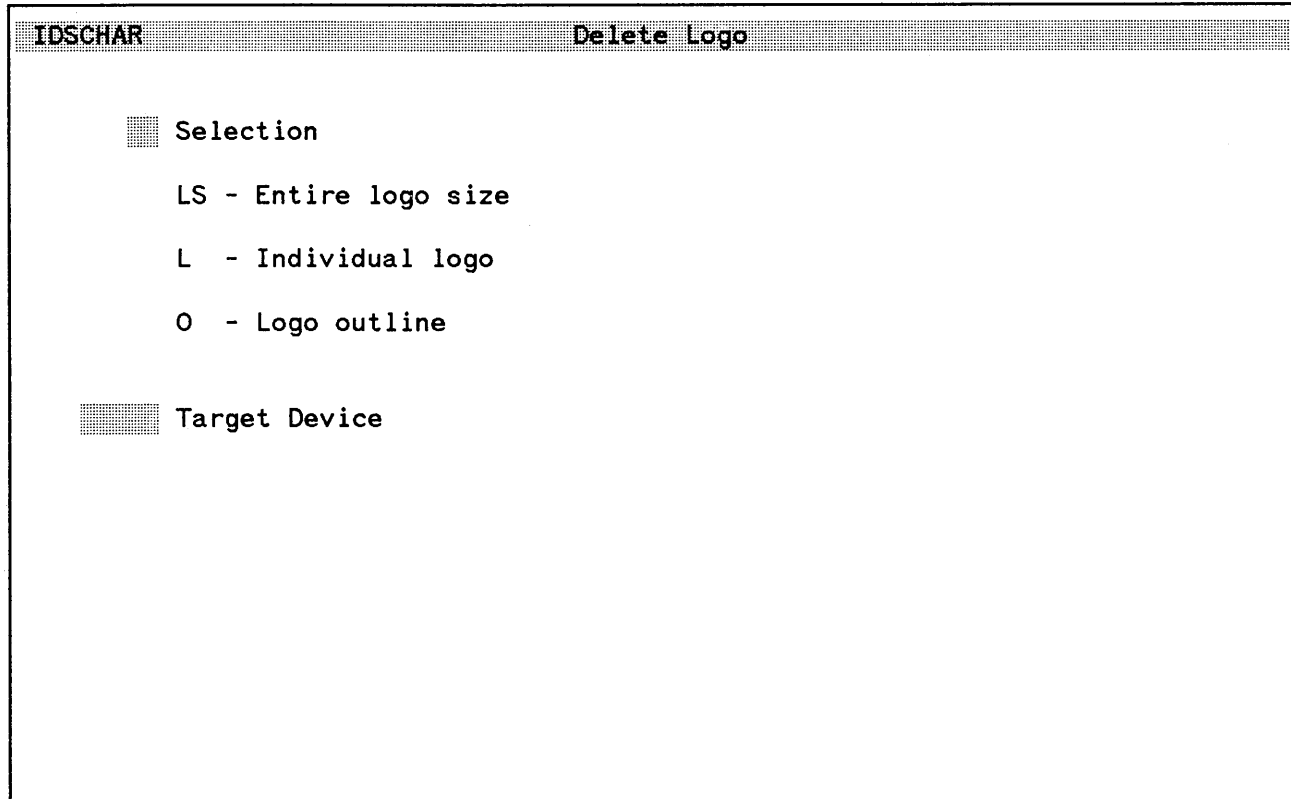

Figure 3-70. Delete Logo Menu

USING IDSCHAR

If the file you are working with is a logo file, the **DELETE LOGO** menu will appear on your terminal screen after the **MAIN** menu. Type in the delete code you want to work with then press **ENTER**. The appropriate delete function menu appears on your terminal screen.

The acceptable codes are:

LS - Entire logo size. Displays the **DELETE LOGO SIZE** menu where you can delete all logo versions for a particular size in a cell file.

L - Individual logo. Displays the **DELETE INDIVIDUAL LOGO** menu where you can delete a particular version of a logo.

O - Logo outline. Displays the **DELETE OUTLINE** menu where you can delete a logo outline.

Delete a Logo Size

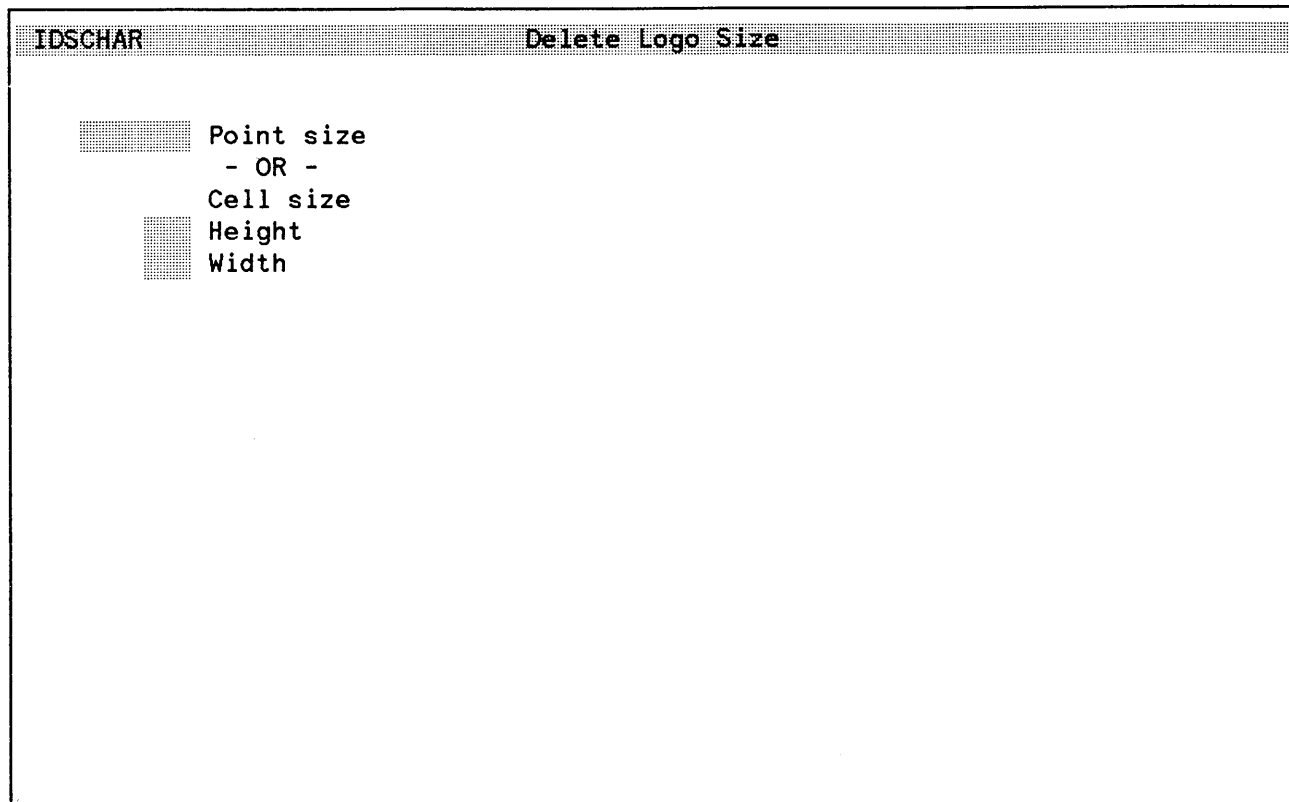

Figure 3-71. Delete Logo Size Menu

When you no longer want to keep a particular logo size, you can delete that size from a logo file. Type in the point size or cell size in grid points on the DELETE LOGO SIZE menu, then press **ENTER**. A message appears asking you to press **ENTER** again if you really want to delete the logo size. Press CANCEL (**↵8**) to prevent deletion.

USING IDSCHAR

NOTE

After you press **ENTER** the second time, the logo size is deleted from IDSCHAR. Be sure to check that you entered the correct information **BEFORE** you press **ENTER** and the information is gone.

Delete an Individual Logo

IDSCHAR	Delete Individual Logo
<input type="checkbox"/>	Version number
<input type="checkbox"/>	Orientation (0, 90, 180 or 270 degrees)
<hr/>	
<input type="checkbox"/>	Point size
	- OR -
<input type="checkbox"/>	Cell size
<input type="checkbox"/>	Height
<input type="checkbox"/>	Width

Figure 3-72. Delete Individual Logo Menu

If you have designed many versions of a logo, you might want to delete the ones that you do not need. Or you can delete a logo that you might not be satisfied with. Type in the logo point size or cell size in grid points. You might also have to enter the version and orientation if you have more than one version of a logo in that logo size. If there is only one version, you do not have to enter the version number.

USING IDSCHAR

Press **ENTER**. A message appears asking you to press **ENTER** again if you really want to delete the logo. Press CANCEL (**ESC**) to prevent the deletion.

NOTE

After you press **ENTER** the second time, the logo is deleted from IDSCHAR. Be sure to check that you entered the correct information **BEFORE** you press **ENTER** and the information is gone.

Delete a Logo Outline

IDSCHAR	Delete Logo Outline
█	Point size
	- OR -
█	Cell size
█	Height
█	Width

Figure 3-73. Delete Logo Outline Menu

You enter the same information for deleting logo outlines as you do for a complete size of character font outlines. To delete an outline, type in the outline point size or the outline cell size in grid points, then press **ENTER**. A message appears asking you to press **ENTER** again if you really want to delete the outline. Press **CANCEL** (**^s**) to prevent the deletion.

USING IDSCHAR

NOTE

After you press **ENTER** the second time, the outline is deleted from IDSCHAR. Be sure to check that you entered the correct information **BEFORE** you press **ENTER** and the information is gone.

This reference guide contains many terms that might be new to you. There are terms unique to IDSCHAR and these you must understand in order to use IDSCHAR successfully. Most of these terms are described in greater detail in the section where they are used.

You should already be familiar with basic typesetting terms to use this reference guide; however, the more important terms you need to know are briefly defined in this section.

Certain terms are unique to IDSCHAR and IDS/3000. On the following pages are terms that you should have a good understanding of before you begin using IDSCHAR for the design of characters and logos. Many of these terms are used through the IDS/3000 system.

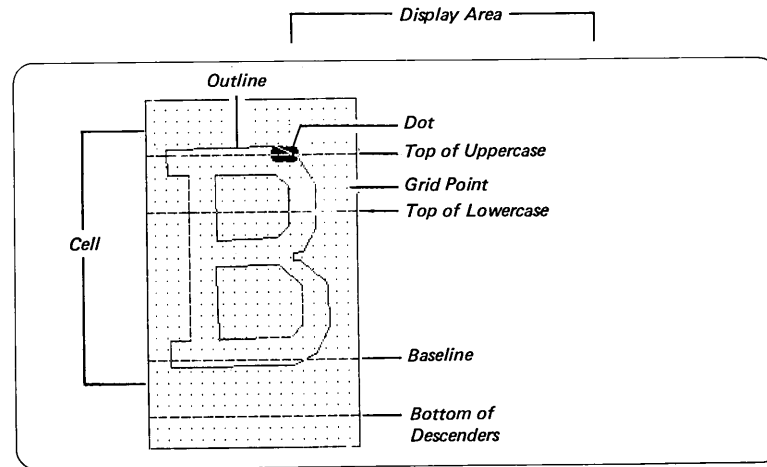

Figure A-1. Display with Sample Cell

GLOSSARY

TERM

EXPLANATION

BASELINE

The character or logo sits on the baseline. When characters in a font are printed, they are aligned according to the baseline. All capital letters and lowercase letters, except for the descender, should sit on the baseline. The baseline default for a cell is line 1 at the bottom. You can change the position of the baseline, but you must always specify where the baseline is. See figure A-1.

By raising or lowering the baseline in a logo cell, you can position the logo within your text.

CELL

The basic unit in which a character or logo is designed. Cell size is measured in point size and/or GRID POINTS. See figure A-1. Point sizes can be any number from 1 to 200. The Cell size minimum is 1 dot by 1 dot and the maximum is 255 dots by 255 dots.

The maximum cell size of 255 dots by 255 dots will represent a point size of 101 on the HP 2680 (180 dot per inch device) and a point size of 60 on the HP 2688 (300 dot per inch device).

CHARACTER

Any letter, number, punctuation mark, scientific or mathematic symbol.

After you design a cell, you must specify what it represents. In Character Font Files, this is called a character. For example, if you design a new "A", you would enter an "A" in the Character field on the SAVE CELL menu.

CHARACTER CODE NUMBER

Instead of the Character representation you can enter the character code number. See Appendix C for a list of characters with the corresponding ASCII character code numbers.

CHARACTER FONT FILE

These files contain character fonts created in varying sizes and created for multiple devices. All characters contained in the file should be of the same typeface. Information about the typeface and the character outlines can be stored in the character font file.

DEFAULTS	Defaults are the most commonly used values entered in fields by IDSCHAR. You can change the defaults if you want. For example, on the CELL FILE DESCRIPTION menu, the defaults are N (no) for Proportionally spaced characters and N (no) for Serifs. If you wish to change a default, type over the default value and press ENTER .
DESCENDER	The part of a letter that goes below the baseline.
DIGITIZE	Digitizing is the process of taking characters, logos, or artwork and tracing an outline on the digitizer that is transferred to the cell in the DISPLAY AREA. See section 2 for more information.
DISPLAY AREA	This is where you do the design of characters or logos. After you determine the parameters of a cell, the cell appears in the DISPLAY AREA.
DOT	A dot drawn in a cell is the representation of a dot on the eventual target device. You can simulate different dot shapes and sizes of target devices.
FAMILY	The name of the typeface. Example: Helvetica Bold and Helvetica Regular are of the same family.
FILE NAME	The name for the character font or logo file. The file name must be eight characters (or less) and begin with a letter. For example: CHROMBLD could be the file name for a Roman Bold character font file.
HINT	
	A good practice is to start the file name with a "CH" for later identification as a <u>C</u> haracter File when listing your files.
FONT	A complete set of type characters for a particular typeface and size. Example: 6 point Helvetica Bold.
GRID LINES	Grid lines are design aids that you set by using the CELL GRAPHICS menu or the TWO LETTER COMMAND LI. You can also change the grid lines by using the CELL SIMULATION menu. These lines are: TOP OF UPPERCASE, TOP OF LOWERCASE, BASELINE, and BOTTOM of descenders. See figure A-1.

GLOSSARY

GRID POINTS

The position at which a DOT can be drawn in a cell. Grid points are also design aids that you can set by using the CELL GRAPHICS menu or the TWO LETTER COMMANDS GR (all grid points) and PG (point only where dots are drawn.) See figure A-1.

When you try to design a character where the dots are very large compared to the grid, PG shows only those grid points that have dots on them saving you some confusion.

HOLD CELL

A special off-screen place to store a cell while the space it was occupying in the DISPLAY is used for another cell. Once you exit from IDSCHAR, the work in the HOLD CELL is lost unless you save it.

LANGUAGE

Which language the FONT is designed for. Example: English, French, Russian.

LOGO

A company or product trademark. Can be a graphic symbol, name, or combination of both.

LOGO FILE

These files contain logos created in varying sizes and created for various target devices. There is only one logo design per logo file, but there can be different versions and sizes.

ORIENTATION

IDSCHAR supports the design of characters to be printed in any of four directions with respect to the normal printing direction of the target device - 0 degrees (normal printing direction), and rotated 90, 180, and 270 degrees clockwise.

OUTLINES

The digitized artwork for the logo or character. There is one outline for each logo in a logo file and one outline for each character in a character font file. You can use an outline of one size to design a character or logo of another size. (See Using an Outline for More than One Cell Size).

POINT SIZE

A unit of type measurement where 72 points equals one inch. Greater than 0 and less than or equal to 200 are the size limits for IDSCHAR, depending on the device for which you are designing.

**PROPORTIONAL
SPACED
FONT**

A character font whose individual characters occupy only the amount of space they need with the cell. Proportional spacing is automatically calculated by IDSCHAR in the following manner:

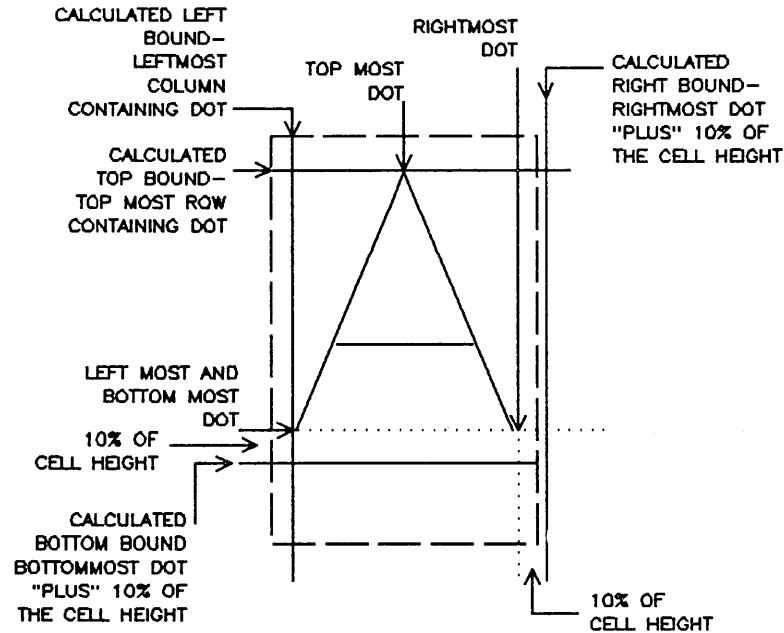

Figure A-2. Proportional Bounds Calculations

RANKING

If you have many versions of a character, you can rank them to indicate which versions are best. Rankings range from 1 to 999, with 1 being the best. When the character is used for printing by the target device, the best version is used.

GLOSSARY

SERIFS

Short cross lines at the end of main strokes of a letter.

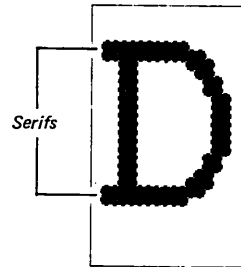

Figure A-3. Letter Showing Serifs

STYLE

Whether the letter is designed upright or in italic type.

TARGET DEVICE

The device that will eventually use the character or logo for printing.

TOP OF LOWERCASE

The line in a cell that denotes where the top of lowercase letter is.

TOP OF UPPERCASE

The line in a cell that denotes the upper limit of Capital (uppercase) letters.

TWO LETTER COMMANDS

Two letter commands quickly perform a variety of functions while you are in the DISPLAY. These functions can also be performed from menus. See section 3 for a list of two letter commands and their functions.

VERSION

You can design more than one character of the same kind by specifying a different version number for each character or logo. The default version is 1. If you try to save a version number that already exists in the file,

GLOSSARY

IDSCHAR will delete the old version before saving the new version, after giving you a chance to interrupt. IDSCHAR select the best ranked version to be used for printing with the target device.

WEIGHT

Whether a character stroke is Bold, Medium, Light, etc.

WIDTH

Whether a character is of normal, condensed, or expanded width.

THIS PAGE SHOULD BE BLANK

Recover/Refresh

The RECOVER/REFRESH key has two functions. One function discussed in section 3 is when you want to redraw the menu, especially after you have used the Y^C keys to stop a process. Refreshing the menu in this instance clears the terminal screen of any dots or lines left by the Y^C keys.

The other function of RECOVER/REFRESH is if you do not receive a response to any of your requests, either when you press a function key, a design key, or the **ENTER** key. If this situation happens, do the following:

1. Don't panic. Wait a reasonable amount of time, at least a minute. Sometimes, because of many users on the computer system, the response time increases. Try again.
2. If you still do not get a response, press the RESET TERMINAL key quickly two times. The screen clears and the message TERMINAL READY appears in the upper left hand corner.
3. Press the RECOVER/REFRESH key (f4). The TERMINAL READY message disappears, and after a few seconds, the menu or cell you were working with is redrawn.
4. If the menu or cell is NOT redrawn, repeat this procedure a few more times. If it is still not redrawn, try the **BREAK** and ABORT procedure.

Accidental/Intentional Break

If you accidentally or intentionally press the **BREAK** key while you are using IDSCHAR, perform the following procedure:

1. Press the **RESET TERMINAL** key quickly two times. The screen clears and the message **TERMINAL READY** appears in the upper left hand corner of the screen.
2. Press the **RETURN** key until you receive a **COLON (:)** prompt.
3. Hold down the **ESC** key and press the colon key.
4. If you pressed the **BREAK** key intentionally to perform a function of the computer operating system, go ahead and perform the operation.

NOTE

When you try to run another product while you are in **BREAK** mode the **ABORT** message is displayed. If you answer **YES**, IDSCHAR is aborted and you lose any work that you did not save. It is better to exit IDSCHAR and perform your operation.

Go to step 5 to resume working in IDSCHAR.

5. Type **RESUME**, then press **RETURN**. The message **READ PENDING** appears on your terminal.
6. Press the **RECOVER/REFRESH** key (f4). The menu you were at or the cell you were working in is redrawn on your screen.

Break and Abort

Sometimes problems occur with the computer that affect IDSCHAR. If you are working with IDSCHAR and you do not receive a response when you press a function key or a design key, then you should first try the RECOVER/REFRESH procedure as described above. If this is not successful, then you will have to **BREAK** and ABORT.

NOTE

This is an EMERGENCY situation only. When you do this you lose anything in the DISPLAY that you did not save with the SAVE CELL menu.

The speed with which the computer responds to your requests depends on a number of factors. Before you **BREAK** and ABORT, wait at least a minute for the computer to respond to your request.

After a reasonable time period, a few minutes, and if you still do not receive a response you your request, do the following:

1. Press the RESET TERMINAL key quickly two times. The screen clears and the message TERMINAL READY appears in the upper left hand corner of the terminal screen.
2. Press the **BREAK** key. A colon prompt appears.

:

Hold down the ESC key and press the COLON (:) key.

Type ABORT

:ABORT

Press **RETURN**

IDSCHAR MAINTENANCE

Your program is aborted.

3. When the colon prompt appears again, you can give the command to run IDSCHAR.

```
:RUN IDSCHAR.PUB.SYS
```

If the problem continues to happen, notify your System Manager.

NOTE

Sometimes a computer system goes down. This means that because of some problem, the computer has turned itself off. If you have a problem with IDSCHAR and none of the procedures on the preceding pages solve your problem, then the computer system has probably shut itself down. If you suspect that the computer is down call your System Manager immediately.

Listing the Cell Files

After you log on to your account and group, you can list the cell files that are in the group or in other groups in your account.

1. When the colon prompt appears, type LISTF

```
:LISTF
```

Press **RETURN**

2. The computer responds with:

```
CHROMAN    CHBOLD    CHMYCELL  CHLOGO    CHLOGO2   CHSPECIAL  
CHHELV    CHHELVIT  CHCONDEN
```

3. You can see that there are 9 files in this group. You can then run IDSCHAR and request one of these files or create a new one.

NOTE

You will find file maintenance easier by using a one or two letter prefix on your filename to denote Character files. This will not only identify the type of file but will list them together on the screen.

4. Or you can list all the files in all the groups in your account. Or you can list the files in any group in your account.

To list all the files in your account, type:

```
:LISTF @.@"
```

To list all the files in other groups in your account, type:

```
:LISTF @.groupname
```

4. You can also identify the types of files in your group by typing:

```
:LISTF,2
```

The computer responds with:

FILENAME	CODE	-----LOGICAL		RECORD-----	----SPACE----				
		SIZE	TYP	EOF	LIMIT	R/B	SECTORS	#X	MX
CHROMAN	PCELL	64W	FB	15	4092	2	64	1	32
CHBOLD	PCELL	64W	FB	15	4092	2	64	1	32
CHMYCELL	PCELL	64W	FB	15	4092	2	64	1	32
CHLOGO	PCELL	64W	FB	15	4092	2	64	1	32
CHLOGO2	PCELL	64W	FB	15	4092	2	64	1	32
CHSPECAL	PCELL	64W	FB	15	4092	2	64	1	32
CHHELV	PCELL	64W	FB	15	4092	2	64	1	32
CHHELVIT	PCELL	64W	FB	15	4092	2	64	1	32
CHCONDEN	PCELL	64W	FB	15	4092	2	64	1	32

IDSCHAR MAINTENANCE

Enlarging a Cell File

Each cell file is allotted a certain amount of computer space. The cell file size is defined for you when you create the cell file. Normally, you do not have to be concerned about running out of cell file space. However, a cell file which contains many sizes, or many cell versions, or very large cells could run out of space. The following procedure can help you find out the cell file size and increase the size of the file if needed.

If you are working with a large cell file, it is advisable to occasionally check the cell file size. If you are in IDSCHAR, you will have to EXIT. For the following example, CHMYCELL will be used for the cell file. To check the amount of space, after the colon prompt (you must be logged on), type the following:

```
:LISTF CHMYCELL,2
```

The computer responds with:

```
ACCOUNT= MYACCT GROUP= MYGROUP
```

FILENAME	CODE	-----LOGICAL RECORD-----	-----SPACE-----						
	SIZE	TYP	EOF	LIMIT	R/B	SECTORS	#X	MX	
CHMYCELL	PCELL	308W	FB	17	408	1	156	1	8

|-----|
|
compare

NOTE

If you do LISTF,2 the screen will list all files. A "PCELL" file code identifies an IDSCHAR file. The corresponding file code number is 1110.

This is the information for CHMYCELL that is stored in the system. To find out how much space is left in the cell file, check EOF (End of File) number against the LIMIT record number. If the numbers are close, you should enlarge the size of your cell file.

Building a New File

You will first have to build a new file (for this example, call it CHNUFILE) by entering the following commands.

```
:BUILD CHNUFILE;REC=64;CODE=1110;DISC=some number greater than the LIMIT
```

record number from the LISTF you just did.

When you get the colon prompt, you will next want to transfer your old file (CHMYCELL) into your new file (CHNUFILE). Type in:

```
:FCOPY FROM=CHMYCELL;TO=CHNUFILE
```

IDSCHAR MAINTENANCE

Purging Old Cell Files

When you no longer have a need for a cell file (you might have created a new enlarged file and want to get rid of the old cell), do the following:

After the colon prompt. Type PURGE and the *filename* you wish to delete.

:PURGE *filename*

Press **RETURN**

The file is permanently removed from the system.

NOTE

Make sure the information you entered for the file is correct BEFORE you press **RETURN**. The file is lost once you purge it.

Characters and ASCII Characters Codes

APPENDIX C

Characters that you design or characters that have been supplied with IDSCHAR must be associated with a character code or a recognized character. For example, if you design a new "A", the character you enter in the "Character is" field of the SAVE CELL menu is "A" Or you can enter the character code "65" in the Character Code Number field.

Each time you want to work with a character, you enter the character representation in the "Character is" field or enter the Character Code Number on the GET CELL menu. Every character, including numbers, punctuation, and small and capital letters, has a character representation or character code number.

The following chart lists all the character representation in IDSCHAR and the associated ASCII character code numbers.

CHARACTER	CHARACTER CODE	CHARACTER	CHARACTER CODE
NUL	0	DLE	16
SOH	1	DC1	17
STX	2	DC2	18
ETX	3	DC3	19
EOT	4	DC4	20
ENQ	5	NAK	21
ACK	6	SYN	22
BEL	7	ETB	23
BS	8	CAN	24
HT	9	EM	25
LF	10	SUB	26
VT	11	ESC	27
FF	12	FS	28
CR	13	GS	29
SO	14	RS	30
SI	15	US	31
		SPACE	32

CHARACTERS AND ASCII CHARACTER CODES

!	33	H	72
"	34	I	73
#	35	J	74
\$	36	K	75
%	37	L	76
&	38	M	77
' (apostrophe)	39	N	78
(40	O	79
)	41	P	80
*	42	Q	81
+	43	R	82
, (comma)	44	S	83
- (hyphen)	45	T	84
.	46	U	85
/	47	V	86
0	48	W	87
1	49	X	88
2	50	Y	89
3	51	Z	90
4	52	[91
5	53	\	92
6	54]	93
7	55	^	94
8	56	_ (underline)	95
9	57		96
:	58	a	97
;	59	b	98
<	60	c	99
=	61	d	100
>	62	e	101
	63	f	102
@	64	g	103
A	65	h	104
B	66	i	105
C	67	j	106
D	68	k	107
E	69	l	108
F	70	m	109
G	71	n	110

CHARACTERS AND ASCII CHARACTER CODES

o	111	y	121
p	112	z	122
q	113	{	123
r	114		124
s	115	}	125
t	116		126
u	117	DEL	127
v	118		
w	119		
x	120		

NOTE

The ASCII character codes 0-31 and 127 are special characters for many devices. **IDSCHAR** will issue a warning if you enter them. If you plan to print something you have saved in one of these character codes, you should be aware of how the devices will work when the character code is received (refer to the specific device reference manual).

THIS PAGE SHOULD BE BLANK

IDSCHAR Messages

APPENDIX D

The following is a list of messages that appears on your terminal when you make an error or perform an incorrect function. The list includes the message and a brief explanation where necessary. The first group of messages is arranged by the message number. The second group of messages is in alphabetical order.

(PSPERR 102) Assertion xxx failed in procedure. *(Call your Hewlett-Packard Systems Engineer if this message appears on your terminal screen.)*

(PSPERR 601) Invalid value for FH'FileType; file damage likely. *(Restore the cell file version to an earlier version. If that doesn't correct the problem notify your Hewlett-Packard Systems Engineer.)*

(PSPERR 604) Invalid value for FH'UnitsUsed; file damage likely. *(Restore the cell file version to an earlier version. If that doesn't correct the problem notify your Hewlett-Packard Systems Engineer.)*

(PSPERR 611) This terminal is not supported by IDS/3000.

(PSPERR 616) Invalid value for FH'DotShape; file damage likely. *(Restore the cell file version to an earlier version. If that doesn't correct the problem notify your Hewlett-Packard Systems Engineer.)*

(PSPERR 631) Too many read errors trying to get the next command.

(PSPERR 639) Unexpected record type was read; file damage likely. *(Restore the cell file version to an earlier version. If that doesn't correct the problem notify your Hewlett-Packard Systems Engineer.)*

(PSPERR 643) No more room in partial dot lines array.

(PSPERR 644) Tried to write past end of file; file damage likely. *(Restore the cell file version to an earlier version. If that doesn't correct the problem notify your Hewlett-Packard Systems Engineer.)*

(PSPERR 654) Tried to read a grounded record; file damage likely. *(Restore the cell file version to an earlier version. If that doesn't correct the problem notify your Hewlett-Packard Systems Engineer.)*

(PSPERR 655) Tried to read invalid record number; file damage likely. *(Restore the cell file version to an earlier version. If that doesn't correct the problem notify your Hewlett-Packard Systems Engineer.)*

(PSPERR 662) Invalid formal file designator xxx.

IDSCHAR MESSAGES

(PSPERR 671) Can't back up past beginning of line; internal error.

(PSPERR 672) Unable to create file xxx. Probably duplicate name.

(PSPERR 683) Infinite loop in file; file damage likely. *(Restore the cell file version to an earlier version. If that doesn't correct the problem notify your Hewlett-Packard Systems Engineer.)*

(PSPERR 686) Tried to read past end of file; file damage likely. *(Restore the cell file version to an earlier version. If that doesn't correct the problem notify your Hewlett-Packard Systems Engineer.)*

(PSPERR 689) Pt size in SH doesn't match SI; file damage likely. *(Restore the cell file version to an earlier version. If that doesn't correct the problem notify your Hewlett-Packard Systems Engineer.)*

(PSPERR 690) DPB size in CV doesn't match CC; file damage likely. *(Restore the cell file version to an earlier version. If that doesn't correct the problem notify your Hewlett-Packard Systems Engineer.)*

(PSPERR 693) Tried to write a grounded record; internal error.

(PSPERR 695) Ran out of space for outline.

(PSPWARN 698) Warning: Cell file was opened for read access only.

The following messages are in alphabetical order and are explained where needed.

Are you sure? Hit CANCEL to cancel, hit ENTER to continue.

Bottom bound must not be above top bound.

Bottom of descenders must be less than baseline.

Choose a smaller scaling value.

Choose a smaller shift down value.

Choose a smaller shift left value.

Choose a smaller shift right value.

Choose a smaller shift up value.

Oct 83

D-2

Current cell's dimensions don't match those for this point size.

Device with address 7 is not supported as a digitizer. *(A device with an address of 7 must be a digitizer to use digitized points)*

Digitizer is unavailable; check power, address, cabling.

Dot is too big to draw; please specify a smaller magnification.

File already contains this cell height, with a different cell width.

Getting the cell

Getting the outline

Graphics is not supported for this terminal. *(You are not logged-on to an HP graphics terminal.)*

IO firmware is not installed in this terminal. *(You have tried print or plot on the digitizer and the proper firmware is not installed in the terminal. Contact your Hewlett-Packard Systems Engineer.)*

Left bound must not be to the right of right bound.

Maximum X coordinate for this cell is nnn.

Maximum Y coordinate for this cell is nnn.

No cell file is currently open.

No more cell heights available for this point size.

No more point sizes available for this cell height.

Out of space in cell file; copy to a bigger file.

Plotter is unavailable; check power, address, cabling.

Press ENTER to continue.

Printer is unavailable; check power, address, cabling.

IDSCHAR MESSAGES

Requested magnification was not possible; closest one was computed.

Right bound must not be to the left of left bound.

Saving the cell

Saving the outline

The file has been updated to the new PCELL format. *(This message appears after IDSCHAR converts an old PCELL file to new PCELL file format.)*

The logo is not in the file.

The requested cell width is not available for this cell height.

The requested cell width is not available in the current file.

There are no character font sizes in this cell file.

There are no logo sizes in this cell file.

There are no more character font sizes in this cell file.

There are no more logo sizes in this cell file.

There are no more sizes for the current device in this cell file

There are no sizes for the current device in this cell file.

There is no outline to save.

There is nothing in the hold cell.

This bound has not been set.

This cell and/or device can't be simulated.

This cell can't be simulated; try a smaller one.

This cell height is outside the valid range for this point size.

This cell is not in the file.

This cell size already exists. Choose another one.

This cell size is not in the file.

This cell version is not in the file.

This device can't be simulated; try smaller dot or bigger grid.

This file is not a cell file.

This is a character font file. Specify a character.

This is a logo file. Do not specify a character.

This operation cannot be done without write access.

This orientation is not in the file.

This outline is not in the file.

This outline size is not in the file.

This point size already exists. Choose another one.

This point size is not in the file.

This point size is outside the valid range for this cell height.

This size has not yet been created in the current file.

Top bound must not be below bottom bound.

Top of lowercase must be greater than baseline.

Top of uppercase must be greater than top of lowercase.

IDSCHAR MESSAGES

Top of uppercase must be greater than baseline.

Warning: Contents of display will be lost. Repeat to exit.

Warning: Contents of hold cell will be lost. Repeat to exit.

Warning: Device specs used to design cell are different from file.

Warning: File will not be updated without write access.

Warning: No write access, so changes here will be ignored.

Warning: Orientation used to design cell was different.

Warning: Predefined cell will be deleted; press ENTER to continue.

Warning: Predefined outline will be deleted; hit ENTER to continue.

Warning: Requested cell width not available for this cell height

Warning: The cell size cannot be changed.

Warning: The point size cannot be changed.

Warning: This character may have special meaning to your printer

INDEX

A

ASCII Character Codes	B-9
Abort	B-3
Accessing the digitizer	3-39
Accidental/Intentional Break	B-2
Active digitizing area	2-11
Adding a new cell size	3-28
Adding a new logo size	3-33
Additional Comments Menu (Logo)	3-99
Additional Comments Menu (Character)	3-101
Additional comments page (Delete)	3-102
Address codes	2-7
Appendices (Contents)	1-1
Appendix A	A-1
Appendix B	B-1
Appendix C	C-1
Appendix D	D-1
Arc (Drawing)	3-47
Arc (Erase)	3-49
Artwork (Preparing)	2-19
Artwork (Tracing)	2-24,2-34

B

Baseline positioning (Logos)	3-20
Baseline	A-2
Bounds (delete)	3-85
Bounds function	3-83
Break Key	2-6
Break and Abort	B-3
Building a new file	B-7

C

Cancel Key	3-40
Cell (Clearing)	3-39
Cell (Definition)	1-2
Cell (Moving)	3-41
Cell File (Definition)	1-2
Cell File (Additional Comments Menu)	3-101
Cell File Description Menu selections	3-7
Cell File Description Menu	3-7
Cell File Descriptive Comments Menu	3-105
Cell Graphics Menu	3-72
Cell Simulation Menu	3-81
Cell bounds (on/off)	3-74
Cell bounds function	3-83
Cell creation	3-42
Cell deletion (Character and Logo)	3-105
Cell designing (Different orientations)	3-61
Cell file additional comments	3-101
Cell file creation	3-5
Cell file description	3-94
Cell file descriptive comments	3-104
Cell graphics function	3-72
Cell lines	3-73
Cell magnification function	3-75
Cell saving	3-56
Cell simulating	3-81
Cell size (Adding new cell size)	3-28
Cell size (Changing parameters)	3-27
Cell size (selecting)	3-24
Cell size parameters (changing)	3-27
Cell sizes	3-12
Cell	3-35,A-2
Cells (Converting)	1-4
Changing cell size parameters	3-27
Changing outline size	3-86

INDEX

Delete outline size	3-113
Descender	A-3
Describing a cell file	3-94
Description of character font	3-97
Descriptive Comments (Cell File)	3-104
Design and Function Keys	3-36
Design keyboard layout	3-38
Designing cells for different orientations	3-61
Device (Target) information	3-103
Device simulating	3-79
Digitize	A-3
Digitizer (HP 9111A)	2-9
Digitizer (HP 9874A)	2-13
Digitizer Cursor	2-16
Digitizer Errors (Correcting)	2-44
Digitizer access	3-39
Digitizers (Using)	2-9
Digitizing (Example)	2-18
Digitizing (Getting Ready)	2-17
Digitizing (HP 9111A)	2-23
Digitizing (HP 9874A)	2-32
Digitizing a complex logo	x-xx
Digitizing an outline	2-32
Digitizing separate lines	2-26
Digitizing separate lines	2-36
Display area functions	3-35
Display area menus	3-55
Display area	2-21
Display area	A-3
Display grid	3-73
Document a file	3-90
Documentation of cell file	3-90
Dot (Drawing)	3-44
Dot	A-3
Draw a circle	3-50

Draw a dot	3-44
Draw an arc	3-47
Draw and line	3-45
Drawing and Cursor Control Keys	3-43

E

Edit Group Keys	2-5
Enlarging a cell file	B-6
Enter Key	2-6
Erase Key	3-40
Erase a filled rectangle	3-53
Erase an arc	3-49
Erasing a digitized line	2-25
Erasing a digitized line	2-35
Erasing a line	3-46
Errors - Digitizer (Correcting)	2-44

F

Family	A-3
File (Character Font)	3-7
File Format Updating	x-xx
File (Logo)	3-7
File creation (Cell)	3-5
File name	A-3
Fill (Erase)	3-53
Fill a rectangle	3-52
Fill an outline	3-54
Filling an outline	2-29
Filling an outline	2-41
Font size (Character)	3-27
Font sizes list (Character)	3-25

INDEX

Font A-3
Function (Bounds) 3-83
Function (Cell magnification) 3-75
Function keys 3-39
Functions (Graphics) 3-72
Functions of display area 3-35
Function and Edit Group Keys 2-5

G

Get Cell Menu 3-62
Get Outline Menu 3-68
Get a cell 3-62
Get an outline 3-68
Graphics Control Group Keys 2-5
Graphics function 3-72
Graphics terminal 2-1
Grid (Display) 3-73
Grid lines (on/off) 3-74
Grid lines 3-15,3-28,1-4
Grid points A-4
Grid width and height 3-96

H

Hardcopy 3-70
Height of Grid 3-96
Hold area (Retrieving a character or logo) 3-65
Hold area 3-63
Hold cell A-4
Holding a cell 3-63
Holding area 3-64

Oct 83

I-4

Home Cursor Key 2-4
Horizontal and vertical line spacing 3-16,3-28

I

Individual Logo Deletion 3-121
Individual Outline (Delete) 3-115
Individual character deletion 3-111
Insert Char Key 2-5
Intentional/Accidental Break B-2
IDSCCHAR (Definition) 1-1
IDSCCHAR Maintenance A-8
IDSCCHAR Messages C-4
IDIFORM (def.) x-xx
IFS/3000 (def.) x-xx

K

Key (Break) 2-6
Key (Cancel) 3-40
Key (Cancel) 3-40
Key (Char Delete) 2-5
Key (Clear Display) 2-4
Key (Enter) 2-6
Key (Erase) 3-40
Key (Home Cursor) 2-4

INDEX

Key (Insert Char)	2-5	Logo Deletion (Individual)	3-121
Key (Main Menu/Display)	3-40,3-89	Logo File (Definition)	1-2
Key (Recover/Refresh)	3-40	Logo File	3-7
Key (Remote)	2-4	Logo Modification Menu	3-17,3-29
Key (Remote)	2-6	Logo Size Menu	3-19,3-33
Key (Reset)	2-6	Logo cell deletion	3-105
Key (Return)	2-6	Logo cell file additional comments	3-99
Key (Tab)	2-4	Logo creation	3-17
Keyboard layout (Design)	3-38	Logo deletion	3-117
Keys (Control Group)	2-3,2-4	Logo file	A-4
Keys (Cursor control)	3-43	Logo modification	3-29
Keys (Design and Function)	3-36	Logo outline (Saving)	3-67
Keys (Drawing and Cursor Control)	3-43	Logo outline (retrieving)	3-69
Keys (Function and Edit Group)	2-5	Logo outline deletion	3-123
Keys (Function)	3-39	Logo saving	3-57
Keys (Graphics Control Group)	2-5	Logo size (Adding a new size)	3-33
Keys (HP 9111A Digitizer)	2-11	Logo size deletion	3-119
Keys (HP 9874A Digitizer)	2-15	Logo size	3-19,3-33
Keys (terminal)	2-4	Logo	A-4

L

Language	A-4
Line (Drawing)	3-45
Line (Erasing)	3-46
Line spacing (Vertical and Horizontal)	3-16,3-28
Lines (Cell)	3-73
Lines (Grid)	3-15
List of Character Font Sizes Menu	3-25
List of character font sizes	3-25
Listing the cell files	B-4
Logging-on to IDSCHAR	1-5
Logo Cell File (Additional Comments Menu)	3-99

INDEX

M

Magnification Menu	3-75	Menu (Making a Hardcopy)	3-70
Magnification feature	3-76	Menu (Save Cell)	3-56
Magnification of cell	3-75	Menu (Save Outline)	3-66
Main Menu/Display Key	3-40,3-89	Menu (Set Bounds)	3-83
Making a hardcopy	3-70	Menu (Target Device Simulation)	3-79
Menu (Cell File Additional Comments)	3-101	Menu (Target Device Description)	3-95
Menu (Cell File Description)	3-7,3-94	Menu (Target Device Information)	3-103
Menu (Cell File Descriptive Comments)	3-105	Menu (Transform Outline)	3-86
Menu (Cell Graphics)	3-72	Menu selection (Cell File Description Menu)	3-7
Menu (Cell Simulation)	3-81	Menu selections (Main)	3-3
Menu (Character Font Size)	3-13,3-27	Menus (Display Area)	3-55
Menu (Character Font Description)	3-97	Messages	C-4
Menu (Character Font Information)	3-104	Modify a cell file	3-21
Menu (Character Modification)	3-11,3-23	Modify a logo	3-29
Menu (Delete Character)	3-107	More than one cell	
Menu (Delete Character Size)	3-109	on the terminal screen display	3-78
Menu (Delete Individual Character)	3-111	Moving a cell	3-41
Menu (Delete Individual Outline)	3-115	Multiple character cells on screen	3-78
Menu (Delete Individual Logo)	3-121		
Menu (Delete Logo Outline)	3-123		
Menu (Delete Logo Size)	3-119		
Menu (Delete Logo)	3-117		
Menu (Delete Outline Size)	3-113		
Menu (Documentation)	3-91		
Menu (Format)	3-2		
Menu (Get Cell)	3-62		
Menu (Get Outline)	3-68		
Menu (List of Character Font Sizes)	3-25		
Menu (Logo Cell File Additional Comments)	3-99		
Menu (Logo Modification)	3-17,3-29		
Menu (Logo Size)	3-19,3-33		
Menu (Magnification)	3-75		
Menu (Main)	3-2		

N

New cell creation	3-42
Number (Version)	3-57

INDEX

O

Options (Character Font Size Menu)	3-15
Ordering Information	10
Orientation	3-59
Orientation	A-4
Outline (Definition)	1-4
Outline (Delete Individual)	3-115
Outline (Saving Character)	3-67
Outline (Saving Logo)	3-67
Outline (Transforming)	3-86
Outline	
(Use to create more than one cell size)	2-45
Outline deletion (Logo)	3-123
Outline filling	3-54
Outline size (delete)	3-113
Outlines	A-4
Overlays (Part Numbers)	9

P

Part numbers (Overlays)	9
Part numbers (Reference Guides)	10
PCELL format updating	x-xx
Placing a cell in hold	3-63
Placing a character or logo in holding area	3-64
Plotter (HP 7245A)	2-8
Plotter (HP 9872A)	2-7
Plotter printing	3-70
Point size	3-12,A-4
Position logos using baseline	3-20
Positioning (Baseline)	3-20
Printer (HP 2631G)	2-8
Printer (HP 7245A)	2-8

Printing to a Plotter	3-70
Proportional Spaced Font	A-5
Proportional spacing	3-9
Proportional spacing bounds (on/off)	3-74
Purge files	B-8

R

Ranking	3-58,A-5
Recover/Refresh Key	3-40
Recover/Refresh	B-1
Reference Guides (Part Numbers)	10
Remote Key	2-4,2-6
Remote computer access	1-5
Reset Key	2-6
Retrieving a character or logo	
from hold area	3-65
Retrieving a logo outline	3-69
Return Key	2-6
Reverse color command	3-74
Rotation (see Orientation)	

INDEX

S

Save Cell Menu	3-56
Save Outline Menu	3-66
Save a cell	3-56
Save a character outline	3-67
Save a character	2-42
Save a logo outline	3-67
Save an outline	2-39
Save and outline	3-66
Saving a character	2-30,3-57
Saving a logo	3-57
Saving an outline	2-28
Selecting cell size	3-24
Selections (Cell File Description Menu)	3-7
Serifs	3-10,A-6
Set Bounds Menu	3-83
Simulating a cell function	3-81
Simulating a device function	3-79
Size (Adding a new Logo size)	3-33
Size (Adding new cell size)	3-28
Size (Character Font)	3-27
Size (Logo)	3-19,3-33
Size deletion (Logo)	3-119
Size selection (Cell)	3-24
Sizes (Cell)	3-12
Sizes (Point)	3-12
Spacing (Changing Defaults)	3-10
Spacing (Proportional)	3-9
Spacing (Vertical line and Horizontal line)	3-16,3-28
Stop digitizing	2-27,2-38,3-39
Style	A-6
Stylus	2-11,2-16
Supported terminals	2-1

Oct 83

I-8

T

Tab Key	2-4
Target Device Description Menu	3-95
Target Device Information Menu	3-103
Target Device Simulation Menu	3-79
Target Device	A-6
Target device information	3-103
Temporary hold area	3-63
Terminal keys	2-4
Terminals supported	2-1
Top of lowercase	A-6
Top of uppercase	A-6
Transform Outline Menu	3-86
Transform outline function	3-86
Two-letter commands	3-74,A-6

U

Using Two-letter Commands	3-74
---------------------------	------

V

Version number	3-57
Version	A-7
Vertical and horizontal line spacing	3-16,3-28

W,X,Y,Z

Weight	A-7
Width of Grid	3-96
Width	A-7
Zoom	3-87

