User's Guide

Real-Time C Debugger for
68040

Notice

Hewlett-Packard makes no warranty of any kind with regard to this material, including, but not limited to, the implied warranties of merchantability and fitness for a particular purpose. Hewlett-Packard shall not be liable for errors contained herein or for incidental or consequential damages in connection with the furnishing, performance, or use of this material.

Hewlett-Packard assumes no responsibility for the use or reliability of its software on equipment that is not furnished by Hewlett-Packard.

© Copyright 1987, 1994, 1996, Hewlett-Packard Company.

This document contains proprietary information, which is protected by copyright. All rights are reserved. No part of this document may be photocopied, reproduced or translated to another language without the prior written consent of Hewlett-Packard Company. The information contained in this document is subject to change without notice.

MS-DOS(R) is a U.S. registered trademark of Microsoft Corporation.

HP-UX 9.* and 10.0 for HP 9000 Series 700 and 800 computers are X/Open Company UNIX 93 branded products.

TrueType(TM) is a U.S. trademark of Apple Computer, Inc.

UNIX(R) is a registered trademark in the United States and other countries, licensed exclusively through X/Open Company Limited.

Windows or MS Windows is a U.S. trademark of Microsoft Corporation.

Hewlett-Packard
P.O. Box 2197
1900 Garden of the Gods Road
Colorado Springs, CO 80901-2197, U.S.A.

RESTRICTED RIGHTS LEGEND Use, duplication, or disclosure by the U.S. Government is subject to restrictions as set forth in subparagraph (c) (1)(ii) of the Rights in Technical Data and Computer Software Clause at DFARS 252.227-7013. Hewlett-Packard Company, 3000 Hanover Street, Palo Alto, CA 94304 U.S.A. Rights for non-DOD U.S. Government Departments and Agencies are as set forth in FAR 52.227-19(c)(1,2).

Printing History

New editions are complete revisions of the manual. The date on the title page changes only when a new edition is published.

A software code may be printed before the date; this indicates the version level of the software product at the time the manual was issued. Many product updates and fixes do not require manual changes, and manual corrections may be done without accompanying product changes. Therefore, do not expect a one-to-one correspondence between product updates and manual revisions.

Edition 1	B3629-97000, September 1994
Edition 2	B3629-97001, February 1996

Safety, Certification and Warranty

Safety and certification and warranty information can be found at the end of this manual on the pages before the back cover.

Real-Time C Debugger — Overview

The Real-Time C Debugger is an MS Windows application that lets you debug C language programs for embedded microprocessor systems.

The debugger controls HP 64700 emulators and analyzers either on the local area network (LAN) or connected to a personal computer with an RS-232C interface or the HP 64037 RS-422 interface. It takes full advantage of the emulator's real-time capabilities to allow effective debug of C programs while running in real time.

The debugger is an MS Windows application

- You can display different types of debugger information in different windows, just as you display other windows in MS Windows applications.
- You can complete a wide variety of debug-related tasks without exiting the debugger. You can, for example, edit files or compile your programs without exiting the debugger.
- You can cut text from the debugger windows to the clipboard, and clipboard contents may be pasted into other windows or dialog boxes.

The debugger communicates at high speeds

- You can use the HP 64700 LAN connection or the RS-422 connection for high-speed data transfer (including program download). These connections give you an efficient debugging environment.

You can debug programs in C context

- You can display C language source files (optionally with intermixed assembly language code).
- You can display program symbols.
- You can display the stack backtrace.
- You can display and edit the contents of program variables.
- You can step through programs, either by source lines or assembly language instructions.
- You can step over functions.
- You can run programs until the current function returns.
- You can run programs up to a particular source line or assembly language instruction.

- You can set breakpoints in the program and define macros (which are collections of debugger commands) that execute when the breakpoint is hit. Break macros provide for effective debugging without repeated command entry.

You can display and modify processor resources

- You can display and edit the contents of memory locations in hexadecimal or as C variables.
- You can display and edit the contents of microprocessor registers including on-chip peripheral registers.
- You can display and modify individual bits and fields of bit-oriented registers.

You can trace program execution

- You can trace control flow at the C function level.
- You can trace the callers of a function.
- You can trace control flow within a function at the C statement level.
- You can trace all C statements that access a variable.
- You can trace before, and break program execution on, a C variable being set to a specified value.
- You can make custom trace specifications.

You can debug your program while it runs continuously at full speed

- You can configure the debugger to prevent it from automatically initiating any action that may interrupt user program execution. This ensures that the user program executes in real time, so you can debug your design while it runs in a real-world operating mode.
- You can inspect and modify C variables and data structures without interrupting execution.
- You can set and clear breakpoints without interrupting execution.
- You can perform all logic analysis functions, observing C program and variable activity, without interrupting program execution.

In This Book

This book documents the Real-Time C Debugger for 68040. It is organized into five parts whose chapters are described below.

Part 1. Quick Start Guide

Chapter 1 quickly shows you how to use the debugger.

Part 2. User's Guide

Chapter 2 shows you how to use the debugger interface.

Chapter 3 shows you how to plug the emulator into target systems.

Chapter 4 shows you how to configure the emulator.

Chapter 5 shows how to perform the tasks that you can use to debug programs.

Part 3. Reference

Chapter 6 contains a summary of the debugger commands as they are used in command files and break macros.

Chapter 7 describes the format for expressions used in commands.

Chapter 8 describes commands that appear in the menu bar.

Chapter 9 describes commands that appear in debugger window control menus.

Chapter 10 describes commands that appear in pop-up menus.

Chapter 11 describes commands that are only available in command files and break macros.

Chapter 12 describes error messages and provides recovery information.

Part 4. Concept Guide

Chapter 13 contains conceptual (and more detailed) information on various topics.

Part 5. Installation Guide

Chapter 14 shows you how to install the debugger.

Chapter 15 shows you how to install or update HP 64700 firmware.

Contents

Part 1 Quick Start Guide

1 Getting Started

Step 1. Start the debugger	25
Step 2. Adjust the fonts and window size	26
Step 3. Change the foreground monitor address	27
Step 4. Map memory for the demo program	28
Step 5. Set up the initial ISP and PC exception vectors	30
Step 6. Load the demo program	32
Step 7. Display the source file	33
Step 8. Set a breakpoint	34
Step 9. Run the demo program	35
Step 10. Delete the breakpoint	36
Step 11. Single-step one line	37
Step 12. Single-step 10 lines	38
Step 13. Display a variable	39
Step 14. Edit a variable	40
Step 15. Monitor a variable in the WatchPoint window	41
Step 16. Run until return from current function	42
Step 17. Step over a function	43
Step 18. Run the program to a specified line	44
Step 19. Display register contents	45
Step 20. Trace function flow	47
Step 21. Trace a function's callers	48
Step 22. Trace access to a variable	50
Step 23. Exit the debugger	51

Part 2 User's Guide

2 Using the Debugger Interface

How the Debugger Uses the Clipboard 57

Debugger Function Key Definitions 58

Starting and Exiting the Debugger 59

To start the debugger 59

To exit the debugger 60

To create an icon for a different emulator 61

Working with Debugger Windows 62

To open debugger windows 62

To copy window contents to the list file 63

To change the list file destination 63

To change the debugger window fonts 64

To set tabstops in the Source window 64

To set colors in the Source window 65

Using Command Files 66

To create a command file 66

To execute a command file 67

To create buttons that execute command files 68

3 Plugging the Emulator into Target Systems

To plug-in the emulator probe 71

To configure the emulator for in-circuit operation 75

4 Configuring the Emulator

Setting the Hardware Options 79

To enable or disable the on-chip caches 79

To specify a clock speed faster than 25 MHz 80

To enable or disable target system interrupts 81

To enable or disable break on writes to ROM 81

To enable or disable breakpoint acknowledge interlock 82

To specify the target memory access size	83
To specify the initial ISP and PC values	83
Mapping Memory	84
To map memory	85
Selecting the Type of Monitor	88
To select the background monitor	89
To select the foreground monitor	90
To use a custom foreground monitor	92
Setting Up the BNC Port	94
To output the trigger signal on the BNC port	94
To receive an arm condition input on the BNC port	94
Saving and Loading Configurations	95
To save the current emulator configuration	95
To load an emulator configuration	96
Setting the Real-Time Options	97
To allow or deny monitor intrusion	98
To turn polling ON or OFF	99

5 Debugging Programs

Loading and Displaying Programs	103
To load user programs	103
To display source code only	104
To display source code mixed with assembly instructions	104
To display source files by their names	105
To specify source file directories	106
To search for function names in the source files	107
To search for addresses in the source files	107
To search for strings in the source files	108
Displaying Symbol Information	109
To display program module information	110
To display function information	110
To display external symbol information	111

Contents

To display local symbol information	112
To display global assembler symbol information	113
To display local assembler symbol information	113
To create a user-defined symbol	114
To display user-defined symbol information	115
To delete a user-defined symbol	115
To display the symbols containing the specified string	116
Stepping, Running, and Stopping the Program	117
To step a single line or instruction	117
To step over a function	118
To step multiple lines or instructions	119
To run the program until the specified line	120
To run the program until the current function return	120
To run the program from a specified address	121
To stop program execution	121
To reset the processor	122
Using Breakpoints and Break Macros	123
To set a breakpoint	124
To disable a breakpoint	125
To delete a single breakpoint	125
To list the breakpoints and break macros	126
To set a break macro	126
To delete a single break macro	129
To delete all breakpoints and break macros	130
Displaying and Editing Variables	131
To display a variable	131
To edit a variable	132
To monitor a variable in the WatchPoint window	133
Displaying and Editing Memory	134
To display memory	134
To edit memory	136
To copy memory to a different location	137
To copy target system memory into emulation memory	138
To modify a range of memory with a value	139
To search memory for a value or string	140

Displaying and Editing I/O Locations	141
To display I/O locations	141
To edit an I/O location	142
Displaying and Editing Registers	143
To display registers	143
To edit registers	145
Tracing Program Execution	146
To trace function flow	148
To trace callers of a specified function	149
To trace execution within a specified function	151
To trace accesses to a specified variable	152
To trace before a particular variable value and break	153
To trace until the command is halted	155
To stop a running trace	155
To repeat the last trace	155
To display bus cycles	156
To display absolute or relative counts	157
To change the disassembly of bus cycle data	157
To display dequeued trace data	158
Setting Up Custom Trace Specifications	159
To set up a "Trigger Store" trace specification	161
To set up a "Find Then Trigger" trace specification	164
To set up a "Sequence" trace specification	168
To edit a trace specification	173
To trace "windows" of program execution	173
To store the current trace specification	175
To load a stored trace specification	176

Part 3 Reference

6 Command File and Macro Command Summary

7 Expressions in Commands

Numeric Constants	187
Symbols	188
Function Codes	191
C Operators	192

8 Menu Bar Commands

File→Load Object...	(ALT, F, L)	197
File→Command Log→Log File Name...	(ALT, F, C, N)	200
File→Command Log→Logging ON	(ALT, F, C, O)	201
File→Command Log→Logging OFF	(ALT, F, C, F)	202
File→Run Cmd File...	(ALT, F, R)	203
File→Load Debug...	(ALT, F, D)	205
File→Save Debug...	(ALT, F, S)	206
File→Load Emulator Config...	(ALT, F, E)	207
File→Save Emulator Config...	(ALT, F, V)	208
File→Copy Destination...	(ALT, F, P)	209
File→Exit	(ALT, F, X)	210
File→Exit HW Locked	(ALT, F, H)	211
File Selection Dialog Boxes		212
Execution→Run (F5),	(ALT, E, U)	213
Execution→Run to Cursor	(ALT, E, C)	214
Execution→Run to Caller	(ALT, E, T)	215
Execution→Run...	(ALT, E, R)	216
Execution→Single Step (F2),	(ALT, E, N)	218
Execution→Step Over (F3),	(ALT, E, O)	219
Execution→Step...	(ALT, E, S)	220
Execution→Break (F4),	(ALT, E, B)	224
Execution→Reset	(ALT, E, E)	225
Breakpoint→Set at Cursor	(ALT, B, S)	226
Breakpoint→Delete at Cursor	(ALT, B, D)	227
Breakpoint→Set Macro...	(ALT, B, M)	228
Breakpoint→Delete Macro	(ALT, B, L)	231

Breakpoint→Edit... (ALT, B, E)	232
Variable→Edit... (ALT, V, E)	234
Variable Modify Dialog Box	236
Trace→Function Flow (ALT, T, F)	237
Trace→Function Caller... (ALT, T, C)	240
Trace→Function Statement... (ALT, T, S)	242
Trace→Variable Access... (ALT, T, V)	244
Trace→Variable Break... (ALT, T, B)	246
Trace→Edit... (ALT, T, E)	248
Trace→Trigger Store... (ALT, T, T)	249
Trace→Find Then Trigger... (ALT, T, D)	252
Trace→Sequence... (ALT, T, Q)	256
Trace→Until Halt (ALT, T, U)	260
Trace→Halt (ALT, T, H)	261
Trace→Again (F7), (ALT, T, A)	262
Condition Dialog Boxes	263
Trace Pattern Dialog Box	266
Trace Range Dialog Box	268
Sequence Number Dialog Box	270
RealTime→Monitor Intrusion→Disallowed (ALT, R, T, D)	271
RealTime→Monitor Intrusion→Allowed (ALT, R, T, A)	272
RealTime→I/O Polling→ON (ALT, R, I, O)	273
RealTime→I/O Polling→OFF (ALT, R, I, F)	274
RealTime→Watchpoint Polling→ON (ALT, R, W, O)	275
RealTime→Watchpoint Polling→OFF (ALT, R, W, F)	276
RealTime→Memory Polling→ON (ALT, R, M, O)	277
RealTime→Memory Polling→OFF (ALT, R, M, F)	278
Assemble... (ALT, A)	279
Settings→Emulator Config→Hardware... (ALT, S, E, H)	280
Settings→Emulator Config→Memory Map... (ALT, S, E, M)	284
Settings→Emulator Config→Monitor... (ALT, S, E, O)	288
Settings→Communication... (ALT, S, C)	292
Settings→BNC→Outputs Analyzer Trigger (ALT, S, B, O)	295
Settings→BNC→Input to Analyzer Arm (ALT, S, B, I)	297
Settings→Font... (ALT, S, F)	298
Settings→Tabstops... (ALT, S, T)	300
Settings→Symbols→Case Sensitive→ON (ALT, S, S, C, O)	301
Settings→Symbols→Case Sensitive→OFF (ALT, S, S, C, F)	301
Settings→Extended→Trace Cycles→User (ALT, S, X, T, U)	302

Settings→Extended→Trace Cycles→Monitor (ALT, S, X, T, M)	302
Settings→Extended→Trace Cycles→Both (ALT, S, X, T, B)	303
Settings→Extended→Load Error Abort→ON (ALT, S, X, L, O)	304
Settings→Extended→Load Error Abort→OFF (ALT, S, X, L, F)	304
Settings→Extended→Source Path Query→ON (ALT, S, X, S, O)	305
Settings→Extended→Source Path Query→OFF (ALT, S, X, S, F)	305
Window→Cascade (ALT, W, C)	306
Window→Tile (ALT, W, T)	306
Window→Arrange Icons (ALT, W, A)	306
Window→1-9 (ALT, W, 1-9)	307
Window→More Windows... (ALT, W, M)	308
Help→About Debugger/Emulator... (ALT, H, D)	309
Source Directory Dialog Box	309
WAIT Command Dialog Box	310

9 Window Control Menu Commands

Common Control Menu Commands	313
Copy→Window (ALT, -, P, W)	313
Copy→Destination... (ALT, -, P, D)	314
Button Window Commands	315
Edit... (ALT, -, E)	315
Expression Window Commands	318
Clear (ALT, -, R)	318
Evaluate... (ALT, -, E)	319
I/O Window Commands	320
Define... (ALT, -, D)	320
Memory Window Commands	322
Display→Linear (ALT, -, D, L)	322
Display→Block (ALT, -, D, B)	323
Display→Byte (ALT, -, D, Y)	323
Display→16 Bit (ALT, -, D, 1)	323
Display→32 Bit (ALT, -, D, 3)	323
Search... (ALT, -, R)	324

Utilities→Copy... (ALT, -, U, C)	326
Utilities→Fill... (ALT, -, U, F)	327
Utilities→Load... (ALT, -, U, L)	328
Utilities→Store... (ALT, -, U, S)	330
 Register Window Commands	 332
Copy→Registers (ALT, -, P, R)	332
Register Bit Fields Dialog Box	333
 Source Window Commands	 335
Display→Mixed Mode (ALT, -, D, M)	335
Display→Source Only (ALT, -, D, S)	336
Display→Select Source... (ALT, -, D, L)	337
Search→String... (ALT, -, R, S)	338
Search→Function... (ALT, -, R, F)	339
Search→Address... (ALT, -, R, A)	341
Search→Current PC (ALT, -, R, C)	342
Search Directories Dialog Box	343
 Symbol Window Commands	 344
Display→Modules (ALT, -, D, M)	344
Display→Functions (ALT, -, D, F)	345
Display→Externals (ALT, -, D, E)	345
Display→Locals... (ALT, -, D, L)	346
Display→Asm Globals (ALT, -, D, G)	347
Display→Asm Locals... (ALT, -, D, A)	347
Display→User defined (ALT, -, D, U)	349
Copy→Window (ALT, -, P, W)	349
Copy→All (ALT, -, P, A)	350
FindString→String... (ALT, -, F, S)	350
User defined→Add... (ALT, -, U, A)	351
User defined→Delete (ALT, -, U, D)	353
User defined→Delete All (ALT, -, U, L)	353
 Trace Window Commands	 354
Display→Mixed Mode (ALT, -, D, M)	355
Display→Source Only (ALT, -, D, S)	355
Display→Bus Cycle Only (ALT, -, D, C)	355

Display→Count→Absolute (ALT, -, D, C, A)	356
Display→Count→Relative (ALT, -, D, C, R)	356
Display→From State... (ALT, -, D, F)	357
Display→Options→Dequeue ON (ALT, -, D, O, O)	359
Display→Options→Dequeue OFF (ALT, -, D, O, F)	359
Copy→Window (ALT, -, P, W)	360
Copy→All (ALT, -, P, A)	360
Search→Trigger (ALT, -, R, T)	361
Search→State... (ALT, -, R, S)	361
Trace Spec Copy→Specification (ALT, -, T, S)	362
Trace Spec Copy→Destination... (ALT, -, T, D)	362
WatchPoint Window Commands	363
Edit... (ALT, -, E)	363

10 Window Pop-Up Commands

BackTrace Window Pop-Up Commands	369
Source at Stack Level	369
Source Window Pop-Up Commands	370
Set Breakpoint	370
Clear Breakpoint	370
Evaluate It	370
Add to Watch	371
Run to Cursor	371

11 Other Command File and Macro Commands

BEEP	375
EXIT	376
FILE CHAINCMD	377
FILE RERUN	378
NOP	379
TERMCMD	380
WAIT	382

12 Error Messages

Error Messages	384
Bad RS-232 port name	385
Bad RS-422 card I/O address	385
Could not open initialization file	385
Could not write Memory	386
Error occurred while processing Object file	387
General RS-232 communications error	388
General RS-422 communications error	388
HP 64700 locked by another user	389
HP 64700 not responding	389
Incorrect DLL version	389
Incorrect LAN Address (HP-ARPA, Windows for Workgroups)	390
Incorrect LAN Address (Novell)	391
Incorrect LAN Address (WINSOCK)	391
Internal error in communications driver	392
Internal error in Windows	392
Interrupt execution (during run to caller)	392
Interrupt execution (during step)	393
Interrupt execution (during step over)	393
Invalid transport name	394
LAN buffer pool exhausted	394
LAN communications error	395
LAN MAXSENDSIZE is too small	395
LAN socket error	395
Object file format ERROR	396
Out of DOS Memory for LAN buffer	397
Out of Windows timer resources	398
PC is out of RAM memory	398
Timed out during communications	399

Part 4 Concept Guide

13 Concepts

Debugger Windows	405
The BackTrace Window	406
The Button Window	407
The Expression Window	408
The I/O Window	409
The Memory Window	410
The Register Windows	411
The Source Window	412
The Status Window	415
The Symbol Window	418
The Trace Window (Emulator Only)	419
The WatchPoint Window	421
Compiler/Assembler Specifications	422
IEEE-695 Object Files	422
Compiling Programs with MCC68K	424
Compiling Programs with AxLS	425
Monitor Programs	427
Monitor Program Options	427
Assembling and Linking the Foreground Monitor with MCC68K	429
Assembling and Linking the Foreground Monitor with AxLS	429
Setting Up the Trace Vector	430
Notes on Foreground Monitors	430
Trace Signals and Predefined Status Values	431

Part 5 Installation Guide

14 Installing the Debugger

- Requirements 437
- Before Installing the Debugger 438
 - Step 1. Connect the HP 64700 to the PC 439
 - To connect via RS-232 439
 - To connect via LAN 442
 - To connect via RS-422 446
 - If you cannot verify RS-232 communication 447
 - If you cannot verify LAN communication 448
 - Step 2. Install the debugger software 449
 - Step 3. Plug the emulator into the demo board 452
 - Step 4. Start the debugger 453
 - If you have RS-232 connection problems 453
 - If you have LAN connection problems 456
 - If you have LAN DLL errors 457
 - If you have RS-422 connection problems 458
 - Step 5. Check the HP 64700 system firmware version 459
- Optimizing PC Performance for the Debugger 460

15 Installing/Updating HP 64700 Firmware

- Step 1. Connect the HP 64700 to the PC 463
- Step 2. Install the firmware update utility 465
- Step 3. Run PROGFLASH to update HP 64700 firmware 468
- Step 4. Verify emulator performance 470

Glossary

Index

Part 1

Quick Start Guide

A few task instructions to help you get comfortable.

Part 1





Getting Started

Getting Started

This tutorial helps you get comfortable by showing you how to perform some measurements on a demo program. This tutorial shows you how to:

- 1 Start the debugger.
- 2 Adjust the fonts and window size.
- 3 Change the foreground monitor address.
- 4 Map memory for the demo program.
- 5 Set up the initial ISP and PC exception vectors.
- 6 Load the demo program.
- 7 Display the source file.
- 8 Set a breakpoint.
- 9 Run the demo program.
- 10 Delete the breakpoint.
- 11 Single-step one line.
- 12 Single-step 10 lines.
- 13 Display a variable.
- 14 Edit a variable.
- 15 Monitor a variable in the WatchPoint window.
- 16 Run until return from current function.
- 17 Step over a function.
- 18 Run the program to a specified line.
- 19 Display register contents.
- 20 Trace function flow.
- 21 Trace a function's callers.
- 22 Trace access to a variable.
- 23 Exit the debugger.

Demo Programs

Demo programs are included with the Real-Time C Debugger in the C:\HP\RTC\M040\DEMO directory (if C:\HP\RTC\M040 was the installation path chosen when installing the debugger software).

Subdirectories exist for the SAMPLE demo program, which is a simple C program that does case conversion on a couple strings, and for the ECS demo program, which is a somewhat more complex C program for an environmental control system.

Each of these demo program directories contains a README file that describes the program and batch files that show you how the object files were made.

This tutorial shows you how to perform some measurements on the SAMPLE demo program.



Step 1. Start the debugger

- Open the HP Real-Time C Debugger group box and double-click the 68040 debugger icon.

Or:

- 1** Choose the File→Run (ALT, F, R) command in the Windows Program Manager.
- 2** Enter the debugger startup command, C:\HP\RTC\M040\B3629.EXE (if C:\HP\RTC\M040 was the installation path chosen when installing the debugger software).
- 3** Choose the OK button.

Step 2. Adjust the fonts and window size

The first time RTC is used, a default window and font size is used. This may not be the best for your display. You may change the font type and size with the Settings→Font... command, and change the window size by using standard Windows 3.1 methods (moving the mouse to the edge of the window and dragging the mouse to resize the window).

- 1** Choose the Settings→Font... (ALT, S, F) command.
- 2** Choose the Font, Font Style, and Size desired in the Font dialog box.
- 3** Choose the OK button to apply your font selections and close the Font dialog box.

The sizes of the RTC window, as well as the sizes of the windows within RTC, and the fonts used will be saved in the B3629.INI file and reused when you enter RTC the next time.

Step 3. Change the foreground monitor address

- 1 Choose the Settings→Emulator Config→Monitor... (ALT, S, E, O) command.
- 2 Enter "10000" in the Monitor Address text box.

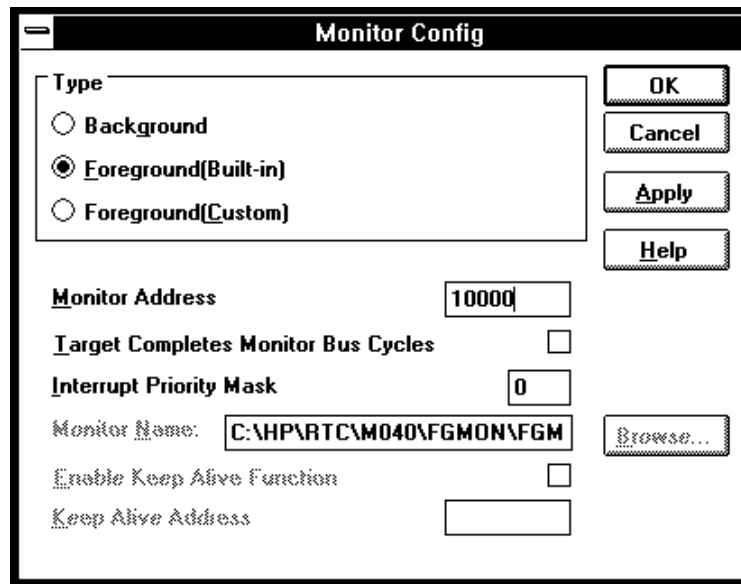

- 3 Choose the OK button.

For information on what the monitor program is and what it does, refer to Monitor Program Options in the "Concepts" part.

The 68040 emulator uses the built-in foreground monitor by default. Because the sample demo program uses locations 0 through 0ffff, the monitor must be relocated.

Step 4. Map memory for the demo program

By default, the emulator assumes all memory addresses are in RAM space in your target system. If you wish to load some of your target program in emulation memory, or identify some of your memory addresses as ROM or Guarded, those specifications must be entered in the memory map.

The demo program reserves addresses 0h-0fffh for ROM and 6000h-0ffffh for RAM. Map these address ranges as emulation memory.

- 1** Choose the Settings→Emulator Config→Memory Map... (ALT, S, E, M) command.
- 2** Enter "0" in the Start text box.
- 3** Tab the cursor to the End text box and enter "0fff."
- 4** Select "erom" in the Type option box.
- 5** Choose the Apply button.
- 6** Enter "6000" in the Start text box and "0ffff" in the End text box.
- 7** Select "eram" in the Type option box.

8 Choose the Apply button.

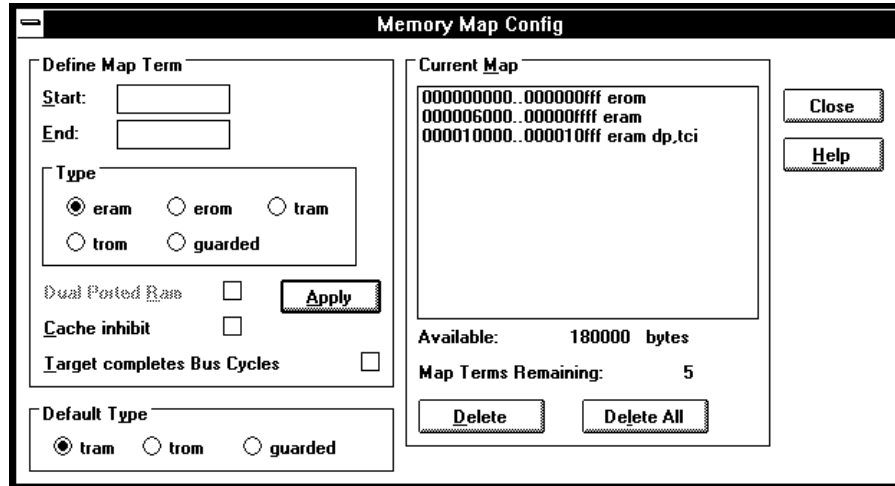

9 Choose the Close button.

Step 5. Set up the initial ISP and PC exception vectors

- 1 Choose the Settings→Emulator Config→Hardware... (ALT, S, E, H) command.
- 2 Enter "8000" in the Initial Stack Pointer Value text box.
- 3 Enter "6cc" in the Initial Program Counter Value text box.

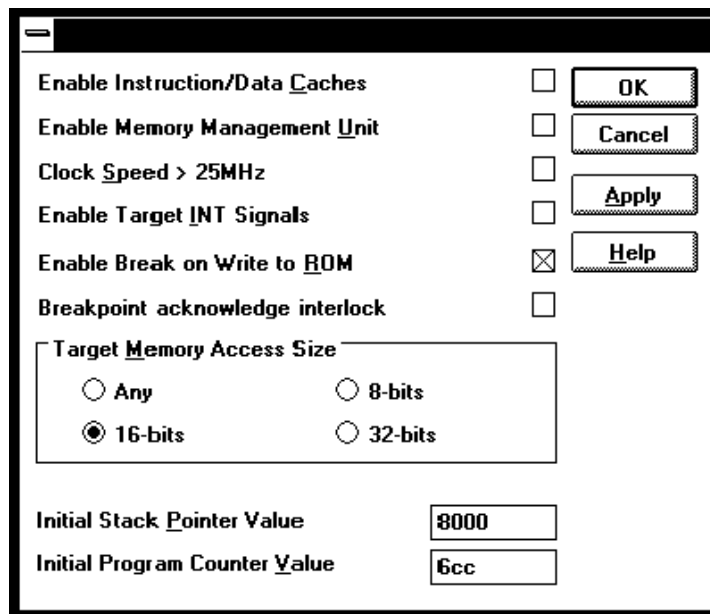

- 4 Choose the OK button.

The 68040 emulator requires the initial interrupt stack pointer (ISP) and program counter (PC) values to be set to even addresses. The initial ISP value should be an address in emulation RAM or in target system RAM.

The monitor reads the reset vector from the exception table to determine the initial ISP and PC register values.

Step 5. Set up the initial ISP and PC exception vectors

You can also set the interrupt stack pointer and program counter values by modifying the ISP and PC registers in the Basic Registers window.



Step 6. Load the demo program

- 1** Choose the Execution→Break... (ALT, E, B) command to make sure the emulator is running in the monitor. The monitor is used when loading programs into single-port emulation memory.
- 2** Choose the File→Load Object... (ALT, F, L) command.
- 3** Choose the Browse button and select the sample program object file, C:\HP\RTC\M040\DEMO\SAMPLE\SAMPLE.X (if C:\HP\RTC\M040 was the installation path chosen when installing the debugger software).
- 4** Choose the OK button in the Object File Name dialog box.
- 5** Choose the Load button.

Step 7. Display the source file

To display the sample.c source file starting from the main function:

- 1 If the Source window is not open, double-click on the Source window icon to open the window. Or, choose the Window→Source command.
- 2 From the Source window's *control menu*, choose Search→Function... (ALT, -, R, F) command.
- 3 Select "main."
- 4 Choose the Find button.
- 5 Choose the Close button.
- 6 From the Source window's *control menu*, choose Display→Source Only (ALT, -, D, S) command.

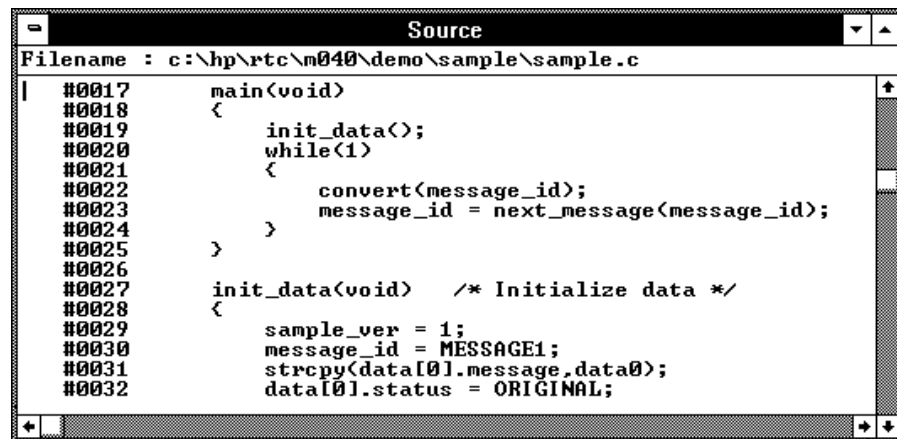

```
Source
Filename : c:\hp\rtc\n040\demo\sample\sample.c
| #0017     main(void)
#0018     <
#0019         init_data();
#0020         while(1)
#0021         <
#0022             convert(message_id);
#0023             message_id = next_message(message_id);
#0024         >
#0025     >
#0026
#0027     init_data(void) /* Initialize data */
#0028     <
#0029         sample_ver = 1;
#0030         message_id = MESSAGE1;
#0031         strcpy(data[0].message,data0);
#0032         data[0].status = ORIGINAL;
```

The window displays sample.c source file, starting from main function.

Step 8. Set a breakpoint

To set a breakpoint on line 22 in sample.c:

- 1 Cursor-select line 22 (that is, move the mouse pointer over line 22 and click the left mouse button).
- 2 Choose the Breakpoint→Set at Cursor (ALT, B, S) command.

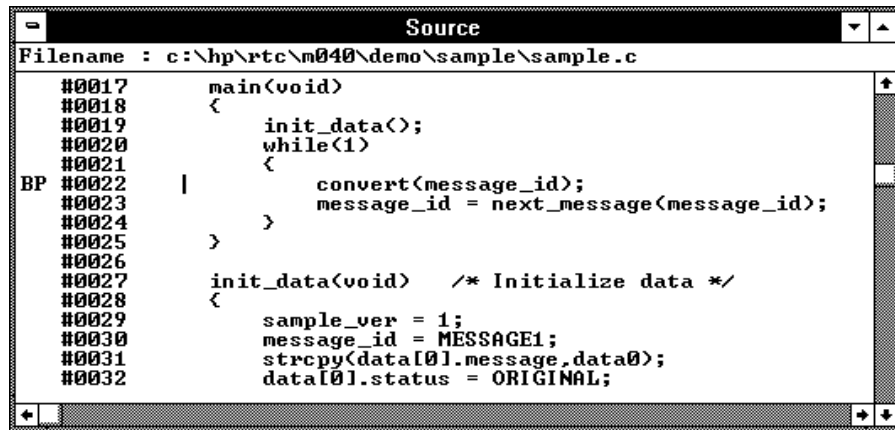

The screenshot shows a window titled "Source" with the following code:

```
Filename : c:\hp\rtc\n040\demo\sample\sample.c
#0017     main(void)
#0018     {
#0019         init_data();
#0020         while(1)
#0021         {
BP #0022     |         convert(message_id);
#0023         |         message_id = next_message(message_id);
#0024         |     }
#0025     }
#0026
#0027     init_data(void) /* Initialize data */
#0028     {
#0029         sample_ver = 1;
#0030         message_id = MESSAGE1;
#0031         strcpy(data[0].message,data0);
#0032         data[0].status = ORIGINAL;
```

The breakpoint is indicated by "BP" on line 22.

Notice that line 22 is marked with "BP," which indicates a breakpoint has been set on the line.

Note

This can be done more quickly by using the pop-up menu available with the right mouse button.

Step 9. Run the demo program

To run the demo program from user reset:

- 1 Choose the Execution→Run... (ALT, E, R) command.
- 2 Select the Start Address option.
- 3 Choose the Run button.

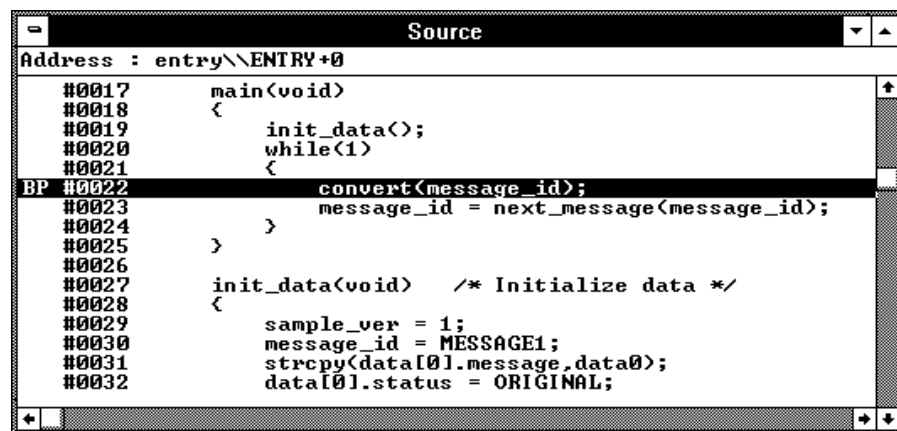

```
Source
Address : entry\\ENTRY+0
#0017  main(void)
#0018  {
#0019      init_data();
#0020      while(1)
#0021      {
BP #0022  convert(message_id);
#0023      message_id = next_message(message_id);
#0024  }
#0025  }
#0026
#0027  init_data(void) /* Initialize data */
#0028  {
#0029      sample_ver = 1;
#0030      message_id = MESSAGE1;
#0031      strcpy(data[0].message,data0);
#0032      data[0].status = ORIGINAL;
```

Notice the demo program runs until line 22. The highlighted line indicates the current program counter.

Step 10. Delete the breakpoint

To delete the breakpoint set on line 22:

- 1** Cursor-select line 22.
- 2** Choose the Breakpoint→Delete at Cursor (ALT, B, D) command.

The "BP" marker disappears in the Source window.

Step 11. Single-step one line

To single-step the demo program from the current program counter:

- Choose the **Execution→Single Step (ALT, E, N)** command. Or, press the **F2** key.

Notice the **C** statement executed and the program counter is at the "convert" function.



Step 12. Single-step 10 lines

To single-step 10 consecutive executable statements from the current PC line:

- 1 Choose the Execution→Step... (ALT, E, S) command.
- 2 Select the Current PC option.
- 3 Enter "10" in the Count text box.

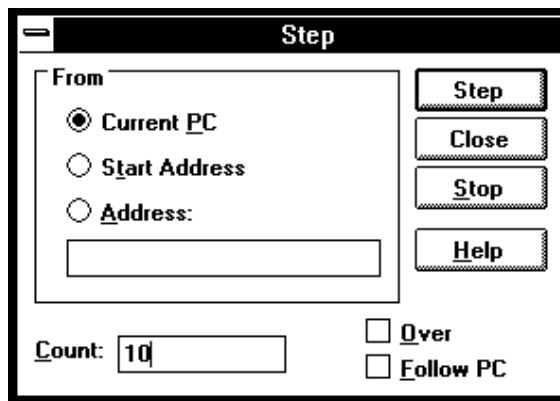

- 4 Choose the Step button. Notice that the step count decrements by one as the program executes step by step. The step count stops at 0.
- 5 Choose the Close button.

Step 13. Display a variable

To display the contents of auto variable `*mes`:

- 1 Drag `*mes` on line 45 in the Source window until it is highlighted.
- 2 Choose the Variable→Edit... (ALT, V, E) command.

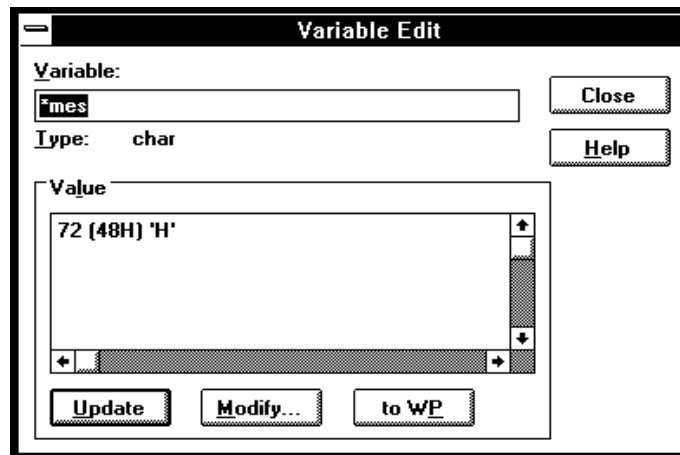

The Variable text box displays `*mes`.

Notice the Value list box displays the contents of `*mes`.

Note

You can only register or display an auto variable as a watchpoint while the program counter is within the function in which the variable name is declared.

Step 14. Edit a variable

To edit the contents of variable "*mes":

- 1 In the Variable Edit dialog box, choose the Modify button.
- 2 Enter "41" in the Value text box.

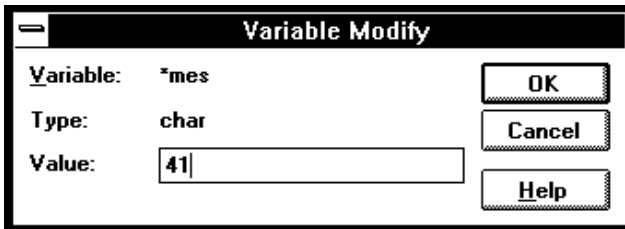

- 3 Choose the OK button.
- 4 Notice the contents of the variable in the Value list box has changed to "41."

Step 15. Monitor a variable in the WatchPoint window

The WatchPoint window lets you define a set of variables that may be looked at and modified often. For these types of variables, using the WatchPoint window is more convenient than using the Variable→Edit... (ALT, V, E) command.

To monitor the variable `*mes` in the WatchPoint window:

- 1 In the Variable Edit dialog box, choose the "to WP" button.
- 2 Choose the Close button.
- 3 Choose the Window→WatchPoint command.

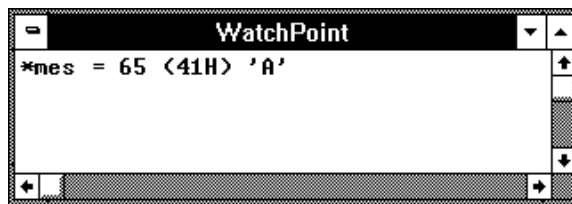

Notice the variable `*mes` has been registered as a watchpoint.

Step 16. Run until return from current function

To execute the program until "convert_case" (the current PC function) returns to its caller:

- 1** Choose the Execution→Run to Caller (ALT, E, T) command.

The program executes until the line that called "convert_case."

- 2** Choose the Execution→Single Step (ALT, E, N) command (or press the F2 key) to go to the line that follows the return from the "convert_case:" function.

Step 17. Step over a function

To step over "change_status":

- Choose the Execution→Step Over (ALT, E, O) command. Or, press the F3 key.

The "change_status" function executes, and the program counter indicates line 41.

Step 18. Run the program to a specified line

To execute the demo program to the first line of "next_message":

- 1 Cursor-select line 63.
- 2 Choose the Execution→Run to Cursor (ALT, E, C) command.

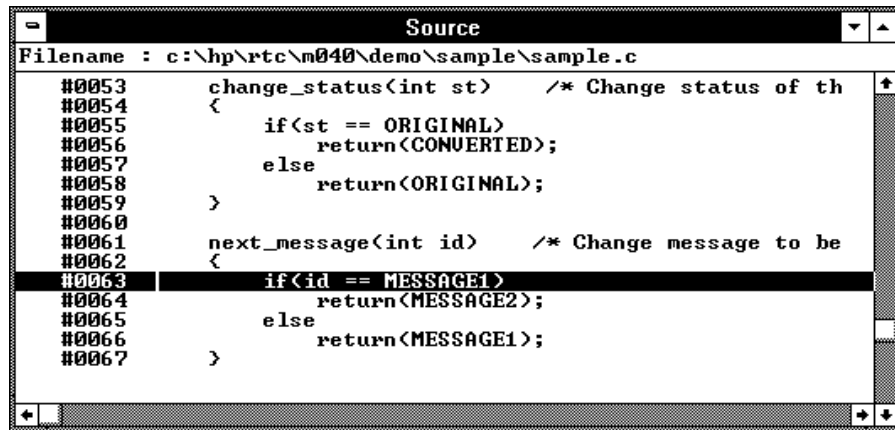

The screenshot shows a window titled "Source" with a filename of "c:\hp\rtc\n040\demo\sample\sample.c". The code is as follows:

```
#0053 change_status(int st) /* Change status of th
#0054 {
#0055     if(st == ORIGINAL)
#0056         return(CONVERTED);
#0057     else
#0058         return(ORIGINAL);
#0059 }
#0060
#0061 next_message(int id) /* Change message to be
#0062 {
#0063     if(id == MESSAGE1)
#0064         return(MESSAGE2);
#0065     else
#0066         return(MESSAGE1);
#0067 }
```

Line 63, which is the first line of the `next_message` function, is highlighted with a thick black bar.

The program executes and stops immediately before line 63.

Step 19. Display register contents

- 1 Choose the Window→Basic Registers command.

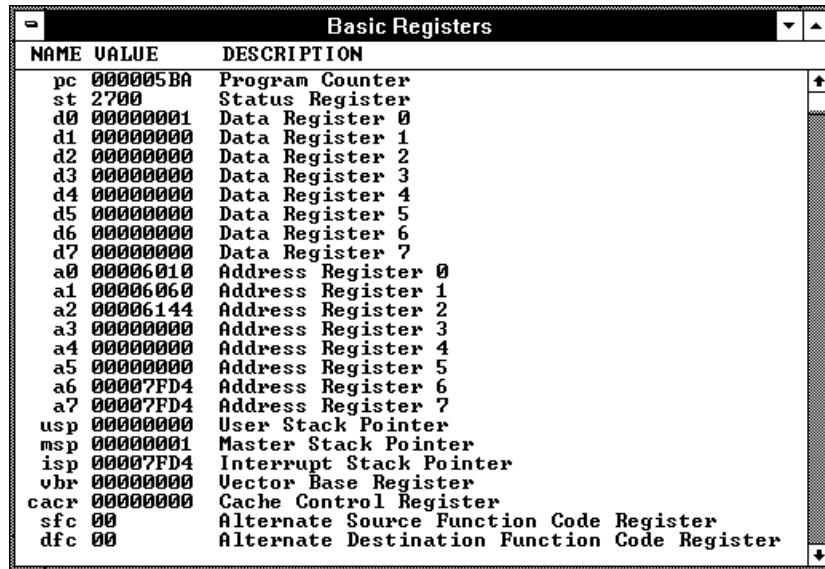

The screenshot shows a window titled "Basic Registers" with a table of register information. The table has three columns: NAME, VALUE, and DESCRIPTION. The registers listed include pc, st, data registers (d0-d7), address registers (a0-a7), and various stack pointers and control registers.

NAME	VALUE	DESCRIPTION
pc	000005BA	Program Counter
st	2700	Status Register
d0	00000001	Data Register 0
d1	00000000	Data Register 1
d2	00000000	Data Register 2
d3	00000000	Data Register 3
d4	00000000	Data Register 4
d5	00000000	Data Register 5
d6	00000000	Data Register 6
d7	00000000	Data Register 7
a0	00006010	Address Register 0
a1	00006060	Address Register 1
a2	00006144	Address Register 2
a3	00000000	Address Register 3
a4	00000000	Address Register 4
a5	00000000	Address Register 5
a6	00007FD4	Address Register 6
a7	00007FD4	Address Register 7
usp	00000000	User Stack Pointer
msp	00000001	Master Stack Pointer
isp	00007FD4	Interrupt Stack Pointer
vbr	00000000	Vector Base Register
cacr	00000000	Cache Control Register
sfc	00	Alternate Source Function Code Register
dfc	00	Alternate Destination Function Code Register

The Basic Registers window opens and displays the register contents. The display is updated periodically.

- 2 To see the effects of preventing monitor intrusion (running in real-time mode), choose the RealTime→Monitor Intrusion→Disallowed (ALT, R, T, D) command.

Chapter 1: Getting Started
Step 19. Display register contents

- 3 To run the program, choose the Execution→Run (ALT, E, U) command. Or, press the F5 key.

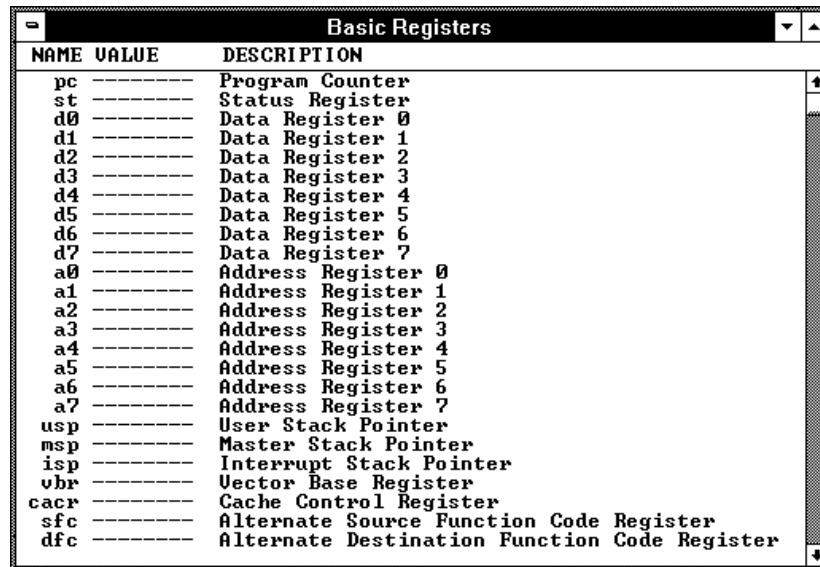

NAME	VALUE	DESCRIPTION
pc	-----	Program Counter
st	-----	Status Register
d0	-----	Data Register 0
d1	-----	Data Register 1
d2	-----	Data Register 2
d3	-----	Data Register 3
d4	-----	Data Register 4
d5	-----	Data Register 5
d6	-----	Data Register 6
d7	-----	Data Register 7
a0	-----	Address Register 0
a1	-----	Address Register 1
a2	-----	Address Register 2
a3	-----	Address Register 3
a4	-----	Address Register 4
a5	-----	Address Register 5
a6	-----	Address Register 6
a7	-----	Address Register 7
usp	-----	User Stack Pointer
msp	-----	Master Stack Pointer
isp	-----	Interrupt Stack Pointer
vbr	-----	Vector Base Register
cacr	-----	Cache Control Register
sfc	-----	Alternate Source Function Code Register
dfc	-----	Alternate Destination Function Code Register

Notice that register contents are replaced with "----" in the display. This shows the debugger cannot update the register display. In order for the emulator to update its register display, the emulation monitor must interrupt target program execution while it reads the registers.

- 4 Choose the RealTime→Monitor Intrusion→Allowed (ALT, R, T, A) command to deselect the real-time mode. Notice that the contents of the registers are updated periodically.

Step 20. Trace function flow

- Choose the Trace→Function Flow (ALT, T, F) command.

The Trace window becomes active and displays execution flow as shown below.

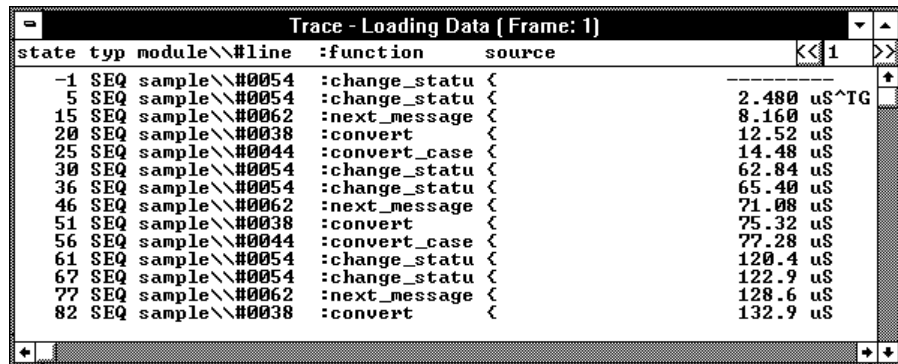

state	typ	module\line	:function	source	
-1	SEQ	sample\#0054	:change_statu	<	
5	SEQ	sample\#0054	:change_statu	<	2.480 uS^TG
15	SEQ	sample\#0062	:next_message	<	8.160 uS
20	SEQ	sample\#0038	:convert	<	12.52 uS
25	SEQ	sample\#0044	:convert_case	<	14.48 uS
30	SEQ	sample\#0054	:change_statu	<	62.84 uS
36	SEQ	sample\#0054	:change_statu	<	65.40 uS
46	SEQ	sample\#0062	:next_message	<	71.08 uS
51	SEQ	sample\#0038	:convert	<	75.32 uS
56	SEQ	sample\#0044	:convert_case	<	77.28 uS
61	SEQ	sample\#0054	:change_statu	<	120.4 uS
67	SEQ	sample\#0054	:change_statu	<	122.9 uS
77	SEQ	sample\#0062	:next_message	<	128.6 uS
82	SEQ	sample\#0038	:convert	<	132.9 uS

The command traces, and stores in trace memory, only the entry points to functions. This lets you check program execution flow.

If the display you have on screen does not look like the trace list above, from the Trace window's control menu, choose the Display→Source Only (ALT, -, D, S) command.

Step 21. Trace a function's callers

To trace the caller of "change_status":

- 1 Double-click "change_status" on line 53 in the Source window.
- 2 Choose the Trace→Function Caller... (ALT, T, C) command.

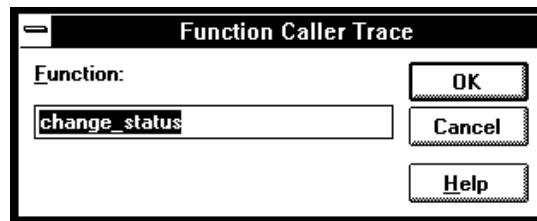

- 3 Choose the OK button.

The Trace window becomes active and displays the caller as shown below.

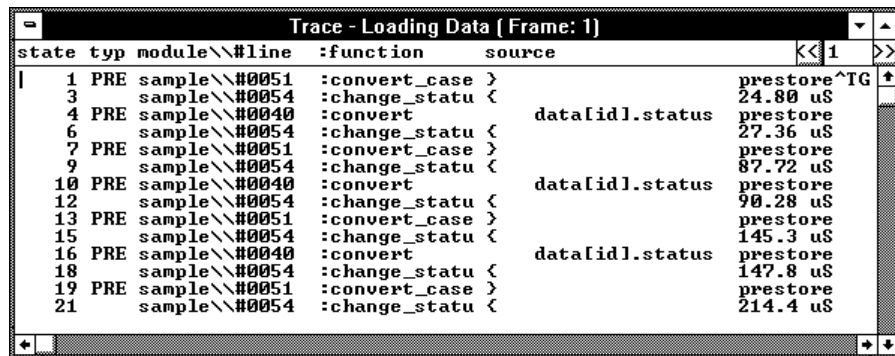

The image shows a window titled "Trace - Loading Data (Frame: 1)". It contains a table with the following columns: state, typ, module\\#line, :function, source, and time. The data is as follows:

state	typ	module\\#line	:function	source	time
1	PRE	sample\\#0051	:convert_case	>	prestore
3		sample\\#0054	:change_statu	<	24.80 uS
4	PRE	sample\\#0040	:convert	data[id].status	prestore
6		sample\\#0054	:change_statu	<	27.36 uS
7	PRE	sample\\#0051	:convert_case	>	prestore
9		sample\\#0054	:change_statu	<	87.72 uS
10	PRE	sample\\#0040	:convert	data[id].status	prestore
12		sample\\#0054	:change_statu	<	90.28 uS
13	PRE	sample\\#0051	:convert_case	>	prestore
15		sample\\#0054	:change_statu	<	145.3 uS
16	PRE	sample\\#0040	:convert	data[id].status	prestore
18		sample\\#0054	:change_statu	<	147.8 uS
19	PRE	sample\\#0051	:convert_case	>	prestore
21		sample\\#0054	:change_statu	<	214.4 uS

This command stores the first statement of a function and prestores statements that occur before the first statement (notice the state type PRE). The prestored statements show the caller of the function. In the above example, "change_status" is called by the "convert" function (at line 40 of the

"sample" module). Because the first statement of "change_status" is prefetched after "convert_case," these states are also included in the trace.



Step 22. Trace access to a variable

To trace access to variable "message_id":

- 1 Double-click "message_id" on line 22 in the Source window.
- 2 Choose the Trace→Variable Access... (ALT, T, V) command.

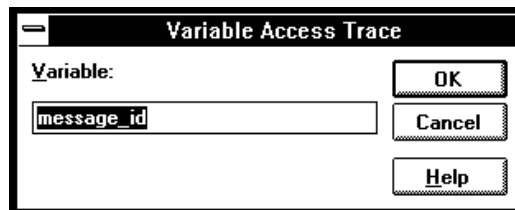

- 3 Choose the OK button.

The Trace window becomes active and displays accesses to "message_id" as shown below.

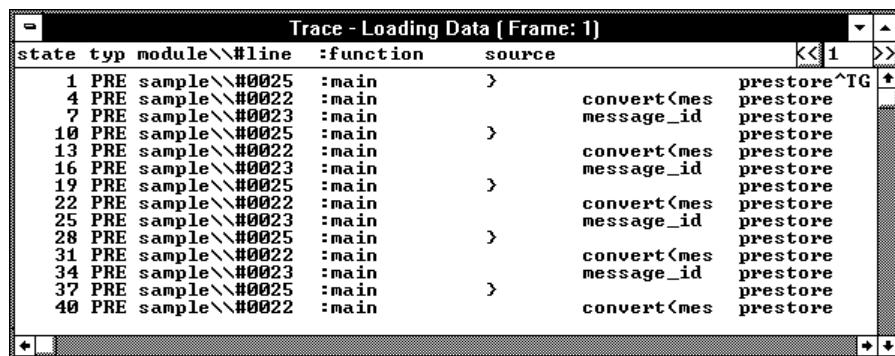

The image shows a window titled "Trace - Loading Data (Frame: 1)". It contains a table with the following columns: state, typ, module\\#line, :function, source, and a column with navigation icons. The table lists several trace events for the variable "message_id".

state	typ	module\\#line	:function	source	
1	PRE	sample\\#0025	:main	}	prestore^TG
4	PRE	sample\\#0022	:main	convert<mes	prestore
7	PRE	sample\\#0023	:main	message_id	prestore
10	PRE	sample\\#0025	:main	}	prestore
13	PRE	sample\\#0022	:main	convert<mes	prestore
16	PRE	sample\\#0023	:main	message_id	prestore
19	PRE	sample\\#0025	:main	}	prestore
22	PRE	sample\\#0022	:main	convert<mes	prestore
25	PRE	sample\\#0023	:main	message_id	prestore
28	PRE	sample\\#0025	:main	}	prestore
31	PRE	sample\\#0022	:main	convert<mes	prestore
34	PRE	sample\\#0023	:main	message_id	prestore
37	PRE	sample\\#0025	:main	}	prestore
40	PRE	sample\\#0022	:main	convert<mes	prestore

Step 23. Exit the debugger

- 1 Choose the File→Exit (ALT, F, X) command.
- 2 Choose the OK button.

This will end your Real-Time C Debugger session.

Part 2

User's Guide

A complete set of task instructions and problem-solving guidelines, with a few basic concepts.

Part 2

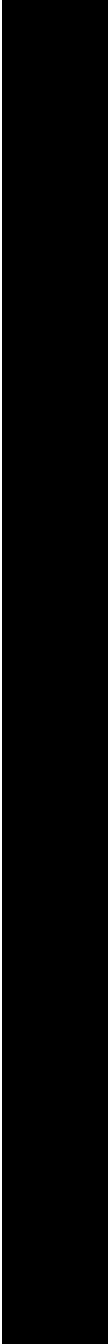



Using the Debugger Interface

Using the Debugger Interface

This chapter contains general information about using the debugger interface.

- How the Debugger Uses the Clipboard
- Debugger Function Key Definitions
- Starting and Exiting the Debugger
- Working with Debugger Windows
- Using Command Files

How the Debugger Uses the Clipboard

Whenever something is selected with the standard windows double-click, it is placed on the clipboard. The clipboard can be pasted into selected fields by clicking the right mouse button.

Double-clicks are also used in the Register and Memory windows to make values active for editing. These double-clicks also copy the current value to the clipboard, destroying anything you might have wanted to paste into the window (for example, a symbol into the memory address field). In situations like this, you can press the CTRL key while double-clicking to prevent the selected value from being copied to the clipboard. This allows you to, for example, double-click on a symbol, CTRL+double-click to activate a register value for editing, and click the right mouse button to paste the symbol value into the register.

Many of the Real-Time C Debugger commands and their dialog boxes open with the clipboard contents automatically pasted in the dialog box. This makes entering commands easy. For example, when tracing accesses to a program variable, you can double-click on the variable name in one of the debugger windows, choose the Trace→Variable Access... (ALT, T, V) command, and click the OK button without having to enter or paste the variable name in the dialog box (since it is has automatically been pasted in the dialog box).

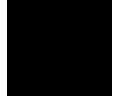

Debugger Function Key Definitions

F1	Accesses context sensitive help. Context sensitive help is available for windows, dialog boxes, and menu items (with Ctrl+F1).
F2	Executes a single source line from the current program counter address (or a single instruction if disassembled mnemonics are mixed with source lines in the Source window).
F3	Same as F2 except when the source line contains a function call (or the assembly instruction makes a subroutine call); in these cases, the entire function (or subroutine) is executed.
F4	Break emulator execution into the monitor. You can use this to stop a running program or break into the monitor from the processor reset state.
F5	Runs the program from the current program counter address.
Shift-F4	Tiles the open debugger windows.
Shift-F5	Cascades the open debugger windows.
F7	Repeats the trace command that was entered last.
Ctrl+F7	Halts the current trace.

Starting and Exiting the Debugger

This section shows you how:

- To start the debugger
- To exit the debugger
- To create an icon for a different emulator

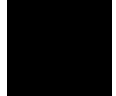

To start the debugger

- Double-click the debugger icon.

Or:

- 1** Choose the File→Run (ALT, F, R) command in the Windows Program Manager.
- 2** Enter the debugger filename, C:\HP\RTC\M040\B3629.EXE (if C:\HP\RTC\M040 was the installation path chosen when installing the debugger software).
- 3** Choose the OK button.

You can execute a command file when starting the debugger by using the "-C<command_file>" command line option.

To exit the debugger

- 1** Choose the File→Exit (ALT, F, X) command.
- 2** Choose the OK button.

This will end your Real-Time C Debugger session.

To create an icon for a different emulator

- 1 Open the "HP Real-Time C Debugger" group box, or make it active by positioning the mouse in the window and clicking the left button.
- 2 Choose the File→New... (ALT, F, N) command in the Windows Program Manager.
- 3 Select the Program Item option and choose OK.
- 4 In the Description text box, enter the icon description.
- 5 In the Command Line text box, enter the
"C:\HP\RTC\M040\B3629.EXE -T<transport> -E<connectname>"
command (if C:\HP\RTC\M040 was the installation path chosen when installing the debugger software). The "-T" and "-E" startup options allow you to bypass the transport and connect name definitions in the B3629.INI file.

<Transport> should be one of the supported transport options (for example, HP-ARPA, RS232C, etc.).

<Connectname> should identify the emulator for the type of transport. For example, if the HP-ARPA transport is used, <connectname> should be the hostname or IP address of the HP 64700; if the RS232C transport is used, <connectname> should be COM1, COM2, etc.
- 6 In the Working Directory text box, enter the directory that contains the debugger program (for example, C:\HP\RTC\M040).
- 7 Choose the OK button.

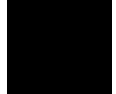

Working with Debugger Windows

This section shows you how:

- To open debugger windows
- To copy window contents to the list file
- To change the list file destination
- To change the debugger window fonts
- To set tabstops in the Source window
- To set colors in the Source window

To open debugger windows

- Double-click the icon for the particular window.
- Or, choose the particular window from the Window→ menu.
- Or, choose the Window→More Windows... (ALT, W, M) command, select the window to be opened from the dialog box, and choose the OK button.

To copy window contents to the list file

- From the window's control menu, choose the Copy→Windows (ALT, -, P, W) command.

The information shown in the window is copied to the destination list file.

You can change the name of the destination list file by choosing the Copy→Destination... (ALT, -, P, D) command from the window's control menu or by choosing the File→Copy Destination... (ALT, F, P) command.

To change the list file destination

- Choose the File→Copy Destination... (ALT, F, P) command, and select the name of the new destination list file.
- Or, from the window's control menu, choose the Copy→Destination... (ALT, -, P, D) command, and select the name of the new destination list file.

Information copied from windows will be copied to the selected destination file until the destination list file name is changed again.

List file names have the ".LST" extension.

To change the debugger window fonts

- 1 Choose the Settings→Font (ALT, S, F) command.
- 2 Select the font, font style, and size. Notice that the Sample box previews the selected font.
- 3 Choose the OK button.

To set tab stops in the Source window

- 1 Choose the Settings→Tabstops (ALT, S, T) command.
- 2 Enter the tab width. This width is also used for source lines in the trace window.
- 3 Choose the OK button.

The tab width must be between 1 and 20.

To set colors in the Source window

- 1 Exit the RTC interface and find the initialization file (B3629.INI). It should be in the directory where you installed the RTC product (C:\HP\RTC\, by default).
- 2 Edit the initialization file to find the "color" entry. You will see:

```
[Color]  
ColorMode=ON|OFF  
ColorPc=<color>  
ColorSource=<color>  
ColorMne=<color>
```

Where: <color> may be any of the following: RED, GREEN, BLUE, YELLOW, PINK, PURPLE, AQUA, ORANGE, SLATE, or WHITE.

- The <color> entry may be in upper-case or lower-case letters.
- When ColorMode=ON, these are the default colors:
 - ColorPC=GREEN
 - ColorSource=RED
 - ColorMne=BLUE
- The default color is black if an option is given a null value.
- The options under [Color] set colors as follows:
 - ColorPc sets the color of the line of the current program counter.
 - ColorSource sets the color of the line numbers of source lines.
 - ColorMne sets the color of the address of all mnemonic lines.

Note

If you have set ColorMode=ON while using a monochrome display, you may see no line numbers in the Source window. Items that will be presented in color on a color display may not be seen at all on a monochrome display.

Using Command Files

This section shows you how:

- To create a command file
- To execute a command file
- To create buttons that execute command files

A command file is an ASCII text file containing one or more debugger commands. All the commands are written in a simple format, which makes editing easy. The debugger commands used in command files are the same as those used with break macros. For details about the format of each debugger command, refer to the "Reference" information.

To create a command file

- 1** Choose the File→Command Log→Log File Name... (ALT, F, C, N) command.
- 2** Enter the command file name.
- 3** Choose the File→Command Log→Logging ON (ALT, F, C, O) command.
- 4** Choose the commands to be stored in the command file.
- 5** Once the commands have been completed, choose the File→Command Log→Logging OFF (ALT, F, C, F) command.

Command files can also be created by saving the emulator configuration.

To execute a command file

- 1 Choose the File→Run Cmd File... (ALT, F, R) command.
- 2 Select the command file to be executed.
- 3 Choose the Execute button.

You can execute command files that have been created by logging commands.

Also, emulator configurations can be restored by executing the associated command file.

You can execute a command file when starting the debugger by using the "-C<command_file>" command line option.

Example

Command File Being Executed

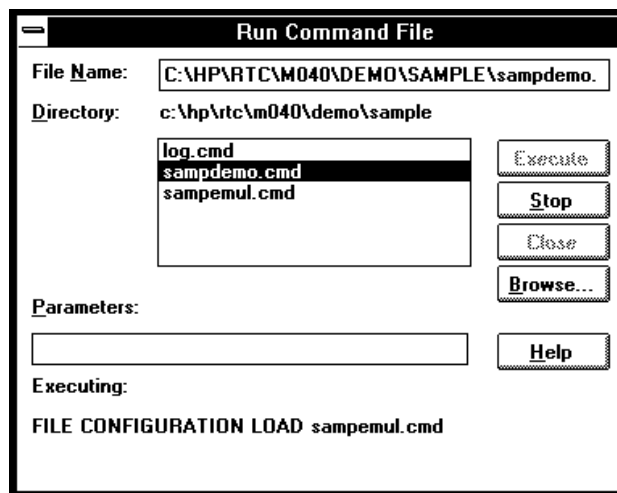

To create buttons that execute command files

- 1** Activate the Button window by clicking on the Button window icon or by choosing the Window→Button command.
- 2** From the Button window's control menu, choose the Edit... (ALT, -, E) command.
- 3** In the Command text box, enter "FILE COMMAND", a space, and the name of the command file to be executed.
- 4** Enter the button label in the Name text box.
- 5** Choose the Add button.
- 6** Choose the Close button.

Once a button has been added, you can click on it to run the command file.

You can also set up buttons to execute other debugger commands.



Plugging the Emulator into Target Systems

Plugging the Emulator into Target Systems

This chapter shows you how:

- To plug-in the emulator probe
- To configure the emulator for in-circuit operation

To plug-in the emulator probe

CAUTION

Possible damage to the emulator probe. The emulation probe contains devices that are susceptible to damage by static discharge. You should take precautions before handling the probe, to avoid damaging the internal components of the probe with static electricity.

CAUTION

Possible damage to the emulator. Make sure both your target system and emulator power are OFF before installing the emulator probe into your target system.

- 1** Turn OFF power to the target system.
- 2** Turn OFF power to the emulator.
- 3** Remove the processor from the target system socket.
- 4** Note the location of pin A1 on the processor and on your target system socket. Store the processor in a protected environment (such as antistatic foam).



Chapter 3: Plugging the Emulator into Target Systems
To plug-in the emulator probe

5 Insert the emulator probe into your target system socket.

CAUTION

The emulator probe will be damaged if incorrectly installed. Make sure to align pin A1 of the probe connector with pin A1 of the socket.

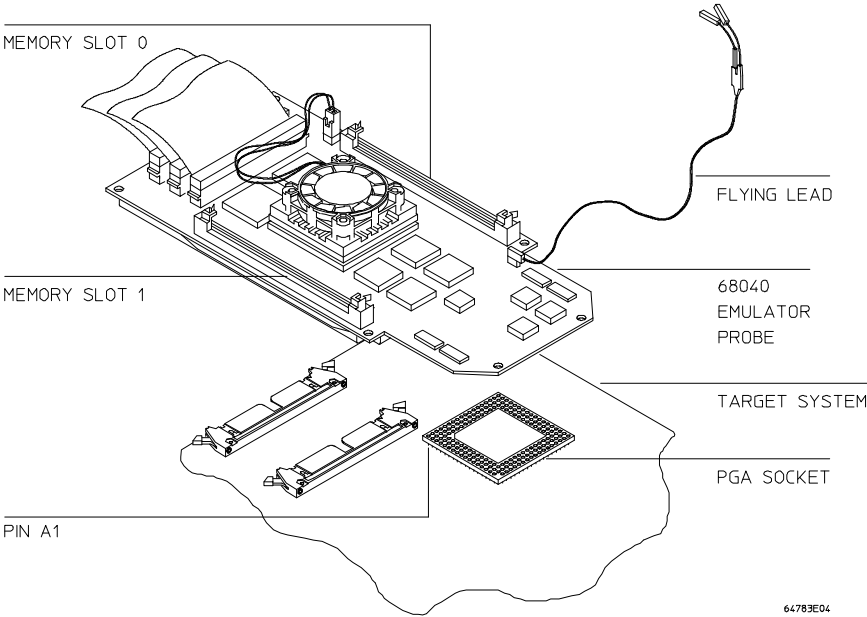

- 6 If you wish to reset circuitry in your target system when the emulation microprocessor is reset, connect the Reset flying lead as shown below.

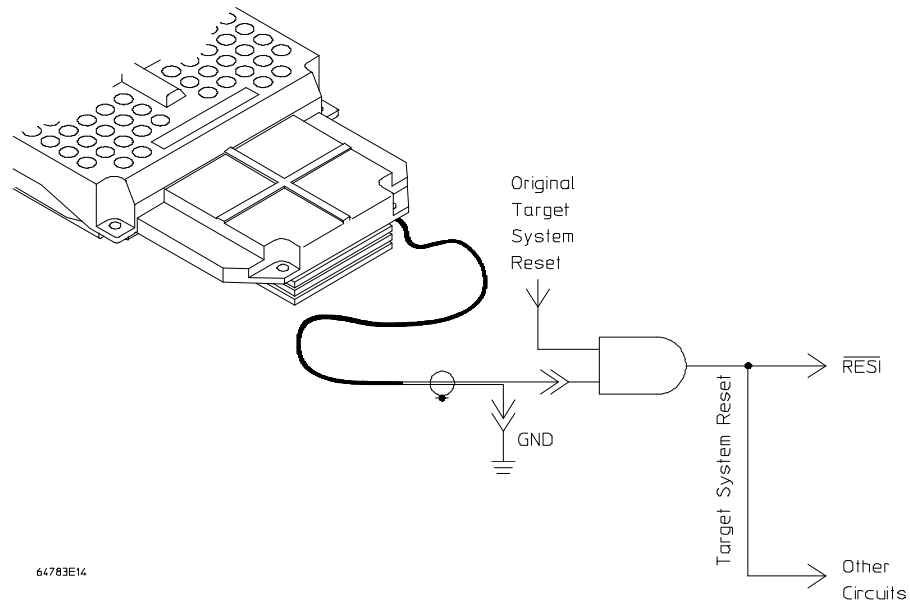

- 7 Turn ON power to the emulator.

CAUTION

Possible damage to the emulator! You must apply power to the emulator before you apply power to your target system. Otherwise, the emulator may be damaged.

- 8 Turn ON power to the target system.

- 9 Start the debugger.

Plugging the emulator into a target system can be difficult because of mechanical constraints. If the mechanical constraints cannot be removed so

Chapter 3: Plugging the Emulator into Target Systems

To plug-in the emulator probe

that the emulator can be plugged directly into the target socket, there are several accessories available to help with the connection:

- Stacking pin protectors.
- PGA rotators, available from Emulation Technology.
- PGA to PGA Flexible Adapter (HP E3429A).

Unfortunately, these accessories have an electrical impact on your target system. In addition to delays, the accessories can cause problems with signal quality. Only use these accessories as a last resort.

To configure the emulator for in-circuit operation

The following outlines the emulator configuration for in-circuit emulation. For details on each configuration option, refer to the "Configuring the Emulator" chapter.

- If the processor clock speed is greater than 25 MHz, choose the Settings→Emulator Config→Hardware... (ALT, S, E, H) command and select the Clock Speed > 25 MHz check box so that the proper number of wait states are inserted for emulation memory accesses.
- Enable or disable target system interrupts by choosing the Settings→Emulator Config→Hardware... (ALT, S, E, H) command and either selecting or deselecting the Enable Target INT Signals check box.
- Specify whether emulation memory accesses should be synchronized with the target system /TA or /TEA signal. When mapping memory (by choosing the Settings→Emulator Config→Memory Map... (ALT, S, E, M) command), either select or deselect the Target Completes Bus Cycles check box.
- Specify whether monitor program accesses should be synchronized with the target system /TA or /TEA signal by choosing the Settings→Emulator Config→Monitor... (ALT, S, E, O) command and either selecting or deselecting the Target Completes Monitor Bus Cycles check box.





Configuring the Emulator

Configuring the Emulator

This chapter contains information about configuring the emulator.

- Setting the Hardware Options
- Mapping Memory
- Selecting the Type of Monitor
- Setting Up the BNC Port
- Saving and Loading Configurations
- Setting the Real-Time Options

Setting the Hardware Options

This section shows you how:

- To enable or disable the instruction cache
- To specify a clock speed faster than 25 MHz
- To enable or disable target system interrupts
- To enable or disable break on writes to ROM
- To enable or disable breakpoint acknowledge interlock
- To specify the target memory access size
- To specify the initial ISP and PC values

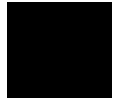

To enable or disable the on-chip caches

- 1** Choose the Settings→Emulator Config→Hardware... (ALT, S, E, H) command.
- 2** Select or deselect the Enable Instruction/Data Caches check box.
- 3** Choose the OK button to exit the Hardware Config dialog box.

You should disable the on-chip instruction and data caches when you trace program execution. This causes all memory accesses to be visible on the external bus (at the expense of processor performance).

The on-chip cache memory is enabled or disabled by controlling the /CDIS signal.

When the check box is selected, the user's /CDIS signal and the Cache Control Register (CACR) determine whether the cache is ultimately enabled.

When the check box is deselected, the emulator will assert the /CDIS signal to prevent the target system from enabling the cache.

When mapping memory, you can inhibit the caches for accesses within particular ranges.

To specify a clock speed faster than 25 MHz

- 1** Choose the Settings→Emulator Config→Hardware... (ALT, S, E, H) command.
- 2** Select or deselect the Clock Speed > 25 MHz check box.
- 3** Choose the OK button to exit the Hardware Config dialog box.

If the external clock is operating at a frequency above 25 MHz, this configuration option **MUST** be selected to force all synchronous and burst mode accesses to emulation memory to be completed with 1 wait state. If the required wait state is not inserted, synchronous and burst mode accesses to emulation memory will be unreliable.

If the external clock is operating at a frequency at or below 25 MHz, synchronous and burst mode accesses to emulation memory can be made without wait states by deselecting this configuration option.

This configuration option has no effect on accesses to target memory, which always complete with no additional wait states required.

To enable or disable target system interrupts

- 1 Choose the Settings→Emulator Config→Hardware... (ALT, S, E, H) command.
- 2 Select or deselect the Enable Target INT Signals check box.
- 3 Choose the OK button to exit the Hardware Config dialog box.

When the check box is selected, the emulator detects interrupts from the target system while running in the user program or foreground monitor. Target system interrupts are ignored when the emulator is running in the background monitor.

When the check box is deselected, the emulator ignores any interrupt from the target system.

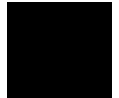

To enable or disable break on writes to ROM

- 1 Choose the Settings→Emulator Config→Hardware... (ALT, S, E, H) command.
- 2 Select or deselect the Enable Break on Write to ROM check box.
- 3 Choose the OK button to exit the Hardware Config dialog box.

When the check box is selected, a running program breaks into the monitor when it writes to a location mapped as ROM.

When the check box is deselected, program writes to locations mapped as ROM do not cause breaks into the monitor.

To enable or disable breakpoint acknowledge interlock

- 1 Choose the Settings→Emulator Config→Hardware... (ALT, S, E, H) command.
- 2 Select or deselect the Breakpoint Acknowledge Interlock check box.
- 3 Choose the OK button to exit the Hardware Config dialog box.

When a software breakpoint instruction (BKPT) is executed, the processor generates a breakpoint acknowledge cycle as part of the instruction. The emulator will terminate the breakpoint acknowledge cycle and initiate a transition into the monitor. If your target system cannot tolerate this behavior, the emulator can be configured to wait for the target system to terminate the breakpoint acknowledge cycle.

When interlocking is deselected, the emulator will terminate breakpoint acknowledge cycles with the /TEA signal. Any termination signals generated by the target system will be ignored.

When interlocking is selected, the target system is responsible for terminating breakpoint acknowledge cycles by asserting /TA or /TEA. If the target system fails to provide the required cycle termination, the processor will remain in a wait state indefinitely.

Modifying this configuration item will reset the processor.

To specify the target memory access size

- 1 Choose the Settings→Emulator Config→Hardware... (ALT, S, E, H) command.
- 2 Select the 8-bits, 16-bits, 32-bits, or Any option for the Target Memory Access Size.
- 3 Choose the OK button to exit the Hardware Config dialog box.

All target system memory and single-port emulation memory accesses occur in the specified size.

To specify the initial ISP and PC values

- 1 Choose the Settings→Emulator Config→Hardware... (ALT, S, E, H) command.
- 2 Enter the initial interrupt stack pointer value in the Initial Stack Pointer Value text box.
- 3 Enter the initial program counter value in the Initial Program Counter Value text box.
- 4 Choose the OK button to exit the Emulator Config dialog box.

The initial interrupt stack pointer (ISP) and program counter (PC) values must be set to even addresses. These are set when the monitor is entered from reset.

When running from user reset, these configuration settings have no effect; instead, the initial interrupt stack pointer and program counter values are retrieved from the reset vector in the target system's exception table. If a target system reset occurs while in the monitor, the interrupt stack pointer and program counter are unaffected.

Mapping Memory

This section shows you how:

- To map memory

By default, the emulator assumes all memory accesses are made to RAM hardware in the target system. If you wish to use emulation memory hardware, or identify some of your target memory space as ROM hardware, you must enter these specifications in the memory map.

To map memory

- 1 Choose the Settings→Emulator Config→Memory Map... (ALT, S, E, M) command.
- 2 Specify the starting address in the Start text box.
- 3 Specify the end address in the End text box.
- 4 Select the memory type in the Type option box.
- 5 Select or deselect the Dual Ported Ram option.
- 6 Select or deselect the Cache Inhibit option.
- 7 Select or deselect the Target Completes Bus Cycles option.
- 8 Choose the Apply button.
- 9 Repeat steps 2 through 8 for each range to be mapped.
- 10 Choose the Close button to exit the Memory Map dialog box.

You should map all memory ranges used by your programs before loading programs into memory.

Up to seven ranges of memory can be mapped, and the resolution of mapped ranges is 256 bytes (that is, the memory ranges must begin on 256-byte boundaries and must be at least 256 bytes in length).

The emulator contains 4 Kbytes of *dual-port emulation memory* and provides two slots for additional, *single-port emulation memory* modules.

The amount of emulation memory that can be mapped depends on the number, and size, of memory modules installed on the emulator board.

Chapter 4: Configuring the Emulator

Mapping Memory

You can specify one of the following memory types for each map term:

eram	Specifies "emulation RAM."
erom	Specifies "emulation ROM."
tram	Specifies "target RAM."
trom	Specifies "target ROM."
guarded	Specifies "guarded memory."

When breaks on writes to ROM are enabled in the emulator configuration, any access from the user program to any memory area mapped as ROM stops the emulator.

The Dual Ported Ram option lets you specify that the 4 Kbytes of dual-port emulation memory be used for that range.

The Cache Inhibit option lets you disable the on-chip instruction and data caches for accesses to the range. All accesses to the range will be external, which makes them visible to the analyzer (at the expense of processor performance).

The Target Completes Bus Cycles option specifies that emulation memory accesses in the range be terminated by the target system /TA or /TEA signals. This makes the timing of emulation memory accesses the same as target system memory accesses.

For non-mapped memory areas, select any of the memory types in the Other option box.

To delete a map term, first select it in the Current Map list box; then, choose the Delete button.

Example

To map addresses 6000h through 0ffffh as an emulation RAM, specify the mapping term as shown below.

Define Map Term

Start:

End:

Type

eram erom tram

trom guarded

Dual Ported Ram

Cache inhibit

Target completes Bus Cycles

Apply

Choose the Apply button to register the current map term.

Then, choose the Close button to quit mapping.

Selecting the Type of Monitor

This section shows you how:

- To select the background monitor
- To select the foreground monitor
- To use a custom foreground monitor

Both types of monitor programs require stacks to be set up in the user program because values are temporarily pushed onto the stack during monitor entry.

The trace exception vector, which must be set up for single-stepping, will be different, depending on the type of monitor program chosen.

Refer to "Monitor Program Options" in the "Concepts" part for a description of emulation monitors and the advantages and disadvantages of using background or foreground emulation monitors.

Note

Select the type of monitor before mapping memory because changing the monitor type resets the memory map.

To select the background monitor

- 1 Choose the Settings→Emulator Config→Monitor... (ALT, S, E, O) command.
- 2 Select the Background option.
- 3 If you wish to synchronize monitor cycles to the target system (that is, have monitor cycles terminated by the target system /TA signal), select the Target Completes Monitor Bus Cycles option; otherwise, deselect this option.
- 4 If you want the background monitor to periodically read from a keep-alive address, select the Enable Keep Alive Function option and enter an address in the Keep Alive Address text box; otherwise, deselect this option.
- 5 Choose the OK button.

Target system interrupts are blocked during background monitor operation.

Also, when using the background monitor, the 68040 MMU cannot be enabled, instruction and data caches cannot be enabled, and the target system cannot perform DMA.

The keep-alive function is provided so that watchdog timer or dynamic RAM refresh circuitry can detect that the processor is still running during background monitor execution.

In order for single-stepping to operate with the background monitor, the trace exception vector must point to an even address in readable memory. If the emulator cannot read from the address that the trace exception vector points to, it attempts to temporarily write the current value of VBR into the trace exception vector (because the vector table is readable).

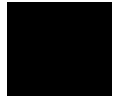

To select the foreground monitor

- 1 Choose the Settings→Emulator Config→Monitor... (ALT, S, E, O) command.
- 2 Select the Foreground (Built-in) option.
- 3 Enter the base address of the foreground monitor in the Monitor Address text box. The address must reside on a 4-Kbyte boundary (in other words, an address ending in 000H) and must be specified in hexadecimal.
- 4 If you wish to synchronize monitor cycles to the target system (that is, have monitor cycles terminated by the target system /TA signal), select the Target Completes Monitor Bus Cycles option; otherwise, deselect this option.
- 5 If you want the foreground monitor to run at a lowered interrupt priority level in order to allow critical target system interrupts to be processed, enter the priority level in the Interrupt Priority Mask text box. When it's safe to lower the interrupt level, the foreground monitor will set the interrupt priority mask to either the level entered or the level in effect before monitor entry, whichever is greater.
- 6 Choose the OK button.
- 7 Use the Settings→Emulator Config→Memory Map... (ALT, S, E, M) to remap the user program memory areas. Selecting the foreground monitor automatically resets the current memory map and adds a new map term for the monitor.
- 8 Load the user program by choosing the File→Load Object... (ALT, F, L) command and entering the name of the user program object file.

When you select the foreground monitor, the emulator automatically loads the default foreground monitor program, resident in emulator firmware, into the 4-Kbyte block of *dual-port emulation memory*. The foreground

monitor is reloaded every time the emulator breaks into the monitor state from the reset state.

In order for single stepping to operate with the foreground monitor, the trace exception vector in the target system must point to the TRACE_ENTRY address in the monitor. In the default foreground monitor, the TRACE_ENTRY address is equal to the Monitor Address plus 680H. If the trace exception vector does not contain the correct value, the emulator attempts to temporarily change the trace a-line and f-line exception vectors to the TRACE_ENTRY address.

For more information on the foreground monitor, refer to the "Monitor Program Options" section in the "Concepts" information.

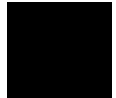

To use a custom foreground monitor

- 1 Edit the foreground monitor program source.
- 2 Assemble and link the foreground monitor program.
- 3 Choose the Settings→Emulator Config→Monitor... (ALT, S, E, O) command.
- 4 Select the Foreground (Custom) option.
- 5 Enter the base address of the foreground monitor in the Monitor Address text box. The address must reside on a 4-Kbyte boundary (in other words, an address ending in 000H) and must be specified in hexadecimal.
- 6 If you wish to synchronize monitor cycles to the target system (that is, have monitor cycles terminated by the target system /TA signal), select the Target Completes Monitor Bus Cycles option; otherwise, deselect this option.
- 7 If you want the foreground monitor to run at a lowered interrupt priority level in order to allow critical target system interrupts to be processed, enter the priority level in the Interrupt Priority Mask text box. When it's safe to lower the interrupt level, the foreground monitor will set the interrupt priority mask to either the level entered or the level in effect before monitor entry, whichever is greater.
- 8 Enter the name of the foreground monitor object file in the Monitor File Name text box.
- 9 Choose the OK button.

- 10 Use the Settings→Emulator Config→Memory Map... (ALT, S, E, M) to remap the user program memory areas. Selecting the foreground monitor automatically resets the current memory map and adds a new map term for the monitor.
- 11 Load the user program by choosing the File→Load Object... (ALT, F, L) command and entering the name of the user program object file.

When customizing the foreground monitor, you must maintain the basic communication protocol between the monitor program and the emulation system controller.

An example foreground monitor is provided with the debugger in the \HP\RTC\M040\FGMON directory. The file is named FGMON.S.

The custom foreground monitor is saved in the emulator (until the monitor type is changed) and reloaded into the 4-Kbyte block of *dual-port emulation memory* every time the emulator breaks into the monitor state from the reset state.

In order for single stepping to operate with the foreground monitor, the trace exception vector in the target system must point to the TRACE_ENTRY address in the monitor. In the default foreground monitor, the TRACE_ENTRY address is equal to the Monitor Address plus 680H. If the trace exception vector does not contain the correct value, the emulator attempts to temporarily change the trace a-line and f-line exception vectors to the TRACE_ENTRY address.

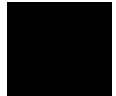

Setting Up the BNC Port

This section shows you how:

- To output the trigger signal on the BNC port
- To receive an arm condition input on the BNC port

To output the trigger signal on the BNC port

- Choose the Settings→BNC→Outputs Analyzer Trigger (ALT, S, B, O) command.

The HP 64700 Series emulators have a BNC port for connection with external devices such as logic analyzers or oscilloscopes.

This command enables the trigger signal from the internal analyzer to be fed to external devices.

To receive an arm condition input on the BNC port

- Choose the Settings→BNC→Input to Analyzer Arm (ALT, S, B, I) command.

The HP 64700 Series emulators have a BNC port for connection with external devices such as logic analyzers or oscilloscopes.

This command allows an external trigger signal to be used as an arm (enable) condition for the internal analyzer.

Saving and Loading Configurations

This section shows you how:

- To save the current emulator configuration
- To load an emulator configuration

To save the current emulator configuration

- 1** Choose the File→Save Emulator Config... (ALT, F, V) command.
- 2** In the file selection dialog box, enter the name of the file to which the emulator configuration will be saved.
- 3** Choose the OK button.

This command saves the current hardware, memory map, and monitor settings to a command file.

Saved emulator configuration files can be loaded later by choosing the File→Load Emulator Config... (ALT, F, E) command or by choosing the File→Run Cmd File... (ALT, F, R) command.

See Also

File→Save Emulator Config... (ALT, F, V) in the "Menu Bar Commands" section of the "Reference" information.

To load an emulator configuration

- 1** Choose the File→Load Emulator Config... (ALT, F, E) command.
- 2** Select the name of the emulator configuration command file to load from the file selection dialog box.
- 3** Choose the OK button.

This command lets you reload emulator configurations that have previously been saved.

Emulator configurations consist of hardware, memory map, and monitor settings.

Setting the Real-Time Options

This section shows you how:

- To allow or deny monitor intrusion
- To turn polling ON or OFF

The monitor program is executed by the emulation microprocessor when target system memory, single-port emulation memory, memory-mapped I/O, and microprocessor registers are displayed or edited. Also, periodic polling to update the Memory, I/O, WatchPoint, and Register windows can cause monitor program execution.

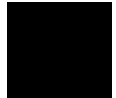

This means that when the user program is running and monitor intrusion is allowed, the user program must be temporarily interrupted in order to display or edit target system memory or single-port emulation memory, to display or edit registers, or to update window contents.

If it's important that your program execute without these kinds of interruptions, you should deny monitor intrusion. You can still display and edit target system memory and microprocessor registers, but you must specifically break emulator execution from the user program into the monitor first.

When monitor intrusion is denied, polling to update window contents is automatically turned OFF.

When monitor intrusion is allowed, you can turn polling for particular windows OFF to lessen the number of interruptions during user program execution.

To allow or deny monitor intrusion

- To deny monitor intrusion, choose the RealTime→Monitor Intrusion→Disallowed (ALT, R, T, D) command.
- To allow monitor intrusion, choose the RealTime→Monitor Intrusion→Allowed (ALT, R, T, A) command.

When you deny monitor intrusion, any debugger command that may interrupt a running user program is prevented. This ensures the user program will execute in real time.

When you allow monitor intrusion, debugger commands that may temporarily interrupt user program execution are allowed.

The current setting is shown by a check mark (✓) next to the command.

To turn polling ON or OFF

- To turn I/O window polling ON or OFF, choose the RealTime→I/O Polling→ON (ALT, R, I, O) or RealTime→I/O Polling→OFF (ALT, R, I, F) command.
- To turn WatchPoint window polling ON or OFF, choose the RealTime→Watchpoint Polling→ON (ALT, R, W, O) or RealTime→Watchpoint Polling→OFF (ALT, R, W, F) command.
- To turn Memory window polling ON or OFF, choose the RealTime→Memory Polling→ON (ALT, R, M, O) or RealTime→Memory Polling→OFF (ALT, R, M, F) command.

When the user program is running and monitor intrusion is denied, polling is automatically turned OFF.

When the user program is running and monitor intrusion is allowed, you can turn polling OFF to reduce the number of user program interrupts made in order to update I/O, WatchPoint, and Memory window contents.

The current settings are shown by check marks (✓) next to the command.

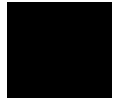



Debugging Programs

Debugging Programs

This chapter contains information on loading and debugging programs.

- Loading and Displaying Programs
- Displaying Symbol Information
- Stepping, Running, and Stopping the Program
- Using Breakpoints and Break Macros
- Displaying and Editing Variables
- Displaying and Editing Memory
- Displaying and Editing I/O locations
- Displaying and Editing Registers
- Tracing Program Execution
- Setting Up Custom Trace Specifications

Loading and Displaying Programs

This section shows you how:

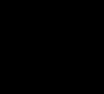
- To load user programs
 - To display source code only
 - To display source code mixed with assembly instructions
 - To display source files by their names
 - To specify source file directories
 - To search for function names in the source files
 - To search for addresses in the source files
 - To search for strings in the source files
- 

To load user programs

- 1** Choose the File→Load Object... (ALT, F, L) command.
- 2** Select the file to be loaded.
- 3** Choose the Load button to load the program.

With this command, you can load any IEEE-695 object file created with any of the Microtec or HP programming tools for 68040.

To display source code only

- 1 Position the cursor on the starting line to be displayed.
- 2 From the Source window control menu, choose the Display→Source Only (ALT, -, D, S) command.

The Source window may be toggled between the C source only display and the C source/mnemonic mixed display.

The display starts from the line containing the cursor.

The source only display shows line numbers with the source code.

To display source code mixed with assembly instructions

- 1 Position the cursor on the starting line to be displayed.
- 2 From the Source window control menu, choose the Display→Mixed Mode (ALT, -, D, M) command.

The mnemonic display contains the address, data, and disassembled instruction mnemonics intermixed with the C source lines.

Example C Source/Mnemonic Mode Display

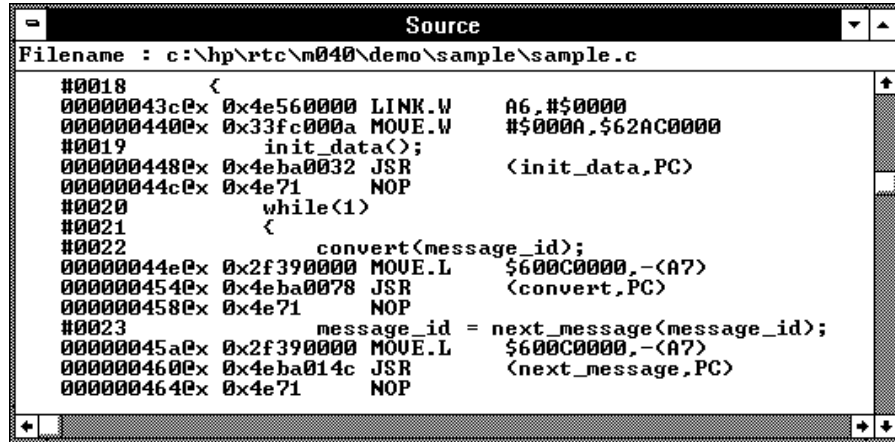

```
Source
Filename : c:\hp\rtc\n040\demo\sample\sample.c
#0018      <
00000043c0x 0x4e560000 LINK.W   A6, #0000
0000004400x 0x33fc000a MOVE.W   #0000, $62AC0000
#0019      init_data<>;
0000004480x 0x4eba0032 JSR     <init_data, PC>
00000044c0x 0x4e71     NOP
#0020      while<1>
#0021      <
#0022      convert<message_id>;
00000044e0x 0x2f390000 MOVE.L   $600C0000, -(A7)
0000004540x 0x4eba0078 JSR     <convert, PC>
0000004580x 0x4e71     NOP
#0023      message_id = next_message<message_id>;
00000045a0x 0x2f390000 MOVE.L   $600C0000, -(A7)
0000004600x 0x4eba014c JSR     <next_message, PC>
0000004640x 0x4e71     NOP
```

To display source files by their names

- 1 Make the Source window the active window, and choose the Display→Select Source... (ALT, -, D, L) command from the Source window's control menu.
- 2 Select the desired file.
- 3 Choose the Select button.
- 4 Choose the Close button.

Note The contents of assembly language source files cannot be displayed.

To specify source file directories

- 1** Make the Source window the active window, and choose the Display→Select Source... (ALT, -, D, L) command from the Source window's control menu.
- 2** Choose the Directory... button.
- 3** Enter the directory name in the Directory text box.
- 4** Choose the Add button.
- 5** Choose the Close button to close the Search Directories dialog box.
- 6** Choose the Close button to close the Select Source dialog box.

If the source files associated with the loaded object file are in different directories from the object file, you must identify the directories in which the source files can be found.

You can also specify them source file directories by setting the SRCPATH environment variable in MS-DOS as follows:

```
set SRCPATH=<full path 1>;<full path 2>
```

To search for function names in the source files

- 1 From the Source window's control menu, choose the Search→Function... (ALT, -, R, F) command.
- 2 Select the function to be searched.
- 3 Choose the Find button.
- 4 Choose the Close button.

Disassembled instructions are displayed in the Source window for assembly language source files.

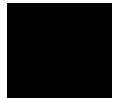

To search for addresses in the source files

- 1 From the Source window's control menu, choose the Search→Address... (ALT, -, R, A) command.
- 2 Type or paste the address into the Address text box.
- 3 Choose the Find button.
- 4 Choose the Close button.

Disassembled instructions are displayed in the Source window for assembly language source files.

To search for strings in the source files

- 1** From the Source window's control menu, choose the Search→String... (ALT, -, R, S) command.
- 2** Type or paste the string into the String text box.
- 3** Select whether the search should be case sensitive.
- 4** Select whether the search should be down (forward) or up (backward).
- 5** Choose the Find Next button. Repeat this step to search for the next occurrence of the string.
- 6** Choose the Cancel button to close the dialog box.

Displaying Symbol Information

This section shows you how:

- To display program module information
- To display function information
- To display external symbol information
- To display local symbol information
- To display global assembler symbol information
- To display local assembler symbol information
- To create a user-defined symbol
- To display user-defined symbol information
- To delete a user-defined symbol
- To display the symbols containing the specified string



To display program module information

- From the Symbol window's control menu, choose the Display→Modules (ALT, -, D, M) command.

To display function information

- From the Symbol window's control menu, choose the Display→Functions (ALT, -, D, F) command.

The name, type, and address range for the functions in the program are displayed.

Example Function Information Display

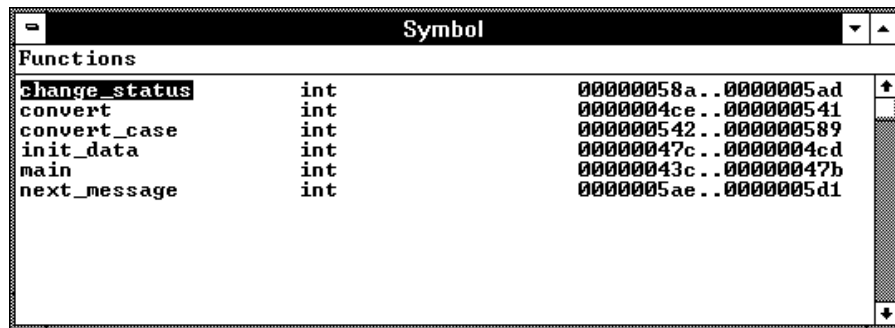

The screenshot shows a window titled "Symbol" with a "Functions" list. The list contains the following entries:

Function Name	Type	Address Range
change_status	int	00000058a..0000005ad
convert	int	0000004ce..000000541
convert_case	int	000000542..000000589
init_data	int	00000047c..0000004cd
main	int	00000043c..00000047b
next_message	int	0000005ae..0000005d1

To display external symbol information

- From the Symbol window's control menu, choose the Display→Externals (ALT, -, D, E) command.

The name, type, and address of the global variables in the program are displayed.

Example

External Symbol Information Display

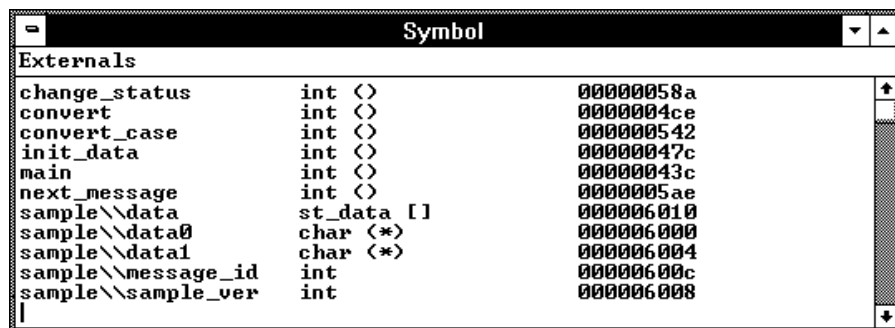

To display local symbol information

- 1 From the Symbol window's control menu, choose the Display→Locals... (ALT, -, D, L) command.
- 2 Type or paste the function for which the local variable information is to be displayed.
- 3 Choose the OK button.

The name, type, and offset from the stack frame of the local variables in the selected function are displayed.

Example Local Symbol Information Display

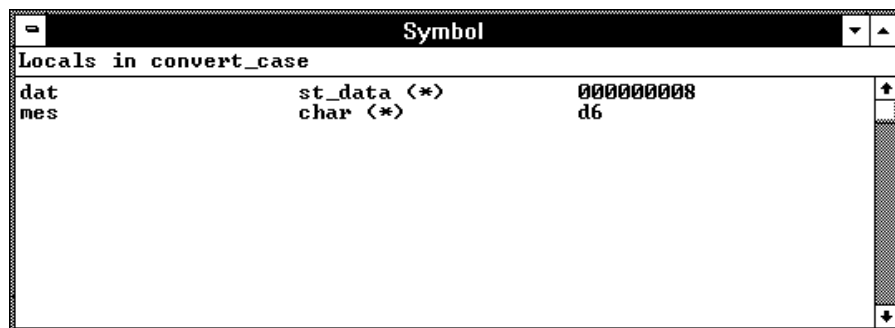

To display global assembler symbol information

- From the Symbol window's control menu, choose the Display→Asm Globals (ALT, -, D, G) command.

The name and address for the global assembler symbols in the program are displayed.

To display local assembler symbol information

- 1 From the Symbol window's control menu, choose the Display→Asm Locals... (ALT, -, D, A) command.
- 2 Type or paste the module for which the local variable information is displayed.
- 3 Choose the OK button.

The name and address for the local assembler variables in the selected module are displayed.

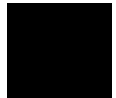

To create a user-defined symbol

- 1 From the Symbol window's control menu, choose the User defined→Add... (ALT, -, U, A) command.
- 2 Type the symbol name in the Symbol Name text box.
- 3 Type the address in the Address text box.
- 4 Choose the OK button.

User-defined symbols, just as standard symbols, can be used as address values when entering commands.

Example

To add the user-defined symbol "jmp_start":

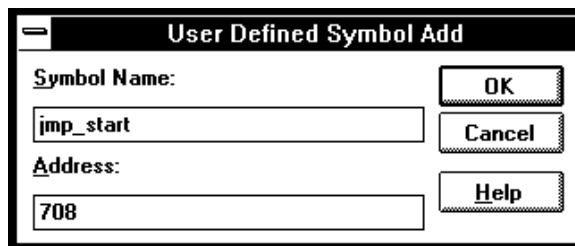

To display user-defined symbol information

- From the Symbol window's control menu, choose the Display→User defined (ALT, -, D, U) command.

The command displays the name and address for the user-defined symbols.

Example

User-Defined Symbol Information Display

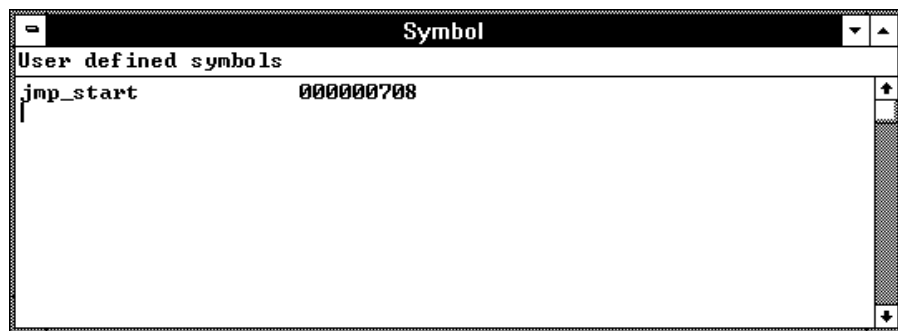

To delete a user-defined symbol

- 1 From the Symbol window's control menu, choose the Display→User defined (ALT, -, D, U) command to display the user-defined symbols.
- 2 Select the user-defined symbol to be deleted.
- 3 From the Symbol window's control menu, choose the User defined→Delete (ALT, -, U, D) command.

To display the symbols containing the specified string

- 1** From the Symbol window's control menu, choose the FindString→String... (ALT, -, F, S) command.
- 2** Type or paste the string in the String text box. The search will be case-sensitive.
- 3** Choose the OK button.

To restore the original nonselective display, redisplay the symbolic information.

Stepping, Running, and Stopping the Program

This section shows you how:

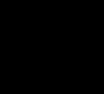
- To step a single line or instruction
 - To step over a function
 - To step multiple lines or instructions
 - To run the program until the specified line
 - To run the program until the current function return
 - To run the program from a specified address
 - To stop program execution
 - To reset the processor
- 

To step a single line or instruction

- Choose the Execution→Single Step (ALT, E, N) command.
- Or, press the F2 key.

In the source display mode, this command executes the C source code line at the current program counter address.

In the source/mnemonic mixed display mode, the command executes the microprocessor instruction at the current program counter address.

Once the source line or instruction has executed, the next program counter address highlighted.

To step over a function

- Choose the Execution→Step Over (ALT, E, O) command.
- Or, press the F3 key.

This command steps a single source line or assembly language instruction except when the source line contains a function call or the assembly instruction makes a subroutine call. In these cases, the entire function or subroutine is executed.

In the source/mnemonic mixed display mode, the command does not distinguish between the following two types of instructions:

```
JSR  
BSR
```

Example

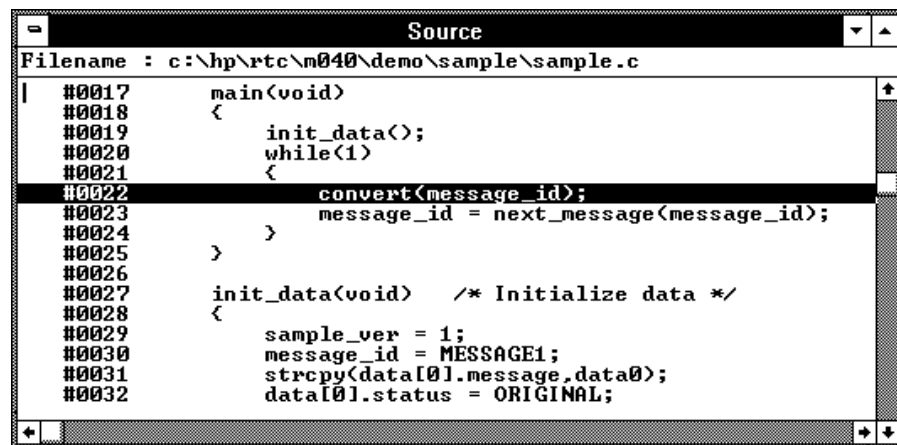

The screenshot shows a debugger window titled "Source" with the filename "c:\hp\rtc\n040\demo\sample\sample.c". The code is displayed as follows:

```
#0017  main(void)  
#0018  {  
#0019      init_data();  
#0020      while(1)  
#0021      {  
#0022          convert(message_id);  
#0023          message_id = next_message(message_id);  
#0024      }  
#0025  }  
#0026  
#0027  init_data(void) /* Initialize data */  
#0028  {  
#0029      sample_ver = 1;  
#0030      message_id = MESSAGE1;  
#0031      strcpy(data[0].message, data0);  
#0032      data[0].status = ORIGINAL;
```

Line 22, `convert(message_id);`, is highlighted with a dark background, indicating it is the current instruction being stepped over.

When the current program counter is at line 22, choosing the Execution→Step Over (ALT, E, O) command steps over the "convert" function. Once the function has been stepped over, the program counter indicates line 23.

To step multiple lines or instructions

- 1 Choose the Execution→Step... (ALT, E, S) command.
- 2 Select one of the Current PC, Start Address, or Address options.
(Enter the starting address when the Address option is selected.)
- 3 In the Count text box, type the number of lines to be single-stepped.
- 4 Choose the Execute button.
- 5 Choose the Close button to close the dialog box.

The Current PC option starts single-stepping from the current PC address. The Start Address option starts single-stepping from the *transfer address*. The Address option starts single-stepping from the address specified in the text box.

In the source only display mode, the command steps the number of C source lines specified. In the source/mnemonic mixed display mode, the command steps the number of microprocessor instructions specified.

When the step count specified in the Count text box is 2 or greater, the count decrements by one as each line or instruction executes. A count of 0 remains in the Count text box. Also, in the Source window, the highlighted line that indicates the current program counter moves for each step.

To step over functions, select the Over check box.

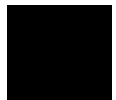

To run the program until the specified line

- 1 Position the cursor in the Source window on the line that you want to run to.
- 2 Choose the Execution→Run to Cursor (ALT, E, C) command.

Execution stops immediately before the cursor-selected line.

Because this command uses breakpoints, you cannot use it when programs are stored in target system ROM.

If the specified address is not reached within the number of milliseconds specified by StepTimerLen in the B3629.INI file, a dialog box appears, asking you to cancel the command by choosing the Stop button. When the Stop button is chosen, the program execution stops, the breakpoint is deleted, and the processor transfers to the RUNNING IN USER PROGRAM status.

Note

This can be done more quickly by using the pop-up menu available with the right mouse button.

To run the program until the current function return

- Choose the Execution→Run to Caller (ALT, E, T) command.

The Execution→Run to Caller (ALT, E, T) command executes the program from the current program counter address up to the return from the current function.

Note

The debugger cannot properly run to the function return when the current program counter is at the first line of the function (immediately after its entry point). Before running to the caller, use the Execution→Single Step (ALT, E, N) command to step past the first line of the function.

To run the program from a specified address

- 1 Choose the Execution→Run... (ALT, E, R) command.
- 2 Select one of the Current PC, Start Address, User Reset, or Address options. (Enter the address when the Address option is selected.)
- 3 Choose the Run button.

The Current PC option executes the program from the current program counter address. The Start Address option executes the program from the *transfer address*.

The User Reset option initiates program execution on receiving a RESET signal from the target system. The reset wait status can be cleared with the Execution→Reset (ALT, E, E) command.

The Address option executes the program from the address specified.

To stop program execution

- Choose the Execution→Break (ALT, E, B) command, or press the F4 key.

As soon as the Execution→Break (ALT, E, B) command is chosen, the emulator starts running in the monitor.

To reset the processor

- Choose the Execution→Reset (ALT, E, E) command.

Once the command has been completed, the processor remains reset if monitor intrusion is disallowed. If monitor intrusion is allowed, the emulation microprocessor may switch immediately from reset to running in monitor, for example, to update the contents of a register window.

If a foreground monitor is selected, it will automatically be loaded when this command is executed. This is done to make sure the foreground monitor code is intact.

Using Breakpoints and Break Macros

This section shows you how:

- To set a breakpoint
- To disable a breakpoint
- To delete a single breakpoint
- To list the breakpoints and break macros
- To set a break macro
- To delete a single break macro
- To delete all breakpoints and break macros

A breakpoint is an address you identify in the user program where program execution is to stop. Breakpoints let you look at the state of the target system at particular points in the program.

A break macro is a breakpoint followed by any number of macro commands (which are the same as command file commands).

Because breakpoints are set by replacing opcodes in the program, you cannot set breakpoints or break macros in programs stored in target system ROM.

All breakpoints are deleted when RTC is exited.

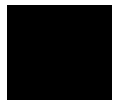

To set a breakpoint

- 1 Position the cursor on the line where you wish to set a breakpoint.
- 2 Choose the Breakpoint→Set at Cursor (ALT, B, S) command.

When you run the program and the breakpoint is hit, execution stops immediately before the breakpoint line. The current program counter location is highlighted.

Example To set a breakpoint at line 56:

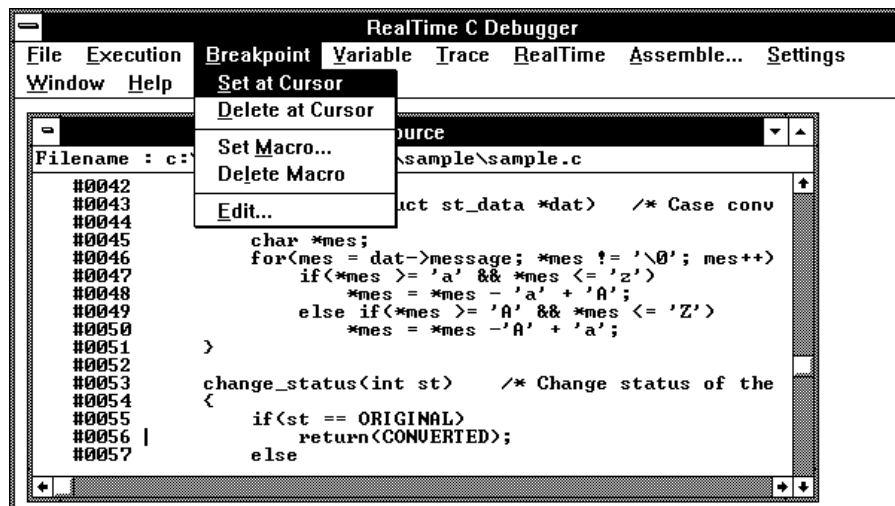

Note This can be done more quickly by using the pop-up menu available with the right mouse button.

To disable a breakpoint

- 1 Choose the Breakpoint→Edit... (ALT, B, E) command.
- 2 Select the breakpoint to be disabled.
- 3 Choose the Enable/Disable button. Notice that "DI" appears next to the breakpoint in the list.
- 4 To close the dialog box, choose the Close button.

You can reenable a breakpoint in the same manner by choosing the Breakpoint→Edit... (ALT, B, E) command, selecting a disabled breakpoint from the list, and choosing the Enable/Disable button.

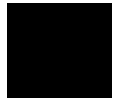

To delete a single breakpoint

- Position the cursor on the line that has the breakpoint to be deleted, and choose the Breakpoint→Delete at Cursor (ALT, B, D) command.

Or:

- 1 Choose the Breakpoint→Edit... (ALT, B, E) command.
- 2 Select the breakpoint to be deleted.
- 3 Choose the Delete button.
- 4 Choose the Close button.

The Breakpoint→Edit... (ALT, B, E) command allows you to delete all the breakpoints and break macros at once with the Delete All button.

To list the breakpoints and break macros

- Choose the Breakpoint→Edit... (ALT, B, E) command.

The command displays breakpoints followed by break macro commands in parentheses.

The Breakpoint Edit dialog box also allows you to delete breakpoints and break macros.

To set a break macro

- 1 Position the cursor on the line where you wish to set a break macro.
- 2 Choose the Breakpoint→Set Macro... (ALT, B, M) command.
- 3 Select the Add Macro check box in the Breakpoint Edit dialog box.
- 4 Specify the macro command in the Macro Command text box.
- 5 Choose the Set button.
- 6 To add another macro command, repeat steps 4 and 5.
- 7 To exit the Breakpoint Edit dialog box, choose the Close button.

The debugger automatically executes the specified macro commands when the *break macro* line is reached.

To add macro commands after an existing macro command, position the cursor on the macro command before choosing Breakpoint→Set Macro... (ALT, B, M).

To add macro commands to the top of an existing break macro, position the cursor on the line that contains the BP marker before choosing Breakpoint→Set Macro... (ALT, B, M).

Example

To set "EVALUATE" and "RUN" break macros:

Position the cursor on line 47; then, choose the Breakpoint→Set Macro... (ALT, B, M) command.

Select the Add Macro check box.

Enter "EVALUATE *mes" in the Macro Command text box.

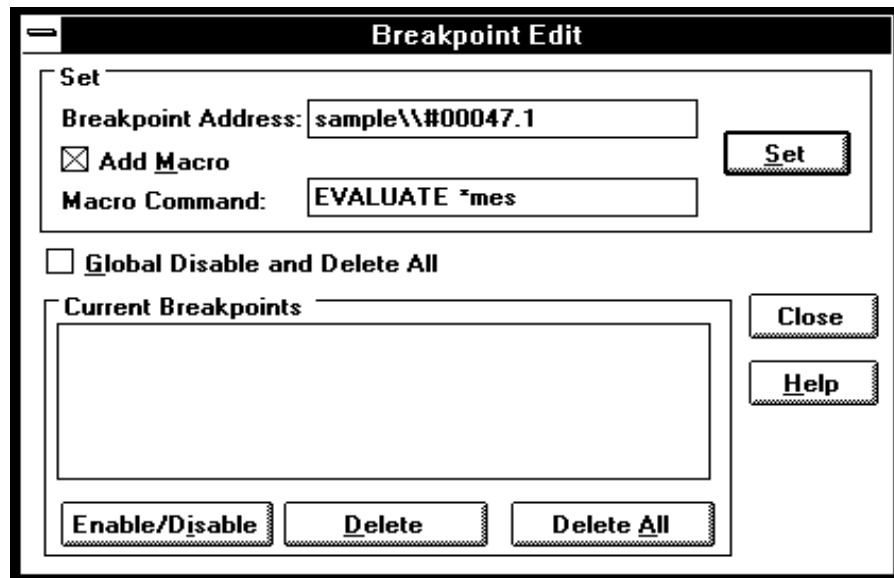

Choose the Set button.

Enter "RUN" in the Macro Command text box.

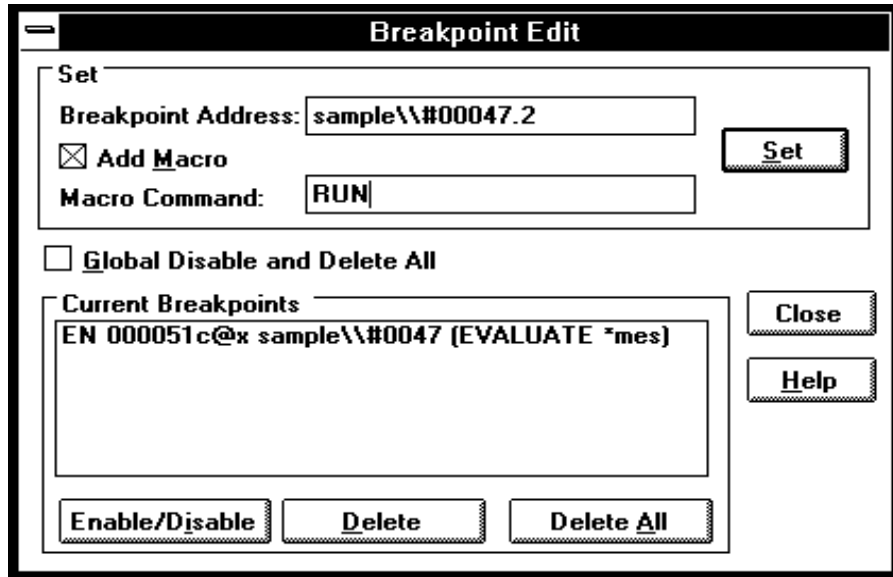

Choose the Set button.

Choose the Close button.

The break macro is displayed in the Source window as shown below.

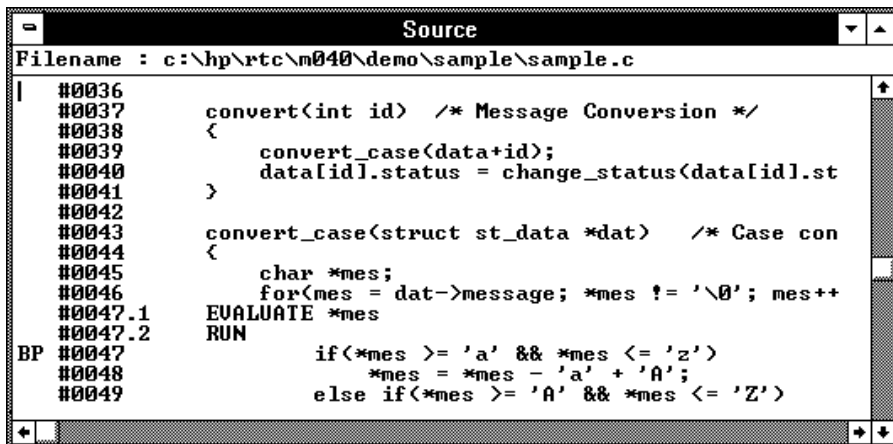

To delete a single break macro

- 1** Position the cursor on the line that contains the break macro to be deleted.
- 2** Choose the Breakpoint→Delete Macro (ALT, B, L) command.

To delete a single macro command that is part of a break macro, position the cursor on the macro command before choosing Breakpoint→Delete Macro (ALT, B, L).

The Breakpoint→Edit... (ALT, B, E) dialog box allows you to delete all the breakpoints and break macros at once by choosing the Delete All button. Also, by selecting the Global Disable and Delete All check box, you can delete all breakpoints and break macros and prevent creation of new breakpoints and break macros.

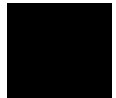

To delete all breakpoints and break macros

- 1 Choose the Breakpoint→Edit... (ALT, B, E) command.
- 2 Choose the Delete All button.
- 3 Select the Global Disable and Delete All check box.
- 4 Choose the Close button.

The Breakpoint→Edit... (ALT, B, E) command allows you to delete all the breakpoints and break macros at once with the Delete All button. Also, you can delete all breakpoints and break macros and prevent creation of new breakpoints and break macros by selecting the Global Disable and Delete All check box.

Displaying and Editing Variables

This section shows you how:

- To display a variable
- To edit a variable
- To monitor a variable in the WatchPoint window

To display a variable

- 1** Position the mouse pointer over the variable in the Source window and double-click the left mouse button.
- 2** Choose the Variable→Edit... (ALT, V, E) command.
- 3** Choose the Update button to read the contents of the variable and display the value in the dialog box.
- 4** To exit the Variable dialog box, choose the Close button.

Note that you can update the contents of an auto variable only while the program executes within the scope of the function.

To edit a variable

- 1 Position the mouse pointer over the variable in the Source window and double-click the left mouse button.
- 2 Choose the Variable→Edit... (ALT, V, E) command.
- 3 Choose the Modify button. This opens the Variable Modify dialog box.
- 4 Type the desired value in the Value text box. The value must be of the type specified in the Type field.

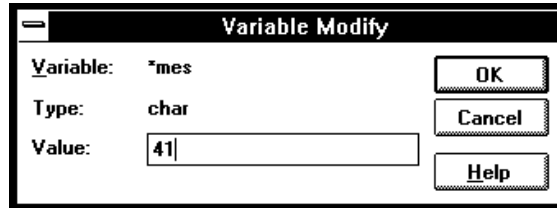

- 5 Choose the OK button.
- 6 Choose the Close button.

Note that you can change the contents of an auto variable only while the program executes within the scope of the function.

To monitor a variable in the WatchPoint window

- 1 Highlight the variable in the Source window by either double-clicking the left mouse button or by holding the left mouse button down and dragging the mouse pointer over the variable.
- 2 Choose the Variable→Edit... (ALT, V, E) command.
- 3 Choose the "to WP" button.
- 4 Choose the Close button.
- 5 To open the WatchPoint window, choose the Window→WatchPoint command.

Note that you can only monitor an auto variable in the WatchPoint window when the program executes within the scope of the function.



Displaying and Editing Memory

This section shows you how:

- To display memory
 - To edit memory
 - To copy memory to a different location
 - To modify a range of memory with a value
 - To search memory for a value or string
-

To display memory

- 1** Choose the RealTime→Memory Polling→ON (ALT, R, M, O) command.
- 2** Choose the Window→Memory command.
- 3** Double-click one of the addresses.
- 4** Use the keyboard to enter the address of the memory locations to be displayed.
- 5** Press the Enter key.

An address may be entered as a value or symbol. You can also select the desired address by using the scroll bar.

To change the size of the data displayed, access the Memory window's control menu; then, choose the Display→Byte (ALT, -, D, Y), Display→16 Bits (ALT, -, D, 1), or Display→32 Bits (ALT, -, D, 3) command. When the Display→Byte (ALT, -, D, Y) command is chosen, ASCII values are also displayed.

To specify whether memory is displayed in a single-column or multicolumn format, access the Memory window's control menu; then, choose the Display→Linear (ALT, -, D, L) or Display→Block (ALT, -, D, B) command. When the Display→Linear (ALT, -, D, L) command is chosen, symbolic information associated with an address is also displayed.

The Memory window display is updated periodically. When the window displays the contents of target system memory, user program execution is temporarily suspended as the display is updated. To prevent program execution from being temporarily suspended (and the Memory window from being updated), choose the RealTime→Monitor Intrusion→Disallowed (ALT, R, T, D) command to activate the real-time mode.

Example Memory Displayed in Byte Format

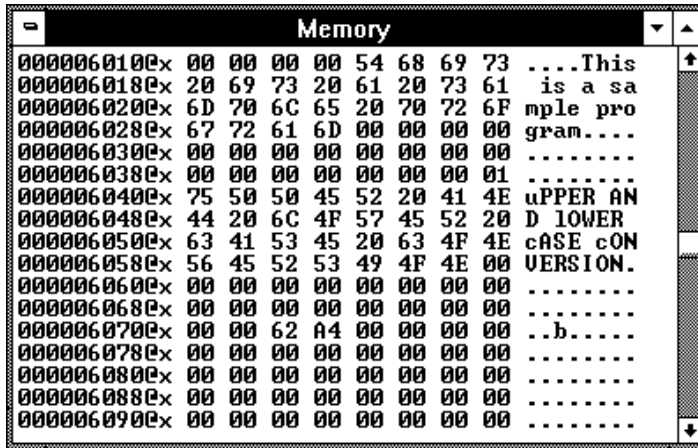

To edit memory

Assuming the location you wish to edit has already been displayed (and Memory window polling is turned ON):

- 1** Double-click the location you wish to edit.
- 2** Use the keyboard to enter a new value.
- 3** Press the Enter key. Notice that the next location is highlighted.
- 4** Repeat steps 2 and 3 to edit successive locations.

Editing the contents of target system memory causes user program execution to be temporarily interrupted. You cannot modify the contents of target memory when the emulator is running the user program and monitor intrusion is disallowed.

To copy memory to a different location

- 1 From the Memory window's control menu, choose the Utilities→Copy... (ALT, -, U, C) command.
- 2 Enter the starting address of the range to be copied in the Start text box.
- 3 Enter the end address of the range to be copied in the End text box.
- 4 Enter the address of the destination in the Destination text box.
- 5 Choose the Execute button.
- 6 To close the Memory Copy dialog box, choose the Close button.

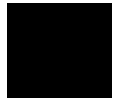

To copy target system memory into emulation memory

- 1** Because the processor cannot read target system memory when it is in the EMULATION RESET state, choose the Execution→Break (ALT, E, B) command, or press the F4 key, to break execution into the monitor.
- 2** From the Memory window's control menu, choose the Utilities→Store... (ALT, -, U, S) command.
- 3** Enter the starting address in the Start text box.
- 4** Enter the end address in the End text box.
- 5** Enter a file name in the File Name text box.
- 6** Choose the Export button.
- 7** Re-map the address range as emulation memory.
- 8** From the Memory window's control menu, choose the Utilities→Load... (ALT, -, U, L) command.
- 9** Enter the file name in the File Name text box.
- 10** Choose the Import button.

This procedure is used to gain access to features that are only available with emulation memory (like breakpoints).

The following commands cannot be used when programs are stored in target system ROM. However, you can use these commands if you copy the contents of target system ROM into emulation memory:

- Breakpoint→Set at Cursor (ALT, B, S)
- Breakpoint→Delete at Cursor (ALT, B, D)
- Breakpoint→Set Macro... (ALT, B, M)
- Breakpoint→Delete Macro (ALT, B, L)
- Execution→Run to Cursor (ALT, E, C)
- Execution→Run to Caller (ALT, E, T)

To modify a range of memory with a value

- 1** From the Memory window's control menu, choose the Utilities→Fill... (ALT, -, U, F) command.
- 2** Enter the desired value in the Value text box.
- 3** Enter the starting address of the memory range in the Start text box.
- 4** Enter the end address in the End text box.
- 5** Select one of the Size options.
- 6** Choose the Execute button.

The Byte, 16 Bit, or 32 Bit size option specifies the size of the values that are used to fill memory.

To search memory for a value or string

- 1 From the Memory window's control menu, choose the Search... (ALT, -, R) command.
- 2 Enter in the Value or String text box the value or string to search for.
- 3 Enter the starting address in the Start text box.
- 4 Enter the end address in the End text box.
- 5 Choose the Execute button.
- 6 Choose the Close button.

When the specified data is found, the location at which the value or string was found is displayed in the Memory window.

Example

To search addresses 6000h through 0ffffh for the string "This":

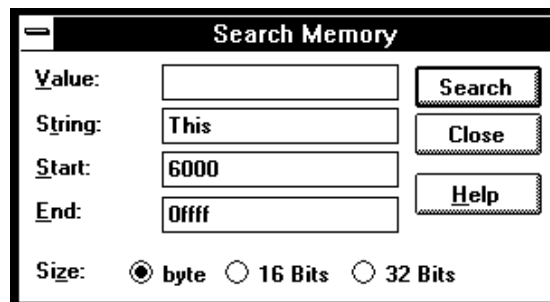

Displaying and Editing I/O Locations

This section shows you how:

- To display I/O locations
- To edit an I/O location

With the 68040 microprocessor, I/O locations are memory-mapped.

To display I/O locations

- 1** Choose the Window→I/O command.
- 2** From the I/O window's control menu, choose the Define... (ALT, -, D) command.
- 3** Enter the address in the Address text box.
- 4** Select whether the size of the I/O location is a Byte or 16 Bits.
- 5** Choose the Set button.
- 6** Choose the Close button.

The Window→I/O command displays the contents of the specified I/O locations.

The debugger periodically reads the I/O locations and displays the latest status in the I/O window. To prevent the debugger from reading the I/O locations (and updating the I/O window), choose the RealTime→I/O Polling→OFF (ALT, R, I, F) command.

Example To display the contents of address 2000:

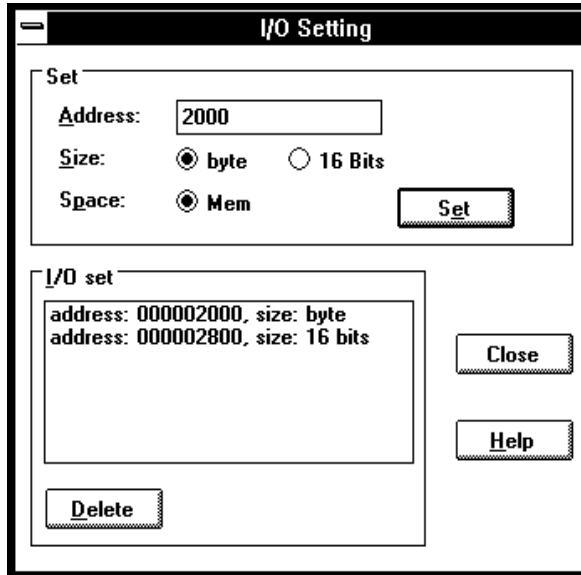

To edit an I/O location

- 1 Display the I/O value to be changed with the Window→I/O command.
- 2 Double-click the value to be changed.
- 3 Use the keyboard to enter a new value.
- 4 Press the Enter key.

To confirm the modified values, press the Enter key for every changed value.

Editing the I/O locations temporarily halts user program execution. You cannot modify I/O locations while the user program executes in the real-time mode or when I/O polling is turned OFF.

Displaying and Editing Registers

This section shows you how:

- To display registers
- To edit registers

To display registers

- Choose the **Window→Register** command.

The register values displayed in the window are periodically updated to show you how the values change during program execution. The decoded flag register flags allow you to identify the register status at a glance.

When the Register window is updated, user program execution is temporarily interrupted. To prevent the user program from being interrupted (and the Register window from being updated), choose the **RealTime→Monitor Intrusion→Disallowed (ALT, R, T, D)** command to activate the real-time mode.

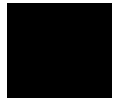

Example Register Contents Displayed in the Register Window

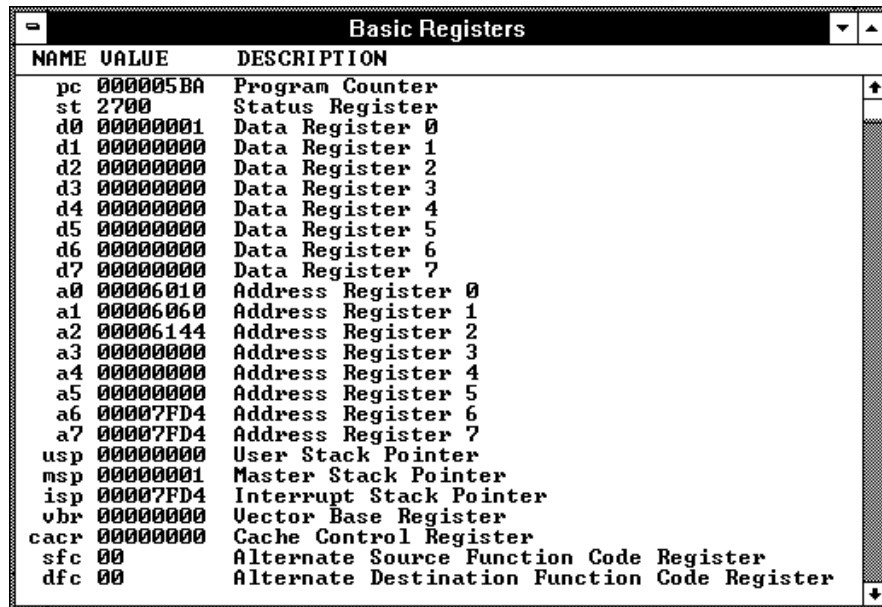

NAME	VALUE	DESCRIPTION
pc	000005BA	Program Counter
st	2700	Status Register
d0	00000001	Data Register 0
d1	00000000	Data Register 1
d2	00000000	Data Register 2
d3	00000000	Data Register 3
d4	00000000	Data Register 4
d5	00000000	Data Register 5
d6	00000000	Data Register 6
d7	00000000	Data Register 7
a0	00006010	Address Register 0
a1	00006060	Address Register 1
a2	00006144	Address Register 2
a3	00000000	Address Register 3
a4	00000000	Address Register 4
a5	00000000	Address Register 5
a6	00007FD4	Address Register 6
a7	00007FD4	Address Register 7
usp	00000000	User Stack Pointer
msp	00000001	Master Stack Pointer
isp	00007FD4	Interrupt Stack Pointer
vbr	00000000	Vector Base Register
cacr	00000000	Cache Control Register
sfc	00	Alternate Source Function Code Register
dfc	00	Alternate Destination Function Code Register

To edit registers

- 1 Display the register contents by choosing the Window→Register command.
- 2 Double-click the value to be changed.
- 3 Use the keyboard to enter a new value.
- 4 Press the Enter key.

Modifying register contents temporarily interrupts program execution. You cannot modify register contents while the user program is running and monitor intrusion is disallowed.

Note that register values are not actually changed until the Enter key is pressed.

Double-clicking the status register (st) contents opens the Register Bit Fields dialog box which you can use to set or clear individual bit fields.

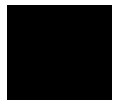

Tracing Program Execution

This section shows you how:

- To trace function flow
- To trace callers of a specified function
- To trace execution within a specified function
- To trace accesses to a specified variable
- To trace before a particular variable value and break
- To trace until the command is halted
- To stop a running trace
- To repeat the last trace
- To display bus cycles
- To display absolute or relative counts
- To change the disassembly of bus cycle data
- To display dequeued trace data

How the Analyzer Works

When you trace program execution, the analyzer captures microprocessor address bus, data bus, and control signal values at each clock cycle. The values captured for one clock cycle are collectively called a state. A trace is a collection of these states stored in analyzer memory (also called trace memory).

The trigger condition tells the analyzer when to store states in trace memory. The trigger position specifies whether states are stored before, after, or about the state that satisfies the trigger condition.

The store condition limits the kinds of states that are stored in trace memory.

When the states stored are limited by the store condition, up to two states which satisfy the prestore condition may be stored when they occur before the states that satisfy the store condition.

After a captured state satisfies the trigger condition, a trace becomes complete when trace memory is filled with states that satisfy the store and prestore conditions.

Note The analyzer traces unexecuted instructions due to prefetching in 68040.

Note You should disable the on-chip instruction and data caches when you trace program execution. This causes all memory accesses to be visible on the external bus (at the expense of processor performance). Also, if the processor's Memory Management Unit is enabled, you will not be able to see symbolic information in the trace results.

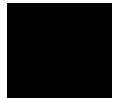

Trace Window Contents

When traces are completed, the Trace window is automatically opened to display the trace results.

Each line in the trace shows the trace buffer state number, the type of state, the module name and line number, the function name, the source file information, and the time information for the state (relative to the other lines, by default).

When bus cycles are included, the address, data, and disassembled instruction or bus cycle status mnemonics are shown.

To trace function flow

- Choose the Trace→Function Flow (ALT, T, F) command.

The command stores function entry points, and the resulting trace shows program execution flow.

The command traces C function entry points only. It does not trace execution for assembly language routines.

Note

When using the MCC68K compiler, you must specify the -Kf option when compiling programs in order for the debugger to be able to trace function flow.

Example

Function Flow Trace

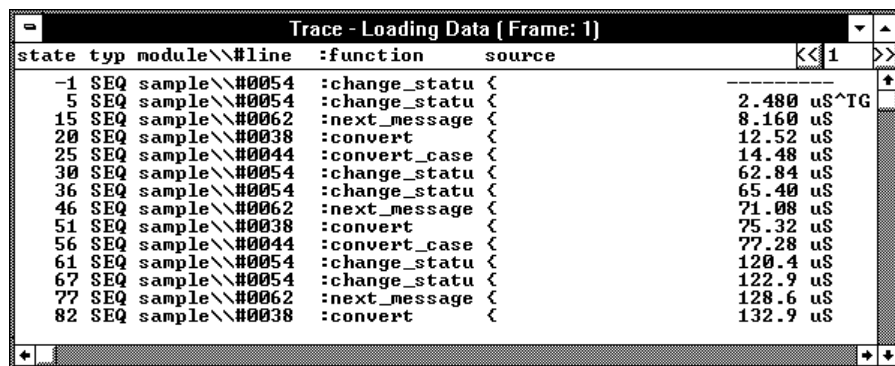

state	typ	module\\#line	:function	source	
-1	SEQ	sample\\#0054	:change_statu	<	
5	SEQ	sample\\#0054	:change_statu	<	2.480 uS
15	SEQ	sample\\#0062	:next_message	<	8.160 uS
20	SEQ	sample\\#0038	:convert	<	12.52 uS
25	SEQ	sample\\#0044	:convert_case	<	14.48 uS
30	SEQ	sample\\#0054	:change_statu	<	62.84 uS
36	SEQ	sample\\#0054	:change_statu	<	65.40 uS
46	SEQ	sample\\#0062	:next_message	<	71.08 uS
51	SEQ	sample\\#0038	:convert	<	75.32 uS
56	SEQ	sample\\#0044	:convert_case	<	77.28 uS
61	SEQ	sample\\#0054	:change_statu	<	120.4 uS
67	SEQ	sample\\#0054	:change_statu	<	122.9 uS
77	SEQ	sample\\#0062	:next_message	<	128.6 uS
82	SEQ	sample\\#0038	:convert	<	132.9 uS

To trace callers of a specified function

- 1 Double-click the function name in one of the debugger windows.
- 2 Choose the Trace→Function Caller... (ALT, T, C) command.
- 3 Choose the OK button.

This command stores the first executable statement of the specified function and prestores statements that execute before it. The prestored statements show the caller of the function.

To identify interrupts in program execution, trace the caller of the interrupt process routine using the Trace→Function Caller... (ALT, T, C) command.

For Assembler symbols, the system traces the last two instructions executed before the specified Assembler symbol is reached. Specifying the first symbol of a subroutine enables the system to trace the caller of the subroutine.

Note

The analyzer may fail in tracing the caller due to prefetching in 68040. To avoid this failure, specify the function by a value of its address + 2.

Chapter 5: Debugging Programs
Tracing Program Execution

Example To trace the caller of "change_status":

Double-click "change_status."

Choose the Trace→Function Caller... (ALT, T, C) command.

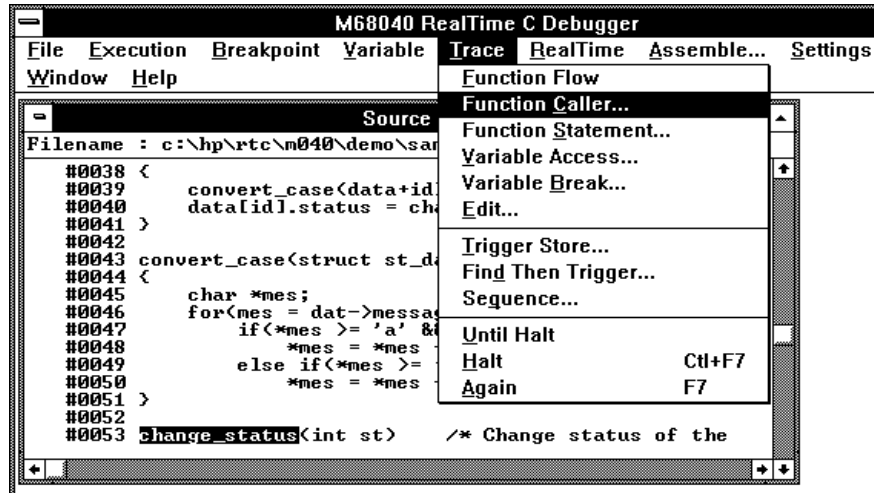

The Trace window becomes active and displays the trace results.

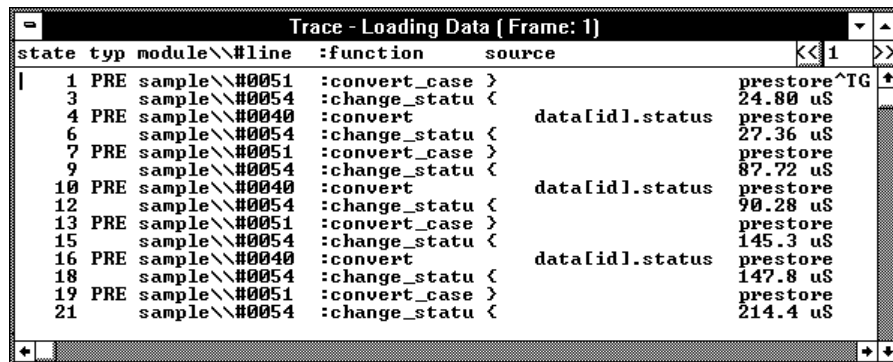

You can see how prefetching affects tracing by choosing the Display→Mixed Mode (ALT, -, D, M) command from the Trace window's control menu.

To trace execution within a specified function

- 1 Double-click the function name in the Source window.
- 2 Choose the Trace→Function Statement... (ALT, T, S) command.

This command traces C functions only. It does not trace execution of assembly language subroutines.

Example

To trace execution within "next_message":

Double-click "next_message."

Choose the Trace→Function Statement... (ALT, T, S) command.

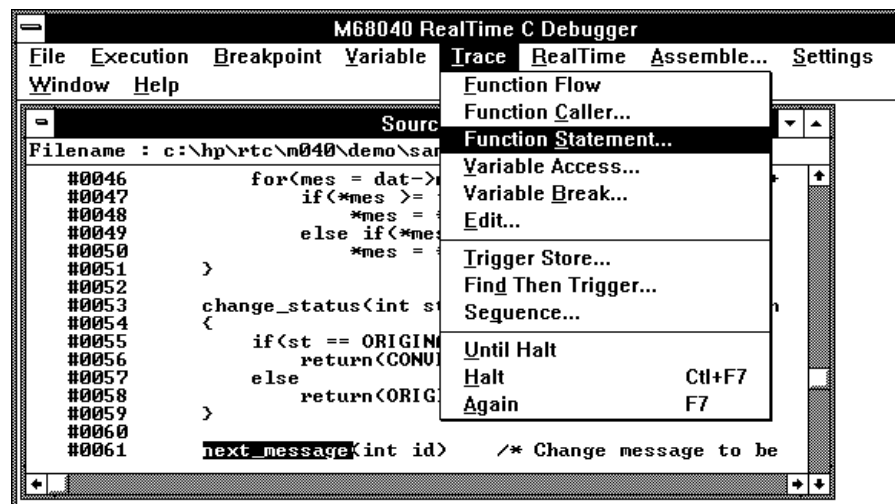

The Trace window becomes active and displays the results. You can see how prefetching affects tracing by choosing the Display→Mixed Mode (ALT, -, D, M) command from the Trace window's control menu.

To trace accesses to a specified variable

- 1 Double-click the global variable name in the Source window.
- 2 Choose the Trace→Variable Access... (ALT, T, V) command.

The command also traces access to the Assembler symbol specified by its name and size.

Example

To trace access to "message_id":

Double-click "message_id."

Choose the Trace→Variable Access... (ALT, T, V) command.

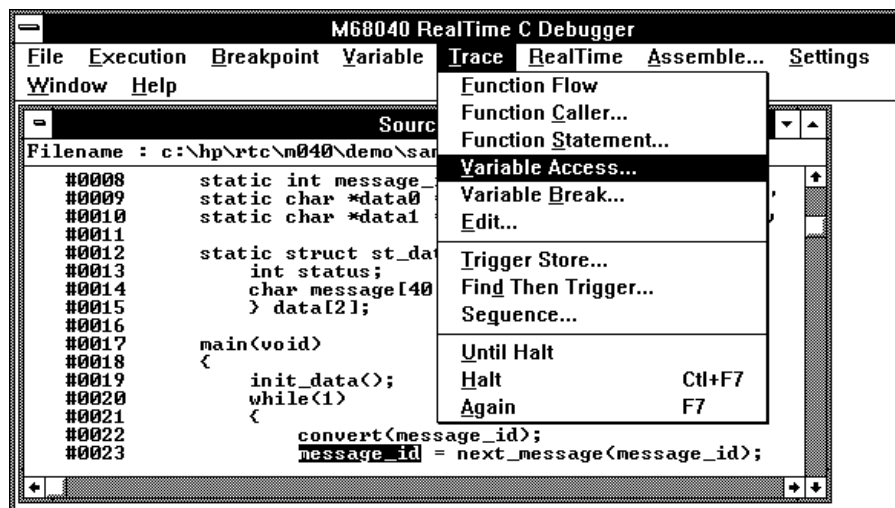

The Trace window becomes active and displays the trace results.

To trace before a particular variable value and break

- 1 Double-click the desired global variable.
- 2 Choose the Trace→Variable Break... (ALT, T, B) command.
- 3 Enter the value in the Value text box.
- 4 Choose the OK button.

The Trace→Variable Break... (ALT, T, B) command breaks execution as soon as the specified value is written to the specified global variable.

The command also breaks execution at the Assembler symbol specified by its name and size.

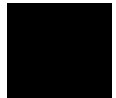

Chapter 5: Debugging Programs
Tracing Program Execution

Example To break execution as soon as "message_id" contains "0":
Double-click "message_id."
Choose the Trace→Variable Break... (ALT, T, B) command.

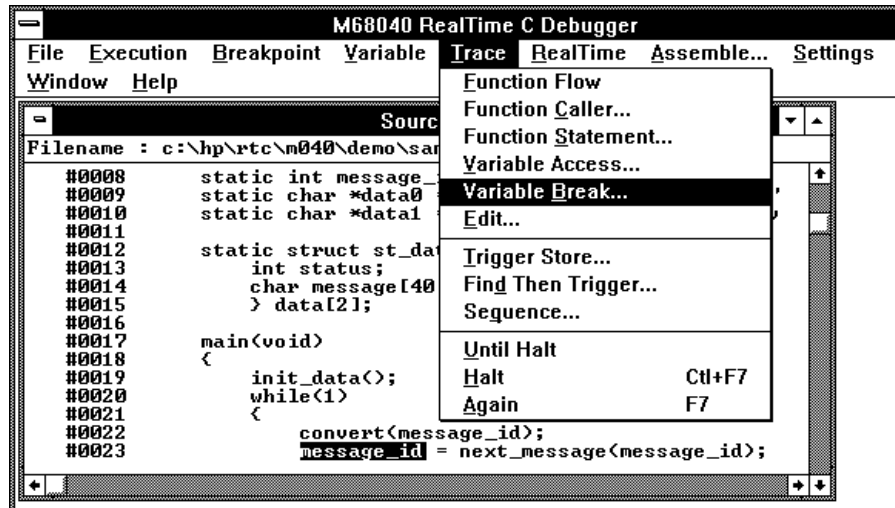

Enter "0" in the Value text box.

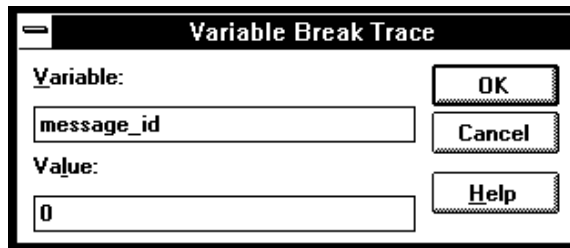

Choose the OK button.

The debugger halts execution as soon as the program writes "0" to the "message_id" variable. Once execution has halted, the Trace window becomes active and displays the results.

To trace until the command is halted

- 1 To start the trace, choose the Trace→Until Halt (ALT, T, U) command.
- 2 When you are ready to stop the trace, choose the Trace→Halt (ALT, T, H) command.

This command is useful, for example, in tracing program execution that leads to a processor halted state or to a break to the monitor.

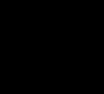

To stop a running trace

- Choose the Trace→Halt (ALT, T, H) command.

The command is used to:

Stop the trace initiated with the Trace→Until Halt (ALT, T, U) command.

Force termination of the trace that cannot be completed due to absence of the specified state.

Stop a trace before the trace buffer becomes full.

To repeat the last trace

- Choose the Trace→Again (ALT, T, A) command, or press the F7 key.

The Trace→Again (ALT, T, A) command traces program execution using the last trace specification stored in the HP 64700.

To display bus cycles

- 1 Place the cursor on the line from which you wish to display the bus cycles.
- 2 From the Trace window's control menu, choose the Display→Mixed Mode (ALT, -, D, M) command or the Display→Bus Cycle Only (ALT, -, D, C) command.

The Display→Mixed Mode (ALT, -, D, M) command displays each source line followed by the bus cycles associated with it.

The Display→Bus Cycle Only (ALT, -, D, C) command displays the bus cycles without the source lines.

The display starts from the cursor-selected line.

To hide the bus cycles, choose the Display→Source Only (ALT, -, D, S) command from the Trace window's control menu.

Example

Bus Cycles Displayed in Trace with "Mixed Mode" selected:

state	typ	module	line	function	source	
		sample	0054	:change_statu	{	
-1	SEQ	0000058a	4e754e56	LINK.W	A6, #0000	
0	SEQ	000007fc4	00000518	supr data wr long		0.120 uS TG
1	SEQ	0000058c	000033fc	supr prog rd long		0.120 uS
2		00000590	000a0000	supr prog rd long		0.200 uS
3		000007fc0	00007fd8	supr data wr long		0.120 uS
4	SEQ	00000594	62bc4aae	supr prog rd long		0.120 uS
5	SEQ	000005ae	4e754e56	supr prog rd long		1.560 uS
6	SEQ	000007fc0	00007fd8	supr data rd long		0.280 uS
7	SEQ	00000542	4e754e56	supr prog rd long		2.800 uS
8	SEQ	000007fd0	00000000	supr data rd long		0.200 uS
		sample	0062	:next_message	{	
9	SEQ	000005ae	4e754e56	LINK.W	A6, #0000	7.520 uS ^TG
10	SEQ	000007fd8	00000464	supr data wr long		0.120 uS

To display absolute or relative counts

- From the Trace window's control menu, choose the Display→Count→Absolute (ALT, -, D, C, A) or Display→Count→Relative (ALT, -, D, C, R) command.

Choosing the Display→Count→Relative (ALT, -, D, C, R) command selects the relative mode where the state-to-state time intervals are displayed.

Choosing the Display→Count→Absolute (ALT, -, D, C, A) command selects the absolute mode where the trace time is displayed as the total time elapsed since the analyzer has been triggered.

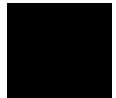

To change the disassembly of bus cycle data

- 1 From the Trace window's control menu, choose the Display→From State... (ALT, -, D, F) command.
- 2 In the State text box, enter the number of the state you want to start disassembly from.
- 3 Select either the High Word or Low Word option to specify which 16-bit word of the 32-bits of captured data to start disassembly from.
- 4 If the bus cycle data is being dequeued, enter the number of the operand cycle state caused by the instruction cycle state you are disassembling from.
- 5 Choose the OK button.

If you see disassembled bus cycle information in the Trace window that does not look correct, you can use the Display→From State... (ALT, -, D, F) command to change which state the disassembly starts from.

To display dequeued trace data

- From the Trace window's control menu, choose the Display→Options→Dequeue ON (ALT, -, D, O, O) command.

During 68040 program execution, operand cycles may not appear on the bus immediately after the instruction cycles that cause them because the 68040 microprocessor prefetches instructions into (and executes them out of) an on-chip cache. Consequently, when you trace microprocessor execution, the captured bus cycle data may be difficult to read and understand.

The Display→Options→Dequeue ON (ALT, -, D, O, O) command shuffles bus cycle states in the Trace window so that operand cycles immediately follow the instruction cycles that caused them. And, unexecuted instructions are removed from the display.

To turn OFF dequeuing, choose the Display→Options→Dequeue OFF (ALT, -, D, O, F) command from the Trace window's control menu.

Setting Up Custom Trace Specifications

This section shows you how:

- To set up a "Trigger Store" trace specification
- To set up a "Find Then Trigger" trace specification
- To set up a "Sequence" trace specification
- To edit a trace specification
- To trace "windows" of program execution
- To store the current trace specification
- To load a stored trace specification

Note

The analyzer traces unexecuted instructions due to prefetching in 68040.

Note

Analyzer memory is unloaded two states at a time. If you use a storage qualifier to capture states that do not occur often, it's possible that one of these states has been captured and stored but cannot be displayed because another state must be stored before the pair can be unloaded. When this happens, you can stop the trace measurement to see all stored states.

When Do I Use the Different Types of Trace Specifications?

When you wish to trigger the analyzer on the occurrence of one state, use the "Trigger Store" dialog box to set up the trace specification.

When you wish to trigger the analyzer on the occurrence of one state followed by another state, or one state followed by another state but only when that state occurs before a third state, use the "Find Then Trigger" dialog box to set up the trace specification.

When you wish to trigger the analyzer on a sequence of more than two states, use the "Sequence" dialog box to set up the trace specification.

Automatic Long Alignment of Program Symbols in Trace Patterns

Because instructions are fetched from program memory space long words at a time (when there is a 32-bit data bus), it's difficult to symbolically set up a state qualifier pattern for program accesses of instructions on odd word boundaries.

To solve this problem, the debugger will automatically long align symbols in trace patterns when the "prog" status qualifier is used. Long alignment is accomplished by setting the two least significant address bits to zeros. Automatic long alignment will not occur if the symbol is part of an expression.

For example, if "main" is at address 2006H, the effective address 2004h would be used. In the examples that follow, only the first address is adjusted. The second example is not adjusted because it is in data space. The remaining examples are not adjusted because they use expressions rather than a symbol for the address value.

PATTERN INPUT	EFFECTIVE PATTERN
a = A:main D:100 S:prog	a = A:2004h D:100 S:prog
a = A:main D:100 S:data	a = A:2006h D:100 S:data
a = A:2006h D:100 S:prog	a = A:2006h D:100 S:prog
a = A:main+0 D:100 S:prog	a = A:2006h D:100 S:prog
a = A:main+1 D:100 S:prog	a = A:2007h D:100 S:prog

If you don't want long alignment to occur for an address within a trace pattern, simply make the symbol part of an expression (for example, main+0) or use the absolute address.

Program Symbols in Trace Results

Because of the way instructions are fetched when there is a 32-bit data bus, trace results can show symbolic information for the instruction on an even word boundary when the instruction on the odd word boundary was actually executed.

To set up a "Trigger Store" trace specification

- 1 Choose the Trace→Trigger Store... (ALT, T, T) command.
- 2 Specify the *trigger condition* using the Address, Data, and/or Status text boxes within the Trigger group box.
- 3 Specify the *trigger position* by selecting the trigger start, trigger center, or trigger end option in the Trigger group box.
- 4 Specify the *store condition* using the Address, Data, and/or Status text boxes within the Store group box.
- 5 Choose the OK button to set up the analyzer and start the trace.

The Trace→Trigger Store... (ALT, T, T) command opens the Trigger Store Trace dialog box:

The screenshot shows the "Trigger Store Trace" dialog box. It has a title bar with a minus sign and the text "Trigger Store Trace". The dialog is divided into two main sections: "Trigger" and "Store".

The "Trigger" section contains:

- A checkbox labeled "NOT".
- Three text boxes labeled "Address", "Data", and "Status".
- An "End Address" text box.
- Three radio buttons: "trigger start" (selected), "trigger center", and "trigger end".

The "Store" section contains:

- A checkbox labeled "NOT".
- Three text boxes labeled "Address", "Data", and "Status".
- An "End Address" text box.

On the right side of the dialog, there are several buttons: "OK", "Cancel", "Clear", "Load...", "Save...", and "Help".

A group of Address, Data, and Status text boxes combine to form a *state qualifier*. You can specify an address range by entering a value in the End Address box. By selecting the NOT check box, you can specify all states other than those identified by the address, data, and *status values*.

Chapter 5: Debugging Programs
Setting Up Custom Trace Specifications

Example To trace execution after the "convert_case" function:
Choose the Trace→Trigger Store... (ALT, T, T) command.
Enter "convert_case" in the Address text box in the Trigger group box.

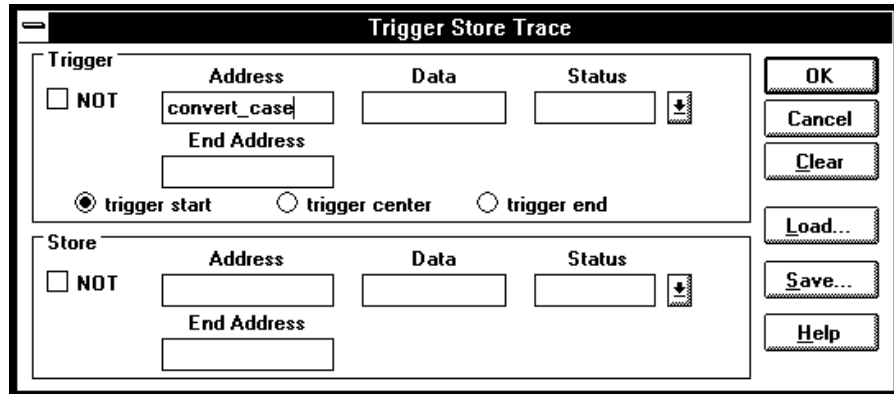

Choose the OK button.

Example To trace execution before and after the "convert_case" function and store only states with "write" status:

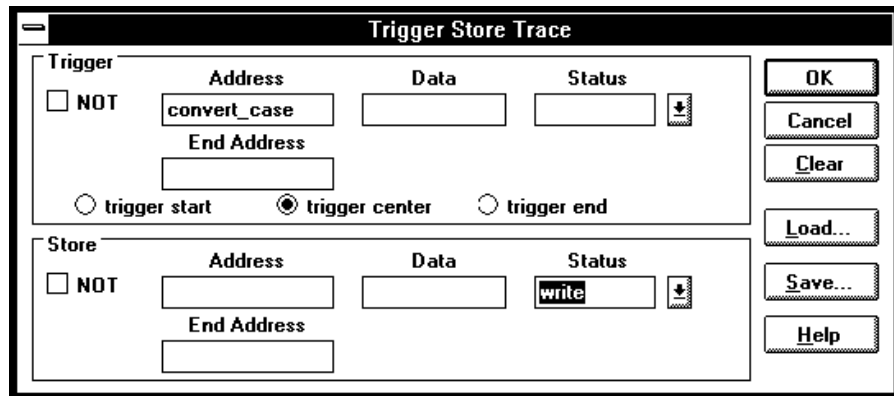

Example

To specify the trigger condition as any address in the range 1000h through 1fffh:

The image shows a dialog box titled "Trigger Store Trace". It is divided into two main sections: "Trigger" and "Store".

Trigger Section:

- There is a checkbox labeled "NOT" which is currently unchecked.
- There are three input fields: "Address" (containing "1000"), "Data" (empty), and "Status" (empty with a dropdown arrow).
- Below these is an "End Address" field (containing "1fff").
- At the bottom of this section are three radio buttons: "trigger start" (selected), "trigger center", and "trigger end".

Store Section:

- There is a checkbox labeled "NOT" which is currently unchecked.
- There are three input fields: "Address" (empty), "Data" (empty), and "Status" (empty with a dropdown arrow).
- Below these is an "End Address" field (empty).

Buttons: On the right side of the dialog, there are seven buttons: "OK", "Cancel", "Clear", "Load...", "Save...", and "Help".

To set up a "Find Then Trigger" trace specification

- 1 Choose the Trace→Find Then Trigger... (ALT, T, D) command.
- 2 Specify the sequence, which is made up of the *enable*, *trigger store*, *trigger*, and *store* conditions.
- 3 Specify the *restart*, *count*, and *prestore* conditions.
- 4 Specify the *trigger position* by selecting the trigger start, trigger center, or trigger end option.
- 5 If you want emulator execution to break to the monitor when the trigger condition occurs, select the *Break On Trigger* check box.
- 6 Choose the OK button to set up the analyzer and start the trace.

The Trace→Find Then Trigger... (ALT, T, D) command opens the Find then Trigger Trace dialog box:

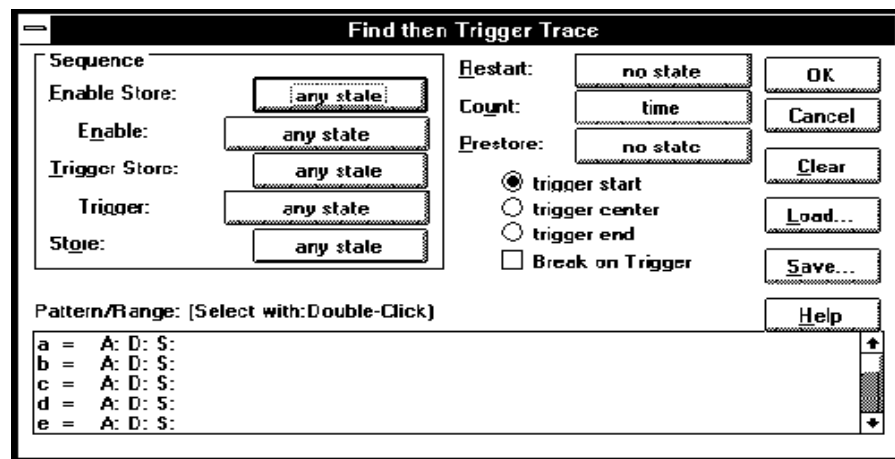

Choosing the enable, trigger, store, count, or prestore buttons opens a Condition dialog box that lets you select "any state," "no state," trace patterns

"a" through "h," "range," or "arm" as the condition. Patterns "a" through "h," "range," and "arm" are grouped into two sets, and resources within a set may be combined using the "or" or "nor" logical operators. Resources from the two sets may be combined using the OR or AND logical operators.

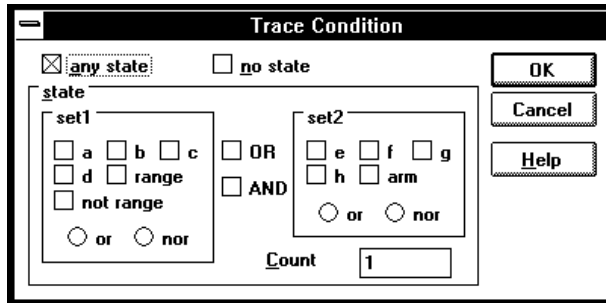

The range and pattern resources are defined by double-clicking on the resource name in the Pattern/Range list box.

If you double-click on a pattern name, the Trace Pattern dialog box is opened to let you specify address, data, and status values. By selecting the NOT check box, you can specify all states other than those identified by the address, data, and *status values*. The Direct check box lets you specify status values other than those that have been predefined.

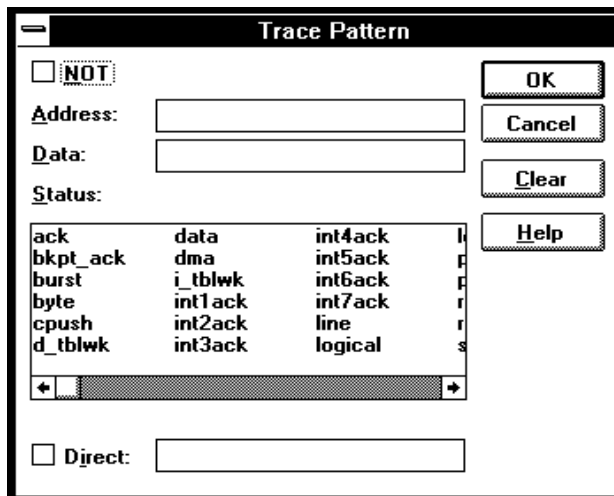

Chapter 5: Debugging Programs
Setting Up Custom Trace Specifications

If you double-click on the range resource (bottom of the Pattern/Range list box), the Trace Range dialog box is opened to let you select either the Address range or the Data range option and enter the minimum and maximum values in the range.

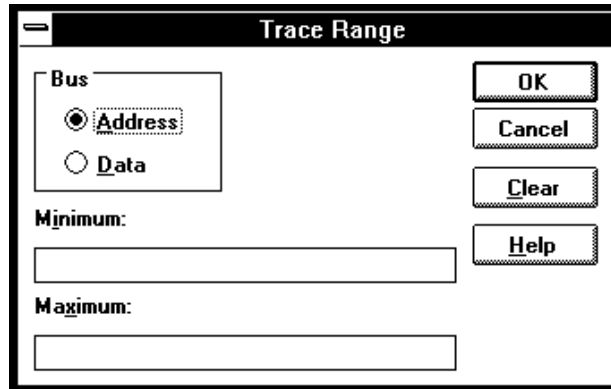

Example

To trace execution after the "convert_case" function:

Choose the Trace→Find Then Trigger... (ALT, T, D) command.

Choose the Trigger button (default: any state).

Select "a."

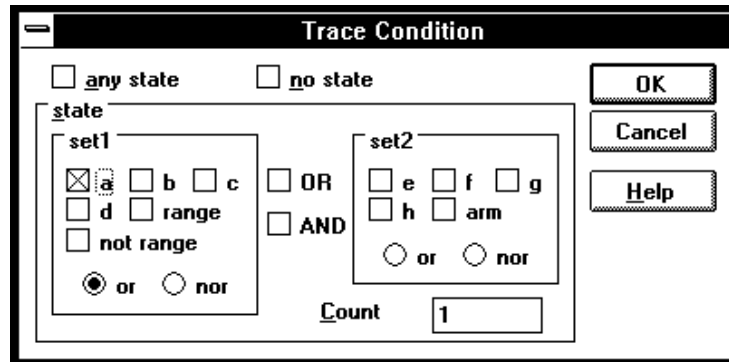

Choose the OK button.

Double-click "a" in the Pattern/Range list box.

Enter "convert_case" in the Address text box in the Trace Pattern dialog box.

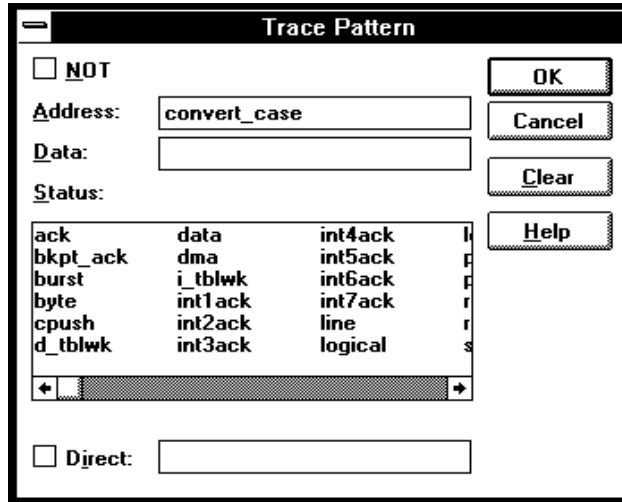

Choose the OK button in the Trace Pattern dialog box.

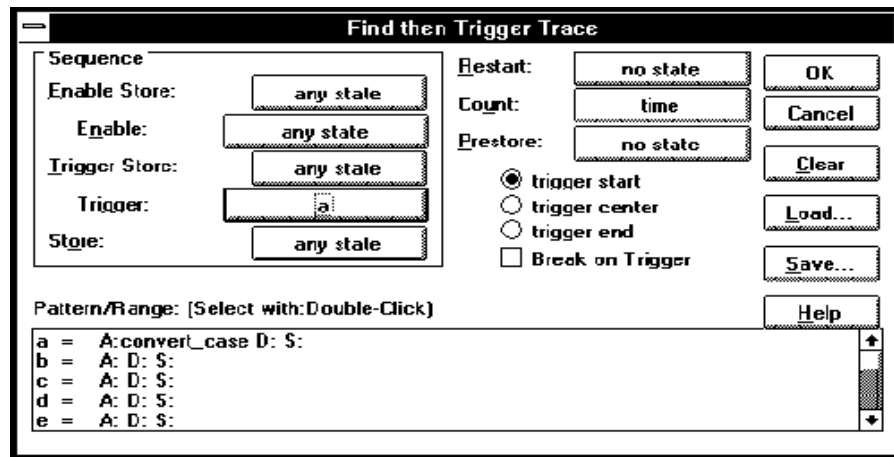

Choose the OK button in the Find then Trigger Trace dialog box.

Example To trace about the "next_message" function when it follows the "change_status" function and store all states after the "change_status" function:

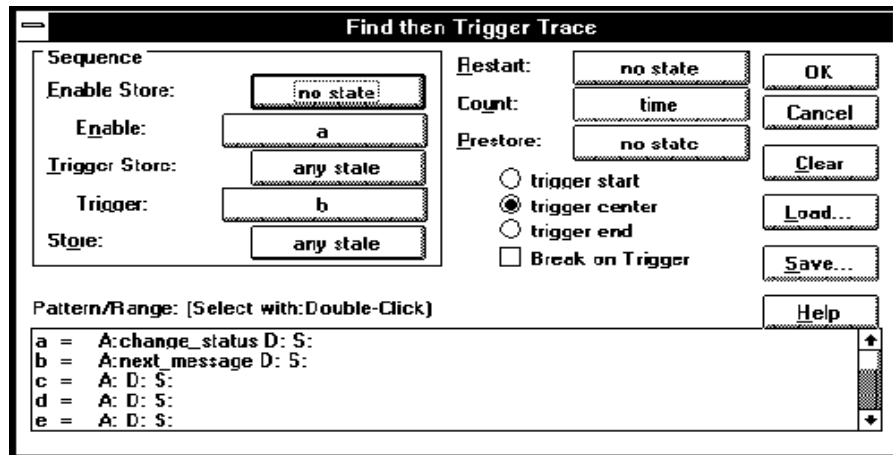

To set up a "Sequence" trace specification

Sequence trace specifications let you trigger the analyzer on a sequence of several captured states.

There are eight sequence levels. When a trace is started, the first sequence level is active. You select one of the remaining sequence levels as the level that, when entered, will trigger the analyzer. Each level lets you specify two conditions that, when satisfied by a captured state, will cause branches to other levels:

```
if (state matches primary branch condition)
    then GOTO (level associated with primary branch)
else if (state matches secondary branch condition)
    then GOTO (level associated with secondary branch)
else
    stay at current level
```

Note that if a state matches both the primary and secondary branch conditions, the primary branch is taken.

Each sequence level also has a store condition that lets you specify the states that get stored while at that level.

- 1 Choose the Trace→Sequence... (ALT, T, Q) command.
- 2 Specify the *primary branch*, *secondary branch*, and *store* conditions for each *sequence level* you will use.
- 3 Specify which sequence level to trigger on. The analyzer triggers on the entry to the specified level. Therefore, the condition that causes a branch to the specified level actually triggers the analyzer.
- 4 Specify the *count* and *prestore* conditions.
- 5 Specify the *trigger position* by selecting the trigger start, trigger center, or trigger end option.
- 6 If you want emulator execution to break to the monitor when the trigger condition occurs, select the *Break On Trigger* check box.

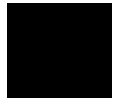

7 Choose the OK button to set up the analyzer and start the trace.

The Trace→Sequence... (ALT, T, Q) command calls the Sequence Trace Setting dialog box, where you make the following trace specifications:

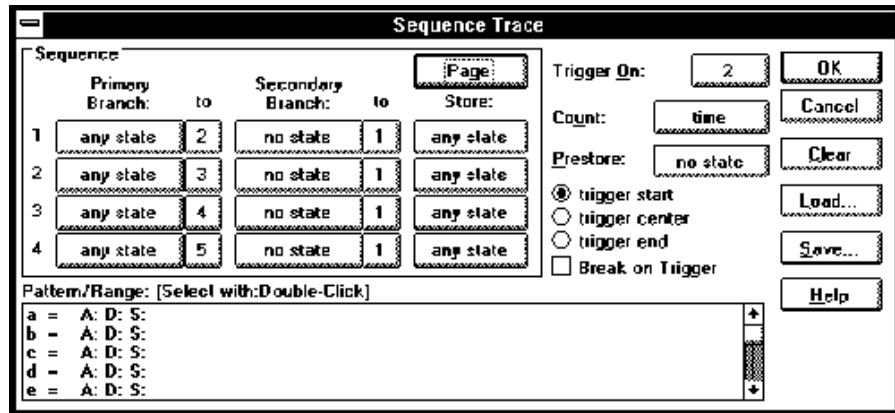

Choosing the primary branch, secondary branch, store, count, or prestore buttons opens a Condition dialog box that lets you select "any state," "no state," trace patterns "a" through "h," "range," or "arm" as the condition. Patterns "a" through "h," "range," and "arm" are grouped into two sets, and resources within a set may be combined using the "or" or "nor" logical operators. Resources in the two sets may be combined using the OR or AND logical operators.

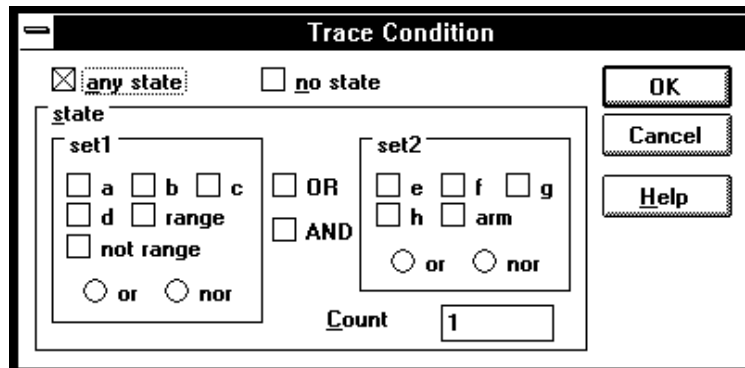

The range and pattern resources are defined by double-clicking on the resource name in the Pattern/Range list box.

If you double-click on a pattern name, the Trace Pattern dialog box is opened to let you specify address, data, and status values. By selecting the NOT check box, you can specify all states other than those identified by the address, data, and *status values*. The Direct check box lets you specify status values other than those that have been predefined.

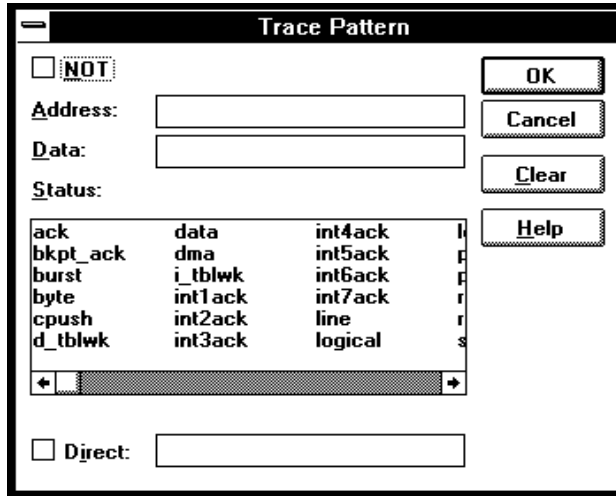

If you double-click on the range resource at the bottom of the Pattern/Range list box, the Trace Range dialog box is opened to let you select either the Address range option or the Data range option and enter the minimum and maximum values in the range.

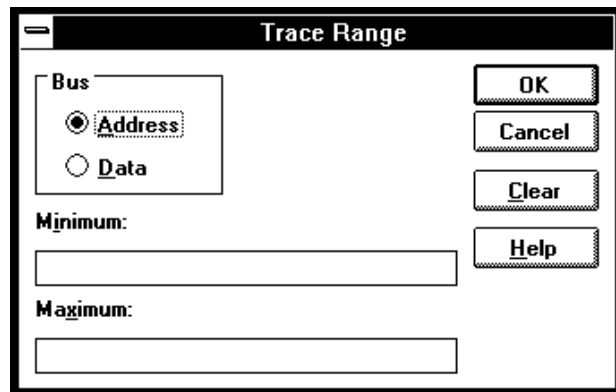

Chapter 5: Debugging Programs
Setting Up Custom Trace Specifications

Example To specify address "convert_case" as the trigger condition:

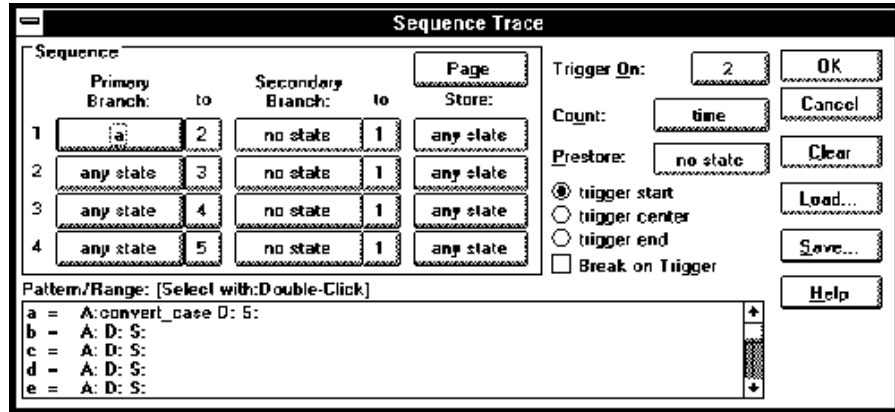

Example To specify execution of "convert_case" and "next_message" as the trigger sequence:

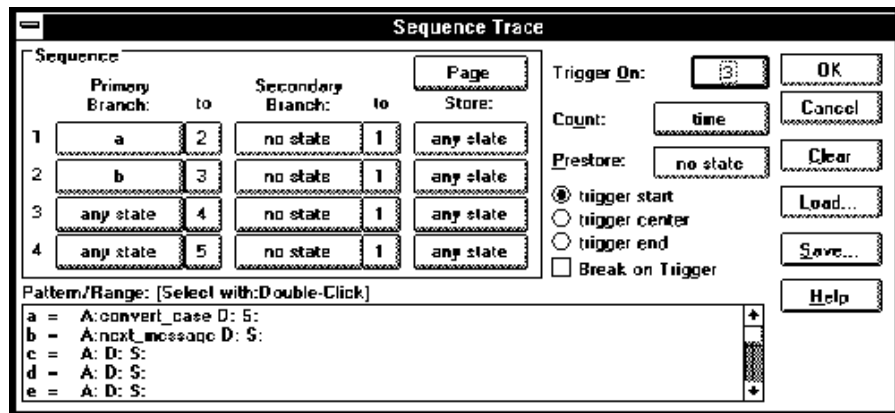

To edit a trace specification

- 1 Choose the Trace→Edit... (ALT, T, E) command.
- 2 Using the Sequence Trace dialog box, edit the trace specification as desired.
- 3 Choose the OK button.

You can use this command to edit trace specifications, including trace specifications that are automatically set up. For example, you can use this command to edit the trace specification that is set up when the Trace→Function Flow (ALT, T, F) command is chosen.

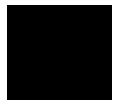

To trace "windows" of program execution

- 1 Because pairs of sequence levels are used to capture window enable and disable states both before and after the trigger, choose the Trace→Sequence... (ALT, T, Q) command.
- 2 Set up the sequence levels, patterns, and other trace options (as described below) in the Sequence Trace dialog box.
- 3 Choose the OK button.

When you trace "windows" of program execution, you store states that occur between one state and another state. Storing states that occur between two states is different from the trace specification set up by the Trace→Statement... (ALT, T, S) command which stores states in a function's range of addresses.

In a typical windowing trace specification, sequence levels are paired. The first sequence level searches for the window enable state, and no states are stored while searching. When the window enable state is found, the second

Chapter 5: Debugging Programs
Setting Up Custom Trace Specifications

sequence level stores the states you're interested in while searching for the window disable state.

If you want to store the window of code execution before and after the trigger condition, use two sets of paired sequence levels: one window enable/disable pair of sequence levels before the trigger, and another disable/enable pair after the trigger as shown below.

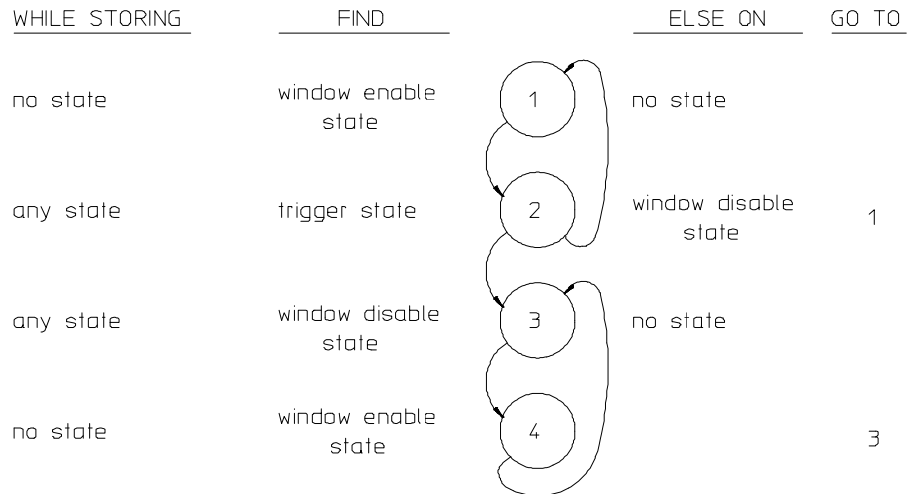

Notice that the order of the second sequence level pair is swapped. In sequence level 2, if the analyzer finds the trigger condition while searching for the window disable state, it will branch to sequence level 3 where it continues its search for the window disable state. After this, the analyzer will remain in sequence levels 3 and 4 until the trace memory is filled, completing the trace.

Example

To trace the window of code execution between lines 46 and 51 of the sample program, triggering on any state in the window:

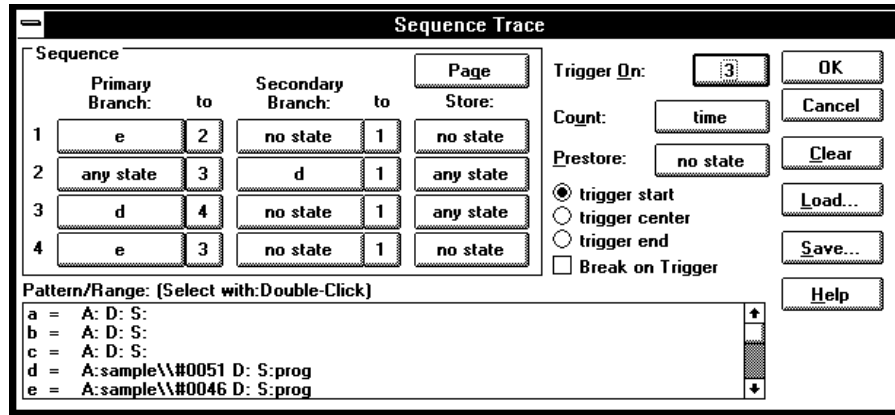

Notice that the analyzer triggers on the entry to sequence level 3. The primary branch condition in level 2 actually specifies the trigger condition.

To store the current trace specification

- 1 Choose the Trace→Edit... (ALT, T, E) command.
- 2 Choose the Save... button.
- 3 Specify the name of the trace specification file.
- 4 Choose the OK button.

You can also store trace specifications from the Trigger Store Trace, Find Then Trigger Trace, or Sequence Trace dialog boxes.

The extension for trace specification files defaults to ".TRC".

To load a stored trace specification

- 1** Choose the Trace→Trigger Store... (ALT, T, T), Trace→Find Then Trigger... (ALT, T, D), Trace→Sequence... (ALT, T, Q), or Trace→Edit... (ALT, T, E) command.
- 2** Choose the Load... button.
- 3** Select the desired trace specification file.
- 4** Choose the OK button.

A "Trigger Store" trace specification file can be loaded into any of the trace setting dialog boxes. A "Find Then Trigger" trace specification file can be loaded into either the Find Then Trigger Trace or Sequence Trace dialog boxes. A "Sequence" trace specification file can only be loaded into the Sequence Trace dialog box.

Part 3

Reference

Descriptions of the product in a dictionary or encyclopedia format.

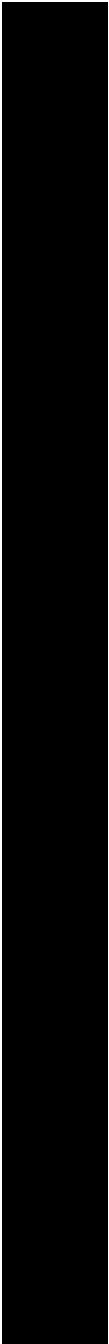

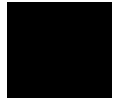

Command File and Macro Command Summary

Command File and Macro Command Summary

This section lists the Real-Time C Debugger break macro and command file commands, providing syntax and brief description for each of the listed commands. For details on each command, refer to the command descriptions.

The characters in parentheses can be ignored for shortcut entry.

Run Control Commands

Command	Param_1	Param_2	Param_3	Param_4	Operation
BRE(AK)					Breaking execution
COM(E)					Run to cursor-indicated line
OVE(R)					Stepping over
OVE(R)	count				Repeated a number of times
OVE(R)	count	address			From specified address
OVE(R)	count	STA(RT)			From transfer address
RES(ET)					Resetting processor
RET(URN)					Until return
RUN					From current address
RUN	address				From specified address
RUN	STA(RT)				From transfer address
RUN	RES(ET)				From reset
STE(P)					Stepping
STE(P)	count				Repeated a number of times
STE(P)	count	address			From specified address
STE(P)	count	STA(RT)			From transfer address

Variable and Memory Commands

Command	Param_1	Param_2	Param_3	Param_4	Operation
MEM(ORY)	address				Changing address displayed
MEM(ORY)	address	TO	value		Edit memory, display size
MEM(ORY)	size	address	TO	value	Edit memory, specify size
MEM(ORY)	FIL(L)	size	addr-range	value	Filling memory contents
MEM(ORY)	COP(Y)	size	addr-range	address	Copying memory contents
MEM(ORY)	LOA(D)	format	filename		Loading memory from a file
MEM(ORY)	STO(RE)	format	addr-range	filename	Storing memory to a file
MEM(ORY)	BYT(E)				Byte format display
MEM(ORY)	WOR(D)				16-Bit format display
MEM(ORY)	ABS(OLUTE)				Single-column display
MEM(ORY)	BLO(CK)				Multi-column display
MEM(ORY)	LON(G)				32-Bit format display
IO	SET	size	space	address	Registering I/O display
IO	DEL(ETE)	size	space	address	Deleting I/O display
IO	size	space	address	TO value	Editing I/O
VAR(IABLE)	address	TO	value		Editing variable
WP	SET	address			Registering watchpoint

WP	DEL(ETE)	address	Deleting watchpoint
WP	DEL(ETE)	ALL	Deleting all watchpoints

Breakpoint Commands

Command	Param_1	Param_2	Param_3	Param_4	Operation
MODE	BKP(TBREAK)	ON OFF			Deletes all/prevents new breakpoints
BM	SET	linenumber	command		Setting break macro
BM	SET	plinum	command		Setting break macro
BM	DEL(ETE)	linenumber			Deleting break macro
BM	DEL(ETE)	plinum			Deleting break macro
BP	SET	address			Setting breakpoint
BP	DEL(ETE)	address			Deleting breakpoint
BP	DEL(ETE)	ALL			Deleting breakpoint
BP	DISABLE	address			Disabling a breakpoint
BP	ENABLE	address			Enabling a breakpoint
EVA(LUATE)	address				Expression window display
EVA(LUATE)	"strings"				Printing string
EVA(LUATE)	CLE(AR)				Clearing Expression window

Window Open/Close Command

Command	Param_1	Param_2	Param_3	Param_4	Operation
DIS(PLAY)	window-name				Opening the named window
ICO(NIC)	window-name				Closing the named window

Configuration Command

Command	Param_1	Param_2	Param_3	Param_4	Operation
MON(ITOR)	STA(RT)				Starting monitor
MON(ITOR)	mon-item	mon-ans			Setting up monitor
MON(ITOR)	END				Ending monitor
CON(FIG)	STA(RT)				Starting configuration
CON(FIG)	config-item	config-ans			Executing configuration
CON(FIG)	END				Ending configuration
MAP	STA(RT)				Starting mapping
MAP	addr-range	memtype	attribute		Executing mapping
MAP	OTHER	memtype			Mapping OTHER area
MAP	END				Ending mapping
MOD(E)	MNE(MONIC)	ON			Enabling Mnemonic display
MOD(E)	MNE(MONIC)	OFF			Enabling Source display
MOD(E)	REA(LTIME)	ON			Enabling real-time mode
MOD(E)	REA(LTIME)	OFF			Disabling real-time mode
MOD(E)	IOG(UARD)	ON			Enabling I/O guard
MOD(E)	IOG(UARD)	OFF			Disabling I/O guard
MOD(E)	MEM(ORYPOLL)	ON			Enabling Memory polling
MOD(E)	MEM(ORYPOLL)	OFF			Disabling Memory polling
MOD(E)	WAT(CHPOLL)	ON			Enabling WatchPoint polling
MOD(E)	WAT(CHPOLL)	OFF			Disabling WatchPoint polling
MOD(E)	LOG	ON			Enabling log file output
MOD(E)	LOG	OFF			Disabling log file output
MOD(E)	BNC	IN			Setting BNC input
MOD(E)	BNC	OUT			Setting BNC output
MOD(E)	TRA(CE)	DIS(PLAY)	FRO(M)	state-num	Change bus cycle disassembly
MOD(E)	TRA(CE)	DIS(PLAY)	HIG(WORD)/LOW(WORD)		Word to disassemble from
MOD(E)	TRA(CE)	DIS(PLAY)	ALI(GN)	state-num	Operand state w/ dequeuing
MOD(E)	TRA(CE)	DIS(PLAY)	DEQ(UEUE)		Dequeue bus cycle data
MOD(E)	TRA(CE)	DIS(PLAY)	NOD(EQUEUE)		Display bus data as captured
MOD(E)	DOW(NLOAD)	ERR(ABORT)			Error causes load abort
MOD(E)	DOW(NLOAD)	NOE(RRABORT)			Load continues after error

Chapter 6: Command File and Macro Command Summary

MOD(E)	SOU(RCE)	ASK(PATH)	Prompt for source paths
MOD(E)	SOU(RCE)	NOA(SKPATH)	Don't prompt for src paths
MOD(E)	TRACECLOCK	BACKGROUND	Trace background cycles
MOD(E)	TRACECLOCK	BOTH	Trace all processor cycles
MOD(E)	TRACECLOCK	USER	Trace user program cycles

File Command

Command	Param_1	Param_2	Param_3	Param_4	Operation
FIL(E)	SOU(RCE)	modulename			Displaying source file
FIL(E)	OBJ(ECT)	filename			Loading object
FIL(E)	SYM(BOL)	filename			Loading symbol
FIL(E)	BIN(ARY)	filename			Loading data
FIL(E)	APPEND	filename			Appending symbol
FIL(E)	CHA(INCMD)	filename			Chaining command files
FIL(E)	COM(MAND)	filename			Executing command file
FIL(E)	LOG	filename			Specifying command log file
FIL(E)	RER(UN)				Re-executes command file
FIL(E)	CON(FIGURATION)	LOA(D)	filename		Loads config. from file
FIL(E)	CON(FIGURATION)	STO(RE)	filename		Stores configuration to file
FIL(E)	ENV(IRONMENT)	LOA(D)	filename		Loads environment from file
FIL(E)	ENV(IRONMENT)	SAV(E)	filename		Stores environment to file

Trace Commands

Command	Param_1	Param_2	Param_3	Param_4	Operation
TRA(CE)	FUN(CTION)	FLO(W)			Tracing function flow
TRA(CE)	FUN(CTION)	CAL(L)	funcname		Tracing function call
TRA(CE)	FUN(CTION)	STA(TEMENT)	funcname		Tracing statement
TRA(CE)	VAR(IABLE)	ACC(ESS)	address		Tracing access to variable
TRA(CE)	VAR(IABLE)	BRE(AK)	address	value	Setting breakpoint variable
TRA(CE)	STO(P)				Stopping tracing
TRA(CE)	ALW(AYS)				Tracing until halt
TRA(CE)	AGA(IN)				Restarting tracing
TRA(CE)	SAV(E)	filename			Storing trace specification
TRA(CE)	LOA(D)	filename			Loading trace specification
TRA(CE)	CUS(TOMIZE)				Starts trace w/loaded spec.
TRA(CE)	DIS(PLAY)	MIX(ED)			Enabling source+bus display
TRA(CE)	DIS(PLAY)	SOU(RCE)			Enabling source display
TRA(CE)	DIS(PLAY)	BUS			Enabling bus display
TRA(CE)	DIS(PLAY)	ABS(OLUTE)			Displaying absolute time
TRA(CE)	DIS(PLAY)	REL(ATIVE)			Displaying relative time
TRA(CE)	COP(Y)	DIS(PLAY)			Copying trace display
TRA(CE)	COP(Y)	ALL			Copying trace results
TRA(CE)	FIN(D)	TRI(GGER)			Centers trigger in window
TRA(CE)	FIN(D)	STA(TE)	state-num		Centers state in window
TRA(CE)	COP(Y)	SPE(C)			Copying specification

Symbol Window Commands

Command	Param_1	Param_2	Param_3	Param_4	Operation
SYM(BOL)	LIS(T)	MOD(ULE)			Displaying module
SYM(BOL)	LIS(T)	FUN(CTION)			Displaying function
SYM(BOL)	LIS(T)	EXT(ERNAL)			Displaying global symbol
SYM(BOL)	LIS(T)	INT(ERNAL)	funcname		Displaying local symbol
SYM(BOL)	LIS(T)	GLO(BAL)			Displaying global asm symbol
SYM(BOL)	LIS(T)	LOC(AL)	modulename		Displaying local asm symbol
SYM(BOL)	ADD	usersymbol	address		Adding user-defined symbol
SYM(BOL)	DEL(ETE)	usersymbol			Deleting user-defined symbol
SYM(BOL)	DEL(ETE)	ALL			Deleting all user symbols
SYM(BOL)	MAT(CH)	"strings"			Displaying matched string

Chapter 6: Command File and Macro Command Summary

SYM(BOL)	COP(Y)	DIS(PLAY)	Copying symbol display
SYM(BOL)	COP(Y)	ALL	Copying all symbols

Command File Control Command

Command	Param_1	Param_2	Param_3	Param_4	Operation
EXIT					Exiting command file
EXIT	VAR(IABLE)	address	value		Exiting with variable cont.
EXIT	REG(ISTER)	regname	value		Exiting with register cont.
EXIT	MEM(ORY)	size	address	value	Exiting with memory contents
EXIT	IO	BYTE/WORD	address	value	Exiting with I/O contents
WAIT	MON(ITOR)				Wait until MONITOR status
WAIT	RUN				Wait until RUN status
WAIT	UNK(NOWN)				Wait until UNKNOWN status
WAIT	SLO(W)				Wait until SLOW CLOCK status
WAIT	TGT(RESET)				Wait until TARGET RESET
WAIT	SLE(EP)				Wait until SLEEP status
WAIT	GRA(NT)				Wait until BUS GRANT status
WAIT	NOB(US)				Wait until NOBUS status
WAIT	TCO(M)				Wait until end of trace
WAIT	THA(LT)				Wait until halt
WAIT	TIM(E)	seconds			Wait a number of seconds

Miscellaneous Commands

Command	Param_1	Param_2	Param_3	Param_4	Operation
ASM	address	user_symbol	"inst_string"		In-line assembler
BEE(P)					Sounding beep
BUTTON	label	"command"			Adds button to Button window
BUTTON	DELETE	label			Deletes button from Button window
BUTTON	DELETEALL				Deletes all buttons from Button window
QUI(T)					Exiting debugger
COP(Y)	TO	filename			Specifying copy destination
COP(Y)	SOU(RCE)				Copying Source window
COP(Y)	REG(ISTER)				Copying Register window
COP(Y)	MEM(ORY)				Copying Memory window
COP(Y)	WAT(CHPOINT)				Copying WatchPoint window
COP(Y)	BAC(KTRACE)				Copying BackTrace window
COP(Y)	IO				Copying I/O window
COP(Y)	EXP(RESSION)				Copying Expression window
CUR(SOR)	address				Positioning cursor
CUR(SOR)	PC				Finding current PC
DIR(ECTORY)	directoryname				Directory for source search
NOP					Non-operative
REG(ISTER)	regname	TO	value		Editing register contents
SEA(RCH)	STR(ING)	direction	case	strings	Searching string
SEA(RCH)	FUN(CTION)	funcname			Selecting function
SEA(RCH)	MEM(ORY)	size	addr-range	value	Searching memory
SEA(RCH)	MEM(ORY)	STR(ING)	"strings"		Searching memory for string
TER(MCOM)	ti-command				Terminal Interface command

Chapter 6: Command File and Macro Command Summary

Parameters

Parameter	Description	Notation
address	Address	See "Reference."
addr-range	Address range	
attribute	For emulation memory	DP, DSI, or DPDSI.
case	Case sensing	
command	Macro command	Commands listed in the "Reference."
config-ans	Setting	See "Reference."
config-item	Configuration	See "Reference."
count	Count	Decimal notation
direction	Search direction	
directoryname	Directory name	
filename	File name	
format	Memory file format	
funcname	Function name	
label	Button label	
linenumber	Line number	
memtype	Memory type	
modulename	Module name	
mon-ans	Setting	See "Reference."
mon-item	Configuration	See "Reference."
plinenum	Macro line number	line number.macro number (ex. 34.1)
regname	Register name	
seconds	Time in seconds	
size	Data size	
space	Memory or I/O space	
strings	String	"string"
usersymbol	User-defined symbol	See "Reference."
value	Value	See "Reference."
window-name	Window name	See "Reference."
	1st 3 characters	

7



Expressions in Commands

Expressions in Commands

When you enter values and addresses in commands, you can use:

- Numeric constants (hexadecimal, decimal, octal, or binary values).
- Symbols (identifiers).
- Function codes.
- C operators (pointers, arrays, structures, unions, unary minus operators) and parentheses (specifying the order of operator evaluation).

Numeric Constants

All numeric constants are assumed to be hexadecimal, except when the number refers to a count; count values are assumed to be decimal. By appending a suffix to the numeric value, you can specify its base.

The debugger expressions support the following numeric constants with or without radix:

Hexadecimal	Alphanumeric strings starting with "0x" or "0X" and consisting of any of '0' through '9', 'A' through 'F', or 'a' through 'f' (for example: 0x12345678, 0xFFFF0000).
	Alphanumeric strings starting with any of '0' through '9', ending with 'H' or 'h', and consisting of any of '0' through '9', 'A' through 'F', or 'a' through 'f' (for example: 12345678H, 0FFFF0000h).
	Alphanumeric strings starting with any of '0' through '9' and consisting of any of '0' through '9', 'A' through 'F', or 'a' through 'f' (for example: 12345678, 0FFFF0000).
	Hexadecimal strings starting with alphabetical characters must be preceded by 0. For example, FF40H must be entered as 0FF40H.
Decimal	Numeric strings consisting of any of '0' through '9' and ending with 'T' or 't' (for example: 128T, 1000t).
Octal	Numeric strings consisting of any of '0' through '7' and ending with 'O' or 'o' (not zero) (for example: 200o, 377O).
Binary	Numeric strings consisting of '0' or '1' and ending with 'Y' or 'y' (for example: 10000000y, 11001011Y).
Don't Care	Numeric strings containing 'X' or 'x' values. All numeric strings must begin with a numeric value. For example, x1x0y must be entered as 0x1x0y.

Symbols

The debugger expressions support the following symbols (identifiers):

- Symbols defined in C source code.
- Symbols defined in assembly language source code.
- Symbols added with the Symbol window control menu's User defined→Add... (ALT, -, U, A) command.
- Line number symbols.

Symbol expressions may be in the following format (where bracketed parts are optional):

```
[module_name\\ ]symbol_name[ , format_spec ]
```

Module Name

The module names include C/Assembler module names as follows:

Assembler module name	(file_path)asm_file_name
--------------------------	--------------------------

C module name	source_file_name (without extension)
---------------	---

Symbol Name

The symbol names include symbols defined in C/Assembler source codes, user-defined symbols, and line number symbols:

User-defined symbols	Strings consisting of up to 256 characters including: alphanumeric characters, _ (underscore), and ? (question mark).
-------------------------	---

Line number symbols	#source_file_line_number
------------------------	--------------------------

The symbol names can also include either * or & to explicitly specify the evaluation of the symbol.

Symbol address &symbol_name

Symbol data *symbol_name

Format Specification

The format specifications define the variable display format or size for the variable access or break tracing:

String s

Decimal d (current size), d8 (8 bit), d16 (16 bit), d32 (32 bit)

Unsigned decimal u (current size), u8 (8 bit), u16 (16 bit), u32 (32 bit)

Hexadecimal x (current size), x8 (8 bit), x16 (16 bit), x32 (32 bit)

Examples

Some example symbol expressions are shown below:

`sample\|#22,x32`

Display the address of line number 22 in the module "sample," formatted as a 32-bit hex number. This form (with the format specification) is used in the watchpoint window, expression window, etc.

`sample\|#22`

Refer to the address of line number 22 in the module "sample." This form (without the format specification) is used in the trace specification, memory display window, etc.

`data[2].message,s`

Display the structure element "message" in the third element of the array "data" as a string.

`dat→message,s`

Display the structure element "message" pointed to by the "dat" pointer as a string.

Symbols

`dat→message ,x32`

Display the structure element "message" pointed to by the "dat" pointer as a 32-bit hex number.

`sample\\data[1].status ,d32`

Display the structure element "status" in the second element of the array "data" that is in the module "sample" as a 32-bit decimal integer.

`&data[0]`

Refer to the address of the first element of the array "data."

`*1000`

Does not do anything. (It displays dashes, as an indication of a parsing error.) Note that you cannot use constants as an address.

Function Codes

Addresses can be specified with a logical function code. Function codes are appended to addresses, preceded by @ (for example: 0a3bc@up). The valid 68040 function codes are:

X	Same as no function code, TM(2:0)=101.
S	Specifies "Supervisor" memory space, TM(2:0)=101.
U	Specifies "User" memory space, TM(2:0)=001.
P	Specifies "Program" memory space, TM(2:0)=101.
D	Specifies "Data" memory space, TM(2:0)=101.
SP	Specifies "Supervisor Program" memory space, TM(2:0)=101.
SD	Specifies "Supervisor Data" memory space, TM(2:0)=101.
UP	Specifies "User Program" memory space, TM(2:0)=001.
UD	Specifies "User Data" memory space, TM(2:0)=001.
0-7	Specifies an explicit value for TM(2:0).
A	Specifies an absolute (physical) address.

The "A" function code may also be appended to any other function code; otherwise, the address is assumed to be logical.

Function codes are not appropriate when:

- Specifying addresses in trace commands (because address qualifiers are compared with values captured on the address bus -- function code information is captured as part of the bus cycle status).
- Referring to a program counter address (because the function code is determined by the Supervisor/User status flag bit).

C Operators

The debugger expressions support the following C operators. The order of operator evaluation can be modified using parentheses '(' and ')'; however, it basically follows C conventions:

Pointers	'*' and '&'
Arrays	'[' and ']'
Structures or unions	'.' and "->"
Unary minus	'-'



Menu Bar Commands

Menu Bar Commands

This chapter describes the commands that can be chosen from the menu bar. Command descriptions are in the order they appear in the menu bar (top to bottom, left to right).

- File→Load Object... (ALT, F, L)
- File→Command Log→Log File Name... (ALT, F, C, N)
- File→Command Log→Logging ON (ALT, F, C, O)
- File→Command Log→Logging OFF (ALT, F, C, F)
- File→Run Cmd File... (ALT, F, R)
- File→Load Debug... (ALT, F, D)
- File→Save Debug... (ALT, F, S)
- File→Load Emulator Config... (ALT, F, E)
- File→Save Emulator Config... (ALT, F, V)
- File→Copy Destination... (ALT, F, P)
- File→Exit (ALT, F, X)
- File→Exit HW Locked (ALT, F, H)
- Execution→Run (ALT, E, U)
- Execution→Run to Cursor (ALT, R C)
- Execution→Run to Caller (ALT, E, T)
- Execution→Run... (ALT, E, R)
- Execution→Single Step (ALT, E, N)
- Execution→Step Over (ALT, E, O)
- Execution→Step... (ALT, E, S)
- Execution→Break (ALT, E, B)
- Execution→Reset (ALT, E, E)
- Breakpoint→Set at Cursor (ALT, B, S)
- Breakpoint→Delete at Cursor (ALT, B, D)
- Breakpoint→Set Macro... (ALT, B, M)
- Breakpoint→Delete Macro (ALT, B, L)
- Breakpoint→Edit... (ALT, B, E)
- Variable→Edit... (ALT, V, E)
- Trace→Function Flow (ALT, T, F)
- Trace→Function Caller... (ALT, T, C)
- Trace→Function Statement... (ALT, T, S)

- Trace→Variable Access... (ALT, T, V)
- Trace→Variable Break... (ALT, T, B)
- Trace→Edit... (ALT, T, E)
- Trace→Trigger Store... (ALT, T, T)
- Trace→Find Then Trigger... (ALT, T, D)
- Trace→Sequence... (ALT, T, Q)
- Trace→Until Halt (ALT, T, U)
- Trace→Halt (ALT, T, H)
- Trace→Again (ALT, T, A)
- RealTime→Monitor Intrusion→Disallowed (ALT, R, T, D)
- RealTime→Monitor Intrusion→Allowed (ALT, R, T, A)
- RealTime→I/O Polling→ON (ALT, R, I, O)
- RealTime→I/O Polling→OFF (ALT, R, I, F)
- RealTime→Watchpoint Polling→ON (ALT, R, W, O)
- RealTime→Watchpoint Polling→OFF (ALT, R, W, F)
- RealTime→Memory Polling→ON (ALT, R, M, O)
- RealTime→Memory Polling→OFF (ALT, R, M, F)
- Assemble... (ALT, A)
- Settings→Emulator Config→Hardware... (ALT, S, E, H)
- Settings→Emulator Config→Memory Map... (ALT, S, E, M)
- Settings→Emulator Config→Monitor... (ALT, S, E, O)
- Settings→Communication... (ALT, S, C)
- Settings→BNC→Outputs Analyzer Trigger (ALT, S, B, O)
- Settings→BNC→Input to Analyzer Arm (ALT, S, B, I)
- Settings→Font... (ALT, S, F)
- Settings→Tabstops... (ALT, S, T)
- Settings→Symbols→Case Sensitive→ON (ALT, S, S, C, O)
- Settings→Symbols→Case Sensitive→OFF (ALT, S, S, C, F)
- Settings→Extended→Trace Cycles→User (ALT, S, X, T, U)
- Settings→Extended→Trace Cycles→Monitor (ALT, S, X, T, M)
- Settings→Extended→Trace Cycles→Both (ALT, S, X, T, B)
- Settings→Extended→Load Error Abort→ON (ALT, S, X, L, O)
- Settings→Extended→Load Error Abort→OFF (ALT, S, X, L, F)
- Settings→Extended→Source Path Query→ON (ALT, S, X, S, O)
- Settings→Extended→Source Path Query→OFF (ALT, S, X, S, F)
- Window→Cascade (ALT, W, C)
- Window→Tile (ALT, W, T)
- Window→Arrange Icons (ALT, W, A)



Chapter 8: Menu Bar Commands

- Window→1-9 <win_name> (ALT, W, 1-9)
- Window→More Windows... (ALT, W, M)
- Help→About Debugger/Emulator... (ALT, H, D)

File→Load Object... (ALT, F, L)

Loads the specified object file and symbolic information into the debugger.

Program code is loaded into emulation memory or target system RAM.

Object files must be IEEE-695 format absolute files. Some software development tools that generate this format are:

Microtec MCC68K Compiler

Microtec ASM68K Assembler

Microtec LNK68K Linker

HP AxLS CC68000 Compiler

HP AxLS AS68K Assembler

HP AxLS LD68K Linker

You can also load Motorola S-Record and Intel Hexadecimal format files; however, no symbolic information from these files will be loaded.

Load Object File Dialog Box

Choosing the File→Load Object... (ALT, F, L) command opens the following dialog box:

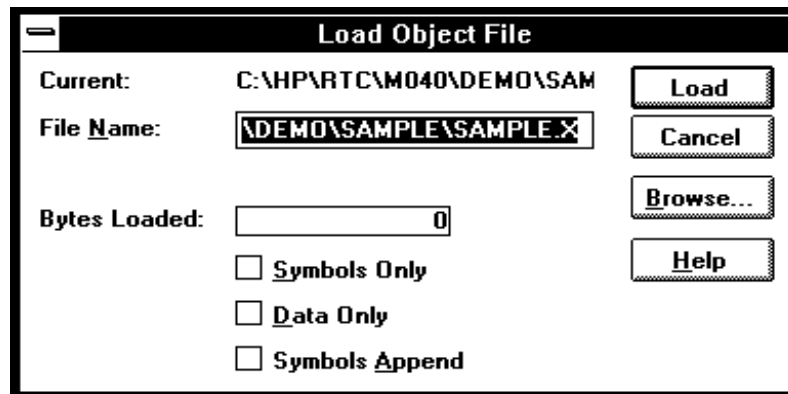

Current	Shows the currently loaded object file.
File Name	Specifies the object file to be loaded. The system defaults the file extension to ".x".
Bytes Loaded	Displays the loaded data in Kbytes.
Symbols Only	Loads only the symbolic information. This is used when programs are already in memory (for example, when the debugger is exited and reentered without turning OFF power to the target system or when code is in target system ROM).
Data Only	Loads program code but not symbols.
Symbols Append	Appends the symbols from the specified object file to the currently loaded symbols. This lets you debug code loaded from multiple object files.
Load	Starts loading the specified object file and closes the dialog box.
Cancel	Closes the dialog box without loading the object file.
Browse...	Opens a file selection dialog box from which you can select the object file to be loaded.

Command File Command

`FIL(E) OBJ(ECT) file_name`

Loads the specified object file and symbols into the debugger.

`FIL(E) SYM(BOL) file_name`

Loads only the symbolic information from the specified object file.

`FIL(E) BIN(ARY) file_name`

Loads only the program code from the specified object file.

`FIL(E) APP(END) file_name`

Appends the symbol information from the specified object file to the currently loaded symbol information.

See Also

"To load user programs" in the "Loading and Displaying Programs" section of the "Debugging Programs" chapter.



File→Command Log→Log File Name... (ALT, F, C, N)

Lets you name a new command log file.

The current command log file is closed and the specified command log file is opened. The default command log file name is "log.cmd".

Command log files can be executed with the File→Run Cmd File... (ALT, F, R) command.

The File→Command Log→Logging OFF (ALT, F, C, F) command stops the logging of executed commands.

This command opens a file selection dialog box from which you can select the command log file. Command log files have a ".CMD" extension.

Command File Command

FIL(E) LOG filename

See Also

"To create a command file" in the "Using Command Files" section of the "Using the Debugger Interface" chapter.

File→Command Log→Logging ON (ALT, F, C, O)

Starts command log file output.

The File→Command Log→Log File Name... (ALT, F, C, N) command specifies the destination file.

Command File Command

MOD(E) LOG ON

See Also

"To create a command file" in the "Using Command Files" section of the "Using the Debugger Interface" chapter.

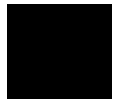

File→Command Log→Logging OFF (ALT, F, C, F)

Stops command log file output.

The File→Command Log→Log File Name... (ALT, F, C, N) command specifies the destination file.

Command File Command

```
MOD(E) LOG OFF
```

See Also

"To create a command file" in the "Using Command Files" section of the "Using the Debugger Interface" chapter.

File→Run Cmd File... (ALT, F, R)

Executes the specified command file.

Command files can be:

- Files created with the File→Command Log→Log File Name... (ALT, F, C, N) command.
- Configuration files having .CMD extension.

Command files are stored as ASCII text files so they can be created or edited with ASCII text editors.

Command File Execution Dialog Box

Choosing the File→Run Cmd File... (ALT, F, R) command opens the following dialog box:

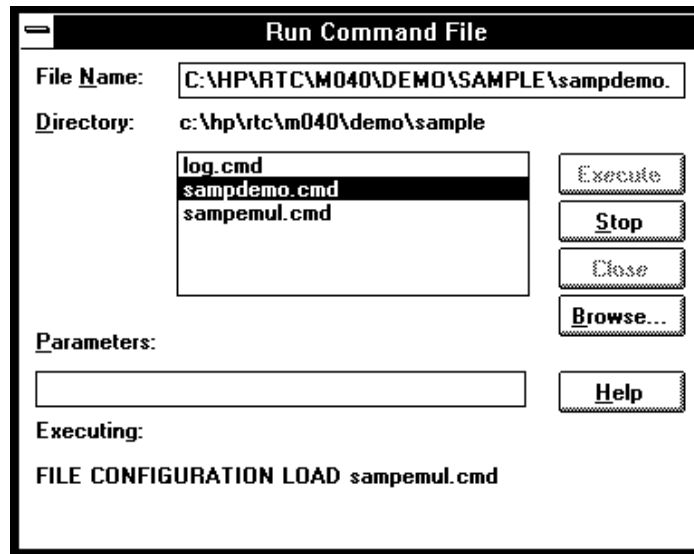

File Name Lets you enter the name of the command file to be executed.

Directory	Shows the current directory and the command files in that directory. You can select the command file name from this list.
Parameters	Lets you specify up to five parameters that replace placeholders \$1 through \$5 in the command file. Parameters must be separated by blank spaces.
Executing	Shows the command being executed.
Execute	Executes the command file.
Stop	Stops command file execution.
Close	Closes the dialog box.
Browse...	Opens a file selection dialog box from which you can select the command file name.

Command File Command

`FIL(E) COM(MAND) filename args`

See Also

"To execute a command file" in the "Using Command Files" section of the "Using the Debugger Interface" chapter.

File→Load Debug... (ALT, F, D)

Loads a debug environment file.

This command opens a file selection dialog box from which you select the debug environment file.

Debug environment files have the extension ".ENV".

Debug environment files contain information about:

- Breakpoints.
- Variables in the WatchPoint window.
- The directory that contains the currently loaded object file.

Command File Command

`FIL(E) ENV(IRONMENT) LOA(D) filename`



File→Save Debug... (ALT, F, S)

Saves a debug environment file.

This command opens a file selection dialog box from which you select the debug environment file.

The following information is saved in the debug environment file:

- Breakpoints.
- Variables in the WatchPoint window.
- The directory that contains the currently loaded object file.

Command File Command

```
FIL(E) ENV(IRONMENT) SAV(E) filename
```

File→Load Emulator Config... (ALT, F, E)

Loads a hardware configuration command file.

This command opens a file selection dialog box from which you select the hardware configuration file.

Emulator configuration command files contain:

- Hardware configuration settings.
- Memory map configuration settings.
- Monitor configuration settings.

Command File Command

```
FIL(E) CON(FIGURATION) LOA(D) filename
```

See Also

"To load an emulator configuration" in the "Saving and Loading Configurations" section of the "Configuring the Emulator" chapter.



File→Save Emulator Config... (ALT, F, V)

Saves the current hardware configuration to a command file.

The following information is saved in the emulator configuration file:

- Hardware configuration settings.
- Memory map configuration settings.
- Monitor configuration settings.

Command File Command

```
FIL(E) CON(FIGURATION) STO(RE) filename
```

See Also

"To save the current emulator configuration" in the "Saving and Loading Configurations" section of the "Configuring the Emulator" chapter.

File→Copy Destination... (ALT, F, P)

Names the listing file to which debugger information may be copied.

The contents of most of the debugger windows can be copied to the destination listing file by choosing the Copy→Window command from the window's control menu.

The Symbol and Trace windows' control menus provide the Copy→All command for copying all of the symbolic or trace information to the destination listing file.

This command opens a file selection dialog box from which you select the name of the output list file. Output list files have the extension ".LST".

Command File Command

COP(Y) TO filename

See Also

"To change the list file destination" in the "Working with Debugger Windows" section of the "Using the Debugger Interface" chapter.

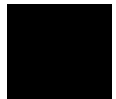

File→Exit (ALT, F, X)

Exits the debugger.

Command File Command

QUI (T)

See Also

"To exit the debugger" in the "Starting and Exiting the Debugger" section of the "Using the Debugger Interface" chapter.

File→Exit HW Locked (ALT, F, H)

File→Exit HW Locked (ALT, F, H)

Exits the debugger and locks the emulator hardware.

When the emulator hardware is locked, your user name and ID are saved in the HP 64700 and other users are prevented from accessing it.

You can restart the debugger and resume your debug session after reloading the symbolic information with the File→Load Object... (ALT, F, L) command.

If you have any breakpoints set when you exit the debugger, you will have to reset the breakpoints when you restart the debugger. All breakpoints are deleted when RTC is exited.

Command File Command

QUI (T) LOC (KED)

See Also

Settings→Communication... (ALT, S, C)

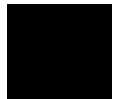

File Selection Dialog Boxes

File selection dialog boxes are used with several of the debugger commands. An example of a file selection dialog box is shown below.

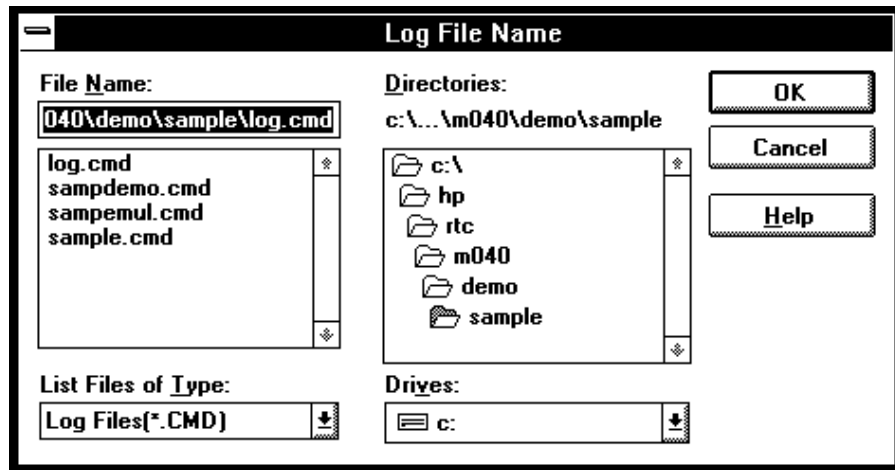

File Name	You can select the name of the file from the list box and edit it in the text box.
List Files of Type	Lets you choose the filter for files shown in the File Name list box.
Directories	You can select the directory from the list box. The selected directory is shown above the list box.
Drives	Lets you select the drive name whose directories are shown in the Directories list box.
OK	Selects the named file and closes the dialog box.
Cancel	Cancels the command and closes the dialog box.
Help	If this button is available, it opens a help window for viewing the associated help information.

Execution→Run (F5), (ALT, E, U)

Runs the program from the current program counter address.

Command File Command

RUN



Execution→Run to Cursor (ALT, E, C)

Runs from the current program counter address up to the Source window line that contains the cursor.

This command sets a breakpoint at the cursor-selected source line and runs from the current program counter address.

If the cursor-selected source line is not reached within the number of milliseconds specified by StepTimerLen in the B3629.INI file, a dialog box appears from which you can cancel the command. When the Stop button is chosen, program execution stops, the breakpoint is deleted, and the processor continues RUNNING IN USER PROGRAM.

Command File Command

COM(E) address

See Also

"To run the program until the specified line" in the "Stepping, Running, and Stopping" section of the "Debugging Programs" chapter.

Execution→Run to Caller (ALT, E, T)

Executes the user program until the current function returns to its caller.

Because this command determines the address at which to stop execution based on stack frame data and object file function information, the following restrictions are imposed:

- A function cannot properly return immediately after its entry point because the stack frame for the function has not yet been generated. Use the Step command to single-step the function before using the Execution→Run to Caller (ALT, E, T) command.
- An assembly language routine cannot properly return, even it follows C function call conventions, because there is no function information in the object file.
- An interrupt function cannot properly return because it uses a stack in a different fashion from standard functions.

Command File Command

RET (URN)

See Also

"To run the program until the current function return" in the "Stepping, Running, and Stopping" section of the "Debugging Programs" chapter.



Execution→Run... (ALT, E, R)

Executes the user program starting from the specified address.

This command sets the processor status to RUNNING IN USER PROGRAM.

Note

If you try to run from an address whose symbol is `START`, `STA`, `RESET`, or `RES` (or any upper- or lower-case variation), the debugger instead runs from the start address or reset address, respectively, because these are the keywords used with the `RUN` command. To fix this problem, use `START+0`, `STA+0`, `RESET+0`, or `RES+0` to force the symbol to be evaluated as an address.

Run Dialog Box

Choosing the `Execution→Run...` (ALT, E, R) command opens the following dialog box:

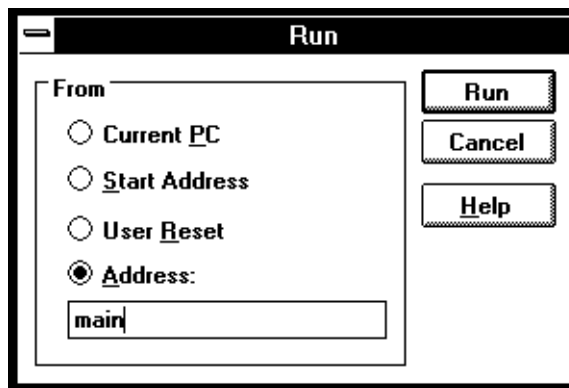

Current PC Specifies that the program run from the current program counter address.

Start Address Specifies that the program run from the *transfer address* defined in the object file.

User Reset	The emulator drives the target reset line and begins executing from the contents of exception vector 0 (this will occur within a few cycles of the reset signal).
Address	Lets you enter the address from which to run.
Run	Initiates program execution from the specified address, then close the dialog box.
Cancel	Cancels the command and closes the dialog box.

Command File Command

RUN

Executes the user program from the current program counter address.

RUN STA(RT)

Executes the user program from the transfer address defined in the object file.

RUN RES(ET)

Drives the target reset line and begins executing from the contents of exception vector 0.

RUN address

Executes the user program from the specified address.

See Also

"To run the program from a specified address" in the "Stepping, Running, and Stopping" section of the "Debugging Programs" chapter.

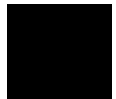

Execution→Single Step (F2), (ALT, E, N)

Executes a single instruction or source line at the current program counter address.

A single source line is executed when in the source only display mode, unless no source is available or an assembly language program is loaded; in these cases, a single assembly language instruction is executed.

When in the mnemonic mixed display mode, a single assembly language instruction is executed.

Command File Command

STE (P)

See Also

"To step a single line or instruction" in the "Stepping, Running, and Stopping" section of the "Debugging Programs" chapter.

Execution→Step Over (ALT, E, O)

Execution→Step... (ALT, E, S)

Execution→Step Over (F3), (ALT, E, O)

Executes a single instruction or source line at the current program counter except when the instruction or source line makes a subroutine or function call, in which case the entire subroutine or function is executed.

This command is the same as the Execution→Single Step (ALT, E, N) command except when the source line contains a function call or the assembly instruction makes a subroutine call (with the BSR or JSR instructions). In these cases, the entire function or subroutine is executed.

Command File Command

OVE (R)

See Also

"To step over a function" in the "Stepping, Running, and Stopping" section of the "Debugging Programs" chapter.

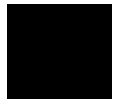

Execution→Step... (ALT, E, S)

Single-steps the specified number of instructions or source lines, starting from the specified address.

Single source lines are executed when in the source only display mode, unless no source is available or an assembly language program is loaded; in these cases, single assembly language instructions are executed.

When in the mnemonic mixed display mode, single assembly language instructions are executed.

Note

If you try to step from an address whose symbol is `START` or `STA` (or any upper- or lower-case variation), the debugger instead steps from the start address because these are the keywords used with the `STEP` and `OVER` commands. To fix this problem, use `START+0` or `STA+0` to force the symbol to be evaluated as an address.

Step Dialog Box

Choosing the Execution→Step... (ALT, E, S) command opens the following dialog box:

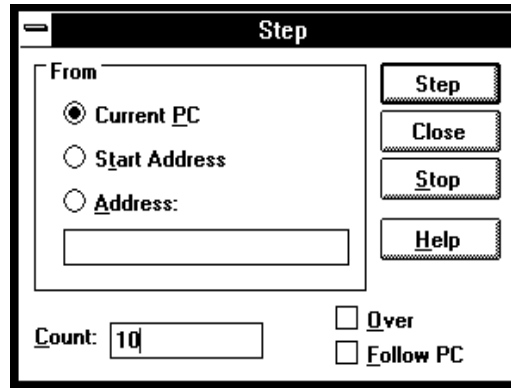

- | | |
|---------------|---|
| Current PC | Specifies that stepping start from the current program counter address. |
| Start Address | Specifies that stepping start from the start address or <i>transfer address</i> . |
| Address | Lets you enter the address from which to single-step. |
| Count | Indicates the step count. The count decrements by one for every step and stops at 0. |
| Over | If the source line to be executed contains a function call or the assembly language instruction to be executed contains a subroutine call, this option specifies that the entire function or subroutine be executed. |
| Follow PC | If you check the Follow PC box, stepping will provide more detail because it will follow the PC for each step, and update the Source window after each step. Leaving this box unchecked speeds the stepping process; the steps will be counted, but the content of the Source window will not be updated until stepping is completed. |

Step	Single-steps the specified number of instructions or source lines, starting from the specified address.
Close	Closes the dialog box.
Stop	Stops single-stepping.

Command File Command

`STE(P) count`

Single-steps the specified number of instructions or source lines, starting from the current program counter address.

`STE(P) count address`

Single-steps the specified number of instructions or source lines, starting from the specified address.

`STE(P) count STA(RT)`

Single-steps the specified number of instructions or source lines, starting from the transfer address defined in the object file.

`OVE(R) count`

Single-steps the specified number of instructions or source lines, starting from the current program counter address. If an instruction or source line makes a subroutine or function call, the entire subroutine or function is executed.

`OVE(R) count address`

Single-steps the specified number of instructions or source lines, starting from the specified address. If an instruction or source line makes a subroutine or function call, the entire subroutine or function is executed.

`OVE(R) count STA(RT)`

Single-steps the specified number of instructions or source lines, starting from the transfer address defined in the object file. If an instruction or source line makes a subroutine or function call, the entire subroutine or function is executed.

See Also

"To step multiple lines or instructions" in the "Stepping, Running, and Stopping" section of the "Debugging Programs" chapter.

Execution→Single Step (ALT, E, N)

Execution→Step Over (ALT, E, O)



Execution→Break (F4), (ALT, E, B)

Stop user program execution and break into the monitor.

This command can also be used to break into the monitor when the processor is in the EMULATION RESET status.

Once the command has been completed, the processor transfers to the RUNNING IN MONITOR status.

Command File Command

BRE (AK)

See Also

"To stop program execution" in the "Stepping, Running, and Stopping" section of the "Debugging Programs" chapter.

Execution→Reset (ALT, E, E)

Resets the emulation microprocessor.

If a foreground monitor is being used, it will automatically be loaded when this command is chosen.

While the processor is in the EMULATION RESET state, no display or modification is allowed for the contents of target system memory or registers. Therefore, before you can display or modify target system memory or processor registers, you must use the Execution→Break (ALT, E, B) command to break into the monitor.

Some emulators, such as the 68040, will automatically break into the monitor (if monitor intrusion is allowed) when a request is made to access a register. Because the debugger sends requests for register information, the emulator status may correctly report RUNNING IN MONITOR before you see the RESET status. If you choose the RealTime→Monitor Intrusion→Disallowed (ALT, R, T, D) command, the emulator will not automatically break into the monitor, and you will see the emulator status say RESET.

Command File Command

RES (ET)

See Also

"To reset the processor" in the "Stepping, Running, and Stopping" section of the "Debugging Programs" chapter.



Breakpoint→Set at Cursor (ALT, B, S)

Sets a breakpoint at the cursor-selected address in the Source window.

The breakpoint marker "BP" appears on lines at which breakpoints are set.

When a breakpoint is hit, program execution stops immediately before executing the instruction or source code line at which the breakpoint is set.

A set breakpoint remains active until it is deleted.

Breakpoints do not function properly when set at addresses where no opcode is found.

The BKPT instruction is used as the breakpoint instruction.

The Breakpoint→Set at Cursor (ALT, B, S) command replaces the original instruction at the specified address with a BKPT #7 instruction if in RAM; if in ROM, the emulator sets up one of the eight hardware resources which "jam" the BKPT instruction when the original opcode is fetched. When the emulator detects the BKPT instruction, it breaks to the monitor. When the emulator detects a BKPT instruction that was not inserted as a breakpoint, the emulator breaks and transfers to the "UNDEFINED BREAKPOINT at address" status.

The Breakpoint→Set at Cursor (ALT, B, S) command may cause BP markers to appear at two or more addresses. This happens when a single instruction is associated with two or more source lines. You can select the mnemonic display mode to verify that the breakpoint is set at a single address.

Command File Command

```
BP SET address
```

See Also

"To set a breakpoint" in the "Using Breakpoints and Break Macros" section of the "Debugging Programs" chapter.

Breakpoint→Delete at Cursor (ALT, B, D)

Deletes the breakpoint set at the cursor-selected address in the Source window.

This command is only applicable to lines that contain "BP" markers (which indicate set breakpoints). Once the breakpoint is deleted, the original instruction is replaced.

Command File Command

BP DEL(ETE) address

See Also

"To delete a single breakpoint" in the "Using Breakpoints and Break Macros" section of the "Debugging Programs" chapter.

Breakpoint→Edit... (ALT, B, E)

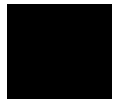

Breakpoint→Set Macro... (ALT, B, M)

Sets a *break macro* immediately before the cursor-selected address in the Source window.

Break macro lines are marked with the "BP" breakpoint marker, and the corresponding addresses or line numbers are displayed in decimal format.

When a break macro is hit, program execution stops immediately before executing the instruction or source code line at which the break macro is set. Then, the commands associated with the break macro are executed. When a "RUN" command is set as the last command in the break macro, the system executes the break macro and resumes program execution.

The break macro remains active until it is deleted with the Breakpoint→Delete Macro (ALT, B, L) command or the Breakpoint→Edit... (ALT, B, E) command.

Because break macros use breakpoints, they cannot be set at addresses in target system ROM.

Additional commands can be added to existing break macros as follows:

- When a source code line or disassembled instruction is cursor-selected, the additional command is inserted at the top of the list of commands.
- When a macro command line is cursor-selected, the additional command is inserted immediately following the cursor-selected command.

Breakpoint Edit Dialog Box

Choosing the Breakpoint→Set Macro... (ALT, B, M) command opens the following dialog box:

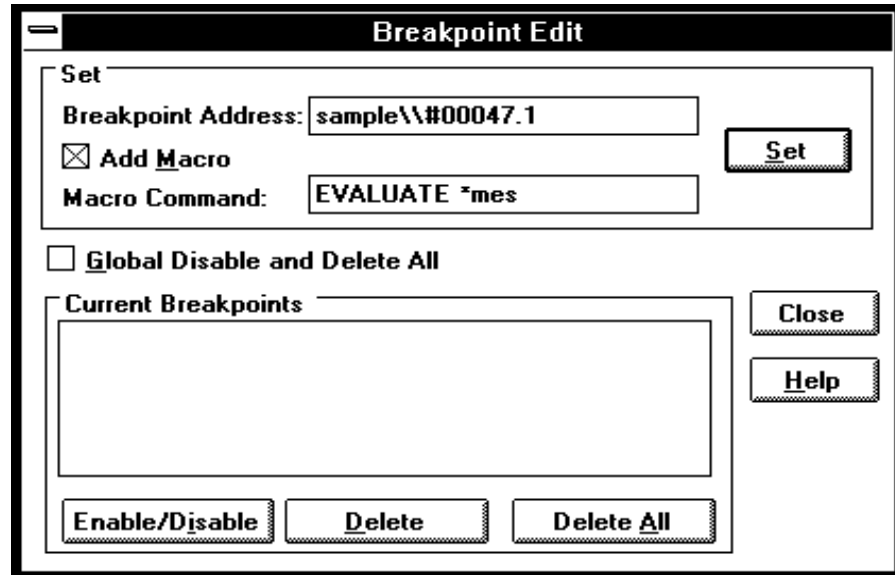

Breakpoint Address Displays the specified line number or address followed by a decimal point and the break macro line number.

Add Macro Activates the Macro Command text box.

Macro Command Specifies the command to be added to the break macro.

Set Inserts the specified macro command at the location immediately preceding the specified source line or address, or inserts the macro command at the location immediately following the specified break macro line.

Two or more commands can be associated with a break macro by entering the first command and choosing Set, then entering the second command and choosing Set, and so on. Commands execute in the order of their entry.

Chapter 8: Menu Bar Commands
Breakpoint→Set Macro... (ALT, B, M)

Global Disable and Delete All	Disables and deletes all current breakpoints and break macros.
Current Breakpoints	Displays the addresses and line numbers of the current breakpoints and break macros. Allows you to select breakpoints or break macros to be deleted.
Enable/Disable	Enable/Disable the selected breakpoint and break macro.
Delete	Deletes the selected breakpoints or break macros from the Current Breakpoints list box.
Delete All	Deletes all breakpoints and break macros from the Current Breakpoints list box.
Close	Closes the dialog box.

Command File Command

BM SET address command

See Also

"To set a break macro" in the "Using Breakpoints and Break Macros" section of the "Debugging Programs" chapter.

Breakpoint→Delete Macro (ALT, B, L)

Removes the break macro set at the cursor-indicated address in the Source window.

This command is only applicable to lines that contain "BP" markers (which indicate set breakpoints) or break macro lines.

When a source code line is cursor-selected, this command removes the breakpoint and all the macros commands set at the line.

When a break macro line is cursor-selected, this command removes the single macro command at the line.

Command File Command

BM DEL(ETE) address

See Also

"To delete a single break macro" in the "Using Breakpoints and Break Macros" section of the "Debugging Programs" chapter.

Breakpoint→Edit... (ALT, B, E)

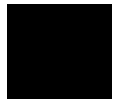

Breakpoint→Edit... (ALT, B, E)

Lets you set, list, or delete breakpoints and break macros. Breakpoints are always globally enabled on initial entry into the RTC interface.

Breakpoint Edit Dialog Box

Choosing the Breakpoint→Edit... (ALT, B, E) command opens the following dialog box:

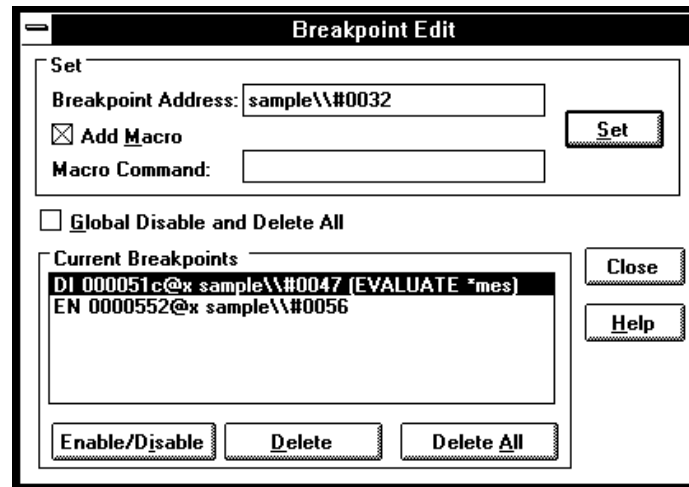

Breakpoint Address	Lets you specify the address at which to set a breakpoint or a break macro.
Add Macro	When selected, this specifies that a break macro should be included with the breakpoint.
Macro Command	Lets you specify the macro to be included with the breakpoint.
Set	Sets a breakpoint with or without a break macro at the specified address.

Global Disable and Delete All	When selected, all existing breakpoints are deleted (not simply disabled), and no new breakpoints can be added.
Current Breakpoints	Displays the addresses and line numbers of the current breakpoints and break macros. Allows you to select the breakpoints or break macros to be enabled/disabled or deleted.
Enable/Disable	Disables or enables the selected breakpoints or breakpoint macros in the Current Breakpoints list box. Enabled breakpoints begin with EN in the Current Breakpoints list and show "BP" at the start of the line in the Source window list. Disabled breakpoints begin with DI in the Current Breakpoints list and show "bp" at the start of the line in the Source window list.
Delete	Deletes the selected breakpoints or break macros from the Current Breakpoints list box.
Delete All	Deletes all the breakpoints and break macros from the Current Breakpoints list box.
Close	Closes the dialog box.

Command File Command

MOD (E) BKP (TBREAK) ON | OFF

BP DEL (ETE) ALL

BP DIS (ABLE) address

BP ENA (BLE) address

See Also

"To disable a breakpoint" and
"To list the breakpoints and break macros" in the "Using Breakpoints and Break Macros" section of the "Debugging Programs" chapter.

Variable→Edit... (ALT, V, E)

Displays or modifies the contents of the specified variable or copies it to the WatchPoint window.

A dynamic variable can be registered as a watchpoint when the current program counter is in the function in which the variable is declared. If the program counter is not in this function, the variable name is invalid and an error results.

Variable Edit Dialog Box

Choosing the Variable→Edit... (ALT, V, E) command opens the following dialog box:

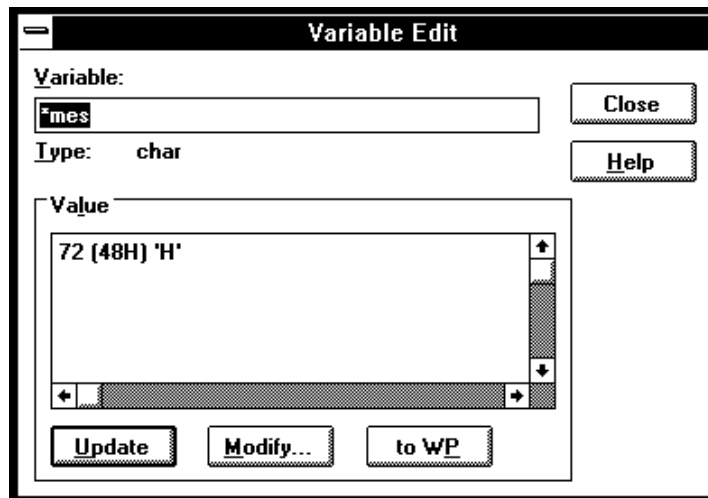

Variable	Specifies the name of the variable to be displayed or modified. The contents of the clipboard, usually a variable selected from another window, automatically appears in this text box.
Type	Displays the type of the specified variable.
Value	Displays the contents of the specified variable.

Update	Reads and displays the contents of the variable specified in the Variable text box.
Modify	Modifies the contents of the specified variable. Choosing this button opens the Variable Modify Dialog Box, which lets you edit the contents of the variable.
to WP	Adds the specified variable to the WatchPoint window.
Close	Closes the dialog box.

Command File Command

VARI(ABLE) variable TO data

Replaces the contents of the specified variable with the specified value.

See Also

"To display a variable" and

"To monitor a variable in the WatchPoint window" in the "Displaying and Editing Variables" section of the "Debugging Programs" chapter.

"Symbols" in the "Expressions in Commands" chapter.

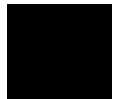

Variable Modify Dialog Box

Choosing the Modify button in the Variable Edit dialog box opens the following dialog box, where you enter the new value and choose the OK button to confirm the new value.

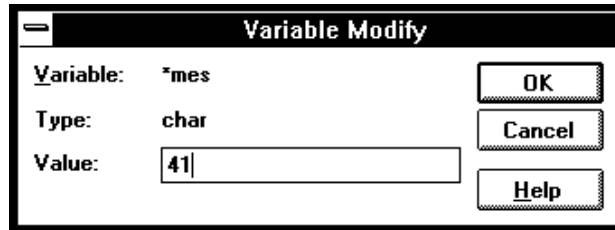

Variable	Shows the variable to be edited.
Type	Indicates the type of the variable displayed in the Variable field.
Value	Lets you enter the new value of the variable.
OK	Replaces the contents of the specified variable with the specified value and closes the dialog box.
Cancel	Cancels the command and closes the dialog box.

See Also

"To edit a variable" in the "Displaying and Editing Variables" section of the "Debugging Programs" chapter.

Trace→Function Flow (ALT, T, F)

Traces function flow by storing function entry points in the trace buffer.

Assembly language functions can also be traced, provided they comply with C function call conventions.

Note

When using the MCC68K compiler, you must specify the -Kf option when compiling programs in order for the debugger to be able to trace function flow. (The -Kf option creates frame pointers for functions.)

Function Flow Trace Limitations

Due to the complexity of the 68040 processor, the function flow trace measurement is not guaranteed to be 100% accurate. Processor architectures that support prefetch, multiple instructions per trace state, and dynamic bus sizing can introduce errors in this measurement. However, useful information can still be obtained from the measurement as long as you are aware of the potential inaccuracies.

When you execute a Trace→Function Flow (ALT, T, F) command, the trace analyzer is automatically set up to capture bus cycles that correspond to function entry. Specifically, the measurement is implemented by looking for LINK instructions with either word or long displacements. The sequence will vary depending on the memory size and the alignment of the instruction.

To see the exact Pattern and Sequence specifications that were used to make the function flow trace measurement, you can enter a Trace→Function Flow (ALT, T, F) command followed by a Trace→Edit (ALT, T, E) command. The Sequence Trace dialog shows the detailed trace specification used to make the measurement.



Sequence					Page
	Primary Branch:	to	Secondary Branch:	to	Store:
1	abc cd	2	ef	3	no state
2	glh	3	any state	1	no state
3	glh	4	any state	1	no state
4	g x2	1	no state	4	any state

PATTERN

```

a = A: D:4e56xxxxh S:prog read word
b = A: D:0xxxx4e56h S:long prog read
c = A: D:480xxxxh S:prog read word
d = A: D:0xxxx480eh S:long prog read
e = A: D:4e56xxxxh S:long prog read
f = A: D:480xxxxh S:long prog read
g = A: D: S:prog read
h = A: D: S:write
  
```

For example in 32-bit mode, if the LINK instruction appears in the high word, the Secondary Branch is taken, and the analyzer looks for a memory write (or a program read) followed by two program reads (opcode fetches). Once the data is captured, it is post-processed to disassemble only the LINK instructions.

If the LINK instruction appears in the low word, the Primary Branch with pattern b or d would be taken. In this case, the analyzer looks for another opcode fetch (program read) followed by a memory write, followed by two program reads (opcode fetches).

In 16-bit mode, the Primary Branch with pattern a or c will be taken. In this case, the analyzer looks for another opcode fetch (program read) followed by a memory write (actually two writes will occur), followed by two program reads (opcode fetches).

Problem Areas. If the processor is prefetching instructions, it is possible that LINK instructions, meeting the criteria stated above, may be prefetched but never executed, thereby creating a misleading measurement. In particular, LINK instructions immediately following RETURN instructions are likely to cause confusion.

Additional spurious analysis states may be included in the trace display. If you think some of these states are inaccurate, you should examine them more closely and ignore them if appropriate.

This problem is most aggravated by functions that contain a loop which prefetches the return and next function link on every iteration. To minimize this, insert some code between the end of the loop and the return, for example, "x=x;" which acts like a NOP.

The algorithm used to implement the Trace Function Flow command works well as long as the LINK instructions are at least six instructions apart. If the code being analyzed contains tightly coded functions with no parameters, the second function call will not be detected. The trace buffer will contain the instruction, but it will not be disassembled or matched to a high-level source line. This problem can be minimized by inserting code around the function calls to ensure that the calls are at least six instructions apart. Compiler options such as the -Kt option in the Microtec compiler add instructions to functions; therefore, using this option would help to minimize the occurrence of this problem.

Minimizing Problems. You can make the function flow trace measurement the most accurate by making sure that your functions start on even word boundaries. Some software development tools provide an option to do this. The HP AxLS Compiler provides this capability; it is accomplished by inserting NOPs where necessary to align the code. If your compiler doesn't provide this feature, you can insert additional NOPs between functions yourself.

If you are using the Microtec Research software development tools, using the -Kt and -Kg compiler options also makes the function flow trace measurement more reliable. The -Kf option will preserve LINK and UNLK instructions in all functions. The -Kt option will generate writes to tags at function entry and exits. This additional instruction usually prevents the undesired prefetch from within a function loop which was mentioned above.

Command File Command

```
TRA(CE) FUN(CTION) FLO(W)
```

See Also

"To trace function flow" in the "Tracing Program Execution" section of the "Debugging Programs" chapter.



Trace→Function Caller... (ALT, T, C)

Traces the caller of the specified function.

The function name can be selected from another window (in other words, copied to the clipboard) before choosing the command; it will automatically appear in the dialog box that is opened.

The analyzer stores only the execution of the function entry point and prestores execution states that occur before the function entry point. These prestored states correspond to the function call statements and identify the caller of the function.

When assembly language programs are used, you can specify the assembler symbol for a subroutine instead of a C function name, and the prestored states will show the instructions that called the subroutine.

Note

Because of prefetching by the 68040 processor, the analyzer may fail in tracing the caller.

Function Caller Trace Dialog Box

Choosing the Trace→Function Caller... (ALT, T, C) command opens the following dialog box:

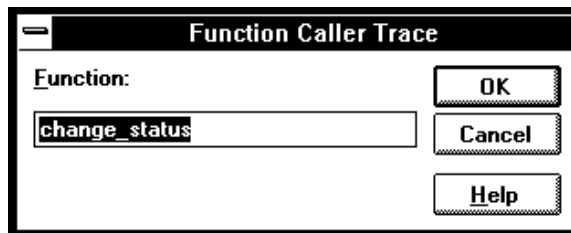

- | | |
|----------|--|
| Function | Lets you enter the function whose callers you want to trace. |
| OK | Executes the command and closes the dialog box. |
| Cancel | Cancels the command and closes the dialog box. |

Command File Command

TRA(CE) FUNC(TION) CAL(L) address

See Also

"To trace callers of a specified function" in the "Tracing Program Execution" section of the "Debugging Programs" chapter.



Trace→Function Statement... (ALT, T, S)

Traces execution within the specified function.

The function name can be selected from another window (in other words, copied to the clipboard) before choosing the command; it will automatically appear in the dialog box that is opened.

The analyzer stores execution states in the function's address range.

Because the analyzer is set up based on function information from the object file, this command cannot be used to trace non-C functions.

Note

The analyzer traces unexecuted instructions due to prefetching by 68040 processor.

Function Statement Trace Dialog Box

Choosing the Trace→Function Statement... (ALT, T, S) command opens the following dialog box:

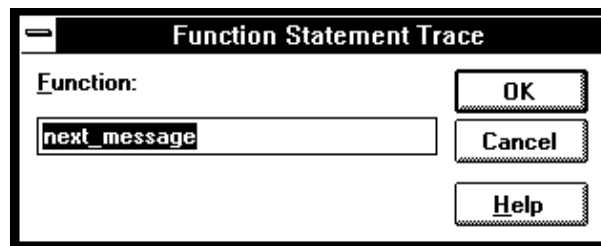

Function	Lets you enter the function whose execution you want to trace.
OK	Traces within the specified function and closes the dialog box.
Cancel	Cancels the command and closes the dialog box.

Command File Command

TRA(CE) FUNC(TION) STA(TEMENT) address

See Also

"To trace execution within a specified function" in the "Tracing Program Execution" section of the "Debugging Programs" chapter.



Trace→Variable Access... (ALT, T, V)

Traces accesses to the specified variable.

The variable name can be selected from another window (in other words, copied to the clipboard) before choosing the command; it will automatically appear in the dialog box that is opened.

You can specify any of the external or static variables, or the variables having a fixed address throughout the course of program execution.

The analyzer stores only accesses within the range of the variable and prestores execution states that occur before the access. These prestored states correspond to the statements that access the variable.

Variable Access Dialog Box

Choosing the Trace→Variable Access... (ALT, T, V) command opens the following dialog box:

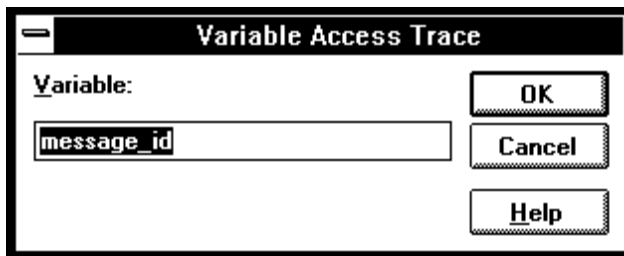

- | | |
|----------|--|
| Variable | Lets you enter the variable name. |
| OK | Traces accesses to the specified variable and closes the dialog box. |
| Cancel | Cancels the command and closes the dialog box. |

Command File Command

TRA(CE) VAR(IABLE) ACC(ESS) address

See Also

"To trace accesses to a specified variable" in the "Tracing Program Execution" section of the "Debugging Programs" chapter.



Trace→Variable Break... (ALT, T, B)

Traces before, and breaks program execution when, a value is written to a variable.

The variable name can be selected from another window (in other words, copied to the clipboard) before choosing the command; it will automatically appear in the dialog box that is opened.

You can specify any of the external or static variables, or the variables having a fixed address throughout the course of program execution.

Variable Break Dialog Box

Choosing the Trace→Variable Break... (ALT, T, B) command opens the following dialog box:

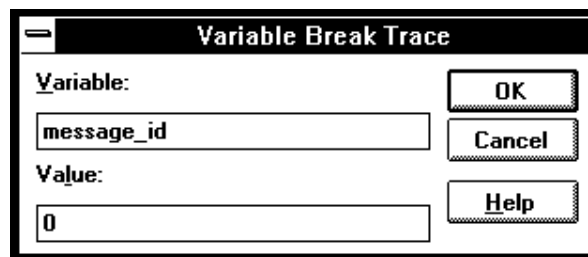

Variable	Lets you enter the variable name.
Value	Lets you enter the value that, when written to the variable, triggers the analyzer.
OK	Starts the trace and closes the dialog box.
Cancel	Cancels the command and closes the dialog box.

Command File Command

```
TRA(CE) VAR(IABLE) BRE(AK) address data
```

See Also

"To trace before a particular variable value and break" in the "Tracing Program Execution" section of the "Debugging Programs" chapter.



Trace→Edit... (ALT, T, E)

Edits the trace specification of the last trace command.

This command is useful for making modifications to the last entered trace command, even if the analyzer was set up automatically as with the Trace→Function or Trace→Variable commands.

Trace specifications are edited with Sequence Trace Setting dialog box.

Command File Command

TRA(CE) SAV(E) filename

Stores the current trace specification to a file.

TRA(CE) LOA(D) filename

Loads the specified trace setting file.

TRA(CE) CUS(TOMIZE)

Traces program execution using the loaded trace setting file.

See Also

"To edit a trace specification" in the "Setting Up Custom Trace Specifications" section of the "Debugging Programs" chapter.

Trace→Sequence... (ALT, T, Q)

Trace→Trigger Store... (ALT, T, T)

Traces program execution as specified in the Trigger Store Trace dialog box.

You can enter address, data, and status values that qualify the state(s) that, when captured by the analyzer, will be stored in the trace buffer or will trigger the analyzer.

Data values are 32-bit values (because the data bus is 32 bits wide). To identify byte or word values on the data bus, use "don't cares" as shown below:

1234xxxx

0xxxx5678

0xxxx56xx

0xxxxxx78

Status values identify the types of microprocessor bus cycles. You may select status values from a predefined list.

Note

The analyzer traces unexecuted instructions due to prefetching by the 68040 processor.



Trigger Store Trace Dialog Box

Choosing the Trace→Trigger Store... (ALT, T, T) command opens the following dialog box:

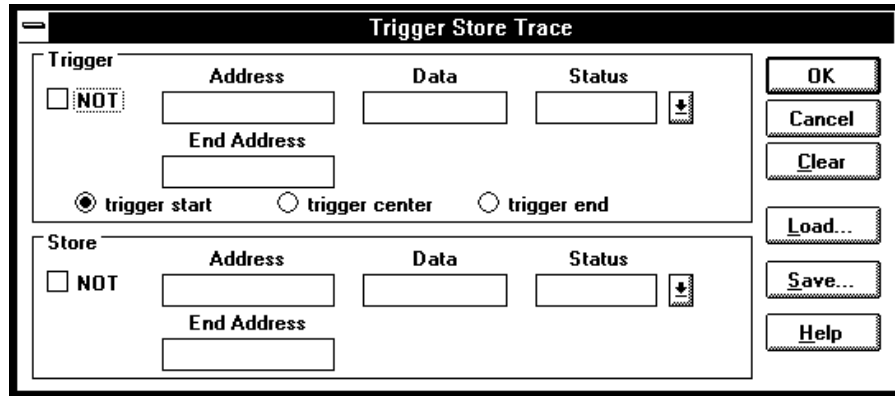

Trigger	This box groups the items that make up the trigger condition.
NOT	Specifies any state that does not match the Address, Data, and Status values.
Address	Specifies the address portion of the state qualifier.
End Address	Specifies the end address of an address range.
Data	Specifies the data portion of the state qualifier.
Status	Specifies the status portion of the state qualifier.
trigger start	Specifies that states captured after the trigger condition be stored in the trace buffer.
trigger center	Specifies that states captured before and after the trigger condition be stored in the trace buffer.
trigger end	Specifies that states captured before the trigger condition be stored in the trace buffer.

Store	This box groups the items that make up the store condition.
OK	Starts the specified trace and closes the dialog box.
Cancel	Cancels the trace setting and closes the dialog box.
Clear	Restores the dialog box to its default state.
Load...	Opens a file selection dialog box from which you select the name of a trace specification file previously saved from the Trigger Store Trace dialog box. Trace specification files have the extension ".TRC".
Save...	Opens a file selection dialog box from which you select the name of the trace specification file.

Command File Command

TRA(CE) LOA(D) filename
Loads the specified trace setting file.

TRA(CE) CUS(TOMIZE)
Traces program execution using the loaded trace setting file.

See Also

"To set up a 'Trigger Store' trace specification" in the "Setting Up Custom Trace Specifications" section of the "Debugging Programs" chapter.

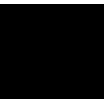

Trace→Find Then Trigger... (ALT, T, D)

Traces program execution as specified in the Find Then Trigger Trace dialog box.

This command lets you set up a two-level sequential trace specification that works like this:

- 1** Once the trace starts, the analyzer stores (in the trace buffer) the states that satisfy the Enable Store condition while searching for a state that satisfies the Enable condition.
- 2** After the Enable condition has been found, the analyzer stores the states that satisfy the Trigger Store condition while searching for a state that satisfies the Trigger condition.
- 3** After the Trigger condition has been found, the analyzer stores the states that satisfy the Store condition.

If any state during the sequence satisfies the Restart condition, the sequence starts over.

You can enter address, data, and status values that qualify state(s) by setting up pattern or range resources. These patterns and range resources are used when defining the various conditions.

A trace is complete when the trace buffer is full.

Note

The analyzer traces unexecuted instructions due to prefetching by the 68040 processor.

Find Then Trigger Trace Dialog Box

Choosing the Trace→Find Then Trigger... (ALT, T, D) command opens the following dialog box:

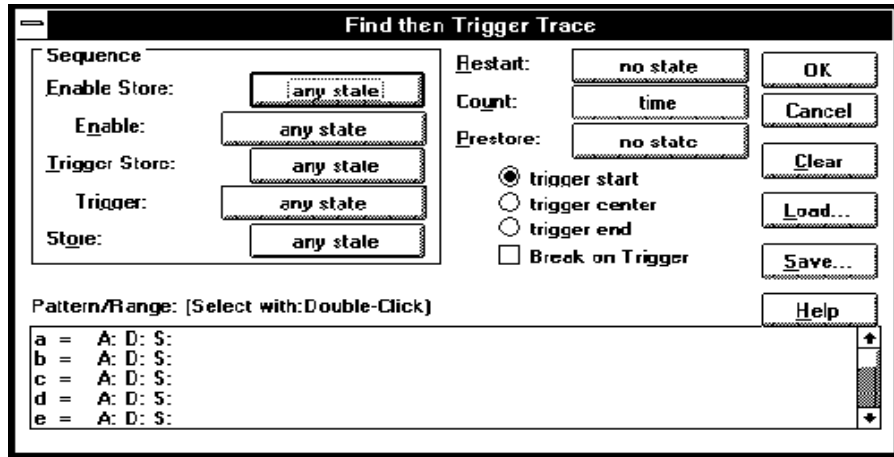

The Sequence group box specifies a two-term sequential trigger condition. It also lets you specify store conditions during the sequence.

Enable Store	Qualifies the states that get stored (in the trace buffer) while searching for a state that satisfies the enable condition.
Enable	Specifies the condition that causes a transfer to the next sequence level.
Trigger Store	Qualifies the states that get stored while the analyzer searches for the trigger condition.
Trigger	Specifies the trigger condition.
Store	Qualifies the states that get stored after the trigger condition is found.
Restart	Specifies the condition that restarts the sequence.

Count	Specifies whether time or the occurrences of a particular state are counted; you can also turn counts OFF. See the Condition Dialog Boxes.
Prestore	Qualifies the states that may be stored before each normally stored state. Up to two states may be prestored for each normally stored state. Prestored states can be used to show from where a function is called or a variable is accessed.
trigger start	The state that satisfies trigger condition is positioned at the start of the trace, and states that satisfy the Store condition will be stored after the trigger. In this case, the states that satisfy the Enable Store and Trigger Store conditions will not appear in the trace.
trigger center	The state that satisfies the trigger condition is positioned in the center of the trace, and states that satisfy the store conditions will be stored before and after the trigger.
trigger end	The state that satisfies the trigger condition is positioned at the end of the trace, and states that satisfy the Enable Store and Trigger Store conditions will be stored before the trigger. In this case, states that satisfy the Store condition will not appear in the trace.
Break on Trigger	When selected, this option specifies that execution break into the monitor when the analyzer is triggered.
Pattern/Range	Specifies the trace patterns for the state conditions. Double-clicking the desired pattern or range in the Pattern/Range list box opens the Trace Pattern Dialog Box or the Trace Range Dialog Box, where you specify the desired trace pattern or range. Clicking the Sequence, Restart, Count, or Prestore buttons causes the Condition Dialog Boxes to be opened. This dialog box lets you select or combine patterns or ranges to specify the condition.

OK	Starts the specified trace and closes the dialog box.
Cancel	Cancels trace setting and closes the dialog box.
Clear	Restores the dialog box to its default state.
Load...	Opens a file selection dialog box from which you select the name of a trace specification file previously saved from the Trigger Store Trace or Find Then Trigger Trace dialog boxes. Trace specification files have the extension ".TRC".
Save...	Opens a file selection dialog box in which you specify a name to identify a file containing the present trace specification.

Command File Command

TRA(CE) LOA(D) filename
Loads the specified trace setting file.

TRA(CE) CUS(TOMIZE)
Traces program execution using the loaded trace setting file.

See Also

"To set up a 'Find Then Trigger' trace specification" in the "Setting Up Custom Trace Specifications" section of the "Debugging Programs" chapter.



Trace→Sequence... (ALT, T, Q)

Traces program execution as specified in the Sequence Trace dialog box.

This command lets you set up a multilevel sequential trace specification that works like this:

- 1** Once the trace starts, the analyzer stays on sequence level 1 until the primary or secondary branch condition is found. (If a state satisfies both primary and secondary branch conditions, the primary branch is taken.) Once the primary or secondary branch condition is found, the analyzer transfers to the sequence level specified by the "to" button.
- 2** The analyzer stays at the next sequence level until its primary or secondary branch condition is met; then, the analyzer transfers to the sequence level specified by the "to" button.
- 3** When the analyzer reaches the sequence level specified in Trigger On, the analyzer is triggered.
- 4** During the above described operation, the analyzer stores the states specified in the Store text box.

The trace is complete when the trace buffer is full.

Note

The analyzer traces unexecuted instructions due to prefetching by the 68040 processor.

Sequence Trace Dialog Box

Choosing the Trace→Sequence... (ALT, T, Q) command opens the following dialog box:

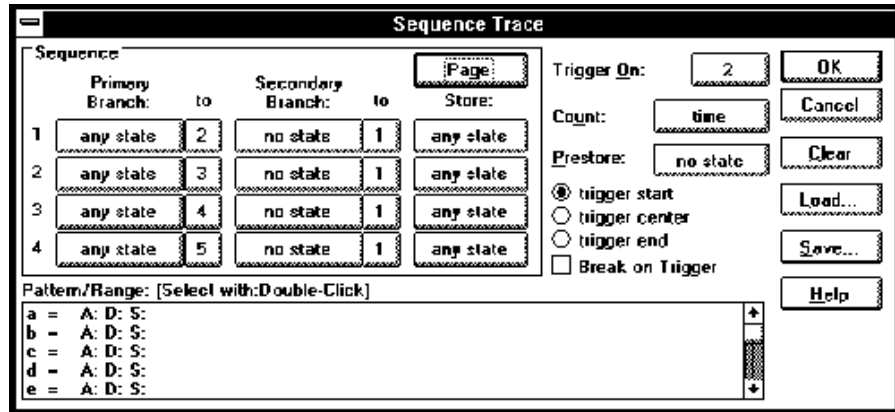

The Sequence group box specifies primary and secondary branch conditions for transferring from one sequence level to another. It also specifies store conditions for each of the eight sequence levels.

Primary Branch Specifies the condition for transferring to the sequence level specified in the "to" text box.

Secondary Branch Specifies the condition for transferring to the sequence level specified in the "to" text box. Secondary branches are used to do things like restart the sequence if a particular state is found.

Store Specifies the states to be stored in the trace buffer at each sequence level.

Page Toggles the display between sequence levels 1 through 4 and levels 5 through 8.

Trigger On Specifies the sequence level whose entry triggers the analyzer. See the Sequence Number Dialog Box.

Count	Specifies whether time or the occurrences of a particular state are counted; you can also turn counts OFF. See the Condition Dialog Boxes.
Prestore	Qualifies the states that may be stored before each normally stored state. Up to two states may be prestored for each normally stored state. Prestored states can be used to show from where a function is called or a variable is accessed.
trigger start	The state that satisfies trigger condition is positioned at the start of the trace, and states that satisfy the store conditions will be stored after the trigger.
trigger center	The state that satisfies the trigger condition is positioned in the center of the trace, and states that satisfy the store conditions will be stored before and after the trigger.
trigger end	The state that satisfies the trigger condition is positioned at the end of the trace, and states that satisfy the store conditions will be stored before the trigger.
Break on Trigger	When selected, this option specifies that execution break into the monitor when the analyzer is triggered.
Pattern/Range	Specifies the trace patterns for the state conditions. Double-clicking the desired pattern or range in the Pattern/Range list box opens the Trace Pattern Dialog Box or the Trace Range Dialog Box, where you specify the desired trace pattern or range. Clicking the Primary Branch, Secondary Branch, Store, Count, or Prestore buttons causes the Condition Dialog Boxes to be opened. This dialog box lets you select or combine patterns or ranges to specify the condition.
OK	Starts the specified trace and closes the dialog box.
Cancel	Cancels trace setting and closes the dialog box.

Clear	Restores the dialog box to its default state.
Load...	Opens a file selection dialog box from which you select the name of a trace specification file previously saved from any of the trace setting dialog boxes. Trace specification files have the extension ".TRC".
Save...	Opens a file selection dialog box from which you select the name of the trace specification file.

Command File Command

TRA(CE) LOA(D) filename
Loads the specified trace setting file.

TRA(CE) CUS(TOMIZE)
Traces program execution using the loaded trace setting file.

See Also

"To set up a 'Sequence' trace specification" in the "Setting Up Custom Trace Specifications" section of the "Debugging Programs" chapter.



Trace→Until Halt (ALT, T, U)

Traces program execution until the Trace→Halt (ALT, T, H) command is chosen.

This command is useful in tracing execution that leads to a processor halt or a break to the background monitor. Before executing the program, choose the Trace→Until Halt (ALT, T, U) command. Then, run the program. After the processor has halted or broken into the background monitor, choose the Trace→Halt (ALT, T, H) command to stop the trace. The execution that led up to the break or halt will be displayed.

Command File Command

TRA(CE) ALW(AYS)

See Also

"To trace until the command is halted" in the "Tracing Program Execution" section of the "Debugging Programs" chapter.

Trace→Halt (ALT, T, H)

Stops a running trace.

This command stops a currently running trace whether the trace was started with the Trace→Until Halt (ALT, T, U) command or another trace command.

As soon as the analyzer stops the trace, stored states are displayed in the Trace window.

Command File Command

TRA(CE) STO(P)

See Also

"To stop a running trace" in the "Tracing Program Execution" section of the "Debugging Programs" chapter.



Trace→Again (F7), (ALT, T, A)

Traces program execution using the last trace specification stored in the HP 64700.

If you haven't entered a trace command since you started the debugger, the last trace specification stored in the HP 64700 may be a trace specification set up by a different user; in this case, you cannot view or edit the trace specification.

Command File Command

TRA (CE) AGA (IN)

See Also

"To repeat the last trace" in the "Tracing Program Execution" section of the "Debugging Programs" chapter.

Condition Dialog Boxes

Choosing the buttons associated with enable, trigger, primary branch, secondary branch, store, or prestore conditions opens the following dialog box:

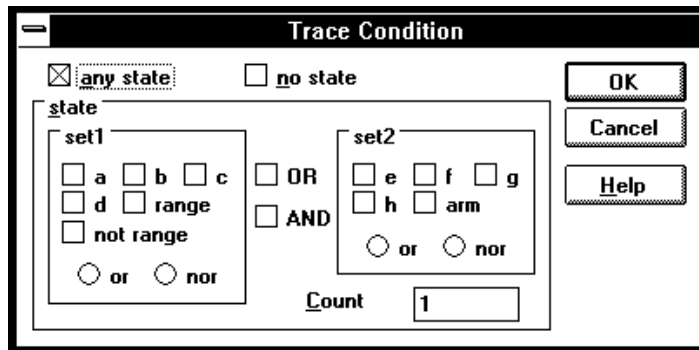

Choosing the button associated with the count condition opens the following dialog box:

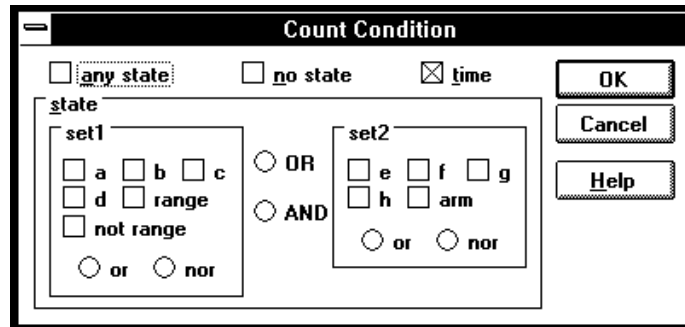

- no state No state meets the specified condition.
- any state Any state meets the specified condition.
- time The analyzer counts time for each state stored in the trace.

Chapter 8: Menu Bar Commands
Condition Dialog Boxes

state	This group box lets you qualify the state that will meet the specified condition. You can qualify the state as one of the patterns "a" through "h," the "range," or the "arm," or you can qualify the state as a combination of the patterns, range, or arm by using the interset or intraset operators.
a b c d e f g h	<p>The patterns that qualify states by identifying the address, data, and/or status values.</p> <p>The values for a pattern are specified by selecting one of the patterns in the Pattern/Range list box and entering values in the Trace Pattern Dialog Box.</p>
range	<p>Identifies a range of address or data values.</p> <p>The values for a range are specified by selecting the range in the Pattern/Range list box and entering values in the Trace Range Dialog Box.</p>
not range	Identifies all values not in the specified range.
arm	Identifies the condition that arms (in other words, activates) the analyzer. The analyzer can be armed by an input signal on the BNC port.
or/nor	<p>You can combine patterns within the set1 or set2 group boxes with these logical operators.</p> <p>You can create the AND and NAND operators by selecting NOT when defining patterns and applying DeMorgan's law (the / character is used to represent a logical NOT):</p> $\begin{array}{l} \text{AND} \quad A \text{ and } B = \ / (/A \text{ or } /B) \quad \text{NOR} \\ \text{NAND} \ / (A \text{ and } B) = \ /A \text{ or } /B \quad \text{OR} \end{array}$
OR/AND	You can combine patterns from the set1 and set2 group boxes with these logical operators.

Count	Appearing in Trace Condition dialog boxes, this value specifies the number of occurrences of the state that will satisfy the condition.
OK	Applies the state qualifier to the specified condition and closes the dialog box.
Cancel	Closes the dialog box.

See Also

"To set up a 'Find Then Trigger' trace specification" and
"To set up a 'Sequence' trace specification" in the "Setting Up Custom Trace Specifications" section of the "Debugging Programs" chapter.

Trace→Find Then Trigger... (ALT, T, D)

Trace→Sequence... (ALT, T, Q)

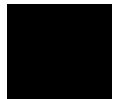

Trace Pattern Dialog Box

Selecting one of the patterns in the Pattern/Range list box opens the following dialog box:

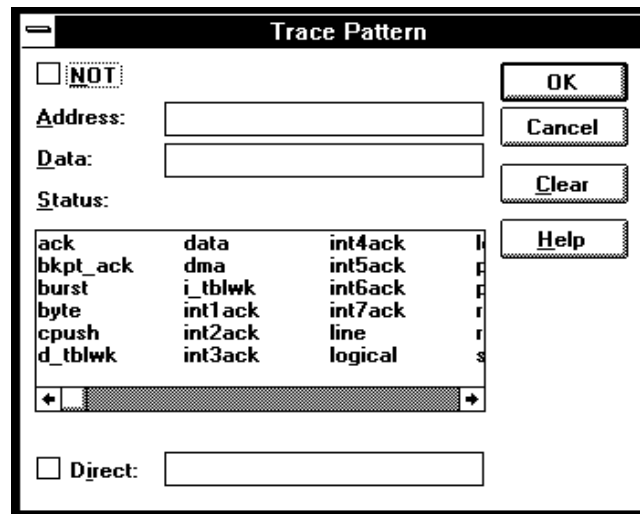

- | | |
|---------|---|
| NOT | Lets you specify all values other than the address, data, and/or status values specified. |
| Address | Lets you enter the address value for the pattern. |
| Data | Lets you enter the data value for the pattern. |
| Status | Lets you select the <i>status value</i> for the pattern. |
| Direct | Lets you enter a status value other than one of the predefined status values. |
| Clear | Clears the values specified for the pattern. |
| OK | Applies the values specified for the pattern, and closes the dialog box. |

Cancel Closes the dialog box.

See Also

"To set up a 'Find Then Trigger' trace specification" and
"To set up a 'Sequence' trace specification" in the "Setting Up Custom Trace
Specifications" section of the "Debugging Programs" chapter.

Trace→Find Then Trigger... (ALT, T, D)

Trace→Sequence... (ALT, T, Q)



Trace Range Dialog Box

Selecting the range at the bottom of the Pattern/Range list box opens the following dialog box:

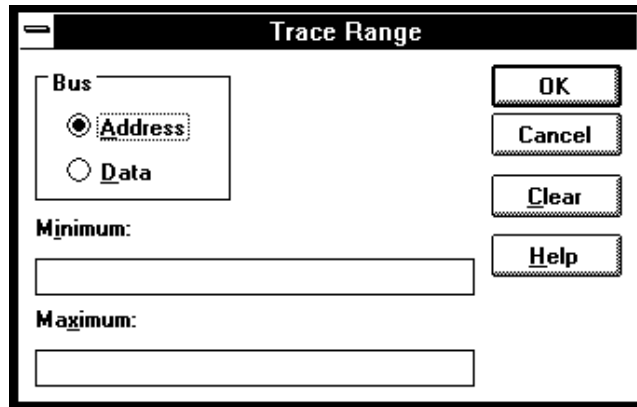

Address	Selects a range of address values.
Data	Selects a range of data values.
Minimum	Lets you enter the minimum value for the range.
Maximum	Lets you enter the maximum value for the range.
OK	Applies the values specified for the range, and closes the dialog box.
Cancel	Closes the dialog box.
Clear	Clears the values specified for the range.

See Also

"To set up a 'Find Then Trigger' trace specification" and
"To set up a 'Sequence' trace specification" in the "Setting Up Custom Trace Specifications" section of the "Debugging Programs" chapter.

Trace→Find Then Trigger... (ALT, T, D)
Trace→Sequence... (ALT, T, Q)



Sequence Number Dialog Box

Choosing the buttons associated with "to" or Trigger On opens the following dialog box:

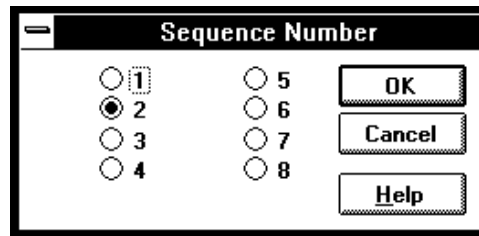

1-8 These options specify the sequence level.

OK Applies the selected sequence level and closes the dialog box.

Cancel Closes the dialog box.

See Also

"To set up a 'Sequence' trace specification" in the "Setting Up Custom Trace Specifications" section of the "Debugging Programs" chapter.

Trace→Sequence... (ALT, T, Q)

RealTime→Monitor Intrusion→Disallowed (ALT, R, T, D)

Activates the real-time mode.

When the user program is running in real-time mode, no command that would normally cause temporary suspension of program execution is allowed. Also, the system hides:

- The Register window.
- Target system memory or single-port emulation memory in the Memory window.
- Target system I/O locations in the I/O window.
- Target system memory or single-port emulation memory variables in the WatchPoint window.
- Target system memory or single-port emulation memory in the Source window.

While the processor is in the RUNNING REALTIME IN USER PROGRAM state, no display or modification is allowed for the contents of target system memory, single-port emulation memory, or registers. Therefore, before you can display or modify target system memory, single-port emulation memory, or processor registers, you must use the Execution→Break (ALT, E, B) command to stop user program execution and break into the monitor.

Command File Command

```
MOD(E) REA(LTIME) ON
```

See Also

"To allow or deny monitor intrusion" in the "Setting the Real-Time Options" section of the "Configuring the Emulator" chapter.

RealTime→Monitor Intrusion→Allowed (ALT, R, T, A)

Deactivates the real-time mode.

Commands that cause temporary breaks to the monitor during program execution are allowed.

Command File Command

```
MOD(E) REA(LTIME) OFF
```

See Also

"To allow or deny monitor intrusion" in the "Setting the Real-Time Options" section of the "Configuring the Emulator" chapter.

RealTime→I/O Polling→ON (ALT, R, I, O)

Enables access to I/O.

Command File Command

MOD(E) IOG(UARD) OFF

See Also

"To turn polling ON or OFF" in the "Setting the Real-Time Options" section of the "Configuring the Emulator" chapter.



RealTime→I/O Polling→OFF (ALT, R, I, F)

Disables access to I/O.

When polling is turned OFF, values in the I/O window are updated on entry to the monitor. When monitor intrusion is not allowed during program execution, the I/O window is not updated and contents are replaced by dashes (-).

Command File Command

```
MOD(E) IOG(UARD) ON
```

See Also

"To turn polling ON or OFF" in the "Setting the Real-Time Options" section of the "Configuring the Emulator" chapter.

RealTime→Watchpoint Polling→ON (ALT, R, W, O)

Turns ON polling to update values displayed in the WatchPoint window.

When polling is turned ON, temporary breaks in program execution occur when the WatchPoint window is updated.

Command File Command

```
MOD(E) WAT(CHPOLL) ON
```

See Also

"To turn polling ON or OFF" in the "Setting the Real-Time Options" section of the "Configuring the Emulator" chapter.



RealTime→Watchpoint Polling→OFF (ALT, R, W, F)

Turns OFF polling to update values displayed in the WatchPoint window.

When polling is turned OFF, values in the WatchPoint window are updated on entry to the monitor. When monitor intrusion is not allowed during program execution, the WatchPoint window is not updated and contents are replaced by dashes (-).

Command File Command

```
MOD(E) WAT(CHPOLL) OFF
```

See Also

"To turn polling ON or OFF" in the "Setting the Real-Time Options" section of the "Configuring the Emulator" chapter.

RealTime→Memory Polling→ON (ALT, R, M, O)

Turns ON polling to update target memory or single-port emulation memory values displayed in the Memory window.

When polling is turned ON, temporary breaks in program execution occur when target system memory or single-port emulation memory locations in the Memory window are updated. When monitor intrusion is not allowed during program execution, the contents of these memory locations are replaced by dashes (-).

Also, when polling is turned ON, you can modify the addresses displayed or contents of memory locations by double-clicking on the address or value, using the keyboard to type in the new address or value, and pressing the Enter key.

Note

Unexpected trace measurements can result if memory polling is enabled and reads of the memory displayed in the Memory window satisfy the trace specification. For example, if memory at address 0 is being displayed and the trace is set up to trigger on anything, the trace will capture reads of memory locations at address 0 even while the emulator is in the RUNNING IN MONITOR state. To eliminate the unwanted memory reads, turn memory polling OFF, or close the Memory window while making the trace measurement.

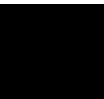

Command File Command

```
MOD(E) MEM(ORYPOLL) ON
```

See Also

"To turn polling ON or OFF" in the "Setting the Real-Time Options" section of the "Configuring the Emulator" chapter.

RealTime→Memory Polling→OFF (ALT, R, M, F)

Turns OFF polling to update target memory values displayed in the Memory window.

When polling is turned OFF, values in the Memory window are updated on entry to the monitor.

Also, when polling is turned OFF, you cannot modify the addresses displayed or contents of memory locations by double-clicking on the address or value.

Command File Command

```
MOD(E) MEM(ORYPOLL) OFF
```

See Also

"To turn polling ON or OFF" in the "Setting the Real-Time Options" section of the "Configuring the Emulator" chapter.

Assemble... (ALT, A)

In-line assembler.

This command lets you modify programs by specifying assembly language instructions which are assembled and loaded into program memory.

Assembler Dialog Box

Choosing the Assemble... (ALT, A) command opens the following dialog box:

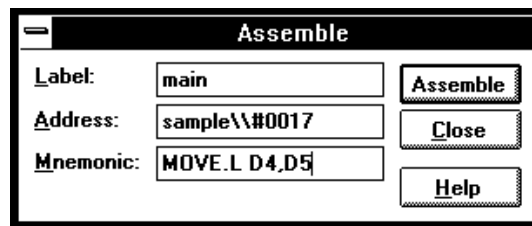

Label	Lets you assign a user-defined symbol to the specified address.
Address	Lets you enter the address at which the assembly language instruction will be loaded.
Mnemonic	Lets you enter the assembly language instruction to be assembled.
Assemble	Assembles the instruction in the Mnemonic text box, and loads it into memory at the specified address.
Close	Closes the dialog box.

Command File Command

ASM address label "inst_string"

Settings→Emulator Config→Hardware... (ALT, S, E, H)

Specifies the emulator configuration.

Hardware Config Dialog Box

Choosing the Settings→Emulator Config→Hardware... (ALT, S, E, H) command opens the following dialog box:

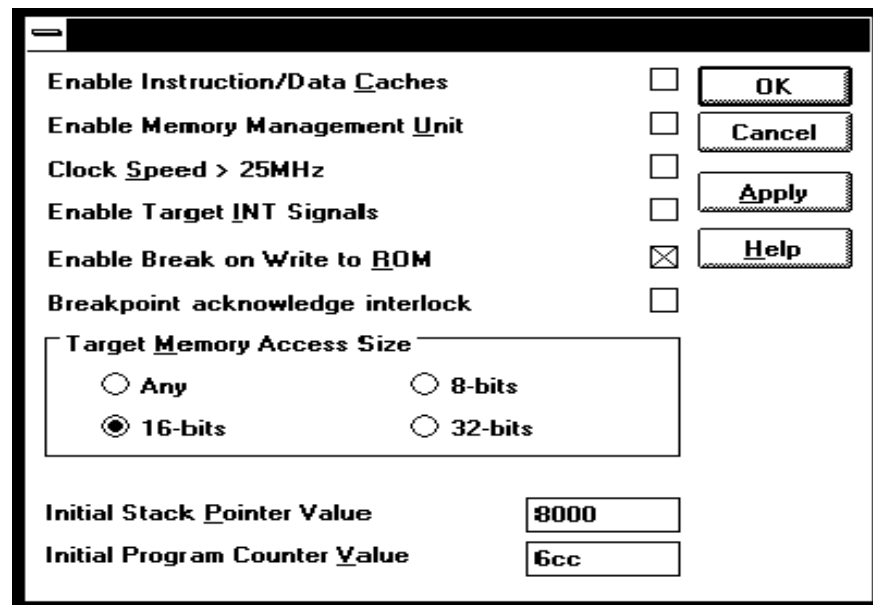

Enable Instruction/Data Cache Lets you disable the on-chip instruction and data caches when you trace program execution. This causes the processor to always access external memory (at the expense of processor performance) so that the accesses are visible to the analyzer.

Enable Memory Management Unit Enables or disables the processor's Memory Management Unit.

Clock Speed > 25 MHz	Tells the emulator whether or not to force synchronous and burst mode accesses to emulation memory to be completed with one wait state. If your clock speed is greater than 25 MHz and you do not select this option, synchronous and burst mode accesses to emulation memory will be unreliable.
Enable Target INT Signals	Enables or disables interrupts from the target system.
Enable Break on Write to ROM	Enables or disables breaks to the monitor when the user program writes to memory mapped as ROM.
Breakpoint Acknowledge Interlock	<p>Enables or disables target system termination of the breakpoint acknowledge cycle (which is generated by BKPT instruction execution).</p> <p>When selected, the target system is responsible for terminating breakpoint acknowledge cycles by asserting /TA or /TEA. If the target system fails to provide the required cycle termination, the processor will remain in a wait state indefinitely.</p> <p>When deselected, the emulator will terminate breakpoint acknowledge cycles with the /TEA signal. Any termination signals generated by the target system will be ignored.</p>
Target Memory Access Size	Specifies the size used to access target system memory. The "Any" option specifies that the emulator select the optimum size to access target memory.
Initial Stack Pointer Value	<p>Specifies the initial value of the interrupt stack pointer (ISP), which is set when the monitor is entered from reset. Enter an even address value. This entry is ignored during a run-from-reset execution, or a target-system reset.</p> <p>By default, "auto" is shown in this field. With auto selected, the monitor reads the reset vector from the target system exception table to find the initial ISP and PC values. The monitor does not duplicate the reset exception processing</p>



sequence to access the reset vector. Therefore, the auto option may not be suitable for your target system.

Initial Program Counter Value Specifies the initial value of the program counter (PC), which is set when the monitor is entered from reset. Enter an even address value. This entry is ignored during a run-from-reset execution or a target-system reset. It is also ignored if you selected auto for the Initial Stack Pointer Value.

OK Stores the current modification and closes the dialog box.

Cancel Cancels the current modification and closes the dialog box.

Apply Loads the configuration settings into the emulator.

Command File Command

CON(FIG) CAC(HE) DIS(ABLE)

Disables the on-chip instruction and data caches.

CON(FIG) CAC(HE) ENA(BLE)

Enables the on-chip instruction and data caches.

CON(FIG) MMU ENA(BLE)

Enables the processor's Memory Management Unit.

CON(FIG) MMU DIS(ABLE)

Disables the processor's Memory Management Unit.

CON(FIG) EMW(AIT) DIS(ABLE)

Use this when the processor clock speed is less than or equal to 25 MHz.

CON(FIG) EMW(AIT) ENA(BLE)

Use this when the processor clock speed is greater than 25 MHz.

CON(FIG) INT DIS(ABLE)

Disables interrupts from the target system.

CON(FIG) INT ENA(BLE)

Enables interrupts from the target system.

CON(FIG) ROM(BREAK) ENA(BLE)

Enables breaks to the monitor when writes to ROM occur.

CON(FIG) ROM(BREAK) DIS(ABLE)

Disables breaks to the monitor when writes to ROM occur.

CON(FIG) BPL(OCK) ENA(BLE)

The target system is responsible for terminating breakpoint acknowledge cycles by asserting /TA or /TEA.

CON(FIG) BPL(OCK) DIS(ABLE)

The emulator will terminate breakpoint acknowledge cycles.

CON(FIG) ACC(ESS) ANY

Specifies that the emulator select the optimum size to access target memory.

CON(FIG) ACC(ESS) BYT(ES)

Specifies that target memory is accessed in byte sized locations.

CON(FIG) ACC(ESS) WOR(DS)

Specifies that target memory is accessed in 16-bit word sized locations.

CON(FIG) ACC(ESS) LON(GS)

Specifies that target memory is accessed in 32-bit longword sized locations.

CON(FIG) RVI(SP) address

Specifies the initial value of the interrupt stack pointer (ISP).

CON(FIG) RVP(C) address

Specifies the initial value of the program counter (PC).

Any of the above command file commands must be preceded and followed by the respective start and end commands:

CON(FIG) STA(RT)

Starts the configuration option command section.

CON(FIG) END

Ends the configuration option command section.

See Also

"Setting the Hardware Options" in the "Configuring the Emulator" chapter.

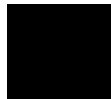

Settings→Emulator Config→Memory Map... (ALT, S, E, M)

Maps memory ranges.

Up to seven ranges of memory can be mapped, and the resolution of mapped ranges is 256 bytes (that is, the memory ranges must begin on 256-byte boundaries and must be at least 256 bytes in length).

The emulator contains 4 Kbytes of *dual-port emulation memory* and provides two slots for additional, *single-port emulation memory* modules.

The amount of emulation memory that can be mapped depends on the number, and size, of memory modules installed on the emulator board.

Emulation memory is made available to the mapper in blocks. When you map an address range to emulation memory, at least one block is assigned to the range. When a block of emulation memory is assigned to a range, it is no longer available, even though part of the block may not be used.

Emulation memory in slot 0 of the emulator probe is divided into four equal blocks, and memory in slot 1 is divided into two equal blocks. The 4-Kbyte block of dual-port emulation memory is one block.

When you map ranges of emulation memory, blocks are allocated so as to leave the greatest amount of emulation memory available. For example, if you map the range 0 through 0FFH as emulation memory, the 4-Kbyte block of dual-port memory is used if possible; if that block has already been used, the next smallest available block is used.

Memory Map Dialog Box

Choosing the Settings→Emulator Config→Memory Map... (ALT, S, E, M) command opens the following dialog box:

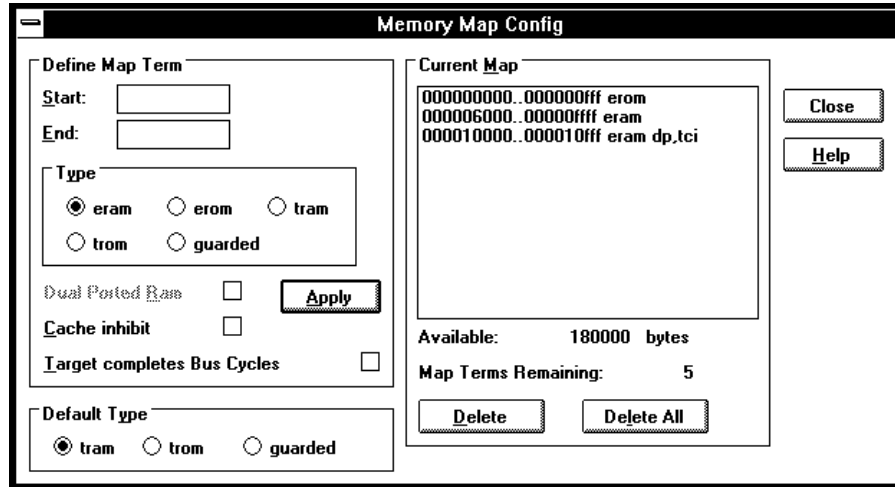

- Start Specifies the starting address of the address range to be mapped.

- End Specifies the end address of the address range to be mapped.

- Type Lets you select the memory type of the specified address range. You can map ranges as emulation RAM, emulation ROM, target system RAM, target system ROM, or as guarded memory.

Guarded memory accesses cause emulator execution to break into the monitor program.

Writes to locations mapped as ROM will cause emulator execution to break into the monitor program if these breaks are enabled in the hardware configuration.

Chapter 8: Menu Bar Commands

Settings→Emulator Config→Memory Map... (ALT, S, E, M)

Dual Ported Ram	<p>Lets you specify that the 4 Kbytes of dual-port emulation memory be used for that range.</p> <p>When a background monitor is used, the Dual Ported Ram is available for general purpose usage. Emulation memory is allocated using a best fit algorithm, utilizing the Dual Ported Ram when it is available.</p> <p>If a foreground monitor is used, it will automatically be mapped to the Dual Ported Ram. The Current Map in the Memory Map Config dialog will show the "dp" attribute for the foreground monitor term.</p>
Cache Inhibit	<p>Lets you disable the on-chip instruction and data caches for accesses to the range. All accesses to the range will be external, which makes them visible to the analyzer (at the expense of processor performance).</p>
Target Completes Bus Cycles	<p>Specifies that emulation memory accesses in the range be terminated by the target system /TA or /TEA signals. This makes the timing of emulation memory accesses the same as target system memory accesses.</p>
Apply	<p>Maps the address range specified in the Define Map Term group box.</p>
Default	<p>Specifies whether unmapped memory ranges are target system RAM, target system ROM, or guarded memory.</p>
Current Map	<p>Lists currently mapped ranges.</p>
Available	<p>Indicates the amount of emulation memory available.</p>
Delete	<p>Deletes the address range selected in the Current Map list box.</p>
Delete All	<p>Deletes all of the address ranges in the Current Map list box.</p>
Close	<p>Closes the dialog box.</p>

Command File Command

MAP addressrange mem_type attribute

Maps the specified address range with the specified memory type. The DP attribute selects the 4-Kbyte block of dual-port emulation memory. The DSI attribute specifies that the target system /TA or /TEA signal terminates the emulation memory access. The CI attribute disables the on-chip caches for accesses in the range.

MAP OTH(ER) mem_type

Specifies the type of the specified non-mapped memory area.

Any of the above command file commands must be preceded and followed by the respective start and end commands:

MAP STA(RT)

Starts the memory mapping command section.

MAP END

Ends the memory mapping command section.

See Also

"Mapping Memory" in the "Configuring the Emulator" chapter.



Settings→Emulator Config→Monitor... (ALT, S, E, O)

Selects the type of monitor program and other monitor options.

Target system interrupts are blocked during background monitor operation, but they may be enabled during foreground monitor operation.

Both types of monitor programs require stacks to be set up in the user program because values are temporarily pushed onto the stack during monitor entry.

The trace exception vector, which must be set up for single-stepping, will be different, depending on the type of monitor program chosen.

- 1** When the background monitor is selected, the trace exception vector must point to an even address in readable memory. If the emulator cannot read from the address that the trace exception vector points to, it attempts to temporarily write the current value of VBR into the trace exception vector (because the vector table is readable).
- 2** When a foreground monitor is selected, the trace exception vector must point to the TRACE_ENTRY address in the monitor. In the default foreground monitor, this address is equal to the base address of the monitor plus 680H. If the trace exception vector does not contain the correct value, the emulator attempts to temporarily change the trace a-line and f-line exception vectors to the TRACE_ENTRY address.

Monitor Config Dialog Box

Choosing the Settings→Emulator Config→Monitor... (ALT, S, E, O) command opens the following dialog box:

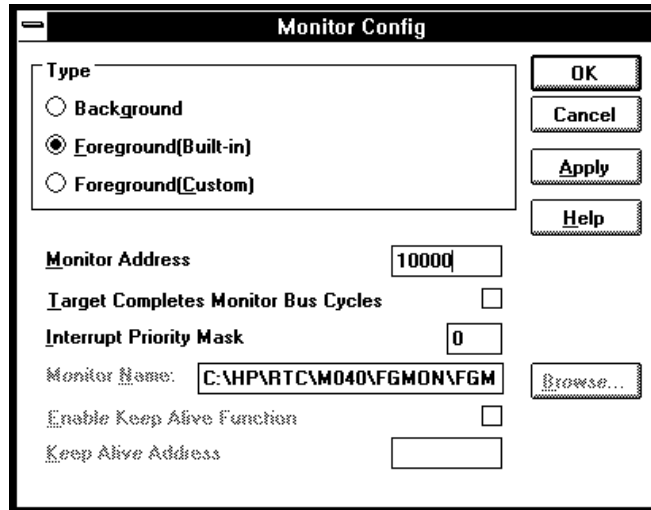

Type Lets you choose between a background monitor, the built-in foreground monitor, or a customized foreground monitor.

Monitor Address When a foreground monitor is selected, this is the base address of the 4-Kbyte block of memory reserved for the monitor program.

Target Completes Monitor Bus Cycles Lets you specify whether monitor program cycles should be terminated by the target system /TA signal.

Interrupt Priority Mask For foreground monitors only, this option lets you run the foreground monitor at a lowered interrupt priority level in order to allow critical target system interrupts to be processed.

When it's safe to lower the interrupt level, the foreground

monitor will set the interrupt priority mask to either the level entered or the level in effect before monitor entry, whichever is greater.

Monitor Name	Lets you enter the name of the foreground monitor object file. The default is C:\HP\RTC\M040\FGMON\FGMON.X (if C:\HP\RTC\M040 was the installation path chosen when installing the debugger software). The foreground monitor will be automatically loaded after each Execution→Reset (ALT, E, E) command. Choosing the Apply button does not load the foreground monitor.
Enable Keep Alive Function	Enables or disables the background monitor function that reads periodically from an address. This function is provided so that watchdog timer or dynamic RAM refresh circuitry can detect that the processor is still running during background monitor execution.
Keep Alive Address	Specifies the address that is periodically read when in the background monitor with the keep-alive function enabled.
Browse...	Opens a file selection dialog box from which you can select the foreground monitor object file to be loaded.
OK	Modifies the monitor configuration as specified and closes the dialog box. When you have selected a foreground monitor, it is not loaded when you choose OK; instead, you must load it using the File→Load Object... (ALT, F, L) command. A foreground monitor will be loaded automatically after each Emulation→Reset (ALT, E, E) command.
Cancel	Cancels the monitor configuration and closes the dialog box.
Apply	Loads the configuration settings into the emulator.

Command File Command

MON(ITOR) PRO(CESS) BAC(K)

Selects the background monitor.

MON(ITOR) PRO(CESS) FOR(E)

Selects the foreground monitor.

MON(ITOR) LOC(K) DIS(ABLE)

Disables the termination of monitor cycles by the target system /TA signal.

MON(ITOR) LOC(K) ENA(BLE)

Enables the termination of monitor cycles by the target system /TA signal.

MON(ITOR) LOC(ATE) address

Specifies the base address of the 4-Kbyte block reserved for the foreground monitor.

MON(ITOR) FIL(ENAME) file_name

Names the foreground monitor object file.

MON(ITOR) KEE(P-ALIVE) DIS(ABLE)

Disables the background monitor keep-alive function.

MON(ITOR) KEE(P-ALIVE) ENA(BLE)

Enables the background monitor keep-alive function.

MON(ITOR) KEE(PALIVE) LOC(ATE) address

Specifies the address that is periodically read when in the background monitor with the keep-alive function enabled.

Any of the above command file commands must be preceded and followed by the respective start and end commands:

MON(ITOR) STA(RT)

Starts the monitor option command section.

MON(ITOR) END

Ends the monitor option command section.

See Also

"Selecting the Type of Monitor" in the "Configuring the Emulator" chapter.

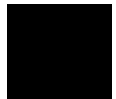

Settings→Communication... (ALT, S, C)

Choosing this command opens the RTC Emulation Connection Dialog Box which lets you identify and set up the communication channel between the personal computer and the HP 64700.

RTC Emulation Connection Dialog Box

Choosing the Settings→Communication... (ALT, S, C) command opens the following dialog box:

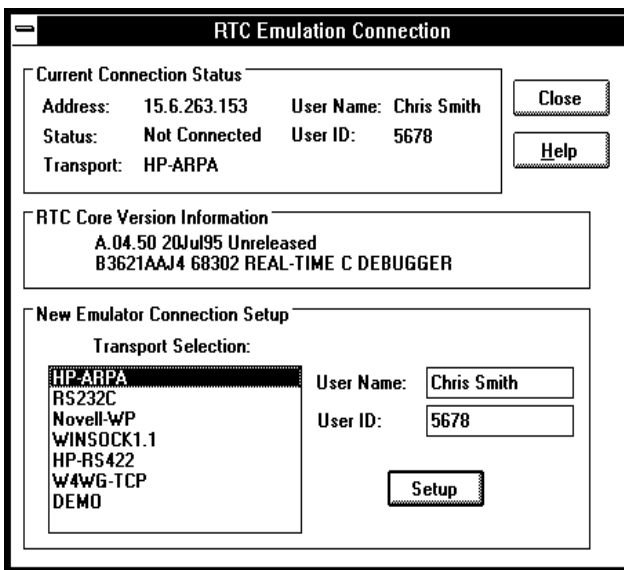

Current Connection Status

This part of the dialog box shows the current communication settings.

RTC Core Version Information

Displays software version information.

New Emulator Connection Setup

Transport Selection Lets you choose the type of connection to be made to the HP 64700. Double-clicking causes the current connection to be tried with the given transport. Single-clicking selects the transport for use with the Setup button.

User Name This name tells the HP 64700 and other users who you are. When other users attempt to access the HP 64700 while you are using it or while it is locked, a message tells them you're using it.

User ID Another method of identifying yourself to the HP 64700 and other users. This is primarily useful in a mixed UNIX and MS-DOS environment; when a UNIX user tries to unlock an emulator, the user ID is used to look into the /etc/passwd entry on the UNIX host for the user name.

If your HP 64700 is on the LAN, we recommend that you change User Name and User ID so that other users can easily tell if an emulator is in use and by whom. Also, if you don't change the User Name/ID from the defaults, the File→Exit HW Locked (ALT, F, H) command has no effect because all users are identical.

Setup Opens a transport-specific dialog box which usually allows you to change the address and unlock the emulator.

In the LAN Setup dialog boxes, enter the IP address or network name of the HP 64700.

In the RS232C Setup dialog box, select the baud rate and the name of the port (for example, COM1, COM2, etc.) to which the HP 64700 is connected.

In the HP-RS422 Setup dialog box, select the baud rate and specify the I/O address you want to use for the HP 64037 card. The I/O address must be a hexadecimal number from 100H through 3F8H, ending in 0 or 8, that does not conflict with other cards in your PC.

The Connect button in any of these Setup dialog boxes starts the debugger with the specified communication settings.

Close Either closes the Real-Time C Debugger, if the current connection failed, or simply closes the dialog box.

The Real-Time C Debugger does not allow you to change connection or transport information without leaving the debugger and reentering it. However, any changes you make will be put in the .INI file and take effect the next time you enter the debugger (assuming that you do not override the .INI information on the command line).

The command line options for connection and transport (-E and -T) take precedence over the values in the .INI file.

Settings→BNC→Outputs Analyzer Trigger (ALT, S, B, O)

Specifies that the analyzer trigger signal be driven on the BNC port.

Selecting the emulator BNC port for output enables the trigger signals to be fed to external devices (for example, logic analyzers) during tracing.

CAUTION

Do not drive the BNC beyond the range of 0 to 5 volts. Doing so may cause permanent damage to the HP 64700.

The BNC's drivers can drive 50-ohm loads.

The following is a logical diagram of the BNC connection. The physical implementation and values of resistors are not exact; this diagram is just to help you understand the BNC interface:

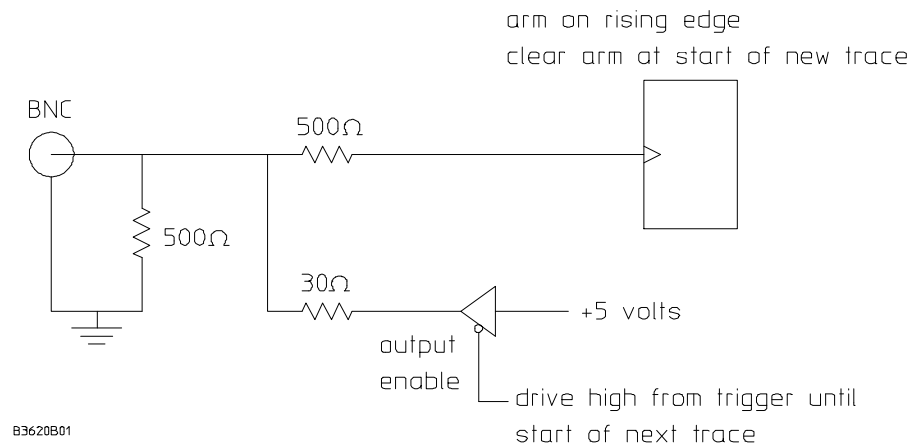

When a trace starts, it stops driving the output (so if nothing else is driving the line, it will fall low due to the 500-ohm pull-down resistor).

When the trigger point is found, the BNC starts driving the output high. It will stay high until the start of the next trace.

Chapter 8: Menu Bar Commands

Settings→BNC→Outputs Analyzer Trigger (ALT, S, B, O)

Command File Command

```
MOD(E) BNC OUT(PUT_TRIGGER)
```

See Also

"To output the trigger signal on the BNC port" in the "Setting Up the BNC Port" section of the "Configuring the Emulator" chapter.

Settings→BNC→Input to Analyzer Arm (ALT, S, B, I)

Allows the analyzer to receive an arm signal from the BNC port.

This command allows an external trigger signal to be used as an arm (enable) condition for the internal analyzer. The internal analyzer will arm (or enable) on a positive edge TTL signal.

CAUTION

Do not drive the BNC beyond the range of 0 to 5 volts. Doing so may cause permanent damage to the HP 64700.

You can use the arm condition when setting up custom trace specifications with the Trace→Find Then Trigger... (ALT, T, D) or Trace→Sequence... (ALT, T, Q) commands. For example, you can trigger on the arm condition or enable the storage of states on the arm condition. The "arm" condition may be selected in "set2" of the Trace Condition or Count Condition dialog boxes.

The BNC port is internally terminated with about 500 ohms; if using a 50-ohm driver, use an external 50-ohm termination (such as the HP 10100C 50-Ohm Feedthrough Termination) to reduce bouncing and possible incorrect triggering.

Command File Command

```
MOD ( E ) BNC INP ( UT_ARM )
```

See Also

Settings→BNC→Outputs Analyzer Trigger (ALT, S, B, O) for a logical schematic of the BNC interface.

"To receive an arm condition input on the BNC port" in the "Setting Up the BNC Port" section of the "Configuring the Emulator" chapter.

Settings→Font... (ALT, S, F)

Selects the fonts used in the debugger windows.

Font Dialog Box

Choosing the Settings→Font... (ALT, S, F) command opens the following dialog box:

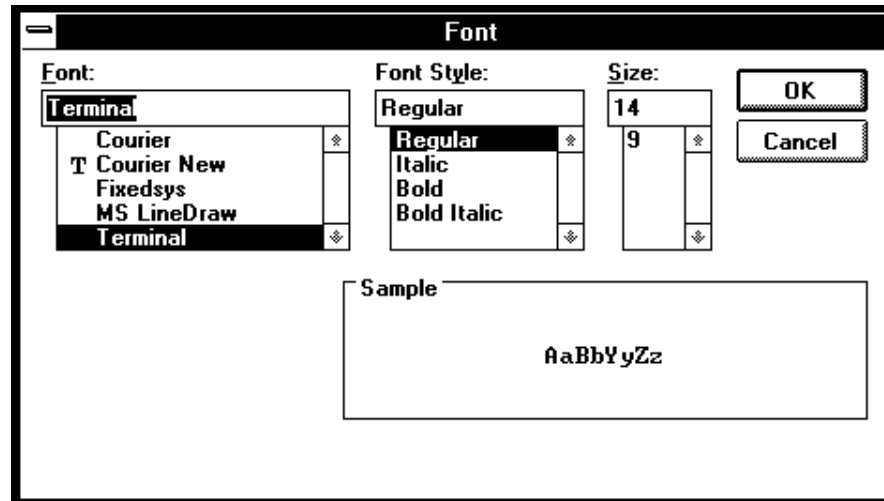

Font Lets you select the font to be used in the Real-Time C Debugger interface. The "T" shaped icon indicates a TrueType font.

Font Style Lets you select the typeface, for example, regular, bold, italic, etc.

Size Lets you select the size of the characters.

Sample Shows you what the selected font looks like.

OK Sets the font, and closes the dialog box.

Cancel Cancels font setting, and closes the dialog box.

See Also

"To change the debugger window fonts" in the "Working with Debugger Windows" section of the "Using the Debugger Interface" chapter.



Settings→Tabstops... (ALT, S, T)

Sets the number of spaces between tab stops.

Source Tab Dialog Box

Choosing the Settings→Tabstops... (ALT, S, T) command opens the following dialog box:

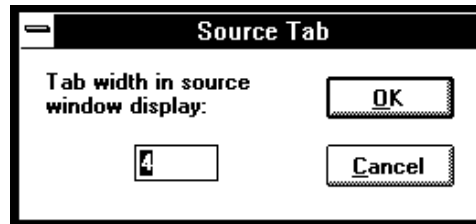

Tab width in source window display Enter the number of spaces between tab stops. This also affects the tab width for source lines in the Trace window. The number must be between 1 and 20.

OK Sets the tab stops, and closes the dialog box.

Cancel Cancels tab stop setting, and closes the dialog box.

See Also

"To set tab stops in the Source window" in the "Working with Debugger Windows" section of the "Using the Debugger Interface" chapter.

Settings→Symbols→Case Sensitive→ON (ALT, S, S, C, O)

Symbol database search is case sensitive.

Command File Command

```
MOD ( E )  SYM ( BOLCASE )  ON
```

See Also

Settings→Symbols→Case Sensitive→OFF (ALT, S, S, C, F)

Settings→Symbols→Case Sensitive→OFF (ALT, S, S, C, F)

Symbol database search is not case sensitive.

If there are case conflicts (for example, FOO and foo), no warning is given, and you cannot predict which symbol will be used. The symbol that is used depends on what type of symbols FOO and foo are and how they were input by the symbol section of the object file.

Command File Command

```
MOD ( E )  SYM ( BOLCASE )  OFF
```

See Also

Settings→Symbols→Case Sensitive→ON (ALT, S, S, C, O)

Settings→Extended→Trace Cycles→User (ALT, S, X, T, U)

Traces foreground emulation microprocessor operation.

This is the normal setting.

Command File Command

```
MOD(E) TRA(CECLOCK) USE(R)
```

See Also

Settings→Extended→Trace Cycles→Monitor (ALT, S, X, T, M)

Settings→Extended→Trace Cycles→Both (ALT, S, X, T, B)

Settings→Extended→Trace Cycles→Monitor (ALT, S, X, T, M)

Traces background emulation microprocessor operation.

This is rarely a useful setting when debugging programs.

Command File Command

```
MOD(E) TRA(CECLOCK) BAC(KGROUND)
```

See Also

Settings→Extended→Trace Cycles→User (ALT, S, X, T, U)

Settings→Extended→Trace Cycles→Both (ALT, S, X, T, B)

Settings→Extended→Trace Cycles→Both (ALT, S, X, T, B)

Traces both foreground and background emulation microprocessor operation.

Command File Command

MOD(E) TRA(CECLOCK) BOT(H)

See Also

Settings→Extended→Trace Cycles→User (ALT, S, X, T, U)

Settings→Extended→Trace Cycles→Monitor (ALT, S, X, T, M)



Settings→Extended→Load Error Abort→ON (ALT, S, X, L, O)

An error during an object file or memory load causes an abort.

Normally, when an error occurs during an object file or memory load, you want the load to stop so that you can fix whatever caused the error.

Command File Command

MOD(E) DOW(NLOAD) ERR(ABORT)

See Also

Settings→Extended→Load Error Abort→OFF (ALT, S, X, L, F)

Settings→Extended→Load Error Abort→OFF (ALT, S, X, L, F)

An error during an object file or memory load does not cause an abort.

If you expect certain errors during an object file or memory load, for example, if part of the file is located at "guarded" memory or "target ROM," you can choose this command to continue loading in spite of the errors.

Command File Command

MOD(E) DOW(NLOAD) NOE(RRABORT)

See Also

Settings→Extended→Load Error Abort→ON (ALT, S, X, L, O)

Settings→Extended→Source Path Query→ON (ALT, S, X, S, O)

You are prompted for source file paths.

When the debugger cannot find source file information for the Source or Trace windows, it may prompt you for source file paths depending on the MODE SOURCE setting.

Command File Command

MOD(E) SOU(RCE) ASK(PATH)

See Also

Settings→Extended→Source Path Query→OFF (ALT, S, X, S, F)

Settings→Extended→Source Path Query→OFF (ALT, S, X, S, F)

You are not prompted for source file paths.

You can turn off source path prompting, for example, to avoid annoying dialog interactions when tracing library functions for which no source files are available.

Command File Command

MOD(E) SOU(RCE) NOA(SKPATH)

See Also

Settings→Extended→Source Path Query→ON (ALT, S, X, S, O)

Window→Cascade (ALT, W, C)

Arranges, sizes, and overlaps windows.

Windows are sized, evenly, to be as large as possible.

Window→Tile (ALT, W, T)

Arranges and sizes windows so that none are overlapped.

Windows are sized evenly.

Window→Arrange Icons (ALT, W, A)

Rearranges icons in the Real-Time C Debugger window.

Icons are distributed evenly along the lower edge of the Real-Time C Debugger window.

Window→1-9 (ALT, W, 1-9)

Opens the window associated with the number.

The nine most recently opened windows appear in the menu list. If the window you wish to open is not on the list, choose the Window→More Windows... (ALT, W, M) command.

Windows are closed just as are ordinary MS Windows, that is, by opening the control menu and choosing Close or by pressing CTRL+F4.

For details on each of the debugger windows, refer to the "Debugger Windows" section in the "Concepts" information.

Command File Command

DIS(PLAY) window-name

Opens the specified window. Use the first three characters of the window name, or, if the window name is "Basic Registers," use "REG."

ICO(NIC) window-name

Closes the specified window. Use the first three characters of the window name, or, if the window name is "Basic Registers," use "REG."

See Also

"To open debugger windows" in the "Working with Debugger Windows" section of the "Using the Debugger Interface" chapter.



Window→More Windows... (ALT, W, M)

Presents a list box from which you can select the window to be opened.

Select Window Dialog Box

Choosing the Window→More Windows... (ALT, W, M) command opens the following dialog box:

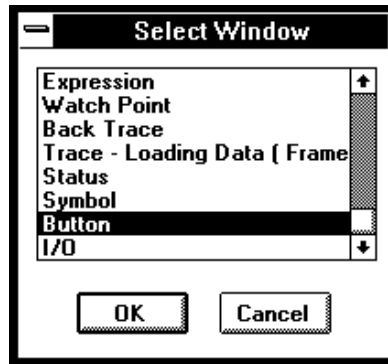

OK Opens the window selected in the list box.

Cancel Closes the dialog box.

Command File Command

DIS(PLAY) window-name

Opens the specified window. Use the first three characters of the window name, or, if the window name is "Basic Registers," use "REG."

ICO(NIC) window-name

Closes the specified window. Use the first three characters of the window name, or, if the window name is "Basic Registers," use "REG."

See Also

"To open debugger windows" in the "Working with Debugger Windows" section of the "Using the Debugger Interface" chapter.

Help→About Debugger/Emulator... (ALT, H, D)

Provides information on the Real-Time C Debugger.

Choosing the Help→About Debugger/Emulator... (ALT, H, D) command opens a dialog box containing the version information on the current Real-Time C Debugger and emulator.

Source Directory Dialog Box

When the source file associated with a symbol cannot be found in the current directory, the following dialog box is opened:

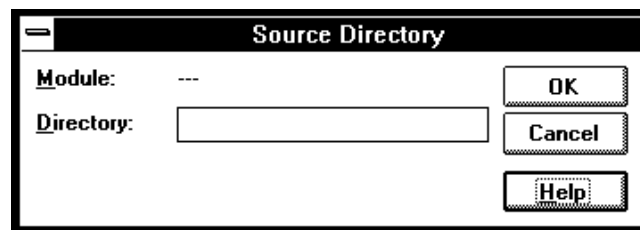

Module	Shows the symbol whose source file could not be found.
Directory	Lets you enter the directory in which the source file associated with the symbol may be found.
OK	Adds the directory entered in the Directory text box to the source file search path.
Cancel	Closes the dialog box.

WAIT Command Dialog Box

This dialog box appears when the WAIT command is included in a command file, break macro, or button.

Choosing the STOP button cancels the WAIT command.



Window Control Menu Commands

Window Control Menu Commands

This chapter describes the commands that can be chosen from the *control menus* in debugger windows.

- Common Control Menu Commands
- Button Window Commands
- Expression Window Commands
- I/O Window Commands
- Memory Window Commands
- Register Window Commands
- Source Window Commands
- Symbol Window Commands
- Trace Window Commands
- WatchPoint Window Commands

Common Control Menu Commands

This section describes commands that appear in the control menus of most of the debugger windows:

- Copy→Window (ALT, -, P, W)
- Copy→Destination... (ALT, -, P, D)

Copy→Window (ALT, -, P, W)

Copies the current window contents to the destination file specified with the File→Copy Destination... (ALT, F, P) command.

Command File Command

COP (Y) BAC (KTRACE)

COP (Y) BUT (TON)

COP (Y) EXP (RESSION)

COP (Y) IO

COP (Y) MEM (ORY)

COP (Y) REG (ISTER)

COP (Y) SOU (RCE)

COP (Y) WAT (CHPOINT)

See Also

"To copy window contents to the list file" in the "Working with Debugger Windows" section of the "Using the Debugger Interface" chapter.

Copy→Destination... (ALT, -, P, D)

Names the listing file to which debugger information may be copied.

This command opens a file selection dialog box from which you can select the listing file. Listing files have the extension ".LST".

Command File Command

COP(Y) TO filename

See Also

"To change the list file destination" in the "Working with Debugger Windows" section of the "Using the Debugger Interface" chapter.

Button Window Commands

This section describes the following command:

- Edit... (ALT, -, E)

Edit... (ALT, -, E)

Lets you define and label buttons in the Button window.

You can set up buttons to execute commonly used commands or command files.

Note that the Copy→Window command will generate a listing file that contains a header followed by commands needed to recreate the buttons. By removing the header, this file may be used as a command file.

Alternatively, you can log commands to a command file as you edit the buttons (refer to "To create a command file" in the "Using Command Files" section of the "Using the Debugger Interface" chapter). To recreate the buttons, just run the command file that you created while editing the buttons.

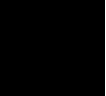

Button Edit Dialog Box

Choosing the Edit... (ALT, -, E) command opens the following dialog box:

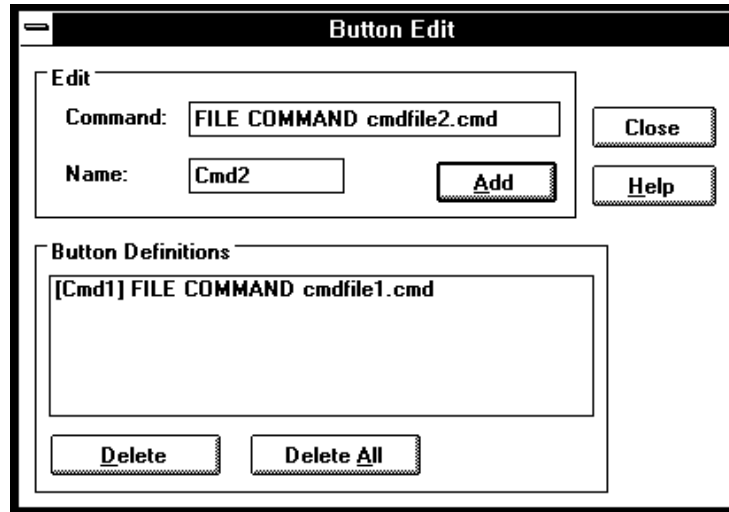

Command Specifies the command to be associated with the button. Command syntax is described at the bottom of most help topics under the "Command File Command" heading. Also, look in the "Command File and Macro Command Summary" chapter in the "Reference" part.

You can only enter a single command here; if you want a series of commands to be executed when this button is used, put them in a command file and use the command "FILE COMMAND filename," where "filename" is the name of your command file.

Name Specifies the button label to be associated with the command.

Add Adds the button to the button window.

Button Definitions Lists the currently defined buttons. You can select button definitions for deletion by clicking on them.

- | | |
|------------|--|
| Delete | Deletes the button definition selected in the Button Definitions list box. |
| Delete All | Deletes all buttons from the Button window. |
| Close | Closes the dialog box. |

Command File Command

BUTTON label "command"

BUTTON DELETE label

BUTTON DELETEALL

See Also

"To create buttons that execute command files" in the "Using Command Files" section of the "Using the Debugger Interface" chapter.

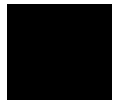

Expression Window Commands

This section describes the following commands:

- Clear (ALT, -, R)
- Evaluate... (ALT, -, E)

Clear (ALT, -, R)

Erases the contents of the Expression window.

Command File Command

EVA(LUATE) CLE(AR)

Evaluate... (ALT, -, E)

Evaluates expressions and displays the results in the Expression window.

Evaluate Expression Dialog Box

Choosing the Evaluate... (ALT, -, E) command opens the following dialog box:

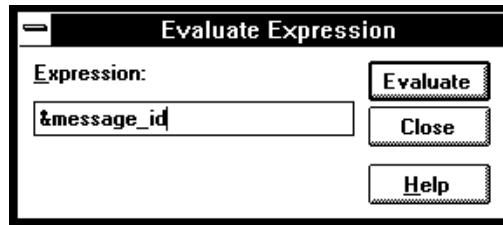

Expression Lets you enter the expression to be evaluated.

Evaluate Makes the evaluation and places the results in the Expression window.

Close Closes the dialog box.

Command File Command

EVA(LUATE) address

EVA(LUATE) "strings"

See Also

"Symbols" in the "Expressions in Commands" chapter.

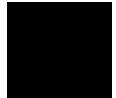

I/O Window Commands

This section describes the following command:

- Define... (ALT, -, D)

Define... (ALT, -, D)

Adds or deletes memory mapped I/O locations from the I/O window.

I/O Setting Dialog Box

Choosing the Edit→Definition... command opens the following dialog box:

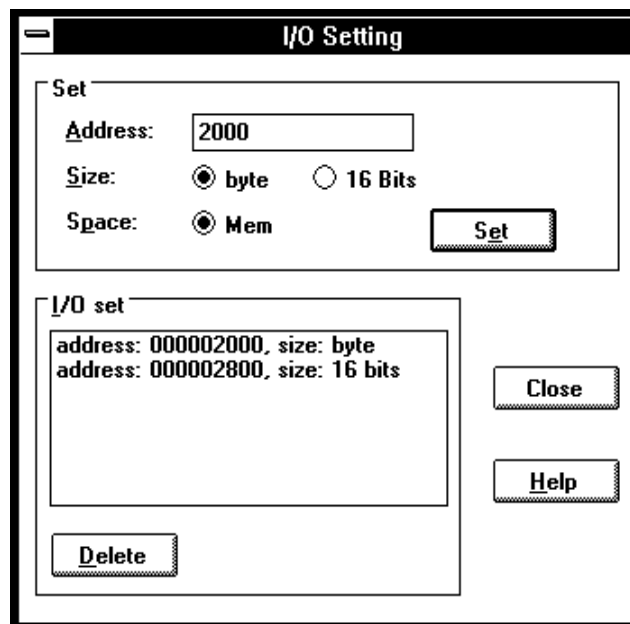

Address	Specifies the address of the I/O location to be defined.
Size	Specifies the data format of the I/O location to be defined. You can select the Byte or 16 Bits option.
Space	Specifies whether the I/O location is in memory or I/O space.
Set	Adds the specified I/O location.
I/O set	Displays the information on the I/O locations that have been set.
Delete	Deletes the I/O locations selected in the I/O set list box.
Close	Closes the dialog box.

Command File Command

`IO BYTE/WORD/LONG IOSPACE/MEMORY address TO data`
Replaces the contents of the specified I/O address with the specified value in the specified size.

`IO SET BYTE/WORD/LONG IOSPACE/MEMORY address`
Registers the I/O address to be displayed in the specified size.

`IO DEL(ETE) BYTE/WORD/LONG IOSPACE/MEMORY address`
Deletes the I/O specified with its address and size.

See Also

"Displaying and Editing I/O Locations" in the "Debugging Programs" chapter.

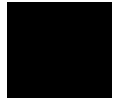

Memory Window Commands

This section describes the following commands:

- Display→Linear (ALT, -, D, L)
- Display→Block (ALT, -, D, B)
- Display→Byte (ALT, -, D, Y)
- Display→16 Bits (ALT, -, D, 1)
- Display→32 Bits (ALT, -, D, 3)
- Search... (ALT, -, R)
- Utilities→Copy... (ALT, -, U, C)
- Utilities→Fill... (ALT, -, U, F)
- Utilities→Load... (ALT, -, U, L)
- Utilities→Store... (ALT, -, U, S)

Display→Linear (ALT, -, D, L)

Displays memory contents in single column format.

Command File Command

MEM(ORY) ABS(OLUTE)

Display→Block (ALT, -, D, B)

Displays memory contents in multicolumn format.

Command File Command

MEM(ORY) BLO(CK)

Display→Byte (ALT, -, D, Y)

Displays memory contents as bytes.

Command File Command

MEM(ORY) BYTE

Display→16 Bit (ALT, -, D, 1)

Displays memory contents as 16-bit values.

Command File Command

MEM(ORY) WORD

Display→32 Bit (ALT, -, D, 3)

Displays memory contents as 32-bit values.

Command File Command

MEM(ORY) LONG

Search... (ALT, -, R)

Searches for a value or string in a range of memory.

When the value or string is found, the location is displayed in the Memory window. Choose the Window→Memory command to open the window.

The value or string can be selected from another window (in other words, copied to the clipboard) before choosing the command; the contents of the clipboard will automatically appear in the dialog box that is opened.

Search Memory Dialog Box

Choosing the Search... (ALT, -, R) command opens the following dialog box:

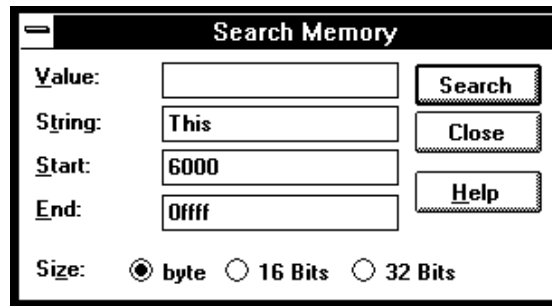

Value	Lets you enter a value.
String	Lets you enter a string.
Start	Lets you enter the starting address of the memory range to search.
End	Lets you enter the end address of the memory range to search.
Size	Selects the data size using the Byte, 16 Bits, or 32 Bits option buttons.
Execute	Searches for the specified value or string.

Close Closes the dialog box.

Command File Command

SEA(RCH) MEM(ORY) BYTE/WORD/LONG addr_range value

SEA(RCH) MEM(ORY) STR(ING) "string"

See Also

"To search memory for a value or string" in the "Displaying and Editing Memory" section of the "Debugging Programs" chapter.

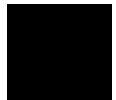

Utilities→Copy... (ALT, -, U, C)

Copies the contents of one memory area to another.

Memory Copy Dialog Box

Choosing the Utilities→Copy... (ALT, -, U, C) command opens the following dialog box:

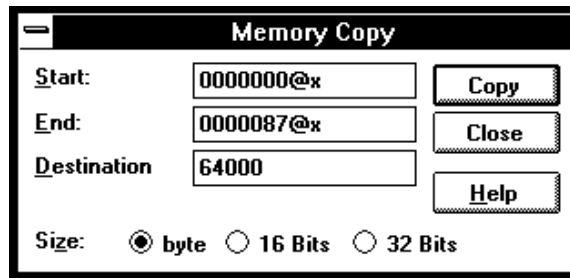

Start	Lets you enter the starting address of the source memory area.
End	Lets you enter the end address of the source memory area.
Destination	Specifies the starting address of the destination memory area.
Size	Selects the data size using the Byte, 16 Bits, or 32 Bits option buttons.
Execute	Copies the memory contents.
Close	Closes the dialog box.

Command File Command

MEM(ORY) COP(Y) size address_range address

See Also

"To copy memory to a different location" in the "Displaying and Editing Memory" section of the "Debugging Programs" chapter.

Utilities→Fill... (ALT, -, U, F)

Fills a range of memory with a specified value.

Memory Fill Dialog Box

Choosing the Utilities→Fill... (ALT, -, U, F) command opens the following dialog box:

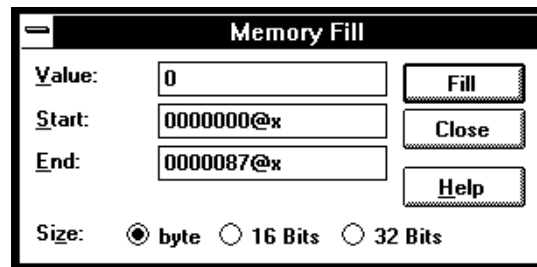

- Value Lets you enter the filling value.
- Start Lets you enter the starting address of the memory area to be filled.
- End Lets you enter the end address of the memory area to be filled.
- Size Selects the size of the filling value. If the value specified is larger than can fit in the size selected, the upper bits of the value are ignored. You can select the size using the Byte, 16 Bits, or 32 Bits option buttons.
- Execute Executes the command.

Close Closes the dialog box.

Command File Command

MEM(ORY) FIL(L) size address_range data

See Also

"To modify a range of memory with a value" in the "Displaying and Editing Memory" section of the "Debugging Programs" chapter.

Utilities→Load... (ALT, -, U, L)

Loads memory contents from a previously stored file.

Load Binary File Dialog Box

Choosing the Utilities→Load... (ALT, -, U, L) command opens the following dialog box:

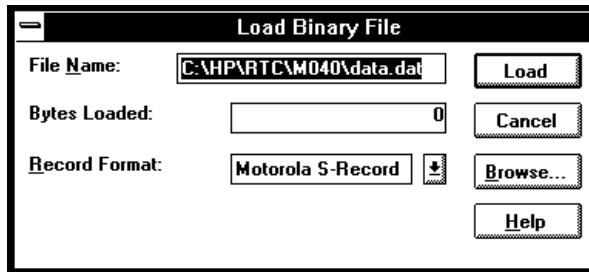

File Name Lets you enter the name of the file to load memory from.

Bytes Loaded After you choose the Import button, this box shows the number of bytes that are loaded.

Record Format Lets you specify the format of the file from which you're loading memory. You can load Motorola S-Record or Intel Hexadecimal format files.

Load	Starts the memory load.
Cancel	Closes the dialog box.
Browse...	Opens a file selection dialog box from which you can select the file name.

Command File Command

MEM(ORY) LOA(D) MOT(OSREC) filename

MEM(ORY) LOA(D) INT(ELHEX) filename

See Also

"To copy target system memory into emulation memory" in the "Displaying and Editing Memory" section of the "Debugging Programs" chapter.

Utilities→Store... (ALT, -, U, S)

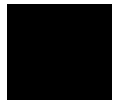

Utilities→Store... (ALT, -, U, S)

Stores memory contents to a binary file.

Store Binary File Dialog Box

Choosing the Utilities→Store... (ALT, -, U, S) command opens the following dialog box:

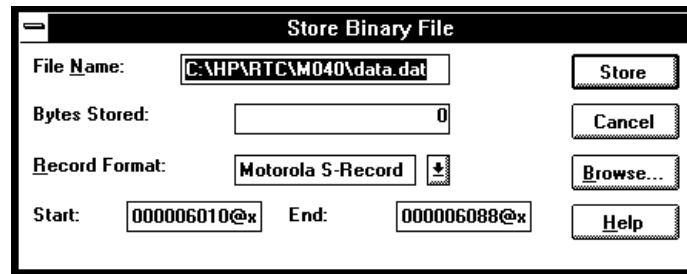

File Name	Lets you enter the name of the file to which memory contents are stored.
Bytes Stored	After you choose the Export button, this box shows the number of bytes that are stored.
Record Format	Lets you specify the format of the file to which you're storing memory. You can select Motorola S-Record or Intel Hexadecimal formats.
Start	Lets you enter the starting address of the memory range to be stored.
End	Lets you enter the ending address of the memory range to be stored.
Store	Starts the memory store.
Cancel	Closes the dialog box.

Browse... Opens a file selection dialog box from which you can select a file name.

Command File Command

MEM(ORY) STO(RE) MOT(OSREC) addr-range filename

MEM(ORY) STO(RE) INT(ELHEX) addr-range filename

See Also

"To copy target system memory into emulation memory" in the "Displaying and Editing Memory" section of the "Debugging Programs" chapter.

Utilities→Load... (ALT, -, U, L)

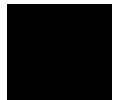

Register Window Commands

This section describes the following command:

- Copy→Registers (ALT, -, P, R)

Copy→Registers (ALT, -, P, R)

Copies the current Register window contents to the destination file specified with the File→Copy Destination... (ALT, F, P) command.

Command File Command

COPY REGISTER

Register Bit Fields Dialog Box

When a register has bit fields, a dialog will pop up and the register value may be edited by changing the whole value or by editing individual bit fields.

Description	Value	Bit(s)
Trace Enable	<input type="checkbox"/>	15-14
Supervisor/User State	<input checked="" type="checkbox"/>	13
Master/Interrupt State	<input type="checkbox"/>	12
<Reserved>	<input type="checkbox"/>	11
Interrupt Mask	<input type="checkbox"/>	10-8
<Reserved>	<input type="checkbox"/>	7-5
Extend	<input type="checkbox"/>	4
Negative	<input type="checkbox"/>	3

When editing in the dialog box, a carriage return is the same as choosing the OK button. To end an edit of a field within the dialog box without quitting, use the Tab key.

The description below a bit field name tells you what has been selected. This description changes when you change the contents of the bit field.

Edited Value Shows the register value that corresponds to the selections made below. You can also change the register's value by modifying the value in this text box.

Chapter 9: Window Control Menu Commands
Register Window Commands

Original Value	Shows the value of the register when the dialog box was opened. If the register could not be read, 'XXXXXXXX' is displayed.
OK	Modifies the register as specified, and closes the dialog box.
Cancel	Closes the dialog box without modifying the register.

Source Window Commands

This section describes the following commands:

- Display→Mixed Mode (ALT, -, D, M)
- Display→Source Only (ALT, -, D, S)
- Display→Select Source... (ALT, -, D, L)
- Search→String... (ALT, -, R, S)
- Search→Function... (ALT, -, R, F)
- Search→Address... (ALT, -, R, A)
- Search→Current PC (ALT, -, R, C)

Display→Mixed Mode (ALT, -, D, M)

Chooses the source/mnemonic mixed display mode.

Command File Command

MOD (E) MNE (MONIC) ON

See Also

"To display source code mixed with assembly instructions" in the "Loading and Displaying Programs" section of the "Debugging Programs" chapter.



Display→Source Only (ALT, -, D, S)

Chooses the source only display mode.

Command File Command

MOD(E) MNE(MONIC) OFF

See Also

"To display source code only" in the "Loading and Displaying Programs" section of the "Debugging Programs" chapter.

Display→Select Source... (ALT, -, D, L)

Displays the contents of the specified C source file in the Source window.

This command is disabled before the object file is loaded or when no source is available for the loaded object file.

Select Source Dialog Box

Choosing the Display→Select Source... (ALT, -, D, L) command opens the following dialog box:

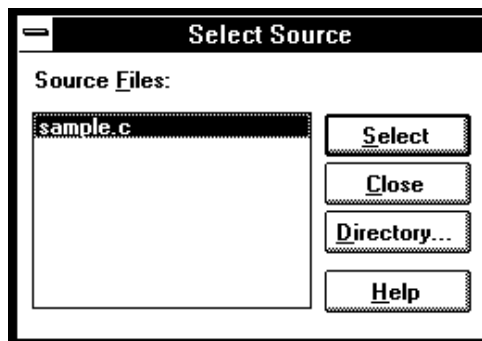

Source Files	Lists C source files associated with the loaded object file. You can select the source file to be displayed from this list.
Select	Switches the Source window contents to the selected source file.
Close	Closes the dialog box.
Directory	Opens the Search Directories Dialog Box from which you can add directories to the search path.

Command File Command

FIL(E) SOU(RCE) module_name

See Also

"To display source files by their names" in the "Loading and Displaying Programs" section of the "Debugging Programs" chapter.

Search→String... (ALT, -, R, S)

Searches for, and displays, a string in the Source window.

The search starts from the current cursor position in the Source window, may be either forward or backward, and may be case sensitive.

The string can be selected from another window (in other words, copied to the clipboard) before choosing the command; it will automatically appear in the dialog box that is opened.

Search String Dialog Box

Choosing the Search→String... (ALT, -, R, S) command opens the following dialog box:

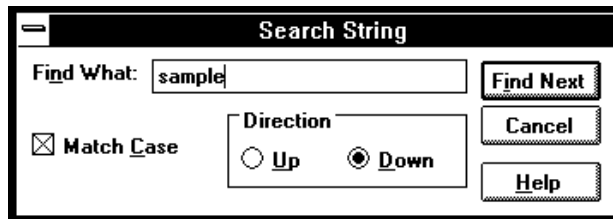

- | | |
|------------|---|
| Find What | Lets you enter the string. |
| Match Case | Selects or deselects case matching. |
| Up | Specifies that the search be from the current cursor position backward. |
| Down | Specifies that the search be from the current cursor position forward. |

Find Next Searches for the string.

Close Closes the dialog box.

Command File Command

`SEA(RCH) STR(ING) FOR/BACK ON/OFF strings`
Searches the specified string in the specified direction with the case matching option ON or OFF.

See Also

"To search for strings in the source files" in the "Loading and Displaying Programs" section of the "Debugging Programs" chapter.

Search→Function... (ALT, -, R, F)

Searches for, and displays, a function in the Source window.

The object file and symbols must be loaded before you can choose this command.

Note

This command displays the source file based on the function information in the object file. Depending on the structure of the function, the command may fail in displaying the declaration of the function.



Search Function Dialog Box

Choosing the Search→Function... (ALT, -, R, F) command opens the following dialog box:

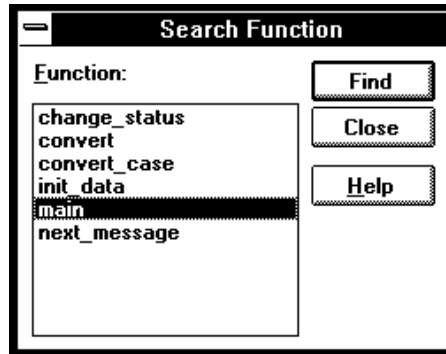

Function Lets you select the function to search for.

Find Searches the specified function.

Close Closes the dialog box.

Command File Command

SEA(RCH) FUNC(TION) func_name

See Also

"To search for function names in the source files" in the "Loading and Displaying Programs" section of the "Debugging Programs" chapter.

Search→Address... (ALT, -, R, A)

Searches for, and displays, an address in the Source window.

Address expressions such as function names or symbols can be selected from another window (in other words, copied to the clipboard) before choosing the command; the contents of the clipboard will automatically appear in the dialog box that is opened.

Search Address Dialog Box

Choosing the Search→Address... (ALT, -, R, A) command opens the following dialog box:

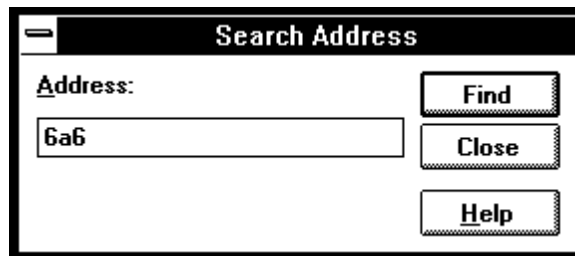

- | | |
|---------|---|
| Address | Lets you enter the address to search for. |
| Find | Searches for the specified address. |
| Close | Closes the dialog box. |

Command File Command

`CUR(SOR) address`

When used before the COME command, this command can be used to run to a particular address.

See Also

"To search for addresses in the source files" in the "Loading and Displaying Programs" section of the "Debugging Programs" chapter.

Search→Current PC (ALT, -, R, C)

Searches for, and displays, the location of the current program counter in the Source window.

Command File Command

`CUR(SOR) PC`

This command can be used to show the current PC in the Source window.

Search Directories Dialog Box

Choosing the Directories... button in the Select Source dialog box opens the following dialog box:

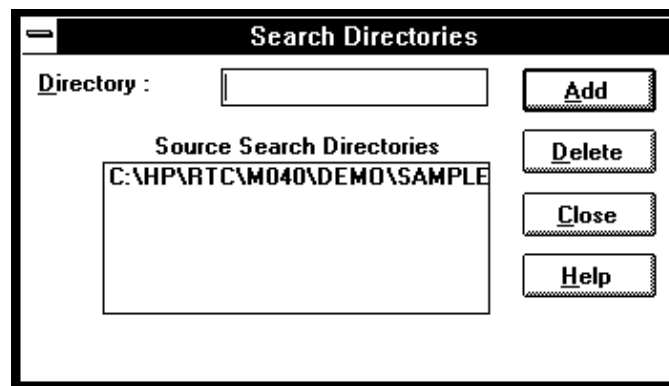

Directory Lets you enter the directory to be added to the source file search path.

Search Source Directories Lists the directories in the source file search path.

Add Adds the directory entered in the Directory text box to the source file search path.

Delete Deletes the directory in the Directory text box from the source file search path.

Close Closes the dialog box.

See Also

"To specify source file directories" in the "Loading and Displaying Programs" section of the "Debugging Programs" chapter.

Symbol Window Commands

This section describes the following commands:

- Display→Modules (ALT, -, D, M)
- Display→Functions (ALT, -, D, F)
- Display→Externals (ALT, -, D, E)
- Display→Locals... (ALT, -, D, L)
- Display→Asm Globals (ALT, -, D, G)
- Display→Asm Locals... (ALT, -, D, A)
- Display→User defined (ALT, -, D, U)
- Copy→Window (ALT, -, P, W)
- Copy→All (ALT, -, P, A)
- FindString→String... (ALT, -, D, M)
- User defined→Add... (ALT, -, U, A)
- User defined→Delete (ALT, -, U, D)
- User defined→Delete All (ALT, -, U, L)

Display→Modules (ALT, -, D, M)

Displays the symbolic module information from the loaded object file.

Command File Command

`SYM(BOL) LIS(T) MOD(ULE)`

See Also

"To display program module information" in the "Displaying Symbol Information" section of the "Debugging Programs" chapter.

Display→Functions (ALT, -, D, F)

Displays the symbolic function information from the loaded object file.

The Symbol window displays the name, type and address range for C functions.

Command File Command

`SYM(BOL) LIS(T) FUN(CTION)`

See Also

"To display function information" in the "Displaying Symbol Information" section of the "Debugging Programs" chapter.

Display→Externals (ALT, -, D, E)

Displays the global variable information from the loaded object file.

The Symbol window displays the name, type and address for global variables.

Command File Command

`SYM(BOL) LIS(T) EXT(ERNAL)`

See Also

"To display external symbol information" in the "Displaying Symbol Information" section of the "Debugging Programs" chapter.

Display→Locals... (ALT, -, D, L)

Displays the local variable information on the specified function.

The function name can be selected from another window (in other words, copied to the clipboard) before choosing the command; the clipboard contents automatically appear in the dialog box that is opened.

The Symbol window displays the name, type and offset from the frame pointer for the local variables for the specified function.

Local Symbol Dialog Box

Choosing the Display→Locals... (ALT, -, D, L) command opens the following dialog box:

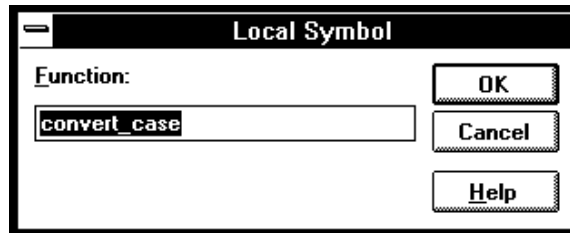

- | | |
|----------|---|
| Function | Selects the function for which the local variable information is displayed. |
| OK | Executes the command and closes the dialog box. |
| Cancel | Cancels the command and closes the dialog box. |

Command File Command

```
SYM(BOL) LIS(T) INT(ERNAL) function
```

See Also

"To display local symbol information" in the "Displaying Symbol Information" section of the "Debugging Programs" chapter.

Display→Asm Globals (ALT, -, D, G)

Displays the global Assembler symbol information from the loaded object file.

The Symbol window displays the name and address for the global assembler symbols.

Command File Command

SYM(BOL) LIS(T) GLO(BALS)

See Also

"To display global assembler symbol information" in the "Displaying Symbol Information" section of the "Debugging Programs" chapter.

Display→Asm Locals... (ALT, -, D, A)

Displays the local symbol information from the specified module.

The module name can be selected from another window (in other words, copied to the clipboard) before choosing the command; the clipboard contents automatically appear in the dialog box that is opened.

The Symbol window displays the name and address for the local symbols for the specified module.

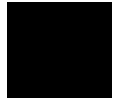

Assembler Symbol Dialog Box

Choosing the Display→Asm Locals... (ALT, -, D, A) command opens the following dialog box:

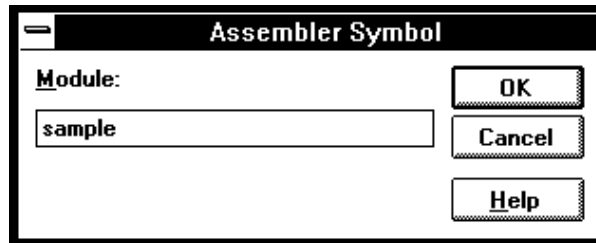

- | | |
|--------|---|
| Module | Selects the module for which the local symbols are displayed. |
| OK | Executes the command and closes the dialog box. |
| Cancel | Cancels the command and closes the dialog box. |

Command File Command

`SYM(BOL) LIS(T) LOC(AL) module`

See Also

"To display local assembler symbol information" in the "Displaying Symbol Information" section of the "Debugging Programs" chapter.

Display→User defined (ALT, -, D, U)

Displays the user-defined symbol information.

The Symbol window displays the name and address for the user-defined symbols.

The User defined→Add... (ALT, -, D, U) command adds the user-defined symbols.

Command File Command

`SYM(BOL) LIS(T) USE(R)`

See Also

"To display user-defined symbol information" in the "Displaying Symbol Information" section of the "Debugging Programs" chapter.

Copy→Window (ALT, -, P, W)

Copies the information currently displayed in the Symbol window to the specified listing file.

The listing file is specified with the File→Copy Destination... (ALT, F, P) command.

Command File Command

`SYM(BOL) COP(Y) DIS(PLAY)`

See Also

"To copy window contents to the list file" in the "Working with Debugger Windows" section of the "Using the Debugger Interface" chapter.

Copy→All (ALT, -, P, A)

Copies all the symbol information to the specified listing file.

The listing file is specified with the File→Copy Destination... (ALT, F, P) command.

Command File Command

SYM(BOL) COP(Y) ALL

FindString→String... (ALT, -, F, S)

Displays the symbols that contain the specified string.

This command performs a case-sensitive search.

Symbol Matches Dialog Box

Choosing the FindString→String... (ALT, -, F, S) command opens the following dialog box:

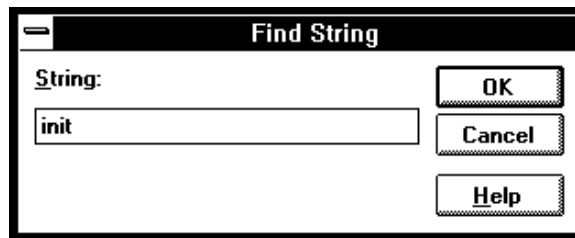

- | | |
|--------|---|
| String | Specifies the string. |
| OK | Executes the command and closes the dialog box. |
| Cancel | Cancels the command and closes the dialog box. |

Command File Command

`SYM(BOL) MAT(CH) string`

See Also

"To display the symbols containing the specified string" in the "Displaying Symbol Information" section of the "Debugging Programs" chapter.

User defined→Add... (ALT, -, U, A)

Adds the specified user-defined symbol.

User-defined symbols may be used in debugger commands just like other program symbols.

The symbol name must satisfy the following requirements:

- The name must begin with an alphabetical, _ (underscore), or ? character.
- The following characters must be any of alphanumerical, _ (underscore), or ? characters.
- The maximum number of characters is 256.

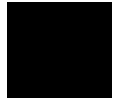

User defined Symbol Dialog Box

Choosing the User defined→Add... (ALT, -, U, A) command opens the following dialog box:

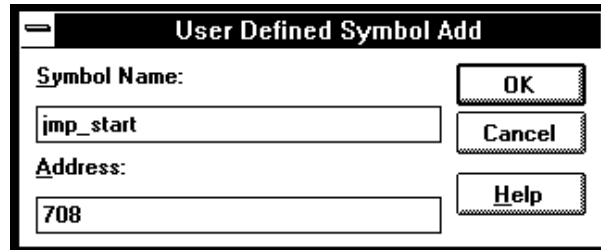

Symbol Name Specifies the symbol to be added.

Address Specifies the address of the symbol.

OK Executes the command and closes the dialog box.

Cancel Cancels the command and closes the dialog box.

Command File Command

```
SYM(BOL) ADD symbol_nam address
```

See Also

"To create a user-defined symbol" in the "Displaying Symbol Information" section of the "Debugging Programs" chapter.

User defined→Delete (ALT, -, U, D)

Deletes the specified user-defined symbol.

This command deletes the user-defined symbol selected in the Symbol window.

Command File Command

```
SYM(BOL) DEL(ETE) symbol_nam
```

See Also

"To delete a user-defined symbol" in the "Displaying Symbol Information" section of the "Debugging Programs" chapter.

User defined→Delete All (ALT, -, U, L)

Deletes all the user-defined symbols.

Command File Command

```
SYM(BOL) DEL(ETE) ALL
```

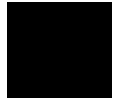

Trace Window Commands

This section describes the following commands:

- Display→Mixed Mode (ALT, -, D, M)
- Display→Source Only (ALT, -, D, S)
- Display→Bus Cycle Only (ALT, -, D, C)
- Display→Count→Absolute (ALT, -, D, C, A)
- Display→Count→Relative (ALT, -, D, C, R)
- Display→From State... (ALT, -, D, F)
- Display→Options→Dequeue ON (ALT, -, D, C, R)
- Display→Options→Dequeue OFF (ALT, -, D, C, F)
- Copy→Window (ALT, -, P, W)
- Copy→All (ALT, -, P, A)
- Search→Trigger (ALT, -, R, T)
- Search→State... (ALT, -, R, S)
- Trace Spec Copy→Specification (ALT, -, T, S)
- Trace Spec Copy→Destination... (ALT, -, T, D)

Display→Mixed Mode (ALT, -, D, M)

Chooses the source/mnemonic mixed display mode.

Command File Command

TRA(CE) DIS(PLAY) MIX(ED)

See Also

"To display source code mixed with assembly instructions" in the "Loading and Displaying Programs" section of the "Debugging Programs" chapter.

Display→Source Only (ALT, -, D, S)

Selects the source only display mode.

Command File Command

TRA(CE) DIS(PLAY) SOU(RCE)

See Also

"To display bus cycles" in the "Tracing Program Execution" section of the "Debugging Programs" chapter.

Display→Bus Cycle Only (ALT, -, D, C)

Selects the bus cycle only display mode.

Command File Command

TRA(CE) DIS(PLAY) BUS

See Also

"To display bus cycles" in the "Tracing Program Execution" section of the "Debugging Programs" chapter.

Display→Count→Absolute (ALT, -, D, C, A)

Selects the absolute mode (the total time elapsed since the trigger) for count information.

Command File Command

TRA(CE) DIS(PLAY) ABS(OLUTE)

See Also

"To display absolute or relative counts" in the "Tracing Program Execution" section of the "Debugging Programs" chapter.

Display→Count→Relative (ALT, -, D, C, R)

Selects the relative mode (the time interval between the current and previous cycle) for count information.

Command File Command

TRA(CE) DIS(PLAY) REL(ATIVE)

See Also

"To display absolute or relative counts" in the "Tracing Program Execution" section of the "Debugging Programs" chapter.

Display→From State... (ALT, -, D, F)

Changes disassembly of bus cycle data in the Trace window.

Bus cycle data in the Trace window is always disassembled. However, because assumptions are made about where instructions start in the captured data, the disassembly may not always be correct. If you see disassembled information that does not look correct, you can use this command to change where the disassembly starts from.

Trace Disassemble From Dialog Box

Choosing the Display→From State... (ALT, -, D, F) command opens the following dialog box:

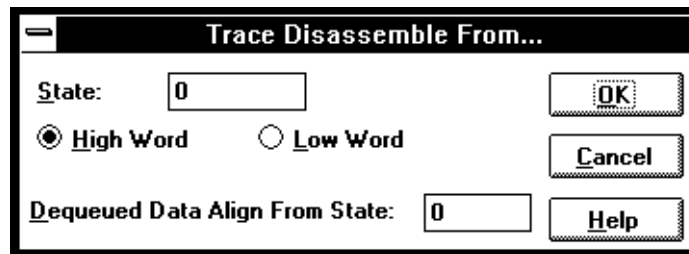

State	Enter the number of the state to start disassembly from. Select the Low Word option when you want to start disassembly from the low 16 bits of the 32 bits of captured data.
Dequeued Data Align From State	When trace data is being dequeued (in other words, when captured states are shuffled so that operand cycles appear with the instruction cycles that cause them), this box lets you enter the number of the operand cycle state that is caused by the instruction cycle state you are disassembling from.
OK	Disassembles and displays the trace data, and closes the dialog box.
Cancel	Cancels the command and closes the dialog box.

Command File Command

MOD(E) TRA(CE) DIS(PLAY) FRO(M) state-num
Specifies the state you want to disassemble from.

MOD(E) TRA(CE) DIS(PLAY) HIG(WORD)/LOW(WORD)
Specifies whether disassembly should start from the high or low 16-bits of the 32-bits of captured data.

MOD(E) TRA(CE) DIS(PLAY) ALI(GN) state-num
When trace data is being dequeued, this command specifies the first operand cycle state associated with the instruction cycle state you are disassembling from.

See Also

"To change the disassembly of bus cycle data" in the "Tracing Program Execution" section of the "Debugging Programs" chapter.

Display→Options→Dequeue ON (ALT, -, D, O, O)

Dequeues bus cycle data in the Trace window.

This command shuffles bus cycle states in the Trace window so that operand cycles immediately follow the instruction cycles that caused them. And, unexecuted instructions are removed from the display.

When dequeuing bus cycle data, ?TAKEN? may appear in disassembled branch instructions when the dequeuer is not able to determine whether the branch was taken. If, later in the trace list, you see the branch was taken, you may need to restart disassembly at the state that contains the branch destination (by using the Display→From State... (ALT, -, D, F) command in the Trace window's control menu).

Command File Command

```
MOD(E) TRA(CE) DIS(PLAY) DEQ(UEUE)
```

See Also

"To display dequeued trace data" in the "Tracing Program Execution" section of the "Debugging Programs" chapter.

Display→Options→Dequeue OFF (ALT, -, D, O, F)

Turns OFF dequeuing of bus cycle data in the Trace window.

Command File Command

```
MOD(E) TRA(CE) DIS(PLAY) NOD(EQUEUE)
```

See Also

"To display dequeued trace data" in the "Tracing Program Execution" section of the "Debugging Programs" chapter.

Copy→Window (ALT, -, P, W)

Copies the information currently in the Trace window to the specified listing file.

The listing file is specified with the File→Copy Destination... (ALT, F, P) command.

Command File Command

```
TRA(CE) COP(Y) DIS(PLAY)
```

See Also

"To copy window contents to the list file" in the "Working with Debugger Windows" section of the "Using the Debugger Interface" chapter.

Copy→All (ALT, -, P, A)

Copies all the trace information to the specified listing file.

The listing file is specified with the File→Copy Destination... (ALT, F, P) command.

Command File Command

```
TRA(CE) COP(Y) ALL
```

Search→Trigger (ALT, -, R, T)

Positions the trigger state at the top of the Trace window.

Command File Command

TRA(CE) FIN(D) TRI(GGER)

Search→State... (ALT, -, R, S)

Positions the specified state at the top of the Trace window.

Search Trace State Dialog Box

Choosing the Search→State... (ALT, -, R, S) command opens the following dialog box:

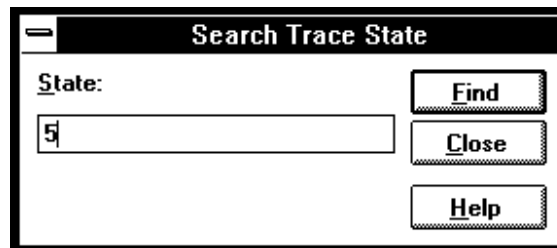

State Lets you enter the trace state number to search for.

Find Searches for the specified trace state.

Close Closes the dialog box.

Command File Command

TRA(CE) FIN(D) STA(TE) state_num

Trace Spec Copy→Specification (ALT, -, T, S)

Copies the current trace specification to the listing file.

Command File Command

TRA(CE) COP(Y) SPE(C)

Trace Spec Copy→Destination... (ALT, -, T, D)

Names the listing file to which debugger information may be copied.

This command opens a file selection dialog box from which you can select the listing file. Listing files have the extension ".LST".

Command File Command

COP(Y) TO filename

WatchPoint Window Commands

This section describes the following command:

- Edit...

Edit... (ALT, -, E)

Registers or deletes watchpoints.

Variables can be selected from another window (in other words, copied to the clipboard) before choosing the Edit... (ALT, -, E) command from the WatchPoint window's control menu, and they will automatically appear in the dialog box that is opened.

Dynamic variables can be registered and displayed in the WatchPoint window when the current program counter is in the function in which the variable is declared. If the current program counter is not in the function, the variable name is invalid and results in an error.

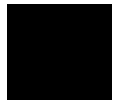

WatchPoint Dialog Box

Choosing the Edit... (ALT, -, E) command from the WatchPoint window's control menu opens the following dialog box:

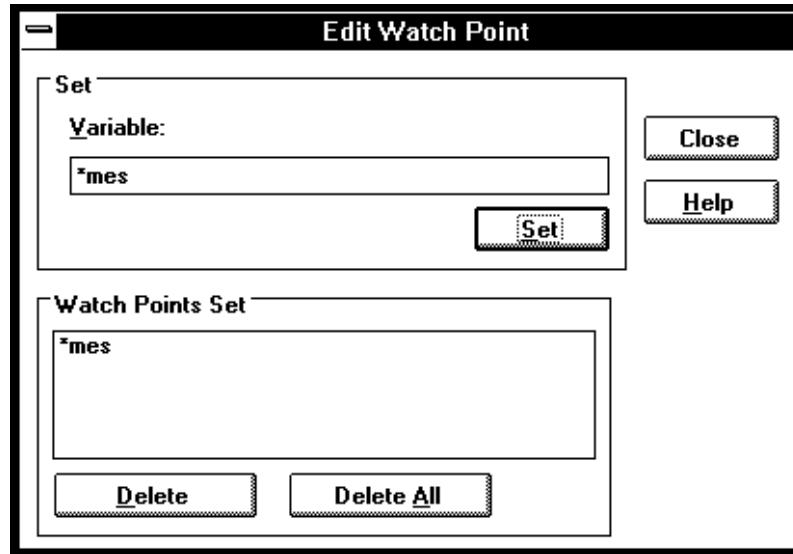

Variable	Lets you enter the name of the variable to be registered as a watchpoint. The contents of the clipboard, usually a variable selected from another window, automatically appears in this text box.
Watch Points Set	Lists the current watchpoints and allows you to select the watchpoint to be deleted.
Set	Copies the specified variable to the WatchPoint window.
Delete	Deletes the variable selected in the Watch Points Set box.
Delete All	Deletes all the watchpoints.
Close	Closes the dialog box.

Command File Command

`WP SET address`

Registers the specified address as a watchpoint.

`WP DEL(ETE) address`

Deletes the specified watchpoint.

`WP DEL(ETE) ALL`

Deletes all the current watchpoints.

See Also

"To monitor a variable in the WatchPoint window" in the "Displaying and Editing Variables" section of the "Debugging Programs" chapter.

"Symbols" in the "Expressions in Commands" chapter.





Window Pop-Up Commands

Window Pop-Up Commands

This chapter describes the commands that can be chosen from the pop-up menus in debugger windows. Pop-Up menus are accessed by clicking the right mouse button in the window.

- BackTrace Window Pop-Up Commands
- Source Window Pop-Up Commands

BackTrace Window Pop-Up Commands

- Source at Stack Level

Source at Stack Level

For the cursor-selected function in the BackTrace window, this command displays the function call in the Source window.



Source Window Pop-Up Commands

- Set Breakpoint
 - Clear Breakpoint
 - Evaluate It
 - Add to Watch
 - Run to Cursor
-

Set Breakpoint

Sets a breakpoint on the line containing the cursor. Refer to the Breakpoint→Set at Cursor (ALT, B, S) command.

Clear Breakpoint

Deletes the breakpoint on the line containing the cursor. Refer to the Breakpoint→Delete at Cursor (ALT, B, D) command.

Evaluate It

Evaluates the clipboard contents and places the result in the Expression window. Refer to the Evaluate... (ALT, -, E) command available from the Expression window's control menu.

Add to Watch

Adds the selected variable (that is, the variable copied to the clipboard) to the WatchPoint window. Refer to the Variable→Edit... (ALT, V, E) command.

Run to Cursor

Executes the program up to the Source window line containing the cursor. Refer to the Execution→Run to Cursor (ALT, R C) command.



Other Command File and Macro
Commands

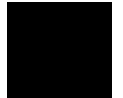

Other Command File and Macro Commands

This chapter describes the commands that are only available in command files, break macros, or buttons.

- BEEP
- EXIT
- FILE CHAINCMD
- FILE RERUN
- NOP
- TERMCOM
- WAIT

BEEP

Sounds beep during command file or break macro execution.

Command File Command

BEEP

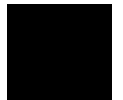

EXIT

Exits, or conditionally exits, command file execution.

Command File Command

EXIT

Exits command file execution.

EXIT VAR(IABLE) address value

Exits command file execution if the variable contains the value.

EXIT REG(ISTER) regname value

Exits command file execution if the register contains the value.

EXIT MEM(ORY) BYTE/WORD/LONG address value

Exits command file execution if the memory location contains the value.

EXIT IO BYTE/WORD address value

Exits command file execution if the I/O location contains the value.

FILE CHAINCMD

Chains command file execution.

This command lets you run one command file from another nonrecursively; in other words, control is not returned to the original command file.

By contrast, the `FILE COMMAND` command is recursive; if you use the `FILE COMMAND` command to run one command file from another, control will be returned to the original command file. `FILE COMMAND` commands can be nested four levels deep.

Command File Command

```
FILE CHAINCMD filename
```

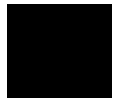

FILE RERUN

Starts command file execution over again.

This command is useful for looping stimulus files or running a demo or other command file continuously.

Command File Command

`FILE RERUN`

NOP

No operation.

This command may be used to prefix comment lines in command files.

Command File Command

NOP

NOP comments

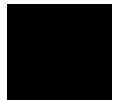

TERMCOM

Sends Terminal Interface commands to the HP 64700.

The HP 64700 Card Cage contains a low-level Terminal Interface, which allows you to control the emulator's functions directly. You can use the TERMCOM command to bypass the RTC Interface and send commands directly to the low-level Terminal Interface.

There is no window in the RTC Interface where you can execute TERMCOM commands directly. The only way to execute them with the RTC Interface is to make them part of a command file and then run the command file from an RTC Interface window.

You may need to start a unique target system that requires emulator intervention that is only available through the Terminal Interface. You can create the command file and then execute it at the appropriate time using a command such as File→Run Cmd File..., and place the name of your command file in the Run Command File dialog box.

The danger in using Terminal Interface commands via the TERMCOM command is that the RTC Interface may not be updated to know the state of the emulator. Some Terminal Interface commands can be executed by using the TERMCOM command, and the RTC Interface will not know that they were executed. Other Terminal Interface commands can be executed and the RTC Interface will be updated immediately. For example:

- If you have a command in your command file that changes the setting of RealTime→Monitor Intrusion→Disallowed/Allowed, (such as, TERMCOM "cf rrt=en"), the RTC Interface will not know about this change and will continue to try to operate according to the earlier setting. In this case, the RTC Interface may try to update its displays when the emulator is set to deny monitor access to the registers and memory.
- If you have a command in your command file that writes a value to memory (such as, TERMCOM "00000..00fff=0"), the Memory window will be updated immediately to show the new value, assuming you have chosen RealTime→Monitor Intrusion→Allowed.

Do not use the following Terminal Interface commands with the RTC
TERMCOM command:

- **stty, po, xp:** These commands will change the operation of the communications channel, and are likely to hang the RTC Interface.
- **echo, mac:** These commands may confuse the communications protocols in use in the channel.
- **wait:** The pod will enter a wait state, blocking access by the RTC Interface.
- **init, pv:** These will reset the emulator and end your session.
- **t:** This will confuse the functions of trace status polling and unload.

Refer to your "Terminal Interface User's Guide" for more information about Terminal Interface commands.

Command File Command

```
TERMCOM "ti-command"
```

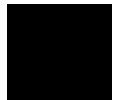

WAIT

Inserts wait delays during command file execution.

Command File Command

WAI (T) MON (I TOR)
Waits until MONITOR status.

WAI (T) RUN
Waits until RUN status.

WAI (T) UNK (NOWN)
Waits until UNKNOWN status.

WAI (T) SLO (W)
Waits until SLOW CLOCK status.

WAI (T) TGT (RESET)
Waits until TARGET RESET status.

WAI (T) SLE (EP)
Waits until SLEEP status.

WAI (T) GRA (NT)
Waits until BUS GRANT status

WAI (T) NOB (US)
Waits until NOBUS status.

WAI (T) TCO (M)
Waits until the trace is complete.

WAI (T) THA (LT)
Wait until the trace is halted.

WAI (T) TIM (E) *seconds*
Waits for a number of seconds.

12

Error Messages



Error Messages

This chapter helps you find details about the following error messages:

- Bad RS-232 port name
- Bad RS-422 card I/O address
- Could not open initialization file
- Could not write Memory
- Error occurred while processing Object file
- General RS-232 communications error
- General RS-422 communications error
- HP 64700 locked by another user
- HP 64700 not responding
- Incorrect DLL version
- Incorrect LAN Address (HP-ARPA, Windows for Workgroups)
- Incorrect LAN Address (Novell)
- Incorrect LAN Address (WINSOCK)
- Internal error in communications driver
- Internal error in Windows
- Interrupt execution (during run to caller)
- Interrupt execution (during step)
- Interrupt execution (during step over)
- Invalid transport name
- LAN buffer pool exhausted
- LAN communications error
- LAN MAXSENDSIZE is too small
- LAN Socket error
- Object file format ERROR
- Out of DOS Memory for LAN buffer
- Out of Windows timer resources
- PC is out of RAM memory
- Timed out during communications

Bad RS-232 port name

RS-232 port names must be of the form "COM<number>" where <number> is a decimal number from 1 to the number of communications ports within your PC.

Bad RS-422 card I/O address

The RS-422 card's I/O address must be a hexadecimal number from 100H through 3F8H whose last digit is 0 or 8 (example 100, 108, 110). Select an I/O address that does not conflict with the other cards in your PC.

Could not open initialization file

The initialization file was not found in the same directory where the executable file was found.

For example, if the application file is b3629.EXE, the initialization file b3629.INI is expected to be found in the same directory.

To fix this problem, you may be able to find the initialization file and move it to the same directory as the executable file, or you can create a new initialization file from the default initialization file. For example:

```
COPY b3629DEF.INI Bxxxx.INI
```

Note that the above command is the DOS COPY command. Do not use the ksh 'cp b3629DEF.INI Bxxxx.INI' command. Use only the DOS 'COPY b3629DEF.INI b3629.INI' command.

If you cannot find the default initialization file either, you can re-install the debugger software.

For correct operation, make certain the b3629.INI file has both read and write permission.

Could not write Memory

You may see this error message when trying to load a file or perform any other task that requires use of the monitor. The emulation monitor is used to load files, which requires writing to memory. If you have chosen RealTime→Monitor Intrusion→Disallowed the monitor will not be usable, and Execution→Reset may prevent use of the monitor in some emulators.

Choose RealTime→Monitor Intrusion→Allowed, and Execution→Break to ensure that the emulation monitor is running. The Status window should show Emulator: RUNNING IN MONITOR.

With this setup, the emulator should be able to write to Memory.

If you are still unable to load a file, select "Symbols Only" in the Load Object File dialog box and try to load the file. If Symbols Only will not load, the problem is in your symbols.

Choose "Data Only" in the Load Object File dialog box and try to load the file. If the symbols loaded, but the data fails to load, the problem is in your program code.

Call your local HP representative.

Error occurred while processing Object file

The following is a list of typical reasons why an error might occur while processing an object file. There are many other possible reasons.

- Bad record in the object file.
- File is in wrong format.
- File does not follow OMF Specifications correctly.
- No memory mapped.
- Attempt to write to guarded memory.
- Emulator restricted to real-time runs. Enter the command, "RealTime→Monitor Intrusion→Allowed".
- Emulator not executing the monitor. Enter the command, "Execution→Break".

Another message often occurs along with this message. View the help information for the other message, if available.

Call your local HP representative.

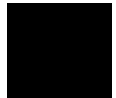

General RS-232 communications error

In general, these messages indicate that the RS-232 communication has intermittent errors. Sometimes you will get this message if you power on the emulator, or when you try to connect to the emulator. In that case, simply retry the connection (by double-clicking on the RS232C driver line in the selection box); if you connect with no problems the second time, you can ignore the original message.

If you get this message other than during connection, you can try to fix the problem by:

- Reducing the length of the RS-232 cable between the PC and the HP 64700.
- Reducing the number of tasks running under Windows.
- Reducing the baud rate (the default is 19200).

For further information, refer to the paragraph titled, "If you have RS-232 connection problems" in the Communications Help screen, or in Chapter 15, "Installing the Debugger" in the Real-Time C Debugger User's Guide.

General RS-422 communications error

In general, these messages indicate that the RS-422 communication has intermittent errors. Sometimes you will get this message if you power on the emulator, or when you try to connect to the emulator. In that case, simply retry the connection (by double-clicking on the HP-RS422 driver line in the selection box); if you connect with no problems the second time, you can ignore the original message.

If you get this message other than during connection, you can try to fix the problem by:

- Reducing the number of tasks running under Windows.
- Reducing the baud rate (the default is 230400).

HP 64700 locked by another user

Because it is possible to destroy another user's measurement by choosing the Unlock button in the error dialog box, check with the other user before unlocking the HP 64700.

Note that if the other user is actually using an interface to the HP 64700, an Unlock request will fail.

HP 64700 not responding

The HP 64700 has not responded within the timeout period. There are several possible causes of this error. For example, a character could have dropped during RS-232 communications, or some network problem could have disrupted communications.

Usually, you must cycle power to the HP 64700 to fix this problem.

See also: The description for the error message titled, "Timed out during communications."

Incorrect DLL version

The version of the dynamic link libraries (.DLLs) used by the Real-Time C Debugger does not match the version of the main program (.EXE).

If you have two versions of the debugger on your system, you may see this message when you try to execute both of them at the same time, or when you execute one version and then the other without restarting Windows. Once DLLs have been loaded into Windows memory, they stay there until you exit Windows. Therefore, exit windows, restart windows, and try again.

This message will also appear if you have somehow loaded a version of the DLLs that is different from the version of the executable. In this case, you must reload your software.

Incorrect LAN Address (HP-ARPA, Windows for Workgroups)

A LAN address can be one of two types: an IP address, or a host name.

An IP address consists of four digits separated by dots. Example:

```
15.6.28.0
```

A hostname is a name that is related (mapped) to an IP address by a database. For example, the file \LANMAN.DOS\ETC\HOSTS (HP-ARPA) or \WINDOWS\HOSTS (Windows for Workgroups) may contain entries of the form:

```
system1 15.6.28.0
```

Note

The directory of the "hosts" file may be different on your system.

If "HP Probe" or "DNR" (Domain Name Resolution) is available on your PC, those are consulted first for a mapping between the hostname and the IP address. If the hostname is not found by that method, or if those services are unavailable, the local "hosts" file is consulted for the mapping.

Note that if "Probe" is available on your system but unable to resolve the address, there will be a delay of about 15-seconds while Probe is attempting to find the name on the network.

Incorrect LAN Address (Novell)

A LAN address can be one of two types: an IP address, or a host name.

An IP address consists of four digits separated by dots. Example:

```
15.6.28.0
```

A hostname is a name that is related (mapped) to an IP address by a database. For example, the file \NET\TCP\HOSTS may contain entries of the form:

```
system1 15.6.28.0
```

Note

The directory of the "hosts" file may be different on your system. Also, all files defined by the PATH TCP_CFG setting under "Protocol TCPIP" in the NET.CFG files are searched.

Incorrect LAN Address (WINSOCK)

A LAN address can be one of two types: an IP address, or a host name.

An IP address consists of four digits separated by dots. Example:

```
15.6.28.0
```

A hostname is a name that is related (mapped) to an IP address by a database. For example, the hosts file may contain entries of the form:

```
system1 15.6.28.0
```

Note

Because WINSOCK is a standard interface to many LAN software vendors, you need to read your LAN vendor's documentation before specifying the LAN address.

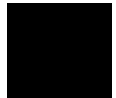

Internal error in communications driver

These types of errors typically occur because other applications have used up a limited amount of some kind of global resource (such as memory or sockets).

You usually have to reboot the PC to free the global resources used by the communications driver.

Internal error in Windows

These types of errors typically occur because other applications have used up a limited supply of some kind of global resource (such as memory, sockets, tasks, or handles).

You usually have to reboot the PC to free the global resources used by Windows.

Interrupt execution (during run to caller)

The Return dialog box appears when running to the caller of a function and the caller is not found within the number of milliseconds specified by StepTimerLen in the .INI file of the debugger application.

You can cancel the run to caller command by choosing the STOP button, which causes program execution to stop, the breakpoint to be deleted, and the processor to transfer to the RUNNING IN USER PROGRAM status.

Interrupt execution (during step)

The Step dialog box appears when stepping a source line or assembly instruction and the source line or instruction does not execute within the number of milliseconds specified by StepTimerLen in the .INI file of the debugger application.

You can cancel the step command by choosing the STOP button, which causes program execution to stop, the breakpoint to be deleted, and the processor to transfer to the RUNNING IN USER PROGRAM status.

Interrupt execution (during step over)

The Step dialog box appears when stepping over a function or subroutine and the function or subroutine does not execute within the number of milliseconds specified by StepTimerLen in the .INI file of the debugger application.

You can cancel the step-over command by choosing the STOP button, which causes program execution to stop, the breakpoint to be deleted, and the processor to transfer to the RUNNING IN USER PROGRAM status.

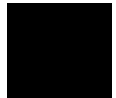

Invalid transport name

The transport name chosen does not match any of the possible transport names (RS232C, HP-ARPA, Novell-WP, WINSOCK1.1, W4WG-TCP, or HP-RS422).

The transport name can be specified either on the command line with the `-t` option or in the `.INI` file:

```
[Port]  
Transport=<transport name>
```

Choosing an appropriate transport in the dialog box that follows this error message will correct the entry in the `.INI` file, but if the error is in the command line option, you must modify the command line (by using the "Properties..." command in the Program Manager).

LAN buffer pool exhausted

The LAN buffer pool is used as a temporary buffer between the time the debugger sends data and the time the LAN actually sends it. When this pool is exhausted, the debugger cannot send any data across the LAN.

The size of the sockets buffer pool is configured in the network installation procedure. The size and number of LAN buffer pools can be changed by editing your network configuration file.

LAN communications error

This message may appear after any kind of LAN error.

Refer to the documentation for your LAN software for descriptions of the types of problems that can cause LAN errors.

LAN MAXSENDSIZE is too small

This message indicates you have configured your LAN with a value or MAXSENDSIZE that is less than 100 bytes. Note that the default is 1024 bytes.

The Real-Time C Debugger requires at least 100 bytes for this parameter.

To fix this, change the following entry in your PROTOCOL.INI file and reboot your PC:

```
[SOCKETS]  
MAXSENDSIZE
```

LAN socket error

A TCP-level error has occurred on the network. See your network administrator.

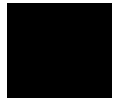

Object file format ERROR

This message is typically caused by one of two conditions:

- Bad format file. Perhaps there is a bad record within the file. If you have a file format verifier, submit your file to it to determine whether or not all records are in the correct format.
- Unknown construct. Perhaps the construct of your file is unfamiliar to the reader.

To respond to this error message, verify the file format, and ensure that the reader can understand the file format in use.

If these steps do not solve the problem, call your local HP representative.

Out of DOS Memory for LAN buffer

This means that there is not enough memory in the lower 1 Mbyte of address space (that is, conventional memory) for the LAN driver to allocate a buffer to communicate with the LAN TSR.

When you are in windows, and execute the DOS command "mem", you cannot see the memory that is in the lower 1 Mbyte that is used by the windows program. If you have the Microsoft program "heapwalker", you can use it to see what programs have allocated space in the address range 0 through FFFFF.

To fix this, you can:

- Reduce the number of TSRs running on your PC (before Windows starts) that use conventional memory.
- Reconfigure your network to have fewer sockets or modules loaded, or to be configured for fewer total connections.
- Use a different memory manager to reduce your network memory usage, such as QEMM.

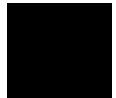

Out of Windows timer resources

The debugger is not able to acquire the timer resources it needs.

There are a limited number of timer resources in Windows. You may be able to free timer resources by closing other applications.

PC is out of RAM memory

The debugger is not able to acquire the memory it needs because other applications are using it, or because of fragmented memory.

You may be able to free memory by closing other applications, or you might have to reboot the PC to cause memory to be unfragmented.

Timed out during communications

The HP 64700 has not responded within the timeout period. There are various causes for this error. For example, a character could have been dropped during RS-232 communications or some network problem could have disrupted communications.

The timeout period for reading and writing to the HP 64700 is defined by TimeoutSeconds in either the [RS232C], [HP-ARPA], [Novell-WP], or [HP-RS422] section of the b3629.INI file. For example, if you are using the RS-232C transport:

```
[RS232C]  
TimeoutSeconds=<seconds>
```

The number of seconds can be between 1 and 32767. The default is 20 seconds.

If you are using RS-232C or RS-422 transport ...

The TimeoutSeconds value is also used for connecting to the HP 64700 (as well as for reading and writing).

If you are using HP-ARPA or Novell-WP transport ...

If there are several gateways or bridges between the PC and the emulator, larger values of TimeoutSeconds may be reasonable.

The timeout period for connecting to the HP 64700 is defined in the PROTOCOL.INI file.

```
[TCP_IP_XFR]  
TCPCONNTIMEOUT=<seconds>
```

The default connection timeout is 30 seconds.

The remainder of this discussion shows you how to overcome the problem of "connection timed out" during large memory fill operations.

The RTC interface sends the memory fill operation to the emulator as a single command. While the command is executing in the emulator, the emulator cannot respond to inquiries from the interface about its status. If the memory fill takes long enough, the connection will time out.

Chapter 12: Error Messages
Timed out during communications

Emulators for some microprocessors take up to one minute per megabyte to perform a memory fill operation. Timeout default values for RTC interfaces shipped from HP are typically 45 seconds.

First Workaround. Modify the TimeoutSeconds field (discussed above) to increase the TimeoutSeconds value. Then exit the interface and restart it (to ensure that the new value of TimeoutSeconds is read). You may experiment with several values of TimeoutSeconds to find the value that allows you to do a memory fill. The problem with this workaround is that all timeouts will take this new longer time, and you may find this annoying when you are not doing memory fill operations.

Second Workaround. Create a command file that contains TERMCOM commands to write to small portions of the overall memory to be filled. For example, suppose the following Memory window command causes the emulator to time out, "Memory→Utilities→Fill→0 to ffff".

You might make a command file named memfill.cmd, and place the following commands in it:

```
TERMCOM "m 0000..00fff=0"  
TERMCOM "m 0100..01fff=0"  
TERMCOM "m 0200..02fff=0"  
TERMCOM "m 0300..03fff=0"  
TERMCOM "m 0400..04fff=0"  
TERMCOM "m 0500..05fff=0"  
TERMCOM "m 0600..06fff=0"  
TERMCOM "m 0700..07fff=0"  
TERMCOM "m 0800..08fff=0"  
TERMCOM "m 0900..09fff=0"  
TERMCOM "m 0a00..0afff=0"  
TERMCOM "m 0b00..0bfff=0"  
TERMCOM "m 0c00..0cfff=0"  
TERMCOM "m 0d00..0dfff=0"  
TERMCOM "m 0e00..0efff=0"  
TERMCOM "m 0f00..0ffff=0"
```

When you choose File→Run Cmd File→... and select your memfill.cmd file, it will not exceed the timeout value. This is because the emulator will be able to respond to inquiries from the interface between execution of each of the TERMCOM commands in your command file.

Part 4

Concept Guide

Topics that explain concepts and apply them to advanced tasks.

Part 4

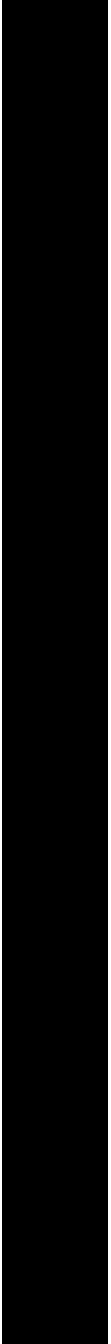

13

Concepts

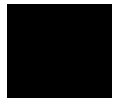

Concepts

This chapter describes the following topics.

- Debugger Windows
- Compiler/Assembler Specifications
- Monitor Programs
- Trace Signals and Predefined Status Values

Debugger Windows

This section describes the following debugger windows:

- BackTrace
- Button
- Expression
- I/O
- Memory
- Register
- Source
- Status
- Symbol
- Trace
- WatchPoint

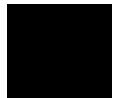

The BackTrace Window

The BackTrace window displays the function associated with the current program counter value and this function's caller functions in backward order. Applicable addresses are prefixed with module\#linenum information. The current arguments of these functions are also displayed.

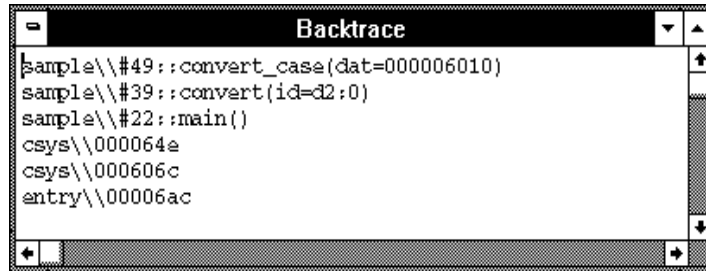

The BackTrace window is updated when program execution stops at an occurrence of breakpoint, break, or Step command.

The BackTrace window lets you copy text strings, to the clipboard by double-clicking words or by holding down the left mouse button and dragging the mouse pointer.

By clicking the right mouse button in the BackTrace window, you can access the Source at Stack Level pop-up menu command. Cursor-select a function in the BackTrace window and choose this command to display (in the Source window) the code that called the function.

See Also

"BackTrace Window Pop-Up Commands" in the "Window Pop-Up Commands" chapter.

The Button Window

The Button window contains user-defined buttons that, when chosen, execute debugger commands or command files.



The Button window's *control menu* provides the Edit... (ALT, -, E) command which lets you add and delete buttons from the window.

See Also

"Using Command Files" in the "Using the Debugger Interface" chapter.

"Button Window Commands" in the "Window Control Menu Commands" chapter.

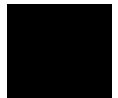

The Expression Window

The Expression window displays the results of the EVALUATE commands in command files or break macros.

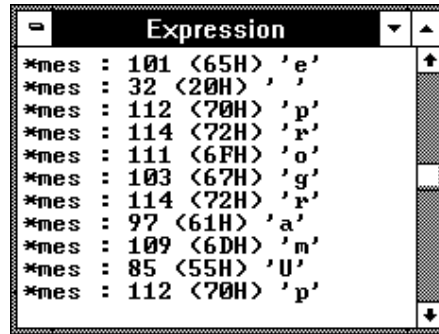

When a variable name is specified with the EVALUATE command, the Expression window displays the evaluation of the variable. When a quoted string of ASCII characters is specified with the EVALUATE command, the Expression window displays the string.

The Expression window's *control menu* provides the Evaluate... (ALT, -, E) command which lets you evaluate expressions and see the results in the window.

See Also

"Expression Window Commands" in the "Window Control Menu Commands" chapter.

The I/O Window

The I/O window displays the contents of the I/O locations.

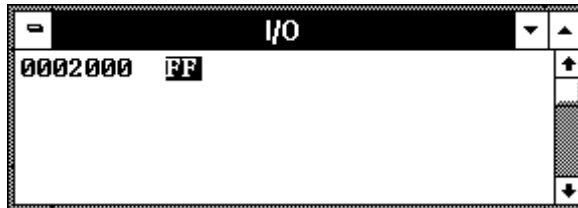

You can modify the contents of I/O locations by double-clicking on the value, using the keyboard to type in the new value, and pressing the Enter key.

The I/O window contents are updated periodically when the processor is running the user program.

If a location is in target system memory, a temporary break from the user program into the monitor program must occur in order for the debugger to update or modify that location's contents. If it's important that the user program execute without these types of interruptions, you should disallow monitor intrusion. Even when monitor intrusion is allowed, you can stop temporary breaks during the window update by turning polling OFF.

See Also

"Displaying and Editing I/O Locations" in the "Debugging Programs" chapter.

"I/O Window Commands" in the "Window Control Menu Commands" chapter.

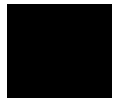

The Memory Window

The Memory window displays memory contents.

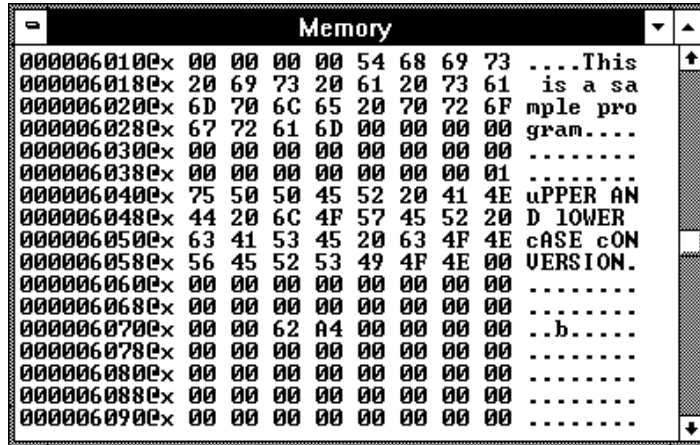

The Memory window has *control menu* commands that let you change the format of the memory display and the size of the locations displayed or modified. When the absolute (single-column) format is chosen, symbols corresponding to addresses are displayed. When data is displayed in byte format, ASCII characters for the byte values are also displayed.

When Memory window polling is turned ON, you can modify the addresses displayed or contents of memory locations by double-clicking on the address or value, using the keyboard to type in the new address or value, and pressing the Enter key.

The Memory window contents are updated periodically when the processor is running the user program.

If a location is in target system memory, a temporary break from the user program into the monitor program must occur in order for the debugger to update or modify that location's contents. If it's important that the user program execute without these types of interruptions, you should disallow monitor intrusion. Even when monitor intrusion is allowed, you can stop temporary breaks during the window update by turning polling OFF.

See Also

"Displaying and Editing Memory" in the "Debugging Programs" chapter.

"Memory Window Commands" in the "Window Control Menu Commands" chapter.

The Register Windows

The Register windows display the contents of registers. There is a separate window for each class of registers. For example, the Basic Registers are in one class of registers.

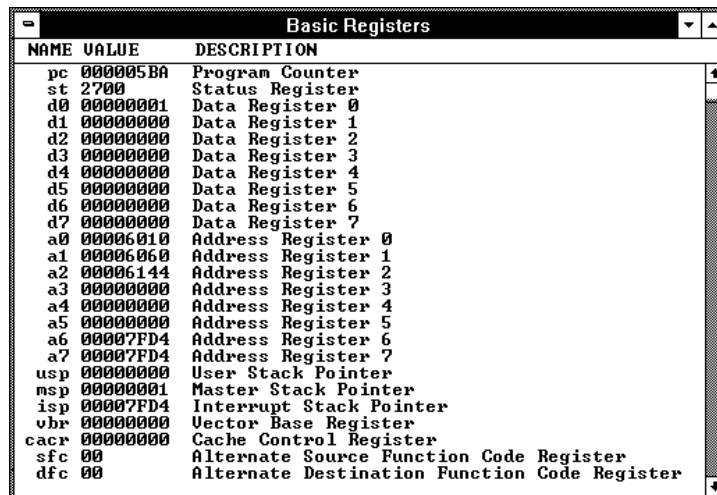

NAME	VALUE	DESCRIPTION
pc	000005BA	Program Counter
st	2700	Status Register
d0	00000001	Data Register 0
d1	00000000	Data Register 1
d2	00000000	Data Register 2
d3	00000000	Data Register 3
d4	00000000	Data Register 4
d5	00000000	Data Register 5
d6	00000000	Data Register 6
d7	00000000	Data Register 7
a0	00006010	Address Register 0
a1	00006060	Address Register 1
a2	00006144	Address Register 2
a3	00000000	Address Register 3
a4	00000000	Address Register 4
a5	00000000	Address Register 5
a6	00007FD4	Address Register 6
a7	00007FD4	Address Register 7
usp	00000000	User Stack Pointer
msp	00000001	Master Stack Pointer
isp	00007FD4	Interrupt Stack Pointer
vbr	00000000	Vector Base Register
cacr	00000000	Cache Control Register
sfc	00	Alternate Source Function Code Register
dfc	00	Alternate Destination Function Code Register

Each register is represented by a row which holds a mnemonic name, a current value, and a description of the register contents.

The registers may be edited by either single clicking or double-clicking on the value. A single click puts you in a mode where the left or right arrow keys may be used for placement of the cursor. Double-clicking puts you in one of two modes; either a Register Bit Fields dialog pops up or the value is highlighted. When the value is highlighted, the backspace key will erase the value and a completely new value may be entered. This mode is applicable to

registers where the value is considered a single number and is not divided by any bit-fields.

The Register windows' contents are updated periodically when the processor is running the user program and monitor intrusion is allowed.

A temporary break from the user program into the monitor program must occur in order for the debugger to update or modify register contents. If it's important that the user program execute without these types of interruptions, you should disallow monitor intrusion.

See Also

"Displaying and Editing Registers" in the "Debugging Programs" chapter.

"Register Window Commands" in the "Window Control Menu Commands" chapter.

The Source Window

The Source window displays source files, optionally with disassembled instructions intermixed.

The Source window contains a cursor whose position is used when setting or deleting breakpoints or break macros or when running the program up to a certain line.

The Source window lets you copy strings, usually variable or function names to be used in commands, to the clipboard by double-clicking words or by holding down the left mouse button and dragging the mouse pointer.

The Source window also provides commands in the *control menu* that let you select whether disassembled instruction mnemonics should appear intermixed with the C source code.

By clicking the right mouse button in the Source window, you can also access pop-up menu commands.

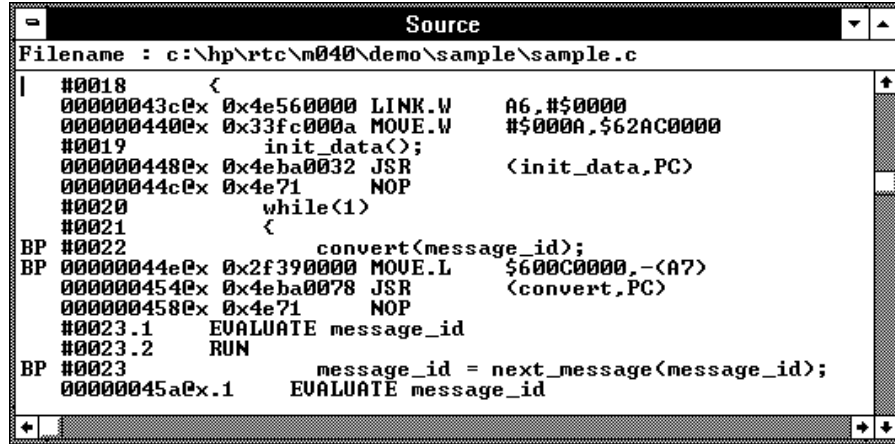

Filename The name of the displayed source file appears at the top of the window.

Source Lines C source code is displayed when available. Source lines are preceded by the corresponding line numbers.

When programs are written in assembly language or when no C source code is available, disassembled instruction mnemonics are displayed.

The interface will only support display in either trace or source windows of source lines numbered less than 32,000.

Disassembled Instructions In the Mnemonic Display mode, disassembled instruction mnemonics are intermixed with the source lines. Disassembled lines contain address, data, and mnemonic information.

When symbolic information is available for the address, the corresponding symbol line precedes the disassembled instruction, displayed in the module_name\symbol_name format.

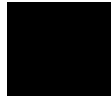

Chapter 13: Concepts
Debugger Windows

Current PC	The line associated with the current program counter is highlighted.
Scroll Bars	For C source files, the display scrolls within the source files. For assembly language programs or programs for which no source code is available, the display scrolls for all the memory space.
"BP" Marker	The breakpoint marker, BP, appears at the beginning of the breakpoint lines or break macro lines.
Break Macro Lines	Decimal points following line numbers or addresses indicate break macro lines.

Note

When programs are stored in target system memory and the emulator is running in real time, source code cannot be displayed.

See Also

"Loading and Displaying Programs,"
"Stepping, Running, and Stopping the Program," and
"Using Breakpoints and Break Macros" in the "Debugging Programs" chapter
"Source Window Commands" in the "Window Control Menu Commands" chapter.
"Source Window Pop-Up Commands" in the "Window Pop-Up Commands" chapter.
"To set colors in the Source window" in the "Working with Debugger Windows" section of the "Using the Debugger Interface" chapter.

The Status Window

The Status window shows:

- Emulator status.
- Trace status.
- Scope of the current program counter value.
- Progress of symbols being loaded from a file.
- Last five asynchronous messages from the emulator.

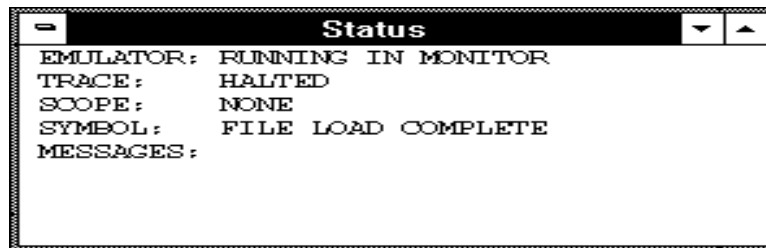

Emulation Processor Status Messages

EMULATION RESET

The emulation processor is being held in the reset state by the emulator.

RUNNING IN MONITOR

The emulation processor is executing the monitor program.

RUNNING IN USER PROGRAM

The emulation processor is executing the user program.

RUNNING REALTIME IN USER PROGRAM

The emulation processor is executing the user program in the real-time mode where:

- Any command that would temporarily interrupt user program execution is disabled.

- Any on-screen information that would be periodically updated by temporarily interrupting user program execution (target system memory or register contents, for example) is disabled.

SLOW CLOCK

No proper clock pulse is supplied from the external clock.

EMULATION RESET BY TARGET

The emulation processor is being held in a reset state by a reset signal from the target system.

BUS GRANT TO TARGET SYSTEM DEVICE

The bus is granted to some device in the target system.

NO BUS CYCLE

The bus cycle is too slow or no bus cycle is provided.

HALTED

The emulation processor has halted.

UNKNOWN STATE

The emulation processor is in an unknown state.

Other Emulator Status Messages

The Status window may also contain status messages other than the emulation processor status messages described above:

BREAK POINT HIT AT module_name#line_number

The breakpoint specified in the source code line was hit and program execution stopped at "line_number" in "module."

BREAKPOINT HIT AT address

The breakpoint specified in the assembled line was hit and program execution stopped at "address."

UNDEFINED BREAKPOINT at address

The breakpoint instruction occurred at "address," but it was not inserted by a breakpoint set command.

WRITE TO ROM BREAK

Program execution has stopped due to a write to location mapped as ROM. These types of breaks must be enabled in the emulator configuration.

ACCESS TO GUARD BREAK

Program execution has stopped due to a write to a location mapped as guarded memory.

TRACE TRIGGER BREAK

The analyzer trigger caused program execution to break into the monitor (as specified by selecting the Break On Trigger option in the trace setting dialog box).

Trace Status Messages

TRACE RUNNING

The trace has been started and trace memory has yet to be filled; this could be because the trigger condition has not occurred or, if the trigger condition has occurred, there have not been enough states matching the store condition to fill trace memory. Contents of the trace buffer cannot be displayed during the TRACE RUNNING status; you must halt the trace before you can display the contents of the trace buffer.

TRACE HALTED

The trace was halted before the trace buffer was filled. The status indicates that the trace was halted immediately after the emulator powerup, or that the trace was force-terminated by the user. In the TRACE HALTED status, the analyzer displays the contents of the trace buffer before the halt in the Trace window.

TRACE COMPLETE

The trace completed because the trace buffer is full. The results are displayed in the Trace window.

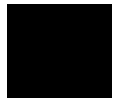

The Symbol Window

The Symbol window displays information on the following types of symbols:

- Modules
- Functions
- Global symbols
- Local symbols
- Global Assembler symbols
- Local Assembler symbols
- User-defined symbols

The Symbol window has *control menu* commands that let you display various types of symbols, add or delete user-defined symbols, copy Symbol window information, or search for symbols that contain a particular string.

The Symbol window lets you copy symbols to the clipboard by clicking the left mouse button. The symbol information can then be pasted from the clipboard in other commands.

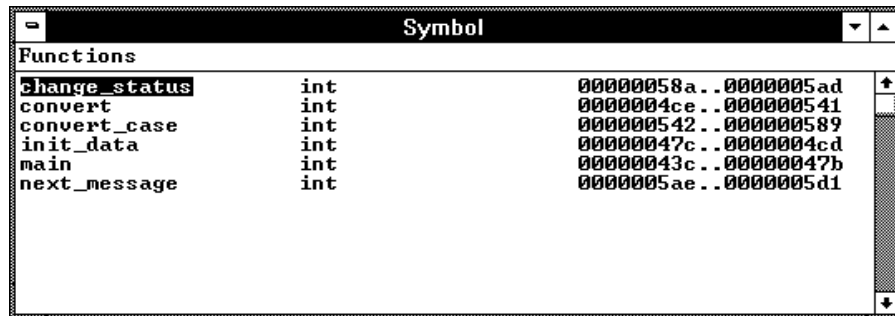

Symbols are displayed with "type" and "address" values where appropriate.

See Also

"Displaying Symbol Information" in the "Debugging Programs" chapter.

"Symbol Window Commands" in the "Window Control Menu Commands" chapter.

The Trace Window (Emulator Only)

The Trace window displays trace results and shows source code lines that correspond to the execution captured by the analyzer. Optionally, bus cycle states can be displayed along with the source code lines.

The Trace window has *control menu* commands that let you display bus cycles, specify whether count information should be shown absolute or relative, or copy information from the window.

The Trace window opens automatically when a trace is complete.

state	typ	module	#line	:function	source	
-1	SEQ	sample	#0054	:change_statu	<	
5	SEQ	sample	#0054	:change_statu	<	2.480 uS
15	SEQ	sample	#0062	:next_message	<	8.160 uS
20	SEQ	sample	#0038	:convert	<	12.52 uS
25	SEQ	sample	#0044	:convert_case	<	14.48 uS
30	SEQ	sample	#0054	:change_statu	<	62.84 uS
36	SEQ	sample	#0054	:change_statu	<	65.40 uS
46	SEQ	sample	#0062	:next_message	<	71.08 uS
51	SEQ	sample	#0038	:convert	<	75.32 uS
56	SEQ	sample	#0044	:convert_case	<	77.28 uS
61	SEQ	sample	#0054	:change_statu	<	120.4 uS
67	SEQ	sample	#0054	:change_statu	<	122.9 uS
77	SEQ	sample	#0062	:next_message	<	128.6 uS
82	SEQ	sample	#0038	:convert	<	132.9 uS

For each line in the Trace window, the trace buffer state number, the type of state, the module name and source file line number, the function name, the source line, and the time count information are displayed.

The << and >> buttons let you move between the multiple frames of trace data that are available with newer analyzers for the HP 64700.

The type of state can be a sequence level branch (SEQ), a state that satisfies the prestore condition (PRE), or a normal state that matches the store conditions (in which case the type field is empty).

Bus cycle states show the address and data values that have been captured as well as the disassembled instruction or status mnemonics.

On startup, the system defaults to the source only display mode, where only source code lines are displayed. The source/bus cycle mixed display mode can be selected by using the Trace window control menu's Display→Mixed

Chapter 13: Concepts
Debugger Windows

Mode (ALT, -, D, M) command. In the source/bus cycle mixed display mode, each source code line is immediately followed by the corresponding bus cycles.

The trace buffer stores bus cycles only. The system displays source lines in the Trace window based on execution bus cycles.

See Also

"Tracing Program Execution" and
"Setting Up Custom Trace Specifications" in the "Debugging Programs"
chapter.

"Trace Window Commands" in the "Window Control Menu Commands"
chapter.

The WatchPoint Window

The WatchPoint window displays the contents of variables that have been registered with the Variable→Edit... (ALT, V, E) command or with the Edit... (ALT, -, E) command in the WatchPoint window's control menu.

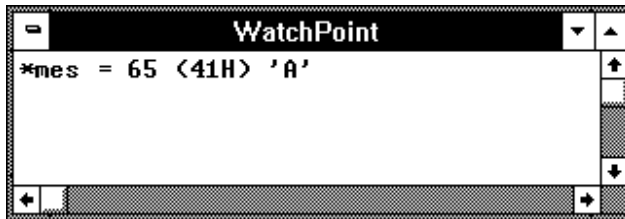

The contents of dynamic variables are displayed only when the current program counter is in the function in which the variable is declared.

You can modify the contents of variables by double-clicking on the value, using the keyboard to type in the new value, and pressing the Enter key.

The WatchPoint window lets you copy text strings, to the clipboard by double-clicking words or by holding down the left mouse button and dragging the mouse pointer.

See Also

"Displaying and Editing Variables" in the "Debugging Programs" chapter.

"WatchPoint Window Commands" in the "Window Control Menu Commands" chapter.

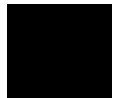

Compiler/Assembler Specifications

This section describes:

- IEEE-695 Object Files
- Compiling Programs with MCC68K
- Compiling Programs with AxLS

IEEE-695 Object Files

This section addresses the IEEE-695 object files compiled or assembled with the following compilers and assemblers:

- Microtec MCC68K Compiler
- Microtec ASM68K Assembler
- HP AxLS Compiler
- HP AxLS Assembler

Assembly Language Source File Display

The IEEE-695 object files do not contain assembly language source file information. Instead, memory contents are disassembled.

Mnemonic Display

An assembly language instruction preceding or following a function entry point may have multiple corresponding source code lines. For this type of instruction, the Source window in the Mnemonic Display mode shows multiple corresponding disassembled lines having the same address.

Single-Stepping Loop Control Statements

The system may fail in single-stepping such loop control statements as "while," "for," or "do while".

Pragma Statement and Debugger Display

When a "pragma" statement is used to describe an assembly language instruction in C source files, the source information is generated as follows in the IEEE-695 object files:

- A pragma instruction has a single line number.
- The address for the pragma instruction indicates the address for the first line of the instruction.
- The line number for the pragma instruction indicates the line number for the last line of the instruction.

This imposes the following display restriction on the Real-Time C Debugger:

The Source window in the Mnemonic Display mode shows lines in a pragma instruction all at one time as listed below.

```
#0010      #pragma asm
#0011          nop
#0012          nop
#0013      #pragma endasm
0001000    00          NOP
0001001    00          NOP
```

During single-stepping, the last line of the pragma instruction is highlighted while the program counter indicates the first line.

```
#0010      #pragma asm
#0011          nop
#0012          nop
#0013      #pragma endasm
```

Program counter indicating line 11

Highlighted line 12

Only the last line of the pragma instruction is displayed in the trace results.

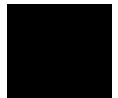

Compiling Programs with MCC68K

- 1 Compile the source files with the `mcc68k` command.
- 2 Assemble the source files with the `asm68k` command.
- 3 Link the object files with the `lnk68k` command.

Required Compiler/Assembler/Linker

Compiler	Microtec MCC68K Compiler
Assembler	Microtec ASM68K Assembler
Linker	Microtec LNK68K Linker

Compiling

For compiling, use the `mcc68k` command in your Microtec C Compiler with the following option switches:

<code>-g</code>	Outputs debugging information.
<code>-Gf</code>	Generates fully-qualified path names for input files.
<code>-nOg</code>	Disables global flow optimization.
<code>-nOR</code>	Disables register variables.
<code>-Kf</code>	Creates frame pointers for functions.

Note The `-nOg` and `-nOR` options allow the debugger to display arguments during backtracing.

Note The `-Kf` option allows the debugger to trace function flow.

Assembling

For assembling, use the `asm68k` command in your Microtec Assembler with the following option switch:

`-fd` Creates local symbols.

Linking

For linking, use the `lnk68k` command in your Microtec Linker. Specify the IEEE-695 file format for the load module.

Example

To compile and link `sample.c` user program into a load module, execute the following command, where `sample.k` is the linker command file:

```
A> mcc68k -g -Gf -Kf -nOg -nOR -l -esample.k -osample.x  
sample.c -Wl,-m > sample.lst
```

Compiling Programs with AxLS

- 1 Compile the source files with the `cc68040` command.
- 2 Assemble the source files with the `as68k` command.
- 3 Link the object files with the `ld68k` command.

Required Compiler/Assembler/Linker

Compiler	HP AxLS CC68040 Compiler
Assembler	HP AxLS AS68K Assembler
Linker	HP AxLS LD68K Linker

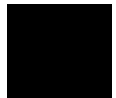

Chapter 13: Concepts
Compiler/Assembler Specifications

Compiling

For compiling, use the `cc68040` command in your HP AxLS C Compiler with the following option switches:

`-Wc,-F` Disables register variables.

Note The `-Wc,-F` option allows the debugger to display arguments during backtracing.

Assembling

For assembling, use the `as68k` command in your HP AxLS Assembler without any option switch.

Linking

For linking, use the `ld68k` command in your HP AxLS Linker. Specify the IEEE-695 file format for the load module.

Note The Real-Time C Debugger does not support simulated I/O locations. You can use the `-N` compiler option to use a linker command file that does not include the simulated I/O library.

Example To compile and link `sample.c` user program into a load module, execute the following command, where `sample.k` is the linker command file:

```
cc68040 -N -Wc,-F -Lix -k sample.k -o sample.x sample.c
```

Monitor Programs

This section describes:

- Monitor Program Options
- Assembling and Linking the Foreground Monitor with MCC68K
- Assembling and Linking the Foreground Monitor with AxLS
- Setting Up the Trace Vector
- Notes on Foreground Monitors

The foreground monitor source file is included with the debugger software and can be found in the C:\HP\RTC\M040\FGMON directory (if C:\HP\RTC\M040 was the installation path chosen when installing the debugger software).

Monitor Program Options

The emulation monitor program is a program that the emulation microprocessor executes as directed by the HP 64700 system controller. The emulation monitor program gives the system controller access to the target system.

For example, when you modify target system memory, the system controller writes a command code to a communications area and switches, or breaks, emulation processor execution into the monitor program. The monitor program reads the command code (and any associated parameters) from the communications area and executes the appropriate machine instructions to modify the target system locations. After the monitor has performed its task, emulation processor execution returns to what it was doing before the break.

The emulation monitor program can execute out of a separate, internal memory system known as background memory. A monitor program executing out of background memory is known as a background monitor program.

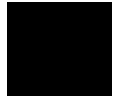

The emulation monitor program can also execute out of the same memory system as user programs. This memory system is known as foreground memory and consists of emulation memory and target system memory. A monitor program executing out of foreground memory is known as a foreground monitor program. Foreground monitor programs must exist in emulation memory.

The emulator firmware includes both background and foreground monitor programs and lets you select either. You can also load and use a customized foreground monitor program if needed.

Background Monitor

Interrupts from the target system are disabled during background monitor execution. If your programs have strict real-time requirements for servicing target system interrupts, you must use a foreground monitor program.

Foreground Monitor

A foreground monitor source file is provided with the emulator. It can be assembled, linked, and loaded into the debugger.

A foreground monitor has the following advantages and disadvantages:

Advantages

- The foreground monitor executes as a part of the user program, and target system interrupts can be enabled during monitor program execution for applications that have strict real-time processing requirements.
- The 68040 MMU can be enabled, instruction and data caches can be enabled, and the target system can perform DMA.
- The foreground monitor can be customized.

Disadvantages

- The foreground monitor occupies processor memory space.

Assembling and Linking the Foreground Monitor with MCC68K

The foreground monitor can be assembled and linked with the Microtec Assembler/Linker.

To assemble the foreground monitor, enter:

```
C> asm68k -l fgmon.s > fgmon.lst
```

To link the foreground monitor, enter:

```
C> lnk68k -c fgmon.k -m -o fgmon.x > fgmon.map
```

Link command file (fgmon.k) contains:

```
format ieee  
load fgmon.obj  
end
```

Assembling and Linking the Foreground Monitor with AxLS

The foreground monitor can be assembled and linked with an HP Assembler/Linker.

To assemble the foreground monitor, enter:

```
as68k -L fgmon.s > fgmon.lst
```

To link the foreground monitor, enter:

```
ld68k -c fgmon.k -L > fgmon.map
```

Link command file (fgmon.k) contains:

```
name fgmon  
load fgmon.o  
end
```

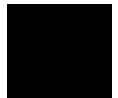

Setting Up the Trace Vector

The foreground monitor uses the 68040 trace vector for single-stepping. The trace exception vector in the target system must point to the TRACE_ENTRY address in the foreground monitor program. In the default foreground monitor, the TRACE_ENTRY address is equal to the Monitor Address plus 680H. If the trace exception vector does not contain the correct value, the emulator attempts to temporarily change the trace a-line and f-line exception vectors to the TRACE_ENTRY address.

Notes on Foreground Monitors

User Program Out of Control

A user program that runs out of control may damage the foreground monitor residing in the user memory space; if this happens, you must reload the foreground monitor. An Execution→Reset (ALT, E, E) command will automatically reload the foreground monitor.

Trace Signals and Predefined Status Values

This section describes how emulation analyzer trace signals are assigned to microprocessor address bus, data bus, and control signals.

Emulation Analyzer Trace Signals

Trace Signals	Signal Name	Signal Description
0-31	A0-A31	Address Lines 0-31
32-63	D0-D31	Processor Data 0-31
64-79		Control Signals (see predefined status below)

Predefined Status Values

Qualifier	Status Bits (79-64)	Description
ack	11xx xxxx xx1x xxxxy	Acknowledge access.
bkptack	11xx xxxx xx1x 000xy	BKPT acknowledge cycle.
burst	0xxxx x0xx xxxx xxxxy	Burst cycle.
byte	0xxxx xx01 xxxx xxxxy	Byte transfer request (SIZ1/SIZ0=01).
cpush	0xxx xxxx xx1x 000xy	Data cache push access.
d_tblwk	0xxx xxxx xx1x 011xy	Data translation table access.
data	0xxx xxxx xx1x x01xy	Data space access.
dma	0xxxx xxxx xx0x xxxxy	Direct memory access.
i_tblwk	0xxx xxxx xx1x 100xy	Instruction translation table access.
int1ack	11xx xxxx xx1x 001xy	Interrupt 1 acknowledge cycle.
int2ack	11xx xxxx xx1x 010xy	Interrupt 2 acknowledge cycle.
int3ack	11xx xxxx xx1x 011xy	Interrupt 3 acknowledge cycle.
int4ack	11xx xxxx xx1x 100xy	Interrupt 4 acknowledge cycle.
int5ack	11xx xxxx xx1x 101xy	Interrupt 5 acknowledge cycle.
int6ack	11xx xxxx xx1x 110xy	Interrupt 6 acknowledge cycle.
int7ack	11xx xxxx xx1x 111xy	Interrupt 7 acknowledge cycle.
line	0xxxx xx11 xxxx xxxxy	Line transfer request (SIZ1/SIZ0=11).
logical	0xx0x xxxx xxxx xxxxy	Logical memory address.
long	0xxxx xx00 xxxx xxxxy	Longword transfer request (SIZ1/SIZ0=00).
physical	0xx1x xxxx xxxx xxxxy	Physical memory address.
prog	0xxx xxxx xx1x x10xy	Program space access.
read	0xxxx xxxx xxx1 xxxxy	Read cycle.
retry	0xxxx xxxx 00xx xxxxy	Retrying a previous bus cycle.
supdata	0xxx xxxx xx1x 101xy	Supervisor data space.
supprog	0xxx xxxx xx1x 110xy	Supervisor program space.
ta	0xxxx xxxx 10xx xxxxy	Transfer acknowledge.
tea	0xxxx xxxx 01xx xxxxy	Transfer error acknowledge.
userdata	0xxx xxxx xx1x 001xy	User data space.
userprog	0xxx xxxx xx1x 010xy	User program space.
word	0xxxx xx10 xxxx xxxxy	Word transfer request (SIZ1/SIZ0=10).
write	0xxxx xxxx xxx0 xxxxy	Write cycle.

Part 5

Installation Guide

Instructions for installing the product.



14

Installing the Debugger

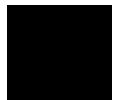

Installing the Debugger

This chapter shows you how to install the Real-Time C Debugger.

- Requirements
- Before Installing the Debugger
- Step 1. Connect the HP 64700 to the PC
- Step 2. Install the debugger software
- Step 3. Plug the emulator into the demo board
- Step 4. Start the debugger
- Step 5. Check the HP 64700 system firmware version
- Optimizing PC Performance for the Debugger

Requirements

- IBM compatible or NEC PC with an 80486 microprocessor and 8 megabytes of memory.
- MS Windows 3.1, set up with 20 megabytes of swap space.
- VGA Display.
- 3 Megabytes available disk space.
- Serial port, HP 64037 RS-422 port, or Novell LAN with Lan Workplace for DOS or Microsoft Lan Manager with HP ARPA Services.
- Revision A.04.00 or greater of HP 64700 system firmware. The last step in this chapter shows you how to check the firmware version number.

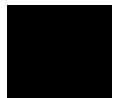

Before Installing the Debugger

- **Install MS Windows according to its installation manual. The Real-Time C Debugger must run under MS Windows in the 386 enhanced mode.**

To ensure your PC is running in the 386 Enhanced Mode, double-click the PIF Editor in the Main or Accessories window. Choose the Mode pulldown in the PIF Editor menu bar. A check mark should be beside "386 Enhanced" in the Mode pulldown.

- **If the HP 64700 is to communicate with the PC via LAN:**

Make sure the HP 64700 LAN interface is installed (see the "HP 64700 Series Installation/Service" manual).

Install the LAN card into the PC, and install the required PC networking software.

Obtain the Internet Address, the Gateway Address, and the Subnet Mask to be used for the HP 64700 from your Network Administrator. These three addresses are entered in integer dot notation (for example, 192.35.12.6).

- **If the HP 64700 is to communicate with the PC via RS-422:**

Install the HP 64037 RS-422 interface card into the PC. The Real-Time C Debugger includes software that configures the RS-422 interface.

Step 1. Connect the HP 64700 to the PC

You can connect the HP 64700 to an RS-232 serial port on the PC, the Local Area Network that the PC is on, or an HP 64037 RS-422 interface that has been installed in the PC.

- To connect via RS-232
- To connect via LAN
- To connect via RS-422

To connect via RS-232

- 1 Set the HP 64700 configuration switches for RS-232C communication. Locate the COMM CONFIG switches on the HP 64700 rear panel, and set them as shown below.

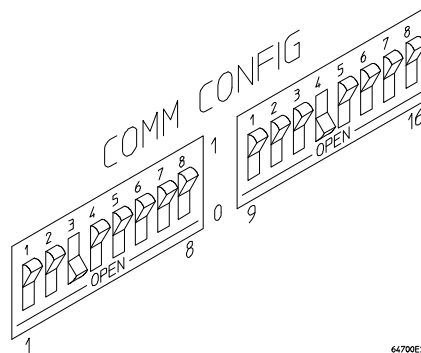

Notice that switches 1 through 3 are set to 001, respectively. This sets the baud rate to 19200.

Notice also that switches 12 and 13 are set to 1 and 0, respectively. This sets the RTS/CTS hardware handshake which is needed to make sure all characters are processed.

Chapter 14: Installing the Debugger
Step 1. Connect the HP 64700 to the PC

- 2 Connect an RS-232C modem cable from the PC to the HP 64700 (for example, an HP 24542M 9-pin to 25-pin cable or an HP 13242N 25-pin to 25-pin cable).

If you want to build your own RS-232 cable, follow one of the pin-outs for HP cables shown in the following figure.

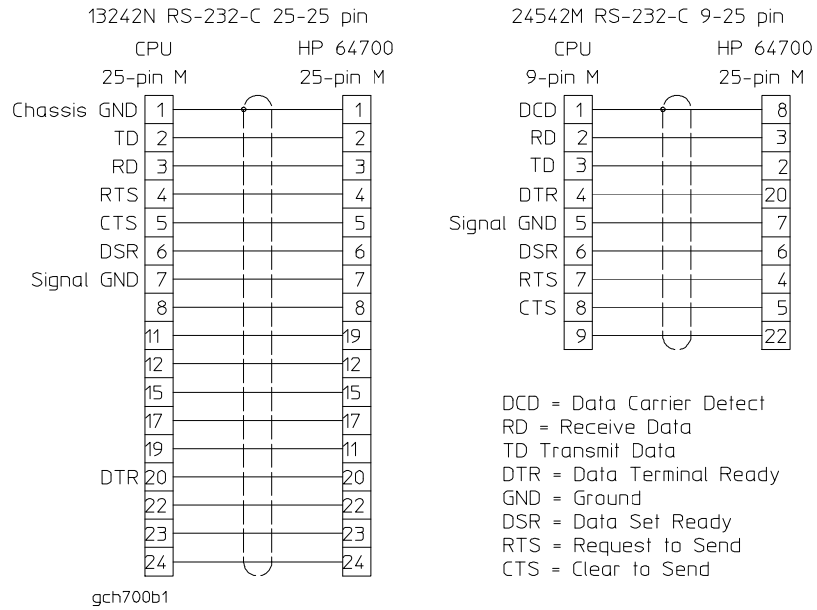

You can also use an RS-232C printer cable, but you must set HP 64700 configuration switch 4 to 1.

- 3 Turn ON power to the HP 64700.

The power switch is located on the lower left-hand corner of the front panel. The power lamp at the lower right-hand corner of the front panel will light.

- 4 Start MS Windows in the 386 enhanced mode.**
- 5 Verify RS-232 communication by using the Terminal program that is found in the Windows "Accessories" group box.**

Double-click on the "Terminal" icon to open the Terminal window. Then, choose the Settings→Communications... (ALT, S, C) command, and select: 19200 Baud Rate, 8 Data Bits, 1 Stop Bit, Parity None, Hardware Flow Control, and the PC's RS-232 interface connector. Choose the OK button.

You should now be able to press the Enter key in the Terminal window to see the HP 64700's Terminal Interface prompt (for example, "R>", "M>", or "U>". The "->" prompt indicates the present firmware does not match the emulator probe, or there is no probe connected). If you see the prompt, you have verified RS-232 communication. If you do not see the prompt, refer to "If you cannot verify RS-232 communication".

If you will be using the RS-232 connection for the debugger, exit the Terminal program and go to "Step 2. Install the debugger software".

If you will be using the LAN connection, go to "To connect via LAN".

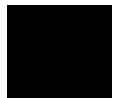

To connect via LAN

1 Set the HP 64700 LAN parameters.

If you're setting the HP 64700 LAN parameters for the first time, you must connect the HP 64700 to the PC via RS-232 before you can access the HP 64700 Terminal Interface. Follow the steps in "To connect via RS-232" and then return here.

If you're changing the LAN parameters of an HP 64700 that is already on the LAN, you can use the "telnet <HP 64700 IP address>" command to access the HP 64700 Terminal Interface.

Once the HP 64700 Terminal Interface has been accessed, display the current LAN parameters by entering the "lan" command:

```
R>lan
lan -i 15.6.25.117
lan -g 15.6.24.1
lan -s 255.255.248.0 <<- HP 64700A ONLY
lan -p 6470
Ethernet Address : 08000909BBC1
```

The "lan -i" line shows the Internet Address (or IP address). The Internet Address must be obtained from your Network Administrator. The value is entered in integer dot notation. For example, 192.35.12.6 is an Internet Address. You can change the Internet Address with the "lan -i <new IP>" command.

The "lan -g" line shows the Gateway Address which is also an Internet address and is entered in integer dot notation. This entry is optional and will default to 0.0.0.0, meaning all connections are to be made on the local network or subnet. If connections are to be made to workstations on other networks or subnets, this address must be set to the address of the gateway machine. The gateway address must be obtained from your Network Administrator. You can change the Gateway Address with the "lan -g <new gateway address>" command.

The "lan -s" line will be shown if you are using the HP 64700A, and will not be shown if you are using the HP 64700B. If this line is not shown, the Subnet Mask is automatically configured. If this line is shown, it shows the Subnet Mask in integer dot notation. This entry is optional and will default to 0.0.0.0. The default is valid only on networks that are not subnetted. (A network is

subnetted if the host portion of the Internet address is further partitioned into a subnet portion and a host portion.) If the network is subnetted, a subnet mask is required in order for the emulator to work correctly. The subnet mask should be set to all "1"s in the bits that correspond to the network and subnet portions of the Internet address and all "0"s for the host portion. The subnet mask must be obtained from your Network Administrator. You can change the Subnet Mask with the "lan -s <new subnet mask>" command .

Both the PC's subnet mask and the emulator's subnet mask must be identical unless they communicate via a gateway or a bridge. Unless your Network Administrator states otherwise, make them the same. You can check the PC's subnet mask with the "lminst" command if you are using HP-ARPA. If you are using Novell LAN WorkPlace, make sure the file \NET.CFG has the entry "ip_netmask <subnet mask>" in the section "Protocol TCPIP".

The "lan -p" line shows the base TCP service port number. The host computer interfaces communicate with the HP 64700 through two TCP service ports. The default base port number is 6470. The second port has the next higher number (default 6471). If the service port is not 6470, you must change it with the "lan -p 6470" command.

The Internet Address and any other LAN parameters you change are stored in nonvolatile memory and will take effect the next time the HP 64700 is powered off and back on again.

- 2 Exit the Terminal or telnet program.**
- 3 Turn OFF power to the HP 64700.**
- 4 Connect the HP 64700 to the LAN. This connection can be made using either the 15-pin AUI connector or the BNC connector.**

DO NOT use both connectors. The LAN interface will not work with both connected at the same time.

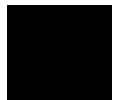

Chapter 14: Installing the Debugger
Step 1. Connect the HP 64700 to the PC

5 Set the HP 64700 configuration switches for LAN communication.

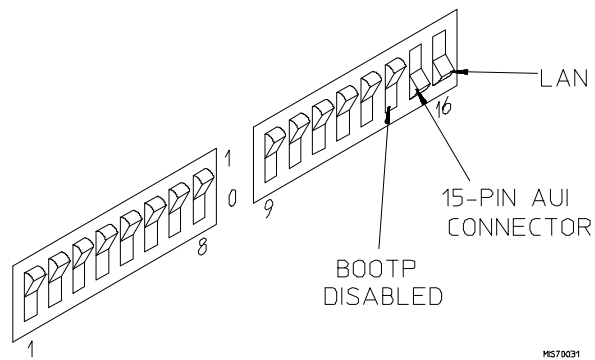
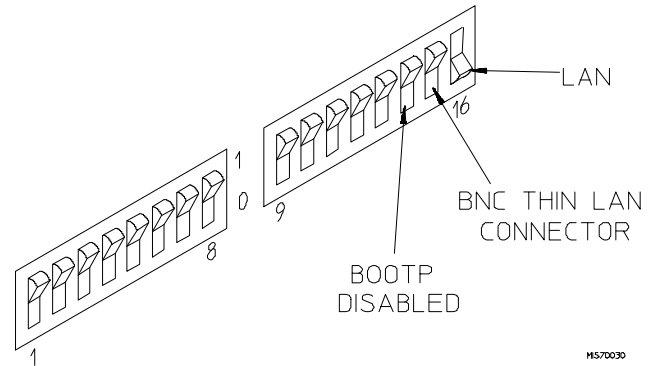

Switch 16 must be set to one (1) indicating that a LAN connection is being made.

Switch 15 should be zero (0) if you are connecting to the BNC connector or set to one (1) if a 15 pin AUI connection is made.

Switch 14 should be zero (0).

Set all other switches to zero (0).

- 6** Turn ON power to HP 64700.
- 7** Verify LAN communication by using a "telnet <HP 64700 IP address>" command. This connection will give you access to the HP 64700 Terminal Interface.

You should now be able to press the Enter key in the telnet window to see the HP 64700's Terminal Interface prompt (for example, "R>", "M>", "U>", etc.). If you see the prompt, you have verified LAN communication. If you cannot connect to the HP 64700's IP address, refer to "If you cannot verify LAN communication".

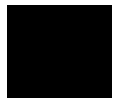

To connect via RS-422

Before you can connect the HP 64700 to the PC via RS-422, the HP 64037 RS-422 Interface must have already been installed into the PC.

- 1** Set the HP 64700 configuration switches for RS-422 communication. Locate the COMM CONFIG switches on the HP 64700 rear panel, and set them as shown below.

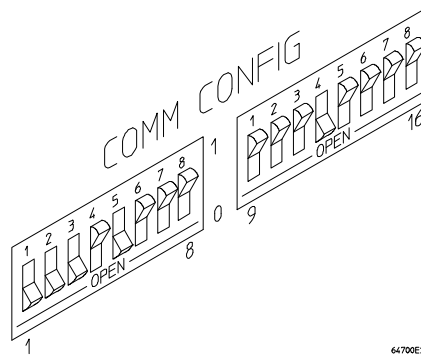

Notice that switches 1 through 3 are set to 111, respectively. This sets the baud rate to 230400.

Notice that switch 5 is set to 1. This configures the 25-pin port for RS-422 communication.

Notice also that switches 12 and 13 are set to 1 and 0, respectively. This sets the RTS/CTS hardware handshake which is needed to make sure all characters are processed.

- 2** Connect the 17355M cable (which comes with the HP 64037 interface) from the PC to the HP 64700.
- 3** Turn ON power to the HP 64700.

The power switch is located on the lower left-hand corner of the front panel. The power lamp at the lower right-hand corner of the front panel will light.

If you cannot verify RS-232 communication

If the HP 64700 Terminal Interface prompt does not appear in the Terminal window:

- Make sure that you have connected the emulator to the proper power source and that the power light is lit.

- Make sure that you have properly configured the data communications switches on the emulator and the data communications parameters on your controlling device. You should also verify that you are using the correct cable.

The most common type of data communications configuration problem involves the configuration of the HP 64700 as a DCE or DTE device and the selection of the RS-232 cable. If you are using the wrong type of cable for the device selected, no prompt will be displayed.

When the RS-232 port is configured as a DCE device (S4 is set to 0), a modem cable should be used to connect the HP 64700 to the host computer of terminal. Pins 2 and 3 at one end of a modem cable are tied to pins 2 and 3 at the other end of the cable.

When the RS-232 port is configured as a DTE device (S4 is set to 1), a printer cable should be used to connect the HP 64700 to the host computer of terminal. Pins 2 and 3 at one end of a printer cable are swapped and tied to pins 3 and 2, respectively, at the other end of the cable.

If you suspect that you may have the wrong type of cable, try changing the S4 setting and turning power to the HP 64700 OFF and then ON again.

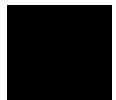

If you cannot verify LAN communication

Use the "telnet" command on the host computer to verify LAN communication. After powering up the HP 64700, it takes a minute before the HP 64700 can be recognized on the network. After a minute, try the "telnet <internet address>" command.

- If "telnet" does not make the connection:
 - Make sure that you have connected the emulator to the proper power source and that the power light is lit.
 - Make sure that the LAN cable is connected. Refer to your LAN documentation for testing connectivity.
 - Make sure the HP 64700 rear panel communication configuration switches are set correctly. Switch settings are only used to set communication parameters in the HP 64700 when power is turned OFF and then ON.
 - Make sure that the HP 64700's Internet Address is set up correctly. You must use the RS-232 port to verify this that the Internet Address is set up correctly. While accessing the emulator via the RS-232 port, run performance verification on the HP 64700's LAN interface with the "lanpv" command.
- If "telnet" makes the connection, but no Terminal Interface prompt (for example, R>, M>, U>, etc.) is supplied:
 - It's possible that the HP 64000 software is in the process of running a command (for example, if a repetitive command was initiated from telnet in another window). You can use CTRL+c to interrupt the repetitive command and get the Terminal Interface prompt.
 - It's also possible for there to be a problem with the HP 64700 firmware while the LAN interface is still up and running. In this case, you must turn OFF power to the HP 64700 and turn it ON again.

Step 2. Install the debugger software

- 1 If you are updating or re-installing the debugger software, you may want to save your b3629.INI file because it will be overwritten by the installation process.
- 2 Start MS Windows in the 386 enhanced mode.
- 3 Insert the 68040 REAL-TIME C DEBUGGER Disk 1 of 2 into floppy disk drive A or B.
- 4 Choose the File→Run... (ALT, F, R) command in the Windows Program Manager. Enter "a:\setup" (or "b:\setup" if you installed the floppy disk into drive B) in the Command Line text box.

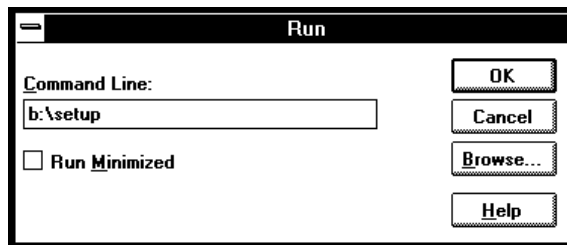

Then, choose the OK button. Follow the instructions on the screen.

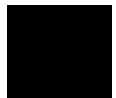

Chapter 14: Installing the Debugger
Step 2. Install the debugger software

You will be asked to enter the installation path. The default installation path is C:\HP\RTC\M040. The default installation path is shown wherever files are discussed in this manual.



You will be asked to enter your user ID. This information is important if the HP 64700 is on the LAN and may be accessed by other users. It tells other users who is currently using, or who has locked, the HP 64700. This information can be modified while using the Real-Time C Debugger by choosing the Settings→Communication... (ALT, S, C) command.

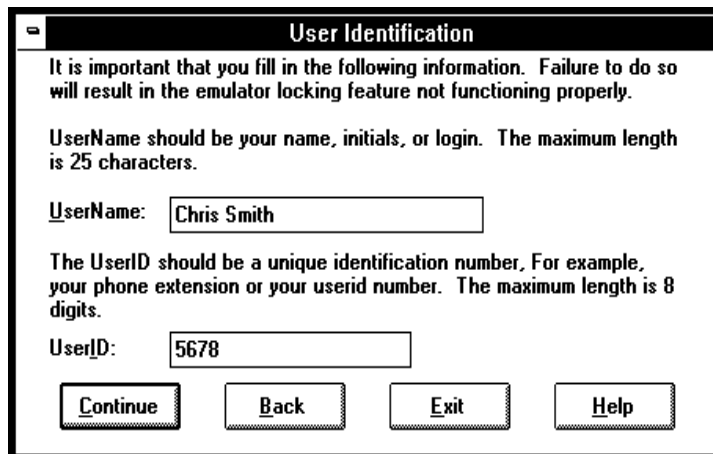

You will be asked to select the type of connection to be made to the HP 64700. This information can be modified while using the Real-Time C Debugger by choosing the Settings→Communication... (ALT, S, C) command.

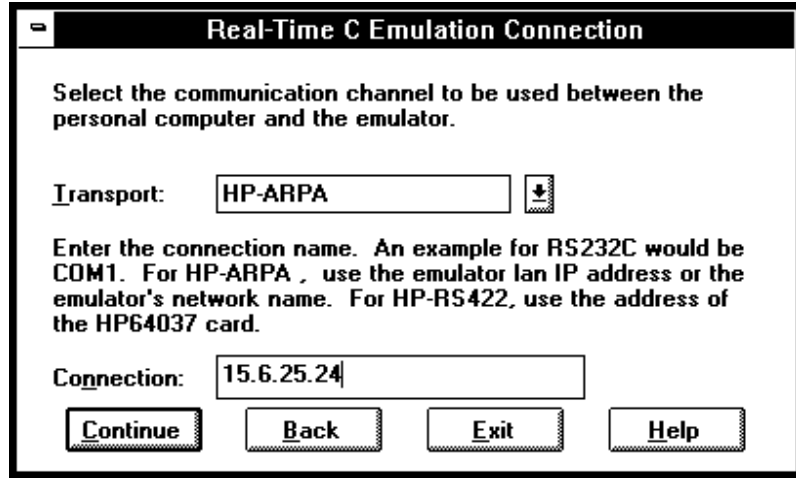

When using the HP-RS422 transport, the connection name is the I/O address you want to use for the HP 64037 card. Enter a hexadecimal number from 100H through 3F8H, ending in 0 or 8, that does not conflict with other cards in your PC.

After you have specified the type of connection, files will be copied to your hard disk. (The b3629.TMP and b3629.HLP files are larger than most of the other files and take longer to copy.) Fill out your registration information while waiting for the files to be copied.

If the Setup program detects that one or more of the files it needs to install are currently in use by Windows, a dialog box informs you that Windows must be restarted. You can either choose to restart Windows or not. If you don't choose to restart Windows, you can either run the _MSETUP.BAT batch file (in the same directory that the debugger software is installed in) after you have exited Windows or reinstall the debugger software later when you are able to restart Windows.



Step 3. Plug the emulator into the demo board

- 1** If the emulator is currently plugged into a target system, turn that target system's power OFF.
- 2** Turn HP 64700 power OFF.
- 3** If the emulator is currently plugged into a target system, unplug the emulator probe from the target system.
- 4** Plug the emulator probe into the demo board.

Make sure the pins are aligned correctly.

- 5** Connect the power supply wires from the HP 64700 to the demo board.

Make sure the connector is aligned properly so that all three pins are connected.

- 6** Turn HP 64700 power ON.

Step 4. Start the debugger

- 1 If the "HP Real-Time C Debugger" group box is not opened, open it by double-clicking in the icon.
- 2 Double-click the "M68040 Real-Time C Debugger" icon.

If you have problems connecting to the HP 64700, refer to:

- If you have RS-232 connection problems
- If you have LAN connection problems
- If you have RS-422 connection problems

If you have RS-232 connection problems

- Remember that Windows 3.1 only allows two active RS-232 connections at a time. To be warned when you violate this restriction, choose Always Warn in the Device Contention group box under 386 Enhanced in the Control Panel.
- Use the "Terminal" program (usually found in the Accessories windows program group) and set up the "Communications..." settings as follows:

```
Baud Rate: 19200 (or whatever you have chosen for the emulator)
Data Bits: 8
Parity: None
Flow Control: Hardware
Stop Bits: 1
```

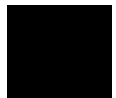

Chapter 14: Installing the Debugger
Step 4. Start the debugger

When you are connected, hit the Enter key. You should get a prompt back. If nothing echos back, check the switch settings on the back of the emulator.

Switches 1 thru 3 set the baud rate as follows:

S1	S2	S3	
0	0	0	9600
0	0	1	19200
0	1	0	2400

Switches 12 and 13 must be set to 1 and 0, respectively. This sets the RTS/CTS hardware handshake, which is needed to make sure all characters are processed.

All other switches should be in the "0" position, especially switch 16 on the HP 64700 (which selects LAN/Serial interface).

Remember that if you change any of the switch positions, you must turn OFF power to the HP 64700 and turn it ON again before the changes will take effect.

- If the switches are in the correct position and you still do not get a prompt when you press return, check the following:
 - Turn off power to the HP 64700 and then turn it on again. Press return to see if you get a prompt.
 - Check to make sure the RS-232 cable is connected to the correct port on your PC, and that the cable is appropriate for connecting the PC to a DCE device. If the cable is intended to connect the PC to a DTE device, set switch 4 to "1" (which makes the emulator a DTE device), turn OFF power to the HP 64700, turn power ON, and try again.
 - Check to make sure your RS-232 cable has the RTS, CTS, DSR, DCD, and DTR pins supported. If your PC RS-232 connection is a 9-pin male connection, HP cable number 24542M will work (set switch 4 to 0 if you use this cable). If your PC has a 25-pin RS-232 connector, HP cable number 13242N will work (set switch 4 to 0).

- If you wish to build your own RS-232 cable, refer to "To connect via RS-232" in the paragraph titled, "Step 1. Connect the HP 64000 to the PC" earlier in this chapter.
- When using certain RS-232 cards, connecting to an RS-232 port where the HP 64700 is turned OFF (or not connected) will halt operation of the PC. The only way to restore operation is to reboot the PC. Therefore, HP recommends you always turn ON the HP 64700 before attempting to connect via RS-232.
- If RTC reports overrun errors or simply times out, RTC may be overrunning the serial interface. In this case, try the following:
 - Stop all unnecessary TSR's and other applications to allow the processor to service the serial interface more often.
 - Overrun errors may occur when the serial interface card is not sufficiently buffered. Check to make sure your serial interface card uses the 16550AF UART, or better. Use the DOS command, "MSD", and when the window opens, select "COM Ports..." to see the UART chip used in your serial interface card.

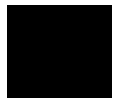

If you have LAN connection problems

- Try to "ping" the emulator:

```
ping <hostname or IP address>
```

- If the emulator does not respond:

- Check that switch 16 on the emulator is "1" (emulator is attached to LAN, not RS-232 or RS-422).
- Check that switch 15 on the emulator is in the correct position for your LAN interface (either the AUI or the BNC).

Remember, if you change any switch settings on the emulator, the changes do not take effect until you turn OFF emulator power and turn it ON again.

- If the emulator still does not respond to a "ping," you need to verify the IP address and subnet mask of the HP 64700. To do this, connect the HP 64700 to a terminal (or to the Terminal application on the PC), change the emulator's switch settings so it is connected to RS-232, and enter the "lan" command. The output looks something like this:

```
lan -i 15.6.25.117
lan -g 15.6.24.1
lan -s 255.255.248.0
lan -p 6470
Ethernet Address : 08000909BBC1
```

The important outputs (as far as connecting) are:

"lan -i"; this shows the internet address is 15.6.25.117 in this case. If the Internet address (IP) is not what you expect, you can change it with the 'lan -i <new IP>' command.

"lan -s"; shows the subnet mask is 255.255.248 (the upper 21 bits -- 255.255.248.0 == FF.FF.F8.0). If the subnet mask is not what you expect, you can change it with the 'lan -s <new subnet mask>' command.

"lan -p"; shows the port is 6470. If the port is not 6470, you must change it with the "lan -p 6470" command.

Both the PC's subnet mask and the emulator's subnet mask must be identical unless they communicate via a gateway or a bridge. Unless your Network

Administrator states otherwise, make them the same. If you are using HP-ARPA, you can check the PC's subnet mask with the "lminst" command in a DOS window. If you are using Novell LAN WorkPlace, make sure the file \NET.CFG has the entry "ip_netmask <subnet mask>" in the section "Protocol TCPIP." If you are using Windows for Workgroups, you can check the PC's subnet mask by looking in the [TCPIP] section of the PROTOCOL.INI file or by looking in the Microsoft TCP/IP Configuration dialog box. If you are using WINSOCK, refer to your LAN software documentation for subnet mask information.

- Occasionally the emulator or the PC will "lock up" the LAN due to excessive network traffic. If this happens, all you can do is turn OFF power to the HP 64700 or PC and turn it back ON, again. If this happens two frequently, you can try placing a gateway between the emulator/PC and the rest of your network.

If you have LAN DLL errors

The various LAN transport selections require the following DLLs:

HP-ARPA	WSOCKETS.DLL.
Novell-WP	WLIBSOCK.DLL.
W4WG-TCP	WSOCKETS.DLL. (Windows for Workgroups)
WINSOCK1.1	WINSOCK.DLL.

These DLLs are included with LAN software. The required DLL must be in your search path. This will be the case if your network software is installed.

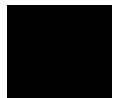

If you have RS-422 connection problems

- Make sure the HP 64700 switch settings match the baud rate chosen when attempting the connection.

Switches 1 thru 3 set the baud rate as follows:

S1	S2	S3	
1	1	1	230400
1	1	0	115200
1	0	1	38400
1	0	0	57600
0	1	1	1200
0	1	0	2400
0	0	1	19200
0	0	0	9600

Switch 5 must be set to 1 to configure the HP 64700 for RS-422 communication.

Switches 12 and 13 must be set to 1 and 0, respectively. This sets the RTS/CTS hardware handshake, which is needed to make sure all characters are processed.

All other switches should be in the "0" position, especially the switch that determines LAN/Serial interface (switch 16 on HP 64700).

Remember that if you change any of the switch positions, you must turn OFF power to the HP 64700 and turn it ON again before the changes will take effect.

- If the switches are in the correct position and you still do not get a prompt when you hit return, try turning OFF the power to the HP 64700 and tuning it ON again.
- If you still don't get a prompt, make sure the HP 17355M RS-422 cable is connected to the correct port on your PC.

Step 5. Check the HP 64700 system firmware version

- Choose the Help→About Debugger/Emulator... (ALT, H, D) command.

The version information under HP 64700 Series Emulation System must show A.04.00 or greater. If the version number is less than A.04.00, you must update your HP 64700 system firmware as described in the Installing/Updating HP 64700 Firmware chapter.

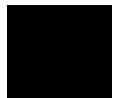

Optimizing PC Performance for the Debugger

The Real-Time C Debugger is a memory and I/O intensive Windows program. Slow user interface performance may be caused by many things:

- Underpowered PC -- The Real-Time C Debugger requires an IBM compatible or NEC PC with an 80486 class microprocessor, 8 megabytes of memory, and 20 megabytes of MS Windows swap space. Because RAM is faster than swap, performance is best when there is enough RAM to accommodate all of the Real-Time C Debugger's memory usage (which is directly related to the size of your programs and the amount of debug information in them).
- Improperly configured PC -- Windows configuration may have a very significant effect on performance. The Windows swap file settings are very important (see the Virtual Memory dialog box under 386 Enhanced in the Control Panel). The larger the swap file, the better the performance. Permanent swap has superior performance.
- Disk performance (due to Windows swap file access and Windows dialog and string resource accesses from the debugger ".EXE" file) -- The disk speed has a direct impact on performance of the Real-Time C Debugger. Use of SMARTDrive or other RAM disk or caching software will improve the performance.

Various PC performance measurement and tuning tools are commercially available. Optimizing your PC performance will improve debugger interface performance and, of course, all your other PC applications will benefit as well.



Installing/Updating HP 64700
Firmware

Installing/Updating HP 64700 Firmware

This chapter shows you how to install or update HP 64700 firmware.

Note

If you are using an HP 64700A, it must contain the optional Flash EPROM memory card before you can install or update HP 64700 system firmware. Flash EPROM memory is standard in the HP 64700B card cage.

The firmware, and the program that downloads it into the HP 64700, are included with the debugger on floppy disks labeled HP 64700 EMUL/ANLY FIRMWARE.

The steps to install or update HP 64700 firmware are:

- Step 1. Connect the HP 64700 to your PC
- Step 2. Install the firmware update utility
- Step 3. Run PROGFLASH to update HP 64700 firmware
- Step 4. Verify emulator performance

Step 1. Connect the HP 64700 to the PC

- 1 Set the COMM CONFIG switches for RS-232C communication. To do this, locate the DIP switches on the HP 64700 rear panel, and set them as shown below.

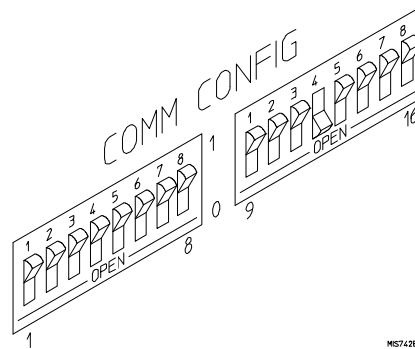

Notice that switches 12 and 13 are set to 1 and 0, respectively. This sets the RTS/CTS hardware handshake, which is needed to make sure all characters are processed. Switches 1, 2, and 3 are set to 0. This sets the baud rate to 9600. Switch settings are read during the HP 64700 power up routine.

- 2 Connect an RS-232C modem cable from the PC to the HP 64700 (for example, an HP 24542M 9-pin to 25-pin cable or an HP 13242N 25-pin to 25-pin cable).

You can also use an RS-232C printer cable, but if you do, you MUST set COMM CONFIG switch 4 to 1.

- 3 Turn ON power to the HP 64700.

The power switch is located on the lower left-hand corner of the front panel. The power lamp at the lower right-hand corner of the front panel will light.

4 Start MS Windows in the 386 enhanced mode.

To ensure your PC is running in the 386 Enhanced Mode, double-click the PIF Editor in the Main or Accessories window. Choose the Mode pulldown in the PIF Editor menu bar. A check mark should be beside "386 Enhanced" in the Mode pulldown.

5 Verify RS-232 communication by using the Terminal program that is found in the Windows "Accessories" group box.

Double-click on the "Terminal" icon to open the Terminal window. Then, choose the Settings→Communications... (ALT, S, C) command, and select: 9600 Baud Rate, 8 Data Bits, 1 Stop Bit, Parity None, Hardware Flow Control, and the PC's RS-232 interface connector to which the RS-232 cable is attached (example: COM1). Choose the OK button.

You should now be able to press the Enter key in the Terminal window to see the HP 64700's Terminal Interface prompt (for example, p>, R>, M>, and U>. A -> prompt indicates the present firmware does not match the emulator probe, or there is no probe connected). If you see the prompt, you have verified RS-232 communication. If you do not see the prompt, refer to "If you cannot verify RS-232 communication" in Chapter 14.

6 Exit the Terminal window.

Step 2. Install the firmware update utility

The firmware update utility and emulation and analysis firmware require about 1.5 Mbytes of disk space.

- 1 Start MS Windows in the 386 enhanced mode.
- 2 Insert the HP 64700 EMUL/ANLY FIRMWARE Disk 1 of 2 into floppy disk drive A or B.
- 3 Choose the File→Run... (ALT, F, R) command in the Windows Program Manager. Enter "a:\setup" (or "b:\setup" if you installed the floppy disk into drive B) in the Command Line text box.

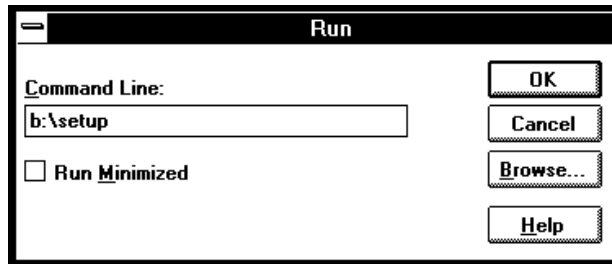

Then, choose the OK button. Follow the instructions on the screen.

You will be asked to enter the installation path. The default installation path is C:\HP64700.

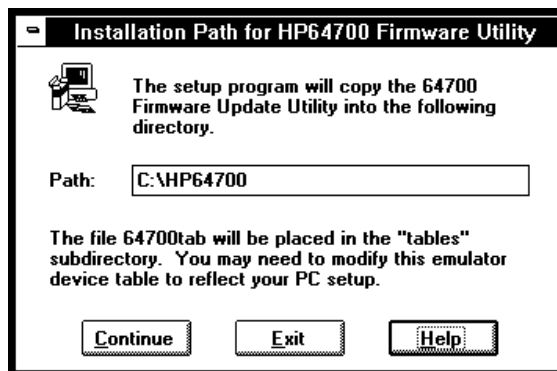

Chapter 15: Installing/Updating HP 64700 Firmware
Step 2. Install the firmware update utility

Wait until the Setup Exit Message dialog box appears. This indicates installation of the firmware update utility is complete.

- 4 After completing the installation, use the editor of your choice and edit the C:\CONFIG.SYS file to include these lines:

```
BREAK=ON  
FILES=20
```

BREAK=ON allows the system to check for two break conditions: CTRL+Break, and CTRL+c.

FILES=20 allows 20 files to be accessed concurrently. This number must be at LEAST 20 to allow the firmware update utility to operate properly.

- 5 If you installed the files in a path other than the default (C:\HP64700), edit the C:\AUTOEXEC.BAT and C:\HP64700\BIN\FLASH.BAT files as follows:

- Edit AUTOEXEC.BAT to set the HP64700 and HPTABLES environment variables. For example:

```
SET HP64700=C:\<installation_path>  
SET HPTABLES=C:\<installation_path>\TABLES
```

- Edit FLASH.BAT to identify the location of PROGFLAS.EXE. For example:

```
C:\<installation_path>\PROGFLAS.EXE
```

- 6 Edit the <installation_path>\TABLES\64700TAB file to indicate the communications connection you will use, as follows:

The default <installation_path>\TABLES\64700TAB file contains entries to establish the communications connection for COM1 and COM2. The content of this file is:

```
EMUL_COM1 unknown COM1 OFF 9600 NONE ON 1 8  
EMUL_COM2 unknown COM2 OFF 9600 NONE ON 1 8
```

If you are using COM3 or COM4 port to update your firmware, you need to edit the <installation_path>\TABLES\64700TAB file. Either add another line or modify one of the existing lines. For example:

```
EMUL_COM3 my_emul COM3 OFF 9600 NONE ON 1 8  
EMUL_COM4 unknown COM4 OFF 9600 NONE ON 1 8
```

7 Ensure the Interrupt Request Line for the selected COMx port is set to its default value. To check the default value:

- 1** Choose Control Panel in the Main window.
- 2** Choose Ports in the Control Panel window.
- 3** Choose the COMx port you are using and click Settings....
- 4** Click Advanced... in the Settings for COMx dialog box.
- 5** Select the default value for the Interrupt Request Line in the Advanced Settings for COMx dialog box. The default settings are:

```
COM1 and COM3 = IRQ 4  
COM2 and COM4 = IRQ 3
```

8 Exit Windows and reboot your PC to activate the changes made to the CONFIG.SYS and AUTOEXEC.BAT files (CTRL+ALT+DEL). Installation of the firmware update utility is now complete.

Step 3. Run PROGFLASH to update HP 64700 firmware

- 1 Start MS Windows in the 386 enhanced mode.
- 2 If the "HP 64700 Firmware Utility" group box is not opened, open it by double-clicking the icon.
- 3 Double-click the "PROGFLASH" icon. (You can abort the PROGFLASH command by pressing CTRL+c.)
- 4 Enter the number that identifies the emulator you want to update. For example, enter "1" if you want to update the emulator identified by the line, "1 emul_com1 my_emul."
- 5 Enter the number that identifies the product whose firmware you want to update. For example, if this product is listed as number 12, enter "12":

```
Product
1  64782
2  E3490
.
.
12 647??
.
```

- 6 Enter "y" to enable status messages.

Chapter 15: Installing/Updating HP 64700 Firmware
Step 3. Run PROGFLASH to update HP 64700 firmware

The PROGFLASH command downloads code from files on the host computer into Flash EPROM memory in the HP 64700. During this download, you will see messages similar to the following:

```
Rebooting HP64700...with init -r

Downloading flash programming code:
'/hp64700/lib/npf.X'
Checking Hardware id code...
Erasing Flash ROM
Downloading ROM code: '/hp64700/update/647???.X'
  Code start 280000H
  Code size 29ABAH
Finishing up...

Rebooting HP64700...
Flash programming SUCCEEDED
```

You can display firmware version information and verify the update by choosing the Help→About Debugger/Emulator... (ALT, H, D) command in the Real-Time C Debugger.



Step 4. Verify emulator performance

- Do the performance verification procedure shown in the Installation/Service/Terminal Interface User's Guide.

Glossary

Defines terms that are used in the debugger help information.

analyzer An instrument that captures data on signals of interest at discreet periods. The emulation bus analyzer captures emulator bus cycle information synchronously with the processor's clock signal.

arm condition A condition that enables the analyzer. The analyzer is always armed unless you set the analyzer up to be armed by a signal received on the BNC port; when you do this, you can identify the arm condition in the trace specification by selecting arm in the Condition dialog boxes.

background memory A separate memory system, internal to the emulator, out of which the background monitor executes.

background monitor program An emulation monitor program that executes out of background memory.

break on trigger Causes emulator execution to break into the monitor when the trigger condition is found. This is known as a hardware breakpoint, and it lets you break on a wider variety of conditions than a software breakpoint (which replaces an opcode with a break instruction); however, depending on the speed of the processor, the actual break point may be several cycles after the one that caused the trigger.

breakpoint An address you identify in the user program where program execution is to stop. Breakpoints let you look at the state of the target system at particular points in the program.

break macro A breakpoint followed by any number of macro commands (which are the same as command file commands).

control menu The menu that is accessed by clicking the control menu box in the upper left corner of a window. You can also access control menus by pressing the "ALT" and "-" keys.



count condition Specifies whether time or the occurrences of a particular state are counted for each state in the trace buffer.

embedded microprocessor system The microprocessor system that the emulator plugs into.

emulation memory Memory provided by the emulator that can be used in place of memory in the target system.

emulation monitor A program, executed by the emulation microprocessor (as directed by the emulation system controller), that gives the emulator access to target system memory, microprocessor registers, and other target system resources.

emulator An instrument that performs just like the microprocessor it replaces, but at the same time, it gives you information about the operation of the processor. An emulator gives you control over target system execution and allows you to view or modify the contents of processor registers, target system memory, and I/O resources.

enable condition Specifies the first condition in a two-step sequential trigger condition.

enable store condition Specifies which states get stored in the trace buffer while the analyzer searches for the enable condition.

foreground memory The memory system out of which user programs execute. Foreground memory is made up of emulation memory and target system memory.

foreground monitor program An emulation monitor program that executes out of the same memory system as user programs. This memory system is known as foreground memory and is made up of emulation memory and target system memory. The emulator only allows foreground monitor programs in emulation memory.

guarded memory Memory locations that should not be accessed by user programs. These locations are specified when mapping memory. If the user program accesses a location mapped as guarded memory, emulator execution breaks into the monitor.

macro Refers to a break macro, which is a breakpoint followed by any number of macro commands (which are the same as command file commands).

monitor A program, executed by the emulation microprocessor (as directed by the emulation system controller), that gives the emulator access to target system memory, microprocessor registers, and other target system resources.

object file An Intel OMF format absolute file that can be loaded into emulation or target system memory and executed by the debugger.

pop-up menu A menu that is accessed by clicking the right mouse button in a window.

prestore condition Specifies the states that may be stored before each normally stored state. Up to two states may be prestored for each normally stored state.

primary branch condition Specifies a condition that causes the analyzer to begin searching at another level.

restart condition Specifies the condition that restarts the two-step sequential trigger. In other words, if the restart condition occurs while the analyzer is searching for the trigger condition, the analyzer starts looking for the enable condition again.

secondary branch condition Specifies a condition that causes the analyzer to begin searching at another level. If a state satisfies both the primary and secondary branch conditions, the primary branch will be taken.

sequence levels Levels in the analyzer that let you specify a complex sequential trigger condition. For each level, the analyzer searches for primary and secondary branch conditions. You can specify a different store condition for each level. The Page button toggles the display between sequence levels 1 through 4 and sequence levels 5 through 8.

state qualifier A combination of address, data, and status values that identifies particular states captured by the analyzer.

status values Values that identify the types of microprocessor bus cycles recognized by the analyzer. You can include status values (along with

address and data values) when specifying trigger and store conditions. The status values defined for the 68040 emulator are listed under "Predefined Status Values" at the end of Chapter 13, "Concepts."

store condition Specifies which states get stored in the trace buffer.

In the "Find Then Trigger" trace set up, the store condition specifies the states that get stored after the trigger.

In the "Sequence" trace set up, each sequence level has a store condition that specifies the states that get stored while looking for the primary or secondary branch conditions.

target system The microprocessor system that the emulator plugs into.

trace state The information captured by the analyzer on a particular microprocessor bus cycle.

transfer address The program's starting address defined by the software development tools and included with the symbolic information in the object file.

trigger The captured analyzer state about which other captured states are stored. The trigger state specifies when the trace measurement is taken.

trigger condition Specifies the condition that causes states to be stored in the trace buffer.

trigger position Specifies whether the state that triggered the analyzer appear at the start, center, or end of the trace buffer. In other words, the trigger position specifies whether states are stored after, about, or before the trigger.

trigger store condition Specifies which states get stored in the trace buffer while the analyzer searches for the trigger condition.

watchpoint A variable that has been placed in the WatchPoint window where its contents can be readily displayed and modified.

Index

- A** abort, during object file or memory load, 304
- absolute count information, displaying, 157, 356
- access size, target memory, 83
- Add to Watch command, 371
- addresses, searching, 107, 341
- analyzer, 471-474
 - editing the trace specification, 173, 248
 - halting, 155, 261
 - repeating last trace, 155, 262
 - setting up with "Find Then Trigger", 164, 252-255
 - setting up with "Sequence", 168, 256-259
 - setting up with "Trigger Store", 161, 249-251
 - trace signals, 431
 - tracing until halt, 155, 260
- arguments, function, 406, 424-425
- arm condition, 94, 164, 168, 263-265, 297, 471-474
- arrays (C operators), 192
- ASCII values in Memory window, 134, 410
- Assemble... (ALT, A) command, 279
- assembler, in-line, 279
- assembling and linking the foreground monitor, 427-430
- assembly language instructions
 - stepping multiple, 119, 220-223
 - stepping single, 117, 218
- assembly language source files, 422
- auto, 280
- auto variables, 131-133
- AUTOEXEC.BAT file, 465-467
- AxLS
 - assembling and linking the foreground monitor with, 429
 - compiling programs with, 425

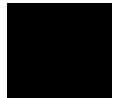

- B** background memory, 471-474
- background monitor, 427
 - program, 471-474
 - selecting, 89, 288-291
- background operation, tracing, 302-303
- BackTrace window, 406
 - displaying source files, 369
- Bad RS-232 port name, 385
- Bad RS-422 card I/O address, 385
- baud rate
 - RS-232, 292
 - RS-422, 292
- beep, sounding from command file, 375
- binary values, how to enter, 187
- blocks (emulation memory), size of, 284-287
- BNC port
 - driving the trigger signal, 295-296
 - output trigger signal, 94
 - receiving an arm condition from, 297
 - receiving an arm condition input, 94
 - setting up, 94
- BP marker, 34, 36, 126, 226-231, 412
- break into monitor, 121, 224
- break macros, 471-474
 - command summary, 180
 - deleting, 129, 231
 - listing, 126, 232-233
 - preventing new, 129
 - setting, 126, 228-230
- break on writes to ROM, enabling or disabling, 81
- Breakpoint→Delete at Cursor (ALT, B, D) command, 227
- Breakpoint→Delete Macro (ALT, B, L) command, 231
- Breakpoint→Edit... (ALT, B, E) command, 232-233
- Breakpoint→Set at Cursor (ALT, B, S) command, 226
- Breakpoint→Set Macro... (ALT, B, M) command, 228-230

- breakpoints, 471-474
 - deleting, 36, 125, 130, 227
 - disabling and enabling, 125
 - listing, 126, 232-233
 - preventing new breakpoints, 130
 - setting, 34, 124, 226
- breakpoint acknowledge interlock, enabling or disabling, 82
- bus cycle dequeuing
 - turning OFF, 158, 359
 - turning ON, 158, 359
- bus cycle disassembly, changing, 157, 357
- bus cycles only, displaying, 355
- bus cycles, displaying, 156
- Button window, 407
 - editing, 68, 315
- buttons that execute command files, creating, 68
- C**
 - C operators, 192
 - caches, enabling or disabling, 79
 - callers (of a function), tracing, 48-49, 149, 240-241
 - chain command files, 377
 - Clear Breakpoint command, 370
 - clipboard, 57
 - clock speeds greater than 25 MHz, 80
 - colors in the Source window, setting, 65
 - command files
 - chain, 377
 - command summary, 180
 - comments, 379
 - creating, 66, 200
 - executing, 67, 203-204
 - executing at startup, 59, 67
 - exiting execution, 376
 - inserting wait delays, 382
 - locating cursor, 341
 - nesting, 377
 - parameters, 203-204
 - rerun, 378
 - sounding beep, 375
 - turning logging on or off, 201-202
 - which include Terminal Interface commands, 380-381

- command line options, 59, 61, 67
 - for connection and transport, 292
- command summary, 180
- comments in command files, 379
- communications (emulator), setting up, 292-294
- CONFIG.SYS file, 465-467
- configuration
 - emulator, 280-283
 - saving and loading, 95-96
- connection problems
 - LAN, 456
 - RS-232, 453
 - RS-422, 458
- connection, command line option, 292
- control menu, 471-474
- Copy→Destination... (ALT, -, P, D) command, 314
- Copy→Registers (ALT, -, P, R) command, 332
- Copy→Window (ALT, -, P, W) command, 313
- Could not open initialization file, 385
- Could not write Memory, 386
- count conditions, 263-265, 471-474
- count information
 - displaying absolute, 157, 356
 - displaying relative, 157, 356
- CTRL key and double-clicks, 57
- current PC in Source window, 342
- cursor, locating cursor from command file, 341
- cursor-select, 34
- cut and paste, 57
- D** DCE or DTE selection and RS-232 cable, 447
 - debugger
 - arranging icons in window, 306
 - cascaded windows, 306
 - exiting, 51, 60, 210
 - exiting locked, 211
 - installing software, 449-451
 - opening windows, 307-308
 - overview, 4
 - starting, 25, 59, 453-458

- debugger (continued)
 - tiled windows, 306
 - startup options, 61
 - windows, opening, 62
 - decimal values, how to enter, 187
 - deleting all breakpoints, 130
 - demo programs, 24
 - loading, 32
 - mapping memory, 28-29
 - running, 35
 - DeMorgan's law, 263-265
 - dequeueing
 - turning OFF, 158, 359
 - turning ON, 158, 359
 - dialog boxes
 - breakpoints, 232-233
 - file selection, 212
 - directories
 - search path, 343
 - source, 309
 - disassembly, changing in Trace window, 157, 357
 - display fonts, changing, 26
 - display mode
 - mixed, 104
 - source only, 104
 - toggling, 335-336, 355
 - Display→Select Source... (ALT, -, D, L) command, 337
 - DLL errors, 457
 - do while statements (C), single-stepping, 422
 - don't care values, how to enter, 187
 - double-clicks and the CTRL key, 57
 - dual-port emulation memory, 284-287
 - dynamic variables, 234-235, 363, 421
- E**
- edit breakpoints, 232-233
 - embedded microprocessor system, 471-474
 - emulation memory, 471-474
 - block size, 284-287
 - copying target system memory into, 138
 - emulation microprocessor, resetting, 122, 225
 - emulation monitor, 471-474
 - emulation monitor programs, 427

- emulator, 471-474
- emulator configuration, 78, 280-283
 - loading, 96, 207
 - saving, 95, 208
- emulator hardware options, setting, 79-83
- emulator probe, plugging-in, 71-74
- enable condition, 471-474
- enable store condition, 471-474
- environment
 - loading, 205
 - saving, 206
- environment variables, 106
 - HP64700 , 465-467
 - HPTABLES, 465-467
 - PATH, 465-467
- error messages, 384
 - Bad RS-232 port name, 385
 - Bad RS-422 card I/O address, 385
 - Could not open initialization file, 385
 - Could not write Memory, 386
 - Error occurred while processing Object file, 387
 - general RS-232 communications error, 388
 - general RS-422 communications error, 388
 - HP 64700 locked by another user, 389
 - HP 64700 not responding, 389
 - Incorrect DLL version, 389
 - Incorrect LAN Address (HP-ARPA, Windows for Workgroups), 390
 - Incorrect LAN Address (Novell), 391
 - Incorrect LAN Address (WINSOCK), 391
 - Internal error in communications driver, 392
 - Internal error in Windows, 392
 - Interrupt execution (during run to caller), 392
 - Interrupt execution (during step over), 393
 - Interrupt execution (during step), 393
 - Invalid transport name, 394
 - LAN buffer pool exhausted, 394
 - LAN communications error, 395
 - LAN MAXSENDSIZE is too small, 395
 - LAN socket error, 395
 - Object file format ERROR, 396

- error messages (continued)
 - Out of DOS Memory for LAN buffer, 397
 - Out of DOS Windows timer resources, 398
 - PC is out of RAM memory, 398
 - Timed out during communications, 399-400
- ethernet address, 442
- Evaluate It command, 370
- exception vectors, setting up the initial ISP and PC, 30-31
- Execution→Break (F4), (ALT, E, B) command, 224
- Execution→Reset (ALT, E, E) command, 225
- Execution→Run (F5), (ALT, E, U) command, 213
- Execution→Run to Caller (ALT, E, T) command, 215
- Execution→Run to Cursor (ALT, E, C) command, 214
- Execution→Run... (ALT, E, R) command, 216-217
- Execution→Single Step (F2), (ALT, E, N) command, 218
- Execution→Step Over (F3), (ALT, E, O) command, 219
- Execution→Step... (ALT, E, S) command, 220-223
- exiting command file execution, 376
- Expression window, 408
 - clearing, 318
 - displaying expressions, 319
- expressions, 186
 - displaying, 319
- externals, displaying symbol information, 111, 345
- F** file selection dialog boxes, 212
 - File→Command Log→Log File Name... (ALT, F, C, N) command, 200
 - File→Command Log→Logging OFF (ALT, F, C, F) command, 202
 - File→Command Log→Logging ON (ALT, F, C, O) command, 201
 - File→Copy Destination... (ALT, F, P) command, 209
 - File→Exit (ALT, F, X) command, 210
 - File→Exit HW Locked (ALT, F, H) command, 211
 - File→Load Debug... (ALT, F, D) command, 205
 - File→Load Emulator Config... (ALT, F, E) command, 207
 - File→Load Object... (ALT, F, L) command, 197-199
 - File→Run Cmd File... (ALT, F, R) command, 203-204
 - File→Save Debug... (ALT, F, S) command, 206
 - File→Save Emulator Config... (ALT, F, V) command, 208
- firmware update utility, installing, 465-467
- firmware update, connecting the HP 64700 to the PC, 463-464

- firmware version information, 309
- firmware
 - ensuring performance after update, 470
 - using PROGFLASH to update, 468-469
- font settings, 298-299
- font sizing, 26
- fonts, changing, 64
- for statements (C), single-stepping, 422
- foreground memory, 471-474
- foreground monitor, 427
 - address, changing, 27
 - program, 471-474
 - assembling and linking with AxLS, 429
 - assembling and linking with MCC68K, 429
 - notes on, 430
 - selecting, 90, 92, 288-291
- foreground operation, tracing, 302-303
- function arguments, 406, 424-425
- function codes, 191
- function flow trace limitations, 237-239
- function keys, 58
- functions
 - displaying symbol information, 110, 345
 - running until return, 42, 120, 215
 - searching, 107, 339
 - stepping over, 43, 118, 219
 - tracing callers, 48-49, 149, 240-241
 - tracing execution within, 151, 242-243
 - tracing flow, 47, 148, 237-239
- G**
 - gateway, 456
 - gateway address, 442
 - general RS-232 communications error, 388
 - general RS-422 communications error, 388
 - global assembler symbols, displaying, 113, 347
 - global symbols, displaying, 111, 345
 - global variables, 111, 152-153, 345
 - glossary, 471-474
 - guarded memory, 85, 284-287, 415, 471-474

- H**
 - hardware options, setting, 79-83
 - hardware requirements, 437
 - hardware, locking on exit, 211
 - help for error messages, 384
 - Help→About Debugger/Emulator... (ALT, H, D) command, 309
 - hexadecimal values, how to enter, 187
 - hostname, 292-294
 - HP-ARPA LAN transport DLL, 457
 - HP 64037 card, I/O address, 292
 - HP 64700
 - connecting to the PC, 439-448
 - connecting via LAN, 442
 - connecting via RS-232, 439
 - connecting via RS-422, 446
 - HP 64700 firmware update
 - connecting the HP 64700 to the PC, 463-464
 - installing update utility, 465-467
 - HP 64700 firmware
 - ensuring performance after update, 470
 - using PROGFLASH to update, 468-469
 - HP 64700 LAN port number, 456
 - HP 64700 locked by another user, 389
 - HP 64700 not responding, 389
 - HP 64700 switch settings
 - LAN, 456
 - RS-232, 453
 - RS-422, 458
 - HP64700 environment variable, 465-467
 - HPTABLES environment variable, 465-467
- I**
 - I/O address for HP 64037 card, 292
 - I/O locations
 - displaying, 141
 - editing, 142
 - guarding, 273-274
 - specifying, 320
 - I/O window, 409
 - turning polling ON or OFF, 99
 - icon, for a different emulator, 61
 - icons (debugger window), arranging, 306
 - IEEE-695 object files, 422

- in-circuit operation, configuring the emulator for, 75
- in-line assembler, 279
- Incorrect DLL version, 389
- Incorrect LAN Address (HP-ARPA, Windows for Workgroups), 390
- Incorrect LAN Address (Novell), 391
- Incorrect LAN Address (WINSOCK), 391
- .INI file, 292
- initial exception vector
 - for interrupt stack pointer, 30-31, 83
 - for program counter, 30-31, 83
- installation path, 449-451
- Internal error in communications driver, 392
- Internal error in Windows, 392
- internals, displaying symbol information, 112, 346
- Internet Address, 292-294, 442, 448
- Interrupt execution (during run to caller), 392
- Interrupt execution (during step over), 393
- Interrupt execution (during step), 393
- interrupt stack pointer, setting the initial exception vector, 30-31, 83
- interrupts (target system), 75, 427
 - enabling or disabling, 81
- interset operators, 263-265
- initial values of stack pointer and program counter, 280
- intraset operators, 263-265
- intrusion, monitor, 98, 271-272
- Invalid transport name, 394
- IP address, 292, 456
- ISP, setting the initial value, 280
- L**
 - labels, 188-190, 279
 - labels, TRACE_ENTRY, 430
 - LAN buffer pool exhausted, 394
 - LAN cards, 437-438
 - LAN communication, 292-294, 453-458
 - LAN communications error, 395
 - LAN connection problems, 456
 - LAN MAXSENDSIZE is too small, 395
 - LAN socket error, 395
 - LAN, connecting HP 64700, 442
 - levels, trace sequence, 168, 173, 256-259, 270

- limitations
 - function flow trace, 237-239
 - Symbol window, 418
 - line (source file), running until, 44, 120, 214
 - line numbers missing in Source window, 65
 - link level address, 442
 - linking the foreground monitor, 427-430
 - list file
 - changing the destination, 63
 - copying window contents to, 63
 - listing files, specifying, 209, 314
 - loading file error, 386
 - local assembler symbols, displaying, 113, 347
 - local symbols, displaying, 112, 346
 - local variables, 112-113, 346
 - lock hardware on exit, 211
 - log (command) files, 66, 200-204
 - logical addresses, 191
 - logical operators, 164, 168, 263-265
 - long alignment of program symbols, 159-176
- M**
- macro, 471-474
 - MCC68K
 - assembling and linking the foreground monitor with, 429
 - compiling programs with, 424
 - memory (target system), copying into emulation memory, 138
 - memory mapping
 - block size, 284-287
 - resolution of mapped ranges, 85
 - memory type, 85, 284-287
 - Memory window, 410
 - displaying 16-bit values, 323
 - displaying 32-bit values, 323
 - displaying bytes, 323
 - displaying multicolumn format, 323
 - displaying single-column format, 322
 - turning polling ON or OFF, 99
 - memory
 - abort during load, 304
 - copying, 137, 326
 - displaying, 134
 - editing, 136

- memory (continued)
 - loading from stored file, 328
 - mapping, 84-87, 284-287
 - mapping for demo program, 28-29
 - modifying a range, 139, 327
 - searching for a value or string in, 140
 - storing to a binary file, 330
- messages, error, 384
- microprocessor, resetting, 122, 225
- mixed display mode, 104, 335, 355, 422
- monitor, 471-474
 - address (foreground), changing, 27
 - assembling and linking, 427-430
 - intrusion, 98, 122, 271-272, 419
 - programs, 427
 - selecting the type, 88-93
- N**
 - nesting command files, 377
 - network name, 292
 - no-operation command, 379
 - noabort, during object file or memory load, 304
 - Novell LAN transport DLL, 457
 - numeric constants, 187
- O**
 - Object file format ERROR, 396
 - object files, 471-474
 - abort during load, 304
 - IEEE-695, 422
 - loading, 103, 197-199
 - loading the foreground monitor, 90, 92
 - on-chip caches, enabling or disabling, 79
 - operators
 - C, 192
 - interset, 263-265
 - intraset, 263-265
 - logical, 164, 168, 263-265
 - optimization option, compiler, 424
 - options, command line, 61
 - Out of DOS Memory for LAN buffer, 397
 - Out of Windows timer resources, 398
 - overview, 4

- P**
- parameters, command file, 203-204
 - paste, cut and, 57
 - PATH environment variable, 465-467
 - path for source file search, 106, 343
 - paths for source files, prompting, 305
 - patterns, trace, 164, 168, 252-259, 263-267
 - PC is out of RAM memory, 398
 - PC
 - connecting HP 64700, 439-448
 - locating in Source window, 342
 - setting the initial value, 280
 - performance (PC), optimizing for the debugger, 460
 - performance verification after firmware update, 470
 - physical addresses, 191
 - ping command, 456
 - platform requirements, 437
 - pointers (C operators), 192
 - polling for debugger windows, turning ON or OFF, 99
 - pop-up menus, 471-474
 - accessing, 368
 - port name, RS-232, 292
 - port
 - BNC, 94, 263-265, 295-297
 - communication, 292-294
 - pragma statements (C), source file information, 422
 - prestore condition, 164, 168, 252-259, 419, 471-474
 - primary branch condition, 168, 256-259, 471-474
 - processor, resetting, 122, 225
 - PROGFLASH firmware update utility, 468-469
 - program counter, 117, 121, 213, 216-217, 220-223, 412
 - setting the initial exception vector, 30-31, 83
 - program modules, displaying symbol information, 110, 344
 - program symbols, long alignment, 159-176
 - programs
 - compiling with AxLS, 425
 - compiling with MCC68K, 424
 - demo, 24
 - loading, 103, 197-199
 - running, 121, 213, 216-217
 - stopping execution, 121
- Q**
- qualifier, state, 161, 249-251

- R**
 - real-time mode
 - disabling, 98, 272
 - enabling, 98, 271
 - real-time options, setting, 97-99
 - RealTime→I/O Polling→OFF (ALT, R, I, F) command, 274
 - RealTime→I/O Polling→ON (ALT, R, I, O) command, 273
 - RealTime→Memory Polling→OFF (ALT, R, M, F) command, 278
 - RealTime→Memory Polling→ON (ALT, R, M, O) command, 277
 - RealTime→Monitor Intrusion→Allowed (ALT, R, T, A) command, 272
 - RealTime→Monitor Intrusion→Disallowed (ALT, R, T, D) command, 271
 - RealTime→Watchpoint Polling→OFF (ALT, R, W, F) command, 276
 - RealTime→Watchpoint Polling→ON (ALT, R, W, O) command, 275
 - register bit fields, 333
 - register variables, 424-425
 - Register windows, 411
 - copying information from, 332
 - registers
 - displaying, 45-46, 143
 - editing, 145
 - relative count information, displaying, 157, 356
 - requirements
 - hardware, 437
 - platform, 437
 - rerun command files, 378
 - reset
 - emulator, 122, 225
 - emulator status, 415
 - running from target system, 121, 216-217
 - resolution, memory mapper, 85
 - restart condition, 164, 252-255, 471-474
 - restriction on number of RS-232 connections, 453
 - return (function), running until, 42, 120, 215
 - ROM, enabling or disabling breaks on writes to, 81
 - RS-232
 - cable and DCE or DTE selection, 447
 - connection problems, 453
 - connections restriction, 453
 - connecting HP 64700, 439
 - RS-422
 - connection problems, 458
 - connecting HP 64700, 446

- RTC Emulation Connection dialog box, 292
- Run to Cursor command, 371
- S**
 - screen fonts, changing, 26
 - search path, 457
 - search path for source files, 106, 343
 - Search→Address... (ALT, -, R, A) command, 341
 - Search→Current PC (ALT, -, R, C) command, 342
 - Search→Function... (ALT, -, R, F) command, 339
 - Search→String... (ALT, -, R, S) command, 338
 - Search... (ALT, -, R) command, 324
 - secondary branch condition, 168, 256-259, 471-474
 - sequence levels, 270, 471-474
 - service ports, TCP, 442
 - Set Breakpoint command, 370
 - Settings→BNC→Input to Analyzer Arm (ALT, S, B, I) command, 297
 - Settings→BNC→Outputs Analyzer Trigger (ALT, S, B, O) command, 295-296
 - Settings→Communication... (ALT, S, C) command, 292-294
 - Settings→Emulator Config→Hardware... (ALT, S, E, H) command, 280-283
 - Settings→Emulator Config→Memory Map... (ALT, S, E, M) command, 284-287
 - Settings→Emulator Config→Monitor... (ALT, S, E, O) command, 288-291
 - Settings→Extended→Load Error Abort→OFF (ALT, S, X, L, F) command, 304
 - Settings→Extended→Load Error Abort→ON (ALT, S, X, L, O) command, 304
 - Settings→Extended→Source Path Query→OFF (ALT, S, X, S, F) command, 305
 - Settings→Extended→Source Path Query→ON (ALT, S, X, S, O) command, 305
 - Settings→Extended→Trace Cycles→Both (ALT, S, X, T, B) command, 303
 - Settings→Extended→Trace Cycles→Monitor (ALT, S, X, T, M) command, 302
 - Settings→Extended→Trace Cycles→User (ALT, S, X, T, U) command, 302
 - Settings→Font... (ALT, S, F) command, 298-299
 - Settings→Symbols→Case Sensitive→OFF (ALT, S, S, C, F) command, 301
 - Settings→Symbols→Case Sensitive→ON (ALT, S, S, C, O) command, 301
 - Settings→Tabstops... (ALT, S, T) command, 300
 - single-port emulation memory, 97-99, 277, 284-287
 - single-step one line, 37
 - software, installing debugger, 449-451

- Source at Stack Level command, 369
- source directory, 309
- source display mode, toggling, 335-336
- source files
 - displaying, 33, 105, 337
 - displaying from BackTrace window, 369
 - information generated for pragma statements, 422
 - prompting for paths, 305
 - running until line, 44, 120, 214
 - searching for addresses, 107, 341
 - searching for function names, 107, 339
 - searching for strings, 108, 338
 - specifying search directories, 106
- source lines
 - stepping multiple, 119, 220-223
 - stepping single, 117, 218
- source only
 - displaying, 104, 355
 - displaying in Memory window, 335-336
- Source window, 412
 - line numbers missing, 65
 - locating current PC, 342
 - setting colors, 65
 - setting tabstops, 64
 - toggling the display mode, 335-336
- SRCPATH environment variable, 106
- startup options, 61
- state qualifier, 161, 249-251, 471-474
- static discharge, protecting against, 71-74
- status values, 431, 471-474
- Status window, 415
- step
 - multiple lines, 38
 - one line, 37
- store, 161
- store conditions, 263-265, 471-474
- strings
 - displaying symbols containing, 116, 350
 - searching memory for, 140, 324
 - searching source files, 108, 338

- structures (C operators), 192
- subnet mask, 442, 456
- subroutines, stepping over, 219
- Symbol window, 418
 - copying information, 349-350
 - searching for strings, 350
- symbols, 188-190
- system setup, 438

T

- tab stop settings, 300
- tab stops in the Source window, setting, 64
- ?TAKEN? in bus cycle disassembly, 359
- target memory access size, selecting, 83
- target system, 471-474
- target system interrupts, 75, 427
 - enabling or disabling, 81
- target system memory, copying into emulation memory, 138
- TCP service ports, 442
- telnet, 442, 448
- TERMCOM command, 380-381
- Terminal Interface commands, 380-381
- text, selecting, 57
- Timed out during communications, 399-400
- TimeoutSeconds, 399-400
- trace dequeuing
 - turning OFF, 158, 359
 - turning ON, 158, 359
- trace disassembly, changing, 157, 357
- trace display mode, toggling, 355
- trace foreground/background operation, 302-303
- trace patterns, 164, 168, 252-259, 263-267
 - long alignment of program symbols, 159-176
- trace range, 268-269
- trace settings, 263-265
- trace signals, 431
- trace specification
 - copying, 362
 - editing, 173, 248
 - loading, 176
 - specifying the destination, 362
 - storing, 175

- trace state, 471-474
 - searching for in Trace Window, 361
- TRACE vector, setting up, 430
- Trace window, 419
 - copying information, 360
 - displaying absolute count information, 356
 - displaying bus cycles only, 355
 - displaying relative count information, 356
 - displaying source only, 355
 - toggling the display mode, 355
- trace, setting up a sequence, 168
- Trace→Again (F7), (ALT, T, A) command, 262
- Trace→Edit... (ALT, T, E) command, 248
- Trace→Find Then Trigger... (ALT, T, D) command, 252-255
- Trace→Function Caller... (ALT, T, C) command, 240-241
- Trace→Function Flow (ALT, T, F) command, 237-239
- Trace→Function Statement... (ALT, T, S) command, 242-243
- Trace→Halt (ALT, T, H) command, 261
- Trace→Sequence... (ALT, T, Q) command, 256-259
- Trace→Trigger Store... (ALT, T, T) command, 249-251
- Trace→Until Halt (ALT, T, U) command, 260
- Trace→Variable Access... (ALT, T, V) command, 244-245
- Trace→Variable Break... (ALT, T, B) command, 246-247
- transfer address, 35, 119, 121, 216-217, 220-223, 471-474
- transport selection, 292
- transport, command line option, 292
- trigger, 161, 471-474
 - condition, 161, 471-474
 - position, 161, 471-474
 - state, searching for in Trace window, 361
 - store condition, 161, 471-474
- tutorial, 24
- type of memory, 85, 284-287

- U**
- unary minus operator, 192
 - unions (C operators), 192
 - unlock emulator, 292
 - user ID, 292, 449-451
 - user name, 292
 - user programs, loading, 103
 - user-defined symbols
 - creating, 114, 351
 - deleting, 115, 353
 - displaying, 115, 349
 - Utilities→Copy... (ALT, -, U, C) command, 326
 - Utilities→Fill... (ALT, -, U, F) command, 327
 - Utilities→Load... (ALT, -, U, L) command, 328
 - Utilities→Store... (ALT, -, U, S) command, 330
- V**
- values, searching memory for, 140, 324
 - Variable→Edit... (ALT, V, E) command, 234-235
 - variables
 - auto, 131-133
 - displaying, 39, 131
 - dynamic, 234-235, 363, 421
 - editing, 40, 132, 234-236
 - environment, 106
 - global, 111, 152-153, 345
 - local, 112-113, 346
 - monitoring in the WatchPoint window, 41, 133
 - register, 424-425
 - tracing a particular value and breaking, 153, 246-247
 - tracing accesses, 50, 152, 244-245
 - verification of emulator performance, 470
 - version information, 309, 459



- W** WAIT command, 310
- wait delays, inserting in command files, 382
- watchpoint, 471-474
- WatchPoint window, 421
 - monitoring variables in, 41, 133
 - turning polling ON or OFF, 99
- watchpoints, editing, 363
- while statements (C), single-stepping, 422
- window contents, copying to the list file, 63
- Window→1-9 (ALT, W, 1-9) command, 307
- Window→Arrange Icons (ALT, W, A) command, 306
- Window→Cascade (ALT, W, C) command, 306
- Window→More Windows... (ALT, W, M) command, 308
- Window→Tile (ALT, W, T) command, 306
- windows (debugger), opening, 307-308
- Windows for Workgroups, 457
- WINSOCK LAN transport DLL, 457
- WINSOCK.DLL, 457
- WLIBSOCK.DLL, 457
- WSOCKETS.DLL, 457
- windows of program execution, tracing, 173
- writes to ROM, enabling or disabling breaks on, 81

Certification and Warranty

Certification

Hewlett-Packard Company certifies that this product met its published specifications at the time of shipment from the factory. Hewlett-Packard further certifies that its calibration measurements are traceable to the United States National Bureau of Standards, to the extent allowed by the Bureau's calibration facility, and to the calibration facilities of other International Standards Organization members.

Warranty

This Hewlett-Packard system product is warranted against defects in materials and workmanship for a period of 90 days from date of installation. During the warranty period, HP will, at its option, either repair or replace products which prove to be defective.

Warranty service of this product will be performed at Buyer's facility at no charge within HP service travel areas. Outside HP service travel areas, warranty service will be performed at Buyer's facility only upon HP's prior agreement and Buyer shall pay HP's round trip travel expenses. In all other cases, products must be returned to a service facility designated by HP.

For products returned to HP for warranty service, Buyer shall prepay shipping charges to HP and HP shall pay shipping charges to return the product to Buyer. However, Buyer shall pay all shipping charges, duties, and taxes for products returned to HP from another country. HP warrants that its software and firmware designated by HP for use with an instrument will execute its programming instructions when properly installed on that instrument. HP does not warrant that the operation of the instrument, or software, or firmware will be uninterrupted or error free.

Limitation of Warranty

The foregoing warranty shall not apply to defects resulting from improper or inadequate maintenance by Buyer, Buyer-supplied software or interfacing, unauthorized modification or misuse, operation outside of the environment specifications for the product, or improper site preparation or maintenance.

No other warranty is expressed or implied. HP specifically disclaims the implied warranties of merchantability and fitness for a particular purpose.

Exclusive Remedies

The remedies provided herein are buyer's sole and exclusive remedies. HP shall not be liable for any direct, indirect, special, incidental, or consequential damages, whether based on contract, tort, or any other legal theory.

Product maintenance agreements and other customer assistance agreements are available for Hewlett-Packard products.

For any assistance, contact your nearest Hewlett-Packard Sales and Service Office.

Safety

Summary of Safe Procedures

The following general safety precautions must be observed during all phases of operation, service, and repair of this instrument. Failure to comply with these precautions or with specific warnings elsewhere in this manual violates safety standards of design, manufacture, and intended use of the instrument. Hewlett-Packard Company assumes no liability for the customer's failure to comply with these requirements.

Ground The Instrument

To minimize shock hazard, the instrument chassis and cabinet must be connected to an electrical ground. The instrument is equipped with a three-conductor ac power cable. The power cable must either be plugged into an approved three-contact electrical outlet or used with a three-contact to two-contact adapter with the grounding wire (green) firmly connected to an electrical ground (safety ground) at the power outlet. The power jack and mating plug of the power cable meet International Electrotechnical Commission (IEC) safety standards.

Do Not Operate In An Explosive Atmosphere

Do not operate the instrument in the presence of flammable gases or fumes. Operation of any electrical instrument in such an environment constitutes a definite safety hazard.

Keep Away From Live Circuits

Operating personnel must not remove instrument covers. Component replacement and internal adjustments must be made by qualified maintenance personnel. Do not replace components with the power cable connected. Under certain conditions, dangerous voltages may exist even with the power cable removed. To avoid injuries, always disconnect power and discharge circuits before touching them.

Do Not Service Or Adjust Alone

Do not attempt internal service or adjustment unless another person, capable of rendering first aid and resuscitation, is present.

Do Not Substitute Parts Or Modify Instrument

Because of the danger of introducing additional hazards, do not install substitute parts or perform any unauthorized modification of the instrument. Return the instrument to a Hewlett-Packard Sales and Service Office for service and repair to ensure that safety features are maintained.

Dangerous Procedure Warnings

Warnings, such as the example below, precede potentially dangerous procedures throughout this manual. Instructions contained in the warnings must be followed.

WARNING

Dangerous voltages, capable of causing death, are present in this instrument. Use extreme caution when handling, testing, and adjusting.

Safety Symbols Used In Manuals

The following is a list of general definitions of safety symbols used on equipment or in manuals:



Instruction manual symbol: the product is marked with this symbol when it is necessary for the user to refer to the instruction manual in order to protect against damage to the instrument.



Indicates dangerous voltage (terminals fed from the interior by voltage exceeding 1000 volts must be marked with this symbol).



OR



Protective conductor terminal. For protection against electrical shock in case of a fault. Used with field wiring terminals to indicate the terminal which must be connected to ground before operating the equipment.



Low-noise or noiseless, clean ground (earth) terminal. Used for a signal common, as well as providing protection against electrical shock in case of a fault. A terminal marked with this symbol must be connected to ground in the manner described in the installation (operating) manual before operating the equipment.



OR



Frame or chassis terminal. A connection to the frame (chassis) of the equipment which normally includes all exposed metal structures.



Alternating current (power line).



Direct current (power line).



Alternating or direct current (power line).

Caution

The Caution sign denotes a hazard. It calls your attention to an operating procedure, practice, condition, or similar situation, which, if not correctly performed or adhered to, could result in damage to or destruction of part or all of the product.

Warning

The Warning sign denotes a hazard. It calls your attention to a procedure, practice, condition or the like, which, if not correctly performed, could result in injury or death to personnel.