

64000

**HP64000
Logic Development
System**

**Model 64500S
Positive PROM
Programmer**

 **HEWLETT
PACKARD**

CERTIFICATION

Hewlett-Packard Company certifies that this product met its published specifications at the time of shipment from the factory. Hewlett-Packard further certifies that its calibration measurements are traceable to the United States National Bureau of Standards, to the extent allowed by the Bureau's calibration facility, and to the calibration facilities of other International Standards Organization members.

WARRANTY

This Hewlett-Packard system product is warranted against defects in materials and workmanship for a period of 90 days from date of installation. During the warranty period, HP will, at its options, either repair or replace products which prove to be defective.

Warranty service of this product will be performed at Buyer's facility at no charge within HP service travel areas. Outside HP service travel areas, warranty service will be performed at Buyer's facility only upon HP's prior agreement and Buyer shall pay HP's round trip travel expenses. In all other cases, products must be returned to a service facility designated by HP.

For products returned to HP for warranty service. Buyer shall prepay shipping charges to HP and HP shall pay shipping charges to return the product to Buyer. However, Buyer shall pay all shipping charges, duties, and taxes for products returned to HP from another country.

HP warrants that its software and firmware designated by HP for use with an instrument will execute its programming instructions when properly installed on that instrument. HP does not warrant that the operation of the instrument, or software, or firmware will be uninterrupted or error free.

LIMITATION OF WARRANTY

The foregoing warranty shall not apply to defects resulting from improper or inadequate maintenance by Buyer, Buyer-supplied software or interfacing, unauthorized modification or misuse, operation outside of the environmental specifications for the product, or improper site preparation or maintenance.

NO OTHER WARRANTY IS EXPRESSED OR IMPLIED. HP SPECIFICALLY DISCLAIMS THE IMPLIED WARRANTIES OF MERCHANTABILITY AND FITNESS FOR A PARTICULAR PURPOSE.

EXCLUSIVE REMEDIES

THE REMEDIES PROVIDED HEREIN ARE BUYER'S SOLE AND EXCLUSIVE REMEDIES. HP SHALL NOT BE LIABLE FOR ANY DIRECT, INDIRECT, SPECIAL, INCIDENTAL, OR CONSEQUENTIAL DAMAGES, WHETHER BASED ON CONTRACT, TORT, OR ANY OTHER LEGAL THEORY.

ASSISTANCE

Product maintenance agreements and other customer assistance agreements are available for Hewlett-Packard products.

For any assistance, contact your nearest Hewlett-Packard Sales and Service Office. Addresses are provided at the back of this manual.

HEWLETT-PACKARD
SERVICE MANUAL
MODEL 64500S
POSITIVE PROM PROGRAMMER

REPAIR NUMBERS

This Manual applies directly to Models with Repair Numbers prefixed 2239A. It also applies to Models that have Repair Numbers prefixed 1924A that have a 64501-66502 board installed. Section VII is the backdating section for Models with Repair Numbers prefixed 1924A that have a 64501-66501 board installed.

© Copyright Hewlett-Packard Company/Colorado Springs Division 1979
1900 Garden of the Gods Road, Colorado Springs, Colorado, U.S.A.

All Rights Reserved

Manual Part Number 64500-90910
Microfiche Part Number 64500-90810

Printed: October 1982
Updated: September 1983

SAFETY SUMMARY

The following general safety precautions must be observed during all phases of operation, service, and repair of this instrument. Failure to comply with these precautions or with specific warnings elsewhere in this manual violates safety standards of design, manufacture, and intended use of the instrument. Hewlett-Packard Company assumes no liability for the customer's failure to comply with these requirements.

GROUND THE INSTRUMENT.

To minimize shock hazard, the instrument chassis and cabinet must be connected to an electrical ground. The instrument is equipped with a three-conductor ac power cable. The power cable must either be plugged into an approved three-contact electrical outlet or used with a three-contact to two-contact adapter with the grounding wire (green) firmly connected to an electrical ground (safety ground) at the power outlet. The power jack and mating plug of the power cable meet International Electrotechnical Commission (IEC) safety standards.

DO NOT OPERATE IN AN EXPLOSIVE ATMOSPHERE.

Do not operate the instrument in the presence of flammable gases or fumes. Operation of any electrical instrument in such an environment constitutes a definite safety hazard.

KEEP AWAY FROM LIVE CIRCUITS.

Operating personnel must not remove instrument covers. Component replacement and internal adjustments must be made by qualified maintenance personnel. Do not replace components with power cable connected. Under certain conditions, dangerous voltages may exist even with the power cable removed. To avoid injuries, always disconnect power and discharge circuits before touching them.

DO NOT SERVICE OR ADJUST ALONE.

Do not attempt internal service or adjustment unless another person, capable of rendering first aid and resuscitation, is present.

DO NOT SUBSTITUTE PARTS OR MODIFY INSTRUMENT.

Because of the danger of introducing additional hazards, do not install substitute parts or perform any unauthorized modification of the instrument. Return the instrument to a Hewlett-Packard Sales and Service Office for service and repair to ensure that safety features are maintained.

DANGEROUS PROCEDURE WARNINGS.

Warnings, such as the example below, precede potentially dangerous procedures throughout this manual. Instructions contained in the warnings must be followed.

WARNING

**Dangerous voltages, capable of causing death, are present in this instrument.
Use extreme caution when handling, testing, and adjusting.**

Table of Contents

Section		Page
I	General Information-----	1-1
	1-1. Introduction-----	1-1
	1-4. Instruments Covered by this Manual-----	1-1
	1-9. Description-----	1-2
II	Installation and Removal-----	2-1
	2-1. Introduction-----	2-1
	2-3. Initial Inspection-----	2-1
	2-5. Installation Procedure-----	2-1
	2-7. PROM Programmer Cable-----	2-2
III	Operation-----	3-1
IV	Performance Verification and Troubleshooting-----	4-1
	4-1. Introduction-----	4-1
	4-3. Equipment Required-----	4-1
	4-7. Running the Operation Verification-----	4-1
	4-8. Running the Performance Verification-----	4-2
	4-9. Performance Verification Theory-----	4-3
	4-17. Troubleshooting Using P.V.-----	4-4
	4-18. PROM Address-----	4-4
	4-23. PROM Data-----	4-5
	4-25. Digital to Analog Converter-----	4-6
V	Adjustments-----	5-1
	5-1. Introduction-----	5-1
	5-3. Safety Requirements-----	5-1
	5-5. Equipment Required-----	5-1
	5-7. Adjustments-----	5-1
	5-9. +5 Volt Adjustment-----	5-1
VI	Replaceable Parts-----	6-1
	6-1. Introduction-----	6-1
	6-3. Abbreviations-----	6-1
	6-5. Replaceable Parts-----	6-1
	6-7. Ordering Information-----	6-2
	6-10. Direct Mail Order System-----	6-2

Table of Contents

Section	Page
VII Manual Backdating-----	7-1
VIII Theory and Schematics-----	8-1
8-1. Introduction-----	8-1
8-4. Block Diagram Theory-----	8-1
8-17. Theory of Operation-----	8-4
8-18. General-----	8-4
8-19. Detailed Theory-----	8-4
8-20. Fail Safe Timer-----	8-4
8-22. Pulse Generators-----	8-4
8-24. Positive PROM Programmer Identification-----	8-5
8-26. Programmer Module Identification-----	8-5
8-29. Programmable Positive Power Supply-----	8-5
8-33. Current Sensor-----	8-6
8-37. Adjustable Voltage Sources-----	8-6
8-39. Positive PROM Programming (not operation)-----	8-6
8-44. PROM Data Verification-----	8-7

List of Illustrations

Figure	Title	Page
1-1.	Model 64500S Prom Programmer.....	1-A
6-1.	Illustrated Parts Breakdown-----	6-4
8-1.	Block Diagram-----	8-2
8-2.	Schematic-----	8-11

List of Tables

Table	Title	Page
6-1.	Reference Designators and Abbreviations-----	6-3
6-2.	Replaceable Parts Lists-----	6-5
6-3.	List of Manufactures' Codes-----	6-7
8-1.	Logic Symbology -----	8-3
8-2.	PROM Programmer Mnemonics-----	8-8



Model 64500S - 64502A Module

Figure 1-1. Model 64500S Prom Programmer Contents

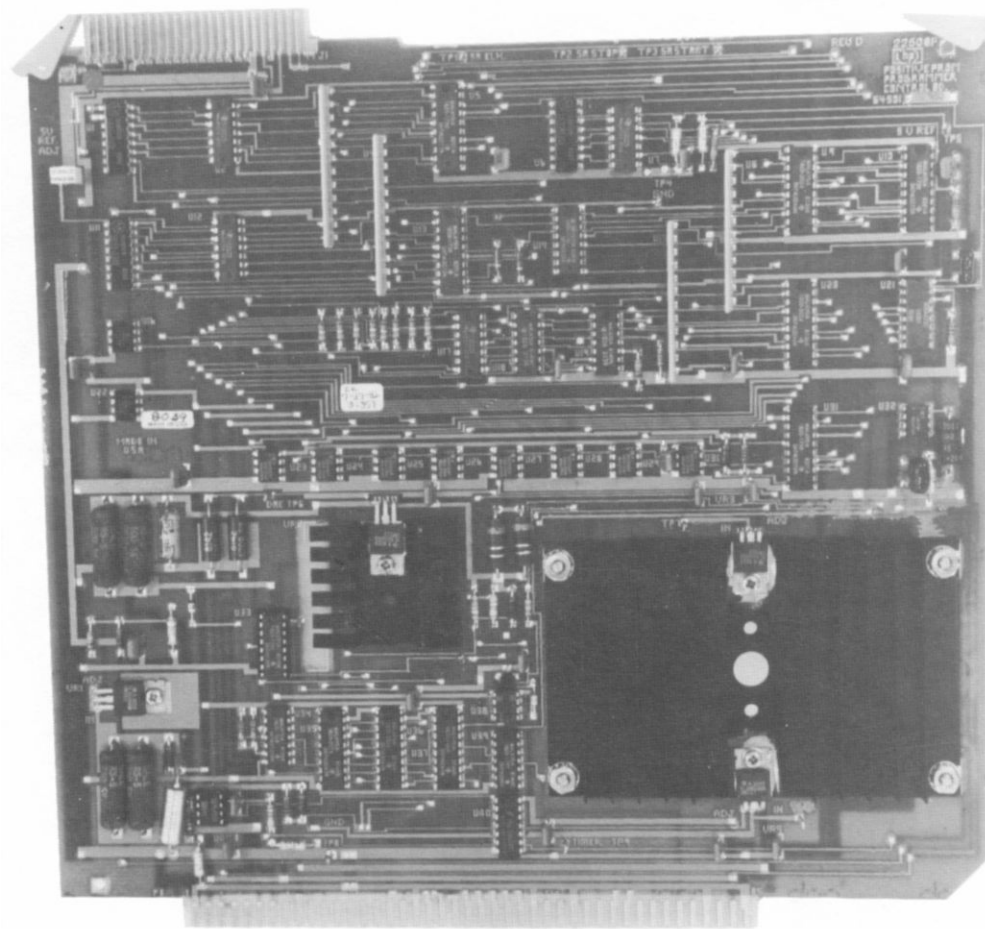

Model 64500S PROM Programmer Control Board



Model 64500S Cable

Figure 1-1. Model 64500S Prom Programmer Contents (continued)

SECTION I

GENERAL INFORMATION

1-1. INTRODUCTION.

1-2. This Service Manual contains information required to install, test and service the Hewlett-Packard Model 64500S PROM Programmer. Operating instructions are provided in a separate Operating Manual supplied with the instrument. It should be kept with the instrument for use by the operator.

1-3. Shown on the title page is a microfiche part number. This number can be used to order the microfilm transparencies of the manual.

1-4. INSTRUMENTS COVERED BY THIS MANUAL.

1-5. Attached to the instrument or printed on the printed circuit board is the repair number. The repair number is in the form: 0000A0000. It is in two parts; the first four digits and the letter are the repair prefix, and the last four are the suffix. The prefix is the same for all identical instruments. The suffix, however, is assigned sequentially and is different for each instrument. The contents of this manual apply to instruments with the repair number prefix(es) listed under REPAIR NUMBERS on the title page.

1-6. An instrument manufactured after the printing of this manual may have a repair number prefix that is not listed on the title page. This unlisted repair number prefix indicates that the instrument has been modified from those described in this manual. The manual for this modified instrument is accomplished by a Manual Change supplement. This supplement contains "change information" that explains how to adapt the manual to the newer instrument.

1-7. In addition to change information, the supplement contains information for correcting errors in the manual. To keep this manual as current as possible, Hewlett-Packard recommends that you periodically request the latest Manual Change supplement. The supplement for this manual is identified with the manual print date and part number, both of which appear on the manual title page. Complimentary copies of the supplement are available from Hewlett-Packard Sales Service office.

1-8. For information concerning a repair number prefix that is not listed on the title page or in the Manual Change supplement, contact your nearest Hewlett-Packard Sales/Service Office.

1-9. DESCRIPTION.

1-10. The Hewlett-Packard Model 64500S Positive PROM Programmer is designed to program a wide variety of positive PROMs and EPROMs.

1-11. The Model 64500S consists of one Model 64501A Positive PROM Programmer and one or more programmer modules. One Model 64502A Programmer Module is supplied with every 64500S. Other programmer modules must be ordered separately by model number, or by option as part of the Model 64500S.

1-12. Throughout this manual the Positive PROM Programmer will be referred to as Model 64501A. It is the same as the Model 64500S except that the 64500S will have options included. The options are the programmer modules, i.e., Model 64503A, 64504A, 64505A, etc. The Model 64500S exists for marketing and ordering purposes. The service information for the programmer modules is covered in the Service Manual for that module.

1-13. The PROM Programmer board may be ordered as Model 64501A. If the board is being ordered for replacement purposes, use the ten digit part number from the material list.

1-14. The Model 64502A is used for Positive PROM Programmer Performance Verification tests, and programming Intel's 2716 and 2758, Texas Instrument's TMS2516, and TMS2532 programmable ROMs.

1-15. Pulse widths and sequences for the PROM being programmed are determined by the software.

1-16. Voltage levels, current levels, and rise or fall times are determined by the specific programmer hardware modules.

1-17. The Model 64500S performs the functions of read, write, and verification of programmable memories.

SECTION II

INSTALLATION AND REMOVAL

2-1. INTRODUCTION.

2-2. This section contains information for installing and removing the Model 64502A. Included are initial inspection procedures and instructions for repacking the instrument for shipment.

2-3. INITIAL INSPECTION.

2-4. Inspect the shipping container for damage. If the shipping container or cushioning material is damaged, it should be kept until contents of the shipment have been checked for completeness and the instrument has been checked mechanically. The electrical Procedures for checking Performance Verification are given in Section IV. If the contents are not complete, if there is mechanical damage or defect, or if the instrument does not pass the performance tests, notify the nearest Hewlett-Packard Sales/Service office. If the shipping container is damaged, or if the cushioning material shows signs of stress, notify the carrier as well as the Hewlett-Packard Sales/Service Office. Keep the shipping materials for carrier's inspection. The HP office will arrange for repair or replacement at HP's option without waiting for claim settlement.

2-5. INSTALLATION PROCEDURE.

2-6. If the Positive PROM Programmer is installed in the Mainframe, it should be positioned in the front most unused connector. This is typically the fourth or fifth connector from the front of the Mainframe. The Input/Output Controller, Display Controller, and the CPU boards occupy the first three connectors respectively. The Floppy or Tape Controller board occupies the fourth connector when installed.

NOTE

The Model 64501A Positive PROM Programmer and programmer modules must be installed and removed with the mainframe's power turned off.

2-7. PROM PROGRAMMER CABLE.

2-8. A 50 conductor ribbon cable, W1, connects the PROM Programmer to the programmer module. The end of the cable with the single connector is connected to the top left corner of the PROM Programmer with the cable towards the front of the mainframe. The cable should be routed across the top of the card cage and down behind the front panel. The two connectors should be visible in the opening for the programmer module. Depending on the module being used, it can have one or two P.C. boards. If it has only one board, use the connector nearest the end of the cable. The P.C. boards and cable connectors are keyed so that they fit together only one way.

SECTION III

OPERATION

The operation of the PROM Programmer is a function of the system software. Complete operation from the keyboard of the system is beyond the scope of the Service Manual. Please refer to the Operator's Manual for the procedures.

```
*****
*
*          CAUTION
*
*   The proper operation of the positive
*   PROM programmer requires that a PROM
*   be inserted ONLY AFTER the PROM
*   programmer software module is called
*   and that the PROM be REMOVED before
*   the PROM programmer software module
*   is exited.
*
*          NOTE
*
*   The PROM software module is called
*   by pressing the "prom_prog" softkey
*   then press the carriage return key.
*   To exit the PROM programmer software
*   module press the "end" softkey then
*   press the carriage return key.
*
*****
```

SECTION IV

PERFORMANCE VERIFICATION AND TROUBLESHOOTING

4-1. INTRODUCTION.

4-2. This section provides two types of performance tests: Operation Verification and Performance Verification. The Operation Verification provides approximately 90% assurance that the PROM Programmer and the 64502A Programmer Module are capable of programming a programmable ROM. The Performance Verification checks the electrical parameters of the PROM Programmer and the 64502A Programmer Module. Unless the detailed Performance Verification is required, we recommend that only the Operation Verification be performed.

4-3. EQUIPMENT REQUIRED.

4-4. No test equipment is required to perform the Operation Verification. However, the Performance Verification does require an Oscilloscope. Signature Analysis is not required for this Model.

4-5. The HP Model 64502A Programmer Module must be installed when running the Positive PROM Programmer Operation or Performance Verification. See the 64502A Service Manual for the installation procedure.

CAUTION

Model 64502A PROM Programmer Module is the only one that should be used when running the Operation or Performance Verifications. Other Modules can be permanently damaged.

4-6. If a problem does occur, refer to the Performance Verification theory for an understanding of its operation. This will help you in troubleshooting the PROM Programmer and the 64502A Programmer Module.

4-7. RUNNING THE OPERATION VERIFICATION.

a. Boot up the Operating System from the Disc. (See Operator's Manual for details).

b. From the Keyboard call up the PROM P.V. This is done by pressing the "opt_test" softkey, and then pressing the return key. When this is done, a table will be displayed indicating the location of the P.C. boards in the card cage of the mainframe. Press the number corresponding to the slot number which the PROM Controller PC board occupies. When this is done and the RETURN key is pressed, the PROM P.V. will be initiated.

NOTE: The following softkeys should be displayed:

START CYCLE END TEST

DAC=10V

c. Press the START softkey to run the Performance Verification and note the response. The test passes when the response "Digital Tests Passed" is displayed on the screen.

NOTE

The P.V. test is normally all that needs to be checked for a 90% confidence level. The following tests are normally performed by Service Personal.

4-8. RUNNING THE PERFORMANCE VERIFICATION.

a. Repeat the Operation Verification (Paragraph 4-7 steps a,b, and c).

b. Connect an oscilloscope to TP6 on the PROM Programmer board and note the following wave form:

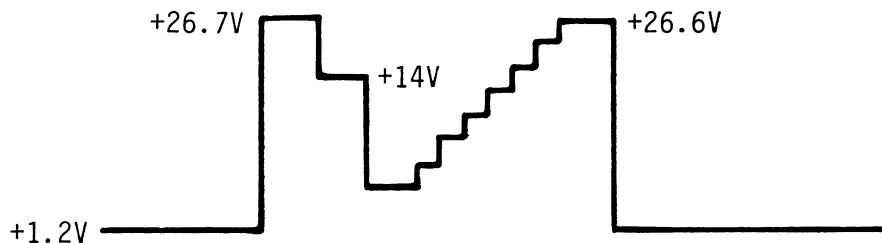

The Waveform should be linear and the steps of equal size.

c. Monitor TP7 on the PROM Programmer board with an oscilloscope and note it is changing states during the Operation Verification test.

d. Momentarily touch a 50 ohm 5 watt wire wound resistor between pin 12 (ground) and pin 21 (DAC output) of the ZIF connector on the programmer module while in the start cycle, and note the test "DAC=26.7 V" fails. This checks the DAC'S overload circuits.

CAUTION

The resistor will get hot!
The DAC is capable of approx. 15 watts.

e. Press DAC=10 V and measure +9.9 V to +10.1 V at TP6 on the PROM Programmer board. See Section V if not within this range.

f. With an oscilloscope connected to TP9 on the Programmer board, press the END TEST softkey and observe that it changes states.

g. Connect the Reset Test Cable (from the Product Support Package Model 64932A) to connector J4 on the Input/Output board. Press the button on the cable and monitor U39 pin8 on the PROM Programmer board. The signal should switch from a high state to a low state (TTL Levels) each time the button is pressed.

4-9. PERFORMANCE VERIFICATION THEORY.

4-10. The Positive PROM Programmer Operation and Performance Verification includes about 50 individual tests of the digital circuits, and is initiated by pressing the START softkey. The tests are ordered in a manner that checks increasingly complex circuits. The tests also check the ability of the Digital to Analog Converter (DAC) to output its voltage range.

4-11. If all the tests pass, the DAC will generate a staircase ramp each time through the test sequence. Linearity of the ramp should be checked at TP6 with an oscilloscope.

4-12. If a failure is detected in the digital tests, the test sequence stops and an error message appears on screen. The message shows the expected inputs and outputs for the test failed.

4-13. Although all the bits are shown, with the most significant bit on the left, only those bits designated by a "L" or "H" are being checked in that test. Investigating the bits noted by an "L" or "H" will quickly locate the fault. When the status of all bits is not indicated, it implies that the unlisted bits are the complement of the listed bits.

4-14. Pressing START again will cause the test sequence to continue. The counter recording the number of tests failed will increment only once at the end of the sequence if a failure has been detected.

4-15. The CYCLE key allows the test sequence to run continuously without stopping when errors are detected. The number of tests and failures are counted by the counter recording that information. The error messages will write over any error messages existing from previous tests.

4-16. S/A is not used to troubleshoot the PROM programmers.

4-17. TROUBLESHOOTING USING PERFORMANCE VERIFICATION.

4-18. PROM Address.

4-19. The Positive PROM Programmer and the Self Test Programmer Module (Model 64502A) are discussed as being one unit since they will not work independently.

4-20. The signal names refer to the inputs/outputs between the PROM Programmer and the programmer module, not the interface to the Mother-board, e.g., CPU data becomes PROM address.

4-21. Tests 1 (HEX) through 17 (HEX) convert the data from the CPU to the address for the programmer module. The programmer module converts the addresss to I.D. codes which are returned to the PROM Programmer.

Table 4-1. Digital Tests of Address Lines

TEST#	NORMAL OUTPUTS U5 AND U13	NORMAL INPUTS U9	COMPONENTS TESTED
01	FFFF, CHECKS A12=1	11H10001	U36,13,9,14,33,35,37
02	FFFF, CHECKS A13=1	1H110001	U36,13,9,14,33,35,37
03	EFFF, CHECKS A12=1	11L10001	U36,13,9,14,33,35,37
04	DFFF, CHECKS A13=0	1L110001	U36,13,9,14,33,35,37
05	FFFF, CHECKS A14=1	1111000H	U22,VR4 (CHECK +40V)
06	BFFF, CHECKS A14=0	1111000L	U22,VR4 (CHECK +40V)
07	FFFF, CHECKS A15=1	111H0001	U13; U3 OF MODULE
08	FFFF, CHECKS MODULE	111HLLL1	U3,6,7 OF MODULE
09	7FFF, CHECKS A15=0	111L0101	U5; U3 OF MODULE
	AND A0-A7=1		
0A	7FFF, CHECKS DAC=+1.2V	111LLHL1	U5,VR3,U16; U3,6,7 OF
	AND A8-A11,A14=1		MODULE
0B	7FFE, SETS A0=0	111HHHH1	TESTS ALL CIRCUI TS ABOVE
0C	7FFD, SETS A1=0	111HHHL1	" " " " "
0D	7FFB, SETS A2=0	111HHLH1	" " " " "
0E	7FF7, SETS A3=0	111HLLL1	" " " " "
0F	7FEF, SETS A4=0	111HLHH1	" " " " "
10	7FDF, SETS A5=0	111HLHL1	" " " " "
11	7FBF, SETS A6=0	111HLLH1	" " " " "
12	7F7F, SETS A7=0	111HLLL1	" " " " "
13	7EFF, SETS A8=0	111LHHH1	" " " " "
14	7DFF, SETS A9=0	111LHHL1	" " " " "
15	7BFF, SETS A10=0	111LHLH1	" " " " "
16	77FF, SETS A11=0	111LHLL1	" " " " "
17	3FFF, SETS A14=0	111LLHH0	" " " " "

NOTE: DAC = +1.2V FOR ALL TESTS.

4-22. Table 4-1 displays the results of tests 1 (HEX) thru 17 (HEX). The CPU outputs a HEX address to the programmer module. When a test fails,that address will remain on U5 (lower byte) and U13 (upper byte) on the control board. That address causes the programmer module to return an ID code to U9, where:

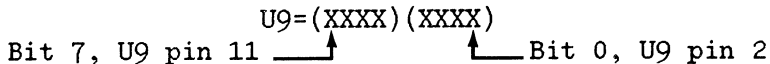

Furthermore, when a failure is displayed, troubleshoot only the bits marked "H" or "L" on U9. These are the only bits examined by software. Therefore, it is possible to chase the failed bits with a logic probe because the PROM Programmer is not addressed after a failure. Note that tests 1 thru 4 check the control circuitry on the PROM Control board and do not use the programmer module.

4-23. PROM Data.

4-24. Table 4-2 is a listing of read/write tests 18 (HEX) thru 27 (HEX) from the CPU. In each test, information is captured by the write data latches. This information is looped back through the module to the PROM Programmer and sent back to the CPU as read data, verifying continuity from the CPU to the PROM socket. The data returned to the CPU for verification is identical to that presented by the CPU for the test. Data is written to U31 where:

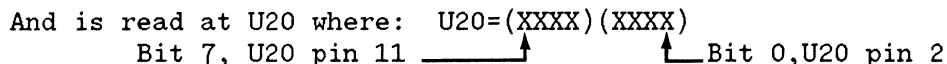
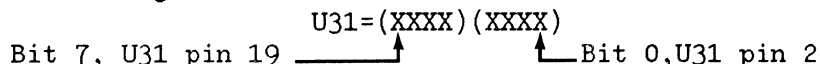

Troubleshoot only the bits marked "H" or "L" of U20.

Table 4-2. Digital READ/WRITE Test

TEST	NORMAL OUTPUT U31	NORMAL INPUT U20	COMPONENTS TESTED
18	01, TEST DW0=1	0000000H	U31,20,19,30,14,33,35,37
19	FE, TEST DW0=0	1111111L	" " " "
1A	02, TEST DW1=1	000000H0	" " " "
1B	FD, TEST DW1=0	111111L1	" " " "
1C	04, TEST DW2=1	00000H00	" " " "
1D	FB, TEST DW2=0	11111L11	" " " "
1E	08, TEST DW3=1	0000H000	" " " "
1F	F7, TEST DW3=0	1111L111	" " " "
20	10, TEST DW4=1	000H0000	" " " "
21	EF, TEST DW4=0	111L0000	" " " "
22	20, TEST DW5=1	00H00000	" " " "
23	DF, TEST DW5=0	11L11111	" " " "
24	40, TEST DW6=1	0H000000	" " " "
25	BF, TEST DW6=0	1L111111	" " " "
26	80, TEST DW7=1	H0000000	" " " "
27	7F, TEST DW7=0	L1111111	" " " "

NOTE: DAC = +1.2V FOR ALL TESTS.

- 4-25. Digital to Analog Converter. (See Table 4-3.)
- 4-26. Test 28 (HEX) does not check anything. It is a delay preceding the Digital to Analog Converter tests.
- 4-27. Tests 29 (HEX) through 2D (HEX) check the Digital to Analog Converter (DAC).
- 4-28. Test 29 (HEX) sets the DAC to its lowest voltage.
- 4-29. Test 2A (HEX) checks the Current Sensor at the DAC's lowest voltage with a 50 ohm load.
- 4-30. Test 2B (HEX) checks the Current Sensor at the DAC's highest voltage, with a 50 ohm load. This insures the current sensing circuits will detect the current overload, and return the detection to the CPU.
- 4-31. Test 2C (HEX) sets the DAC's output to +14V. This is sent to the programmer module, is reduced through a voltage divider, sent to the Priority Encoders, and returned to the CPU via the I.D. codes and the data bus.
- 4-32. Test 2D (HEX) repeats Test 2C (HEX) except the voltage is decreased by .1 V.
- 4-33. Data is written to U10 where:

U10=(XXXX)(XXXX)
 Bit 7, U10 pin 19 $\xrightarrow{\quad}$ \uparrow \quad \uparrow Bit 0, U10 pin 2

And read at U9 as an ID Code. The DAC output can be read at TP6.

Table 4-3. DAC Test

TEST#	NORMAL OUTPUT U10 AND TP6	NORMAL INPUT U9	COMPONENTS TESTED Voltage
29	00, DAC=+1.2V	111LLHL1	U14,10,21,32,VR2
2A	00, DAC=+1.2V	H1100101	U38,Q1 PASSES WITH 50 OHM LOAD
2B	FF, DAC=+26.7V	H1100L11	U14,10,21,32,VR2,U38,Q1 TEST FAILS WITH 50 OHM LOAD
2C	80, DAC=+14.0V	H1100L11	U21,32,VR2
2D	7F, DAC=+13.9V	H1100L11	U21,32,VR2

NOTE: Address lines = 7FFF during DAC test.

SECTION V

ADJUSTMENT PROCEDURE

5-1. INTRODUCTION.

5-2. This section describes adjustments and checks required to return the +5 volt supply to operating capability after repairs have been made.

5-3. SAFETY REQUIREMENTS.

5-4. Although this instrument has been designed in accordance with international safety standards, general safety precautions must be observed during all phases of operation, service, and repair of the instrument. Failure to comply with precautions listed in the Safety Summary at the front of this manual or with specific warnings given throughout the manual could result in serious injury or death. Service adjustments should be performed only by qualified service personnel.

5-5. EQUIPMENT REQUIRED.

5-6. A Voltmeter capable of .01 Volts D.C. accuracy is required for the Adjustment Procedure.

5-7. ADJUSTMENTS.

5-8. There is only one Adjustment on the Positive PROM Programmer Board.

5-9. +5 Volt Adjustment.

5-10. In order to adjust the +5 volt supply, the mainframe must be in the Operation Verification mode. Refer to page 4-1, paragraph 4-7, steps a and b.

5-11. Press the soft key labeled DAC=10 V, and adjust +5V REF, R36, for for +9.97V to +10.03V at the DAC output, TP6. Then check the voltage at TP5 for +4.65V to +5.3V.

SECTION VI

REPLACEABLE PARTS

6-1. INTRODUCTION.

6-2. This section contains information for ordering parts. Table 6-1 lists abbreviations used in the parts list and throughout the manual. Table 6-2 lists all replaceable parts in reference designator order. Table 6-3 contains the names and addresses that correspond to the manufacturers' five-digit code numbers.

6-3. ABBREVIATIONS.

6-4. Table 6-1 lists abbreviations used in the parts list, the schematics and throughout the manual. In some cases, two forms of the abbreviation are used: one, all in capital letters; and two, partial or no capitals. This occurs because the abbreviations in the parts list are always capitals. However, in the schematics and other parts of the manual, other abbreviation forms are used with both lowercase and uppercase letters.

6-5. REPLACEABLE PARTS LIST.

6-6. Table 6-2 is the list of replaceable parts and is organized as follows:

a. Chassis-mounted parts in alphanumerical order by reference designation.

b. Electrical assemblies and their components in alphanumerical order by reference designation.

c. Miscellaneous parts.

The information given for each part consists of the following:

a. The Hewlett-Packard part number and the check digit.

b. The total quantity (Qty) in the instrument.

c. The description of the part.

d. A five-digit code that indicates the manufacturer of the part.

e. The manufacturer's part number.

The total quantity for each part is given only once - at the first appearance of the part number in the list.

6-7. ORDERING INFORMATION.

6-8. To order a part listed in the replaceable parts table, quote the Hewlett-Packard part number and check digit, indicate the quantity required, and address the order to the nearest Hewlett-Packard Sales/Service Office.

6-9. To order a part that is not listed in the replaceable parts table, include the instrument model number, instrument repair number, the description and function of the part, and the number of parts required. Address the order to the nearest Hewlett-Packard Sales/Service Office.

6-10. DIRECT MAIL ORDER SYSTEM.

6-11. Within the USA, Hewlett-Packard can supply parts through a direct mail order system. Advantages of using the system are as follows:

a. Direct ordering and shipment from the HP Parts Center in Mountain View, California.

b. No Maximum or minimum on any mail order (there is a minimum order amount, for parts ordered through a local HP Office when the orders require billing and invoicing).

c. Prepaid transportation (there is a small handling charge for each order).

d. No invoices - to provide these advantages, a check or money order must accompany each order.

6-12. Mail-order forms and specific ordering information are available through your local HP Sales/Service Office. Addresses and phone numbers are located at the back of this manual.

Table 6-1. Reference Designators and Abbreviations

REFERENCE DESIGNATORS

A = assembly	F = fuse	MP = mechanical part	U = integrated circuit
B = motor	FL = filter	P = plug	V = vacuum, tube, neon bulb, photocell, etc
BT = battery	IC = integrated circuit	Q = transistor	VR = voltage regulator
C = capacitor	J = jack	R = resistor	W = cable
CP = coupler	K = relay	RT = thermistor	X = socket
CR = diode	L = inductor	S = switch	Y = crystal
DL = delay line	LS = loud speaker	T = transformer	Z = tuned cavity network
DS = device signaling (lamp)	M = meter	TB = terminal board	
E = misc electronic part	MK = microphone	TP = test point	

ABBREVIATIONS

A = amperes	H = henries	N/O = normally open	RMO = rack mount only
AFC = automatic frequency control	HDW = hardware	NOM = nominal	RMS = root-mean square
AMPL = amplifier	HEX = hexagonal	NPO = negative positive zero (zero temperature coefficient)	RWV = reverse working voltage
BFO = beat frequency oscillator	HG = mercury	NPN = negative-positive-negative	S-B = slow-blow
BE CU = beryllium copper	HR = hour(s)	NRFR = not recommended for field replacement	SCR = screw
BH = binder head	HZ = hertz	NSR = not separately replaceable	SE = selenium
BP = bandpass	IF = intermediate freq	OBD = order by description	SECT = section(s)
BRS = brass	IMPG = impregnated	OH = oval head	SEMICON = semiconductor
BWO = backward wave oscillator	INCD = incandescent	OX = oxide	SI = silicon
CCW = counter-clockwise	INCL = include(s)	P = peak	SIL = silver
CER = ceramic	INS = insulation(ied)	PC = printed circuit	SL = slide
CMO = cabinet mount only	INT = internal	PF = picofarads= 10 ⁻¹² farads	SPG = spring
COEF = coefficient	K = kilo=1000	PH BRZ = phosphor bronze	SPL = special
COM = common	LH = left hand	PHL = phillips	SST = stainless steel
COMP = composition	LIN = linear taper	PIV = peak inverse voltage	SR = split ring
COMPL = complete	LK WASH = lock washer	PNP = positive-negative-positive	STL = steel
CONN = connector	LOG = logarithmic taper	P/O = part of	TA = tantalum
CP = cadmium plate	LPF = low pass filter	POLY = polystyrene	TD = time delay
CRT = cathode-ray tube	M = milli=10 ⁻³	PORC = porcelain	TGL = toggle
CW = clockwise	MEG = meg=10 ⁶	POS = position(s)	THD = thread
DEPC = deposited carbon	MET FLM = metal film	POT = potentiometer	TI = titanium
DR = drive	MET OX = metallic oxide	PP = peak-to-peak	TOL = tolerance
ELECT = electrolytic	MFR = manufacturer	PT = point	TRIM = trimmer
ENCAP = encapsulated	MHZ = mega hertz	PWV = peak working voltage	TWT = traveling wave tube
EXT = external	MINAT = miniature	RECT = rectifier	U = micro=10 ⁻⁶
F = farads	MOM = momentary	RF = radio frequency	VAR = variable
FH = flat head	MOS = metal oxide substrate	RH = round head or right hand	VDCW = dc working volts
FIL H = fillister head	MTG = mounting		W/ = with
FXD = fixed	MY = "mylar"		W = watts
G = giga (10 ⁹)	N = nano (10 ⁻⁹)		WIV = working inverse voltage
GE = germanium	N/C = normally closed		WW = wirewound
GL = glass	NE = neon		W/O = without
GRD = grounded	NI PL = nickel plate		

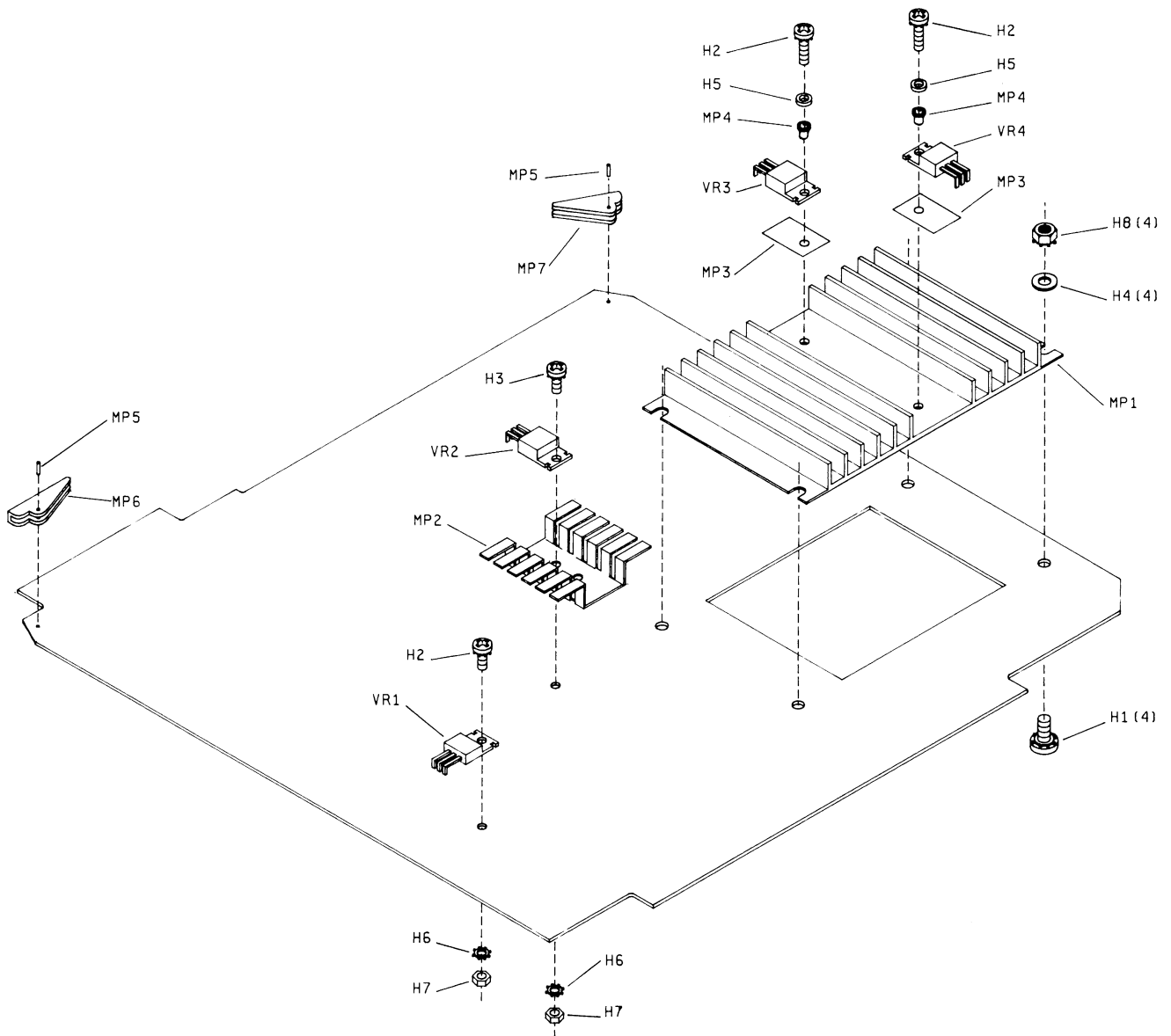

Figure 6-1. Illustrated Parts Breakdown

Table 6-2. Replaceable Parts List

Reference Designation	HP Part Number	C D	Qty	Description	Mfr Code	Mfr Part Number
	64501-66502	0	1	BOARD ASSEMBLY, PROM PROGRAM	28480	64501-66502
C1	0160-3622	8	23	CAPACITOR-FXD .1UF +80-20% 100VDC CER	26654	2130Y5V100R104Z
C2	0180-0230	0	6	CAPACITOR-FXD 1UF+-20% 50VDC TA	56289	150D105X0050A2
C3	0180-0230	0		CAPACITOR-FXD 1UF+-20% 50VDC TA	56289	150D105X0050A2
C4	0160-3622	8		CAPACITOR-FXD .1UF +80-20% 100VDC CER	26654	2130Y5V100R104Z
C5	0160-3622	8		CAPACITOR-FXD .1UF +80-20% 100VDC CER	26654	2130Y5V100R104Z
C6	0160-3622	8		CAPACITOR-FXD .1UF +80-20% 100VDC CER	26654	2130Y5V100R104Z
C7	0160-3622	8		CAPACITOR-FXD .1UF +80-20% 100VDC CER	26654	2130Y5V100R104Z
C8	0160-3622	8		CAPACITOR-FXD .1UF +80-20% 100VDC CER	26654	2130Y5V100R104Z
C9	0160-3622	8		CAPACITOR-FXD .1UF +80-20% 100VDC CER	26654	2130Y5V100R104Z
C10	0160-3622	8		CAPACITOR-FXD .1UF +80-20% 100VDC CER	26654	2130Y5V100R104Z
C11	0160-3622	8		CAPACITOR-FXD .1UF +80-20% 100VDC CER	26654	2130Y5V100R104Z
C12	0160-3622	8		CAPACITOR-FXD .1UF +80-20% 100VDC CER	26654	2130Y5V100R104Z
C13	0160-3622	8		CAPACITOR-FXD .1UF +80-20% 100VDC CER	26654	2130Y5V100R104Z
C14	0160-3622	8		CAPACITOR-FXD .1UF +80-20% 100VDC CER	26654	2130Y5V100R104Z
C15	0160-3622	8		CAPACITOR-FXD .1UF +80-20% 100VDC CER	26654	2130Y5V100R104Z
C16	0160-3622	8		CAPACITOR-FXD .1UF +80-20% 100VDC CER	26654	2130Y5V100R104Z
C17	0180-1794	3	1	CAPACITOR-FXD 22UF+-10% 35VDC TA	56289	150D220X035R2
C18	0160-3622	8		CAPACITOR-FXD .1UF +80-20% 100VDC CER	26654	2130Y5V100R104Z
C19	0180-0269	5	1	CAPACITOR-FXD 1UF+50-10% 150VDC AL	56289	30D105G150BA2
C20	0160-3622	8		CAPACITOR-FXD .1UF +80-20% 100VDC CER	26654	2130Y5V100R104Z
C21	0160-2207	3	1	CAPACITOR-FXD 300PF +-5% 300VDC MICA	28480	0160-2207
C22	0160-3622	8		CAPACITOR-FXD .1UF +80-20% 100VDC CER	26654	2130Y5V100R104Z
C23	0180-0230	0		CAPACITOR-FXD 1UF+-20% 50VDC TA	56289	150D105X0050A2
C24	0140-0203	3	1	CAPACITOR-FXD 30PF +-5% 500VDC MICA	72136	DM15E300J0500HV1CR
C25	0180-0230	0		CAPACITOR-FXD 1UF+-20% 50VDC TA	56289	150D105X0050A2
C26	0160-3622	8		CAPACITOR-FXD .1UF +80-20% 100VDC CER	26654	2130Y5V100R104Z
C27	0160-3622	8		CAPACITOR-FXD .1UF +80-20% 100VDC CER	26654	2130Y5V100R104Z
C28	0160-3622	8		CAPACITOR-FXD .1UF +80-20% 100VDC CER	26654	2130Y5V100R104Z
C29	0160-3622	8		CAPACITOR-FXD .1UF +80-20% 100VDC CER	26654	2130Y5V100R104Z
C30	0180-0230	0		CAPACITOR-FXD 1UF+-20% 50VDC TA	56289	150D105X0050A2
C31	0160-3622	8		CAPACITOR-FXD .1UF +80-20% 100VDC CER	26654	2130Y5V100R104Z
C32	0180-0230	0		CAPACITOR-FXD 1UF+-20% 50VDC TA	56289	150D105X0050A2
C33	0160-3622	8		CAPACITOR-FXD .1UF +80-20% 100VDC CER	26654	2130Y5V100R104Z
H1	2360-0117	6	4	SCREW-MACH 6-32 .375-IN-LG PAN-HD-POZI	00000	ORDER BY DESCRIPTION
H2	2200-0105	4	3	SCREW-MACH 4-40 .312-IN-LG PAN-HD-POZI	00000	ORDER BY DESCRIPTION
H3	2200-0107	6	1	SCREW-MACH 4-40 .375-IN-LG PAN-HD-POZI	00000	ORDER BY DESCRIPTION
H4	3050-0066	8	4	WASHER-FL MTLC NO. 6 .147-IN-ID	28480	3050-0066
H5	3050-0235	3	2	WASHER-FL MTLC NO. 4 .117-IN-ID	28480	3050-0235
H6	2190-0005	0	2	WASHER-LK EXT T NO. 4 .116-IN-ID	28480	2190-0005
H7	2260-0001	5	2	NUT-HEX-DBL-CHAM 4-40=THD .094-IN=THK	28480	2260-0001
H8	2420-0001	5	4	NUT-HEX-W/LKHR 6-32=THD .109-IN=THK	00000	ORDER BY DESCRIPTION
MP1	1205-0380	6	1	HEAT SINK 3PCL-HOLE=PATT	28480	1205-0380
MP2	1205-0376	0	1	HEAT SINK 3GL PLSTC-PWR-CS	13103	60728
MP3	0340-0511	0	2	INSULATOR-XSTR KAPTON	28480	0340-0511
MP4	0340-0676	8	2	INSULATOR-PLG-BSHG NYLON	28480	0340-0676
MP5	1480-0116	8	2	PIN-GRV .062-IN-DIA .25-IN-LG STL	28480	1480-0116
MP6	64501-85002	6	1	EXTRACTOR, LEFT	28480	64501-85002
MP7	64501-85001	5	1	EXTRACTOR, RIGHT	28480	64501-85001
Q1	1854-0642	8	1	TRANSISTOR NPN SI PD=625MH FT=60MHZ	04713	MPS-A17
R1	0684-1511	0	2	RESISTOR 150 10% .25W FC TC=-400/+600	01121	CR1511
R2	0684-1511	0		RESISTOR 150 10% .25W FC TC=-400/+600	01121	CR1511
R3	0684-1021	7	3	RESISTOR 1K 10% .25W FC TC=-400/+600	01121	CR1021
R4	0684-1021	7		RESISTOR 1K 10% .25W FC TC=-400/+600	01121	CR1021
R5	0683-5125	8	1	RESISTOR 5.1K 5% .25W FC TC=-400/+700	01121	CR5125
R6	0683-1135	2	1	RESISTOR 11K 5% .25W FC TC=-400/+800	01121	CR1135
R7	0683-1845	1	8	RESISTOR 180K 5% .25W FC TC=-800/+900	01121	CR1845
R8	0683-1845	1		RESISTOR 180K 5% .25W FC TC=-800/+900	01121	CR1845
R9	0683-1845	1		RESISTOR 180K 5% .25W FC TC=-800/+900	01121	CR1845
R10	0683-1845	1		RESISTOR 180K 5% .25W FC TC=-800/+900	01121	CR1845
R11	0683-1845	1		RESISTOR 180K 5% .25W FC TC=-800/+900	01121	CR1845
R12	0683-1845	1		RESISTOR 180K 5% .25W FC TC=-800/+900	01121	CR1845
R13	0683-1845	1		RESISTOR 180K 5% .25W FC TC=-800/+900	01121	CR1845
R14	0683-1845	1		RESISTOR 180K 5% .25W FC TC=-800/+900	01121	CR1845
R15	0757-0274	5	1	RESISTOR 1.21K 1% .125W F TC=0+-100	24546	C4=1/8-T0=1213-F
R16	0698-3153	9	1	RESISTOR 3.83K 1% .125W F TC=0+-100	24546	C4=1/8-T0=3831-F
R17	0698-3429	2	1	RESISTOR 19.6 1% .125W F TC=0+-100	03888	PME55=1/8-T0=19R6-F
R18	0698-3634	1	2	RESISTOR 470 5% 2W MO TC=0+-200	28480	0698-3634
R19	0698-3634	1		RESISTOR 470 5% 2W MO TC=0+-200	28480	0698-3634
R20	0811-1200	5	2	RESISTOR .1 10% 2W PW TC=0+-800	75042	BWM2=2=1/10-K

See introduction to this section for ordering information

Table 6-2. Replaceable Parts List (continued)

Reference Designation	HP Part Number	C D	Qty	Description	Mfr Code	Mfr Part Number
R21	0811-1200	5		RESISTOR .1 10% 2W PW TC=0+-800	75042	BWH2-2-1/10-K
R22	0757-0416	7	1	RESISTOR 511 1% .125W F TC=0+-100	24546	C4-1/8-T0-511R-F
R23	0811-1854	5	2	RESISTOR 50 5% 5W PW TC=0+-20	28480	0811-1854
R24	0811-1854	5	5	RESISTOR 50 5% 5W PW TC=0+-20	28480	0811-1854
R25	0698-3155	1	1	RESISTOR 4.64K 1% .125W F TC=0+-100	24546	C4-1/8-T0-4641-F
R26	0811-2043	6	1	RESISTOR 12.71K .1% .25W PWW TC=0+-10	20940	143-1/8-E-12711-B
R27	0698-3239	2	1	RESISTOR 1.5K .25% .125W F TC=0+-50	28480	0698-3239
R28	0698-4055	2	1	RESISTOR 1K .25% .125W F TC=0+-100	03888	PHE55-1/8-T0-1001-C
R29	0684-1021	1		RESISTOR 1K 10% .25W FC TC=-400/+600	01121	CB1021
R30	0757-0403	2	3	RESISTOR 121 1% .125W F TC=0+-100	24546	C4-1/8-T0-121R-F
R31	0757-0403	2		RESISTOR 121 1% .125W F TC=0+-100	24546	C4-1/8-T0-121R-F
R32	0811-1853	4	2	RESISTOR 25 5% 5W PW TC=0+-20	28480	0811-1853
R33	0811-1853	4	2	RESISTOR 25 5% 5W PW TC=0+-20	28480	0811-1853
R34	0757-0403	2		RESISTOR 121 1% .125W F TC=0+-100	24546	C4-1/8-T0-121R-F
R35	0698-3445	2	1	RESISTOR 348 1% .125W F TC=0+-100	24546	C4-1/8-T0-348R-F
R36	2100-2520	9	1	RESISTOR-TRMR 50 20% C SIDE=ADJ 1-TRN	30983	EY50X500
TP1-	0360-0535	0	10	TERMINAL TEST POINT PCB	00000	ORDER BY DESCRIPTION
TP10	0360-0535	0		TERMINAL TEST POINT PCB	00000	ORDER BY DESCRIPTION
U1	1810-0301	4	3	NETWORK-RES 16-DIP51.0 OHM X 8	01121	3168510
U2	1906-0074	1	4	DIODE-ARRAY 50V 400MA	28480	1906-0074
U3	1810-0049	7	4	NETWORK-RES 12-SIP6.8K OHM X 10	28480	1810-0049
U4	1810-0049	7	4	NETWORK-RES 12-SIP6.8K OHM X 10	28480	1810-0049
U5	1820-1730	6	4	IC FF TTL LS D-TYPE POS-EDGE-TRIG COM	01295	8N74LS273N
U6	1810-0301	4		NETWORK-RES 16-DIP51.0 OHM X 8	01121	3168510
U7	1906-0074	1		DIODE-ARRAY 50V 400MA	28480	1906-0074
U8	1810-0049	7		NETWORK-RES 12-SIP6.8K OHM X 10	28480	1810-0049
U9	1820-2024	3	3	IC DRVR TTL LS LINE DRVR OCTL	01295	8N74LS244N
U10	1820-1730	6		IC FF TTL LS D-TYPE POS-EDGE-TRIG COM	01295	8N74LS273N
U11	1810-0301	4		NETWORK-RES 16-DIP51.0 OHM X 8	01121	3168510
U12	1906-0074	1		DIODE-ARRAY 50V 400MA	28480	1906-0074
U13	1820-1730	6		IC FF TTL LS D-TYPE POS-EDGE-TRIG COM	01295	8N74LS273N
U14	1820-1240	3	2	IC DCDR TTL S 3-TO-8-LINE 3-INP	01295	8N74S138N
U15	1810-0049	7		NETWORK-RES 12-SIP6.8K OHM X 10	28480	1810-0049
U16	1820-2207	4	2	IC DRVR TTL AND DUAL	01295	8N75471P
U17	1906-0074	1		DIODE-ARRAY 50V 400MA	28480	1906-0074
U18	1826-0138	8	2	IC COMPARATOR GP QUAD 14-DIP-P	04713	LM1339P
U19	1826-0138	8		IC COMPARATOR GP QUAD 14-DIP-P	04713	LM1339P
U20	1820-2024	3		IC DRVR TTL LS LINE DRVR OCTL	01295	8N74LS244N
U21	1826-0188	8	1	IC CONV 8-8-D/A 16-DIP-C	04713	MC1408L-8
U22	1820-2207	4		IC DRVR TTL AND DUAL	01295	8N75471P
U23	1820-2044	7	8	IC DRVR TTL AND DUAL 2-INP	01295	8N75461P
U24	1820-2044	7		IC DRVR TTL AND DUAL 2-INP	01295	8N75461P
U25	1820-2044	7		IC DRVR TTL AND DUAL 2-INP	01295	8N75461P
U26	1820-2044	7		IC DRVR TTL AND DUAL 2-INP	01295	8N75461P
U27	1820-2044	7		IC DRVR TTL AND DUAL 2-INP	01295	8N75461P
U28	1820-2044	7		IC DRVR TTL AND DUAL 2-INP	01295	8N75461P
U29	1820-2044	7		IC DRVR TTL AND DUAL 2-INP	01295	8N75461P
U30	1820-2044	7		IC DRVR TTL AND DUAL 2-INP	01295	8N75461P
U31	1820-1730	6		IC FF TTL LS D-TYPE POS-EDGE-TRIG COM	01295	8N74LS273N
U32	1826-0207	2	1	IC OP AMP MB 8-DIP-P	27014	LM318N
U33	1820-1240	3		IC DCDR TTL S 3-TO-8-LINE 3-INP	01295	8N74S138N
U34	1820-1568	8	1	IC BFR TTL LS BUS QUAD	01295	8N74LS125AN
U35	1820-2075	4	1	IC MISC TTL LS	01295	8N74LS245N
U36	1820-2024	3		IC DRVR TTL LS LINE DRVR OCTL	01295	8N74LS244N
U37	1820-1624	7	1	IC BFR TTL S OCTL 1-INP	01295	8N74S241N
U38	1826-0412	1	1	IC COMPARATOR PRCN 8-DIP-P	01295	LM393
U39	1820-1197	9	1	IC GATE TTL LS NAND QUAD 2-INP	01295	8N74LS00N
U40	1820-1989	7	1	IC CNTR TTL LS 8IN DUAL 4-BIT	07263	74LS93PC
U41	1826-0180	0	1	IC TIMER TTL MONO/ASTBL	04713	MC1455P1
VR1	1826-0393	7	4	LM317T	27014	LM317T
VR2	1826-0393	7		LM317T	27014	LM317T
VR3	1826-0393	7		LM317T	27014	LM317T
VR4	1826-0393	7		LM317T	27014	LM317T
VR5	1902-0074	3	1	DIODE-ZNR 7.15V 5% DO-7 PD=.4W TC=+.047X	28480	1902-0074
VR6	1902-3172	8	1	DIODE-ZNR 11V 2% DO-7 PD=.4W TC=+.062X	28480	1902-3172
W1	8120-4336	7	1	CABLE, POSITIVE PROM	28480	8120-4336
MISCELLANEOUS PARTS						
XU33	1200-0607	3	1	SOCKET-IC 16 PIN	28480	1200-0607
XU41	1200-0607	8	1	SOCKET-IC 8-CONT DIP DIP-SLDR	28480	1200-0607

See introduction to this section for ordering information

Table 6-3. List of Manufacturers' Codes

Mfr No.	Manufacturer Name	Address	Zip Code
00000	ANY SATISFACTORY SUPPLIER		
00466	NORELCO NORTH AMER PHILIPS LTG CORP	LOS ANGELES CA	90021
01121	ALLEN-BRADLEY CO	MILWAUKEE WI	53204
01295	TEXAS INSTR INC SEMICOND CMPNT DIV	DALLAS TX	75222
01928	RCA CORP SOLID STATE DIV	SOMERVILLE NJ	08876
03888	KDI PYROFILM CORP	WHIPPANY NJ	07981
04713	MOTOROLA SEMICONDUCTOR PRODUCTS	PHOENIX AZ	85062
07263	FAIRCHILD SEMICONDUCTOR DIV	MOUNTAIN VIEW CA	94042
09023	CORNELL-DUBILIER ELEK DIV FED PAC	SANFORD NC	27330
13103	THERMALLOY CO	DALLAS TX	75234
19701	MEPCO/ELECTRA CORP	MINERAL WELLS TX	76067
20940	MICRO-OHM CORP	EL MONTE CA	91731
24506	CORNING GLASS WORKS (BRADFORD)	BRADFORD PA	16701
26654	VADAYNE INC	SANTA MONICA CA	90404
27014	NATIONAL SEMICONDUCTOR CORP	SANTA CLARA CA	95051
27777	VARO SEMICONDUCTOR INC	GARLAND TX	75040
28480	HEWLETT-PACKARD CO CORPORATE HQ	PALO ALTO CA	94304
30983	MEPCO/ELECTRA CORP	SAN DIEGO CA	92121
32997	BOURNS INC TRIMPOT PROD DIV	RIVERSIDE CA	92507
34344	MOTOROLA INC	FRANKLIN PARK IL	60131
34649	INTEL CORP	MOUNTAIN VIEW CA	95051
56289	SPRAGUE ELECTRIC CO	NORTH ADAMS MA	01247
71590	CENTRALAB ELEK DIV GLOBE-UNION INC	MILWAUKEE WI	50501
72136	ELECTRO MOTIVE CORP SUB IEC	WILLIMANTIC CT	06226
75042	TRW INC PHILADELPHIA DIV	PHILADELPHIA PA	19108
75382	KULKA ELECTRIC CORP	MT VERNON NY	10550
75915	LITTELFUSE INC	DES PLAINES IL	60016

See introduction to this section for ordering information

SECTION VII

MANUAL BACKDATING

This section contains information for adapting this manual to the 64500S with serial prefix number 1924A that have a 64501-66501 board installed.

CHANGE 1

Page 6-5, table 6-2,

Change: The 64501-66502 board to 64501-66501, CD=0.

Page 8-11, figure 8-2,

Change: Replace schematic with the one attached in this section.

NOTE: The board and schematic will have to be modified. The correct ID (1000H) is not always transmitted on the 64501-66501 board due to the internal bus on the board floating when the ID is read. This usually occurs when other options are installed. Refer to Service Note 64500S-2.

Page 7-3/(7-4 blank) shows the alterations to fix the ID problem.

A 64000 system with the card cage heavily loaded may cause the Model 64501A Prom Programmer Controller to transmit an incorrect ID Code when the option-test softkey is pressed. As a result, the Prom Programmer will not be recognized.

This note applies only to the 64501-66501 circuit card. This problem has been corrected on the 64501-66502 circuit card, serial prefix 2239A.

MODIFICATION INSTRUCTIONS:

1. Remove U33 and solder socket XU33, Part No. 1200-0607, in place.
Add this 16-pin IC socket to the parts list of the 64500S.
2. Cut traces to pins 15 and 6 as shown in figure 1.
3. Cut trace to U33 pin 1 as shown in Figure 2. Add jumpers from from U33 pins 1, 6 and 14 to feedthrough holes as shown in Figure 2.
4. Replace U33.
5. Update the Prom Programmer schematic as shown in Figure 3 and check out the circuits which were modified for shorts & continuity.

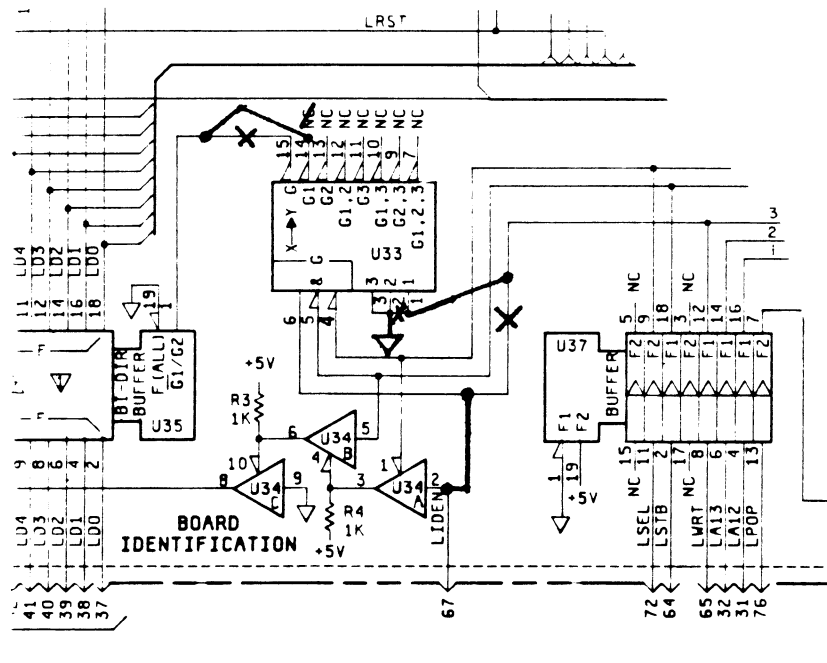
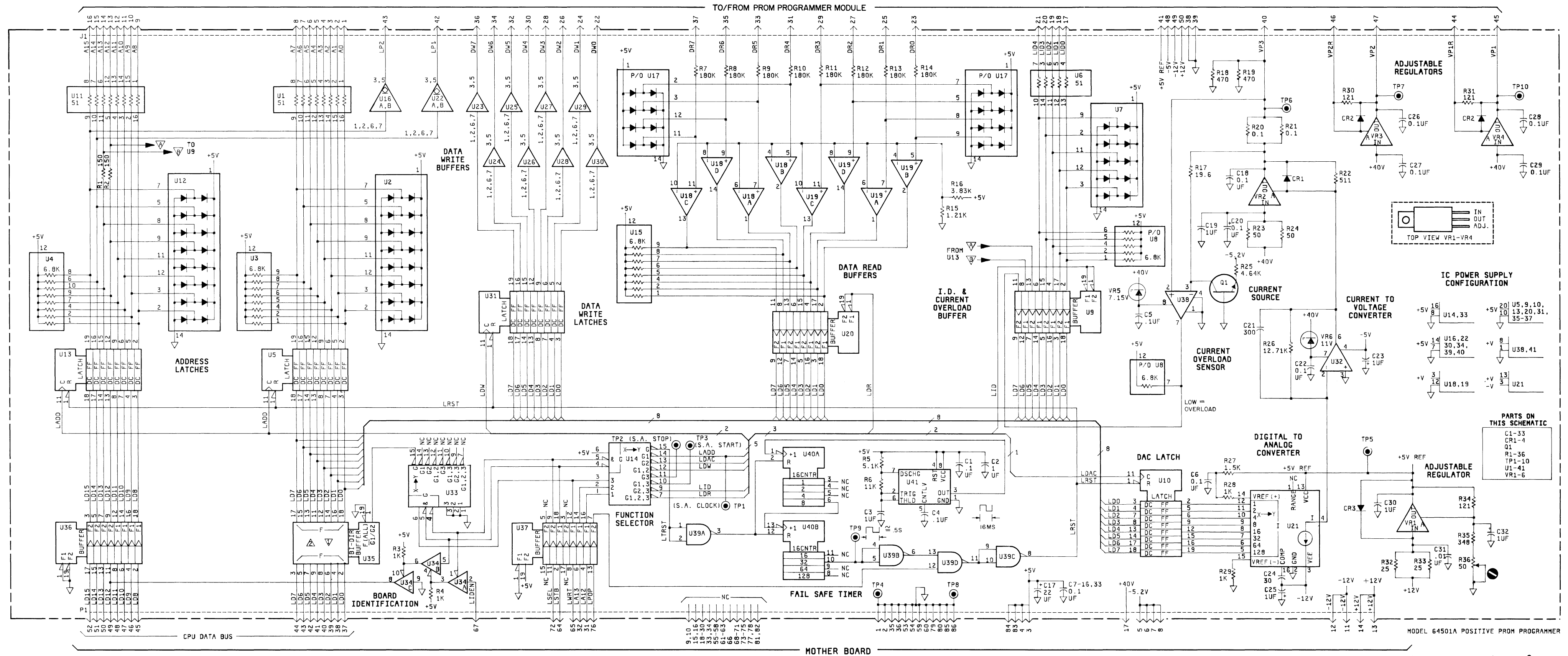
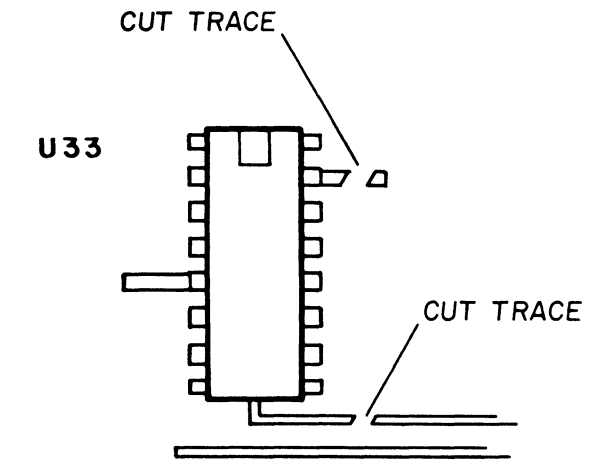

Figure 7-2. Schematic Changes to the 64501-66501 board



MODEL 64501A POSITIVE PROM PROGRAMMER

MANUAL BACKDATING Figure 8-2.
 Prom Programmer Controller Schematic
 64501-66501
 Page 8-11
 PROM Prog 7-3



Component Side 64501-66501

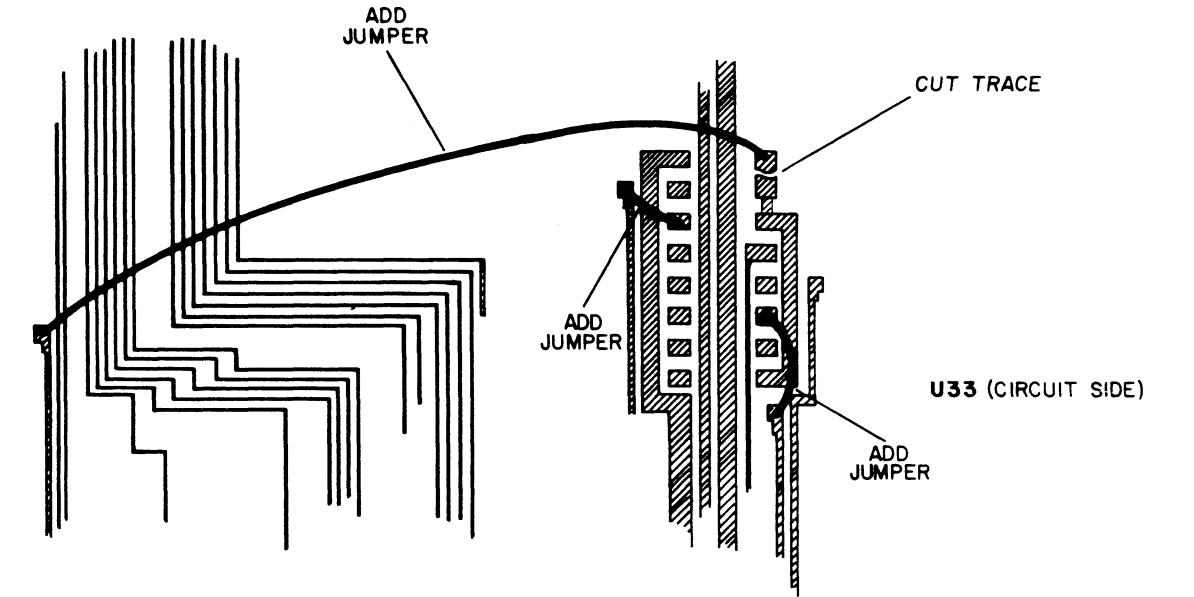

Circuit Side 64501-66501

Figure 7-3. Modifying the 64501-66501 board

SECTION VIII

THEORY AND SCHEMATICS

8-1. INTRODUCTION.

8-2. This section contains information for troubleshooting and repairing the Model 64501A PROM Programmer.

8-3. The block diagram, schematic, component locator, and other service information are provided on fold-out service sheets to help you in servicing the Model 64501A PROM Programmer. Table 8-1 Logic Symbolology will aid you in reading and interpreting the new Logic Symbols.

8-4. BLOCK DIAGRAM THEORY.

8-5. Buffers U35, U36 and U37 are drivers that buffer the Positive PROM Programmer from the CPU Bus.

8-6. Function Selector U14 controls the various functions on the Positive PROM Programmer. U33 determines which direction data will flow through U35.

8-7. U39, U40, and U41 form a Timer to prevent over heating of the Programmer's components if the CPU program fails to operate properly.

8-8. U16 and U22 are used to develop pulses and voltages required to program the PROM.

8-9. U34 develops the board I.D. of the Positive PROM Programmer Identification Code.

8-10. Socket ID and Current Overload Buffer U9 returns the Programmer Module's Identification Code and Current Overload Status to the CPU.

8-11. DAC Latch U10, DAC U21, Current to Voltage Converter U32, and Adjustable Regulators VR1 and VR2, form a programmable voltage source. The range is +1.2 V to +26.7 V in .1 volt steps.

8-12. U38 is a current overload sensor.

8-13. VR3 and VR4 are Adjustable Voltage Regulators.

8-14. Address Latches U5 and U13 develop the PROM's address.

8-15. Data Write Buffers U23 through U31 write the data to the PROM being programmed.

8-16. Data Read Buffers U18, U19, and U20 return the data read from the PROM to the CPU for verification.

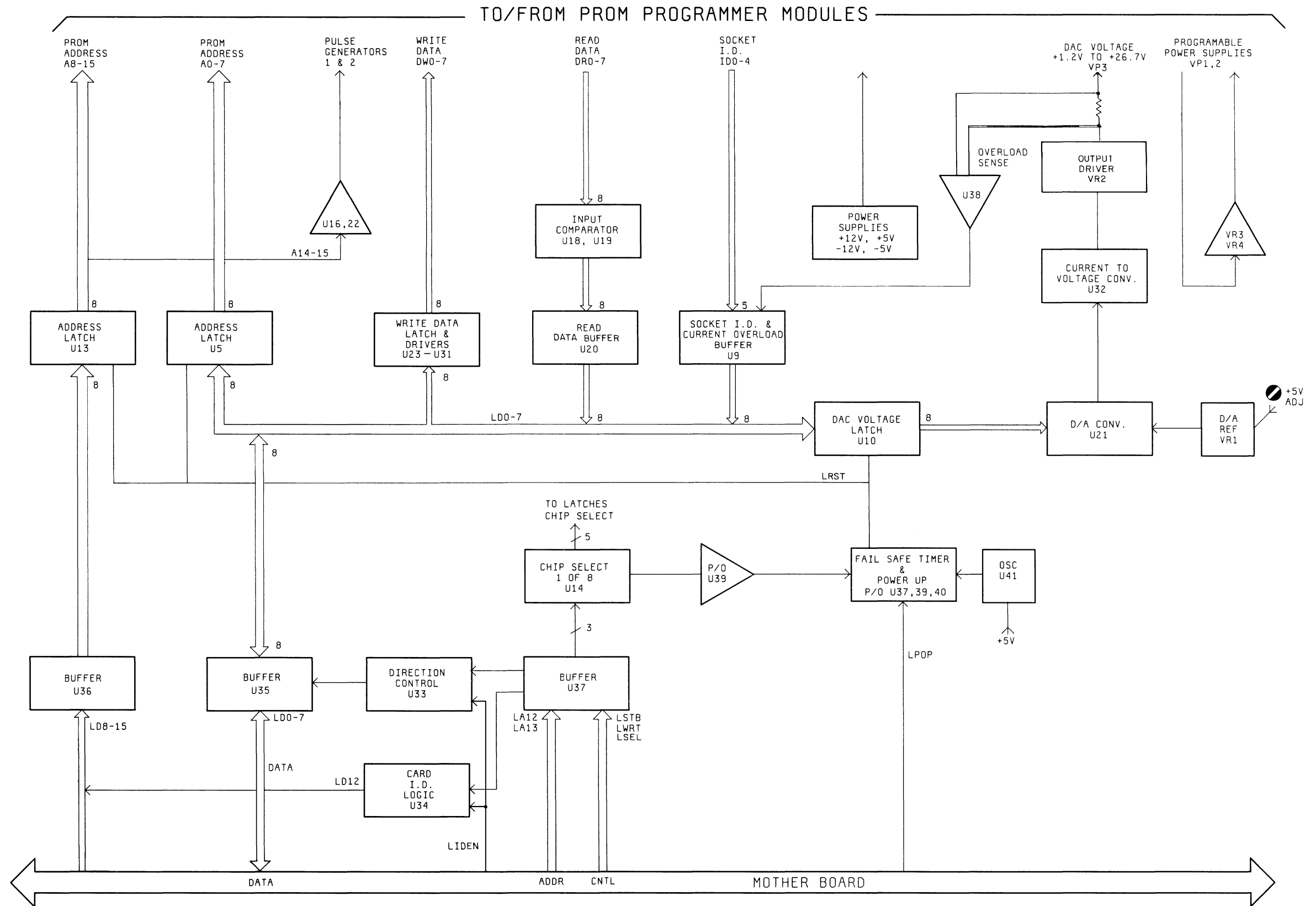

Figure 8-1.
Block Diagram
PROM Prog 8-2

Table 8-1. Logic Symbology

GENERAL

All signals flow from left to right, relative to the symbol's orientation with inputs on the left side of the symbol, and outputs on the right side of the symbol (the symbol may be reversed if the dependency notation is a single term.)

All dependency notation is read from left to right (relative to the symbol's orientation).

An external state is the state of an input or output outside the logic symbol.

An internal state is the state of an input or output inside the logic symbol. All internal states are True = High.

SYMBOL CONSTRUCTION

Some symbols consist of an outline or combination of outlines together with one or more qualifying symbols, and the representation of input and output lines.

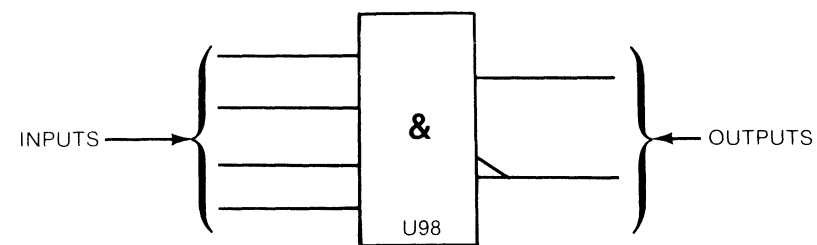

Some have a common Control Block with an array of elements:

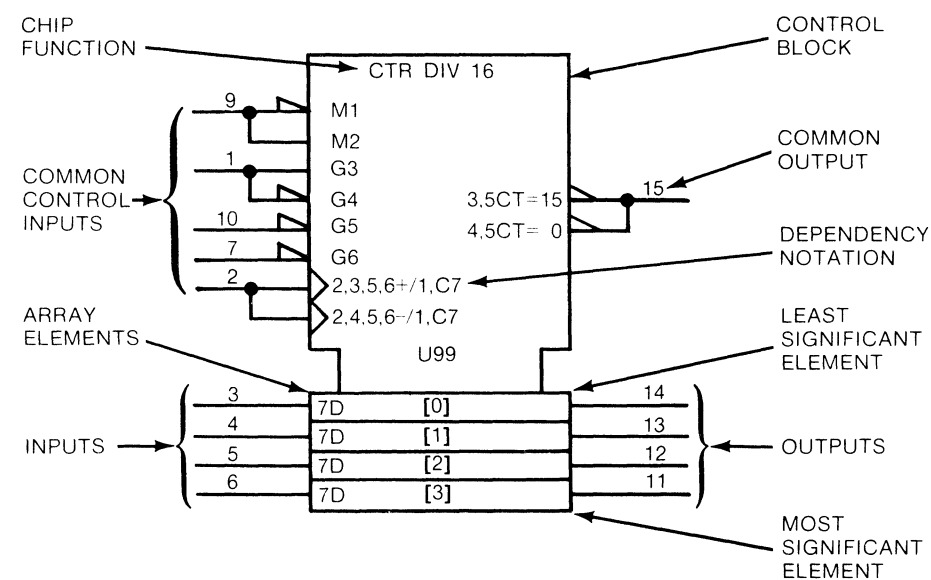

CONTROL BLOCK - All inputs and dependency notation affect the array elements directly. Common outputs are located in the control block. (Control blocks may be above or below the array elements.)

ARRAY ELEMENTS - All array elements are controlled by the control block as a function of the dependency notation. Any array element is independent of all other array elements. Unless indicated, the least significant element is always closest to the control block. The array elements are arranged by binary weight. The weights are indicated by powers of 2 (shown in []).

LS-08-09-82 - 1

Table 8-1. Logic Symbology (cont'd)

INPUTS - Inputs are located on the left side of the symbol and are affected by their dependency notation.

Common control inputs are located in the control block and control the inputs/outputs to the array elements according to the dependency notation.

Inputs to the array elements are located with the corresponding array element with the least significant element closest to the control block.

OUTPUTS - Outputs are located on the right side of the symbol and are effected by their dependency notation.

Common control outputs are located in the control block.

Outputs of array elements are located in the corresponding array element with the least significant bit closest to the control block.

CHIP FUNCTION - The labels for chip functions are defined, i.e., CTR - counter, MUX - multiplexer.

DEPENDENCY NOTATION

Dependency notation is always read from left to right relative to the symbol's orientation.

Dependency notation indicates the relationship between inputs, outputs, or inputs and outputs. Signals having a common relationship will have a common number, i.e., C7 and 7D...C7 controls D. Dependency notation 2,3,5,6+/1,C7 is read as when 2 and 3 and 5 and 6 are true, the input will cause the counter to increment by one count...or (/) the input (C7) will control the loading of the input value (7D) into the D flip-flops.

The following types of dependencies are defined:

- a. AND (G), OR (V), and Negate (N) denote Boolean relationship between inputs and outputs in any combination.
- b. Interconnection (Z) indicates connections inside the symbol.
- c. Control (C) identifies a timing input or a clock input of a sequential element and indicates which inputs are controlled by it.
- d. Set (S) and Reset (R) specify the internal logic states (outputs) of an RS bistable element when the R or S input stands at its internal 1 state.
- e. Enable (EN) identifies an enable input and indicates which inputs and outputs are controlled by it (which outputs can be in their high impedance state).
- f. Mode (M) identifies an input that selects the mode of operation of an element and indicates the inputs and outputs depending on that mode.
- g. Address (A) identifies the address inputs.
- h. Transmission (X) identifies bi-directional inputs and outputs that are connected together when the transmission input is true.

DEPENDENCY NOTATION SYMBOLS

A	Address (selects inputs/outputs) (indicates binary range)	N	Negate (compliments state)
C	Control (permits action)	R	Reset Input
EN	Enable (permits action)	S	Set Input
G	AND (permits action)	V	OR (permits action)
M	Mode (selects action)	Z	Interconnection
		X	Transmission

LS-08-09-82 - 2

Table 8-1. Logic Symbology (cont'd)

OTHER SYMBOLS					
	Analog Signal				
	AND				
	Bit Grouping				
	Buffer				
	Compare				
	Dynamic				
	Exclusive OR				
	Hysteresis				
	Interrogation				
	Internal Connection				
LABELS					
BG	Borrow Generate	CO	Carry Output	J	J Input
BI	Borrow Input	CP	Carry Propagate	K	K Input
BO	Borrow Output	CT	Content	P	Operand
BP	Borrow Propagate	D	Data Input	T	Transition
CG	Carry Generate	E	Extension (input or output)	+	Count Up
CI	Carry Input	F	Function	-	Count Down
MATH FUNCTIONS					
Σ	Adder	>	Greater Than		
ALU	Arithmetic Logic Unit	<	Less Than		
COMP	Comparator	CPG	Look Ahead Carry Generator		
DIV	Divide By	π	Multiplier		
=	Equal To	P-Q	Subtractor		
CHIP FUNCTIONS					
BCD	Binary Coded Decimal	DIR	Directional	RAM	Random Access Memory
BIN	Binary	DMUX	Demultiplexer	RCVR	Line Receiver
BUF	Buffer	FF	Flip-Flop	ROM	Read Only Memory
CTR	Counter	MUX	Multiplexer	SEG	Segment
DEC	Decimal	OCT	Octal	SRG	Shift Register
DELAY and MULTIVIBRATORS					
	Astable				
	Delay				
	Nonretriggerable Monostable				
NV	Nonvolatile				
	Retriggerable Monostable				

8-17. THEORY OF OPERATION.

8-18. General.

a. The theory of the Positive PROM Programmer is discussed in the order of events as they occur under software control.

b. The Positive PROM Programmer communicates with the CPU over the CPU data bus. Only two address lines are used, LA12 and LA13.

c. The addresses for the PROM being programmed are developed on the Positive PROM Programmer P.C. board.

d. U35 buffers the lower eight bits of the CPU data bus. Control lines LWRT, LSEL, and LSTB from the CPU in conjunction with U33 determine if U35 is in the send or receive mode.

e. U36 buffers the upper eight bits of the CPU data bus, and is receive only on the Positive PROM Programmer.

f. U37 buffers CPU control lines LSTB, LWRT, LA12, LA13, LSEL LPOP.

g. Function Selector U14 decodes LA12, LA13, and LWRT to control data flow on the Positive PROM Programmer.

8-19. DETAILED THEORY.

8-20. Fail Safe Timer.

8-21. U39, 40, and U41 form a "Fail-Safe Timer" that uses the output of U41 as the clock. Normally the timer is reset by the software at least every 100 milliseconds. If the program fails to execute properly or some other failure occurs, the timer will not be reset and will count all 32 states (approx 500 milliseconds). This forces U39 pin 8 low, clearing the Address Latches U5 and U13, DAC Latch U10, and Data Write Latch U31.

8-22. Pulse Generators.

8-23. U16 and U22 are dual positive AND drivers. There are two sections of each I.C. which are connected in parallel to provide 500 milliamps of current sinking ability. The two signals developed by the CPU (LD14,15) are used to generate pulses and voltage levels of different values. The different values can be found in the theory of operation for each of the programmer modules.

8-24. Positive PROM Programmer Identification.

8-25. When the CPU forces LIDEN, LSEL, and LSTB low, and the Positive PROM Programmer is present in the mainframe, a low state on LD12 is developed by board I.D. U34. (Pull-up resistors on the CPU data bus pull other data lines high.) EFFF HEX is returned to the CPU on the data bus. If FFFF HEX is returned, the CPU will not allow Positive PROM Programming.

8-26. Programmer Module Identification.

8-27. Programmer module identification code is developed on the module's P.C. board. The I.D. code is generated by grounding combinations of lines ID0 through ID4, A12, and A13 in the programmer module. A12 and A13 are shared between PROM address and I.D. code. R1 and R2 allow the programmer module to pull A12 and A13 low for the I.D. code without damaging the outputs of Address Latch U13, even if they are high.

8-28. The I.D. code is buffered by I.D. and Current Overload Buffer U9, and is returned through U35 when requested by the CPU. The CPU uses the I.D. code to determine which PROMs may be programmed in the module installed in the mainframe. The unique code for each module may be found in the theory of operation for the programmer modules.

8-29. Programmable Positive Power Supply.

8-30. After the PROM is installed, the CPU programs power supply VP3 and checks the power being used by the PROM. The DAC Latch U10 latches digital information from the CPU for the Digital to Analog Converter, U21. DAC U21 is referenced to +5 V supplied by an adjustable regulator, VR1. DAC U21 converts the 8 bit digital word to a programmed current level that drives the Voltage to Current Converter U32.

8-31. U32 is a current to voltage converter referenced to +29 V. Depending on the current from the the DAC U21 the output voltage will range from approximately 0 V to +25.5 V. With the 8 bit resolution of U21, the output of U32 will have a resolution of .1 V.

8-32. Adjustable Regulator VR2 is referenced to +40 V allowing the output to "follow" the Voltage to Current Converter U32. VR2's output is always +1.2 V greater than U32's output. Therefore, the output of VR2 will vary from +1.2 V to +26.7 V in .1 V steps (U21's input: 00 HEX=+1.2 V, FF HEX=+26.7 V). R23 and R24 share power disipation with VR2.

8-33. Current Sensor.

8-34. R20 and R21 are current sensing resistors that develop a voltage proportional to the current being drawn by the PROM. R18 and R19 are load resistors for VR2 when there is no PROM in the module's socket.

8-35. Current Source Q1 develops 20 millivolt across R17 with 1 milliamp of current. R17's 20 millivolt in addition to the voltage developed across R20 and R21, with no load, will keep U38's output in the high state. This indicates to the CPU that less than 400 milliamps is being drawn from VR2.

8-36. When current through R20 and R21 is greater than 400 milliamps, the voltage across R20 and R21 becomes great enough to offset the 20 millivolts across R17. When this happens, the output of U38 goes to a low state indicating to the CPU that an overload condition exists. The CPU then programs the Power Supply to +1.2 V until the overload is removed.

8-37. Adjustable Voltage Sources.

8-38. VR3 and VR4 are adjustable regulators that are referenced by the programmer module. The voltages are different for the various modules and may be found in the theory of operation for the programmer modules. The outputs are +1.2 V more positive than the adjustment inputs.

8-39. POSITIVE PROM PROGRAMMING (not operation).

8-40. The sequence of events is different for the various PROMs and will not be presented in detail here. For detailed information see the appropriate manufacturer's data sheets for the PROM being programmed.

8-41. U5 and U13 latch the address to the PROM being programmed. The address is clocked into the flip-flops by U14 when directed by the CPU. They will be cleared in the event of any power-up sequence by LPOP, or by the Fail-Safe Timer.

8-42. U31 latches the data to be written to the PROM being programmed. The data is clocked into the flip-flops by U14 when directed by the CPU. They will be cleared in the event of any power up sequence by LPOP, or by the Fail-Safe Timer.

8-43. Data Write Buffers U23 through U30 are dual positive AND drivers. Each section of the drivers can sink about 250 milliamps. Both sections are connected in parallel to allow sinking of 500 milliamps. The PROM data write lines are connected in different ways for each programmer module, and is discussed in detail in the theory of operation for each module.

8-44. PROM DATA VERIFICATION.

8-45. During the programming sequence, information is burned into the PROM and then read. This read is a dummy read and nothing is verified. The actual read/verify occurs after the PROM has been completely programmed. After the PROM is programmed, the information in the PROM is read and compared to the information in the user file. If an error occurs during the verification then an error message appears on the screen.

8-46. Verification is done through Data Read Buffers U18 and U19. U18 and U19 provide a high impedance input for the PROM. U18 and U19 are made TTL compatible by R15 and R16, setting the input threshold to +1.2 V. Resistor Package U15 pulls the comparators up for the inputs of the Data Read Buffers U20.

8-47. When requested by the CPU, through Function Selector U14 (LDR), the data will be returned to the CPU for verification via U20 and U35.

8-48. Signals in the PROM Programmer have been assigned Mnemonics that describe the active state and function of the signal line. Mnemonic functional definitions are listed alphabetically in Table 8-2.

Table 8-2. PROM Programmer Mnemonics

Mnemonic	Description
AO-15	Address 0 through 15 -- these sixteen address lines are sent to the Programmer Module from the PROM Programmer. Some or all of them may be used to program a PROM. They are derived from the data sent to the PROM Programmer over the CPU Data Bus (LD0-15) by the CPU.
DR0-7	Data Read 0 through 7 -- these data lines are used to read the data contents of a programmed PROM. The data read is sent to the CPU over the CPU Data Bus for verification. Some or all of these lines may be used.
DW0-7	Data Write 0 through 7 -- these data lines are used to write data to the PROM being programmed. The data sent to the PROM is derived from the information sent over the CPU Data Bus by the CPU. Some or all of these lines may be used.
LID0-4	Low Identification 0 through 4 -- these five lines are used to return Identification Codes from the Programmer Modules to the CPU over the CPU Data Bus. By returning an ID Code, the CPU can determine which Programmer Module is installed, and therefore, can tell the operator via the CRT which PROMs may be programmed.
LA12-13	Low Address 12 and 13 -- two of sixteen address lines from the Address Bus (P/O CPU Bus) used to select different functions on the PROM Programmer.
LADD	Low Address -- when low, allows the information on the CPU Data Bus to be latched into the Address Latches. From the outputs of these two Latches, the information becomes the address for the PROM being programmed.
LD0-15	Low Data 0 through 15 -- a 16 bit bidirectional bus that is part of the CPU Bus.
LDAC	Low Digital to Analog Converter -- when low, allows the CPU's Data Bus information to be latched into the DAC Latch, setting the voltage at TP6 (VP3).
LDR	Low Data Read -- when low, allows the data read from the programmed PROM to be returned to the CPU for verification.

Table 8-2. PROM Programmer Mnemonics (Cont'd)

Mnemonic	Description
LDW	Low Data Write -- when low, allows the CPU's Data Bus information to be latched into the Data Write Latch. The outputs of the Latch become the Data to be written to the PROM being programmed.
LID	Low Identification -- when low, allows the Identification Code from the Programmer Module to be buffered by the I.D. and Current Sense Buffer, and returned to the CPU over the CPU's Data Bus. Current Overload Status is also sent to the CPU at this time.
LIDEN	Low Identification Enable -- when low along with LSEL, and LSTB, LD12 will go low. When LD12 is low and the other Data Lines are high, the CPU will recognize that there is a Positive PROM Programmer installed in the Mainframe's Card Cage.
LP1-2	Low Program 1 and 2 -- these two lines are used in conjunction with VP1 and VP2 to develop the various voltages and waveforms used to program PROMs. Sometimes LP1 and/or LP2 are looped back from the Programmer Module to VP1 and/or VP2.
LPOP	Low Power On Pulse -- resets all latches on the PROM Control Board, so that power dissipation is minimum. LPOP will override the Timer in the event of an A.C. Power transient. When low, causes LRST to go low.
LRST	Low Reset -- when low, LRST will reset both Address Latches, the Data Write Latch, and the DAC Latch. Resetting these Latches causes the Address to be 0000 HEX with 00 HEX being the Data written, and the lowest power dissipation possible in the PROM being programmed.
LSEL	Low Select -- when low, enables the CPU to interact with the Prom Programmer. The CPU can write to (LWRT low), read (LWRT high), or read ID (LIDEN low) from the Prom Programmer.

Table 8-2. PROM Programmer Mnemonics (Cont'd)

Mnemonic	Description
LSTB	Low Strobe -- when LSTB and LWRT are both low, the CPU is writing to a device over the CPU's Data Bus. If LSEL is also low, the PROM Programmer will receive the information. If LSEL is high, the PROM Programmer will not pay attention to the information sent on the bus. If LSTB is low, and LWRT is high, and the PROM Programmer is selected (LSEL low), then the PROM Programmer will return information to the CPU over the CPU's Data Bus.
LTRST	Low Timer Reset -- Resets the failsafe timer when low.
LWRT	Low Write -- when low, indicates the CPU is writing to the addressed device.
VP1-2	Voltage, Programmable 1 and 2 -- Adjustable Regulators used for developing various voltages and waveforms used for programming PROMs. The adjustable inputs (VP1R and VP2R) can be connected to LP1 and LP2 or to voltage dividers located on the Programmer Modules.
VP1R, VP2R	Voltage, Programmable Regulated -- Inputs to VR3 and VR4 which program their outputs to +1.2 volts above VP1R and VP2R respectively.
VP3	Voltage, Programmable 3 -- Output of voltage regulator VR2 used for developing various voltage levels used for programming PROMs. VP3 is under program control due to DAC U21.

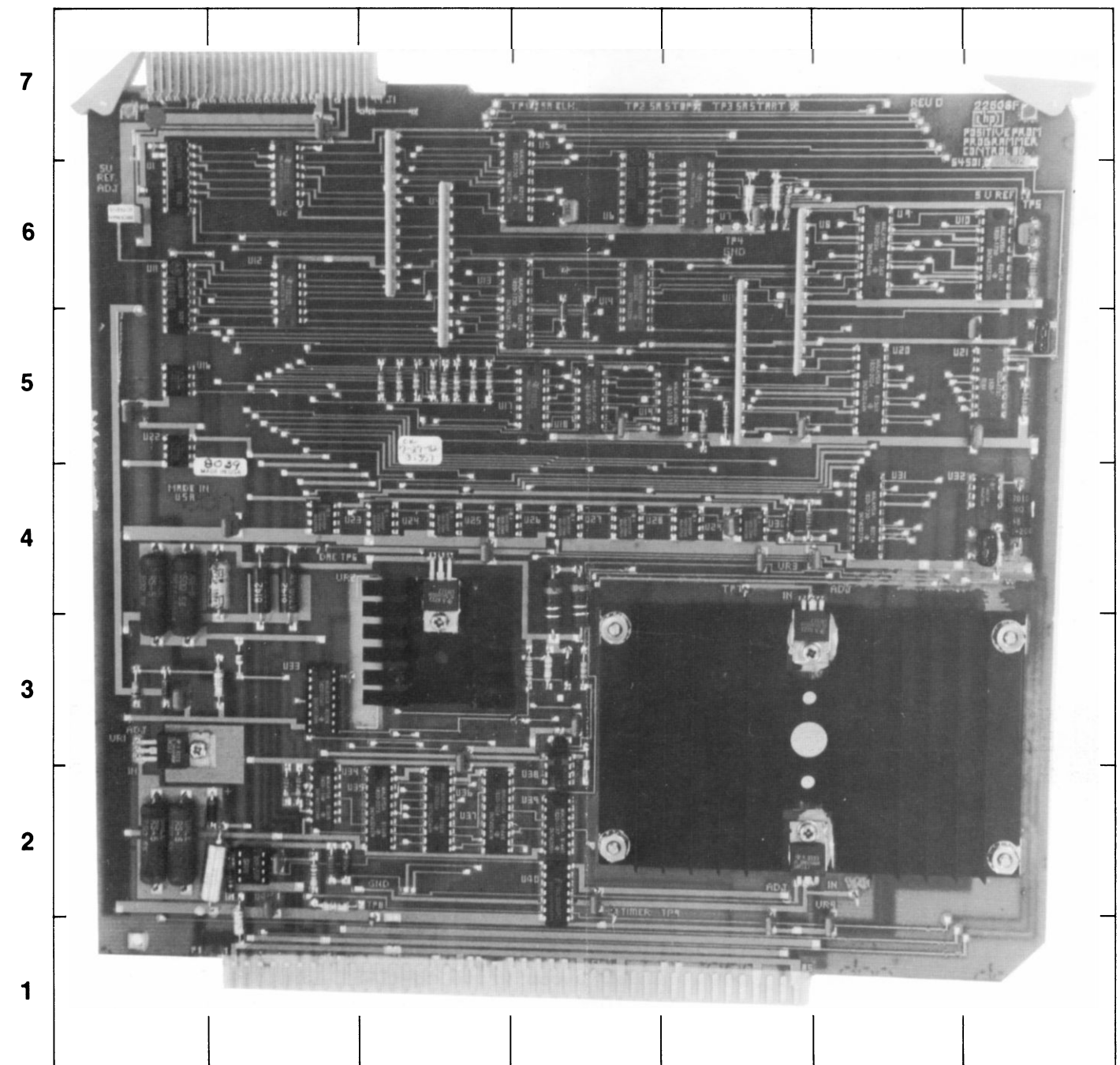

A		B		C		D		E		F		G			
REF DESIG	GRID LOC	REF DESIG	GRID LOC	REF DESIG	GRID LOC	REF DESIG	GRID LOC	REF DESIG	GRID LOC	REF DESIG	GRID LOC	REF DESIG	GRID LOC		
C1	B-2	C18	C-4	CR2	F-4	R12	C-5	R29	G-5	TP10	F-2	U17	D-5	U34	B-2
C2	B-1	C19	B-4	CR3	A-2	R13	C-5	R30	F-4	U1	A-7	U18	D-5	U35	C-2
C3	B-1	C20	C-4	CR4	B-2	R14	C-5	R31	B-2	U2	B-7	U19	E-5	U36	C-2
C4	B-1	C21	G-4	MP1	F-3	R15	E-5	R32	A-2	U3	C-6	U20	F-5	U37	C-2
C5	D-3	C22	G-5	MP2	C-3	R16	E-5	R33	A-2	U4	C-6	U21	G-5	U38	D-2
C6	G-6	C23	G-4	Q1	D-3	R17	D-3	R34	A-3	U5	D-7	U22	A-5	U39	D-2
C7	B-7	C24	G-5	R1	D-6	R18	B-4	R35	A-3	U6	D-6	U23	B-4	U40	D-2
C8	D-6	C25	E-6	R2	D-6	R19	B-4	R36	A-6	U7	E-6	U24	C-4	U41	B-2
C9	E-6	C26	F-4	R3	D-6	R20	B-4	TP1	D-7	U8	F-6	U25	C-4	VR1	A-3
C10	G-5	C27	E-4	R4	B-2	R21	D-4	TP2	E-7	U9	F-6	U26	D-4	VR2	C-4
C11	A-5	C28	E-1	R5	B-2	R22	D-3	TP3	E-7	U10	G-6	U27	D-4	VR3	F-4
C12	D-5	C29	F-1	R6	B-2	R23	A-4	TP4	E-6	U11	A-6	U28	D-4	VR4	F-2
C13	F-5	C30	E-6	R7	C-5	R24	A-4	TP5	G-6	U12	B-6	U29	E-4	VR5	D-2
C14	B-4	C31	A-3	R8	C-5	R25	D-3	TP6	B-4	U13	D-6	U30	E-4	VR6	B-3
C15	E-4	C32	B-3	R9	C-5	R26	G-4	TP7	E-4	U14	D-6	U31	F-4		
C16	C-3	C33	D-2	R10	C-5	R27	E-6	TP8	C-1	U15	E-5	U32	G-4		
C17	A-2	CR1	D-3	R11	C-5	R28	G-6	TP9	D-9	U16	A-5	U33	B-3		

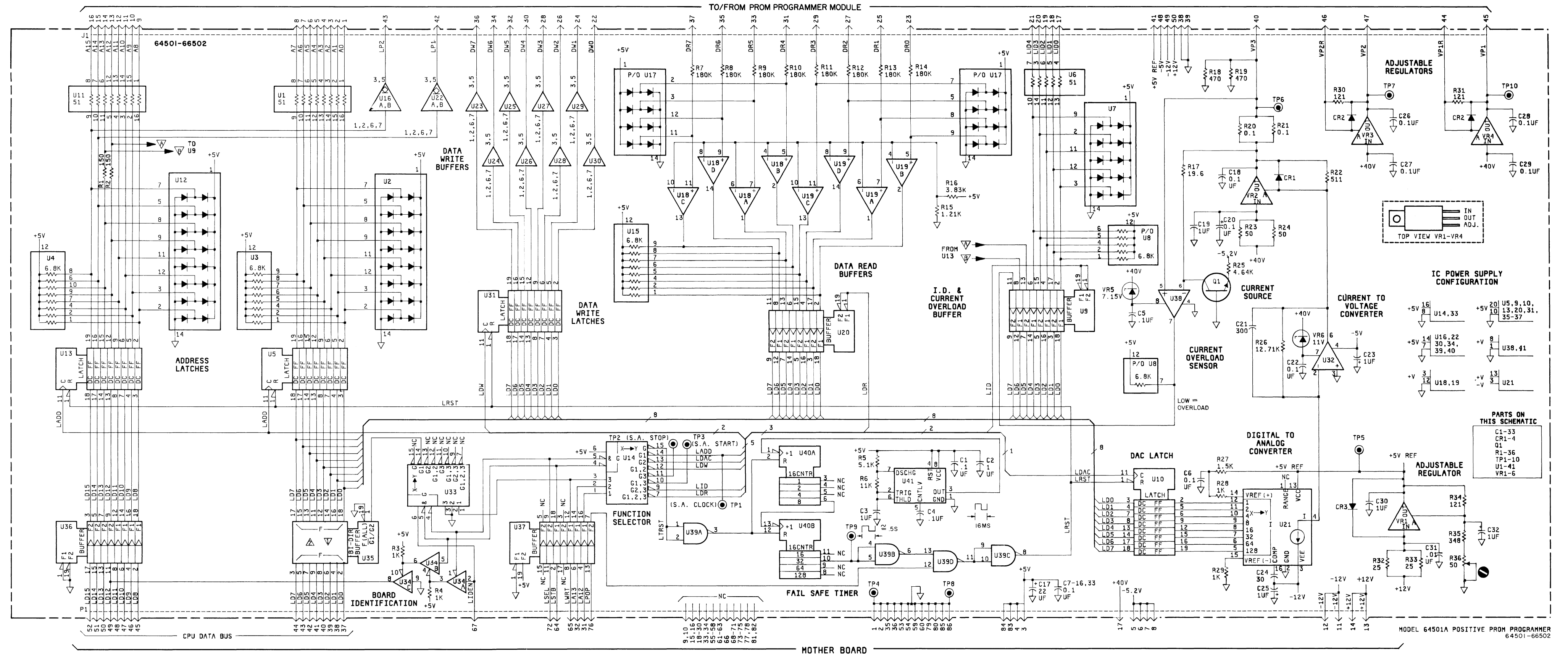

Figure 8-2.
PROM Programmer
PROM Prog 8-11
Change 1



SALES & SUPPORT OFFICES

Arranged alphabetically by country

Product Line Sales/Support Key

- Key Product Line**
- A** Analytical
- CM** Components
- C** Computer Systems Sales only
- CH** Computer Systems Hardware Sales & Services
- CS** Computer Systems Software Sales & Services
- E** Electronic Instruments & Measurement Systems
- M** Medical Products
- MP** Medical Products Primary SRO
- MS** Medical Products Secondary SRO
- P** Personal Computing Products
- Sales only for specific product line
- **** Support only for specific product line

IMPORTANT: These symbols designate general product line capability. They do not insure sales or support availability for all products within a line, at all locations. Contact your local sales office for information regarding locations where HP support is available for specific products.

HP distributors are printed in italics.

ANGOLA
Telectra
Empresa Técnica de Equipamentos Eléctricos, S.A.R.L.
R. Barbosa Rodrigues, 41-1 DT.
Caxa Postal 6487
LUANDA
Tel: 35515.35516
E.M.P

ARGENTINA
Hewlett-Packard Argentina S.A.
Avenida Santa Fe 2035
Martínez 1640 **BUENOS AIRES**
Tel: 798-5735, 792-1293
Tel: 122443 AR CIGY
Cable: HEWPACKARG
A.E,CH,CS,P

Biotron S.A.C.I.y M
Av Paseo Colon 221, 9 Piso
1399 **BUENOS AIRES**
Tel: 30-4846, 30-1851, 30-8384
Tel: 17595 **BIONAR**
M

Fate S.A. I.C.I./Electronica
Venezuela 1326
1095 **BUENOS AIRES**
Tel: 379026, 379027
Tel: 181377, 22754 **ALVAR AR**
P

AUSTRALIA
Adelaide, South Australia Office
Hewlett-Packard Australia Pty.Ltd.
153 Greenhill Road
PARKSIDE, S.A. 5063
Tel: 272-5911
Tel: 82536
Cable: HEWPARAD Adelaide
A*,CH,CM.,E,MS,P

Brisbane, Queensland Office
Hewlett-Packard Australia Pty.Ltd.
5th Floor
Teachers Union Building
495-499 Boundary Street
SPRING HILL, Queensland 4000
Tel: 229-1544
Tel: 42133
Cable: HEWPARD Brisbane
A,CH,CM.,E,MS,P

Canberra, Australia Capital Territory Office
Hewlett-Packard Australia Pty.Ltd.
121 Wollongong Street
FYSHWICK, A.C.T. 2609
Tel: 80 4244 Tel: 62650
Cable: HEWPARD Canberra
A*CH,CM,E,MS,P

BELGIUM
Hewlett-Packard Belgium S.A./N.V.
Blvd de la Woluwe, 100
Woluwedal
B-1200 **BRUSSELS**
Tel: (02) 762-32-00
Tel: 23-494 palobren bru
A,CH,CM,CS,E,MP,P

BRAZIL
Hewlett-Packard do Brasil I.e.C. Ltda.
Alameda Rio Negro, 750
ALPHAVILLE 06400 Barueri SP
Tel: 421-1311
Tel: 011 33872
Cable: HEWPACK Sao Paulo
A,CH,CM,CS,E,MS
Hewlett-Packard do Brasil I.e.C. Ltda.
Avenida Epitacio Pessoa, 4664
22471 **RIO DE JANEIRO**-RJ
Tel: 286-0237
Tel: 021-21905 **HPBR-BR**
Cable: HEWPACK Rio de Janeiro
A,CH,CM,E,MS,P*

CANADA
Alberta
Hewlett-Packard (Canada) Ltd.
210, 7220 Fisher Street S.E.
CALGARY, Alberta T2H 2H8
Tel: (403) 253-2713
A,CH,CM,E*,MS,P*
Hewlett-Packard (Canada) Ltd.
11620A-168th Street
EDMONTON, Alberta T5M 3T9
Tel: (403) 452-3670
A,CH,CM,CS,E,MS,P*
British Columbia
Hewlett-Packard (Canada) Ltd.
10691 Shellbridge Way
RICHMOND, British Columbia V6X 2W7
Tel: (604) 270-2277
Tel: 610-922-5059
A,CH,CM,CS,E*,MS,P*

Manitoba
Hewlett-Packard (Canada) Ltd.
380-550 Century Street
WINNIPEG, Manitoba R3H 0Y1
Tel: (204) 786-6701
A,CH,CM,E,MS,P*

New Brunswick
Hewlett-Packard (Canada) Ltd.
190 Wilbur Street
MONCTON, New Brunswick E2B 2V0
Tel: (506) 386-1677
Tel: 01931470
CH,CM,E*

New Scotia
Hewlett-Packard (Canada) Ltd.
P.O. Box 931
900 Windmill Road
DARTMOUTH, Nova Scotia B2Y 3Z6
Tel: (902) 469-7820
Tel: 01931470
CH,CM,CS,E*,MS,P*

Ontario
Hewlett-Packard (Canada) Ltd.
552 Newbold Street
LONDON, Ontario N6E 2S5
Tel: (519) 686-9181
Tel: 610-352-1201
A,CH,CM,E*,MS,P*

CYPRUS
Wael Pharmacy
P.O. Box 648
BAHRAIN
Tel: 25503-250950
Tel: 84419
P
Wael Pharmacy
P.O. Box 648
BAHRAIN
Tel: 256123
Tel: 8550 **WAEI GJ**
M

CZECHOSLOVAKIA
Hewlett-Packard
Obchodni Zastupitelstvi v CSSR
Post. schranka 27
CS-118 01 **PRAHA 011**
Tel: 66-296
Tel: 121353 **IHC**

DENMARK
Hewlett-Packard A/S
Datavej 52
DK-3460 **BIRKEROD**
Tel: (02) 81-66-40
Telex: 37409 hpas dk
A,CH,CM,CS,E,MS,P

Quebec
Hewlett-Packard (Canada) Ltd.
17500 South Service Road
Trans-Canada Highway
KIRKLAND, Quebec H9J 2M5
Tel: (514) 697-4232
Tel: 05821521
A,CH,CM,CS,E,MP,P*

Hewlett-Packard (Canada) Ltd.
Les Galeries du Vallon
2323 Boulevard du Versant Nord
STE. FOY, Quebec G1N 4C2
Tel: (418) 687-4570
CH

CHILE
Jorge Calcagni y Cia. Ltda.
Arturo Burtie 065
Casilla 16475
SANTIAGO 9
Tel: 222-0222
Tel: Public Booth 0001
A,CM,E,M
Olympia (Chile) Ltd.
Rodrigo de Araya 1045
Casilla 256-V
SANTIAGO 21
Tel: 225-5044
Tel: 40565 **OLYMP CL**
C,P

CHINA, People's Republic of
CEIEC Inc.
44 Beiwai Rd.
BEIJING, China
Tel: 22475 **CEIEC CN**
A,CH,CM,CS,E,P

COLOMBIA
Instrumentación
H. A. Langebaek & Kier S.A.
Apartado Aéreo 6287
BOGOTA 1, D.E.
Carrera 7 No. 48-75
BOGOTA 2, D.E.
Tel: 287-8877
Tel: 44400
Cable: AARIS Bogota
A,CM,E,M,P

COSTA RICA
Cientifica Costarricense S.A.
Avenida 2, Calle 5
San Pedro de Montes de Oca
Apartado 10159
SAN JOSE
Tel: 24-38-20, 24-08-19
Tel: 2367 **GALGUR**
CM,E,M

EL SALVADOR
IPESA de El Salvador S.A.
Boulevard de los Heroes 1148
SAN SALVADOR
Tel: 252787, 259621
Tel: Public Booth 20107
A,CH,CM,CS,E,P

FINLAND
Hewlett-Packard Oy
Revolventitie 7
SF-02100 **ESPOO** 10
Tel: (90) 455-0211
Tel: 121563 **hewpa sf**
A,CH,CM,CS,E,MS,P

FRANCE
Hewlett-Packard France
Le Ligoures
Bureau de Vente de Aix-en-Provence
Place Romée de Villeneuve
F-13090 **AIX-EN-PROVENCE**
Tel: (42) 59-41-02
Tel: 410770F
A,CH,CM,E,MS,P*
Hewlett-Packard France
Boite Postale No. 503
F-25026 **BESANCON**
28 Rue de la République
F-25000 **BESANCON**
Tel: (81) 83-16-22
CH,M

Hewlett-Packard France
Bureau de Vente de Lyon
Chemin des Mouilles
Boite Postale No. 162
F-69130 **ECULLY Cédex**
Tel: (78) 33-81-25
Tel: 531639F
A,CH,CM,CS,E,P*

Hewlett-Packard France
Bureau de Vente de Lille
Immeuble Péricentre
Rue Van Gogh
F-59650 **VILLENEUVE D'ASQ**
Tel: (20) 91-41-25
Tel: 160124F
CH,CM,E,MS,P*

GERMAN FEDERAL REPUBLIC
Hewlett-Packard GmbH
Technisches Büro Berlin
Keithstrasse 2-4
D-1000 **BERLIN** 30
Tel: (030) 24-90-86
Tel: 018 3405 hpbm d
A,CH,CM,E,M,P,X
Hewlett-Packard GmbH
Technisches Büro Böblingen
Herrenberger Strasse 110
D-7030 **BOBLINGEN**
Tel: (07031) 667-1
Tel: 07265739 bbn or 07265743
A,CH,CM,CS,E,MP,P

Hewlett-Packard GmbH
Technisches Büro Düsseldorf
Emanuel-Leutze-Strasse 1
D-4000 **DUSSELDORF**
Tel: (0211) 5971-1
Tel: 085786 533 hpdd d
A,CH,CM,CS,E,MS,P
Hewlett-Packard GmbH
Vertriebszentrale Frankfurt
Berner Strasse 117
Postfach 560 140
D-6000 **FRANKFURT** 56
Tel: (0611) 50-04-1
Tel: 04 13249 hpffm d
A,CH,CM,CS,E,MP,P

Hewlett-Packard Ltd
Traxad House, St. Mary's Walk
MAIDENHEAD
Berkshire, SL6 1ST
Tel: (0628) 39151
CH,CS,E,P
Hewlett-Packard Ltd.
D-2000 **HAMBURG** 60
Tel: (040) 63804-1
Tel: 21 63 032 hphd d
A,CH,CM,CS,E,MS,P

Hewlett-Packard GmbH
Technisches Büro Hannover
Am Grossmarkt 1
D-3000 **HANNOVER** 91
Tel: (0511) 46-60-01
Tel: 092 3259
A,CH,CM,E,MS,P

Hewlett-Packard GmbH
Technisches Büro Mannheim
Rosslauer Weg 2-4
D-6800 **MANNHEIM**
Tel: (621) 70050
Tel: 0462105
A,C,E
Hewlett-Packard GmbH
Technisches Büro Neu Ulm
Messerschmittstrasse 7
D-7910 **NEU ULM**
Tel: 0731-70241
Tel: 65235
Cable: **BLUE STAR**
A

Hewlett-Packard GmbH
Technisches Büro Nürnberg
Neumeyerstrasse 90
D-8500 **NÜRNBERG**
Tel: (0911) 56-30-83
Tel: 0623 860
CH,CM,E,MS,P
Hewlett-Packard GmbH
Technisches Büro München
Eschenstrasse 5
D-8021 **TAUFKIRCHEN**
Tel: (089) 6117-1
Tel: 0524985
A,CH,CM,E,MS,P

Hewlett-Packard GmbH
Technisches Büro Nürnberg
Neumeyerstrasse 90
D-8500 **NÜRNBERG**
Tel: (0911) 56-30-83
Tel: 0623 860
CH,CM,E,MS,P
Hewlett-Packard GmbH
Technisches Büro München
Eschenstrasse 5
D-8021 **TAUFKIRCHEN**
Tel: (089) 6117-1
Tel: 0524985
A,CH,CM,E,MS,P

GREECE
Kostas Karayannis S.A.
8 Omirou Street
ATHENS 133
Tel: 32-30-303, 32-37-371
Tel: 21 59 62 **RKAR GR**
A,CH,CM,CS,E,M,P
PLAISIO S.A.
G. Gerardos
24 Stournara Street
ATHENS
Tel: 36-11-160
Tel: 21 9492
P

GREAT BRITAIN
Hewlett-Packard Ltd.
Trafalgar House
Navigation Road
ALTRINCHAM
Cheshire WA14 1NU
Tel: (061) 928-6422
Tel: 668068
A,CH,CS,E,M
Hewlett-Packard Ltd.
Oakfield House, Oakfield Grove
Clifton
BRISTOL BS8 2BN
Tel: 02765739 bbn or 07265743
A,CH,CM,CS,E,MP,P

Hewlett-Packard Ltd.
14 Wesley Street
CASTLEFORD
Yorkshire WF10 1AE
Tel: (0977) 550016
Tel: 5557355
CH
Hewlett-Packard Ltd.
Fournier House
257-263 High Street
LONDON COLNEY
Herts., AL2 1HA
Tel: (0727) 24400
Tel: 1-8952716
CH,CS,E
Hewlett-Packard Ltd
Traxad House, St. Mary's Walk
MAIDENHEAD
Berkshire, SL6 1ST
Tel: (0628) 39151
CH,CS,E,P

Hewlett-Packard Ltd.
D-2000 **HAMBURG** 60
Tel: (040) 63804-1
Tel: 21 63 032 hphd d
A,CH,CM,CS,E,MS,P
Hewlett-Packard GmbH
Technisches Büro Hannover
Am Grossmarkt 1
D-3000 **HANNOVER** 91
Tel: (0511) 46-60-01
Tel: 092 3259
A,CH,CM,E,MS,P

INDIA
Blue Star Ltd.
11 Magarath Road
BANGALORE 560 025
Tel: 55668
Tel: 0845-430
Cable: **BLUESTAR**
A,CH,CM,CS,E
Blue Star Ltd.
Band Box House
Prabhadevi
BOMBAY 400 025
Tel: 422-3101
Tel: 011 3751
Cable: **BLUESTAR**
A,M

INDONESIA
BERCA Indonesia P.T.
P.O. Box 496/JKT.
Jl. Abdul Muis 62
JAKARTA
Tel: 373009
Tel: 46748 **BERSAL IA**
Cable: **BERSAL JAKARTA**
P
BERCA Indonesia P.T.
Wisma Anlara Bldg., 17th floor
JAKARTA
A,CS,E,M
BERCA Indonesia P.T.
City House, Wabera Street
P.O. Box 30635
NAIROBI
Tel: 331955
Tel: 22639
E,M

IRELAND
Hewlett-Packard Ireland Ltd.
Kestrel House
Clanwilliam Court
Lower Mount Street
DUBLIN 2, Eire
Tel: 680424, 680426
Tel: 30439
A,CH,CM,CS,E,M,P
Cardiac Services Ltd.
Kilmore Road
Arlane
DUBLIN 5, Eire
Tel: (01) 351820
Tel: 30439
M
Blue Star Ltd.
133 Kodambakkam High Road
MADRAS 600 034
Tel: 82057
Tel: 041-379
Cable: **BLUESTAR**
A,M
Blue Star Ltd.
Bhandari House, 7th/8th Floors
91 Nehru Place
NEW DELHI 110 024
Tel: 682547
Tel: 031-2463
Cable: **BLUESTAR**
A,CH,CM,CS,E,M
Blue Star Ltd.
15/16-C Wellesley Rd.
PUNE 411 011
Tel: 22775
Cable: **BLUESTAR**
A
Blue Star Ltd.
1-1-117/1 Sarojini Devi Road
SECUNDERABAD 500 033
Tel: 70126
Tel: 0155-459
Cable: **BLUEFROST**
A,E
Blue Star Ltd.
T.C. 7/603 Poornima
Maruthankuzhi
TRIVANDRUM 695 013
Tel: 65799
Tel: 0884-259
Cable: **BLUESTAR**
E

ICELAND
Edling Trading Company Inc.
Hafnarvot-Tryggvagotu
P.O. Box 895
IS-REYKJAVIK
Tel: 1-58-20, 1-63-03
M

Blue Star Ltd.
Sahas
14/2 Vir Savarkar Marg
Prabhadevi
BOMBAY 400 025
Tel: 422-6155
Tel: 011-4093
Cable: **FROSTBLUE**
A,CH,CM,CS,E,M
Blue Star Ltd.
Kalyan, 19 Vishwas Colony
Alkapuri, **BORODA**, 390 005
Tel: (0734) 784774
Tel: 847178
A,CS,E,M
Hewlett-Packard Ltd.
King Street Lane
WINNERSH, Wokingham
Berkshire RG11 5AR
Tel: (0474) 784774
Tel: 847178
A,CS,E,M

GREECE
Kostas Karayannis S.A.
8 Omirou Street
ATHENS 133
Tel: 32-30-303, 32-37-371
Tel: 21 59 62 **RKAR GR**
A,CH,CM,CS,E,M,P
PLAISIO S.A.
G. Gerardos
24 Stournara Street
ATHENS
Tel: 36-11-160
Tel: 21 9492
P

GREAT BRITAIN
Hewlett-Packard Ltd.
Trafalgar House
Navigation Road
ALTRINCHAM
Cheshire WA14 1NU
Tel: (061) 928-6422
Tel: 668068
A,CH,CS,E,M
Hewlett-Packard Ltd.
Oakfield House, Oakfield Grove
Clifton
BRISTOL BS8 2BN
Tel: (0276) 5739 bbn or 07265743
A,CH,CM,CS,E,MP,P

HONG KONG
Hewlett-Packard Hong Kong, Ltd.
G.P.O. Box 795
5th Floor, Sun Hung Kai Centre
30 Harbour Road
HONG KONG
Tel: 5-8323211
Tel: 66678 **HEWPA HX**
Cable: HP ASIA LTD Hong Kong
E,CH,CS,M
Schmidt & Co. (Hong Kong) Ltd.
Wing On Centre, 28th Floor
Connaught Road, C.
HONG KONG
Tel: 5-455644
Tel: 74766 **SCHMX HX**
A,M

INDONESIA
BERCA Indonesia P.T.
P.O. Box 496/JKT.
Jl. Abdul Muis 62
JAKARTA
Tel: 373009
Tel: 46748 **BERSAL IA**
Cable: **BERSAL JAKARTA**
P
BERCA Indonesia P.T.
Wisma Anlara Bldg., 17th floor
JAKARTA
A,CS,E,M
BERCA Indonesia P.T.
City House, Wabera Street
P.O. Box 30635
NAIROBI
Tel: 331955
Tel: 22639
E,M

IRELAND
Hewlett-Packard Ireland Ltd.
Kestrel House
Clanwilliam Court
Lower Mount Street
DUBLIN 2, Eire
Tel: 680424, 680426
Tel: 30439
A,CH,CM,CS,E,M,P
Cardiac Services Ltd.
Kilmore Road
Arlane
DUBLIN 5, Eire
Tel: (01) 351820
Tel: 30439
M
Blue Star Ltd.
133 Kodambakkam High Road
MADRAS 600 034
Tel: 82057
Tel: 041-379
Cable: **BLUESTAR**
A,M
Blue Star Ltd.
Bhandari House, 7th/8th Floors
91 Nehru Place
NEW DELHI 110 024
Tel: 682547
Tel: 031-2463
Cable: **BLUESTAR**
A,CH,CM,CS,E,M
Blue Star Ltd.
15/16-C Wellesley Rd.
PUNE 411 011
Tel: 22775
Cable: **BLUESTAR**
A
Blue Star Ltd.
T.C. 7/603 Poornima
Maruthankuzhi
TRIVANDRUM 695 013
Tel: 65799
Tel: 0884-259
Cable: **BLUESTAR**
E

INDONESIA
BERCA Indonesia P.T.
P.O. Box 496/JKT.
Jl. Abdul Muis 62
JAKARTA
Tel: 373009
Tel: 46748 **BERSAL IA**
Cable: **BERSAL JAKARTA**
P
BERCA Indonesia P.T.
Wisma Anlara Bldg., 17th floor
JAKARTA
A,CS,E,M
BERCA Indonesia P.T.
City House, Wabera Street
P.O. Box 30635
NAIROBI
Tel: 331955
Tel: 22639
E,M

IRELAND
Hewlett-Packard Ireland Ltd.
Kestrel House
Clanwilliam Court
Lower Mount Street
DUBLIN 2, Eire
Tel: 680424, 680426
Tel: 30439
A,CH,CM,CS,E,M,P
Cardiac Services Ltd.
Kilmore Road
Arlane
DUBLIN 5, Eire
Tel: (01) 351820
Tel: 30439
M
Blue Star Ltd.
133 Kodambakkam High Road
MADRAS 600 034
Tel: 82057
Tel: 041-379
Cable: **BLUESTAR**
A,M
Blue Star Ltd.
Bhandari House, 7th/8th Floors
91 Nehru Place
NEW DELHI 110 024
Tel: 682547
Tel: 031-2463
Cable: **BLUESTAR**
A,CH,CM,CS,E,M
Blue Star Ltd.
15/16-C Wellesley Rd.
PUNE 411 011
Tel: 22775
Cable: **BLUESTAR**
A
Blue Star Ltd.
T.C. 7/603 Poornima
Maruthankuzhi
TRIVANDRUM 695 013
Tel: 65799
Tel: 0884-259
Cable: **BLUESTAR**
E

ICELAND
Edling Trading Company Inc.
Hafnarvot-Tryggvagotu
P.O. Box 895
IS-REYKJAVIK
Tel: 1-58-20, 1-63-03
M

Blue Star Ltd.
Sahas
14/2 Vir Savarkar Marg
Prabhadevi
BOMBAY 400 025
Tel: 422-6155
Tel: 011-4093
Cable: **FROSTBLUE**
A,CH,CM,CS,E,M
Blue Star Ltd.
Kalyan, 19 Vishwas Colony
Alkapuri, **BORODA**, 390 005
Tel: (0734) 784774
Tel: 847178
A,CS,E,M
Hewlett-Packard Ltd.
King Street Lane
WINNERSH, Wokingham
Berkshire RG11 5AR
Tel: (0474) 784774
Tel: 847178
A,CS,E,M

GREECE
Kostas Karayannis S.A.
8 Omirou Street
ATHENS 133
Tel: 32-30-303, 32-37-371
Tel: 21 59 62 **RKAR GR**
A,CH,CM,CS,E,M,P
PLAISIO S.A.
G. Gerardos
24 Stournara Street
ATHENS
Tel: 36-11-160
Tel: 21 9492
P

GREAT BRITAIN
Hewlett-Packard Ltd.
Trafalgar House
Navigation Road
ALTRINCHAM
Cheshire WA14 1NU
Tel: (061) 928-6422
Tel: 668068
A,CH,CS,E,M
Hewlett-Packard Ltd.
Oakfield House, Oakfield Grove
Clifton
BRISTOL BS8 2BN
Tel: (0276) 5739 bbn or 07265743
A,CH,CM,CS,E,MP,P

HONG KONG
Hewlett-Packard Hong Kong, Ltd.
G.P.O. Box 795
5th Floor, Sun Hung Kai Centre
30 Harbour Road
HONG KONG
Tel: 5-8323211
Tel: 66678 **HEWPA HX**
Cable: HP ASIA LTD Hong Kong
E,CH,CS,M
Schmidt & Co. (Hong Kong) Ltd.
Wing On Centre, 28th Floor
Connaught Road, C.
HONG KONG
Tel: 5-455644
Tel: 74766 **SCHMX HX**
A,M

INDONESIA
BERCA Indonesia P.T.
P.O. Box 496/JKT.
Jl. Abdul Muis 62
JAKARTA
Tel: 373009
Tel: 46748 **BERSAL IA**
Cable: **BERSAL JAKARTA**
P
BERCA Indonesia P.T.
Wisma Anlara Bldg., 17th floor
JAKARTA
A,CS,E,M
BERCA Indonesia P.T.
City House, Wabera Street
P.O. Box 30635
NAIROBI
Tel: 331955
Tel: 22639
E,M

IRELAND
Hewlett-Packard Ireland Ltd.
Kestrel House
Clanwilliam Court
Lower Mount Street
DUBLIN 2, Eire
Tel: 680424, 680426
Tel: 30439
A,CH,CM,CS,E,M,P
Cardiac Services Ltd.
Kilmore Road
Arlane
DUBLIN 5, Eire
Tel: (01) 351820
Tel: 30439
M
Blue Star Ltd.
133 Kodambakkam High Road
MADRAS 600 034
Tel: 82057
Tel: 041-379
Cable: **BLUESTAR**
A,M
Blue Star Ltd.
Bhandari House, 7th/8th Floors
91 Nehru Place
NEW DELHI 110 024
Tel: 682547
Tel: 031-2463
Cable: **BLUESTAR**
A,CH,CM,CS,E,M
Blue Star Ltd.
15/16-C Wellesley Rd.
PUNE 411 011
Tel: 22775
Cable: **BLUESTAR**
A
Blue Star Ltd.
T.C. 7/603 Poornima
Maruthankuzhi
TRIVANDRUM 695 013
Tel: 65799
Tel: 0884-259
Cable: **BLUESTAR**
E

INDONESIA
BERCA Indonesia P.T.
P.O. Box 496/JKT.
Jl. Abdul Muis 62
JAKARTA
Tel: 373009
Tel: 46748 **BERSAL IA**
Cable: **BERSAL JAKARTA**
P
BERCA Indonesia P.T.
Wisma Anlara Bldg., 17th floor
JAKARTA
A,CS,E,M
BERCA Indonesia P.T.
City House, Wabera Street
P.O. Box 30635
NAIROBI
Tel: 331955
Tel: 22639
E,M

IRELAND
Hewlett-Packard Ireland Ltd

SALES & SUPPORT OFFICES

Arranged alphabetically by country

2



PANAMA (Con't.)

Foto Internacional, S.A.
Free Zone Colon
Apartado 2068
COLON 3
Tel: 45-2333
Telex: 379 8626, 386 8722
P

PERU

Cía Electro Médica S.A.
Los Flamencos 145, San Isidro
Casilla 1030
LIMA 1
Tel: 41-4325, 41-3703
Telex: Pub. Booth 25306
A,C,M,E,M,P

PHILIPPINES

The Online Advanced Systems
Corporation
Rico House, Amorsolo Cor. Herrera
Street
Legaspi Village, Makati
P.O. Box 1510
Metro MANILA
Tel: 85-35-81, 85-34-91, 85-32-21
Telex: 3274 ONLINE
A,CH,CS,E,M
Electronic Specialists and
Proponents Inc.
690-B Epifanio de los Santos
Avenue
Cubao, QUEZON CITY
P.O. Box 2649 Manila
Tel: 98-96-81, 98-96-82, 98-96-83
Telex: 40018, 42000 ITT GLOBE
MACKAY BOOTH
P

POLAND

Buro Informacji Technicznej
Hewlett-Packard
Ul. Stawki 2, 6P
P.00-950 WARSZAWA
Tel: 39-59-62, 39-67-43
Telex: 812453 hepa pl

PORTUGAL

SOQUIMICA
Av. da Liberdade 220-2
P-1298 LISBOA Codex
Tel: 56 21 81, 56 21 82
Telex: 13316
Telectra-Empresa Técnica de
Equipamentos Eléctricos S.a.r.l.
Rua Rodrigo da Fonseca 103
P.O. Box 2531
P-LISBON 1
Tel: (19) 68-60-72
Telex: 12598
CH,CS,E,P
Mundinter
Intercambio Mundial de Comércio
S.a.r.l.
P.O. Box 2761
Avenida Antonio Augusto de Aguiar
138
P-LISBON
Tel: (19) 53-21-31, 53-21-37
Telex: 16691 munter p
M

PUERTO RICO

Hewlett-Packard Puerto Rico
P.O. Box 4407
CAROLINA, Puerto Rico 00630
Calle 272 Edificio 203
Urb. Country Club
RIO PIEDRAS, Puerto Rico 00924
Tel: (809) 762-7255
Telex: 345 0514
A,CH,CS

QATAR

Nasser Trading & Contracting
P.O. Box 1563
DOHA
Tel: 22170
Telex: 4439 NASSER
M
Compute Arabia
P.O. Box 2570
DOHA
Tel: 329515
Telex: 4806 CHPARB
P

ROMANIA

Hewlett-Packard Reprezentanta
Boulevard Nicolae Balcescu 16
BUCURESTI
Tel: 130725
Telex: 10440

SAUDI ARABIA

Modern Electronic Establishment
P.O. Box 193
AL-KHOBAR
Tel: 44-678, 44-813
Telex: 670136
Cable: ELECTA AL-KHOBAR
CH,CS,E,M,P
Modern Electronic Establishment
P.O. Box 1228, Baghdadiah Street
JEDDAH
Tel: 27-798
Telex: 401035
Cable: ELECTA JEDDAH
CH,CS,E,M,P
Modern Electronic Establishment
P.O. Box 2728
RIYADH
Tel: 62-596, 66-232
Telex: 202049
CH,CS,E,M,P

SCOTLAND

Hewlett-Packard Ltd.
Royal Bank Buildings
Swan Street
BRECHIN, Angus, Scotland
Tel: 3101, 3102
CH,CM
Hewlett-Packard Ltd.
SOUTH QUEENSFERRY
West Lothian, EH30 9GT
GB-Scotland
Tel: (031) 3311000
Telex: 72682
A,CH,CM,CS,E,M

SINGAPORE

Hewlett-Packard Singapore (Pty.)
Ltd.
P.O. Box 58 Alexandra Post Office
SINGAPORE, 9115
6th Floor, Inchcape House
450-452 Alexandra Road
SINGAPORE 0511
Tel: 631788
Telex: HPSGSO RS 34209
Cable: HEWPACK, Singapore
A,CH,CS,E,MS,P

SOUTH AFRICA

Hewlett-Packard South Africa (Pty.)
Ltd.
P.O. Box 120
Howard Place
Pine Park Center, Forest Drive,
Pinelands
CAPE PROVINCE 7450
Tel: 53-7955, 53-7956, 53-7957
Telex: 57-0006
A,CH,CM,E,MS,P

Hewlett-Packard South Africa (Pty.)
Ltd.
P.O. Box 37099
Overport
DURBAN 4067
Tel: 28-4178, 28-4179, 28-4110
CH,CM

Hewlett-Packard South Africa (Pty.)
Ltd.
P.O. Box 33345
Glenstantia 0010 TRANSVAAL
1st Floor East
Constantia Park Ridge Shopping
Centre
Constantia Park
PRETORIA
Tel: 01298-1126
Telex: 32163
CH,E

Hewlett-Packard South Africa (Pty.)
Ltd.
Private Bag Wendywood
SANDTON 2144
Tel: 802-5111, 802-5125
Telex: 89-84782
Cable: HEWPACK Johannesburg
A,CH,CM,CS,E,MS,P

SPAIN

Hewlett-Packard Española S.A.
c/Entenza, 321
E-BARCELONA 29
Tel: (3) 322-24-51, 321-73-54
Telex: 52603 hpbee
A,CH,CM,CS,E,MS,P
Hewlett-Packard Española S.A.
c/San Vicente S/N
Edificio Albia II, 7 B
E-BILBAO 1
Tel: (944) 423-8306, 423-8206
A,CH,CM,E,MS
Hewlett-Packard Española S.A.
Calle Jerez 3
E-MADRID 16
Tel: 458-2600
Telex: 23515 hpe
A,CM,E

Hewlett-Packard Española S.A.
c/o Costa Brava 13
Colonia Mirasierra
E-MADRID 34
Tel: 734-8061, 734-1162
CH,CS,M

Hewlett-Packard Española S.A.
Av Ramón y Cajal 1-9
Edificio Sevilla 1,
E-SEVILLA 5
Tel: 64-44-54, 64-44-58
Telex: 72933
A,CM,CS,MS,P
Hewlett-Packard Española S.A.
C/Ramon Gordillo, 1 (Entlo.3)
E-VALENCIA 10
Tel: 361-1354, 361-1358
CH,CM,P

SWEDEN

Hewlett-Packard Sverige AB
Enighetsvägen 3, Fack
P.O. Box 20502
S-16120 BROMMA
Tel: (08) 730-0550
Telex: (854) 10721 MESSAGES
Cable: MEASUREMENTS
STOCKHOLM
A,CH,CM,CS,E,MS,P

Hewlett-Packard Sverige AB
Sunnanvagen 14K
S-22226 LUND
Tel: (46) 13-69-79
Telex: (854) 10721 (via BROMMA
office)
CH,CM

Hewlett-Packard Sverige AB
Vastra Vintergatan 9
S-70344 OREBRO
Tel: (19) 10-48-80
Telex: (854) 10721 (via BROMMA
office)
CH,CM

Hewlett-Packard Sverige AB
Frötagatan 30
S-42132 VASTRA-FRÖLUNDA
Tel: (031) 49-09-50
Telex: (854) 10721 (via BROMMA
office)
CH,CM,E,P

SWITZERLAND

Hewlett-Packard (Schweiz) AG
Clarastrasse 12
CH-4058 BASLE
Tel: (61) 33-59-20
A,CM
Hewlett-Packard (Schweiz) AG
Bahnhofstrasse 44
3018 BERN
Tel: (031) 56-24-22
CH,CM
Hewlett-Packard (Schweiz) AG
47 Avenue Blanc
CH-1202 GENEVA
Tel: (022) 32-30-05, 32-48-00
CH,CM,CS

Hewlett-Packard (Schweiz) AG
29 Chemin Château Bloc
CH-1219 LE LIGNON-Geneva
Tel: (022) 96-03-22
Telex: 27333 hpag ch
Cable: HEWPACKAG Geneva
A,CM,E,MS,P

Hewlett-Packard (Schweiz) AG
Zürcherstrasse 20
Allmend 2
CH-8967 WIDEN
Tel: (57) 50-111
Telex: 59933 hpag ch
Cable: HPAG CH
A,CH,CM,CS,E,MS,P

SYRIA

General Electronic Inc.
Nuri Basha-Ahmat Ebn Kays Street
P.O. Box 5781
DAMASCUS
Tel: 33-24-87
Telex: 11215 ITIKAL
Cable: ELECTROBOR DAMASCUS
E
Middle East Electronics
Place Azmé
Boite Postale 2308
DAMASCUS
Tel: 334592
Telex: 11304 SATACO SY
M,P

TAIWAN

Hewlett-Packard Far East Ltd.
Kaohsiung Office
2/F 68-2, Chung Cheng 3rd Road
KAOSHIUNG
Tel: 241-2318, 261-3253
E,MS,P

Hewlett-Packard Far East Ltd.
Taichung Office
#33, Cheng Tr Rd.
10th Floor, Room 5
TAICHUNG
Tel: (042) 289274

Hewlett-Packard Far East Ltd.
Taiwan Office
5th Floor
205 Tun Hwa North Road
TAIPEI
Tel: (02) 751-0404
Cable: HEWPACK Taipei
A,CH,CS,E,MS,P
Ing Lih Trading Co.
3rd Floor 18, Po-Ai Road
TAIPEI (100)
Tel: (02) 311-1914
Cable: INGLIH TAIPEI
A

THAILAND

Unimesa
30 Palpong Ave., Suriwong
BANGKOK 5
Tel: (234-091) (234-092)
Telex: TH 81160, TH 81038
Cable: UNIMESA Bangkok
A,C,E,M
Bangkok Business Equipment Ltd.
5/5-6 Dejo Road
BANGKOK
Tel: 234-8670, 234-8671
Telex: 87669-BEQUIPT TH
Cable: BUSIQUIPT Bangkok
P

TRINIDAD & TOBAGO

Caribbean Telecoms Ltd.
50/A Jerningham Avenue
P.O. Box 732
PORT-OF-SPAIN
Tel: 624-4213, 624-4214
Telex: 3235, 3272 HUGCO WG
A,CM,E,M,P

TUNISIA

Tunisie Electronique
31 Avenue de la Liberte
TUNIS
Tel: 280-144
E,P
Corema
1 ter. Av. de Carthage
TUNIS
Tel: 253-821
Telex: 12319 CABAM TN
M

TURKEY

Teknim Company Ltd.
Iran Caddesi No. 7
Kavaklidere, ANKARA
Tel: 275800
Telex: 42155
E
E.M.A.
Medina Eldem Sokak No.41/6
Yüksel Caddesi
ANKARA
Tel: 175 622
M,P

UNITED ARAB EMIRATES

Emilac Ltd.
P.O. Box 1641
SHARJAH
Tel: 354121, 354123
Telex: 68136 Emilac SL
CH,CS,E,M,P



SALES & SUPPORT OFFICES

Arranged alphabetically by country

UNITED KINGDOM

see: **GREAT BRITAIN**
NORTHERN IRELAND
SCOTLAND

UNITED STATES

Alabama

Hewlett-Packard Co.
700 Century Park South
Suite 128
BIRMINGHAM, AL 35226
Tel: (205) 822-6802
CH,CM,MP

Hewlett-Packard Co.
P.O. Box 4207
8290 Whitesburg Drive, S.E.
HUNTSVILLE, AL 35802
Tel: (205) 881-4591
CH,CM,CS,E,M*

Alaska

Hewlett-Packard Co.
1577 "C" Street, Suite 252
ANCHORAGE, AK 99510
Tel: (206) 454-3971
CH*,CM

Arizona

Hewlett-Packard Co.
2336 East Magnolia Street
PHOENIX, AZ 85034
Tel: (602) 273-8000
A,CH,CM,CS,E,MS

Hewlett-Packard Co.
2424 East Aragon Road
TUCSON, AZ 85702
Tel: (602) 889-4631
CH,CM,E,MS**

Arkansas

Hewlett-Packard Co.
P.O. Box 5646
Brady Station
LITTLE ROCK, AR 72215
Tel: (501) 376-1844, (501) 664-8773
CM,MS

California

Hewlett-Packard Co.
99 South Hill Dr.
BRISBANE, CA 94005
Tel: (415) 330-2500
CH,CM,CS

Hewlett-Packard Co.
7621 Canoga Avenue
CANOGA PARK, CA 91304
Tel: (213) 702-8300
A,CH,CM,CS,E,P

Hewlett-Packard Co.
1579 W. Shaw Avenue
FRESNO, CA 93771
Tel: (209) 224-0582
CM,MS

Hewlett-Packard Co.
1430 East Orangethorpe
FULLERTON, CA 92631
Tel: (714) 870-1000
CH,CM,CS,E,MP

Hewlett-Packard Co.
5400 W. Rosecrans Boulevard
LAWDALE, CA 90260
P.O. Box 92105
LOS ANGELES, CA 90009
Tel: (213) 970-7500
CH,CM,CS,MP

Hewlett-Packard Co.
3939 Lankershim Blvd.
NORTH HOLLYWOOD, CA 91604
Tel: (213) 877-1282
Regional Headquarters

Hewlett-Packard Co.
3200 Hillview Avenue
PALO ALTO, CA 94304
Tel: (415) 857-8000
CH,CM,CS,E

Hewlett-Packard Co.
646 W. North Market Boulevard
SACRAMENTO, CA 95834
Tel: (916) 929-7222
A*,CH,CM,CS,E,MS

Hewlett-Packard Co.
9606 Aero Drive
P.O. Box 23333
SAN DIEGO, CA 92123

Tel: (714) 279-3200
CH,CM,CS,E,MP

Hewlett-Packard Co.
Suite A
5553 Hollister

SANTA BARBARA, CA 93111
Tel: (805) 964-3390

Hewlett-Packard Co.
3003 Scott Boulevard
SANTA CLARA, CA 95050
Tel: (408) 988-7000
A,CH,CM,CS,E,MP

Colorado

Hewlett-Packard Co.
24 Inverness Place, East
ENGLEWOOD, CO 80112
Tel: (303) 771-3455
A,CH,CM,CS,E,MS

Connecticut

Hewlett-Packard Co.
47 Barnes Industrial Road South
P.O. Box 5007
WALLINGFORD, CT 06492
Tel: (203) 265-7801
A,CH,CM,CS,E,MS

Florida

Hewlett-Packard Co.
P.O. Box 24210
2727 N.W. 62nd Street
FORT LAUDERDALE, FL 33309
Tel: (305) 973-2600
CH,CM,CS,E,MP

Hewlett-Packard Co.
4080 Woodcock Drive, #132
Brownell Building
JACKSONVILLE, FL 32207
Tel: (904) 398-0663
CM,C*,E*,MS**

Hewlett-Packard Co.
P.O. Box 13910
6177 Lake Ellenor Drive
ORLANDO, FL 32809
Tel: (305) 859-2900
A,CH,CM,CS,E,MS

Hewlett-Packard Co.
6425 N. Pensacola Blvd.
Suite 4, Building 1
PENSACOLA, FL 32575
Tel: (904) 476-8422
A,CM,MS

Hewlett-Packard Co.
110 South Hoover, Suite 120
Vanguard Bldg.
TAMPA, FL 33609
Tel: (813) 872-0900
A*,CH,CM,CS,E*,M*

Georgia

Hewlett-Packard Co.
P.O. Box 105005
2000 South Park Place
ATLANTA, GA 30339
Tel: (404) 955-1500
Telex: 810-766-4890
A,CH,CM,CS,E,MP

Hewlett-Packard Co.
Executive Park Suite 306
P.O. Box 816
AUGUSTA, GA 30907
Tel: (404) 736-0592
CM,MS

Hewlett-Packard Co.
P.O. Box 2103
1172 N. Davis Drive
WARNER ROBINS, GA 31098
Tel: (912) 923-8831
CM,E

Hawaii

Hewlett-Packard Co.
Kawaiahao Plaza, Suite 190
567 South King Street
HONOLULU, HI 96813
Tel: (808) 526-1555
A,CH,CM,E,MS

Idaho

Hewlett-Packard Co.
11311 Chinden Boulevard
BOISE, ID 83707
Tel: (208) 376-6000
CH,CM,M*

Illinois

Hewlett-Packard Co.
211 Prospect Road
BLOOMINGTON, IL 61701
Tel: (309) 663-0383
CH,CM,MS**

Hewlett-Packard Co.
1100 31st Street
DOWNERS GROVE, IL 60515
Tel: (312) 960-5760
CH,CM,CS

Hewlett-Packard Co.
5201 Tollview Drive
ROLLING MEADOWS, IL 60008
Tel: (312) 255-9800
A,CH,CM,CS,E,MP

Indiana

Hewlett-Packard Co.
P.O. Box 50807
7301 No. Shadeland Avenue
INDIANAPOLIS, IN 46250
Tel: (317) 842-1000
A,CH,CM,CS,E,MS

Iowa

Hewlett-Packard Co.
5815 S.W. 5th Street
DES MOINES, IA 50315
Tel: (515) 243-5876
CH,CM,MS**

Hewlett-Packard Co.
2415 Heinz Road
IOWA CITY, IA 52240
Tel: (319) 351-1020
CH,CM,E*,MS

Kansas

Hewlett-Packard Co.
1644 S. Rock
WICHITA, KA 67207
Tel: (316) 265-5200
CH,CM

Kentucky

Hewlett-Packard Co.
10170 Linn Station Road
Suite 525
LOUISVILLE, KY 40223
Tel: (502) 426-0100
A,CH,CM,CS,MS

Louisiana

Hewlett-Packard Co.
P.O. Box 1449
3229 Williams Boulevard
KENNER, LA 70062
Tel: (504) 443-6201
A,CH,CM,CS,E,MS

Maryland

Hewlett-Packard Co.
7121 Standard Drive
HANOVER, MD 21076
Tel: (301) 796-7700
A,CH,CM,CS,E,MS

Hewlett-Packard Co.
2 Choke Cherry Road
ROCKVILLE, MD 20850
Tel: (301) 948-6370
Telex: 710-828-9685
A,CH,CM,CS,E,MP

Massachusetts

Hewlett-Packard Co.
32 Hartwell Avenue
LEXINGTON, MA 02173
Tel: (617) 861-8960
A,CH,CM,CS,E,MP

Michigan

Hewlett-Packard Co.
23855 Research Drive
FARMINGTON HILLS, MI 48024
Tel: (313) 476-6400
A,CH,CM,CS,E,MP

Hewlett-Packard Co.
4326 Cascade Road S.E.
GRAND RAPIDS, MI 49506
Tel: (616) 957-1970
CH,CM,CS,MS

Minnesota

Hewlett-Packard Co.
2025 W. Larpenteur Ave.
ST. PAUL, MN 55113
Tel: (612) 644-1100
A,CH,CM,CS,E,MP

Mississippi

Hewlett-Packard Co.
P.O. Box 5028
322 N. Mart Plaza
JACKSON, MS 39216
Tel: (601) 982-9363
CM,MS

Missouri

Hewlett-Packard Co.
11131 Colorado Avenue
KANSAS CITY, MO 64137
Tel: (816) 763-8000
Telex: 910-771-2087
A,CH,CM,CS,E,MS

Hewlett-Packard Co.
1024 Executive Parkway
ST. LOUIS, MO 63141
Tel: (314) 878-0200
A,CH,CM,CS,E,MP

Nebraska

Hewlett-Packard
7101 Mercy Road
Suite 101, IBX Building
OMAHA, NE 68106
Tel: (402) 392-0948
CM,MS

Nevada

Hewlett-Packard Co.
Suite D-130
5030 Paradise Blvd.
LAS VEGAS, NV 89119
Tel: (702) 736-6610
CM,MS**

New Jersey

Hewlett-Packard Co.
Crystal Brook Professional Building
Route 35
EATONTOWN, NJ 07724
Tel: (201) 542-1384
A*,CM,C*,E*,P*

Hewlett-Packard Co.
W120 Century Road
PARAMUS, NJ 07652
Tel: (201) 265-5000
A,CH,CM,CS,E,MP

Hewlett-Packard Co.
60 New England Av. West
PISCATAWAY, NJ 08854
Tel: (201) 981-1199
A,CH,CM,CS,E

New Mexico

Hewlett-Packard Co.
P.O. Box 11634
11300 Lomas Blvd., N.E.
ALBUQUERQUE, NM 87123
Tel: (505) 292-1330
Telex: 910-989-1185
CH,CM,CS,E,MS

New York

Hewlett-Packard Co.
5 Computer Drive South
ALBANY, NY 12205
Tel: (518) 458-1550
Telex: 710-444-4691
A,CH,CM,E,MS

Hewlett-Packard Co.
9600 Main Street
CLARENCE, NY 14031
Tel: (716) 759-8621
Telex: 710-523-1893
CH

Hewlett-Packard Co.
200 Cross Keys Office
FAIRPORT, NY 14450
Tel: (716) 223-9950
Telex: 510-253-0092
CH,CM,CS,E,MS

Hewlett-Packard Co.
No. 1 Pennsylvania Plaza
55th Floor
34th Street & 8th Avenue
NEW YORK, NY 10119
Tel: (212) 971-0800
CH,CM,CS,E*,M*

Hewlett-Packard Co.
5858 East Molloy Road
SYRACUSE, NY 13211
Tel: (315) 455-2486
A,CH,CM,E,MS

Hewlett-Packard Co.
3 Crossways Park West
WOODBURY, NY 11797
Tel: (516) 921-0300
Telex: 510-221-2183
A,CH,CM,CS,E,MS

North Carolina

Hewlett-Packard Co.
P.O. Box 15579
2905 Guess Road (27705)
DURHAM, NC 27704
Tel: (919) 471-8466
C,M

Hewlett-Packard Co.
5605 Roanne Way
GREENSBORO, NC 27409
Tel: (919) 852-1800
A,CH,CM,CS,E,MS

Ohio

Hewlett-Packard Co.
9920 Carver Road
CINCINNATI, OH 45242
Tel: (513) 891-9870
CH,CM,CS,MS

Hewlett-Packard Co.
16500 Sprague Road
CLEVELAND, OH 44130
Tel: (216) 243-7300
Telex: 810-423-9430
A,CH,CM,CS,E,MS

Hewlett-Packard Co.
962 Crupper Ave.
COLUMBUS, OH 43229
Tel: (614) 436-1041
CH,CM,CS,E*

SALES & SUPPORT OFFICES

Arranged alphabetically by country

4



Ohio (Con't)

Hewlett-Packard Co.
330 Progress Rd.
DAYTON, OH 45449
Tel: (513) 859-8202
A,CH,CM,E*,MS

Oklahoma

Hewlett-Packard Co.
P.O. Box 366
1503 W. Gore Blvd., Suite #2
LAWTON, OK 73502
Tel: (405) 248-4248
C

Hewlett-Packard Co.
P.O. Box 32008
304 N. Meridan Avenue, Suite A
OKLAHOMA CITY, OK 73107
Tel: (405) 946-9499
A*,CH,CM,E*,MS

Hewlett-Packard Co.

P.O. Box 121
9920 E. 42nd Street
TULSA, OK 74145
Tel: (918) 665-3300
A**,CH,CM,CS,M*

Oregon

Hewlett-Packard Co.
1500 Valley River Drive, Suite 330
EUGENE, OR 97401
Tel: (503) 683-8075
C

Hewlett-Packard Co.
9255 S. W. Pioneer Court
WILSONVILLE, OR 97070
Tel: (503) 682-8000
A,CH,CM,CS,E*,MS

Pennsylvania

Hewlett-Packard Co.
1021 8th Avenue
King of Prussia Industrial Park
KING OF PRUSSIA, PA 19406
Tel: (215) 265-7000
Telex: 510-660-2670
A,CH,CM,CS,E,MP

Hewlett-Packard Co.
111 Zela Drive
PITTSBURGH, PA 15238
Tel: (412) 782-0400
A,CH,CM,CS,E,MP

South Carolina

Hewlett-Packard Co.
P.O. Box 6442
6941-D N. Trenholm Road
COLUMBIA, SC 29260
Tel: (803) 782-6493
CH,CM,E,MS

Hewlett-Packard Co.
814 Wade Hampton Blvd.
Suite 10
GREENVILLE, SC 29609
Tel: (803) 232-0917
C

Tennessee

Hewlett-Packard Co.
P.O. Box 22490
224 Peters Road
Suite 102
KNOXVILLE, TN 37922

Tel: (615) 691-2371
A*,CH,CM,MS

Hewlett-Packard Co.
3070 Directors Row
MEMPHIS, TN 38131
Tel: (901) 346-8370
A,CH,CM,MS

Hewlett-Packard Co.
Suite 103
478 Craighead Street
NASHVILLE, TN 37204
Tel: (615) 383-9136
CM,MS**

Texas

Hewlett-Packard Co.
Suite 310W
7800 Shoalocreek Blvd.
AUSTIN, TX 78757
Tel: (512) 459-3143
CM,E

Hewlett-Packard Co.
Suite C-110
4171 North Mesa
EL PASO, TX 79902
Tel: (915) 533-3555
CH,CM,E*,MS**

Hewlett-Packard Co.
5020 Mark IV Parkway
FORT WORTH, TX 76106
Tel: (817) 625-6361
CM,C*

Hewlett-Packard Co.

P.O. Box 42816
10535 Harwin Street
HOUSTON, TX 77036
Tel: (713) 776-6400
A,CH,CM,CS,E,MP

Hewlett-Packard Co.
3309 67th Street
Suite 24
LUBBOCK, TX 79413
Tel: (806) 799-4472
M

Hewlett-Packard Co.
P.O. Box 1270
930 E. Campbell Rd.
RICHARDSON, TX 75081
Tel: (214) 231-6101
A,CH,CM,CS,E,MP

Hewlett-Packard Co.
205 Billy Mitchell Road
SAN ANTONIO, TX 78226
Tel: (512) 434-8241
CH,CM,CS,E,MS

Utah

Hewlett-Packard Co.
3530 W. 2100 South Street
SALT LAKE CITY, UT 84119
Tel: (801) 974-1700
A,CH,CM,CS,E,MS

Virginia

Hewlett-Packard Co.
P.O. Box 9669
2914 Hungary Spring Road
RICHMOND, VA 23228
Tel: (804) 285-3431
A,CH,CM,CS,E,MS

Hewlett-Packard Co.
P.O. Box 4786
3110 Peters Creek Road, N.W.
ROANOKE, VA 24015
Tel: (703) 563-2205
CH,CM,E**

Hewlett-Packard Co.

P.O. Box 12778
5700 Thurston Avenue
Suite 111
VIRGINIA BEACH, VA 23455
Tel: (804) 460-2471
CH,CM,MS

Washington

Hewlett-Packard Co.
15815 S.E. 37th Street
BELLEVUE, WA 98006
Tel: (206) 643-4000
A,CH,CM,CS,E,MP

Hewlett-Packard Co.
Suite A
708 North Argonne Road
SPOKANE, WA 99206
Tel: (509) 922-7000
CH,CM,CS

West Virginia

Hewlett-Packard Co.
4604 MacCorkle Ave., S.E.
CHARLESTON, WV 25304
Tel: (304) 925-0492
A,CM,MS

Wisconsin

Hewlett-Packard Co.
150 S. Sunny Slope Road
BROOKFIELD, WI 53005
Tel: (414) 784-8800
A,CH,CM,CS,E*,MP

URUGUAY

Pablo Ferrando S.A.C. e.l.
Avenida Italia 2877
Casilla de Correo 370
MONTEVIDEO
Tel: 80-2586
Telex: Public Booth 901
A,CM,E,M
Guillermo Kraft del Uruguay S.A.
Av. Lib. Brig. Gral. Lavalleja 2083
MONTEVIDEO
Tel: 234588, 234808, 208830
Telex: 6245 ACTOUR UY
P

U.S.S.R.

Hewlett-Packard Co.
Representative Office
Pokrovsky Blvd. 4/17 KV12
MOSCOW 101000 Tel: 294-2024
Telex: 7825 HEWPACK SU

VENEZUELA

Hewlett-Packard de Venezuela C.A.
Apartado 50933
3A Transversal Los Ruices Norte
Edificio Segre
CARACAS 10711
Tel: 239-4133
Telex: 25146 HEWPACK
A,CH,CS,E,MS,P

YUGOSLAVIA

Iskra-Commerce-Representation of
Hewlett-Packard
Sava Centar Delegacija 30
Milentija Popovica 9
11710 BEOGRAD
Tel: 638-762
Telex: 12042, 12322 YU SAV CEN
Iskra-Commerce-Representation of
Hewlett-Packard
Kopraska 46
61000 LJUBLJANA
Tel: 321674, 315879
Telex:

ZAIRE

Computer & Industrial Engineering
25 Avenue de la Justice
B.P. 10-976
Kinshasha I/Zaire
GOMBE
Tel: 32063
Telex: 21-457 SGEKIN ZR
CH,CS

ZIMBABWE

Field Technical Sales
45 Kelvin Road, North
P.B. 3458
SALISBURY
Tel: 705 231
Telex: 4-122 RH
C,E,M,P

FOR COUNTRIES AND AREAS NOT LISTED:

CANADA

Ontario
Hewlett-Packard (Canada) Ltd.
6877 Goreway Drive
MISSISSAUGA, Ontario L4V 1M8
Tel: (416) 678-9430
Telex: 610-492-4246

EASTERN USA

Maryland
Hewlett-Packard Co.
4 Choke Cherry Road
Rockville, MD 20850
Tel: (301) 258-2000

MIDWESTERN USA

Illinois
Hewlett-Packard Co.
5201 Tollview Drive
ROLLING MEADOWS, IL 60008
Tel: (312) 255-9800

SOUTHERN USA

Georgia
Hewlett-Packard Co.
P.O. Box 105005
450 Interstate N. Parkway
ATLANTA, GA 30339
Tel: (404) 955-1500

WESTERN USA

California
Hewlett-Packard Co.
3939 Lankersim Blvd.
LOS ANGELES, CA 91604
Tel: (213) 877-1282

EUROPEAN AREAS NOT LISTED, CONTACT

SWITZERLAND
Hewlett-Packard S.A.
7 Rue du Bois-du-Lan
CH-1217 MEYRIN 2, Switzerland
Tel: (022) 83-81-11
Telex: 27835 hpse
Cable: HEWPACKSA Geneve

EAST EUROPEAN AREAS NOT LISTED, CONTACT

AUSTRIA
Hewlett-Packard Ges.m.b.H.
Wehlstrasse 29
P.O. Box 7
A-1205 VIENNA
Tel: (222) 35-16-210
Telex: 135823/135066

MEDITERRANEAN AND MIDDLE EAST AREAS NOT LISTED, CONTACT

GREECE
Hewlett-Packard S.A.
Mediterranean & Middle East
Operations
Atrina Centre
32 Kifissias Ave.
Atrina Center
PARADISOS, Amaroussion
Tel: 808-1741-4
Telex: 21-6588 HPAT GR
Cable: HEWPACKSA Athens

INTERNATIONAL AREAS NOT LISTED, CONTACT

OTHER AREAS
Hewlett-Packard Co.
Intercontinental Headquarters
3495 Deer Creek Road
PALO ALTO, CA 94304
Tel: (415) 857-1501
Telex: 034-8300
Cable: HEWPACK

FOR COUNTRIES AND AREAS NOT LISTED, CONTACT:

AFRICA

NORTHERN AND CENTRAL AFRICA

SWITZERLAND
Hewlett-Packard S.A.
7 Rue du Bois-du-Lan
CH-1217 MEYRIN 2, Switzerland
Tel: (022) 98-96-51
Telex: 27835 hpse
Cable: HEWPACKSA Geneve

ASIA

HONG KONG

Hewlett-Packard Asia Ltd.
6th Floor, Sun Hung Kai Center
30 Harbor Rd.
G.P.O. Box 795
HONG KONG
Tel: 5-832 3211
Telex: 66678 HEWPA HK
Cable: HP ASIA LTD Hong Kong

EUROPE

EASTERN EUROPE

AUSTRIA
Hewlett-Packard Ges.m.b.H.
Wehlstrasse 29
P.O. Box 7
A-1205 VIENNA
Tel: (222) 35-16-210
Telex: 135823/135066

NORTHERN EUROPE

THE NETHERLANDS
Hewlett-Packard S.A.
Uilenstede 475
NL-1183 AG AMSTELVEEN, The Netherlands
P.O. Box 999
NL-1180 AZ AMSTELVEEN, The Netherlands
Tel: 20 437771

SOUTH EASTERN EUROPE

SWITZERLAND
Hewlett-Packard S.A.
7 Rue du Bois-du-Lan
CH-1217 MEYRIN 2, Switzerland
Tel: (022) 98-96-51
Telex: 27835 hpse
Cable: HEWPACKSA Geneve
(Offices in the World Trade Center)

MEDITERRANEAN AND MIDDLE EAST

GREECE
Hewlett-Packard S.A.
Mediterranean and Middle East
Operations
Atrina Centre
32 Kifissias Ave.
Amaroussion, ATHENS, Greece
Tel: 808-0359 808-0429
Telex: 21-6588
Cable: HEWPACKSA Athens

OTHER INTERNATIONAL AREAS

Hewlett-Packard Co.
Intercontinental Headquarters
3495 Deer Creek Road
PALO ALTO, CA 94304
Tel: (415) 857-1501
Telex: 034-8300
Cable: HEWPACK
August 1981 5952-6900

64500-90910, OCTOBER 1982
Replaces: 64500-90908, May 1981
UPDATED: SEPTEMBER 1983



PRINTED IN U.S.A.