

Honeywell

CENTRAL PROCESSOR UNIT
WCPU68LA
INSTALLATION MANUAL
58009917

DPS 8 MULTICS (FREESTANDING UNIT)

This document and the information contained herein are confidential to and the property of Honeywell Information Systems, Inc. and are made available only to Honeywell employees for the sole purpose of maintaining Honeywell's products. This document, any copy thereof and the information contained herein shall be maintained in strictest confidence; shall not be copied in whole or in part except as authorized by the employee's manager; and shall not be disclosed or distributed (a) to persons who are not Honeywell employees, or (b) to Honeywell employees for whom such information is not necessary in connection with their assigned responsibilities. Upon request, or when the employee in possession of this document no longer has need for the document for the authorized Honeywell purpose, this document and any copies thereof shall be returned to the employee's manager. There shall be no exceptions to the terms and conditions set forth herein except as authorized in writing by the responsible Honeywell Vice President.

58009917-040
DIST. NCO, XAN

REV E
AUGUST 1984

HONEYWELL CONFIDENTIAL & PROPRIETARY

The following notice is provided in accordance with the United States Federal Communications Commission's (FCC) regulations.

Warning: This equipment generates, uses, and can radiate radio frequency energy and if not installed and used in accordance with the instructions manual, may cause interference to radio communications. As temporarily permitted by regulation it has not been tested for compliance with limits for Class A computing devices pursuant to Subpart J of Part 15 of FCC Rules, which are designed to provide reasonable protection against such interference. Operation of this equipment in a residential area is likely to cause interference in which case the user at his own expense will be required to take whatever measures may be required to correct the interference.

RECORD OF REVISION			
REV	DATE	AUTHORIZATION	PAGES AFFECTED
A	9/81	PHAFPD903	58009917-040 58009979-018, 1F 58009917-014, 1F 58009917-019, 1F 58009917-041, 1F 58009917-017, 1 Thru 4F 1-1 & 1-2F, 2-1 THRU 2-6F, 3-1 THRU 3-7F, 4-1 THRU 4-11F 5-1 THRU 5-3F
B	2/82	PHAFPD904	58009917-040 58009979-018, 1F 58009917-014 58009917, 3-4, 3-4.1 58009917, 4-2
C	7/82	PHAFPD918	58009917-040 58009917-014 58009917-017 SH3 58009917, 1-1, 1-2F 58009917, 3-2, 3-7F 58009917, 4-5, 4-6, 4-7, 4-9, 4-10, 4-11F
D	6/83	PHAFPD949	58009917-040 58009917-014, 1F 58009917-041, 1F 58009917, 3-1
E	8/84	PHAFPD978	58009917-040 58009917-014, 1F 58009917-041, 1F 58009917, 3-1, 3-1.1, 3-4, 3-4.1, 3-4.2

A ISSUED

DPS 8 MULTICS
CENTRAL PROCESSOR UNIT
INSTALLATION MANUAL

58009917

PREFACE

This manual has been prepared to guide and assist you in the installation, check-out or deinstallation of the DPS 8 Multics Central Processor Unit, WCPU68LA.

Contained in this manual are instructions for unpacking, inspection, cable routing and connections. A power-up and equipment check-out procedure will help assure correct equipment operation and efficient performance. Also included in this manual are deinstallation procedures required for safe disconnection and return of the equipment.

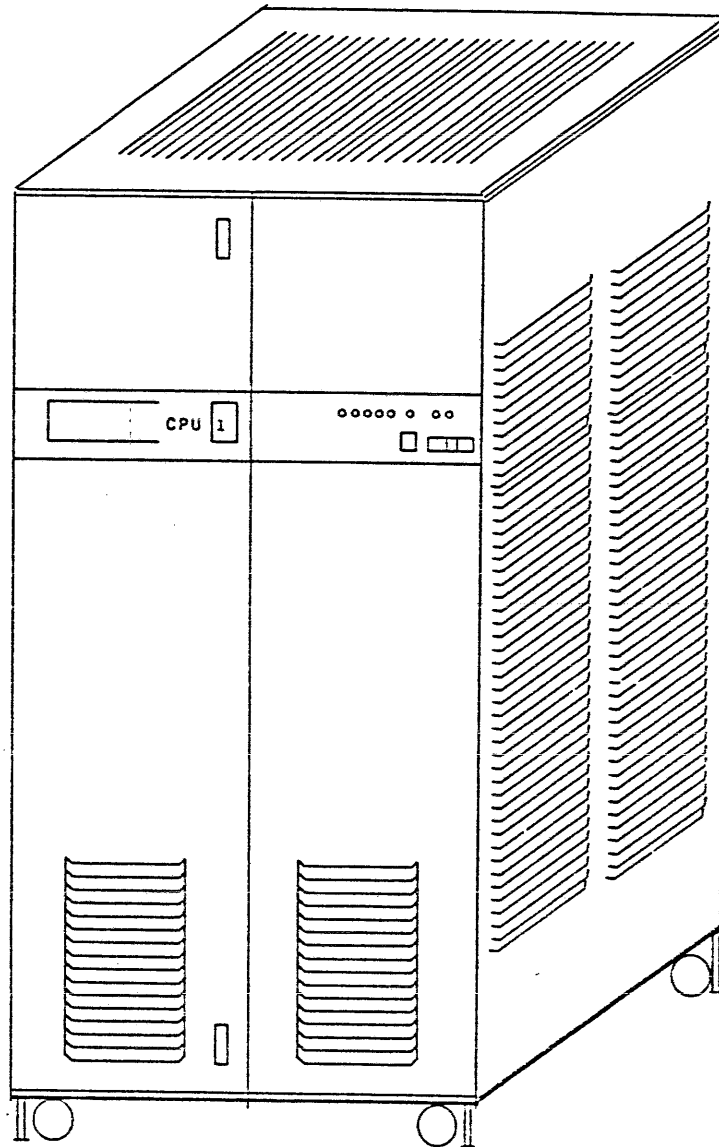

DPS 8 MULTICS
CENTRAL PROCESSOR UNIT
WCPU68LA

MANUAL CONTENTS

	<u>PAGE NO.</u>
1.0 GENERAL	1-1
1.1 INTRODUCTION	1-1
1.2 TOOLS REQUIRED	1-1
1.3 TEST EQUIPMENT REQUIRED	1-1
1.4 TEST MEDIA REQUIRED	1-1
1.5 REFERENCE DOCUMENTATION	1-2F
1.6 FEEDBACK	1-2F
2.0 PREINSTALLATION	2-1
2.1 SITE PREPARATION	2-1
2.2 METHODS OF EQUIPMENT PACKAGING AND CRATING	2-1
2.3 RECEIPT OF EQUIPMENT	2-2
2.4 UNPACKING A NON-CRATED PACK	2-3
2.5 UNPACKING A CRATED PACK	2-4
2.6 UNPACKING	2-5
2.7 VISUAL INSPECTION	2-5
2.8 PLACEMENT OF EQUIPMENT	2-6F
3.0 INSTALLATION OF THE THE DPS 8 MULTICS CENTRAL PROCESSOR UNIT	3-1
3.1 SCOPE	3-1
3.2 LOCATING THE BASIC ELEMENTS	3-3
3.3 CPU LOGIC BOARD LAYOUT	3-3
3.4 TRIM STRIP INSTALLATION	3-5
3.5 GROUNDING	3-6
3.6 POWER ENTRY	3-7F
4.0 APPLYING POWER TO THE CPU	4-1
4.1 PRE-POWER UP INSPECTION	4-1
4.2 APPLYING AC POWER	4-2
4.3 APPLYING DC POWER	4-5
4.4 POWER SHUTDOWN	4-8
4.5 POWER SYSTEM CHECKOUT	4-9
4.6 OFFLINE T&D'S	4-11F
4.7 ONLINE T&D'S	4-11F

MANUAL CONTENTS(CONTINUED)

	<u>PAGE NO.</u>
5.0 DEINSTALLATION	5-1
5.1 SITE INSPECTION	5-1
5.2 EQUIPMENT INVENTORY	5-1
5.3 DEINSTALLATION PROCEDURE	5-2
5.4 HANDLING AND SHIPPING	5-3F

LIST OF ILLUSTRATIONS

<u>FIGURE NO.</u>	<u>TITLE</u>	<u>PAGE NO.</u>
3-1	DPS 8 MULTICS CENTRAL PROCESSOR UNIT (CPU), WCPU68LA	3-1
3-2	CPU COMPONENT LOCATOR	3-2
3-3	CPU LOGIC BOARD LAYOUT	3-4
3-4	TRIM STRIP INSTALLATION	3-5
3-5	GROUND STRAP INSTALLATION	3-6
3-6	POWER ENTRY	3-7F
4-1	OPERATOR CONTROL PANEL (CABINET SHUTDOWN SWITCH)	4-1
4-2	PRIMARY POWER INPUT CIRCUIT BREAKER AT S02 (OFF POSITION)	4-2
4-3	FANS AND DC REGULATORS CIRCUIT BREAKERS AT S03 (OFF POSITION)	4-2
4-4	POWER CONTROL MODULE AT VC1 (MARGINS AND POWER CONTROL SWITCHES)	4-3
4-5	PRIMARY POWER INPUT CIRCUIT BREAKER AT S02 (ON POSITION)	4-3
4-6	POWER CONTROL MODULE AT VC1 (AC ON INDICATOR)	4-4
4-7	OPERATOR CONTROL PANEL (AC PRESENT AND POWER OFF INDICATORS)	4-4
4-8	+5V MASTER REGULATOR AT VJ1 (OFF REMOTE SWITCH)	4-5
4-9	FANS AND DC REGULATORS CIRCUIT BREAKERS AT S03 (ON POSITION)	4-5
4-10	POWER CONTROL MODULE AT VC1 (POWER-ON SWITCH)	4-6
4-11	CONFIGURATION PANEL	4-6
4-12	OPERATOR CONTROL PANEL (POWER OFF AND POWER ON INDICATORS)	4-6
4-13	POWER CONTROL MODULE AT VC1 (DC CONF, DC ON AND TEMP INDICATORS)	4-7

LIST OF ILLUSTRATIONS (CONTINUED)

<u>FIGURE NO.</u>	<u>TITLE</u>	<u>PAGE NO.</u>
4-14	OPERATOR CONTROL PANEL (POWER ON SWITCH)	4-8
4-15	PRIMARY POWER INPUT CIRCUIT BREAKER AT S02 (OFF POSITION)	4-8
4-16	OPERATOR CONTROL PANEL (CABINET SHUTDOWN SWITCH)	4-9
4-17	OPERATOR CONTROL PANEL (POWER OFF AND POWER ON INDICATORS)	4-10
4-18	POWER CONTROL MODULE AT VC1 (DC INDICATORS AND SWITCHES)	4-10
4-19	FANS AND DC REGULATORS CIRCUIT BREAKERS AT S03(SLO BLO FUSES)	4-11F

1.0 GENERAL

1.1 INTRODUCTION

This manual has been prepared to serve as an aid for installing the DPS 8 Central Processor Unit, WCPU68LA. Information for site planning and preparation is contained in the Site Preparation Manual, DN01. A copy of the Site Preparation Manual and the Customer Site Layout Plan, should be obtained from the Honeywell Site Manager prior to installation. Refer to the DPS 8 Multics Central Processor Options Manual, 58009912, for options installation.

1.2 TOOLS REQUIRED

Standard Hand Tools including:

- Hex Wrench 4mm (58020343-002)

1.3 TEST EQUIPMENT REQUIRED

Standard Test Equipment

1.4 TEST MEDIA REQUIRED

- Off-line T&D System Tape(PAS 2/Monitor)

1.5 REFERENCE DOCUMENTATION

In addition to the test media, the following documents will provide installation and checkout aids.

• Site Layout Plan	Provided by FED
• Site Preparation Manual	Later
• System Manual	58009906
• Packaging Specification	58067223
• System Operating Techniques	DD50
• Maintenance Operation Manual (MOM)	58009927
• DPS 8 Multics CPU Options Installation Manual	58009912
• DPS 8 Multics CPU Unit Manual	58009907
• Power and Cooling Manual	Later
• Test and Repair Manual	58009928
• Series 6000 Test and Diagnostics Manual	58008382
• Integrated Firmware and Diagnostics Manual	58009978

1.6 FEEDBACK

In order to maintain this manual as a functional, topical and accurate document, please submit comments through the normal technical support channels, by utilizing the System Technical Action Request (STAR) system, or mail comments directly to:

Honeywell Large Systems Product Support
 P. O. Box 6000, MS K92
 Phoenix, Arizona 85005

2.0 PREINSTALLATION

This section provides the preinstallation procedures for the installation of a DPS 8 Multics Central Processor Unit, WCPU68LA. It includes procedures for receiving, handling, uncrating/unpacking, inspecting and placing the equipment.

2.1 SITE PREPARATION

The Field Engineering Representative (FER) should ensure that the customer is prepared to receive and install the equipment.

2.2 METHODS OF EQUIPMENT PACKAGING AND CRATING

The Central Processor Unit may be shipped in a plastic wrapper for domestic shipments or crated for export shipments. See Packaging Specification 58067223 for detailed packaging instructions.

Uncrated units are shipped in an upright position, protected by four wooden corner assemblies and strapped plastic wrapping. Crated units are also shipped in an upright position.

2.3 RECEIPT OF EQUIPMENT

Upon arrival of the equipment at the site, the Field Engineering Representative (FER) should assist the customer in receiving, inventorying, checking for any external damage, and directing the placement of the equipment. Usually the carrier will unload the equipment and move it to a specified location inside the building. All plastic covers should be removed as soon as possible to prevent moisture formation in the equipment.

CAUTION

THE MASS STORAGE PROCESSOR MUST BE UNLOADED AND HANDLED WITH CARE TO AVOID DAMAGE TO THE EQUIPMENT. THIS UNIT MAY WEIGH IN EXCESS OF 1000 LBS.

1. Prior to receipt of equipment, the FER should assure that the customer obtains shipping documents (Bill of Lading, Memorandum of Shipment) from the carrier.
2. Upon delivery of the equipment, the FER should assure that the customer inventories equipment against shipping documents (Bill of Lading and Memorandum of Shipment).

NOTE

The customer representative should be advised not to sign papers at this time.

3. Check wrapping, crating, and cartons for breaks, tears or other evidence of rough handling or damage.
4. The customer representative should note any loss, damage, moisture, corrosion and mishandling of equipment on shipping documents before signing for equipment, and the Field Engineering Representative should so note on the Traffic Service Evaluation Report.
5. The FER should assure that the customer notifies the Honeywell Traffic Manager of any loss of or damage to the equipment. The notification may be performed through normal telephone contact, but must be promptly confirmed in writing to the Honeywell Traffic Manager. Refer to the Bill of Lading for the current telephone number.

2.4 UNPACKAGING A NON-CRATED PACK

Unpackaging is ordinarily the same for any of the DPS 8 Freestanding cabinets packaged in a non-crated pack. The carrier will normally unpackage the equipment per the following steps and set it in the specified area.

NOTE

The packaging is made of strapped plastic wrapping protected with wooden corner assemblies. No attempt should be made to open the packaging by cutting or prying.



WARNING

BEFORE REMOVING ANY METAL BINDING STRAPS, ENSURE THAT NO ONE IS NEAR THE EQUIPMENT (EXCEPT THE INDIVIDUAL WHO IS REMOVING THE BINDING STRAPS). WHEN CUT, THESE STRAPS MAY SPRING FREE, STRIKING ANY CLOSE OBJECT.

1. Cut external vertical and horizontal binding straps. This action frees the four corner protectors and top spreaders.
2. Remove the plastic wrapping.
3. Remove the wooden corner assemblies which are bolted to the equipment frame.
4. Administratively dispose of any packaging material.

2.5 UNPACKAGING A CRATED PACK

Unpackaging crated cabinets is ordinarily the same for any of the DPS 8 Freestanding cabinets. The carrier will normally unpackage the equipment per the following steps and set it in the specified area.

NOTE

The crates are made of cleated wood and/or laminated paper and wood construction. No attempt should be made to cut or pry crates apart.



WARNING

BEFORE REMOVING ANY METAL BINDING STRAPS, ENSURE THAT NO ONE IS NEAR THE CRATE (EXCEPT THE INDIVIDUAL WHO IS REMOVING THE STRAPS). WHEN CUT, THESE STRAPS MAY SPRING FREE STRIKING ANY CLOSE OBJECT.

1. Cut external vertical and horizontal metal binding straps from crate.
2. Remove the metal bolts from the front panel of the crate. Check for and remove any other bolts or nails that may be in the panel.
3. Remove bolts around lower edge of crate.
4. Lift crate to clear cabinet and remove it from pallet.
5. Cut interior vertical and horizontal binding straps. This action frees the cabinet from the base of the crate.

6. Remove cabinet from pallet with a fork lift or hoist, being careful to avoid damage to the cabinet.
7. Remove remaining straps, plastic wrap and other packing material from the cabinet.
8. Administratively dispose of any crating material.

2.6 UNPACKING

Unpacking is ordinarily the same for any of the DPS 8 Freestanding equipment. The carrier will normally unpack the equipment.

NOTE

Unpacking refers to the removal of any material, including special brackets or devices, which has been placed within the equipment to provide protection from shipping/handling hazards. All packing material must be removed from the equipment.

Ensure that the equipment is unpacked as required. Refer to the Packaging Specification, 58067223 for additional information. Administratively dispose of any packing material.

2.7 VISUAL INSPECTION

After the equipment has been unpacked, it should again be inspected for physical damage and moisture condensation. Complete the following steps:

1. Check the equipment for dents in doors and cabinets, broken indicators and switches, damage to other parts, missing items and moisture condensation.

CAUTION

IF MOISTURE IS FOUND, IT SHOULD BE REMOVED AND THE UNIT ALLOWED TO STABILIZE IN THE OPERATING ENVIRONMENT FOR AT LEAST 24 HOURS. DURING THE LAST EIGHT HOURS, AC AND DC POWER SHOULD BE TURNED ON TO PROMOTE INTERNAL DRYING BEFORE TESTING.

2. Have receiver/customer representative record any loss, concealed damage, or corrosion of equipment, on shipping documents.
3. Report any loss, damage or corrosion, in writing to the Honeywell Traffic Manager.
4. Shipping documents may now be signed by receiver/customer representative.
5. Return Memorandum of Shipment to Honeywell's General Accounting Department at:

Honeywell Information Systems
P.O.Box 6000
Phoenix, Arizona 85005
c/o Manager, General Accounting
Mail Station A75

2.8 PLACEMENT OF EQUIPMENT

CAUTION

UNCRATED CABINETS SHOULD BE CAREFULLY
MOVED ON THEIR CASTERS TO AVOID
TIPPING THE CABINET OVER.

1. Ensure that the unit has been moved to the operational site and positioned per site layout plan.

3.0 INSTALLATION OF DPS 8 MULTICS CENTRAL PROCESSOR UNIT

3.1 SCOPE

This section provides the procedures to install a DPS 8 Multics Central Processor Unit, WCPU68LA, referred to hereinafter as the CPU.

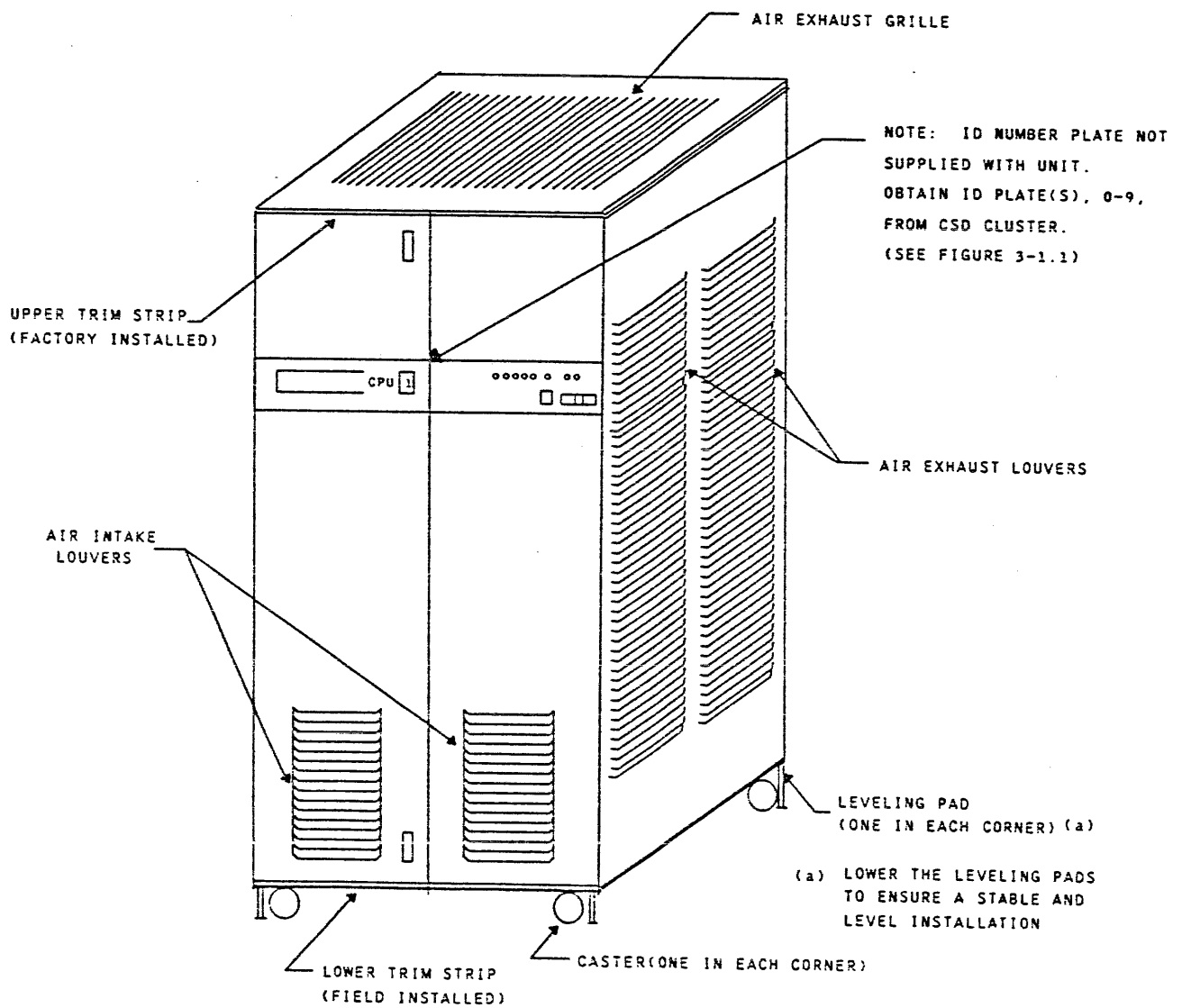
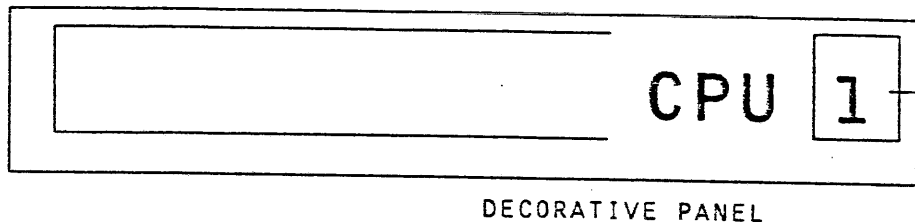

FIGURE 3-1. DPS 8 MULTIC CENTRAL PROCESSOR UNIT (CPU), WCPU68LA

The decorative panel has a cutout for the unit's ID Number to be installed at the customer's site. The numbers are stocked at the CSD logistic clusters and must be ordered by the CSR as required. See part numbers below.

The numbers are on square plates that have magnetic backings for attachment in the cutout of the decorative panel.



<u>ID Number</u>	<u>Part No.</u>
1	58059691-001
2	58059691-002
3	58059691-003
4	58059691-004
5	58059691-005
6	58059691-006
7	58059691-007
8	58059691-008
9	58059691-009
0	58059691-010
BLANK	58059691-011

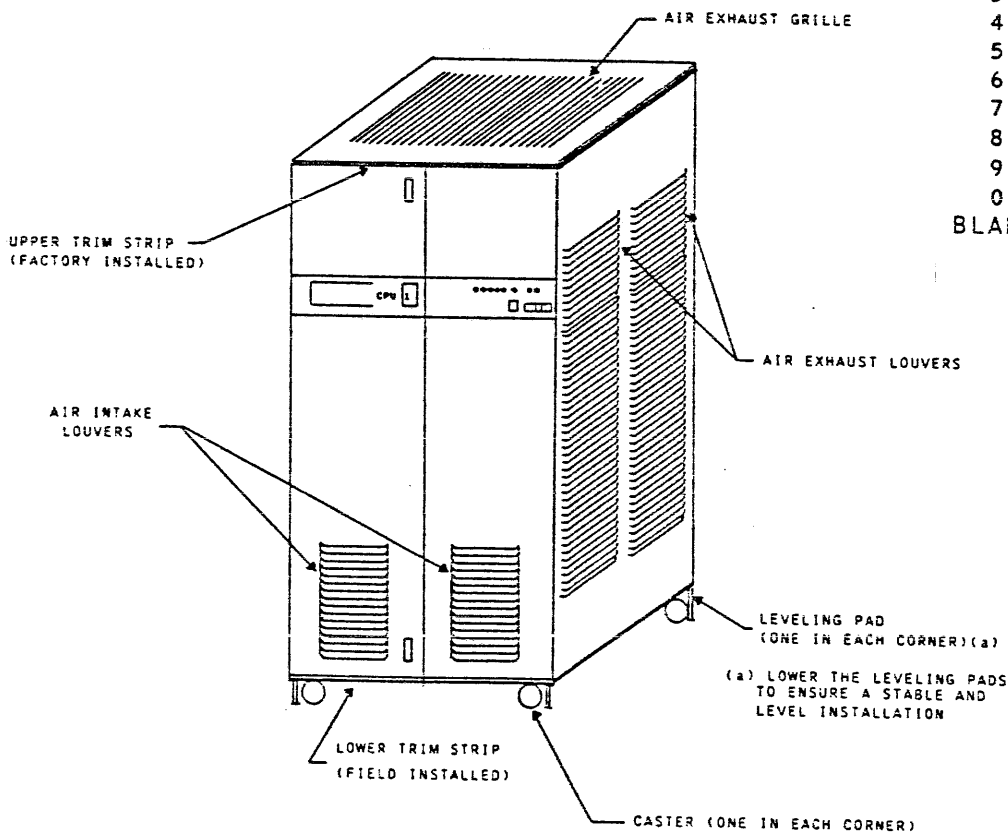
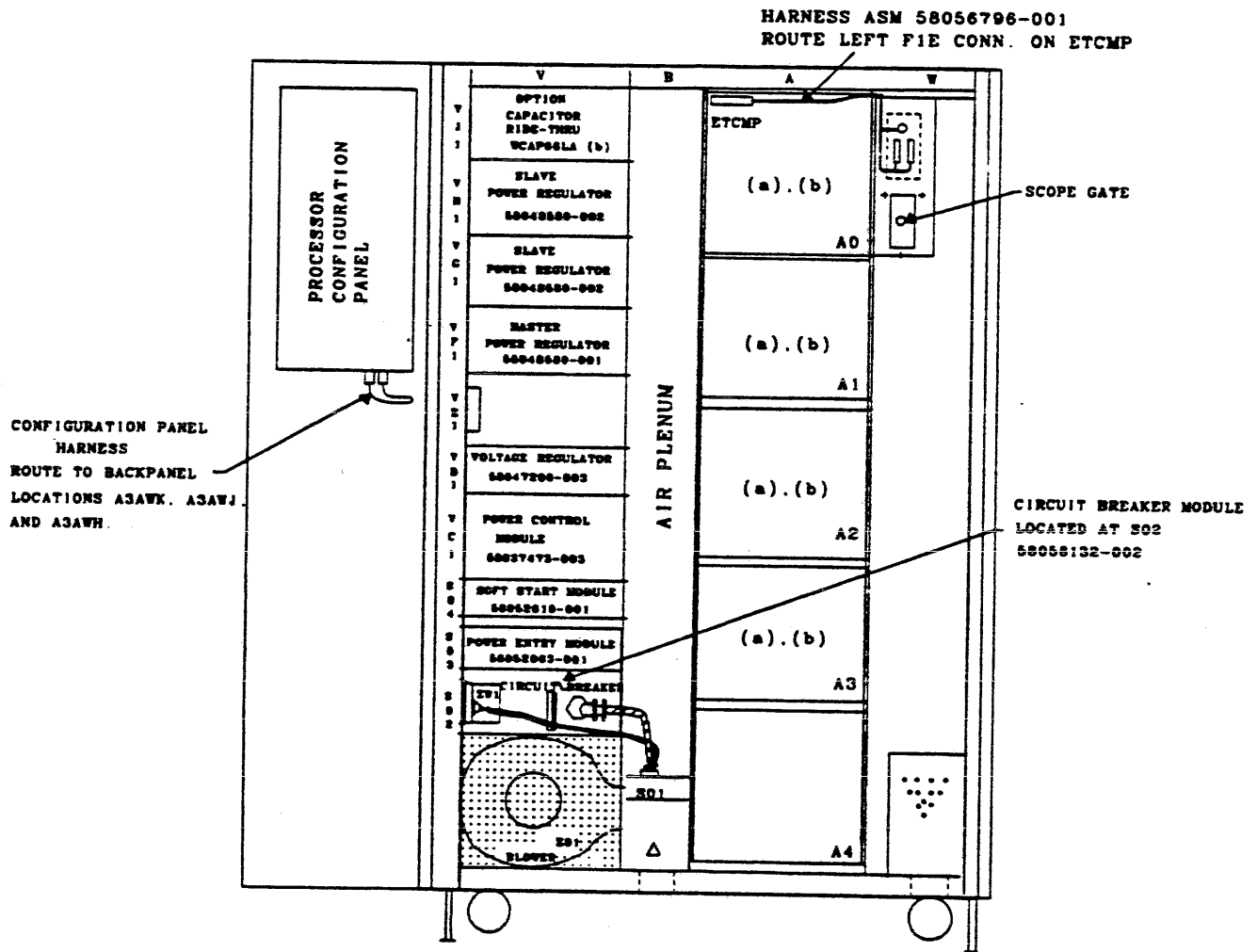

FIGURE 3-1.1. CPU ID NUMBER INSTALLATION



- (a) See Figure 3-3 for Logic Board and Harness Cable Locations.
- (b) For Options Installation see Options Installation Manual. 58009912.

FIGURE 3-2. CPU COMPONENT LOCATOR

3.2 LOCATING THE BASIC ELEMENTS

The CPU minimum configuration is shown in Figures 3-2 and 3-3. This configuration includes the following elements.

- Five Logic Board Modules located at A0, A1, A2, A3 and A4.
- Logic boards as shown in Figure 3-3.
- Power Regulator +5V 180A, 58048580-002, located at VH1.
- Power Regulator +5V 180A, 58048580-002, located at VG1.
- Power Regulator +5V 180A, 58048580-001, located at VF1.
- Voltage Regulator 100W, 58047200-003, located at VD1.
- Power Control Module, 58037473-003, located at VC1.
- Soft Start Module, 58052618-001, located at S04.
- Power Entry Module, 58052063-002, located at S03.
- Circuit Breaker Module, 58058132-002, located at S02.
- Power Entry Junction Box, located at S01.
- Configuration Panel located at Q02 (inside left front door).
- Required harnesses and cables as shown in Figures 3-2 and 3-3.

NOTE

For proper operation of this equipment, the following options are required:

WIPO68LA Active Port Option
 WHCC68LA Cache Cable Option

Options are installed per the DPS 8 Multics CPU Options Installation Manual, 58009912.

3.3 CPU LOGIC BOARD LAYOUT

The CPU logic board layout is shown in Figure 3-3. Refer to the CPU Options Installation Manual, 58009912, for the installation of any additional logic boards and harnessing/cabling, associated with the CPU options.

WARNING

CPU LOGIC BOARDS CONTAIN CIRCUITS
 WHICH MAY BE DAMAGED BY ELECTROSTATIC
 DISCHARGE (ESD). USE PROPER HANDLING
 PROCEDURES TO AVOID DAMAGE.

AA0

0 A	ETCMP-1
0 B	
0 C	EISDN
0 D	ETCDP
0 E	ETCDG
0 F	EISDE
0 G	EISDF
0 H	EISDC
0 J	EISDQ
0 K	EISDR
0 L	EISDB
0 M	EISDM
0 N	645DL
0 P	EISDK
0 Q	EISDD
0 R	EISDA1
0 S	EISDA2
0 T	EISDA3
0 U	EISDA4

AA1

1 A	EISDA5
1 B	EISDA6
1 C	EISDA7
1 D	EISDA8
1 E	EISDJ
1 F	ETCDH
1 G	
1 H	
1 J	ETCAM
1 K	ETCAD
1 L	ETCAJ
1 M	ETCAB
1 N	ETCAE
1 P	ETCAF
1 Q	ETCAN
1 R	ETCAP
1 S	
1 T	
1 U	ETMBG

NOTE: The CPU logic board layout (sheets 1 thru 3) shows the installation of the CPU boards only. For CPU options logic board installation, see the Installation Instructions located in the CPU Options Installation Manual 58009912.

FIGURE 3-3. CPU LOGIC BOARD LAYOUT (Sheet 1 of 3)

AA2

2 A	ETMBL
2 B	
2 C	ETM88
2 D	
2 E	
2 F	
2 G	
2 H	
2 J	
2 K	
2 L	
2 M	
2 N	ETMCH
2 P	
2 Q	ETMCP
2 R	
2 S	ETMCG
2 T	
2 U	ETCCU1

AA3

3 A	ETCCU2
3 B	
3 C	
3 D	
3 E	ETMCQ
3 F	
3 G	
3 H	
3 J	
3 K	
3 L	
3 M	
3 N	
3 P	
3 Q	ETMPH
3 R	
3 S	
3 T	
3 U	

AA4

4 A	ETMPC
4 B	
4 C	ETMPE
4 D	
4 E	ETMPF
4 F	
4 G	
4 H	
4 J	

FIGURE 3-3. CPU LOGIC BOARD LAYOUT (SHEET 2 OF 3)

CABLE CONNECTION CHART				
BOARD MNEMONIC	CONNECTOR IDENT.	BOARD MNEMONIC	CONNECTOR IDENT.	CABLE NO.
EISDM-R	P1	EISDJ-R	P2	58053780-005
ETCAB-R	P2	ETMBG-R	P1	58053720-001
ETMBG-R	P1	ETCCU1-L	P3	
ETMBB-L	P1	ETMPH-L	P2	58053702-001

FREE EDGE CONNECTOR LOCATION CHART		
BOARD MNEMONIC	BOARD MNEMONIC	CONNECTOR NO.
EISDJ-L	ETCDH-L	58047413-008
ETCAN-L	ETCAP-L	58047413-008
ETCAE-R	ETCAN-R	58047413-005
ETMCP-L	ETMCG-L	43C243111G2
ETMPC-R	ETMPE-R	43C243111G2
ETMPE-L	ETMPF-L	43C243111G2
ETMCQ-R		43C175991P1
ETMCQ-L		43C175991P1
ETMCG-R		58040035-004
ETCCU2-L		58060459-001

FIGURE 3-3. CPU LOGIC BOARD LAYOUT (SHEET 3F)

3.4 TRIM STRIP INSTALLATION

The lower trim strips are packaged separately, they are secured to the lower hinge brackets attached to the front and rear door with Phillips head screws and speed nuts as shown in Section A-A, Figure 3-4.

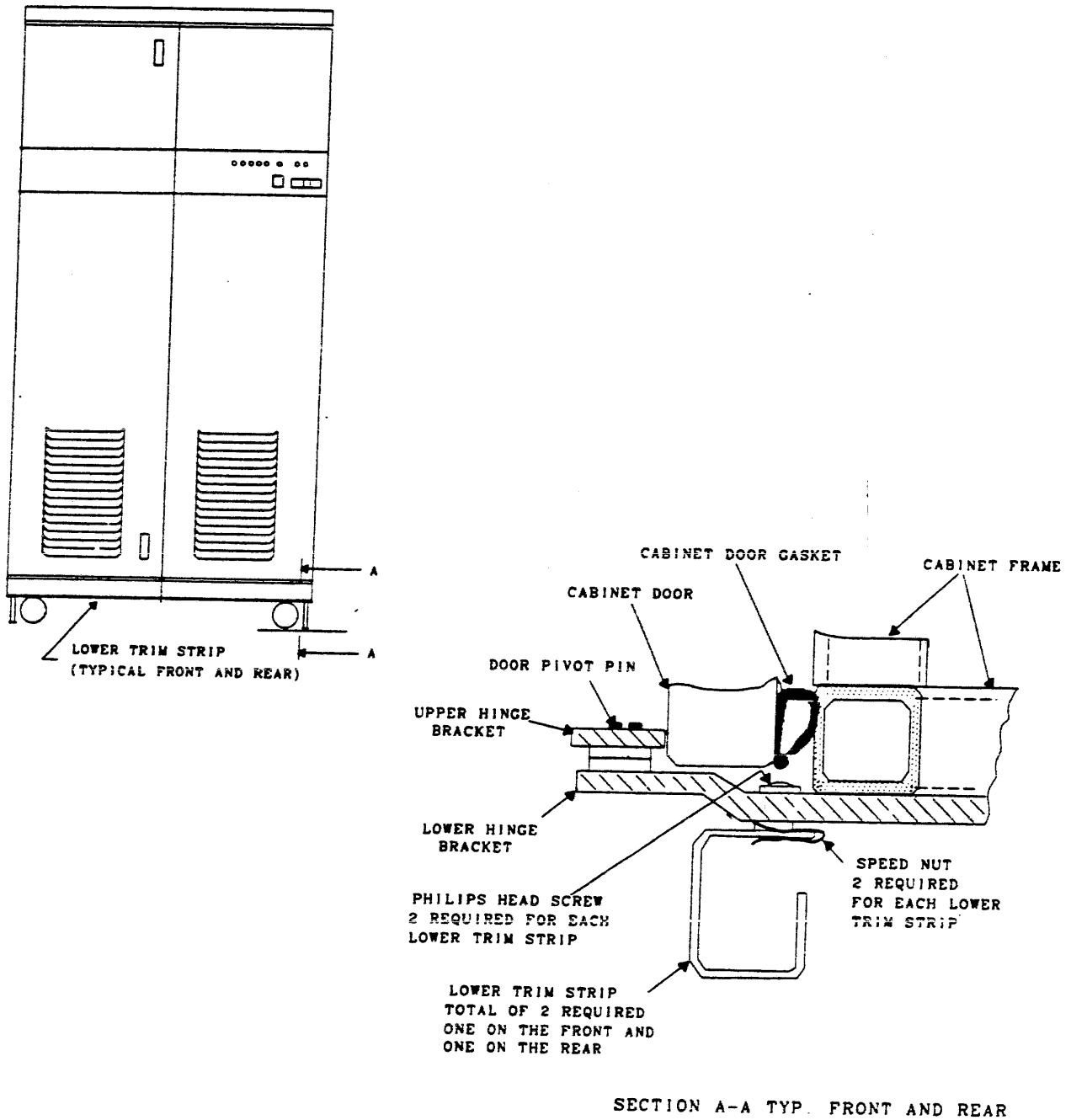

FIGURE 3-4. TRIM STRIP INSTALLATION

3.5 GROUNDING

1. Refer to Figure 3-5.
2. Ensure that the ground strap mounting surfaces are clean and free from any foreign material.
3. Remove metric hardware (M6 hex screw, M6 lock and flat washers) and pressure plate.
4. Place the tinned end of the ground strap on the frame, secure and route as shown in Figure 3-5.
5. For more information on ground strap routing, refer to Site Preparation Manual, DN01.

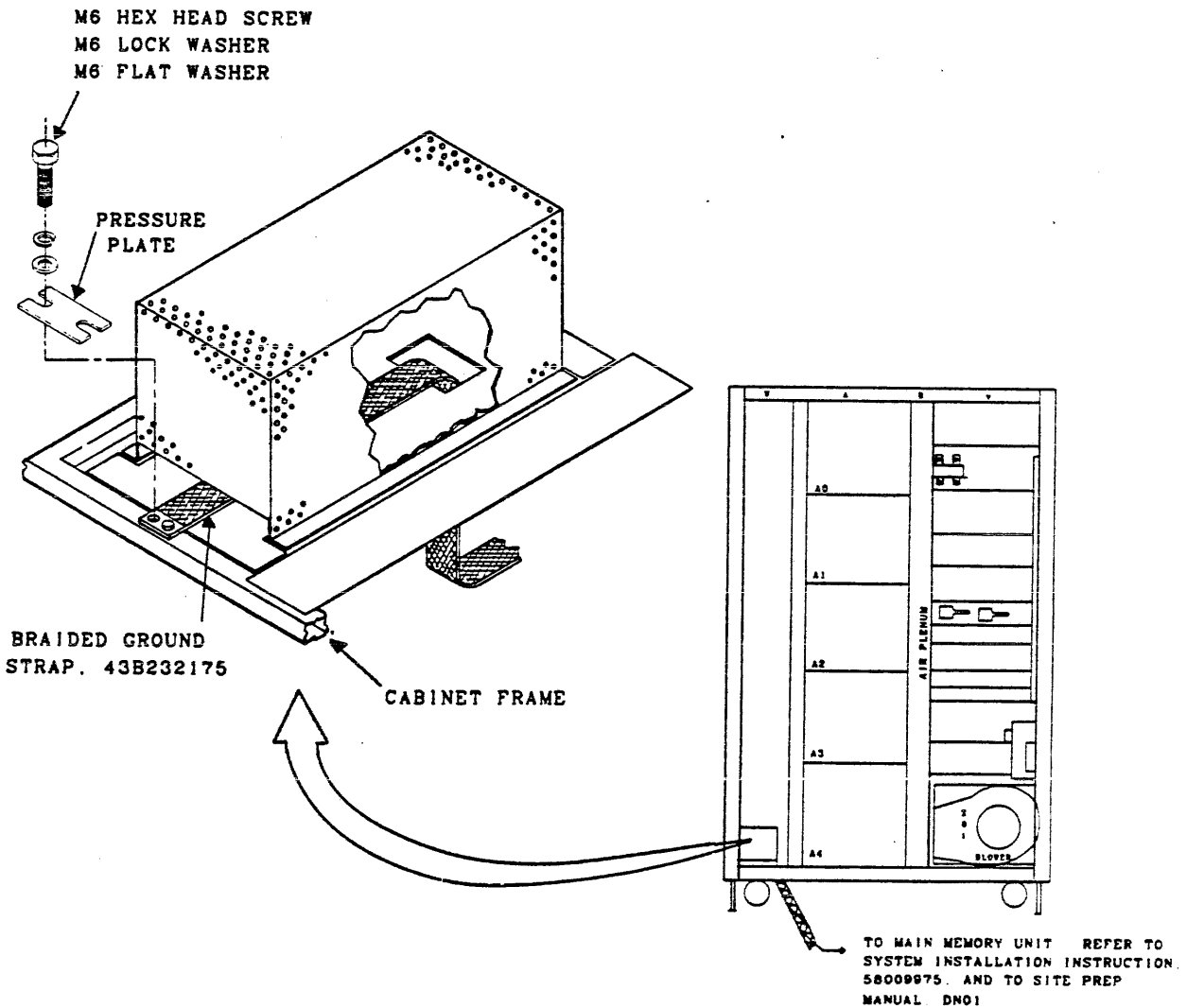

FIGURE 3-5. GROUND STRAP INSTALLATION

3.6 POWER ENTRY

WARNING

ENSURE THAT THE CIRCUIT BREAKER AT S02 IS IN THE OFF POSITION BEFORE MAKING THE POWER CONNECTIONS AT S01.

The customer's electrician will connect the power cable from the customer's power distribution panel to S01-TB1. See Figure 3-6. The neutral (white) lead shall not be brought into the cabinet.

Before connecting power to the CPU, verify that the AC circuit breaker located at S02 is in the OFF position. Ensure that the AC power cable is properly connected.

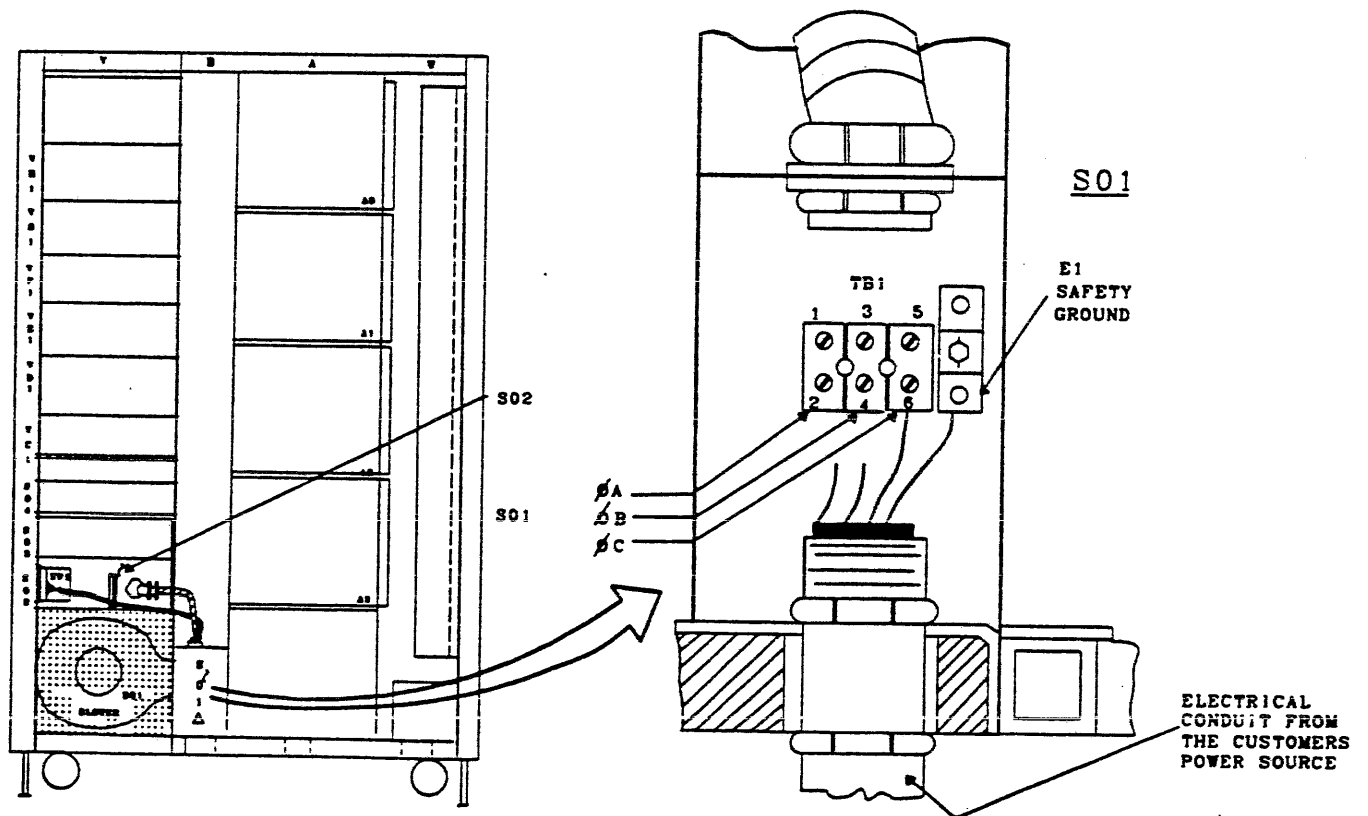

DESCRIPTION	TERMINAL	CONDUCTOR COLOR
PHASE A	TB1-2	BLACK (a)
PHASE B	TB1-4	BLACK (a)
PHASE C	TB1-6	BLACK (a)
SAFETY GROUND	E1	GREEN/YELLOW

(a) THE CONDUCTOR(INSULATION)COLOR IS NORMALLY BLACK EXCEPT AS DEFINED BY LOCAL CODE PER HIS STANDARD. B01.09.

FIGURE 3-6. POWER ENTRY

4.0 APPLYING POWER TO THE CPU

WARNING

OBSERVE ALL CAUTIONS AND WARNINGS
AS HAZARDOUS VOLTAGE MAY BE PRESENT.

4.1 PRE-POWER UP INSPECTION

Perform the following inspection steps:

NOTE

Depressing the CABINET SHUTDOWN switch on the Operator Control Panel bypasses the Power Control Module and the Operator Control Panel POWER OFF switches. Before power can be applied the CABINET SHUTDOWN switch must be in the out position.

1. Ensure that the operations area is clean.
2. Ensure that the CPU is clean and free of foreign matter.
3. Ensure that the cooling system air filters are clean.
4. Ensure that the plenum, blower housing and air intake louvers are clean and free from any obstructions.
5. Ensure that the CABINET SHUTDOWN switch, located on the Operator Control Panel is in the out position. See Figure 4-1.
6. Ensure that all power connections are clean and secure.
7. Verify that all circuit boards are properly located and seated.

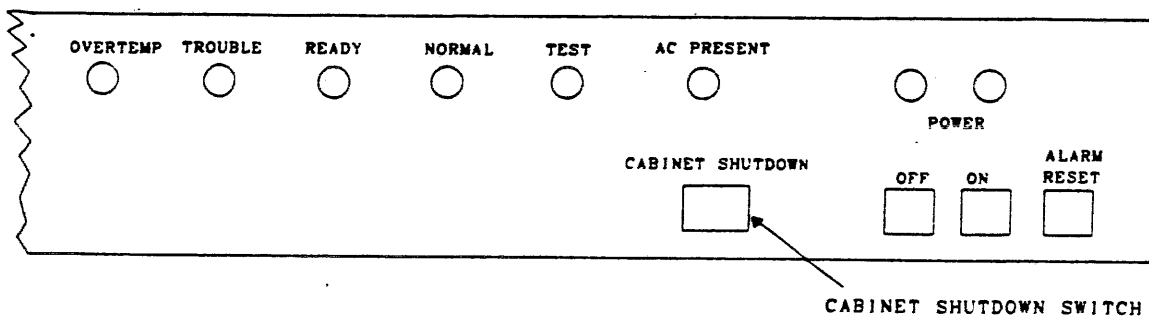

FIGURE 4-1. OPERATOR CONTROL PANEL
(CABINET SHUTDOWN SWITCH)

4.2 APPLYING AC POWER

Before applying power complete the following steps:

CAUTION

THE BLOWER IN THIS UNIT MUST BE WIRED FOR EITHER 50 HZ OR 60 HZ. SEE INSTRUCTION LABEL IN BLOWER COMPARTMENT AT REAR OF CABINET.

1. Verify that the circuit breaker located at S02 is in the OFF position. See Figure 4-2.

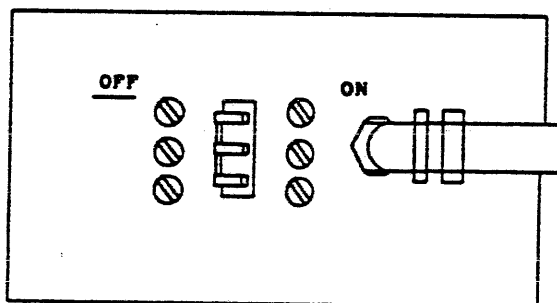

FIGURE 4-2. PRIMARY POWER INPUT CIRCUIT BREAKER AT S02 (OFF POSITION)

2. Verify that the circuit breakers located at S03, labeled FANS and REGULATORS, are in the OFF position. See Figure 4-3.

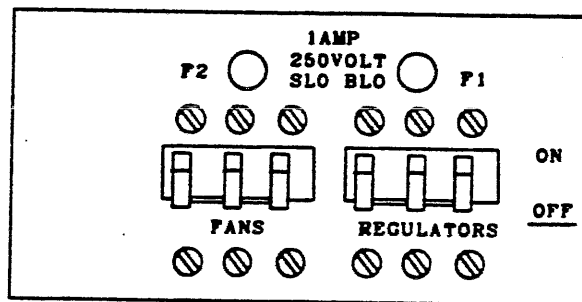

FIGURE 4-3. FANS AND DC REGULATORS CIRCUIT BREAKERS AT S03 (OFF POSITION)

3. Verify that the Power Control Module (located at VC1) POWER CONTROL-REMOTE/LOCAL switch is in the LOCAL position and depress the POWER CONTROL-OFF switch. Also ensure that the MARGINS-REMOTE/LOCAL switch is in the REMOTE position. See Figure 4-4.

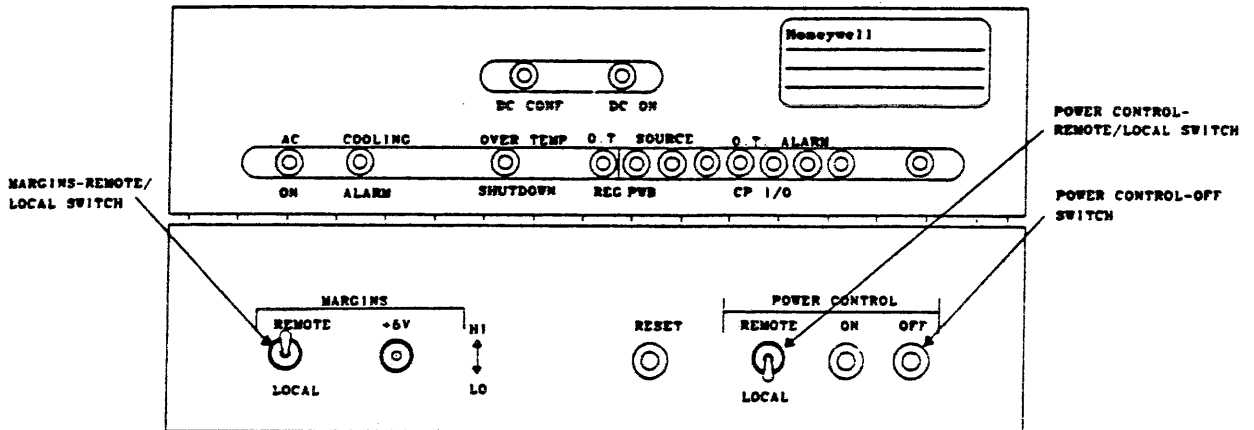

FIGURE 4-4. POWER CONTROL MODULE AT VC1
(MARGINS AND POWER CONTROL SWITCHES)

After these settings are verified, power may be applied in the following manner:

1. Ensure that the applicable circuit breaker on the site power distribution panel is in the ON position.
2. Verify with the electrician that the input power to the CPU is 60 Hz, 3 Phase 208 vac phase to phase. If the power source is 50 Hz, set the customer's circuit breaker to OFF and connect the cooling fans for 50 Hz operation before proceeding. (Connection instructions are located on the S01 housing.)
3. Set the customer's applicable circuit breaker to OFF and replace the S01 junction box cover.
4. Reset the customer's circuit breaker to the ON position.
5. Set the CPU cabinet circuit breaker located at S02 to ON. (Figure 4-5)

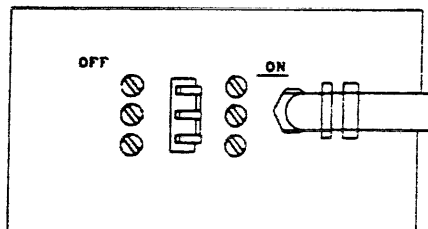

FIGURE 4-5. PRIMARY POWER INPUT CIRCUIT
BREAKER AT S02 (ON POSITION)

- Verify that the AC ON indicator located on the Power Control Module at VC1 is illuminated. See Figure 4-6.

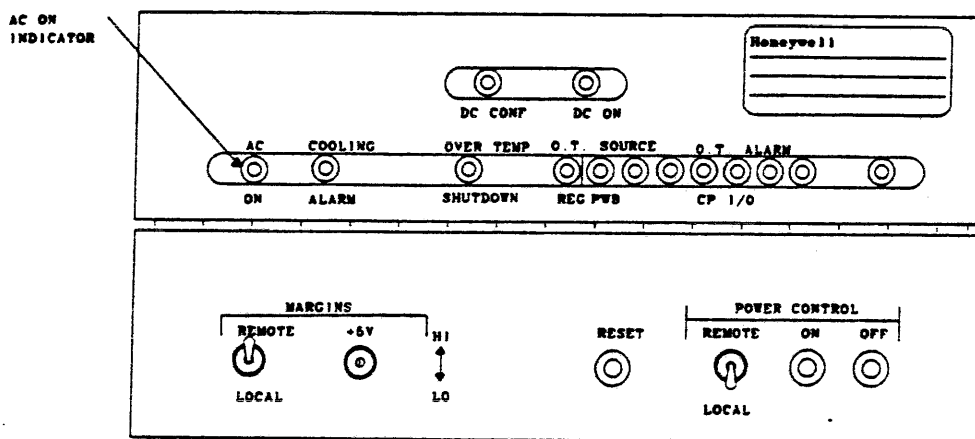

FIGURE 4-6. POWER CONTROL MODULE AT VC1 (AC ON INDICATOR)

- Verify that the AC PRESENT indicator and the POWER OFF indicator located on the Operator Control Panel are illuminated. See Figure 4-7.

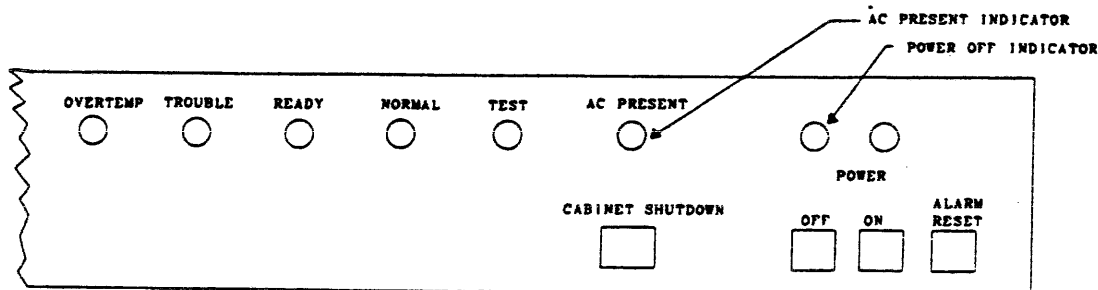

FIGURE 4-7. OPERATOR CONTROL PANEL (AC PRESENT AND POWER OFF INDICATORS)

4.3 APPLYING DC POWER

CAUTION

DO NOT REMOVE OR INSERT LOGIC BOARDS
AFTER DC POWER HAS BEEN APPLIED.

Apply DC power to the equipment in the following manner:

1. Verify that the OFF/REMOTE switch, located on the +5V Master Regulator is in the REMOTE position. See Figure 4-8.

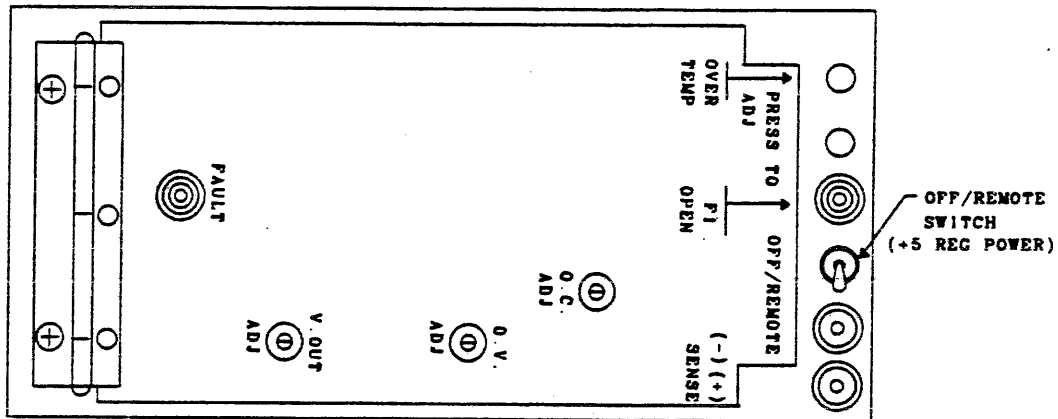

FIGURE 4-8. +5V MASTER REGULATOR AT VJ1
(OFF/REMOTE SWITCH)

2. Set the regulators and fans circuit breakers located at S03 to the ON position. See Figure 4-9.

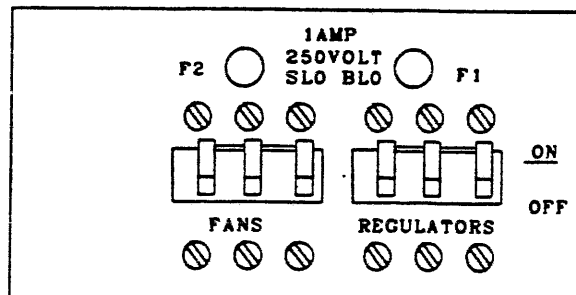

FIGURE 4-9. FANS AND DC REGULATORS CIRCUIT
BREAKERS AT S03 (ON POSITION)

- Depress the POWER CONTROL-ON switch. This switch is located on the Power Control Module at VC1. See Figure 4-10.

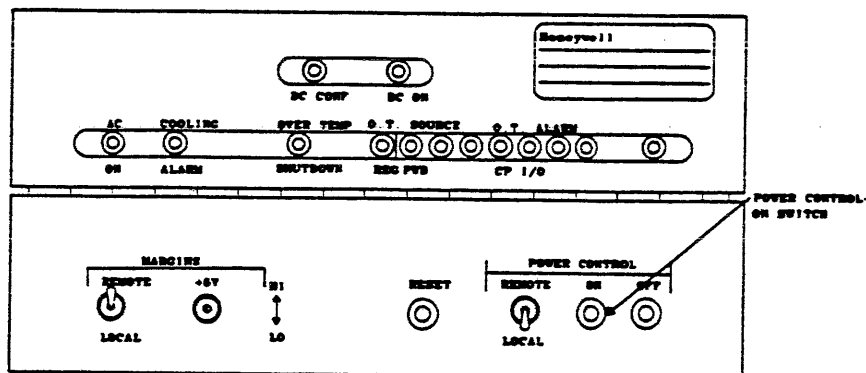

FIGURE 4-10. POWER CONTROL MODULE AT VC1 (POWER-ON SWITCH)

- If the trouble indicator located on the Operator Control Panel illuminates, press the Ini-Clear pushbutton switch located on the Configuration Panel to clear. See Figures 4-11 and 4-12.

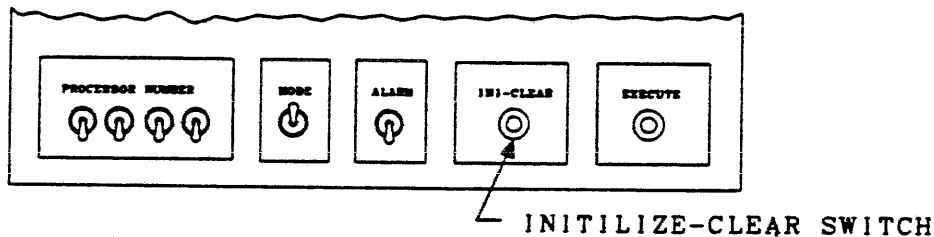

FIGURE 4-11. CONFIGURATION PANEL

- Verify that the POWER ON indicator is illuminated and the POWER OFF indicator is extinguished. These indicators are located on the Operator Control Panel. See Figure 4-12.

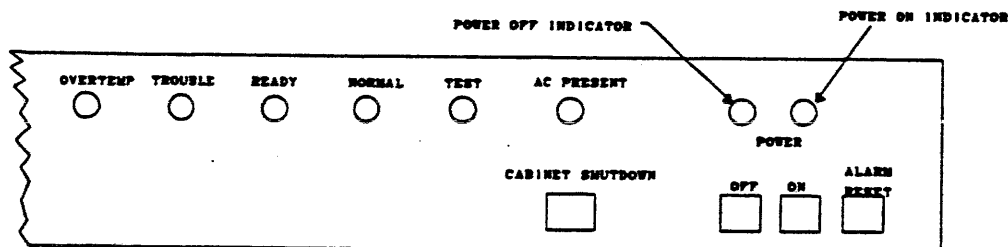

FIGURE 4-12. OPERATOR CONTROL PANEL (POWER OFF AND POWER ON INDICATORS)

- Verify that the Cabinet Cooling System is operating properly.

7. Verify that DC ON and DC CONF (confidence) indicators are illuminated. These indicators are located on the Power Control Module at VC1. See Figure 4-13.

8. Verify that the following LED alarm indicators, located on the Power Control Module at VC1 (Figure 4-13), are not illuminated.
 - COOLING ALARM
 - OVER TEMP SHUTDOWN
 - O.T. REG (over temperature regulator)

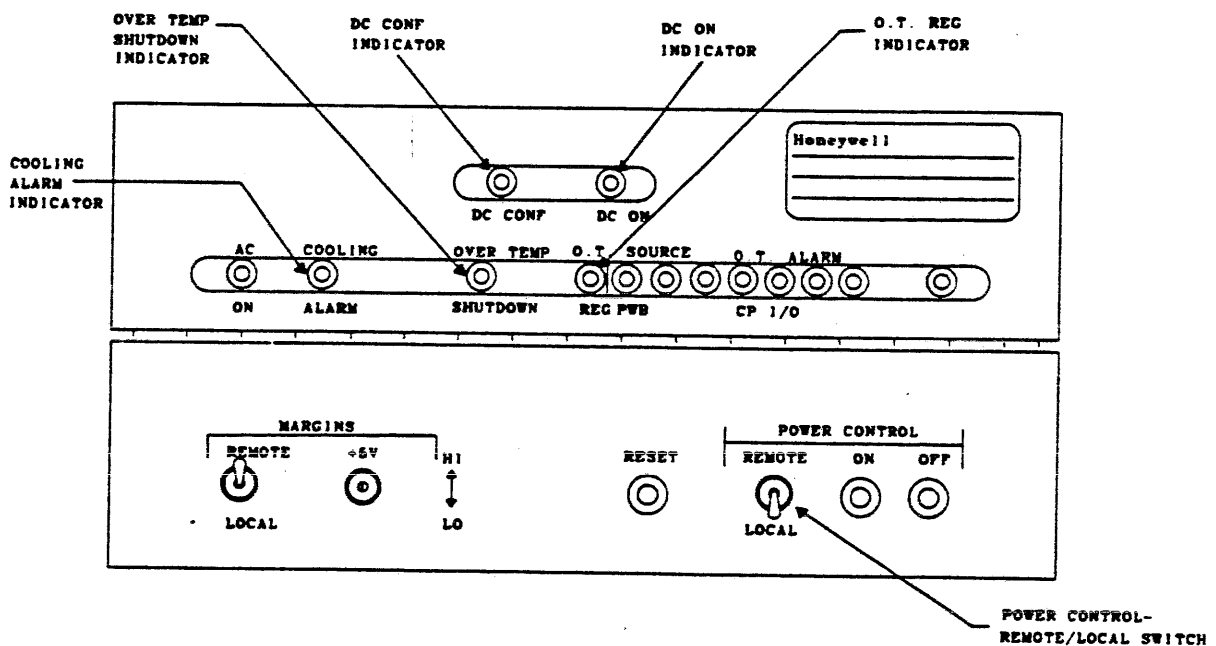

FIGURE 4-13. POWER CONTROL MODULE AT VC1
(DC CONF, DC ON AND TEMP INDICATORS)

9. Verify that the voltage and overcurrent adjustments on the regulators are as specified in the Power and Cooling Manual. (To Be Supplied).

4.4 POWER SHUTDOWN

4.4.1 NORMAL SHUTDOWN

NOTE

The POWER CONTROL-REMOTE/LOCAL switch located at VC1 (see Figure 4-12) must be in the REMOTE position when removing power via the Operator Control Panel.

1. Depress and release the POWER-OFF switch located on the Operator Control Panel. See Figure 4-14.

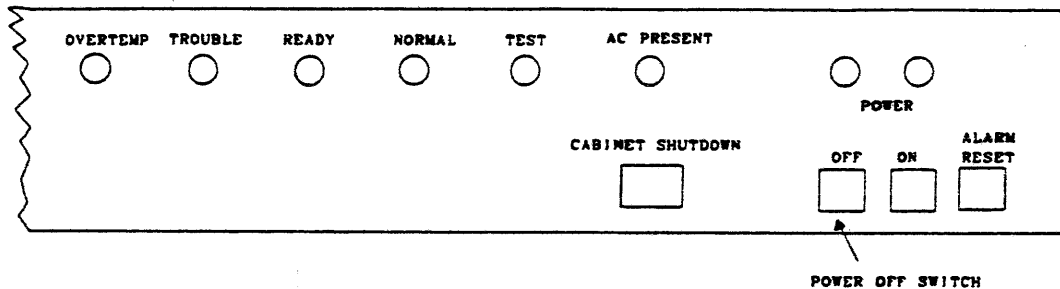

FIGURE 4-14. OPERATOR CONTROL PANEL (POWER OFF SWITCH)

2. Set the CPU PRIMARY POWER INPUT circuit breaker at S02 to OFF. See Figure 4-15.

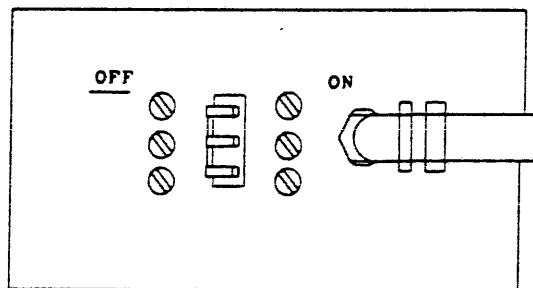

FIGURE 4-15. PRIMARY POWER INPUT CIRCUIT BREAKER AT S02 (OFF POSITION)

3. Set the equipment circuit breaker at the site main power distribution panel to the OFF position.

4.4.2 EMERGENCY SHUTDOWN

Should an emergency shutdown become necessary due to a hazardous condition, equipment malfunction, or otherwise, the following steps are to be followed:

1. Press the CABINET SHUTDOWN switch located on the Operator Control Panel. See Figure 4-16.

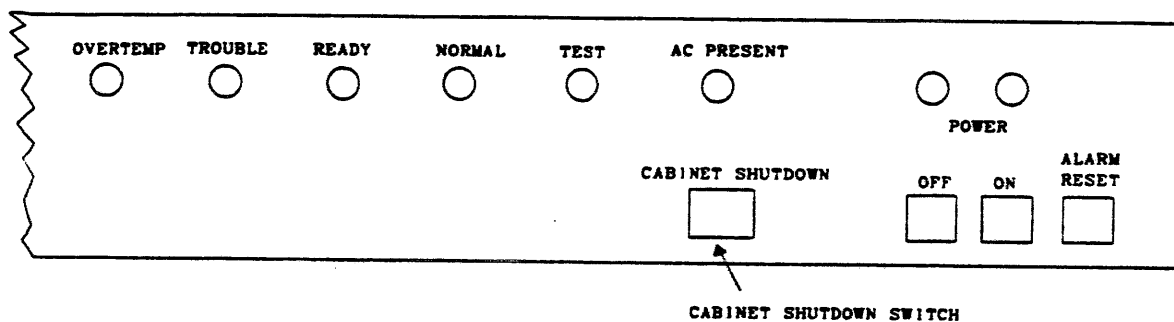

FIGURE 4-16. OPERATOR CONTROL PANEL
(CABINET SHUTDOWN SWITCH)

2. Set the equipment circuit breaker at the site main power distribution panel to the OFF position.

NOTE

Depressing the CABINET SHUTDOWN switch on the Operator Control Panel bypasses the Power Control Module and the Operator Control Panel POWER OFF switches. Before power can be applied the CABINET SHUTDOWN switch must be in the out position.

4.5 POWER SYSTEM CHECKOUT

The position of the POWER CONTROL-REMOTE/LOCAL switch on the Power Control Module (VC1) determines whether DC power will be controlled locally (i.e., at the Power Control Module) or remotely (i.e., at the Operator Control Panel). During the checkout procedure, it will be assumed that the POWER CONTROL-REMOTE/LOCAL switch is set to REMOTE. See Figure 4-18.

Depress the POWER ON switch located on the Operator Control Panel. See Figure 4-17. Verify that the following events occur:

- The POWER ON indicator is illuminated. This indicator is located on the Operator Control Panel. See Figure 4-17.
- The POWER OFF indicator is extinguished. This indicator is located on the Operator Control Panel. See Figure 4-17.

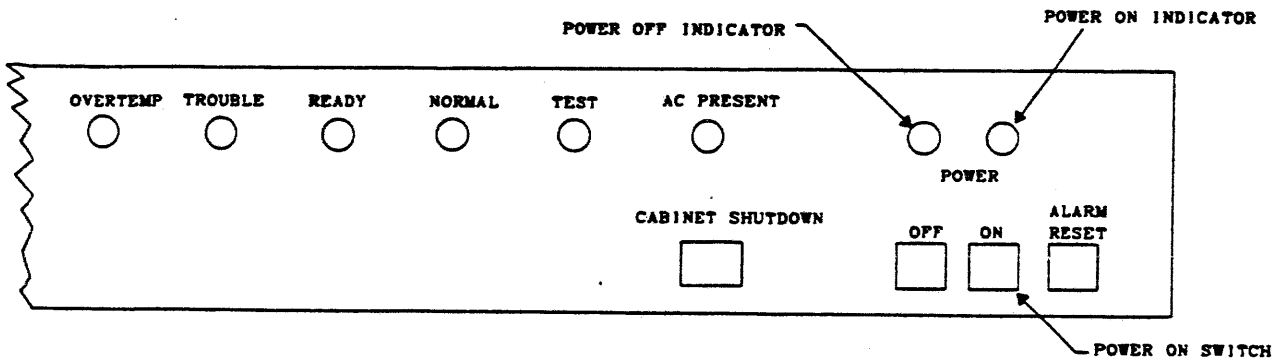

FIGURE 4-17. OPERATOR CONTROL PANEL (POWER OFF AND POWER ON INDICATORS)

- The DC ON and DC CONF indicators are illuminated. The indicators are located on the Power Control Module (VC1). (See Figure 4-18.)

Regulated DC power is now being applied to the logic circuits.

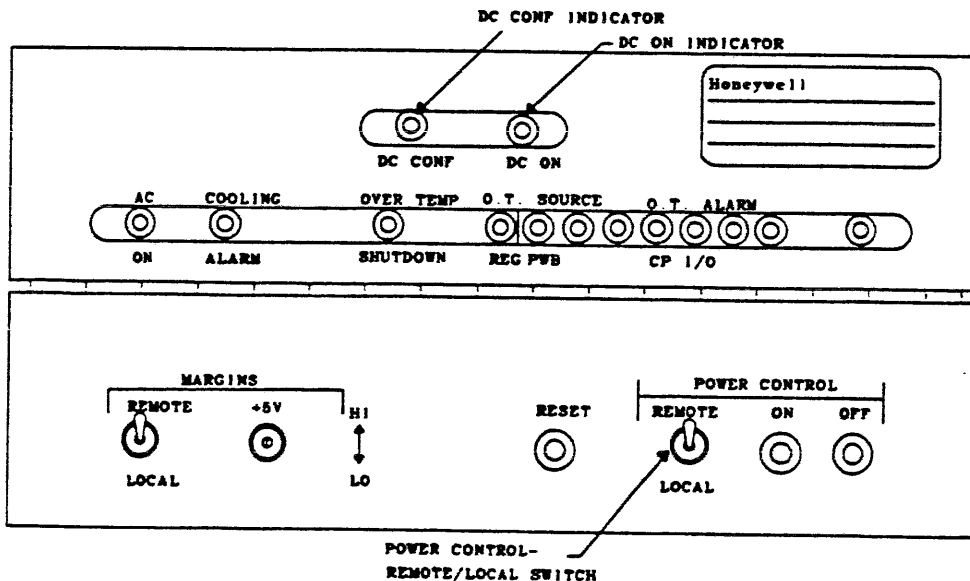

FIGURE 4-18. POWER CONTROL MODULE AT VC1 (DC INDICATORS AND SWITCHES)

Should the DC CONF indicator remain off and/or if a power regulator REG FAULT light is illuminated, resequence the power-up procedure (paragraph 4.3). Replace any power regulator/fuse whose REG FAULT indicator remains illuminated. The fuses (1A, 250V SLO BLO) labeled F1 and F2 located at S03 protect the voltage control circuit. A blown fuse will prevent power from being applied. See Figure 4-19.

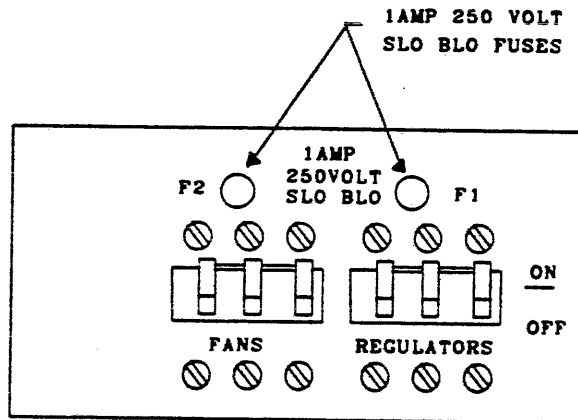

FIGURE 4-19. FANS AND DC REGULATORS CIRCUIT BREAKERS AT S03 (SLO BLO FUSES)

4.6 OFFLINE T&D'S

Run PAS (Processor And Store) test in Multics mode.

4.7 ONLINE T&D'S

Bring system up with Multics.

5.0 DEINSTALLATION

This section provides procedures for the physical removal of the CPU from the customer's operational site. Inspection, inventory, dis-assembly/handling, packing/crating and shipping procedures are also included in this section.

5.1 SITE INSPECTION

Deinstallation, preshipment and site readiness inspection reports shall be made according to the Field Engineering Procedures Manual. These procedures include:

1. Consulting with the customer before and after site inspection, to determine the customer's deinstallation requirements.
2. Obtaining required shipping documents such as the Bill of Lading and the Memorandum of Shipment.
3. Obtaining the unit's FCO (Field Change Order) log book and uninstalled FCO's.
4. Discuss with the customer suitable timing for removal of the equipment that will result in minimum impact on site operations.
5. Note any possible impediments which may hinder the safe removal of the equipment such as doorways, halls, steps/ramps, etc. Also report on packing, crating and loading facilities and if any special packing and handling will be required.

5.2 EQUIPMENT INVENTORY

Complete equipment inventory provides verification that the CPU and its associated logs, uninstalled FCO's and options are present before packing and packaging are initiated.

A careful physical inventory should be made by verifying that equipment serial numbers correspond to inventory serial numbers, where provided, and that any discrepancies are reported immediately to the District Office via the established channels.

5.3 DEINSTALLATION PROCEDURE

The following procedure is given as a guide to the Field Engineering Representative to deinstall the CPU.

WARNING

REMOVE ALL POWER TO THE EQUIPMENT PRIOR TO DEINSTALLATION. OBSERVE ALL WARNING AND CAUTION LABELS ON THE EQUIPMENT. DANGEROUS VOLTAGES MAY BE PRESENT IF THE CAPACITOR OPTION, WCAP68LA IS INSTALLED.

1. Perform a normal unit turn off procedure.
2. Turn off unit main power circuit breaker at S02.
3. Turn off site power to the unit and disconnect the power cable from site power.
4. The customer's electrician should remove the cover at S01 and disconnect the customer's power cable.
5. Remove, inventory and package the options.
6. Disconnect and secure the harnesses to the cabinet frame.
7. Disconnect, oil and tag cables.
8. Inventory the logic boards and ensure that they are properly connected to the backpanel connectors.
9. Remove the frame ground cables (see Figure 3-5).
10. Remove the lower front and rear trim strips.
11. Raise the four leveling pads on the cabinet so that the cabinet is supported on the casters (see Figure 3-1).
12. Carefully move the equipment to the customer's designated packing and shipping area.

5.4 HANDLING AND SHIPPING

During the handling and shipping procedure, perform a final inventory. Shipping documents should be prepared and transportation confirmed.

5.4.1 PACKING AND INVENTORY

Inspect and inventory the cabinet and contents. Ensure that the disconnected harnesses have been taped, tagged and secured to the frame.

Disconnected cables are to be packaged.

To ensure proper packing, refer to the shipping specification, 58067223 and/or contact the Honeywell Packaging Engineer at:

Honeywell Information Systems
P. O. Box 6000
Phoenix, Arizona 85005
Mail Station C38

5.4.2 CRATING AND SHIPPING

Inspect the packing before closing the cabinet doors.

To ensure proper crating, refer to the shipping specification, 58067223 and/or contact the Honeywell Packaging Engineer at:

Honeywell Information Systems
P. o. Box 6000
Phoenix, Arizona 85005
Mail Station C38

Return equipment to:

Honeywell Information Systems
LISD
4001 West Indian School Road
Phoenix, Arizona 85019
c/o Mgr. LISD Warehouse
Mail Station J2

5.4.3 SPECIAL INSTRUCTIONS

Inform the carrier of any special instructions. Obtain and retain the signed equipment receipt.