

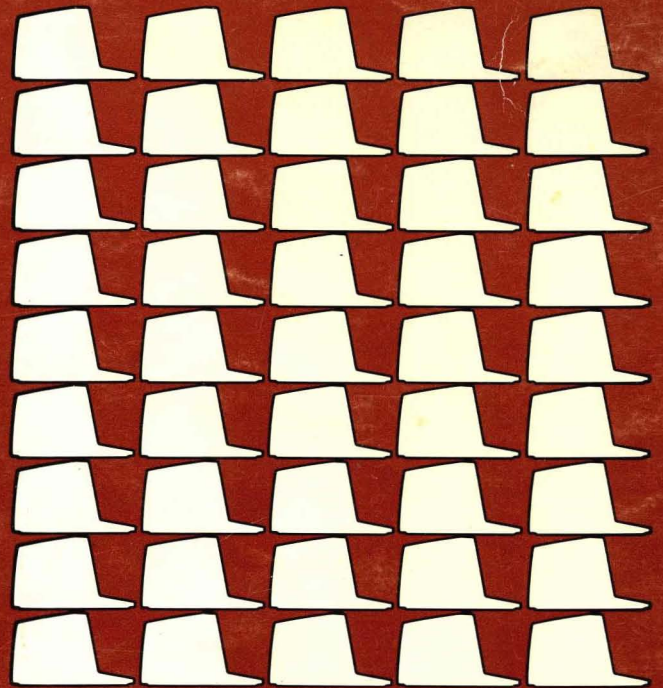

# ***GT-400 USERS MANUAL***

***General Terminal Corporation***



# GT-400

## *Users Manual*

The material in this manual is for informational purposes and is subject to change without notice. General Terminal Corporation assumes no responsibility for any errors which may appear in this manual.

Printed in U.S.A.  
Copyright 1980.  
General Terminal Corporation

This document was composed and set on an IMS 8000 System using a GT-101 Terminal.

Additional copies of this manual (05006-001, \$5.00) and the GT-400 Maintenance Manual (05007-001, \$35.00) may be ordered from GTC, ATT: Sales Administration. 14

TABLE OF CONTENTS

<u>Page</u>	<u>Section</u>	<u>Title</u>	<u>Page</u>	<u>Section</u>	<u>Title</u>
1-1	1.0	INTRODUCTION	5-8	5.5	LINE DRAWING OPTION
1-1	1.1	OPTIONS	5-8	5.6	OPTIONAL KEYBOARDS
1-1	1.2	SPECIFICATIONS	5-8	5.7	BURROUGHS TD/830 EMULATION
1-1	1.3	DEFINITIONS	5-8	5.8	HAZELTINE 2000 EMULATION OPTION
1-2	1.4	START-UP PROCEDURES	5-9	5.9	TIME-SHARING OPERATION OPTION
2-1	2.0	REAR PANEL CONFIGURATION			
3-1	3.0	KEYBOARD			
3-1	3.1	MAIN KEYBOARD			
3-3	3.2	NUMERIC KEYPAD			
3-3	3.3	EDITING KEYPAD			
3-4	3.4	FUNCTION AND SPECIAL KEYS			
3-6	3.5	DISPLAY FORMAT CONTROL			
3-6	3.6	CONTROL SEQUENCE FUNCTION FORMAT			
3-6	3.7	FIELD DESIGNATOR COMMANDS			
3-7	3.8	VIDEO DISPLAY COMMANDS			
3-7	3.9	FIELD DESIGNATOR AND DISPLAY COMMANDS			
3-7	3.10	CONTROL SEQUENCE EXAMPLES			
4-1	4.0	COMMUNICATIONS MODES			
4-1	4.1	COMMUNICATION MODES GENERAL FORMATS			
4-1	4.2	KEYBOARD ACTION MODE			
4-1	4.3	CONTROL REPRESENTATION MODE			
4-1	4.4	INSERT REPLACE MODE			
4-2	4.5	STATUS REPORTING MODE			
4-2	4.6	ERASURE MODE			
4-2	4.7	CHARACTER MODE			
4-2	4.8	MULTIPLE AREA TRANSMIT MODE			
4-2	4.9	TRANSMIT TERMINATION MODE			
4-2	4.10	SELECTED AREA TRANSMIT MODE			
4-2	4.11	NEW LINE MODE			
4-4	4.12	CARRIAGE RETURN NEW LINE MODE			
4-4	4.13	TRANSMIT REQUEST MODE			
4-4	4.14	PRINT COPY MODE			
4-4	4.15	TEXT EDIT MODE			
4-4	4.16	SELECT EDITING EXTENT MODE			
4-5	4.17	EDITING FUNCTIONS			
4-5	4.18	CURSOR CONTROL			
4-5	4.19	TAB CONTROL			
4-6	4.20	ERASE CONTROL			
4-7	4.21	INSERT/DELETE CONTROL			
5-1	5.0	STATUS REPORTING INQUIRY			
5-1	5.1	OPTIONS			
5-1	5.2	THREE-PAGE MEMORY OPTION			
5-2	5.3	BUFFERED PRINTER OPTION INTERFACE			
5-3	5.4	POLLING OPTION			
5-3		Address Definition			
5-8		Broadcast Poll			

LIST OF FIGURES

<u>Figure</u>	<u>Page</u>	<u>Title</u>
1-1	1-2	Controls
2-1	2-4	Rear Controls
2-2	2-4	Typical Serial Data Word
2-3	2-4	20/60 ma Current Loop
3-1	3-2	Standard GT-400 Keyboard
3-2	3-2	Optional Keyboard with extra Function Keys
5-1	5-5	Poll Sequence
5-2	5-6	Fast Select Sequence
5-3	5-7	Poll-Select Sequence
5-4	5-10	Optional AZERTY Main Keyboard
5-5	5-11	Optional QWERTZ Main Keyboard
5-6	5-11	Optional GERMAN Main Keyboard
5-7	5-11	Optional SWEDISH/FINNISH Main Keyboard
5-8	5-12	Optional NORWEGIAN/DANISH Main Keyboard
5-9	5-12	Optional Special SWEDISH/FINNISH
5-10	5-12	Optional Special NORWEGIAN/DANISH
A-1	A-1	ASCII CODE CHART
A-2	A-2	GT-400 CONTROL SET

LIST OF TABLES

<u>Page</u>	<u>Table</u>	<u>Description</u>
2-1	2-1	Rear Panel Switch Settings
2-3	2-2	RS-232C Connector Signal Table
2-4	2-3	Local Copy/RTS in Full/Half Duplex
3-1	3-1	Main Keyboard Control Keys
3-3	3-2	Cursor Control Keys
3-3	3-3	Insert/Delete Keys
3-4	3-4	Function Key Code Sequences
3-4	3-5	Special Keys Description
3-7	3-6	Summary of Field Designator Commands
3-7	3-7	Summary of Video Display Commands
4-3	4-1	Transmission Mode Conditioning of the Xmit Key
4-6	4-2	Incremental Cursor Positioning
4-6	4-3	Sample Cursor Positioning Commands
4-7	4-4	Erase Commands w/ Erasure Mode Reset
4-7	4-5	Erase Commands w/ Erasure Mode Set
4-7	4-6	Insert/Delete Commands
4-8	4-7	Insert Character Function
5-2	5-1	Keyboard Controlled Display Memory Commands in GT400 Multipage Units
5-2	5-2	Remote-Controlled Display Memory Commands in GT-400 Multipage Units
5-3	5-3	Absolute Cursor Positioning in GT-400 Multipage Units
5-4	5-4	Transmission Mode Conditioning of the Xmit Key
5-3	5-5	Data Routing in Polled Terminals with Buffered Printer Interface
5-8	5-6	GT-400 Line Drawing Graphics Set
5-9	5-7	Rear Panel Switch Function for Hazeltine 2000 Emulation Option
5-9	5-8	Modified Rear Panel Switch Functions GT-400 Time-Sharing Operation Option

## 1.0 INTRODUCTION

The General Terminal GT-400 is a general purpose, teletype compatible display terminal designed for highly flexible user interaction in data entry and retrieval systems. The standard GT-400 provides:

- a. 25 line by 80 character display
- b. Complete formatting, editing, and video highlighting capability
- c. Block and character mode transmission
- d. Standard RS-232C and 20/60 milliamperere current loop communications interface
- e. Full 128 ASCII character display set
- f. 50/60 Hz capability
- g. Function sequences are based on ANSI 3.64 and ECMA/TCI standards
- h. Modular design
- i. Single printed circuit board
- j. Solid state detached keyboard
- k. All metal case (EMI/RFI protection)
- l. Quiet, fanless convection cooling

## 1.1 OPTIONS

- a. Green P31 Phosphor Display
- b. Three-page display memory
- c. Fully buffered, separately addressable, serial or parallel printer interface
- d. Polling (General Terminal standard)
- e. Line Drawing with a 32 character set
- f. International version keyboards
- g. Burroughs TD/830 emulation
- h. Hazeltine 2000 emulation
- i. Time Sharing operation

The GT-400 uses a Z80 microprocessor to provide sophisticated data handling capabilities. Command controlled communication modes and video display functions allow optimal terminal control flexibility. The terminal combines high reliability with low cost maintenance and is UL approved.

## 1.2 SPECIFICATIONS

Screen size:	12" diagonal (30cm)
Screen Capacity:	25 lines by 80 columns
Line Spacing:	0.45" (11mm)
Character Format:	5x9 matrix on 7x10 field
Character Spacing:	0.4" (10 mm)
Character Size:	.08"x.19" nominal (2mmX5mm)
Character set:	128 character ASCII
Cursor:	Blinking underscore
Display Modes:	White char/black field Blackchar/white field Full/half intensity Underlined, Blinking, or Security (blank) characters
Display Tube:	P4 white phosphor standard P31 green phosphor opt.
Refresh Rate:	50 or 60 Hz
Data Rates:	50,75,110,134.5,150,200, 300,600,1200,1800,2400, 3600,4800,7200,9600, and 19200
Communication	EIA RS-232-C 20/60ma currentloop
Transmission Modes:	HDX/FDX/BLOCK/CHAR
Parity Selection:	Even, odd, mark or space
Temperature:	For operation: 5 C to 40 C For storage: -30 C to 70 C
Humidity:	5% to 85% non-condensing
Terminal Size:	13"H x 17"W x 16"D (33cmX43cmX41cm)
Keyboard Size:	3"Hx20"Wx8"D (7cmX51cmX20cm)
Terminal Weight:	35 lbs (15.8 Kg)
Keyboard Weight:	10 lbs (4.4 Kg)
Domestic Pwr:	120 watts, 105 to 130 volts, 60 Hz
Export Pwr:	120 watts, 105 to 130 or 210 to 260 volts, 50Hz

## 1.3 DEFINITIONS

The following terms are used extensively throughout this manual.

**SCREEN** Screen refers to the display screen, which is 25 lines by 80 columns.

**HOME** Home is the first position in the upper left corner of the screen, at coordinates 1,1.

**PROTECTED DATA** Protected Data is data on the screen which the user cannot alter from the keyboard. It is displayed at half intensity. The host computer can change protected data.

**UNPROTECTED DATA** Unprotected Data is displayed data which the user can alter from the keyboard. The host computer, of course, can change unprotected data.

**PAGE** Page refers to the entire display screen on the standard GT-400. The Paging Option provides the user with three separate screens of data.

**LINE** Line refers to one of the 25 horizontal lines on the screen which may contain up to 80 characters.

**FIELD** Field refers to a group of contiguous protected or unprotected data positions with identical attributes and a maximum length of one line. The last position in a line defines the end of a field.

**BLOCK** In BLOCK mode, characters entered on the keyboard are displayed on the screen and loaded into the screen buffer. The characters are only transmitted to the host computer when the user depresses the XMIT (transmit) key, or the host computer issues a transmit command.

**CHARACTER** In CHARACTER mode, characters are transmitted to the host computer when the user enters them on the keyboard. The characters may or may not be displayed on the screen.

**AUTOTAB** Autotab is the automatic movement of the cursor out of a protected field to the first unprotected position after the protected field. Autotab occurs when the user attempts to position the cursor in a protected field.

**TABSTOP** Tabstop is a screen position defined by the first position in an unprotected field or the beginning of a line (if that position is unprotected). TAB stops can also be set by using a command sequence.

**CONTROL SEQUENCE FUNCTION** A control sequence function is a sequence of control codes which defines certain characteristics or attributes for the displayed data fields.

**AREA ATTRIBUTE CODE** An area attribute code or ACC is generated by a control sequence function. Each AAC occupies one protected display position and designates the succeeding position as the start of the field it defines. An AAC is not a protected field.

#### 1.4 START-UP PROCEDURES

Follow these procedures to power up and configure the GT-400 before putting the terminal online to the host computer:

- Configure the rear panel switches and the BLOCK and CAPS ONLY keys for the desired mode of operation. Refer to section 2.0 for information on the rear panel switches and section 3.4 for BLOCK and CAPS ONLY keys.
- Turn the POWER switch ON. The terminal powers up in the LOCAL state. After the required 30 second warm up period, a blinking cursor appears on the screen.
- Adjust the brightness and contrast controls to desired levels. See Figure 1-1.
- Enter some data and depress various control keys, (i.e., RETURN LINE FEED, TAB, etc.) to confirm proper operation of the GT-400.

To put the GT-400 online, depress the LINE key on the keyboard. The LED on this key lights to indicate that the terminal is online.

Always take the GT-400 offline before changing any rear panel switches or other functional configuration controls. Then depress the LINE key several times to ensure machine recognition of the new configuration.

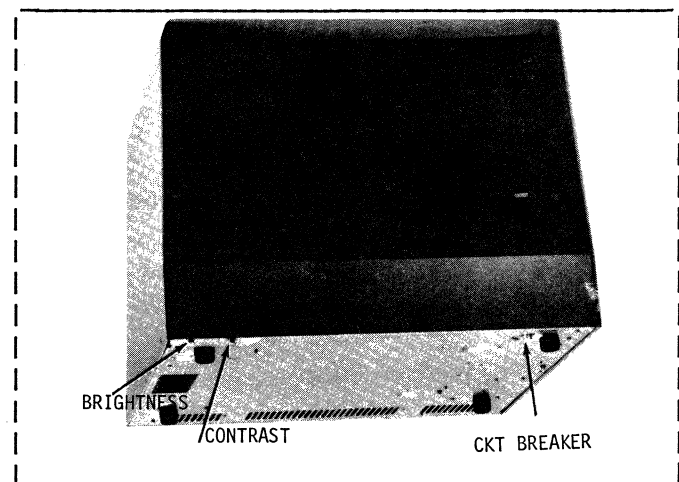

**Figure 1-1. Controls**

**2.0 REAR PANEL CONFIGURATION**

This section details the procedure for configuring the rear panel switches and interface connections on the GT-400.

The GT-400 rear panel is shown in Figure 2-1. The rear panel controls include two sets of switches to define the data communications and two terminal interface connectors. The settings for these switches are shown in Table 2-1.

Configuration of switches S1 and S2 define the data format, local copy status, data communication on the primary and/or secondary communication channels, and normal/reverse video selection.

The seven pin barrier strip provides direct connection capability with an external 20 or 60 milliampere current source. Figure 2-3 illustrates both full and half duplex usage on the rear panel switch configuration. Table 2-3 shows half and full duplex interaction.

TABLE 2-1 REAR PANEL SWITCH SETTINGS

**Switches 1-4. Data Rate Selection**

Set these switches to select one of the 16 available data rates, according to the following chart:

S1-1	S1-2	S1-3	S1-4	BAUD RATE
ON	ON	ON	ON	50
ON	ON	ON	OFF	75
ON	ON	OFF	ON	110
ON	ON	OFF	OFF	134.5
ON	OFF	ON	OFF	150
ON	OFF	ON	OFF	200
ON	OFF	OFF	ON	300
ON	OFF	OFF	OFF	600
OFF	ON	ON	ON	1200
OFF	ON	ON	OFF	1800
OFF	ON	OFF	ON	2400
OFF	ON	OFF	OFF	3600
OFF	OFF	ON	ON	4800
OFF	OFF	ON	OFF	7200
OFF	OFF	OFF	ON	9600
OFF	OFF	OFF	OFF	19200

The GT-400 has a 128 character internal receive buffer which will normally eliminate the need for pad characters. If problems are

encountered in a particular application, null characters may be inserted as padding anywhere in a 128 character stream since the average time for characters entering and leaving the buffer will be optimized by the padding. In most applications, no padding will be required at speeds of 9600 BAUD or less.

**Switches S1-5 and S1-6. Parity Selection**

These switches select the type of parity for both received and transmitted data.

S1-5	S1-6	Parity
OFF	OFF	MARK
OFF	ON	SPACE
ON	OFF	EVEN
ON	ON	ODD

MARK or SPACE parity is generated during transmit, but is not checked during receive.

**Switch S1-7. Stop Bit Selection**

Set this switch to specify the number of stop bits transmitted per character. If the required number of stop bits is unknown, select two stop bits (S1-7 OFF).

ON	1
OFF	2

**Switch S1-8. Local Copy Selection**

This switch is effective in CHARACTER mode only. Set this switch to determine whether data entered from the keyboard is automatically displayed on the screen.

ON Local Copy ON. The screen will display the data as it is entered from the keyboard. Select Local Copy ON only when the Host computer does not perform the desired echoing.

OFF Local Copy OFF. The screen displays data entered from the keyboard only if the Host computer echoes it back. Local Copy should be OFF when the GT-400 is operating in Block mode.

Refer to Table 2-3 for appropriate Local Copy settings in full and half duplex operation.



TABLE 2-1 Continued

**Switch S2-1. Secondary Channel Selection**

Set this switch to select the polarity of the BREAK signal when using the secondary channel. BREAK is on EIA pin 12 (Molex pin 6) of the interface connector on the rear panel.

ON BREAK has the same polarity as the EIA data signals.

OFF BREAK has the same polarity as the other EIA control signals.

**Switch S2-2. Normal/Reverse Video Selection**

Select normal or reverse display of data on the screen as follows:

ON Screen displays black characters on a white background.

OFF Screen displays white characters on a black background.

**Switch S2-3. Internal/External Clock**

Set this switch to select the source of the clock for the communications interface, as follows:

ON The external TTL clock determines the data rate for the communications interface. The external clock rate is 16 times desired bit rate. The maximum allowed clock rate is 16 x 19,200 bits per second (bps). The maximum data rate for the interface is 19,200 bps.

OFF The clock rate for the communications interface is determined by Switch Set 1, Switches 1 through 4.

**Switch S2-4. RTS Selection**

Set this switch to control the RTS (Request to Send) signal at the EIA interface, as follows:

ON RTS is permanently on. Select RTS ON for full-duplex operation.

OFF RTS cycles with the transmission of each character. RTS turns-off when the

terminal receives a line turn-around code, selected with switch S2-6. Select RTS NORM, for half-duplex operation. Refer to Table 2-3.

**Switch S2-5. Primary/Secondary Channel BREAK**

Set this switch to select whether the primary or secondary channel is to transmit the BREAK information.

ON Secondary channel communicates BREAK information and is monitored for a receive BREAK.

OFF Primary channel carries BREAK information and is monitored for a received BREAK.

**Switch S2-6. RTS Reset Selection**

This switch is effective only in Character mode and is typically used only in half-duplex operation. Set this switch to determine when RTS is reset.

ON Transmission of either the Carriage Return (CR) or End of Transmission (EOT) code resets RTS.

OFF Transmission of the EOT code resets RTS.

**Switch S2-7. Field EOT/ETX Selection**

This switch is effective in Block mode only. Set the switch to select transmission to the host of either the EOT (End of Transmission) or ETX (End of Text) character at the end of field transmission. If the end of field and page coincide, one character determined by S2-8 is transmitted.

ON ETX character transmitted.

OFF EOT character transmitted.

**Switch S2-8. Page EOT/ETX Selection**

This switch is effective in Block mode only. Set the switch to select transmission to the host of either the EOT or ETX character at the end of page transmission. If field and page ending coincide, S2-8 overrides S2-7.

ON ETX character transmitted.

OFF EOT character transmitted.

Table 2-2 RS-232C Connector Signal Table

...EIA RS-232-C Name			...Printer EIA Pin No.			...Modem EIA Pin No.		
:	CCITT V-24 Name	:	:	:	...	MOLEX EIA Pin No.	:	:
:	:	Description	:	:	:	:	:	Comments
BA	103	Data transmitted from terminal	-	2	1			Logical "1"=OFF=-12V Logical "0"=ON=+12V 300-ohm source impedance.
CA	105	Request to send signal from terminal	-	4	2			Must be HIGH (+12V) to allow the terminal to transmit.
CB	106	Clear to send signal to terminal	-	5	3			Must be HIGH to allow terminal to send; is supplied by a modem.
BB	104	Data transmitted to terminal	-	3	4			Logical "1"=OFF= -5V to -25V Logical "0"=ON= +5V to +25V 6.8ohm impedance.
CF	109	Carrier present signal to Terminal	-	8	5			Must be HIGH to allow terminal to receive; is supplied by a modem
CD	108.2	Data terminal ready signal terminal	-	20	8			Goes HIGH (+12V) when terminal is on LINE is LOW when terminal is in LOCAL mode.
		External clock input at TTL logic level	-	-	10			For use with RECIEVE RATE selector switch in EXT position.
AB	102	Signal ground	7	7	12			
CC	107	Data set ready	-	6	7			Must be HIGH to allow terminal to operate; is supplied by a modem
SCF	122	Secondary channel Carrier present		12	7			Received Break when Secondary Channel is enabled.
SCA	120	Secondary channel Request to send		19	9			Transmitted Break when Secondary Channel is enabled.
BB*	104	Data to printer	3	-	11			Optional print data.
CB*	106	Clear to send	5	-	-			These signals are connected to the printer's data terminal ready signal
CC*	107	Data set ready	6	-	-			
CF*	109	Carrier present	8	-	-			
CD*	108.2	Data terminal ready	20	-	-			

\* Indicates Printer Port



### 3.0 KEYBOARD

The GT-400 has a solid state, capacitive scan encoded keyboard. The keyboard module is separate from the display screen for ease of operation and improved space utilization. The standard GT-400 keyboard shown in Figure 3-1 includes eight special keys providing eight functions. The optional keyboard configuration, shown in Figure 3-2, offers 24 functions on 16 special keys.

The GT-400 keyboard consists of four sections of keys:

- o The main keyboard
- o The numeric keypad
- o The editing keypad
- o The function and special keys

Each keyboard section and the function of each key is described in detail below:

#### 3.1 MAIN KEYBOARD

The main keyboard of the GT-400 has a standard teletype keyboard layout. It consists of 59 keys, including:

- o Alphabetic keys
- o Numeric keys and special symbols
- o Control keys

The alphabetic keys on the main keyboard include all standard alphabetic characters. When CAPS ONLY mode is disabled and the GT-400 is operating in Block mode, depressing any alphabetic key prints that character, in lower case, on the display screen at the cursor position. In Character mode, depressing any alphabetic key transmits the lower case code for that character. The character is printed on the screen only if the host or modem is echoing transmitted data, or if the GT-400 is in Local Copy mode.

To generate upper case characters in either Block or Character mode, either use the SHIFT key or select CAPS ONLY mode.

The numeric keys and special symbols include all the number keys and arithmetic and text symbol keys on the main keyboard. In Block mode, depressing any of the numeric keys prints that character on the screen at the cursor

position. In Character mode, depressing any of the numeric keys transmits the code for the character. The character is printed on the screen only if the host or modem echoes the transmitted character or if the GT-400 is in Local Copy mode.

The special symbols shown on the lower half of numeric and special symbol keys are displayed and/or transmitted similarly. To display or transmit the special symbols shown on the upper half of the numeric and special symbol keys, depress the SHIFT key together with the desired symbol key.

The control keys on the main keyboard are ESC, CTRL, SHIFT, TAB, BACK SPACE, LINE FEED, RETURN, REPEAT, and BREAK. The function of each key is described in Table 3-1.

<u>TABLE 3-1 MAIN KEYBOARD CONTROL KEYS</u>	
<u>KEY</u>	<u>FUNCTION WHEN PRESSED</u>
ESC	Generates the ASCII ESC control code. This code usually introduces a control sequence function.
CTRL	When depressed in conjunction with other keys on the keyboard, generates the associated control codes shown in columns one and two of the ASCII Code Chart. Does not generate a code when depressed alone.
SHIFT	When depressed together with other keys on the keyboard, generates upper-case characters (With the alphabetic keys) or the upper symbols shown on all the numeric and special symbol keys. Does not generate a code when depressed alone.
TAB	In Block mode, advances the cursor to the beginning of the next unprotected field, which may be on the same or a succeeding line. If the rest of the page is protected, the cursor wraps around to the first unprotected position on the page.  In Character mode, transmits the ASCII HT (Control I) code. If columnar tabs have been set, the TAB function is modified.
BACK SPACE	In Block mode, moves the cursor one screen position to the left, unless that action would move the cursor into a

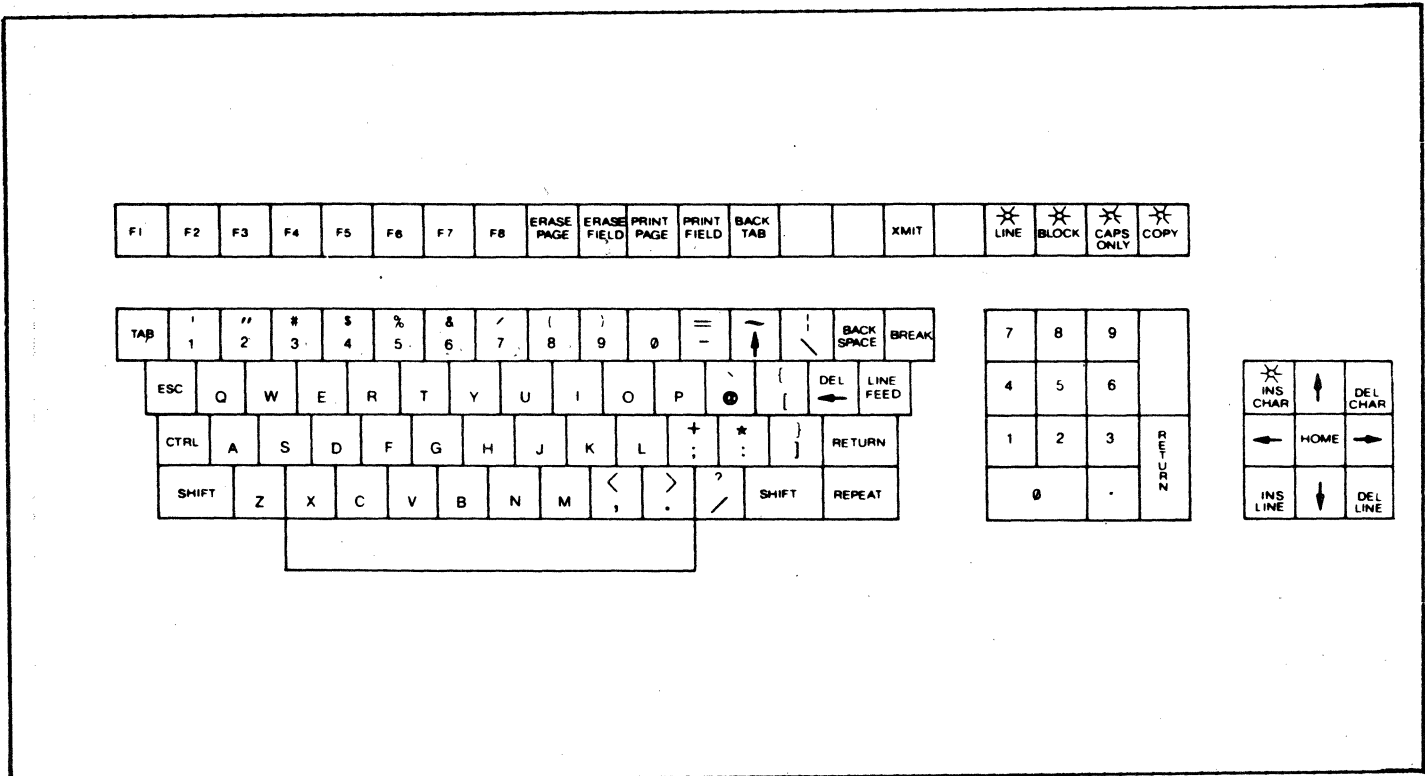

Figure 3-1. Standard GT-400 Keyboard

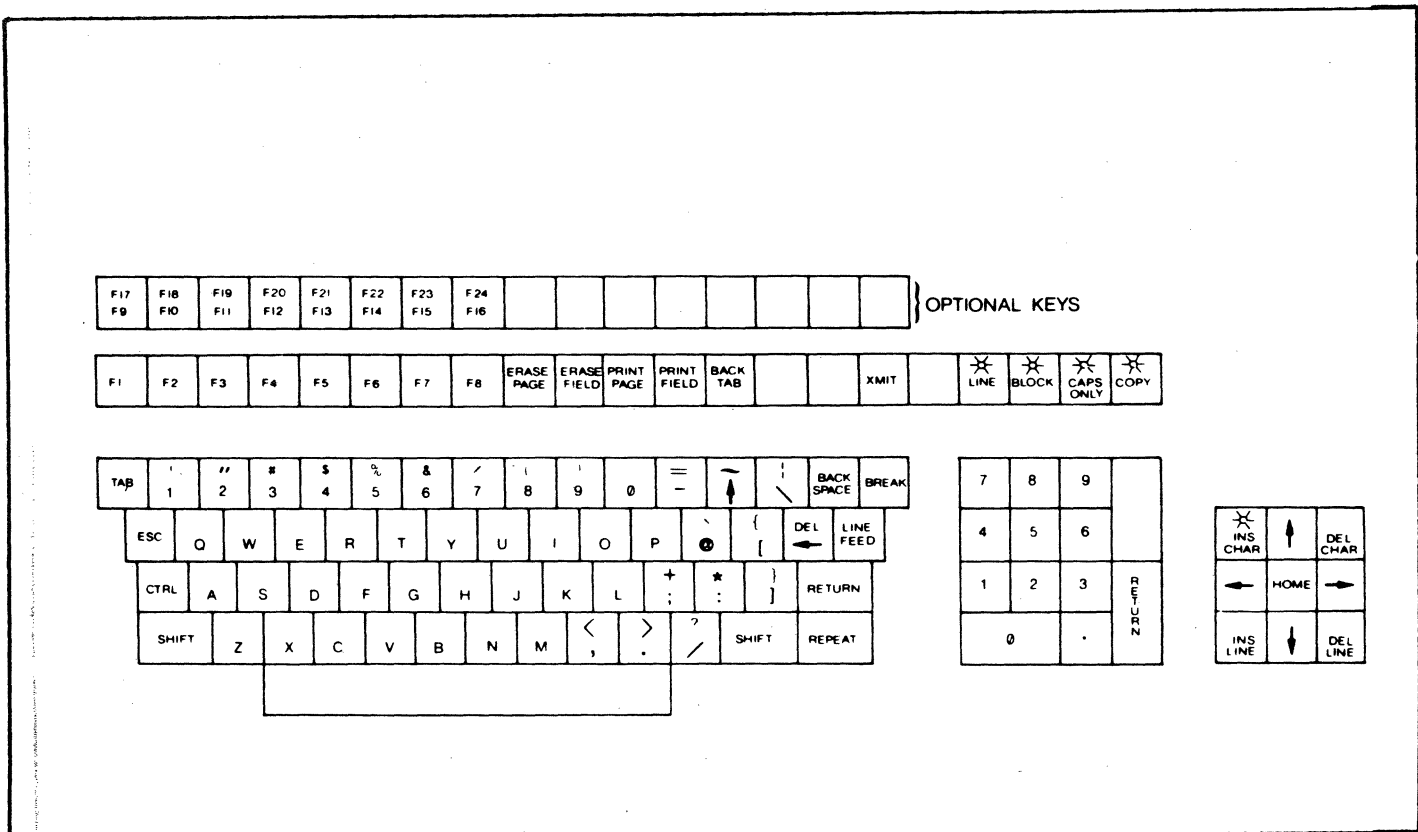

Figure 3-2. Optional Keyboard with Extra Function Keys

TABLE 3-1 Continued

	protected field. In that case, the cursor does not move.
	In Character mode, transmits the ASCII BS code (Control H).
LINE FEED	In Block mode, moves the cursor down one line on the screen unless the cursor already resided in the bottom line of the screen. In that case, the cursor wraps back around to the top line on the screen.
	In Character mode, transmits the ASCII LF (Control J) code. If the LF code is echoed back to the terminal, the cursor moves down one line. If the cursor was at the bottom of the line of the screen, the display scrolls up one line, leaving the cursor on a blank line.
	The LINE FEED key and LF code can be conditioned by command-controlled modes to perform the Carriage Return/Line Feed (CRLF) function.

### 3.2 NUMERIC KEYPAD

The 13 key numeric keypad has the standard adding machine format. This keypad is particularly useful for entry of large amounts of numeric data. The keys are functionally equivalent to their counterparts in the main keyboard section.

### 3.3 EDITING KEYPAD

The editing keypad consists of cursor control and insert/delete keys. The cursor control keys position the cursor. Note that if any cursor movement attempts to place the cursor in a protected position, the cursor automatically tabs (autotabs) to the first succeeding unprotected position on the page. The insert/delete keys insert or delete either characters or lines. The cursor control key functions are described in Table 3-2. The insert/delete key functions are Table 3-3.

TABLE 3-2 CURSOR CONTROL KEYS

KEY	FUNCTION WHEN PRESSED
HOME	In Block mode, moves cursor to the first position on the first line of the page. If that position is protected, the cursor autotabs to the first unprotected position on the page. In Character mode, transmits an ESC[H.
↑	In Block mode, moves cursor up one line. Will wrap from line 1 to bottom line. In Character mode, transmits an ESC[A.
↓	In Block mode, moves the cursor down one line. Will wrap from bottom line to top line. In Character mode, transmits ESC[B.
→	In Block mode, moves cursor right one position. In Character mode, transmits ESC[C.
←	In Block mode, moves the cursor left one position. In Character mode, transmits CTRL H, the ASCII BACKSPACE.

NOTE: The cursor movement is affected by the protected/non-protected status of the position into which the cursor moves. If the specified movement attempts to place the cursor in a protected position, the cursor autotabs to the first succeeding unprotected position.

TABLE 3-3 INSERT/DELETE KEYS

KEY	FUNCTION WHEN DEPRESSED
INSERT CHARACTER (IC)	In Block mode, enables the Insert Replace mode and lights the LED on the key.  In Character mode, transmits ESC[4h to set or ESC[4l to reset Insert Replace mode.
DELETE CHARACTER (DC)	In BLOCK mode, deletes the character at the cursor location and shifts the succeeding characters in either the field or page one position to the left. Whether DC affects only the

TABLE 3-3 Continued

current field or the entire page is a function of the Select Editing Extent mode.

In Character mode, transmits ESC[P.

**INSERT LINE (IL)** In Block mode, moves current lines and all succeeding lines down one position, leaving the cursor on a blank line in the original column position. Any characters that were on the bottom line of the screen are lost.

In Character mode, transmits ESC[L.

**NOTE:** The Select Editing Extend mode must be in the Edit in Page (initial) state to use the Insert Line capability.

**DELETE LINE (DL)** In Block mode, deletes the current line from the display and moves all successive lines up one position.

In Character mode, transmits ESC[M.

**NOTE:** The Select Editing Extent mode must be in the Edit in Page (initial) state to use the Delete Line capability.

### 3.4 FUNCTION AND SPECIAL KEYS

The function keys, F1 through F8 in the standard GT-400 configuration, transmit predefined code sequences when depressed. These code sequences do not affect the terminal. Rather, they are interpreted by the system software, according to the particular application, to signify some more complex function. For example, the code sequence transmitted by depressing F1 might tell the host to "sell one seat", or the F3 code sequence might signify "reserve one double room". These function keys are a form of shorthand, to request a particular complex task with the stroke of a single key.

The standard keyboard provides eight special single-function keys. The optional keyboard provides up to 24 special functions, using the eight single-function keys and eight additional dual-function keys. Each dual-function key

transmits one of two code sequences, depending on whether or not the SHIFT key is depressed concurrently. Table 3-4 lists all 24 function key code sequences.

The functions of the special keys are described in Table 3-5.

TABLE 3-4 FUNCTION KEY CODE SEQUENCES

Key	Code Sequence Transmitted
F1	ESC _ A ESC \ EOT
F2	ESC _ B ESC \ EOT
F3	ESC _ C ESC \ EOT
F4	ESC _ D ESC \ EOT
F5	ESC _ E ESC \ EOT
F6	ESC _ F ESC \ EOT
F7	ESC _ G ESC \ EOT
F8	ESC _ H ESC \ EOT
F9	ESC _ I ESC \ EOT
F10	ESC _ J ESC \ EOT
F11	ESC _ K ESC \ EOT
F12	ESC _ L ESC \ EOT
F13	ESC _ M ESC \ EOT
F14	ESC _ N ESC \ EOT
F15	ESC _ O ESC \ EOT
F16	ESC _ P ESC \ EOT
F17 (F9 & SHIFT)	ESC _ Q ESC \ EOT
F18 (F10 & SHIFT)	ESC _ R ESC \ EOT
F19 (F11 & SHIFT)	ESC _ S ESC \ EOT
F20 (F12 & SHIFT)	ESC _ T ESC \ EOT
F21 (F13 & SHIFT)	ESC _ U ESC \ EOT
F22 (F14 & SHIFT)	ESC _ V ESC \ EOT
F23 (F15 & SHIFT)	ESC _ W ESC \ EOT
F24 (F16 & SHIFT)	ESC _ X ESC \ EOT

TABLE 3-5 SPECIAL KEYS DESCRIPTION

KEY	FUNCTION WHEN PRESSED
BLOCK	Use this key to select either Block or Character mode transmission. The LED (Light Emitting Diode) on the key lights to indicate Block mode. The GT-400 powers-up in Block mode. Depressing this key disables and enables Block mode. <b>NOTE:</b> If the user selects Block or Character mode and the terminal is on-line, the only way to change modes is to go off-line first. The host, however, can change transmission modes while the GT-400 is on-line.

TABLE 3-5 Continued

**CAPS ONLY** Use this key to select generation of either lower or upper case alphabetic characters. The GT-400 powers-up in CAPS ONLY mode, indicated by the lighted LED on the key. Subsequent depression of the key disables or enables CAPS ONLY mode. CAPS ONLY mode does not affect the function of any non-alphabetic keys on the keyboard including the SHIFT key.

**LINE** Use this key to choose either on-line or local mode of operation. The GT-400 powers-up in local mode, so the LED on the key is not lighted. Depressing the key alternately enables and disables on-line operation. Characters entered in local mode are echoed back to the screen and not transmitted to the host. When on-line, the GT-400 asserts the Data Terminal Ready lead at the EIA interface and can transfer data to and receive data from the host.

In Block mode, data entered on the keyboard is displayed directly on the screen. In Character Mode, data entered on the keyboard is transmitted to the host. The data is displayed on the screen only if either the host or modem is echoing transmitted data, or if the user enables Local Copy on the GT-400.

**COPY** Use this key to route received data either to the GT-400 display screen, or to both the screen and an attached hard copy unit (printer). The GT-400 powers-up with the data routed only to the screen. The LED lights to indicate that the data is also enabled to the printer.

The host can enable and disable Copy mode. However, if the user has enabled copy mode, only the user can disable it. Similarly, if the host has enabled Copy mode, only the host can disable it.

**XMIT (TRANSMIT)** With the GT-400 in Block Mode, depress this key to transmit part or all of the data on the screen. The status of the transmission modes define or condition the field of action of the XMIT key. Examples illustrating these transmission modes are: limiting the

effect of the XMIT key to all unprotected fields on the screen, or to only the unprotected fields from the first character position on the screen to the cursor position.

In Character mode operation depressing this key transmits data on the screen as described in the Block mode section above. Since data entered in character mode is automatically transmitted to the host when entered this action is redundant. Therefore, depressing this key in character mode transmits data which has already been transmitted.

**BACK TAB** In Block mode, depress this key to return the cursor to the previous stop, unless the cursor is already residing in the first unprotected position on the page. In that case, the cursor does not move.

In Character mode, depress this key to transmit ESC[Z.

**PRINT FIELD** In Block mode, depress this key to transmit all the data in the field up to the cursor position to the system hard copy device (printer). This transfer occurs at the current GT-400 data rate, so be sure to match the data rates of the GT-400 and the printer. Note that the keyboard is locked during printing. Also, trailing spaces on any lines are not printed.

In Character mode, depress this key to transmit ESC[q.

The GT-400 has an optional buffered printer interface. This interface allows asynchronous operation of GT-400 and the printer, improving speed and efficiency of hard copy production.

**PRINT PAGE** In Block mode, depress this key to print the entire page, regardless of cursor location, as described above under PRINT FIELD. While a page is being printed, the keyboard is locked. Trailing spaces on all lines are compressed; when all characters on a line have been printed, the GT-400 generates a carriage return line feed



TABLE 3-5 Continued

code and goes on to the next line.

In Character mode, depress this key to transmit ESC[r.

**ERASE FIELD** In Block mode, depress this key to erase all unprotected data from the cursor location to the end of the page. To erase all unprotected data on the screen, therefore, position the cursor at the first position on the screen.

The ERASE PAGE key can erase all data, protected and unprotected, when conditioned by the Erasure mode. Typically, the host controls Erasure mode status.

In Character mode, depress this key to transmit ESC[J.

**PAGE** This key operates only in GT-400 units with the Paging option. Press this key to move the display on the screen down to the previous page. Depress PAGE and SHIFT to move the display on the screen up to the next page.

**SCROLL** This key operates only in GT-400 units with the Paging option. Press this key to move the contents of displayed memory down one line. Depress SCROLL and SHIFT to move the contents of displayed memory up one line.

### 3.5 GT-400 DISPLAY FORMAT CONTROL

Commands called control sequence functions define certain characteristics or attributes for the data fields of the display screen. For example, a control sequence function may define a field as protected, blinking, or numeric-only.

These controls sequence functions generate Area Attribute Codes or AACs. Each AAC occupies one protected position on the display screen and designates the next position as the start of the field it defines.

One AAC can combine up to six control sequence

functions. Therefore, a single AAC may define a field, for example, as underlined, blinking, reverse video, and numeric-only.

The two classes of control sequence functions are Field Designator commands and Video Display commands. Both have the same format, described in section 3.6 below. Sections 3.7, 3.8, and 3.9 describe the specific Field Designator and Video Display commands and combination of the commands. Section 3.10 has examples showing how to use control sequence functions.

### 3.6 CONTROL SEQUENCE FUNCTION FORMAT

The control sequence function general format which defines an ACC is:

ESC [ PS f

**ESC** Introduces the control sequence  
**[** is, in most cases, the optional second character in the command sequence. You must use the [ with the Forward Tab and Read Cursor Address control sequence functions.  
**PS** Is a variable selective parameter whose value defines the attribute(s) for the ACC. A control sequence can specify from zero to six selective parameters, separated by semicolons.  
**f** Specifies the class of the control sequence function: either a Field Designator or Video Display command.

### 3.7 FIELD DESIGNATOR COMMANDS

The four Field Designator Commands are summarized in Table 3-6 and explained below. These commands define the accessibility of the fields on the screen. Fields are either unprotected or protected. All unprotected fields are transmittable, but Field Designator commands may also define protected fields as transmittable. They may also define fields to accept only numeric data as valid inputs.

The four Field Designator commands differ only in the selective parameter (PS) value used. The function or f value specified for the Field Designator command is an o.

TABLE 3-6 SUMMARY OF FIELD DESIGNATOR COMMANDS

PS Value	Control Seq	Field Characteristic
Q/Blank	ESC 0 o	Accept all inputs.
1	ESC 1 o	Protected and non-transmittable.
3	ESC 3 o	Accepts numeric inputs only.
8	ESC 8 o	Protected and transmittable.

---

A Field Designator command may specify a protected field as transmittable or non-transmittable. However, only if the Selected Area Transmit mode is set will transmission of the contents of a protected field occur. If the Selected Area Transmit mode is reset, transmission of protected data cannot occur. The command ESC p redefines all unprotected fields and protected, transmittable fields which are unchanged since the previous transmission as non-transmittable.

A numeric-only field accepts only numeric input data, i.e., (0-9, (+), (-), (,), and (.). A beep sounds when a user tries to enter an alphabetic character into a numeric-only field. The field does not accept the character. Note that a numeric-only field accepts the "-" (minus) key from the numeric keypad but not the "-" (hyphen) key from the main keyboard.

### 3.8 VIDEO DISPLAY COMMANDS

The five Video Display Commands are summarized in Table 3-7 and explained below. The commands visually highlight the data fields on the screen.

The format for all the Video Display commands differs only in the selected parameter (PS) value specified. The function or f value for Video Display commands is an m.

The user may combine the field characteristics described in Table 3-6 by using the appropriate PS values separated by semicolons. For example, ESC 4;5 m defines an underlined, blinking field. Recall that the AAC generated for this field occupies a single protected

position on the screen.

TABLE 3-7 SUMMARY OF VIDEO DISPLAY COMMANDS

PS Value	Control Seq	Field Characteristic
Q/Blank	ESC 0 m	Normal video field (as defined by the rear panel switch)
4	ESC 4 m	Underlined field
5	ESC 5 m	Blinking field
7	ESC 7 m	Reverse video field (reverse of field defined by the rear panel switch)
8	Esc 8 m	Security field. Contents of the field are stored in memory but not displayed

---

### 3.9 FIELD DESIGNATOR AND DISPLAY COMMANDS

The host can define fields by stacking or using combinations of up to six Field Designator and Video Display commands: for example, a protected, blinking field. The host must issue the Field Designator commands first, then the Video Display commands. Use a semicolon to separate all selective parameters in a command. A stack or combination of commands still generates a single AAC.

Only the host can stack commands because the keyboard must be locked and autotab disabled to prohibit cursor movement during stacking. The order of commands is important because a Field Designator command overrides any previously set Video Display command at the cursor location, while the reverse is not true.

### 3.10 CONTROL SEQUENCE EXAMPLES

The following examples demonstrate data field specification using AAC's from both Field Designator and Video Display commands.

Note that entering AACs via the data line differs from entering them via the keyboard. Each time the user enters a Field Designator or Video Display command, the cursor moves. The cursor must move because either command creates an AAC which, by definition, occupies a protected position. The AAC, therefore, forces the cursor to autotab out to the next unprotected position.

However, to enter a Field Designator or Video Display command from the data line, the host first locks the keyboard, disabling the autotab. The cursor cannot autotab. The cursor also cannot move unless the host issues a cursor movement command. Once the host generates the AAC, the cursor is locked at the AAC location, which is a protected position. The host must then move the cursor with a Cursor Right command (ESC C) before entering any data into the field. Otherwise, the first character entered writes over the AAC.

**EXAMPLE 1:** Create a protected, non-transmittable field from the data line.

1. Lock the keyboard and disable the autotab by setting the keyboard Action mode using ESC 2 h.
2. Issue the Field Designator command ESC 1 o, creating the AAC which specifies a protected, non-transmittable field.
3. Issue the Cursor Right command, ESC C, to prevent the first data entered from writing over the AAC.
4. Input the data to be protected. If the protected field ends before the end of the line, issue an ESC 0 o to end the protected field. If the protected field extends to the end of the line, no end of field character is required. If the field extends over to the next line, reissue the AAC in the first position of the new line.
5. Unlock the keyboard and enable the autotab by resetting the Keyboard action mode using ESC 2 l.

Result: The data between the ESC 1 o and the ESC 0 o (or the end of the line) is protected and non transmittable.

**EXAMPLE 2:** Create a protected, non-transmittable field from the keyboard

1. Input the data on the desired line(s), leaving the first space in the data field blank. The AAC will occupy this space.
2. Issue an ESC 0 o at the end of the data to terminate the field, unless it fills the entire line. In that case, no termination character is needed.
3. Return the cursor to the blank position preceding the entered data.
4. Issue the Field Designator commands ESC 1 o

to generate the AAC in this position.

Result: The data between the ESC 1 o and the ESC 0 o (or the end of the line) is protected and non-transmittable.

**EXAMPLE 3:** Create a security field from either the data line or the keyboard.

1. Move the cursor to the position preceding the desired start of the security field.
2. Issue the Video Display Command ESC 8 m to create a security field from the position following the AAC to the end of the line.
3. Input the data. The data is stored in memory but not displayed.
4. To terminate the security field before the end of the line, issue ESC 0 o at the point of termination. If the field extends to the end of the line, no field termination character is required.

**EXAMPLE 4:** Create a numeric-only, reverse video field.

NOTE: This is stacking commands and can only be done from the data line. Also, the Field Designator command must precede the Video Display command.

1. Lock the keyboard and disable the autotab using ESC 2h, which sets the Keyboard Action mode.
2. Move the cursor to the position preceding the first position in the desired field.
3. Issue the numeric-only Field Designator command, ESC 3 o.
4. Issue the reverse video Video Display command, ESC 7 m.
5. Move the cursor one position to the right with and ESC C. Do not use the Space character to move the cursor, because it will erase the AAC just generated.
6. Input the data.
7. If the field is to end before the end of the line, terminate it with ESC 0 o, the Field Termination Command. If the field extends to the end of the line, no end of field character is required.
8. Unlock the keyboard and enable the autotab via ESC 2 which resets the Keyboard Action mode.

Use this sequence to stack Field Designator and Video Display commands.

**4.0 COMMUNICATION MODES**

The GT-400 provides fifteen command-controlled modes which condition:

- o Data transmission and data access
- o Data and program editing capabilities
- o Control code interpretation
- o Interaction between the GT-400 and host.

Each mode has two states. Fourteen of the modes are in either a set or reset state. The fifteenth mode, Select Editing Extend mode, is either in a Field/Line or Page state. The GT-400 powers-up with the 14 set/reset modes all in the reset state and Select Editing Extend mode in the Page state. All fifteen of the modes are described below. Note that these modes are also keyboard controllable.

**4.1 COMMUNICATION MODES GENERAL FORMAT**

All of the set/reset modes use the following format to set the mode:

ESC PS h

- ESC Introduces the code sequence  
 PS Is the selective parameter whose value denotes the mode being set. To set more than one mode in a single code sequence, list the desired PS values (up to six), separated by semicolons.
- h Specifies the mode set function and terminates the sequence.

To reset any of the set/reset modes, use the following format:

ESC PS L

- ESC Introduces the code sequence  
 PS Denotes which mode is being reset. To reset more than one mode in a single code sequence, separate the desired PS values (up to six) by semicolons.  
 L Specifies the mode has the following format:

Select Editing Extend has the following format:

ESC PS Q

Where ESC introduces and Q terminates the code sequence and the PS value specifies either Page

or Field/Line mode. (See Section 4.16).

**4.2 KEYBOARD ACTION MODE PS= 2**

ESC 2 h sets Keyboard Action mode to lock the keyboard and disable the autotab. When set, this mode allows the host computer access to every location, protected or unprotected, on the screen. Refer back to Examples 1 and 4 in Section 3.10.

ESC 2 l Resets Keyboard Action mode to unlock the keyboard and enables the autotab.

**4.3 CONTROL REPRESENTATION MODE PS= 3**

ESC 3 h sets Control Representation mode to redefine the interpretation of the control codes from column 1 and 2 of the ASCII code chart. When this "transparent" or "monitor" mode is set, the control codes are not performed. Instead, they are stored and displayed as the corresponding upper case graphic characters, underlined. This display of the control codes is a very useful tool for program debugging.

ESC ESC 3 l resets Control Representation mode to restore normal control code response.

**4.4 INSERT REPLACE MODE PS= 4**

ESC 4 h from the data line or depressing the IC (Insert Character) key on the keyboard sets Insert Replace mode. When this mode is set, entering a character inserts the new character at the cursor position and shifts right the previous occupant of that position and all other characters in the affected field or page. The state of the Select Editing Extend mode determines whether the character insertion affects the current field or whole page (Section 4.16). During character insertion, if the number of characters in the field or page overflows, those characters shifted out are lost.

ESC 4 l resets Insert Replace mode. Any character entered when the mode is reset replaces the character at the current cursor location.

#### 4.5 STATUS REPORTING MODE PS= 5

ESC 5 h sets Status Reporting mode. When the mode is set, the GT-400 transmits terminal status information (cursor location, printer BUSY status, and/or communication error status) whenever the terminal makes a Ready State transition.

ESC 5 l resets Status Reporting mode. When the mode is reset, the GT-400 transmits the terminal status information only on direct request from the host computer.

#### 4.6 ERASURE MODE PS= 6

ESC 6 h sets Erasure mode to condition the Erase commands and keys to affect both unprotected and protected data and the AAC's in the current field or on the page.

ESC 6 l resets Erasure mode. When the mode is reset, the Erase commands and keys affect only unprotected data in the current field or on the page.

#### 4.7 CHARACTER MODE PS= 12

ESC 12 h sets Character mode, placing the GT-400 in the Character mode for transmission.

ESC 12 l resets Character mode, placing the GT-400 in Block mode. Note that if the host selects the first mode state after power-up, then only the host can change the mode. Note also that the user must go off-line to change the mode.

Sections 4.8, 4.9, and 4.10 describe the three transmission modes which interact to condition the effect of the XMIT key. The interaction of the three modes is summarized in Table 4-1.

#### 4.8 MULTIPLE AREA TRANSMIT MODE PS= 15

ESC 15 h sets Multiple Area Transmit mode. When the mode is set, depressing the XMIT key transmits either all fields on the page or all fields up to the cursor location, depending on the state of the Transmit Termination mode. See Table 4-1 and Section 4.9.

#### 4.9 TRANSMIT TERMINATION MODE PS= 16

ESC 16 h sets Transmit Termination mode and

conditions the XMIT key to transmit all data in the current field or on the page (depending on the Multiple Area Transmit mode state, described above) when depressed.

ESC 16 l resets Transmit Termination mode. The XMIT key then transmits data from the beginning of the current field or page (determined by the state of the Multiple Area Transmit mode) up to the cursor location.

#### 4.10 SELECTED AREA TRANSMIT MODE PS= 17

ESC 17 h sets Selected Area Transmit mode. When set, this mode conditions the XMIT key to transmit only the fields selected by the host and the fields changed since the previous transmission. The AAC's of the fields not being transmitted cause transmission of a tab character to delimit for the host the non-transmitted fields on the screen. The starting coordinates of all the transmitted fields are also transmitted.

After a field is selected for transmission, depressing the XMIT key transmits the field whenever the Selected Area Transmit mode is set, unless the field's selected status is reset by an ESC p. The ESC p resets the transmittable status of all protected and unprotected fields which have not changed since the previous transmission.

Note that for proper operation of the Selected Area Transmit mode when set, Multiple Area Transmit mode should also be set and the GT-400 must be in the Block mode transmission state.

ESC 17 l resets Selected Area Transmit mode. When the mode is reset, depressin the XMIT key transmits all the unprotected data selected by the Mutiple Area Transmit and Transmit Termination mode states. Refer to Table 4-1.

#### 4.11 NEW LINE MODE PS= 20

ESC 20 h sets New Line mode and redefines the function of the LINE FEED key and control code. The key and code still transmit only the LINE FEED code; however, they perform a Carriage Return/Line Feed function.

ESC 20 l resets New Line mode and restores the normal function of the LINE FEED key and control code.

TABLE 4-1 TRANSMISSION MODE CONDITIONING OF THE XMIT KEY

State of Transmission Modes:					**		**	
Multiple Transmit Mode	reset	set	reset	set	reset	set	reset	set
Transmit Termination Mode	reset	reset	set	set	reset	reset	set	set
Selected Area Transmit Mode	reset	reset	reset	reset	set	set	set	set
Data Transmitted When the XMIT Key is Depressed:								
Unprotected Data	yes	yes	yes	yes				
Protected Transmittable Data					yes	yes	yes	yes
Field to Cursor	yes				yes			
Page to Cursor		yes				yes		
Entire Field			yes				yes	
Entire Page				yes				yes
Cursor Coordinates of Transmitted Fields					yes	yes	yes	yes
Fields Changed Since Last Transmission					yes	yes	yes	yes

\*\* In either of these Transmission modes, the cursor must reside in the field to be transmitted. If the field is protected, position the cursor by locking the keyboard and disabling the autotab. Then initiate transmission from the host via the ESC S EOT command.

**4.12 CARRIAGE RETURN NEW LINE MODE PS= <**

ESC < h sets Carriage Return (CR) New Line mode and redefines the function of the Carriage Return (RETURN) key and control code. The key and code still transmit only the CR code; however, they perform the Carriage Return/Line Feed function.

ESC < l resets Carriage Return (CR) New Line mode and restores the normal function of the Carriage Return key and control code.

**4.13 TRANSMIT REQUEST MODE PS= =**

ESC = h sets Transmit Request mode and conditions the XMIT key to transmit a transmit request code sequence, ESC\_Z ESC/EOT, to the host prior to initiating data transmission. Data transmission starts when the GT-400 receives the remote transmit command, ESC S EOT, from the host.

ESC = l resets Transmit Request mode, allowing normal data transmission when the XMIT key is pressed.

**4.14 PRINT COPY MODE PS= >**

Esc > h from the host or activating COPY on the keyboard sets Print Copy mode and routes received data to an attached hard copy device. Data is routed to the device through an optionally supplied "Y" cable.

ESC > l or deactivating COPY (so that the LED on the key is not lighted) resets Print Copy mode. When the mode is reset, received data is not routed to the printer.

Note that if the host sets this mode, only the host can reset it. Similarly, if the user sets the mode from the keyboard, then only the user can reset the mode.

**4.15 TEXT EDIT MODE PS= ?**

ESC ? h sets Text Edit mode. When the mode is set, a Carriage Return (CR) is stored in memory and displayed at the current location as M. The rest of the current field is erased, and the cursor returns to the first unprotected position of the current line. If Insert Replace mode (Section 4.4) is reset, normal data entry then occurs.

When Insert Replace mode is set, characters entered in Edit in Field/Line mode (Section 4.16) shift the character string and the M to the right until the M reaches the last unprotected position in the field. The M stays in that position. With each additional character insertion, the character string is lost. When the cursor reaches the position occupied by the M, the next character inserted writes over the M, suspending Text Edit mode. Text Edit mode remains suspended and normal Insert Replace mode data entry occurs until the next carriage return (M) either is encountered in an unprotected field or is generated.

When Insert Replace mode is set, characters entered in Edit in Page mode (Section 4.16) shift the character string and the M to the right until M reaches the last unprotected position in the field. The M stays in that position. With each successive character insertion, the character string shifts one position to the right. The string shifts past the M and wraps around to the next unprotected position(s) following the M, either on the same or a succeeding line. When the cursor reaches the M position, the next character inserted writes over the M. If there are any further Ms on the page, continued character insertion occurs as just described. When there are no further Ms on the page, Text Edit mode is suspended and normal Insert Replace mode character entry occurs.

ESC ? l resets Text Edit mode. When the mode is reset, normal text entry occurs.

**4.16 SELECT EDITING EXTENT MODE**

The state of Select Editing Extent mode determines whether editing functions affect the entire page or only the current Field/Line.

ESC 0 Q or ESC Q selects the Edit in Page state. Any editing functions (for example, insert/delete character or line) performed in this state of the mode affect the entire page.

ESC 2 Q selects the Edit in Field/Line state. In this mode, editing functions performed affect only the field/line in which the cursor is residing. Lines cannot be inserted or deleted in Edit in Field/Line mode.

### 4.17 EDITING FUNCTIONS

The General Terminal GT-400 provides both single-key and software-definable editing functions for

- o Cursor Control
- o Tab Control
- o Erase Control
- o Insert/Delete Control

The general command format for these editing functions is:

ESC P f

- ESC Introduces the editing command sequence
- P Is either the numeric (PN) or the selective (PS) parameter. A numeric parameter specifies how many of the editing functions are to be performed (for example, move the cursor three positions to the right). A selective parameter conditions the editing function being performed (for example, either erase from the cursor to the end of the page or erase the entire page).
- f Specifies the required editing function and terminates the sequence.

The following sections describe the commands for all four types of editing control functions.

### 4.18 CURSOR CONTROL

The GT-400 offers both incremental and absolute cursor position control. Descriptions and examples of both follow:

For incremental cursor positioning the operator may use the appropriate keys on the keyboard. The operator also may use the cursor positioning commands described in Table 4-2 to incrementally position the cursor.

The cursor positioning commands use the following format:

ESC PN f

- ESC Introduces the command sequence
- PN Is the numeric parameter for how far (the number of increments) the cursor moves.
- f Specifies the direction in which the

cursor moves and terminates the command sequence.

Absolute Cursor Positioning is normally done only by the host, because the host can always access any location on the screen if the keyboard is locked and autotab disabled. There is no key on the keyboard for absolute cursor positioning because the user cannot always access all locations on the screen, i.e., any protected fields.

The code sequence format for absolute cursor positioning is:

ESC y;x H

- ESC Introduces the sequence
- y;x Are the desired decimal line (y) and column (x) destination for the cursor. The range for y is 1 to 25, and for x is 1 to 80. Either or both x and y may be omitted. In that case the default value is 1 for each.
- H Specifies the absolute cursor position function and terminates the sequence.

Table 4-3 shows sample commands and describes the resulting cursor movement.

### 4.19 TAB CONTROL

THE GT-400 offers forward and backward tabbing capability for individual or columnar tabs. The presence of columnar tabs affects the action of the forward tab but not that of the back tab. First, forward and back tabbing with no columnar tabs set is described below. Then the effect of columnar tabs is described.

Forward tabbing - from the keyboard (using the TAB key, Section 3) advances the cursor to the first position in the succeeding unprotected field. This may be in the current line or in a following line.

Back tabbing - using the BACK TAB key (Section 3.4) returns the cursor to the start of the previous unprotected field in the current line or to the first unprotected position on the previous line, whichever comes first.

Commands which control forward and back tabbing from the data line have the following format:



ESC [ PN f

- ESC Introduces the sequence
- [ Is the REQUIRED second character in a forward tab sequence and is optional in the back tab sequence.
- PN Is the numeric parameter which specifies the number of tab stops to advance or retreat. A PN value of 0 or a blank is interpreted as specifying 1.
- f Specifies the direction (forward or back) for the tab and terminates the sequence. Use I for forward tabbing. Use Z for back tabbing.

TABLE 4-2 INCREMENTAL CURSOR POSITIONING

f VALUE	COMMAND	FUNCTION
A	ESC PN A	Cursor moves up PN positions.
B	ESC PN B	Cursor moves down PN positions.
C	ESC PN C	Cursor moves right PN positions.
D	ESC PN D	Cursor moves left PN positions.
E	ESC PN E	Cursor moves PN lines down, to column 1 of the new line.
F	ESC PN F	Cursor moves PN lines up, to column 1 of the new line.

TABLE 4-3 SAMPLE CURSOR POSITIONING COMMANDS

COMMAND	ACTION
ESC 3 D	Cursor moves left 3 positions.
ESC 6 E	Cursor moves to the first position six lines below the current line.
ESC H	Cursor moves to the Home position, since the comand implies 1;1 for the y;x values.
ESC 5;63H	Cursor moves to line 5, position 63.
ESC 7H	Cursor moves to line 7, position 1.
ESC ;7H	Cursor moves to line 1, position 7.

The presence of columnar tabs changes the forward tab function. Use columnar tabs typically with unprotected screen formats only. Do not set columnar tabs through protected

fields.

A columnar tab is similar to a columnar tab on a typewriter. It extends the full 25 lines on the screen at the column position where it is set. Set columnar tabs via the data line, using the command ESC I with the cursor in the desired column position. Set a maximum of ten columnar tabs, starting with the left-most tab and moving the cursor right to define each successive columnar tab. Columnar tabs cannot be reset individually. The command ESC 3 g resets all columnar tabs.

When one or more columnar tabs is set, a forward tab, either from the keyboard or the data line, advances the cursor to the first columnar tab stop on the current line. Subsequent forward tabbing advances the cursor to successive columnar tab stops. If there are no subsequent columnar tab stops on the line, an additional forward tab advances the cursor to the last position on the line. Subsequent forward tabbing does not move the cursor.

The user may encounter various problems combining columnar tabs with protected formats. For example, the GT-400 does not recognize tab stops defined by the beginning of unprotected fields or the beginning of lines. In addition, the autotab prevents the GT-400 from positioning the cursor at a columnar tab stop in a protected field. Therefore, use columnar tabs only with unprotected screen formats.

#### 4.20 ERASE CONTROL

The GT-400 provides both keys and commands for control of data erasing. The Erasure mode (Section 4.6) conditions the erase keys (Section 3.4) and erase commands to affect only unprotected data or both unprotected and protected data.

The erase command erase affected data either in the entire current field or page or from the current cursor position to the end of field or page. The general code format erase command is:

ESC PS f

- ESC Introduces the code sequence
- PS Is the selective parameter which specifies whether the command affects data in the

entire field/page or data from the cursor location to the end of the field/page.

- f Delimits the effect of the erase command to the field or page and terminates the sequence.

Table 4-4 describes the erase commands when Erasure mode is in the reset state and Table 4-5 describes the commands when Erasure mode is set.

TABLE 4-4 ERASE COMMANDS w/ ERASURE MODE RESET

PS VALUE	f VALUE	COMMAND	ACTION
Q/Blank	N	ESC 0 N	Erase all unprotected data from the cursor position to the end of the current field.
2	N	ESC 2 N	Erase all unprotected data in the field where the cursor resides.
Q/Blank	J	ESC 0 J	Erase all unprotected data from the cursor position to the end of the page.
2	J	ESC 2 J	Erase all unprotected data on the current page and move the cursor to the home position (or the first unprotected position, if home is a protected position).

TABLE 4-5 ERASE COMMANDS w/ERASURE MODE SET

PS VALUE	f VALUE	COMMAND	ACTION
Q/Blank	N	ESC 0 N	Erase all data from the cursor position to the end of the current field.
2	N	ESC 2 N	Erase all data in the field where the cursor resides.
Q/Blank	J	ESC 0 J	Erase all data from the cursor position to the end of the page.
2	J	ESC 2 J	Erase all data on the page and move the cursor to the home position.

4.21 INSERT/DELETE CONTROL

The GT-400 provides keys and commands to control insertion and deletion of lines and deletion of characters. Character insertion is controlled by modes, not commands. The commands and modes which control insertion and deletion are described below.

The general code sequence format for insert/delete commands is:

ESC PN f

- ESC Introduces the sequence
- PN Is a numeric parameter which specifies how many lines to insert or delete, or how many characters to delete.
- f Specifies the insert/delete function and terminates the sequence.

Table 4-6 summarizes the insert/delete commands.

TABLE 4-6 INSERT/DELETE COMMANDS

f VALUE	COMMAND	ACTION
M	ESC PN M	<u>Line Deletion*</u> : Delete the current line and the following PN-1 lines. The lines below the deletion move up.
L	ESC PN L	<u>Line Insertion*</u> : Move the current line and all succeeding lines down PN lines, leaving the cursor on a blank line.
P	ESC PN P	<u>Character Deletion</u> : Starting at the cursor position, delete PN characters and shift the remaining characters on the field/line or page PN positions to the left.

\* Note: The Select Editing Extend mode must be reset (in Edit in Page) for these two commands to function.

Two modes affect this command: The state of the Select Editing Extend mode determines

whether only the remaining characters on this field/line or all of the remaining characters on the page are affected, as follows:

If the Select Editing Extent Mode is SET, only the characters in the field/line are affected. If the Select Editing Extent Mode is RESET, the characters on the entire page are affected.

If Text Edit mode is set, the extent of the shift is limited to the position of the stored Carriage Return, M unless the end of the field/line precedes the M. If the current M is then written over and there are no other M's on the screen, Text Edit mode is suspended until another M is entered. If Text Edit mode is reset, then only the Select Editing Extent mode conditions the delete character command.

Additional character insertion results in the loss of the characters at the end of the affected string. When the cursor reaches the M, the M is written over and Text Edit mode may be suspended.

SET	SET	RESET
-----	-----	-------

ACTION: The action here is similar to that described in the Set/Set/Set state above with the following exception: when M occupies the last position on the line, additional character insertion results in a wraparound of the shifted characters to the succeeding unprotected position of the next line. The lead character now writes over the character occupying each new position into which it is shifted. Characters are lost only after the lead character is shifted out of the last position.

TABLE 4-7 INSERT CHARACTER FUNCTION

Insert/Replace Text Edit Select Edit Extent

RESET	SET/RESET	SET/RESET
-------	-----------	-----------

ACTION: Data entry is normal

SET	RESET	SET
-----	-------	-----

ACTION: The character at the cursor location and all other characters in the field/line shift one position to the right for each character inserted. Characters shifted out of the field/line are lost.

SET	RESET	RESET
-----	-------	-------

ACTION: The character at the cursor location and all other characters on the page shift one position to the right for each character inserted. Characters shifted off the page are lost.

SET	SET	SET
-----	-----	-----

ACTION: The Carriage Return Character M delimits the end of the affected string in the current field/line. All characters in the field/line up to and including M shift one position to the right for each character inserted. The M writes over the character inserted. The M writes over the character occupying each new position into which it is shifted. When the M reaches the last unprotected position in the field it remains in that position.

If there are one or more protected fields on the current line the M shifts to the last unprotected position in the unprotected field. Additional character insertion does not result in a character wraparound until the M has been written over and Text Edit mode suspended. Then normal character insertion continues.

**5.0 STATUS REPORTING INQUIRY**

The Status Reporting feature of the GT-400 allows the host to monitor certain device status information: the current cursor location, and the printer busy and communication error status. When Status Reporting mode is set, the GT-400 transmits the device status information whenever the GT-400 or any attached device (for example, a printer) makes a Ready State transition, (i.e., the device goes from a Busy to Not Busy state or a Not Busy to Busy state. When the mode is reset, the host must request the status information.

The command ESC [ 6 n ETX requests the current cursor location. The GT-400 responds with ESC [ Y;X R EOT where Y is the current line and X is the current column (both in decimal represented by two ASCII characters). The semicolon is a separator, R EOT are the ending sequence.

The command ESC 5 n ETX requests optional printer buffer Busy and communication error (parity, framing, or overrun errors) status. The GT-400 responds with ESC P a;b ESC, where a and b are characters from the third column of the ASCII code chart, (See Appendix A). The first character, a, does not contain any status information and is not interpreted by the host. The second character, b, returns the optional print buffer Busy status in character bit 2 and the communication error status in bit 4. Note that in GT-400 units with no print buffer, the printer Busy signal is inactive. Refer to the character below and the ASCII code chart in Appendix A.

Character	Bit 7	6	5	4	3	2	1
"b" code=	0	1	1	y	y	y	y
				:	:	:	:
				:	:	:	:
				:	:	:	:
y=1 Communication Error.....:				:	:	:	:
Not Used.....:				:	:	:	:
						:	:
y=1 Printer Busy.....:						:	:
						:	:
Not Used.....:						:	:

**5.1 OPTIONS**

The GT-400 offers the following options:

- o Three-page memory
- o Buffered printer interfaces
- o Polling
- o Line drawing
- o Optional keyboards
- o Burroughs TD/830 emulation
- o Hazeltine 2000 emulation
- o Time-sharing operation

**5.2 THREE-PAGE MEMORY OPTION**

The GT-400 Paging option increases the display memory capacity to three pages (6000 characters) from the standard one page (2000 characters). Note that in GT-400 units with both the Paging option and the Buffered Printer Interface option (Section 5.3), the printer buffer uses one of the available three pages. This combination of options thus limits the Paging option capacity to two pages (4000 characters).

The GT-400 provides additional commands and modes for display control in multipage units and modifies the transmission of control code sequences for various keys. The commands, modes, and affected keys are described below.

The special commands for multipage units provide control of display memory positioning and absolute cursor positioning. The commands can be issued from either the keyboard or the host computer. Table 5-1 summarizes the keyboard-controlled display memory commands. The absolute cursor positioning commands are summarized in Table 5-3.

GT-400 multipage units have four special modes. The interaction of the three transmission modes is somewhat modified from that in single page GT-400 units (See Sections 4.8, 4.9, and 4.10). The three transmission modes are Multiple Area Transmit mode, Transmit Termination mode, and Selected Area Transmit mode. Table 5-4 summarizes the interaction of these modes in data transmission.

Only multipage units offer the fourth mode, Edit Boundary mode. Edit Boundary mode lets the user choose the extent of both editing or cursor movement functions. These functions may

act either within the boundary of the 25 lines currently displayed or within the entire available memory.

In GT-400 multipage units, control code sequences for the following keys are never transmitted:

CURSOR UP, CURSOR RIGHT, CURSOR DOWN, HOME, INS CHAR, INS LINE, DEL CHAR, DEL LINE, BACK TAB, SCROLL, PAGE, CLEAR PAGE, CLEAR FIELD, PRINT PAGE, AND PRINT FIELD.

### 5.3 BUFFERED PRINTER OPTION INTERFACE

The GT-400 offers an optional, fully buffered, separately addressable 2K-word serial/parallel printer interface. A single printed circuit board contains the interface logic, the memory buffer, and the printer driver firmware. The serial interface provides outputs at standard EIA levels and at data rates independent of the receiver data rate. The parallel interface output is slaved to the printer BUSY signal. Both the serial and parallel interfaces offer the Print Page and Print Field/Line capabilities. Note that the buffered printer interface and the GTR-400 operate in parallel.

Using the Status Reporting capability, the host computer requests the BUSY status of the buffered printer interface to monitor the state of data transmission to the printer. The interface cannot accept new data from the keyboard or the host until it finishes outputting the current data to the printer.

In GT-400 units which combine the Polling and Buffered Printer options, the printer interface function is modified. For example, both Copy mode and the normal printer address function are disabled. A routing parameter which follows the terminal's address specifies the data routing according to Table 5-5.

The Baud Rate Switches, U14 (New Board) or U29 (Old Board), should be set to match that of the printers baud rate. The baud rate of the printer is independent of the primary baud rate of the Terminal. The internal clock of the Printer Option is formatted the same as the internal clock of the Terminal.

TABLE 5-1 KEYBOARD CONTROLLED DISPLAY MEMORY  
COMMANDS IN GT-400 MULTIPAGE UNITS

Key Pressed	Code Generated	Action
SCROLL	ESC T	Moves the 25-line memory segment display down one line.
SCROLL/SHIFT	ESC S	Moves the memory segment display up one line.
PAGE	ESCV	Moves the memory down to display the previous page. The cursor moves to the first unprotected display position on the page.
PAGE/SHIFT	ESC U	Moves the memory up to display the next page. The cursor moves to the first unprotected display position on the page.

TABLE 5-2 REMOTE-CONTROLLED DISPLAY MEMORY  
COMMANDS IN GT-400 MULTIPAGE UNITS

Command	Code Generated	Action
Scroll Up	ESC PN S	Moves the memory displayed up PN lines. PN = 0 through 74.
Scroll Down	ESC PN T	Moves memory displayed down PN lines. PN = 0 through 74.
Next Page	ESC PN U	Moves memory displayed up PN pages. The cursor moves to the first unprotected position on the page. PN = 1 or 2.
Form Feed	Control L	Moves memory display to the next page, erases the page, and places the cursor in the home position.

**TABLE 5-3 ABSOLUTE CURSOR POSITIONING  
IN GT-400 MULTIPAGE UNITS**

Command	Code Generated	Action
Horizontal and vertical positioning in all of memory	ESC Y;X f	Moves the cursor to the memory line and column specified by Y and X, respectively. Y = 1 through 75 on three-page unit. X = 1 through 80.
Screen	ESC Y;X H	Moves the cursor within the 25 displayed lines to the line and column specified by Y and X, respectively. Y = 1 through 25. X = 1 through 80.

Note 1: X and Y values are in decimal.

Note 2: The Address Memory command can position the cursor off the displayed portion of the memory to allow data entry anywhere in available memory.

Table 5-4 on next page.

**TABLE 5-5 DATA ROUTING IN POLLED TERMINALS  
WITH BUFFERED PRINTER INTERFACE.**

Parameter	Routing
Not present	Data to CRT
hex 31	Data to CRT
hex 32	Data to Printer
hex 33	Data to CRT/Printer

#### **5.4 POLLING OPTION**

The GT-400 can operate in a polled environment, where several terminals share a communication line to the host computer. The polling option configuration provides for a single-character, double-character, or two character address polling procedure. For information of GT-400 units with both the Polling and Buffered Printer options, see Section 5.3

#### **Address Definition**

The device address may take three forms;

single address character, repeated single character address, or two character address. In all cases the address character(s) must range in value between hex 21 to hex 7E. Address 20 (040) (SPACE) is reserved for BROADCAST POLL. All terminals on the same data line must use the same address form (single, repeated single, or two character address).

The switch bank located at A2 is used to set the first character address (7 bits, switch 1 is LSB) and to determine the number of address characters (switch 8 on for repeated single character address, switch 8 off for one or two character address). The switch bank located at A3 is used for the second address character. If A3 is set to all ones or all zeros single character address is implied.

Switch bank A2 can also be used as a test function by setting its switches to all ones or all zeros. This places the terminal in a monitor mode where it will receive and display all messages independent of address. In this mode the terminal will not transmit nor will it respond to any polls.

NOTE: Each time any address switch is changed the line/local switch must be cycled from line to local and back to line.

TABLE 5-4 TRANSMISSION MODE CONDITIONING OF THE XMIT KEY

State of Transmission Modes:					**		**	
Multiple Transmit Mode	reset	set	reset	set	reset	set	reset	set
Transmit Termination Mode	reset	reset	set	set	reset	reset	set	set
Selected Area Transmit Mode	reset	reset	reset	reset	set	set	set	set
Data Transmitted When the XMIT Key is Depressed:								
Unprotected Data	yes	yes	yes	yes				
Protected Transmittable Data					yes	yes	yes	yes
Field to Cursor	yes				yes			
Page to Cursor		yes				yes		
Entire Field			yes				yes	
Entire Page				yes				yes
Cursor Coordinates of Transmitted Fields					yes	yes	yes	yes
Fields Changed Since Last Transmission					yes	yes	yes	yes

\*\* In either of these Transmission modes, the cursor must reside in the field to be transmitted. If the field is protected, position the cursor by locking the keyboard and disabling the autotab. Then initiate transmission from the host via the ESC S EOT command.





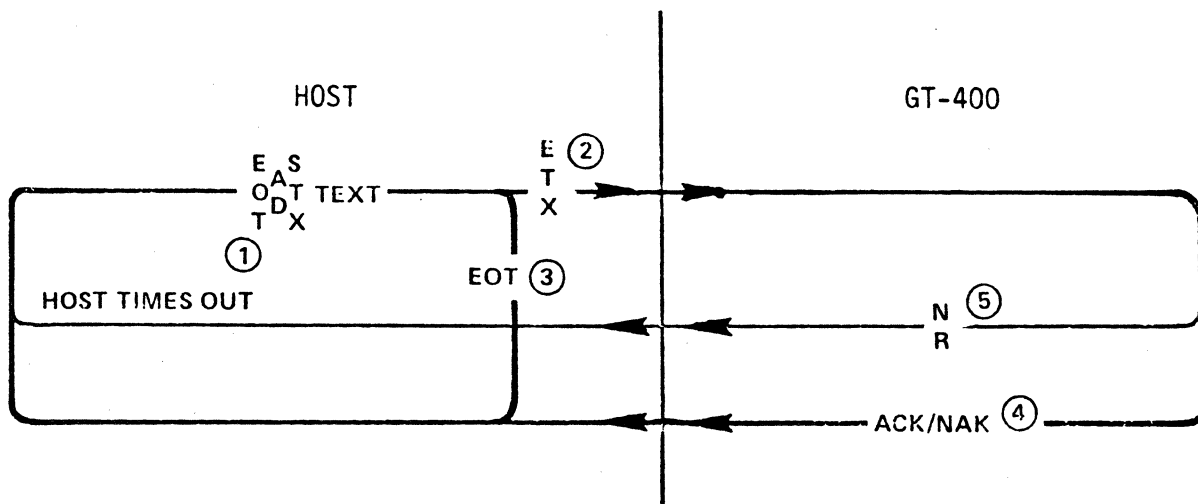

1. See section 5.4 for address definitions.
2. End with ETX if ACK/NAK reply wanted. If status or cursor position report wanted, then end with ENQ.
3. End with EOT if no reply wanted.
4. The link is not broken after reply is sent. To resend data or xmit new data, simply xmit an STX followed by an ETX (or an EOT if reply to last block of data is not wanted).
5. No reponse if Broadcast. If reply expected, Error in addressing, missing ETX due to error or terminal not on-line.

**Figure 5-2. Fast Select Sequence**

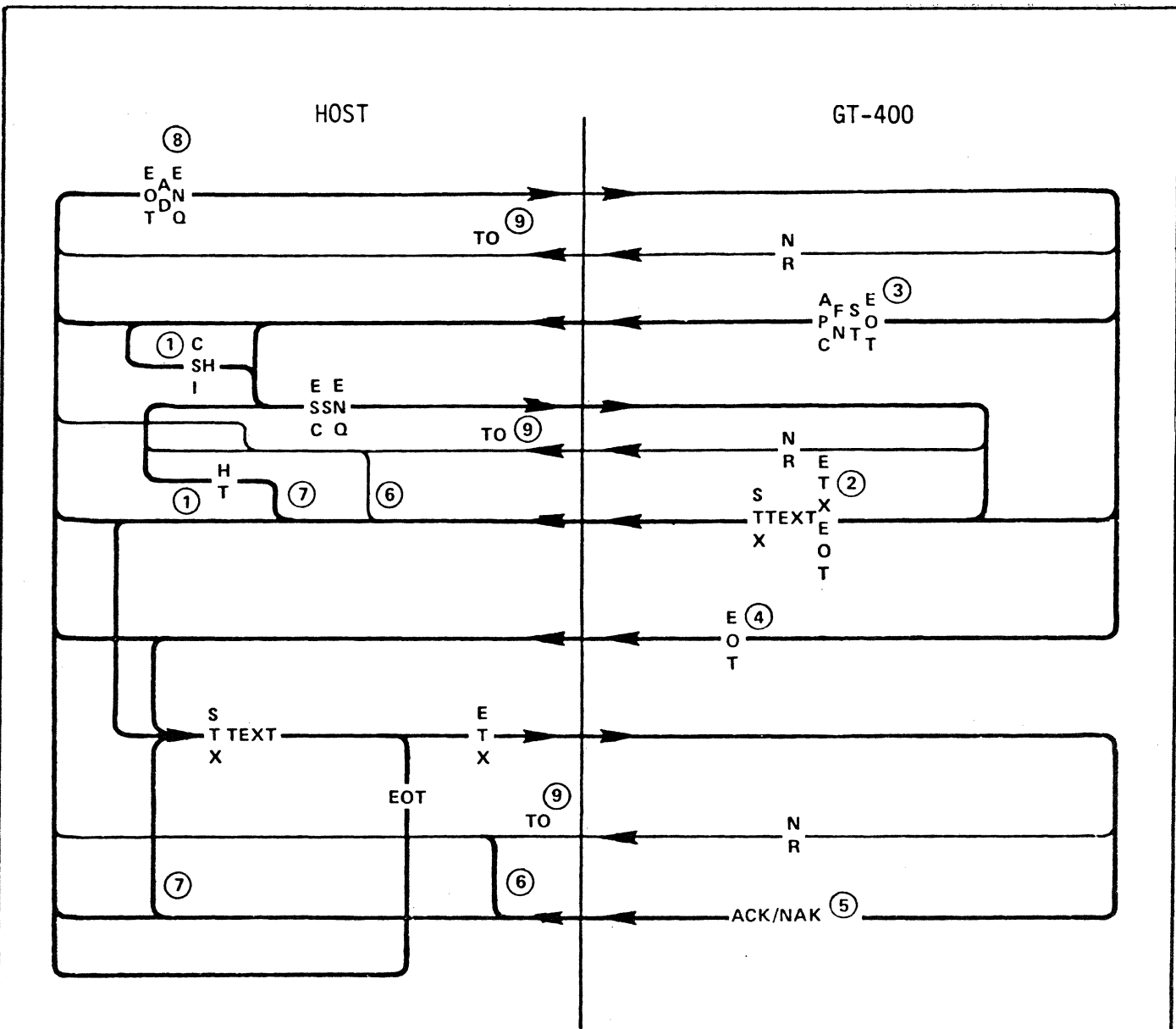

1. Can be any cursor positioning sequence.
2. ETX or EOT determined by switch setting.
3. APC key struck or if TRM set and XMIT key struck Fn=z.
4. If nothing to transmit.
5. See note 4 on Fast Select Sequence Page.
6. Error recovery path.,
7. Multiple text block path.
8. See section 5.4 for address definition.
9. Host system times out.

**Figure 5-3. Poll-Select Sequence**

**Broadcast Poll**

If the host substitutes a space code (hex 20) for an address character then the terminals described below will receive the message but will not respond to the poll. On single address terminals (if the host sends two spaces) the broadcast text will be received and displayed. On terminals using two character address all will receive and display the broadcast text provided the host uses two space characters for address. If the host substitutes only one character with a space code then only some of the terminals will receive the data as described in the following example.

HOST ADDRESS CHARACTERS	RECEIVING TERMINAL
SPACE A	All terminals which use A as the second address character
A SPACE	All terminals which use A as the first address character
SPACE SPACE	All terminals which use two character addresses

**5.5 LINE DRAWING OPTION**

The GT-400 offers a 32-character graphics set which implements the Line Drawing option. Table 5-6 shows 32 graphic characters which correspond to 96 or the 128 defined ASCII codes. When these display characters are created via the Keyboard in Graphic Mode and on-line mode, the normal ASCII codes are sent on the data line. Do not attempt to use the ASCII control codes for graphics.

**5.6 OPTIONAL KEYBOARDS**

The GT-400 is available with the following optional replacements for standard main keyboard section:

- o Azerty
- o Qwertz
- o German
- o Swedish/Finnish
- o Norwegian/Danish
- o Special Swedish/Finnish
- o Special Norwegian/Danish

Figures 5-4 through 5-10 show the international keyboards available for the GT-400 (and their

special keycaps) as listed above.

**TABLE 5-6 GT-400 LINE-DRAWING GRAPHICS SET**

OCTAL	HEX	ASCII CHARACTER	GRAPHIC CHARACTER
00	00	SP @	·
01	01	! A	a
02	02	" B	b
03	03	# C	c
04	04	\$ D	d
05	05	% E	e
06	06	& F	f
07	07	' G	g
10	08	{ H	h
11	09	} I	i
12	0A	* J	j
13	0B	+ K	k
14	0C	, L	l
15	0D	- M	m
16	0E	. N	n
17	0F	/ O	o
20	10	0 P	p
21	11	1 Q	q
22	12	2 R	r
23	13	3 S	s
24	14	4 T	t
25	15	5 U	u
26	16	6 V	v
27	17	7 W	w
30	18	8 X	x
31	19	9 Y	y
32	1A	: Z	z
33	1B	; [	{
34	1C	< \	
35	1D	= ]	}
36	1E	> ^	~
37	1F	? _	DEL

**5.7 BURROUGHS TD/830 EMULATION OPTION**

The GT-400, with modifications, can emulate the operation of the Burroughs TD/830 terminal. For more information on this emulation, consult the GT-400/B User's Manual.

**5.8 HAZELTINE 2000 EMULATION OPTION**

The GT-400 can optionally be configured to emulate the Hazeltine 2000 terminal. In this configuration, the reverse video, blinking

video, and underlined video display capabilities of the standard GT-400 are disabled.

The Hazeltine 2000 emulation option of the GT-400 has three printer options. The emulation uses either the Y-cable printer output from the GT-400 terminal or the optional serial or parallel buffered printer interface (Section 5.3). This emulation cannot utilize the separate address capability of the buffered printer interface.

The functions of three GT-400 rear panel switches change in Hazeltine 2000 emulation. Table 5-7 summarizes the new switch functions.

TABLE 5-7 REAR PANEL SWITCH FUNCTION FOR HAZELTINE 2000 EMULATION OPTION

**BLOCK MODE TERMINATION CHARACTER**

This switch is effective only in BLOCK mode. Set the switch to select the transmission termination character as follows:

- SSW#1 Termination Character
- ON CR is selected
- OFF EOT is selected. Receipt of the EOT character turns on the RTS signal.

**AUTOTAB STATUS**

Autotab operates only in BLOCK mode and under keyboard operation. Set this switch to select the autotab status as follows:

- SSW#2 Autotab Status
- ON Autotab is enabled.
- OFF Autotab is disabled.

**GRAVE ACCENT**

Set this switch to define whether the Grave Accent ASCII character is displayed and interpreted as a TRANSMIT symbol or normally as the Grave Accent symbol.

- SSW#3 Grave Accent Character Status
- ON The character is displayed and interpreted as a TRANSMIT symbol.
- OFF The character is displayed and interpreted normally.

5.9 TIME-SHARING OPERATION OPTION

The standard GT-400, with this TSO option, can operate in a time-sharing environment. The modifications change the function of several switches on the rear panel. Table 5-8 summarizes the new switch functions.

TABLE 5-8 MODIFIED REAR PANEL SWITCH FUNCTIONS GT-400 TIME-SHARING OPERATION OPTION

FUNCTION	SWITCH #	DESCRIPTION
Terminal Reset Selection	SSW #1 (Location Switch Bank S206)	This switch is effective only in Character mode. The terminal enters the transmit state when a key is struck. The terminal enters the receive state as follows:  SSW #1 Reset Condition  ON Transmission of either a CR (Carriage Return) or ETX (end of TEXT) code returns the terminal to the receive state.  OFF Transmission of the ETX code returns the terminal to the receive state.
Block Mode Start Character Selection	SW #2 (Location Switch Bank S2-7)	This switch is effective only in Block Mode. Set the switch to select the Block Mode start character status as follows:  SSW #2 Start Character  ON No start Character is sent.

TABLE 5-8 Continued

Block Mode Termination Character Selection	SSW #3 (Location Switch Bank S2-8)	OFF	The STX (Start of Text) character is sent.
	SSW #3	Termination Character Selected	
		EXT	terminates all Block Mode transmissions.
		OFF	CR terminates all Block Mode transmissions.

- b. The terminal display is always in roll mode.
- c. A CR (Carriage Return) is performed without transmission of the CR code, following all buffered data transmissions.
- d. Depressing of the BLOCK key does not transmit a mode control sequence. Instead, the request is serviced immediately.
- e. Select Editing Extent mode initial (power-up) state is Edit in Field/Line.
- f. Any received STX or EOT is ignored.
- g. A Keyboard BREAK resets RTS (the Request to Send signal).
- h. Control sequence function key commands are executed in both Block and Character modes. However, in Character mode, no control sequence function key commands are transmitted.
- i. The application program command sequence format is ESC @ f, where the f values are the same as with the standard GT-400 firmware.
- j. The three transmission modes (See Section 8.8, 8.9, and 8.10) must all be reset for proper operation in a time-sharing environment.

This TSO option has the following additional operational differences from the GT-400. They are as follows:

- a. Polling and XON-XOFF are not supported.

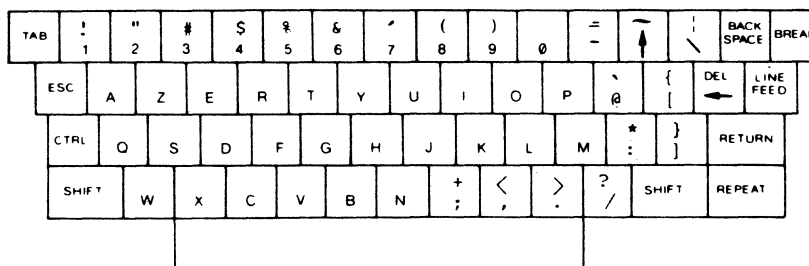
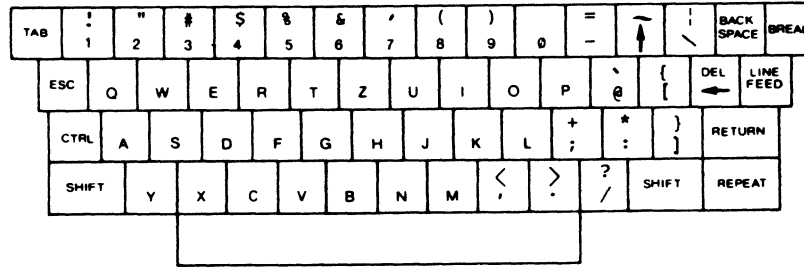
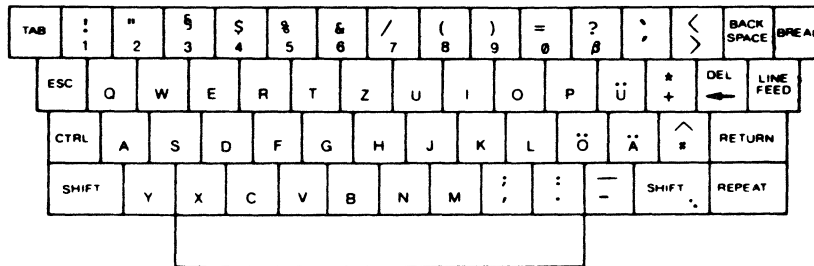

Figure 5-4. Optional AZERTY Main Keyboard



**Figure 5-5. Optional QWERTZ Main Keyboard**



**Figure 5-6. Optional GERMAN Main Keyboard**

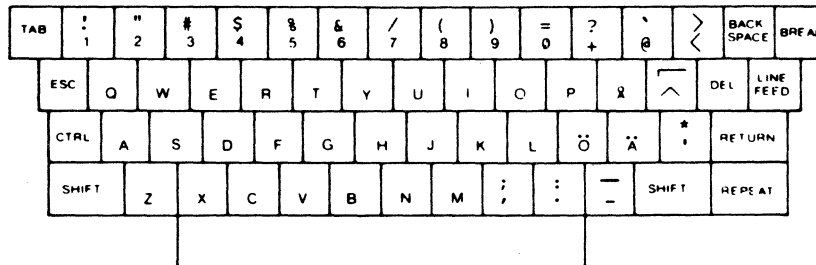

**Figure 5-7. Optional SWEDISH/FINNISH Main Keyboard**

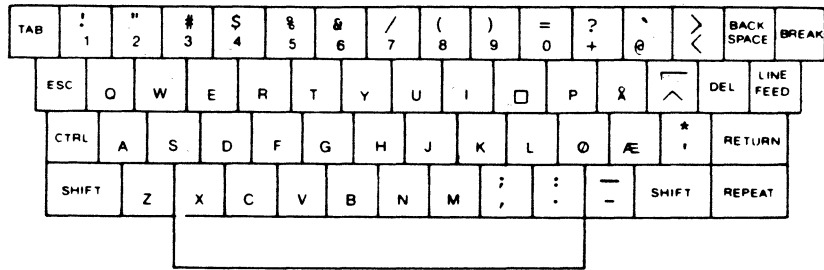

**Figure 5-8. Optional NORWEGIAN/DANISH Main Keyboard**

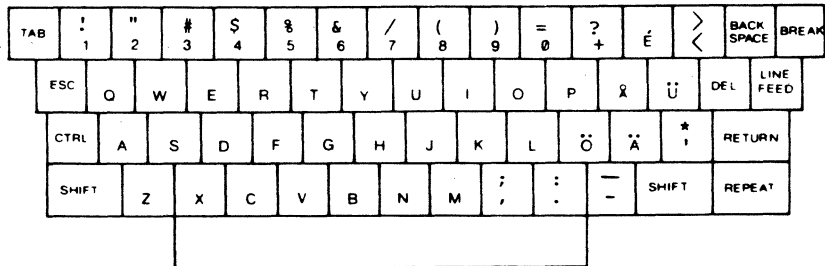

**Figure 5-9. Optional Special SWEDISH/FINNISH Main Keyboard**

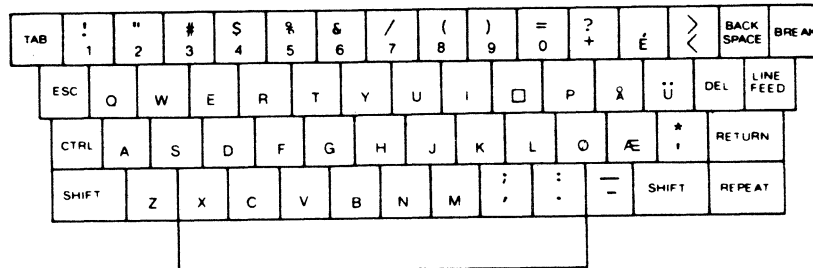

**Figure 5-10. Optional Special NORWEGIAN/DANISH Main Keyboard**

ASCII CODE CHART

Bit 7 →	0	0	0	0	1	1	1	1
Bit 6 →	0	0	1	1	0	0	1	1
Bit 5 →	0	1	0	1	0	1	0	1
bit bit bit bit COLUMN →								
4   3   2   1   ROW	0	1	2	3	4	5	6	7
0   0   0   0   0	NUL	DLE	Space	0	@	P	`	p
0   0   0   1   1	SOH	DC1	!	1	A	Q	a	q
0   0   1   0   2	STX	DC2	"	2	B	R	b	r
0   0   1   1   3	ETX	DC3	#	3	C	S	c	s
0   1   0   0   4	EOT	DC4	\$	4	D	T	d	t
0   1   0   1   5	ENQ	NAK	%	5	E	U	e	u
0   1   1   0   6	ACK	SYN	&	6	F	V	f	v
0   1   1   1   7	BEL	ETB	'	7	G	W	g	w
1   0   0   0   8	BS	CAN	(	8	H	X	h	x
1   0   0   1   9	HT	EM	)	9	I	Y	i	y
1   0   1   0   10	LF	SUB	*	:	J	Z	j	z
1   0   1   1   11	VT	ESC	+	;	K	[	k	{
1   1   0   0   12	FF	FS	,	<	L	\	l	
1   1   0   1   13	CR	GS	-	=	M	]	m	}
1   1   1   1   14	SO	RS	.	>	N	^	n	~
1   1   1   1   15	SI	US	/	?	0	_	o	DEL



GT-400 CONTROL SET

Bit 7 →	0	0	0	0	1	1	1	1
Bit 6 →	0	0	1	1	0	0	1	1
Bit 5 →	0	1	0	1	0	1	0	1
bit bit bit bit COLUMN →								
4   3   2   1   ROW	0	1	2	3	4	5	6	7
0   0   0   0   0	NUL			0		DEC*		DSA
0   0   0   1   1				1	CUU	SEM		PP
0   0   1   0   2	STX			2	CUD	CPR		PF
0   0   1   1   3	ETX			3	CUF	STS*		
0   1   0   0   4	EOT			4	CUB			
0   1   0   1   5	ENQ	NAK		5	CNL			
0   1   1   0   6	ACK			6	CPL			
0   1   1   1   7	BEL			7			RCT	
1   0   0   0   8	BS			8	CUP		SM	
1   0   0   1   9	HT			9	CHT			
1   0   1   0   10	LF			:	ED	CBT		
1   0   1   1   11		ESC		;		CSI		
1   1   0   0   12	FF			<	IL	ST*	RM	
1   1   0   1   13	CR			=	DL		SGR	
1   1   1   0   14				>	EF		DSR	
1   1   1   1   15				?		APC*	DAQ	

\* 2 Character sequence (ESC, CODE)



***General Terminal Corporation***

14831 Franklin Avenue  
Tustin, California 92680  
(800) 854-6925

Part Number  
05006-001