

RETRO- GRAPHICS

USER'S MANUAL

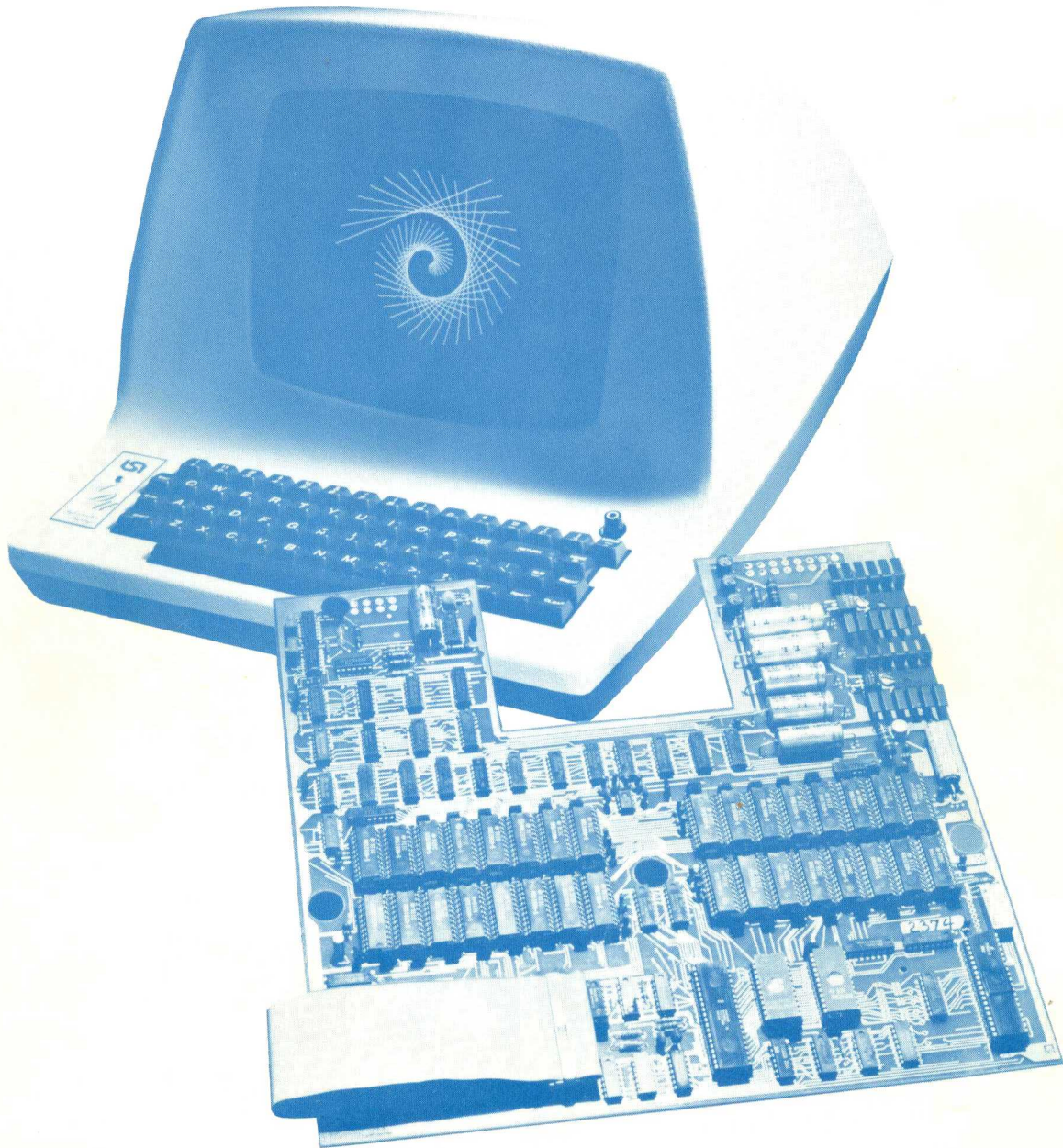

DIGITAL ENGINEERING

I N C O R P O R A T E D

1775-C TRIBUTE RD. • SACRAMENTO, CA 95815 • (916) 920-5600

USER'S MANUAL

**RG-512 RETRO-GRAPHICS CARD
FOR THE ADM-3A COMPUTER TERMINAL**

DIGITAL ENGINEERING INC.
1775 Tribute Road, Suite C
Sacramento, CA 95815
(916) 920-5600

WARRANTY

The DEI RG-512 printed circuit card is warranted against defects in materials and workmanship for a period of three months following date of purchase. Any questions regarding this warranty should be referred to:

Digital Engineering Inc.

(916) 920-5600

Lear Siegler is a registered trademark of Lear Siegler, Inc. Tektronix is a registered trademark of Tektronix, Inc.

The material in this publication is for informational purposes only. Specifications are subject to change without notice.

Copyright 1978, 1979, 1980 by Digital Engineering Inc. All rights reserved. Contents of this publication may not be reproduced in any form without permission of Digital Engineering Inc.

PRINTED IN U.S.A.

DGM512-001C

TABLE OF CONTENTS

1. INTRODUCTION	
1.1 SCOPE	1-1
2. SPECIFICATIONS	
2.1 GENERAL DESCRIPTION	2-1
2.2 PHYSICAL PACKAGING	2-1
3. INSTALLATION AND CHECKOUT	
3.1 UNPACKING THE SHIPPING CARTON	3-1
3.2 IDENTIFICATION OF CONNECTORS	3-1
3.3 INSTALLATION PROCEDURE	3-1
3.4 CHECKOUT	3-2
3.4.1 ADM-3A Alpha Mode	3-2
3.4.2 Vector Mode	3-3
3.4.3 Point Mode	3-3
3.4.4 4010 Alpha Mode	3-3
4. THE RETRO-GRAPHICS EQUIPPED ADM-3A	
4.1 OPERATIONAL MODEL	4-1
4.1.1 Functional Interconnect	4-1
4.1.2 Graphics Plotting Grid	4-2
4.1.3 4010 Alpha Cursor	4-3
4.2 PROGRAMMING FOR THE RG-512	4-3
4.2.1 ADM-3A Alpha Mode	4-3
4.2.2 Vector Mode	4-4
4.2.3 Point Mode	4-4
4.2.4 4010 Alpha Mode	4-4
4.2.5 Selective Erase	4-4
4.2.6 Status Readback	4-4
4.2.7 Hardcopy Provision	4-5
5. APPENDIX	
5.1 RG-512 CONTROL CODE SUMMARY	5-2
5.2 ASCII EQUIVALENTS FOR GRAPHICS COORDINATES	5-3
5.3 ASCII TABLE	5-5

1. INTRODUCTION

1.1 SCOPE

This User's Manual contains all the information necessary to install and operate the RG-512. The user should refer to Section 3 when installing the card. This section contains a detailed, step by step installation and checkout procedure. Performing the checkout procedure will insure that the RG-512 has been installed correctly and will acquaint the user with its features. A complete functional specification is contained in Section 4. This section should be referred to by programmers who are writing software for the RG-512. Section 2 is a summary of the performance specifications with a comparison of the Retro-Graphics equipped ADM-3A with other types of graphics computer terminals.

2. SPECIFICATIONS

2.1 GENERAL DESCRIPTION

The Retro-Graphics printed circuit card is designed to extend the data display capabilities of the Lear Siegler ADM-3A computer terminal. Quite often the relationship between data can be better expressed in the form of a graph, instead of the usual lists of numbers. Other applications may require the ability to display a drawing or diagram. Retro-Graphics is ideally suited to these types of display applications. Graphs and pictures can be readily generated using a powerful set of vector drawing and point plotting capabilities.

The RG-512 employs the "bit map" method of storing graphic images. This means the information is stored in a digital memory as a rectangular array of bits. Each bit in this memory is mapped onto the CRT screen and can cause a bright point to be displayed. The RG-512 displays graphs and pictures by writing the proper bits into the graphics memory. This architecture has several advantages over the traditional storage tube approach which has dominated lower cost graphics terminal designs. Since the CRT is not relied upon for storage of the image, less expensive CRT's employing more conventional long life, brighter phosphors can be used. Another important by-product is the ability to selectively erase portions of the screen. This is desirable if the application requires the use of dynamic displays employing motion or rotation to convey information.

The RG-512 is compatible with Tektronix Plot 10 software. This allows the RG-512 to be brought up on line in a matter of minutes since no software modification or interfacing is required.

The following specifications pertain to ADM-3A's equipped with the RG-512.

Maximum baud settings without handshaking:

Alphanumerics:

ADM-3A Alpha Mode	19200 baud
4010 Alpha Mode	4800 baud

Graphics:

Vector Mode	1200 baud*
Point Mode	9600 baud

Screen Clear Time: 160 ms

Operating Temperature Range: 41 to 100 °F

Power Consumption: 75 watts

*Full length vectors may be drawn continuously at 1200 baud. Refer to Section 4.2 for a complete description of vector drawing.

2.2 PHYSICAL PACKAGING

All circuitry for the RG-512 is packaged on a single 12" by 12.31" printed circuit card. This circuitry consists of four functional elements: Z-80A microprocessor and control, 128,000 bit graphics RAM, raster synchronization and CRT refresh, and power supply. Figure 2-1 illustrates the arrangement of this circuitry on the RG-512 printed circuit card.

An eight position DIP switch is located on the right hand side of the card. Switches 4 through 8 select the terminal's data transmission characteristics. See Table 2-1 for the switch assignments. Switches 1, 2, and 3 on the RG-512 DIP switch are used to select trailer codes and auto LF. Note that the trailer code switches are encoded.

The Z-80A microprocessor and control section performs command decoding and is responsible for the writing of information into the graphics RAM. The Z-80A automatically generates vectors from transmitted endpoints and also performs scaling and character generating functions.

The graphics RAM stores a bit map representation of the display screen. The contents of this memory are automatically displayed on the ADM-3A CRT. The writing of a zero bit into this memory by the Z-80A microprocessor results in a bright point being displayed at the corresponding point on the screen. This means that there is no limit to the number of flicker free points and vectors which may be displayed simultaneously. Information may also be selectively removed from the graphics RAM, providing an erase function. Section 4 contains a complete explanation of the writing and erasing of points and vectors.

The raster synchronization and CRT refresh section continuously accesses the graphics RAM in order to provide a rapidly refreshed image of the graphics data on the ADM-3A CRT. This access is synchronized with the ADM-3A video information so that text generated by the ADM-3A may be used to annotate the RG-512 graphics. Annotation may also be accomplished by the RG-512 via the 4010 Alpha Mode.

The power supply produces the necessary DC voltages to power the circuitry on the RG-512 card. The power supply uses only AC input voltages to avoid loading the ADM-3A DC power supplies. Conservative design of the RG-512 power supply insures correct operation of the RG-512 over the full range of line voltages normally encountered.

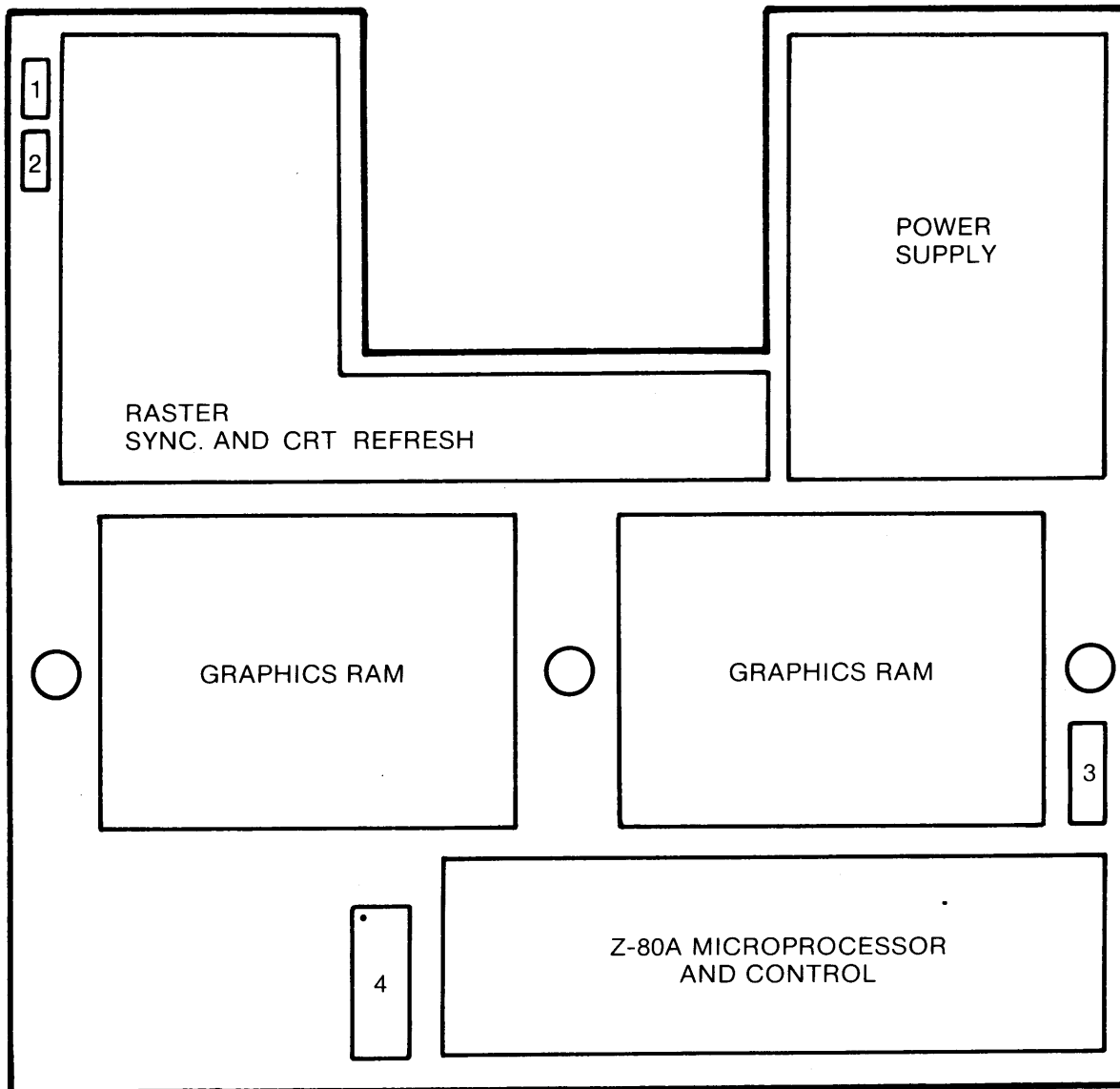

Figure 2-1: Circuit Locations on the RG-512 Card

1. Dot Oscillator Adjustment
2. Brightness
3. DIP Switch
4. UART Socket

Table 2-1: RG-512 Switch Settings

SWITCH	DESCRIPTION	ON	OFF
4	# STOP BITS	1	2
5	BIT 8	0	1
6	PARITY INHIBIT	—	INHIBIT
7	DATA LENGTH	7	8
8	PARITY	ODD	EVEN

S1	S2	TRAILER CODES
ON	ON	CR
OFF	ON	CR, ETX
ON	OFF	CR, EOT
OFF	OFF	NO TRAILER CODES

S3	SELECTION
ON	AUTO-NL
OFF	NO AUTO-NL

Figure 2-2: Retro-Graphics Electrical Interconnect

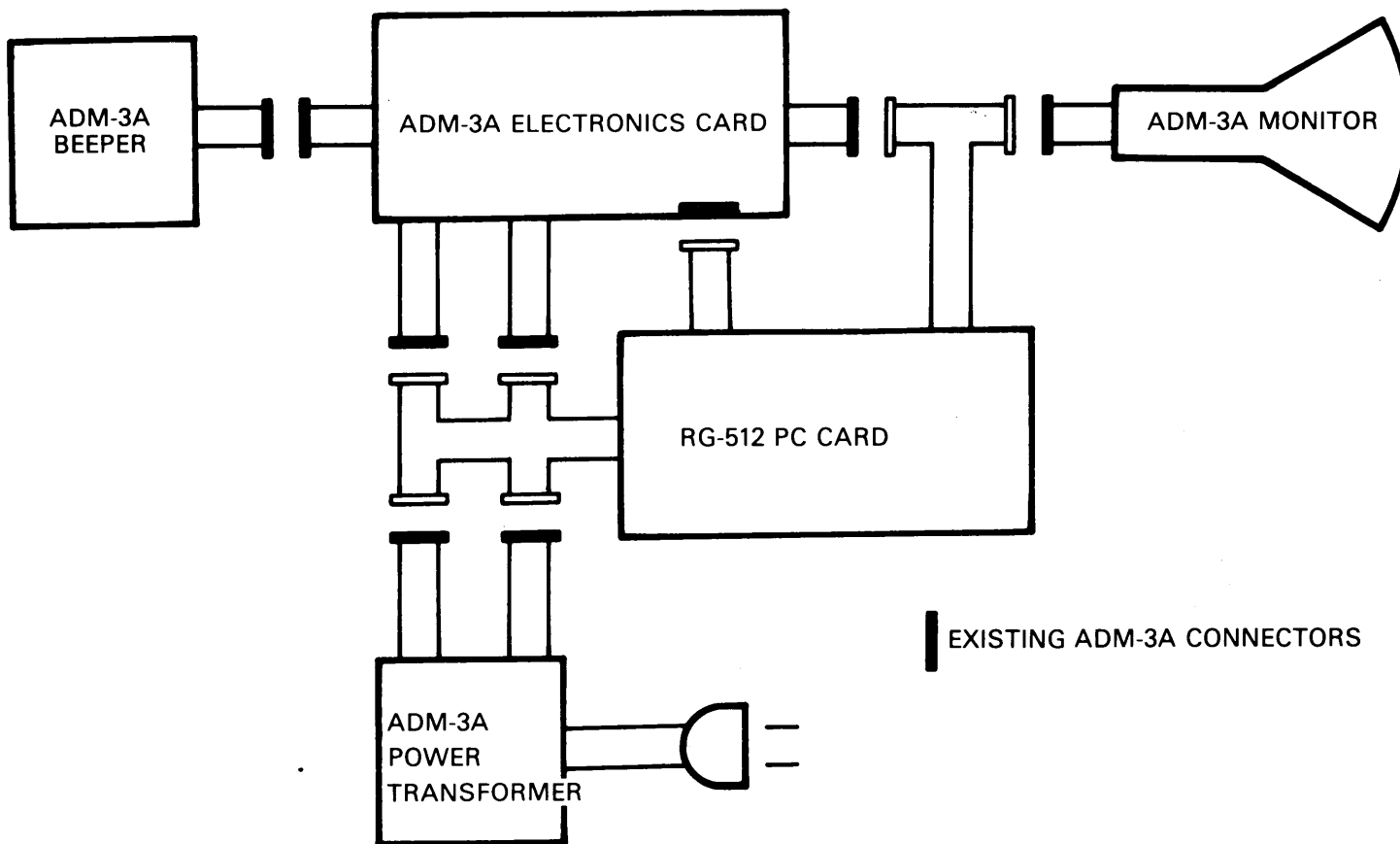

3. INSTALLATION AND CHECKOUT

3.1 UNPACKING THE SHIPPING CARTON

It is recommended that you save the shipping carton and other packing materials should you wish to transport or ship the RG-512 card.

The shipping carton contains the following:

- a. 1 RG-512 card with attached connectors
- b. 2 8" screens
- c. 1 1½" screen
- d. 4 mounting screws
- e. 1 User's Manual

The screens and mounting screws are located underneath the flap on the left side of the shipping carton.

Your RG-512 was thoroughly tested at the factory and delivered to the carrier in perfect operating condition. Carefully inspect the RG-512 for signs of damage during shipment. If damage or a shortage is discovered, request an immediate inspection by a local agent of the carrier. A written report of the agent's findings, with his signature, is necessary to support a claim. Claims must be filed by the customer, with exception to orders shipped by United Parcel Service (UPS). Digital Engineering Inc. will initiate a claim following an inspection by an agent of UPS. Should a claim become necessary, Digital Engineering Inc. will cooperate fully with the customer.

3.2 IDENTIFICATION OF CONNECTORS

The connectors and cables on the RG-512 have been designed to closely resemble the ADM-3A connectors and cables that they will be connected to in order to simplify the installation process. All connectors are polarized, preventing the chance of accidental misinsertion. Before making any connections, be certain that the number and colors of the wires correspond in the two connectors being connected.

Before attempting to install the RG-512, identify all cables and connectors as follows:

Remove the RG-512 card from its protective anti-static plastic pouch. Orient the card so that the large square cutout is at the top, the component side of the card up. A 40-conductor flat cable, terminated with a 40 pin DIP plug is attached at the lower left side of the card. This

cable is referred to as the Data cable in the installation procedure. The 40 pin DIP plug is inserted into a 40 pin DIP socket on the RG-512 in order to prevent damage to the pins during shipment. Leave the DIP plug in the socket until the card is actually installed.

A "T" shaped cable assembly is attached to the top edge of the card at the left. This cable is terminated in two 12-circuit nylon connector housings. One of these connectors will be connected to the ADM-3A electronics card, and the other is connected to the CRT. This cable is called the Video cable in the installation procedure.

Four cables exit from the top right. Each is terminated in a 5-circuit nylon connector housing. The two cables with three wires in them are referred to as the long and short 3-circuit AC power cables. The other two are the long and short 5-circuit AC power cables. The short AC power cables will be connected to the power transformer in the base of the terminal. The long ones connect to the ADM-3A electronics card.

Once the cables and connectors have been identified, the RG-512 may be installed.

3.3 INSTALLATION PROCEDURE

1. Unplug your ADM-3A and removed the two corner screws located underneath the keyboard. Fold back the top half of the terminal enclosure and unplug the four connections to the electronics card. Remove the electronics card.

2. Remove the baffle plates located on either side of the power transformer (Figure 3-1). Riveted baffle plates can be removed by simply pulling the baffle plates up. Then peel off the back strips and mount the screens to the edges of the three openings. Use a firm amount of pressure and check that the screens are securely mounted.

3. Route both transformer cables exactly as shown in Figure 3-2. Be sure the beeper wires are seated in the two slots provided near the speaker and that the cable is lain over the left side of the case as shown in Figure 3-2. Lay the Retro-Graphics card in the base of the ADM-3A enclosure so that it rests on the baffle plate mounting surfaces (see Figure 3-3). Mount it with the four mounting screws. Do not over-tighten.

4. Connect the short 3-circuit and 5-circuit AC power cables to the transformer cables. Push the connectors down below the level of the RG-512 card so they will not interfere with the ADM-3A main electronics card when it is reinstalled.

5. Remove the 40 pin DIP plug from the 40 DIP socket on the RG-512. Transfer the socketed UART from the electronics card (Figure 3-4) to the RG-512 card (Figure 2-1). Care must be taken when handling the UART since static electricity can damage it. Observe the location of pin 1 when installing the UART (notch in the DIP package) (see Figure 3-5).

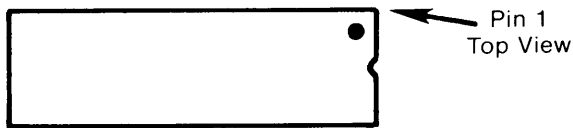

Figure 3-5: UART DIP Package Showing Pin 1 Location

6. Lay the Video cable and the long 5-circuit AC power cable over the rear edge of the terminal base. The long 3-circuit AC power cable should be routed behind the power transformer and laid over the rear edge of the base next to the Video cable at the left. Lay the Data cable over the left side.

7. Lay the ADM-3A electronics card back in the base, lining up with the guide pins. Working clockwise around the base, make the following connections to the electronics card: connect the beeper cable, the 3-circuit AC power cable, the Video cable, and the 5-circuit AC power cable. Then connect the monitor cable from the upper housing to the remaining plug on the Video cable. Install the 40 pin DIP plug into the vacated UART socket on the ADM-3A electronics card. Verify all connections by referring to Figure 3-4.

Clear Key Modification

The following modification to the ADM-3A electronics card is necessary if it is desired to have the keyboard clear key clear the graphics part of the display. Without this modification it is necessary to key in one of the control codes, such as CTRL Y, in order to clear the graphics. This procedure should be performed by a qualified service technician.

1. Isolate UART pin 21 by cutting the trace that connects to it on the solder side of the card.

2. Install a 30 AWG solid, insulated jumper wire from pin 3 of the IC located at D8 to pin 9 of the IC located at H6.

3. Install a 30 AWG solid, insulated jumper wire from pin 8 of the IC at H6 to pin 21 on the UART.

NOTES: The UART is the 40 pin integrated circuit. Jumper wires should be installed on the solder side of the card.

3.4 CHECKOUT

The following checkout procedure should be performed to insure that the RG-512 has been correctly installed. If the card was not installed correctly, it will be apparent almost immediately. In general, if the RG-512 performs the first few tests properly, it will be found to be in perfect working order.

The checkout procedure also serves to acquaint the user with the various features of the RG-512. The three main functions performed by the RG-512 are alphanumeric (via the ADM-3A or by its own character generation), vector drawing, and point plotting. The RG-512 performs one of these functions depending upon the operating mode. These modes are called the ADM-3A Alpha Mode, the Vector Mode, the Point Mode, and the 4010 Alpha Mode.

Throughout the checkout procedure it is necessary to key various ASCII codes into the terminal. The LC EN — UC front panel switch must be in the LC EN position so that the keyboard will generate the proper codes. Note that the symbol "a" means the unshifted A key. "A" means a SHIFT A should be typed. The "_" means type the unshifted RUB key.

3.4.1 ADM-3A ALPHA MODE

The ADM-3A Alpha Mode uses all the alphanumeric features of the ADM-3A terminal. This mode can be used for normal alphanumeric operation or used in conjunction with one of the graphics modes. Graphs and pictures can be labeled using the ADM-3A Alpha Mode since both graphics and alphanumeric data can be displayed on the screen.

Addendum: Clear Key Modification for ADM-3A+ Only

(Installation changes in reference to points 2 and 3 above)

2. Install a 30 AWG solid, insulated jumper wire from pin 3 of the IC located at D8 to pin 11 of the IC located at H6.

3. Install a 30 AWG solid, insulated jumper wire from pin 10 of the IC at H6 to pin 21 at the UART.

ADM-3A Alpha Mode Checkout

Disconnect the terminal from the modem or the computer before beginning the checkout procedure. Select the HDX (half duplex) setting of the terminal's HDX-FDX front panel switch and the LC EN (lower case enable) setting of the LC EN-UC front panel switch.

Step 1: Turn on the power. The RG-512 will enter the ADM-3A Alpha Mode on initial power up. Type any of the alphanumeric characters and note their appearance on the screen.

Step 2: Simultaneously press the SHIFT and CLEAR keys to clear the screen.

3.4.2 VECTOR MODE

The Vector Mode performs automatic vector generation from vector endpoints. The RG-512 uses 512 addressable points on the horizontal (x) axis and 250 addressable points on the vertical (y) axis. The RG-512 graphics grid is automatically scaled to the graphics grid used by Tektronix Plot 10 software (1024 by 780).

Vector Mode Checkout

Step 1: Simultaneously press the CTRL and] keys. This will cause the RG-512 to enter the Vector Mode.

Step 2: The RG-512 will draw a rectangle with diagonals when the following vector endpoints are entered from the keyboard.

space	\	space	@	[initialize to (0,0)]
8	k	space	@	[draw to (0,779)]
8	k	?	-	[draw to (1023,779)]
space	\	?	-	[draw to (1023,0)]
space	\	space	@	[draw to (0,0)]
8	k	?	-	[draw to (1023,779)]
space	\	?	-	[draw to (1023,0)]
8	k	space	@	[draw to (0,779)]

Step 3: The selective erase feature of the RG-512 can now be tested. Press the ESC key, then simultaneously press the SHIFT and RUB keys. This will set the data level to black. Repeat steps 1 and 2 above, and the vectors that compose the rectangle will be erased in the order in which they were drawn. Return the data level to white by pressing the ESC key and then pressing the "a" key.

Step 4: Alternately, the screen can be cleared by simultaneously pressing the CTRL and "y" keys.

3.4.3 POINT MODE

The Point Mode is similar to the Vector Mode except no vector generation occurs.

Point Mode Checkout

Step 1: Simultaneously press the CTRL and \ keys. This causes the RG-512 to enter the Point Mode.

Step 2: The RG-512 will plot points in the middle and corners of the screen when the following coordinates are entered from the keyboard.

#	d	#	D	[point at (100,100)]
4	j	#	D	[point at (100,650)]
4	j	<	D	[point at (900,650)]
#	d	<	D	[point at (900,100)]
,	f	0	@	[point at (512,390)]

Step 3: Simultaneously press the CTRL and y keys. This will clear the screen.

3.4.4 4010 ALPHA MODE

Step 1: Simultaneously press the CTRL and] keys, and press the RETURN key. This will cause the RG-512 to enter the 4010 Alpha Mode. Note the appearance of the blinking, underline 4010 Alpha Cursor.

Step 2: Enter any alphanumeric characters and note their appearance on the screen.

Step 3: Simultaneously press the CTRL and] keys. This will cause the RG-512 to enter the Vector Mode. Now enter the following characters: , f 0 @. The alpha cursor, although not visible, will automatically move to the center of the screen. Simultaneously press the CTRL and _ keys. This will cause the RG-512 to return to the 4010 Alpha Mode, and the cursor will appear. Enter an alphanumeric character, and it will appear at the center of the screen.

Step 4: Simultaneously press the CTRL and y keys. This will clear the screen.

CHECKOUT FOR THE ADM-3A + TERMINAL

The ADM-3A+ has two improvements that result in differences in the RG-512 checkout procedure. These differences are:

1. The ADM-3A+ has an upper/lower case keyboard and therefore does not have a Lower Case Enable Switch (LC EN). Reference to the LC EN switch should be replaced with "The Caps lock key on the ADM-3A+ keyboard must be in the unlocked position."
2. The ADM-3A+ has an unshifted rub key replacing the shifted rub key on the ADM-3A keyboard. Reference to "the unshifted rub key" should be replaced with "the shifted rub key," and reference to "the shifted rub key" should be replaced with "the unshifted rub key."

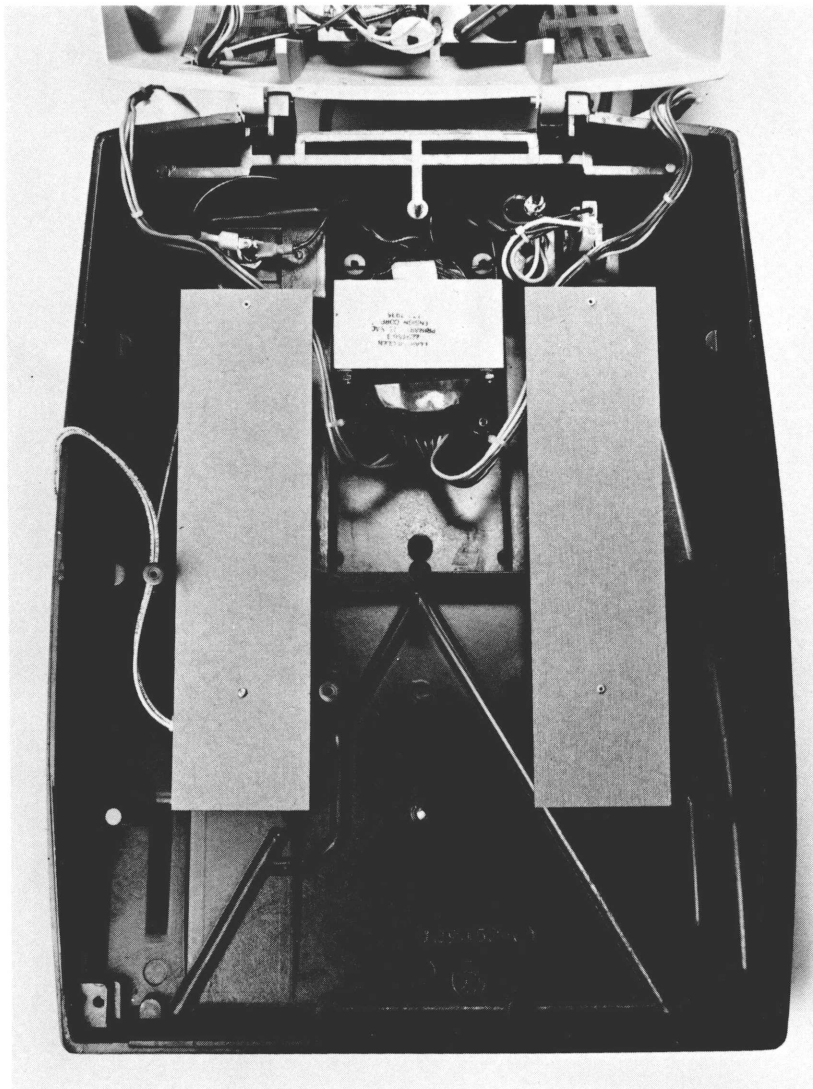

Figure 3-1

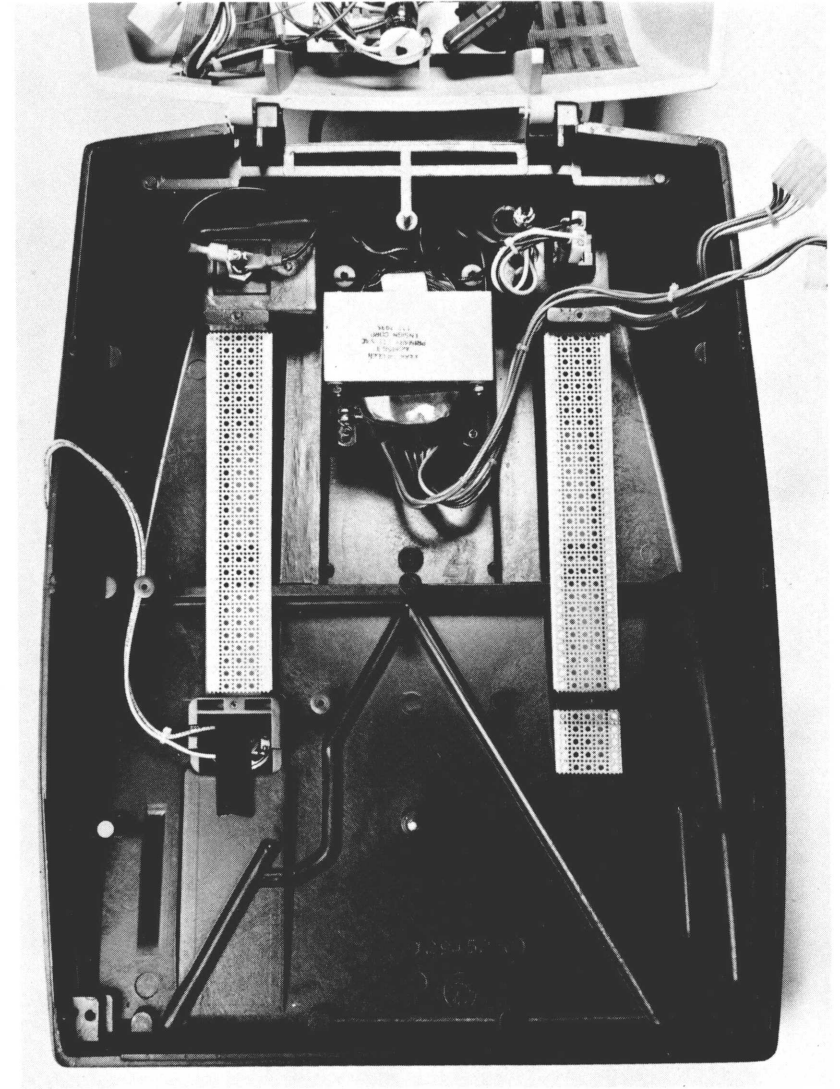

Figure 3-2

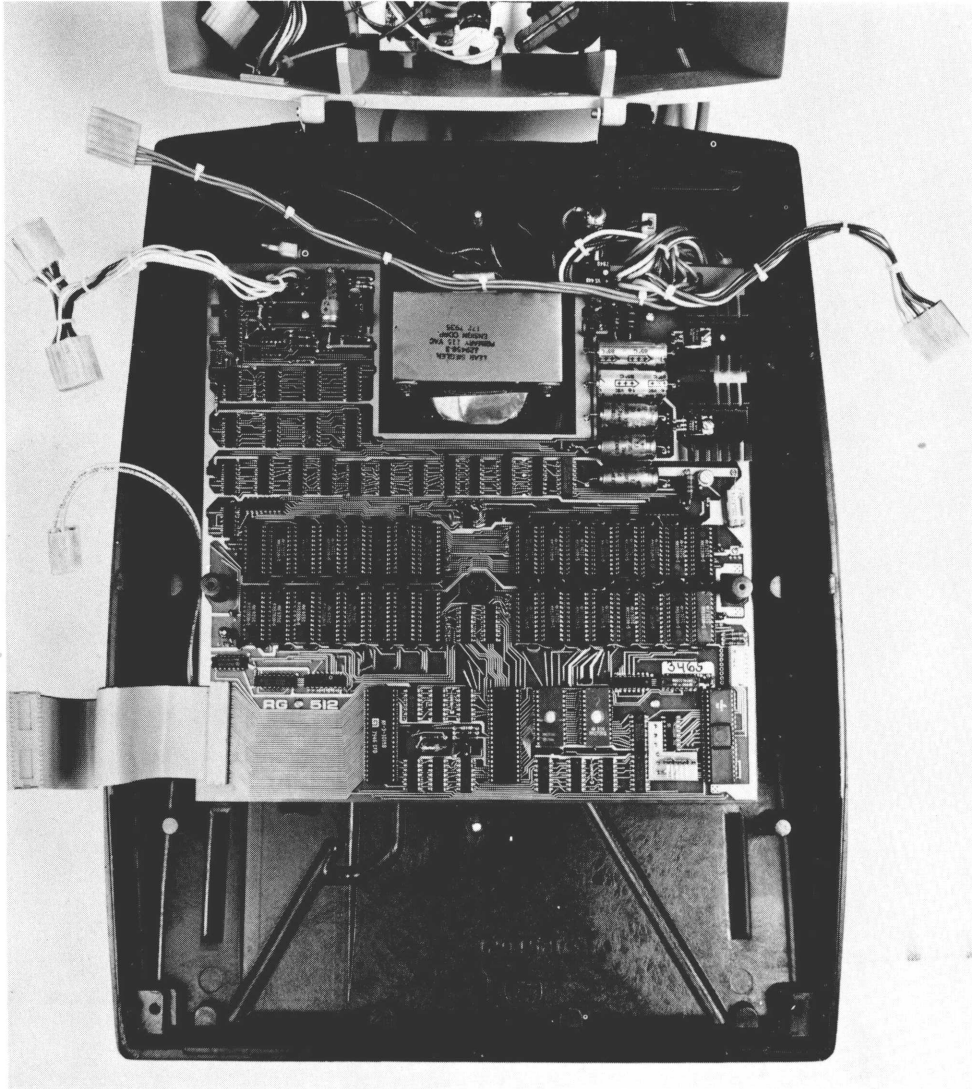

Figure 3-3

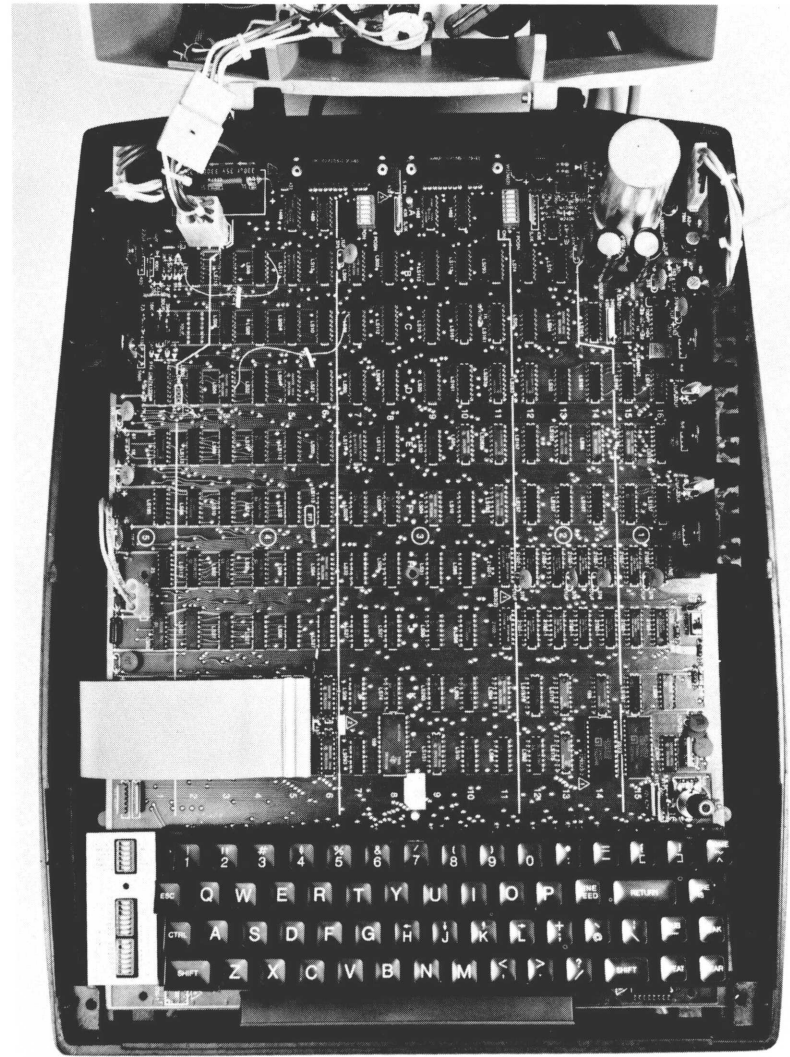

Figure 3-4

4. THE RETRO-GRAPHICS EQUIPPED ADM-3A

4.1 OPERATIONAL MODEL

The Operational Model section contains a description of the various functional blocks in the RG-512 equipped ADM-3A that the programmer can control via software.

4.1.1 FUNCTIONAL INTERCONNECT

The operation of the Retro-Graphics equipped ADM-3A can be best understood by considering the RG-512 card as the terminal controller and the ADM-3A as a "peripheral" device. The RG-512 is situated in series between the ADM-3A and the serial input to the terminal. This means that all incoming ASCII will be received by the RG-512 and processed. Input to the terminal will only reach the ADM-3A circuitry if it is transmitted there by the RG-512.

The RG-512 can perform several functions on the incoming data. The function performed depends on the actual ASCII code received and the RG-512 operating mode. Data may be retransmitted to the ADM-3A as mentioned above if the data were alphanumeric text. This is the usual function performed by the RG-512 when in the ADM-3A Alpha Mode. Certain control codes, called mode transition codes, can set the RG-512 to one of the two graphics modes, the Vector Mode or the Point Mode. An additional alphanumeric mode, the 4010 Alpha Mode, is included and can also be entered by sending the terminal the appropriate mode transition code.

After entering one of the graphics modes, subsequent input is interpreted as x-y coordinate data and is used in the generation of a point or vector display. The RG-512 does not retransmit an ASCII code to the ADM-3A if it is being used as an x-y coordinate.

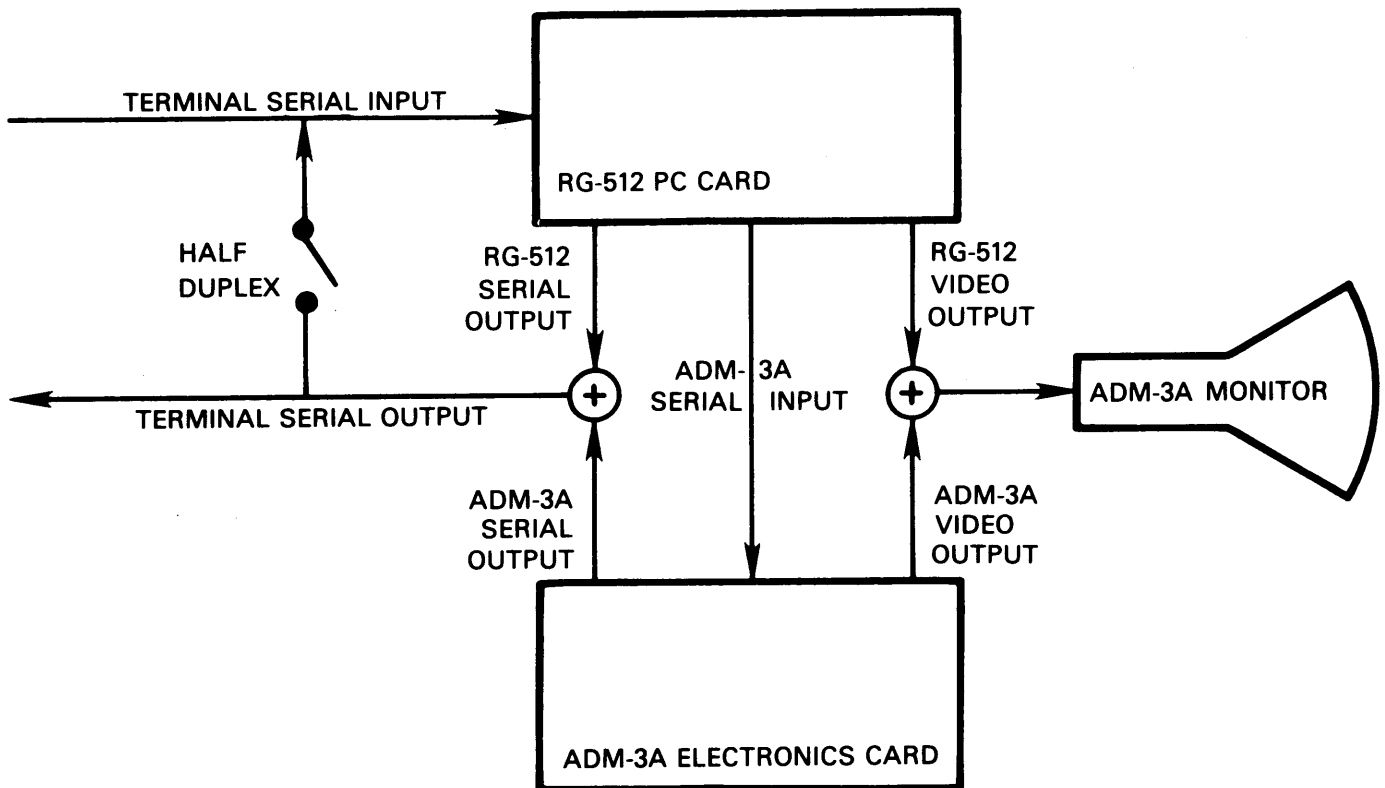

Figure 4-1: RG-512 Functional Block Diagram

If the RG-512 is in the 4010 Alpha Mode the incoming ASCII data is considered to be alphanumeric text and causes the RG-512 to perform its own character generation. This means text displayed in the 4010 Alpha Mode is written into the graphics RAM. The advantage of the 4010 Alpha Mode is that text may be written at any x-y location on the 512 by 250 plotting grid, permitting more precise labeling of graphs and pictures. This feature is required if the terminal is being used with Tektronix Plot 10 software.

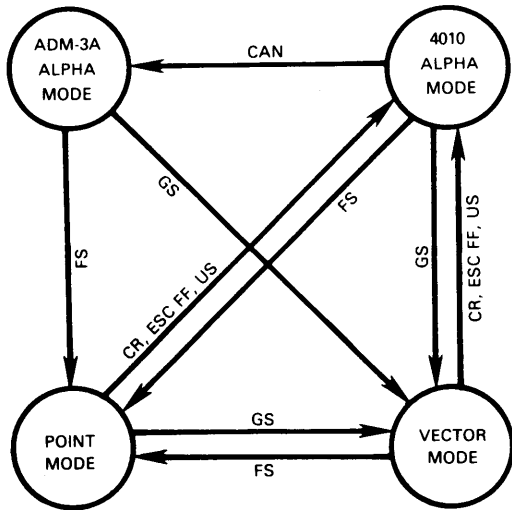

Figure 4-2: Mode Transition Diagram

Output from the terminal can originate from two sources: the ADM-3A keyboard or the RG-512 card. The RG-512 generates output in response to a status inquiry. Status should be checked when operating the terminal in the Vector Mode at 2400 baud or above or in the Point Mode at 19,200 baud. The RG-512 transmits status in response to a status inquiry only when it is ready to receive the next coordinate for vector drawing or point plotting. Handshaking techniques are further described in Section 4.2.6.

The RG-512 will also generate output if a graphics RAM readback is requested. The RG-512 responds by transmitting the contents of the specified row of the graphics RAM in a compressed hexadecimal format. Refer to Section 4.2.7 for a complete description of this feature.

All output sent from the terminal will be received back again through the terminal serial input, either as the result of echoing by the computer or modem or because the ADM-3A is in half duplex. One of these conditions must prevail if information typed on the ADM-3A keyboard is to appear on the CRT screen. This display of transmitted data must be bypassed if the source of the data was the RG-512 enters the "bypass" condition prior to transmitting any data. The bypass condition inhibits the display of received data. This causes the echoed status or readback information to be ignored. Bypass is automatically reset when the RG-512 receives a control code. Note that if a CR trailer code is selected, bypass will automatically reset after the status or readback transmission is completed as a result of the echoing of the CR trailer code.

In addition to entering the bypass condition, the RG-512 also locks the ADM-3A keyboard prior to all transmissions. This prevents the accidental or-ing of keyboard data with the data being transmitted. The RG-512 unlocks the keyboard whenever the bypass condition is reset.

The RG-512 graphics RAM contents are automatically displayed on the CRT screen by mixing it with the ADM-3A text. Because both components of the display (graphics from the RG-512 and alphanumeric from the ADM-3A) originate from separate memories, the entry of text onto plots is non-destructive. Text can be scrolled onto the screen without disturbing the graphics information.

4.1.2 GRAPHICS PLOTTING GRID

The principle feature of the RG-512 is its ability generate point or vector displays from a series of x-y coordinates received through the terminal serial input. This is accomplished by the Z-80A microprocessor which writes the desired point or vector onto the graphics plotting grid. The Z-80A can be caused to plot points or draw vectors by simply entering the appropriate mode (Point or Vector) and supplying the desired coordinates. The actual sequence of ASCII codes required to generate graphics displays are described in Sections 4.2.2 and 4.2.3.

The graphics plotting grid is a rectangular array measuring 512 horizontally by 250 vertically. A point may be plotted at any one of the 128,000 grid intersections, either by the user in the Point Mode, or by the Z-80A as it generates a vector in the Vector Mode from user specified endpoints. Because the graphics RAM contains one bit for each of the 128,000 grid intersections, there is no limit on the number of points which may be plotted in a particular display.

Plotting grid intersections are specified by their absolute coordinate (x from 0 to 511, y from 0 to 249) with the origin (x=0, y=0) at the lower left corner. However, the user may consider the plotting grid to measure 1024 by 780. The Z-80A microprocessor automatically scales the coordinate using the following relations: $x' = x/2$ and $y' = y(82/256)$ where x' and y' are the actual plotting grid intersection coordinates. This insures compatibility with Tektronix Plot 10 software.

Figure 4-3: Screen Format with Automatic Scaling

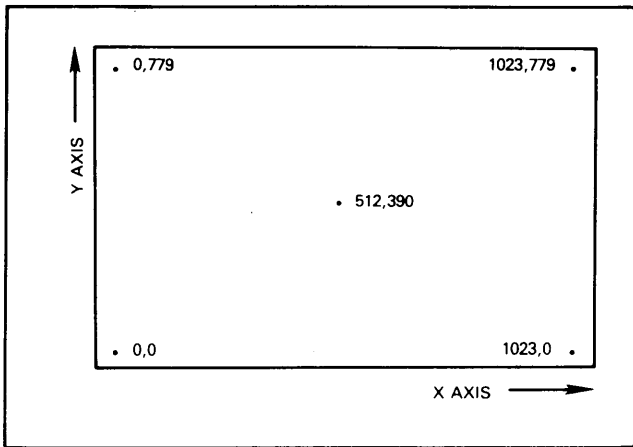

It is also possible to write a black point at a grid intersection. This feature permits the user to selectively erase portions of a graphics display, eliminating time consuming total erasures and redrawing. The writing of a black point or vector is accomplished by setting the graphics plotting grid "data level" to black. The data level setting determines the polarity of all information written onto the graphics plotting grid, including alphanumeric text generated by the RG-512 in the 4010 Alpha Mode. This allows the selective erase of text in addition to points and vectors. The graphics plotting grid can be completely cleared by sending the "clear screen" control code (see Appendix).

4.1.3 4010 ALPHA CURSOR

The RG-512 provides an additional cursor associated with the 4010 Alpha Mode. The 4010 Alpha Cursor controls the entry of text generated in the 4010 Alpha Mode onto the graphics plotting grid. The 4010 Alpha Cursor location can be determined at any time by reading status. The status readback feature includes the current 4010 Alpha Cursor position. Refer to Section 4.2.6 for a complete description of this feature.

The 4010 Alpha Cursor advances normally in response to the cursor control codes listed in the Control Code Summary (Appendix). An important property of the 4010 Alpha Cursor is that its position is always equal to the coordinate of the last grid intersection accessed in the Vector or Point Modes, unless it has been subsequently advanced by displaying text or by responding to a cursor control code. This feature permits the 4010 Alpha Cursor to be easily positioned at any grid intersection by simply entering the Vector Mode and sending the desired coordinate. Note that no vector drawing takes place until the second coordinate is transmitted, the 4010 Alpha Mode should be entered. Any subsequent text strings will be displayed starting at the specified coordinate.

The 4010 Alpha Cursor is displayed as a blinking underline on the CRT screen whenever the RG-512 is in the 4010 Alpha Mode.

4.2 PROGRAMMING FOR THE RG-512

This section contains the detailed descriptions of all the ASCII code sequences associated with the graphics and alphanumeric features of the RG-512. The section is organized into a series of discussions about the functioning of each RG-512 operating mode. Separate discussions of the selective erase feature, status readback, and the hardcopy provision are also included.

4.2.1 ADM-3A ALPHA MODE

The ADM-3A Alpha Mode is entered automatically on initial power up. The RG-512 simply retransmits all received ASCII information to the ADM-3A. Operation in the ADM-3A Alpha Mode is essentially the same as an unmodified ADM-3A. The ADM-3A Alpha Mode must be entered from the 4010 Alpha Mode via a CAN mode transition code.

The ADM-3A Alpha Mode can be used to label graphs and pictures. The cursor addressing feature of the ADM-3A is used to display an alphanumeric character near a particular graphics location. Refer to Table 4-1 which shows formulas for the conversion of graphics grid coordinates to ADM-3A cursor address row and column numbers.

GRAPHICS GRID COORDINATE	CHARACTER ADDRESS
X	$\left\lfloor \frac{X}{6.4} \right\rfloor = \text{COLUMN NUMBER}$
Y	$\left\lfloor \frac{Y-17}{9} \right\rfloor = \text{ROW NUMBER}$

Table 4-1: Equivalent Cursor Address

Alphanumerics data, including the ADM-3A Alpha Cursor, can be temporarily removed from the screen by turning the contrast knob at the upper right hand side of the keyboard. This may be desired when using the 4010 Alpha Mode.

4.2.2 VECTOR MODE

Upon receipt of a GS control code, the RG-512 will enter the Vector Mode. When in this mode, the RG-512 will automatically draw vectors from vector endpoint coordinates.

The first coordinate transmitted determines the initial point for vector drawing. Transmission of a second coordinate will cause a vector to be drawn between the two points. The previous coordinate becomes the starting point of the next vector, causing one vector to be drawn for each coordinate transmitted. A vector can be drawn that does not connect to the previous vectors by preceding the first endpoint with a GS control code. This will reinitialize the vector drawing sequence. See Figure 4-4.

In the case of a long vector, the time for the Z-80A to generate the series of points in the graphics RAM may exceed the transmission time of the vector coordinates if the terminal is operated at or above 2400 baud. This is especially true if the graph or picture being generated contains several long vectors. The RG-512 buffers input while it is drawing vectors so that a long vector can be drawn correctly at the higher baud settings if it is followed by enough short vectors to allow the Z-80A to "catch up." In general it is recommended that a handshake protocol using the status readback feature described in Section 4.2.6 be implemented for all vector drawing at or above 2400 baud, although many times it will be found that most graphs and pictures will plot correctly, especially at 2400 and 4800 baud, without the handshaking.

Figure 4-4: Vector Drawing Sequence

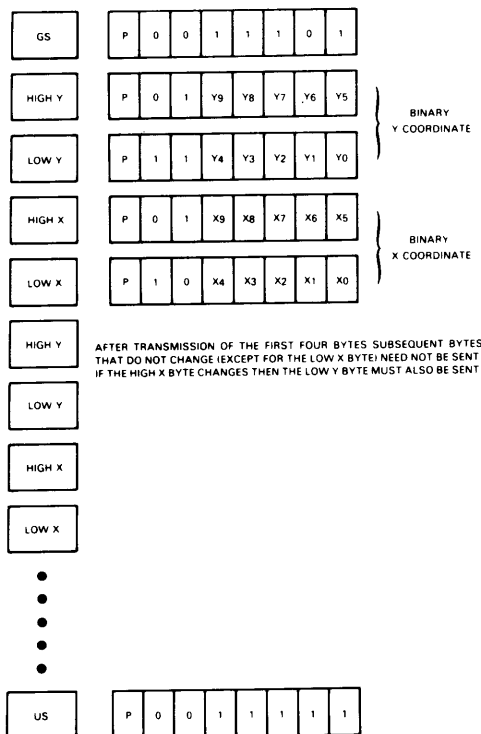

4.2.3 POINT MODE

The Point Mode allows individual points to be plotted on the display screen. An FS mode transition code causes the RG-512 to enter the Point Mode. The subsequent transmission of a series of coordinates will result in the display of those points on the CRT screen. The format for x-y coordinates is identical to that shown for vector drawing in Figure 4-4.

4.2.4 4010 ALPHA MODE

Alphanumeric characters can be written directly into the graphics RAM when in the 4010 Alpha Mode. Lower case characters received are mapped into upper case. The 4010 Alpha Mode uses the same 64 printing characters (including space) that are used by the Tektronix 4006 and 4010. 35 lines of 73 characters can be displayed when in the 4010 Alpha Mode.

A blinking underline cursor indicates the next writing location. The cursor will move to the last coordinate specified when in either the Vector or the Point Mode. A character can be written at any graphics grid location by using this capability.

The 4010 Alpha Mode incorporates the Margin 1 function for functional compatibility with the Plot 10 software. Margin 1 is automatically set when the 35th line of text is reached and the terminal receives a line feed. A second column of text can then be displayed on the right hand side of the screen.

A number of mode transition codes cause the RG-512 to enter the 4010 Alpha Mode. These are listed in the Control Code Summary Table (Appendix). In general any function that clears the screen or performs some initializing function leaves the terminal in the 4010 Alpha Mode. Note that entering the 4010 Alpha Mode will always set the data level to white.

4.2.5 SELECTIVE ERASE

The RG-512 has the capability to selectively erase characters (in the 4010 Alpha Mode), vectors, and points. An ESC followed by a DEL control code will set the data level to black. Rewriting the character, vector, or point will remove it from the graphics RAM. The data level can be reset to white with an ESC "a" or a carriage return. The data level is independent of graphics mode changes.

4.2.6 STATUS READBACK

The status readback feature is included primarily for handshaking during the vector drawing sequences at 2400 baud and above. Note that a ready bit is not included in the status byte since the byte is not sent until the RG-512 is in the "ready" condition. Handshaking should be implemented by sending the sequence ESC ENQ after a coordinate pair (4 byte sequence shown in Figure 4-4) and waiting until the RG-512 transmits the status byte before sending subsequent coordinates. It is generally not necessary to handshake after every coordinate pair since the RG-

512 FIFO buffers its input. The FIFO buffer is long enough to accommodate input strings with handshaking after every 20 to 22 coordinate pairs. The response to ESC ENQ is shown in Figure 4-5.

The RG-512 will also return operating mode information and the 4010 Alpha Cursor position in the status byte.

Figure 4-5: Response to ESC, ENQ

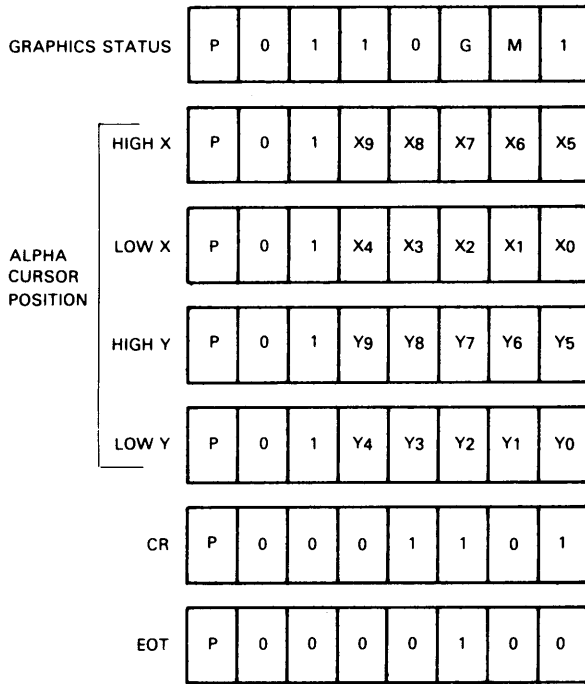

THE GRAPHICS STATUS BYTE IS RETURNED UPON COMPLETION OF THE VECTOR DRAWING SEQUENCE. CR AND EOT ARE SENT WHEN THE RESPECTIVE TRAILER CODE SWITCHES ARE SET. ADDITIONAL TRAILER CODE COMBINATIONS ARE CR, CR ETX AND NO TRAILER CODES.

Table 4-2: Status Bits

BIT	EXPLANATION
2	0 MEANS VECTOR OR POINT MODE, 1 MEANS 4010 ALPHA MODE
1	1 MEANS MARGIN 1

4.2.7 HARDCOPY PROVISION

The RG-512 can read back the graphics RAM to the computer for generation of hardcopy output. Upon receipt of an ESC followed by a DC1 control code and a half line address, the RG-512 will transmit the information contained in that half life. Figure 4-6 shows the graphics RAM half life addresses. A request for a graphics RAM readback is shown in Figure 4-7.

Figure 4-6: Graphics Memory Half Line Addresses

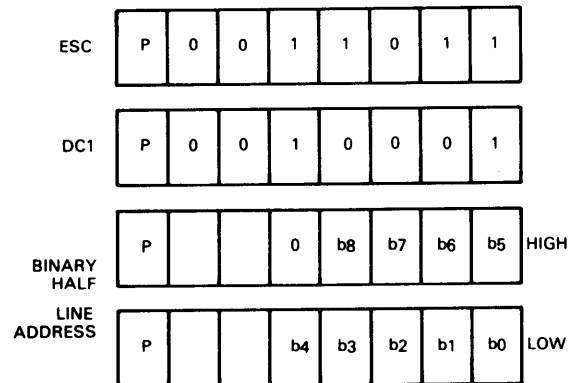
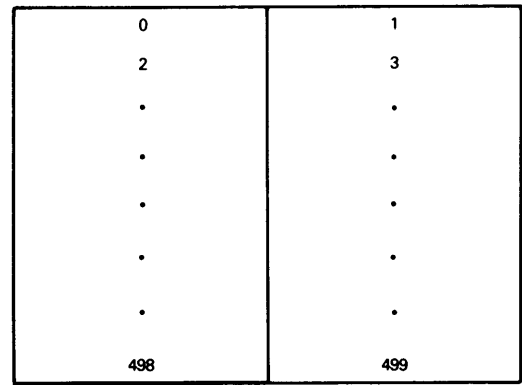
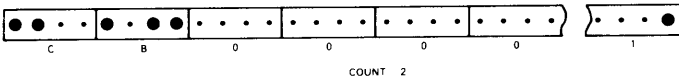

Figure 4-7: Request for Graphics RAM Readback

The RG-512 formats the graphics data in to hexadecimal before transmission to the computer. The equivalent packing efficiency is four bits per byte.

Data compression is used to reduce the time required to perform a graphics RAM readback. Sequences of zero bytes are transmitted as a # followed by a count. An example is shown in Figure 4-8.

Figure 4-8: Use of Graphics RAM Readback



RESPONSE TO ESC, DC1 WITH DATA COMPRESSION:

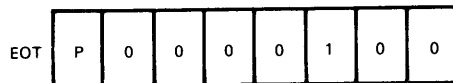
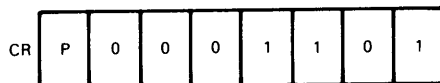
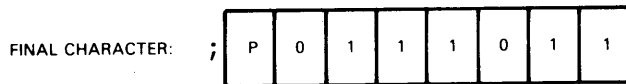
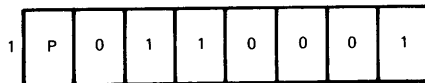
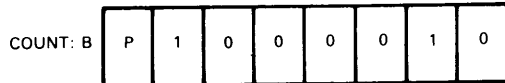
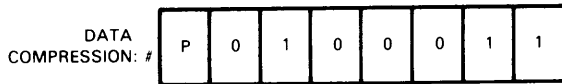
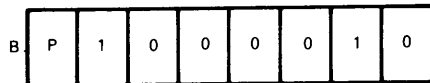
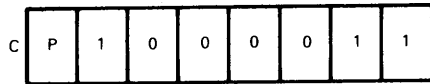
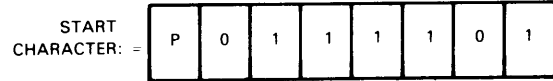

A "." SIGNIFIES THAT THE REMAINDER OF THE HALF LINE IS BLANK. A BLANK HALF LINE IS SENT AS "= ;". THE MOST SIGNIFICANT BIT OF THE COUNT BYTE IS SET TO 1.

5. APPENDIX

5.1 CONTROL CODE SUMMARY

NOP: No Effect

ASCII CODE	ADM-3A ALPHA MODE	4010 ALPHA MODE	VECTOR OR POINT MODE
BEL	Sounds Audible Tone	Sounds Audible Tone	Sounds Audible Tone
BS	ADM-3A Cursor Left	4010 Cursor Left, Cursor X = Cursor X-14	4010 Cursor Left, Cursor X = Cursor X-14
HT	NOP	4010 Cursor Right, Cursor X = Cursor X + 14	4010 Cursor Right, Cursor X = Cursor X + 14
LF	ADM-3A Cursor Down	4010 Cursor Down, Cursor Y = Cursor Y-22	4010 Cursor Down, Cursor Y = Cursor Y-22
VT	ADM-3A Cursor Up	4010 Cursor Up, Cursor Y = Cursor Y + 22	4010 Cursor Up, Cursor Y = Cursor Y + 22
FF	ADM-3A Cursor Right	NOP	NOP
CR	Carriage Return	Carriage Return, Set Data Level to White	Enter 4010 Alpha Mode. Carriage Return, Set Data Level to White
SO	Unlock Keyboard	NOP	NOP
SI	Lock Keyboard	NOP	NOP
CAN	NOP	Enter ADM-3A Alpha Mode	NOP
EM	NOP	Clear Graphics Memory, Set Data Level to White	Clear Graphics Memory, Set Data Level to White
SUB	Clear ADM-3A Alpha Memory	Clear ADM-3A Alpha Memory	Clear ADM-3A Alpha Memory
ESC,a	NOP	Set Data Level to White	Set Data Level to White
ESC, DEL	NOP	Set Data Level to Black	Set Data Level to Black
ESC, DC1	NOP	Read Back Graphics Memory	Read Back Graphics Memory
ESC, FF	NOP	Home 4010 and ADM-3A Cursors, Clear Graphics and ADM-3A Alpha Memories, Set Data Level to White	Enter 4010 Alpha Mode, Home 4010 and ADM-3A Cursors, Clear Graphics and ADM-3A Alpha Memories, Set Data Level to White
ESC, ENQ	NOP	Return 4010 Cursor Position, Return Status Information	Return 4010 Cursor Position, Return Status Information
ESC, =	Begin ADM-3A Cursor Address	NOP	NOP
FS	Enter Point Mode	Enter Point Mode	Enter Point Mode
GS	Enter Vector Mode	Enter Vector Mode	Enter Vector Mode
RS	Home ADM-3A Cursor	NOP	NOP
US	NOP	NOP	Enter 4010 Alpha Mode

5.2 ASCII EQUIVALENTS FOR GRAPHICS COORDINATES

The RG-512 receives graphics plotting information from the computer in four byte sequences. Each four byte sequence corresponds to an x, y graphics grid coordinate. A ten bit binary y coordinate is received in the first two bytes as HIGH and LOW order y. A ten bit binary x coordinate is received in the second two bytes as HIGH and LOW order x. Each byte contains two tag bits and thus encodes to an ASCII character. See Figure 5-1.

Figure 5-1: Four Byte ASCII Equivalent of a Graphics Grid Coordinate

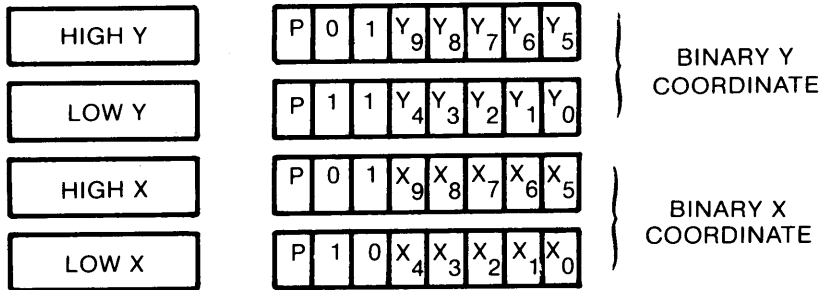

A graphics grid coordinate can be converted to its ASCII equivalent using the following procedure.

1. Divide the y coordinate by 32 to obtain a seven digit number. A whole number between 0 and 31 is to the left of the decimal and is referred to as NN. To the right of the decimal is a five digit remainder, referred to as .MMMMM.
2. Take the NN and find the HIGH Y ASCII equivalent in Table 5-1.
3. Multiply the .MMMMM by 32 and find the LOW Y ASCII equivalent in Table 5-3.
4. Repeat steps 1 through 3 for the x coordinate, using the appropriate tables.

x or y coordinate
32 = NN.MMMMM

Table 5-1

NN	HIGH X or Y
0	SP
1	!
2	"
3	#
4	\$
5	%
6	&
7	'
8	(
9)
10	*
11	+
12	,
13	-
14	.
15	/
16	0
17	1
18	2
19	3
20	4
21	5
22	6
23	7
24	8
25	9
26	:
27	;
28	<
29	=
30	>
31	?

Table 5-2

.MMMMMx32	LOW Y
0	`
1	a
2	b
3	c
4	d
5	e
6	f
7	g
8	h
9	i
10	j
11	k
12	l
13	m
14	n
15	o
16	p
17	q
18	r
19	s
20	t
21	u
22	v
23	w
24	x
25	y
26	z
27	{
28	
29	}
30	~
31	RUB

Table 5-3

.MMMMMx32	LOW X
0	@
1	A
2	B
3	C
4	D
5	E
6	F
7	G
8	H
9	I
10	J
11	K
12	L
13	M
14	N
15	O
16	P
17	Q
18	R
19	S
20	T
21	U
22	V
23	W
24	X
25	Y
26	Z
27	[
28	\
29]
30	^
31	←

5.3 ASCII TABLE

OCTAL	CHAR	OCTAL	CHAR	OCTAL	CHAR	OCTAL	CHAR
000	NUL (CTRL @)	040	SP	100	@	140	`
001	SOH (CTRL A)	041	!	101	A	141	a
002	STX (CTRL B)	042	"	102	B	142	b
003	ETX (CTRL C)	043	#	103	C	143	c
004	EOT (CTRL D)	044	\$	104	D	144	d
005	ENQ (CTRL E)	045	%	105	E	145	e
006	ACK (CTRL F)	046	&	106	F	146	f
007	BEL (CTRL G)	047	'	107	G	147	g
010	BS (CTRL H)	050	(110	H	150	h
011	HT (CTRL I)	051)	111	I	151	i
012	LF (CTRL J)	052	*	112	J	152	j
013	VT (CTRL K)	053	+	113	K	153	k
014	FF (CTRL L)	054	,	114	L	154	l
015	CR (CTRL M)	055	-	115	M	155	m
016	SO (CTRL N)	056	.	116	N	156	n
017	SI (CTRL O)	057	/	117	O	157	o
020	DLE (CTRL P)	060	0	120	P	160	p
021	DC1 (CTRL Q)	061	1	121	Q	161	q
022	DC2 (CTRL R)	062	2	122	R	162	r
023	DC3 (CTRL S)	063	3	123	S	163	s
024	DC4 (CTRL T)	064	4	124	T	164	t
025	NAK (CTRL U)	065	5	125	U	165	u
026	SYN (CTRL V)	066	6	126	V	166	v
027	ETB (CTRL W)	067	7	127	W	167	w
030	CAN (CTRL X)	070	8	130	X	170	x
031	EM (CTRL Y)	071	9	131	Y	171	y
032	SUB (CTRL Z)	072	:	132	Z	172	z
033	ESC (CTRL [)	073	;	133	[173	{
034	FS (CTRL \)	074	<	134	\	174	
035	GS (CTRL])	075	=	135]	175	~
036	RS (CTRL ^)	076	>	136	^	176	
037	US (CTRL ←)	077	?	137	←	177	DEL

IV. OPERATION

4.1 RG-512 Operation

Refer to the Retro-Graphics RG-512 User's Manual for operational instructions on the Retro-Graphics upgraded ADM-3A computer terminal.

4.2 X-12 Operation and Checkout

NOTE: During checkout the terminal must be off line and set to half duplex.

The cursor mode can be entered from either the 4010 alpha, vector, or point modes, e.g. holding the CTRL key down then typing] (GS) enters the vector mode. Typing ESC, then holding the CTRL key down and typing Z (SUB) will turn on the graphics cross-hair cursor. The cursor can be positioned on the terminal's screen with the cursor keypad. Typing any character from the terminal's keypad results in the transmission of that character followed by cursor x, y coordinates. The RG-512 will also exit the cursor mode and return to the previous operating mode.

When the cursor mode, receipt by the terminal of an ESC, CTRL E (ENQ) will result in the transmission of the cross-hair's x, y coordinate. See Figure 4-1.

CURSOR POSITION	HIGH X	P	O	I	X ₉	X ₈	X ₇	X ₆	X ₅
	LOW X	P	O	I	X ₄	X ₃	X ₂	X ₁	X ₀
	HIGH Y	P	O	I	Y ₉	Y ₈	Y ₇	Y ₆	Y ₅
	LOW Y	P	O	I	Y ₄	Y ₃	Y ₂	Y ₁	Y ₀

Figure 4-1: Response to ESC, ENG in cursor mode