

**VAX System Integrity
Monitor (VAXsim)
User Guide**

Order Number: AA-HY46A-TE

digital
software

VAX System Integrity Monitor (VAXsim) User Guide

Order Number: AA-HY46A-TE

September 1986

This document describes how to use the VAX System Integrity Monitor, an interactive error reporting tool.

Software Version: VAXsim Version 2.0

Operating System and Version: VAX/VMS Version 4.2 or later

**digital equipment corporation
maynard, massachusetts**

First Printing, September 1986

The information in this document is subject to change without notice and should not be construed as a commitment by Digital Equipment Corporation. Digital Equipment Corporation assumes no responsibility for any errors that may appear in this document.

The software described in this document is furnished under a license and may be used or copied only in accordance with the terms of such license.

No responsibility is assumed for the use or reliability of software on equipment that is not supplied by Digital Equipment Corporation or its affiliated companies.

Copyright ©1986 by Digital Equipment Corporation

All Rights Reserved.

Printed in U.S.A.

The postpaid READER'S COMMENTS form on the last page of this document requests the user's critical evaluation to assist in preparing future documentation.

The following are trademarks of Digital Equipment Corporation:

DEC	DIBOL	UNIBUS
DEC/CMS	EduSystem	VAX
DEC/MMS	IAS	VAXcluster
DECnet	MASSBUS	VMS
DECsystem-10	PDP	VT
DECSYSTEM-20	PDT	
DECUS	RSTS	
DECwriter	RSX	

digital

**HOW TO ORDER ADDITIONAL DOCUMENTATION
DIRECT MAIL ORDERS**

USA & PUERTO RICO*

Digital Equipment Corporation
P.O. Box CS2008
Nashua, New Hampshire
03061

CANADA

Digital Equipment
of Canada Ltd.
100 Herzberg Road
Kanata, Ontario K2K 2A6
Attn: Direct Order Desk

INTERNATIONAL

Digital Equipment Corporation
PSG Business Manager
c/o Digital's local subsidiary
or approved distributor

In Continental USA and Puerto Rico call 800-258-1710.

In New Hampshire, Alaska, and Hawaii call 603-884-6660.

In Canada call 800-267-6215.

* Any prepaid order from Puerto Rico must be placed with the local Digital subsidiary (809-754-7575).

Internal orders should be placed through the Software Distribution Center (SDC), Digital Equipment Corporation, Westminister, Massachusetts 01473.

CONTENTS

PREFACE	vii
SUMMARY OF TECHNICAL CHANGES	ix
CHAPTER 1	INTRODUCTION
1.1	LAYERS OF THE TREE STRUCTURE 1-3
1.2	VAXSIM BLOCK DIAGRAM 1-5
1.2.1	A Look at the Status Area 1-6
1.2.2	"Phantom" Blocks 1-7
1.3	LINE MODE DISPLAY LIST 1-8
1.4	SUMMARY MODE DISPLAY LIST 1-9
1.5	THE HISTOGRAM DISPLAY (ReGIS TERMINALS ONLY) . . . 1-9
CHAPTER 2	GENERAL USAGE
2.1	VAXsim COMMAND INTERFACE 2-1
2.1.1	Commands to Get You Started: a Brief Look . . . 2-2
2.1.2	Command Line Editor (CLE) 2-3
2.1.3	Intelligent Command Parser 2-4
2.1.4	Autocorrect Facility 2-4
2.1.5	VT200 Keypad Commands 2-5
2.1.6	Online HELP Facility 2-5
2.1.7	Multiple Command Format 2-5
2.1.8	Foreign Command Interface 2-6
2.2	LOGICAL NAMES 2-6
2.3	VAXsim Monitor START-UP 2-7
2.4	VAXsim MONITOR SHUT-DOWN 2-7
2.5	MANAGING YOUR DISPLAY DATABASE 2-8
2.5.1	Adding Nodes 2-8
2.5.2	Removing Nodes 2-9
2.5.3	Adding and Removing Devices 2-10
2.5.4	Updating the Database 2-10
2.5.5	Dynamic Display Mode 2-11
2.6	EXAMINING YOUR DISPLAY DATABASE 2-11
2.6.1	Moving Down (DOWN, ZOOM) 2-12
2.6.2	Moving Up (UP, TOP) 2-12
2.6.3	Moving Sideways (NEXT, BACK) 2-13
2.6.4	Viewing Oversized Screen Displays (RIGHT, LEFT) 2-14
2.7	VISUAL ERROR STATUS INDICATORS 2-16
2.8	TIME COMMANDS (SINCE, BEFORE) 2-17
2.8.1	Absolute Time 2-18
2.8.2	Delta Time 2-19
2.8.3	Notes on VAX/VMS Date/Time Specifications . . 2-20
2.9	ADJUSTING THE CURRENT EVALUATION PERIOD 2-21
2.9.1	Absolute Start and Absolute End Times 2-21
2.9.2	Delta Start and Absolute End Times 2-22
2.9.3	Absolute Start and Delta End Times 2-22
2.9.4	Delta Start and Delta End Times 2-23
2.10	SHOW COMMANDS 2-24
2.10.1	SHOW MODE Command 2-25
2.10.2	SHOW MESSAGE Command 2-25
2.10.3	SHOW PARAMETERS Command 2-25
2.10.4	SHOW VERSION Command 2-25
2.11	RELATIONSHIPS AMONG THE DISPLAY MODES 2-26
2.12	NOTIFY COMMAND 2-28
2.12.1	NOTIFY/ENABLE = list 2-29
2.12.2	NOTIFY/DISABLE = list 2-29
2.13	SPAWN COMMAND 2-30

CHAPTER 3	TECHNICAL NOTES	
3.1	HOW VAXsim ORGANIZES SYSTEM ERRORS	3-1
3.1.1	Device Errors	3-1
3.1.2	Memory Errors	3-2
3.1.3	Events	3-2
3.2	ERROR RATE EVALUATION	3-2
3.2.1	Error Rate Evaluation Algorithm	3-3
3.3	CLIPPING FUNCTION	3-4
3.4	THE MARGIN IN ERROR EVALUATION	3-6
3.5	VAXSIM SOFTWARE COMPONENTS	3-7

CHAPTER 4	VAXSIM COMMANDS REFERENCE SECTION	
4.1	DISPLAY COMMANDS	4-2
4.2	DIRECTIONAL COMMANDS	4-3
4.3	SPECIAL COMMANDS	4-4
4.4	TIME COMMANDS	4-5
4.5	ALPHABETIC SUMMARY	4-5
4.5.1	ADD Command	4-6
4.5.2	AUTOCORRECT Command	4-7
4.5.3	BACK Command	4-8
4.5.4	BEFORE Command	4-9
4.5.5	CLIPPING Command	4-11
4.5.6	CYCLE Command	4-12
4.5.7	DEPTH Command	4-13
4.5.8	DISPLAY Command	4-14
4.5.9	DOWN Command	4-15
4.5.10	EXIT Command	4-16
4.5.11	HELP Command	4-17
4.5.12	LEFT Command	4-18
4.5.13	MARGIN Command	4-19
4.5.14	NEXT Command	4-21
4.5.15	NOTIFY Command	4-22
4.5.16	PRINT Command	4-23
4.5.17	REGIS Command	4-24
4.5.18	REMOVE Command	4-25
4.5.19	REPORT Command	4-26
4.5.20	RIGHT Command	4-27
4.5.21	SHOW MESSAGE Command	4-28
4.5.22	SHOW MODE Command	4-29
4.5.23	SHOW PARAMETERS Command	4-30
4.5.24	SHOW VERSION Command	4-31
4.5.25	SHUTDOWN Command	4-32
4.5.26	SINCE Command	4-33
4.5.27	SPAWN Command	4-34
4.5.28	TOP Command	4-35
4.5.29	UP Command	4-36
4.5.30	UPDATE Command	4-37
4.5.31	WATCH Command	4-38
4.5.32	ZOOM Command	4-39

APPENDIX A	VAXSIM ERROR MESSAGES	
A.1	ERROR MESSAGE FORMAT	A-1
A.2	ERROR MESSAGES	A-2

APPENDIX B	TERMINAL AND PRINTER OPTIONS	
B.1	TERMINAL OPTIONS	B-1
B.1.1	VT52 Option	B-1

B.1.2	VAXsim Hardcopy Option	B-1
B.1.3	ReGIS Color Display Option	B-1
B.2	GRAPHIC PRINTER OPTION	B-2

APPENDIX C GLOSSARY

INDEX

EXAMPLES

2-1	Multiple Command Format	2-5
2-2	Absolute Time Format	2-19
2-3	Delta Time Format	2-20

FIGURES

1-1	The Relationship Between VAXsim and VMS	1-2
1-2	VAXsim Tree Hierarchy	1-4
1-3	VAXsim Block Diagram	1-6
1-4	HAMLET Screen Display	1-6
1-5	A Phantom Block	1-8
1-6	HAMLET Line Mode Display	1-8
1-7	Summary Mode Display	1-9
1-8	The Histogram Display: An Example	1-10
2-1	Adding Nodes Display	2-9
2-2	Removing Nodes Display	2-10
2-3	DOWN/ZOOM Command Illustration	2-12
2-4	UP/TOP Command Illustration	2-13
2-5	NEXT/BACK Command Illustration	2-14
2-6	Oversized Screen Display	2-15
2-7	RIGHT Command Illustration	2-15
2-8	Absolute Start and Absolute End Times Illustration	2-21
2-9	Delta Start and Absolute End Times Illustration	2-22
2-10	Absolute Start and Delta End Times Illustration	2-22
2-11	Evaluation of Entire Database Illustration	2-23
2-12	Delta Start and Delta End Times Illustration	2-24
2-13	Delta Time Illustration	2-24
2-14	Relationship of the Three Display Modes	2-27
3-1	Error Rate Evaluation Without Clipping	3-5
3-2	Error Rate Evaluation With Clipping	3-6

TABLES

1	Summary of Version 2.0 Changes	xi
2-1	Introductory VAXsim Commands	2-2
2-2	Command Line Editor Keys	2-4
2-3	Visual Error Status Indicators	2-16
2-4	Default Operator Class Names	2-29
3-1	VAXsim Error Indication Computations	3-7
4-1	Display Commands	4-2
4-2	Directional Commands	4-3
4-3	Special Commands	4-4
4-4	Time Commands	4-5

PREFACE

MANUAL OBJECTIVES

The VAX System Integrity Monitor (VAXsim) User Guide has the following objectives:

- To give the system manager an understanding of how VAXsim can be used to observe system-wide error conditions and pinpoint their source.
- To provide procedural information and overall guidelines through the General Usage section.
- To provide in-depth information through the Technical Notes and Commands Reference sections.

INTENDED AUDIENCE

This manual is intended for VAX/VMS system managers; that is, those responsible for the overall control and management of the operations of a computer system for the benefit of the users of the system.

STRUCTURE OF THIS DOCUMENT

This manual has four chapters:

Chapter 1, Introduction, introduces the user to VAXsim by describing its basic operation, and the types of display modes offered.

Chapter 2, General Usage, describes the main functions of VAXsim and the command actions in detail, including the command interface, management and examination of the database, visual error indications, and using commands that require evaluation period specifications.

Chapter 3, Technical Notes, details VAXsim's technical aspects. Among the topics discussed are VAXsim's method of organizing system errors, error rate evaluation, thresholds, and margins.

Chapter 4, the Commands Reference Section, provides tables grouping commands by function. Following the tables, the commands are listed alphabetically with guidelines for syntax and use.

The appendices include VAXsim Error Messages, Terminal/Printer options notes, and a Glossary of Terms. Experienced VAXsim users should first read the Summary of Technical Changes following this Preface to find out about major changes in this version.

ASSOCIATED DOCUMENTS

For users new to VAXsim, the tutorial manual Getting Started with VAXsim provides an extensive, interactive exercise in using the program.

For more detailed information on VAX/VMS, refer to the current VAX/VMS document set.

VAXsim Commands

The VAXsim user interface includes commands that allow the user to control and manipulate a VAXsim session. These commands fall into four broad categories:

1. Display Commands - Alter your display database by adding or removing nodes, and select graphic display modes
2. Directional Commands - Allow for movement within the VAXsim Tree Structure: up, down, left, and right.
3. Special Commands - Control special functions, such as printing
4. Time Commands - Determine the size and location of the evaluation period: from June 1 to June 5, for example.

CONVENTIONS

The following conventions are used throughout this manual:

- [] Indicates that the enclosed item is optional.
- <RETURN> Press the RETURN key to terminate command lines.
- CTRL/n Press the CTRL key and the letter key together. CTRL/Z means to press the CTRL key and Z.
- \$ Indicates VMS command level, DCL.
- . Indicates that part of an example is not shown.
- VAXsim> Indicates that you are in the VAXsim program. Information that you enter is preceded by this prompt.
- Red type Indicates user input; enter red text in capital letters, such as DISPLAY LINE, exactly as shown. Lowercase, red text indicates information you must supply, such as ADD nodename_list, where nodename_list is the list of nodes you want to add.

All examples in this document assume a VT100-compatible terminal with Advanced Video Option (AVO), and, in the case of the Histogram display mode, a ReGIS (Remote Graphics Instruction Set) terminal. Other options are described in Appendix B.

VAXsim is fully supported on all VAX processors.

SUMMARY OF TECHNICAL CHANGES

VAXsim Version 2.0 contains many new features and changes that will make the tool easier to use and understand. These changes from Version 1.1 are listed below.

General changes:

- VAXsim now requires VMS Version 4.2 or greater.
- All file names (except for the executable image) have changed to better reflect their functions.
- VAXsim now supports all VAX processors, from the MicroVAX to the largest VAX.
- On a VAXcluster, a single globally-accessible database is used.

Changes to the Display are:

- A dedicated status display has been added that shows pertinent information at all times. This information is useful to the user to better interpret the information on the display screen.
- The command input area has been moved to the top of the display. This change allows more flexibility for displaying information and corresponds to formats of other Digital applications.
- ReGIS is off by default, even though the terminal may support ReGIS. This provides a much faster information flow. Note that to turn on the ReGIS support, the command is REGIS ON versus the V1.1 COLOR ON command.
- VAXsim has been modified to take full advantage of VAXcluster configurations. The top level display will now give the VAXcluster name (VAX/VMS V4.4 or later) instead of individual system names. Consequently, all display levels are simplified. For example, the DISK box now contains all VAXcluster disks regardless of physical connection. This makes it easier to zero in on problems without regard to physical architecture.
- There are two new display modes for viewing the information in the VAXsim database. Consequently, the CHANGE command for toggling between displays has changed for easier access to the desired display. The new command to switch between display modes is:

DISPLAY BOX	for the original-version VAXsim display
DISPLAY LINE	for the original-version line mode display
DISPLAY HISTOGRAM	for a new graphic historical display
DISPLAY SUMMARY	for a new summary of warning/alarm conditions

- Box mode display has changed in the following ways:
 - The number in the display that gave the historical average is no longer present, since its meaning was ambiguous at the higher levels. The single number in the box is now the actual error count, and the severity is (as before) indicated by the attributes of the box.

At the error classification level, both numbers are present. Here, the first number is the actual error count, and the second is the actual threshold. These numbers show how far from a warning or alarm condition the device is.
 - On an oversized display, the "more" indicates how many boxes are outside the display. Therefore, this number is directly related to the box numbers themselves.
 - Box numbers now start at 1 instead of 0.
- Histogram is a graphic method of looking at error counts over time. It requires a ReGIS terminal (ReGIS will automatically be turned on for this display) and shows, in bar-chart format, error counts over time. It provides a method of viewing past performance versus current error counts.
- Summary is a single display that shows only devices that are in a warning or alarm condition. It is a means of viewing systems status from one display. It can be triggered via the normal user interface or via the foreign command interface.
- The Attributes box has been renamed to Node_Info. For a VAXcluster, this information includes compute nodes and HSCs.

Changes to the user interface are the following:

- The applications keypad on the LK201 keyboard may be used for single keystroke commands.
- Mistyped commands that are correctable by the intelligent command parser may be autocorrected. That is, for certain commands the (Correct?) prompt is not issued. Autocorrection is an optional feature and is turned off by default.

Other changes follow:

- You may now be notified of a warning or alarm condition via VMS electronic mail. A user modifiable command procedure allows a flexible mechanism for notification. The OPCOM notification of the past version is still in place and operates in conjunction with the mail notification.
- VAXsim now contains an editor function that is used as an operations tool. This mechanism may be used to purge the database of obsolete records.

The following table summarizes changes between Version 1.1 and Version 2.0 VAXsim commands.

Table 1: Summary of Version 2.0 Changes

Command	Nature of Changes
ADD	Nodenames now separated by commas rather than spaces.
AUTOCORRECT ON/OFF	New command; enables or disables autocorrection facility, which recognizes mistyped commands and either executes intended commands or first asks you for confirmation.
BACK	"Wraps around" from Branch #1 to highest-numbered branch in the current level.
BEFORE	Accepts TODAY and YESTERDAY arguments.
CHANGE	Eliminated from V2.0; replaced by DISPLAY with additional qualifiers for alternate display modes.
DISPLAY	New qualifiers specify alternate display modes: LINE, SUMMARY, and (ReGIS terminals only) HISTOGRAM. Line Mode is default for hardcopy terminals.
NEXT	"Wraps around" from highest-numbered branch to Branch #1 in current level.
REMOVE	Nodenames now separated by commas rather than spaces.
RIGHT and LEFT	Used alone, shift display by one whole screen; used with offset, shift display by specified number of boxes.
SHOW MESSAGE	New command. Displays most recent broadcast message in VAXsim Status Area.
SHOW MODE	New command. Displays current mode and status of Autocorrection, ReGIS, and Clipping features.
SHOW PARAMETERS	Displays evaluation period and other parameters that affect the display.
REGIS	Formerly COLOR.
SINCE	Accepts TODAY and YESTERDAY arguments.

CHAPTER 1

INTRODUCTION

VAXsim, the VAX System Integrity Monitor, is a tool that allows users to monitor the condition of their VAX systems, whether the systems are stand-alone, clustered, or networked. VAXsim provides easy access to most of the information sent to the VMS system error log. However, unlike the VMS error log, VAXsim information is immediately available.

VAXsim is a layered product. It taps into the VMS error logging system so that errors recorded by VMS are sent to VAXsim as well. VAXsim examines these errors (filtering out some extraneous errors) and builds a database of information for each device on which an error has been logged. VAXsim uses this database to create its screen display.

VAXsim thus differs in operation and function from the VAX/VMS ANALYZE/ERROR_LOG command in the following ways. The Analyze Error Log utility, activated by this command, reports on errors after the fact, and does not continually monitor the ERREFMT process as VAXsim does. For additional comparison, see Figure 1-1.

Similarly, VAXsim differs from the VAX/VMS command SHOW ERROR in that it offers historical information about VAXcluster-wide error counts. Furthermore, VAXsim allows the user to determine and adjust the historical error evaluation periods, and also represents devices and system levels fully.

Other important differences between VAXsim and these DCL commands lie in VAXsim's retention of its error database regardless of system shutdown, and in VAXsim's graphic display modes, which are described in this chapter.

Finally, VAXsim, unlike the SHOW and ANALYZE functions, is intended as a high-level, or general, error examination tool. That is, it should prove useful at identifying problem areas of the system, and discovering and tracking overall error trends. It can be used in conjunction with these DCL commands for finding and closely examining error conditions across the system and over time.

INTRODUCTION

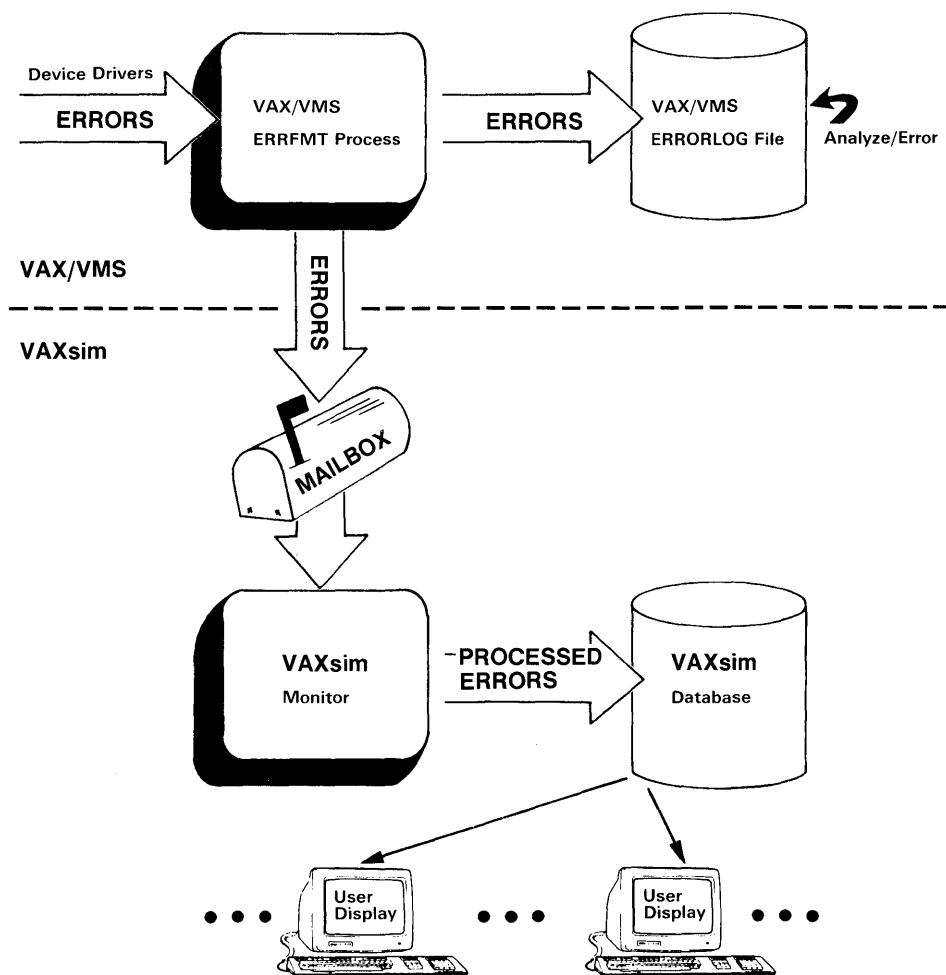

MR-S-4513-86

Figure 1-1: The Relationship Between VAXsim and VMS

VAXsim consists of two major functions: a Monitor process and a Display function.

VAXsim_Monitor, a detached system process on each node, obtains and accumulates new error and event information. The VAXsim_Monitor attaches itself directly to the VMS ERRFMT process using a mailbox interface. The monitor is the active part of VAXsim; specifically, it remains in a hibernation state until it is needed to process and update information from the system error log. When an error is detected, VAXsim_Monitor immediately updates its historical database.

Figure 1-1 shows the importance of the Monitor in tracking and recording system errors and in building the database.

Specifically, the Monitor looks at each record as it is written to the VMS error log (ERRLOG.SYS), filters out extraneous entries, and extracts the information it needs. VAXsim database information includes device name, device class, error type (hard, soft, informational, or media), an error summary code, the count, and the local time. The VAXsim_Monitor is the only process writing information to the historical database file.

INTRODUCTION

While the Monitor is normally "invisible" to you the user, it is the part of VAXsim that performs the work of recording error conditions and maintaining the database. VAXsim_Monitor, however, becomes "visible" when it signals you--through OPCOM, MAIL, or otherwise--that a warning condition is present.

Once the VAXsim_Monitor has informed you, through OPCOM, of such a warning condition, you can call the other, visible part of VAXsim: the Display function. Of course, it is possible to call a VAXsim display without having been alerted by the Monitor. However, it is assumed that most system managers will use the displays when a warning condition has been indicated.

The Display function provides displays of the following formats, each of which has its own specific uses, and tends to be associated with a terminal type:

1. **Box Mode:** The display database is arranged in a five-level tree structure whose branches, or boxes, represent levels and units. The upper levels contain node and subsystem information. The lower levels contain more detailed information, including events, error messages, and counts. This mode is the default for all video terminals.
2. **Line Mode:** The database is presented as a list, or textual summary at several levels. This mode is the default for all hardcopy terminals.
3. **Summary Mode:** Brief summaries of any Warning or Alarm messages are presented at several levels.
4. **Histogram:** The database is presented as bar charts showing error trends over time at several levels. Each bar represents a time period. Histograms can be viewed only on ReGIS (Remote Graphics Instruction Set) terminals.

The Display function enables you to work interactively with the VAXsim historical database. Any number of interactive VAXsim display sessions can be active simultaneously, independent of one another. VAXsim uses information from an historical database file to build a display database in memory. These historical files can be located on any node in a cluster or network running the VAXsim_Monitor process.

Interactive sessions affect only the display database; the historical database remains intact. Using VAXsim commands, you can perform a number of activities, such as displaying and printing error logging activity, updating the display database, and manipulating the (error) evaluation period. VAXsim is fully supported on all VAX and MicroVAX systems.

1.1 LAYERS OF THE TREE STRUCTURE

VAXsim employs a tree structure design composed of five hierarchical levels as shown in Figure 1-2

INTRODUCTION

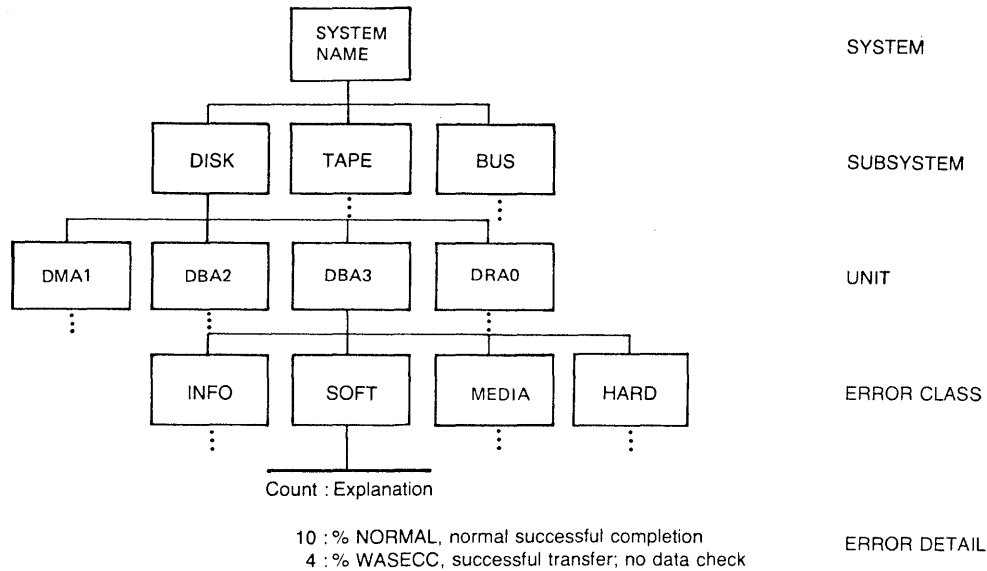

Figure 1-2: VAXsim Tree Hierarchy

A description of each level follows.

1. System Level - Provides an overview of all nodes (systems) currently in the display database. (In VAX/VMS Version 4.4 VAXcluster systems, a VAXcluster name appears at this level.)
2. Subsystem Level - Provides information about the subsystems within a particular node.
3. Unit Level - Provides information on each device in the configuration.

In a VAXcluster configuration, every system component that has had error log activity will be recognized by VAXsim and will be shown in any unit level display.

Clusterwide-available disks, therefore, will be displayed by default--even though all VAX nodes in the VAXcluster system have not been included in the display database. Note also that in many VAXcluster configurations the presence of so many devices will make the Box Mode display larger than the screen display format; thus, the directional commands RIGHT and LEFT will be useful in showing off-screen segments of the Box Mode display.

4. Error Classification Level - Lists errors by device as follows:
 - Device Errors - Hard, Soft, Media, Informational
 - Memory Errors - Hard, Soft
 - Events - Description, not necessarily errors

INTRODUCTION

5. Error Detail Level - Highlights and explains the current errors and their count. The Error Detail level is the most detailed. Messages are translations of VMS status codes, MSCP status codes, or other codes specific to the device type.

Any error message shown with a count of zero was logged outside the current evaluation period.

1.2 VAXSIM BLOCK DIAGRAM

In the VAXsim display structure, the System level is the root and each branch becomes more detailed the further it is from the root. To simplify the viewing and highlighting of different components, VAXsim uses the block diagram shown in Figure 1-3. Each block is composed of the four elements listed below. The numbers enclosed in the parentheses correspond to the figure.

- Branch Label (1) - Identifies your location in the tree using familiar names of nodes, subsystems, devices, and so forth.
- Counter Total (2) - Summarizes the error activity of this branch within the evaluation period. (Note that the default period covers the previous 24 hours.) Each Counter Total is the sum of all the counter totals from the next lower level.
- Threshold (3) - This number appears only at Error Classification Level. It is a combination of the device average error rate and weighted margin and indicates how far the device is from triggering an error condition. (At all other levels of block diagrams, only the Counter Total appears.)
- Branch ID Number (4) - Enables you to tell VAXsim where you want to move in the tree (when used with various commands).

INTRODUCTION

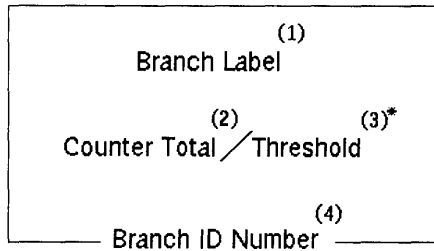

NOTE

The Threshold (*3) appears only at Error Classification Level.

Figure 1-3: VAXsim Block Diagram

Figure 1-4 shows the block configuration, called Box Mode, that you normally see on the screen display.

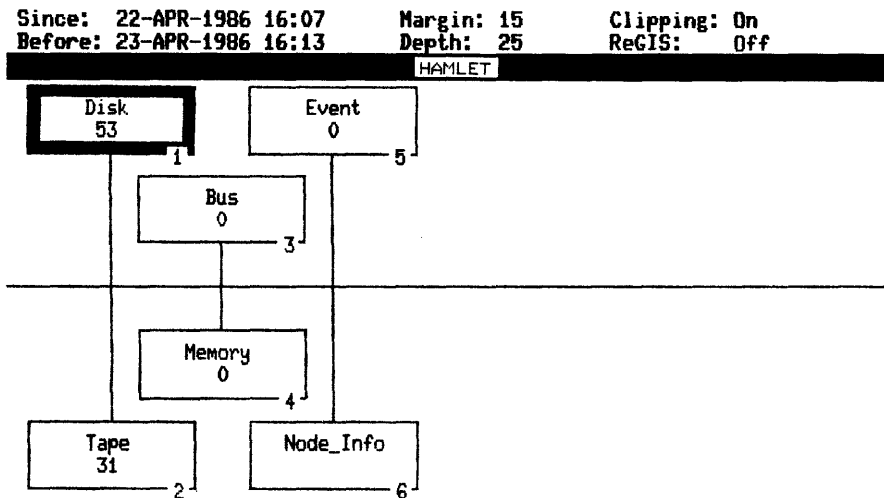

Figure 1-4: HAMLET Screen Display

1.2.1 A Look at the Status Area

At the top of the Box Mode display in the preceding figure, you will notice the **Status Area**, which reports to you about various parameters and settings currently in effect. The following is a brief summary of the fields in the Status Area and the information they contain.

- Since and Before

These fields define the current evaluation period that VAXsim is using to count errors. The "Since" time is the start of the period, and the "Before" time is the end of the period. By default, the Before or end time is the present, and the Since or start time is nearly 24 hours ago. You can adjust these times using the SINCE and BEFORE commands.

INTRODUCTION

- Margin

This field refers to a sensitivity factor or value which VAXsim uses to define normal error-rate fluctuation. By default, the Margin is 15.

- Depth

This field indicates the number of evaluation periods used to determine the Error Rate. The default is 25. You can alter the number of periods using the DEPTH command.

- Clipping

This field refers to a limiting factor which VAXsim uses in its calculation in order to moderate the effects of very short periods of unusually high error rates. Clipping enables VAXsim to reflect error behavior more reliably. By default, Clipping is on. You can disable and enable it by using the CLIPPING command.

- ReGIS

This field refers to the ReGIS (Remote Graphics Instruction Set) feature offered on VT125 and or VT24x terminals; the feature allows the use of color and other graphic effects in VAXsim displays. By default, ReGIS is off. You can enable and disable it by using the REGIS command.

Commands and procedures affecting the Status Area parameters are described in the appropriate chapters. (In particular, Chapter 4 describes all VAXsim commands.) Also, the Status Area differs among display modes--Histogram, for example. Differences are described in the appropriate sections.

1.2.2 "Phantom" Blocks

If for any reason VAXsim cannot obtain information about a branch node, or if you have added a nonexistent branch label, VAXsim represents that branch by a dotted-line or "phantom" block. If you add one nonexistent label, the subsystem level of that node will be displayed; if you add more than one, other levels will be represented. An error message informing you that each node is nonexistent or unavailable will also appear; for example, "Error opening BANQUO as input."

Regardless of its cause, the meaning of a phantom node is simply that there is no basis for evaluating its error performance.

INTRODUCTION

1.4 SUMMARY MODE DISPLAY LIST

Summary Mode is a useful way to spot serious error conditions quickly. This mode consists of a list of Warning and Alarm conditions, along with error counts and the nodes on which they were recorded. A brief example of Summary Mode follows:

```
Summary of Alarm and Warning Conditions

Warning [count= 21] on JULIET Disk #1#DUA152 (RA81) Soft
Warning [count= 22] on JULIET Disk #1#DUA202 (RA81) Soft
Warning [count= 256] on JULIET Tape #10#MFA0 (TU78) Info.
Warning [count= 3421] on JULIET Tape #10#MFA0 (TU78) Soft
Warning [count= 240] on JULIET Bus MERCUT#PAA0 (CI750) Info.
```

Figure 1-7: Summary Mode Display

If you issue a "VAXsim SUMMARY" command from DCL level, a banner different from the one shown will appear at the top of the summary; for instance:

```
Summary of VAXsim Status at 26-MAR-1986 22:52
```

1.5 THE HISTOGRAM DISPLAY (ReGIS TERMINALS ONLY)

The Histogram or bar-chart display is an alternate way of viewing the database. The Histogram shows the historical error counts at levels 1 through 4. This type of display offers a number of advantages; like any bar chart, the Histogram lets the viewer quickly identify historical trends by obvious visual patterns.

The VAXsim Histogram is flexible, allowing you to specify not only the period of time over which performance is reported, but also the way in which this period is divided--into days, hours, minutes, and so on. For example, you can specify fifty "time bars" of three days each for a Histogram showing error counts and trends over the past 150 days. The default Histogram, however, displays error counts of 24 hours each over twenty-five days from the current time.

To use the Histogram feature, you will need a ReGIS-compatible terminal (VT125 or VT24x).

Essentially, the Histogram, displayed by the DISPLAY HISTOGRAM command, is a graphic way of showing the relationship of errors and time. On the bar chart, the "Y" axis (vertical) represents the error count, and the "X" axis (horizontal) represents the period of time over which errors are reported. Each of the vertical bars, therefore, also stands for a unit or division of time: for example, 24 hours, 5 hours, or three days. The rightmost bar alone represents the current SINCE and BEFORE times specified by the user. All bars to the left represent equal units of time, moving back--that is, to the left--along the "X" axis.

If, for example, the SINCE and BEFORE values have not been altered from their defaults the "bar width" will be approximately 24 hours. The number of bars displayed can be determined by the current DEPTH value.

INTRODUCTION

The start and end times for the entire Histogram are displayed at the left and right ends of the X axis respectively. The start time of the bar with the highest error count is displayed directly above that bar, which is also identified by a small "tick mark" at the top.

Here is an example of a Histogram display of disk level; the numbers enclosed in parentheses refer to explanations below the figure. Following these explanations are definitions of the status fields as they uniquely affect the Histogram.

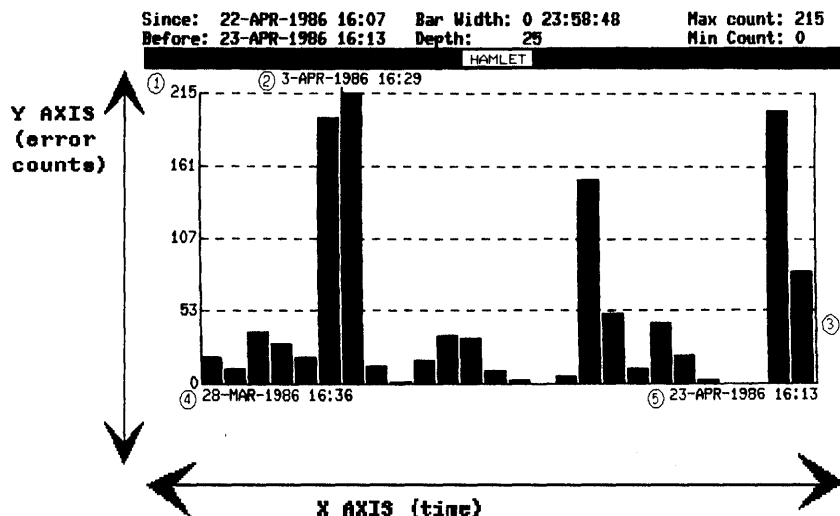

Figure 1-8: The Histogram Display: An Example

Maximum error count ((1)) - Represents the highest error count recorded; in this case, the highest count was during the 24 hours starting at 4:29 PM on April 3rd, 1986.

Starting time of highest error count, as noted above ((2)). This time appears directly over the corresponding vertical bar.

Current or most recent time bar ((3)) - Represents the period between the specified SINCE and BEFORE times; in this case, almost 24 hours during April 22-23, 1986. This amount of time is the same for all preceding bars. Thus, the bar immediately to the left represents the preceding 24 hours of April 21-22--and so on.

Starting time of the first unit of time, or bar ((4)). By default, this time is about 25 days before the time specified as the SINCE value.

Ending time of the last unit of time, or bar ((5)). This time is determined by the specified BEFORE value.

INTRODUCTION

The following status fields have unique meanings for the Histogram:

Bar Width: the unit of time represented by each vertical bar; in this case, it is the default--about 24 hours. (VAXsim rounds off time values to seven-minute intervals because it truncates VMS system time.)

Depth: the number of uniform units of time, preceding the current evaluation period, over which errors are counted; in this case, it is the default--25 periods of about 24 hours each, or approximately 25 days. The Depth number plus one equals the number of vertical bars. Depth can be set by the user.

Max Count: the highest error count within the total evaluation period represented by the Histogram. This number determines the top of the scale.

Min Count: the lowest error count within the total evaluation period.

It is important to remember the following points about the management of time by the Histogram display:

1. The last or rightmost bar represents only the currently specified Since/Before time period. Earlier bars represent consecutive periods of the same duration.
2. With this in mind, the number of time bars or variable evaluation periods can be altered with the DEPTH command. From 1 to 80 bars/periods can be specified.
3. Therefore, the total time shown by the Histogram, though dependent on the Since/Before "time slice" specified, is extremely flexible because the number or Depth of time slices or bars can be varied from 1-80. To convey some idea of this flexibility, here are some possible combinations:

Eight one-hour bars for a history of about one shift.

Seven 24-hour bars for a history of about one week.

Fifty seven-day bars for a history of about one year, or

Twelve thirty-day bars for the same historical period.

The manipulation of the Histogram display is described in more detail in the next chapter, General Usage. See also the DISPLAY command in Chapter 4, Command Reference.

CHAPTER 2

GENERAL USAGE

As noted in the Introduction, VAXsim's two major functions are the Monitor process and Display function, and it is the Monitor process (VAXsim_Monitor) that provides error tracking, recording, and building of the database as required.

The Display function, on the other hand, is the user interface, providing convenient graphic and textual aids that enable you to quickly identify problem areas, selectively view them, and recognize error trends. VAXsim offers four kinds of display, as described in Chapter 1: Box Mode, Line Mode, Summary Mode, and the Histogram (for ReGIS terminals only).

Described in this chapter are the command interface, monitor startup/shutdown, database management methods, time-period adjustments, and special-function commands.

2.1 VAXsim COMMAND INTERFACE

The following conventions apply whenever you want to enter a command:

- VAXsim is ready to receive a command when it displays the VAXsim> prompt.
- After entering a command, you must press <RETURN> to cause the action to be taken.
- You can string multiple commands together by using the backslash (\) or the vertical bar (|).

VAXsim provides several advanced user interface features:

- Command Line Editor (CLE)
- Intelligent Command Parser
- Autocorrection
- Online HELP
- Multiple command format
- Foreign Command Interface

GENERAL USAGE

2.1.1 Commands to Get You Started: a Brief Look

The following table lists the commands you will find most useful in the first stages of learning about VAXsim. They are chiefly the directional commands, which enable you to move about in the VAXsim display--both vertically and horizontally. Experimenting with these commands will quickly acquaint you with the structure of the VAXsim display and with some of the major functions.

For a detailed, hands-on tutorial on VAXsim, see the manual Getting Started with VAXsim.

Table 2-1: Introductory VAXsim Commands

General Function	Command/Examples	Command Function
Use HELP for online assistance		
Moving through the display	DOWN DOWN 2 DOWN DISK	Move to more detailed level; specify branch name or ID number.
↓		
	ZOOM	Move down to next or most severe level of errors.
↑		
	UP UP 2	Move up to more general level; specify multiple levels by number.
	TOP	Move to highest level.
→		
	NEXT NEXT 3	Move horizontally, to higher-numbered branch; specify multiple moves by number.
←		
	BACK BACK 3	Move horizontally, to lower-numbered branch; specify multiple moves by number.
↔		
	RIGHT and LEFT RIGHT 11 LEFT 8	Display more information, in either direction, of large display.

GENERAL USAGE

Table 2-1: Introductory VAXsim Commands (Cont.)

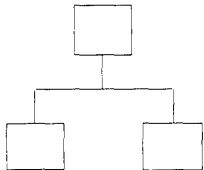
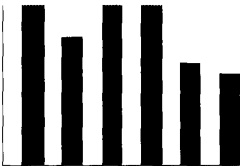
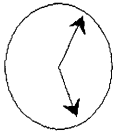
General Function	Command/Examples	Command Function
Selecting a display mode. 	DISPLAY DISPLAY BOX (or DISPLAY)	Select Box Mode, Line Mode, Summary, or Histogram display. Defaults: Box for VT terminals, Line for hardcopy.
[list]	DISPLAY LINE	
[summary]	DISPLAY SUMMARY	
	DISPLAY HISTOGRAM	(ReGIS terminals)
Adjusting evaluation periods 	SINCE SINCE 10PM SINCE 1-MAY-86:8:00 SINCE YESTERDAY BEFORE BEFORE 9AM BEFORE 7-MAY-86:1AM BEFORE TODAY	Specify start time. Default: about 24 hrs before end of period. Specify end time. Default: now.

2.1.2 Command Line Editor (CLE)

Table 2-2 outlines VAXsim's Command Line Editor keys. Characters you enter are added at the cursor position with the cursor moving to the right. Pressing <RETURN> anywhere on the command line sends the entire line to the Intelligent Command Parser.

GENERAL USAGE

Table 2-2: Command Line Editor Keys

Key	Function
Left Arrow	Moves cursor to left, toward beginning of line
Right Arrow	Moves cursor to right, toward end of line
Up Arrow	Recalls previous command in CLE buffer
Down Arrow	Recalls next command in CLE buffer
Delete	Deletes character to left of cursor
Line Feed	Deletes left to the last complete command element
CTRL/B	Recalls earlier command from CLE ring buffer*
CTRL/R	Redisplays the line
CTRL/U	Deletes the line
CTRL/W	Refreshes the screen
CTRL/Z	Exits VAXsim or HELP

* The CLE ring buffer stores the twenty most recently entered commands. The twenty-first command replaces the first and so on.

2.1.3 Intelligent Command Parser

The Intelligent Command Parser interprets abbreviated commands such as H for HELP, DO for DOWN, NE for NEXT, Z for ZOOM, and so on. In a few cases, only the first letter of a command word need be typed; in most cases, the first two letters must be typed.

2.1.4 Autocorrect Facility

Simply, Autocorrection is a feature of the Intelligent Command Parser that interprets and executes certain mistyped VAXsim commands, but asks you to confirm other mistyped commands. (This type of assistance is generally know as DWIM: Do What I Mean.)

Autocorrect is disabled on startup. To enable it, issue the AUTOCORRECT ON command; to disable Autocorrect, issue AUTOCORRECT OFF.

Autocorrect asks you to confirm some commands because in certain cases ambiguity could result in a "wrong guess" by Autocorrect-- which could in turn cause unwanted and lasting effects such as loss of data. If the autocorrect "guess" is the command you meant to enter, just type "Y" to the "(Correct ?)" prompt. If it is not, type "N" and make corrections using the command line editing features.

The following commands, if mistyped, are confirmed by Autocorrect: EXIT, REMOVE, SPAWN, WATCH, ADD, CLIPPING, CYCLE, and DEPTH.

GENERAL USAGE

All other commands will be executed immediately, providing that the mistyped characters bear a reasonable similarity to the correct keyword. While it would be impractical to list all acceptable mistypings for all commands here, the following examples should give you some idea of Autocorrect's capability:

For DOWN: DWO, DW, WOW
For NEXT: NXE, NTX, NX
For ZOOM: ZOM, ZM, ZMO, ZOT
For HELP: HOLP, JELP, HLE

Once you confirm the corrected command (if necessary), it is stored for recall.

2.1.5 VT200 Keypad Commands

For your convenience, several keys on the editing keypads of VT200 Series terminals are equivalent to VAXsim command keywords. Therefore, instead of typing these words (or abbreviations) you can simply type an editing key. The keys are described below:

- <Find> key = ZOOM command
- <Next Screen> key = DOWN command
- <Prev Screen> key = UP command

Additionally, the following keys are equivalent to the HELP command: the <PF2> key, located on the numeric keypad, and of course the <Help> key. All these keypad equivalencies are noted in Chapter 4, the Command Reference section.

2.1.6 Online HELP Facility

The HELP facility provides online information about most VAXsim subjects. VAXsim HELP has the same format as the VMS online HELP facility.

You can get into HELP mode by entering HELP with or without a topic, or by typing the <PF2> function key on VT100/200 Series terminals. If you enter HELP with no qualifier, VAXsim displays a variety of topics, most with subtopics. If you specify the topic, VAXsim displays the actual Help message.

To leave HELP mode and return to your previous VAXsim display, press CTRL/Z or <RETURN>.

2.1.7 Multiple Command Format

To save time moving within the box display, you can combine commands using the vertical bar (|) or the backslash (\) as shown:

Example 2-1: Multiple Command Format

```
VAXsim> ADD ARIEL,CALIBN,MIRAND|ZOOM
```

GENERAL USAGE

In this example, VAXsim adds the new nodes, ARIEL, CALIBN, and MIRAND, and then identifies and moves to the most pressing error condition, if one exists.

VAXsim accepts up to a 256 character multiple command. If you include either the CYCLE or WATCH command, however, VAXsim executes that command and ignores the remainder of the multiple command because you must CTRL/C to terminate either of these two commands.

2.1.8 Foreign Command Interface

You can use the VMS DCL foreign command interface (as described in the VMS documentation) to enter VAXsim with a command line to be executed immediately. The VAXsim prompt is displayed after the foreign command line is executed. The exceptions are the SHUTDOWN, SUMMARY, and REPORT commands where the VAXsim_Monitor stops and you return to the VMS command level.

Foreign commands are subject to the following two restrictions:

1. There is no automatic command correction by the Intelligent Command Parser.
2. The foreign command is not available for past command recall from the CLE ring buffer.

Foreign commands can be useful in a network environment, for example, where you can define a foreign command to include a list of nodes. You can use the foreign command to invoke VAXsim with node information already in the display database and on the screen display. If you end the definition with a command separator (\) as shown, you can easily extend the initial command sequence as needed.

For example:

```
$ VSIM := $VAXsim ADD ARIEL,CALIBN,MIRAND \
```

The following example demonstrates how you can use the previously defined foreign command with the ZOOM command to move directly to a suspected problem:

```
$ VSIM ZOOM
```

2.2 LOGICAL NAMES

Under normal circumstances VAXsim does not require any special logical name definitions beyond the standard SYS\$ names provided by VMS. You may use the following logical names to relocate VAXsim components:

- VAXsim_CLUSTER - Points to the historical database which may be filed in a directory other than SYS\$ERRORLOG. Take care to define VAXsim_CLUSTER as a system-wide logical name before starting the VAXsim_Monitor process to assure that both the Monitor and Display Functions access the same historical database file.

GENERAL USAGE

- VAXsim_CLUSTER\$nodename - Describes how you want VAXsim to access the historical database file when you add nodes.
- VAXSIM\$HELP - Points to VAXsim's online HELP library. SYS\$HELP:VAXsim\$HELP.HLB is the default.

2.3 VAXsim_Monitor START-UP

Three of VAXsim's four essential files are provided on the installation medium. VAXsim creates the fourth file, SYS\$ERRORLOG:VAXsim_CLUSTER.DATA, on site to collect error log data. In order to keep the VAXsim database current, you should always have a VAXsim_Monitor process actively monitoring the error log.

Start the VAXsim_Monitor process as follows:

```
$ @SYS$MANAGER:VAXsim$STARTUP
```

Once started, the VAXsim_Monitor looks for an existing VAXsim_CLUSTER.DATA database file to receive information. If no file exists, the VAXsim_Monitor creates a new (empty) one. If the VAXsim_Monitor finds a V1.0 database on the current node, it automatically converts it to V2.0 format.

NOTE

To ensure that you collect all errors written to the VMS error log file, start VAXsim as soon as possible within the system start-up procedure. Any error information passed to the VMS error log file before the VAXsim_Monitor process starts, is unseen by VAXsim.

2.4 VAXsim_MONITOR SHUT-DOWN

You can stop the VAXsim_Monitor process at any time provided you have operator privileges (OPER) and system-access privileges (SYSPRV). Include the following procedure as part of your system shutdown procedure to allow for cleanup activity:

```
$ VAXsim := $VAXsim
.
.
.
$ VAXsim SHUTDOWN
```

NOTE

SHUTDOWN, abbreviated as SHUT, must be entered at DCL level.

2.5 MANAGING YOUR DISPLAY DATABASE

Information in your private display database remains static until you issue one of the following commands:

- ADD
- REMOVE
- UPDATE
- WATCH
- CYCLE

VAXsim automatically reevaluates the display database each time you enter one of these commands. The reevaluation consists of computing the current Counter Total and the Error Rate for each error classification and altering the visual error status indicators as necessary.

2.5.1 Adding Nodes

You can add nodes singly or in multiples to the display database with the ADD command as follows:

```
VAXSIM> ADD nodename_list
```

where: nodename_list is a list of one or more valid nodenames separated by commas

A valid nodename can be a DECnet node specification (as described in the DECnet-VAX documentation) or can match the nodename portion of a corresponding VAXsim_CLUSTER\$nodename logical name definition. While it is possible to include a DECnet access control string in a nodename, note that the password may appear on the VAXsim display. It is recommended that you place DECnet access control strings in VAXsim_CLUSTER\$nodename logical name definitions.

In the absence of a VAXsim_CLUSTER\$nodename logical name definition, VAXsim uses nodename::SYS\$ERRORLOG:VAXsim_CLUSTER.DATA and attempts to access the historical database file using DECnet.

Whichever access method is used, SYS\$ERRORLOG:VAXsim_CLUSTER.DATA supplies defaults for any unresolved parts of the file specification.

Regardless of the number of nodes you enter or their order of entry, VAXsim arranges the nodes in alphabetical order on the display, as shown in Figure 2-1. If you already have two nodes, HAMLET and LEAR, numbered 1 and 2 respectively, and you add CAESAR, CAESAR becomes node 1 and HAMLET becomes node 2.

GENERAL USAGE

Since: 1-MAR-1986 15:50 Margin: 15 Clipping: On
Before: 2-MAR-1986 15:55 Depth: 25 ReGIS: Off
(Systems)

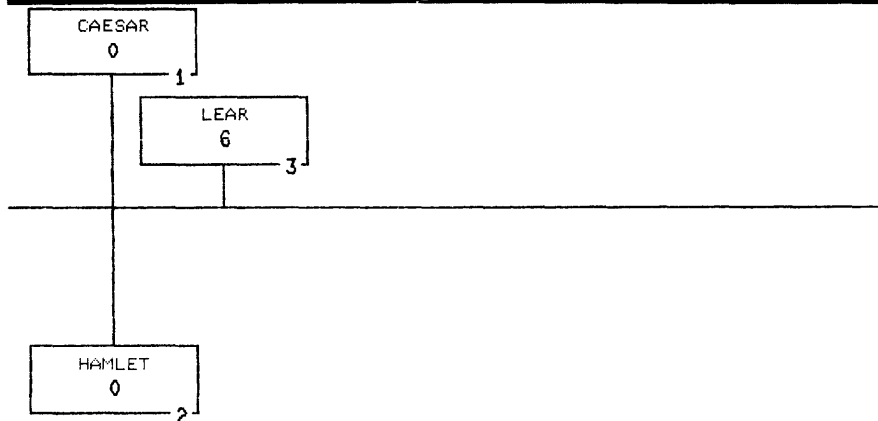

Figure 2-1: Adding Nodes Display

2.5.2 Removing Nodes

You can remove nodes singly or in multiples from the display database with the REMOVE command as follows:

```
VAXsim> REMOVE nodename_list
```

where: nodename_list is a list of one or more valid nodenames separated by commas.

A valid nodename is one of the nodenames displayed at the System level. You must specify the nodename exactly as you entered it with the ADD command when you placed it into your display database.

Regardless of the number of nodes you remove or their order of entry, VAXsim maintains the alphabetical order by compacting the list and renumbering as needed. If you have three nodes, CAESAR, HAMLET, and LEAR, numbered 1, 2, and 3 respectively, and you remove CAESAR, HAMLET becomes node 1, as shown in Figure 2-2.

GENERAL USAGE

Since: 1-MAR-1986 15:50 Margin: 15 Clipping: On
Before: 2-MAR-1986 15:55 Depth: 25 ReGIS: Off
(Systems)

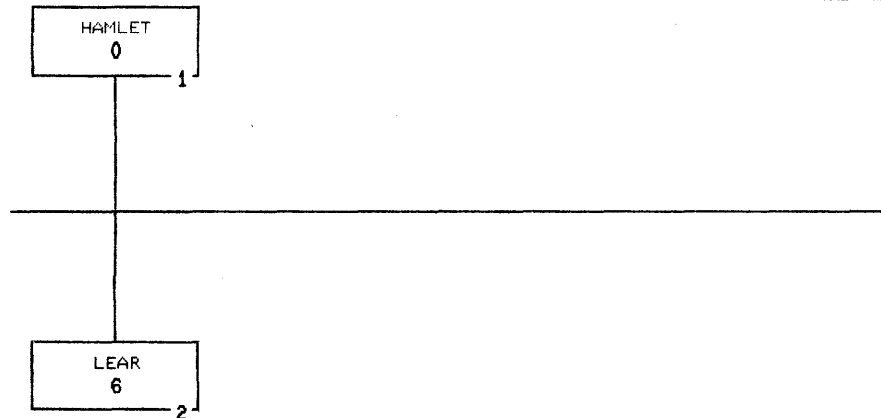

Figure 2-2: Removing Nodes Display

NOTE

The ADD and REMOVE commands affect your display database only. When you remove a node from your display it does not affect the information contained in the (SYS\$ERRORLOG:VAXsim_CLUSTER.DATA) historical database file residing on that node.

2.5.3 Adding and Removing Devices

The VAXsim_Monitor adds a new device when it receives the first error log record for that device. Devices are not removed.

2.5.4 Updating the Database

While you are examining information in your private display database, new data may be accumulating in the historical database file(s). Use the UPDATE command at any time to obtain the latest information. There are two options available with the UPDATE command. You can update the display database for a single node or you can force VAXsim to update the entire display database.

To update a single node, enter the UPDATE command while you are working within the desired node. The UPDATE command modifies the data for that node only.

To update every node in the display database, go to the System Level and enter the UPDATE command or enter UPDATE/ALL from anywhere in the tree.

GENERAL USAGE

UPDATE rereads the database file on the node and overlays existing display data to reflect any changes. Every node in the display database will be updated from the active hosts.

If the host is inaccessible, VAXsim displays a message. If a file is inaccessible for any reason, your previous display database remains intact because information is not being deleted, only replaced.

2.5.5 Dynamic Display Mode

VAXsim offers two dynamic (non-interactive) display modes for periodic refreshing on a dedicated screen display.

The WATCH command freezes a single display on your screen and updates it periodically to show current information. VAXsim stays in dynamic display (WATCH) mode, updating the database every seven minutes, until you press CTRL/C to return to interactive mode.

The CYCLE command fixes VAXsim on one level of the display database and pauses at each display. The amount of time spent at each display defaults to ten seconds but can be changed. At the end of each complete display sequence, VAXsim determines if at least seven minutes have elapsed since the last update. When seven minutes pass, VAXsim updates the information before repeating the display sequence. VAXsim stays in dynamic display (CYCLE) mode until you press CTRL/C to return to interactive mode and the screen display from which you entered the CYCLE command.

2.6 EXAMINING YOUR DISPLAY DATABASE

Each branch of VAXsim's display database offers a different view of accumulated error log data.

The following commands provide the means to the database:

- DOWN
- ZOOM
- UP
- TOP
- NEXT
- BACK
- RIGHT
- LEFT

2.6.1 Moving Down (DOWN, ZOOM)

To move to a more detailed level of information, you can use the DOWN command or ZOOM command. DOWN always moves you one level, expanding upon one of the blocks from your previous display. You select a block by specifying its Branch ID number or branch label. If you omit the Branch ID number, VAXsim chooses one for you based upon error status and a Counter Total/Threshold comparison. If you enter just a Branch ID number as a command itself, VAXsim defaults to the DOWN command.

ZOOM, an extension of the DOWN command, enables you to descend multiple levels in a single operation. You can specify a branch exactly as you do with the DOWN command. ZOOM quickly pinpoints one or more rising error rates. If only one rising error rate exists, the ZOOM command moves down the entire branch to the bottom level. If more than one rising error rate exists, the ZOOM command moves down the common branch as far as it can and stops where you must decide which error to investigate.

ZOOM is equivalent to DOWN when no error status conditions exist.

In Figure 2-3, if you are at A and enter the DOWN command, VAXsim moves you to B. If you enter ZOOM, VAXsim moves you to E.

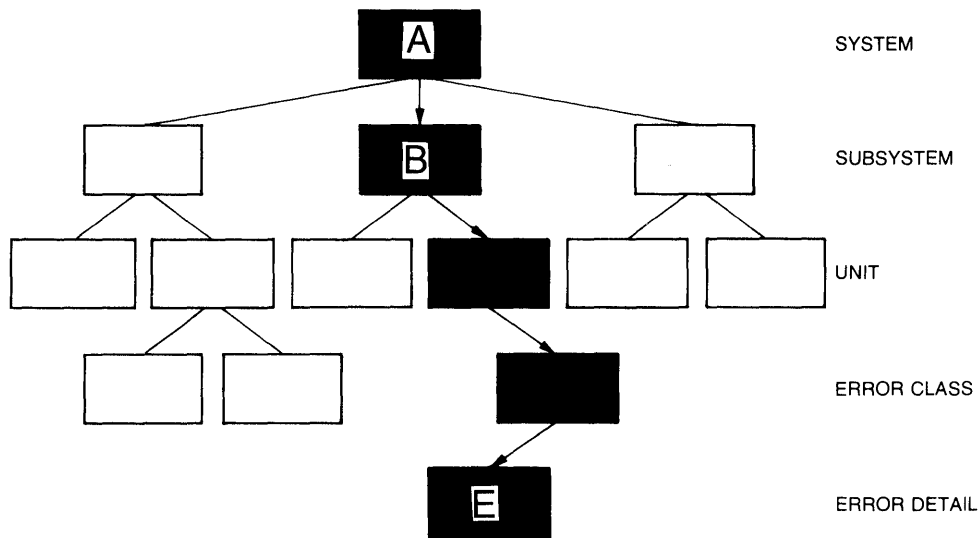

Figure 2-3: DOWN/ZOOM Command Illustration

2.6.2 Moving Up (UP, TOP)

To move up to a less detailed level of information, you can use either the UP or TOP command. The UP command is the opposite of the DOWN command because it moves you up one display level at a time toward the root of the display database tree. Since there is only a single path from any location up to the root, there is no concept of selecting an ascending path. You can, however, ascend multiple levels in a single operation by entering the UP command with an offset or by entering the TOP command.

GENERAL USAGE

TOP always moves you directly to the System level from any location in the tree.

In Figure 2-4, if you are at D and enter the UP command, VAXsim moves you to C. If you enter the TOP command, you go to A, the System level (root of the tree).

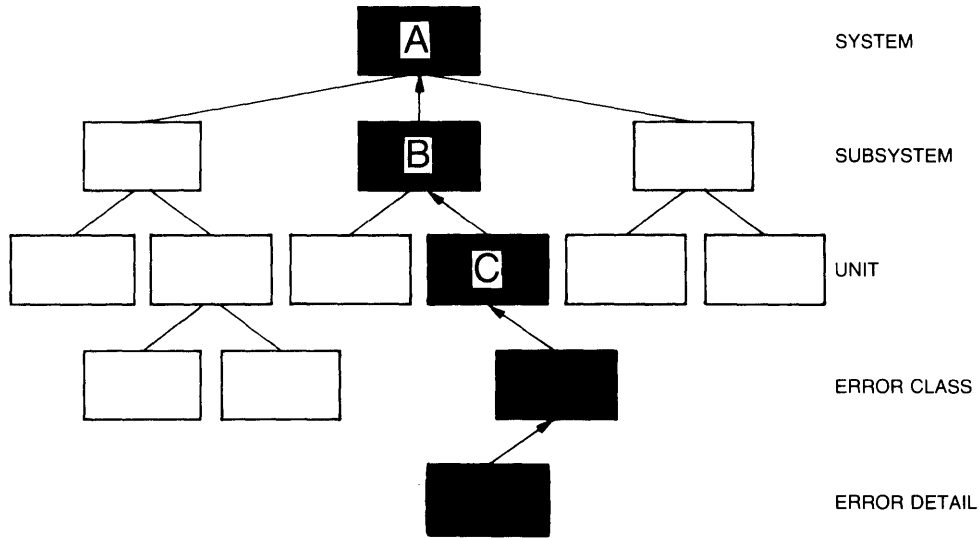

Figure 2-4: UP/TOP Command Illustration

2.6.3 Moving Sideways (NEXT, BACK)

You can use either the NEXT or BACK command to move in a positive or negative direction on a single level of the tree. Enter an offset value with the command to move more than one position.

As shown in Figure 2-5, if you are at A and enter NEXT 2, VAXsim moves you to C. If you are at C and enter BACK, VAXsim moves you to B.

GENERAL USAGE

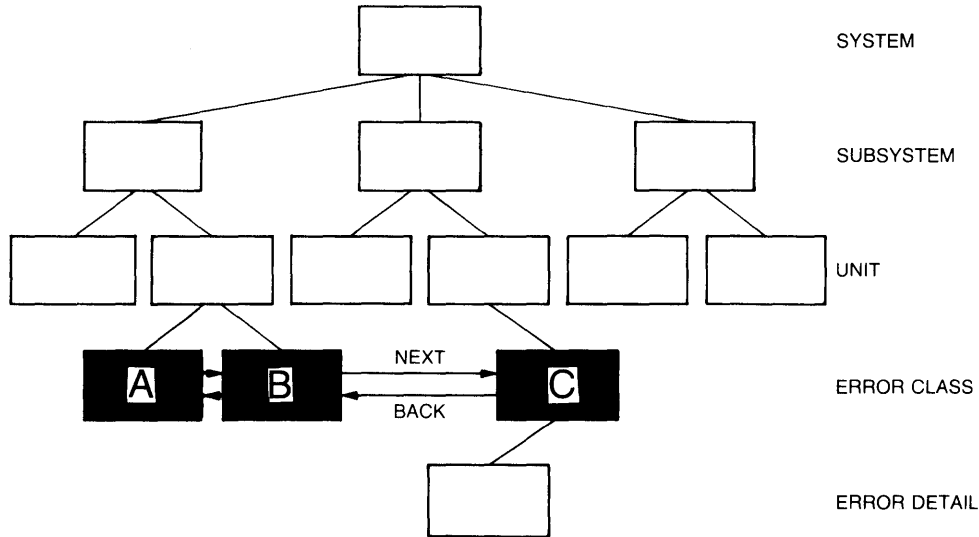

Figure 2-5: NEXT/BACK Command Illustration

2.6.4 Viewing Oversized Screen Displays (RIGHT, LEFT)

In some larger system configurations you may find that your screen display is too small to show all the branches available at a given level. When this occurs, VAXsim displays as many blocks as it can and indicates the presence and number of unseen blocks with a "More" message near the edge of the screen display where information remains to be shown; the number of unseen boxes will also be indicated. When "More" appears at the right edge of the screen display, you can use the RIGHT command to shift your display horizontally to reveal the new information. Conversely, use the LEFT command to redisplay information shifted off the left side.

The RIGHT and LEFT commands used by themselves shift the display by one whole screen.

To shift your screen by a specified number of boxes, use the RIGHT and LEFT commands with an offset:

```
VAXsim> RIGHT 2
```

Figure 2-6 shows a screen display with more information on the right-hand side.

GENERAL USAGE

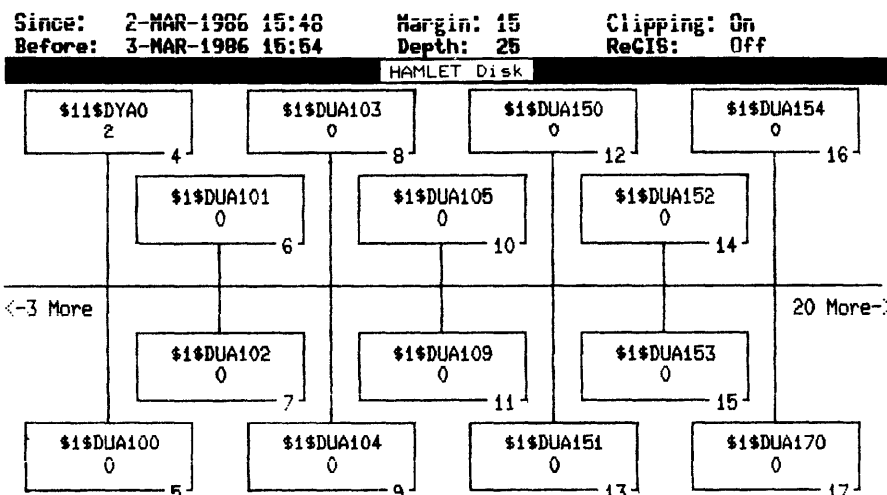

Figure 2-6: Oversized Screen Display

Figure 2-7 shows the new screen display after you enter the RIGHT command.

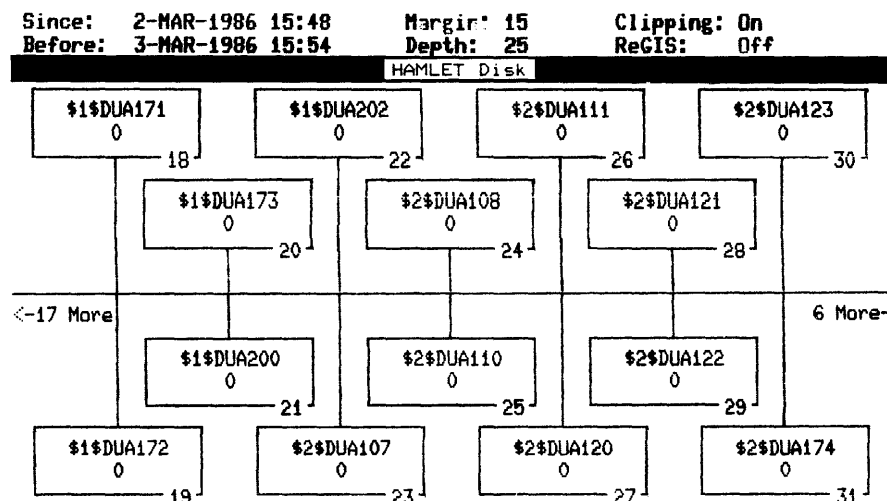

Figure 2-7: RIGHT Command Illustration

Since the "6 More" message is still on the right-hand side of the screen display, there are still 6 more unseen blocks to the right which can be displayed.

Enter LEFT to move back to the original screen display shown in Figure 2-6.

GENERAL USAGE

2.7 VISUAL ERROR STATUS INDICATORS

VAXsim uses special visual effects to emphasize areas within your display database exhibiting a sudden increase in the error rate. Error rates are evaluated at the most detailed level and compared to a threshold value. The result of this comparison determines the status indicator to be applied to the Error Detail level. A status indicator identifies one of three possible conditions:

- Normal - Error rates fall below thresholds.
- Warning - The Soft error rate exceeds the threshold or the Hard error rate is approaching the threshold.
- Alarm - The Hard error rate exceeds the threshold.

Error Detail level status indicators are propagated upward through each successive level of the database so that the status of an upper branch is derived from its subordinate branches and always reflects the worst condition at any lower level.

NOTE

Visual error status indicators are intended to draw your attention to areas that may require further investigation before repair actions are initiated.

Table 2-3 outlines how visual error status indicators appear on various terminal devices.

Table 2-3: Visual Error Status Indicators

Terminal Type	Normal	Warning	Alarm
VT100 Compatible with AVO	Outline	Solid Reverse Video Outline	Blinking Reverse Video
VT100 Compatible without AVO	Outline	Reverse Video Outline	Solid Reverse Video
Color Option	Green	Yellow Outline	Solid Red

GENERAL USAGE

2.8 TIME COMMANDS (SINCE, BEFORE)

When a device or node has a history of errors, it is useful to go back into the database to look at historical information. By adjusting the evaluation period, you can pinpoint possible trends or factors contributing to warning and alarm conditions. The evaluation period is the range of time over which the display database is evaluated. The information you see on the VAXsim display relates directly to the evaluation period you select. (See Chapter 3, Technical Notes, for additional information on the error rate evaluation algorithms.) You can adjust the start and the end of the evaluation period by time, date, or both.

To adjust the Start time, you use the SINCE command. To adjust the End time, you use the BEFORE command. The default for SINCE is 24 hours prior to the End time. The default for BEFORE is now.

VAXsim normally displays error activity for the previous 24 hours.

NOTE

VAXsim rounds off all time values to seven-minute* intervals. As a result, all time tags default to the beginning of the time interval in which they occur, including times that you enter. For this reason, the Status Area fields may not mirror the exact time you specify.

* Each time entered falls into a range of approximately seven minutes. The interval is derived by taking the standard VMS 64 bit system time and truncating it to the first 32 bits.

The following sections describe the formats for entering time period specifications in VAXsim--both absolute and delta. VAXsim accepts the VAX/VMS time/date specification formats, as well as allowing certain convenient extensions; for appropriate notes on this format, see the section following the VAXsim time formats.

GENERAL USAGE

2.8.1 Absolute Time

VAXsim absolute time uses the following format:

```
SINCE  }
        } [dd-mmm[-[yy]yy][:]][hh:mm:ss.cc[AM/PM]]
BEFORE }
```

where:

```
dd =      Day of the month (1-31)

mmm =     One of the following three-character
           abbreviations:
           JAN, FEB, MAR, APR,
           MAY, JUN, JUL, AUG,
           SEP, OCT, NOV, DEC

YYYY =    Year (19 is optional)

hh =      Hours (0-24)

mm =      Minutes (0-59)

ss =      Seconds (0-59)

cc =      Hundredths of seconds (0-99)
```

Additionally, you can do the following in an absolute time specification:

1. You can attach AM or PM to a time.
2. You can use a two-digit year (86 instead of 1986).
3. You can specify the keywords YESTERDAY and TODAY, as defined in the VAX/VMS time specification format. Meanings follow:
 - YESTERDAY specifies a time of approximately midnight of the previous date.
 - TODAY specifies a time of approximately midnight of the current date.

Additionally, the keyword TOMORROW specifies a time of approximately midnight tomorrow.

You can use these keywords in combination with delta times; for example, the command

```
SINCE YESTERDAY-3
```

sets the Begin time to about 9:00 PM yesterday--that is, 3 hours before midnight of yesterday.

As with VMS, any parameters you omit default to the current values.

The following series of examples show how you can use absolute time to adjust the current evaluation period. If you are going to enter the commands at your screen display, start with the first example and enter each example in the order shown.

GENERAL USAGE

Example 2-2: Absolute Time Format

Command	From	To
SINCE 00:00\BEFORE	Midnight	Now
SINCE 1-JAN-86:7PM	7:00 PM, January 1, 1986	Now
SINCE 15-MAR	Current time, March 15th, Current year	Now
SINCE 1-MAR-86:8:00	8:00 AM, March 1, 1986	Now
BEFORE 15:00	8:00 AM, March 1, 1986	3:00 PM today
BEFORE 15-MAR-86:9:30	8:00 AM, March 1, 1986	9:30 AM, March 15, 1986

To reset the evaluation period to the current date and time, reenter the same time commands without parameters. If you adjusted the evaluation period with SINCE and BEFORE, for example, to reset the evaluation period to the current 24 hours, you enter:

```
VAXsim> SINCE\BEFORE
```

2.8.2 Delta Time

VAXsim delta time uses the following format:

```
SINCE }
BEFORE } [dddd] [hh:mm:ss.cc]
```

where:

```
dddd = Days (0-9999)
hh = Hours (0-24)
mm = Minutes (0-59)
ss = Seconds (0-59)
cc = Hundredths of seconds (0-99)
```

As with VMS, any parameters you omit default to the current values.

Absolute time fixes the Start and End times; delta time fixes the duration of the evaluation period itself. When you start VAXsim, for example, the evaluation system period defaults to the 24 hours ending with the current, local system time. As time moves, so does the evaluation period.

The default evaluation period equals the following delta time:

```
VAXsim> SINCE 1\BEFORE "0 00:00:00"
```

GENERAL USAGE

To reset the evaluation period to the 24 hours ending with current, local, system time, you can enter the following commands that are equivalent to the default evaluation period just described:

```
VAXsim> SINCE\BEFORE
```

The format for using delta time is the same for both VAXsim time commands, however, their point of reference differs. The SINCE command is always dependent on the BEFORE command for its point of reference. Because it is a delta time, SINCE is the span of time prior to the BEFORE time. SINCE 3 means the three days preceding the BEFORE time.

The BEFORE command uses the current, local, system time as its point of reference. Because it is a delta time, BEFORE is the span of time prior to now. BEFORE "Ø 5:ØØ" means the evaluation period ending five hours ago.

The following series of examples show how you can use delta time to adjust the current evaluation period. If you are going to enter the commands at your screen display, start with the first example and enter each example in the order shown.

Example 2-3: Delta Time Format

Command	From	To
SINCE 7	7 days ago	Now
SINCE "Ø 3:ØØ"	3 hours ago	Now
BEFORE 4	4 days, 3 hours ago	4 days ago

To reset the evaluation period to the current date and time, reenter the same time commands without parameters. If you adjusted the evaluation period with SINCE and BEFORE, for example, to reset the evaluation period to the current 24 hours, you enter:

```
VAXsim> SINCE\BEFORE
```

2.8.3 Notes on VAX/VMS Date/Time Specifications

As noted, VAX/VMS specification formats for absolute and delta times are accepted by VAXsim. For detailed descriptions of these formats, you can issue the DCL command HELP SPECIFY, or consult the VAX/VMS Digital Command Language Dictionary.

The VAX/VMS formats for specifying absolute times follow:

```
[dd-mmm-yyyy:hh:mm]
```

TODAY, YESTERDAY, TOMORROW

GENERAL USAGE

The following examples illustrate the formats:

Command	From	To
SINCE 1-JAN-86:9:30	9:30 AM, January 1, 1986	Now
SINCE 3-FEB-1986:14:00	2:00 PM, February 3, 1986	Now
SINCE YESTERDAY	24 hours ago	Now

The specification BEFORE TODAY can also be entered, although the VAXsim BEFORE specification is the current time and date ("now") by default.

2.9 ADJUSTING THE CURRENT EVALUATION PERIOD

Before you adjust the time, you must determine the current evaluation period and how you want to change it. This section discusses the following variations of absolute and delta time and provides examples of each:

- Absolute Start and Absolute End Times
- Delta Start and Absolute End Times
- Absolute Start and Delta End Times
- Delta Start and Delta End Times

In all the following examples, it is important to remember that even if you update your display database with the ADD, REMOVE, UPDATE, WATCH, or CYCLE commands, the new data only appears on your screen display if it falls within the evaluation period you define.

2.9.1 Absolute Start and Absolute End Times

You can use a fixed evaluation period to determine the error reporting for a particular period of time. Figure 2-8 shows an evaluation period where both the Start and End times are absolute.

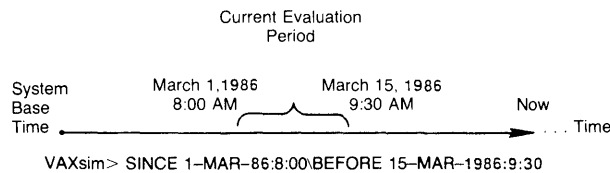

Figure 2-8: Absolute Start and Absolute End Times Illustration

GENERAL USAGE

The evaluation period is fixed at the two week period starting on March 1, 1986 at 8:00 AM and ending on March 15, 1986 at 9:30 AM.

2.9.2 Delta Start and Absolute End Times

Figure 2-9 shows an example of how to combine delta and absolute times.

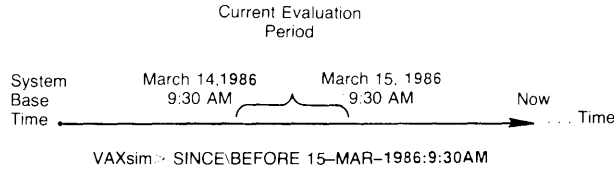

Figure 2-9: Delta Start and Absolute End Times Illustration

In this example, the End time is fixed at March 15, 1986 at 9:30 AM. The SINCE command, with no parameters, defaults to the 24 hours previous to the BEFORE time (March 14, 1986 at 9:30 AM). The SINCE time is a delta time but because it uses the BEFORE time as its point of reference and the BEFORE time in this example is fixed, the SINCE time is effectively fixed.

The Delta Start and Absolute End times format is useful for moving to and examining various evaluation periods of the same duration. By setting the BEFORE time to a series of dates, you can see VAXsim's report for each day, such as BEFORE 16-MAR, BEFORE 17-MAR, and so forth.

2.9.3 Absolute Start and Delta End Times

Figure 2-10 shows another variation of combining absolute and delta times.

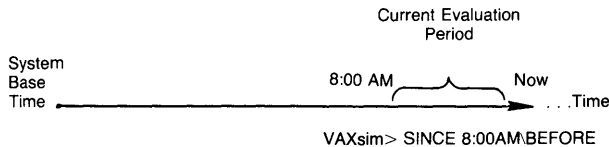

Figure 2-10: Absolute Start and Delta End Times Illustration

GENERAL USAGE

In this example, the Start time is fixed at 8:00 AM this morning. The BEFORE time is now and, therefore, moves with time. As time progresses, the evaluation period expands.

You can use the evaluation period shown in Figure 2-10 to monitor an error rate for a newly repaired device, for example, where the Start time is equal to a time just after the repair. Because the End time is a delta time equal to the current system time, new data added to the display database affects the evaluation period, provided you enter an ADD, REMOVE, UPDATE, WATCH, or CYCLE command.

You can also use the Absolute Start and Delta End times format to examine all errors in the database by fixing the Start time at the system base date and time as follows:

```
VAXsim> SINCE 17-NOV-1858:00:07\BEFORE
```

The new evaluation period, shown in Figure 2-11, extends from the system base time to the current, local system time.

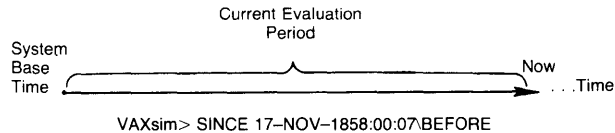

Figure 2-11: Evaluation of Entire Database Illustration

2.9.4 Delta Start and Delta End Times

Figure 2-12 shows a moving evaluation period where both the Start and End times are delta times. VAXsim uses this format to track the default evaluation period of 24 hours prior to the current, local, system time.

GENERAL USAGE

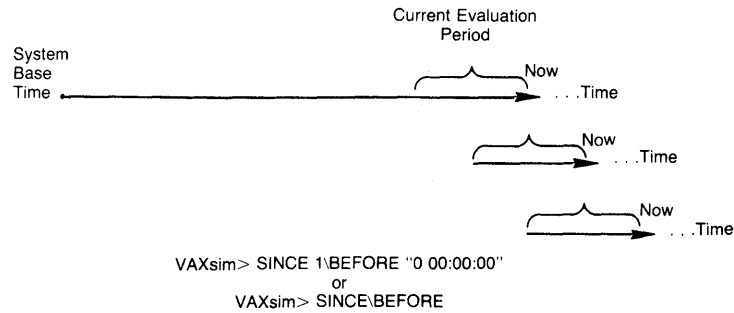

Figure 2-12: Delta Start and Delta End Times Illustration

Because the SINCE time uses the BEFORE time as its point of reference, it moves with time, always maintaining the 24 hour evaluation period.

You can also use the Delta Start and Delta End time format to move back in the database. If you enter SINCE\BEFORE 1, for example, VAXsim shifts the evaluation period to the 24 hours ending one day ago as shown in Figure 2-13.

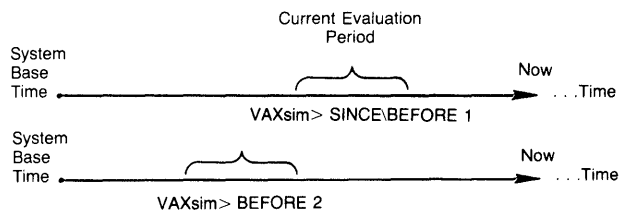

Figure 2-13: Delta Time Illustration

Once you specify the Delta Start time, it remains the same until you change it. To move the evaluation period back another day to the 24 hours ending two days ago, you enter:

```
VAXsim> BEFORE 2
```

2.10 SHOW COMMANDS

The SHOW commands display a variety of information on such matters as parameter settings, defaults, messages, and the status of certain VAXsim features:

- SHOW MODE
- SHOW PARAMETERS
- SHOW VERSION

GENERAL USAGE

2.10.1 SHOW MODE Command

The SHOW MODE command lets you know the current display mode (Box, Line, Summary, Histogram), along with the following information:

- Whether Autocorrection, described in Section 2.1.4, is currently on or off.
- Whether Clipping, described in Section 3.3, is currently on or off. (Clipping applies a sort of 'ceiling' that moderates VAXsim's response to localized error-count peaks.)
- Whether the ReGIS feature, which controls color on ReGIS terminals, is on or off. (This feature is off by default.)

The display produced by SHOW MODE replaces the Status Area at the top of the screen, and looks like this:

```
Display Mode:  Box           ReGIS:  Off
Autocorrection: Off        Clipping: On
```

To refresh the normal Status Area display, enter a SHOW PARAMETERS command (described below).

2.10.2 SHOW MESSAGE Command

The SHOW MESSAGE command enables you to display, in the Status Area, the most recently received broadcast message: for example, a MAIL message or a message from the operator. If there has not been a broadcast message to your terminal during the current VAXsim session, SHOW MESSAGE will so inform you.

2.10.3 SHOW PARAMETERS Command

The SHOW PARAMETERS command is of particular use when the Status Area information at the top of the screen is disrupted for some reason: an error or MAIL message, for example. SHOW PARAMETERS refreshes the status display.

Typing a CTRL/W will refresh the entire display.

2.10.4 SHOW VERSION Command

The SHOW VERSION command enables you to display the version number of the VAXsim program you are running. This information must be supplied when reporting errors or problems.

GENERAL USAGE

2.11 RELATIONSHIPS AMONG THE DISPLAY MODES

The descriptions in this chapter of the directional and time commands have assumed the use of Box Mode, the default for video terminals. These commands, however, apply as well to the other modes: Line Mode and Histogram. The major difference, however, from the user's point of view is that the directional commands are specifically designed for Box Mode, where there is a visible "map" of system levels. Thus, commands such as NEXT, BACK, LEFT, and TOP will make obvious visual "sense" in the box display, but will be less obvious in the other two modes.

This is not to say that such commands cannot be useful if you decide to save time and keystrokes by not using DISPLAY to switch modes. If you have a clear sense of where the current Histogram or Line Mode display is located within the system, you can produce the desired display in the same mode by simply issuing the appropriate directional command. For example, if the current display is a Histogram of disk unit DBA3, and you wish to produce a Histogram of disk unit DBA2, you can enter a BACK command to do so without changing display modes.

Similarly, the ZOOM or DOWN command, issued from a system level Histogram or Line Mode display, will produce a display, in the same mode, that is one or more levels down.

Thus, any directional command can be entered from any display mode; there are obviously many possibilities, too numerous to describe here. Your own experimentation and use of VAXsim will help determine which of these commands make sense in the alternative display modes.

The time commands--BEFORE, SINCE, and DEPTH--work essentially the same for Box and Line Mode, but have some different implications for Histograms. The difference in effect can be summed up by saying that in Histogram mode, the time commands are generally used to project the evaluation period into the past. For example, if you use SINCE and BEFORE to specify an evaluation period of four days, that evaluation period represents one bar on the Histogram chart. So assuming a DEPTH default of 25, the entire Histogram will display error tracking over a total period of about 104 days.

Should you change the BEFORE/SINCE period to three hours and the DEPTH to the maximum of 80, the entire Histogram will display errors over a total period of some 240 hours or about 10 days.

The significant point to remember is that in specifying the length and number of evaluation periods, you are specifying the uniform size of the Histogram's "time slices" and how many it will contain. Obviously, many combinations of length and number are possible, and experimentation will help you determine the most useful of these.

The following diagram shows all three types of display for the same level--in this case, the subsystem level. Note in particular the time relationship between the Histogram and the standard modes: Box and Line.

Figure 2-14: Relationship of the Three Display Modes

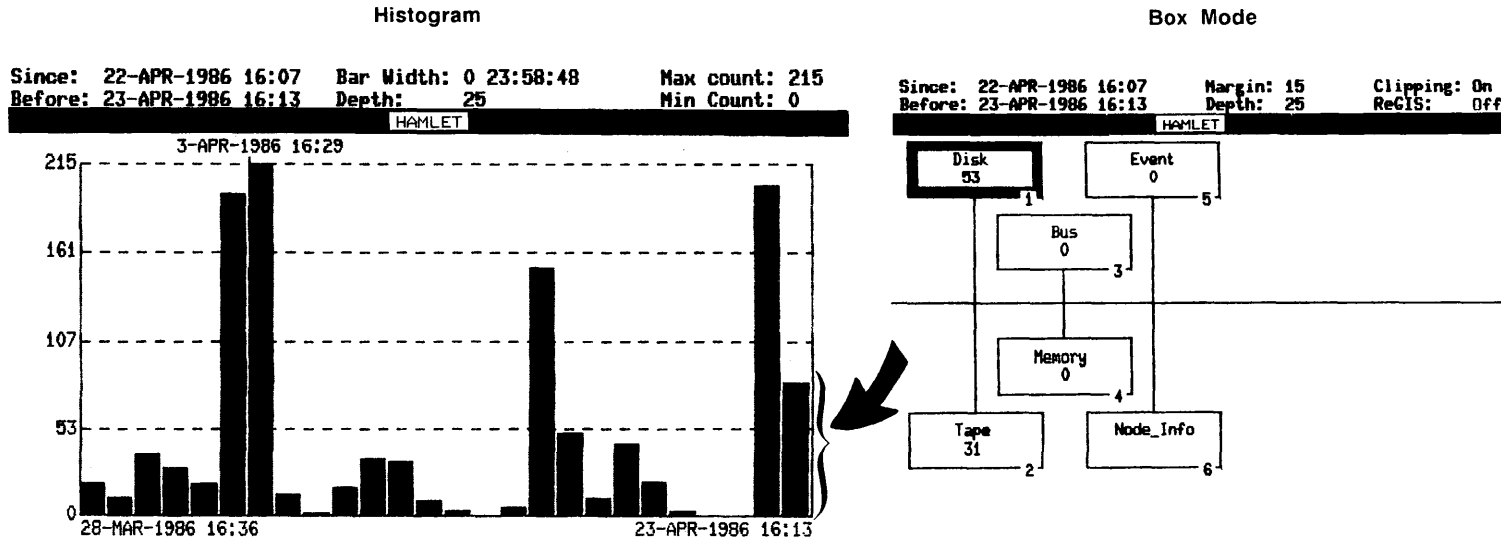

← TIME
 Depth = 25 evaluation periods

Most recent time bar represents current evaluation period: 24 hours. Note the Since/Before fields.

Line Mode
 Since: 22-APR-1986 16:07 Margin: 15 Clipping: On
 Before: 23-APR-1986 16:13 Depth: 25 ReGIS: Off
 HAMLET

Item Name	Count / Threshold	Status
1 Disk	53 / 0	Warning
2 Tape	31 / 0	Normal
3 Bus	0 / 0	Normal
4 Memory	0 / 0	Normal
5 Event	0 / 0	Normal
6 Node_Info	0 / 0	Normal

2-27

GENERAL USAGE

GENERAL USAGE

Finally, it is important to remember that the Histogram's point of view is historical rather than "geographical"; that is, it sums up the error history of an entire level (such as device level) without indicating the errors for individual nodes within that level.

2.12 NOTIFY COMMAND

Changes in error status conditions can now be broadcast to an operator with a NOTIFY command, which uses the same principles as the VMS REPLY (/ENABLE, /DISABLE) command.

The NOTIFY command also permits you to specify that these notification messages be delivered by the VMS MAIL facility. The command specification in this case is an operator class, MAIL_MESSAGE.

NOTIFY must be entered through the VAXsim EDITOR function, and only through the DCL foreign command interface. The NOTIFY command will not be accepted within the VAXsim program.

The format of the command is as follows:

```
$ VAXsim EDITOR NOTIFY/ENABLE = list
$ VAXsim EDITOR NOTIFY/DISABLE = list
```

where: list = Desired class(es) of operators.
The list conforms to DCL syntax where multiple items must be separated by commas and enclosed in parentheses.

VAXsim puts the record in the database with the parameters you specified but the Monitor does not see the record until you shut down and restart the Monitor process. If no NOTIFY record exists when the Monitor starts, the broadcast message goes to the system console (CENTRAL) only.

You can determine which operator classes are currently enabled by examining the Node_Info block found at the subsystem level.

The following subsections describe the NOTIFY command options:

GENERAL USAGE

2.12.1 NOTIFY/ENABLE = list

Specifies the operator class(es) to receive the NOTIFY broadcast message at their terminal. You can use the EDITOR NOTIFY/ENABLE command any number of times to add new operator classes. Note, however, that NOTIFY/ENABLE writes to the database file only. In order for the command to take effect, you must shut down and restart the Monitor process. Once you specify a class, it is enabled until you disable the class with the NOTIFY/DISABLE command and the shutdown/start-up procedure. New NOTIFY/ENABLE commands do not affect the existing enabled classes.

2.12.2 NOTIFY/DISABLE = list

Identifies the operator class(es) that do not receive the NOTIFY broadcast message at their terminals.

It is recommended that you disable all operator classes before you enable any classes:

```
$ VAXsim EDITOR NOTIFY/DISABLE=ALL
```

NOTE

The NOTIFY command must be entered at DCL level as a foreign command and can be abbreviated as EDI NOTI/D or EDI NOTI/E.

You can enter both the /DISABLE and /ENABLE options in the same command line. VAXsim performs the disables first and then the enables, regardless of their order in the command line.

Table 2-4 lists default operator class names:

Table 2-4: Default Operator Class Names

Standard VMS	Site-Specific	VAXsim-Specific
NETWORK	OPER1	ALL*
CLUSTER	OPER2	ERRORLOG_FILE#
CENTRAL	OPER3	MAIL_MESSAGE
DEVICES	OPER4	
DISKS	OPER5	
TAPES	OPER6	
PRINTER	OPER7	
CARDS	OPER8	
SECURITY	OPER9	
	OPER10	
	OPER11	
	OPER12	

*The ALL qualifier enables or disables all the operator classes plus the system console.

#The ERRORLOG_FILE qualifier writes the NOTIFY message to the error log file so that it appears on VMS error analysis reports.

GENERAL USAGE

2.13 SPAWN COMMAND

The SPAWN command enables you to create a subprocess to execute DCL commands without disturbing the VAXsim display database. The following mutually exclusive options are available:

- SPAWN/WAIT - The default; when you enter the DCL command on the same line as this command, control automatically returns to VAXsim on completion of the DCL command. When you enter this command without a DCL command line, the \$ prompt appears showing that you are at DCL level. You can execute as many DCL commands as desired. VAXsim hibernates until you log out from the SPAWNed process.
- SPAWN/NOWAIT - The DCL command is required as part of the /NOWAIT command line. In this case, control is returned to VAXsim before the DCL process is complete. The /NOWAIT option is useful for one-line, noninteractive operations that produce little or no terminal output.
- SPAWN/NOERASE - Same as the /WAIT option except that the current VAXsim display remains on the screen.

CHAPTER 3

TECHNICAL NOTES

This chapter describes the internal or algorithmic aspects of VAXsim: essentially, how it organizes and evaluates system errors and trends, and how you as a system manager can tailor that evaluation to the needs of your installation. Also described are the software components of VAXsim.

3.1 HOW VAXsim ORGANIZES SYSTEM ERRORS

A key VAXsim concept is the manner in which it structures information from the VMS system error log. VAXsim_Monitor analyzes each VMS error log record individually and handles it in one of three ways:

- Records an Error - Device and memory errors are stored in the database with information identifying the specific unit and the problem.
- Records an Event - Each error log record is tagged with a code to indicate the type of system event. Any record that is not recognized as an error is entered into the historical database as an event. When VAXsim displays events, it translates the code into a descriptive message.
- Discards the Record - Many entries in the error log result from activities not directly related to hardware failures. Errors, such as periodic time stamps and write lock violations, are of no value to VAXsim and are not included in its historical database file.

3.1.1 Device Errors

Device errors are classified as follows:

- Hard Errors - Not recoverable; a probable hardware component failure.
- Soft Errors - Successfully recovered through retries. By definition, soft errors are those that are corrected by the system. Unless VAXsim is reporting a lot of soft errors, you need not be alarmed, just informed of a possible trend in soft failures.
- Media Errors - Considered soft errors even when not recoverable because they are unique to the media and do not require a service call.

TECHNICAL NOTES

- Informational Errors - Cannot be evaluated by VAXsim; may or may not be important.

3.1.2 Memory Errors

Memory errors are hard or soft. Note that a soft memory error rate that is greater than zero is common.

- Hard (Uncorrectable) Errors - Cannot be corrected; READ DATA SUBSTITUTE (RDS)
- Soft (Single bit) Errors - Corrected within the memory subsystem; CORRECTED READ DATA (CRD)

NOTE

Digital Equipment Corporation's official policy on the replacement of memory array modules is as follows: "Memory array modules should not be replaced because of single bit errors. Memory array modules should be replaced for hard, uncorrectable errors."

Since VMS has no naming convention for memory, VAXsim uses the following format:

NNx.y

where:

NN = MA for shared multiport memory; MS for local memory

x = Nexus (or TR) number

y = Array number

MA2.4 means shared memory at nexus 2, array 4.

3.1.3 Events

Even though events are not necessarily errors, they appear in the VMS system error log and are accumulated by VAXsim. Events include machine checks, UNIBUS/MASSBUS (UBA/MBA) adapter errors, system boots, restarts, and so on.

3.2 ERROR RATE EVALUATION

Before VAXsim can recognize unusually high error rates, it must first determine a typical error rate for each device. Since most devices encounter errors during the course of routine operation, several factors influence a device's typical error rate, such as:

- Device Characteristics - Magnetic tapes, for example, typically have more errors than disks.
- Activity Levels - A device under constant, heavy use can accumulate errors more rapidly than one that is idle much of the time.

TECHNICAL NOTES

- Local Environmental Conditions - Temperature, humidity, and power fluctuations can affect error rates.

VAXsim allows each device to establish its own typical error rate over time. The current status of any device is always evaluated in relation to that device's past (error) performance. In order to describe the error rate evaluation process, a few terms are necessary:

- Current Evaluation Period - The time range specified by the SINCE and BEFORE commands; the default is a 24 hour (one day) period ending at the current, local, system time.
- Historical Error Rate - The goal of the error rate evaluation process; indicates an average rate of similar errors typically experienced on a given device. At the Error Classification level, this value equals the Error Rate.

Error Rates are always calculated based on the Current Evaluation Period, so that the Counter Total and Error Rate can be compared with no adjustment.

NOTE

For emphasis, the Error Rate is called the Historical Error Rate in the discussions on error rate calculation and evaluation. The Error Rate is the Error accumulation of all known evaluation periods prior to the current evaluation period.

- Historical Evaluation Period - A previous time period of the same duration as the Current Evaluation Period for which VAXsim has knowledge of a particular device.
- Historical Period Count - The number of Historical Evaluation Periods spanned by your database. This count includes all the evaluation periods prior to, but not including, the Current Evaluation Period. The default count is 25 such periods, and this number can be changed by the DEPTH command, as described in Chapter 4.
- Clipping Point - A maximum limit on the number of errors for any single Historical Evaluation Period that can be used in calculating the Historical Error Rate.

Each line of information at the Error Detail level has its own Clipping Point. (Section 3.3 details VAXsim's Clipping function.)

3.2.1 Error Rate Evaluation Algorithm

This section details VAXsim's error rate evaluation algorithm. VAXsim performs the following calculations at the Error Detail level, where it determines the Counter Total and Historical Error Rate:

1. At the Error Detail level, VAXsim counts each error type. The count is displayed with an appropriate description. The count is also added to the Counter Total displayed at the associated Error Classification level.

TECHNICAL NOTES

It is important to note that this total becomes the Clipping Point for errors of the specific type on the specific device.

2. Any earlier errors of the same type are summed into a Historical Total that is displayed at the associated Error Classification level.

If the error count within any given Historical Evaluation Period is greater than the Clipping Point determined in the previous step, the excess portion is ignored.

If, for example, the Clipping Point is 30 and the count for a given period is 50, only 30 is added to the Historical Total.

3. The preceding steps are repeated until all errors within a single Error Classification level are counted.
4. Finally, the Historical Total is divided by the Historical Period Count to determine the Historical Error Rate at a given Error Classification level for a given device.

Section 3.3 compares error rate evaluation with and without the Clipping function.

3.3 CLIPPING FUNCTION

The purpose of VAXsim's Clipping function is to moderate the long term effect of sporadic evaluation periods containing extremely high (unusual) error rates. Without a Clipping function, a very large burst of errors can reduce VAXsim's ability to discriminate between smaller fluctuations that may occur after the problem that caused the extremely high error rate(s) is resolved.

Figure 3-1 demonstrates error rate evaluation without the Clipping function. Figure 3-2 shows the effect of using the Clipping function for the same error rate evaluation.

In both figures, there are 13 evaluation periods. All past evaluation periods (1-12) show a Historical Counter Total of zero with the exception of evaluation periods six and seven, where the error count rises to 1,000 and 1,400, respectively. The Counter Total for the Current Evaluation Period (13) equals 150.

In Figure 3-1, the Historical Error Rate equals the sum of the previous evaluation periods divided by the number of previous evaluation periods as follows:

$$\text{Historical Error Rate} = \frac{\text{Historical Total}}{\text{Historical Period Count}} = \frac{2,400}{12} = 200$$

Without the Clipping function, VAXsim would not flag the Current Evaluation Period's Counter Total of 150 because it is lower than the Historical Error Rate of 200.

TECHNICAL NOTES

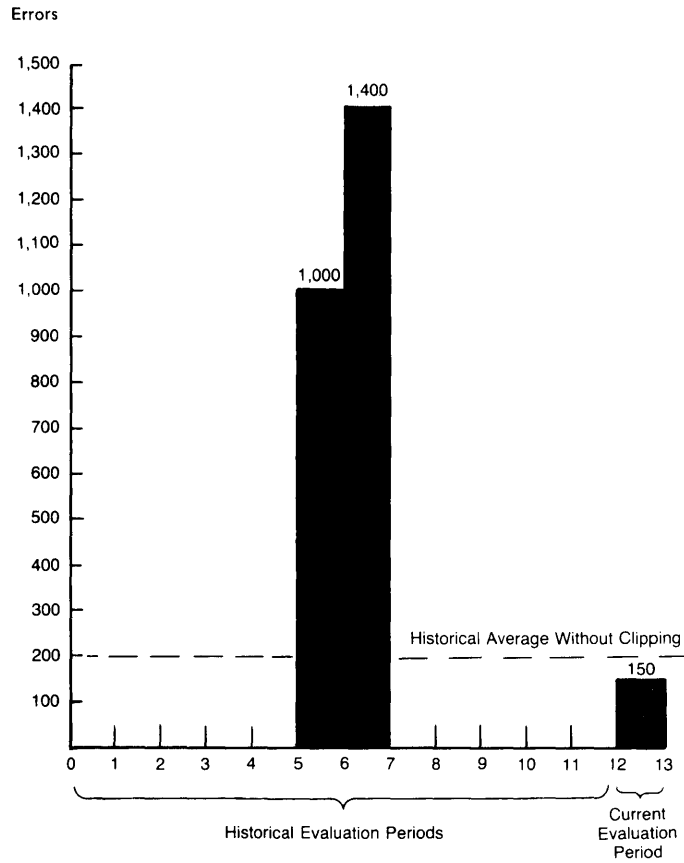

Figure 3-1: Error Rate Evaluation Without Clipping

In Figure 3-2, the Historical Error Rate still equals the sum of the previous evaluation periods divided by the number of previous evaluation periods. Since the error counts in Evaluation Periods six and seven exceed the Clipping Point of 150, as determined by the Counter Total, VAXsim takes the Clipping Point (times two evaluation periods) and ignores the excess error rate as follows:

$$\text{Historical Error Rate} = \frac{\text{Historical Total}}{\text{Historical Period Count}} = \frac{300}{12} = 25$$

Based on the Historical Error Rate of 25, VAXsim flags the Current Evaluation Period's Counter Total of 150.

TECHNICAL NOTES

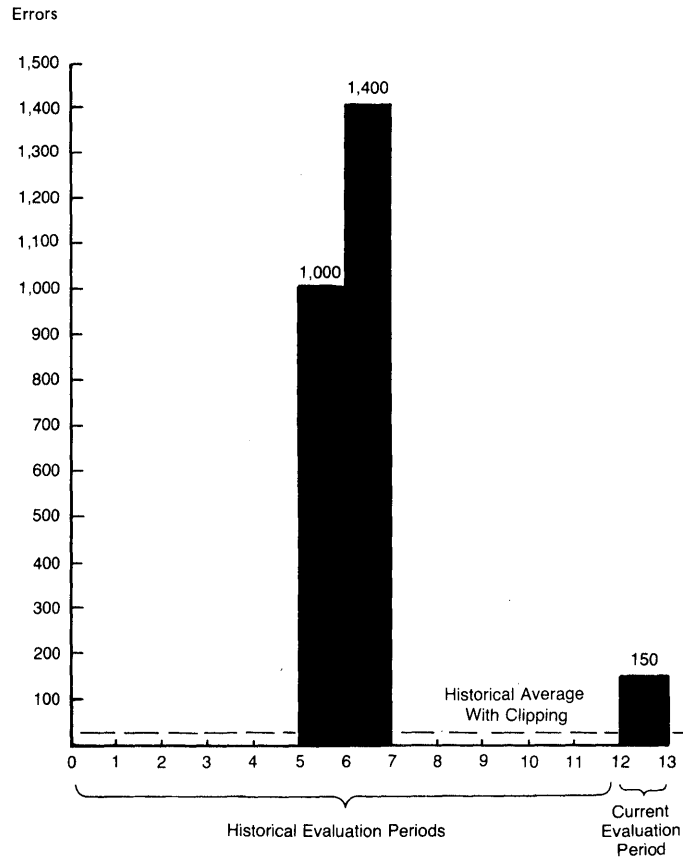

Figure 3-2: Error Rate Evaluation With Clipping

Continue to the following section to see how VAXsim uses the evaluated error rates to determine error status and visual error status indicators.

3.4 THE MARGIN IN ERROR EVALUATION

The error rate evaluation algorithm computes two values that VAXsim needs to determine when to flag rising error rates: the Counter Total, which reflects the current error count and the Error Rate, which reflects the historical error rate.

In order to allow for normal fluctuations in the error rate before flagging an error condition, however, VAXsim also needs a margin factor. The combination of the error rate and this margin determines the Threshold. The Threshold value (shown at the Error Classification level) indicates how far a particular device is from a warning or alarm condition. The rest of this section explains how the VAXsim error evaluation process uses the Margin setting to determine the Threshold.

NOTE

For emphasis, the Error Rate is referred to as the Historical Error Rate in this section.

VAXsim automatically increases the sensitivity to hard errors and decreases the sensitivity to soft, media, and informational errors.

TECHNICAL NOTES

For hard errors, VAXsim's Thresholds for warning and alarm status indicators are as follows:

- For a Warning indication, the Counter Total is greater than (Historical Error Rate + 1/2 Margin) but less than or equal to (Historical Error Rate + Margin).
- For an alarm indication, the Counter Total is greater than (Historical Error Rate + Margin).

For the remaining error classes, VAXsim's Thresholds for warning status indicators are as follows:

- For soft and media Warnings, the Counter Total is greater than (Historical Error Rate + Margin)
- For informational Warnings, the Counter Total is greater than (Historical Error Rate + 2 * Margin).

These computations are summarized in Table 3-1.

Table 3-1: VAXsim Error Indication Computations

Error Class (Condition)	Computation of Thresholds
Hard (Warning)	$1/2 * \text{Margin} + \text{Historical Error Rate}$
Hard (Alarm)	$\text{Margin} + \text{Historical Error Rate}$
Soft/Media (Warning only)	$\text{Margin} + \text{Historical Error Rate}$
Informational (Warning only)	$2 * \text{Margin} + \text{Historical Error Rate}$

Without the Clipping function, described in the previous section, large bursts of errors distort these computations, rendering them meaningless.

3.5 VAXSIM SOFTWARE COMPONENTS

The VAXsim system consists of four files:

1. SYS\$ERRORLOG:VAXsim_CLUSTER.DATA -- Database history file where VAXsim stores accumulated error log information; this file is created on site.
2. SYS\$HELP:VAXsim\$HELP.HLB -- Online HELP information; this file is supplied on the installation medium.

TECHNICAL NOTES

3. SYS\$MANAGER:VAXsim\$STARTUP.COM -- System start-up procedure to create the VAXsim_Monitor process that collects error log data; this file is supplied on the installation medium.
4. SYS\$SYSTEM:VAXsim.EXE -- Executable image file; performs both the VAXsim_Monitor and Display functions.

CHAPTER 4

VAXSIM COMMANDS REFERENCE SECTION

This chapter outlines VAXsim commands. The first part groups commands in tables according to the following functions:

- Display Commands
- Directional Commands
- Special Commands
- Time-Related Commands

The tables are handy references when you know what you want to do but are unsure of the command or its syntax.

The remainder of this chapter lists each VAXsim command alphabetically, detailing its syntax, default, operation notes, and examples. Since this part of the manual is for reference only, the material is presented in a concise format.

Technical details are reserved for Chapter 3, Technical Notes.

VAXSIM COMMANDS REFERENCE SECTION

4.1 DISPLAY COMMANDS

Display commands enable you to affect the current VAXsim screen display. Table 4-1 lists the VAXsim display commands, what they do, their syntax, and how they relate to other commands.

For more information on any Display command, refer to the alphabetic summary in this chapter.

Table 4-1: Display Commands

Command	Action	Syntax	Antonym
ADD A	Adds nodes to the display database	ADD nodename[s]	REMOVE
CYCLE CY	Dynamically reviews displays on one level	CYCLE nn nn=seconds	
DISPLAY DI	Selects display mode: Box, Line, Summary, or Histogram	DISPLAY mode	
REMOVE RE	Removes nodes from the display database	REMOVE nodename[s]	ADD
SHOW MESSAGE SH M	Displays most recent broadcast message	SHOW MESSAGE	
SHOW MODE SH MO	Displays mode and Autocorrect, ReGIS, Clipping status	SHOW MODE	
SHOW PARAMETERS SH P	Displays current parameter values	SHOW PARAMETERS	
SHOW VERSION SH V	Displays VAXsim version number	SHOW VERSION	
WATCH W	Freezes VAXsim on one display	WATCH	

VAXSIM COMMANDS REFERENCE SECTION

4.2 DIRECTIONAL COMMANDS

Directional commands enable you to move within VAXsim. Table 4-2 lists directional commands, what they do, their syntax, and how they relate to other commands.

For more information on any Directional command, refer to the alphabetic summary in this chapter.

Table 4-2: Directional Commands

Command	Direction	Syntax	Antonym
BACK B	Horizontal, Negative	BACK nn nn=offset	NEXT
DOWN D	Down one level	DOWN nn nn=Branch ID DOWN branch label	UP, TOP
LEFT L	Left, large display	LEFT nn nn=offset	RIGHT
NEXT N	Horizontal, Positive	NEXT nn nn=offset	BACK
RIGHT R	Right, large display	RIGHT nn nn=offset	LEFT
TOP T	Up to System level	TOP	DOWN, ZOOM
UP U	Up	UP nn nn=offset	DOWN, ZOOM
ZOOM Z	Down multiple levels along an error path	ZOOM nn nn=Branch ID ZOOM branch label	UP, TOP

* Note that LEFT and RIGHT options are effective only when the current VAXsim display exceeds your screen width.

VAXSIM COMMANDS REFERENCE SECTION

4.3 SPECIAL COMMANDS

Special commands perform a variety of maintenance functions, including reevaluating the database and adjusting the display for color. Table 4-3 lists the Special commands, what they do, and their syntax.

For more information on any Special command, refer to the alphabetic summary in this chapter.

Table 4-3: Special Comands

Command	Action	Syntax	Antonym
AUTOCORRECT AU	Enables/disables Autocorrection facility	AUTOCORRECT AU ON AU OFF	
CLIPPING CL	Turns the clipping function on/off	CLIPPING CLIP ON CLIP OFF	
EXIT E	Leaves VAXsim, returns to DCL (\$)	EXIT	
MARGIN M	Adjusts Warning/Alarm triggering	MARGIN MARGIN/SELECT MARGIN/CLASS	
PRINT P	Prints screen on attached graphics printer	PRINT PRINT/LARGE PRINT/SMALL	
REGIS REGI	Adjusts for ReGIS Terminal	REGIS REGIS ON REGIS OFF	
UPDATE UPD	Reevaluates the display database	UPDATE UPDATE/ALL	

VAXSIM COMMANDS REFERENCE SECTION

4.4 TIME COMMANDS

Time commands enable you to adjust the current evaluation period. Table 4-4 lists the Time commands, what they do, their syntax, and how they relate to other commands.

For more information on any Time command, refer to the alphabetic summary in this chapter.

Table 4-4: Time Commands

Command	Adjustment	Syntax	Antonym
BEFORE B	End time/date	BEFORE date BEFORE time BEFORE date:time BEFORE YESTERDAY/TODAY	SINCE
SINCE SI	Start time/date	SINCE date SINCE time SINCE date:time BEFORE YESTERDAY/TODAY	BEFORE

4.5 ALPHABETIC SUMMARY

The remainder of this chapter lists VAXsim commands alphabetically and provides a brief explanation of the command's use, its syntax, notes, and examples.

For more information, refer to Chapter 2.

4.5.1 ADD Command

ADD
A

OPERATION:

Adds error information from the specified node(s) in a network to the display database within your process memory. VAXsim automatically reevaluates each node in the database each time it encounters an ADD command.

ABBREVIATION:

A

SYNTAX:

ADD nodename_list

where: nodename_list is a list of one or more valid nodenames separated by commas.

NOTES:

If you add one node, VAXsim displays the Subsystem level of that node.

If you add multiple nodes, VAXsim displays the System level containing all the nodes.

If you add a nonexistent node for any reason, it will appear as a dotted-line "phantom block" in the box display; an error message will also appear. The above rule for multiple additions applies as well to phantom nodes.

EXAMPLES:

ADD HENRY
ADD HENRY,LEAR,CAESAR,IAGO

4.5.2 AUTOCORRECT Command

AUTOCORRECT
AU

OPERATION:

Enables or disables the Autocorrect facility, a feature of VAXsim that can interpret mistyped commands correctly, and allow their execution without your correcting them.

ABBREVIATION:

AU

SYNTAX:

AUTOCORRECT ON
AUTOCORRECT OFF

DEFAULT:

AUTOCORRECT OFF

NOTES:

In some cases, Autocorrect asks you to confirm the command you intended to type by displaying its assumed command followed by the prompt "(Correct?)". If the assumed command is correct, type "Y." The purpose of this action is to avoid undesirable effects (such as data loss) that could result from any ambiguity. Autocorrect will ask for confirmation for the following commands: EXIT, REMOVE, SPAWN, WATCH, ADD, CLIPPING, CYCLE, and DEPTH.

The autocorrect feature permits considerable latitude for mistypings; as a general rule, it will recognize unique abbreviations if they are present in the incorrect character string.

The command SHOW MODE will show the current status.

EXAMPLES:

AUTOCORRECT ON
AUTOCORRECT OFF
AU ON
AU
AUT OFF

VAXSIM COMMANDS REFERENCE SECTION

4.5.3 BACK Command

BACK
BA

OPERATION:

Moves you horizontally in the tree, in descending Branch ID Number order. BACK "wraps around" from Branch ID 1 to the highest-numbered block: from Number 1 to Number 9, for example.

ABBREVIATION:

BA

SYNTAX:

BACK
BACK nn

where: nn is an offset expressed as a positive integer, and is the number of branches to move by.

DEFAULT:

One block

NOTES:

Using the offset enables you to move more than one position.

BACK operates in all display modes.

EXAMPLES:

BACK
BACK 2

VAXSIM COMMANDS REFERENCE SECTION

4.5.4 BEFORE Command

BEFORE
BE

OPERATION:

Enables you to adjust the end of the evaluation period to view the error history or overall performance of devices or nodes in your display database. You can set time, date, or both.

ABBREVIATION:

BE

SYNTAX:

BEFORE DD-MMM[-[YY]YY]
BEFORE HH:MM[AM/PM]
BEFORE DD-MMM-YYYY:HH:MM[AM/PM]
BEFORE "DDDD HH:MM:SS:CC" (Delta Time)
BEFORE DDDD (Delta Time)
BEFORE

where: DD = 1-31 for absolute time
DDDD = 1-9999 for delta time
MMM = The three-character abbreviation for month:
JAN, FEB, MAR, APR, MAY, JUN,
JUL, AUG, SEP, OCT, NOV, DEC.
YYYY = Year (19 is optional; defaults to current
year)
HH = Hours (1-24)
MM = Minutes (00-59)
SS = Seconds (00-59)
CC = Hundreths of seconds (00-59)
AM/PM Valid when HH = 1-12

DEFAULT:

Missing fields default to the current, local, system date and time.

NOTES:

You can optionally specify AM or PM by adding it to the time field without a blank space.

You can specify a time and date together by separating the time and date fields with a colon.

Delta time enables you to fix the width of the evaluation period. BEFORE 7, for example, moves the end of the evaluation period back a week from today.

VAXSIM COMMANDS REFERENCE SECTION

BEFORE Command (Continued)

If you enter BEFORE with no parameters VAXsim resets the end of the evaluation period to the current date and time.

EXAMPLES:

```
BEFORE 10:00AM
BEFORE 10AM
BEFORE 1-DEC-83:10:30AM
BEFORE 7
BEFORE YESTERDAY
BEFORE TODAY
BEFORE
```

4.5.5 CLIPPING Command

CLIPPING
CL

OPERATION:

Enables or disables the use of the Clipping function in the error rate calculation. (See Section 3.3. for more information.)

ABBREVIATION:

CL

SYNTAX:

CLIPPING
CLIPPING ON
CLIPPING OFF

DEFAULT:

CLIPPING ON

NOTES:

If you enter the CLIPPING command without a parameter, VAXsim defaults to CLIPPING ON.

The command SHOW MODE will show the current status.

EXAMPLES:

CLIPPING OFF

4.5.6 CYCLE Command

CYCLE
CY

OPERATION:

Directs VAXsim to automatically display all available information for each node in your display database at your current level.

ABBREVIATION

CY

SYNTAX:

CYCLE
CYCLE nn

where: nn equals the number of seconds to pause between displays

DEFAULT:

10 seconds

NOTES:

After you enter the CYCLE command, VAXsim goes to the leftmost position of the current level and starts displaying the items on the level, pausing between each screen display. After VAXsim completes one pass, it does an update (see UPDATE command) and sets a timer for seven minutes. VAXsim continues to display each item on the level and when the timer expires, automatically updates the database.

If several nodes are currently in the display database, each node is monitored in turn.

To go back to interactive mode, press CTRL/C. VAXsim returns to the screen display from which you entered the CYCLE command.

CYCLE operates in all display modes.

EXAMPLES:

CYCLE
CYCLE 15

4.5.7 DEPTH Command

DEPTH
DE

OPERATION:

Enables you to modify the number of evaluation periods used to determine the Error Rate.

For the Histogram display, DEPTH therefore modifies the number of time bars representing evaluation periods. Note that for Histogram mode, the maximum possible DEPTH is 80.

ABBREVIATION:

DE

SYNTAX:

DEPTH = nn

where: nn equals the desired number of evaluation periods

DEFAULT:

25

NOTES:

The larger the DEPTH value, the less effect a large burst of errors has on the Error Rate.

The smaller the DEPTH value, the more effect a large burst of errors has on the Error Rate.

Setting DEPTH equal to zero forces the Error Rate to zero, so that the error evaluation rate is based on margin only.

EXAMPLES:

DEPTH = 15

DEPTH = 40

4.5.8 DISPLAY Command

DISPLAY
DI

OPERATION:

Enables you to select one of the following VAXsim display modes: Box Mode (the default mode), Line Mode, Summary Mode, and Histogram. The command word DISPLAY, used by itself, is sufficient to produce the Box Mode display.

DISPLAY HISTOGRAM can be used with the qualifier /YSCALE=n, where n is the upper limit of the "Y", or error count, scale. For example:

DISPLAY/YSCALE=100 HISTO

ABBREVIATION:

DI

SYNTAX:

DISPLAY
DISPLAY mode nodename
DISPLAY mode nn

where: mode is one of the following display mode names: BOX, LINE, SUMMARY, or HISTOGRAM, and nn and nodename are branch ID number or name respectively.

DISPLAY/YSCALE=n HISTO nn

where: n is the upper limit of the "Y" scale--that is, the vertical error-count scale.

NOTES:

The keyword DISPLAY alone (without a mode) causes Box Mode to be displayed, no matter what mode is currently on the screen. (If Box Mode is currently on display, the keyword has no effect.)

For all other changes of display--from Histogram to Line Mode, for example--the mode must be specified (DISPLAY LINE). Remember also that you need a ReGIS terminal to display the Histogram.

DEFAULTS

The initial display default is Box Mode on video terminals, and Line Mode on hardcopy terminals.

EXAMPLES:

DIS
DISPLAY HISTO
DISPLAY SUM
DISPLAY HIST 6
DIS/YSCALE=50 HISTO 3

4.5.9 DOWN Command

DOWN

D

<Next Screen> key on VT200 editing keypad

OPERATION:

Enables you to move to a more detailed level in the tree by specifying Branch ID Number.

ABBREVIATION:

D

SYNTAX:

DOWN

DOWN nn

nn

where: nn is the Branch ID Number

DOWN name

where: name is the Branch nodename or a unique abbreviation

DEFAULT:

One level

NOTES:

If you enter DOWN with no parameter, VAXsim chooses the branch having the highest error count and moves down to the next level.

If you enter DOWN with a Branch ID Number, or simply the Branch ID Number itself, VAXsim moves to that branch's next level of detail.

DOWN operates in all display modes.

EXAMPLES:

DOWN

DOWN 3

3

DOWN HAMLET

DOWN HAM

VAXSIM COMMANDS REFERENCE SECTION

4.5.10 EXIT Command

EXIT
E

OPERATION:

Enables you to leave the VAXsim program and return control to the VMS command level, represented by the \$ prompt.

ABBREVIATION:

E

SYNTAX:

EXIT

NOTE:

CTRL/Z is equivalent to the EXIT command.

EXAMPLE:

EXIT

4.5.11 HELP Command

HELP

H

<Help> key

<PF2> key on numerical keypads

OPERATION:

Provides online information about all aspects of the VAXsim user interface, including all commands listed in this chapter. The HELP interface itself works like VMS HELP, providing menus of keywords which you can type for specific information on commands, management, and so forth.

ABBREVIATION:

H

SYNTAX:

HELP

NOTE:

If you know the keywords for the specific area where you need information, you can view the information quickly by specifying those keywords with the HELP command; for example: HELP COMMAND ADD.

EXAMPLES:

HELP

H

H MANAGEMENT

H COMMAND ZOOM

4.5.13 MARGIN Command

MARGIN
M

OPERATION:

Enables you to adjust the computations that trigger the warning and alarm visual indications for the VAXsim session.

You can set margins selectively: by branch, device type, and class of error.

ABBREVIATION:

M

SYNTAX:

MARGIN nn

where: nn equals an integer that is used internally as an absolute value

MARGIN/SELECT={nodename or type}/CLASS=error class nn

where: nodename or type is a branch id or a type of device (RA81, for example) for which the specified margin is uniquely set

error class is a class of errors recognized by VAXsim: INFO, HARD, SOFT, or MEDIA.

DEFAULT:

15 errors on a nodename basis

NOTES:

VAXsim compares the short-term Counter Total and the Margin to the overall history reflected in the Error Rate and adjusts the visual error status indicators accordingly.

If you make the margin smaller, 10, for example, you are giving less leeway between the Current Count and the Historical Error Rate, causing VAXsim to display an error status condition sooner than it would using the default.

If you make the margin larger, you are allowing for a wider margin of error, causing VAXsim to display an error status condition later than it would using the default.

MARGIN affects the Display segment of VAXsim, and not the Monitor segment; for example, it does not affect the triggering of OPCOM messages.

You cannot use the /CLASS option without the /SELECT option. /CLASS accepts the wildcard "*", which represents all error classes.

You must specifically restore the default margin with another MARGIN command. To cancel a MARGIN/SELECT setting, re-enter the MARGIN command with a value of zero.

VAXSIM COMMANDS REFERENCE SECTION

MARGIN Command (Continued)

EXAMPLES:

```
MARGIN 10  
MARGIN/SELECT=REALTIME 50  
MARGIN/SEL=DR11W/CLASS=HARD 40  
MAR/SEL=DISK/CLASS=*
```

VAXSIM COMMANDS REFERENCE SECTION

4.5.14 NEXT Command

NEXT
N

OPERATION:

Enables you to move horizontally in the tree, in ascending Branch ID Number direction. NEXT "wraps around" from the highest-numbered branch to Branch ID 1.

SYNTAX:

NEXT
NEXT nn

where: where: nn is an offset expressed as a positive integer, and is the number of branches to move by.

DEFAULT:

One block

NOTES:

If you are at Branch ID Number 1, NEXT moves you to Branch ID Number 2 on the same level. If Branch ID Number 2 does not exist, VAXsim displays an error message.

NEXT operates in all display modes.

EXAMPLE:

NEXT
NEXT 2

VAXSIM COMMANDS REFERENCE SECTION

4.5.15 NOTIFY Command

EDITOR NOTIFY/ENABLE
EDITOR NOTIFY/DISABLE
EDI NOTI/E
EDI NOTI/D

OPERATION:

Enables you to specify what class(es) of operators are to receive the OPCOM message when error-status conditions change.

ABBREVIATION:

EDI NOTI/E
EDI NOTI/D

SYNTAX:

\$ VAXsim EDITOR NOTIFY/ENABLE = list
\$ VAXsim EDITOR NOTIFY/DISABLE = list

where: list = operator class(es)

DEFAULT:

Message defaults to system console (CENTRAL) only

NOTES:

You may use the NOTIFY command only through the DCL foreign command interface.

NOTIFY allows you to specify that notification messages be sent via the VMS MAIL facility. This option is controlled by the special "operator" class MAIL_MESSAGE.

Once you enable a class, it remains enabled until you disable the class with the EDITOR NOTIFY/DISABLE option.

See the Node_Info display for a listing of enabled operator classes.

EXAMPLES

\$ VAXsim EDITOR NOTIFY/DISABLE = ALL_OPERATORS
\$ VAXsim EDITOR NOTIFY/ENABLE = OPER1
\$ VAXsim EDITOR NOTIFY/ENABLE = MAIL

4.5.16 PRINT Command

PRINT
P

OPERATION:

Enables you to print a screen display using an attached graphics printer.

ABBREVIATION:

P
P/L
P/S

SYNTAX:

PRINT
PRINT/LARGE
PRINT/SMALL

DEFAULT:

PRINT/SMALL

NOTES:

To use the PRINT command, you must attach the graphics printer to the printer port on your terminal and enable the ReGIS option. (Refer to Chapter 2, General Usage, for more information.)

The LARGE option prints a double-size copy, approximately twice the size of the screen display.

The SMALL option prints a copy approximately the same size as the screen display.

EXAMPLES:

PRINT
PRINT/SMALL

4.5.17 REGIS Command

REGIS
REGI

OPERATION:

Displays information using the ReGIS feature. If a color monitor is in use, VAXsim translates visual error status to color.

ABBREVIATION:

REGI

SYNTAX:

REGIS
REGIS ON
REGIS OFF

DEFAULT:

REGIS OFF

NOTES:

The command SHOW MODE will display the current ReGIS state.

See Table 2-3 for an outline of the visual error status indicators for various terminal devices.

EXAMPLES:

REGIS
REGIS ON
REGIS OFF

4.5.18 REMOVE Command

REMOVE
RE

OPERATION:

Deletes nodes from your display database.

ABBREVIATION:

RE

SYNTAX:

REMOVE nodename_list

where: nodename_list is a list of one or more valid nodenames separated by commas

NOTES:

The REMOVE command deletes all information for the specified node from the display database only. Historical data remains unchanged.

Refer to Chapter 2, General Usage, for more information.

EXAMPLES:

REMOVE ROMEO
REMOVE ROMEO,JULIET,ARIEL,CALIBN

VAXSIM COMMANDS REFERENCE SECTION

4.5.19 REPORT Command

REPORT
REPO

OPERATION:

Enables you to display a synopsis of the broadcast messages generated by the NOTIFY command without entering the VAXsim program.

ABBREVIATION:

REPO

SYNTAX:

\$ VAXsim REPORT

NOTES:

REPORT is available only to users whose class is specified by the NOTIFY command. (See the NODE_INFO display for a listing of enabled operator classes).

REPORT is a DCL level command that must be entered at the \$ prompt.

EXAMPLE:

\$ VAXsim REPORT

VAXSIM COMMANDS REFERENCE SECTION

4.5.21 SHOW MESSAGE Command

SHOW MESSAGE
SH M

OPERATION:

Displays, in the Status Area, the most recent broadcast message received by your terminal during the current VAXsim session: for example, a MAIL message or a NOTICE message from the operator.

ABBREVIATION:

SH M

SYNTAX:

SHOW MESSAGE

NOTES:

To restore the current Status Area parameters, type SHOW PARAMETERS.

If no message has been received during the current VAXsim session, SHOW MESSAGE will report that fact.

EXAMPLE:

SHOW MESSAGE

VAXSIM COMMANDS REFERENCE SECTION

4.5.22 SHOW MODE Command

SHOW MODE
SH MO

OPERATION:

In the Status Area, displays the following information: the current display mode (Box, Line, Summary, Histogram), and whether the Autocorrection, ReGis, and Clipping features are currently on or off.

To refresh the status area, enter the SHOW PARAMETERS command.

ABBREVIATION:
SH MO

SYNTAX:
SHOW MODE

EXAMPLE:
SHOW MODE

4.5.23 SHOW PARAMETERS Command

SHOW PARAMETERS
SH P

OPERATION:

Refreshes the VAXsim Status Area display for the current mode. This command is useful when an error or a MAIL message notification has obscured the status display--for example, after you have entered the SHOW MESSAGE command to display the most recent message.

ABBREVIATION:

SH P

SYNTAX:

SHOW PARAMETERS

DEFAULTS:

- Current Evaluation Period defaults to the previous 24 hours.
- Current Margin defaults to 15.
- Clipping option defaults to ON.
- ReGIS option defaults to OFF.
- In the Histogram, Bar Width defaults to about 24 hours, and Depth defaults to 25.

EXAMPLE:

SHOW PARAMETERS

VAXSIM COMMANDS REFERENCE SECTION

4.5.24 SHOW VERSION Command

SHOW VERSION
SH V

OPERATION:

Enables you to display the current VAXsim version number.

ABBREVIATION:

SH V

SYNTAX:

SHOW VERSION

EXAMPLE:

SHOW VERSION

VAXSIM COMMANDS REFERENCE SECTION

4.5.25 SHUTDOWN Command

SHUTDOWN
SHUT

OPERATION:

Stops the VAXsim_Monitor that collects data as a detached system process. This command cannot be used during an interactive session. SHUTDOWN, abbreviated as SHUT, must be entered to the VMS command interpreter as a foreign command.

This is the preferred method of shutting down the VAXsim_Monitor process because it allows some cleanup activities to be performed.

SYNTAX:

The following commands can be entered at the DCL level of VMS or added to your SYSHUTDWN.COM command file:

```
$ VAXsim := $VAXsim  
.  
.  
.  
$ VAXsim SHUTDOWN
```

NOTE:

To invoke a shutdown, you need group privileges.

4.5.26 SINCE Command

SINCE
SI

OPERATION:

Enables you to alter the beginning of an evaluation period.

ABBREVIATION:

S

SYNTAX:

SINCE DD-MMM[-[YY]YY]
 SINCE HH:MM[AM/PM]
 SINCE DD-MMM[-[YY]YY][:HH:MM[AM/PM]]
 SINCE "DDDD HH:MM:SS.CC" (Delta Time)
 SINCE DDDD (Delta Time)
 SINCE

where: DD = 1-31 for absolute time
 DDDD = 1-9999 for delta time
 MMM = The three-character abbreviation for month:
 JAN, FEB, MAR, APR, MAY, JUN,
 JUL, AUG, SEP, OCT, NOV, DEC.
 YYYY = Year (19 is optional; defaults to current
 year)
 HH = Hours (1-24)
 MM = Minutes (00-59)
 SS = Seconds (00-59)
 CC = Hundreths of seconds (00-59)
 AM/PM Valid when HH = 1-12

DEFAULT:

Approximately 24 hours before the End time.

NOTES:

You can optionally specify AM or PM by adding it to the time field without a blank space.

You can specify a date and time together by separating the date and time fields with a colon.

Delta time enables you to fix the width of the evaluation period. SINCE 7, for example, moves the start of the evaluation period to a week before the current End time.

If you enter SINCE with no parameter, VAXsim resets the Start time to 24 hours prior to the current End time.

SINCE accepts standard VMS time specification formats.

EXAMPLES:

SINCE 10PM
 SINCE 10:00AM
 SINCE 1-NOV:10:00AM
 SINCE 1-JAN
 SINCE 7
 SINCE YESTERDAY
 SINCE TODAY
 SINCE

VAXSIM COMMANDS REFERENCE SECTION

4.5.27 SPAWN Command

SPAWN
SPAW

OPERATION:

Enables you to create and execute a subprocess to execute DCL commands without affecting your place in VAXsim.

ABBREVIATION:

SPAW

SYNTAX:

```
SPAWN ["DCL_command_line"]
SPAWN/WAIT ["DCL_command_line"]
SPAWN/NOWAIT "DCL_command_line"
SPAWN/NOERASE ["DCL_command_line"]
```

DEFAULT:

SPAWN/WAIT

NOTES:

If you are at the \$ prompt, you can enter multiple DCL commands, but you must log out to return to VAXsim.

When you enter a DCL command on the same line as the SPAWN command, only that command is executed before control is returned to VAXsim. Enclose the DCL command in quotation marks when you enter it on the same line as the SPAWN command.

If you use SPAWN or SPAWN/WAIT, VAXsim hibernates until the DCL command is finished executing. Conversely, if you enter SPAWN/NOWAIT, control returns directly to VAXsim before the DCL command finishes.

SPAWN/NOWAIT must have the DCL command on the same line because as soon as the command starts executing, control is returned to VAXsim.

If you enter SPAWN/NOERASE, the VAXsim display remains on the screen.

Control always returns to the VAXsim screen display from which you entered the SPAWN command.

EXAMPLES:

```
SPAWN "ANALYZE/ERROR_LOG"
SPAWN/WAIT
```

4.5.28 TOP Command

TOP
T

OPERATION:

Enables you to move to and display the System level from anywhere in the tree.

ABBREVIATION:

T

SYNTAX:

TOP

NOTES

TOP operates in all display modes.

EXAMPLE:

TOP

4.5.29 UP Command

UP
U
<Prev Screen> key on VT200 editing keypad

OPERATION:
 Moves you to a less detailed level in the tree.

ABBREVIATION:
 U

SYNTAX:
 UP
 UP nn

 where: nn is an offset expressed as a positive integer, and is
 the number of levels to move up

DEFAULT:
 One level

NOTE:
 UP operates in all display modes.

EXAMPLE:
 UP
 UP 2

VAXSIM COMMANDS REFERENCE SECTION

4.5.30 UPDATE Command

UPDATE
UPD

OPERATION:

Reevaluates either a portion or all of your display database from active hosts, including the local system. If you are viewing a particular node's data when you enter the UPDATE command, VAXsim only updates that node's data from its historical database file. If you are either at the System level or you enter the UPDATE/ALL command, VAXsim updates all nodes in the display database with current information from all active hosts.

ABBREVIATION:

UPD

SYNTAX:

UPDATE
UPDATE/ALL

NOTES:

The UPDATE command loads new information over the existing database. If, for any reason, a node is inaccessible, VAXsim keeps existing data and displays a message.

The ADD, REMOVE, CYCLE, and WATCH commands also force an UPDATE of the database.

UPDATE operates in all display modes.

EXAMPLE:

UPDATE
UPD/ALL

VAXSIM COMMANDS REFERENCE SECTION

4.5.31 WATCH Command

WATCH
W

OPERATION:

Enters dynamic display mode, enables VAXsim to remain stationary and to monitor a single display.

ABBREVIATION:

W

SYNTAX:

WATCH

NOTES:

When VAXsim is in dynamic display mode (WATCH), the database is reloaded every seven minutes.

To cancel the WATCH command and return to interactive mode, press CTRL/C.

WATCH operates in all display modes.

EXAMPLE:

WATCH

4.5.32 ZOOM Command

ZOOM

Z

<Find> key on VT200 editing keypad

OPERATION:

Moves you to a more detailed level of the tree.

ABBREVIATION:

Z

SYNTAX:

ZOOM

ZOOM nn

where: nn is a Branch ID Number

ZOOM name

where: name is the Branch nodename or a unique abbreviation

NOTES:

ZOOM enables you to descend multiple levels in a single operation. You can specify ZOOM alone or with a Branch ID.

ZOOM quickly pinpoints one or more error status conditions.

If only one error status condition exists, the ZOOM command moves down the entire branch to the bottom level.

If more than one error status condition exists, the ZOOM command moves down the common branch as far as it can and stops where you must decide which error to investigate.

ZOOM operates in all display modes.

EXAMPLES:

ZOOM

ZOOM 3

ZOOM CAESAR

ZOOM CA

APPENDIX A
VAXSIM ERROR MESSAGES

A.1 ERROR MESSAGE FORMAT

VAXsim error messages conform to the VAX/VMS operating system error format as follows:

%FACILITY-L-ID, text

where:

FACILITY = The name of the VAX/VMS facility; in this case, VAXsim

L = A severity level indicator as follows:

Code	Meaning
E	Error
I	Information
W	Warning

ID = An abbreviation describing the error message text

text = The actual message

The remainder of this appendix lists VAXsim error messages with an explanation of the error and corrective action. The term <string> indicates words, numbers, or file names that are unique to the error situation.

VAXSIM ERROR MESSAGES

A.2 ERROR MESSAGES

%VAXsim-E-AUTHORIZE, incorrect password - you are not authorized for this operation

Explanation: You lack sufficient privilege for this operation.

Action: Consult system manager

%VAXsim-E-BADQUAL, illegal qualifier used

Explanation: You specified an illegal or nonexistent qualifier with a VAXsim command.

Action: Refer to the Commands Reference section for correct command qualifiers.

%VAXsim-E-BADPARAM, <string> is an illegal parameter for this command.

Explanation: You specified an illegal parameter for a command.

Action: Refer to the Commands Reference section for correct command qualifiers.

%VAXsim-W-BADTIME, present SINCE/BEFORE time combination is invalid

Explanation: The window is invalid because you entered an End date that is before the Start date.

Action: Readjust the window so the Start date is before the End date.

%VAXsim-W-EDGEWRAP, Wrap around, now at <string> edge

Explanation: You have reached the rightmost or leftmost edge of the tree using the NEXT or BACK command.

Action: There is no action required.

%VAXsim-I-NODETAILS, Examine error log for further resolution

Explanation: Contained in message

Action: Contained in message

%VAXsim-W-NOENTITY, unable to find entity named <string>

Explanation: You have specified a nonexistent branch name with a command.

Action: Check the Branch ID Names in the display.

VAXSIM ERROR MESSAGES

%VAXsim-W-NOMONITOR, VAXsim Monitor not running

Explanation: No database is available to the VAXsim_Display process; this condition could be due to VAXsim_Monitor's not running.

Action: Start VAXsim_Monitor; see User Guide or Installation Guide.

%VAXsim-W-IVKEYW, Unrecognized value keyword <string>

Explanation: You have entered the MARGIN command with an incorrect CLASS or SELECT name.

Action: Refer to the Commands Reference section for correct command syntax.

%VAXsim-W-NOMORE, No "More" to <string> side

Explanation: You issued a LEFT or RIGHT command and there was no more data in that direction.

Action: Use a smaller offset or move in the opposite direction.

%VAXsim-I-NOOBVIOUS, there is not an obvious descent path

Explanation: You have issued the ZOOM command but there is no basis on which VAXsim can proceed; for example, there may be no error history for this branch.

Action: There is no action required.

%VAXsim-I-NORMAL, successful recovery (Error log may have more information)

Explanation: Retry was successful after device error.

Action: Consult error log if more information is desired.

%VAXsim-E-NOSPAWN, SPAWN feature is disabled for captive account

Explanation: You have issued a SPAWN command from a captive account

Action: There is no action required.

%VAXsim-E-PWDLENGTH, Password must be at least n characters long

Explanation: The password you have entered is too short.

Action: Choose and enter a password of n or more characters.

VAXSIM ERROR MESSAGES

%VAXsim-E-PWDVfyERR, New password verification error - password not changed

Explanation: In response to the request for verification, you have mistyped your new password. Therefore, your password is unchanged.

Action: Re-enter the new password.

%VAXsim-I-WATCHING, Use ^C to return to command mode

Explanation: You entered either the CYCLE or WATCH command and are now in dynamic mode.

Action: Use CTRL/C to exit.

%VAXsim-E-INSFARG, missing or unrecognized command argument(s)

Explanation: You either failed to enter an argument or entered it incorrectly.

Action: Refer to the Commands Reference section for correct syntax.

%VAXsim-E-INVNUM, invalid format, must be integer <string>

Explanation: The command you entered requires an integer parameter.

Action: Reenter the command with a number or refer to the Commands Reference section for the correct syntax.

%VAXsim-E-NEEDFIRST, <string> required for <string>

Explanation: You failed to satisfy the prerequisites for a desired operation.

Action: Follow the directions provided in the error message or refer to the Commands Reference section for more detailed information.

%VAXsim-E-NOBRANCH, branch <integer> not available here

Explanation: The Branch ID number you entered is not valid for this level.

Action: Look at the screen and choose a valid Branch ID number.

VAXSIM ERROR MESSAGES

%VAXsim-W-NOMATCH, name <string> not found

Explanation: You entered a REMOVE command with a node name that does not match any of the node names contained in your display database.

Action: Enter the TOP command to determine the nodes present in your display database. Reenter the command using a valid node name.

%VAXsim-W-NOWAY, could not do <string>, path ends here

Explanation: You attempted to move beyond the edge of the display database.

Action: Use a smaller offset or move in a different direction.

%VAXsim-E-NUMTOOHI, number out of range: <integer> (upper limit=
<integer>)

Explanation: The number you entered exceeds the range for your command.

Action: Enter a number that is within the stated limit.

%VAXsim-E-NUMTOOLOW, number out of range: <integer> (low limit=
<integer>)

Explanation: The number you entered falls short of the range for your command.

Action: Enter a number within the stated limit.

%VAXsim-E-TOOMNYARG, unexpected or unrecognized command argument(s)

Explanation: The syntax you entered is incorrect.

Action: Refer to the Commands Reference section for the correct syntax.

APPENDIX B
TERMINAL AND PRINTER OPTIONS

B.1 TERMINAL OPTIONS

This appendix outlines the terminal and printer options that VAXsim currently supports.

B.1.1 VT52 Option

If you are using a VT52 terminal instead of a VT100, the following conventions apply:

- Instead of blinking the block, VAXsim depicts a warning condition by outlining the block with question marks (?).
- Instead of outlining the block in reverse video, VAXsim depicts an alarm condition by outlining the block with asterisks (*).

B.1.2 VAXsim Hardcopy Option

VAXsim is not intended to be run from a hardcopy terminal. If you must run VAXsim from an LA120 or other compatible hardcopy terminal, however, these tips can help you avoid excessive form feeds and time-consuming printouts of each screen.

```
$ SET TERMINAL/PAGE=24
```

or

```
$ SET TERMINAL/FORM
```

B.1.3 ReGIS Color Display Option

VAXsim's ReGIS color display option enables you to use color to indicate error status. Green, yellow, and red indicate normal, warning, and alarm conditions, respectively.

In order to enable the ReGIS option, you must connect the ReGIS terminal and enter the VMS SHOW TERMINAL command to ensure that VMS has set the ReGIS characteristic.

TERMINAL AND PRINTER OPTIONS

VAXsim defaults to ReGIS OFF. You can activate the ReGIS option by entering:

```
VAXsim> REGIS ON
```

Remember that a ReGIS terminal is necessary to display the Histogram; make sure also that you have issued the SET TERMINAL/ReGIS command.

B.2 GRAPHIC PRINTER OPTION

VAXsim's graphic printer option enables you to create hardcopy diagrams of desired screen displays.

To copy the desired display, enter one of the following commands:

```
VAXsim> PRINT/LARGE
```

or

```
VAXSIM> PRINT/SMALL
```

The LARGE option prints a double-size copy, approximately twice the size as the screen display. The SMALL option prints a copy approximately the same size of the screen display.

SMALL is the default. When you enter the PRINT command, the ReGIS option is turned on automatically.

APPENDIX C

GLOSSARY

Absolute time

A specific time range that has fixed Start and End times and dates. The week starting on June 3, 1984 and ending on June 10, 1984 is an absolute time range because the ends of the evaluation period are fixed.

ADD

Loads a node's error log information into the display database. You can add one or more nodes at a time.

Alarm condition

Determined by comparing the Counter Total to the Error Rate, given the Margin of allowable error. Once that threshold is reached or exceeded, VAXsim outlines the block in reverse video. The alarm condition is reserved for hard errors only.

AUTOCORRECT

Enables or disables the Autocorrect facility, which is capable of executing mistyped VAXsim commands (ZOK for ZOOM, for example) by assuming the command you meant to type. In some cases, Autocorrect asks you to confirm the assumed command for purposes of data security.

BACK

Moves horizontally in the tree in descending Branch ID Number order. If you are at ID number 1, BACK moves you to ID 0. You can use an offset to move more than one position.

BEFORE

Adjusts the End time and date.

Branch ID Number

Enables you to move within VAXsim. The Branch ID is always located on the lower right-hand corner of the block.

Branch Label

Identifies the block. The Branch Label is always a block's first line of information.

CLIPPING

Enables or disables the use of the Clipping function in the error rate calculation.

Clipping Point

A maximum limit on the number of errors within any single Historical Evaluation Period which may be used in the calculation of the Historical Error Rate; used to moderate the long-term effect of a few periods containing extremely high (unusual) error rates.

GLOSSARY

Command

Invokes the desired action; VAXsim offers a variety of commands that enable you to add and delete nodes, move within the tree, and perform adjustments. The ADD command enables you to add nodes to the display database, for example. Most commands can be abbreviated to the first one or two letters.

Command Line Editor (CLE)

Provides for online command editing. The following editing keys are available:

- Left Arrow - Moves the cursor to the your left
- Right Arrow - Moves the cursor to the your right
- Up Arrow - Recalls the previous command in CLE buffer.
- Down Arrow - Recalls the next command in CLE buffer.
- Delete - Deletes the character to the left of the
 cursor
- Line Feed - Deletes the last command to the left

See Control characters for additional features.

Control characters

Enable you to invoke an action by pressing the CTRL key and the desired letter key. CTRL/Z enables you to exit VAXsim and the HELP facility. VAXsim's control keys are as follows:

- CTRL/B - Enables you to recall the last of 20 possible
 commands stored in the CLE ring buffer
- CTRL/R - Enables you to redisplay the line being entered
- CTRL/U - Enables you to delete the line
- CTRL/W - Enables you to refresh the screen display
- CTRL/Z - Enables you to exit VAXsim and/or the HELP
 facility

VMS control characters such as CTRL/S and CTRL/Q are also valid.

Counter Total

The actual number of errors the unit logged during the current evaluation period. The Counter Total appears only at Error Classification level.

CYCLE

Fixes VAXsim on a particular level and pauses at each display for ten seconds (default). To return to interactive mode, press CTRL/C.

Delete (Key)

Deletes one character to the left of the cursor.

Delta time

Fixes the duration of the evaluation period. As time moves, so does delta time.

GLOSSARY

Device error

VAXsim groups device errors into five types as follows:

1. Hard error - Not recoverable
2. Soft error - Successfully recovered with retries
3. Media error - Considered soft even when not recoverable
4. Informational error - Cannot be evaluated
5. Other - Not recorded by VAXsim

DISPLAY

Enables you to select one of the VAXsim display modes: Box Mode, Line Mode, Summary, or Histogram. DISPLAY alone produces the default Box Mode. You can specify a Branch ID number or name with a DISPLAY command.

Display database

A database built in memory when you use VAXsim interactively. Contains information about nodes that you have ADDED during the interactive session. The display database is reevaluated every time you use the following commands: ADD, REMOVE, CYCLE, UPDATE, WATCH.

DOWN

Enables you to move to a more detailed level of information. You can enter DOWN with or without a Branch ID Number. If you enter DOWN with no Branch ID, VAXsim chooses the branch with the highest Counter Total and moves down one level. If you specify Branch ID, VAXsim moves down one level in the branch. You can also enter a Branch label to specify the branch to which you want to move.

Error Classification Level

The graphic display one level up from the Error Detail Level. Each block represents a summary of all error types within the list below it.

Error Detail Level

The bottom level of your display database where all recorded error types are listed with their current count values.

Error Rate

Established by the unit's own performance; the Error Rate contains all error log information accumulated prior to the Start date.

Error status condition

Means that VAXsim is reporting a moderate to excessive number of errors. If a block is blinking, VAXsim is reporting a warning. If a block is outlined in reverse video, VAXsim is reporting an alarm.

Evaluation Period

The time period specified by the SINCE and BEFORE commands. The default is a 24 hour (one day) period ending at the current, local, system time.

Events

Non-errors such as boots and restarts.

GLOSSARY

DEPTH

Enables you to modify the number of evaluation periods used by VAXsim to determine the Error Rate. For Histograms, DEPTH modifies the number of time bars, each of which represents an evaluation period. The default Depth is 25.

EXIT

Enables you to leave VAXsim and return to VMS command Level, indicated by the \$ prompt.

HELP

Provides a complete catalog of VAXsim information online. You can call HELP by entering HELP or by attaching the desired topic, such as HELP TIME. To exit HELP, press CTRL/Z.

Historical Error Rate

The result of the evaluation process indicating a rate of similar errors typically experienced on a given device. This value appears in the Error Rate field of each box in an Error Classification level display.

Histogram

A VAXsim display mode, possible only on ReGIS terminals, that shows error counts over time as a bar chart; each bar represents the length of the specified evaluation period (about 24 hours by default). The histogram is displayed by the DISPLAY HISTOGRAM command. Histograms can have as many as 80 time period bars, as specified by the DEPTH command; the default is 25.

Historical database

The SYS\$ERRORLOG:VAXsim_CLUSTER.DATA file written by the VAXsim_Monitor process that contains an accumulation of error log information.

Historical Evaluation Period

A time period of the same duration as the Current Evaluation Period for which VAXsim has knowledge of a particular device.

Historical Period Count

The number of Historical Evaluation Periods spanned by your database.

Intelligent command parser

Parses and automatically corrects misspelled commands. The Intelligent command Parser handles commands with too many or too few, missing, or transposed characters by displaying the corrected command. All you have to do is verify the command by entering YES or Y to the verification prompt.

Keypad commands

These are VAXsim commands that can be issued by just typing a key on a specialized keypad (the editing pad on VT200 terminals, or the function keypad on VT100 and VT200 terminals). The VT200 editing keypad commands are as follows:

- ZOOM = <Find> key
- DOWN = <Next Screen> key
- UP = <Prev Screen> key

Also, the <PF2> key on the function keypad of most terminals is equivalent to the HELP command.

GLOSSARY

LEFT

Shifts the display to the left to readjust the screen after viewing a configuration that exceeds the current display width. VAXsim signals when you can use the LEFT command displaying "(More)" on the left-hand side of the screen.

Left arrow

An editing function that enables you to move one character to the left.

Line feed

Deletes one word to the left, enabling you to reenter the desired information. (See command Line Editor.)

Margin

Sensitivity factor which defines how much fluctuation in error rates the VAXsim display should treat as normal. VAXsim assumes a default margin of 15 errors.

Memory error

Hard or soft errors attributed to memory; READ DATA SUBSTITUTE (RDS) or CORRECTED READ DATA (CRD), respectively.

Monitor process

Processes each error record individually and continuously updates the historical database by attaching itself directly to VMS ERRFMT.

Multiple command line format

Enables you to enter more than one command together by joining them with either the backslash (\) or the vertical bar (|) as follows: SINCE 8:00AM\BEFORE 6:30PM|SHOW PARAMETERS.

NEXT

Moves horizontally in ascending Branch ID Number direction. If you are at ID number 1, NEXT moves you to ID 2. You can use an offset to move more than one position. VAXsim provides a message when you reach the last position on the level.

Node

A VAX system that can be added to the VAXsim display database for error log processing. VAX nodes can be local or remote (accessible via DECnet).

Node_Info

Available on the Subsystem level display, the Node_Info block lists the following information about the node:

- Operating system
- Last version of the Monitor that logged an error
- CPU type and ID
- Date of the last database reevaluation (UPDATE)
- Date of the oldest and newest error log entry

NOTIFY

Enables you to specify what class(es) of operators are to receive the OPCOM message when error-status conditions change. By default, the message is received by the system console only. See also REPORT.

GLOSSARY

Offset

A positive integer representing the number of positions to move. The following commands use an offset: BACK, LEFT, NEXT, RIGHT, UP. The default (offset) is 1.

Phantom block

In VAXsim box displays, a block or node drawn in dotted lines because no data can be evaluated for it. The reason for phantom status may be that you have added a nonexistent node, or that for some reason data about an existing node is inaccessible to VAXsim. An error message accompanies a phantom block.

PRINT

Produces a hard copy of any screen display with a graphics printer.

REMOVE

Deletes a node's error log information from the display database.

REPORT

Enables you to display a synopsis of the broadcast messages generated by NOTIFY without entering VAXsim. See also NOTIFY.

RIGHT

Shifts the display to the right, enabling you to view a configuration that exceeds the current screen display width. VAXsim indicates an oversize screen by displaying (More) on the right-hand side of the screen display.

Right arrow

An editing function that enables you to move one character to the right.

SHOW MESSAGE

Displays, in the Status Area, the most recently received broadcast message during the current VAXsim session: for example, a MAIL message or NOTICE message from the operator.

SHOW MODE

Displays, in the Status Area, the current display mode and the status (on or off) of the Autocorrection, ReGIS, and Clipping features.

SHOW PARAMETERS

Useful in refreshing the VAXsim display Status Area in case it is disrupted by an error message or MAIL notification (for example). A CTRL/W will refresh the entire screen.

SHOW VERSION

Enables you to check the VAXsim version number.

SHUTDOWN

Shuts down the VAXsim_Monitor process, from the command level only, provided you have the required privileges.

SINCE

Enables you to adjust the Start time and date.

SPAWN

Enables you to create a subprocess to execute DCL commands without affecting your place in VAXsim

GLOSSARY

Subsystem level

Displays all the device categories attached to the system named. VAXsim also displays a count for Events and Node_Info on this level.

System base time and date

SINCE 17-NOV-1858:00:07; VAXsim's fixed time equivalent for the Smithsonian base date and time for the astronomical calendar (November 17, 1858, 00:00 o'clock).

System level

The top or root of the VAXsim tree; displays all the nodes you have added to the display database. If you enter TOP, VAXsim moves you to the System level.

Threshold

The point at which an error rate progresses from normal to warning status or from warning to alarm status. The threshold is determined by comparing the Counter Total to the Error Rate, given the Margin of allowable error.

Time range

The current evaluation period; affects the error counts on the screen display. The SHOW PARAMETERS command displays the current time range. The default is the previous 24 hour period.

TOP

Enables you to move to the System level from anywhere in the tree.

Unit level

Shows the set of devices that compose a node's subsystem. If a node has a disk subsystem, the Unit level shows the number of disks and their names.

UP

Enables you to move to a less detailed level of the tree. You can use an offset to move up more than one level at a time.

UPDATE

Forces VAXsim to reread the database file on a particular node or all nodes contained in your display database.

WATCH

Enables you to fix VAXsim on one display for continual monitoring. To return to interactive mode, press CTRL/C.

Warning condition

Determined by comparing the Count Total to the Error Rate, given the Margin of allowable error. Once the threshold is reached, VAXsim highlights the block by outlining it in reverse video. Soft, media, and informational errors have thresholds for warning conditions only. Hard errors have thresholds for warning as well as alarm conditions.

GLOSSARY

Wraparound

The ability of VAXsim's horizontal movement commands (NEXT, BACK, RIGHT, and LEFT) to move the display to the lowest- or highest-numbered branch if your command takes the display off-screen. For example, if you are currently displaying the highest-numbered (rightmost) branch, #11, and you issue a NEXT command, the display will move "around" to Branch #1. (If, however, you issue a RIGHT 30 command, and there are fewer than 30 columns to the right, VAXsim will "wrap around" only to the first or leftmost column of the display; the reverse is true of the LEFT command.)

ZOOM

Enables you to quickly pinpoint one or more error status conditions. If only one error status condition exists, the ZOOM command moves down the entire branch to the bottom level. If more than one error status condition exists, the ZOOM commands moves down the common branch as far as it can and stops where you must decide which error to investigate.

INDEX

- Absolute Time
 - See Time
- Add
 - Devices, 2-10
 - Nodes, 2-8
 - Display, 2-9
- ADD command, 2-8, 4-6, C-1
- ANALYZE ERROR LOG, 1-1
- Autocorrect, 2-4, 2-5
- AUTOCORRECT command, 4-7, C-1

- BACK command, 2-13, 4-8, C-1
 - Illustration, 2-14
- Bar chart display
 - See Histogram, 1-9
- BEFORE command, 2-17, 2-18, 2-19, 4-9, C-1
- Block
 - Diagram, 1-5, 1-6
 - Elements, 1-5
- Box Mode, 1-3
- Branch ID Number, 1-5, 2-12, C-1
- Branch Label, 1-5, C-1

- Clipping
 - function, 3-4 to 3-6
 - Point, 3-3, 3-4, C-1
- CLIPPING command, 4-11, C-1
- Command Line Editor, 2-1, 2-3, C-2
 - Keys, 2-4
- Commands
 - Definition, C-2
 - Directional, 4-3
 - Display, 4-2
 - Entering, 2-1
 - Informational
 - SHOW PARAMETERS, 2-25
 - SHOW VERSION, 2-25
 - Introductory, 2-2
 - Multiple
 - See Multiple command format
 - Special, 4-4
 - Time, 4-5
- Commands Reference Section, 4-1 to 4-39
- Control Characters, C-2
- Counter Total, 1-5, 3-3, C-2
- CYCLE command, 2-6, 4-12, C-2

- Database
 - Display, 1-3, 2-10, 2-11, C-3
 - Adding Devices, 2-10
 - Adding Nodes, 2-8
 - Managing, 2-8
 - Removing Devices, 2-10
 - Removing Nodes, 2-9
 - Update, 2-10
- Database (Cont.)
 - Historical, 1-3, 2-6, 2-8, 2-10, 3-1, C-4
 - Adding Devices, 2-10
 - Removing Devices, 2-10
- Delete Key, C-2
- Delta Time
 - See Time
- DEPTH command, 4-13, C-4
- Directional Commands, 4-3
- DISPLAY command, 4-14, C-3
- Display commands, 4-2
- Display modes, 1-3
 - Relationships, 2-25 to 2-28
- Displays
 - Commands for, 4-2
 - Dynamic, 2-11
 - Examining, 2-11 to 2-15
 - Identifying (SHOW MODE), 2-25
 - Introduction, 1-5 to 1-11
 - Oversized, 2-14
- DOWN command, 2-12, 4-15, C-3
 - Illustration, 2-12
- Dynamic Display Mode
 - CYCLE Command, 2-11
 - WATCH Command, 2-11

- ERRFMT process, 1-1
- Error
 - Classification Level, 1-4, C-3
 - Detail Level, 1-5, 3-3, C-3
 - Log analysis, 3-1
 - Messages, A-2 to A-5
 - Organization, 3-2 to 3-3
 - Rate, 1-5, C-3
 - Status, C-3
 - Alarm, 2-16, B-1, C-1
 - Normal, 2-16, B-1
 - Warning, 2-16, B-1, C-7
 - Status Indicators, 2-16
 - Types, 1-4
 - Device, 3-1, C-3
 - Events, 3-2, C-3
 - Memory, 3-2, C-5
- Error Rate Evaluation, 3-4
 - Algorithm, 3-3
 - Error Detail Level, 3-3
 - Historical Period Count, 3-4
 - Historical Total, 3-4
- Errors
 - Organization of, 3-1
- Evaluation Period, 3-3, C-3
 - Adjustment, 2-17
 - Points of Reference, 2-20
- EXIT command, 4-16, C-4

- Foreign Command Interface, 2-1, 2-6

Foreign Commands
 See Foreign Command Interface

Hardcopy Option, B-1

HELP, 2-1, 2-5, 2-7, C-4

HELP command, 4-17

Histogram, 1-3, 1-9 to 1-11, C-4
 Illustration, 1-10
 Relationship to other displays, 2-26, 2-27
 Status area parameters, 1-10

Historical Error Rate, 3-3, C-4

Historical Evaluation Period, 3-3, C-4

Historical Period Count, 3-3, 3-4, C-4

Intelligent command parser, 2-1, 2-4, C-4

Introductory Commands, 2-2

Keypad commands, 2-5, C-4

Left Arrow, C-5

LEFT command, 4-18, C-5

Level
 Error Classification
 See Error, Classification Level
 Error Detail
 See Error, Detail Level
 Subsystem
 See Subsystem Level
 System
 See System Level
 Unit
 See Unit Level

Line Feed, C-5

Line Mode, 1-3

Line Mode Display List, 1-8
 Illustration, 1-8

Logical Names, 2-6
 DECnet Access Control Strings, 2-8
 Undefined, 2-8

MAIL, 1-3

Margin, 3-6, C-5

MARGIN command, 4-19

Memory
 Naming Convention, 3-2

Monitor, 2-6, 2-7, 2-10, 3-1, C-5
 Shut-Down, 2-7
 Start-Up, 2-7

Moving
 Down, 2-12
 Right, Left, 2-14
 Side to Side, 2-13
 Up, 2-12

Multiple command format, 2-1, 2-2, 2-5, C-5
 Example, 2-5

NEXT command, 2-13, 4-21, C-5
 Illustration, 2-14

Node, C-5
 Adding, 2-8

Node Info, C-5

NOTIFY command, 2-28, 2-29, 4-22, C-5

Offset, C-6

OPCOM, 1-3

Overview, 1-1 to 1-3

Phantom block, 1-7

PRINT command, 4-23, C-6

Printer
 Option, B-2

ReGIS
 Color option, B-1
 Terminal for Histogram, 1-9
 Terminal needed for Histogram, 1-3

REGIS command, 4-24, B-2

Remove
 Devices, 2-10
 Nodes, 2-9

REMOVE command, 2-9, 4-25, C-6

REPORT command, 4-26, C-6

Right Arrow, C-6

RIGHT command, 4-27, C-6
 Illustration, 2-15

SHOW ERROR, 1-1

SHOW MESSAGE command, 2-25, 4-28, C-6

SHOW MODE command, 2-24, 4-29, C-6

SHOW PARAMETERS command, 2-24, 2-25, 4-30, C-6

SHOW VERSION command, 2-24, 2-25, 4-31, C-6

SHUTDOWN command, 4-32, C-6

SINCE command, 2-17, 2-18, 2-19, 2-22, 4-33, C-6

SPAWN command, 2-30, 4-34, C-6

Special Commands, 4-4

Status area, 1-6

Subsystem Level, 1-4, C-7

Summary Mode, 1-3

Summary Mode Display List, 1-9

System Base Time, C-7

System Level, 1-4, 2-9, 2-13, C-7

System Management, 3-7
 Files, 3-7
 Logical Names, 2-6
 Shut-Down, 2-7
 Start-up, 2-7

Terminal
 Graphic Printer, B-2
 Hardcopy, B-1
 Options, B-1 to B-2
 ReGIS, B-1

Terminal (Cont.)
 VT52, B-1
Threshold, C-7
Time, 2-17
 Absolute, 2-18, 2-21, C-1
 Format, 2-19
 BEFORE Point of Reference, 2-20
 Commands, 4-5
 Delta, 2-19, 2-21, C-2
 Format, 2-20
 Ranges, C-7
 SINCE Point of Reference, 2-20
Time Range
 See Evaluation Period
TOP command, 2-13, 4-34, 4-35,
 C-7
 Illustration, 2-13

Unit Level, 1-4, C-7
UP command, 2-12, 4-36, C-7
 Illustration, 2-13
Update
 Display Database, 2-10
UPDATE command, 2-10, 4-37, C-7
User interface, 2-1 to 2-6

VAXcluster, 1-4
VAXsim
 Display function, 1-3
 Error rate evaluation, 3-4
 General usage, 2-1 to 2-30
 Monitor Start-Up, 2-7
 Organization of errors, 3-1
 Relationship with VMS, 1-1
 Shut-Down, 2-7
 Software components, 3-7
 Summary of changes, ix to xi
 Technical notes, 3-1 to 3-8
 Tree Structure, 1-3 to 1-7
VAXsim_Monitor, 1-2, 1-3
Version changes in VAXsim, ix to
 xi
Visual error indications, 2-16,
 3-7
VT52 Option, B-1

WATCH command, 2-6, 4-38, C-7
Wraparound, C-8

ZOOM command, 2-12, 4-39, C-8
 Illustration, 2-12

READER'S COMMENTS

NOTE: This form is for document comments only. DIGITAL will use comments submitted on this form at the company's discretion. If you require a written reply and are eligible to receive one under Software Performance Report (SPR) service, submit your comments on an SPR form.

Did you find this manual understandable, usable, and well organized? Please make suggestions for improvement.

Did you find errors in this manual? If so, specify the error and the page number.

Please indicate the type of user/reader that you most nearly represent:

- Assembly language programmer
- Higher-level language programmer
- Occasional programmer (experienced)
- User with little programming experience
- Student programmer
- Other (please specify) _____

Name _____ Date _____

Organization _____

Street _____

City _____ State _____ Zip Code _____
or Country

Do Not Tear - Fold Here and Tape

digital



No Postage
Necessary
if Mailed in the
United States

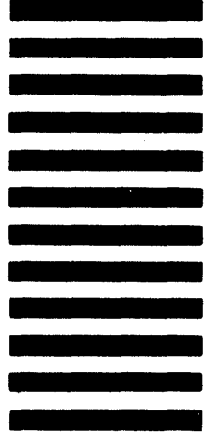

BUSINESS REPLY MAIL

FIRST CLASS PERMIT NO.33 MAYNARD MASS.

POSTAGE WILL BE PAID BY ADDRESSEE

**DIGITAL EQUIPMENT CORPORATION
SSG/ML PUBLICATIONS, ML05-5/E45
146 MAIN STREET
MAYNARD, MA 01754-2571**



Do Not Tear - Fold Here

Cut Along Dotted Line