

Installing and Using The VT330/VT340 Video Terminal

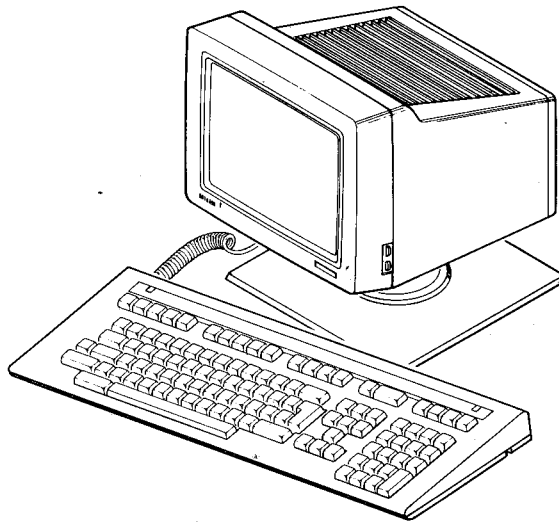

USER'S INFORMATION MAP

Installing and Using The VT330/VT340 Video Terminal

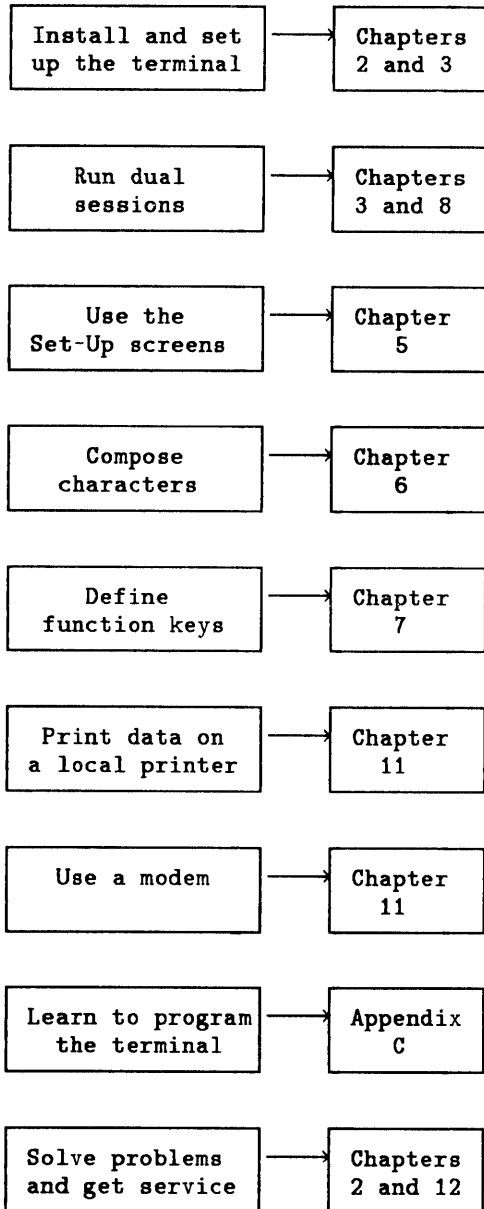

VT330/VT340 Programmer Reference Manual

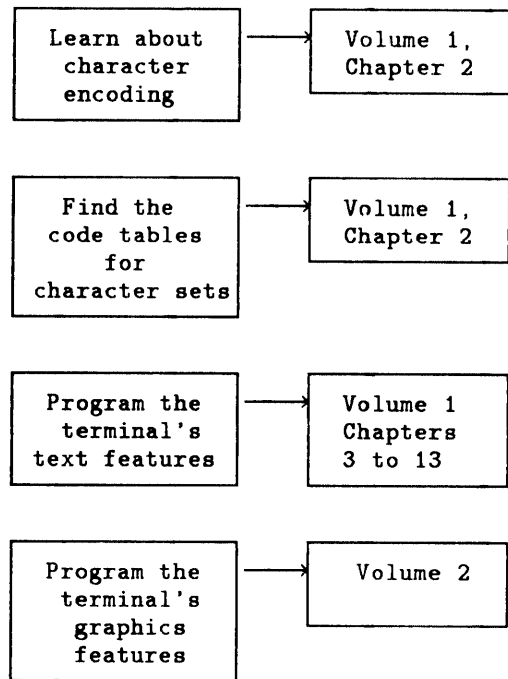

94-0031058/04

EK-VT3XX-UG-002

Installing and Using
The VT330/VT340
Video Terminal

Prepared by Educational Services
of
Digital Equipment Corporation

1st Edition, March 1987

2nd Edition, May 1988

Copyright © 1987, 1988 by Digital Equipment Corporation.

All Rights Reserved.

Printed in Taiwan

The reproduction of this material, in part or whole, is strictly prohibited. For copy information, contact the Educational Services Department, Digital Equipment Corporation, Maynard, Massachusetts 01754.

The information in this document is subject to change without notice. Digital Equipment Corporation assumes no responsibility for any errors that may appear in this document.

FCC Notice: This equipment generates, uses, and may emit radio frequency energy. The equipment has been type tested and found to comply with the limits for a Class A computing device pursuant to Subpart J of Part 15 of FCC Rules, which are designed to provide reasonable protection against such radio frequency interference when operated in a commercial environment. Operation of this equipment in a residential area may cause interference in which case the user at his own expense may be required to take measures to correct the interference.

AT&T is a trademark of American Telephone and Telegraph Company.

Tektronix is a trademark of Tektronix, Inc.

The following are trademarks of Digital Equipment Corporation, Maynard, Massachusetts.

digital ™	DECUS	MicroVAX	SSU
DEC	DECwriter	MicroVMS	UNIBUS
DECmate	DIBOL	PDP	VAX
DECnet	LA12, LA36	P/OS	VMS
DECpage	LA50, LA75	Professional	VT
DECserver	LA100, LA120	Rainbow	VT52, VT100, VT101,
DECsystem-10	LA210	ReGIS	VT102
DECSYSTEM-20	LN01, LN03	RSTS	VT125, VT131, VT220,
DECTalk	LQP02, LQP03	RSX	VT240
			VT330, VT340
			Work Processor

CONTENTS

ABOUT THIS MANUAL • xii

CHAPTER 1 A LOOK AT THE TERMINAL • 1

VT300 Components, 1

Terminal, 1

Keyboard, 2

Your Computer System, 3

Features, 3

Set-Up, 4

Dual-Sessions, 4

Windows, 5

Page Memory, 5

Status Line, 5

User-Defined Keys, 5

Graphics, 6

Color Display, 6

Local Editing, 6

Emulating VT Series Terminals, 6

Character Sets, 7

Programming the Terminal, 7

INSTALLING YOUR VT330/VT340 VIDEO TERMINAL

CHAPTER 2 INSTALLATION • 11

Site Considerations, 11

Unpacking, 12

Installation, 13
Cables for Single or Dual Sessions, 23
Problem Solving, 29

CHAPTER 3 GETTING STARTED • 30

Selecting the Correct Keyboard Language, 31
Setting Up the VT300 for Single or Dual Sessions, 33
 System Connectors, 33
 Setting Up for a Single Session (One Cable), 34
 Setting Up for Dual Sessions (Two Cables), 36
 Setting Up for Dual Sessions with SSU Software (One Cable), 37
Selecting the Correct Baud Rate, 38

USING YOUR VT330/VT340 VIDEO TERMINAL

CHAPTER 4 THE KEYBOARD, CONTROLS, AND INDICATORS • 43

Controls and Connectors, 43
VT300 Cursors, 46
 Text Cursor, 46
 Graphics Cursor, 46
Keyboard, 46
 Keyboard Layout, 47
Main Keypad, 48
 Tab, 48
 Ctrl, 48
 Lock, 49
 Shift, 49
 Return, 49
 <x] (Delete), 49
 Space Bar, 49
 Compose Character, 49
Editing Keypad, 50
Numeric Keypad, 51
 Enter, 51
 Comma (Space), 52
Top-Row Function Keys, 53
 Hold Session, 53
 Ctrl-Hold Session, 54
 Local Print, 54

- Shift-Local Print, 54
- Ctrl-Local Print, 54
- Set-Up, 54
- Ctrl-Set-Up, 54
- Switch Session, 54
- Ctrl-Switch Session, 55
- Break, 55
- Shift-Break, 55
- Ctrl-Break, 55
- F11 (ESC), 55
- F12 (BS), 55
- F13 (LF), 56
- Help, 56
- Do, 56
- Data Processing Keys, 56
 - North American/United Kingdom Keyboard, 57
- Compose Characters, 57
- Indicator Lights, 57
 - Hold Session, 57
 - Lock, 58
 - Compose, 58
 - Wait, 58
- Keyboard Indicators, 58
 - Keyclick, 58
 - Bell, 59
- Status Line, 59

CHAPTER 5 USING SET-UP • 63

- Overview, 63
 - Current and Saved Settings, 63
 - Independent Set-Ups for Dual Sessions, 64
 - A Guide to Set-Up Features, 64
 - Entering and Leaving Set-Up, 66
- Set-Up Directory, 67
 - Screen Title, 67
 - Set-Up Directory Features, 68
 - Set-Up Directions, 68
 - Status Line, 68
 - Set-Up Cursor, 68
 - Action Fields, 69
 - Set-Up Language, 70

Set-Up Directory Fields, 70
Selecting Set-Up Screens, 73
Moving from Screen to Screen, 73
Moving Directly to a Screen, 73
Returning to the Set-Up Directory, 74
Set-Up Screen Format, 74
How to Change a Current Setting, 74
How to Save a New Setting, 75
How to Recall Saved Settings, 75
Global Set-Up, 76
Dual Sessions, 76
General Set-Up, 80
Character Sets, 80
Display Set-Up, 85
Selecting a Page Size, 85
Panning, 86
Communications Set-Up, 91
Entering an Answerback Message, 98
Deleting the Current Answerback Message, 98
Keyboard Set-Up, 99
Keyboard Language, 99
Tab Set-Up, 104

CHAPTER 6 COMPOSING CHARACTERS • 106

Three-Stroke Sequences, 107
Using a Three-Stroke Sequence, 107
Two-Stroke Sequences, 108
Using a Two-Stroke Sequence, 108
Invalid Sequences, 109
Canceling or Restarting a Compose Sequence, 109
Hexadecimal Compose Sequences, 109

CHAPTER 7 USER-DEFINED KEYS • 126

What are User-Defined Keys?, 126
User-Defined Key Set-Up, 127
How to Define and Use a UDK, 128
Saving UDKs, 129
Editing UDKs, 129
Clearing UDKs, 129
Recalling UDKs, 129

Protecting UDKs, 129
Tips on Using UDKs, 130

CHAPTER 8 DUAL SESSIONS AND WINDOWS • 131

What are Sessions?, 131
Dual Sessions, 131
Opening Dual Sessions, 132
 If You Use Two Cables, 132
 If You Use One Cable and SSU Software, 133
 Restoring an Interrupted SSU Session, 135
 SSU Screen Messages, 135
Which Session is Active?, 136
Windows, 137
 How to Select Two Windows, 137
 Keeping the Cursor Visible, 138
 How to Change Horizontal Window Sizes, 139
 Tips on Using Horizontal Windows, 140
 How to Pan, 141
 Notes About Panning, 142

CHAPTER 9 LOCAL EDITING • 143

Local Editing Set-Up Screen, 143
 Entering and Leaving Edit Mode, 144
 Notes on Edit Mode, 145
 Sending Data to the Host System, 145
Local Editing Keys, 151
 Shift-EDIT, 151
 Home Cursor, 152
 Insert/Overstrike, 152
 CLR PAGE/Clr Field, 152
 Shift-CLR PAGE/Clr Field, 152
 Prev Page, 152
 Next Page, 153
 Tab, 153
 Shift-Tab, 153
 Insert Line, 153
 Delete Line, 153
 Delete Char, 154
 Transmit, 154
 Return, 154
 <x] (Delete), 154

CHAPTER 10 GRAPHICS AND COLOR • 155

- Graphics, 155
- Graphics Set-Up Screen, 156
- Color Set-Up Screen (VT340 only), 159
- The Color Map, 159
 - RGB Primary Colors, 160
 - How to Change Colors in the Color Map, 161
- Saving Colors, 162
- Recalling Colors, 162
- Locator Devices: Mouse and Graphics Tablet, 163
 - Mouse, 163
 - Using the Mouse, 164
 - Graphics Tablet, 164

CHAPTER 11 PRINTING AND MODEMS • 166

- Printers, 166
- Selecting a Print Mode, 167
 - Normal Mode: Printing Pages of Text, 167
 - Auto Print Mode: Printing Text from the Host System, 167
 - Printer Controller Mode: Letting the Host Control Printing, 168
 - Local Controller Mode: Setting Up the Printer, 168
 - Printing Graphics, 168
- Printer Set-Up Screen, 169
 - Notes About Printing, 169
- Modems, 175
 - Mode 1 and Mode 2 Modems, 176
 - Connecting to a Modem, 176

CHAPTER 12 SOLVING PROBLEMS AND GETTING SERVICE • 178

- Operating Problems, 178
- Power-Up Self-Test, 178
 - Error Messages, 178
- Digital Service, 181
 - Hardware Services, 181
 - Software Services, 182
- How to Get Service, 183
- Diagnostic Set-Up Screen, 183

APPENDIX A SPECIFICATIONS • 184

APPENDIX B ORDERING PARTS AND DOCUMENTATION • 187

**APPENDIX C USING VT300 CONTROL FUNCTIONS:
A PRIMER • 192**

Control Characters, 193

Control Functions, 193

Including Control Characters and Functions in Your Program, 195

Predefined Control Characters, 195

Using Control Functions with VAX/11 Basic, 197

ESC Constant, 197

Defining CSI, 197

CHR\$ Reserved Word, 198

Program Examples, 199

Using Control Functions with VAX/11 Pascal, 200

Program Examples, 201

Using Control Functions with VAX/11 Fortran, 202

CHAR Function, 202

Program Examples, 203

APPENDIX D KEYBOARDS • 204

APPENDIX E CONNECTOR PIN ASSIGNMENTS • 221

GLOSSARY • 224

INDEX • 232

FIGURES

1-1 VT330 Video Terminal, 2

3-1 Set-Up Directory, 31

3-2 Keyboard Set-Up Screen, 32

3-3 System Connectors, 34

3-4 Global Set-Up Screen, 35

3-5 Communications Set-Up Screen, 39

4-1 Controls and Power Indicator, 44

4-2 Connectors, 45

4-3 VT300 Keyboard (North American/United Kingdom Version), 47

4-4 Main Keypad, 48

4-5 Editing Keypad, 50

- 4-6 Numeric Keypad, 51
- 4-7 Local Editing Template, 52
- 4-8 Top-Row Function Keys, 53
- 4-9 Example of a Data Processing Key, 56
- 4-10 Indicator Lights, 57
- 4-11 Status Line Fields, 60

- 5-1 Independent Set-Up for Dual Sessions, 64
- 5-2 Set-Up Directory, 67
- 5-3 Global Set-Up Field, 76
- 5-4 General Set-Up Screen, 80
- 5-5 Display Set-Up Screen, 85
- 5-6 Communications Set-Up Screen, 91
- 5-7 Keyboard Set-Up Screen, 99
- 5-8 Tab Set-Up Screen, 104

- 6-1 Hexadecimal Compose Keys, 110

- 7-1 User-Defined Key Set-Up Screen, 127

- 8-1 Full-Screen Window, 138
- 8-2 Creating Two Vertical Windows, 138
- 8-3 Creating Two Horizontal Windows, 138
- 8-4 Changing the Size of Horizontal Windows, 139
- 8-5 The Difference Between Scrolling and Panning, 141

- 9-1 Local Editing Set-Up Screen, 144
- 9-2 Local Editing Keys, 151

- 10-1 Graphics Set-Up Screen, 156
- 10-2 Color Set-Up Screen, 159
- 10-3 VSXXX-AA Mouse, 163
- 10-4 VSXXX-AB Graphics Tablet, 165

- 11-1 Printer Set-Up Screen, 169
- 11-2 Connecting a DF02 or DF03 Modem, 177

- 12-1 Diagnostic Set-Up Screen, 183

- C-1 7-Bit ASCII Character Set, 194

Appendix D shows all VT330/VT340 keyboard models. See page 203 for a listing.

TABLES

- 4-1 Controls, 44
- 4-2 Connectors, 45
- 4-3 Status Line Fields, 60

- 5-1 A Guide to Set-Up Features, 65
- 5-2 Set-Up Directory Fields, 70
- 5-3 Global Set-Up Features, 77
- 5-4 General Set-Up Features, 81
- 5-5 Display Set-Up Features, 86
- 5-6 Communications Set-Up Features, 93
- 5-7 Keyboard Set-Up Features, 100
- 5-8 Tab Set-Up Features, 105

- 6-1 Nonspacing Diacritical Marks in Multinational Mode, 110
- 6-2 Compose Sequences for Multinational Mode, 111
- 6-2 Compose Sequences for National Mode, Using Typewriter Keys, 117
- 6-3 Compose Sequences for National Mode. Using Data Processing Keys, 125

- 7-1 User-Defined Key Set-Up Features, 128

- 9-1 Local Editing Set-Up Features, 145

- 10-1 Graphics Set-Up Features, 157

- 11-1 Printer Set-Up Features, 170

- 12-1 Common Operating Problems, 179
- 12-2 Screen Error Messages, 180

- C-1 VAX/11 BASIC Predefined Constants, 196

- E-1 25-Pin Comm1 EIA RS232 Connector Pin Assignments, 221
- E-2 6-Pin DEC-423 Connector Pin Assignments (Comm1, Comm2, and Printer Ports), 223
- E-3 7-Pin Locator Device Pin Assignments, 223

ABOUT THIS MANUAL

This manual provides the information you need to install, operate, and maintain your VT330 or VT340 video terminal. The manual is part of the VT330/VT340 user documentation package. Each manual in the package is for a certain audience.

- **Installing and Using the VT330/VT340 Video Terminal**
For the installer and general user
- **VT330/VT340 Programmer Reference Manual**
For programmers writing applications for the VT330/VT340

Volume 1	Text applications
Volume 2	Graphics applications
Pocket Guide	Summary of volumes 1 and 2

ORGANIZATION

This manual has 12 chapters, 5 appendices, and a glossary.

NOTE: A handy summary of keyboard functions appears at the back of the manual

- Chapter 1, "A Look at the Terminal," gives you an overview of the VT330 and VT340 terminals and their features.

Installing Your VT330/VT340 Video Terminal

- Chapter 2, "Installation," shows you how to install your terminal and connect it to a host computer system, terminal server, or modem. Depending on your installation, you can use the terminal with two computer systems at the same time.

- Chapter 3, "Getting Started," describes how to set your terminal's operating features to match your installation.

Using Your VT330/VT340 Video Terminal

- Chapter 4, "Keyboard, Controls, and Indicators," describes the terminal's keyboard and explains the general function of each key. The chapter also describes the terminal's operating controls, connectors, and indicators.
- Chapter 5, "Using Set-Up," describes how to use the VT300 set-up screens. You use set-up screens to examine and change the settings of operating features from the keyboard.
- Chapter 6, "Composing Characters," describes how to create composite characters (such as accented letters) using a series of keystrokes.
- Chapter 7, "User-Defined Keys," describes how you can define the function of keys on the top row of the keyboard.
- Chapter 8, "Dual Sessions and Windows," describes how to use dual sessions and windows on your VT330/VT340. Depending on your installation, you can log into two computer systems and view information from both systems at the same time.
- Chapter 9, "Local Editing," describes a special editing mode in which the terminal performs your edits without the help of the host computer system. Your application must be set up to work with local editing.
- Chapter 10, "Graphics and Color," describes the Graphics Set-Up screen and Color Set-Up screen (for the VT340). The chapter also describes the optional mouse and graphics tablet you can use to move the cursor on the screen.
- Chapter 11, "Printers and Modems," describes how to use a printer or modem with your terminal.
- Chapter 12, "Solving Problems and Getting Service," provides suggested solutions for typical operating problems and tells you where to get more help.
- Appendix A lists VT330/VT340 specifications.
- Appendix B provides ordering information for options and documentation.

- Appendix C is a primer on how to use VT300 control functions. Programmers use control functions in applications, to make the terminal perform different actions.
- Appendix D shows the different models of the VT330/VT340 keyboard.
- Appendix E lists the pin assignments for the connectors on the rear of the terminal.

CONVENTIONS

VT300

This manual covers operating information for two video terminals — the VT330 monochrome terminal and the VT340 color terminal. This manual uses the term *VT300* when describing features common to both models.

Warnings, Cautions, and Notes

Warnings, cautions, and notes appear throughout this manual. They have the following meanings.

- Warnings provide information to prevent personal injury.
- Cautions provide information to prevent damage to equipment.
- Notes provide general operating information.

Set-Up Features and Keyboard Keys

Set-up features and keyboard keys appear in bold type.

Examples

Press the **Return** key.

Use the **Clear Communications** feature in the **Set-Up Directory** screen.

Glossary Terms

Glossary entries appear in italics when first used in text.

Example

The VT300 stores information in its *page memory*.

A LOOK AT THE TERMINAL 1

This chapter introduces you to two video display terminals in the VT series.

VT330 text and graphics terminal
VT340 text and color graphics terminal

The chapter provides an overview of the terminals and their basic operating features. It also tells you where to look in this manual for more information about each feature.

Both models are general-purpose terminals that you use to communicate with a host computer system. This manual uses the term *VT300* when describing features common to both models.

VT300 COMPONENTS

The VT300 has two main components, a monitor/terminal unit and a keyboard (Figure 1-1). The monitor/terminal unit is simply called the terminal in the rest of this manual.

Terminal

The VT330 uses a 350 mm (14 inch) flat monochrome screen. The VT340 uses a 325 mm (13 inch) color screen. All VT300 screens can display 24 lines of text, in 80 or 132 columns. Line 25 is reserved for the terminal's status line.

The VT300 has a read only memory (ROM) cartridge that stores the operating instructions for the terminal. The *ROM cartridge* is in a slot at the rear of the terminal. This cartridge must be installed to run the terminal.

There are also five connectors on the rear of the terminal. Three connectors are for cables to host systems, one is for a printer, and one is for an optional mouse or graphics tablet. Another name for a mouse or tablet is a *locator device*.

The terminal's tilt and swivel base lets you adjust the screen to the viewing angle you prefer.

Chapter 4 describes the terminal's controls and connectors.

Keyboard

The keyboard has four groups of keys and four indicator lights. The main keypad looks similar to a typewriter keypad. A cable connects the keyboard to the rear of the terminal.

The keyboard is available in 16 models, for use in different countries. Appendix D shows you each keyboard model.

Chapter 4 describes the keyboard.

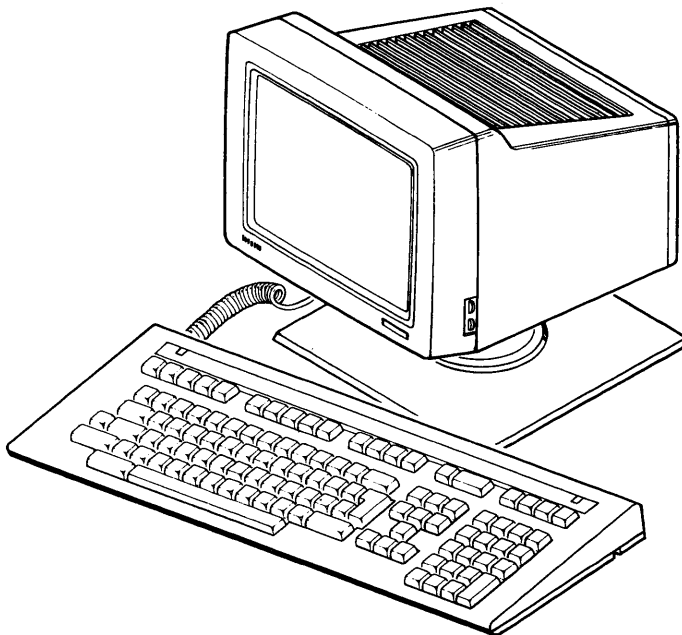

MA.0675-86

Figure 1-1 VT330 Video Terminal

YOUR COMPUTER SYSTEM

You can use the VT300 with one or more computer systems. You have several options for connecting your terminal to a computer. You can connect the VT300 directly to a computer, or indirectly through a *terminal server* or *modem*. The system you connect to is called the *host*.

Normally, you can send information to the host system by typing on the keyboard. Data sent to the terminal appears on the screen as text or graphics. You can print the data displayed on the screen by connecting a printer to the terminal.

You can use the VT300 with the *application software* on your system. For example, your system may have applications that let you do word processing, data entry, programming, or business graphics.

Most applications involve interactive processing. This means the VT300 immediately sends your typed characters from the keyboard to the host. Some applications may use the local editing feature, described later in this chapter.

FEATURES

The VT300 has many features for the general user. Here are some of the main features.

This feature	Lets you....
Set-up	Select operating features from the keyboard.
Dual sessions	Use two computer sessions on one VT300.
Windows	Display information from two sessions at the same time. You can select two horizontal or vertical windows from the keyboard.
Page memory	Store data in the VT300. You can store up to 19,008 characters in 1 to 6 pages of internal memory.
Status line	Check the operating status of the VT300.
User-defined keys	Define special functions for 15 keys.
Graphics	Display images created with different drawing systems. <ul style="list-style-type: none">• Digital's ReGIS software

- Tektronix 4010/4014 terminal emulation
- Sixels

Color (VT340 only)

Display 16 colors from a palette of 4096 colors.

Local editing

Edit data on the terminal, before sending the data to the host system. Your application must support this feature.

Set-Up

Set-up is a series of display screens that let you examine and change the terminal's operating features from the keyboard. Each screen lists a particular set of operating features for the terminal. For example, one set-up screen lists communication features, while another lists keyboard features.

Some features are for your convenience, and some are required by your host computer system. Each set-up feature has a factory-default setting. You can select the settings that are right for your system.

Chapter 5 describes set-up in detail.

Dual Sessions

When you use the terminal to connect to a computer, you have established a *session* on that computer. The VT300 lets you connect to two sessions and display data from two sessions at the same time. You can connect to two different computers, depending on your installation (Chapter 2).

Here are some important tools you use to select and run dual sessions.

- Switch Session key
- Dual Terminal set-up feature
- Terminal Comm Ports set-up feature
- Windows

The Switch Session key lets you easily switch back and forth between two sessions. You must set the Dual Terminal feature in order to use dual sessions. You set the Terminal Comm Ports feature to match your cable connections to the host system.

Chapter 3 describes how to set up the terminal for dual sessions. Chapter 8 describes how to use dual sessions.

Windows

You can divide your screen into two windows. With windows, you can see information from two sessions at the same time. There are three styles of windows.

- full screen (default)

- vertical split screen

- horizontal split screen (adjustable, up or down)

To select a window style, you hold down the Ctrl key and press the Switch Session key.

Chapter 8 describes how to use windows.

Page Memory

The VT300 has memory to store data entered from the keyboard or host system. Many video terminals can only store the data you see on the screen. The VT300 can store 144 lines of text. You can display up to 24 lines of text, in either 80 or 132 columns.

The terminal's memory is called page memory, because you can divide the 144 lines into a different number of pages. By default, the terminal uses 3 pages of 24 lines each. Pages create boundaries that affect the way you display the stored text. Your applications must be able to recognize these page boundaries.

See the Page Arrangement feature in the "Display Set-Up" section of Chapter 5.

Status Line

The VT300 displays a status line at the bottom of the screen by default. The status line has several fields that provide information about the terminal. For example, one field shows you which session you are currently using.

Applications may also use the status line to send you messages.

Chapter 4 describes the status line.

User-Defined Keys

You can define the function of 15 keys on the top row of the keyboard. The VT300 lets you use simple text to define those keys. You use the User-Defined Key Set-Up screen to define keys.

Chapter 7 describes the User-Defined Key Set-Up screen.

Graphics

You can use the VT300 to display sharp graphic images. The screen has a resolution of 800 horizontal pixels by 480 vertical pixels. *Pixels*, or picture elements, are the individual dots that make up the characters you display on your screen. A pixel is the smallest unit you can display.

The VT300 is a bitmap graphics terminal, which means an application can turn individual pixels on or off. The VT300 can display up to four shades of gray. The VT340 can display up to 16 shades of gray or 16 colors at a time.

You can use an optional mouse or graphics tablet to move the cursor and enter graphics data faster.

Drawing graphics requires some programming knowledge. You can use the Graphics Set-Up screen (Chapter 10) to select graphics features used by Digital's ReGIS software, sixel protocol, or Tektronix 4010/4014 terminals. Volume 2 of the *VT330/VT340 Programmer Reference Manual* describes how to use ReGIS, sixel, and 4010/4014 graphics.

Color Display (VT340)

The VT340 color terminal has a Color Set-Up screen. You can select 16 colors for use at one time, from a palette of 4096 possible colors. When you first use a VT340, the foreground is set to white and the background to black.

Chapter 10 describes the Color Set-Up screen.

Local Editing

The VT300 can work as a local editing terminal. When you use this feature, the VT300 stores your typed characters rather than sending them directly to the host system. The host system is free to perform other tasks.

When you finish editing, you can send the edited data to the host system in a single block. The local editing feature is compatible with the local editing feature on Digital's VT131 terminal.

NOTE: Before you use local editing, make sure your host application supports this feature.

Chapter 9 describes how to use local editing.

Emulating VT Series Terminals

The VT300 can operate like other VT series terminals or Tektronix 4010/4014 terminals. This feature is useful when your system has applications designed for those terminals.

The VT300 can emulate the following terminals.

VT200 series
VT100 series
VT52
Tektronix 4010/4014

To make the VT300 emulate another terminal, you use the **Terminal Mode** feature in the General Set-Up screen. See the "General Set-Up" section of Chapter 5.

Character Sets

The VT300 provides different character sets for use with different types of computer systems. You can select the character set to match your keyboard and host system in set-up. You can select from 2 multinational sets or 12 national sets.

When you first use your VT300, the terminal uses the DEC Multinational character set. This 8-bit character set contains the standard characters for the English language, plus most characters used in the major European languages.

You can also select the 8-bit ISO Latin-1 character set of the International Standards Organization. ISO Latin-1 is similar to the DEC Multinational set, with added symbols and characters.

The VT300 also has 12 national replacement character sets (NRCs) for different languages. NRCs are 7-bit character sets. You can only use one NRC set at a time. When you use an NRC set, you cannot use the DEC Multinational character set or any other 8-bit characters.

The *VT330/VT340 Programmer Reference Manual*, Volume 1, Chapter 2 shows the characters in each character set.

You select multinational or national mode from the General Set-Up screen. If you use national mode, you select the specific NRC set from the Keyboard Set-Up screen. See "General Set-Up" in Chapter 5.

PROGRAMMING THE TERMINAL

The VT300 comes with a two-volume programmer reference manual.

- Volume 1 — for text programming
- Volume 2 — for graphics programming

The manual explains the control functions used to access the terminal's features. Programmers use these functions in their applications. You should have some programming experience before you use the programmer reference manual.

Appendix C of this user manual is a primer on how to include control functions in an application program.



**INSTALLING
YOUR VT330/VT340
VIDEO TERMINAL**

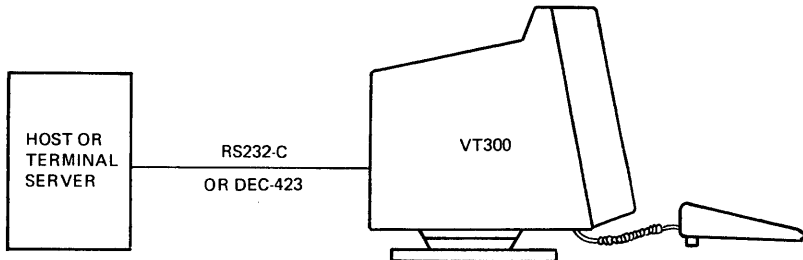

SINGLE SESSION

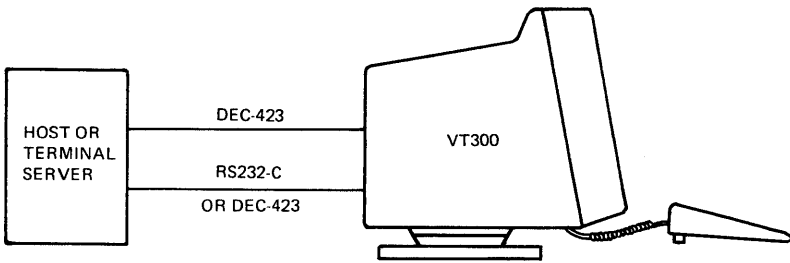

DUAL SESSIONS (2 CABLES)

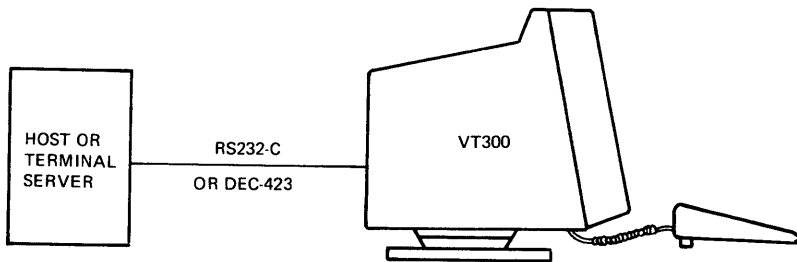

DUAL SESSIONS WITH SSU (1 CABLE)

INSTALLATION 2

This chapter provides step-by-step instructions to install your VT300. Complete all the steps in order. Then go to Chapter 3 to set up the terminal for operation.

Site Considerations

The VT300 lets you run one or two sessions on a host computer system. A *session* is an active connection to a computer. For example, when you log in to a system, you are running a session. The VT300 lets you run two sessions on the same host system or on separate systems.

You need a separate communication cable for each session, unless your system supports Digital's Session Support Utility software. If you use SSU software, you only need one communication cable to run dual sessions. To order cables, see Appendix B.

This chapter shows you how to install communication cables. Chapter 3 describes how to set up the VT300 for single or dual sessions. Chapter 8 describes how to use dual sessions.

Unpack and check the contents of each carton.

WARNING: Use two people to lift the terminal. The VT330 weighs 10.2 kg (22.5 lbs), and the VT340 weighs 15.7 kg (34.5 lbs).

Missing or Damaged Items?

- Stop unpacking.
- Identify the items.
- Contact your sales representative and delivery agent.

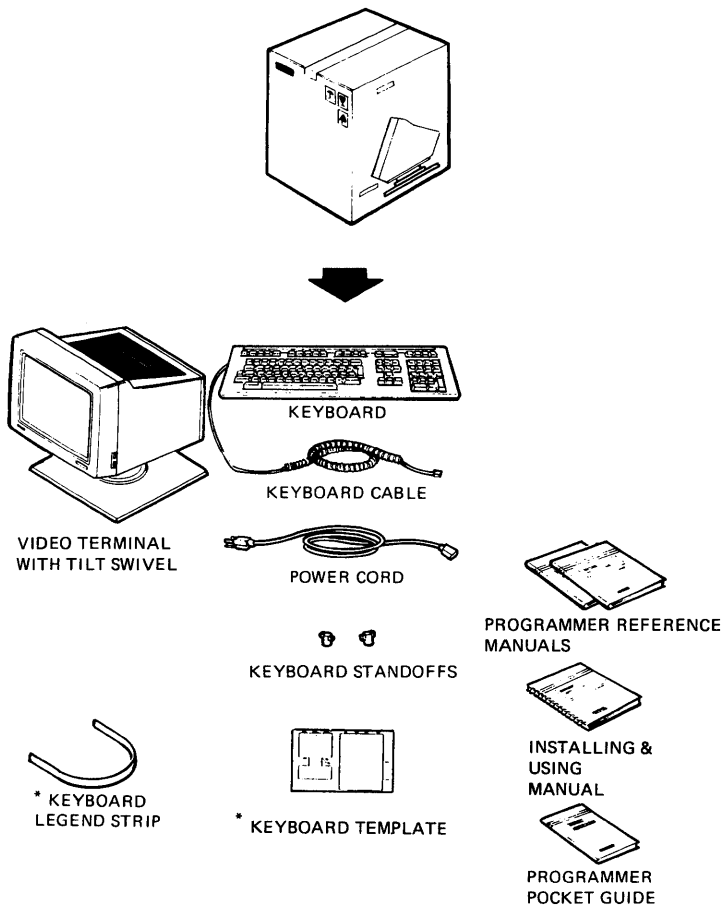

* FOR ALL MODELS EXCEPT THE NORTH AMERICAN / UNITED KINGDOM

MA-0677-86

Place the terminal on a level surface.

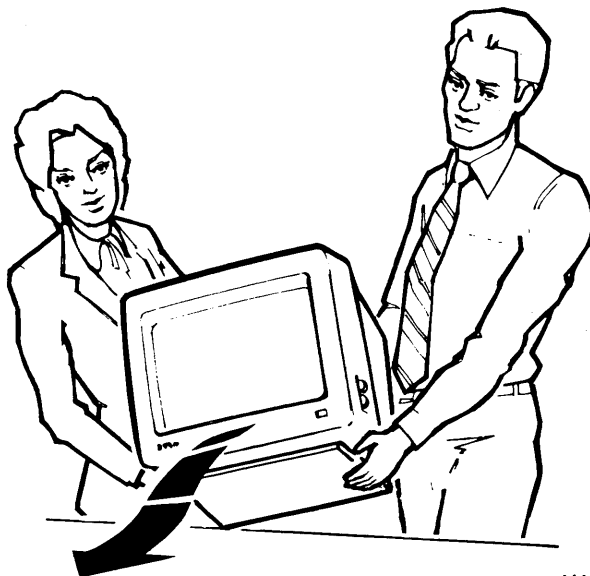

MA-0538-83

CAUTION: Do not place the terminal on top of the host system. You may damage the host system.

Do not place objects on top of the terminal. They may block the cooling vents, causing the terminal to overheat.

Remove the rear panel.

1. Grasp the rear panel from the top and pull toward you.
2. Lower the panel and remove from the terminal. Set the panel aside.

The rear panel covers the cable connectors. Later in this procedure, you will connect cables to the terminal.

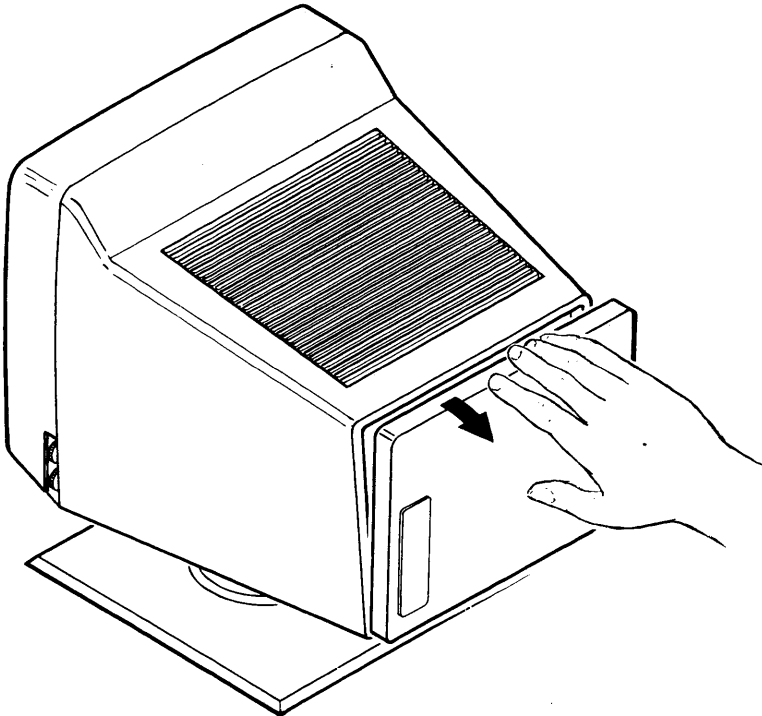

MA-0678-86

If you have the North American/United Kingdom keyboard, go to the next page. Your legend strip is already installed, and you do not need a template.

Install the legend strip.

- Slide the legend strip under the tabs, so it fits over the legend strip already on the keyboard.

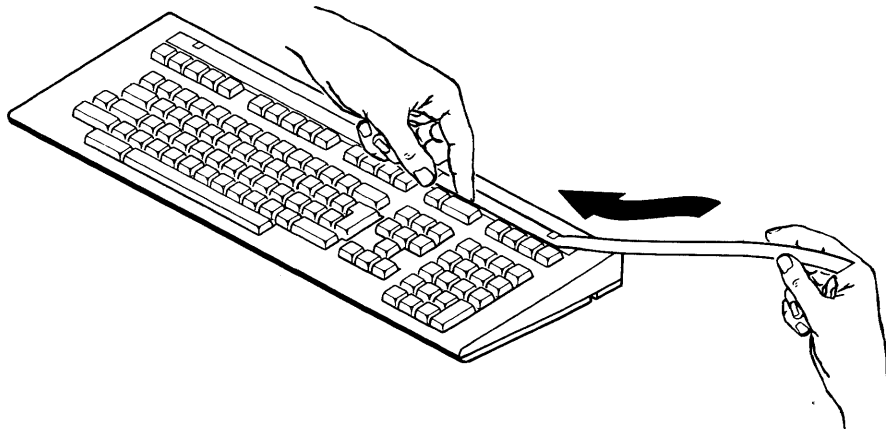

MA-0679-86

Install the template for the local editing keys.

- Place template around the editing and numeric keypads.

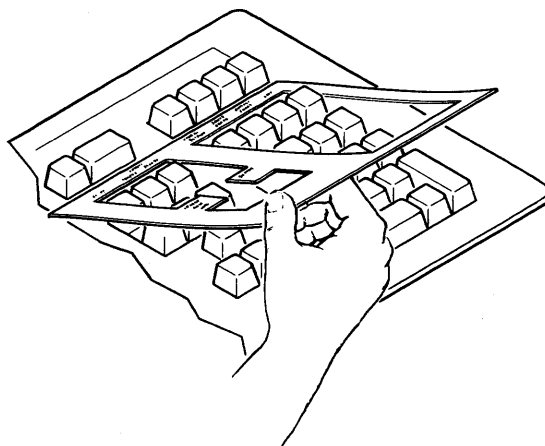

MA-0680-86

Install the keyboard standoffs.

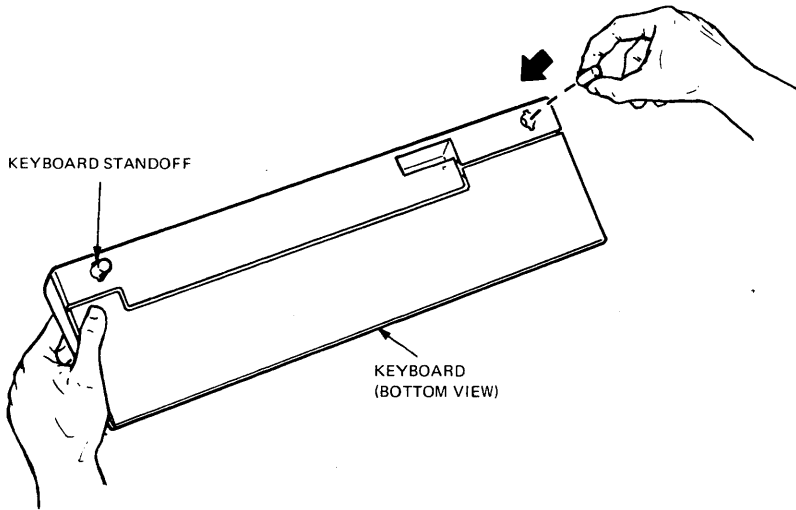

MA-0778-83

NOTE: After you install the VT300, you must select the appropriate keyboard language from the terminal's *Keyboard Set-Up* screen. Chapter 3 shows you how to select the keyboard language.

Connect the keyboard to the terminal.

1. The keyboard cable is already connected to the bottom of the keyboard and routed to the left.

If you want the keyboard cable routed to the right, remove the cable from the short groove and press the cable into the long groove.

2. Insert the other end of the cable into the keyboard connector on the rear of the terminal.

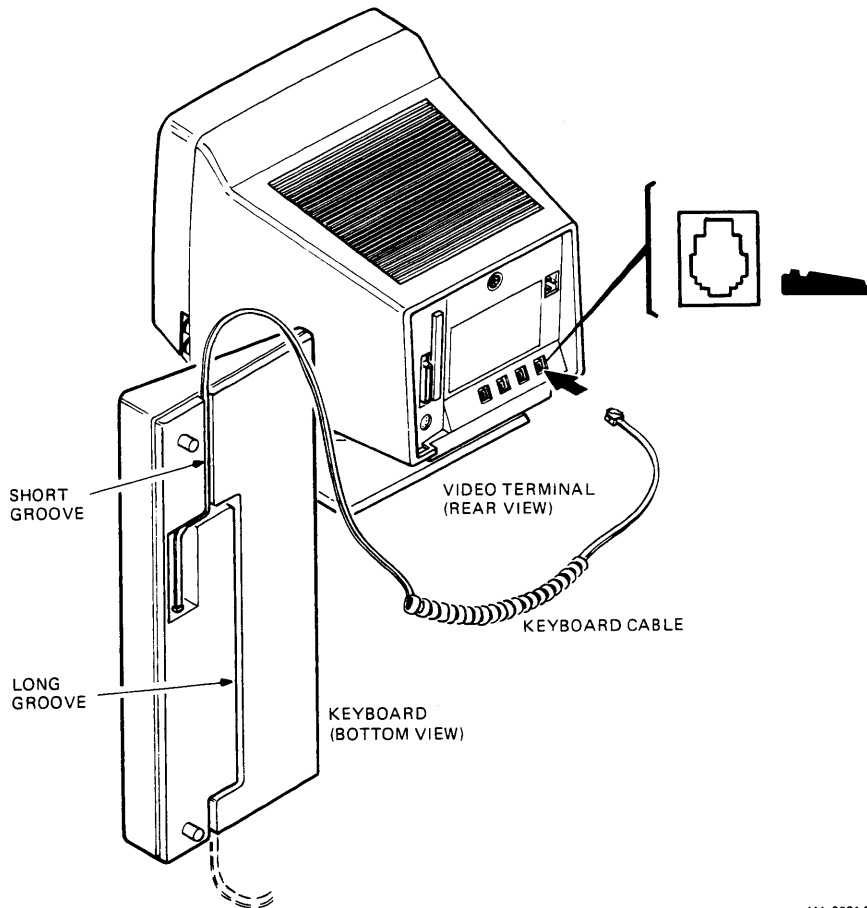

MA-0681-86

Match the power cord to your wall outlet.

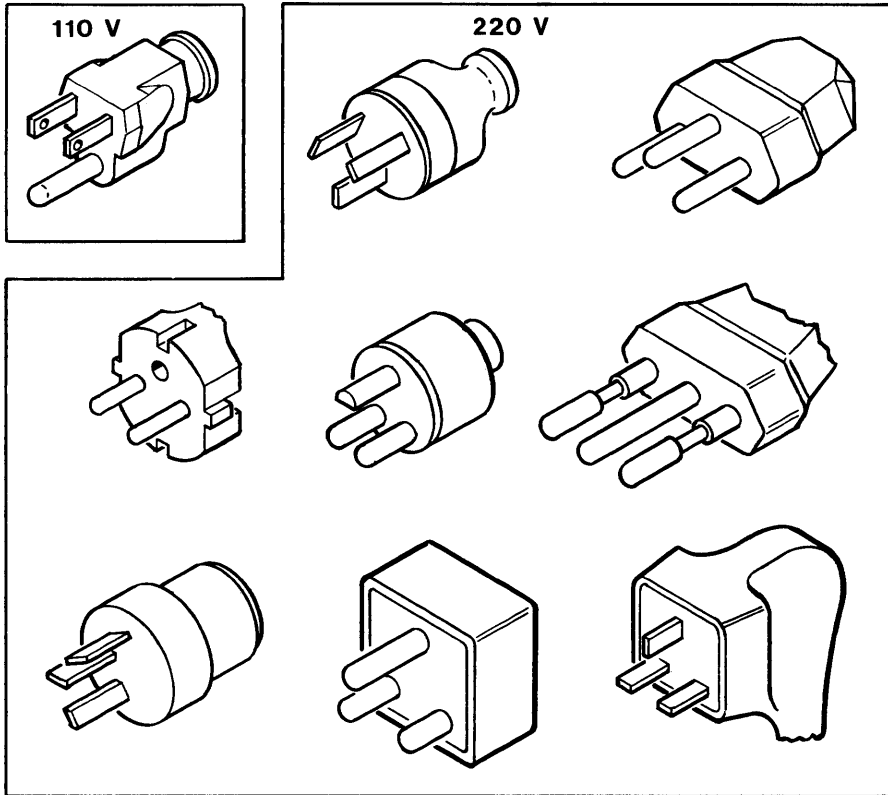

MA-0682-86

Make sure the power switch is in the off (0) position.

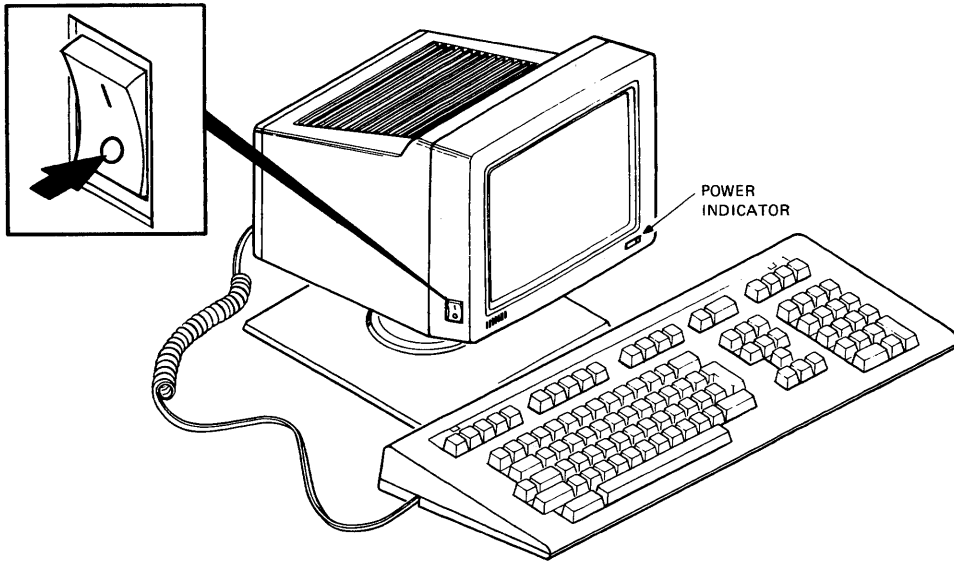

MA-0683-86

Plug the power cord into the power cord connector on the terminal, then into the wall outlet.

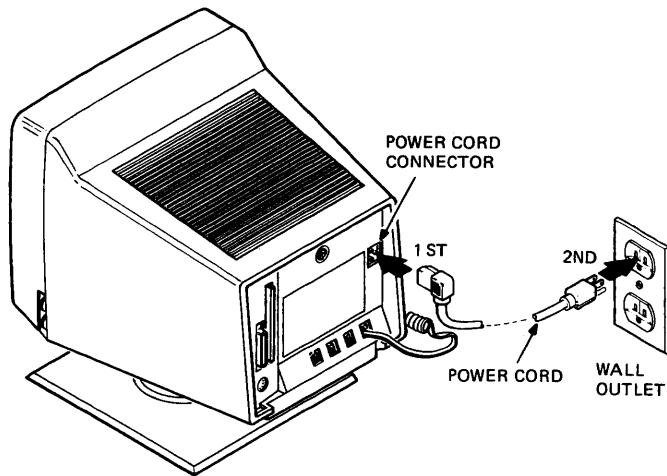

MA-0684-86

Start up your terminal.

1. Turn the power switch on by pressing 1.
2. Make sure the green power indicator is on.

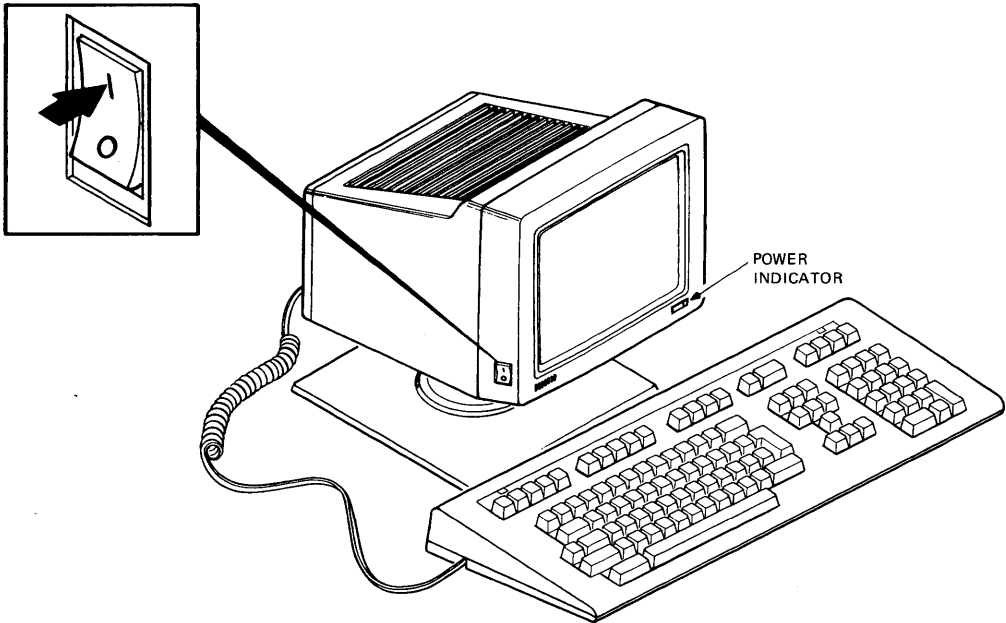

MA-0685-86

3. Listen for a bell tone from the keyboard.
4. Wait about 30 seconds for a "VT330 OK" or "VT340 OK" message to appear on the screen.

NOTE: If you have problems, see the "Problem Solving" section at the end of this chapter.

Set the brightness and contrast controls.

1. Increase both the brightness and contrast to maximum.
2. Decrease the brightness until the raster (white diagonal lines) just disappears.
3. Adjust the contrast for your viewing preference.

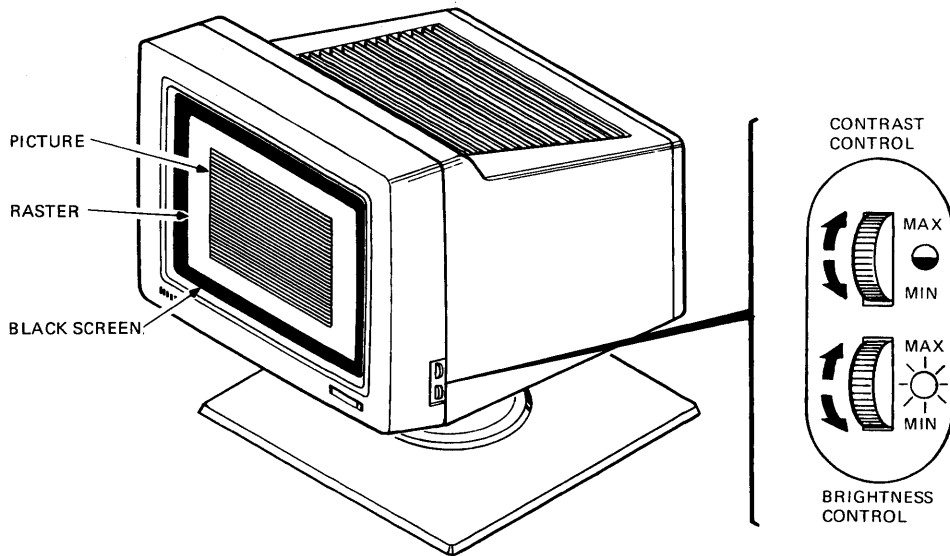

MA-0687-86

Adjust the tilt-swivel stand to a comfortable viewing angle.

To set the angle, tilt the terminal forward or backward to the desired position. You can turn the terminal to any viewing position.

CAUTION: The terminal does not swivel in a complete circle. If you try to swivel the terminal in a complete circle, you may damage the base.

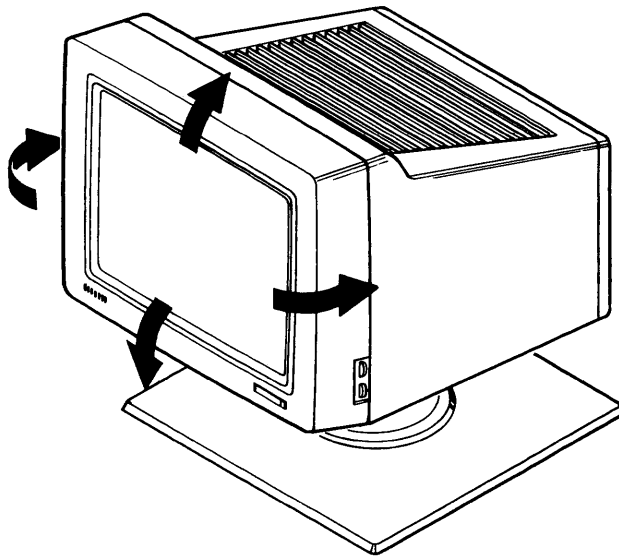

MA-0688-86

Identify the cable connectors.

The next four pages show you how to connect the cable(s) from your host system. Use the following picture to identify the cable connectors.

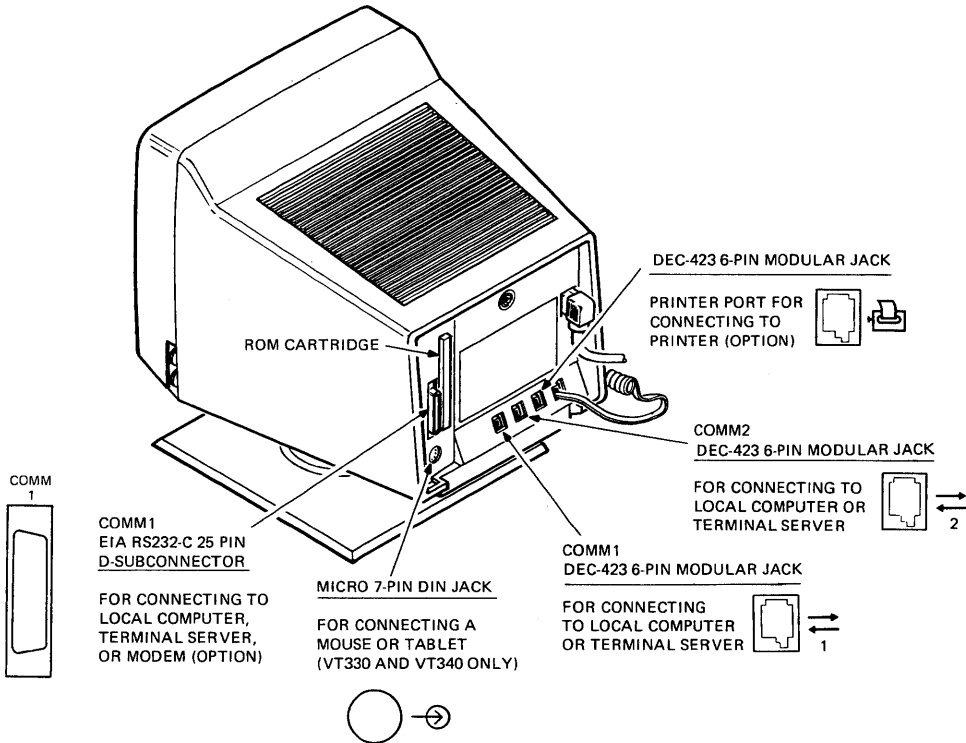

MA-0689-86

Connect your communication cable(s) to the rear of the terminal.

CAUTION: Turn the power switch off (0) before connecting cables.

You have three options, depending on how many sessions you want to use.

- | | |
|---|----------------|
| Single session (one cable) | Go to page 25. |
| Dual sessions (two cables) | Go to page 26. |
| Dual sessions with SSU software (one cable) | Go to page 27. |

If you are installing an RS232-C cable, remove the filler panel on the rear panel and feed the cable through the opening.

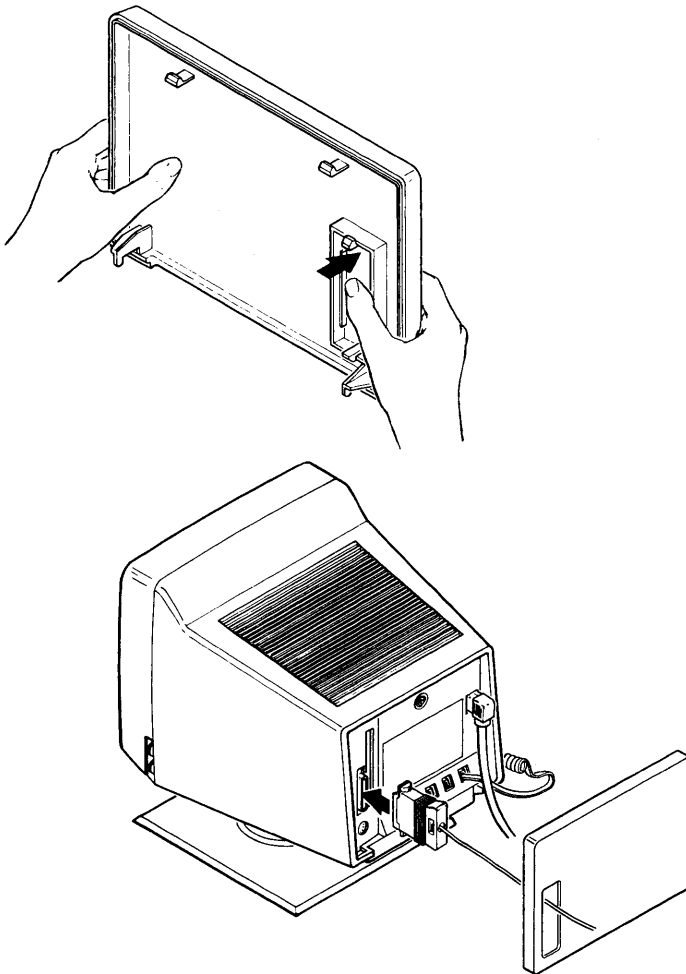

MA-009086

Single Session (One Cable)

There are two ways you can connect a cable to run a single session on the terminal.

A. Connect an RS232-C cable to the 25-pin Comm1 connector on the left.

OR

B. Connect a DEC-423 cable to the 6-pin Comm1 connector.

NOTE: DEC-423 cables and connectors are compatible with EIA RS423 voltage requirements.

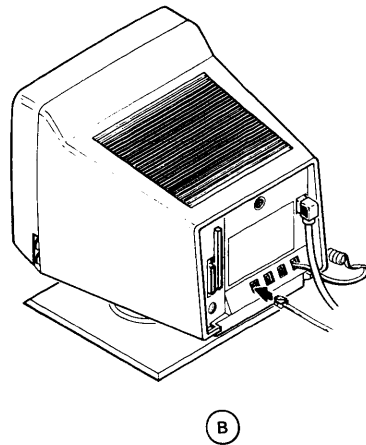
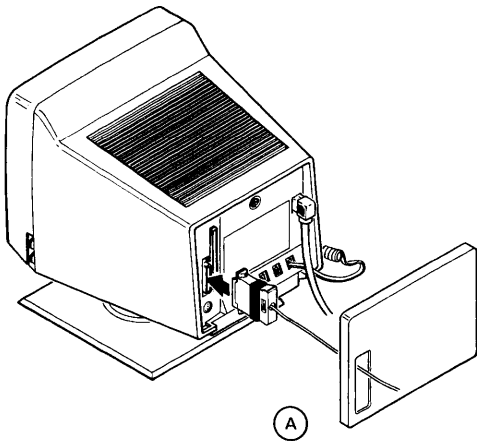

MA-0691-86

IMPORTANT: After you install the VT300, you must set the terminal's operating features to match this cable connection. Chapter 3 shows you what features to set.

Now go to page 28.

Dual Sessions (Two Cables)

There are two ways that you can connect two cables to run dual sessions on your terminal.

- A. Connect an RS232-C cable to the 25-pin Comm1 connector on the left. Connect a DEC-423 cable to the Comm2 connector.

OR

- B. Connect a DEC-423 cable to the 6-pin Comm1 connector. Connect another DEC-423 cable to the Comm2 connector.

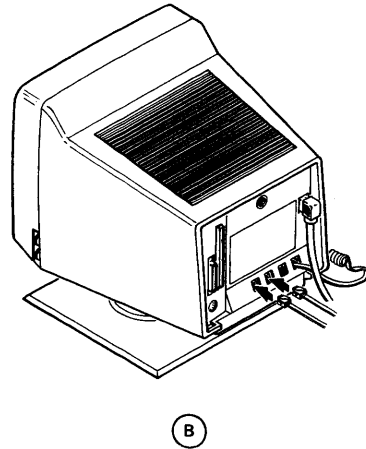
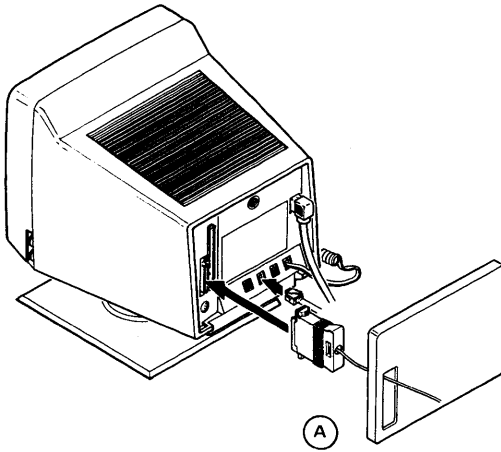

MA-0692-86

IMPORTANT: After you install the VT300, you must set the terminal's operating features to match these cable connections. Chapter 3 shows you what features to set.

Now go to page 28.

Dual Sessions with SSU Software (One Cable)

Check with your system manager to see if your system supports SSU software. If your system does not support SSU software, you must use two cables to run dual sessions (page 26).

There are three ways you can connect a cable to run dual sessions with SSU software.

- A. Connect an RS232-C cable to the 25-pin Comm1 connector on the left.
- OR
- B. Connect a DEC-423 cable to the 6-pin Comm1 connector.
- OR
- C. Connect a DEC-423 cable to the Comm2 connector.

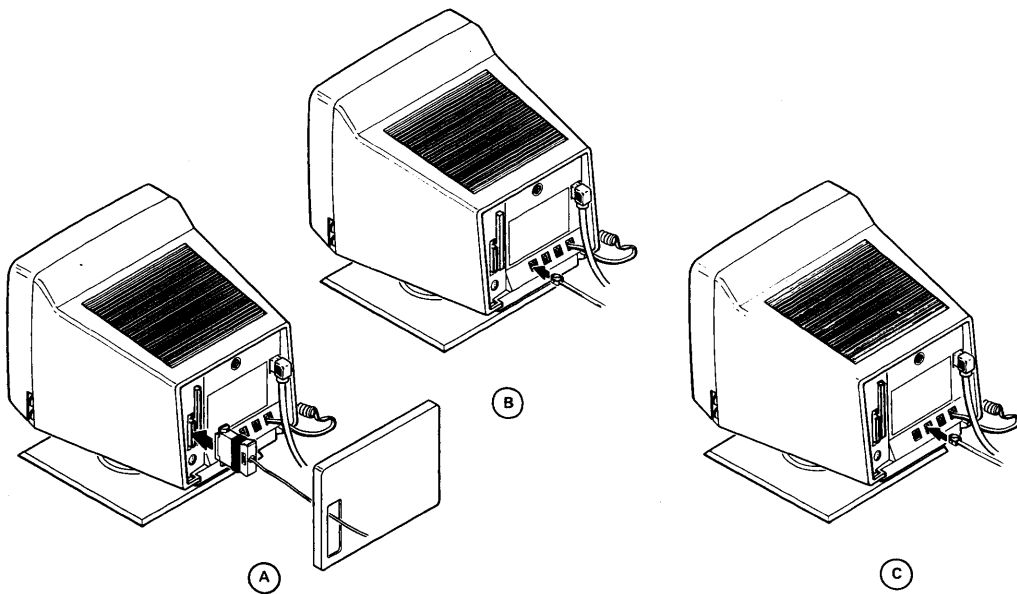

MA-0693-86

IMPORTANT: After you install the VT300, you must set the operating features to match these cable connections. Chapter 3 shows you what features to set.

Now go to page 28.

After you connect the cables, turn the power switch on by pressing 1.

NOTE: If you install a mouse or graphics tablet, remove the filler panel on the rear panel and feed the cable through the opening.

Install the rear panel.

1. Insert the legs of the panel into the bottom slots of the terminal.
2. Lift the panel and snap it into place.

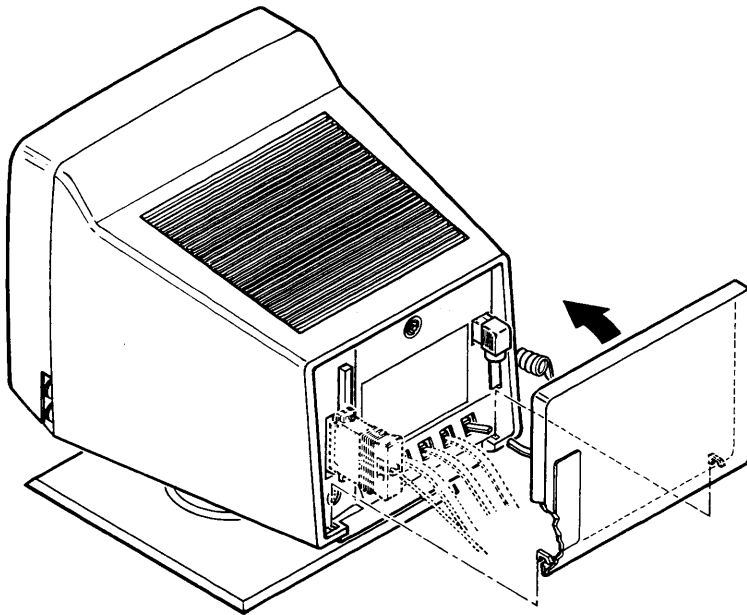

MA-0694-86

You have installed your VT300 successfully. Go to Chapter 3.

Now you must set up your terminal to operate with your host system. Go to Chapter 3.

Problem Solving

Problem

The power indicator is off.

The power indicator is on, the keyboard bell tone sounds, and the screen is blank.

The bell tone does not sound when you turn the terminal on. The keyboard indicator lights are off.

The power indicator flashes.

Any message other than "VT330 OK" or "VT340 OK" appears.

Suggested Solution

Check the wall outlet. Make sure the power cord connections are secure.

Adjust the brightness and contrast until "VT330 OK" or "VT340 OK" appears on the screen. (See page 21.)

The terminal has a CRT saver that turns off the screen display if you do not use the terminal for 30 minutes. Press any key to reactivate the screen display.

Make sure the keyboard is connected to the terminal.

Make sure the ROM cartridge is correctly installed at the rear of the terminal.

Call your local Digital Field Service office for assistance.

3 GETTING STARTED

After you install your VT300, you must set some of the terminal's operating features to

- Use the correct language for your keyboard (page 31).
- Run single or dual sessions (page 33).

All other VT300 operating features are already set to a factory-default setting that works with most Digital systems. You may have to set some features to match your host system. For example, the VT300 must use the same baud rate as your host system.

- To set the baud rate, go to page 38.

The VT300 has a series of set-up screens that list the terminal's operating features. You can examine and change feature settings from the keyboard. The procedures in this chapter explain how to use some set-up screens. If you want to know more about set-up, or if you want to set a feature not covered here, see Chapter 5.

SELECTING THE CORRECT KEYBOARD LANGUAGE

The VT300 has 16 keyboard models, for different languages and dialects. The initial setting for the Keyboard Dialect feature is North American.

If you have the North American/United Kingdom keyboard, you can skip this procedure, unless you want to use the British setting. If you have any other keyboard model, you must complete this procedure to select the correct keyboard language.

1. Press the Set-Up key to enter set-up. The Set-Up Directory screen appears (Figure 3-1). The cursor is on the Global Set-Up field.

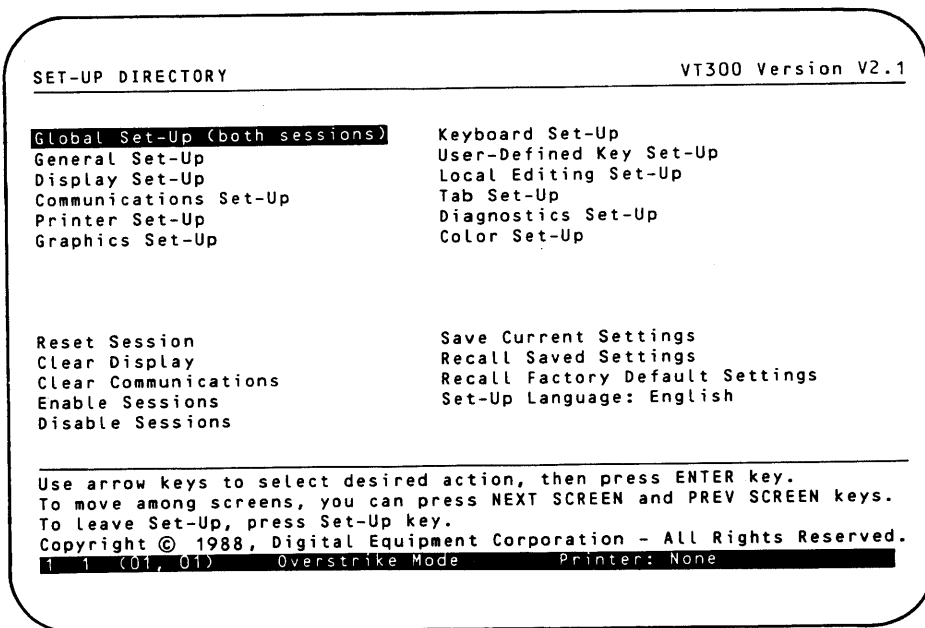

MA-0186-88

Figure 3-1 Set-Up Directory

2. Use the arrow keys to move the cursor to the Keyboard Set-Up field.
3. Press the Enter key. The Keyboard Set-Up screen appears (Figure 3-2). The cursor is on the Keyboard Dialect feature.

KEYBOARD SET-UP		VT300 Version V2.1
Feature	Current Setting	Saved Setting
Keyboard Dialect	North American	North American
Keyboard Mode	typewriter	typewriter
Keypad Mode	numeric	
Cursor Key Mode	normal	
Auto Repeat	enabled	enabled
Keyclick	high	high
Margin Bell	off	off
Warning Bell	high	high
<X> Key	delete	delete
Keypad comma (,)	comma	comma
Lock Key	caps lock	caps lock
Compose	enabled	enabled
Break	enabled	enabled

Use up/down arrow keys to select feature, right/left arrow keys to change current setting. To return to Set-Up Directory, press SELECT key. Copyright © 1988, Digital Equipment Corporation - All Rights Reserved

1 1 (01, 01) Overstrike Mode Printer: None

MA-0187-88

Figure 3-2 Keyboard Set-Up Screen

4. There are 16 possible settings for the **Keyboard Dialect**. You can use the **→** or **←** key to change the setting. Each time you press an arrow key, the setting changes in the "Current Setting" column.
5. After you select the correct setting, press the **Select** key to return to the **Set-Up Directory**.
6. Use the arrow keys to move to the **Save Current Settings** field.
7. Press the **Enter** key. This saves all the current settings in each set-up screen for the current session.
8. Press **Set-Up** again to leave set-up.

If you plan to run dual sessions, you must select the keyboard language for each session independently. To select the keyboard language for the second session, first set up the VT300 for dual sessions (page 33). Then press the **Session Switch** key and repeat steps 1 through 8 above.

SETTING UP THE VT300 FOR SINGLE OR DUAL SESSIONS

The VT300 uses one or two communication cables to send and receive information from your host computer system(s). After installation, you must set up the terminal to operate with the cables you are using and the number of sessions you want to use (one or two).

To set up the terminal correctly, you should know

- what type of cable(s) you are using (RS232 or DEC-423), and
- which cable connector(s) you are using (Comm1 or Comm2).

If you are unsure, read the next section on system connectors.

To set up the terminal, go to the section that matches your installation.

- Single session (one cable) Go to page 34.
- Dual sessions (two cables) Go to page 36.
- Dual sessions with SSU software (one cable) Go to page 37.

Remember, the terminal must use a separate cable for each session, unless your system has Digital's Session Support Utility software. SSU software lets you run two sessions over a single cable.

System Connectors

The VT300 has three connectors on the rear of the terminal for communication cables. Two connectors are called Comm1, and one is called Comm2 (Figure 3-3). The two Comm1 connectors are for different types of cables.

Comm1 RS232 25-pin connector	Connects the VT300 to a <i>primary host</i> computer, directly or indirectly (through a terminal server or modem).
Comm1 DEC-423 6-pin connector	Connects the VT300 to a primary host computer, directly or indirectly (through a terminal server).
Comm2 DEC-423 6-pin connector	Connects the VT300 to a <i>secondary host</i> computer, directly or indirectly (through a terminal server).

Appendix B shows the communication cables you can use.

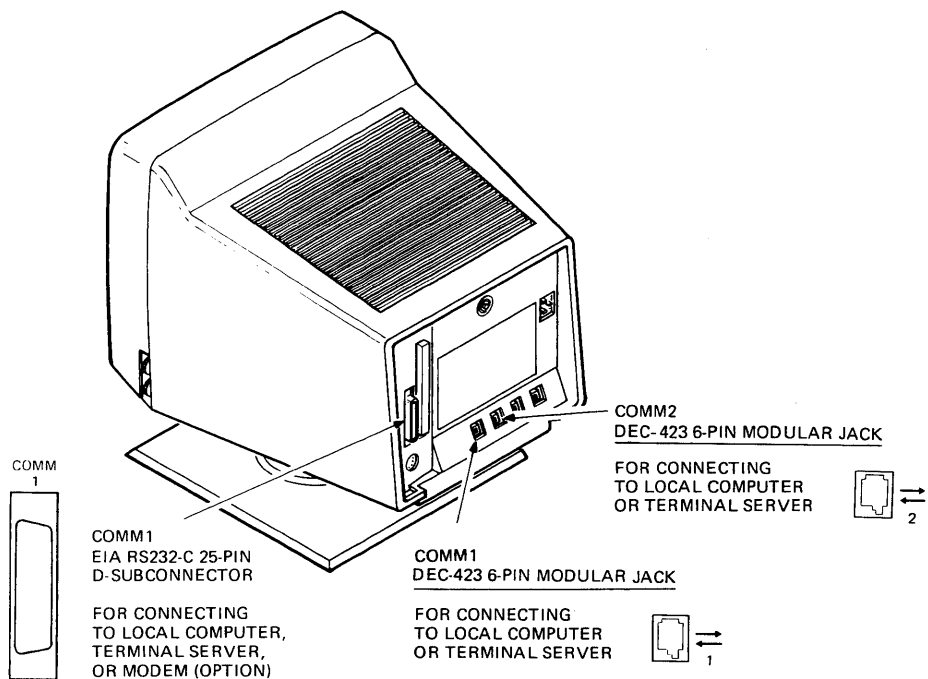

Figure 3-3 System Connectors

Setting Up for a Single Session (One Cable)

You only need one communication cable to run a single session. You can connect the cable to either one of the two Comm1 system connectors on the rear of the terminal. After you connect your cable, you must use the Global Set-Up screen to set up the terminal for a single session.

1. Press the Set-Up key to enter set-up. The Set-Up Directory screen appears (Figure 3-1). The cursor is on the Global Set-Up field.
2. Press the Enter key. The Global Set-Up screen appears (Figure 3-4).

GLOBAL SET-UP		VT300 Version V2.1
Feature	Current Setting	Saved Setting
On-Line/Local	on-line	on-line
Dual Terminal	disabled	disabled
Terminal Comm Ports	S1=Comm1, S2=Comm2	S1=Comm1, S2=Comm2
Printer Assignment	shared	shared
Comm1 Port	RS-232	RS-232
CRT Saver	enabled	enabled
Refresh Rate	60 Hz	60 Hz
Color Map	color-1	color-1



Use up/down arrow keys to select feature, right/left arrow keys to change current setting. To return to the Set-Up Directory, press SELECT key.

Copyright © 1988, Digital Equipment Corporation - All Rights Reserved

1 1 (01, 01) Overstrike Mode Printer: None

MA 0188 88A

Figure 3-4 Global Set-Up Screen

3. Check the setting of the Comm1 Port feature in the "Current Setting" or "Saved Setting" column. Initially, both settings are the same. The Comm1 Port feature selects the active Comm1 connector. The feature has two possible settings, "RS-232" or "DEC-423". This setting should match the connector you are using.
If the setting is already correct, press Set-Up to leave set-up.
To change the setting, go on to step 4.
4. Use the  key to move the cursor to the Comm1 Port feature.
5. Use the  key to change the Comm1 Port setting in the "Current Setting" column.
6. After you select the correct setting, press the Select key to return to the Set-Up Directory.
7. Use the arrow keys to move to the Save Current Settings field.
8. Press the Enter key. This saves all the current settings in each set-up screen. A "Done" message appears at the bottom of the screen.
9. Press Set-Up again to leave set-up.

Setting Up for Dual Sessions (Two Cables)

When you use two communication cables, you connect one cable to one of the Comm1 connectors and one cable to the Comm2 connector. After you connect your cables, you must use the Global Set-Up screen to set up the terminal for dual sessions.

NOTE: You can connect cables to all three system connectors. However, you can only use one Comm1 connector at a time. See step 4 below.

1. Press the Set-Up key to enter set-up. The Set-Up Directory screen appears (Figure 3-1). The cursor is on the Global Set-Up field.
2. Press the Enter key. The Global Set-Up screen appears (Figure 3-4). Use the key to move the cursor to the Dual Terminal feature.
3. The default setting of the Dual Terminal feature is "disabled". If the setting is "disabled", use the or key to change the setting in the "Current Setting" column to "enabled".
4. Check the setting of the Terminal Comm Ports feature. This feature assigns a session to the Comm1 or Comm2 connector. The default setting is

`S1=Comm1, S2=Comm2`

which means session 1 is assigned to Comm1 and session 2 is assigned to Comm2. You can reverse the assignments, by selecting

`S2=Comm1, S1=Comm2`

NOTE: The setting of Terminal Comm Ports is important if you connect your VT300 to two different computers. The VT300 always opens session 1 first. You should match session 1 with the computer you use most often.

If the setting is already correct, go to step 5.

To change the setting, use these steps.

- a. Use the key to move the cursor to Term Comm Ports.
 - b. Use the or key to change the setting in the "Current Setting" column.
5. Check the setting of the Comm1 Port feature. This feature selects the active Comm1 connector. The feature has two settings, "RS-232" or "DEC-423". This setting should match the connector you are using.

If the setting is already correct, go to step 6.

To change the setting, use these steps.

- a. Use the key to move the cursor to **Comm1 Port**.
 - b. Use the or key to change the setting in the "Current Setting" column.
6. If you did not change any settings in steps 3 through 5, you can press **Set-Up** to leave set-up.
If you changed any settings, go on to step 7.
 7. Press the **Select** key to return to the **Set-Up Directory**.
 8. Use the arrow keys to move to the **Save Current Settings** field.
 9. Press the **Enter** key. This saves all the current settings in each set-up screen. A "Done" message appears at the bottom of the screen.
 10. Press **Set-Up** again to leave set-up.

Chapter 8 describes how to use dual sessions.

Setting Up for Dual Sessions with SSU Software (One Cable)

If your host system has Digital's Session Support Utility software, the VT300 can run dual sessions over one communication cable. Your system manager can tell you if your system has SSU software.

You can connect the communication cable to any one of the **Comm1** or **Comm2** connectors. After you connect the cable, you must use the **Global Set-Up** screen to set up your VT300 for dual sessions.

1. Press the **Set-Up** key to enter set-up. The **Set-Up Directory** screen appears (Figure 3-1). The cursor is on the **Global Set-Up** field.
2. Press the **Enter** key. The **Global Set-Up** screen appears (Figure 3-4). Use the down arrow key to move the cursor to the **Dual Terminal** feature.
3. The default setting of the **Dual Terminal** feature is "disabled". If the setting is "disabled", use the or key to change the setting in the "Current Setting" column to "enabled".

4. Use the **↓** key to move the cursor to the **Terminal Comm Ports** feature. You should set this feature to "Sessions on Comm1" if you are using a Comm1 connector, or to "Sessions on Comm2" if you are using the Comm2 connector. Use the **→** or **←** key to change the setting in the "Current Setting" column.
5. Check the setting of the **Comm1 Port** feature. This feature selects the active Comm1 connector. The feature has two settings, "RS-232" or "DEC-423". This setting should match the connector you are using.

If the setting is already correct, go to step 6.

To change the setting, use these steps.

- a. Use the **↓** key to move the cursor to **Comm1 Port**.
 - b. Use the **→** or **←** key to change the setting in the "Current Setting" column.
6. When all feature settings are correct, press the **Select** key to return to the **Set-Up Directory**.
 7. Use the arrow keys to move to the **Save Current Settings** field.
 8. Press **Enter**. This saves all the current settings in each set-up screen. A "Done" message appears at the bottom of the screen.
 9. Press **Set-Up** again to leave set-up.

Chapter 8 describes how to use dual sessions.

SELECTING THE CORRECT BAUD RATE

The VT300 is initially set to a *baud rate* of 9600. This setting works with most Digital systems. The baud rate setting must match the baud rate of your host system. If you are unsure what baud rate your host system uses, ask your system operator or system manager.

To set the baud rate, you use the **Transmit Speed** and **Receive Speed** features on the **Communications Set-Up** screen.

1. Press the **Set-Up** key to enter set-up. The **Set-Up Directory** screen appears (Figure 3-1). The cursor is on the **Global Set-Up** field.

2. Use the arrow keys to move the cursor to the Communications Set-Up field.
3. Press the Enter key. The Communications Set-Up screen appears (Figure 3-5). The cursor is on the Transmit Speed feature.

COMMUNICATIONS SET-UP		Comm1 VT300 Version V2.1
Feature	Current Setting	Saved Setting
Transmit Speed	9600	9600
Receive Speed	receive=transmit	receive=transmit
Receive XOFF Point	64	64
Transmit Flow Control	XON/XOFF	XON/XOFF
Transmit Rate Limiting	enabled	enabled
Character Format	8 bits, no parity	8 bits, no parity
Stop Bits	1	1
Modem Control	disabled	mode 1 (VT220)
Modem High Speed	ignore	ignore
Modem Low Speed	ignore	ignore
Disconnect Delay	2 seconds	2 seconds
Local Echo	disabled	disabled
Auto-Answerback	disabled	disabled
Conceal Answerback	not concealed	not concealed
Answerback Message:	_____	
Copyright © 1988, Digital Equipment Corporation - All Rights Reserved		
1 1 (01, 01) Overstrike Mode Printer: None		

MA 0189 88A

Figure 3-5 Communications Set-Up Screen

4. The Transmit Speed is initially set to 9600. You should use a setting that matches your host system. There are nine possible settings.

You can use the \rightarrow or \leftarrow key to change the setting. Each time you press an arrow key, the setting changes in the "Current Setting" column.

NOTE: Below Transmit Speed is the Receive Speed feature. Most systems use the same speed to transmit and receive. The initial setting for Receive Speed is "receive = transmit", so the receive speed automatically changes to match the transmit speed you select.

5. After you select the correct setting, press the Select key to return to the Set-Up Directory.

6. Use the arrow keys to move to the **Save Current Settings** feature.
7. Press the **Enter** key. This saves all current settings in each set-up screen. A "Done" message appears at the bottom of the screen.
8. Press **Set-Up** again to leave set-up.

If you plan to run dual sessions with two communication cables, you must set the baud rate for each session independently. To set the baud rate for the second session, first set up the VT300 for dual sessions (page 36). Then press the **Switch Session** key and repeat steps 1 through 8 above.

If You Need Help...

If you have carefully followed the procedures in Chapters 2 and 3, but are still having problems, you may call 1-800-DEC-8000 (from within the United States) for installation and set-up assistance.



**USING
YOUR VT330/VT340
VIDEO TERMINAL**



THE KEYBOARD, CONTROLS, AND INDICATORS **4**

This chapter describes the operating controls and connectors on the terminal. The chapter also describes the basic function of each keyboard key. The last section describes the status line you can display on the screen. Later chapters provide more information on keys with special functions.

NOTE: A list of common keyboard functions appears at the back of the manual. You can tear out the page and keep it near the terminal for reference.

CONTROLS AND CONNECTORS

The terminal has a power switch on the left, and brightness and contrast controls on the right (Figure 4-1). Table 4-1 describes their function.

Figure 4-2 shows the connectors on the rear of the terminal. Table 4-2 describes their function.

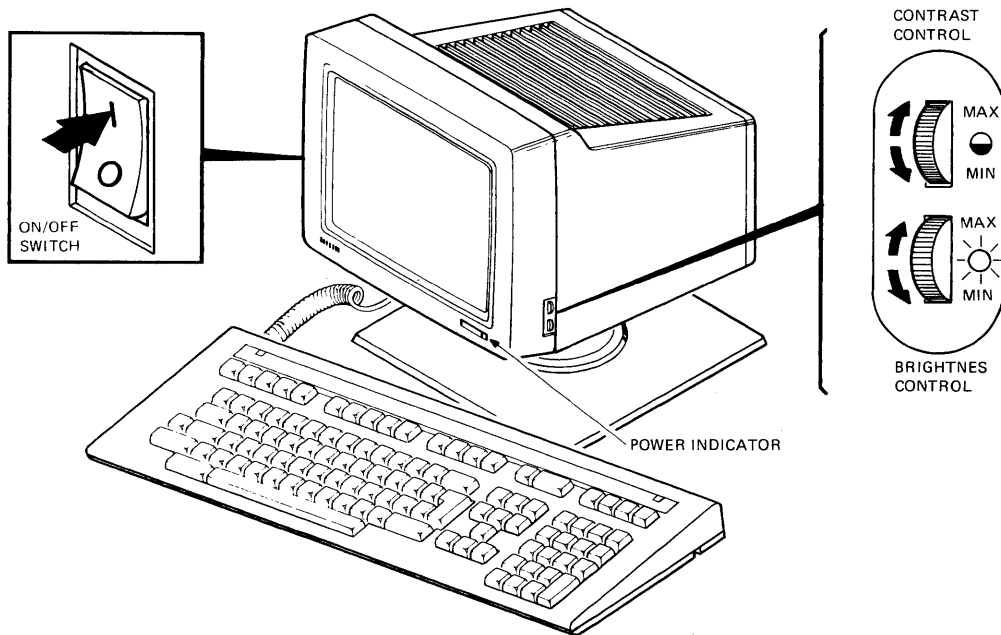

MA-0696-86

Figure 4-1 Controls and Power Indicator

Table 4-1 Controls

Control	Function
Power switch	Turns the terminal on or off. Press 1 to turn the terminal on. Press 0 to turn the terminal off.
Power indicator	Stays on while the terminal is on and receiving the correct power.
Contrast	Adjusts the degree of contrast on the screen. Contrast is the difference in shade between the image you display and the screen background.
Brightness	Adjusts the degree of brightness on the screen.

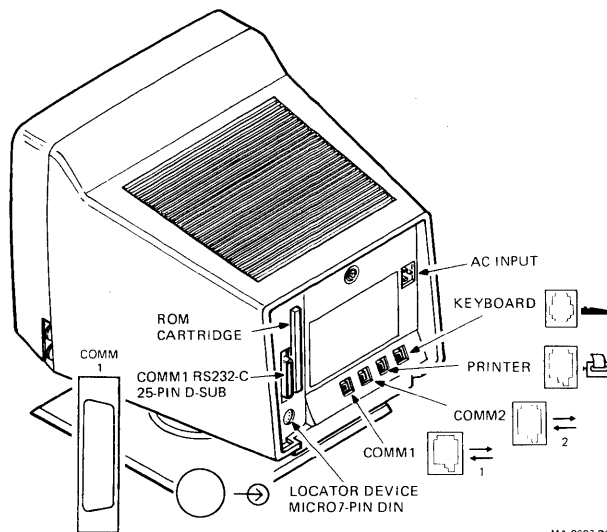

MA-0697-86

Figure 4-2 Connectors

Table 4-2 Connectors

Connector	Function
Comm1 RS232 (25-pin)	Connects the VT300 to a <i>primary host</i> computer, directly or indirectly (through a <i>terminal server</i> or <i>modem</i>).
Comm1 DEC-423 (6-pin)	Connects the VT300 to a primary host computer, directly or indirectly (through a terminal server).
Comm2 DEC-423 (6-pin)	Connects the VT300 to a secondary host computer, directly or indirectly (through a terminal server).
Printer DEC-423 (6-pin)	Connects a printer to the VT300.
Locator device (7-pin)	Connects a mouse or graphics tablet to the VT300.
Keyboard	Connects the keyboard to the terminal.
AC power	Connects the power cord to the terminal.
ROM cartridge	Stores the operating instructions for the VT300.

NOTE: Never remove the ROM cartridge when power is on.

VT300 CURSORS

The VT300 uses different cursors for text and graphics applications.

Text Cursor

The text cursor indicates where the next character will appear on the screen. The standard VT300 cursor is a blinking block. You can change this cursor to a steady block, or to a blinking or steady underline. To change the cursor, you use the Cursor Style and Cursor Blink features in the Display Set-Up screen (Chapter 5).

Graphics Cursor

The VT300 uses special cursors for graphics applications. There are different cursors for different types of graphics applications.

Applications based on Digital's ReGIS software use a diamond cursor by default. You can also use a crosshair, rubber band line, rubber band box, or an application-defined cursor with ReGIS.

Tektronix applications use a crosshair cursor for graphics and a shaded box for text.

The Graphics Set-Up screen lets you decide whether or not to display a cursor for graphics (Chapter 10). Programmers can find out more about graphics cursors in Volume 2 of the *VT330/VT340 Programmer Reference Manual*.

You can use a mouse or graphics tablet for graphics. See "Locator Devices" in Chapter 10.

NOTE: You can only use a mouse or graphics tablet for ReGIS or Tektronix 4010/4014 applications.

KEYBOARD

The VT300 keyboard comes in 16 different versions, for use with different languages. The only physical difference between these keyboards are the legends on the keys. Appendix D shows the different keyboards available.

The figures in this chapter show the North American/United Kingdom keyboard, unless otherwise noted. A special version of the North American/United Kingdom keyboard is available for word processing applications.

The VT300 has a Keyboard Dialect feature that is initially set to North American. If you have a different-language keyboard or want to use the British setting, you must set the the Keyboard Dialect feature to the correct language for your keyboard. This feature is on the Display Set-Up screen. Chapter 3 describes how to select the correct keyboard language.

Keyboard Layout

The keyboard has four groups of keys and four indicator lights (Figure 4-3). The keys are grouped by function.

- Main keypad
- Editing keypad
- Numeric keypad
- Top-row function keys

The keyboard also has two audible indicators, a keyclick and bell.

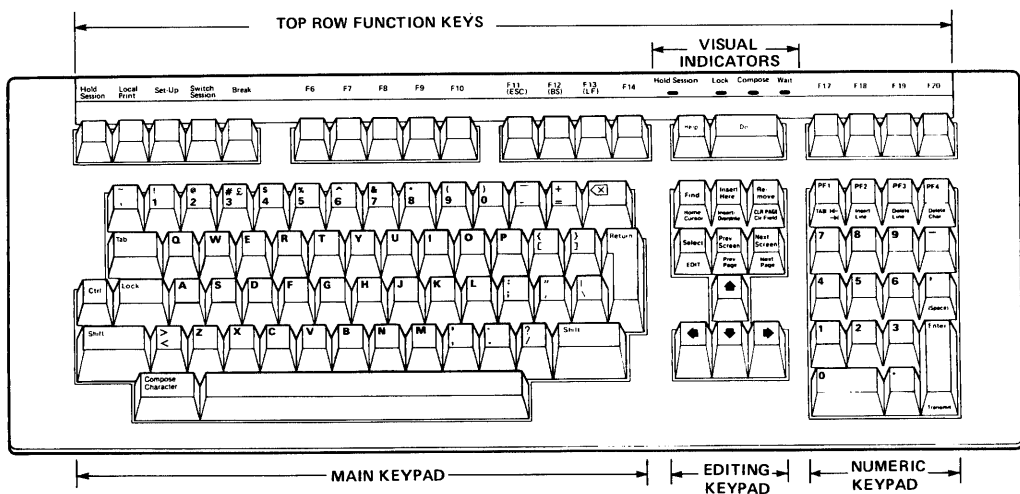

MA-0414-86

Figure 4-3 VT300 Keyboard (North American/United Kingdom Version)

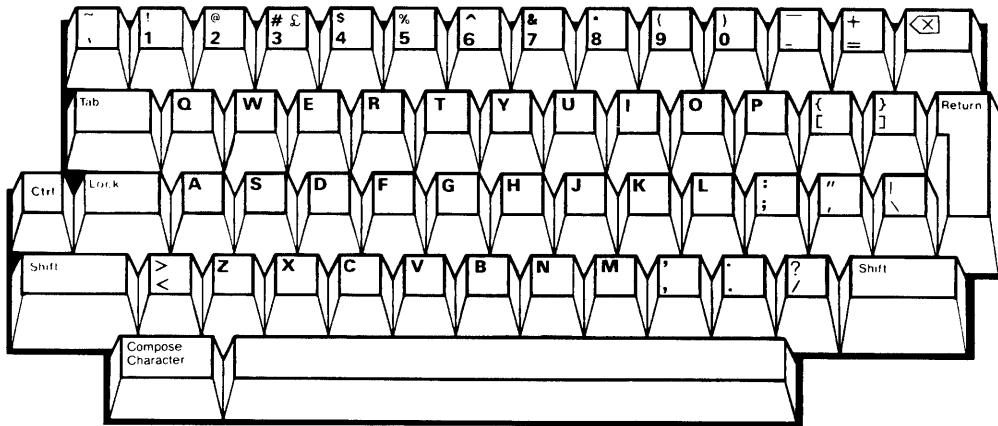

MA 0698-B6

Figure 4-4 Main Keypad

Main Keypad

This keypad (Figure 4-4) is similar to a typewriter keyboard. The main keypad includes standard alphanumeric characters and punctuation marks.

When the VT300 is on-line, the terminal sends the characters you type to the host. The host usually sends these characters back to the terminal for display on the screen. When you type a character in local mode (Global Set-Up screen) or local editing mode (Chapter 9), the terminal displays the characters on the screen without sending them to the host.

The main keypad also has the following special-function keys.

Tab



Pressing Tab sends a horizontal tab, which normally moves the cursor to the next tab stop. You can select the tab stops on the Tab Set-Up screen (Chapter 5). Applications can also change tab stops.

Ctrl



Holding down Ctrl and pressing another key sends a control code to the host.

In this manual, keystrokes that use the Ctrl key appear as follows.

Ctrl-(other key)

For example, Ctrl-Z means to hold down Ctrl and press the Z key.

Lock

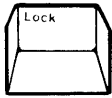

Pressing Lock down makes the alphabetic keys send their uppercase characters. Releasing the Lock key makes the alphabetic keys send their lowercase characters.

If you set the Lock Key feature in the Keyboard Set-Up screen to "shift lock", the Lock key makes all keys send the top character on the key.

Shift

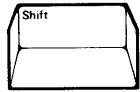

The Shift key has three functions.

- Holding down Shift and pressing a standard key sends the uppercase character (or top character) on the key.
- Holding down Shift and pressing a special-function key starts a predefined control function. In this manual, a control function using Shift appears as follows.

Shift-(other key)

For example, Shift-Local Print means to hold down Shift while pressing the Local Print key.

- Holding down Shift and pressing a user-defined key (UDK) sends a UDK function (Chapter 7).

Return



Pressing Return sends either a carriage return or a carriage return and a line feed (selected in the Display Set-Up screen, Chapter 5).

Pressing Return normally moves the cursor to the beginning of the next line.

<x] (Delete)

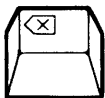

Pressing the <x] key normally sends a DEL (delete) character. Many applications use DEL to delete one character to the left of the cursor.

You can make the <x] key send a BS (backspace) character instead of DEL. You use the Delete feature in the Keyboard Set-Up screen (Chapter 5).

Space bar

Pressing the space bar sends a SP (space) character. You use spaces to separate words or move the cursor forward.

Compose Character

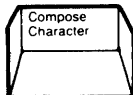

This key lets you display characters that do not appear as standard keys on your keyboard. See Chapter 6.

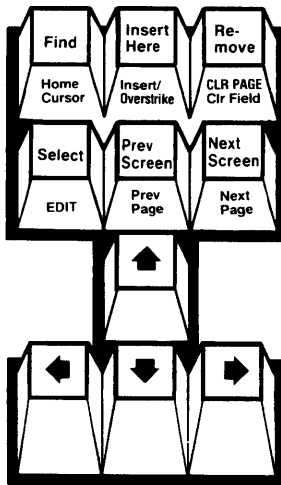

MA-0699-86

Figure 4-5 Editing Keypad

Editing Keypad

The editing keypad has four arrow keys and six editing keys (Figure 4-5).

Pressing an arrow key normally moves the cursor in the direction of the arrow. For example, pressing the  key moves the cursor down one line.

You can use the editing keys in several ways.

- For set-up functions (Chapter 5)
- For panning across pages and changing the size of a window on the screen. (Chapter 8)
- For local editing (Chapter 9)
- For special functions defined by application software.

Application software usually determines how you use editing keys.

For example, some word processing applications may have you use the Next Screen key to scroll new text onto the screen.

Local editing functions appear on the front of the editing keys on the North American/United Kingdom keyboard. All other keyboards have a template that fits over the editing and numeric keypad (Figure 4-7).

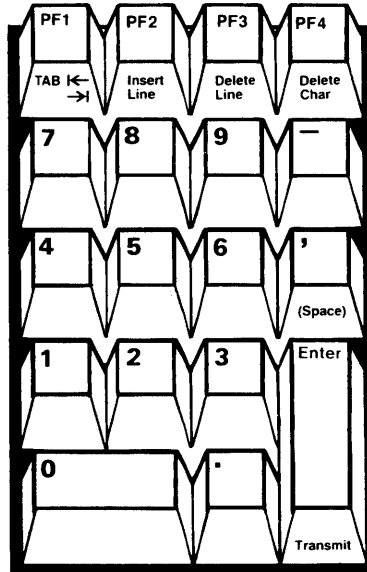

MA-0700-86

Figure 4-6 Numeric Keypad

Numeric Keypad

Numeric keypad keys (Figure 4-6) often have functions assigned by application software, especially PF1 through PF4. For example, you may use a spreadsheet program that assigns special functions to these keys. See your application software manuals for information.

You can use the numeric keypad to enter numeric data as you would with a calculator. Programmers can use this keypad to do hexadecimal compose sequences. See "Hexadecimal Compose Sequences" at the end of Chapter 6.

Like the editing keys, some numeric keys have special functions when you use local editing. These functions appear on the front of the keys on the North American/United Kingdom keyboard. All other keyboards have a template that fits over editing and numeric keypad (Figure 4-7). Chapter 9 describes local editing.

Enter



The Enter key has several functions.

- Normally, this key works like the Return key. Enter sends a carriage return, or a carriage return and a line feed.

- You can also use **Enter** to select features in set-up screens (Chapter 5).
- When you use local editing, you use this key to **Transmit** blocks of data to the host system. Chapter 9 describes local editing.
- Application software may use **Enter** as a special-function key.

Comma
(Space)



This key can send a comma or space character. See the **Keypad Comma** feature in the **Keyboard Set-Up** screen (Chapter 5).

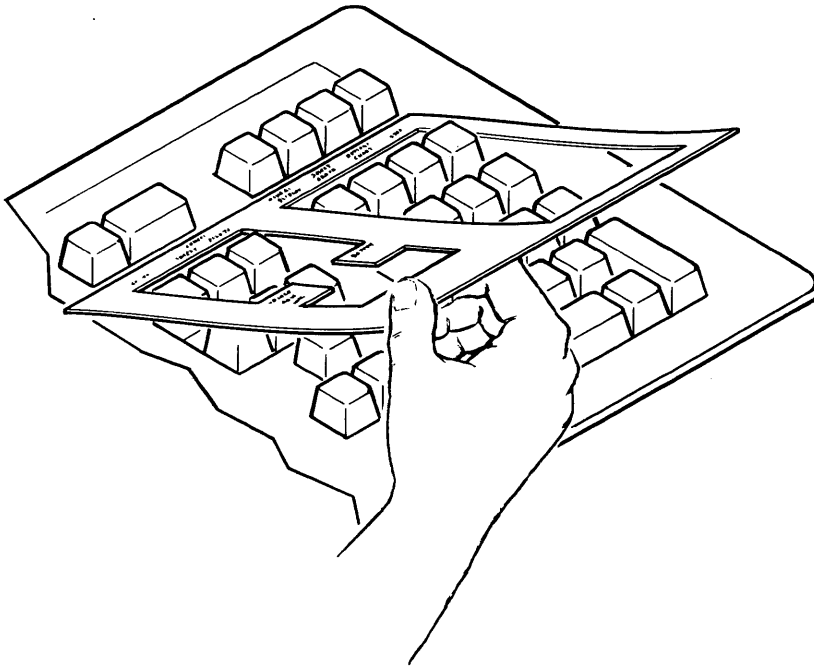

MA-0680-86

Figure 4-7 Local Editing Template

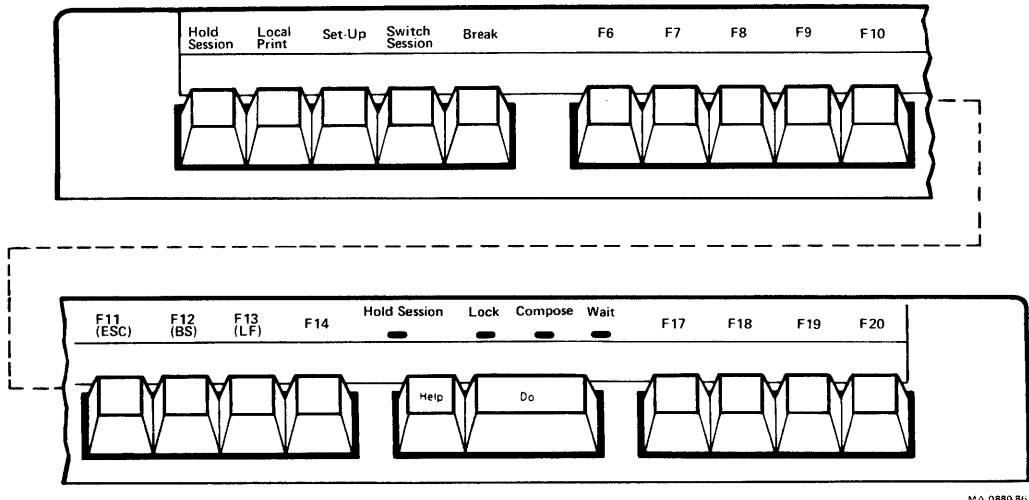

Figure 4-8 Top-Row Function Keys

Top-Row Function Keys

Most of the top-row keys (Figure 4-8) have functions assigned by application software. Your application software manuals should describe the function of these keys.

The first five keys on the left of this row have predefined functions. Applications cannot redefine these keys.

Hold Session



Pressing **Hold Session** freezes incoming data on the screen, so you can read it. When you freeze the screen, the **Hold Screen** indicator turns on.

Pressing **Hold Session** again releases the screen, so new data can appear. The indicator turns off.

With Dual Sessions

If you press **Hold Session** when two sessions are on the screen, you freeze the *active session*. However, the host system can still send screen data to the *inactive session*.

Chapter 8 describes how to use dual sessions.

NOTE: The **Hold Session** key does not work if you set the **Receive XOFF Point** feature to "never" in the **Communications Set-Up** screen (Chapter 5).

**Ctrl-Hold
Session**

Pressing **Ctrl-Hold Session** freezes both sessions.

Local Print



Pressing **Local Print** sends the text from page memory to the printer. Page memory includes the text on the screen. The **Page Arrangement** feature in the **Display Set-Up** screen (Chapter 5) determines the number of lines sent to the printer.

NOTE: Local Print works differently than the Print Screen key on a VT200. Print Screen sends only the text on the screen to the printer.

In 4010/4014 mode, pressing **Local Print** sends graphics and text to the printer.

**Shift-Local
Print**

Pressing **Shift-Local Print** prints the full screen (text and graphics). To print graphics, you must first enable the **Graphics Printing** feature (**Printer Set-Up** screen). If the **Graphics Printing** feature is disabled, pressing **Shift-Local Print** only sends text to the printer.

If you use two windows, **Shift-Local Print** still prints the full screen (both windows). See Chapter 8.

**Ctrl-Local
Print**

Pressing **Ctrl-Local Print** turns auto print mode on or off. In auto print mode, you can automatically print each line of text as it is received from the host system. See "Print Modes" in Chapter 11.

Set-Up



You press **Set-Up (F3)** to enter or leave set-up. When you enter set-up, the terminal displays the **Set-Up Directory** screen. You can leave set-up from any set-up screen. Chapter 5 describes set-up.

Ctrl-Set-Up

Pressing **Ctrl-Set-Up** while in set-up resets many set-up features for both sessions to their saved settings. This action affects screen data and communications, and may also affect the character set selected and user-defined keys (UDK).

For more information, see the *VT330/VT340 Programmer Reference Manual*, Volume 1, Chapter 13.

**Switch
Session**



Pressing **Switch Session** changes the active session. You can switch from session 1 to session 2, or from session 2 to session 1.

Session Switch does not work when

- you are in set-up.
- the Dual Terminal feature (Global Set-Up screen) is disabled.
- you are using a single cable for Dual Sessions and the SSU software is not enabled on the host system.

Ctrl-Switch Session

Pressing Ctrl-Switch Session lets you divide the screen into two windows. Windows let you display two sessions at one time.

Pressing Ctrl-Switch Session

- one time gives you vertical windows.
- a second time gives you horizontal windows.
- a third time returns you to a full screen display. The terminal displays only the active session.

See "Windows" in Chapter 8.

Break



Break works alone or with other keys to perform a function that affects the communication between the host system and your terminal. Pressing Break usually ends communication with a session immediately. If you are running dual sessions under SSU software, the software may interpret the break signal differently or may ignore it completely. Consult your system manager for more information.

You can turn this key on or off with the Break feature in the Keyboard Set-up screen (Chapter 5).

Shift-Break

Pressing Shift-Break ends communication with a modem.

Ctrl-Break

Pressing Ctrl-Break sends the answerback message to the active session. See the Keyboard Set-Up screen in Chapter 5.

NOTE: Ctrl-Break sends the answerback message even if you set the Conceal Answerback Message feature in the Communications Set-Up screen (Chapter 5).

F11 (ESC)



F11 is a function key often defined by application software. In VT100 and VT52 modes, F11 sends an ESC (escape) character. Some keyboards must use Ctrl-3 to send escape sequences. In edit mode, the F11 key is disabled.

NOTE: To send an ESC in VT300 mode, you can usually press Ctrl-3.

F12 (BS)



F12 is a function key often defined by application software. In VT100 and VT52 modes, it sends a BS (backspace) character.

You can also press Ctrl-H to send a backspace.

F13 (LF)



F13 is a function key often defined by application software. In VT100 and VT52 modes, it sends an LF (line feed) character.

You can also press Ctrl-J to send a line feed.

Help



Help is a function key often defined by application software.

Do

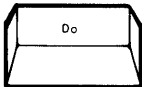

Do is a function key often defined by application software.

In set-up, pressing Do selects some features.

Data Processing Keys

Most VT300 keyboards have some data processing keys. These keys have three or four characters on their keycap. Normally, you use the characters on the left half of the key. These characters are called typewriter characters. The character on the right half are called data processing characters. Figure 4-9 shows an example of a data processing key.

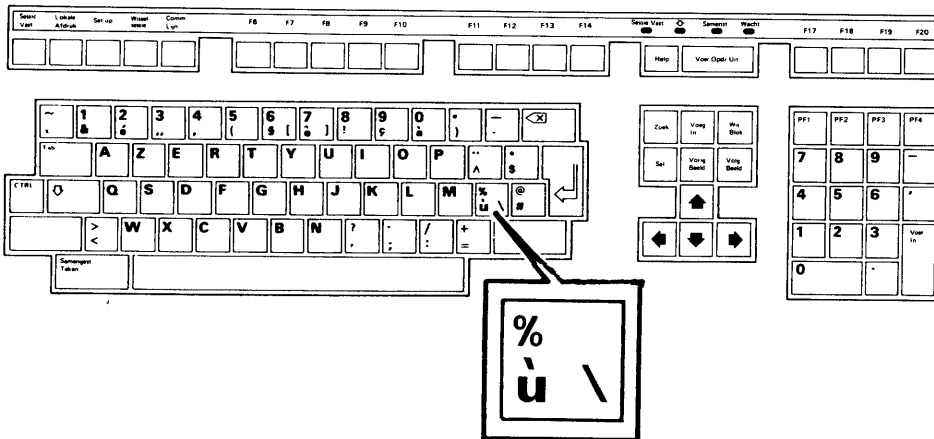

MA-0990-86

Figure 4-9 Example of a Data Processing Key

With one exception, you can select typewriter or data processing characters with the **Keyboard Modes** feature in the **Display Set-Up** (Chapter 5). The one exception is the North American/United Kingdom keyboard.

North American/United Kingdom Keyboard - This keyboard has only one key with three characters.



The way the key works depends on the **Keyboard Dialect** feature in the **Keyboard Set-Up** screen.

If you set the **Keyboard Dialect** to "North American", you can type the # sign but not the £ sign. You cannot set the **Keyboard Modes** feature to "data processing".

If you set the **Keyboard Dialect** to "British", you can use this key as a data processing key. To use the £ sign, set **Keyboard Modes** to "typewriter". To use the # sign you must set features.

- Set **Keyboard Modes** to "data processing".
- Set the **Character Set Mode** in the **General Set-Up** screen to "national".

In this one case, the data processing character is on the left of the key.

Compose Characters

You can use compose sequences to display characters that do not appear as standard keys on your keyboard. Chapter 6 describes how to use compose sequences.

INDICATOR LIGHTS

The keyboard has four indicator lights (Figure 4-10).



MA-0881-86

Figure 4-10 Indicator Lights

Hold Session

This indicator turns on when you press the **Hold Session** key to freeze the screen display. See the "Hold Session" key description.

Lock

This indicator turns on to indicate the terminal is sending only uppercase characters. See the "Lock" key description.

Compose

This indicator turns on when you use the keyboard to compose a character. See Chapter 6.

Wait

This indicator turns on when the keyboard cannot send data. The common term for this condition is a locked keyboard. If the Wait indicator stays on for any time, you may need to unlock the keyboard.

NOTE: It is normal for the Wait indicator to stay on briefly when the VT300 sends a block of data in local editing mode (Chapter 9), or when you perform a graphics print operation (Chapter 11).

You can clear a locked keyboard by using the Clear Communications feature in the Set-Up Directory screen (Chapter 5).

KEYBOARD INDICATORS

The keyboard has three audible indicators: a keyclick, margin bell and warning bell. You can enable or disable these indicators in the Keyboard Set-Up screen (Chapter 5).

Keyclick

You hear the keyclick sound each time you press a key, except under the following conditions.

- You press Shift or Ctrl. These keys never make a keyclick sound.
- The Wait indicator is on. No keys can make a keyclick sound.
- You disable the Keyclick set-up feature.
- You use some keys with the Character Set feature (General Set-Up screen) set to "national".
- You press a key that does have a function in the current Terminal Mode (General Set-Up screen). For example, keys F6 through F10 do not work in VT100 mode.

Bell

The bell tone is a beeping sound. You can use the bell as a margin bell, warning bell or, both.

Margin Bell

This bell sounds when the cursor is eight characters from the right margin.

Warning Bell

This bell sounds for any of the following conditions.

- During the power-up self-test
- When the terminal receives a bell (BEL) character from the host system
- After a compose character error
- When errors occur while you are using local editing
- When SSU errors occur (The bell rings twice.)
- If an "NVR error" message appears at the bottom of the screen (See Table 12-2.)

STATUS LINE

The VT300 uses line 25 at the bottom of the screen to display a status line for the active session. By default, the status line appears in reverse video at the bottom of the screen. You can change the status line by changing the setting of the **Status Display** feature in the **Display Set-Up** screen. Chapter 5 describes how to change set-up settings.

The **Status Display** feature has three settings. You can select when to display the status line and what type of status line to use.

Indicator (default)	The status line appears at all times, providing information on the current active session (Table 4-3).
None	The status line appears when <ul style="list-style-type: none">• you select a set-up screen, or• the host system selects the status line.
Host-writable	Applications can write messages on the status line.

NOTE: The VT300 uses separate set-up settings for each session. Any changes you make only apply to the session you are in. If you want to change a set-up setting for two sessions, you must make the change in each session.

The status line (Figure 4-11) provides information about the terminal's current operations. For example, the status line shows what page in page memory the cursor is on. Unless you change the **Page Coupling** feature in the **Display Set-Up** screen to "disabled", the page indicator also indicates what page is currently displayed.

NOTE: In local editing mode, the page indicator always indicates what page is currently displayed.

The status line has seven fields. Each field displays the status of a particular VT300 feature, such as the session number, cursor position, or printer status. Table 4-3 describes each field.

You can display the status line in English, French, or German. Use the **Set-Up Language** feature in the **Set-Up Directory** screen to select the language.

When you select a *host-writable status line*, applications on your host system can use the status line to send you messages.

1
2
3
4
5
6
7

1 1 (01, 01) Edit Overstrike Mode Printer: None Modem: DSR

MA 0988 86

Figure 4-11 Status Line Fields

Table 4-3 Status Line Fields

Field	Value	Indicates
1		Active session
	1	Session 1
	2	Session 2
2		What page the cursor is on in page memory
	1	Page 1
	2	Page 2
	3	Page 3
	4*	Page 4
	5*	Page 5
	6*	Page 6

* These page numbers never appear when you use dual sessions. Each session can only use three pages.

Table 4-3 Status Line Fields (Cont)

Field	Value	Indicates
3	(x,y)	<p>Cursor position</p> <p>Text cursor position x = row (1 to 24, 36, 72, or 144) y = column (1 to 132)</p> <p>You can use the Column Mode feature in the Display Set-Up screen to select 80 or 132 columns.</p>
	[x,y]	<p>ReGIS graphics cursor position x = horizontal pixel coordinate (0 to 799). y = vertical pixel coordinate (0 to 480). <i>NOTE: The cursor position indicator is disabled in 401X mode.</i></p>
4	Edit	<p>Local editing mode (Chapter 9)</p> <p>This field is blank unless you are using local editing mode.</p>
5		<p>Insert or overstrike mode</p> <p>This field is blank unless you are in set-up or edit mode.</p>
	Insert	<p>The VT300 inserts new characters at the cursor position, without replacing characters on screen. Old characters move right.</p>
	Overstrike (default)	<p>Each new character replaces the old character at the cursor position.</p>
6		<p>Printer status</p>
	Printer: Ready	<p>The printer can receive data for printing (on-line).</p>
	Printer: Not Ready	<p>The printer is not ready to receive data for printing (off-line).</p>
	Printer: None	<p>The printer is off or not connected to the VT300.</p>

Independent Set-Ups for Dual Sessions

The VT300 can run two sessions with the host system at the same time. The terminal stores a separate group of set-up feature settings for each session (Figure 5-1). Only one session is active at a time. The terminal uses the settings for the active session. If you forget which session you are in, you can check the indicator status line. See the "Status Line" section at the end of Chapter 4.

All the feature settings on the Global Set-Up screen and the following printer communication settings in the Printer Set-Up screen affect both sessions:

- Print Speed
- Flow Control
- Character Format
- Stop Bits

*NOTE: You cannot switch sessions in set-up. To switch sessions, you must leave set-up and press the **Switch Session** key.*

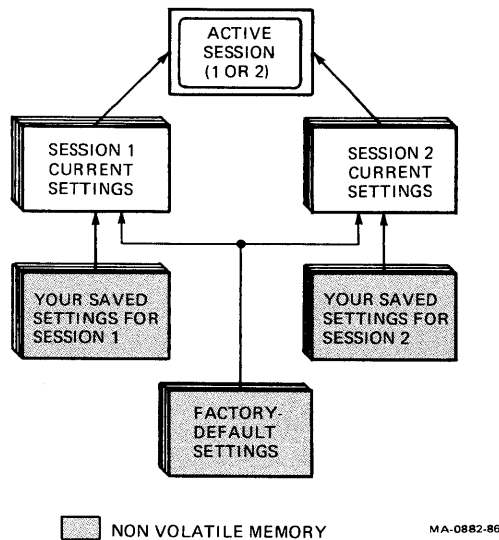

Figure 5-1 Independent Set-Ups for Dual Sessions

A Guide to Set-Up Features

Table 5-1 lists all the VT300 set-up screens and their features. This chapter describes the first seven set-up screens, listed on the first page of the table. The other set-up screen are described in later chapters.

Table 5-1 A Guide to Set-Up Features

Set-Up Directory	General Set-Up	Communications (cont)
Global Set-Up	Terminal Mode	Stop Bits
General Set-Up	Device Attrib Resp	Modem Control
Display Set-Up	Character Set Mode	Modem High Speed
Communications Set-Up	User Pref Character Set	Modem Low Speed
Printer Set-Up	Lock User-Defined Keys	Disconnect Delay
Graphics Set-Up	User Features Lock	Local Echo
Keyboard Set-Up	Update Method	Auto-Answerback
User-Defined Key Set-Up		Conceal Answerback
Local Editing Set-Up	Display Set-Up	Answerback Message
Tab Set-Up		
Diagnostics Set-Up	Scrolling	Keyboard Set-Up
Color Set-Up*	Display Background	Keyboard Dialect
Reset Session	Column Mode	Keyboard Mode
Clear Display	Page Arrangement	Keypad Mode
Clear Communications	Horizontal Coupling	Cursor Key Mode
Enable Sessions	Vertical Coupling	Auto Repeat
Disable Sessions	Page Coupling	Keyclick
Save Current Settings	Status Display	Margin Bell
Recall Saved Settings	Text Cursor	Warning Bell
Recall Factory-Default Settings	Cursor Style	<x Key
Set-Up=Language	Cursor Blink	Keypad comma (,)
	Control Representation Mode	Lock Key
	New Line Mode	Compose
Global Set-Up	Auto Wrap	Break
On-Line/Local	Communications Set-Up	Tab Set-Up
Dual Terminal	Transmit Speed	Clear All Tabs
Terminal Comm Ports	Receive Speed	Set 8 Column Tabs
Printer Assignment	Receive XOFF Point	(You can also set
Comm1 Port	Transmit Flow Control	tabs at any column.)
CRT Saver	Transmit Rate Limiting	
Refresh Rate	Character Format	
Color Map*		

* VT340 only.

Table 5-1 A Guide to Set-Up Features (Cont)

Chapter numbers are in parentheses.

User Defined Key Set-Up (7)	Graphics Set-Up (10)	Printer Set-Up (11)
Clear All Keys	Graphics Cursor	Print Mode
Clear This Key	Sixel Scrolling	Printer Extent Mode
Save User-Defined Keys	Macrograph Reports	Print Terminator
Recall User-Defined Keys	401X Characters	Printed Data Type
	401X CR Processing	Printer to Host
Local Editing Set-Up (9)	401X LF Processing	Communications
	401X DEL Processing	Print Speed
Edit Mode	401X GIN Terminator	Flow Control
Erasure Mode		Character Format
Edit Key Execution Mode	Color Set-Up* (10)	Stop Bits
Transmit Execution Mode		Graphics Printing
Local Editing Applic. Keys	Lets you select 16	Background Printing
Guarded Area Transfer Mode	colors from a palette	Sixel Graphics Level
Selected Area Transfer Mode	of 4096 colors.	Sixel Print Option
Line Transmit Mode		Color Printing*
Multiple Area Transfer Mode		
Transfer Termination Mode		Color Specification*
VT131 Transfer Mode		
Space Compression Mode		Diagnostics Set-Up
		(12)
End of Line Characters		
End of Block Characters		For service personnel.

* VT340 only.

Entering and Leaving Set-Up

To enter set-up, you press the Set-Up key (F3). When you press Set-Up, information on the screen disappears. (This information reappears when you leave set-up.) Then the terminal displays the Set-Up Directory screen.

The Set-Up Directory lists all other set-up screens. You can select any other set-up screen from the Set-Up Directory.

To leave set-up, you press Set-Up again. You can leave set-up from any set-up screen.

NOTE: Most changes you make in set-up take effect when you leave set-up.

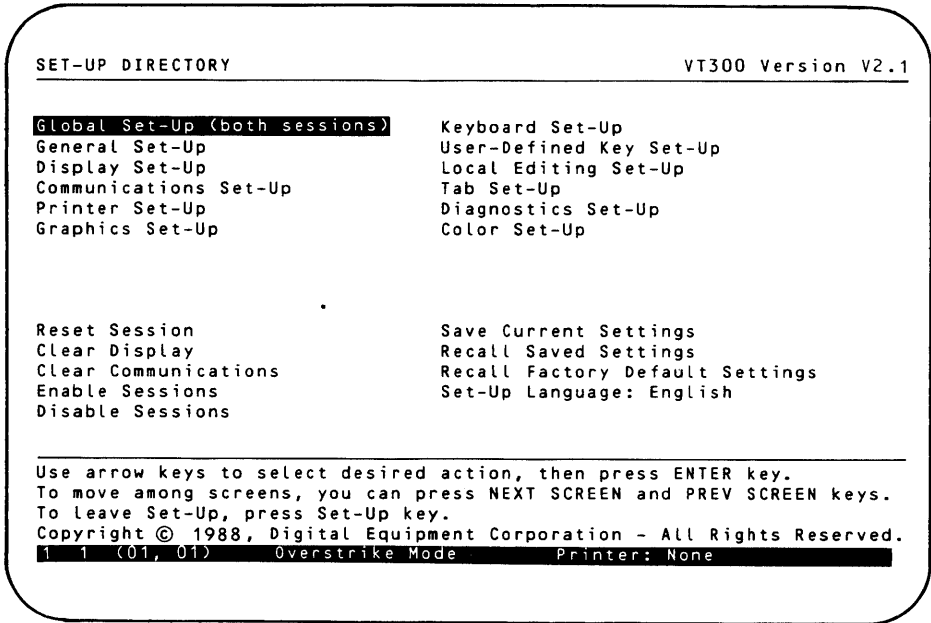

Figure 5-2 Set-Up Directory

SET-UP DIRECTORY

The Set-Up Directory (Figure 5-2) is always the first screen you see in set-up. The Set-Up Directory includes

- a screen title,
- features,
- set-up directions, and
- status line.

All other set-up screens include this information.

NOTE: The set-up screens in this chapter show the factory-default settings.

Screen Title

The screen title shows you the set-up screen name, the model number of your terminal, and the *firmware* version.

SET-UP DIRECTORY

VT300 V2.1

Set-Up Directory Features

The top half of the Set-Up Directory lists the remaining set-up screens.

Global Set-Up (both sessions)	Keyboard Set-Up
General Set-Up	User-Defined Key Set-Up
Display Set-Up	Local Editing Set-Up
Communications Set-Up	Tab Set-Up
Printer Set-Up	Diagnostics Set-Up
Graphics Set-Up	Color Set-Up

The bottom half lists some actions you can perform from this screen.

Reset Session	Save Current Settings
Clear Display	Recall Saved Settings
Clear Communications	Recall Factory Default Settings
Enable Sessions	Set-Up Language: English
Disable Sessions	

Set-Up Directions

Most set-up screens have directions that tell you how to move the cursor and select features. For example, the following directions appear at the bottom of the Set-Up Directory.

```
Use arrow keys to select desired action, then press ENTER key.  
To move among screens, you can press the NEXT SCREEN and PREV SCREEN keys.  
To leave Set-Up, press Set-Up key.  
Copyright c 1987, Digital Equipment Corporation - ALL Rights Reserved  
1 1 (01, 01)      Overstrike Mode      Printer: None
```

Status Line

The VT300 uses the last line on the screen (line 25) to display a status line for the current session, in reverse video. You can select when to display the status line. By default, the status line appears at all times. The status line always appears in set-up. See the "Status Line" section at the end of Chapter 4.

You cannot change the information on the status line, but your host system can display different information in place of the status line. See the Status Display feature in the "Display Set-Up" section of this chapter.

Set-Up Cursor

Set-up uses a special cursor that highlights a screen entry, or field, in reverse video. When you enter set-up, the cursor highlights the Global Set-Up field in the Set-Up Directory (Figure 5-2).

You use the arrow keys to move the cursor to different features.

Action Fields

All the features in the Set-Up Directory are *action fields*. When you select an action field, the terminal immediately performs that action. You press the **Enter** key to select the action field highlighted by the cursor. Most set-up screens have some action fields.

Some actions do not affect the screen, so the VT300 displays a message to let you know if the action was successful. This message appears in place of the status line at the bottom of the screen.

- A "Done" message indicates the action is complete.
- An "NVR error" message indicates the terminal could not perform the action. See Table 12-2.

The VT300 displays messages for the following action fields on the Set-Up Directory screen.

Reset Session	Save Current Settings
Clear Display	Recall Saved Settings
Clear Communications	Recall Factory Default Settings
Enable Sessions	
Disable Sessions	

How to Select an Action Field - The following example shows you how to select the General Set-Up screen from the Set-Up Directory.

1. Press **Set-Up**. The terminal displays the Set-Up Directory.
2. Press the **↓** key. The cursor advances to the **General Set-Up** action field.
3. Press **Enter**. The terminal displays the General Set-Up screen (Figure 5-4).

To return to the Set-Up Directory, press **Select**.

Set-Up Language

The **Set-Up Language** feature lets you display the set-up screens in one of three languages: English, French, or German. The language you select takes effect immediately in set-up. You change the setting as follows.

1. Press **Set-Up**. The terminal displays the **Set-Up Directory**.
2. Use the arrow keys to move the cursor to **Set-Up Language**.
3. Press **Enter** to change **Set-Up Language** setting. Each time you press **Enter**, the language displayed changes immediately.

Set-Up Directory Fields

Table 5-2 describes all the fields on the **Set-Up Directory** screen.

Action Field	Function
Global Set-Up	These fields display the selected set-up screen. For example, you select Global Set-Up to display the Global Set-Up screen.
General Set-Up	
Display Set-Up	
Communications Set-Up	
Printer Set-Up	
Graphics Set-Up	
Keyboard Set-Up	
User-Defined Set-Up	
Local Editing Set-Up	
Tab Set-Up	
Diagnostics Set-Up	
Color Set-Up	
Reset Session	Resets many set-up features to their factory-default settings. Resets internal features to default settings that work with many application programs. Reset Session affects the active session only.

Table 5-2 Set-Up Directory Fields (Cont)

Action Field	Function
Reset Session (cont)	<p>Reset Session does not affect screen data communications, character set mode, user-defined keys, or the color map (VT340 only).</p> <p>Features affected are listed in Table 13-1 of the <i>VT330/VT340 Programmer Reference Manual, Vol. 1</i>.</p>
<p><i>NOTE: You can recall the saved settings for both sessions by pressing Ctrl-Set-Up. This action is similar to turning the terminal on. Pressing Ctrl-Set-Up disconnects communication with the host system.</i></p>	
Clear Display	<p>Clears the screen (including the host-writable status line) when you leave set-up. Affects the active session only.</p>
Clear Communications	<p>Clears communications for the active session as follows.</p> <ul style="list-style-type: none">• Cancels any print operation.• Cancels any escape sequence, control sequence, or device control string (DCS).• Clears the keyboard buffers.• Clears the receive buffer.• Clears the transmit buffer.• Resets Printer Mode (in the Printer Set-Up screen) to normal.• Sends an XON signal to the host.• Resets the XOFF receive flags at the printer and host.• Resynchronizes dual-session protocol.• In local editing mode (Chapter 9), cancels any block transmission in progress.

NOTE: Clear Communications does not disconnect communication with the host system.

Table 5-2 Set-Up Directory Fields (Cont)

Action Field	Function
Enable Sessions	<p>Lets you resume an interrupted session. A session can be interrupted by a power failure to the terminal or host.</p> <p>To use this feature, your system must have SSU software. You also must set two features in the Global Set-Up screen.</p> <ul style="list-style-type: none">• Dual Terminal must be set to "enabled".• Terminal Comm Ports must be set to "Sessions on Comm1" or "Sessions on Comm2". <p>See Chapter 8 for more information.</p>
Disable Sessions	Disables the current SSU sessions.
Save Current Settings	Saves all current settings in most set-up screens for the active session.* The current settings become the saved settings. See "Saved Settings Column" in this chapter.
Recall Saved Settings	Replaces all current settings in most set-up screens with the saved settings for the active session.* This feature also clears the screen. See "Saved Settings Column" in this chapter.

NOTE: If you use a modem or other communication equipment, Recall Saved Settings or Recall Default Settings may disconnect communication with the host system.

Recall Factory-Default Settings	Replaces all current settings in all set-up screens with the default settings. May affect both sessions, because it disables the Dual Terminal feature in Global Set-Up. This feature also performs the following functions.
--	---

* This feature does not affect the current settings in the User-Defined Key Set-Up or Color Set-Up screens. These screens have their own features to recall saved settings.

Table 5-2 Set-Up Directory Fields (Cont)

Action Field	Function
	<ul style="list-style-type: none">• Clears the screen.• Moves the cursor to the top of the screen.• Restores the default color map (Color Set-Up, VT340 only).• Clears any definitions stored by the User-Defined Key Set-Up screen.
Set-Up=Language	Selects one of three languages to use for the set-up screens and terminal status line: English, Francais, or Deutsch.

SELECTING SET-UP SCREENS

There are two ways to select set-up screens. You can move from screen to screen in the order listed on the Set-Up Directory. You can also select a screen directly from the Set-Up Directory.

Moving from Screen to Screen

You can use the Next Screen key to move forward from one screen to the next. The screens appear in the same order listed on the Set-Up Directory screen. The Prev Screen key lets you move back one screen at a time.

1. Press **Set-Up**. The terminal displays the Set-Up Directory. The cursor is on the **Global Set-Up** field.
2. Press **Next Screen**. The terminal displays the **Global Set-Up** screen (Figure 5-3).
3. Continue to press **Next Screen**. The set-up screens appear one at a time.
4. Press **Prev Screen** to move back one screen at a time, until you reach the **Set-Up Directory**.

Moving Directly to a Screen

You can select any set-up screen directly from the Set-Up Directory. This example selects the **Keyboard Set-Up** screen.

1. Press **Set-Up**. The terminal displays the Set-Up Directory. The cursor is on the **Global Set-Up** field.

2. Use the key to move the cursor to the **Keyboard Set-Up** field.
3. Press **Enter**. The **Keyboard Set-Up** screen appears (Figure 5-7).

Returning to the Set-Up Directory

To return to the **Set-Up Directory** from another set-up screen, press the **Select** key.

SET-UP SCREEN FORMAT

Most of the set-up screens have a three-column format.

Feature	Current Setting	Saved Setting
---------	-----------------	---------------

The **feature** column lists each feature you can set from that screen. Each feature has a **current setting** and a **saved setting**.

The **current setting** column shows the setting in effect for that feature.

The **saved setting** column shows the setting stored in the terminal's nonvolatile memory. You do not lose saved settings when you turn off the terminal. The saved settings become the current settings when you turn on the terminal on.

You should save settings that you use most frequently.

How to Change a Current Setting

You use the and keys to move the cursor to any feature on a screen. The cursor highlights the feature, as well as its current and saved settings. You can use the or key to change the current setting of a feature.

For example, suppose you want to change the current setting for the **Printer Assignment** feature in the **Global Set-Up Screen** (Figure 5-3). This feature determines which sessions can use a printer connected to the rear of the terminal.

1. Press **Set-Up**. The terminal displays the **Set-Up Directory**.
2. Press **Enter**. The terminal displays the **Global Set-Up** screen.
3. Press the key three times. The cursor moves to the **Printer Assignment** feature line. If this is the first time the terminal is being used, then the current and saved settings are both "Shared".
4. Press the key one time. The current setting changes to "session 1". The saved setting does not change.

NOTE: If you want to save a new setting, see the next section.

5. Press **Set-Up** to leave set-up. The terminal uses the new setting for the **Printer Assignment** feature until you turn power off or change the setting again.

How to Save a Current Setting

When you turn on the terminal, the current settings and saved settings are the same. If you make changes to current settings, you can save your changes with the **Save Current Settings** feature in the **Set-Up Directory**. This feature saves all current settings in most set-up screens (except the **User-Defined Key Set-Up** and **Color Set-Up** screens) for the active session.

You save the current settings as follows.

1. Press **Set-Up**. The terminal displays the **Set-Up Directory**.
2. Use the arrow keys to move the cursor to the **Save Current Settings** field.
3. Press **Enter** to save all current settings.
4. Press **Set-Up** to leave set-up.

How to Recall Saved Settings

For some applications, you may want to make temporary changes to current settings. When you are finished using the temporary settings, you can recall your saved settings with the **Recall Saved Settings** feature in the **Set-Up Directory**. This feature does not affect the **User-Defined Key** or **Color Set-Up** screens.

You recall saved settings as follows.

1. Press **Set-Up**. The terminal displays the **Set-Up Directory**.
2. Use the arrow keys to move the cursor to the **Recall Saved Settings** field.
3. Press **Enter** to recall all saved settings.
4. Press **Set-Up** to leave set-up.

*NOTE: If you use a modem, **Recall Saved Settings** may disconnect communication with the host system.*

GLOBAL SET-UP		VT300 Version V2.1
Feature	Current Setting	Saved Setting
On-Line/Local	on-line	on-line
Dual Terminal	disabled	disabled
Terminal Comm Ports	S1=Comm1, S2=Comm2	S1=Comm1, S2=Comm2
Printer Assignment	shared	shared
Comm1 Port	RS-232	RS-232
CRT Saver	enabled	enabled
Refresh Rate	60 Hz	60 Hz
Color Map	color-1	color-1

Use up/down arrow keys to select feature,
right/left arrow keys to change current setting.
To return to the Set-Up Directory, press SELECT key.
Copyright © 1988, Digital Equipment Corporation - All Rights Reserved
1 1 (01, 01) OverStrike Mode Printer: None

MA-0188-88A

Figure 5-3 Global Set-Up Screen

GLOBAL SET-UP

This screen (Figure 5-3) has features that affect both sessions when you use dual sessions. Table 5-3 describes each feature on the Global Set-Up screen.

Dual Sessions

You use three features on the Global Set-Up screen to set up the VT300 for dual sessions.

- Dual Terminal
- Terminal Comm Ports
- Comm1 Port

The feature settings must match the system cable connections on the rear of the terminal. Chapter 3 describes how to set up the terminal for dual sessions. Chapter 8 describes how to use dual sessions.

Table 5-3 Global Set-Up Features

Feature	Settings*	Description
On-Line/Local	on-line	Selects whether or not the VT300 can communicate with a host system.
	local	Lets the VT300 communicate with a host. Effectively puts the host on hold. The characters you type go directly to the screen.
Dual Terminal	disabled	Selects whether the VT300 is set up for dual sessions (Chapter 8) or a single session. You can only use a single session. The session has a default page arrangement of 6 pages, with 24 lines each.
	enabled	You can use dual sessions. Each session has a default Page Arrangement in the Display Set-Up screen of 3 pages, with 24 lines each.
Terminal Comm Ports	S1=Comm1, S2=Comm2	Assigns the communication connectors on the rear of the terminal to session 1 or 2. Assigns session 1 to the Comm1 connector, and session 2 to the Comm2 connector.
	S2=Comm1, S1=Comm2	Assigns session 2 to the Comm1 connector, and session 1 to the Comm2 connector.

* Default settings are in bold type.

Table 5-3 Global Set-Up Features (Cont)

Feature	Settings*	Description
Terminal Comm Ports (cont)	Sessions Comm1	Assigns both SSU sessions to the Comm1 connector. Both sessions use the Comm1 cable.†
	Sessions Comm2	Assigns both SSU sessions to the Comm2 connector. Both sessions use the Comm2 cable.†
<i>NOTE: There are two Comm1 connectors. You must set the following Comm1 Port feature to match the Comm1 connector you are using.</i>		
Comm1 Port		Selects which Comm1 connector is active. You can connect cables to both Comm1 connectors, but only one can be active at a time.
	RS-232	Selects the 25-pin Comm1 connector. Conforms to EIA RS232-C standards. You can use this setting for a connection to a host, terminal server, or modem.
	DEC-423	Selects the 6-pin Comm1 connector. Conforms to EIA RS423 standards. you can use this setting for a connection to a host or terminal server.
Printer Assignment		Selects which session can use the printer port.
	shared	Both sessions can use the printer port, but not at the same time.
	session 1	Only session 1 can use the printer port.
	session 2	Only session 2 can use the printer port.

* Default settings are in bold type.

† Before you use these settings, make sure your host system has SSU software (Chapter 8).

Table 5-3 Global Set-Up Features (Cont)

Feature	Settings*	Description
CRT Saver	enabled	Increases screen life. If the terminal is left on but inactive for 30 minutes, the screen goes blank. You can press any key to reactivate the screen. The host can also reactivate the screen by sending any character.
	disabled	CRT saver feature is off.
Refresh Rate	60 Hz	Sets the terminal to refresh the screen at the power line frequency.
	60 Hz	Used in environments where the power line frequency is 60 Hz.
	50 Hz	Used in environments where the power line frequency is 50 Hz.
Color Map	color 1	Selects a color or monochrome display for the VT340. There are two settings for color. See Chapter 10.
	color 1	Selects the color map. You can display 16 colors at one time, from 4096 possible colors.
	color 2	Same as color 1 setting, except the VT340 uses color map entry 8 to display reverse video (negative-image) text.
	monochrome	Selects a gray color map. You can display 16 shades of gray at one time.

* Default settings are in bold type.

GENERAL SET-UP		VT300 Version V2.1
Feature	Current Setting	Saved Setting
Terminal Mode	VT300-7bit	VT300-7bit
Device Attributes Response	VT330 (or VT340)	VT330 (or VT340)
Character Set Mode	multinational	multinational
User Preference Char Set	DEC-MCS	DEC-MCS
Lock User-Defined Keys	unlocked	unlocked
User Features Lock	unlocked	unlocked
Update Method	when available	when available

Use up/down arrow keys to select feature, right/left arrow keys to change current setting. To return to the Set-Up Directory, press SELECT key.

Copyright © 1988, Digital Equipment Corporation - All Rights Reserved

1 1 (01, 01) Overstrike Mode Printer: None

MA-0190-88

Figure 5-4 General Set-Up Screen

GENERAL SET-UP

This screen (Figure 5-4) lets you set general features, such as the type of character set used to display characters on the screen. The **Terminal Mode** feature lets the VT300 emulate any other VT series terminal for software compatibility. Table 5-4 describes the General Set-Up features.

Using Device Attributes with the VMS Operating System

If you are using VMS version 4.6 or greater, use the VT330 or the VT340 device attribute (DA) response. If you are not using VMS V4.6 or greater, select a device attributes response other than the VT330 or the VT340. You select the terminal's DA response in the General Set-Up screen.

Character Sets

The **General Set-Up** screen lets you select the type of character set suited for your computing environment, multinational or national. Both types include the characters for many different languages. However, multinational mode supports 8-bit characters, while national mode restricts you to 7-bit characters.

You use the **Character Set Mode** feature to select multinational or national mode. The *VT330/VT340 Programmer Reference Manual*, Volume 1, Chapter 2, shows all the built-in character sets.

Multinational Mode - This mode supports the DEC Multinational character set or the ISO Latin-1 character set (International Standards Organization). These 8-bit character sets have two parts — the ASCII character set and a supplemental set. The ASCII set (American Standard Code for Information Interchange) contains the letters and numbers for English-speaking countries.

The supplemental set contains most characters used in the major European languages. There are two supplemental sets to select from — DEC Supplemental Graphic and ISO Latin-1 supplemental graphic.

If you select multinational mode, you use the User Pref Character Set to select the supplemental set you prefer, DEC Supplemental or ISO Latin-1. You can display many of the characters in a supplemental set by using compose sequences (Chapter 7).

By default, the VT300 uses the DEC Multinational character set.

National Mode - This mode supports 12 national replacement character sets (NRCs) built into the VT300. Each 7-bit NRC set is for a particular European language or dialect. You select an NRC set with the Keyboard Dialect feature in the Keyboard Set-Up screen (Figure 5-7). You can only use one NRC set at a time.

National mode is for 7-bit computing environments. You cannot use the 8-bit multinational character sets in national mode, or the NRC sets in multinational mode.

NOTE: You cannot select national mode when the Keyboard Dialect feature is set to "North American".

Table.5-4 General Set-Up Features

Feature	Settings*	Function
Terminal Mode		Selects the terminal's operating mode. The VT300 can emulate any VT series terminal.
	VT300-7bit	Lets the terminal use all VT300 features. The terminal uses 7-bit controls and 8-bit graphic characters.

Table 5-4 General Set-Up Features

Feature	Settings*	Function
Terminal Mode (cont)	VT300-7bit	Use this mode for VT200 applications. This is the recommended mode for most applications.
	VT300-8bit	Lets the terminal use all VT300 features. The terminal uses 8-bit controls and 8-bit characters. Use this mode for VT200 applications that use 8-bit control characters.
		Many VT100 applications will work in VT300-8bit mode. This mode is the most efficient, but not yet supported by many applications.
	VT100	Lets the terminal run VT100 applications.
	VT52	Let the terminal run VT52 applications.
Device Attributes Response	4010/4014	Lets the terminal run Tektronix 4010/4014 applications.
	VT330 or VT340	Selects the device attributes response, also called the terminal ID. Some applications require specific DA responses.
	VT240	
	VT220	
	VT131	
	VT125	
	VT102	The DA response lets the host know specific operating characteristics of the terminal. See the <i>VT330/VT340 Programmer Reference Manual</i> , Vol. 1, Chapter 12.
VT101		
VT100		

* Default settings are in bold type.

Table 5-4 General Set-Up Features (Cont)

Feature	Settings*	Function
Character Set Mode		Selects the type of character set used, multinational or national. †
	multinational	Supports the 8-bit DEC Multinational or ISO Latin-1 set. Both include the 7-bit ASCII set. You select the specific set with the User Pref Character Set below.
	national	Makes the VT300 use one of the 7-bit national replacement character (NRC) sets. You select the specific NRC set with the Keyboard Dialect in the Keyboard Set-Up screen.
User Pref Character Set		When Character Set Mode is set to "multinational", selects the DEC Multinational or ISO Latin-1 set. The difference between the sets is their supplemental character set, also called a user-preferred set. †
	DEC-MCS	Selects the DEC Multinational character set. This set is compatible with Digital applications.
	ISO Latin-1	Selects the International Standards Organization (ISO) character set.

*NOTE: If your applications can use the ISO set, you should select "ISO Latin-1". Then save this setting with the **Save Current Settings** feature in the **Set-Up Directory**. The ISO set will be available every time you turn the VT300 on.*

* Default settings are in bold type.

† All VT300 character sets appear in the *VT330/VT340 Programmer Reference Manual*, Volume 1, Chapter 2.

Table 5-4 General Set-Up Features (Cont)

Feature	Settings*	Function
Lock User-Defined Keys		Selects whether or not the host can change user-defined key (UDK) definitions (Chapter 7).
	unlocked	Lets the host change UDK definitions.
	locked	Does not let the host change UDK definitions.
User Features Lock		Selects whether or not the host system can change certain set-up features that users often set to their own preference: Column Mode, Scrolling, Display Background and Auto Repeat.
	unlocked	Lets the host change user preference features.
	locked	Does not let the host change the user preference features.
Update method		Selects how and when to update page memory for the inactive session.
	when available	Updates occur whenever the terminal is not busy with the active session.
	shared	Same as the "when available" setting, except the inactive session is served periodically for a certain amount of time, no matter how busy the active session is.
	never	Prevents updates to page memory for the inactive session.

* Default settings are in bold type.

DISPLAY SET-UP		VT300 Version V2.1
Feature	Current Setting	Saved Setting
Scrolling	smooth-2	smooth-2
Display Background	dark	dark
Column Mode	80	80
Page Arrangement	6x24	6x24
Horizontal Coupling	disabled	disabled
Vertical Coupling	enabled	disabled
Page Coupling	enabled	disabled
Status Display	indicator	indicator
Text Cursor	displayed	displayed
Cursor Style	block	block
Cursor Blink	blink	blink
Control Representation Mode	interpret controls	interpret controls
New Line Mode	no new line	no new line
Auto Wrap	no auto wrap	no auto wrap

Use up/down arrow keys to select feature,
right/left arrow keys to change current setting.
To return to the Set-Up Directory, press SELECT key.
Copyright © 1988, Digital Equipment Corporation - All Rights Reserved
1 .1 (01, 01) Overstrike Mode Printer: None

MA-0191-88

Figure 5-5 Display Set-Up Screen

DISPLAY SET-UP

This screen (Figure 5-5) has features that affect the way data appears on the screen. Table 5-5 describes the Display Set-Up features.

Selecting a Page Size

The VT300 has a *page memory* that can store up to 144 lines of text entered from the keyboard or host system. You can display up to 24 lines of text at a time, in 80 or 132 columns. You can divide the 144 lines into a different number of pages, by using the **Page Arrangement** feature on the Display Set-Up screen.

There are four page sizes available (Table 5-5). If you use a single session, all 144 lines of page memory are available. If you use dual sessions, each session has 72 lines available. By default, the terminal uses 3 pages of 24 lines each. The default page size is the same size as the screen display area.

Pages create boundaries. Before you change the standard page size of 24 lines, make sure your applications can recognize these page boundaries. To display a new page, you must pan to that page from the current page. Your application software may also allow you to display other pages. For more information, see the documentation for your application software.

Panning

The VT300 lets you pan through the information stored in page memory. Chapter 8 describes how to pan from the keyboard. The Display Set-Up screen has three features that determine whether or not the terminal automatically pans: Horizontal Coupling, Vertical Coupling, and Page Coupling.

Table 5-5 **Display Set-Up Features**

Feature	Settings*	Function
Scrolling		Selects how fast lines appear on the screen when you scroll.
	smooth-2	Lines scroll at 6 lines per second.
	smooth-4	Lines scroll at 12 lines per second.
	jump	Lines scroll as fast as the terminal receives them.
Display Background	smooth-1	Lines scroll at 3 lines per second.
		Selects light text on dark background, or dark text on light background. Takes effect in set-up.
	light	Selects light background.
Page Arrangement	dark	Selects dark background.
		Selects the size of pages in the terminal's page memory, based on the number of lines per page.
<i>For Dual Sessions</i>		
	3x24	Selects 3 pages, with 24 lines per page (for each session).
	2x36	Selects 2 pages, with 36 lines per page (for each session).
	1x72	Selects 1 page of 72 lines (for each session).

* Default settings are in bold type.

Table 5-5 Display Set-Up Features (Cont)

Feature	Settings*	Function
<i>For Single Sessions</i>		
	6x24	Selects 6 pages, with 24 lines per page.
<i>NOTE: If you disable the Dual Terminal feature in the Global Set-Up screen, the default page arrangement becomes 6x24.</i>		
	4x36	Selects 4 pages, with 36 lines per page.
	2x72	Selects 2 pages, with 72 lines per page.
	1x144	Selects 1 page of 144 lines.
Column Mode		Selects an 80- or 132-column page width for text. The screen display width is the same as the page width.
		If you change the current setting, page memory clears.
	80	A page can have 80 characters per line.
	132	A page can have 132 characters per line.
Horizontal Coupling		Selects whether or not to automatically pan when the cursor moves beyond the left or right border of a window.†
	disabled	The VT300 does not pan automatically.
	enabled	The VT300 pans automatically to keep the cursor visible.

* Default settings are in bold type.

† Chapter 8 describes how to pan on a page.

Table 5-5 Display Set-Up Features (Cont)

Feature	Settings*	Function
Vertical Coupling	disabled	Selects whether or not to automatically pan when the cursor moves beyond the top or bottom border of a window. The VT300 does not pan automatically.
	enabled	The VT300 pans automatically to keep the cursor visible.
	Page Coupling	Selects whether or not to automatically display a new page when the cursor moves to a new page in page memory.
<i>NOTE: This feature is only useful when the Page Arrangement feature is set to two or more pages.</i>		
	enabled	If the cursor moves to a new page, the VT300 displays the new page.
	disabled	If the cursor moves to a new page, you cannot see the page or the cursor. To display the cursor again, see "Windows" in Chapter 8.
Status Display		Selects how and when to use the status line.
<i>NOTE: The terminal always displays the indicator status line in set-up.</i>		
	indicator	The VT300 displays a status line for the active session, at all times.

* Default settings are in bold type.

Table 5-5 Display Set-Up Features (Cont)

Feature	Settings*	Function
Status Display (cont)	None	The VT300 cannot display a status line outside of set-up.
	host-writable	The host can display information on the status line.
Text Cursor	visible	Selects whether or not to display the text cursor in text mode.
	invisible	Displays the text cursor.
	invisible	Does not display the text cursor.
Cursor Style	block	Selects a block or underline cursor.
	underline	Selects a block cursor.
	underline	Selects an underline cursor.
Cursor Blink	blink	Selects whether the cursor blinks (flashes).
	no blink	The cursor blinks.
	no blink	The cursor does not blink.
Control Representation Mode	interpret controls	Selects whether the terminal displays or processes <i>control characters</i> . You can use this feature as an aid for debugging programs. See "Display Controls Mode" in the <i>VT330/VT340 Programmer Reference Manual</i> , Volume 1, Chapter 2.
	interpret controls	The VT300 processes control characters, but does not display them.

* Default settings are in bold type.

Table 5-5 Display Set-Up Features (Cont)

Feature	Settings*	Function
Control Representation Mode (cont)	display controls	The VT300 displays most control characters without processing them. The terminal displays and processes most ReGIS control characters.
	display Regis	The VT300 displays and processes ReGIS control characters.
New Line	no new line	Selects how the Return key and some control characters work.
	no new line	Pressing Return sends a carriage return character. The VT300 does not move the cursor to a new line.
	new line	Pressing Return sends a carriage return and a line feed. Used for some non-Digital applications.
Auto Wrap	no wrap	Selects whether or not text characters automatically wrap to the next line when you reach the right margin.
	no wrap	When you reach the margin, the VT300 displays each new character in the last column of the line. Each new character overwrites the previous character at that position.
	wrap	When you reach the margin, the VT300 displays new characters on the next line.

* Default settings are in bold type.

COMMUNICATIONS SET-UP		Comm1 VT300 Version V2.1
Feature	Current Setting	Saved Setting
Transmit Speed	9600	9600
Receive Speed	receive=transmit	receive=transmit
Receive XOFF Point	64	64
Transmit Flow Control	XON/XOFF	XON/XOFF
Transmit Rate Limiting	enabled	enabled
Character Format	8 bits, no parity	8 bits, no parity
Stop Bits	1	1
Modem Control	disabled	mode 1 (VT220)
Modem High Speed	ignore	ignore
Modem Low Speed	ignore	ignore
Disconnect Delay	2 seconds	2 seconds
Local Echo	disabled	disabled
Auto-Answerback	disabled	disabled
Conceal Answerback	not concealed	not concealed
Answerback Message: _____		
Copyright © 1988, Digital Equipment Corporation - All Rights Reserved		
1	1 (01, 01)	Overstrike Mode Printer: None

MA-0189-88A

Figure 5-6 Communications Set-Up Screen

COMMUNICATIONS SET-UP

This screen (Figure 5-6) has features the VT300 uses to communicate with your computer system. The default settings work with most of Digital's computer systems. Make sure the settings you use match the settings for your system.

This screen also includes features for use with modems. Chapter 11 has more information on modems.

The first line of the screen indicates what communication line you are using, Comm1 or Comm2.

NOTE: Communications Set-Up features do not affect the printer port.

Table 5-6 describes the Communications Set-Up features. For more information, see *VT330/VT340 Programmer Reference Manual, Volume 1, Appendix B.*

XON/XOFF Control Features

There are two set-up features that affect XON/XOFF flow control, **Receive XOFF Point** and **Transmit Flow Control**. If you want to adjust the data flow control mechanism of your terminal, make sure you consider both of these features.

Receive XOFF Point: 64, 256, 512, never

When this feature is set to "never":

- The terminal cannot send XOFF to the host to control data flow.
- The terminal does not send XON to the host at power-up.
- The **Hold Session** key does not operate.
- You can send XOFF to the host by pressing **Ctrl-S**. You can send XON to the host by pressing **Ctrl-Q**.

Transmit Flow Control: XON/XOFF, disabled

When this feature is set to "XON/XOFF":

- The terminal recognizes XON and XOFF as flow control characters.

When this feature is set to "disabled":

- The terminal ignores any XON or XOFF character it receives. However, the terminal can still send these characters to the host.

Table 5-6 Communications Set-Up Features

Feature	Setting*	Function
Transmit Speed		Selects the baud rate the VT300 uses to send data to the host system.

NOTE: The terminal's transmit speed must match the host's receive speed. However, the VT300 can transmit at one speed and receive at another.

- 75
- 110
- 300**
- 600
- 1200
- 2400
- 4800
- 9600**
- 19.2K

Receive Speed		Selects the baud rate the VT300 uses to receive data from the host system.
---------------	--	--

NOTE: The terminal's receive speed must match the host's transmit speed. However, the VT300 can receive at one speed and transmit at another.

- Receive=Transmit**
- 75
 - 110
 - 150
 - 300
 - 6000**
 - 1200
 - 4800
 - 9600
 - 19.2K

* Default settings are in bold type.

Table 5-6 Communications Set-Up Features (Cont)

Feature	Setting*	Function
Receive XOFF Point	64	Selects the number of characters the VT300 can store in its input buffer before sending the XOFF signal.
	256	
	512	
	never	
Transmit Flow Control		Turns XON/XOFF protocol on or off.
	XON/XOFF	Turns XON/XOFF protocol on.
	disabled	Turns XON/XOFF protocol off.
Transmit Rate Limiting		Selects whether or not to limit the number of characters per second that the VT300 sends. A limited rate reduces the burden on the host system.
	enabled	Limits the terminal to sending 150 to 240 characters per second.
	disabled	Does not limit the transmit rate.
Character Format	8 bits, no parity	Selects the character format used to communicate with the host system. See the <i>VT330/VT340 Programmer Reference Manual</i> , Volume 1, Appendix B.
	8 bits, even parity	
	8 bits, odd parity	
	8-bits, even, no check	
	8-bits, odd, no check	
	7-bits, no parity	
	7 bits, even parity	
	7 bits, odd parity	
	7 bits, mark parity	
	7 bits, space parity	
7-bits, even, no check		
7-bits, even, no check		
Stop Bits	1	Selects the number of stop bits used in the character format.
	2	

* Default settings are in bold type.

Table 5-6 Communications Set-Up Features (Cont)

Feature	Setting*	Function
Modem Control		Sets up the terminal to work with different types of modems. See Chapter 11.
	disabled	Modem control pins (data leads only) on the RS232-C connector are not used.
	mode 1 (VT220)	Selects full modem control and is VT220 compatible.
	mode 2	Selects partial modem control for CCITT v. 25 compatible modems. Supports modems with autodial, auto-originate, and autoanswer features.
Modem High Speed		Selects a baud rate when the modem's speed indicator line is on. The Modem Control feature must be on (mode 1 or mode 2).†
	ignore	The VT300 uses the baud rates selected by the Transmit Speed and Receive Speed features.
	300	
	600	
	1200	
	2400	
	4800	
	9600	
	19.2K	

* Default settings are in bold type.

† See the *VT330/VT340 Programmer Reference Manual*, Volume 1, Appendix B.

Table 5-6 Communications Set-Up Features (Cont)

Feature	Setting*	Function
Modem Low Speed	300	Selects the baud rate when the modem's speed indicator line is off. The Modem Control feature must be on (mode 1 or mode 2).†
	600	
	1200	
	2400	
	4800	
	9600	
	19.2K	
	ignore	
Disconnect Delay	2 s	Selects the time allowed for the VT300 to disconnect from a communication line. The VT300 disconnects when it no longer detects the receive line signal detection (RLSD) signal. Modem Control must be on (mode 1 or mode 2).†
	60 ms	Selects a 2 second delay (used in all countries except the United Kingdom).
	60 ms	Selects a 60 millisecond delay (used in the United Kingdom).
	no disconnect	Turns this feature off.

* Default settings are in bold type.

† See the *VT330/VT340 Programmer Reference Manual*, Volume 1, Appendix B.

Table 5-6 Communications Set-Up Features (Cont)

Feature	Setting*	Function
Local Echo	no local echo	Selects whether or not to send the characters you type directly to page memory.
	local echo	Sends keyboard data to the host system. The host decides whether or not to send the data to the page memory.
	local echo	Sends keyboard data to both the host and page memory.
Auto-Answerback	disabled	Selects whether or not to send the answerback message to the host system after you open a session.
	disabled	Does not send the answerback message to the host after you open a session.
	enabled	Automatically sends the answerback message to the host after you open a session.
Conceal Answerback	not concealed	Selects whether or not the VT300 can display the answerback message.
	not concealed	The VT300 can display the answerback message in set-up.
	concealed	The VT300 does not display the answerback message in set-up.†

* Default settings are in bold type.

† When you press Ctrl-Break, the VT300 sends the answerback message. After concealing a message, you can change the concealed setting by entering a new message in the Answerback Message text field.

Table 5-6 Communications Set-Up Features (Cont)

Feature	Setting*	Function
Answerback Message		Lets you type an answerback message. You can use up to 30 characters. The VT300 sends the answerback message when you press Ctrl-Break , or when the host system sends an ENQ character.

* Default settings are in bold type.

Entering an Answerback Message

The Communications Set-Up screen lets you enter an answerback message. This message is for compatibility with earlier Digital terminals. The VT300 usually sends a *device attributes response* to identify itself to the host system. Some terminals must send a simpler message to the host for identification purposes.

You can enter an answerback message as follows.

1. Select the Communications Set-Up screen.
2. Use the arrow keys to move the cursor to **Answerback Message**:
3. Type your message, up to 30 characters long. For example, you might type "VT100." If you make a mistake, you can correct it by using the **<x]** key, **←** key, or the **→** key.

You can send the answerback message by pressing **Ctrl-Break**. The VT300 must have a communication connection to the host system. When you press **Ctrl-Break**, the terminal sends the message.

Deleting the Current Answerback Message

When the set-up cursor moves down to the answerback message text at the bottom of the Communications Set-Up Screen (Figure 5-6), the cursor first appears one character position to the right of the last character in the message. You can delete the current answerback message by pressing the **Delete** key (**<x]**) until you eliminate the message.

NOTE: If the Answerback Message is currently set to "concealed" and the set-up cursor moves to the answerback message area, you do not have to delete the current message before entering a new message.

KEYBOARD SET-UP		VT300 Version V2.1
Feature	Current Setting	Saved Setting
Keyboard Dialect	North American	North American
Keyboard Mode	typewriter	typewriter
Keypad Mode	numeric	
Cursor Key Mode	normal	
Auto Repeat	enabled	enabled
Keyclick	high	high
Margin Bell	off	off
Warning Bell	high	high
<X> Key	delete	delete
Keypad comma (,)	comma	comma
Lock Key	caps lock	caps lock
Compose	enabled	enabled
Break	enabled	enabled

Use up/down arrow keys to select feature,
right/left arrow keys to change current setting.
To return to Set-Up Directory, press SELECT key.
Copyright © 1988, Digital Equipment Corporation - All Rights Reserved

1 1 (01, 01) Overstrike Mode Printer: None

MA-0187-88

Figure 5-7 Keyboard Set-Up Screen

KEYBOARD SET-UP

This screen (Figure 5-7) lets you control keyboard features such as the keyboard language, keyclick, margin bell, and Compose key. Table 5-7 describes the Keyboard Set-Up features.

Keyboard Language

You use the **Keyboard Dialect** feature to select a character set that matches your keyboard. Chapter 3 provides a step-by-step procedure.

See the "General Set-Up" section in this chapter for more details on character sets. The default setting for the **Keyboard Dialect** is "North American". If you use the "North American" setting, you cannot set the **Character Set Mode** feature in the General Set-Up screen to "national".

Table 5-7 Keyboard Set-Up Features

Feature	Settings*	Function
Keyboard Dialect	North American	Lets you select one of the following languages or dialects to match your keyboard. Takes effect in set-up.
	British	
	Flemish	
	Canadian (French)	
	Danish	
	Finnish	
	German	
	Dutch	
	Italian	
	Swiss (French)	
	Swiss (German)	
	Swedish	
	Norwegian	
French/Belgian		
Spanish		
Portuguese		
Keyboard Mode		Selects the character used when you press a key that has three or four characters on its keycap.†
	typewriter	Selects characters on the left half of keycaps.
	data processing	Selects characters on the right half of keycaps.
* Default settings are in bold type.		
† On the North American/United Kingdom keyboard, you can only use the Data Processing setting when the Keyboard Dialect is set to "British". See "Data Processing Keys" in Chapter 4.		

Table 5-7 Keyboard Set-Up Features (Cont)

Feature	Settings*	Function
Keypad Mode	numeric	Selects the type of characters sent by the numeric keypad. † The keypad sends the ASCII code for the numbers shown on the keycaps.
	application	The keypad sends control sequences (used with some applications).
Cursor Key Mode	normal	Selects whether the arrow keys send ANSI cursor control sequences or application-specific control functions. † Arrow keys send standard ANSI cursor control sequences.
	application	Arrow keys send application-specific control functions.
Auto Repeat	enabled	Selects whether or not a key automatically repeats its character when you hold a key down. Holding down a key sends the character repeatedly, until you release the key. Takes effect in set-up.
	disabled	Holding down a key sends only one character.
Keyclick		Selects whether or not the VT300 makes a keyclick noise when you press keys. The high and low settings take effect in set-up.

* Default settings are in bold type.

† The setting is not saved in nonvolatile memory

Table 5-7 Keyboard Set-Up Features (Cont)

Feature	Settings*	Function
Keyclick (cont)	high	Selects a louder keyclick.
	low	Selects a quieter keyclick.
	off	Selects no keyclick.
Margin Bell		Selects whether or not the VT300 makes a bell tone when the cursor approaches the right margin.
	off	Selects no margin bell.
	high	Selects a louder margin bell.
	low	Selects a quieter margin bell.
Warning Bell		Selects whether or not the warning bell sounds. See "Bell" in Chapter 4.
	high	Selects a louder warning bell.
	low	Selects a quieter warning bell.
	off	Selects no warning bell.
<x] Key		Selects the character sent to the host system when you press the <x] key. In edit mode, the <x] key always deletes one character to the left of the cursor.
	delete	Sends DEL (delete) character.
	backspace	Sends BS (backspace) character. Used with some non-Digital systems.

* Default settings are in bold type.

Table 5-7 Keyboard Set-Up Features (Cont)

Feature	Settings*	Function
Keypad Comma	comma	Selects the character sent by the comma key on the keypad when Keypad Mode is set to numeric.
	space	Sends a comma.
		Sends a space.
Lock Key		Selects the function of the Lock key.
	caps lock	Alphabetic keys send their upper-case character. Other keys still send the bottom character on their keycap.
	shift lock	Alphabetic keys send their upper-case character. Other keys send the top character on their keycap.
Compose		Selects whether or not the compose key works. See Chapter 6.
	enabled	You can use the Compose key.
	disabled	You cannot use the Compose key.
Break		Selects whether or not the Break key sends a break signal. See the Break key description in Chapter 4.
	enabled	The Break key sends a break signal.
	disabled	The Break key does not work alone.†

* Default settings are in bold type.

† You can still use the **Shift-Break** and **Ctrl-Break** functions. See the **Break** key description in Chapter 4.

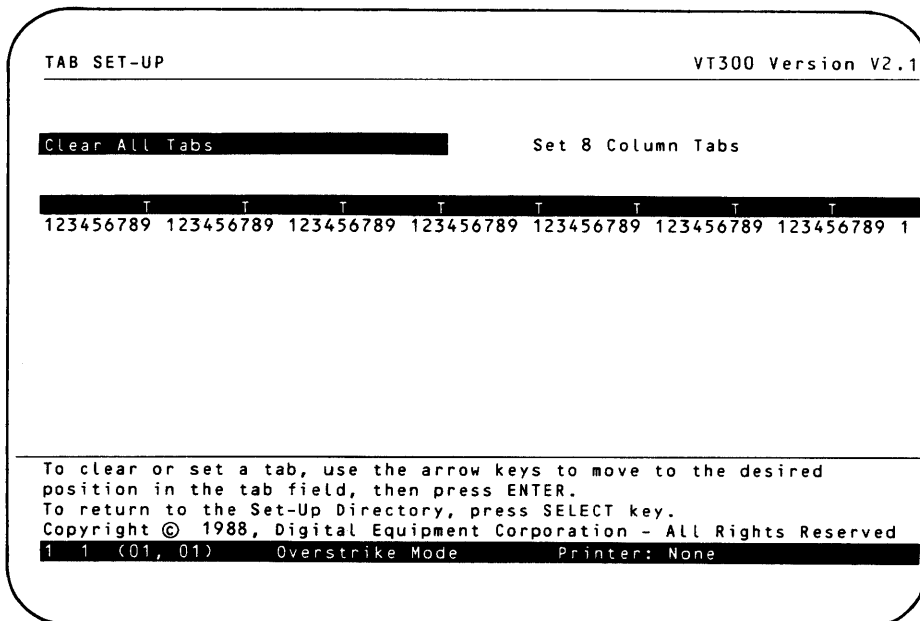

MA-0192-88

Figure 5-8 Tab Set-Up

TAB SET-UP SCREEN

This screen (Figure 5-8) lets you set the number of tab stops on a line. Tab stops on the screen are similar to tab stops on a typewriter. When you press the Tab key outside of set-up, the cursor advances to the next tab stop. Table 5-8 describes the two action fields on this screen.

There is one tab stop field for each column on the screen. You can use a screen display of 80 or 132 columns per line. See Column Mode in the Display Set-Up screen.

There are two possible settings for each tab stop field: the letter T (tab stop) or a blank (no tab stop).

You can move the cursor to a tab stop field with the arrow keys or the Tab key. After you select a field, press Enter to place a T in a blank field or erase a T from that field.

NOTE: You cannot put a tab in column 1.

Table 5-8 Tab Set-Up Features

Feature	Function
Clear All Tabs	Removes all current tab settings shown on the Tab Set-Up screen.
Set 8 Column Tabs	Sets one tab every eight columns, starting at column 9.

COMPOSING CHARACTERS 6

The VT300 lets you display more characters than appear on your keyboard, by typing a *compose sequence*. A compose sequence combines two or three keystrokes to form a single *compose character*. There are three types of compose sequences.

- three-stroke sequences (for all VT300 keyboards)
- two-stroke sequences (for some European keyboards)
- hexadecimal sequences (for programmers)

The compose sequences you can use depend on two basic factors.

- the VT300 keyboard you use
- the Character Set Mode you use: multinational or national (Selected in the General Set-Up screen; see page 80.)

Table 6-2 lists the compose sequences you can use in multinational mode. Some of these sequences depend on the setting of the User Preference Character Set in the General Set-Up screen.

Tables 6-3 and 6-4 list the compose sequences for national mode. The sequences you can use in national mode depend on the setting of the Keyboard Mode feature in the Keyboard Set-Up screen.

Keyboard Mode Setting	Use Table
Typewriter	6-3
Data processing	6-4

See "Data Processing Keys" (page 56) for the difference between standard typewriter keys and data processing keys.

NOTE: Some compose characters also appear as standard keys, depending on the VT300 keyboard you use.

THREE-STROKE SEQUENCES

You can use three-stroke sequences on any VT300 keyboard. All three-stroke sequences start with the Compose Character key. Tables 6-2, 6-3, and 6-4 list all the valid sequences.

NOTE: If your Compose Character key does not work, check the Compose Key feature in the Keyboard Set-Up screen.

If you use a *diacritical mark* in a three-stroke sequence, the VT300 uses an equivalent character. The North American/United Kingdom and Dutch keyboards do not have diacritical marks.

Diacritical Mark	Equivalent Character
Dieresis (umlaut) mark	Double quote "
Acute accent	Apostrophe '
Grave accent	Single quote `
Circumflex accent	Circumflex character ^
Tilde mark	Tilde character ~
Ring mark	Asterisk * or degree °

Using a Three-Stroke Sequence

You can display a three-stroke compose character as follows.

1. Find the character you want in column 1 of Table 6-2, 6-3, or 6-4.
2. Press the Compose Character key. The Compose indicator turns on, indicating the terminal is in compose mode.
3. Type the two characters in column 2 for the character you want.

Example

You can display an e with an acute accent, as follows.

- Press Compose Character, then type e and ' (apostrophe).
- or
- Press Compose Character, then type ' (apostrophe) and e.

2. Press 9 on the numeric keypad.
3. Press 0 on the numeric keypad.

If you type an invalid sequence, the VT300 cancels the sequence and sounds the warning bell (selected in the Keyboard Set-Up screen, Chapter 5).

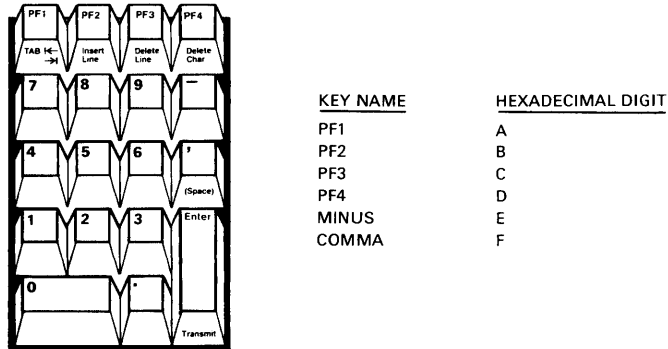

MA-0885-86

Figure 6-1 Hexadecimal Compose Keys

Table 6-1 Nonspacing Diacritical Marks in Multinational Mode*

Keyboard	Grave Accent	Acute Accent	Circumflex Accent	Tilde Mark	Umlaut
Finnish	yes	no	yes	yes	no
Flemish	yes	no	yes	yes	yes
French/Belgian	yes	no	yes	yes	yes
French Canadian	yes	no	yes	yes	no
German/Austrian	yes	yes	yes	yes	no
Portuguese	no	no	no	yes	no
Spanish	yes	yes	yes	yes	yes
Swedish	yes	no	yes	yes	no
Swiss (French)	yes	no	yes	yes	yes
Swiss (German)	yes	no	yes	yes	yes

* Only keyboards with diacritical marks available are listed.

Table 6-2 Compose Sequences for Multinational Mode

(1) Compose Character	(2) Three Strokes*	(3) Two Strokes*
" quotation mark	.. (sp)	.. (sp)
# number sign	+ +	
' apostrophe	' (sp)	' (sp)
@ commercial at	a a or A A	
[opening bracket	((
\ backslash	// or / <	
] closing bracket))	
^ circumflex accent	^ (sp)	^ (sp)
` grave accent	` (sp)	` (sp)
{ opening brace	{ -	
vertical line	/ ^	
} closing brace	} -	
~ tilde	~ (sp)	~ (sp)
¡ inverted !	!!	
¢ cent sign	c / or C / or c or C	
£ pound sign	l- or L- or l= or L=	
¥ yen sign	y- or Y- or y= or Y=	
§ section sign	so or SO or S! or s! or s0 or S0	
¤ currency sign	xo or XO or x0 or X0	
© copyright sign	co or CO or c0 or C0	

* In three-stroke sequences, you can enter required characters in any order unless the table says "in order." You must enter all two-stroke sequences as shown.

Table 6-2 Compose Sequences for Multinational Mode (Cont)

(1) Compose Character	(2) Three Strokes*	(3) Two Strokes*	
ª	feminine ordinal indicator	a- or A-	
«	double open angle brackets	< <	
°	degree sign	0 ^	
±	plus or minus sign	+ -	
²	superscript 2	2 ^	
³	superscript 3	3 ^	
μ	micro sign	/ u or / U (in order)	
¶	paragraph sign	p or P	
·	middle dot	. ^	
¹	superscript 1	1 ^	
º	masculine ordinal indicator	o_ or O_	
»	double closed angle brackets	> >	
¼	fraction one-quarter	1 4 (in order)	
½	fraction one-half	1 2 (in order)	
¿	inverted ?	? ?	
À	A grave	A ^	˘ A
Á	A acute	A ^	˙ A
Â	A circumflex	A ^	ˆ A
Ã	A tilde	A ^	˜ A
Ä	A umlaut	A" or ^ A	¨ A
Å	A ring	A* or A° (degree sign)	
Æ	A E diphthong	AE (in order)	

* In three-stroke sequences, you can enter required characters in any order unless the table says "in order." You must enter all two-stroke sequences as shown.

Table 6-2 Compose Sequences for Multinational Mode (Cont)

(1) Compose Character	(2) Three Strokes*	(3) Two Strokes*
Ç C cedilla	C,	
È E grave	E`	`E
É E acute	E'	'E
Ê E circumflex	E^	^E
Ë E umlaut	E" or ..E	..E
Ì I grave	I`	`I
Í I acute	I'	'I
Î I circumflex	I^	^I
Ï I umlaut	I" or ..I	..I
Ñ N tilde	N~	~N
Ò O grave	O`	`O
Ó O acute	O'	'O
Ô O circumflex	O^	^O
Õ O tilde	O~	~O
Ö O umlaut	O" or ..O	..O
Œ O E diphthong†	O E (in order)	
Ø O slash	o/	
Ù U grave	U`	`U
Ú U acute	U'	'U
Û U circumflex	U^	^U
Ü U umlaut	U" or ..U	..U
ÿ Y umlaut†	Y" or ..Y	..Y

* In three-stroke sequences, you can enter required characters in any order unless the table says "in order." You must enter all two-stroke sequences as shown.

† This character is only available when you use the DEC Multinational character set. See the User Preference Character Set feature in the General Set-Up screen (Chapter 5).

Table 6-2 Compose Sequences for Multinational Mode (Cont)

(1) Compose Character	(2) Three Strokes*	(3) Two Strokes*
ß German small sharp s	ss	
à a grave	a`	`a
á a acute	a'	'a
â a circumflex	a^	^a
ã a tilde	a~	~a
ä a umlaut	a" or ..a	..a
å a ring	a* or a° (degree sign)	
æ a e diphthong	a e (in order)	
ç c cedilla	c , (comma)	
è e grave	e`	`e
é e acute	e'	'e
ê e circumflex	e^	^e
ë e umlaut	e" or ..e	..e
ì i grave	i`	`i
í i acute	i'	'i
î i circumflex	i^	^i
ï i umlaut	i" or ..i	..i
ñ n tilde	n~	~n
ò o grave	o`	`o
ó o acute	o'	'o
ô o circumflex	o^	^o
õ o tilde	o~	~o
ö o umlaut	o" or ..o	..o

* In three-stroke sequences, you can enter required characters in any order unless the table says "in order." You must enter all two-stroke sequences as shown.

Table 6-2 Compose Sequences for Multinational Mode (Cont)

(1) Compose Character	(2) Three Strokes*	(3) Two Strokes*
œ o e diphthong†	o e (in order)	
ø o slash	o/	
ù u grave	u`	`u
ú u acute	u'	'u
û u circumflex	u^	^u
ü u umlaut	u" or ..u	..u
ÿ y umlaut	y" or ..y	..y
ISO Characters‡		
␣ no break space	sp sp	
¦ broken vertical bar	or ! ^	
¬ logical not	- , (in order)	
- soft (syllable) hyphen	--	
® registered trademark	R O	
- macron	- ^ or _ ^	
¾ three quarters	3 4 (in order)	
÷ division sign	- :	
x multiplication sign	x x	
' acute accent	' '	
¸ cedilla	..	

* In three-stroke sequences, you can enter required characters in any order unless the table says "in order." You must enter all two-stroke sequences as shown.

† This character is only available when you use the DEC Multinational character set. See the User Preference Character Set feature in the General Set-Up screen (Chapter 5).

‡ These characters are only available when you use the ISO Latin-1 multinational character set. See the User Preference Character Set feature in the General Set-Up screen.

Table 6-2 Compose Sequences for Multinational Mode (Cont)

(1) Compose Character	(2) Three Strokes*	(3) Two Strokes*
ISO Characters (cont)†		
¨ dieresis	" " or " (sp)	¨(sp)
Ÿ Y acute	Y'	'Y
ÿ y acute	y'	'y
Þ capital Icelandic thorn	T H (in order)	
þ small Icelandic thorn	t h (in order)	
Ð capital Icelandic Eth	- D	
ð small Icelandic Eth	- d	

* In three-stroke sequences, you can enter required characters in any order unless the table says "in order." You must enter all two-stroke sequences as shown.

† These characters are only available when you use the ISO Latin-1 multinational character set. See the User Preference Character Set feature in the General Set-Up screen.

**Table 6-3 Compose Sequences for National Mode,
Using Typewriter Keys**

(1) Compose Character	(2) Three Strokes*	(3) Two Strokes*
British Keyboard		
£ pound sign	l- or L- or l= or L=	
\ backslash	/ <	
" quotation mark	" (sp)	
' apostrophe	' (sp)	
@ commercial at	aa or AA	
[opening bracket	((
] closing bracket))	
{ opening brace	{ -	
}	} -	
vertical bar	^ /	
ˆ circumflex accent	ˆ (sp)	
˘ grave accent	˘ (sp)	
˜ tilde character	˜ (sp)	
Danish Keyboard		
" quotation mark	" (sp)	
# number sign	+ +	
' apostrophe	' (sp)	
@ commercial at	aa or AA or aA	
˘ grave accent	˘ (sp)	
ˆ circumflex accent	ˆ (sp)	
˜ tilde	˜ (sp)	
Å A ring	* A	
Æ AE diphthong	A E (in order)	
Ø O slash	O /	
å a ring	* a	

* In three-stroke sequences, you can enter required characters in any order unless the table says "in order." You must enter all two-stroke sequences as shown.

**Table 6-3 Compose Sequences for National Mode,
Using Typewriter Keys (Cont)**

(1) Compose Character	(2) Three Strokes*	(3) Two Strokes*
æ ae diphthong	a e (in order)	
ø o slash	o /	
Dutch Keyboard		
£ pound sign	l- or L- or l= or L=	
" quotation mark	" (sp)	
' apostrophe	' (sp)	
¼ one quarter	1 4 (in order)	
½ one half	1 2 (in order)	
¾ three quarters	3 4 (in order)	
ij i j sign	i j (in order)	
f Florin	f - (in order)	
vertical bar	/ ^	
` grave accent	` (sp)	
´ acute accent	' '	
ˆ circumflex accent	^ (sp)	
¨ dieresis	" ^	
Finnish Keyboard		
" quotation mark	" (sp)	
# number sign	+ +	
' apostrophe	' (sp)	
@ commercial at	aa or AA or aA	

* In three-stroke sequences, you can enter required characters in any order unless the table says "in order." You must enter all two-stroke sequences as shown.

**Table 6-3 Compose Sequences for National Mode,
Using Typewriter Keys (Cont)**

(1) Compose Character	(2) Three Strokes*	(3) Two Strokes*
Ä A umlaut	" A	
Å A ring	* A	
Ö O umlaut	" O	
Ü U umlaut	" U	
ä a umlaut	" a	
å a ring	* a	
é e acute	' e	
ö o umlaut	" o	
ü u umlaut	" u	
Flemish and French/Belgian Keyboards		
£ pound sign	L- or l- or L= or l=	
" quotation mark	" (sp)	
' apostrophe	' (sp)	
§ section sign	ls or lS or os or oS or Os or OS or 0s or 0S	
° degree sign	O ^ or ° (sp)	
` grave accent	` (sp)	
^ circumflex	^ (sp)	
à (a grave)	` a	
è e grave	` e	
é e acute	' e	
ù u grave	` u	
ç c cedilla	c ,	

* In three-stroke sequences, you can enter required characters in any order unless the table says "in order." You must enter all two-stroke sequences as shown.

**Table 6-3 Compose Sequences for National Mode,
Using Typewriter Keys (Cont)**

(1) Compose Character	(2) Three Strokes*	(3) Two Strokes*
French Canadian Keyboard		
"	quotation mark	" (sp)
#	number sign	+ +
'	apostrophe	' (sp)
à	a grave	`a `a
â	a circumflex	^a ^a
è	e grave	`e `e
é	e acute	'e
ê	e circumflex	^e ^e
î	i circumflex	^i ^i
ô	o circumflex	^o ^o
ù	u grave	`u `u
û	u circumflex	^u ^u
ç	c cedilla	, c

German/Austrian Keyboard

"	quotation mark	" (sp)
#	number sign	+ +
'	apostrophe	' (sp)
§	section sign	Is or IS or os or oS or Os or OS or 0s or 0S
`	grave accent	` (sp)
^	circumflex accent	^ (sp)
ß	German sharp s	ss
Ä	A umlaut	" A
Ö	O umlaut	" O

* In three-stroke sequences, you can enter required characters in any order unless the table says "in order." You must enter all two-stroke sequences as shown.

**Table 6-3 Compose Sequences for National Mode,
Using Typewriter Keys (Cont)**

(1) Compose Character	(2) Three Strokes*	(3) Two Strokes*
Ü U umlaut	" U	
ä a umlaut	" a	
ö o umlaut	" o	
ü u umlaut	" u	
Italian Keyboard		
£ pound sign	l- or L- or l= or L=	
" quotation mark	" (sp)	
' apostrophe	' (sp)	
° degree sign	^ 0	
§ section sign	ls or lS or os or oS or Os or OS or 0s or 0S	
^ circumflex	^ (sp)	
à a grave	` a	` a
è e grave	` e	` e
é e acute	' e	
ì i grave	` i	` i
ò o grave	` o	` o
ù u grave	` u	` u
ç c cedilla	c ,	
Norwegian Keyboard		
" quotation mark	" (sp)	
# number sign	+ +	
' apostrophe	' (sp)	
@ commercial at	aa or AA or aA	

* In three-stroke sequences, you can enter required characters in any order unless the table says "in order." You must enter all two-stroke sequences as shown.

**Table 6-3 Compose Sequences for National Mode,
Using Typewriter Keys (Cont)**

(1) Compose Character	(2) Three Strokes*	(3) Two Strokes*
· grave accent	` (sp)	
ˆ circumflex accent	^ (sp)	
˜ tilde	~ (sp)	
Å A ring	· A	
Æ AE diphthong	A E (in order)	
Ø O slash	O /	
å a ring	· a	
æ ae diphthong	a e	
ø o slash	o /	
Portuguese Keyboard		
" quotation mark	" (sp)	
' apostrophe	' (sp)	
@ commercial at	aa or AA or aA	
ˆ circumflex	^ (sp)	
· grave accent	` (sp)	
˜ tilde	~ (sp)	
Ã A tilde	~ A	~ A
Õ O tilde	~ O	~ O
Ç C cedilla	C ,	
ã a tilde	~ a	~ a
õ o tilde	~ o	~ o
ç c cedilla	c ,	

* In three-stroke sequences, you can enter required characters in any order unless the table says "in order." You must enter all two-stroke sequences as shown.

**Table 6-3 Compose Sequences for National Mode,
Using Typewriter Keys (Cont)**

(1) Compose Character	(2) Three Strokes*	(3) Two Strokes*
Spanish Keyboard		
£ pound sign	l- or L- or l= or L=	
" quotation mark	" (sp)	
' apostrophe	' (sp)	
° degree sign	^ o	
§ section sign	ls or lS or os or oS or Os or OS or 0s or 0S	
¡ inverted !	! !	
¿ inverted ?	? ?	
˘ grave accent	˘ (sp)	
ˆ circumflex	ˆ (sp)	
˜ tilde	˜ (sp)	
Ñ N tilde	˘ N	
ç c cedilla	c ,	
ñ n tilde	˘ N	
Swedish Keyboard		
" quotation mark	" (sp)	
# number sign	+ +	
' apostrophe	' (sp)	
Ä A umlaut	" A	
Å A ring	˘ A	
É E acute	' E	
Ö O umlaut	" O	
Ü U umlaut	" U	
ä a umlaut	" a	

* In three-stroke sequences, you can enter required characters in any order unless the table says "in order." You must enter all two-stroke sequences as shown.

**Table 6-3 Compose Sequences for National Mode,
Using Typewriter Keys (Cont)**

(1) Compose Character	(2) Three Strokes*	(3) Two Strokes*
å a ring	* a	
é e acute	' e	
ö o umlaut	" o	
ü u umlaut	" u	
Swiss (French) and Swiss (German) Keyboards		
" quotation mark	" (sp)	
' apostrophe	' (sp)	
à a grave	` a	` a
ä a umlaut	..a	
è e grave	` e	` e
é e acute	' e	
ê e circumflex	^ e	^ e
î i circumflex	^ i	^ i
ô o circumflex	^ o	^ o
ö o umlaut	..o	
ù u grave	` u	` u
û u circumflex	^ u	^ u
ü u umlaut	..u	
ç c cedilla	c ,	

* In three-stroke sequences, you can enter required characters in any order unless the table says "in order." You must enter all two-stroke sequences as shown.

**Table 6-4 Compose Sequences for National Mode,
Using Data Processing Keys**

(1) Compose Character	(2) Three Strokes*
" quotation mark	" (sp)
# number sign	+ +
' apostrophe	' (sp)
@ commercial at	aa or AA or aA
[opening bracket	((
\ backslash	/ <
] closing bracket	^ (sp)
' apostrophe	' (sp)
{ opening brace	(-
vertical bar	~/
} closing brace)-
~ tilde character	~ (sp)

* In three-stroke sequences, you can enter required characters in any order unless the table says "in order." There are no two-stroke sequences available.

USER-DEFINED KEYS **7**

WHAT ARE USER-DEFINED KEYS?

The VT300 lets you define the function of 15 keys on the top row of the keyboard.

F6 through F14
Help (F15)
Do (F16)
F17 through F20

User-defined keys (UDKs) let you store and recall text and commands that you often use with applications. You should refer to your system documentation for the commands that you can store in user-defined keys.

If you use dual sessions, you can define UDKs for each session. However, you can only save one set of UDK definitions. For each session, you can use a total of 256 characters to define UDKs.

To define a key's function, you use the User-Defined Key Set-Up screen. After you define a UDK, you can use it by pressing **Shift-*defined key***. For example, if you defined the F6 key, you would press **Shift-F6**.

NOTE: Your host system can also define the top-row function keys.

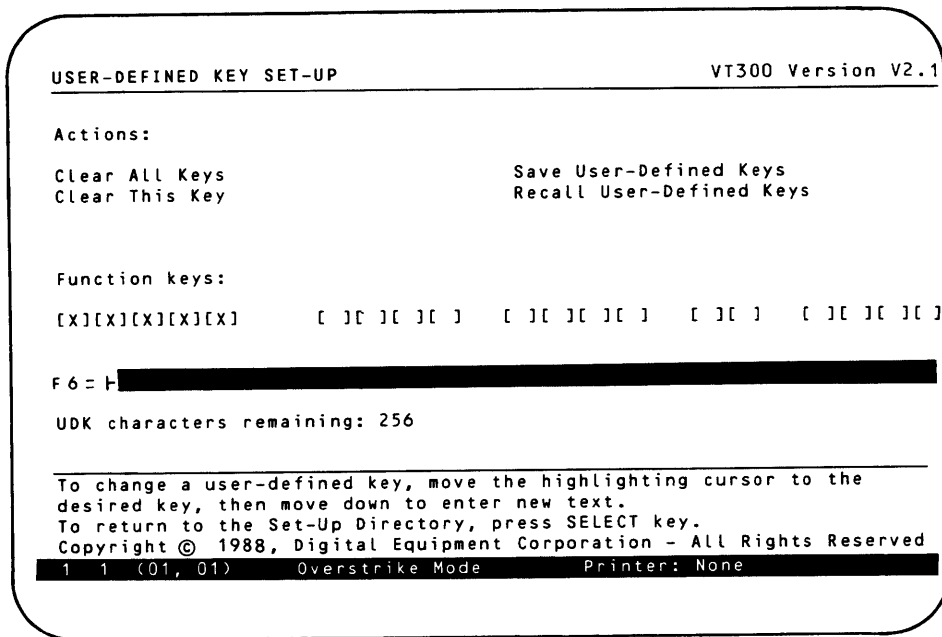

MA-0193-88A

Figure 7-1 User-Defined Key Set-Up Screen

USER-DEFINED KEY SET-UP

Figure 7-1 shows the User-Defined Key Set-Up screen. Table 7-1 describes the features on this screen. All the features are action fields. To select a feature, you move the cursor to that field and press Enter. The terminal immediately performs the action.

The screen also has a diagram of the 20 top-row function keys, F1 through F20. A pair of brackets [] represents each key. You cannot define keys F1 through F5, so the diagram has an x in brackets for those keys.

```

Function keys:
[X][X][X][X][X]      [ ][ ][ ][ ]      [ ][ ][ ][ ]      [ ][ ]      [ ][ ][ ][ ]

F6 = [REDACTED]

UDK characters remaining: 256
  
```

When you first select this set-up screen, the cursor appears at the F6 key. The number of that key appears at the left of the diagram, followed by the key's current definition. You can move the cursor to any key in the diagram. The key number displayed on the left changes as you move the cursor. The diagram also shows you how many characters you can still use to define UDKs in this session.

Table 7-1 User-Defined Key Set-Up Features

Action Field	Function
Clear All Keys	Clears all UDK definitions for the active session only. Updates the number of characters available.
Clear This Key	Clears the definition of the displayed key. Updates the number of characters available.
Save User-Defined Keys	Saves the definitions of UDKs in nonvolatile memory. You can turn the terminal off, without losing your definitions.
<i>NOTE: You can define F6 through F20 in each session. However, you can only save one set of definitions at a time. The saved set replaces any set already stored in the nonvolatile memory.</i>	
Recall User-Defined Keys	Recalls any saved UDK definitions from nonvolatile memory.

HOW TO DEFINE AND USE A UDK

1. Press **Set-Up** to enter set-up. The Set-Up Directory appears.
2. Use the arrow keys to move the cursor to the **User-Defined Key Set-Up** field.
3. Press **Enter**. The User-Defined Key Set-Up screen appears.
4. Use the **→** and **←** keys to move the cursor to the **[]** that represents the key you want to define. When you move the cursor to a key, the number of the key appears on the next line of the screen.
5. Press the **↓** key to move the cursor to the definition line.
6. Enter the definition for the key. You can enter commands, control characters, or text recognized by your application software. If you make a mistake, you can edit your definition.
7. Press **Set-Up** to leave set-up. You must leave set-up before you can use the function key you defined.
8. To use the function key, hold down **Shift** and press the function key: *Shift-defined key*.

SAVING UDKs

You can save the set of UDK definitions you are currently using in a session. Each time you turn the VT300 on, the terminal lets you use these UDK definitions in both sessions.

Use the **Save User Defined Keys** feature to save your current UDK definitions. The VT300 displays a "Done" message on the status line after saving the definitions. If an error occurs, the VT300 displays an "NVR error" message and rings the warning bell (selected in the Keyboard Set-Up screen, Chapter 5).

NOTE: You can define F6 through F20 in each session. However, you can only save one set of definitions at a time. The saved set replaces any set already stored in nonvolatile memory.

EDITING UDKs

You can make changes to your UDK definitions.

When you move the set-up cursor to the definition line, the cursor appears to the right of the last character in the definition. You can delete characters in the current definition by pressing the Delete key (<x|).

NOTE: If you are editing a UDK that contains more than 70 characters, the last 70 characters appear in the UDK field and the cursor appears at the 71st character position.

CLEARING UDKs

You can clear the definition of one UDK or all UDKs. To do this, use the **Clear This Key** or **Clear All Keys** feature.

RECALLING UDKs

You can make temporary changes to your UDKs, then recall the last set of definitions that you saved. Do not save a temporary definition, or you will lose the definition already saved. Use the **Recall User Defined Keys** feature to recall your UDK definitions.

The VT300 displays a "Done" message on the status line after recalling the definitions. If an error occurs, the VT300 displays an "NVR error" message and rings the warning bell (selected in the Keyboard Set-Up screen, Chapter 5).

PROTECTING UDKs

The host system can also define the top-row function keys. You can use the **Lock User-Defined Keys** feature in the General Set-Up screen (Chapter 5) to prevent the host system from changing your UDK definitions.

TIPS ON USING UDKs

Here are some general guidelines you should keep in mind when using UDKs.

- **Save the definitions you want to use again.**
If the terminal loses power, you lose any UDK definitions that are not saved.
- **Clear UDKs before entering new definitions.**
Remember, you can only use 256 characters for all UDK definitions.
- **Keep track of the space available for definitions.**
You can quickly check the amount of space available with the User-Defined Key Set-Up screen.
- **When you clear UDKs, they are empty.**
There are no default definitions for UDKs.
- **You can edit your UDK definitions.**
If you make mistakes when entering a definition, you can correct them by using the <x> key, <- key, or the -> key.
- **In order to define UDKs from the host system, your terminal must be set to VT300 mode.**
You cannot define UDKs if the terminal is emulating another type of terminal (that is, if the Terminal Mode feature in the General Set-Up screen is set to a VT100, VT52, or 4010/4014 mode).
- **You can use your UDKs in local editing mode.**
See Chapter 9 for information on local editing.
- **You can enter control characters as part of a UDK definition.**
Programmers can use UDKs to store control sequences.

DUAL SESSIONS AND WINDOWS

8

This chapter describes how to run two computer sessions on your terminal at the same time. With dual sessions, your VT300 becomes two terminals in one. You can also use the VT300 as a conventional single-session terminal.

Running dual sessions offers many advantages. For example, you can easily display and compare data from two different jobs at the same time. To display data from two sessions, you divide the screen into two *windows*. The second half of this chapter describes how to select and use windows.

WHAT ARE SESSIONS?

A video terminal lets you exchange information with a computer system. In order to communicate with the host system, you must open a session from the terminal. *Session* is simply a term for the active connection between the terminal and a host system. On many computer systems, you must log in to the system to open a session.

DUAL SESSIONS

Most terminals let you run only one session at a time; if you want to open a second session, you must close (or log out of) the first session. The VT300, however, lets you run two sessions at the same time.

Opening two sessions is easy. After you set up the VT300 correctly, you can use the **Switch Session** key to move back and forth between two open sessions. The session you are using is called the *active session*. The next section describes how to open dual sessions.

NOTE: To use the Switch Session key, you must set the Dual Terminal feature in the Global Set-Up screen (Chapter 5) to "enabled".

You can connect the VT300 to a host computer, a *terminal server*, or a *modem*. This means you can run dual sessions on the same host system or on two different systems.

OPENING DUAL SESSIONS

The VT300 uses a communication cable to exchange information with a computer. You can use one or two communication cables for dual sessions. To use one cable, your system must have Digital's Session Support Utility software.

Chapters 2 and 3 describe how to install communication cables and set up the terminal for dual sessions. This section describes how to use dual sessions after you set up the terminal correctly.

The way you select dual sessions depends on how many communication cables you use.

- If you use two cables, go to the next section on this page.
- If you use one cable, go to page 133.

If You Use Two Cables

This section describes how to open dual sessions if you use two communication cables.

IMPORTANT: Make sure your VT300 is set up correctly before you try to open dual sessions. Chapter 3 describes how to set up the terminal for dual sessions. See page 36 for the correct setup using two cables.

Session 1 - You open session 1 the way you normally do on your host system. The VT300 always connects you to the system assigned to session 1. This assignment is based on the cable connections at the rear of the terminal. To assign a system to a session, you use the Terminal Comm Ports feature in the Global Set-Up screen.

Session 2 - After you open session 1, you can press the **Switch Session** key to open session 2. When you press **Switch Session**, the VT300 does the following.

- Maintains session 1. (This session can still receive information from the host system. No information is lost.)
- Lets you open session 2.

Example

The following example shows you how to open (log in to) two sessions on one of Digital's VAX/VMS systems.

NOTE: The VAX/VMS Primer (AA-D030a-TE) provides detailed information on how to log in to the VMS operating system.

1. Turn on the VT300 and wait for the screen to display "VT330 OK" or "VT340 OK".
2. Press the Return key (to tell the system you want to log in).
3. The system prompts you for your user name. Type your *user name* and press Return.
4. The system prompts you for your password. Type your *password* and press Return.

The system does not display your password. When you correctly type your name and password, the system displays a VAX/VMS version number and a \$ (dollar sign prompt). The \$ indicates you have logged in to session 1 successfully.

The login sequence looks like this.

```
<Return>  
Username: Smith <Return>  
Password: (not displayed) <Return>
```

To open session 2, press the Switch Session key and repeat the login sequence.

If You Use One Cable and SSU Software

If your system has Digital's Session Support Utility software, you can run dual sessions over one communication cable. Your system manager can tell you if your system has SSU software.

IMPORTANT: Make sure your VT300 is set up correctly before you try to open dual sessions. Chapter 3 describes how to set up the terminal for dual sessions. See page 37 for the correct setup using one cable and SSU software.

Session open request pending

The host system is servicing an SSU request. Wait briefly for the message to disappear. If the message is followed by "No response from the host for SSU Session Management", check your connection to the host. If your terminal has been disconnected from the host, you must log in and start your SSU sessions over again.

Insufficient host resources to open session

There is an error at the host system's end of the SSU session. Contact your system manager for help.

Data overrun occurred on Session (1 or 2)

A communication error has occurred between the terminal and the host system. If this message disappears and does not reappear, the host has corrected the error on its own. If the message continues to appear, contact your system manager for help.

Session (1 or 2) terminated abnormally

The host system has ended the session. Try opening the session again. If you cannot reopen the session, there is a problem with the host system. Check with your system manager.

Session (1 or 2) terminated normally

The host system has ended the session, usually in response to your direct request.

Sessions disabled

The host system has ended both sessions. Try opening both sessions again. If you cannot reopen both sessions, there is a problem with the host system. Check with your system manager.

No response from host for Session Management

The host system is not responding to Session Management commands. Check with your system manager.

WHICH SESSION IS ACTIVE?

You can display information from two sessions at the same time, by using windows. However, you can only enter information in one session at a time. There are three ways you can tell which session is active.

- Look at the cursors. The active session usually has a blinking cursor. The inactive session has a steady cursor.

NOTE: The Cursor Blink feature in the Display Set-Up screen lets you select a blinking or steady cursor for the current session.

- Type a keyboard character. The VT300 sends the character to the active session. Usually, the active session displays the character.
- Look at the status line. The session number is the first entry at the left of the line.

WINDOWS

The first 24 lines of your video screen are a *window* that lets you see some of the information stored in page memory. The VT300 lets you divide the screen into two windows, so you can display data from two sessions at the same time. You can select one of three window styles.

- One window (full screen)
- Two vertical windows (left and right)
- Two horizontal windows (top and bottom)

Normally, the VT300 uses a single, full-screen window. With a full-screen window, you can only display one session at a time. A full-screen window lets you display 24 lines of text, in 80 or 132 columns. The first half of this chapter shows you how to open two sessions. Figure 8-1 shows you how to display a different session on a full-screen window.

How to Select Two Windows

Before you use two windows, make sure the **Dual Terminal** feature in the **Global Set-Up** screen is set to "enabled".

To select a new window style, you press **Ctrl-Switch Session**. Each time you press **Ctrl-Switch Session**, the style of window on the screen changes.

Pressing Ctrl-Switch Session...	Gives You....
one time	two vertical windows
two times	two horizontal windows
three times	a full-screen window again

Figure 8-2 shows how to select two vertical windows.

Figure 8-3 shows how to select two horizontal windows.

IMPORTANT: Before you use windows, read the next section.

Keeping the Cursor Visible

When you divide the screen into windows, half of the current screen display for the active session disappears. If the cursor for the active session is in the area that disappears, the cursor may also disappear.

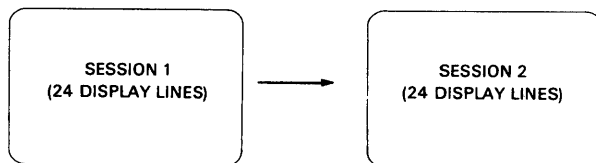

PRESS SWITCH SESSION

MA-0886-86

Figure 8-1 Full-Screen Window

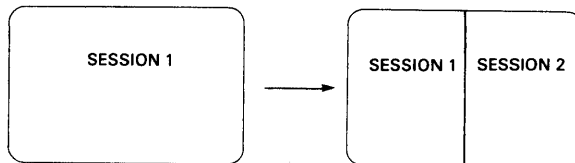

PRESS CTRL + SWITCH SESSION ONCE

MA-0883-86

Figure 8-2 Creating Two Vertical Windows

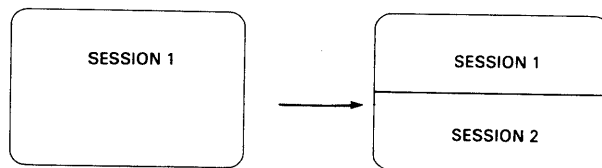

PRESS CTRL + SWITCH SESSION TWICE

MA-0887-86

Figure 8-3 Creating Two Horizontal Windows

For example, if you divide the screen horizontally, the top window displays only the top 12 lines of that session. If the cursor is between lines 13 and 24, you cannot see the cursor.

To make sure the cursor stays visible, you can use the cursor coupling features in the Display Set-Up screen (Chapter 5).

If you use vertical windows

Set the Horizontal Coupling feature to "enabled".

If you use horizontal windows

Set the Vertical Coupling feature to "enabled".

If your application uses multiple pages and you move from page to page in page memory

Set the Page Coupling feature to "enabled".

How to Change Horizontal Window Sizes

When you use horizontal windows, you can change the relative size of the windows. The VT300 displays a border (one-half line of reverse video) between the two windows. You can move the border up or down by pressing Shift-Ctrl-↑ or Shift-Ctrl-↓.

Figure 8-4 shows how to change the size of horizontal windows by moving the border.

You cannot change the size of vertical windows.

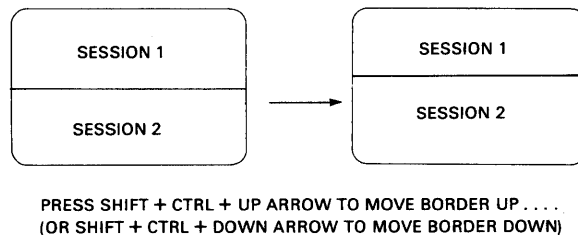

MA-0884-86

Figure 8-4 Changing the Size of Horizontal Windows

Tips on Using Horizontal Windows

If the Vertical Coupling feature is enabled, data on the screen may appear to skip up and down when you move the cursor beyond the top and bottom border of a window. The skipping occurs because the VT300 must update the screen to keep the cursor visible.

This problem occurs most often with applications that involve frequent cursor action (for example, word processors). Here are a few suggested solutions.

- Disable the Vertical Coupling feature in the Display Set-Up screen. This step will stop the skipping motion on the screen. However, the cursor will disappear if it moves to an area of the terminal's memory that is not on the screen.

For example, if you split the screen so that each session displays 12 lines of text, the cursor will disappear if it moves to line 13 in either session.
- Set the application to use only the number of lines actually displayed. When you split the screen horizontally, the terminal displays 12 lines in each session by default. Many applications have commands to limit the number of lines available for editing. Here are two examples.
 - Digital's EDT editor has a SET LINES command that lets you specify the number of lines available for editing. If you set the number of lines to 12 when you use horizontal windows, the skipping motion on the screen stops.
 - Digital's VMS operating system has a SET TERMINAL/PAGE=nn command. This command lets you specify the number of lines used on the screen. Several VMS utilities and applications use this information to limit the number of lines used. If you set the PAGE to one less than the number of displayed lines, applications such as HELP, NOTES, MAIL and TPU (EVE and EDT sections) perform well when you use horizontal windows.

How to Pan

You can pan the window for the active session, to view more data in page memory. *Panning* a window is similar to panning a camera. When you pan a camera over a subject, you can see different parts of the subject while standing in the same position. When you pan a window, you can see another part of page memory without moving the window on the screen.

You can pan a window up or down, left or right. You can also pan to another page in page memory. To pan a window, you use the following keystrokes.

Ctrl-↑
 Ctrl-↓
 Ctrl-←
 Ctrl-→

Ctrl-Prev Screen
 Ctrl-Next Screen

Panning directions are the opposite of scrolling directions. For example, when you pan up, data appears to scroll down on the screen. Figure 8-5 shows the difference between scrolling and panning.

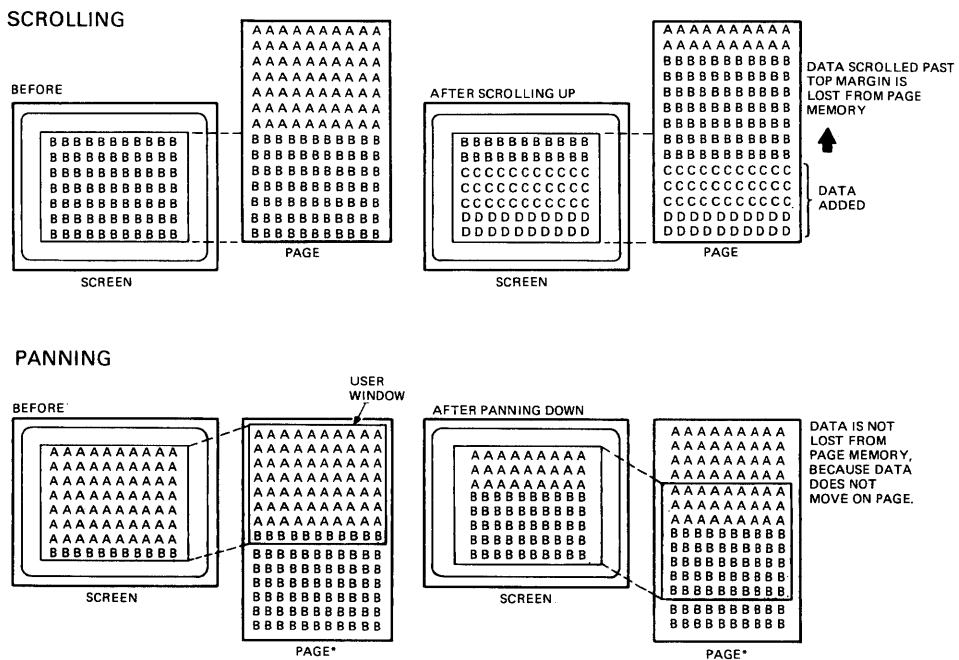



* PAGE MUST BE LARGER THAN 24 LINES

MA-0412-86

Figure 8-5 The Difference Between Scrolling and Panning

Notes About Panning

- If your terminal is configured for multiple pages, you can pan to another page of any size - even if your application does not support the terminal's page memory feature.
- In order to pan on a page, the page size must be larger than the window. The **Page Arrangement** feature in the **Display Set-Up** screen (Chapter 5) determines the page size.
- You can use the **Ctrl-** and **Ctrl-** panning functions to pan a 132-column page in 80-column mode.
- Your cursor may disappear from the screen when you use panning functions. There are two ways you can bring the cursor back on the screen.
 - Look at the status line. It shows you the cursor location. Then use the **Ctrl-arrow keys** to pan the cursor back onto the screen.
 - Make sure the three cursor coupling features in the **Display Set-Up** screen are "enabled": **Horizontal Coupling**, **Vertical Coupling**, and **Page Coupling**.

LOCAL EDITING 9

The VT300 can work as an interactive or editing terminal. As an interactive terminal, the VT300 sends each character you type directly to the host system. The host performs your edits — for example, inserting and deleting text.

As an editing terminal, the VT300 stores your text in page memory. You edit your text on the terminal, then send a block of edited text to the system. This kind of editing is called local editing. When you edit your text on the terminal, the system is free to perform other tasks.

NOTE: Make sure your application software supports local editing.

To select the local editing feature, you use the Local Editing Set-Up screen. To use any of the local editing features, you must change the **Edit Mode** feature in the Local Editing Set-Up Screen to a setting other than "unavailable."

LOCAL EDITING SET-UP SCREEN

This screen (Figure 9-1) lets you select edit mode and set the features for that mode. You use the Local Editing Set-Up screen to monitor local editing features.

Usually, your application software selects the settings for local editing features. However, the application software may instruct you to change some settings to match the application.

Table 9-1 describes the features on the Local Editing Set-Up screen. For more information, see the *VT330/VT340 Programmer Reference Manual*, Volume 1, Chapters 8, 9, and Appendix C.

Feature	Current Setting	Saved Setting
Edit Mode	unavailable	unavailable
Erasure Mode	all	all
Edit Key Execution Mode	immediate	immediate
Transmit Execution Mode	immediate	immediate
Local Editing Applic. Keys	no effect	no effect
Guarded Area Transfer Mode	all	all
Selected Area Transfer Mode	all	all
Multiple Area Transfer Mode	multiple	single
Line Transmit Mode	disabled	disabled
Transfer Termination Mode	enabled	enabled
VT131 Transfer Mode	ANSI	ANSI
Space Compression Mode	disabled	disabled
End of Line Characters	st	st
End of Block Characters	f	f

Use up/down arrow keys to select feature,
right/left arrow keys to change current setting.
To return to the Set-Up Directory, press SELECT key.
Copyright © 1988, Digital Equipment Corporation - All Rights Reserved
1 1 (01, 01) Overstrike Mode Printer: None

MA-0194-88

Figure 9-1 Local Editing Set-Up Screen

Entering and Leaving Edit Mode

There are two ways to select edit mode.

- Set the **Edit Mode** feature in the **Local Editing Set-Up** screen to "Edit". If you save this setting, the VT300 will always start in edit mode when you turn the terminal on.
- OR
- Set **Edit Mode** to "Interactive". Then leave set-up and press **Shift-EDIT**.

To leave edit mode, press **Shift-EDIT**. You can check the status line to see if the terminal is in interactive or edit mode (Chapter 4).

Notes on Edit Mode

- If **Edit Mode** is set to "unavailable",
 - you cannot use **Shift-EDIT** to enter or leave edit mode.
 - the host system cannot put the VT300 into edit mode.
- User-defined keys (UDKs) still work in edit mode when the **Terminal Mode** feature in the General Set-Up screen is set to "VT300", but will only add text to the page memory.
- Edit mode does not work if the terminal is emulating a VT52 or 4010/4014 terminal. See the **Terminal Mode** feature in the General Set-Up screen.

Sending Data to the Host System

In edit mode, you use the **Transmit** key to send a block of data to the host system. When you send data, the VT300 locks the keyboard. You cannot type any new data until the VT300 finishes sending the data to the system.

Table 9-1 Local Editing Set-Up Features

Feature	Settings*	Function
Edit Mode		Determines whether or not you can select local editing.
	Unavailable	Neither you nor the host system can select edit mode.
	Interactive	Selects interactive mode. Each character you type is sent immediately to the host. To turn edit mode on, press Shift-EDIT . The host <i>can</i> turn edit mode off.
	Edit	Selects edit mode. The VT300 stores your edited text in page memory, until you send the text to the host. To turn edit mode off, press Shift-EDIT . The host <i>can</i> turn edit mode off.

* Default settings are in bold type.

Table 9-1 Local Editing Set-Up Features (Cont)

Feature	Settings*	Function
Erasure Mode		Determines which characters you or the host system can erase in edit mode.
	All	You or the host can edit protected and unprotected characters.
	Unprotected	You or the host can only edit unprotected characters.
Edit Key Execution mode		Determines how the VT300 switches between interactive and editing mode.
	Immediate	When you press Shift-EDIT , the VT300 immediately switches modes.
	Deferred	When you press Shift-EDIT , the VT300 sends a request to the host to switch modes.
Transmit Execution Mode		Determines how the VT300 sends a block of data to the host system in edit mode.
	Immediate	When you press Transmit , the VT300 immediately sends data to the host.
	Deferred	When you press Transmit , the VT300 notifies the host that data is available. The terminal locks the keyboard until the terminal receives a transmit instruction from the host.
Local Editing Applic. Keys		Determines how the unshifted function keys F6 through F20 work in edit mode. Your application software may assign functions to these keys.

* Default settings are in bold type.

Table 9-1 Local Editing Set-Up Features (Cont)

Feature	Settings*	Function
Local Editing Applic. Keys (cont)	no effect	F6 through F20 do not work in local editing mode.
	breakthrough	F6 through F20 work immediately in edit mode, if they are assigned functions by application software.
	prefix transmit	If you press F6 through F20, the VT300 sends that function to the host before sending a block of data.
	suffix transmit	If you press F6 through F20, the VT300 sends that function to host after sending a block of data.

NOTE: The next three features let you define which character positions on the current page are eligible to be sent to the host. Table 9-2 in the VT330/VT340 Programmer Reference Manual, Volume 1 summarizes how Guarded Area Transfer Mode, Selected Area Transfer Mode, and Multiple Area Transfer Mode work together.

Guarded Area Transfer Mode		Determines whether or not you can send protected characters to the host system.
	all	When you press Transmit, the VT300 sends protected and unprotected characters.
	unprotected	When you press Transmit, the VT300 sends only unprotected characters.
Selected Area Transfer Mode		Determines whether the VT300 can send all characters or only selected characters to the host system.
	all	When you press Transmit, the VT300 sends all characters on the current page.
	selected	When you press Transmit, the VT300 sends only selected areas.

* Default settings are in bold type.

Table 9-1 Local Editing Set-Up Features (Cont)

Feature	Settings*	Function
Multiple Area Transfer Mode		Determines whether the VT300 can send all selected areas on the page, or only the selected area with the cursor. This mode only works when Selected Area Transfer Mode is set to "selected".
	multiple	When you press Transmit , the VT300 sends all selected areas on the current page.
	single	When you press Transmit , the VT300 sends only the selected area containing the cursor.

*NOTE: The next three features let you define the size of the data block sent to the host system. Table 9-1 in the VT330/VT340 Programmer Reference Manual, Volume 1 summarizes how **Line Transmit Mode**, **Transfer Termination Mode** and **VT131 Transfer Mode** work together.*

Line Transmit Mode		Lets you send characters a line at a time to the host system.
	disabled	When you press Transmit , the VT300 sends a full or partial page. The size of the page depends on the next two features, Transmit Termination Mode and VT131 Transmit Mode .
	enabled	When you press Transmit , the VT300 sends only a line of eligible characters.

*NOTE: When you enable **Line Transmit Mode**, the **Return** key works like the **Transmit** key.*

* Default settings are in bold type.

Table 9-1 Local Editing Set-Up Features (Cont)

Feature	Settings*	Function
Transfer Termination Mode	enabled	When Line Transmit Mode is disabled, this feature determines whether the VT300 sends a partial page or the scrolling region.
		When you press Transmit , the VT300 sends the <i>scrolling region</i> . The scrolling region is the area inside the scrolling margins.
	disabled	When you press Transmit , the VT300 sends a block based on the setting of VT131 Transmit Mode .
VT131 Transfer Mode		When Line Transmit Mode is disabled, this feature selects an ANSI-style or VT131-style data transmission. The size of the block depends on Transmit Termination Mode .
	ANSI	The VT300 works according to ANSI (American National Standards Institute) rules.
	VT131	The VT300 works like a VT131 terminal. Use this setting to run software designed for the VT131. See Chapter 9 and Appendix C in the <i>VT330/VT340 Programmer Reference Manual</i> , Volume 1.
Space Compression	disabled	Determines how the VT300 sends unused character fields and spaces in a data block.
		The VT300 sends a space character for each unused character position.
	enabled	Selects space compression. The VT300 sends a record separator in place of unused characters. The last field on a line contains an End of Line Character .

* Default settings are in bold type.

Table 9-1 Local Editing Set-Up Features (Cont)

Feature	Settings*	Function
End of Line Characters	0D	<p>Lets you select characters used to indicate the end of a line (EOL) in a data block. By default, the VT300 sends a carriage return (CR).</p> <p>You can enter up to six hexadecimal characters. You can edit the characters by using the <xj key, <input type="checkbox"/> key, and <input type="checkbox"/> key.</p> <p>Shows you the hexadecimal value for the current EOL characters. For example, 0D is the hexadecimal value for a carriage return.</p>
	_____	Shows you saved EOL characters.
End of Block Characters	0D†	<p>Lets you select characters used to indicate the end of a data block (EOB). This feature has no default.</p> <p>You can enter up to six hexadecimal characters by using the <xj key, <input type="checkbox"/> key, or <input type="checkbox"/> key.</p> <p>Shows you the hexadecimal value for current EOB characters. For example, 0D is the hexadecimal value for a carriage return.</p>
	_____	Shows you the saved EOB characters.

* Default settings are in bold type.

† There is no default setting for this feature.

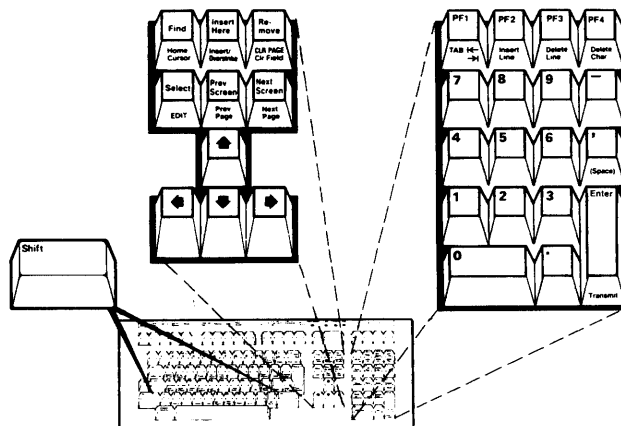

MA-0989-86

Figure 9-2 Local Editing Keys

LOCAL EDITING KEYS

This section describes the keys that have special functions in edit mode. For example, you press Transmit to send a block of data to the system. The local editing keys are on the editing keypad and numeric keypad (Figure 9-2). On the North American/United Kingdom keyboard, local editing functions appear on the front of keys. For all other keyboards, you install a template over both keypads (Chapter 2).

The main keypad and most function keys work in edit mode. For example, Local Print and Shift-Local Print work in edit mode.

The following paragraphs describe the local editing keys. The glossary at the end of the manual defines some terms used to describe the functions of these keys. Your application software manuals may include information on how to use these keys.

Shift-EDIT



You press **Shift-EDIT** to enter or leave edit mode. When you use edit mode, the status line displays the word "Edit".

If the **Edit Mode** feature is set to "unavailable", you *cannot* enter edit mode using **Shift-EDIT**.

You can also enter edit mode by setting the **Edit Mode** feature to "edit".

Home Cursor



Pressing Home Cursor moves the cursor to the top left position on a page in page memory.

NOTE: If your cursor ever disappears, there are two ways you can redisplay it.

- *Look at the status line. It shows you the cursor location. Then use the Ctrl-arrow keys to pan the cursor back onto the screen.*
- *Set the three coupling mode features in the Display Set-Up screen to "enabled."*

Insert/ Overstrike



This key selects whether or not to erase characters in memory when you type new characters. The key selects one of two states, insert or overstrike. Pressing the key changes the state. The status line shows you the state of the Insert/Overstrike key.

The insert state prevents you from erasing characters already on the screen. When you type new characters on a line, characters already on the line move right. The insert state is the default setting.

In the overstrike state, typing a new character replaces the character at the cursor position with the typed character.

CLR PAGE/ Clr Field



Pressing this key clears an *unprotected field* of all characters. The cursor moves to the beginning of the field.

The warning bell rings if you press this key when the cursor is in a *protected field*. The cursor moves to the beginning of the next unprotected field.

Shift- CLR PAGE/Clr Field

Pressing Shift-CLR PAGE/Clr Field clears all unprotected fields in the *scrolling region*. The cursor moves to the first unprotected character position in the scrolling region.

Prev Page



Pressing Prev Page moves the cursor to the beginning of the previous page in page memory. The screen displays the new page.

Next Page



Pressing **Next Page** moves the cursor to the beginning of the next page in page memory. The screen displays the new page.

Tab



Pressing **Tab** advances the cursor to the first occurrence of the following.

- a tab stop at the beginning of an unprotected field
- an unprotected field
- the end of the *scrolling region* (also called the *bottom margin*)

Shift-Tab

Pressing **Shift-Tab** moves the cursor back to the first occurrence of the following.

- the previous *tab stop*
- the beginning of the current unprotected field
- the beginning of the previous unprotected field
- the beginning of the *scrolling region* (also called the *top margin*)

Insert Line



Pressing **Insert Line** adds a blank line on the screen. All following lines move down one line. The new blank line has the same *attributes* as the previous line. The cursor moves to the beginning of the new line.

NOTE: You may lose text if you move lines down into a protected field or past the bottom margin.

The warning bell rings if you press **Insert Line** when the cursor is on a line that has a protected field.

Delete Line



Pressing **Delete Line** deletes a line from the screen. Lines that follow move up one line. The cursor moves to the first column of the new line. The new blank line has the same attributes as the previous line.

The warning bell rings if you press **Delete Line** when the cursor is on a line that has a protected field.

Delete Char



Pressing Delete Char deletes unprotected characters at the cursor. The cursor does not move when you press Delete Char.

The warning bell rings if you try to delete a protected character.

Transmit



Pressing Transmit sends a block of edited text to the host. Use Transmit when you are ready to send data to the host.

Before you send data to the system, make sure the On Line/Local feature in the General Set-Up screen is set to "on line".

The Wait indicator turns on when you press Transmit. The indicator stays on until the VT300 finishes sending your data to the system.

If the Wait indicator stays on longer than expected, the VT300 may have a communication problem. See the description of the Wait indicator in Chapter 4.

Return



This key works like Transmit when you set Line Transmit Mode in the Local Editing Set-Up screen to "enabled".

<x] (Delete)

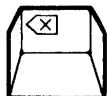

Pressing <x] deletes one character to the left of the cursor.

GRAPHICS AND COLOR 10

The VT330 and VT340 let you use applications to create and display graphics. The VT340 also lets you create color graphics and text. This chapter describes the Graphics Set-Up screen and Color Set-Up screen.

You can use an optional mouse or graphics tablet to send graphics data to the host. The second part of this chapter describes these locator devices.

GRAPHICS

To create and display pictures, you must enter commands in a special graphics language. The VT300 can accept three different types of graphics command languages.

- ReGIS (a graphics instruction set from Digital)
- Tektronix 4010/4014
- Sixel protocol

Volume 2 of the *VT330/VT340 Programmer Reference Manual* describes the commands used with each method listed above.

ReGIS lets you build a graphic image by using standard geometric forms: dots, lines, curves, circles, and arcs.

The VT300 can emulate Tektronix 4010/4014 terminals. Most of the features on the Graphics Set-Up screen are for 4010/4014 emulation.

Programmers often use sixels to design character sets, fonts, or graphic images.

Feature	Current Setting	Saved Setting
Graphics Cursor	enabled	enabled
Sixel Scrolling	enabled	enabled
Macrograph Reports	enabled	enabled
401X Characters	aligned	aligned
401X CR Processing	CR	CR
401X LF Processing	LF	LF
401X DEL Processing	low Y	ignored
401X GIN Terminator	none	CR

Use up/down arrow keys to select feature,
 right/left arrow keys to change current setting.
 To return to the Set-Up Directory, press SELECT key.
 Copyright © 1988, Digital Equipment Corporation - All Rights Reserved
 1 1 (01, 01) Overstrike Mode Printer: None

MA-0195-88

Figure 10-1 Graphics Set-Up Screen

GRAPHICS SET-UP SCREEN

The features on this screen (Figure 10-1) only work when you use your VT300 as a graphics terminal. That is, you must be using one of the graphics command languages: ReGIS, Tektronix 4010/4014, or sixel protocol. Table 10-1 describes each feature on the Graphics Set-Up Screen.

Table 10-1 Graphics Set-Up Features

Feature	Settings*	Function
Graphics Cursor	enabled	Selects whether or not to display a graphics cursor. This feature affects the output cursor only.
	disabled	Displays the graphics cursor. For ReGIS, the default graphics cursor is a diamond with center-cross lines.
Sixel Scrolling	enabled	Does not display the graphics cursor.
	disabled	Sixel images begin at the current ANSI cursor and scroll when they reach the bottom margin.
Macrograph Reports	disabled	Sixels begin at the upper-left corner of the screen and ignore any attempt to draw below the bottom margin. See <i>VT330/340 Programmer Reference Manual, Volume 2, Chapter 14.</i>
	enabled	Selects whether or not the contents of a <i>macrograph</i> report is sent in response to the ReGIS report macrograph command R(M...) . See the <i>VT330/VT340 Programmer Reference Manual, Volume 2, Chapter 9.</i>
	disabled	Sends the macrograph report.
401X Characters	enabled	Does not send the macrograph report.
	disabled	Selects whether to use smaller aligned characters or enlarged characters.

For Tektronix 4010/4014 Mode Only

Table 10-1 Graphics Set-Up Features (Cont)

Feature	Settings*	Function
401X CR Processing	enlarged	Selects enlarged characters. Displays more legible characters in 4010/4014 mode.
	CR	Selects whether or not a received carriage return also causes a line feed.
	CR-LF	Selects a carriage return (CR) only.
401X DEL Processing	CR-LF	Selects a carriage return (CR) and a line feed (LF).
	low Y	Selects whether or not to use the 4010/4014 DEL implies Lo Y strap option.
	ignored	Emulates strap option.
401X LF Processing	ignored	Turns strap option off.
	LF	Selects whether or not a received line feed also causes a carriage return.
	LF-CR	Selects a line feed (LF) only.
401X GIN Terminator	LF-CR	Selects a line feed (LF) and a carriage return (CR).
	none	Selects whether or not to send a terminator after the graphic input mode (GIN) address.
	CR	Does not send a terminator.
	CR-EOT	Sends a carriage return (CR).
		Sends a carriage return (CR) and end-of-transmission (EOT) character.

* Default settings are in bold type.

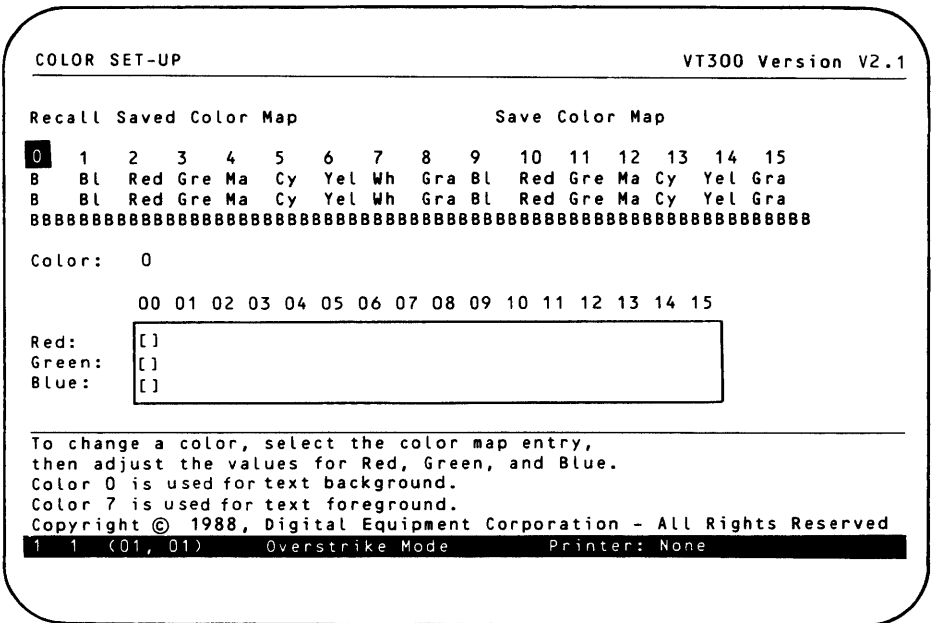

MA-0196-88A

Figure 10-2 Color Set-Up Screen

COLOR SET-UP SCREEN (VT340 ONLY)

This screen (Figure 10-2) lets you select 16 colors at a time for display, from a *palette* of 4096 possible colors. You can change the foreground and background screen colors directly from the Color Set-Up screen. To display other colors in addition to the foreground and background colors, you must use graphics commands.

THE COLOR MAP

The Color Set-Up screen shows you a row of 16 colors currently available for display. The terminal stores these selections in its *color map*. Above each color is a number, from 0 to 15. The number is called a *color map entry*. You use the number to identify that color.

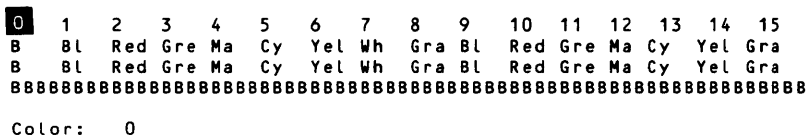

5. Repeat step 2.
6. Use the arrow keys to move each color slide. Move the red slide to column 02, the green slide to column 02, and the blue slide to column 12. The color bar reflects the color adjustments. The new background color becomes blue.

When you leave set-up, the VT340 will display text in the new foreground color of green, on a background of blue.

Note on Changing Foreground and Background Colors

Do not set the foreground color to match the background color, because you will not be able to see text on the screen. If you accidentally set the foreground and background to the same color, follow these steps to reset colors to their default settings:

1. Press SET-Up to display the Set-Up Directory.
2. Move the cursor to "Color Set-Up". Press Enter to display the Color Set-Up screen.
3. Press Enter again to reset the colors to their saved settings.

SAVING COLORS

You can save any changes you make to the color map, by using the Save Color Map feature in the Color Set-Up screen. When you turn the terminal off, the VT340 stores your saved selections. You can only save one set of color map selections even if you are using dual sessions. Each time you use the terminal, the colors you saved are available to both sessions.

The VT340 displays a "Done" message on the status line after saving your color selections. If an error occurs, the VT340 displays an "NVR error" message and rings the warning bell (selected in the Keyboard Set-Up screen, Chapter 5).

When you use the windowing feature to display both sessions at once, the color map for the active session will be used for the entire screen.

RECALLING COLORS

You can make temporary changes in the color map, then recall the last set of colors you saved. To recall saved colors, you use the Recall Saved Color Map feature.

To recall the default color map, you must return to the Set-Up Directory and select **Recall Factory Default Settings**. Remember, this feature changes many other set-up feature settings.

The VT340 displays a "Done" message on the status line after recalling the default settings. If an error occurs, the VT340 displays an "NVR Error" message and rings the warning bell (selected in the Keyboard Set-Up screen, Chapter 5).

LOCATOR DEVICES: MOUSE AND GRAPHICS TABLET

Locator devices are useful for drawing graphics. Locator devices let you move the input cursor on the screen and send the cursor's position to an application. The VT300 can use two kinds of locator devices, a mouse or a graphics tablet.

Locator devices use a coordinate system to move the cursor to a specified position on the screen. Each position has a horizontal (X) coordinate and a vertical (Y) coordinate.

Each coordinate represents a *pixel* on the screen. The VT300 has 800 horizontal by 480 vertical pixels. In ReGIS mode, the status line shows you the current X and Y coordinates of the input cursor (Chapter 4).

If you use a mouse or tablet, the graphics cursor may appear and disappear as you move it across the screen. To move the cursor in a smooth, continuous manner, disable the status display. You can disable the status display by using a control function or the Display Set-Up screen.

Mouse

A mouse is a handheld pointing device with buttons on top and rotating ball on the bottom. When you move the mouse along a tabletop, the cursor moves on the screen. The movement of the rotating ball controls the cursor's position. Your application software defines the meaning of the buttons.

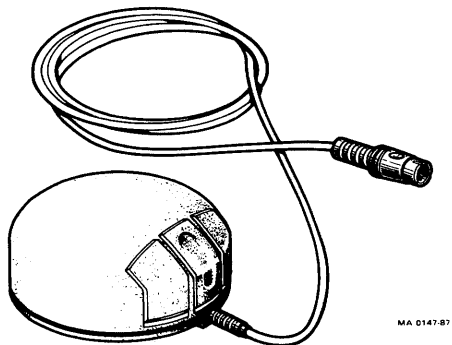

Figure 10-3 VSXXX-AA Mouse

NOTE: You can only use the mouse for ReGIS or Tektronix 4010/4014 graphics applications.

You can order an optional mouse from Digital (Figure 10-3). Digital's VSXXX-AA mouse can detect any movement of 0.128 mm (0.005 inches). The rubber-coated ball on the bottom of the mouse provides excellent tracking on most desktop surfaces.

Using the Mouse

Usually, you place the mouse on the table surface to the right or left of the keyboard. You operate the mouse as follows.

Hold the mouse between your thumb and smallest fingers, with the cable running away from you. Your other fingers should rest on the mouse's buttons.

When you roll the mouse along the desktop, you should see the cursor on the screen move in the same direction.

You move the mouse...	Cursor moves...
left	left
right	right
away from you	up
toward you	down

You should experiment to find the most comfortable position for holding and moving the mouse. You can press the buttons from the front, or down from the top. Most people find it easiest to make small movements using their hand and wrist.

You can pick up the mouse and reposition it at any time. The cursor does not move when you pick up the mouse. Some experienced users will pick up the mouse several times in a single pointing operation.

The three buttons on the mouse are commonly referred to by their position: left (L), middle (M), and right (R). The function of the buttons depends on the software you are using. Refer to your application software manuals.

Graphics Tablet

Like the mouse, a graphics tablet lets you move the input cursor around on the screen. A tablet usually has three parts.

- tablet
- puck
- stylus

Instead of rolling a mouse along a tabletop, you move the puck or stylus along the tablet.

NOTE: You can only use a graphics tablet for ReGIS or Tektronix 4010/4014 graphics applications.

Digital's VSXXX-AB graphics tablet has a digitizing tablet, a four-button puck, and a two-button stylus (Figure 10-4).

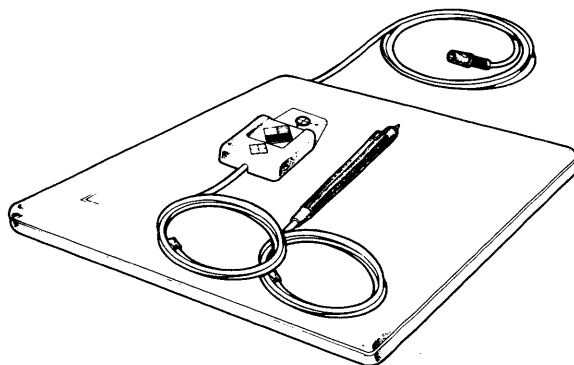

MR-16767
MA-128786

Figure 10-4 VSXXX-AB Graphics Tablet

The digitizing tablet has an active area of 282×282 mm (11 inches \times 11 inches). You can move the puck or stylus within this area. The tablet has a position-sensitive grid that senses any change in the position of the puck or stylus. The tablet has the same high degree of accuracy as the mouse, detecting any movement of 0.128 mm (0.005 inches).

Unlike the mouse, the tablet has its own X- and Y-coordinate system. The coordinates start at the lower-left of the tablet. This point is called the *origin point* and has X- and Y-coordinates of 0. The origin point on the tablet corresponds to the upper-left point on the screen. If you remove the puck or stylus from the tablet surface, the VT300 uses the last known tablet position.

The puck is a handheld device with crosshair markings on the bottom. You can use the crosshairs to find precise positions on the tablet.

The stylus looks like a pen. The stylus makes precise cursor positioning easier than the puck.

The function of the buttons on the puck and stylus depend on your application software. The puck and stylus have cables with 6-pin telephone-style modular connectors. The cables plug into the bottom of the tablet.

11 PRINTERS AND MODEMS

You can connect a printer directly to your VT300. This chapter describes the Printing Set-Up screen and the types of printers you can use. The chapter also describes how to use a modem with the terminal.

PRINTERS

The VT300 has a built-in serial printer interface that supports many draft, letter-quality, and laser printers, including the following Digital printers.

LA Series		Letter-Quality	Laser
LA12	LA100	LQP02	LN01
LA36	LA120	LQP03	LN03
LA50	LA210		
LA75			

SELECTING A PRINT MODE

The VT300 lets you select from four different print modes. These modes control what you can print. To select a print mode, you use the **Print Mode** feature in the **Printer Set-Up** screen.

Mode	Set-Up Screens
Normal (default)	Printer Set-Up
Auto print	Printer Set-Up
Printer controller	Printer Set-Up
Local controller	Set-Up Directory and Printer Set-Up

The status line (Chapter 4) displays the current print mode setting, except for local controller mode.

Normal Mode: Printing Pages of Text

The factory-default setting for Print Mode (Printer Set-Up) is normal. In this mode, you can use the **Local Print** key to send a page of text to the printer. *Page* refers to the current page in the terminal's page memory. This page may be larger than the screen. The size of the page depends on two other set-up features.

Feature	Set-Up Screen	Function
Page Arrangement	Display Set-Up	Selects the page size. Usually, the page size is 24 lines, which matches the screen size.
Printer Extent Mode	Printer Set-Up	Lets you print a page or the <i>scrolling region</i> . The scrolling region is the area within the scrolling margins.

Auto Print Mode: Printing Text From the Host System

In this mode, the VT300 automatically sends a line of text from the screen to the printer when the cursor moves to the next line. Auto print mode lets you print each line as it is received from the host.

To select auto print mode, press **Ctrl-Local Print**. To turn auto print mode off, press **Ctrl-Local Print** again. The VT300 displays the current print mode on the status line.

Printer Controller Mode: Letting the Host Control Printing

In printer controller mode, the host system has direct control of the printer. The VT300 sends characters received from the host directly to the printer, without displaying the characters on the screen.

You cannot use the Local Print key in printer controller mode. The VT300 displays the current print mode on the status line.

NOTE: If you use the Control Representation Mode feature in the Display Set-Up screen, then printer controller mode is temporarily disabled.

Local Controller Mode: Setting Up the Printer

This is a special mode that lets you send information directly from the keyboard to the printer. The terminal does not display the information on the screen.

Programmers can use this print mode to set up certain printers, without involving the host system. See the *VT330/VT340 Programmer Reference Manual*, Volume 1, Chapter 11.

To select local controller mode, you use the following two set-up features.

Feature	Set-Up Screen	Setting
Print Mode	Printer Set-Up	Controller
On line/Local	Global Set-Up	Local

Printing Graphics

To print graphics, you press Shift-Local Print. You can enable or disable Graphics Printing in the Printer Set-Up screen. If graphics printing is disabled, pressing Shift-Local Print only sends text to the printer. During a sixel print operation, you cannot switch the terminal to the alternate session and operate in that session.

NOTE: When you print graphics, the Wait indicator on the keyboard may stay on for up to 30 seconds. At the beginning of a sixel print operation, the Wait indicator turns on and all keyboard input is ignored, except the Set-Up key.

For more information about the Local Print key, see "Top-Row Function Keys" in Chapter 4.

PRINTER SET-UP		VT300 Version V2.1
Feature	Current Setting	Saved Setting
Print Mode	normal	normal
Printer Extent Mode	full page	full page
Print Terminator	none	none
Printed Data Type	national only	national only
Printer to Host Comm	enabled	enabled
Print Speed	4800	4800
Flow Control	XON/XOFF	XON/XOFF
Character Format	8 bits, no parity	8 bits, no parity
Stop Bits	1	1
Graphics Printing	enabled	enabled
Background Printing	enabled	disabled
Sixel Graphics Level	level 1	level 1
Sixel Print Option	compressed	compressed
Color Printing	mono	mono
Color Specification	HLS	HLS

Use up/down arrow keys to select feature,
right/left arrow keys to change current setting.
Copyright © 1988, Digital Equipment Corporation - All Rights Reserved

1 1 (01, 01) Overstrike Mode Printer: None

MA-0197-88A

Figure 11-1 Printer Set-Up Screen

PRINTER SET-UP SCREEN

This screen (Figure 11-1) lets you select features to match those of your printer. Table 11-1 describes the features on the Printer Set-Up screen.

Notes About Printing

- If you enter set-up while printing, the VT300 temporarily suspends print operations. When you leave set-up, the printer resumes print operations.
- For dual sessions: The VT300 can save only one version of printer communication set-up settings (Printer to Host Comm, Print Speed, Flow Control, Character Format, and Stop Bits), because both sessions share a single printer line.
- Make sure the Printer Assignment feature in the Global Set-Up screen (Chapter 5) is set to "shared" or to the session number you want to print from (1 or 2).

Table 11-1 Printer Set-Up Features

Feature	Settings*	Function
Print Mode	normal	Determines when and how printing takes place.
	auto	Prints the current page in page memory when you press Local Print or Shift-Local Print . Prints the current text line when the VT300 receives a line feed, form feed, vertical tab, or autowrap from the host.
	controller	Lets the system send data to the printer without displaying the data on the screen.
Printer Extent Mode	full page	Selects the area of page memory to send to the printer for printing operations.
	scroll region	Selects the current page. Selects the <i>scrolling region</i> . The scrolling region is the area inside the scrolling margins.
	none	Selects whether or not to send a form feed character at the end of a print page operation.
Print Terminator	none	Does not send a form feed.
	FF	Sends a form feed after each page prints.

* Default settings are in bold type.

Table 11-1 Printer Set-Up Features (Cont)

Feature	Settings*	Function
Printed Data Type	national only	<p>Lets you select character sets to match the character sets in the printer.</p> <p>Use with a printer that supports</p> <ul style="list-style-type: none"> • the current national set ("national" mode) or • the ASCII set ("multinational" mode). <p>Example: Digital's LA120 printer.</p>
	national and line drawing	<p>Use with a printer that supports the VT100 line drawing set and the</p> <ul style="list-style-type: none"> • ASCII set ("multinational" mode), or • current national set ("national" mode). <p>Example: Digital's LA100 printer.</p>
	multinational	<p>Use with a printer that supports the multinational and VT100 line drawing character sets.</p> <p>Examples: Digital's LA50 and LA210 printers.</p>
	all characters	<p>Use with a printer that supports all the VT300 character sets.</p> <p>Example: Digital's LA75 printer.</p>

* Default settings are in bold type.

Table 11-1 Printer Set-Up Features (Cont)

Feature	Settings*	Function
Printer to Host Communications	enabled	Selects whether or not the printer port can send control information to the host system. The printer can send control information. <i>NOTE: If the Printer Assignment feature in Global Set-Up is set to "shared", information is only sent to the active session.</i>
	disabled	The printer cannot send control information.
Print Speed	75	Selects the baud rate the VT300 uses to send and receive data from a printer. <i>NOTE: You must set the terminal's baud rate to match the printer's baud rate.</i>
	110	
	150	
	300	
	600	
	1200	
	2400	
	4800	
	9600	
	19.2K	
Flow Control	XON/XOFF	Selects the type of data flow control for the printer port. Selects XON/XOFF flow control. This is the standard for Digital's printers.
	DTR	The terminal checks the data terminal ready (DTR) line to see if the printer can receive characters.

* Default settings are in bold type.

Table 11-1 Printer Set-Up Features (Cont)

Feature	Settings*	Function
Character Format	<p>8b, no parity</p> <p>8b, even parity</p> <p>8b, odd parity</p> <p>7b, no parity</p> <p>7b, even parity</p> <p>7b, odd parity</p> <p>7b, mark parity</p> <p>7b, space parity</p>	<p>Selects a character format for sending data to the printer.</p> <p>Selects 8 bits, no parity.</p> <p><i>NOTE: You should set the terminal's format to match the printer's format.</i></p>
Stop bits	<p>1</p> <p>2</p>	<p>Selects the number of stop bits used by the printer port.</p> <p><i>NOTE: The terminal must use the same number of stop bits as the printer.</i></p>
Graphics Printing	<p>enabled</p> <p>disabled</p>	<p>Selects whether or not you can print graphics.</p> <p>You can print graphics.</p> <p>If you try to print graphics, the VT300 sends a text version to the printer.</p>
Background Printing	<p>enabled</p> <p>disabled</p>	<p>Selects whether or not the terminal sends background colors or shades to the printer when printing graphics.</p>
Sixel Graphics Level		<p>Determines how the VT300 matches the printer's sixel aspect ratio, horizontal grid size, background printing and color printing capabilities.</p>

* Default settings are in bold type.

Table 11-1 Printer Set-Up Features (Cont)

Feature	Settings*	Function
Sixel Graphics Level (cont)		For more information, see the <i>VT330/VT340 Programmer Reference Manual</i> , Volume 2, Chapter 14.
	level 1	Selects a sixel aspect ratio of 2:1 and a horizontal grid size of approximately 188 × 0.025 mm (7.5 × 0.001 inches). Example: Digital's LA50 printer is a level 1 printer.
	level 2	Selects a 1:1 sixel aspect ratio with a variable grid size. Examples: Digital's LA75 and LN03 printers are level 2 printers. <i>NOTE: When printing expanded or rotated images with an LA75 printer, select "Level 1".</i>
	LA210	Selects a sixel aspect ratio of 1.02 to 1, used by Digital's LA210 printer.
Sixel Print Option		Selects the size of the graphic image the VT300 sends to the printer.
	compressed	Selects an image of about 150 × 75 mm (6 × 3 inches).
	expanded	Selects an image of about 300 × 200 mm (12 × 8 inches).
	rotated	Selects an image of about 200 × 300 mm (8 × 12 inches), rotated 90 degrees. This image fits on standard 8-1/2 X 11 inch paper.

* Default settings are in bold type.

Table 11-1 Printer Set-Up Features (Cont)

Feature	Settings*	Function
Color Printing	color	Lets you select color or black and white printing on a printer connected to a VT340 only.
	mono	Selects black and white printing only.
	color	Selects color printing only.
Color Specification	HLS	Selects the color coding method for a printer connected to a VT340 only.
	HLS	Selects the HLS (hue, lightness, saturation) system.
	RGB	Selects the RGB (red, green, blue) system.

* Default settings are in bold type.

MODEMS

You need a modem if you want to connect your VT300 to a computer system through a telephone line. The modem converts the serial characters sent between the terminal and computer into signals that can travel over telephone lines.

The VT300 can operate with full-duplex, asynchronous modems that meet the following national and international standards. The modem you use with your VT300 must be compatible with the modem used by the host system.

- EIA Standard RS232-C/RS423
- CCITT V.24
- CCITT V.25 (partial support)
- CCITT V.26 (V.10)
- CCITT X.20 (V.21)

You can use Digital's DF02, DF03, DF112, DF124, and DF224 modems with the VT300. You can also use compatible modems and acoustic couplers, such as AT&T's 103, 113, and 212 types.

Mode 1 and Mode 2 Modems

To use a modem, you must set the **Modem Control** feature in the **Communications Set-Up** screen to "mode 1" or "mode 2".

Mode 1 is for VT220-style modems. These include Digital's DF02 and DF03 modems, as well as 300 baud and 1200 baud full-duplex modems.

Mode 2 is for CCITT v.25 compatible modems used in Europe. These include 2400 baud and 4800 baud full-duplex modems.

Connecting to a Modem

The VT300 must be certified for connection to non-AT&T type modems used outside of continental North America. Your local Digital Field Service office has detailed information on terminal certification and use of non-AT&T type modems.

NOTE: In the United Kingdom, set the Disconnect Delay feature in the Communications Set-Up screen to "60 ms".

You can use the following steps to connect the VT300 to one of the modems listed above. Figure 11-2 shows you the cable connections between the VT300 and a DF02 or DF03 modem.

1. Connect the modem cable to the Comm 1 25-pin EIA connector at the rear of the terminal.
2. Set the **Comm Port 1** feature in the **Global Set-Up** screen (Chapter 5) to RS232.
3. Set the **Modem Control** feature in the **Communications Set-Up** screen to match the type of modem you use.
 - "mode 1" for VT220-style modems
 - "mode 2" for CCITT v.25 compatible modems
4. Set the **Transmit Speed** and **Receive Speed** features in the **Communications Set-Up** screen to match the settings used by your modem.

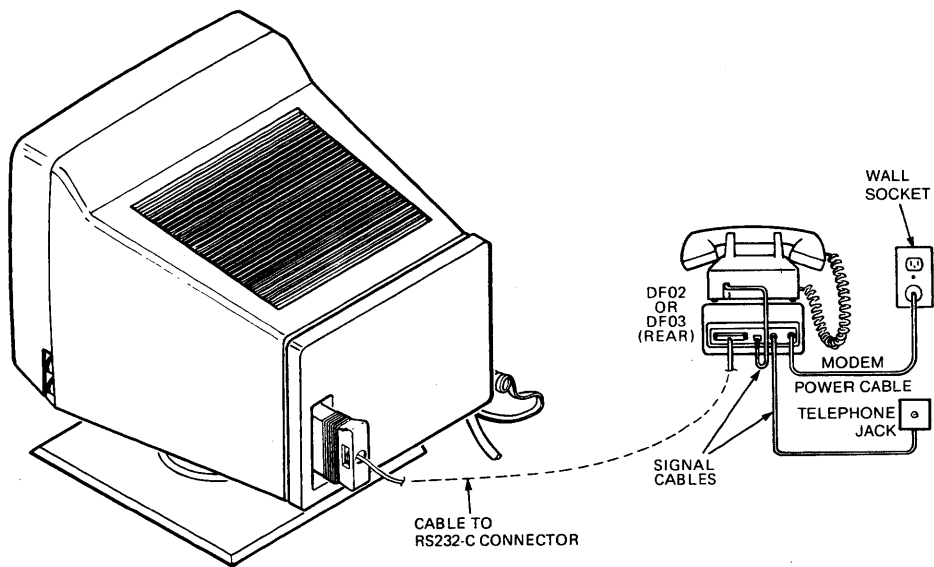

MA-0203-87

Figure 11-2 Connecting a DF02 or DF03 Modem

12 SOLVING PROBLEMS AND GETTING SERVICE

This chapter describes what to do if you have a problem with the VT300. The chapter also includes the Diagnostic Set-Up screen used by Digital service personnel.

OPERATING PROBLEMS

Table 12-1 lists some possible operating problems and their suggested solutions. Check this list before calling for service.

POWER-UP SELF-TEST

Every time you turn the terminal on, the VT300 automatically runs a power-up self-test. This test checks the operating status of many of the terminal's internal parts. If the test is successful, a "VT330 OK" OR "VT340 OK" message appears on the screen.

Error Messages

If the VT300 fails the power-up self-test, the terminal may display one of the error messages in Table 12-2. Only qualified service personnel should try to correct these problems. You should note the error message that appears and call for service.

The keyboard indicator lights may flash on and off during the test. The flashing light patterns are codes that provide service personnel with further information about the terminal's operating condition.

Table 12-1 Common Operating Problems

Problem	Suggested Solution
The VT300 does not turn on when you set the power switch to 1 (on).	Make sure the VT300 power cord is plugged into the wall outlet. Check the power at the wall outlet by plugging in a lamp.
The printer does not print.	Make sure the printer is plugged in and its power switch is on. Make sure the cable connection between the printer and VT300 is tight. Make sure the Printer Assignment feature in Global Set-Up is set to the active session (Chapter 5). Make sure all communication settings on the terminal and printer (such as transmit rate, receive rate, and parity) match.
Data on the screen does not scroll. The Hold Session indicator is on.	Press the Hold Session key to resume scrolling.
The keyboard seems to be locked (the Wait indicator may be on), and the VT300 cannot receive data from the host.	Clear the terminal by using the Clear Communications feature in the Set-Up Directory screen (Chapter 5).
The screen is blank, and the power indicator is on.	The CRT Saver feature in the Global Set-Up screen (Chapter 5) may be on. Press any key to reactivate the screen display. Make sure the brightness and contrast controls (Chapter 4) are correctly adjusted.
The bell tone does not ring when you turn the VT300 on. All keyboard indicator lights are off.	Make sure the keyboard is connected to the terminal.
Power indicator blinks.	Install ROM cartridge.

Table 12-2 Screen Error Messages

Error Message	Problem and Solution
VT300 NVR Error — 1	Nonvolatile memory (set-up storage) is not operating. Turn the terminal on and off. If the problem continues, call Digital Field Service.
VT300 Comm 1 Port Data Error — 2	The problem is inside the terminal. Call Digital Field Service.
VT300 Comm 1 Port Control Error — 3	The problem is inside the terminal. Call Digital Field Service.
VT300 Keyboard Error — 4	<ol style="list-style-type: none">1. Make sure your keyboard is plugged in. If it is,2. Turn the terminal off and on. If the problem continues,3. Try another keyboard if you have one. If the new keyboard works, the old keyboard must be replaced.4. If the new keyboard does not work, the problem is inside the terminal. Call Digital Field Service.
VT300 Comm 1 DEC-423 Data Error — 5	The problem is inside the terminal. Call Digital Field Service.
VT300 Comm 2 DEC-423 Data Error — 6	The problem is inside the terminal. Call Digital Field Service.
VT300 Printer Port Error — 7	The problem is inside the terminal. Call Digital Field Service.

Table 12-2 Screen Error Messages (Cont)

Error Message	Problem and Solution
VT300 Mouse Port Error — 8	<ol style="list-style-type: none">1. Make sure the mouse is plugged in. If it is,2. Turn the terminal off and on. If the problem continues,3. Try another mouse if you have one. If the new mouse works, the old mouse must be replaced.4. If the new mouse does not work, the problem is inside the terminal. Call Digital Field Service.

DIGITAL SERVICE

Digital provides a wide range of maintenance programs that cover small systems and terminals. These include on-site, carry-in, and mail-in maintenance services. You can use these programs to select a plan that suits your service needs.

Hardware Services

On-Site Repair

Digital offers fast, low-cost, quality maintenance performed at your site by Digital-trained Service Specialists. There are several on-site services available.

DECservice

DECservice provides preferred on-site service, with a guaranteed response time when equipment is located within a specified distance of the service facility. DECservice guarantees a continuous repair effort until service is restored. You can choose the hours of coverage, up to 24 hours a day, 7 days a week.

Basic

Basic service provides on-site service during regular business hours, Monday through Friday.

Site Servicenter

If you have at least 50 terminals and can provide workspace at your site, Digital will provide an on-site technician for a predetermined, periodic time interval. The terminals can include a variety of models (for example, VT200s and VT300s).

Per Call

This noncontractual offering provides on-site repair based on time and materials. Per call service is available during regular business hours, Monday through Friday.

DECcall

Similar to Per Call Service. However, you pay a fixed fee per call, with an annual retainer fee.

Off-Site Service

Digital also provides several options for off-site service.

Carry-In Servicenters

Digital Servicenters are located in major cities around the world. They offer convenient, cost-effective repair service with a 48 hour turnaround time. Both contract and per call coverage is offered.

DECmailer

This mail-in service is for module and subassembly repairs. DECmailer provides five day turnaround.

Software Services

DECsupport

This program provides telephone and on-site remedial support (if required), with personalized account focus and scheduled preventive maintenance. Software updates, new releases, and access to Digital's Software Information Network (DSIN) are included where available.

Basic

Basic service includes telephone support, software updates, new releases, and access to DSIN where available.

Self-Maintenance Service

This service provides software updates and new releases.

HOW TO GET SERVICE

Digital has a central service center in your area to help you keep your system running at peak efficiency. To find out more about Digital's hardware and software service offerings

In the United States

Call 1-800-554-3333.

Worldwide

Contact your local Digital Field Service office.

```

DIAGNOSTIC SET-UP                                     VT300 Version V2.1
-----
Feature                                             Current Setting
Comm1 External Loopback (25)                       disabled
Comm1 External Loopback (6)                       disabled
Comm2 External Loopback (6)                       disabled
Printer External Loopback                         disabled
Locator External Loopback                         disabled
Power-Up Test                                     disabled

Run Tests                                         Repeat Tests
Run Screen Tests

Use up/down arrow keys to select feature,
right/left arrow keys to change current setting.
To return to the Set-Up Directory, press SELECT key.
Copyright © 1988, Digital Equipment Corporation - All Rights Reserved
1 1 (01, 01)   Overstrike Mode     Printer: None

```

MA-0198-88

Figure 12-1 Diagnostic Set-Up Screen

DIAGNOSTIC SET-UP SCREEN

This screen (Figure 12-1) is for use by Digital service personnel. Most diagnostics require a special loopback connector.

The power-up self-test runs automatically each time you turn on the terminal. You can operate the terminal after the test runs successfully (about 15 seconds). Table 12-2 describes the error messages for the power-up self-test.

A SPECIFICATIONS

This appendix contains the specifications for the VT330 and VT340 terminals.

Site Planning

Terminal	VT330	VT340
Height	343 mm (13.5 in)	385 mm (15 in)
Width	343 mm (13.5 in)	397 mm (15.5 in)
Depth	350 mm (13.8 in)	436 mm (17 in)
Weight	10.2 kg (22.5 lbs)	15.7 kg (34.5 lbs)
Tilt-swivel	347 degrees	

Keyboard

Height	5.1 cm (2 in)
Width	53.3 cm (21 in)
Depth	17.1 cm (6.75 in)
Weight	2 kg (4.5 lbs)

Electrical Requirements

AC input	Not selectable
120 V nominal	Single-phase, 3-wire, 88 to 132 Vrms
220 to 240 V nominal	Single-phase, 3-wire, 176 to 264 Vrms
Line frequency	47 to 63 Hz
Input power	VT330: 90 watts VT340: 140 watts

Power cord 1.8 m (6 ft) detachable, 3-conductor, grounded

Operating Environment

Temperature 10 to 40 degrees C
(50 to 104 degrees F)

Relative humidity 20% to 80% relative humidity with a maximum wet bulb of 32 degrees C and a minimum dew point of 2 degrees C

Altitude 2400 km (8000 ft) maximum

Display

Active display size	VT330	VT340
Horizontal	230 mm	240 mm
Vertical	150 mm	150 mm

Format 24 lines of 80 or 132 characters

Built-in character sets
ASCII
12 national replacement character (NRC) sets
ISO Latin-1 supplemental graphic
DEC Supplemental Graphic
DEC Technical
DEC Special Graphic

Video attributes Normal, bold, underline, blinking, negative image (reverse video), and invisible — selected individually or in combination

Cursor type
Text Blinking or steady block or underline

Graphics
ReGIS: diamond, crosshair, or rubber band style
Tektronix: crosshair

Keyboard

General	105-key detachable unit Sculptured keys with matte finish Available in 16 languages and an English word processing version
Cord	1.8 m (6 ft) coiled cord with a 4-pin telephone-type modular connector
Home row	30 mm (1.18 in) above desktop
Key size	12.7 mm (0.5 in) square
Key spacing	19 mm (0.75 in) center to center (for single-width keys)
Numeric keypad	18 keys
Function keys	5 predefined keys, 15 user-definable keys
Indicator lights	4 keyboard indicators: Hold, Wait, Lock, and Compose
Audible indicators	
Keyclick	Sounds after each keystroke.
Margin bell	Rings when cursor approaches right margin.
Warning bell	Rings for compose errors, Rings twice for errors in set-up.

ORDERING PARTS AND DOCUMENTATION **B**

This appendix describes the options, documentation, and supplies offered by Digital for the VT330 and VT340 terminals. Part numbers and ordering information are included.

OPTIONS

Modems

Part Number	Description
DF02-AA	Direct-connect, AT&T 103J equivalent, 300 baud, full-duplex modem with EIA RS232-C interface
DF03-AA	Direct-connect, AT&T 103J/212A equivalent, 300/1200 baud, full-duplex modem with EIA RS232-C interface
DF224-AA	Direct-connect, CCITT V.22, AT&T 103J/212A equivalent, 2400 baud, full-duplex modem with EIA RS232-C and DEC-423 interfaces

Mouse and Graphics Tablet

VSXXX-AA	Mouse with 3 buttons
VSXXX-AB	Graphics tablet with digitizing tablet, 4-button puck, and stylus

Cables

Figure B-1 shows different types of cable connections for the VT300.

Part Number	Length	Connector
Adapters		
H8751-A	—	25-pin F
H8751-C	—	25-pin M
Extension Cables		
BC22E-10	10 ft (3 m)	25-pin F RS232 to
BC22E-25	25 ft (7.6 m)	25-pin M RS232
Null Modem Cables		
17-00313-01	10 ft (3 m)	25-pin F RS232 to
17-00313-02	25 ft (7.6 m)	25-pin F RS232
17-00313-03	50 ft (15.2 m)	
Communication Cables		
BC16E-10	10 ft (3 m)	6-pin M DEC-423 to
BC16E-25	25 ft (7.6 m)	6-pin M DEC-423
Keyboard Cable		
17-00294-00	6 ft (1.8 m)	Telephone jack
AC Power Cables		
	Country	
17-00198-08	Australia, New Zealand	
17-00199-13	Austria, Belgium, Finland, France, Germany, Netherlands, Norway, Sweden	
17-00606-06	Canada, Japan, Mexico, United States	
17-00310-06	Denmark	
17-00456-09	India, South Africa	
17-00209-09	Ireland, United Kingdom	
17-00457-09	Israel	
17-00364-09	Italy	
17-00210-06	Switzerland	

M = male, F = female.

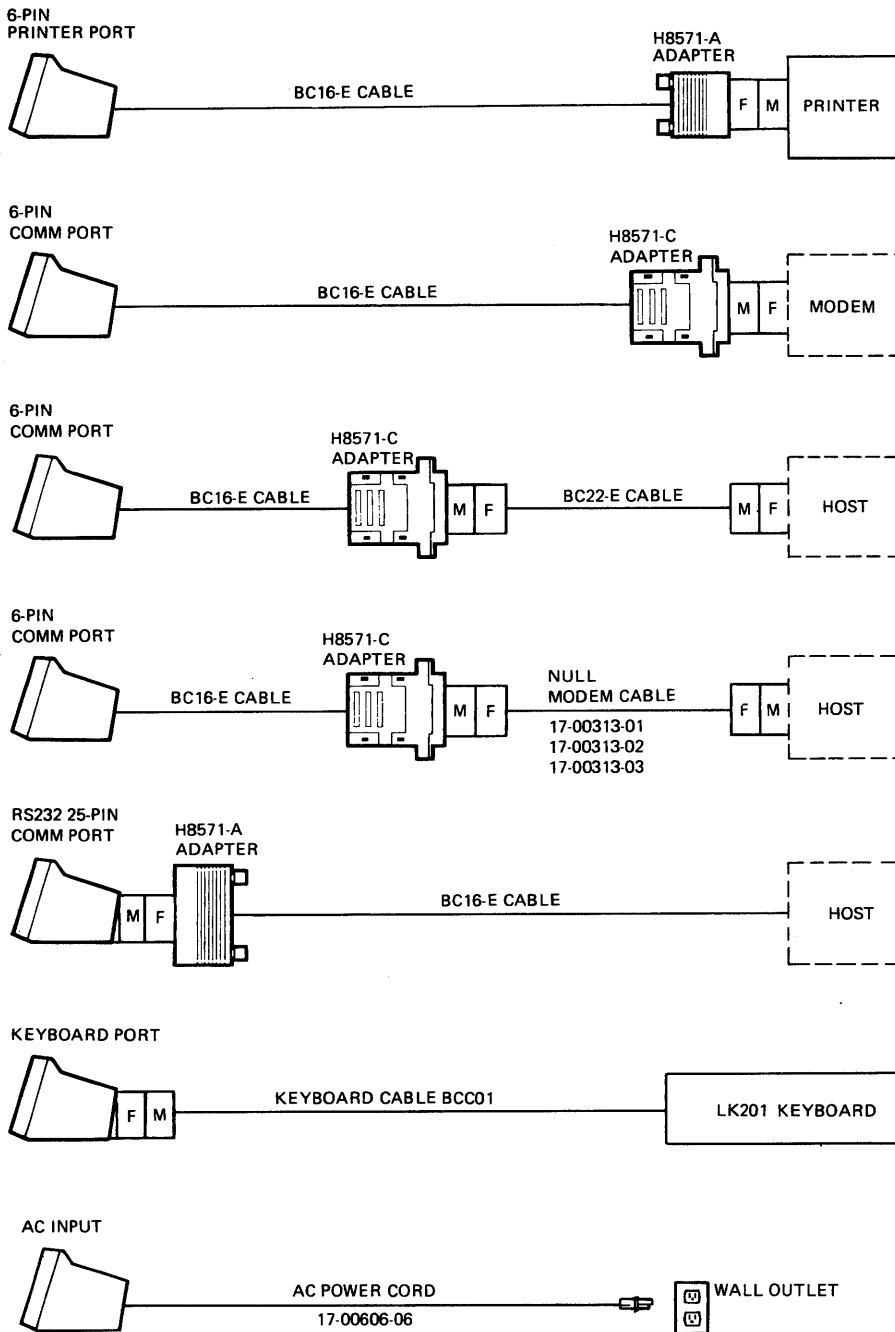

MA-1256-86B

Figure B-1 VT300 Cable Connections

RELATED DOCUMENTATION

Your VT330/VT340 user documentation package includes the following manuals.

Installing and Using the VT330/VT340 Video Terminal	EK-VT3XX-UG
VT330/VT340 Programmer Reference Manual, Vol. 1	EK-VT3XX-TP
VT330/VT340 Programmer Reference Manual, Vol. 2	EK-VT3XX-GP
VT330/VT340 Series Programmer Pocket Guide	EK-VT3XX-HR

You can also order the following VT300 documents from Digital.

VT330 Pocket Service Guide	EK-VT330-PS
VT340 Pocket Service Guide	EK-VT340-PS

These guides provide service personnel with the information needed to test, troubleshoot, and repair the VT330 monochrome video terminal and VT340 color video terminal.

VT330 Video Terminal Illustrated Parts Breakdown	EK-VT330-IP
VT340 Video Terminal Illustrated Parts Breakdown	EK-VT340-IP

These documents provide a detailed parts breakdown of the VT330 and VT340 field replaceable parts. These documents do not contain part numbers for components on the printed circuit boards. However, these components are listed in the *Field Maintenance Print Sets* below, ordered separately.

VT330 Field Maintenance Print Set	MP-02411-01
VT340 Field Maintenance Print Set	MP-02412-01

These documents provide a complete set of electrical and mechanical schematic diagrams for the VT330 and VT340 terminals.

Installing and Using the Session Support Utility	AA-JB84A-TE
--	-------------

This guide provides system managers with instructions for installing SSU software to support dual sessions over a single communication line. The guide is part of an SSU software kit. The kit is available on different media.

Magtape	00-Q*ZAV-HM
RX50	00-Q*ZAV-H3
TK50	00-Q*ZAV-H5

* = processor number.

ORDERING INFORMATION

You can order options, supplies, and documentation by phone from 8:30 a.m. to 6:00 p.m. (EST) or by mail.

Continental USA and Puerto Rico

Call 800-258-1710 or mail to:

Digital Equipment Corporation
P.O. Box CS2008
Nashua, NH 03061

New Hampshire, Alaska, and Hawaii

Call 1-603-884-6660.

Outside the USA and Puerto Rico

Contact your local Digital sales office.

C USING VT300 CONTROL FUNCTIONS: A PRIMER

This appendix is a general introduction on how to use control functions and control characters in computer programs. A control character or control function is a command that tells the VT300 to perform some special action. For example, you can highlight and format the text that you display on the screen.

CAUTION: Control functions can change the way the terminal communicates with your system. They can also change the way other programs run on the terminal. Make sure you understand what a control function does before you use it.

Two important factors affect the way you enter control characters and control functions in programs.

- the programming language you use
- your computer system

This appendix cannot cover all the programming languages and computer systems in use today. However, you can apply the ideas in this appendix to any system or language. The examples that follow use Digital's VAX/VMS operating system (Version 4.2) and three programming languages for that system.

VAX/11 BASIC (Version 2.0)
VAX/11 Pascal (Version 2.2)
VAX/11 FORTRAN (Version 4.0)

The next two sections briefly describe control characters and control functions. For more details, see the *VT330/VT340 Programmer Reference Manual*, Volume 1, Chapter 2. The programmer reference manual and the *VT330/VT340 Programmer Pocket Guide* cover all the control functions you can use with your terminal.

CONTROL CHARACTERS

All computer terminals and printers use stored character sets to display or print characters. Most character sets include two types of characters, graphic characters and control characters. Graphic characters are the characters you can display or print. Control characters make the terminal or printer perform a special action. In the normal mode of operation, the VT300 does not display control characters.

Computers cannot store characters as they appear on your screen. They must encode each character as a series of bits, usually 7 bits or 8 bits long. Your computer system may use 7-bit or 8-bit character sets. The VT300 recognizes both 7-bit and 8-bit characters.

Figure C-1 shows the 7-bit ASCII character set. This is one of the standard sets in the VT300. The characters in this set are defined by the American Standard Code for Information Interchange (ASCII).

The control characters for the ASCII set are in columns 0 and 1. For example, CR is the control character for a carriage return, and FF is for a form feed.

CONTROL FUNCTIONS

Control functions serve the same purpose as control characters. Both control characters and control functions make the VT300 perform a special action. However, a control function is a sequence of characters, rather than just one character. Control functions provide more commands than those available with single control characters.

A control function starts with a special control character, usually ESC or CSI.

The other characters in the sequence may be graphic characters. However, the terminal does not display these characters when they are used in a control function.

For example, the control function ESC # 6 tells the VT300 to expand all characters on the current line to double their normal width. The terminal does not display the ESC # 6 characters.

ROW	COLUMN				0	1	2	3	4	5	6	7								
	BITS				0 0 0 0	0 0 0 1	0 0 1 0	0 0 1 1	0 1 0 0	0 1 0 1	0 1 1 0	0 1 1 1								
	b8	b7	b6	b5	b4	b3	b2	b1												
0	0	0	0	0	NUL	0	DLE	20	SP	40	0	60	@	100	P	120	,	140	p	160
1	0	0	0	1	SOH	1	DC1 (XON)	21	!	41	1	61	A	101	Q	121	a	141	q	161
2	0	0	1	0	STX	2	DC2	22	"	42	2	62	B	102	R	122	b	142	r	162
3	0	0	1	1	ETX	3	DC3 (XOFF)	23	#	43	3	63	C	103	S	123	c	143	s	163
4	0	1	0	0	EOT	4	DC4	24	\$	44	4	64	D	104	T	124	d	144	t	164
5	0	1	0	1	ENQ	5	NAK	25	%	45	5	65	E	105	U	125	e	145	u	165
6	0	1	1	0	ACK	6	SYN	26	&	46	6	66	F	106	V	126	f	146	v	166
7	0	1	1	1	BEL	7	ETB	27	'	47	7	67	G	107	W	127	g	147	w	167
8	1	0	0	0	BS	8	CAN	28	(48	8	68	H	108	X	128	h	148	x	168
9	1	0	0	1	HT	9	EM	29)	49	9	69	I	109	Y	129	i	149	y	169
10	1	0	1	0	LF	10	SUB	30	*	50	:	70	J	110	Z	130	j	150	z	170
11	1	0	1	1	VT	11	ESC	31	+	51	;	71	K	111	[131	k	151	{	171
12	1	1	0	0	FF	12	FS	32	,	52	<	72	L	112	\	132	l	152		172
13	1	1	0	1	CR	13	GS	33	-	53	=	73	M	113]	133	m	153	}	173
14	1	1	1	0	SO	14	RS	34	.	54	>	74	N	114	^	134	n	154	~	174
15	1	1	1	1	SI	15	US	35	/	55	?	75	O	115	_	135	o	155	DEL	175



KEY

CHARACTER	ESC	33	OCTAL
		27	DECIMAL
		1B	HEX

MA-0893-B3

Figure C-1 7-Bit ASCII Character Set

The VT300 can run on a 7-bit or 8-bit system. The terminal offers different control functions for each type of system. For example, the following two sequences perform the same function. They change the screen display to 132 columns per line.

8-bit sequence: CSI 132 \$ |

7-bit sequence: ESC [132 \$ |

You can only use 8-bit sequences on an 8-bit system. You can use 7-bit sequences on a 7-bit or 8-bit system. The following is a list of some common 8-bit control characters and their 7-bit equivalents. These characters are used to start many control functions.

8-Bit Character	Equivalent 7-Bit Sequence
CSI	ESC [
SS3	ESC O
DCS	ESC P
IND	ESC D

INCLUDING CONTROL CHARACTERS AND FUNCTIONS IN YOUR PROGRAM

Using control characters and functions in a program is simple. You include them in an output statement for your programming language. PRINT and WRITE are two common output statements.

The format you use to represent control characters and control functions depends on the language. For example, in VAX/11 BASIC you can enter the actual characters in a PRINT statement.

```
PRINT <control character or function >
```

PREDEFINED CONTROL CHARACTERS

Some programming languages define common control characters as constants. This makes it easier to enter the control characters in a program.

For example, VAX/11 BASIC provides the predefined constants listed in Table C-1. If you use VAX/11 BASIC, you can use these constants in a print statement. The following VAX/11 print statement uses the LF constant to move the cursor to the next line on the screen.

```
PRINT LF
```

Table C-1 VAX/11 BASIC Predefined Constants

Constant	ASCII Value	Purpose
BEL bell	7	Sounds the keyboard bell.
BS backspace	8	Moves the cursor one position to the left.
HT horizontal tab	9	Moves the cursor to the next horizontal tab stop.
LF line feed	10	Moves the cursor to the next line.
VT vertical tab	11	Moves the cursor to the next vertical tab stop.
FF form feed	12	Moves the cursor to the top of the next page.
CR carriage return	13	Moves the cursor to the beginning of the current line.
SO shift out	14	Shift out (for alternate character sets).
SI shift in	15	Shift in (for alternate character sets).
ESC escape	27	Defined the beginning of an escape sequence.
SP space	32	Inserts one space character.
DEL delete	127	Deletes the last character entered.

NOTE: Some control functions in Table C-1 may not work on the VT300 as described here. These codes are specific to VAX/11 BASIC, not to the VT300 terminal.

USING CONTROL FUNCTIONS WITH VAX/11 BASIC

VAX/11 BASIC has two features to help you insert control functions in programs.

ESC constant
CHR\$ reserved word

ESC Constant

The ESC constant defines the beginning of an *escape sequence*. Escape sequence is another term for a 7-bit control function. You can use the following format to insert many 7-bit control functions in a VAX/11 BASIC program.

```
PRINT ESC + "<rest of control function >"
```

Example

The following statement expands all characters on the current line to double their normal width.

```
PRINT ESC + "#6"
```

The following statement uses the same sequence to display the letters AaBbCcDd as double-width characters.

```
PRINT ESC + "#6"; "AaBbCcDd"
```

You would see the following characters on your screen.

```
A a B b C c D d
```

Defining CSI

VAX/11 BASIC does not recognize the 8-bit control character CSI as a predefined constant. You can solve this problem by defining CSI in terms of ESC. For example, at the beginning of your BASIC program, you can insert the statement

```
DECLARE STRING CONSTANT CSI = ESC + "[
```

After you insert the above statement, you can use CSI to start 8-bit control functions in your program. The rest of this appendix assumes that the above declaration has been made.

Example

The following statement uses an 8-bit control function to clear the display on the screen.

```
PRINT CSI + "2J"
```

If you did not declare CSI, you would have to use the equivalent 7-bit control function.

```
PRINT ESC + "[2J"
```

NOTE: Do not insert spaces between the characters in control functions. Your system or terminal will interpret the spaces as part of the control function. For example, the BASIC statements

```
PRINT ESC + "[ 2 J"      (7-bit)
```

```
PRINT CSI + "2 J"       (8-bit)
```

will not clear the screen, as you might think.

Remember that the CSI declaration statement is effective only because the VAX/11 BASIC programming language recognizes ESC as a constant. As you experiment with different programming languages, look for tools such as predefined constants. These tools make it easier to insert control functions in your programs.

CHR\$ Reserved Word

Another feature that VAX/11 BASIC offers is the reserved word CHR\$. This reserved word lets you use a decimal code to represent a character. You can find the decimal code for each character in the ASCII character set (Figure C-1).

Examples

The following statement displays an uppercase C on the screen.

```
PRINT CHR$(67)
```

If you refer to the ASCII character set, you can see that 67 is the decimal code for the uppercase C character.

You can use the reserved word CHR\$ in any control function. The following statements clear the screen, just like the previous example for the ESC constant.

7-Bit

	ESC	[2	J
	↑	↑	↑	↑

```
PRINT CHR$(27) + CHR$(91) + CHR$(50) + CHR$(74)
```

8-Bit

```
          CSI          2          J
          ↑           ↑           ↑
PRINT CHR$(155) + CHR$(50) + CHR$(74)
```

Notes on CHR\$

The CHR\$ reserved word is important for three main reasons.

- It eliminates the restriction of having to use predefined constants.
- It allows you to use all the control functions listed in the *VT330/VT340 Programmer Reference Manual*.
- You can find similar tools in many existing programming languages.

PROGRAMMING TIP: If a control function does not work correctly, check the characters you entered for the function. You can display control characters (such as ESC) on the screen by setting the Control Representation Mode feature (General Set-Up screen) to "Display Controls". This VT300 feature is a useful debugging tool for checking the characters you entered in your control function statements.

Program Examples

The four short BASIC programs that follow use control functions to change the monitor display from 80 columns per line to 132 columns. Three of the programs can run in a 7-bit or 8-bit environment and one can run only in an 8-bit environment.

7-Bit or 8-Bit Compatible

```
1 REM VERY BASIC PROGRAM I
5 REM This program uses an escape sequence to
10 REM change the monitor display to 132 columns per line.
15 PRINT ESC + "[132S]"
20 END
```

```
1 REM VERY BASIC PROGRAM II
5 REM This program uses an escape sequence to
10 REM change the monitor display to 132 columns per line.
15 PRINT CHR$(27) + CHR$(91) + CHR$(49) + CHR$(51) +
CHR$(50) + CHR$(36) + CHR$(124)
20 END
```

```
1 REM VERY BASIC PROGRAM III
5 REM This program uses an escape sequence to
10 REM change the monitor display to 132 columns per line.
15 DECLARE STRING CONSTANT CSI = ESC + "["
20 PRINT CSI + "132S|"
25 END
```

8-Bit Compatible Only

```
1 REM VERY BASIC PROGRAM IV
5 REM This program uses an escape sequence to
10 REM change the monitor display to 132 columns per line.
15 PRINT CHR$(155) + CHR$(49) + CHR$(51) + CHR$(50) +
    CHR$(36) + CHR$(124)
20 END
```

USING CONTROL FUNCTIONS WITH VAX/11 PASCAL

In VAX/11 Pascal, you use `WRITE` or `WRITELN` statements to insert control functions. The `WRITE` statement is the general output statement for the Pascal language. You can use the `WRITE` statement to include any control functions in your Pascal programs.

Here is the basic format for inserting control functions in `WRITE` statements.

`WRITE(<control function>)`

Unlike VAX/11 BASIC, VAX/11 Pascal does not have an `ESC` constant that you can use to define control functions. However, VAX/11 Pascal does understand decimal encoded characters, similar to the the `CHR$` feature of VAX/11 BASIC.

Example

The following `WRITE` statements clear the VT300 screen.

`WRITE('(27)'2J)` (7-bit)

`WRITE('(155)'2J)` (8-bit)

The `(27)` is the decimal code for the `ESC` character. The `(155)` is the decimal code for the `CSI` character.

You must use two single quote marks `' '` before the decimal-encoded characters. You also must use single quotes `(')` around the other characters in the control function, to separate them from the decimal-encoded characters.

Program Examples

The following Pascal program clears the screen, then writes "Control Functions are Easy" in double-width characters on the screen.

```
PROGRAM EASY (INPUT, OUTPUT);

    { This program clears the screen, then writes the
      phrase "Control Functions are Easy" on the
      screen in double-width characters. }

BEGIN

    WRITELN('(27)'[2J]);
    WRITELN('(27)'#6 Control Functions are Easy')

END.
```

The following Pascal program clears the screen, maps the DEC Technical character set into GL, and maps the ISO Latin-1 supplemental set into GR.

NOTE: The VT300 lets you use two character sets at one time. The VT300 stores these two sets in the GL (graphic left) and GR (graphic right) tables in the terminal's memory. You can have up to four characters sets ready for use. You designate these sets as G0, G1, G2, and G3. When you want to use one of these sets, you map it into GL or GR. The VT330/VT340 Programmer Reference Manual, Volume 1, Chapter 5, describes how to designate and map character sets.

```
PROGRAM CHARACTER_SETS (INPUT, OUTPUT);

    { This Pascal program does the following:

      o Clears the screen
      o Maps the DEC Technical character set into GL
      o Maps the ISO Latin-1 supplemental set into GR}

BEGIN

    WRITELN('(27)'[2J]);    { Clear the screen. }

    WRITELN('          DEC Technical is in GL. ');
    WRITELN('          ISO Latin-1 supplemental is in GR. ');

    WRITELN('(27)'>');    { Designate DEC Technical as G1. }
    WRITELN('(14)');      { Map G1 into GL. }

    WRITELN('(27)'/A');   { Designate ISO Latin-1
                          supplemental as G3. }
    WRITELN('(27)'|');    { Map G3 into GR. }

END.
```

NOTE: These examples change the settings of some set-up features. After you use any of these examples, make sure you reset set-up features to their normal settings. To reset these features, enter set-up and select either Recall Saved Settings or Reset Session from the Set-Up Directory.

USING CONTROL FUNCTIONS WITH VAX/11 FORTRAN

In VAX/11 FORTRAN, you use PRINT or WRITE statements to insert control functions. The PRINT statement is the general output statement for the FORTRAN language. You can use the WRITE or PRINT statement to include any control functions in your FORTRAN programs.

Here is the basic format for inserting control functions in PRINT statements.

PRINT*, <control function >

Unlike VAX/11 BASIC, FORTRAN does not have an ESC constant that you can use to define control functions. However, VAX/11 FORTRAN does have a CHAR function, similar to the the CHR\$ feature of VAX/11 BASIC.

CHAR Function

The FORTRAN CHAR function performs the same operation as the BASIC CH\$ reserved word — it lets you use a decimal code to represent a character.

Example

The following PRINT statements clear the VT300 screen.

PRINT*, CHAR(27),'2J' (7-bit)

PRINT*, CHAR(155),'2J' (8-bit)

The (27) is the decimal code for the ESC character. The (155) is the decimal code for the CSI character. You must use single quotes ' ' to enclose the other characters in the control function.

Program Examples

The following FORTRAN program clears the screen, then changes the screen background from dark to light. The program uses PRINT and WRITE statements.

```
1 PROGRAM EASY
C
C This FORTRAN program clears the screen,
C then changes the screen background
C from dark to light.
C
5 PRINT*,CHAR(27),'[2J'
C Clear screen.
C
7 WRITE (6,*) CHAR(27), '[?5h'
C Change screen background to light.
C
10 END
```

The following program sets the page memory format for the terminal to four 80-column pages of 36 lines each.

```
1 PROGRAM SET_PAGE_FORMAT
C
C This FORTRAN program sets the terminal's
C page memory to four 80-column pages of
C 36 lines each.
C
5 WRITE (6,*) CHAR(27), '[80$|'
C Sets page width to 80 columns.
C
7 WRITE (6,*) CHAR(27), '[36t'
C Sets page length to 36 lines.
C
10 END
```

D KEYBOARDS

This appendix shows each model of the VT330/VT340 keyboard. Below each keyboard is the template used for the local editing keys. The North American/United Kingdom keyboard does not use a template.

The North American/United Kingdom keyboard is available in two versions, standard and word processing. The key positions on both versions are the same. However, the word processing version has different labels on some keys, for word processing functions.

Keyboard	Page
North American/United Kingdom	204
word processing version	205
Belgium (Flemish)	206
Canada (French)	207
Denmark	208
Finland	209
France/Belgium.	210
Germany/Austria	211
Holland	212
Italy	213
Norway	214
Portugal	215
Spain	216
Sweden	217
Switzerland (French)	218
Switzerland (German)	219

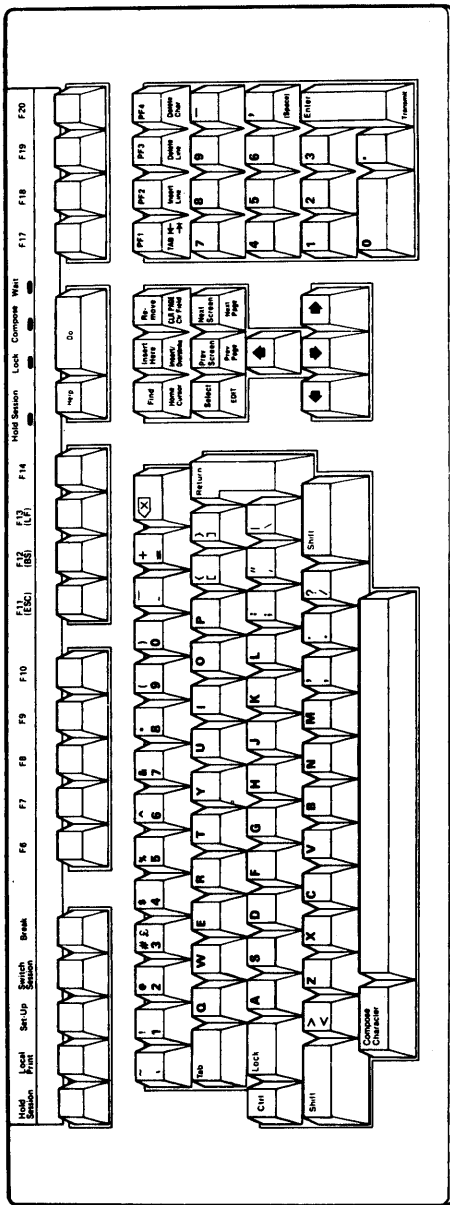

MA-0987-86

North American/United Kingdom

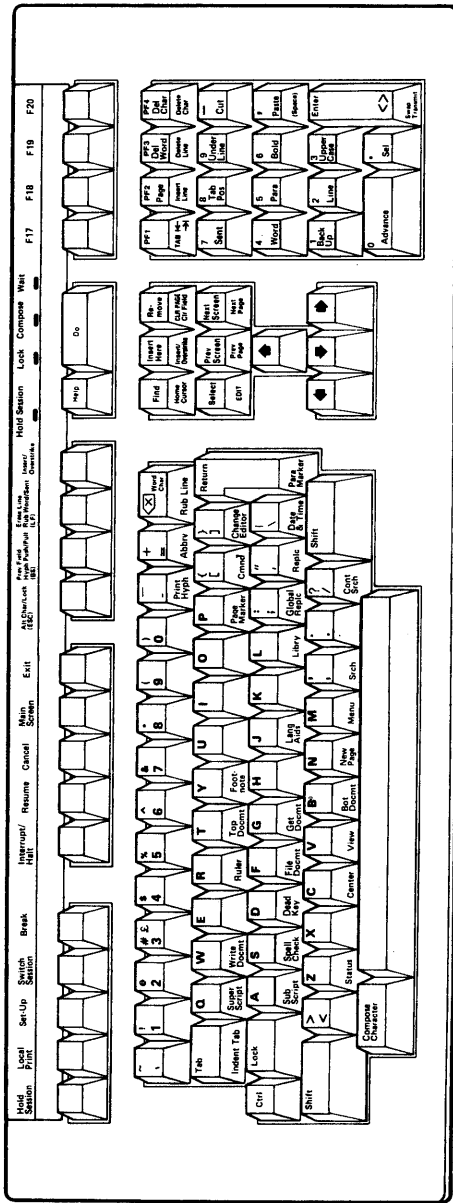

North American/United Kingdom (word processing version)

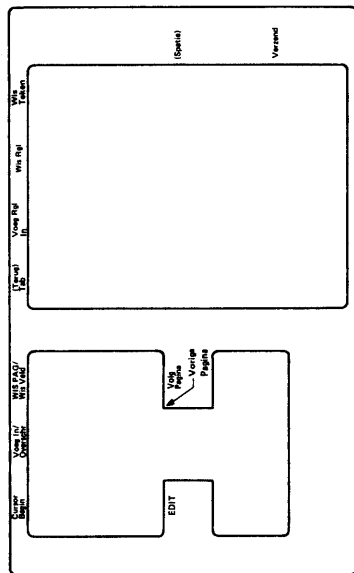
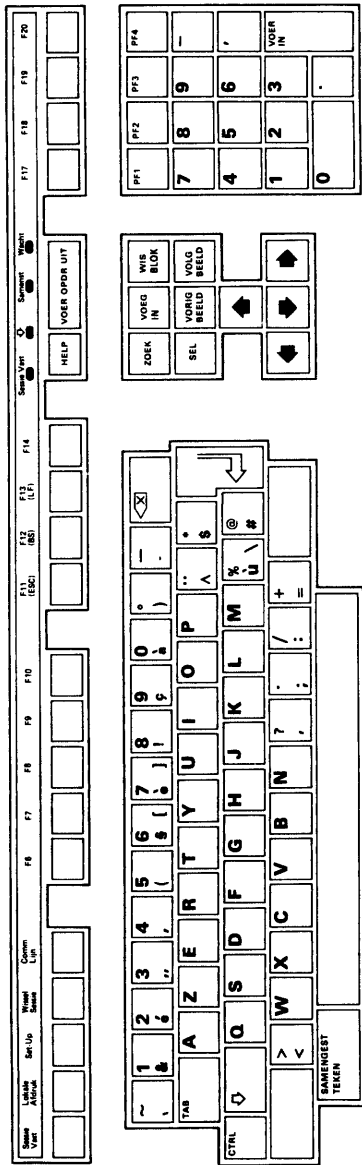

Belgium (Flemish)

MA-1003.86

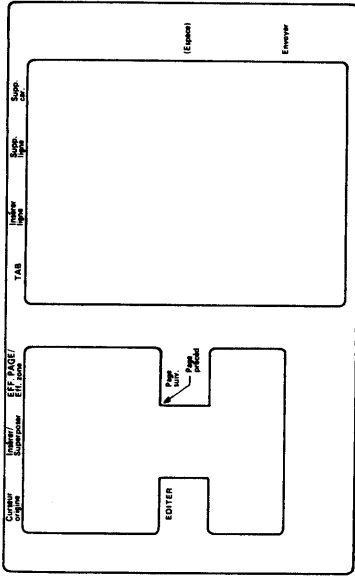
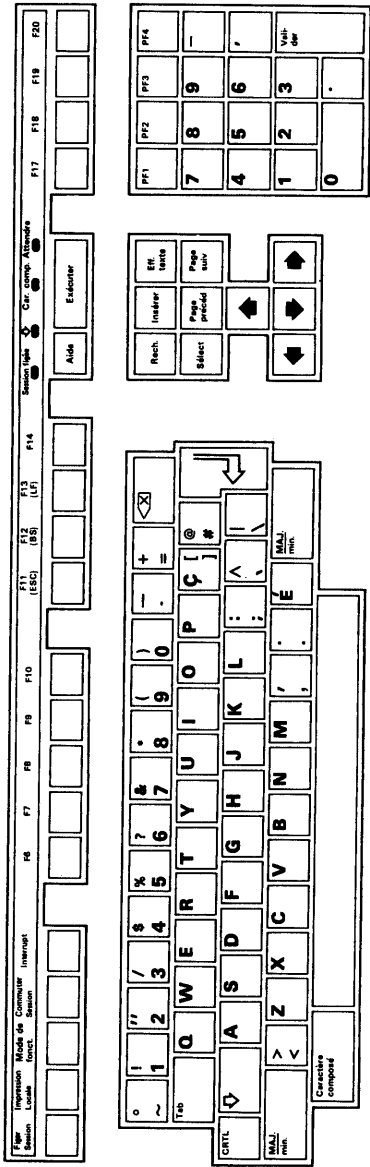

MA-0892-86

Canadian (French)



ESC	Start-up	Start-up	Start-up	Start-up	Start-up	Start-up	Start-up	Start-up	Start-up	Start-up	Start-up	Start-up	Start-up	Start-up	Start-up	Start-up	Start-up	Start-up	Start-up	Start-up
Blank	Blank	Blank	Blank	Blank	Blank	Blank	Blank	Blank	Blank	Blank	Blank	Blank	Blank	Blank	Blank	Blank	Blank	Blank	Blank	Blank
Blank	Blank	Blank	Blank	Blank	Blank	Blank	Blank	Blank	Blank	Blank	Blank	Blank	Blank	Blank	Blank	Blank	Blank	Blank	Blank	Blank
Blank	Blank	Blank	Blank	Blank	Blank	Blank	Blank	Blank	Blank	Blank	Blank	Blank	Blank	Blank	Blank	Blank	Blank	Blank	Blank	Blank
Blank	Blank	Blank	Blank	Blank	Blank	Blank	Blank	Blank	Blank	Blank	Blank	Blank	Blank	Blank	Blank	Blank	Blank	Blank	Blank	Blank

PF1	PF2	PF3	PF4
7	8	9	-
4	5	6	.
1	2	3	^
			Alt
			Alt
			0

Seg	Indirect	Set
Marker	Forge	Name
	Stream	Stream
←	→	→

Code

↵	Q	W	E	R	T	Y	U	I	O	P	↵	↵	↵
⌨	A	S	D	F	G	H	J	K	L	Æ	{	}	;
↵	Z	X	C	V	B	N	M	;	:	'	"	↵	↵

Shift

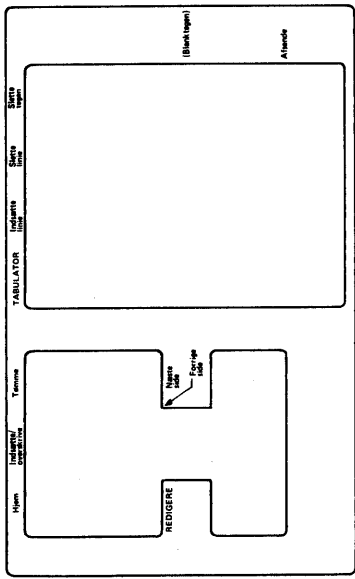

MA-0989-86

Denmark

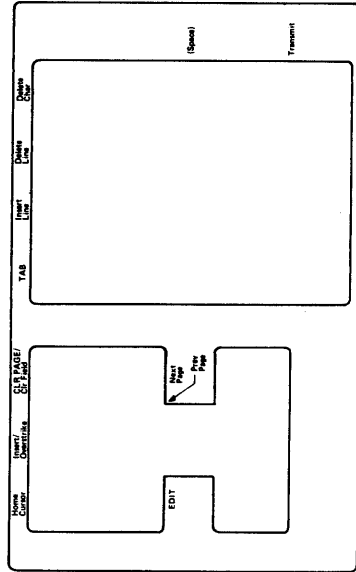
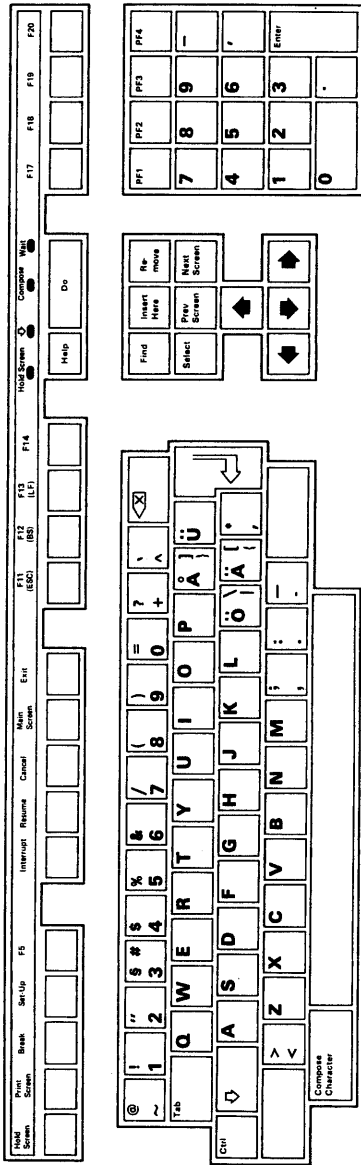

Finland

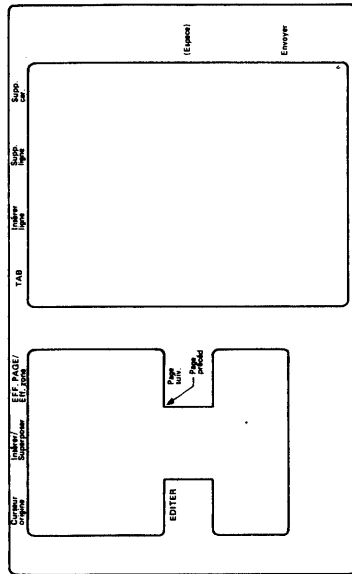
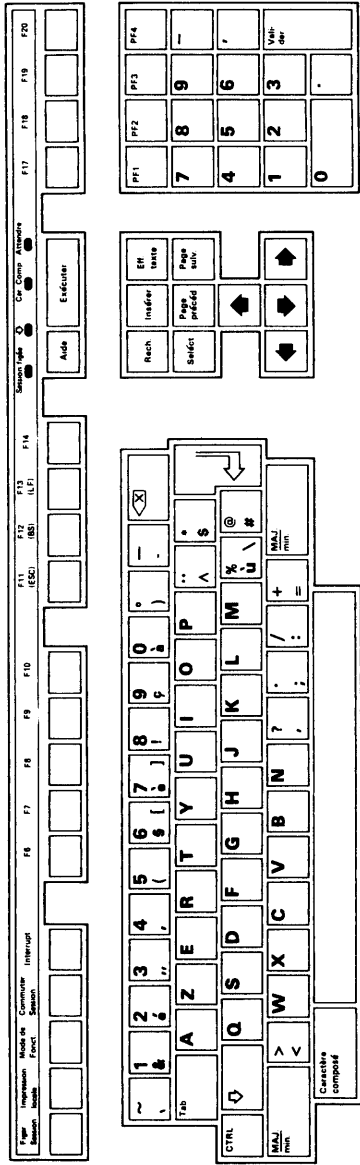

France/Belgium

MA-0991.86

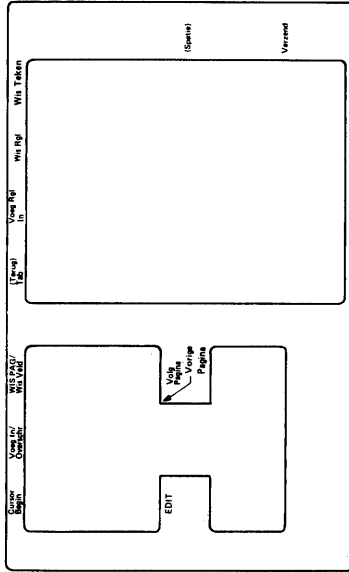
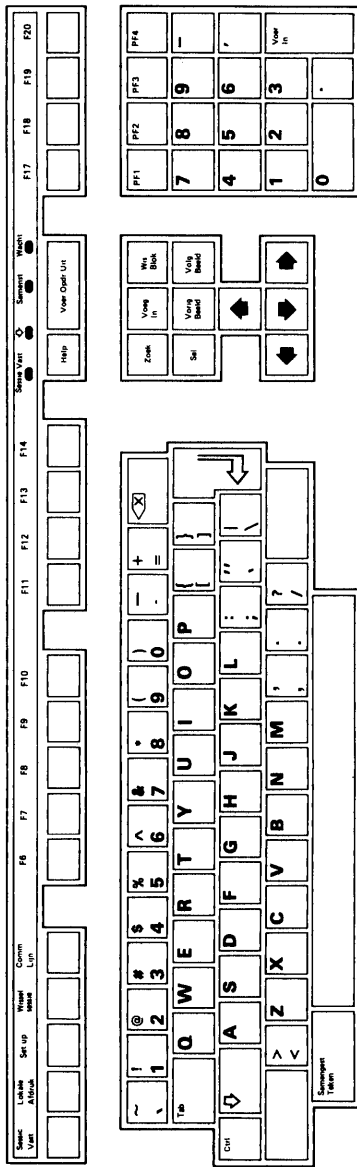

Holland

MA-0995-86

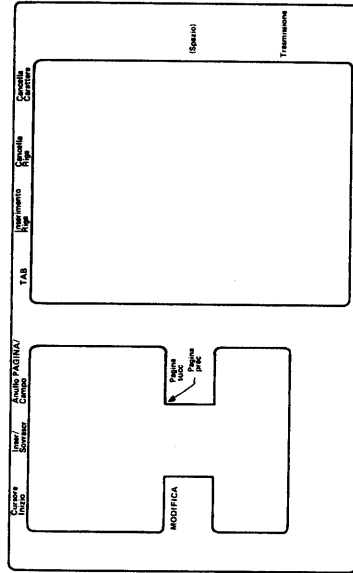
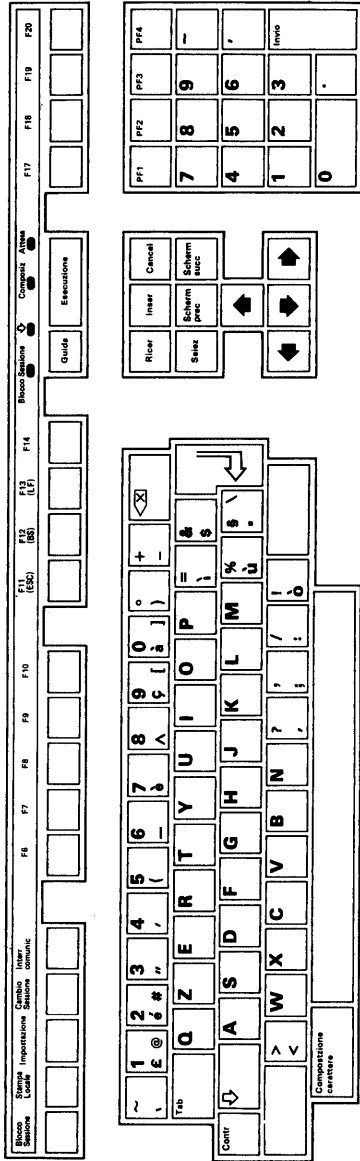

Italy

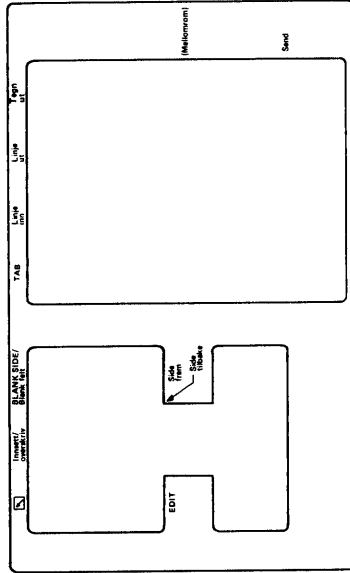
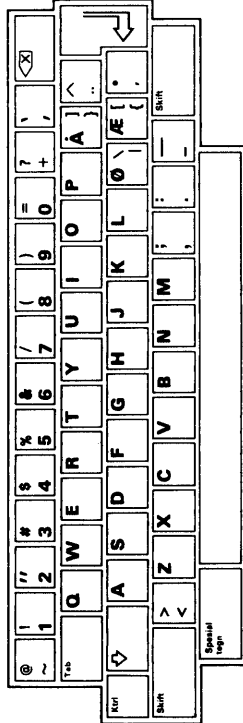
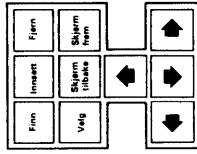
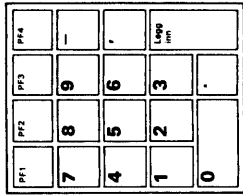
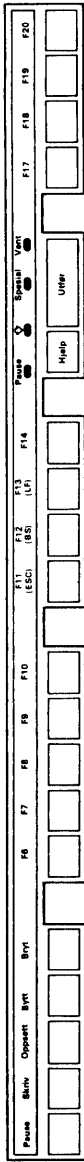

MA-0597-86

Norway

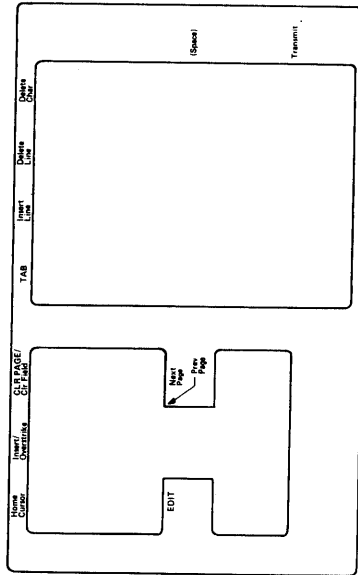
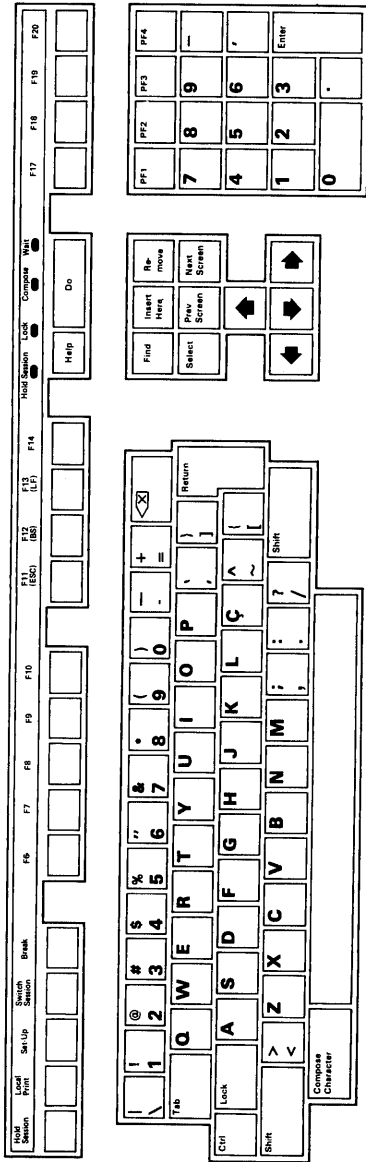

MA-0956-86

Portugal

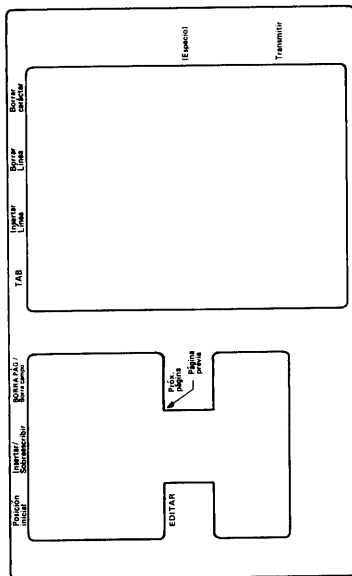
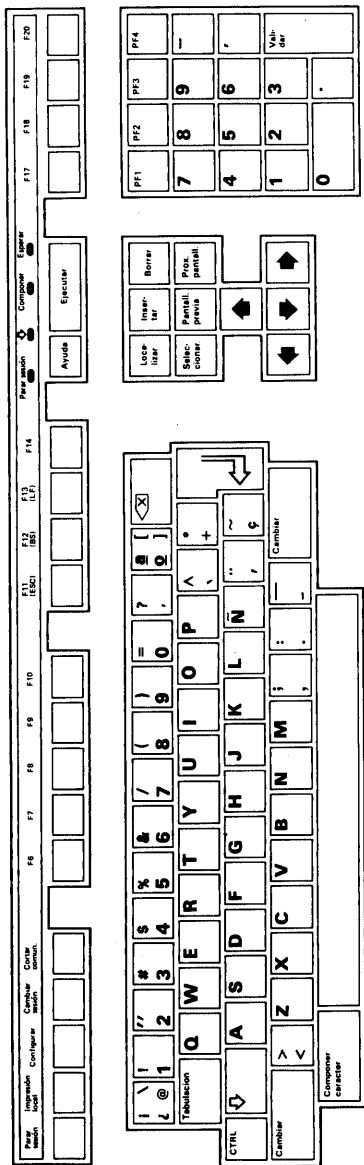

MA 0599-86

Spain

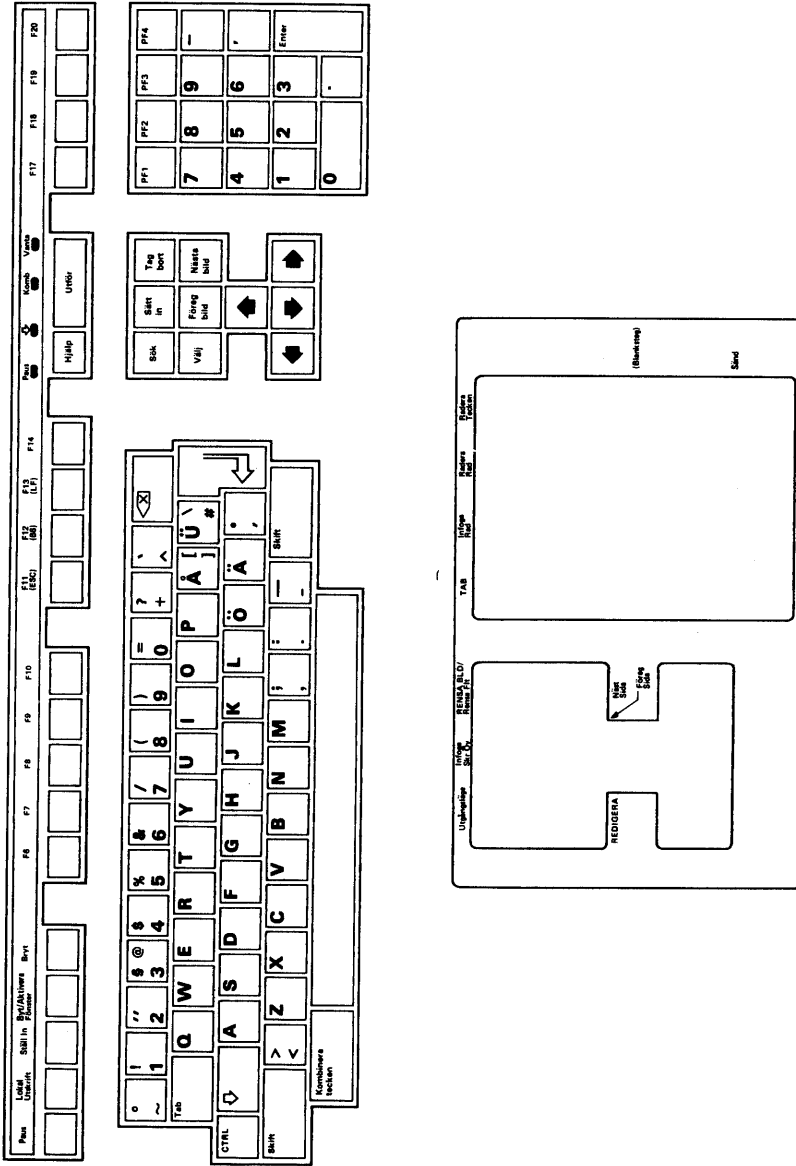

MA-1000-86

Sweden

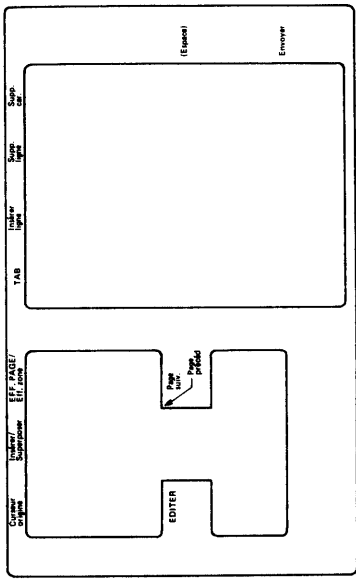
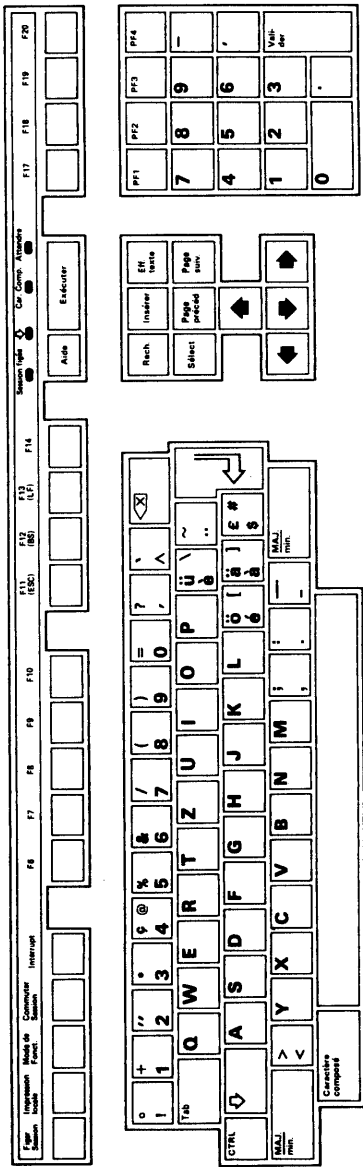

MA-1001-86

Switzerland (French)

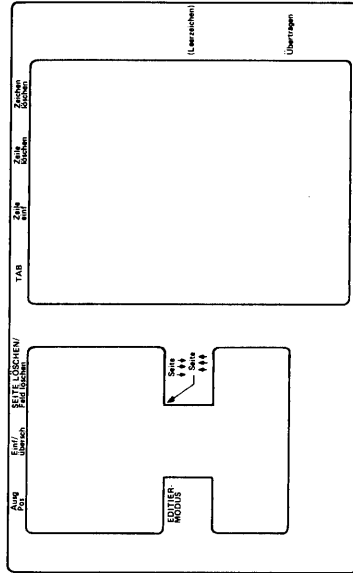
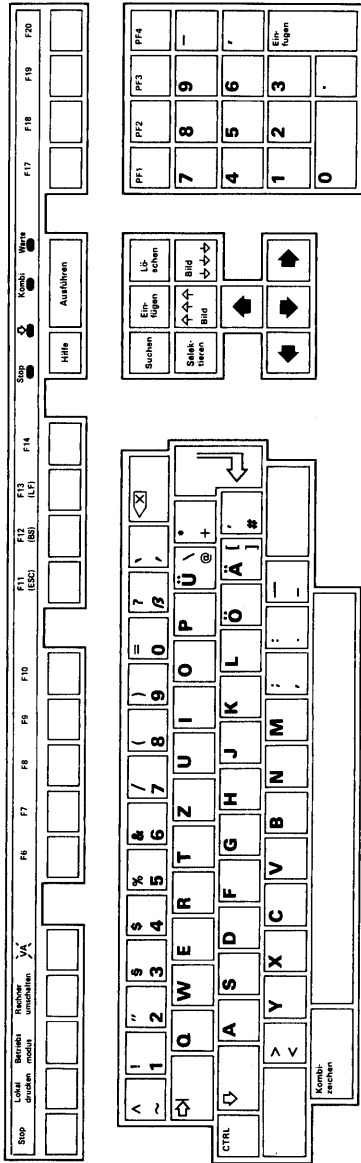

Switzerland (German)

CONNECTOR PIN ASSIGNMENTS **E**

This appendix show the pin assignments for the connectors on the rear of the terminal.

Table E-1 25-Pin Comm1 RS232 Connector Pin Assignments

Pin	Signal	Mnemonic	EIA/CCITT/DIN	Description
2	Transmitted data	TXD	BA/103/D1	<i>From VT300</i> Sends serial characters. Held in mark state when no characters are sent. In modem control modes, sends data only when RTS, CTS, DSR, and DTR are on.
3	Received data	RXD	BB/104/D2	<i>To VT300</i> Receives serial characters. In modem control modes, ignores characters if RLSD is off.
4	Request to send	RTS	CA/105/S2	<i>From VT300</i> When on, places the modem in transmit mode.
5	Clear to send	CTS	CB/106/M2	<i>To VT300</i> When on, tells the terminal that the modem is ready to send.

Table E-1 25-Pin Comm1 RS232 Connector Pin Assignments (Cont)

Pin	Signal	Mnemonic	EIA/CCITT/DIN	Description
6	Data set ready	DSR	CC/107/M1	<i>To VT300</i> When on, tells the terminal that the modem is in the data mode and is ready to exchange RTS, CTS, and RLSD.
7	Signal ground	SGND	AB/102/E2	Serves as common ground reference potential for all connector signals except protective ground.
8	Receive line signal detect (carrier detect)	RLSD	CF/109/M5	<i>To VT300</i> When on, tells the terminal that the signal received on the communication line is good enough to ensure correct demodulation of received data. When off, indicates no signal received, or signal unsuitable for demodulation.
12	Speed indicator	SPDI	CI/112/M4	<i>To VT300</i> When on, enables modem to control terminal transmit and receive speeds. Sets terminal transmit and receive speeds to 1200 bits per second regardless of set-up selection.
20	Data terminal ready	DTR	CD/108.2/S1.2	<i>From VT300</i> When on, tells the modem that the terminal is ready to send or receive.
23	Speed select	SPDS	CH/111/S4	<i>From VT300</i> When on, tells the modem that receive speed selected in set-up is greater than 600 bits per second.

**Table E-2 6-Pin DEC-423 Connector Pin Assignments
(Comm1, Comm2, and Printer Ports)**

Pin	Signal	Mnemonic
1	Data terminal ready	DTR
2	Transmitted data	TXD
3	Transmitted data return	—
4	Received data return	—
5	Received data	RXD
6	Data set ready	—

Table E-3 7-Pin Locator Device Connector Pin Assignments

Pin	Signal	Mnemonic
1	Protective ground	GND
2	Transmitted data	TXD
3	Received data	RXD
4	—	GND/-12
5	—	+5
6	not used	—
7	not used	—

GLOSSARY

Action field

Terminal features in *set-up* that make the VT300 perform an immediate action.

Active session

The *session* that you are currently using on the VT300. You use the Switch Session key to change the active session. The keyboard (and optional mouse or tablet) send data only to the active session.

Application software

A program that performs a specific function for a particular class of computer users. Examples: spreadsheet applications, word processing applications, local editing applications.

Auto print mode

A method of printing information directly from the host system. The VT300 sends a display line to the printer after a carriage return or form feed character.

Bitmap

Random access memory used to store a bit-encoded representation of an image displayed on the screen.

Block

In *local editing* mode, a section of edited data the terminal sends from the terminal's page memory to the host system. This differs from interactive mode, where the terminal sends and receives individual characters.

Bottom margin

The last line of the *scrolling region*.

CCITT

Comite Consultatif International de Telegraphique et Telephonique (International Telegraph and Telephone Consultative Committee). A standards committee for the communication industry in Europe.

Character set

A group of graphic characters and control characters stored as a unit in the terminal. Graphic characters are characters you can display on the screen. Control characters perform special functions.

Color map

Sixteen memory locations that the VT340 uses to store light intensity values. Each location has a color intensity.

Compose character

A character produced when you press two or three keys in a certain sequence. You can use compose sequences to produce characters that do not appear as standard keys on your keyboard.

Current page

The *page in page memory* that the cursor is on.

Current settings

The set-up feature settings that the VT300 is currently using.

Cursor

An indicator that highlights the active position on the screen. The VT300 uses different cursor characters for (1) text, (2) graphics, and (3) set-up.

Data processing keys

Keys that have three or four characters on the top of their keycap. The characters on the right half of the keycap are data processing keys. You must select a special set-up feature to use these characters.

Diacritical marks

Marks or symbols that indicate a change in the standard pronunciation of a letter. Examples of diacritics are acute accent (´), grave accent (`), and tilde (~).

On the VT300, you can use diacritical marks (if available on your keyboard) to start two-stroke compose sequences.

Diagnostics

Tests used to check the operation of the VT300 and isolate problems.

Display

The information that appears on the screen. A display may include text and graphics.

Dual sessions

Two separate *sessions* between the VT300 and host system, running at the same time.

Edit mode

See *Local editing*.

Factory default

A standard setting for a feature. The VT300 uses factory-default settings, unless you select a new setting. For example, many set-up features have default settings.

Field

An area in memory that can extend across characters or lines, which contain the *same* attributes. Fields do not extend across pages.

Full-duplex modem

A *modem* that can handle simultaneous, two-way communications.

Graphics

The use of lines, figures, shapes, and shaded areas to display information.

Graphics tablet

An optional device used to move the graphics input cursor on the screen and to enter data to an application program. Most tablets have three parts: a tablet,

stylus, and puck. To move the cursor you move the puck or stylus across the tablet. Also known as a *locator device*.

Host system

The computer system(s) you connect to the VT300. If you connect the terminal to two systems, one is the primary host and one is the secondary host.

Inactive session

A *session* that you are not currently using. You can run two sessions at the same time on the VT300, but you can only interact with one session at a time.

Local editing

A special editing mode of the VT300. Your terminal sends the characters you type to *page memory* rather than the *host system*. You decide when to send the edited data to the host.

Local editing requires application programs written especially to take advantage of this feature.

Locator device

A mouse or a graphics tablet, used with graphics applications to move the cursor on the screen.

Modem

Modulator - demodulator. A device that converts data from a computer or terminal into signals that can be sent over a telephone line.

Monochrome monitor

A video screen that displays images in shades of one color.

Mouse

An optional device used to move the graphics input cursor on the screen and to enter data to an application program. Moving the mouse along a flat surface changes the position of the cursor. Pressing the buttons on top of the mouse sends commands to the terminal.

National replacement character set

Twelve character sets for many European languages. Each is a 7-bit character set with 94 characters. NRC sets are similar to the ASCII set, except for a few characters.

Nonvolatile memory

Nonvolatile RAM (random access memory). The VT300 uses this memory to store the *saved settings* of set-up features. The settings are not lost when you turn the terminal off.

Page

A section of the terminal's *page memory*. Each page has left, right, top and bottom margins. You can define the size and layout of a page by using the *page arrangement* feature.

Page arrangement

A set-up feature that divides *page memory* into one of four standard page sizes. The default setting of the Page Arrangement feature is 3 pages of 24 lines each (for dual sessions) or 6 pages of 24 lines each (for a single session).

Page memory

Memory in the VT300 that can store the information you enter from the keyboard. The total size of page memory is 144 lines. Page memory is divided into pages. You can select from four standard page sizes. The amount of memory available depends on the page size selected and the number of *sessions* used (one or two).

Protected field

An area in *page memory* that you cannot edit. Usually, you cannot erase, move, or insert characters in a protected field.

Panning

Pointing a *window* to display different parts of *page memory*. Panning a window is similar to panning a camera. The window does not move on the screen; you "point" the window at another location in page memory.

Palette

The selection of possible colors to display on a VT340. The VT340 has a palette of 4096 colors.

Pixel

Picture elements. The smallest displayable unit on a video screen. To display a character or graphics, the terminal turns on a series of pixels.

Port

Another term for connector. All the VT300 connectors are on the rear of the terminal.

Resynchronize

To restore communication with an interrupted *session*.

RGB primaries

The three main colors of light — red, green, and blue — used to create other colors for display on a VT340. Red, green, and blue are also known as the additive primaries, because when added together at the same intensity they produce white light.

ROM cartridge

A read only memory unit that stores the operating instructions for the terminal. The ROM cartridge is in a slot on the rear of the terminal.

Saturated color

A light-source color that does not have any white light mixed in. A pure color.

Saved settings

The settings of set-up features that the VT300 uses when you turn the terminal on. You can change these settings or use the *factory-default* settings.

Scrolling

Moving data between the margins of the page currently displayed. Data scrolled past the margins is lost from *page memory*, but usually not from the *host system*.

Scrolling region

The area on the current *page* that is between the top, bottom, left, and right page margins. The default scrolling region is the complete page. Only a programmer can change the page margins.

Selected area

An area in page memory that you can send to the host system or printer. A selected area may include protected and unprotected fields.

Session

An active connection between the VT300 and a *host system*. When you log in to a computer from the terminal, you open a session. See *dual sessions*.

Set-up

A set of display screens on the VT300 that let you examine and change the settings of the terminal's operating features. You can use the keyboard to change settings.

SSU

Digital's Session Support Utility. This software lets you run two sessions over one communication line.

Status line

A display line that provides information about the terminal's current operating state. The status line appears on line 25 at the bottom of the screen. The VT300's status display feature has three settings indicator, none, and host-writable.

The VT300 always displays the indicator status line for the current *session* in set-up.

Terminal server

An intelligent unit that can connect a number of asynchronous devices (terminals and printers) to a host system. For example, Digital's DECserver 200 can link eight VT300 terminals to a system in a local area network (LAN), using a high-speed Ethernet cable.

Unprotected field

An area in *page memory* that you can edit. Unprotected fields are not affected by the Erasure Mode feature in the Local Editing Set-Up screen.

User-defined keys (UDKs)

Any of the 15 keys (F6 through F20) on the top row of the keyboard for which a user has defined special functions. You can use UDKs to store frequently used text and commands.

Visual character attribute

A quality of a display character that highlights the character, such as bolding and underlining.



Window

A specified area of the screen used to display information from *page memory*. You can divide the screen horizontally or vertically into two windows, to display information from two *sessions* at the same time.

Index

7-bit and 8-bit characters, 7, 80 to 83
7-bit ASCII character set, 193

-A-

Answerback message, 97
 Answerback Message feature, 97
 Auto-Answerback feature, 96
 Conceal Answerback Message feature, 55, 96
 sending a message with Ctrl-Break, 55
Application software, 3
Arrow keys, 50
ASCII character set, 81, 193
 replaced by NRC set, 81
Auto-Answerback feature, 96
Auto print mode, 54, 62, 166
Auto Repeat feature, 100
Auto Wrap feature, 90

-B-

Background display. *See* Display
 Background feature
Background Printing feature, 172
Backspace character
 using the <x] key for, 49
 using the F12 key for, 55

Baud rate, 30
 selecting, 38
 for modems, 94 to 95
 for printing, 171

Bell tone, 59

Bitmap graphics terminals, 6

Block editing. *See* Local editing

Break key feature, 55, 102

Break key, 55

Brightness control, 21, 44

-C-

Cables, 9, 33
 for a single session, 25, 34 to 35
 dual sessions with SSU software
 (one cable), 27, 37 to 38
 dual sessions (two cables), 26, 36
 to 37
 part numbers, 187, 188
CCITT v.25 compatible modems,
 using, 94
Character Format feature, 93
Character Set Mode feature, 80, 83
 and compose characters 105
Character sets, 80 to 81
 ASCII, 193
 multinational mode, 81, 83
 national mode, 81, 83

- overview, 7
- printing, 170
- Characters per line. *See* Column Mode feature
- Clear All Tabs field, 104
- Clear All Keys field, 127, 128
- Clear This Key field, 127, 128
- Clear Communications field, 71
 - to unlock the keyboard, 58
- Clear Display field, 71
- Color display (VT340)
 - overview, 6
- Color Map feature (VT340), 79
- Color Printing feature, 174
- Color Set-Up (VT340), 158 to 161
 - changing foreground and background colors, 159, 160
 - color map, 158
 - RGB primary colors, 159
 - Recall Saved Color Map field, 161
 - Save Color Map field, 160
- Color Specification feature, 174
- Column Mode feature, 87
- Comm1 and Comm2 connectors. *See* Connectors
- Comm1 Port feature, 78
 - selecting single or dual sessions, 35, 36, 37
 - and modems, 175
- Comma (Space) key, 52
- Communication cables. *See* Cables
- Communications Set-Up, 91 to 97
 - Receive Speed, 38, 39, 92
 - selecting a baud rate, 38 to 39
 - Transmit Speed, 38, 39, 92
- Compose Character key, 49, 106, 107
- Compose key feature, 102, 106
- Compose indicator, 57, 106, 107
- Composing characters, 105 to 124
 - canceling or restarting a sequence, 108
 - compose sequences, 105
 - hexadecimal compose sequences, 108 to 109
 - invalid sequences, 108
 - multinational mode, 109 to 115
 - national mode (typewriter keys), 116 to 124
 - national mode (data processing keys), 124
 - three-stroke sequences, 106
 - to display supplemental characters, 81
 - two-stroke sequences, 107
- Computer system, 3. *See also* Host system
- Conceal Answerback message, 55, 96
- Connectors, 23, 43, 45
 - assigning a session to a connector, 77
 - pin assignments, 220 to 222
 - selecting the active Comm1 connector, 78
 - system, 33 to 34
- Contrast control, 21, 44
- Control functions
 - how to use, 191 to 202
- Control Representation Mode feature, 89 to 90
 - effect on printer controller mode, 167
- Controls, 43, 44
- CRT Saver feature, 79
- Ctrl key, 48
- Ctrl-arrow key, 140, 141
- Ctrl-Break, 55, 102
- Ctrl-Hold Session, 54
- Ctrl-Local Print, 54, 167
- Ctrl-Next Screen, 140
- Ctrl-Prev Screen, 140
- Ctrl-Set-Up, 54
- Ctrl-Switch Session, 55, 136, 137
- Cursor Blink feature, 89
- Cursors

- checking the cursor position, 61
- dual sessions, 135
- graphics, 46, 156
- panning, 86, 87 to 88
- set-up, 68 to 69
- text, 46, 89
- Cursor Style feature, 89
- D-**
- Data processing keys, 56 to 57
 - and compose characters 105
- Data set ready (DSR) signal for modems, 62
- Data terminal ready (DTR) signal, 171
- DEC Multinational character set (MCS), 7, 81
 - selecting, 83
- DEC Supplemental character set, 81
- Delete (<x>) key, 49
- Delete feature, 49
- Device Attrib Resp feature, 82
- Device attributes response, 97
- DF02 and DF03 modems, 176
- Diacritical marks, 106, 107
- Diagnostic Set-Up, 182
- Disable Sessions field, 72
- Disconnect Delay feature, 95
- Display Background feature, 86
- Displaying control characters. *See* Control Representation Mode feature
- Display Set-Up, 85 to 90
- Do key, 56
- Documentation, 189
- Dual sessions, 130. *See also* Session Support Utility
 - checking the active session, 135
 - color map (VT340), 160
 - freezing the screen, 53
 - Global Set-Up, 76
 - independent set-ups for, 64
 - opening, 131 to 135
 - overview, 4
 - page sizes, 85
 - resetting set-up features, 54
 - using one cable, 9, 27, 37, 132 to 133
 - using two cables, 9, 24, 36, 131 to 132
- Dual Terminal feature, 77
 - for single or dual sessions, 36, 37
 - effect on Switch Session key, 54
- E-**
- Editing keypad, 50
- Edit mode, 143
 - entering and leaving 143
 - notes, 144
- Edit Mode feature, 144
- Emulating VT series terminals, 80, 82
 - overview, 7
- Enable Sessions field, 39, 72
- Enter key, 51
- Error messages
 - problem solving, 29
 - in set-up, 69
 - list, 179 to 180
- Escape (ESC) key, 55
- F-**
- Factory-default settings
 - recalling, 71, 72
 - used initially, 30, 63
- Features, 3 to 7
- F11 (ESC) key, 55
- F12 (BS) key, 55
- F13 (LF) key, 56
- Function keys, 53 to 56
 - See also* User-defined keys

-G-

General Set-Up, 80 to 84
Getting started, 30 to 40
Global Set-Up, 76 to 79
 dual sessions, 76
 setting up for single or dual sessions, 33 to 38
Graphics, 154 to 157
 overview, 6
 printing, 54, 167
Graphics Printing feature, 172
Graphics Set-Up, 155 to 157
 Tektronix 4010/4014 features, 156 to 157
 Graphics Cursor feature, 156
 Macrograph Reports feature, 156
Graphics tablet, 163 to 164
 note on installing, 28
 uses, 46

-H-

Help key, 56
Hexadecimal compose sequences, 108 to 109
HLS color system, 174
Hold Session indicator, 57
Hold Session key, 53
Horizontal Coupling feature, 87
Horizontal windows, 136 to 138
 changing window sizes, 138
 tips on using, 139
Host system, 3
 cabling, 9, 23 to 28
Host-writable status line, 59, 60

-I-

Indicator lights, 57 to 58
Indicator status line, 49
Insert/overstrike mode, 61
Installation, 11 to 40
 cabling, 23 to 28

connectors, 23
legend strip, 15
local editing template, 15
power cords, 18
set-up, 30 to 40
site considerations, 11
unpacking, 12

ISO Latin-1

character set, 7, 81
supplemental character set, 81
selecting, 83, 84

-K-

Keyboard, 43, 46 to 58
 editing keypad, 50
 installing, 15 to 17
 main keypad, 48 to 50
 models, 203 to 219
 numeric keypad, 51
 overview, 2
 top-row function keys, 53 to 56
Keyboard connector, 45
Keyboard Dialect feature, 31, 32, 98, 99
 effect on #/£ key, 57
 national replacement character sets, 81
 selecting a keyboard language, 31 to 32
Keyboard indicators, 58 to 59
Keyboard language, 98
 selecting, 31 to 32
Keyboard Mode feature, 99
 and data processing characters 56, 57
 and compose characters, 105
Keyboard Set-Up, 98 to 102
 selecting a keyboard language, 31 to 32
Keyclick, 58
Keyclick feature, 58, 100

Keypad Comma feature, 52, 102

Keypad Mode feature, 100

-L-

Legend strip

installing, 15

Line feed (LF) character

using the F13 key for, 56

Local Echo feature, 96

Local editing, 142 to 153

checking the current editing mode,
61

overview, 6

sending data to the host system,
144

template for keys, 15, 52

Wait indicator, 58

Local Editing Keys, 150 to 153

CLR PAGE/Clr Field, 151

Delete Char, 153

Delete Line, 152

Home Cursor, 151

Insert Line, 152

Insert/Overstrike, 151

Next Page, 152

Prev Page, 151

Return, 153

Shift-CLR PAGE/Clr Field, 151

Shift-EDIT, 150

Shift-Tab, 152

Tab, 152

Transmit, 153

Local Editing Set-Up, 143 to 149

Edit Key Execution Mode, 145

Edit Mode, 144

End of Block Characters, 149

End of Line Characters, 149

Erasure Mode, 145

Guarded Area Transfer Mode, 146

Line Transmit Mode, 147

Local Editing Applic. Keys, 145 to

146

Selected Area Transfer Mode, 146

Space Compression, 148

Transfer Termination Mode, 148

Transmit Execution Mode, 145

VT131 Transfer Mode, 148

Local mode

typing characters in, 48

Local Print key, 54, 166, 167, 169

Locator devices, 161 to 164. *See also*

Graphics tablet *and* Mouse

connector, 45

Locked keyboard. *See* Wait indicator

Lock indicator, 58

Lock key, 49

Lock Key feature, 49, 102

Lock User-Defined Keys feature, 84,
128

-M-

Main keypad, 48 to 49

Margin bell, 59

Margin Bell feature, 101

Modem Control feature, 94, 175

Modem High Speed feature, 94

Modem Low Speed feature, 95

Modems, 174 to 176

connecting, 174

ending communication, 55, 72

mode 1 and mode 2, 176

part numbers, 186

standards, 174

status, 62

Mouse, 161

note on installing, 28

using, 162

Multinational character sets, 81

Multinational mode, 83

compose sequences, 109 to 115

selecting, 83

-N-

National mode, 81
 compose sequences, 116 to 124
 selecting, 83
National replacement character sets
 (NRCs), 7, 81, 83
New Line feature, 90
Next Screen key, 73
North American/United Kingdom
 keyboard, 47
 using the # or £ symbol, 57
 and compose sequences, 106, 107
Numeric keypad, 51
 Keypad Comma feature, 102
 Keypad Mode feature, 100

-O-

On-line
 typing characters, 48
On Line/Local feature, 77
Operating problems, 177, 178
Options, 186 to 188
Ordering parts and documentation,
 186 to 190

-P-

Page Arrangement feature, 54, 86,
 87
Page Coupling feature, 88
Page memory, 85
 checking the current page number,
 60
 overview, 5
 printing from, 54
 updating the inactive session, 84
Page sizes, 85, 86 to 87
Panning, 86, 87 to 88
 how to pan, 140
 notes, 141
Pixels, 6
Power

 connector, 45
 indicator, 44
 switch, 44
 and refresh rate, 79
Power-up self-test, 177
 error messages, 177, 179 to 180
Prev Screen key, 73
Printed Data Type feature, 170
Printer Assignment feature, 78, 168
Printer Extent Mode feature, 169
Printers, 165
 connector, 46
Printer Set-Up, 168 to 174
Printer status, 61
Printer to Host Communications fea-
 ture, 171
Printing
 color, 174
 graphics, 54, 167
 notes, 168
 one line at a time, 54, 167
 text, 54, 166, 167
(Printing) Character Format feature,
 172
(Printing) Flow Control feature, 171
(Printing) Stop Bits feature, 172
Print Mode feature, 166, 169
Print modes, 166 to 167. *See also*
 Printer status
 auto print, 166
 local controller, 167
 normal, 166
 printer controller, 167
Print screen. *See Shift-Local Print*
Print Speed feature, 171
Print Terminator feature, 169
Problem solving, 177 to 182
 during installation, 29
Programming the VT300, 8
 primer on control functions, 191 to
 202
Protected and unprotected fields,

151, 152

-R-

Read only memory (ROM) cartridge,
1, 45

Rear panel
installing, 28
removing, 14

Recall Factory Default Settings field,
72

Recall Saved Settings field, 72

Recall User-Defined Keys field, 127,
128

Receive line signal detection (RLSD)
signal, 95

Receive Speed feature, 92. *See also*
Baud rate

Receive XOFF Point feature, 93

Refresh Rate feature, 79

ReGIS graphics software, 6, 154
cursors for, 46
displaying control characters, 90
report macrograph command, 156

Reset Session feature, 70 to 71

Resetting set-up features, 54

Return key, 49
New Line feature, 90

RGB color system, 159
selecting, 174

-S-

Save Current Settings field, 72

Save User-Defined Keys field, 127,
128

Screen messages, 179 to 180
in set-up, 69
with SSU software, 134 to 135

Scrolling feature, 86

Scrolling region, 148

Scrolling versus panning, 140

Select key, 74

Service, 180 to 182

Session, 4, 130. *See also* Single ses-
sion and Dual sessions
checking the active session, 60,
135

Session Support Utility for dual ses-
sions, 9, 132
cabling for, 27
opening SSU sessions, 132 to 133
restoring an interrupted session,
134
screen messages, 134 to 135
set-up for, 37 to 38

Set 8 Column Tabs feature, 104

Set-up
action fields, 69, 70 to 73
as part of installation, 30 to 40
current and saved settings, 63
cursor, 68
entering and leaving, 66
how to change a current setting,
74
how to recall saved settings, 75
how to save a current setting, 75
independent set-ups for dual ses-
sions, 64
language, 59, 70
list of features, 65 to 66
status line, 68
overview, 4, 63
using, 63 to 104

Set-Up Directory, 67 to 73
returning to, 74

Set-Up Language field, 70, 73
and the status line, 59

Set-Up key, 54, 66

Set-up screens
Color Set-Up (VT340), 158
Communications Set-Up, 91
Diagnostic Set-Up, 182
Display Set-Up, 85
format, 74

- General Set-Up, 80
- Global Set-Up, 76
- Graphics Set-Up, 155
- Keyboard Set-Up, 98
- Local Editing Set-Up, 143
- Printer Set-Up, 168
 - selecting, 73
- Set-Up Directory, 67
- Tab Set-Up, 103
- User-Defined Key Set-Up, 126
- Shift key, 49
- Shift-Break, 55, 102
- Shift-Ctrl-arrow key, 138
- Shift-EDIT, 143, 144
- Shift-Local Print, 54
- Single session
 - cabling, 25, 34 to 35
 - page sizes, 85, 87
- Sixel graphics, 6, 154
- Sixel Graphics Level feature, 172 to 173
- Sixel Print Option feature, 173
- Solving problems, 177 to 180
- Specifications, 183 to 185
- (SSU) Disable Sessions field, 72
- (SSU) Enable Sessions field, 39, 72
- SSU software. *See* Session Support Utility
- Status Display feature (for status line), 59, 88
- Status line, 59 to 62, 68
 - overview, 5
 - selecting, 88
- Stop Bits feature, 93
- Storing text or commands in user-defined keys, 125
- Switch Session key, 54, 130, 131, 132
 - used with Ctrl key for windows, 136, 137, 138

-T-

- Tab key, 48, 103
- Tab Set-Up, 48, 103 to 104
- Tektronix 4010/4014
 - cursors for, 46
 - emulation, 82
 - graphics, 154
 - printing, 54, 167
- Tektronix 4010/4014 set-up features,
 - 156 to 157
 - 401X Characters, 156
 - 401X CR Processing, 157
 - 401X DEL Processing, 157
 - 401X GIN Terminator, 157
 - 401X LF Processing, 157
- Template for local editing keys, 56
 - installing, 15
- Terminal Comm Ports feature, 77
 - for single or dual sessions, 36, 37, 38
- Terminal ID. *See* Device Attrib Resp feature
- Terminal Mode feature, 80, 81 to 82
- Terminal server, 3, 229
- Text Cursor feature, 89
- Tilt-swivel stand, 22
- Top-row function keys, 53 to 56. *See also* User-defined keys
- Transmit key, 144, 146, 147, 148
- Transmit Flow Control feature, 93
 - effect on Hold Session key, 54
- Transmit Rate Limiting feature, 93
- Transmit Speed feature, 92. *See also* Baud rate
- Typewriter characters
 - and data processing characters, 52
 - and compose characters 105
 - selecting, 99

-U-

Update Method feature, 84
User-Defined Key Set-Up, 126
User-defined keys (UDKs), 125 to 129
 clearing, 127, 128
 defining and using a key, 127
 locking, 84
 overview, 5, 125
 protecting, 128
 recalling, 127, 128
 saving, 127, 128
 tips on using, 128 to 129
User Features Lock feature, 84
User Pref Character Set feature, 81, 83
 and compose characters, 105

-V-

VAX/VMS systems
 opening dual sessions (two cables), 131
 opening dual sessions with SSU software (one cable), 132
Vertical Coupling feature, 88
Vertical windows, 136, 137
VT modes (VT52, VT100, VT200, VT300). *See* Terminal Mode feature

VT220 compatible modems, using, 94
VT300 as an editing terminal, 142
VT300 components
 keyboard, 2
 terminal, 1
VT300 series
 overview, 1 to 8
VT330 monochrome terminal, 1
VT340 color terminal, 1
 color display, 6

-W-

Wait indicator, 58
Warning bell, 59
Warning Bell feature, 101
Windows, 136 to 141
 full-screen, 136, 137
 horizontal windows, 137, 138, 139
 overview, 5
 panning, 140 to 141
 printing from two windows. *See* Shift-Local Print
 selecting, 55, 136, 137
 vertical windows, 136, 137

-X-

XON/XOFF signals, 93
 for printing, 171
<x| (delete) key, 49
<x| Key feature, 101

VT330/VT340 COMMON KEYBOARD FUNCTIONS

Set-Up Keys (Chapter 5)

Set-Up	Enter and leave set-up.
Arrow keys	Move set-up cursor to selection in set-up screen. Change feature's current setting.
Enter	Perform the action selected by cursor in set-up screen.
Select	Return to Set-Up Directory from another set-up screen.
Next Screen	Move to next set-up screen.
Prev Screen	Move to previous set-up screen.



Printing (Chapters 4 and 11)

Local Print	Print the text in page memory. In 4010/4014 mode, print graphics and text.
Shift-Local Print	Print text and graphics from a full screen.
Ctrl-Local Print	Turn auto print mode on or off. Prints each line of text as it is received from the host system.

Dual Sessions (Chapters 4 and 8)

Switch Session	Change the active session.
Ctrl-Hold Session	Freeze both session displays on the screen.
Ctrl-Set-Up	Reset most set-up features for both sessions to their saved setting. This key sequence only works in set-up.

Windows (Chapters 4 and 8)

Ctrl-Switch Session	Select windows on screen. Press One time: two horizontal windows. Two times: two vertical windows. Three times: one full-screen window.
Shift-Ctrl-  or 	Change horizontal window sizes.

Panning (Chapters 4 and 8)

<i>Ctrl-arrow key</i>	Pan up, down, left, or right on current page.
Ctrl-Prev Screen	Pan to previous page.
Ctrl-Next Screen	Pan to next page.

Communication (Chapters 4 and 11)

Break	Usually ends communication with a session.
Shift-Break	End communication with a modem.
Ctrl-Break	Send answerback message to active session.

VT330/VT340 User Documentation Package

This package contains one copy of the following documents.

Installing and Using The VT330/VT340 Video Terminal	EK-VT3XX-UG-002
VT330/VT340 Programmer Reference Manual	
Volume 1: Text Programming	EK-VT3XX-TP-002
Volume 2: Graphics Programming	EK-VT3XX-GP-002
VT330/VT340 Programmer Pocket Guide	EK-VT3XX-HR-002
VT300 Family Supporting Products Guide	EG-31067-56

TO INSTALL THE TERMINAL

**Go to Chapter 2 of
Installing and Using the VT330/VT340 Video Terminal.**

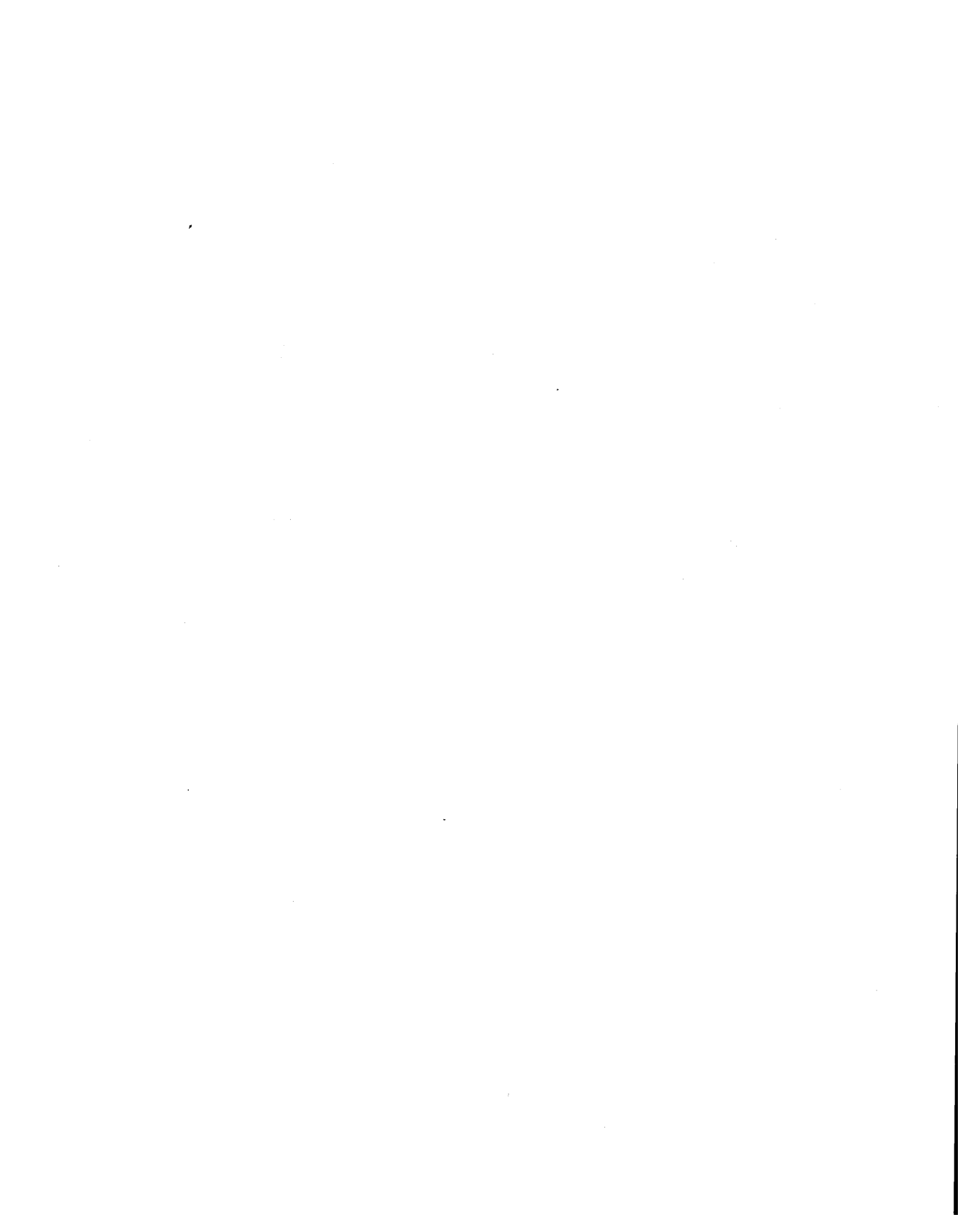



Digital Equipment Corporation • Maynard, MA 01754