

VT 220

Owner's Manual

digital

EK-VT220-UG-003

VT 220

Owner's Manual

1st Edition, August 1983
2nd Edition, July 1984
3rd Edition, December 1984

Copyright © 1983, 1984 by Digital Equipment Corporation.
All Rights Reserved.
Printed in U.S.A.

The reproduction of this material, in part or whole, is strictly prohibited. For copy information, contact the Educational Services Department, Digital Equipment Corporation, Maynard, Massachusetts 01754.

The information in this document is subject to change without notice. Digital Equipment Corporation assumes no responsibility for any errors that may appear in this document.

This equipment generates and uses radio frequency energy and if not installed and used properly, that is, in strict accordance with the manufacturer's instructions, may cause interference to radio and television reception. It has been type tested and found to comply with the limits for a Class B computing device in accordance with specifications in Subpart J of Part 15 of FCC Rules, which are designed to provide reasonable protection against such interference in a residential installation. However, there is no guarantee that interference will not occur in a particular installation. If this equipment does cause interference to radio or television reception, which can be determined by turning the equipment off and on, the user is encouraged to try to correct the interference by one or more of the following methods:

- Reorient the receiving antenna.
- Relocate the computer with respect to the receiver.
- Move the computer away from the receiver.
- Plug the computer into a different outlet so that computer and receiver are on different branch circuits.

If necessary, the user should consult the dealer or an experienced radio/television technician for additional suggestions. The user may find the booklet *How to Identify and Resolve Radio/TV Interference Problems*, prepared by the Federal Communications Commission, helpful. This booklet is available from the U.S. Government Printing Office, Washington, DC 20402, Stock No. 004-000-00345-4.

AT&T is a trademark of American Telephone and Telegraph Company.

Mate-N-Lok is a trademark of AMP, Inc.

The following are trademarks of Digital Equipment Corporation, Maynard, Massachusetts.

digital	DECtalk	PDP	UNIBUS
DEC	DECUS	P/OS	VAX
DECmate	DECwriter	Professional	VMS
DECnet	DIBOL	Rainbow	VT
DECsystem-10	LA	RSTS	Work Processor
DECSYSTEM-20	MASSBUS	RSX	

CONTENTS

INTRODUCTION

CHAPTER 1 A LOOK AT THE TERMINAL

General	1
VT220 Components	1
Monitor/System Unit	2
Keyboard	2
How the VT220 Works	2
Operating States	2
Set-Up	2
On-Line	3
Local	3
Operating Modes	3
VT200 Mode, 7-Bit Controls	3
VT200 Mode, 8-Bit Controls	4
VT100 Mode	4
VT52 Mode	4
Character Set Modes	4
CRT Saver Feature	4

CHAPTER 2 CONTROLS, INDICATORS, AND CONNECTORS

General	5
Terminal	5
Monitor	5
Keyboard	9
Main Keypad	10
Tab	10
Ctrl	10
Lock	11
Shift	11
Return	11
 (Delete)	11
Compose Character	12
Editing Keypad	12
Auxiliary Keypad	12
Top-Row Function Keys	13
Hold Screen	13
Print Screen	14
Set-Up	14
Data/Talk	14
Break	14
F11 (ESC)	14
F12 (BS)	15
F13 (LF)	15
Function Key Summary	15
Visual Indicators	16
Hold Screen Indicator	16
Lock Indicator	16
Compose Indicator	16
Wait Indicator	16
Audible Indicators	16
Keyclick	16
Bell	17

CHAPTER 3 OPERATING PROCEDURES

General	19
Printing	19
Normal Mode	20
Auto Print Mode	20
Printer Controller Mode	20
Local Controller Mode	21

Optional Modem	21
Composing Characters	21
Using a Three-Stroke Compose Sequence	23
Using a Two-Stroke Compose Sequence	23
Aborting or Restarting a Compose Sequence	24

CHAPTER 4 TERMINAL SET-UP

General	35
Using Set-Up	36
Set-Up Screens	36
Screen Title	37
Terminal Identifier	37
Firmware Version Number	38
Status Line	38
Fields	39
Set-Up Controls and Cursor	40
Set-Up Example: Changing Features	41
Set-Up Screen Descriptions	42
Set-Up Directory Screen	44
Display Set-Up Screen	49
General Set-Up Screen	53
Communications Set-Up Screen	58
Printer Set-Up Screen	64
Keyboard Set-Up Screen	69
Tab Set-Up Screen	75

CHAPTER 5 COMMUNICATION

General	77
Host and Printer Port Interfaces	78
Modems	78
Cables	83
Printers	84
Character Format	84
Terminal – Host Data Flow Control	85
Conditions That Send XON	85
Conditions That Send XOFF	86
Buffer Overflow Prevention	86
Use of Fill Characters	87
Connect/Disconnect	88
Terminal – Printer Data Flow Control	88
Note on Printer Installation	88

CHAPTER 6 PROBLEM SOLVING

General	89
Common Operating Problems	89
Power-Up Self-Test	91
Performing the Power-Up Self-Test	91
Digital Service	92

APPENDIX A SPECIFICATIONS

General	93
VT220 Specifications	93

APPENDIX B OPTIONS, DOCUMENTATION, AND SUPPLIES

General	97
Available Options	97
Modems	97
Cables	97
Related Documentation	98
Specifications	99
Ordering Information	99

APPENDIX C KEYBOARDS

General	101
---------------	-----

INDEX

FIGURES

1-1	VT220 Video Terminal	1
2-1	Terminal Controls, Indicators, and Connectors	6
2-2	Monitor Controls and Tilt Leg Release Button	8
2-3	Keyboard (North American)	9
2-4	Main Keypad	10
2-5	Editing Keypad	12
2-6	Auxiliary Keypad	12
2-7	Top Row of Function Keys and Visual Indicators	13
4-1	Set-Up Screens	36
4-2	Sample Set-Up Screen	37
4-3	Set-Up Directory Screen	44
4-4	Display Set-Up Screen	49
4-5	General Set-Up Screen	53
4-6	Communications Set-Up Screen	58
4-7	Printer Set-Up Screen	64
4-8	Keyboard Set-Up Screen	69
4-9	Tab Set-Up Screen	75
5-1	Cables	83
5-2	Character Format	84
6-1	Successful Power-Up Screen Message	91
C-1	North American	102
C-2	United Kingdom	103
C-3	Belgium (Flemish)	104
C-4	Canada (French)	105
C-5	Denmark	106
C-6	Finland	107
C-7	France/Belgium	108
C-8	Germany/Austria	109
C-9	Holland	110
C-10	Italy	111
C-11	Norway	112
C-12	Spain	113
C-13	Sweden	114
C-14	Switzerland (French)	115
C-15	Switzerland (German)	116

TABLES

2-1	Terminal Controls, Indicators, and Connectors	6
2-2	Monitor Controls and Tilt Leg Release Button	8
3-1	Valid Compose Sequences: Multinational Mode	24
3-2	Valid Compose Sequences: National Mode	29
4-1	Status Line Messages	38
4-2	Set-Up Controls and Cursor Functions	40
4-3	Set-Up Screens Summary	43
4-4	Set-Up Directory Screen	45
4-5	Display Set-Up Screen	50
4-6	General Set-Up Screen	54
4-7	Communications Set-Up Screen	59
4-8	Printer Set-Up Screen	65
4-9	Keyboard Set-Up Screen	70
4-10	Tab Set-Up Screen	76
5-1	Comm Port EIA Interface Signals	79
5-2	20 mA Port Interface Signals	81
5-3	Printer Port EIA Interface Signals	81
6-1	Common Operating Problems	89
6-2	Screen Error Messages	92

INTRODUCTION

This manual provides the information you need to operate and maintain your VT220 video terminal. The manual is organized into six chapters and three appendices as follows.

- Chapter 1, "A Look at the Terminal," introduces you to the VT220 terminal. This chapter provides an overview of what the terminal is and what it does, then briefly describes how it works.
- Chapter 2, "Controls, Indicators, and Connectors," describes the terminal controls, indicators, and connectors, and shows their locations.
- Chapter 3, "Operating Procedures," provides information on specific terminal functions and operating procedures.
- Chapter 4, "Terminal Set-Up," describes each set-up screen feature in detail. This chapter shows you how to select set-up features to define the terminal's operating characteristics.
- Chapter 5, "Communication," describes how the VT220 terminal communicates with a host computer and a peripheral device such as a printer.
- Chapter 6, "Problem Solving," describes the self-test used to find terminal hardware problems. This chapter also contains simple troubleshooting information to correct common operating problems.

- Appendix A, "Specifications," provides all VT220 terminal specifications.
- Appendix B, "Options, Documentation, and Supplies," describes the options, related documentation, and supplies mentioned in this manual and how to order them.
- Appendix C, "Keyboards," shows the various keyboards available with the VT220 terminal.

A LOOK AT THE TERMINAL 1

GENERAL

This chapter introduces you to the VT220 terminal. The chapter provides an overview of what the terminal is and what it does, then briefly describes how the terminal works.

VT220 COMPONENTS

The two main components of the VT220 terminal are the monitor/system unit and the keyboard (Figure 1-1).

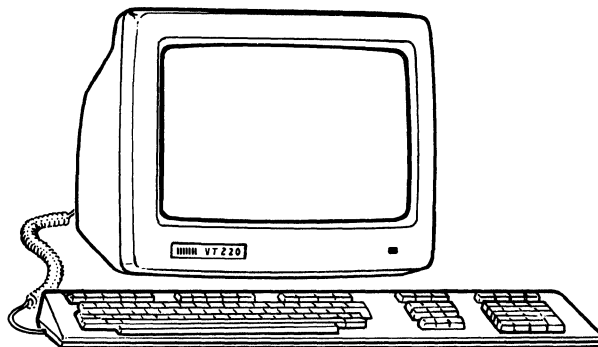

MA-1005-83

Figure 1-1 VT220 Video Terminal

Monitor/System Unit

The monitor/system unit (referred to as the *terminal* from this point on) consists of a monochrome cathode-ray tube (CRT), a terminal controller board, and a power supply/monitor board.

Keyboard

The low-profile keyboard has four groups of keys and four visual indicators. The main keypad operates like a typewriter keyboard. A single coiled cable connects the keyboard to the terminal.

There are 15 basic keyboards available with the VT220. (See Appendix C.) Each keyboard is for a different language.

HOW THE VT220 WORKS

The VT220 is a general-purpose video display terminal that lets you interact with a software application program. You send characters to the application program by typing on the keyboard. Characters sent by the application program appear as text on the terminal screen. You can print the text you create on the terminal if the terminal is connected to a printer. The terminal operates by executing standard American National Standards Institute (ANSI) functions.

OPERATING STATES

The VT220 has three operating states you can select from the keyboard.

- Set-up
- On-line
- Local

Set-Up

The set-up state lets you select or examine terminal operating features. Chapter 4 describes these set-up features in detail. You also use set-up to select the on-line and local states.

You select set-up from the keyboard by pressing the **Set-Up** key.

On-Line

The on-line state lets the terminal communicate with a host computer. Data entered at the keyboard is sent to the host computer. Data received from the host computer is displayed on the monitor. You can also display data entered from the keyboard on the screen, if you select the local echo feature in set-up (Chapter 4).

You can only select on-line in set-up.

Local

The local state lets you place the host computer on hold. Data entered at the keyboard is sent to the monitor, but not to the host computer. Data received from the host computer is stored; this data is sent to the monitor after you put the terminal back on-line.

You can only select local in set-up.

OPERATING MODES

The VT220 has four major operating modes. You can select these modes in set-up. The default operating mode is VT200 mode, 7-bit controls. A *default* setting is a factory setting the terminal uses until you change that setting.

- VT200 mode, 7-bit controls
- VT200 mode, 8-bit controls
- VT100 mode
- VT52 mode

VT200 Mode, 7-Bit Controls

This mode executes standard ANSI functions and lets you use the full range of VT220 capabilities. You should use this mode with application programs that expect 7-bit control characters, and either DEC multinational characters or national replacement characters (depending on the character set selected in set-up).

NOTE: In general, most VT100 application programs will run in VT200 mode, 7-bit controls.

VT200 Mode, 8-Bit Controls

This mode also executes standard ANSI functions and lets you use the full range of VT220 capabilities. You should use this mode with application programs that expect 8-bit control characters and DEC multinational characters.

VT100 Mode

This mode executes standard ANSI functions. You should use VT100 mode with application programs that require strict compatibility with Digital's VT100 terminal.

VT52 Mode

This is a text mode that executes Digital (DEC) private functions (not ANSI). You should use VT52 mode for compatibility with existing application programs designed for Digital's VT52 terminal.

CHARACTER SET MODES

The VT220 has two basic character set modes, multinational and national.

Multinational mode supports the DEC multinational character set (DEC MCS). The DEC MCS is an 8-bit character set that contains most characters used in the major European languages. The ASCII character set is included in the DEC MCS.

National mode supports the national replacement character (NRC) sets. The NRC sets are a group of eleven 7-bit character sets. You can only use one NRC set at a time. The NRC set available depends on the keyboard selected in set-up (Chapter 4). National mode restricts compatibility to a 7-bit environment, so the DEC MCS is not available.

CRT SAVER FEATURE

If during normal operation the terminal is inactive for 30 minutes (no keyboard activity or input from a host computer), the monitor screen goes blank (but data is not lost). Keyboard activity or input from the host computer activates the monitor again. To reactivate the screen, press the **Ctrl** key.

NOTE: This manual describes the use of the North American keyboard, unless otherwise specified. When you use the North American keyboard, the terminal defaults to multinational mode. (National mode is disabled.)

CONTROLS, INDICATORS, AND CONNECTORS **2**

GENERAL

This chapter provides information about the terminal's controls, indicators, and connectors. The chapter also describes the keyboard, including the three keypads and special function keys.

TERMINAL

The terminal controls, indicators, and connectors are shown in Figures 2-1 and 2-2 and described in Tables 2-1 and 2-2.

Monitor

The monitor controls are shown in Figure 2-2 and described in Table 2-2.

6 CONTROLS, INDICATORS, AND CONNECTORS

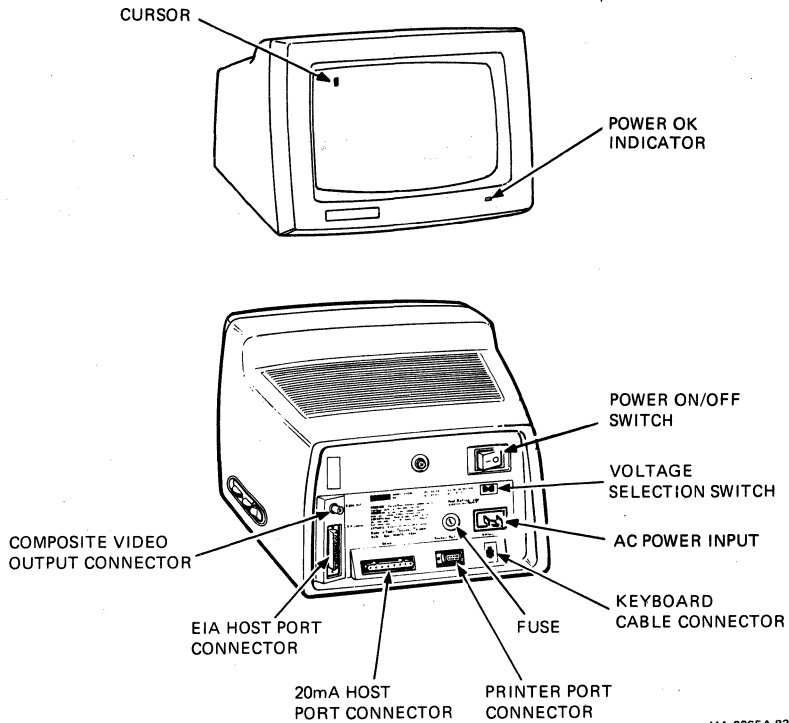

Figure 2-1 Terminal Controls, Indicators, and Connectors

Table 2-1 Terminal Controls, Indicators, and Connectors	
Control/Indicator/Connector	Description
Power switch	Turns the terminal on or off. Pressing 1 turns power on. Pressing 0 turns power off.
EIA host port connector	Connects the terminal to a host computer either directly or via a modem.

Table 2-1 Terminal Controls, Indicators, and Connectors (Cont)

Control/Indicator/Connector	Description
20 mA host port connector	Connects the terminal to a nearby host computer via a 20 mA connection.
Composite video output connector	Provides a complete video output signal to an additional slave monitor.
Power OK indicator	Turns on to indicate power is applied to the terminal.
Printer port connector	Connects a printer to the terminal.
Keyboard connector	Connects the keyboard cable to the terminal.
AC input connector	Connects the power cord to the terminal from the wall outlet.
Fuse	Protects the system from electrical damage.
Voltage select switch	This slide switch lets you match the terminal voltage to the wall outlet voltage. See the <i>VT220 Installation Guide</i> for the correct setting.
<i>CAUTION: An incorrect voltage setting can damage the terminal.</i>	
Cursor	Indicates where the next display character will appear on the monitor screen. You can select an underline cursor or block cursor in the Display Set-Up screen (Chapter 4).

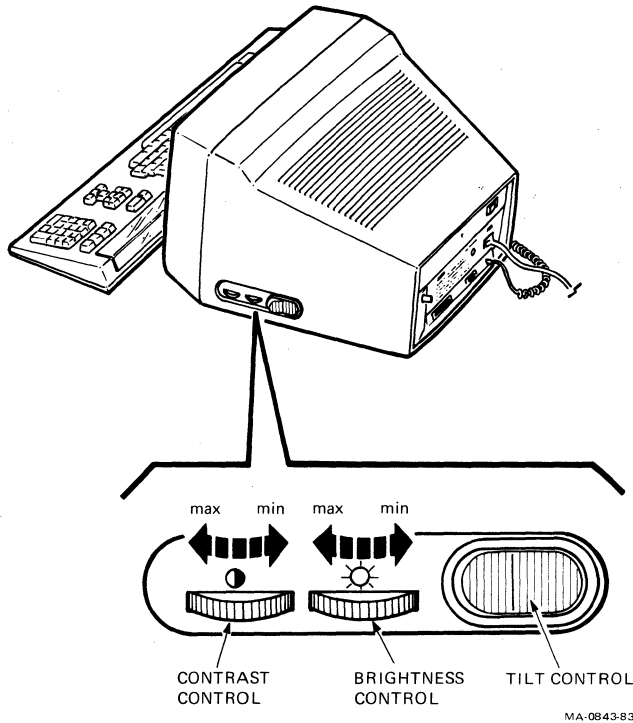
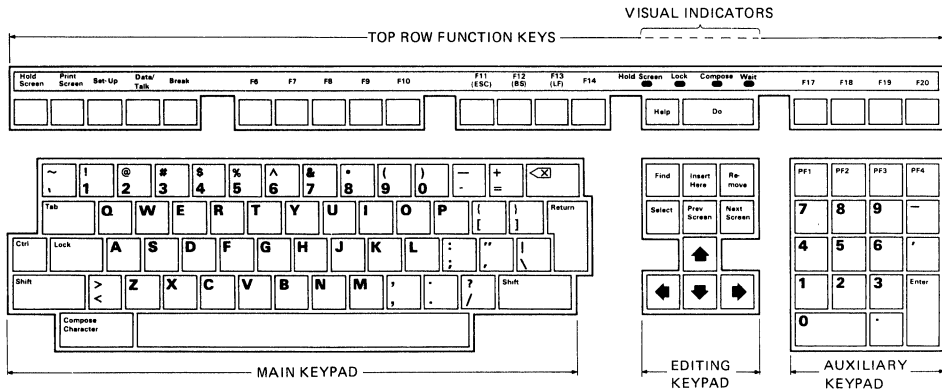

Figure 2-2 Monitor Controls and Tilt Leg Release Button

Table 2-2 Monitor Controls and Tilt Leg Release Button	
Control	Description
Contrast control	Adjusts the degree of contrast on the monitor screen.
Brightness control	Adjusts the degree of brightness on the monitor screen.
Tilt leg release button	Adjusts the viewing angle of the monitor. Pressing the button releases a tilt leg that drops to provide a -5 to +15 degree tilt range.



MA-0646P-83

Figure 2-3 Keyboard (North American)

KEYBOARD

The keyboard (Figure 2-3) consists of the following parts.

- Main keypad
- Editing keypad
- Auxiliary keypad
- Top-row function keys
- Four visual indicators
- Two audible indicators

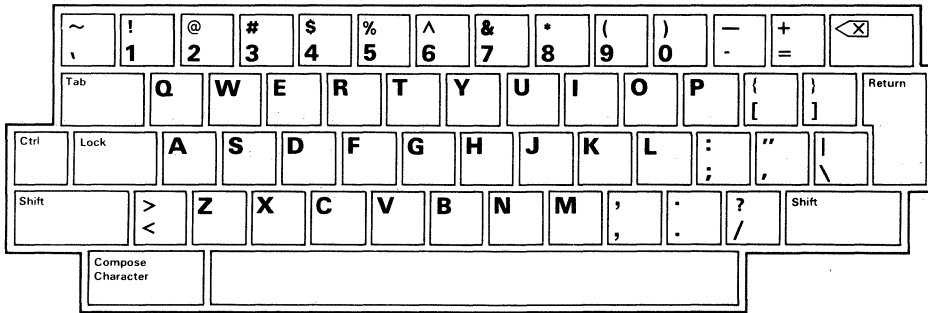

MA-101683

Figure 2-4 Main Keypad

MAIN KEYPAD

This keypad (Figure 2-4) operates like a standard typewriter keyboard.

The main keypad has the following special function keys.

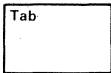

Tab

Pressing the **Tab** key sends a horizontal tab, which normally moves the cursor to the next tab stop.



Ctrl

Holding down the **Ctrl** key and pressing another key sends a control code to the system. A control code tells the system to perform a predefined operation.

In this manual, keyboard control functions using **Ctrl** appear as follows.

Ctrl-(other key)

For example, **Ctrl-Z** means to press and hold **Ctrl** while pressing the **Z** key.

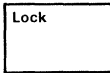
**Lock**

Pressing the **Lock** key down makes the alphabetic keys send uppercase characters. Pressing **Lock** again makes the alphabetic keys send lowercase characters. **Lock** is similar to the Shift Lock key on a typewriter.

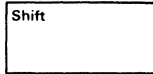
**Shift**

Holding down the **Shift** key and pressing another key sends uppercase characters, or the top symbol on two-character keys.

In some cases, you use **Shift** with another key to send a predefined control function. In this manual, a keyboard control function using **Shift** is shown as follows.



Shift-(other key)

For example, **Shift-Print Screen** means to press and hold **Shift** while pressing the **Print Screen** key.

**Return**

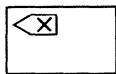
Pressing the **Return** key sends either a carriage return or a carriage return and line feed (selected in the General Set-Up screen, Chapter 4). In some cases, **Return** moves the cursor to the next line when editing text. In others, **Return** is a signal to the system that a particular operation is complete.

**(Delete)**

Pressing the  (delete) key sends a DEL (delete) character. Normally  (delete) erases one character to the left of the cursor. Typing **Shift-** (delete) sends a CAN (cancel) character.

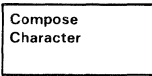

Compose Character

This key lets you create characters that do not exist as standard keys on your keyboard. See the "Composing Characters" section in Chapter 3 to use this key.

EDITING KEYPAD

Normally, you use the editing keypad (Figure 2-5) to control the cursor and edit data that you already entered.

In a typical editing operation, the four arrow keys move the cursor in the direction indicated by the arrow. The six editing keys have functions corresponding to their legends. See your application software manual for specific information.

AUXILIARY KEYPAD

The auxiliary keypad (Figure 2-6) lets you enter numeric data as you would with a standard calculator. Some keys (**PF1**, **PF2**, **PF3**, and **PF4**) may have functions assigned by the application software. See your application software manual for specific information.

The **Enter** key can cause a carriage return or a carriage return and line feed, depending on the General Set-Up screen selection. You also use **Enter** in set-up, to activate a selected feature.

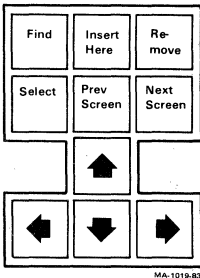

Figure 2-5 Editing Keypad

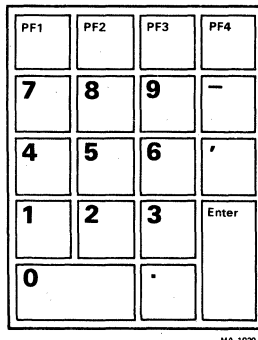
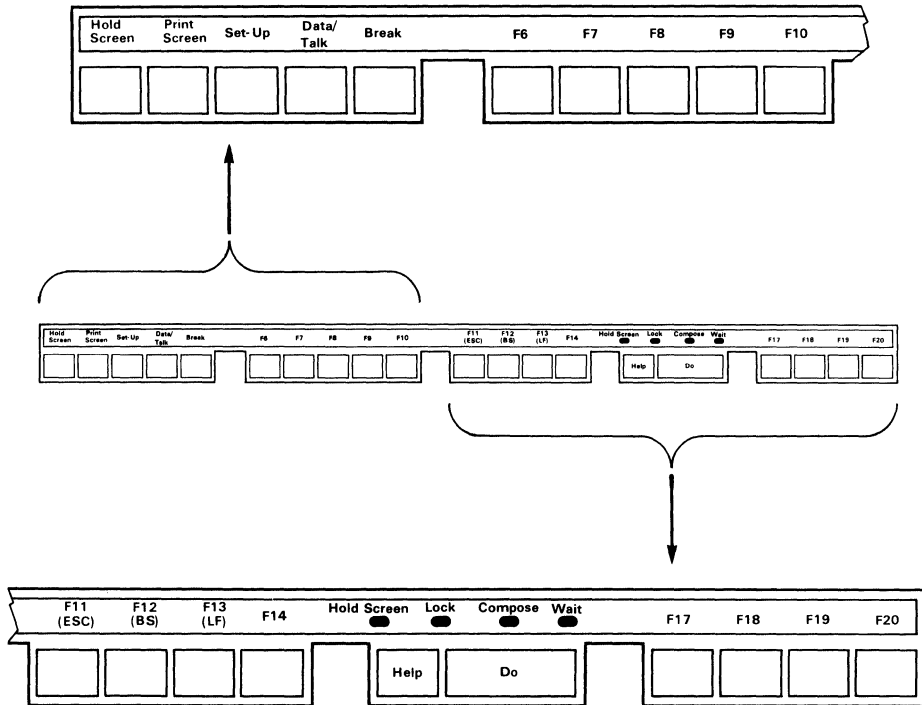

Figure 2-6 Auxiliary Keypad



MA-1017-83A

Figure 2-7 Top Row of Function Keys and Visual Indicators

TOP-ROW FUNCTION KEYS

Most of the top-row function keys (Figure 2-7) have functions assigned by the application software. Your application software manual should describe the function of these keys. The following paragraphs describe the predefined top-row keys.

Hold
Screen



Hold Screen

Pressing the **Hold Screen** key freezes the screen display and stops any new characters from being displayed. The Hold Screen indicator comes on when you press this key. Pressing **Hold Screen** again returns the terminal to normal operation and turns off the Hold Screen indicator.

Print
Screen



Print Screen

Pressing the **Print Screen** key sends the text on the screen to the printer.

Typing **Ctrl-Print Screen** sets or resets auto print mode. See the "Auto Print Mode" section in Chapter 3.

Set-Up



Set-Up

Pressing the **Set-Up** key causes the terminal to enter or exit the set-up state. (See Chapter 4.)

Data/
Talk



Data/Talk

The **Data/Talk** key only operates if EIA modem controls are enabled. (See Chapter 3.)

Break



Break

The **Break** key works alone or with other keys to perform an operation.

- Pressing **Break** alone sends a break if break is enabled in set-up. (See the "Keyboard Set-Up Screen" section in Chapter 4.)
- Typing **Shift-Break** starts a disconnect. (See the "Connect/Disconnect" section in Chapter 5.)
- Typing **Ctrl-Break** sends the answerback message to the host computer. (See the "Keyboard Set-Up Screen" section in Chapter 4.)

F11
(ESC)



F11
(ESC)

F11 is normally a function key used by application programs. In VT100 and VT52 modes, it sends an ESC (escape) character.

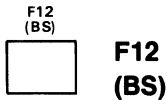

F12 is normally a function key used by application programs. In VT100 and VT52 modes, it sends a BS (backspace) character.

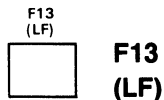

F13 is normally a function key used by application programs. In VT100 and VT52 modes, it sends an LF (line feed) character.

Function Key Summary

The following keys are function keys used by application programs. Each key takes on a meaning defined by the particular application program. The meaning of a key may or may not correspond to the legend on the key. The following list shows typical uses for each key. Actual use depends on the application.

Application-Defined Keys

F6
F7
F8
F9
F10
F11 (ESC)
F12 (BS)
F13 (LF)
F14
Help
Do
F17
F18
F19
F20

PF1
PF2
PF3
PF4

Cursor Positioning Keys

(←)
(→)
(!)
(!)

Editing Keys

Find
Insert Here
Remove
Select
Prev Screen
Next Screen

VISUAL INDICATORS

The keyboard has four visual indicators showing the current terminal status or operation in progress.

Hold Screen Indicator

The Hold Screen indicator is on when the video monitor screen is frozen. See the “Hold Screen” key description.

Lock Indicator

The Lock indicator comes on to indicate that the terminal will send uppercase characters only. See the “Lock” key description.

Compose Indicator

The Compose indicator comes on to indicate you are performing a compose sequence. (See the “Composing Characters” section in Chapter 3.)

Wait Indicator

The Wait indicator is on when the keyboard is prevented (locked) from sending information. You can clear this locked condition by invoking the `Clear Comm` feature from the Set-Up Directory screen (Chapter 4). See Chapter 5 for the causes of the keyboard lock condition.

AUDIBLE INDICATORS

The keyboard can generate two sounds you select from the Keyboard Set-Up screen (Chapter 4), a keyclick and a bell. You can use the bell as a margin bell, warning bell, or both.

Keyclick

The keyclick sound occurs each time you press a key, with the following exceptions.

- You press **Shift** or **Ctrl**. These keys do not make a keyclick, because they do not send a character. They modify characters sent by other keys.
- When the Wait indicator is on; characters from the keyboard are lost.
- The keyclick set-up feature is off.

Bell

The bell tone sounds in each of the following cases.

- As part of the power-up self-test
- When the terminal receives a bell (BEL) character from the computer
- After a compose character error
- When the cursor approaches the right margin

OPERATING PROCEDURES **3**

GENERAL

This chapter helps you to become familiar with some specific terminal functions and operating procedures. However, your main reference source is the documentation for your application software.

PRINTING

The VT220 has a built-in serial printer interface that supports the following optional Digital printers.

- LA34/38
- LA35/LA36
- LA12
- LA100
- LA120
- LA50
- LQP02

The VT220 printing functions operate in one of four modes selected from set-up screens (Chapter 4).

Mode	Set-Up Screen
Normal (default)	Printer Set-Up
Auto print	Printer Set-Up
Printer controller	Printer Set-Up
Local controller	Set-Up Directory and Printer Set-Up

These modes let the terminal perform several print operations selected from the keyboard and/or the computer.

Normal Mode

Normal mode lets you select all local printing functions (such as `Print Full Page`) from the keyboard.

Auto Print Mode

Auto print mode prints the current display line when the cursor moves to the next line. The cursor moves to the next line when the terminal (1) receives a line feed, form feed, or vertical tab code, or (2) automatically wraps the line. When selected, `Auto Print Mode` appears on the status line in set-up. You can use all keyboard printing functions (such as `Print Full Page`) in auto print mode.

To invoke auto print mode, type **Ctrl-Print Screen**. To exit auto print mode, type **Ctrl-Print Screen** again.

Printer Controller Mode

In printer controller mode, the host computer has direct control of the printer. Characters received from the host computer go directly to the printer, and are not displayed on the screen. (See Chapter 5.) When selected, `Printer Controller Mode` appears on the status line in set-up. You cannot select this mode from the keyboard (except by entering set-up).

You cannot use local printing functions in printer controller mode. For example, `Print Full Page` does not work.

Local Controller Mode

Local controller mode is a special mode that lets you send information directly from the keyboard to the printer. You may find this feature useful in setting up certain printers for operation, without involving the host computer.

To select local controller mode, you must select two different set-up features.

1. **Local** - selected in the Set-Up Directory screen.
2. **Printer Controller Mode** - selected in the Printer Set-Up screen.

When you select these two set-up features, the terminal is in local controller mode.

OPTIONAL MODEM

An optional modem lets the VT220 communicate over a telephone line with a remote host computer. The VT220 accepts compatible modems such as the AT&T 103, 113, and 212 types, in addition to Digital's DF02 and DF03. (See Appendix B, "Options, Documentation, and Supplies.") See Chapter 5 for more information on communications.

COMPOSING CHARACTERS

You can use *compose sequences* to create characters that do not exist as standard keys on your keyboard. To use a compose sequence, you press a series of keys. There are two types of compose sequences: three-stroke sequences and two-stroke sequences.

NOTE: The compose sequences you can use depend on the character set mode selected (multinational or national). Table 3-1 lists the valid compose sequences for multinational mode. Table 3-2 lists the valid compose sequences for each keyboard in national mode. In national mode, the compose sequences you can use depend on the keyboard selected.

You can use three-stroke sequences on all VT220 keyboards. First you press the **Compose Character** key, then you press two standard keys whose characters form a valid compose sequence.

You can use two-stroke sequences on all keyboards except the North American keyboard. Two-stroke sequences are faster than three-stroke sequences, but are limited to sequences starting with the following nonspacing diacritical marks: grave accent, acute accent, circumflex accent, tilde mark, diaeresis mark (umlaut), and ring mark. Two-stroke sequences do not use the **Compose Character** key. Instead, you enter a nonspacing diacritical mark first. Then enter a standard character that forms a valid compose sequence with the diacritical mark.

Diacritical marks are available on all but the North American keyboard. The diacritical marks vary among the keyboards, depending on relative use. Also, some keyboards have keys that contain both a standard character and a diacritical mark.

As with standard keys, you select the character you want with the **Shift** and **Lock** keys.

If you use a diacritical mark within a three-stroke sequence, the diacritical mark is treated as its equivalent character.

Diacritical Mark	Equivalent Character
Diaeresis (umlaut) mark	Double quote “
Acute accent	Apostrophe ’
Grave accent	Single quote `
Circumflex accent	Circumflex character ^
Tilde mark	Tilde character ~
Ring mark	Asterisk * or degree °

Tables 3-1 and 3-2 list all valid compose sequences for multinational and national modes respectively. Depending on the keyboard, you can create characters in column 1 in one or more ways.

- With a standard key (if available on that keyboard)
- With a three-stroke compose sequence (always)
- With a two-stroke compose sequence (if the diacritical mark is available on the keyboard)

Using a Three-Stroke Compose Sequence

Create a three-stroke compose sequence as follows.

1. Find the character you want to create in column 1 of Table 3-1 or 3-2.
2. Press the **Compose Character** key. (The Compose indicator comes on, indicating the terminal is in compose mode.)
3. Type the two characters in column 2 for the character you want to create.

For example, to create e with acute accent, press **Compose Character**, and then type e and apostrophe; or press **Compose Character**, and then type apostrophe and e.

When you complete a valid sequence, the Compose indicator turns off and the composite character is sent to the application. If you use an invalid sequence, the sequence is aborted and the bell sounds (if the warning bell is enabled in the Keyboard Set-Up screen, Chapter 4).

NOTE: Function keys abort a compose sequence without sounding the bell.

Using a Two-Stroke Compose Sequence

Create two-stroke compose sequence as follows.

NOTE: You can use two-stroke compose sequences on all keyboards except the North American keyboard.

1. Find the character you want to create in column 1 of Table 3-1 or 3-2. Verify in column 3 that the character can be created.
2. Press the key with the diacritical mark shown in column 3. (The Compose indicator comes on, indicating the terminal is in compose mode.)
3. Type the second character shown in column 3.

For example, to create e with a grave accent on a Danish keyboard, press the key that has the grave accent and then type e.

When you complete a valid sequence, the Compose indicator turns off and the Composite character is sent to the application. If you use an invalid sequence, the sequence is aborted and the bell sounds (if the warning bell is enabled in the Keyboard Set-Up screen, Chapter 4).

NOTE: Function keys abort a compose sequence without sounding the bell.

Aborting or Restarting a Compose Sequence

If you accidentally enter compose mode (by pressing the **Compose Character** key or a diacritical mark key), press the  (delete) key to immediately terminate the compose sequence and exit compose mode. No character is sent to the application.

If you press **Compose Character** during a compose sequence, a new three-stroke sequence starts from that point. The previous sequence is aborted, with no effect on the application.

Table 3-1 Valid Compose Sequences: Multinational Mode

In three-stroke sequences, you can enter required characters in any order unless the table says "order sensitive." You must enter all two-stroke sequences in the order shown.

(1) Composite Character	Required Characters	
	(2) Three-Stroke Sequence	(3) Two-Stroke Sequence
" (quotation mark)	" (sp)	"" (sp)
# (number sign)	++	
' (apostrophe)	' (sp)	' (sp)
@ (commercial at)	a a or A A	
[(opening bracket)	((
\ (backslash)	// or /<	
] (closing bracket)))	
^ (circumflex accent)	^ (sp)	^ (sp)
' (single quote)	' (sp)	' (sp)

Table 3-1 Valid Compose Sequences: Multinational Mode (Cont)

In three-stroke sequences, you can enter required characters in any order unless the table says "order sensitive." You must enter all two-stroke sequences in the order shown.

		Required Characters	
(1) Composite Character		(2) Three-Stroke Sequence	(3) Two-Stroke Sequence
{	(opening brace)	{-	
	(vertical line)	/^	
}	(closing brace)	}-	
~	(tilde)	~ (sp)	~ (sp)
¡	(inverted !)	!!	
¢	(cent sign)	c/ or C/ or c or C	
£	(pound sign)	l- or L- or l= or L=	
¥	(yen sign)	y- or Y- or y= or Y=	
§	(section sign)	s o or s O or s ! or s ! or s Ø or s Ø	
¤	(currency sign)	x o or x O or x Ø or x Ø	
©	(copyright sign)	c o or c O or c Ø or c Ø	
ª	(feminine ordinal indicator)	a- or A-	
«	(angle quotation mark left)	<<	
°	(degree sign)	ø ^ or (sp) # or (sp) °	°(sp)
±	(plus/minus sign)	±	
²	(superscript 2)	2^	
³	(superscript 3)	3^	
µ	(micro sign)	/u or /U (order sensitive)	
¶	(paragraph sign)	p! or P!	
·	(middle dot)	.^	

(sp) = space

Table 3-1 Valid Compose Sequences: Multinational Mode (Cont)

In three-stroke sequences, you can enter required characters in any order unless the table says "order sensitive." You must enter all two-stroke sequences in the order shown.

(1) Composite Character	Required Characters	
	(2) Three-Stroke Sequence	(3) Two-Stroke Sequence
¹ (superscript 1)	1 ^	
º (masculine ordinal indicator)	o- or o-	
» (angle quotation mark right)	>>	
¼ (fraction one-quarter)	1 4 (order sensitive)	
½ (fraction one-half)	1 2 (order sensitive)	
¿ (inverted ?)	??	
À (A grave)	A `	`A
Á (A acute)	A ´	´A
Â (A circumflex)	A ^	^A
Ã (A tilde)	A ~	~A
Ä (A umlaut)	"A or A"	"A
Å (A ring)	A* or A° (degree sign)	°A
Æ (A E ligature)	AE (order sensitive)	
Ç (C cedilla)	C,	
È (E grave)	E `	`E
É (E acute)	E ´	´E
Ê (E circumflex)	E ^	^E
Ë (E umlaut)	E" or E"	"E
Ì (I grave)	I `	`I
Í (I acute)	I ´	´I
Î (I circumflex)	I ^	^I
Ï (I umlaut)	I" or I"	"I

Table 3-1 Valid Compose Sequences: Multinational Mode (Cont)

In three-stroke sequences, you can enter required characters in any order unless the table says "order sensitive." You must enter all two-stroke sequences in the order shown.

		Required Characters	
(1) Composite Character		(2) Three-Stroke Sequence	(3) Two-Stroke Sequence
Ñ (N tilde)		N~	~N
ò (O grave)		o`	`o
ó (O acute)		o'	'o
ô (O circumflex)		o^	^o
õ (O tilde)		o~	~o
ö (O umlaut)		o" or o^^	^^o
œ (O E ligature)		o e (order sensitive)	
ù (U grave)		u`	`u
ú (U acute)		u'	'u
û (U circumflex)		u^	^u
ü (U umlaut)		u" or u^^	^^u
ÿ (Y umlaut)		y" or y^^	^^y
ß (German small sharp s)		ss	
à (a grave)		a`	`a
á (a acute)		a'	'a
â (a circumflex)		a^	^a
ã (a tilde)		a~	~a
ä (a umlaut)		a" or a^^	^^a
å (a ring)		a* or a ^o (degree sign)	^o a
æ (a e ligature)		a e (order sensitive)	
ç (c cedilla)		c ,(comma)	
è (e grave)		e`	`e
é (e acute)		e'	'e

Table 3-1 Valid Compose Sequences: Multinational Mode (Cont)

In three-stroke sequences, you can enter required characters in any order unless the table says "order sensitive." You must enter all two-stroke sequences in the order shown.

(1) Composite Character	Required Characters	
	(2) Three-Stroke Sequence	(3) Two-Stroke Sequence
ê (e circumflex)	e^	^e
ë (e umlaut)	e" or e^^	^^e
ì (i grave)	i`	`i
í (i acute)	i'	'i
î (i circumflex)	i^	^i
ï (i umlaut)	i" or i^^	^^i
ñ (n tilde)	n~	~n
ò (o grave)	o`	`o
ó (o acute)	o'	'o
ô (o circumflex)	o^	^o
õ (o tilde)	o~	~o
ö (o umlaut)	o" or o^^	^^o
œ (o e ligature)	o e (order sensitive)	
ø (o slash)	o/	
ù (u grave)	u`	`u
ú (u acute)	u'	'u
û (u circumflex)	u^	^u
ü (u umlaut)	u" or u^^	^^u
ÿ (y umlaut)	y" or y^^	^^y

Table 3-2 Valid Compose Sequences: National Mode

In three-stroke sequences, you can enter required characters in any order unless the table says "order sensitive." You must enter all two-stroke sequences in the order shown.

(1) Composite Character	Required Characters	
	(2) Three-Stroke Sequence	(3) Two-Stroke Sequence
British Keyboard		
£ pound sign	1- or L- or 1= or L=	
/ backslash	/<	
Flemish Keyboard		
£ (pound sign)	-L or -1 or =L or =1	
§ (section)	!s or !S or os or oS or Os or OS or øS or ØS or	
ù (u grave)	`u	
è (e grave)	`e	
French Canadian Keyboard		
à (a grave)	`a	`a
â (a circumflex)	^a	^a
ç (c cedilla)	,c	
ê (e circumflex)	^e	^e
è (e grave)	`e	`e
î (i circumflex)	^i	^i
ô (o circumflex)	^o	^o
ù (u grave)	`u	`u
û (u circumflex)	^u	^u

Table 3-2 Valid Compose Sequences: National Mode (Cont)

In three-stroke sequences, you can enter required characters in any order unless the table says "order sensitive." You must enter all two-stroke sequences in the order shown.

(1) Composite Character	Required Characters	
	(2) Three-Stroke Sequence	(3) Two-Stroke Sequence
Danish Keyboard		
# (number sign)	++	
Å (A umlaut)	**A	**A
Å (A ring)	* A	
Ø (O slash)	o/	
Û (U umlaut)	**U	**U
ä (a umlaut)	**a	**a
å (a ring)	*a	
ø (o slash)	o/	
ü (u umlaut)	**u	**u
Finnish Keyboard		
# (number sign)	++	
@ (commercial at)	aa OR AA OR aA	
Å (A ring)	*Å	
Û (U umlaut)	"U	
é (e acute)	'e	
å (a ring)	*a	
ü (u umlaut)	"u	
German Keyboard		
Å (A umlaut)	**A	
Û (U umlaut)	**U	
ä (a umlaut)	**a	
ü (u umlaut)	**u	

Table 3-2 Valid Compose Sequences: National Mode (Cont)

In three-stroke sequences, you can enter required characters in any order unless the table says "order sensitive." You must enter all two-stroke sequences in the order shown.

(1) Composite Character	Required Characters	(3) Two-Stroke Sequence
Dutch Keyboard		
£ (pound sign)	-L or -1 or =L or =1	
¾ (three quarters)	3 4 (order sensitive)	
ij (i j sign)	i j (order sensitive)	
½ (one half)	1 2 (order sensitive)	
Florin	f- (order sensitive)	
Italian Keyboard		
£ (pound sign)	-L or -1 or =L or =1	
§ (section)	!s or !S or os or oS or 0s or 0S or øS or ØS	
à (a grave)	`a	`a
ç (c cedilla)	,c	
é (e acute)	'e	

Table 3-2 Valid Compose Sequences: National Mode (Cont)

In three-stroke sequences, you can enter required characters in any order unless the table says "order sensitive." You must enter all two-stroke sequences in the order shown.

(1) Composite Character	Required Characters	
	(2) Three-Stroke Sequence	(3) Two-Stroke Sequence
Swiss (French) Keyboard		
ä (a umlaut)	``a	
ç (c cedilla)	,c	
ê (e circumflex)	^e	^e
î (i circumflex)	^i	^i
ô (o circumflex)	^o	^o
ö (o umlaut)	``o	
û (u circumflex)	^u	^u
ü (u umlaut)	``u	
ù (u grave)	`u	`u
Swiss (German) Keyboard		
à (a grave)	`a	`a
ç (c cedilla)	,c	
ê (e circumflex)	^e	^e
é (e acute)	'e	
è (e grave)	`e	`e
î (i circumflex)	^i	^i
ô (o circumflex)	^o	^o
û (u circumflex)	^u	^u
ù (u grave)	`u	`u

Table 3-2 Valid Compose Sequences: National Mode (Cont)

In three-stroke sequences, you can enter required characters in any order unless the table says "order sensitive." You must enter all two-stroke sequences in the order shown.

(1) Composite Character	Required Characters	
	(2) Three-Stroke Sequence	(3) Two-Stroke Sequence
Swedish Keyboard		
# (number sign)	++	
Å (A ring)	*Å	
É (E acute)	'E	
Ü (U umlaut)	"U	
Å (a ring)	*a	
é (e acute)	'e	
ü (u umlaut)	"u	
Norwegian Keyboard		
# (number sign)	++	
Å (A ring)	*Å	
Ä (A umlaut)	**Å	**Å
Æ (A E diphthong)	Å E (order sensitive)	
Ü (U umlaut)	**Ü	**Ü
ä (a umlaut)	**a	**a
æ (a e diphthong)	a e (order sensitive)	
å (a ring)	*a	
ü (u umlaut)	**u	**u

Table 3-2 Valid Compose Sequences: National Mode (Cont)

In three-stroke sequences, you can enter required characters in any order unless the table says "order sensitive." You must enter all two-stroke sequences in the order shown.

(1) Composite Character	Required Characters	
	(2) Three-Stroke Sequence	(3) Two-Stroke Sequence
French/Belgian Keyboard		
£ (pound sign)	-L or -l or =L or =l	
§ (section)	!s or !S or os or oS or Os or OS or øS or ØS	
è (e grave)	`e	
ù (u grave)	'u	
Spanish Keyboard		
£ (pound sign)	-L or -l or =L or =l	
§ (section)	!s or !S or os or oS or Os or OS or øS or ØS	
¡ (inverted !)	! !	
¿ (inverted ?)	? ?	
° (degree sign)	^ o	

TERMINAL SET-UP 4

GENERAL

This chapter describes the VT220 set-up screens, and how to use them. These screens let you examine or change terminal operating features such as transmit/receive speeds, type of cursor, and so on.

The VT220 stores many of its operating features in an NVR (nonvolatile RAM) memory. NVR memory retains these features even when power is shut off. In addition to storing operator-selected features, the terminal retains the factory-default settings. You can recall these default settings in set-up.

You can change all available set-up features from the keyboard. Some features can be changed by the host computer as described in the *VT220 Programmer Reference Manual*. (See Appendix B to order other documents).

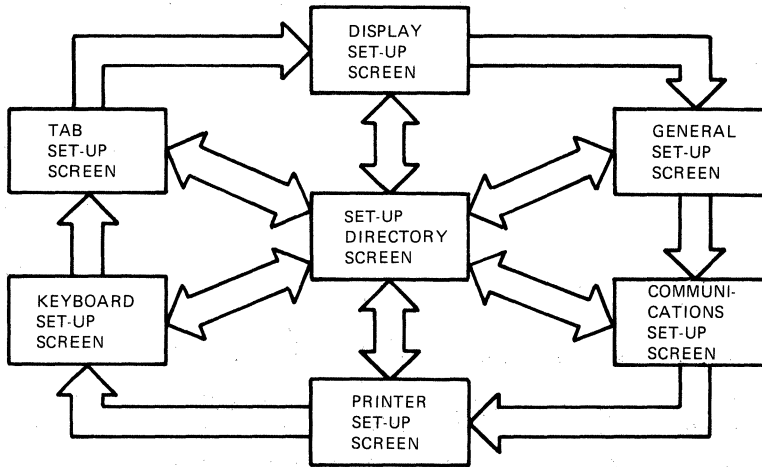

MA-1016-83

Figure 4-1 Set-Up Screens

USING SET-UP

The set-up state is based on selectable displays called set-up screens. You can select any set-up screen from the Set-Up Directory screen displayed when you enter set-up (Figure 4-1). Each set-up screen displays the features for that set-up function and lets you change or keep those features. You can only display one set-up screen at a time. You can enter the Set-Up Directory screen from any other set-up screen.

SET-UP SCREENS

Each set-up screen occupies the bottom third of the monitor screen. (Current screen data is temporarily invisible.) Incoming data is not lost if the host supports XOFF and that feature is enabled. (See the "Communications Set-Up Screen" section in this chapter.) Each screen contains the following information (Figure 4-2).

- Screen title
- Terminal identifier
- Firmware version number
- Status line
- Fields (action, parameter, text parameter)

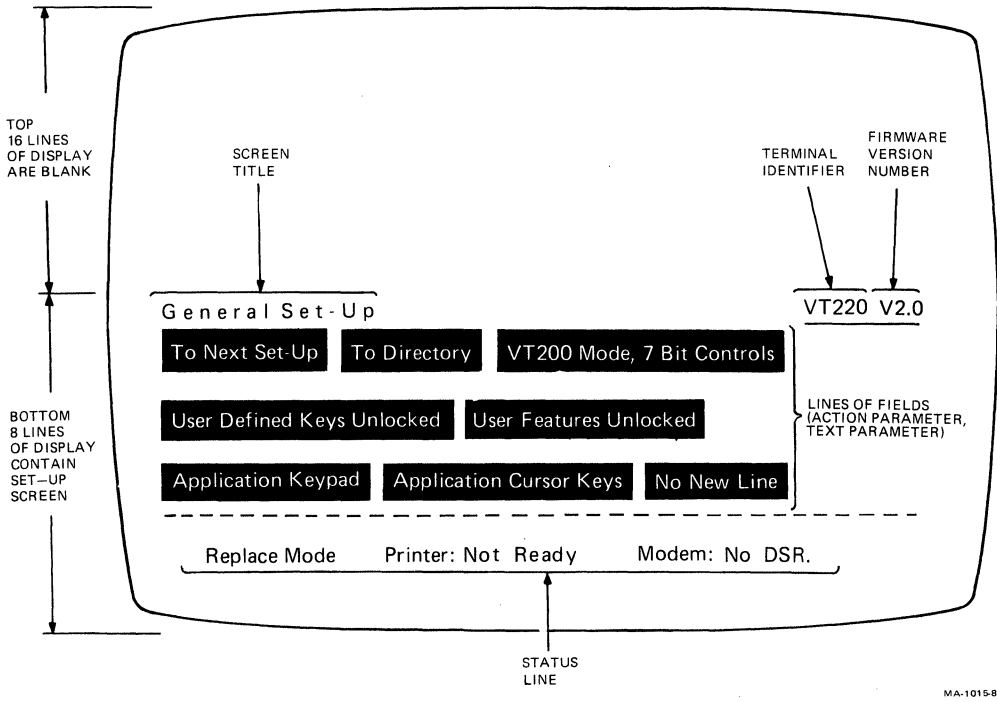

MA-1015-B3

Figure 4-2 Sample Set-Up Screen

Screen Title

The screen title identifies the current set-up screen. There are seven set-up screens.

1. Set-Up Directory
2. Display Set-Up
3. General Set-Up
4. Communications Set-Up
5. Printer Set-Up
6. Keyboard Set-Up
7. Tab Set-Up

Terminal Identifier

The terminal identifier identifies the type of terminal you are using, in this case a VT220.

Firmware Version Number

The firmware version number identifies the level of firmware the terminal is using.

Status Line

The status line appears at the bottom of each set-up screen. This line shows you the current status of the modem (if `E I A M o d e m C o n t r o l` is selected), the printer, and the terminal insert/replace mode. The status line is a reporting line only; you cannot change the status line from the keyboard. Table 4-1 describes the status line messages.

Report	Values	Meaning
Insert/ Replace:	Insert	The terminal is in insert mode. During normal text operation, all new display characters move old characters to the right; old characters moved past the right margin are lost.
	Replace	The terminal is in replace mode. During normal text operation, all new display characters replace old characters at the cursor position. Replace is the normal mode of operation.
Printer:	Ready	The printer is ready.
	Not Ready	The printer is not ready.
	None	No printer is available.
	Auto	The terminal is in auto print mode.
	Controller	The terminal is in printer controller mode.
Modem:	DSR,Data DSR,Talk	The modem is ready to send or receive data.
	No DSR,Data No DSR,Talk	The modem is not ready to send or receive data.

Fields

The fields on each screen are blocks of text describing current operating characteristics. There are three types of fields.

1. *Action Field*

An action field has only one value. When you select an action field and press the **Enter** key, the terminal performs the action.

For example, each screen has an action field that reads `To Directory`. When you select this field and press **Enter**, the Set-Up Directory screen replaces the current screen.

2. *Parameter Field*

A parameter field contains a feature that has two or more values. When you select a parameter field and press **Enter**, the next value replaces the current value.

For example, if you select the keyclick parameter field, it may have a value of `Keyclick`. Pressing **Enter** changes the field to `No Keyclick`.

3. *Text Parameter Field*

A text parameter field lets you enter a value from the keyboard. You can select a text parameter field as follows.

1. Use the arrow keys to move the field cursor to the text parameter field. (See the following "Set-Up Controls and Cursor" section.)
2. Press **Enter**. The terminal prompts you to enter text on the status line at the bottom of the screen, temporarily overwriting the status line.
3. Type the text you want entered as the new value. The value appears next to the prompt.
4. Press **Enter** to enter the new value.

If you make a mistake, press the  (delete) key to erase the last character entered. If you want to abort the entry without changing the original value, press an arrow key to change the field selection. (See the following "Set-Up Controls and Cursor" section.)

Set-Up Controls and Cursor

The VT220 uses a field cursor while in set-up. The field cursor appears as a highlighted field (reverse video) that you can move from field to field with the arrow keys.

Table 4-2 describes the keys used to enter and exit set-up, move the field cursor, and change operating characteristics.

Table 4-2 Set-Up Controls and Cursor Functions	
Control Key	Function
Set-Up	Pressing the Set-Up key one time places the terminal in set-up. Pressing Set-Up again returns the terminal to the operating state (on-line or local).
Arrow keys	Pressing the arrow keys moves the field cursor in the direction of the arrow.
Enter	<p>The Enter key lets you perform the function displayed at the field cursor position.</p> <p>If the cursor is on an action field, pressing Enter immediately performs the action.</p> <p>If the cursor is on a parameter field, pressing Enter changes the value of the field. You can use the Enter key to see the range of available field values. The value displayed is the current value invoked.</p>

SET-UP EXAMPLE: CHANGING FEATURES

This section provides an example of changing the terminal operating characteristics in set-up.

Suppose the terminal is currently set to display its text in 80 columns, and the keyboard keys click each time you press them.

You decide to change these two operating characteristics so the terminal displays 132 columns, and the keys do not click when pressed.

Use the following procedure to change these two operating characteristics in set-up.

1. Press the **Set-Up** key. The terminal enters set-up and displays the Set-Up Directory screen (Figure 4-3).
2. Note that the cursor is on the `Display` field.
3. Press the **Enter** key. The terminal replaces the Set-Up Directory screen with the Display Set-Up screen (Figure 4-4).
4. Use the arrow keys to move the field cursor to the `80 Columns` field.
5. Press **Enter**. The field changes from `80 Columns` to `132 Columns`, indicating that the feature changed.

NOTE: Although many parameter changes are immediate (such as the column feature), some changes do not take effect until you exit set-up.

6. Use the arrow keys to move the field cursor to the `To Directory` field. (You want to change another feature.)
7. Press **Enter**. The terminal replaces the Display Set-Up screen with the Set-Up Directory screen.
8. Use the arrow keys to move the field cursor to the `Keyboard` field.
9. Press **Enter**. The terminal replaces the Set-Up Directory screen with the Keyboard Set-Up screen (Figure 4-8).
10. Use the arrow keys to move the field cursor to the `Keyclick` field.
11. Press **Enter**. The field changes from `Keyclick` to `No Keyclick`, indicating that the feature changed.
12. Press **Set-Up** to exit set-up and return to the operating mode (on-line or local).

SET-UP SCREEN DESCRIPTIONS

The following sections describe the set-up screens and their features. When you select the various set-up features you want to use, make sure to check off the box beside the parameter value selected for that feature. This gives you a record of the values selected, in case the settings are accidentally changed or lost. If repairs to the terminal are necessary, the technician needs this information to reset the set-up feature values.

Table 4-3 summarizes the set-up screens. The table lists the features available on each screen.

Table 4-3 Set-Up Screens Summary

Set-Up Directory	Display Set-Up	General Set-Up
Display Set-Up	To Next Set-Up	To Next Set-Up
General Set-Up	To Directory	To Directory
Communications Set-Up	80/132 Columns	Terminal Mode
Printer Set-Up	Control Representation	VT100 Mode ID
Keyboard Set-Up	Mode	UDK Lock
Tab Set-Up	Auto Wrap	User Features Lock
On-Line/Local	Smooth/Jump Scroll	Character Set Mode
Clear Display	Light/Dark Screen	Keypad Mode
Clear Communications	Cursor	Cursor Key Mode
Reset Terminal	Cursor Style	New Line
Recall Saved Parameters		
Save Parameters		
Set-Up Language		
Keyboard Language		
Factory Defaults		
Exit Set-Up		
Communications Set-Up	Printer Set-Up	Keyboard Set-Up
To Next Set-Up	To Next Set-Up	To Next Set-Up
To Directory	To Directory	To Directory
Transmit Speed	Transmit/Receive Speed	Typewriter/D.P. Keys
Receive Speed	Print Mode	Caps/Shift-Lock
XOFF	Data-Bits Parity	Auto Repeat
Data-Bits/Parity	Stop Bits	Keyclick
Stop Bits	Print Page/Region	Margin Bell
Local Echo	Printed Data Type	Warning Bell
Host Port Selection	Print Terminator	Break
Disconnect		Auto Answerback
Transmit Rate Limit		Answerback=
		Conceal Answerback
Tab Set-Up		
To Next Set-Up		
To Directory		
Clear All Tabs		
Set 8 Column Tabs		
Tab Fields and Ruler		

SET-UP DIRECTORY SCREEN

The Set-Up Directory screen (Figure 4-3) appears immediately when you enter set-up. This screen lets you access any other set-up screen. The Set-Up Directory screen also contains fields you can use to select terminal operating features.

Table 4-4 describes all fields on this screen.

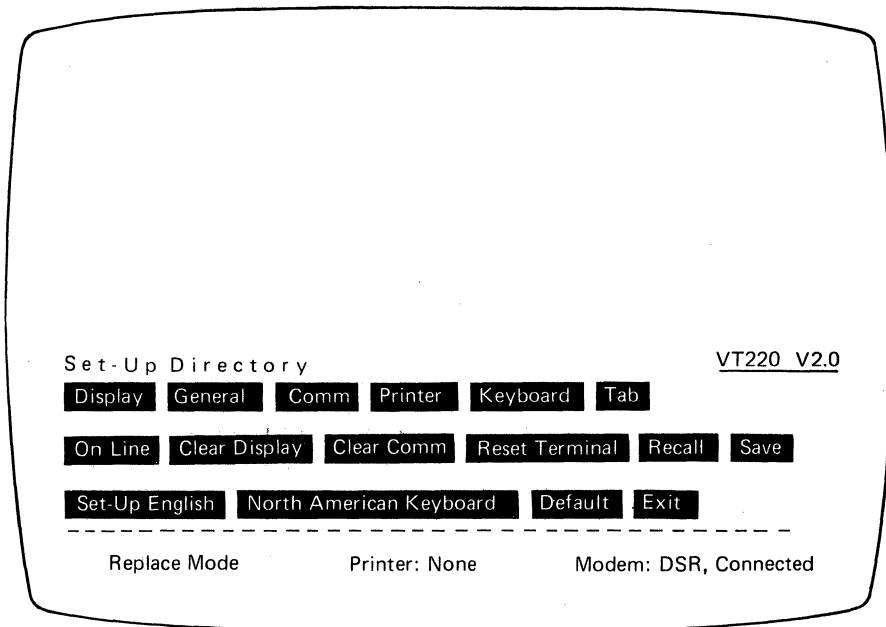

MA-1007-83

Figure 4-3 Set-Up Directory Screen

Table 4-4 Set-Up Directory Screen

Field	Function
Display	Replaces the Set-Up Directory screen with the Display Set-Up screen.
Action field	
Value: Display	
General	Replaces the Set-Up Directory screen with the General Set-Up screen.
Action field	
Value: General	
Comm	Replaces the Set-Up Directory screen with the Communications Set-Up screen.
Action field	
Value: Comm	
Printer	Replaces the Set-Up Directory screen with the Printer Set-Up screen.
Action field	
Value: Printer	
Keyboard	Replaces the Set-Up Directory screen with the Keyboard Set-Up screen.
Action field	
Value: Keyboard	
Tab	Replaces the Set-Up Directory screen with the Tab Set-Up screen.
Action field	
Value: Tab	

Table 4-4 Set-Up Directory Screen (Cont)

Field	Function
<p>On-Line or Local</p> <p>Parameter field</p> <p>Values:</p> <p><input type="checkbox"/> On-Line (default)</p> <p><input type="checkbox"/> Local</p>	<p>Lets you select the mode of operation.</p> <p>Lets the terminal communicate with the host computer.</p> <p>Effectively puts the host computer on hold. Data entered at the keyboard is sent directly to the monitor screen only.</p>
<p>Clear Display</p> <p>Action field</p> <p>Value: Clear Display</p>	<p>Clears the monitor screen when you exit set-up.</p>
<p>Clear Comm</p> <p>Action field</p> <p>Value: Clear Comm</p>	<p>Clears communication as follows.</p> <ul style="list-style-type: none"> • Aborts any print operation in progress. • Aborts any escape sequence, control sequence, or device control string (DCS) processing. • Clears the keyboard buffers. • Clears the receive buffer. • Clears the transmit buffer. • Takes the terminal out of printer controller mode. • Sends XON to the host port. • Resets XOFF received flags on the printer and host ports.

Table 4-4 Set-Up Directory Screen (Cont)

Field	Function
<p>Reset Terminal Action field Value: Reset Terminal</p>	<p>Resets many terminal operating features to a default setting used by most application programs. The screen, communication, national and multinational modes, and user-defined keys are not affected.</p>
<p>Recall Action field</p>	<p>Replaces all existing set-up features with saved values. Clears the monitor screen.</p>
<p><i>NOTE: Recall causes a disconnect to occur.</i></p>	
<p>Value: Recall</p>	
<p>Save Action field</p>	<p>Saves all set-up features in all set-up screens.</p>
<p>Value: Save</p>	
<p>Set-Up=_____ Parameter field</p>	<p>Lets you select the language used to display set-up screens.</p>
<p>Values: <input type="checkbox"/> Set-Up= English <input type="checkbox"/> Set-Up= Francais <input type="checkbox"/> Set-Up= Deutsch</p>	

Table 4-4 Set-Up Directory Screen (Cont)

Field	Function
<p>_____Keyboard</p>	<p>This field lets you select correct terminal operation for the national keyboard you are using.</p>
<p>Parameter field</p>	
<p>Values:</p>	
<p><input type="checkbox"/> North American</p>	
<p><input type="checkbox"/> British</p>	
<p><input type="checkbox"/> Flemish</p>	
<p><input type="checkbox"/> Canadian (French)</p>	
<p><input type="checkbox"/> Danish</p>	
<p><input type="checkbox"/> Finnish</p>	
<p><input type="checkbox"/> German</p>	
<p><input type="checkbox"/> Dutch</p>	
<p><input type="checkbox"/> Italian</p>	
<p><input type="checkbox"/> Swiss (French)</p>	
<p><input type="checkbox"/> Swiss (German)</p>	
<p><input type="checkbox"/> Swedish</p>	
<p><input type="checkbox"/> Norwegian</p>	
<p><input type="checkbox"/> French/Belgian</p>	
<p><input type="checkbox"/> Spanish</p>	
<p>Default</p>	<p>Replaces all current set-up features with factory-default settings. Clears the monitor screen and returns the cursor to the upper-left corner of the screen.</p>
<p>Action field</p>	
<p>Value: Default</p>	
<p><i>NOTE: Default causes a disconnect to occur.</i></p>	
<p>Exit</p>	<p>Exits set-up and returns the terminal to on-line or local.</p>
<p>Action field</p>	
<p>Value: Exit</p>	

DISPLAY SET-UP SCREEN

The Display Set-Up screen (Figure 4-4) lets you define monitor display characteristics.

Table 4-5 describes all fields on this screen.

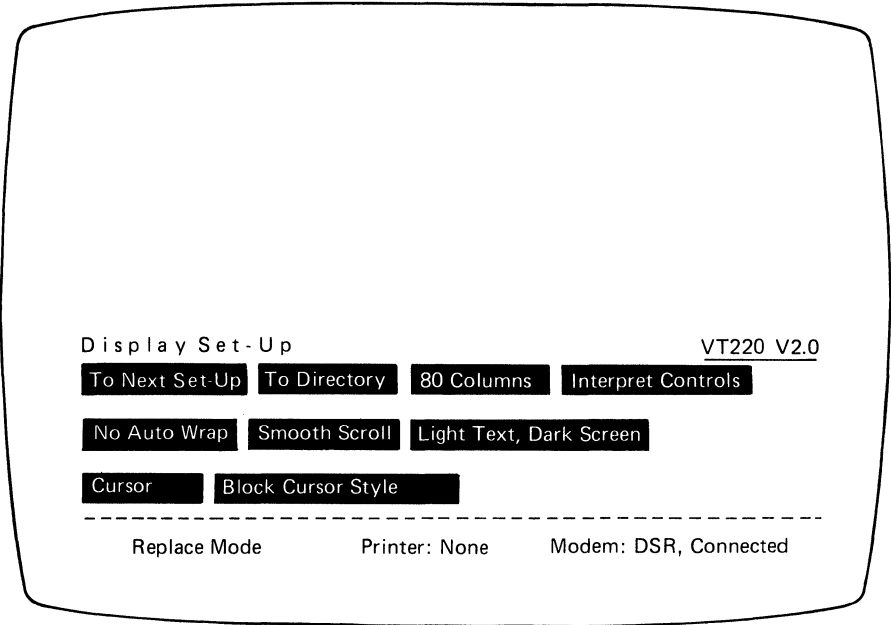

MA-1006-83

Figure 4-4 Display Set-Up Screen

Table 4-5 Display Set-Up Screen

Field	Function
To Next Set-Up	Replaces the Display Set-Up screen with the General Set-Up screen.
Action field	
Value: To Next Set-Up	
To Directory	Replaces the Display Set-Up screen with the Set-Up Directory screen.
Action field	
Value: To Directory	
_____ Columns	Selects an 80 or 132-column screen display for text. A change to this field takes effect immediately and clears the display.
Parameter field	
Values:	
<input type="checkbox"/> 80 Columns (default)	Selects 80-column screen.
<input type="checkbox"/> 132 Columns	Selects 132-column screen.
_____ Controls	Selects how the terminal handles control codes from the host computer.
Parameter field	
Values:	
<input type="checkbox"/> Interpret Controls (default)	Interprets control codes, but does not display them.
<input type="checkbox"/> Display Controls	Displays the control codes as characters, but does not execute them.

Table 4-5 Display Set-Up Screen (Cont)

Field	Function
Auto Wrap	Selects whether or not display text automatically wraps on screen.
Parameter field	
Values:	
<input type="checkbox"/> No Auto Wrap (default)	Causes characters received after the right margin to be overwritten into the last character position of the current line.
<input type="checkbox"/> Auto Wrap	Causes a character received after the right margin to automatically appear in the first character position of the next line.
_____ Scroll	Selects how fast lines appear on the screen.
Parameter field	
Values:	
<input type="checkbox"/> Smooth Scroll (default)	Limits the speed at which new lines appear on the screen, causing a smooth steady scroll.
<input type="checkbox"/> Jump Scroll	Displays new lines as fast as they are received, causing a jump scroll.
_____ Text , _____ Screen	Selects the screen display type.
Parameter field	
Values:	
<input type="checkbox"/> Light Text , Dark Screen (default)	Selects a normal screen display (light text on a dark background).
<input type="checkbox"/> Dark Text , Light Screen	Selects reverse video screen display (dark text on a light background).

Table 4-5 Display Set-Up Screen (Cont)

Field	Function
Text Cursor	Selects whether or not the text cursor is displayed.
Parameter field	
Values:	
<input type="checkbox"/> Cursor (default)	Displays the cursor.
<input type="checkbox"/> No Cursor	Does not display the cursor.
_____ Cursor Style	Selects the text cursor style displayed.
Parameter field	
Values:	
<input type="checkbox"/> Block Cursor (default)	Displays block cursor.
<input type="checkbox"/> Underline Cursor	Displays underline cursor.

GENERAL SET-UP SCREEN

The General Set-Up screen (Figure 4-5) lets you define a group of commonly used general operating features.

Table 4-6 describes all fields on this screen.

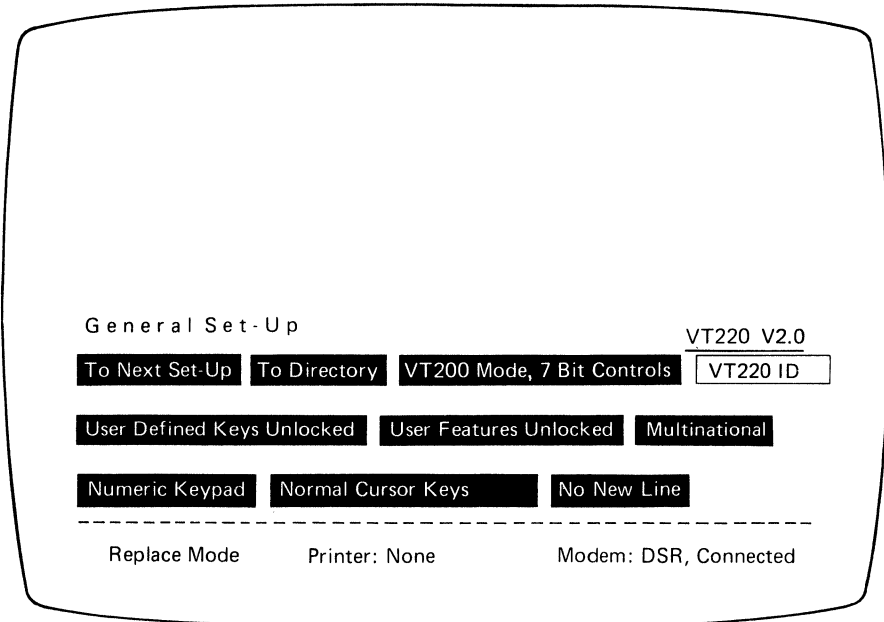

MA-1012-83

Figure 4-5 General Set-Up Screen

Table 4-6 General Set-Up Screen	
Field	Function
<p>To Next Set-Up</p> <p>Action field</p> <p>Value: To Next Set-Up</p>	<p>Replaces the General Set-Up screen with the Communications Set-Up screen.</p>
<p>To Directory</p> <p>Action field</p> <p>Value: To Directory</p>	<p>Replaces the General Set-Up screen with the Set-Up Directory screen.</p>
<p>_____ Mode _____</p> <p>Parameter field</p> <p>Values:</p> <p><input type="checkbox"/> VT200 Mode, 7-Bit Controls (default)</p> <p><input type="checkbox"/> VT200 Mode, 8-Bit Controls</p> <p><input type="checkbox"/> VT52 Mode</p> <p><input type="checkbox"/> VT100 Mode</p>	<p>Selects the basic text operating mode.</p> <p>Sets the terminal to operate with a full range of capabilities, using 8-bit graphic characters and 7-bit controls. This is the recommended mode for most applications.</p> <p>Sets the terminal to operate with a full range of capabilities in an 8-bit environment with 8-bit controls. Many applications designed for the VT100 terminal will run in this mode.</p> <p>Sets the terminal for use with application programs designed for the VT52 terminal.</p> <p>Sets the terminal for use with application programs designed for a VT100 terminal and requiring strict VT100 compatibility. In general, use VT200 mode, 7-bit controls if possible.</p>

Table 4-6 General Set-Up Screen (Cont)

Field	Function
VT100 Mode Terminal ID Parameter field	Selects the Device Attributes response (terminal ID) in VT100 mode.
<i>NOTE: This field is unique. It appears only when the terminal is in VT100 mode.</i>	
Values:	
<input type="checkbox"/> VT220 ID (default)	Causes the terminal to send the device attributes of a VT220 terminal to the host computer.
<input type="checkbox"/> VT100 ID	Causes the terminal to send the device attributes of a VT100 terminal to the host computer.
<input type="checkbox"/> VT101 ID	Causes the terminal to send the device attributes of a VT101 terminal to the host computer.
<input type="checkbox"/> VT102 ID	Causes the terminal to send the device attributes of a VT102 terminal to the host computer.
User Defined Keys _____ Parameter field	Selects whether or not the host can change user-defined key (UDK) definitions.
Values:	
<input type="checkbox"/> User Defined Keys Unlocked (default)	Allows UDKs to be loaded.
<input type="checkbox"/> User Defined Keys Locked	Prevents UDKs from being loaded.

Table 4-6 General Set-Up Screen (Cont)

Field	Function
User Features _____	Selects whether or not the host can change user preference features you have set.
Parameter field	
Values:	
<input type="checkbox"/> User Features Unlocked (default)	Lets the host change user features.
<input type="checkbox"/> User Features Locked	Prevents the host from changing features.
	The following user preference features are affected by this feature.
	<ul style="list-style-type: none"> • Auto Repeat • Smooth/Jump Scroll • Light/Dark Screen • Tab Stops • Keyboard Lock
<i>NOTE: Some software applications expect to control the above user features. If this applies to your particular software, set the value to User Features Unlocked to ensure predictable behavior.</i>	
Character Set Mode	Selects either the national or multinational character set mode.
Parameter field	
<i>NOTE: If the North American keyboard has been selected, only multinational mode is available for use. National mode is disabled.</i>	
Values:	
<input type="checkbox"/> Multinational (default)	Enables the terminal to generate 8-bit multinational characters, including 7-bit ASCII characters.
<input type="checkbox"/> National	Causes the terminal to use one of eleven 7-bit national replacement character sets. The NRC set depends on the keyboard field selected in the Set-Up Directory screen.

Table 4-6 General Set-Up Screen (Cont)

Field	Function
<p>_____ Keypad</p> <p>Parameter field</p> <p>Values:</p> <p><input type="checkbox"/> Numeric Keypad (default)</p> <p><input type="checkbox"/> Application Keypad</p>	<p>Selects whether or not the keypad sends ASCII character codes or escape sequences.</p> <p>Causes the auxiliary keypad to send ASCII character codes corresponding to the numeric characters on the keys.</p> <p>Causes the auxiliary keypad to send escape sequences used by an application program.</p>
<p>_____ Cursor Keys</p> <p>Parameter field</p> <p>Values:</p> <p><input type="checkbox"/> Normal Cursor Keys (default)</p> <p><input type="checkbox"/> Application Cursor Keys</p>	<p>Selects whether or not the cursor keys send ANSI cursor control sequences or application control functions.</p> <p>Cursor keys send ANSI cursor control sequences (up, down, left, and right).</p> <p>Cursor keys send application program control functions.</p>
<p>_____ New Line</p> <p>Parameter field</p> <p>Values:</p> <p><input type="checkbox"/> No New Line (default)</p> <p><input type="checkbox"/> New Line</p>	<p>Selects whether or not the Return key sends a carriage return only, or a carriage return and a line feed.</p> <p>The Return key sends a carriage return only.</p> <p>The Return key sends a carriage return and a line feed.</p>
<p><i>NOTE: When the terminal is in numeric keypad mode, this feature affects the Enter key in the same way it does the Return key.</i></p>	

COMMUNICATIONS SET-UP SCREEN

The Communications Set-Up screen (Figure 4-6) lets you define the communications environment between the terminal and host.

Table 4-7 describes all fields on this screen.

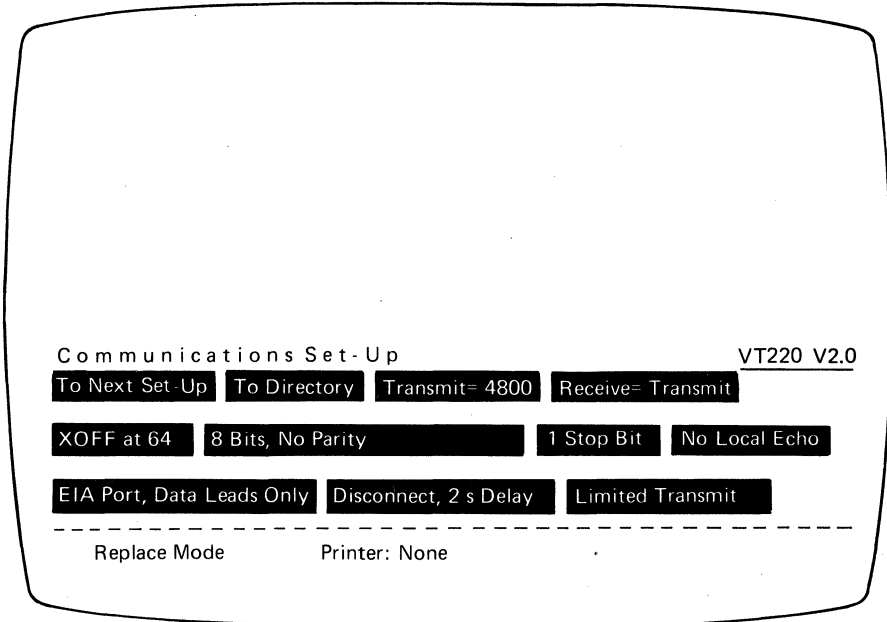

MA-1008-83

Figure 4-6 Communications Set-Up Screen

Table 4-7 Communications Set-Up Screen

Field	Function
<p>To Next Set-Up Action field Value: To Next Set-Up</p>	<p>Replaces the Communications Set-Up screen with the Printer Set-Up screen.</p>
<p>To Directory Action field Value: To Directory</p>	<p>Replaces the Communications Set-Up screen with the Set-Up Directory screen.</p>
<p>Transmit= _____ Parameter field</p>	<p>Selects the rate the terminal uses to send data to the host computer.</p>

NOTE: This feature does not set the format for the printer port.

Values:

- Transmit= 75
- Transmit= 110
- Transmit= 150
- Transmit= 300
- Transmit= 600
- Transmit= 1200
- Transmit= 2400
- Transmit= 4800
(default)
- Transmit= 9600
- Transmit= 19200

The terminal transmit speed must match the computer receive speed. However, the terminal can transmit at one speed and receive at another.

Table 4-7 Communications Set-Up Screen (Cont)

Field	Function
<p>Receive= _____</p> <p>Parameter field</p> <p>Values:</p> <ul style="list-style-type: none"> <input type="checkbox"/> Receive=Transmit (default) <input type="checkbox"/> Receive= 75 <input type="checkbox"/> Receive= 110 <input type="checkbox"/> Receive= 150 <input type="checkbox"/> Receive= 300 <input type="checkbox"/> Receive= 600 <input type="checkbox"/> Receive= 1200 <input type="checkbox"/> Receive= 2400 <input type="checkbox"/> Receive= 4800 <input type="checkbox"/> Receive= 9600 <input type="checkbox"/> Receive= 19200 	<p>Selects the rate the terminal uses to receive data from the host computer.</p> <p>The terminal receive speed must match the computer transmit speed. However, the terminal can receive at one speed and transmit at another.</p>
<p>_____ XOFF _____</p> <p>Parameter field</p> <p>Values:</p> <ul style="list-style-type: none"> <input type="checkbox"/> XOFF at 64 (default) <input type="checkbox"/> XOFF at 128 <input type="checkbox"/> No XOFF 	<p>Selects the XOFF point or disables the automatic XON/XOFF flow control. (See the "Terminal-Host Data Flow Control" section in Chapter 5.)</p> <p>For most applications you should set XOFF at 64 or 128.</p> <p>Selects an XOFF of 64 characters.</p> <p>Selects an XOFF of 128 characters.</p> <p>Disables automatic XON/XOFF.</p>

Table 4-7 Communications Set-Up Screen (Cont)

Field	Function
<p>___ Bits, ___ Parity ___ Parameter field</p>	<p>Selects the character format used for communication with the host computer. (See the "Character Format" section in Chapter 5.)</p>

NOTE: This feature does not set the format for the printer port.

Select the correct character format to match the printer. For example, if you are using a 7-bit compatible printer, then you should select one of the five 7-bit parameter field options.

Values:

- 8 Bits, No Parity
(default)
- 8 Bits, Even Parity
- 8 Bits, Odd Parity
- 7 Bits, No Parity
- 7 Bits, Even Parity
- 7 Bits, Odd Parity
- 7 Bits, Mark Parity
- 7 Bits, Space Parity
- 7 Bits, Even Parity,
No Check
- 7 Bits, Odd Parity,
No Check
- 8 Bits, Even Parity
No Check
- 8 Bits, Odd Parity
No Check

<p>___ Stop Bit___ Parameter field</p>	<p>Sets the number (1 or 2) of stop bits used by the host port (See the "Character Format" section in Chapter 5.)</p>
--	---

NOTE: This feature does not set the format for the printer port.

Values:

- 1 Stop Bit
(default)
- 2 Stop Bits

Table 4-7 Communications Set-Up Screen (Cont)

Field	Function
<p>Local Echo</p> <p>Parameter field</p> <p>Values:</p> <p><input type="checkbox"/> No Local Echo (default)</p> <p><input type="checkbox"/> Local Echo</p>	<p>Enables or disables the local echo feature.</p> <p>Sends data from the keyboard to the host computer only. The host may or may not send the data back to the monitor screen.</p> <p>Sends data from the keyboard to monitor screen as well as the host computer.</p>
<p>_____ Port _____</p> <p>Parameter field</p> <p>Values:</p> <p><input type="checkbox"/> EIA Port , Data Leads Only (default)</p> <p><input type="checkbox"/> 20 mA Port</p> <p><input type="checkbox"/> EIA Port , Modem Control</p>	<p>Selects the type of port used for communication with the host computer. (See the "Host and Printer Port Interfaces" section in Chapter 5.)</p> <p>Select EIA port, data leads only if the terminal connects to the host computer via the EIA host port.</p> <p>Select the 20 mA port if the terminal connects to the host computer via the 20 mA port.</p> <p>Select EIA port, modem control if the terminal connects to the host via the EIA host port and an external modem requiring EIA modem control is used.</p>

Table 4-7 Communications Set-Up Screen (Cont)

Field	Function
Disconnect, _____ Delay	When modem control is used, the disconnect delay feature determines the time allowed before the terminal disconnects from the communications line when the received line signal detection (RLSD) is lost.
Parameter field	
Values:	
<input type="checkbox"/> Disconnect, 2 s Delay (default)	All countries except the United Kingdom should use the 2 s delay.
<input type="checkbox"/> Disconnect, 60 ms Delay	The 60 ms delay is for use in the United Kingdom.
_____ Transmit	Selects a limited or unlimited terminal transmit speed.
Parameter field	
Values:	
<input type="checkbox"/> Limited Transmit (default)	Limits the terminal transmit speed to 150 to 180 characters per second, regardless of the baud rate. This places a minimal interrupt burden on the operating system.
<input type="checkbox"/> Unlimited Transmit	Selects an unlimited terminal transmit speed.

PRINTER SET-UP SCREEN

The Printer Set-Up screen (Figure 4-7) lets you define printer operations with the VT220.

Table 4-8 describes all fields on this screen.

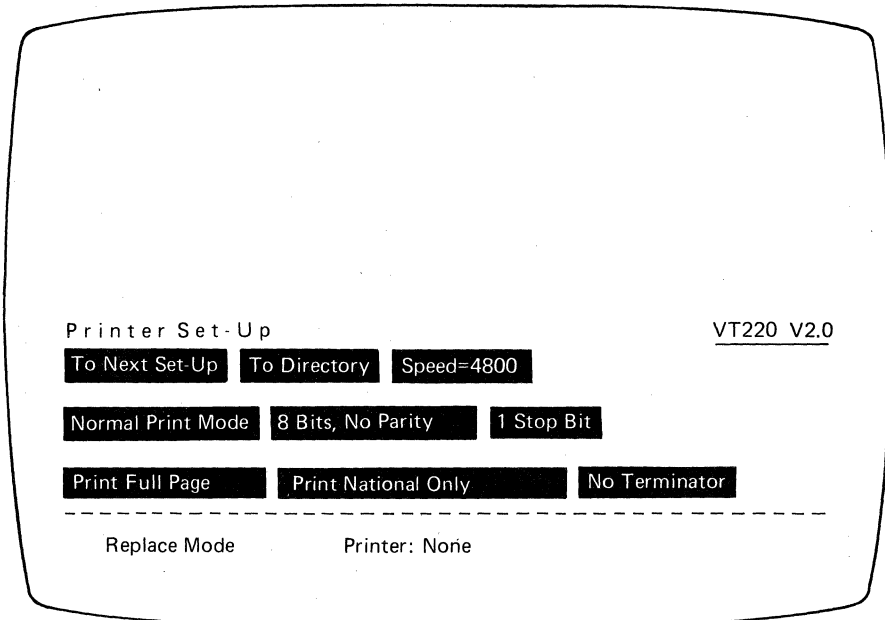

MA-1009-83

Figure 4-7 Printer Set-Up Screen

Table 4-8 Printer Set-Up Screen

Field	Function
To Next Set-Up	Replaces the Printer Set-Up screen with the Keyboard Set-Up screen.
Action field	
Value: To Next Set-Up	
To Directory	Replaces the Printer Set-Up screen with the Set-Up Directory screen.
Action field	
Value: To Directory	
Speed= _____	Selects the rate the terminal uses to send data to a printer.
Parameter field	
Values:	
<input type="checkbox"/> Speed= 75	
<input type="checkbox"/> Speed= 110	
<input type="checkbox"/> Speed= 150	
<input type="checkbox"/> Speed= 300	
<input type="checkbox"/> Speed= 600	
<input type="checkbox"/> Speed= 1200	
<input type="checkbox"/> Speed= 2400	
<input type="checkbox"/> Speed= 4800	
<input type="checkbox"/> Speed= 9600	
<input type="checkbox"/> Speed= 19200	

Table 4-8 Printer Set-Up Screen (Cont)

Field	Function
_____ Mode	Selects the operating mode for the printer.
Parameter field	
Values:	
<input type="checkbox"/> Normal Print Mode (default)	Lets you invoke print functions from the keyboard.
<input type="checkbox"/> Auto Print Mode	Prints the current line of text when the terminal receives a line feed, form feed, or vertical tab code from the host computer.
<input type="checkbox"/> Controller Mode	Causes the printer port to treat the printer as a terminal, while the VT220 monitors traffic. (The host computer transfers data to the printer, without displaying the data on the monitor screen.)
_____ Bits, _____ Parity	Selects the character format used by the printer port. (See the "Character Format" section in Chapter 5.)
Parameter field	
<i>NOTE: Choose the character format to match the printer. For example, if you are using a 7-bit compatible printer, then you should select one of the five 7-bit parameter field options.</i>	
Values:	
<input type="checkbox"/> 8 Bits, No Parity (default)	
<input type="checkbox"/> 8 Bits, Even Parity	
<input type="checkbox"/> 8 Bits, Odd Parity	
<input type="checkbox"/> 7 Bits, No Parity	
<input type="checkbox"/> 7 Bits, Mark Parity	
<input type="checkbox"/> 7 Bits, Space Parity	
<input type="checkbox"/> 7 Bits, Even Parity	
<input type="checkbox"/> 7 Bits, Odd Parity	

Table 4-8 Printer Set-Up Screen (Cont)

Field	Function
<p>Stop Bit _____</p> <p>Parameter field</p>	<p>Sets the number of stop bits to match the printer.</p>
<p>Values:</p> <p><input type="checkbox"/> 1 Stop Bit (default)</p>	<p>Selects 1 stop bit.</p>
<p><input type="checkbox"/> 2 Stop Bits</p>	<p>Selects 2 stop bits.</p>
<p>Print _____</p> <p>Parameter field</p>	<p>Selects how much of the screen is printed during a print page operation.</p>
<p>Values:</p> <p><input type="checkbox"/> Print Full Page (default)</p>	<p>Print the full screen.</p>
<p><input type="checkbox"/> Print Scroll Region</p>	<p>Print only the scrolling region.</p>
<p>Printed Data Type</p> <p>Parameter field</p>	<p>Selects the type of characters (from the terminal's character sets) to send to the printer.</p>
<p>Values:</p> <p><input type="checkbox"/> Print National Only (default)</p>	<p>Use with a printer that supports ASCII (multinational mode) or the current national set (national mode). (Examples: LA34, LA36, LA120, non-Digital printers.)</p>
<p><input type="checkbox"/> Print National and Line Drawing</p>	<p>Use with a printer that supports ASCII and the line drawing sets (multinational mode), or the current national set and the line drawing set (national mode). (Example: LA100.)</p>
<p><input type="checkbox"/> Print Multinational</p>	<p>Use with a printer that supports the multinational and line drawing sets. (Example: LA50.)</p>

Table 4-8 Printer Set-Up Screen (Cont)

Field	Function
Print Terminator Parameter field	Selects whether or not a terminator (form feed) is sent at the end of a print page operation.
Values: <input type="checkbox"/> No Terminator (default)	Selects no terminator.
<input type="checkbox"/> Terminator = FF	Selects the form feed (FF) terminator.

KEYBOARD SET-UP SCREEN

The Keyboard Set-Up screen (Figure 4-8) lets you define keyboard operating features.

Table 4-9 describes all fields on this screen.

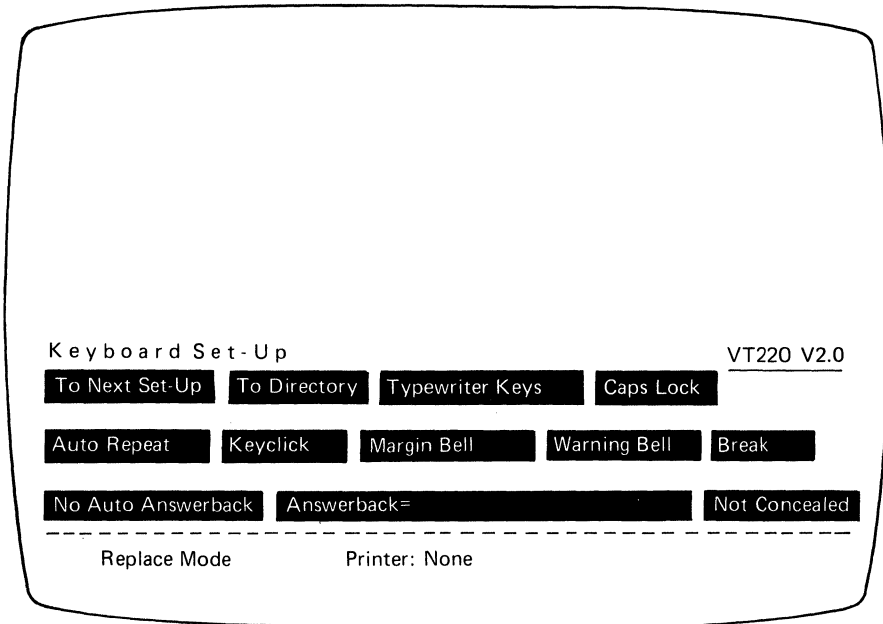

MA-1010-83

Figure 4-8 Keyboard Set-Up Screen

Table 4-9 Keyboard Set-Up Screen

Field	Function
<p>To Next Set-Up Action field Value: To Next Set-Up</p>	<p>Replaces the Keyboard Set-Up screen with the Tab Set-Up screen.</p>
<p>To Directory Action field Value: To Directory</p>	<p>Replaces the Keyboard Set-Up screen with the Set-Up Directory screen.</p>
<p>_____ Keys Parameter field Values: <input type="checkbox"/> Typewriter Keys (default) <input type="checkbox"/> Data Processing Keys</p>	<p>Sets the terminal keyboard map for the type of keyboard you are using.</p> <p>If your keyboard is North American, select Typewriter Keys.</p> <p>For all other keyboards, select either Typewriter Keys or Data Processing Keys.</p> <p>Typewriter Keys selects the characters on the left half of the keycaps; Data Processing Keys selects the characters on the right half of the keycaps.</p> <p><i>Example</i> The French Canadian keyboard uses a key that as a C cedilla Ç (on the left side), and brackets [(on the right side).]</p> <p>Selecting Typewriter Keys makes the key respond as uppercase and lowercase C cedilla Ç.</p> <p>Selecting Data Processing Keys makes the key respond as [.]</p>

Table 4-9 Keyboard Set-Up Screen (Cont)

Field	Function
<p>_____ Lock Parameter field</p>	<p>Selects the function of the Lock key. Pressing Lock key turns on the Lock indicator on the keyboard. To clear the lock function, simply press Lock again. (The Lock indicator turns off.)</p>
<p>Values: <input type="checkbox"/> Caps Lock (default)</p>	<p>The alphabetic keys send uppercase characters only.</p>
<p><input type="checkbox"/> Shift Lock</p>	<p>The alphabetic keys send uppercase characters, and the numeric/symbol keys send the top characters only. Shift Lock can also be cleared by pressing the Shift key.</p>
<p>Auto Repeat Parameter field</p>	<p>Selects whether or not keystrokes automatically repeat when you hold down a key.</p>
<p>Values: <input type="checkbox"/> Auto Repeat (default)</p>	<p>Pressing a key sends the character repeatedly until the key is released.</p>
<p><input type="checkbox"/> No Auto Repeat</p>	<p>Pressing a key sends only one character.</p>
<p>Keyclick Parameter field</p>	<p>Selects whether or not the keyboard makes a clicking sound each time you press a key.</p>
<p>Values: <input type="checkbox"/> Keyclick (default)</p>	<p>Selects the keyclick feature.</p>
<p><input type="checkbox"/> No Keyclick</p>	<p>Turns off the keyclick feature.</p>

Table 4-9 Keyboard Set-Up Screen (Cont)

Field	Function
<p>Margin Bell</p> <p>Parameter field</p> <p>Values:</p> <p><input type="checkbox"/> Margin Bell (default)</p> <p><input type="checkbox"/> No Margin Bell</p>	<p>Selects whether or not the terminal sounds a bell tone when the text cursor approaches the right margin.</p> <p>Selects the margin bell feature.</p> <p>Turns off the margin bell feature.</p>
<p>Warning Bell</p> <p>Parameter field</p> <p>Values:</p> <p><input type="checkbox"/> Warning Bell (default)</p> <p><input type="checkbox"/> No Warning Bell</p>	<p>Selects whether or not the terminal generates a bell tone for operating errors, and for Ctrl-G.</p> <p>Selects the warning bell feature.</p> <p>Turns off the warning bell feature.</p>
<p>Break</p> <p>Parameter field</p> <p>Values:</p> <p><input type="checkbox"/> Break (default)</p> <p><input type="checkbox"/> No Break</p>	<p>Enables or disables the Break key function (See the "Break" section in Chapter 3.)</p> <p>Selects the Break key function.</p> <p>Turns off the Break key function.</p> <p>Terminal disconnect (Shift-Break) is not affected by this feature. (See the "Connect/Disconnect" section in Chapter 5.)</p>

Table 4-9 Keyboard Set-Up Screen (Cont)

Field	Function
<p>Auto Answerback Parameter field</p>	<p>Selects whether or not the answerback message is automatically sent to the host computer after a communication line connection.</p>
<p>Values: <input type="checkbox"/> Auto Answerback (default)</p>	<p>Selects the answerback message feature.</p>
<p><input type="checkbox"/> No Auto Answerback</p>	<p>Turns off the answerback message feature.</p>
<p>Answerback= Text Parameter field</p>	<p>Lets you enter an answerback message.</p>
<p>Value: <code>text entry</code></p>	<p>The terminal sends an answerback message when it receives ENQ or you type Ctrl-Break. In the case of ENQ, the message you enter is sent to the host without affecting screen data or requiring further operator action.</p>
	<p>When you select this field, the set-up status line displays the prompt Enter Answerback = (temporarily overwriting the status line). You can enter any keyboard character, up to a 30-character limit.</p>
	<p>Your message can be concealed using the Concealed field in this set-up screen.</p>

Table 4-9 Keyboard Set-Up Screen (Cont)

Field	Function
<p>Concealed</p> <p>Parameter field</p> <p>Value:</p> <p><input type="checkbox"/> Not Concealed (default)</p> <p><input type="checkbox"/> Concealed</p>	<p>Selects whether or not your answerback message entry is displayed on the screen.</p> <p>The terminal can display the answerback message as entered.</p> <p>Your answerback message is not displayed on the screen, so it will not be revealed. You cannot reset this feature to Not Concealed, except by entering a new answerback message.</p>

TAB SET-UP SCREEN

The Tab Set-Up screen (Figure 4-9) lets you set the terminal's tab stop settings.

Table 4-10 describes all fields on this screen.

The tab stop fields are one character wide. A ruler appears below the tab stop fields on the screen. Refer to the ruler when setting tabs.

There is one tab stop field for each column on the screen display. The display can be 80 or 132 columns wide, depending on the number of columns set. (See Columns in the Display Set-Up screen.)

There are two possible settings for each tab stop field: the letter T (tab stop set) or blank (no tab stop set).

You can move the field cursor to a tab stop field with the arrow keys or the **Tab** key. After you select a field, press the **Enter** key to place a T in a blank field or erase a T from that field.

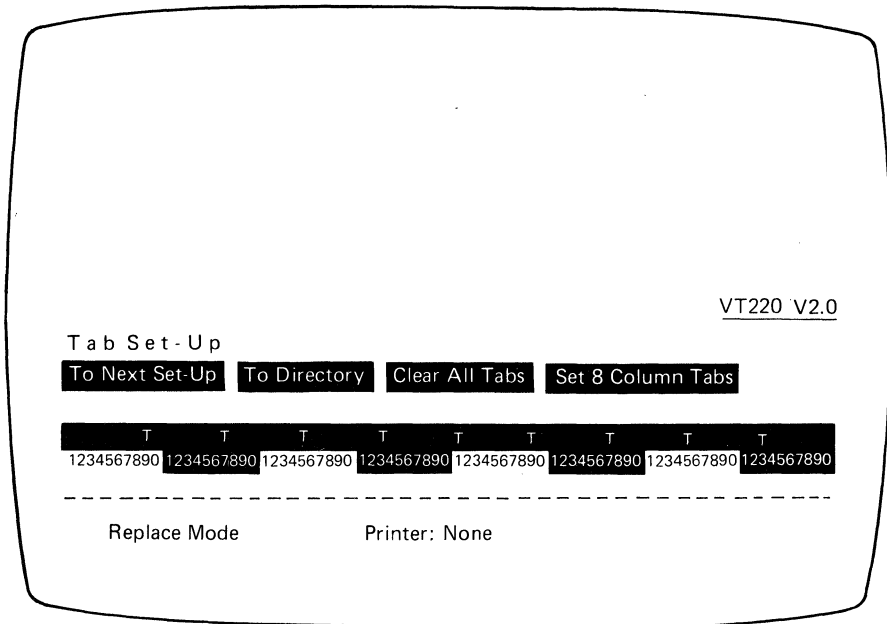

MA-1011-83

Figure 4-9 Tab Set-Up Screen

Table 4-10 Tab Set-Up Screen

Field	Function
To Next Set-Up Action field Value: To Next Set-Up	Replaces the Tab Set-Up screen with the Display Set-Up screen.
To Directory Action field Value: To Directory	Replaces the Tab Set-Up screen with the Set-Up Directory screen.
Clear All Tabs Action field Value: Clear All Tabs	Clears all tabs previously set.
Set 8 Column Tabs Action field Value: Set 8 Column Tabs	Automatically sets tabs every 8 columns, starting with column 9.

COMMUNICATION 5

GENERAL

This chapter describes how the VT220 communicates with a host computer and a printer.

The terminal operates on full-duplex asynchronous lines only, and has ten possible transmit/receive speeds. You select the transmit/receive speeds in set-up for both the terminal (Communications Set-Up screen) and the printer (Printer Set-Up screen).

The VT220 operates in accordance with the following national and international communications standards.

- EIA Standard RS232C/RS423
- CCITT V.24
- CCITT V.26 (V.10)
- CCITT X.20 (V.21)

You can connect the terminal directly to a local host computer with a cable. You can also connect the terminal indirectly to a remote host computer through public-switched or dedicated telephone lines, using a modem or acoustic coupler.

HOST AND PRINTER PORT INTERFACES

The VT220 has two asynchronous serial ports. One port is for communication with a host computer, and the other is for communication with a printer.

There are two host port connectors.

- A 25-pin subminiature D-type (EIA RS232C/RS423) connector that connects the terminal to a local or remote host computer
- An 8-pin EIA Mate-N-Lok (20 mA) connector that connects the terminal to a local host computer

The printer port has one connector.

- A 9-pin subminiature D-type (EIA RS232C/RS423) connector that connects the terminal to a local printer.

Tables 5-1 through 5-3 describe the interface signals for the three connectors.

NOTE: Only the connector pins listed in Tables 5-1 through 5-3 are used.

MODEMS

The VT220 can operate with all modems conforming to the national and international standards listed at the beginning of this chapter. However, the modem at the terminal must be compatible with the modem at the host computer.

The VT220 accepts compatible modems and acoustic couplers such as the AT&T 103, 113, and 212 types, in addition to Digital's DF02 and DF03.

The terminal must be certified for connection to non-AT&T type modems used outside of continental North America. Your local Digital Field Service office has detailed information on terminal certification and use of non-AT&T type modems.

Table 5-1 Comm Port EIA Interface Signals

Pin	Signal	Mnemonic	EIA/CCITT/DIN	Description
2	Transmit data	TXD	BA/103/D1	<p><i>From VT220</i> Transmits serial characters. Held in mark state when no characters are transmitted.</p> <p>In modem control modes, transmits data only when RTS, CTS, DSR, and DTR are on.</p>
3	Received data	RXD	BB/104/D2	<p><i>To VT220</i> Receives serial characters. In modem control modes, ignores characters if RLSD is off.</p>
4	Request to send	RTS	CA/105/S2	<p><i>From VT220</i> When on, places the modem in transmit mode.</p>
5	Clear to send	CTS	CB/106/M2	<p><i>To VT220</i> When on, tells the terminal that the modem is ready to transmit.</p>
6	Data set ready	DSR	CC/107/M1	<p><i>To VT220</i> When on, tells the terminal that the modem is in the data mode and is ready to exchange RTS, CTS, and RLSD.</p>

Table 5-1 Comm Port EIA Interface Signals (Cont)

Pin	Signal	Mnemonic	EIA/CCITT/DIN	Description
7	Signal ground	SGND	AB/102/E2	Serves as common ground reference potential for all connector signals except protective ground.
8	Receive line signal detect (carrier detect)	RLSD	CF/109/M5	<p><i>To VT220</i> When on, tells the terminal that the signal received on the communication line is good enough to ensure correct demodulation of received data.</p> <p>When off, indicates no signal received, or signal is unsuitable for demodulation.</p>
12	Speed indicator	SPDI	CI/112/M4	<p><i>To VT220</i> When on, enables modem to control terminal transmit and receive speeds. Sets terminal transmit and receive speeds to 1200 bits per second, regardless of set-up selection.</p>
20	Data terminal ready	DTR	CD/108.2/S1.2	<p><i>From VT220</i> When on, tells the modem that the terminal is ready to transmit or receive.</p>

Table 5-1 Comm Port EIA Interface Signals (Cont)

Pin	Signal	Mnemonic	EIA/CCITT/DIN	Description
23	Speed select	SPDS	CH/111/S4	<i>From VT220</i> When on, tells the modem that receive speed selected in set-up is greater than 600 bits per second.

Table 5-2 20 mA Port Interface Signals

Pin	Signal
1	-12 V
2	Transmit -
3	Receive -
5	Transmit +
7	Receive +
8	Ground

Table 5-3 Printer Port EIA Interface Signals

Pin	Signal	Mnemonic	EIA/CCITT/DIN	Description
1	Protective ground	PGND	AA/101/E1	Connects to terminal chassis. Also connects to external ground through third wire of power cord.

Table 5-3 Printer Port EIA Interface Signals (Cont)

Pin	Signal	Mnemonic	EIA/CCITT/DIN	Description
2	Transmit data	TXD	BA/103/D1	<i>From VT220</i> Transmits serial characters. Held in mark state when no characters are transmitted.
3	Receive data	RXD	BB/104/D2	<i>To VT220</i> Receives serial characters for flow control.
4	Request to send	RTS	CA/105/S2	<i>From VT220</i> On when the terminal is on.
5	Data terminal ready	DTR	CD/108.2/S1.2	<i>From VT220</i> On when the terminal is on.
6	Data set ready	DSR	CC/107/M1	<i>To VT220</i> Receives DTR on this line. If DSR is present at power-up, the printer controls print operations. If DSR is not present at power-up, the terminal checks for DSR before each character print operation.
7	Signal ground	SGND	AB/102/E2	Common ground reference for all voltages on interface.

CABLES

Figure 5-1 shows the RS232C/RS423 cables you can use to connect the terminal to a host computer and printer.

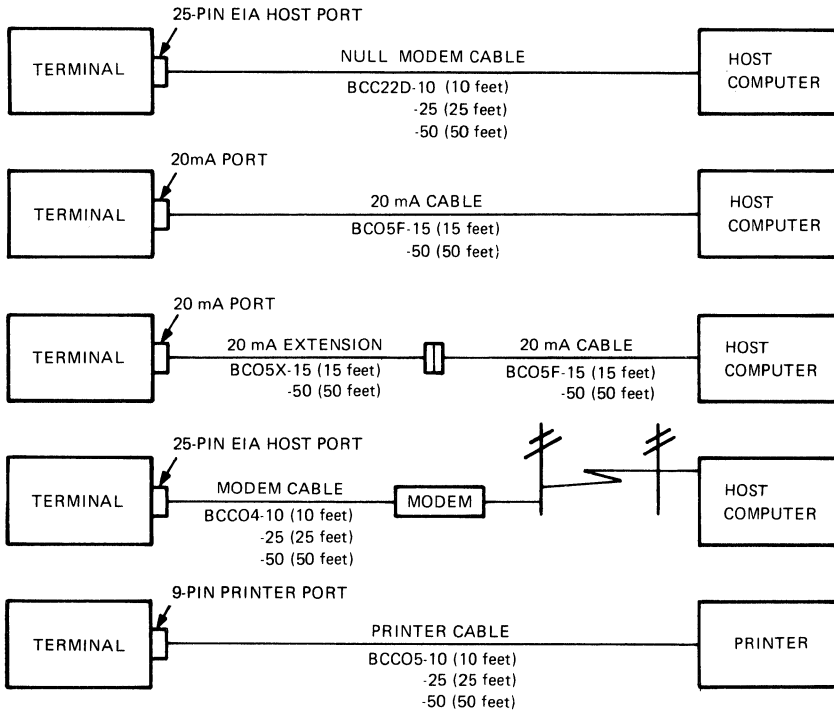

MA-1014-83

Figure 5-1 Cables

PRINTERS

You can connect the terminal to a local asynchronous serial printer by using a null modem cable. Here are some of the Digital printers you can use with the VT220.

LA12	LA50
LA34	LA100
LA35	LA120
LA36	LQP02
LA38	

CHARACTER FORMAT

The terminal sends and receives characters in serial format. You select the character format (Figure 5-2) in set-up.

NOTE: Detailed information on character format is available in ANSI Standard X3.15.

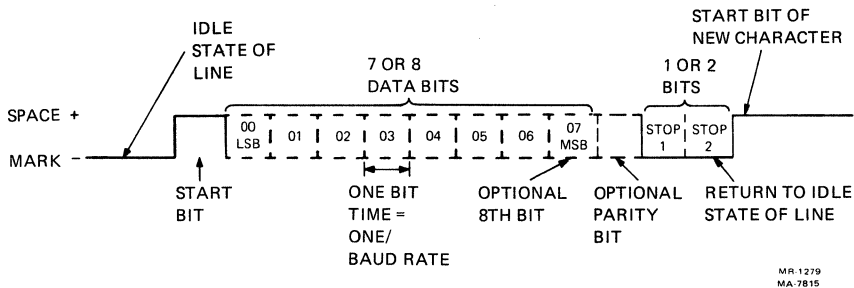

Figure 5-2 Character Format

TERMINAL – HOST DATA FLOW CONTROL

The terminal stores incoming characters in a character input buffer and processes the characters on a first-in/first-out basis. The size of the input buffer is 254 characters. When the input buffer fills to 64 or 128 characters (selected from the Communications Set-Up screen), the terminal sends an XOFF character (if you enabled XOFF from the Communications Set-Up screen) to stop the host computer from sending more characters. If the computer fails to respond to the XOFF character, the terminal sends a second XOFF character when the input buffer fills to 220 characters. The terminal sends a third XOFF character when the buffer is full.

When the input buffer contents falls below 32 characters, the terminal sends an XON character to tell the host computer to start sending characters again.

NOTE: If you disable XOFF in set-up, the terminal does not send XOFF to the host computer when the input buffer fills. The Hold Screen key is also disabled. With XOFF disabled, there is no way to ensure that data will not be lost.

If you enable XON/XOFF, the terminal recognizes received XON and XOFF characters. When the terminal receives XOFF, it stops sending data (except XON/XOFF characters). If the keyboard data buffer overflows, the keyboard locks and the Wait indicator turns on. The terminal resumes transmission when it receives an XON.

Conditions That Send XON

When you enable the XOFF/XON feature in set-up, the following conditions send XON.

- The number of characters in the input buffer reaches the XON point (32 characters) and the last flow control character sent was XOFF.
- A clear comm operation is performed.
- A recall operation is performed.
- The power self-test is completed (Chapter 6).
- You press the **Hold Screen** key to release the screen when the input buffer is at or below the XON point.

Conditions That Send XOFF

When you enable the XOFF/XON feature in set-up, the following conditions send XOFF.

- The number of characters in the input buffer reaches the first XOFF point (64 or 128 characters, selected from the Communications Set-Up screen) for the first time since the last XON was sent.
- The number of characters in the input buffer reaches the second XOFF point (220 characters) for the first time since the last XON was sent.
- The terminal receives a character when the input buffer is full (256 characters).

Buffer Overflow Prevention

If the host computer does not respond to the XOFF from the terminal, the input buffer continues to fill with characters. If the buffer is filled and characters are still coming, the buffer overflows and characters are lost. In place of lost characters, the terminal displays reverse question mark characters (?).

You can use the following formulas to determine how fast the host computer must respond to the first XOFF character, to prevent loss of characters due to buffer overflow. Calculate the overflow first, then host response time.

NOTE: These formulas assume that you set the transmit rate limit feature in the Communications Set-Up screen to Unlimited.

1. Overflow

$$OVFL = (MXBF - XOFF) - [3 \times (RCDR/XMDR)] - (RCDR/600)$$

where:

OVFL = the number of characters to overflow

MXBF = the receive buffer size (254 characters)

XOFF = the first XOFF point (64 or 128)

RCDR = the received data rate (receive speed)

XMDR = the transmitted data rate (transmit speed)

2. Host Response Time

$$\text{HRST} = \text{OVFL} \times [(\text{DATA} + \text{STOP} + \text{PRTY} + 1)/\text{RCDR}]$$

where:

HRST = the host computer response time (in seconds)

OVFL = the number of characters to overflow

DATA = the number of data bits per character

STOP = the number of stop bits per character

PRTY = the number of parity bits per character

Example

The VT220 sends and receives 8-bit characters with no parity at 4800 bits per second. There is 1 stop bit. XOFF is sent when the buffer has 64 characters in it.

$$\begin{aligned} \text{OVFL} &= (254 - 64) - [3 \times (4800/4800)] - (4800/600) \\ &= 179 \text{ characters} \end{aligned}$$

$$\begin{aligned} \text{HRST} &= 179 \times [(8 \text{ bits} + 1 \text{ bit} + 0 \text{ bits} + 1)/4800] \\ &= 0.37 \text{ seconds} \end{aligned}$$

Therefore, the host computer must stop sending data in 0.37 seconds, or the terminal input buffer will overflow.

Use of Fill Characters

Software that does not support XON/XOFF characters from the terminal can still use all terminal features by using fill characters. In some applications, you can use the terminal without XON/XOFF support or fill characters. However, the bit rate must be limited to 9600. And the software must not send the ESC (escape) code, or use slow scrolling, split screen, or the printer port.

Connect/Disconnect

When a connection is made to the host computer via a modem, the terminal performs the following operations to ensure it is ready to send and receive.

- Unlocks the keyboard (if it was locked).
- Clears any transmit in progress.
- Clears the keyboard buffer and all message buffers.
- Clears the input buffer.
- Clears XOFF sent and XOFF received.

The following conditions cause a communications line disconnect.

- Typing **Shift-Break**
- Invoking **Recall** or **Default** values in the Set-Up Directory screen
- Loss of DSR
- Loss of RLSD for a time you defined in set-up
- No RLSD within 30 seconds after DSR
- A self-test command received from the host computer
- Switching from the EIA port to the 20 mA port, or from the 20 mA port to the EIA port

The usual way to disconnect the terminal from the communications line at the end of communications is to type **Shift-Break**. The host computer's response to the disconnect signal depends on the computer and the software.

TERMINAL-PRINTER DATA FLOW CONTROL

The VT220 sends only data characters to the printer; the terminal does not send XON/XOFF. The terminal recognizes only XON/XOFF from the printer (any other characters from the printer are ignored).

When the terminal receives XOFF from the printer, the terminal stops sending data. The terminal starts sending data again when it receives an XON, or when a clear comm operation is performed.

Note on Printer Installation

Using an 8-bit setting for the printer port line implies the use of 8-bit C1 control characters. Using a 7-bit setting implies the use of the 7-bit ESC [form of C1 control characters.

NOTE: Older printers may not recognize the 8-bit form of C1 control characters. With these printers, you must set the printer line to 7-bits for correct operation.

PROBLEM SOLVING 6

GENERAL

This chapter describes what to do if you have a problem with the VT220. The chapter provides a problem checklist and describes the power-up self-test.

COMMON OPERATING PROBLEMS

Table 6-1 lists common operating problems and their possible solutions. Check this list before calling for service.

Problem	Possible Solution
The terminal does not power up when the power switch is set to 1 (on).	<p>Make sure the terminal power cord is plugged into the wall outlet. Check for power at the wall outlet by plugging in a lamp to see if it lights.</p> <p>Make sure the voltage selection switch is in the correct position. (See the <i>VT220 Installation Guide</i> for the correct setting.)</p> <p>Check the fuse and replace if necessary. (If the fuse blows again, there is a possible shorting problem. Contact Digital Field Service.)</p>

Table 6-1 Common Operating Problems (Cont)

Problem	Possible Solution
<p>The printer does not print.</p>	<p>Make sure the printer is plugged in and its power switch is on.</p> <p>Make sure the cable connection between the printer and terminal is tight.</p> <p>Make sure all communication features on the terminal and printer (such as baud rate and parity) match.</p>
<p>The monitor display does not resume scrolling. The Hold Screen indicator is on.</p>	<p>Press the Hold Screen key to resume scrolling.</p>
<p>The terminal seems to be locked and does not respond to data sent from the host.</p>	<p>Clear the terminal by using the Clear Comm field in the Set-Up Directory screen (Chapter 4).</p>
<p>The screen is blank, and the power OK indicator is on.</p>	<p>The CRT saver feature (Chapter 1) may be on. Press any key to reactivate the screen display.</p> <p>Make sure the brightness and contrast controls are correctly adjusted.</p>
<p>The bell tone does not sound when the terminal is turned on. Keyboard visual indicators are not on.</p>	<p>Make sure the keyboard is connected to the terminal.</p>

POWER-UP SELF-TEST

The power-up self-test runs automatically each time you power up the terminal. During the test cycle, the power-up self-test has full control of the terminal. The terminal cannot respond to commands other than those used for the test itself. When the test cycle ends, control returns to the terminal.

In the self-test mode, the monitor screen and the keyboard indicators (Hold Screen, Lock, Compose, and Wait) provide information about the terminal operating status. The monitor screen displays a text message, and the keyboard indicators provide a coded message.

PERFORMING THE POWER-UP SELF-TEST

Start the power-up self-test by setting the terminal power switch to 1 (on).

During the self-test the following events should occur.

- All keyboard indicators turn on and off.
- The bell tone sounds.

A successful power-up self-test ends with all keyboard indicators off and the screen displaying the message shown in Figure 6-1. The message is erased when a character is received from the host computer, or when you press any key.

The terminal displays an error message on the screen (if possible) if the test finds any error. Table 6-2 explains the error messages displayed on the screen.

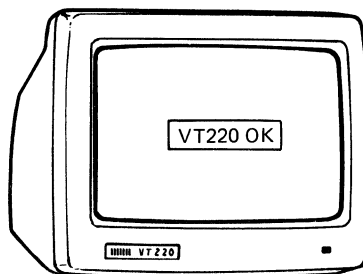

MA-1013-83

Figure 6-1 Successful Power-Up Screen Message

Table 6-2 Screen Error Messages

Error Message	Problem
VT220 NVR Error - 1	<i>Terminal controller board.</i> The nonvolatile memory (set-up storage) is not operating.
VT220 EIA Port Data Error - 2	<i>Terminal controller board.</i> The EIA host port is not operating.
VT220 Keyboard Error - 4	<i>Keyboard.</i> The terminal can only receive input from the host computer.
VT220 Printer Port Error - 6	<i>Printer port.</i> The terminal is operating, but cannot perform printing functions.

DIGITAL SERVICE

If the self-test indicates a problem, call your local Digital Field Service number for assistance. Before calling, make sure to note the exact nature of the problem, when it occurred, and any error messages or codes that appeared.

Information about your warranty, Digital services, terminal supplies, and spare parts is provided on the inside of the back cover of this manual.

SPECIFICATIONS **A**

GENERAL

This appendix lists the specifications of the VT220 video terminal.

VT220 SPECIFICATIONS

Physical

Terminal

Height	28.3 cm (11-1/8 in)
Width	33.3 cm (13-1/8 in)
Depth	38.7 cm (15-1/4 in)
Weight	11.8 kg (26 lbs)
Adjustable tilt	+5 to -15 degrees

Keyboard

Height	5.1 cm (2 in)
Width	53.3 cm (21 in)
Depth	17.1 cm (6.75 in)
Weight	2 kg (4.5 lbs)

Environmental

Operating

Temperature	10° to 40°C (50° to 104°F)
Relative humidity	10% to 90%
Maximum wet bulb	28°C (82°F)
Minimum dew point	2°C (36°F)
Maximum altitude	2.4 km (8000 ft)

Storage

Temperature	-40° to 66°C (-40° to 151°F)
Relative humidity	0% to 95%
Maximum altitude	9.1 km (30,000 ft)

Electrical

Line voltage (switch selectable)	90 to 128 Vac (100 to 120 RMS nominal) single-phase, 3-wire
	180 to 268 Vac (220 to 240 RMS nominal) single phase, 3-wire
Line frequency	47 to 63 Hz
Line current	0.48 amps RMS at 120 Vac RMS 0.24 amps RMS at 240 Vac RMS
Input power	60 watts maximum
Power cord	Detachable, 3-conductor, grounded
Power cord receptacle	EIA specified CEE22-6A

Display

CRT	30.5 cm (12 in) diagonal measure monochrome
Active display size	
Horizontal	20.3 cm (8 in)
Vertical	12.7 cm (5 in)
Format	24 lines of 80 or 132 characters
Character	7 × 9 dot matrix with 2 descenders
Character size	
80 column mode	3.35 × 2.0 mm (0.132 × 0.078 in)
132 column mode	3.35 × 1.3 mm (0.132 × 0.051 in)
Character sets	ASCII, national replacement (NRC), DEC special graphic, and DEC supplemental character sets (each 94 characters)
Video attributes	Reverse video, underline, bold, and blinking – selected individually or in any combination
Cursor type	Blinking block cursor or blinking underline cursor

Keyboard

General	105-key detachable unit with a 1.8 m (6 ft) coiled cord with a 4-pin telephone-type modular connector. Word processing and data processing versions available in 15 languages
Keypad	Sculptured key array. Matte texture finish keys. Home-row key height 30 mm (1.18 in) above desk top
Key size	12.7 mm (0.5 in) square
Key spacing	19 mm (0.75 in) center-to-center (single-width keys)
Numeric keypad	18 keys
Function keys	36 keys, firmware and software driven
Visual indicators	4 LED indicators: Hold, Lock, Wait, and Compose
Audible signals	
Keyclick	Sounds after each keystroke
Bell	Sounds when BEL character is received, when approaching right margin, and when compose errors occur.
Multiple bell	Sounds on error in a set-up save or recall operation.

OPTIONS, DOCUMENTATION, AND SUPPLIES **B**

GENERAL

This appendix describes the options, documentation, and supplies offered by Digital for the VT220. Part numbers and ordering information are included.

AVAILABLE OPTIONS

Modems

There are two modem options available for the VT220. You can order these options from Digital.

Part Number	Description
DF02-AA	Direct-connect, AT&T 103J equivalent, 300 baud, full-duplex Modern with EIA RS232C interface
DF03-AA	Direct-connect, AT&T 103J/212A equivalent, 300/1200 baud full-duplex modem with EIA RS232C interface.

Cables

See Chapter 5 for information on available modem and printer cables.

RELATED DOCUMENTATION

In addition to this owner's manual, you can order the following VT220 documents from Digital.

Title and Part Number	Description
VT220 Programmer Reference Manual (EK-VT220-RM)	Describes VT220 character processing, character codes, and control sequences needed to generate terminal control programs.
VT220 Installation Guide (EK-VT220-IN)	Describes the installation procedure for the VT220. This document comes with the terminal.
VT220 Programmer Pocket Guide (EK-VT220-HR)	Provides a summary of VT220 programming information in a pocket-size guide. This document comes with the terminal.
VT220 Pocket Service Guide (EK-VT220-PS)	Describes the procedures used to troubleshoot and repair the VT220 to the field replaceable unit.
VT220 Video Terminal IPB (EK-VT220-IP)	Provides a detailed parts breakdown of the VT220 field replaceable units. Does not provide part numbers for printed circuit board components.
VT220 Family Field Maintenance Print Set (MP-01732-01)	Provides a complete set of VT220 electrical and mechanical schematic diagrams.

SPECIFICATIONS

ANSI specifications are available from:

Sales Department
American National Standards Institute
1430 Broadway
New York, NY 10018

EIA specifications are available from:

Engineering Department
Electronic Industries Association
2001 Eye Street, NW
Washington, DC 20006

International standards are available from:

CCITT
UN Book Store
United Nations Building
New York, NY 10017

ORDERING INFORMATION

You can order options, supplies, and documentation by phone from 8:30 a.m. to 6:00 p.m. (EST) or by mail.

Continental USA and Puerto Rico

Call 800-258-1710 or mail to:

Digital Equipment Corporation
P.O. Box CS2008
Nashua, NH 03061

New Hampshire, Alaska, Hawaii

Call 1-603-884-6660.

Outside the USA and Puerto Rico

Mail to:

Digital Equipment Corporation
Attn: Accessories and Supplies Business Manager
c/o Local Subsidiary or Digital-Approved Distributor

KEYBOARDS C

GENERAL

This appendix provides illustrations of all national keyboards for the VT220 in the following order.

NOTE: Most of the keyboards are available in two versions, standard and word processing. The key positions on both types of keyboards are the same. However, the word processing version has different key legends, appropriate to word processing only.

North American
United Kingdom
Belgium (Flemish)
Canada (French)
Denmark
Finland
France/Belgium
Germany/Austria
Holland
Italy
Norway
Spain
Sweden
Switzerland (French)
Switzerland (German)

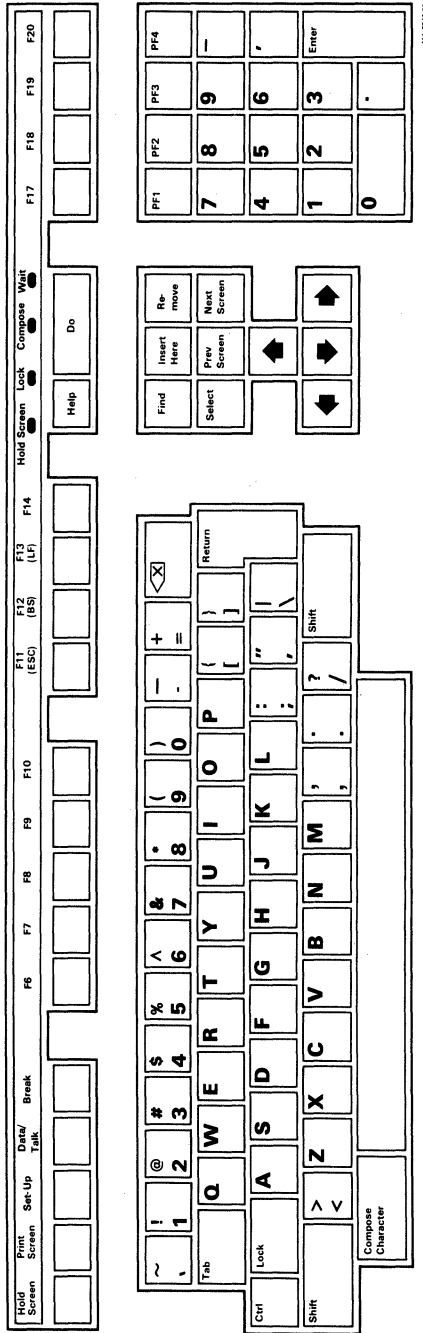

Figure C-1 North American

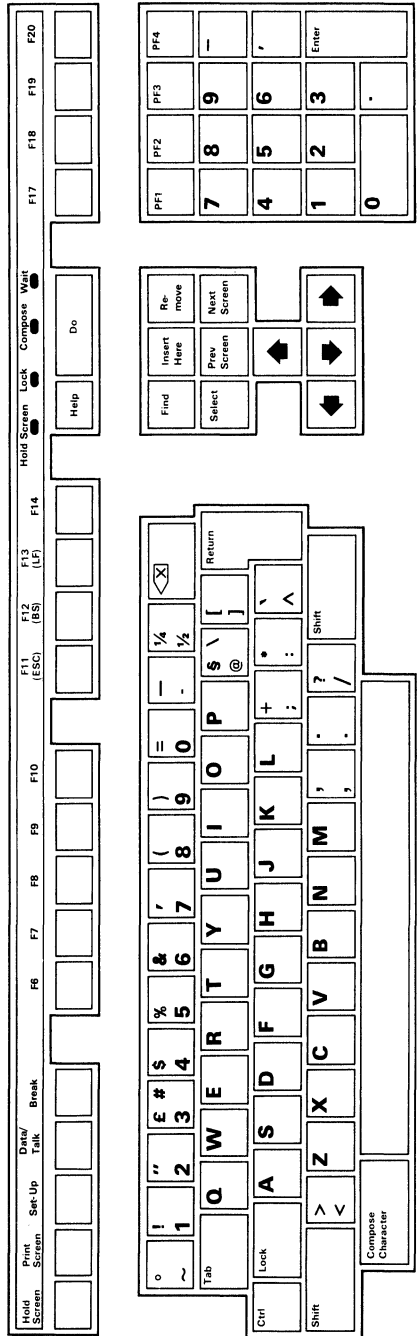

Figure C-2 United Kingdom

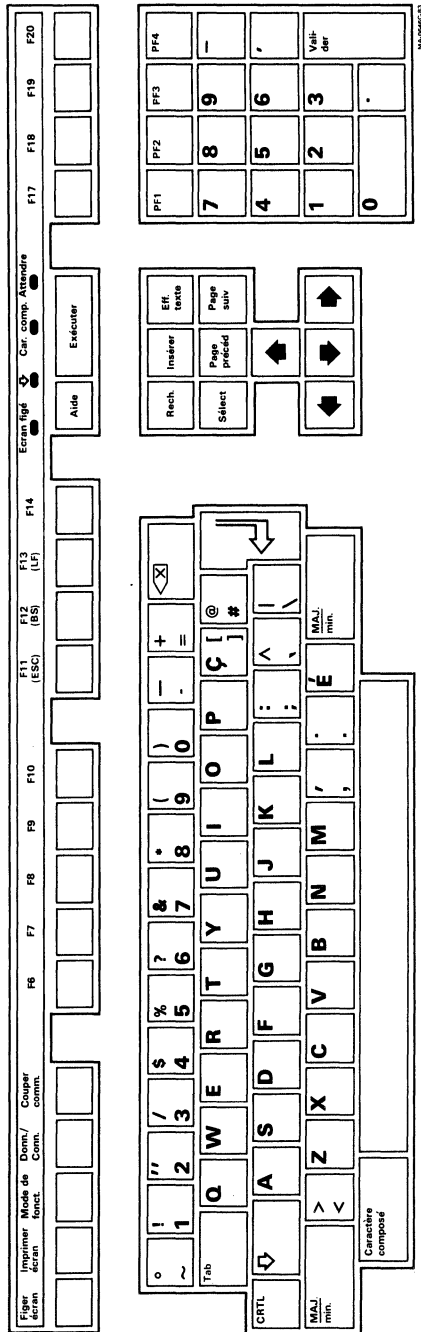

Figure C-4 Canada (French)

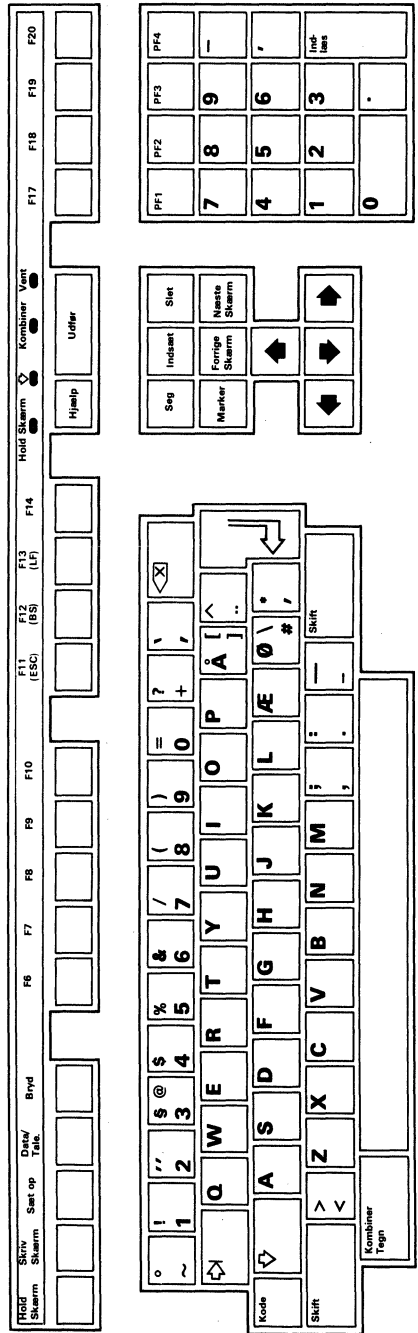

Figure C-5 Denmark

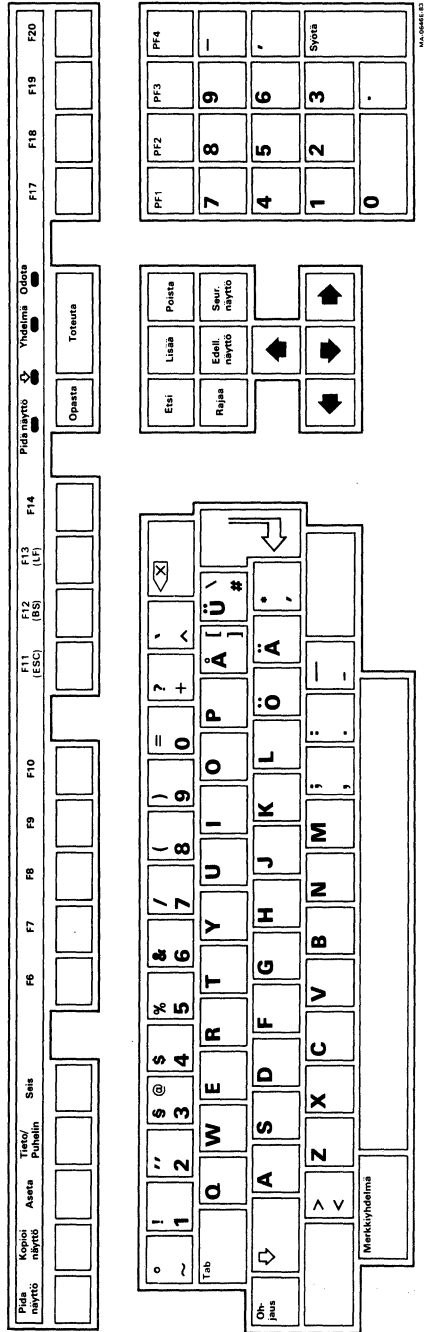

Figure C-6 Finland

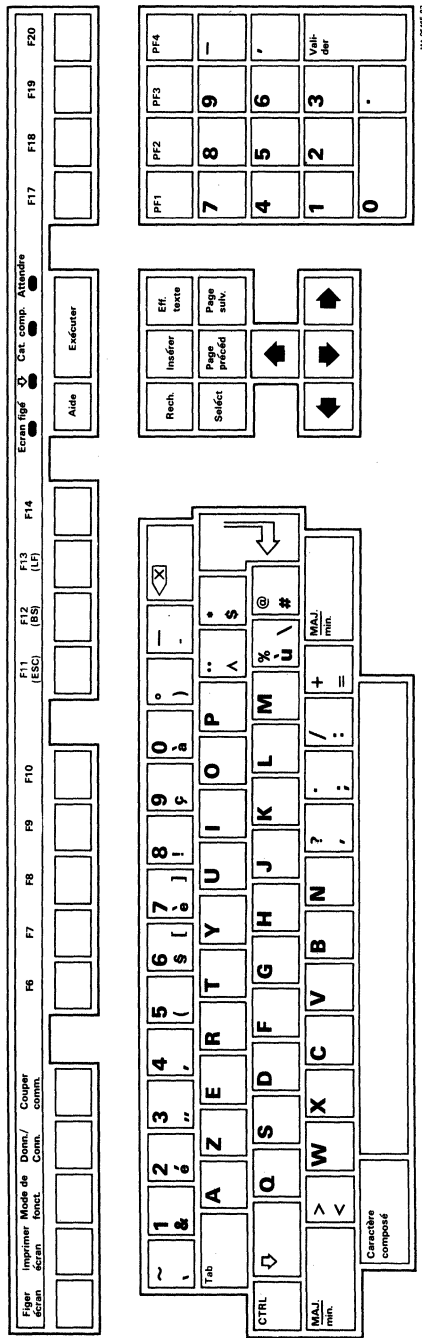

Figure C-7 France/Belgium

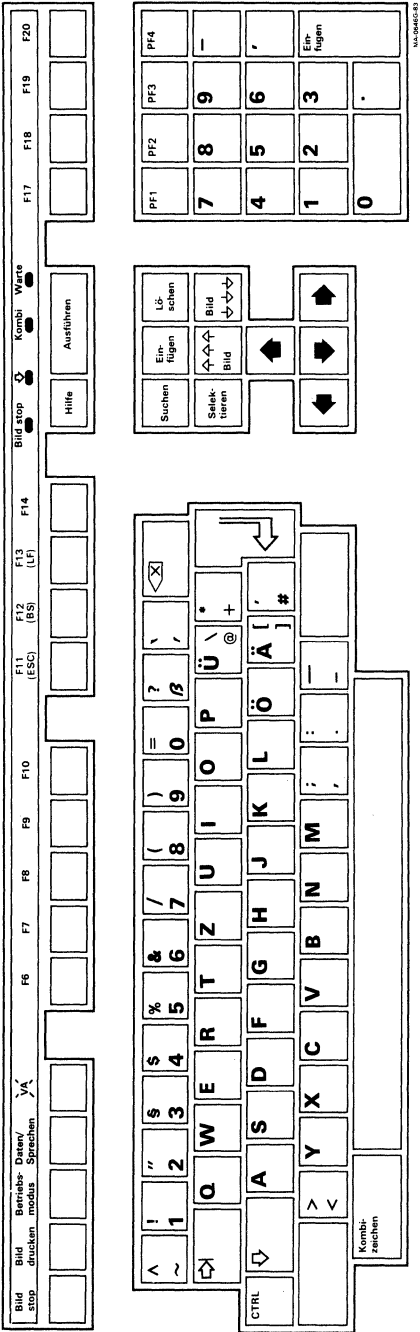

Figure C-8 Germany/Austria

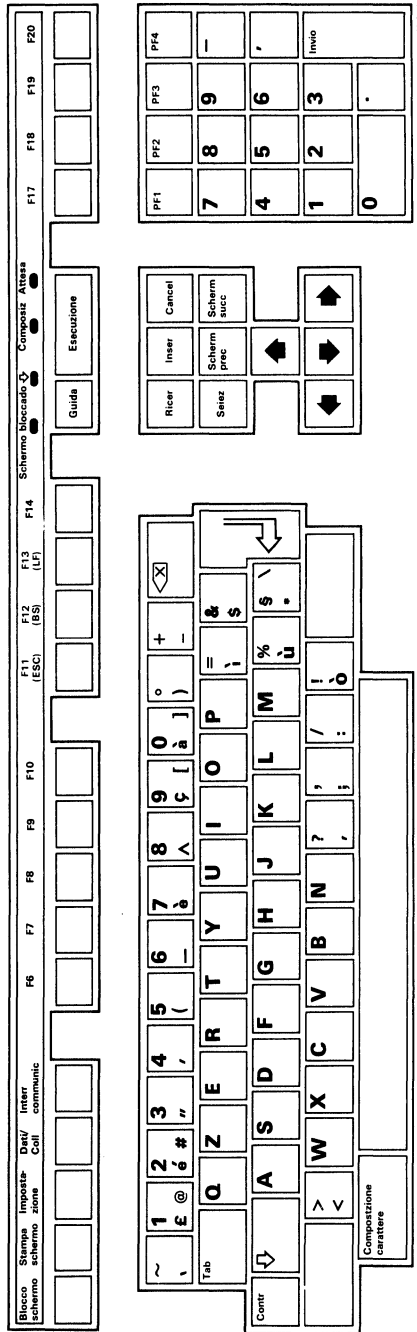

Figure C-10 Italy

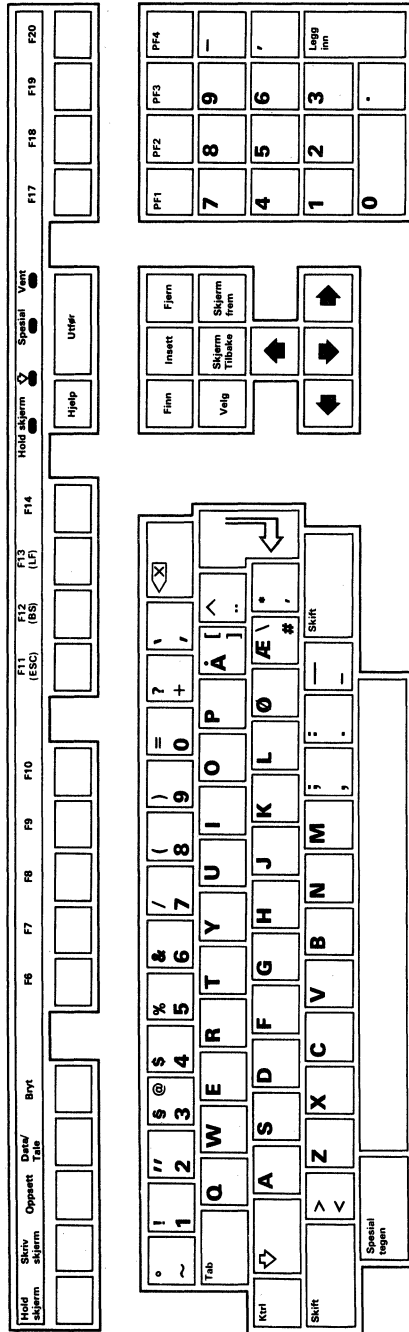

Figure C-11 Norway

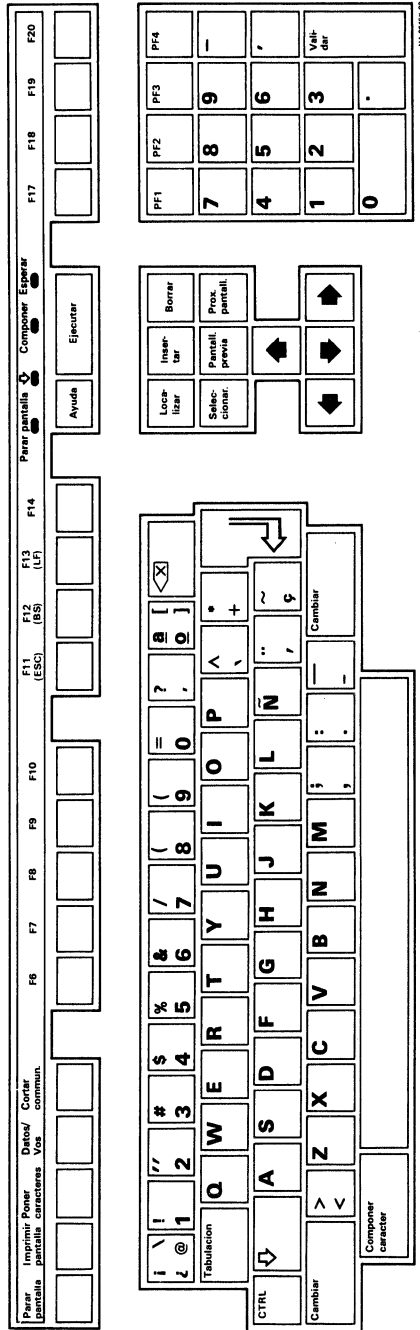

Figure C-12 Spain

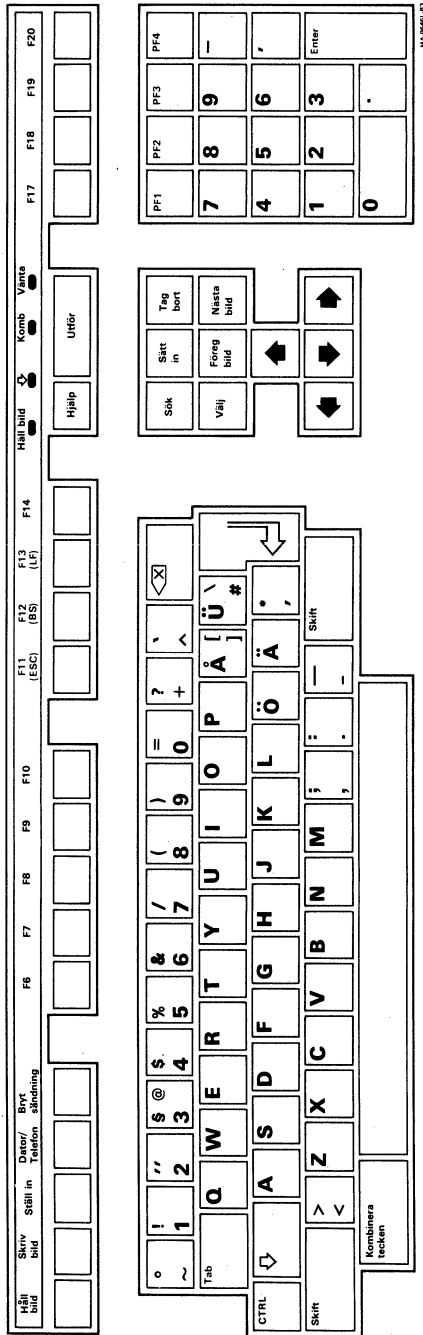

Figure C-13 Sweden

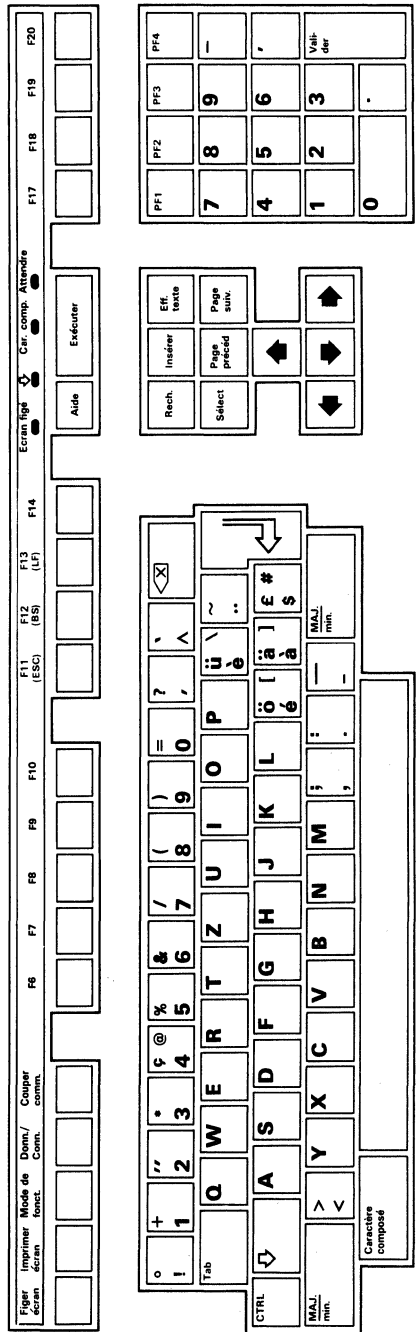

Figure C-14 Switzerland (French)

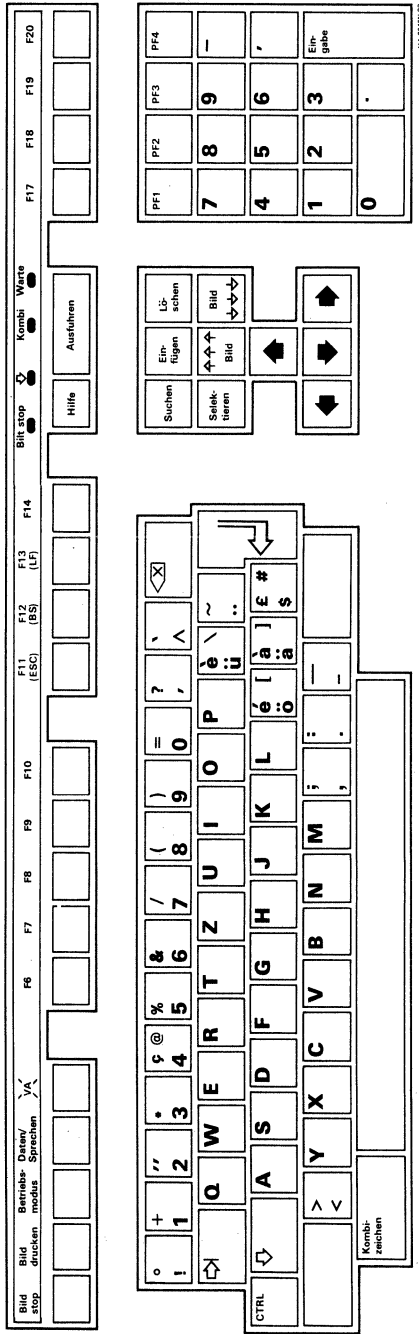

Figure C-15 Switzerland (German)

INDEX

- A -

ANSI standards, 2, 77, 99
Answerback message, 73-74
Application keys, 15
Arrow keys, 12, 40
Auto repeat feature, 71

- B -

Bell, 17, 72
Break key, 14, 72
BS (backspace) key, 15

- C -

Changing operating features.
 See Chapter 4
Character set mode, 56
Character sets, 4
 DEC multinational, 4
 national, 4
Clear display, 46
Communications, 77-88
 buffer overflow, 86-87
 cables, 83

 character format, 84
 connect/disconnect, 88
 fill characters, 87
 host computer, 61-63, 85
 interfaces, 78
 modems, 78
 printer, 66-67, 88
 signals, 79-82
 standards, 77
 XON/XOFF conditions, 85-86
Components, 1-2
Composing characters, 21-34
 aborting or restarting, 24
 Compose Character key, 12,
 21-24
 Compose indicator, 16
 multinational mode, 24-28
 national mode, 29-34
 three-stroke sequence, 21, 23
 two-stroke sequence, 21, 22, 23
Control codes, 50
CRT saver feature, 5
Ctrl (control) key, 10
Cursor keys, 15, 57
Cursors, 7, 14, 52

- D -

Data flow control,
 terminal-host computer, 85-88
 terminal-printer, 88
 Data processing keys, 70
Data/Talk key, 14
 Default settings, 48
 Delete key, 11, 24, 39
 Disconnect delay, 63
 Digital service, 92
 Documentation, 98

- E -

Editing, 12, 15
Enter key, 12, 39, 40, 75
 Entering data, 2
ESC (escape) key, 20

- F -

Function key summary, 15

- H -

Hold Screen
 key, 13, 85, 90
 indicator, 16

- I -

Indicators
 audible, 16-17
 visual, 16
 Interfaces
 20 mA port, 7
 host ports
 (comm and 20 mA), 6-7, 78
 printer port, 7, 78

- K -

Keyboard, 2, 9-17
 auxiliary keypad, 12
 editing keypad, 12
 main keypad, 10-12
 national keyboards, 101-116
 selecting, 48
 top-row function keys, 13-15
 Keyclick, 16, 71
 Keypad characters, 57

- L -

Language
 set-up, 47
 keyboard, 48
LF (line feed) key, 15
 Lights. See Indicators
 Local, 3, 46
 Lock
 key, 11, 71
 indicator, 16, 71

- M -

Modems, 21, 78, 97
 Monitor, 1, 2
 controls, 8
 Multinational mode, 4

- N -

National mode, 4
 National replacement character
 sets, 4

- O -

On-line, 3, 46
 Operating features.
 See Set-up screens summary
 Operating modes
 VT52, 4, 54
 VT100, 4, 54
 VT200, 7-bit controls, 3, 54
 VT200, 8-bit controls, 4, 54
 Operating states, 2
 local, 3
 on-line, 3
 set-up, 3
 Options, 97
 Ordering information, 99

- P -

Power-up self-test, 91
 error messages, 92
 Print characters, 67
 Printers, 19, 84
 Printing, 19
 Printing modes, 20–21, 66
 auto print, 20
 local controller, 21
 normal, 20
 printer controller, 20
Print Screen key, 14
 Print terminator, 68
 Problem solving, 89
 common problems, 89–90

- R -

Recalling operating feature
 settings, 47
 Receive speed, 60
 Reset terminal, 47
Return key, 11, 57

- S -

Saving operating feature
 settings, 47
 Screen display
 type, 51
 width, 50
 Scrolling, 51
 Service, 92
 Set-up, 2, 35
 controls and cursor, 40
 example, 41
 fields, 39
 firmware version, 38
 key, 14, 40
 NVR memory, 35
 status line, 38
 terminal identifier, 37
 Set-up features.
 See Set-up screen summary
 Set-up screens, 36, 42
 Communications, 58–63
 Directory, 44–48
 Display, 49–52
 General, 53–57
 Keyboard, 69–74
 Printer, 64–68
 Summary, 42–43
 Tab, 75–76
 Titles, 37
Shift key, 11, 71
 Specifications, 93–96, 98
 Status line messages 38
 Supplies, 97, 99
 System unit, 1, 2

- T -

Tab key, 10, 75
Tabs, 75-76
Terminal
 controls, 5-8
 ID, 55
 set-up, 35
Transmit speeds,
 to a host computer, 59, 63
 to a printer, 65
Typewriter keys, 70

- U -

User-defined keys, 55
User features
 locking and unlocking, 56

- V -

VT220 components, 1

- W -

Wait indicator, 16
Wrapping test, 51

- X -

 (delete) key, 11, 24, 39
XOFF feature, 36, 60

INSTALLATION, WARRANTY, AND SERVICE INFORMATION

Installation/Warranty

If you purchased directly from Digital, refer to the sales agreement for installation and warranty terms purchased with your system.

If you purchased, leased, or rented from a vendor other than Digital, contact your vendor for information regarding installation and warranty terms.

Digital Services

Digital provides a wide range of maintenance programs to meet your service needs, from complete Digital support to complete self-maintenance.

On-Site Service

For quality maintenance performed at your site, you can choose from DECservice, Basic Service Agreements, or Time and Materials Service.

Carry-In Service

This is "return-to" maintenance at a considerable savings over on-site service.

DECmailer

If you perform your own maintenance, you should use our fast-turnaround, module-and-subassembly repair service, called DECmailer.

For more information on any of Digital's maintenance services, call the Digital Field Service information number in your area during normal business hours.

U.S.A.	(800)554-3333	Italy	(02)617961
Australia	(02)4125555	Japan	(03)9897161
Austria	(222)6776410	New Zealand	(09)595914
Belgium	(02)2425095	Norway	(2)160290
Canada	(800) 267-5251	Portugal	(1)725402
Denmark	(2)889666	Spain	(1)7331900
Finland	(0)423511	Sweden	(08)7338000
France	(6)0778292	Switzerland	(01)8169111
Holland	(30)640293	United Kingdom	(734)868711
Ireland	(1) 308433	West Germany	(089)95910

Training

Digital offers hardware maintenance courses at 17 worldwide training centers or your own facilities.

Spare Parts

If you perform your own maintenance, Digital Customer Spares provides spares inventory planning, maintenance test equipment and documentation, and emergency spare parts.

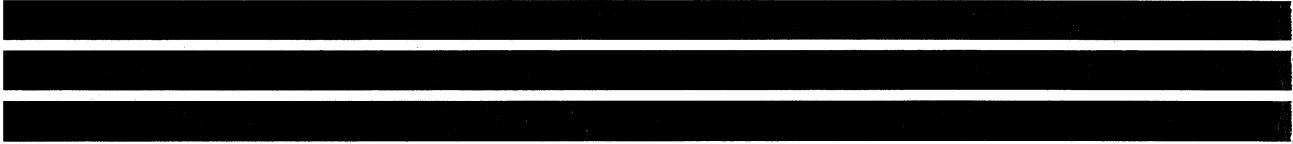

Printed in U.S.A.

EK-VT220-UG-003

VT 220

Owner's Manual Addendum for Models D, E, and F

EK-VT220-UG-003

The information in this addendum applies only to models D, E, and F of the VT220 video terminal. You can identify your model by looking at the label on the rear (Figure 1).

All other information in the *VT220 Owner's Manual* applies to VT220 models A, B, C, D, E, and F.

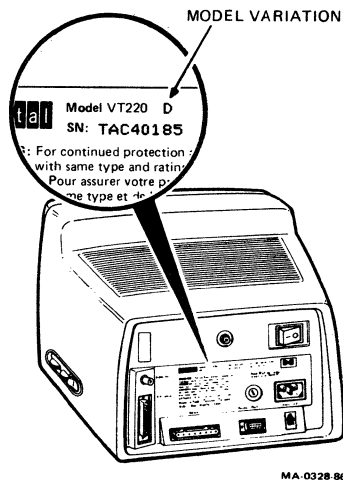

Figure 1 Identifying the VT220 Model

• **Table 3-2 Valid Compose Sequences: National Mode (Models D, E, and F)**

You can use the following compose sequences on the Danish and Norwegian keyboards for models D, E, and F. Pages 5 and 6 of this addendum show these keyboards.

Table 3-2 Valid Compose Sequences: National Mode (Models D, E, and F)

(1) Composite Character	(2) Three-Stroke Sequence	(3) Two-Stroke Sequence
Danish Keyboard		
(Models D, E, and F)		
#	number sign	+ +
Å	A ring	• A
Ø	O slash	Ø /
Æ	AE ligature	A E
å	a ring	• a
ø	o slash	o /
æ	ae ligature	a e
Norwegian Keyboard		
(Models D, E, and F)		
#	number sign	+ +
Å	A ring	• A
Ø	O slash	Ø /
Æ	AE ligature	A E
å	a ring	• a
ø	o slash	o /
æ	ae ligature	a e

- **Table 4-6 General Set-Up Screen**

Add the following note to the description of national mode.

Field	Function
Character Set Mode	
[] National	<p>NOTE (For models D, E, and F) If you select Data Processing Keys (Keyboard Set-Up screen) in national mode, the default character set* is the ASCII set. For keys with more than two characters, this setting selects the characters on the right half of keycaps.</p>

- **Table 4-9 Keyboard Set-Up Screen**

Add the following note to the description of the Typewriter Keys/Data Processing Keys feature.

Field	Function
_____ Keys	<p>NOTE (For models D, E, and F) If you select Typewriter Keys in national mode (General Set-Up Screen), the default character set* is the national replacement character set associated with the selected keyboard.</p> <p>If you select Data Processing Keys in national mode, the default character set is the ASCII set.</p>

* The default character set is the set selected when you turn on or reset the terminal.

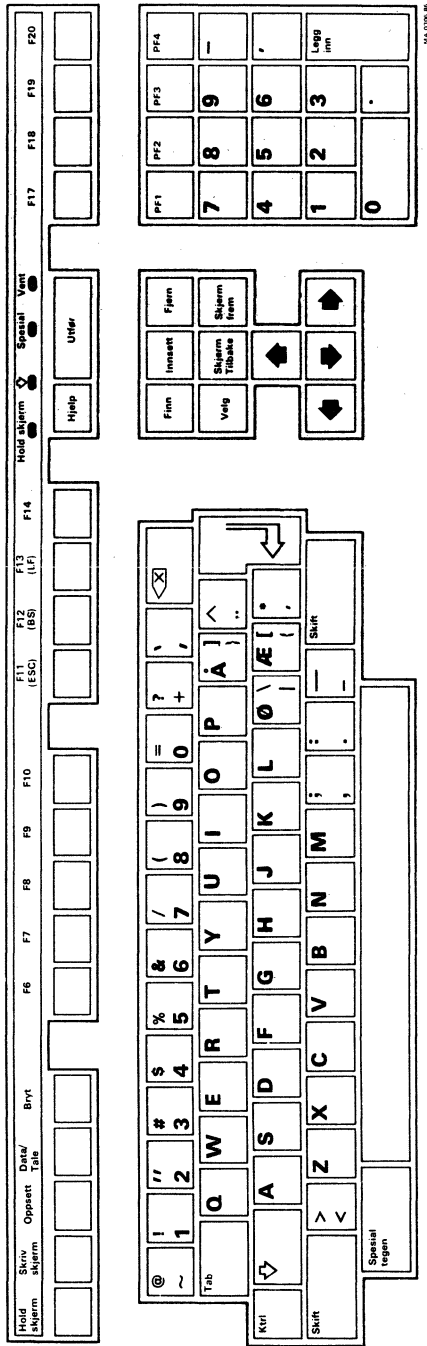

Figure C-11 Norwegian (Models D, E, and F)

• APPENDIX C KEYBOARDS

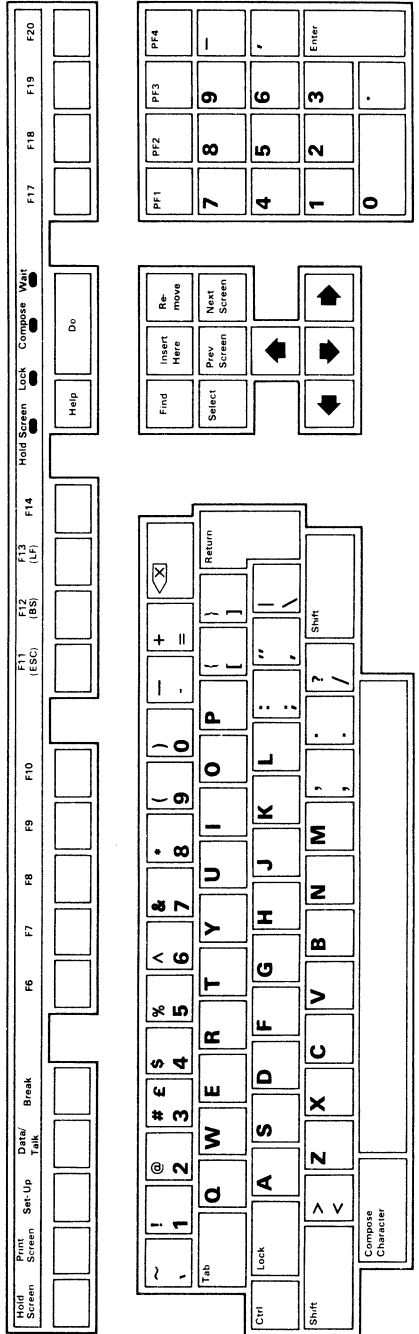

Figure C-2 United Kingdom (Models D, E, and F)

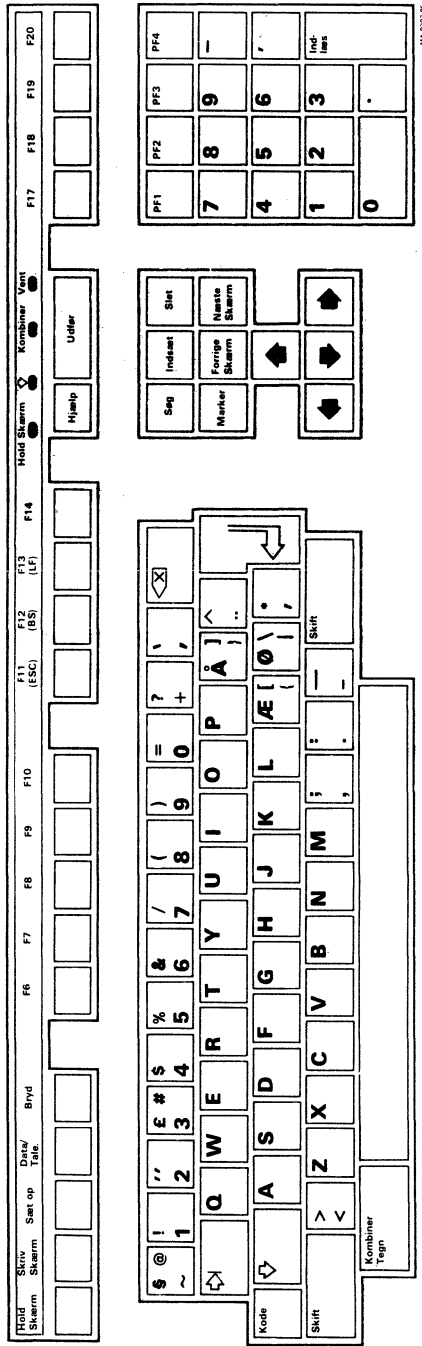

Figure C-5 Denmark (Models D, E, and F)

Printed in U.S.A.

EK-VT220-UG-003