

# SYSTEMS MANUAL

digital



INDUSTRIAL 14 FAMILY

# 14

OF CONTROLLERS

DEC-14-HSMAA-A-D

# INDUSTRIAL 14 SYSTEMS MANUAL

Copyright © 1974 by Digital Equipment Corporation

The material in this manual is for informational purposes and is subject to change without notice.

Digital Equipment Corporation assumes no responsibility for any errors which may appear in this manual.

Printed in U.S.A.

The following are trademarks of Digital Equipment Corporation, Maynard, Massachusetts:

DEC	PDP
FLIP CHIP	FOCAL
DIGITAL	COMPUTER LAB

## CONTENTS

	Page
INTRODUCTION . . . . .	vii
RELATED DOCUMENTS . . . . .	vii
INDUSTRIAL 14 CONTROLLER SPECIFICATIONS . . . . .	viii
VT14 PROGRAMMING TERMINAL SPECIFICATIONS . . . . .	xi
<b>CHAPTER 1    DESCRIPTION</b>	
PURPOSE . . . . .	1-1
APPLICATIONS . . . . .	1-1
Stand-Alone . . . . .	1-1
Computer . . . . .	1-1
DESCRIPTION . . . . .	1-2
General . . . . .	1-2
The I/O System . . . . .	1-3
Converters . . . . .	1-3
Mounting Panels . . . . .	1-6
Terminal Jumpers . . . . .	1-6
I/O Cables . . . . .	1-7
Rails . . . . .	1-8
The Control Unit . . . . .	1-8
Enclosure . . . . .	1-8
Backplane . . . . .	1-9
Fan . . . . .	1-10
Power Supply . . . . .	1-10
Indicator Lights . . . . .	1-10
Modules . . . . .	1-11
Interfacing . . . . .	1-12
OPERATING CONCEPTS . . . . .	1-12
FUNCTIONAL DESCRIPTION . . . . .	1-13
Control Logic . . . . .	1-14
I/O Logic . . . . .	1-14
Main Memory . . . . .	1-14
Internal Functions . . . . .	1-14
I/O Assignment . . . . .	1-16
Assignment Sheets . . . . .	1-18
Input and Output Forms . . . . .	1-18
Input Converter Operation . . . . .	1-18
Output Converter Operation . . . . .	1-20
I/O Multiplexing . . . . .	1-21
TIMING CONSIDERATIONS . . . . .	1-22
DEVELOPING AN INDUSTRIAL 14 CONTROL SYSTEM . . . . .	1-25
ATYPICAL CONFIGURATION . . . . .	1-26
<b>CHAPTER 2    INSTALLATION</b>	
SITE CONSIDERATIONS . . . . .	2-1
Environmental Specifications . . . . .	2-1
Power Requirements . . . . .	2-1
Electrical Noise . . . . .	2-1
GENERAL INFORMATION . . . . .	2-2

## CONTENTS (Cont)

	Page
<b>GENERAL INFORMATION</b> . . . . .	2-2
NEMA-12 Type Enclosure . . . . .	2-2
Control Unit/Power Supply Location . . . . .	2-2
Field Wiring and I/O Cable Routing . . . . .	2-2
System Expansion . . . . .	2-2
Mixing Converter Types . . . . .	2-3
Converter Installation . . . . .	2-4
<b>INSTALLATION PROCEDURE</b> . . . . .	2-5
System Layout . . . . .	2-5
Control Unit/Power Supply Installation . . . . .	2-5
I/O Group Installation . . . . .	2-6
Panel Mounting . . . . .	2-6
Group-Assembly Mounting . . . . .	2-6
Electrical Connections . . . . .	2-7
Power Supply . . . . .	2-7
Field Wiring . . . . .	2-7
I/O Cables . . . . .	2-8
Option/Interface Installation . . . . .	2-9
DA14-E Option . . . . .	2-9
Internal Connections . . . . .	2-10
External Connections . . . . .	2-10
DA14-EL Option . . . . .	2-11
Internal Connections . . . . .	2-11
External Connections . . . . .	2-11
DC14-F Option . . . . .	2-11
Internal Connections . . . . .	2-12
External Connections . . . . .	2-12
M7483 Calibration . . . . .	2-12
M8655 Calibration . . . . .	2-12
Expanding Main Memory of an Industrial 14/30 . . . . .	2-12
VT14/Industrial 14 Interface . . . . .	2-15
VT14/LT33 Teletype <sup>®</sup> Option . . . . .	2-15
<b>INITIAL START-UP PROCEDURE</b> . . . . .	2-16
<b>CHAPTER 3     USER MAINTENANCE</b>	
3.1           INTRODUCTION . . . . .	3-1
3.2           MAINTENANCE PHILOSOPHY . . . . .	3-1
3.3           RECOMMENDED TEST EQUIPMENT . . . . .	3-1
3.4           RECOMMENDED SPARE PARTS . . . . .	3-1
3.5           ISOLATING A FAILURE . . . . .	3-1
3.5.1         Partial Failures . . . . .	3-1
3.5.2         External Failures . . . . .	3-4
3.5.3         Controller . . . . .	3-4
3.5.4         Complete Failure . . . . .	3-15
<b>APPENDIX A    ASSIGNMENT SHEETS</b>	
<b>APPENDIX B    INPUT AND OUTPUT FORMS</b>	

## ILLUSTRATIONS

Figure No.	Title	Page
1-1	Stand-Alone Application . . . . .	1-1
1-2	Monitored Application . . . . .	1-1
1-3	Interactive Application . . . . .	1-2
1-4	A Maximum Configuration Industrial 14 System . . . . .	1-2
1-5	A dc Input and an ac Output Converter . . . . .	1-3
1-6	An ac Input Circuit (a) and a dc Input Circuit (b) . . . . .	1-4
1-7	An ac Output Circuit (a) and a dc Output Circuit (b) . . . . .	1-5
1-8	An H912 Mounting Panel . . . . .	1-6
1-9	Terminal Jumper Strips for I/O Converters . . . . .	1-7
1-10	An I/O Cable (BC14F) . . . . .	1-7
1-11	I/O Cable Locking Connector . . . . .	1-7
1-12	A Set of Mounting Rails . . . . .	1-8
1-13	The Industrial 14 Control Unit . . . . .	1-8
1-14	The Industrial 14 Printed Circuit Backplane . . . . .	1-9
1-15	The Industrial 14 Power Supply . . . . .	1-11
1-16	A Block Diagram of Industrial 14 System Interfacing . . . . .	1-12
1-17	Examples of a Control Circuit and the Equivalent Equation . . . . .	1-12
1-18	Industrial 14 Program Execution Cycle . . . . .	1-13
1-19	A Block Diagram of the Circuitry Contained in the Industrial 14 Control Unit . . . . .	1-13
1-20	Internal Function Partitioning . . . . .	1-15
1-21	Record Full-Depth Reached Using Retentive Memory . . . . .	1-15
1-22	Track a Reject Part Using a Shift Register . . . . .	1-15
1-23	Open Hopper for 32 Seconds Using Time Delay . . . . .	1-16
1-24	Shut-down Station on Three Successive Bad Parts Using an Event Counter . . . . .	1-16
1-25	Limiting Parts on a Conveyor Using an Up-Down Counter . . . . .	1-16
1-26	Clearing a Timer if Power is Lost . . . . .	1-16
1-27	I/O Number Assignments . . . . .	1-17
1-28	Samples of Input, Output, and Internal Function Assignment Sheets . . . . .	1-19
1-29	A Sample of an Input Form . . . . .	1-20
1-30	A Sample of an Output Form . . . . .	1-20
1-31	A Mounting Panel with Input Converter and Control Unit Connections Indicated . . . . .	1-20
1-32	A Mounting Panel with Output Converter and Control Unit Connections Indicated . . . . .	1-21
1-33	H912 Panel Selection Technique . . . . .	1-22
1-34	Industrial 14 Timing Considerations . . . . .	1-23
1-35	Atypical Configurations for the Industrial 14 Controller . . . . .	1-27
2-1	An Industrial 14 System with Six Panels of I/O . . . . .	2-3
2-2	A Typical Industrial 14 Controller . . . . .	2-4
2-3	I/O Converter Installation . . . . .	2-4
2-4	Typical System Layout . . . . .	2-5
2-5	Installing an I/O Mounting Panel . . . . .	2-6
2-6	Power Supply Connections for 120 V and 240 Vac . . . . .	2-7
2-7	Field Wiring Connections to Converters . . . . .	2-7
2-8	Wiring Diagram for the DC I/O Converter . . . . .	2-8
2-9	I/O Cable Connections . . . . .	2-8
2-10	Industrial 14 Interface Options . . . . .	2-9
2-11	The DA14-E and DA14-EL Options Installation . . . . .	2-9
2-12	The DC14-F Option Installation . . . . .	2-11
2-13	Calibration of the Industrial 14 M7483 Module . . . . .	2-13
2-14	Calibration of the M8655 Module for use in the PDP-8 . . . . .	2-14

## ILLUSTRATIONS (Cont)

Figure No.	Title	Page
2-15	G111 Module Layout . . . . .	2-15
2-16	M7431 Module Layout . . . . .	2-15
3-1	Isolating an Installation Failure . . . . .	3-2
3-2	A General Isolation Procedure for a Partial Failure . . . . .	3-3
3-3	Partial Failure Isolation Procedure Using I/O Lights . . . . .	3-5
3-4	Controller Failure Isolation Procedure (No VT14 or Computer Available) . . . . .	3-6
3-5	Controller Failure Isolation Procedure Using a VT14 or Computer . . . . .	3-7
3-6	I/O Fault Isolation Procedure . . . . .	3-9
3-6a	Single Point Failure . . . . .	3-10
3-6b	Vertical Column Failure . . . . .	3-11
3-6c	Complete or Partial Panel Failure . . . . .	3-12
3-6d	Two or More Successive Panels Fail . . . . .	3-14
3-7	Industrial 14/VT14 Interface Check . . . . .	3-16
3-8	Overview of Complete Failure Troubleshooting Procedures . . . . .	3-17
3-8e	Power Up Unsuccessful (Power On Lights) . . . . .	3-18
3-8f	Power Up Unsuccessful (System Run Light) . . . . .	3-19
3-8g	Power Up Unsuccessful (Bus Error Light) . . . . .	3-19
3-8h	Cannot Load and Verify Memory . . . . .	3-20
3-8i	Cannot Verify Memory After Power Cycle . . . . .	3-21
3-8j	All Outputs Inoperative (VT14 Used) . . . . .	3-22
3-8k	All Outputs Inoperative (No VT14) . . . . .	3-24

## TABLES

Table No.	Title	Page
1-1	Indicator Lights . . . . .	1-10
1-2	I/O Logic Functions . . . . .	1-14
1-3	I/O Numbering . . . . .	1-17
1-4	Nominal Execution Time . . . . .	1-24
1-5	Industrial 14 Memory Cycle Time . . . . .	1-24
1-6	System Response Time . . . . .	1-25
2-1	Signal Converters and Panels . . . . .	2-5
2-2	BC14H/M8350 Connections . . . . .	2-10
2-3	BC14K/PDP-8/L Connections . . . . .	2-11
2-4	Partition Address Settings for Internal Functions . . . . .	2-17
3-1	Recommended Spare Parts . . . . .	3-2
3-2	I/O Voltage Checks . . . . .	3-4
3-3	Percentage of Components Checked . . . . .	3-15

## INTRODUCTION

This manual contains systems information for the Industrial 14/30 and 14/35 Controllers. A description of all system components is presented in Chapter 1; Chapter 2 is an installation guide. Chapter 3 contains module-substitution level user maintenance information. This level of maintenance assumes familiarity with industrial control systems and basic electrical repair techniques, but not necessarily programmable controllers. Fault isolation is accomplished by using module substitution techniques.

The Industrial 14 Controllers are programmed by either of two methods: Either on-line with the VT14 Programming Terminal using relay ladder diagram symbology, or off-line with a computer. Operating and programming instructions for the VT14 are presented in the VT14 User's Manual. The Industrial 14 Software Manual contains instructions for programming the 14's by computer.

## RELATED DOCUMENTS

Reference documents for the Industrial 14 Controller are listed in Table 1-1.

Related Documents

Title	Number	Description
Industrial 14 Technical Maintenance Manual	DEC-14-HIMMA-A-D	Detailed maintenance manual for the 14/30, 14/35, and VT14. Intended for use by Digital maintenance personnel.
VT14 User's Manual	DEC-14-GVTMA-A-D	A functional presentation of how the Industrial 14 is programmed with the VT14.
Industrial 14 Software Manual	DEC-14-ISUMA-B-D	A functional presentation of how the Industrial 14 is programmed with a PDP-8 Computer.
PDP-14 User's Manual	DEC-14-GGZC-D	Programming and Systems information for the first generation Industrial Controller.
PDP-14 Maintenance Manual	DEC-14-HGZB-D	Maintenance information for the first generation Industrial Controller.



## INDUSTRIAL 14 CONTROLLER SPECIFICATIONS

### GENERAL

Input Capacity	Up to 512 (ac or dc)
Output Capacity	Up to 256 (ac or dc)
Normal I/O Grouping	512 inputs 256 outputs or shift register bits 128 retentive memories or shift register bits 56 timers or counters 4 up/down counters
I/O Grouping Adjustment	Switch selectable to trade-off multiples of 8 timers and counters for 16 retentive memories or shift register bits and vice versa.
Memory Capacity	4K or 8K words; 0.25K reserved for internal functions
Instruction Execution Time	7.0 $\mu$ s for internal I/O numbers, 2.7 $\mu$ s for others
Memory Cycle Time	2.5 ms per 1K of control program

### ENVIRONMENTAL REQUIREMENTS

Operating Temperature	At control unit: 0° to 65° C or 32° to 150° F Outside mounting cabinet: 0° to 55° C or 32° to 130° F
Storage Temperature	-20° to 85° C or -4° to 185° F
Relative Humidity	5 to 95%, non-condensing
Vibration (in each of three normal axes)	1.25 g's, 0 to 100 Hz (sinusoidal)

### POWER REQUIREMENTS

Voltage	95 to 130 Vac or 190 to 260 Vac single phase
Frequency	47 to 63 Hz
Power Consumption	480 W

### H1500 AC INPUTS

Input Voltage Range	95 to 130 Vac
Loading	20 to 30 mA resistive
Response Times	7 to 17 ms turn-on or turn-off
+5 V Current	3 mA maximum

Isolation Photo isolated

Color Red

#### **H1550 DC INPUT**

Input Voltage Range 10 to 55 Vdc

Loading 15 to 25 mA resistive

Response Times 1.5 to 4 ms turn-on or turn-off

+5 V Current 3 mA maximum

Isolation Photo isolated

Color Blue

#### **H1600 AC OUTPUT**

Output Voltage Range 6 to 140 Vac at 0.1 to 500 Hz

Output Current Rating 10 mA minimum, 2 A steady state, 30 A inrush maximum

Response Times 50  $\mu$ s maximum turn-on, 8 ms maximum turn-off

Output Saturation Voltage 2.1 V maximum

+ 5 V loading 20 mA maximum

Isolation Transformer isolated

Color Red

#### **H1650 DC OUTPUT**

Output Voltage Range 10 to 55 Vdc

Output Current Rating 10 mA minimum, 2 A steady state, 8 A inrush maximum

Response Times 50  $\mu$ s maximum turn-on, 0.5–2.5 ms turn-off

Output Saturation Voltage 2 V maximum

+5 V loading 30 mA maximum

Isolation Photo isolated

Color Blue

## INTERNAL FUNCTIONS

Memory Requirements	256 internal I/O numbers maximum
Timers	0.1 to 99.9 sec or 1 to 999 sec, require 2 I/O numbers, accuracy: $\pm$ one increment (0.1 sec or 1 sec)
Counters	1 to 999 counts, require 2 I/O numbers
Up/Down Counters (4 included)	1 to 999 counts, require 4 I/O numbers
Retentive Memories	Require 1 I/O number
Shift Registers	Require 1 I/O number for the shift function and 1 I/O number for each register bit

All current states and values of internal functions are held during power shutdowns.

## MISCELLANEOUS

I/O Cables (BC14F-X)	Connect up to 8 input or output panels to the Industrial 14 control unit (x indicates cable length; standard lengths are 5, 10, 15 and 25 feet)
Mounting Rails	Mounts up to 8 I/O panels

## MECHANICAL

Control Unit	Dimensions: 22 in or 56 cm high, 17.5 in or 45 cm wide, 10.75 in or 27 cm deep  Weight: 55 lb or 25 kg
Power Supply	Dimensions: 8 in or 20 cm high, 17.5 in or 45 cm wide, 8 in or 20 cm deep  Weight: 35 lb or 16 kg  Dimensions: 4 in or 10 cm high, 17.5 in or 45 cm wide, 3 in or 7.7 cm deep (including height of overlapping connections)  Weight: 10 lb or 5 kg
I/O Group (8 mounting panels)	Dimensions: 32 in or 82 cm high, 17.5 in or 45 cm wide, 3 in or 7.7 cm deep (includes clearance for cable)  Weight: 90 lb or 41 kg

## VT14 PROGRAMMING TERMINAL SPECIFICATIONS

### ENVIRONMENTAL

Operating Ambient Temperature	0° to 50° C or 32° to 122° F
Storage Ambient Temperature	-40° to 65° C or -40° to 149° F
Relative Humidity	10 to 90%, non-condensing
Corrosive Atmosphere	Meets or exceeds NEMA-1 standards

### POWER REQUIREMENTS

Voltage	VT14AA: 95 to 130 Vac at 60 Hz VT14AB: 190 to 260 Vac at 47–63 Hz
Power consumption	200 W
Heat Dissipation	680 BTU/hr

### MECHANICAL

Dimensions	15 in or 38 cm high, 19 in or 48 cm wide, 27 in or 69 cm deep
Weight	88 lb or 40 kg
EMI,RFI	Shielding at the case and decoupling at the power source is provided

Input

AC output  
Switching

Controller

Power  
Supply

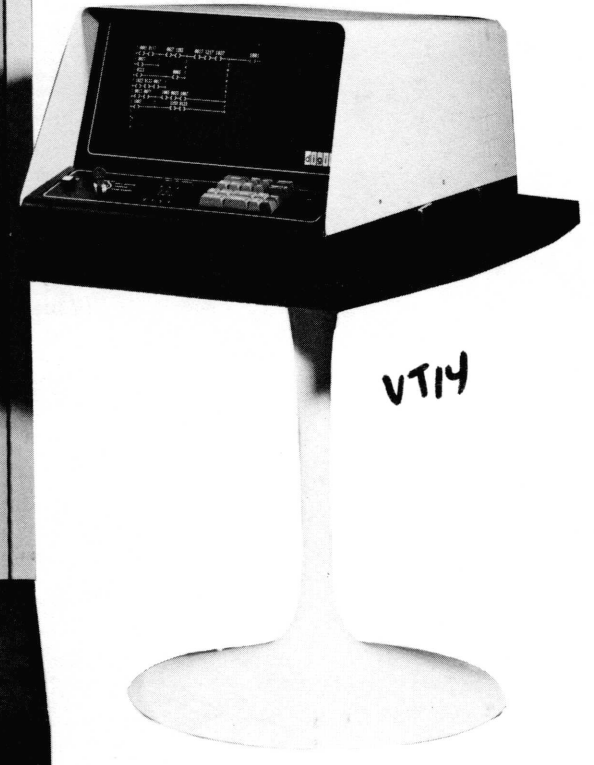
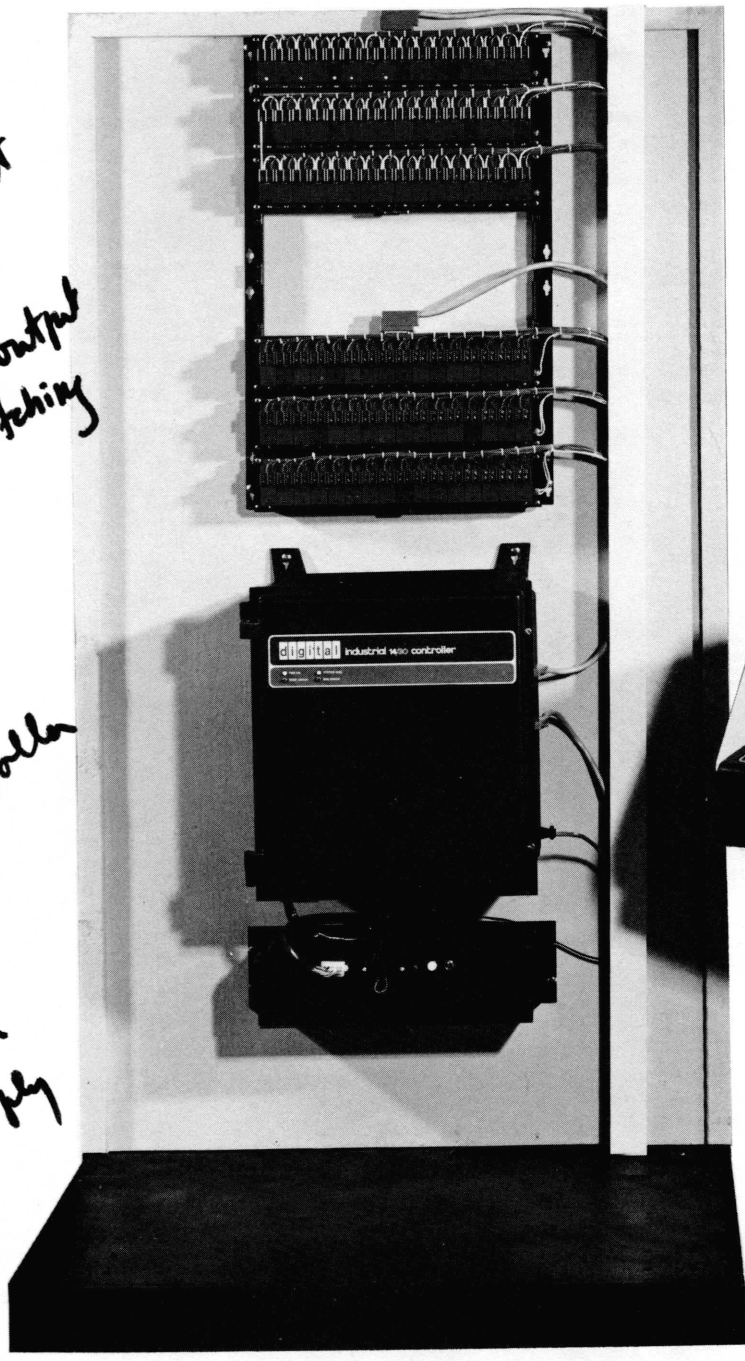

# CHAPTER 1 DESCRIPTION

Two Industrial 14 systems are available: the 14/30, which contains 4,096 (4K) words of core memory expandable to 8K; and the 14/35, which contains 8K words of memory. They are identical in all other respects and are referred to synonymously throughout this manual.

## PURPOSE

These systems were developed to meet the need for a more powerful and flexible control system than the first generation programmable controllers. They offer a complete programmable control system with many internal logic functions that eliminate the need for most optional features. Some of the many applications include automated transfer and assembly lines, process control measuring and gauging, machining and metal working, and material handling. In fact, the 14s can control any operation or process that comprises discrete steps and involves on/off status inputs and on/off control outputs. Some application examples follow.

## APPLICATIONS

### Stand-Alone

Most applications for the Industrial 14 Controller are stand alone, that is, the machine or process system is directly controlled by the Industrial 14 using a program in its Read/Write Memory. This program establishes the control relationships between status inputs and control outputs. Status inputs are provided as on/off inputs from the machine system pushbutton switches, limit switches, etc. The program continually tests the status inputs (and outputs) and, based upon the results, advances the control sequence by turning outputs (to solenoids, motor starters, etc.) on or off. Figure 1-1 is a block diagram of the stand-alone application.

### Computer

The Industrial 14 can be connected to a computer such as the PDP-8/E or PDP-11 for monitoring (Figure 1-2).

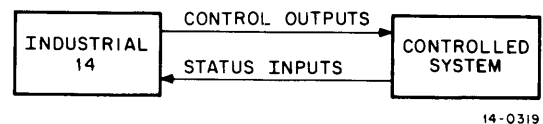

Figure 1-1 Stand-Alone Application

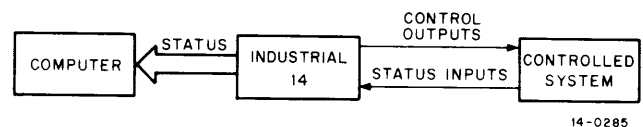

Figure 1-2 Monitored Application

Although the 14 performs control functions for a stand-alone application, it also reports status information to the computer. The computer analyzes this data to determine if the machine is working properly and/or stores production information (e.g., piece counts, cycle times, scheduled tool changes, etc.).

In other monitoring applications, the 14 does not control machine operation — this function is provided by relays or other control systems. Instead, it acts as an interface for the computer and tests inputs from the machine in an order defined by the 14 program (or by the computer) and provides the test results to the computer. The 14 does not control any outputs in this application. A monitoring application can involve several Industrial 14s.

The Industrial 14 can also be used with a computer in an interactive application (Figure 1-3) in which it can provide the fundamental control for the machine and return status information provided by the 14 or other information available to the computer (such as analog signals from a measuring device). An interactive application can involve several Industrial 14s and one or more computers.

**DESCRIPTION**

**General**

Figure 1-4 represents a full capacity Industrial 14/30 or 14/35 System. The term full capacity used here means the maximum number of input and output converters possible (512 and 256, respectively). A 14 system is comprised of a

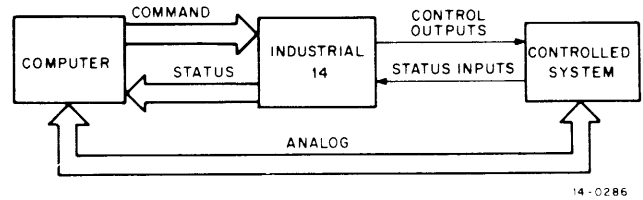

Figure 1-3 Interactive Application

control unit, a power supply, and up to six I/O groups (four input and 2 output). An I/O group consists of one or more panels up to a maximum of eight and each group contains up to 128 individual converters. The numbers shown in Figure 1-4 represent the total number of converters provided by adding each input or output panel; the actual number varies with the application.

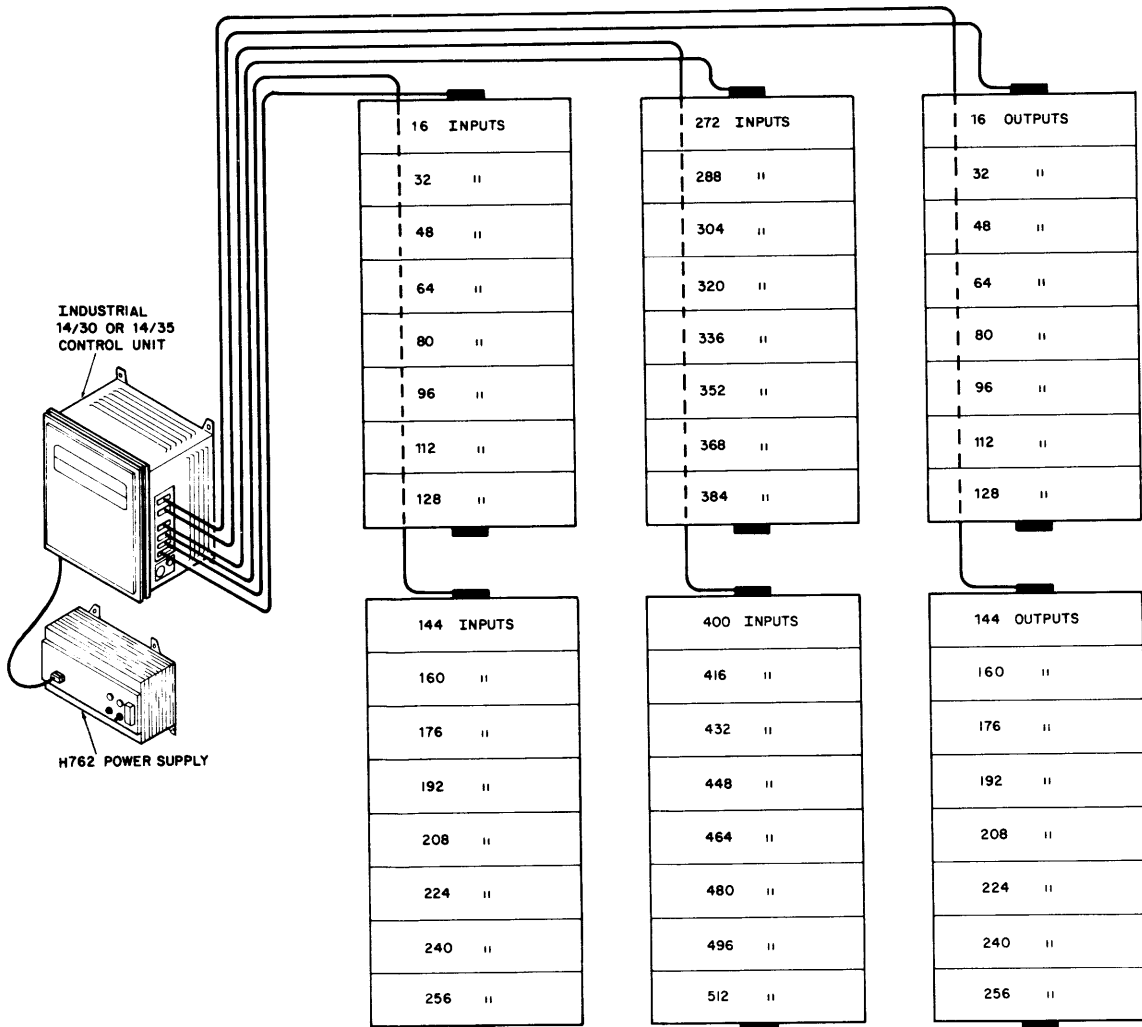

Figure 1-4 A Maximum Configuration Industrial 14 System

Each I/O group is connected to the control unit by a round, multiconductor cable. The I/O cables are identical and are terminated at both ends with 25-pin locking connectors.

The control unit houses the control logic, I/O logic, main memory, and interface options. Cooling is performed by closed convection; free space around the control unit should be maintained as described in Chapter 2 of this manual. An integral part of the control unit is the power supply, which is rated to accommodate the maximum system configuration. It too, must have free air space around it to permit sufficient cooling.

### The I/O System

The I/O system consists of input and output converters, mounting panels, rails, and I/O cables. The following paragraphs describe each.

### Converters

A unique feature of the Industrial 14 Controller is the single point expansion capability made possible by the individual plug-in converters (Figure 1-5). Each of these

units contains two pressure-type screw terminals — one for connecting the input (or load) and one for connecting the supply (or return) voltage. An indicating light (LED) which indicates the ON/OFF state of the external circuit, and a labeling surface for conveniently denoting the field connection to the unit appear on the face of the converter. Each converter is plugged into a mounting panel and secured in place with captive screws.

Figure 1-6 shows how each of the two types of input converters interface with the control unit. The H1500 (red) provides for 120 Vac input signals and represents a 2-3 VA load to the ac line. Signal conversion time is 7–17 milliseconds. The H1550 (blue) provides for 10–55 Vdc input signals and represents a nominal load of 20 milliamps independent of the supply voltage. Signal conversion time is 1.5–4 milliseconds. The input converters change the controlled machine or process system output signals from limit switches, photocells, pushbutton switches, etc., into signals that are compatible with the control unit.

There are also two types of output converters. Figure 1-7 is a block diagram showing how they interface with the control unit. The H1600 (red) provides for 120 Vac output signals that drive output devices with a continuous current rating of 2 A. These units have an inrush capability of 30 A for 30 milliseconds; signal conversion time is less than 0.5 milliseconds turn-on and less than 8 milliseconds turn-off. The H1650 (blue) provides for 10 to 55 Vdc with a continuous current drive of 2 A and a signal conversion time of less than 0.5 milliseconds turn-on and less than 2.5 milliseconds turn-off.

Note the use of a diode clamp across the load of the dc output (H1650) converter. This component is field installed and must be provided for all dc loads. A diode with a PIV of 100 V or greater, such as an IN4002, is recommended. The Field Wiring paragraph in Chapter 2 of this manual discusses the recommended and alternate methods of connecting a load to the dc converters.

If input and output converters are mixed on the same panel, one will not operate. For example, an output converter will not operate if it is plugged into a panel of input converters, yet the input converter operation is unaffected. Similarly, input converters will not operate if plugged into an output panel. The output converters have a white band across the face just below the connection terminals and are therefore easily recognizable if inadvertently plugged into an input panel.

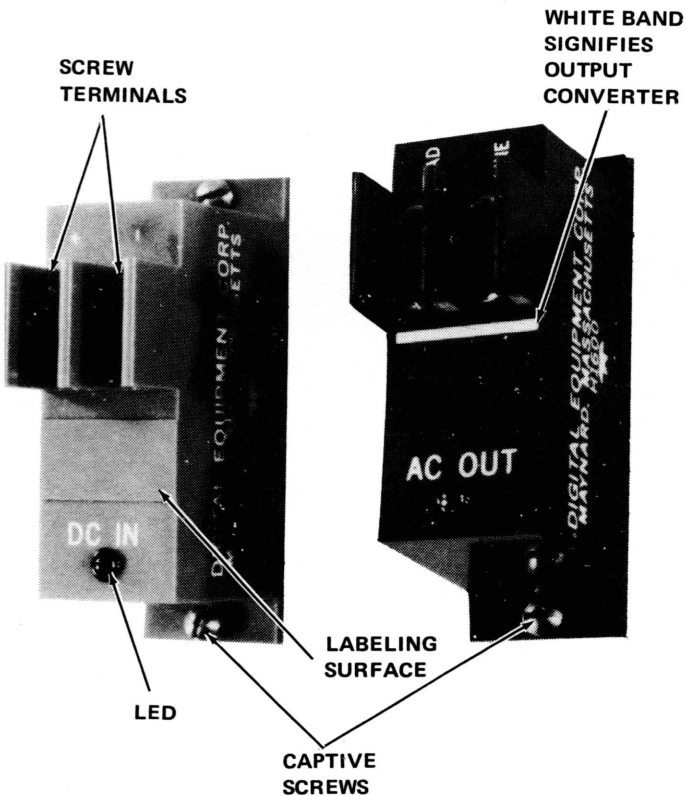
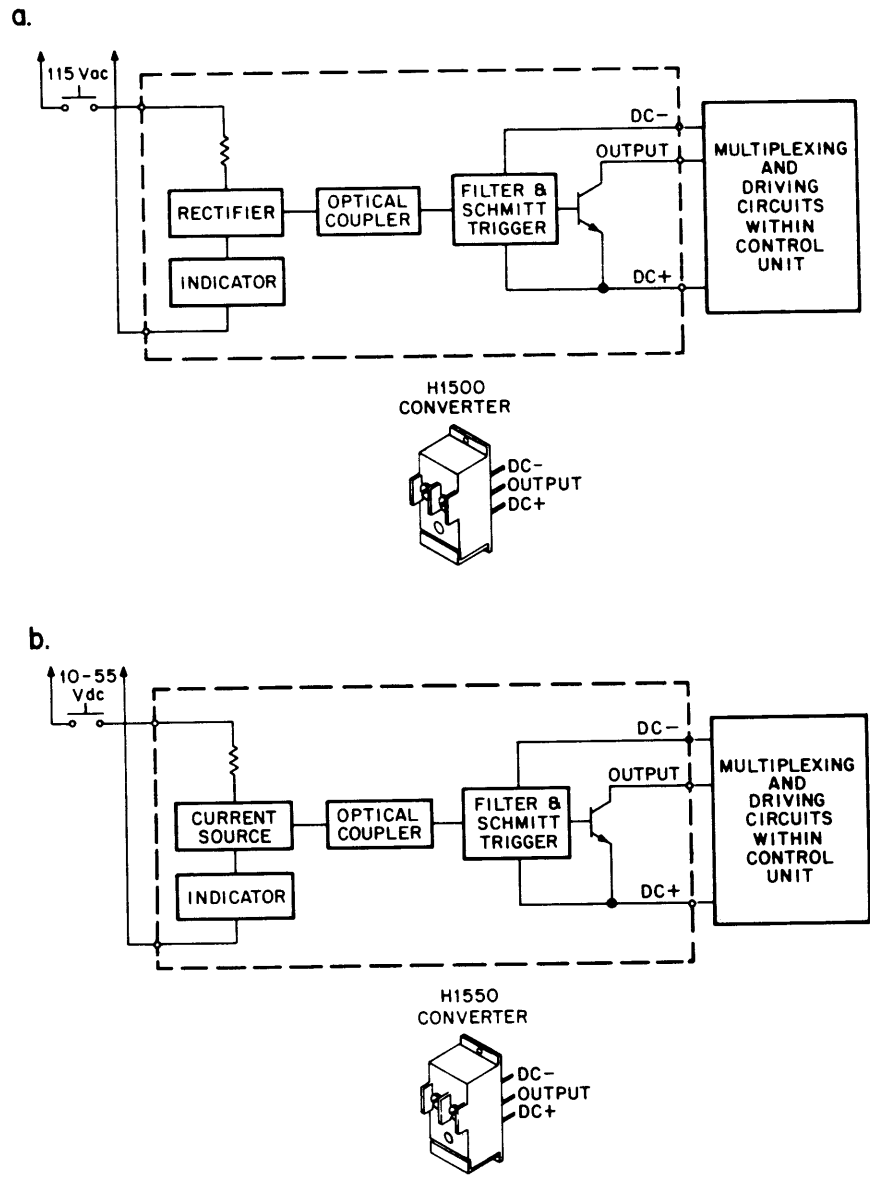

Figure 1-5 A dc Input and an ac Output Converter





14-0320

Figure 1-6 An ac Input Circuit (a) and a dc Input Circuit (b)

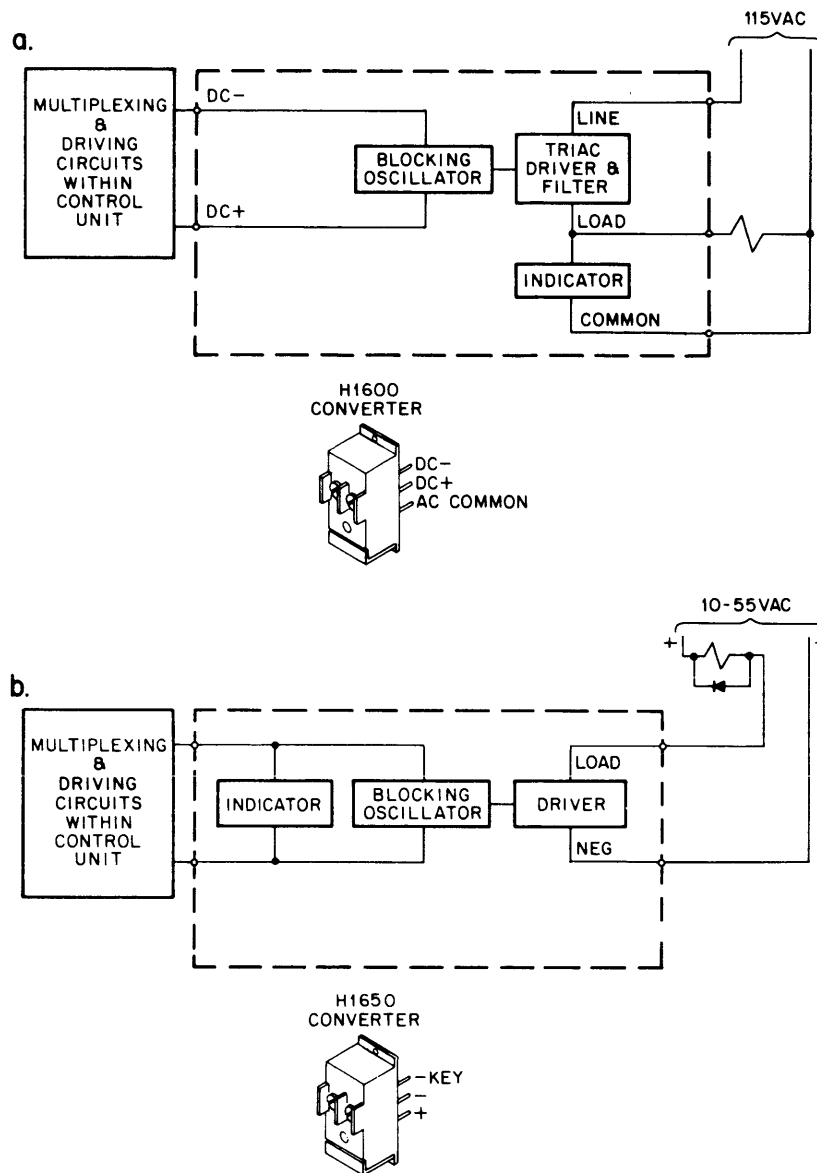

14-0316

Figure 1-7 An ac Output Circuit (a) and a dc Output Circuit (b)

### Mounting Panels

The H912 mounting panel (Figure 1-8) is a multiple socket mother board for connecting up to 16 individual plug-in converters. Any of the four converter types will plug into the mounting panel but for proper operation, input and output converters must be installed on separate panels.

The pressure type screw terminal on the lower right-hand corner of the mounting panel is the ac common for the indicating light on all ac output converters plugged into the panel. No connection is made to the terminal for dc output or input panels. This terminal is connected to ac common

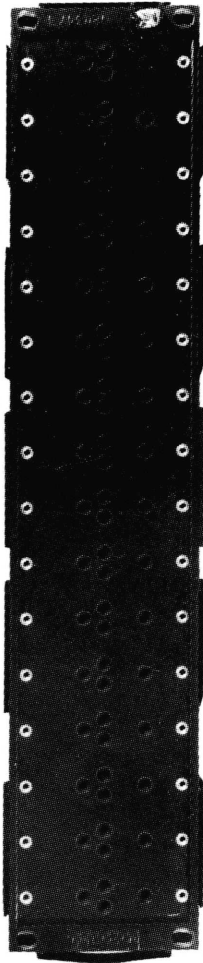

6982

Figure 1-8 An H912 Mounting Panel

in the field and the only current through it is that required to drive the LEDs. Therefore, the ac common for many panels can be connected by the same wire, provided they have the same common.

If a system is to have more than one transformer, the recommended installation must have separate output panels for each transformer. However, more than one transformer may be connected to the same panel if they have the same ac common or neutral and this common point is tied to the ac terminal on the output panel.

Twenty-five pin connectors that route signals between a panel and the control unit, or between panels, are located on the top and bottom edges of each panel. The first (top-most) panel of any I/O group is connected to the control unit with a round, multiconductor, BC14F cable. The top-edge connector of each successive mounting panel connects to the bottom-edge connector of the panel immediately above it. Eight mounting panels accommodating 128 converters can be interconnected in this manner.

### Terminal Jumpers

A terminal jumper (Figure 1-9), an eight-fingered strip of metal with a 16 A rating, is used to connect the common terminal of up to eight converters. With the jumper installed, individual converters can be replaced by loosening the terminal screw on the unit to be replaced and bending the jumper finger away from the converter. There is no need to loosen all eight terminal screws.

The limiting factor for jumpering a number of devices is the amount of current that must pass through the jumper under the worst case (maximum current) condition. The worst case condition for eight output converters is 16 A, which the terminal jumpers are rated to carry. However, when the jumpers are used, a single No. 14 wire normally connects the LINE terminals (negative terminals for dc converters) from the power source. The worst case condition may exceed the rating of No. 14 wire and must be considered before making field connections. Unless the sum of the output loads is less than 15 A at all times, either the field wire size must be increased or less than eight converters must be jumpered together.

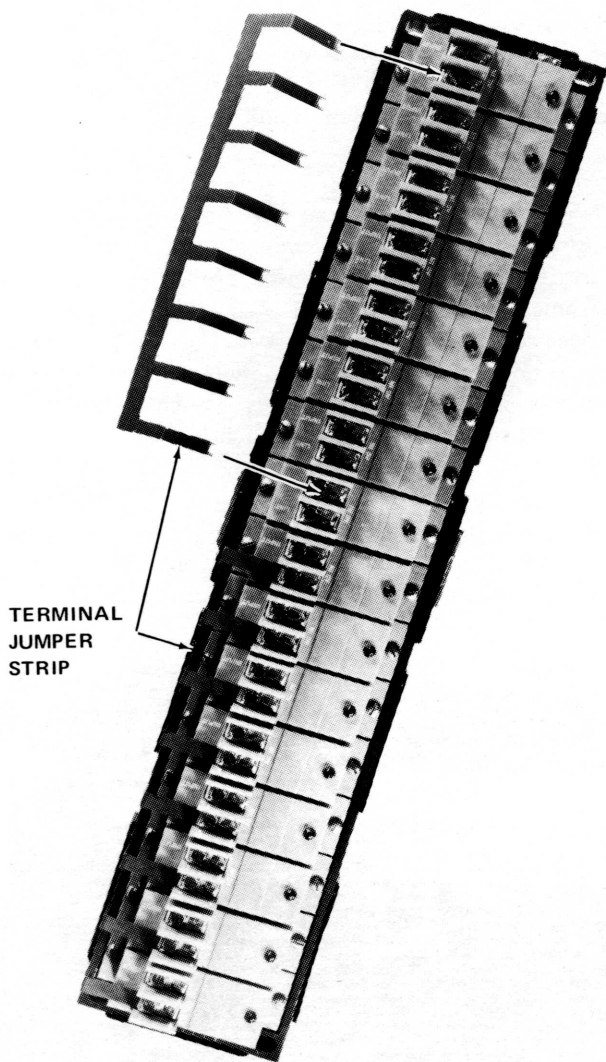

6982-3

Figure 1-9 Terminal Jumper Strips for I/O Converters

### I/O Cables

The I/O cables (BC14F-XX) carry low level dc signals between the control unit and the I/O groups. These cables (Figure 1-10) are round, flexible, and have a 25-pin locking connector on each end. When connected to the control unit or an I/O panel, the connectors are locked in place with a slide lock (Figure 1-11), which ensures a good electrical connection and prevents the connectors from working loose. Each cable contains eight panel select lines, sixteen data lines, and one ground line and are available in four lengths: 5, 10, 15 and 25 ft. Otherwise they are identical.



Figure 1-10 An I/O Cable (BC14F)

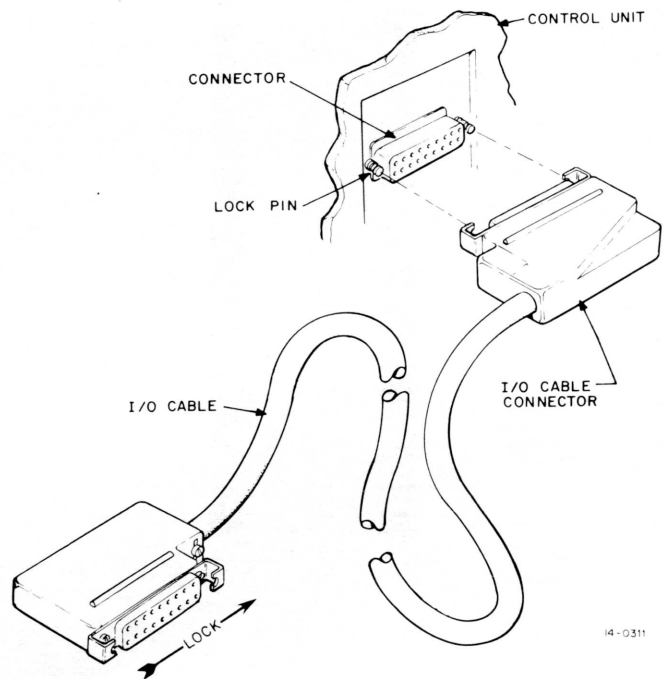

NOTE  
TO MATE THE CABLE CONNECTOR WITH THE CONTROL UNIT OR H912 PANEL CONNECTOR, FIRST PUSH THE SLIDE LOCK AWAY FROM THE CABLE. AFTER THE CONNECTORS ARE SEATED, PUSH THE SLIDE LOCK TOWARD THE CABLE TO LOCK THEM TOGETHER.

Figure 1-11 I/O Cable Locking Connector

### Rails

Mounting rails (H008) are available for mounting the I/O panels and are shown in Figure 1-12. Although they are not required, they facilitate panel mounting by ensuring the appropriate space between panels and they provide space for routing I/O cables behind the panels. For these reasons they are highly recommended.

The rails are 31 inches long and have tapped holes appropriately spaced for mounting eight panels. If space restrictions require shorter rails, they can be cut to accommodate any number of panels from 1 to 7. Any cut should be made between adjacent mounting holes.

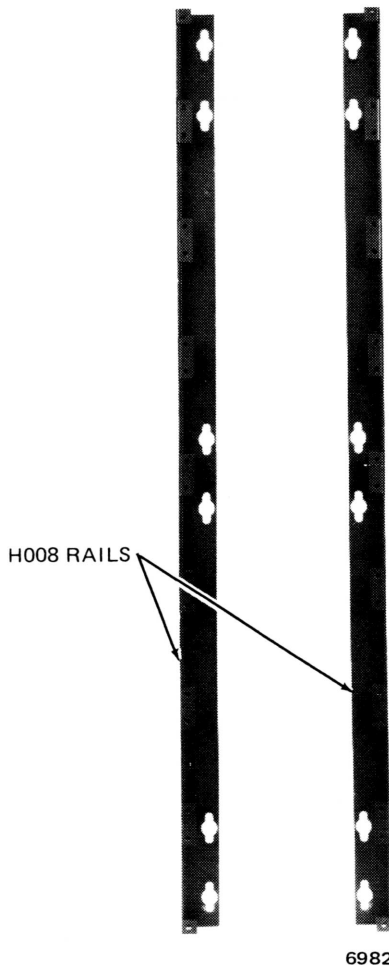

Figure 1-12 A Set of Mounting Rails

### The Control Unit

The backplane, plug-in modules, fan, and associated hardware enclosed in a NEMA-type enclosure make up the control unit (Figure 1-13). Each of these components is briefly described in the following paragraphs.

### Enclosure

A NEMA-12 type cast aluminum housing encloses the Industrial 14/30 or 14/35 control unit. This housing ensures the necessary heat transfer properties to keep the electronics within their operating temperature and protects the electronics and the Read/Write core memory from radiated interference and the contaminants of industrial atmospheres (metal chips, dust, dirt, coolants, etc.). Status lights for indicating proper operation or signaling the failure of a particular sub-system are located on the control unit door. I/O connectors (four input and two output), programming terminal, and computer interface connectors are all mounted outside so that during normal operation there is no need to open the control unit door.



Figure 1-13 The Industrial 14 Control Unit

**Backplane**

A printed circuit backplane provides a parallel bus structure which eliminates the possibility of damaging a module by plugging it into the wrong slot. However, to ensure adequate cooling the modules should be inserted as shown in Figure 1-14.

**NOTE**

Although the backplanes of the Industrial 14 and the PDP-8/E, F, or M are mechanically identical, their signals are not compatible.

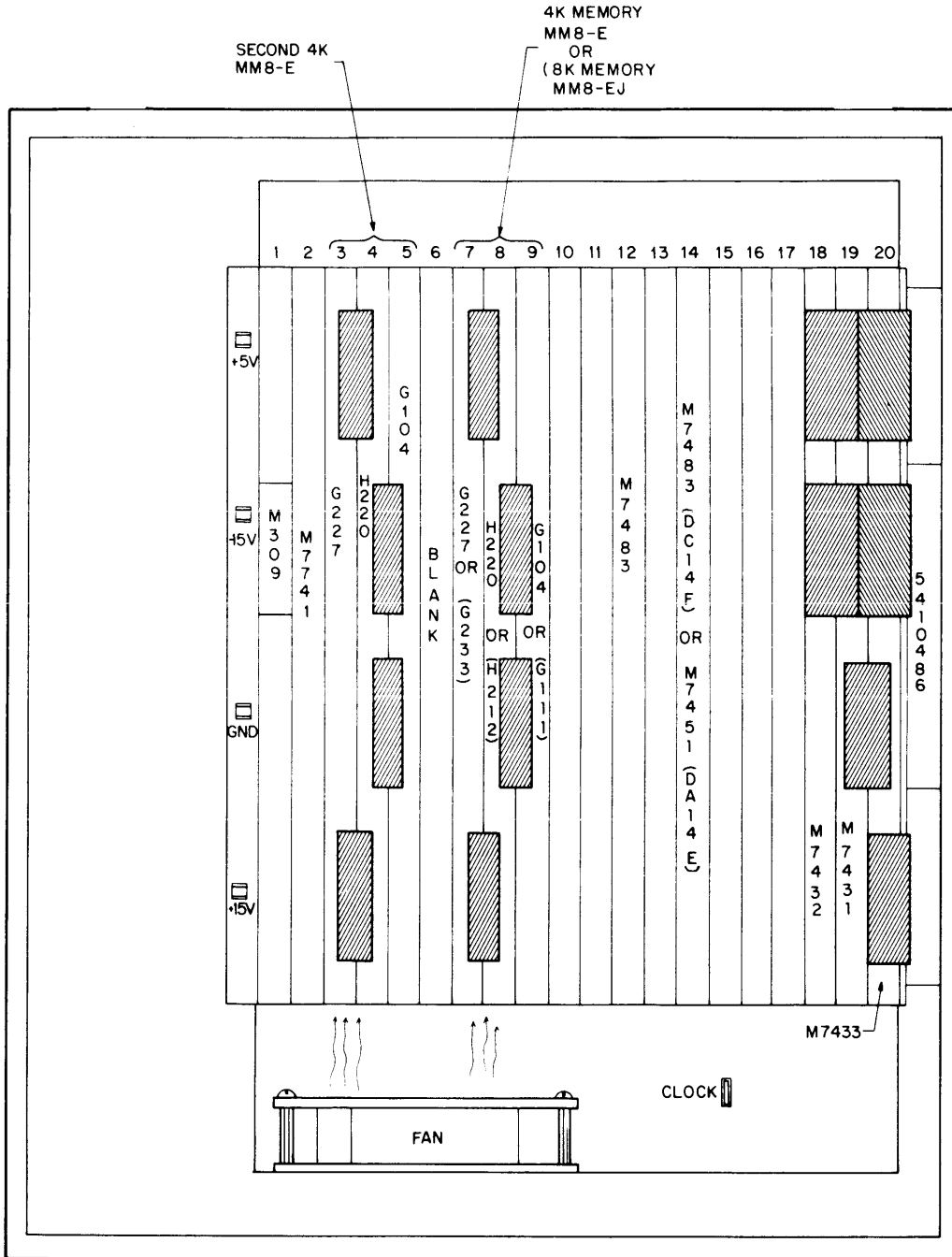

14-0290

Figure 1-14 The Industrial 14 Printed Circuit Backplane

**Fan**

The fan is an important part of the control unit since the cooling process inside the unit is by closed convection. The life expectancy is approximately ten years under normal operating conditions. If it fails, the control unit will continue to operate but the temperature inside the enclosure will increase and module failure may result. Therefore the system should not be allowed to run if the fan is inoperative – it should be replaced immediately.

**Power Supply**

The power supply (Figure 1-15) is enclosed in an extruded aluminum housing which ensures the necessary heat transfer properties to keep the electronics within their normal operating temperatures and provides protection from harsh environments. A 3-wire connection to a 120 V or 240 V, 47–63 Hz ac line is made to a 5-terminal connector strip on the front panel (refer to the power supply connections in Chapter 2). A front panel light indicates when power is switched on. All output signals are available at a 15-terminal Mate-N-Lok connector as indicated by the label (reproduced below) adjacent to the connector. This power supply is sufficient for all Industrial 14/30 or 14/35 Controllers including a 14/30 expanded to 8K of memory.

The following is a list of modules used in the Industrial 14 Control Units:

M7741	Timing and Control
M7431	I/O Memory Control
M7432	I/O Timing and Control
M7433	I/O Multiplexing and Drivers
M7451	Parallel Interface (optional)
M7483	Serial Interface
5410486	Connector Interface
G104	} Main Memory (4K); 14/30
G227	
H220	
G233	} Main Memory (8K); 14/35
H212	
G111	
M309	Power Sequence Filter

**Indicator Lights**

The indicator lights appear on the front panel of the control unit housing. The two green status lights (POWER ON and SYSTEM RUN) indicate the proper operation of the control system and are normally on. The red error lights (ADDRESS ERROR and BUS ERROR) indicate the failure of a particular subsystem and are normally off. Table 1-1 lists the specific function of each light.

**Table 1-1  
Indicator Lights**

Name	Function
PWR ON	+5 Vdc is present
SYSTEM RUN	Timing is running
ADDR ERROR	Illegal program address
BUS ERROR	Illegal data conditions on memory data lines

**Modules**

Figure 1-14 shows the recommended placement of modules in the Industrial 14 Control Unit. The main memory modules (G227, H220, and G104 for the 14/30, or G233, H212, and G111 for the 14/35) are located directly above the right-hand edge of the fan. If a second 4K stack is used to expand a 14/30 to 8K, these modules are inserted directly above the left-hand edge of the fan. These locations

are important because the memory modules should be in the path of maximum air flow to take advantage of the maximum efficiency of the fan. The I/O control modules (M7431, M7432, and M7433) are located at the extreme right-hand side of the backplane. This location is necessary to facilitate the over-the-top connectors associated with the I/O multiplexer.

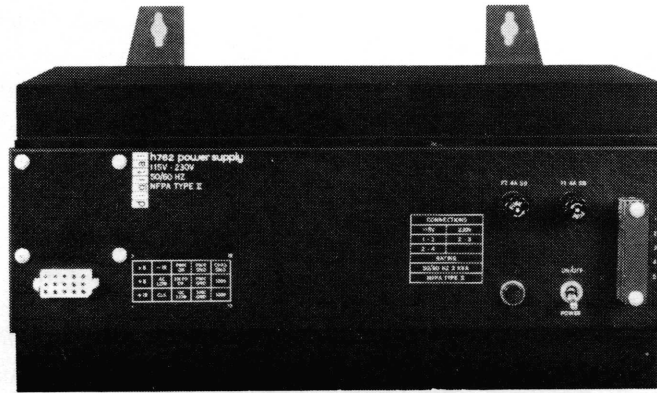

6979

Figure 1-15 The Industrial 14 Power Supply

3	6	9	12	15
+5	-15	PWR OK	PWR GND (Supply Common)	Chassis GND
+5	AC Low	Enable Power OK	PWR GND (Supply Common)	120 Vac
+15	CLK	DC Low	Shield GND (Supply Common)	120 Vac
1	4	7	10	13

Power Supply Connector Pin Configuration



### Interfacing

Figure 1-16 is a block diagram showing the Industrial 14 System interfacing. (Refer to Chapter 2 of this manual for interface installation instructions.) The control unit has a utility port used for programming and a monitoring port used for on-line communication to a computer. These ports are similar because a computer can be interfaced through either, but operationally they are totally independent, using separate output registers for data transfer.

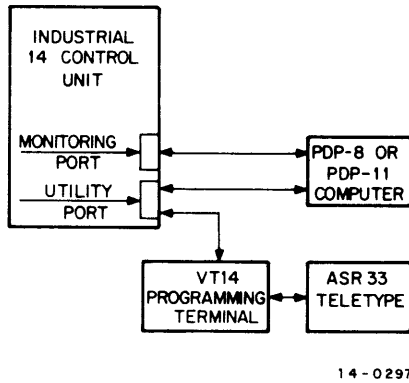

Figure 1-16 A Block Diagram of Industrial 14 System Interfacing

An M7483 Module and a harness connecting it to the utility port are factory installed in the control unit. Similarly an M8655 Module with a BC14J cable attached is factory installed in the VT14. Industrial 14/VT14 interfacing is accomplished by connecting the BC14J cable to the utility port. Using a KL8-JA option, the PDP-8/E, F, or M computer can be interfaced with the Industrial 14 in the same manner; and in both cases a 9600 baud, 20 mA interface is achieved. This connection is used to program an Industrial 14 from a computer using ODP-143.

Two Industrial 14/PDP-8 interface options are available for the monitoring port. One of these is the DC14-F serial interface option which is functionally identical to that interface used in the utility port except that data is passed through a different output register, and physically identical except for an adapter plate that is included to facilitate the connection to the COMP INTER mounting hole. This option provides a second serial communications link between the controller and a computer.

The other option is the DA14 which is a parallel data link between the controller and the PDP-8. The option is comprised of an M7451 Module, a wire harness, and a cable to connect to the COMP INTR mounting hole. The DA14-E

includes a 25 ft. BC14H cable to connect to the PDP-8/E, F, or M. The DA14-EL includes a 25 ft. BC14K cable to connect to the PDP-8L. Programming information to use these interfaces may be found in the *Industrial 14 Software Manual* (DEC-14-ISUMA-A-D).

### OPERATING CONCEPTS

The control unit is the heart of the Industrial 14 System. It directs the machine or process sequence by solving input/output relationships using a program stored in its memory. This is accomplished by continuously passing through the complete program many times a second. On each pass all outputs are "re-evaluated" and compared to the conditions programmed into memory. These programmed conditions include the states of inputs, outputs, and internal functions. When the programmed conditions are met, the output converter is switched on; otherwise it is switched off.

The basic logic operators (AND and OR) for solving input/output relationships are inherent in the arrangement of the Test, Decision, and Operate instructions. Figure 1-17 is an example of a control circuit and the equivalent equation that the controller might be required to solve. To solve the equation in this figure, the controller tests input 1 for an ON condition and then tests input 2 for an ON condition. If the combination of these two tests is true, a Decision instruction links the program to an Operate instruction to set output 1001 ON. Otherwise a different Operate instruction is executed to turn the output OFF. The example in Figure 1-17b is solved by testing both inputs simultaneously. If either input is ON, the SET ON Operate instruction is executed; if both are OFF, the SET OFF Operate instruction is executed.

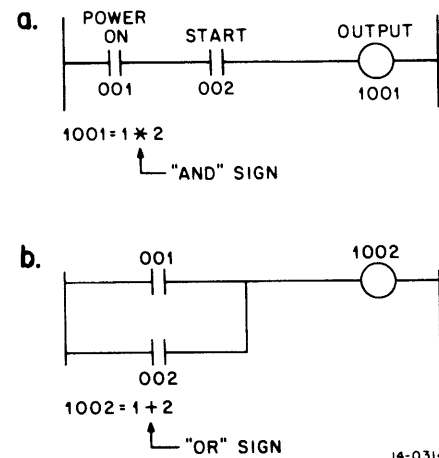

Figure 1-17 Examples of a Control Circuit and the Equivalent Equation

Each Industrial 14 output has a control relationship similar to Figure 1-17. The corresponding Test, Decision, and Operate instructions for all these relationships comprise the Industrial 14 control program. The final instruction in a program is an unconditional jump instruction, which returns the 14 to the first instruction and then the program execution cycle is repeated. Thus the 14 control program consists of a closed loop of instructions that are executed every 3 to 20 milliseconds. (The actual execution time depends on the number of instructions.)

To summarize, a typical Industrial 14 control program is made up of a series of instructions that are stored in its Read/Write memory. These instructions are arranged in groups as shown in Figure 1-18. Each group of instructions tests specific 14 inputs and outputs and, at the end of the test, turns an output either on or off. They are evaluated at random as indicated by the figure.

**FUNCTIONAL DESCRIPTION**

The high-speed circuitry contained in the 14 control unit is comprised of control logic, I/O addressing logic, and main memory. The interaction of these circuit groups is represented by Figure 1-19 and the following paragraphs briefly describe them.

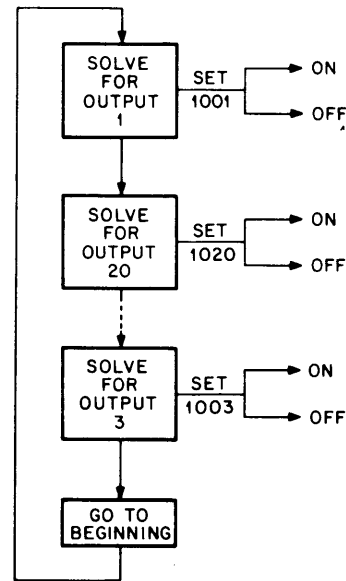

14-0315

Figure 1-18 Industrial 14 Program Execution Cycle

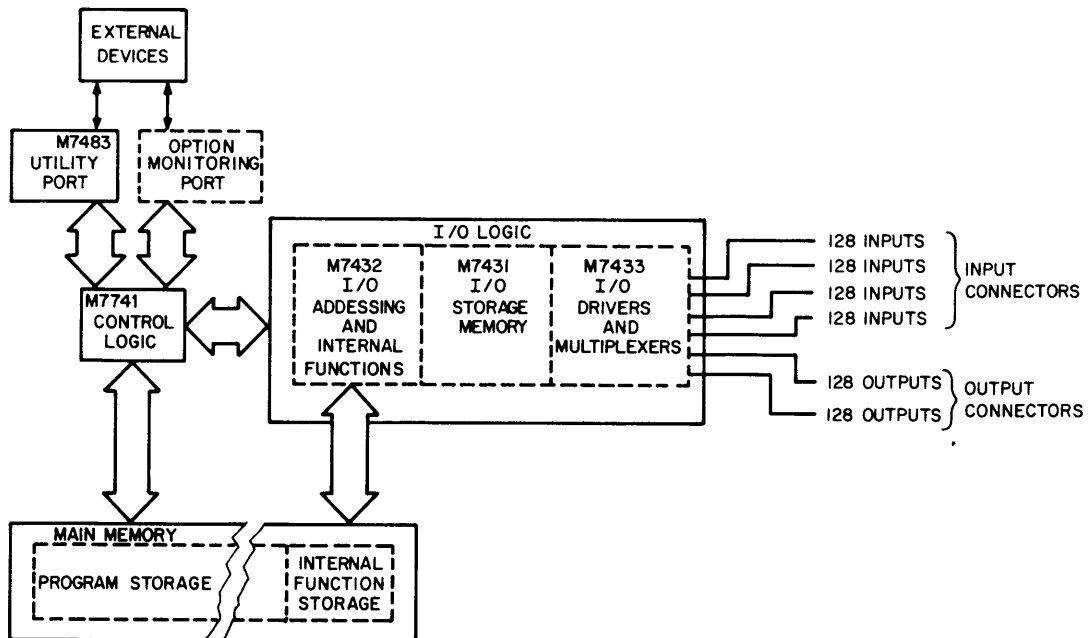

14-0295

Figure 1-19 A Block Diagram of the Circuitry Contained in the Industrial 14 Control Unit

### Control Logic

The control logic consists of a single plug-in module (M7741) which coordinates the I/O and memory functions. Acting on programmed instructions, it samples the proper I/O points (internal and external) and sets each output on or off based on memory instructions and the current I/O conditions. This logic also continuously monitors status and error conditions within the control unit causing a shut-down if an error is detected. A wire harness connects this module to the control unit front panel indicating lights to accomplish this. The logic also interacts with the external interfaces to supply information to, or receive data from, the VT14 Programming Terminal or an external computer.

### I/O Logic

The I/O logic consists of three plug-in modules – M7431, M7432, and M7433 – and the I/O connector card 5410486. They supply the control logic with the on/off conditions of inputs, outputs, and internal functions, receive signals from the control logic to set outputs on or off, or operate internal functions (timers, counters, etc.) as indicated by Table 1-2.

### Main Memory

The main memory provides storage for the control program supplying the stored instructions to the control logic. A small section of memory (256 words) is used to store the preset and current values for internal functions. Thus timers, counters, retentive memories and shift registers are provided.

The Industrial 14s use a ferrite core Read/Write memory offering quick in-plant program changes. However, special attention has been given to its reliable operation in industrial applications: the core is of a design that has good

temperature stability due to a relatively high content of lithium; it is operated at a significantly lower speed than a normal computer memory; and the memory is well protected and shielded by the sealed enclosure of the 14's control unit.

The 14/30 contains 4K words of Read/Write memory that can be extended with a second block of 4K words. The 14/35 contains a maximum of 8K words of memory. The memory can be easily reprogrammed (completely or in small portions) whenever required. Output circuits are scanned at an average of 2.5 milliseconds per 1K of programmed memory, guaranteeing recognition of and response to very fast input signals. (Refer to the timing discussion later in this chapter for more related information.)

The 14's non-formatted memory provides that each control circuit uses only the memory that is required. For example, a small circuit may use six or eight locations and a large circuit may use twenty or more. Output circuits are "solved" as they are entered – in no pre-established numerical order as in some other programmable controllers that use an "executive" system. Using PDP-8 programming techniques, an order can be established; however, the user has no control over the order in which the VT14 stores circuits in memory.

### Internal Functions

Typical control systems require auxiliary status signals in addition to the on and off states of machine inputs and outputs. For example, timers are necessary to provide dwell at the end of a motion or to sequence a batch process. Counters are used to limit the number of pallets on a conveyer or to count the number of parts made each hour.

Table 1-2  
I/O Logic Functions

Module	Function
I/O Control (M7432)	Controls I/O updates, provides the control logic with current I/O states.
I/O Memory (M7431)	Stores all current I/O states and I/O disables.
I/O Multiplexers and Drivers (M7433)	Controls the multiplexer lines to sample the input states, and drives the output converters on or off as specified by the I/O storage memory.

While these functions require additional hardware in most control systems, these and other features are standard in the Industrial 14s. They are achieved internally by using the last 256 words of main memory (either 4K or 8K) to hold the values for these functions. These locations are not available for programming regardless of the number of internal functions actually used. Since auxiliary functions are internal, they do not affect the capacity of the 14 for "real" outputs. Thus 256 external outputs are always available regardless of auxiliary function requirements.

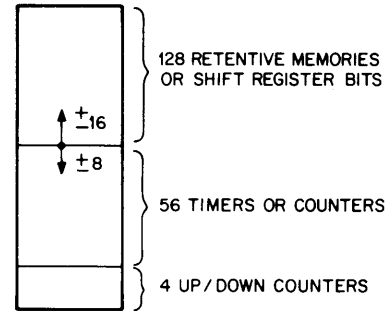

14 - 0298

Figure 1-20 Internal Function Partitioning

The normal grouping of the 256 internal functions is shown in Figure 1-20. The mix, however, can be adjusted to suit a specific application. For example, you could have 128 retentive memories or shift register bits and 60 timers or counters, or you can decrease (or increase) the number of retentive memories and shift register bits (in groups of 16) and correspondingly increase or decrease the number of timers or counters (in groups of 8). The switches for adjusting the internal function mix are located on the M7431 Module.

Following is a brief description and a typical control circuit for retentive memories, shift registers, and timers, including their programming counters, and up/down counters. For more information on internal functions, consult the *VT14 User's Manual* or the *Industrial 14 Software Manual*.

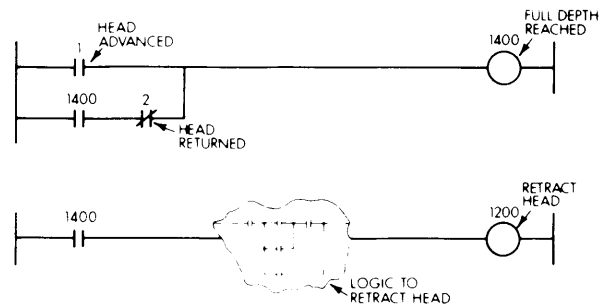

14 - 0307

Figure 1-21 Record Full-Depth Reached Using Retentive Memory

Retentive memories are used like a latching relay to retain a logic state in the event of a power failure. Furthermore, a group of retentive memories may be used to form a shift register that will not lose its contents on a power failure. If required, individual retentive memories can, through programming, be made non-retentive and act like a simple storage output. Figure 1-21 represents a typical application for retentive memories.

Shift registers are formed from a group of retentive memories or unused external outputs. Using an external or internal I/O number, a fully programmable circuit controls the shifting operation. Each bit of the shift register has its own I/O number, so that any or all elements in the shift register may be parallel loaded and/or parallel read. Figure 1-22 represents a typical application for shift registers.

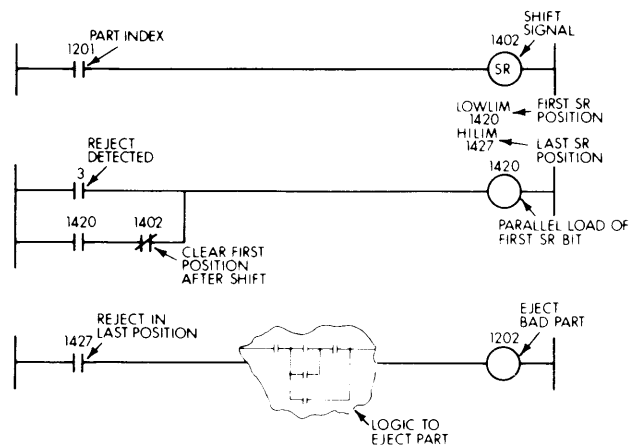

14 - 0308

Figure 1-22 Track a Reject Part Using a Shift Register

Digital timers are provided with an instantaneous and timed out contact so that a timer can be triggered by a pulse and sealed in the timing state. Delays of up to 99.9 seconds in 0.1 second increments, or 999 seconds in 1 second intervals, can be directly implemented. If required, longer intervals are possible by cascading the timer with a counter. Figure 1-23 represents a typical application for a timer.

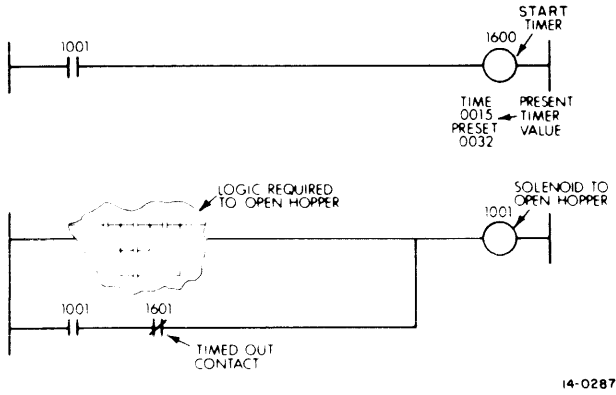

14-0287

Figure 1-23 Open Hopper for 32 Seconds Using Time Delay

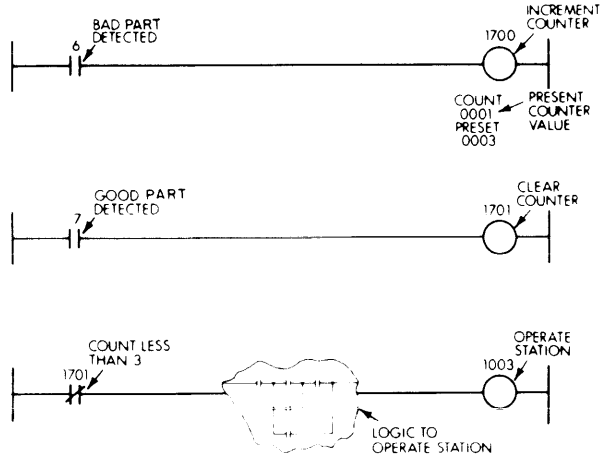

14-0304

Figure 1-24 Shut-down Station on Three Successive Bad Parts Using an Event Counter

Counters have contacts that sense when the current value is greater than or equal to the preset value. Separate circuits are provided to increment the counter and to clear it. Counts of up to 999 events are achieved by a single counter circuit. Still larger counts are possible by cascading two or more counters. Figure 1-24 represents a typical application for a counter.

Up/Down Counters enable the 14s to directly check for an allowable limit of parts (in a conveyor, for example). Four special counters are provided that have a programmable decrement in addition to the increment and clear circuits of a normal counter. Figure 1-25 represents a typical application for an up/down counter.

“Not Initialize” is a special contact that can be used to clear timers or counters or to initiate a special action when the system is first powered up. Figure 1-26 is a typical application for the special contact.

**I/O Assignment**

Inputs, outputs, and internal functions are assigned a block of octal numbers as indicated by Table 1-3. These assignments are fixed in that more outputs cannot be obtained by sacrificing internal functions, or vice versa. The numbers are used by the control program to set inputs or outputs on or off.

On the right hand side of the control unit are two groups of I/O connectors (four input and two output). The lower-most group is numbered from 000 to 777 which corresponds to the block of input numbers in the table. The upper-most group is numbered from 1000 to 1377 – these are the output numbers. I/O cables connect between these connectors and the I/O groups. There is no physical connection to the internal functions since they are accessible only through the control program.

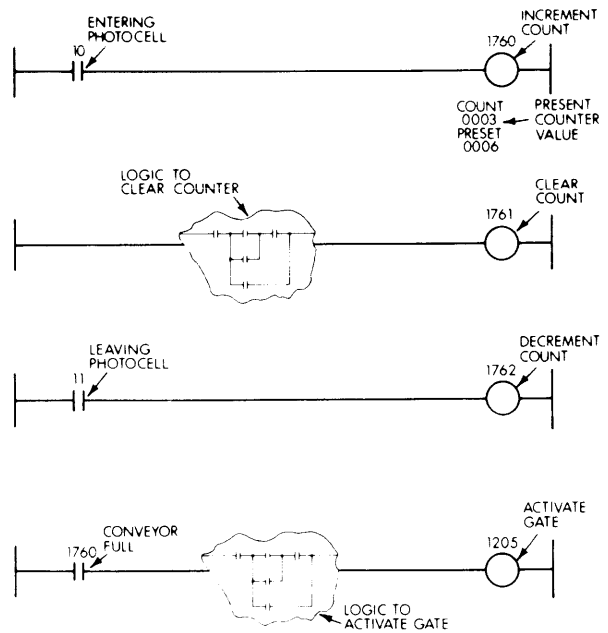

14-0305

Figure 1-25 Limiting Parts on a Conveyor Using an Up-Down Counter

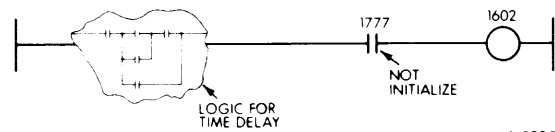

14-0306

Figure 1-26 Clearing a Timer if Power is Lost

**Table 1-3**  
**I/O Numbering**

Function	Numbering Range
Inputs	000-777
Outputs	1000-1377
Internal Functions	1400-1777

The connection of the I/O cables to the control unit determines the I/O number and the physical location of the

individual converters. For example, the I/O group to which cable 000-177 is connected, is numbered starting at the upper left corner and counting from left to right for each panel in the group. The first panel is numbered from 000 for the left-most converter to 017 for the right-most one (Figure 1-27). The second panel is numbered from 020 to 037, etc., up to panel 8 which is numbered from 160 to 177. Thus, each converter is numbered - the number indicating a physical location.

If more than eight panels are required for a particular application, a second I/O cable must be used. As shown by Figure 1-27, there can be four groups of eight panels for inputs and two groups of eight panels for outputs. The

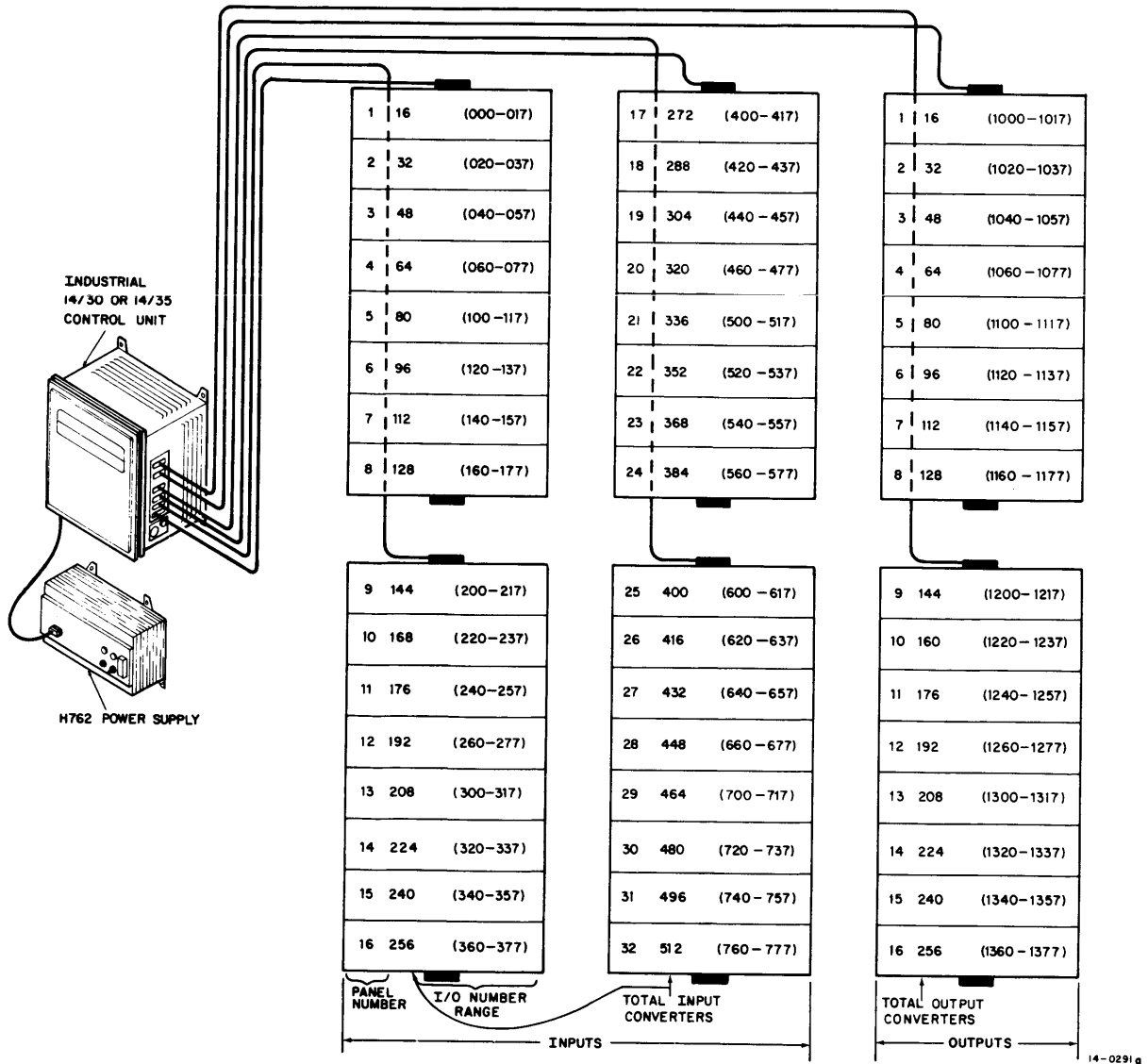

Figure 1-27 I/O Number Assignments

figure indicates the number of panels and the I/O number range for each panel. An I/O group containing less than eight panels is accordingly numbered. For example, four input panels might contain 64 converters numbered from 000 to 077.

### Assignment Sheets

Figure 1-28 contains sample input, output, and internal functions assignment sheets. The entries in the sample sheets represent the applications examples in the Internal Functions paragraph of this chapter. Referring to the retentive memories example (Figure 1-21) notice that inputs 1 and 2 are listed on the input assignment sheet. Pertinent information, such as the input symbol, function, and the normal condition of the input device are also listed. Similarly, entries are made on the output assignment sheet. An assumption is made that the output device is solenoid A, hence, the symbol entry SOLA. If ac (red) and dc (blue) converters are mixed, this should also be noted on the sheets. Finally, internal assignment sheet entries include I/O numbers, symbols, the function of each number, the type of internal function, and the preset or limits if applicable.

These sheets should be completed as the I/O numbers are assigned. A blank copy of each sheet is included in Appendix A and is intended for making duplicate copies.

It may be desirable to group the I/O numbers and their respective converters associated with various control stations in a controlled system or process. If so, reflect this in the assignment sheets. For example, the entries for each station could be grouped or there could be a separate sheet for each station.

### Input and Output Forms

The input and output forms represent a group of four panels of input converters and a group of four panels of output converters respectively. Blank forms are supplied in Appendix B in the back of this manual. Each form is perforated for easy removal and is intended to be a master copy for making duplicates. Proper use of the forms is explained in the following paragraphs.

Figures 1-29 and 1-30 are samples of blank input and output forms. Notice that connected to each converter is a balloon containing incomplete I/O numbers. For example, the upper left-most balloon on the form contains 00. This is actually input number 000 with the leading 0 omitted. The

next number is 001; again the leading 0 is omitted. With a 0 inserted in front of all the numbers on an input form, as shown on the second panel of Figure 1-29, the first four input panels of any Industrial 14 System is represented. If your 14 system has eight input panels, simply make two copies of the form in Appendix A and insert a 0 in front of the input numbers on one copy and insert a 1 on the other. You now have a full group of input converters represented with assigned I/O numbers 000 through 177. You can extend this to include any number of inputs up to the maximum of 512. Each full group of eight input panels requires two input forms.

The same principle applies to the output form. Since outputs are numbered from 1000 to 1377, the second digit (counting from the left) is omitted. By inserting the appropriate numbers, as shown on the second panel in Figure 1-30, any output panel can be represented.

Line terminal jumpering for the input converters is shown on the input form. Output jumpering however, varies with the application requirements. Therefore, a short vertical line is connected to each LINE terminal on the output form. The number of output points that can be jumpered together is a function of the current carrying capacity of the jumper. No. 14 AWG wire normally carries up to 15 A and can be used to jumper up to a full panel of outputs, providing the worst case combination of output loads that are on simultaneously does not exceed 15 A. For example, if an application requires that each output converter pass 2 A, which is the maximum current carrying capability, a maximum of seven converters can be jumpered together with No. 14 AWG wire. If the application is such that the output converters pass 0.9 A or less, then a whole panel can be jumpered together. Terminal jumper strips are also available from Digital and have a current rating of 16 A.

### Input Converter Operation

An input to the Industrial 14 Controller from a controlled machine or process is connected to screw terminals on the face of an input converter. A 120 Vac input connects to an ac input converter (H1500) and a 10–55 Vdc input connects to a dc input converter (H1550); both convert the field input to a +5 Vdc level which is usable by the control unit.

**INPUT ASSIGNMENT SHEET**

I/O Number	Symbol	Function	Normal Condition
001	LS1	HEAD ADVANCED	OPEN
002	LS2	HEAD RETURNED	OPEN

**OUTPUT ASSIGNMENT SHEET**

I/O Number	Symbol	Function
1200	SOLA	RETRACT HEAD

**INTERNAL FUNCTIONS ASSIGNMENT SHEET**

I/O Number	Symbol	Function	Preset or Limits	Type
1400	RTM1	FULL DEPTH REACHED	—	RTM
1401	RTM2	HEAD RETURNED	—	RTM
1600	TMR1	HOPPER OPEN (32 sec)	320	TMR
1601	TMR1D	TIMER 1 DELAYED CONTACTS	320	(.1s)
1700	CNT1	INCREMENT COUNTER 1	3	CNTR
1700	CLCNT1	CLEAR COUNTER 1		

Figure 1-28 Samples of Input, Output, and Internal Function Assignment Sheets



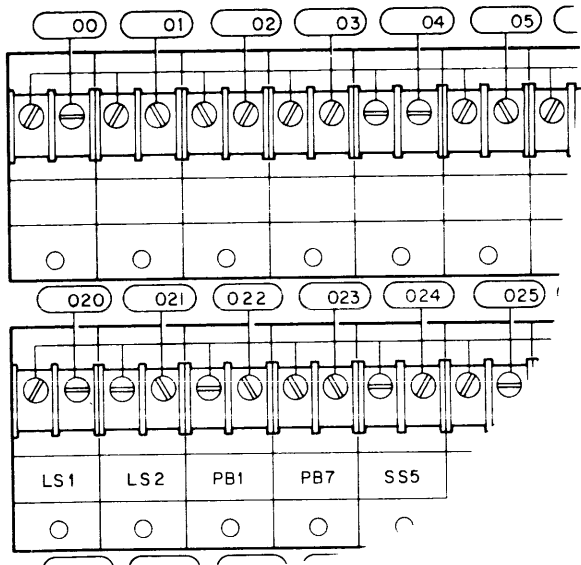

14-0299

Figure 1-29 A Sample of an Input Form

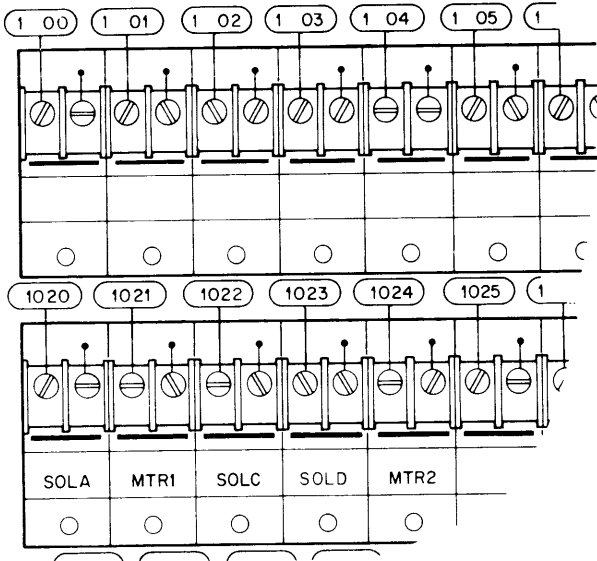

14-0300

Figure 1-30 A Sample of an Output Form

Notice in Figure 1-31 that panel select, data, and ground connections are made between the control unit and the mounting panel via an input cable. Assume that an input from the field has turned an input converter on. The control unit samples the state of the converter by applying dc +, and since the converter is on, it responds with a "low"

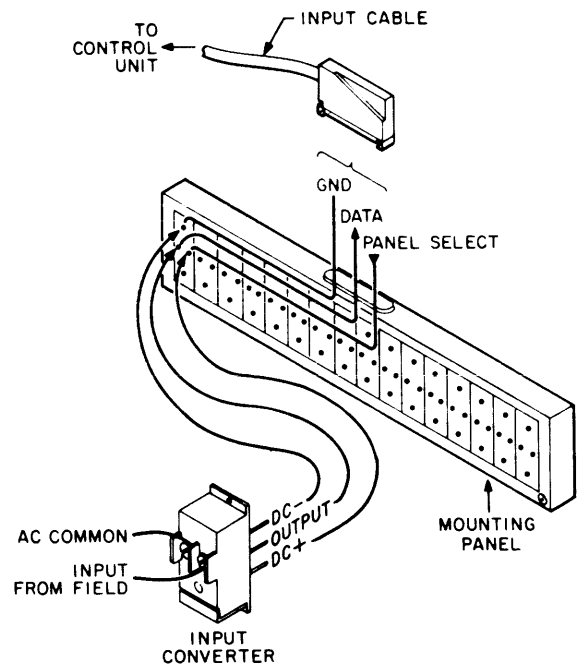

14-0318

Figure 1-31 A Mounting Panel with Input Converter and Control Unit Connections Indicated

output which is read into I/O storage memory on the corresponding data line. The only function of the field voltage is to turn the converter on.

To simplify this, Figure 1-32 shows a single converter and mounting panel and indicates one set of connections between the mounting panel and the control unit. Each panel accommodates up to 16 converters which allows 16 inputs to be read into the control unit via the 16 data lines when the appropriate panel select line is on. The input cable actually contains eight panel select lines and 16 data lines, which are common to the panels connected by the cable. Thus, the control unit can read the 16 inputs on any one panel by turning on the panel select line for that panel and storing the state of the 16 data lines. This selection process is achieved without any electronics within the panels through a multiplexing scheme discussed in the I/O Multiplexing paragraph.

#### Output Converter Operation

An output from the Industrial 14 Controller is connected from output converter screw terminals to a device in the controlled machine or process. The ac output converter (H1600) switches 120 Vac field signals and the dc output converter (H1650) switches 10–55 Vdc field signals. The maximum load for either type is 2 A continuous.

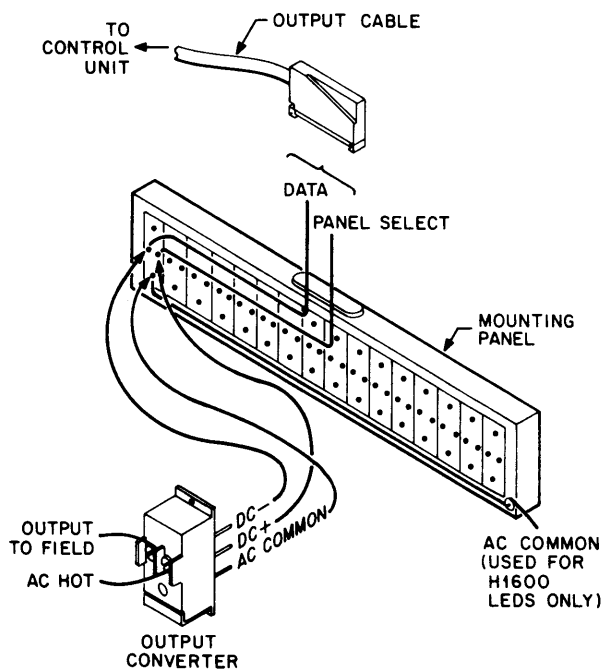

Figure 1-32 A Mounting Panel with Output Converter and Control Unit Connections Indicated

An output converter is switched on by pulsing it for 50 microseconds approximately every 400 microseconds. The control unit performs this task by applying +5 Vdc to the panel select line and simultaneously connecting the data line to ground. When the converter is switched on, it in turn switches on a field voltage. If the converter fails to receive a pulse, it will switch off on the next zero crossing (H1600 ac output) or < 2.5 milliseconds (H1650 dc output). Figure 1-32 illustrates how a single converter connects to a mounting panel and how a panel connects to the control unit via an output cable. Up to 16 converters are connected to the panel in this manner and all are pulsed simultaneously. Up to eight mounting panels are connected to the control unit by the single output cable, but the outputs on only one panel are being pulsed in each 50 microsecond time frame, depending on which panel is selected. At the beginning of the next time frame, the next panel is pulsed for 50 microseconds. This procedure continues until eight panels have been read out regardless of whether or not all eight are present; then the whole procedure is repeated.

The control unit reads out 32 output states simultaneously, sixteen via each of the two output cables. That is, the first output panel on each cable is pulsed for the same 50 microsecond interval then the second pair is pulsed, etc.

This operation occurs continuously, asynchronous to the program operating within the control unit.

### I/O Multiplexing

Figure 1-33 represents a group of eight I/O panels which can be either input or output depending on the I/O cable connection at the control unit end. Each of the eight panel select lines connects to dc+ on one and only one of the eight panels in this group. Select line number 1 connects to panel 1; select line number 2 connects to panel 2, etc. This is accomplished by rotating the lines one place to the left for each panel they pass through and by using the left-most line as the selecting line.

For input multiplexing, all panel select lines are continuously high except for the brief time span when the input buffers are updated, which takes approximately 160 microseconds and occurs approximately every 4 milliseconds. (The term update used here infers storing the current state of the input converters in I/O memory.) The update first turns all select lines off except number 1, which puts the status of all panel 1 converters on the data lines. They are then read into the input section of the I/O memory. Next, all select lines are turned off except number 2, which puts the status of panel 2 on the data lines. Then the state of the panel 2 converters are read into I/O memory. All input panels in the system are sequentially read into memory in this manner. An update cycle for the 32 input panels is approximately 160 microseconds. While an input update is occurring, the control program is installed, which prevents the inputs from changing state within a control circuit.

For output multiplexing, 32 output states are read from I/O memory every 50 microseconds. They are divided into two groups of 16, one for each output cable and fed out on the data lines to the output converters. Simultaneously, the panel select lines for the appropriate panels (one on each cable) are turned on for 50 microseconds and 32 outputs are updated. Updating in this context infers that the output converters are pulsed on if indicated by the data currently held in I/O memory. Another 32 states are read from I/O memory and the next sequential panel select lines are enabled updating the next 32 outputs (16 on each cable). This process continues until all outputs are updated and then the sequence repeats so that each converter that should be on is driven for 50 microseconds in every 400 microseconds. All 256 outputs are updated regardless of whether or not these output converters are present.

Unlike input multiplexing, which stalls the control program and occurs at fixed intervals, output multiplexing is constantly occurring and is only interrupted when inputs

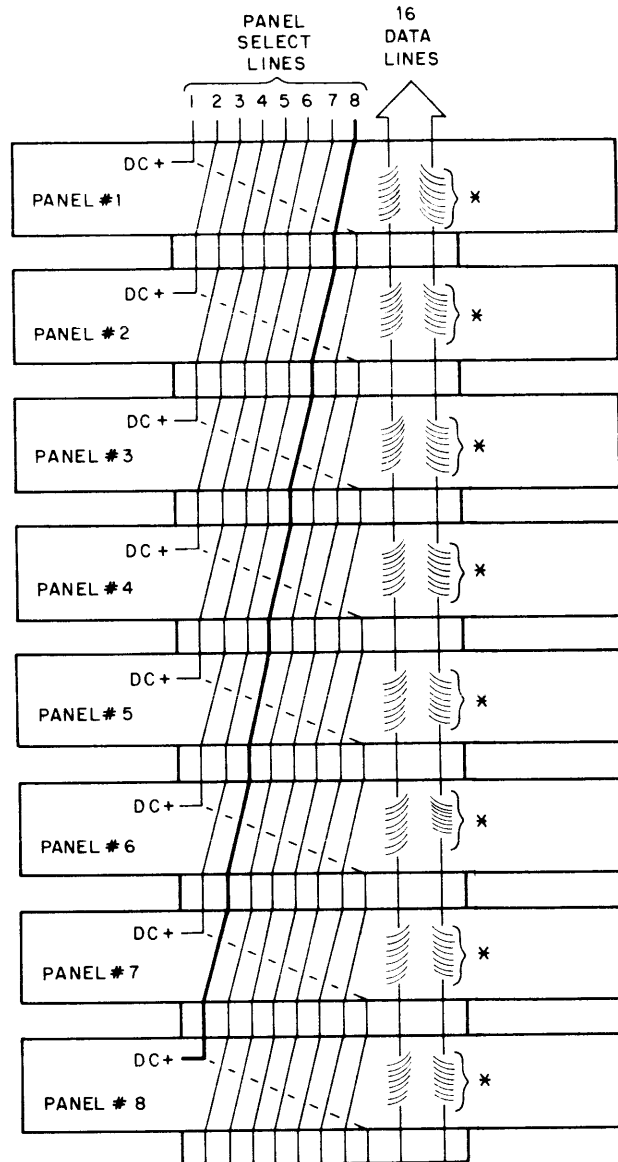

\* DC - FOR OUTPUT CONVERTERS (16XX)  
 OUTPUT FOR INPUT CONVERTERS (15XX)

14-0292

Figure 1-33 H912 Panel Selection Technique

are updated. When an input update request is received, output updating is stopped for the duration of the input update (160 microseconds) and resumes when the update is complete.

#### TIMING CONSIDERATIONS

For most applications, the Industrial 14 circuitry is fast enough so that timing considerations are of little or no consequence. However, in an application where a time span of < 0.05 seconds is significant, a detailed timing analysis may be required. Otherwise, a fast input could be missed in a lengthy Industrial 14 program.

Figure 1-34 illustrates some timing specifications for the Industrial 14 System. Using this figure as a reference, assume that a contact wired to an input converter has just changed state. A small time span is required for the converter to change the incoming signal to 5 Vdc. The time span is indicated in the figure and depends on the type of converter (ac or dc) and on the type of change (on → off or off → on).

After the input signal is converted, it is ready to be stored in I/O memory where it is tested by the control program.

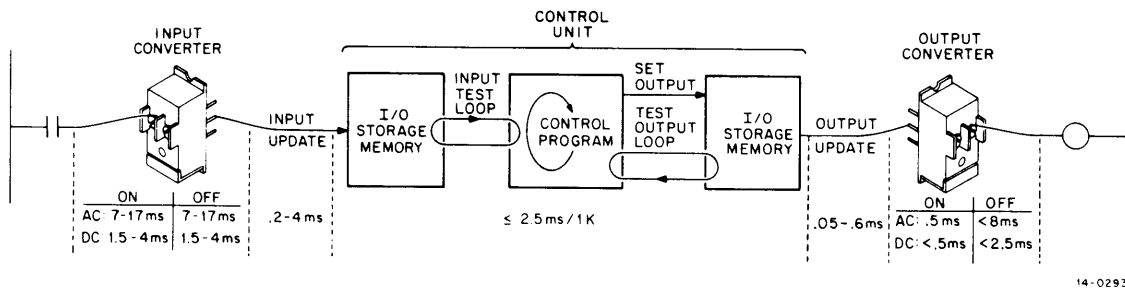

Figure 1-34 Industrial 14 Timing Considerations

When the control program tests an input, however, it does not test the input converter itself — it tests a representation of that input in I/O storage memory. The control program makes a decision based on the input state and sets an output on or off. Again, it is the representation of the output in I/O storage memory that the control program deals with — not the output converter unit.

So the control program is always working with the I/O storage memory testing inputs as represented by the input test loop (and the similar output test loop) and setting outputs as represented by the set output path (Figure 1-34). On the average, approximately 75 percent of the instructions in an Industrial 14 program are executed. For example, each output is either turned on or off and there are corresponding instructions in main memory to perform both functions. If an output is being turned on, the “turn off” instruction is not executed. Other instructions in memory are also unexecuted because conditions in the control circuit for an output are such that the 14 can make a decision to turn the output on or off without completing all of the possibilities for that circuit. For example, if there are parallel branches for a circuit and the first branch is all true, the other two branches are not tested.

Nominal execution times are supplied in Table 1-4 and are subject to a  $\pm 30$  percent variation. Although some of the instructions included in the table may not be familiar, their operation is presented in detail in the Industrial 14 Software Manual.

The input converter states are read into I/O storage memory approximately every 4 milliseconds. This operation requires approximately 160 microseconds and all 512 inputs are updated regardless of their presence. The 14 control logic, however, does not allow an input update to occur while an equation or circuit is being solved. A time loop in the control unit signals that 4 milliseconds has elapsed since the last input update. The control program then continues until the conclusion of the circuit or

equation it is currently processing, which is signaled by an SN or SF instruction. At this point, processing is suspended long enough for the update to occur (160 microseconds) and the program then continues with the next equation or circuit. In the unlikely event that the program has not solved the equation or circuit at the end of a second 4 millisecond period, processing is temporarily suspended as before, and the update occurs regardless. The program resumes processing the unsolved equation or circuit upon completion of the update. In this case, updating occurs at an 8 millisecond interval.

It is important to note that a change in an input condition is not reacted to until a point in the control program is reached which tests that particular input. If the input update, which reads in a changed input state, occurs just prior to the circuit which it affects, then that input is reacted to almost instantaneously.

If the I/O update occurs just after that circuit is solved, the reaction to this particular input does not occur until one full program scan has been made and the program returns to the circuit that is looking at the input. This time span depends on the size of the program and can require up to 2.5 milliseconds per 1K of memory (Table 1-5). If you have a 3.5K program, the time is approximately 9 milliseconds.

Once the control program has tested an input, it sets an output in I/O storage memory immediately. Some time is required, however, before that changed output state is used to set the corresponding output converter. This time varies typically up to approximately 400 microseconds and results from the outputs being read out to the output converters on a “round-robin” basis. That is, 32 outputs are driven to the proper state for 50 microseconds, and then the next 32 are driven. This repeats until all 256 possible outputs have been driven regardless of whether they are all used. So, if there is only one panel of outputs, that panel is driven for 50 microseconds at 400 microsecond intervals regardless of the fact that the other outputs do not exist.

**Table 1-4  
Nominal Execution Time**

Instruction	I/O Reference*	Execution Time (Microseconds)
TN, TF, SN, SF (one word)	Real	2.6
	Internal	7.1
TD, RDBIT, RDWD, SETBIT, CLRBIT, SETWD, CLRWD (two words)	Real	5.1
	Internal	9.5
LDWD (three words)	Real	7.6
	Internal	12.0
MOVWD, MOVBIT (three words)	Real, Real	7.7
	Real, Internal	12.0
	Internal, Internal	16.5
NDP, SKP, JMR, JFF, JFN, CLRPC (one word)		2.5
JMP, JMS, TRM RDMEM		5.0

\* Real is an I/O address between 0 and 1377; Internal is an I/O address between 1400 and 1777.

**Table 1-5  
Industrial 14 Memory Cycle Time**

Memory Size (K)	Computer Programmed	VT14 Programmed
1	2.5 milliseconds	} 10 milliseconds
2	5 milliseconds	
3	7.5 milliseconds	
4	10 milliseconds	
5	12.5 milliseconds	} 20 milliseconds
6	15 milliseconds	
7	17.5 milliseconds	
8	20 milliseconds	

A complete output update typically requires 400 microseconds. However, if an input update occurs during this time frame, the output updating sequence is interrupted for up to 160 microseconds – thus the 0.05 to 0.6 milliseconds range indicated by Figure 1-34.

When the representation of an output is set-in I/O memory, a 5 V signal is sent out to the output converter on its next output update. If the converter (ac or dc) is off, it is driven on almost instantaneously (< 1 millisecond). If it is on, it turns off on the next zero crossing of the current sine wave (ac converter) which can be up to 8 milliseconds. The dc converter is driven off in < 2.5 milliseconds.

Table 1-6 indicates the best and worst case system response times for the Industrial 14 Controller. As the table indicates, the minimum total time required for an output device to react to an input signal is approximately 7.5 milliseconds using ac input and output converters. In this case, the input converter turn-on occurs at the first full ac peak, the control program does an input update at the instant the input converter changes state, the equation or circuit is solved by the control program immediately after the input update, the output is one of the next 32 to be updated, and the output converter transition is from off → on. For the worst case, input converter turn-on occurs at the second ac peak, the input update has just occurred and the control program has just passed the point where that input is recognized, the output is one of the last 32 to be updated, and the output converter transition is from on → off.

If it is necessary to decrease the system response time for a particular application, there are two possible areas for making changes. First, if ac input converters are used, changing them to dc will reduce turn-on time; using the

off → on transition of output converters, instead of the obverse, will reduce switching time. If the output converter transition must be on → off, use a dc converter if possible, since its turn-off time is shorter.

Secondly, there are programming techniques that allow testing an input several times on a single pass through main memory. These techniques require a computer to be used for programming. Refer to the Industrial 14 Software Manual for pertinent programming information.

#### DEVELOPING AN INDUSTRIAL 14 CONTROL SYSTEM

The first step in developing an Industrial 14 Control System to fit a particular application is to compile information on the mechanical operation of the machine to be controlled – including the number of switches, valves, solenoids, etc., and their sequence of operation. Based on this information, the number of converters and mounting panels required can be determined. For example, if the controlled system has 317 devices to be used as Industrial 14 inputs, then 317 input converters are needed. Since there are 16 converters on each panel, divide 16 into 317 to determine the number of mounting panels. Or, if you know the number of converters required, refer to the total converters column in Figure 1-27 to find the number of panels. In this example, 20 panels are required. Similarly, if the 14 System must drive 173 output devices, then using the same arithmetic 173 output converters and 11 mounting panels are required.

If a mix of ac and dc converters is required, the number of each must be determined and requires no additional mounting panels since they can be installed on the same panel. When they *are* mixed, however, they should be grouped with ac on one end and dc on the other end of a panel to facilitate field wiring. Or, you may desire to use separate panels.

**Table 1-6**  
**System Response Time**

Best Case	Worst Case	Function
7.0 milliseconds	17.0 milliseconds	Input Converter Turn-on
0.2 milliseconds	4.0 milliseconds	Input Stored in I/O Memory
0.1 milliseconds	10.0 milliseconds	Control Program Cycle (4K Program)
0.05 milliseconds	0.6 milliseconds	Output Update from I/O Memory
0.0 milliseconds	8.0 milliseconds	Output Converter Transition
~ 7.5 milliseconds	~ 40.0 milliseconds	Totals

Note: System response time used here is the time required to detect an ON input to switch an output using ac converters.

An important consideration at this point is the number of spare converters to keep on hand. Since the units are not repairable, excessive down-time due to a faulty converter can be avoided by having spares available. It is also possible to underestimate the number of converter units required for a given application. If spares are figured into the initial planning, they can be used to fill the deficit and be replaced at a later date. Spare units can also be used for future expansion requirements.

Mounting rails (H008) are optional items but are recommended for all systems. Once the number of panels required is known, the number of rails necessary to mount them is determined easily. One set of rails accommodates up to eight panels. Therefore, to mount 20 panels, three sets of rails are required. Input and output panels may be installed on the same set of rails but they must be separated by one panel width to allow room for the I/O cable connection to the lower group.

One I/O cable (BC14F) is required for each input or output group. A system such as the one set forth in this example needs three input and two output cables. The length required should be specified and depends on the application. No attempt should be made to shorten an I/O cable if it is too long. The cables are round and flexible and any excess length should be coiled and stored out of the way if possible.

Memory size is a very important consideration when planning a system. As a rule, 4K of memory accommodates approximately 200–250 programmed functions, which is the capacity of the Industrial 14/30, and 8K accommodates approximately 450–500 functions, which is the capacity of the Industrial 14/35. This approximation takes into account 0.25K of memory used for storage of internal function values and assumes that an average of approximately 20 memory locations per output are used. The actual number of locations per output varies with the complexity of the control circuits used.

If the controlled system requires most of the memory available in the 14/30 leaving little or no room for future expansion, then the 14/35 should be considered. It is more than adequate for most applications and its memory capacity is rarely exceeded before the number of I/Os and internal functions have been exhausted.

The Industrial 14/30 can also be expanded to 8K of memory. Only a second 4K memory stack (MM8-E module set) is required which plugs into the backplane in the control unit. (Refer to Chapter 2 for installation information.)

#### **ATYPICAL CONFIGURATION**

Available space at the site may dictate an atypical configuration for the Industrial 14 Controller. For example, there may be enough room to install the control unit and power supply but not enough to install the I/Os in their normal configuration. Or the control unit and power supply may be installed somewhat remotely from the I/O. Other atypical configurations are possible; however, the limiting factor is that the total length of cable connected to each I/O connector must not exceed 25 ft.

Figure 1-35a shows a controller with one group of input and one group of output converters – each divided into three subgroups. These subgroups are interconnected by 5-ft lengths of I/O cable and the entire group is connected to the control unit by a 15-ft I/O cable. Figure 1-35b shows an input group and an output group remotely located from the control unit. In this case, a 25-ft I/O cable, which is the maximum length allowable, is used to connect each I/O group to the control unit. In each of these examples, only one group of inputs and one group of outputs are shown to simplify the drawings. A full complement of I/O could be present in either example and the I/O groups can be located anywhere that space allows – restricted only by the 25-ft maximum cable length and the site considerations discussed in Chapter 2.

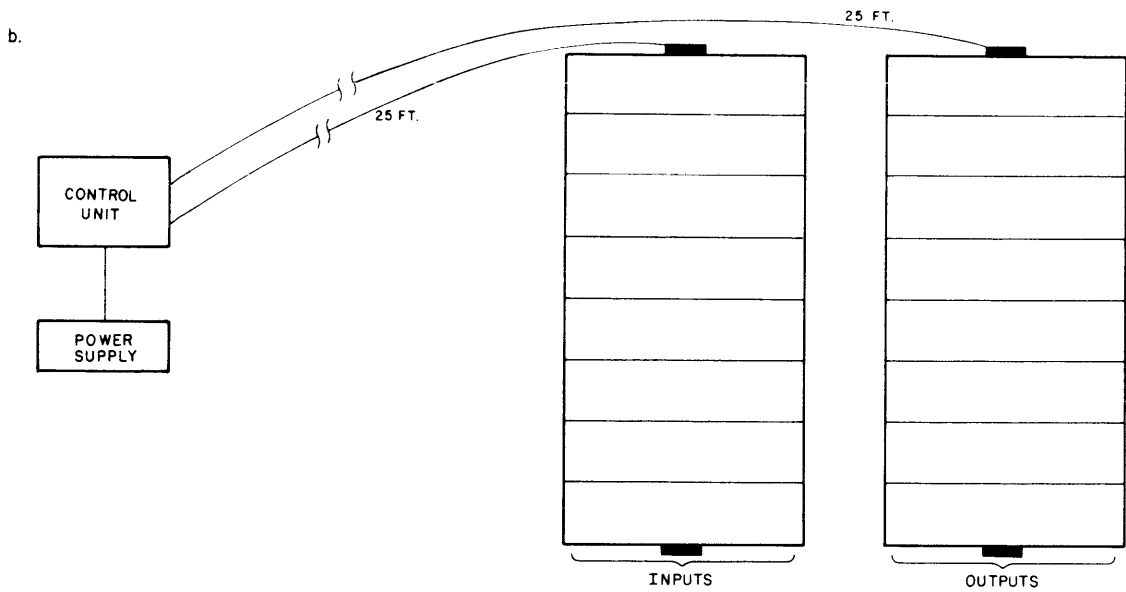
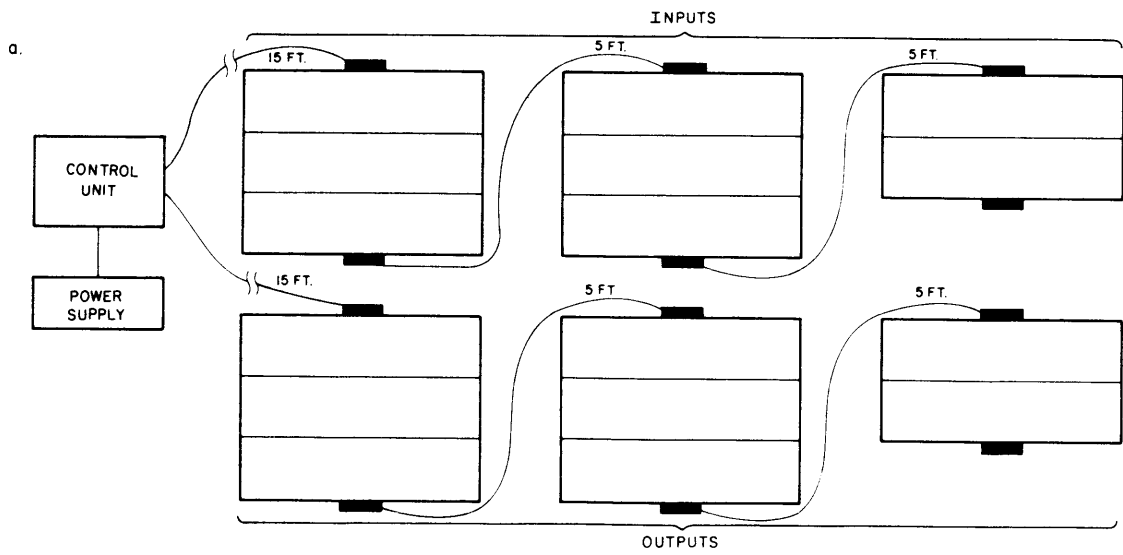

NOTE:  
Total cable length from each I/O connector must not exceed 25FT.

14-0294

Figure 1-35 Atypical Configurations for the Industrial 14 Controller



# CHAPTER 2

## INSTALLATION

### SITE CONSIDERATIONS

#### Environmental Specifications

The Industrial 14 System is designed to operate reliably in rigorous industrial environments. However, extensive exposure to corrosive atmospheres could cause system failure. If the system is to be placed in such an atmosphere, it should be installed in a NEMA-12 type enclosure or equivalent.

The surface temperature of the enclosure must be between 0° and 55° C (32° to 130° F) to ensure that the operating temperature range of the controller does not exceed 0° to 65° C. This temperature range assumes all the thermal effect of the surrounding atmosphere. However, the enclosure should not be located in the direct path of any radiation (such as sunlight). Assuming proper free air space within the enclosure, the Industrial 14 System is designed to be cooled by closed convection with no need for forced air or air conditioning.

The Industrial 14 is shielded against electrical noise. However, unusually strong sources of electrical noise, such as plasma flame cutters, should not be placed in the immediate area of the system.

#### Power Requirements

The 14 System operates on either 95–130 Vac or 190–260 Vac, 47–63 Hz, single phase line voltage. The proper voltage for the system and a true-earth ground should be available at the system location. If 440 Vac is the only voltage available, it must be stepped down by a control transformer.

The power requirement for the 14/30 or 14/35 system is 4 A @ 120 Vac (or 470 W). Additionally, the ac input converter circuits dissipate 0.03 A per unit and the ac output circuits dissipate a maximum of 2 A per unit.

#### Electrical Noise

Electrical noise is common in many industrial environments. Large electrical noise pulses are generated by motor controls, brush-type motors, and other devices that abruptly switch large amounts of power and create arcing. Plasma flame cutters and high power RF heating units produce the worst noise. These noise signals can travel many yards from their source into cables or anything else in the vicinity.

Electronic switching circuits use electrical pulses in their normal operation and must be protected from electrical noise that might be interpreted as valid control signals. Although the obvious place to eliminate electrical noise is at its source, this is not always feasible and can be quite expensive.

If the installation instructions provided in this chapter are followed, the 14 Control System can be operated in almost any industrial environment without concern for noise problems. If the installation is located near unusually high sources of electrical noise (such as plasma flame cutting equipment), some additional precautions may be needed and an Industrial 14 applications engineer should be consulted.

The 14 Control System is protected in the following way:

- a. Circuit design techniques are used that reject false pulses of electrical energy.
- b. Cables and other noise sensitive points are shielded.
- c. An installation arrangement that provides an overall shield protection is recommended.

The following installation precautions will reduce the possibility of noise problems:

- a. The control unit should be operated with its door closed.
- b. The entire system should be mounted in a standard NEMA-12 type enclosure (with true-earth ground connected to the mounting panel) and operated with the enclosure door closed (except for maintenance operations when this is not possible).
- c. An arrangement of ac and control cables, supplied later in this chapter, should be used to further reduce noise transfer.

## GENERAL INFORMATION

### NEMA-12 Type Enclosure

Although not required, usually the Industrial 14 System is mounted in a standard NEMA-12 type enclosure. The enclosures are constructed of heavy gauge steel; they are oil and dust tight equipped with a removable mounting panel, and provide shielding from electrical noise. They are also recommended to protect the 14 System from harsh environments.

The minimum enclosure size for mounting a system such as that in Figure 2-1 is as follows:

Width	30 in.
Depth	12 in.
Height	72 in.

Except for atypical configurations, the height and width dimensions are identical for all Industrial 14 Systems. The width, however, varies with the number of I/O groups. For example, the maximum system configuration (512 inputs and 256 outputs) requires a mounting panel width of approximately 101 in. which requires an enclosure width of approximately 106 in. to accommodate the panel. If other devices, such as a control transformer or motor starters, are to be mounted on the same panel, the width must be greater. Additional unobstructed space is also required immediately in front of the enclosure to allow for door clearance.

### Control Unit/Power Supply Location

You can see in Figure 2-1 that the power supply is positioned a minimum of 6 inches from the bottom of the NEMA type enclosure and the controller is a minimum of 6 inches above the power supply. Since these two units are

cooled by convection, this spacing is necessary to maintain the proper operating temperature. Where possible, such as in larger systems, this space should be increased.

### Field Wiring and I/O Cable Routing

Field wiring and I/O cables should be separated to reduce the possibility of noise interference. Figure 2-2 shows the recommended path for field wiring and I/O cables to accomplish this. All field wires dress to the right from the I/O panels into a wire duct straight to the bottom of the enclosure and then out to the right. I/O cables dress to the right from the control unit into a wire duct and then straight to the top of the enclosure. There is approximately 2 inches between the mounting panel and the top of the enclosure. The I/O cables pass through this space and connect to the top-most connector of the corresponding input or output group. One of the input cables in Figure 2-2 is routed from the top of the enclosure down behind the top input rack to the bottom input rack. This is true of all cables that connect to a rack mounted along the bottom of an enclosure.

Field wiring may enter the enclosure at the top or bottom. If top entry is used, the wires should dress from the point of entry directly to the bottom of the enclosure and then to their respective points as shown in the figure. The wire bundle size for one I/O panel (using No. 14 wire) is approximately 1/2 in. Multiply this number by the number of panels in your system to determine the bundle size at the point where the field wiring enters the enclosure. The field wiring to each rack should be bundled separately with tie wraps from the input or output panels to the point where they fan out into the controlled system. Similarly the bundles should be tied together where appropriate.

### NOTE

**Any excess I/O cable length can be stored by looping it inside the wire duct. No attempt should be made to shorten an I/O cable.**

### System Expansion

The system shown in Figure 2-2 contains 256 input and 128 output points with room provided for future expansion. As shown, the system can be expanded to full capacity, but if it is, there is not enough room for other devices, such as a control transformer, motor starters, circuit breakers, etc. If these devices are to be mounted in the system enclosure, the enclosure should be large enough to accommodate the present system, the devices, and should allow room for future expansion. Other devices should never be mounted in the space above the control unit.

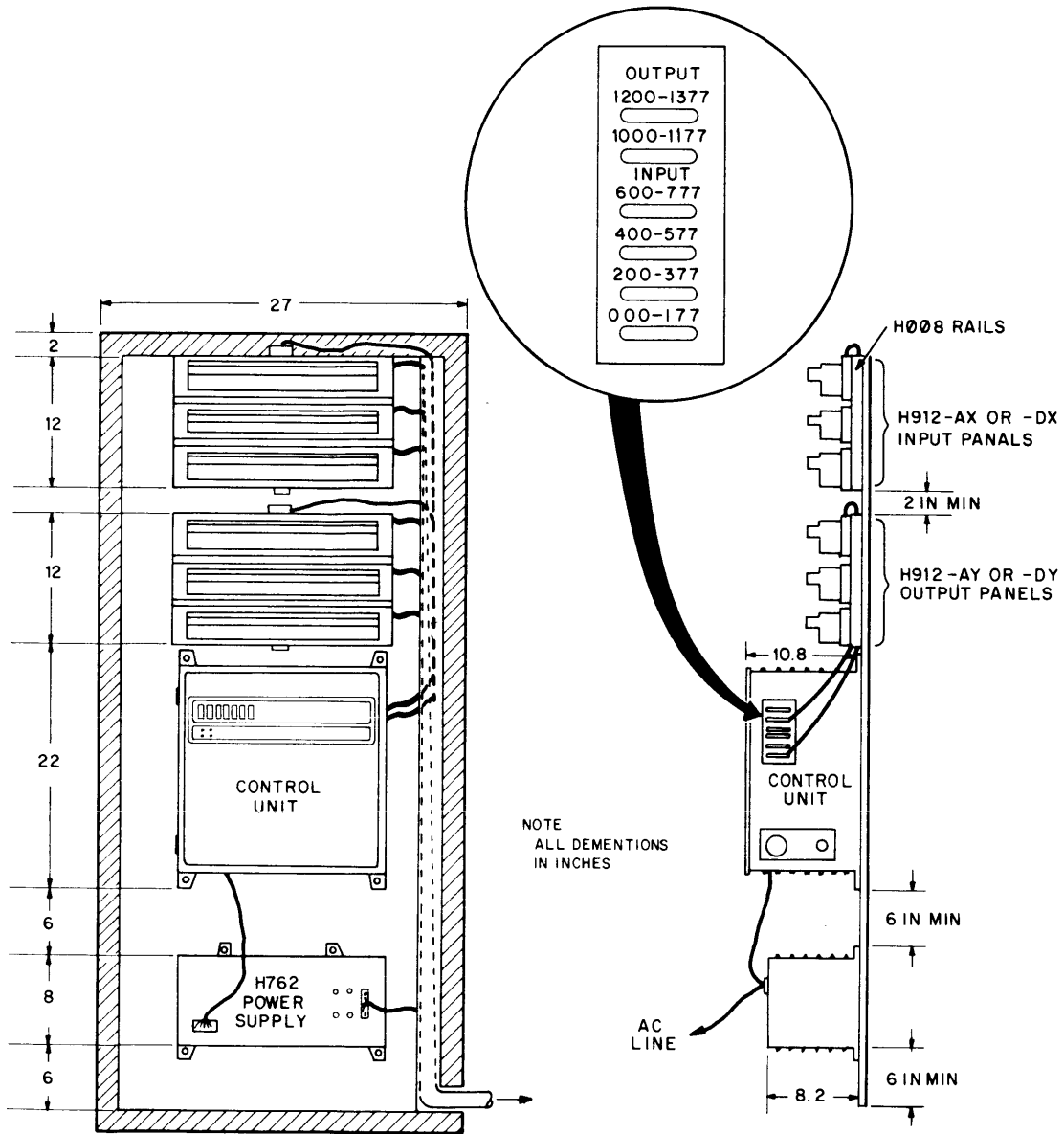

14-0224

Figure 2-1 An Industrial 14 System with Six Panels of I/O

### Mixing Converter Types

Converters, ac and dc, can be installed on the same H912 mounting panel when required by an application. If it is necessary to mix the two voltage types, ac converters should be grouped on one end of the mounting panel and dc on the other to facilitate field wiring.

Input and output converters should not be installed on the same panel. This is physically possible and will not damage the units, but one of the two types will not operate. If they are inadvertently mixed, the output converters are readily recognizable by a white band across the face.

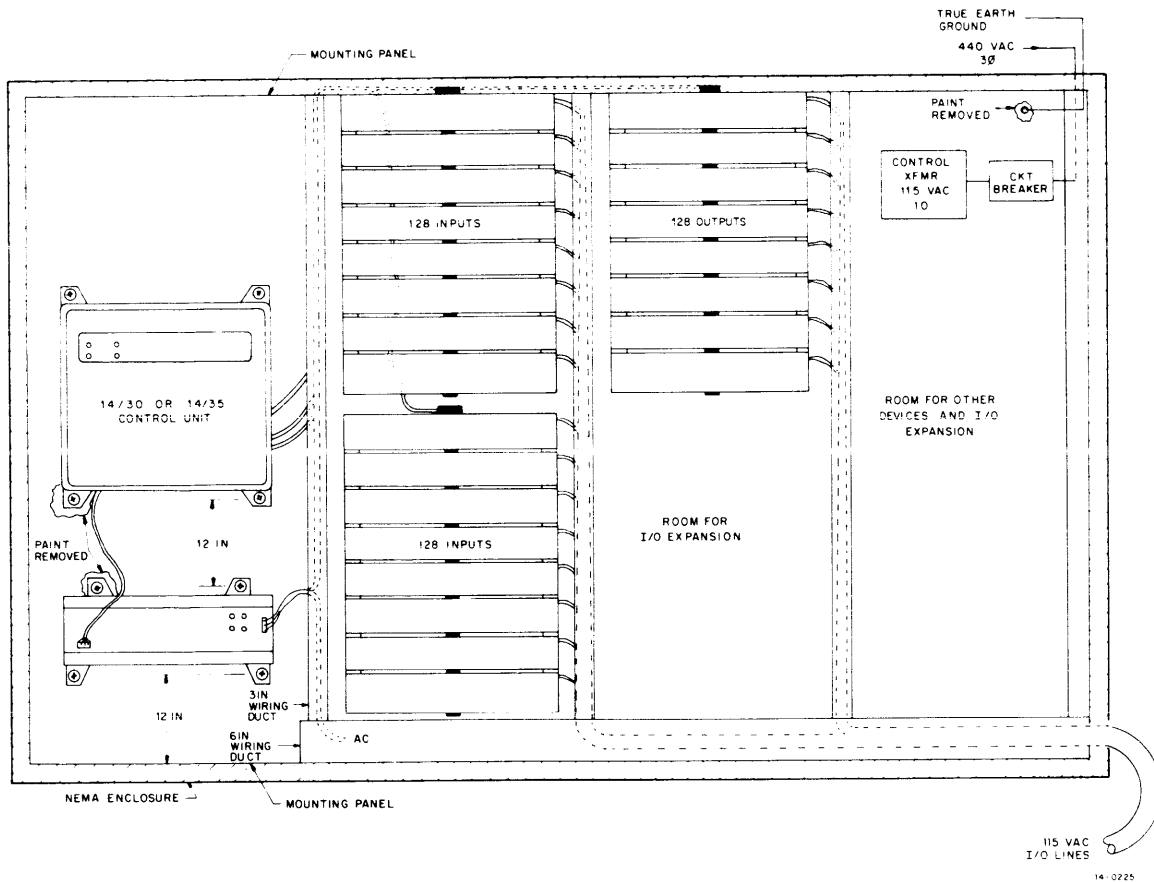

Figure 2-2 A Typical Industrial 14 Controller

### Converter Installation

The following is the procedure for installing the input and/or output converters which are listed in Table 2-1.

1. Align the converter pins with the mounting panel socket holes and carefully insert the converter (Figure 2-3).
2. Secure the converter in place by turning the captive screws clockwise until firmly seated.
3. Repeat this procedure for each converter to be installed (up to 16 on each panel).

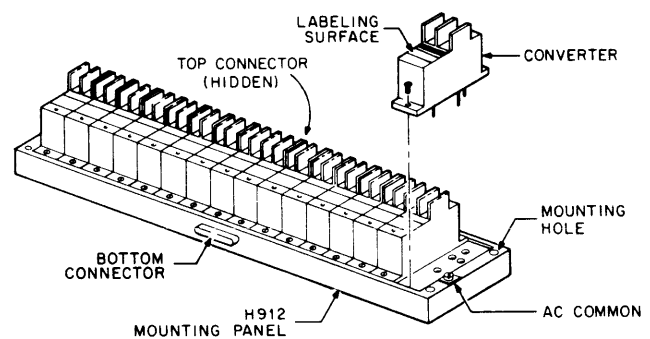

Figure 2-3 I/O Converter Installation

**Table 2-1**  
**Signal Converters and Panels**

Voltage Type	Input	Output
120 Vac	H1500	H1600
10–55 Vdc	H1550	H1650

## INSTALLATION PROCEDURE

### System Layout

One of the first steps prior to physically installing a system is planning the layout (i.e., deciding where each system part is to be located). This should be performed regardless of the size of the system to ensure sufficient air circulation around the power supply, proper I/O cable and field wire routing, etc. Your planning should also incorporate the preceding information in this chapter.

Figure 2-4 represents the hole spacing dimensions for the system represented by Figure 2-2. The mounting surface shown is the NEMA-12 enclosure mounting panel (this could be any mounting surface). In particular, the free

space above and below the power supply should be approximately 14 inches. This space should only be reduced for smaller systems where space is at a premium. The space above the control unit should not be filled with devices such as transformers.

Once the layout is planned, begin the mounting procedure. You should make a reference drawing similar to Figure 2-4 prior to this procedure. If accurate enough, this drawing can be relied upon for mounting hole spacing. Or, simply measure the system parts for mounting hole spacing and mark the dimensions on the mounting surface. If the latter method is chosen, an assembled I/O rack can serve as a template for marking the rack mounting holes.

Drill 0.238 in. diameter holes for all system parts and use 1/4-20 mounting hardware. The maximum size bolt head that will pass through the elongated mounting holes is 1/2 in.

### Control Unit/Power Supply Installation

Since the NEMA-12 enclosure, when installed, must be bonded to the normal ac ground, it is used as the common grounding medium for the control unit/power supply combination. However, the normal ac ground must be a low-impedance-to-true-earth ground or building ground. If

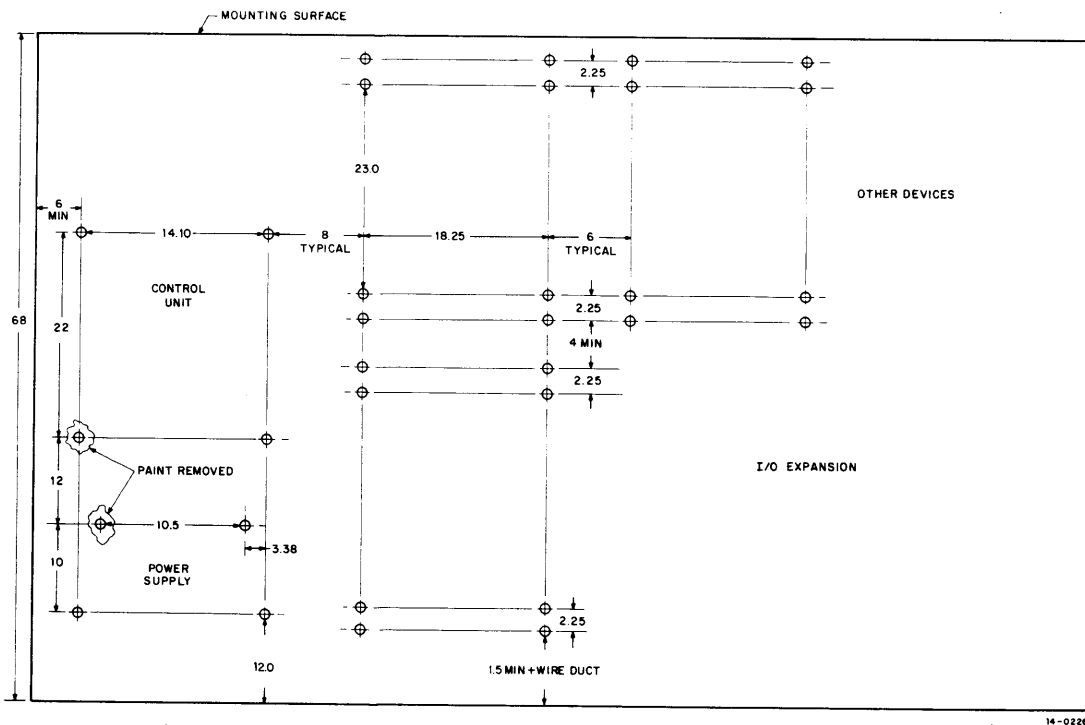

**Figure 2-4** Typical System Layout

the NEMA enclosure is not used, be sure a connection is made from the control unit/power supply combination to true-earth ground.

Since the power supply is positioned under the control unit, it is usually mounted first. The following is the installation procedure for the control unit/power supply:

1. Remove some paint around the lower left mounting hole for the control unit and ground the upper left mounting hole for the power supply (Figure 2-4). This ensures a ground connection between the two enclosures.
2. If RIVNUTS<sup>®</sup> are to be used, install them in the mounting holes.
3. Start the mounting hardware into the threads (4 or 5 turns). The hardware should be 1/4-20 with a 1/2 in. maximum head size.
4. Align the power supply mounting tab holes with the appropriate hardware and hang the unit in place. Tighten the hardware securely.
5. Repeat step 4 for the control unit.

### I/O Group Installation

The I/O group installation procedure is divided into two parts. The first part explains how to mount the panels to the rails; the second is I/O group-assembly installation.

#### Panel Mounting

1. Place the rails (H008) on a flat surface, such as a work bench, with the flanges pointing outward (Figure 2-5).
2. Position an I/O panel at the top end of the rails and fasten in place with No. 10-32 hardware (do not tighten).
3. Place the next panel immediately below the first one; slide it upward so that the connectors mate and seat. Fasten this panel in place, but again do not tighten the hardware.
4. Repeat step 3 for the remaining panels (eight panels for a full group).
5. With all panels in place, square the assembly and then tighten all panel mounting hardware.

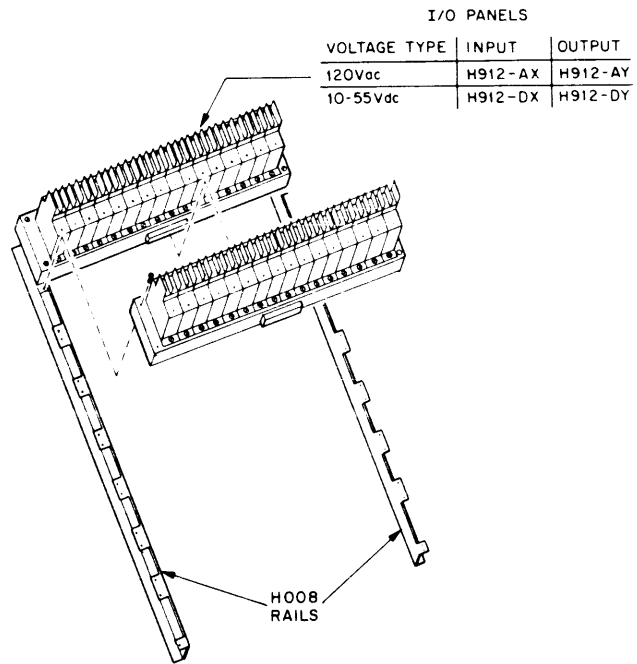

14-0227

Figure 2-5 Installing an I/O Mounting Panel

If input and output panels are to be installed on the same set of rails, the two types of panels must be separated to accommodate the cable connection to the lower group of panels. In this case, the rails accommodate up to seven panels.

#### Group-Assembly Mounting

#### NOTE

If the mounting holes have been drilled skip steps 1–3.

1. If the mounting holes have not been drilled, position the I/O rack on the mounting surface where it is to be located.
2. Use the rack as a template to mark the two upper and two lower mounting holes of each rail (Figure 2-4).
3. Drill the mounting holes (0.238 in. dia.) and install the RIVNUTS<sup>®</sup> if they are to be used.
4. Screw the hardware into the mounting holes far enough to support the weight of an I/O rack (4 or 5 turns).

<sup>®</sup> RIVNUTS is a registered trademark of Lehigh Metals.

5. Align the mounting holes in the rails with the hardware and hang the I/O rack in place.
6. Tighten the hardware securely.

### Electrical Connections

#### Power Supply

The Industrial 14 power supply is suitable for 120 V or 240 Vac operation. Before making any external connections to the supply, be sure the jumpers on the terminal strip are appropriately installed.

Following is a procedure for connecting the power supply to the line and to the controller:

#### WARNING

The ac line voltage should be off when making these connections.

1. Figure 2-6 shows the terminal strip which is located on the face of the power supply. For 120 V operation, connect a jumper between terminals 1 and 3 and another between terminals 2 and 4. Then connect the 3-wire ac line as shown in the figure.
2. For 240 Vac operation, connect a jumper between terminals 2 and 3. Then connect the 3-wire ac line as indicated by the figure.
3. Connect the cable from the bottom left corner of the control unit to the white connector on the left face of the power supply.

#### WARNING

The ac line voltage to the power supply and field voltage to the input converters should be off when making connections.

#### Field Wiring

Figure 2-7 shows the face of an ac input converter and an ac output converter with field wiring connections made to each. Field connections to the dc converters (not shown) are identical to the ac output converter connections, i.e., the load connects to the left-hand terminal.

The worst case condition for eight output converters jumpered together is 16 A, which the terminal jumpers are rated to carry. However, when the jumpers are used, a single No. 14 wire normally connects the LINE terminals (negative terminals for dc converters) from the power source. The worst case condition may exceed the rating of

FOR H762 S/N>10000

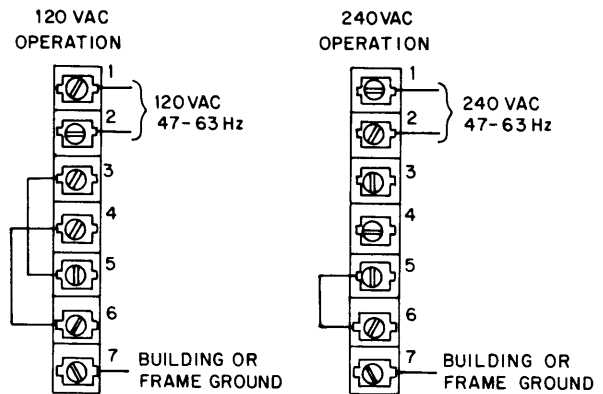

FOR H762 S/N ≤ 10000

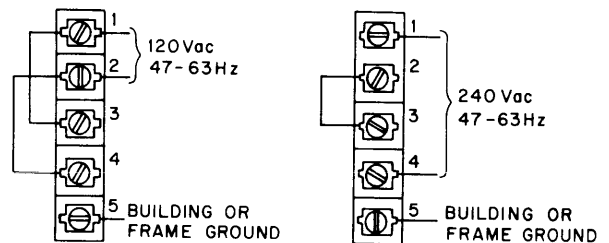

14-0230

Figure 2-6 Power Supply Connections for 120 V and 240 Vac

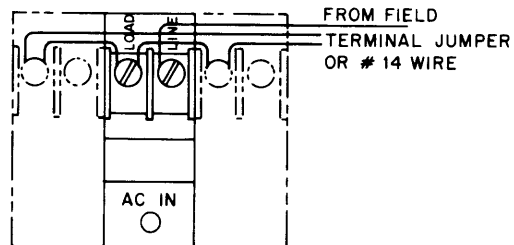
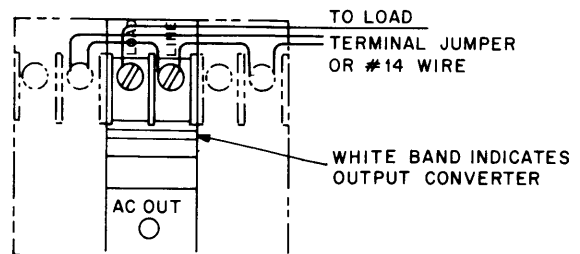

14-0229

Figure 2-7 Field Wiring Connections to Converters

No. 14 wire and must be considered before making field connections. Unless the sum of the output loads is less than 15 A at all times, the field wire size must either be increased or less than eight converters must be jumpered together.

The recommended connection of a field device to the dc input converters (H1550) and the dc output converters (H1650) is illustrated in Figure 2-8. For the input converter, the device is connected to the + terminal; for the output converter, the device is connected to the NEG terminal. Included in the figure is an alternate connection; however, the maintenance information in this manual assumes the use of the recommended method of connection.

Regardless of the wiring method used, a suppression diode with a PIV rating of 100 V or greater must be connected across the dc output converter load (field device). The leads connecting the diode across the load must be as short as possible to minimize inductive coupling.

### I/O Cables

Figure 2-9 shows a full capacity Industrial 14 System (four full racks of input and two full racks of output converters). The I/O cables are shown connecting between the control unit and the top-most panel of the appropriate rack. The input cable connected to the control unit connector labeled 000-177 also connects to the top left rack. The next input cable (200-377) connects to the bottom left rack; the next cable connects to the top center rack, etc. The second

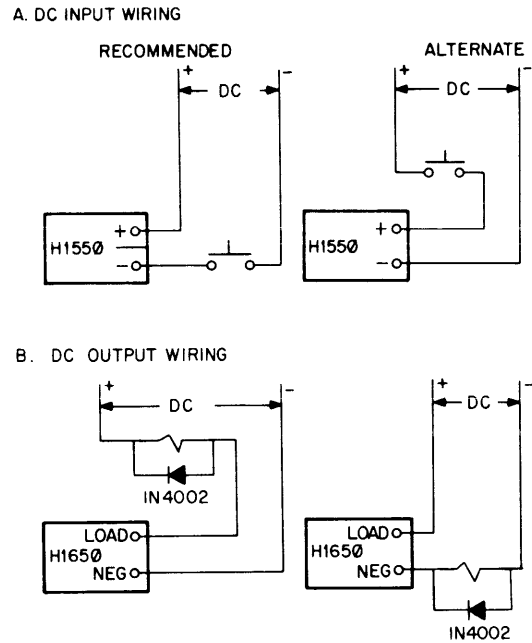

14-0296

Figure 2-8 Wiring Diagram for the DC I/O Converter

output cable connects to the last rack (bottom right). This is the recommended placement of I/O racks within a NEMA enclosure and the recommended routing of the cables. Each cable should be labeled at both ends with the range of input or output numbers that appear on the control unit connector to which it is to be attached.

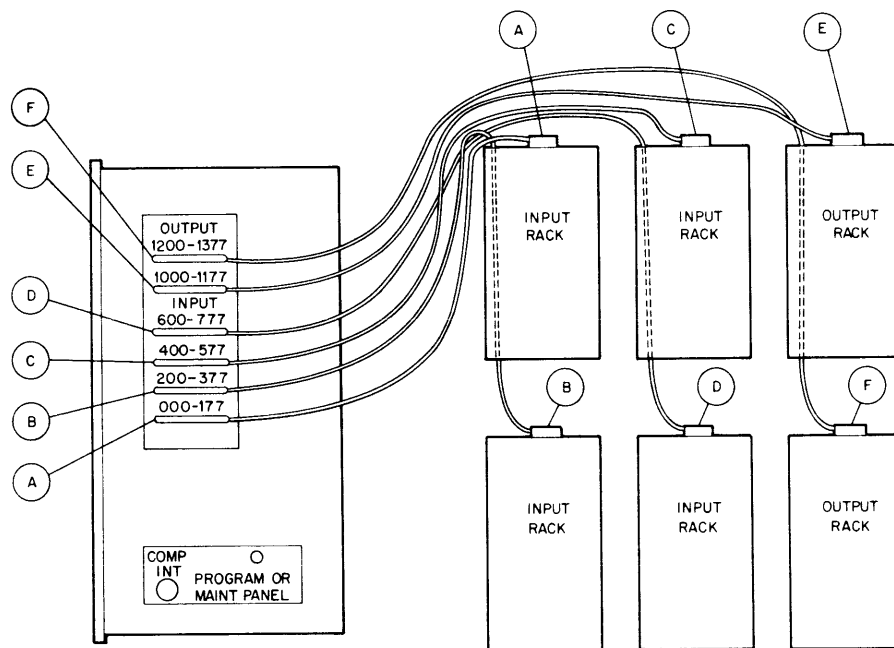

Figure 2-9 I/O Cable Connections

14-0231



**Option/Interface Installation**

The following paragraphs describe the installation procedure for the DA14-E parallel option, the DA14-EL parallel option, the DC14-F serial option, and the VT14 interface connection to the Industrial 14 Controller and to the ASR 33 Teletype, and provides calibration information for the DC14-F option. Since the serial and parallel options include a module and a harness inside the control unit and a cable external to the control unit, the installation procedure is divided into internal connections and external connections. Figure 2-10 is a block diagram of the Industrial 14 System interface connections.

**DA14-E Option (Figure 2-11)**

The DA14-E option is a high speed parallel data link between the Industrial 14 Controller and the PDP-8/E, F, or M computer. This option consists of a M7451 module which plugs into the Industrial 14 backplane, a harness for connecting the module to the COMP INTER connector, and a BC14H cable for interconnecting the controller to the KA8/E interface option of the PDP-8 computer. All of these components are shown in detail in Figure 2-11. The following are installation instructions for the DA14-E:

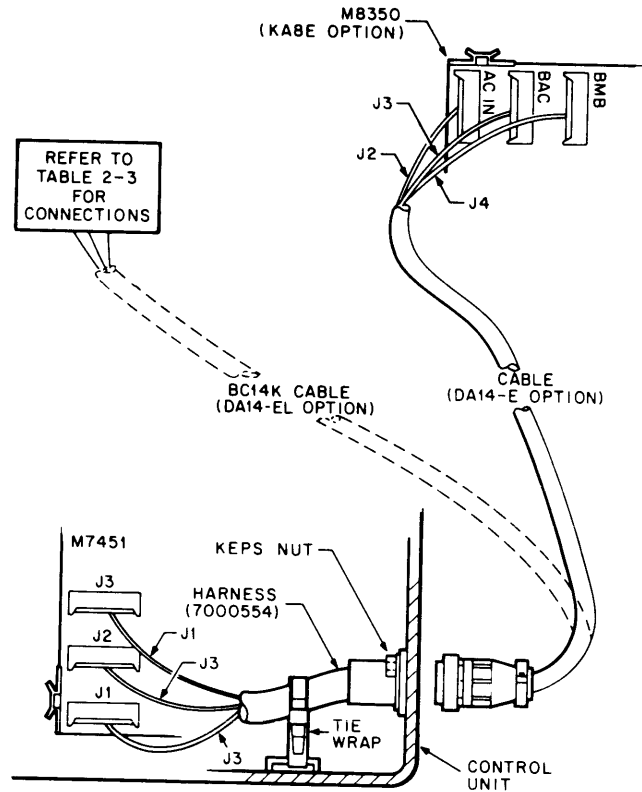

14-0313

Figure 2-11 The DA14E and DA14-EL Options Installation

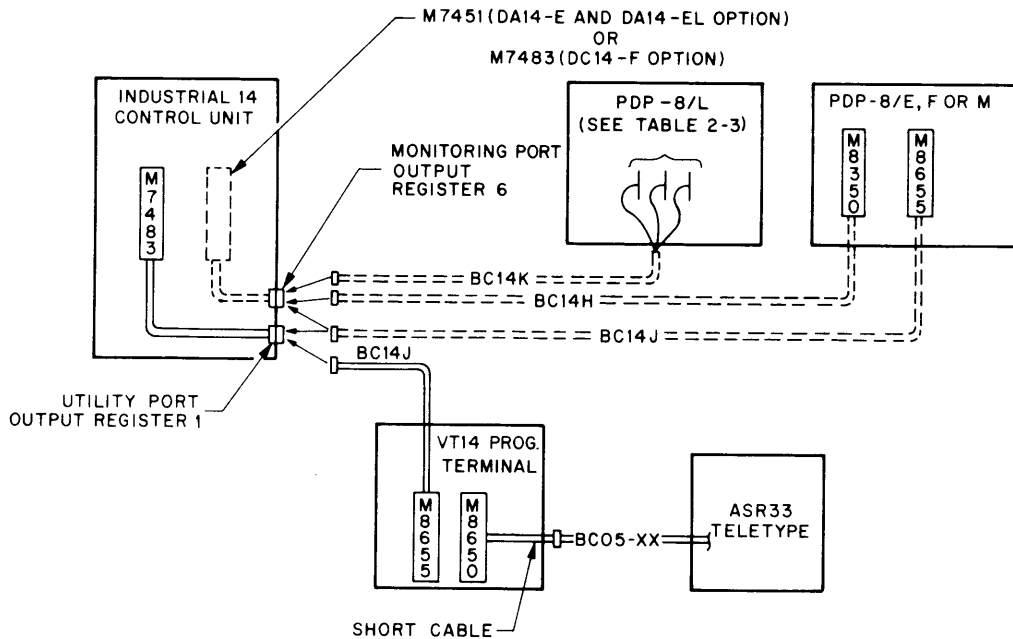

14-0288

Figure 2-10 Industrial 14 Interface Options

**Internal Connections**

1. Power down the Industrial 14 Controller.
2. Attach the flat Berg connector end of the round harness (7009554) to the M7451 Module as follows:

7009554 Harness	M7451 Module
J1 (longest cable)	J3 (connector closest to center of module)
J2	J2 (center connector)
J3 (shortest cable)	J1 (connector closest to edge of module)

3. Open the control unit door and plug the M7451 Interface Module (with the harness attached) into the backplane between the I/O multiplexer and the memory modules.
4. Remove the metal tab from the hole labeled COMP INTER on the lower right hand side of the control unit.
5. Route the harness along the bottom of the control unit and install the 1 in., 63-pin connector end of the round harness in this hole with the No. 6-32 flat head screws provided. The screws should be inserted from the outside of the control unit.
6. Remove the paper from the flat side of the tie wrap mount. Place the mount directly under the cable and press the flat side against the chassis.
7. Pass one end of the tie wrap through the tie wrap mount then around the cable and secure.
8. Close the control unit door.

**External Connections**

1. Power down the PDP-8 computer and remove the top cover to expose the modules.
2. Remove the M8350 Module and attach the flat Berg connector end of the BC14H cable to the module as indicated by Table 2-2:

**Table 2-2  
BC14H/M8350 Connections**

BC14H Cable	M8350 Module
J2 (longest cable)	BMB (connector closest to edge of module)
J3	BAC (center module)
J4 (shortest cable)	AC IN (connector closest to center of module)

3. Re-install the M8350 Module being careful not to disconnect the Berg connectors.
4. Power down the Industrial 14 Controller.
5. Mate and seat the 1 in. round connector end of the BC14H cable with the COMP INTER connector on the lower right-hand side of the control unit. The connectors are keyed and must be properly positioned before they will mate. Turn the cable connector clockwise until a detent is reached to ensure a firm connection.
6. Power up the controller and the PDP-8 computer.

This completes the DA14-E interface option installation. You may wish to run the TEST-143/8 diagnostic supplied with the option to verify proper installation and operation.

**DA14-EL Option (Figure 2-11)**

The DA14-EL option is a high speed parallel data link between the Industrial 14 Controller and the PDP-8/L. It is identical to the DA14-E option except that a BC14K cable is used for interconnecting the controller to the PDP-8/L computer. The following are installation instructions for the DA14-EL option:

**Internal Connections**

Refer to the DA14-E option Internal Connections procedure and perform steps 1–8.

**External Connections**

1. Power down the PDP-8/L computer and remove the top cover.
2. Insert the M903 cable connectors attached to one end of the BC14K cable as indicated by Table 2-3.
3. Power down the Industrial 14 Controller.
4. Mate and seat the 1 in. round connector end of the BC14K cable with the COMP INTER connector on the lower right-hand side of the control unit. The connectors are keyed and must be properly positioned before they will mate. Turn the cable connector clockwise until a detent is reached to ensure a firm connection.
5. Power up the controller and the PDP-8/L computer.

This completes the DA14-EL interface option installation. You may wish to run the TEST-143/8 diagnostic supplied with the option to verify proper installation and operation.

**DC14-F Option (Figure 2-12)**

The DC14-F option is a 9600 baud, general purpose, serial communications link between the Industrial 14 Controller and the PDP-8/E, F, or M computer. This option consists of a second M7483 Module in the Industrial 14, a harness for connecting the module to the COMP INTER connector, an adapter plate for adapting the harness connection. All of these components are shown in detail in Figure 2-12. The following are installation instructions for the DC14-F:

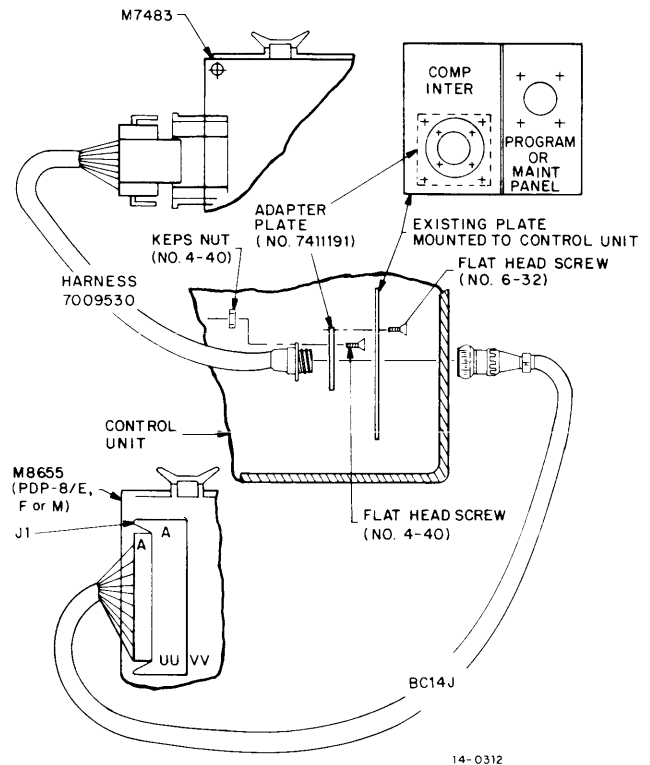

Figure 2-12 The DC14-F Option Installation

**Table 2-3  
BC14K/PDP-8/L Connections**

BC14K Cable	Primary Signal	PDP-8/L (4K) Logic Slots	BA08 (8K) Logic Slots
P1 (shortest cable)	AC IN	D34	B34
P2	BAC 0–11	D36	B36
P3 (longest cable)	BMB 0–11	D35	B35

### Internal Connections

1. Power down the Industrial 14 Controller.
  2. Check the setting of the baud rate switch and the dual-in-line option switches. They must correspond with the settings shown in Figure 2-13 for the module to operate properly with the KL8-JA option of the PDP-8 computer. If they do not, make the appropriate adjustments as indicated by the figure and then proceed with step 3.
  3. Attach the white connector end of the flat ribbon harness (7009530) to the white connector on the M7483 Module. The connectors are keyed to prevent incorrect mating.
  4. Using the hardware provided, attach the adapter plate (7411191, Figure 2-12) to the 1/2 in. round connector.
  5. Open the control unit door and plug the M7483 Module into the backplane between the I/O multiplexer and the memory modules.
  6. Route the harness along the bottom of the control unit toward the lower right-hand side.
  7. Using the hardware provided, attach the adapter plate assembled in step 3 to the existing adapter plate already installed in the COMP INTER hole.
  8. Close the control unit door.
3. Mate and seat the 1/2 in. round connector end of the BC14J cable with the 1/2 in. round connector installed in the COMP INTER hole on the lower right-hand side of the control unit.
  4. Replace the top cover, power up the PDP-8 computer.

This completes the installation of the DC14-F option.

### M7483 Calibration

An M7483 Module is factory calibrated and installed in the Industrial 14 Controller to interface with the VT14 Programming Terminal. When the DC14-F option is purchased, a second M7483 Module, which is part of the DC14-F option, is shipped as a loose part. Before it is installed, check the calibration to ensure that the baud rate switch (S1) and the option switches contained in the dual-in-line package (E26) are set to correspond with Figure 2-13.

### M8655 Calibration

The M8655 Module is calibrated and installed in the VT14 at the factory. However, if a KL8-JA option is purchased for the PDP-8E, F, or M computer, the calibration of the module should be checked before installing it. Figure 2-14 shows the proper TRANSMIT and RECEIVE switch settings and indicates the jumpers that must be installed for this module to interact properly with the Industrial 14 Controller.

### Expanding Main Memory of an Industrial 14/30

An Industrial 14/30 normally has 4K of main memory which operates in field 0. The memory size can be expanded to 8K by adding a second 4K memory stack which operates in field 1. The following is the procedure for expanding main memory from 4K to 8K:

1. Locate and remove the EMA2 jumper on the G104 Module (Figure 2-15) of the 4K stack to be added to the 14/30.
2. Power down the Industrial 14 Controller and open the control unit door.
3. Insert the second 4K stack in slots 3, 4, and 5 of the backplane (Figure 1-14).
4. Remove the M7431 Module from the backplane (slot 19).

### External Connections

1. Power down the PDP-8 computer and remove the top cover.
2. Remove the M8655 Module (KL8-JA option) and attach the flat Berg connector end of the BC14J cable to the module. Pin A of the cable connector mates with pin A of the module connector (Figure 2-12).

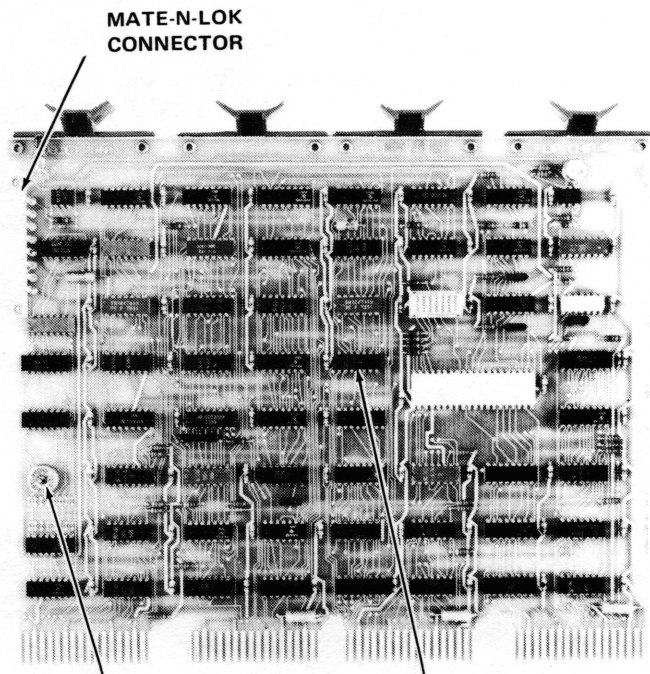

7016-3

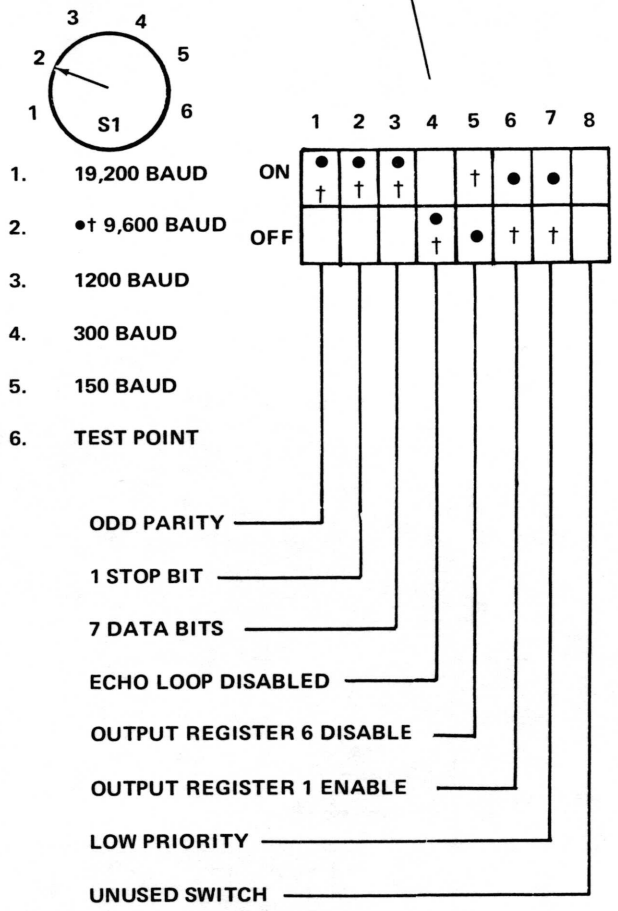

● SETTING FOR USE WITH THE VT14 OR PDP-8  
 † SETTING FOR MONITORING WITH PDP-8

Figure 2-13 Calibration of the Industrial 14 M7483 Module

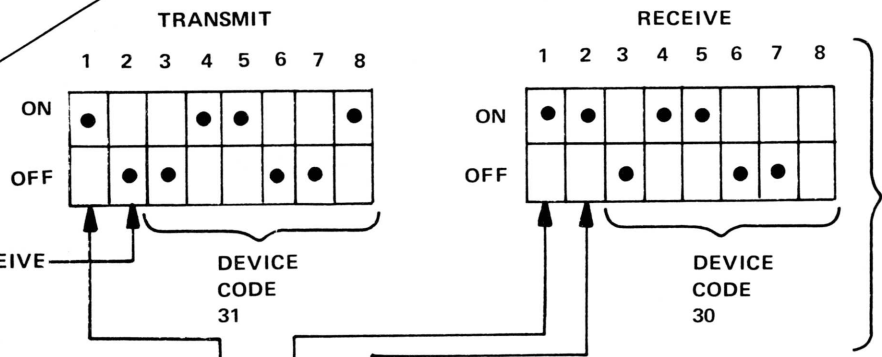
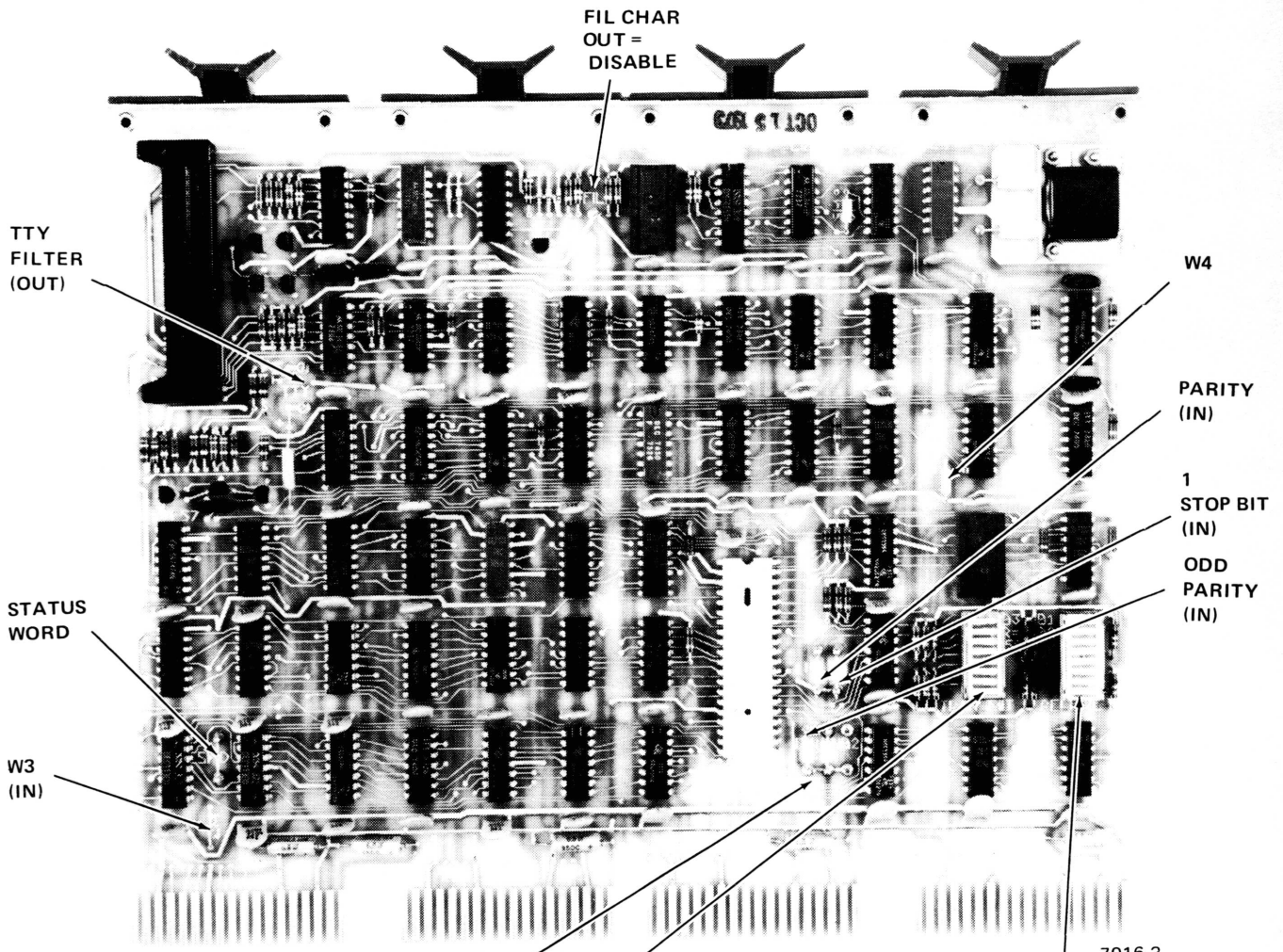

DATA BITS/CHAR	8	*7	6	5
NB1	OUT	IN	OUT	IN
NB2	OUT	OUT	IN	IN

			110
ON			150
		ON	300
ON		ON	600
	ON		1200
ON	ON		2400
	ON	ON	4800
ON	ON	ON	*9600

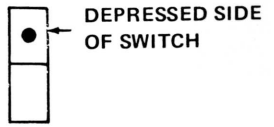

\*FACTORY SETTING FOR USE WITH THE VT14 OR ODP-143/8 SOFTWARE

Figure 2-14 Calibration of the M8655 Module for use in the PDP-8

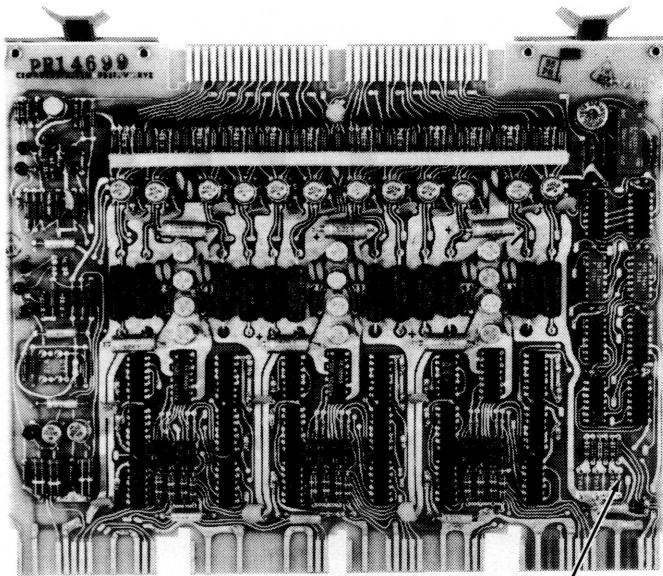

EMA2  
JUMPER

7016-4

Figure 2-15 G111 Module Layout

5. Locate the dual-in-line switch package (E26, Figure 2-16) and set SW5 to OFF.
6. Re-insert the M7431 Module.
7. Close the control unit door and power up the control unit.

The 14/30 system now has 8K of main memory and is ready to be programmed.

#### VT14/Industrial 14 Interface

A M7483 Module is factory installed in the Industrial 14 Control Unit and is internally connected to the PROGRAM OR MAINT PANEL connector. If the controller is to be programmed with the VT14 Programming Terminal, the only interface connection required is to connect the BC14J cable (attached to the VT14) to the control unit. It is recommended that power to the VT14 be turned off before making this connection but it is not necessary to power down the controller. The cable is part of the VT14 and comes attached to the M8655 Module.

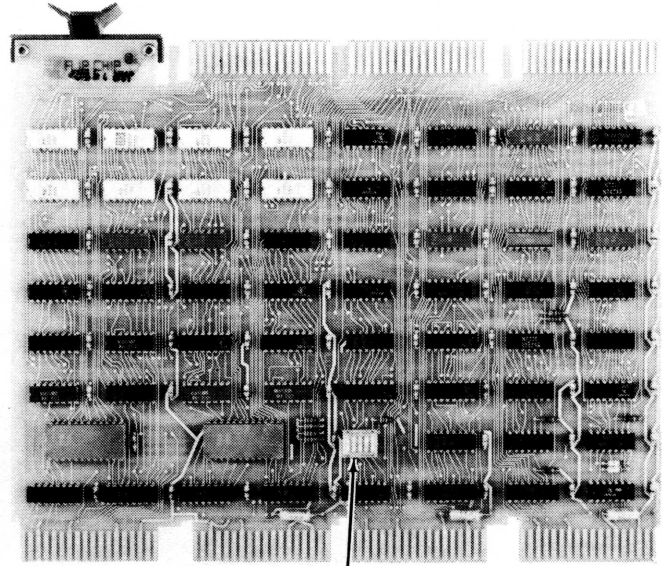

7016-1

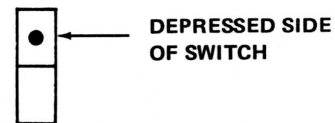
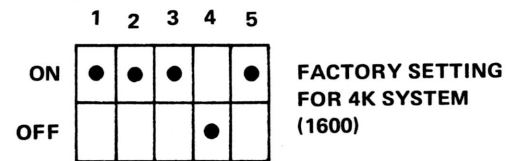

Figure 2-16 M7431 Module Layout

#### VT14/LT33 Teletype<sup>®</sup> Option

A copy of a particular circuit or a complete program can be printed out or punched on paper tape via the LT33 Teletype Option. Instructions for making copies and for reading paper tapes are supplied in Appendix A of the VT14 User's Manual. The following is the procedure for interfacing the VT14 with the LT33 Teletype:

1. Switch off power to the VT14 or the LT33 Teletype.
2. Connect the Mate-N-Lok connector end of the short cable from the back of the VT14 to the LT33 Teletype Signal Cable (BC05-XX).
3. Power up the VT14 or LT33 Teletype.

<sup>®</sup>Teletype is a registered trademark of Teletype Corporation.

## INITIAL START-UP PROCEDURE

After the system installation is complete, the initial start-up procedure should be performed. This is a procedure for checking the operation of the 14 System before connecting it to the controlled machine or process, and includes adjusting the internal I/O grouping:

1. Turn the power off to the controller.
2. Disconnect the I/O cables at the control unit. (Be sure they are marked at both ends with I/O numbers before disconnecting.)
3. Open the control unit door, remove the top-edge connectors from the M7431 Module, and remove the module.
4. If necessary, adjust the grouping of internal functions to fit the desired application by setting switches S1, S2, S3, and S4, on the M7431 Module. The module layout is shown in Figure 2-16. The switch settings and corresponding partition address are listed in Table 2-4.
5. If the system is a 14/30 (4K), switch S5 on this module is set to the ON position. If the system is a 14/35 (8K) or a 14/30 expanded to 8K, switch S5 is set to the OFF position.
6. Re-install the M7431 Module and reconnect the top-edge connectors.
7. If applicable, install any Industrial 14 option, such as the DA14-E or DC14-F.
8. Power up the controller by setting the switch on the power supply to on. The power supply POWER ON light and the control unit PWR ON and SYSTEM RUN light should glow. (If the ADDR ERROR light glows at this point, it should be ignored.)
9. Load the Industrial 14 program either through the VT14 Programming Terminal or a computer. For loading instructions, refer to the VT14 User's Manual for the former, or to the Industrial 14 Software Manual for the latter. When loaded, the program should be punched on paper tape.
10. Power down the Industrial 14 System and reconnect the I/O cables.
11. The Industrial 14 System is now operational. Program and hardware debugging can now begin.



**Table 2-4  
Partition Address Settings for Internal Functions**

PARTITION ADDRESS	4K SYSTEM					8K SYSTEM						
		1	2	3	4	5		1	2	3	4	5
1400	ON	•	•	•	•	•	ON	•	•	•	•	
	OFF						OFF					•
1420	ON		•	•	•	•	ON		•	•	•	
	OFF	•					OFF	•				•
1440	ON	•		•	•	•	ON	•		•	•	
	OFF		•				OFF		•			•
1460	ON			•	•	•	ON			•	•	
	OFF	•	•				OFF	•	•			•
1500	ON	•	•		•	•	ON	•	•		•	
	OFF			•			OFF			•		•
1520	ON		•		•	•	ON		•		•	
	OFF	•	•				OFF	•		•		•
1540	ON	•		•	•		ON	•		•		
	OFF		•				OFF		•			•
1560	ON			•	•		ON			•		
	OFF	•	•	•			OFF	•	•	•		•
1600	ON	•	•	•	•		ON	•	•	•	•	
	OFF				•		OFF				•	•
1620	ON		•	•	•		ON		•	•	•	
	OFF	•			•		OFF	•			•	•
1640	ON	•		•	•		ON	•		•		
	OFF		•		•		OFF		•		•	•
1660	ON			•	•		ON			•		
	OFF	•	•	•			OFF	•	•	•		•
1700	ON	•	•			•	ON	•	•			
	OFF			•	•		OFF			•	•	•
1720	ON		•			•	ON		•			
	OFF	•		•	•		OFF	•		•	•	•
1740	ON	•				•	ON	•				
	OFF		•	•	•		OFF		•	•	•	•
1760	ON					•	ON					
	OFF	•	•	•	•		OFF	•	•	•	•	•

NOTE:  
• = switch state.

14-0289

# CHAPTER 3

## USER MAINTENANCE

### 3.1 INTRODUCTION

This chapter contains user maintenance information for the Industrial 14 Controller presented at the module substitution level. It is assumed that the user has a thorough understanding of the information presented in Chapters 1 and 2 of this manual; therefore, the information presented in this chapter deals primarily with repairing Industrial 14 Controller malfunctions. Failures external to the controller are analyzed only to the extent of isolating the problem.

Two assumptions are made to simplify troubleshooting procedures: All contacts are wired normally open (N/O) as described in the VT14 User's Manual; and load devices for dc converters are connected as indicated in the Field Wiring paragraph in Chapter 2 of this manual.

### 3.2 MAINTENANCE PHILOSOPHY

For the user, the recommended level of repair is module replacement. If the system cannot be repaired by this method, either replace the next larger assembly or contact your Digital Field Service Representative. Module repair should *only* be performed by personnel thoroughly trained in electronic and digital repair techniques.

The Industrial 14 Controller requires no periodic maintenance or adjustments and, therefore, no scheduled downtime. From a maintenance standpoint, it is operated continually unless a malfunction occurs.

The best maintenance tool available is a thorough understanding of how the system operates. Persons responsible for maintenance should become thoroughly familiar with the Industrial 14 Controller and the machine or process that it controls including system layout, nomenclature, operating principles (to a block diagram level), and the Industrial 14 I/O numbering scheme. This information simplifies the process of isolating a malfunction to an area causing the problem.

### 3.3 RECOMMENDED TEST EQUIPMENT

The only test equipment required for user level maintenance is a VOM (such as the Simpson, Model 260 or Triplett, Model 630). If available, the VT14 Programming Terminal and PDP-8 or PDP-11 computer running ODP-143 are useful for troubleshooting.

### 3.4 RECOMMENDED SPARE PARTS

Table 3-1 lists the recommended spare parts for single and multiple system users of the Industrial 14 Controller.

### 3.5 ISOLATING A FAILURE

A failure in an Industrial 14 installation can usually be isolated to one of two main categories — a complete system failure or a partial system failure. Complete failures always originate in the control unit. Partial failures can originate either externally (in the controlled system) or in the controller. Failures in the controller are subdivided into control unit failures, which are associated with the control unit/power supply combination, and I/O failures, which are associated with the I/O components (Figure 3-1).

#### 3.5.1 Partial Failures

A partial system failure is usually discovered when some function in a controlled system fails to occur, e.g. a motor does not start. When analyzing the problem, first determine whether the source of the failure is in the controlled system (external failure) or in the Industrial 14 Controller. Figure 3-2 outlines a general approach for this determination.

For example, if a motor which is connected to ac output converter 1001 fails to start, observe the lamp on that converter. If it is on, the controller has switched field voltage to the motor, therefore, the failure is external. If the output light is off, observe the appropriate input converter light(s) to see if the input condition(s) for driving the output on are present. If the input light(s) are on, the failure is in the controller.

**Table 3-1  
Recommended Spare Parts**

Item	Number of Items		
	1-3 Systems*	4-10 Systems**	>10 Systems***
M7741	1	2	3
M7731	1	2	3
M7432	1	2	3
M7433	1	2	3
H762	1	1	2
M309	1	1	1
54-10486	0	1	1
M7483	0	1	2
MM8-E or MM8-EJ	1	1	2
BC14J-25 (for VT14)	1	1	1
<b>I/O</b>			
BC14F-25	1	2	3
H912-0	1	3	5
H1500†	16	24	32
H1550†			
H1600†	8	16	24
H1650†			

\*Stock the items indicated above or one complete control unit.

\*\*Stock the items indicated above or one control unit plus one each of the following: M7741, M7731, M7432, and M7433.

\*\*\*Stock the items indicated above or two control units plus one each of the following: M7741, M7731, M7432, and M7433.

†Stock appropriate converter types as used in the installed system.

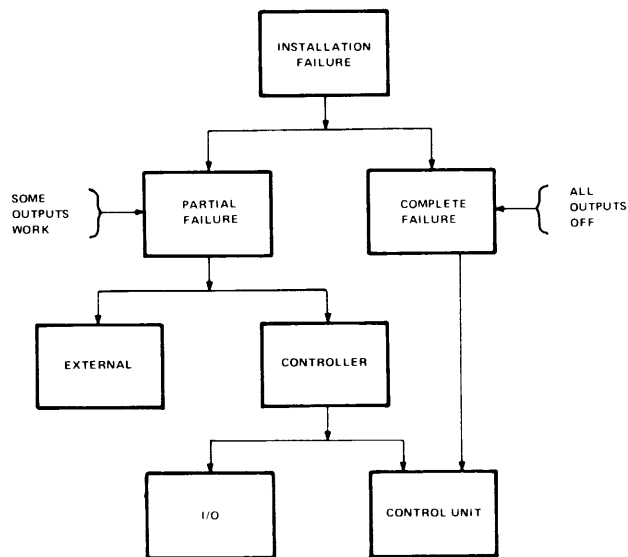

14 0342

Figure 3-1 Isolating an Installation Failure

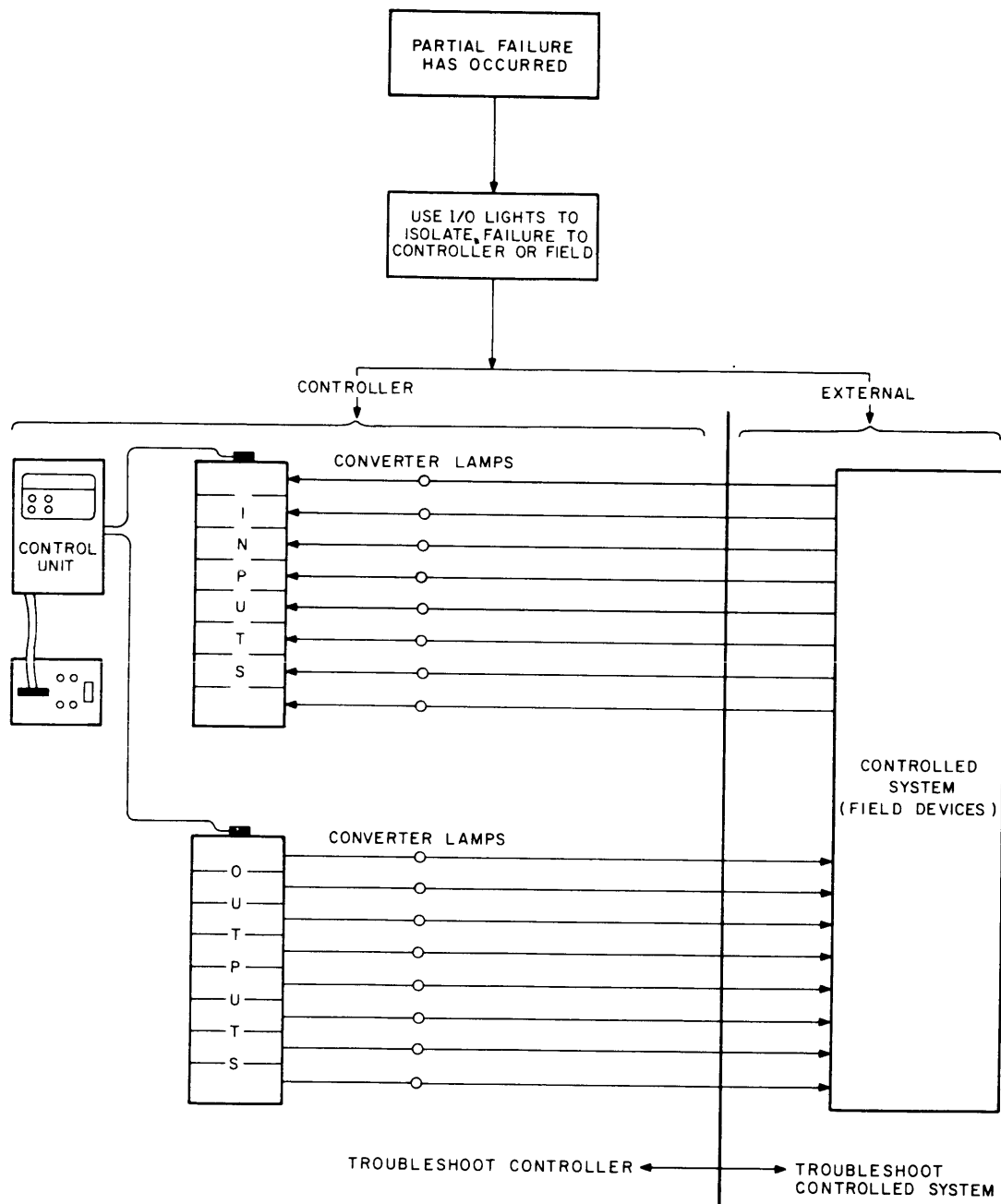

14-0344

Figure 3-2 A General Isolation Procedure for a Partial Failure

If the output converter in the example is dc, the light glowing indicates that the +5 V signal from the control unit is present at the converter, but imparts no information about the state of the converter. However, the state can be determined by measuring the voltage at the dc output converter terminals as shown in Table 3-2. (The recommended connection scheme for dc converters discussed in Chapter 2 and shown in Table 3-2 is assumed.) If the voltage is zero (assuming the supply voltage is present) the converter is on, which indicates an external failure. If the voltage is equal to the supply voltage, the converter is off, indicating a defective converter. Figure 3-3 is a detailed illustration for this type of failure and includes ac and dc converters. The heavy line near the bottom of the figure indicates whether the failure is external or in the controller.

### 3.5.2 External Failures

An external failure can be a broken or disconnected wire, a mechanical problem with a tripping mechanism, an improper ground, a defective electrical contact in an external device, or the device itself. If an installation failure is isolated to an external device, a systematic approach should be used to further isolate the cause of the problem.

### 3.5.3 Controller

Once a failure is isolated to the controller, it should be further isolated to either the I/O or the control unit. Controller failures are more likely to occur in the I/O, however, an apparent I/O failure can be a problem in the control unit. For example, a single converter does not turn on when it should. The solution may be as simple as replacing the converter, but the problem can also be caused by a defective module in the control unit. Or further investigation may show that the problem is more complicated, i.e. a whole column, panel, or group of panels fails to turn on. So, a thorough understanding of the I/O multiplexing scheme and converter operation is necessary. Refer to Chapter 1 for this information.

Figure 3-4 is a flowchart that outlines a controller failure isolation procedure without using a VT14 or computer and Figure 3-5 is a controller failure isolation procedure using a VT14 or computer. Both of these flowcharts make reference to Figure 3-6 which illustrates the patterns that can be exhibited either by input or output converters when a failure occurs. This figure references a specific flowchart for each pattern. For example, if a complete panel of converters turn on (or off) as represented by item C, refer to flowchart C and use that procedure to further isolate the problem.

Table 3-2  
I/O Voltage Checks

MEASUREMENT	RECOMMENDED	ALTERNATE
$V_1 = \frac{AC\ IN}{AC\ FIELD\ VOLTAGE}$ $V_2 = \text{CONVERTER INPUT VOLTAGE}$		
$V_1 = \frac{AC\ OUT}{CONVERTER\ OUTPUT\ VOLTAGE}$ $V_2 = \text{AC SUPPLY VOLTAGE}$		NOT APPLICABLE
$V_1 = \frac{DC\ IN}{DC\ FIELD\ VOLTAGE}$ $V_2 = \text{CONVERTER INPUT VOLTAGE}$		
$V_1 = \frac{DC\ OUT}{CONVERTER\ OUTPUT}$ $V_2 = \text{dc SUPPLY VOLTAGE}$		

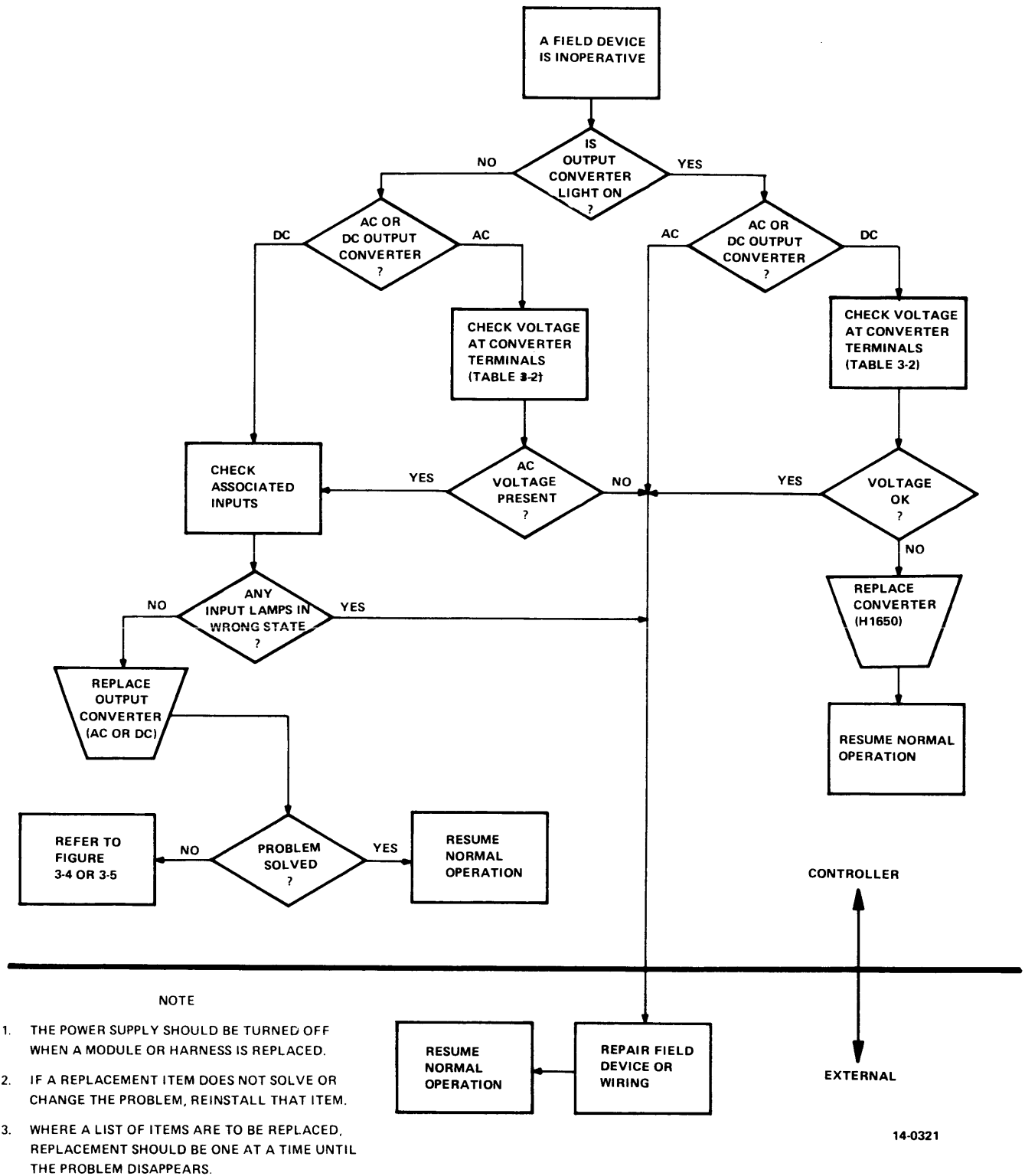
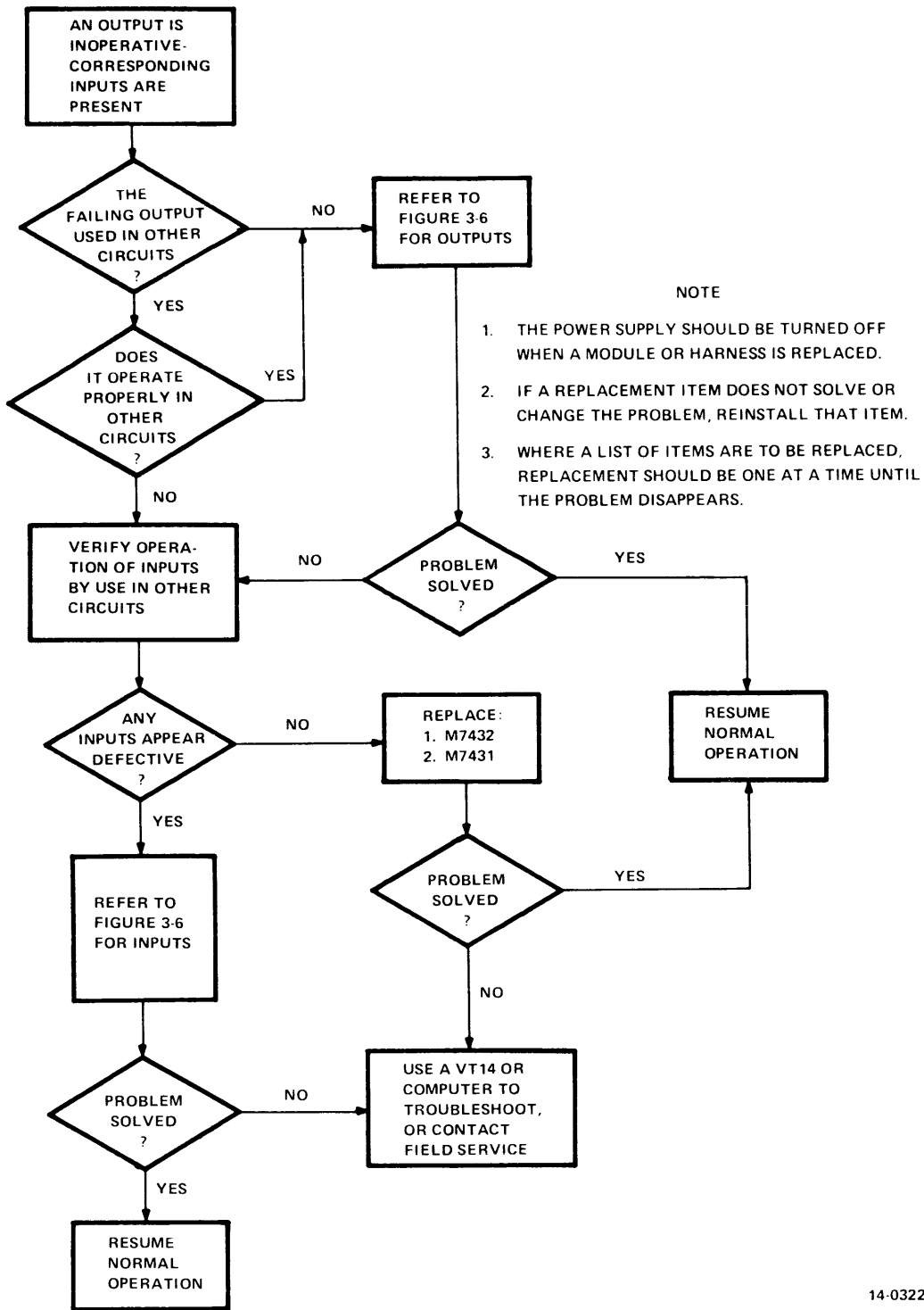

Figure 3-3 Partial Failure Isolation Procedure Using I/O Lights



14-0322

Figure 3-4 Controller Failure Isolation Procedure (No VT14 or Computer Available)

NOTE

1. THE POWER SUPPLY SHOULD BE TURNED OFF WHEN A MODULE OR HARNESS IS REPLACED.
2. IF A REPLACEMENT ITEM DOES NOT SOLVE OR CHANGE THE PROBLEM, REINSTALL THAT ITEM.
3. WHERE A LIST OF ITEMS ARE TO BE REPLACED, REPLACEMENT SHOULD BE ONE AT A TIME UNTIL THE PROBLEM DISAPPEARS.

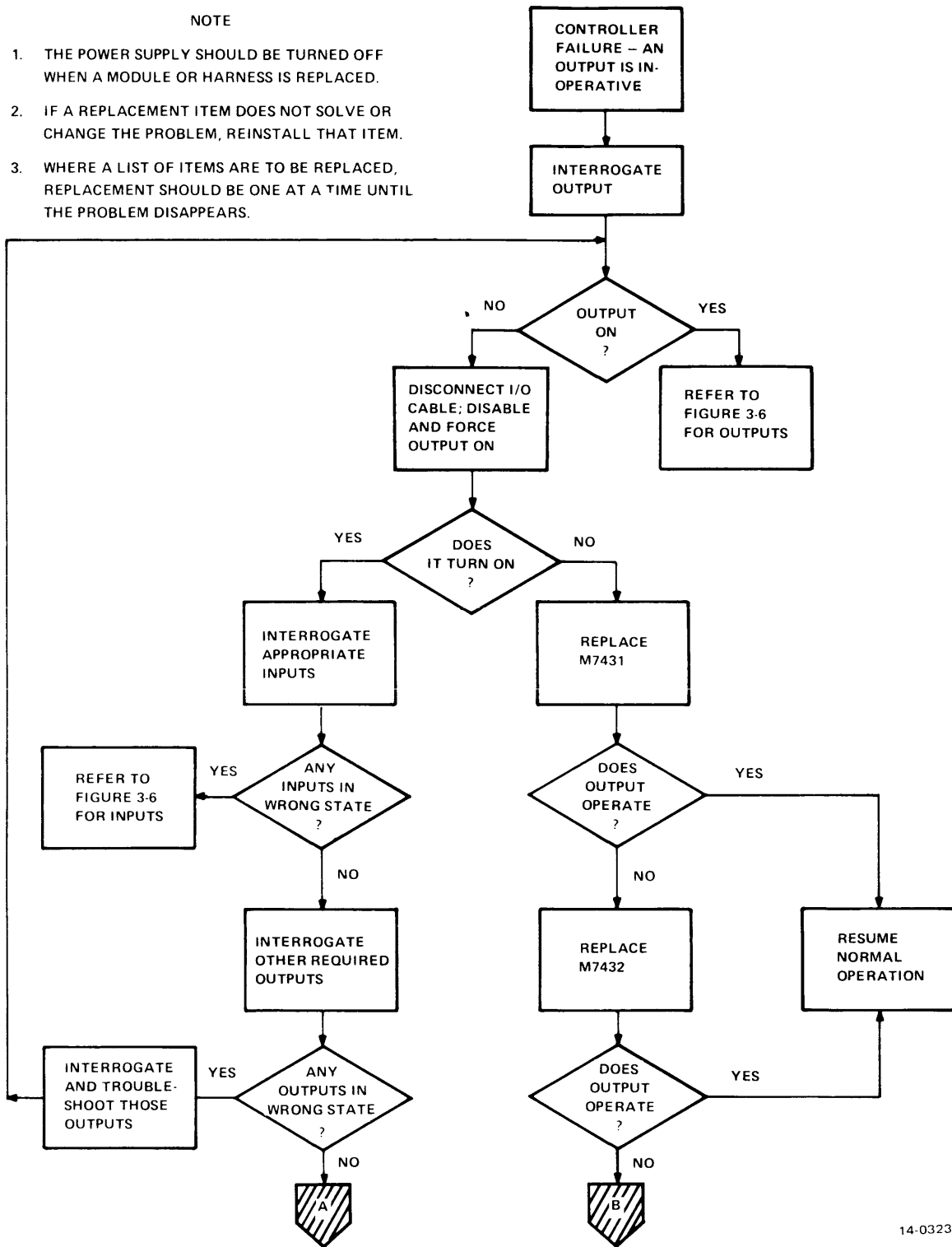

14-0323

Figure 3-5 Controller Failure Isolation Procedure Using a VT14 or Computer (Sheet 1 of 2)



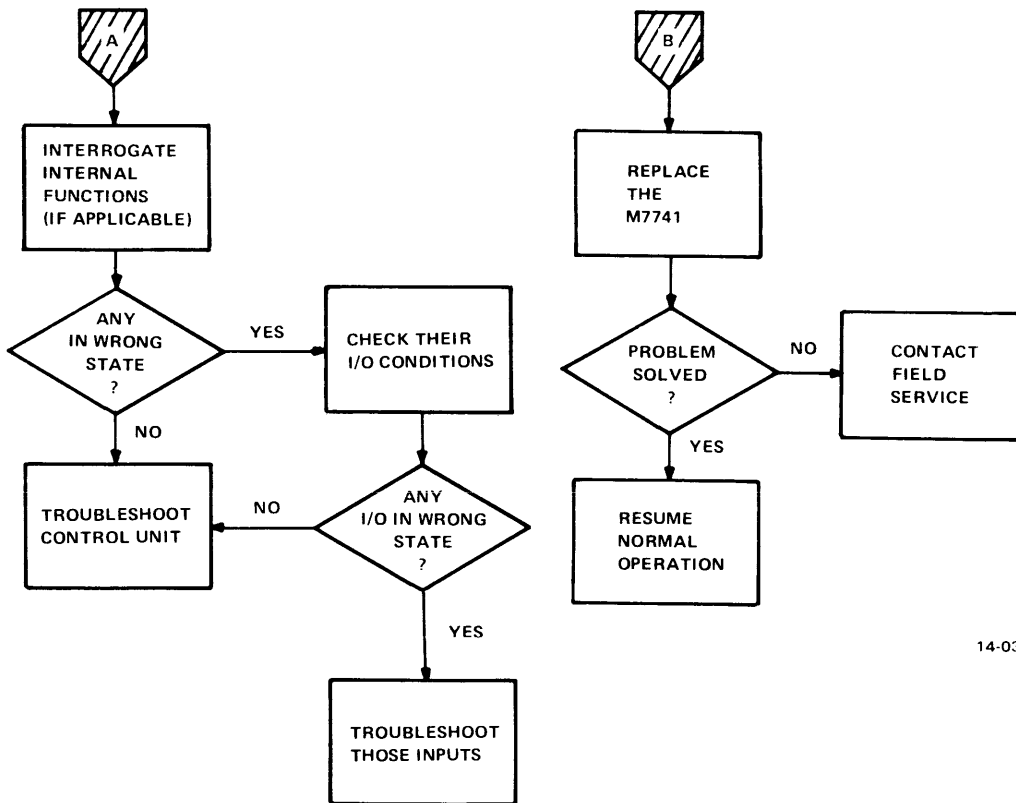

14-0324

Figure 3-5 Controller Failure Isolation Procedure Using a VT14 or Computer (Sheet 2 of 2)

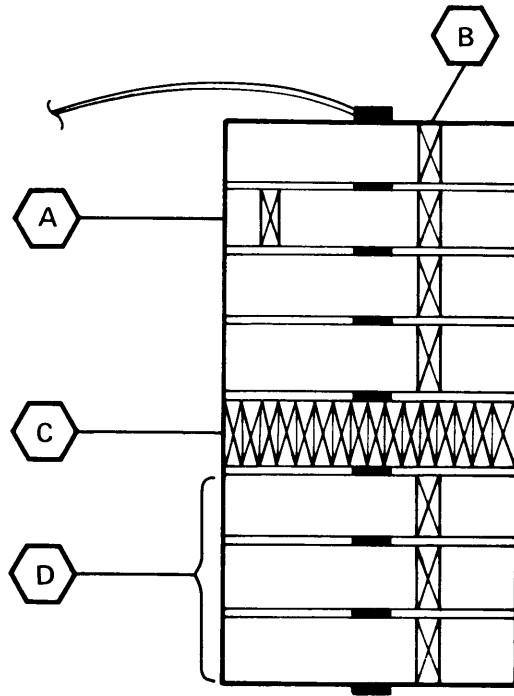

ITEM	SYMPTOM	REFER TO
A	SINGLE POINT FAILURE	FLOW CHART A
B	VERTICAL COLUMN FAILURE	FLOW CHART B
C	COMPLETE OR PARTIAL PANEL FAILURE	FLOW CHART C
D	TWO OR MORE SUCCESSIVE PANELS FAIL	FLOW CHART D

14-0342

Figure 3-6 I/O Fault Isolation Procedure

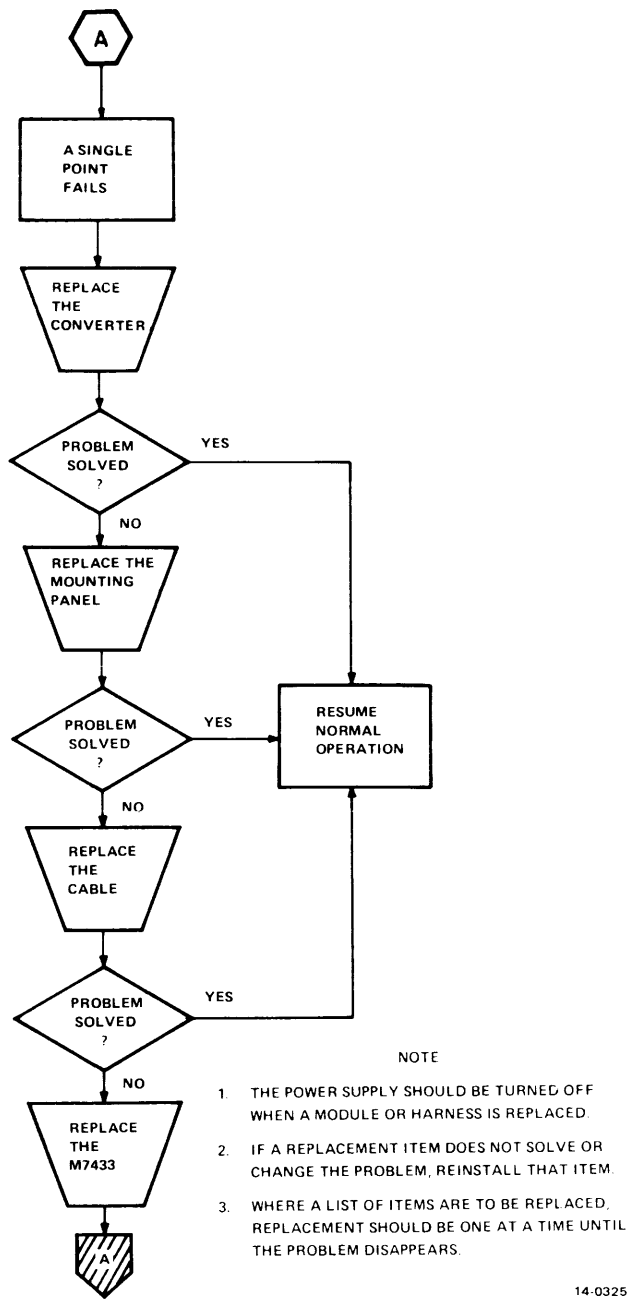

Figure 3-6a Single Point Failure (Sheet 1 of 2)

14-0325

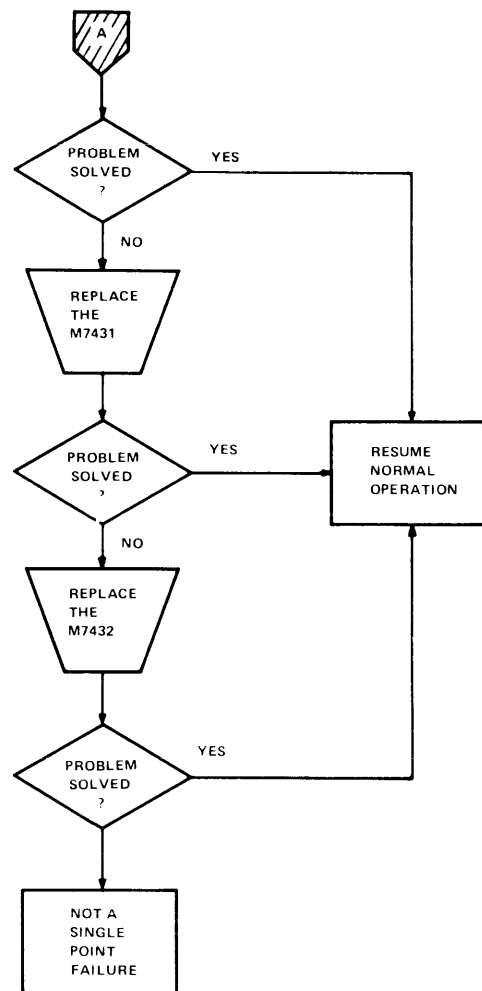
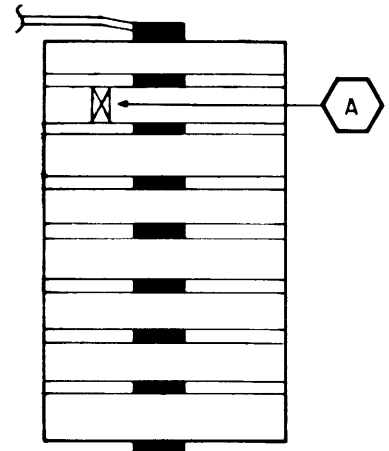
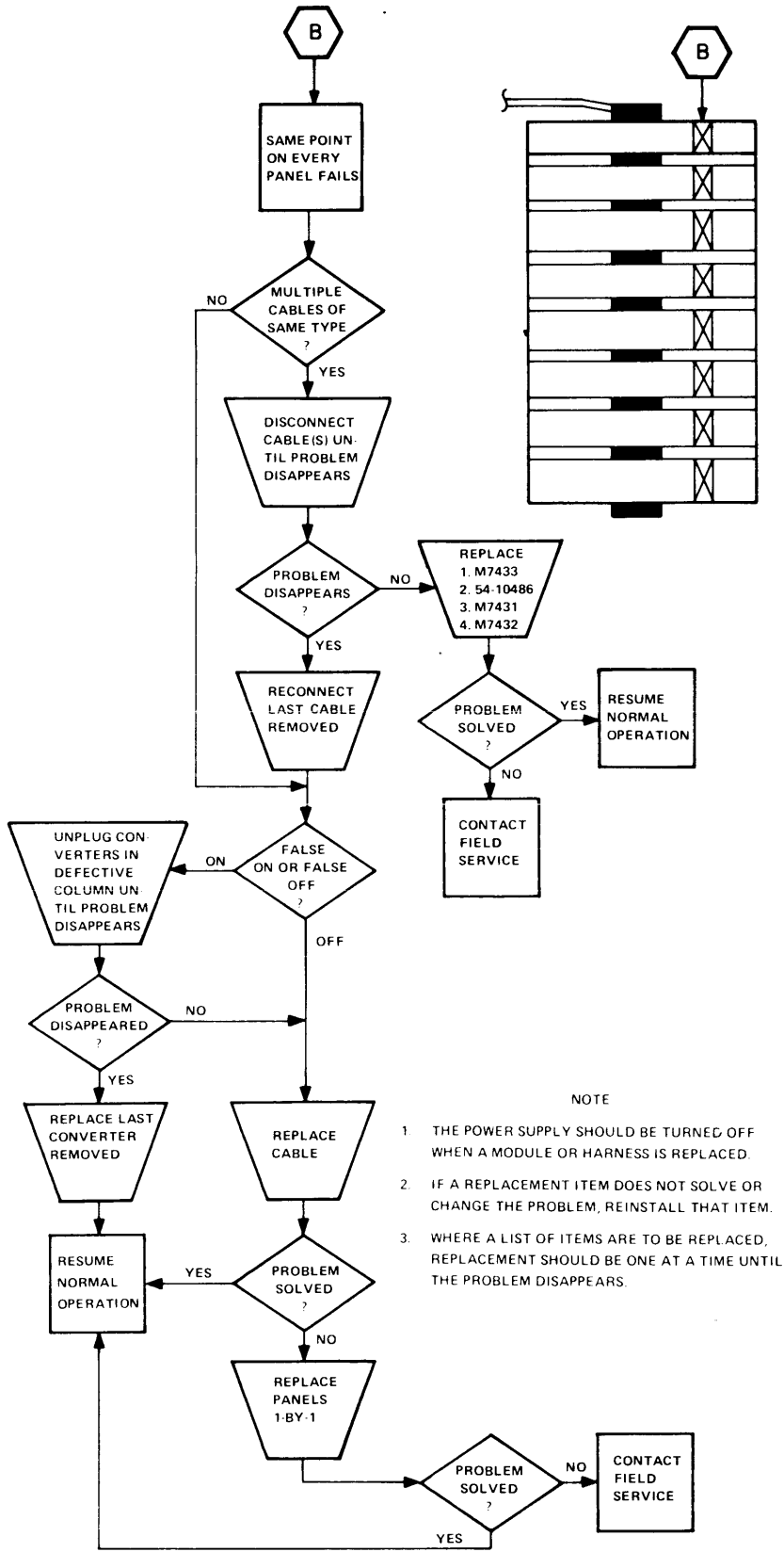

Figure 3-6a Single Point Failure (Sheet 2 of 2)

14-0326



- NOTE
1. THE POWER SUPPLY SHOULD BE TURNED OFF WHEN A MODULE OR HARNESS IS REPLACED.
  2. IF A REPLACEMENT ITEM DOES NOT SOLVE OR CHANGE THE PROBLEM, REINSTALL THAT ITEM.
  3. WHERE A LIST OF ITEMS ARE TO BE REPLACED, REPLACEMENT SHOULD BE ONE AT A TIME UNTIL THE PROBLEM DISAPPEARS.

14 0327

Figure 3-6b Vertical Column Failure

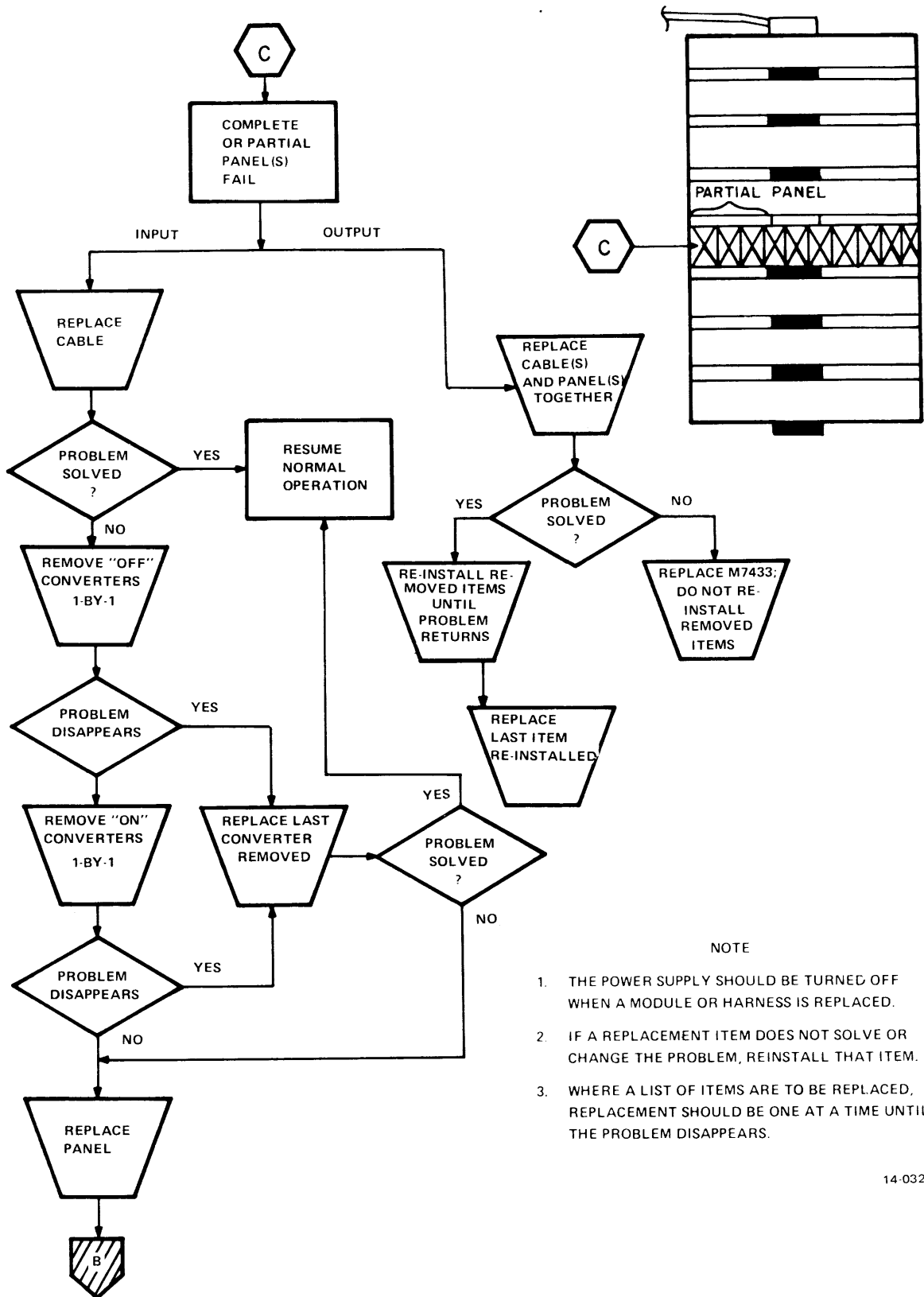
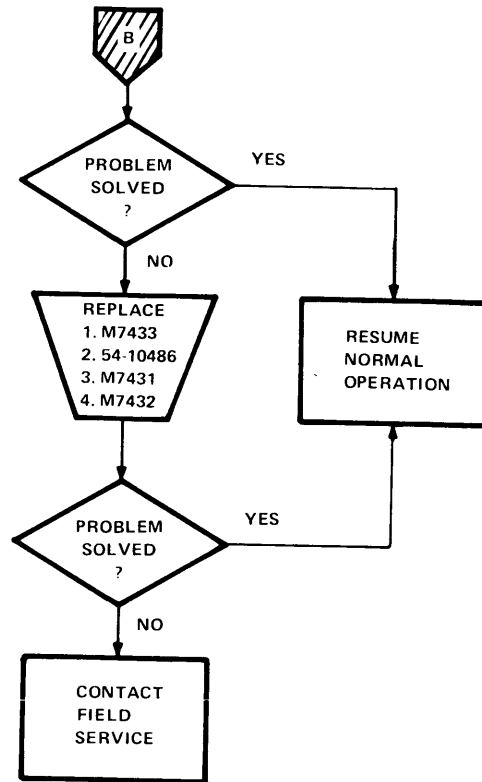

Figure 3-6c Complete or Partial Panel Failure (Sheet 1 of 2)



NOTE

1. THE POWER SUPPLY SHOULD BE TURNED OFF WHEN A MODULE OR HARNESS IS REPLACED.
2. IF A REPLACEMENT ITEM DOES NOT SOLVE OR CHANGE THE PROBLEM, REINSTALL THAT ITEM.
3. WHERE A LIST OF ITEMS ARE TO BE REPLACED, REPLACEMENT SHOULD BE ONE AT A TIME UNTIL THE PROBLEM DISAPPEARS.

14-0330

Figure 3-6c Vertical Column Failure (Sheet 2 of 2)

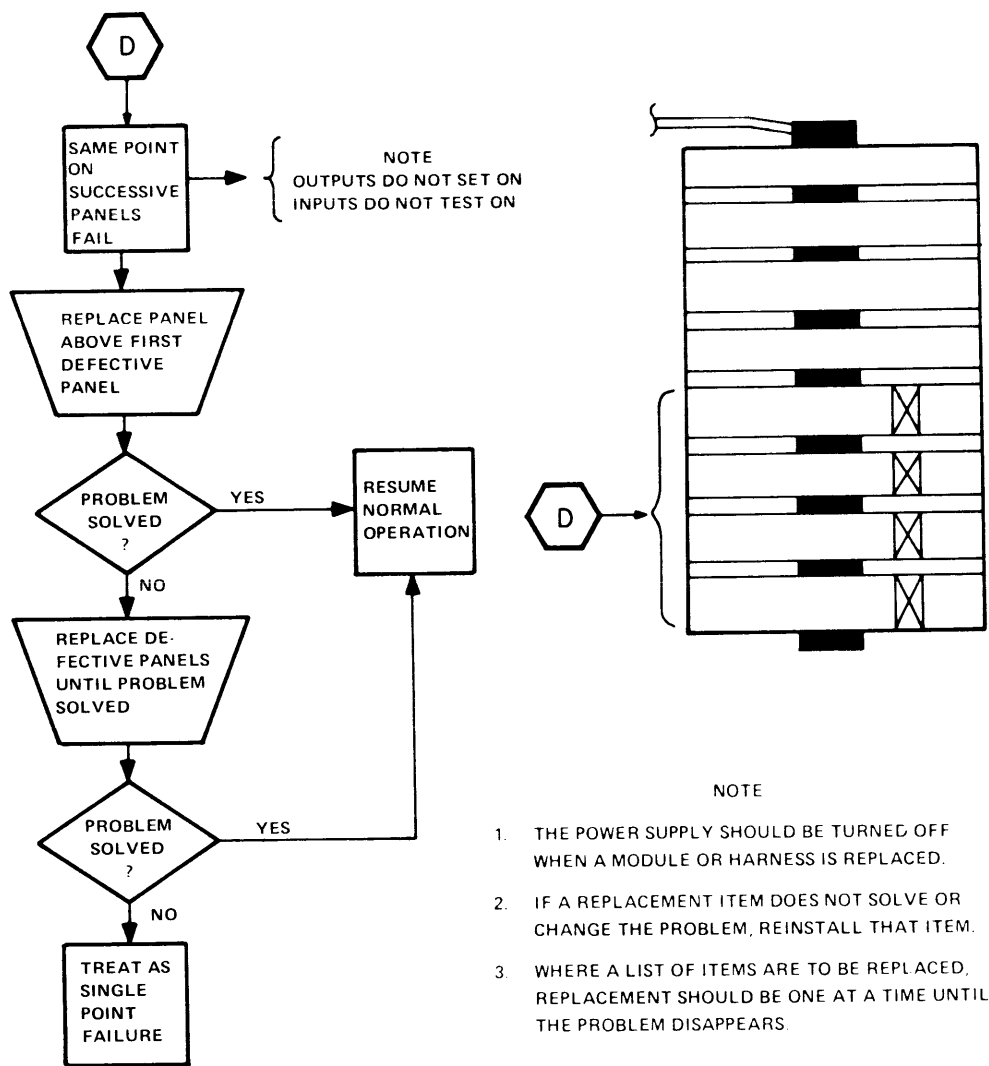

14-0328

Figure 3-6d Two or More Successive Panels Fail

### 3.5.4 Complete Failure

A complete failure of the Industrial 14 System is characterized by all output converters that are off. The symptoms of a complete failure may point to the I/O section of the controller but further investigation always isolates the source of the failure to the control unit, except for a loss of line voltage which is an external problem.

Either a VT14 Programming Terminal or a computer is required to perform some of the troubleshooting procedures in this chapter. For simplifying the documentation, the use of a VT14 is assumed, but a computer can be substituted if preferred. With the VT14, a complete circuit is viewed on the screen and the symbol representing each point observed as it changes state. With a computer, each point is interrogated and compared with the program listing to determine whether or not a point is in the proper state.

Figure 3-7 is a procedure for ensuring that the VT14 and the interface between it and the controller are functioning properly. When performing this procedure, if a test pattern appears on the screen when the VT14 is turned on:

1. Power down the VT14.
2. Remove the top cover.
3. Unplug the M7443 module.
4. Set the switch at the upper right-hand corner of this module to V (Video).
5. Reinsert the M7443 module.
6. Reapply power to the VT14 and continue with the interface checking procedure shown in Figure 3-7.

Figure 3-8 is an overview of the troubleshooting procedures required for isolating the source of a complete failure and Table 3-3 is an estimate of the percentage of components checked by each procedure. If any of these procedures cannot be successfully completed, refer to flowcharts E through K indicated by this figure.

**Table 3-3**  
Percentage of Components Checked

	Power Up 14	Load and Verify Memory	Verify After Power Cycle	I/O Control Check	Run Exerciser Program
System Component	Percentage of components checked by procedure				
M7741 Processor Board	5	70	70	90	95
M7483 Serial Interface	5	99	99	99	99
M7432 I/O Control	5	25	25	65	95
M7431 I/O Memory	5	5	5	65	90
M7433 I/O Drivers	5	25	25	90	95
MM8E (or 8EJ) Memory	5	99	99	99	99
H762 Power Supply	50	70	80	80	99
M309 Power Sequencer	5	5	100	100	100



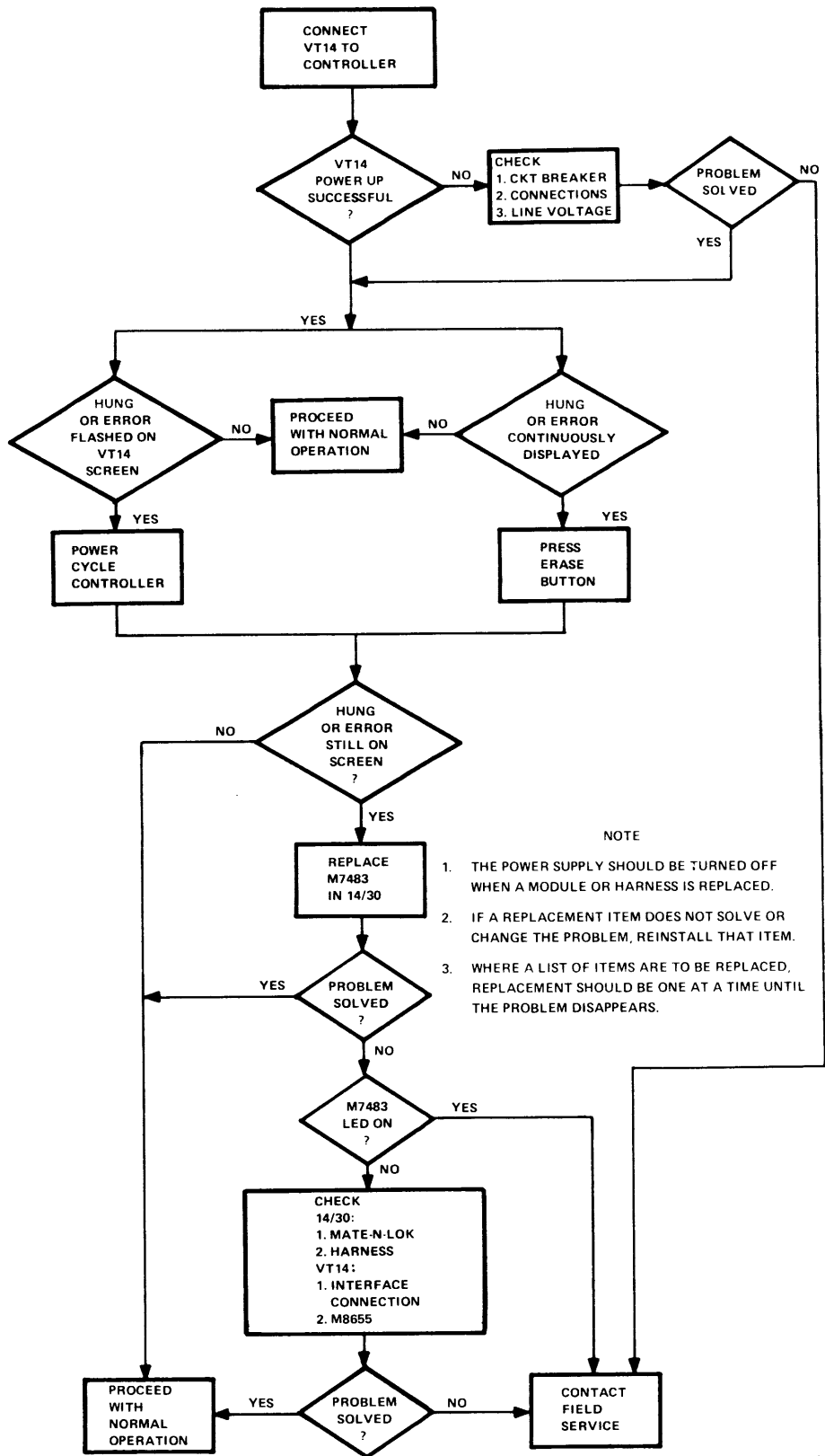

14-0331

Figure 3-7 Industrial 14/VT14 Interface Check

ASSOCIATED  
FLOW CHARTS

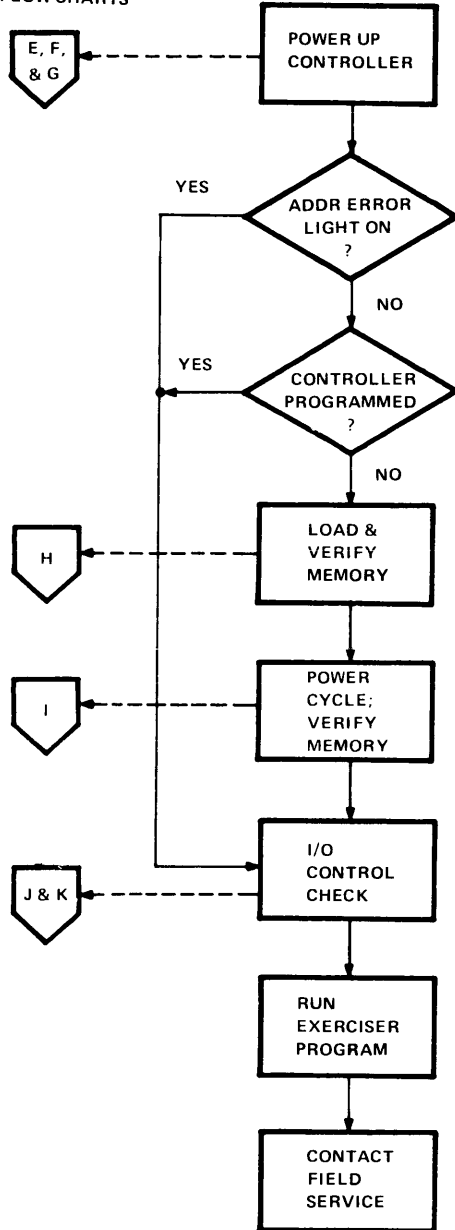

COMMENTS

1. "POWER ON" AND "SYSTEM RUN" LIGHTS ON?
2. "BUS ERROR" LIGHT OFF.
3. IGNORE "ADDR ERROR" LIGHT AT THIS POINT.

1. CLEAR MEMORY
2. LOAD MEMORY FROM TAPE
3. VERIFY MEMORY (COMPARE MEMORY CONTENTS TO TAPE)

1. POWER DOWN THE 14/30 AND IMMEDIATELY POWER UP
2. RE-VERIFY MEMORY CONTENTS

1. SAMPLE INPUTS ON EACH CABLE (ON AND OFF)
2. SAMPLE OUTPUTS ON EACH CABLE (ON AND OFF)
3. SELECTIVELY SET "SAFE" OUTPUTS ON; FORCE ON/OFF

1. ADDRESS ERROR LIGHT = PROBLEM FOUND
2. REFER TO WRITE-UP SUPPLIED WITH TEST

1. CHECK USER PROGRAM FOR PROBLEMS
2. PERFORM A MORE COMPLETE CHECK OF I/O
3. RUN TEST-143
4. CONTACT FIELD SERVICE

14-0332

Figure 3-8 Overview of Complete Failure Troubleshooting Procedures

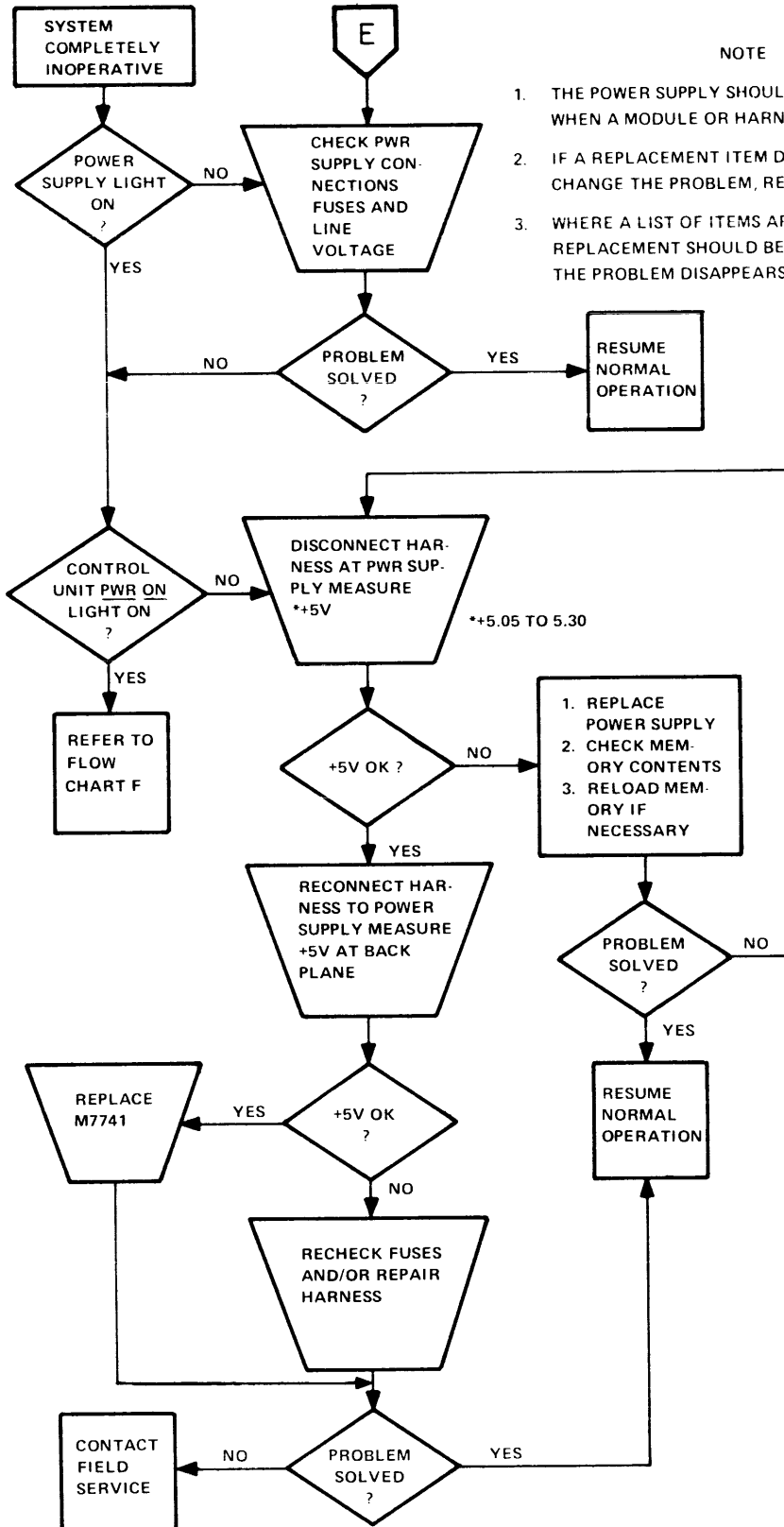

NOTE

1. THE POWER SUPPLY SHOULD BE TURNED OFF WHEN A MODULE OR HARNESS IS REPLACED.
2. IF A REPLACEMENT ITEM DOES NOT SOLVE OR CHANGE THE PROBLEM, REINSTALL THAT ITEM.
3. WHERE A LIST OF ITEMS ARE TO BE REPLACED, REPLACEMENT SHOULD BE ONE AT A TIME UNTIL THE PROBLEM DISAPPEARS.

Figure 3-8e Power Up Unsuccessful (Power On Lights)

14-0333

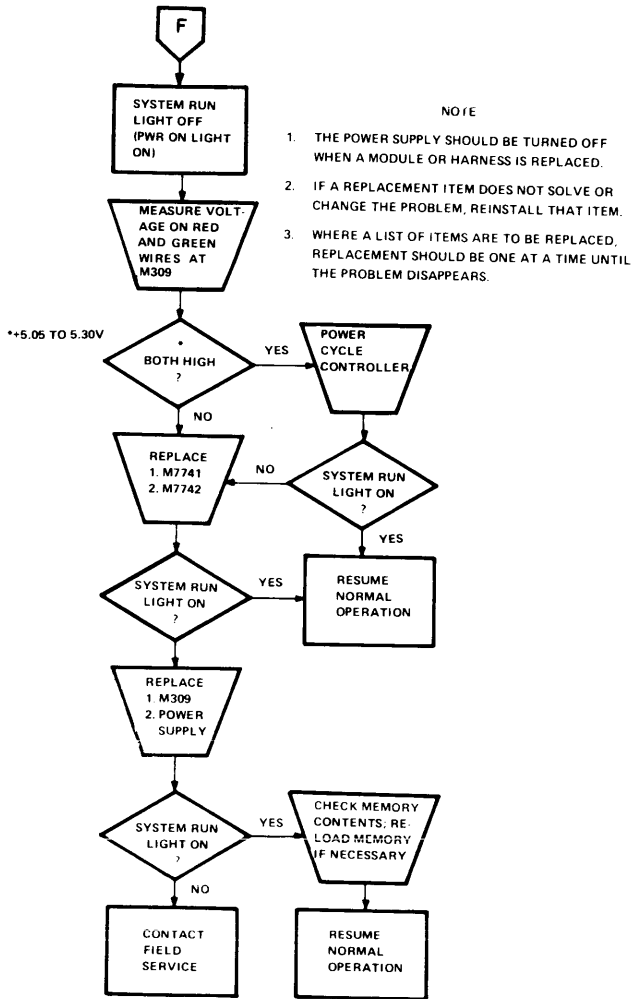
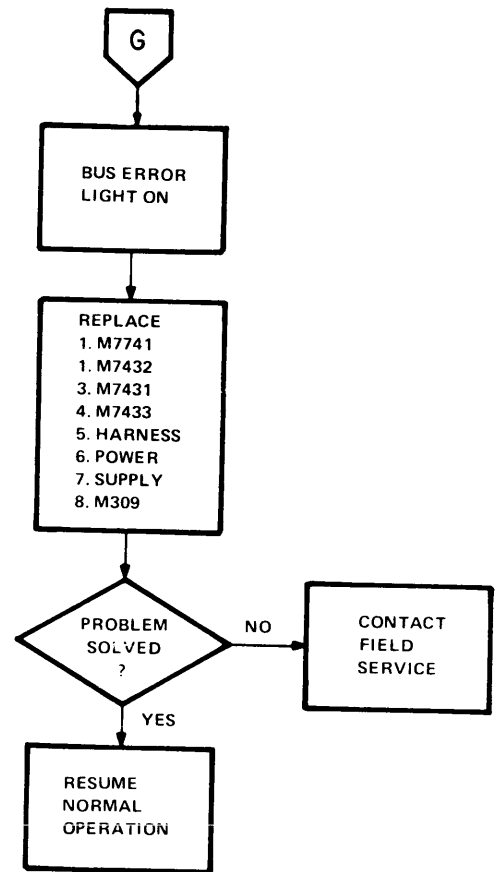

Figure 3-8f Power Up Unsuccessful (System Run Light)

14-0334



**NOTE**

1. THE POWER SUPPLY SHOULD BE TURNED OFF WHEN A MODULE OR HARNESS IS REPLACED.
2. IF A REPLACEMENT ITEM DOES NOT SOLVE OR CHANGE THE PROBLEM, REINSTALL THAT ITEM.
3. WHERE A LIST OF ITEMS ARE TO BE REPLACED, REPLACEMENT SHOULD BE ONE AT A TIME UNTIL THE PROBLEM DISAPPEARS.

14-0336

Figure 3-8g Power Up Unsuccessful (Bus Error Light)

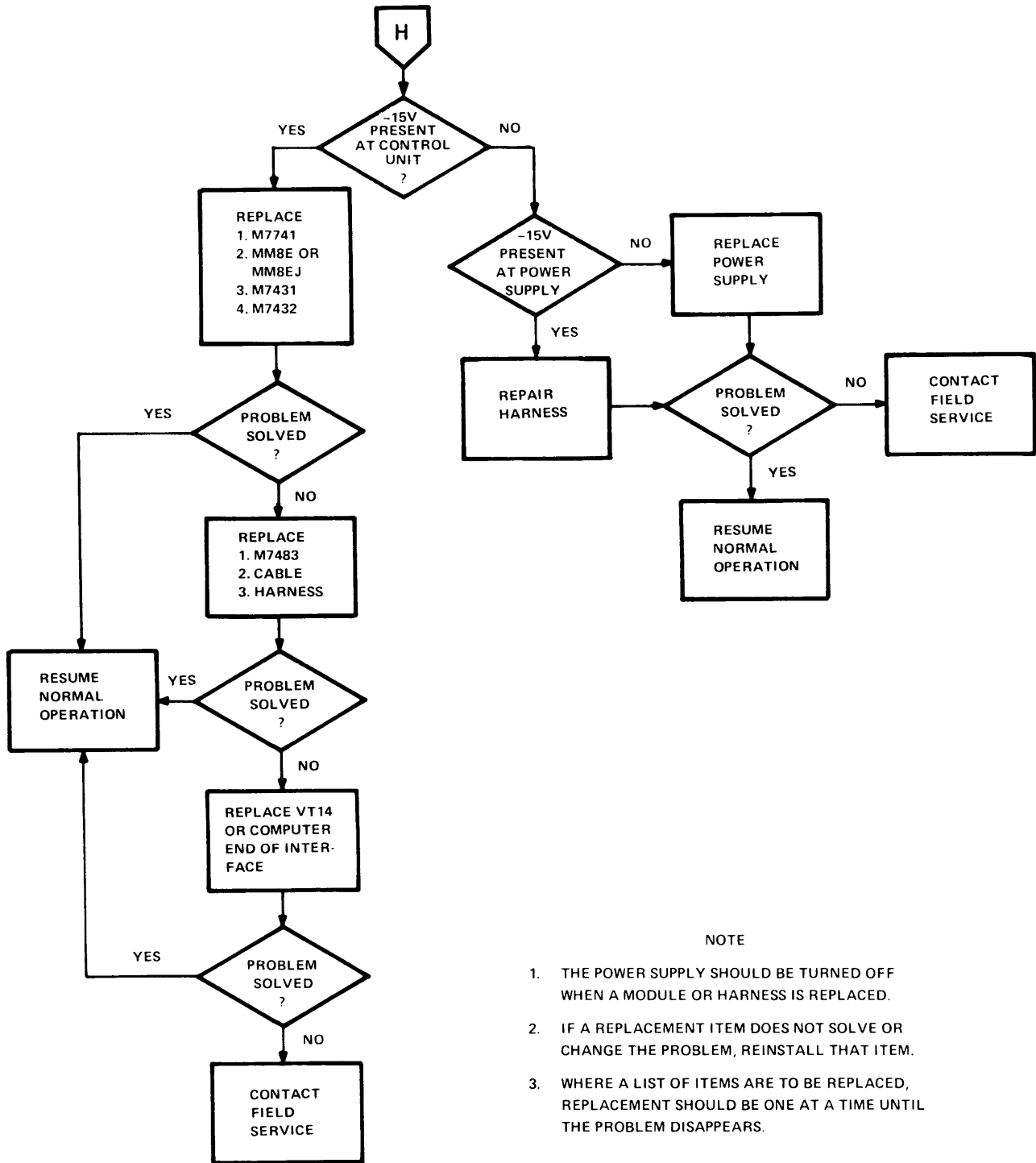

14-0337

Figure 3-8h Cannot Load and Verify Memory

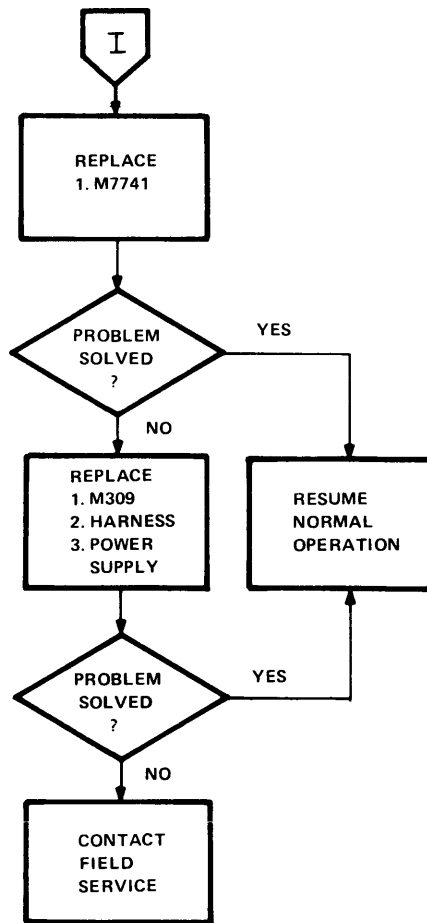

NOTE

1. THE POWER SUPPLY SHOULD BE TURNED OFF WHEN A MODULE OR HARNESS IS REPLACED.
2. IF A REPLACEMENT ITEM DOES NOT SOLVE OR CHANGE THE PROBLEM, REINSTALL THAT ITEM.
3. WHERE A LIST OF ITEMS ARE TO BE REPLACED, REPLACEMENT SHOULD BE ONE AT A TIME UNTIL THE PROBLEM DISAPPEARS.

14-0338

Figure 3-8i Cannot Verify Memory After Power Cycle

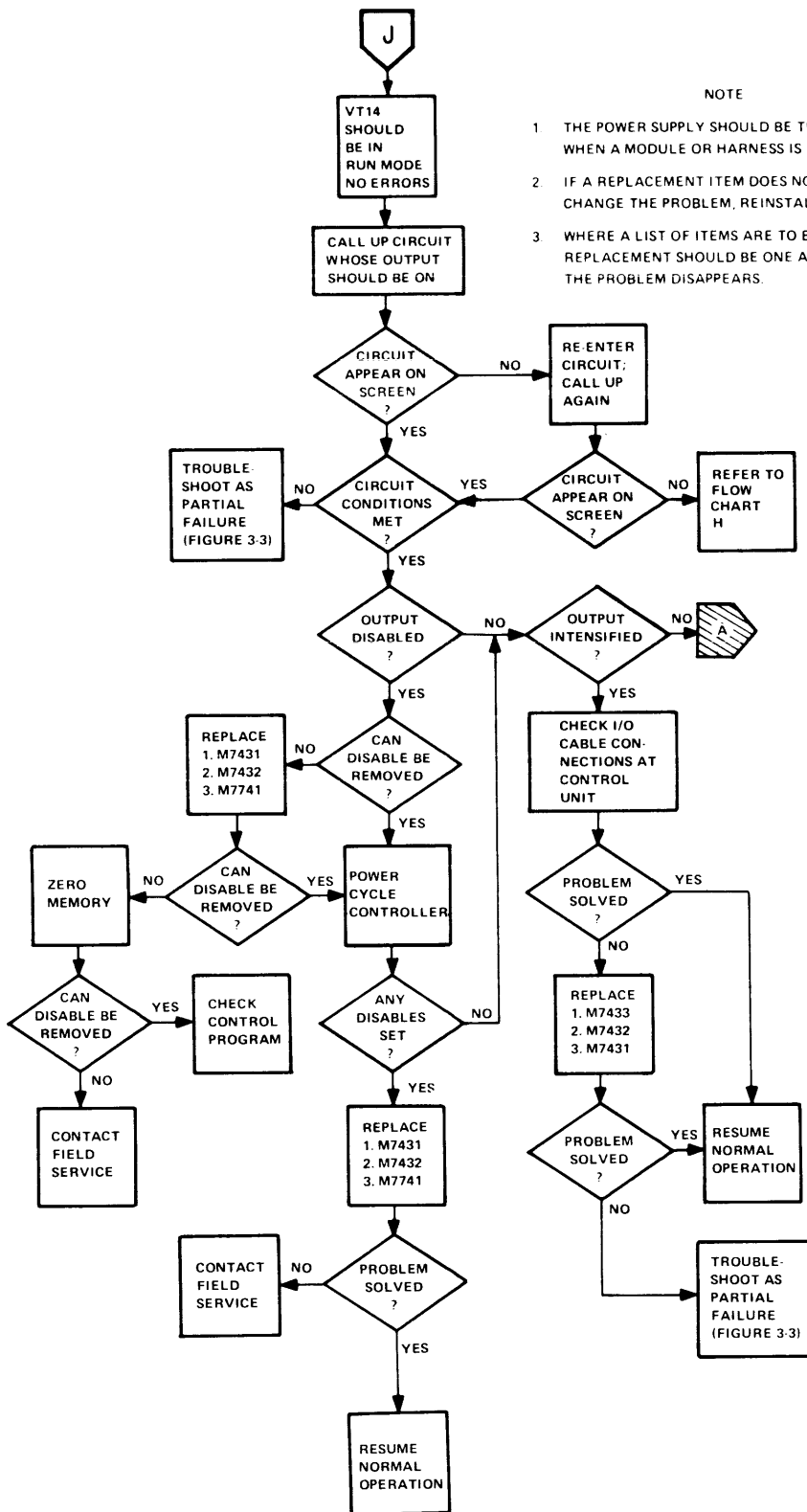

NOTE

1. THE POWER SUPPLY SHOULD BE TURNED OFF WHEN A MODULE OR HARNESS IS REPLACED.
2. IF A REPLACEMENT ITEM DOES NOT SOLVE OR CHANGE THE PROBLEM, REINSTALL THAT ITEM.
3. WHERE A LIST OF ITEMS ARE TO BE REPLACED, REPLACEMENT SHOULD BE ONE AT A TIME UNTIL THE PROBLEM DISAPPEARS.

14 0339

Figure 3-8j All Outputs Inoperative (VT14 Used) (Sheet 1 of 2)

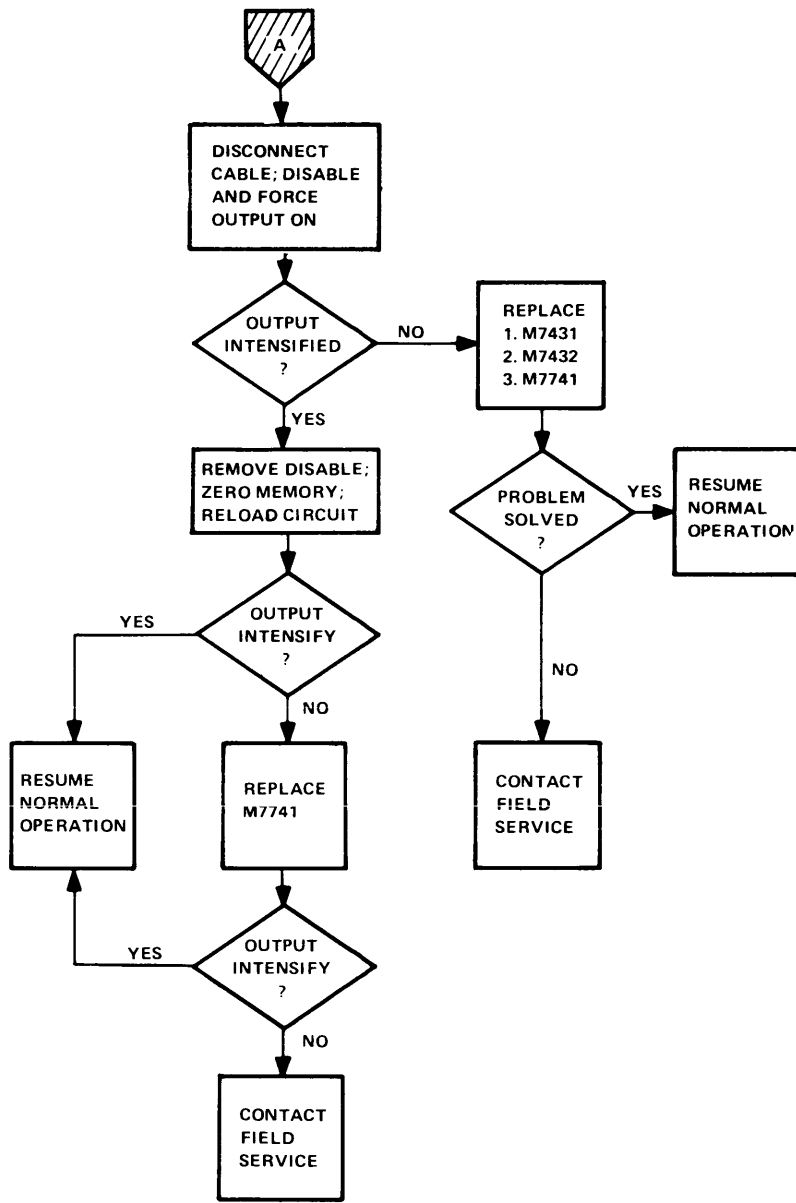

NOTE

1. THE POWER SUPPLY SHOULD BE TURNED OFF WHEN A MODULE OR HARNESS IS REPLACED.
2. IF A REPLACEMENT ITEM DOES NOT SOLVE OR CHANGE THE PROBLEM, REINSTALL THAT ITEM.
3. WHERE A LIST OF ITEMS ARE TO BE REPLACED, REPLACEMENT SHOULD BE ONE AT A TIME UNTIL THE PROBLEM DISAPPEARS.

14-0340

Figure 3-8j All Outputs Inoperative (VT14 Used) (Sheet 2 of 2)



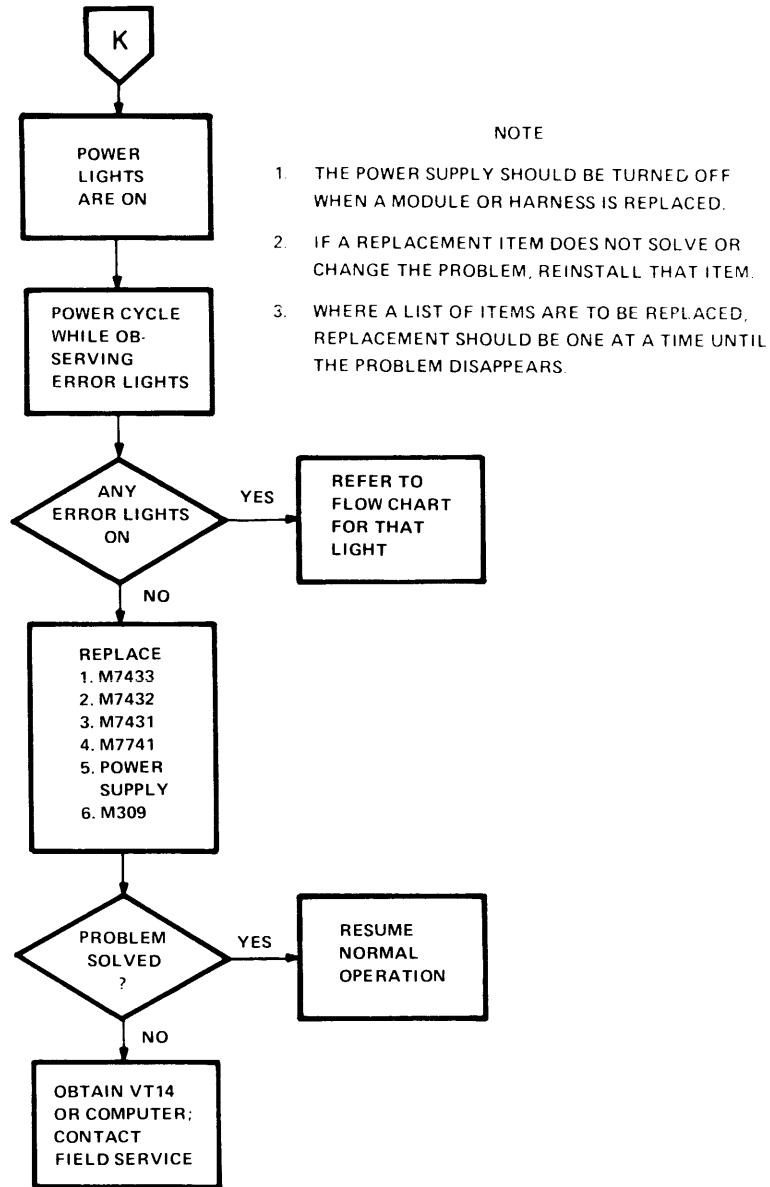

14-0341

Figure 3-8k All Outputs Inoperative (No VT14)

APPENDIX A  
ASSIGNMENT SHEETS

**INPUT ASSIGNMENT SHEET**

<b>I/O Number</b>	<b>Symbol</b>	<b>Function</b>	<b>Normal Condition</b>

**OUTPUT ASSIGNMENT SHEET**

I/O Number	Symbol	Function

**INTERNAL FUNCTIONS ASSIGNMENT SHEET**

I/O Number	Symbol	Function	Preset or Limits	Type

APPENDIX B  
INPUT AND OUTPUT FORMS

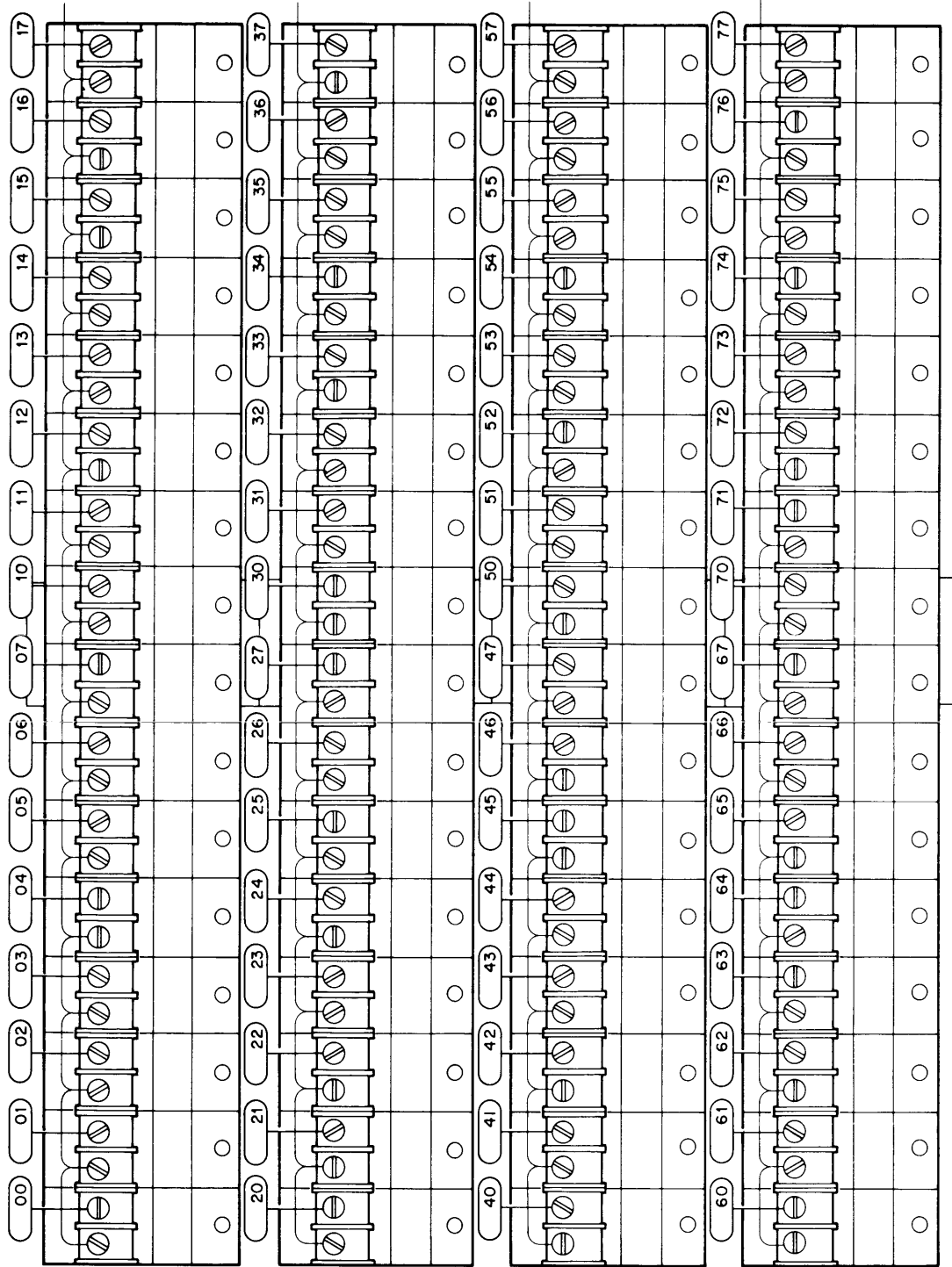

14-0302





# Reader's Comments

Your comments and suggestions will help us in our continuous effort to improve the quality and usefulness of our publications.

What is your general reaction to this manual? In your judgment is it complete, accurate, well organized, well written, etc.? Is it easy to use? \_\_\_\_\_

---

---

---

What features are most useful? \_\_\_\_\_

---

---

---

What faults do you find with the manual? \_\_\_\_\_

---

---

---

Does this manual satisfy the need you think it was intended to satisfy? \_\_\_\_\_

Does it satisfy *your* needs? \_\_\_\_\_ Why? \_\_\_\_\_

---

---

---

Would you please indicate any factual errors you have found. \_\_\_\_\_

---

---

---

Please describe your position. \_\_\_\_\_

Name \_\_\_\_\_ Organization \_\_\_\_\_

Street \_\_\_\_\_ Department \_\_\_\_\_

City \_\_\_\_\_ State \_\_\_\_\_ Zip or Country \_\_\_\_\_

-----  
**Fold Here**  
-----

-----  
**Do Not Tear - Fold Here and Staple**  
-----

**FIRST CLASS  
PERMIT NO. 33  
MAYNARD, MASS.**

**BUSINESS REPLY MAIL  
NO POSTAGE STAMP NECESSARY IF MAILED IN THE UNITED STATES**

Postage will be paid by:

Digital Equipment Corporation  
Technical Documentation Department  
Parker Street PK3-2  
Maynard, Massachusetts 01754

