

decsystem10

KL10-BASED

PHYSICAL DESCRIPTION

1st Edition, November 1975
2nd Printing (Rev), March 1977

The drawings and specifications herein are the property of Digital Equipment Corporation and shall not be reproduced or copied or used in whole or in part as the basis for the manufacture or sale of equipment described herein without written permission.

Copyright © 1977 by Digital Equipment Corporation

The material in this manual is for informational purposes and is subject to change without notice. Digital Equipment Corporation assumes no responsibility for any errors which may appear in this manual.

Printed in U.S.A.

This document was set on DIGITAL's DECset-8000 computerized typesetting system.

The following are trademarks of Digital Equipment Corporation, Maynard, Massachusetts:

DEC	DECtape	PDP
DECCOMM	DECUS	RSTS
DECsystem-10	DIGITAL	TYPESET-8
DECSYSTEM-20	MASSBUS	TYPESET-11
		UNIBUS

CONTENTS

		Page
SECTION 1	1080/1090 SYSTEM COMPONENTS	
1.1	INTRODUCTION – COMPONENTS	1-1
1.2	BA10 HARD COPY CONTROL	1-2
1.3	CP10-D CARD PUNCH	1-3
1.4	CR10 CARD READER	1-4
1.5	DC75-NP SYNCHRONOUS COMMUNICATION SYSTEM	1-6
1.6	DC76 ASYNCHRONOUS COMMUNICATION SYSTEM	1-8
1.7	DF10/DF10C DATA CHANNEL	1-10
1.8	DL10 PDP-10/PDP-11 INTERFACE CHANNEL	1-11
1.9	DN87 UNIVERSAL COMMUNICATION SYSTEM FRONT END	1-12
1.10	DN87S UNIVERSAL COMMUNICATION SYSTEM FRONT END	1-14
1.11	DX10 DATA CHANNEL	1-18
1.12	KL10-A/B ARITHMETIC PROCESSOR	1-19
1.13	LA36 DECwriter II TERMINAL	1-21
1.14	LP10 LINE PRINTER	1-22
1.15	LP100 LINE PRINTER SYSTEM	1-24
1.16	MF10 CORE MEMORY	1-27
1.17	MG10 CORE MEMORY	1-28
1.18	MH10 CORE MEMORY SYSTEM	1-29
1.19	MX10-C MEMORY DATA MULTIPLEXOR	1-30
1.20	RH10 MASSBUS CONTROLLER	1-31
1.21	RH04 FIXED HEAD DISK	1-32
1.22	RP04 DISK PACK DRIVE	1-33
1.23	RP06 DISK PACK DRIVE	1-35
1.24	TD10-C DECtape CONTROL	1-37
1.25	TU16B MASTER TAPE TRANSPORT SYSTEM	1-38
1.26	TU70/TU71 MAGNETIC TAPE DRIVES	1-39
1.27	TU72 MAGNETIC TAPE DRIVE	1-40
1.28	TX01 MAGNETIC TAPE CONTROLLER	1-41
1.29	TX02 MAGNETIC TAPE CONTROLLER	1-42
1.30	VT50 DECscope VIDEO DISPLAY TERMINAL	1-43
1.31	VT52 DECscope VIDEO DISPLAY TERMINAL	1-44
1.32	XY10-A INCREMENTAL PLOTTER SYSTEM	1-46
1.33	PHYSICAL CHARACTERISTIC SUMMARIZATION	1-46
SECTION 2	1080/1090 COMPONENT INTERCONNECTION	
2.1	INTRODUCTION	2-1
2.2	REPRESENTATIVE 1080/1090 SYSTEM CONFIGURATIONS	2-1
2.3	1080/1090 CONNECTORS	2-1
2.4	1080/1090 GROUND MESH	2-1

CONTENTS (Cont)

		Page
SECTION 3	KL10-A/B ARITHMETIC PROCESSOR COMPONENTS (1080/1090)	
3.1	INTRODUCTION	3-1
3.2	I/O CABINET	3-1
3.3	CPU CABINET	3-15
3.4	CONSOLE PROCESSOR CABINET	3-20
3.5	KL10-A/B ARITHMETIC PROCESSOR COMPONENT INTERCONNECTION	3-20

FIGURES

Figure No.	Title	Page
1-1	1080/1090 System	1-1
1-2	BA10 Hard Copy Control	1-2
1-3	CP10-D Card Punch	1-3
1-4	CR10-D Card Reader	1-4
1-5	CR10-E Card Reader	1-5
1-6	CR10-E Card Reader	1-6
1-7	DC75-NP Synchronous Communication System	1-7
1-8	DC75-NP Synchronous Communication System Site Plan	1-8
1-9	DC76 Asynchronous Communication System	1-9
1-10	DF10C Data Channel	1-10
1-11	DL10 PDP-10/PDP-11 Interface Channel	1-11
1-12	DN87 Universal Communication System Front End	1-12
1-13	DN87 Universal Communication System Front End	1-13
1-14	DN87S Universal Communication System Front End	1-15
1-15	DN87S Universal Communication System Front End	1-16
1-16	DX10 Data Channel	1-18
1-17	KL10-A/B Arithmetic Processor	1-19
1-18	KL10-A/B Arithmetic Processor	1-20
1-19	LA36 DECwriter II Terminal	1-21
1-20	LA36 DECwriter II Terminal	1-22
1-21	LP10-F, H Line Printer	1-23
1-22	LP100 Line Printer System	1-25
1-23	LP100 Line Printer System Site Plan	1-26
1-24	MF10 Core Memory	1-27
1-25	MF10 Core Memory Site Plan	1-27
1-26	MG10 Core Memory	1-28
1-27	MH10 Core Memory	1-29
1-28	MH10 Core Memory Site Plan	1-29

FIGURES (Cont)

Figure No.	Title	Page
1-29	MX10 Memory Data Multiplexor	1-30
1-30	RH10 Massbus Controller Site Plan	1-31
1-31	RHS04 Fixed Head Disk Site Plan	1-32
1-32	RP04 Disk Pack Drive	1-33
1-33	RP04 Disk Pack Drive Site Plan	1-34
1-34	RP06 Disk Pack Drive	1-35
1-35	RP06 Disk Pack Drive Site Plan	1-36
1-36	TD10-C DECTape Control	1-37
1-37	TD10-C DECTape Control Site Plan	1-37
1-38	TU16-B Magnetic Tape Transport	1-38
1-39	TU16-B Magnetic Tape Transport Site Plan	1-38
1-40	TU70/71 Magnetic Tape Drive	1-39
1-41	TU72 Magnetic Tape Drive	1-40
1-42	TU72 Magnetic Tape Drive Site Plan	1-40
1-43	TX01 Magnetic Tape Controller	1-41
1-44	TX02 Magnetic Tape Controller	1-42
1-45	TX02 Magnetic Tape Controller Site Plan	1-42
1-46	VT50 DECscope	1-43
1-47	VT52 DECscope	1-45
1-48	XY10-A Incremental Plotter	1-46
1-49	XY10-A Incremental Plotter Site Plan	1-46
2-1	Typical 1080 System Configuration	2-2
2-2	Typical 1090 System Configuration	2-3
2-3	CJ-Type Cable Connector	2-13
2-4	MB-Type Cable Connector	2-13
2-5	QL-Type Cable Connector	2-14
3-1	KL10-A/B Arithmetic Processor (Front)	3-2
3-2	KL10-A/B, Panels Removed (Front)	3-3
3-3	KL10-B, Panels Removed (Front)	3-4
3-4	KL10-A, Panels Removed (Rear)	3-5
3-5	KL10-B, Panels Removed (Rear)	3-6
3-6	Bay 1 and Bay 2 Logic (KL10-A)	3-7
3-7	Bay 1 and Bay 2 Logic (KL10-B)	3-8
3-8	I/O Cabinet – Door Closed Rear View (KL10-B)	3-9
3-9	I/O Cabinet – Rear View (KL10-A)	3-10
3-10	I/O Cabinet – Rear View (KL10-B)	3-11
3-11	H7420 Power Supply No. 1, 2, 3 (KL10-B)	3-12
3-12	H7420 Power Supplies Nos. 2 and 3	3-13
3-13	Massbus, IBus, and KBus Connectors (KL10-B)	3-14
3-14	IBus and KBus Connectors	3-14
3-15	CPU Cabinet Rear Door – Closed	3-16
3-16	CPU Cabinet Rear Door – Open	3-17

FIGURES (Cont)

Figure No.	Title	Page
3-17	CPU Cabinet – Rear View	3-18
3-18	Bay 4 Backplane	3-19
3-19	Console Processor – Side View	3-21
3-20	Console Processor Cabinet – Top Rear View	3-22
3-21	Console Processor Operator Controls	3-23
3-22	863 Power Control (Front)	3-24
3-23	863 Power Control (Rear)	3-25
3-24	H720 Power Supply	3-26
3-25	KL10-A Module Utilization, I/O Logic Assembly (Cabinet No. 1, Bay 1 and 2)	3-27
3-26	KL10-B Module Utilization (Cabinet No. 1, Bay 1 and Bay 2)	3-28
3-27	1080/1090 Module Utilization, CPU Cabinet (Cabinet No. 2, Bay 4)	3-29
3-28	Module Utilization Console Processor Cabinet (BA11-F Mounting Box)	3-30
3-29	TU56/TC11 Module Utilization, Console Processor Cabinet (Cabinet No. 3)	3-31
3-30	KL10-A Component Interconnection (Signal Cables)	3-32
3-31	KL10-B Component Interconnection (Signal Cables)	3-33
3-32	KL10-A/B Component Interconnection (Power Harness Wiring)	3-34

TABLES

Table No.	Title	Page
1-1	VT50 Options	1-44
1-2	VT52 Options	1-45
1-3	1080/1090 System Configuration Summary	1-47
2-1	KL10 IBus Cabling	2-4
2-2	1080/1090 KBus (Memory Bus) Cabling and Memory Multiplexor Bus Cabling	2-6
2-3	Channel Bus Cabling	2-9
2-4	Device Cables	2-10
2-5	Massbus Cabling	2-11
2-6	DECTape Transport Bus	2-12

PREFACE

The Physical Description defines the 1080/1090 computer system. It is divided into two main topic areas in order to discuss the system: System Components and Arithmetic Processor. The System Components level discusses the individual units that can constitute a system; physical characteristics and dimensions are included. The Arithmetic Processor level relates mainly to the KL10-AB, the central processor used in 1080/1090 computer installations. Many photographs and illustrations complement the text.

SECTION 1 1080/1090 SYSTEM COMPONENTS

1.1 INTRODUCTION - COMPONENTS

A brief description of the components in a typical 1080/1090 System follows. Photographs and physical dimensions are included. Figure 1-1 is an overview of the 1080/1090 System.

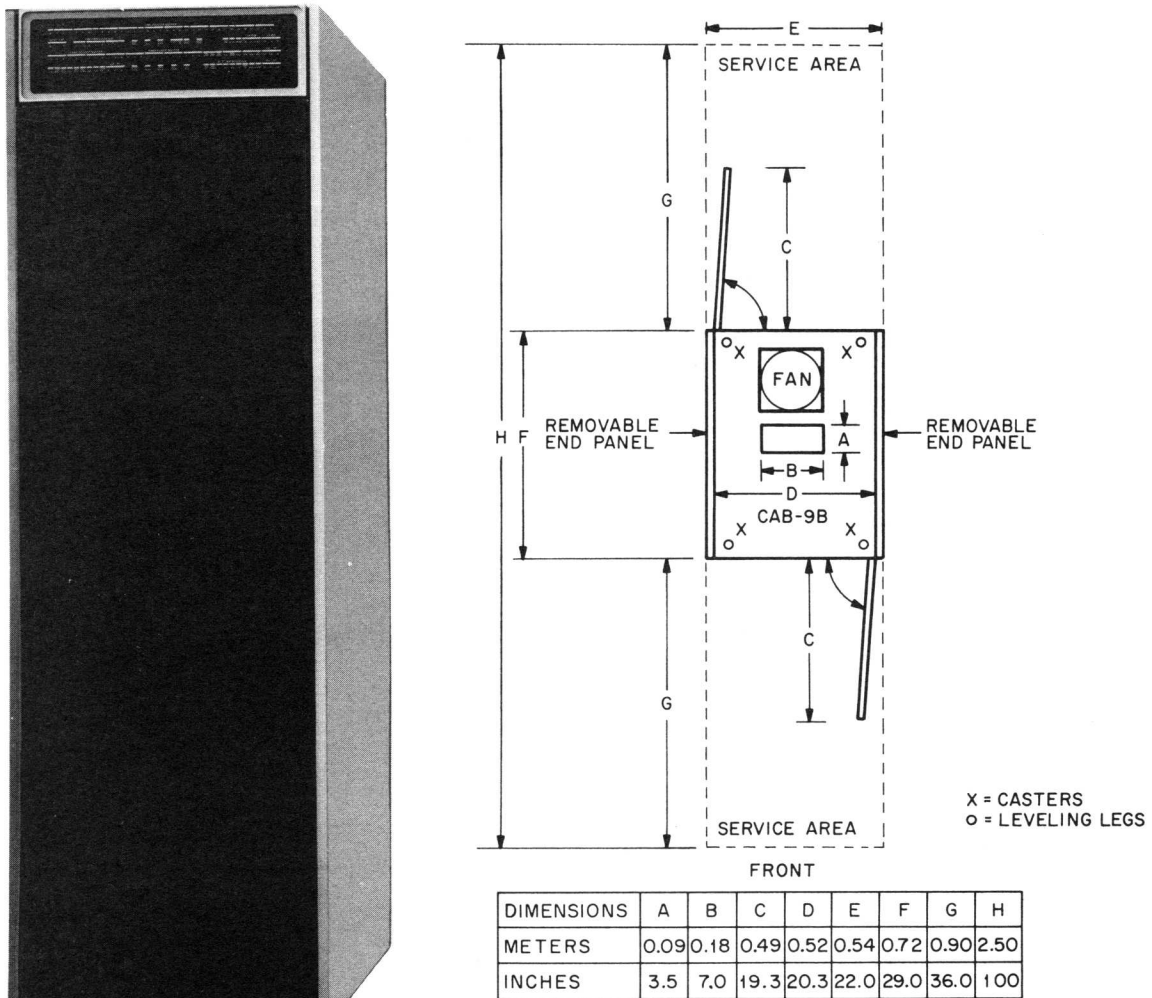

Figure 1-1 1080/1090 System

M0607

1.2 BA10 HARD COPY CONTROL

The BA10 Hard Copy (Figure 1-2) services the CP10 Card Punch, CR10 Card Reader, LP10 Line Printer, and XY10 Plotter (optional on the 1080/1090 System). The BA10 interfaces with the I/O Bus and with not more than one of each type of device. In 50 Hz systems, the BA10 supplies ac power to the CR10-A (and XY10). The 60 Hz version of the CR10-A, and all other devices connected to the BA10, obtain power via an independent power source.



69322-23

10-0452

Figure 1-2 BA10 Hard Copy Control

1.3 CP10-D CARD PUNCH

The CP10-D Card Punch (Figure 1-3) has an operating rate of 100 cards per minute when all 80 columns are punched. A maximum rate of 285 cards per minute is attained by punching only the first column. The card hopper and stacker have the capacity of 1000 cards. The designation for the 120 Vac 60 Hz version of this punch is CP10-DA; the designation for the 240 Vac, 50 Hz version is CP10-DB.

The CP10-D Card Punch operates under the control of the BA10 Hard Copy Control.

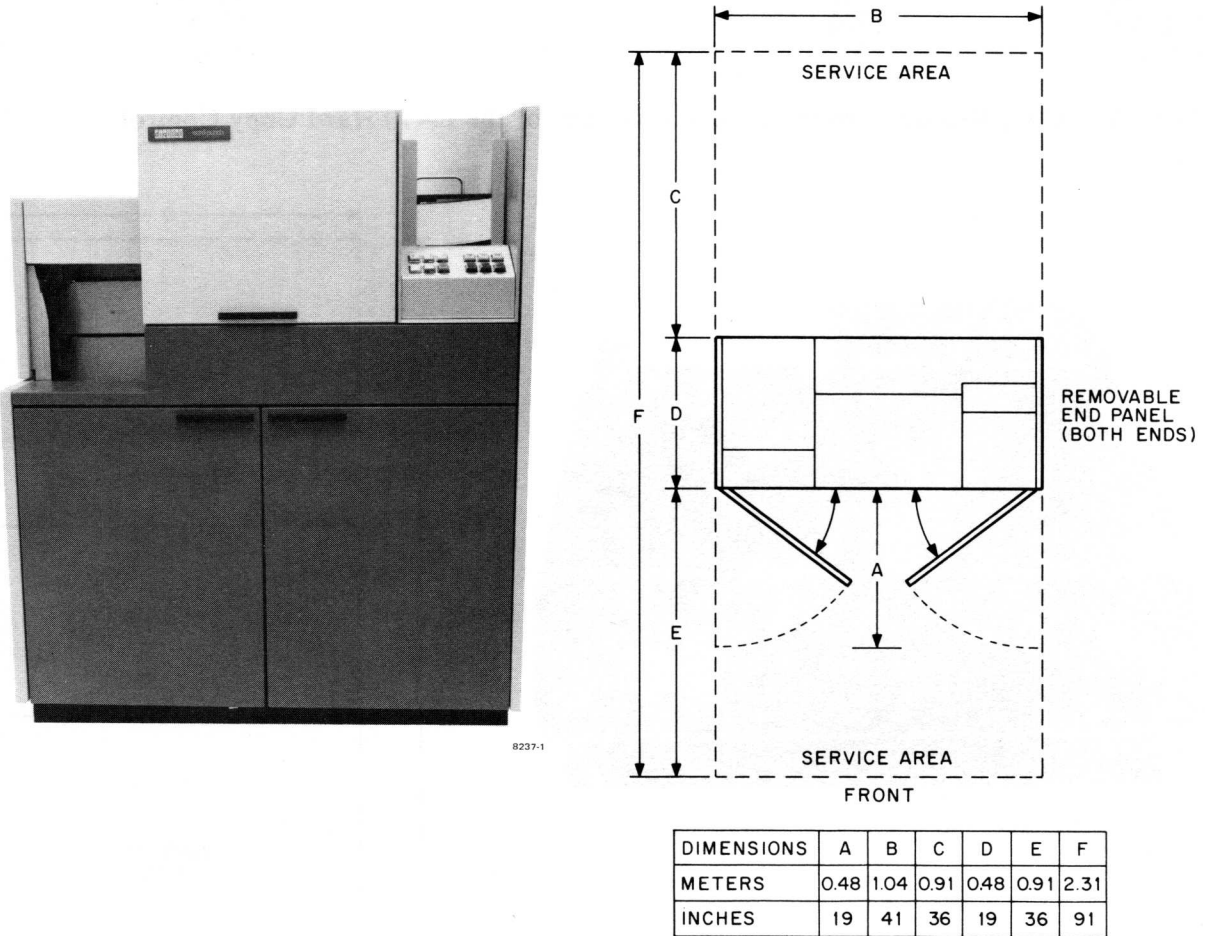

10-2678

Figure 1-3 CP10-D Card Punch

1.4 CR10 CARD READER

The CR10 Card Reader (Figures 1-4 through 1-6) handles standard 12-row 80-column cards and has a maximum operating rate ranging from 300 to 1200 cards per minute depending on the model type. Hopper/stacker capacities are also model-dependent, varying from 550 cards for the small table model to 2200 cards for the floor model. Card reader characteristics follow:

Reader	Cards Per Minute	Hopper/Stacker Capacity	Model Type
CR10-D	1000	950	Table
CR10-E	1200	2200	Floor
CR10-F	300	550	Table

The CR10 Card Reader operates under the control of the BA10 Hard Copy Control.

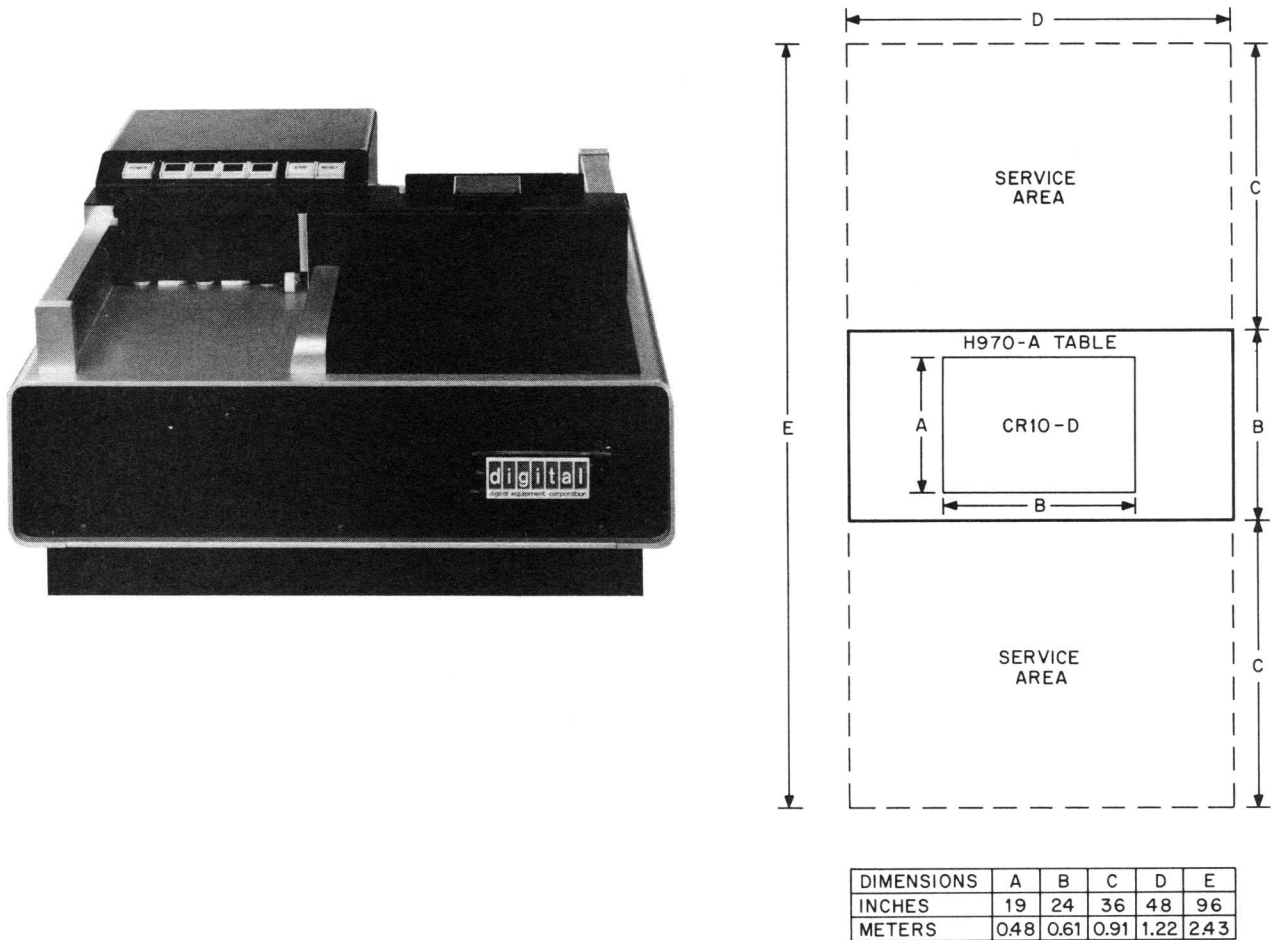

10-0866

Figure 1-4 CR10-D Card Reader

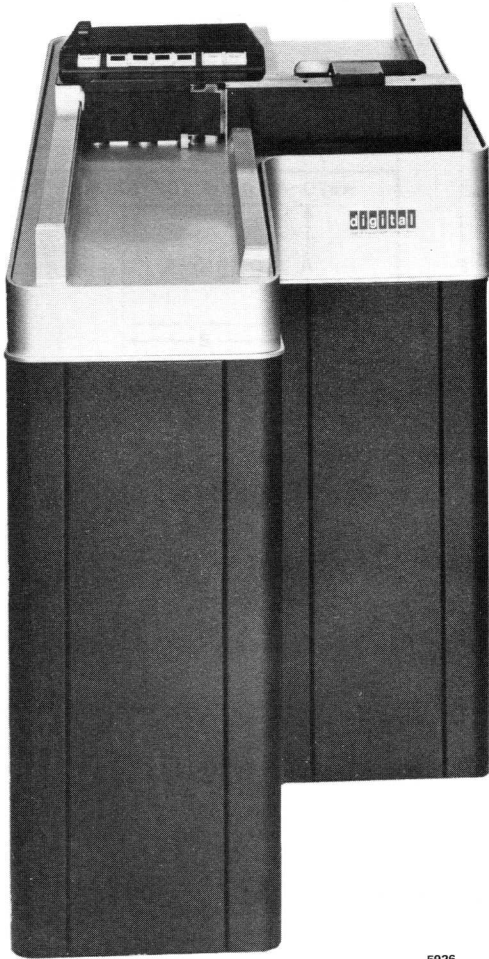

5926

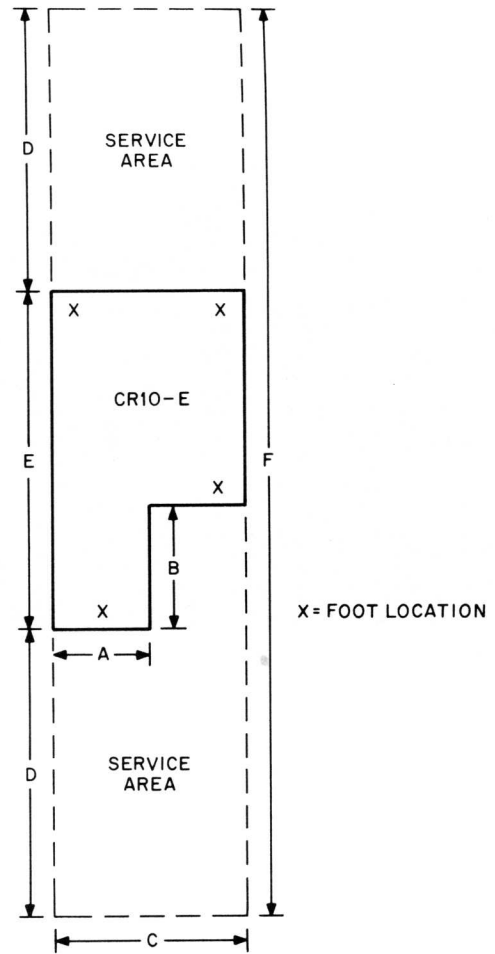

DIMENSIONS	A	B	C	D	E	F
INCHES	12	16	24	36	28	100
METERS	0.3	0.41	0.65	0.91	0.71	2.54

10-0867

Figure 1-5 CR10-E Card Reader

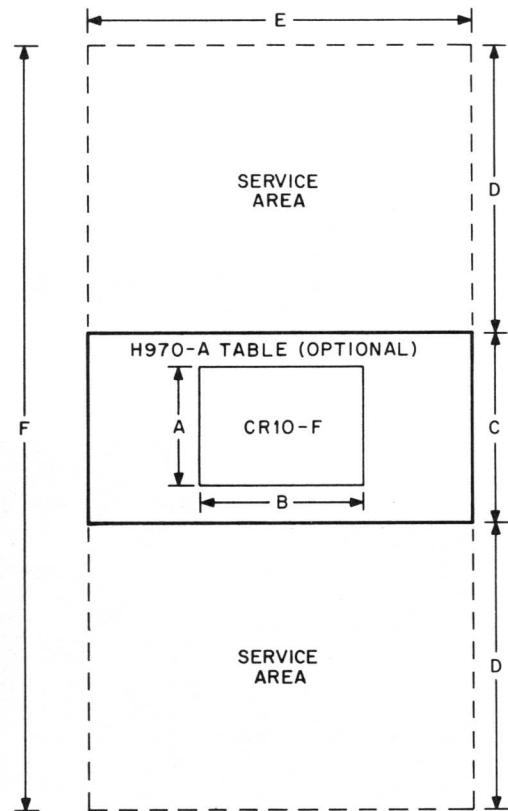
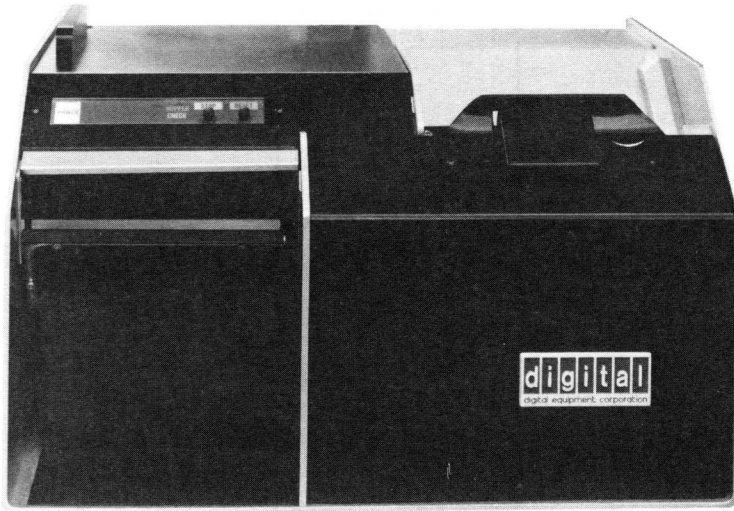

DIMENSIONS	A	B	C	D	E	F
INCHES	15	20	24	36	48	96
METERS	0.38	0.5	0.61	0.91	1.22	2.43

10-0868

Figure 1-6 CR10-E Card Reader

1.5 DC75-NP SYNCHRONOUS COMMUNICATION SYSTEM

The DC75-NP Synchronous Communication System (Figures 1-7 and 1-8) is a PDP-11-based front-end system designed to efficiently handle multiple synchronous lines. The basic DC75-NP system includes a DL10 Data Link, one PDP-11 processor, and a DS11 synchronous modem interface implemented for eight lines.

The DC75-NP system is available in the following configurations:

DC75-NP

Synchronous Communication System – provides direct memory interface for eight full-duplex synchronous lines. This is the basic unit and consists of the DL10, the PDP-11 processor, and the DS11 interface implemented for the eight lines. Total throughput capacity is 40 kilobits/second (i.e., four lines at 9600 bits/second or eight lines at 4800 bits/second, etc.).

DC75-D

Expander Option for DC75-NP – provides an additional 40 kb/s throughput capacity for the DC75-NP. This option adds another PDP-11 and DS11 implemented for eight lines. Up to three DC75-Ds can be added to one DC75-NP providing a total throughput capacity of 160 kb/s.

DC75-E

Incremental Eight-Line Group for DC75-NP or DC75D – provides up to eight additional lines on a DC75-NP or DC75-D for a total of up to 16 lines. This option allows the DS11 in a DC75-NP or DC75-D to accommodate up to eight additional lines. The DC75-E does not increase the throughput capacity, i.e., when a DC75-E is added to a DC75-NP, the 16 lines still run at 40 kilobits/second. The DC75-E is housed within a DC75-NP or DC75-D.

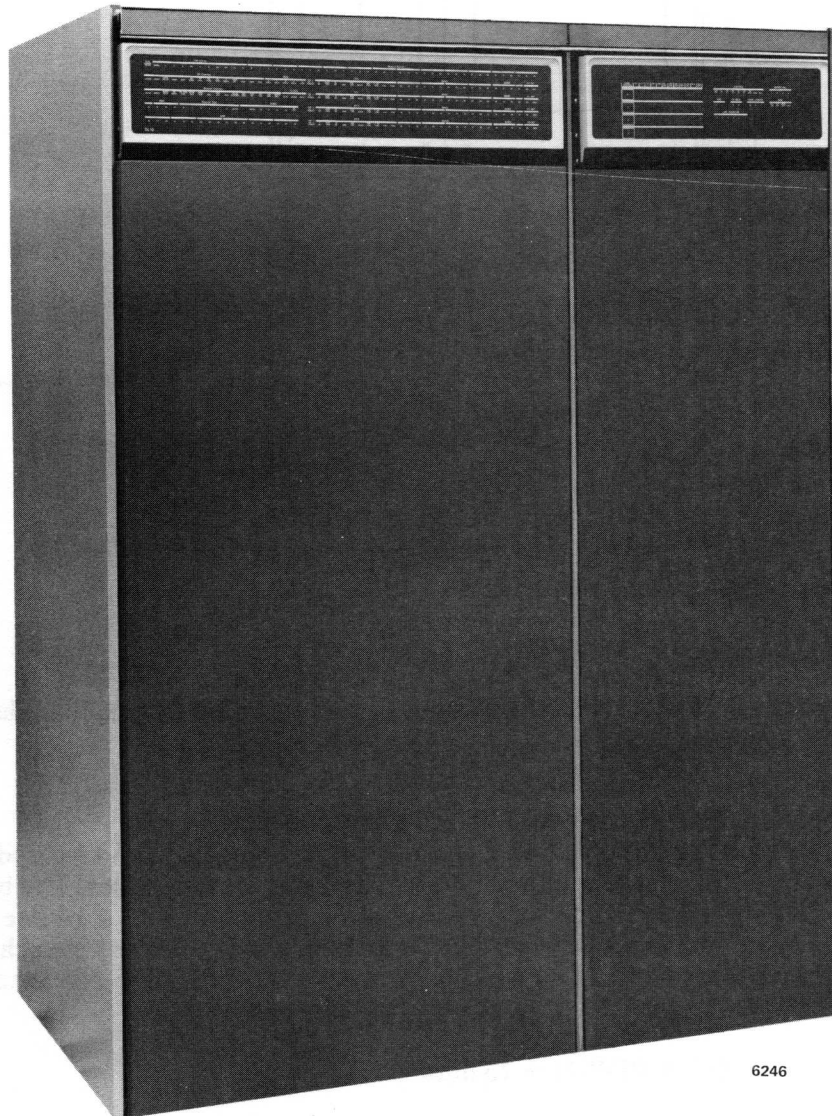
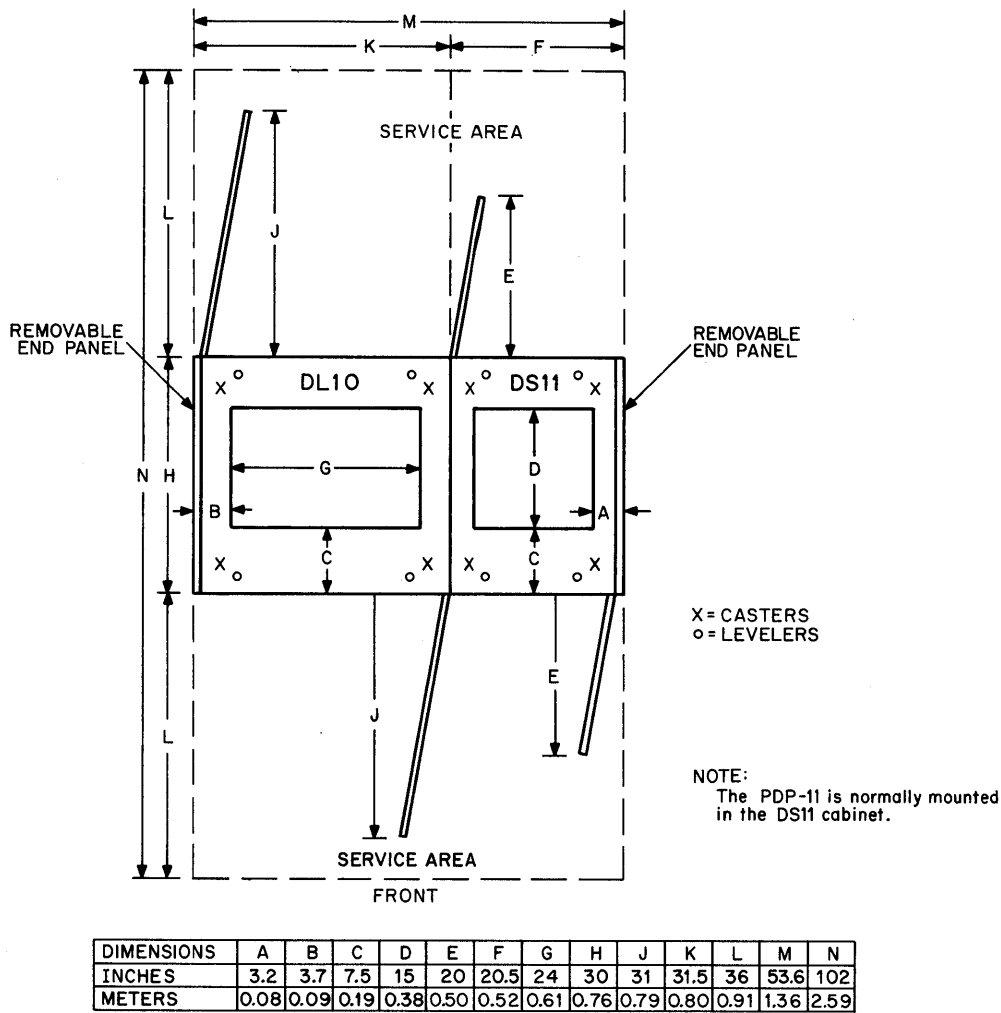

Figure 1-7 DC75-NP Synchronous Communication System



10-0879

Figure 1-8 DC75-NP Synchronous Communication System Site Plan

1.6 DC76 ASYNCHRONOUS COMMUNICATION SYSTEM

The DC76 Asynchronous Communication System (Figure 1-9) is a PDP-11-based front-end system designed to efficiently handle large numbers of asynchronous terminal lines. The basic DC76 system includes a DL10 PDP-10/PDP-11 interface, one PDP-11 processor, and a 16-line DH11 Asynchronous Multiplexer. Up to 64 line multiplexers and interfaces may be housed in each DH11 cabinet. A DC76-D system may be added to a DL10 which is part of an existing DC75-NP Synchronous Communications System.

DC76-A DL + PDP-11 + 16 lines

DC76-D PDP-11 + 16 lines

DC76-EA, -EB Additional 16 lines

- DC76-EC, -ED Additional 16 lines and cabinet
- DC76-FA 20 mA "local" interfaces for 8 lines (no cables)
- DC87-FB CCITT/EIA "local" interfaces for 8 lines (7.5 m, 25 ft cables)
- DC76-FC CCITT/EIA modem interfaces for 8 lines (7.5 m, 25 ft cables)
- DC76-FD Bell-103-compatible answer-only integral modems for 8 lines (7.5 m, 25 ft cables)

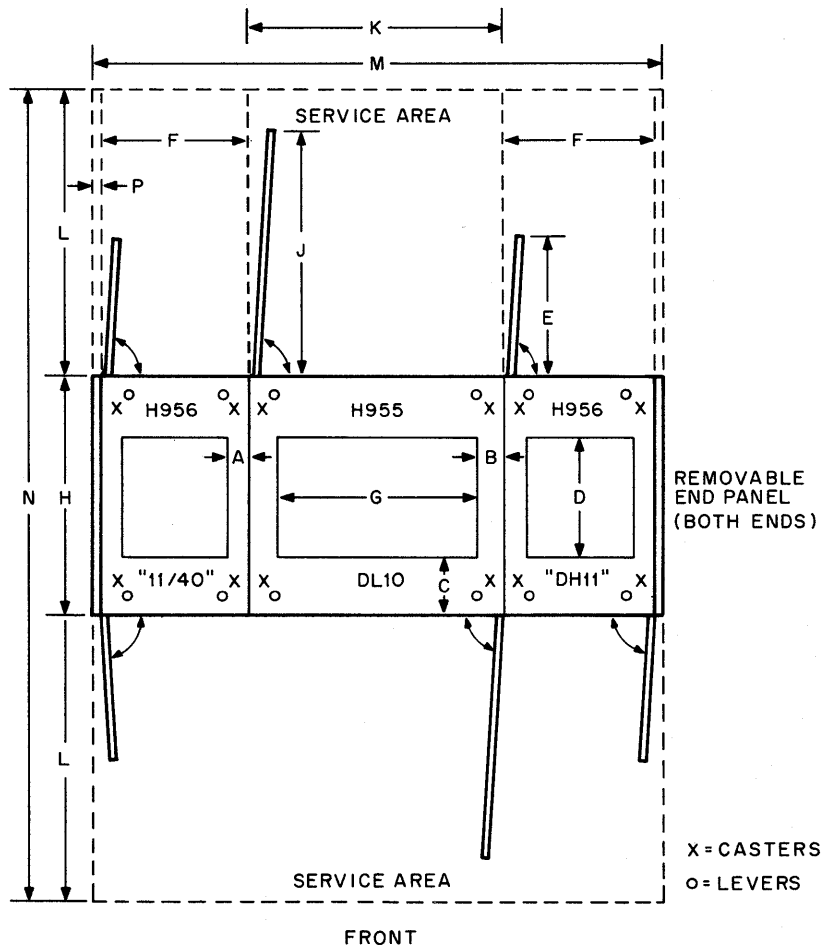

DIMENSIONS	A	B	C	D	E	F	G	H	J	K	L	M	N	P
METERS	0.08	0.09	0.19	0.38	0.50	0.52	0.61	0.76	0.79	0.80	0.91	1.88	2.59	0.016
INCHES	3.2	3.7	7.5	15	20	20.5	24	30	31	31.5	36	74.6	102	0.62

10-1394

Figure 1-9 DC76 Asynchronous Communication System

1.7 DF10/DF10C DATA CHANNEL

The DF10C Data Channel (Figure 1-10) controls high-speed data transfers between external devices and 1080 System's memory, independent of the KL10 Arithmetic Processor. It is an I/O processor which allows block transfers, scatter transfers, and jump-type operations. The DF10C implements either an 18- or 22-bit address.

In typical 1080 configurations, the DF10C is used with the RHP04 Disk Pack System and the RHS04 Fixed Head Disk System.

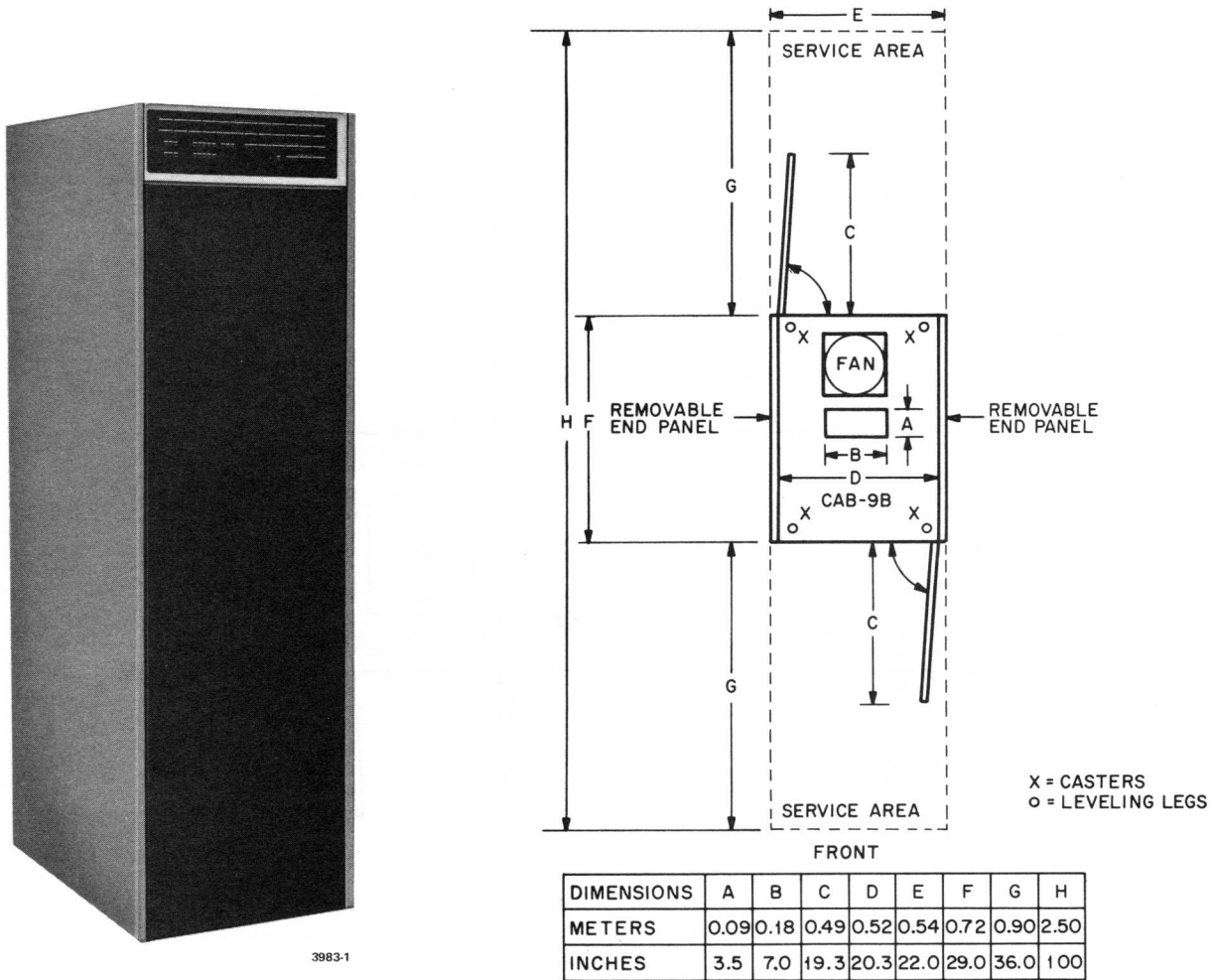

3983-1

10-0452

Figure 1-10 DF10C Data Channel

1.8 DL10 PDP-10/PDP-11 INTERFACE CHANNEL

The DL10 (Figure 1-11) provides an interface for up to four PDP-11 Unibuses with external memory in the 1080/1090 System. It allows a PDP-11 on the Unibus to pack or unpack bytes into or out of external memory while allowing the KL10 Arithmetic Processor to control the operation of the PDP-11. Byte sizes can be 6, 7, 8, 12, or 16 bits.

The DL10 connects to the 1080/1090 Memory Bus (K Bus) and has up to two I/O Bus ports (for control by two arithmetic processors), and up to four Unibus ports. It is available in the following configurations:

- DL10-A Basic DL10 with one I/O bus port and one Unibus port
- DL10-B Second I/O Bus port (maximum 1 additional)
- DL10-C Additional Unibus port (maximum 3 additional)

In the 1080 System, the DL10 is used as part of the DC75-NP and DC76 Communications Systems.

In the 1090 System, the DL10 is used as part of the DN87 Communications Systems.

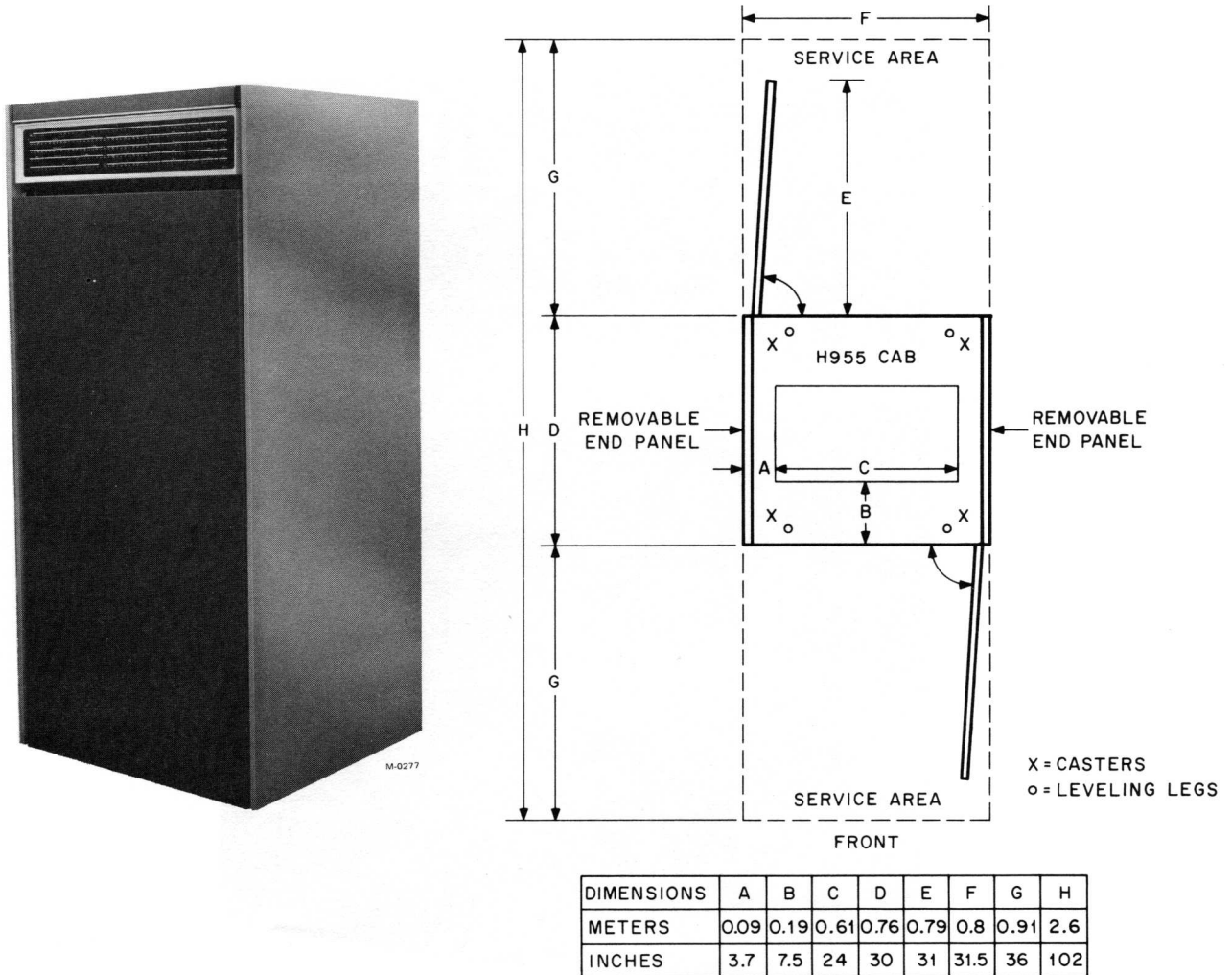

10-0869

Figure 1-11 DL10 PDP-10/PDP-11 Interface Channel

1.9 DN87 UNIVERSAL COMMUNICATION SYSTEM FRONT END

The DN87 Universal Communication System Front End (Figures 1-12 and 1-13) is a PDP-11 based communication front-end processor designed to handle either asynchronous terminal lines, or synchronous terminal lines, or both. The basic DN87 system includes a DL10 (PDP-10/PDP-11 interface) and one PDP-11 processor cabinet. Asynchronous lines are accommodated in expansion cabinets. Up to four synchronous lines may be mounted in the processor cabinet; and additional synchronous lines accommodated in a synchronous expansion cabinet. Up to four DN87s may be accommodated on one DL10. The system variation designations are given below:

- | | |
|---------|--|
| DN87-AA | PDP-11/40 assembly with 16K parity memory. Includes mainframe (115 V, 50 Hz), power supply, doors, panels, miscellaneous hardware, a DL10, DL11, and KG11. |
| DN87-AB | Same as AA except 230 V, 50 Hz. |
| DN87-DA | Same as AA but without DL10. |
| DN87-DB | Same as AB but without DL10. |

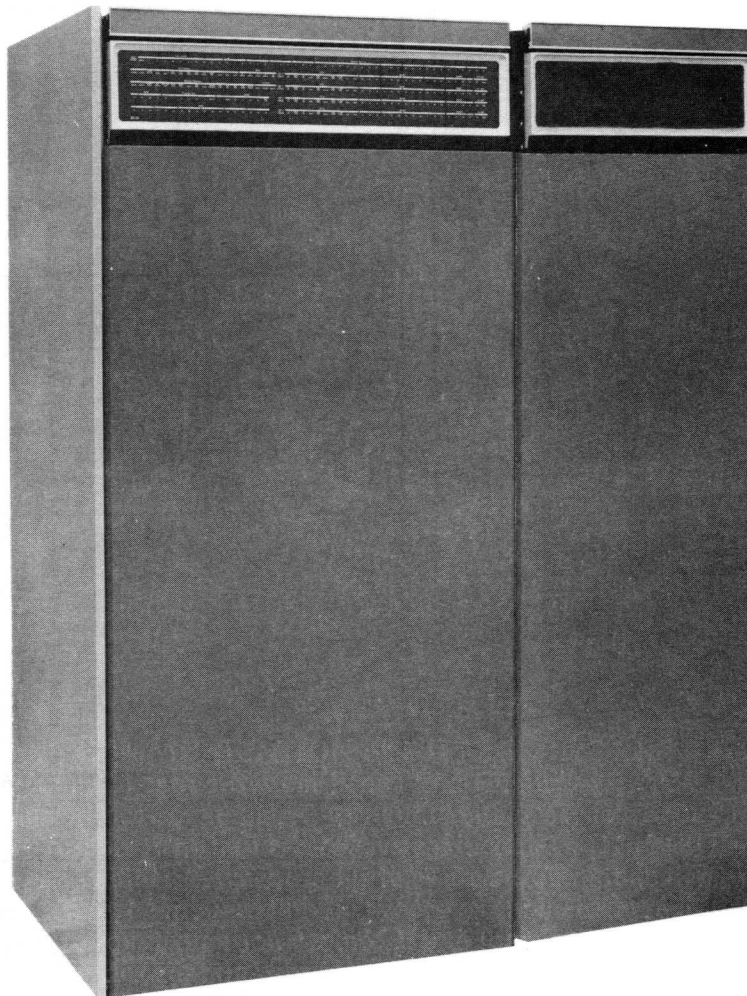

6246-1A

Figure 1-12 DN87 Universal Communication System Front End

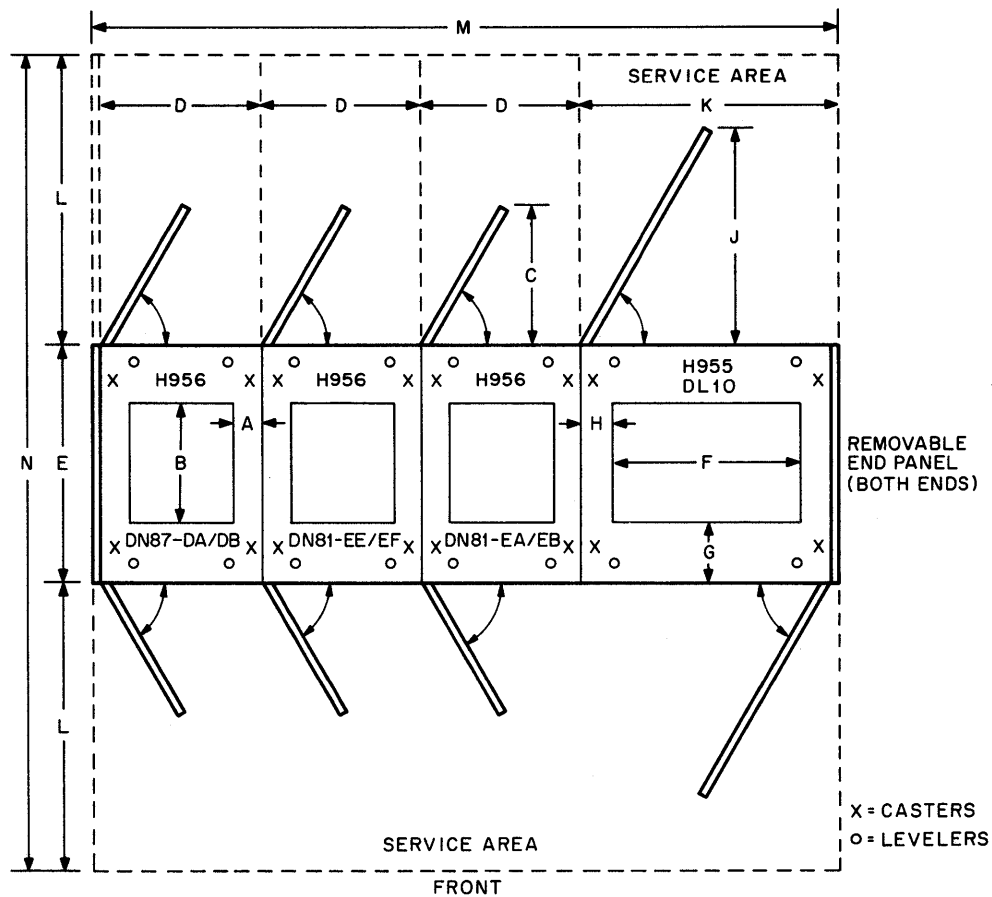

DIMENSIONS	A	B	C	D	E	F	G	H	J	K	L	M	N
METERS	0.08	0.38	0.50	0.52	0.76	0.61	0.19	0.09	0.79	0.80	0.91	2.33	2.59
INCHES	3.2	15	20	20.5	30	24	7.5	3.7	31	31.5	36	94.24	102

10-2487

Figure 1-13 DN87 Universal Communication System Front End

Asynchronous Options

- DN81-EA** Expander cabinet for asynchronous communication interfaces. Includes one DH11 16-line multiplexor with distribution panel, power supply and DM11-BB modem control multiplexor.
- DN81-EB** Same as EA, except 230 V, 50 Hz.
- DN81-EC** Additional DH11 16-line multiplexor with distribution panel, power supply, and DM11-BB modem control multiplexor.
- DN81-ED** Same as EC, except 230 V, 50 Hz.
- DN81-FA** Line adapter for eight 20 mA Teletype lines (data only). Includes two DM11-DAs, telephone panel connector (black), and miscellaneous hardware.

DN81-FB	Line adapter for eight EIA/CCITT lines (data only). Includes two DM11-DBs with 7.6 m (25 ft) cables and null modems.
DN81-FC	Line adapter for eight EIA/CCITT compatible lines equipped with data set control features. Consists of two DM11-DCs.
DN81-FD	Eight internal answer-only modems. Converts FSK tone signals to TTL compatible signals. Consists of eight DN11-BBs.
DN81-FE	Two integral originate-only modems. Consists of two DF11-BAs.
DN81-FF	Automatic calling unit interface. Consists of one DN11-AA prewired system unit for up to four Bell 801 auto calling unit interfaces, and two DN11-DAs [line interfaces for Bell 801 and 7.6 m (25 ft) cables].
DN81-FG	Two line interfaces for Bell 801 automatic calling unit. Consists of two DN11-DAs.

Synchronous Options

DN81-EE	Expander cabinet for NPR synchronous line interfaces, includes mainframe and power supplies (115 V, 60 Hz) and one DQ11-DA/EA.
DN81-EF	Same as DN81-EE except 230 V, 50 Hz.
DN81-H	NPR synchronous line control interface (DQ11-DA) EIA/CCITT up to 10K baud.
DN81-J	Same as DN81-H, except DQ11-EA, TTL to Bell System equivalent modem up to 1 Megabaud.

In general, three configurations are possible using the above options:

Asynchronous	PDP-11/40 processor cabinet and up to two asynchronous expansion cabinets, for up to 112 asynchronous lines.
Synchronous	PDP-11/40 cabinet with up to four synchronous lines and an expansion cabinet with up to eight more synchronous lines.
Universal	Synchronous and asynchronous lines mixed. A maximum of 64 asynchronous lines accommodated with one to four synchronous lines, or a maximum of 32 asynchronous lines with five to eight synchronous lines.

1.10 DN87S UNIVERSAL COMMUNICATION SYSTEM FRONT END

The DN87S Universal Communication System Front End (Figures 1-14 and 1-15) is a PDP-11 based front-end processor designed to handle either asynchronous terminal lines or synchronous terminal lines, or both. The DN87S uses a DTE20 for the PDP-10 to PDP-11 interface. The system variation designations follow.

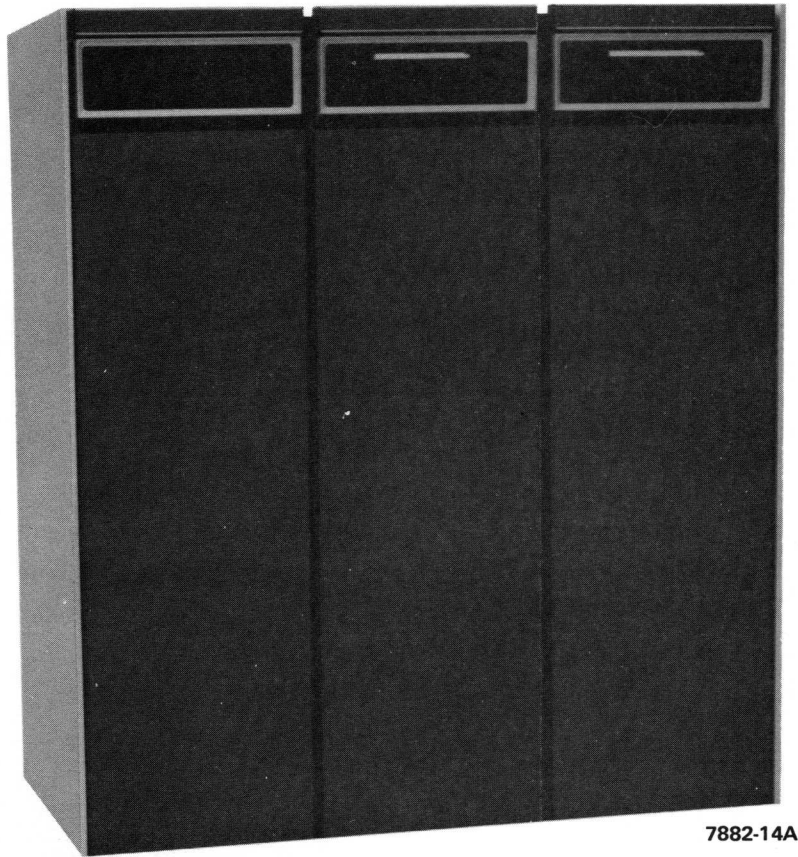

Figure 1-14 DN87S Universal Communication System Front End

DN87S-AA PDP-11/40 assembly with 32K parity memory. Includes mainframe (115 V, 60 Hz), power supply, doors, panels, miscellaneous hardware. DTE20, DL11-C and E, a KG11, BM873-YG, and an H324 ROM switch panel.

DN87S-AB Same as DN87S-AA except 230 V, 50 Hz.

Asynchronous Options

DN81-EA Expander cabinet for asynchronous communication interfaces. Includes one DH11 16-line multiplexor with distribution panel, power supply, and DM11-BB modem control multiplexor.

DN81-EB Same as DN81-EA, except 230 V, 50 Hz.

DN81-EC Additional DH11 16-line multiplexor with distribution panel, power supply, and DM11-BB modem control multiplexor.

DN81-ED Same as DN81-EC, except 230 V, 50 Hz.

DN81-FA Line adapter for eight 20 mA Teletype lines (data only). Includes two DM11-DAs, telephone panel connector (black), and miscellaneous hardware.

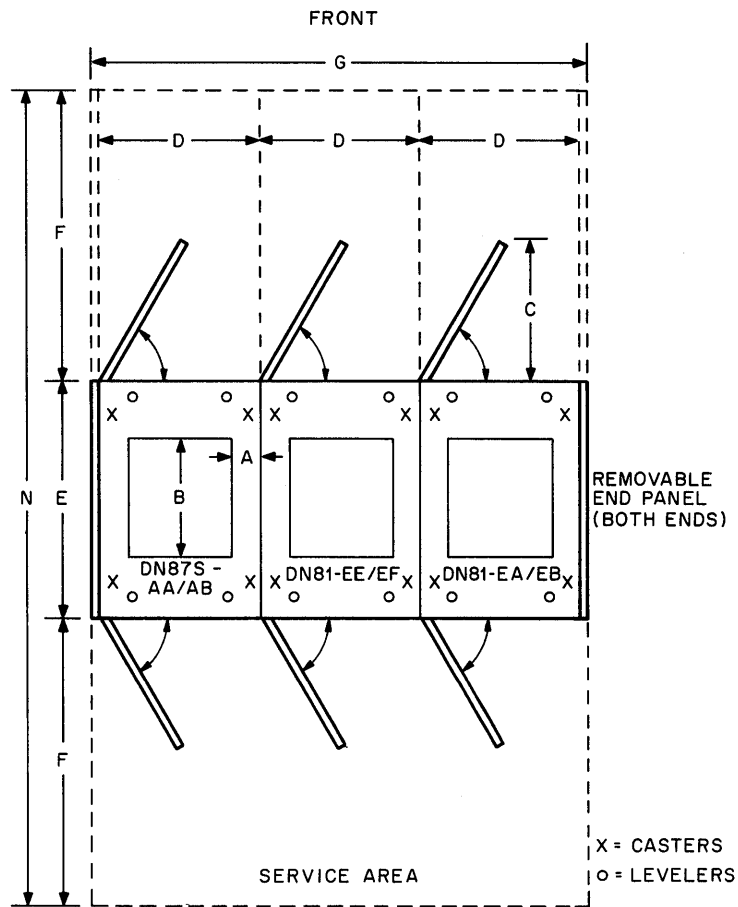

DIMENSIONS	A	B	C	D	E	F	G	H
METERS	0.08	0.38	0.50	0.52	0.76	0.91	1.59	2.59
INCHES	3.2	15	20	20.5	30	36	62.7	102

NOTE:
 The DTE is part of the DN87S but is located in the PDP-10. Maximum distance from last cabinet to DTE20 is 15 feet.
 DN87S - Three Cabinet Configuration.

10-2486

Figure 1-15 DN87S Universal Communication System Front End

- DN81- FB Line adapter for eight EIA/CCITT lines (data only). Includes two DM11-DBs with 7.6 m (25 ft) cables and null modems.
- DN81-FC Line adapter for eight EIA/CCITT compatible lines equipped with data set control features. Consists of two DM11-DCs.
- DN81-FD Eight internal answer-only modems. Converts FSK tone signals to TTL-compatible signals. Consists of eight DF11-BBs.
- DN81-FE Two integral originate only modems. Consists of two DF11-BAs.

DN81-FF Automatic calling unit interface. Consists of one DN11-AA prewired system unit for up to four Bell 801 automatic calling unit interfaces and two DN11-DAs [line interfaces for Bell 801 and 7.6 m (25 ft) cables].

DN81-FG Two line interfaces for Bell 801 automatic calling unit. Consists of two DN11-DAs.

Synchronous Options

DN81-EE Expander cabinet for NPR synchronous line interfaces, includes mainframe and power supplies (115 V, 60 Hz) and one DQ11-DA/EA.

DN81-EF Same as DN81-EE except 230 V, 50 Hz.

DN81-H NPR synchronous line control interface (DQ11-DA) EIA/CCITT up to 10K baud.

DN81-J Same as DN81-H, except DQ11-EA, TTL to Bell System equivalent up to 1 Megabaud.

In general, the following configurations are possible using the above options.

Asynchronous PDP-11/40 processor cabinet and up to two asynchronous expansion cabinets for up to 128 asynchronous lines.

Synchronous PDP-11/40 cabinet with up to four synchronous lines and an expansion cabinet with up to eight more synchronous lines.

Universal Synchronous and asynchronous lines mixed. A maximum of 64 asynchronous lines accommodated with one to four synchronous lines on a maximum of 32 asynchronous lines with five to eight DF11-BBs.

1.11 DX10 DATA CHANNEL

The DX10 Data Channel (Figure 1-16) controls high-speed data transfers between the TX01/TX02 Magnetic Tape Controller and 1080/1090 System's memory. (The TX01 controls up to eight TU70/TU71 Magnetic Tape Drives.) The TX02 controls up to eight TU70/71/72 Magnetic Tape Drives. The DX10 connects to the Memory Bus and to the KL10 Arithmetic Processor's I/O Bus. Data transfer over the Memory Bus is independent of the KL10 Arithmetic Processor, being controlled by a PDP-8A microprocessor located within the DX10 itself.

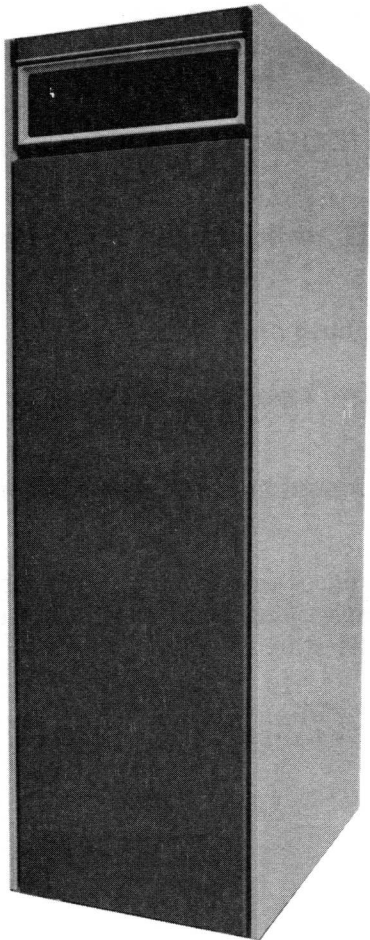

7513-7

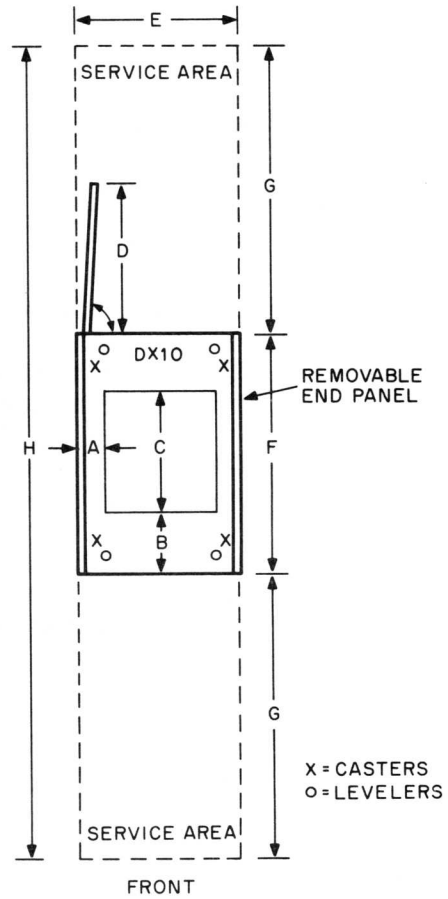

DIMENSIONS	A	B	C	D	E	F	G	H
METERS	0.08	0.19	0.38	0.5	0.52	0.76	0.91	2.58
INCHES	3.2	7.5	15	20	20.5	30	36	102

10-1397

Figure 1-16 DX10 Data Channel

1.12 KL10-A/B ARITHMETIC PROCESSOR

The KL10-A/B (Figures 1-17 and 1-18) is the central processor used in the 1080/1090 System respectively. Its speed is approximately twice that of the KI10 and it is provided with:

- Floating point, byte, double precision and character string handling instructions.
- Eight blocks of first registers.
- Memory protection, memory page mapping and memory cache.
- A console processor for operator and service interface.
- An LA36 console teleprinter.
- Integrated I/O channels and controllers (KL10-B only)

A detailed physical description of the KL10-A/B Arithmetic Processor is given in Subsection 1.3.

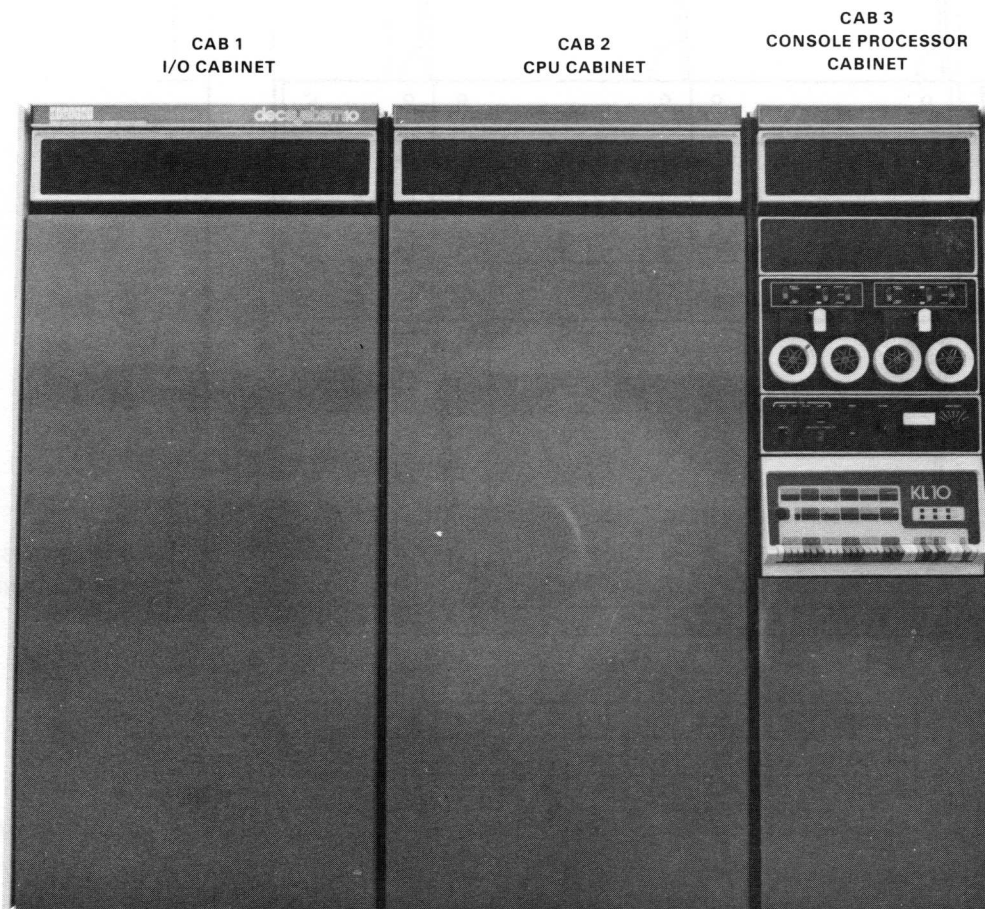

7533 13

Figure 1-17 KL10-A/B Arithmetic Processor

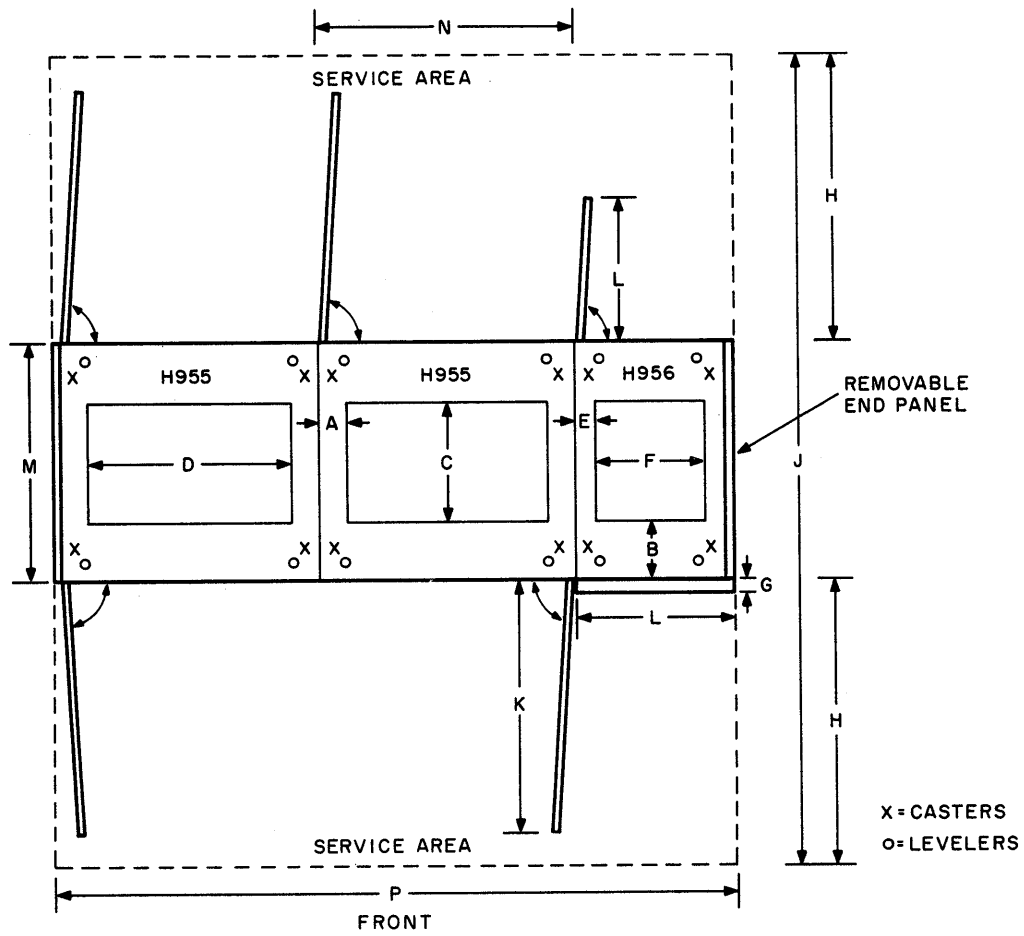

DIMENSIONS	A	B	C	D	E	F	G	H	J	K	L	M	N	P
METERS	0.09	0.19	0.38	0.61	0.08	0.36	0.04	0.91	2.89	0.79	0.50	0.76	0.80	2.18
INCHES	3.7	7.5	15	24	3.2	14	1.5	36	102	31	20	30	31.5	86

10-1395

Figure 1-18 KL10-A/B Arithmetic Processor

1.13 LA36 DECwriter II TERMINAL

The LA36 DECwriter II terminal (Figures 1-19 and 1-20) can be used both as a remote terminal and a local computer I/O device. Throughput of 30 characters per second provides utilization of a 300 baud communications line without the use of fill characters. Data can be sent or received in standard ASCII code at three rates: 110, 150, and 300 baud.

The printer produces a hard copy original plus up to five duplicate copies on tractor-driven continuous forms varying in width from 3 to 14-7/8 inches. Preprinted forms can be positioned in exact vertical alignment by operating a manual clutch on the tractor drive. The standard set of 97 upper-case and lower-case ASCII characters is printed at a horizontal spacing of 10 characters per inch and a vertical spacing of 6 lines per inch. A switch allows selection of a reduced set of 64 upper-case ASCII characters.



7037-14

Figure 1-19 LA36 DECwriter II Terminal

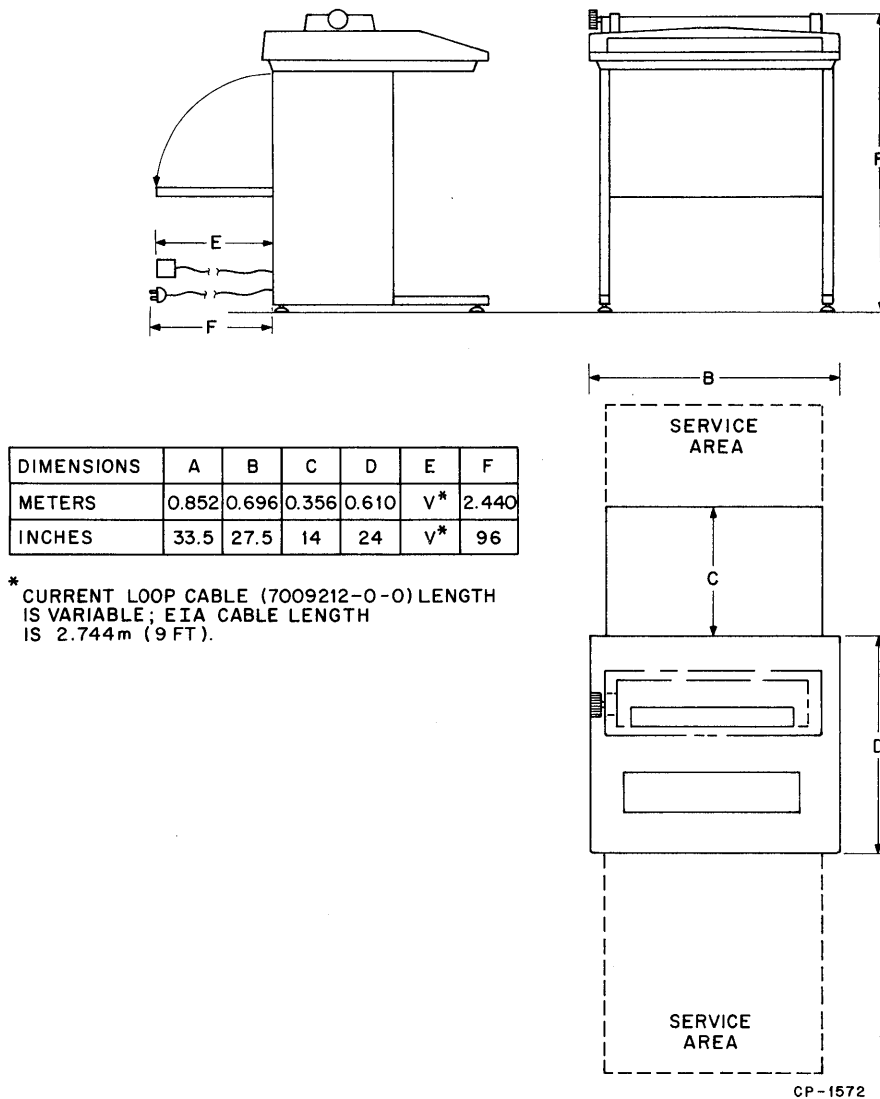

Figure 1-20 LA36 DECwriter II Terminal

1.14 LP10 LINE PRINTER

The LP10 Line Printer (Figure 1-21) outputs hard copy composed of lines 132 characters long at a maximum printing speed that ranges from 675 to 1250 lines per minute depending on the model type. Various character sets are available. Printer characters follow.

Printer	Number of Characters	Lines per Minute	Drum Rotation (rpm)
LP10-F	64	925/1250	1200/1800
LP10-H	95/96	675/925	800/1200

The LP10 Line Printer operates under the control of BA10 Hard Copy Control.



6476-1

Figure 1-21 LP10-F, H Line Printer (Sheet 1 of 2)

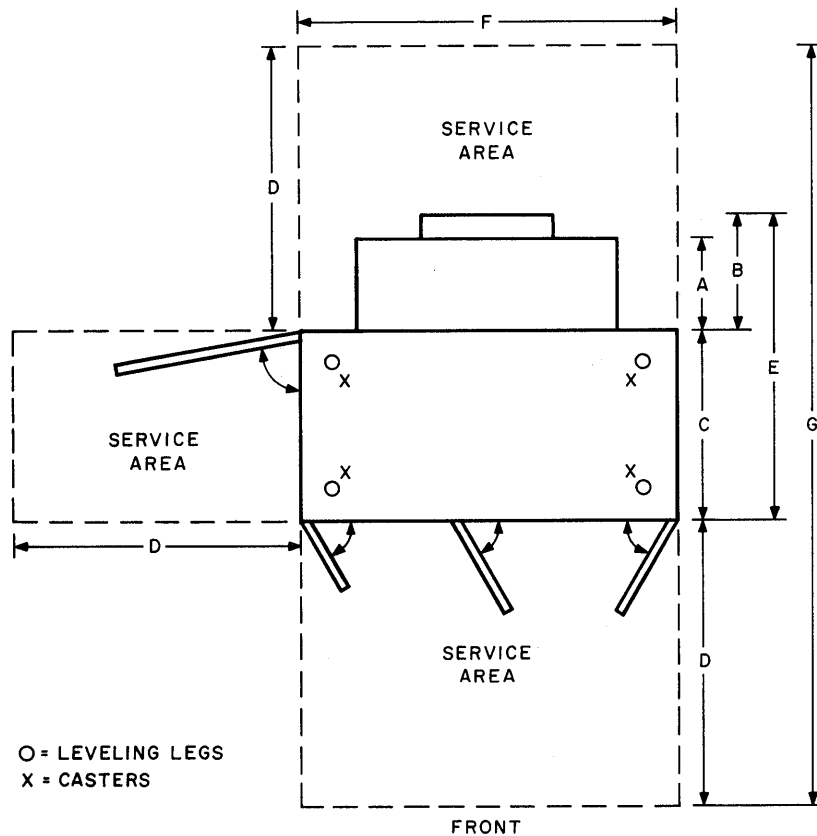

O = LEVELING LEGS
X = CASTERS

DIMENSIONS	A	B	C	D	E	F	G
INCHES	11.5	14	24.5	36	38.5	48.5	96.5
METERS	0.29	0.36	0.62	0.91	0.98	1.23	2.44

10-0935

Figure 1-21 LP10-F, H Line Printer (Sheet 2 of 2)

1.15 LP100 LINE PRINTER SYSTEM

The LP100 Line Printer System (Figures 1-22 and 1-23) is composed of two hardware components, an LP07 Line Printer and an LP100 Line Printer Controller/Interface. Each component is in a free-standing cabinet and each is powered separately.

The Line Printer is a high-performance, horizontal font printer and is designed to provide high print quality with high reliability.

The printed output consists of lines up to 132 columns in length at maximum printing speed from 715 to 1220 lines per minute depending on the model type.

LP100 Line Printer System characteristics are as follows:

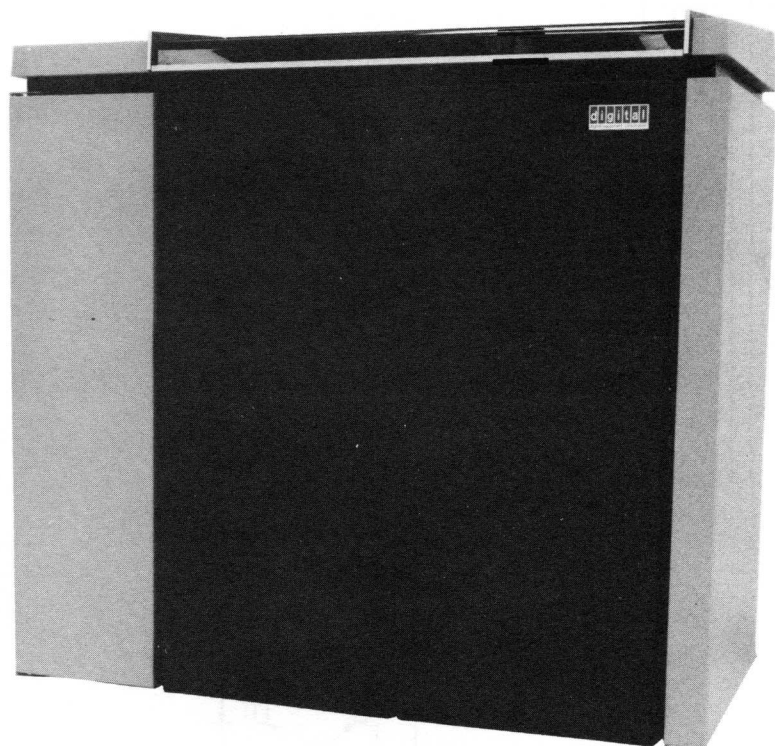

8056-2

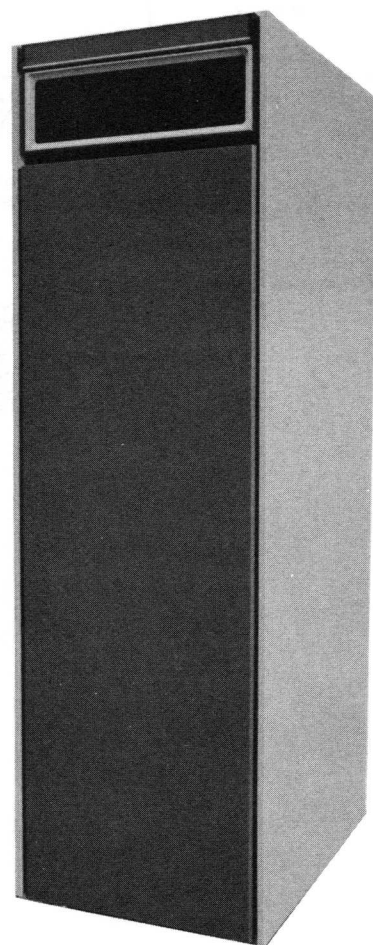

7513-7

Figure 1-22 LP100 Line Printer System

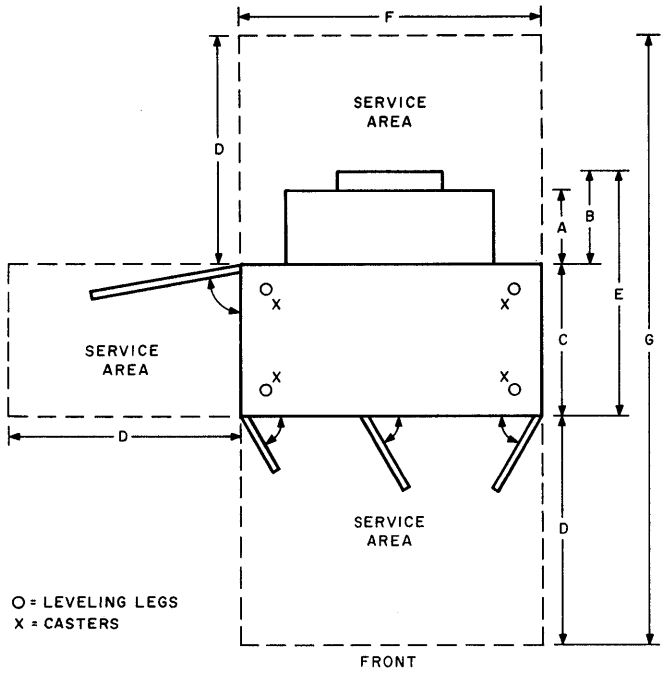

O = LEVELING LEGS
X = CASTERS

DIMENSIONS	A	B	C	D	E	F	G
INCHES	11.5	14	24.5	36	38.5	48.5	96.5
METERS	0.29	0.36	0.62	0.91	0.98	1.23	2.44

10-0935

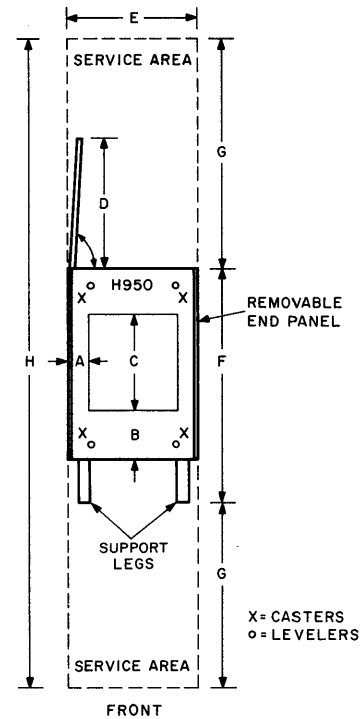

X = CASTERS
O = LEVELERS

DIMENSIONS	A	B	C	D	E	F	G	H
METERS	0.08	0.19	0.38	0.5	0.52	0.97	0.91	2.58
INCHES	3.2	7.5	15	20	20.5	38	36	102

10-0871

Figure 1-23 LP100 Line Printer System Site Plan

1.16 MF10 CORE MEMORY

The MF10 (Figures 1-24 and 1-25) is a ferrite-core memory having a nominal read access time of 550 nanoseconds, a maximum read access time of 610 nanoseconds, and a cycle time of 950 nanoseconds. Each MF10 provides storage of up to 64K words; each word consists of 36 data bits and one parity bit.

An MF10 may contain up to four access ports for connection to processors, data channels, and the data channel multiplexor. The MF10 can be intermixed with other 1080/1090 memories such as the MG10.

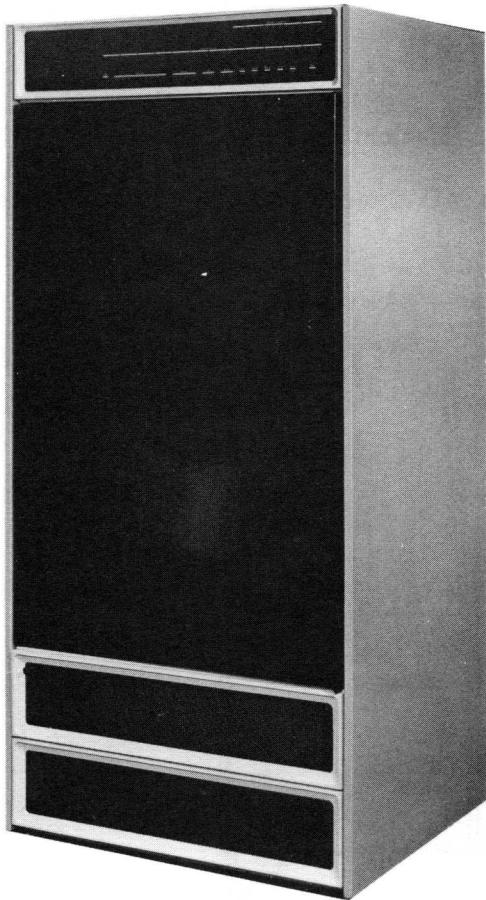
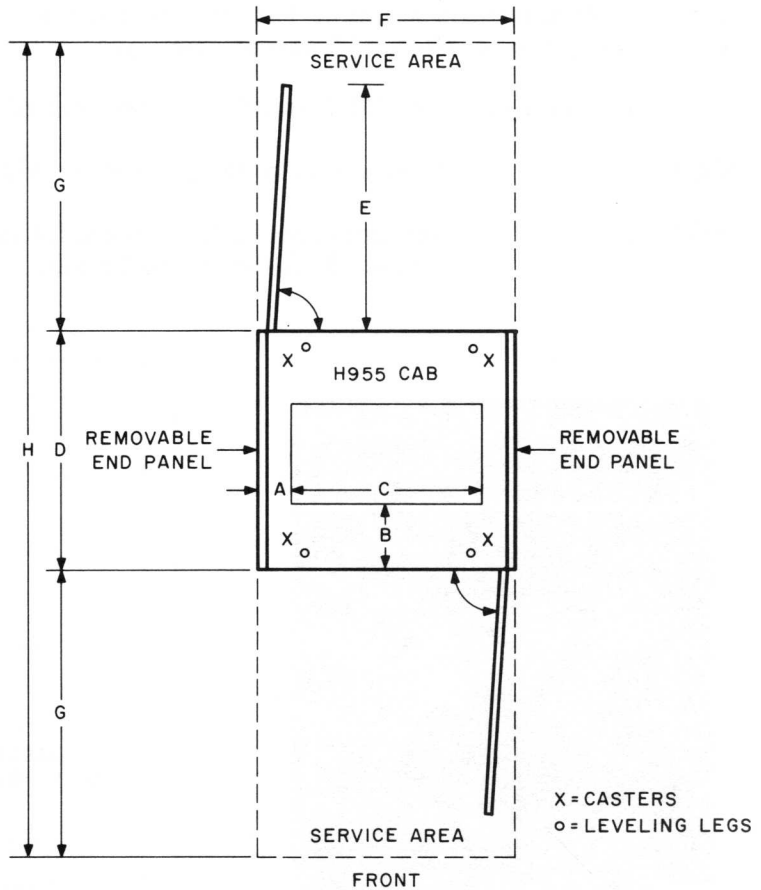

Figure 1-24 MF10 Core Memory



DIMENSIONS	A	B	C	D	E	F	G	H
METERS	0.09	0.19	0.61	0.76	0.79	0.8	0.91	2.6
INCHES	3.7	7.5	24	30	31	31.5	36	102

10-0869

Figure 1-25 MF10 Core Memory Site Plan

1.17 MG10 CORE MEMORY

The MG10 Core Memory System (Figure 1-26) provides up to 128K (131,072) 36-bit words of 1 μ s cycle time memory in each cabinet assembly. Each memory module (cabinet assembly) has provision for eight ports: two of highest priority, two of intermediate priority, and four of lowest priority. Within each priority level, the priority of service rotates, with the most recently served port having the lowest priority. Each memory module has a single set of address and mode switches that control the operation of all eight ports, thus minimizing the possibility of operator error during reconfiguration. Individual ports can be disabled. Each memory module contains up to eight submodules of 16K words each. Dual control logic is provided so that two references, each to a different submodule, can be handled simultaneously. Thus, two of the eight ports can be active simultaneously. The internal submodules may be two-way interleaved; in addition, two MG10 modules (cabinet assemblies) may be two-way interleaved, giving the net effect of four-way interleave.

The MG10 connects to the DEC standard power control bus.

MG10-L 256K words in two cabinets providing equivalent four-way interleave.

MG10-G Additional dual port package for single MG10 memory module (two required for each MG10-L port addition).

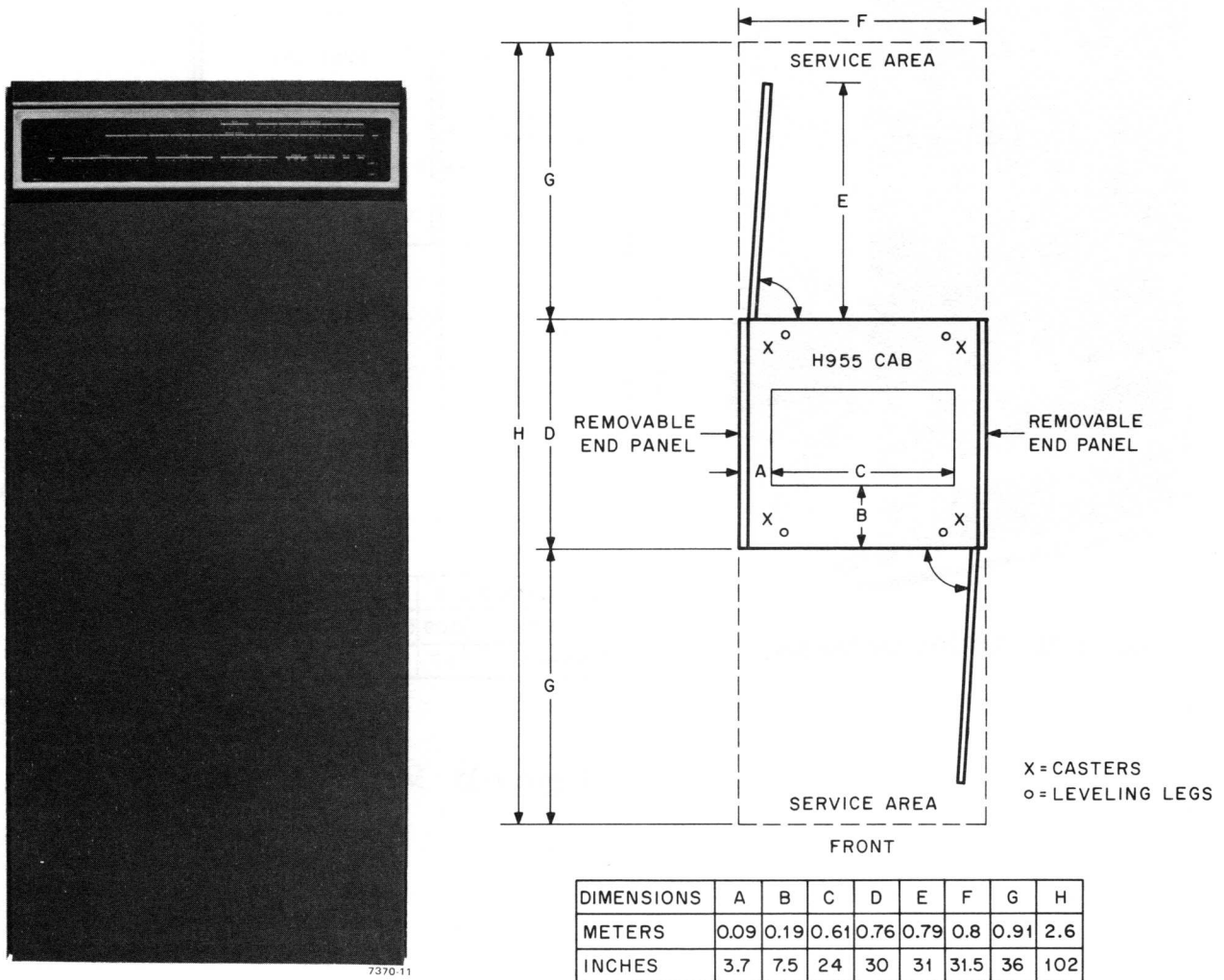

Figure 1-26 MG10 Core Memory

1.18 MH10 CORE MEMORY SYSTEM

The MH10 Core Memory System (Figures 1-27 and 1-28) provides up to 256K (262,144) 36-bit words of 1 μ s cycle time memory in each cabinet assembly. Each memory module (cabinet assembly) has provision for eight ports: two of highest priority, two of intermediate priority, and four of lowest priority. Within each priority level, the priority of service rotates, with the most recently served port having the lowest priority. Each memory module has a single set of address and mode switches that control the operation of all eight ports, thus minimizing the possibility of operator errors during reconfiguration. Individual ports can be disabled. Each memory module contains up to eight submodules of 32K words each. Dual control logic is provided so that two references, each to a different submodule, can be handled simultaneously. Thus, two of the eight ports can be active simultaneously. The internal submodules may be two-way interleaved; in addition, two MH10 modules (cabinet assemblies) may be two-way interleaved, giving the net effect of four-way interleave.

The MH10 is compatible with both old (18-bit address) and new (22-bit address) memory buses. Jumpers and a switch allow each port to be either an 18-bit or a 22-bit bus.

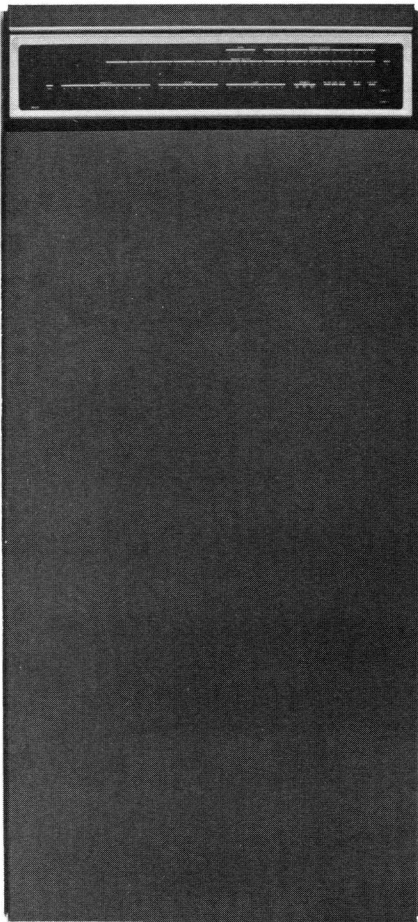
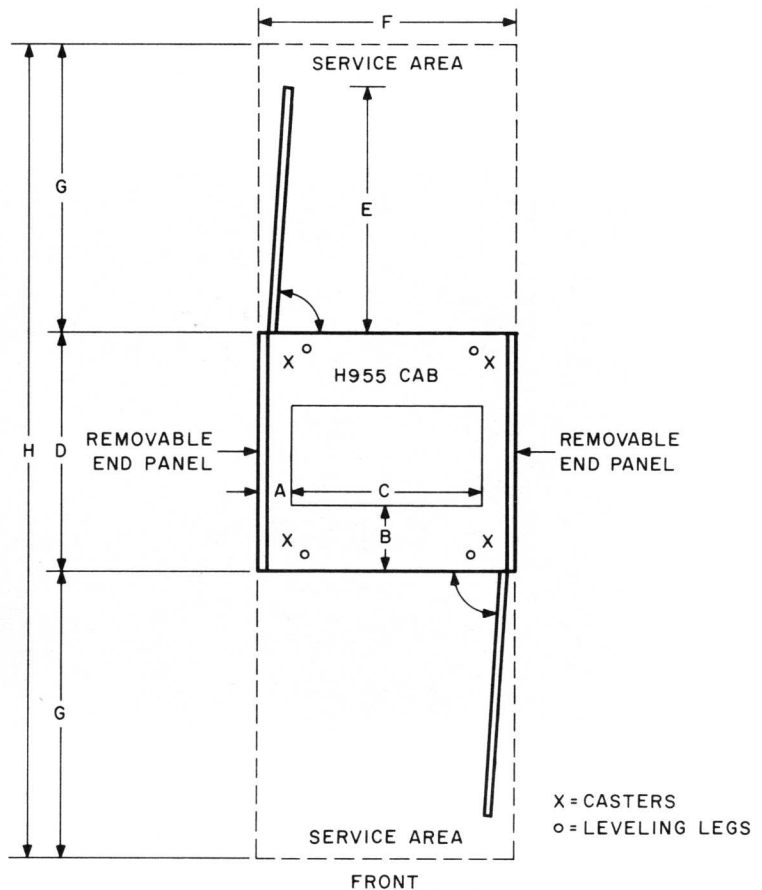

Figure 1-27 MH10 Core Memory



DIMENSIONS	A	B	C	D	E	F	G	H
METERS	0.09	0.19	0.61	0.76	0.79	0.8	0.91	2.6
INCHES	3.7	7.5	24	30	31	31.5	36	102

10-0869

Figure 1-28 MH10 Core Memory Site Plan

When the KL10 processor is connected to an MH10 Memory System, two of the processor's four memory buses (buses 00 and 01) are cabled to MH10 memory module 0 (and 2, 4, etc., if present) and the other two processor memory buses (buses 10 and 11) are cabled to MH10 memory module 1 (and 3, 5, etc., if present). Thus, a KL10 processor effectively occupies two ports of an MH10 memory system. Other ports of the memory system which are in use are cabled to all modules of the memory system.

The MH10 connects to the DEC standard power control bus.

MH10-L 512K words in two cabinets providing equivalent four-way interleave.

MH10-G Additional dual port package for single MH10 memory module (two required for each MH10-L port addition).

1.19 MX10-C MEMORY DATA MULTIPLEXOR

The MX10-C Memory Data Multiplexor (Figure 1-29) is a DECsystem-10 option which permits up to eight I/O channels to access one of the ports within the system memory. The MX10-C provides for either 18- or 22-bit addressing.

The MX10-C is usually housed in a DF10 Data Channel cabinet.

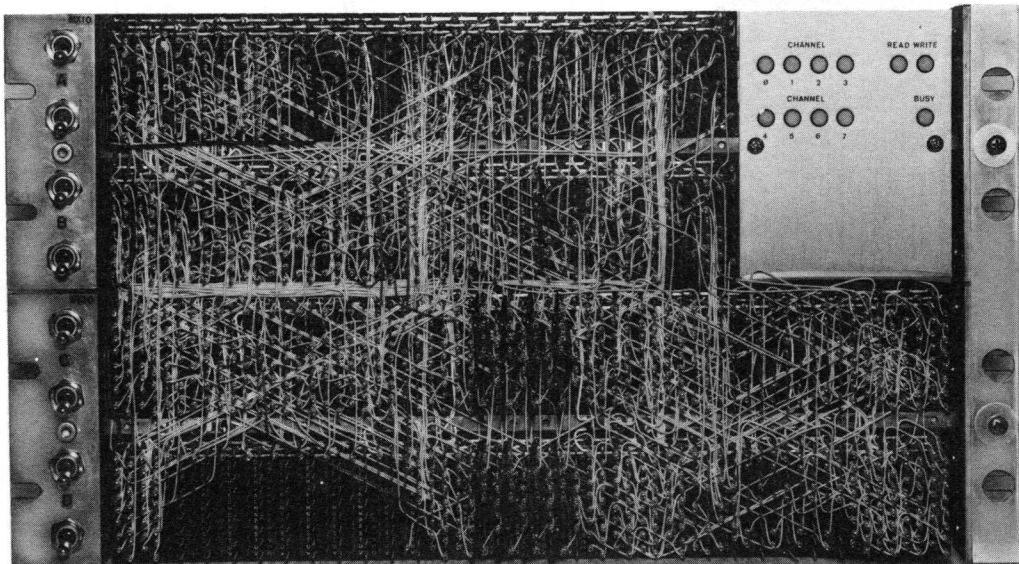

4336-1

Figure 1-29 MX10 Memory Data Multiplexor

1.20 RH10 MASSBUS CONTROLLER

The RH10 Massbus Controller (Figure 1-30) provides an interface for up to eight Massbus peripheral devices such as the RS04 Fixed Head Disk Drive or the RP04 Disk Pack Drive. In addition to the Massbus devices, the RH10 Controller connects to the central processor's I/O bus and to the DF10-C channel bus. Data is transferred directly to and from main memory via the DF10-C channel.

The RH10 main power is controlled by a DEC standard power control bus. The RH10 controls the main power to the RS04 or RP04 using a power sequence cable.

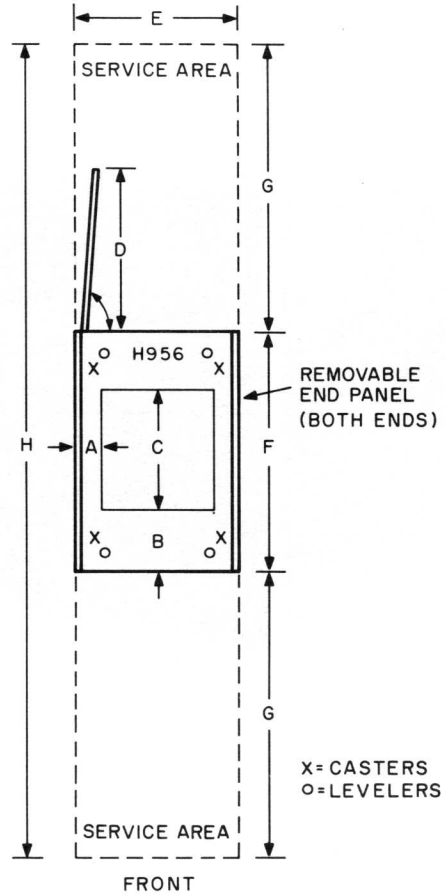
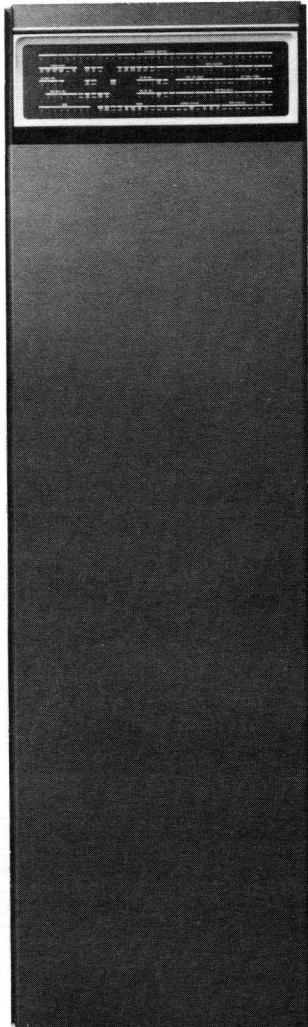

DIMENSIONS	A	B	C	D	E	F	G	H
METERS	0.08	0.19	0.38	0.5	0.52	0.76	0.91	2.58
INCHES	3.2	7.5	15	20	20.5	30	36	102

10-1400

Figure 1-30 RH10 Massbus Controller Site Plan

1.21 RH04 FIXED HEAD DISK

The RS04 Fixed Head Disk (Figure 1-31) provides 256K (262,144) 36-bit words of storage capacity. The RS04 connects to a single Massbus such as that provided by the RH10 Massbus Controller. Up to eight RS04 disks can be connected to a single RH10 to provide a total capacity of four million words. Two disk drives are mounted in a fully extended cabinet.

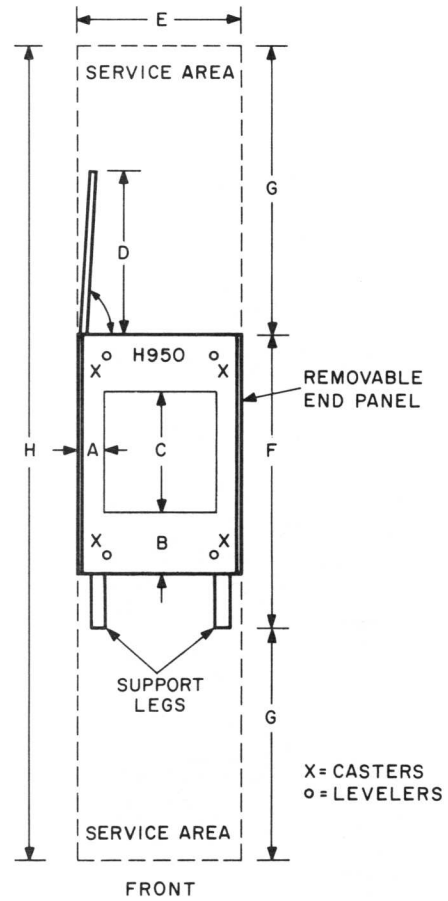
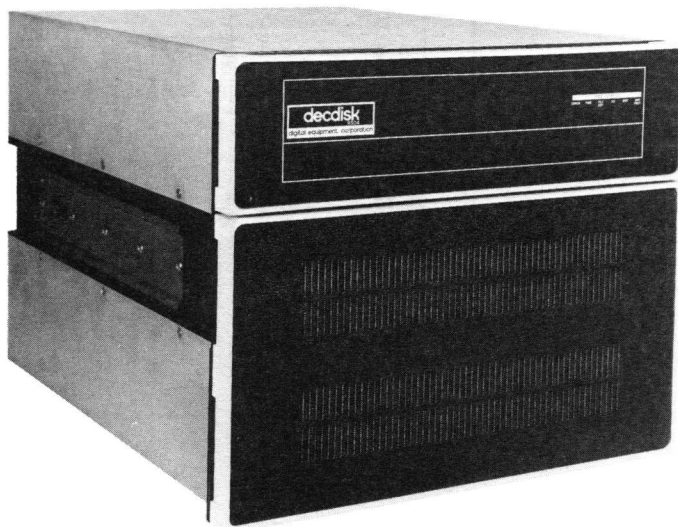

DIMENSIONS	A	B	C	D	E	F	G	H
METERS	0.08	0.19	0.38	0.5	0.52	0.97	0.91	2.58
INCHES	3.2	7.5	15	20	20.5	38	36	102

10-0871

Figure 1-31 RHS04 Fixed Head Disk Site Plan

1.22 RP04 DISK PACK DRIVE

The RP04 Disk Pack Drive (Figures 1-32 and 1-33) provides a storage capacity of 19,991,040 36-bit words (or 43,980,280 16-bit words in 16-bit word mode). An RP04-A drive interfaces to a single Massbus such as that provided by the RH10 Massbus Controller. An RP04-B drive interfaces to two independent Massbuses such as that provided by the RH10 and the RH11 in 1080 and 1090 systems. (The RH11 is contained in the Console Processor portion of the KL10 Arithmetic processor.) Up to eight RP04 type drives can be used on a single controller.

Power up sequencing of the RP04 is controlled via a power sequence cable.

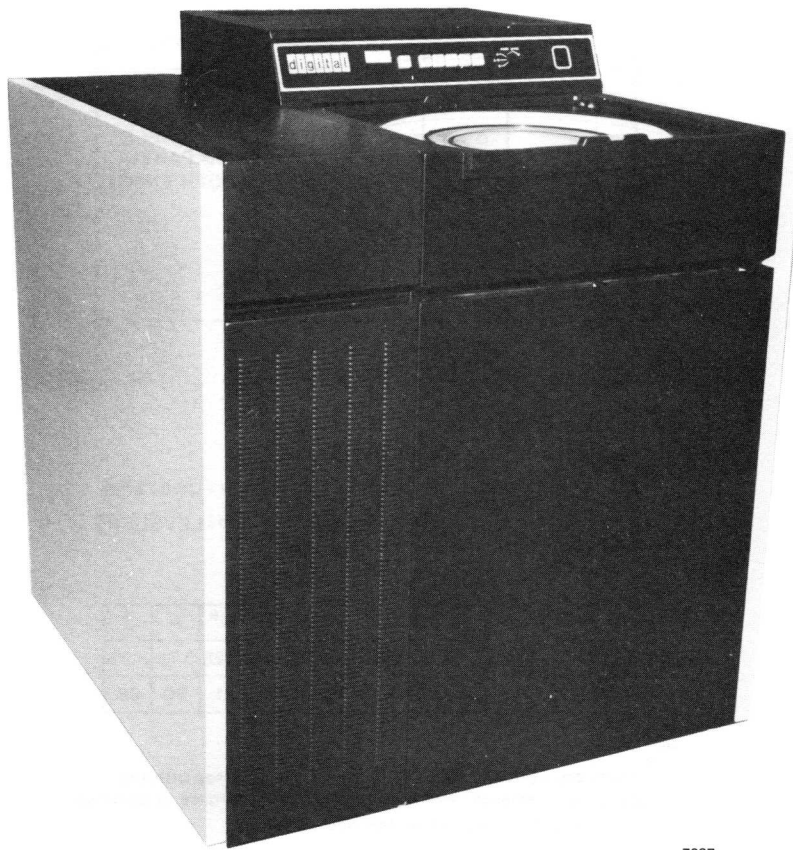

7097

Figure 1-32 RP04 Disk Pack Drive

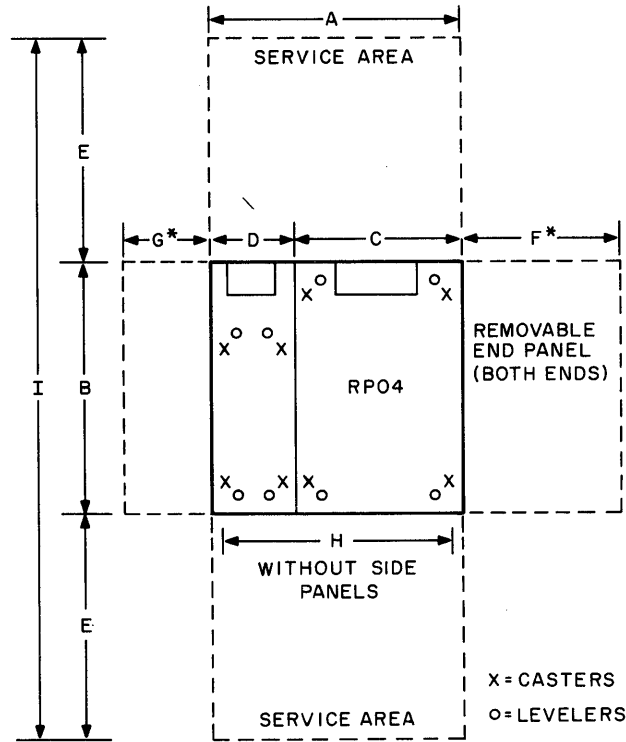

DIMENSIONS	A	B	C	D	E	F*	G*	H	I
METERS	0.82	0.82	0.52	0.28	0.71	0.49	0.28	0.76	2.25
INCHES	32	32	21	11	28	20	11	30	88

NOTE:

* Drives are normally located adjacent to one another with the end panels removed. When necessary, side clearance is obtained by moving the drive out of the line of drives.

10-1396

Figure 1-33 RP04 Disk Pack Drive Site Plan

1.23 RP06 DISK PACK DRIVE

The RP06 Disk Pack Drive (Figures 1-34 and 1-35) is a high-performance, direct-access, single-head-per-surface drive designed to enable a data processing system to store and retrieve blocks of data at any location on a rotating disk. An RP06 can address up to 815 cylinders (87,211,520 16-bit words or 79,283,200 18-bit words).

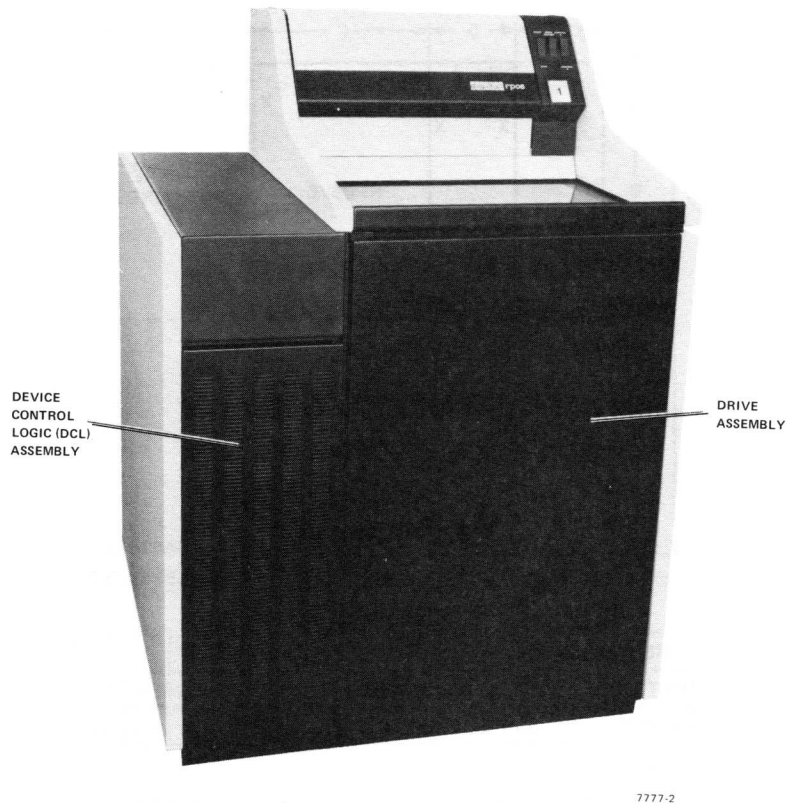
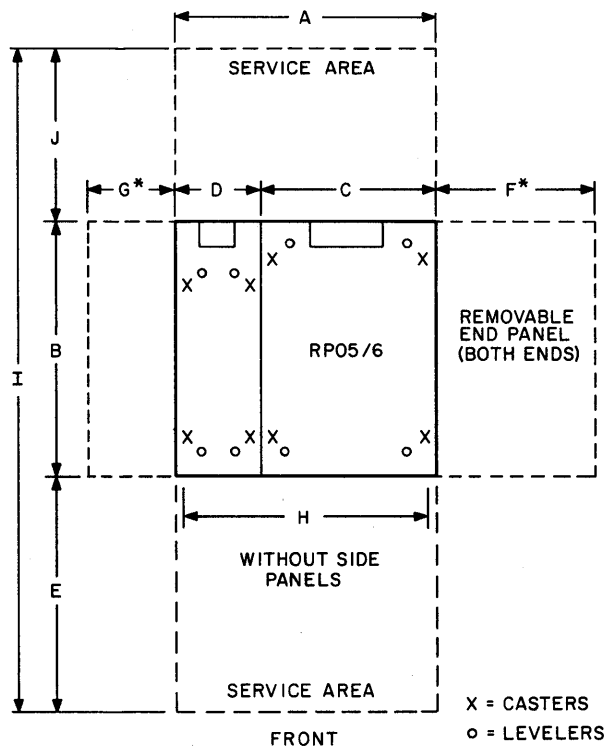

Figure 1-34 RP06 Disk Pack Drive



DIMENSIONS	A	B	C	D	E	F*	G*	H	I	J
METERS	0.85	0.82	0.56	0.28	0.77	0.50	0.28	0.79	2.15	0.56
INCHES	33	32	22	11	30	20	11	31	84	22

NOTE:

* Drives are normally located adjacent to one another with the end panels removed. When necessary, side clearance is obtained by removing the drive out of the line of drives.

10-2413

Figure 1-35 RP06 Disk Pack Drive Site Plan

1.24 TD10-C DECTape CONTROL

The TD10-C DECTape Control (Figures 1-36 and 1-37) can service up to eight TU56 dual-DECTape transports. The TD10 DECTape System is a fixed-address, magnetic tape storage system that provides random access for high-speed reading or writing of files on a 3.8 inch (100 mm) diameter, 260 ft (80 m) reel of magnetic tape. Each DECTape reel can store up to 73,484 36-bit words.

The TD10-C has provisions for mounting an XY10 Plotter Control. Up to three TU56 dual-DECTape Transports may be housed in the TD10-C DECTape control cabinet.

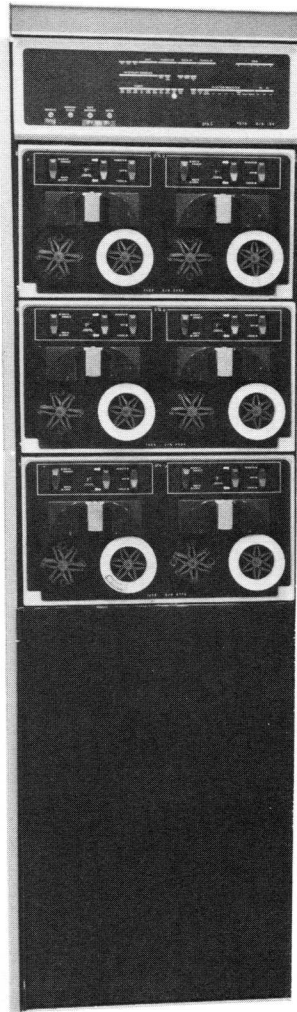

8347-1

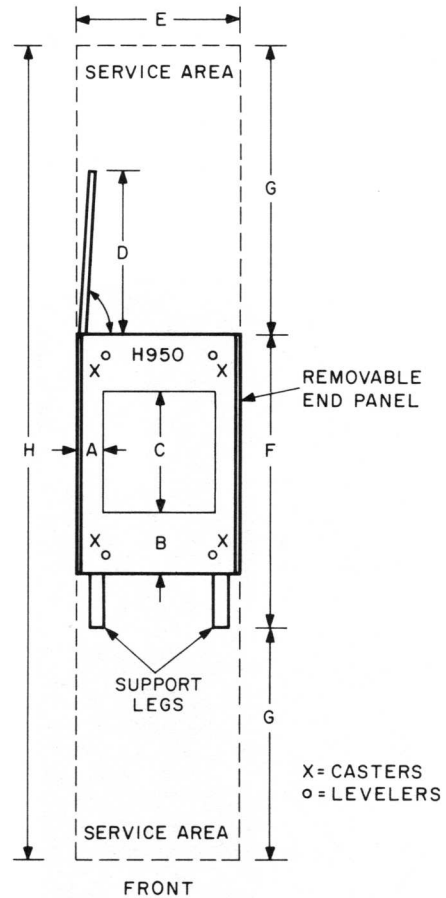

DIMENSIONS	A	B	C	D	E	F	G	H
METERS	0.08	0.19	0.38	0.5	0.52	0.97	0.91	2.58
INCHES	3.2	7.5	15	20	20.5	38	36	102

10-0871

Figure 1-36 TD10-C DECTape Control

Figure 1-37 TD10-C DECTape Control Site Plan

1.25 TU16B MASTER TAPE TRANSPORT SYSTEM

The TU16B Master Tape Transport System (Figures 1-38 and 1-39) reads and writes digital data on standard (ANSI compatible) 12.7 mm (0.5 in) 9-track magnetic tape at a rate of 72,000 characters per second. Recording densities of 8, 22, 32, and 63 rows/mm (200, 556, 800, and 1600 bits/inch) are program selectable. A single capstan drives the tape in the forward or reverse direction at a speed of 1.14 m/s (45 in/s). Tape rewind speed is 3.8 m/s (150 in/s).

The TU16B System consists of a TU16 Tape Transport and the TM02 Tape Controller Logic Assembly. Each TM02 is capable of controlling up to four TU16 Tape Transports. Models available for the TU16B and TU16 are listed below.

TU16B-EA 120 Vac 50 Hz
 TU16B-ED 240 Vac 50 Hz

TU16-EE 120 Vac 60 Hz
 TU16-EJ 240 Vac 50 Hz

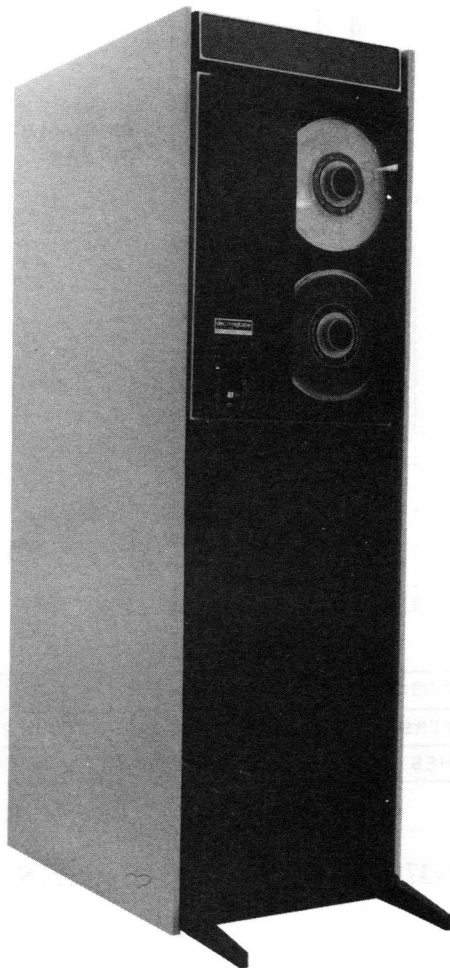

8056-4

Figure 1-38 TU16-B Magnetic Tape Transport

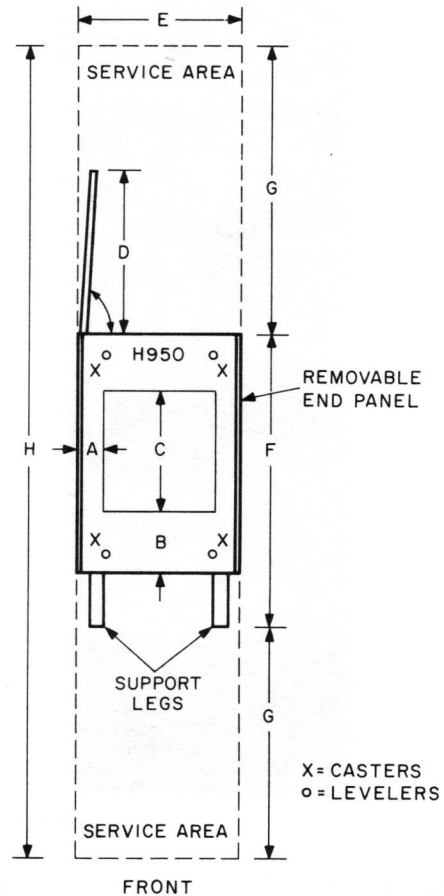

DIMENSIONS	A	B	C	D	E	F	G	H
METERS	0.08	0.19	0.38	0.5	0.52	0.97	0.91	2.58
INCHES	3.2	7.5	15	20	20.5	38	36	102

10-2491

Figure 1-39 TU16-B Magnetic Tape Transport Site Plan

1.26 TU70/TU71 MAGNETIC TAPE DRIVES

The TU10/TU71 Magnetic Tape Drives (Figure 1-40) handle ANSI standard 12.7 mm (0.5 in) magnetic tapes at data transfer rates up to 320,000 characters per second. The TU70 drive provides 9-track operation at 32 rows per millimeter (800 char/in) NRZI and 63 rows per millimeter (1600 char/in) PE. The TU71 drive provides 7-track operation at 8, 22, and 32 rows per millimeter (200, 556, and 800 char/in) NRZI. Both drive types operate at 5 meters/s (200 in/s).

The TU70-TU71 drives are controlled by the TX01 or TX02 Magnetic Tape Controller. Radial cabling is used for the controller connection. Up to eight drives may be installed. Power for each tape drive is supplied from the TX01 or TX02 controller which sequences the power to groups of four drives.

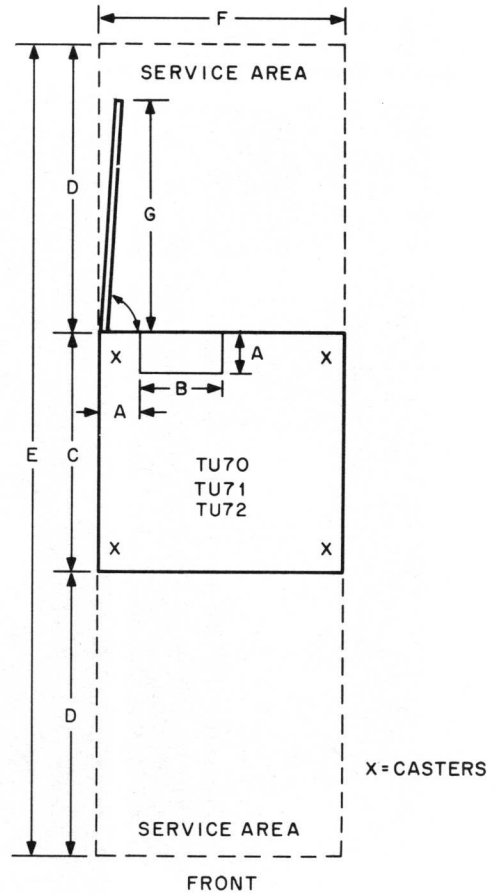
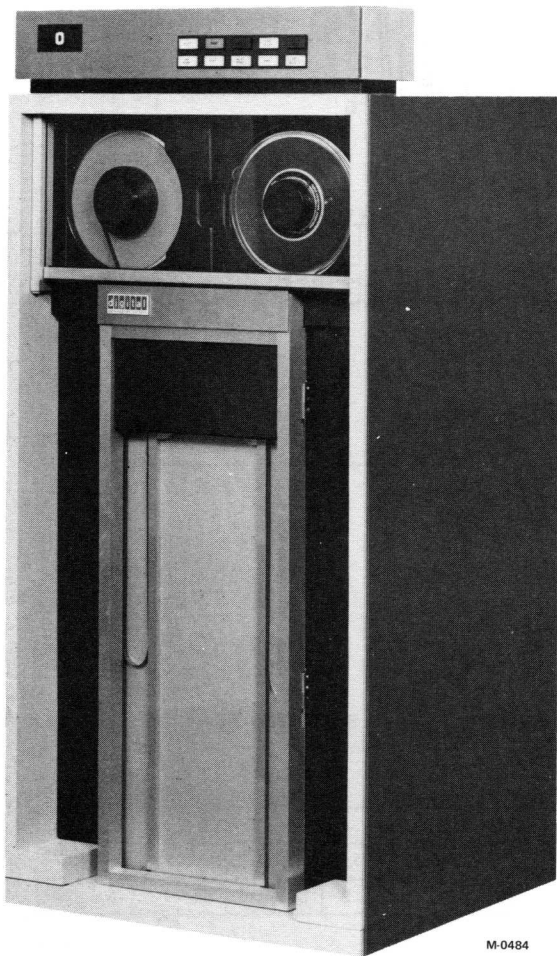

DIMENSIONS	A	B	C	D	E	F	G
METERS	0.13	0.27	0.75	0.93	0.59	0.78	0.76
INCHES	5	10	30	36	102	31	30

10-1399

Figure 1-40 TU70/71 Magnetic Tape Drive

1.27 TU72 MAGNETIC TAPE DRIVE

The TU72 Magnetic Tape Drive (Figures 1-41 and 1-42) connects to the TX02 Magnetic Tape Controller via radial cabling and provides 9-track operation at 250 rows per millimeter (6250 char/in) group coded recording (GCR), and 63 rows per millimeter (1600 char/in) phase encoded (PE). The TU72 drive operates at a speed of 3 m/s (125 in/s).

The TU72-EA is used for 60 Hz operation.

The TU72-EB is used for 50 Hz operation.

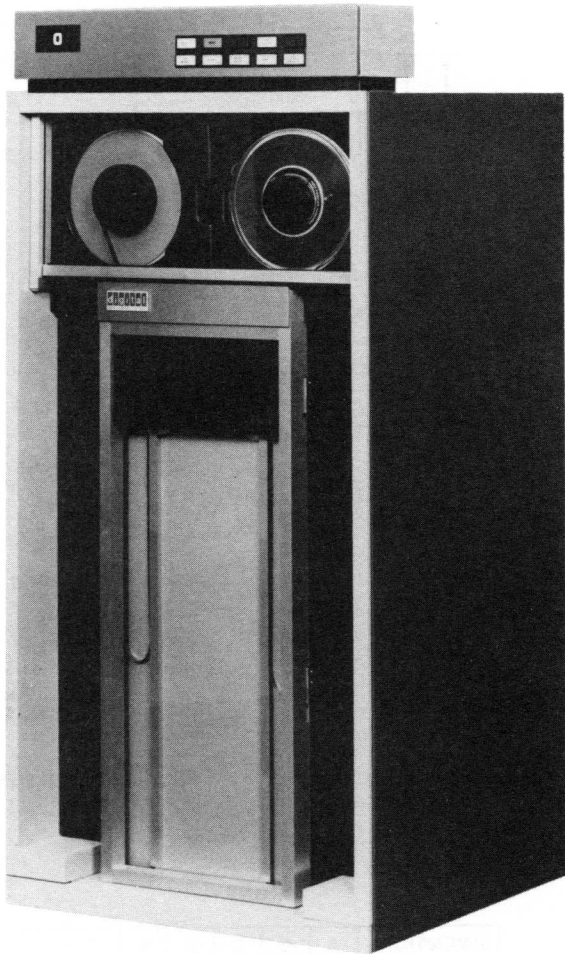

7513-1

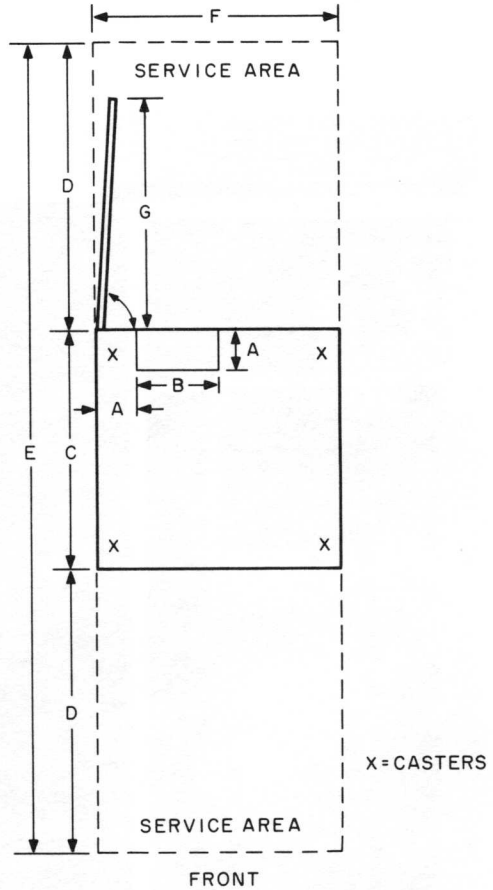

DIMENSIONS	A	B	C	D	E	F	G
METERS	0.13	0.27	0.75	0.93	2.59	0.78	0.76
INCHES	5	10	30	36	102	31	30

10-2509

Figure 1-41 TU72 Magnetic Tape Drive

Figure 1-42 TU72 Magnetic Tape Drive Site Plan

1.28 TX01 MAGNETIC TAPE CONTROLLER

The TX01 Magnetic Tape Controller (Figure 1-43) controls up to eight TU70/TU71 Magnetic Tape drives. It connects to the DX10 Data Channel and to each drive, using radial cabling. Features include microprogram control of tape operations and a diagnostic facility which allows testing of drives (switched off-line) concurrent with on-line operation of the tape system.

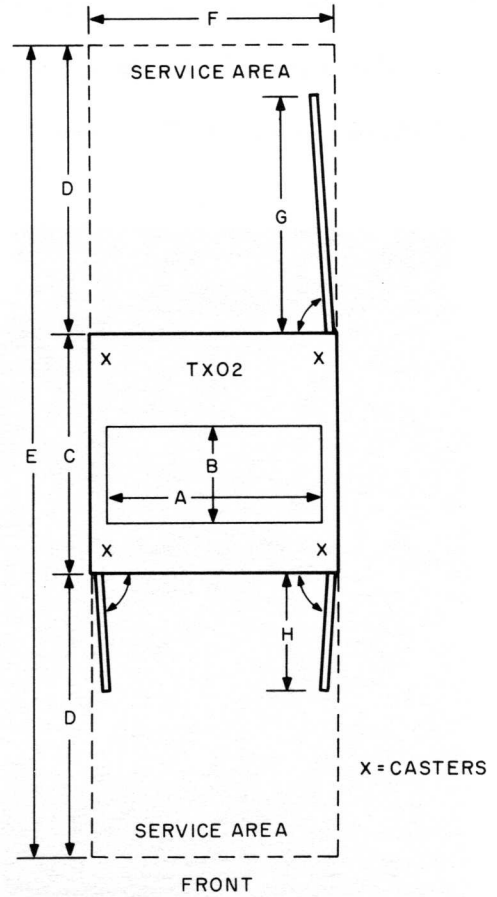
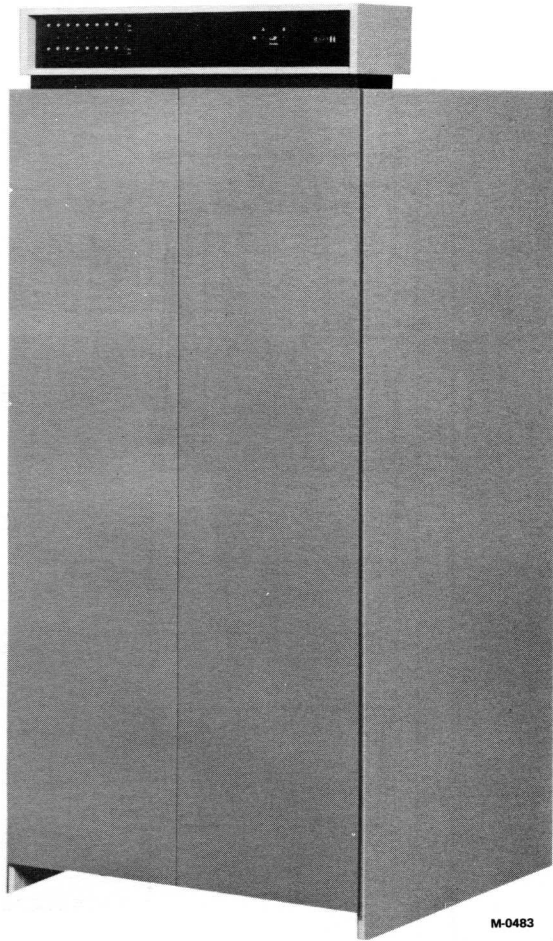

DIMENSIONS	A	B	C	D	E	F	G	H
METERS	0.69	0.30	0.75	0.93	2.59	0.78	0.71	0.37
INCHES	27	12	30	36	102	31	28	15

10-1398

Figure 1-43 TX01 Magnetic Tape Controller

1.29 TX02 MAGNETIC TAPE CONTROLLER

The TX02 Magnetic Tape Controller (Figures 1-44 and 1-45) interfaces one or more TU72 9-track drives and optional TU70 9-track or TU71 7-track drives up to a total of eight to the DX10 Programmable Data Adapter. The TX02 tape controller connects to each drive using radial cables. Power for each drive is supplied from the tape controller which sequences the power to groups of four drives. Two optional switches TX03 and TX05 can be installed in the TX02 controller. The TX03 allows the user to interface two-data channels with up to eight drives. The TX05 allows interface operations between two data channels, two controllers, and up to 16 tape drives.

The TX02-A is used for 60 Hz operation.

The TX02-B is used for 50 Hz operation.

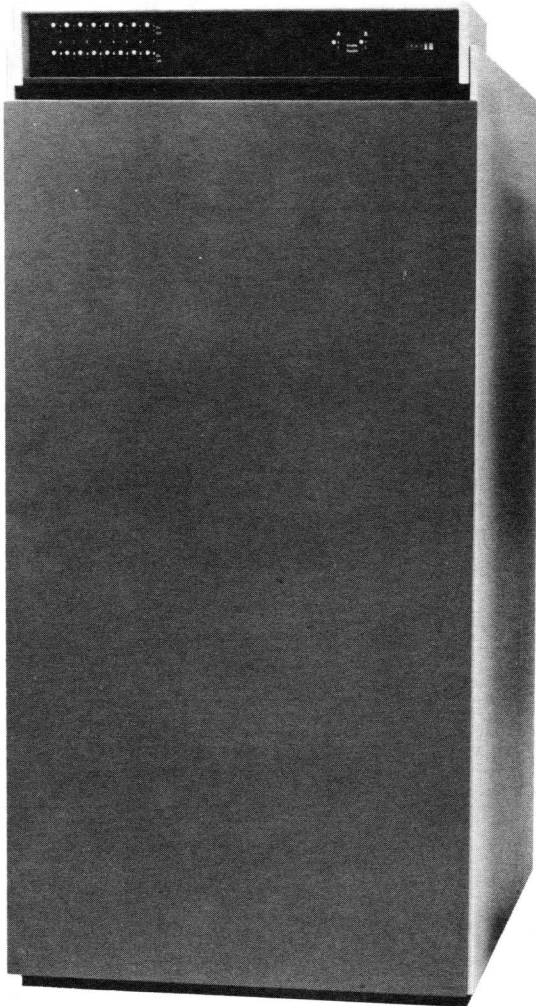

8226-1A

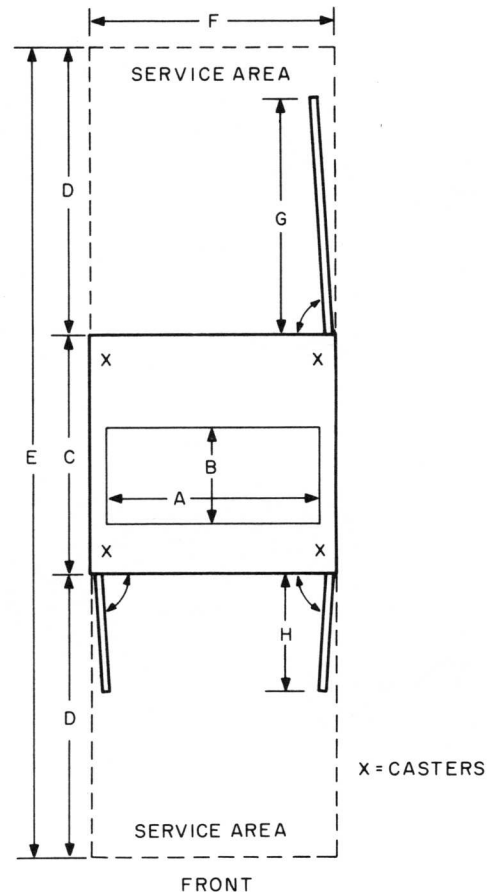

DIMENSIONS	A	B	C	D	E	F	G	H
METERS	0.69	0.30	0.75	0.93	2.59	0.78	0.71	0.37
INCHES	27	12	30	36	102	31	28	15

10-2511

Figure 1-44 TX02 Magnetic Tape Controller

Figure 1-45 TX02 Magnetic Tape Controller Site Plan

1.30 VT50 DECscope VIDEO DISPLAY TERMINAL

The VT50 Video Display Terminal (Figure 1-46) is a serial, asynchronous, alphanumeric keyboard-display unit, with a direct, 20 mA local interface to the DECsystem-10 and an optional EIA/CCITT modem interface. The screen displays up to 960 characters on a display area of 220 mm × 110 mm (8.7 in × 4.3 in). A standard typewriter-layout keyboard generates 64 ASCII upper-case alphanumeric and punctuation characters. Transmission rates are switch-selectable from 75 to 9600 baud, full-duplex, with or without local copy.

Table 1-1 describes VT50 options.

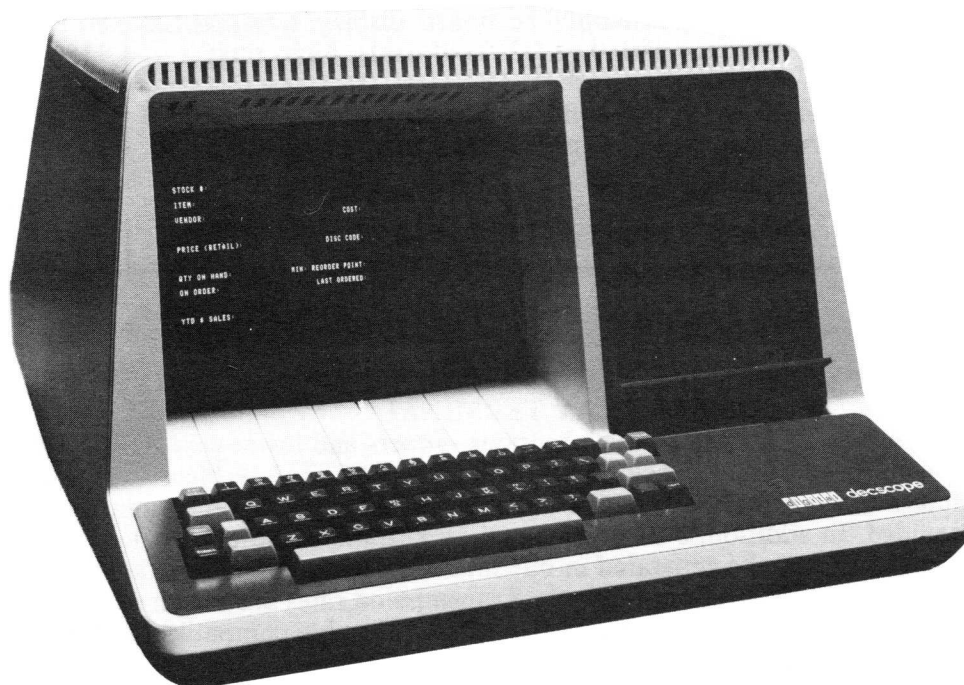

7320-4

Figure 1-46 VT50 DECscope

Table 1-1 VT50 Options

Designation	Description	Frequency/Voltage
VT50-AE	12-line, uppercase-only keyboard display terminal, EIA interface with 7.6 m (25 ft) of cable.	60 Hz 115 Vac
VT50-AF	12-line, uppercase-only keyboard display terminal, EIA interface with 7.6 m (25 ft) of cable.	50/60 Hz 220/240 Vac
VT50-AH	12-line, uppercase-only keyboard display terminal, EIA interface with 7.6 m (25 ft) of cable.	50/60 Hz 100/127 Vac
VT50-CA	12-line uppercase-only keyboard display terminal, 20 mA interface with 4 m (13 ft) of cable, 4-pin plug.	60 Hz 115 Vac
VT50-CB	12-line, uppercase-only keyboard display terminal, 20 mA interface with 4 m (13 ft) of cable, 4-pin plug.	50/60 Hz 220/240 Vac
VT50-CC	12-line, uppercase-only keyboard display terminal, 20 mA interface with 4 m (13 ft) of cable, 4-pin plug.	50/60 Hz 100/127 Vac

1.31 VT52 DECscope VIDEO DISPLAY TERMINAL

The VT52 (Figure 1-47) is a serial, asynchronous, upper- and lower-case ASCII (95 character) video terminal, with either a 20 mA local current loop or EIA (CCITT) interface. The screen displays 24 lines of 80 characters on an area of 210 mm × 105 mm (8.3 in × 4.1 in). A standard typewriter keyboard layout is provided. In addition, a two-way auxiliary keyboard is also provided so that program-compatible numeric codes can be generated in one mode, or escape sequences, as interpreted by the software, can be generated in the alternate mode. Transmission rates are switch selectable from 75 to 9600 baud, full-duplex, with or without local copy. The VT52 is plug compatible and functionally upward-compatible with the VT50.

Table 1-2 describes VT52 options.



7552-2

Figure 1-47 VT52 DECscope

Table 1-2 VT52 Options

Designation	Description	Frequency/Voltage
VT52-AE	24-line, upper/lowercase keyboard display terminal, EIA interface with 7.6 m (25 ft) of cable.	60 Hz 115 Vac
VT52-AF	24-line, upper/lowercase keyboard display terminal, EIA interface with 7.6 m (25 ft) of cable.	50/60 Hz 220/240 Vac
VT52-AH	24-line, upper/lowercase keyboard display terminal, EIA interface with 7.6 m (25 ft) of cable.	50/60 Hz 100/127 Vac
VT52-CA	24-line, upper/lowercase keyboard display terminal, 20 mA interface with 4.0 m (13 ft) of cable, 4-pin plug.	60 Hz 115 Vac
VT52-CB	24-line, upper/lowercase keyboard display terminal, 20 mA interface with 4.0 m (13 ft) of cable, 4-pin plug.	50/60 Hz 220/240 Vac
VT52-CC	24-line upper/lowercase keyboard display terminal, 20 mA interface with 4.0 m (13 ft) of cable, 4-pin plug.	50/60 Hz 100/127 Vac

1.32 XY10-A INCREMENTAL PLOTTER SYSTEM

The XY10-A Incremental Plotter System consists of a XY10-A Incremental Plotter (Figures 1-48 and 1-49) and XY10 Plotter Control. The XY10-A Incremental Plotter is a table-top, high-speed, drum-type pen and ink plotter. The drum or pen carriage is stepped in fixed increments in either a positive or negative direction. The size of the increment (0.01 inch, 0.005 inch, or 0.1 mm) must be specified when ordering the plotter. The plotter operates at a speed of up to 300 steps per second.

The XY10-A Incremental Plotter operates under the control of the XY10 Plotter Control, which may be housed in the BA10 Hard Copy Control or the TD10 DECTape Control.

In 60 Hz systems, ac power is supplied via a standard convenience plug.

In 50 Hz systems, ac power is supplied from the BA10 Hard Copy Control or the TD10 DECTape Control cabinet.

1.33 PHYSICAL CHARACTERISTIC SUMMARIZATION

Table 1-3 summarizes the physical characteristics of all the previously mentioned 1080/1090 system components.

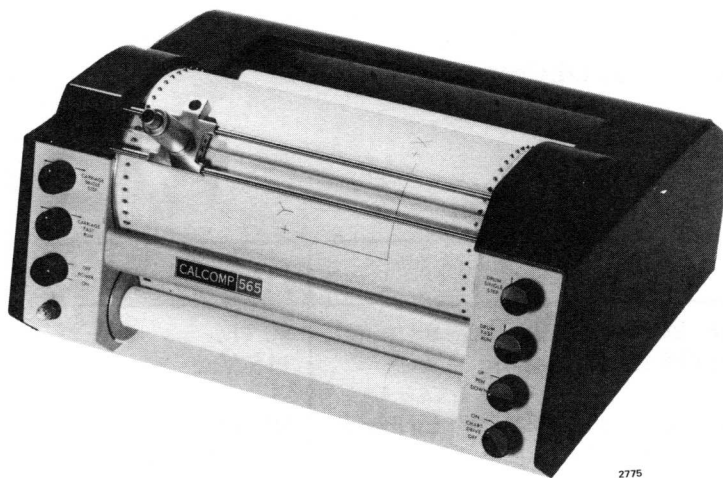
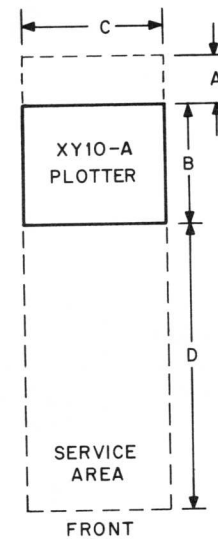

Figure 1-48 XY10-A Incremental Plotter



DIMENSIONS	A	B	C	D
INCHES	6.0	15.0	18.0	36.0
METERS	0.15	0.38	0.46	0.90

10-0460

Figure 1-49 XY10-A Incremental Plotter Site Plan

Table 1-3 1080/1090 System Configuration Summary

Unit	Description	Mechanical				Power			Notes
		Size H x W x D (cm/in)	Includes Cabinet	Weight kg/lb	Environmental	Voltage (See Notes)	Amperes (115 V/Surge)	Power/Heat Dissipation (Watts/Btu per Hr)	Volts Per Phase 115 V 60 Hz 230 V 50 Hz
BA10	Hard Copy Control	783x56x72/72x22x29	X	150/350	DEC Class A	1-phase standard	7/24	800/2700	
CP10-0	Card Punch	127x107x46/50x42x18	X	177/390	DEC Class A	1-phase standard	8.7	1000/3375	
CR10-D	Card Reader	43x61x48/17x24x19	X	45/100	DEC Class B	1-phase standard	4/13	470/1600	
CR10-E	Card Reader	104x61x97/41x24x38	X	140/300	DEC Class B	1-phase standard	4.5/26	550/1900	
CR10-F	Card Reader	33x51x38/13x20x15	X	32/70	DEC Class B	1-phase standard	4/13	470/1600	
DC75- NP	DL10	PDP-10/PDP-11 Interface Channel	X	270/600	DEC Class A	1-phase standard	13.4/ (See Note)	1540/5260	Inrush 400 A peak 10 ms, 100A rms 200 ms
	DS11	Synchronous Modem Interface	X	160/350	DEC Class A	1-phase standard	12.8 (See Note)	1470/4930	Surge: 300A peak 10 ms, 75A rms, 200 ms
	PDP-11	Processor	X (See Note)	180/400	DEC Class A	1-phase standard	12.5/60 (inrush)	1440/4800	PDP-11 Mounted on DS11 cabinet in some units.
DC76	DL10	PDP-10/PDP-11 Interface Channel	X	270/600	DEC Class A	1-phase standard	13.4 (See Note)	1540/5260	Inrush 400A peak 10 ms, 100A rms 200 ms
	DH11	Asynchronous Multiplexor	X	180/400	DEC Class A	1-phase standard	17.5/100 (inrush)	2000/6800	
	PDP-11	Processor	X	180/400	DEC Class A	1-phase standard	12.5/60 (inrush)	1440/4800	
DF10/ DF10C	Data Channel	183x56x72/72x22x29	X	200/450	DEC Class A	1-phase standard	5/12	550/1900	

Table 1-3 1080/1090 System Configuration Summary (Cont)

Unit	Description	Mechanical				Power			Notes
		Size H x W x D (cm/in)	Includes Cabinet	Weight kg/lb	Environmental	Voltage (See Notes)	Amperes (115 V/Surge)	Power/Heat Dissipation (Watts/Btu per Hr)	
DN87	DL10	See DL10 above							
	PDP11/40	Processor	183x56x76/72x22x30	X	180/400	DEC Class A	1-phase standard	18.2/120 (inrush)	3000/10,000
	DN81-EA/EB	Asynchronous Communica- tions Expan- sion Cab	183x56x76/72x22x30	X	180/400	DEC Class A	1-phase standard	17.5/100 (inrush)	2000/6800
	DN81-EE/EF	Synchronous Communica- tions Expan- sion Cab	183x56x76/72x22x30	X	180/400	DEC Class A	1-phase standard	12.8/60 (inrush)	1440/4800
DN87S	PDP-11/40	Front End Processor	183x56x76/72x22x30	X	180/400	DEC Class A	1-phase standard	24.2/200 (inrush)	5360/18,260
	DN81-EA/EB	Asynchronous Communica- tions Expan- sion Cab		Same as DN81-EA/EB above					
	DN81-EE/EF	Synchronous Communica- tions Expan- sion Cab		Same as DN81-EE/EF above					
DX10	Data Channel	72x22x30/183x56x76	X	160/350	DEC Class A	1-phase standard	5/40 (inrush)	600/2000	
KL10A/B	Processor	183x218x80/72x86x32	X 3 Cab	1200/2700	DEC Class A	3-phase standard	55/140 Amps/phase	19,800/68,000	
LA36	DECwriter II Printer	85x67x35/33x27x24	X	46/102	DEC Class B	1-phase standard	3A	300/1100	
LP10F/H	Line Printer	127x123x91/50x48.5x36	X	370/800	DEC Class B	1-phase standard	18/90	2000/6600	

Table 1-3 1080/1090 System Configuration Summary (Cont)

Unit	Description	Mechanical				Power			Notes
		Size H x W x D (cm/in)	Includes Cabinet	Weight kg/lb	Environmental	Voltage (See Notes)	Amperes (115 V/Surge)	Power/Heat Dissipation (Watts/Btu per Hr)	Volts Per Phase 115 V 60 Hz 230 V 50 Hz
LP100 System	LP07	Line Printer Cabinet	117x123x62/46x49x25	X	363/800	DEC Class B	1-phase standard		
	LP100	Line Printer Controller and Data Source Interface	183x56x76/72x22x30	X	91/200	DEC Class B	1-phase standard		
MF10	Core Memory	183x84x76/72x33x30	X	340/740	DEC Class A	1-phase standard	15/35	1800/6000	
MG10	Core Memory	183x84x76/72x33x30	X	350/760	DEC Class A	1-phase standard	18/160 (inrush)	2200/7400	
MH10	Core Memory	183x84x76/72x33x30	X	409/900	DEC Class A	1-phase standard	20/175 (inrush)	2400/8075	
MX10C	Memory Data Multiplexor	27x48x17/10.5x19x6	X	11/25	DEC Class A	1-phase standard	1.5/5 (inrush)	180/620	Normally housed in DF10 cabinet
RHS04	Fixed Head Disk	182x56x76/72x22x30	X	300/650 (See Note)	DEC Class A	1-phase standard	12/20 (See Note)	1200/4100 (See Note)	Figures are for fully extended cabinet. (2 Disks PSR cabinet)
RP04	Disk Pack Drive	100x80x80/39x32x32	X	300/650	DEC Class A	3-phase standard	6/30 @ 208 Vac (Amps per phase)	2100/7000	
RP06	Disk Pack Drive	119x84x81/47x33x32	X	275/600	DEC Class A	3-phase standard	6A/30 @ 208 Vac (Amps per phase)	2100/7000	
TD10C	DECTape Control	183x56x76/72x22x30	X	100/250 (See Note 1.)	DEC Class A	1-phase standard	4A/8A (See Note 2.)	450/1500	1. Weight is without DECTape transports. 2. Current is without DECTape transports Full complement of transports draws 11A @ 120 Vac via the TD10 C.

Table 1-3 1080/1090 System Configuration Summary (Cont)

Unit	Description	Mechanical				Power			Notes
		Size H x W x D (cm/in)	Includes Cabinet	Weight kg/lb	Environmental	Voltage (See Notes)	Amperes (115 V/Surge)	Power/Heat Dissipation (Watts/Btu per Hr)	Volts Per Phase 115 V 60 Hz 230 V 50 Hz
TU70/71	Magnetic Tape Drive	168x78x75/66x31x30	X	480/950	DEC Class A	3-phase (See Note)	6/20 (Amps per phase)	1300/4200	Power from TX01/TX02
TU72	Magnetic Tape Drive	168x78x75/66x31x30	X	400/900	DEC Class A	3-phase (See Note)	6/20 (Amps per phase) 60 A inrush	1800/6100	Power from TX01/TX02
TX01/TX02	Magnetic Tape Con- troller	168x78x75/66x31x30	X	320/700	DEC Class A	3-phase	7.5/40 (inrush) (See Note)	1200/4000	Phases A/B only
VT50/52	Video Display Terminal	36x53x69/114x22x27	X	20/44	DEC Class B	1-phase standard	1A	110/375	
XY10-A	Incremental Plotter	25x46x38/10x18x15	X	15/33	DEC Class A	1-phase small (See Note)	1.5/1.5	170/600	120 V, 50 Hz supplied by BA10 or TD10C for 50 Hz Units

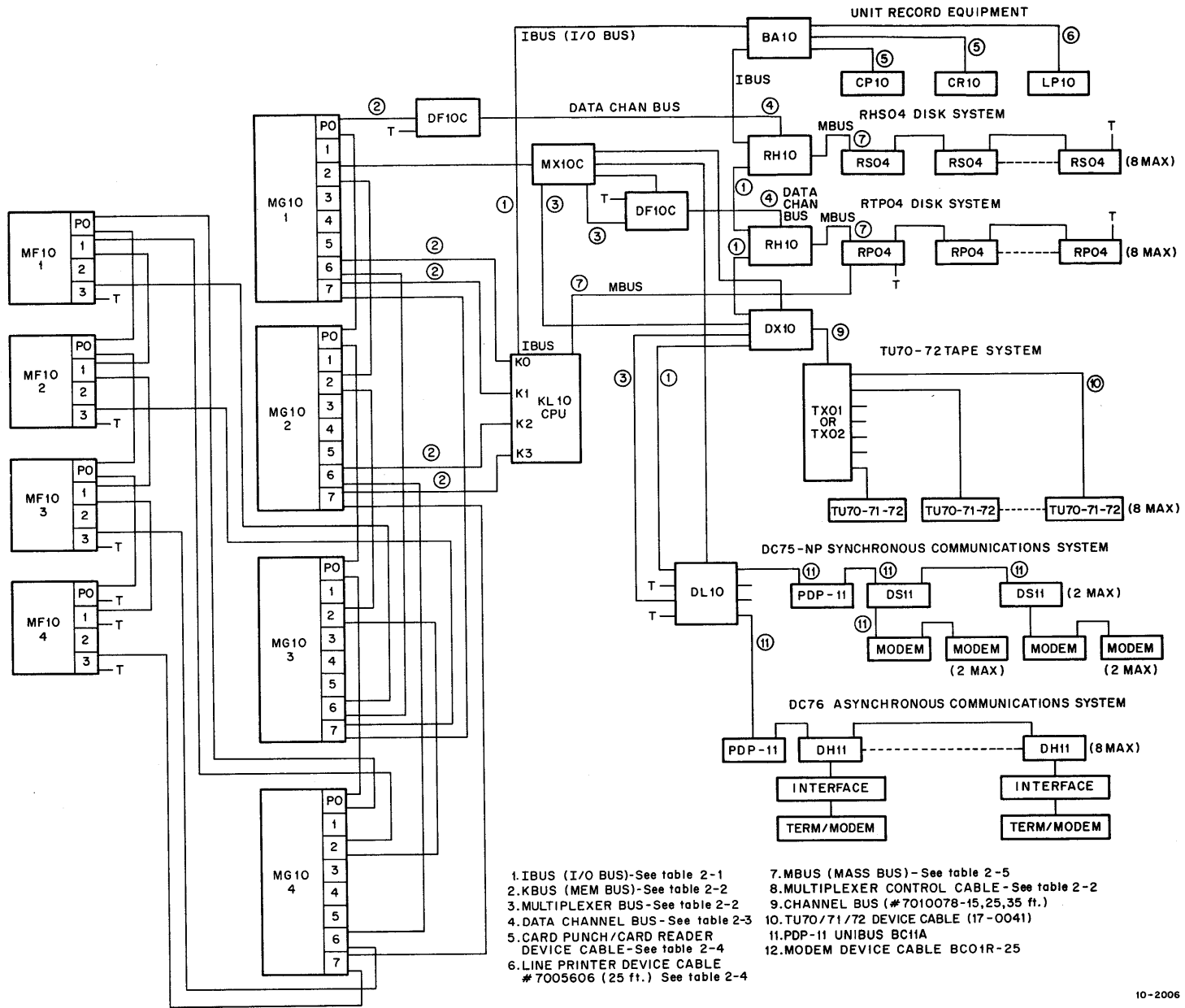
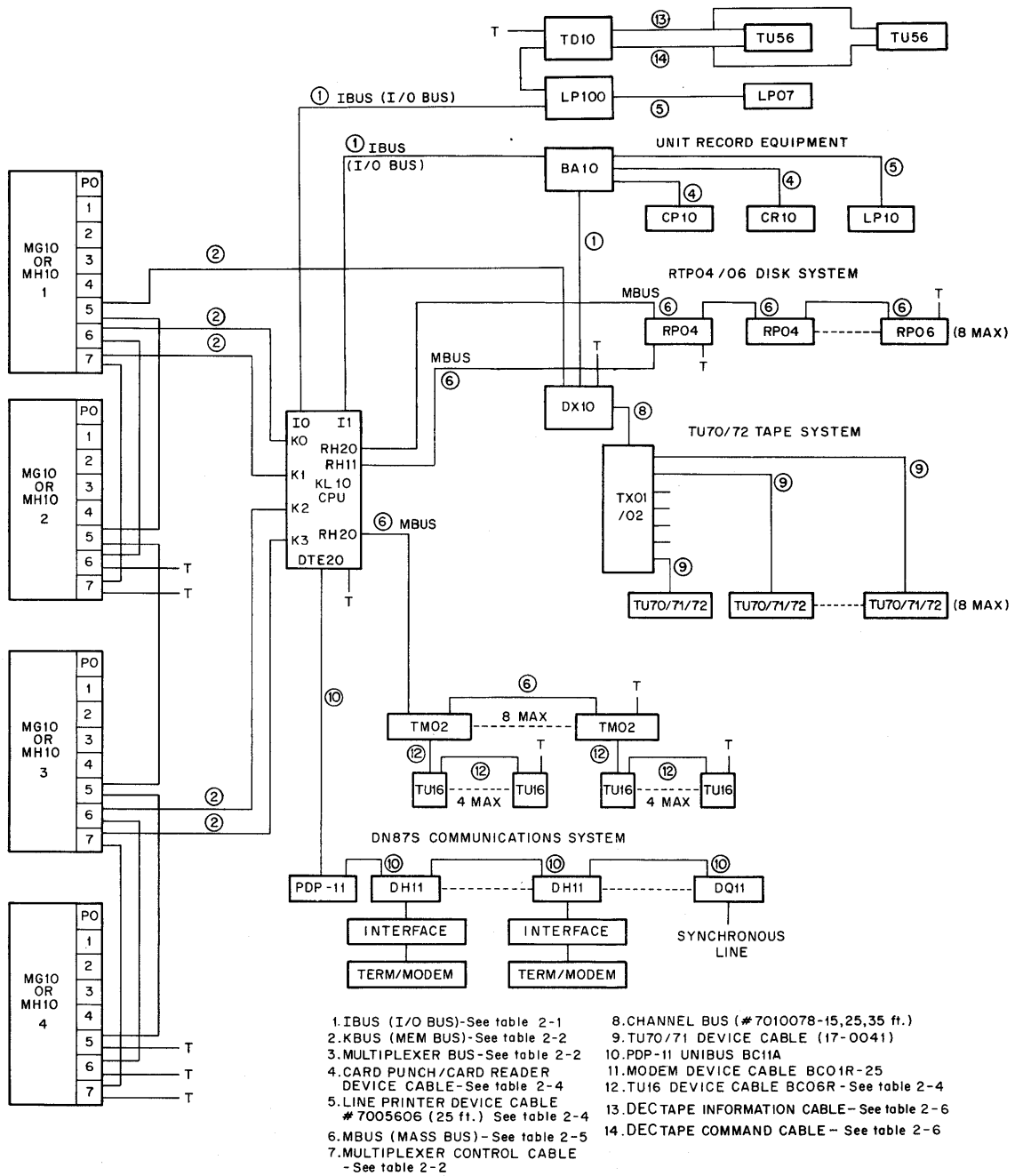

Figure 2-1 Typical 1080 System Configuration



10-2650

Figure 2-2 Typical 1090 System Configuration

Table 2-1 KL10 IBus Cabling

The sum of lengths of cable from the KL10 processor to the farthest device on the IBus must not exceed 30 m (100 ft). Allow 1.5 m (5 ft) per free-standing peripheral cabinet for cable routing inside the cabinet. Unless otherwise noted, any option can be located anywhere along the bus. A terminator is required on each end of the bus.

Option (Note 1)	Cable Conn. Type
BA10	2 × CJ
DL10	2 × CJ
RH10	QL
DX10	QL
KL10	QL
TD10C	2 × CJ
LP100	2 × CJ

Note 1: For information on options not listed, please contact DEC.

IBus Cables

Type	One End Connector	Other End Connector	Standard Lengths								No. Required Per Bus Segment
			ft	5	7	10	15	25	35		
BC10A (Note 4)	CJ	CJ	ft	5	7	10	15	25	35		2
			m	1.5	2.1	3	4.5	7.5	10.5		
BC10H (Note 4)	CJ	CJ	ft	4	5	7	10	15	25	35	2
			m	1.2	1.5	2.1	3	4.5	7.5	10.5	
BC10J	2 × CJ	QL	ft	5	7	10	15	25	35		1
			m	1.5	2.1	3	4.5	7.5	10.5		
BC10K	QL	QL	ft	5	7	10	15	25	35		1
			m	1.5	2.1	3	4.5	7.5	10.5		
BC10D (Note 3)	CJ	4 × W021	ft	5	7	10	15	20	25	35	2
			m	1.5	2.1	3	4.5	6	7.5	10.5	
BC10E (Note 3)	2 × W021	1036	ft	5	7	10	15	25	35		4
			m	1.5	2.1	3	4.5	7.5	10.5		
BC03C (Note 3)	W021	W021	ft	3	5	7	10	15	25	35	8 Flat Coax
			m	0.9	1.5	2.1	3	4.5	7.5	10.5	
7005541 (Note 3)	W021	W021	ft	2	10	15	25	35			8 Round Coax
			m	0.6	3	4.5	7.5	10.5			

Note 2: Not used in a typical 1080/1090 system configuration.

Table 2-1 KL10 IBus Cabling (Cont)

Note 3: Until 1972, BC10A and BC10H cables were constructed by using cable with a relatively high series resistance (identified by a black outer jacket). Later cables were constructed using improved cable (identified by a gray outer jacket). The amount of black cable allowed in KL10 IBus is limited as shown in the following chart. Black and gray cables may be intermixed without regard to order or location along the bus as long as the maximum lengths above are observed. BC10A and BC10H cables can both be used. If these types of cable are required in your 1080/1090 system, BC10H cables are supplied unless otherwise specified. BC10J and BC10K cables are the most commonly used in 1080/1090 system configurations.

Total Length of I/O Bus from Processor to End of Bus	Maximum Amount of Black Cable Allowed	Minimum Amount of Gray Cable Required
less than 50 ft (15m)	entire bus	0 ft (0m)
50 ft (15m)	50 ft (15m)	0 ft (0m)
55 ft (17m)	45 ft (13m)	10 ft (4m)
60 ft (18m)	40 ft (12m)	20 ft (6m)
65 ft (20m)	35 ft (10m)	30 ft (10m)
70 ft (21m)	30 ft (9m)	40 ft (12m)
75 ft (23m)	25 ft (7m)	50 ft (16m)
80 ft (24m)	20 ft (6m)	60 ft (18m)
85 ft (26m)	15 ft (4m)	70 ft (22m)
90 ft (27m)	10 ft (3m)	80 ft (24m)
95 ft (29m)	5 ft (1m)	90 ft (28m)
100 ft (30m)	0 ft (0m)	100 ft (30m)

IBus Terminators (Note 4)

Type	Connector	No. Required Per Bus End
H867	QL	1

Note 4: When a KL10 processor is driving the IBus, a type H867 QL terminator is required.

In order for the RH10 to operate properly on a 1080/1090 System IBus (i.e., provide the automatic interrupt feature, DISPATCH), the IBus cable electrically closest to the KL10 processor must be inserted in the IN slot. The IBus going to the next device controller must be inserted in the OUT slot. This has to be done because these devices intercept the IOB PI GRANT signal. If the device is not requesting an interrupt, then the signal is passed on to the next device.

Table 2-2 1080/1090 KBus (Memory Bus) Cabling and Memory Multiplexor Bus Cabling

The sum lengths of cable from a processor to the farthest memory cabinet must be less than 30 m (100 ft). The MX10C is equivalent to 6 m (10 ft) of cable in any path in which it occurs. The maximum number of memory connections to a memory bus is 16. Each KI10-M is equivalent to the load of two memory bus connections. Thus, the total number of memory connections allowed on a bus is reduced to fourteen (14) if one KI10-M is used, or to twelve (12) if two KI10-Ms are used. Unless otherwise noted, the processor may be located anywhere along the memory bus. A KI10-M is inserted in the KL10 memory bus (or DL10 memory bus when the DL10 is arranged to address 4096K words) between the processor (and ME10 or MF10 memories, if any) and any older memories (e.g., MA10, MB10, MD10) which it serves. The older memories must be located at the end(s) of the memory bus. A terminator is required at each end of the bus except as explained in the notes.

Option (Note 1)	Cable Connector	Option	Cable Connector
DF10	2 × CJ	MD10 (Notes 2 & 3)	2 × CJ
DL10	2 × CJ	ME10 (Notes 2 & 3)	2 × CJ
DX10	QL	MH10	QL
KI10M	QL	MF10	QL
MA10 (Notes 2 & 3)	2 × CJ	MG10	QL
MB10 (Notes 2 & 3)	2 × W021	MX10	2 × CJ (Note 4)

Table 2-2 1080/1090 KBus (Memory Bus) Cabling and Memory Multiplexor Bus Cabling (Cont)

Memory Bus (KBus) Cables

Type	One End Connector	Other End Connector	Standard Lengths								No. Required Per Bus Segment
			ft	3	5	7	10	15	25	35	
BC03C (Note 2)	W021	W021	ft	3	5	7	10	15	25	35	8 Flat Coax
			m	0.9	1.5	2.1	3	4.5	7.5	10.5	
BC10A (2 & 3)	CJ	CJ	ft	5	7	10	15	25	35	2	
			m	1.5	2.1	3	4.5	7.5	10.5		
BC10D (Note 2)	CJ	4 x W021	ft	5	7	10	15	20	25	35	2
			m	1.5	2.1	3	4.5	6	7.5	10.5	
BC10H (Note 2)	CJ	CJ	ft	4	5	7	10	15	25	35	2
			m	1.2	1.5	2.1	3	4.5	7.5	10.5	
BC10J (Note 2)	QL	2 x CJ	ft	5	7	10	15	25	35	1	
			m	1.5	2.1	3	4.5	7.5	10.5		
BC10K	QL	QL	ft	5	7	10	15	25	35	1	
			m	1.5	2.1	3	4.5	7.5	10.5		
BC10M (Note 2)	QL	8 x W021	ft	5	7	10	15	25	35	1	
			m	1.5	2.1	3	4.5	7.5	10.5		
700541 (Note 2)	W021	W021	ft	2	10	15	25	35	8 Round Coax		
			m	0.6	3	4.5	7.5	10.5			

(See notes 1, 2, 3, and 4.)

Multiplexor Control Cable

Option	Cable Connector
MX10	W021
DF10	W021
DL10	W021

Terminators

Type	Connector	No. Required Per Bus End
H866	QL	1
G700	W021	8
G703	½ x CJ	4

Table 2-2 1080/1090 KBus (Memory Bus) Cabling and Memory Multiplexor Bus Cabling (Cont)

Note 1: For information on units not listed please contact DEC.

Note 2: Not used in a typical 1080/1090 system configuration.

Note 3: BC10A cables are allowed only in certain configurations. Add-on older memories are generally shipped with BC10H cables. The chart below shows when BC10A cables are allowed and where BC10H cables are required. ME10s must always be interconnected with BC10H cables. A BC10A cable must not be used between an ME10 and another memory. The ME10s and MF10s should be contiguous and located at one end of the bus. For situations not shown, please consult DEC.

Total Number of ME10s and MF10s on the Bus

	0	1	2	3	4	5	6	7	8	9	10	11	12	13	14	15	16
Total Number of 164s	0	1	2	3	4	5	6	7	8	9	10	11	12	13	14	15	16
MA10s	A	A	A	A	A	A	A	H	H	H	H	H	H	H	H	H	H
MB10s	A	A	A	A	A	A	A	H	H	H	H	H	H	H	H	H	H
MD10s	A	A	A	A	A	A	A	H	H	H	H	H	H	H	H	H	H
ME10s	A	A	A	A	A	A	A	H	H	H	H	H	H	H	H	H	H
MF10s	A	A	A	A	A	A	A	H	H	H	H	H	H	H	H	H	H
	9	10	11	12	13	14	15	16									
	H	H	H	H	H	H	H	H	H	H	H	H	H	H	H	H	H
	H	H	H	H	H	H	H	H	H	H	H	H	H	H	H	H	H
	H	H	H	H	H	H	H	H	H	H	H	H	H	H	H	H	H
	H	H	H	H	H	H	H	H	H	H	H	H	H	H	H	H	H
	H	H	H	H	H	H	H	H	H	H	H	H	H	H	H	H	H
	H	H	H	H	H	H	H	H	H	H	H	H	H	H	H	H	H
	H	H	H	H	H	H	H	H	H	H	H	H	H	H	H	H	H
	H	H	H	H	H	H	H	H	H	H	H	H	H	H	H	H	H
	H	H	H	H	H	H	H	H	H	H	H	H	H	H	H	H	H

Legend
 A = BC10A may be used as well as other cables in list.
 H = BC10A must not be used. BC10H is required for CJ to CJ cables.

Note 4: The MX10 has two memory bus connections, each consisting of 2 x CJ per connection for connecting to memories. Two multiplexor bus memory interface connections (each consisting of 2 x CJ per connection) connect to the devices on the multiplexor bus.

Table 2-3 Channel Bus Cabling

The sum of lengths of cable from the DF10 to the farthest channel device must be less than 30 m (100 ft). Allow 1.5 m (5 ft) per free-standing channel device cabinet for cabling routing inside the cabinet. The maximum number of channel device connections to the channel bus is 16.

Option	Cable Connector
DF10 (Note 1)	2 × CJ
RH10	QL

Channel Bus Data Cables

Type	One End Connector	Other End Connector	Standard Lengths								No. Required Per Bus Segment
			ft	5	7	10	15	25	35		
BC10A (Note 2)	CJ	CJ	ft	5	7	10	15	25	35		1
			m	1.5	2.1	3	4.5	7.5	10.5		
BC10H	CJ	CJ	ft	4	5	7	10	15	25	35	1
			m	1.2	1.5	2.1	3	4.5	7.5	10.5	
BC10J	QL	2 × CJ	ft	5	7	10	15	25	35		1
			m	1.5	2.1	3	4.5	7.5	10.5		
BC10K	QL	QL	ft	5	7	10	15	25	35		1
			m	1.5	2.1	3	4.5	7.5	10.5		

Table 2-4 Device Cables

Option	To	One Connector	Other End Connector	Cable Type	Standard Lengths
CP10-D CR10D,E,F LA36	BA10 BA10 KL10-A/B Console Processor (DL11-C)	Logic Interface Card CJ 4 Prong Phono Plug	Amp Mate-N-Lok	7010553 7008594 LAXX-LK	7.6 m (25 ft) 7.6 m (25 ft) 3 m (9 ft) 7.6 m (25 ft)
LP10-F,H LP100	BA10 LP07	CJ AMP Zero Insertion Force	11S-114P Winchester	7005606 7011426	7.6 m (25 ft) 7.6 m (25 ft)
VT50-A	Communications Option	DB25-P	BN50 Logic Interface Card (EIA)	BN50-A	7.6 m (25 ft)
VT50-C	Communications Option	283B Plug	(20 mA) Logic Interface Card	BN50-C	4 m (13 ft) 7.6 m (25 ft)
VT52-A	Communications Option	DB25-P	BN52 Logic Interface Card (EIA)	BN52-A	7.6 m (25 ft)
VT52-C	Communications Option	283B Plug	(20 mA) Logic Interface Card	BN52-C	4 m (13 ft) 7.6 m (25 ft)
XY10-A TM02 TU16	BA10 TU16 TU16	W02B Berg Berg	SK19 Berg Berg	7005564 BC06R* BC06R	7.6 m (25 ft) 1 m (3 ft) 1.8 m (6 ft)

*Cabled Internally

Table 2-5 Massbus Cabling

From	To	Cable	Available Length	
			Meters	Feet
Central Processor (RH11)	RP04	BC06S	4.5	15
			7.5	25*
			12.0	40
Central Processor (RH20)	RP04/6	BC06S	4.5	15
			7.5	25*
			12.0	40
RP04/6 (See note)	RP04/6	BC06S	0.6/0.75	2/2.5*
			3.0	10
Central Processor (RH20)	TM02	BC06S	4.5	15
			7.5	25*
			12.0	40

*Denotes standard lengths that will be automatically provided if no cable information is provided 60 days prior to scheduled shipment.

NOTE

If Massbus drives are placed in such a way that the supplied standard cables cannot be used because they are too short, cables having the desired length must be ordered. After determining the required cable length, apply the following formula to ensure that the Massbus specification is not violated.

$$15 \leq L \leq 160 - (9TM \text{ or } 12.5 RP)$$

where:

- L = Maximum length in feet
- TM = Number of TM02s on the RH20
- RP = Number of RP04/RP06s on the RH20

Note that eight disk pack drives of any type can be configured at the end of a 12 m (40 ft) controller-to-drive cable. RP04s use a 0.6 m (2 ft) drive-to-drive cable and RP06s use a 0.75 m (2.5 ft) drive-to-drive cable.

Table 2-6 DECTape Transport Bus

The sum of lengths of cable from the TD10 Controller to the farthest transport on the bus is limited to 9 m (30 ft). The TD10 Controller must be on one end of the bus. A minimum of 0.9 m (3 ft) is required between transports.

Option (Note 1)	Control Signal Connector	Data Signal Connector
TD10 type	W023	W032
TU55	W023	W032
TU56	M908	W032

Type	One End Connector	Other End Connector	Standard Lengths								No. Required Per Bus Segment
			ft	3	5	7	10	15	25		
BC02X	M908	M908	m	0.9	1.5	2.1	3	4.5	7.5		1
			ft	3	5	7	10	15	25		
7006223	M908	W023	m	1.5							1
			ft	5							
7405151 (BC02S)	W023	W023	m	0.4	0.9	1.5	4.0				1
			ft	1.5	3	5	13				

Type	One End Connector	Other End Connector	Standard Lengths				No. Required Per Bus Segment
			ft	3	5	13	
7405152	W032	W032	m	0.9	1.5	4.0	1
			ft	3	5	13	

NOTE

For information on units not listed please contact DEC.

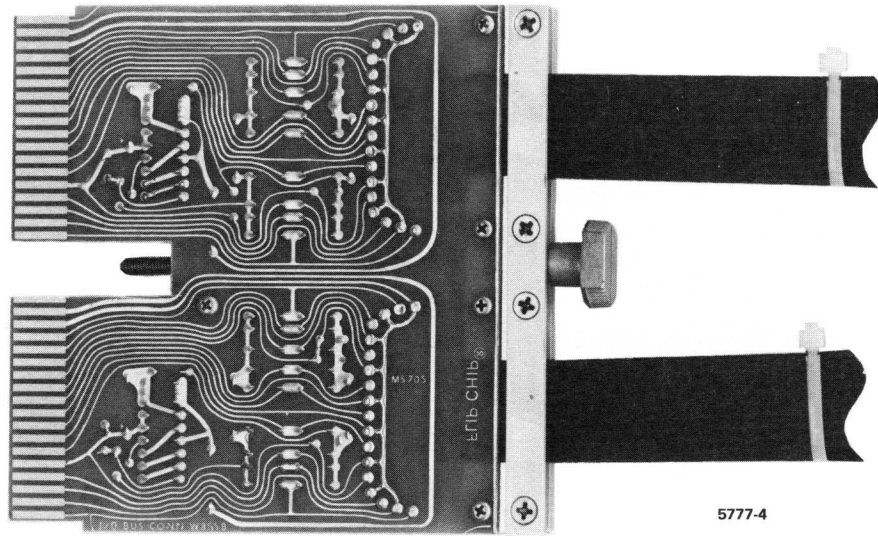

Figure 2-3 CJ-Type Cable Connector



Figure 2-4 MB-Type Cable Connector

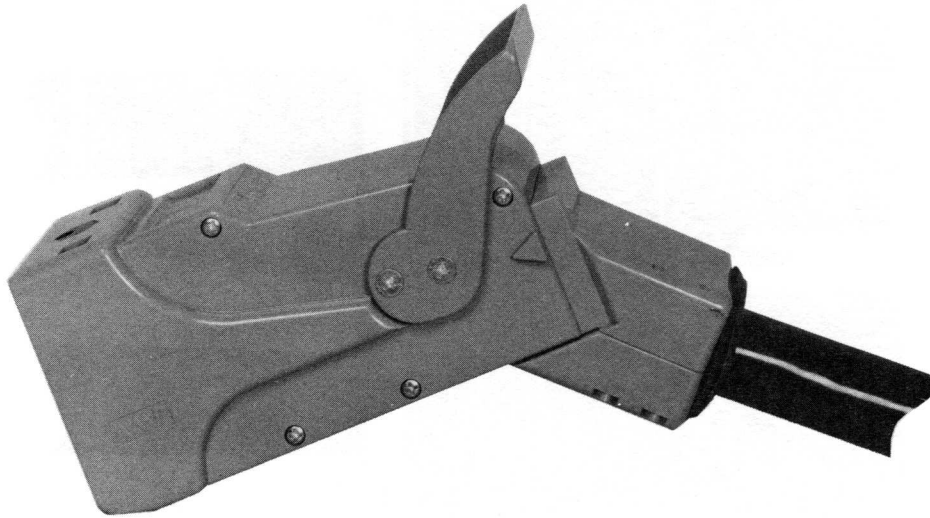

Figure 2-5 QL-Type Cable Connector

A system involving a digital/analog interface usually requires that the digital system ground be tied to the analog system ground at a single point, often at the analog/digital interface. A good ground connection is usually required in these cases. In small systems where no analog interface is involved, the grounding provided by a large electrical conduit may be adequate, although electrical conduit systems often are connected together poorly in terms of a low resistance path to ground. In large systems, additional connections to earth ground may also be advisable. All of these ground connections are in addition to (not in place of) the ground leads carried through the various signal buses (memory, I/O, multiplexor, and channel buses) and the ground conductors contained in the power cables. The green grounding wire in the power cable must also be returned to ground, usually through the conduit of the electrical distribution system.

When two cabinets are bolted together, they should be electrically bonded by connecting the two cabinets by means of a No. 4 AWG conductor or several copper mesh straps.

Auxiliary units such as the line printer and card reader should be grounded to their associated control cabinets with No. 4 AWG (0.20 in, 5 mm) copper wire.

In general, ground conductors should follow the path of the data buses through the system (i.e., in parallel with the memory buses, the I/O bus, the channel bus, etc.).

SECTION 3

KL10-A/B ARITHMETIC PROCESSOR COMPONENTS (1080/1090)

3.1 INTRODUCTION

The KL10-A/B Arithmetic Processor (Figures 3-1, 3-2, 3-3) comprises two H955 cabinets and one H956 cabinet, all bolted together to form one unit. (Overall dimensions are given in Figure 1-18.) The three cabinets are individually numbered 1 – 3 (left to right in Figure 3-1) and are named as follows.

1. I/O cabinet (Cabinet No. 1 – H955)
2. CPU cabinet (Cabinet No. 2 – H955)
3. Console Processor cabinet (Cabinet No. 3 – H956)

The major components in the three cabinets for both the KL10-A and KL10-B are noted in Figures 3-2 through 3-5. A component description for each cabinet follows.

3.2 I/O CABINET

The I/O cabinet contains the following major components. (Refer to Figures 3-6 through 3-14.)

1. Bay 1 Logic (TTL) (KL10-A and KL10-B). Backpanel, wiring, connectors, and modules for the DMA20 Memory Bus Adapter and the DIA20 IBus Adapter. (Refer to Figure 3-26 for Bay 1 module and connector utilization.) The DMA20 interfaces system memory (MG10, MF10, etc.) to the KL10s internal storage bus (SBus). The DIA20 interfaces devices on the IBus to the KL10s internal I/O Bus (EBus).
2. KL10-A BaY 2 Logic (TTL). Backpanel, wiring, connectors and modules for the DTE20 Console Processor Interface. (Refer to Figure 3-25 for Bay 2 module and connector utilization.) The DTE20 is the interface between the Console Processor and the KL10-A CPU.
3. KL10-B Bay 2 Logic (TTL). Backpanel, wiring, connectors and modules for the DTE20 Console Processor Interfaces (maximum of four) and RH20 Massbus Controllers. (Refer to Figure 3-26 for Bay 2 module and connector utilization.)
4. KL10-B H7420 Power Supply (No. 1) (refer to Figure 3-32). Supplier +5 V to RH20 Massbus Controller Logic Assembly.
5. KL10A/B H7420 Power Supply (No. 2). Supplies +5 V to Bay 2 Logic and Bay 4 Logic (in CPU cabinet).
6. KL10A/B H7420 Power Supply (No. 1). Supplies +5 V, -5 V, and -15 V to Bay 1 Logic, -5 V to Bay 2 Logic, and +15 V to the Air Flow Sensors.

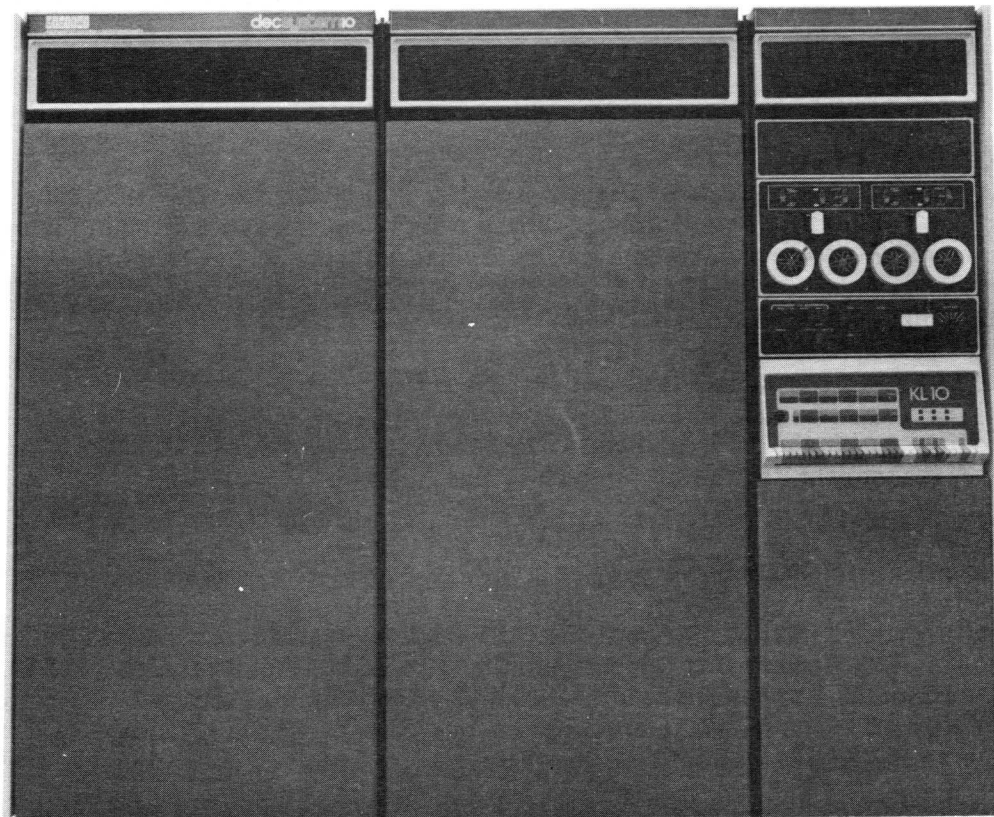

Figure 3-1 KL10-A/B Arithmetic Processor (Front)

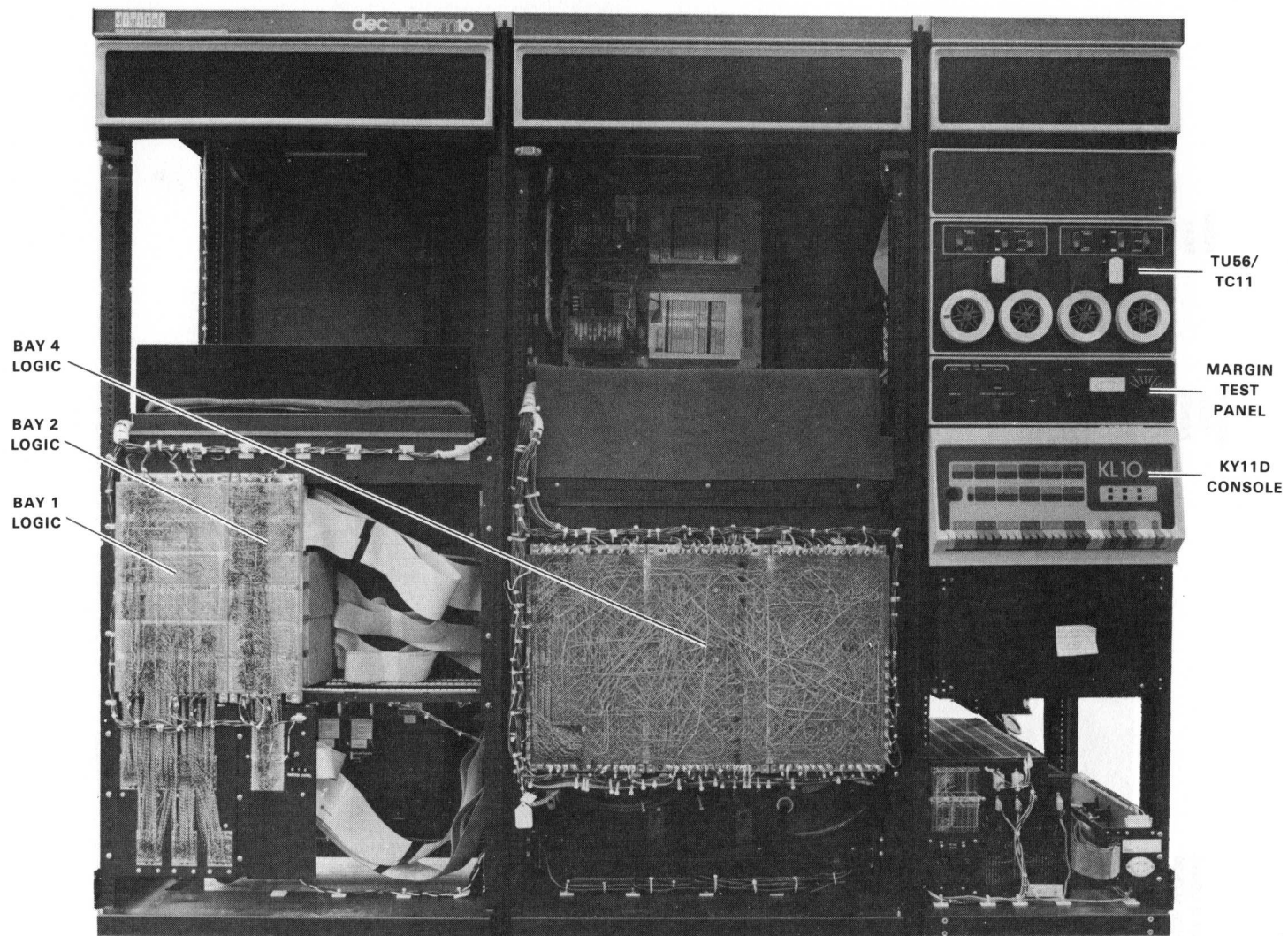

Figure 3-2 KL10-A/1, Panels Removed (Front)

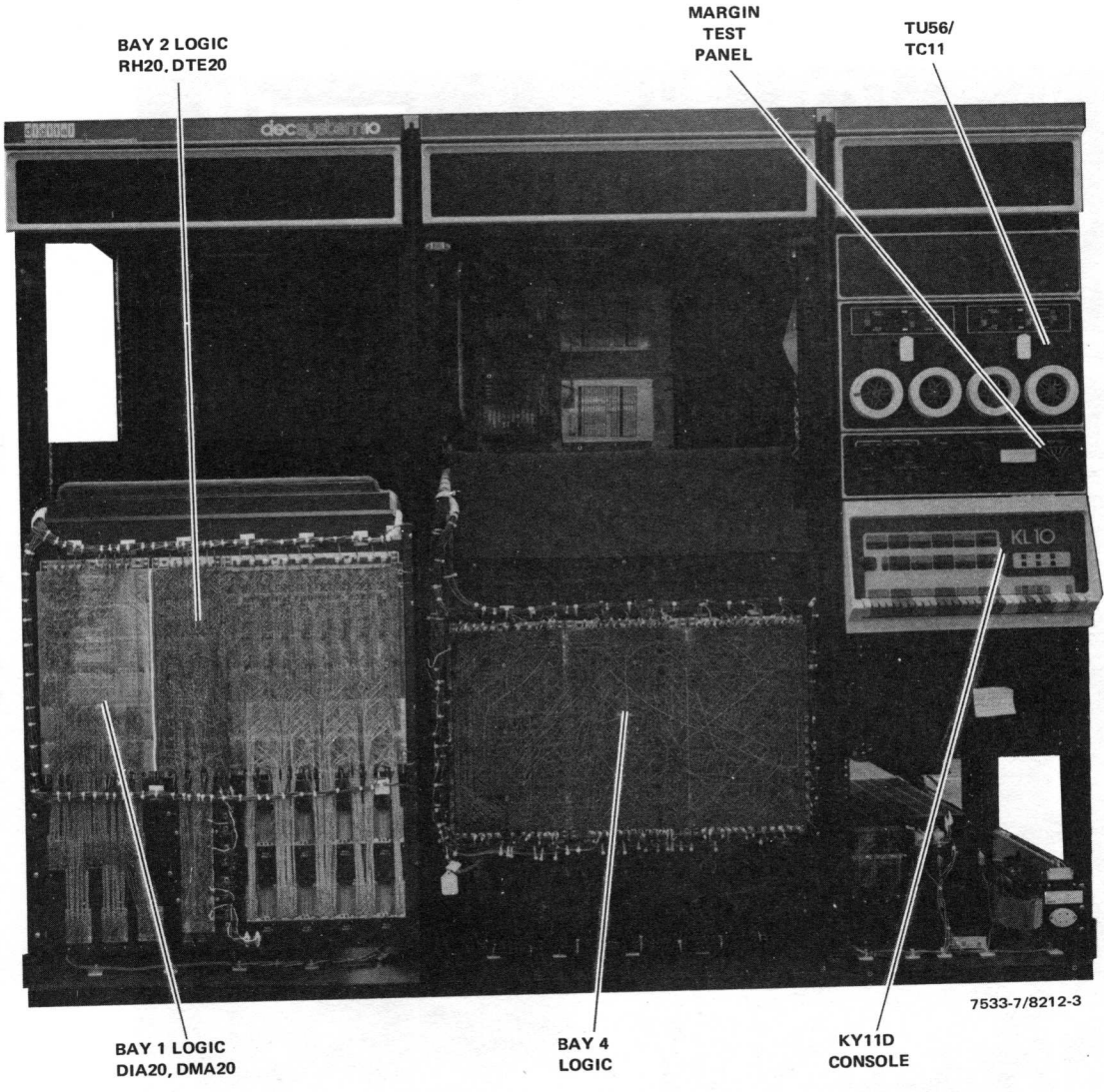

Figure 3-3 KL10-B, Panels Removed (Front)

1090

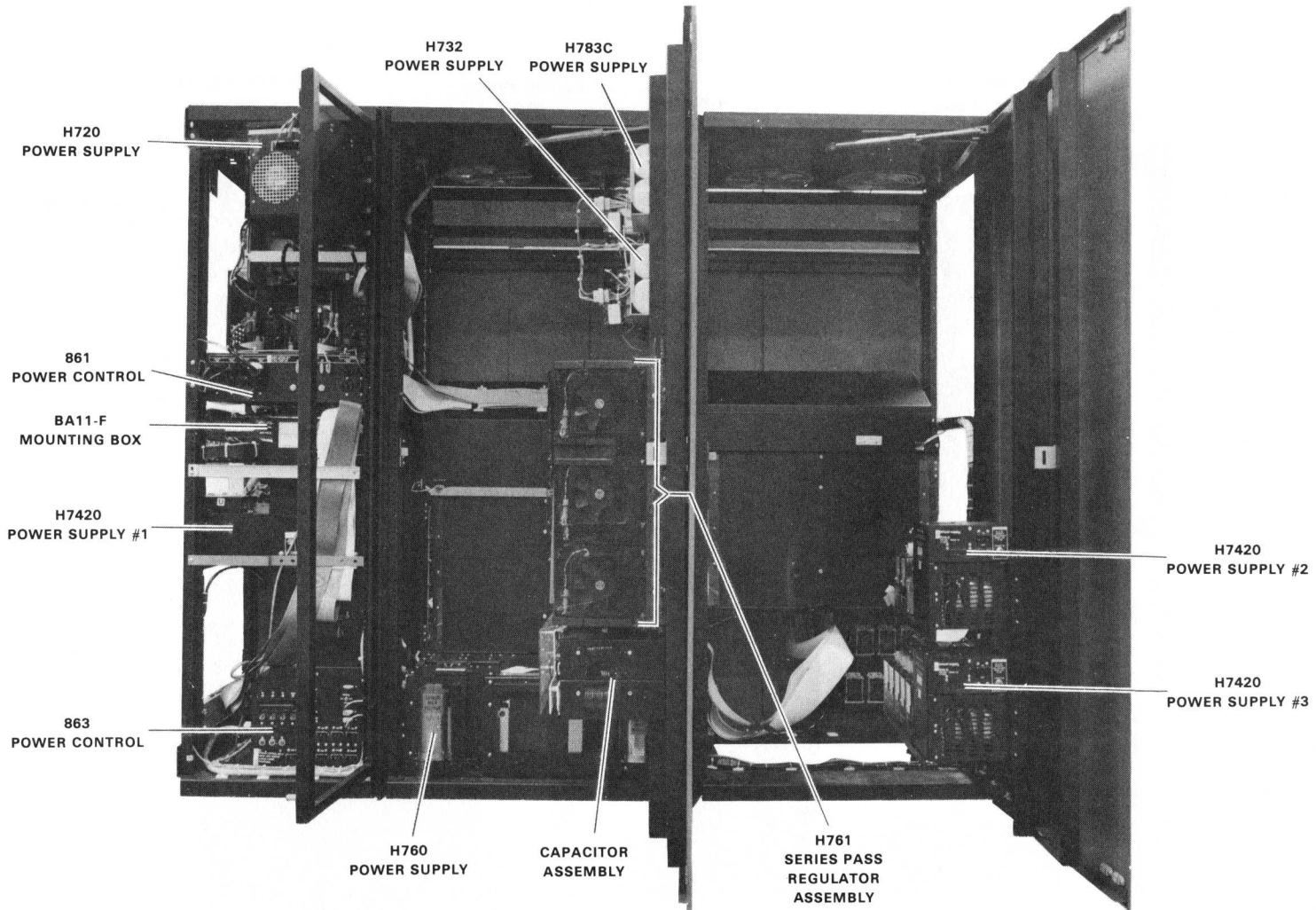

Figure 3-4 KL10-A, Panels Removed (Rear)

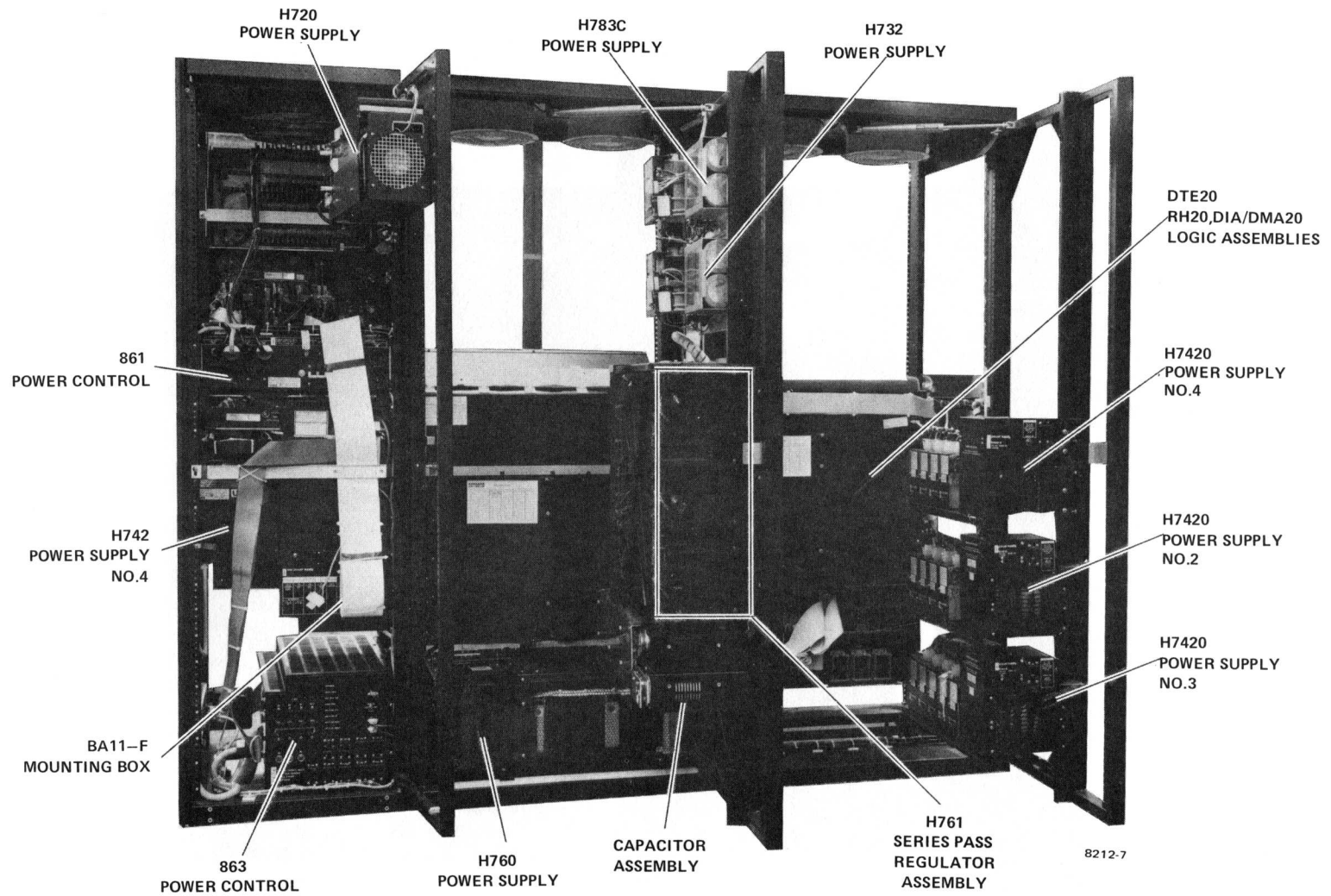
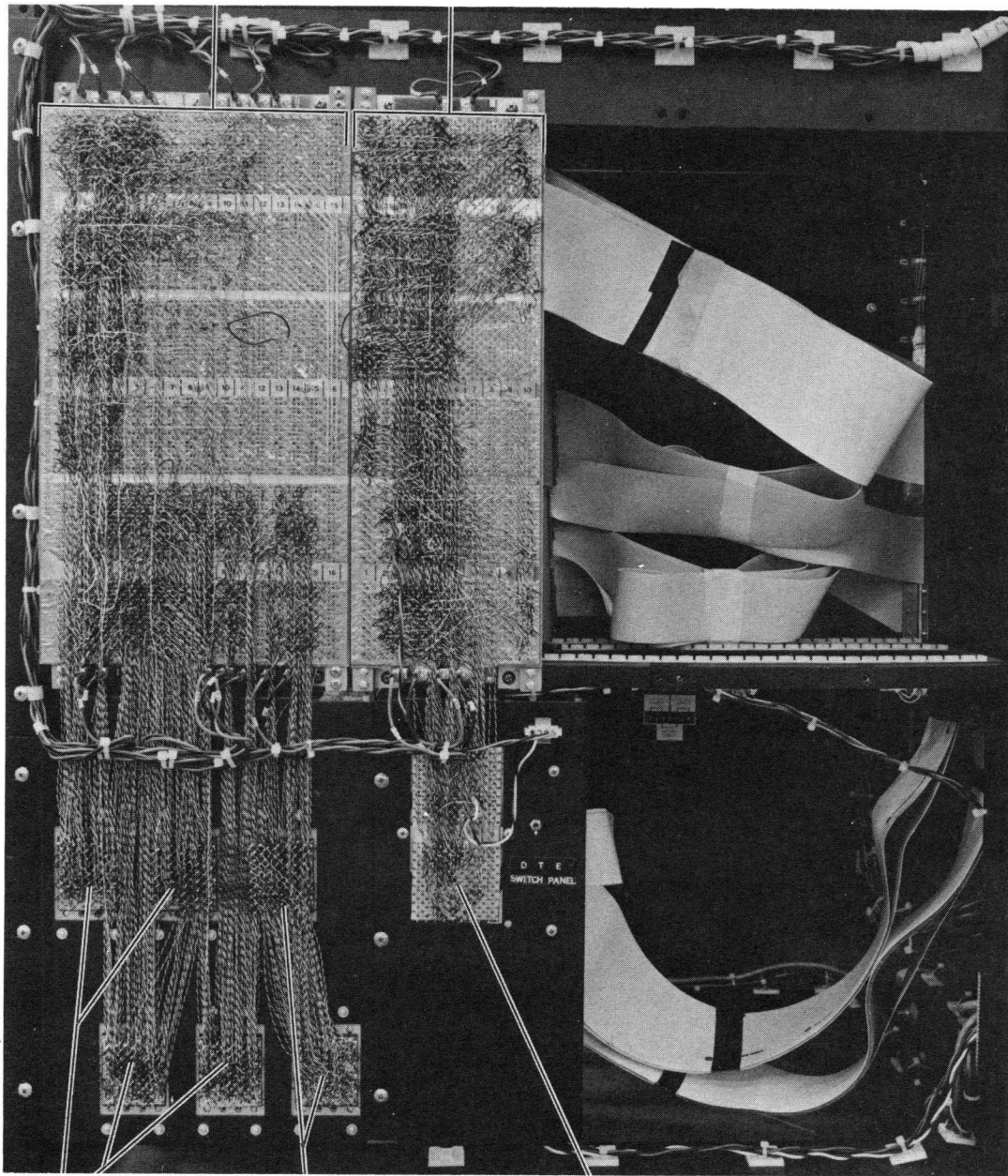

Figure 3-5 KL10-B, Panels Removed (Rear)

BAY 1 LOGIC
BACKPLANE

BAY 2 LOGIC
BACKPLANE



KBUS
CONNECTORS

IBUS
CONNECTORS

UNIBUS
CONNECTOR
BLOCK

7533-6

Figure 3-6 Bay 1 and Bay 2 Logic (KL10-A)

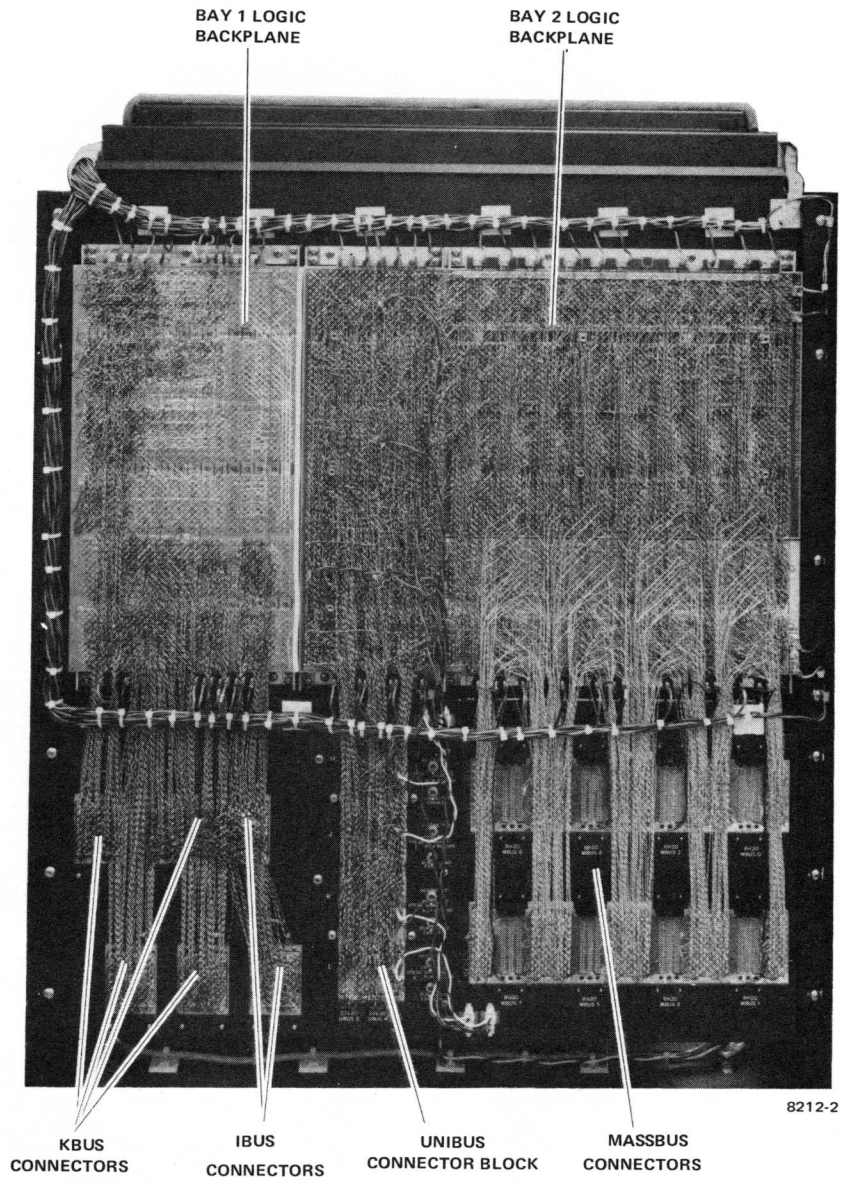
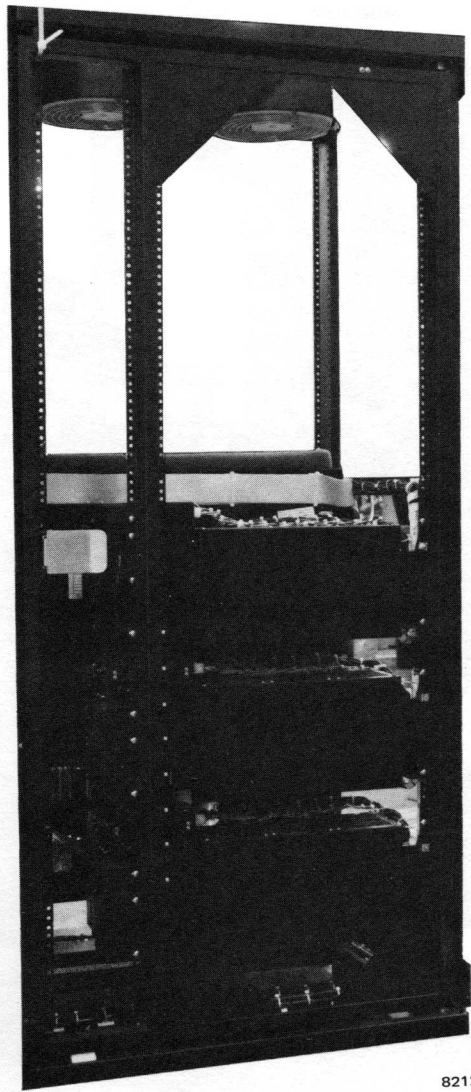
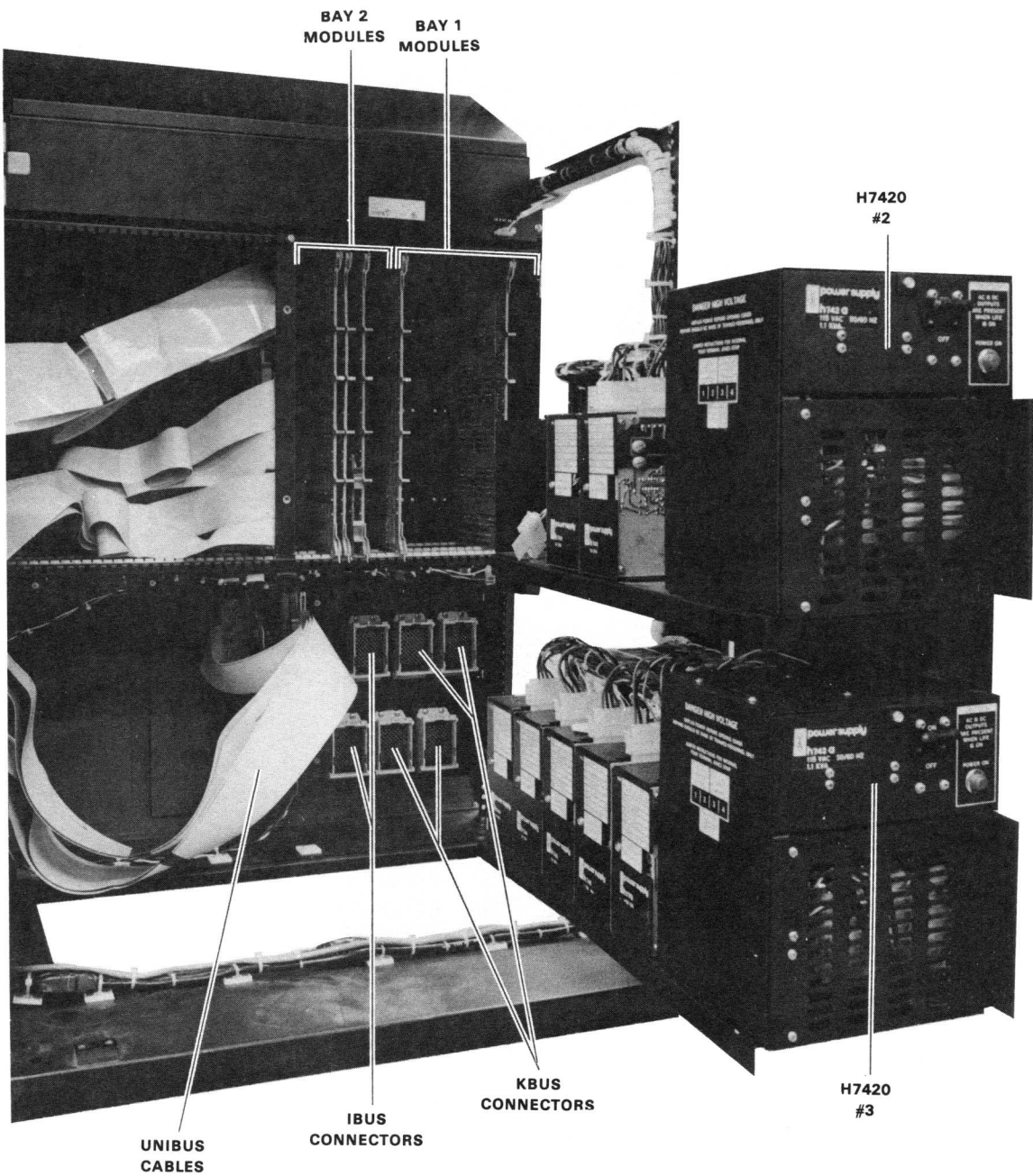

Figure 3-7 Bay 1 and Bay 2 Logic (KL10-B)



8212-1

Figure 3-8 I/O Cabinet – Door Closed Rear View (KL10-B)



7533-21

Figure 3-9 I/O Cabinet – Rear View (KL10-A)

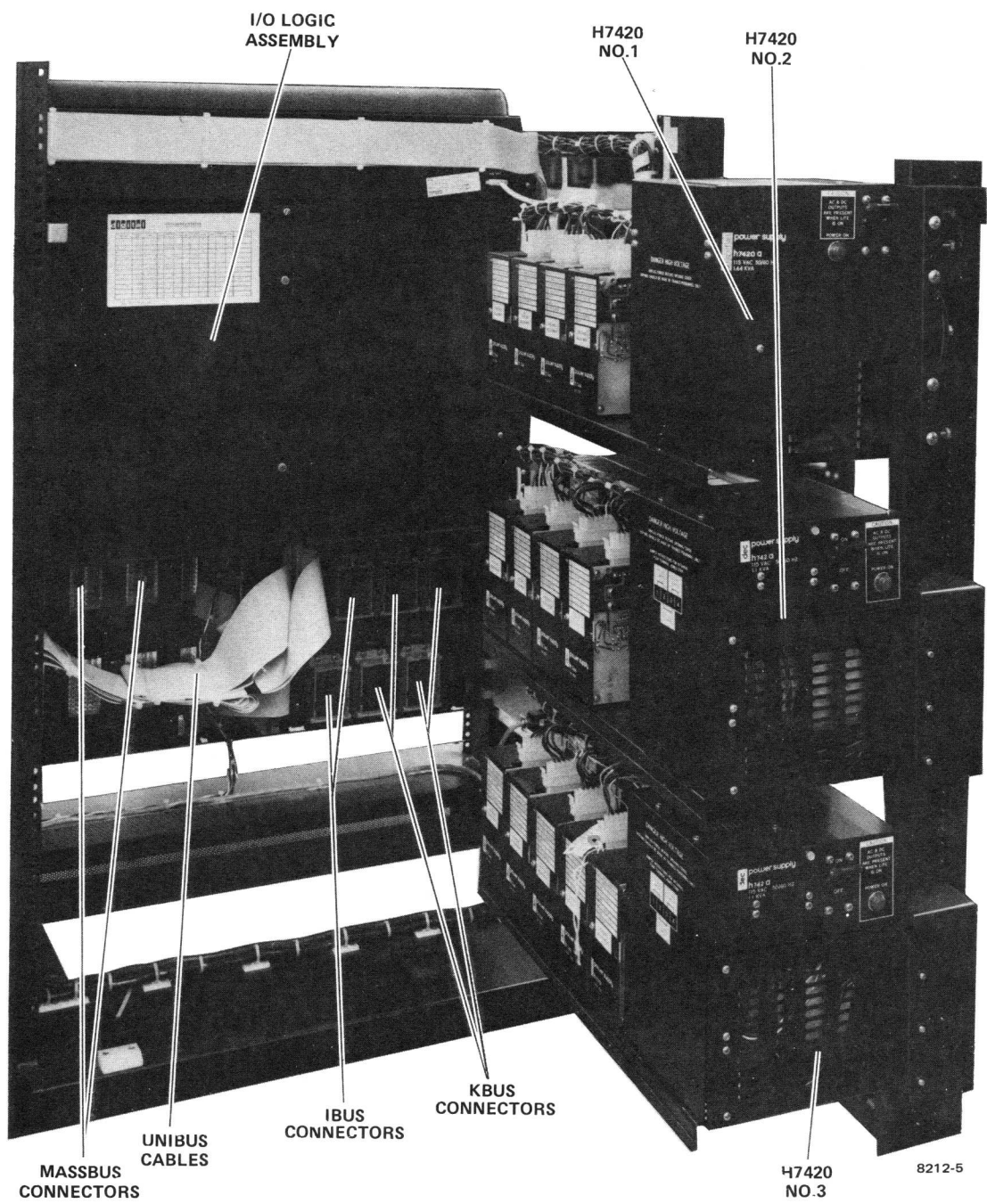
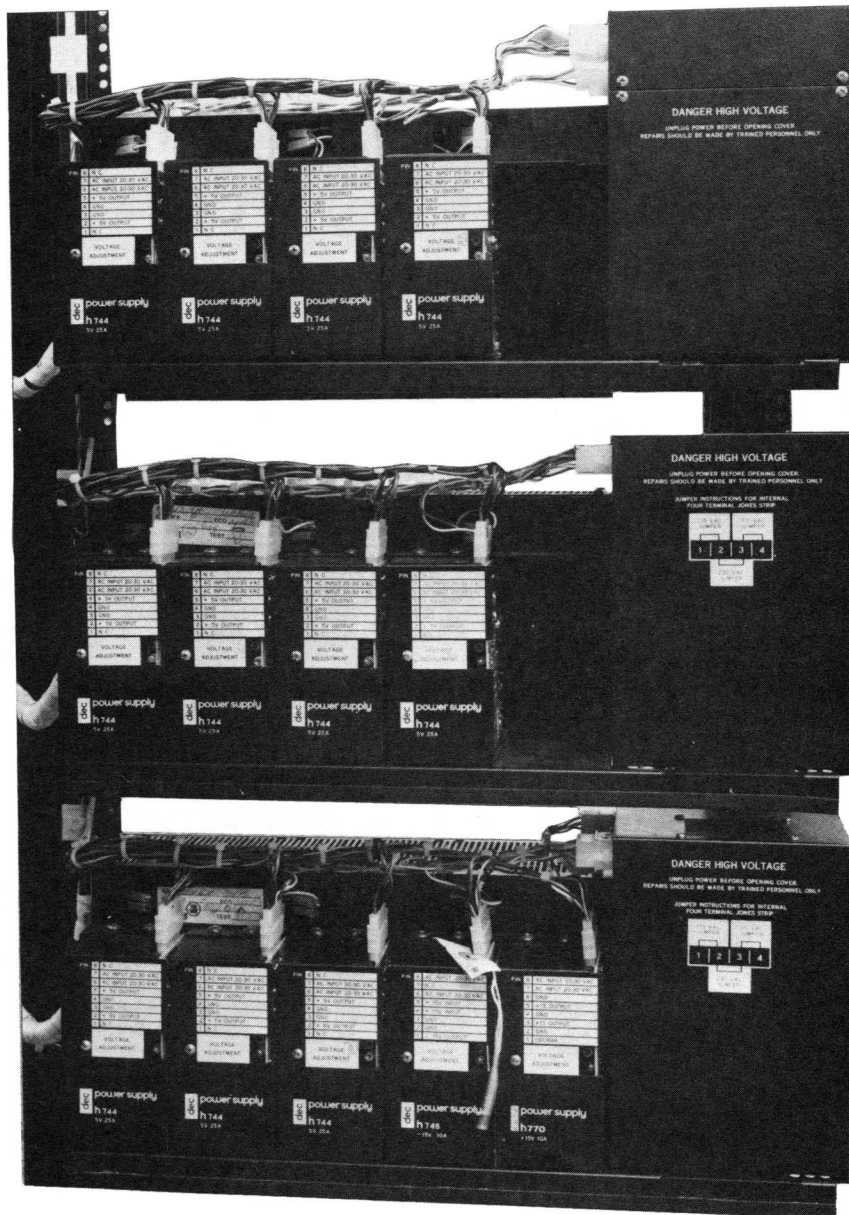
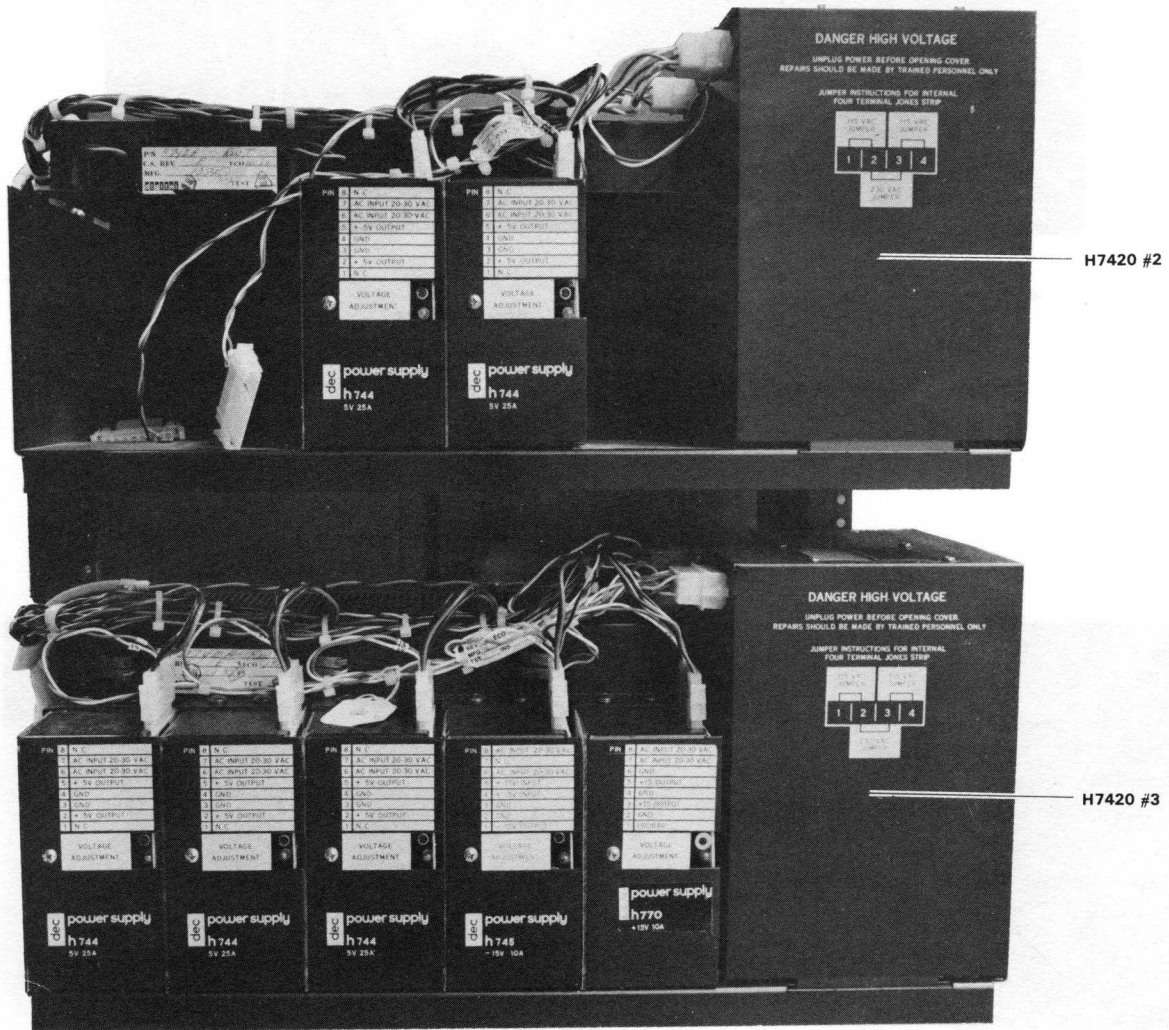

Figure 3-10 I/O Cabinet – Rear View (KL10-B)



8212-8

Figure 3-11 H7420 Power Supply No. 1, 2, 3 (KL10-B)



7533-24

Figure 3-12 H7420 Power Supplies Nos. 2 and 3

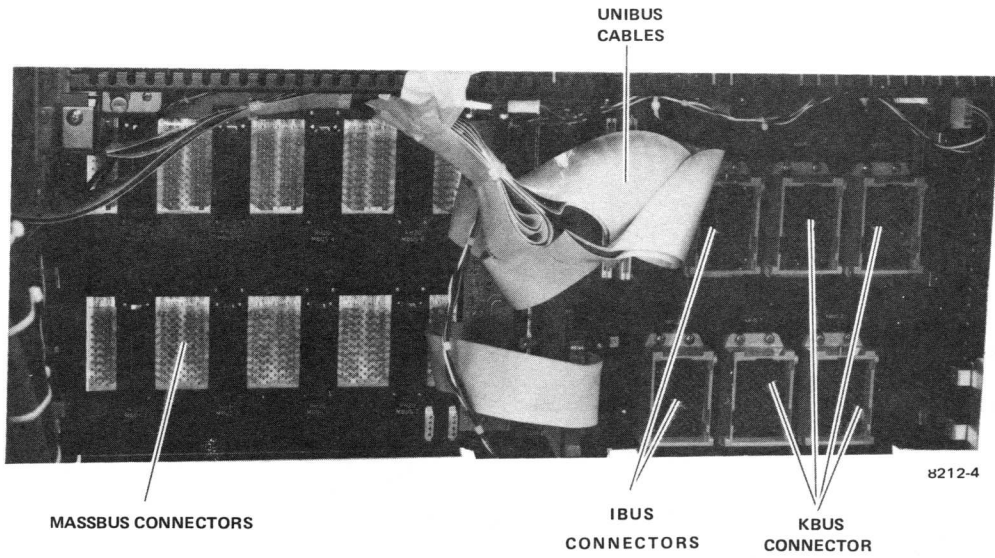
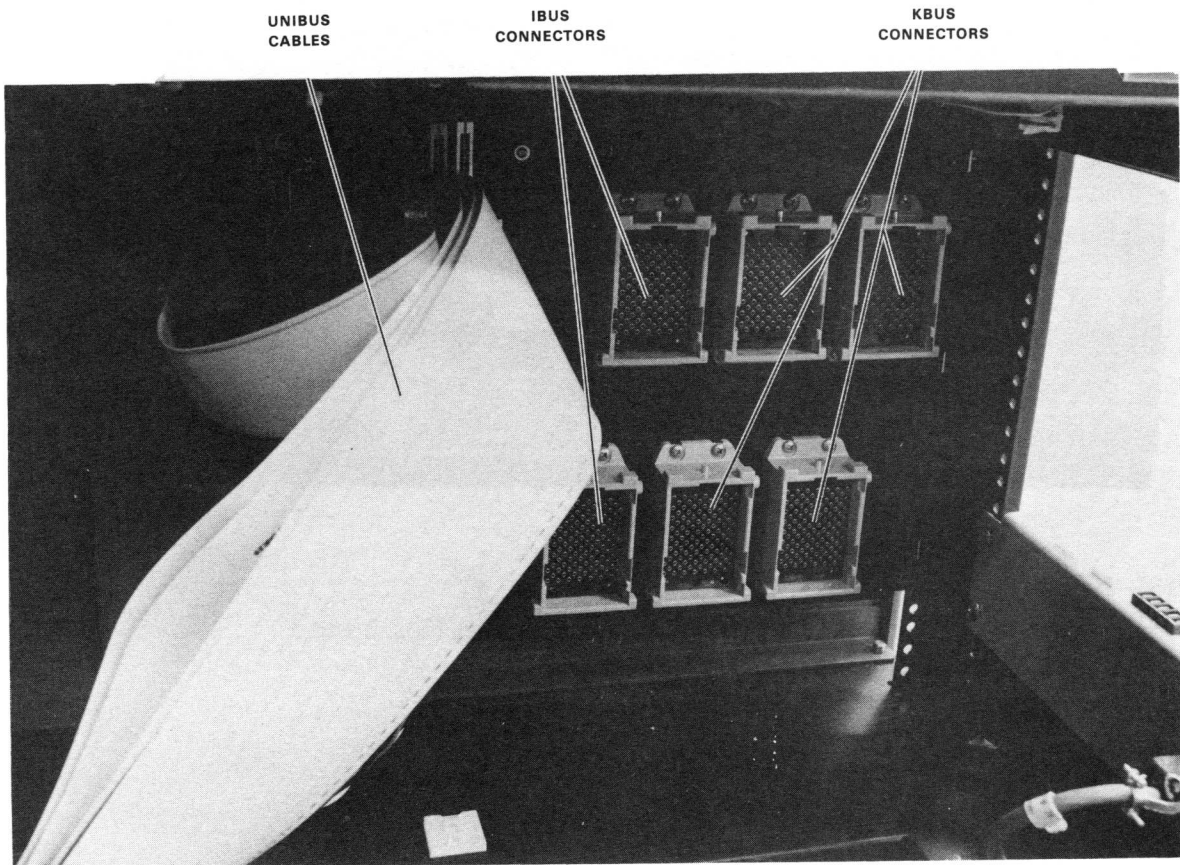

Figure 3-13 Massbus, IBus, and KBus Connectors (KL10-B)



7533-23

Figure 3-14 IBus and KBus Connectors

3.3 CPU CABINET

The CPU cabinet contains the following major components. (Refer to Figures 3-15 through 3-18.)

1. Bay 4 Logic (ECL). Backpanel, wiring and modules for the MBox and EBox. (Refer to Figure 3-27 for Bay 4 module utilization.) The EBox is the execution unit in the KL10 processor; the MBox is the processor's memory interface.
2. H760 Power Supply. In conjunction with the Capacitor Assembly and the H761 Regulated Series Pass Assembly, provides dc power to the ECL circuitry in Bay 4. The H760 supplies -12 V (at 490 A), +15 V, and -15 V.
3. Capacitor Assembly. Thirteen 0.3 Farad capacitors are connected in parallel. The total capacitance of 3.9 Farads provides 20 ms of energy hold-up for Bay 4 logic when system power is removed.
4. H761 Regulated Series Pass Assembly. Supplies and regulates -5.2 V and -2.0 V to Bay 4 logic. Input power to H761 is from the H760 power supply.
5. H732 Power Supply. Supplies +10 V and -15 V to the margin check bus.
6. H738-C Power Supply. Supplies a variable margin check voltage (0-20 V) controlled by an autotransformer mounted on the margin check panel (in Console Processor cabinet).

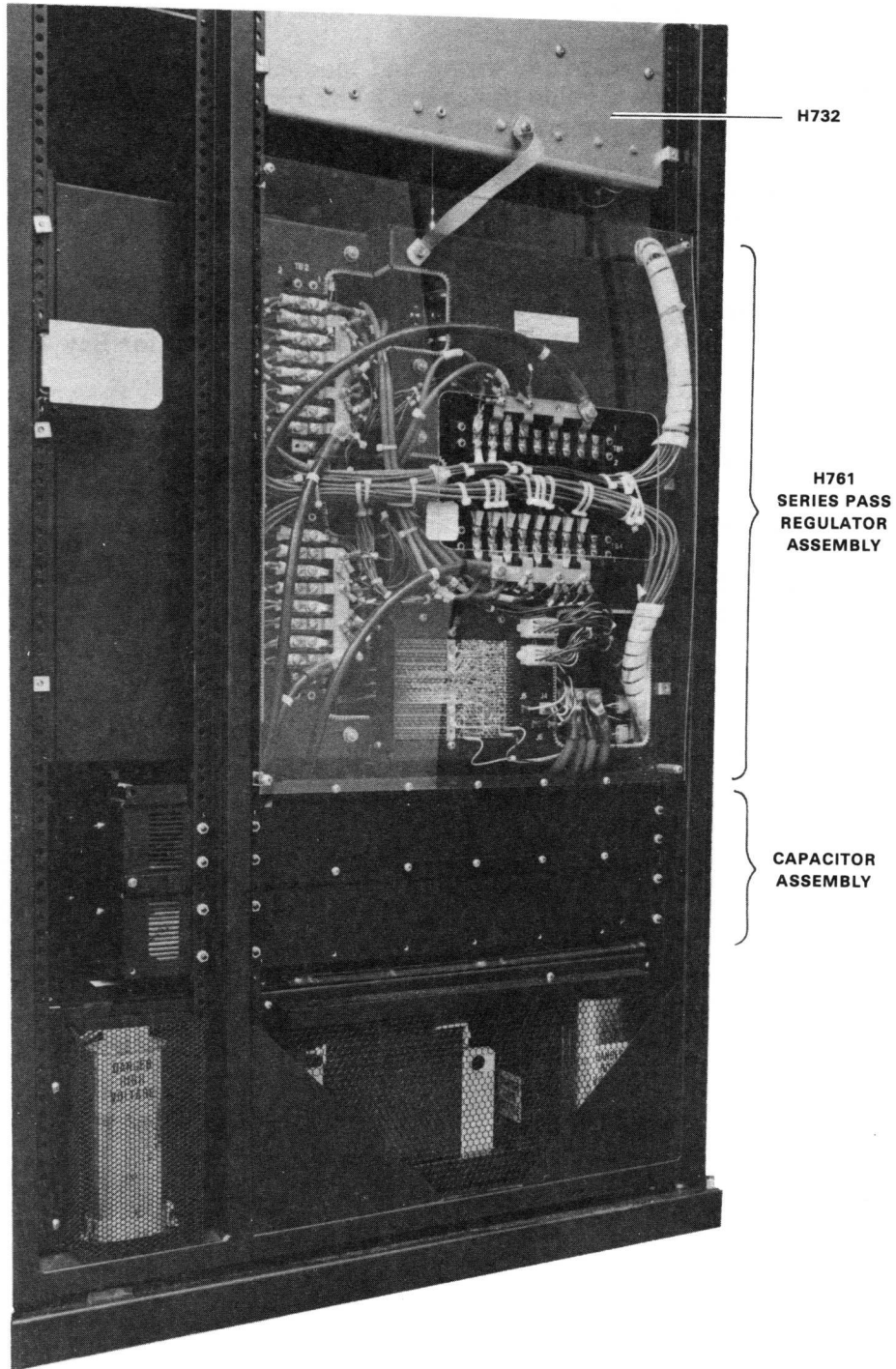

H732

H761
SERIES PASS
REGULATOR
ASSEMBLY

CAPACITOR
ASSEMBLY

7533-20

Figure 3-15 CPU Cabinet Rear Door – Closed

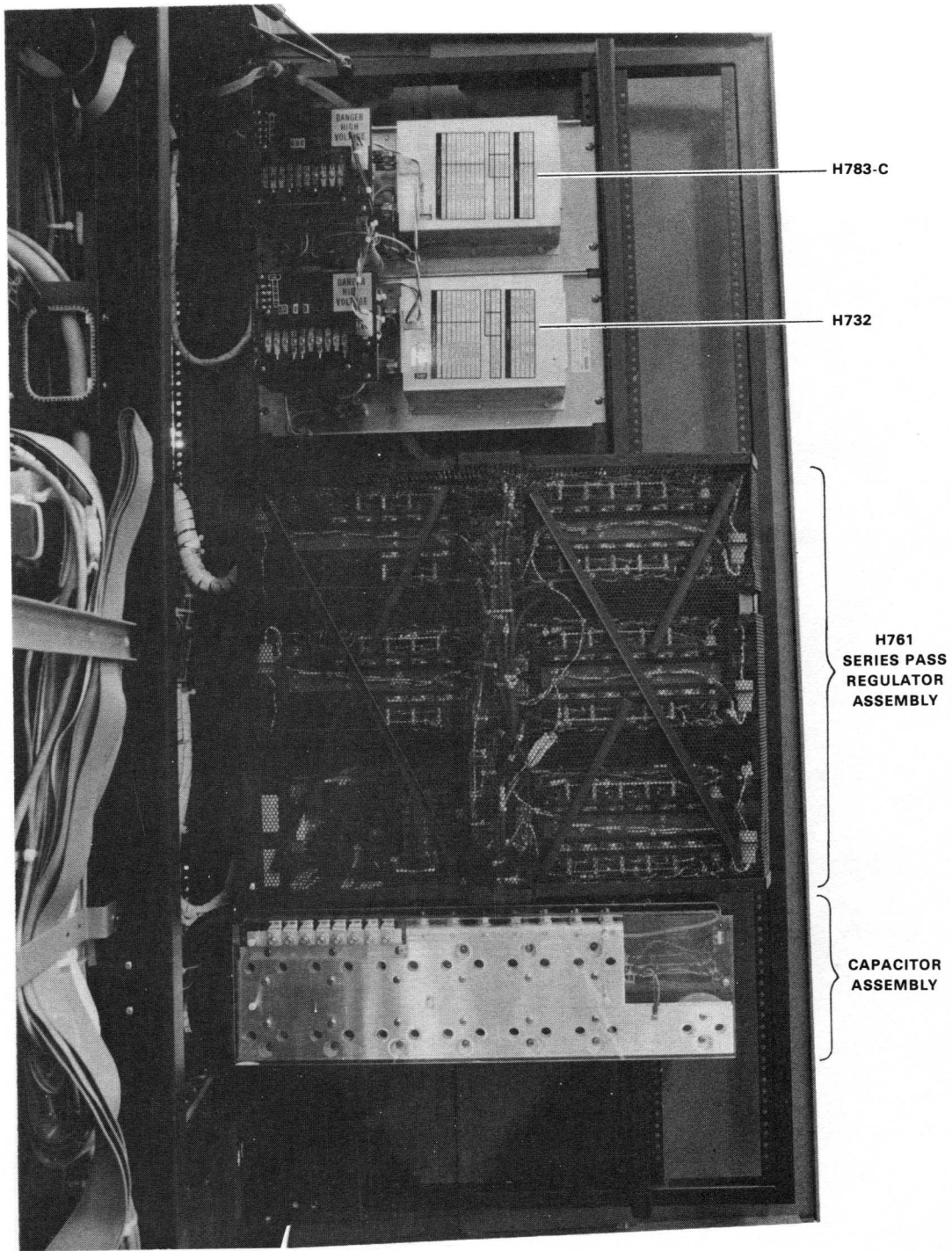

7533-19

Figure 3-16 CPU Cabinet Rear Door - Open

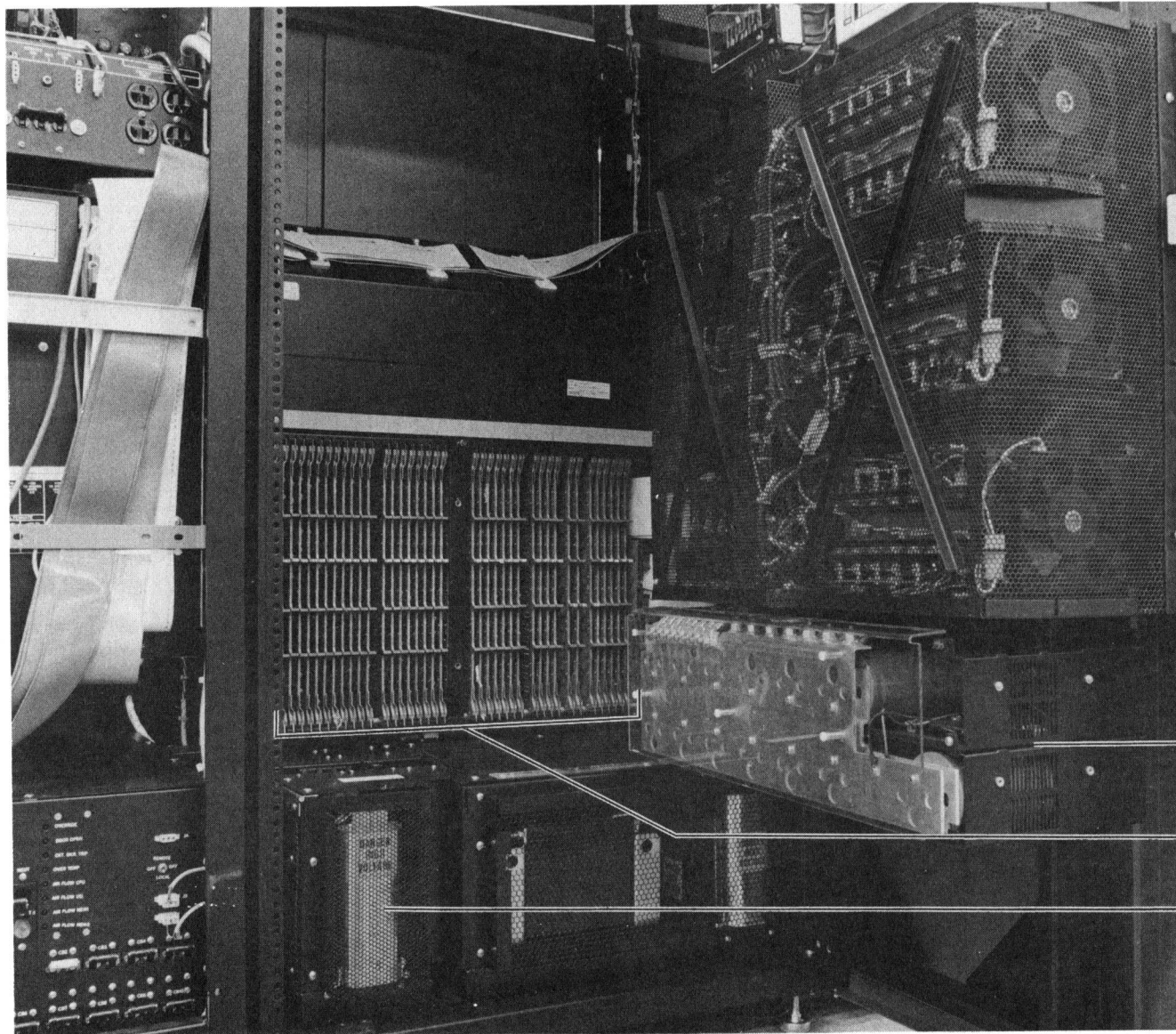

**H761
SERIES PASS
REGULATOR
ASSEMBLY**

**CAPACITOR
ASSEMBLY**

**BAY 4
MODULES**

**H760
POWER SUPPLY**

Figure 3-17 CPU Cabinet – Rear View

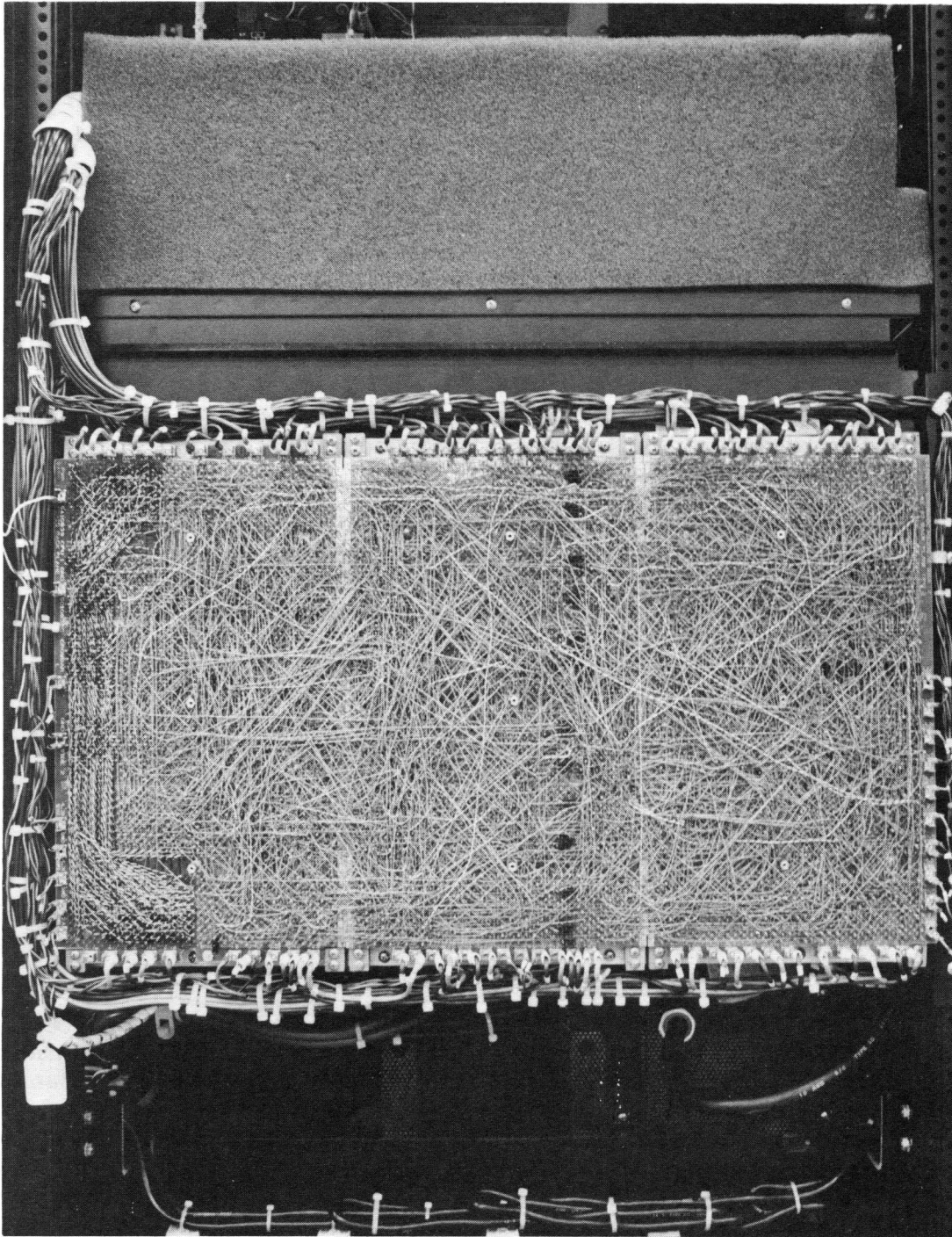

7533-5

Figure 3-18 Bay 4 Backplane

3.4 CONSOLE PROCESSOR CABINET

The Console Processor cabinet contains the principal components of the PDP-11/40 system that is used as a front-end processor in the 1080/1090 system. It also contains the margin check panel and the main power control for the system. Major components (shown in Figures 3-19 through 3-24) follow. (Figures 3-25 through 3-29 show the module utilization for these components.)

1. **KY11-D Programmers Console.** In conjunction with the KD11-A Processor, provides a console control and display facility for the 1080/1090.
2. **BA11-F Mounting Box.** Contains backpanel, wiring, and modules for the KD11-A Processor, DL11-C Asynchronous Line Interface, KW11-L Line Clock, MF11-UP, Core Memory, MM11-UP Expansion Core Memory, RH11 Massbus Device Controller, DL11-E Asynchronous Line Interface and BM873-Y/H ROM Loader. (Refer to Figure 3-28 for BA11-F module utilization.)
3. **Margin Check Panel.** Provides the necessary controls for margin checking KA10/KI10-type devices external to the KL10-A. The panel also contains switches for bootstrapping the system and for powering the system on and off.
4. **TU56/TC11 DECTape and DECTape Control.** One of two media for loading the system. (Refer to Figure 3-29 for TU56/TC11 module utilization.) An RP04 Disk Pack Drive is also provided in the 1080/1090 system. The device is a Massbus dual-port device with one port controlled (via the Unibus) by the RH11 in the Console Processor Cabinet.
5. **H720-E Power Supply.** Supplies +5 V and -15 V to the TU56/TC11 DECTape and DECTape Control.
6. **H7420 Power Supply (No. 1).** Supplies +5 V, -5 V, +20 V, and -15 V to the PDP-11/40 system components contained in the BA11-F Mounting Box.
7. **863 Power Control.** Controls application and removal of ac power to entire 1080/1090 system.
8. **861 Power Control.** Controls application and removal of ac power to the H7420 Power Supply (No. 1), H720 Power Supply, TU56 DECTape, and LA36 DECwriter. Primary input is from the 863.

3.5 KL10-A/B ARITHMETIC PROCESSOR COMPONENT INTERCONNECTION

Signal and power cables interconnect the three cabinets that compose the KL10-A/B Arithmetic Processor. Figures 3-30 and 3-31, and 3-32 illustrate the signal cables and Power Harness wiring, respectively.

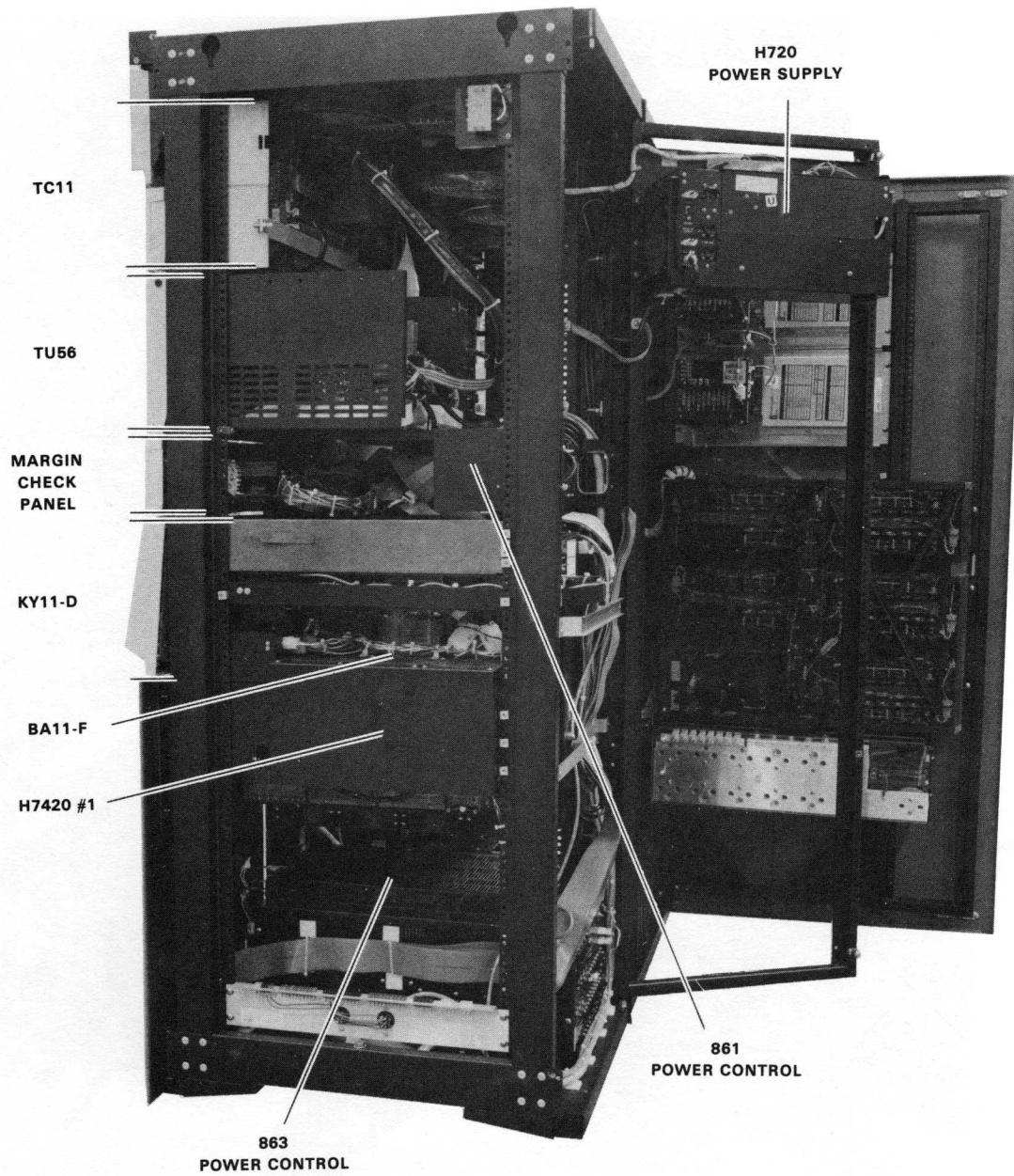

7533-14

Figure 3-19 Console Processor – Side View

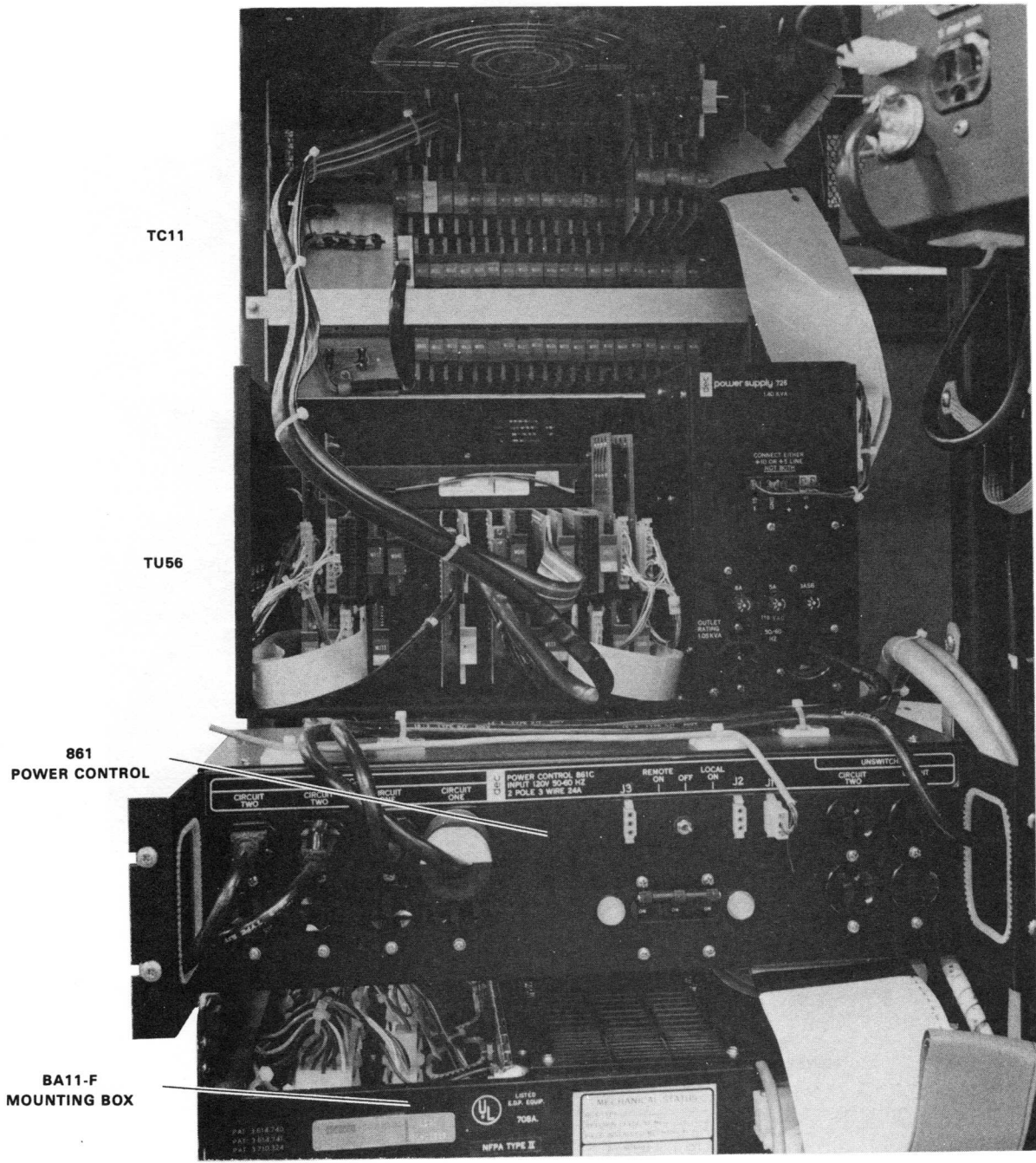

7533-15

Figure 3-20 Console Processor Cabinet – Top Rear View

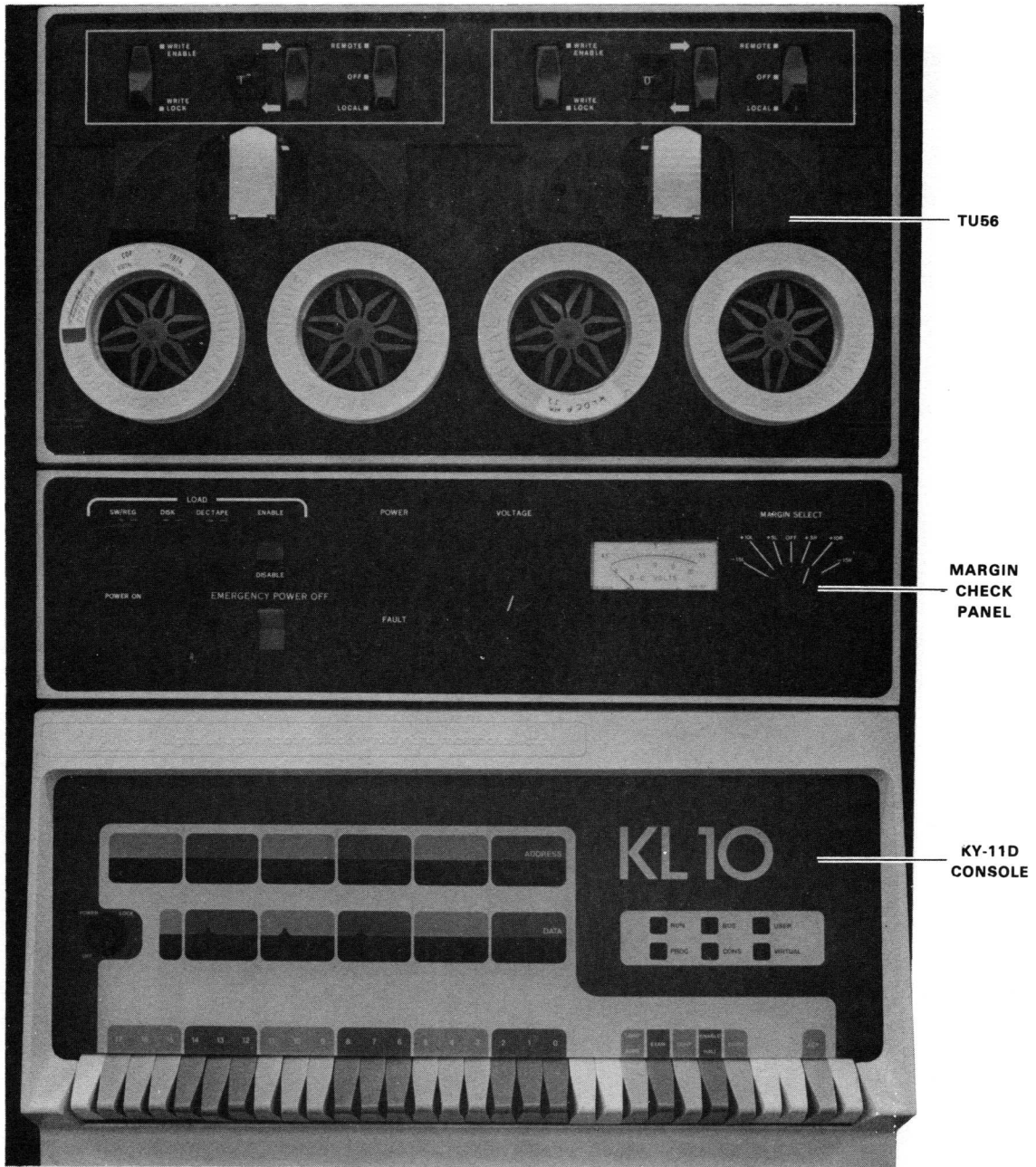
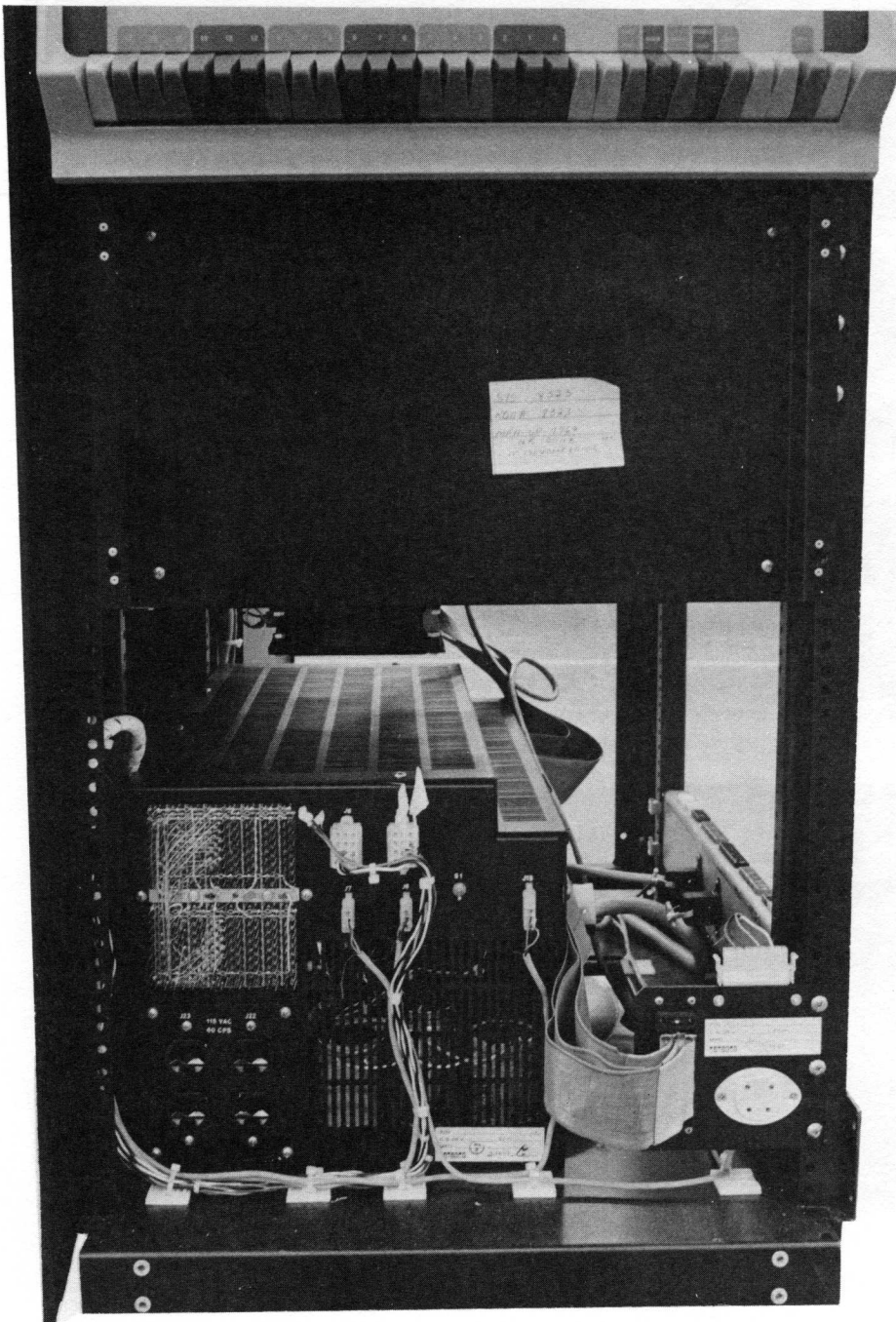

Figure 3-21 Console Processor Operator Controls

7533-11



7533-4

Figure 3-22 863 Power Control (Front)



7533-16

Figure 3-23 863 Power Control (Rear)

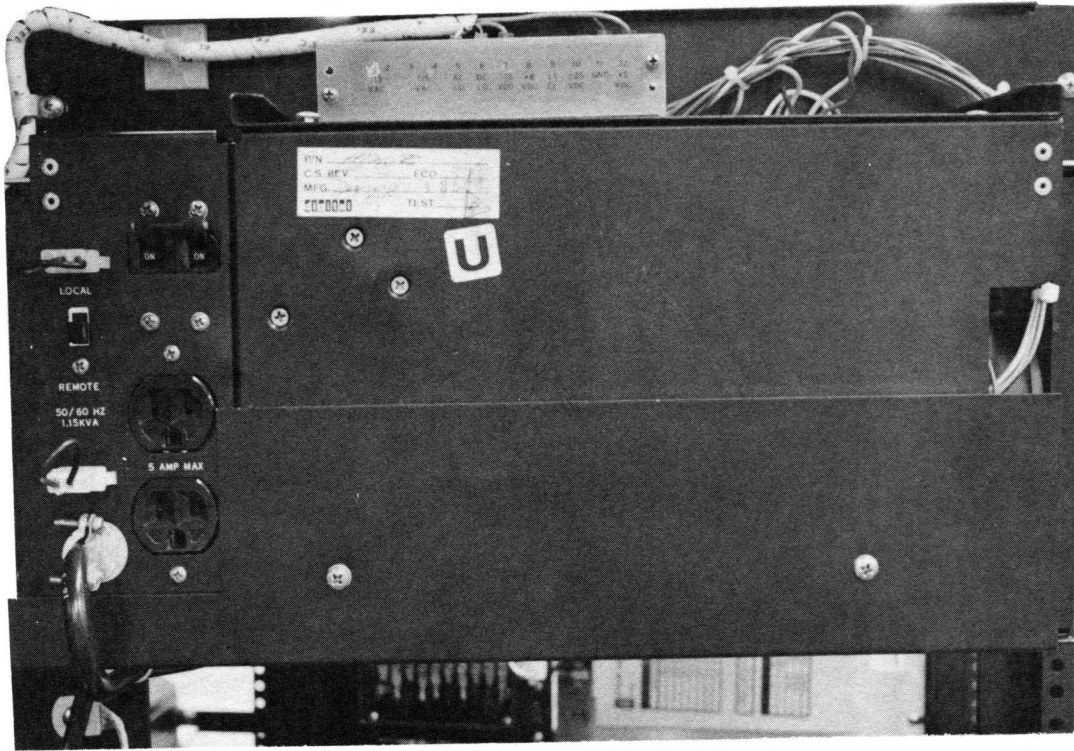

7533-1

Figure 3-24 H720 Power Supply

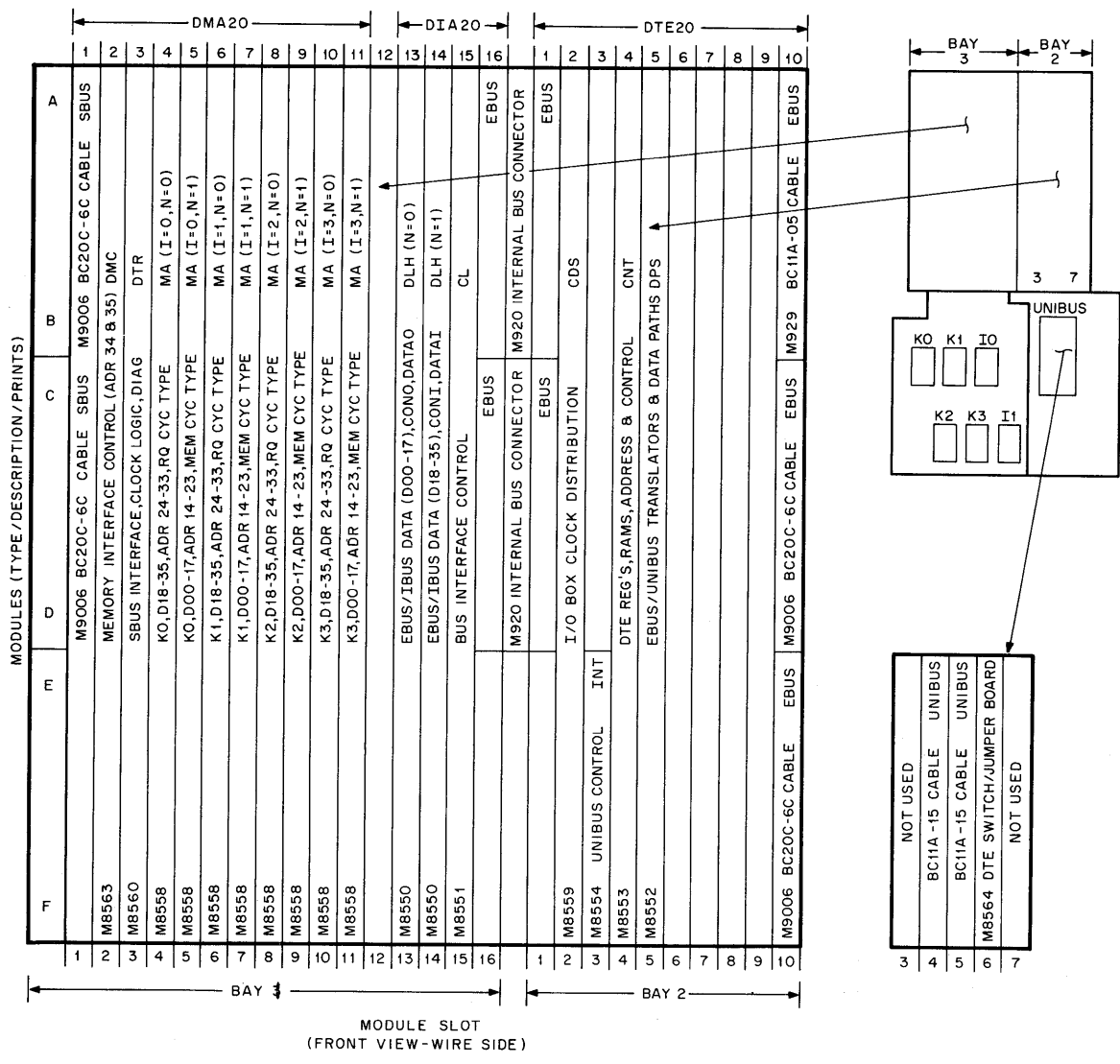

Figure 3-25 KL10-A Module Utilization, I/O Logic Assembly (Cabinet No. 1, Bay 1 and 2)

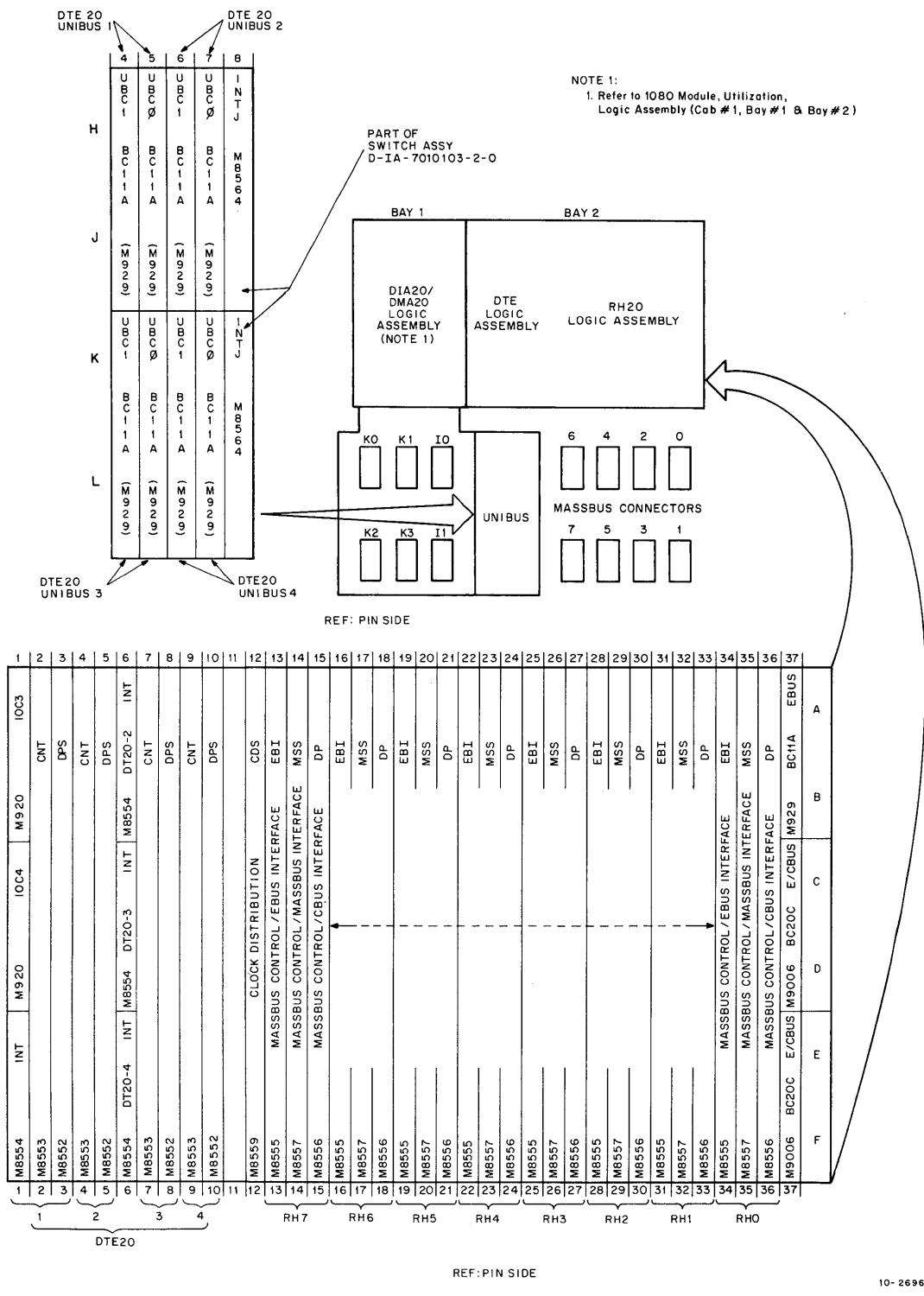

Figure 3-26 KL10-B Module Utilization (Cabinet No. 1, Bay 1 and Bay 2)

MODULE (TYPE /DESCRIPTION /PRINTS)

Module Slot	L	M	O	C	B	A
1	M9006	BC20C-6C	CABLE	EBUS	M9006	BC11A-05 CABLE
2					M9006	BC20C-6C CABLE
3					M9006	BC20C-6C CABLE
4	M8516		EBUS TRANSLATOR (24-35)			TRN (N=24)
5	M8516		EBUS TRANSLATOR (12-23)			TRN (N=12)
6	M8516		EBUS TRANSLATOR (00-11)			TRN (N=00)
7	M8519		SBUS TRANSLATOR (00-17)			MEM (I=0,N=00,P=00)
8	M8519		SBUS TRANSLATOR (18-35)			MEM (I=1,N=18,P=12)
9	M8549-YA	(KL10-A)	M8533	(KL10-B)		OPTION SUBSTITUTION BOARD
10	M8549-YB	(KL10-A)	M8535	(KL10-B)		OPTION SUBSTITUTION BOARD
11			M8536	(KL10-B)		OPTION SUBSTITUTION BOARD
12	M8549-YD	(KL10-A)	M8534	(KL10-B)		OPTION SUBSTITUTION BOARD
13						
14	M8517		MEMORY BUFFERS			MB (N=12)
15	M8517		MEMORY BUFFERS			MB (N=06)
16	M8517		MEMORY BUFFERS			MB (N=00)
17	M8521		CACHE DATA, ADDRESS, PARITY			CHD (N=27)
18						
19	M8521		CACHE DATA, ADDRESS, PARITY			CHD (N=18)
20	M8537		MBOX CONTROL			MBZ
21	M8529		MBOX CONTROL			MBX (N=30)
22	M8531		CACHE CONTROL			MBC (N=22)
23	M8513		CACHE CONTROL			CSH (K=22)
24	M8521		CACHE DATA, ADDRESS, PARITY			CHD (N=09)
25	M8521		CACHE DATA, ADDRESS, PARITY			CHD (N=00)
26						
27	M8514		CACHE DIRECTORY			CHA
28	M8515		CACHE COMPARE, VALID, AND USE BITS			CHX (N=20)
29	M8518		EBR,UBR,PHY ADDR MIXER,ERA			PMA
30	M8520		PAGE TABLE			PAG
31	M8532		PI BOARD			PI
32	M8526		CLOCK CONTROL			CLK (N=30)
33	M8538		METER BOARD			MTR (N=18)
34	M8539		APR FUNCTION CONTROL			APR
35	M8525		EBOX CONTROL			CON (N=18)
36	M8527		EBOX CONTROL : SPEC FUNC, DIAG, DATA			CTL (N=24)
37						
38	M8523		VMA BOARD : REGISTER, ADDER, PC			VMA (N=13)
39	M8512		EBOX DATA PATHS, REGS, ADDERS (30-35)			EDP (N=30)
40	M8528		CONTROL RAM INPUT / OUTPUT			CRM (N=16, M=30)
41	M8512		EBOX DATA PATHS, REGS, ADDERS (24-29)			EDP (N=24)
42	M8528		CONTROL RAM INPUT / OUTPUT			CRM (N=12, M=24)
43	M8512		EBOX DATA PATHS, REGS, ADDERS (18-23)			EDP (N=18)
44	M8528		CONTROL RAM INPUT / OUTPUT			CRM (N=08, M=18)
45	M8511		CONTROL RAM ADDRESS			CRA (N=00)
46	M8510		SHIFT MATRIX CONTROL			SH
47	M8530		MEMORY CONTROL : CYCLE AND ADDRESS			MCL (N=18)
48	M8522		IR, DRAM, CARRY			IR (N=12)
49	M8512		EBOX DATA PATHS, REGS, ADDERS (12-17)			EDP (N=12)
50	M8528		CONTROL RAM INPUT / OUTPUT			CRM (N=04, M=12)
51	M8512		EBOX DATA PATHS, REGS, ADDERS (06-11)			EDP (N=06)
52	M8528		CONTROL RAM INPUT / OUTPUT			CRM (N=00, M=06)
53	M8512		EBOX DATA PATHS, REGS, ADDERS (00-05)			EDP (N=00)
54	M8524		SCAD, PC FLAGS, ARM			SCAD (N=02)

Figure 3-27 1080/1090 Module Utilization, CPU Cabinet (Cabinet No. 2, Bay 4)

MODULE (TYPE/DESCRIPTION/PRINTS)		T	M	D	C	B	A
1							
2							
3							
4							
5							
6							
7							
8							
9							
1							
2							
3							
4							
5							
6							
7							
8							
9							
1							
2							
3							
4							
5							
6							
7							
8							
9							
1							
2							
3							
4							
5							
6							
7							
8							
9							
1							
2							
3							
4							

MODULE SLOT (WIRE SIDE VIEW)		T	M	D	C	B	A
1							
2							
3							
4							
5							
6							
7							
8							
9							

MODULE SLOT (WIRE SIDE VIEW)

*G727 GRANT CONTINUITY MODULES IN D7,8,&9 (RH11) ARE NOT REQUIRED FOR BACKPLANES WIRED PER WIRELIST K-WL-RH11-0-12 OR HIGHER

Figure 3-28 Module Utilization Console Processor Cabinet (BA11-F Mounting Box)

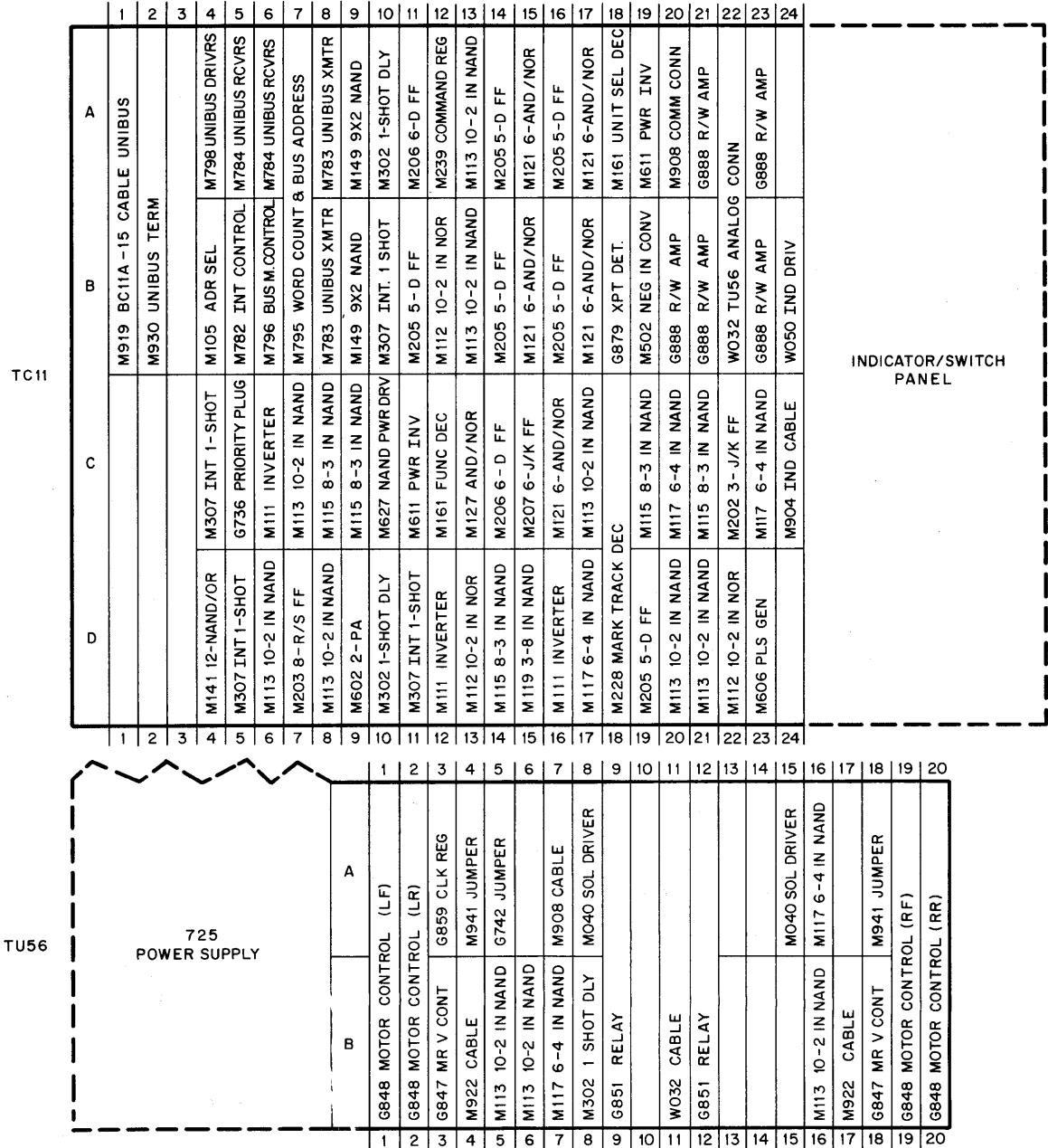

Figure 3-29 TU56/TC11 Module Utilization, Console Processor Cabinet (Cabinet No. 3)

10-2074

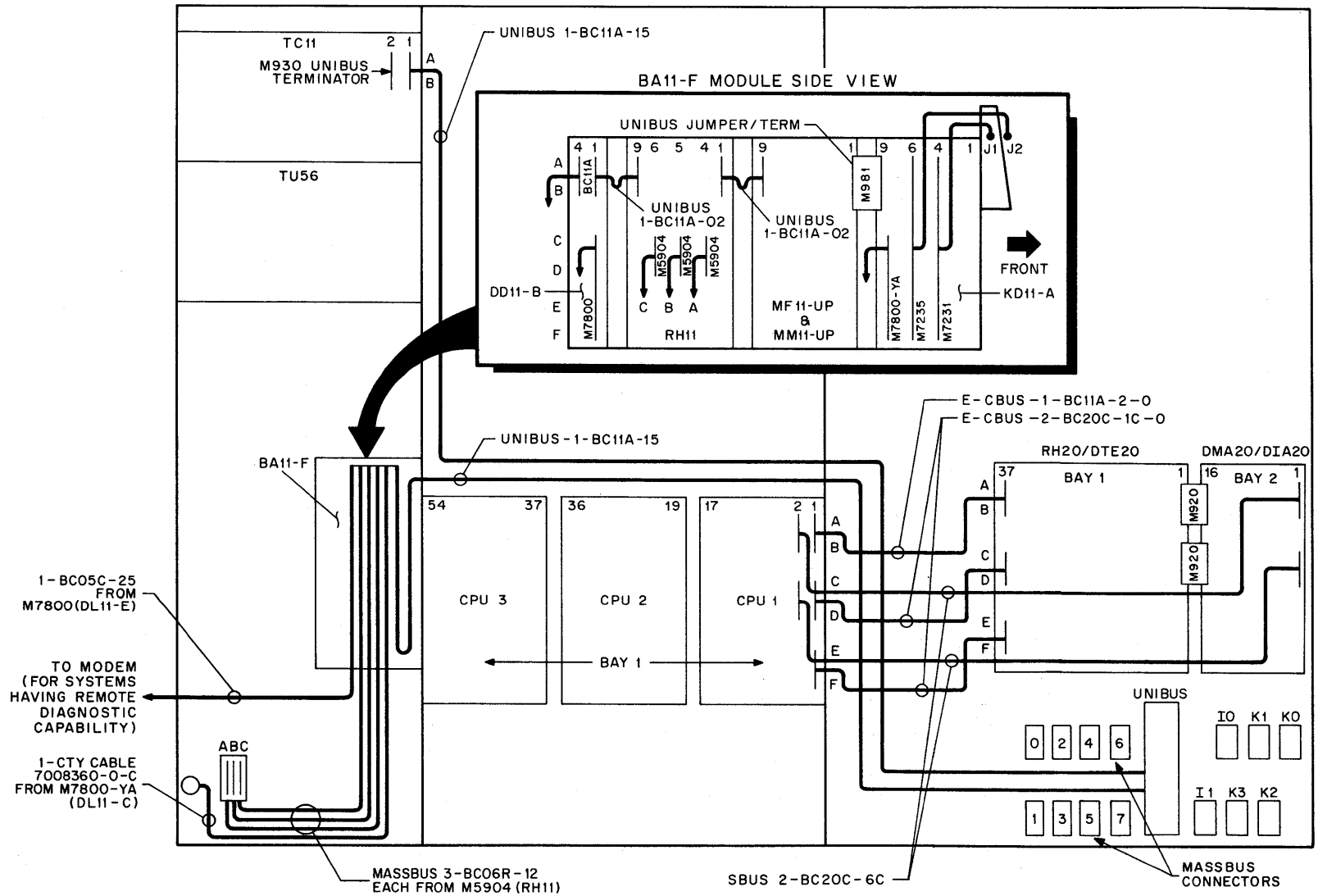
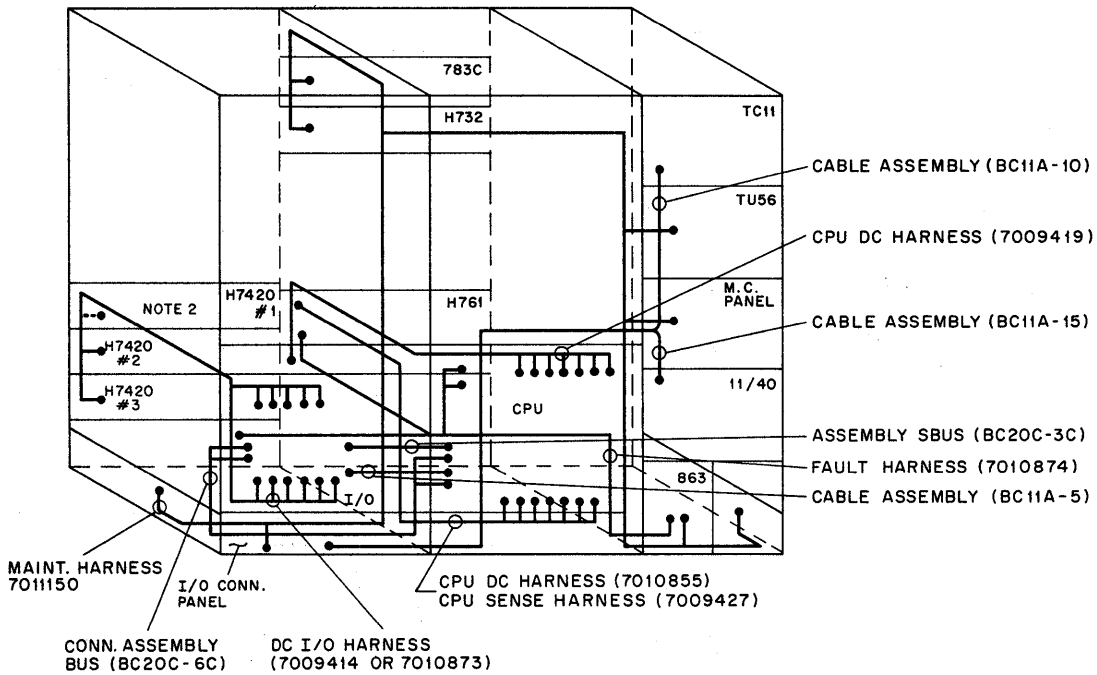
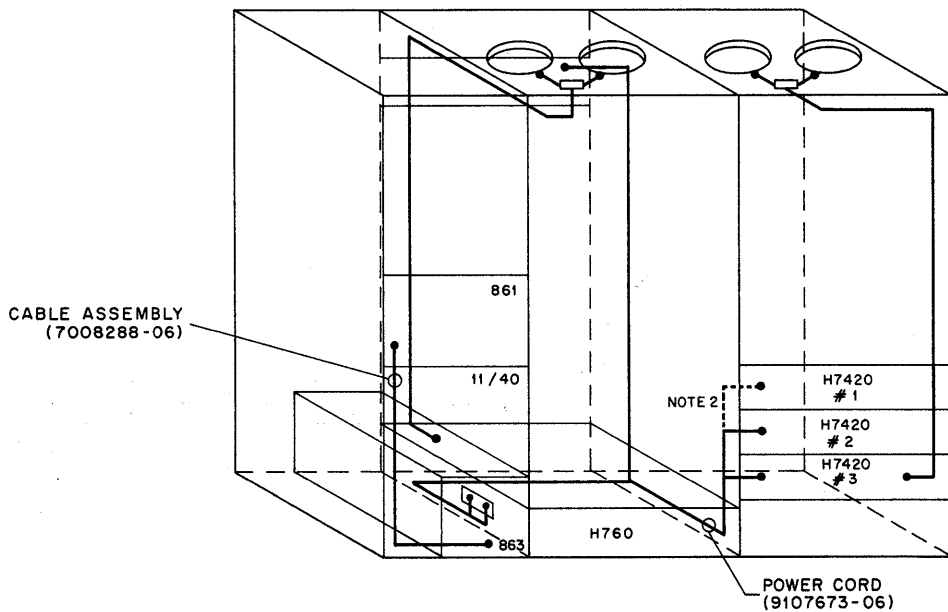

Figure 3-31 KL10-B Component Interconnection (Signal Cables)



FRONT VIEW



REAR VIEW

- NOTES:
 1. Refer to D-UA-KL10-O-O for exact cable routing.
 2. H7420 #1 is used in KL10-B only.

10-2007

Figure 3-32 KL10-A/B Component Interconnection (Power Harness Wiring)

Reader's Comments

KL10-BASED
PHYSICAL DESCRIPTION
EK-108OU-PD-002

Your comments and suggestions will help us in our continuous effort to improve the quality and usefulness of our publications.

What is your general reaction to this manual? In your judgment is it complete, accurate, well organized, well written, etc.? Is it easy to use? _____

What features are most useful? _____

What faults do you find with the manual? _____

Does this manual satisfy the need you think it was intended to satisfy? _____

Does it satisfy *your* needs? _____ Why? _____

Would you please indicate any factual errors you have found. _____

Please describe your position. _____

Name _____ Organization _____

Street _____ Department _____

City _____ State _____ Zip or Country _____

Fold Here -----

Do Not Tear - Fold Here and Staple -----

**FIRST CLASS
PERMIT NO. 33
MAYNARD, MASS.**

**BUSINESS REPLY MAIL
NO POSTAGE STAMP NECESSARY IF MAILED IN THE UNITED STATES**

Postage will be paid by:

**Digital Equipment Corporation
Technical Documentation Department
Maynard, Massachusetts 01754**

