

# PERSONAL WORKSTATION USER GUIDE

THE CORVUS CONCEPT

 **CORVUS SYSTEMS**

## **DISCLAIMER OF ALL WARRANTIES & LIABILITIES**

Corvus Systems, Inc. makes no warranties, either expressed or implied, with respect to this manual or with respect to the software described in this manual, its quality, performance, merchantability, or fitness for any particular purpose. Corvus Systems, Inc. software is sold or licensed "as is." The entire risk as to its quality or performance is with the buyer and not Corvus Systems, Inc., its distributor, or its retailer. The buyer assumes the entire cost of all necessary servicing, repair, or correction and any incidental or consequential damages. In no event will Corvus Systems, Inc. be liable for direct, indirect, incidental or consequential damages, even if Corvus Systems, Inc. has been advised of the possibility of such damages. Some states do not allow the exclusion or limitation of implied warranties or liabilities for incidental or consequential damages, so the above limitation may not apply to you.

Every effort has been made to insure that this manual accurately documents the operation and servicing of Corvus products. However, due to the ongoing modification and update of the software along with future products, Corvus Systems, Inc. cannot guarantee the accuracy of printed material after the date of publication, nor can Corvus Systems, Inc. accept responsibility for errors or omissions.

### **NOTICE**

Corvus Systems, Inc. reserves the right to make changes in the product described in this manual at any time without notice. Revised manuals and update sheets will be published as needed and may be purchased by writing to:

Corvus Systems, Inc.  
2029 O'Toole Avenue  
San Jose, CA 95131

Telephone: (408) 946-7700  
TWX 910-338-0226

**This manual is copyrighted and contains proprietary information. All rights reserved.** This document may not, in whole or in part be copied, photocopied, reproduced, translated or reduced to any electronic medium or machine readable form without prior consent, in writing, from Corvus Systems, Inc.

Copyright© 1982 by Corvus Systems, Inc. All rights reserved.

Mirror® patent pending, The Corvus Concept,™ Transporter,™ Corvus OMNINET,™ Corvus Logicalc,™ Time Travel Editing,™ EdWord,™ Constellation,™ Corvus,™ Corvus Systems,™ Personal Workstation,™ Tap Box,™ Passive Tap Box,™ Active Junction Box,™ Omninet Unit™ are trademarks of Corvus Systems, Inc.

### **FCC WARNING**

This equipment generates, uses, and can radiate radio frequency energy and if not installed and used in accordance with the instruction manual, may cause interference to radio communications. As temporarily permitted by regulation it has not been tested for compliance with the limits for Class A computing devices pursuant to Subpart J of Part 15 of FCC Rules, which are designed to provide reasonable protection against such interference. Operation of this equipment in a residential area is likely to cause interference in which case the user at his own expense will be required to take whatever measures may be required to correct the interference.

# PERSONAL WORKSTATION USER GUIDE

## THE CORVUS CONCEPT

**PART NO.:** 7100-02826

**DOCUMENT NO.:** CCC/30-22/1.3

**RELEASE DATE:** February, 1983

CORVUS CONCEPT™ is a trademark of Corvus Systems, Inc.



**Table of Contents**

**SCOPE** ..... 5

**CHAPTER ONE**  
**SYSTEM STARTUP** ..... 1-1

- Manuals and Software ..... 1-1
  - Standard Software ..... 1-1
  - Optional Software ..... 1-2
- Setting Boot Switches ..... 1-3
- Connecting To An Omninet Tap ..... 1-4
- Power-on ..... 1-5
- Self-diagnostic ..... 1-6
- Log-on ..... 1-8
- Copying Optional Software ..... 1-12
  - Copying LogiCalc To The Hard Disk Drive ..... 1-13
  - Copying Pascal To The Hard Disk Drive ..... 1-14
  - Copying FORTRAN To The Hard Disk Drive ..... 1-15

**CHAPTER TWO**  
**THE KEYBOARD AND DISPLAY** ..... 2-1

- The Keyboard ..... 2-1
  - Modifier Keys ..... 2-2
  - Cursor Keys ..... 2-4
  - Function Keys ..... 2-4
  - Function Key Labels ..... 2-5
  - The Help Label ..... 2-7
  - The Exit Label ..... 2-9
- The Video Display Monitor ..... 2-9
  - Screen Configuration ..... 2-9
    - System window ..... 2-10
    - Command window ..... 2-12
    - Label window ..... 2-12
- Display Control Keys ..... 2-12
  - Interrupt Screen Display ..... 2-13
- The Break Key ..... 2-13
  - Terminating a File Listing ..... 2-13
  - Cold Boot ..... 2-13

**CHAPTER THREE**

**OPERATING SYSTEM** ..... 3-1

- The Dispatcher ..... 3-1
- Dispatcher Level Functions ..... 3-2
- How to Run a Program ..... 3-4
- The Restart Function ..... 3-5
- Warm Boot ..... 3-6
- File Management ..... 3-6
- Logical Units ..... 3-7
- System Volume ..... 3-7
- Current Volume ..... 3-7
- Volume Names ..... 3-7
- File Names ..... 3-8
- Wild Card Characters ..... 3-9
- Setting a Volume ..... 3-9
- Listing a Volume ..... 3-11
- Slash / ..... 3-15
- Exclamation Point ! ..... 3-17
- Output Redirection ..... 3-19
- File Management Functions ..... 3-20
- Delete a File ..... 3-24
- The Q Option ..... 3-26
- Delete a Temporary File ..... 3-27
- Make a File ..... 3-28
- Rename a File ..... 3-31
- Copy a File ..... 3-32
- The D Option ..... 3-36
- The S Option ..... 3-36
- Concatenate Files ..... 3-37
- List a File ..... 3-40
- Changing a Volume ..... 3-41
- Reclaim Volume Space ..... 3-42
- Window Management ..... 3-43
- Create Window ..... 3-45
- Create Temporary Window ..... 3-47
- Delete Window ..... 3-48
- Select Window ..... 3-48
- Clear Window ..... 3-49
- Reverse Background ..... 3-49
- Scroll Mode ..... 3-49
- Defining Userkeys ..... 3-50
- Using Exec Files ..... 3-52
- Automatic Startup File ..... 3-54
- Using The Runtime P-system ..... 3-56

**CHAPTER FOUR**

<b>UTILITIES</b> .....	4-1
System Utilities .....	4-1
Set Date .....	4-3
Set Time .....	4-5
Set Data Communication Parameters .....	4-7
Assign a Driver .....	4-15
List Drivers On-line .....	4-17
Display Test Patterns .....	4-20
Print Window .....	4-21
The Volume Utilities Program .....	4-22
Backing Up Volumes .....	4-23
Copying Floppy Diskettes .....	4-26
Setting the Floppy Unit Number .....	4-28
Setting the Work File .....	4-29
Reading a Floppy Diskette .....	4-29
Writing a Floppy Diskette .....	4-30
Deleting a Work File .....	4-31
System Status Information .....	4-32
Running the Terminal Emulator .....	4-32
Formatting Diskettes .....	4-34
Making Diskettes Bootable .....	4-36
Spooling and Despooling .....	4-39
Spooling a File .....	4-39
Spool Options .....	4-40
Spool .....	4-44
Despool a File .....	4-45
Volume Management .....	4-46
Display Volumes Accessible .....	4-50
Display Volumes Mounted .....	4-51
Selecting a Drive .....	4-52
Changing Volume Attributes .....	4-54

**CHAPTER FIVE**

<b>CHARACTER SETS</b> .....	5-1
Load a Character Set .....	5-2
Load Display Character Set .....	5-2
Load Keyboard Character Set .....	5-3
Alternate Character Set .....	5-4
Edit a Display Character Set .....	5-8

**CHAPTER SIX**

**PERIPHERAL CONNECTIONS** ..... 6-1

- Type of Boot ..... 6-1
- Diskette Connection ..... 6-3
- Local Disk Drive Connection ..... 6-4
- Omninet Connection ..... 6-5
- RS-232 Ports ..... 6-5
  - Connecting a Local Printer ..... 6-5
- Video Display Unit ..... 6-8
  - Changing Screen Orientation ..... 6-9
    - Vertical to Horizontal ..... 6-9
    - Horizontal to Vertical ..... 6-12



SCOPE

**THE NEXT GENERATION OF COMPUTING**

Congratulations! With the Corvus Concept Personal Workstation, you have entered the next generation of computing.

We call the Corvus Concept a Personal Workstation because it was first conceived as a user interface to our local network, the Corvus Omninet. Adding it to a network with other Concepts or different brand of computers takes only a simple connection of twisted pair cable. It is as easy as hooking up a hi-fi speaker.

The Concept can also serve as a powerful stand-alone computer; its advanced 16-bit microprocessor, swivel-screen display capabilities, and other built-in features make it an ideal operator's interface for workprocessing and data processing.

**PURPOSE AND ORGANIZATION**

This guide is intended to give a thorough overview of the Concept Personal Workstation. It is intended as an introduction to computing, to this system, and as a reference guide to be used whenever a question arises pertaining to the Concept.

The guide is divided into six chapters covering the following subjects:

- CHAPTER 1 -- Instructions on setting up the system, powering on, and installing Corvus software.

- CHAPTER 2 -- Familiarization with the Concept keyboard and display monitor, and the uses of the function keys, modifier keys, cursor keys, and display control keys.
- CHAPTER 3 -- In-depth instruction on the function keys, the operating system, file management, user-definable keys, and display screen management.
- CHAPTER 4 -- Instructions on using system utilities, including system management, formatting diskettes, spooling, despooling, and volume management.
- CHAPTER 5 -- Details the methods of loading, creating, and editing character sets.
- CHAPTER 6 -- How to make peripheral connections, boot types, and changing screen orientation.

## CONVENTIONS

The word "Type" is used throughout this guide to mean that two or more characters are to be entered on the Concept keyboard. All words, symbols, spaces and punctuation beginning with the first character to the right of the word Type should be typed exactly as shown. Do not add or delete punctuation at the end of a statement, and type all spaces that appear within the statement. For example,

Type /FCCGEN/SYSGEN

would request "/FCCGEN/SYSGEN" to be typed; the spaces between Type and the first character to its right (a slash here) should not be typed. Characters may be entered in either upper or lower case.

The word "Press" is used throughout this guide to mean that a single character or key-top symbol is to be entered on the Concept keyboard. For example,

Press [RETURN]

requests the carriage return be pressed on the keyboard. When a key-top symbol is used, press the key to which it refers; do not type out the individual letters of the word shown within the key-top symbol.

Function key labels are used like key-top symbols. There are ten function keys at the top of the Concept keyboard, numbered F1 through F10. The functions of these keys displays across the bottom of the Concept screen, and are also graphically depicted throughout this guide.

The function key labels may change with each program. Within a program, each function key may represent up to four separate functions. The first level function is obtained by pressing the function key. For example, from the Dispatcher labels, "Press [SetVol]" equates to pressing the [F4] key.

The second level function is obtained by holding down the [SHIFT] key and simultaneously pressing the appropriate function key.

The third level function is obtained by holding down the [COMMAND] key and simultaneously pressing the appropriate function key. For example, from the Dispatcher labels, "Press [MountMgr]" equates to simultaneously pressing the [COMMAND] key and the [F9] key.

The fourth level function is obtained by holding down the [COMMAND] key and the [SHIFT] key while simultaneously pressing the appropriate function key. For example, from the Dispatcher labels, "Press [Reboot]" equates to simultaneously pressing the [COMMAND] key, the [SHIFT] key, and the [F10] key.

Function key instructions in this guide are always given in terms of the labels at the bottom of the Concept screen, and not by the key number. An instruction such as "Press [ListVol]" leaves no doubt that the function to be performed is listing a volume; if the instruction said "Press [F5]," which is the function key corresponding to the [ListVol] label, this guide would give no clear indication of what function is being performed.

Another term used frequently in this guide is default.

There are many programs and functions in the Corvus Concept Operating System (CCOS) that require responses to be entered from the keyboard. In many instances the program displays the most common answer to the prompt. The answer that the program offers is called the default, and it may be entered by pressing [RETURN]. If the default is not to be used, simply type in the new answer and it will be used by the program.

This chapter is devoted to setting up the Workstation hardware and installing the Corvus-supplied software. It will also give instructions on powering on the Concept and log-on procedures.

## MANUALS AND SOFTWARE

- o Corvus Concept Workstation Manuals
  - The Corvus Concept Personal Workstation Installation Guide
  - The Corvus Concept Personal Workstation User Guide
  - The Corvus Concept EdWord User Guide
  
- o Corvus 8-inch diskette drive manuals
  - The Corvus Concept Diskette Drive Installation Guide
  - The Corvus Concept Disk Drive Installation Guide
  - The Corvus Concept System Manager's Guide
  - The Corvus Concept 68000 Assembler Programmer's Reference Manual
  - The Corvus Concept Operating System Reference Manual

### Standard Software

- o Corvus Concept Operating System, Constellation Network Software, and general utilities
  - FBOOT, FSYSGEN, FCCSYS1, FCCSYS2, FCCSYS3, and FCCSYS4 Diskettes

- o Corvus Concept UCSD p-System Runtime Diskette  
FPSYS Diskette
- o Corvus Concept Editor and Wordprocessing System  
FEDWORD Diskette

**Optional Software**

- o Corvus Concept LogiCalc Spread Sheet program  
FLGICLC Diskette  
The Corvus Concept LogiCalc User Guide  
The Corvus Concept LogiCalc Glossary
- o Corvus Concept ISO Pascal Programming Language  
FPASCAL Diskette  
The Corvus Concept Pascal Reference Manual
- o Corvus Concept FORTRAN 77 Development System  
FFORTRN Diskette  
The Corvus Concept FORTRAN Reference Manual
- o UCSD p-System Development System

If the Concept has not already been installed, refer to "The Corvus Concept Personal Workstation Installation Guide," and follow its instructions on setting up the Workstation. After the Workstation is setup, return to this section and continue with this guide.

**SETTING BOOT SWITCHES**

If a Corvus hard disk has just been initialized following the instructions in "The Corvus Concept Disk Drive Installation Guide," the boot switches have already been set and this section can be skipped. If the Concept is being added to an existing Omninet network, the boot and Omninet switches must be set. If the Concept is setup as a stand-alone unit only the boot switches need to be set.

Open the pull-out drawer on the back of the Concept by loosening the latch screws (see diagram). To loosen the left screw, turn the left knob clockwise. To loosen the right screw, turn the right knob counter-clockwise. Slide the drawer out.

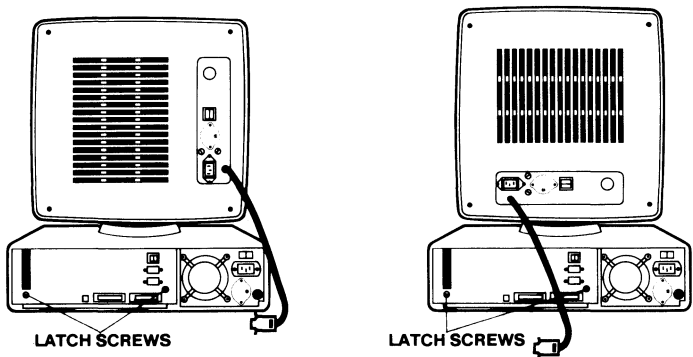

The boot switches are numbers seven and eight on the microswitch box, located along the right side of the pull-out drawer. Set both boot switches in the Concept drawer to the ON position. If the Workstation is being added to an Omninet network the six Omninet switches must be set to a position that has been approved by the system manager, (the person in charge of the network).

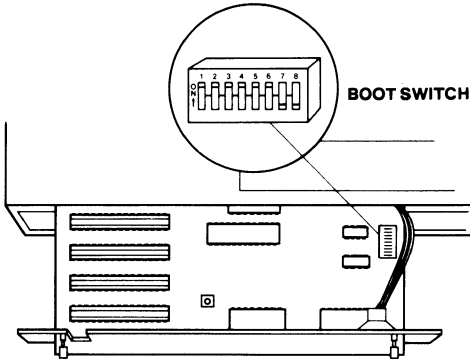

Close the drawer and tighten the latch screws.

**CONNECTING TO AN OMNINET TAP**

The Omninet tap cable connects to the Omninet port on the back of the Concept base unit. The Omninet port is recognized as slot 5 by the Concept.



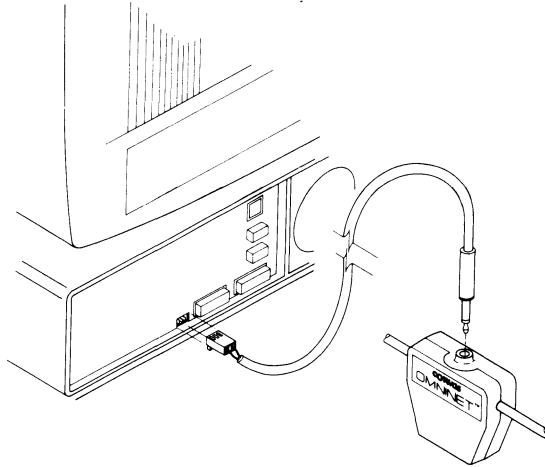

**POWER-ON**

By this time assuming that all the Concept hardware has been properly setup, the system is ready to power-on.

**WARNING! DO NOT POWER-ON OR POWER-OFF THE CONCEPT BASE UNIT WHEN A FLOPPY DISKETTE IS IN THE DISKETTE DRIVE. DOING THIS MAY DESTROY INFORMATION STORED ON THE DISKETTE.**

If there is a floppy diskette in the diskette drive, remove it before continuing with the instructions in the next two paragraphs. Make sure the disk drive is powered on and ready.

Looking at the front of the disk drive cabinet, there are three red indicator lights labeled FAULT, BUSY, and READY. When the drive is powered on all three lights become lit. When the drive is ready (after approximately 30 seconds) only the READY light stays on.

Power-on the Concept display unit. If the display unit is in the horizontal position, depress the left side of

the power switch. If the display unit is in the vertical position, depress the top of the power switch.

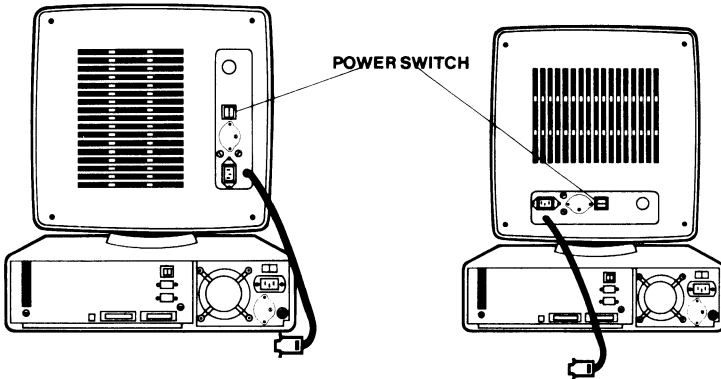

To power-on the Concept base unit, depress the right side of the power switch on the back of the base unit. The Concept should make a beep, and then enter its self-diagnostic program.

### SELF-DIAGNOSTIC

After powering on the Concept, it begins running a twenty second self-diagnostic program. The screen will be blank during the test, and the Concept beeps again when the program is done. Once it is finished, either the log-on prompt or a prompt asking for the type of boot displays.

This time a prompt asking for the type of boot displays on the screen:

-----

CORVUS CONCEPT INITIALIZATION (#.#)  
COPYRIGHT 1982 CORVUS SYSTEMS, INC.  
ALL SYSTEM TESTS PASSED

SELECT BOOT DEVICE (D,F,L,O):

-----

If the Concept is connected to an Omninet network, press O in response to the prompt above. If the Concept is connected to a local hard disk drive, press L. To boot from a floppy diskette press F, and if the Concept has the MACSbug debugger PROMs and you can enter the debugger by pressing D.

If there is some problem with the setup, or with the Concept itself, a boot error may appear. The following is a list of boot errors and what should be done if one appears.

BOOT ERROR #	SYSTEM FAILURE	SOLUTION
1	UART failure	
2	Prom checksum	Call an authorized
3	Static RAM	Corvus service center
4	Dynamic RAM	
5	Dynamic RAM	
-----		
6	Slot device not ready	Ensure all local drives are ready then press [RETURN]
7	Duplicate Omninet host numbers	Set the Omninet dip switches to a unique address

In the future, the boot device prompt may be skipped by setting the boot switches for the device from which the Concept is to boot. To do this, set switch seven ON and switch eight OFF for an Omninet boot, switch seven OFF and switch eight ON for a local disk boot, or leave both switches ON to be prompted for boot type.

**LOG-ON**

After having responded to the boot device prompt, the screen clears, then another prompt appears:

---

\* \* C O R V U S   S Y S T E M S  
\*            C O N S T E L L A T I O N   I I  
\*   \*

Please enter your name:

---

Type the name that has been assigned to you, and press [RETURN]. Another prompt is quickly displayed:

---

Please enter your password:

---

Type your password and press [RETURN]. If you do not have a password, just press [RETURN].

The screen clears, then displays several rows of dots. The cursor will pause several times while they are being printed. The screen will clear again and the following is displayed:

---

```
CCOS v #.#      User: JOE      Station: 1      Volume: /CCSYS
```

---

Mount Constellation II volumes ...

```
Mounting volume CCSYS      on unit 4
Mounting volume *****   on unit 9
Mounting volume CCUTIL     on unit 10
Mounting volume ONE        on unit 11
Mounting volume TWO        on unit 12
```

---

```
+-----+
| Enter Command: |
+-----+
```

```
||| ||| ||| ||| ||| ||| ||| ||| ||| ||| |||
```

---

At the top of the screen is a permanent display which has the version of the operating system on the left, followed by the name of the user, the Workstation number which appears only if the Workstation is connected to an Omninet network, and the current volume. On the right side of the screen is displayed the day of the week, the month, day, year, and the time (in military time). Once set, the date is automatically updated every twenty-four hours. The time is updated by the Concept when the Workstation is idle and in the Dispatcher level.

All the volumes in your access table are automatically mounted. If there is a diskette drive connected to the Concept without a diskette in the unit, a series of asterisks are used in place of the diskette name when "Mounting volume \*\*\*\*\* on unit 9" displays.

If there is a diskette drive with a diskette in the unit, the diskette's name appears where the asterisks are.

The screen has been divided into three separate areas called "windows." Output is displayed in the System window, interaction with the operating system takes place in the Command window, and function key labels are shown in the Label window.

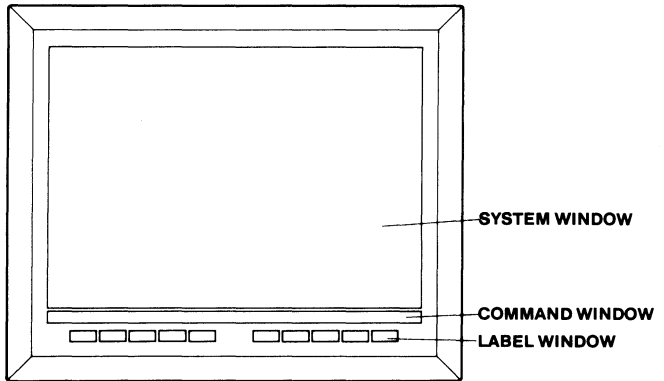

There are many levels of function keys, each with their own set of labels. These levels can be reached by pressing function keys from higher levels which represent a group of interrelated tasks. The highest level of labels is called the Dispatcher level. Each label corresponds to one of the function keys at the top of the Concept keyboard.

The Dispatcher label display shows only one half its labels at a time. By holding down the [COMMAND] key on the keyboard, you can see the other half. With both shifted and unshifted labels, plus those available by

holding down the [COMMAND] key, a maximum of forty labels may be available per level.

DISPATCHER				
F1	F2	F3	F4	F5
p-System		EdWord	SetVol	ListVol
F6	F7	F8	F9	F10
ClrWindow	SelWindow	Restart	Help	

DISPATCHER with [COMMAND] pressed				
F1	F2	F3	F4	F5
FileMgr	WindowMgr	ExecFile	Const II	SysUtils
F6	F7	F8	F9	F10
	TmpWindow			Reboot
RevBkgnd	CreWindow		MountMgr	

**COPYING OPTIONAL SOFTWARE**

Now that the Concept is up and running smoothly, the next step is to transfer any optional programs you have purchased from diskettes to the Corvus hard disk drive.



**Copying LogiCalc To The Hard Disk Drive**

There is one LogiCalc distribution diskette, which is called "Concept LogiCalc Diskette." Copy the files to the hard disk as follows:

1. Place the LogiCalc diskette in the diskette drive.
2. Press [ExecFile]

You will be prompted for a filename in the Command window:

-----  
Execute which command file?  
-----

Type /FLGICLC/SYSTEM.UPDATE  
Press [RETURN]

The System window displays:

-----  
File ID: /FLGICLC/SYSTEM.UPDATE  
SYSTEM.UPDATE assumes volumes /CCSYS and /CCUTIL  
exist and have read/write access  
Continue? [Y/N]:  
-----

3. Press Y

The files on this diskette are automatically copied to the hard disk. When the labels at the bottom of the screen are displayed, the update is complete.

**Copying Pascal To The Hard Disk Drive**

There is one Pascal distribution diskette, which is called "Concept Pascal Diskette." Copy the files to the hard disk as follows:

1. Place the Pascal diskette in the diskette drive.
2. Press [ExecFile]

You will be prompted for a filename in the Command window:

```
-----
Execute which command file?
-----
```

```
Type    /FPASCAL/SYSTEM.UPDATE
Press   [RETURN]
```

The System window displays:

```
-----
File ID: /FPASCAL/SYSTEM.UPDATE

SYSTEM.UPDATE assumes volumes /CCSYS and /CCUTIL
exist and have read/write access

Continue? [Y/N]:
-----
```

3. Press Y

The files on this diskette are automatically copied to the hard disk. When the labels at the bottom of the screen are displayed, the update is complete.

**Copying FORTRAN To The Hard Disk Drive**

There is one FORTRAN distribution diskette, which is called "Concept FORTRAN Diskette." Copy the files to the hard disk as follows:

1. Place the FORTRAN diskette in the diskette drive.
2. Press [ExecFile]

You will be prompted for a filename in the Command window:

-----  
Execute which command file?  
-----

Type /FFORTRN/SYSTEM.UPDATE  
Press [RETURN]

The System window displays:

-----  
File ID: /FFORTRN/SYSTEM.UPDATE  
SYSTEM.UPDATE assumes volumes /CCSYS and /CCUTIL  
exist and have read/write access  
Continue? [Y/N]:  
-----

3. Press Y

The files on this diskette are automatically copied to the hard disk. When the labels at the bottom of the screen are displayed, the update is complete.



This chapter covers the Concept keyboard and display monitor. The use of the function keys, modifier keys, cursor keys, and display control keys are all discussed.

**THE KEYBOARD**

The standard Concept keyboard is a detached Selectric-style QWERTY keyboard. It is connected to the base unit with a telephone-type cord, which extends to a maximum length of six feet.

Although the keyboard is similar to a typewriter keyboard, the Concept keyboard has a numeric keypad and additional keys to control some of the functions of the Workstation.

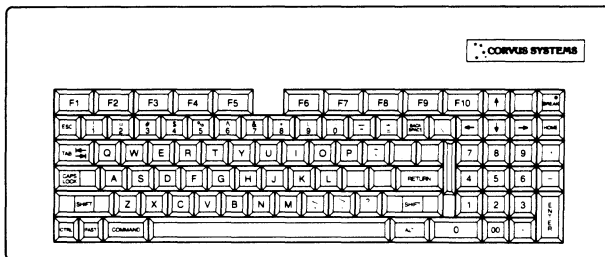

The keys are divided into five groups:

1. Character keys,
2. Function keys,
3. Cursor control keys,
4. Numeric keypad keys,
5. Modifier keys.

All keys on the keyboard automatically repeat when they are held down.

The keyboard has fourteen modifier keys, and ten function keys. When referring to these keys throughout this Guide, they appear within brackets, e.g. [RETURN] and [COMMAND].

### Modifier Keys

The modifier keys are standard keys found on most computer keyboards. These keys change the function of other keys on the keyboard. To do this, they must be held down while another key is pressed, similar to the way typewriters use the [SHIFT] key.

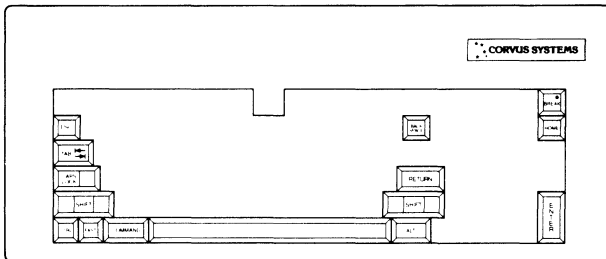

[ALT] stands for "alternate." When held down it causes an alternate character to be displayed when a key is pressed instead of the normal character symbol as shown on the keytops.

- [BACK SPACE] moves the screen cursor backwards. It is used to delete mistakes when typing data in the Command window.
- [BREAK] can perform a cold boot. It may also be used for stopping file listings. For details, see the last section in this chapter.
- [CAPS LOCK] sets all alphabet keys to display as capital letters without having to press [SHIFT].
- [COMMAND] displays a second set of function keys, doubling the number available. For details, see the section titled "Function Keys and Function Key Labels."
- [CTRL] stands for "control." It is used in conjunction with other keys to perform functions such as stopping and starting screen display, rebooting, etc. See the last few sections of this chapter for more information.
- [ENTER] sends data to the processor from the numeric keypad. On the Concept, this key is the same as the [RETURN] key.
- [ESC] stands for "escape." The key is used to exit certain programs. VOLUTIL, HELP, and Mount Manager are examples.
- [FAST] speeds up the cursor keys or displayable keys, it causes the key being pressed to repeat faster than the normal rate.
- [HOME] is used by some Concept programs to put the cursor in the upper left corner of the display screen.
- [RETURN] sends information to the processor. It also performs as the standard typewriter carriage return.
- [SHIFT] is used to type a single upper-case letter, or the upper character on a key.

- [SPACE] causes a blank space to be created. It is the same as the space bar on all typewriters.
- [TAB] causes the cursor to move eight spaces, or another specified length.

### Cursor Keys

The Concept keyboard has four cursor movement keys, which allow the screen cursor to be moved up, down, left, or right. The arrow on the keytop indicates the direction the cursor moves.

Cursor keys are located just above the numeric keypad.

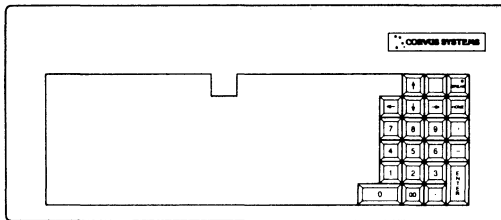

### Function Keys

There are ten function keys across the top of the Concept keyboard labeled F1 through F10. These keys are programmable, and are used by system programs to perform specific functions.



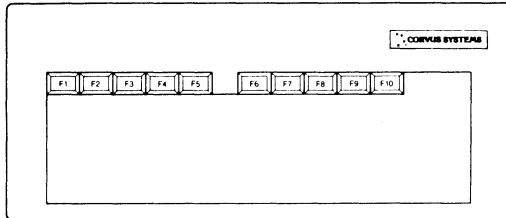

### Function Key Labels

Function key labels are the abbreviated names of programs or functions that can be accessed by pressing a function key.

Function key labels are displayed in the Label window at the bottom of the Corvus Concept display screen. Each of these keys corresponds to one of the function keys, F1 through F10, on the Concept keyboard. The number of the corresponding function key is displayed above each label.

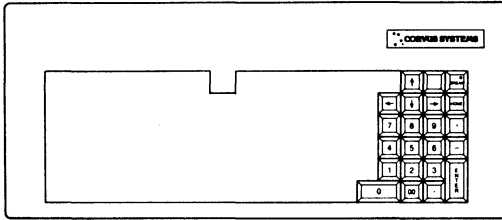

Two sets of function key labels are available. One set of labels is displayed automatically; the other set is displayed when the [COMMAND] key is held down.

Some sets of function key labels contain a row of shifted and unshifted functions. The unshifted label is the lower one in each label box, and the shifted label is the upper one. However, not every label box will have both a shifted and unshifted label; most have only the unshifted label.

F1	F2	F3	F4	F5
shifted labels				
unshifted labels				

F6	F7	F8	F9	F10
shifted labels				
unshifted labels				

This guide treats a label as a key. When a label name is enclosed in brackets, e.g. [ListVol], this guide refers to the function key associated with the label. When a label name is not enclosed, e.g. ListVol, we refer to the task associated with the label not the

physical key.

The function key labels change with each program. Within each program, each function key may represent up to four separate functions. The first level function is obtained by pressing the function key. For example, from the Dispatcher labels, "Press [SetVol]" equates to pressing the [F4] key.

The second level function is obtained by holding down the [SHIFT] key and simultaneously pressing the appropriate function key.

The third level function is obtained by holding down the [COMMAND] key and simultaneously pressing the appropriate function key. For example, from the Dispatcher labels, "Press [MountMgr]" equates to simultaneously pressing the [COMMAND] key and the [F9] key.

The fourth level function is obtained by holding down the [COMMAND] key and the [SHIFT] key while simultaneously pressing the appropriate function key. For example, from the Dispatcher labels, "Press [Reboot]" equates to simultaneously pressing the [COMMAND] key, the [SHIFT] key, and the [F10] key.

**The Help Label**

For a brief description of any function key label, press [Help] then press the function key that corresponds to the label in question.

For example, press the [Help] function key on the keyboard. The machine reads the Help file and displays a prompt for more instructions:

```
+-----+
| Select the appropriate function key for HELP .... |
| Press <ESC> to terminate help processing          |
+-----+
```

Press [ClrWindow]

The following message is displayed near the top of the

display window:

-----  
[ClrWndow] clears everything from the current window.  
-----

For information on another function, just press the appropriate key. For example, if [SelWndow] is pressed after having pressed [ClrWndow] above, a SelWndow help message displays below the ClrWndow help message:

-----  
[ClrWndow] clears everything from the current window.

[SelWndow] allows you to choose one of your defined windows and make it the current window.  
-----

Help continues to give messages until the [ESC] key is pressed. Pressing [ESC] will exit the program and return to the current level.

If the [HELP] key is accidentally pressed, the program can be terminated before it is completely read into memory by pressing any key on the keyboard.

### **The Exit Label**

There are many sets, or levels, of function key labels in the operating system. For example, another level can be reached by pressing [WnDowMgr]. The Exit label leaves the current set of labels and returns to one level higher until the Dispatcher level is reached.

Exit is always associated in some way with the [F10] key. It appears in every set of labels, except the Dispatcher set.

## **THE VIDEO DISPLAY MONITOR**

The Corvus Concept display unit can be arranged in different ways to suit different purposes. The orientation can be changed, and it can be tilted and swiveled. For details on changing the screen orientation from vertical to horizontal or vice versa see the section titled "VIDEO DISPLAY UNIT" in Chapter Six.

### **Screen Configuration**

The video display screen is divided into areas called windows. A window can be considered a section of the screen, or a defined display area. A task being completed in a window does not affect the area outside that window.

At log-on the Concept displays three permanent windows. They are called the System window, the Command window, and the Label window.

**System Window.** The System window is the topmost and largest of the three windows. This is where all normal output is displayed; e.g. characters and graphics output by various programs, as well as system functions such as volume listings.

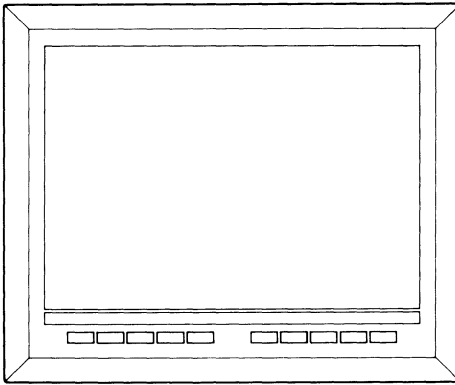

In the horizontal orientation, the size of the System window is 707 pixels by 479 pixels.

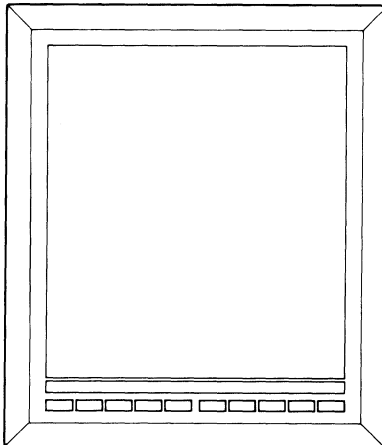

In the vertical orientation, the size of the System window is 545 pixels by 639 pixels.

The following table is a list of the actual number of characters, of different heights and widths, that can be placed within any full sized System window.

TEXT COLUMNS ON SCREEN		
char width in pixels	horizon.	vertical
5	141	109
6	118	91
7	101	78
8	88	68
9	79	61
10	71	55
11	64	50
12	59	45
13	54	42
14	51	39
15	47	36
16	44	34

TEXT LINES ON SCREEN		
char hgt. in pixels	horizon.	vertical
5	96	128
6	80	107
7	68	91
8	60	80
9	53	71
10	48	64
11	44	58
12	40	53
13	37	49
14	34	46
15	32	43
16	30	40

The character set being displayed, the default character set, is 6 by 10 pixels. Therefore in the horizontal orientation 118 characters may be displayed across on 48 separate lines. In the vertical orientation 91 characters may be displayed across on 64 separate lines.

**Command Window.** There is a long narrow rectangle below the System window, called the Command window. This is the area where commands are entered and displayed. The Command window also serves as a message window.



The Command window is composed of two lines. The bottom line is the command line, where commands are typed. The top line is the message line, where the Concept displays messages.

**Label Window.** Function key labels are displayed in the third window. This is at the bottom of the screen below the Command window. The labels in this window stand out, since the lettering is black with a white background. The labels indicate what function each key represents.

**DISPLAY CONTROL KEYS**

Display control keys are keys used in conjunction with the [CTRL] key. This means that the [CTRL] key is held down while another key is simultaneously pressed. These keys and their functions are as follows:

FUNCTION	hold down	.....then press
Stop Screen Display	[CTRL]	S
Restart Screen Display	[CTRL]	S
Restart Screen Display	[CTRL]	Q
Return from Exec level	[CTRL]	D



### **Interrupting Screen Display**

If the Concept is set for scrolling, there are times when you will want to stop the flow of text. To do this hold down the [CTRL] key and press S.

A [CTRL] S may be used to interrupt scrolling in a text file, or long volume listing; it can also suspend the output of a program.

To restart a listing or program's output use the [CTRL] S or a [CTRL] Q commands. Either key may be used to continue scrolling.

Using a [CTRL] S does not terminate a task. Before using the Concept to perform another task you must complete execution by restarting the scroll, and halt program execution.

## **THE BREAK KEY**

### **Terminating a File Listing**

There are occasions where a file listing may take a long time. When large files are listed, and the first part is all that is needed, the [BREAK] key is useful. Pressing the [BREAK] key will terminate a listing and return control of the Concept to the user.

### **Cold Boot**

A cold boot can be performed by holding down [CTRL] and pressing [BREAK]. This reloads the operating system and drivers. However, **DO NOT** use this key when running a program that writes data to the disk, because this may destroy the file being written to.



This chapter covers the Corvus Concept Operating System (CCOS) utilities. There is in-depth instruction on the function keys, file management, display-screen management, user-definable function keys, executable (Exec) files, and entering the runtime p-System.

### THE DISPATCHER

The labels that display at the bottom of the screen at log-on are called the Dispatcher labels. They are the first level of functions available after log-on.

Other sets of labels can be called from the Dispatcher level that allow various features of the Concept to be used. These sets include: the FileMgr labels, the WndowMgr labels, SysUtils labels, LogiCalc labels, EdWord labels, and the Userkey labels.

At this point the Command window appears as follows:

```
+-----+  
|  
| Select Function: |  
+-----+
```

The labels available at the Dispatcher level are shown below.

DISPATCHER				
F1	F2	F3	F4	F5
p-System	LogiCalc	EdWord	SetVol	ListVol

F6	F7	F8	F9	F10
ClrWdow	SelWdow	Restart	Help	Userkeys

DISPATCHER with [COMMAND] pressed				
F1	F2	F3	F4	F5
FileMgr	WdowMgr	ExecFile	Const II	SysUtils

F6	F7	F8	F9	F10
	TmpWdow			Reboot
RevBkgnd	CreWdow		MountMgr	

### Dispatcher Level Functions

- [ClrWdow] clears everything from the current window.
- [Const II] enters the Constellation II level which is used exclusively by System managers.
- [CreWdow] creates new windows inside the System window area. To create a new window press [CreWdow] and follow the directions given.

- [EdWord] enters the Concept editor/word processor program. It is discussed in a separate manual: "The Corvus Concept EdWord User Guide."
- [ExecFile] allows you to execute any Exec file entered on the command line, or run the command interpreter by typing %. To leave the command interpreter you must use [CTRL] D.
- [FileMgr] enters the File Manager level. To return to the Dispatcher level from the File Manager press [Exit].
- [Help] gives you brief descriptions of each label. Press [ESC] to exit from Help.
- [ListVol] lists volumes on-line or file names in a volume. Type the volume name and press [ListVol] to list the files in a particular volume. Type / or ! for listings of volumes and devices on-line and other volume information.
- [LogiCalc] enters the optional Concept spreadsheet program. It is discussed in a separate manual: "The Corvus Concept LogiCalc User Guide."
- [MountMgr] runs the Constellation II Mount Manager program allowing you to manage your volume access.
- [P-System] enters the UCSD Pascal runtime operating system. The current volume must be a UCSD volume. H[alt must be used to return to the CCOS from the p-System.
- [Reboot] automatically reinitializes the system without going through the diagnostic program and log-on procedures.
- [Restart] causes the CCOS to perform the last command that was executed.
- [RevBkgnd] reverses the background of the current window from black to white and vice versa.

- [SelWndow] allows you to choose one of your defined windows and make it the current window.
- [SetVol] allows you to set a volume as the current volume. The current volume is the one where your work is being done.
- [SysUtils] enters the System Utilities level. To return from the System Utilities level. from the System Utilities level press [Exit].
- [TmpWndow] allows you to create a temporary window inside the System window.
- [UserKeys] enters you in the user-definable function key level. These labels are defined in the file USERKEYS.TEXT and can be modified in EdWord to contain any commands you want.
- [WndowMgr] enters the Window Manager level. To return to the Dispatcher level from the Window Manager level press [Exit].

### **How to Run a Program**

At the Dispatcher level, the Concept is in a state of readiness-to-execute. There are two ways to execute, or run, a program: 1) by typing the name of the file that contains a program, 2) by pressing the function key corresponding to a desired label.

To run a program designated by a label, press the function key associated with that label. For example, to use EdWord, the Concept Editor/Word processor, press [EdWord].

To run a program other than one designated by function key labels, type the name of the program and press [RETURN].

For example, to run the Concept diskette formatting program named FFRMT, in the volume /CCUTIL, type the program file name.

Type /CCUTIL/FFRMT  
Press [RETURN]

```
+-----+  
|  
| Select function: /CCUTIL/FFRMT [RETURN]  
|  
+-----+
```

To run a program that is not in the current volume, type the volume name enclosed in slashes followed by the program name and press [RETURN]. For example, to run a program named GRAPH in a volume named WORK,

Type /WORK/GRAPH  
Press [RETURN]

```
+-----+  
|  
| Enter Command: /WORK/GRAPH [RETURN]  
|  
+-----+
```

If a volume name is not specified when running a program, the CCOS first searches the current volume for the file. If the file is not in the current volume, CCOS searches the boot volume, which is the normally volume named CCSYS.

### The Restart Function

For tasks that are to be performed many times in succession the Restart key performs a valuable service. To execute the last command performed

Press [Restart]

The function is performed unless it is a task that does not need to be done over. An example of that would be setting the current volume. Once that volume has been set there is no need to set it again.

**Warm Boot**

When at the Dispatcher level Reboot can be used to perform a warm boot. This reloads the operating system and drivers, and skips the diagnostic program and the regular log-on procedures.

To re-boot this way,

PRESS [Reboot]

**FILE MANAGEMENT**

The Concept File Manager handles most of the tasks of transferring information from one place to another. These tasks include:

1. making disk files,
2. deleting disk files,
3. moving disk files,
4. concatenating files,
5. renaming files,
6. renaming volumes,
7. listing files,
8. listing volumes.

The file manager also keeps track of where files have been placed in a volume, and what system devices are available to be used. A volume has a directory that contains the names and addresses of the files stored within it.

A volume is a named area of disk space, similar to a single diskette. All file management rules that apply to volumes also apply to diskettes.

Volumes and diskettes provide storage areas for files. A file can contain a program, a letter to a friend, a manual, a list of names, or any of a hundred other things. In more technical terms, a file or a volume is a defined area on the disk that contains a collection of data.

There are several types of files in the CCOS. The two most important types are data files and text files. Programs are placed in data files. Letters, manuals,



and lists of names are in text files, which always have a .TEXT automatically appended to their name by EdWord.

### **Logical Units**

A logical unit denotes a general device identifier, while a physical unit is the specific piece of equipment chosen to perform that function. The CCOS requires you to select a physical unit to perform the function for each logical unit.

Volumes are considered physical units, and each is assigned a unique logical unit numbers.

### **System Volume**

The system volume contains the information needed by the Concept at power-on. This volume is normally named /CCSYS and is mounted on logical unit four. Most of the files in the system volume are data files, or programs.

### **Current Volume**

The current volume is the volume where work take place. At boot, the current volume is set to the volume mounted on unit 5. If there is no volume mounted on unit 5, the current volume is set to the system volume.

The current volume can be set to any volume in your account. This is done by using the SetVol function.

### **Volume Names**

A volume name can be from one to seven characters in length. The name can contain only letters, numbers, and periods; it can start with a letter or a number, but not a period.

The following are examples of valid volume names:

ONE	HUSH	232
1	LUMPY	LETTERS
B.VOL7	4545456	XX.MINE

To reference a volume, you must precede the volume name with a slash, as follows:

/HUSH

To the Concept, slashes are volume name delimiters. They tell the Operating System that the name following the slash is a volume name and not a file name.

**File Names**

A file name can contain up to fifteen characters. The name can contain only letters, numbers, periods, dashes, and underline characters; it can start with any legal character. File names can be changed with the RnamFile function described later in this chapter.

The following are examples of valid file names:

REJECTS.IV.TEXT	LETTER.SORT
A FAST PROGRAM	56 TEXT
TRY.324.TEXT	PROGRAM669
...HERE...	.3.FLY

To reference a file in the current volume, simply type the file name, as follows:

SECRET.TEXT

To reference a file in a volume other than the current volume, type the volume name enclosed in slashes followed by the file name, as follows:

/HUSH/SECRET.TEXT

### Wild-Card Characters

There are two wild-card characters that can be used with some of the Concept file functions. These are the asterisk (\*) and the question mark (?).

The question mark can be used to represent any single character. For example, the file name ?OSE.TEXT is equivalent to NOSE.TEXT, HOSE.TEXT, and LOSE.TEXT. The file name FOO?.TEXT is equivalent to FOOL.TEXT, FOOD.TEXT, and FOOT.TEXT.

The asterisk represents any group of characters. For example, the file name F\*.TEXT is equivalent to FUN.TEXT, FUNNY.TEXT, FLOAT.TEXT etc.

If a volume listing is requested using \*.TEXT (/VOL1/\*.TEXT), all the file names in VOL1 that end with .TEXT are listed. If a volume is requested using LET\* (VOL1/LET\*), all file names that begin with the letters LET are listed.

The wild-card characters may be used with the ConcFile, CopyFile, DletFile, DletTemp, ListFile, or ListVol commands.

### Setting a Volume

SetVol designates a volume as the current volume. SetVol appears in both the Dispatcher labels and the FileMgr labels.

Each time the Concept is powered-on, the current volume is set to the volume mounted on unit number five. The current volume can be changed in the manner described below.

To change the current volume press [SetVol], and type the name of the volume to be set as current, then press [RETURN].

For example, to set the volume /VOL1 as current do the following:

Press [SetVol]

The Command window displays:

```
+-----+  
|  
| Set which volume to current?  
|  
+-----+
```

Type /VOL1  
Press [RETURN]

```
+-----+  
|  
| Set which volume to current? /VOL1 [RETURN]  
|  
+-----+
```

When the volume is set, the Concept responds in the Command window:

```
+-----+  
| Current volume is now /VOL1  
| Select FileMgr function:  
|  
+-----+
```

If an error is made typing the volume name, use the [BACKSPACE] key to back up and correct the error. If an invalid volume name is entered, such as "VAL1" instead of "VOL1," an error message displays:

```
+-----+  
| '/VAL1' is not a valid volume name  
|  
+-----+
```

Once a volume is set as the current volume, it remains current until it is changed, or until the next time the Concept is re-booted.

### Listing a Volume

The ListVol function can be used to obtain various kinds of information. ListVol tells which volumes are mounted, the file names in the current volume, or the file names in any other volume. ListVol is found in both the Dispatcher and the FileMgr labels.

To list the files in a volume press [ListVol], type a slash, the volume name, and press [RETURN].

For example

Press [ListVol]

The Command window displays:

```
+-----+
|
| List which volume directory?
+-----+
```

Type /VOL1  
Press [RETURN]

```
+-----+
|
| List which volume directory? /VOL1 [RETURN]
+-----+
```

The following is displayed in the System window:

```

CCOS Volume: VOL1, size = 1024 blocks, 19 files
CVT.TEXT          512 13-Mar-82    6:  4 text
CVT              512 10-Mar-82   10:  5 data
LINKER.TEXT      228 10-Mar-82   15: 14 text
LNKFR8NT.TEXT   380 10-Mar-82   29:  6 text
LNKINTRO.TEXT    90 10-Mar-82   35:  8 text
LIBRARY.TEXT    205 10-Mar-82   43:  6 text
OBJECTF.TEXT    247 10-Mar-82   49: 80 text
LINKMAN.TEXT    333 10-Mar-82  129:  4 text
MER6.TEXT       512 19-Feb-82  133: 24 text
MERO.TEXT       512 13-Mar-82  157: 22 text
MER1.TEXT       512 13-Mar-82  179: 34 text
MER2.TEXT       512 13-Mar-82  213: 26 text
MER3.TEXT       512 13-Mar-82  239: 24 text
MER4.TEXT       512 13-Mar-82  263: 28 text
MER5.TEXT       512 13-Mar-82  291: 24 text
BOLD           512 13-Mar-82  315: 162 data
BOLD1         512 23-Mar-82  477: 500 data
BB.TEXT        512 13-Mar-82   977:  4 text
GRAP.TEXT      512 22-Mar-82  981: 20 text
<...>
19 of 19 files listed.

```

To understand this listing it is best to break it down one section at a time. The top line of the listing gives some important volume information:

```
CCOS Volume: VOL1, size = 1024 blocks, 19 files
```

```
CCOS Volume: VOL1 --
```

```

CCOS tells us that it is a Corvus Concept
volume. A volume could also be a UCSD
volume. The name of the volume being
listed is VOL1.

```

```
size = 1024 blocks --
```

```

this tells us that the volume VOL1 has a
size of 1024 blocks. Each block on the
Concept is 512 bytes, so we now know the
exact size of the volume.

```

19 files --

this tells us that there are nineteen files in the volume VOL1. This includes all text and data files.

The next line, and the lines below it give us valuable information about our files. The information is broken down into six columns:

```
CVT.TEXT          512  13-Mar-82      6:    4  text
```

CVT.TEXT --

this, and every name below it in the left column, is a file name in the volume directory.

512 --

this, and the numbers below it in the second column, is the number of bytes used in the last block of the file. When we add the number of full blocks the file takes, we will know exactly how much space the file uses.

13-Mar-82 --

this is the last date that this file has been updated. The 13 is the day, Mar is the three letter abbreviation for the month March, and 82 represents the year 1982.

6: --

this number is the starting block address of the file.

4 --

this is the number of blocks that the file occupies. If this number is added to the starting block address the result is the starting block address for the next possible file.

text --

this will tell you whether the file is a text or a data file.

The last two lines also give us useful information. They are:

<...> 1001: 23  
19 of 19 files listed.

<...> --

this symbol is in the filename column, and represents no file. This means that the space shown on the right is open space on the volume.

1001: 23 --

this is the starting block address and the size of the open space. It tells where the open space begins, and how large the space is.

19 of 19 files listed. --

this tells us that all the files in the volume were actually listed. There are occasions where a partial listing is preferable to a full one. For a partial listing when only three files are listed, the last line will say 3 of 19 files listed.



**Slash /** To list all the devices, on-line, which includes volumes, press slash then [ListVol].

PRESS /  
PRESS [ListVol]

```

+-----+
| Select function: / [ListVol]
+-----+

```

The following is displayed in the System window:

```

0: /NULL
1: /CONSOLE
2: /SYSTEM
4: # /CCSYS      2048 blks
5: # /VOL1      1024 blks
6: /PRINTER
9: # /FLOPPY     500 blks
11: # /CSD      1024 blks
12: # /CCUTIL   2048 blks
14: # /VOL2     1024 blks
15: # /VOL3     1024 blks
18: # /MYUCSD   1024 blks
22: # /GRAPH    1024 blks
30: /SLOTIO
31: /DTACOM1
32: /DTACOM2
33: /OMNINET
34: /TIMER
35: /KYBD
36: /DISPLAY

```

```

System volume is: /CCSYS
Current volume is: /VOL1

```

To understand the slash type of listing a closer analysis of one line is needed. For this description we will use the following line from the previous listing:

```
14: # /VOL2      1024 blks
```

14: --

this is the logical unit number.

# --

this indicates the device that follows is block structured (i.e., disk volume).

/DTACOM1 --

this is the name of the device. In this case it is a volume named VOL2. Others are /DTACOM1 for the serial data port 1, and /PRINTER for the printer.

1024 blks --

this is the length of the volume in blocks. It is the same number that would be seen on the top line of a volume listing. It is only on a few of the lines in this listing, because not all of the devices are volumes.

The bottom lines add some information regarding the present status of the system.

System volume is: /CCSYS  
Current volume is: /VOL1

The first line tells that the system volume is /CCSYS which we can see is on logical unit four, and is 2048 blocks long.

The second line tells us that the current volume is /VOL1 located on logical unit number five. This volume was set as the current volume at boot since it is mounted on unit five. If you had set another volume to the current volume before doing the ListVol the new volume would be listed as current.

**Exclamation Point !** To list all devices mounted, including the volume block addresses, press exclamation point then [ListVol].

The exclamation point type of volume listing gives more volume information than the slash listing. This extra information includes the active slot number, the disk server number, the drive number, and the starting block address, and both the system and current volumes.

PRESS !  
PRESS [ListVol]

```

+-----+
|
| Select functin: ! [ListVol]
|
+-----+

```

The following is displayed in the System window:

```

0:  /NULL
1:  /CONSOLE
2:  /SYSTEM
4:  # /CCSYS      2048 blks (slt 2 srv 0 drv 1 blk 1232)
5:  # /VOL1      1024 blks (slt 2 srv 0 drv 1 blk 5328)
6:  /PRINTER
9:  # /FLOPPY      500 blks (slt 3 srv 0 drv 0 blk 0)
11: # /CSD      1024 blks (slt 2 srv 0 drv 1 blk 6352)
12: # /CCUTIL    2048 blks (slt 2 srv 0 drv 1 blk 3280)
14: # /VOL2      1024 blks (slt 2 srv 0 drv 1 blk 7376)
15: # /VOL3      1024 blks (slt 2 srv 0 drv 1 blk 8400)
18: # /MYUCSD    1024 blks (slt 2 srv 0 drv 1 blk 9424)
22: # /GRAPH     1024 blks (slt 2 srv 0 drv 1 blk 10448)
30: /SLOTIO
31: /DTACOM1
32: /DTACOM2
33: /OMNINET
34: /TIMER
35: /KYBD
36: /DISPLAY

```

```

System volume is: /CCSYS
Current volume is: /VOL1

```

The listing is the same as the slash type of listing but includes extra volume information. Below is an explanation of the added information.

```
(slt 2 srv 0 drv 1 blk 7376)
```

```
slt 2 --
```

```

this is the slot number that the drive is
connected to. If the volume is on a local
hard disk drive or a diskette drive the
slot number could be
from 1 to 4, depending on which slot the
disk's interface card is in. If the volume
is on an Omninet local area network the
slot number would be 5.

```

srv 0 --

this is the disk server number. The disk server is used to connect a Corvus disk to the Omnet local area network. If the slot number is not 5, this number is irrelevant.

drv 1 --

this is the disk drive number. Since up to four disk drives may be daisy-chained the 1 represents the first drive.

blk 7376 --

this is the starting block address for the volume on the hard disk drive.

**Output Redirection.** Normal output displays in the current window. However, this output can be redirected to a text file or a printer. Redirection works with any of the Concept list functions: ListVol, ListFile, and DrvrVrsn. *LIST VOL* *7376*

The printer driver must be assigned before redirecting output to a printer. Assigning drivers is covered in a later chapter.

Redirected output looks exactly the same in a text file or on paper as it would when displayed on the screen.

The format for redirecting output is as follows:

(device being listed) > (output device)(function key)

The device being listed can, for example, be the current volume. The output device can be a text file or a printer.

The following example shows how to redirect the current volume directory listing to a text file in another volume.

Type /VOL1 > /VOL2/LIST.TEXT [ListVol]

```
+-----+  
|  
| Select function: /VOL1 > /VOL2/LIST.TEXT [ListVol]  
|  
+-----+
```

The next example shows how to redirect the current volume directory listing to a local printer.

```
Type /VOL1 > /PRINTER  
Press [ListVol]
```

```
+-----+  
|  
| Select function: /VOL1 > /PRINTER [ListVol]  
|  
+-----+
```

### FILE MANAGEMENT FUNCTIONS

Concept file management functions include: delete a file, delete a temporary file, make a file, rename a file, copy a file, list a file and reclaim volume space.

When [FileMgr] is pressed from the Dispatcher level, the Concept FileMgr labels display.

FILE MANAGER				
F1	F2	F3	F4	F5
CopyFile	DletFile	ListFile	SetVol	ListVol

F6	F7	F8	F9	F10
ClrWindow	SelWindow	Spool	Help	Exit

FILE MANAGER with [COMMAND] pressed				
F1	F2	F3	F4	F5
MakeFile	DletTemp	RnamFile	ConcFile	Crunch

F6	F7	F8	F9	F10
	TmpWindow			
RevBkgnd	CreWindow	ChngVol	MountMgr	

- [ChngVol] toggles a designated volume between CCOS and the UCSD volume types. DO NOT CHANGE YOUR BOOT VOLUME TO UCSD.
- [ClrWindow] clears everything from the current window.
- [ConcFile] combines two or more files into one continuous file. It can also be used to copy a single file and assign it a different destination file name.
- [Copyfile] copies a file from one volume to another. To copy a file press [CopyFile] and answer the questions.
- [CreWindow] creates new windows within the System window area. To create a new window press [CreWindow] and follow the directions given.
- [Crunch] moves all files in a volume so that all unused space is combined into one large empty space at the end of the volume.
- [Dletfile] deletes a file, or files, from a volume. It may not be possible to retrieve a file after it has been deleted.
- [DletTemp] deletes a temporary file, or files from a volume. A temporary file shows up in a volume listing with ??? where the month normally appears.
- [Exit] returns you to the Dispatcher level.
- [Help] gives brief descriptions of each command label. To leave Help press [ESC].
- [ListFile] lists the contents of a text file in the current window.



- [ListVol] lists volumes on-line or file names in a volume. To list the files in a particular volume press [ListVol], and type the volume name. Type / or ! for listings of devices on-line, volumes mounted and other volume information.
- [MakeFile] creates a file, and asks for the name and size.
- [MountMgr] runs the Constellation II Mount Manager program allowing you to manage your volume access.
- [RevBkgnd] reverses the background of the current window, from black to white and vice versa.
- [RnamFile] renames a file or volume. Press [RnamFile] and answer the questions appropriately.
- [SelWindow] allows you to choose one of your defined windows and make it the current window.
- [SetVol] allows you to set a volume as the current volume. The current volume is the one where your work is being done.
- [Spool] runs the Constellation II spool program. This program allows you to write files to a special volume named Pipes. These files can be despoiled by a station with a local printer using the [Spool] function.
- [TmpWindow] allows you to create a temporary window inside the current window. The window is not cleared at inception.

One important purpose of the file functions is to help keep disk space well organized and clear of unwanted files. Since only 77 files are allowed per volume, you should periodically remove files that are not needed anymore. This is done using the Dletfile function and the Crunch function.

### Delete a File

The DletFile function found in the FileMgr labels allows you to remove files from the directories of volumes and diskettes. After deleting a file the operating system no longer recognizes it, since it has been removed from the volume directory. However, the file is not actually erased unless you have copied other information over the address where that file was placed.

When a file has been deleted from a directory, its directory entry can be reconstructed with the MakeFile function described later in this chapter. However, this works only if other data has not been copied over the place where the file resided.

To delete a file press [DletFile], type the file name, press [RETURN], and press Y for yes when prompted.

The following example deletes the file MESS.TEXT from your current volume called /VOL1.

Press [DletFile]

The Command window displays:

```
+-----+
|
| Delete which file(s)?
|
+-----+
```

Type MESS.TEXT  
Press [RETURN]

```
+-----+
|
| Delete which file(s)? MESS.TEXT [RETURN]
|
+-----+
```

The Command window displays:

```
+-----+
| Delete file "/VOL1/MESS.TEXT"?
|
+-----+
```

In order to delete the file, you must press Y for yes to the prompt shown above. If you do not want to delete the file press N.

Press Y

The Command window displays:

```
+-----+
| Update volume /VOL1 directory?
|
+-----+
```

This message prompts you for a yes or no answer as to whether you want the volume directory updated. You must press Y for yes if you want the file to be deleted. If you press N the file will not be deleted.

Press Y

The file will be deleted, and you will return to the FileMgr level, where the select prompt will reappear:

```
+-----+
| Update volume /VOL1 directory? Y
| Select FileMgr function:
|
+-----+
```

To remove a file from a volume that is not your current volume, you press [DletFile], type the volume name enclosed in slashes followed by the file name, and then press [RETURN]. The procedure is exactly the same as before with the one difference, the volume name must be specified within slashes.

When you are prompted for the file that you want deleted simply type /VOL1/ before the file name, as shown below:

Type /VOL1/MESS.TEXT

When you are deleting files, you can use an asterisk as a wild-card character for any number of characters, and a question mark for single characters.

If you use a wild-card in a file name for DletFile, FileMgr checks all file names that match the wild-card file name. One at a time, and in alphabetical order, the FileMgr asks you if you want to remove the matching files. When you press Y in response to the prompt, the file indicated is removed. If you press N, the file indicated is not removed.

**The Q Option.** To avoid being prompted for each file and the "Update volume /VOL1 directory?" prompt, the DletFile function has a "quiet" option that restrains this prompt. The quiet option is used by placing -q before the name of the files that you want deleted.

In the following example, we use this option:

Press [DletFile]

The Command window displays:

```
+-----+
|
| Delete which file(s)?
|
+-----+
```

Type -Q /VOL2/MESS.TEXT  
Press [RETURN]

```
+-----+
|
| Delete which file(s)? -Q /VOL2/MESS.TEXT [RETURN]
|
+-----+
```

The file will be deleted, and you will return to the FileMgr level where the select function prompt will reappear.

### Delete a Temporary File

Temporary files are created when files are opened by a program and not become closed. Normally, these temporary files are deleted automatically when the program has completed its task. On occasion, errors in the program you are executing cause the operation to terminate before the temporary file can be automatically deleted.

It is easy to spot a temporary file when you list your volume. In the date column a temporary file has three question marks where the month should be.

```
-----
MESS.I           512      0-???-100   978:  344 data
-----
```

Temporary files can be deleted in the same way as regular files. The DletTemp function uses asterisks and question marks as wild card characters in the same way that DletFile does. To delete temporary files, type the file name then press [DletTemp].

In the example below, the temporary file MESS.I is deleted from the current volume /VOL1.

Press [DletTemp]

The Command window displays:

```
+-----+
|       |
| Delete which temporary file(s)? |
+-----+
```

Type /VOL1/MESS.I  
Press [RETURN]

```

+-----+
| Delete which temporary file(s)? /VOL1/MESS.I [RETURN] |
+-----+

```

The Command window displays:

```

+-----+
| Delete file "/VOL1/MESS.I"? |
+-----+

```

Press Y

The file will be deleted, and you will return to the FileMgr level, and see the prompt:

```

+-----+
| Select FileMgr function: |
+-----+

```

**Make a File**

MakeFile allows you to create a file. When you make a file, you are actually creating an entry in the directory of a volume or diskette.

When you have accidentally removed a file this function is very helpfull. The file is not actually erased, unless you have copied other information over the place where that file resided. That is, a file is not destroyed unless you have used the Crunch command, or have saved a file that is the same size or smaller than the file you accidentally erased, and it happened to be written over your lost file. When a file has been deleted from a directory, its directory entry can be reconstructed with the MakeFile function.

To make a file entry, press [MakeFile], type the name of the file, and specify the number of blocks in length you want the file to be. Each block is 512 bytes.

Wild-card characters cannot be used with MakeFile.

In the following example, a file twelve blocks long called BLT.TEXT is created in the current volume.

Press [MakeFile]

The Command window displays:

```
+-----+
|                                             |
| Make which file?                          |
+-----+
```

Type BLT.TEXT

Press [RETURN]

```
+-----+
| Make which file? BLT.TEXT [RETURN]        |
+-----+
```

The Command window displays:

```
+-----+
| How many blocks for file "BLT.TEXT"?     |
+-----+
```

Type 12

Press [RETURN]

```
+-----+
| How many blocks for file "BLT.TEXT"? 12 [RETURN]
+-----+
```

When the MakeFile is finished, it gives a message that the file has been made. The Command window displays:

```

+-----+
| File BLT.TEXT[12] made      |
| Select FileMgr function:   |
+-----+

```

When MakeFile creates a file, it searches the volume directory in which you are creating the file. MakeFile then creates the file in the first empty space in the volume large enough for the size you specified. If you do not specify a size after the file name, MakeFile creates the file in the largest empty space in the volume and makes the file one block smaller than the empty space.

To recreate a lost file, list the volume the file was in and look for a blank space in the listing:

```

Volume: VOL1, size = 1024 blocks, 3 files
BOLD          512  29-NOV-82   6: 162  data
LETTER.TEXT   512  1-DEC-82  168: 12  text
<...>                180: 42
OBJECT.TEXT   512  1-DEC-82  222: 34  text
<...>                256: 768
3 of 3 files listed.

```

The deleted file will appear like the line between LETTER.TEXT and OBJECT.TEXT in the listing above. The filename will be replaced with <...>, and the only information left to identify the file will be its size and address. To recreate that file enter the FileMgr and press MakeFile as in the preceding example, and make a file of exactly 42 blocks length (or however many blocks your deleted file happens to be). This will create a file in that space and will allow you to retrieve the file you thought might have been lost.

If a file was deleted at the end of a volume, that file's space would appear mixed with the empty space at the end. There would be no way to determine the size of the file if you did not have its size in blocks written down or committed to memory.



**Rename a File**

RnamFile allows you to rename a file. You cannot use wild-card characters with RnamFile.

To rename a file, press [RnamFile], type the file name then press [RETURN]. Next type the new name for the file, and press [RETURN].

In the following example, the file OLD.TEXT in your current volume, /VOL1 is changed to NEW.TEXT.

Press [RnamFile]

The Command window displays:

```
+-----+
|
| Rename which file?
|
+-----+
```

Type OLD.TEXT  
Press [RETURN]

```
+-----+
|
| Rename which file? OLD.TEXT [RETURN]
|
+-----+
```

The Command window displays:

```
+-----+
|
| What is new name for file "OLD.TEXT"?
|
+-----+
```

Type NEW.TEXT  
Press [RETURN]

The Command window displays:

```

+-----+
|       |
| What is new name for file "OLD.TEXT"? NEW.TEXT [RETURN] |
|       |
+-----+

```

The Command window displays:

```

+-----+
| File "/VOL1/OLD.TEXT" renamed to "/VOL1/NEW.TEXT" |
| Select FileMgr function: |
+-----+

```

It is possible to rename a volume as well as a file. To rename a volume is more difficult though. The volume name should be changed in both CCOS and in the Constellation II volume tables. The change in Constellation II must be done by the system manager. If you change the volume name in one location, but not the other the volume will have a different name in the operating system and in the Constellation II volume tables. This will cause confusion. Do not change the volume name without first consulting the system manager.

**Copy a File**

CopyFile allows you to copy files from one volume to another. The files will have the original file name. You specify the source file name and the destination volume name. You may use wild card characters with CopyFile and the "quiet" option described in the "Delete a File" section of this chapter can be used.

When you wish to copy a file from one volume to another, press [CopyFile]. When you are prompted, type the name of the file you want to copy then press [RETURN] (if the file is not in your current volume remember to precede the file name with the volume name typed between slashes). Next, type the name of the destination volume. The file name remains the same.

In the following example the file WORK.TEXT is copied from volume /VOL1 to volume /VOL2.

Press [CopyFile]

The Command window displays:

```
+-----+  
|  
| Copy which file(s)?  
+-----+
```

Type /VOL1/WORK.TEXT  
Press [RETURN]

```
+-----+  
|  
| Copy which file(s)? /VOL1/WORK.TEXT [RETURN]  
+-----+
```

The Command window displays:

```
+-----+  
|  
| Copy file(s) to which volume?  
+-----+
```

Type /VOL2  
Press [RETURN]

```
+-----+  
|  
| Copy file(s) to which volume? /VOL2 [RETURN]  
+-----+
```

Copy file then asks for verification:

```
+-----+  
|  
| Copy file "/VOL1/WORK.TEXT"?  
+-----+
```

Press Y [RETURN]

The Command window displays the results of the copy, including the length of the file transferred:

```

+-----+
| /VOL1/WORK.TEXT copied to /VOL2/WORK.TEXT (10 blocks) |
| Select FileMgr function:                               |
+-----+

```

Copying multiple files is similar to copying a single file, except that you use the \* (asterisk) or ? (question mark) wild card character instead of, or with, a file name. Wild card characters are used in the same fashion as described previously in this chapter.

The next example shows how to copy several files. In this example all the files in /VOL1 that begin with the letters RES are transferred to the volume /VOL2.

Press [CopyFile]

The Command window displays:

```

+-----+
| Copy which file(s)?                                   |
+-----+

```

Type /VOL1/RES\*  
Press [RETURN]

```

+-----+
| Copy which file(s)? /VOL1/RES* [RETURN]             |
+-----+

```

The Command window displays:

```
+-----+
|
| Copy file(s) to which volume?
|
+-----+
```

Type /VOL2  
Press [RETURN]

```
+-----+
|
| Copy file(s) to which volume? /VOL2 [RETURN]
|
+-----+
```

You will be asked whether you want to copy each of the files one by one in alphabetical order unless you added the quiet option (-q) at the end of the line specifying the destination volume name. If you press Y to each prompt, or if you used the quiet option the files will be copied.

If you are transferring a file to a volume that contains a file by the same name the Concept File Manager will ask you which copy you want to keep. You will be prompted:

```
+-----+
|
| Delete old "WORK.TEXT" (file dates are the same)?
|
+-----+
```

The prompt will read "(file dates are different)" if the file dates are not the same. The Concept waits for a yes or no answer before copying the file or not.

The System window displays the results of the copy, including the length of each file transferred:

```

-----
/VOL1/REST          copied to /VOL2/REST          (33 blocks)
/VOL1/RESULTS.TEXT copied to /VOL2/RESULTS.TEXT (10 blocks)
/VOL1/RESUME.TEXT  copied to /VOL2/RESUME.TEXT  (12 blocks)
/VOL1/RESCUE       copied to /VOL2/RESCUE       (56 blocks)
-----

```

**The D Option.** This option allows you to give the files you are copying the new system date. If you do not use this option, the old date (the last time the file was updated) remains with the file.

You use this option when you are typing the destination volume name as follows:

```
Type  /VOL2 -D
Press [RETURN]
```

```

+-----+
|       |
| Copy file(s) to which volume? /VOL2 -D [RETURN] |
|       |
+-----+

```

**The S Option.** This option strips all escape codes from a file. If a text file were written in EdWord and included bold face, or underlined characters, the S option will strip the enhancements from the text. This is useful when trying to print a file to a printer that does not accept escape codes. To use this option

```
Type  /VOL2/RESUME.TEXT -S
Press [RETURN]
```

```

+-----+
|       |
| Copy file(s) to which volume? /VOL2/RESUME -S [RETURN] |
|       |
+-----+

```

### Concatenate a File

ConcFile performs two functions: it concatenates several files into one new file, or it copies a single file to a file with a new name. In contrast to CopyFile, you must specify the names of the source file and the destination file, and you need only type the volume name if the files are not in the current volume.

Concatenating files means that the files are combined into one file. The second file named will be appended to the first file. While specifying the source files, it is permissible to use wild card characters.

In the following example, the file NOTES.TEXT in your current volume is copied to the file NTS.TEXT in your current volume.

Press [ConcFile]

The Command window displays:

```
+-----+
|                                             |
| Concatenate which files?                   |
+-----+
```

Type NOTES.TEXT  
Press [RETURN]

```
+-----+
|                                             |
| Concatenate which files? NOTES.TEXT [RETURN] |
+-----+
```

The Command window displays:

```
+-----+
|                                             |
| Output concatenated files to where?       |
+-----+
```

Type NTS.TEXT  
Press [RETURN]

```

+-----+
|                                             |
| Output concatenated files to where? NTS.TEXT [RETURN] |
+-----+

```

The next example shows how to combine two files PORK.TEXT and BEANS.TEXT, both of which are in your current volume. BEANS.TEXT is appended to PORK.TEXT and the output is to a file called PNB.TEXT.

Press [ConcFile]

The Command window displays:

```

+-----+
|                                             |
| Concatenate which files?                    |
+-----+

```

Type PORK.TEXT BEANS.TEXT  
Press [RETURN]

```

+-----+
| Concatenate which files? PORK.TEXT BEANS.TEXT [RETURN] |
+-----+

```

The Command window displays:

```

+-----+
|                                             |
| Output concatenated files to where?        |
+-----+

```

Type PNB.TEXT  
Press [RETURN]



```

+-----+
|
| Output concatenated files to where? PNB.TEXT [RETURN] |
+-----+

```

The next example shows how to use the asterisk wild card to concatenate files. In this example, all the files in your current volume that match the file name LIST\*, according to wild card rules, are concatenated. Output is to a file called LST.TEXT

Press [ConcFile]

The Command window displays:

```

+-----+
|
| Concatenate which files?
+-----+

```

Type LIST\*  
Press [RETURN]

```

+-----+
|
| Concatenate which files? LIST* [RETURN]
+-----+

```

The Command window displays:

```

+-----+
|
| Output concatenated files to where?
+-----+

```

Type LST.TEXT  
Press [RETURN]

```

+-----+
|
| Output concatenated files to where? LST.TEXT [RETURN] |
+-----+

```

**List a File**

ListFile allows you to display the contents of a text file in the current window. You can use wild-card characters with ListFile.

To list a text file, press [ListFile] then type the name of the file. Once the listing starts, you can suspend it with [CTRL] S; either a [CTRL] S or a [CTRL] Q restarts it. To stop a file listing, and terminate the output press [BREAK].

In the following example, the file NOTES.TEXT in your current volume is listed.

Press [ListFile]

The Command window displays:

```
+-----+
|
| List which files?
|
+-----+
```

Type NOTES.TEXT  
Press [RETURN]

```
+-----+
|
| List which file? NOTES.TEXT [RETURN]
|
+-----+
```

The Command window displays the contents of the file.

If the file is not in your current volume, be sure to enter the volume name between slashes just before the file name.

**Changing a Volume**

The ChngVol command allows you to switch the volume type from UCSD to CCOS or vice versa. The key will toggle the volume type if you designate the same volume twice.

To use this function

Press [ChngVol]

A prompt will appear in the command window:

```

+-----+
|
| Change which volume?
|
+-----+

```

If /VOL3 is the volume to be changed

Type /VOL3 [RETURN]

The volume will be switched from whichever type of volume it was before to the other. It will tell you that the change was made, and then return to the File Manager option prompt.

```

+-----+
| Volume /VOL3 is now UCSD format
| Select FileMgr function:
|
+-----+

```

**WARNING! DO NOT CHANGE THE VOLUMES /CCSYS OR /CCUTIL TO UCSD VOLUMES. /CCSYS IS THE BOOT VOLUME AND MUST BE CORVUS CONCEPT VOLUME TYPE -- (CCOS). IF IT IS CHANGED TO UCSD THE SYSTEM WILL NOT BOOT.**

### Reclaim Volume Space

Crunch reclaims unused volume or diskette space. It moves all the unused space to the end of the volume, compacting all files to the beginning of the volume.

To Crunch your current volume, press [Crunch] then press [RETURN]. To Crunch a volume other than your current one, press [Crunch] then type the volume name, and press [RETURN]. You cannot use wild-card characters with Crunch.

The following example shows how to crunch a volume named /VOL2.

Press [Crunch]

The Command window displays:

```
+-----+
|
| Crunch which volume?
|
+-----+
```

Type /VOL2  
Press [RETURN]

```
+-----+
|
| Crunch which volume? /VOL2 [RETURN]
|
+-----+
```

Your screen displays the file names in the System window as they are being moved and when the crunch is done a message to that affect is displayed:

```

-----
Moving CRUMB1.TEXT
Moving CRUMB2.TEXT
Moving MUNCH.TEXT
Moving BITS.TEXT
Moving CRUMB3.TEXT
Volume /VOL2 crunched
-----

```

## WINDOW MANAGEMENT

Windows are user or program defined areas of the Concept display screen. The window that is current displays all normal output. When you first log-on to the Concept three windows are defined by the operating system: the System window, the Command window, and the Label window. As far as the user is concerned these windows are permanent.

The Concept provides you with the means to create and manage several windows of various sizes and dimensions. You can create up to seventeen of your own windows. Each window is a rectangle, and is within the confines of the System window.

The best way for you to learn how to use the Concept window functions is to get hands-on experience. The following are the Window Manager functions: create window [CreWdow], select window [SelWdow], clear window [ClrWdow], reverse window background [RevBkgnd], change scroll [ScrlMode], load keyboard character set [LdKybdCh], load display character set [LdDispCh], and run test patterns.

Pressing [WdowMgr] from the Dispatcher allows you to use the Concept Window Manager utilities. The WdowMgr labels display below the Command window:

```

+-----+
|
| Select WdowMgr function:
+-----+

```

**WINDOW MANAGER**

F1	F2	F3	F4	F5
LdDispCh		LdKybdCh		

F6	F7	F8	F9	F10
ClrWndow	SelWndow	ScrlMode	Help	Exit

**WINDOW MANAGER with [COMMAND] pressed**

F1	F2	F3	F4	F5

F6	F7	F8	F9	F10
	TmpWndow			
RevBkgnd	CreWndow	DelWndow	TestPtrn	

[ClrWndow] clears everything from the current window.

[CreWndow] creates new windows within the System window area. To create a new window press [CreWndow] and follow the directions given. The new window is cleared and becomes the current window. To regain the original window as current press [SelWndow] until the full-sized window reappears.

[DelWndow] deletes the current window. After selecting the window you want to delete, press [DelWndow].

- [Exit] returns you to the Dispatcher level.
- [Help] is left by pressing [ESC].
- [LdDispCh] loads a display character set. After pressing [LdDispCh] type the file name of the character set to be used. This is discussed in Chapter 5.
- [LdKybdCh] loads a keyboard character set. After pressing [LdKybdCh] type the file name of the character set to be used. This is discussed in Chapter 5.
- [RevBkgnd] reverses the background of the current window from black to white, and vice versa.
- [ScrlMode] toggles the screen to display in either scroll mode or page mode. In page mode, you must press [CTRL]-S for each new page.
- [SelWndow] allows you to choose one of your defined windows and make it the current window.
- [TestPtrn] enters a test pattern program to display test patterns on screen.
- [TmpWndow] allows you to create a temporary window inside the System window. The window is not cleared at inception.

### **Create Window**

In addition to the three permanent windows, CreWndow allows you to create up to 17 windows. This function also appears in the Dispatcher labels and the FileMgr labels.

To create a window, press [CreWndow], move the cursor to where you want the upper left corner of the new window and press [RETURN], then move the cursor to where you want the lower right hand corner of the new window and press [RETURN].

The CreWndow function measures windows in character units the size of the character set in the current

window. The following example shows you how to create a window 34 characters long and 22 characters high.

Press[CreWndow]

The cursor moves to the upper left corner of the system window and the following message is displayed in the Command window:

```

+-----+
|                                             |
| Move cursor to upper left corner and press <return> |
+-----+

```

Use the cursor keys to move the cursor. Move the cursor down one space and to the right one space.

Press[RETURN]

The Command window displays:

```

+-----+
|                                             |
| Move cursor to lower right corner and press <return> |
+-----+

```

Move the cursor down two spaces. The Command window displays:

```

+-----+
| New window size is 1 by 3                 |
| Move cursor to lower right corner and press <return> |
+-----+

```

Continue moving the cursor down until the Command window displays:

```

+-----+
| New window size is 1 by 22                |
| Move cursor to lower right corner and press <return> |
+-----+

```



Move the cursor to the right until the Command window displays:

```
+-----+
| New window size is 34 by 22 |
| Move cursor to lower right corner and press <return> |
+-----+
```

PRESS [RETURN]

When you create a window, the operating system automatically selects that window as the current window, draws a box around it, and clears it. As your current window, it is where all program output is displayed. A window remains current until you select or create another.

If you put the second corner of your new window along the same line as the first corner, an error message displays on the top line of the Command window.

```
+-----+
| Invalid Bounds |
| Select Wndwmgr function: |
+-----+
```

If the above message is displayed, you should try again.

### **Create Temporary Window**

In addition to the three permanent windows and the seventeen user-defined windows, TmpWindow allows you to create one temporary window.

The procedure for creating a temporary window is exactly the same as the procedure described in the previous section for creating windows.

The difference is that when you create a temporary window, the operating system automatically selects that window as the current window, draws a box around it, but DOES NOT clear it. Also, as soon as you select another window as the current window, the temporary window is deleted.

### **Delete Window**

DelWnDow allows you to delete your current window. However, this window must be one that you created previously.

When you delete your window, it no longer exists and cannot be selected until it is re-created.

To delete a window

PRESS [SelWnDow]

until the window you want to delete is selected as current, then

PRESS [DelWnDow]

You cannot delete the System window, the Command window, or the Label window.

### **Select Window**

SelWnDow allows you to select the window in which program output is to be displayed. This function also appears in the Dispatcher labels and the FileMgr labels.

You can select the System window or any other window you have created. You must have already created a window for this function to have any use. SelWnDow selects the windows in the order they were created. When you select a window, it becomes the current window and is outlined with a box.

To select the next window

PRESS [SelWnDow]

Each time you press [SelWnDow] the next window is selected in the order that they were created. Once the last window has been selected, the next time you press [SelWnDow] the permanent System window is selected again.

**Clear Window**

ClrWndow allows you to clear your current window. This function also appears in the Dispatcher labels and the FileMgr labels.

When you clear your window, everything within the bounds of the window is erased; i.e. graphics and text.

To clear your current window

PRESS [ClrWndow]

When a window is clear, display output starts at the top of the window; otherwise, it starts where the last task left off.

**Reverse Background**

RevBkgnd allows you to change the screen background of your current window from black to white, or from white to black. This function also appears in the Dispatcher labels and the FileMgr labels.

To reverse the background of your current window

Press [RevBkgnd]

If your background is white, press [RevBkgnd] to change it to black. If your background is black, press [RevBkgnd] to change it to white.

**Scroll Mode**

With ScrlMode, you can set your Concept to display listings one of two ways.

One method of displaying is in the scroll mode. When you power-on your Concept, it is set for scroll mode, which means scrolling occurs one line at a time. If the text being displayed is longer than the window length, scrolling pushes all lines of text up. The top line is pushed off the top of the window, and a new

line displays at the bottom of the window. This process continues until all the text has been scrolled.

The other method of display is the page mode. This means that text is displayed one page at a time. If the text being displayed is longer than the window length, displaying stops when it reaches the bottom of the window. To continue this type of display, you hold down the [CTRL] key and press Q.

If your Concept is set for scroll mode, pressing [ScrlMode] changes it to page mode. The following message is displayed in the Command window when you press [ScrlMode]:

```
+-----+
| Window is now in page mode           |
| Select WndwMgr function:             |
+-----+
```

If your Concept is set for page mode, pressing [ScrlMode] changes it back to scroll mode. A message displays in the Command window:

```
+-----+
| Window is now in scroll mode          |
| Select WndwMgr function:             |
+-----+
```

## DEFINING USERKEYS

There is a file called USERKEYS.TEXT that allows you to create your own levels of function keys. The system looks for the file USERKEYS.TEXT in the volume mounted on unit 5 at boot time, and if it is present, Userkeys will appear in the Dispatcher level.

The file is a text file, and can be edited using Edword. When you first enter the file there are comment lines which help to instruct you in creating your own labels. There are already labels present in the file, but they can be changed by simply typing over them.

A single userkey is defined by two (or more) lines in the following manner:

```
-----
(level) (keynumber) (keylabel)
(command)
[optional (command)]

1 0 Pascal
!PASCAL

1 2 EdWord
!ED
-----
```

The exclamation mark before ED or Pascal in the example above tells the computer that the file is in the system volume. The same information could be entered as /CCSYS/ED instead of !ED.

The level of userkeys is either one, two, or three. It can be thought of as a three story house; you enter from the Dispatcher level on the first Userkey level, you can move to the second level, and then on to the third level in order.

The keynumber defines which function key it will be placed on. The following list shows the correspondance between the numbers and the key position.

```
0 - 9 keys F1 - F10
10 - 19 keys F1 - F10 with shift
20 - 29 keys F1 - F10 with command
30 - 39 keys F1 - F10 with command and shift
```

The keylabel is the name that will appear in the Label window.

Command is the program name that is to be executed when the key is pressed. It should specify the volume name enclosed in slashes followed by the program name, i.e. /VOL1/MYKEY.

After you have edited the file so that the function keys will appear as you want them, execute the program CC.DISPAT. The program reinitializes the Dispatcher

level and includes the new Userkeys. Check to make sure the keys are correct, and be sure that USERKEYS.TEXT is in the volume mounted on unit 5. Once you have placed the file USERKEYS.TEXT in volume 5, userkeys will be available to you every time you boot the system.

Normally, after booting the system the Dispatcher level function key labels display. Userkeys allows the default level to be changed. If the keynumber of 40 is found in the first line of the file USERKEYS.TEXT, then after logging on the Userkeys level specified in the first line will be displayed. For example, if the second Userkeys level is to be the default, the first line of the text file would look like this:

```
-----
2 40

1 0 Pascal
!PASCAL

1 2 EdWord
!ED
. . .
-----
```

## USING EXEC FILES

An Exec file is a text file that contains a list of CCOS commands and program names which you want to execute in a particular order. You can use the Concept command interpreter to execute, in sequence from top to bottom, the contents of the list.

Valid entries in an Exec file are: the file name of any program, and the commands described in "The Corvus Concept Operating System Reference Manual."

In the following example, several programs are listed in a text file named DCHECK.TEXT in your current volume called /VOL1. One program is the Corvus diskette formatting program, one is the Corvus diskette diagnostic program, one is the Corvus disk backup program, and the last one is the Corvus disk diagnostic program.

Each program name must be on a separate line of the file.

```
-----
/CCUTIL/FRMT
/CCUTIL/FDIAG
/CCUTIL/MIRROR
/CCUTIL/DDIAG
-----
```

ExecFile allows you to run the contents of an ExecFile. To run these programs from the Dispatcher level

Press[ExecFile]

The Command window displays:

```
+-----+
|                                     |
| Execute which command file?       |
+-----+
```

Type /VOL1/DCHECK.TEXT  
Press[RETURN]

```
+-----+
|                                     |
| Execute which command file? /VOL1/DCHECK.TEXT [RETURN] |
+-----+
```

The programs listed in the file above are run in the order in which they are listed.

Exec files come in handy when you compile or link a program often. The next example shows how to set up an Exec file to run the linker for a specific program, which saves you the effort of typing several file names every time you want to link the program. The file being linked is called MAIL.OBJ, which is linked to a unit called SETBYTE.OBJ and three libraries found in the system volume.

```
-----
LINKER MAIL SETBYTE !C2LIB !CLLIB !PASLIB
-----
```

Do not include /CCSYS/ED (EdWord), or any EdWord commands in the middle of an Exec file. This may cause problems with the workspace you try to enter and may destroy part or all of the workpad. In order to run EdWord from a command file be sure that it is the last line of the file. The workspace name can be specified as follows:

```
-----
!ED /VOL2/W
-----
```

**Automatic Startup File**

Using an Exec file, CCOS commands and programs can be run automatically when you boot your Concept. To do this you create an Exec file called STARTUP.TEXT and place it in the appropriate volume.

When you boot your Concept, CCOS searches the boot volume and then your personal volume, mounted on unit number 5, for the file STARTUP.TEXT. If this file exists in the boot volume or in your personal volume, it is used as a source of commands to the Operating System.

For example, if you have certain programs that you want to run at boot time, you create a text file that lists file names of these programs. Next, you save a copy of this text file in the volume mounted on unit number 5 and call the file STARTUP.TEXT.

The following is an example of a startup file created by EdWord and saved in the volume mounted on unit number 5:



```
-----  
!CC.WNDMGR CSDISP /CCUTIL/CSD.07.11  
!CC.SETDCP UNIT=PRINTER  
!CC.FILMGR SETVOL /VOL2  
!ED W  
-----
```

The exclamation point used at the beginning of each of these lines tells the Concept to look at the system volume; it is an abbreviation for the boot volume.

The first line of the file calls the window manager program for loading a display character set. The character set to be loaded is /CCUTIL/CSD.07.11, the standard character set for use with character enhancements in EdWord.

The second line calls the set data communication parameter program. That is where the printer driver is assigned.

The third line calls the file manager routine for setting the current volume.

The last line executes the EdWord Editor/Wordprocessor program, and enters the workspace W in the current volume.

These command lines may appear confusing, but if any of these capabilities are appealing you can type the lines in as is into a file named STARTUP.TEXT and use them. The only variables in the lines above are the display character set (/CCUTIL/CSD.07.11), the volume name to be set (/VOL2), and the EdWord workspace name (W).

For more information on what you can do when you are at the Exec level, see "The Corvus Concept Operating System Reference Manual."

**USING THE RUNTIME P-SYSTEM**

To use the runtime UCSD P-system a few steps must be performed to ensure that the system will run. The P-system key will appear in the Dispatcher level, but it will be inoperative unless the following conditions are met:

1. The current volume must be a UCSD volume. To change a CCOS volume to a UCSD volume use the ChngVol function in the FileMgr level. Do not change the boot volume to UCSD, since it must be a Corvus Concept volume. Always run the p-System from another volume.
2. The file CC.PSYSTEM must be in the boot volume /CCSYS. The file should already be in /CCSYS, which is where the file is placed when the system is initialized.
3. The files SYSTEM.PASCAL and SYSTEM.MISCINFO must be in the current volume. These files can be copied from the volume /CCUTIL.
4. The file SYSTEM.INTERP must be in either the current volume or the system volume, /CCSYS. The file should already be in /CCSYS, which is where the file is placed when the system is initialized.

If all of these conditions are met the P-system can be used. To enter the p-System

Press [p-System]

All UCSD volumes you have access to will be displayed, and if there are less than six they will be mounted automatically. If there are six or more UCSD volumes the p-System will ask if each volume should be mounted. A maximum of five optional volumes can be mounted in the p-System. The current volume is always mounted. The p-System considers the RAM disk to be a volume, so it will be included as one of the five volumes from which you may choose.

A few other details to keep in mind include: the [CTRL]-S and [CTRL]-Q commands are still used for stopping and starting screen display, respectively; to

use a printer from the p-System the printer driver must be set in the CCOS; different character sets and different window sizes may be used in the p-System, but they too must be set in the CCOS before entering the p-System.

In order to leave the p-System and return to the CCOS press H for Halt; there is no exit key.



This chapter covers the utilities provided with your Concept; they include system utilities, Corvus disk utilities, and volume management utilities. The Concept utilities allow you to take full advantage of the internal configuration of your Concept Workstation. There are instructions on using the system utilities, formatting diskettes, spooling, despooling, and volume management.

## SYSTEM UTILITIES

The System Utilities programs allow you to update, change, or diagnose certain features of your Concept system. These utilities include assigning a driver, setting printer parameters, setting the date, and setting the time.

Pressing [SysUtils] from the Dispatcher level allows you to enter the System Utilities level where some of the utility programs are available.

```
+-----+
|
| Select SysUtils function:
|
+-----+
```

SYSTEM UTILITIES

F1	F2	F3	F4	F5
AsgnDrvr		SetDtaCm	SetDate	SetTime

F6	F7	F8	F9	F10
EdChrSet			Help	Exit

SYSTEM UTILITIES with [COMMAND] pressed

F1	F2	F3	F4	F5
DrvrVrsn				

F6	F7	F8	F9	F10

[AsgnDrvr] assigns a driver to a logical device. The general format is: "/CCSYS/DRV. EPRNT PRNTER 6 [AsgnDrvr]."

[DrvrVrsn] lists all the assigned drivers, and their devices.

[EdChrSet] enters the Corvus Concept character set editor. Here you may edit, or create, your own display character sets.

[Exit] returns you to the Dispatcher level.

[Help] is left by pressing the [ESC] key.

- [SetDate] sets or displays the current date.
- [SetDtaCm] allows you to set printer parameters for a local printer, or assign parameters for data communication with other devices connected to the RS-232 ports.
- [SetTime] sets or displays the current time.

### Set Date

SetDate allows you to set or display the current date. When you power-on the Concept and log-on, a date is displayed above the upper right corner of the system window.

```
-----
                          Tuesday, August 24, 1982
-----+
                                         |
                                         |
-----+-----
```

When you first set up your Concept you must set the date to the current date and set the time to the current time. Once you set the Concept time, it updates the date every twenty-four hours. See the next section, "Set Time," for information on setting the time on the Concept.

If you press [SetDate], the current date displays in the Command window.

Press [SetDate]

The Command window displays the following:

```
+-----+
| Today is 24-Aug-82          |
| Select SysUtils function:  |
+-----+
```

To set the date, enter the following information then press [SetDate]. The date must be entered in the following format:

DD-MMM-YY

DD is the day, MMM is a three letter abbreviation for the month, and YY is the year. Valid alphabetic abbreviations for months are as follows:

January - Jan	July - Jul
February - Feb	August - Aug
March - Mar	September - Sep
April - Apr	October - Oct
May - May	November - Nov
June - Jun	December - Dec

In the following example, we set the date to September 13, 1982.

Type 13-SEP-82  
Press [SetDate]

```

+-----+
|       |
| Select SysUtils function: 13-SEP-82 [SetDate] |
|       |
+-----+

```

SetDate confirms your change.

```

+-----+
| Date set to 13-Sep-82 |
| Select SysUtils function: |
+-----+

```

The new date displays above the right corner of the System window.



```
-----  
Monday, September 13, 1982  
-----+  
|  
|  
-----
```

You do not have to type every element of the date every time you set the date. If the month and year are already correct, you merely type the day and press [SetDate]. If the year is already correct, you type the day, hyphen, the month and press [SetDate].

For example, if the date is set to 12-Aug-82 and today is August 13, you set the new date as follows:

```
Type    13  
Press  [SetDate]
```

```
+-----+  
|  
| Select SysUtils function: 13 [SetDate]  
|  
+-----+
```

The date will appear in the Command window. Now you should set the actual date so that your system will be accurate.

### Set Time

SetTime allows you to set or display the current time.

When you first set up your Concept you need to set the current time. Once you set the time you will not have to set it again, since the Concept has batteries that keep the time going even when the Concept is powered off. In fact, you should never have to set the date again either, since the Concept clock updates the date every twenty-four hours; it even take into consideration leap year.

To display the current time

Press [SetTime]

The Command window displays the following:

```

+-----+
| The time is 22:59:04          |
| Select SysUtils function:    |
+-----+

```

To set the time, you must type time information then press [SetTime]. The time must be entered in the following format:

00:00

The first 00 represents hours in military time (0 - 23). The next field is minutes.

In the following example, we set the time 9:31 a.m.

Type 09:31  
Press [SetTime]

```

+-----+
|                               |
| Select SysUtils function: 09:31 [SetTime] |
+-----+

```

SetTime confirms your change.

```

+-----+
| Time set to 09:31:00        |
| Select SysUtils function:  |
+-----+

```

In the following example, we set the time 4:59 p.m.

Type 16:59  
Press [SetTime]

```
+-----+
|       |
| Select SysUtils function: 16:59 [SetTime] |
|       |
+-----+
```

Again SetTime confirms the change.

```
+-----+
| Time set to 16:59:00 |
| Select SysUtils function: |
|       |
+-----+
```

Now enter the current time so that your Concept will be accurate from now on.

### Set Data Communication Parameters

SetDtaCm allows you to set parameters for the type of printer you are using. It also lets you set the data communication parameters for the two RS-232 ports on the Concept. This enables you to communicate with modems, terminals, or other devices through the RS-232 ports.

The Printer driver must be assigned before a printer can be used. In other words, the Printer driver must be activated. The procedure described below enables you to do this.

Press [SetDtaCm] for the SetDtaCm label display. If the printer driver is not assigned the Command window will prompt you for the unit you want activated, and will assign the printer for you if that is the unit you select. The default printer values are displayed as soon as the printer driver has been assigned.

Press [SetDtaCm]

```
+-----+
|       |
| Select Unit: |
|       |
+-----+
```

The labels change and your choices of units are shown:

UNIT TYPE				
F1	F2	F3	F4	F5
Printer		DataCom1		DataCom2
F6	F7	F8	F9	F10
				NoChange

If you select Printer the printer driver is loaded, if you select DataCom1 you will be setting the communication parameters for the device connected to Port 1, and if you select DataCom2 you will be setting the communication parameters for the device connected to Port 2.

Press [Printer]

This loads the printer driver and displays the default printer values.

Baud rate: 1200 Parity: Space Xmit/Ignore Rcv Port: 2
Char size: 7 bits Protocol: Xon/Xoff Unit: Printer

The default parameters for the two data communication ports are as follows:

DataCom1:

Baud rate: 9600 Parity: Disabled
Char size: 8 bits Protocol: Xon/Xoff Unit: DataCom1

DataCom2:

```

+-----+
| Baud rate: 1200 Parity: Space Xmit/Ignore Rcv |
| Char size: 7 bits Protocol: Xon/Xoff Unit: DataComm2 |
+-----+

```

**SET DATA COMMUNICATIONS**

F1	F2	F3	F4	F5
BaudRate	Parity	Port	CharSize	Protocol

F6	F7	F8	F9	F10
Unit	PrtrFunc	TestMode	PrtrType	Exit

- [BaudRate] allows you to set the baud rate.
- [CharSize] allows you to set character size.
- [Exit] returns you to the SysUtils level.
- [Parity] allows you to set the parity.
- [Port] allows you to select which RS-232 port is being setup.
- [Protocol] allows you to set handshake protocol.
- [PrtrFunc] allows you to set the number of lines per inch, characters per inch, auto line feed ON/OFF, and load action tables or alternate character tables.
- [PrtrType] allows you to set all the parameters according to standard defined printer types.

[TestMode] allows you to test your parameters by sending or receiving data character by character.

[Unit] allows you to select the driver that will be used. Either the PRINTER driver, or the DTACOM driver in one of the RS-232 ports.

In the following description of the SetDtaCm labels, each group of labels includes a NoChange option. Pressing [NoChange] returns you to the SetDtaCm labels without making changes.

If instead of Printer you choose DataCom1 or Datacom2 two of the Set Data Communication (Comm) labels do not appear. They are the Port label and PrtrType label. Neither label would apply unless printer parameters were being set.

PrtrType allows you to set all the SetDtaCm values for three specific types of printer: a NEC 7710, an Epson MX-100, and an IDS 460.

Press [PrtrType]

The PrtrType labels display:

PRINTER TYPE					
F1	F2	F3	F4	F5	F10
Epson	NEC	IDS			NoChange

Press the appropriate key to set the parameters of your choice. The default values for these printers are as follows:

EPSON --

Baud rate: 4800	Parity: Disabled	Port: 2
Char size: 8 bits	Protocol: Line/DSR/Normal	Unit: Printer

NEC --

```

+-----+
| Baud rate: 1200 Parity: Space Xmit/Ignore Rcv Port: 2 |
| Char size: 7 bits Protocol: Xon/Xoff Unit: Printer |
+-----+
    
```

IDS --

```

+-----+
| Baud rate: 9600 Parity: Disabled Port: 2 |
| Char size: 8 bits Protocol: XON/XOFF Unit: Printer |
+-----+
    
```

BaudRate allows you to set the baud rate. To change the baud rate, press [BaudRate]. The baud rate labels display. Select the key that corresponds to the baud rate on your printer. You will automatically be sent back to the Set Data Comm level.

BAUD RATE				
F1	F2	F3	F4	F5
300	600	1200	2400	4800

F6	F7	F8	F9	F10
9600	19200			NoChange

Parity allows you to set parity. To change parity, press [Parity]. The Parity labels display. Select the key that corresponds to the parity setting on your printer. You will automatically be sent back to the Set Data Comm level.

PARITY					
F1	F2	F3	F4	F5	F10
Disable	Odd	Even	MrkX/NRc	SpX/NRc	NoChange

Port allows you to choose which Concept RS-232 port is used for output. To change the output port, press [Port]. The Port labels display. Port 2 is closest to the Omninet port on the back of your Concept. Select the key that corresponds to the RS-232 port on the back of the concept. You will automatically return to the Set Data Comm level.

PORT					
F1	F2	F3	F4	F5	F10
Port 1	Port 2				NoChange

CharSize allows you to change transmission character size. To Change the character size, press [CharSize]. The CharSize labels display. Select the character size that corresponds to the setting on your printer. You will automatically return to the Set Data Comm level.

CHARACTER SIZE					
F1	F2	F6	F7	F8	F10
8 Bits	7 Bits	10 CPI	12 CPI	16 CPI	NoChange

Protocol allows you to change to the handshake protocol. To change the handshake protocol, press [Protocol]. The Protocol labels display. Select the protocol that corresponds to the setting on your printer. You will automatically return to the Set Data Comm level.

PROTOCOL					
F1	F2	F3	F4	F5	F10
Line	Xon/Xoff	Enq/Ack	Etx/Ack	NoProto	NoChange

Printer functions will allow you to set a number of printer parameters. The number of characters per inch



and lines per inch may both be set here. The default value of each is displayed on the screen. Characters per inch defaults to 10, and lines per inch defaults to 6.

Another parameter that displays with the previous two in the Command window is the setting for automatic line feeds (LF). If the printer has a default of LF on, the Concept's setting should be off, and vice versa. The settings should be opposite each other.

The commands LdAction and LdAltChr allows you to load an action table or an alternate character set translation table. An action table contains the character sequences for a given printer necessary to perform certain operations to create enhancements (such as bold face). An alternate character set translation table contains the character sequences necessary for a given printer necessary to perform certain operations to create the alternate characters found in the upper 127 characters of the alternate character sets. These tables may be created using the programs BLDACT and BLDALT found in /CCUTIL. Instructions for using these programs can be found in the "The Corvus Concept Operating System Reference Guide."

Pressing [Exit] will return you to the Set Data Comm level.

The Command window and the Label window will appear as follows:

```

+-----+
|Characters per inch (CPI): 10      Lines per inch (LPI): 6 |
|Auto Line Feed (LF): ON          |
+-----+

```

PRINTER FUNCTIONS				
F1	F2	F3	F4	F5
10 CPI	12 CPI	6 LPI	8 LPI	LdAction
F6	F7	F8	F9	F10
LdAltChr	LF on	LF off		Exit

The test mode will allow you to test the communication parameter settings by sending or receiving data. If you press [TestMode] you will be prompted for the type of test it will be. The Command and Label windows appear as follows:

```

+-----+
|
| Test mode, Send or Receive :
|
+-----+
    
```

TEST MODE					
F1	F2	F3	F4	F5	F10
Send	Receive				NoChange

Press [Send]

The System window will prompt you for the length of the test sample:

-----  
Enter number of characters to send:  
-----

Type in the number of characters that you want to try as a test of the data communication compatibility.

Type 10  
Press [RETURN]

Another prompt will appear:  
-----

Enter number of characters to send: 10 [RETURN]  
Enter characters to send:  
-----

Now type in any characters you choose. If you are testing the send on a printer, the printer should act as a typewriter. They should be sent to the printer, or other device, without problems. If the printer parameters are not set correctly you should end up with garbage at the receiving end.

The receive test mode works in essentially the same way except that the Concept is on the receiving end of the transmission. You must be hooked up to a device other than a printer, since a printer is made for one way communication only and cannot send data to the Concept.

### **Assign a Driver**

A driver is a system program that controls devices, such as printers, CRTs, disk drives, diskette drives, and volumes. It is the driver that makes the different parts of your Workstation interact with each other.

AsgnDrvr allows you to assign a driver to a device. To

assign a driver, press [AsgnDrvr] and enter the necessary information.

The following example shows you how to assign the Concept printer driver to a printer using AsgnDrvr.

Press [AsgnDrvr]

The Command window displays:

```
+-----+
|                                             |
| What is driver file ID?                    |
+-----+
```

Type /CCSYS/DRV.EPRNT  
Press [RETURN]

```
+-----+
|                                             |
| What is driver file ID? /CCSYS/DRV.EPRNT [RETURN] |
+-----+
```

The Command window displays:

```
+-----+
|                                             |
| What is unit name?                          |
+-----+
```

Type PRINTER  
Press [RETURN]

```
+-----+
|                                             |
| What is unit name? PRINTER [RETURN]        |
+-----+
```

The Command window displays:

```
+-----+
|       |
| What is unit number? |
|       |
+-----+
```

Press 6  
Press [RETURN]

```
+-----+
|       |
| What is unit number? 6 [RETURN] |
|       |
+-----+
```

The unit number is the logical unit number assigned to the device. A logical unit stands for a general device identifier, while a physical unit is the specific piece of equipment you choose to perform that function. CCOS requires you to select a physical unit, or device, to perform the function of each logical unit. You must define each device a logical unit number so that the computer will recognize the device.

For more detailed information on assigning a driver, see "The Corvus Concept Operating System Reference Manual."

### List Drivers On-line

Drvrvrsn allows you to list all assigned drivers. To list the drivers enter System Utilities and press [Drvrvrsn].

```
+-----+
|       |
| Select SysUtils function: |
|       |
+-----+
```

Press [Drvrvrsn]

```

-----
Unit 0: /NULL      unblocked resident 7-Jul-82 NULL device driver
Unit 1: /CONSOLE  unblocked loadable 7-Jul-82 SYSTEMM driver
Unit 2: /SYSTEMM  unblocked loadable 7-Jul-82 SYSTEMM driver
Unit 4: /CCSYS     blocked  resident 7-Jul-82 Local disk driver
Unit 5: /MYSTUFF  blocked  resident 7-Jul-82 Local disk driver
Unit 6: /PRINTER  unblocked loadable 14-Jan-83 PRINTER driver (v 1.0)
Unit 9: /FLOPPY   blocked  loadable 7-Jul-82 8" Corvus floppy disk driver
Unit 10: /MYVOL1  blocked  resident 7-Jul-82 Local disk driver
Unit 11: /MYVOL2  blocked  resident 7-Jul-82 Local disk driver
Unit 12: /MYVOL3  blocked  resident 7-Jul-82 Local disk driver
Unit 28: /MYVOL4  blocked  resident 7-Jul-82 Local disk driver
Unit 29: /MYVOL5  blocked  resident 7-Jul-82 Local disk driver
Unit 30: /SLOTIO  unblocked resident 7-Sep-82 Corvus disk command driver
Unit 31: /DTACOM1 unblocked resident 14-Jan-83 DATACOM driver (v 5.0)
Unit 32: /DTACOM2 unblocked resident 14-Jan-83 DATACOM driver (v 5.0)
Unit 33: /OMNINET unblocked resident 7-Jul-82 NULL device driver
Unit 34: /TIMER   unblocked loadable 22-Oct-82 TIMER driver
Unit 35: /KYBD    unblocked loadable 10-Sep-82 KEYBOARD driver
Unit 36: /DISPLAY unblocked loadable 18-Nov-82 DISPLAY driver
-----

```

To understand this listing it is best to break it down one section at a time. Using the sixth row as an example the different columns are analyzed below:

Unit 6: /PRINTER unblocked loadable 14-Jan-83 PRINTER driver (v 1.0)

Unit 6: --

this is the logical unit number that is assigned to the device listed on this line.

/PRINTER --

this is the name of the device. In this case it is PRINTER.

unblocked --

this tells us that this device is not blocked. A blocked device is capable of storing data, such as a volume or diskette drive.

loadable --

this device is loadable, not a resident device. It must be loaded in order to use it.

14-Jan-83 --

this is the date that the driver was released by Corvus. The date helps to differentiate the driver from other versions.

PRINTER driver (v 1.0) --

this is the name of the driver. As you can see by the listing there are many different drivers, each of which control different devices.

**DISPLAY TEST PATTERNS**

The TestPtrn label in the Window Manager level, allows you to test the graphics capabilities of the Concept display screen. One test draws grids, and the other plots different pixel densities.

From the Window Manager labels

Press [TestPtrn]

The whole screen clears, then the following is displayed:

-----

Display Test Patterns

Screen dimensions in pixels:

Height: 560  
Width: 720

- G - Draw grid on screen
- P - Fill screen with pattern of specified density
- Q - Quit

Pattern will stay on screen until any key is depressed

-----

To draw a grid

Press G

The program prompts you for a number:

-----

G Number of grids [2 - 40]:

-----



You may type any number between two and forty. A grid with that number of bars will be displayed on the screen.

To fill the screen with a certain pixel density

Press P

The program prompts you for a number:

```
-----  
P Pixel frequency:  
-----
```

You may type any number in response. The screen fills with pixels according to the density that you specify. For example, if you were to choose 1, every pixel will be illuminated. If you chose 5, every fifth pixel will be illuminated, et cetera.

## **PRINT WINDOW**

Another function found in the volume /CCUTIL is the Print Window utility. It is listed in the directory as /CCUTIL/PRTWND, and will print whatever appears in the current window.

Before you may use the Print Window utility you must make sure that you have a local dot matrix printer attached to your Workstation, and that your printer driver has been assigned.

The utility is used by first creating a temporary window in the System window that encompasses the area of the screen that you want printed. The create temporary window command, [TmpWndow], is found in the Dispatcher level, the Window Manager level, and the File Manager level.

PRTWND can be used without a temporary window, and can print the entire System window if you choose.

The second step, after having set the window, is to type the command.

Type /CCUTIL/PRTWND [RETURN]

The window being displayed will be printed on a local dot matrix printer. This utility cannot spool to a shared printer or a file.

#### THE VOLUME UTILITIES PROGRAM

The program /CCUTIL/VOLUTIL provides a simple method of backing up volumes and diskette and copying diskettes. VOLUTIL also shows the Concept's sysyem status, giving a brief summary of it's configuration.

To execute the volume utility program,

Type /CCUTIL/VOLUTIL  
Press [RETURN]

A menu appears on the screen with corresponding function keys in the label window:

-----  
Valid options are:

[BckupVol] (B) - Backup volume to floppy disk  
[CopyFlpy] (C) - Copy floppy disk  
[SysmStat] (S) - System status  
[Exit] (E) - Exit program

Select processing operation:  
-----

F1	F5	F6	F10
BckupVol	CopyFlpy	SysmStat	Exit

- [BckupVol] is the volume backup program. It allows you to backup a volume on a diskettes.
- [CopyFlpy] is the floppy diskette copying program. It allows you to write a floppy diskette to the hard disk, and then make unlimited copies of the diskette.
- [Exit] allows you to leave the program. It returns the system to the level of the CCOS that you were at before.
- [SysmStat] is the system status report. It tells how much memory is available in RAM, what types of drives are on-line, and much more.

### Backing Up Volumes

The first function in VOLUTIL is the BckupVol program. This program takes a volume from a hard disk drive, and transfers it to floppy diskettes. There is not restore function to this program. If you have a file that has to go on multiple floppies, it has to be restored manually. This is done with the FileMgr CopyFile and ConcFile functions. To run this program

Press [BckupVol]

The backup program does not include options or other functions. It asks for the volume's name, which diskette drive to copy to, and then gives instructions for switching diskettes as it copies. After pressing [BckupVol] the screen clears and the first question is asked:

-----  
Backup which volume?  
-----

Type VOL3  
Press [RETURN]

The program looks at the volume and prints the number of files and allocated blocks on the volume. It must look at this for its own use to determine how many floppy diskettes have to be used to make the copy.

-----  
Volume VOL3 contains 12 files (724 allocated blocks)  
Backup to which floppy disk unit? 9  
-----

The volume VOL3 contains 724 allocated blocks. This is the number of blocks that are used, and does not include the empty space in a volume. The actual size of VOL3 might be 1024 blocks, 2048 blocks, or any size capable of holding those files.

The question asks which floppy disk unit number to copy the information to. The default is unit 9, since that is the number given the first diskette drive attached to the Concept. This number is only to be changed if there are two or more diskette drives attached to the Concept and the first one is not to be used. The second drive usually has the unit number 10.

Before accepting this value and pressing [RETURN], place a diskette in the drive. The program does not recognize the drive if it does not have any medium for recording data. In other words there must be a diskette there so that a volume exists.

Press [RETURN]

The program gives an instruction here to place the destination diskette in the drive.

-----  
Insert floppy disk (1 of 2) in unit 9, ready? [Y/N]:  
-----

If the diskette that was placed in the drive is not the same diskette that the information is to be backed up on, change it now. Do not be alarmed if you accidentally pressed [RETURN] at this point with the wrong diskette in the drive. The program checks the diskette for any files.

Press [RETURN]

If the diskette has any files on it the following message is given, and a question is asked:

-----  
Volume floppy contains 3 files  
OK to delete all files on volume FLOPPY? [Y/N]:  
-----

If this is the proper diskette

Press Y  
Press [RETURN]

The copy starts at this time, and after each file has been moved a message appears similar to the following:

-----  
Volume VOL3 file 1ST.PRPOSL.TEXT backed up ( 17 blocks)  
-----

After a short period of time, the diskette becomes full. The program stops, and gives another instruction in the System window and Command window:

```
-----
Remove floppy disk (1 of 2) from unit 9
-----
```

```
+-----+
| Press <space> to continue |
+-----+
```

Remove the first diskette and

Press [SPACE]

The procedures are the same for the second and subsequent diskettes as for the first. After pressing [SPACE] the program starts with "Insert floppy disk (2 of 2) ..." and finishes the copy. After this procedure is completed the diskettes have the names BACKUP1, BACKUP2, and so on. To change these names to VOL3-1, VOL3-2, or any other name, use the RnamFile function in the File Manager.

To leave this program press [SPACE] to the "Press <space> to continue" instruction after the copy is complete. To leave it before completing the copy press [BREAK]. This terminates the task, but does not provide a useable copy of the diskette that is being processed at the time.

**Copying Floppy Diskettes**

The second option in the VOLUTIL utility is the Copy Floppy program. To run the program

Press [CopyFlpy]

A new menu displays and the function keys change for the program. They look like the ones below:

-----

Valid options are:

[ReadFlpy] (R) - Read floppy disk to work file  
[WritFlpy] (W) - Write from work file to floppy disk

[SetWorkF] (F) - Set work file name  
[SetFlpyU] (U) - Set floppy unit number  
[DelWorkF] (D) - Delete work file

[Exit] (E) - Exit copy floppy processing

Select processing operation:

-----

F1	F5	F6	F7	F8	F10
ReadFlpy	WritFlpy	SetWorkF	SetFlpyU	DelWorkF	Exit

[DelWorkF] deletes the work file used by the program to store the floppy diskette's information on the hard disk.

[Exit] leaves the CopyFlpy program returning the system to the VOLUTIL main menu.

[ReadFlpy] copies the information from the floppy diskette to the hard disk. The work file name is the destination file for the read floppy function.

[SetFlpyU] sets the unit number of the floppy diskette drive that is communicating with the program. The default is unit 9. With only one floppy diskette drive attached this number will never need to be changed.

- [SetWorkF] sets the work file on the hard disk that is used by the program to transfer the diskette's data from one diskette to another. The file defaults to the file name ...FLOPPY.DATA in the current volume. The volume must have 500 blocks available space in order to use this program.
- [WritFlpy] copies the information from the hard drive to the diskette. It is used for creating the duplicate after the original file has already been written to the disk using the ReadFlpy function.

This program is used to make one or more copies of a floppy diskette. By first using the ReadFlpy option to copy the floppy onto the hard disk. Next the hard disk file is copied onto as many other diskettes as is desired using the WritFlpy option.

**Setting the Floppy Unit Number.** The SetFlpyU option is the least commonly used option available. The floppy diskette drive's logical unit number is defaulted to 9 by the program. The first diskette drive attached to a Concept has a logical unit number of 9. This option is only used when there is a second floppy diskette drive connected to the Concept, and that drive is being used for the CopyFlpy function instead of the first.

To change the floppy unit number

Press [SetFlpyU]

The following prompt is written in the System window:

```
-----
Select floppy unit number: 9
-----
```

```
Type    10
Press   [RETURN]
```

The floppy unit number is changed and the CopyFlpy menu reappears.



**Setting the Work File.** Setting the work file is a far more commonly used option. The work file contains 500 blocks of information that is needed only as long as the copies are being made. The work file must be in a volume that has 500 blocks of available space.

Since the default work file name is ...FLOPPY.DATA it is sent to the current volume. If the current volume does not have 500 free blocks an error message is displayed.

Find a volume that has 500 free blocks, VOL7 for this example, and set the work file name to a file in that volume.

Press [SetWorkF]

-----  
Enter new work file name: ...FLOPPY.DATA  
-----

The default of ...FLOPPY.DATA appears on the screen, but any file name can be entered.

Type /VOL7/COPYFLOPPY  
Press [RETURN]

The work file name is set and the CopyFply main menu reappears.

**Reading a Floppy Diskette.** Reading a floppy diskette is the first step in actually copying a diskette.

ReadFply copies the information from the diskette to the file specified as the work file. To begin the copy

Press [ReadFile]

The following is displayed on the screen, although the numbers on the right are constantly changing as the copy progresses:

-----  
Source file: Floppy unit 9            8  
Destination file: /VOL7/COPYFLOPPY    7 <  
-----

Each time a block is copied the numbers increment by one. As soon as the numbers reach 500 the floppy has been copied to the appropriate file and the CopyFlpy menu reappears.

If this function has been performed already and the work file has not been deleted a prompt appears right after pressing [ReadFlpy]:

-----  
File already exists, delete it? [Y/N]:  
-----

The file mentioned is the old work file, and if yes is answered here only that file is destroyed. The floppy diskette will not be damaged or affected in any way. To continue from this point press Y and the program continues.

**Writing a Floppy Diskette.** Writing a floppy diskette is very similar to reading the diskette. Before a diskette may be written, the ReadFlpy function must have been performed to create a work file full of data.

WritFlpy sends the information from the work file to the diskette in the drive. There must be a work file available to copy, and the work file name must be the same as it was when it was written. The file name does not have to be changed unless CopyFlpy was exited, otherwise it remains the same. To begin the copy

Press [WritFlpy]

There is one question to answer, and it appears every time a copy is made.

-----  
Destroy data on floppy disk? [Y/N]:  
-----

This question is asked regardless of whether there are actually any files on the disk. Do not be overly concerned when this appears after putting in a diskette that was supposed to be new or blank. It probably is blank. But on the same token, do not put in a diskette that has any information that is going to be needed later, it will be destroyed.

Press Y

The copy begins, and the screen display is the same as the ReadFlpy, with one exception: the source file is /VOL7/COPYFLOPPY and the destination file is Floppy unit 9.

This function does not destroy the work file, so WritFlpy can be performed over and over to create as many floppy diskette copies as is desired.

As soon as the copy is complete the CopyFlpy menu reappears.

**Deleting the Work File.** There is a key that deletes the work file automatically, so that the volume space can be regained without going out of the program to the File Manager. To delete the work file

Press [DelWorkF]

A message appears and the main menu stays in place:

-----  
Workfile /VOL7/COPYFLOPPY deleted ....  
-----

### System Status Information

This program gives information regarding the hardware and other internal parts of the Concept. There is information on: the slot assignments, to tell what devices are attached to the Concept; Corvus disk parameters, to tell what types of drives are attached, what size they are, the ROM, and the type of firmware on the disk; system parameters to tell about the size of memory in the machine, the stack pointer position, the Boot PROMS in the machine, and more; the amount of code and stack memory available given both in numbers and through a graphic display.

### RUNNING THE TERMINAL EMULATOR

The terminal emulator program allows a Concept to speak with other computers and act as a terminal.

There are a few options which may be specified when calling the terminal emulator program. Those options include the DataCom port that is being used to connect the Concept and the other computer, and whether the automatic line feed should be on or off for both the send and receive signals.

The terminal emulator may be called by typing /CCUTIL/TERMINAL and pressing [RETURN]. None of the options have been specified, and the first prompt that appears will be as follows:

```
-----
*** No DataCom port specified on command line
    For DATACOM 1 use DC1, for DATACOM 2 use DC2

Select DataCom port [DC1/DC2]: DC1
-----
```

To set the DataCom port to port 1 before entering the terminal emulator

```
Type    /CCUTIL/TERMINAL UNIT=DC1
```

Press [RETURN]

The prompt shown above does not appear, and the terminal emulator is set to communicate with whatever device is connected to DataCom 1. In order to communicate accurately with the other computer the auto line feed settings should be designated. These settings are made in the command line. The format for doing this is:

```
/CCUTIL/TERMINAL UNIT=DC1 SENDALF=ON RCVALF=ON
```

Each of the parameters is optional and the auto line feed options default to on. The unit number is not optional.

Once in the terminal program starts the function keys change to appear as follows:

TERMINAL EMULATOR			
F1	F5	F6	F10
File	Printer	ClrWndw	Exit

The Command window will show the following prompt:

```

+-----+
| Output to screen only |
| Enter text or select function: |
+-----+

```

Characters sent from the Concept DataCom port can be saved in a text file or sent to a printer. To send the output to a file press [File] and type the desired output file name.

Press [File]

The Command window will display the following:

```

+-----+
| Enter file name: ...ECHO.TEXT |
+-----+

```

To accept the file name ...ECHO.TEXT press [RETURN].

To change the name type the desired name and press [RETURN]. A file will be created at this point even if the file is not used. The file key will toggle the output: by pressing the [File] key again the output will not be sent to a file, only the screen. The same is true for the [Printer] key. To send the output to a printer as well

Press [Printer]

The Command window will now appear as follows:

```
+-----+
| Output to file ...ECHO.TEXT and Printer |
| Enter text or select function:          |
+-----+
```

At this point the Concept is set up as a terminal and may operate as one. Any input received by the Concept is sent to a file or printer as specified.

The ClrWndow key operates as it does in the Dispatcher or File Manager levels, and the Exit key will stop the program and return to the level that was current before the terminal emulator was run.

## FORMATTING DISKETTES

The Concept diskette drive uses eight-inch single-sided single-density 3740 type diskettes. Before you can use diskettes with the Corvus Concept diskette drive, the diskettes must be formatted.

Make sure your diskette drive is connected to the Concept, and has been powered on. For instructions on connecting the diskette drive read "The Corvus Concept Diskette Drive Installation Guide."

To format a diskette, run the program FFRMT, which can be found in the volume /CCUTIL and on the distribution diskette /FCCUTL2.

Place a new diskette in the diskette drive.

Type /CCUTIL/FFRMT  
Press [RETURN]

The following is displayed in the Command window:

```

-----
| Corvus Concept 8" Floppy Diskette Formatter 11-May-82 |
| Format which unit number : #                          |
-----

```

Since a diskette drive is normally mounted on logical unit number nine, we respond with a 9 to the above prompt.

Press 9  
Press [RETURN]

The Command window displays:

```

-----
| Corvus Concept 8" Floppy Diskette Formatter 11-May-82 |
| Do you want to initialize the diskette only? (Y/N)    |
-----

```

If the ddiskette is already formatted, but not initialized, the above prompt is displayed to ask you if you want to only initialize the diskette directory and not format the diskette as well. If you respond with a Y for Yes, you will not be prompted to format the diskette. Since the disk is already formatted we could answer Y for yes and not reformat the diskette. However for our example we want to format our diskette, so we respond with an N for No.

Press N

The Command window displays:

```

-----
| Corvus Concept 8" Floppy Diskette Formatter 11-May-82 |
| Do you want to verify the format? (Y/N)              |
-----

```

If you press Y for Yes in response the above prompt, the format is checked as it is formatted. The diskette is formatted much faster without verification.

Press N

The following is displayed briefly in the Command window:

```
+-----+
| Corvus Concept 8" Floppy Diskette Formatter 11-May-82 |
| Initializing the directory.                             |
+-----+
```

Then the following is displayed briefly in the Command window:

```
+-----+
| Corvus Concept 8" Floppy Diskette Formatter 11-May-82 |
| Formatting the diskette.                               |
+-----+
```

Formatting is complete in a few minutes. Repeat this process for each diskette you need formatted.

If you try to format a diskette that is already initialized, the following is displayed in the Command window:

```
+-----+
| Corvus Concept 8" Floppy Diskette Formatter 11-May-82 |
| Is it ok to format volume FLOPPY?                     |
+-----+
```

If you respond with a Y for Yes, the diskette will be reformatted. If you respond with N for No, the program is aborted.

## **MAKING DISKETTES BOOTABLE**

Before you can boot from a diskette, you must make the diskette bootable. This can be done with Corvus utility program called WRITEBOOT, which can be found in the volume /CCUTIL and on the distribution diskette /FCCUTL2.

To make a diskette bootable, run the program WRITEBOOT from the Dispatcher level.



Type /CCUTIL/WRITEBOOT  
Press [RETURN]

The following is displayed in the System window:

-----  
WRITEBOOT - Write the boot routine 07-Oct-82  
Source file -  
-----

This program uses another file that is found in /CCUTIL also. This file is called FLPY.BCOT.

Type /CCUTIL/FLPY.BOOT  
Press [RETURN]

The following is displayed in the System window:

-----  
WRITEBOOT - Write the boot routine 07-Oct-82  
Source file - /CCUTIL/FLPY.BOOT  
Destination disk unit number - 9  
-----

Next, we must enter the logical unit number of the diskette, which is normally 9.

Press 9  
Press [RETURN]

The following is displayed in the System window:

```

-----
WRITEBOOT - Write the boot routine    07-Oct-82

Source file - /CCUTIL/FLPY.BOOT
Destination disk unit number - 9
Depress <return> to continue
-----

```

Press [RETURN]

In a few seconds, the following is displayed in the System window:

```

-----
WRITEBOOT - Write the boot routine    07-Oct-82

Source file - /CCUTIL/FLPY.BOOT
Destination disk unit number - 9
Depress <return> to continue
NEW BOOT WRITTEN
-----

```

The boot blocks have been written on the diskette when the last line above is display. The diskette must also contain the each of the following files from /CCSYS before you can boot from it:

CC.KERNEL	DRV.DISPHZ	DRV.ADISK
CC.SETUP	DRV.DISPVT	DRV.FDISK
CC.DISPAT	DRV.KYBD	CSD.DEFAULT
CC.EXEC	DRV.SYSTRM	CSK.DEFAULT
CC.FILMGR	DRV.TIMER	ASSIGN
CC.WNDMGR		

**SPOOLING AND DESPOOLING**

One of the main purposes of a local area network is to allow a number of people to share disk files and peripheral equipment. The Corvus Constellation II Spool program can be used to perform these functions. The Spool program can either send or receive files from a special volume named Pipes.

Once a file has been sent, or spooled, to the Pipes volume it remains there until it is removed, or despoiled. When a file is despoiled from the Pipes area the destination may be set to a printer, a file, or the console.

The spool program has been developed so that a Concept, or other brand of computer that is Corvus disk compatible, may despool files that have been sent to the Pipes area.

**Spooling a File**

Spool can be found in the File Manager level. To run the Spool program

Press [FileMgr]  
Press [Spool]

The following will display in the system window:

-----

- Slot 1 contains no disk interface
- Slot 2 contains no disk interface
- Slot 3 contains an 8 inch Corvus floppy disk
- Slot 4 contains no disk interface
- Slot 5 contains an OMNINET interface

Enter active slot [5]:        5

-----

Since the default slot is 5 no change is required to spool a file to the pipes area on the shared Omninet disk drive.

Press    [RETURN]

If a number is entered that does not correspond to a valid slot, Spool will respond with "Invalid slot number" and will wait for a new number to be entered. Valid slot numbers are given within brackets on the prompt line.

To leave a function at any time while running the Spool program press the [ESC] key.

**Spool Options.** Some of the default options may need to be changed before spooling a file.

Press    0

The following menu will appear in your System window:

```

-----
      Spool                                Despool
F(ormatted      : TRUE                    L(inefeeds     : TRUE
I(nclude       : {$I                    E(xpand Tabs   : 8
N(ew Page      : .PG                    M(ax lines/page : 55
                                           W(here        : LinePrinter
                                           H(eader       : TRUE
                                           T(railer      : TRUE

      Q(uit          P(ipe name          : PRINTER
Enter options :
-----

```

Options are divided into two groups: spool options on the left half of the screen, and despool options on the right half of the screen. When spooling a file, only the following options are used:

- F(ormatted -- can be true or false. The default, true, indicates that the file being spooled is to add carriage returns and linefeeds. False indicates that the file is not to be formatted, and should be spooled as is.
- I(nclude -- can be any string of three characters. If matching characters are found as the first three characters of a line in the text file being spooled, then the spooler will include the file whose name follows the character string at that point in the file being spooled.
- N(ew Page -- can be any string of three characters. If matching characters are found in the text file being spooled, a form feed character is placed in the spooled file.

P(ipe Name -- can be any name eight characters long. The default name of PRINTER is normally used for sending files to the pipe area that are to be printed.

If the file being spooled is not a text file, F(ormatted should be changed to FALSE. To do this enter the option level and press F.

Press F

Since there are no choices to be made F(ormatted will automatically change to FALSE, and the formatting options I(nclude and N(ew Page will disappear. If F is pressed again it will change back to TRUE and the options will reappear.

When spooling a text file the formatted option should be TRUE.

The N(ew page string .PG is the default. When spooling a file created by EdWord the N(ew Page option will have to be changed. If however, you wish to change the N(ew page string

Press N

The following will appear:

-----  
Enter option : N  
Set newpage to blank to turn off newpage check  
Enter new page prefix: .PG  
-----

Type {\$I

The N(ew page string will be changed in the option table, and the "Enter options" prompt will display again.

The I(nclude option allows th eprinting of multiple files together. On any line of a file a string of three characters followed by the name of another file may be specified. When the spooler finds this include string it will look for a filename following it and

include that file in the spool. After the file has been included the spooler returns to the original file and continues to spool any remaining lines.

To change the include string

Press I

The following will appear:

```

-----
Enter option : I
Set include to blank to turn off include check
Enter include prefix: {$I
-----

```

Type .IN  
Press [RETURN]

The include string will be changed in the option table and the "Enter options" prompt will display again. The following is an example of how an include string may be used in a text file:

```

-----
. . . At this point I would like to show you a copy of
the memo that was sent to all employees on December 7.
..I /VOL1/MEMO.TEXT
As you can see, the memo . . .
-----

```

The file MEMO.TEXT in volume /VOL1 would be included in the spool after the line containing ". . . December 7." The spool would then continue with the line "As you can see. . ."

The last spool option is the P)ipe Name. The default pipe name is PRINTER. It can be any string up to eight characters in length. A different pipe name is used when there are two or more shared printers To change the pipe name

Press P

The following will appear:

-----

Enter option : P  
Enter pipe name: PRINTER

-----

Type LETTER  
Press [RETURN]

The pipe name is now LETTER, and it appears in the options list.

After all the options have been set press Q to quit, and the original menu will appear.

-----

Active slot for Spooling/despooling is 5  
Select option [ S)pool D)espool O)ption Q)uit A)lt slot ]:

-----

**Spool.** Now that the options are set the file can be spooled.

Type S

The following prompt will appear:

-----

Enter file name to be spooled:

-----

Type /VOL1/NEW\_FILE [RETURN]

A second prompt will appear:



-----  
Enter file name to be spooled : /VOL1/NEW\_FILE  
Enter message to be sent with spool. (80 characters max.) :  
-----

Type a message to go with the file. This is useful when files are printed.

Type THIS LISTING IS FOR THE BOSS [RETURN]

The file will be spooled to the pipename LETTER. While it is being spooled a series of dots will appear across the screen and will be followed by a message when the spool is complete:

-----  
Spooling file to pipe LETTER[ 1]

.....

15 blocks written to pipe LETTER[ 1]

Enter file name to be spooled:  
-----

The file has now been spooled, and is waiting to be despoiled from the Pipes volume.

### Despooling a File

Now that the file has been spooled to the Pipes volume it needs to be retrieved with the despooler option of the Spool program. The despooler is described in "The System Manager's Reference Manual."

**VOLUME MANAGEMENT**

Only a limited number of volumes can be handled by CCOS at any one time. There are two command labels in the Dispatcher level that control volumes. They are the Constellation II label, and the Mount Manager label.

The Mount Manager allows you to control which volumes you have mounted, and the Constellation II function allows the system manager to manipulate volumes and user accounts. The Constellation II level is for the exclusive use of the system manager and will not be covered in this guide. Its use is discussed in detail in "The Corvus Concept System Manager's Reference Manual."

If you have many volumes in your account, you may find that you cannot access them all. To be accessible, a volume must be mounted.

To run the Mount Manager program, use the MountMgr function in the Dispatcher level.

PRESS [MountMgr]

The following labels are displayed:

MOUNT MANAGER				
F1	F2	F3	F4	F5
Change			Display	
volume			volume	
F6	F7	F8	F9	F10
List Vol		Select		
Mounted		drive	HELP	EXIT

In the Command window the Mount Manager's main menu is displayed:

```
-----  
Mount Manager [#.#]      DS LOCAL  
Main menu                DRIVE *  
User name: JOE  
-----  
    D - Display volume table  
    C - Change volume status  
    L - List volumes mounted  
  
    S - Select drive  
  
    H - Help  
    E - Exit  
-----  
Please select an option:  
-----
```

Each of the commands may be entered by either the appropriate function key, or by its corresponding letter as is shown in the table above.

The help command in the Mount Manager routine is very limited, and will write only small descriptions of the different commands. To look at the help commands,

```
Press [HELP]  
or  
Press H
```

The following message will display in the Command window:

```
-----  
Mount Manager [#.#]      DS LOCAL  
Help menu                DRIVE *  
User name: SMGR  
-----  
D(isplay   - Display volumes accessible  
Volume  
L(ist      - List volumes mounted.  
Volumes  
E(xit      - Terminate Mount Manager utility.  
S(elect    - Select a new drive to supervise.  
Drive  
C(hange    - Change volume attributes.  
Volume  
-----  
Press <space> to continue, or  
press F to list to a file.  
-----
```

PRESS [SPACE]

A better description of these commands is:

[Change Volume] -- This command allows you to change any of the attributes of a volume including whether it is mounted or unmounted, the unit number assigned to it, and its access [either read-write (RW), or read-only (RO)].

- [Display Volume] -- This command displays a table that includes the names of all volumes in your account, their mount status, and access (RW, or RO).
- [Exit] -- This exits the Mount Manager level, and return you to the Dispatcher.
- [Help] -- This displays the help message shown above.
- [List Vol Mounted] -- This command displays a table like the one in Display Volume. The difference is that this table shows only those volumes that are mounted. Both tables will be the same if all volumes are mounted.
- [Select Drive] -- This allows you to select any drive to which you have access, in order to mount or unmount volumes that are included in your account on the particular drive.

If you looked carefully you would have noticed a line at the bottom of the help message that said,

```
-----
Press <space> to continue, or
press F to list to a file.
-----
```

If you press [SPACE] you will return to the Mount Manager's main menu. This same line is displayed at the bottom of the Help, Display volume, and List Vol Mounted function tables. You may send the information in any of those tables to a file or to the printer by following these steps:

PRESS F

The program responds by prompting you with a default of /PRINTER:

-----  
Press <space> to continue, or  
press F to list to a file.  
Enter name of file: /PRINTER  
-----

You must have a local printer attached with the printer driver assigned in order to send the table to a printer. You may send the table to a file:

TYPE /VOL1/TABLE.TEXT

Now the information in the table is located in the file TABLE.TEXT in VOL1, and it could be spooled to a printer so that you do not need to enter Mount Manager every time you want to see it.

**Display Volumes Accessible**

To display a list of the volumes available to you on a particular drive

Press [Display Volumes]

The following table will appear:

---

Mount Manager [#.#]           DS LOCAL  
Display volume table   DRIVE \*  
User name: JOE

---

Drive:	Drive1			
Volume	Unit	RW	Type	
VOL7	12	x	Corvus	Concept
CCSYS	4	x	Corvus	Concept
CCUTIL	11	x	Corvus	Concept
VOL1	5	x	Corvus	Concept
VOL3	13	x	Corvus	Concept
VOL2	14	x	Corvus	Concept
VOL5	15	x	Corvus	Concept

Number of volumes accesible: 7

---

Press <space> to continue, or  
press F to list to a file.

---

### Display Volumes Mounted

To display a list of the volumes mounted for you on a particular drive

Press [List Vol Mounted]

The following table will appear:

-----

Mount Manager [#.#]           DS LOCAL  
List volumes mounted   DRIVE \*  
User name: JOE

-----

Volume	Unit	RW	Type
CCSYS	4	x	Corvus Concept
CCUTIL	11	x	Corvus Concept
VOL1	5	x	Corvus Concept
VOL3	13	x	Corvus Concept
VOL2	14	x	Corvus Concept
VOL5	15	x	Corvus Concept

Number of volumes accesible: 7

-----

Press <space> to continue, or  
press F to list to a file.

-----

### Selecting a Drive

If the system has more than one drive attached, or a local drive and a network attached drive, and the drive that was boot from is not to be changed, the new drive must be selected. To do this

Press   [SELECT DRIVE]

The following will appear:



-----  
Mount Manager [#.#]        DS LOCAL  
Select drive                DRIVE \*  
User name: JOE  
-----

Enter drive information:

Slot 2 contains a Corvus disk interface  
Slot 5 contains an OMNINET interface  
  
Slot number [2,5]: 2

-----  
If the drive is a local drive press [RETURN], but if  
the desired drive is on Omninet press 5 and [RETURN].

Press [RETURN]

The Concept will then answer the next prompt itself and  
continue as follows:

-----  
Slot number [2,5]: 2  
  
Server name: LOCAL  
  
Drive name: Drivel  
-----

If the Concept has only one drive attached locally both  
prompts are automatically answered by the program, and  
it will return to the main menu. If there is more than  
one local drive the program will skip the server name  
and wait for an answer to the drive name question.  
Type the name of the desired drive and press [RETURN].

**Changing Volume Attributes**

To make any change of a volume's attributes enter the Mount Manager and then,

PRESS [Change volume]

All changes to a volume can be made in this program. After pressing [Change volume] the following is displayed in the System window:

-----  
Mount Manager [#.#]            DS LOCAL  
Change volume table        DRIVE \*  
User name: JOE  
-----

Current volume attributes:

Volume name:  
-----

Type in the name of a volume, in this example volume VOL7 which is not mounted will be mounted.

TYPE VOL7  
PRESS [RETURN]

The program will continue:

-----  
Mount Manager [#.#]           DS LOCAL  
Change volume table        DRIVE \*  
User name: JOE  
-----

Current volume attributes:

Volume name: VOL7  
Mount Status: Unmounted  
Mount Unit: \*  
Access: RW

Change to:

Volume name: VOL7  
Mount status: **Mounted**  
Unit number (5,9..30): **12**  
Access (RO/RW): **RW**

OK to change attributes (Y,N)?**Y**  
-----

Each of the items in **bold face** in the above example are default values given by the program. The program will stop at each of these points to ask if you want to enter any changes in the volume's attributes. Simply type over the default prompt to make any change, or press [RETURN] to keep the old value. In the above example M for mounted was typed when the mount status was questioned. The volume will now be mounted.

You may change your access from read-write (RW) to read-only if you need to, and that change is reversible.

If your volume access is set to read-only (RO), you may not change it, and the program will skip that section. In order to gain access to a volume, or have a volume changed from read-only to read-write you must consult your system manager.

To exit the program press [Exit]. Before being returned to the Dispatcher level a prompt appears asking if these changes should be made permanently or not. If not, these changes remain in effect until the Concept is reboot or powered off.

-----  
Do you wish to save the changes permanently? Y  
-----

To remember the changes, and write them to the disk.

Press [RETURN]

Each System window of the Concept can be set to display a unique character set. These character sets can be changed whenever you choose. They can be changed for the particular window they are in, or the character sets themselves can be changed, edited.

At power-on, the System window, the Command window, and the Label window each have the default character set found in /CCSYS/CSD.DEFAULT.

You can change the character set used by the System window by assigning a new set to that window. You can also create additional windows and assign them new character sets using the LdDispCh function from the Window Manager level.

Character sets are stored in files. When a new window is created it is automatically assigned the character set, found in the current window. After creating a window, its character set can be re-assigned to one of your own making or be one of the character sets found in the volume /CCUTIL. These files are: CSD.06.10, CSD.06.10.ALT, CSD.07.11, CSD.07.11.ALT, CSD.09.14.ALT. The file CSD.06.10 is the same as the default character set found in /CCSYS.

A Concept character set can contain up to 256 elements, or characters. Most character sets, including the default set, have only 128 characters. If a character set has 256 characters, the second 128 characters are displayed when the [ALT] key is held down and a key is pressed.

**Load a Character Set**

Loading a character set is very simple. From the Dispatcher labels, press [WdowMgr]. The two function keys labeled LdDispCh and LdKybdCh are used to load character sets. They are each discussed below.

**Load Display Character Set**

LdDispCh allows a display character set other than the default to be loaded.

To do this select the window where the character set is to display. In the following example we use the character set CSD.09.14.ALT, in the volume /CCUTIL.

Press [LdDispCh]

The Command window displays:

```

+-----+
|
| Enter name of character set file:
|
+-----+

```

Type /CCUTIL/CSD.09.14.ALT  
Press [RETURN]

```

+-----+
|
| Enter name of character set file: /CCUTIL/CSD.09.14.ALT [RETURN]
|
+-----+

```

In the Command window a message is displayed that says the display character set has been loaded.

```

+-----+
| Display character set /CCUTIL/CSD.09.14.ALT loaded
| Select WdowMgr function:
|
+-----+

```

**Load Keyboard Character Set**

LdKybdCh loads a keyboard character set other than the default. The Concept does not come with an alternate set. The only set is the QWERTY set CSK.DEFAULT corresponding to the keyboard provided.

In the following example we load the character set in the file CSK.DEFAULT.

Press [LdKybdCh]

The Command window displays:

```
+-----+
|
| Enter name of keyboard character set file:
+-----+
```

Type CSK.DEFAULT

Press [RETURN]

```
+-----+
|
| Enter name of keyboard character set file: CSK.DEFAULT [RETURN]
+-----+
```

A message is displayed in the Command window that says the keyboard character set has been loaded.

```
+-----+
| Keyboard character set CSK.DEFAULT loaded
| Select WndowMgr function:
+-----+
```

**ALTERNATE CHARACTER SET**

The Corvus-supplied alternate character sets contain characters for most of the 256 possible keys. The second 128 characters are called by pressing the [ALT] key, and contain modified vowels and symbols. The modified vowels are arranged so that, as far as possible, their positions can be remembered easily. The correspondance between shifted and unshifted characters is the same.

To use the alternate characters either CSD.09.14.ALT, CSD.07.11.ALT, or CSD.06.10.ALT must be loaded as was shown in the previous section. In this example we use CSD.09.14.ALT, the largest of the three alternate character sets.

Once the set is loaded the alternate characters may be used by holding down the [ALT] key and pressing any key.

In general the rules for using alternate characters are that holding down [ALT]:

- o and pressing a vowel produces the unlauded version of that vowel.
- o and pressing the preceding alphabetical character to the vowel produces the grave accented version of that vowel. An exception to this rule is O since N is used for n. To get the grave accented O, use M.
- o and pressing the succeeding alphabetical character to the vowel produces the acute accented version of that vowel.
- o and pressing the second succeeding alphabetical character to the vowel produces the circumflex version of that vowel.

The tables on the following two pages show the ASCII number, hexadecimal number, keyboard symbol and character. The second table shows the upper half of the alternate character set. To use these keys the [ALT] key must be held down. These charts can be very helpful when using the character set editor, as well as on other occasions when the alternate character set is used.



ASCII Character Set Table

ASCII	HEX	KEYTOP	CHAR	ASCII	HEX	KEYTOP	CHAR
32	20	SPACE	SPACE	80	50	P	P
33	21	!	!	81	51	Q	Q
34	22	"	"	88	52	R	R
35	23			83	53	S	S
36	24	\$	\$	84	54	T	T
37	25	%	%	85	55	U	U
38	26	&	&	86	56	V	V
39	27	'	'	87	57	W	W
40	28	(	(	88	58	X	X
41	29	)	)	89	59	Y	Y
42	2A	*	*	90	5A	Z	Z
43	2B	+	+	91	5B	[	[
44	2C	,	,	92	5C		
45	2D	-	-	93	5D	]	]
46	2E	.	.	94	5E	^	^
47	2F	/	/	95	5F		
48	30	0	0	96	60		
49	31	1	1	97	61	a	a
50	32	2	2	98	62	b	b
51	33	3	3	99	63	c	c
52	34	4	4	100	64	d	d
53	35	5	5	101	65	e	e
54	36	6	6	102	66	f	f
55	37	7	7	103	67	g	g
56	38	8	8	104	68	h	h
57	39	9	9	105	69	i	i
58	3A	:	:	106	6A	j	j
59	3B	;	;	107	6B	k	k
60	3C	<	<	108	6C	l	l
61	3D	=	=	109	6D	m	m
62	3E	>	>	110	6E	n	n
63	3F	?	?	111	6F	o	o
64	40	@	@	112	70	p	p
65	41	A	A	113	71	q	q
66	42	B	B	114	72	r	r
67	43	C	C	115	73	s	s
68	44	D	D	116	74	t	t
69	45	E	E	117	75	u	u
70	46	F	F	118	76	v	v
71	47	G	G	119	77	w	w
72	48	H	H	120	78	x	x
73	49	I	I	121	79	y	y
74	4A	J	J	122	7A	z	z
75	4B	K	K	123	7B	{	{
76	4C	L	L	124	7C		
77	4D	M	M	125	7D	}	}
78	4E	N	N	126	7E		
79	4F	O	O	127	7F		

ASCII Character Set Table							
ASCII	HEX	KEYTOP	CHAR	ASCII	HEX	KEYTOP	CHAR
160	A0	SPACE	SPACE	208	D0	P	ó
161	A1	!	!	209	D1	Q	ô
162	A2	"	"	210	D2	R	ó
163	A3			211	D3	S	ô
164	A4	\$	\$	212	D4	T	á
165	A5	%	%	213	D5	U	â
166	A6	&	&	214	D6	V	ú
167	A7	'	'	215	D7	W	ü
168	A8	(	(	216	D8	X	Ë
169	A9	)	)	217	D9	Y	Ü
170	AA	*	*	218	DA	Z	ç
171	AB	+	+	219	DB	[	è
172	AC	,	,	220	DC	\	é
173	AD	-	-	221	DD	]	ê
174	AE	.	.	222	DE	^	ë
175	AF	/	/	223	DF	_	
176	B0	0	0	224	E0		
177	B1	1	1	225	E1	a	à
178	B2	2	2	226	E2	b	á
179	B3	3	3	227	E3	c	â
180	B4	4	4	228	E4	d	ã
181	B5	5	5	229	E5	e	ä
182	B6	6	6	230	E6	f	å
183	B7	7	7	231	E7	g	æ
184	B8	8	8	232	E8	h	ï
185	B9	9	9	233	E9	i	í
186	BA	:	:	234	EA	j	ì
187	BB	;	;	235	EB	k	í
188	BC	<	<	236	EC	l	î
189	BD	=	=	237	ED	m	ó
190	BE	>	>	238	EE	n	ô
191	BF	?	?	239	EF	o	õ
192	C0	@	A	240	F0	p	ö
193	C1	A	A	241	F1	q	ó
194	C2	B	A	242	F2	r	ê
195	C3	C	A	243	F3	s	ë
196	C4	D	E	244	F4	t	ä
197	C5	E	E	245	F5	u	ü
198	C6	F	E	246	F6	v	ü
199	C7	G	E	247	F7	w	ü
200	C8	H	I	248	F8	x	Ë
201	C9	I	I	249	F9	y	Ë
202	CA	J	I	250	FA	z	Ë
203	CB	K	I	251	FB	{	«
204	CC	L	Æ	252	FC		»
205	CD	M	ò	253	FD	}	
206	CE	N	ñ	254	FE		
207	CF	O	o	255	FF		



**EDIT A DISPLAY CHARACTER SET**

Corvus provides a character set editor so that anyone can create their own character set or modify an existing one. The EdChrSet label is found in the SysUtils level. The character set editor creates five separate windows inside the System window.

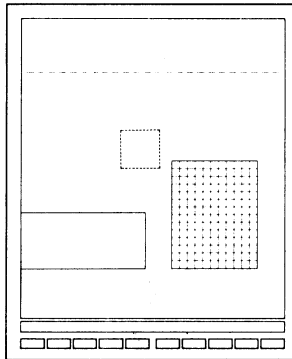

In the example below, we use the character set in the file CSD.09.14.ALT.

To run the character set editor

Press [SysUtils]

Press [EdChrSet]

The first window to be displayed is the Parameter window.

-----  
 Character Set Editor, V.122  
 -----

The Command window prompts for the name of the character set. We are using an existing character set file for this example. However, if you respond with [RETURN] at this point, the Editor asks in the Command Window "New File? Y." Pressing [RETURN] again starts a new file by prompting for the cell size.

```
+-----+
| Character set file:                               |
+-----+
```

Type /CCUTIL/CSD.09.14.ALT  
Press [RETURN]

```
+-----+
| Character set file: /CCUTIL/CSD.09.14.ALT [RETURN] |
+-----+
```

After typing the name of the character set file, EdChrSet displays the current character set parameters for this file in the Parameter window.

```
-----
Width:           9
Height:          14
First char:      32
Last char:       255
-----
```

In the Command window, EdChrSet asks if the parameters are to be changed.

```
+-----+
| Character set file: /CCUTIL/CSD.09.14.ALT         |
| Change parameters? Y                             |
+-----+
```

A response of N for No, causes EdChrSet to use the previous parameters for the set. A response of Y for Yes, causes EdChrSet to prompt for the new parameters. Since Y is the default prompt

Press [RETURN]

```
+-----+
| Character set file: /CCUTIL/CSD.09.14.ALT |
| Change parameters? Y [RETURN]          |
+-----+
```

The Command window is cleared, and the new parameter prompts display one at a time in this window. The first prompt is for the dot height of the character cell, (or Grid window).

Each individual character is contained in what is called a cell. It is a rectangle of dots, or pixels, that make up the shape of the character. The cell can be as large as 16 x 16 dots.

The previous dot width for CSC.09.14.ALT was 9. We will change this parameter to 11.

Type 11  
Press [RETURN]

```
+-----+
|                                         |
| Width (1 - 16)? 11 [RETURN]          |
+-----+
```

The next prompt is for the dot height of the character cell. The previous dot height for CSD.09.14.ALT was 14. We will not change this.

Press [RETURN]

```
+-----+
| Height (1 - 16)? 14 [RETURN]         |
| Width (1 - 16)? 11                   |
+-----+
```

EdChrSet prompts for the first character number. This is the ASCII number which represents the character. This is usually 32, which is the previous first character number for CSD.09.14.ALT. We will not change this parameter either.

Press [RETURN]

```

+-----+
| Height (1 - 16)? 14   First (32 - 255)? 32 [RETURN] |
| Width (1 - 16)? 11   |
+-----+

```

The next prompt is for the last character number. This number can be up to 255, which is what CSD.09.14.ALT was set at. This can be changed to any number between 32 and 255 as long as the number is greater than the first character number just entered. We will cut this file in half by changing this to 127 for our example. Don't worry! This change affects only the copy of this file being used, not the one the Concept has saved on the disk drive. When we are done we can save this file under a new file name, and CSD.09.14.ALT will be the same as before.

Type 127  
Press [RETURN]

```

+-----+
| Height (1 - 16)? 14   First (32 - 255)? 32   |
| Width (1 - 16)? 11   Last (32 - 255)? 127 [RETURN] |
+-----+

```

When this is done EdChrSet asks if these are the parameters that you really want to work with. Pressing N, causes EdChrSet to start again from the "Width?" prompt. Since Y is the default prompt,

Press [RETURN]

```

+-----+
| Height (1 - 16)? 14   First (32 - 255)? 32   |
| Width (1 - 16)? 11   Last (32 - 255)? 127   OK? Y [RETURN] |
+-----+

```

As soon as [RETURN] is pressed, EdChrSet displays the new parameters in their window, and the EdChrSet labels at the bottom of the screen.

CHARACTER EDITOR				
F1	F2	F3	F4	F5
Test		SaveFile		Select
F6	F7	F8	F9	F10
				Exit

- [Exit] gives an opportunity to save the file before returning to the SysUtils level.
- [SaveFile] asks for the name of the file that the character set is to be saved to. It provides the original filename as the default.
- [Select] places the character that the cursor is on at that moment into the character grid, and enters the edit mode.
- [Test] enters the test mode. From there any new characters can be tried in combination, and the character enhancements can be used.

A 14 by 11 grid is displayed in the Grid window.



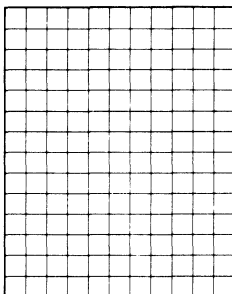

The character set is displayed at the top of the screen in the character set window. The cursor displays at the upper left corner of this window. The cursor arrow keys are used to move the cursor to the character you want to change.

The Command window displays the ASCII number of each character. The number changes as the cursor moves. Move the cursor to the capital J character. The following displays in the Command window:

```
+-----+
| ASCII 74 |
+-----+
```

To work on the character

Press [Select]

Three things happen: 1) 12 real-sized copies of the letter display in the Character window; 2) an enlarged version of the letter displays in the Grid window; 3) and a new set of labels displays at the bottom of the screen. The Character window is shown below:



The Character window shows what the character looks like at normal size.

The Grid window lets you see and work on the dot arrangement of the character.

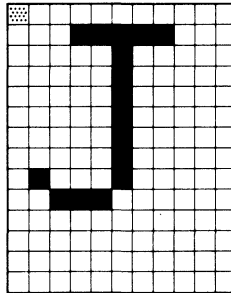

The new set of labels are the editing labels. A brief description of them is given here:

EDITING LEVEL				
F1	F2	F3	F4	F5
				Ins Line
Save Ch	Abandon		Copy Ch	Ins Col
F6	F7	F8	F9	F10
Del Line		Set Col	Set Line	
Del Col	Clear Ch	Clr Col	Clr Line	Flip

- [Abandon] leaves the select mode, without saving the character.
- [Clear Ch] clears the entire Grid window allowing the creation of a character from scratch.
- [Clr Col] turns off all the pixels in the column, or changes them to black.
- [Clr Line] turns off all the pixels in the line, or changes them to black.
- [Copy Ch] asks for a keyboard character. That character is entered into the Grid window.
- [Del Col] deletes the column that the cursor is presently on, and moves all columns to the right of the cursor one space to the left.
- [Del Line] deletes the line that the cursor is presently on, and moves all lines below the cursor up one row.
- [Flip] changes the color of the pixel the cursor is presently on. It turns the pixel on and off like a light switch.

- [Ins Col] inserts a column where the cursor is, and all columns from the cursor position to the right are moved one column to the right.
- [Ins Line] insert a line where the cursor is, and all columns below the cursor are moved down one row.
- [Save Ch] saves the character that is presently in the Grid window in the location where the character is that is being edited.
- [Set Col] turns all the pixels in the column on, or turn them white.
- [Set Line] turns all the pixels in the line on, or turn them white.

A special cursor is displayed in the upper left corner of the Grid window. To move this cursor use the cursor arrow keys on the keyboard.

Before moving the cursor

Press [Flip]

The square containing the cursor turns white. (The images in the diagrams have the opposite color of the actual screen. This is because of the black background on the screen, and the white color of the paper.)

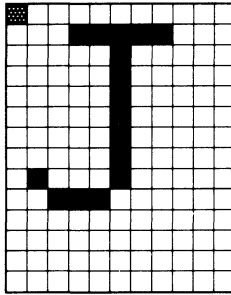

Notice that this change occurs in the Character window also. All changes made in the Grid window are reflected in the Character window.

```

'J'J'J'J'
'J'J'J'J'
'J'J'J'J'

```

To change the corner box back to black, press [Flip] again.

Now move the cursor down two rows, so that it is just below the bar on the top of the J. It is very easy to manipulate the shape of a character as you will see if you follow along with these instructions.

Press [Ins Line]

The entire body of the character should move down one row. Your figure should appear like the one on the left below. If you then decide to fill in the line,

Press [Set Line]

The line should fill in completely, and the grid should look like the one below and on the right.

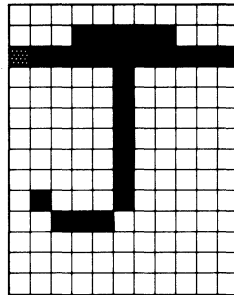
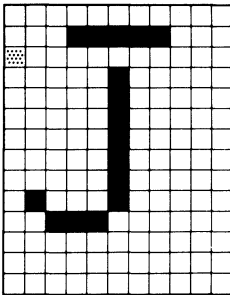

Now if you decided that you wanted that line cleared the way it was before the last command,

Press [Clr Line]

The figure should return to the form it was in previously. If that was not enough of a corrective measure the Del Line function will reverse the previous action.

Press [Del Line]

The line will be deleted and the J should appear as it did at first.

Now try moving the cursor to the right five spaces. The cursor should be on the verticle line of the J.

Press [Ins Col]

The J will be split by this action. Everything from the cursor right will be moved one column to the right, as it appears in the picture below.

Press [Set Col]

The column that the cursor is on should now be lit. The character in the grid window is looking less and less like the letter J now, and should appear like the character in the picture on the right.

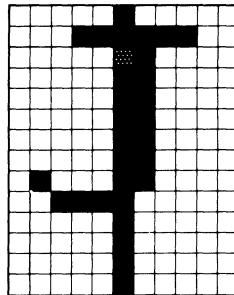
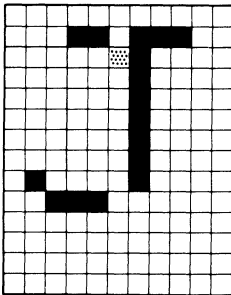

Just as was the case with the Set Line and Clr Line keys, there is a Clr Col for the Set Col.

Press [Clr Col]

The J is taking its previous steps in reverse. Rather than deleting the column now, let's make the J wider. Move the cursor up one line and press [Flip]. Then move the cursor down eight lines, so that it is even with the bottom of the J, and press [Flip] again. The J should appear as it does below.

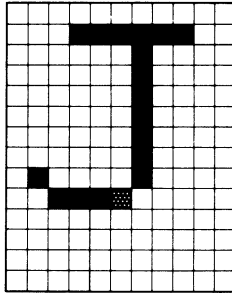

Let's move on to a different character now. The wide J is not really worth keeping at this time, so we can leave the edit mode, and return to the select without saving the character.

Press [Abandon]

The old J and the cursor are now in the Character Set window, and the labels have returned to their original level.

Move the cursor to the letter E.

Press [Select]

The capital letter E is now in the Grid window, and the labels have returned to the edit mode. The command window tells you where you are.

```
+-----+
| Editing ASCII 69 |
+-----+
```

The grid window will appear as below.



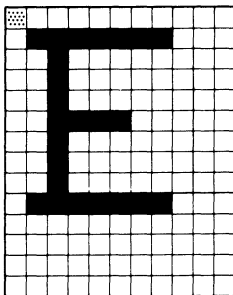

If you want to rearrange the characters in your file, you can begin by moving the J into the E character space.

Press [Copy Ch]  
Press J

The Command window displays the following message briefly as the character is being changed.

```

+-----+
| Copying ASCII 74 |
+-----+

```

The character that is being edited is still the E, but at this time it appears as the letter J. Since you already have a letter J lets clear the grid and start with a new slate.

Press [Clear Ch]

The entire grid clears. Try moving the cursor from place to place, and use the Flip, Set Line, and Set Col commands. See what sort of character you can create.

If you like the character save it.

Press [Save Ch]

The new character and the cursor are now in the Character Set window where the letter E used to be. You are now at the select level again.

If you want to save the file at this point,

Press [SaveFile]

A prompt is displayed in the Command window asking for the filename you wish to save the character set in.

```
+-----+
| Filename: /CCUTIL/CSD.09.14.ALT |
+-----+
```

The default file is the filename of the file being edited. Usually this is the file to save to, but in this case you do not want to, since the letter E has been changed to some other figure.

Type /VOL1/CSD.MYSET

The file has been created and the character set has been saved.

The other useful key at this level is the Test key. This key enters the test mode, so that characters can be seen in combination with others.

Press [Test]

The cursor moves to the test window, and a new set of labels appears.

TEST				
F1	F2	F3	F4	F5
[Bold]	[UndrLine]	[Dbl UndL]		

F6	F7	F8	F9	F10
[ClrWindow]	[RevBkGnd]			[Exit]

- [Bold] makes all the characters typed appear in bold face. The second time it is hit turns off the bold face.
- [ClrWindow] clear the test window of all characters.
- [Dbl UndL] places a double-thick line under each character that follows.
- [Exit] leaves the test mode and return to the select mode.
- [RevBkGnd] reverses the background from white to black and vice versa.
- [UndrLine] places a line under each character typed. The second time it is pressed it is turned off.

To see how large the Test window really is,

Press [RevBkGnd]

Now the Test window and the Character Set window are clearly defined. Type any characters that you want. If you type a capital E, the character you created appears. Try some of the character enhancements next.

Press [Bold]  
 Type This is in BOLD FACE. [RETURN]  
 Press [Bold]

The Test window should look as follows:

-----  
**This is in BOLD FACE.**  
-----

Press [UndrLine]  
Type This is underlined. [RETURN]  
Press [UndrLine]

The Test window should look as follows:

-----  
**This is in BOLD FACE.**  
This is underlined.  
-----

Press [Dbl UndL]  
Type This is double-underlined. [RETURN]  
Press [Dbl UndL]

The Test window should look as follows:

-----  
**This is in BOLD FACE.**  
This is underlined.  
This is double-underlined.  
-----

To leave the test mode

Press [Exit]

This causes the Concept to return to the main menu.  
To leave the character set editor

Press [Exit]

This returns you to the System Utilities level, but first the editor prompts you regarding the file:

```
+-----+
| Save character set file on disk? Y |
|                                     |
+-----+
```

By typing N for No, the editor asks if you are sure. Type Y and [RETURN]. Otherwise the editor prompts you as it does below:

```
+-----+
| Filename? /CCUTIL/CSD.09.14.ALT |
|                                     |
+-----+
```

Type in the new name for the character set, so that the old one will not be affected.

Type /VOL1/CSD.MYSET [RETURN]

The System Utilities labels appear and other areas of the Concept can be used and explored.



This chapter discusses peripheral connections for the Concept and how to change the orientation of the video display unit. This information is useful for setting up a workstation with many different applications.

The first sections explains peripherals and boot types. The last section covers changing the video display unit orientation.

### TYPE OF BOOT

There are three different boot devices available on the Corvus Concept: diskette boot, local disk drive boot, and Omninet boot. The type of boot can be selected by setting the microswitches (boot switches) in the Concept drawer.

The peripheral device must be connected to the appropriate port on the Concept for each type of boot. Then you must set the boot switches inside the pull-out drawer on the back of the Concept to the appropriate settings.

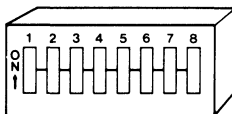

Switches 1 through 6 are used to set the Omninet address for each workstation in a network. The Omninet address

number is displayed next to the word "Station:" above the System window on your screen when the network tap cable is connected. The proper settings for these switches can be found in the booklet called "Corvus Omninet Installation Guide."

Switches 7 and 8 are used to set the type of device from which the Concept will boot. The following table describes the available settings for these switches.

SWITCH 8	SWITCH 7	TYPE OF BOOT
Off	Off	Boot from diskette
On	On	Prompt for type of boot
Off	On	Boot from Omninet
On	Off	Boot from local disk

When the Concept is set to boot from diskette, Omninet, or local disk, the Concept boots immediately when it is powered on.

If you select the second type of boot mentioned in the table above, the following displays in the System window when you power-on the Concept.

```

-----
CORVUS CONCEPT INITIALIZATION (#.#)
(C) COPYRIGHT 1982 CORVUS SYSTEMS, INC.
ALL SYSTEM TESTS PASSED

```

```

SELECT BOOT DEVICE (D,F,L,O):
-----

```

You are offered a choice of which type of boot you want. Press a key on your keyboard that corresponds to one of the letters described below to select the boot device.



- D - allows access to debugger, only if you have the MACSbug debugger ROMs in your Concept.
- F - will allow you to boot from the floppy diskette drive.
- L - will allow you to boot from a local Corvus disk drive.
- O - will allow you to boot from an Omninet network.

**DISKETTE CONNECTION**

The Corvus diskette drive interface card can be plugged into any of the four slots in the Concept pull-out drawer.

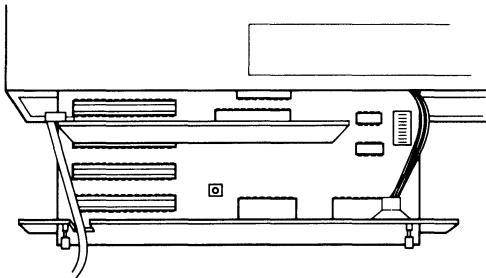

To boot from the diskette drive, set the boot switches as described in the previous section.

**LOCAL DISK DRIVE CONNECTION**

The Corvus disk drive can be plugged into any of the four slots in the Concept pull-out drawer.

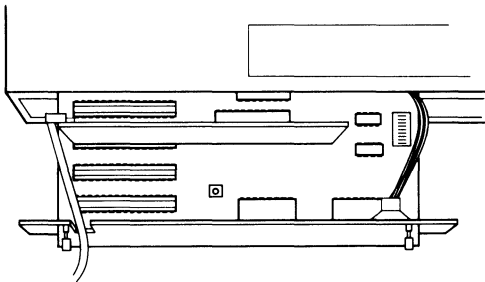

To boot from a disk drive, set the boot switches as described in the first section of this chapter.

More than one disk drive can be connected to the Concept at the same time. When the boot switches are set to boot from a local disk drive and there are two or more local disk interface cards connected to your Concept, the Concept boots from the drive with an interface card in the lowest numbered slot.

For example, if you have a disk drive interface card in slot one and a second in slot two, the Concept will boot from the disk drive with the interface card in slot one. Likewise, if you have a drive interface card in slot two and a drive interface card in slot four, the Concept will boot from the drive with the interface card in slot two.

**OMNINET CONNECTION**

The Omninet tap cable connects to the Omninet port on the back of the Concept base unit. The Omninet port is recognized as slot 5 by the Concept.

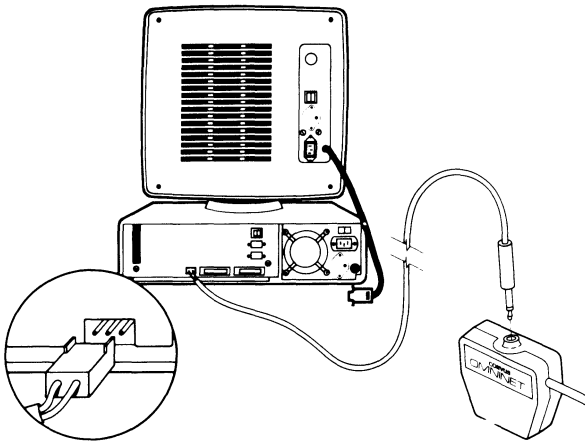

To boot from Omninet, set the boot switches as described in the first section of this chapter.

**RS-232 PORTS**

The Concept has two RS-232 ports on the back of the base unit.

These two ports can be used for printers, modems, etc.

**Connecting a Local Printer**

This section details the equipment and procedures needed to connect a printer, which uses an RS-232C serial communications interface, to the Corvus Concept.

It does not furnish the instructions for setting up any specific printer. It furnishes only those instructions needed to make a physical connection between your printer and the Concept.

It is your responsibility to consult the reference manuals or your specific printer for information such as switch settings, operational specifications, cautions and warnings.

You need the following equipment:

- o A printer with and RS-232C serial asynchronous communications interface.
- o A Modem Eliminator Cable, which is also called a Null Modem.

The Null Modem cable connects to the end of the RS-232C cable from the printer and then to the back of the Concept.

1. The printer should be close enough to the Concept so that the interface cable leading from the printer is slack.

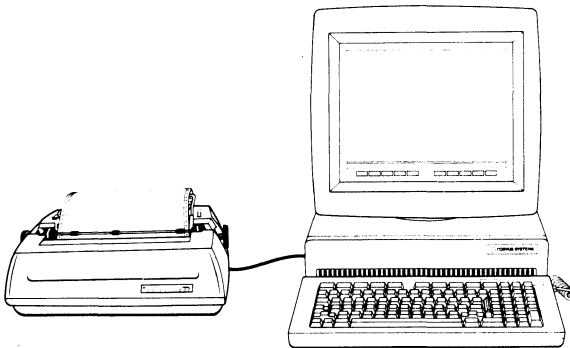

2. Connect the Modem Eliminator Cable to the end of the printer interface cable.

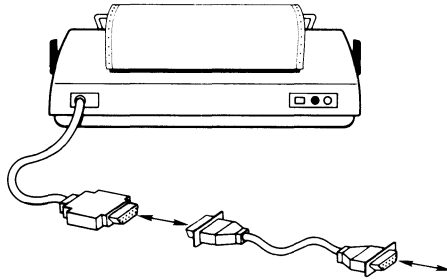

3. Plug the opposite end of the Modem Eliminator cable into one of the RS-232C serial ports on the back of the Concept.

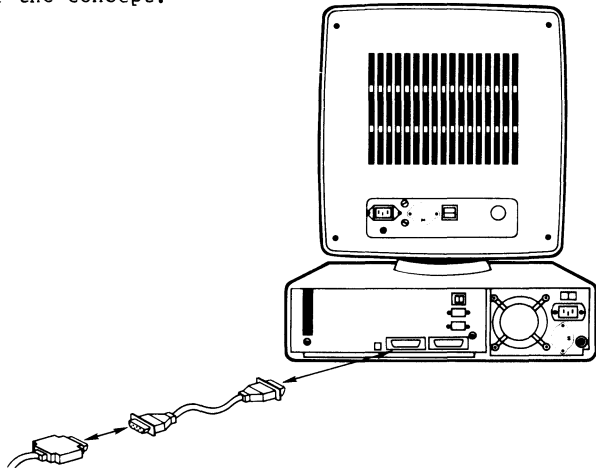

The serial port closest to the power switch on the

Concept is port 1. The switch furthest from the power switch is port 2.

Once you have connected your printer to the Concept, you should prepare your printer for use. This means that you check the communication and operational settings of your printer. The items you must examine are the following:

- o Baud rate
- o Parity
- o Character transmission size
- o Communication handshake protocol

Once you have the appropriate information, you should write it down. Next, consult the section titled "Set Printer Parameters" in Chapter Four of this guide, which explains how to setup a compatible communication link between your printer and Concept.

If you are planning to use EdWord to print your documents, you must first set up your printer and Concept. Printing with EdWord is explained in "The Corvus Concept EdWord User Guide."

## **VIDEO DISPLAY UNIT**

Your Corvus Concept display unit can be arranged in different ways to suit your needs. You can change the orientation of your screen from vertical to horizontal, and vice versa. In either position, you can tilt and swivel the display unit to your liking.

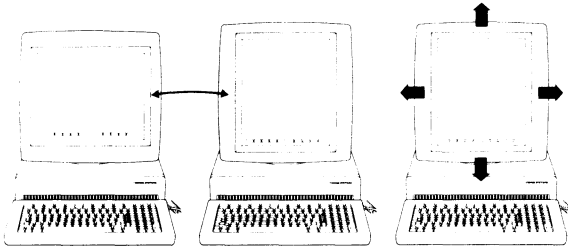

### Changing Screen Orientation

**Vertical to Horizontal.** To change the Concept screen from vertical to horizontal, do the following:

1. Stand in front of the Concept. Push the lock latch back, lift the front of the display slightly and slide it back about an inch.

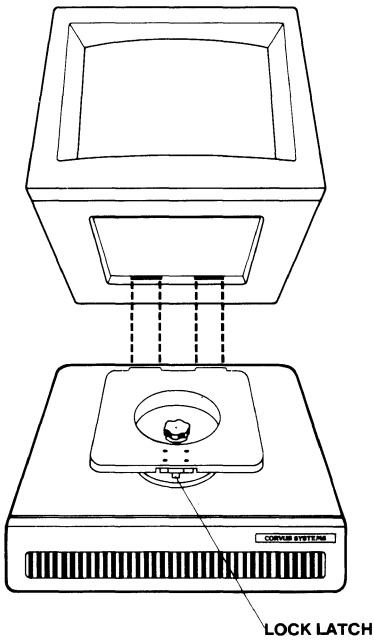



2. Place your left hand on the back lower left corner, and place your right hand on the front upper right corner. Lift the display unit and turn it clockwise.

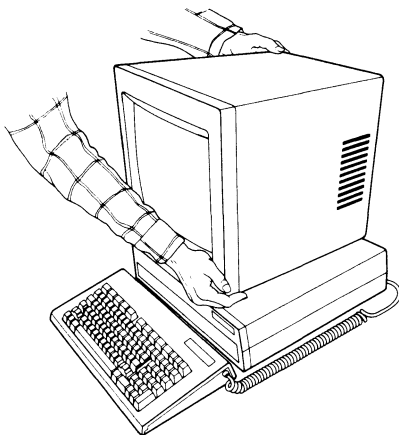

3. Lower the back end first and slide it forward to catch the two projections on the back of the display platform, then lower the front end. Pull the lock latch shut. Check to make sure the display unit is secure.
4. Press the right side of the screen orientation switch located above the video connector on the back of the base unit.

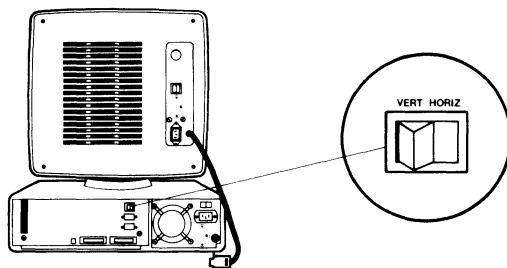

5. Hold down [CTRL] and Press [BREAK] to reboot.

**Horizontal to Vertical.** To change the Concept screen from horizontal to vertical, do the following:

1. Stand in front of the Concept. Push the lock latch back, lift the front of the display slightly and slide it back about an inch.

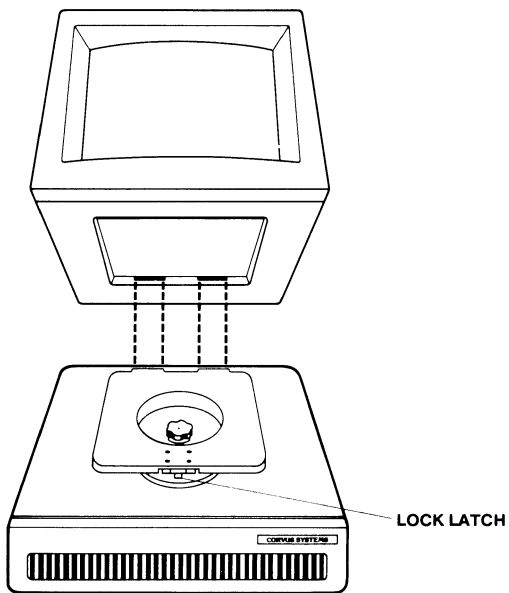

2. Place your left hand on the back upper left corner, and place your right hand on the front lower right corner. Lift the display unit and turn it counter-clockwise.

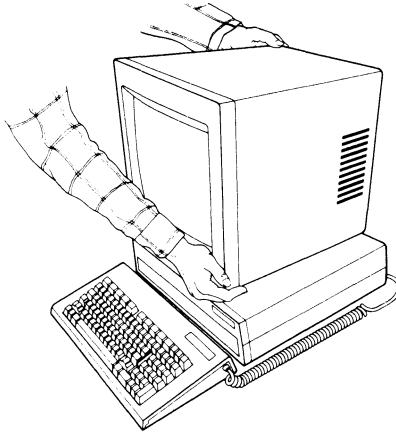

3. Lower the back end first and slide it forward to catch the two projections on the back of the display platform, then lower the front end. Pull the lock latch shut. Check to make sure the display unit is secure.
4. Press the left side of the screen orientation switch located above the video connector on the back of the base unit.

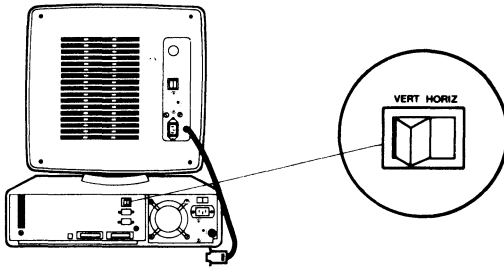

5. Hold down [CTRL] and press [BREAK] to reboot.

