

COMPUTER INDUSTRY ANNUAL 1971-72

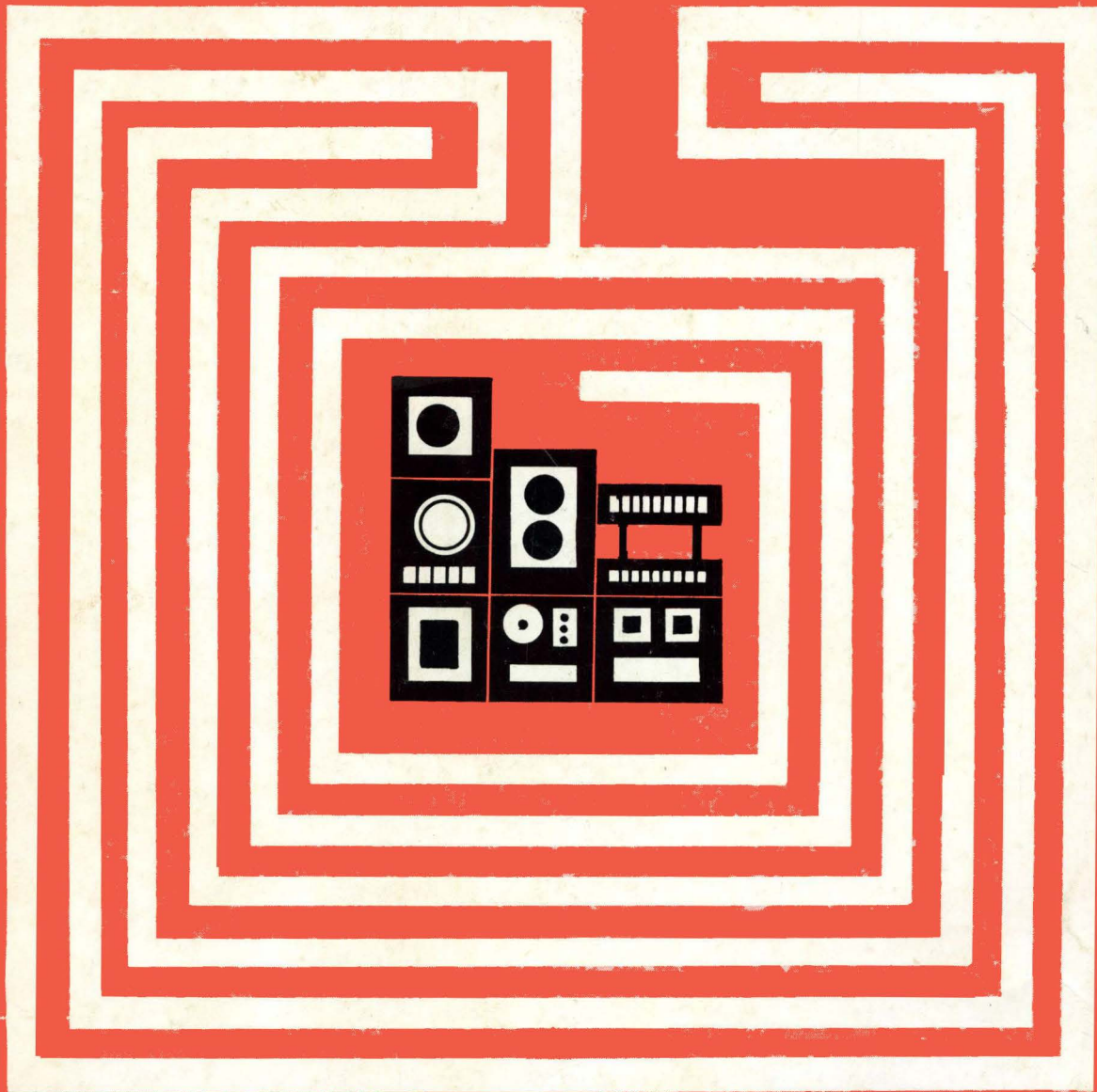

**COMPARATIVE PERFORMANCE ANALYSIS
MANUFACTURERS' CATALOGS
PRODUCT DIRECTORY
MANUFACTURERS' DIRECTORY**

COMPUTER INDUSTRY ANNUAL

1971-72

THIRD EDITION

THANKS FOR THE MEMORIES.

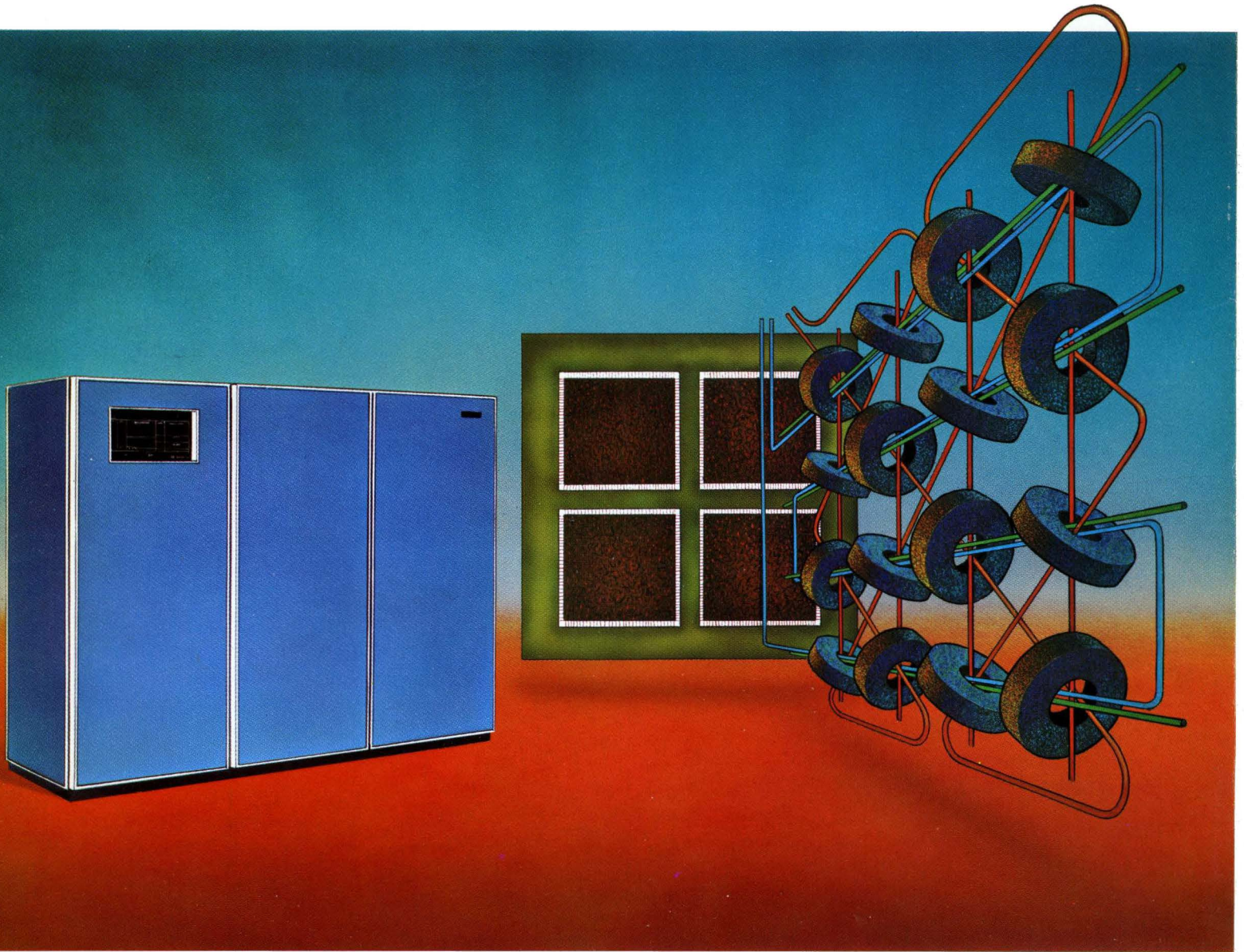

Thanks for your interest when we announced the first commercially available 1 microsecond coincident current core memory system.

Thanks for your response to our 500 nanosecond coincident current memory . . . another first, and our 300 nanosecond thin-film storage system.

Thanks, too, for inquiries about our new LCM+ high-speed mass storage system.

We have delivered over \$100-million worth of cores, planes, stacks, systems and stand-alone mass storage units. Applications include OEM, special proprietary systems, military and airborne, and high-speed computer peripheral storage.

Our success in providing you with quality prod-

ucts has enabled us to expand for even better service. Plants in Hong Kong, Amery, Wisconsin, and Minneapolis, Minnesota are all contributing to the increased Fabri-Tek memory products capability. We intend to continue earning your confidence. Thanks again.

For more information, write or phone: Fabri-Tek Inc., 5901 South County Road 18, Minneapolis, Minnesota 55436. Phone 612-935-8811. TWX 910-576-2913.

FABRI-TEK INC.
MEMORY PRODUCTS DIVISION

LEADER IN MEMORY TECHNOLOGY FOR OVER A DECADE.

1971-72

COMPUTER INDUSTRY ANNUAL

STAFF

Executive Director

Robert Brotherston

Publisher and Editor

Thomas Bergendahl

Advertising Manager

Brian DeLorenzo

Art Director

James Flora

Contributing Editors

Computer Industry Marketplace
Larry Beam

Computers

Abhay Bhushan

John Hoag

Mark Nyberg

Data Communication

Abhay Bhushan

Graphic Data Equipment

Dr. Victor Levadi

Ted Lorber

Memories

Thomas Nau

Keyboard Equipment

Byung Hong

Magnetic Tape Equipment

Richard Lawrance

Paper Tape Equipment

Kenneth Crawford

Punch Card Equipment

Frank Digilio

Printers

Abhay Bhushan

Optical Reading Equipment

Richard Britton

Richard Maihofer

Time Sharing

Robert Guise, Jr.

Business Forms

Norman Creighton

Copyright 1971 by Computer Design
Publishing Corp.

Editorial & Executive Offices
Prof. Bldg — Baker Ave., Concord,
Mass. 01742 (617) 369-6660

No portion of this book may be
reproduced without the express
written permission of the publisher.

Printed in U.S.A. by Storm Printing
Corp., Dallas, Texas

Composition by Whitehall Publications,
Newton Highlands, Mass.

Directory Composition by International
Computaprint Corp., Ft. Washington, Pa.

CONTENTS

How to Use This Annual	page 3
Computer Industry Marketplace	page 5
Part 1: Comparative Characteristics of Computer Equipment	page 12
Table of Contents, Part 1	page 13
Computers	page 15
Data Communications Equipment and Facilities	page 46
Graphic Data Equipment	page 135
Memories	page 160
Keyboard Equipment	page 203
Magnetic Tape Equipment	page 223
Paper Tape Equipment	page 245
Punch Card Equipment	page 261
Printers	page 271
Optical Reading Equipment	page 287
Time Sharing	page 298
Business Forms	page 308
Part 2: Product and Services Directory	page 317
Part 3: Manufacturers' Directory	page 457
Advertisers' Index	page 611

A gift of gab.

Can you talk the technical lingo of modern integrated circuits, and really know what you're talking about? Here's a quick quiz to help you find out. Define these ten IC terms: BEAM LEAD, CARAM, EPIC, FUSIBLE LINK ROM, MULTIPLEXER, PARITY TREE, PHASE-LOCKED LOOP, QUIESCENT DISSIPATION, SAGMOS, STATIC SHIFT REGISTER.

How did you make out? If you missed any, we've got a great free gift for you.

It's the brand new *IC Wordbook*, a glossary of integrated circuit terminology, prepared by the experts at Motorola. (Who else would know more about integrated circuits? Their line of ICs is the broadest in the industry) The glossary includes nearly 500 IC terms, all clearly defined in straightforward language. Get your free copy by calling Harvey today. And if you need any Motorola ICs, you can get them from us, too—exactly what you need, when you need them—but not for free.

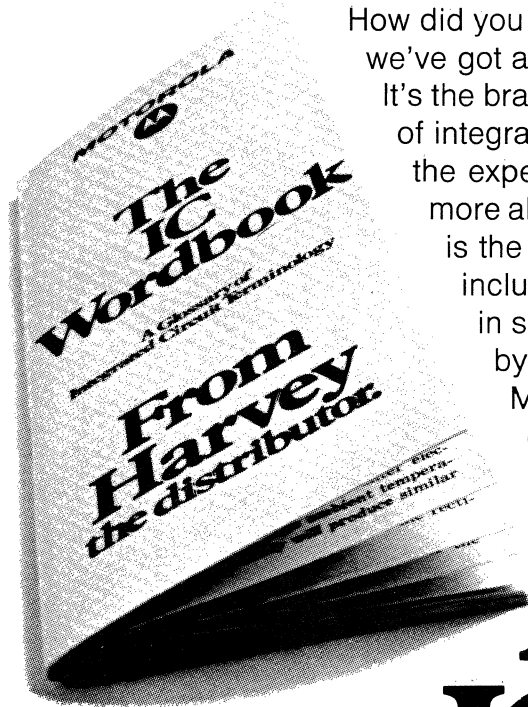

Motorola's new IC glossary. Free. From Harvey the distributor.

Motorola Franchised Locations:

HARVEY/NEW YORK, Woodbury, N.Y. 516-921-8700 • HARVEY/FEDERAL, Binghamton, N.Y. 607-748-8211 • HARVEY/R&D, Lexington, Mass. 617-861-9200

Other Harvey Locations:

HARVEY/DETROIT, Romulus, Mich. 313-729-5500 • HARVEY/NEW JERSEY, Clifton, N.J. 201-473-8558 • HARVEY/PRO AUDIO, New York, N.Y. 212-582-1500

How to Use This Annual

This book is designed to provide product and service information useful to people in or associated with the computer industry. The book is divided into four major sections:

- The **COMPUTER INDUSTRY MARKETPLACE** section provides a marketing-oriented analysis of the computer industry, giving current and future trends.
- **PART 1. COMPARATIVE CHARACTERISTICS OF COMPUTER EQUIPMENT** presents editorial on product and service selection followed by charts covering specific products and services by manufacturer name and equipment characteristics. Look on pages 12 and 13 “Part 1 Contents” to find the pertinent background text and charts on computer equipment or services. The charts are *not* intended to be all-inclusive of product models for each class of equipment. They are *representative* of the range of performance characteristics of equipment currently available in the industry.
- **PART 2. PRODUCT DIRECTORY** is an alphabetical listing of products and services by type with their manufacturers. An index to the hundreds of various products and services begins on page 317.
- **PART 3. MANUFACTURERS’ DIRECTORY** begins on page 457. This section lists alphabetically the complete address, telephone number and TWX/Telex information for over 2000 companies that manufacture computer equipment or provide computer services followed by a list of individual products and/or services that each company offers.

Detailed page headings and frequent indices have been integrated through the book to facilitate reference to section and part. At appropriate intervals, manufacturers and service organizations have provided ads, catalog pages, and data sheets for your further information.

Why 48 firms have chosen GR's 1790 Logic-Circuit Analyzer:

"The 1790 has the best software of all the logic testers we surveyed."

"Our 1790 will pay for itself in the first few months of operation."

"GR's 1790 has significantly reduced the time required to debug engineering prototypes."

"LSI circuits are rapidly tested on our 1790."

Still other satisfied customers have told us how much they like the interactive mode of operation, which allows them to prepare and modify test programs on-line, and the tape-cassette memory for quick access to all existing test programs. Some have mentioned the programmable logic levels and power supplies that permit the testing of marginal conditions and boards with mixed logic families, the control panel and alpha-numeric display scope that simplify and speed test procedures, and the universal

device adaptors that allow all pins to be inputs or outputs and permit checking for shorted inputs.

We can stand behind these comments because we, too, have benefited from using the 1790 in our own development and production efforts. When we decided to build a logic-circuit analyzer, we did it because the system we needed just wasn't available commercially. So we built the best possible analyzer for ourselves, and we've used it for over two years to help manufacture our products with a resulting increase in quality and decrease in price. Now we want you to have the same advantages from your own 1790.

The basic 1790 includes a large I/O capacity (96 input pins and 144 outputs), a high-level test language that technicians can learn in only a few days, computer speed (up to 4000 tests per second), and a simplified GO/NO-GO test mode. The physical contents of the 1790 are a computer with 4096 12-bit words of 1.6- μ s-cycle core memory, teletypewriter, photoelectric tape reader, display scope, control panel, logic probe, and all the needed accessories.

Some great new options will increase the power of your 1790 many times: programmable logic levels for mixed-logic testing, expanded tape-cassette memory with 150,000 12-bit-word capacity, and universal device adaptors for testing a greater variety of devices.

Complete 1790 specifications and operating information are available from your nearest GR District Office or from 300 Baker Avenue, Concord, Mass. 01742. In Europe write Postfach 124, CH 8034, Zurich, Switzerland.



General Radio

NEW YORK (N.Y.) 212 964-2722 (N.J.) 201 791-8990 • BOSTON 617 646-0550
CHICAGO 312 992-0800 • WASHINGTON, D.C. 301 851-5383 • LOS ANGELES 714 540-9890
TORONTO 416 252-3395 • ZÜRICH (01) 55 24 20
GRASON-STADLER 617 369-3787 • TIME/DATA 415 327-8322

Computer Industry Marketplace

The computer industry by 1971 has reached a stage where it is really no different from any other sector in the economy. This industry finds itself affected by the government's fiscal policies and monetary rates, in contrast to the 1960's, which saw the rate of computer installations increase at a rate seemingly impervious to general economic conditions.

Some essential conclusions derived from an evaluation of the industry to this time are:

- The U.S. computer market has begun to reach a point of saturation in most of the computer user sectors.
- The future rate of growth of computer installations will be influenced to no small degree by economic conditions.
- The large, stand-alone, general-purpose digital computer with its multiple input/output peripherals has reached a growth plateau and will experience fairly limited growth increase in terms of annual installations in the next five years.
- The many companies which are dependent upon the manufacturers of these large machines for sale of their products, i.e., memory manufacturers and peripheral manufacturers, will be forced to seek additional avenues for bringing their products to the end user markets.
- In contrast to this somewhat somber outlook, the market for tailored computer packages as dedicated systems using computer techniques is flourishing at an unprecedented rate.
- It must be emphasized that an inescapable conclusion still remains: the outlook for the next five years suggests a very tight, controlled economic situation in which investment in computer products will be decided on much more of an economic priority basis than has been the case for the past decade.

The computer industry has shown remarkable growth — well over 20% per year since 1960. However, the new order rate for computers began to slow in the middle of 1970 and consequently, 1971 shipments will probably be slightly lower in total value than those of 1970. Even the

ubiquitous minicomputer industry has begun to feel the effect of the economic downturn. Many industry experts were predicting shipments of 10,000 units and more in 1971. Most recent investigation would seem to indicate that actual shipments will not exceed 7,000 units and may very well be as little as 6,000.

Another pronounced effect of the slowdown is being seen in the postponement of decisions regarding the use of alternative memory technologies. It would appear that many potential users of solid-state memories, for example, are putting off the innovation necessary to utilize semi-conductors most effectively. The tight economy has tended to make manufacturers cautious about abandoning existing, highly marketable products for the latest advance in computer technology. Also, as in the case of switching to a totally new technology such as semiconductor memories, there is little incentive to disregard an opportunity to add maximum value to a product. Ferrite cores continue to offer the maximum value to the computer manufacturer, particularly to those who have core production facilities already installed. Thus, the current shift in the pattern of economic growth has had a pronounced effect on all aspects of the computer industry. The most important question in the computer industry today remains: How soon will a corresponding upturn in the general economy be felt in the industry?

INDUSTRY PROFILE THROUGH 1971

The tremendous demand by industry and government for increased productivity and information services has greatly contributed to the development of a computer industry that is vastly different from the industry which came into the 1960's. The computer industry has become a major factor in the economic development of the United States. It currently employs in excess of a quarter of a million people and is ranked as the 12th strongest industrial group in the U.S. in terms of sales and employment. Moreover, many companies, particularly in the primary materials sector, depend on the computer industry as a direct market for their components and services. Aside from these factors, the computer itself has been instrumental in creating and sustaining growth in other industries and thereby contributing significantly to the growth of the entire economy.

The manufacture and sales of computer/EDP hardware (including business data processing, peripheral equipment, special military and aerospace systems, control systems, and data communication systems) has increased from \$3.5 billion in 1960 to approximately \$15 billion in 1969. In addition, disposables such as forms and magnetic tape accounted for \$980 million; software services were valued at nearly \$1 billion. Proprietary programs account for 25% of software services and play an important role in holding down total user costs. While hardware sales growth has nearly trebled, software services have increased by approximately five times since 1965. It is anticipated that at the present rate of growth, software expenditures will exceed hardware expenditures by 1973.

U.S. SHARE OF WORLD MARKET FOR COMPUTERS

At the beginning of 1970, there were about 47,000 general purpose digital computers installed in the United States. In addition, there were approximately 15,000 special purpose computer systems installed in the civilian sectors of the U.S. economy. Table 1 shows the present estimated distribution of computers in the world. It is quickly apparent that the U.S. has a commanding share of the world's installed computer capacity at the present time.

**Table 1. World Computer Population
(General-Purpose Machines)**

DECEMBER 1970

United States	53,500
Western Europe	25,000
U.S.S.R.	5,500*
Eastern Europe	1,500*
Japan	6,700
Other	7,000
World Total	99,200

*Scientific American figures, Oct. 1970

With this size of domestic market, it is not surprising that American companies would be in advance of many of the other countries of the world in development of machines and penetration of markets. The U.S. share of world production of electronic computers was about 80 to 85% for the period from 1960 to 1968. From 1968 onward, it began to decline slightly and in 1971 will probably be about 75 to 77% of world production. However, these figures considerably understate the contribution of American-owned *companies* to world production. Subsidiaries of American companies operating in other countries around the world contribute substantially to the production and export figures of those countries.

In Western Europe, the American computer manufacturers' share of production probably accounts for between 35 and 40% of all computer equipment produced. International Business Machines is truly an international company, accounting for well over two-thirds of the total U.S. market and about the same proportions for the rest of the installations outside the U.S. Only in the United Kingdom, Japan and (apparently) the Eastern European countries does IBM's share fall below the 50% point.

MARKET FOR EDP PRODUCTS, 1965-1971

There is no single computer market. The present and future market for computer equipment is almost open-ended. It consists of many and various user sectors, each influenced to some degree by external economic factors over which no single group has control. Many intra-sectoral factors exist which influence a particular industry's or firm's use of EDP equipment. These include:

- Volume of sales of the industry
- Profits of the manufacturers in the industry
- Capital equipment expenditure of the manufacturer
- Plant capacity in use
- Rate of growth of the industry
- Size distribution of the individual customers
- Rate of growth of the individual customers

All of these factors influence the ability of the potential user to buy EDP equipment to some degree. Some other, less tangible, factors which influence his use of the product and vary with each market sector are the technological content of the user's products, his rank in the industry, and the life cycle of his product line.

An analysis of the markets for computer products has shown that the computer industry's recent vulnerability to shifting economic conditions is most related to saturation of the markets. At this point, the number of new companies or groups using computers for the first time seems to be declining.

Computers have been used mostly by large companies and the first groups to use computers were the technical industries. Where the user sector is characterized by relatively top-heavy distribution of companies of very large size, computer sales have declined more rapidly than in sectors where there is a fairly uniform distribution. When a high level of computer usage per firm (penetration factor) is reached, the sale of additional computers to the particular sector becomes heavily dependent upon the economic health of the industry.

However, a contradictory situation presents itself at this time. As noted above, computers are mostly used by large, wealthy firms. An analysis of the user sectors reveals that computers are seldom used by manufacturing firms with less than \$10 million in sales. About the only instances of small sized business groups with computers installed are those in which the primary product is information services. The professional services industry has been the most rapidly growing computer user sector in the economy. Thus, there has been a higher demand for data processing services in this sector.

Since most larger companies tend to have their own computer systems, they use external data processing services only occasionally. Thus, it can be concluded that small companies represent the bulk of the data service industry's business. An investigation of user sectors to determine the point at which an individual firm could make

the decision to purchase computer equipment rather than using a service bureau produced the following conclusions:

- There is a large, potentially lucrative, but still unserved market available to the computer hardware manufacturer.
- Since the utility of the computer has been almost universally recognized in every user group and there are ample programs available for all applications, it must be concluded that the lack of usage is a function of economics.
- The questions of economics is a relative one: the right hardware at the right price. This aspect of the supply function does not appear to be solved to the satisfaction of large numbers of users at this time.

The lower cost boundary of the supply pattern would appear to be about \$2,000 per month or an equivalent rate of purchase price amortization. This amount seems to represent the minimum expense level for hardware, but it must still be supplemented by a programmer/analyst/operator and consequently, the bill for an in-house computer facility is generally around \$5,000 per month. It would appear that management in most companies is still relatively unsure of the tangible benefits of the computer. Where a computer is used, the decision to install one is based upon a simple alternative of investing in people or in a machine to do a specific task, such as accounting. Thus, a significant part of the future growth of the use of computer products will be dependent to a very high degree upon the industry developing products and applications programs tailored to the needs of small businesses.

INDUSTRY DEVELOPMENTS

Unbundling took effect for more than 70% of the U.S. computer industry in January 1970. The results of, and reactions to, unbundling have been mixed. The independent software business, which was supposed to benefit from separate pricing, experienced difficulties, while the mainframe computer firms (particularly IBM) enjoyed increased business. Software firms have attributed their difficulties to overcrowding and the fact that the large mainframe suppliers have been very cautious about charging for their unbundled services.

Eventually, observers believe, unbundling will be the normal order of things, with customers forcing all manufacturers to unbundle within the next year or two.

Unbundling has led to a round of price increases in the computer industry. These increases, which have run about 5%, are attributed to the fact that IBM cut their prices only 3% when they unbundled instead of the anticipated 12 to 18%. The net result was an over-all increase in data processing costs, and, therefore, a larger price increase margin for smaller manufacturers.

Despite current setbacks, it is anticipated that the proprietary software segment of the industry will experience growth ranging from \$30 million to about \$100 million in 1971 and \$2 billion by 1975.

TRENDS

There are currently slightly over three million establishments in the U.S. doing less than \$10 million in annual

sales. Ownership of computer systems in this group represents less than 1% of the 42,000 computer systems presently installed in the private enterprise sector.

An examination of the behavioral patterns of the market for computer products leads to the following basic conclusions:

- The leveling off of the growth in the rate of major computer installations is probably related to saturation of existing users with existing products.
- The value of electronic data processing and its application to daily business problems is universally accepted without regard to the size of the business establishment but, for the moment, most small businesses have been unable to take advantage of these techniques except through service bureaus and time-sharing services. This is due, in most part, to the cost of owning and operating a computer system. The typical minimum cost levels currently found in business (including equipment leasing, personnel, and supplies costs) are between \$2,000 and \$5,000 per month.
- There is a vast, potentially lucrative but untapped market available in small businesses, service groups and government agencies. These users would purchase or lease a computer system to fill their needs if it were available at a price they could afford.

Memories accounted for about 25% of the \$7.5 billion worth of computer systems shipped in 1970, and cores represented about 90% of all memories shipped. To make the memories faster and more compact, the size of the cores and the wires over which they are strung has been reduced to a few thousandths of an inch, and they cannot be made much smaller. Although prices have dropped drastically over the past decade due to improved manufacturing techniques, there seems to be little room for further cost reduction. On the other hand, semiconductor memories are still in relative infancy, and there is much room for improvement.

Despite the predicted potential for semiconductors (estimates of the future semiconductor market range from \$300 million to \$400 million in 1973 to well over \$1 billion by 1980), core volume is growing; even semiconductor companies expect it to keep growing, at least until 1975, though the market share of cores will decrease. Core will continue to dominate the memory market simply because all computers now on the market use it, as well as many which are now in a development stage that is too far advanced to be modified to accommodate semiconductor memories.

The computer industry finds itself in a unique position in 1971. Technologically, all of the system elements are available to assemble the hardware elements of general-purpose systems which would meet a wide number of business requirements for less than \$40,000. This cost is, of course, based upon typical, current hardware quotations and is highly sensitive to demand volume. Some are even being offered now at these prices, including low-level software, e.g., Cascade Data Computer System 80/30.

The small computer began to be an important factor in the computer market place in 1964. At that time, the majority

of small computers were purchased for use as systems elements. The use of small computers in stand-alone systems has grown very much more rapidly than the component segment, and it is considered that the system element will show the most dramatic growth over the next decade as the small business user turns to in-house data processing facilities.

While the small user environment has been somewhat of an enigma to most computer manufacturers, it is precisely this segment of the market which represents the greatest growth potential over the next decade.

SERVICES SECTOR AS END USER OF COMPUTER/EDP PRODUCTS

The industry groups which constitute the services sector (banking; medical services; professional services; retail and wholesale trade, insurance, finance and real estate; transportation services; utilities; telecommunications; education; and government) are the greatest users of computer equipment and have represented the fastest growth sector for use of computer products. The services sector owns and operates more computers than any other group in the U.S. economy, as illustrated in Table 2.

The rate of growth of the services sector has generally been in excess of the gross national product. The services sector has assumed a position of importance in the U.S. economy that is greater than either the primary goods manufacturing industries or the finished products manufacturing groups. The trend has been steady since the Second World War and it is unlikely that it will be reversed for some time.

There are subtle but pervasive factors which influence the utilization of computer equipment by the services sector. Services generally means information services. Of the total sector, probably as much as 65% of the employment is associated with what John Kenneth Galbraith calls the "knowledge industries." These involve persons who are engaged in collecting and analyzing information for use by many other people. Some industries, such as banking and insurance, have what might be termed "soft" products in that no finished article is exchanged, but a service is rendered which produces some form of tangible results. In these industries, the information requirements are very extensive for both the process and the product. The importance of the growth of the services sector, and the increasingly heavy demands on information processing, should not be overlooked. The newest addition to the services sector, the software of computer services centers, has become a very important part of the data processing scene. While the use of external data processing services has been a stop-gap measure for the small business owner who has a need for computer processing, it does perform an important service in processing data for a large number of persons. The professions — medicine, law, and education — are all being impacted by the computer. Since these groups are dependent upon exchanging information for dollars, it is highly likely that they will become even greater users of computer products and services.

The services sector now accounts for over half of the computers installed every year in the United States. By 1975, this group will probably account for 75% of all computer installations.

**Table 2. Significant EDP Indicators
Services Sector**

COMPUTER INSTALLATIONS:

	1965		1966		1967		1968		1969	
	#	%	#	%	#	%	#	%	#	%
BANKING	645	10.9	775	10.0	830	8.1	835	7.8	780	7.7
MEDICAL SERVICES	105	1.8	70	.9	195	1.9	330	3.1	325	3.2
PROFESSIONAL SERVICES	160	2.7	465	6.0	605	5.9	685	6.4	885	8.7
RETAIL AND WHOLESALE TRADE	420	7.1	550	7.1	830	8.1	890	8.3	1015	10.0
INSURANCE, FINANCE AND REAL ESTATE	425	7.2	645	8.3	945	9.2	860	8.0	810	8.0
TRANSPORTATION SERVICES	185	3.1	230	3.0	295	2.9	330	3.1	275	2.7
UTILITIES	100	1.7	140	1.8	235	2.3	195	1.8	205	2.0
TELECOMMUNICATIONS	175	3.0	200	2.6	205	2.0	180	1.7	100	1.0
EDUCATION	310	5.2	420	5.4	800	7.8	805	7.5	700	6.9
FEDERAL, STATE AND LOCAL GOVERNMENT	1230	20.8	890	11.5	915	8.9	1085	10.1	935	9.2
TOTAL	3755	63.5	4385	56.6	5855	57.1	6195	57.8	6030	59.4

PERCENT REFERS TO SHARE OF ALL DOMESTIC C.P.U. INSTALLED.

FORECAST OF U.S. ECONOMY 1971-75 AND ITS EFFECT ON THE FUTURE OF THE COMPUTER INDUSTRY

Forecasting the future sales of an industry as sensitive to change as the computer industry involves an examination of various, relatively unstable factors. The national economy, technological change, the action of competitors, or changes in the supply patterns of critical components or labor can all act to alter the feasibility of a computer manufacturer's plans for continued or accelerated sales growth.

An analysis of industry sectors shows that it is possible to link the sales of computer products to shipments, profits, and capital equipment expenditures, although a forecast of the demand for computer products based on this type of analysis is tentative at best. In terms of forecasting computer sales, the most significant measurement is that of the probable total sales effect on a given industry for a given percentage of change in the GNP. The Department of Commerce's Business and Defense Services Administration has made use of a simple linear regression program to calculate for the various different industry groups:

- The growth that the industry might expect on its own without any help from an expanding GNP.
- The industry's comparative sensitivity to cyclical swings in general business conditions. The first element to be considered in a forecast, therefore, is to establish some probable ranges for the gross national product and the

effect it will have on the various user sectors of computer products.

The accompanying table gives projections of GNP and its composition for the years 1969-75, both by the Council of Economic Advisors and the Wharton School of Economics.

It is important to note that any projection for the future growth of the GNP must be related to changes in the key price indices. If the nation continues to experience inflation at the rate of the period from 1969 through 1970, severe economic action will be required. In the present concept of economic controls, this generally means controlling the cost of money, which, in turn, acts as a deterrent on business activity and consequently, employment. There is some question, however, as to the political reality of using economic techniques which result in unemployment to large segments of the labor force. For the moment, it is apparent that economists differ widely in their views as to what will most effectively control expansion and recession in the economy. The net effect of large scale unemployment on the economy is also not well understood. There has been little done in evaluating the shifting pattern of employment between the manufacturing and the services sectors of the economy. There seems to be a relationship between the increase in employment in the services sector and steady increases in the price indices. While manufacturing firms have tended to intensify their use of capital goods to increase the productivity of its laborers, there has been scant opportunity for this to be done in the services sector. If there is a relationship between services, employment and prices, then we are going to experience considerable pressure on prices in the next five years.

Table 3. Gross National Product, 1969
Projections for 1969-1975
(Billions of Dollars, 1958 Prices)

	1969	1970	1971	1972	1973	1974	1975
GROSS NATIONAL PRODUCT	727.7 727.7	736.9 730.1	765.0 747.9	813.4 805.6	858.7 855.6	893.7 890.9	927.4 925.7
FEDERAL GOVERNMENT PURCHASES	76.1 76.1	69.4 71.8	66.4 69.7	65.6 70.0	64.9 71.0	64.9 72.0	64.1 73.0
STATE AND LOCAL GOVERNMENT PURCHASES	73.7 73.7	75.9 77.6	78.5 82.1	81.3 88.0	85.7 94.0	89.6 100.0	92.9 105.0
PERSONAL CONSUMPTION EXPENDITURES	466.0 466.0	480.6 474.5	501.6 486.9	537.2 524.9	569.7 556.0	594.7 579.1	622.1 603.1
GROSS PRIVATE INVESTMENT	119.9 119.9	111.0 106.2	118.5 109.2	120.8 122.7	138.5 134.6	143.9 139.8	148.3 144.6
BUSINESS FIXED INVESTMENT	81.5 81.5	84.5 82.3	86.1 78.1	91.1 84.3	95.2 94.4	98.4 100.5	102.5 104.8
RESIDENTIAL STRUCTURES	23.5 23.5	21.1 21.0	24.7 25.0	29.1 25.8	33.5 26.7	35.7 27.0	35.7 27.3
OTHER INVESTMENT	6.9 6.9	5.4 2.9	7.7 5.1	8.6 12.6	9.8 13.5	9.8 12.3	10.1 12.5

SOURCE: (LIGHT FIGURES) COUNCIL OF ECONOMIC ADVISORS, ECONOMIC REPORT TO THE PRESIDENT, 1969
(BOLD FIGURES) WHARTON ECONOMIC FORECASTING ASSOCIATES, MARCH 12, 1970

STATE-OF-THE-ART DATA INTERFACE MODULES

- ... D/A Converters
- ... A/D Converters
- ... Multiplexers
- ... Sample & Holds
- ... Data Amplifiers
- ... Power Supplies

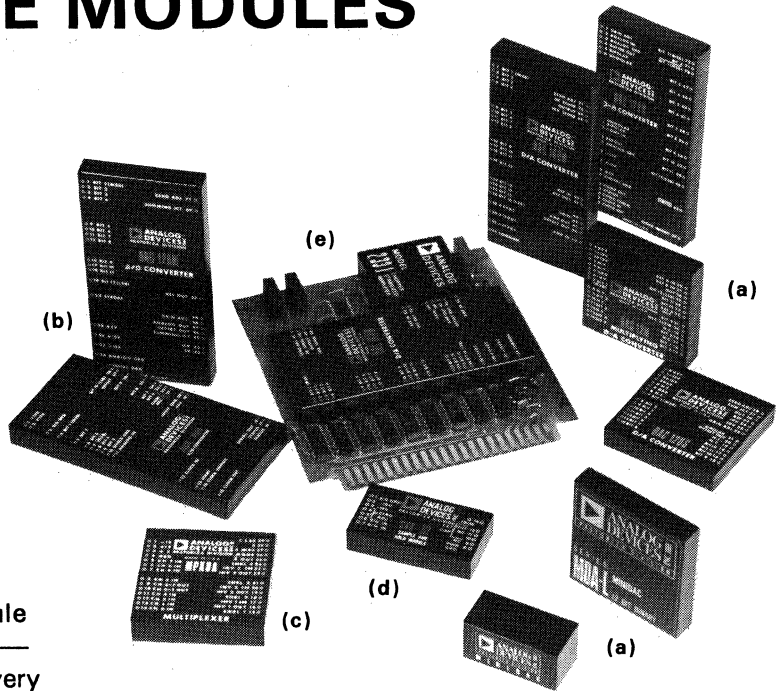

At the heart of our newest state-of-the-art high-performance A-D and D-A converter module designs are Analog Devices' exclusive μ DAC's—unique monolithic IC devices. Spec for spec, every one of these 28 designs is the best in its class. Each provides a superlative combination of **stability, linearity, accuracy, range, and speed.**

Here's what it takes to produce these high performance modules:

- our exclusive *fourth generation* IC μ DAC™ quad switches, which incorporate proprietary circuit and processing innovations. The current quads have unique internal reference compensation and proportional junction geometry. The voltage quads are optimized by dielectric isolation of all critical junctions.
- ultra-stable *fourth generation* μ DAC thin-film resistor networks . . . laser-trimmed for virtually perfect linearity, and designed for optimum compatibility with μ DAC quads.
- new "outer limits" *fourth generation* IC engineering and production facilities.

And every model is priced to compete with ordinary converters.

FIVE REPRESENTATIVE DESIGNS

DAC-16QM—16-bit D/A Converter (also 14-bit DAC-14QM). Linear within 0.0008%! From ordinary $\pm 15V$ op amp supplies — no need for 100 volt current source supplies. Gain T.C. is 1ppm/ $^{\circ}C$. Completely universal — up to 14 possible codes.

DAC-12M—Multiplying 12-bit D/A (also 8-bit DAC-8M). Four-quadrant multiplier; accepts one digital and one or two analog (bipolar or unipolar) inputs; output is their product. Accuracy, $\pm 0.024\%$.

ADC-12QM—12-bit A/D Converter (also 8 bit & 10-bit designs). Relative Accuracy, 0.0125%; differential linearity, $\pm 1/2$ LSB; T.C. of linearity, ± 3 ppm/ $^{\circ}C$; T.C. of reading ± 5 ppm/ $^{\circ}C$. Output: serial/parallel; binary, BCD; TTL;

DAC-12QM—12-bit D/A Converter (also 8-bit & 10-bit designs). Output: 0 to 5 or 10VDC (or ± 5 , $\pm 10V$) @ 10mA; 50V/ μ sec slew rate; Linearity & F.S. Accuracy, $\pm 1/2$ LSB each; T.C., ± 7 ppm/ $^{\circ}C$.

DAC-12QS—12-bit D/A Converter (also 8-bit & 10-bit designs). Same performance as DAC-12QM, but without input storage register.

SIZES: 2" x 2" x 0.4" or 2" x 2" x 0.36" or 2" x 4" x 0.4".

- (a) **D-A Converters**—from DAC-QS modules to sophisticated DAC-16QG converters with digital buffer storage, bipolar output voltage, and switching transient suppression.
- (b) **A-D Converters**—high-speed successive-approximation converters from the low cost ADC-H to the 1 micro-second ADC-F.
- (c) **Multiplexers**—high speed, high accuracy MOSFET multiplexers with binary address control.
- (d) **Sample & Holds**—for all applications, from high speed data acquisition to multichannel data distribution.
- (e) **Amplifiers**—for every application, from high-stability and high speed op amps to modular data amplifiers.

FREE—VALUABLE NEW TECHNICAL LITERATURE

NEW D/A & A/D CONVERSION PRODUCTS — Complete specifications on Analog Devices IC conversion components, and economy converters, high performance, and high-speed converters.

μ DAC FOURTH GENERATION IC D/A CONVERTERS — Technical specifications, application notes, and related reference material for precision D/A conversion applications.

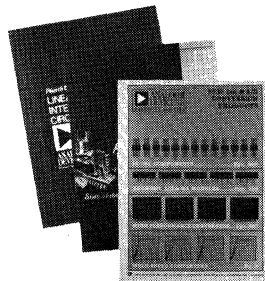

FOURTH GENERATION LINEAR INTEGRATED CIRCUITS—Descriptive material, specifications, and general information on many Analog Devices linear IC products and μ DAC current and voltage switches.

To obtain any of the above publications, or for expert applications consultation without charge or obligation, phone, TWX, or write: Applications Engineering Department, Analog Devices, Inc., Route 1 Industrial Park, Box 280, Norwood, Mass. 02062. TEL.: (617) 329-4700 • TWX: (710) 394-6577

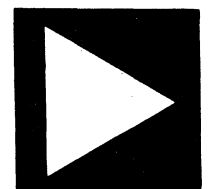

**ANALOG
DEVICES**
Circuit Specialists



Somebody Out There Likes Me.



I'm a counter salesman at the branch of a large department store chain. When people give me a credit card or a check, I instantly check their credit on this fast little terminal unit. It's easy. I can verify a check against a drivers license number in a second just by flipping this MINILEVER™ switch. Of course, I have to flip this switch all day long. But I don't mind. "Credit-Chek", produced by Credit Systems Inc., of Colmar, Pennsylvania, was obviously designed by engineers with compassion. They know

that if some poor soul has to flip a row of switches all day long, it should be easy and comfortable. Comfort produces accuracy.

MINILEVER is an accurate, easy to use switch. Nice large characters, .200 inches high, that "click" into position by the flip of a lever. The MINILEVER gives you up to 12 positions per module. The modules are on 1/2" centers, with as many in a row as you require. When you wish to reset all digits back to "0", all it takes is a sweep of the hand across the levers.

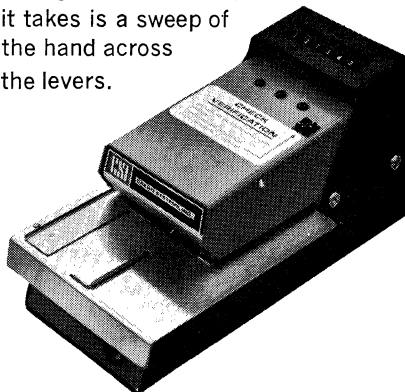

So, be compassionate, think of the other guy and buy MINILEVER. After all, you'd want him to do the same for you.

Send for our new data sheet.

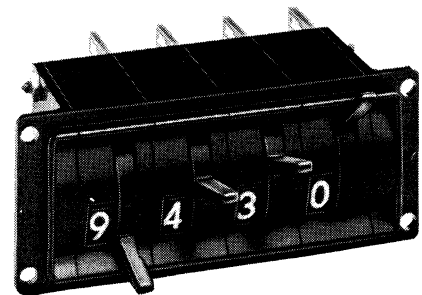

THE DIGITRAN COMPANY

A Division of Becton, Dickinson and Co. **B-D**
 855 S. Arroyo Parkway, Pasadena, Calif. 91105
 Telephone (213) 449-3110 • TWX 910-588-3794

PART 1
Comparative Characteristics
of
Computer Equipment

PART ONE CONTENTS

COMPUTERS	page 15	KEYBOARD EQUIPMENT	page 203
CHARTS		CHARTS	
Digital Computers	page 25	Keyboards	page 211
DATA COMMUNICATIONS EQUIPMENT AND FACILITIES	page 46	Input Typewriters	page 215
CHARTS		Key to Disc Encoders	page 218
Acoustic Couplers	page 69	Key to Tape Encoders	page 220
Communications Oriented Processors	page 72	MAGNETIC TAPE EQUIPMENT	page 223
CRT Data Terminals	page 76	CHARTS	
Magnetic Tape Data Terminals	page 92	Digital Magnetic Tape Transports	page 233
Multi-Device Data Terminals	page 99	Incremental Magnetic Tape Transports	page 242
Paper Tape Data Terminals	page 103	PAPER TAPE EQUIPMENT	page 245
Printer Data Terminals	page 107	CHARTS	
Punch Card Data Terminals	page 113	Paper Tape Punches	page 252
Teleprinter and Teletypewriter Data Terminals	page 116	Paper Tape Readers	page 255
Modems	page 127	PUNCH CARD EQUIPMENT	page 261
GRAPHIC DATA EQUIPMENT	page 135	CHARTS	
CHARTS		Card Punches	page 266
Alphanumeric CRT Consoles	page 146	Card Reader/Punches	page 268
Graphic CRT Consoles	page 149	Card Readers	page 269
Plotters	page 153	PRINTERS	page 271
MEMORIES	page 160	CHARTS	
CHARTS		Printers	page 274
Core Memory Systems	page 167	Computer Output Microfilm Systems	page 284
Semiconductor Memory Systems	page 188	OPTICAL READING EQUIPMENT	page 287
Fixed Head Disc Memory Systems	page 191	CHARTS	
Moving Head Disc Memory Systems	page 193	Optical Character Readers	page 293
Fixed Head Drum Memory Systems	page 199	TIME SHARING	page 298
		CHARTS	
		Commercial Time Sharing Services	page 302
		BUSINESS FORMS	page 308

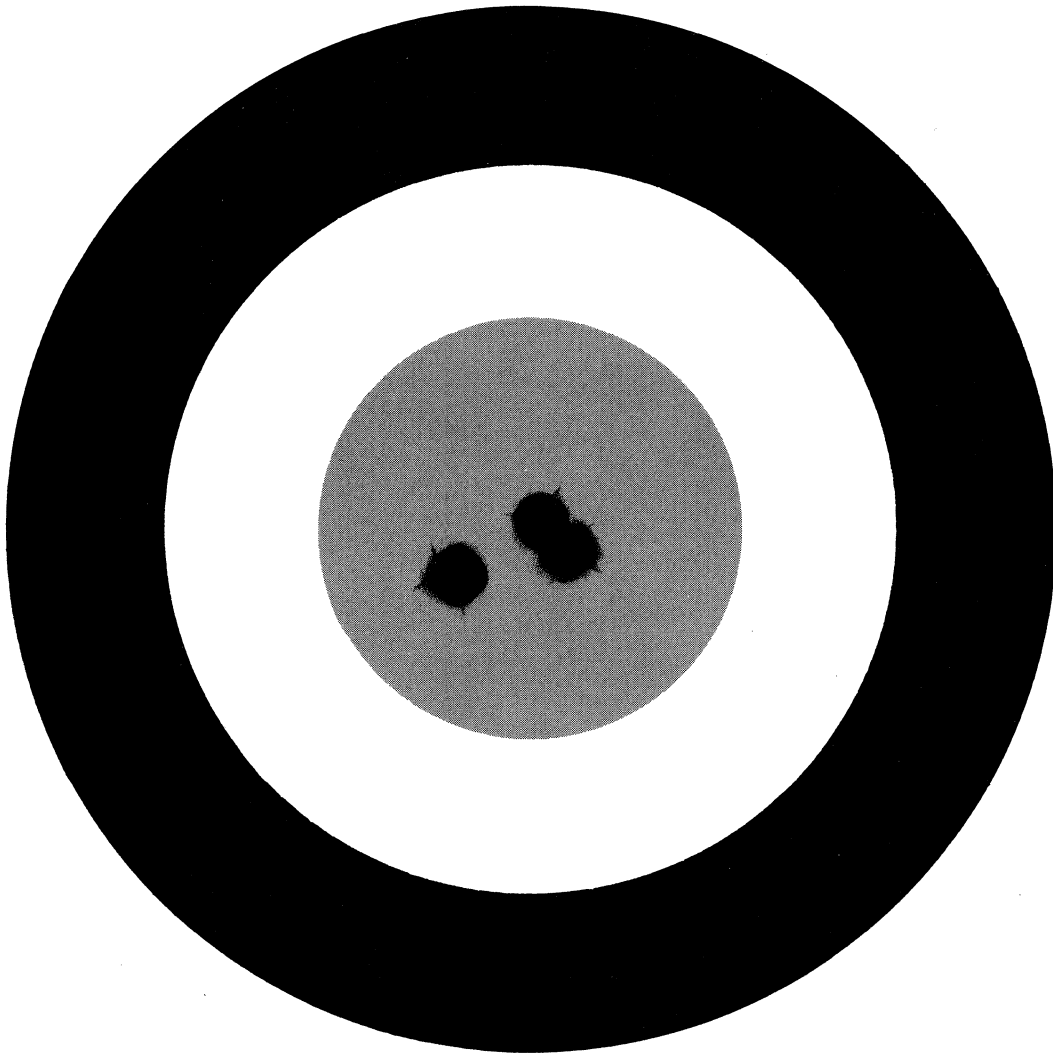

On Target with Solutions

Our systems-capability solutions are dead-center on your minicomputer problems.

We aim to solve your problems in a variety of ways. Aside from our line of general-purpose computers described below, we have a full range of DELIVERABLE software: MOS, FORTRAN IV, BASIC, RPG IV, among others. We offer the largest line of FIELD-PROVEN peripherals. And we have maintenance contracts that are tailored to your system needs. We have a special Systems Engineering Department that DELIVERS.

Now about that hardware...

620/i: The total capability minicomputer. So great, over 1400 used worldwide.

620/f: New, so fast it just did one mega-execution while you read "so fast," completely compatible with the 620/i.

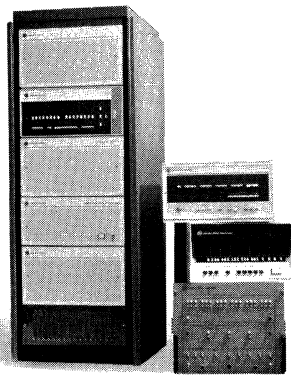

R620/i: The number one ruggedized minicomputer.

520/DC: Today's most cost-effective data communications system.

If you want to be on target with TOTAL solutions, why not talk to the big company in small computers?

U.S. Sales Offices: Downey, San Diego, San Francisco, Calif.; Washington, D.C.; Chicago, Ill.; Waltham, Mass.; Ann Arbor, Mich.; Minneapolis, Minn.; Albuquerque, New Mex.; New Rochelle, Syracuse, N.Y.; Fort Washington, Pa.; Dallas, Houston, Texas. Other offices worldwide.

Varian Data Machines, a Varian subsidiary, 2722 Michelson Dr., Irvine, California 92664. Telephone 714/833-2400.



varian
data machines

The Big Company in Small Computers

Computers

Computers today represent a multibillion dollar industry that is still growing at a remarkable pace. Hundreds of different models are available, with purchase prices ranging from as low as a few thousand dollars to about ten million dollars. The computer mainframe market is estimated to reach \$1.5 billion in 1971 and \$2.5 billion by 1975. In numbers of units, 60,000 computers are expected to be shipped during 1975 of which 50,000 will be so-called minicomputers with minimum mainframes costing under \$10,000. The greatest percentage of increase will be in time-sharing, which is expected to grow from its present \$100 million base to \$700 million in equipment value. Industrial control applications will increase comparably between now and 1975 from roughly a \$200 million to a \$600 million base. The phenomenal growth of the computer industry has been largely the result of new applications brought about by cost and performance improvements. New applications appear every day as the computer finds its way into almost every aspect of business and professional activity.

Traditionally, computers have been broadly classified as commercial or scientific. The scientific class of machines includes small computers typically used for some form of on-line control, and the larger machines used for general computation. Though many computers on the market may be easily identified as either commercial or scientific, it is becoming increasingly difficult to distinguish between commercial and scientific computers, particularly in view of the speed and data formats of the new generation machines.

Regardless of application, all digital computers exhibit the same fundamental architecture, which consists of five basic sections: input, control, memory, arithmetic and output. Beyond this elementary comparison, computer mainframes differ substantially. The design of these five basic sections varies significantly from one machine to another in order to accommodate the specific requirements of particular applications. However, because of this accommodation, selecting the most suitable equipment for given applications requires careful scrutiny and evaluation.

In this survey of computers, particular emphasis has been given to the problems of equipment selection. The various hardware, software and system characteristics have been reviewed as they relate to selection and evaluation procedures. The review is followed by product summary charts of computers currently being produced. Specialized communications-oriented processors which serve as the communications front-end of larger computer systems have not been included in this section, since they are discussed in the section on Data Communications Equipment. For a review of characteristics of various input/output equipment, peripherals and storage systems, the reader is referred to the specific sections on these equipment.

MINICOMPUTERS

A decade ago, minicomputers did not exist. Today, minicomputers are perhaps the most dynamic part of the computer industry. Yet, because of the meteoric growth of the minicomputer industry, many people have only a partial understanding of what minis are and how they are used.

Minicomputers, which are physically small and inexpensive, now come with a variety of peripherals that expand their capabilities considerably. Another plus point for minicomputers is that they have internal speeds that enable them to communicate with a higher degree of flexibility than controllers, which until now have been hard-wired, non-programmable components of analog-to-digital computer systems. Minicomputers also have the capability of functioning as stand-alone, dedicated computers which can control a discrete portion of a process and do it well. An observable trend is that most industrial process systems function in factory environments not really appropriate for a computer's delicate mechanisms. Some of the computer "pollutants" are high electrical noise, H₂S (sulphur dioxide) and corrosive solutions, oil film, metal dust, vibration, shock and temperature and humidity variances. With this in mind, some minicomputer manufacturers have designed their systems to withstand these hostile environments.

The Minicomputer Market

This year, more than 6,000 minicomputers will be installed, representing about \$100 million. Adding associated peripherals and software, this figure jumps to between \$200 and \$250 million.

The growth rate of the minicomputer market has been between 40 and 50 percent per year for the past three years and manufacturing capacity already exists to continue this growth pattern for at least two more years. That is, shipments could be approximately 15,000 systems, exclusive of business systems, without straining the manufacturing capacity of established suppliers.

Presently, the major areas of application are:

- Scientific or laboratory instrumentation
- Industrial or process control
- Data communications
- Time sharing and computation
- Education

1 Equipment Characteristics

A large percentage of laboratory systems include instrumentation, mainframe, peripherals, and software as a package and are usually sold through instrumentation manufacturers. In addition, computer manufacturers offer turn-key systems designed for a specific type of instrument or group of instruments. Some typical functions are instrument monitoring and control, data acquisition, and data reduction and analysis.

Industrial applications of minicomputers can be divided into factory management, discrete manufacturing, quality control and testing, and continuous process control.

In data communications, minicomputers are used as terminals, message concentrators, message switching systems, store-and-forward systems, and pre-processors for large computers. Each application may use a minicomputer, ranging from the lower end of the price range for terminals to the upper end for concentrators and pre-processors.

Industrial and data communications markets will continue to grow more rapidly than scientific markets. Also, significant growth in business systems for both free-standing and batch terminal usage can be anticipated. The entry of most, if not all, of the major business computer manufacturers into the market for EDP applications seems likely. Another potential market for minis, not presently significant, is transportation, both for vehicles and traffic control.

Major divisions of the market for the next five years have been projected to be laboratory, industrial, communications, business, and a miscellaneous grouping of applications such as typesetting, transportation, traffic control, and education. The most significant new development is the anticipated growth of business applications and the accompanying growth of data communications. These applications together are predicted to account for approximately half the 1975 shipments. Markets may grow at a stronger rate than indicated for transportation, education, and hospital automation, but prediction is difficult since each area is presently somewhat volatile.

Types of Minicomputers

There are many ways to categorize minicomputers. All are usually tied to some specific criterion such as system price. Among all the possible classification schemes, perhaps the most commonly used is word length. Although exceptions undoubtedly exist, generically speaking, for general purpose minicomputers, the following guidelines hold up surprisingly well.

Eight-bit word length computers. Most eight-bit word-length machines are not really organized as computers, and those that have are very limited power. As a consequence, they are generally used to control simple repetitive actions, such as uncomplicated industrial machinery, and as such, are many times referred to as "controllers" rather than "computers." A true minicomputer has to have the full elements common to any computer-central processor, core memory, and input-output devices. A further distinction must be made between a general purpose computer and a special purpose device. In one sense, both are "computers," but generically, in most conversations "computer" implies a machine whose function can be changed easily by reading in a new program.

12-bit word length computers. Minicomputers with "short" word lengths are generally used in dedicated applications. Such machines are used to perform single tasks, one task at a time, such as gathering data, performing control functions, acting as a dedicated calculator, or communication device, or performing analytical functions. The more advanced 12-bit minicomputers, however, can be used for multifunctional assignments, where more than one person or piece of equipment shares the computer.

16-bit word length computers. Machines with 16-bit word lengths are used either for more complex dedicated jobs or for more extensive multifunctional assignments. These are the systems that bridge the gap between the control or dedicated computer and the stand-alone multipurpose system.

18-bit word length computers. Minicomputers with word lengths of 18 bits are at the upper end of the small computer spectrum and often are actually medium-scale machines. They can perform highly sophisticated analytical tasks, interactive graphical design, and time-sharing. They are used in a variety of fields, from analytical instrumentation through engineering simulations, often performing several functions simultaneously.

Job functions. There is bound to be overlap between these levels of minicomputer, however. A large 12-bit computer system with 32,768 words of core may be capable of performing a more sophisticated job than an 18-bit computer if the latter is a minimum system configuration. On the other hand, many people do not realize that an IBM 1800 is architecturally a small computer, and that the only reason it is not normally considered a small computer is its price tag.

In summary, minicomputers probably should be categorized in terms of performance rather than price or word length, but a successful method of doing so has yet to be discovered.

Evaluation of Minicomputers

Too often computer buyers are caught up in fads; they are dazzled by new advances in technology. Specifications can be misleading. A small-word-length computer may have a slower cycle time than a larger machine. But if incremental data is packed into more than one word, the cumulative cycle time of the small-word-length machine may exceed that of the "slower," larger-word computer.

Perhaps the major stumbling block in evaluating computers is price. A computer manufacturer selling a mainframe at a new, low price can always be found. But what is the buyer receiving for his money?

When the price of a machine is quoted as \$5,000, the buyer should start wondering what that price includes. Is that with or without teletype or an equivalent I/O device? Does it include the cabinet, a power supply, a console? It may not be a computer at all, but only a piece of a computer.

The actual cost of a computer often represents only a sixth of the total cost of an operating system. Peripheral equipment accounts for another sixth; the software, that is, the coding cost that will be expended on the job, usually runs another two sixths, the installation, setting the

1 Equipment Characteristics

equipment up and running and tied into your own equipment is probably another sixth; and then the on-going service costs account for another sixth.

The percentages, of course, vary from application to application, but the important thing to remember is that the hardware represents, at best, a small portion of the total cost of any system. It is not often that total system performance, that is, mainframe, peripherals, interfacing, software, support and service, is balanced against price.

To evaluate the real price/performance ratio of a mini-computer system, the buyer should lay out the total system configuration he believes will solve his problem and then ask manufacturers to attach a price tag to it. He also should ask the manufacturer about the cost of extra memory and the cost of adding more peripheral capability, such as discs and tapes. He should not use just the basic mainframe price because that bears little relationship to reality.

Let's see how this applies. Suppose you need a computer configuration to acquire and analyze data from some type of instrumentation. First, you have to consider the direct requirements, such as what sort of hardware is needed — the central processor, the size of internal memory, the kind of peripheral storage required, and the interface between the system and the instrument. Then, you must see what sort of software is available. You would also look to see what sort of user documentation and training are available, so you can learn how to use the total system and train your personnel in its operation.

Additionally, you would like to find out how the system is to be maintained and serviced. Many companies have field-service forces, but you are interested in a service that can maintain the system as a unit, not one that merely maintains the mainframe. You must also determine what is needed in the way of spare parts and how much these would cost.

Suppose someone wanted to build a system like the one just discussed and he followed only the hardware specifications. He would then purchase a computer, an interface to his instrument, and extra memory. Where would this leave him?

First of all, he has to assume system responsibility himself. This means he has to make the pieces of hardware work with his instrument. Nobody else is obligated to assume that responsibility. Therefore, as a part of that responsibility, he has to write the software to make the computer system do what he wants it to with his instrument. Also, he must prepare documentation so that his untrained personnel can operate the system. He has to conduct classes to train his people to use the system. And, beyond the basic maintenance of the hardware, he has to establish a comprehensive in-house group to maintain the total system's operation.

He can farm out some of his responsibility by contracting a software house to accept it for him. But, this is also an expense and it's usually high. In short, he must pay the cost of implementing his system out of his own pocket. And, he is in no position to estimate the total cost because he has no way of knowing in advance just how complex his problem is going to be. The hardware costs are known; the other costs, which are not known, could be quite large.

By implementing the system himself, the buyer is burdened with another hidden expense. During the time he is implementing the system, he has lost the use of it. This means that, while the software is being developed and debugged and while the documentation is being written and published, the machine is standing idle. The system costs money by not being able to earn its keep during this period.

The economics of the business will eventually force buyers to cease looking at hardware only. They will have to either be capable of evaluating total systems realistically or else know where to buy the services of someone who can.

A potential minicomputer user should evaluate the total support a manufacturer offers very carefully. For example, how well is the hardware and software documented? Is that documentation usable? Can you understand it?

Training is another support consideration. Does the manufacturer provide software and hardware training? Does he provide training so that the equipment can be maintained by the customer? What kind of service support is available in the field? When the equipment is shipped to its end-use location, are there adequate spares available?

Warranty agreements are important too. Warranties differ from manufacturer to manufacturer. The buyer has to know what all the manufacturers are offering in this respect. For instance, a manufacturer offering a computer that has his own line of replacement modules with a 10-year warranty usually is implying some feeling of confidence that his parts are reliable. In this same vein, the buyer should look at what portion of the total system is built by the computer manufacturer himself rather than purchased on the outside. Manufacturers generally offer better warranties on their own products.

Another important consideration is the range of peripherals a manufacturer offers, as well as the software support that is available to run these devices. The greater the variety of peripherals, the more things that have been interfaced to the computer, the easier it should be for an engineer to put a system together. Manufacturers, in general, have not concentrated on peripheral equipment for small computers.

A buyer should attach a truly realistic price/performance value to the computer system he specifies. He should be able to look at the cost of each piece of the total system, but he should base his evaluation on the total cost of a completely installed system — one ready to use.

COMPUTER SYSTEM CHARACTERISTICS

The meaning of many terms used to describe computer systems varies markedly in the literature. An attempt has been made here to clarify some of the commonly used terms. The various available systems may be classified by their response time, and by the number of programs that may be active at any given time.

The most important terms that relate to response time are *batch processing*, *interactive processing* and *real time*. In a batch processing system, input is held until a suitable group has accumulated; then the input is loaded, processed, and outputted as a group. A payroll run, in which a batch of several thousand time cards are processed and checks are printed, is an example of a batch-processed job.

1 Equipment Characteristics

In interactive processing, each unit of data is processed as soon as it becomes available. The unit of data may be as small as one character. Interactive systems are often referred to as 'conversational' systems because the fast response time makes it appear that a terminal user is holding a dialogue with the system. Interactive processing usually implies 'on line', meaning constantly available system resources, particularly data files. In batch processing modes data files are often only available during the processing of each batch of input. An engineer designing a vehicle with the aid of a CRT console station under the control of a "computer aided design" program is an example of interactive processing. An interactive capability does not imply that the user can interact with the system in "real time."

Real time is a relative concept in which the time between acquisition of information by the system and the logical response to this input is guaranteed to be insignificant relative to the application in question. Real time usually implies some kind of dedicated system, so that no other activity will prevent the fast response that is required. Even if a system meets these requirements, it is usually not considered real time if the period for response is greater than several minutes.

Major terms that relate to the number of programs a system may have active at any given time are *single program mode*, *multiprogramming*, and *time-sharing*. In single program mode, a single program is active and alone remains active until it has run to completion, even if it takes hours or days.

Multiprogramming is a technique by which a system can process more than one program at a time. Thus, several operations may be done in parallel. For instance, Program A may be computing something while Program B is performing Input/Output operations. Indeed, input/output activity is a prime factor in determining the length of the 'time slice' allotted to each program before it is interrupted and another program is given CPU time. Active programs in a multiprogramming environment usually reside in main memory, and remain there until they have run to completion. Multiprogramming should not be confused with "multiprocessing," which refers to there being more than one CPU in the system.

Time-sharing is a technique whereby a large number of programs can be active simultaneously within a system. The time slice each program is allotted between interrupts is much shorter than in a multiprogramming system, and is determined by a sophisticated priority scheme. The number of active programs is not limited to how many can fit in main memory at one time. This advantage is implemented by using secondary storage to hold active programs currently not being processed and swapping them with programs in main memory as their turn of a slice of CPU time approaches. Time-sharing is often used to implement interactive processing systems, but neither is a requirement for the other. Time-sharing is discussed in its own section and will not be further discussed here.

A multiprogramming system may be either batch or interactive. Large recent systems tend to support both modes. The response time for each job is a function of the priorities assigned to each. These priorities may be fixed assignments, first-come-first-served, or may be dynamically

assigned and changed during the course of the job. A sophisticated priority assignment system greatly increases the efficiency of the CPU and can markedly reduce the response time of an interactive system, but at the cost of complex supervisory programs and additional hardware which may be required. The interactive multiprogramming system is used where there is a need for a fast response system but where the usage is not sufficient to justify a dedicated real-time system. In an interactive multiprogramming system, a "background" job, typically batch processing with low priority, may utilize idle CPU time.

The decision to choose an interactive system or use a batch processing mode ultimately depends on the economics of the situation, applying the cost/effectiveness argument to obtain the most suitable alternative. However, there are certain classes of problems that are more suitable for batch processing and others that require an interactive capability. Batch processing is more appropriate for problems in which response time is not critical and large amounts of input/output data are involved. Thus, for applications such as payroll, accounting, preparation of statistics and reports, sorting and other routine work, the batch mode is usually employed since it is more efficient and economical (less overhead).

In applications such as computer-aided design, program debugging, inquiry processing and management-information or decision systems, the response time is usually important. In such systems, the computer system very often dictates what the next step is to be and interaction between man and machine is very important. In fact, user efficiency is much more important than machine efficiency. Thus, for these applications, an interactive processing system is appropriate if not crucial.

Some classes of problems are appropriate for either batch or interactive processing. (These are usually problems in which on-line ability is desirable but interactive processing is not necessary.) Applications such as industrial data collection, inventory control and teller-type banking systems may be implemented in either mode. In batch mode, the data must first be put into a suitable medium for input to the computer, such as punched cards, paper tape, magnetic tape or even disc files, and then "read" by the computer at its leisure. In interactive mode, the data can be supplied on-line using a suitable data communications terminal. Such terminals are discussed extensively in the section on data communications terminals. On-line capability is particularly important when large geographic separation is a characteristic requirement. In such cases, problems of data collection should be minimized by installation of remote terminals. Choice of interactive operation depends also on considerations such as computer usage, economics of the situation, and overall system design.

Many interactive computer systems employ the technique of polling. Polling is a process by which the main computer system ascertains whether any of the remote devices are ready to transmit input messages. Each remote device is checked, in turn, to determine if there are any messages for transmission. By this constant "round-robin" technique, no device is kept waiting beyond some maximum time.

Two system features are particularly useful in multiprogramming and time-sharing: dynamic storage allocation

1 Equipment Characteristics

and storage protection. *Dynamic storage allocation* provides maximum efficiency for system storage of incoming programs and data. Thus, in a time-shared system, a program may occupy a certain location in core storage the first time in, may be swapped out at the end of its time allocation, and be brought back later into an entirely different core location. This function can be accomplished by either software (the executive program or supervisor) or by hardware features (relocation registers). *Storage protection* is necessary to prevent any one program accessing or changing any parts of the core storage outside the area it is using. Thus, a user is prevented from damaging data in programs of others or the system itself. Storage protection is normally a hardware feature employing memory protection registers.

Other system characteristics, such as the number, type and speed of instructions, equipment complexity, supervisory programs and applications programs, are discussed under the appropriate sections.

HARDWARE FEATURES

Hardware technology has made major advances in the last few years. Developments in semiconductor technology and improvements in memories have greatly increased the speed and power of computers. Development of large computing systems that can be time-shared, improvements in machine organization and the introduction of microprogramming have served to reinforce these hardware developments. With large-scale integration now becoming a reality, even more powerful and faster computers are possible. The state of hardware technology is a challenge to the system designer. Since many of the system functions can be provided interchangeably by either hardware or software, integrated hardware/software design is becoming increasingly important.

In spite of technological advances, basic organizational questions remain the same. For example, one is still concerned with the size of the internal memory and how it is related to the characteristics of the application, the proper balance between speed and capacity in a hierarchy of memories, the optimum word size and structure, the number base to be used (binary, decimal etc.), whether or not to have floating point hardware, the optimal balance between "wired-in" and programmed operations, the execution speed for instructions and the input/output capability. Of the above, the input/output capability has assumed increasing importance over the years. Particular emphasis has been given to the I/O capabilities and peripheral devices in the charts at the end of this section. For the purpose of this review, the various hardware elements have been grouped according to the basic functional blocks of the computer: memory, arithmetic control and input/output.

Internal Memory Characteristics

Various internal memory characteristics such as memory size, memory cycle time and word length and structure are perhaps the most important distinguishing characteristics of a computer. The core memory has been the major internal memory device up to the present time. Some machines today use semiconductors as the memory. Plated wire is also in use.

The principal determinant for computer speed is the memory cycle time. No other single factor has so powerful an influence on computer performance. Over the past decade memory cycle time has decreased from about 6 μ s to the sub-microsecond range. For a more extensive discussion of memory, the reader is referred to the Memories section.

Size of internal memory is perhaps the most important contributor to the power of a computing system. Core memories have become larger with million bits being standard for a medium size installation and tens of millions of bits for large installations. The memory is usually organized into words, bytes or characters that have a fixed length. The memory size is usually designated by the number of words it contains. Thus, depending on the word length, a 1K core memory may contain anywhere from 6K to 60K bits of core storage. It is common practice to refer to memories as 1K when, in fact, they contain 1,024 words. Most computer systems available in the market come with a minimum or standard memory size that is expandable to some maximum limit at additional cost.

Memory word size is one of the most common ways of characterizing a computer. The word size refers to the number of binary digits (bits) that can be retrieved from or stored in the computer memory in a fixed time interval (usually the memory cycle time). Although there is nothing intrinsically valuable about a particular word size, when it is considered in combination with memory cycle time. It is often the major indicator of machine performance. Since operations are often memory access limited, the word size also determines the accuracy and efficiency of operations. The optimum word length choice is one in which the word is equal in size to the unit of information to be processed, which, of course, varies from application to application. The usual word lengths of medium and large machines are 24, 32, 36 or 48 bits. Smaller machines used for on-line, real-time control usually have 8-, 12-, 16- or 18-bit word lengths. In the larger-word-length machines, if alphanumeric information is to be processed, a word can store several characters. Thus, it is sometimes important to know the number of characters per word or alternatively the number of bits in a character.

In addition to data bits, some internal memories also have one or more parity bits along with each word. Such bits are useful for additional reliability. A feature that is sometimes very useful is memory protection. Some internal memories have a memory protect bit along with each word, others have area protection and still others have no hardware memory protection at all.

Arithmetic Operations

The speed and nature of arithmetic operations significantly affects the efficiency with which any of the application programs can be performed. Thus, the number base in which the computer operates for its arithmetic is often important in determining its suitability for particular applications. Business data processors usually have decimal arithmetic, while scientific machines employ binary arithmetic. Some machines have both binary and decimal capability and a few employ octal or hexadecimal number bases. An arithmetic technique that is very useful, especially for scientific applications, is floating point hardware, which is much faster and more versatile. While in

1 Equipment Characteristics

many of the machines floating point hardware is an option, the more modern large computer systems have it as a standard feature.

Though memory cycle time is a good indicator of speed and performance of a machine, it alone is not a true measure in actual use. A machine with a faster memory cycle time does not necessarily execute a given program or perform an arithmetic operation in less time than a machine with a slower cycle time. Most business data processors do not have a hardware multiply and divide feature; the instruction is executed by software, which of course, is rather time consuming. Most scientific computers do have a hardware multiply and divide feature since they are required to perform these operations quite often. The smaller scientific/control machines often have multiply/divide in hardware, but sometimes it is optional or even not available.

The speed of arithmetic operations has increased tremendously over the last few years due to technological developments in digital logic. The add and multiply execution speeds have decreased from hundreds of microseconds to well under the microsecond range. Many new small and relatively inexpensive computers have extremely high execution speeds. This trend is bound to continue with the use of large-scale integrated (LSI) arrays.

Control Elements and Other CPU Features

Many control and other CPU features significantly affect the speed and efficiency of the system. The user should carefully consider the number of instructions and the variation in instruction-word formats and addressing techniques in competitive machines. In the earlier machines the storage size and, consequently, the address size, were small, and it was convenient for a single instruction word to contain several addresses. As the size of memories increased, longer addresses were required to access a piece of data, which tended to make it difficult to fit several addresses into a single instruction word. For this reason, most current machines have a single address per instruction.

The *instruction word length* is a function of the number of instructions, the addressing requirements and special features such as indirect addressing and index registers. In order to store instructions and data interchangeably, it is usually desirable to have the instruction word and data word of the same length. For applications requiring larger data word lengths (for higher precision), use of double-word lengths is quite common. Double-word lengths or multiple-word-length operations are especially common in applications using small machines with shorter word lengths. The single address instruction word is usually divided into three basic fields or subdivisions for the operation code (op code), the addressing modes (modifier) and the operand address.

The number of bits allocated to the op code field usually determines the number of instructions in the instruction set. An exception is in some short word length machines in which the instructions are divided into two sets, one that addresses the memory and the other that does not. Now all but one of the op codes can be assigned to the memory reference instructions and the remaining op code can be used to represent the entire set of instructions that do not need memory referencing, such as register-to-register transfers.

One or more bits are usually provided in the modifier field to specify address modification modes such as direct, indirect addressing and indexing. Such features are quite useful for most applications. The remaining bits of the instruction word make up the address field. In small word length machines these are insufficient for directly addressing the full memory and some sort of a relative or abbreviated addressing scheme is employed.

Indirect addressing is a technique in which the memory location specified by the instruction contains the address of the operand rather than the operand itself. Indirect addressing requires an additional memory reference but provides great flexibility such as using the entire word for the operand address. The indicated address in indirect addressing may itself be indirect in machines that permit multilevel indirect addressing.

Useful hardware features to have are *index registers*. They can be used in different ways such as to provide means of addressing memory locations outside current page in systems that use paging, or to keep track of loop operations that may be required for certain programs. Many machines have dedicated hardware registers, while others use various schemes to provide indexing in the memory. Memory index registers usually cost less but the operations are more time consuming.

As mentioned previously in the discussion on system characteristics, *interrupt controls* are extremely useful features to have in a machine. The interrupt capabilities of major interest to the user are the number of interrupt lines, or the number of external interrupts. The interrupt capability is usually provided by means of interrupt registers which may be in the hardware or in memory. Capability to enable or disable individual or a group of interrupts under program control are sometimes very useful features. External system interrupts are also called priority interrupts.

Input/Output Capabilities

The I/O capabilities of computers, as mentioned earlier, are extremely important in the system, especially when the computer is used in real-time applications. Thus, the number of terminals a machine can handle, the number of I/O channels available, the maximum data transfer rate in either bits-per-second or words-per-second and the peripheral devices that the machine can support often are the major contributing factors in its selection for a particular application.

The width of the I/O data channel is typically the word length of the computer memory. Though a wide variety of I/O channels are available in different machines, they generally fall into two basic classes. In one, the I/O transfer is under the direct program control of the CPU; that is, the data path is via the CPU registers, such as in case of programmed data channels and party line I/O. In the other class, the I/O transfer is directly between the memory and the external-device controller such as in direct memory access selector and direct memory channels. In such cases the transfer, once it has been initiated, is independent of program control.

Usually the I/O channels can support more than one terminal or peripheral device. The larger machines often

1 Equipment Characteristics

provide fully buffered channels, sometimes referred to as automatic channels. These channels have the minimum of programming overhead and the CPU is not tied up waiting for the I/O data transfer. Moreover, buffering permits several I/O channels to operate concurrently. Thus, buffering and other features, such as cycle stealing and simultaneous I/O transfer and compute with multiple memory modules, are important, in addition to maximum data transfer rate, in determining whether operations would be I/O bound or CPU bound.

I/O bound operations are those in which system overloading, or delay in response, occurs because the I/O is unable to keep up with the CPU. In *CPU bound* operations, the system overloading occurs because of the slower speed of the CPU. In the latter situation, the I/O sits idle waiting for the CPU to complete processing. Usually, in scientific/engineering applications, the system is necessarily CPU bound, whereas business applications, with extensive data communications, are usually I/O bound and the I/O capabilities are critical in determining the system performance.

SOFTWARE REVIEW

Though the manufacturers have made considerable progress in software development, it is obvious they cannot handle this burdensome task alone. Evidence to this fact is the growing number of computer consulting companies and software firms. These companies provide a broad range of highly specialized services including software development, systems analysis and personnel training and staffing. (See the Directory of Services for a detailed list of computer-related services.) They perform such diverse functions as providing programming languages or operating systems for computer manufacturers to highly specialized systems analysis, applications programming and installation planning for the users. It has been estimated that for each dollar spent on hardware, another is spent on software development or related services.

Many manufacturers are developing software as an integral part of their hardware in order to minimize programming costs and complexity. In effect, users are being relieved somewhat of the tedious programming chores through the availability of new programming aids, improved languages and more extensive applications program. This trend is, of course, not new, but the relationship between the hardware and the software costs has changed dramatically. It frequently makes sense to get a machine with more core storage than to have programmers stretching and straining to fit programs into smaller machines. It also is sensible to use higher level programming languages that are less efficient in use of storage and processor time, rather than spend an undue amount of effort in programming with the lower level assembly languages and possibly missing installation deadlines.

An extremely wide variety of software is offered by the various manufacturers. Most manufacturers include some software in the basic price of the machine. Manufacturers of the larger machines provide not only assemblers, compilers, I/O routines and operating systems but also applications programs and library packages that are included in the basic price. In the small computer market, there is a trend to minimize basic mainframe costs and provide many features as optional. For this reason, many

small computer manufacturers normally include only the assembly programs in the basic price and higher level languages, such as FORTRAN compilers and special purpose applications software if available, are priced separately. Most manufacturers provide their own operating systems and program libraries in addition to compilers for the general-purpose higher level languages.

Assemblers and Assembly Language

The most important basic software for all machines is the assembler, and assembly language is one of the most widely used programming languages. In this form, a programmer has complete access to all machine facilities and yet he is relieved of most of the essentially clerical tasks of keeping track of storage locations of data and instructions. The programmer writes instructions in a symbolic form which is more meaningful to him than a string of numbers as in machine language coding. Assembly languages also have facilities for declarative statements which define the sizes of the relationships between data fields, symbolic names and program constants.

The state of the art in assembly language programming has advanced significantly in the last few years. Many assemblers have more sophisticated features, such as macro instructions and conditional assemblies. Macro-assemblers that occupy less than 3,000 bytes of core storage have been implemented. In evaluating assemblers, specially in the case of the smaller machines, one should consider the core storage required, the number of symbols handled in the symbol table and whether the assembler generates relocatable code in memory.

Assemblers are usually one-pass or two-pass. Some manufacturers provide both kinds. A one-pass assembler does not require the source program to be loaded twice, thus saving time, but it has the limitation of allocating storage at the beginning of program. A two-pass assembler allocates storage and sets up the required address references on the first pass and generates the basic machine code on the second pass. The number of passes refers to the number of times the assembler scans the source program; it should not be confused with the number of times a program may be read from a peripheral device.

Some useful assembler features to have are the provision for pseudo-operation codes and macro-instructions. *Pseudo op codes* are instructions to the assembler itself, which make it easier for the programmer to reserve memory locations for constants. *Macro-instructions* allow the programmer to define a set of instructions along with the desired variables by name and facilitate the inclusion of often used code sequences with the minimum of effort. "Macros" differ from subroutines in that they are assembled only once. Macros involve less linkage overhead and are generally used with higher-level languages. Macro facility is sometimes not available with smaller computers.

Compilers and Higher Level Languages

Compiler languages or higher level languages facilitate the task of programming to a great extent. They are essential for large systems, serving a great many users in diverse applications. In small, real-time control computers, they are used infrequently because the tight timing and machine efficiency requirements dictate use of assembly language.

1 Equipment Characteristics

For many applications and for a very general purpose facility, some list processing and simulation language capability is highly desirable.

Choosing which programming language to use very often involves looking at the surface only and considering its various features, rather than an evaluation of its practical utility as related to the particular applications mix. In a thorough evaluation of languages, it is important to consider quantitative as well as qualitative results. Quantitative results may be obtained by taking a typical mix of benchmark problems in the various languages and considering the various factors such as coding, debugging, compilation and running times and the number of statements in the programs.

Operating Systems and Executive Monitors

The major tasks of an operating system are to provide language translation, job control, data control and diagnostics. The operating system capabilities are of major importance for the larger installations, where a number of users use the system with various languages and with varying requirements. Some of the features that an operating system can provide, such as real-time control and multiprogramming, were discussed under system characteristics. Other features may include data management, file systems and accounting and billing for the computer usage. Thus, it is the power of the operating system rather than that of the basic machine that is of primary importance in the evaluation of larger systems. The operating system performance is, of course, limited by the machine hardware capabilities.

For small, real-time control computers, the operating system is generally referred to as the real-time executive monitor. Its major functions are input/output data transfers, process interrupts and memory allocation and protection. Most real-time monitor software systems handle one dedicated real-time program but some handle more than one program in a multiprogramming environment often called foreground/background, as discussed earlier. Many real-time monitor systems require disc storage for fast storage and retrieval of large amounts of data. In these cases, a separate resident executive program, called the disc operating system, is often provided which enables efficient use of the disc.

A very important feature of an operating system is its diagnostic and debugging capabilities. Diagnostic routines are necessary for all major units of a computer system: the CPU, the memory and the peripherals. They are often very complex but they tremendously improve machine utilization and reliability. Operating systems have become increasingly complex, versatile and expensive to develop, in order to help users take full advantages of the advanced facilities of their hardware. A good operating system can be a very effective means of multiplying programmer productivity, increasing system throughput and reducing the chances of undetected errors. A price, however, has to be paid for the advantages of the operating systems, in that they occupy storage space which in the case of advanced systems can be sizable. These alternatives present trade-off decisions which must be made by the prospective user.

System Routines and Applications Programs

Most software systems include a variety of programs for

functions that are performed very frequently. This assortment of routines is generally referred to as *service* or *utility* routines. The most common system routines are the input/output routines, debugging and program-test routines, sort/merge programs, media conversion and editing routines and report generators. Utility routines offered by the various manufacturers vary widely in quality and capability. They are an extremely useful feature to have especially in larger systems using these functions, since they save the user significant time, but also because they usually perform at maximum efficiency.

Many manufacturers also supply a limited variety of somewhat standard applications programs for commonly occurring applications. If suitable applications programs are available, they will, of course, save the user the large cost of software development. Larger manufacturers especially provide a number of software packages "free" to the user. These packages may be utility routines or applications independent or applications dependent software. In addition, the large manufacturers have users' organizations or forums whereby programs developed by various users may be exchanged. A caution is, however, urged with respect to these organizations, since they generally do not provide an effective monitoring system and many programs may have "bugs." Users' organizations, however, serve as a good means for exchange of ideas.

In addition to manufacturers, numerous software firms sell or lease "packaged programs" of good quality. Companies can save both time and money through the intelligent use of packaged software. These savings result from the software houses ability to distribute the development cost for a package over a number of customers, so that a package can be obtained for less than what the potential customer would pay for a similar in-house development. Evaluation of these packages against the requirements and comparison of packages offered by different firms requires careful analysis and judgment. Once a decision has been made to purchase or lease a software package, the contract negotiations also require careful consideration since that is where many of the pitfalls of using packaged software lie. It is wise to evaluate a software package with either historic data or parallel operations before fully committing to it.

COMPUTER SELECTION AND EVALUATION

The road to successful computer operation is a difficult one and not without pitfalls. It requires careful planning, analysis and administration. Selection of the most suitable equipment for the job can often spell the difference between profitable or unprofitable operation. Though there is no simple, cook-book approach for selecting a computer configuration to satisfy particular applications, the following suggestions combined with the product summary charts may be helpful.

Before proceeding into the task of equipment selection, it is essential to have a clear specification of system objectives and requirements. This specification should preferably be done in a feasibility study process involving both top and line management. One has to view the selection of equipment not only in the context of present requirements but also those of the future must be considered since conversion is usually an expensive proposition. Planning should be at least for a period of five years, and ten years is not unusual.

1 Equipment Characteristics

Comparison of Computer Systems

There is no easy technique for reliable comparison between the total capability of machines since the relative power of a system is not how fast it is internally, but how fast it can perform the complete job. In addition, one must also consider costs and future requirements. A technique that may be helpful is to weigh the various computer systems according to a set of criteria that may be appropriate for a particular case. A commonly useful set of criteria is thruput, expandability and compatibility, languages and additional software, remote terminal and data communications capability, suitability for future requirements, file storage, data management or additional features, system costs and dependability.

Thruput is the real criteria for measuring the system performance. Though the internal power of a computer as shown by the various hardware features is a good indicator, its importance is really determined by the applications and the efficiency of the programming system. Often the effect of internal power of a system is misjudged even when other factors are recognized. For an accurate and reliable comparison of thruput capabilities, it is not sufficient to compare the memory cycle times or store, add and other instruction times alone. For this reason, *instruction-mix* comparisons are more useful. These seem to be quite popular since they are easy to use and the evaluation is not time consuming. Instruction mix comparisons, however, have limitations such as I/O instructions not being included usually, subjective interpretations in the construction of and the use of the mix and the differences in the instruction sets of the different machines. Moreover, instruction mix comparisons relate mainly to efficiency in assembly language programming and reveal little about the higher level software capabilities.

Thus, the results of an instruction mix comparison should be interpreted, at best, as measures of raw internal computing power, giving a quick first estimate. A much better comparison of the internal computing power is given by *kernel problem* comparisons. This is usually easier in the scientific area since one can compare the performance of matrix operations, polynomial solving, evaluation of particular formulas and miscellaneous routines. In the business area more specific kernels may be used such as particular file transactions, line formatting and miscellaneous routines. Kernel evaluations are useful because they are machine independent and provide more than a first estimate.

The real thruput evaluation must naturally consist of a comparison of internal performance but also its interaction with I/O speeds and facilities in addition to the very important factor of programming system efficiency. For this one has to resort to *benchmark problem thruput* comparisons if not *actual job thruput* comparison. Benchmark problem thruput comparisons may be made by either

estimated times or by actual running times. Actual runs of programs are, of course, more accurate but they cannot be always made for all cases. The influence of I/O must be considered if times are to be estimated, especially for business applications, since operations may be I/O bound. Though actual job thruput comparisons are best, they often cannot be made because they may be too time consuming or one may not know beforehand the actual programs, only the classes of programs.

A thorough analysis of the applications and the computing mix and suitability of a given system to satisfy the requirements is bound to be of considerable value to an organization in not only a wise choice of equipment but during the implementation phase as well.

Lease or Buy

A major decision that confronts the buyer after he has selected the equipment is the lease or buy option. A careful analysis of lease costs and ownership costs is required. This necessarily involves a cash flow analysis, since a dollar today is worth more than a dollar tomorrow. Also one must consider the expectation of technological change and new requirements because the risk of obsolescence is greater in the buy decision. Sometimes improved service results from pressure on the manufacturer in case of the lease decision. A good strategy may be to *lease some* equipment and buy other. Sometimes considerable savings can be achieved by leasing the CPU and the major system but buying most of the peripherals with a minimum of risk. Also, one may consider buying parts of the system, particularly the peripherals, from *different* manufacturers who sell at lower cost. Such a strategy has resulted in considerable savings for many organizations. The Product Directory gives a list of leasing firms.

LARGE-SCALE MAINFRAME COMPUTERS

Due to the complexity involved in specifying large mainframe computers and their associated function-oriented architecture for complete systems, these computers have not been charted in this annual. IBM did not desire to submit data as well as some of the other major companies. Companies supplying large-scale mainframe computers and associated equipment usually make a complete analysis and presentation of equipment needs to the prospective customer. Companies to be contacted for large-scale mainframes priced from \$100,000 and up are:

Burroughs Corporation
 Control Data Corporation
 Honeywell Information Systems
 IBM
 NCR
 RCA
 Univac
 Xerox Data Systems

We'd like to put in our 18 bits' worth.

Speaking of teams, *performance teams*, we present a new one for the mini-computer industry.

Strong. Capable. Aggressive. Experienced, informed and imaginative. We take the field as Electronic Processors, Inc., a subsidiary of Samsonite, a \$100 million corporation. Our initial input for the market—a superbly compact, inexpensive, general purpose computer, developed by men who really mattered in making it a winner.

Meet the task force:



Our first product: EPI -118. A low-cost, versatile mini-computer well suited to educational, industrial and scientific applications, with extensive OEM expansion capability. 4K x 18-bit, 900-nanosecond magnetic core memory system, expandable to 32K. Four hardware registers. Selected peripheral device interfaces.

Associated control logic. More.

There'll be others early in '71.

Keep an eye on EPI.

We'll have things going for you. Right on. With a handpicked in-depth team, new ideas, new quality, new devices, and new economies.

ELECTRONIC PROCESSORS, INCORPORATED

5050 So. Federal Blvd. • Englewood, Colorado 80110 • 303/798-9305



1 Equipment Characteristics

DIGITAL COMPUTERS

COMPANY	APPLIED SYSTEMS CORP	ATRON	CINCINNATI MILACRON	CLARY DATA COMP SYSTEMS
MODEL	ASC 1100 Computer Control System	Datamanager 501	CIP/2110	CDS 404
FIRST YEAR DELIVERY	1970	1969	1970	1969
BASIC PURCHASE PRICE (W/4K)	\$4000	\$7475	\$4565	\$10,000
LEASE RATE/MONTH	by request	\$390 plus \$60 maint	n/a	n/a
MEMORY				
Word Length (bits)	8 or 9	8 & parity	16	16
Min/Max Size (words)	32K	4K - 32K	4096 - 32,768 bytes	1K - 64K
Cycle Time (μs)	1.1	2	1.1	2
Type	core	core	core and IC ROM	core
Memory Parity	opt	opt	yes, opt	no
Memory Protect	opt	opt	yes, opt	opt
ROM Available	2K x 16 max	no	yes, 768 - 1024 words	no
ROM Cycle Time (ns)	220		220	no
CPU				
General Purpose Registers	16	var	3	4
Index Registers	opt	3	1	2
Directly Addressable Words	32K	-	3 - 32K bytes	1K
Indirect Addressable	opt	yes	yes	multi-level
Immediate Addressing	yes	yes	yes	yes
Indexed Addressing	yes	yes	yes	yes
Double-Word Instructions	opt var word length	var 1 - 256	yes	yes
Fltg. Point Arithmetic	opt software	no	no	no
Hardware Mult/Div	opt	no	yes	yes
I/O				
Channels	2	6	1	1 I/O, 4 DMA
Type of Channel	DMA, multiplexer	4 selector, 2 DMA	parallel, serial, DMA	
Priority Interrupt Levels	opt multiple	var	64	16
Program Enable/Disable of Indiv. Interrupts	yes	yes	yes	yes
Program Enable/Disable of Interrupt Groups	yes	yes	yes	yes
Cycles Required to Set-up Block Transfer	var		n/a	4
Cycles Stolen (from main prog) per Word Transferred	2 & upward		n/a	none
SOFTWARE				
Compilers	assembler & MACROS	no	no	assblr, RP62
Memory for Compilers	4K +	no	no	4K, 8K
Conversational Compiler	no	no	no	basic
Debug Package	yes, opt	no	yes, opt	opt
Relocatable Assemblers	opt	yes	no	yes
Assembler Macroinstructions	opt	yes	no	no
MISC HARDWARE FEATURES				
Real Time Clock	yes, opt	no	yes, opt	opt
Typewriter Console	yes	opt	yes, opt	opt
Power Fail/Interrupt/Restart	yes, opt	no	yes, opt	opt
Autoload Capability	yes	yes	yes	yes
Control Panel	yes	yes	yes, opt	no
COMMENTS				

1 Equipment Characteristics

DIGITAL COMPUTERS

COMPANY	COMPILER SYSTEMS	COMPUTER LOGIC SYSTEMS	COMPILER SYSTEMS	COMPUTER SIGNAL PROCESSORS
MODEL	CSI 16	CLS-18	CSI 24	CSP-30
FIRST YEAR DELIVERY	1971	1971	1971	1970
BASIC PURCHASE PRICE (W/4K)	\$10,750	\$9870	\$14,950	\$79,000
LEASE RATE/MONTH	\$22.50 to \$33.50/ \$1000	-	by request	\$3500
MEMORY				
Word Length (bits)	16	18	24	16
Min/Max Size (words)	4K - 32K	4K - 262K	4K - 8K	4K - 128K
Cycle Time (μs)	0.900	0.960	0.900	0.900
Type	core	core	core	IC & core
Memory Parity	no	no	no	no
Memory Protect	yes	yes, std	yes	yes
ROM Available	no	yes, 1 - 16K	no	yes to 2K
ROM Cycle Time (ns)	-	960	-	100
CPU				
General Purpose Registers	2	8 - 32	2	32
Index Registers	1	4 - 16	1	16
Directly Addressable Words	1K	512	256K	32K
Indirect Addressing	single level	infinite	single level	multi-level
Immediate Addressing	no	yes	no	yes
Indexed Addressing	yes	yes	yes	yes
Double-Word Instructions	no	yes	no	yes
Fltg. Point Arithmetic	yes	software	yes	software
Hardware Mult/Div	yes	opt	yes	yes
I/O				
Channels		9 - 33		6 - 32
Type of Channel	DMA	DMA & programmed	DMA	4 Prog Data Transfer 2 DMA
Priority Interrupt Levels	256	8 nested & 512 non-nested	256	7 - 55
Program Enable/Disable of Indiv. Interrupts	yes	yes	yes	yes
Program Enable/Disable of Interrupt Groups	yes	yes	yes	yes
Cycles Required to Set-up Block Transfer	average 10	3	average 10	6 approx
Cycles Stolen (from main prog) per Word Transferred	1	1	1	0, ½, or 1
SOFTWARE				
Compilers	Fortran IV, Algol		Fortran IV, Algol	no
Memory for Compilers	4K or 6K (both)		4K or 6K	-
Conversational Compiler	yes (both)		yes	no
Debug Package	yes	yes	yes	yes
Relocatable Assemblers	yes	yes	yes	no
Assembler Macroinstructions	yes	yes	yes	no
MISC HARDWARE FEATURES				
Real Time Clock	opt	opt	opt	opt
Typewriter Console	yes	yes	yes	yes
Power Fail/Interrupt/Restart	opt	opt	opt	yes
Autoload Capability	no	opt	no	yes
Control Panel	yes	yes	yes	yes
COMMENTS				Auto background core fetch & store when operating in IC.

DIGITAL COMPUTERS

COMPANY	CYBERMATION	DATA CRAFT	DATA GENERAL	DATA GENERAL
MODEL	Cybermation-80	6024/5	Nova	Nova 800
FIRST YEAR DELIVERY	1970	1971	1969	1971
BASIC PURCHASE PRICE (W/4K)	\$4500	\$15,500	\$7950	\$6950
LEASE RATE/MONTH	\$105 (5 yr full pay)	n/a		n/a
MEMORY				
Word Length (bits)	8 & parity	24	16	16
Min/Max Size (words)	1K - 32K	4K - 32K	2K - 32K	2K - 32K
Cycle Time (μs)	1/2	1.2	2.6	0.8
Type	core/MOS RMA	core	core	core
Memory Parity	yes	yes	no	no
Memory Protect	yes - 4K partitions	opt	no	no
ROM Available	yes - 32 to 32K bytes	no	yes, 1K	no
ROM Cycle Time (ns)	30/400	no	2.4	no
CPU				
General Purpose Registers	64 per 1K of HSM	6	4	4
Index Registers	0	3	18	2
Directly Addressable Words	256	32K	1024	1024
Indirect Addressing	single level	multi-level	multi-level	multi-level
Immediate Addressing	yes	yes	no	no
Indexed Addressing	no	yes	yes	yes
Double-Word Instructions	yes	yes	no	no
Fixt. Point Arithmetic	software	no	no	no
Hardware Mult/Div	no	yes	opt	opt
I/O				
Channels	7	14	62	62
Type of Channel	all 3 modes	14 (DMA)	multiplexed DMA	multiplexed DMA
Priority Interrupt Levels	14	16	16	16
Program Enable/Disable of Indiv. Interrupts	yes	yes	yes	yes
Program Enable/Disable of Interrupt Groups	yes	yes	yes	yes
Cycles Required to Set-up Block Transfer	1	2	3 - 4	3 - 4
Cycles Stolen (from main prog) per Word Transferred	1	1	1	1
SOFTWARE				
Compilers	Basic, Assembler	F.IV	Fortran, Algol, Basic	Fortran, Algol, Basic
Memory for Compilers	4K	4600	8K	8K
Conversational Compiler	yes, Basic	yes, CAL	yes	yes
Debug Package	yes	yes	yes	yes
Relocatable Assemblers	no	yes	yes	yes
Assembler Macroinstructions	yes	no	no	no
MISC HARDWARE FEATURES				
Real Time Clock	yes	opt	opt	opt
Typewriter Console	yes	yes	opt	opt
Power Fail/Interrupt/Restart	opt	opt	opt	opt
Autoload Capability	yes	opt	no	opt
Control Panel	opt	yes	yes	yes
COMMENTS	Max I/O throughput rate is 1000 KB.	Complete hardware & software compatible with DC 6024/1 & 3		The multiplexed DMA data chnl has special high speed capability.

DIGITAL COMPUTERS

COMPANY	DATA GENERAL	DATA GENERAL	DATA GENERAL	DATAMATE COMPUTER SYSTEMS
MODEL	Nova 1200	Supernova	Supernova SC	DATAMATE 16
FIRST YEAR DELIVERY	1971	1969	1971	1969
BASIC PURCHASE PRICE (W/4K)	\$5450	\$9600	\$11,900	\$14,900 (8K)
LEASE RATE/MONTH	n/a	-	n/a	-
MEMORY				
Word Length (bits)	16	16	16	16
Min/Max Size (words)	2K - 32K	4K - 32K	1K - 32K	4K - 32K
Cycle Time (μ s)	1.2	0.8	0.3	1
Type	core	core	semiconductor	core
Memory Parity	no	no	no	no
Memory Protect	no	opt	opt	no
ROM Available	no	-	no	no
ROM Cycle Time (ns)	no	-	no	-
CPU				
General Purpose Registers	4	4	4	2
Index Registers	2	18	2	1
Directly Addressable Words	1024	1024	1024	512
Indirect Addressing	multi-level	multi-level	multi-level	multi-level
Immediate Addressing	no	relative addressing	no	yes
Indexed Addressing	yes	yes	yes	yes
Double-Word Instructions	no	no	no	yes
Fltg.Point Arithmetic	no	no	no	no
Hardware Mult/Div	opt	opt	opt	yes
I/O				
Channels	62	62	62	2
Type of Channel	multiplexed DMA	multiplexed DMA DMA,prog. note transfer	multiplexed DMA	DMA & PIO
Priority Interrupt Levels	16	16	16	8 - 64
Program Enable/Disable of Indiv. Interrupts	yes	yes	yes	yes
Program Enable/Disable of Interrupt Groups	yes	yes	yes	yes
Cycles Required to Set-up Block Transfer	3 - 4	3 - 4	3 - 4	4
Cycles Stolen (from main prog) per Word Transferred	1	1	1	1
SOFTWARE				
Compilers	Fortran, Algol, Basic	Fortran, Algol, Basic	Fortran, Algol, Basic	Fortran
Memory for Compilers	8K	8K	8K	8K
Conversational Compilers	yes	yes	yes	no
Debug Package	yes	yes	yes	yes
Relocatable Assemblers	yes	yes	yes	yes - 4K
Assembler Macroinstructions	no	no	no	yes
MISC HARDWARE				
Real Time Clock	opt	opt	opt	opt
Typewriter Console	opt	opt	opt	opt
Power Fail/Interrupt/Restart	opt	opt	opt	std
Autoload Capability	opt	yes	yes	opt
Control Panel	yes	yes	yes	yes
COMMENTS			Core memory also available.	

1 Equipment Characteristics

DIGITAL COMPUTERS

COMPANY	DATAMATE COMPUTER SYSTEMS	DIGITAL COMPUTER CONTROLS	DIGITAL COMPUTER CONTROLS	DIGITAL COMPUTER CONTROLS
MODEL	DATAMATE 70	D-112	D-112H	D-216
FIRST YEAR DELIVERY	1970	1970	1971	1970
BASIC PURCHASE PRICE (W/4K)	\$8500	\$3990	\$5400	\$8720
LEASE RATE/MONTH	-	-	-	n/a
MEMORY				
Word Length (bits)	16	12	12	16
Min/Max Size (words)	4K - 32K	32K	32K	256 - 32K
Cycle Time (μs)	1	1.2	1.0	1.2
Type	core	core	core/semi	core &/or semi
Memory Parity	no	opt	opt	opt
Memory Protect	no	yes	no	opt
ROM Available	yes	yes	yes, 4K	yes, 1K
ROM Cycle Time (ns)	800	300	300	1200
CPU				
General Purpose Registers	4	1	2	8
Index Registers	2	8	24	8
Directly Addressable Words	1024	32K	32K	32K
Indirect Addressing	multi-level	single level	single level	single level
Immediate Addressing	yes	no	no	yes
Indexed Addressing	yes	yes	yes	yes
Double-Word Instructions	no	no	no	yes
Fltg.Point Arithmetic	no	opt	opt	no
Hardware Mult/Div	no	opt	opt	opt
I/O				
Channels	2	1 std, 8 opt	infinite	practically unlimited
Type of Channel	DMA & PIO	all	all	DMA
Priority Interrupt Levels	1 - 64	opt	opt	8
Program Enable/Disable of Indiv. Interrupts	yes	opt	opt	yes
Program Enable/Disable of Interrupt Groups	yes	opt	opt	yes
Cycles Required to Set-up Block Transfer	4	2	1	varies
Cycles Stolen (from main prog) per Word Transferred	1	1 or 3	1 or 3	1
SOFTWARE				
Compilers	none	Fortran, Basic, Algol	Fortran, Focal, Basic	yes
Memory for Compilers		4K, 8K	4K, 8K	4096
Conversational Compiler	no	yes, Focal	yes, Focal	yes, Fortran
Debug Package	yes	yes	yes	yes
Relocatable Assemblers	yes, 4K	yes	yes	yes
Assembler Macroinstructions	yes	yes	yes	yes
MISC HARDWARE FEATURES				
Real Time Clock	opt	opt	opt	opt
Typewriter Console	opt	no	no	opt
Power Fail/Interrupt/Restart	std	opt	opt	opt
Autoload Capability	opt	opt	opt	opt
Control Panel	yes	yes	yes	opt
COMMENTS				Plug, program, mechanically compatible with PDP-11 series.

1 Equipment Characteristics

DIGITAL COMPUTERS

COMPANY	DIGITAL EQUIPMENT CORP	DIGITAL EQUIPMENT CORP	DIGITAL EQUIPMENT CORP	DIGITAL EQUIPMENT CORP
MODEL	PDP-8E	PDP-8I	PDP-8L	PDP-11/15
FIRST YEAR DELIVERY				1971
BASIC PURCHASE PRICE (W/4K)	\$6500	\$12,800	\$8500	\$6200
LEASE RATE/MONTH				
MEMORY				
Word Length (bits)	12	12	12	16
Min/Max Size (words)	4K - 32K	4K - 32K	4K - 8K	1K - 32K
Cycle Time (μ s)	1.2/1.4	1.5	1.6	0.950
Type	core	core	core	core
Memory Parity	opt	opt	opt	opt
Memory Protect	opt	opt	opt	no
ROM Available	yes - 256 or 1024	no	no	yes - 1K
ROM Cycle Time (ns)				
CPU				
General Purpose Registers	5	4	4	8
Index Registers	8 auto	8 auto	8 auto	8
Directly Addressable Words	1	1	1	32K
Indirect Addressing				
Immediate Addressing				
Indexed Addressing				
Double-Word Instructions				
Fltg. Point Arithmetic				
Hardware Mult/Div				
I/O				
Channels	1	1	1	
Type of Channel	DMA	DMA	DMA	DMA
Priority Interrupt Levels	12	4	4	4
Program Enable/Disable of Indiv. Interrupts	yes	yes	yes	yes
Program Enable/Disable of Interrupt Groups	yes	yes	yes	yes
Cycles Required to Set-up Block Transfer				
Cycles Stolen (from main prog) per Word Transferred				
SOFTWARE				
Compilers	yes	yes	yes	Fortran IV, Basic
Memory for Compilers				
Conversational Compiler				yes
Debug Package				
Relocatable Assemblers	yes	yes	yes	yes
Assembler Macroinstructions	yes	yes	yes	yes
MISC HARDWARE FEATURES				
Real Time Clock	yes	yes	yes	yes
Typewriter Console	yes	yes	yes	yes
Power Fail/Interrupt/Restart	yes	yes	yes	yes
Autoload Capability				
Control Panel	yes	yes	yes	yes
COMMENTS				

1 Equipment Characteristics

DIGITAL COMPUTERS

COMPANY	DIGITAL EQUIPMENT CORP	DIGITAL EQUIPMENT CORP	DIGITAL EQUIPMENT CORP	DIGITAL SCIENTIFIC
MODEL	PDP-11/20	PDP-12	PDP-15	META 4 Series 16, Model 4001
FIRST YEAR DELIVERY	1970	1969	1970	1970
BASIC PURCHASE PRICE (W/4K)	\$10,800	\$29,900	\$16,500	\$15,650
LEASE RATE/MONTH				\$600 avg
MEMORY				
Word Length (bits)	16	12	18	18
Min/Max Size (words)	1K - 124K	4K - 32K	4K - 131K	4K - 13K
Cycle Time (μ s)	0.950	1.6	0.800	0.900
Type	core	core	core	core & ROM
Memory Parity	opt	opt	opt	yes
Memory Protect	no	opt	opt	yes
ROM Available	yes - 1K	no	no	yes; 1K - 4K
ROM Cycle Time (ns)				90
CPU				
General Purpose Registers	8	4	20	32
Index Registers	8	8	9	var
Directly Addressable Words	32K	1	4K or 8K	65,536
Indirect Addressing				single level
Immediate Addressing				yes
Indexed Addressing				yes
Double-Word Instructions				yes
Fltg. Point Arithmetic				opt
Hardware Mult/Div				yes
I/O				
Channels		1/11 opt	8	22
Type of Channel	DMA	DMA	DMA	prog data transfer
Priority Interrupt Levels	4	4	4	var
Program Enable/Disable of Indiv. Interrupts	yes	yes	yes	yes
Program Enable/Disable of Interrupt Groups	yes	yes	yes	yes
Cycles Required to Set-up Block Transfer				2
Cycles Stolen (from main prog) per Word Transferred				0
SOFTWARE				
Compilers	Fortran IV, Basic	yes	Fortran IV, Algol	Fortran, RPG, APL
Memory for Compilers				8K
Conversational Compiler	yes			yes; APL
Debug Package				opt
Relocatable Assemblers	yes	yes	yes	yes
Assembler Microinstructions				yes
Assembler Macroinstructions	yes	yes	yes	yes
MISC HARDWARE FEATURES				
Real Time Clock	yes	yes	yes	yes
Typewriter Console	yes	yes	yes	yes
Power Fail/Interrupt/Restart	yes	yes	yes	yes
Autoload Capability			yes	yes
Control Panel	yes	yes	yes	opt
COMMENTS				core plus 1K ROM

DIGITAL COMPUTERS

COMPANY	ELBIT COMPUTERS	ELECTRONIC ASSOCIATES	ELECTRONIC PROCESSORS	EMR COMPUTER
MODEL	ELBIT 100	EAI-640	EPI-118	6135
FIRST YEAR DELIVERY	1968	1966	1971	1968
BASIC PURCHASE PRICE (W/4)	\$5850	\$24,500 w/8K	\$5900	\$46,500
LEASE RATE/MONTH				\$1220
MEMORY				
Word Length (bits)	12	16	18	16 + parity + protect
Min/Max Size (words)	1K - 4K	8K - 32K	2K - 32K	8K - 32K
Cycle Time (μ s)	2	1.65	0.900	0.500
Type	core	core	core	core
Memory Parity	no	no	no	yes
Memory Protect	no	yes	no	yes
ROM Available	yes, 256 lines	no	yes	no
ROM Cycle Time (ns)	450			na
CPU				
General Purpose Registers	one	2	2	2
Index Registers	no	1	opt, no limit	3
Directly Addressable Words	256	512	32K	32K
Indirect Addressing	4096	multi-level	opt	multi-level
Immediate Addressing	yes	yes	no	yes
Indexed Addressing	no	yes	opt	yes
Double-Word Instructions	no	no	software	yes
Fltg. Point Arithmetic	no	opt	software	no
Hardware Mult/Div	no	yes	yes	yes
I/O				
Channels	256	2	2	30
Type of Channel	prog data transfer	DMA (1), Prog Data (1)	DMA & prog data transfer	DMA, MVX, prog data transfer
Priority Interrupt Levels	4	4	18	126 opt
Program Enable/Disable of Indiv. Interrupts	no	yes	yes	yes
Program Enable/Disable of Interrupt Groups	yes	yes	yes	yes
Cycles Required to Set-up Block Transfer	1	3	1	5
Cycles Stolen (from main prog) per Word Transferred		0 on DMA	1	1
SOFTWARE				
Compilers		Fortran	no	Fortran & Fortran IV
Memory for Compilers				8K & 10K Fortran
Conversational Compiler		yes - hybrid/dig operations	no	no
Debug Package	yes	yes	yes	yes
Relocatable Assemblers	no	yes	no	yes 8K
Assembler Macroinstructions	yes	no	yes	yes
MISC HARDWARE FEATURES				
Real Time Clock	yes	opt	yes	opt
Typewriter Console	yes	yes	yes	opt
Power Fail/Interrupt/Restart	yes	opt	yes	opt
Autoload Capability	yes	yes	yes	opt
Control Panel	yes	yes	yes	yes
COMMENTS	Assembler available.			

1 Equipment Characteristics

DIGITAL COMPUTERS

COMPANY	FAIRCHILD SYSTEMS TECHNOLOGY	FEDDER DATA CENTERS	FOUR-PHASE SYSTEMS	FRIDEN - SINGER
MODEL	FST-1	APT 1000	System IV/70	System Ten
FIRST YEAR DELIVERY	1970	1970	1971	1970
BASIC PURCHASE PRICE (W/4K)	\$25,000	\$14,950	\$12,100	\$11,000
LEASE RATE/MONTH	by request	\$350	\$335 - 3 yr	\$305 - 5 yr
MEMORY				
Word Length (bits)	24	8 & parity	24	6
Min/Max Size (words)	4K - 16K	1K - 32K	4K - 8K	10K - 110K
Cycle Time (μ s)	1.75/bus	1.1	1.9	3.3
Type	core	core	semiconductor	core
Memory Parity	no	yes	yes	no
Memory Protect	no	opt	no	yes
ROM Available	no	yes, 256 - 1K words	no	yes
ROM Cycle Time (ns)	n/a	220	no	3300
CPU				
General Purpose Registers	2	6	5	
Index Registers	8	1	3	up to 60
Directly Addressable Words	16K	32KX8	32K	10K - partition
Indirect Addressing	multi-level	single level	single level	no
Immediate Addressing	yes	yes	no	yes
Indexed Addressing	yes	yes	yes	yes
Double-Word Instructions	no	yes	no	no
Fltg. Point Arithmetic	no	no	yes	no
Hardware Mult/Div	yes	no	yes	yes
I/O				
Channels	12	3 basic +	8	21
Type of Channel	DMA or PDT	prog data transfer	prog data transfer	data transfer
Priority Interrupt Levels	16	4	8	0
Program Enable/Disable of Indiv. Interrupts	yes	yes	yes	
Program Enable/Disable of Interrupt Groups	enable all	no	yes	
Cycles Required to Set-up Block Transfer	4	cycle steal basis	28	6
Cycles Stolen (from main prog) per Word Transferred	one	1	4	15
SOFTWARE				
Compilers	factor	ESP, MAP	no	RPG
Memory for Compilers	8K	4K	no	9K
Conversational Compiler	no	no	no	no
Debug Package	yes	yes	yes	yes
Relocatable Assemblers	yes - all	no	yes	yes
Assembler Macroinstructions	no	no	no	yes
MISC HARDWARE FEATURES				
Real Time Clock	no	opt	yes	opt
Typewriter Console	yes	yes	no	yes
Power Fail/Interrupt/Restart	no	opt	no	opt
Autoload Capability	no	yes	yes	yes
Control Panel	yes	yes	yes	no
COMMENTS		IBM & 2780 compatible, unlimited peripheral interfacing.		

1 Equipment Characteristics

DIGITAL COMPUTERS

COMPANY	GENERAL AUTOMATION	GENERAL AUTOMATION	GENERAL AUTOMATION	GRI COMPUTER
MODEL	SPC-12	SPC-16	18/30	GRI-909
FIRST YEAR DELIVERY	1967	1970	1969	1970
BASIC PURCHASE PRICE (W/4K)	\$3600	\$9200	\$18,000	\$5650
LEASE RATE/MONTH				
MEMORY				
Word Length (bits)	8	16	16	16
Min/Max Size (words)	4K - 16K	4K - 32K	4K - 32K	1K - 32K
Cycle Time (μ s)	2.16	0.96	0.96	1.76
Type	core	core	core	core/semi
Memory Parity	no	no	yes	no
Memory Protect	no	no	yes	opt
ROM Available	yes, 256 - 4K words	yes, 256 - 4K words	no	yes
ROM Cycle Time (ns)	2160	480		880
CPU				
General Purpose Registers	6	18	16	2 - 14
Index Registers	3	6	3	none
Directly Addressable Words	4096	32K	32,768	32K
Indirect Addressing	single level	single level	single level	no
Immediate Addressing	yes	yes	yes	yes
Indexed Addressing	yes	yes	yes	no
Double-Word Instructions	yes	yes	yes	yes
Fltg. Point Arithmetic	software	software	software	opt
Hardware Mult/Div	no	opt	yes	opt
I/O				
Channels	1 opt	16	5	48
Type of Channel	DMA or data channel	DMA/MUX/ programmed	DMA - data channel	prog or DMA
Priority Interrupt Levels	1 - 64	8 to 64	8 to 61	unlimited
Program Enable/Disable of Indiv. Interrupts	yes	yes	yes	yes
Program Enable/Disable of Interrupt Groups	yes	yes	yes	yes
Cycles Required to Set-up Block Transfer	20	4	4	2
Cycles Stolen (from main prog) per Word Transferred	1	1 on high speed data chnl 3 on multiplexed data chnl	1	1
SOFTWARE				
Compilers		Fortran	Fortran	no
Memory for Compilers		6500 words	3960 words	
Conversational Compiler		no	no	no
Debug Package	yes	yes	yes	yes
Relocatable Assemblers	no	yes	yes	yes
Assembler Macroinstructions	no	yes	no	yes
MISC HARDWARE FEATURES				
Real Time Clock	yes	yes	3 std	opt
Typewriter Console	yes	yes	yes	opt
Power Fail/Interrupt/Restart	opt	yes	yes	opt
Autoload Capability	no	opt	yes	no
Control Panel	yes	yes	yes	yes
COMMENTS			Program compatible with IBM 1130 and 1800.	

1 Equipment Characteristics

DIGITAL COMPUTERS

COMPANY	HETRA	HETRA	HEWLETT-PACKARD, CUPERTINO DIV.	HEWLETT-PACKARD, CUPERTINO DIV.
MODEL	HETRA 200	HETRA 300	2100H	2116C
FIRST YEAR DELIVERY	1970	1970	1971	1970
BASIC PURCHASE PRICE (W/4K)	\$9000	\$6000	\$7250	\$14,000 (8K)
LEASE RATE/MONTH	\$230	\$165		\$322
MEMORY				
Word Length (bits)	8	8	16	16
Min/Max Size (words)	8K-65K	8K-65K	4K-32K	32K
Cycle Time (μ s)	1	1	0.980	1.6
Type	core	core	core	core
Memory Parity	yes	yes	yes	yes, opt
Memory Protect	yes	yes	yes	yes, opt
ROM Available	yes - 8K	yes - 8K	no	no
ROM Cycle Time (ns)	800	800		no
CPU				
General Purpose Registers	64-256	64-256	2	2
Index Registers	3	3	0	0
Directly Addressable Words	65,536	65,536	2048	1024
Indirect Addressing	no	no	multi-level	unlimited
Immediate Addressing	yes	yes	no	
Indexed Addressing	yes	yes	no	
Double-Word Instructions	yes	no	yes	yes
Fltg. Point Arithmetic	no	no	no	no, subroutine
Hardware Mult/Div	no	no	yes	yes, opt
I/O				
Channels	4	4	2	16 (32,48 opt)
Type of Channel	all	all	DMA	DMA, prog data transfer, DMA (opt)
Priority Interrupt Levels	8	8	56	56
Program Enable/Disable of Indiv. Interrupts	yes	yes	yes	yes
Program Enable/Disable of Interrupt Groups	yes	yes	no	no
Cycles Required to Set-up Block Transfer	6	6	20	9
Cycles Stolen (from main prog) per Word Transferred	1	1	1	1
SOFTWARE				
Compilers	yes	no	Fortran II & IV, Algol	Fortran, Algol
Memory for Compilers	no	no	4 or 8K	-4K (Fortran), 8K (Algol)
Conversational Compiler	no	no	Basic	yes, Basic
Debug Package	yes	yes	yes	yes
Relocatable Assemblers	no	yes	yes	yes
Assembler Macroinstructions	no	no	yes	yes
MISC HARDWARE FEATURES				
Real Time Clock	yes	yes	opt	yes, opt
Typewriter Console	yes	yes	opt	yes, opt
Power Fail/Interrupt/Restart	yes	yes	yes	yes, opt
Autoload Capability	opt	opt	yes	yes
Control Panel	opt	opt	yes	yes
COMMENTS				

DIGITAL COMPUTERS

COMPANY	INFOTRONICS	INTERDATA	INTERDATA	INTERDATA
MODEL	Mini/Max	Model 1	Model 4	Model 5
FIRST YEAR DELIVERY	1971	1970		1970
BASIC PURCHASE PRICE (W/4K)	\$12,900	\$5150	\$8500	\$10,500
LEASE RATE/MONTH		n/a		n/a
MEMORY				
Word Length (bits)	16	8	16	16
Min/Max Size (words)	4K-65K	2K-16K	4-65K	4-65K
Cycle Time (μ s)	1	1	1	1
Type	core	core	core	core
Memory Parity	yes	yes, opt	opt	opt
Memory Protect	yes	no	opt	opt
ROM Available	yes	yes, 2K modules	yes	yes
ROM Cycle Time (ns)	1000	1000	400	400
CPU				
General Purpose Registers	16	1	16	16
Index Registers	12	512 or more	15	15
Directly Addressable Words	16	512	65K	65K
Indirect Addressing	single & double	single level	not needed	not needed
Immediate Addressing	yes	yes	yes	yes
Indexed Addressing	yes	yes	yes	yes
Double-Word Instructions	yes	yes	yes	yes
Fltg. Point Arithmetic	opt	no	opt	yes
Hardware Mult/Div	opt	no	opt	yes
I/O				
Channels	depends on type	2	up to 8	up to 8
Type of Channel	all	DMA, multiplexer	selector, multiplexor (DMA)	multiplexor; DMA
Priority Interrupt Levels	256	4, 4 expand	256	256
Program Enable/Disable of Indiv. Interrupts	yes	yes	yes	yes
Program Enable/Disable of Interrupt Groups	no	yes	yes	yes
Cycles Required to Set-up Block Transfer	6	3	1-multiplexor 3-DMA	1 or 3
Cycles Stolen (from main prog) per Word Transferred	depends on rate	1	1	1
SOFTWARE				
Compilers	in development	no	Fortran IV	Fortran IV
Memory for Compilers		n/a	8K	8K
Conversational Compiler	no	no	yes - Fortran	yes - Fortran
Debug Package	yes	yes	yes	yes
Relactable Assemblers	yes	no	yes (no cost)	yes
Assembler Macroinstructions	no	no	no	no
MISC HARDWARE FEATURES				
Real Time Clock	yes	yes	opt	opt
Typewriter Console	yes	yes, opt	yes	yes
Power Fail/Interrupt/Restart	yes	yes, opt	opt	opt
Autoload Capability	yes	yes, opt	opt	yes
Control Panel	yes	yes	yes	yes
COMMENTS				
	Software includes Real Time Executive.	User programmable control ROM.		

1 Equipment Characteristics

DIGITAL COMPUTERS

COMPANY	LOCKHEED DATA PRODUCTS	LOCKHEED DATA PRODUCTS	MICRODATA	MICRODATA
MODEL	MAC Jr.	MAC 16	MICRO 400	MICRO 800
FIRST YEAR DELIVERY	1970	1969	1970	1968
BASIC PURCHASE PRICE (W/4K)	\$7900	\$11,200	\$3750	\$4500
LEASE RATE/MONTH				
MEMORY				
Word Length (bits)	16	16	8	8
Min/Max Size (words)	8K	65K	1K-65K	1K-32K
Cycle Time (μs)	1	1	1.6	1.1
Type	core	core	core, ROM	core
Memory Parity	opt	opt	no	opt
Memory Protect	opt	opt	no	no
ROM Available	no	no	yes (on request)	yes 256/2048
ROM Cycle Time (ns)				220
CPU				
General Purpose Registers	7	7	8	16
Index Registers	1/interrupt level	1/interrupt level	1 or 2	
Directly Addressable Words	512	512	4096	32,768
Indirect Addressing	yes	yes	no	single
Immediate Addressing	yes	yes	no	yes
Indexed Addressing	yes	yes	yes	no
Double-Word Instructions	no	no	yes	no
Fltg. Point Arithmetic	no	no	no	no
Hardware Mult/Div	opt	opt	no	no
I/O				
Channels	3	3	1	32
Type of Channel	all	all	prog D.T., DMA opt	DMA, prog
Priority Interrupt Levels	16	64	32	16
Program Enable/Disable of Indiv. Interrupts	yes	yes	yes	yes
Program Enable/Disable of Interrupt Groups	yes	yes	yes	yes
Cycles Required to Set-up Block Transfer	3 on MDC	3 on MDC	4	
Cycles Stolen (from main prog) per Word Transferred	1	1	1	1
SOFTWARE				
Compilers	Fortran IV	Fortran IV	no	no
Memory for Compilers	8K	8K	no	no
Conversational Compiler	no	no	no	no
Debug Package	yes	yes	yes	no
Relocatable Assemblers	yes	yes	yes	no
Assembler Macroinstructions	yes	yes	yes	no
MISC HARDWARE FEATURES				
Real Time Clock	opt	opt	opt	opt
Typewriter Console	yes	yes	yes	opt
Power Fail/Interrupt/Restart	opt	opt	opt	opt
Autoload Capability	opt	opt	opt	
Control Panel	yes	yes	opt	opt
COMMENTS				

1 Equipment Characteristics

DIGITAL COMPUTERS

COMPANY	MICRODATA	MICRODATA	MODULAR COMPUTER SYSTEMS	MODULAR COMPUTER SYSTEMS
MODEL	MICRO 810	MICRO 820	MODCOMP II	MODCOMP III
FIRST YEAR DELIVERY	1969	1970	1971	1970
BASIC PURCHASE PRICE (W/4K)	\$6040	\$6040	\$9800	\$13,500
LEASE RATE/MONTH			n/a	n/a
MEMORY				
Word Length (bits)	8	8	16	16
Min/Max Size (words)	1K-32K	1K-32K	4K-32K	4K-65K
Cycle Time (μ s)	1.1	1.1	0.8	0.8
Type	core	core	core	core
Memory Parity	no	no	yes	yes
Memory Protect	no	no	no	opt
ROM Available	yes - to 2K	yes to 2048 x 16	yes (512x40)	yes - 1024x40
ROM Cycle Time (ns)	220	220	200	200
CPU				
General Purpose Registers	2	2 (16 bit)	15	15
Index Registers	1	1 (16 bit)	7	7
Directly Addressable Words	32K	32,768	65K	65K
Indirect Addressing	single level	single level	single level	single level
Immediate Addressing	yes	yes	yes	yes
Indexed Addressing	yes	yes	yes	yes
Double-Word Instructions	yes	yes	yes	yes
Fltg. Point Arithmetic	no	opt	no	opt
Hardware Mult/Div	yes	opt	opt	opt
I/O				
Channels	32	32	16	16
Type of Channel	DMA, prog data trans	DMA, multiplexer, prog data	multiplexer prog data trans	DMA, multiplexer prog data trans
Priority Interrupt Levels	16	16	8	32
Program Enable/Disable of Indiv. Interrupts	yes	yes	yes	yes
Program Enable/Disable of Interrupt Groups	yes	yes	yes	yes
Cycles Required to Set-up Block Transfer		3	6	6
Cycles Stolen (from main prog) per Word Transferred	1	1	3 for multiplexer	1 for DMA
SOFTWARE				
Compilers	no	no	Fortran IV	Fortran IV
Memory for Compilers			6K	6K
Conversational Compiler	opt Basic	yes Basic opt	no	no
Debug Package	yes	yes	yes	yes
Relocatable Assemblers	no	yes	yes	yes
Assembler Macroinstructions	no	no	yes	yes
MISC HARDWARE FEATURES				
Real Time Clock	opt	opt	opt	opt
Typewriter Console	opt	opt	yes	yes
Power Fail/Interrupt/Restart	opt	opt	yes	yes
Autoload Capability	yes	yes	yes	yes
Control Panel	opt	opt	yes	yes
COMMENTS				

1 Equipment Characteristics

DIGITAL COMPUTERS

COMPANY	MULTIDATA DIV – SYSTEMS ENGR LABS	NUCLEAR DATA	QANTEL	RAYTHEON DATA SYSTEMS
MODEL	7200	ND-812	Qantel V	704
FIRST YEAR DELIVERY	1971	1970	1970	1970
BASIC PURCHASE PRICE (W/4K)	\$18,995	\$7300	\$11,600	\$9750
LEASE RATE/MONTH	\$555	4%	\$283	
MEMORY				
Word Length (bits)	16	12	8	16
Min/Max Size (words)	32K-524K	4K-16K	4K-8K	4K-32K
Cycle Time (μs)	0.880	2	3	1
Type	core	core	core	core
Memory Parity	opt	no	no	opt
Memory Protect	opt	no	no	no
ROM Available	no	no	yes - 1024 words	no
ROM Cycle Time (ns)		no	1500	
CPU				
General Purpose Registers	8	6	9	1
Index Registers	2	2, core	none	1
Directly Addressable Words	256	16K	8K	2048
Indirect Addressing	single level	4K, single level	yes	
Immediate Addressing	no	yes	no	yes
Indexed Addressing	pre & post	no	no	yes
Double-Word Instructions	no	yes	yes	yes, opt
Fltg. Point Arithmetic	software only	no	no	no
Hardware Mult/Div	opt	yes	yes	opt
I/O				
Channels	1-I/O bus; DMA opt	4096	8 I-O slots	6
Type of Channel		DMA, prog data trans	buffered I-O controllers	DMA, DIO
Priority Interrupt Levels	384 opt	4	handled by prog	16
Program Enable/Disable of Indiv. Interrupts	yes	yes	yes	yes
Program Enable/Disable of Interrupt Groups		no	yes	yes
Cycles Required to Set-up Block Transfer	20	1	n/a	2
Cycles Stolen (from main prog) per Word Transferred	1	1	n/a	1
SOFTWARE				
Compilers	Fortran, Basic	3	yes	Fortran IV, SPIEL 4K-12K
Memory for Compilers	8K	4K/8K	yes	
Conversational Compiler	Basic	yes, Basic	yes	yes, 2 Fortran
Debug Package	yes	yes	yes	yes
Relocatable Assemblers	yes	no	no	yes, 2048
Assembler Macroinstructions	no	no	yes	yes
MISC HARDWARE FEATURES				
Real Time Clock	opt	opt	no	opt
Typewriter Console	std	yes	yes	yes
Power Fail/Interrupt/Restart	opt	yes	yes	opt
Autoload Capability	opt	opt	no	opt
Control Panel	std	yes	opt	yes
COMMENTS				

1 Equipment Characteristics

DIGITAL COMPUTERS

COMPANY	RAYTHEON DATA SYSTEMS	REDCOR	ROLM	SPIRAS SYSTEMS
MODEL	706	RC-70	1601 Ruggednova	Spiras 65
FIRST YEAR DELIVERY	1969	1969	1969	1969
BASIC PURCHASE PRICE (W/4K)	\$19,000	\$14,900	\$20,000	\$9800
LEASE RATE/MONTH		\$447		\$318/3 yr
MEMORY				
Word Length (bits)	16	16	16	16
Min/Max Size (words)	4K - 32K	32K	32K	4K - 65K
Cycle Time (μ s)	0.9	0.860	2.6	1.8
Type	core	core	core, ROM, RAM	core
Memory Parity	opt	yes	no	no
Memory Protect	opt	yes	yes	yes, write only
ROM Available	no	no	yes to 4K	yes, expandable to 1K x 32
ROM Cycle Time (ns)	no	no		450
CPU				
General Purpose Registers	1	5	4	5
Index Registers	1	1	2	2
Directly Addressable Words	2048	1024	1024	65K
Indirect Addressing		single level	70 - 30,976	multi-level to 32K
Immediate Addressing	yes	yes	no	yes
Indexed Addressing	yes	yes	yes	yes
Double-Word Instructions	yes, opt	yes	no	yes
Fltg. Point Arithmetic	no	no	yes	yes
Hardware Mult/Div	opt	yes	yes	yes
I/O				
Channels	6	1 - 4	2	1 to 64 devices
Type of Channel	DMA, prog trans	DMA	DMA, program data trans	DMA
Priority Interrupt Levels	16	32	16	1 - 8
Program Enable/Disable of Indiv. Interrupts	yes	yes	yes	no
Program Enable/Disable of Interrupt Groups	yes	yes	no	yes, all
Cycles Required to Set-up Block Transfer	2	8	2	3 DMA, 6 DMC
Cycles Stolen (from main prog) per Word Transferred	1	1	1	1 DMA, 4 DMC
SOFTWARE				
Compilers	Fortran IV, SPIEL 4K-12K	yes	Fortran IV, Basic	Fortran IV, full
Memory for Compilers		4K	12K 4K	8K x 16
Conversational Compiler	yes, Fortran	no	yes, Basic	no
Debug Package	yes	yes	yes	yes
Relocatable Assemblers	yes, 2048	yes	yes	yes
Assembler Macroinstructions	yes	no	yes	yes
MISC HARDWARE FEATURES				
Real Time Clock	opt	yes	yes	yes, opt
Typewriter Console	yes	yes	yes	yes
Power Fail/Interrupt/Restart	opt	yes	yes	yes, opt
Autoload Capability	yes	yes	opt	yes
Control Panel	yes	yes	opt	yes
COMMENTS			Meets MIL 16400 & MIL E-5400 Class II.	

1 Equipment Characteristics

DIGITAL COMPUTERS

COMPANY	STRUTHERS-DUNN, SYSTEMS DIV	SYSTEMS ENGINEERING LABS	SYSTEMS ENGINEERING LABS	SYSTEMS ENGINEERING LABS
MODEL	VIP 256	Systems 72	Systems 82	Systems 810B
FIRST YEAR DELIVERY	1970	1970	1971	1968
BASIC PURCHASE PRICE (W/4K)	\$2875 - \$14,670	\$18,995	\$9600	\$31,000
LEASE RATE/MONTH	none	\$650	\$356	\$1030
MEMORY				
Word Length (bits)	12	16	16	16
Min/Max Size (words)	256 - 2560	4K - 65K	4K	8K - 32K
Cycle Time (μ s)	10/word	0.880	0.900	0.75
Type	PROM (diode)	core	core	core
Memory Parity	no	opt	opt	yes
Memory Protect	no req	yes	no	opt
ROM Available	yes	no	no	no
ROM Cycle Time (ns)	10	n/a	n/a	n/a
CPU				
General Purpose Registers	2	8	4	2
Index Registers	1	2	3	1
Directly Addressable Words	none	256	128	1024
Indirect Addressing	no	65K	multi-level	multi-level
Immediate Addressing	no	no	yes	yes
Indexed Addressing	yes	yes	yes	yes
Double-Word Instructions	no	no	yes - some	yes
Fltg. Point Arithmetic	no	opt	no	software
Hardware Mult/Div	no	opt	opt	yes
I/O				
Channels	256	1 std	1 to 4	64
Type of Channel	prog data X	opt	DMA opt	DMA and prog
Priority Interrupt Levels		384 max	8 std, 8 opt	96 max
Program Enable/Disable of Indiv. Interrupts		yes	yes	yes
Program Enable/Disable of Interrupt Groups		no	no	yes
Cycles Required to Set-up Block Transfer		8	4	3
Cycles Stolen (from main prog) per Word Transferred		1	1	1
SOFTWARE				
Compilers		Fortran, Basic	none	Fortran IV
Memory for Compilers		4K - 8K	n/a	8K
Conversational Compiler	no	yes	n/a	no
Debug Package	opt	yes	yes	yes
Relocatable Assemblers	no	yes	no	yes
Assembler Macroinstructions	no	no	no	yes
MISC HARDWARE FEATURES				
Real Time Clock	no	opt	yes	opt
Typewriter Console	no	opt	opt	yes
Power Fail/Interrupt/Restart	opt	opt	yes	yes
Autoload Capability	no	opt	no	no
Control Panel	no	yes	yes	yes
COMMENTS				

1 Equipment Characteristics

DIGITAL COMPUTERS

COMPANY	TEMPO COMPUTER	TEXAS INSTRUMENTS	TEXAS INSTRUMENTS	UNICOM
MODEL	Tempo I	Model 960	Model 980	CP8-C
FIRST YEAR DELIVERY	1969	1970	1970	1970
BASIC PURCHASE PRICE (W/4K)	\$13,800	\$8450	\$9580	\$4290
LEASE RATE/MONTH	\$276	\$279/3 yr \$186/5 yr	\$316/3 yr \$211/5 yr	
MEMORY				
Word Length (bits)	16	16	16	8
Min/Max Size (words)	4K - 65K	4K - 65K	4K - 65K	500 - 32K
Cycle Time (μ s)	0.9	1.0	1	1.75
Type	core	core	core	core
Memory Parity	no	yes	yes	opt
Memory Protect	opt	yes	opt	yes
ROM Available	no	no	no	yes
ROM Cycle Time (ns)				350
CPU				
General Purpose Registers	16	16	8	4
Index Registers	16	all G.P. registers	1	1
Directly Addressable Words	65K	all	all	4K
Indirect Addressing	one level	single level	single level	single level
Immediate Addressing	yes	yes	yes	yes
Indexed Addressing	yes	yes	yes	yes
Double-Word Instructions	yes	yes	yes	yes
Fltg. Point Arithmetic	no	software	no	yes
Hardware Mult/Div	opt	opt	yes	yes
I/O				
Channels	up to 7	1 - 8, 64 - 4096	1 - 8, 1 - 256	1
Type of Channel	MPX, prog	DMA, prog data trans	DMA, prog data trans	
Priority Interrupt Levels	16	3	3	4
Program Enable/Disable of Individ. Interrupts	yes	yes	yes	
Program Enable/Disable of Interrupt Groups	no	yes	yes	yes
Cycles Required to Set-up Block Transfer	3	2	2	
Cycles Stolen (from main prog) per Word Transferred	1	1	1	
SOFTWARE				
Compilers	Fortran	Fortran	Fortran IV	
Memory for Compilers	8K	6K	8K	
Conversational Compiler	no	no	no	
Debug Package	yes	yes	yes	
Relocatable Assemblers	yes, std	yes	yes	yes - n/c
Assembler Macroinstructions	yes	yes	no	
MISC HARDWARE FEATURES				
Real Time Clock	opt	opt	no	opt
Typewriter Console	opt	yes	yes	yes
Power Fail/Interrupt/Restart	opt	yes	yes	opt
Autoload Capability	opt	no	opt	
Control Panel	yes	yes	yes	yes
COMMENTS				

1 Equipment Characteristics

DIGITAL COMPUTERS

COMPANY	UNICOMP	UNICOMP	VARIAN DATA MACHINES	VARIAN DATA MACHINES
MODEL	COMP-16	COMP-18	620/L	620/f
FIRST YEAR DELIVERY	1970	1970	1971	1970
BASIC PURCHASE PRICE (W/4K)	\$9800	\$10,500	\$5400	\$10,500
LEASE RATE/MONTH				
MEMORY				
Word Length (bits)	16	18	16	16
Min/Max Size (words)	4K - 65K	4K - 262K	4K - 32K	4K - 32K
Cycle Time (μ s)	0.880	0.880	1.8	0.750
Type	core	core	core	core
Memory Parity	no	no	no	opt
Memory Protect	opt	opt	opt	opt
ROM Available	yes (to 4K)	yes	no	yes, 2K or 4K
ROM Cycle Time (ns)	350	350	n/a	300 ns access
CPU				
General Purpose Registers	1	1	9	9
Index Registers	6	6	2	2
Directly Addressable Words	256	1024	2048	2048
Indirect Addressing	single level	single level	multi-level	multi-level
Immediate Addressing	yes	yes	yes	yes
Indexed Addressing	yes	yes	yes	yes
Double-Word Instructions	no	no	yes	yes
Fltg. Point Arithmetic	yes	yes	no	no
Hardware Mult/Div	opt	opt	opt	opt
I/O				
Channels	1/64	1/64		
Type of Channel	DMA buss	DMA buss	DMA, party line prog data trans	I/O bus, DMA, PMA
Priority Interrupt Levels	to 64 - software	to 64 - software	0-64	0 - 64
Program Enable/Disable of Indiv. Interrupts	yes	yes		
Program Enable/Disable of Interrupt Groups	yes	yes		
Cycles Required to Set-up Block Transfer	3	3		
Cycles Stolen (from main prog) per Word Transferred				
SOFTWARE				
Compilers	Basic	Basic	Fortran IV, Basic, RPG	Fortran IV, Basic, RPG IV
Memory for Compilers	3K words	3K words	4 - 12K	4 - 12K
Conversational Compiler	yes - assembler	yes - assembler	Basic, yes	yes - basic
Debug Package	yes	yes	yes	yes
Relocatable Assemblers	yes	yes	yes	yes
Assembler Macroinstructions	yes	yes		
MISC HARDWARE FEATURES				
Real Time Clock	opt	opt	opt	opt
Typewriter Console	yes	yes	yes	yes
Power Fail/Interrupt/Restart	opt	opt	opt	opt
Autoload Capability	yes	yes		opt
Control Panel	yes	yes	yes	yes
COMMENTS	Full line of peripheral equipment.	Full line of peripheral equipment.		

1 Equipment Characteristics

DIGITAL COMPUTERS

COMPANY	VARIAN DATA MACHINES	VICTOR COMPTOMETER	WESTINGHOUSE COMP. & INSTRUMENTATION	WESTINGHOUSE COMP. & INSTRUMENTATION
MODEL	620/i	820 Series Computer	Prodac 2000	Prodac 2500
FIRST YEAR DELIVERY	1967	1970	1969	1971
BASIC PURCHASE PRICE (W/4K)	\$9950	\$5990 - \$21,990	\$10,000	\$9950
LEASE RATE/MONTH				
MEMORY				
Word Length (bits)	16 (18 opt)	64	16	16
Min/Max Size (words)	4K - 32K	16 - 1K	4K - 65K	4K - 65K
Cycle Time (μ s)	1.8	2.5	0.5, 1.2 and 3	0.850
Type	core	rod cell & core	core	core
Memory Parity	opt	no	opt	opt
Memory Protect	opt	no	opt	opt
ROM Available	no	yes	no	no
ROM Cycle Time (ns)	n/a	2.5	n/a	n/a
CPU				
General Purpose Registers	9	4	21	21
Index Registers	2	4	2	2
Directly Addressable Words	2048	512 data	1K	1K
Indirect Addressing	multi-level	no	multi-level	multi-level
Immediate Addressing	yes	yes	no	no
Indexed Addressing	yes	yes	yes	yes
Double-Word Instructions	yes	no	yes	yes
Fltg. Point Arithmetic	no	yes	opt	opt
Hardware Mult/Div	opt	yes	yes	std
I/O				
Channels		3	128	128
Type of Channel		DMA	direct, buff, DMA	direct, buff, DMA
Priority Interrupt Levels	0 - 64	0	2 sys, (63 & 64)	64 ext interrupts
Program Enable/Disable of Indiv. Interrupts		no	yes	yes
Program Enable/Disable of Interrupt Groups		no	no	yes
Cycles Required to Set-up Block Transfer		n/a	DMA 32	DMA 8
Cycles Stolen (from main prog) per Word Transferred		n/a	DMA 1	DMA 1
SOFTWARE				
Compilers	Fortran IV, Basic, RPG IV	VICTRAN	Fortran IV	Fortran IV; Basic
Memory for Compilers	4 - 12 K	IBM 360 - 64K	12K	8K - 16K
Conversational Compiler	Basic, yes	no	yes, Basic	yes, Basic
Debug Package	yes	yes	yes	yes
Relocatable Assemblers	yes	no	yes, 8K	yes - 8K
Assembler Macroinstructions		yes	no	yes
MISC HARDWARE FEATURES				
Real Time Clock	opt	no	yes	yes
Typewriter Console	yes	yes	yes	yes
Power Fail/Interrupt/Restart	opt	yes	yes	opt
Autoload Capability		n/a	no	opt
Control Panel	yes	opt	yes	yes
COMMENTS	Also available in ruggedized version - (R620i)			

1 Equipment Characteristics

DIGITAL COMPUTERS

COMPANY	XEROX DATA SYSTEMS	XEROX DATA SYSTEMS
MODEL	CF16A	Sigma 3
FIRST YEAR DELIVERY	1970	1969
BASIC PURCHASE PRICE (W/4K)	\$7990	\$33,500 w/8K & ASR-35
LEASE RATE/MONTH	n/a	\$1100 min
MEMORY		
Word Length (bits)	16	16 + parity
Min/Max Size (words)	1K - 32K	8K - 64K
Cycle Time (μ s)	1.6	0.975
Type	core	core
Memory Parity	no	yes
Memory Protect	opt	yes
ROM Available	yes - 256, 512 & 1K	no
ROM Cycle Time (ns)	300	
CPU		
General Purpose Registers	2	5
Index Registers	1	2
Directly Addressable Words	768	1024
Indirect Addressing	multi-level	single level
Immediate Addressing	yes	yes
Indexed Addressing	yes	yes
Double-Word Instructions	no	no
Fltg. Point Arithmetic	yes (Fortran)	no
Hardware Mult/Div	yes	yes
I/O		
Channels	1	4 - 28
Type of Channel	multiplexer	multiplexer & prog
Priority Interrupt Levels	3 std	100
Program Enable/Disable of Indiv. Interrupts	yes	yes
Program Enable/Disable of Interrupt Groups	yes	yes
Cycles Required to Set-up Block Transfer	2	11
Cycles Stolen (from main prog) per Word Transferred	1	none
SOFTWARE		
Compilers	Basic, Fortran	assembler & Fortran IV
Memory for Compilers	2K	7K
Conversational Compiler	Basic, Fortran	no
Debug Package	yes	yes
Relocatable Assemblers	yes	yes
Assembler Macroinstructions	no	yes
MISC HARDWARE FEATURES		
Real Time Clock	opt	yes
Typewriter Console	yes	yes
Power Fail/Interrupt/Restart	opt	yes
Autoload Capability	opt	yes
Control Panel	yes	yes
COMMENTS		DMA is available at extra cost.

Data Communications Equipment & Facilities

There has been a phenomenal growth in data communications in recent years, as measured by the volume of data and the number of data terminals. (Currently, data communications account for about \$450 million of AT&T's revenues. By 1980, this figure is estimated to grow to \$2 billion.) Two factors have contributed to this expansion: (1) the data communications facilities themselves have improved, becoming faster, more accurate and less expensive; (2) the widespread use of computers and automation techniques has fostered the use of data communications in an increasing number of new applications.

The data communications industry is undergoing some fundamental changes, the most far reaching of which are changes in the relationship of the users to the common carriers who supply the communications channels. Until quite recently the communications common carriers supplied nearly all of the data communications equipment. They restricted the use of their public switched facilities by effectively prohibiting the attachment of customer-supplied transmission equipment. The Federal Communications Commission (FCC) restricted the vendors of communications channels to the communications common carriers exclusively. Two landmark decisions by the FCC, the *Carterfone* in 1968 and the *MCI* in 1969, have changed all this, opening the door for competitively supplied data communications equipment and facilities.

THE FOREIGN ATTACHMENTS RULE AND CARTERFONE

Prior to the FCC ruling on *Carterfone*, the legality of the foreign attachments prohibition by the common carriers was examined by the District of Columbia Court of Appeals in the 1957 *Hush-A-Phone* decision. In that case the court upheld the subscriber's right to "use his telephone in ways which are privately beneficial without being publicly detrimental," and ordered AT&T to revise its tariff to permit the attachment of "harmless" customer-owned devices. This was done but AT&T in fact retained the general foreign attachments prohibition through a clever subterfuge.

It was in the June 1968 *Carterfone* decision that the FCC firmly established the right of the telephone subscriber to use any equipment provided it does not cause "actual," as distinguished from "potential" harm to the public telephone network. The Commission maintained that not only should the *Carterfone* device be allowed on the dial network, but that AT&T should issue standard specifications to permit the interfacing of a variety of terminal equipment. Subsequently, the telephone company filed revised tariffs, effective January 1969, permitting the attachment of customer-provided equipment such as modems, acoustic-couplers and private mobile systems to the public switched facility. However, AT&T retained the network functions of dialing and making and breaking the telephone call connection, and the charges for the call. These functions are performed by an arrangement (Data Access Arrangement) with a network control unit. This arrangement, priced at \$2.00 per month, also serves a protective function, limiting the power and range of frequencies of the non-common carrier equipment. The restriction of having to use a carrier-supplied protection and signalling device has considerably reduced the impact of the *Carterfone* decision. A large number of interested parties, in noting the absence of technical specifications, have charged that the revised AT&T tariffs only partially complied with the FCC orders. Still others have questioned AT&T's good faith and have called the tariff structure patently discriminatory.

The *Carterfone* decision nevertheless has had a tremendous effect on the data communications industry and technology. Specifically, the impact has been greatest on the modems which can now be supplied by independent manufacturers for use over the switched communications network. The increased competition has promoted innovation and efficiency, allowing manufacturers to respond to users' needs for irregular transmission speeds, unusual reliability and accuracy and varying costs.

A direct result of the *Carterfone* decision is the new market that is developing for telephone coupler data sets and portable terminals. These portable terminals are usually

1 Equipment Characteristics

lightweight teletypewriters or special keyboard equipment which use acoustic couplers to interface with the public switched network via the conventional telephone set.

Perhaps the most far reaching consequences of the principles established in Carterfone is the encouragement of communications research and new and creative approaches in equipment design. An example of such an approach is the integration of modems and terminal equipment. This eliminates redundant circuitry, improves appearances and reduces packaging size and cost. The development of new data communications technology that permits a more efficient use of the communications network has definitely been accelerated by the relaxation of the foreign attachments rule.

COMMUNICATIONS CARRIERS, MCI AND DATRAN

The FCC initially limited the use of microwave links to the established communications common carriers. This rule was relaxed in the 1959 *Above 890* decision to allow private organizations to construct and operate microwave systems, but only for their own use. Not until August 1969 did the FCC approve the application of Microwave Communications, Inc. (MCI) to lease microwave communications channels to the public between Chicago and St. Louis. This seemingly innocuous decision has resulted in thousands of new microwave station applications by scores of firms proposing to construct some 40,000 miles of public communications facilities throughout the United States.

Most of the applicants, including many MCI affiliates, have proposed MCI-like services. They will lease to subscribers dedicated point-to-point channels of various types (voice, data, facsimile, video, low error rate, etc.) and bandwidths (200 Hz to 960 Hz). The channels would accept analog or digital inputs and would be available on a full-time or part-time basis. Customers would be permitted to interconnect their own equipment or systems to MCI channels. In addition, the rates would be substantially lower in many cases than those charged by existing carriers for comparable service.

The Data Transmission Company (Datran), a subsidiary of University Computing Company, however, has the most ambitious proposal – a coast-to-coast all-digital microwave system (Figure 1) with computer-controlled switching which would provide both dial-up and private-line circuits for data transmission. The proposed Datran communications network is specifically designed and engineered for data transmission. The digital signals would be carried directly, thus obviating the need for modulation equipment. Time division multiplexing (TDM) will be used to permit efficient multiplexing of data channels. The data error rate would be less than one bit per ten million bits transmitted (10^{-7}). The connect time for dial-up calls would be less than 3 seconds and the minimum charge time would be 6 seconds rather than the minimum of 3 minutes or 1 minute of the telephone network. Datran, by using more efficient data transmission techniques, hopes to provide much higher data speeds for about half the present cost.

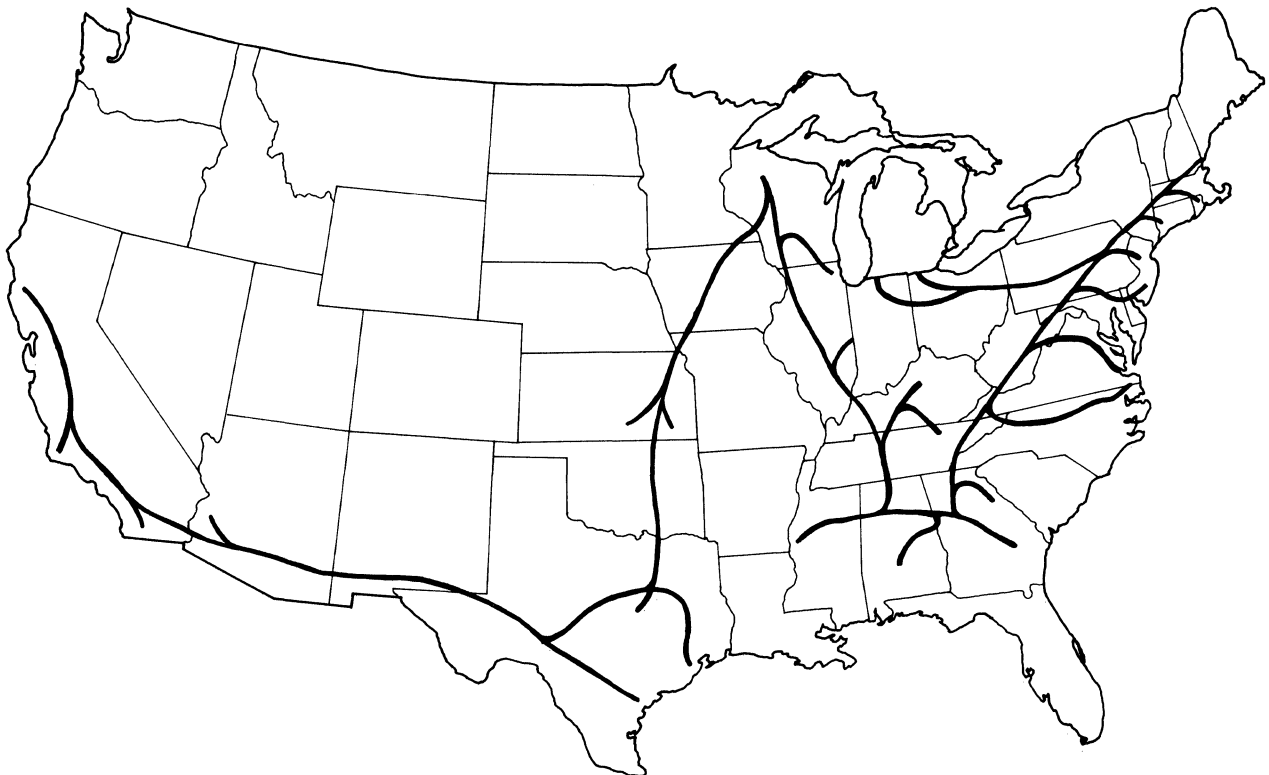

Figure 1. The Proposed Datran System

1 Equipment Characteristics

Though the FCC has not yet approved these applications, there have been indications that they would give the go-ahead to MCI-like carriers and Datran. By accepting the entry of new carriers as "reasonably feasible" and recognizing the need for better data communications service in a published staff position, the FCC appears to be favoring the opening of the communications carriers to competition.

Approval of MCI, Datran and like proposals would very likely lead to many significant changes in the data communications environment. A variety of new applications might then be feasible because of the availability of higher data speeds at lower costs. The telephone companies have been gradually shifting towards transmission on the digital carrier systems. Competition from new carriers like Datran will hasten the day when data can be transmitted directly over the nation-wide digital facilities of the Bell System.

THE GROWTH OF COMMUNICATIONS CAPACITY

In addition to the greater competition promoted by Carterfone and MCI, there have been other significant marketing and technological developments affecting future applications. The first is the increase in capacity of telecommunications channels. Microwave, coaxial cable and communication satellite links capable of carrying over 30,000 voice channels (50 to 200 Mb/s) have already been introduced in the Bell System. There is ample evidence that this channel capacity will continue to increase. The next generation of cross-country links, capable of carrying 100,000 voice channels, using helical waveguides and

communication satellites, have already been proposed. Beyond that the laser offers almost unlimited potential, i.e., laser communication links capable of carrying over 100 billion bits per second can be easily visualized.

This increase in channel capacity has been accompanied by a reduction in dollar cost per circuit mile for these new systems. The economies of scale for different technologies is illustrated in Figure 2. Whether these economies in long-haul transmission will be passed along to the user depends on a number of factors including competitive pressures, high demands and utilization and industry practice regarding tariffs. How the issues of competition, average pricing and specialized services are resolved will greatly affect the data communications costs and therefore volume and utilization.

HIGHER SPEEDS AND GREATER BANDWIDTH

Another reason for the increase in data communications capacity is the development of new technology which permits higher data speeds over existing facilities. The Data Set 203, introduced to the Bell System in 1969, permits data speeds up to 10,800 bps over a private voice-grade line by employing the fundamentally more efficient MLVSB technique. Even though the cost of leasing voice grade lines has increased slightly, the cost per bit transmitted has decreased considerably. Efficient multiplexing methods have also enabled the use of multiple, low-speed channels over a single high-speed voice grade facility.

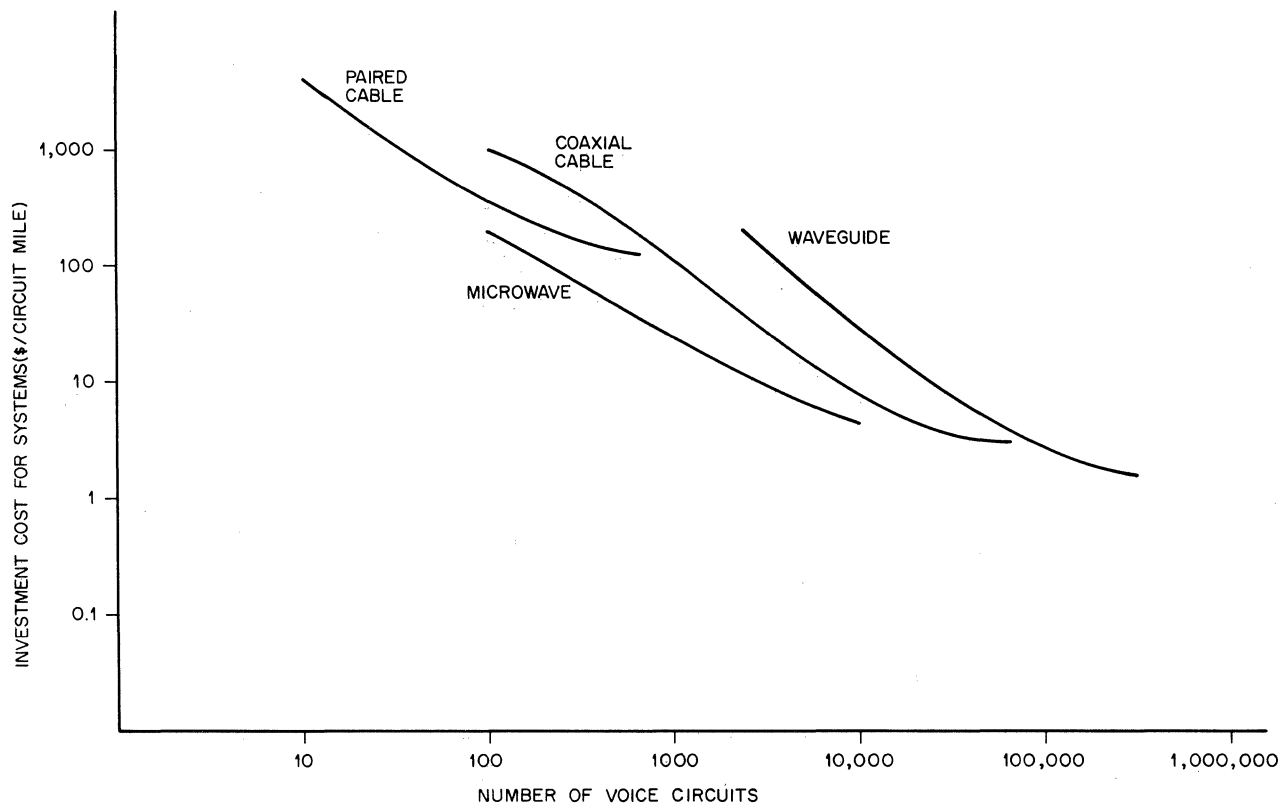

Figure 2. Economics of Scale for Different Communication Technologies

1 Equipment Characteristics

Higher data rates are, of course, possible using wideband communications which utilizes a group of voice channels. A variety of private-line wideband services are available from AT&T, with speeds up to 460,800 bps. Recently, AT&T also introduced the DATA-PHONE 50 service, a wideband switched facility capable of operating at 50,000 bps. Initially, the interstate DATA-PHONE 50 service is available between four cities – Chicago, Los Angeles, New York and Washington, D.C.

The major advantage of wideband data communications is the significantly faster response time. Where data traffic volume is high, it offers economies of scale as well. Availability of wideband services has opened new application areas in computer communications. It is now possible to interact with the computer from a remote sophisticated graphics display terminal. A reel of tape can be transmitted within minutes. Computer load-sharing can be more effective. The possibilities are unlimited. Unfortunately, the cost of wideband communication is still very high, thus discouraging its widespread use.

DEVELOPMENTS IN DATA COMMUNICATIONS EQUIPMENT

A recent innovation that is opening vast new application areas is the TOUCH-TONE service. Originally designed as a method for faster and more accurate dialing of calls on the regular telephone network, the TOUCH-TONE service has become one of the lowest cost computer input devices and is widely used in the industry. For users located in areas not yet equipped with TOUCH-TONE service, auxiliary push button pads are available in addition to the rotary dial to send numeric information to computers and other business machines. The real importance of the touch-tone telephone is that it is so widely available at little or no extra cost.

There is a parallel movement towards using the conventional telephone receiver as an output device. This is apparent from the market growth for audio response units and other voice answerback equipment. These devices provide the least expensive way of receiving responses from the computer over the telephone. This fact, coupled with the touch-tone input, is playing a major role in the extensive use of computers for inquiry processing.

Another important development in terminals is the proliferation of the cathode-ray tube (CRT). The CRT displays have made new applications possible because of their higher speed, quiet operation and the ability to selectively alter and display data. Technological developments have improved the cost and performance of the CRT terminals to such an extent that they have become practical for such diverse applications as computer time-sharing, on-line reservations, inquiry-response, inventory control and management information systems.

There is a substantial market for multiplexing equipment which allows the user to utilize economies of scale in data transmission. This market will continue to expand in the near future but will gradually be replaced by message switching systems which provide convenient multiplexing and switching of a large variety of data speeds and formats very economically. The price of minicomputers and communications processors has become so low that it is now practical to employ them as communications front-end

equipment for larger machines, handling most of the communications-related tasks.

There is an enormous potential for use of stored program computers in solving data communications problems. Several companies have already seized the opportunity and are marketing integrated data communications equipment to diverse customers.

SYSTEMS AND TECHNIQUES

It is important to recognize that there are three basic types of data communications systems: *person-to-person*, *computer-to-person* and *computer-to-computer*. Data transmission between persons is the oldest, dating back to the beginning of telegraphy and newswire. Even today considerable data communications traffic is generated between teletypewriters without any computer involvement. The large-scale use and development of data communications began only in the mid 1950's when it was recognized that the teletypewriter circuits and machines could also be used for transmitting data to and from the computer. This uncovered vast and wholly new application areas, permitting the human to interact with the computer, thus utilizing its high resources for information processing. Inter-computer communications is only beginning and is utilized in such applications as load-sharing, data-base sharing and message handling.

Basic Elements

Figure 3 illustrates the basic components of data communications systems. The information source, usually a person or a computer, transmits data via an input device or terminal which encodes the data into binary signals. If the transmission channel is inherently analog, as is the case on the telephone system, a modulator is required to convert the binary dc signal into compatible tones. At the receiving end a demodulator is required to convert the signal tones back into binary signals. These signals are decoded by an output device or terminal which passes the data to the information sink – a person or a computer. In the case of a human, the information is usually displayed in a suitable form by the computer.

Other elements may also be present in a data communications system. Multiplexers or other data-combining equipment may be used to reduce the communications cost per channel; error-control devices may be employed to reduce error rates and improve reliability; and the transmission channel itself may be a switched facility or a multipoint network. A discussion of channel types, transmission modes, modulation techniques, information codes, error control and system configuration is essential to understanding equipment characteristics.

Types of Channels

The channel, or data link, is a transmission path between two or more points and may be a single wire, a group of wires or a special part of the radio frequency spectrum. These channels are generally classified into three groups according to their bandwidth:

1. *Narrowband Channels*: Bandwidth less than voice channel. Characterized by speeds of 50 to 200 bits per second. Capable of handling manual keyboard devices, and used primarily with telegraph and teletypewriter equipment.

1 Equipment Characteristics

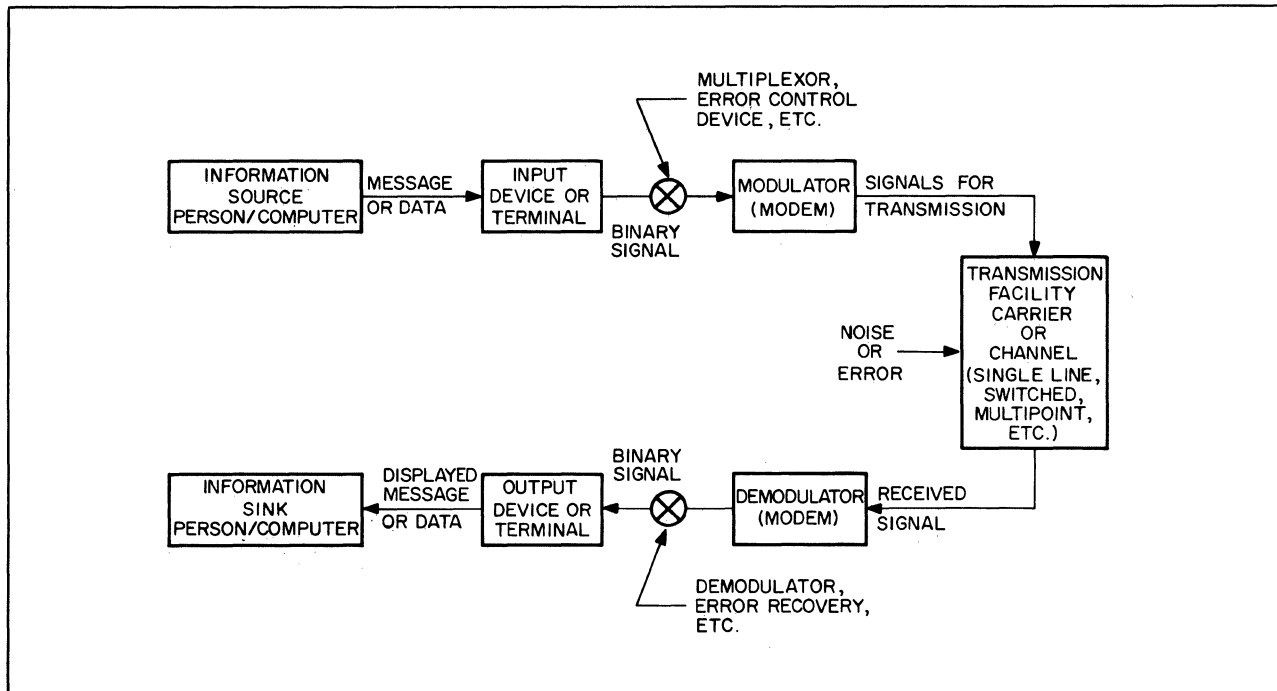

Figure 3. Basic Components of Data Communications Systems

2. *Voiceband Channels:* A 3-kHz bandwidth (frequency range of 300 to 3400 Hz). Characterized by speeds of 600 to 10,800 bits per second. Generally used for handling voice transmission.

3. *Wideband Channels:* Bandwidth greater than voice channel. Characterized by a variety of data speeds ranging from a few thousand to about 500,000 bits per second or higher. Also called broadband channels.

The speed of transmission depends not only on the bandwidth but also on the modulation technique. In general, the greater the bandwidth of a channel, the higher the speed at which data can be transmitted. Transmission speed is usually expressed in bits per second (bps), bauds, words per minute (wpm) or characters per second. Of the above measures, bits per second is preferable as a true measure of information transfer rate independent of the coding and transmission technique. The speed in bauds is the number of signal events per second. When each signal event represents other than one bit (as in dibit), baud does not equal bits per second. The measures, words per minute or characters per second are remnants of telegraphy and depend on the character code employed. The conversion from wpm to bps can be made using the following formula:

$$\begin{aligned} \text{Bit rate in bps} &= \frac{\text{wpm} \times 6 \text{ char/word} \times \text{bits/char}}{60 \text{ seconds}} \\ &= \frac{\text{wpm} \cdot \text{bits/char}}{10 \text{ seconds}} \end{aligned}$$

The bit rate for a 60-wpm teletypewriter service using Baudot (7.42 bits/char) can now be calculated as:

$$\text{Bit rate} = \frac{60 \times 7.42}{10} = 44.52 \text{ bps}$$

The available channels can be either switched through public exchanges or permanently connected. Facilities for switching wideband channels such as the DATAPHONE 50 service of the Bell System are not widely available. The "public" or "switched" lines allow the dialing of different machines from the same terminal, giving the user great flexibility. They also have a cost advantage if terminal usage is low. The "private" or "leased" lines are connected permanently or semi-permanently between terminals and may be less expensive if the terminal is used heavily. The break-even point between switched and leased lines depends on the circuit mileage and is usually a few hours a day. Leased lines have other advantages such as the ability to obtain higher quality lines that permit high speeds with low error rates.

Transmission Modes

While the channel may appear as a single data path to the user, the information bits may be transmitted either serially on a single link or in parallel over multiple communication paths. Parallel transmission is usually serial-by-character and parallel-by-bit, requiring at least as many separate channels as there are bits in a character. Parallel transmission is generally not used over long distances as it incurs higher transmission costs. Several low-speed lines are more expensive than a single higher speed line, and even when frequency division multiplexing is used (bits traveling simultaneously on the same line using different frequency bands), the cost of such equipment must be considered. Parallel transmission, however, has the advantage of lower terminal cost. It is therefore commonly used over short distances (several hundred feet) where the wires laid down by the user are relatively inexpensive. Occasionally, parallel transmission is also used over longer distances to increase the effective transmission speeds if wideband channels are

1 Equipment Characteristics

unavailable. Many facilities also employ a combination of serial and parallel transmissions.

Data transmission can be either synchronous or asynchronous. In *synchronous* transmission, the characters (and bits) are transmitted at a fixed rate with the transmitter and the receivers synchronized. In *asynchronous* transmission, the interval of time between characters can vary arbitrarily; this usually means start and stop elements must be transmitted with each character. Synchronous transmission is therefore the more efficient of the two. For this reason most high-speed terminals capable of continuous operation utilize the synchronous option. Asynchronous transmission is most often used on unbuffered keyboard devices where the time interval between characters is necessarily arbitrary.

The channels as well as transmission can also be classified on the basis of simultaneity into three basic types:

1. *Simplex* is strictly unidirectional transmission.
2. *Half-duplex* is the ability to transmit in either direction, but not simultaneously.
3. *Full-duplex* is the ability to transmit in both directions simultaneously.

Simplex lines find very limited use in data communications as some feedback is usually desirable. The choice between half-duplex and full-duplex lines depends largely on the characteristics of the terminal equipment. Since half-duplex terminals are less expensive, this mode of transmission is more common at the present time. Half-duplex operation, however, requires line-turnaround time when the direction of transmission is to be changed. Where full-duplex operation is possible, it is generally advantageous since full-duplex lines usually cost only 10% more. Even in cases when the terminal operates half-duplex, a full-duplex channel may be used to improve the response time.

In most instances half-duplex transmission is over a 2-wire circuit and full-duplex over a 4-wire circuit. However, full-duplex transmission can also be handled by a 2-wire circuit with separate frequency bands for the two directions.

Modulation Techniques

As mentioned earlier, modulation and demodulation are generally required to convert the baseband signal into a form suitable for transmission. The equipment that performs this task is referred to as a *modem*, abbreviated from *modulator-demodulator*. There are fundamentally two kinds of modulation schemes, one using analog techniques and the other using pulse techniques. In analog or continuous modulation a sine wave carrier of a frequency higher than the signal is modulated. Depending on whether the amplitude, the frequency or the phase of the carrier is varied in accordance with the data signal, there are three basic types of modulation schemes — *amplitude modulation* (AM), *frequency modulation* (FM) and *phase modulation* (PM).

The data signal transmitted is usually the two-level binary signal, but it is possible to use multiple levels such as four-level dibit transmission which approximately doubles

the transmission rate. Though four- or eight-level transmission increases the speed, it makes the signal more susceptible to error. Of the three modulation schemes, amplitude modulation is most susceptible to noise and therefore unsuited for dibit transmission. Phase modulation is the least sensitive to noise and is used frequently for multilevel transmission.

In pulse modulation, the base band signal is sampled at regular intervals and the sample results used to vary the amplitude width or position of the pulse. The schemes are called pulse amplitude modulation (PAM), pulse width modulation (PWM), and pulse position modulation (PPM). The most important and useful pulse modulation technique, however, is pulse code modulation (PCM), in which the amplitude of the sampled pulse is “quantized”; that is, a digital code is used to represent the value of amplitude. Pulse code modulation offers great noise immunity since the pulses are of uniform height and width. Regenerative repeaters can be used at regular intervals to obtain error rates as low as one in ten billion bits (10^{-10}). Pulse modulation requires much larger bandwidths than analog modulation, but in spite of this, the future lies with PCM and time division multiplexing rather than with analog methods and frequency division multiplexing.

Information Codes

In order to allow communications between terminals, a uniform method of exchanging information is needed. This requires the establishment of a character code structure for interpretation of bits as characters, a message syntax to form characters into messages, and data communication control procedures for exchanging the messages.

Although many codes are used in communications today and many new codes are being developed for various applications, there is a trend toward the universal use of the ASCII 8-bit code. The ASCII or USASCII code (Figure 4) was introduced by the USA Standards Institute and has been accepted as the U.S. Federal standard. Message format and data communications control procedures based on the USASCII code have also been proposed. Techniques for transmitting “transparent” or binary data also exist within the structure of the USASCII code. Special characters are set aside for the purposes of communications control. These control functions include synchronization, message heading and control.

Of the other existing codes, the more widely used ones are the 5-bit Baudot code (Figure 5) found in old teleprinter equipment, the 6-bit transcode, the IBM punched card Hollerith code (Figure 6), the 7-bit BCD and the 8-bit EBCDIC code (Figure 7) used extensively in IBM equipment. In the Baudot code, since five bits can accommodate only 32 unique codes, two of the codes are “figures” (FIGS) and “letters” (LTRS) to allow extension to two characters, thus including both upper and lower case letters.

The Hollerith code, used almost exclusively for punched card equipment, is a 12-level code designed to represent the alphabet and the digits 1 through 9. The code lends itself to easy detection of errors. The binary coded decimal (BCD) is an extension of the Hollerith code. The code is structured by converting punched card designations to a binary pattern. This code, extended to include eight bits, becomes the EBCDIC code.

1 Equipment Characteristics

b ₇		b ₆		b ₅		b ₄		b ₃		b ₂		b ₁		COLUMN		0	0	0	0	1	0	1	0	1	0	1	1	1	1	
b ₇		b ₆		b ₅		b ₄		b ₃		b ₂		b ₁		ROW		0	1	2	3	4	5	6	7							
0	0	0	0	0	0	0	0	0	0	0	0	0	0	0	0	NUL	DLE	SP	0	@	P									
0	0	0	1	1	1	1	1	1	1	1	1	1	1	1	1	SOH	DC1		1	A	Q	a	q							
0	0	1	0	0	0	0	0	0	0	0	0	0	0	0	0	STX	DC2	*	2	B	R	b	r							
0	0	1	1	1	1	1	1	1	1	1	1	1	1	1	1	ETX	DC3	#	3	C	S	c	s							
0	1	0	0	0	0	0	0	0	0	0	0	0	0	0	0	EOT	DC4	S	4	D	T	d	t							
0	1	0	1	0	1	0	1	0	1	0	1	0	1	0	1	ENQ	NAK	%	5	E	U	e	u							
0	1	1	0	0	0	0	0	0	0	0	0	0	0	0	0	ACK	SYN	&	6	F	V	f	v							
0	1	1	1	0	0	0	0	0	0	0	0	0	0	0	0	BEL	ETB	'	7	G	W	g	w							
1	0	0	0	0	0	0	0	0	0	0	0	0	0	0	0	BS	CAN	(8	H	X	h	x							
1	0	0	1	0	0	0	0	0	0	0	0	0	0	0	0	HT	EM)	9	I	Y	i	y							
1	0	1	0	0	0	0	0	0	0	0	0	0	0	0	0	LF	SUB	*	:	J	Z	j	z							
1	0	1	1	0	0	0	0	0	0	0	0	0	0	0	0	VT	ESC	+	;	K	[k	}							
1	1	0	0	0	0	0	0	0	0	0	0	0	0	0	0	FF	FS	,	<	L	\	l								
1	1	0	1	0	0	0	0	0	0	0	0	0	0	0	0	CR	GS	-	=	M]	m	{							
1	1	1	0	0	0	0	0	0	0	0	0	0	0	0	0	SO	RS	.	>	N	^	n	~							
1	1	1	1	0	0	0	0	0	0	0	0	0	0	0	0	SI	US	/	?	O	_	o	DEL							

Figure 4. USA Standard Code for Information Interchange (USASCII)

CHARACTER		IMPULSE POSITION				
LOWER CASE	UPPER CASE	1	2	3	4	5
A	.	•	•			
B	?	•			•	•
C	:		•	•	•	
D	\$	•			•	
E	3	•				
F	!	•		•	•	
G	8		•		•	•
H	#			•		•
I	&		•	•		
J	'	•	•		•	
K	(•	•	•	•	
L)		•			•
M	•			•	•	•
N	,			•	•	
O	9				•	•
P	0		•	•		•
Q	1	•	•	•		•
R	4		•		•	
S	BELL	•		•		
T	5					•
U	7	•	•	•		
V	;		•	•	•	•
W	2	•	•			•
X	/	•		•	•	•
Y	6	•		•		•
Z	*	•				•
LETTERS (SHIFT TO LOWER CASE)		•	•	•	•	•
FIGURES (SHIFT TO UPPER CASE)		•	•		•	•
SPACE				•		
CARRIAGE RETURN						•
LINE FEED			•			
BLANK						
PRESENCE OF • INDICATES MARKING IMPULSE ABSENCE OF • INDICATES SPACING IMPULSE						

Figure 5. Baudot Code Format

BIT POSITIONS		01		00		00		01		10		11					
4567	23	00	01	10	11	00	01	10	11	00	01	10	11				
0000	NUL					Blank	B	-									
0001							/			a	j		A	J	S	1	
0010										b	k	s		B	K	S	2
0011										c	l	t		C	L	T	3
0100	PF	RES	BYP	PN						d	m	u		D	M	U	4
0101	HT	NL	LF	RS						e	n	v		E	N	V	5
0110	LC	BS	EOB	UC						f	o	w		F	O	W	6
0111	DEL	IDL	PRE	EOT						g	p	x		G	P	X	7
1000										h	q	y		H	Q	Y	8
1001										i	r	z		I	R	Z	9
1010										?		§					
1011										+	!	#					
1100										←	*	%	⊙				
1101										()	^	'				
1110										+	-	=					
1111										±	±	√					

Figure 6. Hollerith (IBM Punched Card) Code

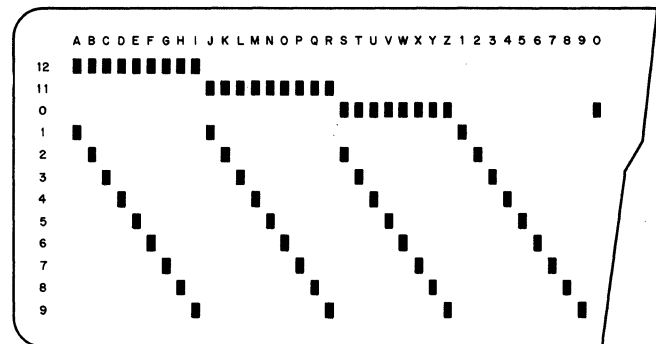

Figure 7. Extended Binary-Coded-Decimal Interchange Code (EBCDIC)

Another code that deserves mention is the four-of-eight code. In this code four bits are always "1" and four bits are always "0." Although this code and a similar two-of-five code are much less efficient than ASCII, they are ideal in applications where high accuracy and easy error detection are required. Typical applications are credit card verifications and Bell System touch tone units.

A slight variation of the ASCII code that should also be mentioned is the Data Interchange Code used in machines manufactured by Teletype Corporation. In this version of the ASCII code, some printing characters are replaced by nonprinting control characters and the parity is specified. Terminal equipment utilizing a different code may be accommodated by code conversion techniques, either by hardware in the communications interface or by program. Where time is a premium, code conversion by logic networks is preferable. It is extremely fast, but rather costly and inflexible.

Error Control and Reliability

All communications facilities are affected by noise, fading, distortions, and other transmission impairments. The probability of error-inducing impairments increases with distance and increased switching points or different physical equipment. Partially to overcome the lack of error control in codes such as the Baudot code, new codes with built-in aids towards error control were devised. These codes require proportionately larger numbers of bits per

1 Equipment Characteristics

characters, and thus make less efficient use of the channel. Some of the more common error control techniques employed are as follows:

1. Character-oriented error detection such as character parity check, 4 out of 8 and 2 out of 5 codes. Error detection is accomplished by means of redundancy in coding, i.e., using more bits than the minimum required per character. This type of error control allows detection of at least single errors in each character and is used in most existing codes such as ASCII and EBCDIC.

2. Block-oriented error detection such as the longitudinal redundancy check (LRC) and the cyclic redundancy check (CRC). One or more check character or pattern of bits are generated by applying a previously agreed upon error detection code (block parity, cyclic codes, etc.). Often a combination of block and character-oriented error detection schemes are used which allow limited error correction also. Usually error-control using the CRC is so powerful in detection of errors that it obviates the need for character parity.

3. Error correcting codes such as Hamming and cyclic codes. The data is encoded using a highly-redundant self-corrective scheme. These codes permit automatic detection and correction of various error pattern within given burst lengths. The forward corrective transmission is generally less efficient in its use of channel capacity but may be necessary, if line has a high error rate.

The error detection techniques outlined above are used extensively in feedback retransmission systems. The receiving terminal checks the incoming data and instructs the transmitting terminal whether or not to retransmit data. The rejected data may be retransmitted via operator intervention as in *check and stop transmission* or automatically as in *check and re-transmission*.

More sophisticated error control techniques also ensure against loss of messages by use of message sequence numbers placed in the heading of messages. These indicate the sequence of the message compared to the previous one, and checks can be made to ensure the correct sequence of messages.

Data communication systems generally require more reliability than just detection of errors in messages. Protection must exist against system and equipment failures, and down-time must be minimized. To ensure this, techniques with message protection, storage protection, and duplication of vital information have been suggested. For greater reliability and error protection, it is advisable to error-check supervisory control sequences (including retransmission requests). Error recovery procedures for other kinds of faults may also be necessary.

System Configuration

The simplest possible system structure is that of a point-to-point connection, with a single line connecting two terminals. The connection may be fixed as a private line or switched as on the dial network.

Next in complexity is the multipoint connection, a party-line structure in which several users share the same time.

Many pairings of conversations are possible, but little organization is achievable on a system basis except through polling and selection or computer message control.

A more orderly structure for a system with many users is a centralized system with a star configuration in which all users communicate with a central point that has supervisory control over the system. Users communicate with each other only by permission of this central supervisor.

The most elegant system structure is perhaps a distributed system with a multiple star configuration in which there are several supervisory or exchange points, each with its own set of users and a means for direct communication between the central points. Such a distributed structure appears to offer considerable advantage in reducing cost of terminal communications by permitting installations to be located near concentration of terminals. However, few distributed networks have been implemented because distributed data bases are infrequent and the communications cost has been minor when compared to computation investment. With solutions of the data base management problem and the increasing complexity of individual systems and terminals, it is likely that many more distributed systems will emerge in the future.

In applications where the reliability of continuous communications is extremely important, such as defense networks, the distributed delta or the mesh structure in which every point is connected to several neighboring points may be preferred. The various system configurations are illustrated in Figure 8.

The system configuration and costs are closely related. As the number of terminals and lines increase, the cost factors start dominating system design. For example, multiplexers may be used to concentrate a number of low-speed lines into a single, less expensive high-speed line. Terminal control units may be employed to reduce the cost of communications to a group of terminals. Shared buffers or terminal control units also may be used to minimize the cost of an individual terminal. A store-and-forward message switching system may be the most economical system where there is high density of traffic between each pair of points and fast response is required.

EQUIPMENT AND FACILITIES: SELECTION AND EVALUATION

If a large number of terminal points and many processing functions are required in a data communications system, the design will be complex not only because of the size of the system but also because of different user requirements and many possible approaches. The interrelated design parameters force compromises and trade-offs which the designer must consider. System requirements for reliability, accuracy, throughput, response time, expandability and maintainability have to be balanced against cost.

The first step before the selection of equipment and facilities is that of establishing the information flow requirements. This includes the nature and volume of information, the number of information sources and sinks and their location, the acceptable response times and the accuracy and reliability needed. These requirements depend on the application, which, of course, largely determines the

1 Equipment Characteristics

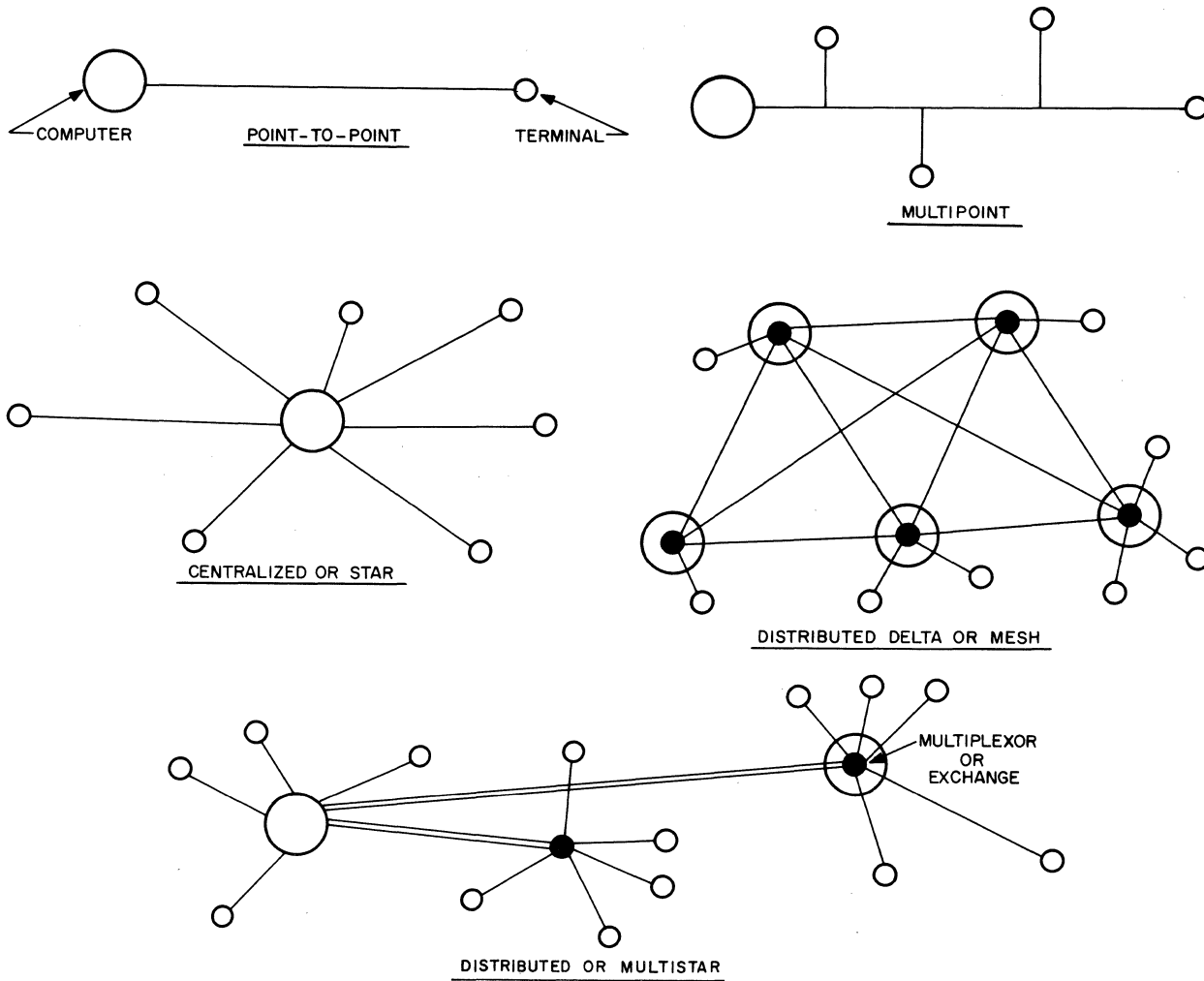

Figure 8. System Configurations

choice of terminals, processing equipment and communications facilities.

Applications

Current applications of data communications systems vary widely in their functions, scope and requirements and span all user groupings – commercial, industrial, scientific and military/aerospace.

Within the commercial area there exist many different types of applications and new applications are being developed every day. Some indication of their variety is given below:

- Message switching
- Airline reservation
- Hotel reservation
- Brokerage transactions
- Brokerage ticker service
- Branch banking
- Credit checking
- Multiple-warehouse order processing
- Truck or rail system management

- Computer aided instruction
- Computer aided design
- Hospital administration
- Customer account inquiry processing
- Management information systems
- Retail point-of-sales inventory control
- Time-sharing computational facilities
- Load-sharing between computers

The industrial area of application involves process control, on-line production control, and automatic inspection systems. Industrial data-gathering applications are considered to fall in the commercial area because their implementation has characteristics in common with many commercial systems.

The scientific area of application involves, principally, the instrumentation of laboratories for physical and biomedical experimentation.

The military/aerospace area involves tactical and strategic command and control, range instrumentation, count-down, onboard guidance, and other applications.

1 Equipment Characteristics

Fundamental Types

Functionally, the whole spectrum of data communications applications may be divided into a few fundamental classes, such as:

1. *Data collection.* Collection and transmission to a central processing point of information concerning the operations of geographically separated facilities. When large quantities of data are transmitted, this is usually done on a block-by-block basis. Blocks are generally fixed in size, 80 characters being popular because of the punched card.
2. *Data distribution.* The distribution of data generated and/or processed at a central facility to outlying locations. The communication mode is similar to that in data collection.
3. *Inquiry processing.* To provide prompt responses to inquiries to a centralized data base. Messages are short and formats highly tailored to the application to obtain efficiency in transmission and to minimize the incidence of incorrect requests or non-executable orders.
4. *Computer time-sharing.* Making the facilities of a computer system available to multiple users. The communication mode is similar to that in inquiry processing.
5. *Message switching.* To provide an efficient system for handling the communications of a particular organization. Store-and-forward communications are generally employed.
6. *Inter-computer communications.* Computer-to-computer communications for the purpose of load sharing, data base-sharing, etc. Communications may be block-by-block or store-and-forward.

Terminal Devices

The most significant consideration affecting terminal selection is matching the functional capability of the terminal to the functional requirements of the applications. The best evidence of this importance lies in the variety of special-purpose terminals developed for such applications as airlines reservations, on-line banking, industrial data collection and brokerage houses. The application primarily sets the requirements of speed, permissible error rates, input/output medium, information codes and formats and storage in a terminal.

Data communications terminals generally employ the alphanumeric data format though many specialized terminals also exist. Most terminals have extensive error-control procedures and are oriented towards the operational requirements of common carrier facilities. The speeds of transmission reflect economical combinations of interface devices and common carrier facilities.

Data communications terminals have three basic features:

1. Input/output (I/O) or interfacing the user, through a keyboard display, etc., to the transmission facility by coding and decoding information.
2. Storage or buffering to compensate for the differences in speed or in the time of operation of the user interface device and the communications channel.

3. Controlling the transmission by monitoring the data flow, exchanging supervisory information and error control.

These capabilities may exist independently in free-standing terminals or be time-shared either in the communications interface of a computer system or in a terminal control unit which directs a large number of terminals. A wide variety of terminals with many different types of user interface, buffering and control are available on the market today.

I/O Interface

The type of interface or the I/O device is the fundamental distinguishing property of a terminal. The I/O method employed usually determines the transmission speed capability of the terminal and often dictates the error control techniques. Proper matching of the I/O device speed and the communications line speed optimizes design. Many types of I/O interfacing devices exist. Often the functions of interface and bulk storage are combined into one unit. The standard available devices include:

- Keyboards
- Teletypewriters and teleprinters
- Card readers and punches
- Paper tape readers and punches
- Page and line printers; strip printers
- Magnetic tape units
- CRT displays

Keyboards are the most common input mechanism for all systems. Since the keyboard is a slow device, buffering is desirable to remove the I/O bottlenecks.

Block-by-Block Transmission

Card, paper tape, line printer and magnetic tape equipment usually employ block-by-block transmission in moving large quantities of data. The basic functional characteristics of this group of terminals are:

1. To provide an interface between the user's data media (card, paper tape, etc.) and the transmission facility.
2. To provide a bulk storage capability for message accumulation or transmission.
3. To achieve compatibility between the interface and storage devices and the transmission facility through speed and code conversion.
4. To control the transmission and correct errors.

Data transcription equipment may be used either in preparing data for more efficient computer input (as in the case of card-to-tape devices) or in displaying the computer output (as in the use of tape-to-printer devices). In addition to performing these basic media conversion operations, some data transcription devices can also be used for extensive editing, sorting and reformatting operations. Sometimes small general-purpose computers are used to facilitate the data transcription process.

Many of the data terminals listed at the end of the section in charts can perform multiple input/output operations; these are sometimes called multi-device terminals.

1 Equipment Characteristics

Buffered and Unbuffered Terminals

The terminals may be provided with a buffer storage to make a more efficient use of the communications and computational facilities. The unbuffered terminal is character-oriented; that is, a character code is immediately transmitted when the user strikes a key. A buffered terminal, on the other hand, is line or page oriented. One or more lines of data are stored in a terminal buffer and are sent to the computer when the user explicitly gives the signal to transmit (press a transmit key, etc.).

In comparing the buffered and unbuffered terminals for a particular application, the primary emphasis should be on cost. The buffered terminals are, in general, more expensive but allow local editing and use less computer time. If the computation costs are significantly higher and the terminal functions such as editing and receiving characters severely degrade CPU efficiency, then it is preferable to use buffered terminals. Buffered terminals are fundamentally more efficient for communications also, but this advantage cannot be easily utilized in practice.

The unbuffered terminal has a lower cost and possible advantages in human factors. The user does not have to press a "transmit" key or keep track of what information has been transmitted to the computer. He can also use the full editing capabilities of the central computer which are usually more powerful (and also more expensive). The unbuffered terminals also are less expensive to operate and maintain because they are less complex. A problem with some unbuffered CRT display terminals may be refreshing of the CRT image. Storage tube CRT terminals, however, require no buffering or refreshing.

The selection between a buffered or unbuffered terminal should be made on the basis of relative computation and terminal costs. The cost and advantages of local versus central editing should also be taken into consideration. The user's relative efficiency in his use of the two types of terminals for the particular application is also an important factor.

Terminal Control

The control unit performs functions such as interfacing to communication lines, transmission control, code conversion, error control, serial-to-parallel conversion, synchronization of operations and buffering to accommodate speed differences. A terminal control unit also permits the operation of more than one device on a communication line and reduces the cost per terminal by performing the common functions for all the terminals. That is, a number of terminals share the facilities provided by the terminal control unit.

The modulation-demodulation function can be either integrated into the terminal control unit or provided by a modem supplied by an independent manufacturer or the common carrier. If the modem is obtained separately, the standard applicable to the interconnection of terminals and modems is the *EIA Standard RS-252-B*. This specifies the interface to the modem by defining the means of exchanging control signals and binary serialized signals between the terminal and the modem. *Details of the standard may be obtained by writing to: Electronic*

Industries Assoc., 2001 Eye Street, N.W., Washington, D.C. 20006.

The terminal control unit is closely associated with the requirement of the end use of the system. In addition to the basic functions, many terminal control units provide editing, translation and error recovery logic as well. The individual terminals may be centrally controlled or polled in a multipoint configuration.

Inquiry-Response Terminals

The inquiry-response data terminal serves the broad class of requirements where the amount of data transmitted is small and the operational efficiency of the terminal station is an important factor.

Broadly speaking, the functional characteristics of inquiry response terminals are comparable to those of block-by-block terminals. The principal areas of distinction are:

1. The inquiry response terminal is not intended to store messages of any significant size.
2. Entry of information is usually from a manually-operated keyboard or card insertion station.
3. Display of information is generally restricted to a short message, a momentary display, or just a simple acknowledgement signal.
4. The entry and display mechanisms are highly tailored to the specific application. Their design, furthermore, minimizes operator training requirements and attempts to preclude operator errors from affecting a transmission. The operator rarely has control over message formats.
5. These terminals characteristically place low-duty cycle loads on communications lines. It is often economical to operate several of them through a common control unit which provides buffering and multiplexing functions between the group of terminals and the communications line to the central processor of the system.

The inquiry-response type of data terminals takes many forms. These may be broadly separated into four classes: industrial data collection terminals, on-line teller systems, the CRT display console and small keyboard printer and card equipment. Applications of specialized devices such as savings-bank window machines, special cash registers and numerous kinds of automatic data collection devices are increasing rapidly. In this discussion we shall concentrate mainly on the industrial data collection terminals and the CRT display terminals.

Industrial Data Collection Terminals

Data collection terminals collect, record and transmit information in a machine-readable form for use by the computer. These terminals usually contain a combination of several basic data entry modes:

1. Manually inserted punched card reader;
2. Manually inserted badge or token reader;
3. Variable inputs such as dials, pull-down levers or switches;

1 Equipment Characteristics

4. Restricted inputs such as plugboard or locked dials and slides.

Output media are usually punched tapes, punched cards or magnetic tapes. Industrial data collection systems require careful planning, meticulous design and a high degree of error control and reliability.

Operating a data collection station is no more difficult than operating a time clock. The employee merely sets up the switches, inserts the card or badge and presses a "Transmit" button. The operator usually cannot control the message format or content and hence the system is relatively free from human errors. If invalid combinations of data are set on the switches, the message is rejected by the system. The employee/operator can then check the controls and retransmit the message.

The programmed interaction of the industrial data collection system example given above generally typifies the inquiry-response terminals. In on-line banking, for example, the terminal keyboard looks, for all practical purposes, like a conventional accounting machine with a few extra keys. All functions are called out by keys that cause execution of exactly-specified operations. Elaborate features are provided to meet the protective requirements of the banking field. The teller's inquiry consists of keystroking a potential entry to a customer's account and the central computer's response consists essentially of permission to make the entry plus possibly the printing out of supplementary information on the account obtained from central records not accessible to the teller. The response is locked into the terminal system so that the teller not only has no choice about accepting it, but may not even appreciate what has happened.

CRT Display Terminals

Cathode-ray tube (CRT) display terminals are widely used in inquiry-response applications as "electronic blackboards" to provide rapid access to data stored in computer systems. These terminals find use in such diverse applications as time-sharing systems, computer-aided design and instruction facilities, on-line reservation and banking systems and inventory control systems.

The primary input mechanism is the keyboard equipped with alphanumeric and some special keys. CRT terminals are preferred due to their higher speed resulting in more efficient use of the telephone line and human reading capabilities, quiet operation and the ability to alter selectively the displayed data. The disadvantage is the lack of a convenient hard copy. Complete graphics CRT consoles with both alphanumeric and vector capabilities are discussed in the section on graphic data systems. The terminals listed in this section have an alphanumeric capability, are capable of remote operation and, in general, cost an order of magnitude lower than the full graphics CRT terminals.

The distinguishing features of the CRT display units are: display area size, display arrangement, total number of characters storable, storage facility, transmission speed and other special features such as editing and control and auxiliary outputs. Additional characteristics such as the method of character generation, the character size used,

brightness of the image, the regeneration rate are also important in selecting equipment.

CRT display terminals may be either "stand alone" terminals or multistation configurations. In multistation configurations some number of terminals share common storage and control. Where a number of terminals are relatively clustered, such as in airline reservations systems, the multi-station configuration is particularly attractive since it allows many users to share the cost of control and storage equipment and communications facilities.

Local storage is usually required for CRT terminals since regeneration is necessary for a flicker-free image. This buffer storage is furnished in a variety of ways: core memory, magnetic drums and discs, delay lines and scan converter tubes. Random-access memories such as discs, drums and core are inherently the most flexible. There is a growing awareness that display buffers should, in fact, be small, general-purpose digital computers. Imlac Corporation is now producing low-cost stand-alone display terminals which operate over a regular telephone line employing a programmable computer with 4K to 8K core memory. The user can program special features to suit his application.

The use of storage-CRT in display terminals has made the unbuffered stand-alone terminals quite attractive. Storage-CRT terminals have a low cost (about \$8,000) and can be connected directly on the telephone line. In addition, the storage tube is absolutely flicker-free. The main disadvantages are the lower brightness of display and the inability to alter data selectively. For altering data, the whole or a large part of the screen has to be erased, which makes editing cumbersome.

The editing facilities are a very important feature on any CRT terminal as they provide the user great ease and flexibility in entering, modifying or correcting data. Most commercial display units use a visible cursor or entry marker to indicate the character position upon which the operator is editing. Other editing facilities commonly provided in display terminals include: character and/or line insert and delete; transmission of partial display and split screen; and format control functions such as horizontal and vertical tabulation, space and back space, and carriage return.

Other features offered as either standard or optional features include alternate outputs and hard-copy devices, auxiliary inputs, special function keys or additional characters and error control capabilities.

For applications where cost minimization is required and low data rates are sufficient, there exist very simple alphanumeric terminals that provide combinations of keyboard, printer, and manual card reader. These terminals often make clever use of the touch-tone dialing system. The ultimate system of this type is the audio response system as it uses nothing but a touch-tone telephone for the terminal and a single time-shared audio response unit to compose the replies and steer them in audible form onto the telephone line.

COMMUNICATIONS PROCESSING EQUIPMENT

To perform the various data communications functions,

1 Equipment Characteristics

communications processing capability is required. Processing equipment is needed to control the flow of data to and from the computer, to code the information into a suitable form, such as an ASCII message, for transmission, and to decode it upon reception. The functions also include protection and security of the computer facilities as well as resource allocation and billing.

Communications processing may be an integral computer function or it can be handled by special computer communications systems or communications processors. Other processing equipment such as data concentrators, remote multiplexors and audio response units may be employed to reduce communications cost or provide specialized functions.

Integrated Communications Processing

Third generation processors with extensive multi-programming capabilities often handle communications processing because they can provide dedicated as well as integrated operation equally well. These integrated processing systems require only specific transmission control units and/or communications adapter units to interface to the communications facilities and adapt to the particular communications needs.

There are also processors which normally perform communications functions and can be classified as communications processors. These are often dedicated systems and serve as the communications front-end for larger computer systems.

The choice between an integrated communications data processor or dedicated communications processing equipment connected to a "host" computer is based on some of the following considerations:

1. Functions required at the center
2. Hardware availability and expandability requirements
3. Ease in programming and software requirements
4. Volume of communications
5. Total cost

Of the above considerations, perhaps the most far-reaching is the third. Software cost is a major contributor to the overall cost of a communications data processing system. The manufacturer's offering in the areas of communications software and its applicability to the system requirements is of critical importance. Although the use of general-purpose digital computers is quite broad, there are a few control problems that are best handled by special processing equipment due to either obvious functional requirements or economic considerations.

Computer Communications Systems

There is today a need for more harmonious blending of computer and communication techniques throughout the system design. A properly organized computer/communication complex using small identical communications-oriented processors throughout the system makes it possible to achieve the goals of continuous service, adequate traffic, error protection and expandability. It is also likely to result in reduction of line costs through the use of the

more efficient distributed multiple star structures, and in data processing costs by relieving the general purpose computers of many housekeeping chores which they are not designed to do efficiently. A system that can be delivered completely programmed and tested will further result in lower programming and start-up costs than that of a custom design.

The computer communication systems attempt to provide a general solution to a general problem common to a wide variety of information networks. They can be used more or less independently of the various types of computing and peripheral equipment and provide communication for a variety of terminals, with different transmission requirements, operating at a wide range of speeds. The design objectives for implementation of such systems are to separate the data communication and data processing functions, orient the hardware and program elements of the data communication system to its communications task and eliminate the requirement for user programming of the communication system.

Communications Processors

Communications processors are special-purpose computers which contain such advantageous features for handling specific communications characteristics as:

1. Large number of low-speed lines;
2. Anticipated error rates;
3. Required communications control procedures;
4. Character codes and message format employed.

To minimize the cost of terminating a large number of low-speed channels, all of these machines generally employ bit-buffering. This technique saves considerable hardware but also utilizes a very large amount of high-speed memory time. To avoid "gagging" the machine with programmed bit-to-character operations, these machines all have special logic, which uses channel control words to perform the bit-to-character exchanges in usually three memory cycles per channel serviced.

The special switching computers generally have a separate mode for the bit-to-character operations. It operates either continuously, interlaced with normal program execution, or is entered periodically under program control. This communications mode is distinct from the mode under which conventional computer peripheral devices operate. These machines also generally utilized 8-bit characters well before ASCII or "third-generation computers."

It is well established that communications programs required chained list data organization both within core memory and in the random access file. Most applications have achieved this data design purely by program design.

Remote Multiplexers

Frequently, in data communications systems, a large number of low-duty-cycle devices require access to a central processing facility. To give each device a direct line is rather expensive. In these situations, it is frequently possible to obtain a significant cost savings by multiplexing groups of

1 Equipment Characteristics

these devices into a single computer channel. A substantial reduction in communications costs is also obtained when a number of low-speed lines are multiplexed onto a single high-speed line. A variety of remote multiplexers have been developed within the industry to provide for these situations.

There are two basic types of multiplexing techniques in use today: *frequency division multiplexing* (FDM) and *time division multiplexing* (TDM). In frequency division multiplexing the channel bandwidth is split into several smaller frequency bands. Each of these bands is then used as a separate channel. In time division multiplexing, individual bits (bit-TDM) or groups of bits (byte-TDM) are interleaved from several slower data streams into a single high-speed bit stream.

Frequency division multiplexing has the advantage in ease of multipoint operation, that is, the terminals on the multiplexed line can be scattered geographically. Time division multiplexing is more efficient, offering improved cost performance for a large number of subchannels. Of the two, byte-TDM is more efficient than bit-TDM.

Multiplexing is generally less expensive than programmable data concentrators for data combining. Data concentrators, however, may be more economical for specific applications due to specific functional requirements or the existence of a variety of line speeds and transmission modes.

Audio Response Units

The audio response or voice answerback unit is a device used to transmit programmable messages in spoken language. This type of equipment is normally controlled by a general-purpose computer and is used with remote terminals, consisting of telephone equipped with touch-tone capability, to provide answers in an inquiry-response system.

The remote subscriber obtains access to the computer by regular dialing, and then further keys in a brief inquiry via the touch-tone. The computer interprets the inquiry, processes it against master files and composes a reply. It then creates a set of instructions to the audio response unit that cause it to issue the correct audible reply.

There are basically two types of audio response techniques, analog and digital. The analog unit consists essentially of a rotating drum with many tracks. On each track is pre-recorded a standard word or phrase. Associated with each telephone line into the audio response unit is a bank of audio pickup heads, one per track. A message is programmed out of the audio response unit to a given telephone line by programming a sequence of drum revolutions during each of which a particular head is energized and connected to the telephone line.

In the digital recording technique, the voice sound is coded into data bits readily stored on a disc or other bulk-storage. The computer program can manipulate these sounds and provide a very large vocabulary. The digital recording technique also provides less disjointed sounds.

The performance of an audio response unit can be measured by the number of words in its vocabulary and the number of calls it can handle simultaneously. Other factors

are the quality of sound and use of distinguishable vocabulary terms.

TRANSMISSION FACILITIES

The concept of distance that characterizes most data communications applications is that of "many miles." Consequently, it is necessary to think in terms of obtaining communication facilities from the established common carriers, the telephone companies and the Western Union Telegraph Company. While microwave and other radio facilities are doing an excellent job in many application areas, wire is still by far the most widely used medium.

There are two basically different types of service that the common carriers offer. One is the public or exchange service which consists of subscriber lines connected to a switching system, as the telephone network. The other is the private line or channel leasing service which consists of full-time leased point-to-point or multipoint lines connecting locations belonging to only one customer. The cost of the exchange service usually consists of toll charges based on the distance and length of connection, and a monthly service charge to maintain system access. The cost of private line service consists of a monthly rental based on the length and type of lines.

The system designer is primarily concerned with the rate at which data can be transmitted over a link and the cost of that link. The lines available from the common carriers are usually characterized by bandwidth, i.e., narrowband, voiceband and wideband. A number of line types permitting varying transmission speeds are available from the common carrier. These are summarized in Table 1.

To achieve a desired transmission speed (in bps) with an acceptable error rate, it is necessary to specify not only the channel bandwidth and line type but also the line quality, conditioning, the number of wires in the channel and the modem. Private lines can be conditioned at additional cost to improve line quality for data transmission. The telephone company provides three types of *conditioning* of voice lines — types C1, C2 and C4 (formerly types 4A, 4B, and 4C). The conditioned lines have smaller envelope delays and a flatter frequency response.

Modems

The modems or data sets enable higher speed data transmission over long distances. The type of modulation scheme used in the modem equipment inherently affects its performance. Amplitude modulation and its variations are most commonly employed. The improved characteristics of the conditioned lines permit the use of modems with very high data transmission capabilities. The net effect of the combination of line quality and modem equipment is illustrated by Table 2, using the information provided by the Rixon Electronics Company. It should be noted that the higher speeds are available only with the synchronous option.

The modems may be built into the data terminal, purchased from independent manufacturer or rented from the common carrier. No additional equipment is required when using independently purchased modems with the private line leased from the common carrier. The non-common carrier modems are generally less expensive for the same

1 Equipment Characteristics

capability but service and maintenance can be a problem. Non-common carrier equipment can also be used with the public switched network of the telephone company provided that a data access arrangement with network control unit is used for interfacing. This unit is available from the telephone company at \$2.00/month.

The telephone company is also developing new modem equipment with improved performance. The Data Set 203, introduced in 1969, deserves mention in this respect. Major features of the Data Set 203 are the use of the more

efficient MLVSB technique for modulation and the large number of optional speed and service arrangements available. These are summarized in Table 3. The multilevel operation permits speeds as high as 10,800 bps over a voice grade line but higher level options increase susceptibility to errors. Two of the options provide an asynchronous 150 bps simultaneous secondary channel capability. An optional, forward-acting error control unit for Data Set 203 is expected to be available in 1971. This error-correcting code requires about 20% more bits to be transmitted but reduces the error rate substantially.

Table 1. Summary of Line Types

Nominal Speed (bps)	A.T.&T.		Western Union	Half or Full Duplex
	New Names	Former Names		
Narrowband				
45	Type 1002	Schedule 1	Class A	Both
55	Type 1002	Schedule 2	Class B	Both
75	Type 1005	Schedule 3	Class C	Both
150	Type 1006	Schedule 3A		Full Duplex
180			Class D	Both
Voiceband				
600			Broadband Exchange Schedule 1	Full Duplex
1200	Type 3002	Schedule 4	Class G	Both
1400	Type 3002 with C1 conditioning	Type 3003 with 4A conditioning	Class E	Both
2400	Type 3002 C2 conditioning	Type 3004 4B conditioning	Class F	Both
4800	Type 3002 C4 conditioning	Type 3005 4C conditioning	Class H	Both
Wideband				
19,200	Type 8803			Full Duplex
40,800	Type 8801		Wideband Channel	Full Duplex
105,000	Type 5700 or	Telpak C	Telpak C	Full Duplex
240,000	Type 5800			
500,000	Type 5800	Telpak D	Telpak D	Full Duplex

Table 2. Modems, Line Conditioning and Transmission Speed

Rixon Modem	Modulation Scheme	AT&T Line Conditioning	Synch or Asynch	Transmission Speed (bps)
FM-18	Frequency shift keying	C1 or C2	Asynch	1200-1800
PM-24	Phase shift keying	C1 or C2	Synch	1200-2400
Sebit-40C	AM Vestigial sideband	C4	Synch	4000-4800
PM-48	8-phase	C2	Synch	4800
Sebit-72	AM Vestigial sideband	C2	Synch	3600-7200
Sebit-96	AM Vestigial sideband	C4	Synch	4800-9600

Table 3. Summary of Data Set 203 Options

Option	Line Symbol Rate (bauds)	Speed (bps)			Simultaneous Secondary 150 bps Channel	Recommended Use
		Number of Levels				
		2-Level	4-Level	8-Level		
A	2400	2400	4800	7200	No	4800 bps on 4-wire C2 private line
B	1800	1800	3600	5400	Yes	3600 bps on switched network or C2 private line (2- or 4-wire)
C	2400	2400	4800	7200	Yes	4800 bps on switched network or C2 private line (2- or 4-wire)
D	3200	3200	6400	9600	No	6400 bps on 4-wire C2 private line
E	3600	3600	7200	10800	No	7200 bps on 4-wire C2 private line

Acoustic Couplers

Telephone coupler data sets, usually employing acoustic coupling, are available from a number of manufacturers. These couplers allow data to be transmitted via the ordinary telephone set. The acoustic couplers send audible tones over the telephone line similar to those generated in touch-tone signalling. The audible tones are decoded at the other end to recover binary signals.

Acoustic couplers are generally less expensive than modems and have the advantage that the terminal can be easily made portable. Another side benefit is that voice and data needs can be combined. Usually lower transmission speeds such as those with teletypewriters and like terminals are used, but acoustic couplers with speeds of 1200 bits per second are also available on the market. Acoustic coupling is less efficient than direct coupling, and high data transmission speeds are difficult to obtain.

Common Carrier Services

The common carriers, mainly the American Telephone and Telegraph Company (AT&T), General Telephone and Electronics (GT&E) and Western Union Telegraph Company offer a wide variety of communications services both with and without modems. The services mentioned in this section are presented to give an introduction to some of the communications facilities available today. The representatives of the communications companies should be consulted in order to obtain current information on tariffs (interstate and intrastate), availability of service, channels and other devices pertinent to data transmission.

The communications services offered by the carriers take on a variety of forms and names with which the user should become familiar. Some of these services are described below:

- *TWX* or Teletypewriter Exchange service is the narrowband dial network connecting low-speed (100 wpm) terminals formerly operated by AT&T, TWX is in the process of being transferred to Western Union. The charges vary with distance and time and there is a three minute minimum charge.

- *TELEX* is the Western Union Teletypewriter Exchange service providing nominal speed of 66 wpm. There is no 3-minute minimum charge and fractions of minutes are proportionately charged.

- *Private Line Services* are the leased line services provided by both AT&T and Western Union. The variety of line types from narrowband (less than 4 Hz) to wideband (up to 1 MHz) are available. Voice grade leased lines are most commonly employed with extra charges for conditioning. The lines are leased on miles/month basis and the rates are telescopic, dropping by approximately 15% after 250 miles and 25% after 500 miles.

- *Public Telephone Network* provides voiceband switched communications between points throughout the world. The charges are on a call-by-call basis depending on the time taken by the call and distance called. There is a minimum 3-minute or 1-minute charge. This is the most used facility.

- *Wide Area Telephone Service (WATS)* allows the telephone subscriber to have access to other subscribers in a wide geographical area for less than the normal toll charges. WATS service allows inward or outward calling but not both. It provides a single access line, thereby allowing only one call at a time for each service or line.

Under the WATS arrangement, the United States is divided into six zones or bands. These bands are numbered 1 through 6, with each band including those with a lower number. In addition to these bands which are intrastate authorized under FCC tariffs, most states offer an interstate WATS authorized under state tariffs. The subscriber is billed according to the band he uses on a full-time or measured-time basis.

- *Measured WATS* includes a total of 10 hours of usage per month for a fixed monthly charge. Overtime usage is charged at a fixed amount per hour in increments of tenths of an hour. The charges range from \$130/month for band 1 to about \$300/month for band 6.

- *Full Time WATS* provides for unlimited total usage per month on the WATS line for a fixed monthly charge. This

1 Equipment Characteristics

charge is much higher than Measured WATS, ranging from about \$500 for band 1 to about \$2,000 for band 6. The economic crossover point between Measured WATS and Full Time WATS is between 40 to 80 hours of service.

- *Broadband Exchange (BEX)* is a Western Union voice-grade (2 kHz and 4 kHz bandwidth) dial network. The charges for the call depend on areas and time. There is no minimum charge and tenths of minutes are proportionately charged.

- *TELPAC* is the name given to the service in which several telephone-grade lines are leased as a group between two points. It is essentially a pricing arrangement as the rates for service are substantially lower than an equivalent number of voice channels. The group of lines can be employed for any type of usage such as wideband data communications, voice, teletypewriter or facsimile transmission. Telpak C has about 240-kHz bandwidth (60 voice channels) and Telpak D has about 1-MHz bandwidth (240 voice channels).

- *DATA-PHONE* provides for the transmission of data between a variety of terminal equipment using the regular dial telephone network or the WATS service. The cost to the customer is the same as the ordinary communications service cost in addition to a monthly rate for the Data Set.

- *DATA-PHONE 50* is the name of the new switched wideband data communications service of the Bell system. A subscriber can now dial a call and send data at speeds up to 50,000 bits/sec; a 25-fold increase over the present "voiceband" DATA-PHONE service. This service is initially available between four cities: New York, N.Y., Washington, D.C., Chicago, Ill., and Los Angeles, Calif.

- *INFO-COM* is the name of a new store-and-forward message or data communications service developed by Western Union.

- *DIAL-PAK* is the name of a new concept by Western Union that will provide direct computer-to-computer communications using a 48-kHz wideband switched system.

The charts at the end of the section list the characteristics of most data communications equipment. These charts should be used for preliminary screening in the comparative evaluation.

GLOSSARY

The rapid development of data communications technology has given rise to many new technical words and has caused the redefinition of some of the older terms. This glossary is limited to terms that are used primarily in the data communications field.

Whenever possible, standard definitions have been used in this glossary. Most terms were either adapted from other recognized glossaries or specially written for this glossary.

acoustic coupler — a device that converts electrical signals into audio signals, enabling data to be transmitted over the public telephone network via a conventional telephone set.

ASCII — American Standard Code for Information Interchange. Usually pronounced "ask'-ee." This is the code

established by the USA Standards Institute (formerly American Standards Association) to achieve compatibility between data devices. Also called *USASCII*.

amplitude modulation (AM) — a method of transmission whereby the amplitude of the carrier wave is modified in accordance with the amplitude of the signal wave.

asynchronous transmission — transmission in which the interval of time between each character or word of data can vary arbitrarily usually by use of start and stop elements. Also called *start-stop transmission*.

Automatic Calling Unit (ACU) — a dialing device supplied by the communications common carrier, which permits a business machine to automatically dial calls over the communications network.

Automatic Dialing Unit (ADU) — a device capable of automatically generating dialing digits.

bandwidth — the range of frequencies assigned to a channel or system. The difference expressed in Hertz between the highest and lowest frequencies of a band.

baseband signalling — transmission of signal at its original frequencies, i.e., unmodulated.

baud — a unit of signalling speed. The speed in bauds is the number of signal events per second. Baud is the same as bits per second only if each signal event represents exactly one bit condition.

Baudot code — a code for the transmission of data in which five bits represent one character. This code is used in most DC teleprinter systems.

bit rate — speed at which bits are transmitted usually expressed in *bits per second (bps)*, *kilobits per second (kb/s)* or *megabits per second (Mb/s)*.

broadband — see wideband.

broadband exchange (BEX) — public switched communication system of Western Union featuring various bandwidth full-duplex connections.

buffer — a storage device used to compensate for a difference in rate of data flow when transmitting data from one device to another.

carrier — a continuous frequency capable of being modulated or impressed with a signal.

carrier system — a means of obtaining a number of channels over a single path by modulating each channel upon a different "carrier" frequency and demodulating at the receiving point to restore the signals to their original form.

channel — a one-way transmission facility between two or more points.

channel capacity — a term which expresses the maximum bit rate that can be handled by the channel.

circuit — a means of both-way communication between two points, comprising associated go and return channels.

1 Equipment Characteristics

communications common carrier – a company which furnishes communications services to the general public and which is subject to public utility regulation.

conditioning – the addition of equipment to a leased voice-grade channel to make it suitable for efficient data transmission.

cross talk – the unwanted transfer of energy from one circuit, called the *disturbing* circuit to another circuit called the *disturbed circuit*.

Cyclic Redundancy Check (CRC) – an error detection scheme in which the check character is generated by taking the remainder after dividing all the serialized bits in a block of data by a predetermined binary number.

DATA PHONE – a trade mark as well as a service mark of the AT&T Company. As a trade mark it identifies the data sets manufactured and supplied by the Bell System for use in the transmission of data over the regular telephone network. As a service mark it identifies the transmission of data over the regular telephone network.

DATA-PHONE 50 – a public switched communications service of the Bell System featuring high-speed data communications at 50 kb/s.

data set – a device which converts the signals from a business machine into signals suitable for transmission over communications line. (See also *modem*).

DATASPEED – an AT&T marketing term for a family of medium-speed paper tape transmitting and receiving units.

delay distortion – distortion resulting from non-uniform speed of transmission of the various frequency components of a signal through a transmission medium.

DIAL-PAK – the name of a new service concept by Western Union that will provide direct computer-to-computer communications using 48 KHz wide band switched system.

Direct Distance Dialing (DDD) – a telephone exchange service which enables a user to dial directly telephones outside his local area without operator assistance.

duplex – simultaneous two-way independent transmission in both directions. Also referred to as full-duplex.

EBCDIC – Extended Binary Coded-Decimal Interchange Code. An 8-bit character code used primarily in older IBM equipment.

echo – a portion of the transmitted signal returned from the distant point to the source with sufficient magnitude and delay so as to cause interference.

echo suppressor – a device used to suppress the effects of an echo.

equalization – compensation for the increase of attenuation with frequency. Its purpose is to produce a flat frequency response.

frequency division multiplexing (FDM) – dividing the

available transmission frequency range into narrower bands each of which is used for a separate channel.

frequency modulation (FM) – a method of transmission whereby the frequency of the carrier wave is changed to correspond to changes in the signal wave.

frequency shift keying (FSK) – also called frequency shift signalling. A method of frequency modulation in which frequency is made to vary at significant instants by smooth as well as abrupt transitions.

full-duplex (FD, FDX) – see *duplex*.

half-duplex (HD, HDX) – a circuit designed for transmission in either direction but not both directions simultaneously.

INFO-COM – a new store-and-forward message or data communications service developed by Western Union.

leased line – a line reserved for the exclusive use of a leasing customer without interexchange switching arrangements. Also called private line.

local exchange – an exchange in which subscribers lines terminate. (Also called *end office*.)

Long Distance Xerography (LDX) – a name used by Xerox Corporation to identify its high-speed facsimile system which uses a wide band data communications channel.

longitudinal redundancy check (LRC) – a system of error control based on transmission of a block check character based on preset rules. The check formation rule is applied in the same manner to each character.

mark – presence of signal. In telegraphy, mark represents the closed condition or current flowing. Equivalent to a binary one condition.

message switching – a technique whereby a message is received from the calling party, held until the proper outgoing circuit is available and then retransmitted. (Also see *store and forward*).

MLVSB – Multilevel pulse amplitude modulation with Vestigial Sideband spectrum shaping – a fundamentally more efficient modulation technique employed by the Bell System Data Set 203.

modem – a contraction of modulator-demodulator. A device which modulates and demodulates signals transmitted over communications facilities.

multiplexing – the division of a transmission facility into two or more channels. (also see *Frequency Division Multiplexing, Time Division Multiplexing*).

multiplexer – a device used for multiplexing which may or may not be a stored program computer.

narrowband channels – sub-voice grade channels characterized by a speed range of 100 to 200 bps.

noise – undesirable disturbances in a communications system. Noise can generate errors in transmission.

1 Equipment Characteristics

parallel transmission — method of data transfer in which all bits of a character or byte are transmitted simultaneously either over separate communication lines or on different carrier frequencies on the same communication line.

parity check — addition of non-information bits to data, making the number of ones in each grouping of bits either always odd for *odd parity* or always even for *even parity*. This permits single error detection in each group.

phase modulation (PM) — a method of transmission whereby the angle of phase of the carrier wave is varied in accordance with the signal.

Polling — a means of controlling communications lines. The controlling device invites (or polls) terminals to send messages as distinguished from free-for-all basis (referred to as contention).

private line — see leased line.

pulse code modulation (PCM) — modulation of a pulse train in accordance with a code.

serial transmission — a method of transmission in which each bit of information is sent sequentially on a single channel rather than simultaneously as in parallel transmission.

signal-to-noise ratio (SNR) — relative power of the signal to the noise in a channel. Usually measured in decibels.

simplex mode — operation of a channel in one direction only with no capability for reversing.

store-and-forward — messages are accepted from the sender wherever he offers it, held in a physical store, and forwarded to the receiver whenever he is able to accept it.

synchronous transmission — the data characters and bits are transmitted at a fixed rate with the transmitter and receiver synchronized.

tariff — the published rate for a specific unit of equipment, facility or type of service provided by a communications common carrier.

Teletypewriter Exchange Service (TWX) — a public teletypewriter exchange (switched) service in United States and Canada formerly belonging to AT&T Company which is now being purchased by the Western Union Telegraph Company. Both Baudot- and ASCII-coded machine are used.

Telex Service — a Western Union World-wide teletypewriter exchange service that uses the public telegraph network. Baudot equipment is used.

TELPAK — the name given to the pricing arrangement by AT&T in which many voice-grade telephone lines are leased as a group between two points.

tie line — a private line communications channel of the type

provided by communications common carriers for linking two or more points together.

time-division multiplexing — a system of multiplexing in which channels are established by connecting terminals one at a time at regular intervals by means of an automatic distribution.

touch-tone — AT&T term for *pushbutton dialing*. The signal form is multiple tones.

USASCII — See *ASCII*.

voice-grade channel — a channel used for speech transmission usually with a frequency range of 300 to 3400 Hertz. It is also used for transmission of analog and digital data. Up to 10,800 bits per second can be transmitted on a voice-grade channel using special modems.

WATS (Wide Area Telephone Service) — a service provided by telephone companies in the United States which permits a customer to make calls to or from telephones in specific zones for a flat monthly charge. The monthly charges are based on size of the zone instead of number of calls. WATS may be used on a measured-time or full-time basis.

wideband — communications channel having a bandwidth greater than a voice-grade channel characterized by data transmission speeds of 10,000 to 500,000 bps.

words per minute (WPM) — a common measure of speed in telegraph systems. In telegraphy a word is six characters (including space). For Baudot code a speed of 60 wpm is about 45 bps.

References

1. W. R. Bennett and J. R. Davey, "Data Transmission," McGraw-Hill, 1965.
2. "Transmission Systems for Communications," Members of the Technical Staff, Bell Telephone Laboratories, Inc., 1964.
3. James Martin, "Telecommunications and the Computer," Prentice-Hall, 1969.
4. James Martin, "Teleprocessing Network Organization," Prentice-Hall, 1970.
5. S. L. Mathison and P. M. Walker, "Computers and Telecommunications: Issues in Public Policy," Prentice-Hall, 1970.
6. "1970 Communications and Terminals Supplement," Computerworld, July 1, 1970.
7. L. N. Holzman and W. J. Lawless, "The Data Set 203," Computer, Sept/Oct 1970.
8. W. W. Peterson, "Error-correcting Codes," The M.I.T. Press, 1961.

**GULTON
COMPUTER TERMINALS &
TAPE READER/RECORDERS**

Optimum performance,
convenience,
and reliability.
High speed.
Solid-state.
Minimum
maintenance.
Long Life.



**DATASERV
TELETYPE TERMINALS**

Highly
sophisticated
time-share
terminals.
IC design.
Utmost
dependability
and freedom
from error.
Portable.

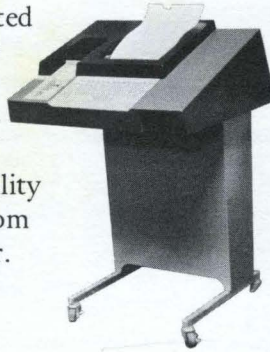

DATASERV

One of the PURDY Group of Companies

**TERMINALS
PERIPHERALS &
INTERFACES for
ELECTRONIC
DATA PROCESSING**

**EXECUPORT PORTABLE
TRANSCEIVER TERMINAL**

Operates anywhere, over
ordinary telephone lines.
Prints transmitted and
received data.
High speed.



**LIVERMORE MODEL 81A
ACOUSTICAL DATA SET/
MAGNETIC TAPE STORE**

Data communications interface
along with magnetic tape storage.



Inexpensive
tape buffer
store.

**DELTA VIDEO
DISPLAY TERMINALS**

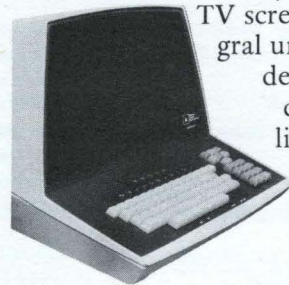

Full keyboard and
TV screen in integral unit. Insert,
delete, blink
characters,
lines. Color
coding.
Tabular
displays.

**LIVERMORE DATA SYSTEMS
DATA MODEMS & COUPLERS**



For linking any data-processing
equipment to a telephone line,
Numerous options:
full/half duplex, power supply,
coupling mode, etc.

**DATA SERV
DIGITAL MODEMS**

Couple any
data processing
device to any
other. Error-free.
Trouble-free.
Small, high-speed,
low-powered,
low-cost.



**DECICOM DATA
COLLECTION STATIONS**

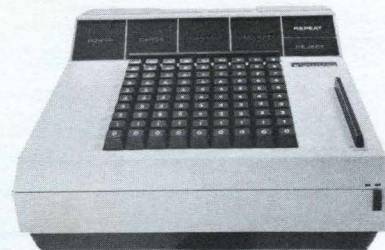

Simple card-reader and numerical
keyboard input terminals for
collection of data of identical
format. Low cost. No training
time.

FULL SUPPORT SERVICES

- Maintenance
- Repair
- Equipment Loans
- Review
- Updating
- Operator Training

**COMPLETE TURNKEY
SYSTEMS**

From the analysis of your
requirements to installation
and checkout. DATASERV
supervises and expedites
all elements of the system.

ANY TERMS

LEASE — options to Buy, etc.
PURCHASE — with complete
support services.
RENT — month-to-month, with
services.

CONDENSED SPECIFICATIONS TERMINALS

GULTON LG 10/30

Computer Terminal & Tape Reader/Recorder

TRANSMISSION:

Speed: 10, 15, or 30 characters/sec (110, 150, or 300 baud).
Mode: Full or half duplex, asynchronous.

PRINTING — Impact, original plus 5 copies:

Spacing: 10 characters/inch, up to 132 positions/line, adjustable; 6 lines/inch.
Characters: Any 63 of 128 available, USASCII.
Keyboard Controls: 26 and escape.
Paper, Ink: 6-part sprocketed (or 3-part "No Carbon Required"), up to 14-7/8" wide. Black, red, green, or violet ink.

TAPE READER/RECORDER, LG 10/30 ASR

Speed: 10, 15, or 30 characters/sec.
Tape: 1/8" cassette, 60 min. storage, 50,000 characters at 30 characters/sec.
 Fully incremental write (interfaces to any 8-level RS-232B).



EXECUPORT 300 — Page Printing Transceiver Terminal

INPUT: 96-character Alphanumeric Keyboard.

OUTPUT: Thermal page printer.

USASCII columns 2, 3, 4, 5, 6 & 7; 10 characters/inch (80/line); 6 lines/inch.

DATA TRANSMISSION

Speed: 10, 15, or 30 characters/sec. (110, 165, or 300 baud).
Mode: Full or half duplex, serial by bit.
Parity: Odd or even.

Computer Interface: Integral Acoustic Coupler, compatible with AT&T 103 data set. EIA RS-232 optional.

DIMENSIONS: 18" x 18" x 6" case (27 pounds).

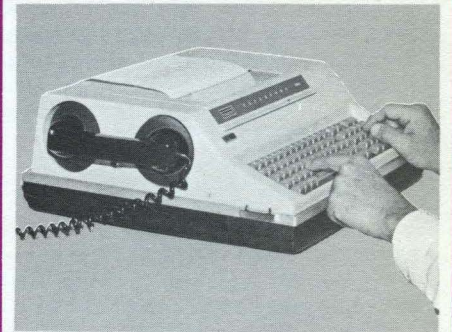

DELTA 1, TELTERM 1, 2, 3 — Video Display Terminals

Model	TelTerm 1, 2, 3	Delta 1
Display	14" TV screen. 500 characters standard, 80/line, 27 lines.	12" TV screen, 960 characters standard, 40/line, 24 lines.
Character Repertory	64 standard (96 optional). USASCII.	64 standard. USASCII. Graphics display.
Editing Modes	ERASE character, message, memory. INSERT or DELETE characters or lines (except TelTerm 1). BLINK any character or group, 2 times/sec. FORMAT — fixed and variable data; transmit only variables.	
Paging	Page through memory line by line using display area as a window. Page to either start or end of memory.	COLOR — Red, green, yellow, or blue character displays, selectable.
Transmission	Full or half duplex.	Full or half duplex.
Input/Output Communications	ATT 103, 201, 202 data set, acoustic coupler.	
	Up to 600 baud standard (to 9600 optional), asynchronous.	Synchronous or asynchronous, any rate up to 15,000 byte.
Cursor	Blinking underline. 8 controls.	Blinking underline. 6 controls.
IBM Compatibility	Talks directly to IBM 360 via 2701 Data Adaptor unit. (TelTerm 3 and Delta 1 only).	
Options & Accessories	Line drawing set, Light pen, Multiplexers, Printers, Recorders, Card readers, Built-in Modems, Computer Interfaces, Slave monitors.	

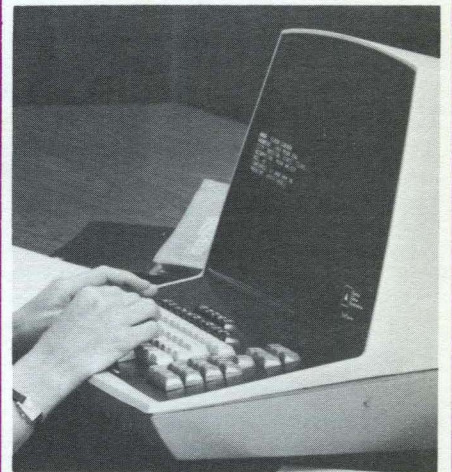

DATASERV 110A — Integrated Acoustic Data Terminals COUPLER

Frequencies: Transmit— 1070 and 1270 Hz. Receive — 2025 and 2225 Hz.

LCM (Line Condition Meter): Indicates carrier on and carrier strength.

Coupling: Acoustic. Compatible with Dataphone 103 A2 or 101.

Transmission: Full or half duplex.

TELETYPE

Speed: 10 characters/sec (110 baud).

Characters: 64 standard; 74 or 89 per line.

Code: USASCII 8 level, 1 start, 2 stop. 11 bit total.

Printer: Impact type page printer.

Paper, Feed: 8½" wide, friction or sprocket feed.

MODELS: 110AM— mounted on mobile cart.
 110AC — mounted on "Caribar" frame — fits automobile seats.

OPTIONS: ASR-33 modification: 105 characters/line.
 Acoustic Silencer: Hood reduces acoustic interference.



CONDENSED SPECIFICATIONS COUPLERS, MODEMS, DATA SETS and MAGNETIC TAPE UNITS

DATASERV DIGITAL DATA MODEMS

DATA RATE: Up to 300 bits/sec.
MODES: Full or half duplex, asynchronous. "Originate" or "Answer" (selectable).
LINE: Voice-grade (dial-up) telephone line.
COUPLING: Bell System Data Access Arrangement (Model 1321) or built-in acoustic coupling (Model 1324).
CARRIER FREQUENCIES: 1070 Hz, 1270 Hz, 2025 Hz, 2225 Hz.
TRANSMITTER: Crystal-controlled digital frequency-shift modulator.
RECEIVER: Crystal-controlled digital discriminator.
TRANSMIT LEVEL: -10 dBm to +5 dBm (adjustable).
RECEIVER SENSITIVITY: -35 dBm to +5 dBm.
INTERFACE: Compatible with RS-232C.
OPTIONS: P.C. card or stand alone self powered.

LIVERMORE DATA SYSTEMS MODEL 81A ACOUSTICAL DATA SET/MAGNETIC TAPE STORE

DATA RATE: Up to 300 Baud.
OPERATING FREQUENCIES:

Originate Mode	Transmit F1	Space - 1070 Hz	Mark 1270 Hz
Answer Mode	Receive	Space - 2025 Hz	Mark 2225 Hz
	Transmit F1	Space - 2025 Hz	Mark 2225 Hz
	Receive	Space - 1070 Hz	Mark 1270 Hz

EIA INTERFACE: Compatible with the RS-232C Standards.
TELETYPE INTERFACE: 20 milliampere loop, wired for full duplex.
REMOTE TAPE RUN INTERFACE: Allows remote timing and control of the tape drive electronics.
SWITCHES: Duplex - Half/Full/Local Mode - Answer/Originate
 Tape Run - (Local Control) Send - (Record/Play) Receive - (Record/Play)
 Power On
RECORDER CONTROLS: Record Control Tape Drive Control
 Write Inhibit Control Record Level Meter
TAPE RECORDING: Norelco Tape Cassette Carry Corder "150".
LAMPS: Received Data Transferred Received Carrier Detected
 Power On Tape Run

SERIES 71 - DATA MODEMS

Model Number (Note 1)	Integral Package	P. C.-Card Construction	Acoustic Coupling	Direct-Access Coupling	Answer Mode	Originate Mode	Power Supply	Full Duplex	Half Duplex	Indicators (Note 2)
71A	✓	-	✓	-	-	✓	Integral	-	✓	DT/CD
71B	✓	-	✓	-	-	✓	Integral	-	✓	DT/CD
71C	✓	-	✓	-	-	✓	Integral	✓	✓	DT/CD
71D	✓	-	✓	-	-	✓	Integral	-	✓	DT/CD
71E	✓	-	✓	-	-	✓	Integral	-	✓	DT/CD
71F	✓	-	✓	-	-	✓	Integral	-	✓	DT/CD
71G	✓	-	✓	-	-	✓	Integral	✓	✓	DT/CD
71H	✓	-	✓	-	-	✓	Integral	-	✓	DT/CD
71J	✓	-	✓	-	-	✓	Integral	✓	✓	DT/CD
71K	-	✓	✓	-	-	✓	(Note 3)	-	✓	(Note 4)
71L	-	✓	✓	-	-	✓	(Note 3)	-	✓	(Note 4)
71M	-	✓	✓	-	-	✓	(Note 3)	✓	✓	(Note 4)

- All models compatible with Bell 103A2, RS-232, and Teletypewriter (20 mA).
- DT = "Data Transferred" Indicator. CD = "Carrier Detected" Indicator.
- External power required: $\pm 12 \pm 0.1$ VDC @ ± 200 mA, Regulated to $\pm 0.1\%$.
- DT/CD circuits provided for external indicators (not supplied).

ACCESSORIES & SUPPLIES

Formatters & Concentrators; A/D Conversion Systems; Code Converters.
 Cards, Forms, Badges, Tags - all types; Teletypewriter paper - single or multiple;
 Strip-Printer rolls or 2-folds - all in standard, inkless, thermal, photographic, and
 electro-responsive formulation... plain or pre-formatted.

CONDENSED SPECIFICATIONS— DECICOM DATA COLLECTION STATIONS

SERIES DCS-1000: Single card-reader for fixed-format input.

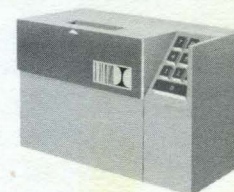

SERIES DCS-2000: Card-reader plus adding-machine keyboard for fixed format input plus quantities, prices, etc.

SERIES DCS 2000

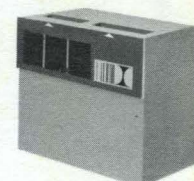

SERIES DCS-3000: Card-Reader plus adding machine keyboard plus up to five response indicators ("OK-Transmit," "Out of Stock," "Account Overdrawn," etc.)

SERIES DCS 4000

SERIES DCS-4000: Two card-readers for twin fixed-format input (e.g., book card & borrower's card), plus response.



SERIES DCS-5000: Two card-readers plus cash-register keyboard (for numerical coding, etc.), plus response.

SERIES DCS 5000

SERIES DCS-6000: Card-reader plus cash-register keyboard, plus response, plus tape print-out for both data entered and confirming response.

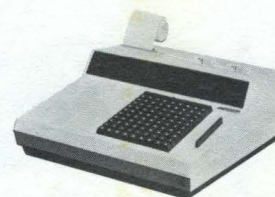

SERIES DCS-7000: Two card-readers plus cash-register keyboard, plus response, plus tape print out.

SERIES DCS 7000

DATASERV SPECIAL SYSTEMS

Most general purpose computers and data processing systems are designed to be "all things to all men." None of them and, very likely, no one manufacturer has the capabilities or combination of elements perfectly tailored to a given set of specific requirements.

Dataserv "Special Systems" believes that a direct custom assembly is the most efficient and economical solution to a specific problem. "Special Systems" is committed to no particular line or lines of EDP equipment, and in designing a specific system chooses freely among available units and components to achieve a combination tailor-made to the user's needs.

"Special Systems" has experience in almost every area of commercial and scientific data processing, is constantly up-dating its firsthand knowledge of new devices and equipment, and is prepared to examine any problem - however "special" - and to design and supply a unique solution for it.

DATASERV "SPECIAL SYSTEMS",
 15114 Downey Avenue, Paramont, California 90723
 (213) 631-6161

Branch Offices: (see page 2).

DATASERV IS

a logical response to the enormous and increasing use of and need for electronic data processing in almost every segment of today's business, industry, science, medicine, technology, education, and government.

The need may vary from the simplest kind of storage and retrieval of single-format, repetitive data to highly sophisticated manipulation of complex sets of facts or hypotheses. Yet most people who require any of these functions know nothing whatever about computing, programming, or electronic data processing.

This is where DATASERV comes in. The company maintains a very large inventory — \$750,000 worth on the average — of data-processing equipment: terminals of many kinds, as well as peripheral recording and data-storage equipment, and a wide range of interface accessories. It also deploys a highly knowledgeable engineering staff, to analyze the user's requirements, and then to recommend the kind of computer service and terminal equipment that will best satisfy those requirements.

DATASERV is currently supplying terminal systems to retail businesses, manufacturers, laboratories, hospitals, libraries, engineers, accountants, consultants, sales offices and salesmen . . . in activities of all sorts . . . at a rate now approaching 100 installations per month.

DATASERV PROVIDES

first, expert, completely objective advice on what you will need to get maximum benefit from data-processing. (Because we can furnish every type of data processing equipment our recommendations are free from any "technical prejudice.")

Second, encyclopedic knowledge of the field. We know where the best time-sharing facilities for you are, what they will cost, what programs and systems have already been developed and proved, and exactly what you will require in the way of "hardware and software" for optimum results.

Then we install the hardware — in working order,

Finally, DATASERV supplies a complete array of supporting services from operator training, through maintenance and repair (including equipment loans to minimize "down time"), to periodic review of your system to modify or expand it, if necessary.

DATASERV GUARANTEES

the validity of the entire system installed.

It will do the job promised efficiently and dependably for the full period of the service contract.

DATASERV support services implement this guarantee, providing all routine maintenance and repairs, and temporary replacement of any system element when necessary.

DATASERV STOCKS

a wide variety of terminal equipment, ranging from simple card or badge readers, with or without adding machine or cash register keyboards, to elaborate transceivers with 96-character keyboards, some with page-size video displays that can be used to edit and manipulate data before transmission or storage. Some terminals are portable for field use anywhere.

DATASERV provides a broad range of peripheral devices — printers, tape recorders or readers, card punches or readers for permanent ("hard-copy") recording of data.

It also provides telephone or telephone couplers as well as modems, buffers, translators, etc. that serve as links, or "interfaces" between peripheral devices and the transmitting terminal (and its line to the computer) or between different peripherals at the same location if they have different codes or data rates or sequences.

DATASERV also stocks all necessary supplies and accessories.

DATASERV IS PREPARED

to provide your system on Your Terms

. . . **LEASING** arrangements are available on all systems, from one to five years, with or without the option to buy, to extend the lease, or to replace it by expanded or modified system leases, at some later date.

. . . **PURCHASE** of the complete system installation, outright, is always available — without relinquishing the advantages of the support-services package, at the same annual rates as in leases or rentals.

. . . **RENTAL** on a month-to-month basis is offered on many systems, and on all continuing services in the standard support package.

. . . **TURNKEY SYSTEMS** are the rule rather than the exception at DATASERV. From the analysis of your requirements until the day you take over a complete, functioning system. DATASERV supervises, guides, advises, and expedites all elements of the system.

. . . **DELIVERY FROM STOCK** is typical at DATASERV. It is unusual for more than ten days to elapse between the firm commitment and the installation of the hardware.

CALL — In San Francisco Area, call (415) 342-0877;
770 Airport Boulevard Burlingame, California 94010

In Salt Lake City, Utah, call (801) 322-2345;
138 South 2nd East, Salt Lake City, Utah 84111

In Los Angeles Area, call (213) 631-6161;
15114 Downey Avenue, Paramount, California 90723

In Denver Area, call (303) 794-4225;
1449 W. Littleton Boulevard, Littleton, Colorado 80120

In Portland, Oregon call (503) 665-8125
P. O. Box 108, Fairview, Oregon 97024

In Phoenix, Arizona, call (602) 277-7983;
4747 North 16th Street, Phoenix, Arizona 85016

In Seattle, Washington, call (206) 763-2755
6133 Maynard Avenue South, Seattle, Washington 98108

1 Equipment Characteristics

ACOUSTIC COUPLERS

COMPANY	COMDATA	COMDATA	COMDATA	COMDATA	COMMUNICATIONS LOGIC
MODEL	301A2	301P2	301B2	310A2	Coupler II
FIRST DELIVERY YEAR	1968	1970	1969	1970	1969
BASIC PURCHASE PRICE	\$295	\$295	\$315	\$210	\$295
LEASE RATE/MONTH	\$10.62	\$10.62	\$11.34		
TRANSMISSION SPEED (bps)	300	300	300	300	0-300
SIMULTANEITY	FD	FD	FD	FD	HD & FD
MODES	originate, answer & originate/answer	originate or answer	originate, answer & originate/answer	originate or answer	originate only
COMMENTS	RS-232 & TTY interface. Carrier detector & indicator.	Kit form avail for series 33 Teletype w/o mod.	Hard-wire conn to DAA as well as acoustic coupling.	Separate acoustic coupling unit. Modems - 4"x5" P.C. card.	answer mode, DAA opt. TTY or EIA interface.

ACOUSTIC COUPLERS

COMPANY	COMPUTER COMMUNICATIONS	COMPUTER-LINK	CYBERMATION	DATA ACCESS SYSTEMS	DATA ACCESS SYSTEMS
MODEL	CC-302 Telephone Coupler	TC800	1103AC	1210	1610
FIRST DELIVERY YEAR	1968	1970	1970	1969	1969
BASIC PURCHASE PRICE	\$600	\$300	\$340	\$295	\$395
LEASE RATE/MONTH	\$24	\$10		\$18	\$22
TRANSMISSION SPEED (bps)	300	300	to 1200	300	300
SIMULTANEITY	HD & FD	HD & FD	HD & FD	HD & FD	HD & FD
MODES	originate mode	originate only	originate only	originate only complete 103 capability	ans/orig, ans send/ans st
COMMENTS		Acoustic coupling-xmit. Inductive coupling-rcv.		Auto answer acoustically or hard-wire	Auto answer acoustically or hard-wire

1 Equipment Characteristics

ACOUSTIC COUPLERS

COMPANY	DATA PRODUCTS TELECOMMUNICATIONS	DATASERV	DELTA DATA SYSTEMS	DESIGN ELEMENTS	DIGITAL TECHNIQUES
MODEL	703AC	71 series - Livermore Data Systems	Delta I Data Set 4004	Design 76	2300
FIRST DELIVERY YEAR	1970	1970	1969	1969	1968
BASIC PURCHASE PRICE	\$380	\$275	\$650	\$185-\$345	\$295
LEASE RATE/MONTH		\$9.35	\$19 incl maint		\$18
TRANSMISSION SPEED (bps)	300	300	300	over 300	300
SIMULTANEITY	HD & FD	HD & FD	HD&FD upright-inverted	HD & FD switchable	HD & FD
MODES	originate/answer, originate only	originate/answer	originate	originate only, answer only, originate & answer	originate only
COMMENTS	Monitor speaker, direct line (DAA) interface, TTY & RS-232 interface, local/remote test modes.	Molded plastic case.	Operation independent of sig level changes.	Uses LC filtering; upright/inverted acoustic or inductive pick-up switch.	33/35 Teletype interface & mag rcvr coupling.

ACOUSTIC COUPLERS

COMPANY	DIGITAL TECHNIQUES	DIGITAL TECHNIQUES	DIGITAL TECHNIQUES	DIRECT ACCESS COMPUTING	I/ONEX DIV. OF SONEX
MODEL	2310	3300	3310	Telemate 300	31
FIRST DELIVERY YEAR	1968	1969	1969		1970
BASIC PURCHASE PRICE	\$352	\$289.75	\$311.50	\$250	\$280
LEASE RATE/MONTH	\$20	\$17	\$18		
TRANSMISSION SPEED (bps)	300	150	150	300	300
SIMULTANEITY	HD & FD	HD & FD	HD & FD	HD & FD	HD & FD
MODES	originate only	originate only	originate only	originate only/answer only/answer originate	async, originate only
COMMENTS	33/35 Teletype interface & acoustic coupling on receive	Designed as modular part of 33/35 Teletype. Mag coupling on receive.	Designed as modular part of 33/35 Teletype. Acoustic coupling on receive.	TTY Model 33 interface.	

ACOUSTIC COUPLERS

COMPANY	I/ONEX DIV. OF SONEX	I/ONEX DIV. OF SONES	MOHAWK DATA SCIENCES	NATIONAL MIDCO INDUSTRIES	MULTITECH DATA
MODEL	30	Type 20 Data Card	2010	ADC 300	440/MS
FIRST DELIVERY YEAR	1970	1970	1970	1969	1968
BASIC PURCHASE PRICE	\$295	\$115	\$395	\$336	\$825
LEASE RATE/MONTH					
TRANSMISSION SPEED (bps)	300	300	500	0 to 300	1800/5
SIMULTANEITY	HD & FD	HD & FD	HD & FD	HD & FD switchable	HDX
MODES	async, originate only	async, originate only	originate and answer	originate only or answer only	originate
COMMENTS				Various options avail.	

ACOUSTIC COUPLERS

COMPANY	MULTITECH DATA	MULTITECH DATA	NOVATION	OMNITEC	RFL INDUSTRIES
MODEL	440/MQ	440/MX	TM-103A/DC-103A	703A Originate/ Auto-Answer	13A0/TTY
FIRST DELIVERY YEAR	1969	1971	1971	1970	1969
BASIC PURCHASE PRICE	\$635	\$1025	\$415	\$445	\$430
LEASE RATE/MONTH			\$29		\$25
TRANSMISSION SPEED (bps)	600/600	1200/1200	330/440	300	300
SIMULTANEITY	FD	"Flip" mode HDX	HD & FD	HD & FD switchable	HD & FD switchable
MODES	originate or answer	originate	answer/originate	originate/answer DAA	originate only
COMMENTS			Various options avail.	Designed for auto unattended term operation Bell 103A2 compatible.	EIA interface also avail.

COMMUNICATIONS-ORIENTED PROCESSORS

COMPANY	APPLIED SYSTEMS	COMPAT	COMPUTER COMMUNICATIONS
MODEL	ASC1170 Communications Processor	COMFILE 88-33	CC-70 Computer Communicator
FIRST DELIVERY YEAR	1970	1970	1970
BASIC PURCHASE PRICE (W/4K)	\$5000	\$13,000	\$30,000
LEASE RATE/MONTH	varies w/options	\$438	\$900
MEMORY			
Word Length (bits)	8 or 9 core; 16 ROS	16	16
Min/Max Size (words)	256 words-32K bytes	4K-16K	4K-32K
Cycle Time (us)	1.1 μ sec core; 220 nsec ROS	2	1
Type	core or ROS	core	core & ROM
NUMBER OF CHANNELS			
Narrow-Band	64	4	120
Voice-Band	8	2	120
Broad-Band	1		120
MAX TOTAL COMMUNICATIONS DATA RATE	50K bytes/sec	48KC	10,000 char/sec (avg); 20,000 char/sec (peak)
ERROR CONTROL	parity options & as programmed	auto retrans	depends on terminal used
COMMENTS	Pre-processor or remote data concentrator		Interfaces: IBM 360/370/1130, XDS Sigma series, CDC 3000/6000 series.

COMMUNICATIONS-ORIENTED PROCESSORS

COMPANY	COMPUTER COMMUNICATIONS	COMPUTER TERMINALS OF MINNESOTA	CYBERMATION
MODEL	CC-71 Communications Concentrator	UT 1000	80
FIRST DELIVERY YEAR	1971	1970	1970
BASIC PURCHASE PRICE (W/4K)	\$28,500	\$41,000	\$4500
LEASE RATE/MONTH	\$860	\$1550	\$105 (5 yr full pay)
MEMORY			
Word Length (bits)	16	8	8 plus parity
Min/Max Size (words)	4K-32K	4K-32K	1K-32K
Cycle Time (us)	1	4	1
Type	core and ROM	core	core
NUMBER OF CHANNELS			
Narrow-Band	120	n/a	32/64
Voice-Band	120	2	8
Broad-Band	120	n/a	1
MAX TOTAL COMMUNICATIONS DATA RATE	10,000 char/sec (avg); 20,000 char/sec (peak)	5000 baud	500 KB/sec
ERROR CONTROL	depends on terminal used	cyclic parity	parity, CRC, LRC, VRC
COMMENTS	Auto retrans under CC-71 software control.	IBM 360 & Univac 1108 compatible.	

1 Equipment Characteristics

COMMUNICATIONS-ORIENTED PROCESSORS

COMPANY	DIGITAL COMPUTER CONTROLS	DIGITAL COMPUTER CONTROLS	DIGITAL SCIENTIFIC
MODEL	D-112	D-216	META 4 Series 16, Model 4001
FIRST DELIVERY YEAR	1970	1970	1970
BASIC PURCHASE PRICE (W/4K)	\$3990		\$15,650
LEASE RATE/MONTH		n/a	\$600
MEMORY			
Word Length	12	16	16
Min/Max Size (words)	4096-37,768	4096-37,768	4K-131K
Cycle Time (us)	1.2	1.2	0.90
Type	core	core	core & ROM
NUMBER OF CHANNELS			
Narrow-Band	128 max	256 max	to 256 lines
Voice-Band	8 max	16 max	16 lines
Broad-Band	2 max	4 max	16 lines
MAX TOTAL COMMUNICATIONS DATA RATE	~16,000 char/sec	~32,000 char/sec	
ERROR CONTROL	parity	parity	
COMMENTS	PDP-8 compatible	PDP-11 compatible	4K core plus 1K ROM

COMMUNICATIONS-ORIENTED PROCESSORS

COMPANY	FEDDER DATA CENTERS	GE TELECOMMUNICATION PRODUCTS	INTERACTIVE DATA SYSTEMS
MODEL	APT 1000	DigiNet 1600 Remote Data Concentrator	IDS-64 Communications System
FIRST DELIVERY YEAR	1970	1970	1970
BASIC PURCHASE PRICE (W/4K)	\$14,950	by request	\$22,000
LEASE RATE/MONTH	\$350	by request	\$1000
MEMORY			
Word Length (bits)	8, 4K bytes	16	16
Min/Max Size (words)	4K-32K	4096-32,768	4K-32K
Cycle Time (us)	1.1	1.6	1
Type	core	core	core
NUMBER OF CHANNELS			
Narrow-Band		256	256
Voice-Band	one voice	64	64
Broad-Band			10
MAX TOTAL COMMUNICATIONS DATA RATE	150/sec	33,927 16-bit words/sec	50K baud
ERROR CONTROL	lat, long, spiral parity, auto retrans	high-speed chnls-hdwre parity; low-speed async chnls-software	yes
COMMENTS	IBM & 2780 compatible.	Modems or freq div multiplex built-in.	

COMMUNICATIONS-ORIENTED PROCESSORS

COMPANY	INTERDATA	INTERDATA	ITT-DATA EQUIPMENT & SYSTEMS
MODEL	14	15	Preprocessor ITT 600
FIRST DELIVERY YEAR	1969	1969	1970
BASIC PURCHASE PRICE (W/4K)	\$13,500	\$21,900	\$43,300
LEASE RATE/MONTH	n/a	n/a	\$1300
MEMORY			
Word Length (bits)	16	16	24
Min/Max Size (words)	4 KB-64 KB (dir addressable)	4 KB-64 KB (dir addressable)	4K-64K
Cycle Time (us)	1	1	2
Type	core	core	core
NUMBER OF CHANNELS			
Narrow-Band	32	64	1024
Voice-Band	1	2	192
Broad-Band	0	1	64
MAX TOTAL COMMUNICATIONS DATA RATE	7200 band	12,000 band	86,400 char/sec
ERROR CONTROL	software	software	hard wired lat/long
COMMENTS	IBM 360 interface.	IBM 360 interface.	Relieves CPU of all repetitive tasks.

COMMUNICATIONS-ORIENTED PROCESSORS

COMPANY	QANTEL	RAYTHEON	SYSTEMS CONCEPTS
MODEL	Qantel V	Synelector 70	SCI Model 8800 RPS
FIRST DELIVERY YEAR	1970	1970	1970
BASIC PURCHASE PRICE (W/4K)	\$13,950	depends upon options	\$25,000
LEASE RATE/MONTH	\$383	depends upon options	\$900
MEMORY			
Word Length (bits)	8 bit bytes	16	
Min/Max Size (words)	8K bytes	4K-32K	
Cycle Time (us)	3	1.0	
Type	core	core, tape, disc (fixed & moving head)	
NUMBER OF CHANNELS			
Narrow-Band	up to 8	64-128	16
Voice-Band	up to 8	8-32	1
Broad-Band		0-4	n/a
MAX TOTAL COMMUNICATIONS DATA RATE	4800 baud	250,000 bps	9600 bps
ERROR CONTROL		firmware and software	ARQ on voice band channel
COMMENTS			

The quad-squad

(from INCOTERM™)

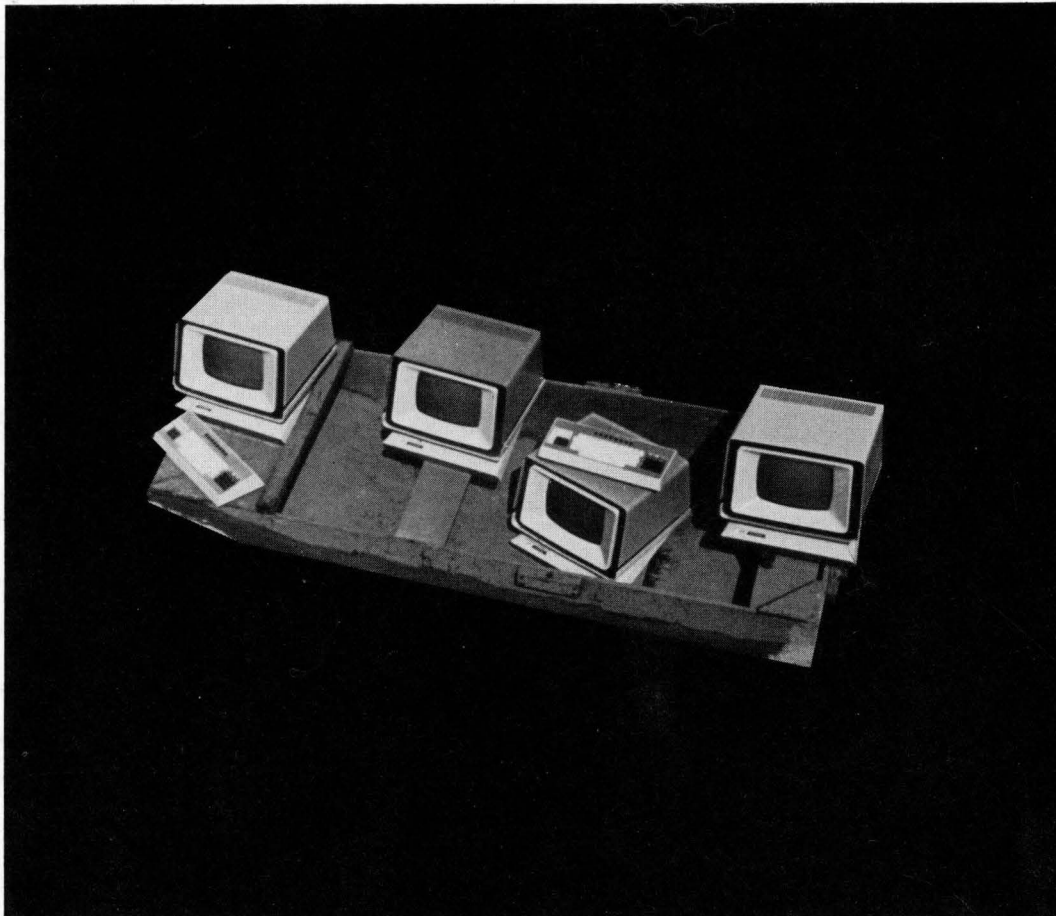

Four friendly faces from INCOTERM — each with its own keyboard — each with functionally independent access to the powerful 2K computer that is built right into the Master terminal — each permitting up to 256 characters on the screen.

All this for under \$100 a month per operator position.

Each operator can verify, qualify and format input — right at the source. And because of the built-in computer, each fully programmable terminal is compatible with

virtually any mainframe system and with most other types of terminals you may now be using.

If you want hard-copy output, there's the SPD™-P Printer. If you want to change jobs, there's the SPD™-L Program Loader. And for tying it all together, we offer the SPD™-M Multiplexer. Let's face it: that's a powerful lot.

For details, call or write M.R. Clement, Jr., *Vice President of Marketing*.

 **INCOTERM™**
CORPORATION
... the international computer terminals people

Hayes Memorial Drive / Marlborough, Massachusetts 01752
Tel: (617) 481-2000

CRT DATA TERMINALS

COMPANY	APPLIED DIGITAL DATA SYSTEMS	APPLIED DIGITAL DATA SYSTEMS	ATLANTIC TECHNOLOGY	ATLANTIC TECHNOLOGY
MODEL	Envoy 600	Consul 880	ATC 2000 Data Display Terminal	2263
FIRST DELIVERY YEAR	1970	1970	1970	1970
BASIC PURCHASE PRICE	\$3195	\$3995	\$6900 local multi-station (960 char.)	\$3250
LEASE RATE/MONTH	2 yr \$151, 4 yr \$88	1 yr \$188, 3 yr \$134, 4 yr \$110		\$90
TRANSMISSION				
Data Set Interface	built in acoustic coupler	EIA, TTY, built in modem	EIA RS-232B (WE 201B, 202D)	202/201
Speed (bps)	110, 300 switch selectable	110, 300, 1200, 1800, 2400	1200/2400 std, 4800 max. std	1200/2400
Simultaneity	HD	HD	HD	HD
Codes	ASCII	ASCII	ASCII (EBCDIC for S/360)	USASCII & EBCDIC
Error Detection	-	-	parity bit	VRC & LRC
CRT CHARACTERISTICS				
Screen Size (inches)	5" diag	12" diag TV monitor, built in	7 x 9.5	7 x 9.5
Brightness (ft.-L)	-	-	75 nom	75
Spot Diameter (inches)	-	-	0.015	0.015
Phosphor	-	-	P31 aluminized	P31 aluminized
DISPLAY FORMAT				
Characters/Line	32	80	80, 64, or 40	80, 40
Line/Display	16	24	48 to 3	3, 6
Max Char/Display	512	1920	1920	240
Character Size	-	-	.15 x .20/.12 x .18 (max .33 x .33)	.15 x .20
Generation Method	TV raster	TV raster, black char on white "page"	cursive stroke	cursive stroke
BUFFER MEMORY				
Type	MOS shift register	MOS shift registers	delay line	delay line
Size (characters)	-	-	1920	1920
Refresh Rate (frames/sec)	60	60	60 cps	60
EDITING FEATURES				
Insert	no	char	char	char
Delete	no	char	char	char
Cursor	yes	yes	yes	blinking non-destructive
ALTERNATE OUTPUTS				
	BNC for slaved TV monitor	BNC for slave TV monitors	hard copy printer	printer (opt)
SPECIAL FEATURES	-	-	char addressing, formatting ability, protect mode, auto tab erase	IBM 2260 compatible protected formatting ability
COMMENTS	3 modes: char, line or page	3 modes: char, line or page	-	-

Also see Alphanumeric and Graphic CRT Console charts.

1 Equipment Characteristics

CRT DATA TERMINALS

COMPANY	ATLANTIC TECHNOLOGY	ATLANTIC TECHNOLOGY	ATLANTIC TECHNOLOGY	BEEHIVE MEDICAL ELECTRONICS
MODEL	2264	2265	2266	Model I/I-A
FIRST DELIVERY YEAR	1970	1970	1970	1970
BASIC PURCHASE PRICE	\$3500	\$3750	\$4000	\$2495/\$3143
LEASE RATE/MONTH	\$95	\$100	\$105 w/maint	—
TRANSMISSION				
Data Set Interface	202/201	202/201	202/201	EIA RS-232B
Speed (bps)	1200/2400	1200/2400	1200/2400	110, 150, 300, (300-1200), (1200-2400)
Simultaneity	HD	HD	HD	HD, FD, local
Codes	USASCII & EBCDIC	USASCII & EBCDIC	USASCII & EBCDIC	ASCII
Error Detection	VRC & LRC	LRC & LRC	VRC & LRC	parity (even/odd/none)
CRT CHARACTERISTICS				
Screen Size (inches)	7 x 9.5	7 x 9.5	7 x 9.5	12" diag
Brightness (ft.-L)	75	75	75	40
Spot Diameter (inches)	0.015	0.015	0.015	—
Phosphor	P31 aluminized	P31 aluminized	P31 aluminized	P4
DISPLAY FORMAT				
Characters/Line	80, 40	80, 64, 40	80, 64, 40	40/80
Lines/Display	6, 12	12, 15, 24	24, 30, 48	20
Max Char/Display	480	960	1920	800/1600
Character Size	.15 x .20	.15 x .20	.12 x .18	≈0.1" x 0.2"
Generation Method	cursive stroke	cursive stroke	cursive stroke	dot matrix
BUFFER MEMORY				
Type	delay line	delay line	delay line	MOS
Size (characters)	1920	1920	1920	800/1600
Refresh Rate (frames/sec)	60	60	60	60
EDITING FEATURES				
Insert	char	char	char	—
Delete	char	char	char	—
Cursor	blinking non-destructive	blinking non-destructive	blinking non-destructive	cursor, home, clear
ALTERNATE OUTPUTS	printer (opt)	printer (opt)	printer (opt)	—
SPECIAL FEATURES	IBM 2260 compatible protected formatting	IBM 2260 compatible protected formatting	IBM 2260 compatible protected formatting	—
COMMENTS	—	—	—	Opt: parallel I/O, 3-level priority blink

Also see Alphanumeric and Graphic CRT Console charts.

1 Equipment Characteristics

CRT DATA TERMINALS

COMPANY	BEEHIVE MEDICAL ELECTRONICS	BEEHIVE MEDICAL ELECTRONICS	BUNKER-RAMO	BUNKER-RAMO
MODEL	Model III/III-A	Model IV/IV-A	2206/17 Display Station	2210 Display Station
FIRST DELIVERY YEAR	1970	1971	1965	1970
BASIC PURCHASE PRICE	\$2987/\$3635	\$3495/\$4143	\$1825	\$850
LEASE RATE/MONTH	—	—	\$39 - 2 yr, \$33 - 5 yr	\$42 - 2 yr, \$33 - 5 yr
TRANSMISSION				
Data Set Interface	EIA RS-232B	EIA RS-232B	EIA RS-232	EIA RS-232
Speed (bps)	110, 150, 300 (300-1200), (12-2400)	2400 baud, 1200	2400 sync or 1200 async	2400 sync or 1200 async
Simultaneity	HD, FD, local	FD	HD or FD	HD or FD
Codes	ASCII	ASCII	7-bit ASCII	7-bit ASCII
Error Detection	parity (even/odd/none)	VRC, LRC (parity)	vert & horiz parity	vert & horiz parity
CRT CHARACTERISTICS				
Screen Size (inches)	12" diag	12" diag	17	3
Brightness (ft.-L)	40	40	160	160
Spot Diameter (inches)	—	—	.020	.020
Phosphor	P4	P4	P31	P31
DISPLAY FORMAT				
Characters/Line	40/80	40/80	80 or 37	20
Lines/Display	20	20	12 or 24	10 (1 line must have only 18 char)
Max Char/Display	800/1600	800/1600	960	198
Character Size	0.1" x 0.2" approx	0.1" x 0.2" approx	1/8 to 1/4"	1/8"
Generation Method	dot matrix	dot matrix	5 x 7 dot matrix char gen	5 x 7 dot matrix
BUFFER MEMORY				
Type	MOS	MOS	delay line	delay line
Size (characters)	800/1600	800/1600	1032	258
Refresh Rate (frames/sec)	60	60	54	54
EDITING FEATURES				
Insert	char, line & page	—	char	—
Delete	char, line & page	—	char	—
Cursor	yes	—	yes	yes
ALTERNATE OUTPUTS				
—	—	—	printer	printer
SPECIAL FEATURES				
—	—	IBM 2265 compatible (replacement)	16 special fcn keys	6 special application keys
COMMENTS				
—	Numerous options	Popular options	—	—

Also see Alphanumeric and Graphic CRT Console charts.

1 Equipment Characteristics

CRT DATA TERMINALS

COMPANY	BUNKER-RAMO	COMMUNITYTYPE	COMMUNITYTYPE	COMPUTER COMMUNICATIONS
MODEL	2212 Display Station	COMMUNITYTYPE 1000	COMMUNITYTYPE 1023	CC-30 Comm. Station
FIRST DELIVERY YEAR	1965	1970	1970	1967
BASIC PURCHASE PRICE	\$1770	\$3350	\$3950	\$7045
LEASE RATE/MONTH	\$46 - 2 yr, \$39 - 5 yr	\$143 incl maint	\$159.50 incl maint	\$197
TRANSMISSION				
Data Set Interface	EIA RS-232	RS-232 for all Bell sets	RS-232 for all Bell sets	100, 200, or 300 series data set, or equiv
Speed (bps)	2400 sync, 1200 async	110-9600 baud	110-9600 baud	50,000 max serial; 500,000 char/sec parallel
Simultaneity	HD or FD	HD or FD	HD or FD	HD or FD
Codes	7-bit ASCII	ASCII std; EBCDIC opt	ASCII std; EBCDIC opt	USASCII
Error Detection	vert or horiz parity	parity	parity	char parity checking; auto retrans under software control
CRT CHARACTERISTICS				
Screen Size (inches)	6	any monitor	any monitor	—
Brightness (ft.-L)	160	—	—	TV monitor used
Spot Diameter (inches)	.020	—	—	TV monitor used
Phosphor	P31	P4; others avail	P4; others avail	—
DISPLAY FORMAT				
Characters/Line	37	40	72	40
Lines/Display	12	20	20	20, 24 opt
Max Char/Display	444	800	1440	960
Character Size	5 x 7 dot matrix	.16" high, .12" wide (12" monitor)	12" monitor	12" TV
Generation Method	—	5 x 7 dot matrix	5 x 7 dot matrix	5 x 7 dot matrix
BUFFER MEMORY				
Type	delay line	MOS, static shift registers	MOS, static shift registers	core
Size (characters)	516	800	1440	1024 word (9-bit) buffer
Refresh Rate (frames/sec)	54	60	60	60
EDITING FEATURES				
Insert	char, line	char insertion opt	char insertion opt	no
Delete	char	char deletion opt	char deletion opt	no
Cursor	yes	yes	yes	yes, full cursor control
ALTERNATE OUTPUTS	printer	mag tape cassettes; printers	mag tape cassettes; printers	hard copy outputs TTY, (33/35 RO, KSR, ASR)
SPECIAL FEATURES	12 special application keys	—	—	interfaces IBM 1130, 360, XDS Sigma series, CDC 3000/6000 series, & DEC PDP-8/12
COMMENTS	Block keyboard aids non-typist.	RF output for use on any TV set.	Multiple monitor display via any video monitor.	—

Also see Alphanumeric and Graphic CRT Console charts.

1 Equipment Characteristics

CRT DATA TERMINALS

COMPANY	COMPUTER COMMUNICATIONS	COMPUTER COMMUNICATIONS	CORNING GLASS WORKS	DATA ACCESS SYSTEMS
MODEL	CC-36 Televideo Conversational/Batch Station	CC-335 Totelcom	CORNING 904 Terminal	VST2000 Video Display
FIRST DELIVERY YEAR	1968	1970	1970	1969
BASIC PURCHASE PRICE	\$23,900, \$39,900	\$3950 - \$4250	\$19,650	\$2870
LEASE RATE/MONTH	\$875 & \$1175	n/a	\$820 1 yr, \$670 4 yr	\$159
TRANSMISSION				
Data Set Interface	100, 200, 300 series data sets or equiv	100 or 200 series data sets or equiv	modem - std voice grade phone	EIA
Speed (bps)	50,000 serial; 500,000 char/sec parallel	110, 150, 300, 600 or 1200 baud	110, 150, 300 baud (10, 15 & 30 char/sec)	to 2400
Simultaneity	HD or FD	HD or FD	HD & FD	HD/FD
Codes	USASCII	USASCII	ASCII	ASCII
Error Detection	char parity check: auto retrans	even or odd parity	none	parity
CRT CHARACTERISTICS				
Screen Size (inches)	—	3.25 x 8.25	8.5 x 11 (4608 alphanumeric char)	80 sq in.
Brightness (ft.-L)	} TV Monitor	2-ft. 25-L	8	—
Spot Diameter (inches)		.010	20 mils	—
Phosphor		P4 or P31	n/a (projected image)	—
DISPLAY FORMAT				
Characters/Line	40	72 or 80	72	72
Lines/Display	20, 24 opt	12	64	18
Max Char/Display	960	960	4608 alphanumeric (90-degree rotation avail)	10,000
Character Size	12" TV	.15" height	125 x 90 mils	0.20" x 0.10"
Generation Method	5 x 7 dot matrix	5 x 7 matrix	dot matrix	delay line
BUFFER MEMORY				
Type	core	MOS dynamic shift registers	none(storage display)	delay line
Size (characters)	1024 word (9 bit) buffer	960 max	—	1300
Refresh Rate (frames/sec)	60	60	—	60 Hz
EDITING FEATURES				
Insert	no	yes	none	char
Delete	no	yes	none	char
Cursor	yes, full cursor controls	yes, full cursor controls	yes	yes
ALTERNATE OUTPUTS				
	—	opt (hard-copy; mag tape cassette)	—	I/O computer device
SPECIAL FEATURES				
	4 color capability, interfaces for IBM 1130, 360, XDS Sigma series, CDC 3000/6000 series & PDP 8/12	—	built-in hard copy & slide overlay	to 8 page storage
COMMENTS				
	—	—	Terminal has software	Compatible std closed circuit TV system.

Also see Alphanumeric and Graphic CRT Console charts.

1 Equipment Characteristics

CRT DATA TERMINALS

COMPANY	DATASERV	DELTA DATA SYSTEMS	DELTA DATA SYSTEMS	DELTA DATA SYSTEMS
MODEL	Telterm 1 & 2	Delta I Display (Mod 1010)	Delta I Color (Mod 2010)	Teleterm I
FIRST DELIVERY YEAR	1970	1968	1968	1970
BASIC PURCHASE PRICE	\$3000-\$3500	\$5500	\$7700	\$3000
LEASE RATE/MONTH	from \$80	—	—	\$80
TRANSMISSION				
Data Set Interface	RS 232B	RS232	RS232	RS232
Speed (bps)	to 9600	to 15 kHz	to 15 kHz	to 3.5 megabits
Simultaneity	HD & FD	HD & echoplex	HD & echoplex	HD & echoplex
Codes	ASCII	ASCII	ASCII	ASCII
Error Detection	parity (response/ no response)	odd, even, none	odd, even, none	odd, even, none
CRT CHARACTERISTICS				
Screen Size (inches)	14	12	19	14
Brightness (ft.-L)	—	60	50	75
Spot Diameter (inches)	—	15	12	9
Phosphor	—	P4	P4	P31
DISPLAY FORMAT				
Characters/Line	30	40	40	80
Lines/Display	27 (expandable)	24	24	27
Max Char/Display	3000	960	960	2160
Character Size	—	.25" x .12" nom	.28" x .29" nom	.16 x .09"
Generation Method	7 x 9 dot matrix	dot matrix 5 x 7	dot matrix 5 x 7	dot matrix 7 x 9
BUFFER MEMORY				
Type	MOS (packed memory)	core	core	MOS
Size (characters)	500-3000	960	960	500-3000
Refresh Rate (frames/sec)	60	60	60	60
EDITING FEATURES				
Insert	char & line	yes, opt	yes, opt	no
Delete	char & line	yes, opt	yes, opt	no
Cursor	yes-4 controls-addressable	yes	yes	yes
ALTERNATE OUTPUTS				
	party line I/O	party line - most computer interfaces	party line - most computer interfaces	party line
SPECIAL FEATURES				
	Blink, format & paging	most options available	4 color control - blink - format color controller keyb. - TV compat	exclusive paging - blink/format control std, separate numeric pad
COMMENTS				
	—	cursor fully addressable	—	popular options avail

Also see Alphanumeric and Graphic CRT Console charts.

1 Equipment Characteristics

CRT DATA TERMINALS

COMPANY	FOUR-PHASE SYSTEMS	HAZELTINE	HONEYWELL	HONEYWELL
MODEL	System IV/70 Multi-terminal System	Hazeltine 2000	DN765	Type 2317
FIRST DELIVERY YEAR	1970	1969	1969	1969
BASIC PURCHASE PRICE	CPU \$12,100 Video Terminal \$980	\$2995	\$4118	\$2100 - \$3360
LEASE RATE/MONTH	CPU \$370 Video Terminal \$38	\$88 + maint \$20/mo.	—	\$47 - \$74, 5 yr.
TRANSMISSION				
Data Set Interface	Bell 103A, 113, 202C/D, 201B/D, 201A/B or equiv	RS232B	RS232C	202C, 202D, 201A3, 201B1
Speed (bps)	async to 2400 baud, sync to 9600 baud	to 9600 baud	1200 async; 1800-4000 sync	1200, 2000, 2400
Simultaneity	FD	HD, FD, HD batch	HD	HD (sync & async)
Codes	ASCII, EBCDIC, or user-programmed code	ASCII	ASCII	ASCII subset
Error Detection	yes	parity	char & long.	vert & horiz parity, address error, buffer overflow
CRT CHARACTERISTICS				
Screen Size (inches)	12" CRT, 7 x 9 horiz viewing area	12" diag	14 std - opt to 23	12 (viewing area: 9 x 6½)
Brightness (ft-L)	operator adjustable	20	75	n/a
Spot Diameter (inches)	.015" nom	—	—	n/a
Phosphor	P39	P39	P4	P51
DISPLAY FORMAT				
Characters/Line	48 or 81	74	47 & 92	37 - 80
Lines/Display	24 or 12	27	22	6 - 24
Max Char/Display	1152	1998	1012 & 2024	960
Character Size	.15" high x .12" wide	1/8" x 1/4"	std = 0.19"h x 0.14"w	1/8" x 7/32"
Generation Method	8 x 10 dot matrix	dot matrix on TV raster	dot matrix	dot matrix
BUFFER MEMORY				
Type	MOS/LSI	core	delay line	core
Size (characters)	12K - 24K bytes	2047	1012 & 2024	960
Refresh Rate (frames/sec)	60 Hz	60	60 Hz	54
EDITING FEATURES				
Insert	char, line	yes	—	char
Delete	char, line	yes	—	char
Cursor	yes - full cursor control blinking, nondestructive	yes	yes	yes
ALTERNATE OUTPUTS				
	disk, IBM compatible mag tape, cards, punched tape, printer	printer, tape cassette, remote TV monitor	yes	RO printer
SPECIAL FEATURES				
	Up to 32 IV/70 Video terminals are controlled by one IV/70 CPU	All popular features avail	special keyboards	horiz tabulation, multi-message format
COMMENTS	Replaces IBM 2260/2848 w/no software modification			

Also see Alphanumeric and Graphic CRT Console charts.

CRT DATA TERMINALS

COMPANY	HONEYWELL	INCOTERM	INFOREX	INFOTON
MODEL	Type 2323	SPD 10/20 CRT Display Terminal	Intelligent Key Entry System	VISTA-1
FIRST DELIVERY YEAR	1969	1970	1970	1970
BASIC PURCHASE PRICE	\$10,500	\$5150/50 Qty	1301 Control Unit: \$25,500; Keystation: \$1,200	\$1995 - \$2995
LEASE RATE/MONTH	\$230/5 yr	\$124/50 Qty	1301 Control Unit: \$560 2901 Keystation: \$50	\$95 - \$128
TRANSMISSION				
Data Set Interface	202C, 202D, 201A3, 201B1	RS232C	EIA std interface to 201A modem or equiv	RS232C and/or current loop
Speed (bps)	1200, 2000, 2400	sync to 4800, async to 2400	2400 baud	110-4800 async (std)
Simultaneity	HD (sync & async)	HD or FD	HD	FD
Codes	ASCII subset	ASCII or EBCDIC	EBCDIC, BDC, Honeywell Octal	ASCII
Error Detection	vert & horiz parity, address error, buffer overflow	vert & long. parity & cyclic check	CRC Block counts	parity (indicator light)
CRT CHARACTERISTICS				
Screen Size (inches)	12 (viewing area: 9 x 6½)	9.5 wide x 7 high	6 x 4	12" diag
Brightness (ft-L)	n/a	not specified	50	5
Spot Diameter (inches)	n/a	.030	25 mil	14 mil
Phosphor	P51	P39	P39	P4
DISPLAY FORMAT				
Characters/Line	80	64	32	32/40/64/80
Lines/Display	12	30	4	10 or 20
Max Char/Display	960	1920	128 max	1600
Character Size	1/8" x 7/32"	0.1" wide, 0.14" high	.175" high x .125" wide	.10" x .15"
Generation Method	dot matrix	raster	5 x 7 dot matrix	5 x 7 dot matrix
BUFFER MEMORY				
Type	core	core	core	MOS S.R.
Size (characters)	960	4096 - 8 bit bytes	for ea sta - 128 bytes	320 to 1600
Refresh Rate (frames/sec)	54	60	60	60
EDITING FEATURES				
Insert	char	through software	char, line & records may be added	no
Delete	char	through software	records	no
Cursor	yes	yes	yes	yes
ALTERNATE OUTPUTS				
	RO printer	8 I/O channels	mag tape - 7- & 9-track	printer, cassette
SPECIAL FEATURES				
	horiz tabulation, multi-message format	2K x 16 computer	printer, expanded tape processing, communications systems interconnection	numeric pad, blink feature
COMMENTS				
	-	Numerous options	-	teletype compatible

Also see Alphanumeric and Graphic CRT Console charts.

1 Equipment Characteristics

CRT DATA TERMINALS

COMPANY	INFOTON	MARK COMPUTER SYSTEMS	MARK COMPUTER SYSTEMS	OLIVETTI
MODEL	VISTA - 2	DD - 10 (Data Display)	DD - 70	TCV 260
FIRST DELIVERY YEAR	1970	1969	1971	1970
BASIC PURCHASE PRICE	\$2845-\$3395	\$1995	\$3995	\$5000
LEASE RATE/MONTH	\$120 - \$136	-	-	\$174
TRANSMISSION				
Data Set Interface	RS232C, current loop, parallel	self-contained modem - EIA RS232C	self-contained modem or dc interface	EIA 232B
Speed (bps)	110-8600	to 1200 baud	to 1200 baud-modem; 50,000 baud	1200
Simultaneity	buffered HD	-	-	HD.
Codes	ASCII	EBCDIC	ASCII	ASCII
Error Detection	parity (odd or even)	parity	parity	VRC, LRC
CRT CHARACTERISTICS				
Screen Size (inches)	12 diag	9 rect - 35 sq in	12 rect - 95 sq in	12
Brightness (ft-L)	5	50	50	-
Spot Diameter (inches)	14 mils	.015	.012	-
Phosphor	P4	P4	P31	std JEDEC
DISPLAY FORMAT				
Characters/Line	40 or 80	8	32 or 64	64
Lines/Display	10 or 20	2 or 4	8, 16, or 32	16
Max Char/Display	1600	32 std to 80 opt	1024	1024
Character Size	.10" x .15"	.25 x .18 - adjustable	.13" x .08"	-
Generation Method	5 x 7 dot matrix	stroke	5 x 7 dot matrix	5 x 7 dot matrix
BUFFER MEMORY				
Type	MOS S.R.	LSI - bipolar RAM	MOS LSI dynamic RAM	delay line
Size (characters)	400 - 1600	128 bits - std	1024 x 10 bits max	1024
Refresh Rate (frames/sec)	60	45	48	40
EDITING FEATURES				
Insert	yes (page & field)	n/a	char	char, line
Delete	yes (page & field)	n/a	char	char, line
Cursor	yes	n/a	yes	yes
ALTERNATE OUTPUTS				
	printer, cassette	401E data set	TTY compatible	printer 40 Hz, 132 char/line
SPECIAL FEATURES				
	protected format, tabbing	Data General Nova & Supernova compatible	compatible w/all Data General Nova & Supernova computers	blinking, transmit or print partial screen
COMMENTS				
	switch selectable I/O rate of 110 - 4800 baud, polling, auto retrans.	-	format capability	IBM 2260/2848 compatible

Also see Alphanumeric and Graphic CRT Console charts.

1 Equipment Characteristics

CRT DATA TERMINALS

COMPANY	PHOTOPHYSICS	PHOTOPHYSICS	PHOTOPHYSICS	PHOTOPHYSICS
MODEL	Keyboard, Display & Integral copier, '45' Series, Model 20/24	Keyboard, Display & Integral Copier, '45' Series, Model 40/44	Keyboard & Display '45' Series, Model 60/64	Keyboard & Display '45' Series, Model 80/84
FIRST DELIVERY YEAR	1970	1971	1970	1971
BASIC PURCHASE PRICE	\$5000-\$8000	\$5500-\$8900	\$2580-\$4100	\$2800-\$4650
LEASE RATE/MONTH	by request	by request	by request	by request
TRANSMISSION				
Data Set Interface	Bell 103 or 202 series or equiv	202 or 201B or equiv	Bell 103 or 202 series or equiv	Bell 202 or 201B or equiv, 1200 or 2400 baud
Speed (bps)	110, 150, 300, 600 or 1200 baud	1200 or 2400 baud	110, 150, 300, 600 or 1200 baud	1200 or 2400 baud
Simultaneity	HD or FD	polled, HD	HD or FD	polled, HD
Codes	USASCII	USASCII	USASCII	USASCII
Error Detection	none	lat & long.	none	lat & long.
CRT CHARACTERISTICS				
Screen Size (inches)	9" diag	9" diag	9" diag	9" diag
Brightness (ft-L)	40	40	40	40
Spot Diameter (inches)	.01	.01	.01	.01
Phosphor	P4	P4	P4	P4
DISPLAY FORMAT				
Characters/Line	40/80	40/80	40/80	40/80
Lines/Display	25/12	25/12	25/12	25/12
Max Char/Display	1000	1000/960	1000/960	1000/960
Character Size	.20 x .13"/.09"	.20 x .13"/.09"	.20 x .13"/.09"	.20 x .13"/.09"
Generation Method	5 x 7 dot matrix	5 x 7 dot matrix	5 x 7 dot matrix	5 x 7 dot matrix
BUFFER MEMORY				
Type	MOS	MOS	MOS	MOS
Size (characters)	1040/960	1040/960	1040/960	1040/960
Refresh Rate (frames/sec)	60	60	60	60
EDITING FEATURES				
Insert	char & line	char & line	char & line	char & line
Delete	char & line	char & line	char & line	char & line
Cursor	yes, non-destructive, blinking	yes, non-destructive, blinking	yes, non-destructive, blinking	yes, non-destructive, blinking
ALTERNATE OUTPUTS	display & copier, copier	display & copier, copier	display & copier, copier	display & copier, copier
SPECIAL FEATURES	3 graphic characters	3 graphic characters	3 graphic characters	3 graphic characters
COMMENTS	stand-alone; no shared or dedicated controller required.	stand-alone; no shared or dedicated controller required.	stand-alone; no shared or dedicated controller required.	stand-alone; no shared or dedicated controller required.

Also see Alphanumeric and Graphic CRT Console charts.

1 Equipment Characteristics

CRT DATA TERMINALS

COMPANY	RAYTHEON	RAYTHEON	RAYTHEON	SANDERS DATA SYSTEMS
MODEL	DIDS-401-3 Display	DIDS Data-Select 401-M16	DIDS-402-3	622 Stand-alone Display System
FIRST DELIVERY YEAR	1969	1968	1969	1968
BASIC PURCHASE PRICE	\$3700	\$7000	\$6000	by request
LEASE RATE/MONTH	\$115	negotiated	\$200	by request
TRANSMISSION				
Data Set Interface	RS-232B	none	RS-232B	any modem
Speed (bps)	2400	500,000	2400	1800 async; 2400 sync (opt)
Simultaneity	HD	n/a	HD	HD
Codes	ASCII	ASCII	ASCII	ASCII
Error Detection	char & block	none	char & block	VRC & LRC
CRT CHARACTERISTICS				
Screen Size (inches)	7.0 x 9.0 (14" tube)	6.5 x 8.5	7.0 x 9.0 (14" tube)	9.5 x 7.5
Brightness (ft-L)	50	50	50	30 min
Spot Diameter (inches)	.015	.015	.015	.015 max
Phosphor	P31	P31	P31	P4, type W mod
DISPLAY FORMAT				
Characters/Line	40, 65, 80	45	40, 65, 80	64 (80 opt)
Lines/Display	12, 16, 12	23	12, 16, 12	32
Max Char/Display	1040	1035	1040	1024
Character Size	adjustable to .16" x .21"	0.12" x 0.10"	adjustable from .10" x .12" to .16" x .21"	0.13" x 0.08" nom
Generation Method	symbolray monoscope	symbolray monoscope	symbolray monoscope	continuous sequential stroke
BUFFER MEMORY				
Type	delay line	delay line	delay line	delay line
Size (characters)	1040	1035	1040	1024
Refresh Rate (frames/sec)	60	67	60	60 Hz
EDITING FEATURES				
Insert	char	no	char	—
Delete	char	no	char	—
Cursor	yes, non-destructive	yes	yes, non-destructive	yes
ALTERNATE OUTPUTS	printer	printer	printer	hard copy option
SPECIAL FEATURES	mask & tab char for formatting	20 line-select keys	mask & tab char for formatting	two-block format capability
COMMENTS	controller required, handles 12 displays	designed for high-speed, bit parallel local interface to processor	controller required, handles 12 displays	—

Also see Alphanumeric and Graphic CRT Console charts.

1 Equipment Characteristics

CRT DATA TERMINALS

COMPANY	SANDERS DATA SYSTEMS	SPIRAS SYSTEMS	TEC	TEC
MODEL	720 Data Display System	Model TE	Series 400 - DST 5020	Series 400 - DSR 7224
FIRST DELIVERY YEAR	1965	1971	1970	1971
BASIC PURCHASE PRICE	by request	\$7000-\$9000	Display-\$1833 Keyboard-\$325	Display-\$1640 Keyboard-\$325
LEASE RATE/MONTH	by request	by request	n/a	n/a
TRANSMISSION				
Data Set Interface	any modem	RS232B/C	RS232 (opt TTL levels) 20 ma current loop	RS232 (opt TTL levels) 20 ma current loop
Speed (bps)	async (110, 1200, 1800, 2000 & 2400) synch (2000 & 2400)	2400	110 to 2400 baud	110 to 2400 baud
Simultaneity	HD	HD	HD or FD	HD or FD
Codes	ASCII	ASCII	ASCII	ASCII
Error Detection	VRC & LRC	lat & long.	—	—
CRT CHARACTERISTICS				
Screen Size (inches)	7 x 9.5	9 x 7	8 w x 6 h	8 w x 6 h
Brightness (ft-L)	30 min	50	27 nom	27 nom
Spot Diameter (inches)	0.020 max	0.015	15 mil nom	15 mil nom
Phosphor	P4, type W mod	P31	P4 white	P4 white
DISPLAY FORMAT				
Characters/Line	vert displays — 52 horiz displays - 64, 84 (opt)	80 max (operator var)	50	72
Lines/Display	vert 40; horiz 32	32 displayed	20	24
Max Char/Display	1024, 512 or 256	1024	1000	1728
Character Size	0.12" x 0.09" nom	0.09" x 0.14"	.187 x .125	n/a
Generation Method	continuous sequential stroke	monoscope	5 x 7 dot matrix	5 x 7 dot matrix
BUFFER MEMORY				
Type	delay line	MOS SR	MOS	MOS
Size (characters)	1024	1024 std (up to 4096)	1000	1728
Refresh Rate (frames/sec)	46.5 Hz	65	60	60
EDITING FEATURES				
Insert	char & line	char (continuous)	yes	no
Delete	char & line	char, line	yes	no
Cursor	yes	yes (visible & I/O separate)	yes	yes
ALTERNATE OUTPUTS	hard-copy printer	printer (selectric), cassette (I/O)	to multiple monitors, to TTY compatible printer	to multiple monitors, to TTY compatible printer
SPECIAL FEATURES	multi-block format capabilities	var margin, col. tab protected format, blink field, line adjust	data panel option	—
COMMENTS	—	—	blink, tab, screen protect	—

Also see Alphanumeric and Graphic CRT Console charts.

1 Equipment Characteristics

CRT DATA TERMINALS

COMPANY	TEC	TEC	ULTRONIC SYSTEMS	UNICOM
MODEL	420 (DSA-5020)	425 (DSA-8024)	Videomaster 7000	CT 3000
FIRST DELIVERY YEAR	1970	1971	1969	1970
BASIC PURCHASE PRICE	Display \$2325 Keyboard \$325	Display \$2570 Keyboard \$325	\$4980	\$2820
LEASE RATE/MONTH	—	—	\$170	—
TRANSMISSION				
Data Set Interface	RS232	RS232	EIA RS232C	option
Speed (bps)	100-9600 baud	100-9600 baud	120-2400	10K
Simultaneity	HD or FD	HD or FD	HD	—
Codes	ASCII	ASCII	ASCII	ASCII
Error Detection	char parity	char parity	VRC on char, LRC on message	—
CRT CHARACTERISTICS				
Screen Size (inches)	12" rect (slave monitors, any size)	12" rect (slave monitors, any size)	9.5 w x 7.5 h	9-23
Brightness (ft-L)	27 nom	27 nom	—	depends on size
Spot Diameter (inches)	15 mils nom	15 mils nom	—	TV monitor used
Phosphor	P4	P4	P4 white	any
DISPLAY FORMAT				
Characters/Line	50	80	80 char/12 lines	40
Lines/Display	20	24	64 char/15 lines	10 (20 option)
Max Char/Display	1000	1920	960	800
Character Size	.187	.150 nom	80 mils w x 120 mils h	depends on monitor size
Generation Method	dot matrix	dot matrix	dot matrix	5 x 7
BUFFER MEMORY				
Type	MOS	MOS	delay line	MOS
Size (characters)	1000	1920	963	400 or 800
Refresh Rate (frames/sec)	60	60	60 Hz	60 Hz
EDITING FEATURES				
Insert	yes	yes	no	yes
Delete	yes	yes	yes	yes
Cursor	yes	yes	yes, non-destructive	yes
ALTERNATE OUTPUTS				
	printer	printer	printer	computer output
SPECIAL FEATURES				
	blink, protect, tab	blink, protect, tab	format entry	can drive 10 TV monitors
COMMENTS				
	this is a polled, addressable display	this is a polled, addressable display	IBM 360 compatible	page roll, protect zone

Also see Alphanumeric and Graphic CRT Console charts.

1 Equipment Characteristics

CRT DATA TERMINALS

COMPANY	UNICOMP	UNIVAC	VERNITRON DATA DEVICES	VERNITRON DATA DEVICES
MODEL	522	UNISCOPE 100	40	72
FIRST DELIVERY YEAR	1970	1970	1969	1969
BASIC PURCHASE PRICE	\$4500	\$2950	\$3400	\$3650
LEASE RATE/MONTH	—	\$85 w/maint	by request	by request
TRANSMISSION				
Data Set Interface	EIA RS232	Bell 103, 202 & 201 or equiv	Bell std	Bell std
Speed (bps)	110, 150, 300, 600, 1200	300 - 9600	110, 160, 330 baud opt: 1200-9600 baud	110, 160, 330 baud opt: 1200-9600 baud
Simultaneity	selectable	HDX	HD or FD	HD or FD
Codes	ASCII	ASCII	ASCII	ASCII
Error Detection	—	request/ack.-retrans	parity, transmit & receive	parity, transmit & receive
CRT CHARACTERISTICS				
Screen Size (inches)	12	5 x 10	CRT monitor or TV	CRT monitor or TV
Brightness (ft-L)	—	operator var	—	—
Spot Diameter (inches)	—	—	—	—
Phosphor	—	P31	P4 or P31	P4 or P31
DISPLAY FORMAT				
Characters/Line	74	32, 64 or 80	40	72
Lines/Display	27	6, 12 or 16	20	20
Max Char/Display	1998	1024	800	1440
Character Size	—	.113 x .15 or .091 x .135	.16 h, .12 w for 12" diag	.16 h, .12 w for 12" diag
Generation Method	5 x 7 dot matrix	stroke	5 x 7 matrix	5 x 7 matrix
BUFFER MEMORY				
Type	core	core	MOS static shift registers	MOS static shift registers
Size (characters)	2048	1024	6400 bits	11,520 bits
Refresh Rate (frames/sec)	60	60	60 Hz	60 Hz
EDITING FEATURES				
Insert	char, line	char (line or display)	option	option
Delete	char, line	char (line or display)	option	option
Cursor	yes	yes	yes	yes
ALTERNATE OUTPUTS.				
	hard copy	printer	TTY printouts, mag tape cassette	TTY printouts, mag tape cassette
SPECIAL FEATURES				
	—	format protect, blinking, keyboard lock, tab	to 25 monitors (std TV) driven by one controller	to 25 monitors (std TV) driven by one controller
COMMENTS				
	—	—	all popular options	all popular options

Also see Alphanumeric and Graphic CRT Console charts.

CRT DATA TERMINALS

COMPANY	VIDEO SYSTEMS	VIDEO SYSTEMS	VIDEO SYSTEMS	VIDEO SYSTEMS
MODEL	VST-1000	VST-2000	VST-5000	VST-7000
FIRST DELIVERY YEAR	1969	1969	1970	1970
BASIC PURCHASE PRICE	\$1990	\$2870	\$3990	\$4990
LEASE RATE/MONTH	\$79	\$109	\$159	\$179
TRANSMISSION				
Data Set Interface	RS232	RS232	RS232	RS232
Speed (bps)	110, 150, 300	110 - 2400	110 - 2400	110 - 2400
Simultaneity	HD & FD	HD & FD	HD & FD	HD & FD
Codes	ASCII	ASCII	ASCII	ASCII
Error Detection	parity	parity	parity	parity
CRT CHARACTERISTICS				
Screen Size (inches)	12	12	12	12
Brightness (ft-L)	—	—	—	—
Spot Diameter (inches)	0.02	0.02	0.02	0.02
Phosphor	P4	P4	P4	P4
DISPLAY FORMAT				
Characters/Line	36	72	72	72
Lines/Display	18	18	18	18
Max Char/Display	1296	2592	5184	7776
Character Size	0.25 x 0.17	0.2 x 0.1	0.2 x 0.1	0.2 x 0.1
Generation Method	5 x 7 dot matrix	5 x 7 dot matrix	5 x 7 dot matrix	5 x 7 dot matrix
BUFFER MEMORY				
Type	delayline, MOS opt	delay line, MOS opt	delay line, MOS opt	delay line, MOS opt
Size (characters)	1406	1406	2812	5218
Refresh Rate (frames/sec)	60	60	60	60
EDITING FEATURES				
Insert	yes	char, line	char, line	char, line
Delete	yes	char, line	char, line	char, line
Cursor	yes	yes	yes	yes
ALTERNATE OUTPUTS				
	composite video, TTY, peripheral	composite video, TTY, peripheral	composite video, TTY, peripheral	composite video, TTY, peripheral
SPECIAL FEATURES				
	2 pages, adding machine keyboard	2 pages	4 pages, adding machine keyboard	6 pages, adding machine keyboard
COMMENTS				
	—	—	—	—

Also see Alphanumeric and Graphic CRT Console charts.

Sanders offers you six systems.



Sanders Stand-Alone Data Display System. Low-cost, remote desk-top terminal for high speed entry and retrieval.

Sanders multi-terminal Data Display System. Local or remote, on-line, real-time, high volume entry and inquiry system.

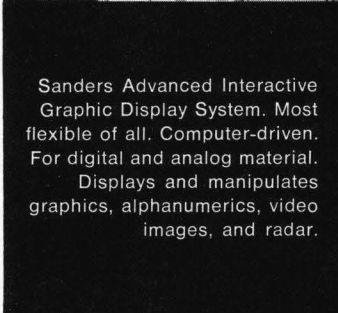

Sanders Advanced Interactive Graphic Display System. Most flexible of all. Computer-driven. For digital and analog material. Displays and manipulates graphics, alphanumerics, video images, and radar.

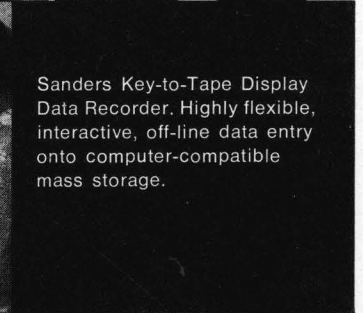
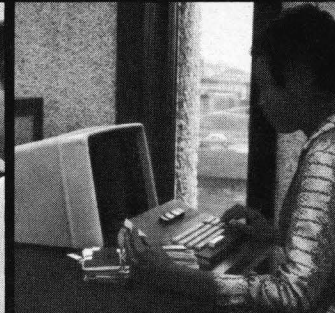
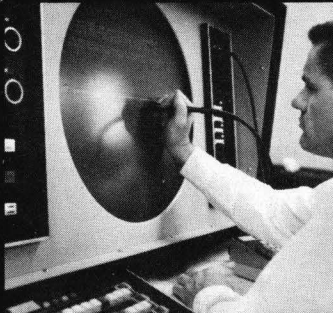

Sanders Key-to-Tape Display Data Recorder. Highly flexible, interactive, off-line data entry onto computer-compatible mass storage.



Sanders Key-to-Punched Tape Display Data Recorder. Produces verified tape rapidly, inexpensively. Field-proven.

Sanders Sandac Programmable Communications Processor. Flexible, modular, fully programmable, expandable, real-time controller.



And two networks.

Backing up each of the systems you see here are two Sanders networks. One is a nationwide systems engineering network organized to help you set up a data processing or communications system that is most practical for you.

Our other network is no less important—to us as well as to you. The Sanders field service organization. A countrywide staff of well-trained (and continually retrained) technicians fully supported by headquarters engineering and logistics facilities.

For information on Sanders data or communications systems, engineering, or field service, write Marketing Manager, Sanders Data Systems, Inc., Daniel Webster Highway South, Nashua, N.H. 03060. Or call (603) 885-4211

 **SANDERS DATA SYSTEMS**

MAGNETIC TAPE DATA TERMINALS

COMPANY	COMMUNITYTYPE	COMMUNITYTYPE	COMPAT	DATA INSTRUMENTS
MODEL	COMMUNITYTYPE 100	COMMUNITYTYPE 105	COMFILE 88-23/110	Recording/Transmitting Typewriter - T30
FIRST DELIVERY YEAR	1968	1968	1970	1969
BASIC PURCHASE PRICE	\$11,600	\$14,000	\$26,000	\$3400
LEASE RATE/MONTH	\$340	\$370	\$875	\$95
TRANSMISSION				
Speed (char/sec)	150	150	1200 - 2000 baud	50
Simultaneity	HD	HD		FD
Synchronization	sync	sync	sync	async
ERROR DETECTION				
Lateral/Longitudinal	lateral/longitudinal	lateral/longitudinal	both	lateral
Other				
Corrective Action	retype auto retransmission	retype auto retransmission	auto retransmission	retransmission backspace or word erase - retype
TAPE FORMAT				
No. of Channels	7	7	7 or 9	2
Density (bpi)	80	80	556 or 800	160
Record Length	variable	variable	fixed variable up to 1024	variable
CODES				
I/O Medium	7-level IBM Selectric & BCD	7-level IBM Selectric & BCD	any	ASCII
Transmission Medium	7-level IBM Selectric & BCD	7-level IBM Selectric & BCD	EBCDIC	modified ASCII, async
COMMUNICATION MEDIUM				
Type of Channel	voiceband	voiceband	voice grade &/ private line	DDD network or Type 3002 - (Schedule 4)
Modem Required	Bell - 202C	Bell-202C	Bell-202C, 201A	Bell-202E
COMMENTS				
	200,000-char capacity tape cartridge; batch or line transmission. IBM 360 compatible	200,000-char capacity mag tape cartridge.		

Also see Digital and Incremental Magnetic Tape Transport charts.

1 Equipment Characteristics

MAGNETIC TAPE DATA TERMINALS

COMPANY	DATASERV	DESIGN ELEMENTS	DICOM INDUSTRIES	DIGI-DATA
MODEL	Gulton G1031	Design 301	Dicom 344	System 40, 2121 Receiver
FIRST DELIVERY YEAR	1970	1970	1969	1965
BASIC PURCHASE PRICE	\$1200		\$3150	\$9800
LEASE RATE/MONTH	\$41			\$355
TRANSMISSION				
Speed (char/sec)	30	14.7	436	100
Simultaneity	HD/FD	HD or FD, switchable	FD	HD
Synchronization	async	async	async RS-232-B	async
ERROR DETECTION				
Lateral/Longitudinal		longitudinal	longitudinal	yes
Other			bit cell count	yes
Corrective Action		retransmit	rubout/retype	retransmit
TAPE FORMAT				
No. of Channels		2	1	7 or 9 track
Density (bpi)		563	550	200, 556 or 800
Record Length		130 characters	variable up to 98 characters	80 char with multiple blocking
CODES				
I/O Medium	ASCII	ASCII, EBCDIC	ASCII	BCD, EBCDIC
Transmission Medium	10 bit async	9/10/11 bit async	10 or 11 bit async	8 bit async
COMMUNICATION MEDIUM				
Type of Channel	voice	unconditioned lines (voice band)	telephone line	direct dial
Modem Required	Bell 103	acoustic coupler/ direct EIA-R5232B	RS-232-B compatible	Bell 202C2
COMMENTS				
		Storage capacity of 200,000 char per cassette.	Used only for data capture & transmission. Planning to implement remote command response.	

Also see Digital and Incremental Magnetic Tape Transport charts.

1 Equipment Characteristics

MAGNETIC TAPE DATA TERMINALS

COMPANY	DIGITRONICS	DIGITRONICS	DIGITRONICS	DIGITRONICS
MODEL	Dial-O-Verter Model 522	Dial-O-Verter Model 524	Dial-O-Verter Model 5225	Data-Verter Model 5237
FIRST DELIVERY YEAR	1966	1967	1969	1970
BASIC PURCHASE PRICE	\$47,775	\$48,900	\$29,400	\$12,750
LEASE RATE/MONTH	\$1302 w/maint	\$1325 w/maint	\$600 w/maint	\$485 w/maint
TRANSMISSION				
Speed (char/sec)	up to 1200	up to 1200	up to 1200	up to 1200
Simultaneity	HD reverse or FD	HD or FD	HD with reverse channel	HD with reverse channel
Synchronization	sync	sync	sync	sync
ERROR DETECTION				
Lateral/Longitudinal	lat/long, control sequence overflow, read after write	vert & long parity, control sequence check, overflow con- trol, read after write	vert & long parity, control sequence check & overflow control	vert parity
Other	block count	block count	block count	sprocket, read after write
Corrective Action	auto retransmission	auto retransmission	auto retransmission	error is replaced with error-flag character
TAPE FORMAT				
No. of Channels	7 or 9	7 or 9	7 or 9	7 or 9
Density (bpi)	200/566/800	200/566/800	200/566/800	200/566/800
Record Length	1020 char			
CODES				
I/O Medium	BCD, ASCII	optional	optional	5 or 8 level
Transmission Medium	8-level ASCII			
COMMUNICATION MEDIUM				
Type of Channel	voice	voice	voice	voice
Modem Required	Bell 202C, 201B or any EIA RS-232	Bell 202 or 201	Bell 202C or 201B	Bell 202C
COMMENTS				

Also see Digital and Incremental Magnetic Tape Transport charts.

1 Equipment Characteristics

MAGNETIC TAPE DATA TERMINALS

COMPANY	FEDDER DATA CENTERS	INFOREX	INFORMATION MACHINES	INFOTEC
MODEL	APT 1000	Intelligent Key Entry System	Registron R-600	Data Station DS-20
FIRST DELIVERY YEAR	1970	1970	1970	1968
BASIC PURCHASE PRICE	\$14,950	1301 Control Unit \$25,500 2901 Keystation \$1200 (up to 8 per CU)	\$3895	\$18,015
LEASE RATE/MONTH	\$350	1301 Control Unit \$560 2901 Keystation \$50 (up to 8 per CU)	\$95 to \$125	\$415
TRANSMISSION				
Speed (char/sec)	150	2000 baud	incremental	up to 50,000
Simultaneity	HD			FD
Synchronization	async	sync	async	sync or async
ERROR DETECTION				
Lateral/Longitudinal	lat/long, spiral	LRCC	parity check and lost data detector and indicator	yes
Other		block CRC check, read-after-write check, block count		checksum
Corrective Action	auto retransmission	auto retry (3 times)	rerun	retransmission
TAPE FORMAT				
No. of Channels	9	7 or 9	9	7 or 9
Density (bpi)	800	7 track - 556 or 800 9 track - 800 or 1600	800	200, 556 or 800
Record Length	256	16 - 125 char; blocked 800 char (max)	20 - 60 char	any record length
CODES				
I/O Medium	ASCII	BCD, EBCDIC; Honeywell octal	EBCDIC	any code
Transmission Medium	9 async	8 bit code sync plus line control char		
COMMUNICATION MEDIUM				
Type of Channel	dialup	dial up (switched network) or private		switched, or private leased line
Modem Required	integral	Bell 201A or equivalent	may be operated through telephone modem	Bell 201, 202 or 303
COMMENTS	Unattended, 4K, expandable to 32K, IBM & 2780 compatible, unlimited peripheral interfacing.			Programmable terminal, compresses data.

Also see Digital and Incremental Magnetic Tape Transport charts.

MAGNETIC TAPE DATA TERMINALS

COMPANY	LUNDY ELECTRONICS & SYSTEMS	MSI DATA	MSI DATA	MSI DATA
MODEL	Transceiver 9671	MSI-100 Recorder/ Transmitter System	MSI-2900	Source 2002 Portable Alphanumeric Terminal
FIRST DELIVERY YEAR	1970	1967	1970	1970
BASIC PURCHASE PRICE	\$24,000			
LEASE RATE/MONTH	\$600			
TRANSMISSION				
Speed (char/sec)	500	40 or 60	40 or 60	40 or 60
Simultaneity		simplex send only	simplex receive only; HD	HD
Synchronization		async	async	async
ERROR DETECTION				
Lateral/Longitudinal	both	lateral	lateral	lateral
Other		dbl key depression, component failure		dbl key depression (numeric only)
Corrective Action	retransmit, automatic	retype	replace error char w/ special char; retransmit	retype
TAPE FORMAT				
No. of Channels	7 or 9	1	7 or 9 track	1
Density (bpi)	556 or 800		556, 800	1200
Record Length	256 char	character string	user specified; vari	char string
CODES				
I/O Medium	ASCII	output=4 bit binary	input = ASCII and 4 bit binary output = BCD, EBCDIC, ASCII	output = ASCII
Transmission Medium		Manchester	Manchester	Manchester, or 10 bit async
COMMUNICATION MEDIUM				
Type of Channel	voice	voice grade	voice grade	voice grade
Modem Required	supplied by Lundy	acoustic, Bell 202E, DAA	Bell 202C or equiv	acoustic, DAA
COMMENTS			Receive only (std); receive & transmit (opt).	

Also see Digital and Incremental Magnetic Tape Transport charts.

1 Equipment Characteristics

MAGNETIC TAPE DATA TERMINALS

COMPANY	NOVAR	SYCOR	TALLY	TALLY
MODEL	Novar Tape Terminal Model 5-51	340	T1800 Magnetic Tape Data Terminal	V820 Datascribe Communicator
FIRST DELIVERY YEAR	1969	1970	1970	1970
BASIC PURCHASE PRICE	\$6715	\$6600	\$13,750	\$10,630
LEASE RATE/MONTH	\$195 w/modem & service	\$150	\$700 includes maint	\$255
TRANSMISSION				
Speed (char/sec)	15 to 250 (134 - 2400 baud)	1200/2000/2400	up to 180	120
Simultaneity	HD	HD	HD	HD
Synchronization	async (binary-sync opt)	sync or start/stop	async	sync
ERROR DETECTION				
Lateral/Longitudinal	parity lat (std); LRCC or CRCC (opt)	vertical, horizontal parity	LRCC	LRCC
Other	no	recall count	record number/ binary summation	right & left diag parity
Corrective Action	opt avail	auto retransmission	auto retransmission	auto retry
TAPE FORMAT				
No. of Channels	proprietary cartridge	2 (cassette type)	7 or 9	7 or 9
Density (bpi)		800	200/556/800 on 7 tk 800 on 9 tk	200/556/800 CPI for 7 track; 800 for 9 tk
Record Length	variable	1-256 char	up to 2048 char	up to 200 char
CODES				
I/O Medium	correspondence, PTTC/BCD, PTTC/EBCD	ASCII	mirror image	BCD transmission for 7 track to EBCDIC or USASCII for 9 track
Transmission Medium	9/10 bit async	8 or 10 bits	10 bit async	
COMMUNICATION MEDIUM				
Type of Channel	voice grade/direct line		voice grade or private line	voice grade or private line
Modem Required	Bell 103A & 202, Dataphone	Bell 202 or 201	integral Tally modem or Bell 202C6 1402D2 or equiv.	Bell 202C6 or equiv
COMMENTS	Transmission speeds up to 2400 baud, built-in modem or EIA interface.	Includes CRT, printer, card reader, accumulators (opt).		Data compression feature can more than double transmission speed.

Also see Digital and Incremental Magnetic Tape Transport charts.

MAGNETIC TAPE DATA TERMINALS

COMPANY	TRANSITEL COM- PUTER SUPPORT SYSTEMS	TRANSITEL COM- PUTER SUPPORT SYSTEMS	TRANSITEL COM- PUTER SUPPORT SYSTEMS	TRANSITEL COM- PUTER SUPPORT SYSTEMS
MODEL	DS7100	DS7300	DS9100	DS9300
FIRST DELIVERY YEAR	1969	1970	1969	1970
BASIC PURCHASE PRICE	\$7640	\$9510	\$8200	\$10,310
LEASE RATE/MONTH	\$140	\$200	\$155	\$220
TRANSMISSION				
Speed (char/sec)		1200, 1600, 3600		1200, 1600, 3600
Simultaneity		HD		HD
Synchronization		async		async
ERROR DETECTION				
Lateral/Longitudinal	yes	all normal checks	yes	all normal checks
Other	read after write	all normal checks	read after write	all normal checks
Corrective Action	auto retry switch	auto retransmission.	auto retry switch	auto retransmission
TAPE FORMAT				
No. of Channels	7	6 level BCD & parity	9	8 level EBCDIC & parity
Density (bpi)	200, 556 (800 opt)	200, 556 (800 opt)	800	800
Record Length	80 & 100 (20 to 240 selectable - opt)	80 and 100 (20 to 240 opt)	80, 100, 120 selectable (20 to 240 opt)	80, 100, 120 (20 to 240 selectable-opt)
CODES				
I/O Medium	BCD	BCD	EBCDIC	EBCDIC
Transmission Medium		modified BCD - 4 bit numeric; 8 bit non- numeric		modified BCD - 4 bit numeric; 8 bit non- numeric
COMMUNICATION MEDIUM				
Type of Channel		2-wire, reverse chnl voice band		2-wire, reverse chnl voice band
Modem Required		Sangamo T202CSA or equiv		Sangamo T202CSA or equiv
COMMENTS				
	Basic data enter/ verify model. Other opt avail.		Basic data enter/ verify model. Other options avail.	

Also see Digital and Incremental Magnetic Tape Transport charts.

MULTI DEVICE DATA TERMINALS

COMPANY	APPLIED SYSTEMS	ATRON	ATRON	ATRON
MODEL	ASC 1100 Computer Processing System	Datamanager Terminal 360/20-I	Datamanager Terminal 360/20-II	Datamanager Terminal 2780-I/II
FIRST DELIVERY YEAR	—	1971	1971	1970
BASIC PURCHASE PRICE	\$16,000 min	\$38,950	\$66,790	\$26,400/\$35,450
LEASE RATE/MONTH	\$600 min	\$1115 plus \$280 maint	\$1815 plus \$435 maint	\$710/\$995 plus \$210/\$245 maint
INPUT MECHANISMS	magnetic tape, magnetic disc, punched cards, manual keyboard	keyboard console, 400 cpm reader	keyboard console, 1000 cpm reader, 25 ips 7 or 9 tk tape	200/400 cpm card reader
OUTPUT MECHANISMS	magnetic tape, line printer	300 lpm printer, keyboard printer	keyboard printer, 1250 lpm printer, 25 ips 7 or 9 tk tape	135/300 lpm line printer
TRANSMISSION				
Speed	2400 to 9600 baud max	2000 to 50,000 bps	2000 to 50,000 bps	1200 bps to 4800 bps
Simultaneity	H.D. & F.D.	H.D. & F.D.	H.D. & F.D.	H.D. & F.D.
Synchronization	sync	sync or async	sync	sync or async
ERROR DETECTION				
Lateral/Longitudinal	parity checking option, and as programmed	16 bit CRC	16 bit CRC	16 bit CRC or 12 bit CRC
Corrective Action	software dependent — options available	programmed retrans	programmed retrans	programmed retrans
FORMATS	ASCII or EBCDIC — software options	EBCDIC with transparency	EBCDIC with transparency	EBCDIC with transparency
CODES				
I/O Medium	IBM compatible	EBCDIC	EBCDIC	EBCDIC
Transmission Medium	ASCII or EBCDIC	EBCDIC	EBCDIC	EBCDIC
COMMUNICATION MEDIUM				
Type of Channel	direct interconnection or private wire of leased line	I/O channel	I/O channel	I/O channel
Modem Required	Bell 201 or equivalent for higher speeds	Bell 201 A/B, 203, 303, 301 or equiv	Bell 201 A/B, 203, 303, 301 or equiv	Bell 202, 201, A/B or equiv
COMMENTS	Designed for either high speed batch I/O processing, such as tape or disc to printer, or as a communications batch terminal.	Model 2780-III has mag tape input.		

1 Equipment Characteristics

MULTI DEVICE DATA TERMINALS

COMPANY	CYBERMATION	DATA 100	DATA 100	ELDORADO ELECTRODATA
MODEL	System 80 Intelligent Terminal	Model 70 – Remote Batch Terminal	Model 78 – Programmed Terminal	Data Terminal 102
FIRST DELIVERY YEAR	1970	1970	1970	1970
BASIC PURCHASE PRICE	\$8040	\$29,000	\$44,050	\$7500
LEASE RATE/MONTH	\$190 – 5 yr	\$810 – 1 yr w/maint \$750 – 3 yr w/maint	\$1169 – 1 yr w/maint \$1075 – 3 yr w/maint	\$210 w/maint
INPUT MECHANISMS	keyboard, card opt	300 cpm card reader	card reader, magnetic tape (opt), paper tape (opt), CRT (opt), TTY (opt)	Selectric typewriter keyboard, tape cassette
OUTPUT MECHANISMS	printer (lo, med, or high speed), video opt	printer & card punch (opt)	printer, punch, mag tape, paper tape, CRT, TTY	Selectric typewriter printer, cassette
TRANSMISSION				
Speed	up to 9600 BPS	250-1200	250-1200	(10-960) 30 std
Simultaneity	H.D. & F.D.	H.D.	H.D. (interleaving avail on 360/20 compatible unit)	H.D.
Synchronization	sync/async	sync	sync	sync/async
ERROR DETECTION				
Lateral/Longitudinal	CRC, LRC, VRC	yes	yes	LRC & VRC
Corrective Action		retransmission	retransmission	auto retrans
FORMATS	programmable	see comment	see comment	variable length records
CODES				
I/O Medium	Binary/BCD USASCII, EBCDIC, or any other as option			ASCII
Transmission Medium		IBM binary sync	IBM binary sync, UNIVAC ANS1 & others	8 level
COMMUNICATION MEDIUM				
Type of Channel	Medium speed or Bell 103, 201, 203 or non-common carrier as option			voice
Modem Required		Bell 201, 203	Bell 201, 203	no, 300 baud unit built-in
COMMENTS		IBM 2780 compatible. Standard price includes card reader & line printer.	IBM 360/20, IBM 2780, or UNIVAC DCT2000 compatible. Standard price includes card reader & line printer.	Flexible terminal with 1K core storage. Capable of being expanded; many options.

1 Equipment Characteristics

MULTI DEVICE DATA TERMINALS

COMPANY	ELDORADO ELECTRODATA	ENTREX	LUNDY ELECTRONICS & SYSTEMS	MARK COMPUTER SYSTEMS
MODEL	Programmable Data Terminal 125	System 480	MICR Bank Data System 960-30	System Seventy
FIRST DELIVERY YEAR	1970	1971	1970	1970
BASIC PURCHASE PRICE	\$13,000	\$51,735 for control grouping (central processor, disk, tape) & \$3930/terminal	\$65,000 - \$75,000	\$34,995
LEASE RATE/MONTH	\$350 w/maint	\$1245 for control grouping & \$94/terminal, incl maint	\$1650 - \$1850	—
INPUT MECHANISMS	Selectric typewriter keyboard, cassette tape, 10-key auxiliary keyboard, optional card reader	keyboard terminals & 480-char CRT	MICR, keyboard	DD-10 CRT; DD-70 CRT, TTY, card reader, badge reader, scale
OUTPUT MECHANISMS	Selectric typewriter printer cassette optional line printer	mag tape	tape, printer	IBM compatible tape, front end to S/360
TRANSMISSION				
Speed	(10-960) 120 std	1200-2400 bps	500	up to 50,000 baud
Simultaneity	H.D.	H.D.		
Synchronization	sync/async	binary sync		async to terminals
ERROR DETECTION				
Lateral/Longitudinal	LRC & VRC	Lat & Long parity & CRC for 9 track tape	both	to tape
Corrective Action	auto retrans	software controlled	auto retransmit	re-reader, re-write
FORMATS	variable length records	7tk .75 in. IRG, NRZI, 9 tk .60 in. IRG, NRZI, 9 tk 1600 Dpi pi		all CPU-defined
CODES				
I/O Medium		BCD (7 tk) and EBCDIC (9 tk)	ASCII	IBM compatible tapes or front-end to S/360
Transmission Medium	ASCII, EBCDIC & transcode optional			ASCII
COMMUNICATION MEDIUM				
Type of Channel	voice	Bell 201/202 or equiv	voice	leased telephone line
Modem Required	no, 1200 baud unit built-in		supplied by Lundy	self-contained in terminal
COMMENTS	Can be stand-alone or terminal. Has 4K CPU, two cassette drives communication software for IBM 2780, Univac 1004 and DCT 2000 compatibility.	A data entry & verification system with up to 64 CRT terminals; disk for intermediate data storage; central processor for validating, editing, and reformatting data; mag tape drive for final output that is ready for immediate processing.		

1 Equipment Characteristics

MULTI DEVICE DATA TERMINALS

COMPANY	NOLLER CONTROL SYSTEMS	OLIVETTI	SAGETEC	SAGETEC
MODEL	DTS 100A	TC380	2600 Data Link	6500 Data Link
FIRST DELIVERY YEAR	1968	1970	1970	1970
BASIC PURCHASE PRICE	\$49,529	\$5760	\$3300 to \$4250	\$2200 to \$3075
LEASE RATE/MONTH	\$1290 - 1 yr \$1095 - 5 yrs	\$201	10% to 5%	10% to 5%
INPUT MECHANISMS	std: punched card, teletype opt: mag tape 7 or 9 tk CRI keyboard	keyboard, paper tape	any binary or BCD source	ASCII or TTY
OUTPUT MECHANISMS	PPT, line printer	printer, paper tape, 2nd printer (40 cps) opt	serial & parallel ASCII	parallel binary or BCD words
TRANSMISSION				
Speed	2000-50,000 bps	120	char/sec adjustable 10 to 1000	char/sec adjustable 10 to 1000
Simultaneity	H.D. and/or F.D.	H.D.	F.D.	F.D.
Synchronization	sync	async	async	async
ERROR DETECTION				
Lateral/Longitudinal	vertical, long parity & cyclic redundant check & correct control coding	VRC, LRC	-	-
Corrective Action	retry & operator diagnostics routine & system performance log	auto retransmission	parity	parity
FORMATS	1108 Ex 2 & 8 & CSCX 360/2780 CDC6000 series, mark series, & others as required	3 independent tabulation programs	front panel slide switch controlled	front panel slide switch controlled
CODES				
I/O Medium	any 6 to 12 bit code		ASCII or any 7 or 8 level code	ASCII or any 7 or 8 level code
Transmission Medium	any 6 to 9 bit code	ASCII	serial data sets on lines	serial data sets on lines
COMMUNICATION MEDIUM				
Type of Channel	dial up or dedicated lines	voice grade	TTY I/O or special buffered I/O	TTY I/O or special buffered I/O
Modem Required	any RS-232 B/C compatible	EIA 232	none required but unit is compatible with all modems	none required but unit is compatible with all modems
COMMENTS	Fully programmable - no hardware changes to vary formats; many optional output mechanisms.	Programmable machine with arithmetic capabilities (opt), checkdigit verification (opt).	Couples relatively slow speed instruments directly to a computer through its TTY I/O channel or to the computer through any modem.	This unit takes serial data from a TTY or computer via a modem & produces parallel binary or BCD words of variable length.

1 Equipment Characteristics

PAPER TAPE DATA TERMINALS

COMPANY	BUNKER-RAMO	BUNKER-RAMO	COMPAT	CONNECTICUT TECHNICAL CORP.
MODEL	2295 Paper Tape Reader	2296 Paper Tape Punch	Comfile 88-23/140	700 GA
FIRST DELIVERY YEAR	1968	1968	1970	1968
BASIC PURCHASE PRICE	\$2390	\$5395	\$15,100	\$4920
LEASE RATE/MONTH	\$56 - 2 yr.	\$130 - 2 yr.	\$518	\$225
INPUT MECHANISMS	100 char/sec	CPU	paper tape reader selectric keyboard	keyboard or tape recorder
OUTPUT MECHANISMS	to CPU	110 char/sec	hard copy	paper tape
TRANSMISSION				
Speed (char/sec)	120 async, 300 sync	120 async, 300 sync	1200 - 2000 baud	10
Simultaneity	HD or FD	HD or FD		HD
Synchronization	async or sync	async or sync	sync	async & sync
ERROR DETECTION				
Lateral/ Longitudinal	lateral/ longitudinal	lateral/ longitudinal	lateral/ longitudinal	
Corrective Action	request retrans	request retrans	auto retrans	n/a
Other				
DOCUMENT CHARACTERISTICS			hard copy	typewritten page
CODES				
I/O Medium	5, 6, 7 or 8 level	5, 6, 7 or 8 level	any	all 6 level
Transmission Medium	7-bit ASCII	7-bit ASCII	EBCDIC	telephone line
COMMUNICATION MEDIUM				
Channel Type	2222 controller	2222 controller	voice grade and/or line	
Modem Required	EIA RS-232	EIA RS-232	202C, 201A	
COMMENTS				graphic arts special unit

Also see Paper Tape Punches and Reader charts.

1 Equipment Characteristics

PAPER TAPE DATA TERMINALS

COMPANY	CONNECTICUT TECHNICAL CORP.	DIGITRONICS	DIGITRONICS	DIGITRONICS
MODEL	Hyperperf '70 Series	507 Paper Tape Transmitter	509 Paper Tape Receiver	5079 Paper Tape Terminal
FIRST DELIVERY YEAR	1970	1967	1965	1968
BASIC PURCHASE PRICE	\$2795 - \$6500	\$7875	\$10,500	\$14,400
LEASE RATE/MONTH	n/a	\$152 w/maint	\$189 w/maint	\$300 w/maint
INPUT MECHANISMS	keyboard or tape	paper tape reader	n/a	paper tape reader
OUTPUT MECHANISMS	punched tape or communications interface	n/a	paper tape punch	paper tape punch
TRANSMISSION				
Speed (char/sec)	non-print: 50 print: 16.7	100 or 150	100	300 transmit & 100 receive
Simultaneity	FD	HD or FD w/ reverse chnl	HD or FD w/ reverse chnl	HD or FD w/ reverse chnl
Synchronization	async or sync	sync	sync	sync
ERROR DETECTION				
Lateral/ Longitudinal	optional	control sequence, vert & long. parity checks	vert, long. parity & control sequence checks	vert, horiz parity, control sequence check
Corrective Action		auto retrans	auto retrans	auto retrans
Other		block count	block count	block count
DOCUMENT CHARACTERISTICS	typewritten page	n/a	n/a	n/a
CODES				
I/O Medium	all	5, 6, 7, or 8 level paper tape	5, 6, 7, or 8 level	5, 6, 7, or 8 level
Transmission Medium	telephone lines		BCD, Friden 5-level TTY, ASCII	5, 6, 7, or 8 level
COMMUNICATION MEDIUM				
Channel Type		voice	voice	voice
Modem Required		yes	yes	yes
COMMENTS	Off line or on line unit. Hardwire or acoustic couple.			

Also see Paper Tape Punches and Reader charts.

1 Equipment Characteristics

PAPER TAPE DATA TERMINALS

COMPANY	INFORMATION MACHINES CORP.	ITT DATA EQUIPMENT AND SYSTEMS DIV.	MSI DATA	OKI ELECTRIC INDUSTRY
MODEL	Registron R-600	Envoy – ITT 3010	MSI-211 Data Receiver	2400 Tape Send/Receive Terminal
FIRST DELIVERY YEAR	1969	1970	1968	1969
BASIC PURCHASE PRICE	\$3895	\$2750		
LEASE RATE/MONTH	\$95 - \$125	\$84		
INPUT MECHANISMS	Registron point of sale data recorder	paper tape reader keyboard		reading system – photoelectric
OUTPUT MECHANISMS	paper tape punch	paper tape punch, hard copy printer		punching system
TRANSMISSION				
Speed (char/sec)	as required by output device	10	40 or 60	343
Simultaneity		HD or FD	simplex	HD or FD
Synchronization	async	async	async	
ERROR DETECTION				
Lateral/Longitudinal	parity check & lost data detector	lateral	lateral	accessory equip available
Corrective Action	error indication & rerun	special symbol printed out	replace error char w/ special char	
Other				
DOCUMENT CHARACTERISTICS		any friction or sprocketed feed form, up to 6 copies		
CODES				
I/O Medium	as required by user or USASI	ASCII – full set	input = 4 bit binary output = 8 chnl paper tape	8 levels
Transmission Medium		ASCII – full set	manchester	paper tape
COMMUNICATION MEDIUM				
Channel Type		leased line or dial up network	voice grade	telephone lines
Modem Required	can operate w/ modem	103	202C or equiv	yes
COMMENTS		Local mode tape read & write for reproduction, editing.		A tape-based send/receive terminal station.

Also see Paper Tape Punches and Reader charts.

1 Equipment Characteristics

PAPER TAPE DATA TERMINALS

COMPANY	OMNITEC	SANDERS DATA SYSTEMS	SYNER-DATA	TELETYPE
MODEL	500A Terminal	5700 Display/Tape System	Beta ASR	Telespeed Series
FIRST DELIVERY YEAR	1968	1967	1970	
BASIC PURCHASE PRICE	\$1250	by request	\$5195	Xmtr \$1000/\$4800 Rcvr \$2850/\$6200
LEASE RATE/MONTH	\$72 - 24 mos.	by request	n/a	
INPUT MECHANISMS	keyboard 51 key (plus space bar) paper tape reader	high-speed reader	TTY serial, EIA RS232C	
OUTPUT MECHANISMS	8½" pg. (impact printing) paper tape punch	high-speed punch	above plus impact print & paper tape	
TRANSMISSION				
Speed (char/sec)	10	180	10 - 30	75 - 120
Simultaneity	HD & FD switchable	n/a	loc - HD - FD	
Synchronization	async	strobe provided to punch by Model 5709	async	
ERROR DETECTION				
Lateral/Longitudinal		n/a - off line system		
Corrective Action				horiz & spiral parity check
Other				
DOCUMENT CHARACTERISTICS			edge-sprocketed, 6-part forms, plus paper tape	800 ft. tape supply
CODES				
I/O Medium	ASCII	ASCII, Baudot	ASCII	5 - 8 level & ASCII
Transmission Medium	acoustic coupling to telephone line	cable	odd, even, marking parity	
COMMUNICATION MEDIUM				
Channel Type		n/a	TTY serial or RS 232C	
Modem Required	acoustic modem built-in	n/a	RS232C compatible	
COMMENTS	Has DAA capabilities.			

Also see Paper Tape Punches and Reader charts.

1 Equipment Characteristics

PRINTER DATA TERMINALS

COMPANY	A.B. DICK	APPLIED SYSTEMS	BUNKER-RAMO	BUNKER-RAMO
MODEL	Videojet 9600	ASC1170 Communica-tions Terminal	2290 (R-O)	2292 (R-O)
FIRST DELIVERY YEAR	1969		1968	1968
BASIC PURCHASE PRICE	\$6250	\$17,000 & up	\$1210	\$2650
LEASE RATE/MONTH	\$188 - 2 yr	\$600 & up	\$32 - 2yr, \$29 - 3 yr, \$26 - 5 yr	\$69 - 2 yr, \$64 - 3 yr \$60 - 5 yr
INPUT MECHANISM	data set or I/O bus of computer	punched cards, magnetic tape, keyboard, paper tape	CPU or CRT	CPU or CRT
OUTPUT PRINTER SPEED (LPM)	250/300 char/sec	132 col. optionally: 135/300/400/600/1100	10 char/sec	10 char/sec
TRANSMISSION				
Speed (char/sec)	250/300	2400-9600 bps	120 async, 300 sync	120 async, 300 sync
Simultaneity		HD & FD	HD & FD	HD & FD
Synchronization	sync or async (w/buffer)	sync	sync or async	sync or async
ERROR DETECTION				
Lateral/Longitudinal	parity - lat and long	parity checking options, and as programmed	lateral/longitudinal	lateral/longitudinal
Corrective Action	ACK/NAK response		request retrans	request retrans
Other	flags print line where parity error occurs	software options avail		
FORMAT	flexible 132 to 200 char/line max	var, buffers provided	74 char/line	75 or 80 char/line
DOCUMENT CHARACTERISTICS	std computer forms up to 14-7/8 in width	IBM standards	typeface: Murray	typeface: Murray
CODES				
I/O Medium	USASCII	IBM compatible ASCII or EBCDIC	8-level ASCII	8-level ASCII
Transmission Medium	USASCII		7-bit ASCII	7-bit ASCII
COMMUNICATION MEDIUM				
Type of Channel	voice grade line	private or leased line	printer control via 2222 controller	printer control via 2222 controller
Modem Required	Bell 202 or 201 series data sets	Bell 201 or higher speed equiv	EIA RS-232	EIA RS-232
COMMENTS	Serial, parallel or buffered interfaces avail. Vert forms control also avail. Silent nonimpact printing.	Remote batch communications terminal	Same as Teletype Model 33 R-O	Same as Teletype Model 35 R-O

Also see "Printer" charts.

1 Equipment Characteristics

PRINTER DATA TERMINALS

COMPANY	BUNKER-RAMO	COMPAT	COMPUTER DEVICES	COMPUTER DEVICES
MODEL	2299 (R-O)	COMFILE 88-23/120	Teleterm CDI 1010	Teleterm CDI 1030
FIRST DELIVERY YEAR	1970	1970	1970	1970
BASIC PURCHASE PRICE	\$4500	\$26,600	\$2100	\$3500
LEASE RATE/MONTH	\$110 - 2 yr, \$100 - 3 yr, \$95 - 5 yr	\$903	\$70	\$130
INPUT MECHANISMS	CPU or CRT	Selectric typewriter keyboard, magnetic tape, punch cards	built-in acoustic coupler, DAA conn, RS 232C conn, accessory conn.	built-in acoustic coupler, DAA conn, RS 232C conn, accessory conn.
OUTPUT PRINTER SPEED (LPM)	30 char/sec	600	7.5 (80 ch/line)	22.5 (80 ch/line)
TRANSMISSION				
Speed (char/sec)	120 async, 300 sync	1200-2000 baud	10	10,15, & 30 - switch selectable
Simultaneity	HD & FD		HD & FD - switch selectable	HD & FD - switch selectable
Synchronization	sync or async	sync	async	async
ERROR DETECTION				
Lateral/Longitudinal	lateral/longitudinal	both	parity (odd or even) send, receive & check	parity (odd or even) send, receive & check
Corrective Action	request retrans	auto retrans	parity error lite	parity error lite
Other				
FORMAT	118 char/line	free text	8½"x11" paper 80 ch/line, 10 ch/in., 6 lines/in.	8½" roll fed paper 80 ch/line, 10 ch/in., 6 lines/in.
DOCUMENT CHARACTERISTICS		hard copy	64 char set, impact printer, up to 4 copies	96 char set, thermal printer
CODES				
I/O Medium	8-level ASCII	any	ASCII, RS 232-C	ASCII, RS 232C
Transmission Medium	7-bit ASCII	EBCDIC	normal dial-up phone line	normal dial-up phone line
COMMUNICATION MEDIUM				
Type of Channel	printer control via 2222 controller	voice grade and/or private line	normal dial-up phone line	normal dial-up phone line
Modem Required	EIA RS 232	Bell 202C, 201A	built-in	built-in
COMMENTS	Same as GE Terminet Printer			

Also see "Printer" charts.

1 Equipment Characteristics

PRINTER DATA TERMINALS

COMPANY	COMPUTER TRANS- CEIVER SYSTEM	DATA COMPUTING	DATA COMPUTING	DATA COMPUTING
MODEL	Execuport 300	Typeliner I	Typeliner OEM I	Typeliner II
FIRST DELIVERY YEAR	1969	1970		
BASIC PURCHASE PRICE	\$3800	\$8250	\$4125	\$9600
LEASE RATE/MONTH	\$179 - 2 yr, \$126 - 3 yr (3rd party leasing)	\$245		\$285
INPUT MECHANISMS	keyboard	serial ASCII at 6, 12, 2400 baud	parallel ASCII	serial ASCII at 6, 12 2400 baud
OUTPUT PRINTER SPEED (LPM)	22.5 lpm/30 cps	100	100	100
TRANSMISSION				
Speed (char/sec)	10, 15 or 30	120-240	variable to 240	120-240
Simultaneity	HD & FD			
Synchronization	async			
ERROR DETECTION				
Lateral/Longitudinal		lateral	parity signal available	lateral
Corrective Action		reverse chnl signal		reverse chnl signal
Other	generates odd or even parity			
FORMAT	characters 5x7 dot matrix, 80 col			
DOCUMENT CHARACTERISTICS	heat sensitive paper roll - 100 ft	9-7/8	9-7/8	14-7/8
CODES				
I/O Medium	ASCII			
Transmission Medium	ASCII	ASCII	ASCII	ASCII
COMMUNICATION MEDIUM				
Type of Channel	voice grade phone line	dial up	none	dial up
Modem Required	acoustic/acoustic	202	none	202
COMMENTS				

Also see "Printer" charts.

PRINTER DATA TERMINALS

COMPANY	DATA COMPUTING	DATA COMPUTING	DATA COMPUTING	DATA PRODUCTS
MODEL	Typeliner OEM II	Typeliner III	Typeliner IV	8280 A1
FIRST DELIVERY YEAR				1969
BASIC PURCHASE PRICE	\$4800	\$8925	\$10,600	\$17,100
LEASE RATE/MONTH		\$270	\$315	\$470
INPUT MECHANISM	parallel ASCII	serial ASCII at 6, 12, 2400 baud	serial ASCII at 6, 12, 2400 baud	common carrier lines at rates up to 9600 baud, receive only printer
OUTPUT PRINTER SPEED (LPM)	100	100	100	70 col at 1100 80 col at 356
TRANSMISSION				
Speed (char/sec)	variable to 240	120-240	120-240	up to 9600 baud
Simultaneity				HD operation on FD lines
Synchronization				sync
ERROR DETECTION				
Lateral/Longitudinal	parity signal available	lateral	lateral	character and LRC
Corrective Action		reverse channel signal	reverse channel signal	deletion only
Other				
FORMAT				1-80 column
DOCUMENT CHARACTERISTICS	14-7/8	9-7/8	14-7/8	std fanfold up to 11" length 4-9 7/8" wide
CODES				
I/O Medium	ASCII			ASCII
Transmission Medium		ASCII	ASCII	ASCII-BSC
COMMUNICATION MEDIUM				
Type of Channel	none	dial up	dial up	voice
Modem Required	none	202	202	yes
COMMENTS				Extensive formatting capability including data compression and vertical tabbing

Also see "Printer" charts.

1 Equipment Characteristics

PRINTER DATA TERMINALS

COMPANY	DATA PRODUCTS	DIGITRONICS	DIGITRONICS
MODEL	8280 B1	Dial-O-Verter Model 4021 Printer	Dial-O-Verter Model 5122 Card Transmitter/Printer Terminal
FIRST DELIVERY YEAR	1969	1968	1969
BASIC PURCHASE PRICE	\$21,600	\$42,420	\$54,500
LEASE RATE/MONTH	\$600	\$650 w/maint	\$850 w/maint
INPUT MECHANISM	common carrier lines at rates up to 9600 baud, receive only printer	n/a	punched card reader
OUTPUT PRINTER SPEED (LPM)	24 col at 1100 132 col at 245	300	300
TRANSMISSION			
Speed (char/sec)	up to 9600 baud	600	533 (transmitting) 600 (receiving)
Simultaneity	HD operation on FD lines	HD w/reverse chnl or FD	HD w/reverse chnl or FD
Synchronization	sync	sync	sync
ERROR DETECTION			
Lateral/Longitudinal	character and LRC	vert & long parity modulo 8 block count & control sequence check	vert & long parity modulo 8 block count & control sequence check
Corrective Action	deletion only	auto retrans	auto retrans
Other			
FORMAT	1-132 column	vert & horiz tabbing	vert & horiz tabbing
DOCUMENT CHARACTERISTICS	std fanfold up to 11" length 4-9 7/8" wide	120 or 132 char/line	120 or 132 char/line
CODES			
I/O Medium	ASCII	any 5 thru 8 level code	any 5 thru 8 level code
Transmission Medium	ASCII-BSC	telephone lines	telephone lines
COMMUNICATION MEDIUM			
Type of Channel	voice	voice	voice
Modem Required	yes	yes	yes
COMMENTS	Extensive formatting capability including data compression and vertical tabbing	Other fonts available	Other fonts available

Also see "Printer" charts.

PRINTER DATA TERMINALS

COMPANY	DIGITRONICS	OKI ELECTRIC INDUSTRY	UNIVAC
MODEL	Dial-O-Verter Model 5072 Paper Tape Transmitter/Printer Terminal	OKIDATA-2400 Terminal Printer	DCT 2000
FIRST DELIVERY YEAR	1968	1969	1967
BASIC PURCHASE PRICE	\$42,950		\$16,170
LEASE RATE/MONTH	\$750 w/maint		\$435 incl maint
INPUT MECHANISM	paper tape reader		card reader, paper tape
OUTPUT PRINTER SPEED (LPM)	300	190	250
TRANSMISSION			
Speed (char/sec)	300 (transmitting) 600 (receiving)	separate controller	250-600
Simultaneity	HD w/reverse chnl or FD		HD
Synchronization	sync		sync
ERROR DETECTION			
Lateral/Longitudinal	vert & long parity, modulo 8 block count & control sequence check	separate controller	yes
Corrective Action	auto retrans		request retrans
Other			
FORMAT	vert & horiz tabbing	136 char/line	ASCII
DOCUMENT CHARACTERISTICS	120 or 132 char/line		80 or 128 char print line, multi-form
CODES			
I/O Medium	any 5 thru 8 level code	8 levels	ASCII
Transmission Medium	telephone lines		ASCII or XS3
COMMUNICATION MEDIUM			
Type of Channel	voice		voice grade
Modem Required	yes		Bell 201 or equiv
COMMENTS	Other fonts available		

Also see "Printer" charts.

1 Equipment Characteristics

PUNCH CARD DATA TERMINALS

COMPANY	APPLIED SYSTEMS	COMPAT	DATA COMPUTING	DATA COMPUTING
MODEL	ASC1170 Communications Terminal	COMFILE 88-23/130	CARDLINER 10	CARDLINER 15 BCD/C
FIRST DELIVERY YEAR		1970	1969	1969
BASIC PURCHASE PRICE	\$15,000 & upwards	\$15,600	\$3060	\$3060
LEASE RATE/MONTH	\$500 & upwards	\$533	\$90	\$90
INPUT MECHANISMS	punch cards, magnetic tape, paper tape	punch cards, Selectric typewriter keyboard	punched card	punched card
OUTPUT MECHANISMS	card punch, magnetic tape, line printers	hard copy		
TRANSMISSION				
Speed (char/sec)	2400 to 9600 bps	1200-2000 baud	10	14.8
Simultaneity	HD & FD		HD & FD	HD & FD
Synchronization	sync	sync	async	async
ERROR DETECTION				
Lateral/Longitudinal	as programmed, w/parity checking options	both	lateral	lateral
Corrective Action		auto retrans	none	none
Other				
DOCUMENT CHARACTERISTICS	IBM standards	hard copy	standard Hollerith card	standard Hollerith card
CODES				
I/O Medium	IBM compatible	any	Hollerith	Hollerith
Transmission Medium	ASCII or EBCDIC	EBCDIC	ASCII	BCD/corr
COMMUNICATION MEDIUM				
Channel Type	private wire or leased lines	voice grade and/or private line	voice grade	voice grade
Modem Required	Bell 201 or higher speed equiv	Bell 202C, 201A	Bell 103	Bell 103
COMMENTS	Remote batch communications terminal.		Compatible with 33, 35 TTY.	2741, Datel, Dura, Novar compatible.

Also see Card Punches, Card Reader/Punches and Card Reader charts.

PUNCH CARD DATA TERMINALS

COMPANY	DATA COMPUTING	DATA PATHING	DATA PATHING	DATRON SYSTEMS
MODEL	CARDLINER 30	Multi-Input Terminal - 1204	Print Card Punch-5210 / Batch Card Reader-5101	102 Card Transmitter
FIRST DELIVERY YEAR	1969	1967	1970	1968
BASIC PURCHASE PRICE	\$3390			\$1000-\$625
LEASE RATE/MONTH	\$315			\$23-\$14
INPUT MECHANISMS	punched card	photo-optical scanner, photo-optical badge reader, variable keyboard	none	card reader, keyboard
OUTPUT MECHANISMS		mag tape	outpunch punch only / mag tape	
TRANSMISSION				
Speed (char/sec)	30	300	300	12
Simultaneity	HD & FD	HD & FD	HD & FD	
Synchronization	async	sync	sync	
ERROR DETECTION				
Lateral/Longitudinal	lateral	both	both	record length count
Corrective Action	none	auto retrans	auto retrans	retrans
Other		error analysis to operator		
DOCUMENT CHARACTERISTICS	standard Hollerith card	80 col cards, 22 col cards, coded badge, 10 numerics	80 col cards	80 col cards
CODES				
I/O Medium	Hollerith	BCD	BCD	3 out of 14
Transmission Medium	ASCII	BCD, ASCII or Ex BCD	BCD, ASCII or EXBCD	
COMMUNICATION MEDIUM				
Channel Type	voice grade	voice grade	voice grade	
Modem Required	Bell 103	Bell 301B or equiv - 3002 C1 line	Bell 301B or equiv - 3002 C1 line	401E2 data set
COMMENTS	Terminet 300, Beta, Gulton, Datapoint 3300, Courier.	Interactive, stored-program terminal for use w/DPI source data management systems.	Card output terminal intended for use w/DPI source data management systems.	

Also see Card Punches, Card Reader/Punches and Card Reader charts.

1 Equipment Characteristics

PUNCH CARD DATA TERMINALS

COMPANY	DIGI-DATA	INFORMATION MACHINES	OKI ELECTRIC INDUSTRY	WESTERN TELEMATIC
MODEL	System 40, 2020 Transmitter	Registron R-600	OKI Data Collection Station	Interactive Card RDR Terminal, CT41
FIRST DELIVERY YEAR	1965	1969	1968	1969
BASIC PURCHASE PRICE	\$3816	\$3895		\$3836 to \$4775
LEASE RATE/MONTH	\$165	\$95 to \$125		\$135 to \$180
INPUT MECHANISMS	Hollerith card reader	Registron point of sale data recorder	card reader, badge card reader, slide dial	80 col punch cards
OUTPUT MECHANISMS	none	IBM 026, 029		RS232 &/or IBM 2741 Selectric or equiv
TRANSMISSION				
Speed	100	15	200 bps	15 (sync to terminal)
Simultaneity	HD		HD or simplex	HD
Synchronization	async	async		async
ERROR DETECTION				
Lateral/Longitudinal	yes	parity ck & lost data detector	horiz & vert parity	depends on software in computer
Corrective Action	retransmit card	rerun	auto retrans	depends on software in computer
Other	yes			
DOCUMENT CHARACTERISTICS	punched cards			full page, 132 char, friction or pin feed from 2741
CODES				
I/O Medium	Hollerith code	as required by user	80 col card, Bach card & slide dial	serial by bit
Transmission Medium	BCD			7 level, IBM, Corr. or EBCD
COMMUNICATION MEDIUM				
Channel Type	direct dial			voice grade
Modem Required	direct access arrangement		yes	Bell 103A or equiv
COMMENTS				

Also see Card Punches, Card Reader/Punches and Card Reader charts.

TELEPRINTER AND TELETYPEWRITER DATA TERMINALS

COMPANY	A.B. DICK	APPLIED COMPUTER SYSTEMS	BUNKER-RAMO	COMDATA
MODEL	Videojet 9600	George DPT-100	2297 KSR (Keyboard Send-Receive)	33-AFT-32113
FIRST DELIVERY YEAR	1969	1970	1968	1968
BASIC PURCHASE PRICE	\$6250	\$30,000	\$2950	\$888
LEASE RATE/MONTH	\$188 - 2 yrs	—	\$81-2 yr, \$74-3 yr, \$67-5 yr plus \$68 maint	\$31.97 - 3 yrs
INPUT MECHANISMS	data set or I/O bus of computer	teletype, card reader	keyboard	punched tape reader, keyboard
OUTPUT MECHANISMS	250/300 char/sec	line printer, CRT, teletype	CPU	paper tape punch, printer
FORMAT	flexible 132 to 200 char/line max	compatible with CDC 6600, IBM 360, others	75 or 80 chars/line	10 char/inch, 74 char/line
DOCUMENT CHARACTERISTICS	standard computer forms	—	typeface: Murray	friction feed paper
CODES				
I/O Medium	USASCII	—	8-level ASCII	ASCII
Transmission Medium	USASCII	switched or private lines	7-bit ASCII	bit serial
TRANSMISSION				
Speed	250/300 char/sec, 2000 or 2400 baud	up to 4800 baud	120 asyn, 300 sync	10
Simultaneity		H.D. & F.D.	H.D. & F.D.	H.D. & F.D.
Synchronization	sync or async (with buffer)	asyn or sync	sync or asyn	asyn
ERROR DETECTION				
Lateral/Longitudinal	lateral/longitudinal parity	parity	lateral/longitudinal	none
Corrective Action	ACK/NAK response	retransmission	request retransmission	
Other	flags print line where parity error occurs	cyclic redundancy check (CRC)	—	
COMMENTS	Serial, parallel or buffered interfaces available. Vertical forms control also available. Silent, non-impact printing.	Minicomputer based batch processing terminal	Same as Teletype Model 35 KSR	Series 33 ASR Teletype modified for use as time-sharing terminal. Available with mobile stand and built-in acoustically coupled data set.

Also see "Input Typewriter" charts.

1 Equipment Characteristics

TELEPRINTER AND TELETYPEWRITER DATA TERMINALS

COMPANY	COMPAT	COMPUTER DEVICES	COMPUTER DEVICES	COMPUTER TERMINAL SYSTEMS
MODEL	COMFILE 88-03	Teleterm CDI 1010	Teleterm CDI 1030	Portable Data Terminal Model 111
FIRST DELIVERY YEAR	1970	1970	1970	1970
BASIC PURCHASE PRICE	\$4200	\$2100	\$3500	\$1500
LEASE RATE/MONTH	\$146	\$70	\$130	
INPUT MECHANISMS	Selectric typewriter keyboard	built-in acoustic coupler, DAA connector, RS-232 connector, & accessory connector	built-in acoustic coupler, direct access connector, accessory connector, RS 232-C connector	64 character alphanumeric keyboard
OUTPUT MECHANISMS	Selectric typewriter keyboard	all above & hard copy printer	all above & hard copy printer	strip printer & acoustic coupler or tape cassette
FORMAT	free text	8½" page printer - 80 col/line	ASCII; 8½" page printer - 80 col/line	single horiz line
DOCUMENT CHARACTERISTICS	hard copy	8½"x11" paper, 64 char, 6 lines/in, 10 ch/in	96 char, 6 lines/inch, 10 char/inch	permanent hard copy on pressure sensitive paper
CODES				
I/O Medium	ASCII	ASCII & RS 232C	ASCII & RS-232C	ASCII 5 level baud
Transmission Medium	ASCII	acoustic or DAA phone line	acoustic or DAA phone line	
TRANSMISSION				
Speed	110-150 baud	10	10, 15 & 30 switch selectable	35 ave.
Simultaneity	—	H.D. & F.D. switch selectable	H.D. & F.D. switch selectable	F.D.
Synchronization	async	async	async	async
ERROR DETECTION				
Lateral/Longitudinal	lateral	parity (odd or even) send & receive and check	parity send & receive & check	none
Corrective Action	none	parity error light	parity error light	
Other	—			
COMMENTS	—	Portable — 25 pounds	Portable — 22 pounds	Paper take-up optional

Also see "Input Typewriter" charts.

1 Equipment Characteristics

TELEPRINTER AND TELETYPEWRITER DATA TERMINALS

COMPANY	COMPUTER TERMINAL SYSTEMS	DATA ACCESS SYSTEMS	DATA PRODUCTS TELECOMMUNICATIONS	DATA SERV
MODEL	Time Clock Terminal Model 113	TTY-DF33ASR-1	PortaCom PC-8110	EXECUPORT '300'
FIRST DELIVERY YEAR	1970		1969	1969
BASIC PURCHASE PRICE	\$3000	\$1495	\$2450	\$3800
LEASE RATE/MONTH	- - - -	\$64 (2 yr)	\$95	\$129.20
INPUT MECHANISMS	badge or credit card, internal julian (day-hour-min) time clock	keyboard or paper tape	keyboard, paper tape, mag. tape	keyboard with numeric data entry feature.
OUTPUT MECHANISMS	strip printer and tape cassettes or telephone lines	keyboard or paper tape	page printer, mag tape data recorder	thermal printer
FORMAT	single horiz line	72 character line	ASCII	80 characters per line
DOCUMENT CHARACTERISTICS	permanent hard copy on pressure sensitive paper	roll paper	8½" fanfold pin feed	8½" thermally sensitive paper
CODES				
I/O Medium	ASCII 5 level Baud	ASCII	ASCII	ASCII
Transmission Medium		direct dial network		10 or 11 bit async
TRANSMISSION				
Speed	35 ave.	10	10	30
Simultaneity	F.D.	H.D. & F.D.	H.D. & F.D.	H.D. & F.D.
Synchronization	async	async	async	async
ERROR DETECTION	none	n/a		
Lateral/Longitudinal			character parity	
Corrective Action			prints error symbol	
Other				
COMMENTS	Badge reader reads up to 22 columns and accommodates clip-style badges.	Includes choice of acoustic or hard-wired coupler. \$1100 without coupler. Complete line of TTY equipment available.	Packaged as briefcase for portable use. Weighs only 29 pounds.	Portable (28 lb) with integral luggage carrying case.

Also see "Input Typewriter" charts.

1 Equipment Characteristics

TELEPRINTER AND TELETYPEWRITER DATA TERMINALS

COMPANY	DATA SERV	DI/AN CONTROLS	DI/AN CONTROLS	FEDDER DATA CENTERS
MODEL	GULTON LG 10/30	Series 90, RO 9010	Series 90, KSR 9030	APT 1000
FIRST DELIVERY YEAR	1970	1970	1971	1970
BASIC PURCHASE PRICE	\$3950	\$1650		\$14,950
LEASE RATE/MONTH	\$129	none	none	\$350
INPUT MECHANISMS	keyboard with number, data entry feature	none	keyboard, mag tape	Selectric typewriter
OUTPUT MECHANISMS	inpact printer	impact page printer	7 x 5 dot matrix mechanism	Selectric or high speed printer
FORMAT	132 char/line	80 col/line	80 char/line 132 char/line (option)	variable
DOCUMENT CHARACTERISTICS		8½" - 3-part stock, friction feed	9-7/8" (standard) one to six-part stock sprocket feed	typewritten
CODES				
I/O Medium	ASCII	ASCII	ASCII & BCD, TTY (optional)	ASCII
Transmission Medium	10 bit async	telephone lines	telephone lines	dialup
TRANSMISSION				
Speed	30	10	30	150
Simultaneity	H.D. & F.D.	H.D. & F.D.	H.D. & F.D.	H.D.
Synchronization	async	async	async	async
ERROR DETECTION				
Lateral/Longitudinal		longitudinal	longitudinal	lateral/longitudinal/spiral
Corrective Action		error symbol printout	error symbol printout	auto retransmission
Other				
COMMENTS	Porelon inking technique. Original plus six copies. Forms control.		Also available in RO and ASR models.	Unattended, 4K, expandable to 32K, IBM compatible, 2780 compatible, unlimited peripheral interfacing.

Also see "Input Typewriter" charts.

TELEPRINTER AND TELETYPEWRITER DATA TERMINALS

COMPANY	FUJITSU	FUJITSU	GE COMMUNICATION & CONTROL DEVICE PRODUCTS	INFOREX
MODEL	FACOM 1530	FACOM 1520	Termi Net 300 Teleprinter	Model 1301 Control Unit; 2901 Keystation
FIRST DELIVERY YEAR	1968	1969	1969	1970
BASIC PURCHASE PRICE	-----	-----	\$3625-KSR; \$3080-RO; \$5860-ASR	-----
LEASE RATE/MONTH	-----	-----	\$145-KSR	-----
INPUT MECHANISMS	terminal writer, keyboard printer, paper tape reader	keyboard printer, printer, paper tape reader	paper tape, keyboard, parallel interface option for use with card readers etc.	64 char std keyboard, 7 or 9 tk tape; 556, 800, or 1600 bpi
OUTPUT MECHANISMS	paper tape punch, printer	printer, paper tape punch	impact printer	7 or 9 tk tape or line printer
FORMAT			10 char/inch horiz & 6 lines/inch vertical	programmed, batch processing, variable record length, 16 to 800 char long
DOCUMENT CHARACTERISTICS			standard paper; original +6 copies; friction or pin feed	user designed
CODES				IBM BCD or EBCDIC, Honeywell octal disc storage or tape
I/O Medium	ISO code		USASCII-upper & lower case	
Transmission Medium	ISO code	ISO code	EIA RS-232 interface voicegrade	Bell 201A modem, switched network
TRANSMISSION				
Speed	20-120	5 or 20	10, 15, 30, 120 (120-from paper tape only)	250 (2000 baud)
Simultaneity			H.D. or F.D.	
Synchronization		start-stop	async	sync
ERROR DETECTION				
Lateral/Longitudinal			character parity error detection. When an error is detected, an alarm will sound & a diamond symbol will be printed	CRC-cyclic redundancy checking
Corrective Action				error messages displayed on station CRT monitor
Other				
COMMENTS	Banking application.		Options include: horiz & vert tabulation, built-in modem (originate only), selective addressing answerback.	Transmission does not interfere with normal operator data entry activity at either end of line. Remote or slave unit may be fully unattended.

Also see "Input Typewriter" charts.

1 Equipment Characteristics

TELEPRINTER AND TELETYPEWRITER DATA TERMINALS

COMPANY	ITT-DATA EQUIP- MENT & SYSTEMS	MICRODYNE	MITE	NOVAR
MODEL	Envoy ITT3010	Microdyne Input/ Output Typewriter	Model 123T Portable Terminal	Novar Model 5-41
FIRST DELIVERY YEAR	1970	1967	1970	1969
BASIC PURCHASE PRICE	\$2750	\$190*	\$2100	\$4500
LEASE RATE/MONTH	\$84	none	by request	\$115 w/modem & service
INPUT MECHANISMS	keyboard, paper tape	IBM Selectric typewriter- compatible with compu- ter mag tape, paper tape, etc. with appro- priate interface	full ASCII keyboard, 123T has connections for parallel input such as tape reader or mag tape cassette	Selectric typewriter
OUTPUT MECHANISMS	impact printing, paper tape	same as above	alphanumeric hard copy (to 6 copies)	printer
FORMAT	variable	- - - -	80 print positions/line	Selectric
DOCUMENT CHARACTERISTICS	friction feed & sprocket feed, up to 6 copies	- - - -	sprocket or pin feed paper 8.5" wide, pres- sure fed paper from 5"-8.5" can be used	hard copy, continuous form, etc.
CODES				
I/O Medium	ASCII full set	IBM correspondence, BCD, ASCII	10 or 11 unit ASCII code/dial up voice grade facilities - acoustically coupled	correspondence, PTTC/BCD, PTTC/EBCD
Transmission Speed	ASCII			9/10 bit async
TRANSMISSION				
Speed	10	15	11	15
Simultaneity	H.D. or F.D.	H.D.	H.D. or F.D.-switchable	H.D.
Synchronization	async	async	async	async
ERROR DETECTION		electronic parity check- ing	123K keyboard generates odd or even parity, par- ity check on incoming data, parity error causes printing of special symbol	parity lateral
Lateral/Longitudinal	lateral			
Corrective Action	special character printed out			no
Other				no
COMMENTS	Two color printing to distinguish input from output - red for send, black for receive. Up to 30 character electronic answer back included. 96 printable characters.	*100 quantity including 11" IBM Model 721 Selectric typewriter	123T uses plain paper & std typewriter ribbons, weighs less than 30 lbs, dimensions 7" high, 13" wide, 18 1/2" deep, acous- tic coupler stores in the case.	Options & features include reverse break capability, parity error detection, 2 character buffer, built-in modem or EIA interface, copy holder, terminal to terminal communications, unattended operation, automatic answering, in- terrupt capability.

Also see "Input Typewriter" charts.

1 Equipment Characteristics

TELEPRINTER AND TELETYPEWRITER DATA TERMINALS

COMPANY	OKI ELECTRIC INDUSTRY	OLIVETTI	OMNITEC	OMNITEC
MODEL	OKIDATA-200 Com- munication Terminal	TE 308 SH	800 & 800A	500 & 500K
FIRST DELIVERY YEAR	1968	1969	1969	1968
BASIC PURCHASE PRICE	- - - -	\$2160	\$895/\$1750	\$1250/\$960
LEASE RATE/MONTH	- - - -	\$75	\$43/\$72	\$72/\$53
INPUT MECHANISMS	keyboard, mechanical tape reader	keyboard, paper tape	keyboard solid-state	keyboard 51-key (plus space bar)
OUTPUT MECHANISMS	printer (cylinder type), tape punch	printer, paper tape	strip printer (impact sensitive paper)	8½" page (impact printing)
FORMAT	120 char/line or 132 char/line		single row, approx 9 char/in	72 char/line
DOCUMENT CHARACTERISTICS		80 printing positions		
CODES				
I/O Medium	8 levels		ASCII/2741 compatible	63 printable (ASCII) characters plus space
Transmission Medium		ASCII	acoustic coupling to phone line	acoustic coupling to phone line
TRANSMISSION				
Speed	200 bits/sec	10	10/14.8	10
Simultaneity	H.D. (alternating bothway)	H.D.	H.D. & F.D. switchable	H.D. & F.D. switchable
Synchronization	start-stop sync	async	async	async
ERROR DETECTION				
Lateral/Longitudinal	H/V parity check	VRC	no provisions for check- ing except for visual verification of input data when typed	no provisions for checking except for visual verifi- cation of input
Corrective Action	automatic retransmission	none		
Other	format check			
COMMENTS	Use in the time sharing system.	Heavy duty machine.	Under 25 lbs, approx 26 lbs with carrying case. Acoustic coupler built-in.	Acoustic coupler built-in. Model 500K has paper tape reader and punch.

Also see "Input Typewriter" charts.

1 Equipment Characteristics

TELEPRINTER AND TELETYPEWRITER DATA TERMINALS

COMPANY	SYNER-DATA	TELETYPE	TELETYPE	TELETYPE
MODEL	Beta KSR	Teletype 37 Terminals	Teletype 35 Terminals	Teletype 33 Terminals
FIRST DELIVERY YEAR	1969			
BASIC PURCHASE PRICE	\$3680	RO \$2125-\$2550, KSR \$2550-up, ASR \$4050-up	RO \$1425-\$1550, KSR \$1700-\$2200, ASR \$2850-\$3250	RO \$540-\$640, KSR \$600-\$715, ASR \$800-\$975
LEASE RATE/MONTH	n/a			
INPUT MECHANISMS	TTY serial, EIA RS232C, parallel TTL data (ground-true)			
OUTPUT MECHANISMS	same as above plus im- pact print, 10 char/in.			
FORMAT	26 to 132 col, open gothic font	full line, half line; for- ward and reverse line space control		
DOCUMENT CHARACTERISTICS	3-5/8 in to 14-7/8 in, edge-sprocketed, single to 6-part forms			
CODES				
I/O Medium	8 bit std ASCII ground-true	ASCII (7 information bits plus parity), 10 unit	8-level, 11 unit (ASCII)	8 level
Transmission Medium	odd-even-marking parity (selectable)			
TRANSMISSION				
Speed	10-15-30 (selectable)	15	10	10 or slower
Simultaneity	local - H.D. - F.D. (selectable)			
Synchronization	async	async	async	async
ERROR DETECTION	none	even vertical parity	even vertical parity	unit can generate even vertical parity
Lateral/Longitudinal				
Corrective Action				
Other				
COMMENTS	Solid-state keyboard with rollover prot.			

Also see "Input Typewriter" charts.

1 Equipment Characteristics

TELEPRINTER AND TELETYPEWRITER DATA TERMINALS

COMPANY	TELETYPE	TELETYPE	TERMINAL EQUIPMENT	TRANSCOM
MODEL	Teletype Inktronic Terminals	Teletype 4210 Magnetic Data Terminal	TYCOM 20/20 - ASCII	CT 264 Alpha Numeric Terminal
FIRST DELIVERY YEAR			1970	1970
BASIC PURCHASE PRICE	RO \$5700-\$6400, KSR \$6700-\$7450	\$2200-\$2375	\$3000 ASCII, \$1800 Selectric code/prices include typewriter	\$1600
LEASE RATE/MONTH				\$37
INPUT MECHANISMS			Selectric typewriter	keyboard, plastic card reader (opt)
OUTPUT MECHANISMS			Selectric typewriter	strip printer
FORMAT			ASCII	open-end
DOCUMENT CHARACTERISTICS			hard typewritten copy	5 x 7 dot matrix - electro-static
CODES				
I/O Medium	RO = ASCII & 5 level KSR = ASCII	ASCII	USASCII, Selectric	11 bit USASCII
Transmission Medium			voice grade lines	voice-grade dialed network
TRANSMISSION				
Speed	120	up to 240	10 (ASCII), 15 (Selectric)	10
Simultaneity			H.D.	H.D.
Synchronization		sync	async	async
ERROR DETECTION				
Lateral/Longitudinal		even vertical parity	even, odd or no parity-switchable	vertical parity
Corrective Action			sonalarm, light, print underscore	
Other				
COMMENTS	With Teletype 4210 magnetic tape data terminal the Inktronic KSR will become an ASR.	Can be used with Teletype 33, 35, 37 and Inktronic KSR terminals to give ASR capabilities.	Prices reduced by \$600 for customer supplied typewriter. Tycom base-plate adapter requires no modification to typewriter.	20 lbs. Acoustic coupler option. Self-contained modem.

Also see "Input Typewriter" charts.

1 Equipment Characteristics

TELEPRINTER AND TELETYPEWRITER DATA TERMINALS

COMPANY	UNIVAC	UNIVAC	XEROX DATA SYSTEMS
MODEL	DCT 500	DCT 1000	Model 7018 Remote Keyboard/Printer
FIRST DELIVERY YEAR	1970	1971	1971
BASIC PURCHASE PRICE	\$2880	\$4500	\$4600
LEASE RATE/MONTH	\$80 w/maint	\$115 w/maint	\$104 – 4 yr
INPUT MECHANISMS	keyboard, paper tape reader	keyboard, card reader, paper tape reader	alphanumeric keyboard, optional paper tape reader
OUTPUT MECHANISMS	printer, paper tape punch	printer, paper tape punch	printer, optional paper tape
FORMAT			8/10
DOCUMENT CHARACTERISTICS	edge sprocketed forms, 3.6"-14.8" wide	edge sprocketed forms, 3.6"-14.8" wide	pin-feed
CODES			
I/O Medium	ASCII	ASCII	96 char ASCII
Transmission Medium	ASCII	ASCII	
TRANSMISSION			
Speed	10, 15 or 30	10-600	15
Simultaneity	H.D. & F.D.	H.D.	H.D. & F.D.
Synchronization	async	async or sync	
ERROR DETECTION			async
Lateral/Longitudinal	character parity	char & long parity chk & generation	
Corrective Action	print or punch asterisk, light lamp		lateral
Other		retransmit	lights indicator
COMMENTS			none
			ASR-37. Prices include controller.

Also see "Input Typewriter" charts.

We designed the T113ATS Sangamodem

for originate mode
teletype applications
at up to 300 bits/sec.



That's why it's so reasonably priced.

Sangamo's T113ATS is a completely solid state data modem designed for two-wire full duplex operation. Total price is under \$200. End to end compatibility with thousands of Western Electric 103A2 or 103E data sets permits immediate assimilation into existing systems without any terminal modifications. Since the T113ATS is electrically connected to the telephone network, 60 db channel separation is guaranteed. And performance is not degraded by second harmonic distortion prevalent in other coupling methods. By designing the T113ATS for a specific application, the cost was minimized. Data set lease

charges for only 7 months will more than equal the total purchase price. It's easy to install, with only a medium sized screwdriver.

For more data on Sangamo's new T113ATS or any other Sangamodem contact:

Communication Systems

**SANGAMO
ELECTRIC COMPANY**

P.O. Box 3347, Springfield, Illinois 62708,
(217) 544-6411

T707

1 Equipment Characteristics

MODEMS

COMPANY	AMERICAN DATA SYSTEMS	APPLIED DIGITAL DATA SYSTEMS	CARTERPHONE COMMUNICATIONS	CODEX	COMDATA
MODEL	ADS-448 AEM	COM 120/130	MB132 Modem Bank	AE-96	201/301F2/301F4
FIRST DELIVERY YEAR	1969	1970	1970	1967	1970
BASIC PURCHASE PRICE	\$6000	\$365/\$435	\$400/chl	\$11,500	\$395
LEASE RATE/MONTH	\$192	n/a	n/a	\$375	\$14.22/3 yr
INTERFACE	EIA	acoustic/hard-wired	hard-wire	EIA232B, hard-wire	hard-wire
TRANSMISSION SPEED (bps)	4800	to 300 baud	440	9600	110, 150, 300, 500
SERIAL OR PARALLEL	serial	serial	serial	serial	serial
TYPE OF CHANNEL	leased line or dial-up	voice	voice	type 3002 C-2	voice
NO. OF CHANNELS		1	16 - 48	1	14
MODES					
Synchronous/Asynchronous	async, sync	async start/stop	async	sync	async
Simplex/HD/FD	simplex, HD or FD	simplex/HD/FD	HD/FD	simplex, HD or FD	FD
PRIVATE LINE MANDATORY	no	no	no	yes	yes
AUTOMATIC CALL UNIT	no	no	no	no	no
MODULATION SCHEME	3 amplitude, 12 phase	FSK, Bell 103 compatible	FSK	PAM with SSB	FSK
COMMENTS	Automatic equalization.		Auto answer.		RS-232 & TTY interface. Various options on 301F2 and 301F4.

MODEMS

COMPANY	COMPUTER CONVERSIONS	COMPUTER TRANSMISSION	CYBERMATION	DATAMAX	DATA PRODUCTS TELECOMMUNICATIONS
MODEL	503/512	OPTRAN 1815 A/B	Lo-Speed Modem 1103	QB-24/QB-48	901
FIRST DELIVERY YEAR	1970	1970	1970	1970	1970
BASIC PURCHASE PRICE	\$99/\$199	\$2900/\$2950	\$325	\$3300/\$6800	\$900
LEASE RATE/MONTH	n/a	\$109/\$111		\$150/\$250	n/a
INTERFACE	PC card	hard-wire EIA or high speed current	hard-wire (acoustic, PC opt)	PC card - RS232C	hard-wire
TRANSMISSION SPEED (bps)	300/1200	to 20,000/ to 250,000	up to 1800	2400/4800	2400
SERIAL OR PARALLEL	serial	serial	serial	serial	serial
TYPE OF CHANNEL	voice	none - line of sight infrared	voice	voice grade, 3002 type	voice
NO. OF CHANNELS	1	unlimited (when used w/CTC MULTITRAN units)	1	1	1
MODES					
Synchronous/Asynchronous	async	sync/async	async	sync	sync
Simplex/HD/FD	HD/FD	HD/FD	HD/FD	HD & FD	HD or FD
PRIVATE LINE MANDATORY	no	no	no	yes - C2	no
AUTOMATIC CALL UNIT	no	no	opt	no	yes
MODULATION SCHEME	FSK	modified PM	FSK	AM vestigial sideband	AM (VSB)
COMMENTS		Field-changeable data rates.			

1 Equipment Characteristics

MODEMS

COMPANY	DATASERV	DA-TEL RESEARCH	DIGITAL TECHNIQUES	EMR COMPUTER	GENERAL ELECTRIC
MODEL	1310 & 1340	Series 6800	4520A	Astroset 120/400	TDM-110D10
FIRST DELIVERY YEAR	1970	1968	1969	1970	1968
BASIC PURCHASE PRICE	\$450	\$325	\$389.75		\$645
LEASE RATE/MONTH	\$15	n/a	\$24		by request
INTERFACE	PC card & hard-wire	hard-wire	DAA option II hard-wire	PC card	hard-wire
TRANSMISSION SPEED (bps)	300	300	150 baud	1800/9600	300
SERIAL OR PARALLEL	serial	serial	serial	bit serial	serial
TYPE OF CHANNEL	voice	voice	DDD network	voice or Type 4	voice
NO. OF CHANNELS		6	1	dual	1
MODES					
Synchronous/Asynchronous	async	async	async	async/sync	async
Simplex/HD/FD		FD	HD or FD, originate/automatic answer	HD	selectable HD/FD
PRIVATE LINE MANDATORY	no	no	no	either	yes
AUTOMATIC CALL UNIT	yes	no	no	no	no
MODULATION SCHEME	FSK	FS	FSK	dual channel FM	FSK data - phone compatible
COMMENTS	MOS & bipolar digital sine wave generator & discriminator.	Trans & rec.	Full auto & attended operation.		Auto answering in TDM-III D10 for \$750.

MODEMS

COMPANY	GENERAL ELECTRIC	GENERAL ELECTRIC	INTERNAT'L COMMUNICA.	INTERNAT'L COMMUNICA.	INTERNAT'L COMMUNICA.
MODEL	TDM-330E20	TDM-401/402/403	300/3A & 4A	1100	4400/24 PB
FIRST DELIVERY YEAR	1970	1968	1970	1969	1967
BASIC PURCHASE PRICE	\$925	\$3100		\$2000 - \$2800	\$5050
LEASE RATE/MONTH	by request	by request		\$65 - \$85	\$155
INTERFACE	hard-wire	hard-wire	EIA RS-232B or C or 20 ma current	EIA RS-232B/ Bell 301B	EIA RS-232B or C or CCITT V.24
TRANSMISSION SPEED (bps)	9600/4800/2400	50,000/40,800	0-300	4800 - 1,000,000	2400
SERIAL OR PARALLEL	serial	serial	serial	serial	serial
TYPE OF CHANNEL	4-wire twisted-pr, non-loaded	exchange plant cable	DDD or dedicated	solid conductor	Type 3002 unconditioned
NO. OF CHANNELS	1	1	n/a	n/a	n/a
MODES					
Synchronous/Asynchronous	sync	either	async	sync	sync
Simplex/HD/FD	HD/FD	HD/FD	HD/FD	FD	HD/FD
PRIVATE LINE MANDATORY	yes	yes	no	solid conductor	no
AUTOMATIC CALL UNIT	no	no	n/a	n/a	n/a
MODULATION SCHEME	PM	baseband data set	FSK	diphase	differential 8-phase
COMMENTS	Auto line equalization & auto rcvr sync.	W.E. 303C series compatible.	Bell 103 series compatible		

1 Equipment Characteristics

MODEMS

COMPANY	INTERNAT'L COMMUNICA.	I/ONEX-SONEX	ITI ELECTRONICS	LENKURT ELECTRIC	LENKURT ELECTRIC
MODEL	5500/96	Type 20	Type IT-332A	25B Data Trans System	26C Data Set
FIRST DELIVERY YEAR	1970	1970	1970	1968	1965
BASIC PURCHASE PRICE	\$11,500	\$115	\$210	\$600/chnl terminal	\$1600
LEASE RATE/MONTH	\$350		n/a	n/a	n/a
INTERFACE	EIA RS-232 B or C & CCITT V.24	P.C. Card - hard-wire	acoustic/magnetic	hard-wire	hard-wire
TRANSMISSION SPEED (bps)	9600	300 baud	300	75, 110, 150, 200, 600	150, 300, 600, 1200, 2400
SERIAL OR PARALLEL	serial	serial	serial	serial	serial
TYPE OF CHANNEL	3002 C2 conditioned	voice	voice	voice	voice
NO. OF CHANNELS	n/a	1	1	to 25	2
MODES					
Synchronous/Asynchronous	sync	async	async	async	async to 1800 b/s, sync at 2400 b/s
Simplex/HD/FD	FD	HD/FD		simplex HD/FD	simplex HD/FD
PRIVATE LINE MANDATORY	yes	no	no	no	no
AUTOMATIC CALL UNIT	n/a	no	no	no	no
MODULATION SCHEME	4-level amp VSB	FSK	FSK	FSK	FSK
COMMENTS					Multi-point polling applications.

1 Equipment Characteristics

MODEMS

COMPANY	LENKURT ELECTRIC	LYNCH COMMUNICA.	LYNCH COMMUNICA.	MULTITECH DATA PRODUCTS	NOVATION
MODEL	26C/40.8 kb/s Data Set	B313	L2202C	440/MR & MS	DC-102A & AD
FIRST DELIVERY YEAR	1966	1969	1971	1968	1970
BASIC PURCHASE PRICE	\$1600	\$2500		\$825	\$315/\$350
LEASE RATE/MONTH	n/a			23%/mo. w/ 80% applicable to purchase	\$11.34/\$12.60 3 yr.
INTERFACE	hard-wire	hard-wire	wired to tel. line	acoustic	acoustic/DAA
TRANSMISSION SPEED (bps)	20, 400 & 40,800	64 Kbps & 256 Kbps	max 1800 w/ C2	1200/5 or 1800/5	450 max
SERIAL OR PARALLEL	serial	serial	serial	serial	serial
TYPE OF CHANNEL	group bw (48 kHz)	voice	switched or private		voice
NO. OF CHANNELS	1	4 x 64 Kbps & 1 x 256 Kbps			1
MODES					
Synchronous/Asynchronous	sync	sync, async	async	async	async
Simplex/HD/FD	simplex, HD/FD	FD	HD/FD		HD/FD
PRIVATE LINE MANDATORY	yes	no	yes	no	no
AUTOMATIC CALL UNIT	no	no	yes, opt	available	no
MODULATION SCHEME	FSK	PCM	FSK	FSK	FSK
COMMENTS			WE202C compatible.		Dual TTY/EIA interface. Originate or answer only.

1 Equipment Characteristics

MODEMS

COMPANY	PENRIL DATA COMMUNICA.	PENRIL DATA COMMUNICA.	PULSE COMMUNICA.	RFL INDUSTRIES	SANGAMO ELECTRIC
MODEL	PDC 2400A	4800B	4080	3952	T103A1 & T103A2
FIRST DELIVERY YEAR	1970	1970	1970	1970	1969
BASIC PURCHASE PRICE		\$3500	\$140	\$2100	\$580
LEASE RATE/MONTH				\$90	none
INTERFACE	hard-wire	hard-wire	PC card, hard-wire	EIA RS232C hard-wire	hard-wire
TRANSMISSION SPEED (bps)	2400 w/ 300 baud reverse chnl	4800	300	2400	0 - 300
SERIAL OR PARALLEL	serial	serial	serial	serial	serial
TYPE OF CHANNEL	voice	voice	voice	DDD	voice
NO. OF CHANNELS		1	1	1	1
MODES					
Synchronous/Asynchronous	sync or async	sync	async	sync	async
Simplex/HD/FD	HD/FD	FD		HD - 2-wire FD - 4-wire	FD
PRIVATE LINE MANDATORY	no	yes	no	no	no
AUTOMATIC CALL UNIT	no	no	yes	yes	yes
MODULATION SCHEME	AM vestigial sideband	AM vestigial sideband	FSK	4-level phase	FM
COMMENTS			Bell 103/108/ 113 series compatible		

MODEMS

COMPANY	SANGAMO ELECTRIC	TELE-DYNAMICS	TEL-TECH	ULTRONIC	VADIC
MODEL	T201B½ & ¼E	7103 & 4	TT-201 A/B	Data Pump 4800	VA1200
FIRST DELIVERY YEAR	1969	1970	1970	1970	1969
BASIC PURCHASE PRICE	\$2365/\$2410	\$250	\$1495	\$3175	\$250
LEASE RATE/MONTH	none	n/a		\$167.96	
INTERFACE	hard-wire	hard-wire	hard-wire	hard-wire	hard-wire
TRANSMISSION SPEED (bps)	2400	300 or 1200	2400	4800	1200 - 1800
SERIAL OR PARALLEL	serial	serial	serial	serial	serial
TYPE OF CHANNEL	voice	voice	voice/sch 4	3002 w/C2	1200 voice, 1800 w/ C2
NO. OF CHANNELS	1	1	1	1	
MODES					
Synchronous/Asynchronous	sync	async	sync	sync	async
Simplex/HD/FD	HD/FD	HD/FD	simplex/ HD/FD	simplex/ HD/FD	HD - 2-wire FD - 4-wire
PRIVATE LINE MANDATORY	yes, w/ C2	no	no	yes	no
AUTOMATIC CALL UNIT	no	yes, opt	no	no	yes, opt VA801
MODULATION SCHEME	PM	FSK	4-phase	SSB AM	Phase coherent FSK
COMMENTS		7103 compatible to Bell 103; 7104 compatible to Bell 202.	All on-line. Bell compatible.		Bell 202 equiv.

Graphic Data Equipment

“Computer graphic systems” refers to the technology whereby essentially pictorial information is entered into, processed by, and displayed from digital computers. Current interest in computer graphics systems focuses so intently on man-machine communication through CRT consoles that it often blurs the fact that the field of computer graphics is much broader. Many important graphic problems are, in fact, completely beyond the capabilities of the attractive and versatile CRT consoles.

The swift and easy retrieval of information represents the principal strength of a display terminal – the ability to provide a great deal of information very quickly.

Data displayed by a CRT display terminal can be in the form of alphabetic letters, digits, punctuation marks and special symbols. Some units can display only a subset, such as digits, of the character set mentioned. More sophisticated display devices can display graphs and other complex shapes.

The basic function of alphanumeric terminals is to provide rapid, easy access to data stored in a computer system, or to the computational facilities of the computer. Communications terminals other than display units can match this function, but not so rapidly nor easily.

Programming of the computer at the central site represents a large portion of the implementation task of nearly every display system. Manufacturers of commercial computers, in some cases, provide software support for many of the applications of the terminals.

Important characteristics of alphanumeric display terminals that transmit and receive data from remote computers over communications lines include:

1. Transmission characteristics, such as speed, code, synchronization technique
2. General input/output capabilities of the display device and auxiliary equipment
3. Cost
4. Display characteristics
5. Editing capabilities
6. Control, including buffering and configuration limitations

The actual size of the display area, the display arrangement (number of characters per line, number of lines per display) the total number of characters per display, the number of

different characters or symbols that can be displayed and the character generation technique distinguish display units.

The ease and flexibility with which data can be entered or modified is governed by the editing facilities provided for the operator’s use. Commercial display units use a visible cursor or entry marker to indicate to the operator the position at which the next character will be displayed when entered. Normally, control keys are included within the keyboard layout to permit the operator to position the cursor to enter data at specified locations.

Editing facilities provided in display units commonly include:

- *Horizontal tabulation* – Allows operator to set specified “stops” within a display, and later skip to these stops in the same way as on a typewriter.
- *Line insertion/deletion* – Allows operator to insert data within a line (or delete it), with the previously displayed data being automatically shifted over.
- *Transmission of partial display* – Permits transmission of a selected portion of the total display, vs. having to transmit the full display each time.
- *Split screen* – Permits previously displayed data to be retained while new data is being entered or received.

Due to additional requirements for editing, buffered displays will continue to exceed, by about 25%, the cost of character-oriented displays. Protected formatting, automatic tabbing (forward and backward), line and character insertion/deletion and full, or partial, message transmission are all editing features that buffered terminals will require. They are necessary to guarantee the accuracy of a composed message before it is sent. It is far more difficult to correct errors at the computer with software than at the message source.

Off-line data accumulation reduces the cost of data transmission. As a result, the off-line use of terminals will expand. Data can be gathered during working hours on low-cost, high-density tape cassette storage devices, and transmitted to a remoted computer in those hours when communication rates are lowest. This process is not without danger. Without operator monitoring, data transferred from one storage medium to another over a data line can develop errors.

Only cost will deter the growth in the use of display terminals with graphics capability. To develop the software necessary to operate such a terminal requires enormous cost. In our opinion, this presents the only obstacle.

1 Equipment Characteristics

The proprietary nature of an expensive software routine gives it the value of a trade secret. Until general-purpose software becomes available from a display manufacturer, the use of graphics terminals will be limited.

Variable screen presentation capacities of 1000 characters offer the broadest user appeal in both character- and word-oriented displays. Screen formats of 64-80 characters a line and 18-20 lines are in the greatest demand.

Flexibility in screen size will soon become the greatest demand. Excess memory positions, when idle, cost money. Display users in time-sharing will buy equipment only reluctantly if it comes in a single size. The successful manufacturers will be those whose equipment is designed with built-in flexibility for growth, which can be accomplished by simple modifications in the field.

The ideal display terminal will act effectively as a controller for several other peripherals, including tape cassettes, printing devices and credit, or badge, card readers. Shared electronics achieved by the display acting as the master for other slave units will reduce costs significantly.

From a hardware point of view, computer graphic systems consist essentially of four types of elements: input (graphic-to-digital), output (digital-to-graphic), processing, and storage. Graphic input and output are based on three areas of device technology: the cathode-ray tube, facsimile equipment (scanners) and the plotter.

Computer graphic systems impose substantial requirements upon software. One such requirement is pattern-recognition. Another of substantial magnitude is the graphical language required for communicating graphically rather than in conventional terms. There is also the situation of excessive requirements on computer memory and running time that seems to be characteristic of graphical languages. Hardware is frequently employed in graphic input/output systems to perform certain processing functions that would be very time-consuming under program control such as pattern preprocessing, character and line generation, and display rotation, translation etc.

In this section, particular emphasis is given to equipment and hardware. The importance of software is recognized and should not be underestimated. Products and technology covered in this commentary are restricted to those that have a direct connection with digital computers.

BASIC CHARACTERISTICS OF COMPUTER GRAPHIC SYSTEMS

A graphic data system, functionally speaking, is a system which permits the user to exchange essentially pictorial data with a computer and obtain processing results that embody graphic concepts. To give this definition more meaning, it is necessary to develop a workable, detailed definition of graphic data and to give similar detailed definitions to graphic processes. Graphic data originates as a visible image. From the viewpoint of computer operations, this data may be considered in three classes which depend on how readily the raw image may be defined or how compactly it may be represented in digital form. These classes are as follows:

- *Symbolic* – Data is completely representable in finite sets of symbols such as alphanumeric data which is completely representable by a character code and if necessary, by a font type and a location.

- *Functional* – Data is completely representable by a reasonably compact mathematical expression.

- *Pictorial* – Data is representable only by a complete description of the state of every resolvable point in the array on which the image is stored.

An important sub-class of data is a combination of pictorial and functional data. In this sub-class the data represents a line figure image of the displayed object. Such images are compactly represented by a group of lines, each meeting the specifications of functional data, but no functional rule being possible for naming the set of lines. The above distinctions are significant in the discussion of graphic techniques and functions.

GRAPHIC PROCESSING FUNCTIONS

Graphic processing functions can be considered in three classes:

- *Entry* – The entry of graphic data into a digital computer system from a visual source involves several possible processes:

1. Scanning, recognition, and definition as a discrete symbol

2. Scanning, analysis, and definition as a set of parameters of a mathematical function

3. Scanning, possibly compaction, and storage of a pictorial image array

4. Scanning and association of data with previously stored data

- *Display* – Display in graphic form of previously received graphic data involves several processes:

1. Displaying image of discrete symbol based on defined symbol

2. Displaying graph of defined function

3. Displaying pictorial data

4. Determination of symbolization required by analysis of data

5. Transformation of data from storage format to display format

- *Processing* – Some processing functions that are essentially graphic in their objectives are:

1. Changing the overall geometric basis for the image (scale, projection, viewing angle)

2. Selective displaying of sections of images

3. Combination and overlaying of images

1 Equipment Characteristics

4. Distortion and constraining of images
5. Editing of graphic records

TECHNIQUES

A discussion of techniques for graphic computer system implementation is oriented around a discussion of graphic input/output devices and their key technological limitations. Graphic devices fall into three major groups:

- *Input devices* – Document scanners, graphic recorders, and film scanners.
- *Output devices* – Plotters, CRT displays, and film exposing printer plotters.
- *Interacting devices* – CRT consoles with input capability.

The extent to which these devices can be used in any given application is determined by certain basic technological limitations which are discussed below.

- *Resolving Power* – A fundamental limit on all graphic I/O devices is their ability to resolve an image in a set of individual points. This limit applies equally to input and output devices.
- *Image Fidelity* – Another important limit on graphic I/O is image fidelity including grey-scale rendition, linearity, color rendition, and accuracy of image positioning.
- *Display Capacity* – Certain display devices are definitely limited in the amount of image detail that can be shown at once.
- *Computer Requirements* – The computer requirements of a graphic I/O device are limitations that may be considered economic when they take the form of memory and running time requirements, or may be considered technological when they take the form of a functional requirement such as pattern recognition that may not be capable of being met under any reasonable condition.
- *Operability* – Graphic input devices frequently involve manual operations. There are distinct limits on the ability of a human being to achieve results superficially available with a given instrument due to its operability (or inoperability).

Computer graphic systems employ several different system concepts. In certain cases the graphic I/O device may be operated off-line from the digital computer, with magnetic tape serving as the interface medium. In other cases, the graphic device may be tied-in directly on-line to the computer. Systems employing the off-line approach frequently make use of special-purpose processors in the off-line configuration to achieve flexibility and minimize demands on large computational facilities. For economy, on-line CRT display systems almost invariably employ special processors between the displays and the main computer.

SOFTWARE REQUIREMENTS

The extent of software requirements depends on the hardware configuration of the computer graphic systems.

Many vendors of graphic devices supply the user with applications and system software. The utility or service programs supplied by the manufacturer extend the hardware so that user functions become available to the application programmer without his concern for programming them. The value of system software support should not be underestimated in graphic data systems. Basic system software is almost always available but a great variation exists between vendors in applications programs.

APPLICATIONS

Computer graphic systems are used in numerous applications for very specific input or output operations as well as for interactive use in an integrated graphic data processing system. A basic characterization of these applications is given below.

• ENTRY ONLY

1. Document reading (checks, bills, credit-card forms)
2. Graphic recording and film scanning (scientific data acquisition)

• DISPLAY ONLY

1. Plotting (charts, graphs, templates, design studies)
2. Film plotting (charts, graphs, printed reports)
3. CRT display (printed reports, tracked object presentations, etc.)
4. Photo-typesetting

• INTERACTIVE SYSTEMS

1. Computer-aided design
2. On-line programming and data system operation
3. Computer-aided instruction
4. Remote on-line enquiry-response systems (on-line reservations, banking, inventory control systems etc.)

CATHODE-RAY TUBE CONSOLES

The history of the development of graphic CRT's is a varied one, but primarily one of terminals custom-designed for specific computers and particular applications such as military command and control, process control, and engineering design. Only recently have terminals designed to interface to a variety of equipment without custom engineering become popular, and most of these incorporate a minicomputer for local storage and manipulation of the data base. Such minicomputer terminals can be locally or remotely interfaced to a larger time-sharing computer, and can often be expanded to self-contained graphic computers using minicomputer options and peripheral devices.

For several years the cathode-ray tube console has been used as a computer output device for the display of graphic and alphanumeric data. More recent application of the CRT console has been as interactive computer input/output device for on-line man-computer communication. Coupled

1 Equipment Characteristics

with a camera or other picture or graphic reproduction system, the CRT console can also provide a hard-copy output. Most consoles are equipped with a means for the user to enter information into the computer. Entry devices include alphanumeric keyboards, item-pointing devices such as "light pens," "mouse" and "joy sticks" and devices for creating items in the display such as push-buttons and switches. Integrated graphical communication devices such as the SKETCHPAD, RAND tablet and Sylvania data tablet are also available and have been mainly used for applications related to computer-aided design.

The interactive CRT console having both input and output capability is most appropriately considered as a device through which the user "converses" with the computer. The ease with which the CRT display consoles allow man-machine interaction has caused them to be employed in situations requiring strictly alphanumeric information exchange as well as in cases where the data has genuine graphic characteristics that cannot be handled by typewriter-like devices. A prime advantage of the CRT console is the speed at which it can receive and display information. At the maximum telephone line rates of 120 to 400 characters per second as compared with 10 to 20 characters per second for typewriters, the CRT terminal allows greater use efficiency by a better matching with human scanning speed. Another advantage of the CRT console is the ability to change or delete data selectively. Quietness of operation is also an attractive characteristic. The major disadvantages are higher cost and difficulty in obtaining a hard copy. Alphanumeric CRT display consoles with no graphic capabilities are available in the market, and are generally used as data communications terminals in enquiry-response applications. These have been discussed in the section on data communications terminals.

CRT Characteristics

Cathode-ray tubes are available in a great variety of shapes, sizes, display arrangements, screen persistencies and resolution. Performance of the CRT console is largely determined by the image quality it produces. This is usually limited by the resolution capability and the positional accuracy of the tube image grid. Other limitations are imposed because of the computer time required to execute certain desired functions and by the availability of software to execute users' commands.

In most CRT consoles, the tube has no image storage capability and it is necessary for the image to be re-generated from 15 to 40 times per second to achieve flicker-free appearance. This requirement places an upper limit on the richness of the image because it implies an upper limit on the number of places to which the beam can be directed. In addition, a device for storing the image is required to ease the burden on the main computer and permit remote operation. Recently, with the development of the cathode-ray storage tube by Tektronix, there has been considerable interest in the storage-tube display terminal. Several companies including Computer Displays Inc., the first to develop such a terminal, and Tektronix have come out with production models on the market.

The CRT's generally utilize electromagnetic beam deflection because the electrostatic approach, even though it yields very high deflection speeds, requires operating voltages that are too high for semiconductor devices if large

areas are involved. If many symbols are to be displayed, then high deflection speeds are necessary. To permit rich images to be displayed, many cathode-ray tubes are equipped with dual deflection systems — conventional electromagnetic deflection for images and character positioning and electrostatic or special high-speed electro-magnetic deflection for generating the character delineating pattern.

CRT consoles are sometimes classified as video and as digital. Video displays use television techniques such as raster scan and are generally restricted to performing output functions. Digital displays use a computer-controlled x-y positioning to draw images on the screen. This display technique differs from raster scan and shaping techniques used in many alphanumeric displays, in such displays the electron beam is directed through a mask into which alphanumeric characters have been pierced. The advantages of the video display are the lower cost, simpler storage (i.e. analog tapes) and greater range of tone. The disadvantage of the video display is that it gives lower quality images and that it is difficult to interact with graphic elements larger than a single point.

Character and Line Generators

Character shapes and lines can be created by programmed control of the CRT beam position but this approach requires too much computer time. In order to reduce the drain on computational capacity and improve plotting speed, point-plotting scopes have been supplemented by the addition of character and line generators which can draw a picture element with a single command, and do it much faster. Several approaches exist for generating character shapes directly in response to a simple character-indicating code such as ASCII. Characters may be generated by beam shaping as previously mentioned. High quality character images are provided this way but the available alphabet is frozen into the mask inside the tube and cannot be changed except by replacing the tube. Electronic methods of character generation by beam steering are preferred in displays because they are flexible and economical at some sacrifice in image quality. An electronic character generator may be shared by several display consoles.

There are two basic approaches to electronic character generation: raster and function. The raster approach involves generation of characters as a set of lines or dots selected from a fixed array. The typical dot-matrix array is 5 columns by 7 rows. Characters generated in this manner usually tend to show the raster or array pattern quite clearly. The functional or waveform synthesis approach to character generation involves the steering of a beam through a sequence of line stroke or dots that create the character shapes. There is no necessity for a fixed array but this approach generally relies upon composing the characters out of a set of basic image elements. Character speeds range from a few to about a hundred microseconds, depending on the method of generation and the characteristics of the scope deflection system.

Two basic types of line generators are available: analog to digital. The analog type has integrator circuits which permit the cathode-ray beam to be swept linearly from one point on the scope to another. Analog line generators are still the more widely used type in display systems, but have two technical problems that require special attention — maintaining uniform intensity for different line lengths, and

1 Equipment Characteristics

achieving satisfactory plotting accuracy. The digital methods are usually more accurate and permit substantial off-line display manipulation.

Buffer Storage Techniques

To maintain a flicker free image on the CRT face usually requires regeneration at 40 frames per second. In a reasonably rich display this places a load of 30,000 to 90,000 commands per second, thereby monopolizing the time of the computer supplying the control information. It is normal practice to remove this load from the computer by providing the display with a local storage device and simple image regeneration control. Buffer storage is furnished in a variety of ways: core memory, magnetic drums and discs, delay lines and scan converter tubes. The random-address core memory is inherently the most flexible and there is a growing awareness that display buffers should in fact be small general purpose computers.

For applications where more than one display is to be used, it is common to centralize the display buffer memory and character generator in a central control that can be time-shared by several consoles. Different approaches are offered to suit individual requirements. If the consoles sharing the central control are to be used for independent operations, the buffer is generally a core memory, and vector or digital techniques for generation of images are used. If the displays are all to see the same information, a TV raster video system is the least expensive and the storage function may be implemented using scan converter tubes as well as digital methods.

Interactive Devices

The CRT console has associated with it means by which the user can interact with the system. The variety of input devices range from simple function keys to complex position detecting mechanisms such as the RAND tablet. The principal entry devices currently in use are three: keyboard, light-pen and function keys. In simple applications where the display is used primarily to present alphanumeric information in page format, a keyboard is usually sufficient.

In cases where it is necessary for the user to point at specific information in the display, a pointing device such as the light-pen is required. The light-pen is a photoelectric device which when activated identifies the position on the screen at which it is pointing. This information can be used in a variety of ways depending on the application and the hardware. The pen can also be used to enter new information into the system. In this mode a small beam pattern is generated and acquired by the pen. As the pen moves the pattern follows it. Software or hardware responses to light-pen interrupts are implemented by function-keys.

The function-keys may be thought of as permanent pre-written or hand-wired procedures for specific tasks. Physically these function-keys are normally push-buttons which may be under light-pen control as suggested earlier. Another class of input devices such as potentiometers, "joy sticks," "tracking balls," "mouse" etc. provide continuous information to the program. These are hand-manipulated to provide positional, angular or other data the program can use, for example to rotate or translate an image or position a cursor (small symbol used for pointing on display).

An entirely different approach that is possible is to couple a graphic recorder to the same computer that is driving the display. Information entered from the graphic recorder can be presented on the CRT instantly. This approach is desirable when graphic information originating on a document is to be entered into the computer. The graphic recorder's performance is not limited by the CRT and the documents will not block the operator's view of the tube.

The charts at the end of this section list most CRT graphic consoles. These consoles have both alphanumeric and line drawing capability and can be used for graphics applications. CRT consoles primarily designed for data communications in enquiry-response type applications are listed in the section on data communications terminals.

GRAPHIC RECORDERS

Graphic recorders are devices used to extract information from previously-recorded images and convert it directly into digital form. These devices are designed to be used on a wide variety of source data with no specific standards imposed as to format, image quality, or information content. There are three basic types of devices in this class - manual curve followers, automatic curve followers, and film scanners.

Manual Curve Followers

A manual curve follower consists essentially of a freely-movable arm coupled with X-axis and Y-axis position indicators, a control unit, and a recording mechanism. The arm is positioned over a flat work surface on which the graphic source is mounted. In operation, the arm is moved over the graphic source and positioned over image elements of interest. Positional information as well as textual information is recorded when appropriate, the decision in either case being made by the operator.

The performance of manual curve followers is determined by the pointing accuracy and resolution of the device, and the recording speed achievable by the operator. Most manual curve followers on the market are intended for use in applications where moderate accuracy and good recording speed are desired. These devices generally yield accuracy in the range of 0.004" to 0.015" on work surfaces of 18" x 24" up to 40" x 60", and recording speeds of 500 to 1500 points per hour under realistic operating conditions. Resolution of these devices varies from 0.001" to 0.015" and is quite independent of accuracy. It is questionable whether the very high resolution claimed in certain of these devices is useful in view of the limitations that generally prevail on the operator's visual acuity, the quality and stability of source graphics, etc.

Serial keyboards or thumbwheel panels are furnished on most graphic recorders for entry of textual information. The ease with which the operator can perform this operation is another performance-limiting design factor.

There are manually-operable graphic recorders available capable of yielding accuracy better than 0.001". These devices are precision coordinatographs, normally operated by feed screws, and are designated for use with a low-power microscope. As their recording speed is extremely low, on the order of 10 points per hour, these devices are considered more in nature of precision instruments for industrial measurement rather than graphic recorders of reasonably large quantities of data for computer use.

Manual curve followers are available in a number of basic product configurations. The most common configuration resembles a drafting machine and consists of a two-axis traveling carriage mounted on a conventional drafting board. Position sensing is accomplished using either optical coding or potentiometers coupled to the carriage. This type of curve follower is useful in taking recordings from very large source graphics, particularly when data points are rather widely spread. The mechanism is rather bulky and its inertia is high. These factors limit the usefulness of this type of follower in situations where the data is intricate and small but frequent differences must be recorded.

There are a number of manual curve followers available that provide very high agility for recording intricate curves. Their basic drawback relative to the large drafting machine type discussed above is that the size of the work surface is somewhat limited. The mechanizations of these high agility followers are rather individual and ingenious. They are discussed briefly below.

- *Magnetically-coupled Plotter* — A very lightweight cursor generates a magnetic field. Under the work surface, which is glass, there is a two-axis carriage similar to the carriage found in flat-bed plotters. On the carriage is a magnetic pick-up which senses the signal emitted by the cursor. The carriage is servo-driven to follow the cursor, and pulley-driven shaft encoders give the positional information.

- *Optical Grid Sensing Follower* — A light well-balanced arm which is positioned by the operator over the graphic. Underneath the table is a branch of the arm containing a light source which traverses over a glass plate on which is etched a grid pattern. As the light source moves about, a photocell underneath the glass plate picks up the beam. Interruptions of the beam caused by the grid pattern are detected as pulses. These pulses are fed to counters that indicate cursor position.

- *Capacity Driven Pencil* — A free-moving pencil receives position-indicating pulse signals by means of capacitive coupling. The signals are generated in the writing surface. A unique design of the writing surface permits each point on a 1024 x 1024 element field to be uniquely identified by a 20-bit pulse code which is picked up by the pencil.

- *Pulley-driven Encoder* — The product utilizes shaft encoders coupled to the cursor by a string and pulley system. One company uses a magnetic encoder while another uses an optical device.

The manual curve followers previously described are generally usable for any type of graphic source material that can fit on the work surface. Many of these units can be equipped with media transport accessories such as spoolers for strip charts and film projection systems. Certain curve followers are made specifically for conversion of strip charts.

All of the devices in this class are basically capable of recording data on any conventional medium such as card, paper tape, or magnetic (usually incremental) tape, although not all products are offered with these options. The device used to make the final record can possibly limit the recording speed of the curve follower, depending on the rate at which data is being generated and the formats used.

Automatic Curve Followers

The fact that manual curve following is tedious and error-prone has created an interest in the automation of the process. The simplest product concept for automatic line following involves the use of a plotter equipped with a photosensitive head in place of pen to follow the line automatically. The photohead detects the line by virtue of its relative brightness and signals a control system which drives the plotter in a specific pattern. The plotter pattern permits the photocell to determine the edges of the line and to seek a direction that steers the plotter along the line. The performance of these followers is critically dependent upon the clarity of the line being followed and the absence of any extraneous lines that might mislead the follower.

Film Scanners

Film scanners represent another approach to the automatic acquisition of graphic data in digital form. The working end of a film scanner is essentially a CRT flying spot scanner. The flying spot scans a frame of previously exposed film and the scanned pattern is digitized and transmitted to a general-purpose computer for subsequent analysis. The raster over which the spot moves is considered as a grid on which the film image can be analyzed.

Film scanners in use are best described in terms of the accuracy and resolving power of the scanner section. For single frame systems (one CRT image to the film frame), the limits are consistent with CRT performance as discussed elsewhere. Systems are available in which the CRT pattern interrogates a small portion of the film frame at a time and a high-precision film transport is programmed to obtain full coverage of the film. Such an approach is capable of extending the accuracy and precision of the scanner to considerable lengths, depending on the quality of the film transport.

The type of mechanism described above is quite capable of reading a graphic and creating a digital record of the image. Such a record, however, is raw and unprocessed data. In most applications it is necessary to be able to identify the information in the source, to distinguish various sections of this information, and to make estimates of true values of the information on the basis of redundant or possible erroneous information in the raw data. Such processing functions require substantial amounts of computer time. In many interesting cases the feasibility of accomplishing such data reduction automatically has yet to be demonstrated. The usefulness of film scanners in automatic graphic data reduction is accordingly limited not so much by the instrumentation as by the consequent requirement for automatic data reduction.

DIGITAL PLOTTERS

The development of digital plotters closely parallels the development of the computer. It can accept data from almost any input source. Plotters are drafting machines capable of being driven under computer control. Functionally speaking, a plotter is a machine that can draw a line or a symbol on a sheet of paper or film. Plotters are available in a wide range of capabilities and prices. Plotters differ from other graphic output devices that are based on facsimile or cathode-ray tube technology in the following particulars:

1 Equipment Characteristics

- Plotters are generally capable of drawing line images of very high resolution, unlimited density, and virtually unlimited size.
- Plotters are capable of producing output on virtually any medium capable of accepting markings.
- Plotters “draw images” rather than compose them on a raster.

As soon as the word digital is admitted, the use of digital computers is implied. Very basically, a plot can be reduced to the concept that a tracing element, a pen, is in a given position and the desire is to move the pen to another position. Therefore, within the computer, there must be the capability of defining the next position of the pen. Through the use of computer software, this determination is made. The software may be designed to reference some input source that clearly specifies the coordinate location of the next point. It may also determine the next point location as the result of some analytical process. Indeed, the preliminary software or driving program may be quite sophisticated and require significant analysis procedures. However, at the end of this process, a next point location will be developed. This next point value will be expressed in a dimensional fashion such as inches or millimeters.

The digital plotter movements are commanded by a series of incremental requests which must be generated from the positional or linear movement request. Thus, a utility type program that analyzes the request for linear movement by an algorithm based on the plotter incremental capabilities is used to determine the required incremental commands. Finally, the incremental commands or codes must be presented to the plotter and the utility program in conjunction with the host computer I/O commanding features will cause the commands to be issued, resulting in the movement of the plotter pen to the prescribed location.

Devices composing a system are listed below.

Host Computer
Plotting I/O Software

Plotter Drivers
On-line controllers
Off-line tape units
Tape-to-plotter signal translators
Off-line tape units
Tape-to-plotter or tape-to-controller-to-plotter signal generators, utilizing compressed tape formats

All plotters have the same basic functional elements (although in certain cases some of those functions may be provided in a central computer rather than in the plotter itself). These basic functions are:

Storage for a series of plotting commands:

1. A pen (or set of pens) mounted on a carriage that can move freely in two coordinates
2. A paper-holding mechanism
3. A control system for reading the plotting commands and translating them into the proper sequence of pen motions

The performance of plotters is generally reckoned in terms of the accuracy and precision with which they can execute pen motions in response to commands. Speed, paper handling capability, and the sophistication of the internal control system are also important characteristics. Since currently-available plotters exhibit a wide range of performance, it is necessary to discuss them in some detail.

The most fundamental performance feature of a plotter is its accuracy. The accuracy of a plotter is a measure of its ability to plot points or lines “where they should be” anywhere on the plottable surface. Since high accuracy is achievable only through expensive construction, plotters generally are manufactured in two distinctive product groups – utility plotters and precision plotters.

Utility plotters normally have an accuracy of less than 0.01” (meaning these plotters make positional errors of 0.01” or more). Actually, the accuracy of these plotters is somewhat sensitive to the size of the plottable surface and is more properly expressed as a fraction of full scale, on the order of 1/1000 to 1/4000, rather than an absolute distance. Utility plotters are quite accurate enough for producing curves of scientific or business data, for schematic drawings or templates for cutting products whose accuracy requirements are relatively low, such as fabric or sheet metal, and for other low-accuracy tasks. Utility plotter mechanisms are light and inexpensive. The linework produced is not of the highest quality.

Precision plotters are available with accuracies in the range of 0.005” to 0.001”. These plotters are used for work where high accuracy is essential. Applications include printed-circuit and integrated-circuit artwork, map gratitudes, and high-precision templates. Plotters built to meet these accuracy requirements frequently are also required to prepare very large graphics and the accuracy specifications must be held everywhere on a large working surface (typically 40” x 60”). Since meeting these requirements for accuracy and size alone make the plotter quite expensive, it is normal to find these machines equipped with a variety of special control features intended to maximize the usefulness of a very substantial investment.

Closely associated with accuracy as a plotter specification is repeatability, which is the ability of the plotter to return to the same point on the plotting surface in response to a repetition of a coordinate positioning command, even if the point in question is not where it should be. Repeatability is governed by fewer factors than those that affect accuracy and therefore is generally better than accuracy on any given plotter.

The precision of a plotter, its ability to resolve fine detail, is another measure of its performance. Precision is more closely related to repeatability than to accuracy, and will generally be at least as good, numerically, as repeatability.

The productivity of a plotter is a direct function of its achievable plotting speed. Plotting speeds range from roughly 1 inch/second to 20 inches/second. The higher plotting speeds are generally available only in the less expensive utility plotters or in the precision plotters at some sacrifice in accuracy. Speeds are sometimes necessarily limited by the requirements of the pen or recording tool (a scribing point or light source). Many plotters are capable of running at a variety of speeds. A common feature is a high-speed slewing mode (with the pen up) of

1 Equipment Characteristics

roughly ten times normal plotting speed. Plotters driven by an analog servo are capable of travelling at a relatively high speed in a continuous or free-running mode.

Plotters are built in two basic physical forms: flat-bed and drum. The flat-bed style is versatile and used in inexpensive utility plotters as well as in precision plotters where it is mandatory. It will accept any type of paper or other media that will fit on the table. The drum plotter is simple and very compact. The pen is driven only in the Y-axis while the paper feed drum can be driven in both directions to supply X-axis motion. The limitations of the drum plotters are their inherent low accuracy in the X-direction and the requirement that special paper be used for all plotting tasks.

The pen motion system for the plotter may employ either an analog servo or a digital stepping motor drive. An analog servo drive requires that a position-sensing potentiometer or encoder be coupled to the pen carriage to supply a feed-back signal. A digital stepping motor drive theoretically does not require position-sensing since a running count of stepping pulses delivered to the motor is intended to indicate the pen carriage position. For low-accuracy utility plotters this assumption is valid and gives the digital drive an economic advantage over the analog drive, particularly when the plotter is coupled directly to the output channel of a digital computer. For high-accuracy plotters, position-sensing is required regardless of the type of drive.

The type of driving motor used affects other aspects of the plotter's performance. A digital motor drives the plotter in discrete steps. If the steps are large, allowing high speed, then the "staircase" image inherent in the digital drive will be noticeable and perhaps unacceptable. If the step size is small, on the order of 0.001", as is the case in some high precision plotters, then the "stair-case" image is imperceptible to the naked eye. Analog drives are capable of accepting direct motion commands from one point to another and producing perfectly smooth lines. It is always possible to plot a complex curve by decomposing it into a succession of straight line segments each of which is plotted separately. With analog servo drives, it is possible to obtain rather high plotting speeds for complex curves by issuing direction commands to the plotter in time with its motion, thereby avoiding start-stop plotting of every line segment.

Plotters are available with a wide range of control concepts. The simplest approach to plotter control involves direct coupling of a digital step-motor driven plotter to a data channel of a computer. With this approach, all computation of plotter commands is done by programs executed in the computer and the plotter receives nothing but a sequence of pulses which drive the stepping motors back and forth, plus the necessary pen-up and pen-down commands. This approach is economical when viewing the costs of adding a plotter to an on-going data processing system where plotter use is intended to be relatively light. The highly economical "skeleton" plotter control just described relies upon program control to convert vector and symbol commands such as:

"Plot line from (X_1, Y_1) to (X_2, Y_2) "
 "Print A B C D starting at (X_3, Y_3) "

into a sequence of step-motor pulses and pen up/down commands. A number of plotters are equipped with self-contained control systems that allow the plotter to

interpret these commands directly. Such plotters are intended for operation without direct connection to a computer and are equipped with either card, paper tape, or magnetic tape input. Analog servo driven plotters normally operate from absolute coordinate information of the sort given in the example above and easily accept manual control of scale, offset, and pen position. Step-motor driven plotters require a considerable amount of logic to provide comparable local control.

The plotting operation begins with a set of input data to be plotted, expressed as an equation in two or three variables, either as a set of discrete points, or as any other computer-sensible description of the picture to be generated. The input data can also contain alphanumeric information which is used to annotate the picture.

The computer interprets the input data and creates an output sequence of information which is routed either to the plotter through interface circuitry or to an intermediate storage medium for off-line plotting.

When the data arrives at the plotter, it is decoded and the plotting is performed. The input usually consists of coordinate information interleaved with commands such as *Pen Up*, *Pen Down*, *Draw a Circle*, *Draw an Arc*, *Draw a Straight Line*, etc.

The coordinate information is expressed as an increment or as an absolute value. Absolute values are expressed with respect to an origin that is established by an operator entry or by a preliminary command. Incremental values are measured from the current plotted point position.

The incremental method of plotting uses the on-line computer and off-line storage very effectively. For the value $(X_2 - X_1)$, the incremental value is usually much smaller (and occupies less storage) than either X_2 or X_1 ; the plotter needs no hardware to "remember" the location of the origin so the system is less expensive.

When the plotter has some internal read-write storage and an appropriate set of logic, it is possible to specify some kinds of plots with relatively small amounts of data. For example, when plotting a circle, you can specify, point by point, a set of coordinates that the plotter can draw to form the circle. With more advanced logic, which calls for less strain on the input computer, the input specifies the origin of the circle in incremental or absolute coordinates, and the radius; the plotter then draws the circle automatically.

As another example, suppose you want to draw a dotted line. Usually, the input command sequence — whether with absolute or incremental coordinates — will define the path to be drawn, with the (X, Y) information interleaved with alternating *Pen Up* and *Pen Down* commands. Each stroke that makes up the dotted line is defined with a set of inputs. If a more sophisticated plotter is used, the input defines the starting point and the end point (or the direction and magnitude) of the entire line segment, along with a *Dotted Line* command.

Equipment Selection

When selecting plotting equipment, consider the following:

- *Work area of interest* — Be sure to evaluate anticipated

1 Equipment Characteristics

uses. A 12" width might work today, but tomorrow a 30" or 34" width may be required. The wider plotters can usually accommodate the smaller width papers and may be a more practical buy for the long haul.

- *Accessory capabilities* – Liquid ink, ballpoint pens, strippable film cutters

- *Plotter resolution or step size and line generation rate* – The line generation rate is determined by two primary factors; the increment size and the incremental rate. For a given model plotter having a fixed incremental rate, the line generation rate will vary directly with the increment size. The larger the increment size, the greater the line generation rate. But, the smaller the increment size, the greater the resolution of the output. Thus, a trade-off between resolution and speed is a definite consideration for most applications.

Features available in plotter systems include:

- Direct printing of symbols (from turret)
- Selection of pen type (turret-mounted)
- Selection of line type (solid, dashed, etc.)
- Searching of input tape for specific records
- Generation of strobed symbols (pen-stroked)
- Scaling, offset, and rotation of axes
- Linear interpolation
- Curvilinear interpolation
- Curve following (with creation of digital record)

The most comprehensive of plotter control systems actually employs a self-contained digital computer.

Minicomputers will give more users access to computers and permit computer penetration into smaller business and scientific areas. This, in turn, will warrant special small interface development to provide such users with graphic capability.

For larger scale computers, the amount of time generating plot data may become prohibitively large in cost so that on-line plotter use is not feasible. If the plotting work load is large and off-line plotting capabilities are required, additional benefits can be derived by going to more sophisticated off-line systems that generate the plot commands. This leaves the host computer with the simpler task of recording only the essential plotter requests and data and not the entire list of command characters to drive a plotter.

Plotters record information on a variety of media. Utility plotters are generally confined to inked-pen tracing on paper. Drum plotters require the use of special paper to fit the feed mechanism. Flat-bed plotters will accept any medium that will fit the table. The more expensive precision plotters can handle a variety of media. Inked-pen on paper is commonly used but highest quality work is produced by scribing of lines in an opaque surface on a dimensionally-stable plastic, or exposing a photographic negative on a similar backing. It is thus normal for precision plotters to be equipped with pen turrets and replaceable carriages to permit recording on a variety of media.

COMPUTER-OUTPUT-MICROFILM PLOTTERS

COM plotters are systems for exposing photographic film from a cathode-ray tube image. They are capable of

producing images of moderate quality on film at a very high rate of speed when compared to pen moving plotters. The quality of the images produced by these machines is essentially limited by the inherent properties of the cathode-ray tube. The output of these plotters is a rather small film image and subsequent use generally requires projection and possible printing of an enlargement.

COM plotters usually have the following basic elements:

- A magnetic tape transport to hold image driving tapes prepared on a computer
- A cathode-ray tube which generates symbolic vector images in response to commands originating on tape and interpreted by the plotter's control section
- A film transport system including feed reel, exposure gate, in-line developing system, and take-up reel
- A slide projector for superimposing standard form information on the film being exposed
- A monitor system to permit in-line examination of film immediately upon development
- An internal control system

The key limitations on performance of COM plotters are those imposed by the cathode-ray tube used to generate the images. Since the face of the tube is used to compose the entire image exposed on a single film frame, the CRT's characteristics place an absolute limit on the accuracy and resolution of the resultant image. Allowing for differences in the form of various manufacturers specifications, it is generally found that, on the average, film plotters offer resolution of image to a grid of 2048 X 2048 points (one part in 2000) and positional accuracy of roughly 1%.

The limitations described above are based upon the principle that the film image is composed from a single CRT image. It is quite possible to avoid this limitation by designing a film plotter in which the film image is composed from several CRT images. To make such a system operate, it is necessary to provide a highly precise mechanical film transport that can index the film relative to the CRT. Such systems are available now or in development.

COM plotters offer a variety of features. The images may be composed using various combinations of character and vector generation. Films of various sizes may be exposed, including 16mm, 35mm, and 105mm microfiche/105mm full frame. Monitoring is available using either direct projection viewing or printed full-size hard copy. For information storage and retrieval applications, these plotters can expose a retrieval bar code on the edge of the film. The simpler models are restricted to character printing in a fixed format. The more elaborate models allow free composition of alphabetic and graphic data. Slide projectors may be used to superimpose standard forms on the film being exposed. The positioning of the projected image relative to the CRT image is accurate to roughly ½%.

The speed of COM plotters is limited primarily by the density of the images being plotted and the writing speed of the CRT. Practical speeds on the order of a frame a second are achievable.

The computer output microfilm plotter-printer charts are presented on pages 284-286 in the chapter on "Printers."

SUMMARY

While the internal speeds of computers are increasing, the input/output capability has generally lagged behind; hence, throughput has not necessarily increased in proportion to the increased processor speeds.

Various attempts at increasing the efficiency of computer graphic systems are being made. These newer systems permit the central processor to communicate in a mode that provides maximum efficiency for the class of problems to be displayed. This added efficiency normally entails the use of active logic resident within the computer graphic system. Since the price-performance ratio for this logic is gradually being reduced, it is possible to provide a significant amount of "computational power" within the computer graphic system. Excess capability, if it exists, can be used to support a variety of other devices including modem interfaces and paper tape equipment.

Certain applications are in need of equipment as described in the previous paragraph. For example, a numerically controlled tool manufacturing company would use the system to read paper tape generated for their tool controller. This tape would be read by the computer graphic system and a plot of the tool path made to allow quick and reliable verification of the data on the tape. With the addition of a communication modem interface the computer graphic system could communicate on-line to a large central processor and save manual data transfer.

In summary, as computing systems increase in size and complexity, more and more users will place a portion of the additional load imposed by graphics in more powerful peripheral computer graphic systems. This will permit the user to have increased control over his computer graphic system while at the same time increasing main computer throughput and reducing overall costs.

Celco Yokes for CRT DISPLAYS

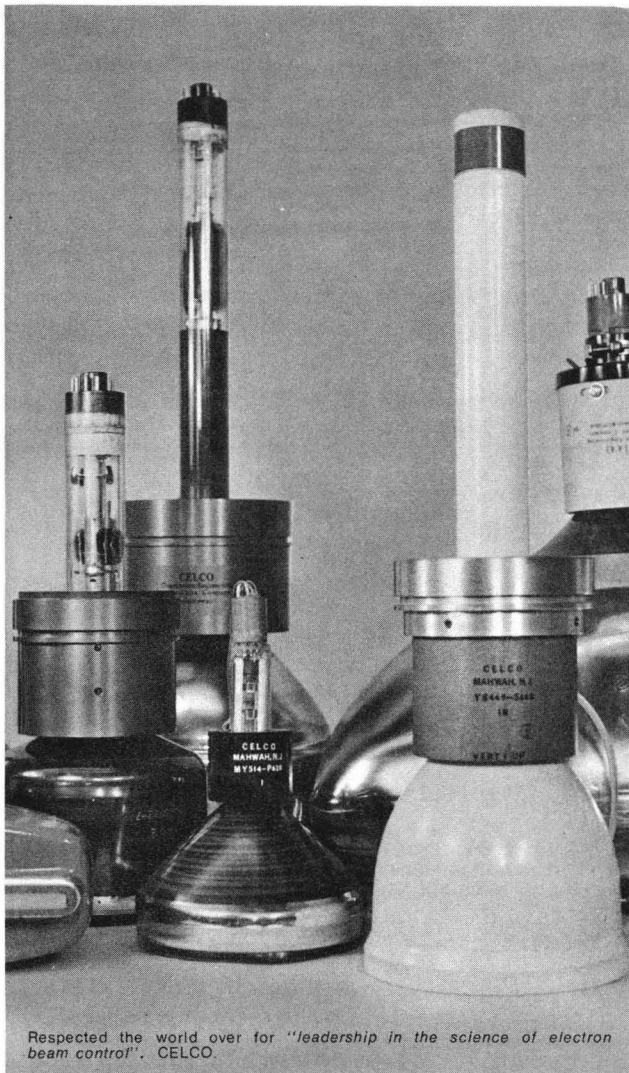

Respected the world over for "leadership in the science of electron beam control". CELCO.

CELCO makes YOKES. They make them good. In fact, CELCO has been making the best CRT deflection yokes and focus coils in the industry for the past twenty years.

CELCO makes yokes for precision displays when you must have the highest performance available.

And CELCO makes yokes for computer terminal displays when you need reliable repetitive scan yokes for commercial purposes, at low cost.

Not only does CELCO make good yokes, but they make sure you get the right yoke for your particular CRT display requirements.

Call CELCO on your present display problem. A CELCO yoke will solve it. (It might even be one of the standard CELCO yokes listed below:)

CELCO PRECISION DISPLAY YOKES:

- DNA702 "superfastDYNAYOKE"
(2 μ sec recovery time to 0.1%)
- HDN428 Low-Zero Approach
- HDQ428 Mini-Spot, (CRT/Yoke matched)

CELCO COMPUTER TERMINAL DISPLAY YOKES:

- PW Position-Write Yokes
- PWM Position-Write, with Pincushion Correction
- YA Resonant Drive, Hi-Q

CONSTANTINE ENGINEERING LABORATORIES COMPANY
 MAHWAH, N. J. 07430 TEL. 201-327-1123 TWX: 710-988-1018
 UPLAND, CAL. 91786 TEL. 714-982-0215 TWX: 910-581-3401

Go ahead and call CELCO. All you've got to lose are your yoke problems.



1 Equipment Characteristics

ALPHANUMERIC CRT CONSOLES

COMPANY	COMPUTEK	COMPUTER DISPLAYS	DATA DISC
MODEL	100 CRT Display System	ARDS 100	6500 Graphic Display System
FIRST DELIVERY YEAR	1969	1968	1969
BASIC PURCHASE PRICE	\$3000	\$7950	\$11,000 (2 chnl sys)
LEASE RATE/MONTH	n/a		
DISPLAY CHARACTERISTICS			
Display Area (inches)	7 x 9.3	56 sq	opt - uses std TV monitors
Character Size (inches)	.140 x .190	.08 x .06 other size opt	depends on monitor - 4 sizes programmable
Character Positions	100	4160	262,000 possible
Characters/Line	50, 72, 80	80	85
Total Lines	20, 14, 13	52	51
Refresh Rate	60/sec	no refresh - direct view storage tube	30 frames/sec
Brightness (ft-Lamberts)	30	3	adjustable - TV monitor
Contrast	10:1	3:1	adjustable - TV monitor
Resolution (lines/inch)	100	equiv to 400/inch	depends on monitor - 525 line
Deflection Type	electromagnetic	electromagnetic	depends on monitor typ. magnetic
CHARACTER GENERATION			
Method	unique dot/stroke	7 x 9 dot matrix	5 x 7 dot matrix
Repertoire	64 and 96 ASCII	96 or 192 char	64 char ASCII
Writing Rate (t/char)	14 μ sec/char	604 μ s/char to 1244 μ s/char	~40 msec/char
No. Flicker Free	1000	4160	4335 or more
CONTROL FUNCTIONS			
Input Devices	keyboard, key pad, touch screen	keyboard	input made to associated computer by: keyboard ASR-33
Memory	serial associative memory	direct view storage tube - data read only memory - core - 63 bit matrix	disc - 32K bytes/display
Function Switches	yes (key pad)	yes	opt
Software Package	yes	graphs/plot	opt
MISCELLANEOUS FEATURES			
Image Manipulation	yes	no	yes - opt
Status Indicators	no	yes	yes
Hard Copy Output	yes	yes	yes -opt
Color Available	no	no	yes
COMMENTS			Handles up to 32 displays. Graphic capability also.

Also see "CRT Data Terminal" charts.

1 Equipment Characteristics

ALPHANUMERIC CRT CONSOLES

COMPANY	HARRIS-INTERTYPE	IMLAC	INTERACTIVE TERMINALS - BENDIX
MODEL	Harris 1100 Editing & Proofing Terminal	PDS-1	Logiport/1
FIRST DELIVERY YEAR	1970	1970	1970
BASIC PURCHASE PRICE	\$14,500	\$9620	\$2950
LEASE RATE/MONTH	n/a	\$250	\$97
DISPLAY CHARACTERISTICS			
Display Area (inches)	15 diag (8½ high x 11 wide)	10 x 8	5 x 7
Character Size (inches)	.20	1/10 x 1/8	0.22 x 0.14
Character Positions	2000		512
Characters/Line	80 or 40	80 std, up to 128 opt	32
Total Lines	25	40 std, up to 64 opt	16
Refresh Rate	60 (sync to local power)	40 frames/sec std, 30 & 60 also avail	60 frames/sec
Brightness (ft-Lamberts)	25 ft candles	50	
Contrast	10:1	10:1 std; 20:1 opt	
Resolution (lines/inch)	over 80	128	
Deflection Type		electromagnetic	proprietary
CHARACTER GENERATION			
Method	vert raster	vector stroke	5 x 7 dot matrix
Repertoire	118	full ASCII supplied	97 generated, 64 displayed
Writing Rate (t/char)	110 Hz	~25 µsec/char	n/a
No. Flicker Free		1200	all
CONTROL FUNCTIONS			
Input Devices	off-line: paper tape reader/punch; on-line: communication adaptor CX/BRPE emulator	light pen, paper tape, mag-tape cassette, function-key-board, disk	acoustic coupler integral, keyboard, EIA RS-232B interface
Memory	2-8,000	core, 4Kx16 (expan to 32K)	semiconductor 512
Function Switches	yes	yes	yes
Software Package	no	extensive	not applicable
MISCELLANEOUS FEATURES			
Image Manipulation	no	yes	no
Status Indicators	yes	yes	yes, power, carrier
Hard Copy Output	no	yes	EIA RS 232B interface jack provided
Color Available	no	option	no
COMMENTS	Terminal designed for text manipulation; has editing controls	Software library avail.	30 lbs. unit is stand-alone, portable.

Also see "CRT Data Terminal" charts.

1 Equipment Characteristics

ALPHANUMERIC CRT CONSOLES

COMPANY	ITT - DATA EQUIP & SYSTEMS	SPIRAS SYSTEMS	TEKTRONIX
MODEL	Alphascope ITT 3100	IRASCOPE Model TE	T4002 Graphic Computer Terminal
FIRST DELIVERY YEAR	1970	1971	1969
BASIC PURCHASE PRICE	\$1200	\$7000 to \$9000	T4002 \$8800, RS232-B interface \$600
LEASE RATE/MONTH	\$40	by request	T4002 \$338.80, RS232-B interface \$23.10
DISPLAY CHARACTERISTICS			
Display Area (inches)	4.5 x 7.5	54 sq	8¼ x 6 or 11 diag
Character Size (inches)	.07 x .11	0.09 x 0.14	two .070 x .090" & .140" x .180"
Character Positions	1360	1024	approx 3000
Characters/Line	80	80 max	85
Total Lines	17	32 (displayed roll up/down gives up to 4096)	39
Refresh Rate	50	65 Hz	storage CRT
Brightness (ft-Lamberts)		50	at least 6
Contrast			at least 6:1
Resolution (lines/inch)	620		equiv to 287 line prs vert equiv to 400 line prs horiz
Deflection Type		magnetic	electromagnetic
CHARACTER GENERATION			
Method	dot matrix	monoscope	7 x 9 dot matrix
Repertoire	ASCII	124 char & special symbols	ASCII-96 printable
Writing Rate (t/char)		12 µsec	at least 5000 char/sec avg
No. Flicker Free	1360	1024	no flicker - storage CRT
CONTROL FUNCTIONS			
Input Devices	keyboard	modem, keyboard, cassette opt	keyboard (full ASCII) joystick
Memory		MOS SR up to 4096 x 8 (1024 x 8 std)	storage CRT
Function Switches	yes	yes	yes
Software Package	compatible with std IBM 2260 software	ROM	std access routines
MISCELLANEOUS FEATURES			
Image Manipulation	yes	yes	yes
Status Indicators	yes	yes	yes
Hard Copy Output	yes	yes - opt	yes
Color Available	no	no	no
COMMENTS	5 program keys provide immediate customer control transfer fens fixed & vari format std		

Also see "CRT Data Terminal" charts.

GRAPHIC CRT CONSOLES

COMPANY	COMPUTEK	COMPUTER DISPLAYS	DATA DISC	DATA DISC
MODEL	400 CRT Display System	ARDS 100	6500 Graphic Display System	6600
FIRST DELIVERY YEAR	1969	1968	1969	1970
BASIC PURCHASE PRICE	\$6700	\$7950	\$11,000 (2-chnl sys)	\$30,000 (4-chnl sys)
LEASE RATE/MONTH	n/a			
DISPLAY CHARACTERISTICS				
Display Area (inches)	6.4 x 8.25	56 sq in.	optional - uses std TV monitors	uses std TV monitors
Grid Size-Dots	1024 x 800	.006	512 x 512	480 x 640
Total Lines	40/display	1081 x 1405	no limit - any combination in 512 x 512 dot matrix	525 line TV
Refresh Rate	storage tube	no refresh-direct view storage tube	30 frames/sec	30 frames/sec
Brightness (ft-Lamberts)	6 min	3	adjustable - TV monitor	adjustable - TV monitor
Contrast	6:1 min	3:1	adjustable - TV monitor	adjustable - TV monitor
Deflection Type	electromagnetic	electromagnetic	raster scan - vertical	raster scan - horizontal
Random Positioning		yes	n/a	n/a
Positioning Accuracy	.01%	1 part in .008	n/a	n/a
Stability	.02%	perfect	.03%	.03%
VECTOR GENERATION				
Type	phaseplot - velocity controlled tuned filter	binary rate multiplex (BRM)	plotted on 512 x 512 screen x point	plotting pt x pt on 480 x 640 matrix
Point Plotting Speed	5000 points/sec	125-500/sec	15,750/sec to 9.45 x 10 ⁶ /sec	15,750/sec to 10 ⁷ /sec
Vector Plotting Speed	2000"/sec min	1000 increments/sec	same as above	same as above
End Point Registration	.01%	1 part in 8000	0.2%	0.2%
Linearity	0.1% to scope-scope linearity is less	1 part in 2000	depends on TV monitor - typ 1%	depends on TV monitor - typ 1%
CHARACTER GENERATION				
Type	smooth-stroke curves	7 x 9 dot matrix	5 x 7 dot matrix, 4 char sizes	7 x 10 dot matrix, 4 char sizes
No. Characters	800,000 points cap	96 or 192 diff char, 4160 char screen capacity	64-ASCII subset	96-ASCII
CONTROL FUNCTIONS				
Input Devices	keyboard, tablet, joystick, cursor	keyboard, mouse, joystick, graphic tablet	trackball, joystick, ASR-33, light pen, keyboard	trackball & keyboard
Memory	storage tube-over 800,000 flicker force points	direct view storage tube 6.5 x 8.5"	disc - 32K bytes/display	memory stores video image in digital format. disc, 38.4K bytes/display
Function Switches	yes	yes	yes	yes
Software Package	yes, complete	graphsys/plot	opt	opt
MISCELLANEOUS FEATURES				
Image Manipulation	no	no	yes, opt	yes, prog cont
Status Indicators	yes	yes	yes, opt	yes
Hard Copy Output	yes, two types	yes	yes, opt	yes, opt
Color Available	no	no	yes, requires 3-chnl & color TV monitor	yes - with 4 or 16 level gray scale
COMMENTS			2-chnl min sys expandable to 32-chnl interfaces available for many popular 16 bit computers.	4 or 16 level gray scale chnls made by combining prs of B&W chnls. 4,8, 12, 16 or 20 chnls avail.

Also see "CRT Data Terminal" charts.

GRAPHIC CRT CONSOLES

COMPANY	DICOMED	DICOMED	IMLAC CORP	INFORMATION DISPLAYS
MODEL	DICOMED 31	DICOMED 36	IMLAC PDS-1	IDIOM 60-0010
FIRST DELIVERY YEAR	1970	1970	1970	1967
BASIC PURCHASE PRICE	\$17,800	\$24,500	\$9620	\$59,500
LEASE RATE/MONTH			\$250	\$2540 w/maint
DISPLAY CHARACTERISTICS				
Display Area (inches)	8 circular	7 x 7	10 x 8	12 x 12
Grid Size-Dots	1024 x 1024	2048 x 2048	1024 x 1024	1024 x 1024
Total Lines	1024 vert, 1024 horiz	2048 vert, 2048 horiz		2000 vectors at 30 Hz frame rate
Refresh Rate	req'd storage-CRT (no refresh)	req'd storage-CRT (no refresh)	40/sec, programmable	30 Hz or line freq multiples
Brightness (ft-Lamberts)	15	15	50	variable
Contrast	3:1	3:1	10:1 std; 20:1 opt	variable
Deflection Type	electromagnetic	electromagnetic	electromagnetic	electromagnetic
Random Positioning	yes	yes	yes	yes, absolute or incremental
Positioning Accuracy	± 0.005"	± 0.005"	.008"	± 3% of full scale
Stability	no movement	no movement	± 1.25%	0.5% of full scale
VECTOR GENERATION				
Type	point plotting	point plotting	digital, stroke drawing	proportional writing time
Point Plotting Speed	250 μsec per axis	250 μsec per axis	var, depending on method	proportional (average time of 3 μsec)
Vector Plotting Speed			from 4 to 32 μsec in., depending on method	proportional 3 μsec to 25 μsec
End Point Registration	± 0.005"	± 0.005"	no end matching error	± 0.5% of full scale
Linearity			± ½ LSB, 1 part per 4096	± 0.5% of full scale
CHARACTER GENERATION				
Type	none	none	stroke	proportional number and length of strokes
No. Characters			programmable, full ASCII supplied	3000 char at 30 Hz frame rate
CONTROL FUNCTIONS				
Input Devices	none	none	light pen, paper tape, mag tape cassette, disk, function keyboard	alpha numeric keyboard, light pen, trackball, joystick, panel switches, mag tape, paper tape
Memory	none - uses storage CRT	none - uses storage CRT	core, 4K x 16 (expandable to 32K)	4K to 32K core 16 bits/word disc and drum memories opt
Function Switches	no	no	yes	yes, 32 keys
Software Package	none	none	extensive	assembly, diagnostic, applications
MISCELLANEOUS FEATURES				
Image Manipulation			yes	yes
Status Indicators	yes	yes	yes	yes
Hard Copy Output	no	no	yes	yes
Color Available	no	no	optional	yes
COMMENTS				
	Designed to present pictorial (64 intensity levels) as well as graphic information.	Designed to present pictorial (64 intensity levels) as well as graphic information.	Full systems/applications software library available to all customers, including assemblers, debugger, symbol form II, various I/O service routines, host computer Fortran pkgs.	

Also see "CRT Data Terminal" charts.

GRAPHIC CRT CONSOLES

COMPANY	LUNDY ELECTRONICS & SYSTEMS	SANDERS DATA SYSTEMS	SANDERS DATA SYSTEMS	SANDERS DATA SYSTEMS
MODEL	Computer Graphic Display - System 32	ADDS/900 Advanced Data Display System	ADDS/900 Advanced Data Display System	ADDS/900 Advanced Data Display System
FIRST DELIVERY YEAR	1970	1965	1965	1965
BASIC PURCHASE PRICE	\$50,000-\$120,000	by request	by request	by request
LEASE RATE/MONTH	by request	by request	by request	by request
DISPLAY CHARACTERISTICS				
Display Area (inches)	314 sq. in.	Model 912 5¼x7¼	Model 913 8x8	Model 930 12x12
Grid Size-Dots		true TV display	true TV display	true TV display
Total Lines	1430	729		525
Refresh Rate	10 to 100 cps (adjustable)	60 frames/sec	60 frames/sec	60 frames/sec
Brightness (ft-Lamberts)	40			
Contrast	5:1	10:1	2:1	4:1
Deflection Type	electromagnetic	electromagnetic	electrostatic	electromagnetic
Random Positioning	yes			
Positioning Accuracy	± .02"	± 1%	± 1%	± 1%
Stability	0.5%	0.1%	± 0.15%	± 0.1%
VECTOR GENERATION				
Type	stroke	constant velocity vector generation	constant velocity vector generation	constant velocity vector generation
Point Plotting Speed				
Vector Plotting Speed	.75 in./μsec avg	60 μsec max with speed 1 on 960	60 μsec max with speed 1 on 960	60 μsec max with speed 1 on 960
End Point Registration	± .02 in.			
Linearity	3%			
CHARACTER GENERATION				
Type	stroke	constant velocity vector generation	constant velocity vector generation	constant velocity vector generation
No. Characters	(opt) 96 uc-96 lc (opt) - total 192	64 uc ASCII, 32 lc ASCII (opt), 32 special symbols (opt), 16 control char	64 uc ASCII, 32 lc ASCII (opt), 32 special symbols (opt), 16 control char	64 uc ASCII, 32 lc ASCII (opt), 32 special symbols (opt), 16 control char
CONTROL FUNCTIONS				
Output Devices	light pen, function keyboard, AN keyboard	console control module, photopen unit, and alphanumeric/function keyboard	console control module, photopen unit, and alphanumeric/function keyboard	console control module, photopen unit, and alphanumeric/function keyboard
Memory	16K x 16, 8K x 16 (opt) - core	core 16 bits (expandable to 32,768 words)	core 16 bits (expandable to 32,768 words)	core 16 bits (expandable to 32,768 words)
Function Switches	yes	yes	yes	yes
Software Package	graphic sub-routine package, debug program	yes	yes	yes
MISCELLANEOUS FEATURES				
Image Manipulation	yes	yes	yes	yes
Status Indicators	yes	yes	yes	yes
Hard Copy Output	no	yes	yes	yes
Color Available	no	no	no	no
COMMENTS	Rectangular, circle and ellipse, alternate vector, point vector generator, 3-axis rotation with orthogonal projection.			

Also see "CRT Data Terminal" charts.

GRAPHIC CRT CONSOLES

COMPANY	SANDERS DATA SYSTEMS	TEKTRONIX	TEKTRONIX	XEROX DATA SYSTEMS
MODEL	ADDS/900 Advanced Data Display System	T4002 Graphic Computer Terminal	T4005 Graphic Display	7580 Graphic Display Unit
FIRST DELIVERY YEAR	1965	1969	1970	1968
BASIC PURCHASE PRICE	by request	\$8800, RS232-B interface = \$600	\$7850, 1130 interface = \$850	\$45,000
LEASE RATE/MONTH	by request	\$338.80, RS232-B interface = \$23.10	\$302.23, 1130 interface = \$32.73	\$1013 - 4 yr
DISPLAY CHARACTERISTICS				
Display Area (inches)	Model 960 14x14	storage CRT 8- $\frac{1}{4}$ x6 (refreshed line buffer 21 cm x 1 cm)	8- $\frac{1}{4}$ x6	10x10
Grid Size-Dots	true TV display	1024 hor x 760 vert viewable points	1280 hor x 1024 vert display points	1024x1024
Total Lines	525	equiv to 287x400 line prs	300x400 line pairs	
Refresh Rate	60 frames/sec	none - storage CRT	direct view bistable storage tube	60 Hz or variable
Brightness (ft-Lamberts)		at least 6	6	n/a
Contrast	4:1	at least 6:1	6:1	n/a
Deflection Type	electromagnetic	electromagnetic	electromagnetic	magnetic
Random Positioning		n/a	n/a	7 μ sec (< 0.5"), 13 μ sec (> 0.5")
Positioning Accuracy	1%	settling time - 3.5 μ sec/cm + 5 μ sec	settling time - 3.5 μ sec/cm + 5 μ sec	0.5%
Stability	0.1%	storage CRT		2%
VECTOR GENERATION				
Type	constant velocity vector generation	linear interpolation	incremental plot	analog
Point Plotting Speed			8.5 μ sec/point	9-16 μ sec
Vector Plotting Speed	60 μ sec max with speed 1 on 960	8 ms/vector	1.5 msec/in.	short. 6 μ sec (\leq $\frac{1}{4}$ "), long. 41 μ sec (0" fullscreen)
End Point Registration			n/a	n/a
Linearity			3%	n/a
CHARACTER GENERATION				
Type	constant velocity vector generation	7x9 dot matrix	software	stroke
No. Characters	64 uc ASCII, 32 lc ASCII (opt), 32 special symbols (opt), 16 control char	96 ASCII		64 (EBCDIC)
CONTROL FUNCTIONS				
Input Devices	console control module, photopen unit, and alphanumeric/function keyboard	interactive graphic unit and joystick	electronic cursor 1 point in 8192 x 8192 matrix	alphanumeric keyboard, function keyboard, action keys, light gun
Memory	core 16 bits (expandable to 32,768 words)	storage CRT	11" storage CRT	refreshes direct from Sigma computer core
Function Switches	yes	yes	yes	yes
Software Package	yes	standard access level	plotting system	yes (graphic display library, GDL)
MISCELLANEOUS FEATURES				
Image Manipulation	yes	yes	yes	no
Status Indicators	yes	yes	yes	no
Hard Copy Output	yes	yes	yes	via plotter
Color Available	no	no	no	no
COMMENTS			real time clock, interrupt lines, hardware scaling and offset, multiple display	2 vector gen provided, one for vectors 0- $\frac{1}{4}$ ", the other for vectors > $\frac{1}{4}$ ". char set may be changed by programmer. Price includes controller.

Also see "CRT Data Terminal" charts.

1 Equipment Characteristics

PLOTTERS

COMPANY	AUTO-TROL	AUTO-TROL	AUTO-TROL	BOSTON DIGITAL
MODEL	6030	6035	6040	N/CV
FIRST DELIVERY YEAR	1970	1970	1971	1968
BASIC PURCHASE PRICE	\$27,100	\$30,450	\$21,000	\$17,000
LEASE RATE/MONTH	5%	5%	5%	—
TABLE CHARACTERISTICS				
Plotting Area	40" x 60"	40" x 60"	36" wide roll	11-1/2" x 120'
Vertical/Horizontal	tilt	—	—	drum
AXES				
Number	2	2	2	3
X and Y Reversal	yes	yes	yes	yes
Axis Offset	yes	yes	yes	yes
PLOTTING CHARACTERISTICS				
Maximum Plotting Speed	10"/sec	10"/sec	12"/sec	180"/min
Smallest Plotting Unit (in.)	.0005	.0005	.0005	.005
Adjustable Scaling Factors	1:1, 1/2:1, 2:1	1:1, 1/2:1, 2:1	1:1, 1/2:1, 2:1	1/10, 1/2, 1, 2
Accuracy (in.)	± .004	± .004	± .004 y axis	.010
Repeatability (in.)	± .001	± .001	± .001	.010
Modes (Absolute, Incremental)	abs or inc	abs or inc	abs or inc	inc
INPUT MECHANISMS				
Keyboard	yes	yes	yes	—
Punched Tape	yes, 8 chnl	yes, 8 chnl	yes, 8 chnl	yes, 9 chnl
Magnetic Tape (bpi)	yes, to 800	yes, to 800	yes, to 800	—
Other	punch card, cpu, & term	punch card, cpu, & term	punch card, cpu, & term	—
SYMBOL PRINTER (No. Symbols)	64 char	64 char	60 char	no
SYMBOL GENERATOR	software	software	software	no
DASHED-LINE GENERATOR	yes	yes	yes	no
CIRCULAR GENERATOR	no	no	no	yes
INTERPOLATION OUTPUT				
Paper	yes	yes	yes	yes
Scribe Cote	yes	yes	no	—
Film	yes	yes	no	—
Paper Roll Feed	no	yes	yes	yes
PEN TYPES	rapidograph, ballpoint	rapidograph, ballpoint	rapidograph, ballpoint	ball, ink
VACUUM HOLD	yes	yes	yes	no
COMMENTS	—	—	—	format selection: 0.4, 1.4, 2.4, 2.3

PLOTTERS

COMPANY	CALIF. COMPUTER PRODUCTS	CALIF. COMPUTER PRODUCTS	COMPUTER-LINK	COMPUTERVISION
MODEL	Digital Incremental Drum Plotter	Flatbed Plotter Series Series	Time Share Plotter 500 Plotter 500	Interactgraphic 1
FIRST DELIVERY YEAR	1961/1970	—	1970	1970
BASIC PURCHASE PRICE	—	\$17,000-\$69,960	\$3200	\$47,500
LEASE RATE/MONTH	—	by request	\$145	\$1800
TABLE CHARACTERISTICS				
Plotting Area	11" x 120'	to 54" x 72"	11" x 17"	34" x 44"
Vertical/Horizontal	horiz	horiz, fixed & tilt	tilt - vert to horiz	tilt
AXES				
Number	2	2	2	4
X and Y Reversal	yes	yes	no	yes
Axis Offset	software	no	yes	yes
PLOTTING CHARACTERISTICS				
Maximum Plotting Speed	6.5" axial, 9.2" dia	1.4 - 255"/sec	30 ips	14 ips
Smallest Plotting Unit (in.)	.0025	to .0001	1/759	.002
Adjustable Scaling Factors	software or y-axis trim adj	software	software	infinite
Accuracy (in.)	—	—	± 0.2%-full scale	± 0.005
Repeatability (in.)	± 1 incr	—	± 0.1%-full scale	0.002
Modes (Absolute, Incremental)	inc	inc or zip	abs	abs & inc
INPUT MECHANISMS				
Keyboard	yes	yes	yes	yes
Punched Tape	yes	yes	yes, 8 level	yes
Magnetic Tape (bpi)	yes, to 1600	yes, to 1600	no	yes
Other	card reader & disk	on-line to most computers	modem	computer interface
SYMBOL PRINTER (No. Symbols)	no	no	yes	infinite
SYMBOL GENERATOR	yes	yes	yes	no
DASHED-LINE GENERATOR	yes	yes	yes	no
CIRCULAR GENERATOR	yes	yes	yes	no
INTERPOLATION OUTPUT				
Paper	yes	yes	yes	yes
Scribe Cote	no	yes	no	yes
Film	no	no	no	no
Paper Roll Feed	yes	yes	yes	no
PEN TYPES	ballpoint or liquid ink	ink, ballpoint	ballpoint, felt, ink	any
VACUUM HOLD	yes	yes	yes	no
COMMENTS	many models & options	many models & options	—	includes full crt display

1 Equipment Characteristics

PLOTTERS

COMPANY	CONCORD CONTROL	ELECTRONIC ASSOC.	ELECTRONIC ASSOC.	HONEYWELL TEST INSTRUMENTS DIV
MODEL	Coordinatograph Mark 8	130, 135, 145, 230	430 series Dataplotter	540 X-Y-Y' Recorder
FIRST DELIVERY YEAR	1961	1970	1969	1969
BASIC PURCHASE PRICE	\$200,000	\$3450-\$6250	\$33,000-\$52,000	\$2340
LEASE RATE/MONTH	—	—	\$726 up	by request
TABLE CHARACTERISTICS				
Plotting Area	60" x 60"	12" x 144'	31" to 76"	11" x 17"
Vertical/Horizontal	vert (fixed)	horiz, fixed	horiz, fixed	fixed
AXES				
Number	3	2	2	3
X and Y Reversal	yes	yes	software	yes
Axis Offset	yes	yes	software	yes
PLOTTING CHARACTERISTICS				
Maximum Plotting Speed	120 ipm	270-450 incr/sec	12-16"/sec	30"/sec
Smallest Plotting Unit (in.)	0.001	0.005, .005/1.010	0.001	0.1 max
Adjustable Scaling Factors	software	software	software	—
Accuracy (in.)	0.001" RMS	—	—	.2% FS (15)
Repeatability (in.)	0.0005" RMS	—	0.003	.1% FS (15)
Modes (Absolute, Incremental)	software	incr	—	incr
INPUT MECHANISMS				
Keyboard	yes	—	no	no
Punched Tape	yes	—	no	no
Magnetic Tape (bpi)	yes, 200-800	—	yes, 556 & 800	no
Other	—	on-line computer	on-line computer	analog input
SYMBOL PRINTER (No. Symbols)	Photoelectric	—	48	n/a
SYMBOL GENERATOR	yes	yes	yes	n/a
DASHED-LINE GENERATOR	yes	yes	yes	no
CIRCULAR GENERATOR	yes	yes	yes	no
INTERPOLATION OUTPUT				
Paper	yes	yes	yes	yes
Scribe Cote	yes	no	yes	no
Film	yes	no	no	no
Paper Roll Feed	yes	yes	yes	no
PEN TYPES	ballpen & ink	ballpoint, fibre tips	ink, fibre tip, ballpoint	Sapphire & fiber tips
VACUUM HOLD	yes	no	yes	yes
COMMENTS	MTBF 1000 hours min	—	Auto velocity control	—

PLOTTERS

COMPANY	HOUSTON INSTRUMENT	KONGSBERG SYSTEMS	KONGSBERG SYSTEMS	OMEGA-T SYSTEMS
MODEL	DP-1, -3, 5	Kingmatic 1215	Kingmatic 1800	Fasplot 1030/40/50
FIRST DELIVERY YEAR	1968/69	1966	1968	1970
BASIC PURCHASE PRICE	\$3550-\$11,000	—	—	\$3500-\$3900
LEASE RATE/MONTH	\$177-\$550	—	—	3 year, \$130/mo
TABLE CHARACTERISTICS				
Plotting Area	11" to 144'	4' x 5'	6' to 12'	11" x 17"
Vertical/Horizontal	horiz	horiz, fixed	vert, fixed	0° to 90°
AXES				
Number	2	3	3	2
X and Y Reversal	yes	yes	yes	yes
Axis Offset	yes	yes	yes	yes
PLOTTING CHARACTERISTICS				
Maximum Plotting Speed	300-1200 steps/sec	400 in./min	600 in./min	10 in./sec
Smallest Plotting Unit (in.)	0.05	.00025	.00025	.001 x .001
Adjustable Scaling Factors	yes	.00001 to 9.99999	.00001 to 9.99999	0" to 15"
Accuracy (in.)	± 1 step	± .002	± .0004	0.2% /full scale
Repeatability (in.)	± 1 step	± .0006	± .0008	.01 max
Modes (Absolute, Incremental)	incr	abs & incr	abs & incr	abs, incr, on & offline
INPUT MECHANISMS				
Keyboard	no	yes	yes	yes
Punched Tape	no	yes, all	yes, all	yes, 8 level ASCII
Magnetic Tape (bpi)	yes, 200 or 800	yes, 200, 800	yes, 200, 800	yes
Other	—	punch cards, on line	punch cards, on line	crt
SYMBOL PRINTER (No. Symbols)	no	no	no	infinite
SYMBOL GENERATOR	no	yes	yes	yes
DASHED-LINE GENERATOR	no	yes	yes	yes
CIRCULAR GENERATOR	opt	yes	yes	no
INTERPOLATION OUTPUT				
Paper	yes	yes	yes	yes
Scribe Cote	no	yes	yes	yes
Film	no	yes	yes	no
Paper Roll Feed	opt	yes	yes	no
PEN TYPES	ballpoint & fibre tip	ink, ballpoint, pencil, scribes, photohead	ink, ballpoint, pencil, scribes, photohead	felt tip
VACUUM HOLD	no	yes	yes	yes
COMMENTS	various models			

PLOTTERS

COMPANY	TIMESHARE DEVICES	UNIVERSITY COMPUTING GRAPHIC SYSTEMS	VERSATEC	VERSATEC
MODEL	C/P 701/2	Incremental Drum Plotters	Matrix 100 & 200	Matrix 1100
FIRST DELIVERY YEAR	1969	1965	1970	1971
BASIC PURCHASE PRICE	\$3037-\$3300	\$4300-\$16,500	\$5900-\$6500	\$7200
LEASE RATE/MONTH	—	\$129-\$580	\$195-\$215/40 mo	\$240/40 mo
TABLE CHARACTERISTICS				
Plotting Area	to 10" x 15"	to 14" x 100'	7.75" (500' roll)	10.24" (500' roll)
Vertical/Horizontal	—	—	fixed	fixed
AXES				
Number	2	2	2	2
X and Y Reversal	no	yes	no	no
Axis Offset	yes	yes	no	no
PLOTTING CHARACTERISTICS				
Maximum Plotting Speed	0.3 sec/plot point	3 or 4"/sec	1.656"/sec	1.2"/sec
Smallest Plotting Unit (in.)	1/759	0.005/0.010	.00138	.001
Adjustable Scaling Factors	computer control	no	1:1	1:1
Accuracy (in.)	0.020	± 1 step	—	—
Repeatability (in.)	0.020	± 1 step	—	—
Modes (Absolute, Incremental)	abs	incr	incr	incr
INPUT MECHANISMS				
Keyboard	no	no	no	no
Punched Tape	yes - 8	yes	no	no
Magnetic Tape (bpi)	no	yes	yes - 800	yes - 800
Other	yes - computers	on-line & punched cards	computer	computer
SYMBOL PRINTER (No. Symbols)	no	—	software	software
SYMBOL GENERATOR	yes	yes	yes	yes
DASHED-LINE GENERATOR	yes	yes	yes	yes
CIRCULAR GENERATOR	yes	yes	yes	yes
INTERPOLATION OUTPUT				
Paper	yes	yes	yes	yes
Scribe Cote	no	no	no	no
Film	no	yes	no	no
Paper Roll Feed	no	yes	yes	yes
PEN TYPES	ink	ink, ballpoint, & felt tip	electrostatic	electrostatic
VACUUM HOLD	electrostatic	yes	no	no
COMMENTS	various models	various models & options	software & interface available	software & interface available

PLOTTERS

COMPANY	XEROX DATA SYSTEMS	XEROX DATA SYSTEMS	XYNETICS
MODEL	7530 Graph Plotter	7531 Graph Plotter	1000 Auto. Drafting System
FIRST DELIVERY YEAR	1967	1969	1970
BASIC PURCHASE PRICE	\$13,000	\$22,000	\$110,000
LEASE RATE/MONTH	\$293 (4 yr)	\$495 (4 yr)	\$3000
TABLE CHARACTERISTICS			
Plotting Area	12" drum	30" drum	60" x 96"
Vertical/Horizontal	n/a	n/a	fixed, horiz
AXES			
Number	2	2	2
X and Y Reversal	no	no	yes
Axis Offset	no	no	yes
PLOTTING CHARACTERISTICS			
Maximum Plotting Speed	180"/sec	120"/sec	40"/sec
Smallest Plotting Unit (in.)	to .005	to .005	.001
Adjustable Scaling Factors	no	no	± .001 X to ± 9999.999 X
Accuracy (in.)	—	—	± .001 within 1 sq ft
Repeatability (in.)	—	—	± .001
Modes (Absolute, Incremental)	incr	incr	abs or incr
INPUT MECHANISMS			
Keyboard	no	no	yes
Punched Tape	no	no	yes - 8 level
Magnetic Tape (bpi)	no	no	yes — 556-800
Other	Sigma computer	Sigma computer	on-line interface
SYMBOL PRINTER (No. Symbols)	software	software	software
SYMBOL GENERATOR	no	no	yes
DASHED-LINE GENERATOR	no	no	yes
CIRCULAR GENERATOR	no	no	yes
INTERPOLATION OUTPUT			
Paper	no	no	yes
Scribe Cote	no	no	yes
Film	no	no	yes
Paper Roll Feed	yes	yes	yes
PEN TYPES	ballpoint, ink	ballpoint, ink	ink, ballpoint, scribe, cut & peel, photo, thermochromic
VACUUM HOLD	no	no	yes - opt
COMMENTS	Price includes controller	Price includes controller	8K memory & controller. Also software.

Lean Mama

RCA announces a low cost 4K x 18 expandable memory system.

Our new one-microsecond-or-faster system plugs into mini-computers, data buffers, terminal devices and specialized industrial processors. And RCA's famous reliability and flexibility plug in with it.

The heart of the system is our Lean Baby, a planar 3-wire, coincident-current memory stack with continuous stringing for greater reliability.

But there's more. Byte operation. Built-in timing and registers. Three

operating modes: clear/write, read/regenerate, and read/modify/write. 7400 series T²L logic. All standard.

Words can be 8 to 19 bits long. And modular construction permits expansion to 32K. Whatever system size you need, it fits a standard EIA 19-inch rack.

If you have special requirements, check these options. Parity bit. Power supply. Expansion logic. And parallel

operation for 38-bit words.

Expand your computer's mind. Write RCA Memory Products, Needham Heights, Mass. 02194. Or call 617-444-7200.

We like taking orders.

RCA

Memory products for industry

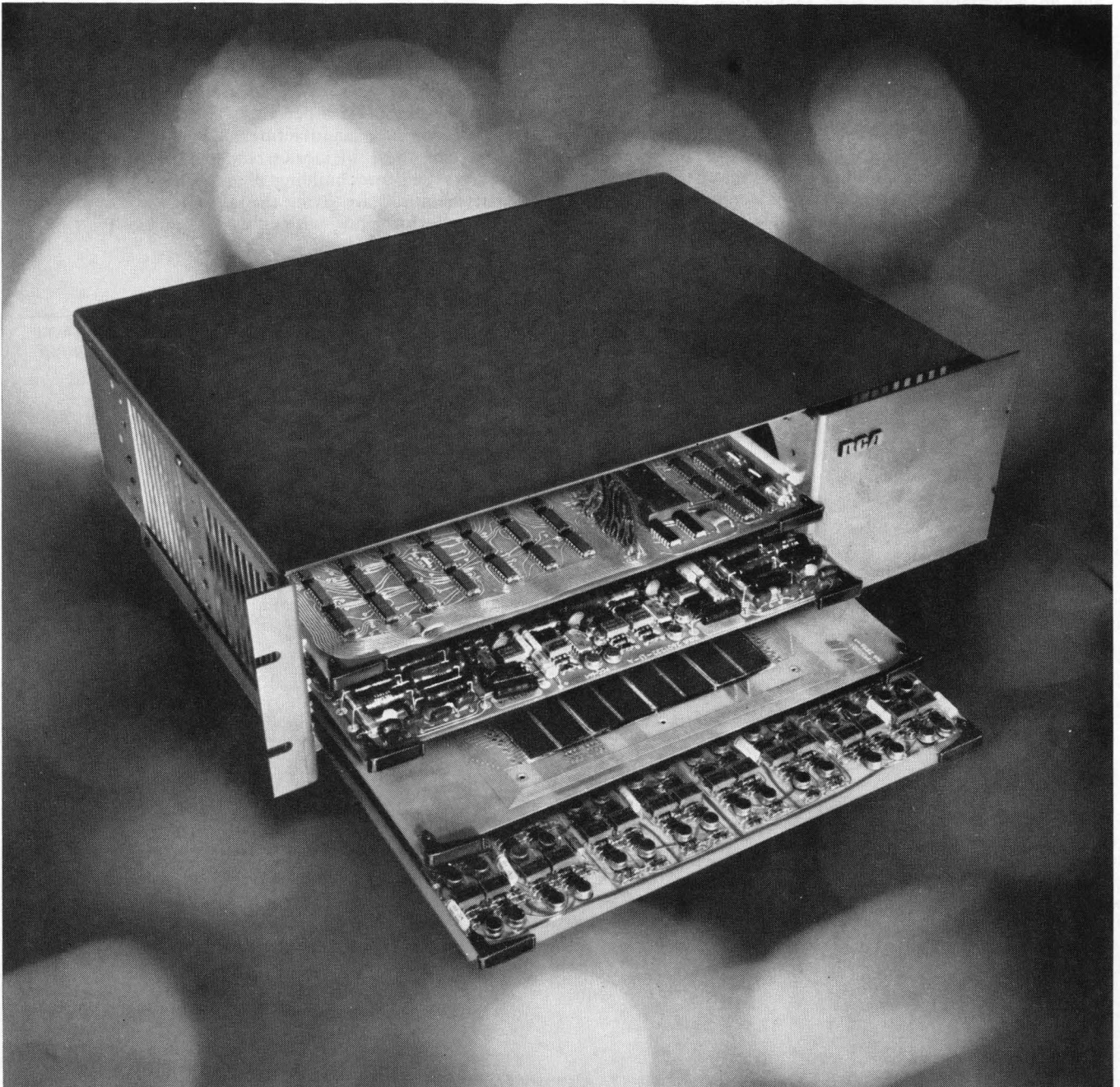

Memories

MEMORY HIERARCHY

The technologies prevalent by the 1980's are evolving to meet the concept of a memory hierarchy which will allow the user to have adequate direct access to his primary data and an acceptable access time to his large banks of data (Figure 1). The technologies will also allow the user to place all the storage equipment within the computer room, that is, 10^{14} bits of archival storage might take up a room only $10 \times 10 \times 13$ feet.

In 1971 the primary new mainframe memory technology, semiconductor, will be far more prevalent in new computer introductions as well as buffer memories for peripheral equipment. Core will still maintain its dominance, however, because of low cost, proven reliability, adequate per-

formance (speed), and because there is huge production capability (approximately 30 billion good bits per year). Plated wire will still maintain its position in special situations, but probably not have a wide industry acceptance. 1971 production for the various memory areas is expected to be equivalent to the 1969 demand.

The requirement for more mainframe memory will be maintained, as the user expands his memory requirements on an average of 25% per year. This is still a large market for the computer manufacturer. The user now has a second source for these memories. Independent memory manufacturers who are building plug-to-plug compatible mainframe memories are giving the user a lower cost alternative, equal in performance, with equivalent reliability.

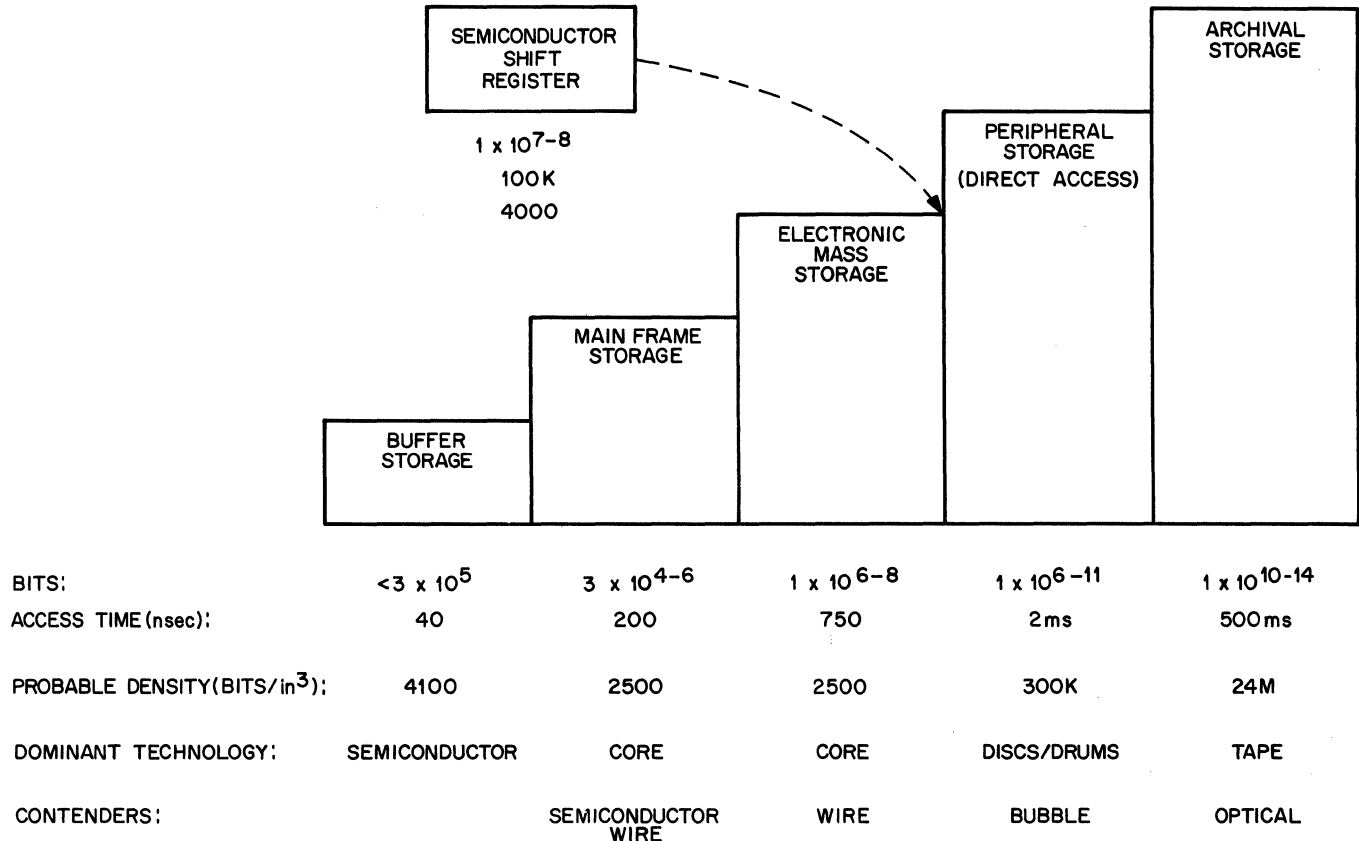

Figure 1. Memory Hierarchy

1 Equipment Characteristics

Mass core memory of 1 to 2 million byte units will be used on more equipment, especially in large computer systems for time-sharing and scientific applications. This market is now served by a variety of independent manufacturers besides the computer manufacturer. The independents have built plug-to-plug compatible units with performance equal to or better than the computer manufacture, with the only restriction being a performance characteristic, i.e., in many cases the operating system cannot effectively use the memory's speed.

<u>Electronic Storage</u>	<u>1971 Production Estimate</u>
Core	20 billion bits
Plated wire	1.0 billion bits
MOS	0.3 billion bits
Bi-Polar	0.1 billion bits
Electronic Storage (mass core)	200 (5M bit) systems
Fixed Disc & Drum Systems	6,000
Removable Disc Pack Systems (Spindles)	
single disc	7,000 drives
greater than 8 discs/pack	20,000 drives
Tape Drives (excluding cassettes)	30,000 drives

Between mass core and fixed disc, a memory with 100-microsecond access time is now available with cost performance, based on access time, almost equal to fixed head discs. This concept, which uses shift registers operating like a long delay line, will become more prominent as more operating systems are available to use memory hierarchies effectively.

The introduction of fixed disc/drum systems with access time in the 2 to 5 millisecond range is the wave of the future, as more efforts are placed on speeding the access to large banks of data and improving central processor utilization. As remote computing becomes more prevalent, i.e., time-sharing both independent and inter-concern, this requirement will increase.

Removable disc pack systems are now as important as tape drives were to first generation and early second generation computing systems. Almost every system built today uses or has the capability to use removable pack drives. Both the primary computer manufacturers and independent manufacturers now produce drives which use single, six high, and ten high packs. The independents are producing them compatible from format to head-to-plug, giving the user numerous, lower cost alternatives. The industry has established standards for the removable files to the point that in some cases, the disc packs written on one manufacturer's drive can be read on another. As disc technology becomes more widespread, the drive to standardization should increase to the point where data written on manufacturers "A" pack by manufacturers "B" drive will be read by manufacturers "C" drive. This total standardization is still many years off, but as the industry matures, technology innovation becomes more expensive, and the supply lines to the user through marketing consolidations stabilize, the standardization will come faster and faster. This will

happen in all areas, since to use the total processing capability and its labor-saving capability, systems must be readily able to work on the same data banks.

BUFFER, MAINFRAME, AND MASS ELECTRONIC STORAGE

In determining the memory required for any specific application, the primary parameters are:

1. Cost
2. Cycle Time
3. Capacity

The rapid technological evolution coupled with large increases in volume have made it difficult to select what will be the most economical product selection for the future, especially considering the length of product development followed by the hope for a long product life. Therefore, selecting the most economical memory technology for a long-term application requires a certain amount of technological forecasting. It can mean that it may pay to review the memory technology used in the memory design instead of looking at the memory as just a black box.

Presently, there are three contenders for electronic memory storage — core, plated wire and semiconductor memory with a new technology, the flux ring, out to establish a position as a new low-cost, compatible technology. Core has been the dominant technology for the last 10 years and will be a significant factor for the next 10 years. Plated wire is a new technology — specifically from the production standpoint; that is, core production is in excess of 30 billion bits per year, and wire production is between 1 and 2 billion bits per year. Semiconductor technology is making large strides as the semiconductor industry strives to make semiconductors the leading technology for memories. At the present time 256 bits on one chip for a random access memory is being produced in production quantities. A few 1024 bit devices are now on the market.

Cost

Today, core technology is the leader in cost by at least two and one-half times, but it is projected that by 1975 the large buyer of memory will almost pay the same relative cost per bit for core, wire, MOS and bipolar memory, that is, 0.8 to 1.5c/bit (Figure 2).

Cycle Time and Capacity

The speed difference must also be considered in technology selection for cycle times above and below 1 microsecond. Generally, the faster the speed, the greater the price. Many core memory systems are available and in high volume production. In Figure 3 the minimum cycle time based on the optimum cost and capacity projections of Figure 2 are shown.

Further exploration of semiconductor technology can mean determining the difference in performance parameters between versions of MOS. In comparing them to bipolar technology in Table 1, C-MOS (complementary metal oxide semiconductor) technology appears to be the long term winner because the cost difference between C-MOS and N-MOS (Nitride-MOS) should be only 5 to 10%.

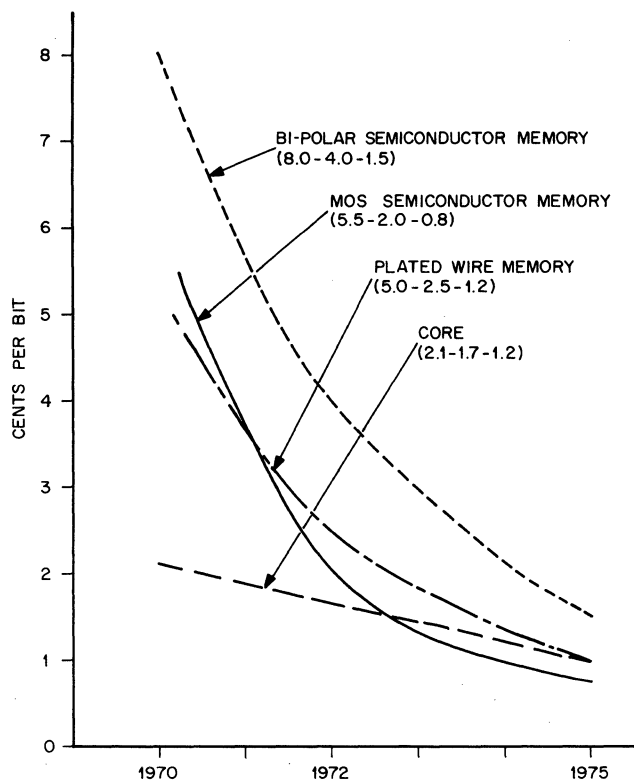

Figure 2. Mainframe Memory Cost per Bit Projection (1 Million Bytes)

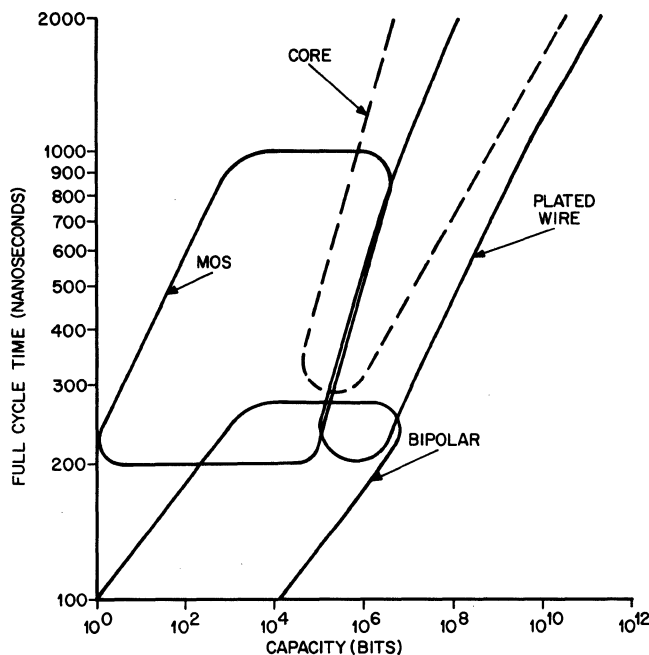

Figure 3. Optimum Cost/Performance/Capacity of Various Memory Technologies

Table 1. Semiconductor Technology Comparison Ranking (1 Best to 10 Worst)

TECHNOLOGY	CYCLE TIME nanoseconds	POWER	CHIP AREA	COST	COMPATIBILITY TO BIPOLAR	AVERAGE
BI-POLAR	few	4	4	4	-	3
C-MOS	200	1	1	3	1	1.5
N-MOS	400	2	2	2	2	2
P-MOS	800	3	3	1	3	2.5

Memory Performance Criteria

Memory applications are limited only by the intrinsic operating speed of the memory, its data storage capacity, and the availability of appropriate interface electronics. These factors will be examined successively, below.

Memory Speed. Conventional criteria of memory stack speed include "access time," "half-cycle time," and "full cycle time."

- **Access Time** is the time required to gain access to a piece of information in storage. More specifically, it is the time interval between the instant a memory receives a request

for information, and the instant that this information begins to be available in useful form.

- **Half-cycle time** is the time required to accomplish a complete Read (or Write) operation.
- **Full-cycle time** is the time required to complete a Clear/Write or a Read/Restore operation. Usually, this time is less than two half-cycles.

While these parameters of a memory stack are significant to a memory system designer, since they fix absolute upper limits on operating speeds, the values most useful to the EDP System designer are those for the memory system,

1 Equipment Characteristics

which include both the memory and interface time requirements. Timing is of the essence; all circuits involved in a given operation must be allowed the necessary time to react, and to settle, for each discrete transition in the sequence, to assure absolutely dependable performance of the system.

Storage Capacity. Memory storage capacity is expressed by two quantities: the number of individual addresses at which information can be stored, and the number of "bits" of information that can be stored at a single address. The information in one address is variously described as a "character," "data-word," or "word," of a specific bit-length (assuming that all bit positions are used). Thus a 4K x 18 memory system has storage space for 4096 18-bit words. The number of words (in standard memories) is always a power of 2 (2^{12} in this case), and the number is rounded off to the nearest thousand for convenience in expression. Memory storage requirements vary enormously, according to the application — from a few hundred words in small buffer memories and programmers for simple machinery or industrial processes, to hundreds of thousands of words in scientific or military master data centrals.

Interface Electronics. Most of the properties, functions, and capabilities ascribed to a memory, except the capabilities of retaining digital data at its individual addresses and reciting them upon request, are actually those of its interface elements, not the memory stack itself. All communications between the stack and the rest of the EDP system is accomplished by means of current pulses. While it is possible to deliver these pulses to (and accept them from) the stack directly, it is much more practical to procure the stack as a system, equipped with interface elements that optimize the input and output signals, and synchronize them to obtain maximum operating speeds without interference, or loss of information.

Operating Modes

In core memories information to be stored is "written" into the selected address; information to be retrieved from storage is "read" out of the selected address; reading-out a piece of information, then writing in a piece of information, constitutes a "full cycle."

Clear write mode. The information stored in a particular address is "cleared" (erased, by reading it out without saving it); then new information is written into that address. This is a full-cycle operation.

Read/restore mode. The information stored in a particular address is read out to external circuits, or to an output register to await external use; then the same information is written back into that same address. This is a full-cycle operation. This restore cycle is not required for plated wire operating in the NDRO mode.

Half-cycle/read mode. During each "half-cycle" interval, information is read out from selected address. No information is restored.

Half-cycle/write mode. During each half-cycle interval, information is written into some selected address. The addresses used will have been cleared of information in an earlier operation.

Split-cycle mode. Information stored at a selected memory address is read out to an output register, where it is modified by external signals, and the resultant information is restored, or written back into that same address, all within a standard full-cycle interval. (Also known as Read/Modify/Write Mode.)

Read-only mode. This is actually a special case of Read/Restore operating mode. A series or set of "permanent" data is first stored at selected addresses in the memory; for example, the sines of all integral angles from 1 to 180° may be stored in 180 sequential addresses. The memory could then be employed as a reference table of sines; the sine of any particular angle or angles can be obtained by reading out the information stored at the address identified with each angle. Whenever any information is read out, it is also automatically written back into the same address, and is therefore continually available for reference. The memory (or at least this sector of the memory) is thus used only to provide readouts; the stored information is not modified, erased, replaced, or supplemented — hence the "Read Only" mode designation.

Access Modes

The "access mode" of a memory describes the sequence in which its individual data-storage addresses may be programmed automatically, in any series of operations. The ability to operate in more than one access mode multiplies the versatility of a memory enormously.

Random access. In this mode, address locations are selected through an internal address register that can be set to any location in the memory stack; addresses can be selected in any desired sequence.

Sequential access. In this mode, the memory is addressed by the same address register used for Random Access, but under the control of an internal address counter that advances the register by one count after each cycle (or half-cycle); all memory locations are thus addressed in sequence. A single external command signal places the memory in Sequential Access mode. External command signals can also be applied to reset the address counter to zero, or to advance it to any number, enabling the sequential addressing to begin (and end) wherever desired.

Sequential interlace access. In this mode, the same address register is used as in the above, but is controlled by two address counters giving independent control of Read and Write functions; the counters are advanced, reset to zero, or set to any desired number, independently, by external commands. Information may thus be written into any series of addresses, and interlaced with reading out other previously stored information at any other series of memory addresses.

Random Access mode is inherent in all memories; Sequential and Sequential Interlace modes are provided by adding the address counter or counters necessary to program the address register.

DISC AND DRUM MEMORIES

In the early days of data processing, magnetic tape was the primary medium for mass data storage. Since 1964, disc and drum memories have been replacing magnetic tape in

1 Equipment Characteristics

many applications as the primary working peripheral mass storage device. These direct access peripheral storage products are now diverse, offering the user numerous selections for memory expansion. The technology has advanced almost tenfold in the last two to three years in the area of access time and capacity per square inch.

These advances in technology coupled with product diversity and new companies emerging as sources for discs and drums tend to complicate the selection of peripheral memory. The questions to be answered in selection are:

1. Removable or non-removable media
2. Access time
3. Data transfer rate
4. Multiple access channels
5. Overlapped record search capability
6. System modularity
7. Serviceability

These parameters are usually based on the capacity requirement; i.e., access time and data transfer rate are the important criteria for memories below 50 million bits, and multiple access channels, overlapped record searches and system modularity are the primary parameters above that amount. In both areas serviceability is as important as reliability and cost.

Removable or Non-Removable Media

This selection is a function of the data base required for the application. If the system is operating in an analytical laboratory, controlling laboratory equipment only, a few hundred thousand bytes may be required for on-line storage. Therefore, a small fixed head disc system or a single disc pack system may be appropriate. In a large real-time time-sharing system, large fixed head disc systems with millions of bytes of on-line storage may be required to serve all users properly. A medium size business data processing operation where the jobs consist of payroll production, production scheduling, labor reporting and other similar jobs will probably require a multiple disc pack system with a few million bytes of on-line information.

Capacity

System	Capacity
Fixed-head disc or drum	0.1 – 100 megabytes
Movable-head, fixed disc or drum	0.1 – 600 megabytes
Removable media	1 – 800 megabytes

Transfer Rate

System	Data Transfer Rate
Fixed-head disc or drum	0.2 – 3 megabytes/second
Movable-head, fixed disc or drum	0.1 – 0.4 megabytes/second
Removable media (disc pack)	0.2 – 0.8 megabytes/second

Access Time

The access time is a function of the type of system. Fixed head per track disc and drum systems have access times in the range of 2 to 40 milliseconds; movable head disc and drum systems with fixed media access the data in 40 to 90 milliseconds. Disc pack systems have access times in the range of 30 to 110 milliseconds.

Data Transfer Rate

The data transfer rate is a function of the number of heads reading or writing data.

Multiple Access Channels

Multiple access channels provide for parallel and redundant data and control paths. They also allow for portions of the files to be operating while repair or preventive maintenance procedures are carried out on other segments of the files. This feature is extremely important in cases where real-time accessibility to data is important to the user.

Overlapped Record Searches

The file controller, which is an integral part of large file systems, besides handling bookkeeping, can take over from the central processing unit (CPU) and carry on multiple record searches, thus freeing the CPU and providing data for processing in continuous streams.

System Modularity

System modularity allows the user to add capacity without basic changes in the operational system. This feature is very important as memory requirements are constantly expanding. The normal rule of thumb is that the average user will expand memory by 25% per year.

Serviceability

Is the system easy to repair, that is, are components pluggable, allowing for fast servicing? Is it designed to allow working access to other portions of the file while repairs are

1 Equipment Characteristics

being carried out on other segments? These questions should be answered and weighed based on the application, that is, the importance of access to the file while other portions are unoperative becomes increasingly important as the demand increases for real-time processing.

Device Configurations

The physical configurations of the various types of rotating memories are described in order to relate them to the above terminology.

Magnetic drum. The memory element is a metal cylinder, magnetically coated over its curved surface, and rotating about the axis through its circular ends. In the fixed-head version, the heads are fixed in the drum housing, always sweeping the same circular track, and a head exists for each track. In the movable-head version, a head exists for each group of m tracks, and all heads are moved within their

groups by a mechanical positioner. Drum memories are fixed-medium.

Magnetic disc file. The memory element is one or a number of metal discs, magnetically coated on both flat sides, and rotating about the axis perpendicular to the centers of its flat sides. If there are more than one disc, they are stacked on this axis, and rotate on a common shaft. In the fixed-head version, fixed heads are mounted so as to cover all tracks on all disc surfaces. Several movable-head versions are possible: one has only one pair of heads which can move to any position on any disc; another has one or more heads per disc surface, all moving parallel to the recording surface; other variations also have been implemented.

A data cylinder in the drum or disc memory consists of the contents of all the tracks under heads at any position of the positioning mechanism. Latency time for both devices is the rotation period of the disc or drum. Disc files can be either fixed- or removable-media.

Cambridge Memories would like to show you how to avoid buying a memory system.

When you tell most memory manufacturers what you need, they'll try to sell you what they have on hand. Usually a complete memory system which often duplicates much of the existing hardware.

At CMI, we don't have to do that.

You see, we've got a field expandable system called ExpandaCore 18. And we'll sell you as much of it or as little of it as you need.

That way you don't have to buy something you've already got in your computer. You buy only what you need. So for all practical purposes, you just about build your own memory system.

Let's say you already have the registers. Then you just buy our 4K x 18 digital stack. This single plug-in card contains the core stack, selection circuits, current source, sense amplifier, digit drivers, and temperature compensation circuitry.

If you add registers, timing and address decoding to the digital stack it becomes a complete system, without all the usual expense.

If you're an OEM who needs a little more, we've got a complete 4K system on just two plug-in circuit cards. And they only measure 11.5 x 13.7 inches. If you want to expand the system you just buss-wire one additional card for each 4K. Up to a 16K system.

However, if your needs won't allow you to avoid buying a complete memory system, we can sell you ExpandaCore 18 in a rack mountable enclosure. (5 1/4" x 17" x 22"). It's a complete 16K x 18 system with word capacities ranging from 4K to 16K words. Word lengths are 12, 16 and 18 bits.

Over 500 units have already proven themselves in the field.

So, whether you buy the whole system or just the modules you need, ExpandaCore 18 will give you complete flexibility and reliability.

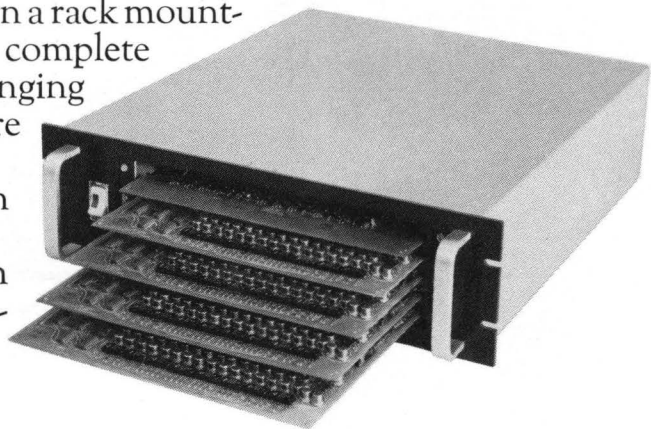
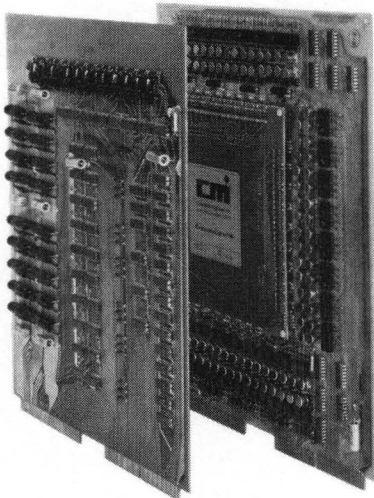
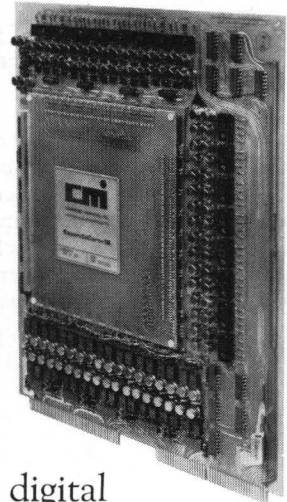

CAMBRIDGE MEMORIES, INC., 285 Newtonville Ave., Newtonville, Massachusetts 02160, (617) 969-0050

CORE MEMORY SYSTEMS

COMPANY	AMPEX COMPUTER PRODUCTS	AMPEX COMPUTER PRODUCTS	AMPEX COMPUTER PRODUCTS	CAMBRIDGE MEMORIES	CAMBRIDGE MEMORIES
MODEL	ARM Series	Extended Core Memory (ECM)	RGM	EconoCore 8	Unicore 9
FIRST DELIVERY YEAR	1971	1969	1970	1970	1969
UNIT PURCHASE PRICE	\$214,500- \$308,600	\$289,000	—	\$1100	\$1100
FULL CYCLE TIME (us)	0.75	1.8	1	2.0	0.950
ACCESS TIME (us)	—	0.700	0.400	0.5	0.300
ORGANIZATIONAL STRUCTURE	3D-4 wire	3D-4 wire	3D-4 wire	3D-3 wire	3D-3 wire
CAPACITY					
Min. Words	128K bytes/unit	1,000,000 bytes/unit	4K	4096	1024
Max. Words	256K bytes/unit	—	16K	4096	1024
Min. Bits/Word	—	—	18	8	9
Max. Bits/Word	8 bytes/memory cycle	4 or 8 bytes/ memory cycle	36 (4K only)	8	8
Bits/Word Increment	—	—	—	—	1
OPERATION MODES					
Split Cycle	Matches IBM 360 Series	Matches IBM 360 Series	—	yes	yes
Half Cycle	Matches IBM 360 Series	Matches IBM 360 Series	—	yes	no
ADDRESS INCREMENTING BY ADDRESS REG. COUNTER	n/a	n/a	no	no	no
SEPARATE REGISTER CLEAR	n/a	n/a	no	no	no
PARITY GEN. & LOGIC CHECK	n/a	n/a	no	no	no
DATA TRANSFER MODE (Single or Double Rail)	n/a	n/a	SR	no	no
LOGIC COMPATIBILITY	IBM 360	IBM 360	TTL	TTL	TTL
ENVIRONMENTAL FACTORS					
Operating Temp (°C)	60-95 °F	60-95 °F	-20 to 55	0-50	0-50
Temp Compensating Currents	n/a	n/a	yes	yes	yes
Wide Temp Cores	n/a	n/a	yes	yes	yes
COMMENTS	—	2361 replace- ment for IBM 360/50, 65, 67 & 75	MIL-QPL components SCL-6200	Single plug-in card	Single card; two voltages

CORE MEMORY SYSTEMS

COMPANY	CAMBRIDGE MEMORIES	DATA CRAFT	DATA PRODUCTS	DATA PRODUCTS	DATARAM
MODEL	ExpandaCore 18	DC-38	Store/33	System/6361 LCS	PDM-20
FIRST DELIVERY YEAR	1969	1970	1969	1970	1970
UNIT PURCHASE PRICE	\$3000	\$8140 (16K x 18)	\$2990	\$284,250	\$1800
FULL CYCLE TIME (us)	1.0	0.9	0.650	2.0	1.8
ACCESS TIME (us)	0.350	0.35	0.275	1.25	0.7
ORGANIZATIONAL STRUCTURE	3D-3 wire	3D-3 wire	3D	2½D-2 wire	3D-4 wire
CAPACITY					
Min. Words	4096	4K	4K	256K	2K
Max. Words	16K	64K	16K	512K	4K
Min. Bits/Word	12	9	6	36	10
Max. Bits/Word	18	54	48	72	16
Bits/Word Increment	2	—	2	36	2
OPERATION MODES					
Split Cycle	yes	yes	yes	—	yes
Half Cycle	yes	no	read only	—	yes
ADDRESS INCREMENTING BY ADDRESS REG. COUNTER	no	no	no	yes	no
SEPARATE REGISTER CLEAR	no	no	no	no	no
PARITY GEN. & LOGIC CHECK	no	no	opt	yes	no
DATA TRANSFER MODE (Single or Double Rail)	SR	SR	SR	—	SR
LOGIC COMPATIBILITY	TTL	TTL, DTL, HLTTL	—	IBM 8080	—
ENVIRONMENTAL FACTORS					
Operating Temp (°C)	0-50	0-50	0-55	10-40	0-50
Temp Compensating Currents	yes	yes	yes	yes	internal
Wide Temp Cores	yes	yes	yes	—	opt
COMMENTS	Single card expansion; two voltages	—	Byte zone control - opt Power system - opt	—	Can be expanded to 65K x 16.

1 Equipment Characteristics

CORE MEMORY SYSTEMS

COMPANY	DATARAM	DATARAM	DATARAM	ELECTRONIC MEMORIES	ELECTRONIC MEMORIES
MODEL	PDM-21	PDM-22	PDM-950	Megamemory 1000	Nanomemory 2500
FIRST DELIVERY YEAR	1971	1971	1970	1971	1970
UNIT PURCHASE PRICE	\$1050 (2K x 10)	\$395 (8K x 1) \$350 (4K x 1)	\$2000	\$0.015/bit	\$0.063/bit
FULL CYCLE TIME (us)	0.950	2.0	0.950	1.5	0.500
ACCESS TIME (us)	0.350	0.750	0.350	0.850	0.300
ORGANIZATIONAL STRUCTURE	3D-3 wire	3D-3 wire	3D	2-1/2D-2 wire	2-1/2D-3wire
CAPACITY					
Min. Words	512	512	2K	32,768	4096
Max. Words	2048	8192	4K	524,288	16,384
Min. Bits/Word	8	1	12	8	8
Max. Bits/Word	10	1	16	160	36
Bits/Word Increment	1	—	2	2	4 (18-bit avail)
OPERATION MODES					
Split Cycle	yes	yes	yes	yes	yes
Half Cycle	no	yes	yes	no	no
ADDRESS INCREMENTING BY ADDRESS REG. COUNTER	no	no	no	custom orders only	custom orders only
SEPARATE REGISTER CLEAR	no	no	no	yes	yes
PARITY GEN. & LOGIC CHECK	no	no	no	opt	opt
DATA TRANSFER MODE (Single or Double Rail)	SR	SR	SR	various	SR
LOGIC COMPATIBILITY	—	—	—	—	—
ENVIRONMENTAL FACTORS					
Operating Temp (°C)	0-50	0-70	0-50	0-50	0-50
Temp Compensating Currents	yes, internal	—	internal	yes	yes
Wide Temp Cores	—	yes	—	yes	no
COMMENTS	expandable to 8K x 10 by adding cards	—	Byte control; expandable to 65K	—	—

CORE MEMORY SYSTEMS

COMPANY	ELECTRONIC MEMORIES	ELECTRONIC MEMORIES	FABRI-TEK	FABRI-TEK	FABRI-TEK
MODEL	Nanomemory 3650	Nanomemory 4850	480	482	490
FIRST DELIVERY YEAR	1969	1970	1970	1971	1971
UNIT PURCHASE PRICE	\$0.035/bit	\$0.033/bit	—	—	—
FULL CYCLE TIME (us)	0.650	0.850	0.900	0.900	0.900
ACCESS TIME (us)	0.325	0.350	0.350	0.400	0.350
ORGANIZATIONAL STRUCTURE	2-1/2D-3 wire	3D-3 wire	3D-3 wire	3D-3 wire	3D-3 wire
CAPACITY					
Min. Words	16,384	4096	4K	16K	4K
Max. Words	65,536	32,768	32K	65K	—
Min. Bits/Word	8	8	36	—	—
Max. Bits/Word	56	40	—	—	—
Bits/Word Increment	4	4 (18-bit avail)	—	—	—
OPERATION MODES					
Split Cycle	yes	yes	full or split	full or split	full or split
Half Cycle	no	no	—	—	—
ADDRESS INCREMENTING BY ADDRESS REG. COUNTER	custom orders only	custom orders only	no	no	no
SEPARATE REGISTER CLEAR	yes	yes	auto	auto	auto
PARITY GEN. & LOGIC CHECK	opt	opt	opt	opt	opt
DATA TRANSFER MODE (Single or Double Rail)	SR	SR	SR	SR	SR
LOGIC COMPATIBILITY	—	—	—	—	—
ENVIRONMENTAL FACTORS					
Operating Temp (°C)	0-50	0-50	0-50	0-50	0-50
Temp Compensating Currents	yes	yes	—	—	—
Wide Temp Cores	no	—	—	—	—
COMMENTS	—	—	—	—	—

CORE MEMORY SYSTEMS

COMPANY	FABRI-TEK	FERROXCUBE	FERROXCUBE	FERROXCUBE	FERROXCUBE
MODEL	491	FI-2	FI-3 Series	FI-4 Series	FI-23
FIRST DELIVERY YEAR	1971	1968	1968	1970	1969
UNIT PURCHASE PRICE	—	\$790	\$2900 avg	\$3400 avg	\$435
FULL CYCLE TIME (us)	0.900	4	3	1	8
ACCESS TIME (us)	0.350	0.600	1.0	0.390	2.0
ORGANIZATIONAL STRUCTURE	—	3D-4 wire	3D-3 wire	3D-3 wire	3D-3 wire
CAPACITY					
Min. Words	4K	1024	1024	4096	80
Max. Words	16K	1024	8192	16,384	160
Min. Bits/Word	—	8	6	8	—
Max. Bits/Word	—	8	20	40	17
Bits/Word Increment	—	—	2	2	—
OPERATION MODES					
Split Cycle	full or split	yes	yes	yes	no
Half Cycle	—	—	yes	yes	no
ADDRESS INCREMENTING BY ADDRESS REG. COUNTER	—	no	yes	yes	yes
SEPARATE REGISTER CLEAR	auto	no	no	—	—
PARITY GEN. & LOGIC CHECK	opt	no	no	yes	—
DATA TRANSFER MODE (Single or Double Rail)	SR	DR	SR	SR	SR
LOGIC COMPATIBILITY	—	—	—	—	—
ENVIRONMENTAL FACTORS					
Operating Temp (°C)	0-50	0-55	0-50	0-50	0-50
Temp Compensating Currents	—	—	yes	—	—
Wide Temp Cores	—	—	—	—	—
COMMENTS	—	—	AC & DC memory retention	—	AC or DC memory retention avail

1 Equipment Characteristics

CORE MEMORY SYSTEMS

COMPANY	FERROXCUBE	HONEYWELL	HONEYWELL	HONEYWELL	INFORMATION CONTROL
MODEL	FI-25	ICM-100	ICM-161	ICM-500E	Comrac 50
FIRST DELIVERY YEAR	1970	1970	1969	1968	1970
UNIT PURCHASE PRICE	\$925	\$725	\$3090 (4K x 16)	\$17,560 (16K x 18)	—
FULL CYCLE TIME (us)	1	1	1.6	0.600	1.5
ACCESS TIME (us)	0.350	0.310	0.650	0.320	0.45
ORGANIZATIONAL STRUCTURE	3D-5 wire	3D	3D	2-1/2D	3D-3 wire
CAPACITY					
Min. Words	256	1024	4096	4096	2K
Max. Words	1024	1024	16,384	16,384	32K
Min. Bits/Word	9	8	8	8	8
Max. Bits/Word	18	10	32	36	18
Bits/Word Increment	—	1	4	4 for 4K & 8K; 2 for 16K	1
OPERATION MODES					
Split Cycle	yes	yes	yes	yes	yes
Half Cycle	yes	yes	no	no	no
ADDRESS INCREMENTING BY ADDRESS REG. COUNTER	no	no	yes - opt	yes - opt	no
SEPARATE REGISTER CLEAR	—	no	no	no	yes
PARITY GEN. & LOGIC CHECK	—	no	no	no	no
DATA TRANSFER MODE (Single or Double Rail)	SR	SR	SR	SR	SR
LOGIC COMPATIBILITY	—	DTL & TTL	DTL & TTL	TTL	—
ENVIRONMENTAL FACTORS					
Operating Temp (°C)	0-50	0-50	0-50	0-50	0-60
Temp Compensating Currents	—	yes	yes	yes	yes
Wide Temp Cores	—	no	no	no	yes
COMMENTS	—	—	—	—	—

1 Equipment Characteristics

CORE MEMORY SYSTEMS

COMPANY	INFORMATION CONTROL	INFORMATION CONTROL	INFORMATION CONTROL	INFORMATION CONTROL	LOCKHEED DATA PRODUCTS
MODEL	Comrac 90	Comrac 1010	Milrac 300	Milrac 525	CC50
FIRST DELIVERY YEAR	1969	1968	1968	1970	1971
UNIT PURCHASE PRICE	—	—	—	—	—
FULL CYCLE TIME (us)	0.9	0.9	2.0	1.9	0.500
ACCESS TIME (us)	0.35	0.35	0.7	0.55	0.250
ORGANIZATIONAL STRUCTURE	3D-4 wire	3D-4 wire	3D-4 wire	3D-4 wire	3D-3 wire
CAPACITY					
Min. Words	512	8K	512	8K	4K
Max. Words	32K	64K	16K	16K	64K
Min. Bits/Word	8	18	4	8	8
Max. Bits/Word	18	36	80	40	72
Bits/Word Increment	1	18	4	4	8
OPERATION MODES					
Split Cycle	yes	yes	yes	yes	yes
Half Cycle	yes	no	yes	yes	no
ADDRESS INCREMENTING BY ADDRESS REG. COUNTER	no	no	no	no	opt
SEPARATE REGISTER CLEAR	yes	yes	yes	yes	yes
PARITY GEN. & LOGIC CHECK	no	opt	no	yes	opt
DATA TRANSFER MODE (Single or Double Rail)	SR	SR	SR	SR	SR
LOGIC COMPATIBILITY	—	—	—	—	—
ENVIRONMENTAL FACTORS					
Operating Temp (°C)	0-50	0-50	-55-+85	-30-+85	0-60
Temp Compensating Currents	yes	yes	yes	yes	yes
Wide Temp Cores	yes	yes	yes	yes	yes
COMMENTS	—	—	—	—	—

1 Equipment Characteristics

CORE MEMORY SYSTEMS

COMPANY	LOCKHEED DATA PRODUCTS	LOCKHEED DATA PRODUCTS	LOCKHEED DATA PRODUCTS	MEMORY TECHNOLOGY	QUADRI
MODEL	CR-75	CE 100	CC 150	Nanoram 90	401-01
FIRST DELIVERY YEAR	1969	1967	1971	1970	1968
UNIT PURCHASE PRICE	—	—	—	\$975	\$0.05 - 0.09/bit
FULL CYCLE TIME (us)	0.750	1	1.5	0.190	0.100
ACCESS TIME (us)	0.350	0.450	0.750	0.090	0.050
ORGANIZATIONAL STRUCTURE	3D	3D	3D	braid transformer	2D
CAPACITY					
Min. Words	4K	4K	64K	64	as required
Max. Words	8K	16K	512K	4096	64
Min. Bits/Word	4	8	18	10	as required
Max. Bits/Word	40	40	144	80	25
Bits/Word Increment	4	4	18	1	64 x 25
OPERATION MODES					
Split Cycle	opt	yes	yes	—	read cycle
Half Cycle	no	no	no	—	—
ADDRESS INCREMENTING BY ADDRESS REG. COUNTER	opt	yes	yes	no	no
SEPARATE REGISTER CLEAR	yes	yes	yes	yes	automatic
PARITY GEN. & LOGIC CHECK	yes	yes	yes	no	no
DATA TRANSFER MODE (Single or Double Rail)	SR	SR	SR	SR	SR
LOGIC COMPATIBILITY	—	—	—	TTL	—
ENVIRONMENTAL FACTORS					
Operating Temp (°C)	-20 - +60	0-55	0-50	0-70	0-55
Temp Compensating Currents	yes	yes	yes	not required	not required
Wide Temp Cores	yes	yes	yes	yes	yes
COMMENTS	10,000 hour MTBF	—	—	Read only memory	

CORE MEMORY SYSTEMS

COMPANY	QUADRI	QUADRI	QUADRI	QUADRI	RCA MEMORY PRODUCTS
MODEL	401-03	401-16	401-18	401-19	RLM-1000
FIRST DELIVERY YEAR	1970	1970	1970	1970	1970
UNIT PURCHASE PRICE	\$0.04 - 0.08/bit	\$0.03-0.06/bit	\$0.025-0.05/bit	\$0.025-0.05/bit	—
FULL CYCLE TIME (us)	0.500	0.300	0.200	0.300	1.0
ACCESS TIME (us)	0.150	0.130	0.75	0.125	0.400
ORGANIZATIONAL STRUCTURE	2D	2D	2D	2D	3D-3 wire
CAPACITY					
Min. Words	as required	as required	as required	as required	4K
Max. Words	256	512	4096	8192	32K
Min. Bits/Word	as required	as required	12	12	16
Max. Bits/Word	20	48	96	48	18
Bits/Word Increment	256 x 20	512 x 48	512 x 96, 1K x 48, 2K x 24, 3K x 16, 4K x 12	2K x 48, 4K x 24, 8K x 12	
OPERATION MODES					
Split Cycle	read cycle	read cycle	read cycle	read cycle	yes
Half Cycle	—	—	—	—	no
ADDRESS INCREMENTING BY ADDRESS REG. COUNTER	no	no	no	no	no
SEPARATE REGISTER CLEAR	automatic	automatic	automatic	automatic	no
PARITY GEN. & LOGIC CHECK	no	no	no	no	opt
DATA TRANSFER MODE (Single or Double Rail)	SR	SR	SR	SR	SR
LOGIC COMPATIBILITY	—	—	—	—	TTL, DTL
ENVIRONMENTAL FACTORS					
Operating Temp (°C)	0-55	0-60	0-60	0-60	0-50
Temp Compensating Currents	not required	not required	not required	not required	yes
Wide Temp Cores	yes	yes	yes	yes	yes
COMMENTS	—	—	—	—	—

CORE MEMORY SYSTEMS

COMPANY	STANDARD LOGIC	STANDARD MEMORIES	STANDARD MEMORIES	STANDARD MEMORIES	STANDARD MEMORIES
MODEL	Flat-Store	4K & 8K EB18CP	4096ED8MM	16K-65K EF18CP12	4K-16K EF18CP5
FIRST DELIVERY YEAR	1970	1968	1970	1970	1970
UNIT PURCHASE PRICE	1K x 8, \$695 4K x 8, \$1125	\$3075 & \$5390 w/power	\$1083	\$8530-\$25,275 w/power	\$3170-\$7705 w/power
FULL CYCLE TIME (us)	1.8	0.900	2.0	0.750	0.750
ACCESS TIME (us)	0.600	0.400	0.600	0.325	0.325
ORGANIZATIONAL STRUCTURE	—	3D-3 wire	3D-3 wire	3D-3 wire	3D-3 wire
CAPACITY					
Min. Words	1024	4096	1024	4096	4096
Max. Words	4096	8192	4096	65,536	16,384
Min. Bits/Word	8	14	8	12	12
Max. Bits/Word	18	18	8	36	18
Bits/Word Increment	—	—	—	2	2
OPERATION MODES					
Split Cycle	—	yes	yes	yes	yes
Half Cycle	yes	yes	no	no	no
ADDRESS INCREMENTING BY ADDRESS REG. COUNTER					
	—	no	no	no	no
SEPARATE REGISTER CLEAR					
	—	yes	no	yes	internal
PARITY GEN. & LOGIC CHECK					
	—	no	no	no	no
DATA TRANSFER MODE (Single or Double Rail)					
	—	SR	SR	SR	SR
LOGIC COMPATIBILITY					
	DTL/TTL	TTL/DTL	TTL/DTL	TTL/DTL	TTL/DTL
ENVIRONMENTAL FACTORS					
Operating Temp (°C)	0-50	0-50	0-50	0-50	0-50
Temp Compensating Currents	yes	yes	no	yes	yes
Wide Temp Cores	yes	yes	yes	yes	yes
COMMENTS					
	—	—	Avail as Card set only	Avail as OEM card set	Avail as OEM card set

1 Equipment Characteristics

CORE MEMORY SYSTEMS

COMPANY	UNICOM	UNITED TELECONTROL	UNITED TELECONTROL	UNITED TELECONTROL
MODEL	UI-1011	Series 200	1030	5036
FIRST DELIVERY YEAR	1970	1969	1971	1970
UNIT PURCHASE PRICE	\$695	—	\$2950	\$2775
FULL CYCLE TIME (us)	1.75	2	0.900	2
ACCESS TIME (us)	0.600	0.800	0.350	0.800
ORGANIZATIONAL STRUCTURE	3D	3D-4 wire	3D-3 wire	3D-4 wire
CAPACITY				
Min. Words	—	1024	4096	1024
Max. Words	1024	4096	4096	8192
Min. Bits/Word	—	8	16	8
Max. Bits/Word	8	24	18	18
Bits/Word Increment	8	4	2	2
OPERATION MODES				
Split Cycle	—	yes	no	no
Half Cycle	yes	yes	no	no
ADDRESS INCREMENTING BY ADDRESS REG. COUNTER	opt	yes	no	no
SEPARATE REGISTER CLEAR	yes	yes	yes	no
PARITY GEN. & LOGIC CHECK	no	no	no	no
DATA TRANSFER MODE (Single or Double Rail)	SR	SR	SR	SR
LOGIC COMPATIBILITY	TTL	TTL	TTL	TTL
ENVIRONMENTAL FACTORS				
Operating Temp (°C)	0-50	0-50	0-50	0-50
Temp Compensating Currents	—	yes	yes	yes
Wide Temp Cores	—	no	no	no
COMMENTS	—	Rack mounted	3 Card set	3 Card set

the one stop memory shop.

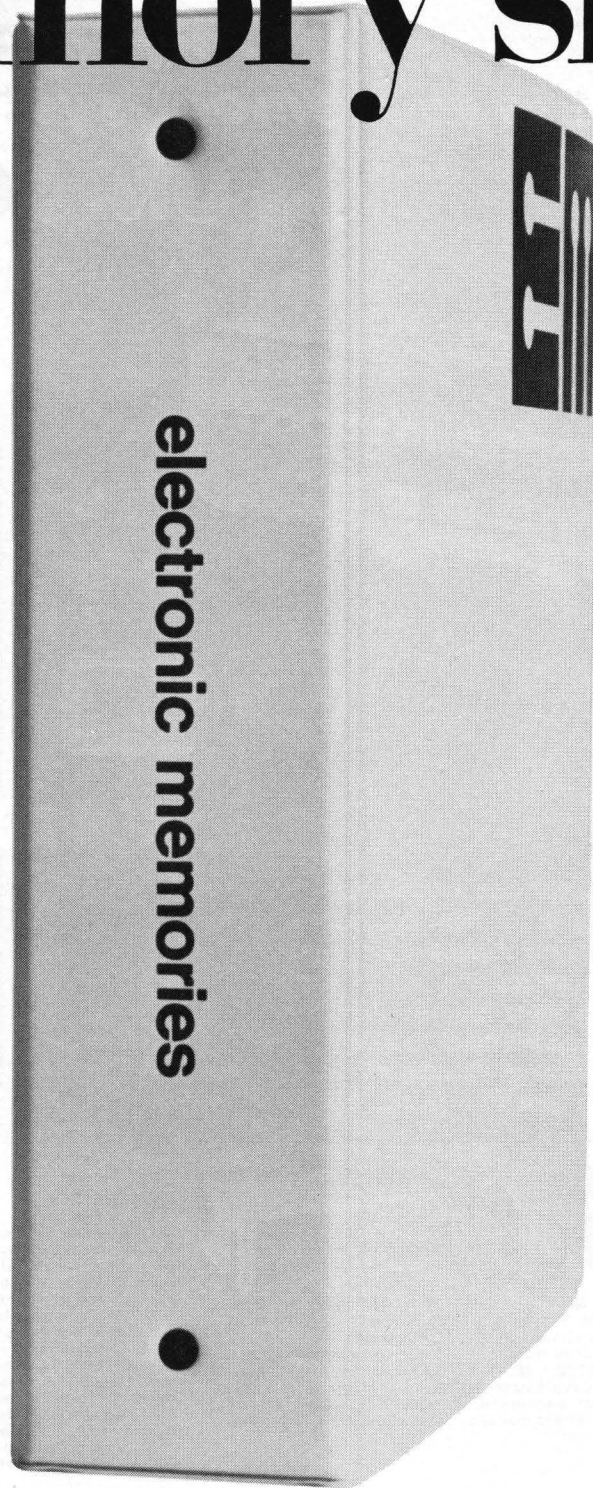

No one offers quite the range of things we do: cores, stacks and systems; aerospace, military and commercial.

All here.

Electronic Memories, Inc.,
12621 Chadron Avenue,
Hawthorne, California 90250
(213) 772-5201.

world-wide leadership in memory systems

**Only from Ferroxcube
the ultimate in memory-system evolution
the UN-COMPUTER**

PROGRAMMABLE DIGITAL CONTROLLER

**SERIES FDC-300
DIGITAL CONTROL
SYSTEMS**

The most flexible, least committed, programmable digital control system ever produced. Equivalent to far more expensive systems. . . yet does a more efficient job because it is designed specifically to provide low-cost, reliable, high-speed data manipulation, in a *completely modular system*. This modularity provides every control function required — without waste or compromise. Check the block diagram — *every block shown is an independent option*. Backup includes the most comprehensive software package in this class. Save from \$5,000 to \$15,000 per installation.

Block Diagram Components:

- ME-300 MEMORY EXPANSION 4K x 18
- PS-303 POWER SUPPLY
- FDC-302 DIGITAL CONTROLLER 4K x 18, 2.5 μsec, RAM
- PI-30 PRIORITY INTERRUPT
- DM-30 DIRECT MEMORY ACCESS CONTROLLER
- BX-300 BUS EXPANDER
- RT-30 REAL TIME CLOCK
- TR-30 TTY READ CONTROLLER
- TP-30 TTY PRINT CONTROLLER
- CS-30 CLOCK & SENSE SWITCH CONTROLLER
- CP-302 CONTROL PANEL
- PT-30 CONTROLLER FOR PAPER-TAPE READER
- CR-30 CARD-READER CONTROLLER
- AD-30 A/D CONVERTER 12 BIT
- DA-30 D/A CONVERTER 9 BIT
- DI-30 DIGITAL INPUT
- DO-30 DIGITAL OUTPUT
- SC-30 SERIAL COMMUNICATIONS CONTROLLER
- TT-330 ASR-33 TELETYPE
- PT-254 DIGITRONICS MODEL 2540 PAPER-TAPE READER
- CR-300 CARD READER
- MP-30 MULTIPLEXER 16 CHANNEL
- ACI-30 115V AC INPUT SENSOR
- ACO-30 CONTROLLED 115V AC OUTPUT
- CRT TERMINAL

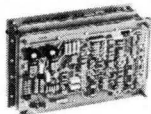

FI-2 Memory Systems
Small, Compact, Complete. . . Only 8 1/2" x 5" x 3-3/8" but contains 1024 x 8 storage, and all electronics — decoding, drive, data, and timing. 4 μsec full-cycle time.

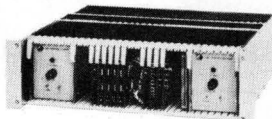

FI-3 Memory System
Fast, Versatile, Flexible. . . 2.5 μsec full-cycle time. Storage capacities from 1024 x 6 to 8192 x 18. Full/half/split-cycle operation. Random, Sequential, Sequential-Interlace options. Very economical.

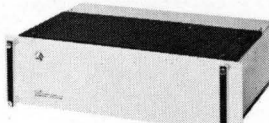

FI-4/40 Memory Systems
High-Speed, Zone Control, Expandable. . . 1 microsecond full-cycle time. 390ns access time. Capacities from 4K x 20 to 8K x 20 or 4K x 40 bits. Zone Control operation. Data Retention.

**NEW!
FI-31 Card Set
Memory System**
Shelf-Standard. . . Low Cost. . . Full Standard-System Warranty. All modes — full/half/split cycle. . . Zone control. . . 2.5 μsec full-cycle time. . . DTL/TTL compatible. 9 standard capacities: 1K x 12 to 4K x 18 — expandable by stack substitution only. Data Register and memory retention control line included. Standard Options: Address register; memory-retention power detector; rack-mounting enclosure, compatible power supplies.

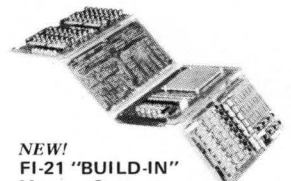

**NEW!
FI-21 "BUILD-IN"
Memory Systems**
Shelf-Standard. . . Low-Cost. . . Fast. . . All Modes. . . Full/half/split cycle. . . 1.6 μsec full-cycle time. 1024 x 8. . . Operates from standard logic voltages. Includes data register and memory retention control line.



FERROXCUBE CORPORATION / SAUGERTIES, N.Y.



*Pioneers in magnetic ferrites — memory cores — memory stacks — memory systems — digital controllers.
Every Ferroxcube product reflects years of experience and technical leadership.*

CORE MEMORIES, LOGIC MODULES, AND LIGHT PENS FROM ICC

MEMORY SYSTEMS FOR MINI-COMPUTERS AND TERMINALS

ComRac 50-Plug-In Memory

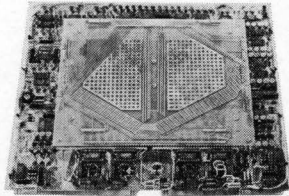

1.5 μ sec cycle time, 4K x 18, inexpensively field expanded to 32K x 18 in 4K increments. Data Guard, timing, address and data registers and byte control standard. DTL/TTL compatible. Chassis and power supplies optional.

ComRac 90-Plug-In Memory

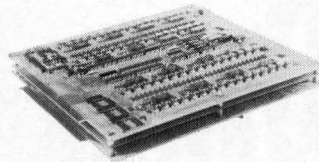

900 nsec full cycle time, 350 nsec access and 600 nsec $\frac{1}{2}$ cycle times. 1K x 8 to 4K x 18 or 8K x 9 in an 11" x 12" x 2" configuration. Expandable to 32K. 8, 9, 12, and 16 bit lengths also available. Compatible chassis and power supplies optional.

MEMORY SYSTEMS FOR MAINFRAMES

ComRac 1010

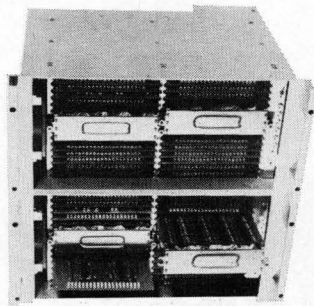

Data Guard & Read/Modify/Write are all standard.

900 nsec full cycle, 350 nsec access times. 8K x 36 field-expandable to 65K x 36, in (4) 8 $\frac{3}{4}$ " high rack mounted chassis. Compatible power supply available. Byte control,

ComRac 1100

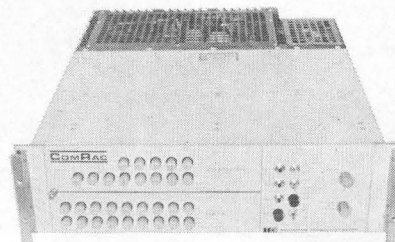

Byte control and Data Guard standard.

900 nsec full cycle time, 350 nsec access & 600 nsec $\frac{1}{2}$ cycle times. 8K x 18 field-expandable to 16K x 18. Power supply and built-in tester included in low profile 5 $\frac{1}{4}$ " x 19" rack

MILITARY MEMORIES

MilRac 525

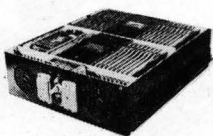

1.9 μ sec full cycle, 600 nsec access and 1 μ sec $\frac{1}{2}$ cycle times. Field expandable. Capacity 4K x 18 to 8K x 40 or 16K x 20 in a single 6.4" x 13.6" x 17.5" less than 40 lb. chassis. Data Guard standard. Power supply and parity check available. Qualified per MIL-E-16400; VAST compatible. -30°C to +85°C operation.

MilRac 200

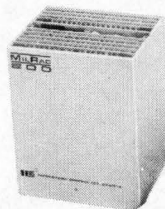

2 μ sec full cycle time, 4K x 16 memory system qualified per MIL-E-16400; -30°C to +85°C operation. MTBF greater than 10,000 hrs. MTTR less than 5 mins. 5.1" x 8.2" x 6.3" chassis.

MilRac 300

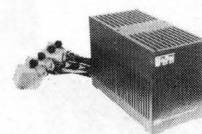

2 μ sec cycle time. Up to 4K x 80 or 8K x 40 capacity in a 12.5" x 8.2" x 6.25" chassis. Meets MIL-E-16400 and MIL-E-4158. MTBF greater than 5000 hrs. MTTR less than 5 mins.

Logic Modules

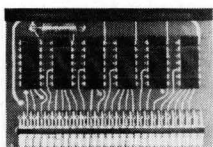

Complete family of over 190 high density, high reliability, analog and digital versions. Size only 2" x 3" with 52 pin, pin and socket connector. 0.1" center wire wrapped interconnections between modules. Extensive line of associated mounting hardware, tools and accessories available.

Military and Commercial Light Pens



Solid state, fast response (less than 300 nsec), high resolution (less than 20 mils available) models. Finder beam, touch actuation standard.

Information Control Corporation

9610 Bellanca Ave., Los Angeles 90045, Calif. (213) 641-8520.

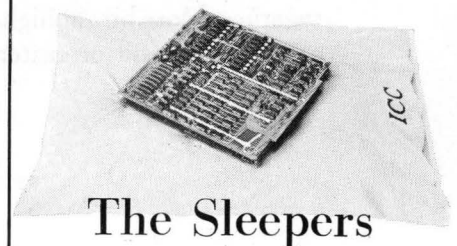

The Sleepers

**Walt Tucker ships more bits of memory
and complex PCs than any other man in America.**

Now he's going for the minicomputer record.



Walt ships what we make. More complex printed circuits than everyone else put together. More bits of high-speed memory—one microsecond or faster—than all other

independent manufacturers combined. And now that we make MAC compact control computers, Walt's got a new challenge. We're behind him all the way.

Lockheed Electronics

Data Products Division
A Division of Lockheed Aircraft Corporation
6201 E. Randolph St., Los Angeles, California 90040
213/722-6810

FLUX RING-A completely new approach to batch fabricated thick film memories

Flux Ring is a unique new, batch-fabricated planar technique providing magnetic thick film storage elements which are deposited as the center of a toroid. The materials are chosen so that the flux from the film element finds a lower reluctance path in the surrounding ring than in the air. Thus, the lowest energy state exists when the magnetic vector of the element lines up across the diameter of the ring. The result is lower drive current requirements than plated-wire, less expensive than core and with faster complete cycle times-plus-assured high reliability, no deterioration of performance due to aging, and unusually high packing densities.

MEMORY ARRAYS

8192 bits: 128 x 64 — 100 to 250 nsec cycle times

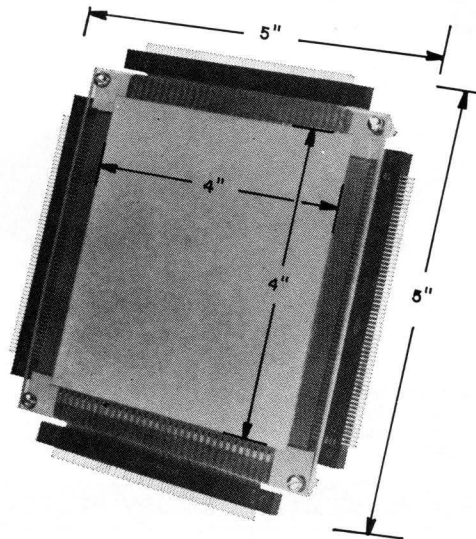

DRIVE REQUIREMENTS

Word Current

Amplitude: 450 mA
 Rise time: $10 \leq t_r \leq 40$ ns
 Fall time: Function of system cycle time
 Pulse width: $50 \leq P_w \leq 100$ ns
 Breakdown voltage: 100V dc

Digit Drive Current

Amplitude: 150 mA
 Rise time: $10 \leq t_r \leq 100$ ns
 Fall time: Function of system cycle time
 Pulse width: $20 \leq P_w \leq 50$ ns
 Breakdown voltage: 100V dc
 Minimum overlap: 40 ns

Signal Galaxies, Inc.

6955 Hayvenhurst Avenue
 Van Nuys, California 91406
 Telephone (213) 988-1570

A Subsidiary of The Signal Companies, Inc.

FEATURES

- Nonvolatile
- Cycle time as low as 100 nsec for NDRO, or 250 nsec for DRO
- 100% bit redundancy
- 1600 to 4800 bits per square inch
- Linear select, 2D organization

MEMORY STACKS

1, 2, 4, 8K capacities — 8 to 100 bit words
 100 to 250 nsec full cycle times

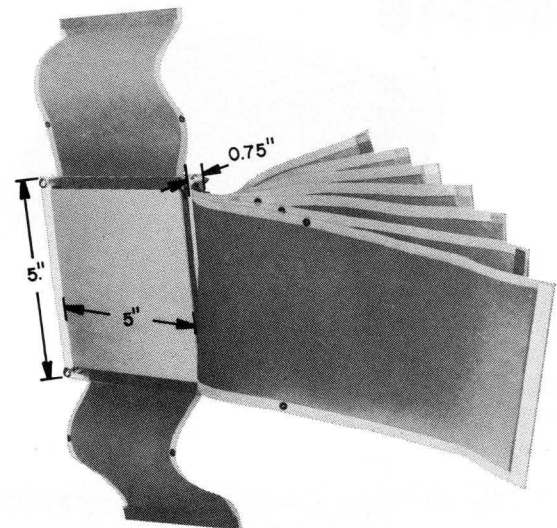

Impedance Characteristics

Word impedance: 20 ohms nominal
 Digit line impedance: 80 ohms nominal

OUTPUT SIGNAL CHARACTERISTICS

Amplitude: 3.0 mV
 Duration: Output signal rise follows the applied word current rise characteristic
 Access time: 40 ns nominal

**Send For Bulletins
 7010 and 7011**

QUADRI...ON THE MOVE!

BIPOLAR READ/WRITE MEMORY SYSTEM

811-01

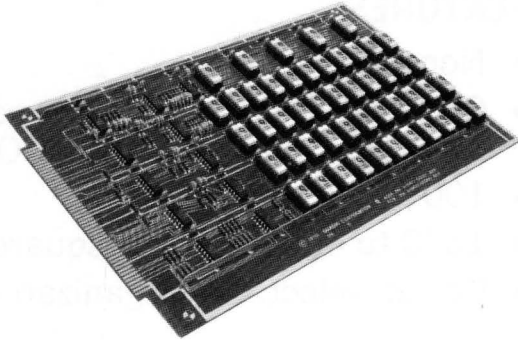

Capacity: 10K bits per module
Speed: 70 ns cycle time

MOS READ/WRITE MEMORY SYSTEM

811-02

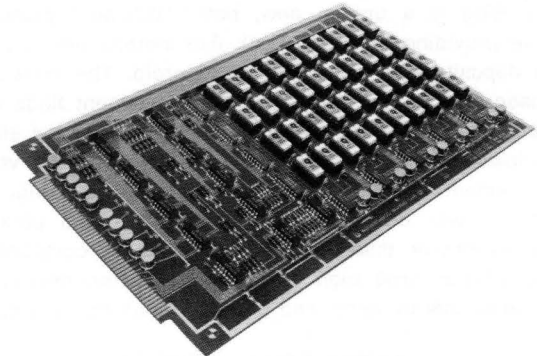

Capacity: 40K bits per module
Speed: 500 ns cycle time

TOROID READ ONLY MEMORY SYSTEM

401-16

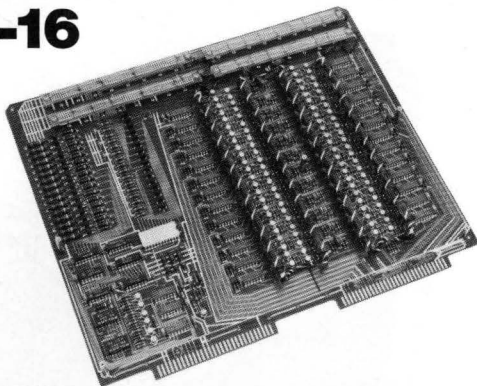

Capacity: 25K bits per module
Speed: 300 ns cycle time
130 ns Access
Field Alterable

MILITARY READ/WRITE MEMORY SYSTEM

805

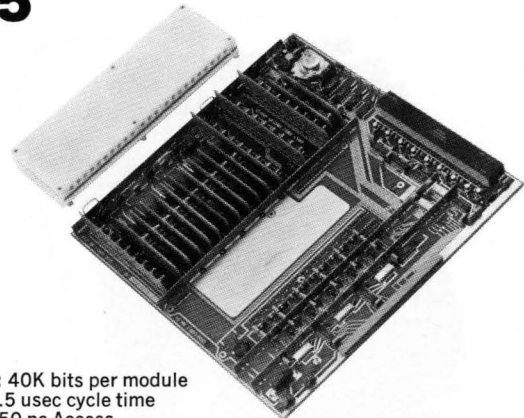

Capacity: 40K bits per module
Speed: 1.5 usec cycle time
750 ns Access
Pluggable Stack

TOROID READ ONLY MEMORY SYSTEM

401-01

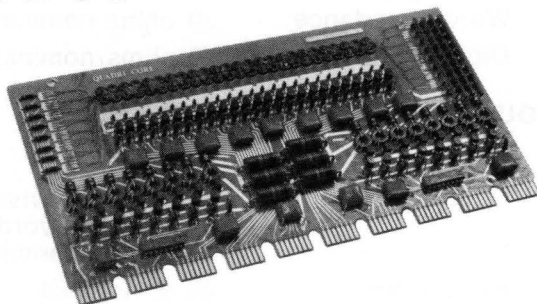

Capacity: 1600 bits
Speed: 100 ns cycle time
50 ns Access
Field Alterable
Severe Environment

TOROID READ ONLY MEMORY SYSTEM

401-17

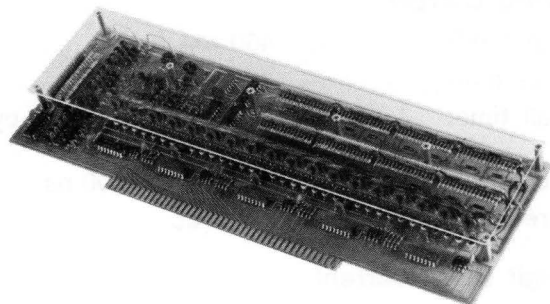

Capacity: 8K to 18K bits per module
Speed: 200 ns cycle time
125 ns Access
Field Alterable

... FOR COMPLETE INFORMATION ON OUR NEWEST



PROGRAMMABLE READ ONLY MEMORY

809-01

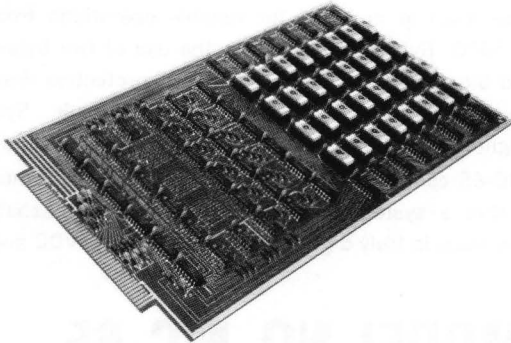

Capacity: 8K bits per module
Speed: 80 ns cycle time
Field Alterable

"Q CORE"™ READ ONLY MEMORY SYSTEM

401-18

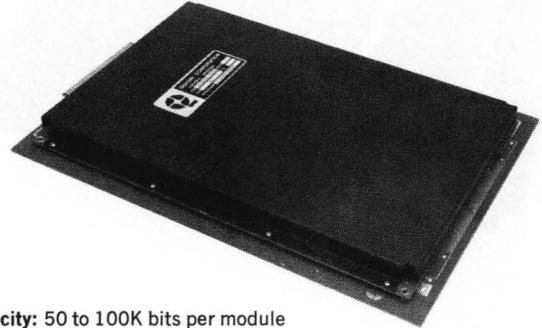

Capacity: 50 to 100K bits per module
Speed: 200 ns cycle time
75 ns Access
Pluggable Magnetic Matrix
Field Alterable

MILITARY READ/WRITE STACK

701

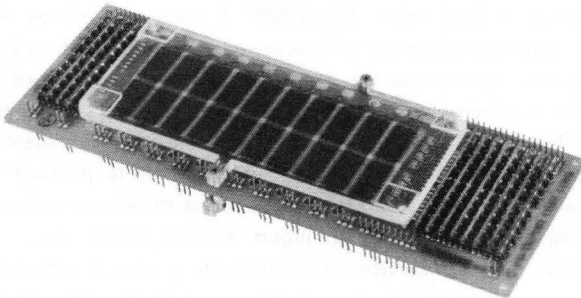

Capacity: 20K bits
Speed: 1.5 usec cycle time
750 ns Access
Pluggable

TOROID READ ONLY MEMORY SYSTEM

401-06

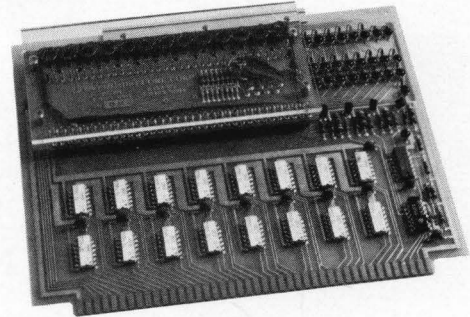

Capacity: 1500 bits
Speed: 150 ns cycle time
80 ns Access
Field Alterable
Pluggable Magnetic Matrix

TOROID READ ONLY MEMORY SYSTEM

401-03

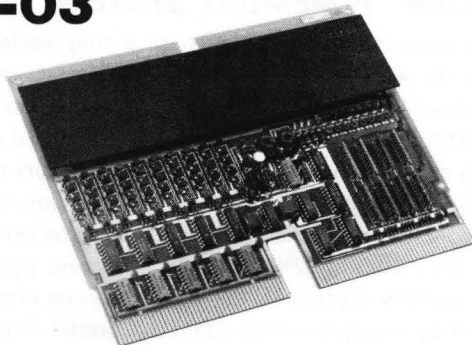

Capacity: 5K bits per module
Speed: 500 ns cycle time
150 ns Access
Field Alterable

Field Alterable PROM • HI-Speed Bipolar Read/Write • Military Magnetic Read/Only • Dynamic MOS Read/Write • Magnetic Read/Only • Military Read/Write Stacks & Systems • PLUS — special order "toughies" to meet specific customer requirements.



QUADRI
CORPORATION
2950 WEST FAIRMONT
PHOENIX, ARIZONA 85017
(602) 263-9555

PRODUCT DEVELOPMENTS WRITE OR CALL TODAY!

send for Technical Bulletin TB-1001

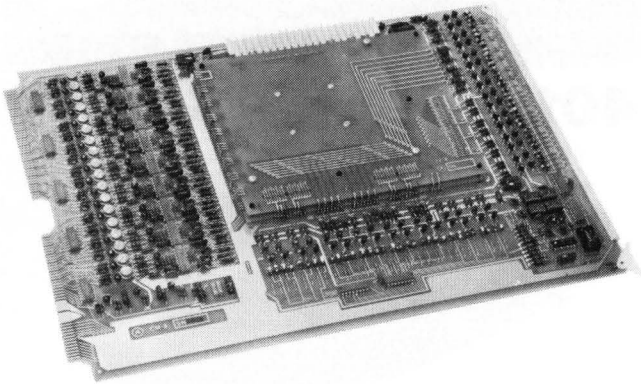

MODEL 4KEF18MM

4K x 18 MEMORY MODULE

SMI now provides a 4096 x 18 memory on a single 11.50" x 16.00" PC board. The **ecom**[®] F can be connected to provide long word lengths or large word capacity systems by the use of multiple modules. Full cycle time is 750 nanoseconds with data available in 250 nanoseconds! Temperature compensation is included for reliable operations from 0°C to +50°C. Byte control permits the use of two bytes for each 18 bit word. Data saver circuits for protection due to power failures is included in the memory module. Systems designers may use the **ecom**[®] F memory module with the MC-65 controller described below or integrate the **ecom**[®] F within a system having internal controller capability. The interface is truly digital, requiring only ±15VDC and +5VDC.

send for Technical Bulletin TB-1002

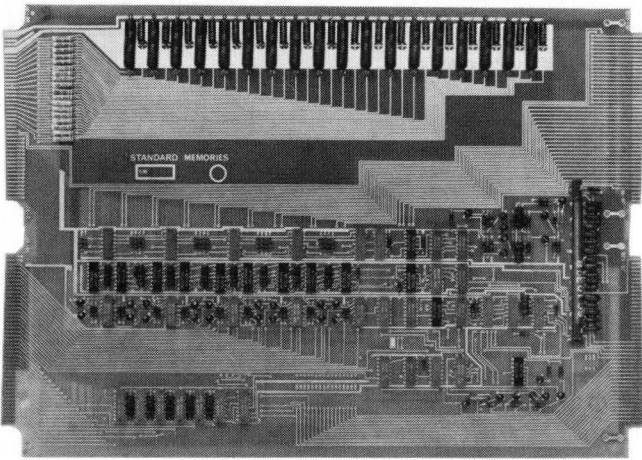

MODEL NO. MC-65

MEMORY CONTROLLER

The MC-65 Memory Controller is a completely separate PC board with identical dimensions as those of the **ecom**[®] F. (11.50" x 16.00"). The MC-65 provides the balance of circuitry for users that do not wish to integrate address and data registers within their own systems. The MC-65 can service up to sixteen (16) **ecom**[®] F memory modules with an address register for 65K words. A separate eighteen (18) bit data register and the heat producing inhibit resistors are also mounted on the MC-65. The advantages of a single control board with the capacity to handle up to 16 memory modules are obvious to any designer that is pressed for space, concerned with costs and anxious to reduce heat radiating components to a minimum since a single set of 18 inhibit resistors service up to 16 memory modules. Interface wiring is provided by two (2) 86 pin connector tabs on the PC board.

send for Technical Bulletin TB-1003

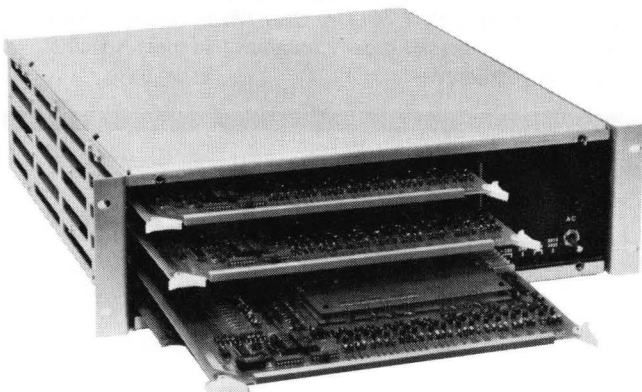

MODEL 16KEF18CP5

ECOM[®] F MEMORY SYSTEM

For users that wish to purchase a fully enclosed memory system with integral power supply — this is the simple answer. In a small package any capacity from 4K x 18 up to 16K x 18 with power supply in just 5 1/4" of panel height. The complete system utilizes four (4) memory modules, one (1) memory controller, a card cage enclosure and power supply. By use of the byte control, systems can be operated as 8K x 9 up to 32K x 9. Users will never again be limited by memory capacity — this system can be expanded at any time by simply inserting additional **ecom**[®] F modules up to a maximum of four (4) memory modules. For users with requirements exceeding 16K, the Mini-Mass™ is your solution. See following page.

STANDARD MEMORIES

INCORPORATED
A Subsidiary of Applied Magnetics Corporation

Telephone (213) 788-3010

TWX 910-495-1738

15130 Ventura Blvd. • Sherman Oaks, California • 91403

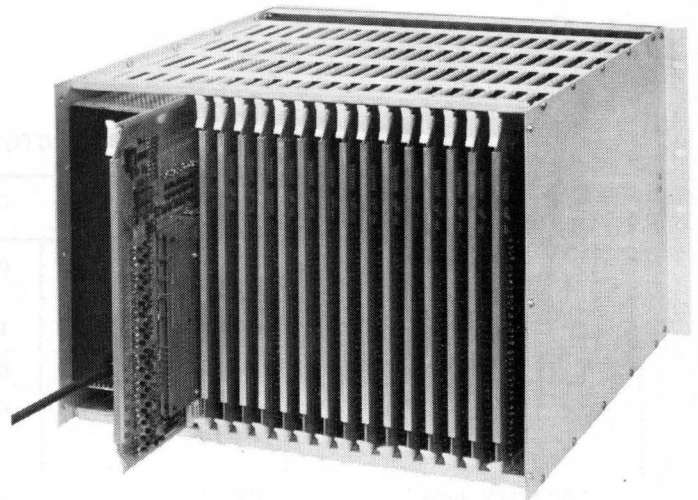

MINI-MASS™

65KEF18 MINI-MASS™

This is the ultimate memory system for storing large blocks of random data. 12¼" of panel height houses an entire 1,179,648 bit memory system. The Mini-Mass™ can be configured as a 32K x 36, 65K x 18, 131K x 9. Capacities start at 16K x 18 or 8K x 36 and can be expanded by simply inserting a single PC board for each 4K increment. Data save, byte control, power supply, systems enclosure, temperature tracking and wide range lithium core arrays are standard features. Field expansion is ultra fast and ultra

simple. Remember, the memory controller is built to address 65K words. By using two (2) controllers, the word length can be doubled to 36 bits with 32K words or you can operate as two separate 32K x 18 memory systems in the same enclosure. The entire I/O wiring for 65K x 18 is contained on two (2) 86 pin connectors and four (4) 86 pin connectors for two (2) 32K x 18 or a 32K x 36 unit. Specifications are shown below.

MINI-MASS™

SYSTEMS SPECIFICATIONS

Memory Type Coincident current, 3 wire

Storage Capacity

Words Per 12¼" Enclosure
Up to 65,536

Bits/Word 9-18-36

Operation Modes

Full Cycle Read-Restore or Clear-Write

Split Cycle Read-Pause-Write

Operating Speed

Full Cycle 750 nanoseconds

Split Cycle 800 nanoseconds

Access Time 325 nanoseconds

For full specifications and timing, send for Technical Bulletin TB-1004

Power Requirements

Voltage 105 to 125V RMS
210 to 280V RMS

Current 4A RMS

Frequency 47 to 440HZ

Environment

Temperature 0°C to 50°C operating
-40°C to 100°C storage

Humidity 95% RH without condensation

Mechanical

Panel RETMA 12.25" x 19.00"

Depth 20.00"

I/O Connectors (2) 86 pin card edge type with solder tabs. Furnished with unit.

STANDARD MEMORIES

INCORPORATED
A Subsidiary of Applied Magnetics Corporation

Telephone (213) 788-3010
TWX 910-495-1738
15130 Ventura Blvd. • Sherman Oaks, California • 91403

SEMICONDUCTOR MEMORY SYSTEMS

COMPANY	CAMBRIDGE MEMORIES	COGAR	COGAR	COGAR
MODEL NUMBER	MOS-8S	08C05	08C09	15C07
FIRST DELIVERY YEAR	1969	1970	1970	1970
UNIT PURCHASE PRICE	\$480	\$2750	\$775	\$2100
TYPE	MOS	bipolar	bipolar	bipolar
CAPACITY (bits)	150 x 8	9,216	2,304	18,432
SYSTEM ORGANIZATION	50 to 200 x 1 to 8	512 x 18	128 x 18	1024 x 18
ACCESS/CYCLE TIME (ns)	1000	40/80	40/80	125/150
OUTPUT COMPATIBILITY	TTL	ECL	ECL	TTL
POWER (watts)	9	57	22	45
POWER SUPPLY (volts)	+5/-24	-5.2	-5.2	+5.0
COMMENTS	RAM	RAM	RAM	RAM

SEMICONDUCTOR MEMORY SYSTEMS

COMPANY	COGAR	COGAR	COGAR	KENICS ELECTRONICS
MODEL NUMBER	15C23	30C06	30C04	B-100 ROM
FIRST DELIVERY YEAR	1970	1970	1970	1970
UNIT PURCHASE PRICE	\$600	\$7275	\$1875	\$92
TYPE	bipolar	MOS	MOS	bipolar
CAPACITY (bits)	4,608	147,456	36,864	1536
SYSTEM ORGANIZATION	256 x 18	8192 x 18	2048 x 18	64 x 24
ACCESS/CYCLE TIME (ns)	125/150	250/300	250/300	70
OUTPUT COMPATIBILITY	TTL	TTL	TTL	TTL
POWER (watts)	19	61	22	0.5
POWER SUPPLY (volts)	+5.0	+5, +10, -7	+5, +10, -7	+5
COMMENTS	RAM	RAM	RAM	

SEMICONDUCTOR MEMORY SYSTEMS

COMPANY	QUADRI	QUADRI	QUADRI	SEMICONDUCTOR ELECTRONIC MEM.
MODEL NUMBER	811-02	811-01	809-01	RAM 18A
FIRST DELIVERY YEAR	1970	1970	1970	1970
UNIT PURCHASE PRICE	3c/bit max	10c/bit max	3c/bit max	\$223
TYPE	MOS	bipolar	bipolar	bipolar
CAPACITY (bits)	40,000	10,000	8192	1024
SYSTEM ORGANIZATION	2D	2D	2D	128 x 8
ACCESS/CYCLE TIME (ns)	350 access, R/W cycle 525	70	80/80	180/200
OUTPUT COMPATIBILITY	TTL	TTL	TTL	TTL/DTL
POWER (watts)	26	28	17.5	2.0
POWER SUPPLY (volts)	5/-5/20	5	+5 ±2%	±5
COMMENTS				Can be electrically reconfigured to 256 x 4, 512 x 2, 1024 x 1.

SEMICONDUCTOR MEMORY SYSTEMS

COMPANY	SEMICONDUCTOR ELECTRONIC MEM.	SEMICONDUCTOR ELECTRONIC MEM.	STANDARD LOGIC	STANDARD LOGIC
MODEL NUMBER	RAM 48A	RAM 89B	MM 1024/10	MM 2048/10
FIRST DELIVERY YEAR	1970	1970	1970	1970
UNIT PURCHASE PRICE	\$490	\$960	1K x 10 = \$575, 1K x 6 = \$425	\$1150
TYPE	bipolar	bipolar	MOS Memory, bipolar control drive	MOS Memory, bipolar control drive
CAPACITY (bits)	4096	9216	1K to 10,240	20,480
SYSTEM ORGANIZATION	512 x 8	1024 x 9	1024 x 1 to 10	2K x 10
ACCESS/CYCLE TIME (ns)	180/200	180/200	475/600	475/600
OUTPUT COMPATIBILITY	TTL/DTL	TTL/DTL	DTL/TTL (3 state)	DTL/TTL (3 state)
POWER (watts)	3.4	6.1	12.5	25
POWER SUPPLY (volts)	±5	±5	+5	+5
COMMENTS	Can be electrically reconfigured to 1024 x 4, 2048 x 2 and 4096 x 1.			

The DISKSTOR 510® is a mass memory system with removable media. This operator-replaceable, head-per-track disc storage system will add fast access memory capacity to data processing equipment (average access of 8.7 ms.) Double-surfaced discs, which store up to 5 million bits per surface, can be changed simply and quickly. Ideal for mini-computers, auxiliary memories, process control, automatic test systems, data acquisition, etc.

DRUM MEMORIES from General Instrument are fast and reliable, with less than one error in 10^{11} bits under normal operating conditions. Stand-alone design is turntable mounted to give full 360° access to all circuits and checkpoints from the front. Data electronics are part of the package, including a bit serial interface that matches the drum to your controller. Optionally, controller logic can be provided to interface with a central processor. SA 7000 Series single-drum capacities range from 10 million to 150 million bits, with 256, 512, 1024 or 1536 tracks, (average access of 8.7 ms.) SA 8000 Series provide capacities ranging from 3.5 million to 30 million bits, with 128, 256, 512, or 1024 tracks—each with its own read/write flying head, (average access of 3.8 ms.) General Instrument drum memories add up to low bit cost and high throughput.

DIGITAL MAGNETIC TAPE HEADS are available in a wide range of designs and performance characteristics. Typical are those shown below, designed to provide full IBM track compatibility. The dual gap, read/write, or read after write head is for tape speeds of 200 IPS. Supplied in 7 or 9 channel modes for use at 1600 bpi. The cassette head shown is available for 1 or 2 track, either read or write, or read after write, with tape speeds of 1 IPS to 20 IPS.

When requesting information, please specify product interest.

unforgettable memories.

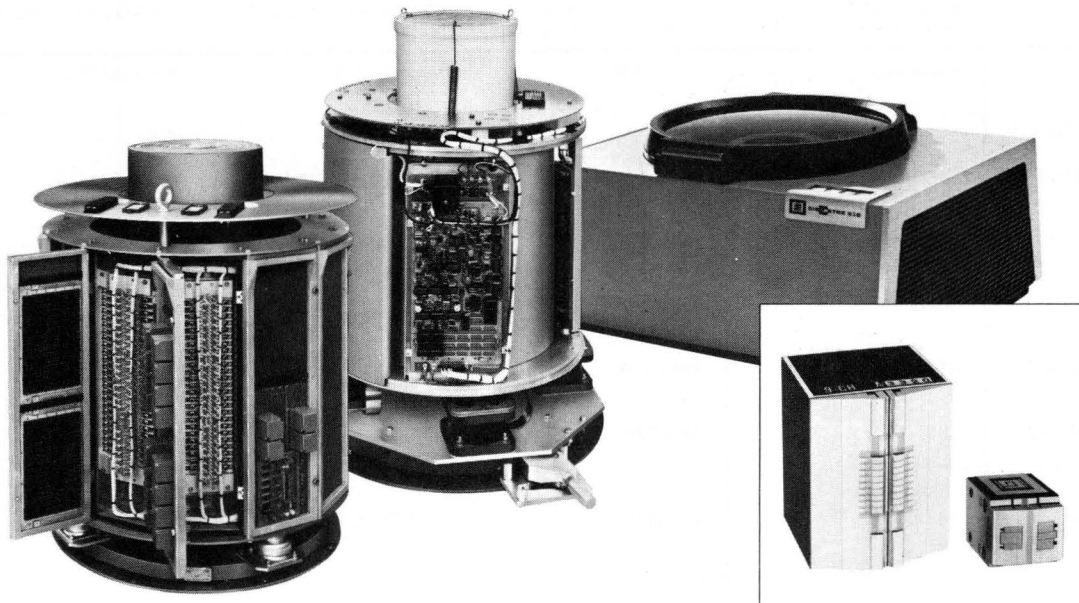

**SYSTEMATICS /
MAGNE-HEAD DIVISION**
GENERAL INSTRUMENT CORPORATION
13040 So. Cerise Ave., Hawthorne, Calif. 90250.
(213) 679-3377. TWX 910-325-6203.

FIXED HEAD DISC MEMORY SYSTEMS

COMPANY	ALPHA DATA	DATA DISC	DATA DISC	DATA DISC	DIGITAL DEVELOPMENT
MODEL	10128	1700 Series	5200 Series	7200 Series	DDC 70
FIRST DELIVERY YEAR	1969	1969/1970	1968/1970	1969/1970	1970
BASIC PURCHASE PRICE	\$2750 - \$6830	\$5800 - \$58,200	\$9920 - \$33,020	\$4200 - \$16,000	\$8700
LEASE RATE/MONTH	n/a	\$150 - \$350			n/a
CAPACITY (megabits)	4	32K - 4M words	0.8 - 8	0.8 - 17	2.2 - 4.4
AVG ACCESS TIME (ms @ rpm)	8.4 @ 3600	16.7 @ 1800	16.7 @ 1800	16.7 @ 1800	8.5 @ 3450
NO. OF TRACKS	128	8 - 512	8 - 80	8 - 128	64 or 128
BIT DENSITY (bpi)	1750	3300 - 4400	3300	3300 or 4400	1150 phase mod recording
TRANSFER RATE (megabits/sec)	1.85 MHz	30 - 250K wds/sec	3/track	3 or 4	2 MHz serial
ACCURACY (error/bits)	1/10 ¹²	1/10 ¹⁰	1/10 ¹⁰	1/10 ¹⁰	1/10 ¹²
COMMENTS		Interfaces for all popular computers. Over 45 models.	Fully parallel read/write.		

FIXED HEAD DISC MEMORY SYSTEMS

COMPANY	DIGITAL DEVELOPMENT	DIGITAL DEVELOPMENT	DYNA- COUSTICS	ENGINEERED DATA PERIPHERALS	ENGINEERED DATA PERIPHERALS
MODEL	Series 7300	Series 7310	501-1, 2, 3	EDP-2000 Series	EDP-3000 Series
FIRST DELIVERY YEAR	1965/1967	1971	1970	1969	1969
BASIC PURCHASE PRICE	\$12,800 - \$36,000	\$10,500 - \$39,000	\$4950 - \$7900	\$3300 - \$8500	\$3300 - \$8500
LEASE RATE/MONTH	n/a	n/a			
CAPACITY (megabits)	8.96	8.45 - 67.58	0.5 - 1.5	0.4 - 6	0.4 - 6
AVG ACCESS TIME (ms @ rpm)	8.5 @ 3450 nom	8.5 @ 3450	8.7 @ 3600	8.5	17
NO. OF TRACKS	64 - 1024	64 - 1024	23, 35, 50	8 - 120	8 - 120
BIT DENSITY (bpi)	1150 phase mod recording	2200 tri-period recording	700 or 1000	1800	1800
TRANSFER RATE (megabits/sec)	2 MHz max serial	3.96 MHz serial	1.2 or 1.75	3 MHz	1.5 MHz
ACCURACY (error/bits)	1/10 ¹²	1/10 ¹²	1/10 ¹²	1/10 ¹²	1/10 ¹²
COMMENTS					

FIXED HEAD DISC MEMORY SYSTEMS

COMPANY	ENGINEERED DATA PERIPHERALS	GENERAL INSTRUMENT SYSTEMATICS/MAGNE-HEAD	KEMPER ENGINEERING	MAGNAFILE	MAGNAFILE
MODEL	EDP-4000 Series	Diskstor 510	DC-Series	5000	6000
FIRST DELIVERY YEAR	1969	1970	1970	1970	1970
BASIC PURCHASE PRICE	\$3600 - \$6950	\$5200 in qty.	\$17,500	\$3000	\$8000
LEASE RATE/MONTH		n/a			
CAPACITY (megabits)	0.68 - 5.4	10	6 - 24	1	8
AVG ACCESS TIME (ms @ rpm)	17	8.7 @ 3600	18 @ 1800	8.5	17 @ 1800
NO. OF TRACKS	8 - 64	128	64/disc	32	128
BIT DENSITY (bpi)	2500	1800	100K bits/tk	1600	2500
TRANSFER RATE (megabits/sec)	2.54MHz	0.5 - 3.3	3.0	1.82	1.8
ACCURACY (error/bits)	1/10 ¹²	1/10 ¹¹	1/10 ¹⁰	1/10 ¹⁰	1/10 ¹⁰
COMMENTS					

FIXED HEAD DISC MEMORY SYSTEMS

COMPANY	MAGNAFILE	SINGER - LIBRASCOPE	UNICOMP	XEROX DATA SYSTEMS
MODEL	8000	Series L107	324	7200 RAD Series
FIRST DELIVERY YEAR	1969	1969		1967/1968
BASIC PURCHASE PRICE	\$6000	\$2750 & up	\$5400	\$18,000 - \$60,000
LEASE RATE/MONTH		n/a		\$405 - \$1350/4 yr.
CAPACITY (megabits)	5	0.5 - 3	0.6	6 - 49.6
AVG ACCESS TIME (ms @ rpm)	8.5 @ 3600	8.5	16.7	17 @ 1800
NO. OF TRACKS	128	to 100	16	128 - 512
BIT DENSITY (bpi)	1600	1860	1000	1100 or 2200
TRANSFER RATE (megabits/sec)	1.2 @ 1800	1.8	1.1	1.5 - 24.0
ACCURACY (error/bits)	1/10 ¹⁰	1/10 ¹²		
COMMENTS				

1 Equipment Characteristics

MOVING HEAD DISC MEMORY SYSTEMS

COMPANY	AMPEX COMPUTER PRODUCTS	BRYANT COMPUTER PRODUCTS	BRYANT COMPUTER PRODUCTS	BRYANT COMPUTER PRODUCTS
MODEL	DM-312	1100-1 & 1100-1/25	1100-2 & 1100-3	4000A2A & 4000C2A
FIRST DELIVERY YEAR	1971	1970	1970	1969
BASIC PURCHASE PRICE	\$14,000			
LEASE RATE/MONTH	\$300 (in groups of three)			
CAPACITY (megabits)	29.176 megabits	58 (1 record/track)	43.2 & 21.6 (fixed record length)	2,103 & 4,381
ACCESS TIME (ms)				
Min.	8	25	25	100
Avg.	32	75	75 & 60	undefined
Max.	58	135	135 & 90	265
NO. OF CYLINDERS	200 + 3 spares	200 + 3 spares	200 & 100 + 3 spares	256
TRACKS PER CYLINDER	20	10	10	144 & 300
BIT DENSITY (bpi)	2200	765-1105	765-1105	800
TRANSFER RATE (megabits/sec)	312,000 bytes/sec	1.25	1.25	1.14 avg.
ACCURACY (error/bits)		undefined	undefined	undefined
REMOVABLE OR FIXED MEMORY	removable, uses IBM 2316 disk pack	removable	removable	fixed, field expandable
COMMENTS	Replacement for IBM 2314.	IBM 2311-1/25 compatible. Logically compatible w/ IBM 360/25.	IBM 360/20 CPU compatible. IBM 2311-2&3 compatible.	

MOVING HEAD DISC MEMORY SYSTEMS

COMPANY	CALIF. COMPUTER PRODUCTS	CALIF. COMPUTER PRODUCTS	CALIF. COMPUTER PRODUCTS	CALIF. COMPUTER PRODUCTS
MODEL	CD-1	CD 12 & 22	DS-12 Disk Storage System	1015 Dual Density Disk
FIRST DELIVERY YEAR	1969	1970	1971	1971
BASIC PURCHASE PRICE	\$12,720 w/ 1 yr. maintenance	\$18,720-CD 12/ \$33,840-CD 22	\$25,680 w/ 1 yr. maintenance	\$160,420
LEASE RATE/MONTH	upon request	upon request	upon request	upon request
CAPACITY (megabits)	7.25 million 8-bit bytes	29,176,000 & 58,352,000 8-bit bytes	10,240,000 16-bit words	233,408,000 bytes (on-line)
ACCESS TIME (ms)				
Min.	10	12	12	12
Avg.	30	35	35	
Max.	60	65	65	55
NO. OF CYLINDERS	203	203	203	400
TRACKS PER CYLINDER	10	20	20	20
BIT DENSITY (bpi)	29,000 bits/track	58,352 bits/track		58,352 bits/track
TRANSFER RATE (megabits/sec)	156,000 8-bit bytes/sec	312,000 8-bit bytes/sec	125,000 16-bit words/sec	312,000 8-bit bytes/sec
ACCURACY (error/bits)	IBM compatible	IBM compatible	IBM compatible	IBM compatible
REMOVABLE OR FIXED MEMORY	removable	removable	removable	removable
COMMENTS	IBM 360 & 370 compatible.	Compatible with IBM 360 & 370. CD 22 is a dual spindle drive.	IBM 1130 compatible.	IBM 360 & 370 compatible.

MOVING HEAD DISC MEMORY SYSTEMS

COMPANY	COMPUTER HARDWARE	DACONICS	DATA PRODUCTS	DATA PRODUCTS
MODEL	CHI 1111	2923	6040 Large Disc Store	7114 & 7314
FIRST DELIVERY YEAR	1970	1970	1971	1971
BASIC PURCHASE PRICE	\$25,500		\$81,000	\$161,700 & \$152,000
LEASE RATE/MONTH	\$750 - 2 yr.			\$4675 & \$3305 (+ \$550 maint)
CAPACITY (megabits)	40.96	12 & 24	2,000	2.10 ⁹
ACCESS TIME (ms)				
Min.	10	50	10 ns	10
Avg.	30	70	55 ns	55
Max.	60	130	100 ns	100
NO. OF CYLINDERS	200 (usable)	203	4061 positioner module	406
TRACKS PER CYLINDER	10	2	40	40
BIT DENSITY (bpi)	1100	2200	1800	1800
TRANSFER RATE (megabits/sec)	.896	.8	234 K/bytes/sec (1.875 x 10 ⁶ bps)	
ACCURACY (error/bits)	1/10 ¹⁰		recoverable error rate 1/10 ¹¹ bits	1.10 ⁹
REMOVABLE OR FIXED MEMORY	removable	removable	fixed	fixed
COMMENTS	Interface for IBM 1130 & IBM 1800. Fully hdwre compatible w/ 5 IBM 2310's.	Popular computer interfaces available.	IBM 2314 compatible.	Controller included.

MOVING HEAD DISC MEMORY SYSTEMS

COMPANY	DATA SYSTEMS DESIGN	DIABLO SYSTEMS	DYNACOUSTICS	HONEYWELL
MODEL	Series 130	31	1101	DU1100
FIRST DELIVERY YEAR	1970	1970	1970	1970
BASIC PURCHASE PRICE	\$11,000	under \$3,000 OEM qty	\$9,950	\$6,100
LEASE RATE/MONTH		n/a		
CAPACITY (megabits)	24	24	12	24.6
ACCESS TIME (ms)				
Min.	12	15	55	25
Avg.	60	70	190	75
Max.	70	125	455	135
NO. OF CYLINDERS	203	200	203	200 + 3 spares
TRACKS PER CYLINDER	2	2	2	2/pack (2 Pks)
BIT DENSITY (bpi)	2200	2200	1000	1100
TRANSFER RATE (megabits/sec)	1.56	1.56	0.72	1.248
ACCURACY (error/bits)		non-recoverable errors are failures	10 ¹¹	
REMOVABLE OR FIXED MEMORY	removable	removable	removable: IBM 2315 cartridge	2 - removable
COMMENTS	Software package included. Interface available.	4,000 hour MTBF		IBM 2311 compatible

MOVING HEAD DISC MEMORY SYSTEMS

COMPANY	HONEYWELL	HONEYWELL	HONEYWELL	INFORMATION STORAGE SYSTEMS
MODEL	DU1701	MDD-1 & MDD-2	MDD-7	701
FIRST DELIVERY YEAR	1970			1969
BASIC PURCHASE PRICE	\$11,000	\$8125 & \$9125	\$4525	\$12,900
LEASE RATE/MONTH				
CAPACITY (megabits)	233.36	62.4 & 124.8	12.48	58
ACCESS TIME (ms)				
Min.	10	20	20	10
Avg.	30	50	100	30
Max.	60	110	200	60
NO. OF CYLINDERS	200 + 3 spares	200 + 3 spares	200 + 3 spares	203
TRACKS PER CYLINDER	20	10 & 20	2	10
BIT DENSITY (bpi)	2200	1100	1100	1100
TRANSFER RATE (megabits/sec)	2.496	1.248	.885	1.25
ACCURACY (error/bits)	10-9 (recoverable)			< 1 in 10 ¹²
REMOVABLE OR FIXED MEMORY	removable	removable	removable	removable
COMMENTS	IBM 2312 compatible.	IBM 2311 compatible.	IBM 2310 compatible.	IBM 2311 compatible.

MOVING HEAD DISC MEMORY SYSTEMS

COMPANY	INFORMATION STORAGE SYSTEMS	INTERACTIVE DATA SYSTEMS	IOMEC	IOMEC
MODEL	714 & 724	DC-16/114	Iodisc 1001 & 1011	Iodisc 1010 & 1022
FIRST DELIVERY YEAR	1970	1969	1971	1971
BASIC PURCHASE PRICE	\$17,400 & \$25,000	DC-16: \$8,000 114: \$16,700	\$4775 & \$5525	\$9550 & \$11,050
LEASE RATE/MONTH				
CAPACITY (megabits)	232-29 million bytes & 188	224	11	22
ACCESS TIME (ms)				
Min.	10	10	35 & 30	35 & 30
Avg.	32	30	150 & 60	60
Max.	60	75	200 & 90	90
NO. OF CYLINDERS	203	200	200 + 3 spares	400 + 3 spares
TRACKS PER CYLINDER	20	20	2	2
BIT DENSITY (bpi)	2200		1080	1080
TRANSFER RATE (megabits/sec)	2.5	2.4	720,000	720,000
ACCURACY (error/bits)	< 1 in 10 ¹²		1/10 ⁹	1/10 ⁹
REMOVABLE OR FIXED MEMORY	removable	removable	removable	removable
COMMENTS	IBM 2314 compatible. Compatible w/ many 12 & 16-bit computers.			

MOVING HEAD DISC MEMORY SYSTEMS

COMPANY	IOMEC	IOMEC	IOMEC	IOMEC
MODEL	Iodisc 1012	Iodisc 1023 & 2023	Iodisc 1024 & 2024	Iodisc 2012 & 2022
FIRST DELIVERY YEAR	1969	1971	1971	1970
BASIC PURCHASE PRICE	\$7020	\$12,545 & \$15,575	\$14,040 & \$17,200	\$8600 & \$13,950
LEASE RATE/MONTH				
CAPACITY (megabits)	22	33 & 72	44 & 96	48
ACCESS TIME (ms)				
Min.	35	35	35	35 & 30
Avg.	70	70	70	70
Max.	90	90	90	90
NO. OF CYLINDERS	400 + 6 spares	600 + 6 spares	800 + 12 spares	400 + 6 spares
TRACKS PER CYLINDER	2	2	2	2
BIT DENSITY (bpi)	1080	1080 & 2200	1080 & 2200	2200
TRANSFER RATE (megabits/sec)	720,000	720,000 & 1,560,000	720,000 & 1,560,000	1,560,000
ACCURACY (error/bits)	1/10 ⁹	1/10 ⁹	1/10 ⁹	1/10 ⁹
REMOVABLE OR FIXED MEMORY	both	both	both	both
COMMENTS				

MOVING HEAD DISC MEMORY SYSTEMS

COMPANY	IOMEC	MARSHALL DATA SYSTEMS	MARSHALL DATA SYSTEMS	PERIPHERAL EQUIPMENT
MODEL	Iodisc 2011	M2500 Discdrive	M2800 Discsystem	MD-5101 & MD-5121
FIRST DELIVERY YEAR	1970	1968	1970	1971
BASIC PURCHASE PRICE	\$6975	\$12,000	\$18,000 per drive	\$3560 to \$4155
LEASE RATE/MONTH		\$495	\$432	
CAPACITY (megabits)	24	7.25	Up to 233 for 8 spindles	12 & 24
ACCESS TIME (ms)				
Min.	30	18	12	15
Avg.	60	48	30	60
Max.	90	65	60	110
NO. OF CYLINDERS	200 + 3 spares	200	200	203
TRACKS PER CYLINDER	2	10	20	2 & 4
BIT DENSITY (bpi)	2200	1100	2200	1100
TRANSFER RATE (megabits/sec)	1,560,000		312	1,562
ACCURACY (error/bits)	1/10 ⁹			1/10 ¹²
REMOVABLE OR FIXED MEMORY	removable		removable 2316 pack or equivalent	removable & fixed
COMMENTS			Controller \$52,000	

1 Equipment Characteristics

MOVING HEAD DISC MEMORY SYSTEMS

COMPANY	PERIPHERAL EQUIPMENT	PERIPHERALS GENERAL	PERIPHERALS GENERAL	POTTER INSTRUMENT
MODEL	MD-5201 & MD-5221	711	733	DD 4311
FIRST DELIVERY YEAR	1971	1970	1970	1969
BASIC PURCHASE PRICE	\$3825	\$9000	\$13,500	\$18,000
LEASE RATE/MONTH		\$395/includes 24 hr. service	\$325/includes 24 hr. service	\$450
CAPACITY (megabits)	25 & 50	7.25	29.4	58
ACCESS TIME (ms)				
Min.	15			19
Avg.	60	75	60	52
Max.	110			104
NO. OF CYLINDERS	203	200	200	203
TRACKS PER CYLINDER	2 & 4	20	20	10
BIT DENSITY (bpi)	2200	765-1105	1530-2210	1530-2210
TRANSFER RATE (megabits/sec)	1.562	156,000 8 bit bytes/sec	312,500 8 bit bytes/sec	.156 8-bit bytes/sec
ACCURACY (error/bits)	1/10 ¹²	1/10 ¹⁰	1/10 ¹⁰	
REMOVABLE OR FIXED MEMORY	removable & fixed			removable (IBM 1316 or equiv.)
COMMENTS		Control unit available.	Control unit available.	Plug-to-plug com- patible to IBM 2311 disk drive.

MOVING HEAD DISC MEMORY SYSTEMS

COMPANY	POTTER INSTRUMENT	UNICOMP	XEROX DATA SYSTEMS	XEROX DATA SYSTEMS
MODEL	DD4314	320	7242 Removable Disk Stor. Sys.	7246 Removable Disk Stor. Sys.
FIRST DELIVERY YEAR	1970		1969	1970
BASIC PURCHASE PRICE	\$20,000	\$7600	\$52,000	\$28,000
LEASE RATE/MONTH	\$380		\$1170 - 4 yr.	\$630 - 4 yr.
CAPACITY (megabits)	233	12	393	196.5
ACCESS TIME (ms)				
Min.	19	32		
Avg.	54	70	87.5	87.5
Max.	107	150	160	160
NO. OF CYLINDERS	203	203	406	203
TRACKS PER CYLINDER	20	2	20	20
BIT DENSITY (bpi)		1100	2200	2200
TRANSFER RATE (megabits/sec)	.312 8-bit bytes/sec	.8	2.5	2.5
ACCURACY (error/bits)				
REMOVABLE OR FIXED MEMORY	removable (IBM 2316 Disk Pack)	removable	removable	removable
COMMENTS				

1 Equipment Characteristics

MEMC BBS

FIXED HEAD DRUM MEMORY SYSTEMS

COMPANY	INFORMATION SYSTEMS	INFORMATION SYSTEMS	INFORMATION SYSTEMS	INFORMATION SYSTEMS	INFORMATION SYSTEMS	INFORMATION SYSTEMS
MODEL	7000 Series	8000 Series	10000 Series	10000 Series	10000 Series	10000 Series
FIRST DELIVERY YEAR	1969	-	1970	1964	1964	1964
MANUFACTURER'S PRICE	-	-	-	-	-	-
MAX. RATE/REVOLUTION	-	-	-	-	-	-
CAPACITY (WORDS)	52	63	96	200 K/L	200 K/L	200 K/L
AVERAGE ACCESS TIME (msec)	8.2 to 10.7	8.3	20	12 to 15	12 to 15	12 to 15
NO. OF TRACKS	84	6	200	200 to 200	200 to 200	200 to 200
BIT DENSITY (bits/in)	1000	1000	1000	1000	1000	1000
TRANSFER RATE (words/msec)	1.2 (800)	1.2 (800)	1.2 (800)	1.2 (800)	1.2 (800)	1.2 (800)
ACCURACY (bits/msec)	-	-	-	10 ⁻⁷	-	-
COMMENTS	-	-	-	-	-	-

201

Vermont Research proudly announces page 201

You don't have to listen to an ad.
Just listen to the specs.

The nuts and bolts information is right there in black and white. Our whole line of drum memories and controllers (including the new Series 6100).

And if you want to know more, write us: Vermont Research Corporation, Precision Park, North Springfield, Vermont 05150. Or phone us: (802) 886-2256.

All we want to do is expand your memory a little.

FIXED HEAD DRUM MEMORY SYSTEMS

COMPANY	BRYANT COMPUTER PRODUCTS	BRYANT COMPUTER PRODUCTS	BRYANT COMPUTER PRODUCTS	BRYANT COMPUTER PRODUCTS	DACONICS	DATUM	DATUM
MODEL	Auto-Lift 10A-D Series	Auto-Lift 18.5 A-D Series	A75512	CLC-1	2901	6038/68/78H Series	6038/68/78HP Series
FIRST DELIVERY YEAR	1970	1970	1970	1970	1969	1970	1970
BASIC PURCHASE PRICE	-	-	-	-	\$10,500	\$5550-\$9250	\$5800-\$9800
LEASE RATE/MONTH	-	-	-	-	2.25%/mo - 5 yr	\$142-\$240	\$142-\$240
CAPACITY (megabits)	4.8 to 38.5	19.2 to 154.3	13.5	2.4	-	0.5/1.5/3	0.5/1.5/3
AVG ACCESS TIME (ms @ rpm)	8.4 @ 3600	16.7 @ 1800	6.3 @ 4800	8.4 @ 3600	8.7	16.6 @ 1800	8.7 @ 3600
NO. OF TRACKS	128 to 512	256 to 1024	512	64	-	16/32/64	16/32/64
BIT DENSITY (bpi)	1200 or 2400	1300 or 2600	1110	1200	1100	1900/1800	1900/1800
TRANSFER RATE (megabits/sec)	2.26 or 4.52	2.26 or 4.52	2.2	2.26	1.1	1.92/3.84/7.68	1.92/3.84/7.68
ACCURACY (error/bits)	undefined	undefined	undefined	undefined	n/a	1/10 ¹¹	1/10 ¹¹
COMMENTS	Interface & controller avail.	Interface & controller avail.		Controller is optional.	Complete w/ controller for HP2114, 2115 & 2116.	For Honeywell 316, 516 computers.	For Hewlett-Packard 2114, 2115, and 2116 computers.

FIXED HEAD DRUM MEMORY SYSTEMS

COMPANY	ELECTRON OHIO	GENERAL INSTRUMENT SYSTEMATICS/MAGNE-HEAD	GENERAL INSTRUMENT SYSTEMATICS/MAGNE-HEAD	GENERAL INSTRUMENT SYSTEMATICS/MAGNE-HEAD	GENERAL INSTRUMENT SYSTEMATICS/MAGNE-HEAD	GENERAL INSTRUMENT MAGNE-HEAD	GENERAL INSTRUMENT MAGNE-HEAD
MODEL	1800	SA7008 & 12-256	SA7008 & 12 & 18 - 512	SA7012 & 18 - 1024	SA7018 - 1536	SA8008 Series	Diskstor 510
FIRST DELIVERY YEAR	1968	1969	1969	1969	1969	1970	1970
BASIC PURCHASE PRICE	\$2500	\$16,100 & \$17,200 in quan	\$23,400 - \$32,300 in quan	\$40,100 & \$45,200 in quan	\$59,500 in quan	\$13,100-\$31,500 in quan	\$7300 less controller
LEASE RATE/MONTH	-	n/a	n/a	n/a	n/a	-	-
CAPACITY (megabits)	.102400	10 or 17	20/35/50	70 or 100	150	4/8/16/30	10 (5/side)
AVG ACCESS TIME (ms @ rpm)	15 @ 1800	8.7 @ 3600	8.7 @ 3600	8.7 @ 3600/ 17.4 @ 1800	17.4 @ 1800	4.3 @ 7200	8.7 @ 3600
NO. OF TRACKS	128	256	512	1024	1536	128/256/512/1024	128 or less
BIT DENSITY (bpi)	50	to 1800	to 1800	to 1800	to 1800	1800	1800
TRANSFER RATE (megabits/sec)	24,000 bps	3.3	3.3	3.3	3.3	3.3	0.5-2.35 MHz
ACCURACY (error/bits)	1/10 ²⁰	1/10 ¹¹	1/10 ¹¹	1/10 ¹¹	1/10 ¹¹	1/10 ¹¹	1/10 ¹¹
COMMENTS	Amb temp = -30°C to 70°C. 32 tracks with addressing electronics.						

FIXED HEAD DRUM MEMORY SYSTEMS

COMPANY	INFORMATION DATA SYSTEMS	INFORMATION DATA SYSTEMS	INFORMATION DATA SYSTEMS	VERMONT RESEARCH	VERMONT RESEARCH	VERMONT RESEARCH	VERMONT RESEARCH
MODEL	7000 Series	8000 Series	10,000 Series	1004	1016	1032	2032 & 2064
FIRST DELIVERY YEAR	1969	—	1970	1968	1968	1968	1968
BASIC PURCHASE PRICE	—	—	—	—	—	—	—
LEASE RATE/MONTH	—	—	—	—	—	—	—
CAPACITY (megabits)	3.2	0.15	25	.56 to 4.4	2.24 to 17.9	4.48 to 35.8	8.96 to 143.2
AVG ACCESS TIME (ms @ rpm)	8.3 or 16.7	8.3	25	8.7 @ 3450	8.7 @ 3450	8.7 @ 3450	17.5 @ 1750
NO. OF TRACKS	64	8	256	16 to 128	64 to 512	128 to 1924	128 to 2048
BIT DENSITY (bpi)	1200	1200	1300	1100	1100	1100	1100
TRANSFER RATE (megabits/sec)	1.2 MHz	1.2 MHz	2 MHz	2	2	2	2
ACCURACY (error/bits)	—	—	—	1/10 ¹¹	—	—	—
COMMENTS							

MOS.

You get less, but it does more.

MOS encoding, coupled with proven solid state switch modules, brings new miniaturization and flexibility to MICRO SWITCH keyboards.

What you get less of are the things that can go wrong. Like discrete components. We've eliminated more than a hundred. Reducing behind-panel space.

And we've also reduced the number of solder connections. All of which results in a simpler, more reliable keyboard. At a lower cost to you.

What you get more of is the ability to generate just about any code. Because there's no need for logical pairing. And speaking of codes, up to four levels

can be produced from the same key.

Keyboard interaction with your system is expanded with features such as one-character storage, keyboard output inhibit and system shift. More than was ever possible before from a single keyboard.

You can get more information by calling or writing your MICRO SWITCH Branch Office.

MICRO SWITCH

FREEPORT, ILLINOIS 61032
A DIVISION OF HONEYWELL



HONEYWELL INTERNATIONAL: Sales and service offices in all principal cities of the world.

Keyboard Equipment

We frequently see the irony of modern travel: a trip to the airport takes longer than the actual flight. This analogy seems relevant to the current data processing situation. Despite modern improvements in computer technology — improvements which affect speed, cost, reliability, and operational simplicity of the machine — the data entry technique has not significantly improved. As a result, today's data preparation and input expenses account for 50 percent of data processing expenditures per installation.

By 1975, the data preparation equipment costs will be an estimated 75 percent of an average data processing department.

On the other hand, recent data output technology has kept pace with computer advances. Impact printers with speeds up to 3000 lines per minute and COM (computer output microfilm) systems with a speed of 30,000 lines per minute (120,000 characters per second) are now available.

After 30 years of keypunch dominancy, several different methods of data preparation have been developed and favorably accepted by users. While each system offers some advantages, none has been successful enough to disturb the predominant position of keypunch until 1965.

Why has the keypunch remained so popular? It fails to meet the goals of high speed, accuracy, low cost, simplicity of operation, small size, reliability, and high data throughput. The first and most important reason is that keypunch has existed and been in use for a long time. Also, the keypunch has been the closest human-related sector of the EDP field, and users have maintained a very conservative attitude toward it. They feel comfortable with the familiar. While they complain about the machine, they still add their names to the customer list, a list which today exceeds ½ million users. This conservative aspect of human nature may be depicted with an oriental saying: "Old shoes and wives are better than new ones; they may not be shiny, but they sure are comfortable."

During the last few years, the keypunch's position has been affected by the advent of newer data entry products. These include key-to-tape, key-to-disc, and OCR methods. It is estimated that nearly 7% of the keypunch-dominated market has been taken over by key-to-tape devices. However, the keypunch still leads its closest competitors, OCR and key-to-tape devices, by 2 to 1 and 3 to 1, respectively, according to sales margins in 1970.

KEYPUNCH EQUIPMENT

The punched card serves as a storage medium and as a permanent record which can be read by an operator. A wide variety of storage applications using punched cards,

aperture cards, and mark sensing cards is available. The handling of the cards is relatively easy. They can be sorted and filed manually or automatically. They are also very convenient to search and update. Because a card serves as a unit record, any record can be located without examining all the data on the preceding cards. All the data can be translated into other media, such as paper tape or magnetic tape. Because of these advantages, keypunch is not expected to be replaced by its competitors in the near future. However, continued dynamic market penetration by key-to-tape and key-to-disc equipment is in store due to the inherent disadvantages of the keypunch as a data entry device.

Keypunch's most serious disadvantage is that the card input requires expensive processing. The keypunch requires additional equipment, such as a card reader and card verifier, in order to transfer and translate information from cards to computer-compatible magnetic tape or discs. It also requires expensive processing, editing, reformatting, resorting, collating, etc. In addition, the punching mechanism is so slow that a skilled operator can outpace the equipment. Accordingly, the keypunch direct cost is very high.

Although the card itself is reasonably inexpensive, its use requires many expensive human operations. The cards are bulky and they require large storage space. For contrast, one average reel (2400 ft) of magnetic tape can store the same amount of data as 32,000 punched cards.

Keypunch equipment can be placed in three categories:

1. Keyboard to card punch
2. Typewriter to card punch
3. Manual card punch

Most of today's keypunch equipment falls under the first category. Key arrangement is similar to an ordinary typewriter, but there are significant differences. (The nature and effect of these differences will be discussed under the heading of Key Arrangement.)

Card punches which fall under the second category produce cards with a typewriter as input keyboard. There are more than a dozen manufacturers of such products, each offering advantages and flexibilities. Most of these products are, or can be equipped with a paper tape punch in addition to the card punch. Some are offered with additional features such as a paper tape reader and an edge card punch and reader.

Card punches of the third category produce punched cards with a manual lever after positioning appropriate code levers or buttons.

KEY-TO-TAPE DATA ENTRY EQUIPMENT

Two forms of keyboard-to-magnetic tape (key-to-tape) devices have been introduced into the data processing equipment market. One records keyboard data directly onto computer-compatible magnetic tape, bypassing the card punch operation. The other records keyboard data from a typewriter onto magnetic tape in cartridges or cassettes. Information recorded on computer-compatible devices can be fed directly to the central processing unit (CPU), while the data recorded on the latter type of equipment must be transferred and translated before it can be fed to the CPU.

Computer-Compatible Key-to-Tape Equipment

These products are manufactured by more than ten firms. Mohawk Data Science Corporation introduced the first key-to-tape data entry device in 1965. It was the first serious offering of a replacement for the keypunch. This infant product emerged in the data processing world with the mission of "David" to challenge "Goliath." The position of the new product was strengthened and fortified by the announcement of Honeywell Keytape in 1968. It was a long awaited "amen" and endorsement by a major computer manufacturer. In 1969, only four years after the entry of key-to-tape devices, a single year's total of key-to-tape data entry devices was estimated to be nearly 33% of the same period's sales of keypunch devices.

While sharing the same function as the logical substitute for keypunch machines and improved data input devices, the various key-to-tape devices vary from one another. To assist you in evaluating and understanding these products, some significant features and differences are described below.

Four different basic designs are utilized in current key-to-tape data input devices:

1. Reel-to-reel drive with vacuum metering
2. Reel-to-bin drive with single capstan metering
3. Reel-to-reel drive with capstan metering
4. Cartridge drive

The first method allows use of the total length of tape (2400 feet of tape stored on a 10½-inch reel). Because the metering function is done by vacuum via the read/write head, this design minimizes the risk of damaging tape and causing tape transport irregularities. Also, a super precision reel drive is not required since the vacuum chambers achieve tape guiding and tensioning. With this design, the tape has very little chance to attract dust from the ambient atmosphere, with or without static charge, because its only contact with ambient atmosphere is made in reel-to-reel movement. This type of tape drive permits tape speed of 24 inches per second and a recording density of up to 800 bits per inch.

The second method, which employs reel-to-bin drive with a single capstan metering, collects recorded tape in a bin instead of with a take-up reel. The design requires precision tape guides and a capstan. The capacity of the bin has to be big enough to store at least one day's work of an operator.

Most reel-to-bin systems use a 10½-inch reel with 2400 feet of tape; of this, 1200 feet can be stored in the bin, the capacity of which is usually adequate. This design, however, requires that the tape be exposed to the ambient atmosphere for a long time, and consequently, its chances of gathering dust are high. Also, the tape has to be in contact with guides and the capstan, the probability of tape transport irregularities and tape damage cannot be ignored.

The third method, which employs reel-to-reel drive with capstan metering, permits reel-to-reel storage. The tape has very little chance of attracting dust from the atmosphere. But a design of this nature requires mechanical tape guides in addition to the capstan, and each guide contacts with the face of the tape.

The fourth method employs a cartridge with magnetic tape enclosed. This method usually permits easy and safe loading and storage. Most of the cassette or cartridge tape drives are used for noncomputer-compatible tape recording of textual data.

Key-to-tape products have been well accepted by the data processing world but not without some difficulties and complaints. Keyboard operators or their supervisors are accustomed to keypunch operation. Clicking, rattling, mechanical impact of keypunch devices and sight of punched card movement gives a tangible feeling of operating something. But all key-to-tape equipment is very quiet; no mechanical movement results from a depression of keys (except keystrokes and "release" operation). Operators have the feeling of working into "nothing." This kind of argument makes us wonder what would have happened if key-to-tape devices had come to the world before keypunch devices.

In order to help overcome the problem of seeing physical evidence of work, all key-to-tape products are equipped with displays. The issue with these displays has been whether the whole format or only a program code representing the current location is to be displayed. Some manufacturers display the whole format on a CRT, a system which is very helpful to trainee operators or for keying unusual formats. Those manufacturers not featuring a display claim that skilled operators with high volume production do not have time to refer to the format. This is equal to saying that operators are not expected to look at the keyboard to locate the desired key. Major key-to-tape device manufacturers such as Honeywell and Mohawk do not provide the whole format display, accepting the philosophy that their products are basically for high-volume data entry applications.

All key-to-tape equipment is offered with many features and configurations. Usual optional features include:

1. Communications (standard speed, high speed)
2. Card Reader
3. Pooler
4. Adding Machine
5. Check Digit
6. Paper Reader

1 Equipment Characteristics

7. Input/Output Typewriter

There are two methods of offering these features. One is to set up an array of models especially tailored for particular combinations of input/output devices. The other is to offer a basic model, with each feature offered as an attachment. Manufacturers of these products will use the second method to suit the unpredictable, individual applications of the data processing field.

Noncompatible Key-to-Tape Equipment

Several keyboard-to-cassette devices have been developed, but these devices do not provide direct computer compatibility. Information is recorded on a magnetic cartridge and read to the multiplexer channel of a computer system by a separate tape reader.

This noncompatible equipment presently has no ability to store data in the device itself, but it can accommodate up to 720 character records.

Lack of computer compatibility largely precludes the marketing of key-to-cassette equipment as a substitute for keypunch.

KEY ARRANGEMENT

Regardless of data input methods or equipment, there is one area which deserves a special discussion. It is the key arrangement. All computer-compatible key-to-tape equipment offered as a logical substitute for keypunch is equipped with IBM 029 type key arrangement.

As direct data entry methods bypassing keypunch operation steadily obtain appropriate recognition, keyboard designers have begun to compare the IBM 029 type key arrangement as in Figure 1; 3-row teleprinter key arrangement as in Figure 2; USA standard electric typewriter key arrangement as Figure 3; and in USA standard manual typewriter key arrangement as in Figure 4.

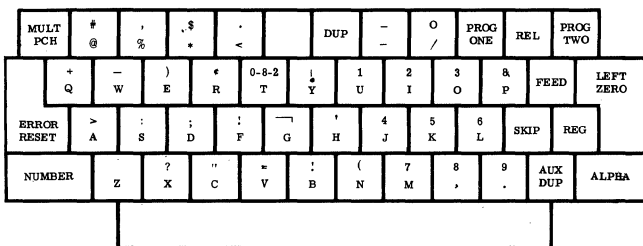

Figure 1. IBM 029 Key Arrangement

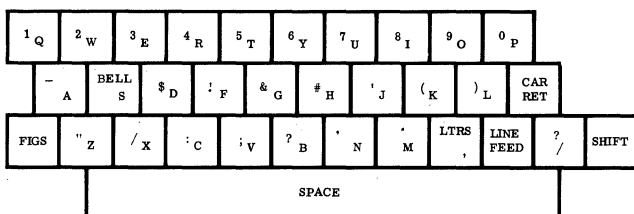

Figure 2. Typical 3-Row Teleprinter Keyboard

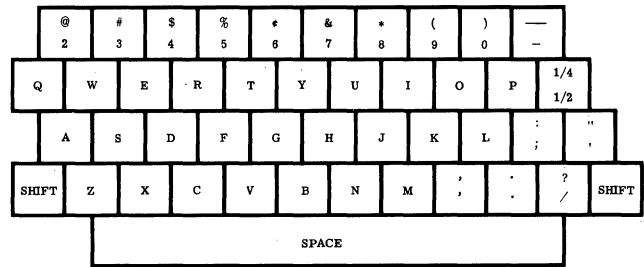

Figure 3. USA Standard Electric Typewriter Keyboard

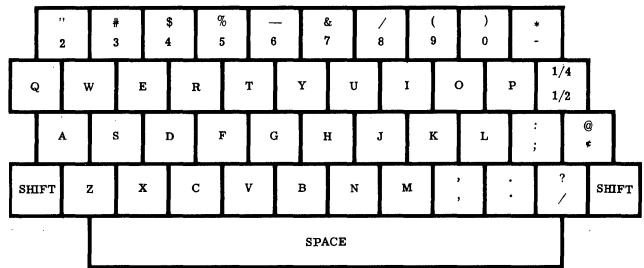

Figure 4. USA Standard Manual Typewriter Keyboard

In the development of a variety of data processing and data communication products, the necessity for a common code was strongly felt by manufacturers, users, and government. Subsequently, a new set of codes was developed and named United States of America Code for Information Interchange (USASCII or ASCII). When the USASCII Code was adopted as a Federal Standard, all the new computers had to offer USASCII capability.

As shown in Figure 5, USASCII code layout has been arranged so that the column and row of any graphic or control character can be determined by developing the decimal equivalent of the four least significant bits and the three most significant bits.

BITS		Column						
b ₇	b ₆	b ₅	b ₄	b ₃	b ₂	b ₁	b ₀	
0	0	0	0	0	0	0	0	
0	0	0	1	0	0	0	0	
0	0	0	1	1	0	0	0	
0	0	1	0	0	0	0	0	
0	0	1	0	1	0	0	0	
0	1	0	0	0	0	0	0	
0	1	0	0	1	0	0	0	
0	1	0	1	0	0	0	0	
0	1	1	0	0	0	0	0	
0	1	1	0	1	0	0	0	
0	1	1	1	0	0	0	0	
1	0	0	0	0	0	0	0	
1	0	0	0	1	0	0	0	
1	0	0	1	0	0	0	0	
1	0	0	1	1	0	0	0	
1	0	1	0	0	0	0	0	
1	0	1	0	1	0	0	0	
1	0	1	1	0	0	0	0	
1	0	1	1	1	0	0	0	
1	1	0	0	0	0	0	0	
1	1	0	0	1	0	0	0	
1	1	0	1	0	0	0	0	
1	1	0	1	1	0	0	0	
1	1	1	0	0	0	0	0	
1	1	1	0	1	0	0	0	
1	1	1	1	0	0	0	0	
1	1	1	1	1	0	0	0	

Figure 5. USA Standard Code for Information Interchange (USASCII)

1 Equipment Characteristics

In the USASCII Code as shown, code for A and B are 100-0001 and 100-0010 respectively. Their decimal equivalents are 4-1 and 4-2, which correspond to column 4, row 1 for A and column 4, row 2 for B. Another significant point of USASCII Code is that upper case-lower case shift can be accomplished by the inversion of a single bit. For example, codes for "A" and "a" are 1000001 and 1100001 respectively. For "A" bit 6 is 0 and for "a" it is 1.

This arrangement is called a logical pairing. Such a pairing makes keyboard logic design simple and inexpensive and has become the top priority preference of keyboard designers.

Keyboard designers have already noticed that none of the key arrangements as shown in Figures 1 through 4 meets the preferred requirement of the logical pairing. That is the reason why most key-to-tape device manufacturers reluctantly ignored the USASCII Code and either adopted Extended Binary Coded Decimal Interchange Code (EBCDIC) as shown in Figure 6 or did not and could not take advantage of logical pairing.

		0000		0001		0010		0011		0100		0101		0110		0111		1000		1001		1010		1011		1100		1101		1110		1111	
Row	Col	0	1	2	3	4	5	6	7	8	9	10	11	12	13	14	15	0	1	2	3	4	5	6	7	8	9	10	11	12	13	14	15
0	0																																
0	1																NUL																
0	2																																
0	3																																
0	4																																
0	5																																
0	6																																
0	7																																
0	8																																
0	9																																
0	10																																
0	11																																
0	12																																
0	13																																
0	14																																
0	15																																
1	0																																
1	1																																
1	2																																
1	3																																
1	4																																
1	5																																
1	6																																
1	7																																
1	8																																
1	9																																
1	10																																
1	11																																
1	12																																
1	13																																
1	14																																
1	15																																

Figure 6. Extended Binary-Coded-Decimal Interchange Code (EBCDIC)

If the keyboard is not logically paired for USASCII, it requires not only expensive encoding and decoding but a code converter via hardware or software to convert non-USASCII Code to USASCII inside the system. For this reason, both manufacturers and users will probably be inclined to logical pairing keyboards in the future.

Previously unsolved, the problem of taking advantage of the economic merit of USASCII Code and, at the same time, accommodating the keypunch-type or typewriter-type key arrangement, has been resolved by Honeywell's Data Products Division and Honeywell's Microswitch Division. The new keyboard design is based upon an MOS approach. It is capable of outputting four modes, all in USASCII. Two modes are for upper and lower case keypunch-type arrangement, and the remaining two modes are for logically paired typewriter-type key arrangement. The new keyboard is used in the keystations of Honeywell's Keyplex multi-station data entry system. The keyboard utilizes Hall-effect switching, which can minimize or eliminate strobe delay requirements.

In an effort to standardize keyboard arrangement accommodating the character sets of USASCII, the United States of America Standards Institute has proposed two types of standard key arrangements. One of them is a logical bit

pairing key arrangement (see Figure 7) and the other is a typewriter pairing key arrangement (see Figure 8).

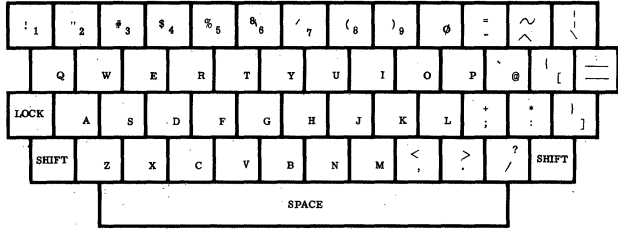

Figure 7. Logical Bit Pairing

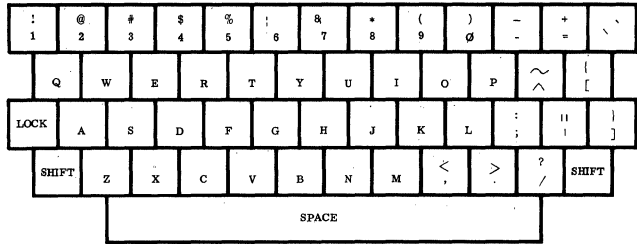

Figure 8. Typewriter Pairing

When this proposal is adopted by American National Standards Institute X4-A9 Keyboard Arrangement Committee, which consists of representatives of major computer companies and the United States Government, it will have the immediate possibility of being adopted as a Federal Standard. The action of the Standards Committee deserves close attention.

MULTISTATION DATA ENTRY SYSTEMS

The next logical phase of data preparation development is multistation keyboard entry. In 1969, Logic Corporation and Computer Machinery Corporation introduced their multi-keyboard entry systems. Honeywell introduced its Keyplex multi-station data entry system, using shared processor control, early in 1970. A typical block diagram of multistation systems is shown in Figure 9.

The multistation systems are a new generation in replacement for keypunch devices. New systems enable up to 64 keyboard operators to enter data, via multiplexing, into the central processor. In some systems a supervisor using a supervisor station can, at the end of any work period, transfer any or all accumulated data onto magnetic tape via the central processor. The disc memory is capable of accumulating the keyed data of 32 keyboard operators at full capability and 64 operators at reduced capability over a period of 8 hours.

Individual keyboard operators may have at their disposal up to 900 different key entry formats, depending on the individual system. Various types of errors will cause the keyboard to lock and error lamps to be illuminated.

Numeric and alphanumeric displays present keyed data, column number, and format information. LED (light

1 Equipment Characteristics

emitting diode) readouts are employed for this purpose in most systems. Lamp readouts inform the operator of the status of batch number, format, program level, and other operating parameters.

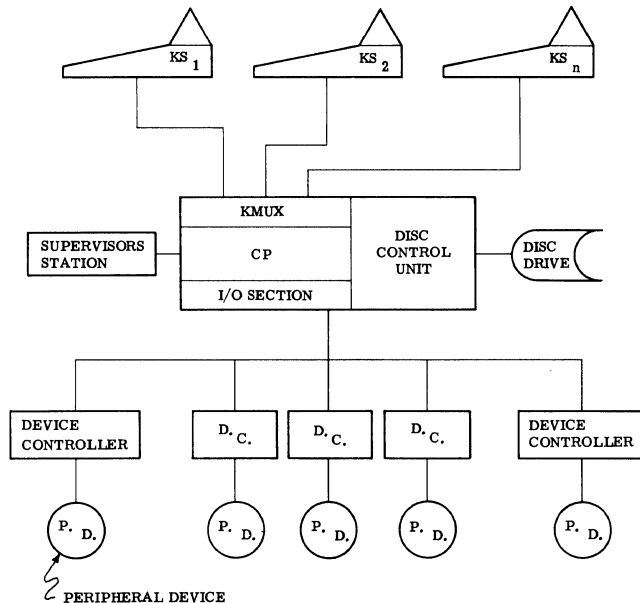

Figure 9. Typical Block Diagram of a Multistation System

Most multistation systems employ a single supervisory station, permitting monitoring of all data handling operations. Supervisory functions include operator assessment, assignment of batch numbers, and determinations of occupied and available areas of the storage disc.

The flexibility of the system is enhanced by the provision of multiple outputs for peripheral devices. Up to 16 peripheral devices may be simultaneously attached, as they are in key-to-tape equipment.

Peripheral attachments typically include the following:

1. Communications-suitable for on-line, off-line, point-to-point and multipoint applications
2. Line printer
3. Paper tape reader
4. Card reader
5. Additional tape drives

Since no handling of punch cards is necessary, the data entry process is fast and convenient for the key operator. Only the input data need be handled, since storage is confined to disc and tape. Elimination of impact punch devices results in an almost noise-free environment. Verification can be achieved by rekeying the data or by programmed auto-check procedures. Corrections are made by rekeying one stroke, instead of repunching an entire

card. An audio tone generator simulates key clicks and warns of errors and end-of-line position.

Operating economy results from a 30% to 50% increase in processed data, in comparison to a keypunch. The cost of cards is about \$1 per 1000, whereas a reel of magnetic tape may be used repeatedly. Storage space of tape reels is negligible when compared to that required for punched cards.

In most multistation systems, software packages provide a large library of business forms, plus many special functions. These include operator efficiency analysis, batch balancing and check digit control. Batch balancing reduces retype validation by automatically verifying the amount-field. Check digit control offers automatic validation of identification numbers. Numerous tallies and records can be supplied automatically by program function or upon command of the supervisor.

CHOOSING A DATA ENTRY SYSTEM

Although it is impossible to list in detail all of the items to be considered when evaluating various data entry systems, the following guidelines will provide an insight into this difficult and sometimes confusing dilemma. First, the user should carefully evaluate the supplier. Among the questions which should be asked are:

1. What is the company's corporate reputation?
2. Have they actually delivered, installed, and made their equipment operational?
3. Is service readily available?
4. Will they supply adequate training and support?
5. Are they willing to take you to an installed site and allow you to discuss their equipment and its operation with the user?

Important Considerations

These are not necessarily listed in any priority, but all should be used in a data entry system evaluation.

- *The Operators* – Although the operators are the last to be affected by a decision, they do perform the actual work. The quantity and quality of the output is dependent on the operator's input. Their acceptance of the system is of the utmost importance and should be given appropriate consideration. If the new system gives the operator a feeling that her job is being upgraded, you have a winner.

- *Operator Training* – If operator turnover is a problem, the amount of training required could be costly. One system may require two weeks of training while another can be learned in two days.

- *System Redesign* – How much systems redesigning will be required? Does this system fit in with your overall data processing equipment and procedures? Will there be any reprogramming required, new forms to be developed, new codes, audit procedures or equipment required? Can the new system be installed without disrupting operations? These tasks can be both expensive and time consuming.

1 Equipment Characteristics

- *Reliability* – Will the new system provide the reliability your data processing department requires? Is service readily available and is there any backup equipment that could be used in an emergency? How good are error control procedures, error checking, the clarity of the indicators, system status indicators, etc?

- *Modularity* – Is there room for growth? Can additional data entry stations be easily added without taking the entire system down? Are there other peripherals which may be added to improve the overall functions, such as printers, remote communicators, etc?

- *Control and Editing* – Is the amount of control capability in this new system adequate? How much is automatic and how much is manual? What type of editing is available – automatic skipping, duplicating, deletions, insertions and the like? Can files be pooled off-line to reduce media handling and improve the efficiency of the computer operations?

- *Record Lengths* – How large a record will the system handle? Longer record lengths can be advantageous to the entire data processing operation. For example, longer records typically allow more keystrokes per hour per operator. More data can be recorded on tape or disk, and longer records provide a more efficient computer operation by minimizing inter-record gaps.

- *Simplicity of Use* – A system that is complex or difficult to use can often defeat the advantages of key-to-tape/disc systems. For example, how difficult is it to enter a format program or correct a record keyed in 20 minutes ago? How easily are tape labels recorded? Is there a record counter to assist the operator in keeping track of work accomplished?

- *Other Considerations* – Can the recording media be removed and placed directly in the computer, or is there an intermediate stage of conversion or translation? Does the entire record have to be operator-verified? And last, but not least, will this system do your job, faster, better and with less cost? A more efficient total operation justifies initial costs.

GLOSSARY

Alphanumeric – a descriptive term used to define a set containing the letters of an ethnic alphabet, the digits 0 (zero) through 9, and punctuation marks or special symbols.

array – the arrangement of keys and character designations on the keys.

batch – a group of documents to be processed; an arbitrary subdivision of a job by the supervisor into smaller, more manageable parts. Batch is the smallest group of such documents accessible by name (number) for data entry, data verify, peripheral device transfers, etc.

bit output – the encoded output from the keyboard which is presented at the system interface in the form of logic “0” or logic “1.”

block – (1) A group of words considered as a unit; most often used in the context of data transfers. (2) a circuit assemblage which functions as a unit.

block array – an arrangement of keys where the rows are not offset but rather appear in vertical columns. The block array is most commonly used for function or numeric clusters.

byte – a group of binary digits usually operated upon as a unit.

card edge connector – a connector that mates with pads on the edge of the printed circuit board. It permits simple interfacing of the keyboard to a system.

character – one symbol of a set of elementary symbols corresponding to the keyboard keys; for example, letters A-Z, digits 0–9, punctuation marks, operation symbols, etc.

control character – a functional character, as distinct from a graphic character, which is intended to facilitate information interchange by controlling or modifying the function of machines or systems. Control characters are intended to be interpreted by machines rather than human beings and are, therefore, normally nonprinting characters. In the USASCII code table they comprise Columns 0 and 1.

control mode – the condition of the keyboard when a Control Function Key is operated. In this mode, those keys having control characters will generate their respective control code regardless of the status of the shift or shift lock key.

displacement – the total travel of the button from free position to full overtravel.

document – a form, voucher, or written evidence of a transaction.

dual mode – a keyboard with two code assignments for all or some of the keys. A shift key is used to determine which code is presented to the system.

electrical monitor – a circuit arrangement consisting of a network of resistors attached to each key. This circuit is used within the keyboard to block strobe when more than one key is operated at the same time.

enable – additional logic, added to the basic shift circuit, which will initiate shift of a code that would not take place with the standard shift logic circuit.

field – an assigned area in a record to be marked with information; a field is a group of one or more characters.

file – an organized collection of information directed toward some purpose.

format – a predetermined arrangement of characters and fields within a record.

format control – a set of descriptions of, or restrictions on, the characters which are controlled by that format; for example lower shift, Auto Skip/Dup, etc.

format number – the number given to a specific format; these numbers are used to make a library from which certain formats are used by the operator according to the structure of the documents in a particular job. Format

1 Equipment Characteristics

Number is identical to Program Number in this context, but the latter is used because it corresponds to what the operators are accustomed to on keypunch.

function key – a key, such as the Shift or Control key which initiates or modifies a machine function, but which does not generate or represent a coded character in the USA Standard Code for Information Interchange.

inboard control – those controls that are positioned on keys that normally contain one or both of the unshifted and shifted graphics in the USASCII code. These controls are operated in conjunction with a Control Function key.

inhibit – additional logic, added to the shift circuit, which prevents the shift of a code that would normally take place with the basic shift.

intercharacter time – the time interval between successive key strokes. On an electronic keyboard it is the time from the operating point of the second key depressed.

interface – a common boundary between the system and the keyboard.

interlock – a method of preventing erroneous data entry as a result of the operation of a second key before the first is released. Early types of interlocks were mechanical; however, electrical interlocks are much more suited to high-speed data entry and communications equipment.

item – has two meanings: (1) in IBM 029 parlance an item is a collection of records associated with one (source) document; (2) for most of the computer industry, an item is a set of one or more fields containing related information. An item is then an arbitrary subdivision of a record.

job – an organized collection of information (usually documents) directed toward some purpose. Synonymous with file.

keyboard – that area of the device in which the keys associated with characters are arranged.

keyboard arrangement – the positioning of keys with relation to each other and their association with specific characters.

legend – a character or a group of characters (numerals, letters or symbols) on a button's top surface.

logic outputs – the output from the keyboard to the system where logic "0" and logic "1" are defined levels.

logical bit pairing – the assignment of characters on a keyboard in such a manner that their codes differ by only one bit between the shifted and unshifted modes. Thus, shift may be accomplished by the inversion of this single bit.

metering – function of assuring that the tape moves past the transducer at a uniform rate, using tape supplied by the first half of the reeling function and delivering to the second half of this function.

monomode – a keyboard with only one code assignment per key.

MSP – most significant position of a field; can include several subfields.

outboard controls – those controls that are positioned on keys by themselves and do not operate in conjunction with a control function key.

parity – a binary digit appended to an array of bits to make the sum of all bits always odd or always even.

program field – a term used to indicate the format control in effect for a particular column.

program level – corresponds to the P1 and P2 of IBM 029.

record – a group of related fields of information treated as a unit.

quiescent state – a state where no keys are operated.

rollover – the operation of a second key before the first key is fully released. A phenomena occurring as a skilled typist reaches "burst" speeds while typing frequently used words such as "the" and "and."

sector – a fixed-size group of characters or bytes used as a unit of I/O transfer. (To the disc only.)

trifunction – associated with inboard control character assignment. A keyboard having three character assignments per key on all or some keys: one in the unshifted mode; a second in the shifted mode; and a third in a control mode.

two-key rollover – a keyboard option that permits the operator to type at "burst" speeds without generating a system error. It permits a second key to be operated before the first key is released. This is accomplished with circuitry which blocks strobe output during the interval when more than one key is depressed.

unit record – a separate record that is similar in form and content to other records.

unshifted mode – the condition of the keyboard when the shift keys are not operated. In this mode, the alphabetic keys are associated with the lower-case letters, the numeric keys with the numerals, and other keys with their corresponding lower graphic symbol.

validate – to insure correctness of data which has been (previously) or is being entered by any of a number of means, including check digit, batch total, numeric only field, and verification.

No contacts. No reeds. No sweat

Just our unique proximity switching, using a single transistor. Combined with our read only memory encoding, you get a keyboard with fewer parts that requires less than 100 ma at 5 volts. (No - 12 volts required.) It's that damn simple. Other features of the CDK include low profile, light weight and rugged construction.

For a few bucks more, we'll fix it so that if the girl dumps her morning coffee onto the CDK, there's no danger, no problem. And the total price will still be competitive with keyboards that can't match our reliability and long life. If you're using, or planning to use keyboards, write for our keyboard spec kit. We'll send it by return mail.



CONTROL DEVICES, INC.

204 New Boston Street
Woburn, Massachusetts 01801 (617) 935-1105



the no-switch switch

1 Equipment Characteristics

KEYBOARDS

COMPANY	CHERRY ELECTRICAL	CONNECTICUT TECHNICAL	CONNECTICUT TECHNICAL	CONTROL DEVICES
MODEL	B65, B70, B80	KB-200	K-301	CDK Numeric 1
FIRST DELIVERY YEAR	1970	1965	1968	1970
UNIT PRICE	\$300	\$750	\$100 - \$450	\$20 - \$45
TYPE OF MECHANISM	electronic plus reeds	mech encoding	reed	solid-state
NUMBER OF KEYS	60	53	10 - 135	10 to 12
KEY FORMAT	any	A-N std IBM type-writer	3/4" ctrs. - in-line or stagger	adding machine
ENCODING	any	all	all or uncoded	BCD
LOGIC COMPATIBILITY	TTL, DTL, MOS	TTL, DTL	TTL, DTL	TTL/DTL neg logic
KEYBOARD OPTIONS				
Keyboard Output Inhibit	yes	no	yes	internal strobe
System Shift	yes	limited	yes	no
Two-Key Rollover	yes	yes	yes	"N" key rollover
Strobe Delay	yes	no	yes	bounceless outputs
Repeat Function	yes	no	yes	no
Error Signal	yes	no	no	no
Odd or Even Parity	both	opt	opt	none
COMMENTS		Selectric keyboard module.		

KEYBOARDS

COMPANY	CONTROL DEVICES	CONTROL DEVICES	DATA GRAPHICS	DATA GRAPHICS
MODEL	CDK-III	CDK-IV	AN-43	N-17
FIRST DELIVERY YEAR	1970	1971	1969	1969
UNIT PRICE	\$98 - \$235	\$100 - \$250	\$250	\$85
TYPE OF MECHANISM	solid-state	solid-state	reed	reed
NUMBER OF KEYS	53	72	47	17
KEY FORMAT	ASR-33	ASR-33, adding machine, function array	alphanumeric	numeric
ENCODING	ASCII (96 char subset)	ASCII (96 char subset)	any	any
LOGIC COMPATIBILITY	TTL/DTL pos or neg logic	TTL/DTL pos or neg logic	TTL	TTL
KEYBOARD OPTIONS				
Keyboard Output Inhibit	internal strobe	internal strobe	yes	yes
System Shift	yes	yes	yes	no
Two-Key Rollover	yes	yes	no	no
Strobe Delay	bounceless outputs	bounceless outputs	yes	yes
Repeat Function	opt	opt	no	no
Error Signal	no	no	no	no
Odd or Even Parity	either	either	both	both
COMMENTS	Custom keyboards on request.			

KEYBOARDS

COMPANY	DIGITRONICS	DIGITRONICS	DIGITRONICS	ELBIT COMPUTERS
MODEL	PK244	PK264	PK275	Miniterminal
FIRST DELIVERY YEAR	1967	1967	1967	1969
UNIT PRICE	\$230	\$280	\$405	\$2000
TYPE OF MECHANISM	photoelec encoding	photoelec encoding	photoelec encoding	contactless
NUMBER OF KEYS	48 max	64 max	90 max	56
KEY FORMAT	diag rows std, vert rows opt	diag rows std, vert rows opt	diag rows std, vert rows opt	029
ENCODING	all	all	all	special Elbit code
LOGIC COMPATIBILITY	TTL	TTL	TTL	0 to +24V std, DTL opt
KEYBOARD OPTIONS				
Keyboard Output Inhibit	yes	yes	yes	yes
System Shift	yes	yes	yes	
Two-Key Rollover	no	no	no	yes
Strobe Delay	no	no	no	yes
Repeat Function	no	no	no	no
Error Signal	no	no	no	yes
Odd or Even Parity	either	either	either	opt
COMMENTS				Special numeric functions keyboard available.

KEYBOARDS

COMPANY	ELEC-TROL	ELEC-TROL	ELEC-TROL	FLEX KEY
MODEL	KB1001-0001, KB-1003-0005	KB1005-0000	KB1007 & KB1009	DK-1
FIRST DELIVERY YEAR	1970	1970	1970	1970
UNIT PRICE	\$18 & \$21	\$27	\$198 & \$178	\$12.95
TYPE OF MECHANISM	reed	reed	reed	proprietary elastomeric membrane
NUMBER OF KEYS	10 & 12	16	62 & 52 plus spacebar	11
KEY FORMAT	0 - 9 & 0 - 12 (3 x 4 array)	0 - 9, A,B,C,D,E,F (4 x 4 array)	TTY & control keys	decimal - adding machine
ENCODING	none	none	ASCII	none
LOGIC COMPATIBILITY	switch closures only	switch closures only	TTL-DTL	all types
KEYBOARD OPTIONS				
Keyboard Output Inhibit	no	no	yes	n/a
System Shift	no	no	yes	n/a
Two-Key Rollover	no	no	yes	n/a
Strobe Delay	no	no	yes	n/a
Repeat Function	no	no	yes	n/a
Error Signal	no	no	yes	n/a
Odd or Even Parity	no	no	both	n/a
COMMENTS			KB1009 does not have 10 control keys.	

KEYBOARDS

COMPANY	LICON DIV - ILLINOIS TOOL	MICRO SWITCH	MICRO SWITCH	MICRO SWITCH
MODEL	Solid State Series 550	4NW3-1 & 4NW7-1	12NW Series	16NW Series
FIRST DELIVERY YEAR	1969	1970	1968	1969
UNIT PRICE	\$100 in qty	\$4.70 & \$5.30	\$6.20 to \$31	\$7.60 to \$41
TYPE OF MECHANISM	ferrite core	mechanical	mechanical	mechanical
NUMBER OF KEYS	unlimited	4	12	16
KEY FORMAT	complete flexibility	1 x 4 switch strip	3 x 4 block switch matrix	4 x 4 block switch matrix
ENCODING	all	none	ASCII, BCD, excess 3 or none	ASCII, BCD, excess 3 or none
LOGIC COMPATIBILITY	DTL, TTL	TTL/DTL	TTL/DTL	TTL/DTL
KEYBOARD OPTIONS				
Keyboard Output Inhibit	no	no	no	no
System Shift	yes	no	no	no
Two-Key Rollover	yes	no	no	no
Strobe Delay	yes	no	no	no
Repeat Function	yes	no	no	no
Error Signal	no	no	no	no
Odd or Even Parity	both	no	no	no
COMMENTS		½" Square or truncated buttons.	½" Square or truncated buttons or key pad.	½" Square or truncated buttons or key pad.

KEYBOARDS

COMPANY	MICRO SWITCH	MICRO SWITCH	MICRO SWITCH	MICRO SWITCH
MODEL	12SW1-1 & 12SW3-1	51SW5-2	53SW1-1	61SW12-1 & -2
FIRST DELIVERY YEAR	1969	1969	1970	1970
UNIT PRICE	\$33 & \$40.50	\$256	\$261	\$325 & \$394
TYPE OF MECHANISM	solid state, Hall effect	solid state, Hall effect	solid state, Hall effect	solid state, Hall effect, MOS encoding
NUMBER OF KEYS	12 & 16	51	53	61
KEY FORMAT	numeric, block array	data preparation, skewed array	model 033 type, skewed array	typewriter, skewed array
ENCODING	BCD	EBCDIC, 4-mode	ASCII, 4-mode	ASCII, 3-modes
LOGIC COMPATIBILITY	TTL/DTL	DTL/TTL	DTL/TTL	DTL/TTL
KEYBOARD OPTIONS				
Keyboard Output Inhibit	no	no	no	no
System Shift	no	yes	yes	yes
Two-Key Rollover	no	yes	yes	yes
Strobe Delay	not required	yes	yes	yes
Repeat Function	no	no	no	no
Error Signal	no	yes	no	yes
Odd or Even Parity	none	odd	odd	odd
COMMENTS	Stock item.	Enclosure and connector included.	Enclosure and connector included.	Enclosure and connector included.

KEYBOARDS

COMPANY	MICRO SWITCH	MICRO SWITCH	MICRO SWITCH	GEORGE RISK INDUSTRIES
MODEL	67SW1-3	69SW1-2	78SW1-7 Series	GRI-547
FIRST DELIVERY YEAR	1969	1969	1970	1968
UNIT PRICE	\$306	\$315	\$329 to \$395	\$320 w/cab
TYPE OF MECHANISM	solid state, Hall effect	solid state, Hall effect	solid state, Hall effect	dry reed
NUMBER OF KEYS	67	69	skewed A/N w/ 2 x 5 or 5 x 5 block	47 & space bar
KEY FORMAT	typewriter, skewed array	graphic arts, skewed array	78	std diag & in-line
ENCODING	ASCII, 2-modes	6-bit, mono-mode	ASCII, dual-mode	ASCII, BCD, IBM & other
LOGIC COMPATIBILITY	DTL/TTL	DTL/TTL	DTL/TTL	DTL/TTL
KEYBOARD OPTIONS				
Keyboard Output Inhibit	no	no	no	yes
System Shift	yes	no	yes	yes
Two-Key Rollover	yes	yes	yes	yes
Strobe Delay	yes	yes	yes	yes
Repeat Function	no	no	no	opt
Error Signal	no	no	no	opt
Odd or Even Parity	odd/even	not required	odd	either
COMMENTS	15 keys may be assigned ASCII codes.	23 keys reserved for code selection.	25 keys reserved for code selection.	

KEYBOARDS

COMPANY	GEORGE RISK INDUSTRIES	GEORGE RISK INDUSTRIES	TEC	UNIMAX SWITCH	UNIMAX SWITCH
MODEL	GRI-556	GRI-573	Citation 600 Series	64K100	per customer spec
FIRST DELIVERY YEAR	1968	1968	1970	1970	1970
UNIT PRICE	\$358 w/cab	\$426 w/cab	\$69.50/5K qty	\$150	\$100 to \$400
TYPE OF MECHANISM	dry reed	dry reed	opto - electronic	mechanical one shot switch	one-shot msec switches
NUMBER OF KEYS	56 & space bar	73 & space bar	46 & 62 & space bar	64	per customer spec
KEY FORMAT	std & in-line	std & in-line	typewriter or TTY	typewriter - sholes	per customer spec
ENCODING	ASCII, BCD, IBM & other	ASCII, BCD, IBM & other	ASCII, EBCIDIC	ASCII	ASCII or any 8 bit code
LOGIC COMPATIBILITY	DTL/TTL	DTL/TTL	TTL/DTL	TTL/DTL	TTL/DTL
KEYBOARD OPTIONS					
Keyboard Output Inhibit	yes	yes	yes	yes	yes
System Shift	yes	yes	yes	yes	yes
Two-Key Rollover	yes	yes	yes	(N-key roll over) by-pass	true bypass
Strobe Delay	yes	yes	yes	no - not nec	yes
Repeat Function	opt	opt	yes	yes	yes
Error Signal	opt	opt	yes	yes	yes
Odd or Even Parity	either	either	yes	yes	either
COMMENTS			Bounce free, contactless.		Interlocks & 2 KRO not necessary.

1 Equipment Characteristics

INPUT TYPEWRITERS

COMPANY	COMDATA	COMPUTER DEVICES	COMPUTER DEVICES	COMPUTER TERMINALS OF MINNESOTA
MODEL	33-KFT-13001	Teleterm CDI 1010	Teleterm CDI 1030	Teleprinter TP-110
BASIC PURCHASE PRICE	\$670	\$2100	\$3500	\$1500
RATE (char/sec)	10	10	10, 15, & 30	10, 11 std - 15 opt
TYPE OF MECHANISM	impact printer	electromechanical	thermal printing	electromechanical
CODE	ASCII	ASCII - RS232C	ASCII & RS-232C	ASCII-88 encoding - 64 printable
CHASSIS		14" x 19"	14" x 19" x 6" - 22#	portable - carrying case avail
COMMENTS	Modified Series 33 KSR Teletype w/various options.	Avail. w/ or w/out built-in modem.	Avail. w/ or w/out built-in modem.	Offers numerous built-in features.

INPUT TYPEWRITERS

COMPANY	COMPUTER TERMINALS OF MINNESOTA	DACONICS	DATA ACCESS SYSTEMS	DATA ACTION
MODEL	Teleprinter TP-1200	2902	Silent 700 Model 720	220 Typescribe
BASIC PURCHASE PRICE	\$2250	\$4300	\$3000	\$3675
RATE (char/sec)	11 std - 15 opt	15	10/15/70	15 (input typewriter)
TYPE OF MECHANISM	electronic - electro-mechanical	selectric	thermal print	electromechanical
CODE	ASCII-88 encoding - 64 printable	correspondence	ASCII	special
CHASSIS	desk top operation			sheet metal
COMMENTS	Offers numerous built-in features.	IBM 731/735 I/O writer w/interface & software for HP family of computers.	Portable electronic printer self contained.	

Also see "Teleprinter and Teletypewriter Data Terminal" charts.

INPUT TYPEWRITERS

COMPANY	DATACON INTERNATIONAL	DESIGN ELEMENTS	FACIT-ODHNER INC.	FUJITSU
MODEL	DATACON 440	DESIGN 101	FACIT Model 3821	FI-788 A
BASIC PURCHASE PRICE	\$1800	\$1800	\$990	\$6000
RATE (char/sec)	15.5	14.8	14.5	10
TYPE OF MECHANISM	TTL, 5 volt level	electromechanical	photo cells, codes in typebars	electromechanical
CODE	Hollerith, ASCII, EBCDIC, BCD	Selectric alphanumeric, BCD; EBCDIC; ASCII opt	ASCII std - opt: 411, 6 bits codes	IBM
CHASSIS	IBM Selectric 11", 13", or 15"	IBM Selectric, industrial version	typewriter Facit 1820	
COMMENTS	Machine readily adaptable for general usage.	Totally self-contained unit, built-in pwr supplies, TTL compat, other features.	Output typewriter: Facit 3841; I/O typewriter: Facit 3851.	

INPUT TYPEWRITERS

COMPANY	FUJITSU	FUJITSU	FUJITSU	FUJITSU
MODEL	FACOM 789 A	FACOM 791 A	FACOM 792 A	FACOM 801 O
BASIC PURCHASE PRICE	\$7500	\$6875	\$4625	\$5000
RATE (char/sec)	10	15	20	15
TYPE OF MECHANISM	electromechanical	electromechanical	electromechanical	electromechanical
CODE	INVAC	ISO	ISO	Facom writer code
CHASSIS				
COMMENTS				

Also see "Teletypewriter and Teletypewriter Data Terminal" charts.

1 Equipment Characteristics

INPUT TYPEWRITERS

COMPANY	ITT - DATA EQUIPMENT AND SYSTEMS	MICRODYNE	UNICOMP
MODEL	Envoy ITT 3010	Microdyne Input/Output Typewriter	400 - ASR33 TTY
BASIC PURCHASE PRICE	\$2750	\$910*	\$1475
RATE (char/sec)	10	15	10
TYPE OF MECHANISM	electromechanical	IBM Selectric - electro-mechanical	electromechanical
CODE	ASCII	IBM correspondence - BCD-ASCII	ASCII
CHASSIS		IBM Selectric	pedestal
COMMENTS	Heavy duty, includes hard copy printing & paper tape read & punch.	*100 qty including 11" IBM 721 Selectric typewriter.	

INPUT TYPEWRITERS

COMPANY	XEROX DATA SYSTEMS	XEROX DATA SYSTEMS	TERMINAL EQUIPMENT CORP.
MODEL	7012 Keyboard/Printer	7021 Keyboard/Printer	TYCOM Baseplate
BASIC PURCHASE PRICE	\$6000	\$7500	\$750 (w/o typewriter)
RATE (char/sec)	10	10	to 15.4
TYPE OF MECHANISM	electromechanical	electromechanical	electromechanical baseplate
CODE	EBCDIC	EBCDIC	Selectric - parallel
CHASSIS			Selectric typewriter
COMMENTS	Modified KSR-35. Price includes controller.	Modified 35 ASR Teletype.	Readily converts std IBM Selectric to full I/O device.

Also see "Teleprinter and Teletypewriter Data Terminal" charts.

KEY-TO-DISC ENCODERS

COMPANY	COMPUTER MACHINERY	COMPUTER MACHINERY	COMPUTER MACHINERY
MODEL	CMC-5	CMC-7	CMC-9
FIRST DELIVERY YEAR	1971	1970	1969
BASIC PURCHASE PRICE	6 sta \$39,600	20 sta \$104,000	32 sta \$156,300
LEASE RATE/MONTH	\$990 plus \$116 maint.	\$2400 plus \$230 maint.	\$3615 plus \$342 maint.
RECORDING CHARACTERISTICS			
Min. Record (char)	1	1	1
Max. Record (char)	112	112 to 176	240
Max. Char/Field	64	64	64
Max. Field/Record	32	32	32
NUMBER OF FORMATS	100	199 to 700	1000
OUTPUT CHARACTERISTICS			
Computer Format	all	all	all
No. of Tracks	7 or 9	7 or 9	7 or 9
Density (bpi)	556, 800, 1600	200, 556, 800, 1600	200, 556, 800, 1600
Reel Size	7"/10½"	10½"	10½"
Compatibility	yes	yes	yes
EDITING			
Before Entry	yes	yes	yes
After Recording	yes	yes	yes
DISPLAY			
Form	English alphanumeric	English alphanumeric	English alphanumeric
Field Position	yes	yes	yes
Simultaneous Display	1	1	1
KEYBOARD			
Compatibility	IBM 029	IBM 029	IBM 029
PROCESSOR			
Programmable	yes	yes	yes
Storage Capacity	n/a	n/a	n/a
Optional Software	yes	yes	yes
OPERATOR AIDS			
Backspace	yes	yes	yes
Error	yes	yes	yes
Control Function	yes	yes	yes
Alarm	yes	yes	yes
NUMBER KEYSTATIONS			
Min.	1	1	1
Max.	12	32	32
MONITOR STATION			
Device Type	ASR 33	ASR 33	ASR 33
Entry Monitoring	yes	yes	yes
Software	yes	yes	yes
Supervisory Functions	extensive supervisory reports		

1 Equipment Characteristics

KEYBOARD

KEY-TO-DISC ENCODERS

COMPANY	CONSOLIDATED COMPUTER	DATA SYNTEKS	ENTREX
MODEL	Key-Edit 100	Magnescriber-11	System 480
FIRST DELIVERY YEAR	1969	1971	1970
BASIC PURCHASE PRICE	\$79,900	\$105,000 (15-term., 7-track)	\$80,435
LEASE RATE/MONTH	\$1180 plus \$350 maint.	\$2650 plus \$725 maint.	\$1927 plus \$264 maint
RECORDING CHARACTERISTICS			
Min. Record (char)	80	one	none
Max. Record (char)	560	400 to 1000	4096 opt, 480 std
Max. Char/Field	560	400	no limit
Max. Field/Record	560	400	no limit
NUMBER OF FORMATS	—	std: 30, ea 7 prog levels opt: 100, ea 7 prog levels	std 10/file (batch) 1000 in library
OUTPUT CHARACTERISTICS			
Computer Format	BCD, ASCII, EBCDIC	ASCII, EBCDIC	BCD or EBCDIC
No. of Tracks	7 or 9	7 or 9	7 or 9
Density (bpi)	200, 556, 800, 1600	200, 556, or 800	556 or 800 (7-tr) 800 or 1600 (9-tr)
Reel Size	10½"	10"	to 10½"
Compatibility	IBM/Honeywell, RCA, CDC, Burroughs, NCR	industry/IBM	std ½"
EDITING			
Before Entry	yes	yes	yes
After Recording	yes	yes	yes
DISPLAY			
Form	English alphanumeric	alphanumeric	alphanumeric
Field Position	yes	yes	yes
Simultaneous Display	single character	1 alphanumeric or 9 decimal	to 64
KEYBOARD			
Compatibility	029	029	029 keypunch or std typewriter
PROCESSOR			
Programmable	yes	yes, Data Synteks' FORGRAM	yes
Storage Capacity	up to 32K	8K, 12K or 16K opt	65K max
Optional Software	yes	yes	yes
OPERATOR AIDS			
Backspace	yes	yes	yes
Error	yes	yes	yes
Control Function	yes	yes	yes
Alarm	yes	yes	yes
NUMBER KEYSTATIONS			
Min.	8	1	8
Max.	32	31	64
MONITOR STATION			
Device Type	typewriter	any terminal at any time, plus printed output via ASR-33	CRT or typewriter
Entry Monitoring	yes	yes	yes
Software	yes	yes	yes
Supervisory Functions	—	—	—

KEY-TO-TAPE ENCODERS

COMPANY	DATA ACTION	DATA GRAPHICS	ELBIT COMPUTERS	KEYMATIC DATA SYSTEMS	POTTER INSTRUMENT
MODEL	150 Magnetic Data Inscrber	Datos 302-18 Series	VALIDATA	Keymatic 1093	KDR
FIRST DELIVERY YEAR	1970	1969	1969	1969	1969
BASIC PURCHASE PRICE	\$6900	\$7000 & \$8100	\$100,000 (12 term sys)	\$9570	\$7200
LEASE RATE/MONTH	\$135				\$135
MAINT. RATE/MONTH	\$20			\$37	
RECORDING CHARACTERISTICS					
Min. Record (char)	1	1	1	1	20
Max. Record (char)	720	arbitrary	200	10,000 (unlimited)	160
Max. Char/Field	15	unlimited	64	unlimited	160
Max. Field/Record	48	unlimited	16	unlimited	160
NUMBER OF FORMATS	8	totally programmable	100		2
OUTPUT CHARACTERISTICS					
Computer Format	EBCDIC	ASCII, EBCDIC, IBM 7-level	char, serial, ASCII, BCD	EBCDIC	IBM compatible
No. of Tracks	9	7 or 9	7/9	9	7 or 9
Density (bpi)	20 char/in.	556 or 800	200, 556, 800, 1600	800	200, 556, 800
Reel Size	100'	8½"	8.5/10.5	to 1200'	10½"
Compatibility	Data Action Tape pooler & IBM 2495	IBM	IBM/any other	360	IBM
EDITING					
Before Entry		no	yes	yes	yes
After Recording	yes	no	yes	no	yes
DISPLAY					
Form	alphanumeric	binary	alphanumeric	alpha & binary	binary
Field Position	yes	no	yes	yes	yes
Simultaneous Display	no	1 char	14	80	3
KEYBOARD					
Compatibility	std, keypunch	std alphanumeric	029	typewriter	
PROCESSOR					
Programmable		yes	yes, minicomputer (Elbit 100)	no	n/a
Storage Capacity		none	8K	none	
Optional Software		no	yes	yes	
OPERATOR AIDS					
Backspace	yes (opt)	no	yes	yes	yes
Error	yes	yes	yes	yes	yes
Control Function	yes	yes	yes	yes	yes
Alarm	yes	no	yes	yes	yes
NUMBER KEYSTATIONS					
Min.	1	1	1	stand alone	1
Max.	unlimited (stand-alone units)	1	12		1
MONITOR STATION					
Device Type		none	ASR 33	none	n/a
Entry Monitoring			yes		
Software			yes		
Supervisory Functions					
COMMENTS		7 & 9 Track models. 1200' tape.	1200' tape.		

1 Equipment Characteristics

KEY-TO-TAPE ENCODERS

COMPANY	SCHULTZ INSTRUMENTS	TRANSITEL COMPUTER SUPPORT SYSTEMS DIV-SANGAMO	TRANSITEL COMPUTER SUPPORT SYSTEMS DIV-SANGAMO	TRANSITEL COMPUTER SUPPORT SYSTEMS DIV-SANGAMO	TRANSITEL COMPUTER SUPPORT SYSTEMS DIV-SANGAMO
MODEL	68MD6.1 Tape Loader	Data Station-7100	Data Comm Terminal-7300	Data Station-9100	Data Comm Terminal-9300
FIRST DELIVERY YEAR	1968	1969	1969	1969	1969
BASIC PURCHASE PRICE	\$2200	\$7640	\$9510	\$8200	\$10,310
LEASE RATE/MONTH		\$140	\$200	\$155	\$220
MAINT. RATE/MONTH	n/a	\$18	\$32	\$22	\$35
RECORDING CHARACTERISTICS					
Min. Record (char)	3	20	20	20	20
Max. Record (char)	capacity of tape	240	240	240	240
Max. Char/Field	3	240	240	240	240
Max. Field/Record	variable	n/a	n/a	n/a	n/a
NUMBER OF FORMATS	custom	2	2	2	2
OUTPUT CHARACTERISTICS					
Computer Format	custom	BCD	BCD	EBCDIC	EBCDIC
No. of Tracks	1 track	7 track	7 track	9 track	9 track
Density (bpi)	n/a	556 std, 200 or 800 opt 800 opt	556 std, 200 or 800 opt 800 opt	800	800
Reel Size	cassette	7"	10½"	7"	10½"
Compatibility	acoustic				
EDITING					
Before Entry	yes	yes (through format control)	yes (through format control)	yes (through format control)	yes (through format control)
After Recording	no	yes	yes	yes	yes
DISPLAY					
Form	binary	alpha & binary	alpha & binary	alpha & binary	alpha & binary
Field Position	no	column indicator	column indicator	column indicator	column indicator
Simultaneous Display	0 (zero)				
KEYBOARD					
Compatibility	self-contained	IBM (47 & 64), BURR, HON, GE, NCR, RCA, UNIVAC	IBM (47 & 64), BURR, HON, GE, NCR, RCA, UNIVAC	EBCDIC	EBCDIC
PROCESSOR					
Programmable	any could be used, w/proper programming	n/a	n/a	n/a	n/a
Storage Capacity	depends on processor				
Optional Software	depends on processor				
OPERATOR AIDS					
Backspace	no	yes - field memory & record	yes - field, memory & record	yes - field, memory & record	yes - field, memory & record
Error	yes	yes	yes	yes	yes
Control Function	yes	yes	yes	yes	yes
Alarm	no	yes	yes	yes	yes
NUMBER KEYSTATIONS					
Min.	1 (one)	n/a	n/a	n/a	n/a
Max.	4				
MONITOR STATION					
Device Type	acoustic	n/a	n/a	n/a	n/a
Entry Monitoring	no				
Software	yes				
Supervisory Functions	depends on software				
COMMENTS					

**THINK
SMALL**

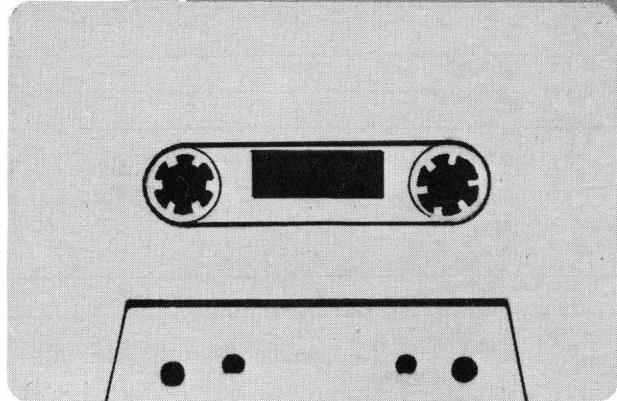

THINK BIG

**THINK OF CLIFTON WHEN YOU NEED
A MOTOR TO DRIVE A TAPE REEL**

Need a motor to drive cassette tape reels?

Clifton has a size 13 DC servo motor designed to directly drive cassette reel tapes at speeds from two to twenty inches per second without any intervening mechanical gearing. A low ripple torque keeps tape drive uniform and read/write speed control accurate to within $\pm 3\%$. A high starting torque means start times range from 3 milliseconds to 8 milliseconds, depending on speed. On a rewind or fast forward setting, the motor will drive a full 300 foot tape in less than 90 seconds.



How about a motor to drive 16-inch tape reels?

For the larger reels, Clifton has a new DC torque motor which features a long wearing gold alloy commutator (rather than an ordinary copper or gold plated copper commutator) for longer motor life, and specially formulated magnetic material alloys which eliminate the prob-

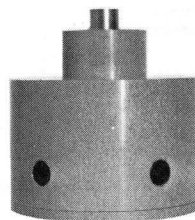

lem of degraded motor performance due to "plugging."

Readily accessible cartridge-type brushes permit field brush replacement without disassembling the motor. Bearings are lubricated for life and double-shielded to prevent any dirt contamination.

A high torque-to-inertia ratio design produces a 5500 Rad/Sec^2 theoretical acceleration. A standard low ripple torque of 5% average-to-peak assures smooth operation at tape speeds as low as $\frac{7}{8}$ inch per second. Lower ripple torques are available.

For further information on either or both motors, contact your local Clifton Sales office or 5050 State Road, Drexel Hill, Pa. 19026.

CLIFTON 
DIVISION OF LITTON INDUSTRIES

Magnetic Tape Equipment

A discussion of magnetic tape units for use with digital computer systems must start with some serious mention of magnetic disc devices and systems also, indicating, at least generally, some of the economic and technological comparisons between these two forms of moving-medium digital data storage.

The first consideration is whether the data processing job to be done poses an absolute requirement for one type of device or the other. For example, in a fast-response reservation system, where randomly located particular information is needed within a few seconds from inquiry, a conventional pure tape system cannot do the job, thus disc capability is necessary.

There are, however, many business and scientific applications where the processing is inherently or conveniently batch-oriented or sequential, and in these cases, a full knowledge of the economics of using tapes or of using discs is very desirable.

Although various storage cost figures in terms of fractional cents per bit with tapes and with discs can be found in survey literature and in various private reports, the bases for computation of these costs are usually not given and the results are therefore hard to compare and possibly quite considerably in error. It is part of our purpose here to suggest a common-sense objective, explicit method of calculating storage costs for discs and tape, attempting to take into account all costs assignable to data storage without favoring either discs or tape unfairly. Regrettably, cost comparisons calculated on this suggested basis are not presently available, but it is hoped that next year's edition will be able to present such results.

Such cost comparisons are sometimes presented in unnecessarily varied ways — cost per bit, per 6 bit byte, per 8 bit byte with checking bit, etc. Accordingly, it is proposed here that the standardized basis of quoting *per checked byte* be adopted, i.e., that figures be calculated per byte (eight bits) with one extra bit included for checking, preamble/postamble, and the like. Such a convention might well be adopted for main memory cost comparisons also.

The proposed calculation scheme is somewhat easier to describe than to implement, but does have the merit of reflecting, in each case, a representative existing usage, by actual computer users, of on-the-market equipment and software. For descriptive purposes, let us divide the tape users into small systems (*overall outright cost* of tape transports, tape control electronics, reels of tape, and other costs such as library storage totaling less than \$75,000, for example); medium-sized system (corresponding figures between \$75,000 and \$300,000 say); and large systems (above \$300,000). Similarly, we divide the disc users. For a

small number of hopefully-typical users in each classification, let us tabulate all pertinent facts concerning equipment involved, number of reels of tape or disc packs owned, record sizes (showing the influence of system size on storage efficiency), etc. Finally, we will have an *overall cost of ownership* and an *overall total size of files*, two figures whose ratio gives the meaningful result desired.

Note that the major stumbling block of making some initial assumption as to the number of reels of tape per tape transport or of disc packs per disc drive is completely avoided, since the user presumably does not own many more reels or discs than he needs to conduct his business effectively. Furthermore, a grand average of all usage is taken automatically, covering everything from program storage to working media to archive storage.

Such numbers would represent the real world. Individual-user figures would probably be averaged within classifications for publication anonymity, but each would represent some approach to optimization as carried out for his own business purposes by the particular user in question.

The value to a computer user of knowing how well his usage compares to the appropriate average should be sufficient to make him willing to provide the necessary raw data. Detailed knowledge of this type and scope would be sufficiently useful to existing users, to prospective users, and to the equipment manufacturer's product planners and marketers to make the data-gathering and analysis well worth doing. Comparison of such results with currently-available fragmentary or hunch-type figures should be most illuminating.

MAGNETIC TAPE TRANSPORTS FOR HALF-INCH TAPE

Nearly all magnetic tape equipment in use today is of the standard half-inch variety, with the usage divided between the older seven-track and the newer nine-track formats (Figures 1-3). Considerable standards activity involving manufacturers of tape transports and of magnetic tape, together with other interested parties, has been taking place over the past several years (Table 1). This work has resulted in several issued standards and in other proposed standards, all of general usefulness and importance.

We will refer to several of these documents, the sources of which are listed at the end of this section. Those documents already accepted as standards are issued by the American National Standards Institute (ANSI) — formerly known as American Standards Association (ASA) and United States of American Standards Institute (USASI). The sponsoring organization for each of these American Standards is the Business Equipment Manufacturer's Association (BEMA),

1 Equipment Characteristics

under whose auspices the detailed committee work is carried out; in the pre-approval stage the documents carry a BEMA working number such as X3.2.1/402, and when issued as a proposed ANSI standard, the small prefix "p" indicates the "proposed" status.

A natural dividing line is recognized between standards for *unrecorded* tape and those for recorded tape. The former standard is the foundation and prerequisite for the latter. It covers in detail the physical properties, magnetic properties, and dimensional details of the tape itself, the mechanical dimensions and details of the reels, nature and placement of beginning-of-tape and end-of-tape markers, etc., all of which are prerequisites for a reel of tape to accept recording from any conforming device and to yield suitable playback signals when run on any conforming device, regardless of supplier of tape or device.

The *unrecorded magnetic tape* standard carries a title which refers to various nine-track recording formats. But where is a standard for seven-track magnetic tape? The answer is that the unrecorded standard is understood to apply in full to the seven-track usage also. The thrust of the standardizing effort is directed at providing "a standard for 1/2-inch wide unrecorded magnetic tape and reels to enable mechanical and magnetic *interchangeability* of tape between information processing systems, communication systems, and associated equipment *using the ASCII*,

X3.4-1968 and amendments thereto" (italics supplied). Since this American Standard Code for Information Interchange (ASCII or USASCII, pronounced "as-key") requires seven data bits, it cannot be fitted neatly together with the extra parity bit, into a seven-track recording format. All referred-to usages thus deal with the nine-track recording format, which accommodates ASCII and other current coding schemes. A *recorded* standard for seven-track usage was drafted at one time but has not appeared as an issued standard since it has been decided that issued standards will be confined to ASCII and interchange media.

Table 1. Industry Standard Tape Formats

		Coding	Error Protection
7-track	— 200 cpi	NRZI	VRC, LRC
7-track	— 556 cpi	NRZI	VRC, LRC
7-track	— 800 cpi	NRZI	VRC, LRC
9-track	— 800 cpi	NRZI	VRC, LRC CRC
9-track	— 1600 cpi	PE	VRC, ID Burst

NOTES VRC = Vertical Redundancy Check or Lateral Parity Check (Odd)
 LRC = Longitudinal Redundancy Check Character
 CRC = Cyclic Redundancy Check Character
 ID Burst identifies PE recording and when present it conditions a dual density read system to decode this correctly. When absent, the system expects an NRZI recording to be on the tape.

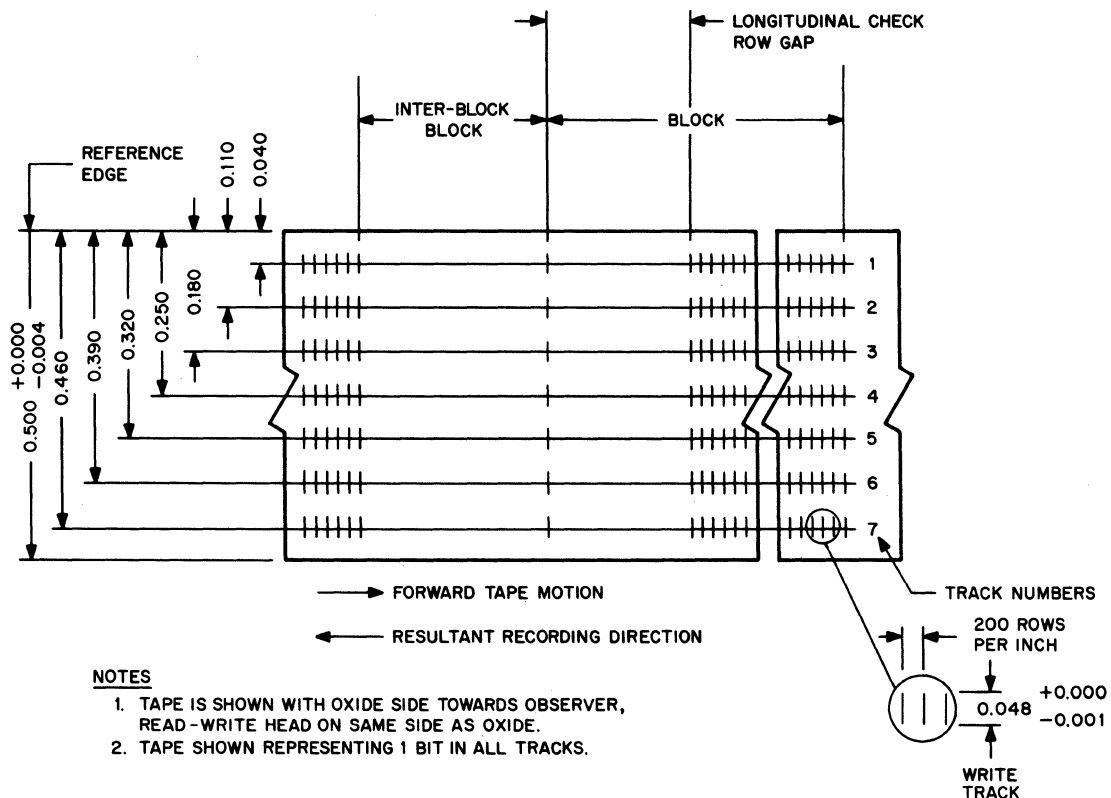

Figure 1. 7-Track Tape Format (Source USASI) 200 cpi

1 Equipment Characteristics

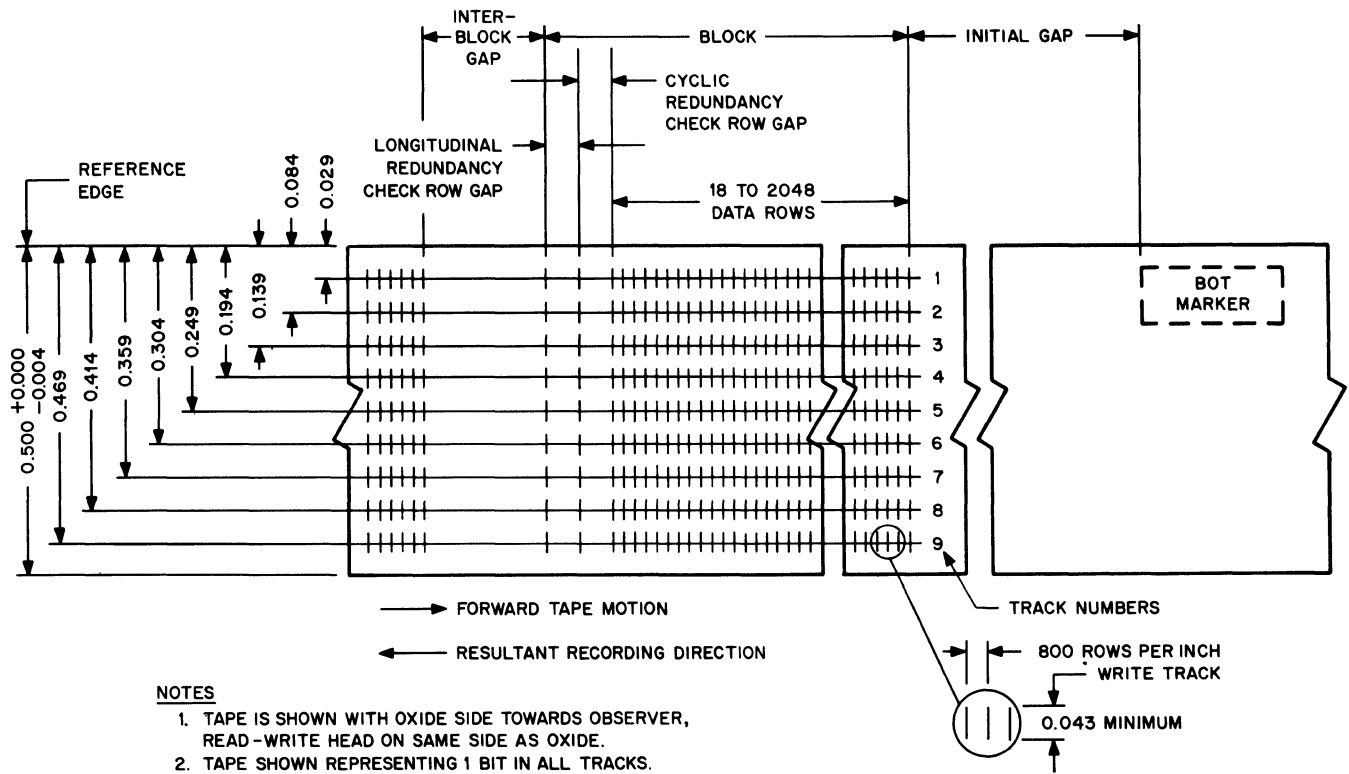

Figure 2. 9-Track Tape Format (Source USASI) 800 cpi

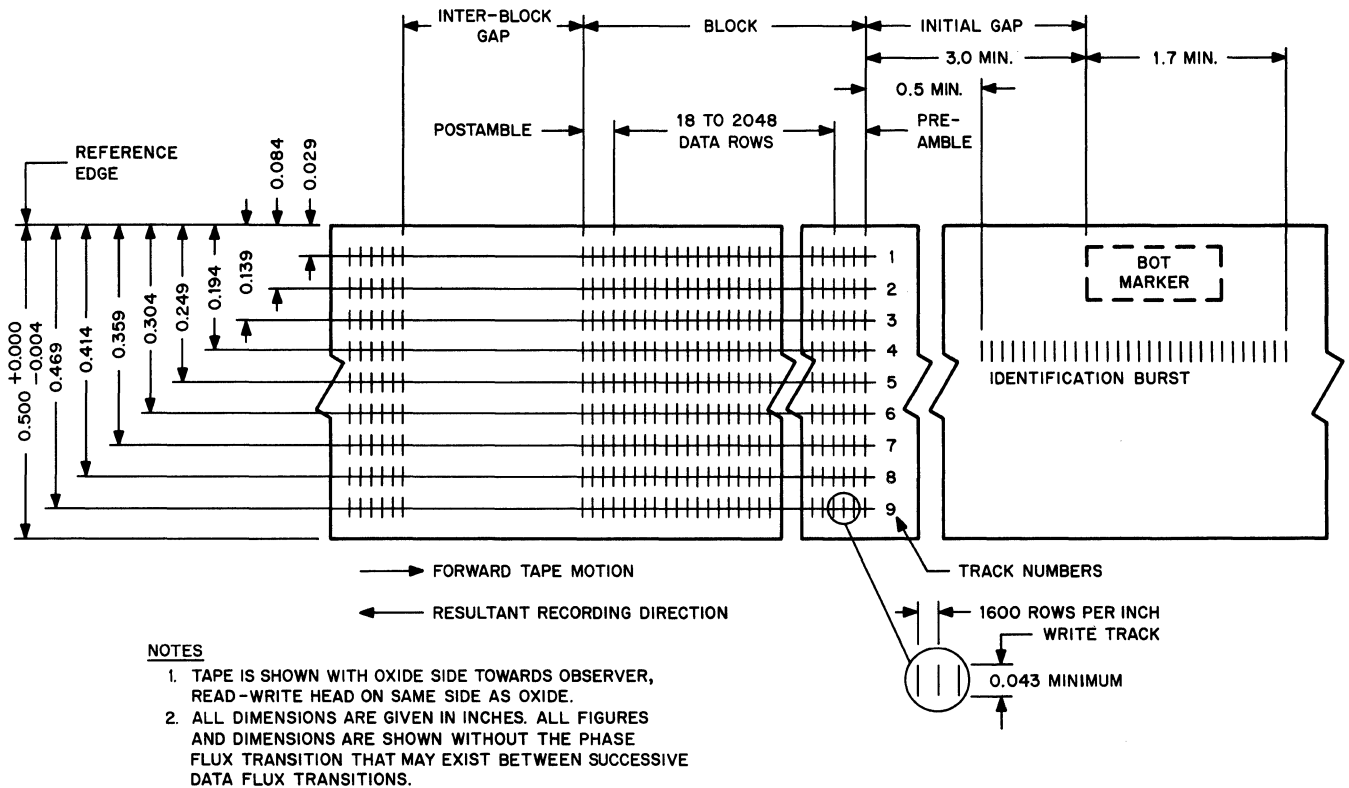

Figure 3. 9-Track 1600 cpi PE Format (Source USASI)

1 Equipment Characteristics

CHARACTERISTICS OF EQUIPMENT PRESENTLY IN SERVICE

Use of magnetic tape equipment in the field is characterized by increasing diversity. At one end of the spectrum, there is a flourishing used-equipment market which includes significant amounts of equipment now considered obsolete — medium- and high-speed transports with pinch-roller clutching, tapes with greater than half-inch width, etc. Higher recording densities and increased data-transfer rates have continued to become available and in many cases field upgrading of existing equipment has been made possible. The result is that a tape system user considering what equipment will best serve his immediate and long-term data-processing needs can choose from many possible alternatives, including no changes at all. At the other end of the spectrum, the introduction some three years ago of high-performance tape equipment with automatic tape loading (threading past the head, attachment to the takeup reel, and positioning at the beginning-of-tape "load point") has been followed by generally similar offerings from several manufacturers, with others expected soon. Satisfactory field experience has been obtained with such systems. Apart from significant savings in tape mounting and dismounting time (about 11 seconds is typical), these equipments eliminate most operator contact with the magnetic tape and its reel, with beneficial reduction in damage, errors, and rerun time attributable to such contact.

The remaining portion of this section consists of a few brief comments on standard half-inch tape systems, which may be of interest to users of magnetic tape equipment.

TAPE PATH CONSIDERATIONS

In recent years, all newly introduced full-sized magnetic tape transports have featured placement of the magnetic head above rather than below the tape; i.e., the tape reaches the head oxide-side-up. This completes the adoption of the configuration (as used by some manufacturers for more than a dozen years) that eliminates all contact between the oxide surface of the tape and any mechanical parts (loop-chamber sides, turnaround rollers, etc.) except the magnetic head itself. This feature has always been useful, and with the advent of 1600-bit per inch recording, it has become a vital necessity in obtaining good tape life and reliable performance. Various types of oxide-contacting tape cleaners are also incorporated in new designs, and some of these implementations yield excellent results.

STOP-START MOTION

In keeping with the avoidance of contact between the oxide surface of the tape and mechanical parts of the transport, the use of pinch-rollers has virtually disappeared from new equipment. Modern tape transports employ one of two techniques for producing bidirectional stop-start motion, both techniques being quite satisfactory. The older of these involves counter-rotating vacuum capstans with suction or air lubrication selectively valved to the capstans and to a brake member to control tape motion. (A variation involving air-pressure applied from overhead "shoes" is also in use.) The other technique, now quite widely employed, is the use of a high-performance direct-current servo motor driving a lightweight single capstan — starting, stopping, and reversing as required by the control unit commands. Interestingly enough, a clutch-and-brake implementation of

the reversible single-capstan approach was used in one of the very first commercial tape transports; the intervening evolution of suitable servo motors and driving circuits has now made the single capstan one of the designs of choice.

TAPE INTERCHANGEABILITY

A word of caution is perhaps appropriate with regard to questions of interchangeability of tapes between transports of different design. One edge of the tape is designated in the standards as the reference edge, and it is general practice to lightly spring-load the tape forward into contact with a reference surface at two locations, one to the left and one to the right of the magnetic head. Let us call these spring-loading guide points by the name "lateral confining station," or LCS for short. It is perhaps not universally appreciated how important it is for achieving fully satisfactory interchange compatibility that the transport mechanisms involved have identical or substantially identical distance between the LCS's and substantially identical placement of the read-write head between LCS's. To be sure, the interchange standard calls for no more than ± 225 microinch skew between outer tracks; in reality, tapes are practically never inspected for this parameter before being delivered to a customer and receiving his recorded data. The important question is thus, once data intended for interchange has been recorded on a non-conforming "snaky" tape, how can successful data interchange be accomplished? In the author's experience, it is a stringent (and not unexpected) necessity for the two tape unit designs in question to have the substantially-identical LCS and head geometries described above. This is necessary but not sufficient, and other criteria such as stringent monitoring of the character timing packet spread at the time of recording are also required. Only thus can data-interchange failure, with its inefficiency and irritation, be entirely avoided.

TAPE REELS

The standards documents contain rather complete specifications for the half-inch reels, including not only critical mounting and clearance dimensions but also a maximum allowable value for the moment of inertia, dictated by the reel-motor capabilities of an important fraction of the tape transports in the field. This latter limitation has, in practice, made it impossible to introduce sturdier reels with flanges less flexible than those of standard-conforming reels. A consequence of flange flexibility is that operators must be careful not to pick up or carry reels by squeezing the flanges, particularly if these are not substantially supported by an in-place, wrap-around storage seal. Occasional protruding layers of tape in the windup on a reel — sometimes referred to as "pop-outs" or "stagger wind" — are not entirely avoidable, considering tape manufacturing process variations, winding tension variations within and between transport mechanisms, and the temperature and humidity fluctuations to which the tape may be exposed, particularly in transit. Crushing of such protruding layers of tape when the reel flanges are pushed or squeezed is a prime potential cause of tape damage. Careful operator technique is necessary in order to obtain best performances; it is even worthwhile to enforce good operator handling by charging the operating crew with down-time and rerun time resulting from such tape edge damage or from folded-leader damage. It is also to be noted that although a 5- to 10-ounce range of tape winding tension is specified in the standard, it is preferable for the equipment to use higher rather than

1 Equipment Characteristics

lower values of winding tension: obviously a lower-tension wind on the inner portion of the reel is in some danger of cinching and slippage if the outer layers are wound on a second equipment which employs higher winding tension than the first.

BOT AND EOT REFLECTIVE PATCHES

The reflecting patches (Figure 4) used for photoelectric sensing of beginning and end of tape are of quite thin material (eight ten-thousandths inch maximum), but embossing of the patch through many successive layers of the tape does produce noticeable and eventually severe effect on the recording oxide surface. The effects are of roughly equal severity with the BOT patch and with the EOT patch, but the former is encountered at least once per usage of a reel of tape whereas the latter is reached only if the tape is recorded for practically its entire length. Thus, a common operating precaution (particularly with high-density recording such as 1600 bpi) is to avoid the first several feet of tape following the load point, where BOT embossing is most severe. This can be accomplished by having the software precede the first block-writing operation by a series of skip-erases (each generally about 3 inches long) until a sufficient footage of tape has been traversed. Notice that the standard requires that this initial skip-erased

portion not exceed 25 feet: an initial erased region of 10 to 15 feet is a useful practical compromise.

HIGH-RESOLUTION TAPES

The last two years have seen a rather limited but successful commercial use of high-resolution tapes with very interesting and promising properties. The parameters of DuPont "Crolyn®" tape (utilizing a proprietary chromium dioxide magnetic component) have been rather closely approximated by the 3M Company's "High Energy" tape, which uses magnetic material different both from CrO_2 and from the conventional gamma ferric oxide of standard tapes. The higher coercivity and greater resolution of these tapes has enabled one manufacturer to successfully produce tape systems operating at 1200 bits per inch NRZI, whereas 800 BPI is the highest density on the market for use with ordinary ferric oxide tapes. It is regrettable that the effect of the standards-writing activity concerned with 1600 bpi tape has been to prevent usage of these technically superior tapes in commercial equipment. It may be that magnetic disc coatings will be the first widespread use of these superior-resolution formulations. Parenthetically, the various persistent rumors of instability, toxicity, temperature sensitivity etc., have never been confirmed in laboratory or actual usage; the rumors may perhaps well be dismissed as not of disinterested origin.

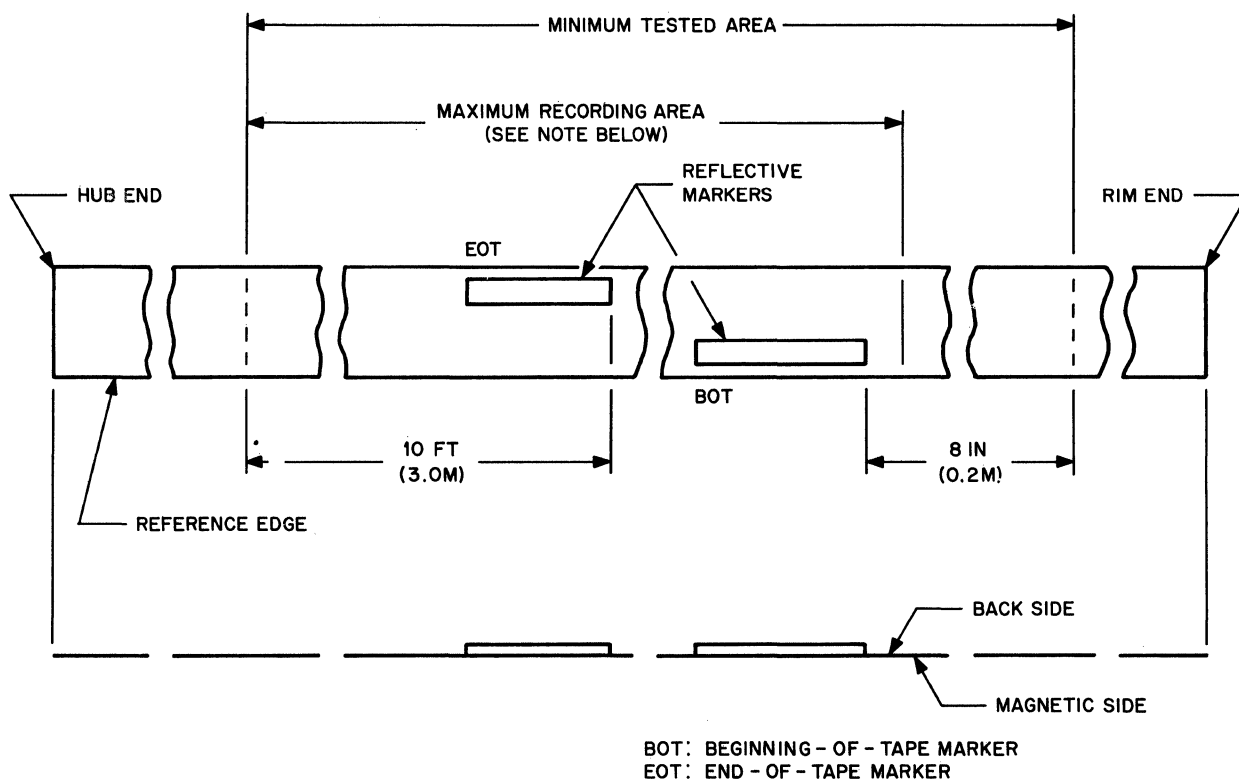

NOTE

THE RIGHT HAND END OF THE "MAXIMUM RECORDING AREA" IS DEPENDENT UPON THE PLACEMENT OF THE IDENTIFICATION BURST BUT SHOULD NOT EXTEND BEYOND THE TESTED AREA.

Figure 4. Reflective Markers and Recording Area (USASI)

1 Equipment Characteristics

HEAD AND TAPE WEAR

The standards are understandably vague about head wear and tape wear, since the number of possible combinations of head configuration, head materials, tape formulation, tension, wrap angle, tape speed, etc., are too many to make any useful general statements possible. Only one or two specific points will be mentioned here. First, there have been tapes placed on the market which produce catastrophic head wear; unfortunately, not all tape manufacturers perform adequate evaluation of this parameter prior to selling their product. Second, the standard tolerances on width to which the tape is slit are unfortunately rather broad, allowing a maximum of 0.500 inch and a minimum of 0.496 inch. Much closer manufacturing control of slitting is feasible and is always obtained in practice. Since the wear of the head is typically in the form of sharp-sided trenches at the edges of tape contact, and since on such a worn head a wider tape will experience great error difficulties whereas a narrower tape will not, there is a practically universal tendency for the width of commercial tape to lie in the low-end range of 0.496 to 0.497 or perhaps 0.498 inch. In recent times, the difficulties produced by head trenching have been largely avoided by the use of "margin grooves" or "gutters" — relief grooves machined in the head surface at the two places when trenching would otherwise occur. This has been generally a satisfactory solution. Another trend, particularly needed for 1600 bpi heads, has been the employment of very hard surface coatings on the head (except right at the magnetic gap lines). Hard chrome plating and proprietary refractory compounds are important examples.

INTERFERENCE GENERATION AND SUSCEPTIBILITY

Finally, it is worth emphasizing that no magnetic tape equipment can be considered adequate unless it is satisfactory both with regard to freedom from producing spurious electrical transients and with regard to being itself influenced adversely by ambient electrical noise. The entire frequency spectrum is involved here, and, in the jargon, the equipment should be satisfactory with regard to Radio Frequency Interference (RFI) and Electro-Magnetic Compatibility (EMC). As a practical matter, both mechanically operated switches and solid-state devices are able to produce damped-oscillation transients with energy in the range from tens or hundreds of kilohertz up to at least 200 megahertz. The equipment design should be such as to minimize the production of such transients and also the transmission of any remaining transients to other associated pieces of equipment — by power lines, signal lines, direct radiation, or capacitive or inductive coupling. Safety considerations such as equipment grounding requirements play a part in such matters. It is also important to minimize the sensitivity of the internal low-level electronics to such transients as are present. A final caution is that circuit design and packaging should be such as to avoid malfunction-producing interference by powerful radar and other transmitting equipment, since it can be assumed that data-processing installations will be made in locations (near airports, for example) where such interfering signals in volts-per-meter field strengths will be present.

CASSETTE AND CARTRIDGE EQUIPMENT

The foregoing discussion was concerned with the usage of

½-inch tape; equipment of this class has been evolving both in the direction of higher performance (with higher recording densities and higher tape speeds) and in the opposite direction of lower cost, involving the same standard densities but generally lower tape speeds and data rates. Other designs of smaller devices using cartridge-enclosed tapes have been used to a limited extent but widespread serious attempts to depart from the use of ½-inch tape began in earnest with the spectacular entertainment-market success of the Philips-designed tape cassettes. In all cases the driving consideration has been a desire to make dramatic reductions — threefold to tenfold — in the cost of magnetic tape equipment applicable to data capture, communications terminals, small computers, etc. It has been widely recognized that major benefit is to be realized if ¼-inch tape and its spooling arrangements are contained in a small cartridge which is easily stored, easily carried, and easily inserted into and removed from the transport mechanism, with no operator contact with the tape itself.

In discussion of such devices, we shall not use the terms "cartridge" and "cassette" synonymously — "cassette" will refer to the basic Philips entertainment-type unit and its modifications for data processing application, while the general name "cartridge" will include these and all other enclosed tape designs.

It is too early to report on practical usage of these devices since large-scale field utilization of digital cassette devices is only about to begin. Many product announcements of Philips cassette digital transports have been made, nearly all by independent suppliers seeking to enter the OEM market. It is important to realize that devices of this class must meet service reliability requirements which are extraordinarily severe, since the low cost objective is, in reality, a requirement for *low life cost* rather than low product cost alone. Only if the necessity for field adjustment, replacement, and repair is reduced literally to zero can the objective of low life cost truly be realized.

In the meantime, considerable standards-writing activity is taking place, both in the United States and in Europe. At this time, the European progress appears to be somewhat ahead of that in the United States; in both cases serious proposals for alternative recording formats are under consideration and in the United States, the question of a quite different cartridge design and tape width is still open. There appears to be a strong possibility that at least two different classes of cartridge equipment will find their way to the marketplace.

References

- Recorded Magnetic Tape for Information Interchange (800 CPI, NRZI) X3.22-1967, ANSI, 1430 Broadway, New York, N.Y.
- Recorded Magnetic Tape for Information Interchange (200 CPI, NRZI), X3.14-1969, ANSI (same address).
- (Proposed ANSI Standard) Unrecorded Magnetic Tape for Information Interchange (9 track-200 and 800 CPI, NRZI and 1600 CPI, P.E.), ANSI (same address).
- Standard for Data Interchange on Magnetic Tape Cassette at 31.5 bits per mm (800 bpi) Phase Encoded, August 1970, European Computer Manufacturers Association (ECMA) for International Organization for Standardization (ISO) (Draft, in process of revision) ISO/TC97/SC4/WG-1 (ECMA-8).

1 Equipment Characteristics

DIGITAL MAGNETIC TAPE TRANSPORTS

COMPANY	AMPEX COM- PUTER PRODUCTS	AMPEX COM- PUTER PRODUCTS	AMPEX COM- PUTER PRODUCTS	AMPEX COM- PUTER PRODUCTS
MODEL	ATM-13	TM-8	TM-20	TM-1624,29 & TMA
FIRST DELIVERY YEAR	1967	1971	1971	1968/71
BASIC PURCHASE PRICE	\$22,975	\$3395	\$17,965	\$7500 - \$15,000
TAPE MEDIA	reel	reel	reel &/or cartridge	reel/auto cartridge
MAX. READ/WRITE SPEED (ips)	112.5	45	200	112.5
MAX. PACKING DENSITY (bpi)	800	1600	1600	800 or 1600
MAX. TRANSFER RATE (bps)	90 kHz	72K	320 kHz	90K or 180K
START/STOP TIMES (ms)	5.4	8	3	3
ENCODING TECHNIQUE	NRZI	NRZI phase encoded	phase encoding	NRZI & phase encoding
LOGIC COMPATIBILITY	TTL, most controllers	most controllers	IBM 360/370	IBM 360/370
COMMENTS	Ruggedized for MIL- E-5400 class 1A. 10½" reel.	10½" reel.	Replacement for IBM 2401-5,6 & 2420-V, VII drives. 10½" reel.	Replacement for IBM 2401 & 729 series. 10½" reel.

DIGITAL MAGNETIC TAPE TRANSPORTS

COMPANY	AMPEX COM- PUTER PRODUCTS	AMPEX COM- PUTER PRODUCTS	ASTRO-SCIENCE	AURICORD SCOVILL
MODEL	TMC	TMX, Y & Z	ADIR-1000 Series	CAS-1 & 3
FIRST DELIVERY YEAR	1970	1970/71	1970	1969
BASIC PURCHASE PRICE	\$375	\$1700 - \$2700	\$9000	\$37 - \$75
TAPE MEDIA	Phillips cassette	reel	reel	cassette
MAX. READ/WRITE SPEED (ips)	12	12.5 & 37.5	37.5	to 6
MAX. PACKING DENSITY (bpi)	800	800 & 1600	556 or 800	n/a
MAX. TRANSFER RATE (bps)	9600	10 kHz to 60 bps	30K	n/a
START/STOP TIMES (ms)	40	10-28	14 at 25 ips	150
ENCODING TECHNIQUE	phase encoding or NRZI	NRZI/phase encoded	NRZI	n/a
LOGIC COMPATIBILITY	most controllers	most controllers	DTL	n/a
COMMENTS	Meets requirements of ECMA.	7", 8½" or 10½" reel.	2400' on 10½" IBM reels.	With heads but less electronics.

Also see "Magnetic Tape Data Terminal" charts.

DIGITAL MAGNETIC TAPE TRANSPORTS

COMPANY	AURICORD SCOVILL	BRIGHT INDUSTRIES	BRIGHT INDUSTRIES	BUCODE
MODEL	CAS-10	BI 2400	BI 2600 Series	2010/2015/2045
FIRST DELIVERY YEAR	1970	1971	1970/71	1970
BASIC PURCHASE PRICE	\$88 - \$300	\$9000	\$3750 - \$4850	\$3900 - \$4100
TAPE MEDIA	cassette	reel	reel	reel
MAX. READ/WRITE SPEED (ips)	1.5 - 15	75	37.5 & 45	25 & 45
MAX. PACKING DENSITY (bpi)	n/a	1600	1600	1600
MAX. TRANSFER RATE (bps)	n/a	120K	60K & 72K	40 & 72
START/STOP TIMES (ms)	48	5	9	15 & 8
ENCODING TECHNIQUE	n/a	NRZI or PE	NRZI or PE	NRZI, PE opt
LOGIC COMPATIBILITY	n/a	DTL	DTL	DTL/TTL
COMMENTS	With heads but less electronics.	10½" IBM reels.	8½" & 10½" IBM reels.	8.5" reel.

DIGITAL MAGNETIC TAPE TRANSPORTS

COMPANY	BUCODE	CHALCO ENGINEERING	COMPUTER ACCESS SYSTEMS	COMPUTER DEVICES
MODEL	20291/92/93	RMC-1	250 & 350A	CDI 3600
FIRST DELIVERY YEAR	1970	1970	1970	1970
BASIC PURCHASE PRICE	\$9000 to \$14,000	\$295	\$198 - \$720	\$900
TAPE MEDIA	reel & IBM tape cartridge	cassette	cassette	cassette
MAX. READ/WRITE SPEED (ips)	120/150/200	30	20	10 - 30 cps
MAX. PACKING DENSITY (bpi)	1600	800	800	
MAX. TRANSFER RATE (bps)	192/240/320	10K	16K	300 baud
START/STOP TIMES (ms)	depends on speed	n/a	30 & 20	character incremental
ENCODING TECHNIQUE	NRZI, PE opt	NRZI	various	NRZI
LOGIC COMPATIBILITY	DTL/TTL	TTL/DTL	DTL/TTL	RS-232C, DTL & TTL
COMMENTS	Fully auto loading.		Read/write & servo circuits.	Replaces paper tape at 10, 15, or 30 kHz.

Also see "Magnetic Tape Data Terminal" charts.

DIGITAL MAGNETIC TAPE TRANSPORTS

COMPANY	DACONICS	DATA ACTION	DATASONICS	DESIGN ELEMENTS
MODEL	2914	2870/2890	TS 1130-C; TS 8-C	Element 301
FIRST DELIVERY YEAR	1969	1970	1969	1970
BASIC PURCHASE PRICE	\$9000	\$4095	\$10,000	
TAPE MEDIA	reel	reel	reel	cassette
MAX. READ/WRITE SPEED (ips)	45	25 - 37½	75	15
MAX. PACKING DENSITY (bpi)	800	1600	800	563
MAX. TRANSFER RATE (bps)	36K	60K	60K	8448
START/STOP TIMES (ms)	IBM compatible	13 ± 1		15
ENCODING TECHNIQUE	NRZI	NRZI or phase		NRZI
LOGIC COMPATIBILITY	TTL	PEC 6840		DTL/TTL
COMMENTS	With universal controller.			

DIGITAL MAGNETIC TAPE TRANSPORTS

COMPANY	DICOM	HEWLETT-PACKARD MOUNTAIN VIEW	HONEYWELL	HONEYWELL
MODEL	Dicom 344	7970A	MTD20-27 Series	MTD40-48 Series
FIRST DELIVERY YEAR	1969	1970	1968	1969
BASIC PURCHASE PRICE	\$2750	\$4700	\$6545 - \$9490	\$2450 - \$3750
TAPE MEDIA	cassette	reel	reel	reel
MAX. READ/WRITE SPEED (ips)	10.6	45	36 - 120	16 or 26
MAX. PACKING DENSITY (bpi)	550	800	800	800
MAX. TRANSFER RATE (bps)	4000	20 kHz	28,800 - 96,000	12,800 or 20,800
START/STOP TIMES (ms)	15 max/10 max	15 (25 ips)/ 10 (37.5 ips)		
ENCODING TECHNIQUE	diphase (mod PE)	NRZI	NRZ	NRZ
LOGIC COMPATIBILITY	DTL/TTL (EIA RS-232-B)	TTL/DTL	custom	custom
COMMENTS	Tape control & formatting in system.	IBM or ANSI compatible. 10½" reel.	Dual capstan, 7 or 9 track.	Dual vacuum capstan, 7 or 9 track.

Also see "Magnetic Tape Data Terminal" charts.

DIGITAL MAGNETIC TAPE TRANSPORTS

COMPANY	HONEYWELL	HONEYWELL	INCRE-DATA	INFOTEC
MODEL	MTH300	MTH501 - 504 Series	Mark II Data Acq. System	TD7/TD9
FIRST DELIVERY YEAR	1968	1969	1968	1969
BASIC PURCHASE PRICE	\$10,050	\$5500 - \$8100	\$19,950	\$2850
TAPE MEDIA	reel	reel	cartridge	reel
MAX. READ/WRITE SPEED (ips)	37.5	18.75 or 37.5	incremental to 2000 steps/second	7.5
MAX. PACKING DENSITY (bpi)	800	800 or 1600	200	200 - 556 - 800
MAX. TRANSFER RATE (bps)	30K	15K - 60K	n/a	6 kHz
START/STOP TIMES (ms)			1	66.7
ENCODING TECHNIQUE	NRZ	NRZ	NRZI	NRZI & IBM compatible
LOGIC COMPATIBILITY	custom	custom	DTL/TTL	DTL/TTL
COMMENTS	Single capstan, 7 track.	Single capstan, 7 or 9 track.	7" x 8" x 13"	7 or 9 tracks & 7" reel.

DIGITAL MAGNETIC TAPE TRANSPORTS

COMPANY	INFOTEC	INFOTEC	KENNEDY	3M INSTRUMENT & DATA PRODUCTS
MODEL	TD45	600D	3110/3112/8000	DPC-202
FIRST DELIVERY YEAR	1970	1970	1969/70	1970
BASIC PURCHASE PRICE	\$4400	\$6500	\$2500 - \$9000	less than \$100 in 1000 qty
TAPE MEDIA	reel	reel	reel	Philips cassette
MAX. READ/WRITE SPEED (ips)	45	75	25	12
MAX. PACKING DENSITY (bpi)	200 - 556 - 800	200 - 556 - 800	800 or 1600	800
MAX. TRANSFER RATE (bps)	38 kHz	60 kHz		9600
START/STOP TIMES (ms)	9.3	5.6	internally generated	50 at 4 ips
ENCODING TECHNIQUE	NRZI & IBM compatible	NRZI & IBM compatible	NRZI/phase encoded	phase or NRZ
LOGIC COMPATIBILITY	DTL/TTL	DTL/TTL	DTL	TTL/DTL
COMMENTS	10 1/2" reel.	10 1/2" reel.	7 or 9 track IBM compatible.	Options available.

Also see "Magnetic Tape Data Terminal" charts.

1 Equipment Characteristics

DIGITAL MAGNETIC TAPE TRANSPORTS

COMPANY	DATA RECORD'G SYSTEMS – NEWELL	PERIPHERAL EQUIPMENT	PERIPHERAL EQUIPMENT	POTTER INSTRUMENT
MODEL	DI 100 C	6X40, 6X60	7X20, 30, 40	AT 1082 & 1092
FIRST DELIVERY YEAR	1970	1969	1969	1970
BASIC PURCHASE PRICE	\$1650 - \$2500	\$3660	\$2390	\$9700 - \$10,950
TAPE MEDIA	cartridge	reel	reel	reel or cartridge
MAX. READ/WRITE SPEED (ips)	120	75	12.5	150 or 200
MAX. PACKING DENSITY (bpi)	800	1600	1600	1600 PE
MAX. TRANSFER RATE (bps)	96K	120	20	240K or 320K
START/STOP TIMES (ms)	40	5	30 at 12.5 ips	3.25 or 1.5
ENCODING TECHNIQUE	NRZ Mark	NRZI, phase encoded	NRZI, phase encoded	NRZ & PE
LOGIC COMPATIBILITY	TTL	DTL	DTL	DTL/TTL
COMMENTS	7½ - 120 ips serial or parallel versions.			

DIGITAL MAGNETIC TAPE TRANSPORTS

COMPANY	POTTER INSTRUMENT	POTTER INSTRUMENT	POTTER INSTRUMENT	POTTER INSTRUMENT
MODEL	AT2402-27	SC 1035, 51, 81	SC2402, 3, 5, 6	SC7294, 5, 6
FIRST DELIVERY YEAR	1971	1970	1969	1968
BASIC PURCHASE PRICE	\$16,500 - \$33,000	\$3570 - \$7950	\$15,500 - \$21,500	\$14,500 - \$15,500
TAPE MEDIA	reel/cartridge	reel	reel	reel
MAX. READ/WRITE SPEED (ips)	75 - 200	45 - 150	75 & 112.5	75 or 112.5
MAX. PACKING DENSITY (bpi)	800 & 1600	1600	800 & 1600	556 or 800
MAX. TRANSFER RATE (bps)	60 - 320 kHz	72K - 240K	60 - 180 kHz	62.5 - 90 kHz
START/STOP TIMES (ms)		3.25-7		
ENCODING TECHNIQUE	NRZI/phase encoding	NRZ & PE	NRZI	NRZI
LOGIC COMPATIBILITY	IBM 2401 & 2420 series	DTL/TTL	IBM 2401 series	IBM 729-IV/VI
COMMENTS		Electronic reel braking.		

Also see "Magnetic Tape Data Terminal" charts.

DIGITAL MAGNETIC TAPE TRANSPORTS

COMPANY	PRECISION INSTRUMENT	RAYMOND ENGINEERING	S-I ELECTRONICS	STORAGE TECHNOLOGY
MODEL	PI-1217/19	6406-01	DT-03 Series	ST2400 Series
FIRST DELIVERY YEAR	1969	1970	1963	1970
BASIC PURCHASE PRICE	\$4000	\$380 quan	\$21,500	\$19,750 - \$25,650
TAPE MEDIA	reel	cassette	reel	reel
MAX. READ/WRITE SPEED (ips)	45	15	75	75 - 112.5
MAX. PACKING DENSITY (bpi)	NRZI 800/PE 1600	12K	800	800 or 1600
MAX. TRANSFER RATE (bps)	72 kHz	12K	60 kHz	90 - 320K
START/STOP TIMES (ms)	8	100	5 max - adjustable for desired IBG	2 - 3.5
ENCODING TECHNIQUE	NRZI or phase encoded	bi-phase	NRZI	NRZI/PE
LOGIC COMPATIBILITY	DTL/TTL	DTL/TTL	DTL	IBM
COMMENTS	IBM compatible 7 or 9 channel.	Options available.	Qualified MIL-E-5400.	

DIGITAL MAGNETIC TAPE TRANSPORTS

COMPANY	STORAGE TECHNOLOGY	TENNECOMP SYSTEMS	TENNECOMP SYSTEMS	UNICOMP
MODEL	ST3400 Series	TP1351, 71, 72	TP1980	310
FIRST DELIVERY YEAR	1971	1968/70	1970	1970
BASIC PURCHASE PRICE	\$19,125 - \$25,650	\$1990 - \$3700	\$8950	\$5700
TAPE MEDIA	reel	cartridge	reel	reel
MAX. READ/WRITE SPEED (ips)	75 - 200	7½	300 steps/sec	37½
MAX. PACKING DENSITY (bpi)	556 - 1600	500 & 600	556	1600
MAX. TRANSFER RATE (bps)	41.7K - 320K	3700 or 4500	300 - 7 or 9 trk	
START/STOP TIMES (ms)	2 - 3.5	500/300	incremental	10
ENCODING TECHNIQUE	PE/NRZI	RTZ/phase encoding	NRZI	NRZ to 800 bpi - phase encode
LOGIC COMPATIBILITY		TTL	TTL	Comp-16, Comp-18
COMMENTS		Interface & software for most computers.	Transport & controller (includes cables).	

Also see "Magnetic Tape Data Terminal" charts.

world-wide leadership in recording heads

IBM-Compatible DIGITAL TAPE HEADS

Permit upgrading of tape transports by simple retrofit! 7-track and 9-track. Read/Write and Read/Write/Erase. Gap Alignment within 1 minute of arc. Gap scatter <50 micro-inches. Gap Parallelism within 100 microinches. Gap Definition maintained throughout rated life.

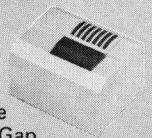

FLYING DISC & DRUM Recording Heads

Flying distances as low as 50 microinches! Absolutely no affinity for dust, dirt, magnetic-media particles. Precision contouring minimizes possibility of "dive-in". Greatest track-to-track uniformity ever attained. Tightest control of individual gap geometry ever achieved!

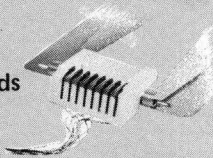

POLE PIECES for Recording Heads

Optimized magnetic characteristics for superior performance of finished head, with minimum constraint on associated electronics. . . greater freedom of choice of assembly and processing techniques. Available as individual pieces, or as pre-gapped bonded sets, with either glass or epoxy bond. CI, CC, or Open-Butt configurations.

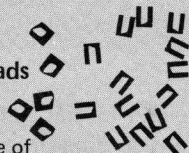

AUDIO Recording Heads

Standard and special, for home and studio, audio-visual, office and hi-fi, record/playback, and commercial duplicating.

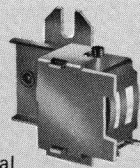

INSTRUMENTATION Recording Heads

Meet or exceed IRIG specifications for Low and Intermediate Frequency Band operation. Interleaved operation for 7 and 14 channels. 500KHz bandwidth.

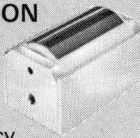

STUDIO Recording Heads

Record and Reproduce models. Full Frequency Range All Glass-Bonded-Construction. Both Highest Quality Professional and Home-Entertainment designs.

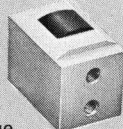

DUPLICATING Recording Heads

Cassette and Cartridge designs. Glass-bonded construction, for thousands of hours of operation, around the clock, at speeds of 60 to 120 IPS. Broadband recording capability produces duplicate tapes with response flat to 10 KHz at 1-7/8 IPS playback tape speed.

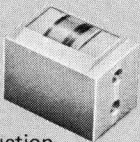

CASSETTE Recording Heads

Record/Playback and Erase models. Monaural and Stereo. Very low distortion. Useful life in excess of 1000 hours, minimum tape wear. Low-cost, mass-produced units rigid quality control.



VOICE-FILE & COMMUNICATIONS Recording Heads

Meet IRIG specs for width, spacing, interleaving, 1/4, 1/2, and 1-inch tape. As many as 31 independent, high performance channels per inch of tape! Speeds as low as 15/16 IPS. Glass-bonded construction.

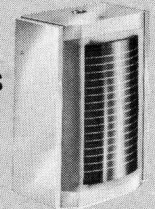

UNIQUE GLASS BONDING METHOD

Ferroxcube's patented Glass-Bonding Process produces recording heads that outlast and outperform any other head you can buy. Head gaps are completely filled with a hard, inert, glass material that fuses with the ferrite pole pieces, and presents a smooth, homogeneous, highly-polished ceramic surface to the recording medium, good for thousands of hours of in-spec operation with virtually no wear. Gap dimensions — and characteristics — are precisely controlled and *permanent*. Initial high performance is maintained throughout the entire life of the head.



FERROXCUBE CORPORATION / SAUGERTIES, N.Y. NORTH AMERICAN PHILIPS COMPANY

Only Ferroxcube has complete, in-house control of the entire manufacturing process, from the initial firing of the raw material for a ferrite core, to the final polish of the carefully contoured glass-bonded surface. Every Ferroxcube product reflects years of experience and technical leadership.

**DATUM SERIES—
IBM-COMPATIBLE**

**MINI-DIGITAL
HEADS FOR
FLEXIBLE
OR
RIGID MEDIA**

.150" Cassette format
MODEL DC41J09N
4-Channel read-write
MODEL DC 12P11L
Read-After-Write . . . meets
proposed ECMA standards . . . also units
for ANSI and ISO requirements
MODEL DC2ZR19N
Tunnel-Write
ASK FOR CATALOG SUPPLEMENT 9208

¼" format
MODEL DQ Series
Read-After-Write—Up to 5 channels
Read/Write—Up to 5 channels
Card Reader Heads—Relieved or
Flush Face—Single and Dual Channel
ASK FOR CATALOG SUPPLEMENT 9205

MODEL D79E026
Read 7 or 9 track with 1 dual gap head!

MODEL D92C022
High Speed Read-After-Write Head
with or without flux gates

MODEL D11A015
Tape Certifier/Evaluator,
optional piggy-backed erase
ASK FOR CATALOG SUPPLEMENT 9203

At **NORTRONICS®**
we're compatible
with everyone

We got to be the world leader in magnetic heads by innovating and by solving recording problems of all kinds—and then by engineering and manufacturing the requisite heads.

Whether you're working on a system that requires IBM-compatible heads, or mini-digital heads in ¼" or .150" cassette format, Nortronics has what you need. We're not only size-compatible, but media-compatible too . . . tape, disk, drum, card readers, etc. Whatever your digital recording needs, head first for Nortronics.

We've illustrated some of our special purpose catalog items here . . . and we have the old stand-bys too. Of course, we want to work with you to develop exactly the head you need. If you don't see it, ask for it. If we don't already have it, we'll make it.



NORTRONICS COMPANY, INC.

8101 Tenth Avenue North • Minneapolis, Minnesota 55427
Telephone: (612) 545-0401

The digital recorder for industrial use

DATACORD'S NEW DI-100C DIGITAL RECORDER OFFERS DESIGN FLEXIBILITY FOR INDUSTRIAL CONTROL APPLICATION:

1. Continually repeats programs of any length without delays or rewinding.
2. Reads or writes incrementally or continuously in both directions.
3. Operates at any two speeds from 7½ to 125 ips.
4. Transfers data at any rate up to 100,000 bits/sec.
5. Records redundantly on two tracks for low error rate.
6. Stores over 19 million bits per cartridge.

This conservatively rated digital tape recorder is designed for those tough industrial applications requiring high reliability combined with outstanding performance. The DI-100C is extremely flexible from a systems design viewpoint in that either serial or parallel read/write data can be accommodated at any rate up to 100,000 bits/sec. You can write data at any slow speed (incremental mode) and read at any continuous speed or vice versa, or both read and write can be performed at either the slow or fast speed. Since the DI-100C records in four bi-directional passes along the ¼" tape (two passes in each direction), a data program can be prerecorded at either end of the tape to be read as a continually repeating data loop without rewinding the tape (the time to reverse tape direction is exactly the same as one stop/start cycle). The DI-100C is available with either bit-serial or 8-bit parallel data electronics. Serial data configuration requires user generated inter-record gap, data-formatting and parity generation and checking. These functions are provided with parallel data formatting electronics. The cartridge used with the DI-100C contains 500' of magnetic tape which can store over 19 million bits of data with simple plug-in convenience. Yes, Datacord's rugged DI-100C is the digital recorder for industrial use in N/C machines, process control equipment, and those difficult applications requiring continuous performance with high reliability. For complete specifications on the versatile DI-100C write or call Datacord today.

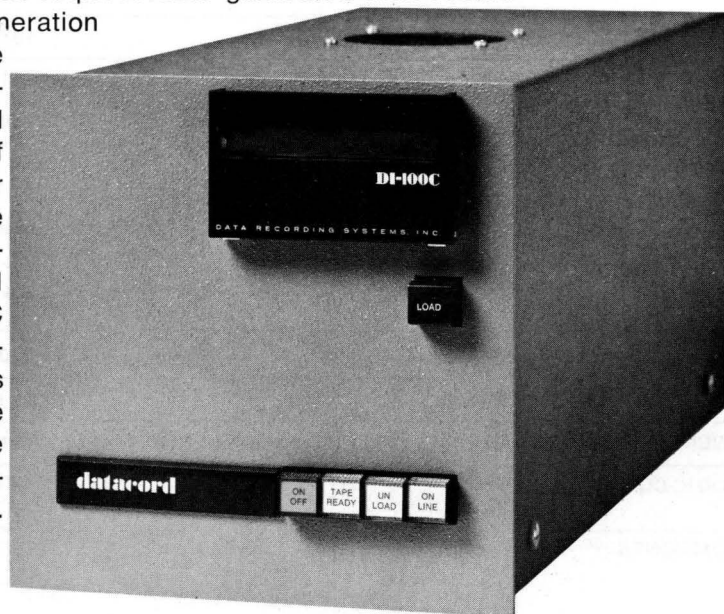

datacord

DATA RECORDING SYSTEMS, INC. 795 Kifer Road, Sunnyvale, Calif. 94086 (408) 732-7540
A Subsidiary of Newell Industries

INCREMENTAL MAGNETIC TAPE TRANSPORTS

COMPANY	ASTRO-SCIENCE	BRIGHT INDUSTRIES	CIPHER DATA
MODEL	DIR-940	BI 2600	70 & 85
FIRST DELIVERY YEAR	1967	1970	1969
BASIC PURCHASE PRICE	—	\$4200	\$2050 & \$2350
TAPE MEDIA	reel	reel	reel
MAX. READ/WRITE SPEEDS (char/sec)	Asynchronous	200 - write only async	1000 cps write only
	Synchronous		30,000 read only
			write 0-300
			read/write = 5 ips
MAX. PACKING DENSITY (bpi)	200	1600	556
MAX. TRANSFER RATE (bps)	40,000	8000	1000
ENCODING TECHNIQUE	NRZI	NRZI or PE	IBM compatible NRZI
LOGIC COMPATIBILITY	TTL	DTL	TTL/DTL
COMMENTS	Military qualified. 950' of 1 mil tape.	8½" reels.	70 - 7" reels 85 - 8½" reels

INCREMENTAL MAGNETIC TAPE TRANSPORTS

COMPANY	CIPHER DATA	CIPHER DATA	DATA RECORDING SYSTEMS
MODEL	70H, 85H & 100	C200	DI100C, Incremental
FIRST DELIVERY YEAR	1969	1970	1970
BASIC PURCHASE PRICE	\$3200, \$3500 & \$3900	\$1150	\$2500
TAPE MEDIA	reel	Philips cassette	cartridge
MAX. READ/WRITE SPEEDS (char/sec)	Asynchronous	write 0-1000 read 0-300	user option
	Synchronous	read/write = 25 ips	6 & 24 ips
			100
			9600
MAX. PACKING DENSITY (bpi)	800	3200	800
MAX. TRANSFER RATE (bps)	20,000	38,000	96,000
ENCODING TECHNIQUE	IBM compatible, NRZI	phase encoding	NRZ - Mark
LOGIC COMPATIBILITY	DTL/TTL	DTL/TTL	TTL
COMMENTS	70H - 7" reels 85H - 8½" reels 100 - 10½" reels		Can operate incrementally & continuously.

Also see "Magnetic Tape Data Terminal" charts.

1 Equipment Characteristics

INCREMENTAL MAGNETIC TAPE TRANSPORTS

COMPANY	DIGI-DATA	DIGI-DATA	DIGI-DATA
MODEL	1100	1300, 1400 & 1500	1700
FIRST DELIVERY YEAR	1970	1968	1970
BASIC PURCHASE PRICE	\$1800	\$2100-\$3600	\$2400
TAPE MEDIA	reel	reel	reel
MAX. READ/WRITE SPEEDS (char/sec)			
Asynchronous		500 or 3000	
Synchronous		3000	
MAX. PACKING DENSITY (bpi)	800, 1600	800	800, 1600
MAX. TRANSFER RATE (bps)	10 kc, 20 kc	3000	30 kc, 60 kc
ENCODING TECHNIQUE	NRZI, phase	NRZI	NRZI, phase
LOGIC COMPATIBILITY	IC	IC	IC
COMMENTS	7" reel, used w/controller.	Speed is 7 or 10 ips.	10 1/2" reel, used w/controller.

INCREMENTAL MAGNETIC TAPE TRANSPORTS

COMPANY	INTERNATIONAL COMPUTER PRODUCTS	KENNEDY COMPANY	MICRODYNE
MODEL	PI-70	1600	ICR-1000 Cartridge Recorder
FIRST DELIVERY YEAR	1970	1968	1970
BASIC PURCHASE PRICE	\$369-\$769	\$2750	\$595/100 quan
TAPE MEDIA	Philips cassette	reel	cartridge
MAX. READ/WRITE SPEEDS (char/sec)			
Asynchronous	2"/sec at BOT	0-1500	step to 30 Hz/sec
Synchronous			constant run at 5"/sec
MAX. PACKING DENSITY (bpi)	550	800	500
MAX. TRANSFER RATE (bps)	300	—	2 kHz/track
ENCODING TECHNIQUE	BMS	NRZI	NRZI
LOGIC COMPATIBILITY	DTL/TTL	DTL	TTL
COMMENTS	Stop start = 10 ms.	IBM compatible, 7- or 9- track.	Price w/o electronics. Electronics avail.

Also see "Magnetic Tape Data Terminal" charts.

1 Equipment Characteristics

INCREMENTAL MAGNETIC TAPE TRANSPORTS

COMPANY	MOBARK INSTRUMENTS	MOBARK INSTRUMENTS	MOBARK INSTRUMENTS
MODEL	300 & 305	400T	405 & 425
FIRST DELIVERY YEAR	1969	1971	1970
BASIC PURCHASE PRICE	\$1050 & \$1020	\$1820	\$1220 & \$2370
TAPE MEDIA	Philips cassette	Philips cassette	Philips cassette
MAX. READ/WRITE SPEEDS (char/sec)			
Asynchronous	120 write	10/15/30	120 write only
Synchronous	300 read	10/15/30	120
MAX. PACKING DENSITY (bpi)	333	333	333
MAX. TRANSFER RATE (bps)	2400	240	960
ENCODING TECHNIQUE	NRZI	NRZI	phase encoding
LOGIC COMPATIBILITY	TTL/DTL	TTL/DTL	DTL/TTL
COMMENTS		EIA RS 232C interface std.	425 accepts up to 32 parallel bits per byte.

INCREMENTAL MAGNETIC TAPE TRANSPORTS

COMPANY	PERIPHERAL EQUIPMENT	PERIPHERAL EQUIPMENT	PRECISION INSTRUMENT
MODEL	IX00	IX20	PI-1387
FIRST DELIVERY YEAR	1967	1967	1968
BASIC PURCHASE PRICE	\$3600	\$5700	\$2450
TAPE MEDIA	reel	reel	reel
MAX. READ/WRITE SPEEDS (char/sec)			
Asynchronous	1000	1000	200
Synchronous		8 (1½ to) 25 ips	
MAX. PACKING DENSITY (bpi)		800	200
MAX. TRANSFER RATE (bps)	1000	1000 asyn & 20,000 sync	200 char/sec
ENCODING TECHNIQUE	optical	optical	NRZI
LOGIC COMPATIBILITY	NRZI, IBM	NRZI, IBM	DTL/TTL
COMMENTS	8 different models.	12 models.	7 Channel IBM compatible.

Also see "Magnetic Tape Data Terminal" charts.

Paper Tape Equipment

Punched paper tape has long been associated with and been an important medium for the recording and transmission of message communications. The past few years have seen rapid growth of this medium in numerical control and minicomputers, two of the major applications for punched tape. Even though there has been much discussion of direct computer control of machine tools to by-pass the traditional punched tape control, in the near future the industry will continue to purchase large quantities of tape readers.

Additionally, automatic test equipment and the transmission of digital data have contributed to the growth of punched paper tape as a more important and still popular medium. In various data preparation applications where paper tape is generated as a by-product of a keyboard operation, new recording techniques such as cassettes or cartridges are not easily replacing tape readers or punches because of the inherent flexibility of paper tape itself. The advantage of being able to tear off a tape and transmit it while preparing a second tape is just one technique not economically feasible with magnetic tape. Information pertinent to a customer, etc., in the form of paper tape can be filed in a folder along with other related documents.

In general, all the advantages that made paper tape a popular and revolutionary medium back in its early history are still pertinent today. And, of course, still a large contributing factor for its continued popularity as a recording medium is its low cost.

The sales in 1970 for punched tape equipment have been estimated as about \$65,000,000 (including accessory equipment). The growth rate of punched tape equipment had been 10-15 percent over the past few years. The first half of 1970 saw a sharp decline in the numerical control market and, to a slightly lesser extent, a decline in the other major application areas of punched tape. All indications are that this decline bottomed out at the end of 1970. Expectations are that 1971 should see a slight rise, about 5 percent, over 1970. This is somewhat predicated by the general economic turnaround.

All tape perforators manufactured today, and probably in the foreseeable future, are basically electromechanical devices. Technological trends are primarily toward improving reliability, price and performance. More and more applications are requiring the punch to handle such exotic tapes as Mylar-paper laminates, Mylar-foil laminates, and pure polyesters. The increased punch forces and wear associated with these tapes are dictating improvements and refinements of the basic punching mechanisms.

Tape readers, on the other hand, have seen and are continuing to see technological changes. The major growth in tape readers has been in applications requiring 200 to

500 characters per second. Most readers in this speed range are using photoelectric sensing techniques. Improvements are being made in the sensing area using such media as fiber-optics. Changes are being made in those electronics which amplify and those which provide the user with IC interface compatibility. Readers are being designed which provide the ability to read tapes with varying transmissivity interchangeably without adjustments. Another area of change has been in moving tape. Stepping motor and servo capstan drives are replacing the pinch roller-brake method of moving tape.

READERS

Punched tape readers are broadly classified as either mechanical or photoelectric, depending upon the method used for sensing punched holes. Mechanical readers are used in low-speed, usually less than 100 characters per second (cps), reading applications, while photoelectric readers dominate high-speed reading applications. In photoelectric readers, the tape is usually edge-guided, while in mechanical readers, sprocket wheels are used for tape alignment and guiding. Regardless of the method used for hole sensing, the internal organization of most readers is based on similar logical design and amplification principles.

Reading speed is usually specified in characters per second or lines per second, both of which are identical. Tape reader manufacturers will generally specify the maximum speed attainable when reading continuously (synchronously) as well as the maximum line-at-a-time (asynchronous) speed. Block readers, on the other hand, read many lines of information simultaneously; therefore, reading speed is measured in blocks per second or perhaps milliseconds per block. Tape advance methods, inertia, and contact bounce limit the speed of most mechanical readers to less than 100 characters per second. A few photoelectric readers have been designed for speeds up to 1000 characters per second; however, most current photoelectric reader applications are in the 200- to 500-characters-per-second range. Photoelectric reading speed is limited only by the response time of the photocell and by the tape transport mechanism.

Naturally, cost goes up with speed; therefore, prospective users must carefully determine speed requirements for each individual application before making commitments. There are a multitude of tape reader applications, particularly in machine tool control, test equipment, programming, and telecommunications where high speed is often unnecessary, unwarranted, or perhaps even undesirable.

Stopping the tape motion, which can be accomplished upon sensing a STOP code punched in the tape, is a relatively simple matter in mechanical readers. In high-speed photoelectric readers, braking distance is a function of

1 Equipment Characteristics

transport speed and must not "overshoot" the next character to be read or expensive buffer memory stages will be necessary. At speeds up to 500 characters per second, the tape can be stopped on the STOP code. At higher speeds, the tape will come to rest between the STOP code and the next character to be read. The stop time is usually less than 1 millisecond in currently available photoelectric readers.

MECHANICAL READERS

Mechanical readers detect perforations when electrical contacts are made by sensing the holes by using spring-loaded pins, star wheels, brushes, or similar techniques. Due to inertia, contact bounce, and sprocket-guiding methods, most mechanical readers operate more reliably at slow speeds. Moving contacts must be constructed with special alloys or precious metals to eliminate wear and to provide high resistance to erosion. An important consideration in all types of readers is tape life, which is measured by the number of passes through the reading head. To increase the tape life in mechanical readers, paper tape (generally capable of 300 passes) can be replaced by other materials such as paper-coated Mylar or Mylar-coated foil which can withstand up to 50,000 or more passes.

Mechanical sensing pins represent one of the simplest and most common sensing methods in use. Spring-loaded pins or brushes travel along the surface of the tape, making contact as holes pass beneath the pins. This technique is sufficiently reliable at low reading speeds (about 10 characters per second) and is quite economical since pin retraction circuitry is not required. Pin sensing allows continual reading accuracy even when the tape becomes worn or when hole-to-hole tolerance exceeds ANSI Standards. Longer tape life and less contact wear is possible with retractable pins which do not rub against the tape while the tape is in motion. However, an obvious design problem with retractable pin mechanisms is that of providing a positive means of preventing tape motion during the read cycle. The timing of pin retraction and tape advance must be coordinated to prevent damage to the reader and the tape.

Star wheel sensing is another mechanical sensing technique. This type of sensing requires one star wheel for each tape channel to be read. The star wheel mechanism is designed so that the presence of two successive holes or no-holes in the same channel allows the star wheel carrier arm and its corresponding wire contact to remain in position. When one of the points of a star wheel centers a hole, an arm carrying the star wheel closes a switch.

PHOTOELECTRIC READERS

Photoelectric readers employ light-sensing elements to detect punched holes. The sensing elements are triggered as light is transmitted through a hole or, as in some readers, when light is reflected from a no-hole area. Photoelectric readers are capable of speeds up to 1000 char/sec. Photocell response and tape transport mechanisms are usually the only consideration which might limit reading speed. The cost of photoelectric readers has been reduced significantly in the past few years as a result of several important design improvements. In the past, expensive circuits were required to reduce drift in photo-diodes and amplifiers. Also, intricate devices for insuring accurate optical alignment of each cell as well as the overly-elaborate

tape transport mechanisms contributed to the high cost. Now, simplified tape transport designs, ac coupling of amplifier circuits, and photovoltaic detectors have allowed major price reductions of photoelectric readers while improving accuracy and reliability.

A typical photoelectrical mechanism uses a single silicon photovoltaic cell with nine separate elements for sensing. The photovoltaic cell converts light energy directly into electrical energy. The nine elements provide eight data channel outputs and one strobe or sprocket channel output for use with standard five-, seven-, and eight-channel tapes. The individual sensing elements can be made from the same silicon sample to minimize variations from element to element. As with all photocell readers, there are no reading contacts to wear out or to produce spurious signals due to bounce.

The leading edge of the sprocket hole is used to initiate the sampling of the data channels. Since data holes are larger in diameter than sprocket holes, yet have a common longitudinal centerline, data holes are optically aligned for reading by the time the edge of the sprocket hole comes into view. A transistor amplifier associated with the sprocket channel commonly is used to strobe the data channels, thus permitting simultaneous reading of all holes appearing in a single row.

When the photodiode lenses, consisting of synthetic rubies in some readers, protrude slightly above the surface of the reading head, the motion of the tape continually removes dust particles from the photocells. This self-wiping feature is particularly advantageous in machine shops and other industrial and military environments where fine particles of dirt and dust often cause reading errors.

Signal-to-noise ratio is another important consideration in photocell sensing. To achieve and maintain a maximum signal-to-noise ratio, tape transmissivity should be low (40% is adequate) and the tape should be free of any defects. Also, the lamp voltage should be stable to assure consistent photodiode response.

DIELECTRIC SENSING

A rather unique sensing technique developed by a Swedish firm, Facit, is called "dielectric reading." The punched tape forms the dielectric of a capacitor whose capacitance is changed as a hole passes the read station. Unlike most photocell sensing devices, dielectric readers are insensitive to environmental dust and low-quality paper. Also, since lamps and photocells are not used, there is no problem of long-term drift and aging.

TAPE PUNCHES

Paper tape punches have been in use for many years as data recording devices. In the past few years, there has been a sustained increase in the number and variety of tape punch applications. This increase is due in part to design improvements and in part to demands imposed by new applications. Although punches are commonly referred to as "paper" tape punches, many commercially-available units are capable of punching other materials such as Mylar, paper-coated Mylar, etc.

1 Equipment Characteristics

Today's major applications include computer output, data logging and data acquisition, message and data communications systems, numerical control, and automatic testing operations.

Punched tape has many advantages over other recording media. It is less expensive and less vulnerable to variations in moisture, temperature and handling. In contrast to magnetic tape, punched data cannot be erased.

BASIC PUNCH DESIGN

There are many differences in the basic design of tape punches currently being marketed, while tape dimensions, holes codes, and channel capacities (five, six, seven, or eight) remain standard. The basic function of the punch, of course, is to react to incoming pulses by activating punch pins which are forced through paper, Mylar, vulcanized fiber, or aluminized tape. The particular punch pins to be energized correspond directly to the bit configuration of the character to be recorded.

The perforating action of tape punches dictates an electromechanical design approach requiring special consideration for the inherent problems of inertia, vibration, noise and mechanical wear. As punching speeds increase, punch design problems become more acute. For example, in a 300-char/sec punch, shaft rotation rates up to 9,000 rpm are likely, with feed shafts rotating up to 18,000 rpm. Also, at this speed, one cubic inch of chad (confetti) forms every 6 seconds when punching 8 channels. Removing the chad so that it does not clog the punch mechanism is a necessary precaution.

Frequently used devices for activating punch pins are described below.

- *Solenoids* — Solenoid-actuated punch mechanisms employ one solenoid for each channel and one for punching the sprocket hole. Also, the functions of bail and transport each require two solenoids. A maximum of 13 solenoids would then be required for an eight-channel punch.
- *Interposer-Cam* — The reciprocating motion required for cycling the tape feed and punching operations can be accomplished by the use of triangular cams driven from a constant rotational power source. An electromagnet activates an interposer, inserting it between the cam and the punch pin at the proper time in a cycle.
- *Electromagnets* — A scheme which uses the holding power of small, efficient, electromagnets combined with off-center springs to activate the punch pins. The electromagnets require less than 2 watts for up to 50 percent of duty cycle at up to 3000 RPM of main shaft.
- *Clutches* — Punch mechanisms are controlled by motor-driven clutches activated by a pulse which is simultaneously applied to electromagnets. When the electromagnets are energized, the clutch assembly rotates and by an eccentric linkage forces the corresponding punch pin through the paper and retracts it.
- *Tuned Reeds* — A unique tape punch does not require energy from a motor to punch the tape. Instead, this energy is stored in a tuned reed while it is attracted to a magnet. The reed (a steel bar) and its associated magnet and

electronics are tuned to operate as a unit at a certain frequency. A reed is linked to a punch pin for each code level. When the reed is released by its respective magnet, the punch pin is driven through the tape.

PUNCH SELECTION CONSIDERATIONS

To satisfy user requirements, most manufacturers offer basic punch mechanisms with or without housing, feed and take-up reels, drive mechanism, and interface logic. This is advantageous for those users who intend to interface the punch with other equipment which is capable of providing mechanical drive and timing. This flexibility also satisfies the needs of the users who require a punch complete with timing drive, logic, amplifiers and mounting hardware.

System designers consider punching speed one of the most important functional characteristics when selecting a punch. The commercially-available punches discussed in this section operate at speeds ranging from 10 to 300 char/sec. The slow-speed (10 char/sec) units are generally interfaced with electric typewriters, page printers, and other keyboard devices which are used when an operator is preparing tapes. For recording output data from a computer, acquisition system, or data logging device, medium- or high-speed (60 to 300 char/sec) perforators are usually required. If a 10-char/sec punch is used to produce an object tape as a computer output, it is conceivable that the punching operation would take a few hours for a program of a few thousand instructions. The additional cost for a faster punch (in many applications) is certainly warranted when considering the attendant savings in computer output time.

Although some punches can be adjusted to punch either five, six, seven, or eight channels, the eight-channel codes offer greater storage capacity as well as parity checking. Until recently, five-level codes were used extensively in communications equipment. Now, however, eight-level ASCII code is an American standard. In the graphic arts industry, six-level tapes with advanced feed holes are commonly used. In selecting the channel capacity, the system designer must consider code compatibility implications in order to avoid expensive buffering and code conversion equipment.

To maintain recording accuracy, punches are available which sense parity errors before punching and then inhibit punching when a parity error is detected. Parity checking is generally offered as an option and is usually not included as a standard feature. Other error detecting features are broken tape sensing and out-of-tape sensing.

The ability to activate the punch automatically under program control (on-line) or manually (off-line) from a keyboard or other code selection device is a feature often required in computers and digital data recording systems. Some punches are ideally suited to this type of system integration, while other punches are primarily designed for off-line tape preparation.

Tape feed reels are generally included as standard items with the punch; however, take-up reels and spoolers are usually offered as options. Reversing the direction of the feed reel is possible in some punches to permit code deletion and tape editing, but punching is done in one direction only.

1 Equipment Characteristics

A wide variety of packaging schemes is offered by the punch manufacturers in order to satisfy diversified systems and OEM requirements. The user can usually specify whether the basic punch mechanism is to be rack-mounted or supplied in a desk-top package or console housing. Before selecting the packaging scheme, the system designer must consider the problems of chad disposal and air in-take locations for proper cooling.

TAPE HANDLING EQUIPMENT

Tape winding, spooling, braking and tension-control features are important considerations in the selection of paper tape readers even though these functions may not be directly associated with the reading process. Therefore, this section would not be complete without some mention of tape handling equipment.

All tape reader manufacturers, with a few exceptions, offer tape handling equipment either as options or as integral items. In selecting these additional features, the systems designer must weigh the advantages as they relate to his particular application. There are many tape reader applications which do not require reading lengthy program tapes. In many of these cases, slow-speed readers without additional tape handling devices adequately satisfy the requirements of the system and the user.

High-speed readers, on the other hand, are used to their full advantage when reading long tapes at speeds in the vicinity of 300 characters per second. When a tape reader is used as an input device to a computer or data processing system, program tapes frequently exceed 200 feet in length. The likelihood of tape damage due to fouling, abrupt starting and stopping, and repeated handling becomes greater as the tape length and reading speed increase. Consequently, provisions for tape handling and breaking become more crucial in high-speed reading of relatively long tapes. The four most common tape handling configurations are described below.

- *Single, motor-driven reel with no tension control mechanism* — This is used with slow-speed readers for feeding and rewinding tape. A basic design may consist of a unidirectional motor which is disengaged during the feed operation and is energized only for re-winding the tape.
- *Dual, motor-driven reels with simple, tension-arm control* — One reel serves as the winder and the other serves as the unwinder. Each has its own tension arm. When the tension arm of the winder is forced from its normal position, the winder motor is energized and begins pulling tape. The tension arm associated with the unwinder merely controls the tape feed rate by stopping the motor when excessive tape slack is detected.
- *Spooler units with multiple position tension arms* — Spooler mechanisms consist of a take-up reel and a feed reel, each driven by a separate, bi-directional, torque motor. Since the reader accelerates and decelerates the tape at rates much faster than the motor-driven reels, intricate tape tension control devices are required. As the tape tension varies, the tension arms travel back and forth in a curved path. The tension arm will signal the associated reel motor to stop, produce full take-up torque, or produce full feedout torque. In this manner, the tension control devices serve as mechanical buffers between the reels and the reader.

- *Servo-controlled reels* — This device provides continuous control of tape tension using variable torque motors. Unlike the spooler units whose tension arms sensed only three control zones along their curved paths, the servo-type tension-arm continuously provide control signals to their reels.

PAPER TAPE SUPPLIES AND ACCESSORIES

For effective utilization of paper tape equipment, a variety of accessory devices and consumable supplies are available. Proper selection of tape supplies and accessories could contribute substantially to convenient trouble-free operation. Included in this class of products are reels, splicers, winders, tape, correction materials, tape holders and storage containers. Suppliers of all the various types of paper tape accessories are listed in the Directory of Products and Services.

REELS

There now exists an American National Standards Institute (ANSI) Standard, "Take-up reels for one-inch perforated tape for information interchange." This standard covers the physical dimensions of take-up (or storage) reels, with either fixed or separable flanges, so that reels of perforated tape may be interchanged among machines of various manufacturers, and is intended to serve as a guide in the coordination of equipment design. Two types of reels are specified. Both are intended for use with 1-inch tape, the difference being in the size and shape of the drive hubs.

The small diameter drive reel is driven by a ½-inch spindle. The small hub size limits the permissible drive torque and acceleration but permits maximum tape capacity for any outside diameter. The outside hub diameter is a nominal 2 inches. The outside diameter of the reel flange is 6, 7-½, 8-½ or 10-½ inches.

The large diameter drive reel (NAB) is driven by a 3-inch spindle and is suitable for operation at high-speed. The outside hub diameter is a minimum of 3-¼ inches and a maximum of 3-¾ inches. The outside diameter of the reel flange is 8, 10-½ or 14 inches.

Both of these standard reels will accommodate 7/8 and 11/16 inch wide tapes. While many other reel variations have been and still are available, the whole purpose of the "standard" is for the user benefit of information interchange.

SPLICERS AND PORTABLE PUNCHES

For correcting or changing code patterns already punched or for repairing damaged tapes, portable splicing devices are available. A correction seal or patch is first applied to the area to be modified. The splicer may or may not be adapted with a manual punch mechanism. The units adapted with punches generally have feed hole pins and sequences to insure proper alignment prior to punching the new codes. The splicer unit is also convenient to use as a portable punch when access to a high-speed, automatic punch is not possible.

1 Equipment Characteristics

WINDERS

Several types of tape winders are available for rewinding and transferring tapes from reel to reel. These units are portable and may or may not be motorized.

Many low-cost computers do not have provisions for tape handling even though paper tape may be the primary input-output medium. Tape winders are quite useful for preventing tape tears and tangles in the paper tape. The basic winder is a portable unit which can be manually operated or it may be equipped with a small motor.

Some computers have provisions for spoolers or automatic tape take-up as integral units. A separate, motorized winder is available which can be positioned next to the computer for direct take-up of punched tape. These units generally include tape tension arms which control the speed of the winder. The winder automatically stops when the tape becomes taut, and it starts automatically when tape is fed.

PAPER TAPE

The term "paper tape" is used here as a generic word and includes Mylar, paper-coated Mylar, or aluminum Mylar. Standard tape widths are 11/16, 7/8 and 1 inch.

Tapes which are used in numerical control applications must withstand repeated usage, and therefore, should have a high tensile strength, tear strength and must be within allowable limits of shrinkage and elongation.

CORRECTION SEAL

Correction seals or splicing patches are used to repair torn tape or to modify previously punched holes. The seal has adhesive material on one side and it generally has greater tensile strength than the paper to be corrected. The patches may be used on any type of tape including paper and Mylar.

STORAGE DEVICES

Any computer system that operates primarily on perforated tape as an input-output medium will eventually accumulate several thousand feet of program tapes. Typical programs coded on punched tape include loader routines, diagnostic routines, assemblies, compilers, and applications programs. Each program tape must be marked or labelled so that it can be easily located and identified. Many convenient devices are available for filing and storing tapes, and computer users are advised to make maximum use of these units to preserve the investments of time and money that were made in preparing the tapes. The most popular storage devices for paper tape consist of partitioned plastic boxes. Paper boxes are also frequently used for storage and mailing purposes.

GLOSSARY

FORMAT

bit—literally binary digit. Refers to the 0 or 1 state corresponding to the no-hole and hole conditions.

block—a group of consecutive characters, separated by a unique block code.

byte—the smallest addressable unit of main storage in a computer system. The byte consists of eight data bits and one parity bit.

channel—a path along which data, particularly a series of digits or characters, may flow. A channel comprises several parallel tracks.

character—a combination of punched holes (bits) across the tape.

level—same as channel.

line—the vertical row of bits forming a character.

parity—a check which tests whether the number of ones is odd or even.

word—a number of consecutive characters or portions thereof.

GUIDANCE

advanced-feed-sprocket—the leading edge of the sprocket holes is in line with the leading edge of the data holes. Normally used in graphic arts.

center-feed-sprocket—the center line of the sprocket hole is normally aligned with the center line of the data holes. Some readers drive the tape by means of a sprocket wheel (capstan) which engages the sprocket holes. Other readers use a friction drive.

skew—the term skew is a measure of the degree to which tape does not follow an ideal path as it travels over the read station.

sprocket/feed hole—this hole is generated by the punch for each character on the tape. There may, or may not, be data holes accompanying the sprocket hole.

1 Equipment Characteristics

MATERIAL

chad—the small piece of material punched from the tape.

Chadless—refers to a tape where the data holes are deliberately not through-punched. A flap of material remains attached to the tape corresponding to the chad.

Opacity—equal to 100% minus the transmissivity.

Transmissivity—the tendency of tape to transmit light in other than punched areas. The greater the transmissivity, the higher the probability of faulty readout in photoelectric readers.

Transmissivity is expressed as the percentage of unwanted light appearing on the dark side of the tape, compared to that on the lighted side. The standard area chosen to set the acceptance level is a square .020 x .020 inch.

MODE

asynchronous/incremental operation—the command or step sequence at a random rate of speed.

bidirectional—capable of controlled operation in either direction of tape movement along its long axis.

slew—equal to, or greater than, the synchronous rate. Generally used for rewind or fast forward.

step—one character (or block) read at a time. The tape starts from rest and ends up at rest after having read the punched data.

synchronous operation—a continuous-run mode in which the maximum rate of information transfer occurs. The limit is set by the mechanical and/or electrical characteristics of the reader.

uni-directional—capable of controlled reading operation in one direction of tape movement (direction specified by manufacturer).

MOTION

start time—the acceleration time (from stop to full speed) from start command to reach full speed.

stop-before-next-character—a measure of breaking performance following the stop command.

stop distance—the distance the tape moves after the stop command. To stop within a given number of characters.

stop-on-character—the ability to stop on the same character at which the stop command was initiated.

**“Now for Less than Half
the Cost* you get High
Speed Data Entry”**



New Interface for Mini-Computers

— without computer modification

- PDP 8 I/L ■ PDP 11 ■ H-P 2114, 15, 16
- Nova ■ Super Nova

Just plug our interface card and cable card into your mini-computer and you're on line. Datascan's DRB-500 paper tape reader operates at 500 CPS, is bi-directional and has stop *on-a-character* capability. Another important benefit: it can use any type of 5 to 8 channel tape — oiled or dry paper, paper-mylar, aluminized mylar or solid mylar.

Call for a demonstration — or get complete information by return mail.

* PDP-8 \$1,155.
H-P 2114, 15, 16 \$1,365.

Datascan

Your New Interface system sounds good —

- Send me information by return mail
- Call me for a demonstration on my computer.
I have a mini-computer.

CIA

NAME _____

TITLE _____

COMPANY _____

ADDRESS _____

CITY _____ STATE _____

ZIP _____

PHONE _____

DATASCAN, INC.
1111 Paulison Avenue, Clifton, N. J. 07013
Telephone 201-478-2800

PAPER TAPE PUNCHES

COMPANY	ADDO-X	ADVANCED SPACE AGE PRODUCTS	CHALCO ENGINEERING	DATA ACCESS SYSTEMS	DIGITRONICS
MODEL	Tape Punch	P150-P300 Series	4070	780 Punch/Reader	1560
FIRST DELIVERY YEAR	1962	1969	1970	1970	1968
BASIC PURCHASE PRICE	\$2250	\$2600-\$5200	\$1795	\$1475	\$475
LEASE RATE/MONTH	by request	n/a	n/a	\$80	n/a
MAX. PUNCH. SPEED (char/sec)	20	150-300	75	30	60
NO. OF TRACKS	5-8	5-8	5-8	8	5-8
TAPE CAPACITY (feet)	1000	1000-3000	1000	500	1000
PARITY ERROR SENSING	yes	yes	opt	yes	no
END OF TAPE SENSING	yes	yes	yes	yes	yes
TAPE SUPPLY LEVEL SENSING	yes	yes	yes	yes	yes
ERROR CORRECTION	yes	no	yes	no	no
LOGIC COMPATIBILITY	any 5-8 level code	DTL/TTL	TTL/DTL	yes	TTL
PACKAGING STYLES	console	any	rack	desk top	rack
COMMENTS		Pwr & tape supply & electronics incl.	Vacuum-assist chad box std.		

PAPER TAPE PUNCHES

COMPANY	FACIT-ODHNER	FRIDEN - SINGER	FRIDEN - SINGER	INTERNATIONAL COMPUTER APPLIANCES	REMEX/EXCELL-O
MODEL	4060 & 4070	TP-020 & 030	TP-020M & 030M	PEC	RPM30 & 1075
FIRST DELIVERY YEAR	1969	1971	1971	1968	1970
BASIC PURCHASE PRICE	\$1590-\$1860	-	-	\$525	\$400 & \$795
LEASE RATE/MONTH	-	n/a	n/a	none	none
MAX. PUNCH SPEED (char/sec)	75/150	20 & 30	20 & 30	manual	30 & 75
NO. OF TRACKS	5-8	5-8	5-8	8	8
TAPE CAPACITY (feet)	1000	n/a	950	8"	no
PARITY ERROR SENSING	opt	yes, opt	yes, opt	no	no
END OF TAPE SENSING	yes	yes, std	yes, std	no	no
TAPE SUPPLY LEVEL SENSING	yes	no	yes, opt	-	no
ERROR CORRECTION	opt	no	no	yes	no
LOGIC COMPATIBILITY	neg/pos logic	-	-	-	+48 or +24 v
PACKAGING STYLES	desk top or rack	partial cover	desk top	portable	-
COMMENTS	All drive electronics incl.	Punching mechanism only.	Punching mechanism w/motor.	For making short tapes.	Punch mechanism only. All std tape width options.

Also see "Paper Tape Data Terminal" charts.

1 Equipment Characteristics

PAPER TAPE PUNCHES

COMPANY	REMEX/EX-CELL-O	ROBINS DATA PRODUCTS	TALLY	TALLY	TALLY
MODEL	RPR&S 1075	DCN-64 Hand Encoder	BP-30	P-120	420
FIRST DELIVERY YEAR	1971	1969	1971	1965	1960
BASIC PURCHASE PRICE	\$1515-\$1690	\$103-\$248	\$395	\$1500	\$1200
LEASE RATE/MONTH	none	none	—	—	—
MAX. PUNCH. SPEED (char/sec)	75	manual	30	120	60
NO. OF TRACKS	8	8	5-8	5-8	5-8
TAPE CAPACITY (feet)	1000		1000	1000	1000
PARITY ERROR SENSING	no	no	opt	yes, opt	no
END OF TAPE SENSING	yes	no - coded	opt	yes, opt	opt
TAPE SUPPLY LEVEL SENSING	yes	none	opt	yes, opt	opt
ERROR CORRECTION	yes	yes	opt	yes, opt	no
LOGIC COMPATIBILITY	TTL/DTL		separate driver fcn	separate driver fcn	separate driver fcn
PACKAGING STYLES	rack	portable	rack panel opt	rack	rack
COMMENTS	All std tape width options.	Price in qty only - min 25 units - \$248.	Mechanism only.		7½" take up reel for 750'.

PAPER TAPE PUNCHES

COMPANY	TELETYPE	TELETYPE	UNICOMP	UNIVAC	XEROX DATA SYSTEMS
MODEL	High Speed BRPE	High Speed DRPE	210	Paper Tape Subsystem	7063
FIRST DELIVERY YEAR	—	—	—	1967	1968
BASIC PURCHASE PRICE	\$850-\$1000	\$2500-\$3000	\$2650	\$13,020	\$9500
LEASE RATE/MONTH	—	—	—	\$346	\$214 - 4 yr
MAX. PUNCH SPEED (char/sec)	110	240	60	110	120
NO. OF TRACKS	5-8	5-8	8	8	8
TAPE CAPACITY (feet)	1000	3000	—	10" dia spool	1000
PARITY ERROR SENSING	no	yes, opt	yes	yes	yes
END OF TAPE SENSING	yes	yes	no	yes	no
TAPE SUPPLY LEVEL SENSING	no	yes	no	yes	yes
ERROR CORRECTION	no	yes, opt	no	—	no
LOGIC COMPATIBILITY	no	yes	comp-16 & 18	9000 series	Sigma
PACKAGING STYLES	desk top & rack	desk, rack or console	rack	console	rack
COMMENTS				300 cps reader can be added.	Includes controller.

Also see "Paper Tape Data Terminal" charts.

read about it -

Write for Catalog

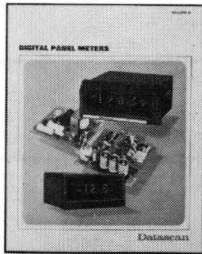

Digital Panel Meters

Whatever your requirement, check the Datascan line of Uni-polar with and without under-range "zeroing" capability — Bi-polar — Auto polarity — $2\frac{1}{2}$, $3\frac{1}{2}$, $4\frac{1}{2}$ digits. New flush mount bezel or standard bezel.

Special industrial OEM applications:

- Dual Ranges
- Industrial Packaging
- PH Meters
- Temperature Measurement Units
- Preset Controllers
- Ratiometers
- LVDT Readouts
- Accumulators
- Event Counters
- Frequency Counters
- Repackaging To Replace Analog Meters

Write for Bulletin



Convert Paper Tape to Mag Tape — Off Line with Verta-Tape —

converts coded information from 5, 6, 7 or 8 channel paper tape to 64 character magnetic tape code set.

- stand alone terminal
- 7 track mag. tape density 220, 556 or 800 bpi
- 9 track mag. tape density 800 bpi (IBM System 360 compatible)
- paper tape input at 500 cps

Write for Bulletin



High Speed Paper Tape Reader

... for reading 5, 6, 7 or 8 channel tapes

- speeds to 500 cps, bi-directional
- stop-on-a-character
- photo-electric reading
- heavy-duty construction and components
- available as rack mounted or with 1000 cps spooler or fanfolding equipment

Write for Bulletin



Save with Mini-Computer Interfaces (Paper Tape Input)

for PDP-8 I and L; HP 2114, 15, 16; Nova and Super Nova ... about half the customary prices.

- PC board plugs directly into computer
- complete with 500 cps bi-directional paper tape reader, connecting cable and interface card

Get your free copy.

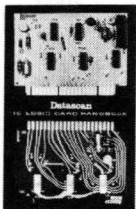

Logic Card Handbook

There are hundreds of pages in our new I.C. LOGIC CARD HANDBOOK to help you lower costs ... DTL, HTL (for high noise environment) and TTL circuits you don't have to design — plus function cards, accessories and systems.

Write for complete information or demo.

Datascan

DATASCAN, INC.
1111 Paulison Avenue, Clifton, N. J. 07013
Telephone 201-478-2800

1 Equipment Characteristics

PAPER TAPE READERS

COMPANY	CHALCO ENGINEERING	COMPUTER MECHANISMS	COMPUTER MECHANISMS
MODEL	5101 & 5401	CMC 18	CMC 60
FIRST DELIVERY YEAR	1968	1967	1969
BASIC PURCHASE PRICE	\$650 & \$750	\$215	\$395
LEASE RATE/MONTH			
MAX. READING SPEED (char/sec)	625	30	120
MAX. ASYNC. SPEED (char/sec)	150 & 300	30	120
START TIME (ms)	5	17	
NO. OF TRACKS	5, 6, 7, 8	8	8
SENSING ELEMENTS	photocells	starwheel	starwheel
READING METHOD	through tape	through tape	through tape
TAPE MOVEMENT (Uni-, Bi-directional)	both	uni-directional	bi-directional
TAPE CAPACITY (feet)			
BLOCK OR LINE READER	line	line	line
LOGIC COMPATIBILITY	TTL/DTL	relay or IC	relay or IC
PACKAGING	rack	rack	desk-top
COMMENTS			

PAPER TAPE READERS

COMPANY	DATA PRODUCTS TELECOMMUNICATIONS	DATA SCAN	DATATERM
MODEL	PTT-62	DRB-500	HS-400 Series
FIRST DELIVERY YEAR	1970	1969	1969
BASIC PURCHASE PRICE	\$900	\$765-\$890	\$775
LEASE RATE/MONTH			
MAX. READING SPEED (char/sec)	75	500	400
MAX. ASYNC. SPEED (char/sec)	n/a	150	300
START TIME (ms)	n/a	6.5	2.5
NO. OF TRACKS	5, 6, 7, 8	8	8
SENSING ELEMENTS	starwheel	photocells	photocells
READING METHOD	through tape		through tape
TAPE MOVEMENT (Uni-, Bi-directional)	bi-directional	bi-directional	both
TAPE CAPACITY (feet)	n/a	1000	110
BLOCK OR LINE READER	n/a	yes	line
LOGIC COMPATIBILITY	integral 402C modem w/rev chnl	DTL or TTL	DTL or TTL
PACKAGING	desk top	rack	rack
COMMENTS		PDP-8 I/L interfaces available.	One moving part reads all tapes.

Also see "Paper Tape Data Terminal" charts.

PAPER TAPE READERS

COMPANY	DECITEK – JAMESBURY	DECITEK – JAMESBURY	DECITEK – JAMESBURY
MODEL	240A9	241A9	342A9
FIRST DELIVERY YEAR	1968	1968	1968
BASIC PURCHASE PRICE	\$673	\$824	\$1285
LEASE RATE/MONTH	none	none	none
MAX. READING SPEED (char/sec)	60	150	300
MAX. ASYNC. SPEED (char/sec)	60	150	150
START TIME (ms)	n/a	—	n/a - stepping motor
NO. OF TRACKS	8 + spkt	8 + spkt	8 + spkt
SENSING ELEMENTS	9 element phototransistor array	9 element phototransistor array	9 element phototransistor array
READING METHOD	through tape	through tape	through tape
TAPE MOVEMENT (Uni-, Bi-directional)	bi-directional	bi-directional	bi-directional
TAPE CAPACITY (feet)	loop or basket	loop or basket	1000
BLOCK OR LINE READER	line	line	line
LOGIC COMPATIBILITY	DTL or TTL	DTL or TTL	DTL or TTL
PACKAGING	rack or desk top	rack or desk top	rack
COMMENTS			

PAPER TAPE READERS

COMPANY	DECITEK – JAMESBURY	DIGITRONICS	DIGITRONICS
MODEL	443A9	2060	B2540 Series
FIRST DELIVERY YEAR	1969	1968	1968
BASIC PURCHASE PRICE	\$998	\$235	\$540-\$905
LEASE RATE/MONTH	none	—	—
MAX. READING SPEED (char/sec)	600	60	600
MAX. ASYNC. SPEED (char/sec)	150	60	150
START TIME (ms)	n/a - stepping motor	—	10 max
NO. OF TRACKS	8 + spkt	5, 6, 7, 8	5, 6, 7, 8
SENSING ELEMENTS	9 element phototransistor array	ball sensing	photocells
READING METHOD	through tape	through tape	through tape
TAPE MOVEMENT (Uni-, Bi-directional)	bi-directional	uni-directional	either
TAPE CAPACITY (feet)	300	determined by tape handler	determined by tape handler
BLOCK OR LINE READER	line	line	line
LOGIC COMPATIBILITY	DTL or TTL	outputs are form A sws	TTL
PACKAGING	rack or desk top	rack	rack
COMMENTS	Fan fold box.	Options available.	Options: power supply & electronics package.

Also see "Paper Tape Data Terminal" charts.

1 Equipment Characteristics

PAPER TAPE READERS

COMPANY	DIGITRONICS	ELECTRONIC ENG'RG CO. OF CALIF.	ELECTRONIC ENG'RG CO. OF CALIF.
MODEL	B3000	MTR-2000	8002
FIRST DELIVERY YEAR	1966	1970	1970
BASIC PURCHASE PRICE	\$1745	\$500	\$975
LEASE RATE/MONTH	—	—	—
MAX. READING SPEED (char/sec)	1000	200 w/stop-on-char	750 w/stop-on-char
MAX. ASYNC. SPEED (char/sec)	100	200	300
START TIME (ms)	3 max	2	5
NO. OF TRACKS	5, 6, 7, 8	8	8
SENSING ELEMENTS	photocells	photocell	photovoltaic cell
READING METHOD	through tape	through tape	fiber optics through tape
TAPE MOVEMENT (Uni-, Bi-directional)	bi-directional	uni-directional	both
TAPE CAPACITY (feet)	determined by tape handler	—	1200 with EECO 8003 spooler
BLOCK OR LINE READER	line	line	line
LOGIC COMPATIBILITY	TTL	DTL, TTL, RTL	DTL, TTL, RTL
PACKAGING	rack	console plus options	rack plus options
COMMENTS	Options avail.		

PAPER TAPE READERS

COMPANY	FACIT-ODHNER	HONEYWELL	HONEYWELL
MODEL	4001	PTR60 Series	TR6301
FIRST DELIVERY YEAR	1962	1964	1970
BASIC PURCHASE PRICE	\$2190	\$510	\$405
LEASE RATE/MONTH	—	—	—
MAX. READING SPEED (char/sec)	1000	125	150
MAX. ASYNC. SPEED (char/sec)	—	125	150
START TIME (ms)	—	—	—
NO. OF TRACKS	5, 6, 7, 8	8 + spkt	8 + spkt
SENSING ELEMENTS	dielectric	photocells	photocell
READING METHOD	—	through tape	through tape
TAPE MOVEMENT (Uni-, Bi-directional)	uni-directional	bi-directional	bi-directional
TAPE CAPACITY (feet)	1000	—	—
BLOCK OR LINE READER	line reader	—	—
LOGIC COMPATIBILITY	negative logic, positive opt	RTL	RTL, DTL, TTL
PACKAGING	desk top or rack	rack	rack
COMMENTS			

Also see "Paper Tape Data Terminal" charts.

PAPER TAPE READERS

COMPANY	HONEYWELL	MOHAWK DATA	MOHAWK DATA
MODEL	TR7000 Series	2119 & 2166	2121
FIRST DELIVERY YEAR	1969	1964	1968
BASIC PURCHASE PRICE	uni-dir \$720, bi-dir \$895	\$385 & \$200	\$655
LEASE RATE/MONTH	—	—	—
MAX. READING SPEED (char/sec)	1000	30	65
MAX. ASYNC. SPEED (char/sec)	240	30	65
START TIME (ms)	3	15	3
NO. OF TRACKS	8 + spkt	5, 7, 8	5, 7, 8
SENSING ELEMENTS	photocells	starwheel	starwheel
READING METHOD	through tape	contact closure	contact closure
TAPE MOVEMENT (Uni-, Bi-directional)	both	either	bi-directional
TAPE CAPACITY (feet)	—	—	1000
BLOCK OR LINE READER	both	—	—
LOGIC COMPATIBILITY	RTL, DTL, TTL	24, 48, 90 vdc	24 vdc
PACKAGING	rack	rack	rack
COMMENTS			

PAPER TAPE READERS

COMPANY	REMEX	REMEX	REMEX
MODEL	RR&S-305	RRS3000	RR-4001
FIRST DELIVERY YEAR	1970	1968	1968
BASIC PURCHASE PRICE	\$840-\$1295	\$1750	\$1430
LEASE RATE/MONTH	none	none	none
MAX. READING SPEED (char/sec)	300	300	1200
MAX. ASYNC. SPEED (char/sec)	over 100 (in slip mode)	up to continuous speed in slew (async) operation	up to continuous speed in slew (async) operation
START TIME (ms)	16	8	3
NO. OF TRACKS	5, 6, 7, 8	8	5, 6, 7, 8
SENSING ELEMENTS	photocell	photocell	photocells
READING METHOD	through tape	through tape	through tape
TAPE MOVEMENT (Uni-, Bi-directional)	both	both	both
TAPE CAPACITY (feet)		1200	
BLOCK OR LINE READER	line	line	line
LOGIC COMPATIBILITY	TTL/DTL	TTL/DTL	TTL/DTL
PACKAGING	rack or desk top	rack	rack
COMMENTS			

Also see "Paper Tape Data Terminal" charts.

1 Equipment Characteristics

PAPER TAPE READERS

COMPANY	SINGER – FRIDEN	TALLY	TALLY
MODEL	TR&RR-300 Series	HR-150	R-50
FIRST DELIVERY YEAR	1971	1968	1968
BASIC PURCHASE PRICE	—	\$855, w/reeling \$1195	\$350
LEASE RATE/MONTH	—	—	—
MAX. READING SPEED (char/sec)	300	150	50
MAX. ASYNC. SPEED (char/sec)	120	150	50
START TIME (ms)	0.100 max	—	—
NO. OF TRACKS	5, 6, 7, 8	5, 6, 7, 8	5, 6, 7, 8
SENSING ELEMENTS	silicon photo-transistors	starwheel	starwheel
READING METHOD	through tape	—	—
TAPE MOVEMENT (Uni-, Bi-directional)	bi-directional	bi-directional	uni-directional
TAPE CAPACITY (feet)	1000	1000' on 8½" reels	integral reeling not offered
BLOCK OR LINE READER	—	line	line
LOGIC COMPATIBILITY	DTL/TTL	function of sep. driver	function of sep. driver
PACKAGING	rack	rack	panel mount; rack panel opt
COMMENTS			

PAPER TAPE READERS

COMPANY	TALLY	TALLY	TELETYPE
MODEL	R-5000	500RM	CX
FIRST DELIVERY YEAR	1970	1966	
BASIC PURCHASE PRICE	\$1100, w/reeling \$1500	\$9990	\$500-\$600
LEASE RATE/MONTH	—	—	—
MAX. READING SPEED (char/sec)	1200 search	1000 search	105
MAX. ASYNC. SPEED (char/sec)	300	150	
START TIME (ms)	2	3.5	within a cycle
NO. OF TRACKS	5, 6, 7, 8	5, 6, 7, 8	5, 6, 7, 8
SENSING ELEMENTS	photocells	photocells	sensing pins
READING METHOD	through tape	—	through tape
TAPE MOVEMENT (Uni-, Bi-directional)	bi-directional	bi-directional	uni-directional
TAPE CAPACITY (feet)	750 on 7½" reels	1000	independent of reader
BLOCK OR LINE READER	line	line	line
LOGIC COMPATIBILITY	DTL/TTL	discrete	contact closers
PACKAGING	rack	rack	desk top, rack or console
COMMENTS		Meets military environment.	

Also see "Paper Tape Data Terminal" charts.

PAPER TAPE READERS

COMPANY	TELETYPE	TRANSCOM	UNICOMP
MODEL	DX	PT-20 Reader/Xmitter	202
FIRST DELIVERY YEAR		1970	1970
BASIC PURCHASE PRICE	\$675-\$1020	\$1260	\$1950
LEASE RATE/MONTH		29	
MAX. READING SPEED (char/sec)	360	20	600
MAX. ASYNC. SPEED (char/sec)	360		300
START TIME (ms)			1
NO. OF TRACKS	5, 6, 7, 8	5, 6, 7, 8	8
SENSING ELEMENTS	sensing pins	photocells	photocells
READING METHOD	drag sense contacts	through tape	by char > 50% tape transparency
TAPE MOVEMENT (Uni-, Bi-directional)	uni-directional	uni-directional	bi-directional
TAPE CAPACITY (feet)	independent of reader	any	250
BLOCK OR LINE READER	line	—	line
LOGIC COMPATIBILITY	contact closers	—	comp-16 & comp-18
PACKAGING	desk top, rack or console	desk top	desk top, rack or console
COMMENTS			

PAPER TAPE READERS

COMPANY	UNIVAC	XEROX DATA SYSTEMS
MODEL	Paper Tape Subsystem	7062
FIRST DELIVERY YEAR	1967	1968
BASIC PURCHASE PRICE	\$9140	\$9000
LEASE RATE/MONTH	\$251	\$203
MAX. READING SPEED (char/sec)	300	300
MAX. ASYNC. SPEED (char/sec)	300	300
START TIME (ms)	—	6
NO. OF TRACKS	8	8
SENSING ELEMENTS	photocell	photocell
READING METHOD	through tape	chad tape-photoelectric
TAPE MOVEMENT (Uni-, Bi-directional)	bi-directional	uni-directional
TAPE CAPACITY (feet)	5" dia spool	1000
BLOCK OR LINE READER	line	—
LOGIC COMPATIBILITY	9000 series	Sigma
PACKAGING	console	rack
COMMENTS		Price includes controller.

Also see "Paper Tape Data Terminal" charts.

Punch Card Equipment

Punch card equipment is one of several current methods used to communicate with a computer. Data from many and varied sources, such as time reports, sales slips, and accounting reports, must be provided to the computer. However, since the computer cannot recognize data as humans do, there must be a conversion to its language.

CARDS

One method of obtaining the recognizable language is by using the standard 80-column Hollerith tabulating punched card made from highly refined 0.007" thick stock cut to 7-3/8 x 3-1/4" under controlled conditions of both temperature and humidity. These cards usually have a corner cut for proper orientation for the card processing, but are also available with rounded corners as an aid to more reliable card handling. IBM has introduced a 96-column Hollerith card which is smaller (3-1/4 x 2-5/8") than the 80-column card. It has 32 columns in each of three zones. The latest trend in card equipment is the emergence of low-cost card oriented computer systems, such as the IBM 96 column, card oriented, System 3.

Another method of data preparation is the Mark Read or Mark Sense where cards are marked with a soft pencil in designated areas. These marks are then sensed electrically or optically.

VIRTUES AND FAULTS

Punched card processing is the most commonly used method of inputting data for computer processing, and many of the smaller computer systems utilize the card as a file storage which is easily expanded, contracted, or revised. However, the card is a relatively bulky medium which requires large amounts of floor space, and the system requires special handling so as to create as little machine handling problems as possible. The conditions under which cards are stored and processed should be kept under rigid temperature and humidity control. A card should be stored under the same conditions as it was processed; in many environments and conditions where this may not be possible, a logistics problem may arise for the heavy user.

CARD READERS

The card reader is an electromechanical device which reads and translates the data on a punched card and transmits it to the computer. Card readers fall into two broad categories: manual and automatic. Manual readers are used as data entry devices in remote terminal applications and rely upon the manual insertion of the card. The reading or sensing of the data is accomplished by pin sensing or by electro-optical means. Where a hole exists a pin will make electrical contact or light will pass through to excite

a photoelectric device. The speed of this device is of course the card insertion speed. Automatic card readers are capable of reading cards in excess of 2000 per minute. The function of this type reader is to select or pick a card, read the card, determine if the data looks marginal, and then stack the card.

Picking a card is accomplished by one of the following methods:

1. *Picker Knife* (Figure 1) – This method utilizes a reciprocating knife edge, less than the thickness of a card, which selects the bottom card during each cycle. A metering device (throat) causes only one card to pass through a restriction which is larger than one but less than two card thicknesses. This picking system starts and stops (feed) by demand of some form of clutch, low inertia motor, or solenoid.

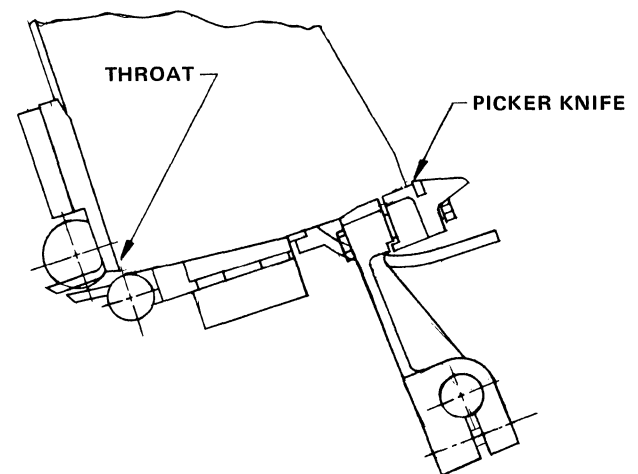

Figure 1. Picker Knife

2. *Friction Speed* (Figure 2) – A high friction material sufficient to drive the card from beneath the stack, utilizing wheels or belts, is the basis for friction feeding. Some of the variations on the friction technique are:

- a. Starting and stopping the friction device.
- b. Actuating the friction device to the bottom of the card stack (Figure 2).

Selection of one card is usually accomplished by using a throat, or counter-rotating wheels or belts which act upon the following card.

1 Equipment Characteristics

3. *Vacuum Friction Feed* – This method of feeding is accomplished two ways:

- a. In the first, vacuum is introduced into a set of fingers, and the card is attracted to the fingers because of the pressure differential. The fingers are then actuated bringing the card onto a friction wheel, which then feeds the card.
- b. The second method has the friction wheel evacuated and ported (vacuum). The fingers are actuated, bringing the card to the vacuum wheel which feeds the card.

Single card selection is accomplished as previously discussed.

The design of the input magazine is directly influenced by the method utilized in picking a card and the speed. For example, high speeds require large input card capacities to avoid operator fatigue. Large capacities usually create too high a load on the picking mechanisms. This results in a further extension of design to feed the cards on edge (Figure 2), tilting the input magazine to reduce the normal card load, or file feeding the cards.

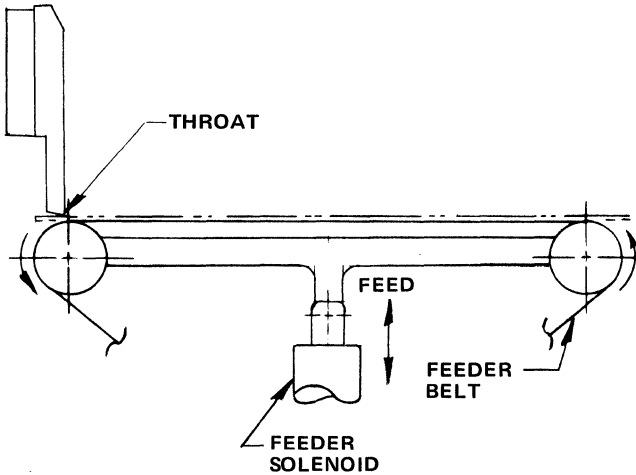

Figure 2. Friction Feed

Reading

Reading, as previously mentioned, is by means of pin sensing, fiber optics/photoelectric technique or conductive brush with read roll sensing. Pin sensing is primarily used for static readers.

The conductive brush and reading roll read technique is presently being used, but is being displaced with the fiber optic/photoelectric technique. This method is similar to pin sensing in that the electrical contact is made through the hole, but the reading roll in many applications rotates, resulting in a surface velocity equal to the cards. Brushes (80 for 80 columns, plus common brushes) ride on the rollers and the card "makes and breaks" the electrical circuit. They are made of many strands of conducting wire which fall into and out of the punched card holes (Figure 3).

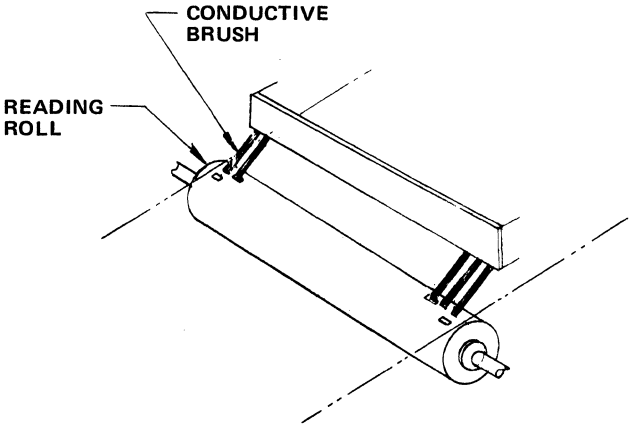

Figure 3. Conductive Brush

The fiber optic/photoelectric method relies on the occlusion or non-occlusion of the photocell from the light source by the absence or presence of a hole in the card. Sensing of the holes will occur almost simultaneously. Fiber optics is merely a light distributor, which seemingly bends the light and uses a single light source (Figure 4). This so called light bending is merely a result of internal reflection of light passing through plastic or glass fibers.

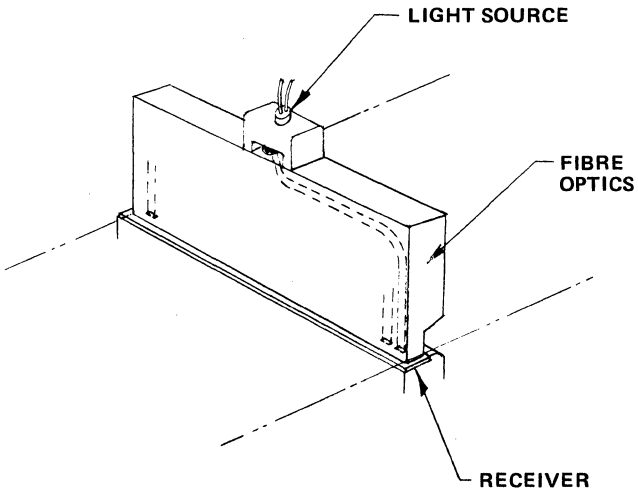

Figure 4. Fibre Optics Read

Data Strobing

As the holes are being read, it is important to know the column or row. To accomplish this, data strobes are generated at a predetermined time which corresponds to the appropriate column or row.

Two techniques are in common use today: a countdown and a leading or trailing edge detection method. Both have resulted in extremely low read error rates.

In the countdown method a photoelectric or electromagnetic device is motivated by the same roller shaft that drives the card through the read station so that the data

1 Equipment Characteristics

strobe and the card do not vary from each other even though the machine speed varies. When the leading edge of the card is detected by the read station, an electronic clock, which generates a known number of pulses between data strobes, counts down to the theoretical column or row center, and generates another strobe which looks for data. The amount to count down is known because column and row positions are known. As the number of pulses generated by the electronic clock increases, the accuracy of row or column reading increases.

Leading or trailing edge detection relies upon the data holes being located the correct specified distance from the leading or trailing edge (as does the count down technique). For every data position, row, or column, a strobe is generated when the card covers or uncovers the detectors which are placed at fixed columns or row positions. If reading is row by row, 12 detectors must be used. For column reading, photoelectric masking and electrical techniques must be used to avoid the expense of 80 detector cells.

Read Check

A self-checking feature of a card reader is the read check. The machine should be capable of detecting invalid codes as well as that data which appears marginal.

Stacker

After the card has been read it is transported to the stacker which must receive all cards and keep them in the same order or file. It is important that the stacker be unloaded while the machine is in operation. Stacking can be accomplished by the following methods:

1. *Gravity* – The cards are ejected onto the preceding cards from the elevated transport area.

2. *Radial* (Figure 5) – The cards are ejected from the read station into the stacker area as one end is prevented from falling. This causes the opposite end to fall radially about the held end. The card end then falls onto a shuttle plate which urges the cards, on end, into the stacker.

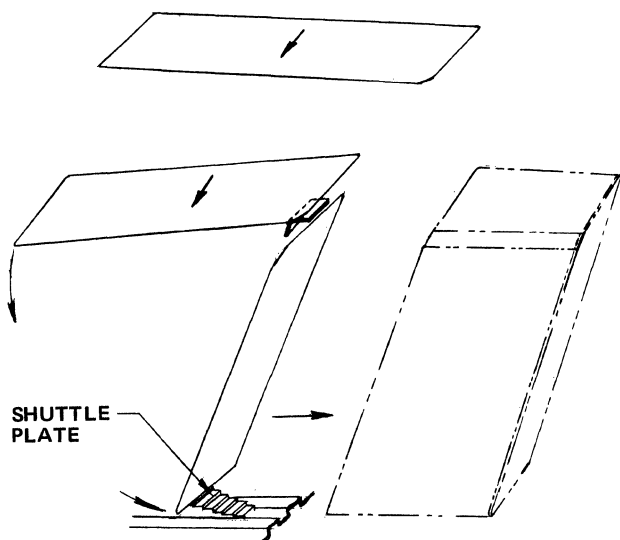

Figure 5. Radial Stacker

3. *Power Drive* – There are a few variations of this technique. One variation has the card positively driven into the stack by a non-marking belt. Another power stacking method is to drive the card into the belt, drum system and stack the cards on edge.

Serial or Parallel Feed, Read & Stack

All of the feeding, reading, and stacking techniques can be applied to a serial device or a parallel device (serial, meaning a column by column mode, parallel a row-by-row mode). Each has its advantages. There is also a combination of both serial and parallel which has the inherent advantages of both methods (Figure 6).

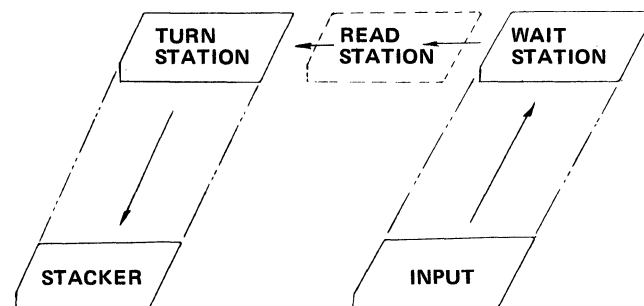

Figure 6. Serial Parallel Feed, Read and Stack

CARD PUNCHES

The card punch, an output device, is one of the most sophisticated electromechanical devices to be found in data processing systems. These devices perform at speeds in the neighborhood of 160 cycles per second. If this in itself is not impressive, consider next that the accuracy in card positioning is in the order of thousandths parts of an inch.

All of the previous discussions relating to card readers apply to card punches in regards to picking, in some cases reading, and stacking. A card punch can punch row-by-row or column by column. Row-by-row punches contain 80 punches with their associated dies, guides, and interposers. A column punch can have 12, 24, or perhaps 48 punches.

Die Set

The die set is that assembly which contains the punches, guides, and die. The function of this device is to punch the 0.125 x 0.055" hole from the card with as clean a cut as possible. Punches are made of very hard tool steels or carbides ground to extremely close tolerances; guides are made of special hardened steels and in some cases carbide machined by exotic processes.

1 Equipment Characteristics

Interposers

There is an interposer mechanism for each punch. When actuated electromagnetically, the interposer causes its associated punch to punch (or not to punch) during that cycle. The number of different types of punch interposer manufacturers exceeds the number of card punch manufacturers.

Indexing

After the first row or column is punched, the card must be moved or indexed to the next punch position. Here again there are many different types of indexing systems, but three general classes:

1. *Gate and Skid Rolls* — In this system the card is urged against a gate by a set of constantly rotating skid rolls. These gates are actuated and lifted above or below the card. The card will then move to the next gate by the constant urging of the skid rolls. These gates will act sequentially in a row by row device; or in a serial device under processor control can cause a card to skip between columns, increasing the throughput of the device.

2. *Indexing Knives* (Figure 7) — This device is more suited to a row by row punch. The indexing fingers are analogous to picker knives. If instead of 1 knife there were 12, the card would be picked or indexed 12 times.

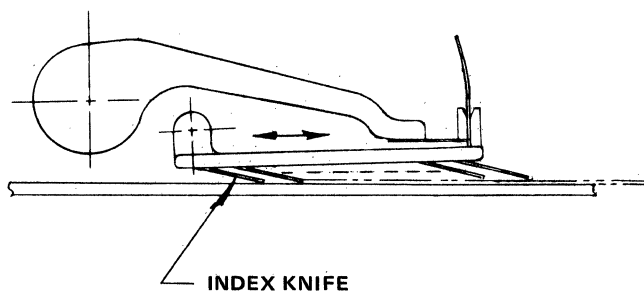

Figure 7. Indexing Knives

3. *Indexing Rollers* — The indexing roller is probably the most common means by which a card is indexed. If a card is gripped between a set of indexing rollers which rotate a fixed amount, the card will move a fixed amount. The methods by which these rollers are indexed are clever and varied; some are:

a. *Stepper motors* — Devices when given an electrical pulse will rotate a discrete amount.

b. *Servo motors* — Devices having low inertia (resistance to change) in combination with monitoring systems will rotate discrete amounts.

c. *Clutch and Brakes* — Devices which start and stop upon electrical commands.

d. *Pure mechanical drives* — Devices which add two motions algebraically, resulting in constant angular displacements.

Punch Checking

Punch checking, as in read checking, is a self-checking feature of a punch. Some devices perform a check during the same punch cycle, whereas others look at the entire card, one card cycle later.

KEYPUNCHES

Cards prepared for computer inputs are often prepared under computer control. There exist many cases in which cards must be prepared manually by an operator. Such data preparation is known as keypunching. This device is similar to a card punch, except that it has a keyboard which the operator utilizes to punch the appropriate data. Card picking, indexing, and stacking is automatic when the eightieth column is punched or the operator initiates an eject.

The keypunch has other automatic features such as the program drum which accepts a program card prepared by the operator to select various fields to be punched. It also permits repetitious data to be put into each card. Some keypunches called interpreting punches will print the character above the punched column.

EVALUATION AND SELECTION OF CARD EQUIPMENT

The equipment specifier when confronted with the overwhelming number of devices has a difficult decision to make. A discussion of the salient features of punch card equipment can make his task a little easier. The following suggestions can help him make the proper choice.

First, know the application. How many cards will be read or punched in a shift? Will it be necessary to read 300,000 in an 8-hour shift, or will it be more like 25,000? Will 140,000 cards be punched per 8 hour shift, or 5,000? Don't get confused by the horsepower race; however, don't expect a pony to do a horse's job. Once the speed range has been decided, the more difficult job comes into focus. The number of devices in a particular range can be extensive. The job now becomes getting the best device for the money, and the task now becomes evaluation. This is not accomplished by test, it must be done by poking under the covers; by studying published statistics; by determining what features are available; and by checking on service.

1 Equipment Characteristics

A check list that one might use is:

1. Maintainability

- a. What is the availability of spare parts?
- b. What is the service?
- c. How long would I be out of commission if a failure occurred?

2. What is the expected life of the device? – This is a very important consideration in a device which probably warrants a knowledgeable mechanical engineer.

3. How much noise does the device produce? – Is the noise tolerable?

4. What is the reliability of the device? The manufacturers should be able to furnish such statistics as:

- a. Card picking reliability - number of mis-picks per thousands of cards.
- b. Transport jams/jams per thousands.
- c. Stacker jams.

Items a, b, and c may be a specified composite number.

5. Read Errors

- a. What is the undetected read error rate?
- b. What is the detected read error rate?
- c. What is the read error rate for mis-registered cards (margin)?

6. Punch Errors

- a. What is the undetected punch error rate?
- b. What is the detected punch error rate?

7. Soft Errors – The device indicated a punch error when none existed. What is this rate?

8. Punch Registration – What is the expected rate of cards being mis-registered from the standard of + 0.010 at the time of punching.

9. Operator Accessibility

- a. Can jams be cleared readily?
- b. Can the device be loaded and unloaded during operation?
- c. Does the operator feel comfortable with the device?

1 Equipment Characteristics

CARD PUNCHES

COMPANY	COMPUTER-LINK	DATA PRODUCTS	DATRON SYSTEMS
MODEL	ACI-960	SP-120	601 plastic card punch
FIRST DELIVERY YEAR	1969	1966	1968
BASIC PURCHASE PRICE	\$99		\$1345
LEASE RATE/MONTH	n/a		\$67.25
PUNCH SPEED (cpm)	manual	100	6
INPUT HOPPER CAPACITY	1	1000	1
NO. OF OUTPUT STACKERS	none	1	
OUTPUT STACKER CAPACITY (per)	n/a	1000	1
LOGIC COMPATIBILITY	alphanumeric punching		
PROTECTIVE FEATURES			
COMMENTS			Hollerith codes plastic credit & ID cards.

CARD PUNCHES

COMPANY	DECISION DATA	DECISION DATA	HONEYWELL
MODEL	9640 Series	9660 Sorting Data Recorder	214-1
FIRST DELIVERY YEAR	1971	1971	1968
BASIC PURCHASE PRICE	\$5900 - \$7200	\$8400	\$14,700
LEASE RATE/MONTH		\$175	\$331/5 yr
PUNCH SPEED (cpm)	120	60	100 - 400
INPUT HOPPER CAPACITY	2000	400 or 600	1200
NO. OF OUTPUT STACKERS	3	6	1
OUTPUT STACKER CAPACITY (per)	1200 each	400	1300
LOGIC COMPATIBILITY	360 interface or electronics	BCD (96 col code)	Honeywell Series 200 computers
PROTECTIVE FEATURES	all		all
COMMENTS	128 positions of printing (96 col cards) std. 500 cpm read option.	Performs the free standing functions.	Speed depends upon no. of col punched.

Also see "Punch Card Data Terminal" charts.

1 Equipment Characteristics

CARD PUNCHES

COMPANY	HONEYWELL	HONEYWELL	HONEYWELL
MODEL	MCP-01A	P641A & B	P-648
FIRST DELIVERY YEAR	1969	1969	1968
BASIC PURCHASE PRICE	\$12,500	\$1525 & \$1630	\$2780
LEASE RATE/MONTH			
PUNCH SPEED (cpm)	400	40	200
INPUT HOPPER CAPACITY	1200	500	1500
NO. OF OUTPUT STACKERS	1	1	1
OUTPUT STACKER CAPACITY (per)	1300	450	1500
LOGIC COMPATIBILITY	custom	custom	custom
PROTECTIVE FEATURES	no cams, gears, or sliding parts in punch & feed mech	yes	yes
COMMENTS			

CARD PUNCHES

COMPANY	UNICOMP	VARIFAB	VARIFAB	XEROX DATA SYSTEMS
MODEL	MOD 260 Card Punch	400 Series	Series 600	7160 & 7165
FIRST DELIVERY YEAR		1969/70	1971	1966/69
BASIC PURCHASE PRICE	\$11,600	\$675 - \$920	\$1000 - \$2500	\$19,600 & \$32,000
LEASE RATE/MONTH		\$24/\$33-3 yr	\$35 - \$87.50	\$441/\$720-4 yr
PUNCH SPEED (cpm)	60	720	720	300 & 100
INPUT HOPPER CAPACITY	1000	manual feed	manual feed	1000
NO. OF OUTPUT STACKERS	1	manual feed	manual feed	2 or 1
OUTPUT STACKER CAPACITY (per)	1000	manual feed	manual feed	1000
LOGIC COMPATIBILITY	DTL	DTL/TTL	DTL/TTL	Sigma
PROTECTIVE FEATURES		power driven punches in & out. U.L. approved		read after punch verify
COMMENTS	12 parallel data lines, punch ready, & data request.	Punches plastic or tab cards.	12 models.	Price includes controller.

Also see "Punch Card Data Terminal" charts,

1 Equipment Characteristics

CARD READER/PUNCHES

COMPANY	DECISION DATA	DECISION DATA	UNITED BUSINESS COMMUNICATIONS
MODEL	9633	9645 Printing Reader Punch	CP60
FIRST DELIVERY YEAR	1971	1971	1970
BASIC PURCHASE PRICE	\$4000	\$5500	\$8800
READ SPEED (CPM)	300 (96 col)	300 (96 col)	n/a
PUNCH SPEED (CPM)	60 (96 col)	60 (96 col)	60 - fully laced
INPUT HOPPER CAPACITY	600 primary, 400 secondary	600 primary, 400 secondary	1000
OUTPUT STACKER CAPACITY (PER)	400 each	400 each	1000
NO. OF OUTPUT STACKERS	2	2	one
LOGIC COMPATIBILITY	basic electronics	basic electronics	DTL/TTL
PROTECTIVE FEATURES	read checking	read checking	registration error, card jam pick fail
COMMENTS	500 cpm read feature option	500 cpm read feature option	—

CARD READER/PUNCHES

COMPANY	UNITED BUSINESS COMMUNICATIONS	UNITED BUSINESS COMMUNICATIONS	UNITED BUSINESS COMMUNICATIONS
MODEL	CR300	MR300	500
FIRST DELIVERY YEAR	1971	1970	1968
BASIC PURCHASE PRICE	\$1890	\$2800	\$2990
READ SPEED (CPM)	300	200	600
PUNCH SPEED (CPM)	n/a	n/a	n/a
INPUT HOPPER CAPACITY	500	400	1000
OUTPUT STACKER CAPACITY (PER)	600	400	1000
NO. OF OUTPUT STACKERS	one	one	one
LOGIC COMPATIBILITY	DTL, TTL	DTL, TTL	DTL, TTL
PROTECTIVE FEATURES	light check, stacker error, card error, feed error	motion error, stacker error, feed error, light dark error	—
COMMENTS	—	reads, punches or marks	no restrictive throat in card track

Also see "Punch Card Data Terminal" charts.

CARD READERS

COMPANY	BRIDGE DATA PRODUCTS	BRIDGE DATA PRODUCTS	BRIDGE DATA PRODUCTS	DATA PRODUCTS CARD EQUIPMENT
MODEL	8096 & 8800	8000 & 8060	8600 & 9600	SR-Series
FIRST DELIVERY YEAR	1970/71	1970/71	1970/71	1968
BASIC PURCHASE PRICE	\$1690 - \$2500	\$1300 - \$2000	\$1530 - \$2250	
LEASE RATE/MONTH	n/a	n/a	n/a	
READING SPEED (cpm)	to 1000	400 or 650	800 or 1000	300 - 1500
INPUT HOPPER CAPACITY	1000	1000	1000	650 - 2500
NO. OF OUTPUT STACKERS	1	1 or 2	1 or 2	1 or 2
OUTPUT STACKER CAPACITY (per)	1000	1000	1000	650 - 2000
SENSING METHOD	photoelectric	photoelectric	photoelectric	photoelectric
COLUMN CARDS	80 or 96	80	96	51 or 80
LOGIC COMPATIBILITY	DTL/TTL	DTL/TTL	DTL/TTL	TTL
PROTECTIVE FEATURES				
Feed Stop	yes	yes	yes	yes
Operator Attention Lights	yes	yes	yes	yes
Motor-Shut Down on Jam	yes	yes	yes	yes
COMMENTS	Reads 80 or 96 col cards.	1000 hours MTBF	1000 hours MTBF	

CARD READERS

COMPANY	DATRON	DECISION DATA	DECISION DATA	DOCUMATION
MODEL	102	9625	9630 Series	M 200
FIRST DELIVERY YEAR	1968	1971	1970	1971
BASIC PURCHASE PRICE	\$625 - \$1000	\$800	\$4500 - \$5800	\$1950
LEASE RATE/MONTH	\$14 - \$23			n/a
READING SPEED (cpm)	12	300	1200	225
INPUT HOPPER CAPACITY	1	600	2000	500
NO. OF OUTPUT STACKERS	1	1	3	1
OUTPUT STACKER CAPACITY (per)	1	600	1200	500
SENSING METHOD	photoelectric - fiber optic	phototransistor	phototransistor	infrared LED/photo transistor
COLUMN CARDS	80	96	96	80
LOGIC COMPATIBILITY			360 interface or electronics	TTL/DTL/others (opt)
PROTECTIVE FEATURES				
Feed Stop		yes	yes	yes
Operator Attention Lights		yes	yes	yes
Motor-Shut Down on Jam		yes	yes	impossible to jam
COMMENTS				Handles mutilated, warped & damaged cards.

Also see "Punch Card Data Terminal" charts.

1 Equipment Characteristics

CARD READERS

COMPANY	DOCUMATION	HONEYWELL	HONEYWELL	PERIPHERAL DYNAMICS
MODEL	M300-M1000	223 Series	CRZ, L617 & MCR Series	C301, 2/601,2
FIRST DELIVERY YEAR	1970	1967/68	1968	1970
BASIC PURCHASE PRICE	\$2495 - \$3395	\$13,500 - \$15,120	\$1100 - \$7900	\$1455 - \$2500
LEASE RATE/MONTH	none	\$296/\$337.5 yr		
READING SPEED (cpm)	300/600/1000	800 & 1050	300 - 1050	300 & 600
INPUT HOPPER CAPACITY	1000	3000	500 - 3000	450 & 900
NO. OF OUTPUT STACKERS	1	1	1 or 2	1
OUTPUT STACKER CAPACITY (per)	1000	2500	500 - 2500	500 or 1000
SENSING METHOD	infrared LED/photo transistor	photoelectric	photocell	photoelectric
COLUMN CARDS	80	51/80/90	80	80
LOGIC COMPATIBILITY	TTL/DTL/others (opt)	Honeywell Series 200 computers	custom	TTL
PROTECTIVE FEATURES				
Feed Stop	yes	yes	yes	yes
Operator Attention Lights	yes	yes	yes	yes
Motor-Shut Down on Jam	impossible to jam	yes	yes	yes
COMMENTS	Upgradable to 600 or 1000 cpm.	Validity check & cycle check.		Table top or rack.

CARD READERS

COMPANY	POTTER INSTRUMENT	OMNITEC	UNICOMP	XEROX DATA SYSTEMS
MODEL	CS8000 & 8015	300 Series	250	7121
FIRST DELIVERY YEAR		1966	1970	1969
BASIC PURCHASE PRICE		\$1245	\$2900	\$8800 - \$24,000
LEASE RATE/MONTH		none		\$198/\$540-4 yr
READING SPEED (cpm)	1500 sync	300	200	200 - 1500
INPUT HOPPER CAPACITY	1000 or 2000	500	400	1400 or 2500
NO. OF OUTPUT STACKERS	1 or 6	1	1	1 or 2
OUTPUT STACKER CAPACITY (per)	600 or 1000	750	400	1000 or 2000
SENSING METHOD	optical (opt Potter mag char code)	light sensing	photo	photoelectric, fiber optics
COLUMN CARDS	96	80	80	80
LOGIC COMPATIBILITY		TTL	Comp-16, Comp-18	Sigma
PROTECTIVE FEATURES				
Feed Stop	yes	yes	yes	yes
Operator Attention Lights	yes	yes	yes	yes
Motor-Shut Down on Jam	yes	yes		yes
COMMENTS				Price includes controller.

Also see "Punch Card Data Terminal" charts.

Printers

The printer, the most widely used computer output device, performs two basic functions. The first, data monitoring, provides a permanent, continuous, and human-readable record of events over a period of time without human attention. The second, high-speed data accumulation, records data at a rate much higher than humans can accept. Most printer applications such as report generation, data logging, hard-copy computer output, instrumentation, and communications manifest both functions.

The large variety of printer models available on the market today may be classified into three broad categories: *line printers*, *character printers*, and *strip printers*. The line printer prints a line-at-a-time and is characterized by higher-speeds, wide formats (over 132 columns), and a line- or character-serial data entry mode. Line printers serve as the work horse for hard-copy computer output and report generation. The character printer prints character-at-a-time and is characterized by low to medium speeds, a format of 80 columns or less, and a character- or bit-serial data entry mode. Character printers are generally used in communications applications, often as user terminals. The strip printer prints one or more characters at a time and is characterized by an extremely limited column width, low speeds and a parallel data-entry mode. Strip printers are often used in data logging applications.

When selecting a printer, it is best to focus on the requirements for your application in such critical areas as speed or throughput, cost, character repertoire, output format, data entry, and multiple copy capability. These requirements often indicate the printing technique of the printer. For example, non-impact printers (electrostatic, inkjet, etc.) are essential for applications requiring speeds of over 2000 lines per minute. However, if multiple copy capability is desired, then the use of an impact printer (drum, chain, etc.) is indicated. Specification of basic application requirements will help you in quickly narrowing down the choice to a few models, which may then be evaluated in detail.

Detailed evaluation of models that meet your application requirements should include a comparison of cost/throughput measures, reliability, print quality, flexibility (in changing formats and character fonts), and manufacturer-related considerations such as delivery, service, maintenance and viability. The cost measure should reflect not only the cost of the unit, but also interfacing and recurring costs (such as paper). Many of the printer characteristics (speed, reliability, quality, flexibility and costs) are closely related to the printing mechanism employed by the printer.

PRINTING MECHANISMS

The printing mechanisms used in line printers may be classified into two broad categories, i.e., impact and

non-impact. The impact printers employ a hammer mechanism that impacts a character image on paper via a transfer medium such as a ribbon. The non-impact printers employ an electrostatic, thermal, inkjet or other non-impact mechanism to transfer the character image. Usually, specially sensitized paper (more expensive) is required for use with the non-impact printers. The main advantages of the non-impact printer are its inherently higher-speed, negligible noise level, generally better reliability and excellent vertical and horizontal alignment. The disadvantages are its higher operating costs and lack of multiple copies.

Impact Printers

In impact printers, character type faces are presented selectively from a character set to a print position on paper. The manner in which character-set is made selective largely determines the speed and print mechanism. The following basic techniques are commonly encountered:

1. Individual character-type bars which can be moved to a single print position on command.
2. Prepositioned font bar which contains the entire character set and is selectively movable so the desired character can be brought to the print position. This is frequently referred to as "tab" printing.
3. Continuously-moving font bar which presents all the characters in the set to each print position so that a properly-timed firing of a hammer will print the selected

Type-bar printing, the slowest of the three techniques, is limited to speeds of 10 characters per second. The prepositioned font bar or "tab" technique is capable of printing at considerably higher speeds, depending on the number of columns used in simultaneous printing. The continuously moving font bar or "on-the-fly" technique is capable of printing at speeds of 40 characters per second per column. This technique is used in most impact line printers.

A variety of mechanisms have evolved, using the "on-the-fly" printing technique. The more common of these are drum, chain, belt and oscillating bar. Each of these mechanisms is comparable in speed, cost, reliability, and quality but there are some subtle differences. The chain mechanism is sometimes preferred over the drum, as timing inaccuracies in the chain produce only a horizontal displacement. This is much less objectionable than the vertical displacement of characters encountered by similar inaccuracies in drums. However, there are applications such as optical character recognition (OCR) in which horizontal alignment is more important and the drum is preferable. The chain and belt printers are also more flexible if fonts are to be changed frequently.

1 Equipment Characteristics

While most line printers on the market use chain or drum mechanism, two promising new techniques have been introduced recently: (1) the dot-matrix techniques used in the Potter LP3000 dot matrix printer, and (2) the oscillating bar mechanism used in Bright Industries BI1215 bar printer. The dot matrix printer is relatively inexpensive and provides great flexibility, since fonts may be changed electronically by a selector switch. It is also more reliable as it uses fewer hammers. The oscillating bar printer also provides for quick and inexpensive change of font bars. The print quality is considerably better than most drum and chain printers, since there is almost no vertical and horizontal misalignment. The only disadvantage with these units is that they are medium-speed (100-300 lines per minute) devices. Where speed or throughput is not the major criterion, the oscillating bar and the dot matrix printers are attractive.

Non-Impact Printers

The non-impact printers, except for inkjet types, require special paper that is sensitive to electricity, light or heat. Among the non-impact printers, the most widely used are the electrostatic type, the most renowned of those being the Varian Statos 21 with a speed of 5000 lines per minute. Other noteworthy electrostatic printers are manufactured by Versatec, Repco and Gould. The electrostatic printers employ a stylus matrix in the print head from which current passes through the electrosensitive paper to a ground plate behind it. The majority of electrostatic printers offer only an 80-column format. An exception is the Gould 4800 which offers 132 characters per line.

The thermal printers are usually character printers used in low-speed communications and terminal applications. The printing is on a heat-sensitive paper at a rate of about 10 to 30 characters per second. The most notable thermal printers are the NCR units, the Texas Instruments Silent 700 series and the portable Computer Devices Model 1030.

The inkjet printers have the additional advantage, that they do not require special paper. A consideration of inkjet printers is that speeds are generally limited to 100 lines per minute. The most noteworthy inkjet printers are Teletype's Inktronic and A.B. Dick's Video Jet models. The print quality in inkjet printers is excellent (Figure 1).

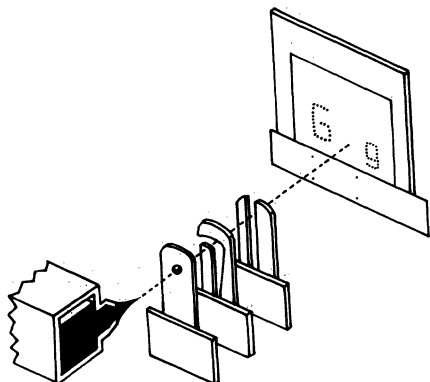

Figure 1. One Method of Inkjet Printing
(Courtesy of Teletype Corp.)

SELECTION CONSIDERATIONS

Throughput

The speed or throughput (characters per second or lines per minute) requirement usually determines the type of machine needed and has the greatest influence on cost. Usually, a throughput requirement of 150 char/sec or less indicates the use of character printers, and over 200 char/sec indicates line printer speeds in excess of 2000 lines/min., thus requiring the non-impact line printer.

The throughput of the printer is affected by line speed, number of columns or characters per line, number of characters in character repertoire and format of data. The speed is a function of the number of characters in repertoire, since it takes a finite time to present each character in set to the printing position when moving font techniques are used. Consequently, in such printers, a larger character set means lower throughput. You should take this into account when comparing two machines that offer different character sets.

Costs

In comparing costs, you should consider not only the purchase or lease costs but also operating costs (paper, etc.), maintenance costs, service costs and interfacing costs. Operating costs are higher for non-impact machines but maintenance and service costs are usually lower. The interfacing costs are affected by data entry mode, buffer control, and logic compatibility.

For some applications it may be useful to evaluate printers by using cost performance measures such as throughput per unit cost. In other applications, where excess capacity cannot be utilized, the consideration may be to choose the unit which offers the desired throughput at the lowest cost. You should choose the strategy that is appropriate for your application.

Interface

The interface between the printer and data source (computer) is an important selection consideration. Along with the mechanical and electrical interface problems, you should examine timing problems, device and buffer control, and differences in the form of data at source and printer. Often, auxiliary storage, control and converter devices are required to solve the interfacing problems.

These interfacing problems not only add to cost but often mean a delay which may render the printer unsuitable for your application. You should investigate the interface options offered by manufacturers, as these may prove economically useful. If a compatible interface is not available, the cost of a custom unit can be as high as 50% of the printer cost. Logic compatibility with TTL, or the logic of your data source, may mean easier and less expensive custom interface.

Character Set and Print Quality

A consideration of the character set and code available with the printer is useful in that a large number of printer models may be eliminated on this basis. For example, if the application requirements call for use of 96 ASCII printable

1 Equipment Characteristics

graphics (and 32 control characters), then only those printers which provide full-ASCII capability should be considered in detailed evaluation. The number of characters in the character set also affects the printer speed in a majority of printer types.

The variety of fonts available and the ease with which these can be changed may be important selection criteria in applications which require use of different types of fonts. The dot matrix printer and most of the non-impact printers offer great flexibility, as fonts may be changed electronically.

The quality of the printed characters is an important consideration in applications involving aspects of report generation. You should examine the print quality to determine if it meets the standards desirable for your application. The vertical alignment of characters is more important than horizontal alignment except in applications using OCR equipment, where the reverse is usually true. Non-impact printers generally have better alignment of characters, and among impact printers, the bar printer is considered superior.

Format Considerations

The number of columns required in an application is based on the desired organization of the printout. This requirement directly affects throughput and cost, since a larger line means a higher cost. In many cases it is possible to change the printout organization to reduce printer costs for given throughput requirements.

In a number of applications including report generation and computer printouts, format control is an important consideration. If a great deal of forms printing is anticipated in your application, then a large number of formatting channels are essential. Formatting is usually controlled by means of a paper tape loop attached to the printer. A recent trend towards the use of magnetic tapes or small core memories eliminates the delays associated with the

paper tape loop. The availability of color printing should be considered in applications such as accounting reports in which it is desirable.

Reliability

The reliability of printers generally depends on the quality of its construction and the print mechanism used. The non-impact printers, which use fewer moving parts and no hammer-like mechanisms, are usually more reliable than impact printers. Among the impact printers, the dot matrix printer is considered more reliable than chain and drum printers.

Reliability, generally expressed in statistical terms as mean-time-between-failures (MTBF), can be derived from documented failure rates or from a statistically-valid sample of controlled-system life tests. In the mechanical impact printers, MTBF figures in the order of 1000 hours are generally considered good. A well-built machine with fewer mechanical adjustments is likely to be more reliable. Also, using good quality paper and ribbon is likely to improve performance and reduce breakdowns.

Other Factors

Other factors that should be considered in examining a printer are the ease and frequency of paper loading and ribbon replacement. Such manufacturer related factors as delivery schedules, service and maintenance support, and viability of the manufacturer should also be carefully considered before making the final decision.

After the choice has been narrowed down, it is suggested that you ask the manufacturer for a demonstration, so that the various design features can be discussed firsthand. Further, you should try to determine how reliable the printer is from supported MTBF figures or, better still, from actual user experience.

COMPUTER OUTPUT MICROFILM PRINTERS

The text description for COM plotter-printer systems is presented on page 143 of the section "Graphic Data Equipment."

PRINTERS

COMPANY	A. B. DICK	AMERICAN REGITEL	ANADEX INSTRUMENTS	BECKMAN INSTRUMENTS
MODEL	Videojet 9600	4440C30, C40 & C80	DP-650 Series	1454
FIRST DELIVERY YEAR	1969	1969 - 1970	1970	1970
BASIC PURCHASE PRICE	\$6250	\$1375, \$1475, \$1600	\$745 to \$795	\$1095
LEASE RATE/MONTH	\$219	n/a		\$85
TYPE	100-200 lpm	6 point	strip	line
SPEED	300 char/sec	40 char/sec	180 lpm	180 lpm
THROUGHPUT (char/sec)	300	1000	63	63
MAXIMUM NO. COLUMNS	200	30, 40, 80	21	21
CHARACTERS/COLUMN	one	one char/col	16	16
MECHANISMS TYPE	Inkjet	impact-wheel & hammer	drum	calculator
DATA ENTRY	serial or parallel	serial RS232 baud parallel 8 bit ASCII	parallel	word parallel
CHARACTER SETS	USASCII	ASCII	BCD	parallel decimal printout
LOGIC COMPATIBILITY	DTL-TTL	DTL	1, 2, 4, 8 pos true DTL/TTL	transistor, IC, MOS
BUFFER CONTROL	200 char buffer opt	line	none	no
ZERO SUPPRESSION	no	yes	no	no
COLUMN INHIBIT	no	yes	no	yes
FORMAT CONTROL	yes	no	no	yes
COLOR AVAILABLE	no	yes	yes	red/black
MAX. MULTIPLE COPIES	single copy	6	3	variable
COMMENTS	Variable print density & graphics capability			

Also see "Printer Data Terminal" charts.

1 Equipment Characteristics

PRINTERS

COMPANY	BRIGHT INDUSTRIES	CENTRONICS DATA COMPUTER	COMPUTER HARDWARE	COMPUTER TERMINAL SYSTEMS
MODEL	BI 1215	101	CHI 2410	4 Strip
FIRST DELIVERY YEAR	1970	1971	1970	1970
BASIC PURCHASE PRICE	\$9000	\$2400	\$21,800	\$270
LEASE RATE/MONTH	\$350	none	\$890 (2 yr)	
TYPE	line	char	line	char
SPEED	300 lpm	165 char sec; 55 to 200 lpm - dependent on line length	550 avg	35 char/sec avg
THROUGHPUT (char/sec)	660	130 continuous	788	50
MAXIMUM NO. COLUMNS	132	132	132	1
CHARACTERS/COLUMN	64, 96, or 128	63	1	64
MECHANISM TYPE	oscillating type bar	Mosaic 5x7 dot matrix impact	drum	impact on-the-fly
DATA ENTRY	char serial, bit parallel or multiple char in parallel	serial (RS232) or parallel	char - serial	opt
CHARACTER SETS	any required set	ASCII - EBCEDIC	ASCII	ASCII
LOGIC COMPATIBILITY	DTL/TTL	TTL	n/a	opt
BUFFER CONTROL	full line	line 132	24 char	opt
ZERO SUPPRESSION	no	yes	no	n/a
COLUMN INHIBIT	no	yes	no	n/a
FORMAT CONTROL	yes	yes	yes	n/a
COLOR AVAILABLE	no	no	no	no
MAX. MULTIPLE COPIES	6	5	6	1
COMMENTS	For \$9500 offset print quality.		Can be interfaced to IBM's 1130 & 1800.	No electronics or pwr supply.

Also see "Printer Data Terminal" charts.

PRINTERS

COMPANY	CONNECTICUT TECHNICAL	DACONICS	DATADYNE	DATA PRINTER
MODEL	II B	2909	722/22-10-1B-22	V-132-C
FIRST DELIVERY YEAR	1970	1970	1969	1970
BASIC PURCHASE PRICE	\$800-\$2000	\$11,900	\$990	\$9720
LEASE RATE/MONTH	n/a	2.25%/mo of list on 5 yr lease	none	n/a
TYPE	typebar mechanism	line	full ASCII 22 col	line
SPEED	16 cps	200 lpm	1320 lpm	600 lpm
THROUGHPUT (char/sec)	16 cps		13,200	1320
MAXIMUM NO. COLUMNS	184	132	22	132
CHARACTERS/COLUMN	10 & 12 pitch		64	64
MECHANISM TYPE	typebar	chain	drum	impact, drum
DATA ENTRY	serial	parallel	bit parallel, column parallel	char-serial
CHARACTER SETS	std & options	48, 64 & 96	ASCII	ASCII std, others opt
LOGIC COMPATIBILITY	custom & all - DTL, TTL	interfaces to HP, DEC, XDS	TTL or discrete	TTL
BUFFER CONTROL	10 char	line	buffered input	line
ZERO SUPPRESSION	on command	n/a	yes	no
COLUMN INHIBIT	yes	n/a	yes	no
FORMAT CONTROL	yes	yes IBM control tape	yes	yes, 8 ch std, 12 ch opt
COLOR AVAILABLE	yes (black & red - 2 color)		no	no
MAX. MULTIPLE COPIES	10	6	3	6
COMMENTS	A converted elec type-writer.	All popular compatible interfaces		

Also see "Printer Data Terminal" charts.

PRINTERS

COMPANY	DATA PRODUCTS	DATA PRODUCTS	DATASONICS	DI/AN CONTROLS
MODEL	2310 Line Printer	5200 ACT	Infotec Off-Line Print Station	Series N Lister/Printer
FIRST DELIVERY YEAR	1968	1968	1970	1968
BASIC PURCHASE PRICE		\$62,380		\$5800
LEASE RATE/MONTH		\$1765		
TYPE	80 col 64 or 96 char	line	line	32 col-infinite lines
SPEED	356-1110 lpm	670-2000 lpm	600 lpm	2400 lpm
THROUGHPUT (char/sec)			1320	1280
MAXIMUM NO. COLUMNS	80	136	132	32
CHARACTERS/COLUMN	64, 86, 96	1	64	16 numeric, 48 alpha-numeric
MECHANISM TYPE	impact	drum		impact (drum)
DATA ENTRY	bit parallel, char serial			char-serial, 6 bits in parallel
CHARACTER SETS	ASCII & others	any 6 or 8 bit code	ASCII, EBCDIC, BCD: others avail	option
LOGIC COMPATIBILITY	TTL	off line		yes
BUFFER CONTROL	20 char	up to 4096 char		line or column
ZERO SUPPRESSION	no	no		yes, opt
COLUMN INHIBIT	no	no		no
FORMAT CONTROL	no	yes	yes	yes, opt
COLOR AVAILABLE		yes		no
MAX. MULTIPLE COPIES	6	6		3
COMMENTS		Satellite printer.		

Also see "Printer Data Terminal" charts.

PRINTERS

COMPANY	DI/AN CONTROLS	DIGITRON	GOULD GRAPHICS	HONEYWELL
MODEL	Strip Printer	2014H	4800-11	222-7
FIRST DELIVERY YEAR	1968	1969	1969	1969
BASIC PURCHASE PRICE	\$195	\$715	\$10,900	\$25,410
LEASE RATE/MONTH	n/a	n/a	\$600	\$560 (5-yr)
TYPE	char	line	line printer/plotter	line
SPEED	20 char/sec	150 lpm	up to 4800 lpm	300
THROUGHPUT (char/sec)	20	35	250,000	300
MAXIMUM NO. COLUMNS	infinite	14	132	132
CHARACTERS/COLUMN	one of 64	12 max	varies w/paper length output; up to 8 char lines/in.	1
MECHANISM TYPE	drum	individual char wheel-common hammer	electrostatic	drum
DATA ENTRY	parallel or serial	parallel char	serial and parallel	char serial
CHARACTER SETS	ASCII, Baudot, EBCDIC	numeric, partial alpha (12 char), special	ASCII or EBCDIC	ASCII, Honeywell, others
LOGIC COMPATIBILITY	DTL-TTL-RS232	DTL, TTL, MOS, bipolar relay, BCD, Berkley	TTL/RTL	Honeywell series 200 computers
BUFFER CONTROL	n/a	opt-char groups of 6 or 7	132 char buffer	line
ZERO SUPPRESSION	yes	no	no	yes
COLUMN INHIBIT	yes	yes	no	no
FORMAT CONTROL	n/a	yes	no	yes
COLOR AVAILABLE	no	fixed-not variable	no	no
MAX. MULTIPLE COPIES	1	2	no	8
COMMENTS	For continuous duty.	Special fonts on custom basis.	Can be used as digital printer & plotter on- & off-line.	

Also see "Printer Data Terminal" charts.

1 Equipment Characteristics

PRINTERS

COMPANY	HONEYWELL	KDI-ADTROL	LITTON DATALOG	NOVAR
MODEL	I-541	Strip SP-1	MC-8800	5-51 Multiple Magnetic Tape Batch Terminal
FIRST DELIVERY YEAR	1969	1969	1966	1970
BASIC PURCHASE PRICE	\$4190	\$995	\$12,900	\$8155
LEASE RATE/MONTH		n/a	none	\$235
TYPE	64 char	char	line	char
SPEED	200 lpm	200 char/sec	6000 lpm	15 char/sec
THROUGHPUT (char/sec)		200	8800	same (trans speed to 240)
MAXIMUM NO. COLUMNS	136	1	88	130 or 156
CHARACTERS/COLUMN	10 char/inch	full alpha-numeric	64	1
MECHANISM TYPE	shuttle	non impact	electro-optical	Selectric typewriter
DATA ENTRY	parallel	char-serial	char-serial	bit & char-serial
CHARACTER SETS	ASCII	ASCII	any 64 char set	correspondence, EBCD, BCD or ASCII
LOGIC COMPATIBILITY	custom		TTL	
BUFFER CONTROL	char	char	char	char, word or line
ZERO SUPPRESSION	yes	not req'd	no	no
COLUMN INHIBIT	yes	not req'd	yes	no
FORMAT CONTROL	yes	yes	yes	yes
COLOR AVAILABLE	no	no	no	yes
MAX. MULTIPLE COPIES	6	1	none	6
COMMENTS				

Also see "Printer Data Terminal" charts.

PRINTERS

COMPANY	ODEC COMPUTER SYSTEMS	POTTER INSTRUMENT	REPCO	SYNER-DATA
MODEL	1321	HSP 3502A	120	Alpha 101
FIRST DELIVERY YEAR	1970	1967	1970	1970
BASIC PURCHASE PRICE	\$7900	\$11,000	\$1500	\$6660 (80-col)
LEASE RATE/MONTH	\$260.70/40 mos	n/a	third party only	
TYPE	line	line	char	line
SPEED	110 lpm	360 lpm, 32 char	120 char/sec	300 lpm
THROUGHPUT (char/sec)	242		80 - 80 col line	
MAXIMUM NO. COLUMNS	132	132	80	80 and 132
CHARACTERS/COLUMN	all char/column	up to 192	1	64
MECHANISM TYPE	direct drive char belt	rotating chain	non-impact electro-static	impact
DATA ENTRY	char-serial	parallel	async serial or parallel	char-serial, bit parallel
CHARACTER SETS	ASCII 64, 96 and special	ASCII, EBCDIC or up to 192 diff char	basic ASCII 63 char + space	ASCII
LOGIC COMPATIBILITY	TTL or DTL	TTL	RS232 serial TTL serial & parallel	DTL/TTL
BUFFER CONTROL	full line	full line	128 buffer opt avail to provide compatibility w/ TTY data format	one-line
ZERO SUPPRESSION	n/a	no	no	no
COLUMN INHIBIT	n/a	yes	no	no
FORMAT CONTROL	yes	yes	no	no
COLOR AVAILABLE	no	no	no	no
MAX. MULTIPLE COPIES	6	6	1	6
COMMENTS	Print on the fly.	Alphanumeric, numeric & symbolic capability.	Options: keyboard, 128 char buffer	

Also see "Printer Data Terminal" charts.

1 Equipment Characteristics

PRINTERS

COMPANY	SYSTRON-DONNER	TELEX COMPUTER PRODUCTS	TEXAS INSTRUMENTS	UNICOM
MODEL	5103	5403/5821 System	Silent 700-Model	PR-2000
FIRST DELIVERY YEAR	1969	1971	1970	1970
BASIC PURCHASE PRICE	\$945	\$64,700-\$104,860	\$3750	\$790
LEASE RATE/MONTH		\$1520-\$2480	\$170	
TYPE	line	line		char
SPEED	3 lps	1200 lpm, 2400 lpm (burst)	10, 15 or 30 char/sec	10 char/sec
THROUGHPUT (char/sec)		2.62 KC/S, 5.24 KC/S (burst)	10, 15 or 30	10
MAXIMUM NO. COLUMNS	21	132	80	120
CHARACTERS/COLUMN	16	288	1 char/column	∞
MECHANISM TYPE	rotating drum	high speed train	friction feed	typewriter
DATA ENTRY	parallel	char serial (9 bit byte)	serial or parallel	parallel
CHARACTER SETS	BCD 8-4-2-1, 4-2-2-1, 2-4-2-1	EBCDIC (any set avail)	BCD/PTT	mod ASCII
LOGIC COMPATIBILITY	positive & negative	TTL	EIA or TTL	74-series TTL
BUFFER CONTROL	no	yes	100 char	yes - opt
ZERO SUPPRESSION	yes	controller software		yes - opt
COLUMN INHIBIT	no	controller software		yes - opt
FORMAT CONTROL	yes	yes, paper tape loop or core memory	no	yes - opt
COLOR AVAILABLE	yes	yes, special ribbon	no	yes - opt
MAX. MULTIPLE COPIES	3	6	1	5
COMMENTS	Built-in time code option.	Numerous options.	IBM 1051/52 compatible	Upper-lower case letters.

Also see "Printer Data Terminal" charts.

PRINTERS

COMPANY	UNICOMP	UNITED SYSTEMS	UNIVAC
MODEL	275	691	0758-00
FIRST DELIVERY YEAR	1970	1969	1965
BASIC PURCHASE PRICE	\$11,650	\$770 to \$1155	\$43,500
LEASE RATE/MONTH		n/a	\$1250
TYPE	line	line	line
SPEED	350 lpm	180 lpm	1600 lpm
THROUGHPUT (char/sec)		63	3400
MAXIMUM NO. COLUMNS	80	21	132
CHARACTERS/COLUMN	64	16	63
MECHANISM TYPE	hammer-drum	drum	drum
DATA ENTRY	parallel	parallel	parallel
CHARACTER SETS	ASCII	BCD	V
LOGIC COMPATIBILITY	Comp-16, Comp-18	TTL, DTL, RTL	1100 series
BUFFER CONTROL	line	n/a	line
ZERO SUPPRESSION	yes	no	yes
COLUMN INHIBIT	yes	yes	yes
FORMAT CONTROL	yes	yes	yes
COLOR AVAILABLE	no	yes	no
MAX. MULTIPLE COPIES	6	3	6
COMMENTS		Fan-fold paper, 4 input channels.	

Also see "Printer Data Terminal" charts.

PRINTERS

COMPANY	VARIAN GRAPHICS & DATA SYSTEMS	VERSATEC	XEROX DATA SYSTEMS
MODEL	STATOS 2111	1300	7446
FIRST DELIVERY YEAR	1971	1971	1971
BASIC PURCHASE PRICE	\$13,450	\$6700	\$62,000
LEASE RATE/MONTH	3rd party leasing avail.	\$240/40 mos	\$1305 (4 yr)
TYPE	line	line	line
SPEED	5000 lpm	480 lpm (sync or async)	1500 lpm
THROUGHPUT (char/sec)	6400	1056	
MAXIMUM NO. COLUMNS	80	132	132
CHARACTERS/COLUMN	64	132 of 7x9 dot matrix char	64
MECHANISM TYPE	electrostatic-liquid toner	electrostatic	drum
DATA ENTRY	byte parallel	series or parallel	char-serial
CHARACTER SETS	ASCII, EBCDIC	ASCII-64	ASCII or EBCDIC
LOGIC COMPATIBILITY	TTL	TTL	Sigma
BUFFER CONTROL	80 char line buff.	1-line (2-line opt)	full line
ZERO SUPPRESSION	no	n/a	yes
COLUMN INHIBIT	no	no	no
FORMAT CONTROL	yes (opt)	yes	yes
COLOR AVAILABLE	yes (single color)	no	no
MAX. MULTIPLE COPIES	1	1	6
COMMENTS	Plots graphics w/ printing at no reduction in line rate.	Interface & software avail.	Price includes controller.

Also see "Printer Data Terminal" charts.

COMPUTER OUTPUT MICROFILM SYSTEMS

COMPANY	CALIFORNIA COMPUTER PRODUCTS	CALIFORNIA COMPUTER PRODUCTS	COMPUTER MICRO- IMAGE SYSTEMS	EASTMAN KODAK
MODEL	835 COM Plotter	1670 COM System	CMS 7000	KOM-90 Microfilmer
FIRST DELIVERY YEAR	1966	1970	1969	1969
TYPE (alphanumeric and/or graphic)	both	both	alpha	alpha
BASIC PURCHASE PRICE	by request	by request	\$130,000	\$89,000
LEASE RATE/MONTH	by request	by request	\$4000	\$2650 - 1 yr.
INPUT				
On/Off Line	on/off	on/off	off	off
Magnetic Tape (bpi/7- or 9-track)	200, 556, 800, 1600/ 7, 9, or 7 & 9	200, 556, 800, 1600/ 7, 9, or 7 & 9	1600/7 & 9	200, 556, 800, 1600/ 7 & 9
Tape Drive Included?			no	opt
SPEED (ipm)			40K & 20K	20,000 - 25,000
CHARACTERS				
Sizes	unlimited	unlimited	3/bold-italics	2
Number	64 - 256	94 - 256	64 & 128	64 std to 121
OUTPUT				
Roll/Fiche Size (mm)	16, 35	16, 35, 105	16, 35, 105	16, 35, 82.5, 105
Max Image Area (in.)				.569 x .460
COMPUTER (Model)			none	none
RETRIEVAL CODES			all available	codeline, image control, Miracode
GRAPHICS CAPABILITY	yes	yes	no	no
HARD COPY OUTPUT	no	no	no, display monitor, to preview input	no
FORMS OVERLAY	no	yes	yes	yes
DISPLAY MONITOR	opt	opt	yes	yes
LANGUAGES ACCEPTED	BCD, EBCDIC	BCD, EBCDIC	all	BCDIC & EBCDIC
COMMENTS		105 full frame capability		

COMPUTER OUTPUT MICROFILM SYSTEMS

COMPANY	MEMOREX	PERIPHERAL TECHNOLOGY	RECOGNITION EQUIPMENT	RECOGNITION EQUIPMENT
MODEL	1603 Microfilm Printer	PTI-1300 & 2600	Output Image 400 & 500	Output Image 600 & 700
FIRST DELIVERY YEAR	1970	1970	1971	1969
TYPE (alphanumeric and/or graphic)	alpha	alpha	alpha	both
BASIC PURCHASE PRICE	\$44,250	\$46,950 - \$59,750	\$68,000 & \$94,000	\$130,000 & \$153,000
LEASE RATE/MONTH	\$895	\$1450 - \$1985	\$2015 & \$2740	\$3845 & \$4525
INPUT				
On/Off Line	on	on or off	off	off
Magnetic Tape (bpi/7- or 9-track)	n/a	556, 800, 1600/ 7 or 9	556, 800, 1600/ 7 or 9	556, 800, 1600/ 7 or 9
Tape Drive Included?	n/a	yes		
SPEED (lpm)	10,000	13,000 or 26,000	23,680	31,750
CHARACTERS				
Sizes	0.00632 in./line, upper case	normal sizes	1	3
Number	64	64 or 90 char set	64	128 std
OUTPUT				
Roll/Fiche Size (mm)	16 roll	16 roll, 16 & 105 Fiche	16, 35, 70, 105 roll	16, 35, 70, 105 roll
Max Image Area (in.)	.5" x 16 mm	.44 x .55	.315 x .315	.315 x .315
COMPUTER (Model)	IBM 360-25 and above	none	hardwired format controller	DEC PDP-8/E
RETRIEVAL CODES	image count	image count, Miracode, codeline	image count, Miracode	image count, Miracode
GRAPHICS CAPABILITY	no	no	no	yes
HARD COPY OUTPUT	no	no	no	no
FORMS OVERLAY	yes	yes - opt	yes - std	yes - std
DISPLAY MONITOR	no	no	optical viewer	optical viewer
LANGUAGES ACCEPTED	EBCDIC	BCD, EBCDIC, ASCII	ASCII, BCD, EBCDIC	any
COMMENTS				131K Words disk, 32K word core memory option.

COMPUTER OUTPUT MICROFILM SYSTEMS

COMPANY	SEACO COMPUTER DISPLAY	SINGER-LINK / MICROGRAPHIC SYSTEMS	TERMINAL DATA	TERMINAL DATA	UNIVERSITY COMPUTING GRAPHIC SYSTEMS
MODEL	401 COM	MS-5000 & 6000 COM, Plotter - Printer	Filmer DMF-2 & 3	Recorder SMR-2400	Microfilm Printer/ Plotter 300-2 & 3
FIRST DELIVERY YEAR	1970	1970/1971	1969/1970	1970	1969
TYPE (alphanumeric and/or graphic)	alpha	either/both	both	both	alpha
BASIC PURCHASE PRICE	\$39,850	\$135,000 & up			\$115,000 & \$139,000
LEASE RATE/MONTH	\$1355 - 3 yr.	\$4400 & up			\$3175 & \$4560
INPUT					
On/Off Line	off	on/off			off
Magnetic Tape (bpi/7- or 9-track)	556, 800/ 7 or 9	556, 800, 1600/ 7 and/or 9	n/a	n/a	7 and/or 9
Tape Drive Included?	yes	yes			yes
SPEED (ipm)					
		9090	can expose to 20 frames/sec	up to 40 documents/sec	12,000
CHARACTERS					
Sizes		8	reduction ratios between 10X & 50X	reduction ratios 25X to 50X	1 or 2
Number	64 to 160	64 to 128			64 std
OUTPUT					
Roll/Fiche Size (mm)	16 or 105	35, 16, 105 fiche	Roll: 16,35,& 70 Fiche: 82.55 & 105	Roll: 16	16 - 105
Max Image Area (in.)	140 char/line 64 lines/pg	1,433 x 1.1 max (35 mm)			depends on film used
COMPUTER (Model)	401	Datacraft 6024 series	n/a		any
RETRIEVAL CODES	image count	Miracode (others opt)	image count mark, Miracode, BCD & others	BCD, eye readable, barcode	image count, Miracode, codeline
GRAPHICS CAPABILITY	no	yes	n/a	n/a	no
HARD COPY OUTPUT	no	no	n/a	n/a	yes - opt
FORMS OVERLAY	yes - opt	yes	n/a	n/a	yes - std
DISPLAY MONITOR	yes - opt	yes - std	n/a	n/a	no
LANGUAGES ACCEPTED	EBCDIC, ASCII, BCD & SEACO standard set	any data code	n/a	n/a	ASCII, BCD, EBCDIC, other
COMMENTS					

Optical Reading Equipment

About a decade and a half ago, when the computer industry was entering its early stages of growth, input was recognized as a problem which would require increasing attention in the future. However, the demands on the EDP Industry to improve performance in speed and cost of the processor have been so great, that we have seen a great advance in the technology of processing data, ranging from the simple entry of a debit or credit to putting a man on the moon and bringing him back safely. In doing so, a great gap has been created in our ability to efficiently feed information to the computer in a fashion which lends itself to the everyday demands of the business community. We still find ourselves creating data in practically the same fashion as was originally devised over 30 years ago, keying one character at a time. The early computer technology forced us to this means as the punched card was the only language directly compatible to the processor. The card required manual keypunching in conjunction with other repetitive steps to insure that all information was transcribed correctly. It has been the lack of advance in communication from man to machine that has caused the present EDP nemesis, the "input bottleneck."

Certain improvements have been made in the past which are now lending themselves to utilization of more advanced techniques. Punched paper tape and later magnetic tape were designed to be created from sources other than the limited keypunch unit. Cash registers, adding machines and keyboard devices were implemented to provide the ability to create source media as a byproduct of doing a specific job. This was a step in the right direction towards source data automation, a system designed around doing a normal day's job with data directly communicated to a computer without additional human intervention.

Optical character recognition (OCR) was introduced about 14 years ago in commercial industry and was tagged immediately as the breakthrough to eliminating the input crisis. However, keypunching and keying peripherals have remained as the center stage attraction in input techniques while OCR has remained backstage, viewed as a standin, but not accepted as a practical challenge to the star. Today, OCR has raised the curtain and is now asserting itself as an effective technique for meeting the challenge of source data capture and conversion to a computer language.

The change began a few years ago as potential users throughout the industry began to ask, "What happened to OCR?" The traditional pessimists, unwilling to accept the resurgence in interest, said the industry had failed — reneged on its decade-old promise to reduce input costs and boost the efficiency and accuracy involved in the handling of source documents. In short, they said OCR manufacturers had not provided the devices needed to meet user requirements. Their arguments are rapidly diminishing.

Today, the OCR industry has ended the old "justification vs. keypunching" argument and is beginning its own state-of-the-art advance. The direction of the industry, the shape of future OCR developments, will depend largely on how well the OCR specialists communicate and demonstrate to their potential users that the question of this decade is not, "What happened to OCR?", but "what is happening to OCR?"

WHAT IS OCR?

By way of definition, OCR is a technology which enables a machine to automatically read and convert typewritten, machine-printed, mark-sensed or hand-printed characters into electrical impulses for processing by a computer. In other words, OCR devices are designed to read man-readable data and convert it directly to a computer language.

THE INPUT BOTTLENECK

The term "input bottleneck" is vague, yet does describe one of the largest and most expensive problems facing the EDP world today, and is the heart of OCR interest and growth.

The limited advances of source data capturing devices and alternate methods of rekeying data have not solved the problem, but merely diminished it. The present crisis is a result of the fact that EDP suppliers have done exceptionally well in meeting the business community's demands for processing data, but are still searching for ways of feeding the computer by an acceptable, effective and economic means. These means must incorporate the ability to convert original source data directly, usable as a way of communication from man to man and, simultaneously, from man to computer. This is the basic function of optical character recognition.

WHAT HAPPENED TO OCR?

The advantage of OCR as a user technology lies in its unique ability to capture source data without additional transcription. OCR offers flexibility and economy not found in other means of data input. Key punch/key verify, key to tape or direct access terminals all require keyboard operation in one form or another and therefore require expensive skilled labor. As a result, business and industry remain quite receptive to any method of capturing data that eliminates this need. Early OCR systems did not incorporate the features necessary to do what had to be done. Although presenting a cost justification by reducing keypunch costs in many application areas, they still did not offer true source data automation.

1 Equipment Characteristics

Many reasons contributed to the slow growth of OCR, which has seen less than 1,000 OCR devices installed in a marketplace which contains over 45,000 computer sites. Some of the more prominent reasons include:

1. *High cost to users.* The initial cost of purchase or lease of an OCR device and the expensive changeover of data flow systems to meet machine requirements, have been prohibitive in many cases. OCR readers range in price from \$20,000 to \$1,000,000 and over. Cost justification, especially with heavy emphasis on "re-type and scan" methods, has not always been obvious.
2. *High cost to manufacturers.* Early OCR companies were essentially engineering houses. The scanners were basically designed around engineering capabilities without enough consideration for the everyday problems they were intended to solve. Also, with a limited number of machines being delivered, costs per unit remained high to cover initial design costs.
3. *Specialized readers.* The first OCR systems were, in most cases, built to address a relatively narrow range of applications. Some were page readers, some were document readers, and others were journal tape readers, and each did their particular function well. But the user having a need to address a variety of applications and paper forms often found himself faced with justification of *another* OCR device.
4. *Competing technologies.* With the above problems hindering a potentially major OCR breakthrough, other devices such as key/tape, key/disc and terminal devices have been introduced and have furthered the confusion for the EDP manager. In many cases, such machines have significantly penetrated application areas where OCR might be used. Low unit cost and a less comprehensive change in business procedures made them an easier choice.
5. *Technical limitations.* Because of the original concept of OCR breaking the input bottleneck through its ability to utilize source documents as a basic means of man/machine communication, the business community expected far more from OCR than was possible with early OCR machines. The fact that reading handprint, which represents a very high percentage of source data recording, only became widely feasible in 1968 is an example of problems that have existed. Until recently, OCR readers have frequently placed unrealistic burdens on the user to meet machine specifications, either in forms design or procedure. Users have had to work hard to realize the benefits of OCR.

WHAT'S HAPPENING TO OCR?

Manufacturers have learned from these early experiences. Indications are that OCR manufacturers exhibit greater understanding of the problems that exist and the type of OCR devices that are needed to do the job. The early marketeers of OCR now realize that their doors are not about to be broken down by those who want OCR, but that they must employ better equipment, more system expertise and better understanding of user needs in order to increase the population of OCR equipment successfully.

To understand better what is happening, we might take a quick look at what has happened to OCR. OCR has not been completely free of technical and application problems.

A scanner is still a machine and still subject to certain operating specifications which must be met to provide an effective operating system. Because of the original optimism towards OCR, many of those who jumped in with both feet, assuming that the original devices were capable of handling everyday source data problems, found themselves with, in many cases, only a different set of ground rules to follow:

1. A certain weight of paper with other qualifying characteristics had to be used.
2. Print quality from typewritten or preprinted media had to be of a certain density and uniform across the line.
3. Preprinted forms with exact preprinted reading instructions or marks had to be present.
4. Hand-printed characters had to be of consistent density and within determined page parameters.
5. Forms had to be of uniform size in width and length.
6. Specific fonts had to be employed.

There were, and still are, other problems, many of which are associated only with individual manufacturer's equipment. The above requirements provided certain trade-offs in various application areas. For example, many success stories are available in turnaround document applications involving preprinted forms and rigid printing requirements, which have been adhered to and represent significant savings over previous methods. Retype-scan applications have been the most predominant in the page reading environments and have afforded like savings over other methods. The features offered on most readers in the past have just not lent themselves to the magnitude of cost reduction which should be available through this medium. The past two years have seen significant breakthroughs by manufacturers, giving a good indication that OCR is catching up and is now ready to strongly meet the challenge put before it. A fast overview of the present state of the art in OCR will support this point. Two of the most critical aspects of OCR are the scanning and recognition technology employed. Tables 1 and 2 outline the most common techniques.

Other significant portions (Figure 1) which make up the scanning device include:

1. *A transport mechanism* which moves a form or source document, turn-around document, page or journal from the input area through the scanning system to the output area.
2. *A control unit* which generally governs the operation of all other units incorporated in the OCR system. This encompasses the document feeding control and the dissemination of recognized characters to the output media. The unit also receives and interprets instructions from an operator. In most current systems an off-the-shelf mini-computer has been incorporated to perform these tasks.
3. *Output*, or the end result of recognition and conversion, is normally industry-compatible magnetic tape, seven- or nine-channel, and ranging in densities from 200 to 1600 BPI. Punched card, punched tape and, more recently, communications modems are other optional methods.

Table 1. Comparison of Scanner Units*

Type	Description	Advantage	Disadvantage
Mechanical	Consists of a lens system, a rotating disc, a fixed aperture plate, and a photomultiplier. The lens system directs light reflected from the characters through the rotating disc to form light samples detected by the photomultiplier which converts them to electric signals.	Cost	Relatively slow speed
Flying Spot Scanner	Consists of a cathode-ray tube (CRT), lens system, and phototube. The CRT scans the document with a beam of light, which the lens system directs to the phototube for conversion to electrical signals.	Flexibility to scan selected portions of the documents	High cost
Parallel Photocells	Consists of a row of photocells. Characters are passed under the photocells, which simultaneously sample a number of elements of the character and convert them to electrical signals. A more expensive variation uses a full matrix of photocells to increase speed.	High speed	Limited flexibility and high cost
Vidicon	Characters are projected onto a vidicon television camera tube, scanned by an electron beam, and converted to electrical signals.	No requirement to move documents	Limits on number of characters stored on tube and limits in speed

*Extracted from Auerbach Technology Evaluation Service, 1970.

Table 2. Comparison of Recognition Units*

Type	Description	Advantage	Disadvantage
Optical Matching	Consists of two photographic masks for each recognizable character. Recognition is performed by detecting the quantity of light passed through the masks and selecting the best match.	Simplicity; lower cost; ability to identify full alphanumeric character set	Susceptibility to errors; unsuitable for handprinting
Matrix Matching	Consists of digital registers and resistor matrices representing each recognizable character. The electrical output of the scanner is stored in the digital register and compared electrically to each resistor matrix. Recognition is based on the relative comparison among the matrices. Can also be implemented by comparing the binary image of a character with images stored in memory.	Speed; flexibility to change character sets and to identify full alphanumeric character set	Cost
Stroke Analysis	Consists of a special-purpose computer. Recognition is based upon analysis of the stroke or line formation of each character in comparison with stored information for each recognizable character.	Ability to identify full alphanumeric character set	Low speed; unsuitable for handprinting
Curve Tracing	Each character's outline curvature is traced by either movement of the scanner beam or by logical decisions of the recognition unit. Recognition is based on such features as character splits, line junctures, line directions, straightness of lines, and line magnitude.	Suitable for handprint numerics	Difficulty in reading certain alphanumeric characters

*Extracted from Auerbach Technology Evaluation Service, 1970.

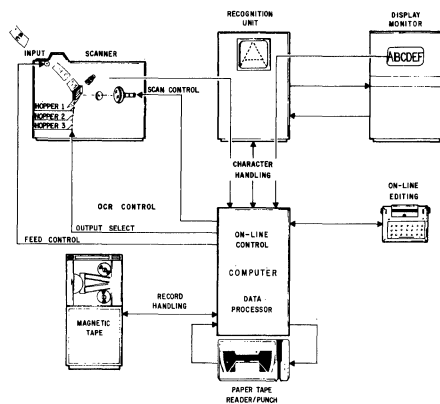

Figure 1. Data Flow

It is important to differentiate between scanning (reading) and recognition. Scanning involves searching a form for marks, bars or characters and converting these to electronic impulses, which then undergo recognition via comparison to stored reference signals.

TYPES OF OCR DEVICES

At the bottom of the line of capability and versatility in OCR are *Mark/Bar Readers* which determine a position of a mark or line with reference to some predetermined point(s) on a form. Mark readers generally have a very limited input capability and often require special forms and special data density. Because of their specialized use and associated cost of approximately \$4,000 and up, mark readers still have

1 Equipment Characteristics

widespread use in such applications as test scoring, survey processing, payroll, inventory control and similar uses.

There are also a variety of *Stylized Font Readers* which are designed to read and recognize only a single font. Usually this font is highly stylized. Some single font readers may accept only pages, documents or both, and are available with full or limited handprint and mark read capability.

Single font readers were among the first OCR systems on the market and, ironically, their widespread use has been a factor in limiting user flexibility for a number of years. Early OCR manufacturers often created specialized fonts which were recognized only by their equipment, thus giving birth to and fostering a standardization problem throughout the industry. One of the most significant areas of development in OCR is *Multi-Font Systems*, especially those which can accept forms ranging from document size to full legal page size. Such systems make possible the true source data automation needed to gain the full economic advantages of optical character reading as an input technique. As with other classes of equipment, there is a wide variety of multifont readers. Several accept a minimum of two or three standard typewriter fonts, including upper and lower case and handprint. Since the fonts are determined in advance, these machines are generally hardwired or programmed to read one font at a time or several intermixed. Such capability is not inexpensive compared with the cost of single-font units and can range in price from \$200,000 up. But it is here, unless the world suddenly standardizes on one font, that the true advantages of OCR can be realized.

TYPES OF OCR SYSTEMS AVAILABLE

An analysis of the original OCR product lines shows that it was not the cost of the single unit per se which slowed down the number of installations, but rather the fact that it often became almost an impossibility for the business world to adhere to the limitations of each device offered and prepare source data input with the restrictions specified. To expand utility of OCR meant the installation of *additional* readers designed to handle the new applications.

For example, the most common OCR systems found in the marketplace today are basically defined as follows:

1. Journal tape readers
2. Document readers
3. Page readers

It should be noted that the prime difference between a page and document reader is the ability of the latter to read a relatively few lines rather than any specific size document but usually from small pieces of paper. Each of the above carry many features capable of providing cost justification direct comparison to keypunching costs. Here is where most comparisons are performed in justification of OCR but this represents a limited few of the real economy afforded by this medium. In reality, OCR can be used in almost all applications, provided the input is designed to meet the specifications of the reading device. The whole secret of success in implementing an OCR System appears to be in properly matching the characteristics of the reading unit to the input data. One of the newest innovations in scanning was introduced by Scan-Data Corporation last

year with a software package that enabled their series of reading devices to virtually recognize any consistent font or character set. While many companies in the OCR field have experimented with software or selfteaching techniques, most have delayed their use primarily because they have been unable to develop a font-reading capability flexible enough to compensate for the slower speeds and larger core associated with software recognition. Such systems generally are thought of as fourth generation in which the user presents the reader with a sample of the font to be read, letting it study and store the font. The system then can read characters printed in this font.

FONTS

The recently declining cost of integrated circuitry is making its impact in the OCR manufacturing areas and specifically relates to the increase in multi-font or even omni-font reading capabilities. There is no doubt that fonts, or stylized character sets, have been one of the major factors in slowing the advance of OCR. Early deficiencies in scanning technology forced each manufacturer to utilize or standardize on one or two specific style character sets to insure reliability in recognition standards. Popular character sets are shown in Figure 2.

```

OCR-A
ALPHA CHARACTER SET: A B C D E F G H I J K L M N O P Q R S T U V W X Y Z
NUMERIC CHARACTER SET: 0 1 2 3 4 5 6 7 8 9
PUNCTUATION: . , ' : ; ' "
SYMBOLS: - / W A J * % & * + { } |
OPTIONAL: ■ A = T ↓ E = W / Δ °
NOTES: 5

OCR-B UPPER CASE
ALPHA CHARACTER SET: A B C D E F G H I J K L M N O P Q R S T U V W X Y Z
NUMERIC CHARACTER SET: 0 1 2 3 4 5 6 7 8 9
PUNCTUATION: . , ' : ; ' "
SYMBOLS: @ $ & / = [ ] + - %
NOTES: 1

OCR-B UPPER AND LOWER CASE
ALPHA CHARACTER SET:
UPPER CASE: A B C D E F G H I J K L M N O P Q R S T U V W X Y Z
LOWER CASE: a b c d e f g h i j k l m n o p q r s t u v w x y z
NUMERIC CHARACTER SET: 0 1 2 3 4 5 6 7 8 9
PUNCTUATION: . , ' : ; ' "
SYMBOLS: - = [ ] + / @ $ % & *
NOTES: 1

PICA 72
ALPHA CHARACTER SET:
UPPER CASE: A B C D E F G H I J K L M N O P Q R S T U V W X Y Z
LOWER CASE: a b c d e f g h i j k l m n o p q r s t u v w x y z
NUMERIC CHARACTER SET: 1 2 3 4 5 6 7 8 9 0
PUNCTUATION: ? - - - -
SYMBOLS: $ & + ( ) * % # = / - @
NOTES: 1, 2, and 3

1403 SELECTRIC
ALPHA CHARACTER SET: A B C D E F G H I J K L M N O P Q R S T U V W X Y Z
NUMERIC CHARACTER SET: 0 1 2 3 4 5 6 7 8 9
PUNCTUATION: . , ' : ; ' "
SYMBOLS: / - @ $ % & * = + *
NOTES: 1 AND 3

HANDPRINT
ALPHA CHARACTER SET: ACTX
NUMERIC CHARACTER SET: 1234567890
OPTIONAL: + /

```

Figure 2. Character Sets

The banking industry is a perfect example of the industry problems which could evolve about a specific font selection. Their selection of E-13B for Magnetic Character Recognition (MICR) took several years. During this time

1 Equipment Characteristics

period, various manufacturers of MICR equipment strongly advocated the stylized characters which best suited their individual technological capabilities. Although E-13B was not aesthetically pleasing to the eye, the application demanded a definite standardization and quick solution. Imagine the problems of handling checks today had not such a decision finally been made. The font problem in OCR is much different from that of the banking industry. The check application was universal, permitting a definite standard. The applications evolving about OCR are so varied and different, it would be very difficult for anyone to say any one font is best suited for all. Therein lies the basis for one of the largest controversies among OCR manufacturers. There are many arguments for and against a so-called standard font. However, those manufacturers that have gained sufficient advanced technology in recognition have found that it is not the problem today that it once was. Today, the OCR manufacturer has relaxed restrictions in this area and some now offer equipment that accepts almost any known consistent font or character set.

Naturally, there is a price to be paid for the number of different fonts to be read by one reader, but it in no way approaches past costs. The other important factor is the human element or aesthetic value. The original fonts were more than slightly stylized and did not lend themselves to be pleasing to the human eye. Many felt that the subsequent cost savings would more than overcome this objection. But more and more, demands will increase to provide character sets that are not only recognizable to the logic of the system but are readily recognizable and pleasing to the human eye. As OCR replaces rehandling of original source information, the style font will become more and more a point of human factors. Today's OCR manu-

facturers commonly offer OCR-A, OCR-B and 1403 fonts in their reading capabilities. Others have gone further and included availability of Pica and Elite, both upper and lower case. And there has been the introduction of a software technique to recognize virtually any consistent font in a given reader, even though not hard wired. So, the font discussions will no doubt continue, with the Europeans feeling OCR-B should be more of a standard and many domestic manufacturers claiming OCR-A. Nevertheless, the user will ultimately win out, probably demanding multi-font capabilities. It is becoming cheaper to introduce a flexible reading technology than to restrict the nature of the source documents characterizing the marketplace.

THE FUTURE OF OCR

Cost justification of OCR devices has become somewhat controversial and will definitely impact the future of this industry. Recent surveys place price as one of the key factors in determining the growth factor of OCR in replacing present input systems. Present OCR systems are cost justified mainly by a very simple method of keypunch (or other keyboards) replacement. The accepted national average for a given keypunch station is \$600 per month including equipment, labor, overhead, etc. (Table 3). If this is compared to the typical cost of a multi-font OCR system, i.e., \$5,500 a month, we see that the breakeven point is about one OCR system for 9 keypunching stations. This type of justification will continue since there will, no doubt, continue to be consideration of the types of readers that are presently available. But, it is felt, that in order for OCR to really meet the challenge, the following events will have to take place:

Table 3. Annual Comparative Cost

<u>KEYPUNCH</u>		<u>KEY TAPE</u>		<u>OPTICAL</u>	
<u>OPERATORS</u>	<u>ANNUAL</u>	<u>OPERATORS</u>	<u>ANNUAL</u>	<u>CHARACTER RECOGNITION</u>	<u>ANNUAL</u>
<u>AND</u>	<u>COST</u>	<u>AND</u>	<u>COST</u>	<u>OPERATOR</u>	<u>COST**</u>
<u>MACHINES*</u>		<u>MACHINES*</u>		<u>AND</u>	
				<u>MACHINE</u>	
7	\$ 46,200	5	\$ 39,000	1	\$ 70,800
10	66,000	7	54,600	1	76,800
13	85,800	9	70,200	1	82,740
20	132,000	14	109,200	1	96,600
30	198,000	21	163,800	1	116,400
50	330,000	35	273,000	1+	156,000
ASSUMPTIONS:		KEY PUNCH EQUIPMENT	\$ 600 PER ANNUM		
		KEY TAPE EQUIPMENT	1,800 PER ANNUM		
		OPERATOR FOR ABOVE	6,000 PER ANNUM		
		OCR EQUIPMENT	48,000 PER ANNUM		
		OCR OPERATOR	9,000 PER ANNUM		

* INCLUDES VERIFICATION.

** ASSUMES 30% OF KEY PUNCH COST AS NOT DISPLACEABLE OR SUBSTITUTE EXPENSE FOR CONTROL CLERKS AND OFF-LINE EDITING EXPENSE.

+ OVER 50 MACHINES, IT IS LIKELY THAT A SECOND OCR DEVICE OR A HIGHER PERFORMANCE, MORE EXPENSIVE OCR SYSTEM WOULD BE CONSIDERED.

1 Equipment Characteristics

1. Lower prices for existing readers.
2. Increased capabilities in number of fonts recognized; methods of error correction; types and sizes of documents capable of being handled on one feed mechanism; increased throughput rates, improved handprint reading capabilities.
3. Introduction of low cost OCR devices to facilitate handling of source data at multiple locations with communication capabilities to centralized processing areas.
4. Introduction of low-cost, direct read systems.
5. Introduction of low-cost, retype/scan systems.
6. Generally improved price performance.

Recent announcements by several manufacturers indicate that some of these trends are already taking place.

OCR TERMINALS

The ability to scan source data at multiple locations and subsequently transmit this information to a centralized processing area represents a large potential market. The fact that such devices have already been announced indicates that the ability to scan and convert to transmission mode is possible. Such devices may be broken down into three major classifications, depending upon the demand of the application and/or the configuration of processing equipment at the central location. All will enter into the final pricing structure of the OCR device.

1. *Scan Only* – This terminal would be used to scan the form, transmitting images on-line to a recognition unit located at the central processing site. Here, recognition, formatting and editing of data would occur. This type of system would basically require a dedicated CPU to handle incoming data and might cause some problems in the area of handling nonrecognizable characters and/or unreadable documents since the original source document will not be available to the central site. However, this is only one consideration which could be outweighed by the overall cost savings of such a system.

2. *Scan and Recognize* – This unit would incorporate a recognition unit with the scanner and eliminate some of the problems outlined above. Here, the system would read, recognize, and transmit information directly to a receiving device at the central processing area for editing and formatting.

3. *Scan, Recognize and Output, Off-Line* – This type system would offer the most flexibility in that scheduling of scanning and transmission would not be wholly dependent on the central site and information could be scanned at random, captured on a dedicated magnetic tape or disc, and periodically transmitted to a central site. This method affords the most flexibility and, with the ever decreasing component costs, could easily be justifiable in many situations.

All of the above must be evaluated as to specific applications. A modular system which would lend itself to field upgrading to any three of the levels indicated above would offer great flexibility to the user as application areas are discovered for utilization of such a system.

THE OCR REVOLUTION

In the past, OCR manufacturers fell short in providing an OCR device realistically compatible with industry needs. Potential users found that OCR was only a trade-off – although with substantial savings in many areas. It has often been difficult to realize effective use of OCR because justification becomes much more difficult when applications spill over into the areas of different size documents; means of printing which require multi-font OCR capabilities; applications directly related to using journal tapes as input from source; handling degraded print quality; easily placing nonrecognized characters into the system without losing valuable data integrity and sacrificing throughput speeds; conversion from one application to another without requiring highly technical skilled labor or programmers; initiating new applications without lengthy time lags to permit programmers to write appropriate software. These are just a few of the challenges confronting the OCR manufacturers. Problems which are everpresent in the real world of EDP and ones which must be directly answered by OCR.

IS OCR THE ANSWER?

To predict the failure or success of any one technology within the world of EDP would be hazardous. However, when the basic concept, the progress being made and the compatibility of the basic media with man are considered, it should succeed. Paper is fundamental to communication between men, a necessity in the business community, and unlikely to be among the missing elements of future business systems. It seems very remote that man will give up the written word or proof that has long been an integral part of our society.

With the estimated installation of computers approaching the 100,000 mark, with over 500,000 keypunches still feeding them, there remains a great market opportunity for *Optical Character Reading*. If the previous justification of one OCR device for each 9 keypunch stations is used, there could be a marketplace for over 50,000 scanners. As the price structure is lowered in this industry, the installed base will build. We cannot assume all sites will switch to OCR, especially with the many other types of source data capture equipment now available. But it still appears that the marketplace for OCR machines does exceed a population of over 10,000 units in the late 1970's. The figure of 10,000 could be relatively conservative, if the OCR manufacturers continue their present trends and dedicated efforts. Manufacturers are taking steps now to meet the challenge of the 1970's by increasing marketing personnel, vast training programs, greater emphasis on the immediate input problems that must be solved, and establishing field service organizations to support these installations properly. For those who feel OCR had its chance and failed, one needs only to refer to the original forecasts of OCR by such leading authorities as Stanford Research and National Bureau of Standards. Both indicated a great rise in OCR popularity and increased installation population between 1972-1975, with the OCR industry hitting its peak in the 1980's. A close look at the present state of the art strongly backs up these predictions, with a major breakthrough by OCR possible in the very near future.

OPTICAL CHARACTER READERS

COMPANY	CAMBRIDGE INFORMATION SYSTEMS	COGNITRONICS	CUMMINS-CHICAGO CORP.	DATATYPE
MODEL	A.I.S. 11, 12	System/70	Scanak 216	3400 & 3800 Systems
FIRST DELIVERY YEAR	1970	1970	1967	1970
BASIC PURCHASE PRICE	\$3500	\$33,600	\$40,000 - \$65,000	\$9450 & \$25,000
LEASE RATE/MONTH	\$145		\$1200 - \$2000	\$300 & \$600
READING SPEED				
Max. Char/Sec.	10	50	n/a	60
Max. Docu/Min	20	depends on size, no. lines, no characters, type of font	225 - 625, dependent on output device	1 full pg/min
DOCUMENT				
Feed		friction	friction drive knife separation	auto or hand feed
Transport	transport	drive rollers	drive rollers	drive rollers
Size (inches)	1 x 3½ per char (max)	8½ x 14	min - 4¼ x 2¼ max - 8¼ x 4	up to 8½ x 14
CHARACTERS				
Sets	marks	OCR-A alphanumeric	mark-code, A-M bar code, computer-printed BCD "ones-code", perforated code	64 or 88 char set
Type Fonts		all std numeric fonts, hand printed numerics		DF-1 or DF-2
RECOGNITION				
Scanning Method	scanning	laser	photocell	phototransistors
Recognition Method			n/a	miniature bar code recognition
FORMAT				
Max. Char/Line	n/a	76 machine; 38 hand printed	81	70
Max. Lines/Inch		6	n/a	6
OUTPUT	identical to teletype printer	mag & paper tape	mag & paper tape, data trans	mag & paper tape or communications
COMMENTS		On line correction console & keyboard.		For 3800, data goes through minicomputer to output devices.

OPTICAL CHARACTER READERS

COMPANY	HONEYWELL	INFOTON	INFOTON	NATIONAL COMPUTER SYSTEMS
MODEL	Type 243	Challenger I	Challenger II	Sentry/70
FIRST DELIVERY YEAR	1970	1970	1971	1970
BASIC PURCHASE PRICE	\$67,200	\$35,000	\$45,000	\$70,000
LEASE RATE/MONTH	\$1475/5 yr	\$1000	\$1500	\$2300
READING SPEED				
Max. Char/Sec.	1280	1320	1200	
Max. Docu/Min	1100	12	12	100
DOCUMENT				
Feed	picker, pusher, and vacuum drum	manual	manual	vacuum
Transport	belt			belt
Size (inches)	4 max height	12 wide - 14 long	3 x 5 up to 14 x 17	8½ x 11 to 11 x 17
CHARACTERS				
Sets	10 numerals, 3 special chars, long vert line	OCR-A - upper case - 57 char std; OCR-A - lower case - 26 char opt	96 char ANSI	marks
Type Fonts	ASA standard font (OCR-A)	hardprint - numeric - constrained - 14 char opt	OCR-A, OCR-B	
RECOGNITION				
Scanning Method	photocell	photo-mechanical	electro-mechanical	parallel read head
Recognition Method	stroke analysis	feature extraction - correlation	feature extraction/ correlation	darkest mark
FORMAT				
Max. Char/Line	70	110	110	60 marks/line
Max. Lines/Inch	1 line/document	6 std (12 opt)	3	6
OUTPUT	Series 200 computer (on-line) - all std processor outputs	mag tape & RS-232-C interface	IBM 360 compatible tape RS232C serial, sync or async on-line to computer	mag tape
COMMENTS				

1 Equipment Characteristics

OPTICAL CHARACTER READERS

COMPANY	OPTICAL SCANNING	ORBITAL SYSTEMS	RECOGNITION EQUIPMENT	RECOGNITION EQUIPMENT
MODEL	Opscan 288	Orbit/1	Electronic Retina Computing Reader	Input 3
FIRST DELIVERY YEAR	1969	1970	1964	1971
BASIC PURCHASE PRICE	\$89,000	\$33,350	\$675,000	\$33,000
LEASE RATE/MONTH	\$2000	\$882	\$18,000	\$950 - \$1400
READING SPEED				
Max. Char/Sec.	1000	108	2400	75
Max. Docu/Min	975	130	1200	8
DOCUMENT				
Feed	friction roller	friction		
Transport	belt - mechanical	drum/belts	both unit-sized doc. & page-sized doc.	
Size (inches)	2½ x 3½ to 4½ x 8½	3 x 4 to 4 x 8		
CHARACTERS				
Sets	machine - 0 to 9 and C,N,S,T,X,Z, + and - hand - 0 to 9	numerics & marks	full alphanumeric	
Type Fonts	USASI-A	ANSI, IBM 1428, FARR 12F, OCR-B	up to 360 type styles	
RECOGNITION				
Scanning Method	vertical optical array	rotating disc		retinal sensing
Recognition Method	matrix matching	feature extraction	photo array (matrix)	
FORMAT				
Max. Char/Line	80 char max machine print	80		
Max. Lines/Inch		1/doc		
OUTPUT	mag tape	mag tape	mag tape & line printer	IBM System 3, 360, 370, mag tape
COMMENTS				

1 Equipment Characteristics

OPTICAL CHARACTER READERS

COMPANY	RECOGNITION EQUIPMENT	SCAN-DATA	SCAN-DATA	SCAN-DATA
MODEL	Input 80	200 Page Reader	250 Page Document	300 Page Reader
FIRST DELIVERY YEAR	1971	1969	1970	1967
BASIC PURCHASE PRICE	\$446,000	\$198,000	\$215,000	\$250,000
LEASE RATE/MONTH	\$11,895	\$4000	\$4500	\$4315
READING SPEED				
Max. Char/Sec.	3600	800	800	800
Max. Docu/Min	300	17	17	17
DOCUMENT				
Feed		gravity friction	gravity friction	gravity friction
Transport	page-sized doc.	vacuum belt	vacuum belt	vacuum belt
Size (inches)		6½ x 8½ min, 11 x 14 max	5 to 11 width; 3 to 14 length	6½ x 8½ min, 11 x 14 max
CHARACTERS				
Sets	complete alphanumeric	alphanumeric, punct marks, special upper & lower case	alphanumeric, punct marks, special upper & lower case	alphanumeric, punct marks, special upper & lower case
Type Fonts		OCR-A, OCR-B, 1403, Pica 72, handprint	OCR-A, OCR-B, 1403, Pica 72, handprint	reads any font
RECOGNITION				
Scanning Method	integrated retinal sensing	flying spot	flying spot	flying spot
Recognition Method		features analysis	features analysis	features analysis
FORMAT				
Max. Char/Line		80	80	80
Max. Lines/Inch		6	6	6
OUTPUT	mag tape & line printer	mag tape	mag tape	mag tape
COMMENTS				Journal tape opt.

OPTICAL CHARACTER READERS

COMPANY	SCAN-DATA	SCAN-OPTICS	UNIVAC
MODEL	350 Page Document	20/20	Optical Document Reader
FIRST DELIVERY YEAR		1970	1970
BASIC PURCHASE PRICE	\$228,900	\$120,000	\$42,000
LEASE RATE/MONTH	\$4815	\$3100	\$1050
READING SPEED			
Max. Char/Sec.	800	2000	1500
Max. Docu/Min	17	500	600
DOCUMENT			
Feed	gravity/friction	friction	friction
Transport	vacuum belt	vacuum belt	belt
Size (inches)	5 to 11 width; 3 to 14 length	3 x 4½ to 9 x 14	3 x 2.75 min, 8.75 x 4.25 max
CHARACTERS			
Sets	alphanumeric, punct marks, special upper & lower case	alphanumeric, punct marks, etc	numeric plus symbols
Type Fonts	reads any font	OCR-A, 1428, 7B, 12F, E-13B, etc	USASCSOCR-A, H-14
RECOGNITION			
Scanning Method	flying spot	image dissector	vertical photocell array
Recognition Method	features analysis	feature matching	matrix matching
FORMAT			
Max. Char/Line	80	80	78
Max. Lines/Inch	6	6	2
OUTPUT	mag tape	mag tape	card, tape, disc pack via computer
COMMENTS	Journal tape opt.	Page & document reader in one.	

Time Sharing

The primary business of computer time-sharing bureaus consists of making available to their customers the use of modern digital computer systems, connected to data files on one side and a communications network on the other. The feature which distinguishes the time-sharing bureau's business from the many computer service bureaus which exist throughout the United States today is that the bureau's system is available on a shared basis to many diverse remotely connected users. To understand the significance of time-sharing, certain historical facts concerning the computer-using community should be reviewed.

Many organizations or divisions within organizations wish to have the use of a major computer, but do not need a computer on a full-time basis. For such limited use, the cost of a large computer is generally prohibitive. One answer to the needs of these organizations has been the traditional service bureau, which has a computer or tabulating system and makes its use available to a number of customers on equipment operated and controlled by the service bureau personnel bases through a method known as "batch processing." Under this method the customer's data is transported to the service bureau and entered into the computer through an input device such as a card reader, tape reader or keyboard. The central processing unit then performs as instructed by the customer's program, usually specified by the customer and written by the service bureau personnel, and the results are returned to the service bureau operator through an output device such as a card punch, tape punch or printer and are subsequently manually delivered to the customer. Customer's jobs are usually scheduled and processed chronologically. Thus, while the service bureau makes the facilities of a computer available to a customer for only his proportionate share of the cost of its use, the "batch processing" method results in queues of jobs awaiting processing and delivery resulting in waiting periods ranging from several hours to several days before the customer receives his results. The central processing unit, which is the most expensive component of a computer system and which performs its functions at high speeds — far exceeding the speeds of current input and output devices — is often used at less than maximum capacity due to the imbalance of speed between these interactive and interdependent components.

The use of magnetic tape, disc storage and other developments (such as ability to process several programs through a large central processor almost simultaneously and the development of "remote batch processing") have assisted service bureaus in making more efficient use of their central processing units and in reducing customer waiting time. However, the traditional service bureau continues to require the customer to collect his data in batches and transport or transmit it to the service bureau, which in turn, processes and returns it to the customer.

In the past decade, computer manufacturers have designed and built large computer systems, which, if programmed with an appropriate software system, can be used by many individuals concurrently to perform a wide variety of applications ranging from solving advanced mathematical problems to preparing simple payrolls.

Computer time-sharing users lease or purchase permanent or portable terminal units usually consisting of a teletype machine and a telephone coupler which connects the teletype to a customer's telephone. The terminal unit then enables the customer to communicate with the computer over standard telephone lines. Once the computer's telephone number is dialed and communication is established, the customer may run previously stored programs, design new programs for his own use or run any of the library of applications programs available in permanent computer mass storage.

It is important to note that most of the 1965-1968 offerings were designed primarily for use by the scientific-engineering community and that viable application packages for the generalized business community have been emerging slowly. At the close of 1968, it is reliably estimated that 70 percent of the gross time-sharing business was in the scientific-engineering calculation market, that another 15 percent went to academic institutions, and the balance to the business community. It is interesting to note that 80% of time-sharing sold for scientific-engineering calculation was sold to large business organizations who own and operate large computer installations.

Accounting applications, inventory control, and many other classes of information retrieval and management information systems are just beginning to evolve. This is clearly because the first time-sharing systems were designed by computer scientists, engineers, and programmers and marketed to the same community. Another reason is that time-shared computing in many commercial transactions is barely economical at this time. In addition to the historical and economic factors, the early time-sharing systems had monumental reliability problems, which only the scientific-engineering community could tolerate.

The fundamental economic hypotheses supporting the commitment of large sums of money to time-shared computing were and still are:

1. Computers and their attendant peripherals are becoming larger, faster, and less expensive every year.
2. A small piece of big computer is more economical than a big piece of small computer.
3. The number of people needing to use computers is rapidly increasing.

1 Equipment Characteristics

THE UTILITY CONCEPT

The data processing industry today is serving two basic communities: time-sharing users who wish to interact with the computer on a minute-to-minute basis from remote terminal devices, and batch-processing users who are not really interested in an interactive environment for eventual processing. Two different types of processing and two differently designed and programmed machines are involved.

The utility concept, on the other hand, is one that will allow a time-sharing bureau to satisfy both communities with a spectrum of services performed by a single computer system. Included in this spectrum are both conversational time-sharing and remote batch processing, a relatively new capability that we call remote job entry.

Essentially, this new mode of data processing permits a user to send a batch-type job to the computer via a high-speed communications device located at his own place of business. As in time-sharing mode, data is transmitted over communications lines provided by the common carriers, but here the similarity ends. Once remote job entry data reaches the computer, it sits on a queue to await processing, exactly as it would at the traditional service bureau. Turnaround time ranges from one to several hours, with results transmitted after processing to a remote high-speed printer or other output device at the user's location.

In addition to providing complete data processing service for any kind of business, scientific, educational, or engineering application, the utility concept includes the capability for an interconnected, nationwide data communications network that makes the computer utility service available on a local-call basis anywhere in the country.

HARDWARE AND SOFTWARE

Essential to the actualization of any data service concept is some hardware embodiment. Even a one-man accounting firm working at home must at least have a desk or worktable, a supply of pencils and paper, usually a typewriter and calculator, and space to house them all.

Hardware technology has made major advances in the last few years. The speed and power of computers has been greatly enhanced by recent improvements in memory, machine organization and semiconductor technology. In spite of technological advances, the basic organizational questions remain the same. This is particularly true for time-sharing bureaus striving for the utility concept. The organizational questions are not only those associated with singularly obtaining the proper balance between speed and capacity in the hierarchy of central processors, mass storage units, I/O devices and communications equipment but also ones of systems software to produce the market-oriented environments required. With large-scale integration causing even more powerful and faster computers to become a reality, software combined with hardware are causing organizational problems of increasing complexity for the time-sharing industry.

The essential criterion with respect to hardware for a time-sharing bureau is the necessity that the relative

importance of its role diminish. As a corollary, the time-sharing company in which hardware's role is large and likely to remain so, or in which it is not likely to diminish at a rate comparable to those of other companies, will find itself in serious trouble. The reason is simple: as available physical capacities of the hardware continue to grow more rapidly than the ability to make effective use of that capacity, competition among time-sharing suppliers will become ever more "murderous," and prices will continue to decline.

In contrast customers are prepared to pay generously for effective use of hardware in problem solving at rates that may go to several thousand dollars per computer hour. And they will be willing to continue paying at this level, or higher so long as there is good prospect of good results. Such results will depend mainly on the quality of the personnel and the software governing the hardware.

This is not to say that one can afford to ignore the choice and disposition of hardware. What matters, of course, is the way tools are used; but poor tools can defeat the most skillful user.

The main criteria in selecting time-sharing hardware configurations are:

- Amount and speed of primary storage in the CPU
- Organization of primary storing
- Basic instruction set, to include scope and speed
- Word size and structure
- Control of mass data storage to include the availability of multiple access, high transfer speeds and a reasonable transfer accuracy checking system
- Communications interface which should be able to accept many simultaneous incoming variable speed lines.

No one hardware manufacturer today can supply all of the forementioned criteria, not to mention software. Therefore, the design and configuration of time-sharing systems, especially those "utility" oriented, is mostly a "black art" of the individual vendors. The hardware system and software system combined are the real manifestation of a utility offering; therefore, a look at two approaches to the utility goal will further illustrate the problems and criteria for selection.

Two Approaches to the Utility Goal

There are vendors today who offer both time-sharing and remote batch services that resemble this utility concept. Typically, these companies have developed multiprogramming systems that are basically oriented to batch processing. Any conversational computing capability they offer is embedded in the batch system as a separate program. Responsibility for scheduling under this scheme is given to the batch processor, which schedules the time-sharing program just as it does the other programs it is batching through the system.

The drawback to this approach is that a rather trivial batch scheduler is given the job that could be handled better by a

1 Equipment Characteristics

more sophisticated time-sharing scheduler. If control and the ability to look at the total system were given to the time-sharing scheduler, tremendous savings could be made in system efficiency. System overhead could be greatly reduced, and the number of simultaneous users the system could handle relative to its total capability could be increased.

For these reasons and because a system "born of batch" does not concern itself with providing the highly interactive, responsive environment that users have learned to expect, the preferred approach to the utility gives scheduling responsibility to the time-sharing monitor. Commercial time-sharing experience to date overwhelmingly supports the idea that the requirements of a system necessary to support both conversational and remote batch processing can be best met by designing a unified system that will be grounded in time-sharing but will make all definable services available to customers.

While in-depth discussion of the design and implementation methodology of specific systems is time-prohibitive in this discussion, certain basic philosophies can be stated here.

The main design emphasis on a system oriented to the utility goal should be placed on interaction. However, equal importance is given to remote job entry. By making the time-sharing monitor responsible for scheduling through an optimization mechanism in the form of command file and remote job features, the monitor can make remote job entry functions totally compatible with time-sharing. The computer's interactive capabilities will be suppressed only for those users who have chosen to use a nonconversational mode of entering the system. In this way, both interactive and remote batch processing will be provided as equal components in a unified design and without degradation to either level of service.

Further extending the capabilities of such a system will be primarily a matter of designing a communications interface to handle the higher speed terminals required for remote job entry. This interface will be responsible for receiving data from remote high-speed terminals and loading that data onto a disc for subsequent processing. After execution, the interface will transmit the output back to the user's remote terminal.

The scheme will allow the user to write, test, and debug a program in a highly interactive environment, using a lower speed (interactive) terminal, and then to batch that program in the same language, on the same language processor, using a high-speed terminal. Separate computers as communications processors are not mandatory but desirable. Normally, these machines are nominally small as compared to the main interactive user central processor.

NETWORKS

The time-sharing marketplace cannot be served unless the information can be carried to user terminals at many distant locations. To obtain the multiplier effect from programs servicing industry-oriented applications, access must be provided from more than just major cities. The most feasible way to provide such service now is via common carrier telephone lines.

Newer time-sharing bureaus which hope to serve several cities in the near future are not aware of the real difficulties associated with establishing a national network. Too often the assumption is made that the problems of installing a communications network are few because the vendor is always American Telephone and Telegraph and its associated companies. Even those few companies with a working network have only just begun to solve the problems involved in offering the kind of reliable, variable-speed service required by industry. Varied and higher speed data transmission, as well as geographic expansion of communications availability, continue to pose great difficulties for time-sharing companies.

The following random sampling of some of the difficulties encountered in establishing a national network will illustrate the problem.

1. Time-sharing service vendors are currently experiencing longer delays in the delivery of both new equipment and standard equipment and facilities which are, and have been, the fundamental offerings of the carriers to their data communications customers. Delays and long delivery lead times are particularly harmful to the time-sharing vendor. The companies in this industry have a very high overhead — computers and trained personnel are expensive. The necessity of having equipment stand idle while waiting for the communications common carrier to install lines or provide equipment is intolerable. However, once the equipment arrives, the troubles are only beginning. In an internal study of one time-sharing company's new installations in Pittsburgh, Los Angeles, and New York, during the first quarter of 1969, only 20 percent of the data sets were reported as having been installed correctly initially. An additional six to eight weeks were required before the faults were corrected by the telephone companies involved.

2. Inconsistencies between AT&T and local public utilities commissions are causing another set of problems in constructing a national network. Nonuniform or untimely decisions by the various public utilities commissions may prevent the time-sharing bureaus from offering certain services in parts of the United States.

3. Communications maintenance is also a major problem in numerous areas throughout the country. Often the maintenance of data facilities is performed by personnel trained primarily in voice communication. This paucity of sufficiently trained data communications maintenance personnel, manifested in excessive repair times or in substandard repair, deals a body blow to the time-sharing industry which, of necessity, must be entirely dependent on the communications common carriers. Ironically, most remote communications equipment or remote communications processors are capable of correctly diagnosing outages or failures of an attached telephone line (even to the satisfaction of the local telephone company) and of reporting the problem to the central computer, which brings the problem to the attention of the computer operator.

4. The quality of data communications lines is not consistently good. Serious problems are often found in switching centers when outdated switching equipment is utilized, or when pulse signaling techniques are used. Excessive noise and widely varying changes in gain on leased lines is also found.

1 Equipment Characteristics

5. Many time-sharing bureaus have also been concerned with the limited number of transmission speeds offered by the common carriers. The Carterfone decision will certainly ameliorate this problem by permitting a vast variety of privately produced modems to be used when the "direct access arrangement" (and most importantly, the automatic answering version) becomes available.

This does not completely solve the problem of providing a variety of transmission speeds. In reality, by allowing direct access to the DDD network, communications customers may now make their own trade-off between transmission speed and error rate. The curve on which this trade-off may be made is fixed by the frequency bandwidth and signal-to-noise ratio characteristics of the DDD network, which were determined, rather arbitrarily, by the fact that the network was designed for voice transmission. This trade-off reaches a point of diminishing returns where it no longer pays to increase the transmission rate beyond approximately 10,000 bits per second. Interestingly enough, at least for the present, it is faster to send a reel of magnetic tape via commercial airlines than to use data transmission equipment on the switched (DDD) network. There is a definite need for a higher speed switched voice network in order to provide reliable service at a reasonable price.

Going in the opposite direction, there are a great number of customers who require very limited communications of less than 300 baud. However, under current tariffs they must purchase service with capabilities exceeding their requirements by perhaps a factor of 30. In dealing with this very question, the BEMA DePodwin Study concludes that "... the nature of the demand is not such that decreasing costs can be realized through standardization."

For the reasons cited above and others, the Computer Time-Sharing Service Section of ADAPSO recommended to the Federal Communications Commission in mid-1969 that it require the communications common carriers to publish meaningful specifications of transmission line quality and insure compliance with these specifications. This is absolutely necessary to upgrade and maintain the quality of the service.

New Network Needed

These basic limitations of today's switched voice network, coupled with substantial requirements for both lower speed and reliable intermediate speed switched service, substantiate the argument for a separate network designed specifically for data transmission, one which would not be limited by the influences and constraints of concomitant voice communication. One alternative would take the form of a Pulse Code Modulation network, such as the one being contemplated in Western Europe.

This need could also be fulfilled by a special class of microwave common carriers geared for the transmission of data. These common carriers could take advantage of technical advances such as lower priced microwave hardware produced in competitive equipment markets and offer a wide range of quality, capacity, and price levels as well as more rapidly adapt to the varying needs of their customers.

A significant step was taken by the Federal Communications Commission when they approved the class of service proposed by Microwave Communications, Inc., in Docket No. 16509-16519. This decision and others to come will increase the possibility that effective data communications services can be expeditiously established. A pending recommendation that the commission encourage interconnection between that service and the switched telephone network will further enhance the communications situation.

That such communications problems exist should not have a discouraging effect, for they present a lesser total problem for the industry than did the basic system software and hardware problems of the recent past. The point that should become clear is that the future growth of the time-sharing industry is dependent upon its entry into the commercial applications field. The rapidly changing technology of time-sharing must be influenced by the demands of this marketplace rather than by the design expertise of the industry innovators.

1 Equipment Characteristics

COMMERCIAL TIME SHARING SERVICES

COMPANY	ALLEN-BABCOCK COMPUTING	AMERICAN COMPUTER SERVICES	BURLINGTON MANAGEMENT SERVICES
COMPUTER USED	IBM 360/50	GE/615	RCA Spectra 70/46 (2)
USER LANGUAGES	Rush, PL/1, Cobol, Fortran, BAL	APT III, Quickpath (numerical control)	Cobol, Fortran-IV, Basic Assy Language, & File Editor
TERMINALS	IBM 2741, TTY 33, 35	TTY	TTY-33, 35, 37, TTY-Inktronic, IBM-2741, RCA 70/752 Video Data Terminal
NO. OF USERS	70	200	48 Interactive & 16 batch (each system)
STATES SERVED	Calif., Ore., Wash., Ill., Tex., Mass., N.Y., N.J., Pa., Conn., D.C.	All East of Mississippi River	East Coast
CHARGES			
Minimum (\$/month)	none	none	\$100
Connection (\$/hr)	none	\$12	Low Speed: \$9-\$12 Hi Speed: \$17
CPU (\$/min)		\$18	\$3
Storage (char/month)	\$14/100,000 bytes	\$1/1280	50,000 no charge; \$6 each addl. 25,000
COMMENTS			Both commercial and scientific applications.

COMMERCIAL TIME SHARING SERVICES

COMPANY	C & C COMPUTER SYSTEMS	CTC COMPUTER	COMMUNITY COMPUTER CORP.
COMPUTER USED	IBM 360-65	IBM 360/40, 256K, 2314	HP 2116B
USER LANGUAGES	Foreground: RPL (A PL/I subset) and B	n/a	Basic
TERMINALS	IBM 2741, 2780, 1130, 360 & TTY	IBM 2740, 1062	TTY, CRT, Hi-Speed Printer
NO. OF USERS	100 Simultaneous	27	48
STATES SERVED	Calif., Colo., Ore., Wash.	Calif.	Pa., N.J., Del.
CHARGES			
Minimum (\$/month)	\$50	\$.15/acct/mo. plus special reports	none
Connection (\$/hr)	1st 20 hours: \$6 2nd 20 hours: \$4	n/a	\$7
CPU (\$/min)	\$6, \$.025/4K storage	\$2 for special processing	none
Storage (char/month)	\$.90/7.3K	n/a	\$.10/160
COMMENTS		The system is an on-line/real time service for credit unions & is currently processing in excess of 300,000 accounts.	

1 Equipment Characteristics

COMMERCIAL TIME SHARING SERVICES

COMPANY	COMPUTER NETWORK (COMNET)	COMPU-TIME	CONSOLIDATED COMPUTER SERVICES INT'L
COMPUTER USED	IBM 360/65	Dual GE 430 System	CCS 2100 Time Shared System
USER LANGUAGES	360 OS Languages	Super-Basic, Fortran IV	Most popular languages
TERMINALS	2741, TTY, IBM 2780 1130	ASCII Compatible, speeds of 10 & 30 char/sec	M33 type, M35 type, CRT's printers card readers, card punch speeds 10, 20, 30 cps
NO. OF USERS	100 plus	100 to 200	16 simultaneous users
STATES SERVED	Eastern	Fla., S.C., N.C., Kent., Tenn., La., Ga.	United States and Canada
CHARGES			
Minimum (\$/month)	0	\$10	Pricing depends upon specific equipment used.
Connection (\$/hr)	\$7	\$10	
CPU (\$/min)	Approx. \$10	\$0.06	
Storage (char/month)	7000 char block \$1	\$1.50/1620	
COMMENTS	OS compatible time-sharing under proprietary operating system - ALPHA		Application packages avail: Inventory control, sales reporting, attribute retrieval & budget variance

COMMERCIAL TIME SHARING SERVICES

COMPANY	CYPHERNETICS CORP.	DATASONICS	DIALOG COMPUTING
COMPUTER USED	PDP-10	XDS 940; GE 435; 360/50	360/65
USER LANGUAGES	Extended Basic, Fortran IV, Cobol	Basic	Most popular languages
TERMINALS	110, 134, 150 baud	TTY, 2741, etc.	TTY, 2741, DCT 500, Novar Datel, Memorex, CRT, Plotters
NO. OF USERS	100		120
STATES SERVED	Ohio.; Pa., Ill., Mich., N.Y., Wisc., Ind.	Northeast	Ill., Ind., Ohio, Pa., N.Y., N.J., Conn., Mass.
CHARGES			
Minimum (\$/month)	n/a	\$150	none
Connection (\$/hr)	prime: \$10, off-peak: \$3	\$14	\$10
CPU (\$/min)	\$.02/CPU; CPU's = page sec. x priority x software coefficient	\$10	\$.12/unit including memory size & I/O access
Storage (char/month)	\$1/1000		\$.50 to \$1.65/2048
COMMENTS		Prices approx. - and depend upon system being used; Datasonics Budget Analysis System offered through time sharing firms. Raw time not sold.	Servicing Engr. Scientific markets compatible w/IBM for program development. Large Library w/spec. languages as COGO etc.

COMMERCIAL TIME SHARING SERVICES

COMPANY	GENERAL ANALYTICS	THE MATRIX CORP.	MEGASYSTEMS
COMPUTER USED	XDS SIGMA-7	GE 635	IBM 360/67
USER LANGUAGES	Fortran, Cobol, Basic	Basic, Fortran, Text Editor	Most popular languages
TERMINALS	TTY, Data Point 3300 (30 CPS) 2741	TTY, & TTY-Compatible	TTY 33, 35; IBM 2741, 2780; Dura, TST
NO. OF USERS	42 lines	10 - 50	72
STATES SERVED	Calif.	Calif., Ore., Wash., Okla., Ariz.	N.Y., Conn., D.C., Md., Pa., Va., N.C., N.J., Del.
CHARGES			
Minimum (\$/month)	nomimum	none	\$200*
Connection (\$/hr)	\$5	\$10	\$8 (10 & 15 char/sec) \$10 (2000,2400 baud)
CPU (\$/min)	\$6	\$0.28	\$0.30/SMU**
Storage (char/month)	\$0.30/1000	\$0.25/1000	\$10/120,000 bytes
COMMENTS		Offer remote batch thru any of above terminals, plus GE 105, GE 115, UNIVAC 1004, 1005; others.	*\$200 min. covers one contract including all three services. **1 SMU = 1 virtual CPU second

COMMERCIAL TIME SHARING SERVICES

COMPANY	ON-LINE SYSTEMS	NATIONAL CSS	MULTICOMP
COMPUTER USED	DEC PDP-10	IBM 360/67	(2) CDC-3600 (2) PDP-8
USER LANGUAGES	Fortran IV, Basic, AID, LISP 1.6	All popular types	Most popular languages
TERMINALS	ASCII, BCD, EBCDIC	All popular types	TTY 33, 35; IBM 2741 & equiv.; 30 cps terminals
NO. OF USERS	64 ea. of 3 systems	n/a	64/computer
STATES SERVED	N.Y., N.J., Pa., Md., D.C., Va., Ohio, Texas, Wisc., Fla., Ga.	N.Y., N.J., Mass., Conn., Pa., Calif., Ariz., Ill., Montreal, Quebec, Toronto, Ontario	Mass., N.Y., D.C., Conn., R.I.
CHARGES			
Minimum (\$/month)	\$5/user number	none	\$70
Connection (\$/hr)	\$10	\$10	\$10
CPU (\$/min)	\$3	\$22.80	\$12
Storage (char/month)	\$1/3200 char	User specified amt. up to 1.4 billion. From \$.166/1000 to .083/1000	\$1.50/2048
COMMENTS			

1 Equipment Characteristics

COMMERCIAL TIME SHARING SERVICES

COMPANY	PHI COMPUTER SERVICES	PROGRAMS & ANALYSIS	QUIKDATA
COMPUTER USED	IBM 360/65	GE-430	GE-635
USER LANGUAGES	Proprietary Info. Stor. & Ret. - Datalogue	Fortran & Basic	"FIX" = Business Application Codes
TERMINALS	2741, TTY, TTY-CRT, 2265	33 ASR	TTY
NO. OF USERS	5	39	15
STATES SERVED	Mass., Vt., Conn., R.I., N.H., Me., N.Y., N.J.	Mass., R.I., N.H., Me., Ohio, Kent.	Calif., Minn., Ontario Canada
CHARGES			
Minimum (\$/month)	\$500	\$100	Per Item Processed:
Connection (\$/hr)	\$12	\$10	\$5/input item
CPU (\$/min)		\$3.60	\$.25/output document
Storage (char/month)	\$0.08/1000 to \$0.25/1000 (depending on volume)	\$.85/1000	
COMMENTS	A generalized storage & retrieval service.		

COMMERCIAL TIME SHARING SERVICES

COMPANY	REALTIME SYSTEMS	SCIENTIFIC TIME SHARING	TECHNOLOGY FOR INFORMATION MGNT.
COMPUTER USED	2-Burroughs B5500	360/50	GE 430
USER LANGUAGES	Fortran IV, Cobol, Algol, Basic	APL	Basic, X-Basic, Fortran IV
TERMINALS	TTY's, 30 CPS, CRT & Printer Terminals	Various IBM; TST; Datel & Novar	TTY 33 & 35, Friden 7200, Olivetti
NO. OF USERS	40		40
STATES SERVED	N.Y., N.J., Conn.	Conn., N.Y., N.J., Del., Md., Pa., Va., D.C., Calif.	Ill., Ind., Wisc., N.Y.,
CHARGES			
Minimum (\$/month)	\$100	none	no minimum
Connection (\$/hr)	\$15	\$12	\$8
CPU (\$/min)	\$8.35/day \$6.65/after 6 PM	\$6	\$3
Storage (char/month)	\$0.03/1000 per day. Basic storage rates available on request.	\$10/32,000 bytes	\$0.10/180
COMMENTS	Avail. library programs include: simultaneous languages like DYNAMO, GPSS, SIMULA. Extensive financial library also available to users.		

COMMERCIAL TIME SHARING SERVICES

COMPANY	TELCOMP CORP. OF AMERICA (BB&N)	TRAVCOM	UNITED COMPUTING SYSTEMS
COMPUTER USED	PDP-10	360/40	CDC 6400 (UCS-VI)
USER LANGUAGES	Telcomp-III, Basic Fortran IV, Macro		Fortran, Basic, Superbasic, Algol
TERMINALS	ASCII-110, 150, 300 baud	2741 - IBM	All popular types
NO. OF USERS	64	30	409
STATES SERVED	N.H., Vt., Mass., Conn., R.I., N.Y., N.J., Pa., Del., Md., Va., N.C.	All	Ill., Ga., Miss., Ala., Ohio Mo., Colo., Kan., La., Tex., Okla., Pa., N.Y.; Calif., D.C., Mass., Va., Del., Mich.
CHARGES			
Minimum (\$/month)		\$785	none
Connection (\$/hr)	\$10	\$12 hr/day included in above	\$15
CPU (\$/min)	\$.05/4K wds/sec.	none	\$36 depending on program size
Storage (char/month)	\$.40/640-char. block	none	\$.50/1,280
COMMENTS	Programs for elec. & financial analysts.	A/R, inventory, billing	*All users have access to batch languages and programs from time-sharing & remote batch terminals.

COMMERCIAL TIME SHARING SERVICES

COMPANY	VITRO LABORATORIES	COM-SHARE	RAPIDATA
COMPUTER USED	IBM 360/65	XDS-940	GE 437
USER LANGUAGES	ATS/360 (Text Editing Language)	Fortran II, TAP, Basic New Basic, XTRAN	Basic, Fortran, Plea
TERMINALS	IBM 2741, Datel, etc. (Correspondence code)	Wide Selection	ASR 33, 35; Typagraph; Dura 1041; Datel 2741; Corning 904
NO. OF USERS	28		2,000
STATES SERVED	D.C., Md., Va.	Mich., Va., Mass., N.Y., Ill., Ohio, Kent., Pa., Conn., Ind., Mo., Calif., Minn., Md., D.C., Wisc., La., N.J., Tenn., Ontario	N.H., Del., N.J., Conn., Va., Mass., N.Y., R.I., Pa., Vt., Md., W. Va., D.C., Calif.
CHARGES			
Minimum (\$/month)	\$75/mo/access	Competitive prices vary with reference to equipment utilized	\$10
Connection (\$/hr)	\$3		\$5-13
CPU (\$/min)	\$5		\$.06
Storage (char/month)	\$.15/1550 bytes (based on avg. daily use)		\$.60/unit/mo to 500 units \$.30/unit/mo above 500 units
COMMENTS			



NAMES & ADDRESSES

ARE OUR BUSINESS

IN GENERAL, our specialized services and data processing include

SUBSCRIPTION FULFILLMENT

INQUIRY PROCESSING

MAILING LIST MAINTENANCE

DATA BANK/RETRIEVAL SYSTEMS

DIRECTORY COPY PHOTOCOMPOSITION

Getting down to cases, this is the sort of thing we do well....

Case 1 A large computer manufacturer . . . we maintain their Sales Lead Data Bank . . . heavily encoded with customer and prospect information . . . the complete file is used for newsletter and general mailings, projections and analyses . . . programmed selections from it are made for pin-pointed direct mail marketing, computer-written letters, continuous form envelopes, and lists for research and sales offices, etc.

Case 2 A national association . . . we maintain a membership list of some 60,000 names, produce address labels for a monthly newspaper and one-line labels for each member's insurance policy, computer-printed membership cards, and keep track of dues payments and chapter enrollments.

Case 3 A large controlled-circulation business publication . . . we co-operated in the initial design of their list maintenance and fulfillment systems. We now manage and maintain their list of 45,000 names, monitor its quality, periodically re-verify each subscriber's qualifications, handle circulation audits, and provide analyses for editorial and advertising sales support.

Case 4 Medium-sized paid-circulation business publication . . . our list maintenance includes invoicing, statements, renewal notices, subscriber correspondence, subscription promotion sales evaluation, subscriber information acquisition, complete circulation audit statistics . . . and analyses for editorial and advertising sales support.

Case 5 Major trade publication . . . we handle the processing of some 350,000 annual inquiries to items advertised and editorialized in the magazine. Routine inquiry processing at economical rates is secondary in value to the production of sales promotion/support history reports and qualitative analyses.

When you need a specialist in names & address data processing

COMPUTER FULFILLMENT 225 EAST STREET WINCHESTER, MASS. 01890 (617) 729-4650

Business Forms

Business form volume has passed the billion dollar mark and expectations are that by 1980 the annual volume will be in excess of \$2 billion. Industry analysts state that as more sophisticated equipment is introduced, requiring and producing more and more data, the predicted \$2 billion volume may be far below actual potential. Business forms volume has increased at an average rate of 10% each year, with no diminution of this trend expected in the next decade or two.

The growth of the industry over the past ten years can be illustrated by the growth of Moore Business Forms, Inc. In 1950 the company's sales were approximately \$58 million. In 1960, sales were \$155 million; in 1965, \$241 million; in 1969 sales reached \$398 million. Since Moore sells approximately 28% of the potential in the United States, this might indicate that the future market for the business forms industry as a whole will be in excess of \$3 to \$4 billion annually and that the industry anticipates increasing use of its form products by business over the foreseeable future.

INCREASED EFFICIENCY

Coordinating form sizes and layout with the machine room scheduling can yield significant savings. Printer specifications normally give optimum speed, which in reality is seldom realized. Both vertical and horizontal form layout have a strong impact upon how much of the printer's potential speed is actually used. Proper planning can minimize the need to change carriage control tapes, plugboards, tractor positioning, and other operator controls. Using compatible form sizes and formats can help minimize delay between jobs and operator attention during the run.

When a form jams in the printer, it is certainly not the value of the mutilated form which is of concern. Nor is it necessarily any attendant computer downtime. The major cost is reconstructing the page or pages of information involved. If the forms are consecutively numbered, such as checks, the problem is worse. If it is a small system where printout is on-line from a disc file, there may be still another dimension to the problem. Unless some special precaution is taken, re-running could cause part of the file to be ruined by being updated twice.

CUSTOM FORMS

All the above considerations have direct bearing upon overall computer system throughput. But such considerations may not be the only ones, or even the major ones. In all honesty, it can be stated that both forms salesmen and forms buyers often put too much stress on machine efficiency without taking into account the bigger picture.

For instance, with the emerging pre-eminence of "image," some companies are using more and more custom forms. This means a form change with each job. Forms should be "conditioned" in the machine room, or in an area with identical atmospheric conditions. Delivery of custom forms may be as long as three or four weeks. This all adds up to a really significant problem in form storage and inventory control.

Here is what is considered to be essential information about a line printer in order to design adequate forms with minimum trial and error.

1. *Character spacing.* This is almost always given, although it is the easiest to guess anyway. All printers manufactured in the United States seem to have now standardized on 10 characters per inch. The only departures are with certain accounting machines, teletypewriters, non-impact printers, the older "tab" printers, and the Bull printer mechanism now becoming common in this country.

2. *Line spacing.* This should be given in lines per vertical inch, any variations possible, and if so, how much work it is to change from one to the other. Sometimes pulley changes are needed to change from six to eight lines per inch, as well as a different carriage control tape. Availability of single-double spacing under operator control should also be given.

3. *Vertical format control.* Is there a vertical format control unit using a paper tape as a standard feature? How many functions can be handled by the tape (number of channels)?

4. *Skipping speed.* This is useful in determining how much care should be taken to minimize skipping within and between forms. It is useful to know how much time is lost by skipping specific distances; in terms of number of lines skipped.

5. *Number of printing positions.* This normally corresponds with the number of hammers, and is sometimes called "line length." Options are normally offered here. It is good to know which is considered "standard."

6. *Characters available at each position.* This information should include how many, what they are, and what is the standard sequence. It should be specified whether the print element (drum, chain, train, or stick) is interchangeable to offer expanded character sets, and how this affects speed. If effective speed varies, depending upon the characters selected by the program, representative speeds should be given.

7. *Absolute maximum form width.* This is the width (from form edge to form edge) which can be handled with the tractors spread to their limits.

1 Equipment Characteristics

8. *Maximum width to write anywhere.* This is always less than the absolute maximum. It is the width which can be used that permits writing up to within a half inch of either the left edge of the form or the right edge.

9. *Relate form widths to area that can be written.* With line lengths commonly limited to 96, 120, 132, or sometimes 160 positions, obviously the full width of many wide forms cannot be written. Horizontal adjustment of the print unit or forms tractors can vary a great deal. A diagram should be provided showing the area that can be written with common standard-width forms, particularly with the wider ones: 14-7/8 (as many as 50% of all forms are estimated to be this width), 16-3/4 and 17-25/32. Distance of first and last not printing positions to the form margin should be shown with each of the common line lengths available with the printer, with full left adjustment and full right adjustment.

10. *Horizontal and vertical vernier control.* Availability of such controls often determines the practicability of designing a form with close registration. When these are not available, it is good to use a relatively "loose" layout, even though it may not be making effective use of the form area.

11. *Vertical and horizontal form tension control.* One of the main barriers to good "write through" is air space which develops between the parts of a form. For this reason impression quality through a wide form is not usually as good as through a narrow form. To minimize slack in the form, which affects how well the impression will carry through the form, it should be properly tensioned. Availability of two sets of tractors, and controls to adjust the distance between them, have a lot to do with what kind of write-through can be expected with varying width and thickness forms.

12. *Write-through expectancy.* Admittedly there are many other variables here, not to mention the lack of accurate standards for describing papers and carbons. But some effort should be made to describe the outer limits, in terms of the number of readable copies of given form thicknesses that can be expected.

Then there is the obvious factor (which is often overlooked) – the cost of the form itself. Continuous forms are expensive. With moderate usage, one line printer can use \$50,000 to \$75,000 worth of forms a year.

Most line printers do not consume this volume, although some exceed it. Surveys indicate that the average line printer consumes about \$10,000 per year in forms. But it is obvious that the cost of the forms per year sometimes approaches the value of the hardware itself, and it often exceeds its rental. So in a business data processing operation, forms cost can be a very real factor in the financial balance sheet.

At one time, "use cost" was many times the forms cost, but this is now almost a cliché. Yet one that is expensive to ignore. In most cases, what happens to the form after it is written by the computer really tells the tale of whether the form is doing its job or not. "Afterhandling" operations, such as bursting and decollating, can be a problem but there is much more. Does the form perform its "end use" job effectively? Is the impression sharp and intense on all copies? Does the message come through loud and clear?

Will it stay that way as long as it could possibly be needed? Form specifications that enable the form to meet these demands are much more important than those which relate to its efficiency in the computer printer. The printer is only a means to an end.

Surrounding the computer itself is a much larger complex, composed of forms which are not physically passed through the computer printer. The value of these forms – both in their cost and the office work involved in their use – is often much greater than the continuous forms used in the computer itself. But the design of all these forms, especially those leading up to the generation of computer input, should be closely linked to the EDP operation. Large savings can be garnered by replacing home-made "flat" forms with well-designed unit set forms. Although the scope of this article is not broad enough to treat these peripheral forms, it should be stressed that they are an important part of EDP forms technology, and should not be ignored.

Most important, in business applications, the form should be viewed, for proper perspective, as the final end product. The written form carries information not only within the company, but often also to the public. Here is where computer users are sometimes penny wise and dollar foolish. Attractively-printed and clearly-written forms are probably the biggest bargain available from the "end use" standpoint. Compared with the cost of systems planning, hardware, programming, and operation of the EDP system which produces these documents, the cost of the document itself is very small. This is why some organizations are using forms made of better materials than the line printer demands. It is why many forms are being printed in two or three colors. Size and layout might be such that effective line printer speed is far below its optimum. Yet the intangible benefit derived from the impact of the document upon the human being for which it was designed more than compensates for the added purchase and document preparation cost.

Demands placed on forms by EDP – both from the standpoint of performance in the computer printer and this bigger picture – are complex, and sometimes contradictory. It is the challenge which EDP poses for the forms industry. Computer users will be better qualified in dealing with forms vendors, and assessing their capability to meet these needs once they have acquired some knowledge of the nature of the forms industry.

IMPROVED MATERIALS

Among the major developments which have enabled forms to meet these demands is improved materials. There are now better bond papers, one-time carbon papers, carbonless papers, and duplicating masters.

Several mills have now made available relatively light-weight (9# and 12#), smooth-finish papers, which often do not carry a premium price tag. Yet they are thin enough to carry an impression through seven or eight parts on some high-speed printers.

But there are very distinct limits and dangers inherent in the lightweight papers. Opacity must be sufficient for good legibility; it must handle well in business forms manufacturing equipment; there must be enough strength to pass

1 Equipment Characteristics

through the high-speed line printer; and it has to be rigid enough to refold properly after being written on, and during the decollating operation.

Sometimes, as a compromise for strength and ease of handling, lightweight plies are sandwiched between heavier weight "external" plies. However, since the hammers strike through the entire form against the moving type, any thick ply in the set reduces the write-through on all parts. So the thick final-ply, traditional with tab forms, is now avoided.

Although there is much talk about carbonless papers, improvements in old-fashioned carbon paper are just as significant. In general, high-speed printers require carbon on the hard side of medium, to minimize "framing" bleed when packed in the carton and smudging after the form is written. Better formulations have been developed which meet these needs, yet they provide sufficient intensity. Again, because of the light impact of computer printers, efforts are being made to reduce forms bulk by using lighter weight carbon paper. One of the major development efforts now going on is the search for techniques to coat lower grade, lightweight carbonizing base paper so as to reduce the price of the lightest weight carbon papers.

Thinner tissues and formulations with superior release, mated with new smooth-surfaced lightweight bonds, permit today's continuous forms to yield the extra copies many users demand in the face of the lighter impact of high-speed printers.

CARBONLESS PAPERS

Carbonless papers are making inroads in the continuous forms area. They offer the following advantages:

- Because there are no "interleaves," feeding through the printer is better;
- There is no "useless sheet" to take out and destroy after the form is written;
- There is no security problem posed by discarded carbon paper (which helps explain the heavy use of carbonless papers in government agencies);
- In some types the image is more permanent and less able to be altered than the carbon image;
- Some carbonless papers have less bulk, so more length can be packed into a carton, thereby reducing form changes or splicing;
- With self-contained carbonless papers, forms can be written without a ribbon;
- Certain types yield more copies than carbon interleaves.

Some disadvantages are:

- The form is usually more expensive;
- The blue image produced by some types is unacceptable in some applications, for example when it has to be copied or scanned;
- Some types yield fewer copies than carbon interleaves;

- The form is easily marred during handling before and after being written;
- Back printing may prevent an impression transfer in that area;
- "Desensitizing" or blocking out certain areas may be impossible or difficult;
- The types with a dark back coating prevent back printing;
- The coatings or surface textures are considered objectionable in some applications.

FORMS CONSTRUCTION FOR EDP

Construction features such as fastenings, perforations, narrow plies, or carbon are closely related to the line printer requirements, the end use of the form, and how the form is to be decollated and burst.

Normally, the customer does not specify the perforations desired. There are too many variables here. Plants select perforating blades and wheels by long experience or by balancing out the following considerations: weight and quality of the paper, its grain, kind of carbon paper, whether the perforation will be made on press or collator, number of plies in the form, whether the ply is on the inside or exposed, the line printer with which it will be used, and how it will be burst (manually or by machine).

Sometimes customers do not specify fastenings, but they should. Knowledge of the kinds available and proper selection can spell the difference between success and failure in some applications. But it is essential that the forms supplier also be consulted, since some factories are not equipped to furnish certain fastenings.

There are four major choices when it comes to fastenings. The parts can be *unfastened*, they can be *temporarily fastened*, they can have *permanent fastenings*, or there can be a *combination*. Permanent fastenings can be either *firm* or *flexible*.

In most cases, cost is an insignificant consideration in the selection of fastenings. There is no additional charge for some. So the decision to leave a form unfastened should not be based on lower cost. There are advantages. One is that an unfastened form has margins which are free of cuts or foreign objects that can cause feeding problems in the printer and buildup on the margins when the form is flat-pack folded. Another is that after the form is written, removing the carbon and separating the parts is simplified.

It is generally recognized, however, that fastened forms feed better through a line printer than unfastened. Certainly above two or three parts some kind of fastening should be used. The fastened form is also easier to load into the printer, since the marginal punching maintains better alignment.

Crimping is a compromise solution which offers many of the advantages of no fastening and a permanent fastening. No foreign material such as glue or staples is introduced into the form. After writing, it can normally be easily pulled apart. However, crimps can vary widely in their holding power.

1 Equipment Characteristics

The normal crimp consists of a set of small cuts through the form along one or both margins. Spacing may be as close as every two inches, or only one or two on each form. The lightest crimp has just three "fingers." For tighter gripping, there are others with four or five cuts on each, sets of opposing cuts, and crimps alternating from one side of the form to the other. Some of these types hold almost as tightly as staples, although with thick forms – five or more parts – the holding power of all crimps dwindles.

Depending upon how tight they are, crimps can have a number of advantages. Many plants have equipment that permits them to be made on the collator, so there is no upcharge. They permit the form to "flex," which is most helpful, as described below. Ideally, they are tight enough to hold the form in alignment (ply to ply) when it is being loaded into the printer, yet with mechanical decollators, can be pulled apart, obviating the need for special margin trimming attachments. One other kind of fastening which offers many of the same advantages is a rubber-cement-like adhesive called fugitive glue. Unlike crimping, this does not lose its holding power with thick formsets, and can be selectively applied to certain parts.

IMPORTANCE OF FLEX

Inserting a permanent fastening into a continuous form introduces the problem of flex. This can be appreciated by considering what happens in forms manufacturing, at the rotary collator. The marginal holes have been either punched on the press in each ply separately, then brought into alignment on the collator, or are punched through all plies together on the collator. In either case, with a five- or six-part form, picture what happens to the marginal holes when the form is folded back on itself during zig-zag folding. There will be internal pressure within the form to cause the holes to become staggered, since the inside ply will not travel as long a distance as the outside.

For many years, forms manufacturers had been accustomed to making unit-set forms by pasting along the stub. Most collators were therefore equipped with pasting attachments. But this paste did not set fast enough for continuous forms, allowing misalignment of the feed holes to be frozen into place after zig-zag folding. And when the form was straightened out the folds would not flatten, creating a problem called tenting.

Regardless of the alignment of the feed holes, another forms problem is associated with using a firmly-fastened form in a machine like a typewriter or tab printer. When the form is passed around the platen, once again it is turned back on itself, and internal stresses are created. Unless each ply can move a bit ("flex") to adjust to these pressures, there will be buckling and binding, and perhaps misfeeding.

When the form takes a more or less straight line path, as it does in high-speed printers, this problem is avoided. So the requirement for fastenings are different. But for machines both with and without platens, there is today a fairly wide choice of permanent fastenings.

Fastenings like bumping, sewing, or the traditional staple offer the advantage of a slight amount of flex. However, all three of these fastenings tend to be more expensive than

others, since to apply them is often a separate operation. Furthermore, many printer manufacturers warn against the use of stapled fastenings in their printers. However, the newer, smaller staples, positioned so the long dimension lies perpendicular to the length of the form often pose no problem. Care should be taken to make sure the fastened margin is clear of the ribbon and printing assembly.

The bump fastening and sewing are less common than the staples, and only a few manufacturers offer them. The danger of entering spurious metal into the printer is eliminated, and more flexing is possible. Sewing is with a thin nylon thread, normally on just one margin. The bump fastening consists of small tongues of paper cut out along one margin, which are locked by being folded back and passed through slits in the form. Because of the relatively low speed of machines to make these fastenings and added cost, they will probably not become common; they have been more widely used in Europe.

Pasting is the most widely-used permanent fastening for continuous forms. To overcome the problem described above, there have been developed hot melt gluing systems to apply glue that sets almost instantly, avoiding the slippage and tenting problem. Gluing may be either solid-line or spot. Solid-line gluing can cause stiffness and curling in the fastened margin, which may interfere with feeding in the printer, and also can cause excessive buildup in the stacked pack.

Spot gluing has the advantage of using less glue, creating less buildup in the pack (if the spots are staggered), makes margins more flexible, and minimizes tenting.

Gluing of either type offers a number of unique advantages. If the form is to be fastened in one operation, most other fastenings require that the entire set be fastened together. But with gluing there is complete flexibility as to what is fastened to what. When certain parts are to remain together – as when mailing two parts of an invoice to the customer – these, and only these, need be glued, perhaps with a supplementary crimp holding together the entire set. In addition, special carbon extraction arrangements can be built into the form, and alternate margins can be glued for distributing buildup, enhancing flexibility, or making a double-stub set when the form has been burst. Although the gluing system for a collator is expensive, once installed, the running costs are low. Forms can be glued with little or no collator slowdown, so often there is no upcharge. The following are a few of the problems created by gluing.

1. Margins must be trimmed in order to separate the form.
2. The coated surface of the carbon paper sometimes interferes with the holding power of the glue.
3. It is a firm fastening which does not let the form flex. Flex is obviously important with machines having a platen. Some EDP users also feel flex assists in reliable form feeding in a line printer since it lets the feed holes realign themselves when they reach the tractors.

FORMS HANDLING EQUIPMENT

Speedy output printers can be a curse, as well as a blessing, when viewed, for instance, by clerical personnel attempting to prepare the written continuous forms for distribution.

1 Equipment Characteristics

The major operations required are bursting or cutting the forms apart, getting out the carbon paper (deleaving), separating the parts (decollating), and sometimes imprinting signatures, branch office addresses, or the like. Fortunately, equipment has been developed to mechanize these operations. Some of this equipment places the most critical demands of all on the forms. Selecting "forms handling equipment" is closely linked to the form's end use function, its construction (in particular the fastenings), and the materials.

The least-expensive equipment is a lightweight "waterfall" decollator and single-part burster. The form is separated two parts at a time, and the carbon paper wound automatically onto a spindle for easy disposal. Then each part is run through the burster where it is torn (hopefully) at the cross perforations.

Sometimes it is desirable to leave parts of the form together. In this case the carbon can be removed from the unfastened side with a deleaver, without disturbing the fastened margin. Then the form can be burst into sets with a heavy-duty, multipart burster.

The European approach to separating forms is to cut them rather than tear them apart at the perforations. Some such equipment can cut out the perforation with two close cuts and, also, trim off the marginal punching. The resulting documents are cut clean on all four sides. These "guillotines," along with the expanded character selection now available with many line printers for upper and lower case, have greatly increased the use of computers in writing documents such as insurance policies, "personalized" form letters, and certificates. In general, these cutters are considerably more expensive and slower than bursters.

Most decollators and deleavers can be equipped with slitting blades to trim off the pinfeed margins, and, in some cases, cut the form down the middle as well (when they are printed "two-up"). The type of crimping is worthy of special attention. With most decollators, a heavy crimp will have to be trimmed off. If both margins are fastened and have to be trimmed, the marginal holes cannot be used for binding. Another problem is paper thickness and stiffness. The newer lightweight papers — now used much more because of the lighter impact of computer printers — often create serious problems. In decollators, lightweight papers often buckle or refold improperly. In bursters, the lighter the paper, the more likely tearing or jamming will happen, especially if the perforations are just not right.

Most major producers of business forms offer a line of forms handling equipment and accessories. Some are available directly from independent manufacturers.

STANDARDIZING TERMS

It would help if everyone could get together on terminology. Confusion, and sometimes expensive errors, result from language problems.

For example, sometimes form width is specified as the distance from tractor pin center to tractor pin center, rather than from form edge to form edge. "Skipping" is also called "slewing" or "feedout." "Positions" are also called "columns." In the form specs published by one printer manufacturer, "crimps" are termed "perforation-

type fastening." All this would seem to indicate lack of communication between the forms industry and EDP equipment manufacturers, and among the computer manufacturers themselves.

FUTURE OUTLOOK FOR THE FORMS INDUSTRY

Meeting the needs of data processing equipment is just one phase of the forms industry's contribution to data operations. The research facilities of the industry have introduced innovations in business forms that make them do more than simply convey data. A forward step taken by forms manufacturers is in providing new generations of business forms that augment the benefits of new and existing data processing equipment.

Certainly, there will be future innovations in equipment that may lessen business forms volume in certain areas, but growth of the computer industry and the need for hard copies will offset some forms losses, and, in fact, should greatly increase hard copy uses and volume. For example, COM (Computer Output Microfilm) is a comparative newcomer in the processing field, providing archival copies of records. This might result in the loss of a single part of some form sets, which will be more than taken up by new installations of other types of equipment. Likewise, COM affects only archival records, as it does not supplant business forms for checks, statements, invoices, and other documents sent outside the company.

Impactless printing is another newcomer that viewers say might affect business forms usage. Industry leaders, however, point out that an additional operation is required to provide the hard copies necessary, increasing costs and slowing speeds of data availability; therefore, its impact on business forms usage probably will be minimal.

One interesting phase of computer usage is the increasing use of mass direct mailings by larger concerns. With computer-stored lists now usable at computer speeds, and with computers able to process letters and individualize them with the recipient's name, a new field is opening for the business forms industry. Continuous envelopes, continuous letterheads and/or letterheads carrying tabulating cards used for the recipient to order or to ask for more information are growing rapidly — an example of a new market developing.

The role of the forms representative, particularly in the area of systems counseling, is very important. Knowing equipment and its requirements, and with practically unlimited reference to multithousands of case histories, the forms representative is in a unique position to help the business man get the right form, the right system, and the utmost from his data processing equipment. The systems counsel offered makes business forms perform at maximum efficiency — thus the planning of a well-designed system, using exactly the right form, is viewed by business men as a wise investment. Systems change, expand, involve new objectives, processes, and equipment and the business form industry's "know how" and products will be in even greater demand when these changes come.

Thus, the business forms industry is not static, but growing. New equipment brings new needs. New markets are being opened as high-speed processing provides additional uses for business forms. The future looks highly promising.

For —

Computers — Analog, Digital, Hybrid
Computer Systems & Subsystems
Data Acquisition & Data Terminals
Business Machines
Control Systems
Instruments & Test Systems...

Use INTERSWITCH

Thumbwheel Switches for rapid switching
of frequently changed settings
Matrices for high-density interconnections
Data Modules for semi-permanent programming
Tape Readers for fixed programs

INTERSWITCH

Programming Devices offer the greatest

- Operational Simplicity & Convenience
- Logic-Code Versatility
- Ease & Economy of Assembly
- Reliability at Low Cost

*Sophisticated Components,
Mechanisms, and Arrays that Optimize
the Interface between Man & Machine*

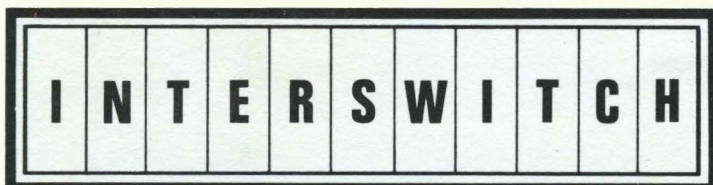

ONE OF THE PURDY GROUP OF COMPANIES
770 AIRPORT BLVD , BURLINGAME, CALIFORNIA 94010
TEL (415) 347-8217 • TWX 910-347-2353 • TELEX 34-9373

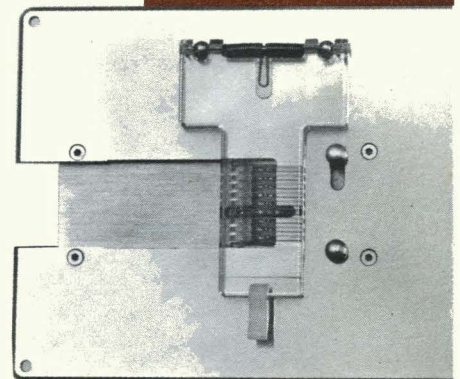
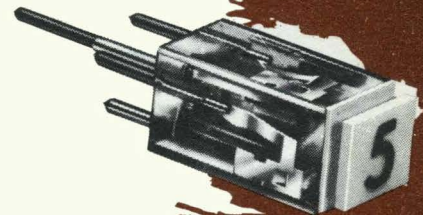

Programming Matrix Boards

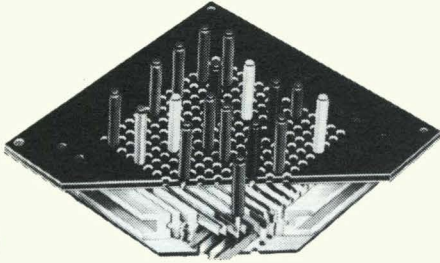

SINGLE-LEVEL MATRIX BOARD
(Cutaway view)

Stock Sizes: Hole Patterns with 3mm spacing: 20 x 20. Hole Patterns with 4.5mm spacing: 10 x 10. Hole Patterns with 6mm spacing: 10 x 10, 10 x 15, 15 x 15, 15 x 31, 20 x 20, 31 x 31.

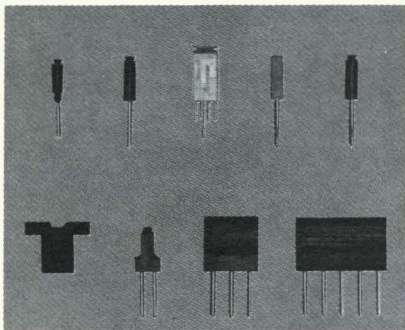

PROGRAMMING ELEMENTS

When compared to such programming devices as cards, tapes, crossbars, or relay matrices, matrix boards offer many important advantages — design simplicity, programming ease and flexibility, high density, and visual presentation of the circuit linkages, to name a few.

An Interswitch Matrix board is a rectangular array of coordinate holes that locate circuit intersections. On a “one-level” (two-layer) board, the horizontal contact bars are mounted directly behind the panel with the vertical bars beneath them. Each bar has an end terminal for conventional connections at the rear of the panel. Insertion of a shorting pin or diode plug in any hole connects the horizontal and vertical bars intersecting at that point, and hence their terminals. Circuits can be linked one-to-one, one-to-many, or many-to-many.

Three- and four-level boards enable the programmer to link up four-wire systems, to program distributive-format conversions (serial-to-parallel) or collective-format conversions (parallel-to-serial), or simply to conserve panel space (for example, a triple-level 10 x 10 matrix is the equivalent of a 10 x 30 matrix).

Apart from shorting pins and diode plugs with short or long handles in any of eight colors, Interswitch programming elements include plug-in lamps (red, green, or white), dummy plugs to cover “forbidden” intersections, and cable plugs permitting connection of any intersection to external trouble-shooting equipment. Custom accessories include dual and triple-segment shorting pins, programming templates, and special diode/shorting-segment pins.

Interswitch Matrix Boards are stocked in seven standard formats (sizes). Larger arrays can be built up from these, and matrices of almost any size or shape can be furnished on request. Appropriate symbols, nomenclature, programming stripes, and other markings, in various colors, can easily be applied to show clearly the circuit or equipment connected to each line and column bus.

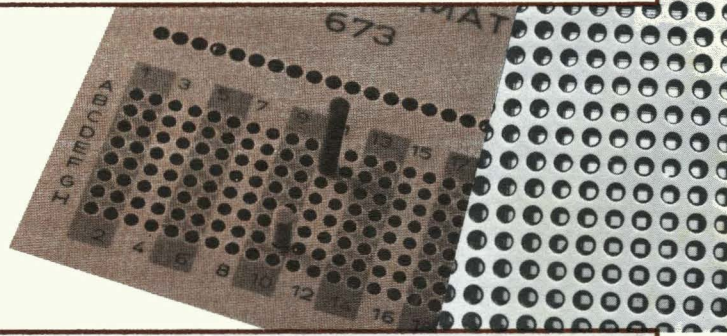

Data Programming Modules

Each module consists of a switch body and a programming plug, or key. The switch bodies are available in two forms — for plug-in to 3mm matrix boards, or to PC boards. Four diodes in the switch body are connected to pins on the base and to spring contacts in the upper section. Insertion of a numbered key closes the spring contacts appropriate for the binary equivalent of the selected number. Keys are available in 7mm and 5mm sizes and in various colors. For relatively permanent programs, keys may be plugged-in to a flexible plastic template for rapid insertion or removal of many characters simultaneously. Many codes available. Operating life: 10^4 switching cycles.

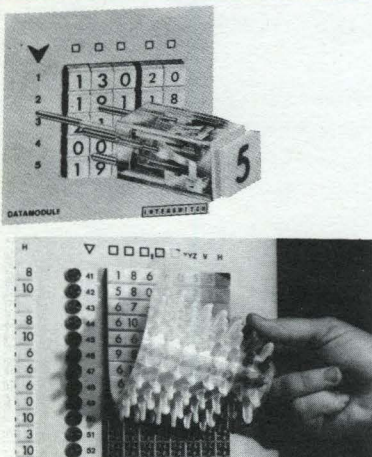

SUMMARY-STANDARD CHARACTERISTICS OF THUMBWHEEL SWITCHES

Type and Bulletin Nos.	NOMINAL DIMENSIONS (PER MODULE)			NO. OF POLES & POSITIONS	TERMINALS**					NOTES
	Width	Height	Depth*		WW	PCP	PCC	SSL	CMC	
B Bulletins C2000, C9001	1/2"	2-1/4"	2-5/8"	2/2 1/8 1/16 1/10	X	O	✓	O	✓	Largest Numerals & widest choice of poles/position formats.
C Bulletins C7000, C9006	3/8"	1-5/16"	3-1/4"	2/2 1/10 1/11	X	X	O	✓	O	Integral circuit board for logic elements to create active code outputs, etc.
F Bulletins C4000, C9003	3/8"	1-5/16"	2-1/16"	2/10 4/2	X	X	O	✓	O	Two independent P. C. boards (e.g., for dual binary codes)
H Bulletins C3000, C9002	3/8"	1-5/16"	1-9/16"	2/2 1/10 1/11	O	O	✓	O	✓	Largest Numeral in a 3/8" switch.
K Bulletins C5000, C9004	3/8"	1-5/16"	2-3/16"	2/2 1/10 1/11	X	X	O	✓	O	Largest Numeral in a 3/8" switch.
S Bulletins C6000, C9005	3/8"	1-5/16"	1-9/16"	2/2 1/10 1/11	O	O	✓	O	✓	Sealed circuitry.
M Bulletins C1000, C9000	5/16"	1-5/16"	1-1/2"	2/2 1/10 1/11	O	O	✓	O	✓	Thinnest thumbwheel switch made.

* Depth of switch body, including longest terminals

** TERMINAL CODES: WW = Wire Wrap; PCP = Printed-Circuit Pins; PCC = Printed-Circuit Connector; SSL = Short Solder-Lug; CMC = Component-mounting Connector

TERMINAL AVAILABILITY: ✓ = STOCK STANDARD; X = SPECIAL ORDER ONLY; O = NOT AVAILABLE

PERFORMANCE SPECIFICATIONS

Working Voltage: 0.5 to 50 Volts DC or AC RMS.
Contact Rating: 0.1 Ampere, resistance switching.
Current Capacity: 1 Ampere, maximum,
Contact Resistance: 0.07 Ohms (including printed circuitry).
Insulation Resistance: 100K Megohms (per MIL-STD-202, Method 302).

Dielectric Strength: 500 VAC RMS for 2 minutes at 25°C.

Operating Temperature: -40°C to +85°C.

Humidity: 96 hours at 95% RH (per MIL-STD-202, Method 101B).

Shock: 15G (per MIL-STD-202, Method 202B).

Vibration: Withstands MIL-STD-202, Method 204A.

Rated Operating Life: In excess of 1,000,000 detent operations.

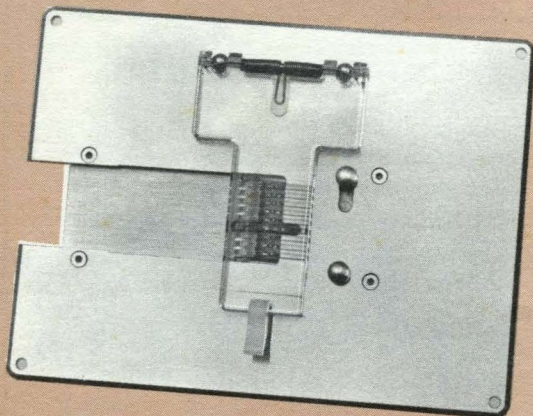

Paper Tape Reader

Model DTR-70 is a unidirectional, asynchronous unit for desk-top or console mounting. It reads up to 70 characters per second and will accommodate punched tapes of any material and any standard width.

Punched holes are sensed by individually rotating star wheels — a method tolerant of tape imperfections. Switches are gold plated and shielded from tape dust and foreign particles. Heavy duty construction eliminates vibration and contributes to long, trouble-free performance.

Thumbwheel Switches

"Finger-wheel" Switches. Refined through continuous development based on field-performance studies of over a million units over the past ten years, these unique switches present a number of paradoxes: small size, yet highly legible readout; featherweight action, yet excellent switching characteristics; smooth transition, yet absolutely positive detent. Indeed, the action — the "feel" — of these switches is so fast and easy that many engineers call them "the only finger-wheel switches."

Design Freedom. Despite their compact size and easy action, these switches provide dependable operation and unequalled electrical stability through millions of steps. Moreover, they provide the logic designer and packaging engineer with almost unlimited choice of electrical and mechanical configurations, switching logic, terminations, color combinations, and circuit capacity. The multiple options available in each of these areas can be variously combined to produce over 5 million different switch types. Yet they are all put together from a few basic stock parts and sub-systems, easily and quickly assembled for rapid delivery of virtually any design — standard or custom.

Logic Versatility. Over 140 available logic codes range from simple 2-pole, 2 position (1/0 or +/-) and 10- or 11- position decimal outputs, through 1-2-2-4 Berkely, 1-2-4-2 Aiken, 1-2-2-4 Ninth Complement, to such sophisticated codes as 1-2-4-8- Binary Excess Three with Parity for direct decimal/binary encoding.

Mechanical Flexibility. Switches are available in three widths (including 5/16 inches, the smallest switch made). Terminal options include wire-wrap, PC pins, solder lugs, and board edge terminations (for use with in-line PC board connectors). Housings are available in two colors and thumbwheels in six, and characters may be imprinted (by a thermographic process) in color as well as black or white.

Accessories. End plates and tie rods complete the assembly of individual switches into groups. As many as 50 may be stacked side by side using standard rods (more on special order). Division plates serve to segregate digit groups. Spacer plates may be blank or marked (decimal point, x-sign, bar, etc). Blind slave modules may be used for ganging.

Mounting. No hardware is required — only a simple rectangular panel cutout, into which the switch assembly slips. It is held firmly in place by retaining springs on the end plates and division plates. The panel space occupied by a thumbwheel switch assembly is, of course, only a small fraction of that required for an equivalent number of rotary switches.

Use Interswitch Thumbwheel Selector Switches wherever you require:

- Minimum panel space
- Maximum accessibility
- Easy, rapid operation
- Complex, multi-format capability
- Code translation
- Long life
- Low cost
- Utmost reliability — mechanical & electrical

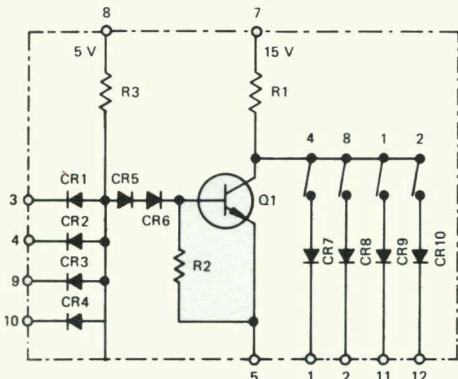

The Interswitch Type C series switches are designed to be active modules in the circuitry in which they are employed. The housing provides a PC card on which components and IC modules may be mounted in various configurations providing complete logic functions. Typically, 16 diodes, resistors, and transistors may be used to create an active BCD-coded character generator, programmed decimally by the thumbwheel.

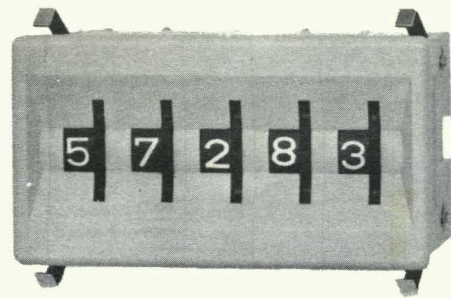

TYPICAL STANDARD CODES

M-010	10-Position, Decimal Output	M-011	11-Position Decimal Output
M-034	1-2-2-4	M-043	1-2-4-8 Excess Three with Parity
M-036	1-2-4-8 Excess Three	M-531	1-2-4-8 with Complement
M-038	1-2-2-4 (Berkely)	M-032	1-2-2-4 Special
M-040	1-2-2-8	M-161	1-2-4-8 Complement of M-031
M-052	1-2-4-8 (9th Complement)	M-140	1-2-4-8 True/Not True
M-001	DPDT switch (repeating)	M-031	1-2-4-8 BCD

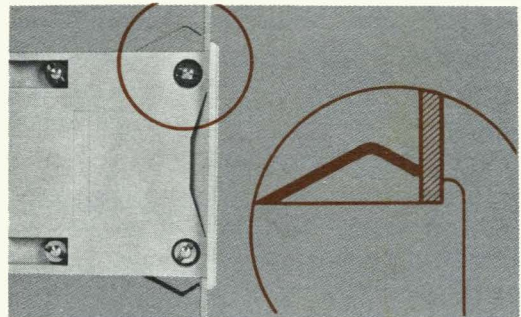

Up to 46% LESS PANEL AREA —
Up to 62% LESS VOLUME —
Up to 140% MORE FUNCTIONAL CAPACITY

The unique mechanical design of Interswitch Thumbwheel Switches provides optimum performance in only a fraction of the space formerly required. Type M, for example, the world's thinnest thumbwheel switch, is only 5/16" wide, 1.2" high, and 1.5" deep; a ten-decade switch assembly occupies slightly more than three inches of horizontal panel space, requires only a single rectangular panel cutout.

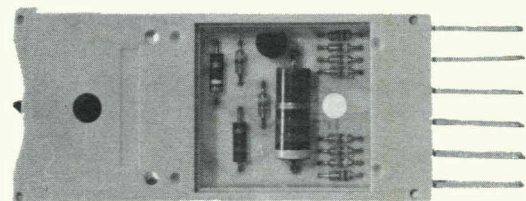
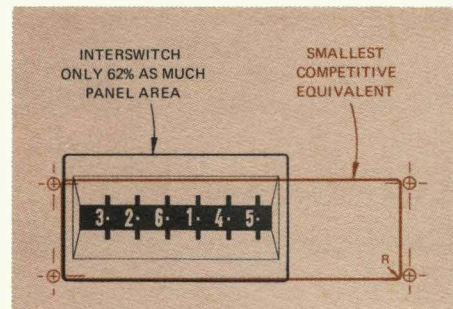

Type C Thumbwheel Switch

PART 2

Product Directory

The products and services in this directory are arranged in one alphabetical sequence beginning on page 320.

As an added convenience, they are associated in broad categories and indexed below.

1. COMPUTERS

Calculators, Programmable	329
Computers, Aerospace	339
Computers, Analog (General-Purpose)	339
Computers, Digital (General-Purpose, Small-Scale)	339
Computers, Digital (General-Purpose, Medium-Scale)	340
Computers, Digital (General-Purpose, Large Scale)	340
Computers, Fire Control	341
Computers, Hybrid	341
Computers, Mini (General-Purpose)	341
Computers, Navigation	341
Computers, Process Control	341
Computers, Special Purpose	342
Computers, Time Sharing	342

2. COMPUTING SYSTEM COMPONENTS

Amplifiers, D.C.	321
Amplifiers, Instrumentation	321
Amplifiers, Operational	322
Amplifiers, Servo	322
Amplifiers, Video	322
Attenuators, Decade Digital	323
Blowers, Fans, Cooling Assemblies	324
Boards, Printed Circuit (Without Components)	324
Brakes and Clutches	325
Breadboards	325
Bus Bar Systems	325
Cable Assemblies (With Connectors)	327
Cable, Coaxial (Flexible)	327
Cable, Coaxial (Semi/Rigid)	327
Cable, Fine Lead	328
Cable, Flat, Printed and Ribbon	328
Cable, Multiconductor	328
Cable, Shielded (Not Coaxial)	328
Capacitors, Computer Grade	329
Capstans, Idlers, and Guides (For Tape Drives)	329
Cells, Photoconductive	330
Circuit Cards, Linear (With Discrete Components)	331
Circuit Cards, Linear (With IC's)	331
Circuit Cards, Logic (With Discrete Components)	331
Circuit Cards, Logic (With IC's)	332
Circuits, Hybrid (IC and Discrete-Digital)	332
Circuits, Monolithic (Digital Logic)	333
Circuits, Monolithic (Diode Matrices)	333
Circuits, Monolithic (Linear-Excl. OP Amps)	333
Circuits, Monolithic (LSI-Bipolar)	333
Circuits, Monolithic (LSI-MOS)	333
Circuits, Monolithic (OP Amps)	334
Circuits, Thick Film (Digital)	334
Circuits, Thin Film (Digital)	334
Clocks, Digital (Real-Time)	335
Commutators, Switching (Electric)	339
Connectors, Coaxial (Computer-Grade)	342
Connectors, Miniature and Sub- Miniature (Computer-Grade)	342

Connectors, PC and IC Board (Computer-Grade)	342
Connectors, Power (Computer-Grade)	343
Connectors, Rack and Panel (Computer-Grade)	343
Consoles, Computer Control (Wired)	343
Controllers, Motor	360
Converters, Analog-to-Digital	361
Converters, Binary-to-Decimal	362
Converters, DC-to-Frequency	362
Converters, Digital-to-Analog	362
Converters, Digital-to-Synchro	363
Converters, Document-to-Magnetic Tape	363
Converters, Document-to-Paper Tape	363
Converters, Document-to-Unit Records	364
Converters, Frequency-to-DC	364
Converters, Magnetic Tape-to- Facsimile	364
Converters, Magnetic Tape-to- Magnetic Tape	364
Converters, Magnetic Tape-to- Microfilm	364
Converters, Magnetic Tape-to- Paper Tape	364
Converters, Magnetic Tape-to-Printer	364
Converters, Magnetic Tape-to-Punched Card	364
Converters, Paper Tape-to-Magnetic Tape	365
Converters, Paper Tape-to-Paper Tape	365
Converters, Paper Tape-to-Printer	365
Converters, Paper Tape-to-Punched Card	365
Converters, Polar-to-Rectangular	365
Converters, Pulse-to-Digital	365
Converters, Punched Card-to- Magnetic Tape	365
Converters, Punched Card-to- Paper Tape	365
Converters, Punched Tag-to- Magnetic Tape	366
Converters, Punched Tag-to- Punched Card	366
Converters, Scan	366
Converters, Synchro-to-Digital	366
Converters, Voltage-to-Frequency	366
Cords, Patch	366
Counters, Decade	367
Counters, Digital Readout	367
Counters, Stepping Switch	368
Counters, Up-Down	368
CRT Deflection Yokes	368
Crystal Units, Quartz (For Frequency Control)	368
Delay Lines, Electromagnetic	377
Delay Lines, Glass	377
Delay Lines, Magnetostrictive	377
Digitizers, Programmable	378
Diodes, Germanium	379
Diodes, Not-Carrier	379
Diodes, Light Emitting	379
Diodes, Silicon	379
Diodes, Tunnel	379
Diodes, Variable Capacitance	380

Diodes, Video Detector	380
Diodes, Zener	380
Discs, Magnetic Memory	381
Display Drivers	381
Displays, Magnetic	382
Displays, Three-Dimensional	382
Encoders, Digital	383
Encoders, Optical	384
Encoders, Shaft Angle	384
Extractors, Circuit Board	385
Fasteners, Equipment	385
Fiber Optic Bundles	385
Fiber Optics Assemblies (For Punched Code Readers and Mark Sensors)	385
Filters (Active, LC, Noise, etc.)	386
Gears, Peripheral Equipment	387
Guides, Circuit Cards	388
Handles, Test Point Strips (For Circuit Cards)	388
Heat Sinks, Circuit Board Mounting	388
Indicators, Alphanumeric	388
Indicators, Digital	388
Indicators, Elapsed Time	389
Indicators, Illuminated	389
Inverters, DC-AC	390
Jacks, Jack Panels, Plugs, Assemblies	390
Knobs, Dials (For Computer Consoles)	390
Lamps, Glow	391
Lamps-Panel, Pilot and Dial (Incandescent)	391
Light Pens (For CRT Terminal Input/Output)	392
Magnetic Discs & Drums	392
Modules, Digital Logic Encapsulated	399
Modules, Linear (Encapsulated)	399
Modules, Memory (Encapsulated)	399
Modules, Resistance Networks (Encapsulated)	399
Monitors, Particulate	400
Monitors, TV	400
Motors, Servo	400
Motors, Stepping	400
Motors, Synchronous	401
Motors, Torque	401
Multiplexer-Converter (Single Unit With Multiplexer, Sample & Hold Amplifier & A-to-D Converter)	401
Multiplexers, Analog-Relay (Sequential Sampling)	401
Multiplexers, Analog-Solid State (Sequential Sampling)	402
Multiplexers, Digital	402
Oscillators, Magnetic	403
Oscillators, Voltage Controlled	403
Packaging Systems	403
Panels, Power Distribution	403
Plugboards, Programming	405
Potentiometers, Trim (Film)	406
Potentiometers, Trim (Wire-Wound)	406
Power Supplies, AC	406
Power Supplies, DC	407
Power Supplies, Digitally-Controlled	408
Power Supplies, Uninterruptable	408
Protectors, Circuit and Equipment Overload	417

Readers, Magnetic Card 418
 Readers, Payment Coupons 419
 Readers, Perforated Document 419
 Readers, Static 420
 Readouts and Displays, Numeric and Alphanumeric (other than CRT) 420
 Readouts, CRT 421
 Rectifiers, Silicon Controlled 423
 Regulators, Current 424
 Regulators, Frequency 424
 Regulators, Voltage 424
 Relays, Dry Reed (Computer Grade) 425
 Relays, Mercury Wetted (Computer Grade) 425
 Relays, Solid-State (Computer Grade) 425
 Resistors, Precision 426
 Scanners, Image 426
 Scanners, Input 426
 Servos, Computer 440
 Signal Conditioners 440
 Sockets, IC Mounting 441
 Sockets, PCB Mounting 441
 Sockets, Semiconductor Mounting 441
 Solenoids 441
 Spindles 441
 Static Elimination Equipment 442
 Switch Arrays, Encoded 442
 Switches, Coaxial 442
 Switches, Code Bar 442
 Switches, Dry Reed 442
 Switches, Keyboard 442
 Switches, Lever 442
 Switches, Pushbutton 442
 Switches, Pushbutton (Illuminated) 443
 Switches, Rotary 443
 Switches, Snap Action 443
 Switches, Solid State 444
 Switches, Thumbwheel 444
 Switches, Toggle (Miniature) 444
 Synchros-Resolvers, Control Transformers 444
 Terminal Blocks, Strips, Boards 447
 Thermistors 451
 Thermocouple Reference Systems 451
 Timers, Event (Impulse) 451
 Timers, Interval 451
 Transducers, Digital 453
 Transformers, Power (Computer Grade) 453
 Transformers, Pulse (Computer Grade) 454
 Transistors, Field Effect 454
 Transistors, Germanium 454
 Transistors, Photo 454
 Transistors, Silicon 454
 Tubes, Cathode Ray 454
 Voltage Dividers 455

3. DATA COMMUNICATIONS EQUIPMENT

Acoustic Couplers 320
 Communications-Oriented Processors, Multiple Channel Controllers 335
 Communications-Oriented Processors, Single Channel Controllers 336
 Communications-Oriented Processors, Stored Program 336
 Communication Systems, Data Transmission 337
 Communication Systems, Facsimile 338
 Communication Systems, Teleprinter 338
 Controllers, Modem 360
 Data Acquisitions Systems, Automatic 369
 Data Concentrators 370
 Data Terminals, Block-by-Block (Graphic Digitizers) 370
 Data Terminals, Block-by-Block (Magnetic Card) 371
 Data Terminals, Block-by-Block (Magnetic Tape) 371
 Data Terminals, Block-by-Block (Multi-Purpose) 371
 Data Terminals, Block-by-Block (Optical) 372
 Data Terminals, Block-by-Block (Paper Tape) 372

Data Terminals, Block-by-Block (Plotter) 372
 Data Terminals, Block-by-Block (High Speed Printer) 372
 Data Terminals, Block-by-Block (Medium Speed Printer) 373
 Data Terminals, Block-by-Block (Punched Card) 373
 Data Terminals, Block-by-Block (Teleprinter) 373
 Data Terminals, Incremental (Magnetic Tape) 374
 Data Terminals, Inquiry-Response (Alphanumeric Keyboard) 374
 Data Terminals, Inquiry-Response (Audio Response) 375
 Data Terminals, Inquiry-Response (Badge-Token Readers) 375
 Data Terminals, Inquiry-Response (CRT with Keyboard) 375
 Data Terminals, Inquiry-Response (Portable) 376
 Data Terminals, Inquiry-Response (Special-Purpose) 376
 Dialers, Automatic 378
 Modems, Acoustic 397
 Modems, Hard-Wired 398
 Modems, PC Card 398
 Multiplexers, Time Division 403
 Scanners, Facsimile 427
 Transceivers, Facsimile 453

4. EDP FORMS AND FORMS HANDLING EQUIPMENT

Cards, Conventional Punch 330
 Cards, Edge-Punch 330
 Cards, Magnetic 330
 Cards, Microfilm Aperture 330
 Envelopes, Continuous 385
 Forms, Continuous (Machine Processed) 386
 Forms Handling, Bursters 386
 Forms Handling, Carbon Deleavers 387
 Forms Handling, Collators 387
 Forms Handling, Decollators 387
 Forms Handling, Detachers 387
 Forms Handling, Document Counters 387
 Forms Handling, Label Applicators 387
 Forms Handling, OCR Source Document 387
 Forms Handling, Punched Card Source 387
 Forms Handling, Slitters 387
 Forms Handling, Stackers 387
 Labels, Continuous and Gummed (Machine Application) 390
 Labels, Continuous and Pressure Sensitive (Machine Application) 391
 Paper (For MICR Equipment) 403
 Paper (For OCR Equipment) 404
 Paper (For Printers) 404
 Paper (For Recorders and Plotters) 404
 Payment Coupon Books, Machine Readable 404

5. EDP SUPPLIES AND ACCESSORIES

Air Conditioners (For EDP Installations) 321
 Cabinets and Enclosures (For Key punches, Printers) 325
 Cabinets, Enclosures, Consoles, Electronic (For General Equipment) 325
 Cabinets, Racks, Vaults (For Magnetic Tape Storage) 326
 Cabinets, Trays (For Punched Card Storage) 326
 Cannisters, Magnetic Tape 329
 Cards, Conventional Punch 330
 Cards, Edge-Punch 330
 Cards, Magnetic 330
 Cards, Microfilm Aperture 330
 Chassis, Slides, Racks 330
 Cleaners, Disc Pack 335
 Cleaners, Magnetic Tape 335
 Cleaners, Magnetic Tape Heads 335
 Coatings, Anti-Static 335
 Containers, Disk Pack Storage 359
 Containers, Paper Tape Storage 359
 Correction Seals, MICR Documents 367

Correction Seals, Punch Card 367
 Correction Seals, Paper Tape 367
 Covers, Acoustic (For Keyboards, Teletypewriters, etc.) 368
 Desks, Tables and Stands (For Calculators) 378
 Desks, Tables and Stands (For Key punch Units) 378
 Desks, Tables and Stands (For Programmer Stations) 378
 Desks, Tables and Stands (For Typewriters) 378
 Documents, DCR/OMR 382
 Envelopes (For Filing Tapes) 385
 Files, Punched Card 385
 Flooring (For EDP Rooms) 386
 Floor Planning Aids (For EDP Rooms) 386
 Holders, Binder 388
 Mark Sensing Supplies 393
 Reel Clips and Belts, Magnetic Tape 424
 Reels, Magnetic Tape 424
 Reels, Paper Tape 424
 Ribbons, Ink (For Printers and Tab Equipment) 426
 Safes, Magnetic Tape Storage 426
 Tags (For EDP Processing) 444
 Tape, Magnetic (Cartridge) 445
 Tape, Magnetic (Cassette) 445
 Tape, Magnetic (Reels) 445
 Tape, Punch (Mylar) 445
 Tape, Punch (Mylar-Coated Foil) 445
 Tape, Punch (Paper) 445
 Tape, Punch (Paper-Coated Mylar) 446
 Tape, Punch (Paper-Coated Aluminum) 446
 Templates, Flow Chart 447

6. EDUCATIONAL SYSTEMS AND TRAINING AIDS

Aids, Key punch Performance 320
 Audio/Visual Training Aids 323
 Boards, Visual Control (Graphic) 325
 Computers, Analog (Educational) 339
 Computers, Digital (Educational) 339
 Demonstrators and Kits, Educational (Digital Logic) 377
 Displays, Panels, Viewgraphs (For Computer Training) 382
 Instructional Systems, Computer-Based 389
 Training Systems, Card Punch 453

7. GRAPHIC DATA EQUIPMENT

Cameras, COM 329
 Cameras, Data Recording (Excl. Oscilloscopes) 329
 Consoles, CRT (Alphanumeric and Graphic) 343
 Consoles, CRT (Color-Alphanumeric and Graphic) 344
 Consoles, CRT (Graphic) 344
 Controllers, Plotting 361
 Plotters, Film Exposing 368
 Curve Tracers-Digitizers, Automatic 369
 Curve Tracers-Digitizers, Manual 369
 Data Acquisition and Reduction Systems 369
 Data Retrieval Systems, Micro-Film (Computer-Controlled) 370
 Drafting Systems, Computer-Controlled Storage 382
 Film Scanners 386
 Graphic Tablets 388
 Microfiche 396
 Microfilm Data Retrieval Systems, Aperture Cards 396
 Microfilm Data Retrieval Systems, Computer Controlled 396
 Microfilm Data Retrieval Systems, Computer Controlled (Graphic) 396
 Microfilm Rolls 397
 Microstrips (For Microfilm) 397
 Plotters, Film Exposing 368
 Plotters, Moving Pen (Analog Controller) 405
 Plotters, Moving Pen (Digital Controller) 405
 Plotters, Non-Impact 405
 Processors, Microfilm 410

Projectors, Optical (Computer Controlled Slide Selecting) 417
 Projectors, Optical (Computer Controlled Scribing) 417
 Reader/Printer, Microfilm/Microfiche 418
 Readers, Microfilm/Microfiche 418
 Recorders, Graphic 422
 Recorders, Hard-Copy (With CRT) 422
 Recorders, Microfilm/Microfiche 422

8. KEYBOARD EQUIPMENT

Encoders, Keyboard (Alphanumeric) 383
 Encoders, Keyboard (Numeric) 384
 Encoders, Keyboard-to-Graphic Display 384
 Encoders, Keyboard-to-Magnetic Disc 384
 Encoders, Keyboard-to-Magnetic Disc Tape 384
 Encoders, Keyboard-to-Magnetic Drum 384
 Encoders, Keyboard-to-Magnetic Tape 384
 Encoders, Keyboard-to-Paper Tape 384
 Encoders, Keyboard-to-Printed Tape 384
 Typewriters, Computer Input-Output 455

9. MAGNETIC TAPE EQUIPMENT

Certifiers, Magnetic Tape 330
 Cleaner/Certifiers, Magnetic Tape 334
 Controllers, Magnetic Tape 360
 Demagnetizers, Magnetic Tape 377
 Erasers, Bulk (Magnetic Tape) 385
 Formatters, Magnetic Tape 386
 Magnetic Tape Storage Systems (Includes Controller) 392
 Poolers, Magnetic Tape 406
 Reconditioning Equipment, Magnetic Tape 421
 Recorders, Digital Cassette 421
 Recorders, Magnetic Tape 422
 Skew Meters, Magnetic Tape 441
 Splicers, Magnetic Tape 441
 Tape Transports, Magnetic (Digital-Excl. Cassette) 446
 Tape Transports, Magnetic (Digital Cassette) 446
 Tape Transports, Magnetic (Incremental) 447
 Tape Transports, Magnetic (With Keyboard Input) 447
 Winders, Magnetic Tape 456

10. MEMORIES AND MEMORY COMPONENTS

Certifiers, Disc Pack 330
 Controllers, Magnetic Disc 359
 Controllers, Magnetic Drum 360
 Cores, Ferrite Memory 366
 Disc Drives, Fixed Head (Including Controller) 380
 Disc Drives, Movable Head (Including Controller) 380
 Disc Drives, Removable Cartridge 380
 Disc Packs, Magnetic 381
 Disc Storage Systems 381
 Drum Storage Equipment, Magnetic (Including Controller) 382
 Memory Planes and Stacks, Magnetic Core (W/O Electronics) 393
 Memory Planes and Stacks, Plated Wire (W/O Electronics) 393
 Memory Planes and Stacks, Thin Film 393
 Memory Systems, Delay Line 393
 Memory Systems, Diode 394
 Memory Systems, Magnetic Core 394
 Memory Systems, Magnetic Disc 394
 Memory Systems, Magnetic Drum 394
 Memory Systems, Optical 394
 Memory Systems, Plated Wire 394
 Memory Systems, Read-Only 395
 Memory Systems, Semiconductor 396
 Memory Systems, Semiconductor (MOS) 396
 Memory Systems, Thin Film 396

Plated Wire 405
 Pole Pieces, Ferrite 406
 Recording Heads, Magnetic Card 423
 Recording Heads, Magnetic Disc 423
 Recording Heads, Magnetic Drum 423
 Recording Heads, Magnetic Tape 423

11. OPTICAL RECOGNITION EQUIPMENT

Cameras, OCR 329
 Handwriting Systems, Electronic 388
 Imprinters, Magnetic Ink Character 388
 Imprinters, Optically-Sensed Character 388
 Mark Sensing Equipment 393
 Pattern Recognition Equipment 404
 Readers, Magnetic Ink Character 418
 Readers, Optical Character Scanning 419
 Readers, Optical Mark Sensing 419
 Scanners, Optical 427

12. PAPER TAPE EQUIPMENT

Accounting Machines, Paper Tape Programmed 320
 Duplicators-Verifiers, Paper Tape 382
 Perforators, Document 404
 Perforators, Paper Tape 404
 Printer/Punch, Paper Tape 408
 Punches, Paper Tape 417
 Racks, Paper Tape 418
 Readers, Paper Tape 419
 Recorders, Paper Tape 422
 Reproducers, Paper Tape (Automatic) 426
 Splicers, Paper Tape 441
 Spoilers, Paper Tape 442
 Verifiers, Paper Tape 455
 Winders, Paper Tape 456

13. PRINTERS

Printers, Digital Strip Recording 409
 Printers, Keyboard 409
 Printers, Line (Low & Medium Speed) 409
 Printers, Line (High Speed) 410
 Printers, Microfilm/Microfiche 410
 Printers, Non-Impact, Special Purpose 410

14. PROGRAMMING LANGUAGE DEVELOPMENT

Programming Language Development (Consultants) 410
 Programming Language Development (Contract Programming) 412
 Programming Language Development (Dedicated Application Systems) 413
 Programming Language Development (Proprietary Software Products) 415

15. PUNCH CARD EQUIPMENT

Accounting Machines, Card-Programmed 320
 Collators, Punched Card 335
 Controllers, Punched Card 361
 Holders, Punched Card 388
 Input-Output Conveyors, Punched Card 389
 Mailers, Punched Card 392
 Programmers, Punched Card 410
 Punches, Card (Edge-Punching) 417
 Punches, Card (Over 100 CPM) 417
 Punches, Card (Portable) 417
 Punches, Card (Up to 100 CPM) 417
 Readers/Punches, Punched Card 418
 Readers, Edge-Punched Card 418
 Readers, Punched Card (Up to 100 CPM) 420
 Readers, Punched Card (100 to 300 CPM) 420
 Readers, Punched Card (Over 300 CPM) 420
 Readers, Punched Card (Static) 420
 Readers, Punched Tag 420

Reconditioning Equipment, Punched Card 421
 Reproducers, Punched Card (Automatic) 426
 Retrieval Units, Punched Card (Random Access) 426
 Sorters, Punched Card 441
 Verifiers, Punched Card 455

16. SERVICES

Consulting (Accounting, Business and Commercial Applications) 344
 Consulting (Advanced Computer Equipment Design and Feasibility Studies) 347
 Consulting (Computer Evaluations, Selections, Installation Planning) 349
 Consulting (Data Communications Systems Planning) 351
 Consulting (Computer Product Planning Surveys, Market Research Studies) 353
 Consulting (Management Information Systems Planning) 355
 Consulting (Scientific Applications) 357
 Leasing, EDP Equipment (Other than Mfgs) 391
 Services, Computer-Aided Design 427
 Services, Computer Output Microfilm 428
 Services, Facility Management 428
 Services, List Maintenance 430
 Services, Magnetic Tape Certification 430
 Services, Management Information Systems 430
 Services, Processing (Commercial EDP) 432
 Services, Processing (Analog or Hybrid, Scientific) 434
 Services, Processing (Digital Scientific) 434
 Services, Time Sharing (Commercial) 435
 Services, Time Sharing (Research) 437
 Services, Automated Wire-Wrapping 437
 Services, Hardware Maintenance 438
 Services, Systems Analysis 438
 Training Institutes, Commercial Computer Courses, Seminars, Correspondence Courses 452
 Training Systems, Computer Service 453
 Used Equipment (Buying, Selling, Leasing) 455

17. TEST EQUIPMENT

Analyzers, Computer Performance 323
 Analyzers, Continuity 323
 Analyzers, Differential 323
 Analyzers, Pulse Height 323
 Analyzers, Waveform 323
 Generators, Byte 387
 Generators, Character (CRT) 387
 Generators, Random Number 387
 Generators, Time Code 387
 Recorders, Strip Chart 423
 Test Systems, Computer Performance 448
 Test Systems, CRT Terminals 448
 Test Systems, Disc Drives 448
 Testers, Circuit 448
 Testers, Data Interface 448
 Testers, Digital Data Transmission 448
 Testers, Digital Logic Modules and Cards 449
 Testers, Disc Heads 450
 Testers, Integrated Circuit 450
 Testers, Magnetic Disc 450
 Testers, Magnetic Drum 450
 Testers, Magnetic Tape (Cassette) 450
 Testers, Magnetic Tape Transports 450
 Testers, Memory Planes, Stacks and Systems 450
 Testers, Semiconductor 450
 Voltmeters, AC, DC, Differential 456
 Voltmeters, Digital 456
 Voltmeters, Printing 456

BUY - RENT - LEASE ACOUSTIC COUPLERS all types • all brands

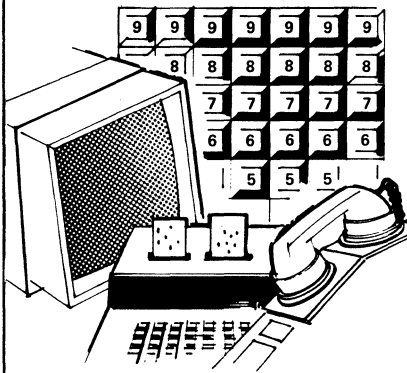

We are the West's largest, most experienced, best-stocked, factory-approved source for EDP terminals, peripherals and interfaces of every description

controllers • converters
processors • acoustic couplers
copiers • modems
display consoles
keyboards • transceivers
printers • teleprinters
readers • recorders
accessories • supplies

Our experienced EDP engineers analyze system requirements thoroughly, design and install custom turnkey systems, and provide expert consultation on system expansion or modification as requirements change.

We are thoroughly familiar with the capabilities and limitations of all reputable brands of EDP equipment, and are impartial in recommending and selecting equipment strictly on its merit for the application.

For more information on how to get the EDP system or equipment you need — and get it on your terms — see DataServ catalog insert.

DataSERV

Burlingame, California
Denver • Salt Lake City • Seattle •
Phoenix • Los Angeles
One of the **PURDY** group of companies

2 Product Directory

ACCOUNTING MACHINES, CARD-PROGRAMMED

ADDO-X INC. ADP DIV.
437 Madison Ave. New York, N Y 10022
CUSTOM DATA PROCESSING SERVICES
P O Box 14685, Phoenix, Ariz 85031
DATA PROCESSING AND ACCOUNTING SERVICES
50 Van Ness Ave, San Francisco, Cal 94102
DYNAMIC ACCESS CORP.
220 Park Ave S, New York, N Y 10003
IOA DATA CORP.
383 Lafayette St, New York, N Y 10003
MAI EQUIPMENT CORP.
300 E 44th St, New York, N Y 10017
REN ELECTRONICS
775 New Ludlow Rd, So Hadley, Mass 01075
SINGER CO., THE, FRIDEN DIV.
2350 Washington St, San Leandro, Cal 94577
SYSTEMS ANALYSIS INC.
11110 N E 8th, Bellevue, Wash 98004

ACCOUNTING MACHINES, PAPER TAPE PROGRAMMED

ADDO-X INC. ADP DIV.
437 Madison Ave. New York, N Y 10022
BURROUGHS CORP. BUSINESS MACHINES GROUP
6071 2nd Ave, Detroit, Mich 48232
CUSTOM DATA PROCESSING SERVICES
P O Box 14685, Phoenix, Ariz 85031
FACIT-ODHNER INC.
501 Winsor Dr, Secaucus, N J 07094
QANTEL CORP.
3474 Investment Blvd, Hayward, Cal 94545
SINGER CO., THE, FRIDEN DIV.
2350 Washington St, San Leandro, Cal 94577

ACOUSTIC COUPLERS

ANDERSON JACOBSON INC.
1065 Morse Ave., Sunnyvale, Cal 94086
APPLIED DIGITAL DATA SYSTEMS INC.
100 Marcus Blvd, Hauppauge, N Y 11787
CARTERFONE COMMUNICATION CORP
11710 E NW Hwy, Dallas, Tex 75218
COMDATA CORP.
7544 W Oakton St, Niles, Ill 60648
COMMUNICATIONS LOGIC INC.
6400 Westpark, Houston, Tex 77024
COMPUTER COMMUNICATION INC.
701 W Manchester Blvd, Inglewood, Cal 90301
COMPUTER COMPLEX, INC.
6400 Westpark, Houston, Tex 77027
COMPUTER DEVICES INC.
10 Sonar Dr, Woburn, Mass 01801
COMPUTER-LINK CORP.
14 Cambridge St, Burlington, Mass 01803
CYBERMATION INC.
P O Box 58 River Rd, Washngtn Xing, Pa 18977
DATA ACCESS SYSTEMS INC.
503 Rte 10 Mt 19, Dover, N J 07801
DATA AUTOMATION COMMUNICATIONS INC.
7505 Carpenter Fwy, Dallas, Tex 75247
DATA COMPUTING INC.
2219 W Shangri La Rd, Phoenix, Ariz 85029
DATA PRODUCTS TELECOMMUNICATIONS
17 Amelia Place, Stamford, Conn 06902
DATASERV DIV., WILLIAM J. PURDY CORP.
770 Airport Blvd, Burlingame, Cal 94010
DELMARVA COMPUTER INDUSTRIES INC.
5865 Robert Oliver Pl, Columbia, Md 21043
DELTA DATA SYSTEMS CORP.
Woodhaven Ind Park, Cornwells Hgts, Pa 19020
DESIGN ELEMENTS INC.
356 Norton Ave, Columbus, Ohio 43212
DIGI-LOG SYSTEMS INC.
107 W Ridge Pike, Conshohocken, Pa 19428
DIGITAL TECHNIQUES CORP.
4248 Delemere Court, Royal Oak, Mich 48073
DIRECT ACCESS COMPUTING CORP.
984 Livernois Rd, Troy, Mich 48084
ELECTRONIC INFORMATION SYSTEMS INC.
2400 Industrial Lane, Broomfield, Conn 80020
EMR COMPUTER
8001 Bloomington Fwy, Minneapolis, Minn 55420
FORD INDUSTRIES INC.
5001 SE Johnson Ck, Portland, Ore 97206
GENERAL ELECTRIC CO. COMM. SYS. DIV.
Mountain View Rd, Lynchburg, Va 24502

GRECO ENTERPRISES INC. TSA DATA DIV.
2000 Texas, El Paso, Tex 79901
HI-G INC.
580 Spring St, Windsor Locks, Conn 06096
HYBRID SYSTEMS DIV. DIGITAL RESOURCES CORP.
4301 Dacoma Rd, Houston, Tex 77018
IMLAC CORP.
296 Newton St, Waltham, Mass 02154
INFO-MAX
1248 Alderwood, Sunnyvale, Cal 94086
IONEX DIV. OF SONEX INC.
20 E Herrman St, Philadelphia, Pa 19144
ITEL INFORMATION PRODUCTS DIV
2585 Bayshore, Palo Alto, Cal 94303
LIVERMORE DATA SYSTEMS INC.
2050 Research Dr, Livermore, Cal 94550
MARK/OPS DIV., NORTH EASTERN SYSTEMS ASSOC.
INC.
475 Commonwealth Ave, Boston, Mass 02215
METROPROCESSING CORP. OF AMERICA
64 Prospect St, White Plains, N Y 10606
MOHAWK DATA SCIENCES CORP.
Palisade St, Herkimer, N Y 13350
MOHAWK DATA SCIENCES CORP. FRANKLIN ELECT.
DIV
P O Box 406, King of Prussia, Pa 19406
MSI DATA CORP.
4751 Holt Ave, Mont Clair, Cal 91763
MULTITECH DATA PRODUCTS
583 Monterey Pass Rd, Monterey Park, Cal 91754
NATIONAL MIDCO INDUSTRIES INC.
Box 5433, Trenton, N J 08638
NOVATION INC.
18664 Topham, Tarzana, Cal 91356
NYTRONICS INC.
3rd Ave, Alpha, N J 08865
OLIVETTI CORP. OF AMERICA
500 Park Ave, New York, N Y 10016
OMNITEC CORP. A NYTRONICS CORP.
903 N 2nd St, Phoenix, Ariz 85004
PURDY CORP., WM. J.
770 Airport Blvd, Burlingame, Cal 94010
RFL INDUSTRIES INC. COMMUNICATION DIV.
Powerville Rd, Boonton, N J 07005
SHINTRON CO INC.
144 Rogers St, Cambridge, Mass 02142
SHIRAK TELEMETERING OF AMERICA
8926 Kester Ave, Van Nuys, Cal 91402
SIMULATORS, INC.
95 Randall St, Elk Grove Vill, Ill 60007
TEL-TECH CORP.
11810 Parklawn Dr, Rockville, Md 20852
TELE-DATA CORP.
130 U S Hwy 22, N Plainfield, N J 07060
TELECTRO SYSTEMS CORP.
96-18 43rd Ave, Corona, N Y 11368
TIME-SHARING TERMINALS INC.
2351 Shady Grove Rd, Rockville, Md 20850
TIMESHARE DEVICES INC.
225 Crescent St, Waltham, Mass 02154
TUCK ELECTRONICS
235 Market St, New Cumberland, Pa 17070
TYMSHARE INC.
525 University Ave, Palo Alto, Cal 94301
ULTRONIC SYSTEMS CORP.
Mt Laurel Ind Pk, Moorestown, N J 08057
UNICOM INC.
1275 Bloomfield Ave, Fairfield, N J 07006
UNIVERSITY COMPUTING CO.
P O Box 6228, Dallas, Tex 75222
UNIVERSITY COMPUTING CO.
888 N Sepulveda Blvd, El Segundo, Cal 90245
UNIVERSITY COMPUTING CO. DATEL DIV.
1 Tysons Corner Ctr, McLean, Va 22101
VADIC CORP., THE
916 Commercial St, Palo Alto, Cal 94303
VERNITRON CORP. DATA DEVICE DIV.
176 Central Ave, Farmingdale, N Y 11735
WANG LABORATORIES INC.
836 N St, Tewksbury, Mass 01876

AC VOLTMETERS (SEE VOLTMETERS)

AIDS, KEYPUNCH PERFORMANCE

DECISION DATA CORP.
300 Jacksonville Rd, Warminster, Penn 18974
ENTELEK INC.
42 Pleasant St, Newburyport, Mass 01950

2 Product Directory

AIR CONDITIONERS (FOR EDP INSTALLATIONS)

A.C. MANUFACTURING CO.
Old Cuthbert & Deer, Cherry Hill, N J 08034
AGNEW-HIGGINS, INC.
7532 Anthony Ave, Garden Grove, Cal 92641
APOLLO COMPUTER ROOM INSTALLATIONS INC.
Po Box 132, Bellmore, N Y 11710
BLAZER CORP.
400 Paterson Plank Rd, E Rutherford, N J 07073
COMPUTER PREPARATIONS INC.
112 S Dean St, Englewood, N J 07631
CREATED SPACE INC.
16 W 40th St, New York, N Y 10018
FLOATING FLOORS INC. SUB. NATIONAL LEAD CO.
5400 N Detroit Ave, Toledo, Ohio 43612
MACS COMPUTER ACCESSORIES INC
104 Park Towne Pl, Philadelphia, Pa 19130
PAMOTOR INC., WILLIAM J. PURDY CORP.
770 Airport Blvd, Burlingame, Cal 94010
PURDY CORP., WM. J.
770 Airport Blvd, Burlingame, Cal 94010
TATE ARCHITECTURAL PRODUCTS INC.
Box 349c Montevideo, Jessup, Md 20794
WEBER TECHNICAL PRODUCTS DIV. WALTER KIDDE & CO.
1340 Monroe Ave NW, Grand Rapids, Mich 49502
WESTINGHOUSE ELECTRIC CORP.
Westinghouse Bldg, Pittsburgh, Pa 15222
WESTINGHOUSE ELECTRIC CORP. ARCHITECTURAL SYS.
4300 36th St SE, Grand Rapids, Mich 49508
ZERO MANUFACTURING CO. ZERO-WEST DIV.
1121 Chestnut St, Burbank, Cal 91503

ALARM SYSTEMS (SEE DETECTORS)

AMPLIFIERS, D.C.

ALTEC DIV., LTV LING ALTEC INC.
1515 So Manchester Av, Anaheim, Cal 92803
AMPEREX ELECTRONIC CORP. A NO AMERICAN PHILIPS CO
P O Box 98, Slatersville, R I 02876
ANALOG DEVICES INC.
221 5th St, Cambridge, Mass 02142
ANALOGIC CORP.
Audubon Rd, Wakefield, Mass 01880
APPLIED COMPUTER SYSTEMS INC.
P O Box 6479, Austin, Tex 78702
ARGONAUT ASSOCIATES INC.
P O Box K, Beaverton, Ore 97005
AVCO CORP. ELECTRONICS DIV.
4807 Bradford, Huntsville, Ala 35805
BERGEN LABORATORIES INC. SUB. ZYROTRON INC.
60 Spruce St, Paterson, N J 07501
BFA CORP.
1309 S Inca, Denver, Colo 80223
BOWMAR INSTRUMENT CORP. ELECTRONIC SYS. DIV
800 Bluffton Rd, Fort Wayne, Ind 46809
BULOVA WATCH ELECTRONICS DIV.
6120 Woodside Ave, Woodside Li, N Y 11377
BURR-BROWN RESEARCH CORP.
6730 S Tucson Blvd, Tucson, Ariz 85706
CELCO.CONSTANTINE ENGINEERING LABS. CO.
70 Constantine Dr, Mahwah, N J 07430
CENTURY ELECTRONICS & INSTRUMENTS INC.
P O Box C Adm Sta, Tulsa, Okla 74115
CHRONETICS INC.
500 Nuber Ave, Mount Vernon, N Y 10550
COLUMBIA COMPONENTS CORP.
60 Madison Ave, Hempstead, N Y 11550
CONSOLIDATED OHMIC DEVICES INC.
115 Old Country Rd, Carle Place, N Y 11514
CONSTANTINE ENGINEERING LABS CELCO
70 Constantine Dr, Mahwah, N J 07430
CONTROL TECHNOLOGY CO., INC.
41-16 29th St, Long Island Cty, N Y 11101
DATA CONTROL SYSTEMS INC.
Commerce Dr, Danbury, Conn 06810
DATUM INC.
170 E Liberty Ave, Anaheim, Cal 92801
DDC DIV. SOLID STATE SCIENTIFIC DEVICES
100 Tec St, Hicksville, N Y 11801
DENELCOR INC.
5975 Broadway, Denver, Colo 80216
DYNAMIC MEASUREMENTS CORP.
6 Lowell Ave, Winchester, Mass 01890
ELECTRO-CRAFT CORP.
1600 S 2nd St, Hopkins, Minn 55343
ELECTRONIC ASSOCIATES INC.
485 Monmouth Pkwy, W Long Branch, N J 07764

ELECTRONIC MODULES CORP.
P O Box 141, Timonium, Md 21093
ESTERLINE ANGUS DIV., ESTERLINE CORP.
Po Box 24000, Indianapolis, Ind 46224
FAIRCHILD CAMERA & INST. CO. FAIRCHILD CONT. DIV
225 Park Ave, Hicksville, N Y 11802
GENERAL DEVICES INC.
P O Box 253, Princeton, N J 08540
HELIPOT DIV. BECKMAN INSTRUMENTS INC.
2500 Harbor Blvd, Fullerton, Cal 92634
HEWLETT PACKARD NEW JERSEY DIV.
100 Locust Ave, Berkeley Heights, N J 07922
HONEYWELL INC. TEST INSTRUMENTS DIV.
P O Box 5227, Denver, Colo 80217
INCOR INSTRUMENTATION INC.
29 Newtown Rd, Plainview, N Y 11803
INTERSIL INC.
10900 N Tantu, Cupertino, Cal 95014
JULIE RESEARCH LABORATORIES INC.
211 West 161 St, New York, N Y 10023
KEPCO INC.
131 38 Sanford Ave, Flushing, N Y 11352
MAYBERRY ELECTRONICS CO.
1250 Industrial Ave, Escondido, Cal 92025
MB ELECTRONICS DIV. TEXTRON INC.
781 Whalley Ave, New Haven, Conn 06515
MICRODOT INC. CONNECTOR & CABLE DIV.
220 Pasadena Ave, S Pasadena, Cal 91030
MILLETRON INC.
540 Alpha Dr, Pittsburgh, Pa 15238
MULTITECH DATA PRODUCTS
583 Monterey Pass Rd, Monterey Park, Cal 91754
NATIONAL SEMICONDUCTOR CORP.
2900 Semicon Dr, Santa Clara, Cal 95051
NEFF INSTRUMENT CORP.
1088 E Hamilton Rd, Duarte, Cal 91010
OPTICAL ELECTRONICS INC.
P O Box 11140, Tucson, Ariz 85706
OPTIMATION, INC.
9421 Telfair Ave, Sunn Valley, Cal 91352
PRECISION MONOLITHICS INC.
1500 Space Park Dr, Santa Clara, Cal 95050
PRESTON SCIENTIFIC INC.
805 E Cerritos Ave, Anaheim, Cal 92805
PRINCETON APPLIED RESEARCH CORP.
P O Box 565, Princeton, N J 08540
RAYTHEON CO. EQUIPMENT DIV.
528 Boston Post Rd, Sudbury, Mass 01776
SCIENTIFIC MEASUREMENTS INC.
9701 N Kenton, Skokie, Ill 60076
SINGER CO., THE, DIEHL DIV.
Finderne Ave, Somerville, N J 08876
SOLID STATE ELECTRONICS CORP.
15321 Rayen St, Sepulveda, Cal 91343
SRC DIV. MOXON INC.
2222 Michelson Dr, Newport Beach, Cal 92664
TELEDYNE PHILBRICK NEXUS
Allied Dr At Rte 128, Dedham, Mass 02026
TUSTIN ELECTRONICS CO.
17942 E Main St, Tustin, Cal 92680
VECTROL INC.
1010 Westmore Ave, Rockville, Md 20850
VIRGINIA ELECTRONICS CO. INC.
2901 Telear Court, Falls Church, Va 22042
WESTAMP INC.
1542 15th St, Santa Monica, Cal 90404
WISE INSTRUMENTATION & CONTROLS INC.
3568 Amherst Court, Mt View, Cal 94040
ZELTEX INC.
1000 Chalomar Rd, Concord, Cal 94520

AMPLIFIERS, INSTRUMENTATION

ADVANCED MICRO DEVICES INC.
901 Thompson Pl, Sunnyvale, Cal 94086
AMPEREX ELECTRONIC CORP. A NO AMERICAN PHILIPS CO
P O Box 98, Slatersville, R I 02876
ANALOG DEVICES INC.
221 5th St, Cambridge, Mass 02142
ANALOGIC CORP.
Audubon Rd, Wakefield, Mass 01880
APPLIED COMPUTER SYSTEMS INC.
P O Box 6479, Austin, Tex 78702
ARGONAUT ASSOCIATES INC.
P O Box K, Beaverton, Ore 97005
ASTRONAUTICS CORPORATION OF AMERICA
907 S First St, Milwaukee, Wis 53204
AVCO CORP. ELECTRONICS DIV.
4807 Bradford, Huntsville, Ala 35805
BABCOCK & WILCOX AUTOMTD MACHINE DIV
950 S Rochester Rd, Rochester, Mich 48063

When you cool
by air . . .
**GO FIRST CLASS—
AT ECONOMY FARE**

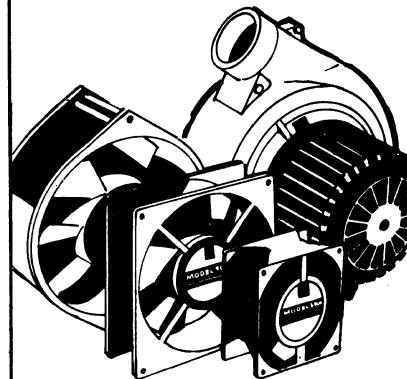

Every PAMOTOR fan is priced competitively with all others in its class, yet provides these distinctly superior characteristics:

- highest air-cooling capacity
- durable all-metal construction
- maximum reliability
- lowest noise and vibration
- lifetime rated performance
- lower operating temperature
- reduced electromagnetic field

In addition, every premium-grade PENTAFLOW™ series PAMOTOR miniature (4½") and subminiature (3") fan carries a 5-Year Warranty on materials and workmanship.

Dollar for dollar, and spec for spec, PAMOTOR is your coolest buy every time. Why settle for less?

See PAMOTOR catalog insert for summary data on our complete line of OPTIMIZED COOLING DEVICES.



PAMOTOR

PENTAFLOW is a trademark of PAMOTOR, one of the PURDY group of companies.

2 Product Directory

BAGANOFF ASSOCIATES INC.
6809 W Florissant, St Louis, Mo 63136

BERGEN LABORATORIES INC. SUB. ZYROTROIN INC.
60 Spruce St, Paterson, N J 07501

BFA CORP.
1309 S Inca, Denver, Colo 80223

BRISTOL CO., DIV AMERICAN CHAIN & CABLE CO.
Bristol Rd, Waterbury, Conn 06720

BULOVA WATCH ELECTRONICS DIV.
6120 Woodside Ave, Woodside Li, N Y 11377

BURR-BROWN RESEARCH CORP.
6730 S Tucson Blvd, Tucson, Ariz 85706

CENTURY ELECTRONICS & INSTRUMENTS INC.
P O Box C Adm Sta, Tulsa, Okla 74115

COHU ELECTRONICS INC. SAN DIEGO DIV.
P O Box 623, San Diego, Cal 92112

COMPUTER CORP. OF AMERICA
6216 Evergreen St, Houston, Tex 77036

CONSOLIDATED OHMIC DEVICES INC.
115 Old Country Rd, Carle Place, N Y 11514

CONTROL TECHNOLOGY CO., INC.
41-16 29th St, Long Island Cty, N Y 11101

DATA CONTROL SYSTEMS INC.
Commerce Dr, Danbury, Conn 06810

DATUM INC.
170 E Liberty Ave, Anaheim, Cal 92801

DYNAMIC MEASUREMENTS CORP.
6 Lowell Ave, Winchester, Mass 01890

ELECTRONIC ASSOCIATES INC.
485 Monmouth Pkwy, W Long Branch, N J 07764

ELECTRONIC MODULES CORP.
P O Box 141, Timonium, Md 21093

ESTERLINE ANGUS DIV., ESTERLINE CORP.
Po Box 24000, Indianapolis, Ind 46224

FAIRCHILD CAMERA & INST. CO. FAIRCHILD CONT. DIV.
225 Park Ave, Hicksville, N Y 11802

GAP INSTRUMENT CORP.
110 Marcus Blvd, Hauppauge, N Y 11787

GENERAL RADIO CO.
300 Baker Ave, Concord, Mass 01742

GOULD INC. BRUSH DIV.
3631 Perkins Ave, Cleveland, Ohio 44114

HEWLETT PACKARD NEW JERSEY DIV.
100 Locust Ave, Berkeley Heights, N J 07922

HEWLETT PACKARD CO.
1501 Page Mill Rd, Palo Alto, Cal 94304

HONEYWELL INC. TEST INSTRUMENTS DIV.
P O Box 5227, Denver, Colo 80217

HYCOMP INC.
146 Main St, Maynard, Mass 01754

INCOR INSTRUMENTATION INC.
29 Newtown Rd, Plainview, N Y 11803

INTERSIL INC.
10900 N Tantu, Cupertino, Cal 95014

KEPCO INC.
131 38 Sanford Ave, Flushing, N Y 11352

LECROY RESEARCH SYSTEMS CORP.
126 N Rte 303, W Nyack, N Y 10994

MAYBERRY ELECTRONICS CO.
1250 Industrial Ave, Escondido, Cal 92025

MB ELECTRONICS DIV. TEXTRON INC.
781 Whalley Ave, New Haven, Conn 06515

METRA INSTRUMENTS INC.
1340 Space Park Way, Mt View, Cal 94040

MILLETRON INC.
540 Alpha Dr, Pittsburgh, Pa 15238

MULTITECH DATA PRODUCTS
583 Monterey Pass Rd, Monterey Park, Cal 91754

NATEL ENGINEERING CO. INC.
8944 Mason Ave, Canoga Park, Cal 91306

NATIONAL SEMICONDUCTOR CORP.
2900 Semicon Dr, Santa Clara, Cal 95051

NEFF INSTRUMENT CORP.
1088 E Hamilton Rd, Duarte, Cal 91010

NUCLEAR DATA INC.
P O Box 451, Palatine, Ill 60067

OPTICAL ELECTRONICS INC.
P O Box 11140, Tucson, Ariz 85706

OPTIMIZATION, INC.
9421 Telfair Ave, Sunn Valley, Cal 91352

PRECISION MONOLITHICS INC.
1500 Space Park Dr, Santa Clara, Cal 95050

PRESTON SCIENTIFIC INC.
805 E Cerritos Ave, Anaheim, Cal 92805

PRINCETON APPLIED RESEARCH CORP.
P O Box 565, Princeton, N J 08540

RAYTHEON COMPUTER
2700 S Fairview St, Santa Ana, Cal 92704

RESALAB INC. RESALAB SCIENTIFIC DIV.
4000 Campbell Ave, Menlo Park, Cal 94025

SCHAEVITZ ENGINEERING
Rte 130 & Union Ave, Pennsauken, N J 08110

SCIENTIFIC MEASUREMENTS INC.
9701 N Kenton, Skokie, Ill 60076

SIGMA INSTRUMENTS INC.
170 Pearl St, Braintree, Mass 02185

SOLID STATE ELECTRONICS CORP.
15321 Rayen St, Sepulveda, Cal 91343

SRC DIV. MOXON INC.
2222 Michelson Dr, Newport Beach, Cal 92664

SYSTEMS RESEARCH LABS, INC.
7001 Indian Ripple Rd, Dayton, Ohio 45440

TELEDYNE BROWN ENGINEERING
300 Sparkman Dr, Huntsville, Ala 35807

TELEDYNE PHILBRICK NEXUS
Allied Dr At Rte 128, Dedham, Mass 02026

TUSTIN ELECTRONICS CO.
17942 E Main St, Tustin, Cal 92680

UNIVERSAL AD-YU ELECTRONICS INC.
249-259 Terhune Ave, Passaic, N J 07055

VARIAN ASSOCIATES GRAPHICS & DATA SYSTEMS DIV.
611 Hansen Way, Palo Alto, Cal 94303

ZELTEX INC.
1000 Chalomar Rd, Concord, Cal 94520

AMPLIFIERS, OPERATIONAL

ADAGE INC.
1079 Commonwealth Ave, Boston, Mass 02109

ADVANCED MICRO DEVICES INC.
901 Thompson Pl, Sunnyvale, Cal 94086

ALTEC DIV., LTV LING ALTEC INC.
1515 So Manchester Av, Anaheim, Cal 92803

AMPEREX ELECTRONIC CORP. A NO AMERICAN PHILIPS CO
P O Box 98, Slatersville, R I 02876

ANALOG DEVICES INC.
221 5th St, Cambridge, Mass 02142

ANALOGIC CORP.
Audubon Rd, Wakefield, Mass 01880

AVCO CORP. ELECTRONICS DIV.
4807 Bradford, Huntsville, Ala 35805

BFA CORP.
1309 S Inca, Denver, Colo 80223

BULOVA WATCH ELECTRONICS DIV.
6120 Woodside Ave, Woodside Li, N Y 11377

BURR-BROWN RESEARCH CORP.
6730 S Tucson Blvd, Tucson, Ariz 85706

COLUMBIA COMPONENTS CORP.
60 Madison Ave, Hempstead, N Y 11550

COMPUTER CORP. OF AMERICA
6216 Evergreen St, Houston, Tex 77036

COMPUTER LABS INC.
1109 S Chapman St, Greensboro, N C 27403

DATA CONTROL SYSTEMS INC.
Commerce Dr, Danbury, Conn 06810

DDC DIV. SOLID STATE SCIENTIFIC DEVICES
100 Tec St, Hicksville, N Y 11801

DENELCOR INC.
5975 Broadway, Denver, Colo 80216

DICKSON ELECTRONICS CORP.
P O Box 1390, Scottsdale, Ariz 85252

DIGITAL EQUIPMENT CORP.
146 Main St, Maynard, Mass 01754

DYNAMIC MEASUREMENTS CORP.
6 Lowell Ave, Winchester, Mass 01890

ELCOM ELECTRONICS INC.
200 Allen Blvd, Farmingdale, N Y 11735

ELECTRO-CRAFT CORP.
1600 S 2nd St, Hopkins, Minn 55343

ELECTRONIC ASSOCIATES INC.
485 Monmouth Pkwy, W Long Branch, N J 07764

FAIRCHILD CAMERA & INST. CO. FAIRCHILD CONT. DIV.
225 Park Ave, Hicksville, N Y 11802

GPS CORP.
14 Burr St, Framingham, Mass 01701

HARVEY INDUSTRIAL DIV.
60 Crossway Pk W, Woodbury Li, N Y 11797

HYBRID SYSTEMS DIV. DIGITAL RESOURCES CORP.
4301 Dacoma Rd, Houston, Tex 77018

INCOR INSTRUMENTATION INC.
29 Newtown Rd, Plainview, N Y 11803

INTERSIL INC.
10900 N Tantu, Cupertino, Cal 95014

KEPCO INC.
131 38 Sanford Ave, Flushing, N Y 11352

LANCER ELECTRONICS CORP.
1416 W Main St, Norristown, Penn 19401

LEDEX INC.
123 Webster St, Dayton, Ohio 45401

MILLETRON INC.
540 Alpha Dr, Pittsburgh, Pa 15238

MULTITECH DATA PRODUCTS
583 Monterey Pass Rd, Monterey Park, Cal 91754

NATIONAL SEMICONDUCTOR CORP.
2900 Semicon Dr, Santa Clara, Cal 95051

OPTICAL ELECTRONICS INC.
P O Box 11140, Tucson, Ariz 85706

OPTIMIZATION, INC.
9421 Telfair Ave, Sunn Valley, Cal 91352

PRECISION MONOLITHICS INC.
1500 Space Park Dr, Santa Clara, Cal 95050

PRINCETON APPLIED RESEARCH CORP.
P O Box 565, Princeton, N J 08540

RAYTHEON CO. EQUIPMENT DIV.
528 Boston Post Rd, Sudbury, Mass 01776

SCIENTIFIC MEASUREMENTS INC.
9701 N Kenton, Skokie, Ill 60076

SIGNETICS CORP. SUB. CORNING GLASS
811 E Arques Ave, Sunnyvale, Cal 94086

SILICON GENERAL INC.
7382 Bolsa Ave, Westminster, Cal 92683

SOLID STATE ELECTRONICS CORP.
15321 Rayen St, Sepulveda, Cal 91343

SOLITRON DEVICES INC.
8808 Balboa Ave, San Diego, Cal 92123

SPRAGUE ELECTRIC CO.
551 Marshall St, N Adams, Mass 01247

SYSTRON-DONNER CORP.
888 Galindo St, Concord, Cal 94520

TELEDYNE PHILBRICK NEXUS
Allied Dr At Rte 128, Dedham, Mass 02026

TRANSITRON ELECTRONIC CORP.
168 Albion St, Wakefield, Mass 01880

ZELTEX INC.
1000 Chalomar Rd, Concord, Cal 94520

AMPLIFIERS, SERVO

ELECTRO-CRAFT CORP.
1600 S 2nd St, Hopkins, Minn 55343

AMPLIFIERS, VIDEO

ADVANCED MICRO DEVICES INC.
901 Thompson Pl, Sunnyvale, Cal 94086

ALCOR INC.
215 S Tioga St, Ithaca, N Y 14050

AMERICAN ASTRONICS INC., SUB TECHNICALOR INC.
855 No Cahuenga Blvd, Hollywood, Cal 90038

AMPEREX ELECTRONIC CORP. A NO AMERICAN PHILIPS CO
P O Box 98, Slatersville, R I 02876

ANALOG DEVICES INC.
221 5th St, Cambridge, Mass 02142

ASTRONAUTICS CORPORATION OF AMERICA
907 S First St, Milwaukee, Wis 53204

BALL BROTHERS RESEARCH CORP.
P O Box 1062, Boulder, Colo 80302

BOWMAR INSTRUMENT CORP. ELECTRONIC SYS. DIV
800 Bluffton Rd, Fort Wayne, Ind 46809

BURR-BROWN RESEARCH CORP.
6730 S Tucson Blvd, Tucson, Ariz 85706

CELCO, CONSTANTINE ENGINEERING LABS. CO.
70 Constantine Dr, Mahwah, N J 07430

COHU ELECTRONICS INC. SAN DIEGO DIV.
P O Box 623, San Diego, Cal 92112

COLUMBIA COMPONENTS CORP.
60 Madison Ave, Hempstead, N Y 11550

CONSTANTINE ENGINEERING LABS CELCO
70 Constantine Dr, Mahwah, N J 07430

DYNAIR ELECTRONICS INC.
6360 Federal Blvd, San Diego, Cal 92114

INTERSIL INC.
10900 N Tantu, Cupertino, Cal 95014

LECROY RESEARCH SYSTEMS CORP.
126 N Rte 303, W Nyack, N Y 10994

LORCH ELECTRONICS, LORCH ADRET CORP.
105 Cedar Ln, Englewood, N J 07631

NATIONAL SEMICONDUCTOR CORP.
2900 Semicon Dr, Santa Clara, Cal 95051

OPTICAL ELECTRONICS INC.
P O Box 11140, Tucson, Ariz 85706

RESALAB INC. RESALAB SCIENTIFIC DIV.
4000 Campbell Ave, Menlo Park, Cal 94025

SIERRA SYSTEMS INC.
2255 Old MidHd Way, Mountain View, Cal 94040

SIGNETICS CORP. SUB. CORNING GLASS
811 E Arques Ave, Sunnyvale, Cal 94086

SILICON GENERAL INC.
7382 Bolsa Ave, Westminster, Cal 92683

SPRAGUE ELECTRIC CO.
551 Marshall St, N Adams, Mass 01247

SYSTEMS RESEARCH LABS, INC.
7001 Indian Ripple Rd, Dayton, Ohio 45440

VIRGINIA ELECTRONICS CO. INC.
2901 Telesar Court, Falls Church, Va 22042

WISE INSTRUMENTATION & CONTROLS INC.
3568 Amherst Court, Mt View, Cal 94040

2 Product Directory

ZELTEX INC.

1000 Chalomar Rd, Concord, Cal 94520

ANALOG COMPUTERS (SEE COMPUTERS)

ANALOG-TO-DIGITAL CONVERTERS (SEE CONVERTERS)

ANALOG MULTIPLEXERS (SEE MULTIPLEXERS)

ANALYZERS, COMPUTER PERFORMANCE

ALLIED COMPUTER TECHNOLOGY INC.
1610 26 St, Santa Monica, Cal 90404
AMERICAN COMPUTER TECHNOLOGY INC.
8740 Shirley Ave, Northridge, Cal 91324
BOOLE & BABBAGE INC.
18990 Homestead Rd, Cupertino, Cal 95014
CANOGA DIGITAL SYSTEMS
8851 Mason Ave, Canoga Park, Cal 93106
COMPUMATIC SYSTEMS CORP.
5303 Comercio Ln, Woodland Hills, Cal 91364
COMPUTER & PROGRAMMING ANALYSIS INC.
1 Wynnwood Rd, Wynnwood, Pa 19096
COMPUTER LEARNING & SYSTEMS CORP.
5530 Wisconsin Ave, Chevy Chase, Md 20015
COMPUTER SYNECTICS INC.
283 Brokaw Rd, Santa Clara, Cal 95050
COMPRESS INC.
No 2 Research Court, Rockville, Md 20850
DATA DISPLAY SYSTEMS INC.
139 Terwood Rd, Willow Grove, Pa 19090
DATAPROBE INC.
290 Huyler St, S Hackensack, N J 07606
FAIRCHILD/ELECTRO-METRICS CORP.
100 Church St, Amsterdam, N Y 12010
FEDERAL SCIENTIFIC CORP.
615 W 131st St, New York, N Y 10027
IAC COMPUTER SYSTEMS INC.
260 Newton Rd, Plainview, N Y 11803
LIBRASCOPE DIV. THE SINGER CO
808 Western Ave, Glendale, Cal 91201
TELEMODEM INC.
98-05 217 St, Queens Village, N Y 11429
TRANSMISSION MEASUREMENTS INC
1051 Clinton St, Buffalo, N Y 14206

ANALYZERS, CONTINUITY

AMERICAN COMPUTER TECHNOLOGY INC.
8740 Shirley Ave, Northridge, Cal 91324
CANOGA DIGITAL SYSTEMS
8851 Mason Ave, Canoga Park, Cal 93106
DATAPROBE INC.
290 Huyler St, S Hackensack, N J 07606
DIMENSIONAL SYSTEMS INC.
393 Totten Pond Rd, Waltham, Mass 02154
DIT-MCO INTERNATIONAL
5612 Brighton Terr, Kansas City, Mo 64130
ELECTRONIC SYSTEMS & PROGRAMMING INC.
7320 S Lacienege Blvd, Inglewood, Cal 90302
LIBRASCOPE DIV. THE SINGER CO
808 Western Ave, Glendale, Cal 91201
MICRO METRICS INC.
253 Crooks Ave, Clifton, N J 07011
RESALAB INC. AUTOMATION DYNAMICS DIV.
35 Industrial Pky, Northvale, N J 07647
SCI ELECTRONICS INC.
7705 La Porte Fwy, Houston, Tex 77012
TELESCIENCES INC.
351 New Albany Rd, Moorestown, N J 08057

ANALYZERS, DIFFERENTIAL

CANOGA DIGITAL SYSTEMS
8851 Mason Ave, Canoga Park, Cal 93106
DATA GENERAL CORP.
Rte 9, Southboro, Mass 01772
DUPONT DE NEMOURS, & CO., E.I. CO., INC.
1007 Market St, Wilmington, Del 19898
FABRI-TEK INC.
5901 S County Rd 18, Minneapolis, Minn 55436
LIBRASCOPE DIV. THE SINGER CO
808 Western Ave, Glendale, Cal 91201

ANALYZERS, PULSE HEIGHT

CANOGA DIGITAL SYSTEMS
8851 Mason Ave, Canoga Park, Cal 93106
CHRONETICS INC.
500 Nuber Ave, Mount Vernon, N Y 10550
COMPUMATIC SYSTEMS CORP.
5303 Comercio Ln, Woodland Hills, Cal 91364
COMPUTER CORP. OF AMERICA
6216 Evergreen St, Houston, Tex 77036
DATA GENERAL CORP.
Rte 9, Southboro, Mass 01772
DIGITAL EQUIPMENT CORP.
146 Main St, Maynard, Mass 01754
EL INSTRUMENTS INC.
61 1st St, Derby, Conn 06418
FABRI-TEK INC.
5901 S County Rd 18, Minneapolis, Minn 55436
FEDERAL SCIENTIFIC CORP.
615 W 131st St, New York, N Y 10027
HEWLETT PACKARD CO.
1501 Page Mill Rd, Palo Alto, Cal 94304
LIBRASCOPE DIV. THE SINGER CO
808 Western Ave, Glendale, Cal 91201
MICRO INSTRUMENT CO.
12901 Crenshaw Blvd, Hawthorne, Cal 90250
SPACETAC INC.
Burlington Rd, Bedford, Mass 01730
SYSTRON-DONNER CORP. DATAPULSE DIV.
10150 W Jefferson Blv, Culver City, Cal 90230
TENNECOMP SYSTEMS INC.
795 Oak Ridge Tpk, Oak Ridge, Tenn 37830
VICTOREEN INSTRUMENT CO.
10101 Woodlawn Ave, Cleveland, Ohio 44104

ANALYZERS, WAVEFORM

BENDIX CORP., THE ELECTRICAL COMPONENTS DIV.
Sherman Ave, Sidney, N Y 13838
CANOGA DIGITAL SYSTEMS
8851 Mason Ave, Canoga Park, Cal 93106
CHRONETICS INC.
500 Nuber Ave, Mount Vernon, N Y 10550
DATA DISC INC.
686 W Maude Ave, Sunnyvale, Cal 94086
DATA DISPLAY SYSTEMS INC.
139 Terwood Rd, Willow Grove, Pa 19090
DIGITECH DATA INDUSTRIES INC.
66 Grove St, Ridgefield, Conn 06877
E-H RESEARCH LABORATORIES INC
P O Box 1289, Oakland, Cal 94604
FABRI-TEK INC.
5901 S County Rd 18, Minneapolis, Minn 55436
FAIRCHILD/ELECTRO-METRICS CORP.
100 Church St, Amsterdam, N Y 12010
FEDERAL SCIENTIFIC CORP.
615 W 131st St, New York, N Y 10027
HEWLETT PACKARD CO.
1501 Page Mill Rd, Palo Alto, Cal 94304
HICKOK ELECTRICAL INSTRUMENT CO.
10514 Dupont Ave, Cleveland, Ohio 44108
LECROY RESEARCH SYSTEMS CORP.
126 N Rte 303, W Nyack, N Y 10994
LIBRASCOPE DIV. THE SINGER CO
808 Western Ave, Glendale, Cal 91201
PRINCETON APPLIED RESEARCH CORP.
P O Box 565, Princeton, N J 08540
RENTAL ELECTRONICS INC. SUB. PEPSI CO.
16600 Oakmont Ave, Gaithersburg, Md 20760
ROCKLAND SYSTEMS CORP.
131 Erie St E, Blauvelt, N Y 10913
ROHDE & SCHWARZ SALES CO. USA INC.
111 Lexington Ave, Passaic, N J 07055
SIGNAL ANALYSIS INDUSTRIES CORP.
595 Old Willets Path, Hauppauge, N Y 11787
TEKTRONIX INC.
P O Box 500, Beaverton, Ore 97005
UNIVERSAL AD-YU ELECTRONICS INC.
249-259 Terhune Ave, Passaic, N J 07055
WILLARD LABORATORIES INC.
4221 Redwood Ave, Los Angeles, Cal 90066

ANTI-STATIC COATINGS (SEE COATINGS)

ASSEMBLER LANGUAGES (SEE PROGRAMMING LANGUAGE DEVELOPMENT)

ATTENUATORS, DECADE DIGITAL

ALTEC DIV., LTV LING ALTEC INC.
1515 So Manchester Av, Anaheim, Cal 92803
ELECTRONIC ASSOCIATES INC.
485 Monmouth Pkwy, W Long Branch, N J 07764
FLUKE, JOHN MFG. CO. INC.
P O Box 7428, Seattle, Wash 98133
HYBRID SYSTEMS DIV. DIGITAL RESOURCES CORP.
4301 Dacoma Rd, Houston, Tex 77018
LORCH ELECTRONICS, LORCH ADRET CORP.
105 Cedar Ln, Englewood, N J 07631
MCGRAW-EDISON DAVEN DIV.
Grenier Field, Manchester, N H 03103
TECH LABORATORIES INC.
Bergen & Edsall Blvd, Palisades Park, N J 07650

AUDIO RESPONSE UNITS (SEE MODEMS)

AUDIO/VISUAL TRAINING AIDS

A.B. DICK CO.
5700 W Touhy, Chicago, Ill 60648
ADDRESSOGRAPH MULTIGRAPH CORP BRUNING DIV.
1200 Babbitt Rd, Cleveland, Ohio 44117
ADVANCED SYSTEMS INC.
1100 W NW Hwy, Mt Prospec, Ill 60056
ALCOR INC.
215 S Tioga St, Ithaca, N Y 14050
APPLIED COMPUTER SYSTEMS INC.
P O Box 6479, Austin, Tex 78702
ARVIN SYSTEMS INC.
1771 Springfield St, Dayton, Ohio 45403
ASTRO MOBILE PRODUCTS CORP. MAGNAGRAPH DIV.
11-25 44 Rd, Long Island, N Y 11101
AVCO CORP. ELECTRONICS DIV.
4807 Bradford, Huntsville, Ala 35805
BOLT BERANEK & NEWMAN INC. DATA EQUIPMENT DIV.
1762 McGaw St, Santa Ana, Cal 92705
BURLINGTON MANAGEMENT SERVICES CO.
P O Box 21207, Greensboro, N C 27420
COMPUTER METHODS CORP.
470 Mamaroneck Ave, White Plains, N Y 10605
CURTIS 1000 INC.
1000 Curtis Dr, Smyrna, Ga 30080
DECISION SYSTEMS INC.
E 66 Midland Ave, Paramus, N J 07652
DYNAPHONICS INC.
2975 Far Hill, Dayton, Ohio 45419
EDUCATION AND TRAINING CONSULTANTS CO.
P O Box 49899, Los Angeles, Cal 90049
ELCO CORP.
Maryland Rd, Willow Grove, Pa 19090
ELECTRONIC ASSOCIATES INC.
485 Monmouth Pkwy, W Long Branch, N J 07764
FELSENTHAL INSTRUMENTS CO.
7450 W Wilson Ave, Chicago, Ill 60656
FRIDEN DIV. THE SINGER CO.
97 Humboldt St, Rochester, N Y 14602
GORDON ENTERPRISES INC., ALAN
5362 Cahuenga Blvd, N Hollywood, Cal 91601
GTE DATA SERVICES INC.
5422 Bay Center Dr, Tampa, Fla 33609
HONEYWELL INFORMATION SYSTEMS
60 Walnut St, Wellesley Hills, Mass 02181
LEHIGH VALLEY ELECTRONICS INC.
Po Box 125, Fogelsville, Pa 18051
LITTON SYSTEMS INC. MELLONICS DIV.
1001 W Maude Ave, Sunnyvale, Cal 94086
LOGIC SCIENCE INC.
P O Box 10096, San Diego, Cal 92110
3M CO.
3m Center, St Paul, Minn 55101
MADATRON CORP.
P O Box 172, Princeton, N J 08540
MAST DEVELOPMENT CO. SUB. AV ELECTRONICS INC.
2212 E 12th St, Davenport, Iowa 52803
NEWMAR PRODUCTS CORP.
P O Box 568, Scarsdale, N Y 10583
PAYMENT SYSTEMS INC.
405 Lexington Ave, New York, N Y 10017
PHILCO-FORD CORP., COMPUTER SERVICES NETWORK
Tioga & C Sts, Philadelphia, Pa 19134
PROGRAMMING SCIENCES CORP.
S E 42 St, New York, N Y 10016

**Don't
just blow on it...
COOL IT,
MAN!**

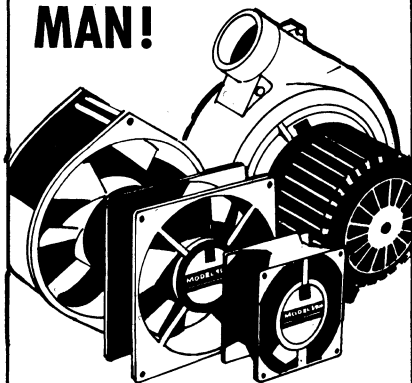

To be *sure* that the internal operating temperature of your valuable electronic instrument or EDP equipment will be kept below the maximum allowable, even after years of service, use fans whose performance does not fade away. With PAMOTOR fans, you can be sure of permanently quiet, efficient cooling — no bearing lubrication failure, no loss in efficiency from warped plastic blades, no increased noise due to excessive wear.

PAMOTOR fans cost no more — but every one gives you this distinctly superior performance over others in its class:

- highest air-cooling capacity
 - durable all-metal construction
 - maximum reliability
 - lowest noise and vibration
 - lifetime rated performance
 - lower operating temperature
 - reduced electromagnetic field
- Dollar for dollar, and spec for spec, PAMOTOR is your coolest buy every time. Why settle for less?

See PAMOTOR catalog insert for summary data on our complete line of OPTIMIZED COOLING DEVICES.



PAMOTOR

One of the PURDY group of companies.

770 Airport Boulevard
Burlingame, California 94010
(415) 347-1203

2 Product Directory

PROGRAMMING SCIENCES CORP.
1900 Ave of The Stars, Los Angeles, Cal 90067
RANK PRECISION INDUSTRIES INC.
260 N Rt 303, W Nyack, N Y 10994
TAYLOR MERCHANT CORP.
25 W 45 St, New York, N Y 10013
TECH LABORATORIES INC.
Bergen & Edsall Blvd, Palisades Park, N J 07650
TELECTRO SYSTEMS CORP.
96-18 43rd Ave, Corona, N Y 11368
TELEDYNE FREDERICK POST
P O Box 803, Chicago, Ill 60690
TRAID CORP., PHOTO INSTRUMENT DIV.
900 Grand Central, Glendale, Cal 91201
WARREN ASSOCIATES
15 Royal Crest Dr, Marlboro, Mass 01752

AUTOMATED WIRE WRAPPING (SEE SERVICES)

AUTOMATIC CHECK-OUT SYSTEMS (SEE TEST SYSTEMS)

BINARY SCALERS (SEE COUNTERS)

BLOWERS, FANS, COOLING ASSEMBLIES

ACE-SYCAMORE INC.
448 Dekalb Ave, Sycamore, Ill 60178
AMETEK/LAMB ELECTRIC
627 Lake St, Kent, Ohio 44240
ASHLAND ELECTRIC PRODUCTS INC
3202 Queens Blvd, Long Is Cy, N Y 11101
ASTRODYNE INC.
353 Middlesex Ave, Wilmington, Mass 01887
DIAMOND POWER SPECIALTY CORP.
P O Box 415, Lancaster, Ohio 43130
DYNACOO MANUFACTURING CO INC
1 Russell St, Saugerties, N Y 12477
ELCOM ELECTRONICS INC.
200 Allen Blvd, Farmingdale, N Y 11735
EQUIPTO ELECTRONICS CORP.
435 Woodlawn Ave, Aurora, Ill 60537
FIELDTEC INC.
4262 Campus Dr, Newport Beach, Cal 92660
GENERAL CABLE CORP.
730 3rd Ave, New York, N Y 10017
GENERAL DEVICES CO. INC.
525 S Webster Ave, Indianapolis, Ind 46219
GENERAL ELECTRIC CO. GENERAL PURPOSE MOTOR DEPT.
200 Taylor St, Ft Wayne, Ind 46804
HARVEY INDUSTRIAL DIV.
60 Crossway Pk W, Woodbury Li, N Y 11797
HOWARD INDUSTRIES
2420 18 St, Racine, Wisc 53403
IMC MAGNETICS CORP., EASTERN DIV.
570 Main St, Westbury, N Y 11591
IMC MAGNETICS CORP., NEW HAMPSHIRE DIV.
Route 16b, Rochester, N H 03867
INSTRUMENT SYSTEMS CORP. ROTATING COMP. DIV.
1560 5th Ave, Bayshore, N Y 11706
INTERNATIONAL ELECTRONIC RESEARCH CORP.
135 W Magnolia Blvd, Burbank, Cal 91502
KOOLTRONIC FAN CO.
P O Box 504, Princeton, N J 08540
MCLEAN ENGINEERING LABS.
70 Washington Rd, Princeton Jct, N J 08550
MINNESOTA ELECTRIC TECHNOLOGY INC.
304 Main N, Winnebago, Minn 56098
NUCLEAR SYSTEMS INC.
406 S Yale St, Garland, Tex 75040
PAMOTOR INC., WILLIAM J. PURDY CORP.
770 Airport Blvd, Burlingame, Cal 94010
PREMIER METAL PRODUCTS CO.
337 Manida St, Bronx, N Y 10474
PURDY CORP., WM. J.
770 Airport Blvd, Burlingame, Cal 94010
ROTRON INC.
Hasbrouck Ln, Woodstock, N Y 12498
SANDERS ASSOCIATES INC. SYSTEMS DIV.
Daniel Webster Hwy S, Nashua, N H 03060
SINGER CO., THE, DIEHL DIV.
Finderne Ave, Somerville, N J 08876
THERMALLOY CO.
8717 Diplomacy Row, Dallas, Tex 75247
TORIN CORP.
100 Franklin Dr, Torrington, Conn 06790

TRW INC. GLOBE DIV.
2275 Stanley Ave, Dayton, Ohio 45404

BOARDS, PRINTED CIRCUIT (WITHOUT COMPONENTS)

A.D. CIRCUITS INC.
Panorama Creek Dr, Rochester, N Y 14625
A.D. DATA SYSTEMS INC.
830 Linden Ave, Rochester, N Y 14625
ANSLEY ELECTRONICS CORP. SUB. THOMAS & BETTS
Old Easton Rd, Doylestown, Pa 18901
ARIES TECHNOLOGY DIV. UNIDEX INC.
3475 Victor St, Santa Clara, Cal 95050
AVCO CORP. ELECTRONICS DIV.
4807 Bradford, Huntsville, Ala 35805
BUREAU OF ENGRAVING INC. INDUSTRIAL DIV.
219 N 2nd St, Minneapolis, Minn 55401
CINCH-GRAPIK DIV. OF TRW
200 S Turnbull Canyon, Cy of Industry, Cal 91744
CIRCUIT SCIENCE INC.
615 N County Rd 18, Minneapolis, Minn 55427
CIRCUIT-STIK INC.
1518 W 132nd, Gardena, Cal 90249
CIRCUITS INC.
59 Deming Rd, Berlin, Conn 06037
COLLINS RADIO CO.
1200 N Alma Rd, Dallas, Tex 75207
CONDUCTORLAB, INC.
Main St, Groton, Mass 01450
CONTROL DATA CORP. CIRCUITS DIV.
7800 Computer Ave, Minneapolis, Minn 55435
DATA TECHNOLOGY CORP.
1050 E Meadow Cir, Palo Alto, Cal 94303
DEFIANCE CIRCUIT CORP. SUB. HI-G INC.
12 Shepard St, Lawrence, Mass 01843
DIGITAL EQUIPMENT CORP.
146 Main St, Maynard, Mass 01754
DIGITAL PRODUCTS CORP.
6950 NW 12 Ave, Ft Lauderdale, Fla 33309
ELECTRALAB DIV. TYCO LABORATORIES INC.
P O Box 548, Encinitas, Cal 92024
ELECTRONIZED CHEMICALS CORP.
S Bedford St, Burlington, Mass 01803
ELFAB CORP.
P O Box 34555, Dallas, Tex 75234
EPEC INDUSTRIES INC.
Industrial Pk, New Bedford, Mass 02745
FABRI-TEK INC.
5901 S County Rd 18, Minneapolis, Minn 55436
FAIRCHILD SYSTEMS TECHNOLOGY
974 E Arques Ave, Sunnyvale, Cal 94086
FARRINGTON MANUFACTURING CO.
6707 Electronics Dr, Springfield, Va 22151
FLEXIBLE CIRCUITS INC.
Paul Valley Ind Pk, Warrington, Pa 18976
GENERAL CIRCUITS INC.
95 Mt Read Blvd, Rochester, N Y 14611
HI-G INC.
580 Spring St, Windsor Locks, Conn 06096
INDEL INC.
P O Box 15800, Tulsa, Okla 74115
INTERNATIONAL ELECTRONIC RESEARCH CORP.
135 W Magnolia Blvd, Burbank, Cal 91502
KEYSTONE ELECTRONICS CORP.
49 Bleecker St, New York, N Y 10012
LANCER ELECTRONICS CORP.
1416 W Main St, Norristown, Penn 19401
LITTON SYSTEMS INC. CIRCUITRY DIV.
4811 W Kearney St, Springfield, Mo 65803
LOCKHEED ELECTRONICS CO. DATA PRODUCTS DIV.
6201 E Randolph St, Los Angeles, Cal 90650
METRIC SYSTEMS CORP.
736 N Beal St, Ft Walton Beach, Fla 32548
MICA CORP.
4031 Elenda St, Culver City, Cal 90230
MICRODATA CORP.
644 E Young St, Santa Ana, Cal 92705
MULTIPLEX COMMUNICATIONS INC.
123 Marcus Blvd, Hauppauge, N Y 11787
NATIONAL TECHNOLOGY
220 W Central Ave, Santa Ana, Cal 92707
NATIONAL TEL-TRONICS
55 Northern Blvd, Great Neck, N Y 11021
NORRICH PLASTIC CORP.
200 Allen Blvd, Farmingdale, N Y 11575
NUCLEAR DATA INC.
P O Box 451, Palatine, Ill 60067
POLY CABLE CO.
5235 N Rose St, Rosemont, Ill 60018
PRECISION CIRCUITS INC. DIV. HARVARD INDUS.
P O Box 605, Farmingdale, N J 07727
PRINTED CIRCUIT CORP.
180 Elm St, Waltham, Mass 02154

2 Product Directory

PRINTEX CORP.

1911 Plymouth St, Mt View, Cal 94040
ROBINSON-NUGENT INC.
800 E 8th St, New Albany, Ind 47150
ROBINTECH INC. E-M DIV.
P O Box 714, Binghamton, N Y 13902
SEMICON INC.
10 N Ave, Burlington, Mass 01803
STELLARMETRICS AN AYDIN CO.
P O Box 719, Santa Barbara, Cal 93102
SUPERIOR CIRCUITS DIV. RESALAB INC.
2200 Ladybird Ln, Dallas, Tex 75220
SYSTEMS ENGINEERING LABORATORIES INC.
P O Box 9148, Fort Lauderdale, Fla 33310
SYSTEMS RESEARCH LABS, INC.
7001 Indian Ripple Rd, Dayton, Ohio 45440
SYSTREX CORP.
303 Child St, Rochester, N Y 14611
TECHRON CORP.
20 Simmons St, Boston, Mass 02120
TYCO LABORATORIES INC.
16 Hickory Dr, Waltham, Mass 02154
UNIVERSAL INSTRUMENTS CORP.
E Frederick St, Binghamton, N Y 13902
V.I.Z. MANUFACTURING CO.
335 E Price St, Philadelphia, Pa 19144
VECTOR ELECTRONIC CO. INC.
12460 Gladstone Ave, Sylmar, Cal 91342
VERO ELECTRONICS INC.
176 Central Ave, Farmingdale, N Y 11735
WESTINGHOUSE ELECTRIC CORP.
Westinghouse Bldg, Pittsburgh, Pa 15222

BOARDS, PROGRAMMING (SEE PLUGBOARDS)

BOARDS, VISUAL CONTROL (GRAPHIC)

ABT ASSOCIATES INC. TECHNOLOGY GROUP
55 Wheeler St, Cambridge, Mass 02138
ACME VISIBLE RECORDS INC.
510 Allview Dr, Crozet, Va 22932
ASTRO MOBILE PRODUCTS CORP. MAGNAGRAPH DIV.
11-25 44 Rd, Long Island, N Y 11101
FERRANTI PACKARD LTD., ELECTRONICS DIV.
121 Industry St, Toronto 15, CANADA
GILLOTTE, ROBERT P. & CO. INC
2230 Commerce Dr, Columbia, S C 29205
MAGNETIC AIDS INC.
11 W 42nd St, New York, N Y 10036
METHODS RESEARCH CORP.
105 Willow Ave, Staten Island, N Y 10305
OCHMAN SYSTEMS, EDWARD
Po Box 141, Fairfield, Conn 06430
PRYOR MARKING PRODUCTS INC.
21 E Hubbard St, Chicago, Ill 60611
REL-QUAL ASSOCIATES INC.
18 Hamilton St, Bound Brook, N J 08805
REMINGTON RAND OFFICE SYSTEMS DIV. SPERRY RAND
P O Box 171, Marietta, Ohio 45750
STEWART CO., WM A. ROL-A-CHART DIV.
P O Box 67, Somerset, Cal 95684
VISIRECORD
54 Railroad Ave, Copiague, N Y 11726
WARREN ASSOCIATES
15 Royal Crest Dr, Marlboro, Mass 01752

BRAKES AND CLUTCHES

AMERICAN PRECISION INDUSTRIES INC. DELEVAN DIV.
270 Quaker Rd, E Aurora, N Y 14052
ELECTROID CO.
119 Progress St, Union, N J 07083
LEAR SIEGLER INC. POWER EQUIPMENT DIV
P O Box 6719, Cleveland, Ohio 44101
LEM INSTRUMENT CORP.
20 Sarah Dr, Farmingdale, N Y 11735
STEARNS ELECTRIC CORP.
120 N Broadway, Milwaukee, Wisc 53202
VIBRAC CORP. AFFILIATE USM CORP.
11 Alpha Rd, Chelmsford, Mass 01824
WARNER ELECTRIC BRAKE & CLUTCH CO.
Beloit, Wisc 53511

BREADBOARDS

A.D. CIRCUITS INC.
Panorama Creek Dr, Rochester, N Y 14625
AMERICAN COMPUTER TECHNOLOGY INC.
8740 Shirley Ave, Northridge, Cal 91324
CAMBRIDGE THERMIONIC CORP.
445 Concord Ave, Cambridge, Mass 02138
CIRCUIT SCIENCE INC.
615 N County Rd 18, Minneapolis, Minn 55427
CIRCUIT-STIK INC.
1518 W 132nd, Gardena, Cal 90249
DATA TECHNOLOGY CORP.
1050 E Meadow Cir, Palo Alto, Cal 94303
EL INSTRUMENTS INC.
61 1st St, Derby, Conn 06418
ELFAB CORP.
P.O.Box 34555, Dallas, Tex 75234
FLEXIBLE CIRCUITS INC.
Paul Valley Ind Pk, Warrington, Pa 18976
GAP INSTRUMENT CORP.
110 Marcus Blvd, Hauppauge, N Y 11787
HEWLETT PACKARD CO. CUPERTINO DIV.
1100 Wolfe Rd, Cupertino, Cal 95014
KEYSTONE ELECTRONICS CORP.
49 Bleecker St, New York, N Y 10012
LITTON SYSTEMS INC. CIRCUITRY DIV.
4811 W Kearney St, Springfield, Mo 65803
MARK COMPUTER SYSTEMS INC.
One Patterson Pl, Garden City, N Y 11530
METHODE ELECTRONICS INC.
7447 W Wilson Ave, Chicago, Ill 60656
MICRODATA CORP.
644 E Young St, Santa Ana, Cal 92705
MULTIPLEX COMMUNICATIONS INC.
123 Marcus Blvd, Hauppauge, N Y 11787
NORTH AMERICAN ROCKWELL CORP. AUTONETICS DIV.
3370 Miraloma Ave, Anaheim, Cal 92803
ROBINSON-NUGENT INC.
800 E 8th St, New Albany, Ind 47150
ROBINTECH INC. E-M DIV.
P O Box 714, Binghamton, N Y 13902
ROSEMOUNT PLUG-IN INC.
P O Box 107, Nashville, Tenn 37202
SYSTEMS RESEARCH LABS, INC.
7001 Indian Ripple Rd, Dayton, Ohio 45440
SYSTREX CORP.
303 Child St, Rochester, N Y 14611
TROTT ELECTRONICS INC.
30 Ridgeland Rd, Rochester, N Y 14623
UNIVERSAL INSTRUMENTS CORP.
E Frederick St, Binghamton, N Y 13902
UNIVERSITY COMPUTING CO.
888 N Sepulveda Blvd, El Segundo, Cal 90245
VECTOR ELECTRONIC CO. INC.
12460 Gladstone Ave, Sylmar, Cal 91342
VERO ELECTRONICS INC.
176 Central Ave, Farmingdale, N Y 11735

BUS BAR SYSTEMS

AMP INC.
Eisenhower Blvd, Harrisburg, Pa 17105
AMP INC. CAPITRON DIV.
1595 S Mount Joy St, Elizabethtown, Pa 17022
ARROW BUS BAR CORP.
23 A Dana St, Malden, Mass 02148
BUSSCO ENGINEERING INC.
122 Penn St, El Segundo, Cal 90245
CHEM ACRO INC.
231 E Lomita Blvd, Wilmington, Cal 90744
CHEMICAL MICRO MILLING CO.
1601 Hylton Rd, Pennsauken, N J 08101
CONTROL DATA CORP. CONNECTOR OPERATION
31829 W Latienda Dr, Westlake Vil, Cal 91360
DATA TECHNOLOGY CORP.
1050 E Meadow Cir, Palo Alto, Cal 94303
ELCO CORP.
Maryland Rd, Willow Grove, Pa 19090
ELDRE COMPONENTS INC.
1239 University Ave, Rochester, N Y 14607
FLEXIBLE CIRCUITS INC.
Paul Valley Ind Pk, Warrington, Pa 18976
GARRETT ELECTRONICS & CABLE CO.
24 Central Dr, Farmingdale, N Y 11735
JANCO CORP.
311 Winona Ave, Burbank, Cal 91504
LEAR SIEGLER INC., ELECTRONIC INSTRUMENTATION DIV
714 N Brookhurst St, Anaheim, Cal 92803
MALCO MANUFACTURING CO. INC.
5150 W Roosevelt Rd, Chicago, Ill 60650

METHODE ELECTRONICS INC.
7447 W Wilson Ave, Chicago, Ill 60656
ROGERS CORP.
Rogers, Conn 06263
SEASTROM MANUFACTURING CO.
701 Sonora Ave, Glendale, Cal 91201

CABINETS AND ENCLOSURES (FOR KEYPUNCHES, PRINTERS)

AMCO ENGINEERING CO.
7333 W Ainslie, Chicago, Ill 60656
AUDIO SUTTLE CORP. SUB.OF RAY PROOF
50 Keeler Ave, Norwalk, Conn 06856
BARRY-WRIGHT CORP. WRIGHT LINE DIV.
160 Gold Star Blvd, Worcester, Mass 01606
COMPUTER ACCESSORIES CO.
131 W 154th St, Gardena, Cal 90248
COMPUTER-LINK CORP.
14 Cambridge St, Burlington, Mass 01803
COMPUTER PREPARATIONS INC.
112 S Dean St, Englewood, N J 07631
ECCO BUSINESS SYSTEMS INC.
50 E 42nd St, New York, N Y 10017
ECONOMET INC.
1033 W Kirkwall Rd, Azusa, Cal 91702
ELECTRORACK PRODUCTS CO.
1742 S Clementine St, Anaheim, Cal 92802
GATES ACOUSTINET INC.
P O Box 1406, Santa Rosa, Cal 95403
GENERAL DEVICES CO. INC.
525 S Webster Ave, Indianapolis, Ind 46219
INGERSOLL PRODUCTS DIV. BORG-WARNER CORP.
1000 W 120th St, Chicago, Ill 60643
INTERNATIONAL COMPUTERS LTD.
1cl House Putney, London S W 15, UNITED K
JOBBS INC., WILLIAM F.
Aurora, Ill 60507
KLEINSCHMIDT DIV., SCM CORP.
Lake-Cook Rd, Deerfield, Ill 60015
MACS COMPUTER ACCESSORIES INC
104 Park Towne Pl, Philadelphia, Pa 19130
METHODE ELECTRONICS INC.
7447 W Wilson Ave, Chicago, Ill 60656
NUMERIDEX TAPE SYSTEMS INC.
4711 W North Ave, Chicago, Ill 60639
NYTRONICS INC.
3rd Ave, Alpha, N J 08865
OCHMAN SYSTEMS, EDWARD
Po Box 141, Fairfield, Conn 06430
ORIGINAL COMPUTER PRODUCTS INC.
204 Worcester St, Wellesley Hills, Mass 02181
PIONEER ALUMINUM
3800 E 26th St, Los Angeles, Cal 90023
RAY PROOF CORP.
50 Keller Ave, Norwalk, Conn 06856
REPUBLIC STEEL CORP. MANUFACTURING DIV.
1315 Albert St, Youngstown, Ohio 44505
STINAFFS INC.
181 E Exchange St, Akron, Ohio 44304
TAB PRODUCTS
2690 Hanover St, Palo Alto, Cal 94304
TYCO LABORATORIES INC.
16 Hickory Dr, Waltham, Mass 02154
URAY PROOF CORP.
50 Keeler Ave, Norwalk, Conn 06856
VISIBLE COMPUTER SUPPLY CORP.
9865 Derby Ln, Westchester, Ill 60153
WARWICK PRODUCTS CO.
7909 Rockside Rd, Cleveland, Ohio 44131
ZERO MANUFACTURING CO. ZERO-WEST DIV.
1121 Chestnut St, Burbank, Cal 91503
ZERO MFG. CO. ZERO-KRESKY DIV.
2nd & H St, Petaluma, Cal 94952

CABINETS, ENCLOSURES, CONSOLES, ELECTRONIC (FOR GENERAL EQUIPMENT)

ALDEN PRODUCTS CO.
117 N Main St, Brockton, Mass 02401
AMCO ENGINEERING CO.
7333 W Ainslie, Chicago, Ill 60656
ANETSBERGER BROTHERS INC. SYS. ENCLOSURES DIV
200 Anets Dr, Northbrook, Ill 60062
AUDIO SUTTLE CORP. SUB.OF RAY PROOF
50 Keeler Ave, Norwalk, Conn 06856
AUGAT INC.
33 Perry Ave, Attleboro, Mass 02703
BARRY-WRIGHT CORP. WRIGHT LINE DIV.
160 Gold Star Blvd, Worcester, Mass 01606

For cool cabinets and consoles . . . WHY USE TWO— WHEN 1 WILL DO?

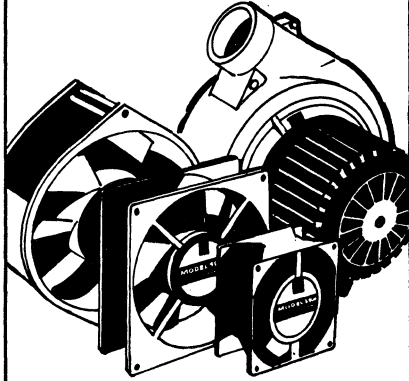

One PAMOTOR 6-inch Model 7500 fan cools a large enclosure or densely-packed cabinet more efficiently — more reliably — much more quietly than do two smaller fans . . . or one 7"-10" fan of conventional design. The Model 7500 saves you space, money, and headaches.

In fact, *every* PAMOTOR fan (many 3", 4½", and 6" models to select from) is priced competitively with all others in its class, yet provides these distinctly superior characteristics:

- highest air-cooling capacity
- durable all-metal construction
- maximum reliability
- lowest noise and vibration
- lifetime rated performance
- lower operating temperature
- reduced electromagnetic field

Dollar for dollar, and spec for spec, PAMOTOR is your coolest buy every time. Why settle for less?

See PAMOTOR catalog insert for summary data on our complete line of OPTIMIZED COOLING DEVICES.



PAMOTOR

One of the PURDY group of companies.

770 Airport Boulevard
Burlingame, California 94010
(415) 347-1203

2 Product Directory

BORG-WARNER/INGERSOLL PRODUCTS/EMCOR
1000 W 120th St, Chicago, Ill 60643
CABTRON CORP.

1900 W Kinzie St, Chicago, Ill 60622
CALABRO PLASTICS INC. UNITRACK DIV.
8738 W Chester Pike, Upper Darby, Pa 19082
COMPUTER ACCESSORIES CO.

131 W 154th St, Gardena, Cal 90248
DAHLSTROM MANUFACTURING CORP.
443 Buffalo St, Jamestown, N Y 14701
DIGITAL EQUIPMENT CORP.

146 Main St, Maynard, Mass 01754
DOLIN METAL PRODUCTS INC.
475 President St, Brooklyn, N Y 11215
ECONOMET INC.

1033 W Kirkwall Rd, Azusa, Cal 91702
ELCO CORP.

Maryland Rd, Willow Grove, Pa 19090
ELECTRORACK PRODUCTS CO.
1742 S Clementine St, Anaheim, Cal 92802
ENDLESS TAPE REEL CO.

81 Haven St, Reading, Mass 01867
EQUIPTO ELECTRONICS CORP.

435 Woodlawn Ave, Aurora, Ill 60537
GENERAL DEVICES CO. INC.

525 S Webster Ave, Indianapolis, Ind 46219
GENERAL DEVICES CO. INC. VENT-RAK DIV.
525 S Webster Ave, Indianapolis, Ind 46219
HOFFMAN ENGINEERING CO.

9th And Tyler, Anoka, Minn 55303
INGERSOLL PRODUCTS DIV. BORG- WARNER CORP.

1000 W 120th St, Chicago, Ill 60643
INTERNATIONAL CONTROLS CORP.

200 Fairfield Rd, Fairfield, N J 07006
JOBIBINS INC., WILLIAM F.

Aurora, Ill 60507
METHODE ELECTRONICS INC.

7447 W Wilson Ave, Chicago, Ill 60656
NYTRONICS INC.

3rd Ave, Alpha, N J 08865
OCHMAN SYSTEMS, EDWARD

Po Box 141, Fairfield, Conn 06430
ORIGINAL COMPUTER PRODUCTS INC.

204 Worcester St, Wellesley Hills, Mass 02181
PIONEER ALUMINUM

3800 E 26th St, Los Angeles, Cal 90023
PREMIER METAL PRODUCTS CO.

337 Manida St, Bronx, N Y 10474
RAY PROOF CORP.

50 Keller Ave, Norwalk, Conn 06856
REPUBLIC STEEL CORP. MANUFACTURING DIV.

1315 Albert St, Youngstown, Ohio 44505
ROSEMOUNT PLUG-IN INC.

P O Box 107, Nashville, Tenn 37202
SCANBE MANUFACTURING CO.

3445 Fletcher Ave, El Monte, Cal 91750
SCIENTIFIC ATLANTA INC.

P O Box 16345, Atlanta, Ga 30345
TAB PRODUCTS

2690 Hanover St, Palo Alto, Cal 94304
TECHMAR CORP.

2232 S Cotner Ave, Los Angeles, Cal 90064
TYCO LABORATORIES INC.

16 Hickory Dr, Waltham, Mass 02154
URAY PROOF CORP.

50 Keeler Ave, Norwalk, Conn 06856
VECTOR ELECTRONIC CO. INC.

12460 Gladstone Ave, Sylmar, Cal 91342
VERO ELECTRONICS INC.

176 Central Ave, Farmingdale, N Y 11735
WARWICK PRODUCTS CO.

7909 Rockside Rd, Cleveland, Ohio 44131
XEROX DATA SYSTEMS

701 S Aviation, El Segundo, Cal 90245
ZERO MANUFACTURING CO. ZERO-WEST DIV.

1121 Chestnut St, Burbank, Cal 91503
ZERO MFG. CO. ZERO-KRESKY DIV.

2nd & H St, Petaluma, Cal 94952

CABINETS, RACKS, VAULTS (FOR MAGNETIC TAPE STORAGE)

ACRATOD COMPANY
Po Box 66847, Houston, Tex 77006
AMCO ENGINEERING CO.

7333 W Ainslie, Chicago, Ill 60656
AUDIO SUTTLE CORP. SUB OF RAY PROOF

50 Keeler Ave, Norwalk, Conn 06856
BARRY-WRIGHT CORP. WRIGHT LINE DIV.

160 Gold Star Blvd, Worcester, Mass 01606
COMPUTER ACCESSORIES CO.

131 W 154th St, Gardena, Cal 90248
DEXION INC.

39-27 59th St, New York, N Y 11377

DIEBOLD INC.

818 Mulberry Rd SE, Canton, Ohio 44702
DOLIN METAL PRODUCTS INC.

475 President St, Brooklyn, N Y 11215
ECONOMET INC.

1033 W Kirkwall Rd, Azusa, Cal 91702
ELECTRORACK PRODUCTS CO.

1742 S Clementine St, Anaheim, Cal 92802
ICA CORP.

200 N 3rd St, Minneapolis, Minn 55401
INGERSOLL PRODUCTS DIV. BORG- WARNER CORP.

1000 W 120th St, Chicago, Ill 60643
INTERNATIONAL COMPUTER APPLIANCES CORP.

200 N Third St, Minneapolis, Minn 55401
INTERNATIONAL COMPUTERS LTD.

lcl House Putney, London S W 15, UNITED K
MACS COMPUTER ACCESSORIES INC

104 Park Towne Pl, Philadelphia, Pa 19130
MONARCH METAL PRODUCTS INC.

Mac Arthur Ave, New Windsor, N Y 12550
MOSLER SAFE CO., THE INFO. SYS. DIV.

1561 Grand Blvd., Hamilton, Ohio 45012
NEWMADE PRODUCTS CORP.

P O Box 568, Scarsdale, N Y 10583
NUMERIDEX TAPE SYSTEMS INC.

4711 W North Ave, Chicago, Ill 60639
NYTRONICS INC.

3rd Ave, Alpha, N J 08865
OCHMAN SYSTEMS, EDWARD

Po Box 141, Fairfield, Conn 06430
ORIGINAL COMPUTER PRODUCTS INC.

204 Worcester St, Wellesley Hills, Mass 02181
PRYOR COMPUTER INDUSTRIES

400 N Michigan Ave, Chicago, Ill 60611
RAY PROOF CORP.

50 Keller Ave, Norwalk, Conn 06856
REMINGTON RAND OFFICE SYSTEMS DIV. SPERRY

RAND
P O Box 171, Marietta, Ohio 45750

REPUBLIC STEEL CORP. MANUFACTURING DIV.
1315 Albert St, Youngstown, Ohio 44505

SCHWAB SAFE CO. INC.
3000 Main St, Lafayette, Ind 47902

SHAW-WALKER CO.
P O Box 208, Muskegon, Mich 49443

SMITH SYSTEM MANUFACTURING CO.
56 Emerald St SE, Minneapolis, Minn 55414

STINAFFS INC.
181 E Exchange St, Akron, Ohio 44304

SUPREME EQUIPMENT & SYSTEMS CORP.
170 53rd St, Brooklyn, N Y 11232

TAB PRODUCTS
2690 Hanover St, Palo Alto, Cal 94304

TYCO LABORATORIES INC.
16 Hickory Dr, Waltham, Mass 02154

URAY PROOF CORP.
50 Keeler Ave, Norwalk, Conn 06856

VISIBLE COMPUTER SUPPLY CORP.
9865 Derby Ln, Westchester, Ill 60153

WARWICK PRODUCTS CO.
7909 Rockside Rd, Cleveland, Ohio 44131

ZERO MANUFACTURING CO. ZERO-WEST DIV.
1121 Chestnut St, Burbank, Cal 91503

ZERO MFG. CO. ZERO-KRESKY DIV.
2nd & H St, Petaluma, Cal 94952

CABINETS, TRAYS (FOR PUNCHED CARD STORAGE)

ACRATOD COMPANY

Po Box 66847, Houston, Tex 77006
BARRY-WRIGHT CORP. WRIGHT LINE DIV.

160 Gold Star Blvd, Worcester, Mass 01606
BORG-WARNER/INGERSOLL PRODUCTS/EMCOR

1000 W 120th St, Chicago, Ill 60643
BUSINESS SUPPLIES CORP. OF AMERICA

475 5th Ave, New York, N Y 10017
COMPUTER ACCESSORIES CO.

131 W 154th St, Gardena, Cal 90248
DIEBOLD INC.

818 Mulberry Rd SE, Canton, Ohio 44702
DOLIN METAL PRODUCTS INC.

475 President St, Brooklyn, N Y 11215
ECONOMET INC.

1033 W Kirkwall Rd, Azusa, Cal 91702
INGERSOLL PRODUCTS DIV. BORG- WARNER CORP.

1000 W 120th St, Chicago, Ill 60643
INTERNATIONAL COMPUTER APPLIANCES CORP.

200 N Third St, Minneapolis, Minn 55401
INTERNATIONAL COMPUTERS LTD.

lcl House Putney, London S W 15, UNITED K
LYON METAL PRODUCTS INC.

P O Box 671, Aurora, Ill 60507

2 Product Directory

MACS COMPUTER ACCESSORIES INC
104 Park Towne Pl, Philadelphia, Pa 19130

MONARCH METAL PRODUCTS INC.
Mac Arthur Ave, New Windsor, N Y 12550

MOSLER SAFE CO., THE INFO. SYS. DIV.
1561 Grand Blvd., Hamilton, Ohio 45012

NUMERIDEX TAPE SYSTEMS INC.
4711 W North Ave, Chicago, Ill 60639

NYTRONICS INC.
3rd Ave, Alpha, N J 08865

OCHMAN SYSTEMS, EDWARD
Po Box 141, Fairfield, Conn 06430

ORIGINAL COMPUTER PRODUCTS INC.
204 Worcester St, Wellesley Hills, Mass 02181

REPUBLIC STEEL CORP. MANUFACTURING DIV.
1315 Albert St, Youngstown, Ohio 44505

SHAW-WALKER CO.
P O Box 208, Muskegon, Mich 49443

STINAFFS INC.
181 E Exchange St, Akron, Ohio 44304

SUPREME EQUIPMENT & SYSTEMS CORP.
170 53rd St, Brooklyn, N Y 11232

TAB PRODUCTS
2690 Hanover St, Palo Alto, Cal 94304

VISIBLE COMPUTER SUPPLY CORP.
9865 Derby Ln, Westchester, Ill 60153

VISIRECORD
54 Railroad Ave, Copiague, N Y 11726

WARWICK PRODUCTS CO.
7909 Rockside Rd, Cleveland, Ohio 44131

WHEELDEX INC.
1000 N Division St, Peekskill, N Y 10566

ZERO MANUFACTURING CO. ZERO-WEST DIV.
1121 Chestnut St, Burbank, Cal 91503

ZERO MFG. CO. ZERO-KRESKY DIV.
2nd & H St, Petaluma, Cal 94952

CABLE ASSEMBLIES (WITH CONNECTORS)

A.D. CIRCUITS INC.
Panorama Creek Dr, Rochester, N Y 14625

ALDEN PRODUCTS CO.
117 N Main St, Brockton, Mass 02401

ANSLEY ELECTRONICS CORP. SUB. THOMAS & BETTS
Old Easton Rd, Doylestown, Pa 18901

ANSLEY MANUFACTURING CO. SUB. THOMAS & BETTS
4100 N Figueroa St, Los Angeles, Cal 90065

ARTISAN ELECTRONICS CORP.
5 Eastman Rd, Parsippany, N J 07054

ASTRO-SPACE LABS., INC.
110 Wynn Drive NW, Huntsville, Ala 35806

AUGAT INC.
33 Perry Ave, Attleboro, Mass 02703

AVCO CORP. ELECTRONICS DIV.
4807 Bradford, Huntsville, Ala 35805

BENDIX CORP., THE ELECTRICAL COMPONENTS DIV.
Sherman Ave, Sidney, N Y 13838

BOSTON INSULATED WIRE AND CABLE CO. INC.
65 Bay St, Boston, Mass 02102

CONTROL DATA CORP. CONNECTOR OPERATION
31829 W Latienda Dr, Westlake VII, Cal 91360

CYPRUS MINES CORP. ROME CABLE DIV.
421 Ridge St, Rome, N Y 13440

DIGITAL APPLICATIONS INC.
6300 Westpark Ste 150, Houston, Tex 77027

ELECTRONIC MOLDING CORP.
96 Mill St, Woonsocket, RI 02895

ELECTRONIZED CHEMICALS CORP.
S Bedford St, Burlington, Mass 01803

ELETRVERT INC.
86 Hartford Ave, Mt Vernon, N Y 10553

FARRINGTON MANUFACTURING CO.
6707 Electronics Dr, Springfield, Va 22151

FLEXIBLE CIRCUITS INC.
Paul Valley Ind Pk, Warrington, Pa 18976

GAP INSTRUMENT CORP.
110 Marcus Blvd, Hauppauge, N Y 11787

GORE & ASSOCIATES INC., W.L.
555 Papermill Rd, Newark, Del 19711

HITEMP WIRES INC.
12 Morris Ave., Glen Cove, N Y 11542

HUGHES AIRCRAFT CO. CONNECTING DEV. DIV
500 Superior Ave, Newport Beach, Cal 92663

ICORE ELECTRO-PLASTICS INC.
3015 Copper Rd, Santa Clara, Cal 95051

INTERDYNE
2217 Purdue Ave, Los Angeles, Cal 90064

ITT CANNON ELECTRIC DIV. ITT CORP.
3208 Humboldt St, Los Angeles, Cal 90031

JOHNSON CO., E.F.
299 Tenth Ave SW, Waseca, Minn 56093

KDI INTERACTIVE DATA SYSTEMS
17785 Skypark Circle, Irvine, Cal 92664

LANE-INDUSTRIES ELECTRONICS DIV.
7254 Atoil Ave, North Hollywood, Cal 91605

METHODE ELECTRONICS INC.
7447 W Wilson Ave, Chicago, Ill 60656

MICRO METRICS INC.
253 Crooks Ave, Clifton, N J 07011

MICRO SYSTEMS INC.
644 E Young St, Santa Ana, Cal 92705

MICRODATA CORP.
644 E Young St, Santa Ana, Cal 92705

MICRODOT INC. CONNECTOR & CABLE DIV.
220 Pasadena Ave, S Pasadena, Cal 91030

MOTOROLA INC. CONTROL SYSTEMS DIV
P O Box 5409, Phoenix, Ariz 85010

MULTIPLX COMMUNICATIONS INC.
123 Marcus Blvd, Hauppauge, N Y 11787

NORRICH PLASTIC CORP.
200 Allen Blvd, Farmingdale, N Y 11575

PHALO CORP. A TRANSITRON GROUP CO.
530 Boston Tpk, Shrewsbury, Mass 01545

POLY CABLE CO.
5235 N Rose St, Rosemont, Ill 60018

POMONA ELECTRONICS CO. INC.
1500 E 9th St, Pomona, Cal 91766

PRECISION TUBE CO. INC.
P O Box 176, North Wales, Pa 19454

RANK PRECISION INDUSTRIES INC.
260 N Rt 303, W Nyack, N Y 10994

ROBINSON-NUGENT INC.
800 E 8th St, New Albany, Ind 47150

ROBINTECH INC. E-M DIV.
P O Box 714, Binghamton, N Y 13902

ROGERS CORP.
Rogers, Conn 06263

ROLM, CORP.
10300 N Tantau, Cupertino, Cal 95014

ROWE INDUSTRIES INC.
1702 Airport Hwy, Toledo, Ohio 43609

SEAELECTRO CORP.
225 Hoyt St, Mamaroneck, N Y 10543

SOLITRON DEVICES INC.
256 Oak Tree Rd, Tappan, N Y 10983

STANDARD WIRE AND CABLE CO.
3440 Overland Ave, Los Angeles, Cal 90034

SWITCHCRAFT INC.
5555 N Elston Ave, Chicago, Ill 60630

TELEDYNE BROWN ENGINEERING
300 Sparkman Dr, Huntsville, Ala 35807

TIMES WIRE & CABLE CO. SUB. INSILCO CORP.
358 Hall Ave, Wallingford, Conn 06492

TRANSITRON ELECTRONIC CORP.
168 Albion St, Wakefield, Mass 01880

TROMPETER ELECTRONICS INC.
8936 Comanche Ave, Chatsworth, Cal 91311

U.S. COMPONENTS INC.
1320 Zerega Ave, Bronx, N Y 10462

VIKING INDUSTRIES INC.
21001 Nordhoff St, Chatsworth, Cal 91311

VIRGINIA ELECTRONICS CO. INC.
2901 Telearstar Court, Falls Church, Va 22042

ZIPPERTUBING CO.
13000 S Broadway, Los Angeles, Cal 90061

CABLE, COAXIAL (FLEXIBLE)

ALCOR INC.
215 S Tioga St, Ithaca, N Y 14050

BENDIX CORP., THE ELECTRICAL COMPONENTS DIV.
Sherman Ave, Sidney, N Y 13838

BOSTON INSULATED WIRE AND CABLE CO. INC.
65 Bay St, Boston, Mass 02102

BRAND-REX SUB. AKZONA
P O Box 498, Willimantic, Conn 06226

CALMONT ENGINEERING & ELECTRONICS CORP.
420 E Alton St, Santa Ana, Cal 92707

CHESTER CABLE OPERATION CITIES SERVICE CO.
Oakland Ave, Chester, N Y 10918

CICOIL CORP.
9324 Topanga Cyn Blvd, Chatsworth, Cal 91311

COMM/SCOPE CORP. A SUPERIOR CONTINENTAL CO.
P O Box 2406, Hickory, N Y 28601

CONSOLIDATED WIRE AND ASSOCIATED CORPS.
1635 S Clinton St, Chicago, Ill 60616

CYPRUS MINES CORP. ROME CABLE DIV.
421 Ridge St, Rome, N Y 13440

ELECTRONIZED CHEMICALS CORP.
S Bedford St, Burlington, Mass 01803

ELECTRONIZED CHEMICALS CORP. JUDD WIRE DIV.
50 Turnpike Rd, Turners Falls, Mass 01376

ESSEX INTERNATIONAL IND. WIRE PDTS. DIV
6235 S Harlem Ave, Chicago, Ill 60638

ESSEX WIRE & CABLE CO.
1601 Wall St, Ft Wayne, Ind 46804

FLEXIBLE CIRCUITS INC.
Paul Valley Ind Pk, Warrington, Pa 18976

GARRETT ELECTRONICS & CABLE CO.
24 Central Dr, Farmingdale, N Y 11735

GENERAL CABLE CORP.
730 3rd Ave, New York, N Y 10017

GENERAL ELECTRIC CO. WIRE & CABLE DEPT.
1285 Boston Ave, Bridgeport, Conn 06602

GORE & ASSOCIATES INC., W.L.
555 Papermill Rd, Newark, Del 19711

HITEMP WIRES INC.
12 Morris Ave., Glen Cove, N Y 11542

ICORE ELECTRO-PLASTICS INC.
3015 Copper Rd, Santa Clara, Cal 95051

LENZ ELECTRIC MANUFACTURING CO.
1751 N Western Ave, Chicago, Ill 60647

MARKEL AND SONS, L. FRANK
School Lane, Norristown, Pa 19404

MICRODOT INC. CONNECTOR & CABLE DIV.
220 Pasadena Ave, S Pasadena, Cal 91030

NYTRONICS INC.
3rd Ave, Alpha, N J 08865

PAIGE ELECTRIC CORP.
10 Commerce Court, Newark, N J 07102

PHALO CORP. A TRANSITRON GROUP CO.
530 Boston Tpk, Shrewsbury, Mass 01545

PROTOTYPE ASSEMBLIES INC.
70 Jaconnet St, Newton Hglds, Mass 02161

ROBINSON-NUGENT INC.
800 E 8th St, New Albany, Ind 47150

ROWE INDUSTRIES INC.
1702 Airport Hwy, Toledo, Ohio 43609

SOLITRON DEVICES INC.
256 Oak Tree Rd, Tappan, N Y 10983

SOLITRON DEVICES INC. TRANSISTOR DIV.
1177 Blue Heron Blvd, Riviera Beach, Fla 33404

STANDARD WIRE AND CABLE CO.
3440 Overland Ave, Los Angeles, Cal 90034

TIMES WIRE & CABLE CO. SUB. INSILCO CORP.
358 Hall Ave, Wallingford, Conn 06492

TRANSITRON ELECTRONIC CORP.
168 Albion St, Wakefield, Mass 01880

TROMPETER ELECTRONICS INC.
8936 Comanche Ave, Chatsworth, Cal 91311

TRW AND CABLE DIV.
720 Main St, Holyoke, Mass 01040

UNIVERSITY COMPUTING CO.
888 N Sepulveda Blvd, El Segundo, Cal 90245

ZIPPERTUBING CO.
13000 S Broadway, Los Angeles, Cal 90061

CABLE, COAXIAL (SEMI/RIGID)

BENDIX CORP., THE ELECTRICAL COMPONENTS DIV.
Sherman Ave, Sidney, N Y 13838

BRAND-REX SUB. AKZONA
P O Box 498, Willimantic, Conn 06226

CHESTER CABLE OPERATION CITIES SERVICE CO.
Oakland Ave, Chester, N Y 10918

COMM/SCOPE CORP. A SUPERIOR CONTINENTAL CO.
P O Box 2406, Hickory, N Y 28601

CONSOLIDATED WIRE AND ASSOCIATED CORPS.
1635 S Clinton St, Chicago, Ill 60616

CYPRUS MINES CORP. ROME CABLE DIV.
421 Ridge St, Rome, N Y 13440

ELECTRONIZED CHEMICALS CORP.
S Bedford St, Burlington, Mass 01803

ELECTRONIZED CHEMICALS CORP. JUDD WIRE DIV.
50 Turnpike Rd, Turners Falls, Mass 01376

ESSEX INTERNATIONAL IND. WIRE PDTS. DIV
6235 S Harlem Ave, Chicago, Ill 60638

ESSEX WIRE & CABLE CO.
1601 Wall St, Ft Wayne, Ind 46804

GARRETT ELECTRONICS & CABLE CO.
24 Central Dr, Farmingdale, N Y 11735

GENERAL CABLE CORP.
730 3rd Ave, New York, N Y 10017

GENERAL ELECTRIC CO. WIRE & CABLE DEPT.
1285 Boston Ave, Bridgeport, Conn 06602

HITEMP WIRES INC.
12 Morris Ave., Glen Cove, N Y 11542

MARKEL AND SONS, L. FRANK
School Lane, Norristown, Pa 19404

MICRODOT INC. CONNECTOR & CABLE DIV.
220 Pasadena Ave, S Pasadena, Cal 91030

NYTRONICS INC.
3rd Ave, Alpha, N J 08865

PAIGE ELECTRIC CORP.
10 Commerce Court, Newark, N J 07102

PHALO CORP. A TRANSITRON GROUP CO.
530 Boston Tpk, Shrewsbury, Mass 01545

2 Product Directory

PRECISION TUBE CO. INC.
P O Box 176, North Wales, Pa 19454
PROTOTYPE ASSEMBLIES INC.
70 Jaconnet St, Newton Hglds, Mass 02161
ROWE INDUSTRIES INC.
1702 Airport Hwy, Toledo, Ohio 43609
SOLITRON DEVICES INC.
256 Oak Tree Rd, Tappan, N Y 10983
SOLITRON DEVICES INC. TRANSISTOR DIV.
1177 Blue Heron Blvd, Riviera Beach, Fla 33404
STANDARD WIRE AND CABLE CO.
3440 Overland Ave, Los Angeles, Cal 90034
TIMES WIRE & CABLE CO. SUB. INSILCO CORP.
358 Hall Ave, Wallingford, Conn 06492
TRANSITRON ELECTRONIC CORP.
168 Albion St, Wakefield, Mass 01880
TRW AND CABLE DIV.
720 Main St, Holyoke, Mass 01040
UNIVERSITY COMPUTING CO.
888 N Sepulveda Blvd, El Segundo, Cal 90245
ZIPPERTUBING CO.
13000 S Broadway, Los Angeles, Cal 90061

CABLE, FINE LEAD

BENDIX CORP., THE ELECTRICAL COMPONENTS DIV.
Sherman Ave, Sidney, N Y 13838
BRAND-REX SUB. AKZONA
P O Box 498, Willimantic, Conn 06226
CALMONT ENGINEERING & ELECTRONICS CORP.
420 E Alton St, Santa Ana, Cal 92707
CICOIL CORP.
9324 Topanga Cyn Blvd, Chatsworth, Cal 91311
CONSOLIDATED WIRE AND ASSOCIATED CORPS.
1635 S Clinton St, Chicago, Ill 60616
CYPRUS MINES CORP. ROME CABLE DIV.
421 Ridge St, Rome, N Y 13440
ELECTRONIZED CHEMICALS CORP.
S Bedford St, Burlington, Mass 01803
ELECTRONIZED CHEMICALS CORP. JUDD WIRE DIV.
50 Turnpike Rd, Turners Falls, Mass 01376
ESSEX INTERNATIONAL IND. WIRE PDTS. DIV
6235 S Harlem Ave, Chicago, Ill 60638
GARRETT ELECTRONICS & CABLE CO.
24 Central Dr, Farmingdale, N Y 11735
GENERAL CABLE CORP.
730 3rd Ave, New York, N Y 10017
GENERAL ELECTRIC CO. WIRE & CABLE DEPT.
1285 Boston Ave, Bridgeport, Conn 06602
GORE & ASSOCIATES INC., W.L.
555 Papermill Rd, Newark, Del 19711
HITEMP WIRES INC.
12 Morris Ave., Glen Cove, N Y 11542
LANE INDUSTRIES ELECTRONICS DIV.
7254 Atoll Ave, North Hollywood, Cal 91605
METHODE ELECTRONICS INC.
7447 W Wilson Ave, Chicago, Ill 60656
NYTRONICS INC.
3rd Ave, Alpha, N J 08865
PAIGE ELECTRIC CORP.
10 Commerce Court, Newark, N J 07102
PHALO CORP. A TRANSITRON GROUP CO.
530 Boston Tpk, Shrewsbury, Mass 01545
PROTOTYPE ASSEMBLIES INC.
70 Jaconnet St, Newton Hglds, Mass 02161
ROWE INDUSTRIES INC.
1702 Airport Hwy, Toledo, Ohio 43609
SANDERS ASSOCIATES INC. SYSTEMS DIV.
Daniel Webster Hwy S, Nashua, N H 03060
SPECTRA-STRIP CORP.
7100 Lampson Ave, Garden Grove, Cal 92642
STANDARD WIRE AND CABLE CO.
3440 Overland Ave, Los Angeles, Cal 90034
TRANSITRON ELECTRONIC CORP.
168 Albion St, Wakefield, Mass 01880
TRW AND CABLE DIV.
720 Main St, Holyoke, Mass 01040
ZIPPERTUBING CO.
13000 S Broadway, Los Angeles, Cal 90061

CABLE, FLAT, PRINTED AND RIBBON

ANSLEY ELECTRONICS CORP. SUB. THOMAS & BETTS
Old Easton Rd, Doylestown, Pa 18901
ANSLEY MANUFACTURING CO. SUB. THOMAS & BETTS
4100 N Figueroa St, Los Angeles, Cal 90065
AUGAT INC.
33 Perry Ave, Attleboro, Mass 02703
BRAND-REX SUB. AKZONA
P O Box 498, Willimantic, Conn 06226
BURNDY CORP.
Richard Ave, Norwalk, Conn 06852
CABLE-TECH INC.
P O Box 177, Staffordville, Conn 06077
CALMONT ENGINEERING & ELECTRONICS CORP.
420 E Alton St, Santa Ana, Cal 92707
CHESTER CABLE OPERATION CITIES SERVICE CO.
Oakland Ave, Chester, N Y 10918

CICOIL CORP.
9324 Topanga Cyn Blvd, Chatsworth, Cal 91311
CONSOLIDATED WIRE AND ASSOCIATED CORPS.
1635 S Clinton St, Chicago, Ill 60616
ELECTRALAB DIV. TYCO LABORATORIES INC.
P O Box 548, Encinitas, Cal 92024
ELECTRONIZED CHEMICALS CORP.
S Bedford St, Burlington, Mass 01803
ELECTRONIZED CHEMICALS CORP. JUDD WIRE DIV.
50 Turnpike Rd, Turners Falls, Mass 01376
ESSEX WIRE & CABLE CO.
1601 Wall St, Ft Wayne, Ind 46804
FLEXIBLE CIRCUITS INC.
Paul Valley Ind Pk, Warrington, Pa 18976
GENERAL CIRCUITS INC.
95 Mt Read Blvd, Rochester, N Y 14611
GORE & ASSOCIATES INC., W.L.
555 Papermill Rd, Newark, Del 19711
HITEMP WIRES INC.
12 Morris Ave., Glen Cove, N Y 11542
HUGHES AIRCRAFT CO. CONNECTING DEV. DIV
500 Superior Ave, Newport Beach, Cal 92663
IDEAS INC.
118 Grand Ave, Laramie, Wyo 82070
INSTRUTEC CORP. INSTRUMENT WIRE DIV
7 Just Rd, Fairfield, N J 07006
ITT CANNON ELECTRIC DIV. ITT CORP.
3208 Humboldt St, Los Angeles, Cal 90031
LANE INDUSTRIES ELECTRONICS DIV.
7254 Atoll Ave, North Hollywood, Cal 91605
3M CO.
3m Center, St Paul, Minn 55101
METHODE ELECTRONICS INC.
7447 W Wilson Ave, Chicago, Ill 60656
MICRO SYSTEMS INC.
644 E Young St, Santa Ana, Cal 92705
MICRODATA CORP.
644 E Young St, Santa Ana, Cal 92705
PAIGE ELECTRIC CORP.
10 Commerce Court, Newark, N J 07102
PHALO CORP. A TRANSITRON GROUP CO.
530 Boston Tpk, Shrewsbury, Mass 01545
POLY CABLE CO.
5235 N Rose St, Rosemont, Ill 60018
PROTOTYPE ASSEMBLIES INC.
70 Jaconnet St, Newton Hglds, Mass 02161
ROGERS CORP.
Rogers, Conn 06263
ROWE INDUSTRIES INC.
1702 Airport Hwy, Toledo, Ohio 43609
SANDERS ASSOCIATES INC. SYSTEMS DIV.
Daniel Webster Hwy S, Nashua, N H 03060
SPECTRA-STRIP CORP.
7100 Lampson Ave, Garden Grove, Cal 92642
STANDARD WIRE AND CABLE CO.
3440 Overland Ave, Los Angeles, Cal 90034
TRANSITRON ELECTRONIC CORP.
168 Albion St, Wakefield, Mass 01880
TRW AND CABLE DIV.
720 Main St, Holyoke, Mass 01040
ZIPPERTUBING CO.
13000 S Broadway, Los Angeles, Cal 90061

CABLE, MULTICONDUCTOR

ANSLEY ELECTRONICS CORP. SUB. THOMAS & BETTS
Old Easton Rd, Doylestown, Pa 18901
ANSLEY MANUFACTURING CO. SUB. THOMAS & BETTS
4100 N Figueroa St, Los Angeles, Cal 90065
BENDIX CORP., THE ELECTRICAL COMPONENTS DIV.
Sherman Ave, Sidney, N Y 13838
BOSTON INSULATED WIRE AND CABLE CO. INC.
65 Bay St, Boston, Mass 02102
BRAND-REX SUB. AKZONA
P O Box 498, Willimantic, Conn 06226
CABLE-TECH INC.
P O Box 177, Staffordville, Conn 06077
CALMONT ENGINEERING & ELECTRONICS CORP.
420 E Alton St, Santa Ana, Cal 92707
CHESTER CABLE OPERATION CITIES SERVICE CO.
Oakland Ave, Chester, N Y 10918
CICOIL CORP.
9324 Topanga Cyn Blvd, Chatsworth, Cal 91311
CONSOLIDATED WIRE AND ASSOCIATED CORPS.
1635 S Clinton St, Chicago, Ill 60616
CYPRUS MINES CORP. ROME CABLE DIV.
421 Ridge St, Rome, N Y 13440
ELECTRALAB DIV. TYCO LABORATORIES INC.
P O Box 548, Encinitas, Cal 92024
ELECTRONIZED CHEMICALS CORP.
S Bedford St, Burlington, Mass 01803
ELECTRONIZED CHEMICALS CORP. JUDD WIRE DIV.
50 Turnpike Rd, Turners Falls, Mass 01376

ESSEX INTERNATIONAL IND. WIRE PDTS. DIV
6235 S Harlem Ave, Chicago, Ill 60638
ESSEX WIRE & CABLE CO.
1601 Wall St, Ft Wayne, Ind 46804
GENERAL CABLE CORP.
730 3rd Ave, New York, N Y 10017
GENERAL CIRCUITS INC.
95 Mt Read Blvd, Rochester, N Y 14611
GENERAL ELECTRIC CO. WIRE & CABLE DEPT.
1285 Boston Ave, Bridgeport, Conn 06602
GORE & ASSOCIATES INC., W.L.
555 Papermill Rd, Newark, Del 19711
HITEMP WIRES INC.
12 Morris Ave., Glen Cove, N Y 11542
IDEAS INC.
118 Grand Ave, Laramie, Wyo 82070
LANE INDUSTRIES ELECTRONICS DIV.
7254 Atoll Ave, North Hollywood, Cal 91605
LENZ ELECTRIC MANUFACTURING CO.
1751 N Western Ave, Chicago, Ill 60647
MARKEL AND SONS, L. FRANK
School Lane, Norristown, Pa 19404
MICRODATA CORP.
644 E Young St, Santa Ana, Cal 92705
MICRODOT INC. CONNECTOR & CABLE DIV.
220 Pasadena Ave, S Pasadena, Cal 91030
MILLETRON INC.
540 Alpha Dr, Pittsburgh, Pa 15238
MOORE & CO., SAMUEL
Main & Orchard, Mantua, Ohio 44255
NYTRONICS INC.
3rd Ave, Alpha, N J 08865
OKONITE CO., THE, WIRE & CABLE DIV.
P O Box 340, Ramsey, N J 07446
PAIGE ELECTRIC CORP.
10 Commerce Court, Newark, N J 07102
PER DATA
102 New South Rd, Hicksville, N Y 11801
PHALO CORP. A TRANSITRON GROUP CO.
530 Boston Tpk, Shrewsbury, Mass 01545
PROTOTYPE ASSEMBLIES INC.
70 Jaconnet St, Newton Hglds, Mass 02161
ROWE INDUSTRIES INC.
1702 Airport Hwy, Toledo, Ohio 43609
SPECTRA-STRIP CORP.
7100 Lampson Ave, Garden Grove, Cal 92642
STANDARD WIRE AND CABLE CO.
3440 Overland Ave, Los Angeles, Cal 90034
SUPERIOR CABLE & EQUIPMENT DIV. SUPERIOR
CANT.
P O Box 489, Hickory, N C 28601
TIMES WIRE & CABLE CO. SUB. INSILCO CORP.
358 Hall Ave, Wallingford, Conn 06492
TRANSITRON ELECTRONIC CORP.
168 Albion St, Wakefield, Mass 01880
TRW AND CABLE DIV.
720 Main St, Holyoke, Mass 01040
ZIPPERTUBING CO.
13000 S Broadway, Los Angeles, Cal 90061

CABLE, SHIELDED (NOT COAXIAL)

ANSLEY ELECTRONICS CORP. SUB. THOMAS & BETTS
Old Easton Rd, Doylestown, Pa 18901
ANSLEY MANUFACTURING CO. SUB. THOMAS & BETTS
4100 N Figueroa St, Los Angeles, Cal 90065
BENDIX CORP., THE ELECTRICAL COMPONENTS DIV.
Sherman Ave, Sidney, N Y 13838
BOSTON INSULATED WIRE AND CABLE CO. INC.
65 Bay St, Boston, Mass 02102
BRAND-REX SUB. AKZONA
P O Box 498, Willimantic, Conn 06226
CALMONT ENGINEERING & ELECTRONICS CORP.
420 E Alton St, Santa Ana, Cal 92707
CHESTER CABLE OPERATION CITIES SERVICE CO.
Oakland Ave, Chester, N Y 10918
CICOIL CORP.
9324 Topanga Cyn Blvd, Chatsworth, Cal 91311
CONSOLIDATED WIRE AND ASSOCIATED CORPS.
1635 S Clinton St, Chicago, Ill 60616
CYPRUS MINES CORP. ROME CABLE DIV.
421 Ridge St, Rome, N Y 13440
ELECTRONIZED CHEMICALS CORP.
S Bedford St, Burlington, Mass 01803
ELECTRONIZED CHEMICALS CORP. JUDD WIRE DIV.
50 Turnpike Rd, Turners Falls, Mass 01376
ESSEX INTERNATIONAL IND. WIRE PDTS. DIV
6235 S Harlem Ave, Chicago, Ill 60638
ESSEX WIRE & CABLE CO.
1601 Wall St, Ft Wayne, Ind 46804
FLEXIBLE CIRCUITS INC.
Paul Valley Ind Pk, Warrington, Pa 18976

2 Product Directory

GENERAL CABLE CORP.
730 3rd Ave, New York, N Y 10017
GENERAL ELECTRIC CO. WIRE & CABLE DEPT.
1285 Boston Ave, Bridgeport, Conn 06602
GORE & ASSOCIATES INC., W.L.
555 Papermill Rd, Newark, Del 19711
HITEMP WIRES INC.
12 Morris Ave., Glen Cove, N Y 11542
ICORE ELECTRO-PLASTICS INC.
3015 Copper Rd, Santa Clara, Cal 95051
LENZ ELECTRIC MANUFACTURING CO.
1751 N Western Ave, Chicago, Ill 60647
MARKEL AND SONS, L. FRANK
School Lane, Norristown, Pa 19404
MILLETRON INC.
540 Alpha Dr, Pittsburgh, Pa 15238
MOORE & CO., SAMUEL
Main & Orchard, Mantua, Ohio 44255
NYTRONICS INC.
3rd Ave, Alpha, N J 08865
OKONITE CO., THE, WIRE & CABLE DIV.
P O Box 340, Ramsey, N J 07446
PAIGE ELECTRIC CORP.
10 Commerce Court, Newark, N J 07102
PENNWALT CORP.
3 Penn Ctr, Philadelphia, Pa 19102
PER DATA
102 New South Rd, Hicksville, N Y 11801
PERFECTION MICA CO. MAGNETIC SHIELD DIV
748 Thomas Dr, Bensenville, Ill 60106
PHALO CORP. A TRANSTRON GROUP CO.
530 Boston Tpk, Shrewsbury, Mass 01545
POLY CABLE CO.
5235 N Rose St, Rosemont, Ill 60018
PROTOTYPE ASSEMBLIES INC.
70 Jaconnet St, Newton Hglds, Mass 02161
ROGERS CORP.
Rogers, Conn 06263
ROWE INDUSTRIES INC.
1702 Airport Hwy, Toledo, Ohio 43609
STANDARD WIRE AND CABLE CO.
3440 Overland Ave, Los Angeles, Cal 90034
SUPERIOR CABLE & EQUIPMENT DIV. SUPERIOR
CONT.
P O Box 489, Hickory, N C 28601
SWITCHCRAFT INC.
5555 N Elston Ave, Chicago, Ill 60630
TIMES WIRE & CABLE CO. SUB. INSILCO CORP.
358 Hall Ave, Wallingford, Conn 06492
TRANSTRON ELECTRONIC CORP.
168 Albion St, Wakefield, Mass 01880
TRW AND CABLE DIV.
720 Main St, Holyoke, Mass 01040
ZIPPERTUBING CO.
13000 S Broadway, Los Angeles, Cal 90061

CALCULATORS, PROGRAMMABLE (ALSO SEE COMPUTERS)

BURROUGHS CORP., BUSINESS MACHINES GROUP
6071 2nd Ave, Detroit, Mich 48232
BUSICOM U.S.A. INC.
31 E 28th St, New York, N Y 10016
CANON U.S.A. INC.
64-10 Queens Blvd, Woodside, N Y 11377
CITIZEN AMERICA CORP.
9201 Olympic Blvd, Beverly Hills, Cal 90212
COMPUTER AUTOMATION INC.
895 W 16th St, Newport Beach, Cal 92660
COMPUTER DESIGN CORP.
12401 W Olympic Blvd, Los Angeles, Cal 90064
DATA GENERAL CORP.
Rte 9, Southboro, Mass 01772
DIETZGEN CO., EUGENE
2425 N Sheffield, Chicago, Ill 60614
HEWLETT PACKARD CO.
1501 Page Mill Rd, Palo Alto, Cal 94304
IBM CORP., DATA PROCESSING DIV.
1133 Westchester Ave, White Plains, N Y 10604
IME SALES CORP.
7800 River, North Bergen, N J 07047
IOA DATA CORP.
383 Lafayette St, New York, N Y 10003
MATHATRONICS OF PENNSYLVANIA INC.
241 Crescent St, Waltham, Mass 02154
MONROE, THE CALCULATOR CO. DIV. LITTON INDUS.
550 Central Ave, Orange, N J 07051
OLIVETTI CORP. OF AMERICA
500 Park Ave, New York, N Y 10016
SCM CORP. SMITH CORONA MARCHANT DIV.
299 Park Ave, New York, N Y 10017
SINGER CO., THE, FRIDEN DIV.
2350 Washington St, San Leandro, Cal 94577

TECHNICAL ADVISORS INC.
4455 Fletcher St, Wayne, Mich 48184
UNIVERSITY COMPUTING CO.
888 N Sepulveda Blvd, El Segundo, Cal 90245
WANG LABORATORIES INC.
836 N St, Tewksbury, Mass 01876

CALCULATORS, PROGRAMMABLE (ALSO SEE COMPUTERS)

CAMERAS, COM

BABCOCK & WILCOX LTD.
Coronahon Blvd, Galt Ontario, CANADA
BOURNS/CAI INC. PACIFIC OPTICAL DIV
5221 W 102nd St, Los Angeles, Cal 90045
BURROUGHS CORP., BUSINESS MACHINES GROUP
6071 2nd Ave, Detroit, Mich 48232
CANON U.S.A. INC.
64-10 Queens Blvd, Woodside, N Y 11377
COMPUTER MICRO-IMAGE SYSTEMS INC.
9600 Desoto Ave, Chatsworth, Cal 91311
CONTROL DATA CORP.
8100 34th Ave S, Minneapolis, Minn 55440
GORDON ENTERPRISES INC., ALAN
5362 Cahuenga Blvd, N Hollywood, Cal 91601
TEKTRONIX INC.
P O Box 500, Beaverton, Ore 97005
TERMINAL DATA CORP.
16130 Stagg St, Van Nuys, Cal 91324
TRAID CORP., PHOTO INSTRUMENT DIV.
900 Grand Central, Glendale, Cal 91201
UNIVERSITY COMPUTING CO. GRAPHIC SYSTEMS DIV
14761 Califa St, Van Nuys, Cal 91401

CAMERAS, DATA RECORDING (EXCL. OSCILLOSCOPES)

ADVANCED TERMINALS INC.
220 3rd Ave, Herkimer, N Y 13350
BFA CORP.
1309 S Inca, Denver, Colo 80223
COMPUTER MICRO-IMAGE SYSTEMS INC.
9600 Desoto Ave, Chatsworth, Cal 91311
GORDON ENTERPRISES INC., ALAN
5362 Cahuenga Blvd, N Hollywood, Cal 91601
ITEK CORP.
10 Maguire Rd, Lexington, Mass 02173
PHOTO TECHNICAL PRODUCTS INC. SUB. EPOI
623 Stewart Ave, Garden City, N Y 11530
TRAID CORP., PHOTO INSTRUMENT DIV.
900 Grand Central, Glendale, Cal 91201

CAMERAS, OCR

TERMINAL DATA CORP.
16130 Stagg St, Van Nuys, Cal 91324

CANNISTERS, MAGNETIC TAPE

ACRATOD COMPANY
Po Box 66847, Houston, Tex 77006
AMPEX CORP. MAGNETIC TAPE DIV.
401 Broadway, Redwood City, Cal 94063
BARRY-WRIGHT CORP. WRIGHT LINE DIV.
160 Gold Star Blvd, Worcester, Mass 01606
COMPUTER ACCESSORIES CO.
131 W 154th St, Gardena, Cal 90248
DATA PACKAGING CORP.
205 Broadway, Cambridge, Mass 02139
INDEL INC.
P O Box 15800, Tulsa, Okla 74115
INTERNATIONAL COMPUTERS LTD.
1cl House Putney, London S W 15, UNITED K
3M CO. MAGNETIC PRODUCTS DIV.
3 M Ctr, St Paul, Minn 55101
MACS COMPUTER ACCESSORIES INC
104 Park Towne Pl, Philadelphia, Pa 19130
MONARCH METAL PRODUCTS INC.
Mac Arthur Ave, New Windsor, N Y 12550
OCHMAN SYSTEMS, EDWARD
Po Box 141, Fairfield, Conn 06430
ORIGINAL COMPUTER PRODUCTS INC.
204 Worcester St, Wellesley Hills, Mass 02181
PRYOR COMPUTER INDUSTRIES
400 N Michigan Ave, Chicago, Ill 60611
SYNCOM INC. SHIELDATA DIV.
1914 Colvin Ave, Tonawanda, N Y 14150
TAB PRODUCTS
2690 Hanover St, Palo Alto, Cal 94304

CAPACITORS, COMPUTER GRADE

AEROVOX CORP.
740 Belleville Ave, New Bedford, Mass 02741
AIRCO SPEER ELECTRONICS, DIV. OF AIR REDUCTION
CO
800 Theresia St, St Marys, Pa 15857
AMERICAN COMPONENTS INC.
8th Ave And Harry St, Conshohocken, Pa 19428
AMERICAN LAVA CORP. SUB. OF 3M CO.
Manufacturer's Rd, Chattanooga, Tenn 37405
ITT SEMICONDUCTORS
3301 Electronics Way, W Palm Beach, Fla 33407
CAL-R INC. DIV. OF CAP-TECH.
1601 Olympic Blvd, Santa Monica, Cal 90404
COMPONENT RESEARCH CO. INC.
1719 19 St, Santa Monica, Cal 90404
COMPONENTS INC.
Smith St, Biddeford, Me 04005
CORNELL-DUBILIER ELECTRONICS
150 Avenue L, Newark, N J 07101
CORNING GLASS WORKS
Houghton Park, Corning, N Y 14830
DEL ELECTRONIC CORP.
250 Sandford Blvd, Mt Vernon, N Y 10550
ELECTRO MOTIVE MANUFACTURING CO. INC.
South Park St, Willimantic, Conn 06226
ELECTRONIC ASSOCIATES INC.
485 Monmouth Pkwy, W Long Branch, N J 07764
ELNETIC ELECTRONICS INC.
2100 Zeno Pl, Venice, Cal 90291
ENGINEERED COMPONENTS CO.
2134 W Rosecrans Ave, Gardena, Cal 90249
ERIE TECHNOLOGICAL PRODUCTS INC.
644 W 12th St, Erie, Pa 16512
GULTON INDUSTRIES INC. GUEDEMAN DIV.
340 W Huron St, Chicago, Ill 60610
INDUSTRIAL CONDENSER CORP.
3243 N California Ave, Chicago, Ill 60618
3M CO.
3m Center, St Paul, Minn 55101
MALLORY & CO. INC., P.R.
3029 E Washington, Indianapolis, Ind 46218
MONOLITHIC DIELECTRICS INC.
P O Box 647, Burbank, Cal 91503
MONOLITHIC DIELECTRICS INC.
P O Box 647, Burbank, Cal 91503
NUCLEONIC PRODUCTS CO. INC.
6660 Variel Ave, Canoga Park, Cal 91303
NYTRONICS INC.
3rd Ave, Alpha, N J 08865
PAKTRON, DIV. ILLINOIS TOOL WORKS, INC.
1321 Leslie Ave, Alexandria, Va 22301
PFC MFG. DIV. ARCO/DIV. LORAL
Community Dr, Great Neck, N Y 11022
PLASTIC CAPACITORS INC.
2620 N Clybourn Ave, Chicago, Ill 60614
PURDY CORP., WM. J.
770 Airport Blvd, Burlingame, Cal 94010
REPUBLIC ELECTRONICS CORP.
176 E 7th St, Paterson, N J 07524
SANGAMO ELECTRIC CO.
P O Box 3347, Springfield, Ill 62708
SKOTTIE ELECTRONICS, INC.
Line St, Archbald, Pa 18403
SPRAGUE ELECTRIC CO.
551 Marshall St, N Adams, Mass 01247
STETTNER-TRUSH INC.
67 Albany St, Cazenovia, N Y 13035
TANSITOR ELECTRONICS INC.
West Rd, Bennington, Vt 05201
TRW INC. CAPACITOR DIV.
112 W 1st St, Oeallala, Neb 69153
U.S. CAPACITOR CORP.
2151 N Lincoln St, Burbank, Cal 91504
UNION CARBIDE CORP. COMPONENTS DEPT.
P O Box 5928, Greenville, S C 29606
WESCO ELECTRICAL CO. INC.
27 Olive St, Greenfield, Mass 01301

CAPSTANS, IDLERS, AND GUIDES (FOR TAPE DRIVES)

MPB CORP.
Precision Park, Keene, N H 03431
STRATOJET CORP.
P O Box 909, Azusa, Cal 91702

2 Product Directory

CARD PUNCHES (SEE PUNCHES)

CARD READERS (SEE READERS)

CARD READER/PUNCHES (SEE READER/PUNCHES)

CARDS, CONVENTIONAL PUNCH

ABINGTON KEYPUNCH INC.
920 Fox Chase Rd, Rockledge, Pa 19111
ADVANCED COMPUTER SUPPLIES INC.
Bldg 529 Raritan Ctr, Edison, N J 08817
BUSINESS SUPPLIES CORP. OF AMERICA
475 5th Ave, New York, N Y 10017
COMPUTER ACCESSORIES CO.
131 W 154th St, Gardena, Cal 90248
CYBERMATICS INC.
2460 Lemoine Ave, Fort Lee, N J 07024
DATA DOCUMENTS INC.
105 S 70th St, Omaha, Nebr 68132
DATA PACIFIC CORP.
116 E Ash, Fullerton, Cal 92631
ELDORADO ELECTRODATA
601 Chalomar Rd, Concord, Cal 94520
GRECO ENTERPRISES INC. TSA DATA DIV.
2000 Texas, El Paso, Tex 79901
HACKETT CORP.
2100 W Fullerton Ave, Chicago, Ill 60647
INTERNATIONAL COMPUTERS LTD.
1cl House Putney, London S W 15, UNITED K
JERSEY TAB CARD CORP.
649 Rahway Ave, Union, N J 07083
LEWIS BUSINESS FORMS INC.
P O Box M, Jacksonville, Fla 32203
MOORE BUSINESS FORMS INC.
110-112 Pkwy Inn Bldg, Niagara Falls, N Y 14302
MORLEY CO., THE
909 Islington St, Portsmouth, N H 03801
NCR INDUSTRIAL PRODUCTS DIV.
Main And K St, Dayton, Ohio 45409
OMNITEC CORP. A NYTRONICS CORP.
903 N 2nd St, Phoenix, Ariz 85004
PRYOR COMPUTER INDUSTRIES
400 N Michigan Ave, Chicago, Ill 60611
SCM ALLIED EGRY BUSINESS SYSTEMS
P O Box 125 Wc Br, Dayton, Ohio 45449
STINAFFS INC.
181 E Exchange St, Akron, Ohio 44304
VISIRECORD
54 Railroad Ave, Copiague, N Y 11726

CARDS, EDGE-PUNCH

ACME VISIBLE RECORDS INC.
510 Allview Dr, Crozet, Va 22932
AMERICAN BUSINESS FORMS INC.
114 S Canal St, Chicago, Ill 60606
ARNDT ASSOCIATES
727 Howard St, Evanston, Ill 60202
BURROUGHS CORP., BUSINESS FORMS & SUPPLIES
1150 Univ Ave, Rochester, N Y 14607
COMPUTER ACCESSORIES CO.
131 W 154th St, Gardena, Cal 90248
CYBERMATICS INC.
2460 Lemoine Ave, Fort Lee, N J 07024
DATACAP INTERNATIONAL INC.
37 W 2950 S, Salt Lake City, Utah 84101
ECCO BUSINESS SYSTEMS INC.
50 E 42nd St, New York, N Y 10017
ELDORADO ELECTRODATA
601 Chalomar Rd, Concord, Cal 94520
FRIDEN DIV. THE SINGER CO.
97 Humboldt St, Rochester, N Y 14602
ITEL INFORMATION PRODUCTS DIV
2585 Bayshore, Palo Alto, Cal 94303
NUMERIDEX TAPE SYSTEMS INC.
4711 W North Ave, Chicago, Ill 60639
OHRTRONICS INC., SUB MOHAWK DATA SCIENCES
CORP.
P O Box 406, King of Prussia, Pa 19406
ORIGINAL COMPUTER PRODUCTS INC.
204 Worcester St, Wellesley Hills, Mass 02181
STINAFFS INC.
181 E Exchange St, Akron, Ohio 44304
VISIRECORD
54 Railroad Ave, Copiague, N Y 11726

CARDS, LOGIC (SEE CIRCUIT CARDS)

CARDS, MAGNETIC

ACME VISIBLE RECORDS INC.
510 Allview Dr, Crozet, Va 22932
AMERICAN COMPUTER & COMMUNICATIONS CO.
2576 W Carson St, Torrance, Cal 90509
CURTIS 1000 INC.
1000 Curtis Dr, Smyrna, Ga 30080
CYBERMATICS INC.
2460 Lemoine Ave, Fort Lee, N J 07024
GRECO ENTERPRISES INC. TSA DATA DIV.
2000 Texas, El Paso, Tex 79901
MARQUETTA ELECTRONICS INC.
3712 W Elm St, Milwaukee, Wisc 53209
NCR INDUSTRIAL PRODUCTS DIV.
Main And K St, Dayton, Ohio 45409
NUMERIDEX TAPE SYSTEMS INC.
4711 W North Ave, Chicago, Ill 60639
OLIVETTI CORP. OF AMERICA
500 Park Ave, New York, N Y 10016
STINAFFS INC.
181 E Exchange St, Akron, Ohio 44304

CARDS, MICROFILM APERTURE

APPLIED MICROFILM CORP.
107 Binney St, Watertown, Mass 02142
GRECO ENTERPRISES INC. TSA DATA DIV.
2000 Texas, El Paso, Tex 79901
INTERNATIONAL COMPUTERS LTD.
1cl House Putney, London S W 15, UNITED K
ITEK BUSINESS PRODUCTS
1001 Jefferson Rd, Rochester, N Y 14603
MARQUETTA ELECTRONICS INC.
3712 W Elm St, Milwaukee, Wisc 53209
REMINGTON RAND OFFICE SYSTEMS DIV. SPERRY
RAND
P O Box 171, Marietta, Ohio 45750
TELEDYNE FREDERICK POST
P O Box 803, Chicago, Ill 60690
WHEELDEX INC.
1000 N Division St, Peekskill, N Y 10566

CATHODE RAY TUBES (SEE TUBES)

CELLS, PHOTOCONDUCTIVE

BALDWIN ELECTRONICS INC.
1101 McAlmont St, Little Rock, Ark 72203
CENTRALAB SEMICONDUCTOR GLOBE-UNION INC.
4501 N Arden Dr, El Monte, Cal 91734
CLAIREX CORP.
560 S 3rd Ave, Mount Vernon, N Y 10550
ELECTRONIC MICRO SYSTEMS INC.
1672 Kaiser Ave, Santa Ana, Cal 92705
HARVEY INDUSTRIAL DIV.
60 Crossway Pk W, Woodbury Li, N Y 11797
MILLETRON INC.
540 Alpha Dr, Pittsburgh, Pa 15238
PIONEER ELECTRIC & RESEARCH DIV. JOHNSON
SER.CO.
743 Circle Ave, Forest Park, Ill 60130
RAYTHEON CO. INDUSTRIAL COMPONENT
OPERATION
465 Centre St., Quincy, Mass 02169
SIGMA INSTRUMENTS INC.
170 Pearl St, Braintree, Mass 02185
SOLAR SYSTEMS INC.
8124 N Central Park, Skokie, Ill 60076
TYCO LABORATORIES INC.
16 Hickory Dr, Waltham, Mass 02154

CERTIFICATION SERVICE, MAGNETIC TAPE (SEE SERVICES)

CERTIFIERS, DISC PACK

COMPUTER-LINK CORP.
14 Cambridge St, Burlington, Mass 01803
ELDORADO ELECTRODATA
601 Chalomar Rd, Concord, Cal 94520
INTERSCAN INC.
407 N Rockwell Ave, Oklahoma City, Okla 73127
NCR INDUSTRIAL PRODUCTS DIV.
Main And K St, Dayton, Ohio 45409
SCIENTIFIC MEASUREMENT SYSTEMS INC.
351 New Albany Rd, Moorestown, N J 08057

WABASH COMPUTER CORP. PI DIV.
10202 N 19th St, Phoenix, Ariz 85021

CERTIFIERS, MAGNETIC TAPE

ACRATOD COMPANY
Po Box 66847, Houston, Tex 77006
COMPUTER-LINK CORP.
14 Cambridge St, Burlington, Mass 01803
CONTROL DATA CORP.
8100 34th Ave S, Minneapolis, Minn 55440
CTM LEASING CORP.
4924 Hampden Lane, Bethesda, Md 20014
DATA PRODUCTS CORP.
16055 Ventura Blvd, Encino, Cal 91316
DATASERV DIV., WILLIAM J. PURDY CORP.
770 Airport Blvd, Burlingame, Cal 94010
DYTRO CORP.
63 Tec St, Hicksville, N Y 11801
GENERAL KINETICS INC.
11425 Isaac Newt Sq S, Reston, Va 22070
HEWLETT PACKARD CO. MOUNTAIN VIEW DIV.
690 Middlefield Rd, Mtn View, Cal 94040
INDEL INC.
P O Box 15800, Tulsa, Okla 74115
KYBE CORP.
132 Calvary St, Waltham, Mass 02154
KYROS CORP.
P O Box 406, Madison, Wisc 53701
MACS COMPUTER ACCESSORIES INC
104 Park Towne Pl, Philadelphia, Pa 19130
MORLEY CO., THE
909 Islington St, Portsmouth, N H 03801
ORIGINAL COMPUTER PRODUCTS INC.
204 Worcester St, Wellesley Hills, Mass 02181
PURDY CORP., WM. J.
770 Airport Blvd, Burlingame, Cal 94010
RECORTEC INC.
162 S Whisman, Mt View, Cal 94040
TELETRON SYSTEMS CORP.
96-18 43rd Ave, Corona, N Y 11368
TELEX COMPUTER PRODUCTS
6422 E 41st St, Tulsa, Okla 74135
VIRGINIA PANEL CORP.
1400 N Hope Rd, Waynesboro, Va 22980

CHARACTER GENERATORS (SEE GENERATORS)

CHARTS, GRAPHIC DISPLAY (SEE BOARDS)

CHASSIS, SLIDES, RACKS

ACCURIDE DIV. SUB. STANDARD PRECISION INC.
12311 S Shoemaker, Santa Fe Spgs, Cal 90670
ALDEN PRODUCTS CO.
117 N Main St, Brockton, Mass 02401
BORG-WARNER/INGERSOLL PRODUCTS/EMCOR
1000 W 120th St, Chicago, Ill 60643
CABTRON CORP.
1900 W Kinzie St, Chicago, Ill 60622
CALABRO PLASTICS INC. UNITRACK DIV.
8738 W Chester Pike, Upper Darby, Pa 19082
ECONOMET INC.
1033 W Kirkwall Rd, Azusa, Cal 91702
ELECTRORACK PRODUCTS CO.
1742 S Clementine St, Anaheim, Cal 92802
GENERAL DEVICES CO. INC.
525 S Webster Ave, Indianapolis, Ind 46219
GENERAL DEVICES CO. INC. CHASSIS-TRAK DIV.
525 S Webster Ave, Indianapolis, Ind 46219
GRANT PULLEY & HARDWARE CO. DIV INST. SYS.
CORP
582 High St, West Nyack, N Y 10994
INFORMATION CONTROL CORP.
9610 Bellanca Ave, Los Angeles, Cal 90045
INGERSOLL PRODUCTS DIV. BORG- WARNER CORP.
1000 W 120th St, Chicago, Ill 60643
INTERNATIONAL ELECTRONIC RESEARCH CORP.
135 W Magnolia Blvd, Burbank, Cal 91502
NORRICH PLASTIC CORP.
200 Allen Blvd, Farmingdale, N Y 11575
NYTRONICS INC.
3rd Ave, Alpha, N J 08865
PIONEER ALUMINUM
3800 E 26th St, Los Angeles, Cal 90023
PREMIER METAL PRODUCTS CO.
337 Manida St, Bronx, N Y 10474
SCANBE MANUFACTURING CO.
3445 Fletcher Ave, El Monte, Cal 91750

2 Product Directory

SCIENTIFIC ATLANTA INC.
P O Box 16345, Atlanta, Ga 30345
SMITH SYSTEM MANUFACTURING CO.
56 Emerald St SE, Minneapolis, Minn 55414
SUPREME EQUIPMENT & SYSTEMS CORP.
170 53rd St, Brooklyn, N Y 11232
TECHMAR CORP.
2232 S Cotner Ave, Los Angeles, Cal 90064
VERO ELECTRONICS INC.
176 Central Ave, Farmingdale, N Y 11735
ZERO MANUFACTURING CO. ZERO-WEST DIV.
1121 Chestnut St, Burbank, Cal 91503
ZERO MFG. CO. ZERO-KRESKY DIV.
2nd & H St, Petaluma, Cal 94952

CIRCUIT BOARDS, ETCHED (SEE BOARDS)

CIRCUIT CARDS, LINEAR (WITH DISCRETE COMPONENTS)

ANALOGIC CORP.
Audubon Rd, Wakefield, Mass 01880
APPLIED COMPUTER SYSTEMS INC.
P O Box 6479, Austin, Tex 78702
AVCO CORP. ELECTRONICS DIV.
4807 Bradford, Huntsville, Ala 35805
BERGEN LABORATORIES INC. SUB. ZYROTRON INC.
60 Spruce St, Paterson, N J 07501
BUREAU OF ENGRAVING INC. INDUSTRIAL DIV.
219 N 2nd St, Minneapolis, Minn 55401
CAMBRIDGE THERMIONIC CORP.
445 Concord Ave, Cambridge, Mass 02138
CENTRALAB ELECTRONICS, DIV.
5757 N Green Bay, Milwaukee, Wisc 53201
CLAIREX CORP.
560 S 3rd Ave, Mount Vernon, N Y 10550
COMPUTER CONVERSIONS CORP.
6 Dunton Court, E Northport, N Y 11731
COMPUTER CORP. OF AMERICA
6216 Evergreen St, Houston, Tex 77036
CONDUCTORLAB, INC.
Main St, Groton, Mass 01450
DATA CONTROL SYSTEMS INC.
Commerce Dr, Danbury, Conn 06810
DATA TECHNOLOGY CORP.
1050 E Meadow Cir, Palo Alto, Cal 94303
DIGITAL PRODUCTS CORP.
6950 NW 12 Ave, Ft Lauderdale, Fla 33309
DYNAMIC MEASUREMENTS CORP.
6 Lowell Ave, Winchester, Mass 01890
ELBIT COMPUTERS/SUB. CONTROL DATA CORP.
6 Tovim St, Haifa, ISRAEL
ELECTRONIC MODULES CORP.
P O Box 141, Timonium, Md 21093
FLEXIBLE CIRCUITS INC.
Paul Valley Ind Pk, Warrington, Pa 18976
GENERAL CIRCUITS INC.
95 Mt Read Blvd, Rochester, N Y 14611
INCOR INSTRUMENTATION INC.
29 Newtown Rd, Plainville, N Y 11803
INFORMATION CONTROL CORP.
9610 Bellanca Ave, Los Angeles, Cal 90045
INNOVATEK ENTERPRISE
Smithfield Rd, Millerton, N Y 12546
KDI INTERACTIVE DATA SYSTEMS
17785 Skypark Circle, Irvine, Cal 92664
LOCKHEED ELECTRONICS CO. DIV. LOCKHEED ACRFT CORP.
U S Hwy 22, Plainfield, N J 07060
MARK COMPUTER SYSTEMS INC.
One Patterson Pl, Garden City, N Y 11530
METHODE ELECTRONICS INC.
7447 W Wilson Ave, Chicago, Ill 60656
METRIC SYSTEMS CORP.
736 N Beal St, Ft Walton Beach, Fla 32548
MILLETTRON INC.
540 Alpha Dr, Pittsburgh, Pa 15238
MULTIPLY COMMUNICATIONS INC.
123 Marcus Blvd, Hauppauge, N Y 11787
MULTITECH DATA PRODUCTS
583 Monterey Pass Rd, Monterey Park, Cal 91754
NORTH AMERICAN ROCKWELL CORP. AUTONETICS DIV.
3370 Miraloma Ave, Anaheim, Cal 92803
POWER/MATE CORP.
514 S River St, Hackensack, N J 07601
PRINTED CIRCUIT CORP.
180 Elm St, Waltham, Mass 02154
SCIENTIFIC MEASUREMENTS INC.
9701 N Kenton, Skokie, Ill 60076
SEMICON INC.
10 N Ave, Burlington, Mass 01803

STRUTHER-DUNN INC. SYSTEMS DIV.
1114 State St, Bettendorf, Iowa 52722
TECHNICAL MATERIAL CORP.
700 Fenimore Rd, Mamaroneck, N Y 10543
TEMPO INSTRUMENT DIV. ALLEN ELECTRIC&EQUIP. CO.
9135 Independence Ave, Chatsworth, Cal 91311
UNIVERSITY COMPUTING CO.
888 N Sepulveda Blvd, El Segundo, Cal 90245
WARLOCK COMPUTER CORP.
Rte 7, Georgetown, Conn 06829
WEISMANTEL INC.
P O Box 1957, St Paul, Minn 55111
WYLE LABORATORIES
128 Maryland St, El Segundo, Cal 90245
XEROX DATA SYSTEMS
701 S Aviation, El Segundo, Cal 90245

CIRCUIT CARDS, LINEAR (WITH IC'S)

ANALOGIC CORP.
Audubon Rd, Wakefield, Mass 01880
APPLIED COMPUTER SYSTEMS INC.
P O Box 6479, Austin, Tex 78702
AVCO CORP. ELECTRONICS DIV.
4807 Bradford, Huntsville, Ala 35805
BERGEN LABORATORIES INC. SUB. ZYROTRON INC.
60 Spruce St, Paterson, N J 07501
BUREAU OF ENGRAVING INC. INDUSTRIAL DIV.
219 N 2nd St, Minneapolis, Minn 55401
CAMBRIDGE THERMIONIC CORP.
445 Concord Ave, Cambridge, Mass 02138
CENTRALAB ELECTRONICS, DIV.
5757 N Green Bay, Milwaukee, Wisc 53201
COMPUTER CONVERSIONS CORP.
6 Dunton Court, E Northport, N Y 11731
COMPUTER CORP. OF AMERICA
6216 Evergreen St, Houston, Tex 77036
COMPUTER PRODUCTS, INC.
P O Box 23849, Ft Lauderdale, Fla 33307
COMPUTER SIGNAL PROCESSORS INC.
209 Middlesex Tpk, Burlington, Mass 01803
CONDUCTORLAB, INC.
Main St, Groton, Mass 01450
DATA CONTROL SYSTEMS INC.
Commerce Dr, Danbury, Conn 06810
DATA TECHNOLOGY CORP.
1050 E Meadow Cir, Palo Alto, Cal 94303
DIGITAL PRODUCTS CORP.
6950 NW 12 Ave, Ft Lauderdale, Fla 33309
DYNAMIC MEASUREMENTS CORP.
6 Lowell Ave, Winchester, Mass 01890
ELBIT COMPUTERS/SUB. CONTROL DATA CORP.
6 Tovim St, Haifa, ISRAEL
ELECTRONIC MODULES CORP.
P O Box 141, Timonium, Md 21093
FLEXIBLE CIRCUITS INC.
Paul Valley Ind Pk, Warrington, Pa 18976
GENERAL CIRCUITS INC.
95 Mt Read Blvd, Rochester, N Y 14611
INFORMATION CONTROL CORP.
9610 Bellanca Ave, Los Angeles, Cal 90045
INNOVATEK ENTERPRISE
Smithfield Rd, Millerton, N Y 12546
KDI INTERACTIVE DATA SYSTEMS
17785 Skypark Circle, Irvine, Cal 92664
LOCKHEED ELECTRONICS CO. DIV. LOCKHEED ACRFT CORP.
U S Hwy 22, Plainfield, N J 07060
MARK COMPUTER SYSTEMS INC.
One Patterson Pl, Garden City, N Y 11530
METHODE ELECTRONICS INC.
7447 W Wilson Ave, Chicago, Ill 60656
METRIC SYSTEMS CORP.
736 N Beal St, Ft Walton Beach, Fla 32548
MILLETTRON INC.
540 Alpha Dr, Pittsburgh, Pa 15238
MULTIPLY COMMUNICATIONS INC.
123 Marcus Blvd, Hauppauge, N Y 11787
MULTITECH DATA PRODUCTS
583 Monterey Pass Rd, Monterey Park, Cal 91754
NORTH AMERICAN ROCKWELL CORP. AUTONETICS DIV.
3370 Miraloma Ave, Anaheim, Cal 92803
POWER/MATE CORP.
514 S River St, Hackensack, N J 07601
PRECISION MONOLITHICS INC.
1500 Space Park Dr, Santa Clara, Cal 95050
PRINTED CIRCUIT CORP.
180 Elm St, Waltham, Mass 02154
SCIENTIFIC MEASUREMENTS INC.
9701 N Kenton, Skokie, Ill 60076
SOLID STATE ELECTRONICS CORP.
15321 Rayen St, Sepulveda, Cal 91343

STRUTHER-DUNN INC. SYSTEMS DIV.
1114 State St, Bettendorf, Iowa 52722
TECHNICAL MATERIAL CORP.
700 Fenimore Rd, Mamaroneck, N Y 10543
TELEDYNE BROWN ENGINEERING
300 Sparkman Dr, Huntsville, Ala 35807
TEMPO INSTRUMENT DIV. ALLEN ELECTRIC&EQUIP. CO.
9135 Independence Ave, Chatsworth, Cal 91311
UNIVERSITY COMPUTING CO.
888 N Sepulveda Blvd, El Segundo, Cal 90245
VARIAN ASSOCIATES GRAPHICS & DATA SYSTEMS DIV.
611 Hansen Way, Palo Alto, Cal 94303
WARLOCK COMPUTER CORP.
Rte 7, Georgetown, Conn 06829
WEISMANTEL INC.
P O Box 1957, St Paul, Minn 55111
WYLE LABORATORIES
128 Maryland St, El Segundo, Cal 90245
XEROX DATA SYSTEMS
701 S Aviation, El Segundo, Cal 90245

CIRCUIT CARDS, LOGIC (WITH DISCRETE COMPONENTS)

ALLEN-BRADLEY
1201 S 2nd St, Milwaukee, Wisc 53204
AMERICAN COMPUTER TECHNOLOGY INC.
8740 Shirley Ave, Northridge, Cal 91324
ANALOGIC CORP.
Audubon Rd, Wakefield, Mass 01880
APPLIED COMPUTER SYSTEMS INC.
P O Box 6479, Austin, Tex 78702
AVCO CORP. ELECTRONICS DIV.
4807 Bradford, Huntsville, Ala 35805
BERGEN LABORATORIES INC. SUB. ZYROTRON INC.
60 Spruce St, Paterson, N J 07501
BUREAU OF ENGRAVING INC. INDUSTRIAL DIV.
219 N 2nd St, Minneapolis, Minn 55401
CAMBRIDGE THERMIONIC CORP.
445 Concord Ave, Cambridge, Mass 02138
CLAIREX CORP.
560 S 3rd Ave, Mount Vernon, N Y 10550
COMPUTER CONVERSIONS CORP.
6 Dunton Court, E Northport, N Y 11731
CONDUCTORLAB, INC.
Main St, Groton, Mass 01450
CONSOLIDATED OHMIC DEVICES INC.
115 Old Country Rd, Carle Place, N Y 11514
CONTROL LOGIC INC.
3 Strathmore Rd, Natick, Mass 01760
DATA CONTROL SYSTEMS INC.
Commerce Dr, Danbury, Conn 06810
DATA TECHNOLOGY CORP.
1050 E Meadow Cir, Palo Alto, Cal 94303
DATASCAN INC.
1111 Paulson Ave, Clifton, N J 07013
DIGITAL DATA SYSTEMS
18819 Bryant St, Northridge, Cal 91324
DIGITAL EQUIPMENT CORP.
146 Main St, Maynard, Mass 01754
DIGITAL PRODUCTS CORP.
6950 NW 12 Ave, Ft Lauderdale, Fla 33309
DYNAGE INC.
1331 Blue Hills Ave, Bloomfield, Conn 06002
DYNAMIC MEASUREMENTS CORP.
6 Lowell Ave, Winchester, Mass 01890
ELBIT COMPUTERS/SUB. CONTROL DATA CORP.
6 Tovim St, Haifa, ISRAEL
ELECTRONIC ENGRG. CO. OF CAL. ELECTRONIC PRD. DIV.
1441 E Chestnut Ave, Santa Ana, Cal 92702
ELECTRONIC MODULES CORP.
P O Box 141, Timonium, Md 21093
EVANS & SUTHERLAND COMPUTER CORP.
3 Research Rd, Salt Lake City, Utah 84112
FLEXIBLE CIRCUITS INC.
Paul Valley Ind Pk, Warrington, Pa 18976
GENERAL CIRCUITS INC.
95 Mt Read Blvd, Rochester, N Y 14611
INFORMATION CONTROL CORP.
9610 Bellanca Ave, Los Angeles, Cal 90045
INNOVATEK ENTERPRISE
Smithfield Rd, Millerton, N Y 12546
KDI INTERACTIVE DATA SYSTEMS
17785 Skypark Circle, Irvine, Cal 92664
LEHIGH VALLEY ELECTRONICS INC.
Po Box 125, Fogelsville, Pa 18051
LOCKHEED ELECTRONICS CO. DIV. LOCKHEED ACRFT CORP.
U S Hwy 22, Plainfield, N J 07060
LOGIC SCIENCE INC.
P O Box 10096, San Diego, Cal 92110

2 Product Directory

MARK COMPUTER SYSTEMS INC.
One Patterson Pl, Garden City, N Y 11530

MASSEY DICKINSON CO. INC.
9 Elm St, Saxonville, Mass 01701

MCG ELECTRONICS INC.
279 Skidmore Rd, Deer Park, N Y 11729

MESUR-MATIC ELECTRONICS CORP.
Church St, Warner, N H 03278

METHODE ELECTRONICS INC.
7447 W Wilson Ave, Chicago, Ill 60656

METRIC SYSTEMS CORP.
736 N Beal St, Ft Walton Beach, Fla 32548

MILLETRON INC.
540 Alpha Dr, Pittsburgh, Pa 15238

MULTIPLY COMMUNICATIONS INC.
123 Marcus Blvd, Hauppauge, N Y 11787

MULTITECH DATA PRODUCTS
583 Monterey Pass Rd, Monterey Park, Cal 91754

NORTH AMERICAN ROCKWELL CORP. AUTONETICS DIV.
3370 Miraloma Ave, Anaheim, Cal 92803

POWERTEC
9168 Desoto St, Chatsworth, Cal 91311

PRINTED CIRCUIT CORP.
180 Elm St, Waltham, Mass 02154

RAYCON INC.
218 Brunswick Blvd, Pointe Claire, CANADA

RAYTHEON COMPUTER
2700 S Fairview St, Santa Ana, Cal 92704

SEMICON INC.
10 N Ave, Burlington, Mass 01803

STANDARD LOGIC INC.
1630 S Lyon St, Santa Ana, Cal 92705

STELLARMETRICS AN AYDIN CO.
P O Box 719, Santa Barbara, Cal 93102

STRUTHER-DUNN INC. SYSTEMS DIV.
1114 State St, Bettendorf, Iowa 52722

TECHNICAL MATERIAL CORP.
700 Fenimore Rd, Mamaroneck, N Y 10543

TEMPO INSTRUMENT DIV. ALLEN ELECTRIC&EQUIP. CO.
9135 Independence Ave, Chatsworth, Cal 91311

TRANSMAGNETICS INC.
210 Adams Blvd, Farmingdale, N Y 11735

TYCO INSTRUMENT DIV. TYCO LABS. INC.
Waltham, Mass 02154

WARLOCK COMPUTER CORP.
Rte 7, Georgetown, Conn 06829

WEISMANTEL INC.
P O Box 1957, St Paul, Minn 55111

WYLE LABORATORIES
128 Maryland St, El Segundo, Cal 90245

XEROX DATA SYSTEMS
701 S Aviation, El Segundo, Cal 90245

CIRCUIT CARDS, LOGIC (WITH IC'S)

ALLEN-BRADLEY
1201 S 2nd St, Milwaukee, Wisc 53204

AMERICAN COMPUTER TECHNOLOGY INC.
8740 Shirley Ave, Northridge, Cal 91324

ANALOGIC CORP.
Audubon Rd, Wakefield, Mass 01880

APPLIED COMPUTER SYSTEMS INC.
P O Box 6479, Austin, Tex 78702

AVCO CORP. ELECTRONICS DIV.
4807 Bradford, Huntsville, Ala 35805

BERGEN LABORATORIES INC. SUB. ZYROTRON INC.
60 Spruce St, Paterson, N J 07501

BUREAU OF ENGRAVING INC. INDUSTRIAL DIV.
219 N 2nd St, Minneapolis, Minn 55401

CAMBRIDGE THERMIONIC CORP.
445 Concord Ave, Cambridge, Mass 02138

COMCET INC.
1950 W County Rd, St Paul, Minn 55113

COMPACE CORP.
7413 Washington Ave S, Edina-Minnepols, Minn 55435

COMPUTER CONVERSIONS CORP.
6 Dunton Court, E Northport, N Y 11731

COMPUTER CORP. OF AMERICA
6216 Evergreen St, Houston, Tex 77036

COMPUTER PRODUCTS, INC.
P O Box 23849, Ft Lauderdale, Fla 33307

COMPUTER SIGNAL PROCESSORS INC.
209 Middlesex Tpk, Burlington, Mass 01803

CONDUCTORLAB, INC.
Main St, Groton, Mass 01450

CONSOLIDATED OHMIC DEVICES INC.
115 Old Country Rd, Carle Place, N Y 11514

CONTROL LOGIC INC.
3 Strathmore Rd, Natick, Mass 01760

DATA CONTROL SYSTEMS INC.
Commerce Dr, Danbury, Conn 06810

DATA DISPLAY SYSTEMS INC.
139 Terwood Rd, Willow Grove, Pa 19090

DATA GRAPHICS CORP.
8402 Speedway, San Antonio, Tex 78230

DATA TECHNOLOGY CORP.
1050 E Meadow Cir, Palo Alto, Cal 94303

DATACOM INC.
40 Lincoln Dr, Ft Walton Beach, Fla 32548

DATASCAN INC.
1111 Paulson Ave, Clifton, N J 07013

DIGITAL DATA SYSTEMS
18819 Bryant St, Northridge, Cal 91324

DIGITAL EQUIPMENT CORP.
146 Main St, Maynard, Mass 01754

DIGITAL PRODUCTS CORP.
6950 NW 12 Ave, Ft Lauderdale, Fla 33309

DYNAGE INC.
1331 Blue Hills Ave, Bloomfield, Conn 06002

DYNAMIC MEASUREMENTS CORP.
6 Lowell Ave, Winchester, Mass 01890

ELBIT COMPUTERS/SUB. CONTROL DATA CORP.
6 Tovim St, Haifa, ISRAEL

ELECTRONIC ENGRG. CO. OF CAL. ELECTRONIC PRD. DIV.
1441 E Chestnut Ave, Santa Ana, Cal 92702

ELECTRONIC MODULES CORP.
P O Box 141, Timonium, Md 21093

EVANS & SUTHERLAND COMPUTER CORP.
3 Research Rd, Salt Lake City, Utah 84112

FLEXIBLE CIRCUITS INC.
Paul Valley Ind Pk, Warrington, Pa 18976

GENERAL AUTOMATION INC.
1055 S East St, Anaheim, Cal 92805

GENERAL CIRCUITS INC.
95 Mt Read Blvd, Rochester, N Y 14611

GENERAL DYNAMICS CORP. ELECTRONICS DIV.
P O Box 2566, Orlando, Fla 32802

INFORMATION CONTROL CORP.
9610 Bellanca Ave, Los Angeles, Cal 90045

INNOVATEK ENTERPRISE
Smithfield Rd, Millerton, N Y 12546

KDI INTERACTIVE DATA SYSTEMS
17785 Skypark Circle, Irvine, Cal 92664

LEHIGH VALLEY ELECTRONICS INC.
Po Box 125, Fogelsville, Pa 18051

LITTON SYSTEMS INC. DATA SYSTEMS DIV.
8000 Woodley Ave, Van Nuys, Cal 91409

LOCKHEED ELECTRONICS CO. DIV. LOCKHEED ACRFT CORP.
U S Hwy 22, Plainfield, N J 07060

LOGIC SCIENCE INC.
P O Box 10096, San Diego, Cal 92110

MARK COMPUTER SYSTEMS INC.
One Patterson Pl, Garden City, N Y 11530

MCG ELECTRONICS INC.
279 Skidmore Rd, Deer Park, N Y 11729

MESUR-MATIC ELECTRONICS CORP.
Church St, Warner, N H 03278

METHODE ELECTRONICS INC.
7447 W Wilson Ave, Chicago, Ill 60656

METRIC SYSTEMS CORP.
736 N Beal St, Ft Walton Beach, Fla 32548

MICRO SYSTEMS INC.
644 E Young St, Santa Ana, Cal 92705

MILLETRON INC.
540 Alpha Dr, Pittsburgh, Pa 15238

MOTOROLA INC. CONTROL SYSTEMS DIV.
P O Box 5409, Phoenix, Ariz 85010

MULTIPLY COMMUNICATIONS INC.
123 Marcus Blvd, Hauppauge, N Y 11787

MULTITECH DATA PRODUCTS
583 Monterey Pass Rd, Monterey Park, Cal 91754

NORTH AMERICAN ROCKWELL CORP. AUTONETICS DIV.
3370 Miraloma Ave, Anaheim, Cal 92803

POWERTEC
9168 Desoto St, Chatsworth, Cal 91311

PRECISION MONOLITHICS INC.
1500 Space Park Dr, Santa Clara, Cal 95050

PRINTED CIRCUIT CORP.
180 Elm St, Waltham, Mass 02154

RAYTHEON COMPUTER
2700 S Fairview St, Santa Ana, Cal 92704

ROLM CORP.
10300 N Tantau, Cupertino, Cal 95014

SCIENTIFIC MEASUREMENTS INC.
9701 N Kenton, Skokie, Ill 60076

STANDARD LOGIC INC.
1630 S Lyon St, Santa Ana, Cal 92705

STELLARMETRICS AN AYDIN CO.
P O Box 719, Santa Barbara, Cal 93102

STRUTHER-DUNN INC. SYSTEMS DIV.
1114 State St, Bettendorf, Iowa 52722

SYSTEMS DATA, INC.
1951 W Market St, Akron, Ohio 44313

TECHNICAL MATERIAL CORP.
700 Fenimore Rd, Mamaroneck, N Y 10543

TELEDYNE BROWN ENGINEERING
300 Sparkman Dr, Huntsville, Ala 35807

TEMPO INSTRUMENT DIV. ALLEN ELECTRIC&EQUIP. CO.
9135 Independence Ave, Chatsworth, Cal 91311

TRANSMAGNETICS INC.
210 Adams Blvd, Farmingdale, N Y 11735

TYCO INSTRUMENT DIV. TYCO LABS. INC.
Waltham, Mass 02154

VARIAN ASSOCIATES GRAPHICS & DATA SYSTEMS DIV.
611 Hansen Way, Palo Alto, Cal 94303

WARLOCK COMPUTER CORP.
Rte 7, Georgetown, Conn 06829

WEISMANTEL INC.
P O Box 1957, St Paul, Minn 55111

WYLE LABORATORIES
128 Maryland St, El Segundo, Cal 90245

XEROX DATA SYSTEMS
701 S Aviation, El Segundo, Cal 90245

CIRCUIT PROTECTORS (SEE PROTECTORS)

CIRCUITS, HYBRID (IC AND DISCRETE-DIGITAL)

ALLEN-BRADLEY
1201 S 2nd St, Milwaukee, Wisc 53204

AMPEREX ELECTRONIC CORP. A NO AMERICAN PHILIPS CO
P O Box 98, Slatersville, R I 02876

ANALOG DEVICES INC. PASTORIZA DIV.
221 5th St, Cambridge, Mass 02142

AVCO CORP. ELECTRONICS DIV.
4807 Bradford, Huntsville, Ala 35805

BOURNS INC.
1200 Columbia Ave., Riverside, Cal 92507

BURR-BROWN RESEARCH CORP.
6730 S Tucson Blvd, Tucson, Ariz 85706

CAMBRIDGE THERMIONIC CORP.
445 Concord Ave, Cambridge, Mass 02138

CERMETEK INC.
660 National Ave, Mt View, Cal 94040

COLUMBIA COMPONENTS CORP.
60 Madison Ave, Hempstead, N Y 11550

CONTROL DATA CORP. CIRCUITS DIV.
7800 Computer Ave, Minneapolis, Minn 55435

DATA CONTROL SYSTEMS INC.
Commerce Dr, Danbury, Conn 06810

DICKSON ELECTRONICS CORP.
P O Box 1390, Scottsdale, Ariz 85252

DIGITAL EQUIPMENT CORP.
146 Main St, Maynard, Mass 01754

ELBIT COMPUTERS/SUB. CONTROL DATA CORP.
6 Tovim St, Haifa, ISRAEL

ELECTRONIC ENGRG. CO. OF CAL. ELECTRONIC PRD. DIV.
1441 E Chestnut Ave, Santa Ana, Cal 92702

ELECTRONIC MODULES CORP.
P O Box 141, Timonium, Md 21093

ERIE TECHNOLOGICAL PRODUCTS INC.
644 W 12th St, Erie, Pa 16512

FAIRCHILD SEMICONDUCTOR
464 Ellis St, Mt View, Cal 94040

FILM MICROELECTRONICS INC.
17 A St, Burlington, Mass 01803

GENERAL INSTRUMENT CORP. MICROELECT DIV.
600 W John St, Hicksville, N Y 11802

HALEX INC.
3500 W Torrance Blvd, Torrance, Cal 90509

HARVEY INDUSTRIAL DIV.
60 Crossway Pk W, Woodbury Li, N Y 11797

HELIPOT DIV. BECKMAN INSTRUMENTS INC.
2500 Harbor Blvd, Fullerton, Cal 92634

HYCOMP INC.
146 Main St, Maynard, Mass 01754

INFORMATION CONTROL CORP.
9610 Bellanca Ave, Los Angeles, Cal 90045

LEDEX INC.
123 Webster St, Dayton, Ohio 45401

MCG ELECTRONICS INC.
279 Skidmore Rd, Deer Park, N Y 11729

MEPCO INC.
Columbia Rd, Morristown, N J 07960

MESUR-MATIC ELECTRONICS CORP.
Church St, Warner, N H 03278

METRIC SYSTEMS CORP.
736 N Beal St, Ft Walton Beach, Fla 32548

MILLETRON INC.
540 Alpha Dr, Pittsburgh, Pa 15238

2 Product Directory

MOTOROLA SEMICONDUCTOR PRODUCTS INC.
5005 E Mc Dowell Rd, Phoenix, Ariz 85008
MULTITECH DATA PRODUCTS
583 Monterey Pass Rd, Monterey Park, Cal 91754
NATIONAL SEMICONDUCTOR CORP.
2900 Semicon Dr, Santa Clara, Cal 95051
NESS PACIFIC INC.
470 N San Antonio Rd, Palo Alto, Cal 94306
NORTH AMERICAN ROCKWELL CORP. AUTONETICS DIV.
3370 Miraloma Ave, Anaheim, Cal 92803
NUCLEONIC PRODUCTS CO. INC.
6660 Variel Ave, Canoga Park, Cal 91303
NYTRONICS INC.
3rd Ave, Alpha, N J 08865
POWERTEC
9168 Desoto St, Chatsworth, Cal 91311
PRECISION MONOLITHICS INC.
1500 Space Park Dr, Santa Clara, Cal 95050
RAYTHEON CO. INDUSTRIAL COMPONENT OPERATION
465 Centre St., Quincy, Mass 02169
RAYTHEON COMPUTER
2700 S Fairview St, Santa Ana, Cal 92704
RCA CORP. SOLID STATE DIV.
Rte 202, Somerville, N J 08876
SAGE ELECTRONICS CORP. SUB. NYTRONICS INC.
P O Box 3926, Rochester, N Y 14610
SPACETAC INC.
Burlington Rd, Bedford, Mass 01730
SPRAGUE ELECTRIC CO.
551 Marshall St, N Adams, Mass 01247
STRUTHER-DUNN INC. SYSTEMS DIV.
1114 State St, Bettendorf, Iowa 52722
SYSTEMS DATA, INC.
1951 W Market St, Akron, Ohio 44313
TELECTRO SYSTEMS CORP.
96-18 43rd Ave, Corona, N Y 11368
TELEDYNE CRYSTALONICS
147 Sherman St, Cambridge, Mass 02140
TRW SEMICONDUCTOR DIV.
14520 Aviation Blvd, Lawndale, Cal 90260

CIRCUITS, MONOLITHIC (DIGITAL LOGIC)

ADVANCED MICRO DEVICES INC.
901 Thompson Pl, Sunnyvale, Cal 94086
AMERICAN MICRO-SYSTEMS INC.
3800 Homestead Rd, Santa Clara, Cal 95051
AMPEREX ELECTRONIC CORP. A NO AMERICAN PHILIPS CO
P O Box 98, Slatersville, R I 02876
AVCO CORP. ELECTRONICS DIV.
4807 Bradford, Huntsville, Ala 35805
ITT SEMICONDUCTORS
3301 Electronics Way, W Palm Beach, Fla 33407
CERMETEK INC.
660 National Ave, Mt View, Cal 94040
CONTROL DATA CORP. CIRCUITS DIV.
7800 Computer Ave, Minneapolis, Minn 55435
DIONICS INC.
65 Rushmore St, Westburn, N Y 11590
ELCOM ELECTRONICS INC.
200 Allen Blvd, Farmingdale, N Y 11735
ELECTRONIC ARRAYS INC.
501 Ellis St, Mt View, Cal 94040
FAIRCHILD SEMICONDUCTOR
464 Ellis St, Mt View, Cal 94040
GENERAL INSTRUMENT CORP. MICROELECT. DIV.
600 W John St, Hicksville, N Y 11802
HARVEY INDUSTRIAL DIV.
60 Crossway Pk W, Woodbury Li, N Y 11797
HUGHES AIRCRAFT CO. M O S DIV.
500 Superior Ave, Newport Beach, Cal 92660
INTERSIL INC.
10900 N Tantu, Cupertino, Cal 95014
KENICS SYSTEMS CORP.
125 Harvard St, Cambridge, Mass 02139
METRIC SYSTEMS CORP.
736 N Beal St, Ft Walton Beach, Fla 32548
MOTOROLA SEMICONDUCTOR PRODUCTS INC.
5005 E Mc Dowell Rd, Phoenix, Ariz 85008
NATIONAL SEMICONDUCTOR CORP.
2900 Semicon Dr, Santa Clara, Cal 95051
NORTH AMERICAN ROCKWELL CORP. AUTONETICS DIV.
3370 Miraloma Ave, Anaheim, Cal 92803
NUCLEONIC PRODUCTS CO. INC.
6660 Variel Ave, Canoga Park, Cal 91303
PRECISION MONOLITHICS INC.
1500 Space Park Dr, Santa Clara, Cal 95050
QUALIDYNE
3699 Tahoe Way, Santa Clara, Cal 95051

RCA CORP. SOLID STATE DIV.
Rte 202, Somerville, N J 08876
SIGNETICS CORP. SUB. CORNING GLASS
811 E Arques Ave, Sunnyvale, Cal 94086
SILCONIX INC.
2201 Laurelwood Rd, Santa Clara, Cal 95054
SPRAGUE ELECTRIC CO.
551 Marshall St, N Adams, Mass 01247
STEWART WARNER MICROCIRCUITS
824 E Evelyn Ave, Sunnyvale, Cal 94086
TRANSITRON ELECTRONIC CORP.
168 Albion St, Wakefield, Mass 01880
UNIVERSITY COMPUTING CO.
888 N Sepulveda Blvd, El Segundo, Cal 90245

CIRCUITS, MONOLITHIC (DIODE MATRICES)

AMPEREX ELECTRONIC CORP. A NO AMERICAN PHILIPS CO
P O Box 98, Slatersville, R I 02876
AVCO CORP. ELECTRONICS DIV.
4807 Bradford, Huntsville, Ala 35805
ITT SEMICONDUCTORS
3301 Electronics Way, W Palm Beach, Fla 33407
CONTROL DATA CORP. CIRCUITS DIV.
7800 Computer Ave, Minneapolis, Minn 55435
DIONICS INC.
65 Rushmore St, Westburn, N Y 11590
FAIRCHILD SEMICONDUCTOR
464 Ellis St, Mt View, Cal 94040
HARRIS SEMICONDUCTOR A DIV.OF HARRIS-INTERTYPE
P O Box 883, Melbourne, Fla 32901
HELIPOT DIV. BECKMAN INSTRUMENTS INC.
2500 Harbor Blvd, Fullerton, Cal 92634
METRIC SYSTEMS CORP.
736 N Beal St, Ft Walton Beach, Fla 32548
NORTH AMERICAN ROCKWELL CORP. AUTONETICS DIV.
3370 Miraloma Ave, Anaheim, Cal 92803
QUALIDYNE
3699 Tahoe Way, Santa Clara, Cal 95051
SOLITRON DEVICES INC.
256 Oak Tree Rd, Tappan, N Y 10983

CIRCUITS, MONOLITHIC (LINEAR-EXCL. OP AMPS)

ADVANCED MICRO DEVICES INC.
901 Thompson Pl, Sunnyvale, Cal 94086
AMPEREX ELECTRONIC CORP. A NO AMERICAN PHILIPS CO
P O Box 98, Slatersville, R I 02876
ANALOG DEVICES INC.
221 5th St, Cambridge, Mass 02142
AVCO CORP. ELECTRONICS DIV.
4807 Bradford, Huntsville, Ala 35805
ITT SEMICONDUCTORS
3301 Electronics Way, W Palm Beach, Fla 33407
BOURNS INC.
1200 Columbia Ave., Riverside, Cal 92507
DIONICS INC.
65 Rushmore St, Westburn, N Y 11590
ELCOM ELECTRONICS INC.
200 Allen Blvd, Farmingdale, N Y 11735
FAIRCHILD SEMICONDUCTOR
464 Ellis St, Mt View, Cal 94040
HARRIS SEMICONDUCTOR A DIV.OF HARRIS-INTERTYPE
P O Box 883, Melbourne, Fla 32901
HARVEY INDUSTRIAL DIV.
60 Crossway Pk W, Woodbury Li, N Y 11797
HELIPOT DIV. BECKMAN INSTRUMENTS INC.
2500 Harbor Blvd, Fullerton, Cal 92634
INTERSIL INC.
10900 N Tantu, Cupertino, Cal 95014
METRIC SYSTEMS CORP.
736 N Beal St, Ft Walton Beach, Fla 32548
MOTOROLA SEMICONDUCTOR PRODUCTS INC.
5005 E Mc Dowell Rd, Phoenix, Ariz 85008
NATIONAL SEMICONDUCTOR CORP.
2900 Semicon Dr, Santa Clara, Cal 95051
NORTH AMERICAN ROCKWELL CORP. AUTONETICS DIV.
3370 Miraloma Ave, Anaheim, Cal 92803
NUCLEONIC PRODUCTS CO. INC.
6660 Variel Ave, Canoga Park, Cal 91303
OPTICAL ELECTRONICS INC.
P O Box 11140, Tucson, Ariz 85706
PRECISION MONOLITHICS INC.
1500 Space Park Dr, Santa Clara, Cal 95050

QUALIDYNE
3699 Tahoe Way, Santa Clara, Cal 95051
RCA CORP. SOLID STATE DIV.
Rte 202, Somerville, N J 08876
SIGNETICS CORP. SUB. CORNING GLASS
811 E Arques Ave, Sunnyvale, Cal 94086
SILCONIX INC.
2201 Laurelwood Rd, Santa Clara, Cal 95054
SILICON GENERAL INC.
7382 Bolsa Ave, Westminster, Cal 92683
SOLITRON DEVICES INC.
256 Oak Tree Rd, Tappan, N Y 10983
SPRAGUE ELECTRIC CO.
551 Marshall St, N Adams, Mass 01247
TELEDYNE CRYSTALONICS
147 Sherman St, Cambridge, Mass 02140

CIRCUITS, MONOLITHIC (LSI-BIPOLAR)

ADVANCED MEMORY SYSTEMS INC.
1276 Hammerwood Ave, Sunnyvale, Cal 94086
ADVANCED MICRO DEVICES INC.
901 Thompson Pl, Sunnyvale, Cal 94086
AMPEREX ELECTRONIC CORP. A NO AMERICAN PHILIPS CO
P O Box 98, Slatersville, R I 02876
AVCO CORP. ELECTRONICS DIV.
4807 Bradford, Huntsville, Ala 35805
ITT SEMICONDUCTORS
3301 Electronics Way, W Palm Beach, Fla 33407
COMPUTER MICROTECHNOLOGY INC.
P O Box 7050, Sunnyvale, Cal 94086
CONTROL DATA CORP. CIRCUITS DIV.
7800 Computer Ave, Minneapolis, Minn 55435
DIONICS INC.
65 Rushmore St, Westburn, N Y 11590
ELCOM ELECTRONICS INC.
200 Allen Blvd, Farmingdale, N Y 11735
FAIRCHILD SEMICONDUCTOR
464 Ellis St, Mt View, Cal 94040
HARRIS SEMICONDUCTOR A DIV.OF HARRIS-INTERTYPE
P O Box 883, Melbourne, Fla 32901
HARVEY INDUSTRIAL DIV.
60 Crossway Pk W, Woodbury Li, N Y 11797
INTERSIL INC.
10900 N Tantu, Cupertino, Cal 95014
KENICS SYSTEMS CORP.
125 Harvard St, Cambridge, Mass 02139
METRIC SYSTEMS CORP.
736 N Beal St, Ft Walton Beach, Fla 32548
MOTOROLA SEMICONDUCTOR PRODUCTS INC.
5005 E Mc Dowell Rd, Phoenix, Ariz 85008
NATIONAL SEMICONDUCTOR CORP.
2900 Semicon Dr, Santa Clara, Cal 95051
NORTH AMERICAN ROCKWELL CORP. AUTONETICS DIV.
3370 Miraloma Ave, Anaheim, Cal 92803
PRECISION MONOLITHICS INC.
1500 Space Park Dr, Santa Clara, Cal 95050
QUALIDYNE
3699 Tahoe Way, Santa Clara, Cal 95051
RAYTHEON CO. EQUIPMENT DIV.
528 Boston Post Rd, Sudbury, Mass 01776
RCA CORP. SOLID STATE DIV.
Rte 202, Somerville, N J 08876
SIGNETICS CORP. SUB. CORNING GLASS
811 E Arques Ave, Sunnyvale, Cal 94086
SOLITRON DEVICES INC.
256 Oak Tree Rd, Tappan, N Y 10983
SPRAGUE ELECTRIC CO.
551 Marshall St, N Adams, Mass 01247

CIRCUITS, MONOLITHIC (LSI-MOS)

ADVANCED MEMORY SYSTEMS INC.
1276 Hammerwood Ave, Sunnyvale, Cal 94086
AMERICAN MICRO-SYSTEMS INC.
3800 Homestead Rd, Santa Clara, Cal 95051
AVCO CORP. ELECTRONICS DIV.
4807 Bradford, Huntsville, Ala 35805
ITT SEMICONDUCTORS
3301 Electronics Way, W Palm Beach, Fla 33407
BOURNS INC.
1200 Columbia Ave., Riverside, Cal 92507
COLLINS RADIO CO.
1200 N Alma Rd, Dallas, Tex 75207
COLLINS RADIO CO.
19700 Jamboree Blvd, Newport Beach, Cal 92663
COMPUTER MICROTECHNOLOGY INC.
P O Box 7050, Sunnyvale, Cal 94086

2 Product Directory

ELECTRONIC ARRAYS INC.
501 Ellis St, Mt View, Cal 94040
FAIRCHILD SEMICONDUCTOR
464 Ellis St, Mt View, Cal 94040
GENERAL INSTRUMENT CORP. MICROELECT. DIV.
600 W John St, Hicksville, N Y 11802
HARVEY INDUSTRIAL DIV.
60 Crossway Pk W, Woodbury Li, N Y 11797
HUGHES AIRCRAFT CO. M O S DIV.
500 Superior Ave, Newport Beach, Cal 92660
INTERSIL INC.
10900 N Tantu, Cupertino, Cal 95014
KENICS SYSTEMS CORP.
125 Harvard St, Cambridge, Mass 02139
MACRODATA CO.
20440 Corrisco St, Chatsworth, Cal 91311
MOS TECHNOLOGY INC.
Valley Forge Ind Park, Valley Forge, Pa 19406
MOSTEK CORP.
1400 Upfield Dr, Carrollton, Tex 75006
MOTOROLA SEMICONDUCTOR PRODUCTS INC.
5005 E Mc Dowell Rd, Phoenix, Ariz 85008
NATIONAL SEMICONDUCTOR CORP.
2900 Semicon Dr, Santa Clara, Cal 95051
NORTH AMERICAN ROCKWELL CORP. AUTONETICS DIV.
3370 Miraloma Ave, Anaheim, Cal 92803
NUCLEONIC PRODUCTS CO. INC.
6660 Variel Ave, Canoga Park, Cal 91303
ON LINE COMPUTER CORP.
370 Ludlow St, Stamford, Conn 06902
QUALIDYNE
3699 Tahoe Way, Santa Clara, Cal 95051
RAYTHEON CO. EQUIPMENT DIV.
528 Boston Post Rd, Sudbury, Mass 01776
RCA CORP. SOLID STATE DIV.
Rte 202, Somerville, N J 08876
SIGNETICS CORP. SUB. CORNING GLASS
811 E Arques Ave, Sunnyvale, Cal 94086
SOLITRON DEVICES INC.
256 Oak Tree Rd, Tappan, N Y 10983
SOLITRON DEVICES INC.
8808 Balboa Ave, San Diego, Cal 92123
SPRAGUE ELECTRIC CO.
551 Marshall St, N Adams, Mass 01247
TRANSITRON ELECTRONIC CORP.
168 Albion St, Wakefield, Mass 01880

CIRCUITS, MONOLITHIC (OP AMPS)

ADVANCED MICRO DEVICES INC.
901 Thompson Pl, Sunnyvale, Cal 94086
AMPEREX ELECTRONIC CORP. A NO AMERICAN PHILIPS CO
P O Box 98, Slatersville, R I 02876
ANALOG DEVICES INC.
221 5th St, Cambridge, Mass 02142
ANALOG DEVICES INC. PASTORIZA DIV.
221 5th St, Cambridge, Mass 02142
AVCO CORP. ELECTRONICS DIV.
4807 Bradford, Huntsville, Ala 35805
ITT SEMICONDUCTORS
3301 Electronics Way, W Palm Beach, Fla 33407
BOURNS INC.
1200 Columbia Ave., Riverside, Cal 92507
BURR-BROWN RESEARCH CORP.
6730 S Tucson Blvd, Tucson, Ariz 85706
ELCOM ELECTRONICS INC.
200 Allen Blvd, Farmingdale, N Y 11735
FAIRCHILD SEMICONDUCTOR
464 Ellis St, Mt View, Cal 94040
GPS CORP.
14 Burr St, Framingham, Mass 01701
HARRIS SEMICONDUCTOR A DIV.OF
HARRIS-INTERTYPE
P O Box 883, Melbourne, Fla 32901
HARVEY INDUSTRIAL DIV.
60 Crossway Pk W, Woodbury Li, N Y 11797
INTERSIL INC.
10900 N Tantu, Cupertino, Cal 95014
MOTOROLA SEMICONDUCTOR PRODUCTS INC.
5005 E Mc Dowell Rd, Phoenix, Ariz 85008
NATIONAL SEMICONDUCTOR CORP.
2900 Semicon Dr, Santa Clara, Cal 95051
NUCLEONIC PRODUCTS CO. INC.
6660 Variel Ave, Canoga Park, Cal 91303
OPTICAL ELECTRONICS INC.
P O Box 11140, Tucson, Ariz 85706
PRECISION MONOLITHICS INC.
1500 Space Park Dr, Santa Clara, Cal 95050
QUALIDYNE
3699 Tahoe Way, Santa Clara, Cal 95051
RCA CORP. SOLID STATE DIV.
Rte 202, Somerville, N J 08876

SIGNETICS CORP. SUB. CORNING GLASS
811 E Arques Ave, Sunnyvale, Cal 94086
SILCONIX INC.
2201 Laurelwood Rd, Santa Clara, Cal 95054
SILICON GENERAL INC.
7382 Bolsa Ave, Westminster, Cal 92683
SOLITRON DEVICES INC.
256 Oak Tree Rd, Tappan, N Y 10983
SOLITRON DEVICES INC.
8808 Balboa Ave, San Diego, Cal 92123
SPRAGUE ELECTRIC CO.
551 Marshall St, N Adams, Mass 01247
TELEDYNE PHILBRICK NEXUS
Allied Dr At Rte 128, Dedham, Mass 02026
TRANSITRON ELECTRONIC CORP.
168 Albion St, Wakefield, Mass 01880
TRW SEMICONDUCTOR DIV.
14520 Aviation Blvd, Lawndale, Cal 90260

CIRCUITS, THICK FILM (DIGITAL)

AMPEREX ELECTRONIC CORP. A NO AMERICAN PHILIPS CO
P O Box 98, Slatersville, R I 02876
ANALOG DEVICES INC. PASTORIZA DIV.
221 5th St, Cambridge, Mass 02142
ASTRO-SPACE LABS., INC.
110 Wynn Drive NW, Huntsville, Ala 35806
BOURNS INC.
1200 Columbia Ave., Riverside, Cal 92507
CAL-R INC. DIV. OF CAP-TECH.
1601 Olympic Blvd, Santa Monica, Cal 90404
CENTRALAB ELECTRONICS, DIV.
5757 N Green Bay, Milwaukee, Wisc 53201
CERMETEK INC.
660 National Ave, Mt View, Cal 94040
COLLINS RADIO CO.
1200 N Alma Rd, Dallas, Tex 75207
COLUMBIA COMPONENTS CORP.
60 Madison Ave, Hempstead, N Y 11550
CONTROL DATA CORP. CIRCUITS DIV.
7800 Computer Ave, Minneapolis, Minn 55435
CTS CORP.
905 NW Blvd, Elkart, Ind 46514
DALE ELECTRONICS INC. SUB. LIONEL CORP.
1360 28th Ave, Columbus, Nebr 68601
DATEL/VARADYNE
1020 Turnpike St, Canton, Mass 02021
ELBIT COMPUTERS/SUB. CONTROL DATA CORP.
6 Tovim St, Haifa, ISRAEL
ELECTRONIC MICRO SYSTEMS INC.
1672 Kaiser Ave, Santa Ana, Cal 92705
ELECTRONIC MODULES CORP.
P O Box 141, Timonium, Md 21093
ERIE TECHNOLOGICAL PRODUCTS INC.
644 W 12th St, Erie, Pa 16512
GENERAL INSTRUMENT CORP. MICROELECT. DIV.
600 W John St, Hicksville, N Y 11802
HELIPOT DIV. BECKMAN INSTRUMENTS INC.
2500 Harbor Blvd, Fullerton, Cal 92634
HI-G INC.
580 Spring St, Windsor Locks, Conn 06096
INTERSIL INC.
10900 N Tantu, Cupertino, Cal 95014
LEDEX INC.
123 Webster St, Dayton, Ohio 45401
MEPCO INC.
Columbia Rd, Morristown, N J 07960
MICROTEK DIV. OF SPACETAC
Rte 62 Burlington Rd, Bedford, Mass 01730
MOTOROLA SEMICONDUCTOR PRODUCTS INC.
5005 E Mc Dowell Rd, Phoenix, Ariz 85008
MULTITECH DATA PRODUCTS
583 Monterey Pass Rd, Monterey Park, Cal 91754
NUCLEONIC PRODUCTS CO. INC.
6660 Variel Ave, Canoga Park, Cal 91303
NYTRONICS INC.
3rd Ave, Alpha, N J 08865
POWER PHYSICS CORP.
P O Box 626 Indus Way, Eatontown, N J 07724
RAYTHEON CO. EQUIPMENT DIV.
528 Boston Post Rd, Sudbury, Mass 01776
RAYTHEON CO. INDUSTRIAL COMPONENT OPERATION
465 Centre St., Quincy, Mass 02169
SAGE ELECTRONICS CORP. SUB. NYTRONICS INC.
P O Box 3926, Rochester, N Y 14610
SOLITRON DEVICES INC.
256 Oak Tree Rd, Tappan, N Y 10983
SPACETAC INC.
Burlington Rd, Bedford, Mass 01730
SPRAGUE ELECTRIC CO.
551 Marshall St, N Adams, Mass 01247

TRANSITRON ELECTRONIC CORP.
168 Albion St, Wakefield, Mass 01880
UNIVERSITY COMPUTING CO.
888 N Sepulveda Blvd, El Segundo, Cal 90245

CIRCUITS, THIN FILM (DIGITAL)

AMPEREX ELECTRONIC CORP. A NO AMERICAN PHILIPS CO
P O Box 98, Slatersville, R I 02876
ANALOG DEVICES INC. PASTORIZA DIV.
221 5th St, Cambridge, Mass 02142
COLLINS RADIO CO.
1200 N Alma Rd, Dallas, Tex 75207
COLLINS RADIO CO.
19700 Jamboree Blvd, Newport Beach, Cal 92663
CONTROL DATA CORP. CIRCUITS DIV.
7800 Computer Ave, Minneapolis, Minn 55435
ELECTRONIC MICRO SYSTEMS INC.
1672 Kaiser Ave, Santa Ana, Cal 92705
FIELDTEC INC.
4262 Campus Dr, Newport Beach, Cal 92660
FILM MICROELECTRONICS INC.
17 A St, Burlington, Mass 01803
GENERAL INSTRUMENT CORP. MICROELECT. DIV.
600 W John St, Hicksville, N Y 11802
HALEX INC.
3500 W Torrance Blvd, Torrance, Cal 90509
INTERSIL INC.
10900 N Tantu, Cupertino, Cal 95014
MOTOROLA SEMICONDUCTOR PRODUCTS INC.
5005 E Mc Dowell Rd, Phoenix, Ariz 85008
NATIONAL SEMICONDUCTOR CORP.
2900 Semicon Dr, Santa Clara, Cal 95051
NUCLEONIC PRODUCTS CO. INC.
6660 Variel Ave, Canoga Park, Cal 91303
QUALIDYNE
3699 Tahoe Way, Santa Clara, Cal 95051
RAYTHEON CO. EQUIPMENT DIV.
528 Boston Post Rd, Sudbury, Mass 01776
SPACETAC INC.
Burlington Rd, Bedford, Mass 01730
SPRAGUE ELECTRIC CO.
551 Marshall St, N Adams, Mass 01247
TELEDYNE CRYSTALONICS
147 Sherman St, Cambridge, Mass 02140
TRANSITRON ELECTRONIC CORP.
168 Albion St, Wakefield, Mass 01880
TRW SEMICONDUCTOR DIV.
14520 Aviation Blvd, Lawndale, Cal 90260

CIRCUITS, ENCAPSULATED (SEE MODULES)

CLEANER/CERTIFIERS, MAGNETIC TAPE

ACME VISIBLE RECORDS INC.
510 Allview Dr, Crozet, Va 22932
ACRATOD COMPANY
Po Box 66847, Houston, Tex 77006
COMPUTER-LINK CORP.
14 Cambridge St, Burlington, Mass 01803
CTM LEASING CORP.
4924 Hampden Lane, Bethesda, Md 20014
DATA DEVICES INC. SUB. DATA PROD.CORP
18360 Topham St, Tarzana, Cal 91356
DATA PRODUCTS CORP.
16055 Ventura Blvd, Encino, Cal 91316
DATASERV DIV., WILLIAM J. PURDY CORP.
770 Airport Blvd, Burlingame, Cal 94010
FORET, P. G.
60 Union Ave, Sudbury, Mass 01776
GENERAL KINETICS INC.
11425 Isaac Newt Sq S, Reston, Va 22070
GRAHAM MAGNETICS INC.
Graham, Tex 76046
HEWLETT PACKARD CO. MOUNTAIN VIEW DIV.
690 Middlefield Rd, Mtn View, Cal 94040
INDEL INC.
P O Box 15800, Tulsa, Okla 74115
JERSEY TAB CARD CORP.
649 Railway Ave, Union, N J 07083
KYBE CORP.
132 Calvary St, Waltham, Mass 02154
KYROS CORP.
P O Box 406, Madison, Wisc 53701
MACS COMPUTER ACCESSORIES INC
104 Park Towne Pl, Philadelphia, Pa 19130
MERIX CHEMICAL CO.
2234 E 75th St, Chicago, Ill 60649

2 Product Directory

MORLEY CO., THE
909 Islington St, Portsmouth, N H 03801
ORIGINAL COMPUTER PRODUCTS INC.
204 Worcester St, Wellesley Hills, Mass 02181
PURDY CORP., WM. J.
770 Airport Blvd, Burlingame, Cal 94010
RECORTEC INC.
162 S Whisman, Mt View, Cal 94040
TELECTRO SYSTEMS CORP.
96-18 43rd Ave, Corona, N Y 11368
TEXWIPE COMPANY, THE
51 Prospect Place, Hillsdale, N J 07642
VIRGINIA PANEL CORP.
1400 N Hope Rd, Waynesboro, Va 22980

CLEANERS, DISC PACK

INTERSCAN INC.
407 N Rockwell Ave, Oklahoma City, Okla 73127
KYBE CORP.
132 Calvary St, Waltham, Mass 02154

CLEANERS, MAGNETIC TAPE

ACRATOD COMPANY
Po Box 66847, Houston, Tex 77006
BARRY-WRIGHT CORP. WRIGHT LINE DIV.
160 Gold Star Blvd, Worcester, Mass 01606
COMPUTER-LINK CORP.
14 Cambridge St, Burlington, Mass 01803
DATA DEVICES INC. SUB. DATA PROD.CORP
18360 Topham St, Tarzana, Cal 91356
GENERAL KINETICS INC.
11425 Isaac Newt Sq S, Reston, Va 22070
INDEL INC.
P O Box 15800, Tulsa, Okla 74115
JERSEY TAB CARD CORP.
649 Rahway Ave, Union, N J 07083
KYBE CORP.
132 Calvary St, Waltham, Mass 02154
MACS COMPUTER ACCESSORIES INC
104 Park Towne Pl, Philadelphia, Pa 19130
MERIX CHEMICAL CO.
2234 E 75th St, Chicago, Ill 60649
MORLEY CO., THE
909 Islington St, Portsmouth, N H 03801
ORIGINAL COMPUTER PRODUCTS INC.
204 Worcester St, Wellesley Hills, Mass 02181
PRYOR COMPUTER INDUSTRIES
400 N Michigan Ave, Chicago, Ill 60611
SIMCO CO. INC.,THE
920 Walnut St, Lansdale, Pa 19446
TEXWIPE COMPANY, THE
51 Prospect Place, Hillsdale, N J 07642

CLEANERS, MAGNETIC TAPE HEADS

ACRATOD COMPANY
Po Box 66847, Houston, Tex 77006
AMPEX CORP. MAGNETIC TAPE DIV.
401 Broadway, Redwood City, Cal 94063
CAIG LABORATORIES INC.
455a Union Ave, Westbury, N Y 11590
COMPUTER-LINK CORP.
14 Cambridge St, Burlington, Mass 01803
FRIDEN DIV. THE SINGER CO.
97 Humboldt St, Rochester, N Y 14602
INDEL INC.
P O Box 15800, Tulsa, Okla 74115
MERIX CHEMICAL CO.
2234 E 75th St, Chicago, Ill 60649
OCHMAN SYSTEMS, EDWARD
Po Box 141, Fairfield, Conn 06430
TEXWIPE COMPANY, THE
51 Prospect Place, Hillsdale, N J 07642

CLOCKS, DIGITAL (REAL-TIME)

A. W. HAYDON CO., THE
232 N Elm St, Waterbury, Conn 06720
APPLIED COMPUTER SYSTEMS INC.
P O Box 6479, Austin, Tex 78702
ARTISAN ELECTRONICS CORP.
5 Eastman Rd, Parsippany, N J 07054
AUSTRON, INC.
10214 N Interregional, Austin, Tex 78753
BECKMAN INSTRUMENTS INC. ELECT. INSTR. DIV.
2200 Wright Ave, Richmond, Cal 94804
BEEHIVE MEDICAL ELECTRONICS INC.
1473 S 6th W, Salt Lake City, Utah 84104
BFA CORP.
1309 S Inca, Denver, Colo 80223

BULOVA WATCH ELECTRONICS DIV.
6120 Woodside Ave, Woodside Li, N Y 11377
CHRONO-LOG CORP.
2583 W Chester Pike, Broomall, Pa 19008
COMPUTER CORP. OF AMERICA
6216 Evergreen St, Houston, Tex 77036
COMPUTER PRODUCTS, INC.
P O Box 23849, Ft Lauderdale, Fla 33307
CONTROL EQUIPMENT CORP.
32 Kearney Rd, Needham Heights, Mass 02194
DATA CONTROL SYSTEMS INC.
Commerce Dr, Danbury, Conn 06810
DATATRON INC.
1562 Reynolds Ave, Santa Ana, Cal 92707
DI/AN CONTROLS INC.
944 Dorchester Ave, Boston, Mass 02125
DIGITAL DATA SYSTEMS
18819 Bryant St, Northridge, Cal 91324
DIGITAL EQUIPMENT CORP.
146 Main St, Maynard, Mass 01754
DIGITAL PRODUCTS CORP.
6950 NW 12 Ave, Ft Lauderdale, Fla 33309
DIGITAL TECHNIQUES CORP.
4248 Delemere Court, Royal Oak, Mich 48073
EL INSTRUMENTS INC.
61 1st St, Derby, Conn 06418
ELBIT COMPUTERS/SUB. CONTROL DATA CORP.
6 Tovim St, Haifa, ISRAEL
ELECTRONIC RESEARCH CO., A TEXTRON CO.
10000 W 75th St, Shawnee Mission, Kan 66202
HATHAWAY INSTRUMENTS INC.
5250 E Evans Ave, Denver, Colo 80120
HEWLETT PACKARD CO. CUPERTINO DIV.
1100 Wolfe Rd, Cupertino, Cal 95014
INTERNATIONAL CONTROLS CORP.
200 Fairfield Rd, Fairfield, N J 07006
LOGIC CORP.
21 Oldley Ave, Cherry Hill, N J 08034
METRIC SYSTEMS CORP.
736 N Beal St, Ft Walton Beach, Fla 32548
MICROWAVE MAGNETICS INC. MMI INSTRUMENT DIV.
Rte 1, Danvers, Mass 01923
MONITOR LABS INC.
10451 Roselle, San Diego, Cal 92121
NATIONAL SEMICONDUCTOR CORP.
2900 Semicon Dr, Santa Clara, Cal 95051
NATIONWIDE ELECTRONIC SYSTEMS INC.
7 N 662 Rte 53, Itasca, Ill 60143
PARABAM INC.
3017 E Las Hermanas, Compton, Cal 90221
PIONEER ELECTRIC & RESEARCH DIV. JOHNSON
SER.CO.
743 Circle Ave, Forest Park, Ill 60130
POWERTEC
9168 Desoto St, Chatsworth, Cal 91311
RAYCON INC.
218 Brunswick Blvd, Pointe Claire, CANADA
SCIENTIFIC CONTROL CORP.
1215 Crosby Rd, Carrollton, Tex 75080
SCIENTIFIC MEASUREMENTS INC.
9701 N Kenton, Skokie, Ill 60076
SIMPLEX TIME RECORDER CO.
26 South Lincoln St, Gardner, Mass 01440
SOLID STATE ELECTRONICS CORP.
15321 Rayen St, Sepulveda, Cal 91343
SRC DIV. MOXON INC.
2222 Michelson Dr, Newport Beach, Cal 92664
STRUTHER-DUNN INC. SYSTEMS DIV.
1114 State St, Bettendorf, Iowa 52722
SYSTRON-DONNER CORP.
888 Galindo St, Concord, Cal 94520
TUSTIN ELECTRONICS CO.
17942 E Main St, Tustin, Cal 92680
TYCO INSTRUMENT DIV. TYCO LABS. INC
.. Waltham, Mass 02154
UNICOMP INC.
18219 Parthenia, Northridge, Cal 91324
UNIVERSITY COMPUTING CO.
888 N Sepulveda Blvd, El Segundo, Cal 90245
VIDAR CORP.
77 Ortega Ave, Mountain View, Cal 94040

COATINGS, ANTI-STATIC

CUSTOM MATERIALS INC.
Alpha Industrial Park, Chelmsford, Mass 01824
MERIX CHEMICAL CO.
2234 E 75th St, Chicago, Ill 60649
SIMCO CO. INC.,THE
920 Walnut St, Lansdale, Pa 19446

COAXIAL CABLE (SEE CABLE)

COAXIAL FILTERS (SEE FILTERS)

CODE CONVERTERS (SEE CONVERTERS)

COLLATORS, PUNCHED CARD

CUSTOM DATA PROCESSING SERVICES
P O Box 14685, Phoenix, Ariz 85031
DATA PROCESSING AND ACCOUNTING SERVICES
50 Van Ness Ave, San Francisco, Cal 94102
DYNAMIC ACCESS CORP.
220 Park Ave S, New York, N Y 10003
IOA DATA CORP.
383 Lafayette St, New York, N Y 10003
MAI EQUIPMENT CORP.
300 E 44th St, New York, N Y 10017
REN ELECTRONICS
775 New Ludlow Rd, So Hadley, Mass 01075

COMMERCIAL TIME SHARING SERVICES (SEE SERVICES)

COMMUNICATIONS-ORIENTED PROCESSORS, MULTIPLE CHANNEL CONTROLLERS

AMERICAN DATA SYSTEMS
8851 Mason Ave, Canoga Park, Cal 91306
AMERICAN TOTALISATOR CO. UNI-TOTE DIV.
383 Hillen Rd, Towson, Md 21204
APPLIED SYSTEMS CORP.
18325 W McNichols Ave, Detroit, Mich 48219
BERKELEY COMPUTER CORP.
2398 4th St, Berkeley, Cal 94710
BURROUGHS CORP.,BUSINESS MACHINES GROUP
6071 2nd Ave, Detroit, Mich 48232
COLLINS RADIO CO.
1200 N Alma Rd, Dallas, Tex 75207
COMCET INC.
1950 W County Rd, St Paul, Minn 55113
COMDATA CORP.
7544 W Oakton St, Niles, Ill 60648
COMMUNICATIONS LOGIC INC.
6400 Westpark, Houston, Tex 77024
COMMUNICATIONS TECHNOLOGY INC.
1900 York Rd, Timonium, Md 21093
COMPUTER AUTOMATION INC.
895 W 16th St, Newport Beach, Cal 92660
COMPUTER COMMUNICATION INC.
701 W Manchester Blvd, Inglewood, Cal 90301
COMPUTER CONSULTANTS CORP.
U S Rte 46 E, Denville, N J 07834
COMPUTER SIGNAL PROCESSORS INC.
209 Middlesex Tpk, Burlington, Mass 01803
COMPUTER TERMINALS OF MINNESOTA INC.
4815 W 77th St, Minneapolis, Minn 55435
CONTROL DATA CORP.
8100 34th Ave S, Minneapolis, Minn 55440
CYBERMATION INC.
P O Box 58 River Rd, Washngtn Xing, Pa 18977
DACOM INC.
1060 Morse Ave, Sunnyvale, Cal 94086
DASH DATA SYSTEMS INC.
69 Jefferson St, Stamford, Conn 06902
DATA CONTROL SYSTEMS INC.
Commerce Dr, Danbury, Conn 06810
DATA GENERAL CORP.
Rte 9, Southboro, Mass 01772
DATA PACIFIC CORP.
116 E Ash, Fullerton, Cal 92631
DATA PATHING INC.
370 San Aleso Ave, Sunnyvale, Cal 94086
DATA 100 CORP.
7450 France Ave S, Minneapolis, Minn 55435
DELTA DATA SYSTEMS CORP.
Woodhaven Ind Park, Cornwells Hgts, Pa 19020
DEVONSHIRE COMPUTER CORP.
377 Elliot St, Newton, Mass 02164
DIGITAL COMPUTER CONTROLS INC
23 Just Rd, Fairfield, N J 07006
DYNALEX INC.
885 Front St, Burbank, Cal 91502
ELDORADO ELECTRODATA
601 Chalomar Rd, Concord, Cal 94520
ELPAC INC.
18651 Von Karman Ave, Irvine, Cal 92664

2 Product Directory

EMR COMPUTER
8001 Bloomington Fwy, Minneapolis, Minn 55420
GENERAL DYNAMICS CORP. ELECTRONICS DIV.
P O Box 2566, Orlando, Fla 32802
HONEYWELL INFORMATION SYSTEMS
60 Walnut St, Wellesley Hills, Mass 02181
IBM CORP., DATA PROCESSING DIV.
1133 Westchester Ave, White Plains, N Y 10604
INTERDATA
2 Crescent Pl, Oceanport, N J 07757
INTERNATIONAL COMPUTERS LTD.
Icl House Putney, London S W 15, UNITED K
ITT DATA EQUIPMENT & SYSTEMS DIV.
187 E Union Ave, E Rutherford, N J 07073
ITT DEFENSE COMMUNICATIONS DIV.
492 River Rd, Nutley, N J 07110
KDI INTERACTIVE DATA SYSTEMS
17785 Skypark Circle, Irvine, Cal 92664
LITTON SYSTEMS INC. DATA SYSTEMS DIV.
8000 Woodley Ave, Van Nuys, Cal 91409
LOGICON INC.
Del Amo Financial Ctr, Torrance, Cal 90503
MAXSON ELECTRONICS CORP. DIV. RIXKER MAXSON
Sunrise Hwy, Great River, N Y 11739
MICRO SYSTEMS INC.
644 E Young St, Santa Ana, Cal 92705
MICRODATA CORP.
644 E Young St, Santa Ana, Cal 92705
NORTH AMERICAN ROCKWELL CORP. AUTONETICS
DIV.
3370 Miraloma Ave, Anaheim, Cal 92803
OKI ELECTRIC INDUSTRIES CO. LTD.
875 Ave of Americas, New York, N Y 10001
OLIVETTI CORP. OF AMERICA
500 Park Ave, New York, N Y 10016
ON-LINE SYSTEMS INC.
4721 Mc Knight Rd, Pittsburg, Pa 15237
RAYTHEON CO. CADPO OPERATION
1415 Providence Tpk, Norwood, Mass 02062
RAYTHEON CO. EQUIPMENT DIV.
528 Boston Post Rd, Sudbury, Mass 01776
SANDERS ASSOCIATES INC. SYSTEMS DIV.
Daniel Webster Hwy S, Nashua, N H 03060
SCANTLIN ELECTRONICS, INC.
5454 Beethoven St, Los Angeles, Cal 90060
SCI-TEK COMPUTER CENTER INC.
1707 Gilpin Ave, Wilmington, Del 19806
SIERRA RESEARCH CORP. COMPUTER PROD. GRP.
167 Bedford St., Burlington, Mass 01803
SYS COMPUTER CORP.
17-25 Dicarolis Court, Hackensack, N J 07601
TEC INC.
6700 S Wash Ave, Eden Prarie, Minn 55343
TECHNITREND INC.
7300 N Crescent Blvd, Pennsauken, N J 08110
TENET INC.
927 Thompson Pl, Sunnyvale, Cal 94086
TEXAS INSTRUMENTS INC. DIGITAL SYSTEMS DIV
P O Box 66027, Houston, Tex 77006
TIME ZERO CORP.
3530 Torrance Blvd, Torrance, Cal 90510
TREPAC CORP. OF AMERICA
30 W Hamilton Ave, Englewood, N J 07631
ULTRONIC SYSTEMS CORP.
Mt Laurel Ind Pk, Moorestown, N J 08057
UNICOMP INC.
18219 Parthenia, Northridge, Cal 91324
UNIVERSITY COMPUTING CO.
P O Box 6228, Dallas, Tex 75222
UNIVERSITY COMPUTING CO.
888 N Sepulveda Blvd, El Segundo, Cal 90245
UNIVERSITY COMPUTING CO. DATA COMM. SYSTEMS
2659 Nova Dr, Dallas, Tex 75229
VARIAN DATA MACHINES
2722 Michelson Dr, Irvine, Cal 92664
WANG LABORATORIES INC.
836 N St, Tewksbury, Mass 01876
WEISMANTEL INC.
P O Box 1957, St Paul, Minn 55111
WELLS TP SCIENCES INC. SUB. WELLS MGT CORP
1450 Broadway, Laurence Levine, Vp 10018

COMMUNICATIONS-ORIENTED PROCESSORS, SINGLE CHANNEL CONTROLLERS

AMERICAN TOTALISATOR CO. UNI-TOTE DIV.
383 Hillen Rd, Towson, Md 21204
BURROUGHS CORP., BUSINESS MACHINES GROUP
6071 2nd Ave, Detroit, Mich 48232
COMDATA CORP.
7544 W Oakton St, Niles, Ill 60648
COMMUNICATIONS LOGIC INC.
6400 Westpark, Houston, Tex 77024

COMPUTER COMMUNICATION INC.
701 W Manchester Blvd, Inglewood, Cal 90301
COMPUTER TERMINALS OF MINNESOTA INC.
4815 W 77th St, Minneapolis, Minn 55435
CONTROL DATA CORP.
8100 34th Ave S, Minneapolis, Minn 55440
CYBERMATION INC.
P O Box 58 River Rd, Washngtn Xing, Pa 18977
DATA CONTROL SYSTEMS INC.
Commerce Dr, Danbury, Conn 06810
DATA GENERAL CORP.
Rte 9, Southboro, Mass 01772
DATA PACIFIC CORP.
116 E Ash, Fullerton, Cal 92631
DELTA DATA SYSTEMS CORP.
Woodhaven Ind Park, Cornwells Hgts, Pa 19020
ELPAC INC.
18651 Von Karman Ave, Irvine, Cal 92664
EMR COMPUTER
8001 Bloomington Fwy, Minneapolis, Minn 55420
GENERAL DYNAMICS CORP. ELECTRONICS DIV.
P O Box 2566, Orlando, Fla 32802
HONEYWELL INFORMATION SYSTEMS
60 Walnut St, Wellesley Hills, Mass 02181
IBM CORP., DATA PROCESSING DIV.
1133 Westchester Ave, White Plains, N Y 10604
INTERDATA
2 Crescent Pl, Oceanport, N J 07757
INTERNATIONAL COMPUTERS LTD.
Icl House Putney, London S W 15, UNITED K
ITT DATA EQUIPMENT & SYSTEMS DIV.
187 E Union Ave, E Rutherford, N J 07073
ITT DEFENSE COMMUNICATIONS DIV.
492 River Rd, Nutley, N J 07110
KDI INTERACTIVE DATA SYSTEMS
17785 Skypark Circle, Irvine, Cal 92664
MICRO SYSTEMS INC.
644 E Young St, Santa Ana, Cal 92705
MICRODATA CORP.
644 E Young St, Santa Ana, Cal 92705
NORTH AMERICAN ROCKWELL CORP. AUTONETICS
DIV.
3370 Miraloma Ave, Anaheim, Cal 92803
OKI ELECTRIC INDUSTRIES CO. LTD.
875 Ave of Americas, New York, N Y 10001
RAYTHEON CO. CADPO OPERATION
1415 Providence Tpk, Norwood, Mass 02062
ROLM CORP.
10300 N Tantau, Cupertino, Cal 95014
SCANTLIN ELECTRONICS, INC.
5454 Beethoven St, Los Angeles, Cal 90060
SCI-TEK COMPUTER CENTER INC.
1707 Gilpin Ave, Wilmington, Del 19806
SIERRA RESEARCH CORP. COMPUTER PROD. GRP.
167 Bedford St., Burlington, Mass 01803
SYSTEMS CONCEPTS INC.
17-45 Clintonville St, Whitestone, N Y 11357
TEC INC.
6700 S Wash Ave, Eden Prarie, Minn 55343
TECHNITREND INC.
7300 N Crescent Blvd, Pennsauken, N J 08110
TIME ZERO CORP.
3530 Torrance Blvd, Torrance, Cal 90510
ULTRONIC SYSTEMS CORP.
Mt Laurel Ind Pk, Moorestown, N J 08057
UNIVERSITY COMPUTING CO.
P O Box 6228, Dallas, Tex 75222
UNIVERSITY COMPUTING CO.
888 N Sepulveda Blvd, El Segundo, Cal 90245
UNIVERSITY COMPUTING CO. DATA COMM. SYSTEMS
2659 Nova Dr, Dallas, Tex 75229
VARIAN DATA MACHINES
2722 Michelson Dr, Irvine, Cal 92664
WEISMANTEL INC.
P O Box 1957, St Paul, Minn 55111

COMMUNICATIONS-ORIENTED PROCESSORS, STORED PROGRAM

AMERICAN TOTALISATOR CO. UNI-TOTE DIV.
383 Hillen Rd, Towson, Md 21204
APPLIED SYSTEMS CORP.
18325 W McNichols Ave, Detroit, Mich 48219
ATRON CORP.
1256 Trapp Rd, St Paul, Minn 55118
AUTOMATED SYSTEMS CORP.
600 Houst Nat Gas Bld, Houston, Tex 77002
BERKELEY COMPUTER CORP.
2398 4th St, Berkeley, Cal 94710
BURROUGHS CORP., BUSINESS MACHINES GROUP
6071 2nd Ave, Detroit, Mich 48232
COLLINS RADIO CO.
1200 N Alma Rd, Dallas, Tex 75207

COMCET
2 Research Court, Rockville, Md 20850
COMDATA CORP.
7544 W Oakton St, Niles, Ill 60648
COMMUNICATIONS TECHNOLOGY INC.
1900 York Rd, Timonium, Md 21093
COMPAT CORP.
177 Cantiague Rock Rd, Westbury, N Y 11590
COMPUTER AUTOMATION INC.
895 W 16th St, Newport Beach, Cal 92660
COMPUTER COMMUNICATION INC.
701 W Manchester Blvd, Inglewood, Cal 90301
COMPUTER CONSULTANTS CORP.
U S Rte 46 E, Denville, N J 07834
COMPUTER SIGNAL PROCESSORS INC.
209 Middlesex Tpk, Burlington, Mass 01803
COMPUTER TERMINALS OF MINNESOTA INC.
4815 W 77th St, Minneapolis, Minn 55435
CONTROL DATA CORP.
8100 34th Ave S, Minneapolis, Minn 55440
CYBERMATION INC.
P O Box 58 River Rd, Washngtn Xing, Pa 18977
DASH DATA SYSTEMS INC.
69 Jefferson St, Stamford, Conn 06902
DATA CONTROL SYSTEMS INC.
Commerce Dr, Danbury, Conn 06810
DATA GENERAL CORP.
Rte 9, Southboro, Mass 01772
DATA PACIFIC CORP.
116 E Ash, Fullerton, Cal 92631
DATA PATHING INC.
370 San Alejo Ave, Sunnyvale, Cal 94086
DATA TRENDS INC.
P O Box 82, Mt Lake, N J 07046
DATA 100 CORP.
7450 France Ave S, Minneapolis, Minn 55435
DELTA DATA SYSTEMS CORP.
Woodhaven Ind Park, Cornwells Hgts, Pa 19020
DIGITAL COMPUTER CONTROLS INC
23 Just Rd, Fairfield, N J 07006
DIGITAL SCIENTIFIC CORP.
11455 Sorrento Vly Rd, San Diego, Cal 92121
DYNALEX INC.
885 Front St, Burbank, Cal 91502
ELDORADO ELECTRODATA
601 Chalmar Rd, Concord, Cal 94520
ELPAC INC.
18651 Von Karman Ave, Irvine, Cal 92664
EMR COMPUTER
8001 Bloomington Fwy, Minneapolis, Minn 55420
FEDDER DATA CENTERS INC.
307 S Sharp St, Baltimore, Md 21201
GENERAL AUTOMATION INC.
1055 S East St, Anaheim, Cal 92805
GENERAL DYNAMICS CORP. ELECTRONICS DIV.
P O Box 2566, Orlando, Fla 32802
GENERAL ELECTRIC CO. COMM. SYS. DIV.
Mountain View Rd, Lynchburg, Va 24502
IBM CORP., DATA PROCESSING DIV.
1133 Westchester Ave, White Plains, N Y 10604
INTERNATIONAL COMPUTERS LTD.
Icl House Putney, London S W 15, UNITED K
ITT DATA EQUIPMENT & SYSTEMS DIV.
187 E Union Ave, E Rutherford, N J 07073
ITT DEFENSE COMMUNICATIONS DIV.
492 River Rd, Nutley, N J 07110
LITTON SYSTEMS INC. DATA SYSTEMS DIV.
8000 Woodley Ave, Van Nuys, Cal 91409
LOGICON INC.
Del Amo Financial Ctr, Torrance, Cal 90503
3M CO.
3m Center, St Paul, Minn 55101
MICRO SYSTEMS INC.
644 E Young St, Santa Ana, Cal 92705
MICRODATA CORP.
644 E Young St, Santa Ana, Cal 92705
MOHAWK DATA SCIENCES CORP.
Palisade St, Herkimer, N Y 13350
NORTH AMERICAN ROCKWELL CORP. AUTONETICS
DIV.
3370 Miraloma Ave, Anaheim, Cal 92803
OKI ELECTRIC INDUSTRIES CO. LTD.
875 Ave of Americas, New York, N Y 10001
OLIVETTI CORP. OF AMERICA
500 Park Ave, New York, N Y 10016
QANTEL CORP.
3474 Investment Blvd, Hayward, Cal 94545
RAYTHEON CO. CADPO OPERATION
1415 Providence Tpk, Norwood, Mass 02062
RAYTHEON CO. EQUIPMENT DIV.
528 Boston Post Rd, Sudbury, Mass 01776
ROLM CORP.
10300 N Tantau, Cupertino, Cal 95014
SCANTLIN ELECTRONICS, INC.
5454 Beethoven St, Los Angeles, Cal 90060

2 Product Directory

SCIENTIFIC CONTROL CORP.
1215 Crosby Rd, Carrollton, Tex 75080
SCI-TEK COMPUTER CENTER INC.
1707 Gilpin Ave, Wilmington, Del 19806
SYSTEMS CONCEPTS INC.
17-45 Clintonville St, Whitestone, N Y 11357
SYSTEMS EQUIPMENT CORP.
458 Plasamour Dr, Atlanta, Ga 30324
TEC INC.
6700 S Wash Ave, Eden Prairie, Minn 55343
TELE-DATA CORP.
130 U S Hwy 22, N Plainfield, N J 07060
TEMPO COMPUTERS INC.
1550 S St College Blv, Anaheim, Cal 92806
TIME ZERO CORP.
3530 Torrance Blvd, Torrance, Cal 90510
ULTRONIC SYSTEMS CORP.
Mt Laurel Ind Pk, Moorestown, N J 08057
UNICOMP INC.
18219 Parthenia, Northridge, Cal 91324
UNIVERSITY COMPUTING CO.
P O Box 6228, Dallas, Tex 75222
UNIVERSITY COMPUTING CO.
888 N Sepulveda Blvd, El Segundo, Cal 90245
UNIVERSITY COMPUTING CO. DATA COMM. SYSTEMS
2659 Nova Dr, Dallas, Tex 75229
VARIAN DATA MACHINES
2722 Michelson Dr, Irvine, Cal 92664
WEISMANTEL INC.
P O Box 1957, St Paul, Minn 55111
WELLS TP SCIENCES INC. SUB. WELLS MGT CORP
1450 Broadway, Laurence Levine, Vp 10018

COMMUNICATION SYSTEMS, DATA TRANSMISSION

ADDO-X INC. ADP DIV.
437 Madison Ave, New York, N Y 10022
ADDRESSOGRAPH MULTIGRAPH CORP BRUNING DIV.
1200 Babbitt Rd, Cleveland, Ohio 44117
ALDEN ELECTRONIC & IMPULSE RECORDING EQUIP. CO
Washington St, Westboro, Mass 01581
AMBAC INDUSTRIES INC. TELE-DYNAMICS DIV.
525 Virginia Dr, Ft Washington, Pa 19034
AMERICAN COMPUTER TECHNOLOGY INC.
8740 Shirley Ave, Northridge, Cal 91324
AMERICAN TOTALISATOR CO. UNI-TOTE DIV.
383 Hillen Rd, Towson, Md 21204
ANDERSON JACOBSON INC.
1065 Morse Ave., Sunnyvale, Cal 94086
AUTOMATIC ELECTRIC SUB. GT&E
400 No Wolf Rd, North Lake, Ill 60164
BAGANOFF ASSOCIATES INC.
6809 W Florissant, St Louis, Mo 63136
BENDIX CORP., THE, ENVRNMNTL SCI. DIV.
1400 Taylor Ave, Baltimore, Md 21204
BERKELEY COMPUTER CORP.
2398 4th St, Berkeley, Cal 94710
BONNAR-VAWTER INC.
96 Dunbar St, Keene, N H 03431
BRAMCO CONTROLS DIV. LEDEX INC.
College & South St, Piqua, Ohio 45356
BUNKER RAMO CORP., THE, BUSINESS & IND. DIV
445 Fairfield Ave, Stamford, Conn 06904
CANTELTECH LTD.
1970 Ellesmere Rd, Scarborough 722, CANADA
CARROLL GRAPHICS INC.
5301 Michigan Ave, Rosemont, Ill 60018
CODEX CORP.
15 Riverdale Ave, Newton, Mass 02195
COGNITRONICS CORP.
333 Bedford Rd, Mt Kisco, N Y 10549
COHU ELECTRONICS INC. SAN DIEGO DIV.
P O Box 623, San Diego, Cal 92112
COLLINS RADIO CO.
1200 N Alma Rd, Dallas, Tex 75207
COLLINS RADIO CO.
19700 Jamboree Blvd, Newport Beach, Cal 92663
COLORADO INSTRUMENTS INC.
1 Park St, Broomfield, Colo 80020
COMDATA CORP.
7544 W Oakton St, Niles, Ill 60648
COMMUNICATIONS LOGIC INC.
6400 Westpark, Houston, Tex 77024
COMMUNICATIONS TECHNOLOGY INC.
1900 York Rd, Timonium, Md 21093
COMMUNITYPE CORP.
767 Fifth Ave, New York, N Y 10022
COMPAT CORP.
177 Cantigue Rock Rd, Westbury, N Y 11590
COMPERIPHERALS INC.
437 Madison Ave, New York, N Y 10022

COMPUTER COMMUNICATION INC.
701 W Manchester Blvd, Inglewood, Cal 90301
COMPUTER CONSULTANTS CORP.
U S Rte 46 E, Denville, N J 07834
COMPUTER CONTROL SYSTEMS INC.
6116 N Central Expwy, Dallas, Tex 75206
COMPUTER CONVERSIONS CORP.
6 Dunton Court, E Northport, N Y 11731
COMPUTER DEVICES INC.
10 Sonar Dr, Woburn, Mass 01801
COMPUTER ENTRY SYSTEMS CORP.
2141 Industrial Pkwy, Silver Spring, Md 20904
COMPUTER TRANSMISSION CORP.
1508 Cotner Ave, Los Angeles, Cal 90025
CONRAC CORP.
330 Madison Ave, New York, N Y 10017
CONRAC CORP. DATEX DIV.
1600 S Mountain Ave, Duarte, Cal 91010
CONTROL DATA CORP.
8100 34th Ave S, Minneapolis, Minn 55440
CREDIT SYSTEMS INC.
P O Box 105, Colmar, Pa 18915
CYBERMATION INC.
P O Box 58 River Rd, Washngtn Xing, Pa 18977
DACOM INC.
1060 Morse Ave, Sunnyvale, Cal 94086
DASH DATA SYSTEMS INC.
69 Jefferson St, Stamford, Conn 06902
DATA ACCESS SYSTEMS INC.
503 Rte 10 Mt 19, Dover, N J 07801
DATA CONTROL SYSTEMS INC.
Commerce Dr, Danbury, Conn 06810
DATA GENERAL CORP.
Rte 9, Southboro, Mass 01772
DATA INPUT DEVICES INC.
Tinkham Ind Pk, Derry, N H 03038
DATA PACIFIC CORP.
116 E Ash, Fullerton, Cal 92631
DATA PATHING INC.
370 San Aleso Ave, Sunnyvale, Cal 94086
DATA PRODUCTS CORP.
16055 Ventura Blvd, Encino, Cal 91316
DATA PRODUCTS TELECOMMUNICATIONS
17 Amelia Place, Stamford, Conn 06902
DATA 100 CORP.
7450 France Ave S, Minneapolis, Minn 55435
DATACOM INC.
40 Lincoln Dr, Ft Walton Beach, Fla 32548
DATASONICS INC.
P O Box 4553, New York, N Y 10017
DATATERM INC.
1671 Manning Blvd, Levittown, Pa 19057
DA-TEL RESEARCH CO.
930 N Park Ave, Montrose, Colo 81401
DATRAN CORP.
179 W Rocks Rd, Norwalk, Conn 06851
DELTA DATA SYSTEMS CORP.
Woodhaven Ind Park, Cornwells Hgts, Pa 19020
DEMEX INC.
2130 Jefferson, Kansas City, Mo 64108
DESIGN ELEMENTS INC.
356 Norton Ave, Columbus, Ohio 43212
DEVONSHIRE COMPUTER CORP.
377 Elliot St, Newton, Mass 02164
DIAMOND POWER SPECIALTY CORP.
P O Box 415, Lancaster, Ohio 43130
DIGI-DATA CORP.
4315 Baltimore Ave, Bladensburg, Md 20710
DIGITAL AUTOMATION CO. INC.
1018 Whitehead Rd Ext, Trenton, N J 08638
DIGITAL EQUIPMENT CORP.
146 Main St, Maynard, Mass 01754
DIGITAL PRODUCTS
335 W 7th St, San Pedro, Cal 90733
DIGITRONICS CORP.
1 Albertson Ave, Albertson, N Y 11507
ELBIT COMPUTERS/SUB. CONTROL DATA CORP.
6 Tovim St, Haifa, ISRAEL
ELDORADO ELECTRODATA
601 Chalomar Rd, Concord, Cal 94520
ELECTRONIC LABS, INC.
3726 Daocoma St, Houston, Tex 77018
EMR COMPUTER
8001 Bloomington Fwy, Minneapolis, Minn 55420
FRIDEN DIV. THE SINGER CO.
97 Humboldt St, Rochester, N Y 14602
FUJITSU LTD. N.Y.LIAISON OFFICE
680 Fifth Ave, New York, N Y 10019
GENERAL ATRONICS CORP. SUB. OF MAGNAVOX
Mermaid Lane, Philadelphia, Pa 19118
GENERAL DYNAMICS CORP. ELECTRONICS DIV.
P O Box 2566, Orlando, Fla 32802
GENERAL ELECTRIC CO. COMM. SYS. DIV.
Mountain View Rd, Lynchburg, Va 24502

GULTON INDUSTRIES INC.
212 Durham Ave, Metuchen, N J 08840
HATHAWAY INSTRUMENTS INC.
5250 E Evans Ave, Denver, Colo 80120
HEWLETT PACKARD CO. CUPERTINO DIV.
1100 Wolfe Rd, Cupertino, Cal 95014
HI-G INC.
580 Spring St, Windsor Locks, Conn 06096
HONEYWELL INFORMATION SYSTEMS
60 Walnut St, Wellesley Hills, Mass 02181
HOUSTON RESEARCH INC. SUB. SCI. ELECT.
6001 Gulf Fwy, Houston, Tex 77023
HYPERTECH CORP.
7343 W Wilson Ave, Harwood Hgts, Ill 60656
IBM CORP. DATA PROCESSING DIV.
1133 Westchester Ave, White Plains, N Y 10604
INFOREX INC.
21 N Ave, Burlington, Mass 01803
INFOTEC INC.
70 Newton Rd, Plainview, N Y 11803
INTERNATIONAL COMMUNICATIONS CORP., SUB. OF MILGO
7620 NW 36th Ave, Miami, Fla 33147
INTERNATIONAL COMPUTERS LTD.
Icl House Putney, London S W 15, UNITED K
ITEL INFORAMTION PRODUCTS DIV
2585 Bayshore, Palo Alto, Cal 94303
ITT DATA EQUIPMENT & SYSTEMS DIV.
187 E Union Ave, E Rutherford, N J 07073
ITT DEFENSE COMMUNICATIONS DIV.
492 River Rd, Nutley, N J 07110
KDI INTERACTIVE DATA SYSTEMS
17785 Skypark Circle, Irvine, Cal 92664
KIMBALL SYSTEMS DIV. LITTON INDUS.
151 Cortlandt St, Belleville, N J 07109
KLEINSCHMIDT DIV., SCM CORP.
Lake-Cook Rd, Deerfield, Ill 60015
LARSE CORP.
1070 E Meadow Cir, Palo Alto, Cal 94303
LENKURT ELECTRIC CO., INC. SUB. OF GT&E
1105 County Rd, San Carlos, Cal 94070
LITTON SYSTEMS INC. DATA SYSTEMS DIV.
8000 Woodley Ave, Van Nuys, Cal 91409
LOGIC CORP.
21 Oldey Ave, Cherry Hill, N J 08034
LOGICON INC.
Del Amo Financial Ctr, Torrance, Cal 90503
LUNDY ELECTRONICS & SYSTEMS INC.
Robert Lane, Glen Head, N Y 11545
LYNCH COMMUNICATION SYSTEMS INC.
695 Bryant St, San Francisco, Cal 94107
MANAGEMENT SYSTEMS INC.
420 W Campbell Ave., Roanoke, Va 24016
MARK COMPUTER SYSTEMS INC.
One Patterson Pl, Garden City, N Y 11530
MARQUETTA ELECTRONICS INC.
3712 W Elm St, Milwaukee, Wisc 53209
MAXSON ELECTRONICS CORP. DIV. RIXKER MAXSON
Sunrise Hwy, Great River, N Y 11739
METRIC SYSTEMS CORP.
736 N Beal St, Ft Walton Beach, Fla 32548
MICRO SYSTEMS INC.
644 E Young St, Santa Ana, Cal 92705
MICRODATA CORP.
644 E Young St, Santa Ana, Cal 92705
MICROWAVE MAGNETICS INC. MMI INSTRUMENT DIV.
Rte 1, Danvers, Mass 01923
MILGO ELECTRONIC CORP.
7620 NW 36th Ave, Miami, Fla 33147
MOHAWK DATA SCIENCES CORP.
Palisade St, Herkimer, N Y 13350
MSI DATA CORP.
4751 Holt Ave, Mont Clair, Cal 91763
MULTIPEX COMMUNICATIONS INC.
123 Marcus Blvd, Hauppauge, N Y 11787
MULTITECH DATA PRODUCTS
583 Monterey Pass Rd, Monterey Park, Cal 91754
NATIONAL MIDCO INDUSTRIES INC.
Box 5433, Trenton, N J 08638
NORTH AMERICAN ROCKWELL CORP. AUTONETICS DIV.
3370 Miraloma Ave, Anaheim, Cal 92803
OKI ELECTRIC INDUSTRIES CO. LTD.
875 Ave of Americas, New York, N Y 10001
OLIVETTI CORP. OF AMERICA
500 Park Ave, New York, N Y 10016
PIONEER ELECTRIC & RESEARCH DIV. JOHNSON SER.CO.
743 Circle Ave, Forest Park, Ill 60130
PRINTER TECHNOLOGY INC.
Sixth Rd, Woburn, Mass 01801
PULSE COMMUNICATIONS INC.
5214 Columbia Pike, Falls Church, Va 22041
RAYTHEON CO. CADPO OPERATION
1415 Providence Tpk, Norwood, Mass 02062

2 Product Directory

RAYTHEON CO. EQUIPMENT DIV.
528 Boston Post Rd, Sudbury, Mass 01776

SANDERS ASSOCIATES INC. SYSTEMS DIV.
Daniel Webster Hwy S, Nashua, N H 03060

SCANTLIN ELECTRONICS, INC.
5454 Beethoven St, Los Angeles, Cal 90060

SCI ELECTRONICS INC.
7705 La Porte Fwy, Houston, Tex 77012

SCIENTIFIC CONTROL CORP.
1215 Crosby Rd, Carrollton, Tex 75080

SCI-TEK COMPUTER CENTER INC.
1707 Gilpin Ave, Wilmington, Del 19806

SHIRAK TELEMETERING OF AMERICA
8926 Kester Ave, Van Nuys, Cal 91402

SIERRA RESEARCH CORP. COMPUTER PROD. GRP.
167 Bedford St., Burlington, Mass 01803

SINGER CO., THE, FRIDEN DIV.
2350 Washington St, San Leandro, Cal 94577

SPECTRON CORP.
10060 Kings Hwy N, Cherry Hill, N J 08034

SYLVANIA ELECTRONIC SYSTEMS EASTERN DIV.
77 A St, Needham Heights, Mass 02194

SYMETRICS INDUSTRIES INC.
1227 S Patrick Dr, Satellite Beach, Fla 32935

SYS COMPUTER CORP.
17-25 Dicarolis Court, Hackensack, N J 07601

SYSTEMS CONCEPTS INC.
17-45 Clintonville St, Whitestone, N Y 11357

TALLY CORP.
8301 S 180th St, Kent, Wash 98031

TECHNICAL MATERIAL CORP.
700 Fenimore Rd, Mamaroneck, N Y 10543

TEL-TECH CORP.
11810 Parklawn Dr, Rockville, Md 20852

TELE-DATA CORP.
130 U S Hwy 22, N Plainfield, N J 07060

TELECTRO SYSTEMS CORP.
96-18 43rd Ave, Corona, N Y 11368

TELEDYNE GEOTECH
P O Box 28277, Dallas, Tex 75228

TELEMODEM INC.
98-05 217 St, Queens Village, N Y 11429

TELETYPE CORP.
5555 W Touhy Ave, Skokie, Ill 60076

TEMPO COMPUTERS INC.
1550 S St College Blv, Anaheim, Cal 92806

TEXAS INSTRUMENTS INC. DIGITAL SYSTEMS DIV
P O Box 66027, Houston, Tex 77006

TIMEPLEX INC.
65 Oak St, Norwood, N J 07648

TRANSCOM INC. SUB. OF HI-G INC.
12 Tobey Rd, Bloomfield, Conn 06002

TRANSITEL, DIV. OF SANGAMO ELECTRIC CO.
P O Box 7255, Denver, Colo 80207

TREPAC CORP. OF AMERICA
30 W Hamilton Ave, Englewood, N J 07631

TUCK ELECTRONICS
235 Market St, New Cumberland, Pa 17070

TYMSHARE INC.
525 University Ave, Palo Alto, Cal 94301

ULTRONIC SYSTEMS CORP.
Mt Laurel Ind Pk, Moorestown, N J 08057

UNICOMP INC.
18219 Parthenia, Northridge, Cal 91324

UNITED BUSINESS COMMUNICATIONS INC.
6405 Metcalf Ave, Shawnee Mission, Kans 66202

UNIVERSITY COMPUTING CO.
P O Box 6228, Dallas, Tex 75222

UNIVERSITY COMPUTING CO.
888 N Sepulveda Blvd, El Segundo, Cal 90245

UNIVERSITY COMPUTING CO. DATA COMM. SYSTEMS
2659 Nova Dr, Dallas, Tex 75229

VARIAN DATA MACHINES
2722 Michelson Dr, Irvine, Cal 92664

WEISMANTEL INC.
P O Box 1957, St Paul, Minn 55111

WELLS TP SCIENCES INC. SUB. WELLS MGT CORP
1450 Broadway, Laurence Levine, Vp 10018

WESTERN TELEMATIC INC.
5507 Peck Rd, Arcadia, Cal 91006

WORLD COMPUTER CORP.
1615 Stemmons Fwy, Dallas, Tex 75221

COMMUNICATION SYSTEMS, FACSIMILE

ADDRESSOGRAPH MULTIGRAPH CORP BRUNING DIV.
1200 Babbitt Rd, Cleveland, Ohio 44117

ALDEN ELECTRONIC & IMPULSE RECORDING EQUIP.
CO
Washington St, Westboro, Mass 01581

COLORADO VIDEO INC.
P O Box 928, Boulder, Colo 80302

DACOM INC.
1060 Morse Ave, Sunnyvale, Cal 94086

DIAMOND POWER SPECIALTY CORP.
P O Box 415, Lancaster, Ohio 43130

EDGERTON GERMESHAUSEN GRIER INC.
Crosby Dr, Bedford, Mass 01730

GIBBS MANUFACTURING & RESEARCH CORP.
450 N Main, Janesville, Wisc 53545

HONEYWELL INFORMATION SYSTEMS
60 Walnut St, Wellesley Hills, Mass 02181

INTERNATIONAL COMMUNICATIONS CORP., SUB. OF
MILGO
7620 NW 36th Ave, Miami, Fla 33147

KDI INTERACTIVE DATA SYSTEMS
17785 Skypark Circle, Irvine, Cal 92664

LENKURT ELECTRIC CO., INC. SUB. OF GT&E
1105 County Rd, San Carlos, Cal 94070

LOGIC CORP.
21 Oldey Ave, Cherry Hill, N J 08034

MILGO ELECTRONIC CORP.
7620 NW 36th Ave, Miami, Fla 33147

MUIRHEAD INC.
1101 Bristol Rd, Mountainside, N J 07092

RAYTHEON CO. EQUIPMENT DIV.
528 Boston Post Rd, Sudbury, Mass 01776

SCI-TEK COMPUTER CENTER INC.
1707 Gilpin Ave, Wilmington, Del 19806

SHINTRON CO INC.
144 Rogers St, Cambridge, Mass 02142

STEWART WARNER CORP./DATAFAX
1300 N Kostner Ave, Chicago, Ill 60651

SYSTEMS CONCEPTS INC.
17-45 Clintonville St, Whitestone, N Y 11357

TECHNICAL MATERIAL CORP.
700 Fenimore Rd, Mamaroneck, N Y 10543

TEL AUTOGRAPH CORP.
8700 Bellanca Ave, Los Angeles, Cal 90045

UNIVERSITY COMPUTING CO.
888 N Sepulveda Blvd, El Segundo, Cal 90245

WEISMANTEL INC.
P O Box 1957, St Paul, Minn 55111

COMMUNICATION SYSTEMS, TELEPRINTER

AMERICAN REGITEL CORP.
870 Industrial Way, San Carlos, Cal 94070

ANDERSON JACOBSON INC.
1065 Morse Ave., Sunnyvale, Cal 94086

BUNKER RAMO CORP., THE, BUSINESS & IND. DIV
445 Fairfield Ave, Stamford, Conn 06904

COMDATA CORP.
7544 W Oakton St, Niles, Ill 60648

COMPACE CORP.
7413 Washington Ave S, Edina-Minnepols, Minn
55435

COMPAT CORP.
177 Cantigue Rock Rd, Westbury, N Y 11590

COMPUTER COMMUNICATION INC.
701 W Manchester Blvd, Inglewood, Cal 90301

COMPUTER CONTROL SYSTEMS INC.
6116 N Central Expwy, Dallas, Tex 75206

COMPUTER DEVICES INC.
10 Sonar Dr, Woburn, Mass 01801

CONRAC CORP. DTEX DIV.
1600 S Mountain Ave, Duarte, Cal 91010

CONTROL DATA CORP.
8100 34th Ave S, Minneapolis, Minn 55440

DASH DATA SYSTEMS INC.
69 Jefferson St, Stamford, Conn 06902

DATA ACCESS SYSTEMS INC.
503 Rte 10 Mt 19, Dover, N J 07801

DATA AUTOMATION COMMUNICATIONS INC.
7505 Carpenter Fwy, Dallas, Tex 75247

DATA COMPUTING INC.
2219 W Shangri La Rd, Phoenix, Ariz 85029

DATA DIMENSIONS INC.
51 Weaver St, Greenwich, Conn 06830

DATA GENERAL CORP.
Rte 9, Southboro, Mass 01772

DATA PATHING INC.
370 San Aleso Ave, Sunnyvale, Cal 94086

DATA PRODUCTS TELECOMMUNICATIONS
17 Amelia Place, Stamford, Conn 06902

DATA 100 CORP.
7450 France Ave S, Minneapolis, Minn 55435

DATALOG DIV. LITTON SYSTEMS INC.
1 Executive Pk, Englewood, Colo 80110

DATAMETRIC CORP.
7630 Gloria Ave, Van Nuys, Cal 91406

DATATERM INC.
1671 Manning Blvd, Levittown, Pa 19057

DA-TEL RESEARCH CO.
930 N Park Ave, Montrose, Colo 81401

DIAMOND POWER SPECIALTY CORP.
P O Box 415, Lancaster, Ohio 43130

DIGITAL AUTOMATION CO. INC.
1018 Whitehead Rd Ext, Trenton, N J 08638

ELBIT COMPUTERS/SUB. CONTROL DATA CORP.
6 Tovim St, Haifa, ISRAEL

FUJITSU LTD. N.Y. LIAISON OFFICE
680 Fifth Ave, New York, N Y 10019

GENERAL ELECTRIC CO. COMM. SYS. DIV.
Mountain View Rd, Lynchburg, Va 24502

GOULD INC. BRUSH DIV.
3631 Perkins Ave, Cleveland, Ohio 44114

GULTON INDUSTRIES INC. COMPUTER SYS. DIV.
13041 Cerise Ave, Hawthorne, Cal 90250

HI-G INC.
580 Spring St, Windsor Locks, Conn 06096

IBM CORP., DATA PROCESSING DIV.
1133 Westchester Ave, White Plains, N Y 10604

INFOTEC INC.
70 Newton Rd, Plainview, N Y 11803

INTERNATIONAL COMMUNICATIONS CORP., SUB. OF
MILGO
7620 NW 36th Ave, Miami, Fla 33147

INTERNATIONAL COMPUTERS LTD.
Ici House Putney, London S W 15, UNITED K

ITEL INFORMATION PRODUCTS DIV
2585 Bayshore, Palo Alto, Cal 94303

ITT DATA EQUIPMENT & SYSTEMS DIV.
187 E Union Ave, E Rutherford, N J 07073

ITT DEFENSE COMMUNICATIONS DIV.
492 River Rd, Nutley, N J 07110

KLEINSCHMIDT DIV., SCM CORP.
Lake-Cook Rd, Deerfield, Ill 60015

LENKURT ELECTRIC CO., INC. SUB. OF GT&E
1105 County Rd, San Carlos, Cal 94070

MAXSON ELECTRONICS CORP. DIV. RIXKER MAXSON
Sunrise Hwy, Great River, N Y 11739

MICRO SYSTEMS INC.
644 E Young St, Santa Ana, Cal 92705

MICRODATA CORP.
644 E Young St, Santa Ana, Cal 92705

MILGO ELECTRONIC CORP.
7620 NW 36th Ave, Miami, Fla 33147

MITE CORP. DATA EQUIPMENT DIV.
446 Blake St, New Haven, Conn 06514

MULTIPLEX COMMUNICATIONS INC.
123 Marcus Blvd, Hauppauge, N Y 11787

NCR INDUSTRIA PRODUCTS DIV.
Main And K St, Dayton, Ohio 45409

NOVAR CORP.
2370 Charleston Rd, Mt View, Cal 94040

OKI ELECTRIC INDUSTRIES CO. LTD.
875 Ave of Americas, New York, N Y 10001

OLIVETTI CORP. OF AMERICA
500 Park Ave, New York, N Y 10016

PATH COMPUTER EQUIPMENT INC.
65 Commerce Rd, Stamford, Conn 06904

PIONEER ELECTRIC & RESEARCH DIV. JOHNSON
SER.CO.
743 Circle Ave, Forest Park, Ill 60130

PRINTER TECHNOLOGY INC.
Sixth Rd, Woburn, Mass 01801

SHIRAK TELEMETERING OF AMERICA
8926 Kester Ave, Van Nuys, Cal 91402

SPECTRON CORP.
10060 Kings Hwy N, Cherry Hill, N J 08034

SYLVANIA ELECTRONIC SYSTEMS EASTERN DIV.
77 A St, Needham Heights, Mass 02194

TELETYPE CORP.
5555 W Touhy Ave, Skokie, Ill 60076

TERMINAL EQUIPMENT CORP.
750 Hamburg Tpk, Pompton Lakes, N J 07442

TEXAS INSTRUMENTS INC. DIGITAL SYSTEMS DIV
P O Box 66027, Houston, Tex 77006

TIME-SHARING TERMINALS INC.
2351 Shady Grove Rd, Rockville, Md 20850

TIMESHARE DEVICES INC.
225 Crescent St, Waltham, Mass 02154

TREPAC CORP. OF AMERICA
30 W Hamilton Ave, Englewood, N J 07631

TUCK ELECTRONICS
235 Market St, New Cumberland, Pa 17070

ULTRONIC SYSTEMS CORP.
Mt Laurel Ind Pk, Moorestown, N J 08057

UNICOMP INC.
18219 Parthenia, Northridge, Cal 91324

WESTERN UNION TELEPROCESSING CO.
82 McKee Dr, Mahwah, N J 07436

2 Product Directory

COMMUTATORS, SWITCHING (ELECTRIC)

A.D. DATA SYSTEMS INC.
830 Linden Ave, Rochester, N Y 14625
AIRFLYTE ELECTRONICS CO.
56 New Hook Rd, Bayonne, N J 07002
AMERICAN COMPUTER TECHNOLOGY INC.
8740 Shirley Ave, Northridge, Cal 91324
BENDIX CORP., THE, ENVRNMNTL SCI. DIV.
1400 Taylor Ave, Baltimore, Md 21204
CONTROL EQUIPMENT CORP.
32 Kearney Rd, Needham Heights, Mass 02194
CUNNINGHAM CORP. SUB. GLEASON WORKS
10 Carriage St, Honeoye Falls, N Y 14472
INTEGRAL DATA DEVICES INC.
35 Orville Dr, Bohemia, N Y 11716
ROGERS CORP.
Rogers, Conn 06263
SOLID STATE ELECTRONICS CORP.
15321 Rayen St, Sepulveda, Cal 91343
STELLARMETRICS AN AYDIN CO.
P O Box 719, Santa Barbara, Cal 93102
TAFT ELECTROSYSTEMS, INC.
P O Box 43, Metuchen, N J 08840
TELEDYNE CRYSTALONICS
147 Sherman St, Cambridge, Mass 02140
TREPAC CORP. OF AMERICA
30 W Hamilton Ave, Englewood, N J 07631
V.I.Z. MANUFACTURING CO.
335 E Price St, Philadelphia, Pa 19144

COMPILERS (SEE PROGRAMMING LANGUAGE DEVELOPMENT)

COMPUTER-AIDED DESIGN SERVICES (SEE SERVICES)

COMPUTER EVALUATIONS (SEE CONSULTING)

COMPUTERIZED DIRECT MAIL SERVICES & LIST MAINTENANCE (SEE SERVICES)

COMPUTER OUTPUT MICROFILM (SEE MICROFILM DATA RETRIEVAL SYSTEMS)

COMPUTERS, ANALOG (EDUCATIONAL)

AMF INC.
261 Madison Ave, New York, N Y 10016
APPLIED DYNAMICS COMPUTER SYS DV RELIANCE ELEC CO
P O Box 1488, Ann Arbor, Mich 48106
BASIC COMPUTING ARTS INC.
2680 E Bayshore Frtge, Mt View, Cal 94040
BURR-BROWN RESEARCH CORP.
6730 S Tucson Blvd, Tucson, Ariz 85706
DENELCOR INC.
5975 Broadway, Denver, Colo 80216
NATIONAL ELECTRO-MECHANICAL SYSTEMS INC.
32 Broad Ave, Binghamton, N Y 13904
SCIENTIFIC MEASUREMENTS INC.
9701 N Kenton, Skokie, Ill 60076
TELEDYNE PHILBRICK NEXUS
Allied Dr At Rte 128, Dedham, Mass 02026
WARREN ASSOCIATES
15 Royal Crest Dr, Marlboro, Mass 01752

COMPUTERS, AEROSPACE

ASTRONAUTICS CORPORATION OF AMERICA
907 S First St, Milwaukee, Wis 53204
SPACETAC INC.
Burlington Rd, Bedford, Mass 01730

COMPUTERS, ANALOG (GENERAL-PURPOSE)

APPLIED DYNAMICS COMPUTER SYS DV RELIANCE ELEC CO
P O Box 1488, Ann Arbor, Mich 48106
BAILEY METER CO. SUB. BABCOCK&WILCOX
29801 Euclid Ave, Wickliffe, Ohio 44092
BUSINESS COMPUTER SERVICE INC
1027 Virginia St E, Charleston, W Va 25301
CENTURY ELECTRONICS & INSTRUMENTS INC.
P O Box C Adm Sta, Tulsa, Okla 74115
ELECTRONIC ASSOCIATES INC.
485 Monmouth Pkwy, W Long Branch, N J 07764
FOXBORO CO., THE
Neponset Ave, Foxboro, Mass 02035
GPS CORP.
14 Burr St, Framingham, Mass 01701
HONEYWELL INFORMATION SYSTEMS
60 Walnut St, Wellesley Hills, Mass 02181
HYBRID SYSTEMS DIV. DIGITAL RESOURCES CORP.
4301 Dacoma Rd, Houston, Tex 77018
ISEC
206 Center, Princeton, N J 08540
NATIONAL ELECTRO-MECHANICAL SYSTEMS INC.
32 Broad Ave, Binghamton, N Y 13904
NORDEN DIV., UNITED AIRCRAFT CORP.
Helen St, Norwalk, Conn 06850
SIMULATORS, INC.
95 Randall St, Elk Grove Vill, Ill 60007
SYSTRON-DONNER CORP.
888 Galindo St, Concord, Cal 94520
TYROTEK INC.
P O Box 254, Moraga, Cal 94556

COMPUTERS, DIGITAL (EDUCATIONAL)

ADTECH INC.
P O Box 10415, Honolulu, Haw 96816
ADVANCED SYSTEMS INC.
1100 W NW Hwy, Mt Prospec, Ill 60056
APPLIED COMPUTER SYSTEMS INC.
P O Box 6479, Austin, Tex 78702
APPLIED COMPUTER TIME SHARE INC.
29200 Southfield Rd, Southfield, Mich 48075
BURLINGTON MANAGEMENT SERVICES CO.
P O Box 21207, Greensboro, N C 27420
CGA COMPUTER ASSOCIATES INC.
715 Park Ave, East Orange, N J 07017
COMPUTER DESIGN CORP.
12401 W Olympic Blvd, Los Angeles, Cal 90064
COMPUTER SCIENCES CORP. INFO. NETWORK DIV.
1901 Building, Los Angeles, Cal 90067
CTC COMPUTER CORP.
1000 Elwell Court, Palo Alto, Cal 94303
CUSTOM COMPUTER SYSTEMS INC.
40 South Mall, Plainview, N Y 11803
DATACAP INTERNATIONAL INC.
37 W 2950 S, Salt Lake City, Utah 84101
DELTA AUTOMATED SYSTEMS INC.
816 Thayer Ave, Silver Spring, Md 20910
DENELCOR INC.
5975 Broadway, Denver, Colo 80216
DIGIAC CORP.
Ames Court, Plainview, N Y 11803
FABRI-TEK INC.
5901 S County Rd 18, Minneapolis, Minn 55436
FOUR-PHASE SYSTEMS INC.
10420 N Tantau Ave, Cupertino, Cal 95014
HEWLETT PACKARD CO.
1501 Page Mill Rd, Palo Alto, Cal 94304
HEWLETT PACKARD CO. CUPERTINO DIV.
1100 Wolfe Rd, Cupertino, Cal 95014
MICRO SYSTEMS INC.
644 E Young St, Santa Ana, Cal 92705
NATIONAL ELECTRO-MECHANICAL SYSTEMS INC.
32 Broad Ave, Binghamton, N Y 13904
PROGRAMMING SCIENCES CORP.
1900 Ave of The Stars, Los Angeles, Cal 90067
SCIENTIFIC MEASUREMENTS INC.
9701 N Kenton, Skokie, Ill 60076
SPIRAS SYSTEMS INC. AFFIL. USM CORP.
332 Second Ave, Waltham, Mass 02154
SYSTREX CORP.
303 Child St, Rochester, N Y 14611
UNICOMP INC.
18219 Parthenia, Northridge, Cal 91324
WANG LABORATORIES INC.
836 N St, Tewksbury, Mass 01876
WARREN ASSOCIATES
15 Royal Crest Dr, Marlboro, Mass 01752

WEISMANTEL INC.
P O Box 1957, St Paul, Minn 55111

COMPUTERS, DIGITAL (GENERAL-PURPOSE, SMALL-SCALE)

APPLIED SYSTEMS CORP.
18325 W McNichols Ave, Detroit, Mich 48219
ATRON CORP.
1256 Trapp Rd, St Paul, Minn 55118
AUTOMATION SCIENCE INTL CORP. SUB AUTO. SCI. INC.
15 Columbus Cir, New York, N Y 10023
BAILEY METER CO. SUB. BABCOCK&WILCOX
29801 Euclid Ave, Wickliffe, Ohio 44092
BFA CORP.
1309 S Inca, Denver, Colo 80223
BURROUGHS CORP. BUSINESS MACHINES GROUP
6071 2nd Ave, Detroit, Mich 48232
CINCINNATI MILACRON
State Rte 48, Lebanon, Ohio 45036
CLARY DATACOMP SYSTEMS INC.
404 Junipero Serra, San Gabriel, Cal 91776
COLLINS RADIO CO.
1200 N Alma Rd, Dallas, Tex 75207
COMPAT CORP.
177 Cantigue Rock Rd, Westbury, N Y 11590
COMPILER SYSTEMS INC.
P O Box 366, Ridgefield, Conn 06877
COMPUTER AUTOMATION INC.
895 W 16th St, Newport Beach, Cal 92660
COMPUTER CORP. OF AMERICA
6216 Evergreen St, Houston, Tex 77036
COMPUTER DESIGN CORP.
12401 W Olympic Blvd, Los Angeles, Cal 90064
COMPUTER LOGIC SYSTEMS INC.
225 Crescent St, Waltham, Mass 02154
COMPUTER MICRO-IMAGE SYSTEMS INC.
9600 Desoto Ave, Chatsworth, Cal 91311
COMPUTER SIGNAL PROCESSORS INC.
209 Middlesex Tpk, Burlington, Mass 01803
COMPUTER USAGE CORP.
100 Putnam Green, Greenwich, Conn 06830
CONTROL DATA CORP.
8100 34th Ave S, Minneapolis, Minn 55440
CREDIT SYSTEMS INC.
P O Box 105, Colmar, Pa 18915
DATA GENERAL CORP.
Rte 9, Southboro, Mass 01772
DATACOMPUTER CORP.
7900 Computer Blvd, Minneapolis, Minn 55435
DATAMATE COMPUTER SYSTEMS SUB. SIBONEY CORP.
P O Box 310, Big Spring, Tex 79720
DIETZGEN CO., EUGENE
2425 N Sheffield, Chicago, Ill 60614
DIGITAL COMPUTER CONTROLS INC
23 Just Rd, Fairfield, N J 07006
DIGITAL EQUIPMENT CORP.
146 Main St, Maynard, Mass 01754
DIGITAL PRODUCTS
335 W 7th St, San Pedro, Cal 90733
DIGITAL SCIENTIFIC CORP.
11455 Sorrento Vly Rd, San Diego, Cal 92121
DIMENSIONAL SYSTEMS INC.
393 Totten Pond Rd, Waltham, Mass 02154
DYNALOX INC.
885 Front St, Burbank, Cal 91502
ECLECTIC COMPUTER CORP.
3707 Rawlins Ste 301, Dallas, Tex 75219
ELECTRONIC ASSOCIATES INC.
485 Monmouth Pkwy, W Long Branch, N J 07764
ELECTRONIC PROCESSORS INC. SUB. SAMSONITE CORP
5050 S Federal Blvd, Englewood, Colo 80110
EMR COMPUTER
8001 Bloomington Fwy, Minneapolis, Minn 55420
ENTREKIN COMPUTERS INC. SUB. THE CROSS CO.
9475 Center Rd, Fenton, Mich 48430
FAIRCHILD GRAPHIC EQUIPMENT
221 Fairchild Ave, Plainview, N Y 11803
FARRINGTON MANUFACTURING CO.
6707 Electronics Dr, Springfield, Va 22151
FOUR-PHASE SYSTEMS INC.
10420 N Tantau Ave, Cupertino, Cal 95014
FOXBORO CO., THE
Neponset Ave, Foxboro, Mass 02035
FUJITSU LTD. N.Y. LIAISON OFFICE
680 Fifth Ave, New York, N Y 10019
GENERAL AUTOMATION INC.
1055 S East St, Anaheim, Cal 92805
GRI COMPUTER CORP.
320 Needham St, Newton, Mass 02164

2 Product Directory

HETRA
P O Box 970, Melbourne, Fla 32901
HEWLETT PACKARD CO.
1501 Page Mill Rd, Palo Alto, Cal 94304
HONEYWELL INFORMATION SYSTEMS
60 Walnut St, Wellesley Hills, Mass 02181
IAC COMPUTER SYSTEMS INC.
260 Newton Rd, Plainview, N Y 11803
IBM CORP., DATA PROCESSING DIV.
1133 Westchester Ave, White Plains, N Y 10604
INFOTRONICS CORP.
8500 Cameron Rd, Austin, Tex 78753
INTERDATA
2 Crescent Pl, Oceanport, N J 07757
INTERNATIONAL COMPUTERS LTD.
Icl House Putney, London S W 15, UNITED K
K&M ELECTRONICS CO.
109 Hopkins Pl, Baltimore, Md 21201
LITTON SYSTEMS INC. DATA SYSTEMS DIV.
8000 Woodley Ave, Van Nuys, Cal 91409
LOCKHEED ELECTRONICS CO. DATA PRODUCTS DIV.
6201 E Randolph St, Los Angeles, Cal 90650
LOCKHEED ELECTRONICS CO. DIV. LOCKHEED ACRFT
CORP
U S Hwy 22, Plainfield, N J 07060
MAI EQUIPMENT CORP.
300 E 44th St, New York, N Y 10017
MICRO SYSTEMS INC.
644 E Young St, Santa Ana, Cal 92705
MICRODATA CORP.
644 E Young St, Santa Ana, Cal 92705
MODULAR COMPUTER SYSTEMS
2709 N Dixie Hwy, Ft Lauderdale, Fla 33308
MULTIDATA INC.
7300 Bolsa Ave, Westminster, Cal 92683
NATIONAL ELECTRO-MECHANICAL SYSTEMS INC.
32 Broad Ave, Binghamton, N Y 13904
NATIONWIDE ELECTRONIC SYSTEMS INC.
7 N 662 Rte 53, Itasca, Ill 60143
NORTH AMERICAN ROCKWELL CORP. AUTONETICS
DIV.
3370 Miraloma Ave, Anaheim, Cal 92803
NUCLEAR DATA INC.
P O Box 451, Palatine, Ill 60067
OKI ELECTRIC INDUSTRIES CO. LTD.
875 Ave of Americas, New York, N Y 10001
OLIVETTI CORP. OF AMERICA
500 Park Ave, New York, N Y 10016
PERIPHERAL DATA MACHINES INC.
102 New S Rd, Hicksville, N Y 11801
QANTEL CORP.
3474 Investment Blvd, Hayward, Cal 94545
RAYTHEON CO. EQUIPMENT DIV.
528 Boston Post Rd, Sudbury, Mass 01776
RAYTHEON COMPUTER
2700 S Fairview St, Santa Ana, Cal 92704
RCA COMPUTER SYSTEMS DIV.
200 Forest Ave, Marlboro, Mass 01752
REDCOR CORP.
21200 Victory, Woodland Hills, Cal 91364
ROLM, CORP.
10300 N Tantau, Cupertino, Cal 95014
SCANTLIN ELECTRONICS, INC.
5454 Beethoven St, Los Angeles, Cal 90060
SCIENTIC CONTROL CORP.
1215 Crosby Rd, Carrollton, Tex 75080
SINGER CO., THE, FRIDEN DIV.
2350 Washington St, San Leandro, Cal 94577
SINGER-GENERAL PRECISION KEARFOTT DIV.
1150 McBride Ave, Little Falls, N J 07424
SPIRAS SYSTEMS INC. AFFIL. USM CORP.
332 Second Ave, Waltham, Mass 02154
SYLVANIA ELECTRONIC SYSTEMS EASTERN DIV.
77 A St, Needham Heights, Mass 02194
SYS COMPUTER CORP.
17-25 Dicarolis Court, Hackensack, N J 07601
SYSTEMS CONCEPTS INC.
524 2nd St, San Francisco, Cal 94107
SYSTEMS ENGINEERING LABORATORIES INC.
P O Box 9148, Fort Lauderdale, Fla 33310
SYSTEMS EQUIPMENT CORP.
458 Plasamour Dr, Atlanta, Ga 30324
TEMPO COMPUTERS INC.
1550 S St College Blv, Anaheim, Cal 92806
TEXAS INSTRUMENTS INC. DIGITAL SYSTEMS DIV
P O Box 66027, Houston, Tex 77006
TRACOR DATA SYSTEMS INC.
4201 Ed Bluestein Blv, Austin, Tex 78721
UNICOMP INC.
18219 Parthenia, Northridge, Cal 91324
UNIVERSITY COMPUTING CO.
888 N Sepulveda Blvd, El Segundo, Cal 90245
USM CORP. ELECTRONIC CONTROL GROUP
140 Federal St, Boston, Mass 02107

VARIAN DATA MACHINES
2722 Michelson Dr, Irvine, Cal 92664
WEISMANTEL INC.
P O Box 1957, St Paul, Minn 55111
WESTINGHOUSE COMPUTER & INSTRUMENTATION
DIV
100 Beta Dr, Pittsburgh, Pa 15238
WESTINGHOUSE ELECTRIC CORP.
Westinghouse Bldg, Pittsburgh, Pa 15222
XEROX DATA SYSTEMS
701 S Aviation, El Segundo, Cal 90245

COMPUTERS, DIGITAL (GENERAL-PURPOSE, MEDIUM-SCALE)

ADAGE INC.
1079 Commonwealth Ave, Boston, Mass 02109
AMERICAN DATA SYSTEMS
8851 Mason Ave, Canoga Park, Cal 91306
AUTOMATION SCIENCE INTL CORP. SUB AUTO. SCI.
INC.
15 Columbus Cir, New York, N Y 10023
BAILEY METER CO. SUB. BABCOCK&WILCOX
29801 Euclid Ave, Wickliffe, Ohio 44092
BURROUGHS CORP., BUSINESS MACHINES GROUP
6071 2nd Ave, Detroit, Mich 48232
CINCINNATI MILACRON
State Rte 48, Lebanon, Ohio 45036
COLLINS RADIO CO.
1200 N Alma Rd, Dallas, Tex 75207
COMPILER SYSTEMS INC.
P O Box 366, Ridgefield, Conn 06877
COMPUTER CORP. OF AMERICA
6216 Evergreen St, Houston, Tex 77036
COMPUTER LOGIC SYSTEMS INC.
225 Crescent St, Waltham, Mass 02154
COMPUTER MICRO-IMAGE SYSTEMS INC.
9600 Desoto Ave, Chatsworth, Cal 91311
COMPUTER SIGNAL PROCESSORS INC.
209 Middlesex Tpk, Burlington, Mass 01803
CONTROL DATA CORP.
8100 34th Ave S, Minneapolis, Minn 55440
DATACRAFT CORP.
1200 NW 70 St, Ft Lauderdale, Fla 33307
DATAMATE COMPUTER SYSTEMS SUB. SIBONEY
CORP.
P O Box 310, Big Spring, Tex 79720
DIEBOLD COMPUTER LEASING INC.
Park 80 Plaza E, Saddle Brook, N J 07667
DIGITAL EQUIPMENT CORP.
146 Main St, Maynard, Mass 01754
DIGITAL SCIENTIFIC CORP.
11455 Sorrento Vly Rd, San Diego, Cal 92121
DIMENSIONAL SYSTEMS INC.
393 Totten Pond Rd, Waltham, Mass 02154
ELECTRONIC ASSOCIATES INC.
485 Monmouth Pkwy, W Long Branch, N J 07764
ELECTRONIC PROCESSORS INC. SUB. SAMSONITE
CORP
5050 S Federal Blvd, Englewood, Colo 80110
EMR COMPUTER
8001 Bloomington Fwy, Minneapolis, Minn 55420
ENTREKIN COMPUTERS INC. SUB. THE CROSS CO.
9475 Center Rd, Fenton, Mich 48430
FOUR-PHASE SYSTEMS INC.
10420 N Tantau Ave, Cupertino, Cal 95014
FOXBORO CO., THE
Neponset Ave, Foxboro, Mass 02035
FUJITSU LTD. N.Y. LIAISON OFFICE
680 Fifth Ave, New York, N Y 10019
HEWLETT PACKARD CO.
1501 Page Mill Rd, Palo Alto, Cal 94304
HEWLETT PACKARD CO. CUPERTINO DIV.
1100 Wolfe Rd, Cupertino, Cal 95014
HONEYWELL INFORMATION SYSTEMS
60 Walnut St, Wellesley Hills, Mass 02181
IBM CORP., DATA PROCESSING DIV.
1133 Westchester Ave, White Plains, N Y 10604
INFOTRONICS CORP.
8500 Cameron Rd, Austin, Tex 78753
INTERDATA
2 Crescent Pl, Oceanport, N J 07757
INTERNATIONAL COMPUTERS LTD.
Icl House Putney, London S W 15, UNITED K
IOA DATA CORP.
383 Lafayette St, New York, N Y 10003
LITTON SYSTEMS INC. DATA SYSTEMS DIV.
8000 Woodley Ave, Van Nuys, Cal 91409
LOGICON INC.
Del Amo Financial Ctr, Torrance, Cal 90503
MAI EQUIPMENT CORP.
300 E 44th St, New York, N Y 10017

MICRODATA CORP.
644 E Young St, Santa Ana, Cal 92705
MODULAR COMPUTER SYSTEMS
2709 N Dixie Hwy, Ft Lauderdale, Fla 33308
MYLEE DIGITAL SCIENCES INC.
16 Progress Pkwy, Maryland Hts, Mo 63043
NORTH AMERICAN ROCKWELL CORP. AUTONETICS
DIV.
3370 Miraloma Ave, Anaheim, Cal 92803
OKI ELECTRIC INDUSTRIES CO. LTD.
875 Ave of Americas, New York, N Y 10001
RAYTHEON CO. EQUIPMENT DIV.
528 Boston Post Rd, Sudbury, Mass 01776
RCA COMPUTER SYSTEMS DIV.
200 Forest Ave, Marlboro, Mass 01752
SCIENTIC CONTROL CORP.
1215 Crosby Rd, Carrollton, Tex 75080
SINGER-GENERAL PRECISION KEARFOTT DIV.
1150 McBride Ave, Little Falls, N J 07424
SPIRAS SYSTEMS INC. AFFIL. USM CORP.
332 Second Ave, Waltham, Mass 02154
STANDARD COMPUTER CORP.
633 Young St, Santa Ana, Cal 92705
SYLVANIA ELECTRONIC SYSTEMS EASTERN DIV.
77 A St, Needham Heights, Mass 02194
SYSTEMS CONCEPTS INC.
524 2nd St, San Francisco, Cal 94107
SYSTEMS ENGINEERING LABORATORIES INC.
P O Box 9148, Fort Lauderdale, Fla 33310
TEMPO COMPUTERS INC.
1550 S St College Blv, Anaheim, Cal 92806
TENET INC.
927 Thompson Pl, Sunnyvale, Cal 94086
UNIVERSITY COMPUTING CO.
888 N Sepulveda Blvd, El Segundo, Cal 90245
WEISMANTEL INC.
P O Box 1957, St Paul, Minn 55111
WESTINGHOUSE COMPUTER & INSTRUMENTATION
DIV
100 Beta Dr, Pittsburgh, Pa 15238
WESTINGHOUSE ELECTRIC CORP.
Westinghouse Bldg, Pittsburgh, Pa 15222
XEROX DATA SYSTEMS
701 S Aviation, El Segundo, Cal 90245

COMPUTERS, DIGITAL (GENERAL-PURPOSE, LARGE SCALE)

AUTOMATION SCIENCE INTL CORP. SUB AUTO. SCI.
INC.
15 Columbus Cir, New York, N Y 10023
BAILEY METER CO. SUB. BABCOCK&WILCOX
29801 Euclid Ave, Wickliffe, Ohio 44092
BERKELEY COMPUTER CORP.
2398 4th St, Berkeley, Cal 94710
BURROUGHS CORP., BUSINESS MACHINES GROUP
6071 2nd Ave, Detroit, Mich 48232
COMPILER SYSTEMS INC.
P O Box 366, Ridgefield, Conn 06877
CONTROL DATA CORP.
8100 34th Ave S, Minneapolis, Minn 55440
DIEBOLD COMPUTER LEASING INC.
Park 80 Plaza E, Saddle Brook, N J 07667
DIGITAL EQUIPMENT CORP.
146 Main St, Maynard, Mass 01754
FUJITSU LTD. N.Y. LIAISON OFFICE
680 Fifth Ave, New York, N Y 10019
GENERAL COMPUTER SERVICES INC.
1332 Meridan St NE, Huntsville, Ala 35801
HONEYWELL INFORMATION SYSTEMS
60 Walnut St, Wellesley Hills, Mass 02181
IBM CORP., DATA PROCESSING DIV.
1133 Westchester Ave, White Plains, N Y 10604
INTERNATIONAL COMPUTERS LTD.
Icl House Putney, London S W 15, UNITED K
MAI EQUIPMENT CORP.
300 E 44th St, New York, N Y 10017
OKI ELECTRIC INDUSTRIES CO. LTD.
875 Ave of Americas, New York, N Y 10001
RAYTHEON CO. EQUIPMENT DIV.
528 Boston Post Rd, Sudbury, Mass 01776
RCA COMPUTER SYSTEMS DIV.
200 Forest Ave, Marlboro, Mass 01752
SYSTEMS CONCEPTS INC.
524 2nd St, San Francisco, Cal 94107
UNIVERSITY COMPUTING CO.
888 N Sepulveda Blvd, El Segundo, Cal 90245
WEISMANTEL INC.
P O Box 1957, St Paul, Minn 55111
XEROX DATA SYSTEMS
701 S Aviation, El Segundo, Cal 90245

2 Product Directory

COMPUTERS, FIRE CONTROL

CONTROL DATA CORP.
8100 34th Ave S, Minneapolis, Minn 55440
DELCO ELECTRONICS DIV., SUB. GENERAL MOTORS CORP
7929 S Howell Ave, Milwaukee, Wisc 53201
DYNALOX INC.
885 Front St, Burbank, Cal 91502
FELSENTHAL INSTRUMENTS CO.
7450 W Wilson Ave, Chicago, Ill 60656
GAP INSTRUMENT CORP.
110 Marcus Blvd, Hauppauge, N Y 11787
LITTON SYSTEMS INC. DATA SYSTEMS DIV.
8000 Woodley Ave, Van Nuys, Cal 91409
LITTON SYSTEMS INC. GUIDANCE & CONTROL SYS.DIV.
5500 Canoga Ave, Woodland Hills, Cal 91364
ROLM. CORP.
10300 N Tantau, Cupertino, Cal 95014
SIMPLEX TIME RECORDER CO.
26 South Lincoln St, Gardner, Mass 01440
SINGER-GENERAL PRECISION KEARFOTT DIV.
1150 McBride Ave, Little Falls, N J 07424

COMPUTERS, HYBRID

ADAGE INC.
1079 Commonwealth Ave, Boston, Mass 02109
APPLIED DYNAMICS COMPUTER SYS DV RELIANCE ELEC CO
P O Box 1488, Ann Arbor, Mich 48106
BRISTOL CO., DIV AMERICAN CHAIN & CABLE CO.
Bristol Rd, Waterbury, Conn 06720
DENELCOR INC.
5975 Broadway, Denver, Colo 80216
DIGI-LOG SYSTEMS INC.
107 W Ridge Pike, Conshohocken, Pa 19428
ELECTRONIC ASSOCIATES INC.
485 Monmouth Pkwy, W Long Branch, N J 07764
ESAN ELECTRONIC LABORATORIES INC.
2653 E 14th St, Brooklyn, N Y 11235
GENERAL COMPUTERS INC.
5990 W Pico Blvd, Los Angeles, Cal 90035
HYBRID SYSTEMS DIV. DIGITAL RESOURCES CORP.
4301 Dacoma Rd, Houston, Tex 77018
RAYTHEON CO. EQUIPMENT DIV.
528 Boston Post Rd, Sudbury, Mass 01776
SINGER-GENERAL PRECISION KEARFOTT DIV.
1150 McBride Ave, Little Falls, N J 07424
SYSTRON-DONNER CORP.
888 Galindo St, Concord, Cal 94520
TRACOR DATA SYSTEMS INC.
4201 Ed Bluestein Blv, Austin, Tex 78721
XEROX DATA SYSTEMS
701 S Aviation, El Segundo, Cal 90245

COMPUTERS, MINI GENERAL PURPOSE (ALSO SEE CALCULATORS)

APPLIED SYSTEMS CORP.
18325 W McNichols Ave, Detroit, Mich 48219
ATRON CORP.
1256 Trapp Rd, St Paul, Minn 55118
COMMUNITYTYPE CORP.
767 Fifth Ave, New York, N Y 10022
COMPILER SYSTEMS INC.
P O Box 366, Ridgefield, Conn 06877
COMPUTER AUTOMATION INC.
895 W 16th St, Newport Beach, Cal 92660
COMPUTER COMMUNICATION INC.
701 W Manchester Blvd, Inglewood, Cal 90301
COMPUTER CORP. OF AMERICA
6216 Evergreen St, Houston, Tex 77036
COMPUTER LOGIC SYSTEMS INC.
225 Crescent St, Waltham, Mass 02154
COMPUTER MICRO-IMAGE SYSTEMS INC.
9600 Desoto Ave, Chatsworth, Cal 91311
COMPUTER TERMINAL CORP.
9725 Datapoint Dr, San Antonio, Tex 78229
COMPUTER USAGE CORP.
100 Putman Green, Greenwich, Conn 06830
CYBERMATION INC.
P O Box 58 River Rd, Washngtn Xing, Pa 18977
DATA GENERAL CORP.
Rte 9, Southboro, Mass 01772
DATACAP INTERNATIONAL INC.
37 W 2950 S, Salt Lake City, Utah 84101
DATAMATE COMPUTER SYSTEMS SUB. SIBONEY CORP.
P O Box 310, Big Spring, Tex 79720
DIGITAL COMPUTER CONTROLS INC
23 Just Rd, Fairfield, N J 07006

DIGITAL EQUIPMENT CORP.
146 Main St, Maynard, Mass 01754
DIGITAL PRODUCTS
335 W 7th St, San Pedro, Cal 90733
DIMENSIONAL SYSTEMS INC.
393 Totten Pond Rd, Waltham, Mass 02154
ELBIT COMPUTERS/SUB. CONTROL DATA CORP.
6 Tovim St, Haifa, ISRAEL
ELECTRONIC PROCESSORS INC. SUB. SAMSONITE CORP
5050 S Federal Blvd, Englewood, Colo 80110
FEDDER DATA CENTERS INC.
307 S Sharp St, Baltimore, Md 21201
FUJITSU LTD. N.Y.LIAISON OFFICE
680 Fifth Ave, New York, N Y 10019
GENERAL AUTOMATION INC.
1055 S East St, Anaheim, Cal 92805
GENERAL ELECTRIC CO. PROCESS COMPUTER DEPT.
2255 W Desert Cove Rd, Phoenix, Ariz 85029
GRI COMPUTER CORP.
320 Needham St, Newton, Mass 02164
HETRA
P O Box 970, Melbourne, Fla 32901
HEWLETT PACKARD CO.
1501 Page Mill Rd, Palo Alto, Cal 94304
HEWLETT PACKARD CO. CUPERTINO DIV.
1100 Wolfe Rd, Cupertino, Cal 95014
HONEYWELL INFORMATION SYSTEMS
60 Walnut St, Wellesley Hills, Mass 02181
INFOTRONICS CORP.
8500 Cameron Rd, Austin, Tex 78753
INTERDATA
2 Crescent Pl, Oceanport, N J 07757
JACKSON ASSOCIATES
4663 Executive Dr, Columbus, Ohio 43220
LITTON SYSTEMS INC. DATA SYSTEMS DIV.
8000 Woodley Ave, Van Nuys, Cal 91409
LITTON SYSTEMS INC. GUIDANCE & CONTROL SYS.DIV.
5500 Canoga Ave, Woodland Hills, Cal 91364
LOCKHEED ELECTRONICS CO. DATA PRODUCTS DIV.
6201 E Randolph St, Los Angeles, Cal 90650
LOCKHEED ELECTRONICS CO. DIV. LOCKHEED ACRFT CORP
U S Hwy 22, Plainfield, N J 07060
MICRO SYSTEMS INC.
644 E Young St, Santa Ana, Cal 92705
MICRODATA CORP.
644 E Young St, Santa Ana, Cal 92705
MODULAR COMPUTER SYSTEMS
2709 N Dixie Hwy, Ft Lauderdale, Fla 33308
MOTOROLA INC. CONTROL SYSTEMS DIV
P O Box 5409, Phoenix, Ariz 85010
NUCLEAR DATA INC.
P O Box 451, Palatine, Ill 60067
RAYTHEON CO. EQUIPMENT DIV.
528 Boston Post Rd, Sudbury, Mass 01776
RAYTHEON COMPUTER
2700 S Fairview St, Santa Ana, Cal 92704
RCA COMPUTER SYSTEMS DIV.
200 Forest Ave, Marlboro, Mass 01752
ROLM. CORP.
10300 N Tantau, Cupertino, Cal 95014
SCM CORP. SMITH CORONA MERCHANT DIV.
299 Park Ave, New York, N Y 10017
SPIRAS SYSTEMS INC. AFFIL. USM CORP.
332 Second Ave, Waltham, Mass 02154
SYS COMPUTER CORP.
17-25 Dicarolis Court, Hackensack, N J 07601
SYSTEMS ENGINEERING LABORATORIES INC.
P O Box 9148, Fort Lauderdale, Fla 33310
SYSTEMS EQUIPMENT CORP.
458 Plasamour Dr, Atlanta, Ga 30324
TAB PRODUCTS
2690 Hanover St, Palo Alto, Cal 94304
TEC INC.
6700 S Wash Ave, Eden Prairie, Minn 55343
TELE-DATA CORP.
130 U S Hwy 22, N Plainfield, N J 07060
TEXAS INSTRUMENTS INC. DIGITAL SYSTEMS DIV
P O Box 66027, Houston, Tex 77006
TYMSHARE INC.
525 University Ave, Palo Alto, Cal 94301
UNICOM INC.
1275 Bloomfield Ave, Fairfield, N J 07006
UNICOMP INC.
18219 Parthenia, Northridge, Cal 91324
USM CORP. ELECTRONIC CONTROL GROUP
140 Federal St, Boston, Mass 02107
VARIAN DATA MACHINES
2722 Michelson Dr, Irvine, Cal 92664
WANG LABORATORIES INC.
836 N St, Tewksbury, Mass 01876

WESTINGHOUSE COMPUTER & INSTRUMENTATION DIV
100 Beta Dr, Pittsburgh, Pa 15238
WESTINGHOUSE ELECTRIC CORP.
Westinghouse Bldg, Pittsburgh, Pa 15222
XEROX DATA SYSTEMS
701 S Aviation, El Segundo, Cal 90245

COMPUTERS, MINI (SEE ALSO CALCULATORS)

COMPUTERS, NAVIGATION

ASTRONAUTICS CORPORATION OF AMERICA
907 S First St, Milwaukee, Wis 53204
AUSTRON, INC.
10214 N Interregional, Austin, Tex 78753
BOWMAR INSTRUMENT CORP. ELECTRONIC SYS. DIV
800 Bluffton Rd, Fort Wayne, Ind 46809
COLLINS RADIO CO.
1200 N Alma Rd, Dallas, Tex 75207
COMPUTER SIGNAL PROCESSORS INC.
209 Middlesex Tpk, Burlington, Mass 01803
CONTROL DATA CORP.
8100 34th Ave S, Minneapolis, Minn 55440
DELCO ELECTRONICS DIV., SUB. GENERAL MOTORS CORP
7929 S Howell Ave, Milwaukee, Wisc 53201
DIMENSIONAL SYSTEMS INC.
393 Totten Pond Rd, Waltham, Mass 02154
FELSENTHAL INSTRUMENTS CO.
7450 W Wilson Ave, Chicago, Ill 60656
GAP INSTRUMENT CORP.
110 Marcus Blvd, Hauppauge, N Y 11787
LITTON SYSTEMS INC. GUIDANCE & CONTROL SYS.DIV.
5500 Canoga Ave, Woodland Hills, Cal 91364
NORTH AMERICAN ROCKWELL CORP. AUTONETICS DIV.
3370 Miraloma Ave, Anaheim, Cal 92803
RAYTHEON CO. EQUIPMENT DIV.
528 Boston Post Rd, Sudbury, Mass 01776
ROLM. CORP.
10300 N Tantau, Cupertino, Cal 95014
SINGER-GENERAL PRECISION KEARFOTT DIV.
1150 McBride Ave, Little Falls, N J 07424
SPACETAC INC.
Burlington Rd, Bedford, Mass 01730
UNICOMP INC.
18219 Parthenia, Northridge, Cal 91324
WESTON-TRANSICOIL A SCHLUMBERGER CO.
Trooper Rd, Worcester, Pa 19490

COMPUTERS, PROCESS CONTROL

APPLIED SYSTEMS CORP.
18325 W McNichols Ave, Detroit, Mich 48219
BAILEY METER CO. SUB. BABCOCK&WILCOX
29801 Euclid Ave, Wickliffe, Ohio 44092
BASIC COMPUTING ARTS INC.
2680 E Bayshore Frtge, Mt View, Cal 94040
BRISTOL CO., DIV AMERICAN CHAIN & CABLE CO.
Bristol Rd, Waterbury, Conn 06720
CINCINNATI MILACRON
State Rte 48, Lebanon, Ohio 45036
COLLINS RADIO CO.
1200 N Alma Rd, Dallas, Tex 75207
COMPACE CORP.
7413 Washington Ave S, Edina-Minneapolis, Minn 55435
COMPILER SYSTEMS INC.
P O Box 366, Ridgefield, Conn 06877
COMPUTER AUTOMATION INC.
895 W 16th St, Newport Beach, Cal 92660
COMPUTER LOGIC SYSTEMS INC.
225 Crescent St, Waltham, Mass 02154
COMPUTER SIGNAL PROCESSORS INC.
209 Middlesex Tpk, Burlington, Mass 01803
CONTROL DATA CORP.
8100 34th Ave S, Minneapolis, Minn 55440
DATA GENERAL CORP.
Rte 9, Southboro, Mass 01772
DATACRAFT CORP.
1200 NW 70 St, Ft Lauderdale, Fla 33307
DATAMATE COMPUTER SYSTEMS SUB. SIBONEY CORP.
P O Box 310, Big Spring, Tex 79720
DIGI-LOG SYSTEMS INC.
107 W Ridge Pike, Conshohocken, Pa 19428
DIGITAL EQUIPMENT CORP.
146 Main St, Maynard, Mass 01754

2 Product Directory

DIGITAL PRODUCTS

335 W 7th St, San Pedro, Cal 90733
DIMENSIONAL SYSTEMS INC.
393 Totten Pond Rd, Waltham, Mass 02154
ELECTRONIC ASSOCIATES INC.
485 Monmouth Pkwy, W Long Branch, N J 07764
ENTREKIN COMPUTERS INC. SUB. THE CROSS CO.
9475 Center Rd, Fenton, Mich 48430
FAIRCHILD SYSTEMS TECHNOLOGY
974 E Arques Ave, Sunnyvale, Cal 94086
FOXBORO CO., THE
Neponset Ave, Foxboro, Mass 02035
FUJITSU LTD. N.Y. LIAISON OFFICE
680 Fifth Ave, New York, N Y 10019
GAP INSTRUMENT CORP.
110 Marcus Blvd, Hauppauge, N Y 11787
GENERAL AUTOMATION INC.
1055 S East St, Anaheim, Cal 92805
GENERAL ELECTRIC CO. PROCESS COMPUTER DEPT.
2255 W Desert Cove Rd, Phoenix, Ariz 85029
GRI COMPUTER CORP.
320 Needham St, Newton, Mass 02164
HONEYWELL INFORMATION SYSTEMS
60 Walnut St, Wellesley Hills, Mass 02181
IBM CORP., DATA PROCESSING DIV.
1133 Westchester Ave, White Plains, N Y 10604
INFORMATION INSTRUMENT INC.
62 Enterprise Dr, Ann Arbor, Mich 48106
INTERDATA
2 Crescent Pl, Oceanport, N J 07757
LEEDS & NORTHRUP CO.
Sumney Town Pike, North Wales, Pa 19454
LOCKHEED ELECTRONICS CO. DATA PRODUCTS DIV.
6201 E Randolph St, Los Angeles, Cal 9065C
LOCKHEED ELECTRONICS CO. DIV. LOCKHEED ACRFT
CORP
U S Hwy 22, Plainfield, N J 07060
LOGICON INC.
Del Amo Financial Ctr, Torrance, Cal 90503
MICRO SYSTEMS INC.
644 E Young St, Santa Ana, Cal 92705
MODULAR COMPUTER SYSTEMS
2709 N Dixie Hwy, Ft Lauderdale, Fla 33308
NATIONWIDE ELECTRONIC SYSTEMS INC.
7 N 662 Rte 53, Itasca, Ill 60143
NORTH AMERICAN ROCKWELL CORP. AUTONETICS
DIV.
3370 Miraloma Ave, Anaheim, Cal 92803
NUCLEAR DATA INC.
P O Box 451, Palatine, Ill 60067
OKI ELECTRIC INDUSTRIES CO. LTD.
875 Ave of Americas, New York, N Y 10001
PROCESS SYSTEMS INC.
3061 Sheridan St, Las Vegas, Nev 89102
RAYCON INC.
218 Brunswick Blvd, Pointe Claire, CANADA
RCA COMPUTER SYSTEMS DIV.
200 Forest Ave, Marlboro, Mass 01752
ROLM, CORP.
10300 N Tantau, Cupertino, Cal 95014
SCHAEVITZ ENGINEERING
Rte 130 & Union Ave, Pennsauken, N J 08110
SCIENTIFIC CONTROL CORP.
1215 Crosby Rd, Carrollton, Tex 75080
SPIRAS SYSTEMS INC. AFFIL. USM CORP.
332 Second Ave, Waltham, Mass 02154
STRUTHER-DUNN INC. SYSTEMS DIV.
1114 State St, Bettendorf, Iowa 52722
SYLVANIA ELECTRONIC SYSTEMS EASTERN DIV.
77 A St, Needham Heights, Mass 02194
SYSTEMS ENGINEERING LABORATORIES INC.
P O Box 9148, Fort Lauderdale, Fla 33310
TAYLOR INSTRUMENT PROCESS CONTROL DIV
95 Ames, Rochester, N Y 14601
TEXAS INSTRUMENTS INC. DIGITAL SYSTEMS DIV
P O Box 66027, Houston, Tex 77006
UNICOM INC.
1275 Bloomfield Ave, Fairfield, N J 07006
UNICOMP INC.
18219 Parthenia, Northridge, Cal 91324
UNIVERSITY COMPUTING CO.
888 N Sepulveda Blvd, El Segundo, Cal 90245
WESTINGHOUSE COMPUTER & INSTRUMENTATION
DIV
100 Beta Dr, Pittsburgh, Pa 15238
WESTINGHOUSE ELECTRIC CORP.
Westinghouse Bldg, Pittsburgh, Pa 15222
XEROX DATA SYSTEMS
701 S Aviation, El Segundo, Cal 90245

COMPUTERS, SPECIAL PURPOSE

BOWMAR INSTRUMENT CORP. ELECTRONIC SYS. DIV
800 Bluffton Rd, Fort Wayne, Ind 46809
CONRAC CORP. NEW JERSEY DIV.
Sherwood Ln, Fairfield, N J 07006
ESAN ELECTRONIC LABORATORIES INC.
2653 E 14th St, Brooklyn, N Y 11235
MACNEAL-SCHWENDLER CORP., THE
7442 N Figueroa St, Los Angeles, Cal 90041
NORDEN DIV., UNITED AIRCRAFT CORP.
Helen St, Norwalk, Conn 06850
TIME/DATA CORP. SUB. GENL. RADIO CO
490 San Antonio Rd, Palo Alto, Cal 94306

COMPUTERS, TIME SHARING

HEWLETT PACKARD CO. CUPERTINO DIV.
1100 Wolfe Rd, Cupertino, Cal 95014

COMPUTING SERVICES (SEE SERVICES)

CONNECTORS, COAXIAL (COMPUTER-GRADE)

AIRBORN INC.
2618 Manana, Dallas, Tex 75220
AMP INC.
Eisenhower Blvd, Harrisburg, Pa 17105
BENDIX CORP., THE ELECTRICAL COMPONENTS DIV.
Sherman Ave, Sidney, N Y 13838
BURNDY CORP.
Richard Ave, Norwalk, Conn 06852
CONTROL DATA CORP. CONNECTOR OPERATION
31829 W Latienda Dr, Westlake Vil, Cal 91360
ELCOM ELECTRONICS INC.
200 Allen Blvd, Farmingdale, N Y 11735
GENERAL RADIO CO.
300 Baker Ave, Concord, Mass 01742
HARVEY INDUSTRIAL DIV.
60 Crossway Pk W, Woodbury Li, N Y 11797
JOHNSON CO., E.F.
299 Tenth Ave SW, Waseca, Minn 56093
MICRODOT INC. CONNECTOR & CABLE DIV.
220 Pasadena Ave, S Pasadena, Cal 91030
MOLEX PRODUCTS CO.
5224 Katrine, Downers Grove, Ill 60515
NATIONAL TEL-TRONICS
55 Northern Blvd, Great Neck, N Y 11021
PROGRAM DATA CO.
739 E 223 St, Torrance, Cal 90502
PROTOTYPE ASSEMBLIES INC.
70 Jaconnet St, Newton Hglds, Mass 02161
SEAELECTRO CORP.
225 Hoyt St, Mamaroneck, N Y 10543
SOLITRON DEVICES INC.
256 Oak Tree Rd, Tappan, N Y 10983
SOLITRON DEVICES INC. TRANSISTOR DIV.
1177 Blue Heron Blvd, Riviera Beach, Fla 33404
TROMPETER ELECTRONICS INC.
8936 Comanche Ave, Chatsworth, Cal 91311
U.S. COMPONENTS INC.
1320 Zerega Ave, Bronx, N Y 10462
VIRGINIA ELECTRONICS CO. INC.
2901 Telestar Court, Falls Church, Va 22042
WINCHESTER ELECTRONICS DIV. LITTON INDUS.
Main St & Hillside, Oakville, Conn 06779

CONNECTORS, MINIATURE AND SUB-MINIATURE (COMPUTER-GRADE)

AIRBORN INC.
2618 Manana, Dallas, Tex 75220
AMP INC.
Eisenhower Blvd, Harrisburg, Pa 17105
AMP INC., SYSCOM DIV.
P O Box 3608, Harrisburg, Pa 17105
AMPHENOL INDUSTRIAL DIV. BUNKER-RAMO CORP.
1830 S 54 Ave, Chicago, Ill 60650
ANSLEY MANUFACTURING CO. SUB. THOMAS & BETTS
4100 N Figueroa St, Los Angeles, Cal 90065
AUGAT INC.
33 Perry Ave, Attleboro, Mass 02703
BARNES CORP.
24 N Lansdowne Ave, Lansdowne, Pa 19050
BENDIX CORP., THE ELECTRICAL COMPONENTS DIV.
Sherman Ave, Sidney, N Y 13838
BURNDY CORP.
Richard Ave, Norwalk, Conn 06852
CAMBRIDGE THERMIONIC CORP.
445 Concord Ave, Cambridge, Mass 02138
COLLINS RADIO CO.
1200 N Alma Rd, Dallas, Tex 75207
COMCET INC.
1950 W County Rd, St Paul, Minn 55113

CONTINENTAL CONNECTOR CORP.

34-63 56th St, Woodside, N Y 11377
CONTROL DATA CORP. CONNECTOR OPERATION
31829 W Latienda Dr, Westlake Vil, Cal 91360
CURTIS DEVELOPMENT & MANUFACTURING CO.
3266 N 33rd St, Milwaukee, Wis 53216
DALE ELECTRONICS INC. SUB. LIONEL CORP.
1360 28th Ave, Columbus, Nebr 68601
EBY CO., HUGH H. DIV. REDM CORP.
4701 Germantown Ave, Philadelphia, Pa 19104
ELCO CORP.
Maryland Rd, Willow Grove, Pa 19090
FABRI-TEK INC. NATIONAL CONNECTOR DIV.
9210 Science Ctr, Minneapolis, Minn 55428
HARVEY INDUSTRIAL DIV.
60 Crossway Pk W, Woodbury Li, N Y 11797
HUGHES AIRCRAFT CO. CONNECTING DEV. DIV
500 Superior Ave, Newport Beach, Cal 92663
HYPERTRONICS CORP.
50 Hunt St, Watertown, Mass 02172
INTERDYNE
2217 Purdue Ave, Los Angeles, Cal 90064
ITT CANNON ELECTRIC DIV. ITT CORP.
3208 Humboldt St, Los Angeles, Cal 90031
JOHNSON CO., E.F.
299 Tenth Ave SW, Waseca, Minn 56093
MASTERITE INDUSTRIES INC.
2841 Lomita Blvd, Torrance, Cal 90505
MICRODOT INC. CONNECTOR & CABLE DIV.
220 Pasadena Ave, S Pasadena, Cal 91030
MOLEX PRODUCTS CO.
5224 Katrine, Downers Grove, Ill 60515
NATIONAL TEL-TRONICS
55 Northern Blvd, Great Neck, N Y 11021
NORRICH PLASTIC CORP.
200 Allen Blvd, Farmingdale, N Y 11575
PINLITES INC.
P O Box 453, Caldwell, N J 07006
PINS INC.
P O Box 6409, Santa Ana, Cal 92706
POMONA ELECTRONICS CO. INC.
1500 E 9th St, Pomona, Cal 91766
PROGRAM DATA CO.
739 E 223 St, Torrance, Cal 90502
PROTOTYPE ASSEMBLIES INC.
70 Jaconnet St, Newton Hglds, Mass 02161
SEAELECTRO CORP.
225 Hoyt St, Mamaroneck, N Y 10543
SOLITRON DEVICES INC. TRANSISTOR DIV.
1177 Blue Heron Blvd, Riviera Beach, Fla 33404
SWITCHCRAFT INC.
5555 N Elston Ave, Chicago, Ill 60630
TECHNICAL MATERIAL CORP.
700 Fenimore Rd, Mamaroneck, N Y 10543
TROMPETER ELECTRONICS INC.
8936 Comanche Ave, Chatsworth, Cal 91311
U.S. COMPONENTS INC.
1320 Zerega Ave, Bronx, N Y 10462
VECTOR ELECTRONIC CO. INC.
12460 Gladstone Ave, Sylmar, Cal 91342
VERNITRON ELEC. COMPONENTS BEAU PRODUCTS
DIV.
117 Union Ave, Laconia, N H 03246
WINCHESTER ELECTRONICS DIV. LITTON INDUS.
Main St & Hillside, Oakville, Conn 06779

CONNECTORS, PC AND IC BOARD (COMPUTER-GRADE)

AIRBORN INC.
2618 Manana, Dallas, Tex 75220
AMP INC.
Eisenhower Blvd, Harrisburg, Pa 17105
AMP INC., SYSCOM DIV.
P O Box 3608, Harrisburg, Pa 17105
AMPHENOL INDUSTRIAL DIV. BUNKER-RAMO CORP.
1830 S 54 Ave, Chicago, Ill 60650
ANSLEY MANUFACTURING CO. SUB. THOMAS & BETTS
4100 N Figueroa St, Los Angeles, Cal 90065
AUGAT INC.
33 Perry Ave, Attleboro, Mass 02703
BARNES CORP.
24 N Lansdowne Ave, Lansdowne, Pa 19050
BENDIX CORP., THE ELECTRICAL COMPONENTS DIV.
Sherman Ave, Sidney, N Y 13838
BURNDY CORP.
Richard Ave, Norwalk, Conn 06852
CAMBRIDGE THERMIONIC CORP.
445 Concord Ave, Cambridge, Mass 02138
COLLINS RADIO CO.
1200 N Alma Rd, Dallas, Tex 75207
COMCET INC.
1950 W County Rd, St Paul, Minn 55113

2 Product Directory

COMPONENTS CORP.

106 Main St, Denville, N J 07834
CONTINENTAL CONNECTOR CORP.
34-63 56th St, Woodside, N Y 11377
CONTROL DATA CORP. CONNECTOR OPERATION
31829 W Latienda Dr, Westlake VII, Cal 91360
CURTIS DEVELOPMENT & MANUFACTURING CO.
3266 N 33rd St, Milwaukee, Wis 53216
DALE ELECTRONICS INC. SUB. LIONEL CORP.
1360 28th Ave, Columbus, Nebr 68601
DIGITAL EQUIPMENT CORP.
146 Main St, Maynard, Mass 01754
EBY CO., HUGH H. DIV. REDM CORP.
4701 Germantown Ave, Philadelphia, Pa 19104
ELCO CORP.

Maryland Rd, Willow Grove, Pa 19090
ELECTRONIC MOLDING CORP.

96 Mill St, Woonsocket, R I 02895
ELFAB CORP.

P O Box 34555, Dallas, Tex 75234
FABRI-TEK INC.

5901 S County Rd 18, Minneapolis, Minn 55436
FABRI-TEK INC. NATIONAL CONNECTOR DIV.

9210 Science Ctr, Minneapolis, Minn 55428
HARVEY INDUSTRIAL DIV.

60 Crossway Pk W, Woodbury Li, N Y 11797
HUGHES AIRCRAFT CO. CONNECTING DEV. DIV

500 Superior Ave, Newport Beach, Cal 92663
HYPERTRONICS CORP.

50 Hunt St, Watertown, Mass 02172
INTERDYNE

2217 Purdue Ave, Los Angeles, Cal 90064
ITT CANNON ELECTRIC DIV. ITT CORP.

3208 Humboldt St, Los Angeles, Cal 90031
MALCO MANUFACTURING CO. INC.

5150 W Roosevelt Rd, Chicago, Ill 60650
MASTERITE INDUSTRIES INC.

2841 Lomita Blvd, Torrance, Cal 90505
MEPCO INC.

Columbia Rd, Morristown, N J 07960
METHODE ELECTRONICS INC.

7447 W Wilson Ave, Chicago, Ill 60656
MICRODOT INC. CONNECTOR & CABLE DIV.

220 Pasadena Ave, S Pasadena, Cal 91030
MOLEX PRODUCTS CO.

5224 Katrine, Downers Grove, Ill 60515
PINS INC.

P O Box 6409, Santa Ana, Cal 92706
PROGRAM DATA CO.

739 E 223 St, Torrance, Cal 90502
PROTOTYPE ASSEMBLIES INC.

70 Jaconnet St, Newton Hglds, Mass 02161
SCANBE MANUFACTURING CO.

3445 Fletcher Ave, El Monte, Cal 91750
SOLITRON DEVICES INC. TRANSISTOR DIV.

1177 Blue Heron Blvd, Riviera Beach, Fla 33404
STELLARMETRICS AN AYDIN CO.

P O Box 719, Santa Barbara, Cal 93102
SWITCHCRAFT INC.

5555 N Elston Ave, Chicago, Ill 60630
TELEDYNE KINETICS SUB. TELEDYNE INC.

410 S Cedros St, Solana Beach, Cal 92075
TERADYNE INC.

183 Essex St, Boston, Mass 02111
TRANSITRON ELECTRONIC CORP.

168 Albion St, Wakefield, Mass 01880
U.S. COMPONENTS INC.

1320 Zerega Ave, Bronx, N Y 10462
V.I.Z. MANUFACTURING CO.

335 E Price St, Philadelphia, Pa 19144
VECTOR ELECTRONIC CO. INC.

12460 Gladstone Ave, Sylmar, Cal 91342
VERO ELECTRONICS INC.

176 Central Ave, Farmingdale, N Y 11735
VIKING INDUSTRIES INC.

21001 Nordhoff St, Chatsworth, Cal 91311
WINCHESTER ELECTRONICS DIV. LITTON INDUS.

Main St & Hillside, Oakville, Conn 06779

CONNECTORS, POWER (COMPUTER-GRADE)

AMP INC., SYSCOM DIV.

P O Box 3608, Harrisburg, Pa 17105
AMPHENOL INDUSTRIAL DIV. BUNKER-RAMO CORP.

1830 S 54 Ave, Chicago, Ill 60650
BURNDY CORP.

Richard Ave, Norwalk, Conn 06852
CONTINENTAL CONNECTOR CORP.

34-63 56th St, Woodside, N Y 11377
CONTROL DATA CORP. CONNECTOR OPERATION

31829 W Latienda Dr, Westlake VII, Cal 91360
CURTIS DEVELOPMENT & MANUFACTURING CO.

3266 N 33rd St, Milwaukee, Wis 53216

DALE ELECTRONICS INC. SUB. LIONEL CORP.

1360 28th Ave, Columbus, Nebr 68601
DIGITAL EQUIPMENT CORP.

146 Main St, Maynard, Mass 01754
ELCO CORP.

Maryland Rd, Willow Grove, Pa 19090
FABRI-TEK INC.

5901 S County Rd 18, Minneapolis, Minn 55436
FABRI-TEK INC. NATIONAL CONNECTOR DIV.

9210 Science Ctr, Minneapolis, Minn 55428
HARVEY INDUSTRIAL DIV.

60 Crossway Pk W, Woodbury Li, N Y 11797
HUGHES AIRCRAFT CO. CONNECTING DEV. DIV

500 Superior Ave, Newport Beach, Cal 92663
HYPERTRONICS CORP.

50 Hunt St, Watertown, Mass 02172
ITT CANNON ELECTRIC DIV. ITT CORP.

3208 Humboldt St, Los Angeles, Cal 90031
MALCO MANUFACTURING CO. INC.

5150 W Roosevelt Rd, Chicago, Ill 60650
METHODE ELECTRONICS INC.

7447 W Wilson Ave, Chicago, Ill 60656
MICRODOT INC. CONNECTOR & CABLE DIV.

220 Pasadena Ave, S Pasadena, Cal 91030
MOLEX PRODUCTS CO.

5224 Katrine, Downers Grove, Ill 60515
NATIONAL TEL-TRONICS

55 Northern Blvd, Great Neck, N Y 11021
SOLITRON DEVICES INC. TRANSISTOR DIV.

1177 Blue Heron Blvd, Riviera Beach, Fla 33404
U.S. COMPONENTS INC.

1320 Zerega Ave, Bronx, N Y 10462
VERNITRON ELEC. COMPONENTS BEAU PRODUCTS

DIV.
117 Union Ave, Laconia, N H 03246
VIKING INDUSTRIES INC.

21001 Nordhoff St, Chatsworth, Cal 91311
VIRGINIA ELECTRONICS CO. INC.

2901 Telearstar Court, Falls Church, Va 22042
WESTINGHOUSE ELECTRIC CORP.

Westinghouse Bldg, Pittsburgh, Pa 15222
WINCHESTER ELECTRONICS DIV. LITTON INDUS.

Main St & Hillside, Oakville, Conn 06779

CONNECTORS, RACK AND PANEL (COMPUTER-GRADE)

AIRBORN INC.

2618 Manana, Dallas, Tex 75220
AMP INC.

Eisenhower Blvd, Harrisburg, Pa 17105
AMP INC., SYSCOM DIV.

P O Box 3608, Harrisburg, Pa 17105
AMPHENOL INDUSTRIAL DIV. BUNKER-RAMO CORP.

1830 S 54 Ave, Chicago, Ill 60650
ANSLEY ELECTRONICS CORP. SUB. THOMAS & BETTS

Old Easton Rd, Doylestown, Pa 18901
ANSLEY MANUFACTURING CO. SUB. THOMAS & BETTS

4100 N Figueroa St, Los Angeles, Cal 90065
BENDIX CORP., THE ELECTRICAL COMPONENTS DIV.

Sherman Ave, Sidney, N Y 13838
BURNDY CORP.

Richard Ave, Norwalk, Conn 06852
CAMBRIDGE THERMIONIC CORP.

445 Concord Ave, Cambridge, Mass 02138
CONTINENTAL CONNECTOR CORP.

34-63 56th St, Woodside, N Y 11377
CONTROL DATA CORP. CONNECTOR OPERATION

31829 W Latienda Dr, Westlake VII, Cal 91360
CURTIS DEVELOPMENT & MANUFACTURING CO.

3266 N 33rd St, Milwaukee, Wis 53216
DALE ELECTRONICS INC. SUB. LIONEL CORP.

1360 28th Ave, Columbus, Nebr 68601
EBY CO., HUGH H. DIV. REDM CORP.

4701 Germantown Ave, Philadelphia, Pa 19104
ELCO CORP.

Maryland Rd, Willow Grove, Pa 19090
FABRI-TEK INC.

5901 S County Rd 18, Minneapolis, Minn 55436
FABRI-TEK INC. NATIONAL CONNECTOR DIV.

9210 Science Ctr, Minneapolis, Minn 55428
HARVEY INDUSTRIAL DIV.

60 Crossway Pk W, Woodbury Li, N Y 11797
HUGHES AIRCRAFT CO. CONNECTING DEV. DIV

500 Superior Ave, Newport Beach, Cal 92663
HYPERTRONICS CORP.

50 Hunt St, Watertown, Mass 02172
ITT CANNON ELECTRIC DIV. ITT CORP.

3208 Humboldt St, Los Angeles, Cal 90031
MALCO MANUFACTURING CO. INC.

5150 W Roosevelt Rd, Chicago, Ill 60650
METHODE ELECTRONICS INC.

7447 W Wilson Ave, Chicago, Ill 60656

MICRODOT INC. CONNECTOR & CABLE DIV.

220 Pasadena Ave, S Pasadena, Cal 91030
MOLEX PRODUCTS CO.

5224 Katrine, Downers Grove, Ill 60515
SOLITRON DEVICES INC.

256 Oak Tree Rd, Tappan, N Y 10983
SOLITRON DEVICES INC. TRANSISTOR DIV.

1177 Blue Heron Blvd, Riviera Beach, Fla 33404
SWITCHCRAFT INC.

5555 N Elston Ave, Chicago, Ill 60630
TRANSITRON ELECTRONIC CORP.

168 Albion St, Wakefield, Mass 01880
U.S. COMPONENTS INC.

1320 Zerega Ave, Bronx, N Y 10462
VERNITRON ELEC. COMPONENTS BEAU PRODUCTS

DIV.
117 Union Ave, Laconia, N H 03246
VIKING INDUSTRIES INC.

21001 Nordhoff St, Chatsworth, Cal 91311
VIRGINIA ELECTRONICS CO. INC.

2901 Telearstar Court, Falls Church, Va 22042
VIRGINIA PANEL CORP.

1400 N Hope Rd, Waynesboro, Va 22980
WINCHESTER ELECTRONICS DIV. LITTON INDUS.

Main St & Hillside, Oakville, Conn 06779

CONSOLES, COMPUTER CONTROL (WIRED)

AMCO ENGINEERING CO.

7333 W Ainslie, Chicago, Ill 60656
AMERICAN COMPUTER TECHNOLOGY INC.

8740 Shirley Ave, Northridge, Cal 91324
CLARE SYSTEMS DIV. C.P. CLARE & CO.

3101 W Pratt Ave, Chicago, Ill 60645
COMPUTER DEVICES INC.

10 Sonar Dr, Woburn, Mass 01801
FOXBORO CO., THE

Neponset Ave, Foxboro, Mass 02035
LITTON SYSTEMS INC. DATA SYSTEMS DIV.

8000 Woodley Ave, Van Nuys, Cal 91409
MACPANEL CO. ADAMS-MILLIS CORP.

P O Box 5027, High Point, N C 27262
NORTH AMERICAN ROCKWELL CORP. AUTONETICS

DIV.
3370 Miraloma Ave, Anaheim, Cal 92803
RAYCON INC.

218 Brunswick Blvd, Pointe Claire, CANADA
STACOSWITCH INC.

1139 Baker St, Costa Mesa, Cal 92626
SYSTEMS CONCEPTS INC.

17-45 Clintonville St, Whitestone, N Y 11357
SYSTRON-DONNER CORP.

888 Galindo St, Concord, Cal 94520
WEISMANTEL INC.

P O Box 1957, St Paul, Minn 55111

CONSOLES, CRT (ALPHANUMERIC) -(SEE DATA TERMINALS)

CONSOLES, CRT (ALPHANUMERIC AND GRAPHIC)

ADAGE INC.

1079 Commonwealth Ave, Boston, Mass 02109
ASTRONAUTICS CORPORATION OF AMERICA

907 S First St, Milwaukee, Wis 53204
ATLANTIC TECHNOLOGY CORP.

505 W Hamilton Ave, Linwood, N J 08221
BALL BROTHERS RESEARCH CORP.

P O Box 1062, Boulder, Colo 80302
COMPUK INC.

143 Albany St, Cambridge, Mass 02139
COMPUTER COMMUNICATION INC.

701 W Manchester Blvd, Inglewood, Cal 90301
COMPUTER DEVICES INC.

10 Sonar Dr, Woburn, Mass 01801
COMPUTER DISPLAY INC.

223 Cresent St, Waltham, Mass 02154
COMPUTER INC.

143 Albany St, Cambridge, Mass 02139
COMPUTER MICRO-IMAGE SYSTEMS INC.

9600 Desoto Ave, Chatsworth, Cal 91311
COMPUTERVISION CORP.

NW Ind Park S Ave, Burlington, Mass 01803
CONTROL DATA CORP.

8100 34th Ave S, Minneapolis, Minn 55440
CONTROL DATA CORP. TERMINAL SUBSYS.DIV

2401 N Fairview Ave, St Paul, Minn 55113
CORNING GLASS WORKS

Houghton Park, Corning, N Y 14830

2 Product Directory

CURRAN COMPUTER CORP.
946 Main St, Hackensack, N J 07601

DACONICS
925 Thompson Pl, Sunnyvale, Cal 94086

DATA ACCESS SYSTEMS INC.
503 Rte 10 Mt 19, Dover, N J 07801

DATA DISC INC.
686 W Maude Ave, Sunnyvale, Cal 94086

DELMARVA COMPUTER INDUSTRIES INC.
5865 Robert Oliver Pl, Columbia, Md 21043

DELTA DATA SYSTEMS CORP.
Woodhaven Ind Park, Cornwells Hgts, Pa 19020

DIGITAL EQUIPMENT CORP.
146 Main St, Maynard, Mass 01754

ECONOMET INC.
1033 W Kirkwall Rd, Azusa, Cal 91702

EVANS & SUTHERLAND COMPUTER CORP.
3 Research Rd, Salt Lake City, Utah 84112

FOUR-PHASE SYSTEMS INC.
10420 N Tantau Ave, Cupertino, Cal 95014

HARRIS-INTERTYPE CORP. INTERTYPE DIV.
Palm Bay Rd, Melbourne, Fla 32901

HEWLETT PACKARD CO.
1501 Page Mill Rd, Palo Alto, Cal 94304

HOUSTON ENGINEERING RESEARCH CORP.
P O Box 35495, Houston, Tex 77035

IBM CORP., DATA PROCESSING DIV.
1133 Westchester Ave, White Plains, N Y 10604

IMLAC CORP.
296 Newton St, Waltham, Mass 02154

INFORMATION DISPLAY INC.
333 N Bedford Rd, Mt Kisco, N Y 10549

INFORMATION INTERNATIONAL INC.
12435 W Olympic Blvd, Los Angeles, Cal 90064

ITT DATA EQUIPMENT & SYSTEMS DIV.
187 E Union Ave, E Rutherford, N J 07073

LITTON SYSTEMS INC. DATA SYSTEMS DIV.
8000 Woodley Ave, Van Nuys, Cal 91409

LUNDY ELECTRONICS & SYSTEMS INC.
Robert Lane, Glen Head, N Y 11545

METRA INSTRUMENTS INC.
1340 Space Park Way, Mt View, Cal 94040

MICROFORM DATA SYSTEMS INC.
830 Maude Ave, Mountain View, Cal 94040

OPTIMATION, INC.
9421 Telfair Ave, Sunn Valley, Cal 91352

RC-95 INC.
2 Westchester Plaza, Elmsford, N Y 10523

RCA COMPUTER SYSTEMS DIV.
200 Forest Ave, Marlboro, Mass 01752

SYLVANIA ELECTRONIC SYSTEMS EASTERN DIV.
77 A St, Needham Heights, Mass 02194

SYSTEMS CONCEPTS INC.
524 2nd St, San Francisco, Cal 94107

SYSTEMS ENGINEERING LABORATORIES INC.
P O Box 9148, Fort Lauderdale, Fla 33310

TEKTRONIX INC.
P O Box 500, Beaverton, Ore 97005

UNIVERSAL TECHNOLOGY INC.
3 Spielman Rd, Fairfield, N J 07006

WYLE LABORATORIES
128 Maryland St, El Segundo, Cal 90245

XEROX DATA SYSTEMS
701 S Aviation, El Segundo, Cal 90245

CONSOLES, CRT (COLOR-ALPHANUMERIC AND GRAPHIC)

ADAGE INC.
1079 Commonwealth Ave, Boston, Mass 02109

BALL BROTHERS RESEARCH CORP.
P O Box 1062, Boulder, Colo 80302

COMPUTEK INC.
143 Albany St, Cambridge, Mass 02139

COMPUTER COMMUNICATION INC.
701 W Manchester Blvd, Inglewood, Cal 90301

COMPUTER INC.
143 Albany St, Cambridge, Mass 02139

COMPUTER MICRO-IMAGE SYSTEMS INC.
9600 Desoto Ave, Chatsworth, Cal 91311

DACONICS
925 Thompson Pl, Sunnyvale, Cal 94086

DATA DISC INC.
686 W Maude Ave, Sunnyvale, Cal 94086

DELTA DATA SYSTEMS CORP.
Woodhaven Ind Park, Cornwells Hgts, Pa 19020

ECONOMET INC.
1033 W Kirkwall Rd, Azusa, Cal 91702

INFORMATION DISPLAY INC.
333 N Bedford Rd, Mt Kisco, N Y 10549

LIBRASCOPE DIV. THE SINGER CO
808 Western Ave, Glendale, Cal 91201

OPTIMATION, INC.
9421 Telfair Ave, Sunn Valley, Cal 91352

SYLVANIA ELECTRONIC SYSTEMS EASTERN DIV.
77 A St, Needham Heights, Mass 02194

SYSTEMS ENGINEERING LABORATORIES INC.
P O Box 9148, Fort Lauderdale, Fla 33310

TEKTRONIX INC.
P O Box 500, Beaverton, Ore 97005

CONSOLES, CRT (GRAPHIC)

ADAGE INC.
1079 Commonwealth Ave, Boston, Mass 02109

BALL BROTHERS RESEARCH CORP.
P O Box 1062, Boulder, Colo 80302

BASIC COMPUTING ARTS INC.
2680 E Bayshore Frtge, Mt View, Cal 94040

COMPUTEK INC.
143 Albany St, Cambridge, Mass 02139

COMPUTER DISPLAY INC.
223 Cresent St, Waltham, Mass 02154

COMPUTER INC.
143 Albany St, Cambridge, Mass 02139

COMPUTER MICRO-IMAGE SYSTEMS INC.
9600 Desoto Ave, Chatsworth, Cal 91311

CONTROL DATA CORP.
8100 34th Ave S, Minneapolis, Minn 55440

CONTROL DATA CORP. TERMINAL SUBSYS.DIV
2401 N Fairview Ave, St Paul, Minn 55113

DATA DISC INC.
686 W Maude Ave, Sunnyvale, Cal 94086

DATATROL INC.
Kane Industrial Dr, Hudson, Mass 01749

DELMARVA COMPUTER INDUSTRIES INC.
5865 Robert Oliver Pl, Columbia, Md 21043

DELTA DATA SYSTEMS CORP.
Woodhaven Ind Park, Cornwells Hgts, Pa 19020

DIAMOND POWER SPECIALTY CORP.
P O Box 415, Lancaster, Ohio 43130

DICOMED CORP.
7600 Parklawn Ave, Minneapolis, Minn 55435

DIGITAL EQUIPMENT CORP.
146 Main St, Maynard, Mass 01754

DIGITAL RESOURCES CORP.
6250 W Park Suite 100, Houston, Tex 77027

DIMENSIONAL SYSTEMS INC.
393 Totten Pond Rd, Waltham, Mass 02154

ECONOMET INC.
1033 W Kirkwall Rd, Azusa, Cal 91702

EVANS & SUTHERLAND COMPUTER CORP.
3 Research Rd, Salt Lake City, Utah 84112

GOULD INC. BRUSH DIV.
3631 Perkins Ave, Cleveland, Ohio 44114

IBM CORP., DATA PROCESSING DIV.
1133 Westchester Ave, White Plains, N Y 10604

IMLAC CORP.
296 Newton St, Waltham, Mass 02154

INFORMATION DISPLAY INC.
333 N Bedford Rd, Mt Kisco, N Y 10549

INFORMATION INTERNATIONAL INC.
12435 W Olympic Blvd, Los Angeles, Cal 90064

LUNDY ELECTRONICS & SYSTEMS INC.
Robert Lane, Glen Head, N Y 11545

METRA INSTRUMENTS INC.
1340 Space Park Way, Mt View, Cal 94040

MONITOR DISPLAYS
401 Commerce Dr, Ft Washington, Pa 19034

OPTIMATION, INC.
9421 Telfair Ave, Sunn Valley, Cal 91352

SPATIAL DATA SYSTEMS INC.
132 Aero Camino, Goleta, Cal 93017

SYLVANIA ELECTRONIC SYSTEMS EASTERN DIV.
77 A St, Needham Heights, Mass 02194

SYSTEMS CONCEPTS INC.
524 2nd St, San Francisco, Cal 94107

SYSTEMS ENGINEERING LABORATORIES INC.
P O Box 9148, Fort Lauderdale, Fla 33310

TEKTRONIX INC.
P O Box 500, Beaverton, Ore 97005

TELONIC INDUSTRIES INC.
Po Box 277, Laguna Beach, Cal 92652

UNIVERSAL TECHNOLOGY INC.
3 Spielman Rd, Fairfield, N J 07006

CONSULTING (ACCOUNTING, BUSINESS AND COMMERCIAL APPLICATIONS)

ACADEMY COMPUTING CORP.
5005 N Lincoln Blvd, Oklahoma City, Okla 73105

ACME VISIBLE RECORDS INC.
510 Allview Dr, Crozet, Va 22932

ADAPT INC.
624 S 62nd St, Philadelphia, Pa 19143

ADATACO
1475 N Broadway, Walnut Creek, Cal 94596

ADMINISTRATIVE SYSTEMS INC.
131 Mineola Blvd, Mineola, N Y 11501

ADP-AUTOMATIC DATA PROCESSING OF SF INC.
4250 W Williams Rd, San Jose, Cal 95129

ADVANCE DATA
221 Hughes Dr, Jonesboro, Ark 72401

ADVANCED COMPUTER SYSTEMS INC
3131 S Dixie Dr, Dayton, Ohio 45305

ADVANCED COMPUTER TECHNIQUES CORP.
437 Madison Ave, New York, N Y 10022

ADVANCED MANAGEMENT SYSTEMS INC.
3310 Richmond Ave, Houston, Tex 77006

AERO TECHNICAL APPLICATIONS INC.
8011 Clayton Rd, St Louis, Mo 63117

AGRICULTURAL COMPUTING CO. DBA
ASSOCIOMETRICS
P O Box 1259, Grand Prairie, Tex 75050

AHART & ASSOC. INC., JAMES R.
225 S Main St, Dayton, Ohio 45402

ALLEN-BABCOCK COMPUTING INC.
1800 Ave of The Stars, Los Angeles, Cal 90067

ALPHA COMPUTER SERVICE CORP.
226 W 37th St, New York, N Y 10018

AMERICAN COMPUTER LEASING CORP.
14 E 4th St, Cincinnati, Ohio 45202

AMERICAN COMPUTER SERVICES CORP.
14 E 4th St, Cincinnati, Ohio 45202

ANACOMP INC.
6161 Hillside Ave, Indianapolis, Ind 46220

ANALYTICS INC.
179 Washington Lane, Jenkintown, Pa 19046

ANCOM SYSTEMS, DIV. GENERAL ANALYTICS CORP.
9841 Airport Blvd, Los Angeles, Cal 90045

ANDROCOR INC.
5949 Hohman Ave, Hammond, Ind 46320

APPLIED COMPUTER SCIENCES INC.
361 Park Rd, W Hartford, Conn 06107

APPLIED COMPUTER TIME SHARE INC.
29200 Southfield Rd, Southfield, Mich 48075

APPLIED CYBERNETICS CORP.
1285 Forgewood Ave, Sunnyvale, Cal 94086

APPLIED DIGITAL SYSTEMS INC.
3848 Campus Dr 112, Newport Beach, Cal 92660

APT COMPUTER CENTER
5309 W Touhy, Skokie, Ill 60076

ARIES CORP.
1651 Old Meadow Rd, Mc Lean, Va 22101

ARISTA INFORMATION SYSTEMS INC.
P O Box 4775, Winston-Salem, N C 27107

AUDITEK INC.
866 6th Ave, New York, N Y 10001

AUERBACH ASSOCIATES INC.
121 W Broad St, Philadelphia, Pa 19107

AUTOCOMP INC.
4720 Montgomery Ln, Bethesda, Md 20014

AUTOMATED COMPUTER SERVICES INC.
517 W Grace St, Richmond, Va 23220

AUTOMATED CONCEPTS INC.
477 Madison Ave, New York, N Y 10017

AUTOMATED FACTS & FIGURES CO.
4551 S Racine Ave, Chicago, Ill 60609

AUTOMATED INFORMATION SYSTEMS INC.
1064 River Rd, Edgewater, N J 07020

AUTOMATED SYSTEMS CORP.
600 Houst Nat Gas Bld, Houston, Tex 77002

AUTOMATION SERVICES CORP.
182 Forbes Rd, Braintree, Mass 02184

AZREX INC.
105 Terrace Hall Ave, Burlington, Mass 01803

BANKERS DATA SERVICES, INC.
430 Lamar, Houston, Tex 77002

BCD COMPUTING CORP.
100 E Industry Court, Deer Park, N Y 11729

BENDIX CORP., THE, ELECTRODYNAMICS DIV
11600 Sherman Way, No Hollywood, Cal 91605

BIZ-MATIC DATA CONTROL CENTERS INC.
232 Summer St, Boston, Mass 02210

BLAIR & ASSOCIATES, NEIL F.
4026 N 48th Dr, Phoenix, Ariz 85031

BMS DATA PROCESSING CORP.
415 E Paces Ferry Rd, Atlanta, Ga 30305

BONNER&MOORE ASSOCIATES INC.
500 Jefferson Bldg, Houston, Tex 77002

BOOTHE DATA SYSTEMS INC.
485 Lexington Ave, New York, N Y 10001

BOOTHE RESOURCES INTERNATIONAL INC.
3435 Wilshire Blvd, Los Angeles, Cal 90005

BOSTON COMPUTER SYSTEMS CORP.
15 School St, Boston, Mass 02108

BOSWORTH & ASSOCIATES, S.
9 Forest Dr, Plainview, N Y 11803

2 Product Directory

- BRADDOCK, DUNN & MCDONALD INC.
8027 Leesburg Pike, Mc Lean, Va 22101
- BRANDON APPLIED SYSTEMS INC.
1700 Broadway, New York, N Y 10019
- BRANDON APPLIED SYSTEMS INC.
1611 N Kent St, Arlington, Va 22209
- BURLINGTON MANAGEMENT SERVICES CO.
P O Box 21207, Greensboro, N C 27420
- C&C COMPUTER SYSTEMS INC.
1006 S E Grand, Portland, Ore 97214
- C-O-M SYSTEMS INC.
75 Maiden Lane, New York, N Y 10038
- CALL-A-COMPUTER INC.
633 Young St, Santa Ana, Cal 92702
- CALTEC INC.
1931 Sylvania Ave, Toledo, Ohio 43613
- CAL-WESTERN DATA SYSTEMS INC.
13517 Ventura Blvd, Sherman Oaks, Cal 91403
- CAMBRIDGE COMPUTER ASSOCIATES INC.
220 Alewife Brook Pky, Cambridge, Mass 02138
- CENTRAL COMPUTING CORP.
749 Water P O Box 681, Decatur, Ill 62525
- CENTRAL COMPUTING CORP.
180 N Mich Ave, Chicago, Ill 60601
- CENTRAL COMPUTING, INC.
2627 E Central, Wichita, Kans 67214
- CENTRAL DATA SYSTEMS INC.
1215 Valley Belt Rd, Cleveland, Ohio 44131
- CENTURY DATA PROCESSING INC.
1006 Coronado Towers, El Paso, Tex 79912
- CGA COMPUTER ASSOCIATES INC.
715 Park Ave, East Orange, N J 07017
- CHAPARRAL SYSTEMS INC. MANAGEMENT,
Po Box 5755, Bethesda, Md 20014
- CHI CORP.
11000 Cedar Ave, Cleveland, Ohio 44106
- CHICAGO TABULATING SERV. INC.
425 N Michigan, Chicago, Ill 60611
- COMMERCIAL TECHNOLOGY INC.
P O Box 10616, Knoxville, Tenn 37919
- COMPAC COMPUTER SYSTEMS INC.
911 Hennepin, Minneapolis, Minn 55403
- COM PU DAT DIV. SOUTHEASTERN NEWSPAPERS
CORP.
P O Box 3806, Augusta, Ga 30904
- COMPUMATICS INC.
327 S Lasalle St, Chicago, Ill 60604
- COMPUMEDIC CONTROLS CORP.
432 Park Ave S, New York, N Y 10016
- COMPU SYS INC.
Po Box 11104, Albuquerque, N M 87112
- COMPU-TIME INC.
327 Orange Ave, Daytona, Fla 32014
- COMPUTE AMERICA CORP. DBA COMERICA
1515 Classen Blvd, Oklahoma City, Okla 73106
- COMPUTER ADVISORS TO MANAGEMENT
120 S Riverside Plaza, Chicago, Ill 60606
- COMPUTER AGE INDUSTRIES INC.
8800 Arlington Blvd, Fairfax, Va 22030
- COMPUTER AID COMPANIES INC.
5925 Forest Lane, Dallas, Tex 75201
- COMPUTER AMERICA CORP.
818 Roeder Rd, Silver Spring, Md 20910
- COMPUTER APPLICATIONS CENTER, INC.
516 Hutton Pl, Columbus, Ohio 43215
- COMPUTER ASSISTANCE INC.
298 Park Rd, West Hartford, Conn 06119
- COMPUTER AUDIT SYSTEMS, INC.
725 Park Ave, E Orange, N J 07017
- COMPUTER CENTER, INC.
350 Royal Palm Way, Palm Beach, Fla 33480
- COMPUTER CENTER OF ATLANTA DIV. COMP. CNTRS
INC
2695 Buford Hwy NE, Atlanta, Ga 30324
- COMPUTER COMMAND & CONTROL CO
1717 Penn Ave NW, Washington, D C 20006
- COMPUTER COMMAND AND CONTROLS COMPANY
4025 Chestnut St, Philadelphia, Pa 19104
- COMPUTER CONSULTANTS CORP.
U S Rte 46 E, Denville, N J 07834
- COMPUTER CONSULTING SERVICES
1176 Iowa, Dubuque, Iowa 52001
- COMPUTER DIMENSIONS, INC.
511 Akard, Dallas, Tex 75201
- COMPUTER DYNAMICS INC.
1760 Solano Ave, Berkeley, Cal 94707
- COMPUTER DYNAMICS INC.
100 Hegenberger Rd, Oakland, Cal 94621
- COMPUTER EXCHANGE INC., THE
30 E 42nd St, New York, N Y 10017
- COMPUTERIA INC.
14 Wood Rd, Braintree, Mass 02143
- COMPUTER INFORMATION SERVICES INC.
6701 N Broad St, Philadelphia, Pa 19126
- COMPUTER INFORMATION CORP.
3645 Wrrmsville Ctr Rd, Cleveland, Ohio 44122.
- COMPUTER INVESTMENTS & LEASING CORP.
9 Tanner St, Haddonfield, N J 08033
- COMPUTER MANAGEMENT INC.
3101 Eullid Ave, Cleveland, Ohio 44115
- COMPUTER METHODS CORP.
470 Mamaroneck Ave, White Plains, N Y 10605
- COMPUTER NETWORK CORP.
5185 Macarthur Blvd, Washington, D C 20016
- COMPUTER POWER INC.
30 S Laura St, Jacksonville, Fla 32202
- COMPUTER PROCESSING INC.
200 Manhattan Bldg, Muskogee, Okla 74401
- COMPUTER PROCESSING INC.
300 6th Ave, Pittsburgh, Pa 15222
- COMPUTER PROGRAMMING CONCEPTS INC.
101 Atkinson Sq, Cincinnati, Ohio 45246
- COMPUTER RESOURCES INC.
5091 W 164th St, Cleveland, Ohio 44142
- COMPUTER SCIENCES CORP. INFO. NETWORK DIV.
1901 Building, Los Angeles, Cal 90067
- COMPUTER SERVICENTER CORP.
16 Maple St, Latham, N Y 12110
- COMPUTER SERVICE OF E. TEXAS
P O Box 5981, Jasper, Tex 75951
- COMPUTER SERVICES CORP.
200 Bank Savings Bldg, Birmingham, Ala 35203
- COMPUTER SERVICES INC.
500 Clark St, Paducah, Ky 42001
- COMPUTER SERVICES INC.
47 Congress St, Salem, Mass 01970
- COMPUTER SERVICES OF INDIANA, INC.
214 S 13 1/2 St, Terre Haute, Ind 47808
- COMPUTER SHARING SERVICES
2492 W 2nd Ave, Denver, Colo 80223
- COMPUTER SYSTEM TECHNOLOGY INC.
700-42 Fox Pavilion, Jenkintown, Pa 19046
- COMPUTER SYSTEMS
400 Wing Bldg, Grants Pass, Ore 97526
- COMPUTER SYSTEMS CO. INC.
1470 St Charles Ave, Cleveland, Ohio 44107
- COMPUTER SYSTEMS CORP. U.S. INDUSTRIES INC
P O Box 64400, Dallas, Tex 75206
- COMPUTER SYSTEMS INC.
19619 81st Ave S, Kent, Wash 98031
- COMPUTER TABULATING CORP.
136 Main St, Hemstead, N Y 11550
- COMPUTER TASK GROUP INC.
5586 Main St, Buffalo, N Y 14221
- COMPUTER TECHNOLOGY INC. SUB. UNIV.
COMPUTING CO.
P O Box 47911, Dallas, Tex 75247
- COMPUTER TIME
368 Village Sq, Orinda, Cal 94563
- COMPUTER TUTOR, THE, DIV. COMPUT INC.
12 Emerald Court, Commack, N Y 11725
- COMPUTER UNIVERSAL CORP.
1641 Universal Rd, Columbus, Ohio 43207
- COMPUTER USAGE CO.
7315 Wisconsin Ave Nw, Washington, D C 20014
- COMPUTER USAGE CO.
387 Elliot St, Newton Uppr Fls, Mass 02164
- COMPUTER USAGE CO.
3181 Porter Dr, Palo Alto, Cal 94304
- COMPUTER USAGE CORP.
100 Putman Green, Greenwich, Conn 06830
- COMPUTER USAGE CORP.,
8939 S Sepulveda Blvd, Los Angeles, Cal 90045
- COMP/UTILITY INC.
1 Center Plaza, Boston, Mass 02108
- COMPUTING & SOFTWARE INC., EAST COAST DIV.
3700 Mt Vernon Ave, Alexandria, Va 22305
- COMPUTING EFFICIENCY INC. COMPUTING EFF. DIV.
35 Orville Dr, Bohemia, N Y 11716
- COMPUTONE SYSTEMS INC.
361 E Paces Ferry Rd, Atlanta, Ga 30305
- COMRESS INC.
No 2 Research Court, Rockville, Md 20850
- COMSERV CORP.
4025 Chestnut St, Philadelphia, Pa 19104
- COMSI INC.
1211 W 22 St, Oakbrook, Ill 60521
- COMSONIC CORP., THE
123 Pleasant Ave, Upper Saddle R, N J 07458
- COMTECH NEW ENGLAND INC.
534 Boston Post Rd, Wayland, Mass 01778
- COMTEK ASSOCIATES
2077 Center Ave, Fort Lee, N J 07024
- CONDATA INC.
1809 Walnut St, Philadelphia, Pa 19103
- CONSAD RESEARCH CORP.
5600 Forward Ave, Pittsburgh, Pa 15217
- CONSENTIVE INC.
3525 Lancaster Ave, Philadelphia, Pa 19104
- CONSULTANTS ASSOCIATED INC.
Lakeside Office Park, Wakefield, Mass 01880
- CONSUMER SYSTEMS CORP.
15 Spinning Wheel Rd, Hinsdale, Ill 60521
- CONTINENTAL DATA PROCESSING INC.
300 Market St., Kingston, Pa 18704
- CONTROL DATA CORP. CEIR PROF. SERV. DIV.
5272 River Rd, Washington, D C 20016
- CONTROL TECHNOLOGY INC.
3450 E Spring St, Long Beach, Cal 90806
- COOPER DATA SYSTEMS INC.
826 Union St, New Orleans, La 70112
- CORPORATE DATA PROCESSING
1724 Silver Lake Blvd, Los Angeles, Cal 90026
- CREDIT SYSTEMS INC.
P O Box 105, Colmar, Pa 18915
- CSI COMPUTER SYSTEMS INC.
P O Box 75008, Cincinnati, Ohio 45275
- CTC COMPUTER CORP.
1000 Elwell Court, Palo Alto, Cal 94303
- CUMMINS ASSOCIATES, J.J.
29 Towpath Trail, Fairport, N Y 14450
- CUSTOM DATA PROCESSING SERVICES
P O Box 14685, Phoenix, Ariz 85031
- CYBERMATICS INC.
2460 Lemoine Ave, Fort Lee, N J 07024
- D.P.&W. INC.
1107 Commonwealth Ave, Boston, Mass 02215
- DACONICS
925 Thompson Pl, Sunnyvale, Cal 94086
- DAILEY INC., R.N.
300 Madison Ave, New York, N Y 10017
- DATA ARCHITECTS INC.
213 3rd Ave, Waltham, Mass 02154
- DATA CENTER CORP.
3002 Midvale St, Los Angeles, Cal 90034
- DATA COMPUTING CORP.
229 Baldwin Rd, Hempsted, N Y 11551
- DATA CONTROL CO.
405 E Easterday Ave, Sault Ste Marie, Mich 49783
- DATA COPY INC.
760 Bryant St, San Francisco, Cal 94107
- DATA CORP., THE
1111 W 6th St, Los Angeles, Cal 90017
- DATA CORP., THE PENINSULA COMPUTER CENTER
DIV
1190 Coleman Ave, San Jose, Cal 95110
- DATA DIMENSIONS INC.
51 Weaver St, Greenwich, Conn 06830
- DATA MANAGEMENT SERVICES INC.
1845 Walnut St, Philadelphia, Pa 19103
- DATA-PACK INC.
269 Brookside Rd, Waterbury, Conn 06720
- DATA PROCESSING AND ACCOUNTING SERVICES
50 Van Ness Ave, San Francisco, Cal 94102
- DATA PROCESSING CENTER DIV FROST REALTY CO
P O Box 1600, San Antonio, Tex 78206
- DATA PROCESSING SERVICE INC.
270 Main St, Painesville, Ohio 44077
- DATA PROCESSORS INC.
2703 W 28th Ave, Pine Bluff, Ark 71601
- DATA SERVICE CORP.
1907 Division St, Nashville, Tenn 37203
- DATA SERVICE OF TEXAS INC.
1415 W 5th, Plainview, Tex 79072
- DATA SYSTEMS ANALYSTS INC.
N Park Dr, Pennsauken, N J 08109
- DATA SYSTEMS INC.
434 Stinson Blvd, Minneapolis, Minn 55413
- DATA SYSTEMS INC.
707 S E Belmont St, Portland, Ore 97214
- DATA-TRONICS CORP. SUB. ARKANSAS BEST CORP.
310 Townson Ave, Fort Smith, Ark 72901
- DATA USAGE CORP.,
2460 Lemoine Ave, Fort Lee, N J 07024
- DATACAP INTERNATIONAL INC.
37 W 2950 S, Salt Lake City, Utah 84101
- DATALOGICS INC.
12025 Shakee Blvd, Cleveland, Ohio 44120
- DATAMATION SERVICES INC.
461 Eighth Ave, New York, N Y 10001
- DATASONICS INC.
P O Box 4553, New York, N Y 10017
- DATATAB
740 N Rush St, Chicago, Ill 60611
- DATATRONIC SERVICE CO.
1250 Guardian Blvd, Detroit, Mich 48226
- DA-TRONICS INC.
2962 Market Ave N, Canton, Ohio 44714
- DECISION SYSTEMS INC.
E 66 Midland Ave, Paramus, N J 07652
- DELMARVA COMPUTER INDUSTRIES INC.
5865 Robert Oliver Pl, Columbia, Md 21043
- DELTA AUTOMATED SYSTEMS INC.
816 Thayer Ave, Silver Spring, Md 20910

2 Product Directory

- DELTA SYSTEMS CORP.
Edens Executive Ctr, Wilmette, Ill 60091
DESIGNERS & BUILDERS OF INFORMATION SYSTEMS
35 W 53 St, New York, N Y 10019
DEUSSEN ASSOCIATES INC.
576 Hyannis Dr, Sunnyvale, Cal 94087
DIGITAL PROGRAMMING SERVICES INC.
60 Hickory Dr, Waltham, Mass 02154
DIGITAL SYSTEMS DESIGN
P O Box 305 Fdr Sta, New York, N Y 10022
DIGITRON INC.
P O Box 5836, Columbus, S C 29205
DIPIETRO & WILSON INC.
1107 Commonwealth Ave, Boston, Mass 02215
DIRECT ACCESS COMPUTING CORP.
984 Livernois Rd, Troy, Mich 48084
DIVERSIFIED COMPUTER APPLICATIONS
2525 E Bayshore Rd, Palo Alto, Cal 94302
DUMEY, ARNOLD I.
641 Mt Lucas Rd, Princeton, N J 08540
DYNAMIC ACCESS CORP.
220 Park Ave S, New York, N Y 10003
EASTERN COMPUTER SERVICES INC
920 Fox Chase Rd, Rockledge, Pa 19111
ECCO BUSINESS SYSTEMS INC.
50 E 42nd St, New York, N Y 10017
EICO ELECTRONIC INSTRUMENT CO INC.
283 Malta St, Brooklyn, N Y 11207
ELECTROMECC COMPUTING & TECH. SERVICES CO.
2964 Peachtree Rd NW, Atlanta, Ga 30305
ELECTRONIC ACCOUNTING SYSTEMS INC.
255 Alexander St, Rochester, N Y 14607
ELECTRONIC BUSINESS SERVICE
P O Box 368, Visalia, Cal 93277
ELECTRONIC COMPUTER PROG. INSTITUTE
49 N Progress Ave, Harrisburg, Pa 17109
ELECTRONIC DATA PREPARATION CORP.
P O Box 1446, Bradenton, Fla 33505
ELECTRONIC DATA SERVICE INC.
18 Germay Dr, Wilmington, Del 19804
ELECTRONIC TABULATING SERVICE INC.
P O Box 85, Atlanta, Ga 30301
ELMIRA DATA PROCESSING CO.
221 E Church St, Elmira, N Y 14902
ENGINEERING TECHNOLOGY ANALYSTS INC.
3310 Richmond Ave, Houston, Tex 77006
ESAN ELECTRONIC LABORATORIES INC.
2653 E 14th St, Brooklyn, N Y 11235
FABRI-TEK INFORMATION MANAGEMENT, INC.
5901 S County Rd 18, Edina, Minn 55436
FEDDER DATA CENTERS MANAGEMENT INC.
1654 Central Ave, Albany, N Y 12205
FEDDER DATA CENTERS INC.
307 S Sharp St, Baltimore, Md 21201
FIRST BUSINESS COMPUTING
1020 Houston Bk&Tr Tr, Houston, Tex 77002
FLORES ASSOCIATES
108 8th Ave, Brooklyn, N Y 11215
GANNETT, FLEMING, CORDDRY & CARPENTER INC.
P O Box 1963, Harrisburg, Pa 17105
GARRETT GRUNER
1204 First, Jackson, Mich 49203
GENASYS CORP.
2011 Gye St NW, Washington, D C 20006
GENERAL COMPUTER SERVICES INC.
1332 Meridan St NE, Huntsville, Ala 35801
GENESEE COMPUTER CENTER INC.
20 University Ave, Rochester, N Y 14605
GOODHEW, J.W. & ASSOCIATES INC.
11600 Nebel St, Rockville, Md 20854
GRAPHIC IMAGE CORP.
612 S Clinton St, Chicago, Ill 60607
GRAY & ASSOCIATES INC., H.J.
2501 Cedar Springs Rd, Dallas, Tex 75201
GREYHOUND COMPUTER CORP.
130 S Canal St, Chicago, Ill 60606
GROWTH INDUSTRY COMPUTING INC.
1111 Wilshire Blvd, Los Angeles, Cal 90017
GTE DATA SERVICES INC.
5422 Bay Center Dr, Tampa, Fla 33609
GULLEY, DALE L. & ASSOCIATES, INC.
2300 E 14th St, Tulsa, Okla 74104
HAVERLY SYSTEMS INC.
4 2nd Ave, Denville, N J 07834
HOBBS ASSOCIATES, INC.
Po Box 686, Corona Del Mar, Cal 92625
HONEYWELL INFORMATION SYSTEMS INC. INFO.
SERV.DIV
2701 4th Ave S, Minneapolis, Minn 55408
HOUSING DATA CORP.
29433 Southfield Rd, Southfield, Mich 48075
HOUSING DATA CORP.
23400 Michigan, Dearborn, Mich 48124
HOWARD ASSOC. INC., DANIEL D.
307 N Michigan Ave, Chicago, Ill 60601
- HYDRA COMPUTER CORP.
P O Box 17883, Raleigh, N C 27609
IAC COMPUTER SERVICES INC.
260 Newton Rd, Plainview, N Y 11803
ICM COMPUTER CORP.
P O Box 7220, Tulsa, Okla 74105
INDECON INC.
30 N Lasalle St, Chicago, Ill 60602
INFODATA SYSTEMS INC.
680 Ridge Rd, Webster, N Y 14580
INFONET SYSTEMS INC.
358 McKinley Blvd, Paramus, N J 07652
INFORMATICS INC.
21050 Vanower St, Canoga Park, Cal 91303
INFORMATION DEVELOPMENT ASSOCIATES INC.
P O Box 2285, Bethlehem, Pa 18018
INFORMATION MANAGEMENT INC.
447 Battery St, San Francisco, Cal 94111
INFORMATION SCIENCES INC.
14 Jefferson Blvd, Warwick, R I 02888
INFORMATION SERVICES INC.
90 Broad St, Babson Park, Mass 02157
INFOSCI INC.
P O Box 464, Menlo Park, Cal 94025
INFOTRAN INC.
860 Fifth Ave, New York, N Y 10021
INNOVATIVE SOFTWARE INC.
486 Totten Pond Rd, Waltham, Mass 02154
INPUT DATA CO. INC.
1187 Valley Rd, Stirling, N J 07980
INPUT INC.
500 Old Elm Rd, Highland Park, Ill 60035
INSTITUTE FOR CYBERNETIC DEVELOPMENT
3031 Bateman St, Berkeley, Cal 94705
INTECH INC.
2915 Wayzata Blvd, Minneapolis, Minn 55405
INTERACTIVE SCIENCES CORP.
60 Brook Dr, Braintree, Mass 02184
INTERNATIONAL COMPUTER CORP.
1 N Broadway, White Plains, N Y 10601
INTERNATIONAL COMPUTER PROGRAMS INC.
2511 E 46th St, Indianapolis, Ind 46205
INTERNATIONAL DATA APPLICATIONS INC.
100 Main St, Reading, Mass 08167
INTERNATIONAL SYSTEMS ASSOCIATES, LTD.
350 5th Ave, New York, N Y 10001
INTERNATIONAL TELECOMPUTER NETWORK CORP.
4919 Fairmont Ave, Bethesda, Md 20014
INTERNATIONAL TELECONTROL CORP.
4300 Pine St, Wilmington, Del 19802
ITT DATA SERVICES
7822 Bonhomme, St Louis, Mo 63105
ITT DATA SERVICES DIV.
P O Box 402, Paramus, N J 07652
JACKSON ASSOCIATES
4663 Executive Dr, Columbus, Ohio 43220
JOHNSON WAX SERV. PRODUCTS DIV.
1525 Howe St, Racine, Wis 53403
JONES & CO., GAYLE W.
3846 E 14th St, Oakland, Cal 94601
KEYSTONE COMPUTER ASSOCIATES INC.
1055 Virginia Dr, Ft Washington, Pa 19034
KRANZLEY & CO. INC. ARTHUR S.
1010 S Kings Hwy, Cherry Hill, N J 08034
LAHEY COMPUTER SYSTEMS INC.
4747 N 16th St, Phoenix, Ariz 85016
LEASCO DATA PROCESSING EQUIPMENT CORP.
280 Park Ave, New York, N Y 10017
LIMITED FOURS UNLIMITED
1030 13th St, Boulder, Colo 80302
LITTON SYSTEMS INC. MELLONICS DIV.
1001 W Maude Ave, Sunnyvale, Cal 94086
LOCKHEED ELECTRONICS DATA MANAGEMENT
SERVICES
16811 El Camino Real, Houston, Tex 77058
LOGICON INC.
Del Amo Financial Ctr, Torrance, Cal 90503
LOHMAN DATA PROCESSING INC.
1818 State St, Quincy, Ill 62301
LOWENTHAL PROGRAMMING CO.
30 Rock Ridge Dr, Pt Chester, N Y 10573
MANEGMATICS INC.
2 Pennsylvania Plaza, New York, N Y 10001
MANAGEMENT & COMPUTER SERVICES INC.
104 Park Towne Pl E, Philadelphia, Pa 19130
MANAGEMENT COMPUTER CONTROLS INC.
3385 Airway Blvd., Memphis, Tenn 38116
MANAGEMENT CONCEPTS INC.
2 Decker Sq, Bala-Cynwyd, Pa 19004
MANAGEMENT DATA PROCESSING SYSTEMS
385 Lakeview Ave, Clifton, N J 07011
MANAGEMENT REPORTING SERVICES INC.
5929 E 38th Ave, Denver, Colo 80207
MANAGEMENT SCIENCE AMERICA INC.
1389 Peachtree St NE, Atlanta, Ga 30309
- MANAGEMENT SCIENCE SYSTEMS INC.
1530 E Jefferson St, Rockville, Md 20852
MANAGEMENT SYSTEMS CORP.
7007 Preston Rd, Dallas, Tex 75205
MARCOM INC.
30 E 42nd St, New York, N Y 10017
MARKET DATA SYSTEMS CORP.
919 3rd Ave, New York, N Y 10022
MARK/OPS DIV., NORTH EASTERN SYSTEMS ASSOC.
INC.
475 Commonwealth Ave, Boston, Mass 02215
MASTECH COMPUTER SYSTEMS INC.
7026 W North Ave, Chicago, Ill 60635
MATRIX CORP., THE
931 S Douglas St, El Segundo, Cal 90245
MCAULIFFE ASSOC. INC., JOHN INC.
1181 Broadway, New York, N Y 10001
MCDONNELL AUTOMATION CO.
500 Jefferson Bldg, Houston, Tex 27002
MCDONNELL AUTOMATION CO.
360 W Federal Savings, Denver, Colo 80202
MCDONNELL AUTOMATION CO.
P O Box 516, St Louis, Mo 63166
MEMPHIS METHODS & TABULATING SERVICE INC.
56 N Main St, Memphis, Tenn 38103
METRIDATA COMPUTING INC.
6600 Grade Lane, Louisville, Ky 40221
MICHIANA LEASING CORP.
1814 S Main St, S Bend, Ind 46613
MICRO SYSTEMS INC.
644 E Young St, Santa Ana, Cal 92705
MILNEE BROTHERS PRODUCTS
8000 Blackburn Ave, Los Angeles, Cal 90048
MNEMOTECH COMPUTER SYSTEMS
55 Liberty St, New York, N Y 10005
MOBILITY SYSTEMS D P SERVICES DEPT.
3530 De La Cruz Blvd, Santa Clara, Cal 95050
MODERN BUSINESS RECORDS
6030 Chase, Dearborn, Mich 48126
MOSLER SAFE CO., THE INFO. SYS. DIV.
1561 Grand Blvd., Hamilton, Ohio 45012
MTI BUSINESS SCHOOLS OF SACRAMENTO INC.
2731 Capitol Ave, Sacramento, Cal 95816
MULTICOMP INC.
36 Washington St, Wellesley Hills, Mass 02181
NATIONAL C.S.S.
460 Summer St, Stamford, Conn 06901
NATIONAL COMPUTER ANALYSTS INC.
Us Hwy 1, Princeton, N J 08540
NATIONAL DATA PROCESSING INC.
P O Box 3393, Wilmington, N C 28401
NATIONAL INFORMATION SYSTEMS CORP.
150 Allendale Rd, Valley Forge, Pa 19481
NEOTERIC INC.
2800 Euclid Ave, Cleveland, Ohio 44115
NETWORK DATA PROCESSING CORP.
823 Commerce Dr, Oak Brook, Ill 60521
NETWORK DATA PROCESSING CORP.
118 2nd Ave SE, Cedar Rapids, Iowa 52407
NORDEN DIV., UNITED AIRCRAFT CORP.
Helen St, Norwalk, Conn 06850
O. K. DATA SERVICES
P O Box 3001, Darien, Conn 06820
OFFICE SERVICES, INC.
2919 Allen Parkway, Houston, Tex 77019
OPERATIONS RESEARCH INC.
1400 Spring St, Silver Spring, Md 20910
ORIGINAL COMPUTER PRODUCTS INC.
204 Worcester St, Wellesley Hills, Mass 02181
PANSOPHIC SYSTEMS INC.
230 Roosevelt Rd, Lombard, Ill 60148
PAPERWORK DATA COMM. SERVICES INC.
1703 S Ave, Syracuse, N Y 13207
PARSONS & WILLIAMS, INC.
Nyruupsgade 43, 1602 Copenhagen, DENMARK
PAYMENT SYSTEMS INC.
405 Lexington Ave, New York, N Y 10017
PAYROLL SPECIALISTS INC.
714 E 200th St, Cleveland, Ohio 44119
PENNDATA CORP.
1729 Cedar Ave, Scranton, Pa 18505
PG DATA CENTER INC.
P O Box 11, Garrettsville, Ohio 44231
PHI COMPUTER SERVICES INC.
800 Massachusetts Ave, Arlington, Mass 02174
PHILCO-FORD CORP., COMPUTER SERVICES NETWORK
Tioga & C Sts, Philadelphia, Pa 19134
PIONEER DATA SYSTEMS INC.
606 Merle Hay Tower, Des Moines, Iowa 50310
PLANNING RESEARCH CORP.
1100 Glendon Ave, Los Angeles, Cal 90024
PRINCETON INFORMATRIX INC.
1 Palmer Sq, Princeton, N J 08540
PRINCETON TIME SHARING SERVICES, INC.
Us Hwy 1, Princeton, N J 08540

2 Product Directory

PROFIMATICS INC.
6355 Topanga Canyon, Woodland Hills, Cal 91364
PROGRAMMING SCIENCES CORP.
S E 42 St, New York, N Y 10016
PROGRAMMING SCIENCES CORP.
1900 Ave of The Stars, Los Angeles, Cal 90067
PROGRAMS & ANALYSIS INC.
21 Ray Ave, Burlington, Mass 01803
PRYOR COMPUTER INDUSTRIES
400 N Michigan Ave, Chicago, Ill 60611
PUBLIC DATA PROCESSING CORP.
640 N Lasalle St, Chicago, Ill 60610
QUIKDATA INTERNATIONAL INC.
8444 Wilshire Blvd, Beverly Hills, Cal 90211
REALTIME SYSTEMS INC.
866 3rd Ave, New York, N Y 10022
REILAND, PAGE & ASSOCIATES INC.
1521 E Broad St, Columbus, Ohio 43205
REL-QUAL ASSOCIATES INC.
18 Hamilton St, Bound Brook, N J 08805
REMOTE COMPUTING CORP.
A40 Palo Alto Off Ctr, Palo Alto, Cal 94301
REPUBLIC SYSTEMS INC.
100 Plaza Centre, Secaucus, N J 07094
REPUBLIC SYSTEMS INC.
715 Park Ave, E Orange, N J 07017
REPUBLIC SYSTEMS OF CONNECTICUT INC.
350 S Main St, Cheshire, Conn 06410
RIDGEWOOD ASSOCIATES INC.
10 Wilsey Sq, Ridgewood, N J 07450
SAGE ACTION INC.
P O Box 416, Ithaca, N Y 14850
SAID INC.
1243 W Broad St, Falls Church, Va 22046
SARNA ASSOCIATES INC.
22 Russell St, Brookline, Mass 02146
SC DATA CENTER, INC.
1112 7th Ave, Monroe, Wis 53566
SCANFORMS INC.
312 Fox Pavilion, Jenkintown, Pa 19095
SCIENTIFIC COMPUTERS, INC.,
919 Second Ave S, Minneapolis, Minn 55402
SCIENTIFIC SOFTWARE CORP.
5300 S Ulster, Englewood, Colo 80110
SCI-TEK COMPUTER CENTER INC.
1707 Gilpin Ave, Wilmington, Del 19806
SEGALL ASSOCIATES, M. HARVEY
1019 Rust Bldg, Tacoma, Wash 98402
SEVAN COMPUTER SERVICES INC.
Pollitt Dr S, Fair Lawn, N J 07410
SMITH CORP., A.O. DATA SYSTEMS DIV.
3533 N 27 St, Milwaukee, Wisc 53201
SOFTTECH INC.
391 Totten Pond Rd, Waltham, Mass 02154
SOFTWARE GUIDANCE ASSOCIATES INC.
432 Park Ave S, New York, N Y 10016
SOFTWARE METHODS INC.
10 E 40th St, New York, N Y 10016
SOFTWARE PROGRAMMING ASSOCIATES INC.
1209 Tropic St, Titusville, Fla 32780
SOUTHERN DATA PROCESSING SERVICE INC.
P O Box 123, Augusta, Ga 30903
SOUTHERN SIMULATION SERVICES INC.
P O Box 1155, Tampa, Fla 33601
SOUTHERN VERMONT COMPUTER CENTER&DATA
SCHOOL
219 Belmont Ave, Bennington, Vt 05201
SPACETRONICS CO.
43 Hassemer Ave, Cherry Hill, N J 08034
STANDARD PROCESSING CO. INC.
P O Box 703, Pharr, Tex 78577
SYKES DATATRONICS INC.
375 Orchard St, Rochester, N Y 14606
SYSTEM DEVELOPMENT CORP.
2500 Colorado Ave, Santa Monica, Cal 90406
SYSTEM IMPLEMENTATION CORP.
18 E 48th St, New York, N Y 10017
SYSTEMATICS INC.
411 Victory, Little Rock, Ark 72201
SYSTEMS & ELECTRONICS, INC.
223 Park Ave, Rutherford, N J 07070
SYSTEMS & PROGRAMMING SERVICES
1001 Daniel Bldg, Greenville, S C 29602
SYSTEMS ANALYSIS INC.
11110 N E 8th, Bellevue, Wash 98004
SYSTEMS ASSOCIATES INC.
356 Penn St, Reading, Pa 19602
SYSTEMS EQUIPMENT CORP.
458 Plasamour Dr, Atlanta, Ga 30324
SYSTEMS GENERAL CORP.
10889 Wilshire Blvd, Los Angeles, Cal 90024
SYSTEMS PROGRAMMING INC.
175 Main St, White Plains, N Y 10601
SYSTEMS RESEARCH ASSOCIATES, INC.
27 W 67th St, New York, N Y 10023

SYSTEMS, SCIENCE & SOFTWARE INC.
Po Box 1620, La Jolla, Cal 92037
TAB DATA SYSTEMS INC.
4833 Everett Ave, Los Angeles, Cal 90058
TABULATING CONSULTANTS INC.
1011 W Alameda Ave, Burbank, Cal 91506
TECHNOLOGY FOR INFORMATION MANAGEMENT INC.
1654 Central Ave, Albany, N Y 12205
TEL-DATA SERVICE CORP.
1221 4th Ave, San Diego, Cal 92101
TELE-DATA CORP.
130 U S Hwy 22, N Plainfield, N J 07060
TEVCO INC.
3260 J St, Sacramento, Cal 95816
TIME SHARE CORP.
3 Lebanon St, Hanover, N H 03755
TIME SHARING SCIENCES INC.
1180 Ave Americas, New York, N Y 10036
TIME-SHARING SYSTEMS, INC.,
1840 N Farwell Ave, Milwaukee, Wis 53202
TRACOR COMPUTING CORP.
1705 Guadalupe St, Austin, Tex 78701
TRAVCOM INC.
1425 E McMillan, Cincinnati, Ohio 45206
TRAVCOM INC. UNITED DATA PROC DV
70 E 14th St, Eugene, Oreg 97401
TRI-DEX DATA SERVICES
2146 E Main St, Visalia, Cal 93277
TRIOLOG ASSOCIATES INC.
1700 Market St, Philadelphia, Pa 19103
TRW SYSTEMS GROUP SOFTWARE & INFORMATION
SYS DIV
1 Space Park, Redondo Beach, Cal 90278
TURNKEY SYSTEMS INC.
111 E Ave, Norwalk, Conn 06851
TYMSHARE INC.
1001 Watertown St, West Newton, Mass 02165
U.S. TIME-SHARING INC.
1831 Michael Faraday, Reston, Va 22070
UNGERLEIDER & CO.
P O Box 1180, Alexandria, Va 22313
UNITED COMPUTING CORP.
22500 S Avalon Blvd, Carson, Cal 90744
UNITED DATA CENTERS INC.
100 Putnam Green, Greenwich, Conn 06830
UNITED SYSTEMS INC.
1020 Kings Hwy N, Cherry Hill, N J 08034
UNIVERSAL DATA SYSTEMS INC.
14482 Beach Blvd, Westminster, Cal 92626
UNIVERSAL INFORMATION SYSTEMS INC.
S-10 Rte 17 At Rte 4, Paramus, N J 07652
UNIVERSITY COMPUTING CO.
P O Box 6228, Dallas, Tex 75222
URS DATA SCIENCE CO.
155 Bovet Rd, San Mateo, Cal 94402
VIRTUAL COMPUTER SERVICES INC
1119 Springfield Rd, Union, N J 07083
WALSH ASSOC., RICHARD M.
310 Jefferson Ave, Scranton, Pa 18503
WANG LABORATORIES INC.
836 N St, Tewksbury, Mass 01876
WARREN ASSOCIATES
15 Royal Crest Dr, Marlboro, Mass 01752
WELLINGTON COMPUTER SYSTEMS CORP.
405 Lexington Ave, New York, N Y 10017
WENGEL SERVICE CORP.
1101 State Rd, Princeton, N J 08540
WEST FLORIDA DATA PROCESSING CENTER INC.
P O Box 1460, Panama City, Fla 32401
WESTERN OPERATIONS INC.
120 Montgomery St, San Francisco, Cal 94104
WESTERN UNION TELEPROCESSING CO.
82 McKee Dr, Mahwah, N J 07436
WESTINGHOUSE ELECTRIC CORP.
Westinghouse Bldg, Pittsburgh, Pa 15222
WESTINGHOUSE TELE-COMPUTER SYSTEMS CORP.
2040 Ardmore Blvd, Pittsburgh, Pa 15221
WILSON CO., W.E., COMPUTER AUTOMATION GROUP
2564 Via Tejon, Palos Vrd Est, Cal 90274
WORLD COMPUTER CORP.
1615 Stemmons Fwy, Dallas, Tex 75221
WORLDWIDE COMPUTER SERVICES, INC.
280 N Central Pk Ave, Hartsdale, N Y 10530
WORLDWIDE TIME SHARING INC.
180 N Michigan, Chicago, Ill 60601
XEROX DATA SYSTEMS
701 S Aviation, El Segundo, Cal 90245
ZENITH INTEGRATED-DATA PROCESSING INC.
950 Fulton Ave, Sacramento, Cal 95825

CONSULTING (ADVANCED COMPUTER EQUIPMENT DESIGN AND FEASIBILITY STUDIES)

ACADEMY COMPUTING CORP.
5005 N Lincoln Blvd, Oklahoma City, Okla 73105
ADVANCED COMPUTER TECHNIQUES CORP.
437 Madison Ave, New York, N Y 10022
ADVANCED MANAGEMENT SYSTEMS INC.
3310 Richmond Ave, Houston, Tex 77006
ANALYTICS INC.
179 Washington Lane, Jenkintown, Pa 19046
ANDROCOR INC.
5949 Hohman Ave, Hammond, Ind 46320
APPLIED COMPUTER TIME SHARE INC.
29200 Southfield Rd, Southfield, Mich 48075
APPLIED SYSTEMS CORP.
18325 W McNichols Ave, Detroit, Mich 48219
ARIES CORP.
1651 Old Meadow Rd, Mc Lean, Va 22101
AUERBACH ASSOCIATES INC.
121 W Broad St, Philadelphia, Pa 19107
AVCO CORP. ELECTRONICS DIV.
4807 Bradford, Huntsville, Ala 35805
AZREX INC.
105 Terrace Hall Ave, Burlington, Mass 01803
BAGANOFF ASSOCIATES INC.
6809 W Florissant, St Louis, Mo 63136
BASIC COMPUTING ARTS INC.
2680 E Bayshore Frtge, Mt View, Cal 94040
BCD COMPUTING CORP.
100 E Industry Court, Deer Park, N Y 11729
BEDFORD ASSOCIATES INC.
P O Box 327, Bedford, Mass 01730
BLAIR & ASSOCIATES, NEIL F.
4026 N 48th Dr, Phoenix, Ariz 85031
BONNER&MOORE ASSOCIATES INC.
500 Jefferson Bldg, Houston, Tex 77002
BOSTON COMPUTER SYSTEMS CORP.
15 School St, Boston, Mass 02108
BRANDON APPLIED SYSTEMS INC.
1700 Broadway, New York, N Y 10019
BRANDON APPLIED SYSTEMS INC.
1611 N Kent St, Arlington, Va 22209
BURLINGTON MANAGEMENT SERVICES CO.
P O Box 21207, Greensboro, N C 27420
CALTEC INC.
1931 Sylvania Ave, Toledo, Ohio 43613
CAMBRIDGE COMPUTER ASSOCIATES INC.
220 Alewife Brook Pky, Cambridge, Mass 02138
CENTRAL COMPUTING, INC.
2627 E Central, Wichita, Kans 67214
CHICAGO TABULATING SERV. INC.
425 N Michigan, Chicago, Ill 60611
COMPUTATIC SYSTEMS CORP.
5303 Comercio Ln, Woodland Hills, Cal 91364
COMPUTATICS INC.
327 S Lasalle St, Chicago, Ill 60604
COMPUMEDIC CONTROLS CORP.
432 Park Ave S, New York, N Y 10016
COMPU SYS INC.
Po Box 11104, Albuquerque, N M 87112
COMPU-TIME INC.
327 Orange Ave, Daytona, Fla 32014
COMPUTER ADVISORS TO MANAGEMENT
120 S Riverside Plaza, Chicago, Ill 60606
COMPUTER ART SERVICES CO. DIV. OF AGARD
40 Nassau Terminal Rd, New Hyde Park, N J 11040
COMPUTER COMMAND & CONTROL CO
1717 Penn Ave NW, Washington, D C 20006
COMPUTER COMMAND AND CONTROLS COMPANY
4025 Chestnut St, Philadelphia, Pa 19104
COMPUTER CONSULTANTS CORP.
U S Rte 46 E, Denville, N J 07834
COMPUTER CORP. OF AMERICA
6216 Evergreen St, Houston, Tex 77036
COMPUTER GUILD INC.
12 Mercer Rd, Natick, Mass 01760
COMPUTER HARDWARE INC.
2550 Fair Oaks Blvd, Sacramento, Cal 95825
COMPUTERIA INC.
14 Wood Rd, Braintree, Mass 02143
COMPUTER INVESTMENTS & LEASING CORP.
9 Tanner St, Haddonfield, N J 08033
COMPUTER MANAGEMENT INC.
3101 Eullid Ave, Cleveland, Ohio 44115
COMPUTER METHODS CORP.
470 Mamaroneck Ave, White Plains, N Y 10605
COMPUTER NETWORK CORP.
5185 Macarthur Blvd, Washington, D C 20016
COMPUTER PROCESSING INC.
300 6th Ave, Pittsburgh, Pa 15222
COMPUTER SCIENCES CORP. INFO. NETWORK DIV.
1901 Building, Los Angeles, Cal 90067

2 Product Directory

COMPUTER SYSTEM TECHNOLOGY INC.
700-42 Fox Pavilion, Jenkintown, Pa 19046
COMPUTER SYSTEMS CO. INC.
1470 St Charles Ave, Cleveland, Ohio 44107
COMPUTER SYSTEMS FOR MEDICINE INC.
340 Longwood Ave, Boston, Mass 02115
COMPUTER TECHNOLOGY INC. SUB. UNIV.
COMPUTING CO.
P O Box 47911, Dallas, Tex 75247
COMPUTER TUTOR, THE, DIV. COMPTUT INC.
12 Emerald Court, Commack, N Y 11725
COMPUTER USAGE CO.
7315 Wisconsin Ave Nw, Washington, D C 20014
COMPUTER USAGE CO.
387 Elliot St, Newton Uppr Fls, Mass 02164
COMPUTER USAGE CO.
3181 Porter Dr, Palo Alto, Cal 94304
COMPUTER USAGE CORP.
100 Putman Green, Greenwich, Conn 06830
COMPUTER USAGE CORP.,
8939 S Sepulveda Blvd, Los Angeles, Cal 90045
COMPUTING EFFICIENCY INC. COMPUTING EFF. DIV.
35 Orville Dr, Bohemia, N Y 11716
COMRESS INC.
No 2 Research Court, Rockville, Md 20850
COMSI INC.
1211 W 22 St, Oakbrook, Ill 60521
COMSONIC CORP., THE
123 Pleasant Ave, Upper Saddle R, N J 07458
CONSULTANTS ASSOCIATED INC.
Lakeside Office Park, Wakefield, Mass 01880
CONSUMER SYSTEMS CORP.
15 Spinning Wheel Rd, Hinsdale, Ill 60521
CONTROL TECHNOLOGY INC.
3450 E Spring St, Long Beach, Cal 90806
CTC COMPUTER CORP.
1000 Elwell Court, Palo Alto, Cal 94303
CYBERMATICS INC.
2460 Lemoine Ave, Fort Lee, N J 07024
CYBERMATION INC.
P O Box 58 River Rd, Washngtn Xing, Pa 18977
DAILEY INC., R.N.
300 Madison Ave, New York, N Y 10017
DASA CORP./CYBER-TRONICS SUB. DASA CORP.
15 Stevens St., Andover, Mass 01810
DATA ARCHITECTS INC.
213 3rd Ave, Waltham, Mass 02154
DATA DIMENSIONS INC.
51 Weaver St, Greenwich, Conn 06830
DATA ENGINEERING ASSOC. INC.
300 Kings Hwy E, Haddonfield, N J 08033
DATA MANAGEMENT SERVICES INC.
1845 Walnut St, Philadelphia, Pa 19103
DATA PROCESSING AND ACCOUNTING SERVICES
50 Van Ness Ave, San Francisco, Cal 94102
DATA PROCESSING SERVICE INC.
270 Main St, Painesville, Ohio 44077
DATA PROCESSORS INC.
2703 W 28th Ave, Pine Bluff, Ark 71601
DATA SYSTEMS ENGINEERING INC.
1505 E 17th St, Santa Ana, Cal 92701
DATA SYSTEMS INC.
434 Stinson Blvd, Minneapolis, Minn 55413
DATA TECHNOLOGY CORP.
1050 E Meadow Cir, Palo Alto, Cal 94303
DATA-TRONICS CORP. SUB. ARKANSAS BEST CORP.
310 Townson Ave, Fort Smith, Ark 72901
DATAROYAL INC.
Simon St, Nashua, N H 03060
DESIGN AUTOMATION INC.
809 Massachusetts Ave, Lexington, Mass 02173
DEUSSEN ASSOCIATES INC.
576 Hyannis Dr, Sunnyvale, Cal 94087
DIGITAL COMPUTER CONTROLS INC
23 Just Rd, Fairfield, N J 07006
DIGITAL SYSTEMS DESIGN
P O Box 305 Fdr Sta, New York, N Y 10022
DIMENSIONAL SYSTEMS INC.
393 Totten Pond Rd, Waltham, Mass 02154
DIPIETRO & WILSON INC.
1107 Commonwealth Ave, Boston, Mass 02215
DYNAMIC ACCESS CORP.
220 Park Ave S, New York, N Y 10003
EASTERN COMPUTER SERVICES INC
920 Fox Chase Rd, Rockledge, Pa 19111
EDUCATION AND TRAINING CONSULTANTS CO.
P O Box 49899, Los Angeles, Cal 90049
ELECTROMEC COMPUTING & TECH. SERVICES CO.
2964 Peachtree Rd NW, Atlanta, Ga 30305
ELECTRONIC DATA SERVICE INC.
18 Germay Dr, Wilmington, Del 19804
ELMIRA DATA PROCESSING CO.
221 E Church St, Elmira, N Y 14902
ENGINEERING TECHNOLOGY ANALYSTS INC.
3310 Richmond Ave, Houston, Tex 77006

ESAN ELECTRONIC LABORATORIES INC.
2653 E 14th St, Brooklyn, N Y 11235
FERRANTI PACKARD LTD. ELECTRONICS DIV.
121 Industry St, Toronto 15, CANADA
FLORES ASSOCIATES
108 8th Ave, Brooklyn, N Y 11215
GENASYS CORP.
2011 Gye St NW, Washington, D C 20006
GENERAL ELECTRIC CO. PROCESS COMPUTER DEPT.
2255 W Desert Cove Rd, Phoenix, Ariz 85029
GREYHOUND COMPUTER CORP.
130 S Canal St, Chicago, Ill 60606
GRUYE VOGT OPPERMAN INC.
439 Tasso St, Palo Alto, Cal 94301
HOBBS ASSOCIATES, INC.
Po Box 686, Corona Del Mar, Cal 92625
HOLLANDER ASSOCIATES
P O Box 2276, Fullerton, Cal 92633
HONEYWELL INFORMATION SYSTEMS INC. INFO.
SERV.DIV
2701 4th Ave S, Minneapolis, Minn 55408
HOUSING DATA CORP.
23400 Michigan, Dearborn, Mich 48124
HOUSTON ENGINEERING RESEARCH CORP.
P O Box 35495, Houston, Tex 77035
HOUSTON RESEARCH INC. SUB. SCI. ELECT.
6001 Gulf Fwy, Houston, Tex 77023
HUB RATLIFF CONSULTANT
P O Box 22487, Houston, Tex 77027
ICM COMPUTER CORP.
P O Box 7220, Tulsa, Okla 74105
INFONET SYSTEMS INC.
358 McKinley Blvd, Paramus, N J 07652
INFORMATICS INC.
21050 Vanover St, Canoga Park, Cal 91303
INFORMATION DEVELOPMENT ASSOCIATES INC.
P O Box 2285, Bethlehem, Pa 18018
INFORMATION MANAGEMENT INC.
447 Battery St, San Francisco, Cal 94111
INFORMATION SCIENCES INC.
14 Jefferson Blvd, Warwick, R I 02888
INFOSCI INC.
P O Box 464, Menlo Park, Cal 94025
INFOTRAN INC.
860 Fifth Ave, New York, N Y 10021
INTERACTIVE SYSTEMS INC.
327 S Fourth Ave, Ann Arbor, Mich 48108
INTERNATIONAL COMPUTER CORP.
1 N Broadway, White Plains, N Y 10601
ITT DATA SERVICES DIV.
P O Box 402, Paramus, N J 07652
JACKSON ASSOCIATES
4663 Executive Dr, Columbus, Ohio 43220
KDI INTERACTIVE DATA SYSTEMS
17785 Skypark Circle, Irvine, Cal 92664
KEMPER ENGINEERING CO.
9337 Shoshone Ave, Northridge, Cal 91324
KENICS SYSTEMS CORP.
125 Harvard St, Cambridge, Mass 02139
KERN INDUSTRIES
22 Tannery St, Ayer, Mass 01432
KEYDATA CORP.
108 Water St, Watertown, Mass 02172
KEYSTONE COMPUTER ASSOCIATES INC.
1055 Virginia Dr, Ft Washington, Pa 19034
KRANZLEY & CO. INC. ARTHUR S.
1010 S Kings Hwy, Cherry Hill, N J 08034
LAHEY COMPUTER SYSTEMS INC.
4747 N 16th St, Phoenix, Ariz 85016
LEASCO DATA PROCESSING EQUIPMENT CORP.
280 Park Ave, New York, N Y 10017
LIMITED FOURS UNLIMITED
1030 13th St, Boulder, Colo 80302
LITTON SYSTEMS INC. DATA SYSTEMS DIV.
8000 Woodley Ave, Van Nuys, Cal 91409
LITTON SYSTEMS INC. MELLONICS DIV.
1001 W Maude Ave, Sunnyvale, Cal 94086
LOGIC INC.
1712 Commerce St, Dallas, Tex 75201
LOGICON INC.
Del Amo Financial Ctr, Torrance, Cal 90503
MACNEAL-SCHWENDLER CORP., THE
7442 N Figueroa St, Los Angeles, Cal 90041
MANAGEMENT & COMPUTER SERVICES INC.
104 Park Towne Pl E, Philadelphia, Pa 19130
MANAGEMENT CONCEPTS INC.
2 Decker Sq, Bala-Cynwyd, Pa 19004
MANAGEMENT SCIENCE AMERICA INC.
1389 Peachtree St NE, Atlanta, Ga 30309
MARCOM INC.
30 E 42nd St, New York, N Y 10017
MARK COMPUTER SYSTEMS INC.
One Patterson Pl, Garden City, N Y 11530
MASTECH COMPUTER SYSTEMS INC.
7026 W North Ave, Chicago, Ill 60635

MCDONNELL AUTOMATION CO.
500 Jefferson Bldg, Houston, Tex 27002
MCDONNELL AUTOMATION CO.
P O Box 516, St Louis, Mo 63166
MEMPHIS METHODS & TABULATING SERVICE INC.
56 N Main St, Memphis, Tenn 38103
METRIDATA COMPUTING INC.
6600 Grade Lane, Louisville, Ky 40221
MICRO SYSTEMS INC.
644 E Young St, Santa Ana, Cal 92705
MNEMOTECH COMPUTER SYSTEMS
55 Liberty St, New York, N Y 10005
MULTIDATA INC.
7300 Bolsa Ave, Westminster, Cal 92683
NATIONAL C.S.S.
460 Summer St, Stamford, Conn 06901
NATIONAL COMPUTER ANALYSTS INC.
Us Hwy 1, Princeton, N J 08540
NATIONAL INFORMATION SYSTEMS CORP.
150 Allendale Rd, Valley Forge, Pa 19481
NORDEN DIV., UNITED AIRCRAFT CORP.
Helen St, Norwalk, Conn 06850
ON-LINE SYSTEMS INC.
4721 Mc Knight Rd, Pittsburg, Pa 15237
OPERATIONS RESEARCH INC.
1400 Spring St, Silver Spring, Md 20910
PANSOPHIC SYSTEMS INC.
230 Roosevelt Rd, Lombard, Ill 60148
PARSONS & WILLIAMS, INC.
Nyrupsgade 43, 1602 Copenhagen, DENMARK
PAYMENT SYSTEMS INC.
405 Lexington Ave, New York, N Y 10017
PENNDATA CORP.
1729 Cedar Ave, Scranton, Pa 18505
PHI COMPUTER SERVICES INC.
800 Massachusetts Ave, Arlington, Mass 02174
PLANNING RESEARCH CORP.
1100 Glendon Ave, Los Angeles, Cal 90024
PROGRAMMING SCIENCES CORP.
S E 42 St, New York, N Y 10016
PROGRAMMING SCIENCES CORP.
1900 Ave of The Stars, Los Angeles, Cal 90067
PRYOR COMPUTER INDUSTRIES
400 N Michigan Ave, Chicago, Ill 60611
QUANTUM SCIENCE CORP. SUB. SAMSON ASSOC.
245 Park Ave, New York, N Y 10017
RAYTHEON CO. EQUIPMENT DIV.
528 Boston Post Rd, Sudbury, Mass 01776
REL-QUAL ASSOCIATES INC.
18 Hamilton St, Bound Brook, N J 08805
REMOTE COMPUTING CORP.
A40 Palo Alto Off Ctr, Palo Alto, Cal 94301
REPUBLIC SYSTEMS INC.
100 Plaza Centre, Secaucus, N J 07094
REPUBLIC SYSTEMS INC.
715 Park Ave, E Orange, N J 07017
RIDGEWOOD ASSOCIATES INC.
10 Wilsay Sq, Ridgewood, N J 07450
ROSENBERG ASSOCIATES, PAUL
330 5th Ave, Pelham, N Y 10803
SAGE ACTION INC.
P O Box 416, Ithaca, N Y 14850
SARNA ASSOCIATES INC.
22 Russell St, Brookline, Mass 02146
SCANFORMS INC.
312 Fox Pavilion, Jenkintown, Pa 19095
SCHULTZ INSTRUMENTS INC.
P O Box 13385, Gainesville, Fla 32601
SCIENTIFIC SYSTEMS SERVICES INC.
476 N Hwy A1a, Satellite Beach, Fla 32935
SCI-TEK COMPUTER CENTER INC.
1707 Gilpin Ave, Wilmington, Del 19806
SINGER-GENERAL PRECISION KEARFOTT DIV.
1150 McBride Ave, Little Falls, N J 07424
SOFTTECH INC.
391 Totten Pond Rd, Waltham, Mass 02154
SOFTWARE GUIDANCE ASSOCIATES INC.
432 Park Ave S, New York, N Y 10016
SOFTWARE METHODS INC.
10 E 40th St, New York, N Y 10016
SOFTWARE PROGRAMMING ASSOCIATES INC.
1209 Tropic St, Titusville, Fla 32780
SPECTRON CORP.
10060 Kings Hwy N, Cherry Hill, N J 08034
SYKES DATATRONICS INC.
375 Orchard St, Rochester, N Y 14606
SYSTEM DEVELOPMENT CORP.
2500 Colorado Ave, Santa Monica, Cal 90406
SYSTEM IMPLEMENTATION CORP.
18 E 48th St, New York, N Y 10017
SYSTEMS ANALYSIS INC.
11110 N E 8th, Bellevue, Wash 98004
SYSTEMS ASSOCIATES INC.
356 Penn St, Reading, Pa 19602

2 Product Directory

SYSTEMS CONCEPTS INC.
17-45 Clintonville St, Whitestone, N Y 11357
SYSTEMS, SCIENCE & SOFTWARE INC.
Po Box 1620, La Jolla, Cal 92037
TELEDYNE BROWN ENGINEERING
300 Sparkman Dr, Huntsville, Ala 35807
THEORY ANALYSIS GROUP
22 E Elm St, Chicago, Ill 60611
TIME-SHARING SYSTEMS, INC.,
1840 N Farwell Ave, Milwaukee, Wis 53202
TRACOR COMPUTING CORP.
1705 Guadalupe St, Austin, Tex 78701
U.S. TIME-SHARING INC.
1831 Michael Faraday, Reston, Va 22070
UNIVERSAL DATA SYSTEMS INC.
14482 Beach Blvd, Westminster, Cal 92626
UNIVERSITY COMPUTING CO.
P O Box 6228, Dallas, Tex 75222
VIRTUAL COMPUTER SERVICES INC
1119 Springfield Rd, Union, N J 07083
WALSH ASSOC., RICHARD M.
310 Jefferson Ave, Scranton, Pa 18503
WARREN ASSOCIATES
15 Royal Crest Dr, Marlboro, Mass 01752
WESTERN UNION TELEPROCESSING CO.
82 McKee Dr, Mahwah, N J 07436
WESTINGHOUSE ELECTRIC CORP.
Westinghouse Bldg, Pittsburgh, Pa 15222
WILLARD LABORATORIES INC.
4221 Redwood Ave, Los Angeles, Cal 90066
WISE INSTRUMENTATION & CONTROLS INC.
3568 Amherst Court, Mt View, Cal 94040
WORLDWIDE COMPUTER SERVICES, INC.
280 N Central Pk Ave, Hartsdale, N Y 10530

CONSULTING (COMPUTER EVALUATIONS, SELECTIONS, INSTALLATION PLANNING)

ACADEMY COMPUTING CORP.
5005 N Lincoln Blvd, Oklahoma City, Okla 73105
ADMINISTRATIVE SYSTEMS INC.
131 Mineola Blvd, Mineola, N Y 11501
ADVANCED COMPUTER TECHNIQUES CORP.
437 Madison Ave, New York, N Y 10022
ADVANCED MANAGEMENT SYSTEMS INC.
3310 Richmond Ave, Houston, Tex 77006
AERO TECHNICAL APPLICATIONS INC.
8011 Clayton Rd, St Louis, Mo 63117
ALLIED COMPUTER TECHNOLOGY INC.
1610 26 St, Santa Monica, Cal 90404
ANALYTICS INC.
179 Washington Lane, Jenkintown, Pa 19046
ANCOM SYSTEMS, DIV. GENERAL ANALYTICS CORP.
9841 Airport Blvd, Los Angeles, Cal 90045
ANDROCOR INC.
5949 Hohman Ave, Hammond, Ind 46320
APPLIED COMPUTER SCIENCES INC.
361 Park Rd, W Hartford, Conn 06107
APPLIED COMPUTER TIME SHARE INC.
29200 Southfield Rd, Southfield, Mich 48075
APPLIED CYBERNETICS CORP.
1285 Forgewood Ave, Sunnyvale, Cal 94086
APPLIED DIGITAL SYSTEMS INC.
3848 Campus Dr 112, Newport Beach, Cal 92660
APPLIED PROGRAMMING TECHNOLOGY CORP
275 D Cox St, Hudson, Mass 01749
APT COMPUTER CENTER
5309 W Touhy, Skokie, Ill 60076
ARIES CORP.
1651 Old Meadow Rd, Mc Lean, Va 22101
ARISTA INFORMATION SYSTEMS INC.
P O Box 4775, Winston-Salem, N C 27107
AUERBACH ASSOCIATES INC.
121 W Broad St, Philadelphia, Pa 19107
AUTOCOMP INC.
4720 Montgomery Ln, Bethesda, Md 20014
AUTOMATED COMPUTER SERVICES INC.
517 W Grace St, Richmond, Va 23220
AUTOMATED CONCEPTS INC.
477 Madison Ave, New York, N Y 10017
AUTOMATED FACTS & FIGURES CO.
4551 S Racine Ave, Chicago, Ill 60609
AUTOMATED SYSTEMS CORP.
600 Houst Nat Gas Bld, Houston, Tex 77002
AUTOMATION SERVICES CORP.
182 Forbes Rd, Braintree, Mass 02184
AVCO CORP. ELECTRONICS DIV.
4807 Bradford, Huntsville, Ala 35805
AZREX INC.
105 Terrace Hall Ave, Burlington, Mass 01803
BANKERS DATA SERVICES, INC.
430 Lamar, Houston, Tex 77002

BASIC COMPUTING ARTS INC.
2680 E Bayshore Frtge, Mt View, Cal 94040
BECK & ASSOCIATES, R.W.
200 Tower Bldg, Seattle, Wash 98101
BEDFORD ASSOCIATES INC.
P O Box 327, Bedford, Mass 01730
BERGLUND ASSOCIATES INC.
1060 Kings Hwy N, Cherry Hill, N J 08034
BIZ-MATIC DATA CONTROL CENTERS INC.
232 Summer St, Boston, Mass 02210
BLAIR & ASSOCIATES, NEIL F.
4026 N 48th Dr, Phoenix, Ariz 85031
BONNER&MOORE ASSOCIATES INC.
500 Jefferson Bldg, Houston, Tex 77002
BOOTHE DATA SYSTEMS INC.
485 Lexington Ave, New York, N Y 10001
BOOTHE RESOURCES INTERNATIONAL INC.
3435 Wilshire Blvd, Los Angeles, Cal 90005
BOSTON COMPUTER SYSTEMS CORP.
15 School St, Boston, Mass 02108
BOSWORTH & ASSOCIATES, S.
9 Forest Dr, Plainview, N Y 11803
BRADDOCK, DUNN & MCDONALD INC.
8027 Leesburg Pike, Mc Lean, Va 22101
BRANDON APPLIED SYSTEMS INC.
1700 Broadway, New York, N Y 10019
BRANDON APPLIED SYSTEMS INC.
1611 N Kent St, Arlington, Va 22209
BURLINGTON MANAGEMENT SERVICES CO.
P O Box 21207, Greensboro, N C 27420
C&C COMPUTER SYSTEMS INC.
1006 S E Grand, Portland, Ore 97214
CAMBRIDGE COMPUTER ASSOCIATES INC.
220 Alewife Brook Pky, Cambridge, Mass 02138
CENTRAL COMPUTING CORP.
180 N Mich Ave, Chicago, Ill 60601
CENTRAL COMPUTING, INC.
2627 E Central, Wichita, Kans 67214
CENTRAL DATA SYSTEMS INC.
1215 Valley Belt Rd, Cleveland, Ohio 44131
CGA COMPUTER ASSOCIATES INC.
715 Park Ave, East Orange, N J 07017
CHICAGO TABULATING SERV. INC.
425 N Michigan, Chicago, Ill 60611
COMMERCIAL TECHNOLOGY INC.
P O Box 10616, Knoxville, Tenn 37919
COMPAC COMPUTER SYSTEMS INC.
911 Hennepin, Minneapolis, Minn 55403
COM PU DAT DIV. SOUTHEASTERN NEWSPAPERS CORP.
P O Box 3806, Augusta, Ga 30904
COMPUTATIC SYSTEMS CORP.
5303 Comercio Ln, Woodland Hills, Cal 91364
COMPUTATICS INC.
327 S Lasalle St, Chicago, Ill 60604
COMPMUMEDIC CONTROLS CORP.
432 Park Ave S, New York, N Y 10016
COMPU SYS INC.
Po Box 11104, Albuquerque, N M 87112
COMPU-TIME INC.
327 Orange Ave, Daytona, Fla 32014
COMPUTATION AND SYSTEMS CORP.
12061 Wilshire Blvd, Los Angeles, Cal 90025
COMPUTER & PROGRAMMING ANALYSIS INC.
1 Wynnewood Rd, Wynnewood, Pa 19096
COMPUTER ADVISORS TO MANAGEMENT
120 S Riverside Plaza, Chicago, Ill 60606
COMPUTER AID COMPANIES INC.
5925 Forest Lane, Dallas, Tex 75201
COMPUTER ASSISTANCE INC.
298 Park Rd, West Hartford, Conn 06119
COMPUTER CENTER, INC.,
350 Royal Palm Way, Palm Beach, Fla 33480
COMPUTER CENTER OF ATLANTA DIV. COMP. CNTRS INC
2695 Buford Hwy NE, Atlanta, Ga 30324
COMPUTER COMMAND & CONTROL CO
1717 Penn Ave NW, Washington, D C 20006
COMPUTER COMMAND AND CONTROLS COMPANY
4025 Chestnut St, Philadelphia, Pa 19104
COMPUTER CONSULTANTS CORP.
U S Rte 46 E, Denville, N J 07834
COMPUTER CORP. OF AMERICA
6216 Evergreen St, Houston, Tex 77036
COMPUTER DYNAMICS INC.
100 Hegenberger Rd, Oakland, Cal 94621
COMPUTER EXCHANGE INC., THE
30 E 42nd St, New York, N Y 10017
COMPUTER HARDWARE CONSULTANTS & SERVICES
1409 Easton Rd, Warrington, Pa 18976
COMPUTERIA INC.
14 Wood Rd, Braintree, Mass 02143
COMPUTER INVESTMENTS & LEASING CORP.
9 Tanner St, Haddonfield, N J 08033

COMPUTER LEARNING & SYSTEMS CORP.
5530 Wisconsin Ave, Chevy Chase, Md 20015
COMPUTER MANAGEMENT INC.
3101 Euclid Ave, Cleveland, Ohio 44115
COMPUTER NETWORK CORP.
5185 Macarthur Blvd, Washington, D C 20016
COMPUTER POWER INC.
30 S Laura St, Jacksonville, Fla 32202
COMPUTER PROCESSING INC.
200 Manhattan Bldg, Muskogee, Okla 74401
COMPUTER PROCESSING INC.
300 6th Ave, Pittsburgh, Pa 15222
COMPUTER SCIENCES CORP. INFO. NETWORK DIV.
1901 Building, Los Angeles, Cal 90067
COMPUTER SERVICES CORP.
200 Bank Savings Bldg, Birmingham, Ala 35203
COMPUTER SERVICES INC.
500 Clark St, Paducah, Ky 42001
COMPUTER SERVICES INC.
47 Congress St, Salem, Mass 01970
COMPUTER SERVICES OF INDIANA, INC.
214 S 13 1/2 St, Terre Haute, Ind 47808
COMPUTER SYNECTICS INC.
283 Brokaw Rd, Santa Clara, Cal 95050
COMPUTER SYSTEM TECHNOLOGY INC.
700-42 Fox Pavilion, Jenkintown, Pa 19046
COMPUTER SYSTEMS
400 Wing Bldg, Grants Pass, Oreg 97526
COMPUTER SYSTEMS CO. INC.
1470 St Charles Ave, Cleveland, Ohio 44107
COMPUTER SYSTEMS CORP. U.S. INDUSTRIES INC
P O Box 64400, Dallas, Tex 75206
COMPUTER SYSTEMS INC.
19619 81st Ave S, Kent, Wash 98031
COMPUTER TASK GROUP INC.
5586 Main St, Buffalo, N Y 14221
COMPUTER TECHNOLOGY INC. SUB. UNIV. COMPUTING CO.
P O Box 47911, Dallas, Tex 75247
COMPUTER TUTOR, THE, DIV. COMPUTUT INC.
12 Emerald Court, Commack, N Y 11725
COMPUTER UNIVERSAL CORP.
1641 Universal Rd, Columbus, Ohio 43207
COMPUTER USAGE CO.
7315 Wisconsin Ave Nw, Washington, D C 20014
COMPUTER USAGE CO.
387 Elliot St, Newton Uppr Fls, Mass 02164
COMPUTER USAGE CO.
3181 Porter Dr, Palo Alto, Cal 94304
COMPUTER USAGE CORP.
100 Putman Green, Greenwich, Conn 06830
COMPUTER USAGE CORP.,
8939 S Sepulveda Blvd, Los Angeles, Cal 90045
COMP/UTILITY INC.
1 Center Plaza, Boston, Mass 02108
COMPUTING & SOFTWARE INC., EAST COAST DIV.
3700 Mt Vernon Ave, Alexandria, Va 22305
COMPUTING EFFICIENCY INC. COMPUTING EFF. DIV.
35 Orville Dr, Bohemia, N Y 11716
COMRESS INC.
No 2 Research Court, Rockville, Md 20850
COMSI INC.
1211 W 22 St, Oakbrook, Ill 60521
CONSAD RESEARCH CORP.
5600 Forward Ave, Pittsburgh, Pa 15217
CONSENTIVE INC.
3525 Lancaster Ave, Philadelphia, Pa 19104
CONSOLIDATED ANALYSIS CENTERS, INC.,
225 Santa Monica Blvd, Santa Monica, Cal 90401
CONSULTANTS ASSOCIATED INC.
Lakeside Office Park, Wakefield, Mass 01880
CONSUMER SYSTEMS CORP.
15 Spinning Wheel Rd, Hinsdale, Ill 60521
CONTINENTAL DATA PROCESSING INC.
300 Market St., Kingstons, Pa 18704
CONTROL DATA CORP. CEIR PROF. SERV. DIV.
5272 River Rd, Washington, D C 20016
CONTROL TECHNOLOGY INC.
3450 E Spring St, Long Beach, Cal 90806
CTC COMPUTER CORP.
1000 Elwell Court, Palo Alto, Cal 94303
CYBERMATICS INC.
2460 Lemoine Ave, Fort Lee, N J 07024
D.P.&W. INC.
1107 Commonwealth Ave, Boston, Mass 02215
DAILEY INC., R.N.
300 Madison Ave, New York, N Y 10017
DASA CORP./CYBER-TRONICS SUB. DASA CORP.
15 Stevens St., Andover, Mass 01810
DATA ARCHITECTS INC.
213 3rd Ave, Waltham, Mass 02154
DATA CENTER CORP.
3002 Midvale St, Los Angeles, Cal 90034

2 Product Directory

DATA CORP., THE PENINSULA COMPUTER CENTER DIV

1190 Coleman Ave, San Jose, Cal 95110
DATA DIMENSIONS INC.

51 Weaver St, Greenwich, Conn 06830
DATA MANAGEMENT SERVICES INC.

1845 Walnut St, Philadelphia, Pa 19103
DATA PROCESSING AND ACCOUNTING SERVICES

50 Van Ness Ave, San Francisco, Cal 94102
DATA PROCESSING SERVICE INC.

270 Main St, Painesville, Ohio 44077
DATA PROCESSORS INC.

2703 W 28th Ave, Pine Bluff, Ark 71601
DATA SYSTEMS ANALYSTS INC.

N Park Dr, Pennsauken, N J 08109
DATA SYSTEMS INC.

434 Stinson Blvd, Minneapolis, Minn 55413
DATA-TRONICS CORP. SUB. ARKANSAS BEST CORP.

310 Townsend Ave, Fort Smith, Ark 72901
DATA USAGE CORP.

2460 Lemoine Ave, Fort Lee, N J 07024
DATACAP INTERNATIONAL INC.

37 W 2950 S, Salt Lake City, Utah 84101
DATALOGICS INC.

12025 Shakee Blvd, Cleveland, Ohio 44120
DATAPRO RESEARCH CORP.

2204 Walnut St, Philadelphia, Pa 19103
DATAROYAL INC.

Simon St, Nashua, N H 03060

DATASERV DIV., WILLIAM J. PURDY CORP.
770 Airport Blvd, Burlingame, Cal 94010

DECISION SYSTEMS INC.
E 66 Midland Ave, Paramus, N J 07652

DELMARVA COMPUTER INDUSTRIES INC.
5865 Robert Oliver Pl, Columbia, Md 21043

DELTA SYSTEMS CORP.
Edens Executive Ctr, Wilmette, Ill 60091

DEUSSEN ASSOCIATES INC.
576 Hyannis Dr, Sunnyvale, Cal 94087

DIEBOLD COMPUTER LEASING INC.
Park 80 Plaza E, Saddle Brook, N J 07667

DIGITAL APPLICATIONS INC.
6300 Westpark Ste 150, Houston, Tex 77027

DIGITAL PROGRAMMING SERVICES INC.
60 Hickory Dr, Waltham, Mass 02154

DIGITAL SYSTEMS DESIGN
P O Box 305 Fdr Sta, New York, N Y 10022

DIMENSIONAL SYSTEMS INC.
393 Totten Pond Rd, Waltham, Mass 02154

DIPIETRO & WILSON INC.
1107 Commonwealth Ave, Boston, Mass 02215

DIRECT ACCESS COMPUTING CORP.
984 Livernois Rd, Troy, Mich 48084

DIVERSIFIED SHOPPER APPLICATIONS
2525 E Bayshore Rd, Palo Alto, Cal 94302

DUMEY, ARNOLD I.
641 Mt Lucas Rd, Princeton, N J 08540

DYNAMIC ACCESS CORP.
220 Park Ave S, New York, N Y 10003

EASTERN COMPUTER SERVICES INC
920 Fox Chase Rd, Rockledge, Pa 19111

ELECTRONIC COMPUTER PROG. INSTITUTE
49 N Progress Ave, Harrisburg, Pa 17109

ELECTRONIC DATA PREPARATION CORP.
P O Box 1446, Bradenton, Fla 33505

ELECTRONIC DATA SERVICE INC.
18 Germay Dr, Wilmington, Del 19804

ELMIRA DATA PROCESSING CO.
221 E Church St, Elmira, N Y 14902

ENGINEERING TECHNOLOGY ANALYSTS INC.
3310 Richmond Ave, Houston, Tex 77006

ENTREKIN COMPUTERS INC. SUB. THE CROSS CO.
9475 Center Rd, Fenton, Mich 48430

ESAN ELECTRONIC LABORATORIES INC.
2653 E 14th St, Brooklyn, N Y 11235

FABRI-TEK INFORMATION MANAGEMENT, INC.
5901 S County Rd 18, Edina, Minn 55436

FIMACO INC.
2 Pennsylvania Plaza, New York, N Y 10001

FIRST BUSINESS COMPUTING
1020 Houston Bk&Tr Tr, Houston, Tex 77002

FLORES ASSOCIATES
108 8th Ave, Brooklyn, N Y 11215

GANNETT, FLEMING, CORDDRY & CARPENTER INC.
P O Box 1963, Harrisburg, Pa 17105

GARRETT GRUNER
1204 First, Jackson, Mich 49203

GENASYS CORP.
2011 Gye St NW, Washington, D C 20006

GENERAL AUTOMATION INC.
1055 S East St, Anaheim, Cal 92805

GENERAL COMPUTER SERVICES INC.
1332 Meridan St NE, Huntsville, Ala 35801

GOODHEW, J.W. & ASSOCIATES INC.
11600 Nebel St, Rockville, Md 20854

GREYHOUND COMPUTER CORP.
130 S Canal St, Chicago, Ill 60606

GTE DATA SERVICES INC.
5422 Bay Center Dr, Tampa, Fla 33609

HAYERLY SYSTEMS INC.
4 2nd Ave, Denville, N J 07834

HOBBS ASSOCIATES, INC.
Po Box 686, Corona Del Mar, Cal 92625

HOLLANDER ASSOCIATES
P O Box 2276, Fullerton, Cal 92633

HONEYWELL INFORMATION SYSTEMS INC. INFO.
SERV.DIV

2701 4th Ave S, Minneapolis, Minn 55408
HOUSING DATA CORP.

29433 Southfield Rd, Southfield, Mich 48075
HOUSING DATA CORP.

23400 Michigan, Dearborn, Mich 48124
HOUSTON ENGINEERING RESEARCH CORP.

P O Box 35495, Houston, Tex 77035
HOUSTON RESEARCH INC. SUB. SCI. ELECT.

6001 Gulf Fwy, Houston, Tex 77023
HOWARD ASSOC. INC., DANIEL D.

307 N Michigan Ave, Chicago, Ill 60601
HRB-SINGER INC.

Science Park, State College, Pa 16801
HUB RATLIFF CONSULTANT

P O Box 22487, Houston, Tex 77027
IAC COMPUTER SYSTEMS INC.

260 Newton Rd, Plainview, N Y 11803
ICM COMPUTER CORP.

P O Box 7220, Tulsa, Okla 74105
INDECON INC.

30 N Lasalle St, Chicago, Ill 60602
INFONET SYSTEMS INC.

358 McKinley Blvd, Paramus, N J 07652
INFORMATICS INC.

21050 Vanower St, Canoga Park, Cal 91303
INFORMATION DEVELOPMENT ASSOCIATES INC.

P O Box 2285, Bethlehem, Pa 18018
INFORMATION MANAGEMENT INC.

447 Battery St, San Francisco, Cal 94111
INFORMATION SCIENCES INC.

14 Jefferson Blvd, Warwick, R I 02888
INFOSCI INC.

P O Box 464, Menlo Park, Cal 94025
INFOTRAN INC.

860 Fifth Ave, New York, N Y 10021
INNOVATIVE SOFTWARE INC.

486 Totten Pond Rd, Waltham, Mass 02154
INPUT INC.

500 Old Elm Rd, Highland Park, Ill 60035
INTECH INC.

2915 Wayzata Blvd, Minneapolis, Minn 55405
INTERACTIVE SYSTEMS INC.

327 S Fourth Ave, Ann Arbor, Mich 48108
INTERNATIONAL COMPUTER CORP.

1 N Broadway, White Plains, N Y 10601
INTERNATIONAL DATA APPLICATIONS INC.

100 Main St, Reading, Mass 08167
INTERNATIONAL SYSTEMS ASSOCIATES, LTD.

350 5th Ave, New York, N Y 10001
INTERNATIONAL TELECOMPUTER NETWORK CORP.

4919 Fairmont Ave, Bethesda, Md 20014
INTERNATIONAL TELECONTROL CORP.

4300 Pine St, Wilmington, Del 19802
JACKSON ASSOCIATES

4663 Executive Dr, Columbus, Ohio 43220
JONES & CO., GAYLE W.

3846 E 14th St, Oakland, Cal 94601
KEYSTONE COMPUTER ASSOCIATES INC.

1055 Virginia Dr, Ft Washington, Pa 19034
KRANZLEY & CO. INC. ARTHUR S.

1010 S Kings Hwy, Cherry Hill, N J 08034
LAHEY COMPUTER SYSTEMS INC.

4747 N 16th St, Phoenix, Ariz 85016
LEASCO DATA PROCESSING EQUIPMENT CORP.

280 Park Ave, New York, N Y 10017
LEHIGH VALLEY ELECTRONICS INC.

Po Box 125, Fogelsville, Pa 18051
LIMITED FOURS UNLIMITED

1030 13th St, Boulder, Colo 80302
LITTON SYSTEMS INC. MELLONICS DIV.

1001 W Maude Ave, Sunnyvale, Cal 94086
LOCKHEED ELECTRONICS DATA MANAGEMENT SERVICES

16811 El Camino Real, Houston, Tex 77058
LOCKHEED ELECTRONICS CO. DIV. LOCKHEED ACRFT
CORP

U S Hwy 22, Plainfield, N J 07060
LOGIC INC.

1712 Commerce St, Dallas, Tex 75201
LOGICON INC.

Del Amo Financial Ctr, Torrance, Cal 90503
LOWENTHAL PROGRAMMING CO.

30 Rock Ridge Dr, Pt Chester, N Y 10573

MACNEAL-SCHWENDLER CORP., THE
7442 N Figueroa St, Los Angeles, Cal 90041

MACRO CORP.
1260 Virginia Dr, Ft Washington, Pa 19034

MANAGEMATICS INC.
2 Pennsylvania Plaza, New York, N Y 10001

MANAGEMENT & COMPUTER SERVICES INC.
104 Park Towne Pl E, Philadelphia, Pa 19130

MANAGEMENT SCIENCE AMERICA INC.
1389 Peachtree St NE, Atlanta, Ga 30309

MANAGEMENT SYSTEMS CORP.
7007 Preston Rd, Dallas, Tex 75205

MARCOM INC.
30 E 42nd St, New York, N Y 10017

MARK COMPUTER SYSTEMS INC.
One Patterson Pl, Garden City, N Y 11530

MARK/OPS DIV., NORTH EASTERN SYSTEMS ASSOC.
INC.

475 Commonwealth Ave, Boston, Mass 02215
MASTECH COMPUTER SYSTEMS INC.

7026 W North Ave, Chicago, Ill 60635
MCAULIFFE ASSOC. INC., JOHN INC.

1181 Broadway, New York, N Y 10001
MCDILL CORP.

P O Box 98, Montgomery, Ala 36101
MCDONNELL AUTOMATION CO.

500 Jefferson Bldg, Houston, Tex 27002
MCDONNELL AUTOMATION CO.

P O Box 516, St Louis, Mo 63166
MELPAR DIV. LTV ELECTROSYSTEMS INC.

7700 Arlington Blvd, Falls Church, Va 22046
METRIDATA COMPUTING INC.

6600 Grade Lane, Louisville, Ky 40221
MICHIANA LEASING CORP.

1814 S Main St, S Bend, Ind 46613
MICRO SYSTEMS INC.

644 E Young St, Santa Ana, Cal 92705
MILNEE BROTHERS PRODUCTS

8000 Blackburn Ave, Los Angeles, Cal 90048
MNMOTECH COMPUTER SYSTEMS

55 Liberty St, New York, N Y 10005
MOBILITY SYSTEMS D P SERVICES DEPT.

3530 De La Cruz Blvd, Santa Clara, Cal 95050
MTI BUSINESS SCHOOLS OF SACRAMENTO INC.

2731 Capitol Ave, Sacramento, Cal 95816
NATIONAL C.S.S.

460 Summer St, Stamford, Conn 06901
NATIONAL COMPUTER ANALYSTS INC.

Us Hwy 1, Princeton, N J 08540
NATIONAL INFORMATION RESEARCH INSTITUTE

8444 Wilshire Blvd, Beverly Hills, Cal 90211
NATIONAL INFORMATION SYSTEMS CORP.

150 Allendale Rd, Valley Forge, Pa 19481
NELLISSSEN INC., ALBERT

510 Madison Ave, New York, N Y 10022
NEOTERIC INC.

2800 Euclid Ave, Cleveland, Ohio 44115
NETWORK DATA PROCESSING CORP.

118 2nd Ave SE, Cedar Rapids, Iowa 52407
NORDEN DIV., UNITED AIRCRAFT CORP.

Helen St, Norwalk, Conn 06850
OPERATIONS RESEARCH INC.

1400 Spring St, Silver Spring, Md 20910
ORIGINAL COMPUTER PRODUCTS INC.

204 Worcester St, Wellesley Hills, Mass 02181
PANSOPHIC SYSTEMS INC.

230 Roosevelt Rd, Lombard, Ill 60148
PAYMENT SYSTEMS INC.

405 Lexington Ave, New York, N Y 10017
PENNDATA CORP.

1729 Cedar Ave, Scranton, Pa 18505
PHI COMPUTER SERVICES INC.

800 Massachusetts Ave, Arlington, Mass 02174
PHILCO-FORD CORP., COMPUTER SERVICES NETWORK

Tioga & C Sts, Philadelphia, Pa 19134
PIONEER DATA SYSTEMS INC.

606 Merle Hay Tower, Des Moines, Iowa 50310
PLANNING RESEARCH CORP.

1100 Glendon Ave, Los Angeles, Cal 90024
PRC COMPUTER CENTER INC. PLANNING RSCH CORP.

7670 Old Springhouse, McLean, Va 22101
PRINCETON TIME SHARING SERVICES, INC.

Us Hwy 1, Princeton, N J 08540
PROFIMATICS INC.

6355 Topanga Canyon, Woodland Hills, Cal 91364
PROGRAMMING SCIENCES CORP.

S E 42 St, New York, N Y 10016
PROGRAMMING SCIENCES CORP.

1900 Ave of The Stars, Los Angeles, Cal 90067
PRYOR COMPUTER INDUSTRIES

400 N Michigan Ave, Chicago, Ill 60611
PUBLIC DATA PROCESSING CORP.

640 N Lasalle St, Chicago, Ill 60610
PURDY CORP., WM. J.

770 Airport Blvd, Burlingame, Cal 94010

2 Product Directory

QUIKDATA INTERNATIONAL INC.
8444 Wilshire Blvd, Beverly Hills, Cal 90211

RAYTHEON CO. EQUIPMENT DIV.
528 Boston Post Rd, Sudbury, Mass 01776

REALTIME SYSTEMS INC.
866 3rd Ave, New York, N Y 10022

REILAND, PAGE & ASSOCIATES INC.
1521 E Broad St, Columbus, Ohio 43205

REL-QUAL ASSOCIATES INC.
18 Hamilton St, Bound Brook, N J 08805

REMOTE COMPUTING CORP.
440 Palo Alto Off Ctr, Palo Alto, Cal 94301

REPUBLIC SYSTEMS INC.
100 Plaza Centre, Secaucus, N J 07094

REPUBLIC SYSTEMS INC.
715 Park Ave, E Orange, N J 07017

REPUBLIC SYSTEMS OF CONNECTICUT INC.
350 S Main St, Cheshire, Conn 06410

RIDGEWOOD ASSOCIATES INC.
10 Wilsey Sq, Ridgewood, N J 07450

SAGE ACTION INC.
P O Box 416, Ithaca, N Y 14850

SAID INC.
1243 W Broad St, Falls Church, Va 22046

SARNA ASSOCIATES INC.
22 Russell St, Brookline, Mass 02146

SCANFORMS INC.
312 Fox Pavilion, Jenkintown, Pa 19095

SCHULTZ INSTRUMENTS INC.
P O Box 13385, Gainesville, Fla 32601

SCIENTIFIC CALCULATIONS INC.
110 Allens Creek Rd, Rochester, N Y 14618

SCIENTIFIC COMPUTERS, INC.,
919 Second Ave S, Minneapolis, Minn 55402

SCIENTIFIC LEASING INC.
77 Meadowgate, Wethersfield, Conn 06109

SCIENTIFIC SOFTWARE CORP.
5300 S Ulster, Englewood, Colo 80110

SCIENTIFIC SYSTEMS SERVICES INC.
476 N Hwy A1a, Satellite Beach, Fla 32935

SCI-TEK COMPUTER CENTER INC.
1707 Gilpin Ave, Wilmington, Del 19806

SEGALL ASSOCIATES, M. HARVEY
1019 Rust Bldg, Tacoma, Wash 98402

SEVAN COMPUTER SERVICES INC.
Pollitt Dr S, Fair Lawn, N J 07410

SOFTWARE ASSOCIATES INC.
501 S 1st Ave Ste O, Arcadia, Cal 91006

SOFTWARE GUIDANCE ASSOCIATES INC.
432 Park Ave S, New York, N Y 10016

SOFTWARE METHODS INC.
10 E 40th St, New York, N Y 10016

SOFTWARE PROGRAMMING ASSOCIATES INC.
1209 Tropic St, Titusville, Fla 32780

SORBUS
875 First Ave, King of Prussia, Pa 19406

SOUTHERN DATA PROCESSING SERVICE INC.
P O Box 123, Augusta, Ga 30903

SOUTHERN VERMONT COMPUTER CENTER&DATA SCHOOL
219 Belmont Ave, Bennington, Vt 05201

SPACETRONICS CO.
43 Hassemer Ave, Cherry Hill, N J 08034

STANDARD PROCESSING CO. INC.
P O Box 703, Pharr, Tex 78577

SYKES DATATRONICS INC.
375 Orchard St, Rochester, N Y 14606

SYSTEM DEVELOPMENT CORP.
2500 Colorado Ave, Santa Monica, Cal 90406

SYSTEM IMPLEMENTATION CORP.
18 E 48th St, New York, N Y 10017

SYSTEMATICS INC.
411 Victory, Little Rock, Ark 72201

SYSTEMS & ELECTRONICS, INC.
223 Park Ave, Rutherford, N J 07070

SYSTEMS & PROGRAMMING SERVICES
1001 Daniel Bldg, Greenville, S C 29602

SYSTEMS ANALYSIS INC.
11110 N E 8th, Bellevue, Wash 98004

SYSTEMS ASSOCIATES INC.
356 Penn St, Reading, Pa 19602

SYSTEMS CONCEPTS INC.
17-45 Clintonville St, Whitestone, N Y 11357

SYSTEMS GENERAL CORP.
10889 Wilshire Blvd, Los Angeles, Cal 90024

SYSTEMS RESEARCH ASSOCIATES, INC.
27 W 67th St, New York, N Y 10023

SYSTEMS RESEARCH LABS, INC.
7001 Indian Ripple Rd, Dayton, Ohio 45440

SYSTEMS, SCIENCE & SOFTWARE INC.
Po Box 1620, La Jolla, Cal 92037

TAYLOR INSTRUMENT PROCESS CONTROL DIV
95 Ames, Rochester, N Y 14601

TELE-DATA CORP.
130 U S Hwy 22, N Plainfield, N J 07060

TELEDYNE BROWN ENGINEERING
300 Sparkman Dr, Huntsville, Ala 35807

TIME SHARING SCIENCES INC.
1180 Ave Americas, New York, N Y 10036

TRAVCOM INC. UNITED DATA PROC DV
70 E 14th St, Eugene, Oreg 97401

TRILOG ASSOCIATES INC.
1700 Market St, Philadelphia, Pa 19103

TRW SYSTEMS GROUP SOFTWARE & INFORMATION SYS DIV
1 Space Park, Redondo Beach, Cal 90278

TURNKEY SYSTEMS INC.
111 E Ave, Norwalk, Conn 06851

UNITED COMPUTING CORP.
22500 S Avalon Blvd, Carson, Cal 90744

UNITED SYSTEMS INC.
1020 Kings Hwy N, Cherry Hill, N J 08034

UNIVERSAL DATA SYSTEMS INC.
14482 Beach Blvd, Westminster, Cal 92626

UNIVERSAL INFORMATION SYSTEMS INC.
S-10 Rte 17 At Rte 4, Paramus, N J 07652

UNIVERSITY COMPUTING CO.
P O Box 6228, Dallas, Tex 75222

URS DATA SCIENCE CO.
155 Bovet Rd, San Mateo, Cal 94402

VIRTUAL COMPUTER SERVICES INC
1119 Springfield Rd, Union, N J 07083

WALSH ASSOC., RICHARD M.
310 Jefferson Ave, Scranton, Pa 18503

WARREN ASSOCIATES
15 Royal Crest Dr, Marlboro, Mass 01752

WELLINGTON COMPUTER SYSTEMS CORP.
405 Lexington Ave, New York, N Y 10017

WEST FLORIDA DATA PROCESSING CENTER INC.
P O Box 1460, Panama City, Fla 32401

WESTERN OPERATIONS INC.
120 Montgomery St, San Francisco, Cal 94104

WESTERN UNION TELEPROCESSING CO.
82 McKee Dr, Mahwah, N J 07436

WESTINGHOUSE ELECTRIC CORP.
Westinghouse Bldg, Pittsburgh, Pa 15222

WESTINGHOUSE TELE-COMPUTER SYSTEMS CORP.
2040 Ardmore Blvd, Pittsburgh, Pa 15221

WILLARD LABORATORIES INC.
4221 Redwood Ave, Los Angeles, Cal 90066

WORLD COMPUTER CORP.
1615 Stemmons Fwy, Dallas, Tex 75221

WORLDWIDE COMPUTER SERVICES, INC.
280 N Central Pk Ave, Hartsdale, N Y 10530

CONSULTING (DATA COMMUNICATIONS SYSTEMS PLANNING)

ACADEMY COMPUTING CORP.
5005 N Lincoln Blvd, Oklahoma City, Okla 73105

ADVANCED COMPUTER SYSTEMS INC
3131 S Dixie Dr, Dayton, Ohio 45305

ADVANCED COMPUTER TECHNIQUES CORP.
437 Madison Ave, New York, N Y 10022

AERO TECHNICAL APPLICATIONS INC.
8011 Clayton Rd, St Louis, Mo 63117

AMBAC INDUSTRIES INC. TELE-DYNAMICS DIV.
525 Virginia Dr, Ft Washington, Pa 19034

ANALYTICS INC.
179 Washington Lane, Jenkintown, Pa 19046

ANCOM SYSTEMS, DIV. GENERAL ANALYTICS CORP.
9841 Airport Blvd, Los Angeles, Cal 90045

ANDROCOR INC.
5949 Hohman Ave, Hammond, Ind 46320

APPLIED COMPUTER SCIENCES INC.
361 Park Rd, W Hartford, Conn 06107

APPLIED COMPUTER SYSTEMS INC.
P O Box 6479, Austin, Tex 78702

APPLIED COMPUTER TIME SHARE INC.
29200 Southfield Rd, Southfield, Mich 48075

APPLIED DIGITAL SYSTEMS INC.
3848 Campus Dr 112, Newport Beach, Cal 92660

APPLIED SYSTEMS CORP.
18325 W McNichols Ave, Detroit, Mich 48219

ARIES CORP.
1651 Old Meadow Rd, Mc Lean, Va 22101

AUERBACH ASSOCIATES INC.
121 W Broad St, Philadelphia, Pa 19107

AUTOMATED COMPUTER SERVICES INC.
517 W Grace St, Richmond, Va 23220

AUTOMATED CONCEPTS INC.
477 Madison Ave, New York, N Y 10017

AUTOMATED FACTS & FIGURES CO.
4551 S Racine Ave, Chicago, Ill 60609

AUTOMATED INFORMATION SYSTEMS INC.
1064 River Rd, Edgewater, N J 07020

AUTOMATED SYSTEMS CORP.
600 Houst Nat Gas Bld, Houston, Tex 77002

consultation • planning
COMPLETE EDP SYSTEMS
design • installation •
support

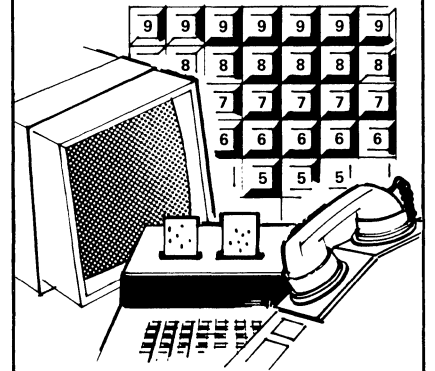

We have the largest, most experienced staff of EDP equipment consultants and system designers in the West. Our engineers analyze system requirements thoroughly, design custom data-handling systems, and provide expert consultation on system expansion or modification.

As a factory-approved supplier of EDP terminals, peripherals, and interfaces of every description, we know the capabilities, the advantages, and the limitations of all reputable brands. We recommend and select EDP equipment strictly on its merit for the application, without special bias or "technical prejudice."

We have everything you need to take full advantage of every form of Data Processing. . . including large stocks of equipment and supplies, and a complete array of support services. . . on *your* terms.

Lease • Purchase • Rental
Complete Turnkey Systems
planned • designed • installed • serviced

For more information on how to get the EDP system or equipment you need . . . and get it on your terms . . . see DataServ catalog insert.

DataSERV
Burlingame, California
Denver • Salt Lake City • Seattle • Phoenix • Los Angeles
One of the PURDY group of companies

2 Product Directory

- AUTOMATION SERVICES CORP.
182 Forbes Rd, Braintree, Mass 02184
- AZREX INC.
105 Terrace Hall Ave, Burlington, Mass 01803
- BAGANOFF ASSOCIATES INC.
6809 W Florissant, St Louis, Mo 63136
- BEDFORD ASSOCIATES INC.
P O Box 327, Bedford, Mass 01730
- BERGLUND ASSOCIATES INC.
1060 Kings Hwy N, Cherry Hill, N J 08034
- BLAIR & ASSOCIATES, NEIL F.
4026 N 48th Dr, Phoenix, Ariz 85031
- BONNER&MOORE ASSOCIATES INC.
500 Jefferson Bldg, Houston, Tex 77002
- BOOTHE DATA SYSTEMS INC.
485 Lexington Ave, New York, N Y 10001
- BOOTHE RESOURCES INTERNATIONAL INC.
3435 Wilshire Blvd, Los Angeles, Cal 90005
- BOSTON COMPUTER SYSTEMS CORP.
15 School St, Boston, Mass 02108
- BOSWORTH & ASSOCIATES, S.
9 Forest Dr, Plainview, N Y 11803
- BRADDOCK,DUNN&MCDONALD INC.
8027 Leesburg Pike, Mc Lean, Va 22101
- BRANDON APPLIED SYSTEMS INC.
1700 Broadway, New York, N Y 10019
- BRANDON APPLIED SYSTEMS INC.
1611 N Kent St, Arlington, Va 22209
- BURLINGTON MANAGEMENT SERVICES CO.
P O Box 21207, Greensboro, N C 27420
- C&C COMPUTER SYSTEMS INC.
1006 S E Grand, Portland, Ore 97214
- CALL-A-COMPUTER INC.
633 Young St, Santa Ana, Cal 92702
- CAMBRIDGE COMPUTER ASSOCIATES INC.
220 Alewife Brook Pky, Cambridge, Mass 02138
- CARROLL GRAPHICS INC.
5301 Michigan Ave, Rosemont, Ill 60018
- CENTRAL COMPUTING CORP.
749 Water P O Box 681, Decatur, Ill 62525
- CENTRAL COMPUTING, INC.
2627 E Central, Wichita, Kans 67214
- CHAPARRAL SYSTEMS INC. MANAGEMENT,
Po Box 5755, Bethesda, Md 20014
- CHICAGO TABULATING SERV. INC.
425 N Michigan, Chicago, Ill 60611
- CODEX CORP.
15 Riverdale Ave, Newton, Mass 02195
- COLLINS RADIO CO.
1200 N Alma Rd, Dallas, Tex 75207
- COMMUNICATIONS LOGIC INC.
6400 Westpark, Houston, Tex 77024
- COMPAC COMPUTER SYSTEMS INC.
911 Hennepin, Minneapolis, Minn 55403
- COMPUMATICS INC.
327 S LaSalle St, Chicago, Ill 60604
- COMPUMEDIC CONTROLS CORP.
432 Park Ave S, New York, N Y 10016
- COMPU SYS INC.
Po Box 11104, Albuquerque, N M 87112
- COMPUTER ADVISORS TO MANAGEMENT
120 S Riverside Plaza, Chicago, Ill 60606
- COMPUTER AID COMPANIES INC.
5925 Forest Lane, Dallas, Tex 75201
- COMPUTER ASSISTANCE INC.
298 Park Rd, West Hartford, Conn 06119
- COMPUTER CENTER, INC.,
350 Royal Palm Way, Palm Beach, Fla 33480
- COMPUTER COMMAND & CONTROL CO
1717 Penn Ave NW, Washington, D C 20006
- COMPUTER COMMAND AND CONTROLS COMPANY
4025 Chestnut St, Philadelphia, Pa 19104
- COMPUTER CONSULTANTS CORP.
U S Rte 46 E, Denville, N J 07834
- COMPUTER DYNAMICS INC.
1760 Solano Ave, Berkeley, Cal 94707
- COMPUTER DYNAMICS INC.
100 Heegenberger Rd, Oakland, Cal 94621
- COMPUTER EXCHANGE INC., THE
30 E 42nd St, New York, N Y 10017
- COMPUTERIA INC.
14 Wood Rd, Braintree, Mass 02143
- COMPUTER INVESTMENTS & LEASING CORP.
9 Tanner St, Haddonfield, N J 08033
- COMPUTER MANAGEMENT INC.
3101 Euclid Ave, Cleveland, Ohio 44115
- COMPUTER NETWORK CORP.
5185 Macarthur Blvd, Washington, D C 20016
- COMPUTER PROCESSING INC.
300 6th Ave, Pittsburgh, Pa 15222
- COMPUTER SCIENCES CORP. INFO. NETWORK DIV.
1901 Building, Los Angeles, Cal 90067
- COMPUTER SYSTEM TECHNOLOGY INC.
700-42 Fox Pavilion, Jenkintown, Pa 19046
- COMPUTER SYSTEMS CO. INC.
1470 St Charles Ave, Cleveland, Ohio 44107
- COMPUTER TASK GROUP INC.
5586 Main St, Buffalo, N Y 14221
- COMPUTER TECHNOLOGY INC. SUB. UNIV.
COMPUTING CO.
P O Box 47911, Dallas, Tex 75247
- COMPUTER TUTOR, THE, DIV. COMPTUT INC.
12 Emerald Court, Commack, N Y 11725
- COMPUTER UNIVERSAL CORP.
1641 Universal Rd, Columbus, Ohio 43207
- COMPUTER USAGE CO.
7315 Wisconsin Ave Nw, Washington, D C 20014
- COMPUTER USAGE CO.
387 Elliot St, Newton Uppr Fls, Mass 02164
- COMPUTER USAGE CO.
3181 Porter Dr, Palo Alto, Cal 94304
- COMPUTER USAGE CORP.
100 Putman Green, Greenwich, Conn 06830
- COMPUTER USAGE CORP.,
8939 S Sepulveda Blvd, Los Angeles, Cal 90045
- COMPUTING & SOFTWARE INC., EAST COAST DIV.
3700 Mt Vernon Ave, Alexandria, Va 22305
- COMPUTING EFFICIENCY INC. COMPUTING EFF. DIV.
35 Orville Dr, Bohemia, N Y 11716
- COMPUTONE SYSTEMS INC.
361 E Paces Ferry Rd, Atlanta, Ga 30305
- COMRESS INC.
No 2 Research Court, Rockville, Md 20850
- COMSI INC.
1211 W 22 St, Oakbrook, Ill 60521
- COMSONIC CORP., THE
123 Pleasant Ave, Upper Saddle R, N J 07458
- COMTEK ASSOCIATES
2077 Center Ave, Fort Lee, N J 07024
- CONDATA INC.
1809 Walnut St, Philadelphia, Pa 19103
- CONRAD RESEARCH CORP.
5600 Forward Ave, Pittsburgh, Pa 15217
- CONSULTANTS ASSOCIATED INC.
Lakeside Office Park, Wakefield, Mass 01880
- CONSUMER SYSTEMS CORP.
15 Spinning Wheel Rd, Hinsdale, Ill 60521
- CONTROL DATA CORP. CEIR PROF. SERV. DIV.
5272 River Rd, Washington, D C 20016
- CONTROL TECHNOLOGY INC.
3450 E Spring St, Long Beach, Cal 90806
- CTC COMPUTER CORP.
1000 Elwell Court, Palo Alto, Cal 94303
- CUMMINS ASSOCIATES, J.J.
29 Towpath Trail, Fairport, N Y 14450
- CYBERMATICS INC.
2460 Lemoine Ave, Fort Lee, N J 07024
- D.P.&W. INC.
1107 Commonwealth Ave, Boston, Mass 02215
- DAILEY INC., R.N.
300 Madison Ave, New York, N Y 10017
- DASH DATA SYSTEMS INC.
69 Jefferson St, Stamford, Conn 06902
- DATA ARCHITECTS INC.
213 3rd Ave, Waltham, Mass 02154
- DATA DIMENSIONS INC.
51 Weaver St, Greenwich, Conn 06830
- DATA MANAGEMENT SERVICES INC.
1845 Walnut St, Philadelphia, Pa 19103
- DATA PROCESSING AND ACCOUNTING SERVICES
50 Van Ness Ave, San Francisco, Cal 94102
- DATA PROCESSING SERVICE INC.
270 Main St, Painesville, Ohio 44077
- DATA PROCESSORS INC.
2703 W 28th Ave, Pine Bluff, Ark 71601
- DATA SYSTEMS ANALYSTS INC.
N Park Dr, Pennsauken, N J 08109
- DATA SYSTEMS INC.
434 Stinson Blvd, Minneapolis, Minn 55413
- DATA TECHNOLOGY CORP.
1050 E Meadow Cir, Palo Alto, Cal 94303
- DATA-TRONICS CORP. SUB. ARKANSAS BEST CORP.
310 Townson Ave, Fort Smith, Ark 72901
- DATA 100 CORP.
7450 France Ave S, Minneapolis, Minn 55435
- DATALOGICS INC.
12025 Shaker Blvd, Cleveland, Ohio 44120
- DATAMAX CORP.
3941 Research Park Dr, Ann Arbor, Mich 48104
- DATAROYAL INC.
Simon St, Nashua, N H 03060
- DELTA SYSTEMS CORP.
Edens Exective Ctr, Wilmette, Ill 60091
- DEUSSEN ASSOCIATES INC.
576 Hyannis Dr, Sunnyvale, Cal 94087
- DIGITAL PROGRAMMING SERVICES INC.
60 Hickory Dr, Waltham, Mass 02154
- DIGITAL SYSTEMS DESIGN
P O Box 305 Fdr Sta, New York, N Y 10022
- DIPIETRO & WILSON INC.
1107 Commonwealth Ave, Boston, Mass 02215
- DIRECT ACCESS COMPUTING CORP.
984 Livernois Rd, Troy, Mich 48084
- DIVERSIFIED COMPUTER APPLICATIONS
2525 E Bayshore Rd, Palo Alto, Cal 94302
- DUMEY, ARNOLD I.
641 Mt Lucas Rd, Princeton, N J 08540
- DYNAMIC ACCESS CORP.
220 Park Ave S, New York, N Y 10003
- EASTERN COMPUTER SERVICES INC
920 Fox Chase Rd, Rockledge, Pa 19111
- ELECTRONIC GRAPHICS INC.
2834 W Kingsley Rd, Garland, Tex 75040
- ELMIRA DATA PROCESSING CO.
221 E Church St, Elmira, N Y 14902
- ENTREX INC.
113 Hartwell Ave, Lexington, Mass 02173
- GENASYS CORP.
2011 Gye St NW, Washington, D C 20006
- GENERAL ATRONICS CORP. SUB. OF MAGNAVOX
Mermaid Lane, Philadelphia, Pa 19118
- GENERAL AUTOMATION INC.
1055 S East St, Anaheim, Cal 92805
- GENERAL COMPUTER SERVICES INC.
1332 Meridan St NE, Huntsville, Ala 35801
- GENESEE COMPUTER CENTER INC.
20 University Ave, Rochester, N Y 14605
- GOODHEW, J.W. & ASSOCIATES INC.
11600 Nebel St, Rockville, Md 20854
- GREYHOUND COMPUTER CORP.
130 S Canal St, Chicago, Ill 60606
- GTE DATA SERVICES INC.
5422 Bay Center Dr, Tampa, Fla 33609
- HAVERLY SYSTEMS INC.
4 2nd Ave, Denville, N J 07834
- HOBBS ASSOCIATES, INC.
Po Box 686, Corona Del Mar, Cal 92625
- HOLLANDER ASSOCIATES
P O Box 2276, Fullerton, Cal 92633
- HONEYWELL INFORMATION SYSTEMS INC. INFO.
SERV.DIV
2701 4th Ave S, Minneapolis, Minn 55408
- HOUSING DATA CORP.
29433 Southfield Rd, Southfield, Mich 48075
- HOUSING DATA CORP.
23400 Michigan, Dearborn, Mich 48124
- HOUSTON ENGINEERING RESEARCH CORP.
P O Box 35495, Houston, Tex 77035
- HOUSTON RESEARCH INC. SUB. SCI. ELECT.
6001 Gulf Fwy, Houston, Tex 77023
- HOWARD ASSOC. INC., DANIEL D.
307 N Michigan Ave, Chicago, Ill 60601
- HUB RATLIFF CONSULTANT
P O Box 22487, Houston, Tex 77027
- HYDRA COMPUTER CORP.
P O Box 17883, Raleigh, N C 27609
- IAC COMPUTER SYSTEMS INC.
260 Newton Rd, Plainview, N Y 11803
- ICM COMPUTER CORP.
P O Box 7220, Tulsa, Okla 74105
- INFONET SYSTEMS INC.
358 McKinley Blvd, Paramus, N J 07652
- INFORMATICS INC.
21050 Vanover St, Canoga Park, Cal 91303
- INFORMATION DEVELOPMENT ASSOCIATES INC.
P O Box 2285, Bethlehem, Pa 18018
- INFORMATION MANAGEMENT INC.
447 Battery St, San Francisco, Cal 94111
- INFORMATION SCIENCES INC.
14 Jefferson Blvd, Warwick, R I 02888
- INFOSCI INC.
P O Box 464, Menlo Park, Cal 94025
- INFOTEC INC.
70 Newton Rd, Plainview, N Y 11803
- INFOTON INC.
2nd Ave, Burlington, Mass 01803
- INFOTRAN INC.
860 Fifth Ave, New York, N Y 10021
- INSTITUTE FOR CYBERNETIC DEVELOPMENT
3031 Bateman St, Berkeley, Cal 94705
- INTECH INC.
2915 Wayzata Blvd, Minneapolis, Minn 55405
- INTEGRAL DATA DEVICES INC.
35 Orville Dr, Bohemia, N Y 11716
- INTERACTIVE SCIENCES CORP.
60 Brook Dr, Braintree, Mass 02184
- INTERNATIONAL COMMUNICATIONS CORP.,SUB. OF
MILGO
7620 NW 36th Ave, Miami, Fla 33147
- INTERNATIONAL COMPUTER CORP.
1 N Broadway, White Plains, N Y 10601
- INTERNATIONAL TELECOMPUTER NETWORK CORP.
4919 Fairmont Ave, Bethesda, Md 20014

2 Product Directory

INTERNATIONAL TELECONTROL CORP.
4300 Pine St, Wilmington, Del 19802
ITT DATA EQUIPMENT & SYSTEMS DIV.
187 E Union Ave, E Rutherford, N J 07073
ITT DATA SERVICES
7822 Bonhomme St, Louis, Mo 63105
ITT DATA SERVICES DIV.
P O Box 402, Paramus, N J 07652
ITT DEFENSE COMMUNICATIONS DIV.
492 River Rd, Nutley, N J 07110
JACKSON ASSOCIATES
4663 Executive Dr, Columbus, Ohio 43220
JONES & CO., GAYLE W.
3846 E 14th St, Oakland, Cal 94601
KDI INTERACTIVE DATA SYSTEMS
17785 Skypark Circle, Irvine, Cal 92664
KEMPER ENGINEERING CO.
9337 Shoshone Ave, Northridge, Cal 91324
KEYSTONE COMPUTER ASSOCIATES INC.
1055 Virginia Dr, Ft Washington, Pa 19034
KRANZLEY & CO. INC. ARTHUR S.
1010 S Kings Hwy, Cherry Hill, N J 08034
LAHEY COMPUTER SYSTEMS INC.
4747 N 16th St, Phoenix, Ariz 85016
LEASCO DATA PROCESSING EQUIPMENT CORP.
280 Park Ave, New York, N Y 10017
LIMITED FOURS UNLIMITED
1030 13th St, Boulder, Colo 80302
LITTON SYSTEMS INC. DATA SYSTEMS DIV.
8000 Woodley Ave, Van Nuys, Cal 91409
LITTON SYSTEMS INC. MELLONICS DIV.
1001 W Maude Ave, Sunnyvale, Cal 94086
LOCKHEED ELECTRONICS DATA MANAGEMENT SERVICES
16811 El Camino Real, Houston, Tex 77058
LOGIC INC.
1712 Commerce St, Dallas, Tex 75201
LOGICON INC.
Del Amo Financial Ctr, Torrance, Cal 90503
MACRO CORP.
1260 Virginia Dr, Ft Washington, Pa 19034
MANAGEMATICS INC.
2 Pennsylvania Plaza, New York, N Y 10001
MANAGEMENT SCIENCE AMERICA INC.
1389 Peachtree St NE, Atlanta, Ga 30309
MANAGEMENT SYSTEMS CORP.
7007 Preston Rd, Dallas, Tex 75205
MARCOM INC.
30 E 42nd St, New York, N Y 10017
MARK COMPUTER SYSTEMS INC.
One Patterson Pl, Garden City, N Y 11530
MARK/OPS DIV., NORTH EASTERN SYSTEMS ASSOC. INC.
475 Commonwealth Ave, Boston, Mass 02215
MASTECH COMPUTER SYSTEMS INC.
7026 W North Ave, Chicago, Ill 60635
MCDILL CORP.
P O Box 98, Montgomery, Ala 36101
MCDONNELL AUTOMATION CO.
500 Jefferson Bldg, Houston, Tex 27002
MCDONNELL AUTOMATION CO.
P O Box 516, St Louis, Mo 63166
MEIER ASSOCIATES
46 White Birch Rd, Ridgefield, Conn 06877
MELPAR DIV. LTV ELECTROSYSTEMS INC.
7700 Arlington Blvd, Falls Church, Va 22046
METRIDATA COMPUTING INC.
6600 Grade Lane, Louisville, Ky 40221
METROPROCESSING CORP. OF AMERICA
64 Prospect St, White Plains, N Y 10606
MICRO SYSTEMS INC.
644 E Young St, Santa Ana, Cal 92705
MILGO ELECTRONIC CORP.
7620 NW 36th Ave, Miami, Fla 33147
MILNEE BROTHERS PRODUCTS
8000 Blackburn Ave, Los Angeles, Cal 90048
MNEMOTECH COMPUTER SYSTEMS
55 Liberty St, New York, N Y 10005
MULTICOMP INC.
36 Washington St, Wellesley Hills, Mass 02181
NATIONAL COMPUTER ANALYSTS INC.
Us Hwy 1, Princeton, N J 08540
NATIONAL INFORMATION SYSTEMS CORP.
150 Allendale Rd, Valley Forge, Pa 19481
NEOTERICS INC.
2800 Euclid Ave, Cleveland, Ohio 44115
NORTHWEST MANAGEMENT SERVICES INC.
2300 Elake Ave E, Seattle, Wash 98102
OPERATIONS RESEARCH INC.
1400 Spring St, Silver Spring, Md 20910
PANSOPHIC SYSTEMS INC.
230 Roosevelt Rd, Lombard, Ill 60148
PARSONS & WILLIAMS, INC.
Nyrupsgade 43, 1602 Copenhagen, DENMARK

PAYMENT SYSTEMS INC.
405 Lexington Ave, New York, N Y 10017
PENNDATA CORP.
1729 Cedar Ave, Scranton, Pa 18505
PHI COMPUTER SERVICES INC.
800 Massachusetts Ave, Arlington, Mass 02174
PIONEER DATA SYSTEMS INC.
606 Merle Hay Tower, Des Moines, Iowa 50310
PLANNING RESEARCH CORP.
1100 Glendon Ave, Los Angeles, Cal 90024
PRC COMPUTER CENTER INC. PLANNING RSCH CORP.
7670 Old Springhouse, McLean, Va 22101
PRINCETON TIME SHARING SERVICES, INC.
Us Hwy 1, Princeton, N J 08540
PROGRAMMING SCIENCES CORP.
S E 42 St, New York, N Y 10016
PROGRAMMING SCIENCES CORP.
1900 Ave of The Stars, Los Angeles, Cal 90067
PRYOR COMPUTER INDUSTRIES
400 N Michigan Ave, Chicago, Ill 60611
RAYTHEON CO. CADPO OPERATION
1415 Providence Tpk, Norwood, Mass 02062
RAYTHEON CO. EQUIPMENT DIV.
528 Boston Post Rd, Sudbury, Mass 01776
REALTIME SYSTEMS INC.
866 3rd Ave, New York, N Y 10022
REL-QUAL ASSOCIATES INC.
18 Hamilton St, Bound Brook, N J 08805
REMOTE COMPUTING CORP.
A40 Palo Alto Off Ctr, Palo Alto, Cal 94301
REPUBLIC SYSTEMS INC.
100 Plaza Centre, Secaucus, N J 07094
REPUBLIC SYSTEMS INC.
715 Park Ave, E Orange, N J 07017
REPUBLIC SYSTEMS OF CONNECTICUT INC.
350 S Main St, Cheshire, Conn 06410
RIDGEWOOD ASSOCIATES INC.
10 Wilsey Sq, Ridgewood, N J 07450
ROSENBERG ASSOCIATES, PAUL
330 5th Ave, Pelham, N Y 10803
SAGE ACTION INC.
P O Box 416, Ithaca, N Y 14850
SAID INC.
1243 W Broad St, Falls Church, Va 22046
SANDERS ASSOCIATES DIGITAL COMMUNICATIONS DEPT
Daniel Webster Hwy S, Nashua, N H 03060
SANDERS ASSOCIATES INC. SYSTEMS DIV.
Daniel Webster Hwy S, Nashua, N H 03060
SARNA ASSOCIATES INC.
22 Russell St, Brookline, Mass 02146
SCHULTZ INSTRUMENTS INC.
P O Box 13385, Gainesville, Fla 32601
SCIENTIFIC CALCULATIONS INC.
110 Allens Creek Rd, Rochester, N Y 14618
SCIENTIFIC COMPUTERS, INC.
919 Second Ave S, Minneapolis, Minn 55402
SCIENTIFIC MEASUREMENTS INC.
9701 N Kenton, Skokie, Ill 60076
SCIENTIFIC SYSTEMS SERVICES INC.
476 N Hwy A1a, Satellite Beach, Fla 32935
SCI-TEK COMPUTER CENTER INC.
1707 Gilpin Ave, Wilmington, Del 19806
SERVICE BUREAU CORP., THE
1350 Ave Americas, New York, N Y 10019
SEVAN COMPUTER SERVICES INC.
Pollitt Dr S, Fair Lawn, N J 07410
SHIRAK TELEMETERING OF AMERICA
8926 Kester Ave, Van Nuys, Cal 91402
SINGER TELE-SIGNAL CORP.
250 Crossway Park Dr, Woodbury, N Y 11797
SOFTTECH INC.
391 Totten Pond Rd, Waltham, Mass 02154
SOFTWARE ASSOCIATES INC.
501 S 1st Ave Ste O, Arcadia, Cal 91006
SOFTWARE METHODS INC.
10 E 40th St, New York, N Y 10016
SOFTWARE PROGRAMMING ASSOCIATES INC.
1209 Tropic St, Titusville, Fla 32780
SOUTHERN DATA PROCESSING SERVICE INC.
P O Box 123, Augusta, Ga 30903
SOUTHERN VERMONT COMPUTER CENTER&DATA SCHOOL
219 Belmont Ave, Bennington, Vt 05201
STANDARD PROCESSING CO. INC.
P O Box 703, Pharr, Tex 78577
SYKES DATATRONICS INC.
375 Orchard St, Rochester, N Y 14606
SYNERGISTICS INC. IKON DATA SYS. DIV.
2619 2nd Ave, Seattle, Wash 98121
SYSTEM IMPLEMENTATION CORP.
18 E 48th St, New York, N Y 10017
SYSTEMATICS INC.
411 Victory, Little Rock, Ark 72201

SYSTEMS & PROGRAMMING SERVICES
1001 Daniel Bldg, Greenville, S C 29602
SYSTEMS ANALYSIS INC.
11110 N E 8th, Bellevue, Wash 98004
SYSTEMS CONCEPTS INC.
17-45 Clintonville St, Whitestone, N Y 11357
SYSTEMS, SCIENCE & SOFTWARE INC.
Po Box 1620, La Jolla, Cal 92037
TECHNICAL MATERIAL CORP.
700 Fenimore Rd, Mamaroneck, N Y 10543
TECHNOMETRICS INC.
6000 Telegraph Ave, Oakland, Cal 94609
TEL-TECH CORP.
11810 Parklawn Dr, Rockville, Md 20852
TELE-DATA CORP.
130 U S Hwy 22, N Plainfield, N J 07060
TIME SHARING SCIENCES INC.
1180 Ave Americas, New York, N Y 10036
TIME ZERO CORP.
3530 Torrance Blvd, Torrance, Cal 90510
TIMEPLEX INC.
65 Oak St, Norwood, N J 07648
TRACOR COMPUTING CORP.
1705 Guadalupe St, Austin, Tex 78701
TRANS-DATA SYSTEMS
6394 Freeport B, Sacramento, Cal 95822
TREPAC CORP. OF AMERICA
30 W Hamilton Ave, Englewood, N J 07631
TRI-DEX DATA SERVICES
2146 E Main St, Visalia, Cal 93277
TRILOG ASSOCIATES INC.
1700 Market St, Philadelphia, Pa 19103
TRW SYSTEMS GROUP SOFTWARE & INFORMATION SYS DIV
1 Space Park, Redondo Beach, Cal 90278
TURNKEY SYSTEMS INC.
111 E Ave, Norwalk, Conn 06851
U.S. TIME-SHARING INC.
1831 Michael Faraday, Reston, Va 22070
UNITED COMPUTING SYSTEMS INC.
3130 Broadway, Kansas City, Mo 64111
UNITED SYSTEMS INC.
1020 Kings Hwy N, Cherry Hill, N J 08034
UNIVERSAL DATA SYSTEMS INC.
14482 Beach Blvd, Westminster, Cal 92626
UNIVERSITY COMPUTING CO.
P O Box 6228, Dallas, Tex 75222
URS DATA SCIENCE CO.
155 Bovet Rd, San Mateo, Cal 94402
VOICEPRINT LABORATORIES DIV. OF FARRINGTON
68 Finnerde Ave, Somerville, N J 08876
WALSH ASSOC., RICHARD M.
310 Jefferson Ave, Scranton, Pa 18503
WARREN ASSOCIATES
15 Royal Crest Dr, Marlboro, Mass 01752
WEISMANTEL INC.
P O Box 1957, St Paul, Minn 55111
WELLINGTON COMPUTER SYSTEMS CORP.
405 Lexington Ave, New York, N Y 10017
WESTERN OPERATIONS INC.
120 Montgomery St, San Francisco, Cal 94104
WESTERN UNION TELEPROCESSING CO.
82 McKee Dr, Mahwah, N J 07436
WESTINGHOUSE ELECTRIC CORP.
Westinghouse Bldg, Pittsburgh, Pa 15222
WESTINGHOUSE TELE-COMPUTER SYSTEMS CORP.
2040 Ardmore Blvd, Pittsburgh, Pa 15221
WILLARD LABORATORIES INC.
4221 Redwood Ave, Los Angeles, Cal 90066
WORLDWIDE COMPUTER SERVICES, INC.
280 N Central Pk Ave, Hartsdale, N Y 10530
XEROX DATA SYSTEMS
701 S Aviation, El Segundo, Cal 90245

CONSULTING (COMPUTER PRODUCT PLANNING SURVEYS, MARKET RESEARCH STUDIES)

ACADEMY COMPUTING CORP.
5005 N Lincoln Blvd, Oklahoma City, Okla 73105
ADAPT INC.
624 S 62nd St, Philadelphia, Pa 19143
ADVANCED COMPUTER TECHNIQUES CORP.
437 Madison Ave, New York, N Y 10022
ADVANCED MANAGEMENT SYSTEMS INC.
3310 Richmond Ave, Houston, Tex 77006
APPLIED COMPUTER TIME SHARE INC.
29200 Southfield Rd, Southfield, Mich 48075
APPLIED CYBERNETICS CORP.
1285 Forgewood Ave, Sunnyvale, Cal 94086
APPLIED PROGRAMMING TECHNOLOGY CORP.
275 D Cox St, Hudson, Mass 01749
AUERBACH ASSOCIATES INC.
121 W Broad St, Philadelphia, Pa 19107

2 Product Directory

- BERGLUND ASSOCIATES INC.
1060 Kings Hwy N, Cherry Hill, N J 08034
- BLAIR & ASSOCIATES, NEIL F.
4026 N 48th Dr, Phoenix, Ariz 85031
- BONNER&MOORE ASSOCIATES INC.
500 Jefferson Bldg, Houston, Tex 77002
- BOOTHE DATA SYSTEMS INC.
485 Lexington Ave, New York, N Y 10001
- BOOTHE RESOURCES INTERNATIONAL INC.
3435 Wilshire Blvd, Los Angeles, Cal 90005
- BOSTON COMPUTER SYSTEMS CORP.
15 School St, Boston, Mass 02108
- BRANDON APPLIED SYSTEMS INC.
1700 Broadway, New York, N Y 10019
- BRANDON APPLIED SYSTEMS INC.
1611 N Kent St, Arlington, Va 22209
- BURLINGTON MANAGEMENT SERVICES CO.
P O Box 21207, Greensboro, N C 27420
- CALTEC INC.
1931 Sylvania Ave, Toledo, Ohio 43613
- CAMBRIDGE COMPUTER ASSOCIATES INC.
220 Alewife Brook Pky, Cambridge, Mass 02138
- CENTRAL COMPUTING, INC.
2627 E Central, Wichita, Kans 67214
- CHAPARRAL SYSTEMS INC. MANAGEMENT,
Po Box 5755, Bethesda, Md 20014
- CHICAGO TABULATING SERV. INC.
425 N Michigan, Chicago, Ill 60611
- COMMERCIAL SCIENCES CORP.
P O Box 5328, Pompano Beach, Fla 33064
- COMPUMATIC SYSTEMS CORP.
5303 Comercio Ln, Woodland Hills, Cal 91364
- COMPUMEDIC CONTROLS CORP.
432 Park Ave S, New York, N Y 10016
- COMPU-TIME INC.
327 Orange Ave, Daytona, Fla 32014
- COMPUTER & PROGRAMMING ANALYSIS INC.
1 Wynnewood Rd, Wynnewood, Pa 19096
- COMPUTER AID COMPANIES INC.
5925 Forest Lane, Dallas, Tex 75201
- COMPUTER COMMAND & CONTROL CO
1717 Penn Ave NW, Washington, D C 20006
- COMPUTER COMMAND AND CONTROLS COMPANY
4025 Chestnut St, Philadelphia, Pa 19104
- COMPUTERFILES INC.
Prof Bldg Baker Ave, Concord, Mass 01742
- COMPUTER MANAGEMENT INC.
3101 Eullid Ave, Cleveland, Ohio 44115
- COMPUTER NETWORK CORP.
5185 Macarthur Blvd, Washington, D C 20016
- COMPUTER PROCESSING INC.
300 6th Ave, Pittsburgh, Pa 15222
- COMPUTER SYSTEMS CO, INC.
1470 St Charles Ave, Cleveland, Ohio 44107
- COMPUTER SYSTEMS CORP. U.S. INDUSTRIES INC
P O Box 64400, Dallas, Tex 75206
- COMPUTER TASK GROUP INC.
5586 Main St, Buffalo, N Y 14221
- COMPUTER TECHNOLOGY INC. SUB. UNIV.
COMPUTING CO.
P O Box 47911, Dallas, Tex 75247
- COMPUTER TUTOR, THE, DIV. COMPUT. INC.
12 Emerald Court, Commack, N Y 11725
- COMPUTER USAGE CO.
7315 Wisconsin Ave Nw, Washington, D C 20014
- COMPUTER USAGE CO.
3181 Porter Dr, Palo Alto, Cal 94304
- COMPUTER USAGE CORP.
100 Putman Green, Greenwich, Conn 06830
- COMPUTER USAGE CORP.,
8939 S Sepulveda Blvd, Los Angeles, Cal 90045
- COMRESS INC.
No 2 Research Court, Rockville, Md 20850
- CONSENTIVE INC.
3525 Lancaster Ave, Philadelphia, Pa 19104
- CONSUMER SYSTEMS CORP.
15 Spinning Wheel Rd, Hinsdale, Ill 60521
- CONTINENTAL DATA PROCESSING INC.
300 Market St., Kingston, Pa 18704
- CUMMINS ASSOCIATES, J.J.
29 Towpath Trail, Fairport, N Y 14450
- DATA ARCHITECTS INC.
213 3rd Ave, Waltham, Mass 02154
- DATA COMPUTING CORP.
229 Baldwin Rd, Hempsted, N Y 11551
- DATA DIMENSIONS INC.
51 Weaver St, Greenwich, Conn 06830
- DATA ENGINEERING ASSOC. INC.
300 Kings Hwy E, Haddonfield, N J 08033
- DATA MANAGEMENT SERVICES INC.
1845 Walnut St, Philadelphia, Pa 19103
- DATA PROCESSING AND ACCOUNTING SERVICES
50 Van Ness Ave, San Francisco, Cal 94102
- DATA PROCESSING SERVICE INC.
270 Main St, Painesville, Ohio 44077
- DATA SYSTEMS INC.
434 Stinson Blvd, Minneapolis, Minn 55413
- DATA-TRONICS CORP. SUB. ARKANSAS BEST CORP.
310 Townson Ave, Fort Smith, Ark 72901
- DATAMATION SERVICES INC.
461 Eighth Ave, New York, N Y 10001
- DATAPRO RESEARCH CORP.
2204 Walnut St, Philadelphia, Pa 19103
- DATASONICS INC.
P O Box 4553, New York, N Y 10017
- DATATAB
740 N Rush St, Chicago, Ill 60611
- DELTA SYSTEMS CORP.
Edens Executive Ctr, Wilmette, Ill 60091
- DEUSSEN ASSOCIATES INC.
576 Hyannis Dr, Sunnyvale, Cal 94087
- DIGITAL SYSTEMS DESIGN
P O Box 305 Fdr Sta, New York, N Y 10022
- DIPIETRO & WILSON INC.
1107 Commonwealth Ave, Boston, Mass 02215
- DIRECT ACCESS COMPUTING CORP.
984 Livernois Rd, Troy, Mich 48084
- DYNAMIC ACCESS CORP.
220 Park Ave S, New York, N Y 10003
- EASTERN COMPUTER SERVICES INC
920 Fox Chase Rd, Rockledge, Pa 19111
- ELMIRA DATA PROCESSING CO.
221 E Church St, Elmira, N Y 14902
- ENGINEERING TECHNOLOGY ANALYSTS INC.
3310 Richmond Ave, Houston, Tex 77006
- FLORES ASSOCIATES
108 8th Ave, Brooklyn, N Y 11215
- GAMS & ASSOCIATES INC., T.C.
2222 Morris Ave, Union, N J 07083
- GOODHEW, J.W. & ASSOCIATES INC.
11600 Nebel St, Rockville, Md 20854
- GRAY & ASSOCIATES INC., H.J.
2501 Cedar Springs Rd, Dallas, Tex 75201
- GTE DATA SERVICES INC.
5422 Bay Center Dr, Tampa, Fla 33609
- HEFFELFINGER ASSOCIATES INC.
888 Washington St, Dedham, Mass 02026
- HOBBS ASSOCIATES, INC.
Po Box 686, Corona Del Mar, Cal 92625
- HOLLANDER ASSOCIATES
P O Box 2276, Fullerton, Cal 92633
- HOUSING DATA CORP.
29433 Southfield Rd, Southfield, Mich 48075
- HOUSING DATA CORP.
23400 Michigan, Dearborn, Mich 48124
- HOWARD ASSOC. INC., DANIEL D.
307 N Michigan Ave, Chicago, Ill 60601
- HUB RATLIFF CONSULTANT
P O Box 22487, Houston, Tex 77027
- HYDRA COMPUTER CORP.
P O Box 17883, Raleigh, N C 27609
- ICM COMPUTER CORP.
P O Box 7220, Tulsa, Okla 74105
- INFODATA SYSTEMS INC.
680 Ridge Rd, Webster, N Y 14580
- INFONET SYSTEMS INC.
358 McKinley Blvd, Paramus, N J 07652
- INFORMATICS INC.
21050 Vanover St, Canoga Park, Cal 91303
- INFORMATION DEVELOPMENT ASSOCIATES INC.
P O Box 2285, Bethlehem, Pa 18018
- INFORMATION SCIENCES INC.
14 Jefferson Blvd, Warwick, R I 02888
- INFOSCI INC.
P O Box 464, Menlo Park, Cal 94025
- INTERNATIONAL COMPUTER CORP.
1 N Broadway, White Plains, N Y 10601
- INTERNATIONAL COMPUTER PROGRAMS INC.
2511 E 46th St, Indianapolis, Ind 46205
- INTERNATIONAL DATA APPLICATIONS INC.
100 Main St, Reading, Mass 08167
- INTERNATIONAL DATA CORP.
60 Austin St, Newtonville, Mass 02160
- JACKSON ASSOCIATES
4663 Executive Dr, Columbus, Ohio 43220
- KEYDATA CORP.
108 Water St, Watertown, Mass 02172
- KEYSTONE COMPUTER ASSOCIATES INC.
1055 Virginia Dr, Ft Washington, Pa 19034
- KRANZLEY & CO. INC. ARTHUR S.
1010 S Kings Hwy, Cherry Hill, N J 08034
- LEASCO DATA PROCESSING EQUIPMENT CORP.
280 Park Ave, New York, N Y 10017
- LOGIC, INC.
1712 Commerce St, Dallas, Tex 75201
- MANAGEMENT CONCEPTS INC.
2 Pennsylvania Plaza, New York, N Y 10001
- MANAGEMENT CONCEPTS INC.
2 Decker Sq, Bala-Cynwyd, Pa 19004
- MANAGEMENT SCIENCE AMERICA INC.
1389 Peachtree St NE, Atlanta, Ga 30309
- MARCOM INC.
30 E 42nd St, New York, N Y 10017
- MARK COMPUTER SYSTEMS INC.
One Patterson Pl, Garden City, N Y 11530
- MATRIX CORP., THE
931 S Douglas St, El Segundo, Cal 90245
- MILNEE BROTHERS PRODUCTS
8000 Blackburn Ave, Los Angeles, Cal 90048
- MNEMOTECH COMPUTER SYSTEMS
55 Liberty St, New York, N Y 10005
- NORDEN DIV., UNITED AIRCRAFT CORP.
Helen St, Norwalk, Conn 06850
- OPERATIONS RESEARCH INC.
1400 Spring St, Silver Spring, Md 20910
- ORIGINAL COMPUTER PRODUCTS INC.
204 Worcester St, Wellesley Hills, Mass 02181
- PANSOPHIC SYSTEMS INC.
230 Roosevelt Rd, Lombard, Ill 60148
- PARSONS & WILLIAMS, INC.
Nyrupsgade 43, 1602 Copenhagen, DENMARK
- PAYMENT SYSTEMS INC.
405 Lexington Ave, New York, N Y 10017
- PENNDATA CORP.
1729 Cedar Ave, Scranton, Pa 18505
- PHI COMPUTER SERVICES INC.
800 Massachusetts Ave, Arlington, Mass 02174
- PIONEER DATA SYSTEMS INC.
606 Merle Hay Tower, Des Moines, Iowa 50310
- PLANNING RESEARCH CORP.
1100 Glendon Ave, Los Angeles, Cal 90024
- PROGRAMMING SCIENCES CORP.
S E 42 St, New York, N Y 10016
- PROGRAMMING SCIENCES CORP.
1900 Ave of The Stars, Los Angeles, Cal 90067
- QUANTUM SCIENCE CORP. SUB. SAMSON ASSOC.
245 Park Ave, New York, N Y 10017
- REALTIME SYSTEMS INC.
866 3rd Ave, New York, N Y 10022
- REL-QUAL ASSOCIATES INC.
18 Hamilton St, Bound Brook, N J 08805
- REMOTE COMPUTING CORP.
A40 Palo Alto Off Ctr, Palo Alto, Cal 94301
- REPUBLIC SYSTEMS INC.
100 Plaza Centre, Secaucus, N J 07094
- REPUBLIC SYSTEMS INC.
715 Park Ave. E Orange, N J 07017
- SAGE ACTION INC.
P O Box 416, Ithaca, N Y 14850
- SAID INC.
1243 W Broad St, Falls Church, Va 22046
- SARNA ASSOCIATES INC.
22 Russell St, Brookline, Mass 02146
- SCIENTIFIC CALCULATIONS INC.
110 Allens Creek Rd, Rochester, N Y 14618
- SCIENTIFIC COMPUTERS, INC.,
919 Second Ave S, Minneapolis, Minn 55402
- SCIENTIFIC SYSTEMS SERVICES INC.
476 N Hwy A1a, Satellite Beach, Fla 32935
- SCI-TEK COMPUTER CENTER INC.
1707 Gilpin Ave, Wilmington, Del 19806
- SOFTWARE PROGRAMMING ASSOCIATES INC.
1209 Tropic St, Titusville, Fla 32780
- SOUTHERN VERMONT COMPUTER CENTER&DATA
SCHOOL
219 Belmont Ave, Bennington, Vt 05201
- SYKES DATATRONICS INC.
375 Orchard St, Rochester, N Y 14606
- SYSTEMATICS INC.
411 Victory, Little Rock, Ark 72201
- SYSTEMS ANALYSIS INC.
11110 N E 8th, Bellevue, Wash 98004
- SYSTEMS ASSOCIATES INC.
356 Penn St, Reading, Pa 19602
- SYSTEMS CONCEPTS INC.
17-45 Clintonville St, Whitestone, N Y 11357
- SYSTEMS GENERAL CORP.
10889 Wilshire Blvd, Los Angeles, Cal 90024
- SYSTEMS RESEARCH ASSOCIATES, INC.
27 W 67th St, New York, N Y 10023
- SYSTEMS, SCIENCE & SOFTWARE INC.
Po Box 1620, La Jolla, Cal 92037
- TECHNOMETRICS INC.
6000 Telegraph Ave, Oakland, Cal 94609
- UNGERLEIDER & CO.
P O Box 1180, Alexandria, Va 22313
- UNIVERSAL DATA SYSTEMS INC.
14482 Beach Blvd, Westminster, Cal 92626
- UNIVERSITY COMPUTING CO.
P O Box 6228, Dallas, Tex 75222
- VIRTUAL COMPUTER SERVICES INC
1119 Springfield Rd, Union, N J 07083
- WARREN ASSOCIATES
15 Royal Crest Dr, Marlboro, Mass 01752

2 Product Directory

WELLINGTON COMPUTER SYSTEMS CORP.
405 Lexington Ave, New York, N Y 10017
WESTERN UNION TELEPROCESSING CO.
82 McKee Dr, Mahwah, N J 07436
WILLARD LABORATORIES INC.
4221 Redwood Ave, Los Angeles, Cal 90066
WILSON CO., W.E., COMPUTER AUTOMATION GROUP
2564 Via Tejon, Palos Vrd Est, Cal 90274
WORLDWIDE COMPUTER SERVICES, INC.
280 N Central Pk Ave, Hartsdale, N Y 10530

CONSULTING (MANAGEMENT INFORMATION SYSTEMS PLANNING)

ACADEMY COMPUTING CORP.
5005 N Lincoln Blvd, Oklahoma City, Okla 73105
ADAPT INC.
624 S 62nd St, Philadelphia, Pa 19143
ADATACO
1475 N Broadway, Walnut Creek, Cal 94596
ADVANCED COMPUTER SYSTEMS INC
3131 S Dixie Dr, Dayton, Ohio 45305
ADVANCED COMPUTER TECHNIQUES CORP
437 Madison Ave, New York, N Y 10022
ADVANCED MANAGEMENT SYSTEMS INC.
3310 Richmond Ave, Houston, Tex 77006
AERO TECHNICAL APPLICATIONS INC.
8011 Clayton Rd, St Louis, Mo 63117
AHART & ASSOC. INC., JAMES R.
225 S Main St, Dayton, Ohio 45402
ALLEN-BABCOCK COMPUTING INC.
1800 Ave of The Stars, Los Angeles, Cal 90067
ALPHA COMPUTER SERVICE CORP.
226 W 37th St, New York, N Y 10018
ANALYTIC SCIENCES CORP., THE
6 Jacob Way, Reading, Mass 01867
ANALYTICS INC.
179 Washington Lane, Jenkintown, Pa 19046
ANCOM SYSTEMS, DIV. GENERAL ANALYTICS CORP.
9841 Airport Blvd, Los Angeles, Cal 90045
ANDROCOR INC.
5949 Hohman Ave, Hammond, Ind 46320
APPLIED COMPUTER SCIENCES INC.
361 Park Rd, W Hartford, Conn 06107
APPLIED COMPUTER TIME SHARE INC.
29200 Southfield Rd, Southfield, Mich 48075
APPLIED CYBERNETICS CORP.
1285 Forgewood Ave, Sunnyvale, Cal 94086
APPLIED DIGITAL SYSTEMS INC.
3848 Campus Dr 112, Newport Beach, Cal 92660
ARIES CORP.
1651 Old Meadow Rd, Mc Lean, Va 22101
AUERBACH ASSOCIATES INC.
121 W Broad St, Philadelphia, Pa 19107
AUTOMATED CONCEPTS INC.
477 Madison Ave, New York, N Y 10017
AUTOMATED INFORMATION SYSTEMS INC.
1064 River Rd, Edgewater, N J 07020
AUTOMATED SYSTEMS CORP.
600 Houst Nat Gas Bld, Houston, Tex 77002
AUTOMATION SERVICES CORP.
182 Forbes Rd, Braintree, Mass 02184
AZREX INC.
105 Terrace Hall Ave, Burlington, Mass 01803
BEDFORD ASSOCIATES INC.
P O Box 327, Bedford, Mass 01730
BIZ-MATIC DATA CONTROL CENTERS INC.
232 Summer St, Boston, Mass 02210
BLAIR & ASSOCIATES, NEIL F.
4026 N 48th Dr, Phoenix, Ariz 85031
BONNER&MOORE ASSOCIATES INC.
500 Jefferson Bldg, Houston, Tex 77002
BOOTHE DATA SYSTEMS INC.
485 Lexington Ave, New York, N Y 10001
BOOTHE RESOURCES INTERNATIONAL INC.
3435 Wilshire Blvd, Los Angeles, Cal 90005
BOSTON COMPUTER SYSTEMS CORP.
15 School St, Boston, Mass 02108
BOSWORTH & ASSOCIATES, S.
9 Forest Dr, Plainview, N Y 11803
BRADDOCK, DUNN&MCDONALD INC.
8027 Leesburg Pike, Mc Lean, Va 22101
BRANDON APPLIED SYSTEMS INC.
1700 Broadway, New York, N Y 10019
BRANDON APPLIED SYSTEMS INC.
1611 N Kent St, Arlington, Va 22209
BURLINGTON MANAGEMENT SERVICES CO.
P O Box 21207, Greensboro, N C 27420
C&C COMPUTER SYSTEMS INC.
1006 S E Grand, Portland, Ore 97214
C-O-M SYSTEMS INC.
75 Maiden Lane, New York, N Y 10038
CALL-A-COMPUTER INC.
633 Young St, Santa Ana, Cal 92702

CALTEC INC.
1931 Sylvania Ave, Toledo, Ohio 43613
CAMBRIDGE COMPUTER ASSOCIATES INC.
220 Alewife Brook Pky, Cambridge, Mass 02138
CENTRAL COMPUTING CORP.
749 Water P O Box 681, Decatur, Ill 62525
CENTRAL COMPUTING CORP.
180 N Mich Ave, Chicago, Ill 60601
CENTRAL COMPUTING, INC.
2627 E Central, Wichita, Kans 67214
CENTRAL DATA SYSTEMS INC.
1215 Valley Belt Rd, Cleveland, Ohio 44131
CENTURY DATA PROCESSING INC.
1006 Coronado Towers, El Paso, Tex 79912
CGA COMPUTER ASSOCIATES INC.
715 Park Ave, East Orange, N J 07017
CHAPARRAL SYSTEMS INC. MANAGEMENT,
Po Box 5755, Bethesda, Md 20014
CHICAGO TABULATING SERV. INC.
425 N Michigan, Chicago, Ill 60611
COMPAC COMPUTER SYSTEMS INC.
911 Hennepin, Minneapolis, Minn 55403
COMPUMATIC SYSTEMS CORP.
5303 Comercio Ln, Woodland Hills, Cal 91364
COMPUMEDIC CONTROLS CORP.
432 Park Ave S, New York, N Y 10016
COMPU SYS INC.
Po Box 11104, Albuquerque, N M 87112
COMPU-TIME INC.
327 Orange Ave, Daytona, Fla 32014
COMPUTATION AND SYSTEMS CORP.
12061 Wilshire Blvd, Los Angeles, Cal 90025
COMPUTE AMERICA CORP. DBA COMERICA
1515 Classen Blvd, Oklahoma City, Okla 73106
COMPUTER ADVISORS TO MANAGEMENT
120 S Riverside Plaza, Chicago, Ill 60606
COMPUTER AID COMPANIES INC.
5925 Forest Lane, Dallas, Tex 75201
COMPUTER APPLICATIONS CENTER, INC.
516 Hutton Pl, Columbus, Ohio 43215
COMPUTER ASSISTANCE INC.
298 Park Rd, West Hartford, Conn 06119
COMPUTER CENTER OF ATLANTA DIV.COMP. CNTRS
INC
2695 Buford Hwy NE, Atlanta, Ga 30324
COMPUTER COMMAND & CONTROL CO
1717 Penn Ave NW, Washington, D C 20006
COMPUTER COMMAND AND CONTROLS COMPANY
4025 Chestnut St, Philadelphia, Pa 19104
COMPUTER CONSULTANTS CORP.
U S Rte 46 E, Denville, N J 07834
COMPUTER DYNAMICS INC.
1760 Solano Ave, Berkeley, Cal 94707
COMPUTER DYNAMICS INC.
100 Heegenberger Rd, Oakland, Cal 94621
COMPUTER EXCHANGE INC., THE
30 E 42nd St, New York, N Y 10017
COMPUTERIA INC.
14 Wood Rd, Braintree, Mass 02143
COMPUTER INVESTMENTS & LEASING CORP.
9 Tanner St, Haddonfield, N J 08033
COMPUTER LEARNING & SYSTEMS CORP.
5530 Wisconsin Ave, Chevy Chase, Md 20015
COMPUTER MANAGEMENT INC.
3101 Euclid Ave, Cleveland, Ohio 44115
COMPUTER MEASUREMENTS CO.
12970 Bradley Ave, San Fernando, Cal 91342
COMPUTER METHODS CORP.
470 Mamaroneck Ave, White Plains, N Y 10605
COMPUTER NETWORK CORP.
5185 Macarthur Blvd, Washington, D C 20016
COMPUTER POWER INC.
30 S Laura St, Jacksonville, Fla 32202
COMPUTER PROCESSING INC.
300 6th Ave, Pittsburgh, Pa 15222
COMPUTER SCIENCES CORP. INFO. NETWORK DIV.
1901 Building, Los Angeles, Cal 90067
COMPUTER SERVICENTER CORP.
16 Maple St, Latham, N Y 12110
COMPUTER SERVICES INC.
47 Congress St, Salem, Mass 01970
COMPUTER SYSTEM TECHNOLOGY INC.
700-42 Fox Pavilion, Jenkintown, Pa 19046
COMPUTER SYSTEMS
400 Wing Bldg, Grants Pass, Oreg 97526
COMPUTER SYSTEMS CO. INC.
1470 St Charles Ave, Cleveland, Ohio 44107
COMPUTER SYSTEMS CORP. U.S. INDUSTRIES INC
P O Box 64400, Dallas, Tex 75206
COMPUTER TASK GROUP INC.
5586 Main St, Buffalo, N Y 14221
COMPUTER TECHNOLOGY INC. SUB. UNIV.
COMPUTING CO.
P O Box 47911, Dallas, Tex 75247

COMPUTER TUTOR, THE, DIV. COMPTUT INC.
12 Emerald Court, Commack, N Y 11725
COMPUTER UNIVERSAL CORP.
1641 Universal Rd, Columbus, Ohio 43207
COMPUTER USAGE CO.
7315 Wisconsin Ave Nw, Washington, D C 20014
COMPUTER USAGE CO.
387 Elliot St, Newton Uppr Fls, Mass 02164
COMPUTER USAGE CO.
3181 Porter Dr, Palo Alto, Cal 94304
COMPUTER USAGE CORP.
100 Putman Green, Greenwich, Conn 06830
COMPUTER USAGE CORP.,
8939 S Sepulveda Blvd, Los Angeles, Cal 90045
COMPUTING & SOFTWARE INC., EAST COAST DIV.
3700 Mt Vernon Ave, Alexandria, Va 22305
COMPUTING EFFICIENCY INC. COMPUTING EFF. DIV.
35 Orville Dr, Bohemia, N Y 11716
COMPUVISOR INC.
P O Box 381, Ithaca, N Y 14850
COMPRESS INC.
No 2 Research Court, Rockville, Md 20850
CONSERV CORP.
4025 Chestnut St, Philadelphia, Pa 19104
COMTECH NEW ENGLAND INC.
534 Boston Post Rd, Wayland, Mass 01778
COMTEK ASSOCIATES
2077 Center Ave, Fort Lee, N J 07024
CONSAD RESEARCH CORP.
5600 Forward Ave, Pittsburgh, Pa 15217
CONSENTIVE INC.
3525 Lancaster Ave, Philadelphia, Pa 19104
CONSOLIDATED ANALYSIS CENTERS, INC.,
225 Santa Monica Blvd, Santa Monica, Cal 90401
CONSULTANTS ASSOCIATED INC.
Lakeside Office Park, Wakefield, Mass 01880
CONSUMER SYSTEMS CORP.
15 Spinning Wheel Rd, Hinsdale, Ill 60521
CONTINENTAL DATA PROCESSING INC.
300 Market St., Kingston, Pa 18704
CONTROL DATA CORP. CEIR PROF. SERV. DIV.
5272 River Rd, Washington, D C 20016
CONTROL TECHNOLOGY INC.
3450 E Spring St, Long Beach, Cal 90806
CORPORATE DATA PROCESSING
1724 Silver Lake Blvd, Los Angeles, Cal 90026
CTC COMPUTER CORP.
1000 Ellwell Court, Palo Alto, Cal 94303
CUMMINS ASSOCIATES, J.J.
29 Towpath Trail, Fairport, N Y 14450
CYBERMATIC INC.
2460 Lemoine Ave, Fort Lee, N J 07024
D.P.&W. INC.
1107 Commonwealth Ave, Boston, Mass 02215
DACONICS
925 Thompson Pl, Sunnyvale, Cal 94086
DATA ARCHITECTS INC.
213 3rd Ave, Waltham, Mass 02154
DATA COMPUTING CORP.
229 Baldwin Rd, Hempsted, N Y 11551
DATA COPY INC.
760 Bryant St, San Francisco, Cal 94107
DATA CORP., THE PENINSULA COMPUTER CENTER
DIV
1190 Coleman Ave, San Jose, Cal 95110
DATA DIMENSIONS INC.
51 Weaver St, Greenwich, Conn 06830
DATA MANAGEMENT SERVICES INC.
1845 Walnut St, Philadelphia, Pa 19103
DATA-PACK INC.
269 Brookside Rd, Waterbury, Conn 06720
DATA PROCESSING AND ACCOUNTING SERVICES
50 Van Ness Ave, San Francisco, Cal 94102
DATA PROCESSING SERVICES INC.
270 Main St, Painesville, Ohio 44077
DATA SYSTEMS ANALYSTS INC.
N Park Dr, Pennsauken, N J 08109
DATA SYSTEMS INC.
434 Stinson Blvd, Minneapolis, Minn 55413
DATA-TRONICS CORP. SUB. ARKANSAS BEST CORP.
310 Townson Ave, Fort Smith, Ark 72901
DATAFLOW SYSTEMS INC.
7758 Wilconsin Ave, Bethesda, Md 20014
DATALOGICS INC.
12025 Shakee Blvd, Cleveland, Ohio 44120
DATAMATION SERVICES INC.
461 Eighth Ave, New York, N Y 10001
DATAROYAL INC.
Simon St, Nashua, N H 03060
DATASONICS INC.
P O Box 4553, New York, N Y 10017
DECISION SYSTEMS INC.
E 66 Midland Ave, Paramus, N J 07652
DELMARVA COMPUTER INDUSTRIES INC.
5865 Robert Oliver Pl, Columbia, Md 21043

2 Product Directory

- DELTA SYSTEMS CORP.
Edens Exective Ctr, Wilmette, Ill 60091
- DEUSSEN ASSOCIATES INC.
576 Hyannis Dr, Sunnyvale, Cal 94087
- DIGITAL PROGRAMMING SERVICES INC.
60 Hickory Dr, Waltham, Mass 02154
- DIGITAL SYSTEMS DESIGN
P O Box 305 Fdr Sta, New York, N Y 10022
- DIGITRON INC.
P O Box 5836, Columbus, S C 29205
- DIKEWOOD CORP.,THE
1009 Bradbury Dr SE, Albuquerque, N M 87106
- DIMENSIONAL SYSTEMS INC.
393 Totten Pond Rd, Waltham, Mass 02154
- DIPIETRO & WILSON INC.
1107 Commonwealth Ave, Boston, Mass 02215
- DIRECT ACCESS COMPUTING CORP.
984 Livernois Rd, Troy, Mich 48084
- DIVERSIFIED COMPUTER APPLICATIONS
2525 E Bayshore Rd, Palo Alto, Cal 94302
- DUMEY, ARNOLD I.
641 Mt Lucas Rd, Princeton, N J 08540
- DYNAMIC ACCESS CORP.
220 Park Ave S, New York, N Y 10003
- EASTERN COMPUTER SERVICES INC
920 Fox Chase Rd, Rockledge, Pa 19111
- ECONOMIC INFORMATION SYSTEMS INC.
21 W 38 St, New York, N Y 10018
- EDUCATION AND TRAINING CONSULTANTS CO.
P O Box 49899, Los Angeles, Cal 90049
- ELECTROMECH COMPUTING & TECH. SERVICES CO.
2964 Peachtree Rd NW, Atlanta, Ga 30305
- ELECTRON OHIO INC.
1278 W 9th St, Cleveland, Ohio 44113
- ELECTRONIC DATA PREPARATION CORP.
P O Box 1446, Bradenton, Fla 33505
- ELMIRA DATA PROCESSING CO.
221 E Church St, Elmira, N Y 14902
- ENGINEERING TECHNOLOGY ANALYSTS INC.
3310 Richmond Ave, Houston, Tex 77006
- ENTREKIN COMPUTERS INC. SUB. THE CROSS CO.
9475 Center Rd, Fenton, Mich 48430
- ESSEX SYSTEMS CO. INC.
24 Forge St, Jamesburg, N J 08831
- EXPRESS SOFTWARE SYSTEMS INC.
342 Madison Ave, New York, N Y 10017
- FABRI-TEK INFORMATION MANAGEMENT, INC.
5901 S County Rd 18, Edina, Minn 55436
- FEDDER DATA CENTERS MANAGEMENT INC.
1654 Central Ave, Albany, N Y 12205
- FIRST BUSINESS COMPUTING
1020 Houston Bk&Tr Tr, Houston, Tex 77002
- FISHER-STEVENS INC.
120 Brighton Rd, Clifton, N J 07012
- FLORES ASSOCIATES
108 8th Ave, Brooklyn, N Y 11215
- GARRETT GRUNER
1204 First, Jackson, Mich 49203
- GENASYS CORP.
2011 Gye St NW, Washington, D C 20006
- GENESEEE COMPUTER CENTER INC.
20 University Ave, Rochester, N Y 14605
- GOODHEW, J.W. & ASSOCIATES INC.
11600 Nebel St, Rockville, Md 20854
- GREYHOUND COMPUTER CORP.
130 S Canal St, Chicago, Ill 60606
- GTE DATA SERVICES INC.
5422 Bay Center Dr, Tampa, Fla 33609
- GULLEY, DALE L. & ASSOCIATES, INC.
2300 E 14th St, Tulsa, Okla 74104
- HAVERLY SYSTEMS INC.
4 2nd Ave, Denville, N J 07834
- HOLLANDER ASSOCIATES
P O Box 2276, Fullerton, Cal 92633
- HONEYWELL INFORMATION SYSTEMS INC. INFO. SERV.DIV
2701 4th Ave S, Minneapolis, Minn 55408
- HOUSING DATA CORP.
29433 Southfield Rd, Southfield, Mich 48075
- HOUSING DATA CORP.
23400 Michigan, Dearborn, Mich 48124
- HOUSTON ENGINEERING RESEARCH CORP.
P O Box 35495, Houston, Tex 77035
- HOWARD ASSOC. INC., DANIEL D.
307 N Michigan Ave, Chicago, Ill 60601
- HRB-SINGER INC.
Science Park, State College, Pa 16801
- HUB RATLIFF CONSULTANT
P O Box 22487, Houston, Tex 77027
- ICM COMPUTER CORP.
P O Box 7220, Tulsa, Okla 74105
- INDECON INC.
30 N Lasalle St, Chicago, Ill 60602
- INFODATA SYSTEMS INC.
680 Ridge Rd, Webster, N Y 14580
- INFONET SYSTEMS INC.
358 McKinley Blvd, Paramus, N J 07652
- INFORMATICS INC.
21050 Vanover St, Canoga Park, Cal 91303
- INFORMATION DEVELOPMENT ASSOCIATES INC.
P O Box 2285, Bethlehem, Pa 18018
- INFORMATION MACHINES CORP.
8811 Cuyamaca St, Santee, Cal 92071
- INFORMATION MANAGEMENT INC.
447 Battery St, San Francisco, Cal 94111
- INFORMATION SCIENCES INC.
14 Jefferson Blvd, Warwick, R I 02888
- INFORMATION SERVICES INC.
90 Broad St, Babson Park, Mass 02157
- INFORMATION SYSTEMS MANAGEMENT
120 Montgomery St, San Francisco, Cal 94104
- INFOSCI INC.
P O Box 464, Menlo Park, Cal 94025
- INFOTON INC.
2nd Ave, Burlington, Mass 01803
- INNOVATIVE SOFTWARE INC.
486 Totten Pond Rd, Waltham, Mass 02154
- INPUT INC.
500 Old Elm Rd, Highland Park, Ill 60035
- INSTITUTE FOR CYBERNETIC DEVELOPMENT
3031 Bateman St, Berkeley, Cal 94705
- INTECH INC.
2915 Wayzata Blvd, Minneapolis, Minn 55405
- INTERACTIVE SCIENCES CORP.
60 Brook Dr, Braintree, Mass 02184
- INTERNATIONAL COMPUTER CORP.
1 N Broadway, White Plains, N Y 10601
- INTERNATIONAL DATA APPLICATIONS INC.
100 Main St, Reading, Mass 08167
- INTERNATIONAL SYSTEMS ASSOCIATES, LTD.
350 5th Ave, New York, N Y 10001
- INTERNATIONAL TELECOMPUTER NETWORK CORP.
4919 Fairmont Ave, Bethesda, Md 20014
- INTERNATIONAL TELECONTROL CORP.
4300 Pine St, Wilmington, Del 19802
- INTERNATIONAL TIMESHARING CORP.
Its Bldg Jonathan Ind, Chaska, Minn 55318
- ITT DATA SERVICES
7822 Bonhomme, St Louis, Mo 63105
- ITT DATA SERVICES DIV.
P O Box 402, Paramus, N J 07652
- JACKSON ASSOCIATES
4663 Executive Dr, Columbus, Ohio 43220
- JONES & CO., GAYLE W.
3846 E 14th St, Oakland, Cal 94601
- KEYSTONE COMPUTER ASSOCIATES INC.
1055 Virginia Dr, Ft Washington, Pa 19034
- KRANZLEY & CO. INC. ARTHUR S.
1010 S Kings Hwy, Cherry Hill, N J 08034
- LEASCO DATA PROCESSING EQUIPMENT CORP.
280 Park Ave, New York, N Y 10017
- LEVER DATA PROCESSING SERVICES, INC.
390 Park Ave, New York, N Y 10022
- LIMITED FOURS UNLIMITED
1030 13th St, Boulder, Colo 80302
- LITTON SYSTEMS INC. MELLONICS DIV.
1001 W Maude Ave, Sunnyvale, Cal 94086
- LOCKHEED ELECTRONICS DATA MANAGEMENT SERVICES
16811 El Camino Real, Houston, Tex 77058
- LOCKHEED ELECTRONICS CO. DIV. LOCKHEED ACRFT CORP
U S Hwy 22, Plainfield, N J 07060
- LOGIC INC.
1712 Commerce St, Dallas, Tex 75201
- LOGICON INC.
Del Amo Financial Ctr, Torrance, Cal 90503
- MACRO CORP.
1260 Virginia Dr, Ft Washington, Pa 19034
- MANAGEMENTICS INC.
2 Pennsylvania Plaza, New York, N Y 10001
- MANAGEMENT & COMPUTER SERVICES INC.
104 Park Towne Pl E, Philadelphia, Pa 19130
- MANAGEMENT COMPUTER CONTROLS INC.
3385 Airway Blvd., Memphis, Tenn 38116
- MANAGEMENT CONCEPTS INC.
2 Decker Sq, Bala-Cynwyd, Pa 19004
- MANAGEMENT REPORTING SERVICES INC.
5929 E 38th Ave, Denver, Colo 80207
- MANAGEMENT SCIENCE AMERICA INC.
1389 Peachtree St NE, Atlanta, Ga 30309
- MANAGEMENT SCIENCE SYSTEMS INC.
1530 E Jefferson St, Rockville, Md 20852
- MANAGEMENT SYSTEMS CORP.
7007 Preston Rd, Dallas, Tex 75205
- MARCOM INC.
30 E 42nd St, New York, N Y 10017
- MARK COMPUTER SYSTEMS INC.
One Patterson Pl, Garden City, N Y 11530
- MASTECH COMPUTER SYSTEMS INC.
7026 W North Ave, Chicago, Ill 60635
- MATRIX CORP., THE
931 S Douglas St, El Segundo, Cal 90245
- MC AULIFFE ASSOC. INC., JOHN INC.
1181 Broadway, New York, N Y 10001
- MCDILL CORP.
P O Box 98, Montgomery, Ala 36101
- MCDONNELL AUTOMATION CO.
500 Jefferson Bldg, Houston, Tex 27002
- MCDONNELL AUTOMATION CO.
360 W Federal Savings, Denver, Colo 80202
- MCDONNELL AUTOMATION CO.
P O Box 516, St Louis, Mo 63166
- META-LANGUAGE PRODUCTS INC.
4 E 43 St, New York, N Y 10017
- METRIDATA COMPUTING INC.
6600 Grade Lane, Louisville, Ky 40221
- MICRO SYSTEMS INC.
644 E Young St, Santa Ana, Cal 92705
- MICROFORM DATA SYSTEMS INC.
830 Maude Ave, Mountain View, Cal 94040
- MICROMATON SYSTEMS INC.
3610 East St, Landover, Md 20785
- MILNEE BROTHERS PRODUCTS
8000 Blackburn Ave, Los Angeles, Cal 90048
- MNMOTTECH COMPUTER SYSTEMS
55 Liberty St, New York, N Y 10005
- MOBILITY SYSTEMS D P SERVICES DEPT.
3530 De La Cruz Blvd, Santa Clara, Cal 95050
- MOSLER SAFE CO., THE INFO. SYS. DIV.
1561 Grand Blvd., Hamilton, Ohio 45012
- MULTICOMP INC.
36 Washington St, Wellesley Hills, Mass 02181
- NATIONAL C.S.S.
460 Summer St, Stamford, Conn 06901
- NATIONAL COMPUTER ANALYSTS INC.
Us Hwy 1, Princeton, N J 08540
- NATIONAL INFORMATION SYSTEMS CORP.
150 Allendale Rd, Valley Forge, Pa 19481
- NEOTERIC INC.
2800 Euclid Ave, Cleveland, Ohio 44115
- NETWORK DATA PROCESSING CORP.
823 Commerce Dr, Oak Brook, Ill 60521
- NORDEN DIV., UNITED AIRCRAFT CORP.
Helen St, Norwalk, Conn 06850
- ON-LINE SYSTEMS INC.
4721 Mc Knight Rd, Pittsburg, Pa 15237
- OPERATIONS RESEARCH INC.
1400 Spring St, Silver Spring, Md 20910
- PANSOPHIC SYSTEMS INC.
230 Roosevelt Rd, Lombard, Ill 60148
- PAPERWORK DATA COMM. SERVICES INC.
1703 S Ave, Syracuse, N Y 13207
- PARSONS & WILLIAMS, INC.
Nyrupsgade 43, 1602 Copenhagen, DENMARK
- PAYMENT SYSTEMS INC.
405 Lexington Ave, New York, N Y 10017
- PENNDATA CORP.
1729 Cedar Ave, Scranton, Pa 18505
- PHI COMPUTER SERVICES INC.
800 Massachusetts Ave, Arlington, Mass 02174
- PHILCO-FORD CORP., COMPUTER SERVICES NETWORK
Tioga & C Sts, Philadelphia, Pa 19134
- PIONEER DATA SYSTEMS INC.
606 Merle Hay Tower, Des Moines, Iowa 50310
- PLANNING RESEARCH CORP.
1100 Glendon Ave, Los Angeles, Cal 90024
- PRINCETON INFORMATRIX INC.
1 Palmer Sq, Princeton, N J 08540
- PRINCETON TIME SHARING SERVICES, INC.
Us Hwy 1, Princeton, N J 08540
- PROFIMATICS INC.
6355 Topanga Canyon, Woodland Hills, Cal 91364
- PROGRAMMING SCIENCES CORP.
S E 42 St, New York, N Y 10016
- PROGRAMMING SCIENCES CORP.
1900 Ave of The Stars, Los Angeles, Cal 90067
- PRYOR COMPUTER INDUSTRIES
400 N Michigan Ave, Chicago, Ill 60611
- PUBLIC DATA PROCESSING CORP.
640 N Lasalle St, Chicago, Ill 60610
- QUIKDATA INTERNATIONAL INC.
8444 Wilshire Blvd, Beverly Hills, Cal 90211
- RAYTHEON CO. CADPO OPERATION
1415 Providence Tpk, Norwood, Mass 02062
- REALTIME SYSTEMS INC.
866 3rd Ave, New York, N Y 10022
- REILAND, PAGE & ASSOCIATES INC.
1521 E Broad St, Columbus, Ohio 43205
- REL-QUAL ASSOCIATES INC.
18 Hamilton St, Bound Brook, N J 08805
- REMOTE COMPUTING CORP.
440 Palo Alto Off Ctr, Palo Alto, Cal 94301

2 Product Directory

- REPUBLIC SYSTEMS INC.
100 Plaza Centre, Secaucus, N J 07094
- REPUBLIC SYSTEMS INC.
715 Park Ave, E Orange, N J 07017
- REPUBLIC SYSTEMS OF CONNECTICUT INC.
350 S Main St, Cheshire, Conn 06410
- RIDGEWOOD ASSOCIATES INC.
10 Wilsey Sq, Ridgewood, N J 07450
- SAGE ACTION INC.
P O Box 416, Ithaca, N Y 14850
- SANDERS ASSOCIATES INC. SYSTEMS DIV.
Daniel Webster Hwy S, Nashua, N H 03060
- SARNA ASSOCIATES INC.
22 Russell St, Brookline, Mass 02146
- SCANFORMS INC.
312 Fox Pavilion, Jenkintown, Pa 19095
- SCIENTIFIC CALCULATIONS INC.
110 Allens Creek Rd, Rochester, N Y 14618
- SCIENTIFIC COMPUTERS, INC.,
919 Second Ave S, Minneapolis, Minn 55402
- SCIENTIFIC SOFTWARE CORP.
5300 S Ulster, Englewood, Colo 80110
- SCIENTIFIC SYSTEMS SERVICES INC.
476 N Hwy A1a, Satellite Beach, Fla 32935
- SCIENTIFIC TIME SHARING CORP.
2101 S St NW, Washington, D C 20008
- SCI-TEK COMPUTER CENTER INC.
1707 Gilpin Ave, Wilmington, Del 19806
- SEGALL ASSOCIATES, M. HARVEY
1019 Rust Bldg, Tacoma, Wash 98402
- SERVICE BUREAU CORP., THE
1350 Ave Americas, New York, N Y 10019
- SEVAN COMPUTER SERVICES INC.
Pollitt Dr S, Fair Lawn, N J 07410
- SIERRA RESEARCH CORP. COMPUTER PROD. GRP.
167 Bedford St., Burlington, Mass 01803
- SOFTECH INC.
391 Totten Pond Rd, Waltham, Mass 02154
- SOFTWARE GUIDANCE ASSOCIATES INC.
432 Park Ave S, New York, N Y 10016
- SOFTWARE METHODS INC.
10 E 40th St, New York, N Y 10016
- SOFTWARE PROGRAMMING ASSOCIATES INC.
1209 Tropic St, Titusville, Fla 32780
- SOUTHERN DATA PROCESSING SERVICE INC.
P O Box 123, Augusta, Ga 30903
- SOUTHERN VERMONT COMPUTER CENTER&DATA SCHOOL
219 Belmont Ave, Bennington, Vt 05201
- SPACE TRONICS CO.
43 Hassemer Ave, Cherry Hill, N J 08034
- SPS INC.
4485 N W 36th St, Miami, Fla 33166
- STANDARD PROCESSING CO. INC.
P O Box 703, Pharr, Tex 78577
- SYKES DATA TRONICS INC.
375 Orchard St, Rochester, N Y 14606
- SYNERGISTIC SOFTWARE SYSTEMS, INC.
Po Box 36097, Houston, Tex 77036
- SYSTEM DEVELOPMENT CORP.
2500 Colorado Ave, Santa Monica, Cal 90406
- SYSTEM IMPLEMENTATION CORP.
18 E 48th St, New York, N Y 10017
- SYSTEMATICS INC.
411 Victory, Little Rock, Ark 72201
- SYSTEMS ANALYSIS CO.
9 Office Park Cir, Birmingham, Ala 35223
- SYSTEMS ANALYSIS INC.
11110 N E 8th, Bellevue, Wash 98004
- SYSTEMS ASSOCIATES INC.
356 Penn St, Reading, Pa 19602
- SYSTEMS CONCEPTS INC.
17-45 Clintonville St, Whitestone, N Y 11357
- SYSTEMS GENERAL CORP.
10889 Wilshire Blvd, Los Angeles, Cal 90024
- SYSTEMS, SCIENCE & SOFTWARE INC.
Po Box 1620, La Jolla, Cal 92037
- TECHNOLOGY FOR INFORMATION MANAGEMENT INC.
1654 Central Ave, Albany, N Y 12205
- TECHNOMETRICS INC.
6000 Telegraph Ave, Oakland, Cal 94609
- TELE-DATA CORP.
130 U S Hwy 22, N Plainfield, N J 07060
- TELEDYNE BROWN ENGINEERING
300 Sparkman Dr, Huntsville, Ala 35807
- TIME SHARING SCIENCES INC.
1180 Ave Americas, New York, N Y 10036
- TIME-SHARING SYSTEMS, INC.,
1840 N Farwell Ave, Milwaukee, Wis 53202
- TRACOR COMPUTING CORP.
1705 Guadalupe St, Austin, Tex 78701
- TRAFFIC & DISTRIBUTION SERVICES INC.
30 Boylston St, Cambridge, Mass 02138
- TRAVCOM INC.
1425 E McMillan, Cincinnati, Ohio 45206
- TRAVCOM INC. UNITED DATA PROC DV
70 E 14th St, Eugene, Oreg 97401
- TRILOG ASSOCIATES INC.
1700 Market St, Philadelphia, Pa 19103
- TRW SYSTEMS GROUP SOFTWARE & INFORMATION SYS DIV
1 Space Park, Redondo Beach, Cal 90278
- TURNKEY SYSTEMS INC.
111 E Ave, Norwalk, Conn 06851
- TYMSHARE INC.
1001 Watertown St, West Newton, Mass 02165
- UNITED COMPUTING CORP.
22500 S Avalon Blvd, Carson, Cal 90744
- UNITED COMPUTING SYSTEMS INC.
3130 Broadway, Kansas City, Mo 64111
- UNITED SYSTEMS INC.
1020 Kings Hwy N, Cherry Hill, N J 08034
- UNIVERSAL DATA SYSTEMS INC.
14482 Beach Blvd, Westminster, Cal 92626
- UNIVERSITY COMPUTING CO.
P O Box 6228, Dallas, Tex 75222
- URBAN DATA PROCESSING INC.
552 Massachusetts Ave, Cambridge, Mass 02139
- URS DATA SCIENCE CO.
155 Bovet Rd, San Mateo, Cal 94402
- VIRTUAL COMPUTER SERVICES INC
1119 Springfield Rd, Union, N J 07083
- WARREN ASSOCIATES
15 Royal Crest Dr, Marlboro, Mass 01752
- WELLINGTON COMPUTER SYSTEMS CORP.
405 Lexington Ave, New York, N Y 10017
- WENGL SERVICE CORP.
1101 State Rd, Princeton, N J 08540
- WESTERN OPERATIONS INC.
120 Montgomery St, San Francisco, Cal 94104
- WESTERN UNION TELEPROCESSING CO.
82 McKee Dr, Mahwah, N J 07436
- WESTINGHOUSE ELECTRIC CORP.
Westinghouse Bldg, Pittsburgh, Pa 15222
- WESTINGHOUSE TELE-COMPUTER SYSTEMS CORP.
2040 Ardmore Blvd, Pittsburgh, Pa 15221
- WORLD COMPUTER CORP.
1615 Stemmons Fwy, Dallas, Tex 75221
- WORLDWIDE COMPUTER SERVICES, INC.
280 N Central Pk Ave, Hartsdale, N Y 10530
- XEROX DATA SYSTEMS
701 S Aviation, El Segundo, Cal 90245
- ZENITH INTEGRATED-DATA PROCESSING INC.
950 Fulton Ave, Sacramento, Cal 95825
- ### CONSULTING (SCIENTIFIC APPLICATIONS)
- ABT ASSOCIATES INC. TECHNOLOGY GROUP
55 Wheeler St, Cambridge, Mass 02138
- ACADEMY COMPUTING CORP.
5005 N Lincoln Blvd, Oklahoma City, Okla 73105
- ADAPT INC.
624 S 62nd St, Philadelphia, Pa 19143
- ADVANCED COMPUTER TECHNIQUES CORP.
437 Madison Ave, New York, N Y 10022
- AHART & ASSOC. INC., JAMES R.
225 S Main St, Dayton, Ohio 45402
- ALLEN-BABCOCK COMPUTING INC.
1800 Ave of The Stars, Los Angeles, Cal 90067
- AMERICAN COMPUTER SERVICES CORP.
14 E 4th St, Cincinnati, Ohio 45202
- ANACOMP INC.
6161 Hillside Ave, Indianapolis, Ind 46220
- ANALYTIC SCIENCES CORP., THE
6 Jacob Way, Reading, Mass 01867
- ANALYTICS INC.
179 Washington Lane, Jenkintown, Pa 19046
- ANDROCOR INC.
5949 Hohman Ave, Hammond, Ind 46320
- APPLIED COMPUTER SYSTEMS INC.
P O Box 6479, Austin, Tex 78702
- APPLIED COMPUTER TIME SHARE INC.
29200 Southfield Rd, Southfield, Mich 48075
- APPLIED CYBERNETICS CORP.
1285 Forgewood Ave, Sunnyvale, Cal 94086
- APPLIED DIGITAL SYSTEMS INC.
3848 Campus Dr 112, Newport Beach, Cal 92660
- APPLIED GEODATA SYSTEMS INC.
675 Massachusetts Ave, Cambridge, Mass 02139
- APPLIED PROGRAMMING TECHNOLOGY CORP.
275 D Cox St, Hudson, Mass 01749
- ARIES CORP.
1651 Old Meadow Rd, Mc Lean, Va 22101
- AUERBACH ASSOCIATES INC.
121 W Broad St, Philadelphia, Pa 19107
- AUTOMATED INFORMATION SYSTEMS INC.
1064 River Rd, Edgewater, N J 07020
- AUTOMATION SERVICES CORP.
182 Forbes Rd, Braintree, Mass 02184
- AZREX INC.
105 Terrace Hall Ave, Burlington, Mass 01803
- BAGANOFF ASSOCIATES INC.
6809 W Florissant, St Louis, Mo 63136
- BAIRD-ATOMIC INC.
125 Middlesex Tpk, Bedford, Mass 01730
- BASIC COMPUTING ARTS INC.
2680 E Bayshore Frtge, Mt View, Cal 94040
- BECK & ASSOCIATES, R.W.
200 Tower Bldg, Seattle, Wash 98101
- BONNER&MOORE ASSOCIATES INC.
500 Jefferson Bldg, Houston, Tex 77002
- BOOTHE DATA SYSTEMS INC.
485 Lexington Ave, New York, N Y 10001
- BOOTHE RESOURCES INTERNATIONAL INC.
3435 Wilshire Blvd, Los Angeles, Cal 90005
- BRADDOCK, DUNN&MCDONALD INC.
8027 Leesburg Pike, Mc Lean, Va 22101
- BURLINGTON MANAGEMENT SERVICES CO.
P O Box 21207, Greensboro, N C 27420
- C&C COMPUTER SYSTEMS INC.
1006 S E Grand, Portland, Ore 97214
- CALL-A-COMPUTER INC.
633 Young St, Santa Ana, Cal 92702
- CALTEC INC.
1931 Sylvania Ave, Toledo, Ohio 43613
- CAMBRIDGE COMPUTER ASSOCIATES INC.
220 Alewife Brook Pky, Cambridge, Mass 02138
- CHEMICAL MICRO MILLING CO.
1601 Hylton Rd, Pennsauken, N J 08101
- CHI CORP.
11000 Cedar Ave, Cleveland, Ohio 44106
- CHICAGO TABULATING SERV. INC.
425 N Michigan, Chicago, Ill 60611
- COMPAC COMPUTER SYSTEMS INC.
911 Hennepin, Minneapolis, Minn 55403
- COMPACE CORP.
7413 Washington Ave S, Edina-Minnepolis, Minn 55435
- COMPUMATIC SYSTEMS CORP.
5303 Comercio Ln, Woodland Hills, Cal 91364
- COMPUMEDIC CONTROLS CORP.
432 Park Ave S, New York, N Y 10016
- COMPU SYS INC.
Po Box 11104, Albuquerque, N M 87112
- COMPUTATION AND SYSTEMS CORP.
12061 Wilshire Blvd, Los Angeles, Cal 90025
- COMPUTER AID COMPANIES INC.
5925 Forest Lane, Dallas, Tex 75201
- COMPUTER APPLICATIONS CENTER, INC.
516 Hutton Pl, Columbus, Ohio 43215
- COMPUTER COMMAND & CONTROL CO
1717 Penn Ave NW, Washington, D C 20006
- COMPUTER COMMAND AND CONTROLS COMPANY
4025 Chestnut St, Philadelphia, Pa 19104
- COMPUTER CONSULTANTS CORP.
U S Rte 46 E, Denville, N J 07834
- COMPUTER CORP. OF AMERICA
6216 Evergreen St, Houston, Tex 77036
- COMPUTER DIODE CORP.
Pollitt Dr S, Fair Lawn, N J 07410
- COMPUTER GUILD INC.
12 Mercer Rd, Natick, Mass 01760
- COMPUTER INFORMATION SERVICES INC.
6701 N Broad St, Philadelphia, Pa 19126
- COMPUTER MANAGEMENT INC.
3101 Euclid Ave, Cleveland, Ohio 44115
- COMPUTER NETWORK CORP.
5185 Macarthur Blvd, Washington, D C 20016
- COMPUTER PROCESSING INC.
300 6th Ave, Pittsburgh, Pa 15222
- COMPUTER PRODUCTS, INC.
P O Box 23849, Ft Lauderdale, Fla 33307
- COMPUTER PROGRAMMING CONCEPTS INC.
101 Atkinson Sq, Cincinnati, Ohio 45246
- COMPUTER SCIENCES CORP. INFO. NETWORK DIV.
1901 Building, Los Angeles, Cal 90067
- COMPUTER SERVICE OF E. TEXAS
P O Box 5981, Jasper, Tex 75951
- COMPUTER SHARING SERVICES
2492 W 2nd Ave, Denver, Colo 80223
- COMPUTER SYSTEMS CO. INC.
1470 St Charles Ave, Cleveland, Ohio 44107
- COMPUTER SYSTEMS CORP. U.S. INDUSTRIES INC
P O Box 64400, Dallas, Tex 75206
- COMPUTER SYSTEMS FOR MEDICINE INC.
340 Longwood Ave, Boston, Mass 02115
- COMPUTER TECHNOLOGY INC. SUB. UNIV. COMPUTING CO.
P O Box 47911, Dallas, Tex 75247
- COMPUTER TUTOR, THE, DIV. COMPTUT INC.
12 Emerald Court, Commack, N Y 11725

2 Product Directory

- COMPUTER UNIVERSAL CORP.
1641 Universal Rd, Columbus, Ohio 43207
- COMPUTER USAGE CO.
7315 Wisconsin Ave Nw, Washington, D C 20014
- COMPUTER USAGE CO.
387 Elliot St, Newton Uppr Fls, Mass 02164
- COMPUTER USAGE CO.
3181 Porter Dr, Palo Alto, Cal 94304
- COMPUTER USAGE CORP.
100 Putnam Green, Greenwich, Conn 06830
- COMPUTER USAGE CORP.,
8939 S Sepulveda Blvd, Los Angeles, Cal 90045
- COMPUTING & SOFTWARE INC., EAST COAST DIV.
3700 Mt Vernon Ave, Alexandria, Va 22305
- COMPUTING EFFICIENCY INC. COMPUTING EFF. DIV.
35 Orville Dr, Bohemia, N Y 11716
- COMPUTONE SYSTEMS INC.
361 E Paces Ferry Rd, Atlanta, Ga 30305
- COMSERV CORP.
4025 Chestnut St, Philadelphia, Pa 19104
- COMTEK ASSOCIATES
2077 Center Ave, Fort Lee, N J 07024
- CONSAD RESEARCH CORP.
5600 Forward Ave, Pittsburgh, Pa 15217
- CONSENTIVE INC.
3525 Lancaster Ave, Philadelphia, Pa 19104
- CONSUMER SYSTEMS CORP.
15 Spinning Wheel Rd, Hinsdale, Ill 60521
- CONTROL DATA CORP. CEIR PROF. SERV. DIV.
5272 River Rd, Washington, D C 20016
- CONTROL TECHNOLOGY INC.
3450 E Spring St, Long Beach, Cal 90806
- CTC COMPUTER CORP.
1000 Elwell Court, Palo Alto, Cal 94303
- CYBERMATICS INC.
2460 Lemoine Ave, Fort Lee, N J 07024
- CYPHERNETICS CORP., THE
333 Maple Village Ctr, Ann Arbor, Mich 48103
- DACONICS
925 Thompson Pl, Sunnyvale, Cal 94086
- DATA ARCHITECTS INC.
213 3rd Ave, Waltham, Mass 02154
- DATA ENGINEERING ASSOC. INC.
300 Kings Hwy E, Haddonfield, N J 08033
- DATA MANAGEMENT SERVICES INC.
1845 Walnut St, Philadelphia, Pa 19103
- DATA SYSTEMS INC.
434 Stinson Blvd, Minneapolis, Minn 55413
- DATALOGICS INC.
12025 Shakee Blvd, Cleveland, Ohio 44120
- DATAROYAL INC.
Simon St, Nashua, N H 03060
- DECISION SYSTEMS INC.
E 66 Midland Ave, Paramus, N J 07652
- DELMARVA COMPUTER INDUSTRIES INC.
5865 Robert Oliver Pl, Columbia, Md 21043
- DESIGN AUTOMATION INC.
809 Massachusetts Ave, Lexington, Mass 02173
- DESIGNERS & BUILDERS OF INFORMATION SYSTEMS
35 W 53 St, New York, N Y 10019
- DEUSSEN ASSOCIATES INC.
576 Hyannis Dr, Sunnyvale, Cal 94087
- DIGITAL APPLICATIONS INC.
6300 Westpark Ste 150, Houston, Tex 77027
- DIGITAL PROGRAMMING SERVICES INC.
60 Hickory Dr, Waltham, Mass 02154
- DIGITAL SYSTEMS DESIGN
P O Box 305 Fdr Sta, New York, N Y 10022
- DIKEWOOD CORP., THE
1009 Bradbury Dr SE, Albuquerque, N M 87106
- DIMENSIONAL SYSTEMS INC.
393 Totten Pond Rd, Waltham, Mass 02154
- DIRECT ACCESS COMPUTING CORP.
984 Livernois Rd, Troy, Mich 48084
- DYNAMIC ACCESS CORP.
220 Park Ave S, New York, N Y 10003
- EASTERN COMPUTER SERVICES INC.
920 Fox Chase Rd, Rockledge, Pa 19111
- ELECTROMEC COMPUTING & TECH. SERVICES CO.
2964 Peachtree Rd NW, Atlanta, Ga 30305
- ELECTRONIC ASSOCIATES INC.
485 Monmouth Pkwy, W Long Branch, N J 07764
- ELECTRONIC GRAPHICS INC.
2834 W Kingsley Rd, Garland, Tex 75040
- ENGINEERING TECHNOLOGY ANALYSTS INC.
3310 Richmond Ave, Houston, Tex 77006
- FEDDER DATA CENTERS MANAGEMENT INC.
1654 Central Ave, Albany, N Y 12205
- FIRST BUSINESS COMPUTING
1020 Houston Bk&Tr Tr, Houston, Tex 77002
- FLORES ASSOCIATES
108 8th Ave, Brooklyn, N Y 11215
- GAMS & ASSOCIATES INC., T.C.
2222 Morris Ave, Union, N J 07083
- GANNETT, FLEMING, CORDDRY & CARPENTER INC.
P O Box 1963, Harrisburg, Pa 17105
- GARRETT GRUNER
1204 First, Jackson, Mich 49203
- GENERAL APPLIED SCIENCE LABORATORIES INC.
Merrick & Stewart Ave, Westbury, N Y 11590
- GENERAL AUTOMATION INC.
1055 S East St, Anaheim, Cal 92805
- GENESEE COMPUTER CENTER INC.
20 University Ave, Rochester, N Y 14605
- GOODHEW, J.W. & ASSOCIATES INC.
11600 Nebel St, Rockville, Md 20854
- GRAPHICAL TECHNOLOGY CORP.
47-34 33rd St, Long Is Cy, N Y 11101
- GRAY & ASSOCIATES INC., H.J.
2501 Cedar Springs Rd, Dallas, Tex 75201
- GREYHOUND COMPUTER CORP.
130 S Canal St, Chicago, Ill 60606
- GULLEY, DALE L. & ASSOCIATES, INC.
2300 E 14th St, Tulsa, Okla 74104
- HALMAR ELECTRONICS INC.
1544 W Mound St, Columbus, Ohio 43223
- HAVERLY SYSTEMS INC.
4 2nd Ave, Denville, N J 07834
- HONEYWELL INFORMATION SYSTEMS INC. INFO. SERV.DIV
2701 4th Ave S, Minneapolis, Minn 55408
- HOUSING DATA CORP.
23400 Michigan, Dearborn, Mich 48124
- HOUSTON ENGINEERING RESEARCH CORP.
P O Box 35495, Houston, Tex 77035
- HOUSTON RESEARCH INC. SUB. SCI. ELECT.
6001 Gulf Fwy, Houston, Tex 77023
- HRB-SINGER INC.
Science Park, State College, Pa 16801
- HUB RATLIFF CONSULTANT
P O Box 22487, Houston, Tex 77027
- HYDRA COMPUTER CORP.
P O Box 17883, Raleigh, N C 27609
- IAC COMPUTER SYSTEMS INC.
260 Newton Rd, Plainview, N Y 11803
- ICM COMPUTER CORP.
P O Box 7220, Tulsa, Okla 74105
- INFONET SYSTEMS INC.
358 McKinley Blvd, Paramus, N J 07652
- INFORMATICS INC.
21050 Vanover St, Canoga Park, Cal 91303
- INFORMATION DEVELOPMENT ASSOCIATES INC.
P O Box 2285, Bethlehem, Pa 18018
- INFORONICS INC.
146 Main St, Maynard, Mass 01754
- INFOTON INC.
2nd Ave, Burlington, Mass 01803
- INFOTRAN INC.
860 Fifth Ave, New York, N Y 10021
- INNOVATEK ENTERPRISE
Smithfield Rd, Millerton, N Y 12546
- INPUT INC.
500 Old Elm Rd, Highland Park, Ill 60035
- INTECH INC.
2915 Wayzata Blvd, Minneapolis, Minn 55405
- INTERACTIVE SCIENCES CORP.
60 Brook Dr, Braintree, Mass 02184
- INTERNATIONAL COMPUTER CORP.
1 N Broadway, White Plains, N Y 10601
- ITT DATA SERVICES DIV.
P O Box 402, Paramus, N J 07652
- JACKSON ASSOCIATES
4663 Executive Dr, Columbus, Ohio 43220
- KEMPER ENGINEERING CO.
9337 Shoshone Ave, Northridge, Cal 91324
- KENICS SYSTEMS CORP.
125 Harvard St, Cambridge, Mass 02139
- KERN INDUSTRIES
22 Tannery St, Ayer, Mass 01432
- KEYSTONE COMPUTER ASSOCIATES INC.
1055 Virginia Dr, Ft Washington, Pa 19034
- LAHEY COMPUTER SYSTEMS INC.
4747 N 16th St, Phoenix, Ariz 85016
- LEASCO DATA PROCESSING EQUIPMENT CORP.
280 Park Ave, New York, N Y 10017
- LEHIGH VALLEY ELECTRONICS INC.
Po Box 125, Fogelsville, Pa 18051
- LITTON SYSTEMS INC. MELLONICS DIV.
1001 W Maude Ave, Sunnyvale, Cal 94086
- LOCKHEED ELECTRONICS DATA MANAGEMENT SERVICES
16811 El Camino Real, Houston, Tex 77058
- LOGIC INC.
1712 Commerce St, Dallas, Tex 75201
- LOGICON INC.
Del Amo Financial Ctr, Torrance, Cal 90503
- MACNEAL-SCHWENDLER CORP., THE
7442 N Figueroa St, Los Angeles, Cal 90041
- MAGNETIC ARTS CORP.
1310 Industrial Ave, Escondido, Cal 92025
- MANAGEMENTICS INC.
2 Pennsylvania Plaza, New York, N Y 10001
- MANAGEMENT & COMPUTER SERVICES INC.
104 Park Towne Pl E, Philadelphia, Pa 19130
- MANAGEMENT COMPUTER CONTROLS INC.
3385 Airway Blvd., Memphis, Tenn 38116
- MANAGEMENT SCIENCE SYSTEMS INC.
1530 E Jefferson St, Rockville, Md 20852
- MARCOM INC.
30 E 42nd St, New York, N Y 10017
- MATRIX CORP., THE
931 S Douglas St, El Segundo, Cal 90245
- MCDONNELL AUTOMATION CO.
500 Jefferson Bldg, Houston, Tex 27002
- MCDONNELL AUTOMATION CO.
360 W Federal Savings, Denver, Colo 80202
- MCDONNELL AUTOMATION CO.
P O Box 516, St Louis, Mo 63166
- MDC TECHNOLOGY CORP. SUB. MNGMNT. DATA CORP.
530 W St Rd, Warminster, Pa 18974
- MEIER ASSOCIATES
46 White Birch Rd, Ridgefield, Conn 06877
- MELPAR DIV. LTV ELECTROSYSTEMS INC.
7700 Arlington Blvd, Falls Church, Va 22046
- MEMPHIS METHODS & TABULATING SERVICE INC.
56 N Main St, Memphis, Tenn 38103
- METRIDATA COMPUTING INC.
6600 Grade Lane, Louisville, Ky 40221
- MICRO SYSTEMS INC.
644 E Young St, Santa Ana, Cal 92705
- MICROWAVE MAGNETICS INC. MMI INSTRUMENT DIV.
Rte 1, Danvers, Mass 01923
- MILNEE BROTHERS PRODUCTS
8000 Blackburn Ave, Los Angeles, Cal 90048
- MNEMOTECH COMPUTER SYSTEMS
55 Liberty St, New York, N Y 10005
- MOBILITY SYSTEMS D P SERVICES DEPT.
3530 De La Cruz Blvd, Santa Clara, Cal 95050
- MULTICOMP INC.
36 Washington St, Wellesley Hills, Mass 02181
- MULTIDATA INC.
7300 Bolsa Ave, Westminster, Cal 92683
- NATIONAL C.S.S.
460 Summer St, Stamford, Conn 06901
- NATIONAL COMPUTER ANALYSTS INC.
Us Hwy 1, Princeton, N J 08540
- NORDEN DIV., UNITED AIRCRAFT CORP.
Helen St, Norwalk, Conn 06850
- NORTHERN RESEARCH AND ENGINEERING CORP.
219 Vassar St, Cambridge, Mass 02139
- ON-LINE SYSTEMS INC.
4721 Mc Knight Rd, Pittsburgh, Pa 15237
- OPERATIONS RESEARCH INC.
1400 Spring St, Silver Spring, Md 20910
- PENNDATA CORP.
1729 Cedar Ave, Scranton, Pa 18505
- PHI COMPUTER SERVICES INC.
800 Massachusetts Ave, Arlington, Mass 02174
- PHILCO-FORD CORP., COMPUTER SERVICES NETWORK
Tioga & C Sts, Philadelphia, Pa 19134
- PIONEER DATA SYSTEMS INC.
606 Merle Hay Tower, Des Moines, Iowa 50310
- PLANNING RESEARCH CORP.
1100 Glendon Ave, Los Angeles, Cal 90024
- PRC COMPUTER CENTER INC. PLANNING RSCH CORP.
7670 Old Springhouse, McLean, Va 22101
- PRINCETON INFORMATIX INC.
1 Palmer Sq, Princeton, N J 08540
- PROGRAMMING SCIENCES CORP.
S E 42 St, New York, N Y 10016
- PROGRAMMING SCIENCES CORP.
1900 Ave of The Stars, Los Angeles, Cal 90067
- PRYOR COMPUTER INDUSTRIES
400 N Michigan Ave, Chicago, Ill 60611
- QUICKDATA INTERNATIONAL INC.
8444 Wilshire Blvd, Beverly Hills, Cal 90211
- RAMSAY ENGINEERING CO.
707 N Anaheim Blvd, Anaheim, Cal 92805
- RAYTHEON CO. EQUIPMENT DIV.
528 Boston Post Rd, Sudbury, Mass 01776
- REILAND, PAGE & ASSOCIATES INC.
1521 E Broad St, Columbus, Ohio 43205
- REL-QUAL ASSOCIATES INC.
18 Hamilton St, Bound Brook, N J 08805
- ROSENBERG ASSOCIATES, PAUL
330 5th Ave, Pelham, N Y 10803
- SAGE ACTION INC.
P O Box 416, Ithaca, N Y 14850
- SARNA ASSOCIATES INC.
22 Russell St, Brookline, Mass 02146
- SCANFORMS INC.
312 Fox Pavilion, Jenkintown, Pa 19095

2 Product Directory

SCHULTZ INSTRUMENTS INC.
P O Box 13385, Gainesville, Fla 32601
SCIENTIFIC CALCULATIONS INC.
110 Allens Creek Rd, Rochester, N Y 14618
SCIENTIFIC COMPUTER APPLICATIONS INC.
2310 4th Natl Bank Bg, Tulsa, Okla 74119
SCIENTIFIC LEASING INC.
77 Meadowgate, Wethersfield, Conn 06109
SCIENTIFIC MEASUREMENTS INC.
9701 N Kenton, Skokie, Ill 60076
SCIENTIFIC SOFTWARE CORP.
5300 S Ulster, Englewood, Colo 80110
SCIENTIFIC SYSTEMS SERVICES INC.
476 N Hwy A1a, Satellite Beach, Fla 32935
SCI-TEK COMPUTER CENTER INC.
1707 Gilpin Ave, Wilmington, Del 19806
SEVAN COMPUTER SERVICES INC.
Pollitt Dr S, Fair Lawn, N J 07410
SINGER-GENERAL PRECISION KEARFOTT DIV.
1150 McBride Ave, Little Falls, N J 07424
SMITH CORP., A.O. DATA SYSTEMS DIV.
3533 N 27 St, Milwaukee, Wisc 53201
SOFTTECH INC.
391 Totten Pond Rd, Waltham, Mass 02154
SOFTWARE ASSOCIATES INC.
501 S 1st Ave Ste O, Arcadia, Cal 91006
SOFTWARE GUIDANCE ASSOCIATES INC.
432 Park Ave S, New York, N Y 10016
SOFTWARE PROGRAMMING ASSOCIATES INC.
1209 Tropic St, Titusville, Fla 32780
SOUTHERN SIMULATION SERVICES INC.
P O Box 1155, Tampa, Fla 33601
SPACETRONICS CO.
43 Hassemer Ave, Cherry Hill, N J 08034
SYKES DATATRONICS INC.
375 Orchard St, Rochester, N Y 14606
SYSTEMS ANALYSIS CO.
9 Office Park Cir, Birmingham, Ala 35223
SYSTEMS ANALYSIS INC.
11110 N E 8th, Bellevue, Wash 98004
SYSTEMS RESEARCH ASSOCIATES, INC.
27 W 67th St, New York, N Y 10023
SYSTEMS RESEARCH LABS, INC.
7001 Indian Ripple Rd, Dayton, Ohio 45440
SYSTEMS, SCIENCE & SOFTWARE INC.
Po Box 1620, La Jolla, Cal 92037
SYSTREX CORP.
303 Child St, Rochester, N Y 14611
TECHNOLOGY FOR INFORMATION MANAGEMENT INC.
1654 Central Ave, Albany, N Y 12205
TECHNOMETRICS INC.
6000 Telegraph Ave, Oakland, Cal 94609
TEVCO INC.
3260 J St, Sacramento, Cal 95816
THEORY ANALYSIS GROUP
22 E Elm St, Chicago, Ill 60611
TIME SHARING SCIENCES INC.
1180 Ave Americas, New York, N Y 10036
TIME ZERO CORP.
3530 Torrance Blvd, Torrance, Cal 90510
TIME-SHARING SYSTEMS, INC.
1840 N Farwell Ave, Milwaukee, Wis 53202
TRACOR COMPUTING CORP.
1705 Guadalupe St, Austin, Tex 78701
TRACOR DATA SYSTEMS INC.
4201 Ed Bluestein Blv, Austin, Tex 78721
TRANS-DATA SYSTEMS
6394 Freeport B, Sacramento, Cal 95822
TRW SYSTEMS GROUP SOFTWARE & INFORMATION
SYS DIV
1 Space Park, Redondo Beach, Cal 90278
TURNKEY SYSTEMS INC.
111 E Ave, Norwalk, Conn 06851
TYMSHARE INC.
1001 Watertown St, West Newton, Mass 02165
U.S. TIME-SHARING INC.
1831 Michael Faraday, Reston, Va 22070
UNIVERSAL DATA SYSTEMS INC.
14482 Beach Blvd, Westminster, Cal 92626
UNIVERSITY COMPUTING CO.
P O Box 6228, Dallas, Tex 75222
UTILITY CONSULTING SERVICES CO.
888 N Sepulveda Blvd, El Segundo, Cal 90245
VIRTUAL COMPUTER SERVICES INC
1119 Springfield Rd, Union, N J 07083
VOICEPRINT LABORATORIES DIV. OF FARRINGTON
68 Finderne Ave, Somerville, N J 08876
WARREN ASSOCIATES
15 Royal Crest Dr, Marlboro, Mass 01752
WELLINGTON COMPUTER SYSTEMS CORP.
405 Lexington Ave, New York, N Y 10017
WESTINGHOUSE ELECTRIC CORP.
Westinghouse Bldg, Pittsburgh, Pa 15222
WESTINGHOUSE TELE-COMPUTER SYSTEMS CORP.
2040 Ardmore Blvd, Pittsburgh, Pa 15221

WORLDWIDE COMPUTER SERVICES, INC.
280 N Central Pk Ave, Hartsdale, N Y 10530
XEROX DATA SYSTEMS
701 S Aviation, El Segundo, Cal 90245

CONTAINERS, DISK PACK STORAGE

ACRATOD COMPANY
Po Box 66847, Houston, Tex 77006
BARRY-WRIGHT CORP. WRIGHT LINE DIV.
160 Gold Star Blvd, Worcester, Mass 01606
COMPUTER ACCESSORIES CO.
131 W 154th St, Gardena, Cal 90248
CUSTOM MATERIALS INC.
Alpha Industrial Park, Chelmsford, Mass 01824
DATA PACKAGING CORP.
205 Broadway, Cambridge, Mass 02139
DATA TECHNOLOGY CORP., PLASTRONICS DIV.
1600 Las Plumas Ave, San Jose, Cal 95133
MONARCH METAL PRODUCTS INC.
Mac Arthur Ave, New Windsor, N Y 12550
MOSLER SAFE CO., THE INFO. SYS. DIV.
1561 Grand Blvd., Hamilton, Ohio 45012
OCHMAN SYSTEMS, EDWARD
Po Box 141, Fairfield, Conn 06430
ORIGINAL COMPUTER PRODUCTS INC.
204 Worcester St, Wellesley Hills, Mass 02181
SCHWAB SAFE CO. INC.
3000 Main St, Lafayette, Ind 47902
STINAFFS INC.
181 E Exchange St, Akron, Ohio 44304
TAB PRODUCTS
2690 Hanover St, Palo Alto, Cal 94304

CONTAINERS, PAPER TAPE STORAGE

ACME VISIBLE RECORDS INC.
510 Allview Dr, Crozet, Va 22932
ACRATOD COMPANY
Po Box 66847, Houston, Tex 77006
BARRY-WRIGHT CORP. WRIGHT LINE DIV.
160 Gold Star Blvd, Worcester, Mass 01606
COMPUTER ACCESSORIES CO.
131 W 154th St, Gardena, Cal 90248
CUSTOM MATERIALS INC.
Alpha Industrial Park, Chelmsford, Mass 01824
ENDLESS TAPE REEL CO.
81 Haven St, Reading, Mass 01867
ICA CORP.
200 N 3rd St, Minneapolis, Minn 55401
INTERNATIONAL COMPUTER APPLIANCES CORP.
200 N Third St, Minneapolis, Minn 55401
NUMERIDEX TAPE SYSTEMS INC.
4711 W North Ave, Chicago, Ill 60639
OCHMAN SYSTEMS, EDWARD
Po Box 141, Fairfield, Conn 06430
ORIGINAL COMPUTER PRODUCTS INC.
204 Worcester St, Wellesley Hills, Mass 02181
SCHWAB SAFE CO. INC.
3000 Main St, Lafayette, Ind 47902
SMITH INC., JAY
292 E State St, Westport, Conn 06880
STINAFFS INC.
181 E Exchange St, Akron, Ohio 44304
TAB PRODUCTS
2690 Hanover St, Palo Alto, Cal 94304

CONTROL CONSOLES (SEE CONSOLES)

CONTROLLERS, MAGNETIC DISC

AMERICAN COMPUTER TECHNOLOGY INC.
8740 Shirley Ave, Northridge, Cal 91324
AMERICAN REGITEL CORP.
870 Industrial Way, San Carlos, Cal 94070
BEDFORD ASSOCIATES INC.
P O Box 327, Bedford, Mass 01730
BFA CORP.
1309 S Inca, Denver, Colo 80223
BRYANT COMPUTER PRODUCTS DIV. EX-CELL-O CORP
850 Ladd Rd, Walled Lake, Mich 48088
BURROUGHS CORP., OEM PRODUCT SALES
1649 Wilshire Blvd, Los Angeles, Cal 90017
CALIFORNIA COMPUTER PRODUCTS INC.
2411 W La Palma Ave, Anaheim, Cal 92801
CENTURY DATA SYSTEMS INC.
1630 S St Collg Blvd, Anaheim, Cal 92806
COMPUTER PERIPHERALS CORP.
5037 Ruffner St, San Diego, Cal 92111
CYBERMATION INC.
P O Box 58 River Rd, Washngtn Xing, Pa 18977

DACONICS
925 Thompson Pl, Sunnyvale, Cal 94086
DATA DISC INC.
686 W Maude Ave, Sunnyvale, Cal 94086
DATA GENERAL CORP.
Rte 9, Southboro, Mass 01772
DATA PRODUCTS CORP.
16055 Ventura Blvd, Encino, Cal 91316
DATA PRODUCTS CORP. SYSTEMS DIV.
6219 Desoto Ave, Woodland Hills, Cal 91364
DATA SYSTEMS DESIGN INC.
1122 University Ave, Berkeley, Cal 94702
DATASERV DIV., WILLIAM J. PURDY CORP.
770 Airport Blvd, Burlingame, Cal 94010
DIGITAL SCIENTIFIC CORP.
11455 Sorrento Vly Rd, San Diego, Cal 92121
DIGITRON CORP.
2544 W Main St, Norristown, Pa 19401
DISCOM INC., SUB. MAGNAFILE, COMDISK
P O Box 231, Mesa, Ariz 85201
DYNACOUSTICS INC.
1980 National Ave, Hayward, Cal 94545
DYNALEX INC.
885 Front St, Burbank, Cal 91502
ELDORADO ELECTRODATA
601 Chalomar Rd, Concord, Cal 94520
ELECTRONIC ENGRG. CO. OF CAL. COMPUTER EQUIP
DIV
1601 E Chestnut Ave, Santa Ana, Cal 92702
GENERAL AUTOMATION INC.
1055 S East St, Anaheim, Cal 92805
GENERAL INSTRUMENT CORP. MAGNE-HEAD DIV.
13040 Cerise Ave, Hawthorne, Cal 90250
HEWLETT PACKARD CO. CUPERTINO DIV.
1100 Wolfe Rd, Cupertino, Cal 95014
HONEYWELL INFORMATION SYSTEMS
P O Box 12313, Oklahoma City, Okla 73112
IBM CORP., DATA PROCESSING DIV.
1133 Westchester Ave, White Plains, N Y 10604
INFORMATION DATA SYSTEMS INC.
7550 Walnut Lake Rd, Walled Lake, Mich 48088
INFORMATION STORAGE SYSTEMS
10435 N Tantau Ave, Cupertino, Cal 95014
IOMEC INC.
345 Mathew St, Santa Clara, Cal 95050
KDI INTERACTIVE DATA SYSTEMS
17785 Skypark Circle, Irvine, Cal 92664
KEMPER ENGINEERING CO.
9337 Shoshone Ave, Northridge, Cal 91324
MAGNAFILE INC.
2602 E Magnolia, Phoenix, Ariz 85034
MANZANO LABORATORIES INC.
146 Quincy N E, Albuquerque, N M 87108
MEMOREX EQUIPMENT GROUP
San Tomas At Central, Santa Clara, Cal 95052
MEMORY TECHNOLOGY INC.
83 Boston Post Rd, Sudbury, Mass 01776
MICRO SYSTEMS INC.
644 E Young St, Santa Ana, Cal 92705
MICRODATA CORP.
644 E Young St, Santa Ana, Cal 92705
MULTIDATA INC.
7300 Bolsa Ave, Westminster, Cal 92683
NCR INDUSTRIA PRODUCTS DIV.
Main And K St, Dayton, Ohio 45409
NIGITRON CORP.
2544 W Main St, Norristown, Pa 19401
NORTH AMERICAN ROCKWELL CORP. AUTONETICS
DIV.
3370 Miraloma Ave, Anaheim, Cal 92803
PERIPHERAL DATA MACHINES INC.
102 New S Rd, Hicksville, N Y 11801
PERIPHERALS GENERAL, INC.
Cherry Hill Ind Pk, Cherry Hill, N J 08034
PURDY CORP., WM. J.
770 Airport Blvd, Burlingame, Cal 94010
RCA COMPUTER SYSTEMS DIV.
200 Forest Ave, Marlboro, Mass 01752
SYSTEM INDUSTRIES INC.
535 Del Rey Ave, Sunnyvale, Cal 94305
SYSTEMS CONCEPTS INC.
524 2nd St, San Francisco, Cal 94107
TALCOTT COMPUTER LEASING CO.
1290 Ave The Americas, New York, N Y 10019
TELEX COMPUTER PRODUCTS
6422 E 41st St, Tulsa, Okla 74135
TEMPO COMPUTERS INC.
1550 S St College Blv, Anaheim, Cal 92806
TIME ZERO CORP.
3530 Torrance Blvd, Torrance, Cal 90510
TRACOR DATA SYSTEMS INC.
4201 Ed Bluestein Blv, Austin, Tex 78721
TRACOR DATA SYSTEMS MARKETING
601 California St, San Francisco, Cal 94108

2 Product Directory

UNICOMP INC.

18219 Parthenia, Northridge, Cal 91324
WABASH COMPUTER CORP. PI DIV.
10202 N 19th St, Phoenix, Ariz 85021
XEBEC SYSTEMS INC.
918 N Rengstorff Ave, Mountain View, Cal 94040
XEROX DATA SYSTEMS
701 S Aviation, El Segundo, Cal 90245

CONTROLLERS, MAGNETIC DRUM

AMERICAN COMPUTER TECHNOLOGY INC.
8740 Shirley Ave, Northridge, Cal 91324
AMERICAN TOTALISATOR CO. UNI-TOTE DIV.
383 Hillen Rd, Towson, Md 21204
BFA CORP.
1309 S Inca, Denver, Colo 80223
BRYANT COMPUTER PRODUCTS DIV. EX-CELL-O CORP
850 Ladd Rd, Walled Lake, Mich 48088
DACONICS
925 Thompson Pl, Sunnyvale, Cal 94086
DATA GENERAL CORP.
Rte 9, Southboro, Mass 01772
DATASERV DIV., WILLIAM J. PURDY CORP.
770 Airport Blvd, Burlingame, Cal 94010
DATUM INC.
170 E Liberty Ave, Anaheim, Cal 92801
DIGITAL SCIENTIFIC CORP.
11455 Sorrento Vly Rd, San Diego, Cal 92121
DIGITRON CORP.
2544 W Main St, Norristown, Pa 19401
DYNACOUSTICS INC.
1980 National Ave, Hayward, Cal 94545
DYNALEX INC.
885 Front St, Burbank, Cal 91502
GENERAL AUTOMATION INC.
1055 S East St, Anaheim, Cal 92805
GENERAL INSTRUMENT CORP. MAGNE-HEAD DIV.
13040 Cerise Ave, Hawthorne, Cal 90250
HEWLETT PACKARD CO. CUPERTINO DIV.
1100 Wolfe Rd, Cupertino, Cal 95014
IBM CORP., DATA PROCESSING DIV.
1133 Westchester Ave, White Plains, N Y 10604
INFORMATION DATA SYSTEMS INC.
7550 Walnut Lake Rd, Walled Lake, Mich 48088
MULTIDATA INC.
7300 Bolsa Ave, Westminster, Cal 92683
NIGITRON CORP.
2544 W Main St, Norristown, Pa 19401
OKI ELECTRIC INDUSTRIES CO. LTD.
875 Ave of Americas, New York, N Y 10001
PURDY CORP., WM. J.
770 Airport Blvd, Burlingame, Cal 94010
RCA COMPUTER SYSTEMS DIV.
200 Forest Ave, Marlboro, Mass 01752
SYSTEMS CONCEPTS INC.
524 2nd St, San Francisco, Cal 94107
TEMPO COMPUTERS INC.
1550 S St College Blv, Anaheim, Cal 92806
TIME ZERO CORP.
3530 Torrance Blvd, Torrance, Cal 90510
UNICOMP INC.
18219 Parthenia, Northridge, Cal 91324

CONTROLLERS, MAGNETIC TAPE

APPLIED COMPUTER SYSTEMS INC.
P O Box 6479, Austin, Tex 78702
BRIGHT INDUSTRIES INC.
1 Maritime Plaza, San Francisco, Cal 94111
BUCODE INC.
175 Engineers Dr, Hauppauge, N Y 11787
CALIFORNIA COMPUTER PRODUCTS INC.
2411 W La Palma Ave, Anaheim, Cal 92801
CONTROL DATA CORP.
8100 34th Ave S, Minneapolis, Minn 55440
DATA GRAPHICS CORP.
8402 Speedway, San Antonio, Tex 78230
DATACOM INC.
40 Lincoln Dr, Ft Walton Beach, Fla 32548
DATASONICS INC.
P O Box 4553, New York, N Y 10017
DATUM INC.
170 E Liberty Ave, Anaheim, Cal 92801
DIGITAL INFORMATION DEVICES INC.
210 Welsh Pool Rd, Lionville, Pa 19353
DYNACOUSTICS INC.
1980 National Ave, Hayward, Cal 94545
DYNALEX INC.
885 Front St, Burbank, Cal 91502
GENERAL AUTOMATION INC.
1055 S East St, Anaheim, Cal 92805
HEWLETT PACKARD CO. MOUNTAIN VIEW DIV.
690 Middlefield Rd, Mtn View, Cal 94040

HONEYWELL INFORMATION SYSTEMS

P O Box 12313, Oklahoma City, Okla 73112
HONEYWELL INFORMATION SYSTEMS
60 Walnut St, Wellesley Hills, Mass 02181
INTERNATIONAL COMPUTER PRODUCTS INC.
P O Box 34484, Dallas, Tex 75234
ITT DEFENSE COMMUNICATIONS DIV.
492 River Rd, Nutley, N J 07110
MANZANO LABORATORIES INC.
146 Quincy N E, Albuquerque, N M 87108
MOBARK INSTRUMENTS CORP.
1038 Evelyn, Sunnyvale, Cal 94086
MULTIDATA INC.
7300 Bolsa Ave, Westminster, Cal 92683
PER DATA
102 New South Rd, Hicksville, N Y 11801
RCA COMPUTER SYSTEMS DIV.
200 Forest Ave, Marlboro, Mass 01752
STORAGE TECHNOLOGY CORP.
P O Box 3524, Boulder, Colo 80303
SYS COMPUTER CORP.
17-25 Dicarolis Court, Hackensack, N J 07601
SYSTEM INDUSTRIES INC.
535 Del Rey Ave, Sunnyvale, Cal 94305
SYSTEMS CONCEPTS INC.
524 2nd St, San Francisco, Cal 94107
TEMPO COMPUTERS INC.
1550 S St College Blv, Anaheim, Cal 92806
XEBEC SYSTEMS INC.
918 N Rengstorff Ave, Mountain View, Cal 94040

CONTROLLERS, MODEM

AMERICAN TOTALISATOR CO. UNI-TOTE DIV.
383 Hillen Rd, Towson, Md 21204
ANALOGIC CORP.
Audubon Rd, Wakefield, Mass 01880
AUTOMATION DEVELOPMENT CO. DIV. AMER DIG
CORP.
9903 W Jefferson Blvd, Culver City, Cal 90230
BUNKER RAMO CORP., THE, BUSINESS & IND. DIV
445 Fairfield Ave, Stamford, Conn 06904
BURROUGHS CORP., BUSINESS MACHINES GROUP
6071 2nd Ave, Detroit, Mich 48232
COLLINS RADIO CO.
19700 Jamboree Blvd, Newport Beach, Cal 92663
COLORADO INSTRUMENTS INC.
1 Park St, Broomfield, Colo 80020
COMDATA CORP.
7544 W Oakton St, Niles, Ill 60648
COMMUNICATIONS LOGIC INC.
6400 Westpark, Houston, Tex 77024
COMPACE CORP.
7413 Washington Ave S, Edina-Minneapolis, Minn
55435
COMPUTER AUTOMATION INC.
895 W 16th St, Newport Beach, Cal 92660
COMPUTER CONVERSIONS CORP.
6 Dunton Court, E Northport, N Y 11731
COMPUTER DEVICES INC.
10 Sonar Dr, Woburn, Mass 01801
CONTROL DATA CORP.
8100 34th Ave S, Minneapolis, Minn 55440
CREDIT SYSTEMS INC.
P O Box 105, Colmar, Pa 18915
DACONICS
925 Thompson Pl, Sunnyvale, Cal 94086
DASH DATA SYSTEMS INC.
69 Jefferson St, Stamford, Conn 06902
DATA ACCESS SYSTEMS INC.
503 Rte 10 Mt 19, Dover, N J 07801
DATA CONTROL SYSTEMS INC.
Commerce Dr, Danbury, Conn 06810
DATA GENERAL CORP.
Rte 9, Southboro, Mass 01772
DATA GRAPHICS CORP.
8402 Speedway, San Antonio, Tex 78230
DATA PACIFIC CORP.
116 E Ash, Fullerton, Cal 92631
DATA TRENDS INC.
P O Box 82, Mt Lake, N J 07046
DATA 100 CORP.
7450 France Ave S, Minneapolis, Minn 55435
DATASERV DIV., WILLIAM J. PURDY CORP.
770 Airport Blvd, Burlingame, Cal 94010
DELTA DATA SYSTEMS CORP.
Woodhaven Ind Park, Cornwells Hgts, Pa 19020
DIGI-LOG SYSTEMS INC.
107 W Ridge Pike, Conshohocken, Pa 19428
DIGITAL EQUIPMENT CORP.
146 Main St, Maynard, Mass 01754
ELDORADO ELECTRODATA
601 Chalomar Rd, Concord, Cal 94520

EMR COMPUTER

8001 Bloomington Fwy, Minneapolis, Minn 55420
FUJITSU LTD. N.Y. LIAISON OFFICE
680 Fifth Ave, New York, N Y 10019
GENERAL AUTOMATION INC.
1055 S East St, Anaheim, Cal 92805
GENERAL ELECTRIC CO. COMM. SYS. DIV.
Mountain View Rd, Lynchburg, Va 24502
INTERNATIONAL COMMUNICATIONS CORP., SUB. OF
MILGO
7620 NW 36th Ave, Miami, Fla 33147
ITEL INFORMAMTION PRODUCTS DIV
2585 Bayshore, Palo Alto, Cal 94303
ITT DEFENSE COMMUNICATIONS DIV.
492 River Rd, Nutley, N J 07110
LITTON SYSTEMS INC. DATA SYSTEMS DIV.
8000 Woodley Ave, Van Nuys, Cal 91409
MEMOREX EQUIPMENT GROUP
San Tomas At Central, Santa Clara, Cal 95052
METRIC SYSTEMS CORP.
736 N Beal St, Ft Walton Beach, Fla 32548
MICRO SYSTEMS INC.
644 E Young St, Santa Ana, Cal 92705
MICRODATA CORP.
644 E Young St, Santa Ana, Cal 92705
MILGO ELECTRONIC CORP.
7620 NW 36th Ave, Miami, Fla 33147
NATIONAL MIDCO INDUSTRIES INC.
Box 5433, Trenton, N J 08638
NORTH AMERICAN ROCKWELL CORP. AUTONETICS
DIV.
3370 Miraloma Ave, Anaheim, Cal 92803
OKI ELECTRIC INDUSTRIES CO. LTD.
875 Ave of Americas, New York, N Y 10001
OLIVETTI CORP. OF AMERICA
500 Park Ave, New York, N Y 10016
PERIPHERAL DATA MACHINES INC.
102 New S Rd, Hicksville, N Y 11801
PULSE COMMUNICATIONS INC.
5214 Columbia Pike, Falls Church, Va 22041
PURDY CORP., WM. J.
770 Airport Blvd, Burlingame, Cal 94010
RAYTHEON CO. CADPO OPERATION
1415 Providence Tpk, Norwood, Mass 02062
SYNERGISTICS INC. IKON DATA SYS. DIV.
2619 2nd Ave, Seattle, Wash 98121
TREPAC CORP. OF AMERICA
30 W Hamilton Ave, Englewood, N J 07631
TUCK ELECTRONICS
235 Market St, New Cumberland, Pa 17070
ULTRONIC SYSTEMS CORP.
Mt Laurel Ind Pk, Moorestown, N J 08057
UNICOMP INC.
18219 Parthenia, Northridge, Cal 91324
UNITED BUSINESS COMMUNICATIONS INC.
6405 Metcalf Ave, Shawnee Mission, Kans 66202
UNIVERSITY COMPUTING CO.
P O Box 6228, Dallas, Tex 75222
VARIAN DATA MACHINES
2722 Michelson Dr, Irvine, Cal 92664

CONTROLLERS, MOTOR

ALLEN-BRADLEY
1201 S 2nd St, Milwaukee, Wisc 53204
BABCOCK & WILCOX AUTOMTD MACHINE DIV
950 S Rochester Rd, Rochester, Mich 48063
BULOVA WATCH ELECTRONICS DIV.
6120 Woodside Ave, Woodside Li, N Y 11377
CONTROL TECHNOLOGY CO., INC.
41-16 29th St, Long Island Cty, N Y 11101
DIGI-LOG SYSTEMS INC.
107 W Ridge Pike, Conshohocken, Pa 19428
INFORMATION INSTRUMENT INC.
62 Enterprise Dr, Ann Arbor, Mich 48106
MB ELECTRONICS DIV. TEXTRON INC.
781 Whalley Ave, New Haven, Conn 06515
MEASUREMENT SYSTEMS INC.
523 West Ave, Norwalk, Conn 06850
MILLETRON INC.
540 Alpha Dr, Pittsburgh, Pa 15238
OHMITE MANUFACTURING CO.
3601 Howard St, Skokie, Ill 60076
STRUTHER-DUNN INC. SYSTEMS DIV.
1114 State St, Bettendorf, Iowa 52722
TEXAS INSTRUMENTS INC. CONTROLS DIV.
34 Forest St, Attleboro, Mass 02703
THETA INSTRUMENT CORP.
24 Dwight Pl, Fairfield, N J 07006
TREPAC CORP. OF AMERICA
30 W Hamilton Ave, Englewood, N J 07631
TROTT ELECTRONICS INC.
30 Ridgeland Rd, Rochester, N Y 14623

2 Product Directory

USM CORP. ELECTRONIC CONTROL GROUP
140 Federal St, Boston, Mass 02107
VECTROL INC.
1010 Westmore Ave, Rockville, Md 20850

CONTROLLERS, PLOTTING

APPLIED COMPUTER SYSTEMS INC.
P O Box 6479, Austin, Tex 78702
BOSTON DIGITAL CORP.
Main St, Ashland, Mass 01721
BRISTOL CO., DIV AMERICAN CHAIN & CABLE CO.
Bristol Rd, Waterbury, Conn 06720
CALIFORNIA COMPUTER PRODUCTS INC.
2411 W La Palma Ave, Anaheim, Cal 92801
COMPUTER AUTOMATION INC.
895 W 16th St, Newport Beach, Cal 92660
COMPUTER DEVICES INC.
10 Sonar Dr, Woburn, Mass 01801
COMPUTER MICRO-IMAGE SYSTEMS INC.
9600 Desoto Ave, Chatsworth, Cal 91311
DIMENSIONAL SYSTEMS INC.
393 Totten Pond Rd, Waltham, Mass 02154
GENERAL AUTOMATION INC.
1055 S East St, Anaheim, Cal 92805
GERBER SCIENTIFIC INSTRUMENT CO., THE
P O Box 305, Hartford, Conn 06101
LEEDS & NORTHRUP CO.
Sumney Town Pike, North Wales, Pa 19454
MEASUREMENT SYSTEMS INC.
523 West Ave, Norwalk, Conn 06850
MEMORY TECHNOLOGY INC.
83 Boston Post Rd, Sudbury, Mass 01776
TEKTRONIX INC.
P O Box 500, Beaverton, Ore 97005
TIME SHARE PERIPHERALS CORP.
P O Box 361, Wilton, Conn 06897
TIMESHARE DEVICES INC.
225 Crescent St, Waltham, Mass 02154
WEISMANTEL INC.
P O Box 1957, St Paul, Minn 55111

CONTROLLERS, PUNCHES CARD

SINGER CO., THE, FRIDEN DIV.
2350 Washington St, San Leandro, Cal 94577

CONTROLS, ALARM SYSTEM (SEE DETECTORS)

CONVERTERS, ANALOG-TO-DIGITAL

A.D. DATA SYSTEMS INC.
830 Linden Ave, Rochester, N Y 14625
ADAGE INC.
1079 Commonwealth Ave, Boston, Mass 02109
AIRPAX ELECTRONICS INC.
P O Box 8488, Ft Lauderdale, Fla 33310
AMERICAN ASTRONICS INC., SUB TECHNICAL INC.
855 No Cahuenga Blvd, Hollywood, Cal 90038
AMERICAN DATA SYSTEMS
8851 Mason Ave, Canoga Park, Cal 91306
ANALOG DEVICES INC, PASTORIZA DIV.
221 5th St, Cambridge, Mass 02142
ANALOGIC CORP.
Audubon Rd, Wakefield, Mass 01880
APPLIED COMPUTER SYSTEMS INC.
P O Box 6479, Austin, Tex 78702
ASTROSYSTEMS INC.
6 Nevada Dr, Lake Success, N Y 11040
AUTO-TROL CORP.
6621 W 56th Ave, Arvada, Colo 80002
AVCO CORP. ELECTRONICS DIV.
4807 Bradford, Huntsville, Ala 35805
BALDWIN ELECTRONICS INC.
1101 McAlmont St, Little Rock, Ark 72203
BASIC COMPUTING ARTS INC.
2680 E Bayshore Frtge, Mt View, Cal 94040
BECKMAN INSTRUMENTS INC. ELECT. INSTR. DIV.
2200 Wright Ave, Richmond, Cal 94804
BENDIX CORP., THE, ENVRNMNTL SCI. DIV.
1400 Taylor Ave, Baltimore, Md 21204
BFA CORP.
1309 S Inca, Denver, Colo 80223
BOWMAR INSTRUMENT CORP. ELECTRONIC SYS. DIV.
800 Bluffton Rd, Fort Wayne, Ind 46809
BURR-BROWN RESEARCH CORP.
6730 S Tucson Blvd, Tucson, Ariz 85706
CAMBRIDGE THERMIONIC CORP.
445 Concord Ave, Cambridge, Mass 02138
CLIFTON DIV. LITTON SYSTEMS INC.
Marple At Broadway, Clifton Heights, Pa 19018

COLLINS RADIO CO.
1200 N Alma Rd, Dallas, Tex 75207
COLUMBIA COMPONENTS CORP.
60 Madison Ave, Hempstead, N Y 11550
COMPUTER CONVERSIONS CORP.
6 Dunton Court, E Northport, N Y 11731
COMPUTER CORP. OF AMERICA
6216 Evergreen St, Houston, Tex 77036
COMPUTER LABS INC.
1109 S Chapman St, Greensboro, N C 27403
COMPUTER PRODUCTS, INC.
P O Box 23849, Ft Lauderdale, Fla 33307
CONRAC CORP. NEW JERSEY DIV.
Sherwood Ln, Fairfield, N J 07006
CONRAC CORP. INSTRUMENT/ CONTROLS DIV.
1600 S Mountain Ave, Duarte, Cal 91010
CONTROL DATA CORP.
8100 34th Ave S, Minneapolis, Minn 55440
CONTROL EQUIPMENT CORP.
32 Kearney Rd, Needham Heights, Mass 02194
CONTROL LOGIC INC.
3 Strathmore Rd, Natick, Mass 01760
CONTROL TECHNOLOGY CO., INC.
41-16 29th St, Long Island Cty, N Y 11101
DATA GENERAL CORP.
Rte 9, Southboro, Mass 01772
DATA TECHNOLOGY CORP.
1050 E Meadow Cir, Palo Alto, Cal 94303
DATACOM INC.
40 Lincoln Dr, Ft Walton Beach, Fla 32548
DATASCAN INC.
1111 Paulison Ave, Clifton, N J 07013
DATAWEST CORP.
7503 E Osborn Rd, Scottsdale, Ariz 85251
DATEL/VARADYNE
1020 Turnpike St, Canton, Mass 02021
DATUM INC.
170 E Liberty Ave, Anaheim, Cal 92801
DDC DIV. SOLID STATE SCIENTIFIC DEVICES
100 Tec St, Hicksville, N Y 11801
DIGILIN, INC.
1007 Air Way, Glendale, Cal 91201
DIGITAL EQUIPMENT CORP.
146 Main St, Maynard, Mass 01754
DIGITAL PRODUCTS CORP.
6950 NW 12 Ave, Ft Lauderdale, Fla 33309
DIGITAL RESOURCES CORP.
6250 W Park Suite 100, Houston, Tex 77027
DIGITRON CORP.
2544 W Main St, Norristown, Pa 19401
DYNALOX INC.
885 Front St, Burbank, Cal 91502
DYNAMIC MEASUREMENTS CORP.
6 Lowell Ave, Winchester, Mass 01890
DYNAMIC SYSTEM ELECTRONICS
1040 W Alameda Dr, Tempe, Ariz 85281
DYTRO CORP.
63 Tec St, Hicksville, N Y 11801
ELBIT COMPUTERS/SUB. CONTROL DATA CORP.
6 Tovim St, Haifa, ISRAEL
ELECTRONIC ENGRG. CO. OF CAL. ELECTRONIC PRD. DIV.
1441 E Chestnut Ave, Santa Ana, Cal 92702
ELECTRONIC MODULES CORP.
P O Box 141, Timonium, Md 21093
ELECTRONIC RESEARCH CO., A TEXTRON CO.
10000 W 75th St, Shawnee Mission, Kan 66202
FARRAND CONTROLS INC.
99 Wall St, Valhalla, N Y 10595
FLUKE, JOHN MFG. CO. INC.
P O Box 7428, Seattle, Wash 98133
FOXBORO CO., THE
Neponset Ave, Foxboro, Mass 02035
GAP INSTRUMENT CORP.
110 Marcus Blvd, Hauppauge, N Y 11787
GENERAL AUTOMATION INC.
1055 S East St, Anaheim, Cal 92805
GENERAL DEVICES INC.
P O Box 253, Princeton, N J 08540
GENERAL DYNAMICS CORP. ELECTRONICS DIV.
P O Box 2566, Orlando, Fla 32802
GRALEX INDUSTRIES DIV. GENL.MICROWAVE CORP
155 Marine St, Farmingdale, N Y 11735
GULTON INDUSTRIES INC.
212 Durham Ave, Metuchen, N J 08840
HALEX INC.
3500 W Torrance Blvd, Torrance, Cal 90509
HALMAR ELECTRONICS INC.
1544 W Mound St, Columbus, Ohio 43223
HELIPOT DIV. BECKMAN INSTRUMENTS INC.
2500 Harbor Blvd, Fullerton, Cal 92634
HEWLETT PACKARD CO.
1501 Page Mill Rd, Palo Alto, Cal 94304
HEWLETT PACKARD CO. CUPERTINO DIV.
1100 Wolfe Rd, Cupertino, Cal 95014

HICKOK ELECTRICAL INSTRUMENT CO.
10514 Dupont Ave, Cleveland, Ohio 44108
HONEYWELL INFORMATION SYSTEMS
60 Walnut St, Wellesley Hills, Mass 02181
HUGHES AIRCRAFT CO. M O S DIV.
500 Superior Ave, Newport Beach, Cal 92660
HYCOMP INC.
146 Main St, Maynard, Mass 01754
INFORMATION CONTROL CORP.
9610 Bellanca Ave, Los Angeles, Cal 90045
INNOVATEK ENTERPRISE
Smithfield Rd, Millerton, N Y 12546
LANGER ELECTRONICS CORP.
1416 W Main St, Norristown, Penn 19401
LEAR SIEGLER INC. CIMRON DIV.
1152 Morena Blvd, San Diego, Cal 92110
LECROY RESEARCH SYSTEMS CORP.
126 N Rte 303, W Nyack, N Y 10994
LEEDS & NORTHRUP CO.
Sumney Town Pike, North Wales, Pa 19454
LEM INSTRUMENT CORP.
20 Sarah Dr, Farmingdale, N Y 11735
LITTON SYSTEMS INC. DATA SYSTEMS DIV.
8000 Woodley Ave, Van Nuys, Cal 91409
LITTON SYSTEMS INC. ENCODER DIV.
20745 Nordoff St, Chatsworth, Cal 91311
MB ELECTRONICS DIV. TEXTRON INC.
781 Whalley Ave, New Haven, Conn 06515
MEASUREMENT SYSTEMS INC.
523 West Ave, Norwalk, Conn 06850
MICROWAVE MAGNETICS INC. MMI INSTRUMENT DIV.
Rte 1, Danvers, Mass 01923
MILLETRON INC.
540 Alpha Dr, Pittsburgh, Pa 15238
MODULAR COMPUTER SYSTEMS
2709 N Dixie Hwy, Ft Lauderdale, Fla 33308
MONITOR LABS INC.
10451 Roselle, San Diego, Cal 92121
MONSANTO CO. ELECTRONIC PDTS. & CONTROLS DIV.
11636 Administration, St Louis, Mo 63141
MOTOROLA INC. CONTROL SYSTEMS DIV
P O Box 5409, Phoenix, Ariz 85010
NATIONAL SEMICONDUCTOR CORP.
2900 Semicon Dr, Santa Clara, Cal 95051
NATIONWIDE ELECTRONIC SYSTEMS INC.
7 N 662 Rte 53, Itasca, Ill 60143
NIGITRON CORP.
2544 W Main St, Norristown, Pa 19401
NON-LINEAR SYSTEMS INC.
P O Box N, Del Mar, Cal 92014
NORDEN DIV., UNITED AIRCRAFT CORP.
Helen St, Norwalk, Conn 06850
NORTH AMERICAN ROCKWELL CORP. AUTONETICS DIV.
3370 Miraloma Ave, Anaheim, Cal 92803
NUCLEAR DATA INC.
P O Box 451, Palatine, Ill 60067
OPTICAL ELECTRONICS INC.
P O Box 11140, Tucson, Ariz 85706
PHOENIX DATA INC.
3384 W Osborn Rd, Phoenix, Ariz 85017
PRECISION MONOLITHICS INC.
1500 Space Park Dr, Santa Clara, Cal 95050
PRESTON SCIENTIFIC INC.
805 E Cerritos Ave, Anaheim, Cal 92805
RAYTHEON CO. EQUIPMENT DIV.
528 Boston Post Rd, Sudbury, Mass 01776
RAYTHEON COMPUTER
2700 S Fairview St, Santa Ana, Cal 92704
RC-95 INC.
2 Westchester Plaza, Elmsford, N Y 10523
REDCOR CORP.
21200 Victory, Woodland Hills, Cal 91364
REO DATA PRODUCTS INC.
7346 Bolsa Ave, Westminster, Cal 92683
ROLM, CORP.
10300 N Tantau, Cupertino, Cal 95014
SCIENTIFIC MEASUREMENTS INC.
9701 N Kenton, Skokie, Ill 60076
SINGER-GENERAL PRECISION KEARFOTT DIV.
1150 McBride Ave, Little Falls, N J 07424
SOLID STATE ELECTRONICS CORP.
15321 Rayen St, Sepulveda, Cal 91343
SOLITRON DEVICES INC.
8808 Balboa Ave, San Diego, Cal 92123
SPACETAC INC.
Burlington Rd, Bedford, Mass 01730
SPRAGUE ELECTRIC CO.
551 Marshall St, N Adams, Mass 01247
SRC DIV. MOXON INC.
2222 Michelson Dr, Newport Beach, Cal 92664
STANDARD LOGIC INC.
1630 S Lyon St, Santa Ana, Cal 92705

2 Product Directory

STELLARMETRICS AN AYDIN CO.
P O Box 719, Santa Barbara, Cal 93102
STRUTHER-DUNN INC. SYSTEMS DIV.
1114 State St, Bettendorf, Iowa 52722
SYSTEMS CONCEPTS INC.
524 2nd St, San Francisco, Cal 94107
SYSTEMS DATA, INC.
1951 W Market St, Akron, Ohio 44313
SYSTREX CORP.
303 Child St, Rochester, N Y 14611
TELEDYNE PHILBRICK NEXUS
Allied Dr At Rte 128, Dedham, Mass 02026
TEMPO INSTRUMENT DIV. ALLEN ELECTRIC&EQUIP.
CO.
9135 Independence Ave, Chatsworth, Cal 91311
THETA INSTRUMENT CORP.
24 Dwight Pl, Fairfield, N J 07006
TOWNER SYSTEMS CO.
1829 Clement Ave, Alameda, Cal 94501
TRANSMAGNETICS INC.
210 Adams Blvd, Farmingdale, N Y 11735
TROTT ELECTRONICS INC.
30 Ridgeland Rd, Rochester, N Y 14623
TUSTIN ELECTRONICS CO.
17942 E Main St, Tustin, Cal 92680
UNICOMP INC.
18219 Parthenia, Northridge, Cal 91324
VARIAN ASSOCIATES GRAPHICS & DATA SYSTEMS
DIV.
611 Hansen Way, Palo Alto, Cal 94303
VERNITRON CORP. MOTOR PRODUCTS DIV.
300 Marcus Blvd, Deer Park, N Y 11729
VIDAR CORP.
77 Ortega Ave, Mountain View, Cal 94040
XEROX DATA SYSTEMS
701 S Aviation, El Segundo, Cal 90245
ZELTEX INC.
1000 Chalomar Rd, Concord, Cal 94520

CONVERTERS, BINARY-TO-DECIMAL

ADDO-X INC. OEM DIV.
437 Madison Ave, New York, N Y 10022
ADVANCED SPACE AGE PRODUCTS
4308 Wheeler Ave, Alexandria, Va 22313
AMERICAN COMPUTER TECHNOLOGY INC.
8740 Shirley Ave, Northridge, Cal 91324
ANALOGIC CORP.
Audubon Rd, Wakefield, Mass 01880
APPLIED COMPUTER SYSTEMS INC.
P O Box 6479, Austin, Tex 78702
ASTROSYSTEMS INC.
6 Nevada Dr, Lake Success, N Y 11040
AVCO CORP. ELECTRONICS DIV.
4807 Bradford, Huntsville, Ala 35805
BECKMAN INSTRUMENTS INC. ELECT. INSTR. DIV.
2200 Wright Ave, Richmond, Cal 94804
BFA CORP.
1309 S Inca, Denver, Colo 80223
BOWMAR INSTRUMENT CORP. ELECTRONIC SYS. DIV
800 Bluffton Rd, Fort Wayne, Ind 46809
CAMBRIDGE THERMIONIC CORP.
445 Concord Ave, Cambridge, Mass 02138
CLIFTON DIV. LITTON SYSTEMS INC.
Marple At Broadway, Clifton Heights, Pa 19018
COMPUTER CONVERSIONS CORP.
6 Dunton Court, E Northport, N Y 11731
COMPUTER CORP. OF AMERICA
6216 Evergreen St, Houston, Tex 77036
CONTROL EQUIPMENT CORP.
32 Kearney Rd, Needham Heights, Mass 02194
DATA GRAPHICS CORP.
8402 Speedway, San Antonio, Tex 78230
DATA TECHNOLOGY CORP.
1050 E Meadow Cir, Palo Alto, Cal 94303
DATASCAN INC.
1111 Paulison Ave, Clifton, N J 07013
DATAWEST CORP.
7503 E Osborn Rd, Scottsdale, Ariz 85251
DIGITAL PRODUCTS CORP.
6950 NW 12 Ave, Ft Lauderdale, Fla 33309
DIGITRON CORP.
2544 W Main St, Norristown, Pa 19401
ELBIT COMPUTERS/SUB. CONTROL DATA CORP.
6 Tovim St, Haifa, ISRAEL
ELECTRONIC ENGRG. CO. OF CAL. ELECTRONIC PRD.
DIV
1441 E Chestnut Ave, Santa Ana, Cal 92702
ELPAC INC.
18651 Von Karman Ave, Irvine, Cal 92664
GAP INSTRUMENT CORP.
110 Marcus Blvd, Hauppauge, N Y 11787
GENERAL INSTRUMENT CORP. MICROELECT. DIV.
600 W John St, Hicksville, N Y 11802

GRALEX INDUSTRIES DIV. GENL.MICROWAVE CORP
155 Marine St, Farmingdale, N Y 11735
INFORMATION CONTROL CORP.
9610 Bellanca Ave, Los Angeles, Cal 90045
LECROY RESEARCH SYSTEMS CORP.
126 N Rte 303, W Nyack, N Y 10994
LEM INSTRUMENT CORP.
20 Sarah Dr, Farmingdale, N Y 11735
METRIC SYSTEMS CORP.
736 N Beal St, Ft Walton Beach, Fla 32548
NATIONWIDE ELECTRONIC SYSTEMS INC.
7 N 662 Rte 53, Itasca, Ill 60143
NIGITRON CORP.
2544 W Main St, Norristown, Pa 19401
NORDEN DIV., UNITED AIRCRAFT CORP.
Helen St, Norwalk, Conn 06850
NORTH AMERICAN ROCKWELL CORP. ACOUSTONICS
DIV.
3370 Miraloma Ave, Anaheim, Cal 92803
RAYTHEON COMPUTER
2700 S Fairview St, Santa Ana, Cal 92704
RC-95 INC.
2 Westchester Plaza, Elmsford, N Y 10523
ROLM, CORP.
10300 N Tantau, Cupertino, Cal 95014
SCIENTIFIC MEASUREMENTS INC.
9701 N Kenton, Skokie, Ill 60076
SINGER-GENERAL PRECISION KEARFOTT DIV.
1150 McBride Ave, Little Falls, N J 07424
SPACETAC INC.
Burlington Rd, Bedford, Mass 01730
SPRAGUE ELECTRIC CO.
551 Marshall St, N Adams, Mass 01247
SRC DIV. MOXON INC.
2222 Michelson Dr, Newport Beach, Cal 92664
STRUTHER-DUNN INC. SYSTEMS DIV.
1114 State St, Bettendorf, Iowa 52722
THETA INSTRUMENT CORP.
24 Dwight Pl, Fairfield, N J 07006
UNICOMP INC.
18219 Parthenia, Northridge, Cal 91324
VERNITRON CORP. MOTOR PRODUCTS DIV.
300 Marcus Blvd, Deer Park, N Y 11729

CONVERTERS, DC-TO-FREQUENCY

AIRPAX ELECTRONICS INC.
P O Box 8488, Ft Lauderdale, Fla 33310
ALTEC DIV., LTV LING ALTEC INC.
1515 So Manchester Av, Anaheim, Cal 92803
ANALOGIC CORP.
Audubon Rd, Wakefield, Mass 01880
ARNOLD MAGNETICS CORP.
P O Box K, Culver City, Cal 90230
ASTROSYSTEMS INC.
6 Nevada Dr, Lake Success, N Y 11040
AVTEL CORP.
1130 E Cypress St, Covina, Cal 91722
BFA CORP.
1309 S Inca, Denver, Colo 80223
BULOVA WATCH ELECTRONICS DIV.
6120 Woodside Ave, Woodside Li, N Y 11377
CAMBRIDGE THERMIONIC CORP.
445 Concord Ave, Cambridge, Mass 02138
CARTER MOTOR CO.
2711 W George St, Chicago, Ill 60618
CLIFTON DIV. LITTON SYSTEMS INC.
Marple At Broadway, Clifton Heights, Pa 19018
COMPUTER CONVERSIONS CORP.
6 Dunton Court, E Northport, N Y 11731
COMPUTER CORP. OF AMERICA
6216 Evergreen St, Houston, Tex 77036
CONTROL EQUIPMENT CORP.
32 Kearney Rd, Needham Heights, Mass 02194
CONTROL TECHNOLOGY CO., INC.
41-16 29th St, Long Island Cty, N Y 11101
DA-TEL RESEARCH CO.
930 N Park Ave, Montrose, Colo 81401
DEL ELECTRONIC CORP.
250 Sandford Blvd, Mt Vernon, N Y 10550
DIGITRON CORP.
2544 W Main St, Norristown, Pa 19401
ELBIT COMPUTERS/SUB. CONTROL DATA CORP.
6 Tovim St, Haifa, ISRAEL
ELECTRIC INDICATOR CO. INC.
195 Danbury Rd, Wilton, Conn 06897
ELECTRO PRODUCTS LABORATORIES INC.
6125 W Howard St, Chicago, Ill 60648
FOXBORO CO., THE
Neponset Ave, Foxboro, Mass 02035
GAP INSTRUMENT CORP.
110 Marcus Blvd, Hauppauge, N Y 11787
HICKOK ELECTRICAL INSTRUMENT CO.
10514 Dupont Ave, Cleveland, Ohio 44108

LORAIN PRODUCTS CORP.
1122 F St, Lordin, Ohio 44052
MICROTRAN COMPANY INC.
145 E Mineola Ave, Valley Stream, N Y 11582
NIGITRON CORP.
2544 W Main St, Norristown, Pa 19401
OPTICAL ELECTRONICS INC.
P O Box 11140, Tucson, Ariz 85706
PLASTIC CAPACITORS INC.
2620 N Clybourn Ave, Chicago, Ill 60614
RC-95 INC.
2 Westchester Plaza, Elmsford, N Y 10523
RHO ENGINEERING CO.
2234 Colby Ave, Los Angeles, Cal 90064
SBD ELECTRONIC SYSTEMS INC.
275 Dixon Ave, Amityville, N Y 11701
SINGER-GENERAL PRECISION KEARFOTT DIV.
1150 McBride Ave, Little Falls, N J 07424
SOLID STATE ELECTRONICS CORP.
15321 Rayen St, Sepulveda, Cal 91343
STATIC PRODUCTS INC.
2511 National Dr, Garland, Tex 75040
TECHNIPOWER INC. SUB. BENRUS CORP.
Benrus Center, Ridgefield, Conn 06877
THETA INSTRUMENT CORP.
24 Dwight Pl, Fairfield, N J 07006
TUSTIN ELECTRONICS CO.
17942 E Main St, Tustin, Cal 92680
VARO INC. STATIC POWER DIV.
1600 Dallas Pkwy, Plano, Tex 75074
VIDAR CORP.
77 Ortega Ave, Mountain View, Cal 94040
WANLASS ELECTRIC CO.
1815 S Ritohey St, Santa Ana, Cal 92705

CONVERTERS, DIGITAL-TO-ANALOG

ADAGE INC.
1079 Commonwealth Ave, Boston, Mass 02109
AIRPAX ELECTRONICS INC.
P O Box 8488, Ft Lauderdale, Fla 33310
AMERICAN ASTRONICS INC., SUB TECHNICALOR INC.
855 No Cahuenga Blvd, Hollywood, Cal 90038
AMERICAN DATA SYSTEMS
8851 Mason Ave, Canoga Park, Cal 91306
ANALOG DEVICES INC. PASTORIZA DIV.
221 5th St, Cambridge, Mass 02142
ANALOGIC CORP.
Audubon Rd, Wakefield, Mass 01880
APPLIED COMPUTER SYSTEMS INC.
P O Box 6479, Austin, Tex 78702
ASTROSYSTEMS INC.
6 Nevada Dr, Lake Success, N Y 11040
AVCO CORP. ELECTRONICS DIV.
4807 Bradford, Huntsville, Ala 35805
BASIC COMPUTING ARTS INC.
2680 E Bayshore Frtge, Mt View, Cal 94040
BENDIX CORP., THE ENVRNMENTL SCI. DIV.
1400 Taylor Ave, Baltimore, Md 21204
BFA CORP.
1309 S Inca, Denver, Colo 80223
BOWMAR INSTRUMENT CORP. ELECTRONIC SYS. DIV
800 Bluffton Rd, Fort Wayne, Ind 46809
BURR-BROWN RESEARCH CORP.
6730 S Tucson Blvd, Tucson, Ariz 85706
CAMBRIDGE THERMIONIC CORP.
445 Concord Ave, Cambridge, Mass 02138
CLIFTON DIV. LITTON SYSTEMS INC.
Marple At Broadway, Clifton Heights, Pa 19018
COLLINS RADIO CO.
1200 N Alma Rd, Dallas, Tex 75207
COLUMBIA COMPONENTS CORP.
60 Madison Ave, Hempstead, N Y 11550
COMPUTER CONVERSIONS CORP.
6 Dunton Court, E Northport, N Y 11731
COMPUTER CORP. OF AMERICA
6216 Evergreen St, Houston, Tex 77036
COMPUTER LABS INC.
1109 S Chapman St, Greensboro, N C 27403
COMPUTER PRODUCTS, INC.
P O Box 23849, Ft Lauderdale, Fla 33307
CONTROL DATA CORP.
8100 34th Ave S, Minneapolis, Minn 55440
CONTROL LOGIC INC.
3 Strathmore Rd, Natick, Mass 01760
CONTROL TECHNOLOGY CO., INC.
41-16 29th St, Long Island Cty, N Y 11101
DATA CONTROL SYSTEMS INC.
Commerce Dr, Danbury, Conn 06810
DATA GENERAL CORP.
Rte 9, Southboro, Mass 01772
DATA TECHNOLOGY CORP.
1050 E Meadow Cir, Palo Alto, Cal 94303

2 Product Directory

DATAWEST CORP.
7503 E Osborn Rd, Scottsdale, Ariz 85251
DATEL/VARADYNE
1020 Turnpike St, Canton, Mass 02021
DATUM INC.
170 E Liberty Ave, Anaheim, Cal 92801
DDC DIV. SOLID STATE SCIENTIFIC DEVICES
100 Tec St, Hicksville, N Y 11801
DIGITAL EQUIPMENT CORP.
146 Main St, Maynard, Mass 01754
DIGITAL PRODUCTS CORP.
6950 NW 12 Ave, Ft Lauderdale, Fla 33309
DIGITAL RESOURCES CORP.
6250 W Park Suite 100, Houston, Tex 77027
DIGITRON CORP.
2544 W Main St, Norristown, Pa 19401
DYNALOX INC.
885 Front St, Burbank, Cal 91502
DYNAMIC MEASUREMENTS CORP.
6 Lowell Ave, Winchester, Mass 01890
ELBIT COMPUTERS/SUB. CONTROL DATA CORP.
6 Tovim St, Haifa, ISRAEL
ELECTRONIC ENGRG. CO. OF CAL. ELECTRONIC PRD.
DIV
1441 E Chestnut Ave, Santa Ana, Cal 92702
ELPAC INC.
18651 Von Karman Ave, Irvine, Cal 92664
FARRAND CONTROLS INC.
99 Wall St, Valhalla, N Y 10595
FLUKE, JOHN MFG. CO. INC.
P O Box 7428, Seattle, Wash 98133
FOXBORO CO., THE
Neponset Ave, Foxboro, Mass 02035
GAP INSTRUMENT CORP.
110 Marcus Blvd, Hauppauge, N Y 11787
GENERAL AUTOMATION INC.
1055 S East St, Anaheim, Cal 92805
GENERAL DEVICES INC.
P O Box 253, Princeton, N J 08540
GENERAL DYNAMICS CORP. ELECTRONICS DIV.
P O Box 2566, Orlando, Fla 32802
GRALEX INDUSTRIES DIV. GENL. MICROWAVE CORP
155 Marine St, Farmingdale, N Y 11735
GULTON INDUSTRIES INC.
212 Durham Ave, Metuchen, N J 08840
HALEX INC.
3500 W Torrance Blvd, Torrance, Cal 90509
HARRIS SEMICONDUCTOR A DIV. OF
HARRIS-INTERTYPE
P O Box 883, Melbourne, Fla 32901
HELIPOT DIV. BECKMAN INSTRUMENTS INC.
2500 Harbor Blvd, Fullerton, Cal 92634
HEWLETT PACKARD NEW JERSEY DIV.
100 Locust Ave, Berkley Heights, N J 07922
HEWLETT PACKARD CO.
1501 Page Mill Rd, Palo Alto, Cal 94304
HONEYWELL INFORMATION SYSTEMS
60 Walnut St, Wellesley Hills, Mass 02181
HYBRID SYSTEMS DIV. DIGITAL RESOURCES CORP.
4301 Dacoma Rd, Houston, Tex 77018
HYCOMP INC.
146 Main St, Maynard, Mass 01754
INFORMATION CONTROL CORP.
9610 Bellanca Ave, Los Angeles, Cal 90045
INTERSIL INC.
10900 N Tantu, Cupertino, Cal 95014
KEPCO INC.
131 38 Sanford Ave, Flushing, N Y 11352
LANCER ELECTRONICS CORP.
1416 W Main St, Norristown, Penn 19401
LECROY RESEARCH SYSTEMS CORP.
126 N Rte 303, W Nyack, N Y 10994
LORCH ELECTRONICS, LORCH ADRET CORP.
105 Cedar Ln, Englewood, N J 07631
MACNEAL-SCHWENDLER CORP., THE
7442 N Figueroa St, Los Angeles, Cal 90041
MB ELECTRONICS DIV. TEXTRON INC.
781 Whalley Ave, New Haven, Conn 06515
METRIC SYSTEMS CORP.
736 N Beal St, Ft Walton Beach, Fla 32548
MILLETRON INC.
540 Alpha Dr, Pittsburgh, Pa 15238
MODULAR COMPUTER SYSTEMS
2709 N Dixie Hwy, Ft Lauderdale, Fla 33308
MOTOROLA INC. CONTROL SYSTEMS DIV
P O Box 5409, Phoenix, Ariz 85010
NATIONAL SEMICONDUCTOR CORP.
2900 Semicon Dr, Santa Clara, Cal 95051
NATIONWIDE ELECTRONIC SYSTEMS INC.
7 N 662 Rte 53, Itasca, Ill 60143
NIGITRON CORP.
2544 W Main St, Norristown, Pa 19401
NON-LINEAR SYSTEMS INC.
P O Box N, Del Mar, Cal 92014

NORDEN DIV., UNITED AIRCRAFT CORP.
Helen St, Norwalk, Conn 06850
NORTH AMERICAN ROCKWELL CORP. AUTONETICS
DIV.
3370 Miraloma Ave, Anaheim, Cal 92803
OPTICAL ELECTRONICS INC.
P O Box 11140, Tucson, Ariz 85706
PHOENIX DATA INC.
3384 W Osborn Rd, Phoenix, Ariz 85017
PRECISION MONOLITHICS INC.
1500 Space Park Dr, Santa Clara, Cal 95050
PRESTON SCIENTIFIC INC.
805 E Cerritos Ave, Anaheim, Cal 92805
RAYTHEON CO. EQUIPMENT DIV.
528 Boston Post Rd, Sudbury, Mass 01776
RAYTHEON COMPUTER
2700 S Fairview St, Santa Ana, Cal 92704
RC-95 INC.
2 Westchester Plaza, Elmsford, N Y 10523
REDCOR CORP.
21200 Victory, Woodland Hills, Cal 91364
ROLM, CORP.
10300 N Tantau, Cupertino, Cal 95014
SCIENTIFIC MEASUREMENTS INC.
9701 N Kenton, Skokie, Ill 60076
SINGER-GENERAL PRECISION KEARFOTT DIV.
1150 McBride Ave, Little Falls, N J 07424
SPACETAC INC.
Burlington Rd, Bedford, Mass 01730
SRC DIV. MOXON INC.
2222 Michelson Dr, Newport Beach, Cal 92664
STANDARD LOGIC INC.
1630 S Lyon St, Santa Ana, Cal 92705
STELLARMETRICS AN AYDIN CO.
P O Box 719, Santa Barbara, Cal 93102
STRUTHER-DUNN INC. SYSTEMS DIV.
1114 State St, Bettendorf, Iowa 52722
SYSTEMS CONCEPTS INC.
524 2nd St, San Francisco, Cal 94107
SYSTEMS DATA, INC.
1951 W Market St, Akron, Ohio 44313
TELEDYNE CRYSTALONICS
147 Sherman St, Cambridge, Mass 02140
TELEDYNE PHILBRICK NEXUS
Allied Dr At Rte 128, Dedham, Mass 02026
TEMPO INSTRUMENT DIV. ALLEN ELECTRIC&EQUIP.
CO.
9135 Independence Ave, Chatsworth, Cal 91311
THETA INSTRUMENT CORP.
24 Dwight Pl, Fairfield, N J 07006
TRANSMAGNETICS INC.
210 Adams Blvd, Farmingdale, N Y 11735
TUSTIN ELECTRONICS, INC.
17942 E Main St, Tustin, Cal 92680
UNICOMP INC.
18219 Parthenia, Northridge, Cal 91324
VARIAN ASSOCIATES GRAPHICS & DATA SYSTEMS
DIV.
621 Hansen Way, Palo Alto, Cal 94303
VERNITRON CORP. MOTOR PRODUCTS DIV.
300 Marcus Blvd, Deer Park, N Y 11729
VIDAR CORP.
77 Ortega Ave, Mountain View, Cal 94040
XEROX DATA SYSTEMS
701 S Aviation, El Segundo, Cal 90245
ZELTEX INC.
1000 Chalomar Rd, Concord, Cal 94520

CONVERTERS, DIGITAL-TO-SYNCHRO

ANALOG DEVICES INC. PASTORIZA DIV.
221 5th St, Cambridge, Mass 02142
ANALOGIC CORP.
Audubon Rd, Wakefield, Mass 01880
ASTROSYSTEMS INC.
6 Nevada Dr, Lake Success, N Y 11040
BENDIX CORP., THE, ENVRNMENTL SCI. DIV.
1400 Taylor Ave, Baltimore, Md 21204
BFA CORP.
1309 S Inca, Denver, Colo 80223
BOWMAR INSTRUMENT CORP. ELECTRONIC SYS. DIV
800 Bluffton Rd, Fort Wayne, Ind 46809
CLIFTON DIV. LITTON SYSTEMS INC.
Marple At Broadway, Clifton Heights, Pa 19018
COMPUTER CONVERSIONS CORP.
6 Dunton Court, E Northport, N Y 11731
CONTROL TECHNOLOGY CO., INC.
41-16 29th St, Long Island City, N Y 11101
DDC DIV. SOLID STATE SCIENTIFIC DEVICES
100 Tec St, Hicksville, N Y 11801
DYNALOX INC.
885 Front St, Burbank, Cal 91502
ELBIT COMPUTERS/SUB. CONTROL DATA CORP.
6 Tovim St, Haifa, ISRAEL

FARRAND CONTROLS INC.
99 Wall St, Valhalla, N Y 10595
GAP INSTRUMENT CORP.
110 Marcus Blvd, Hauppauge, N Y 11787
METRIC SYSTEMS CORP.
736 N Beal St, Ft Walton Beach, Fla 32548
NATEL ENGINEERING CO. INC.
8944 Mason Ave, Canoga Park, Cal 91306
NORDEN DIV., UNITED AIRCRAFT CORP.
Helen St, Norwalk, Conn 06850
NORTH AMERICAN ROCKWELL CORP. AUTONETICS
DIV.
3370 Miraloma Ave, Anaheim, Cal 92803
NORTH ATLANTIC INDUSTRIES INC.
200 Terminal Dr, Plainview, N Y 11803
PHOENIX DATA INC.
3384 W Osborn Rd, Phoenix, Ariz 85017
RC-95 INC.
2 Westchester Plaza, Elmsford, N Y 10523
ROLM, CORP.
10300 N Tantau, Cupertino, Cal 95014
SINGER-GENERAL PRECISION KEARFOTT DIV.
1150 McBride Ave, Little Falls, N J 07424
SPACETAC INC.
Burlington Rd, Bedford, Mass 01730
THETA INSTRUMENT CORP.
24 Dwight Pl, Fairfield, N J 07006
TRANSMAGNETICS INC.
210 Adams Blvd, Farmingdale, N Y 11735
UNICOMP INC.
18219 Parthenia, Northridge, Cal 91324
VERNITRON CORP. MOTOR PRODUCTS DIV.
300 Marcus Blvd, Deer Park, N Y 11729
WESTON-TRANSICOIL A SCHLUMBERGER CO.
Trooper Rd, Worcester, Pa 19490

CONVERTERS, DOCUMENT-TO-MAGNETIC TAPE

ADDRESSOGRAPH MULTIGRAPH CORP BRUNING DIV.
1200 Babbitt Rd, Cleveland, Ohio 44117
DATA GRAPHICS CORP.
8402 Speedway, San Antonio, Tex 78230
DESIGN ELEMENTS INC.
356 Norton Ave, Columbus, Ohio 43212
DIGITAL PRODUCTS CORP.
6950 NW 12 Ave, Ft Lauderdale, Fla 33309
DYNAMIC SYSTEM ELECTRONICS
1040 W Alameda Dr, Tempe, Ariz 85281
ELBIT COMPUTERS/SUB. CONTROL DATA CORP.
6 Tovim St, Haifa, ISRAEL
METRIC SYSTEMS CORP.
736 N Beal St, Ft Walton Beach, Fla 32548
NATIONWIDE ELECTRONIC SYSTEMS INC.
7 N 662 Rte 53, Itasca, Ill 60143
SYSTEMS CONCEPTS INC.
17-45 Clintonville St, Whitestone, N Y 11357
UNIVERSITY COMPUTING CO. GRAPHIC SYSTEMS DIV
14761 Califa St, Van Nuys, Cal 91401

CONVERTERS, DOCUMENT-TO-PAPER TAPE

ADDRESSOGRAPH MULTIGRAPH CORP BRUNING DIV.
1200 Babbitt Rd, Cleveland, Ohio 44117
DATA GRAPHICS CORP.
8402 Speedway, San Antonio, Tex 78230
DATA TECHNOLOGY INC.
65 Grove St, Watertown, Mass 02172
DATATERM INC.
1671 Manning Blvd, Levittown, Pa 19057
DIGITAL PRODUCTS CORP.
6950 NW 12 Ave, Ft Lauderdale, Fla 33309
ELBIT COMPUTERS/SUB. CONTROL DATA CORP.
6 Tovim St, Haifa, ISRAEL
ELDORADO ELECTRODATA
601 Chalomar Rd, Concord, Cal 94520
FRIDEN DIV. THE SINGER CO.
97 Humboldt St, Rochester, N Y 14602
NATIONWIDE ELECTRONIC SYSTEMS INC.
7 N 662 Rte 53, Itasca, Ill 60143
STRUTHER-DUNN INC. SYSTEMS DIV.
1114 State St, Bettendorf, Iowa 52722
SYSTEMS CONCEPTS INC.
17-45 Clintonville St, Whitestone, N Y 11357
UNIVERSITY COMPUTING CO.
888 N Sepulveda Blvd, El Segundo, Cal 90245
UNIVERSITY COMPUTING CO. GRAPHIC SYSTEMS DIV
14761 Califa St, Van Nuys, Cal 91401

2 Product Directory

CONVERTERS, DOCUMENT-TO-UNIT RECORDS

ADDRESSOGRAPH MULTIGRAPH CORP BRUNING DIV.
1200 Babbitt Rd, Cleveland, Ohio 44117
COMPUTER MICRO-IMAGE SYSTEMS INC.
9600 Desoto Ave, Chatsworth, Cal 91311
ELBIT COMPUTERS/SUB. CONTROL DATA CORP.
6 Tovim St, Haifa, ISRAEL
NATIONWIDE ELECTRONIC SYSTEMS INC.
7 N 662 Rte 53, Itasca, Ill 60143
STRUTHER-DUNN INC. SYSTEMS DIV.
1114 State St, Bettendorf, Iowa 52722
SYSTEMS CONCEPTS INC.
17-45 Clintonville St, Whitestone, N Y 11357
UNIVERSITY COMPUTING CO. GRAPHIC SYSTEMS DIV
14761 Califa St, Van Nuys, Cal 91401

CONVERTERS, FREQUENCY-TO-DC

AIRPAX ELECTRONICS INC.
P O Box 8488, Ft Lauderdale, Fla 33310
ALTEC DIV., LTV LING ALTEC INC.
1515 So Manchester Av, Anaheim, Cal 92803
ANADIX INSTRUMENTS INC.
7833 Haskell Ave, Van Nuys, Cal 91406
ANALOGIC CORP.
Audubon Rd, Wakefield, Mass 01880
ARNOLD MAGNETICS CORP.
P O Box K, Culver City, Cal 90230
BULOVA WATCH ELECTRONICS DIV.
6120 Woodside Ave, Woodside Li, N Y 11377
COMPUTER CONVERSIONS CORP.
6 Dunton Court, E Northport, N Y 11731
COMPUTER CORP. OF AMERICA
6216 Evergreen St, Houston, Tex 77036
DEL ELECTRONIC CORP.
250 Sandford Blvd, Mt Vernon, N Y 10550
DIGITRON CORP.
2544 W Main St, Norristown, Pa 19401
ELBIT COMPUTERS/SUB. CONTROL DATA CORP.
6 Tovim St, Haifa, ISRAEL
ELECTRIC INDICATOR CO. INC.
195 Danbury Rd, Wilton, Conn 06897
ELECTRO PRODUCTS LABORATORIES INC.
6125 W Howard St, Chicago, Ill 60648
FOXBORO CO., THE
Neponset Ave, Foxboro, Mass 02035
LORAIN PRODUCTS CORP.
1122 F St, Lordin, Ohio 44052
LORCH ELECTRONICS, LORCH ADRET CORP.
105 Cedar Ln, Englewood, N J 07631
MARQUETTA ELECTRONICS INC.
3712 W Elm St, Milwaukee, Wisc 53209
MAYBERRY ELECTRONICS CO.
1250 Industrial Ave, Escondido, Cal 92025
MICRODOT INC. CONNECTOR & CABLE DIV.
220 Pasadena Ave, S Pasadena, Cal 91030
NATEL ENGINEERING CO. INC.
8944 Mason Ave, Canoga Park, Cal 91306
NIGITRON CORP.
2544 W Main St, Norristown, Pa 19401
OPTICAL ELECTRONICS INC.
P O Box 11140, Tucson, Ariz 85706
PEERLESS ELECTRICAL PRODUCTS DIV.
1515 S Manchester Ave, Anaheim, Cal 92803
PLASTIC CAPACITORS INC.
2620 N Clybourn Ave, Chicago, Ill 60614
RAMSAY ENGINEERING CO.
707 N Anaheim Blvd, Anaheim, Cal 92805
RC-95 INC.
2 Westchester Plaza, Elmsford, N Y 10523
RHO ENGINEERING CO.
2234 Colby Ave, Los Angeles, Cal 90064
SBD ELECTRONIC SYSTEMS INC.
275 Dixon Ave, Amityville, N Y 11701
SOLID STATE ELECTRONICS CORP.
15321 Rayen St, Sepulveda, Cal 91343
TEMPO INSTRUMENT DIV. ALLEN ELECTRIC&EQUIP. CO.
9135 Independence Ave, Chatsworth, Cal 91311
TUSTIN ELECTRONICS CO.
17942 E Main St, Tustin, Cal 92680
VARO INC. STATIC POWER DIV.
1600 Dallas Pkwy, Plano, Tex 75074
VIDAR CORP.
77 Ortega Ave, Mountain View, Cal 94040
WANLASS ELECTRIC CO.
1815 S Ritohay St, Santa Ana, Cal 92705

CONVERTERS, MAGNETIC TAPE-TO-FACSIMILE

DATA DISC INC.
686 W Maude Ave, Sunnyvale, Cal 94086
EDGERTON GERMESHAUSEN GRIER INC.
Crosby Dr, Bedford, Mass 01730
ELBIT COMPUTERS/SUB. CONTROL DATA CORP.
6 Tovim St, Haifa, ISRAEL

CONVERTERS, MAGNETIC TAPE-TO-MAGNETIC TAPE

ATRON CORP.
1256 Trapp Rd, St Paul, Minn 55118
COGAR CORP. INFORMATION SYS.DIV
Cosby Manor Rd, Utica, N Y 13502
COMMUNITYTYPE CORP.
767 Fifth Ave, New York, N Y 10022
DATACOM INC.
40 Lincoln Dr, Ft Walton Beach, Fla 32548
DIGI-DATA CORP.
4315 Baltimore Ave, Bladensburg, Md 20710
DIGITRON CORP.
2544 W Main St, Norristown, Pa 19401
DYNAMIC SYSTEM ELECTRONICS
1040 W Alameda Dr, Tempe, Ariz 85281
DYTRO CORP.
63 Tec St, Hicksville, N Y 11801
ELBIT COMPUTERS/SUB. CONTROL DATA CORP.
6 Tovim St, Haifa, ISRAEL
ELDORADO ELECTRODATA
601 Chalomar Rd, Concord, Cal 94520
ELECTRONIC LABS, INC.
3726 Dacoma St, Houston, Tex 77018
FRIDEN DIV. THE SINGER CO.
97 Humboldt St, Rochester, N Y 14602
INTERNATIONAL COMPUTER PRODUCTS INC.
P O Box 34484, Dallas, Tex 75234
LITTON SYSTEMS INC. MELLONICS DIV.
1001 W Maude Ave, Sunnyvale, Cal 94086
MCA TECHNOLOGY INC. UDAC DIV
P O Box 36166, Houston, Tex 77035
NATIONWIDE ELECTRONIC SYSTEMS INC.
7 N 662 Rte 53, Itasca, Ill 60143
NIGITRON CORP.
2544 W Main St, Norristown, Pa 19401
SAGETEC CORP.
9177 Kelvin Ave, Chatsworth, Cal 91311
SYS COMPUTER CORP.
17-25 Dicarolis Court, Hackensack, N J 07601
SYSTEMS CONCEPTS INC.
17-45 Clintonville St, Whitestone, N Y 11357

CONVERTERS, MAGNETIC TAPE-TO-MICROFILM

BETA INSTRUMENT CORP.
20 Ossipee Rd, Newton Upr Flis, Mass 02164
COMPUTER MICRO-IMAGE SYSTEMS INC.
9600 Desoto Ave, Chatsworth, Cal 91311
ELBIT COMPUTERS/SUB. CONTROL DATA CORP.
6 Tovim St, Haifa, ISRAEL
JERSEY TAB CARD CORP.
649 Rahway Ave, Union, N J 07083
SEQUENTIAL INFORMATION SYSTEMS INC.
145 Palisade St, Dobbs Ferry, N Y 10522
STROMBERG DATAGRAPHIX INC.
P O Box 2449, San Diego, Cal 92112
UNIVERSITY COMPUTING CO.
888 N Sepulveda Blvd, El Segundo, Cal 90245

CONVERTERS, MAGNETIC TAPE-TO-PAPER TAPE

ADVANCED SPACE AGE PRODUCTS
4308 Wheeler Ave, Alexandria, Va 22313
BFA CORP.
1309 S Inca, Denver, Colo 80223
CONNECTICUT TECHNICAL CORP.
3000 Main St, Hartford, Conn 06120
DATATERM INC.
1671 Manning Blvd, Levittown, Pa 19057
DIGI-DATA CORP.
4315 Baltimore Ave, Bladensburg, Md 20710
DIGITRON CORP.
2544 W Main St, Norristown, Pa 19401
DYTRO CORP.
63 Tec St, Hicksville, N Y 11801
ELBIT COMPUTERS/SUB. CONTROL DATA CORP.
6 Tovim St, Haifa, ISRAEL

ELDORADO ELECTRODATA
601 Chalomar Rd, Concord, Cal 94520
I/O SYSTEMS INC.
P O Box 36, Natick, Mass 01760
NATIONWIDE ELECTRONIC SYSTEMS INC.
7 N 662 Rte 53, Itasca, Ill 60143
NIGITRON CORP.
2544 W Main St, Norristown, Pa 19401
OKI ELECTRIC INDUSTRIES CO. LTD.
875 Ave of Americas, New York, N Y 10001
SRC DIV. MOXON INC.
2222 Michelson Dr, Newport Beach, Cal 92664
SYS COMPUTER CORP.
17-25 Dicarolis Court, Hackensack, N J 07601
SYSTEMS CONCEPTS INC.
17-45 Clintonville St, Whitestone, N Y 11357
TALLY CORP.
8301 S 180th St, Kent, Wash 98031

CONVERTERS, MAGNETIC TAPE-TO-PRINTER

ADDRESSOGRAPH MULTIGRAPH CORP BRUNING DIV.
1200 Babbitt Rd, Cleveland, Ohio 44117
ADVANCED SPACE AGE PRODUCTS
4308 Wheeler Ave, Alexandria, Va 22313
ATRON CORP.
1256 Trapp Rd, St Paul, Minn 55118
BFA CORP.
1309 S Inca, Denver, Colo 80223
DATA PRODUCTS CORP.
16055 Ventura Blvd, Encino, Cal 91316
DATASERV DIV., WILLIAM J. PURDY CORP.
770 Airport Blvd, Burlingame, Cal 94010
DATUM INC.
170 E Liberty Ave, Anaheim, Cal 92801
DIGITRON CORP.
2544 W Main St, Norristown, Pa 19401
DYTRO CORP.
63 Tec St, Hicksville, N Y 11801
ELBIT COMPUTERS/SUB. CONTROL DATA CORP.
6 Tovim St, Haifa, ISRAEL
ELDORADO ELECTRODATA
601 Chalomar Rd, Concord, Cal 94520
HETRA
P O Box 970, Melbourne, Fla 32901
I/O SYSTEMS INC.
P O Box 36, Natick, Mass 01760
NATIONWIDE ELECTRONIC SYSTEMS INC.
7 N 662 Rte 53, Itasca, Ill 60143
NIGITRON CORP.
2544 W Main St, Norristown, Pa 19401
OKI ELECTRIC INDUSTRIES CO. LTD.
875 Ave of Americas, New York, N Y 10001
PRINTER TECHNOLOGY INC.
Sixth Rd, Woburn, Mass 01801
PURDY CORP., WM. J.
770 Airport Blvd, Burlingame, Cal 94010
SYSTEMS CONCEPTS INC.
17-45 Clintonville St, Whitestone, N Y 11357

CONVERTERS, MAGNETIC TAPE-TO-PUNCHED CARD

ADVANCED SPACE AGE PRODUCTS
4308 Wheeler Ave, Alexandria, Va 22313
BFA CORP.
1309 S Inca, Denver, Colo 80223
DIGITRON CORP.
2544 W Main St, Norristown, Pa 19401
ELBIT COMPUTERS/SUB. CONTROL DATA CORP.
6 Tovim St, Haifa, ISRAEL
ELDORADO ELECTRODATA
601 Chalomar Rd, Concord, Cal 94520
HETRA
P O Box 970, Melbourne, Fla 32901
NATIONWIDE ELECTRONIC SYSTEMS INC.
7 N 662 Rte 53, Itasca, Ill 60143
NIGITRON CORP.
2544 W Main St, Norristown, Pa 19401
OKI ELECTRIC INDUSTRIES CO. LTD.
875 Ave of Americas, New York, N Y 10001
SYSTEMS CONCEPTS INC.
17-45 Clintonville St, Whitestone, N Y 11357
TELE-DATA CORP.
130 U S Hwy 22, N Plainfield, N J 07060
UNICOMP INC.
18219 Parthenia, Northridge, Cal 91324
WARLOCK COMPUTER CORP.
Rte 7, Georgetown, Conn 06829

2 Product Directory

CONVERTERS, PAPER TAPE-TO-MAGNETIC TAPE

ADVANCED SPACE AGE PRODUCTS
4308 Wheeler Ave, Alexandria, Va 22313
CONNECTICUT TECHNICAL CORP.
3000 Main St, Hartford, Conn 06120
DATACOM INC.
40 Lincoln Dr, Ft Walton Beach, Fla 32548
DATACON INTERNATIONAL INC.
2745 Bernice Rd, Lansing, Ill 60438
DATASCAN INC.
1111 Paulison Ave, Clifton, N J 07013
DATATERM INC.
1671 Manning Blvd, Levittown, Pa 19057
DIGI-DATA CORP.
4315 Baltimore Ave, Bladensburg, Md 20710
DIGITRON CORP.
2544 W Main St, Norristown, Pa 19401
ELBIT COMPUTERS/SUB. CONTROL DATA CORP.
6 Tovim St, Haifa, ISRAEL
ELDORADO ELECTRODATA
601 Chalomar Rd, Concord, Cal 94520
FRIDEN DIV. THE SINGER CO.
97 Humboldt St, Rochester, N Y 14602
I/O SYSTEMS INC.
P O Box 36, Natick, Mass 01760
NATIONWIDE ELECTRONIC SYSTEMS INC.
7 N 662 Rte 53, Itasca, Ill 60143
NIGITRON CORP.
2544 W Main St, Norristown, Pa 19401
SINGER CO., THE, FRIDEN DIV.
2350 Washington St, San Leandro, Cal 94577
SYS COMPUTER CORP.
17-25 Dicarolis Court, Hackensack, N J 07601
SYSTEMS CONCEPTS INC.
17-45 Clintonville St, Whitestone, N Y 11357
TALLY CORP.
8301 S 180th St, Kent, Wash 98031
UNICOMP INC.
18219 Parthenia, Northridge, Cal 91324

CONVERTERS, PAPER TAPE-TO-PAPER TAPE

ADVANCED SPACE AGE PRODUCTS
4308 Wheeler Ave, Alexandria, Va 22313
CONNECTICUT TECHNICAL CORP.
3000 Main St, Hartford, Conn 06120
DATACON INTERNATIONAL INC.
2745 Bernice Rd, Lansing, Ill 60438
DATATERM INC.
1671 Manning Blvd, Levittown, Pa 19057
DIGITRON CORP.
2544 W Main St, Norristown, Pa 19401
ELBIT COMPUTERS/SUB. CONTROL DATA CORP.
6 Tovim St, Haifa, ISRAEL
ELDORADO ELECTRODATA
601 Chalomar Rd, Concord, Cal 94520
GENERAL INSTRUMENT CORP. MAGNE-HEAD DIV.
13040 Cerise Ave, Hawthorne, Cal 90250
I/O SYSTEMS INC.
P O Box 36, Natick, Mass 01760
KLEINSCHMIDT DIV., SCM CORP.
Lake-Cook Rd, Deerfield, Ill 60015
NATIONWIDE ELECTRONIC SYSTEMS INC.
7 N 662 Rte 53, Itasca, Ill 60143
NIGITRON CORP.
2544 W Main St, Norristown, Pa 19401
OKI ELECTRIC INDUSTRIES CO. LTD.
875 Ave of Americas, New York, N Y 10001
PIONEER ELECTRIC & RESEARCH DIV. JOHNSON
SER.CO.
743 Circle Ave, Forest Park, Ill 60130
SHIRAK TELEMETERING OF AMERICA
8926 Kester Ave, Van Nuys, Cal 91402
SYSTEMS CONCEPTS INC.
17-45 Clintonville St, Whitestone, N Y 11357

CONVERTERS, PAPER TAPE-TO-PRINTER

ADVANCED SPACE AGE PRODUCTS
4308 Wheeler Ave, Alexandria, Va 22313
CONNECTICUT TECHNICAL CORP.
3000 Main St, Hartford, Conn 06120
DATACON INTERNATIONAL INC.
2745 Bernice Rd, Lansing, Ill 60438
DATASERV DIV., WILLIAM J. PURDY CORP.
770 Airport Blvd, Burlingame, Cal 94010
DATATERM INC.
1671 Manning Blvd, Levittown, Pa 19057

DIGITRON CORP.
2544 W Main St, Norristown, Pa 19401
ELBIT COMPUTERS/SUB. CONTROL DATA CORP.
6 Tovim St, Haifa, ISRAEL
ELDORADO ELECTRODATA
601 Chalomar Rd, Concord, Cal 94520
FRIDEN DIV. THE SINGER CO.
97 Humboldt St, Rochester, N Y 14602
I/O SYSTEMS INC.
P O Box 36, Natick, Mass 01760
ITEL INFORMATION PRODUCTS DIV
2585 Bayshore, Palo Alto, Cal 94303
KLEINSCHMIDT DIV., SCM CORP.
Lake-Cook Rd, Deerfield, Ill 60015
NATIONWIDE ELECTRONIC SYSTEMS INC.
7 N 662 Rte 53, Itasca, Ill 60143
NIGITRON CORP.
2544 W Main St, Norristown, Pa 19401
PIONEER ELECTRIC & RESEARCH DIV. JOHNSON
SER.CO.
743 Circle Ave, Forest Park, Ill 60130
PRINTER TECHNOLOGY INC.
Sixth Rd, Woburn, Mass 01801
PURDY CORP., WM. J.
770 Airport Blvd, Burlingame, Cal 94010
SHIRAK TELEMETERING OF AMERICA
8926 Kester Ave, Van Nuys, Cal 91402
SYSTEMS CONCEPTS INC.
17-45 Clintonville St, Whitestone, N Y 11357

CONVERTERS, PAPER TAPE-TO-PUNCHED CARD

ADVANCED SPACE AGE PRODUCTS
4308 Wheeler Ave, Alexandria, Va 22313
DATACON INTERNATIONAL INC.
2745 Bernice Rd, Lansing, Ill 60438
DATATERM INC.
1671 Manning Blvd, Levittown, Pa 19057
DIGITAL AUTOMATION CO, INC.
1018 Whitehead Rd Ext, Trenton, N J 08638
DIGITRON CORP.
2544 W Main St, Norristown, Pa 19401
ELBIT COMPUTERS/SUB. CONTROL DATA CORP.
6 Tovim St, Haifa, ISRAEL
ELDORADO ELECTRODATA
601 Chalomar Rd, Concord, Cal 94520
GENERAL INSTRUMENT CORP. MAGNE-HEAD DIV.
13040 Cerise Ave, Hawthorne, Cal 90250
INTERNATIONAL COMPUTERS LTD.
Icl House Putney, London S W 15, UNITED K
KLEINSCHMIDT DIV., SCM CORP.
Lake-Cook Rd, Deerfield, Ill 60015
NATIONWIDE ELECTRONIC SYSTEMS INC.
7 N 662 Rte 53, Itasca, Ill 60143
NIGITRON CORP.
2544 W Main St, Norristown, Pa 19401
SYSTEMS CONCEPTS INC.
17-45 Clintonville St, Whitestone, N Y 11357

CONVERTERS, POLAR-TO-RECTANGULAR

COMPUTER CONVERSIONS CORP.
6 Dunton Court, E Northport, N Y 11731
ELBIT COMPUTERS/SUB. CONTROL DATA CORP.
6 Tovim St, Haifa, ISRAEL
GAP INSTRUMENT CORP.
110 Marcus Blvd, Hauppauge, N Y 11787
NATEL ENGINEERING CO. INC.
8944 Mason Ave, Canoga Park, Cal 91306
NORDEN DIV., UNITED AIRCRAFT CORP.
Helen St, Norwalk, Conn 06850
OPTICAL ELECTRONICS INC.
P O Box 11140, Tucson, Ariz 85706
SINGER-GENERAL PRECISION KEARFOTT DIV.
1150 McBride Ave, Little Falls, N J 07424
TRANSMAGNETICS INC.
210 Adams Blvd, Farmingdale, N Y 11735

CONVERTERS, PULSE-TO-DIGITAL

AMERICAN ASTRONICS INC., SUB TECHNICOLOR INC.
855 No Cahuenga Blvd, Hollywood, Cal 90038
ASTROSYSTEMS INC.
6 Nevada Dr, Lake Success, N Y 11040
CERMETEK INC.
660 National Ave, Mt View, Cal 94040
COMPUTER CONVERSIONS CORP.
6 Dunton Court, E Northport, N Y 11731
COMPUTER CORP. OF AMERICA
6216 Evergreen St, Houston, Tex 77036

CYBERMATION INC.
P O Box 58 River Rd, Washngtn Xing, Pa 18977
DATA DISC INC.
686 W Maude Ave, Sunnyvale, Cal 94086
EL INSTRUMENTS INC.
61 1st St, Derby, Conn 06418
ELBIT COMPUTERS/SUB. CONTROL DATA CORP.
6 Tovim St, Haifa, ISRAEL
ELPAC INC.
18651 Von Karman Ave, Irvine, Cal 92664
FOXBORO CO., THE
Neponset Ave, Foxboro, Mass 02035
GAP INSTRUMENT CORP.
110 Marcus Blvd, Hauppauge, N Y 11787
LECROY RESEARCH SYSTEMS CORP.
126 N Rte 303, W Nyack, N Y 10994
NORTH AMERICAN ROCKWELL CORP. AUTONETICS
DIV.
3370 Miraloma Ave, Anaheim, Cal 92803
PIONEER ELECTRIC & RESEARCH DIV. JOHNSON
SER.CO.
743 Circle Ave, Forest Park, Ill 60130
RAYTHEON CO. CADPO OPERATION
1415 Providence Tpk, Norwood, Mass 02062
RC-95 INC.
2 Westchester Plaza, Elmsford, N Y 10523
SINGER-GENERAL PRECISION KEARFOTT DIV.
1150 McBride Ave, Little Falls, N J 07424
THETA INSTRUMENT CORP.
24 Dwight Pl, Fairfield, N J 07006

CONVERTERS, PUNCHED CARD-TO-MAGNETIC TAPE

ADDRESSOGRAPH MULTIGRAPH CORP BRUNING DIV.
1200 Babbitt Rd, Cleveland, Ohio 44117
ADVANCED SPACE AGE PRODUCTS
4308 Wheeler Ave, Alexandria, Va 22313
ATRON CORP.
1256 Trapp Rd, St Paul, Minn 55118
DATA PACIFIC CORP.
116 E Ash, Fullerton, Cal 92631
DATACON INTERNATIONAL INC.
2745 Bernice Rd, Lansing, Ill 60438
DIGITAL AUTOMATION CO, INC.
1018 Whitehead Rd Ext, Trenton, N J 08638
DIGITRON CORP.
2544 W Main St, Norristown, Pa 19401
ELBIT COMPUTERS/SUB. CONTROL DATA CORP.
6 Tovim St, Haifa, ISRAEL
ELDORADO ELECTRODATA
601 Chalomar Rd, Concord, Cal 94520
HETRA
P O Box 970, Melbourne, Fla 32901
NATIONWIDE ELECTRONIC SYSTEMS INC.
7 N 662 Rte 53, Itasca, Ill 60143
NIGITRON CORP.
2544 W Main St, Norristown, Pa 19401
SYSTEMS CONCEPTS INC.
17-45 Clintonville St, Whitestone, N Y 11357
TELE-DATA CORP.
130 U S Hwy 22, N Plainfield, N J 07060
UNICOMP INC.
18219 Parthenia, Northridge, Cal 91324
WESTERN TELEMATIC INC.
5507 Peck Rd, Arcadia, Cal 91006

CONVERTERS, PUNCHED CARD-TO-PAPER TAPE

ADVANCED SPACE AGE PRODUCTS
4308 Wheeler Ave, Alexandria, Va 22313
DATA PACIFIC CORP.
116 E Ash, Fullerton, Cal 92631
DATACON INTERNATIONAL INC.
2745 Bernice Rd, Lansing, Ill 60438
DIGITAL AUTOMATION CO, INC.
1018 Whitehead Rd Ext, Trenton, N J 08638
DIGITRON CORP.
2544 W Main St, Norristown, Pa 19401
ELBIT COMPUTERS/SUB. CONTROL DATA CORP.
6 Tovim St, Haifa, ISRAEL
ELDORADO ELECTRODATA
601 Chalomar Rd, Concord, Cal 94520
FRIDEN DIV. THE SINGER CO.
97 Humboldt St, Rochester, N Y 14602
GENERAL INSTRUMENT CORP. MAGNE-HEAD DIV.
13040 Cerise Ave, Hawthorne, Cal 90250
INTERNATIONAL COMPUTERS LTD.
Icl House Putney, London S W 15, UNITED K
KLEINSCHMIDT DIV., SCM CORP.
Lake-Cook Rd, Deerfield, Ill 60015

2 Product Directory

NATIONWIDE ELECTRONIC SYSTEMS INC.
7 N 662 Rte 53, Itasca, Ill 60143
NIGITRON CORP.
2544 W Main St, Norristown, Pa 19401
OKI ELECTRIC INDUSTRIES CO. LTD.
875 Ave of Americas, New York, N Y 10001
SYSTEMS CONCEPTS INC.
17-45 Clintonville St, Whitestone, N Y 11357
WESTERN TELEMATIC INC.
5507 Peck Rd, Arcadia, Cal 91006

CONVERTERS, PUNCHED TAG-TO-MAGNETIC TAPE

ADVANCED SPACE AGE PRODUCTS
4308 Wheeler Ave, Alexandria, Va 22313
ELBIT COMPUTERS/SUB. CONTROL DATA CORP.
6 Tovim St, Haifa, ISRAEL
ELDORADO ELECTRODATA
601 Chalomar Rd, Concord, Cal 94520
KIMBALL SYSTEMS DIV. LITTON INDUS.
151 Cortlandt St, Belleville, N J 07109
NATIONWIDE ELECTRONIC SYSTEMS INC.
7 N 662 Rte 53, Itasca, Ill 60143
SYSTEMS CONCEPTS INC.
17-45 Clintonville St, Whitestone, N Y 11357

CONVERTERS, PUNCHED TAG-TO-PUNCHED CARD

ADVANCED SPACE AGE PRODUCTS
4308 Wheeler Ave, Alexandria, Va 22313
ELBIT COMPUTERS/SUB. CONTROL DATA CORP.
6 Tovim St, Haifa, ISRAEL
ELDORADO ELECTRODATA
601 Chalomar Rd, Concord, Cal 94520
KIMBALL SYSTEMS DIV. LITTON INDUS.
151 Cortlandt St, Belleville, N J 07109
NATIONWIDE ELECTRONIC SYSTEMS INC.
7 N 662 Rte 53, Itasca, Ill 60143
SYSTEMS CONCEPTS INC.
17-45 Clintonville St, Whitestone, N Y 11357

CONVERTERS, SCAN

ASTROSYSTEMS INC.
6 Nevada Dr, Lake Success, N Y 11040
COMPUTER MICRO-IMAGE SYSTEMS INC.
9600 Desoto Ave, Chatsworth, Cal 91311
DATA DISC INC.
686 W Maude Ave, Sunnyvale, Cal 94086
DATASERV DIV., WILLIAM J. PURDY CORP.
770 Airport Blvd, Burlingame, Cal 94010
ELBIT COMPUTERS/SUB. CONTROL DATA CORP.
6 Tovim St, Haifa, ISRAEL
ELECTRO FIBEROPTICS CORP.
99 Hartwell St, West Boylston, Mass 01583
FAIRCHILD DUMONT ELECTRON TUBES
750 Bloomfield Ave, Clifton, N J 07015
HUGHES AIRCRAFT CO. INDUS. PRDTS. DIV.
2020 Oceanside Blvd, Oceanside, Cal 92054
NATEL ENGINEERING CO. INC.
8944 Mason Ave, Canoga Park, Cal 91306
PRINCETON ELECTRONIC PRODUCTS INC.
P O Box 101, N Brunswick, N J 08902
PURDY CORP., WM. J.
770 Airport Blvd, Burlingame, Cal 94010
SINGER-GENERAL PRECISION KEARFOTT DIV.
1150 McBride Ave, Little Falls, N J 07424
TREPAC CORP. OF AMERICA
30 W Hamilton Ave, Englewood, N J 07631

CONVERTERS, SYNCHRO-TO-DIGITAL

ANALOG DEVICES INC. PASTORIZA DIV.
221 5th St, Cambridge, Mass 02142
ANALOGIC CORP.
Audubon Rd, Wakefield, Mass 01880
ASTRONAUTICS CORPORATION OF AMERICA
907 S First St, Milwaukee, Wis 53204
ASTROSYSTEMS INC.
6 Nevada Dr, Lake Success, N Y 11040
BENDIX CORP., THE, ENVRNMENTAL SCI. DIV.
1400 Taylor Ave, Baltimore, Md 21204
BFA CORP.
1309 S Inca, Denver, Colo 80223
CLIFTON DIV. LITTON SYSTEMS INC.
Marple At Broadway, Clifton Heights, Pa 19018
COMPUTER CONVERSIONS CORP.
6 Dunton Court, E Northport, N Y 11731

CONRAC CORP.
330 Madison Ave, New York, N Y 10017
DDC DIV. SOLID STATE SCIENTIFIC DEVICES
100 Tec St, Hicksville, N Y 11801
DYNALEX INC.
885 Front St, Burbank, Cal 91502
ELBIT COMPUTERS/SUB. CONTROL DATA CORP.
6 Tovim St, Haifa, ISRAEL
FARRAND CONTROLS INC.
99 Wall St, Valhalla, N Y 10595
GAP INSTRUMENT CORP.
110 Marcus Blvd, Hauppauge, N Y 11787
METRIC SYSTEMS CORP.
736 N Beal St, Ft Walton Beach, Fla 32548
NATEL ENGINEERING CO. INC.
8944 Mason Ave, Canoga Park, Cal 91306
NORDEN DIV., UNITED AIRCRAFT CORP.
Helen St, Norwalk, Conn 06850
NORTH AMERICAN ROCKWELL CORP. AUTONETICS DIV.
3370 Miraloma Ave, Anaheim, Cal 92803
NORTH ATLANTIC INDUSTRIES INC.
200 Terminal Dr, Plainview, N Y 11803
PHOENIX DATA INC.
3384 W Osborn Rd, Phoenix, Ariz 85017
RC-95 INC.
2 Westchester Plaza, Elmsford, N Y 10523
ROLM. CORP.
10300 N Tantau, Cupertino, Cal 95014
SINGER-GENERAL PRECISION KEARFOTT DIV.
1150 McBride Ave, Little Falls, N J 07424
SPACETAC INC.
Burlington Rd, Bedford, Mass 01730
THETA INSTRUMENT CORP.
24 Dwight Pl, Fairfield, N J 07006
TRANSMAGNETICS INC.
210 Adams Blvd, Farmingdale, N Y 11735
UNICOMP INC.
18219 Parthenia, Northridge, Cal 91324
VERNITRON CORP. MOTOR PRODUCTS DIV.
300 Marcus Blvd, Deer Park, N Y 11729
WESTON-TRANSICOIL A SCHLUMBERGER CO.
Trooper Rd, Worcester, Pa 19490

CONVERTERS, VOLTAGE-TO-FREQUENCY

AIRPAX ELECTRONICS INC.
P O Box 8488, Ft Lauderdale, Fla 33310
ALTEC DIV., LTV LING ALTEC INC.
1515 So Manchester Av, Anaheim, Cal 92803
ANADIX INSTRUMENTS INC.
7833 Haskell Ave, Van Nuys, Cal 91406
ANALOGIC CORP.
Audubon Rd, Wakefield, Mass 01880
ARNOLD MAGNETICS CORP.
P O Box K, Culver City, Cal 90230
ASTROSYSTEMS INC.
6 Nevada Dr, Lake Success, N Y 11040
BECKMAN INSTRUMENTS INC. ELECT. INSTR. DIV.
2200 Wright Ave, Richmond, Cal 94804
BERGEN LABORATORIES INC. SUB. ZYROTRON INC.
60 Spruce St, Paterson, N J 07501
BULOVA WATCH ELECTRONICS DIV.
6120 Woodside Ave, Woodside Li, N Y 11377
COMPUTER CONVERSIONS CORP.
6 Dunton Court, E Northport, N Y 11731
COMPUTER CORP. OF AMERICA
6216 Evergreen St, Houston, Tex 77036
CONTROL EQUIPMENT CORP.
32 Kearney Rd, Needham Heights, Mass 02194
DIGITRON CORP.
2544 W Main St, Norristown, Pa 19401
ELBIT COMPUTERS/SUB. CONTROL DATA CORP.
6 Tovim St, Haifa, ISRAEL
ELECTRIC INDICATOR CO. INC.
195 Danbury Rd, Wilton, Conn 06897
ERA TRANSPAC CORP.
67 Sand Park Rd, Cedar Grove, N J 07009
FOXBORO CO., THE
Neponset Ave, Foxboro, Mass 02035
GAP INSTRUMENT CORP.
110 Marcus Blvd, Hauppauge, N Y 11787
HEWLETT PACKARD CO.
1501 Page Mill Rd, Palo Alto, Cal 94304
HICKOK ELECTRICAL INSTRUMENT CO.
10514 Dupont Ave, Cleveland, Ohio 44108
INDUSTRIAL TEST EQUIPMENT CO INC.
20 Beechwood Ave, Pt Washington, N Y 11050
LORAIN PRODUCTS CORP.
1122 F St, Lordin, Ohio 44052
MACNEAL-SCHWENDLER CORP., THE
7442 N Figueroa St, Los Angeles, Cal 90041

MARQUETTA ELECTRONICS INC.
3712 W Elm St, Milwaukee, Wisc 53209
NIGITRON CORP.
2544 W Main St, Norristown, Pa 19401
OPTICAL ELECTRONICS INC.
P O Box 11140, Tucson, Ariz 85706
PEERLESS ELECTRICAL PRODUCTS DIV.
1515 S Manchester Ave, Anaheim, Cal 92803
RC-95 INC.
2 Westchester Plaza, Elmsford, N Y 10523
RHO ENGINEERING CO.
2234 Colby Ave, Los Angeles, Cal 90064
SOLID STATE ELECTRONICS CORP.
15321 Rayen St, Sepulveda, Cal 91343
THETA INSTRUMENT CORP.
24 Dwight Pl, Fairfield, N J 07006
TUSTIN ELECTRONICS CO.
17942 E Main St, Tustin, Cal 92680
VARO INC. STATIC POWER DIV.
1600 Dallas Pkwy, Plano, Tex 75074
VIDAR CORP.
77 Ortega Ave, Mountain View, Cal 94040

CORDS, PATCH

ALDEN PRODUCTS CO.
117 N Main St, Brockton, Mass 02401
AMP INC.
Eisenhower Blvd, Harrisburg, Pa 17105
AVCO CORP. ELECTRONICS DIV.
4807 Bradford, Huntsville, Ala 35805
CAMBRIDGE THERMIONIC CORP.
445 Concord Ave, Cambridge, Mass 02138
COMPUTER ACCESSORIES CO.
131 W 154th St, Gardena, Cal 90248
INFO-LITE CORP.
2337 Lemoine Ave, Fort Lee, N J 07024
INTERDYNE
2217 Purdue Ave, Los Angeles, Cal 90064
INTERSWITCH DIV. WILLIAM J. PURDY CORP.
770 Airport Blvd, Burlington, Cal 94010
JOHNSON CO., E.F.
299 Tenth Ave SW, Waseca, Minn 56093
MACPANEL CO. ADAMS-MILLIS CORP.
P O Box 5027, High Point, N C 27262
NATIONAL TEL-TRONICS
55 Northern Blvd, Great Neck, N Y 11021
OCHMAN SYSTEMS, EDWARD
Po Box 141, Fairfield, Conn 06430
ROWE INDUSTRIES INC.
1702 Airport Hwy, Toledo, Ohio 43609
STANDARD WIRE AND CABLE CO.
3440 Overland Ave, Los Angeles, Cal 90034
SYSTRON-DONNER CORP.
888 Galindo St, Concord, Cal 94520
VECTOR ELECTRONIC CO. INC.
12460 Gladstone Ave, Sylmar, Cal 91342
VIRGINIA ELECTRONICS CO. INC.
2901 Telear Court, Falls Church, Va 22042
VIRGINIA PANEL CORP.
1400 N Hope Rd, Waynesboro, Va 22980

CORES, FERRITE MEMORY

AMPEX CORP. COMPUTER PRODUCTS DIV.
9937 W Jefferson Blvd, Culver City, Cal 90230
BURROUGHS CORP., BUSINESS MACHINES GROUP
6071 2nd Ave, Detroit, Mich 48232
CORE MEMORIES INC.
2525 Charleston Rd, Mt View, Cal 94041
DATA PRODUCTS CORP.
16055 Ventura Blvd, Encino, Cal 91316
DATAPAC INC.
3839 S Main St, Santa Ana, Cal 92702
DATARAM CORP.
Rte 206, Princeton, N J 08540
DIGITAL EQUIPMENT CORP.
146 Main St, Maynard, Mass 01754
ELECTRONIC MEMORIES
12621 Chadron Ave, Hawthorne, Cal 90250
FABRI-TEK INC.
5901 S County Rd 18, Minneapolis, Minn 55436
FERROXCUBE CORP.
Po Box 359, Saugerties, N Y 12477
LOCKHEED ELECTRONICS CO. DATA PRODUCTS DIV.
6201 E Randolph St, Los Angeles, Cal 90650
LOCKHEED ELECTRONICS CO. DIV. LOCKHEED ACRFT CORP
U S Hwy 22, Plainfield, N J 07060
MICRO SYSTEMS INC.
644 E Young St, Santa Ana, Cal 92705
QUADRI CORP.
2959 W Fairmount, Phoenix, Ariz 85017

2 Product Directory

RCA MEMORY PRODUCTS DIV
150 A St, Needham Heights, Mass 02194
STANDARD MEMORIES INC.
15130 Ventura Blvd, Sherman Oak, Cal 91403
WANG LABORATORIES INC.
836 N St, Tewksbury, Mass 01876

CORRECTION SEALS, MICR DOCUMENTS

ACRATOD COMPANY
Po Box 66847, Houston, Tex 77006
OCHMAN SYSTEMS, EDWARD
Po Box 141, Fairfield, Conn 06430
VISIBLE COMPUTER SUPPLY CORP.
9865 Derby Ln, Westchester, Ill 60153

CORRECTION SEALS, PUNCH CARD

ACRATOD COMPANY
Po Box 66847, Houston, Tex 77006
COMPUTER ACCESSORIES CO.
131 W 154th St, Gardena, Cal 90248
OCHMAN SYSTEMS, EDWARD
Po Box 141, Fairfield, Conn 06430
VISIBLE COMPUTER SUPPLY CORP.
9865 Derby Ln, Westchester, Ill 60153

CORRECTION SEALS, PAPER TAPE

ACRATOD COMPANY
Po Box 66847, Houston, Tex 77006
COMPUTER ACCESSORIES CO.
131 W 154th St, Gardena, Cal 90248
DELMARVA COMPUTER INDUSTRIES INC.
5865 Robert Oliver Pl, Columbia, Md 21043
DONAULD INC.
P O Box 104, Ridgewood, N J 07451
INTERNATIONAL COMPUTER APPLIANCES CORP.
200 N Third St, Minneapolis, Minn 55401
NUMERIDEX TAPE SYSTEMS INC.
4711 W North Ave, Chicago, Ill 60639
OCHMAN SYSTEMS, EDWARD
Po Box 141, Fairfield, Conn 06430
ORIGINAL COMPUTER PRODUCTS INC.
204 Worcester St, Wellesley Hills, Mass 02181
VISIBLE COMPUTER SUPPLY CORP.
9865 Derby Ln, Westchester, Ill 60153

COUNTERS, DECADE

ADVANCED MICRO DEVICES INC.
901 Thompson Pl, Sunnyvale, Cal 94086
ALCO ELECTRONIC PRODUCTS INC.
8 Marblehead St, North Andover, Mass 01845
AMERICAN COMPUTER TECHNOLOGY INC.
8740 Shirley Ave, Northridge, Cal 91324
ANADIX INSTRUMENTS INC.
7833 Haskell Ave, Van Nuys, Cal 91406
ANALOGIC CORP.
Audubon Rd, Wakefield, Mass 01880
APPLIED COMPUTER SYSTEMS INC.
P O Box 6479, Austin, Tex 78702
AVCO CORP. ELECTRONICS DIV.
4807 Bradford, Huntsville, Ala 35805
BFA CORP.
1309 S Inca, Denver, Colo 80223
BURROUGHS CORP., ELECTRONICS COMPONENTS DIV.
P O Box 1226, Plainfield, N J 07061
CAMBRIDGE THERMIONIC CORP.
445 Concord Ave, Cambridge, Mass 02138
CLARE SYSTEMS DIV. C.P. CLARE & CO.
3101 W Pratt Ave, Chicago, Ill 60645
COMPONENTS, CORP.
106 Main St, Denville, N J 07834
COMPUTER CORP. OF AMERICA
6216 Evergreen St, Houston, Tex 77036
COMPUTER PRODUCTS, INC.
P O Box 23849, Ft Lauderdale, Fla 33307
CONTROL EQUIPMENT CORP.
32 Kearney Rd, Needham Heights, Mass 02194
DATA GRAPHICS CORP.
8402 Speedway, San Antonio, Tex 78230
DIGITRON CORP.
2544 W Main St, Norristown, Pa 19401
DURANT DIGITAL INSTRUMENTS A CUTLER HAMMER CO.
600 N Cass St, Milwaukee, Wisc 53201
DYONIC INC.
71 Pine St, Woburn, Mass 01801
ELBIT COMPUTERS/SUB. CONTROL DATA CORP.
6 Tovim St, Haifa, ISRAEL

GEAR SYSTEMS DIV. OF USM CORP.
Rte 128, Wakefield, Mass 01880
GENERAL EQUIPMENT & MANUFACTURING CO.
3300 Fern Valley Rd, Louisville, Ky 40213
GENERAL INSTRUMENT CORP. MICROELECT. DIV.
600 W John St, Hicksville, N Y 11802
GENERAL RADIO CO.
300 Baker Ave, Concord, Mass 01742
HECON CORP.
31 Park Rd, New Shrewsbury, N J 07724
HI-G INC.
580 Spring St, Windsor Locks, Conn 06096
INDUSTRIAL ELECTRONIC ENGINEERS INC.
7720-40 Lemona Ave, Van Nuys, Cal 91405
INSTRUMENT DISPLAYS INC. SUB. KELTRON CORP.
223 Crescent St, Waltham, Mass 02154
LANDIS AND GYR INC.
4 Westchester Plaza, Elmsford, N Y 10523
LEHIGH VALLEY ELECTRONICS INC.
Po Box 125, Fogelsville, Pa 18051
LUMINETICS CORP.
P O Box 1943, Pompano Beach, Fla 33061
MASSEY DICKINSON CO. INC.
9 Elm St, Saxonville, Mass 01701
MEKONTROL INC.
56 Hudson St, Northboro, Mass 01532
MICRO METRICS INC.
253 Crooks Ave, Clifton, N J 07011
MILLETRON INC.
540 Alpha Dr, Pittsburgh, Pa 15238
MOTOROLA SEMICONDUCTOR PRODUCTS INC.
5005 E Mc Dowell Rd, Phoenix, Ariz 85008
NANOSECOND SYSTEMS INC.
176 Linwood Ave, Fairfield, Conn 06430
NIGITRON CORP.
2544 W Main St, Norristown, Pa 19401
NUCLEONIC PRODUCTS CO. INC.
6660 Variel Ave, Canoga Park, Cal 91303
PARABAM INC.
3017 E Las Hermanas, Compton, Cal 90221
PRACTICAL AUTOMATION
P O Box 313, Shelton, Conn 06484
RANK PRECISION INDUSTRIES INC.
260 N Rt 303, W Nyack, N Y 10994
RAYTHEON COMPUTER
2700 S Fairview St, Santa Ana, Cal 92704
SCIENTIFIC MEASUREMENTS INC.
9701 N Kenton, Skokie, Ill 60076
SIGNETICS CORP. SUB. CORNING GLASS
811 E Arques Ave, Sunnyvale, Cal 94086
SPRAGUE ELECTRIC CO.
551 Marshall St, N Adams, Mass 01247
THETA INSTRUMENT CORP.
24 Dwight Pl, Fairfield, N J 07006
TRANSITRON ELECTRONIC CORP.
168 Albion St, Wakefield, Mass 01880
VEEDER-ROOT
70 Sargeant St, Hartford, Conn 06102

COUNTERS, DIGITAL READOUT

A. W. HAYDON CO., THE
232 N Elm St, Waterbury, Conn 06720
ABRAMS INSTRUMENT CORP. J A MAURER INC.
606 E Shiawassee St, Lansing, Mich 48901
ALCO ELECTRONIC PRODUCTS INC.
8 Marblehead St, North Andover, Mass 01845
ALLEN-BRADLEY
1201 S 2nd St, Milwaukee, Wisc 53204
AMERICAN COMPUTER TECHNOLOGY INC.
8740 Shirley Ave, Northridge, Cal 91324
AMPHENOL CONTROLS DIV. BUNKER RAMO CORP.
120 S Main St, Janesville, Wisc 53545
ANADIX INSTRUMENTS INC.
7833 Haskell Ave, Van Nuys, Cal 91406
ANALOGIC CORP.
Audubon Rd, Wakefield, Mass 01880
AUTOMATION DEVELOPMENT CO. DIV. AMER DIG CORP.
9903 W Jefferson Blvd, Culver City, Cal 90230
BECKMAN INSTRUMENTS INC. ELECT. INSTR. DIV.
2200 Wright Ave, Richmond, Cal 94804
BFA CORP.
1309 S Inca, Denver, Colo 80223
BURROUGHS CORP., ELECTRONICS COMPONENTS DIV.
P O Box 1226, Plainfield, N J 07061
CALIFORNIA INSTRUMENTS CO.
5150 Convoy St, San Diego, Cal 92111
CHRONO-LOG CORP.
2583 W Chester Pike, Broomall, Pa 19008
CITIZEN AMERICA CORP.
9201 Olympic Blvd, Beverly Hills, Cal 90212

COMPACE CORP.
7413 Washington Ave S, Edina-Minnepols, Minn 55435
COMPUTER CONVERSIONS CORP.
6 Dunton Court, E Northport, N Y 11731
COMPUTER CORP. OF AMERICA
6216 Evergreen St, Houston, Tex 77036
COMPUTER MEASUREMENTS CO.
12970 Bradley Ave, San Fernando, Cal 91342
CONRAC CORP.
330 Madison Ave, New York, N Y 10017
CONRAC CORP. CRAMER DIV.
Mill Rock Rd, Old Saybrook, Conn 06475
CONTROL EQUIPMENT CORP.
32 Kearney Rd, Needham Heights, Mass 02194
DATA GRAPHICS CORP.
8402 Speedway, San Antonio, Tex 78230
DATA TECHNOLOGY INC.
65 Grove St, Watertown, Mass 02172
DIGILIN, INC.
1007 Air Way, Glendale, Cal 91201
DIGITRON CORP.
2544 W Main St, Norristown, Pa 19401
DURANT DIGITAL INSTRUMENTS A CUTLER HAMMER CO.
600 N Cass St, Milwaukee, Wisc 53201
DYNAMICS RESEARCH CORP.
38 Montvale Ave, Stoneham, Mass 02180
EL INSTRUMENTS INC.
61 1st St, Derby, Conn 06418
ELBIT COMPUTERS/SUB. CONTROL DATA CORP.
6 Tovim St, Haifa, ISRAEL
GAP INSTRUMENT CORP.
110 Marcus Blvd, Hauppauge, N Y 11787
GENERAL EQUIPMENT & MANUFACTURING CO.
3300 Fern Valley Rd, Louisville, Ky 40213
GENERAL INSTRUMENT CORP. MICROELECT. DIV.
600 W John St, Hicksville, N Y 11802
GENERAL RADIO CO.
300 Baker Ave, Concord, Mass 01742
GIBBS MANUFACTURING & RESEARCH CORP.
450 N Main, Janesville, Wisc 53545
GRALEX INDUSTRIES DIV. GENL. MICROWAVE CORP
155 Marine St, Farmingdale, N Y 11735
HAYDON SWITCH&INSTRUMENT INC. SUB. TRI-TECH INC.
1500 Meriden Rd, Waterbury, Conn 06720
HECON CORP.
31 Park Rd, New Shrewsbury, N J 07724
HEWLETT PACKARD CO.
1501 Page Mill Rd, Palo Alto, Cal 94304
HICKOK ELECTRICAL INSTRUMENT CO.
10514 Dupont Ave, Cleveland, Ohio 44108
HUGHES AIRCRAFT CO. M O S DIV.
500 Superior Ave, Newport Beach, Cal 92660
IKL INC.
4360 Campus Dr, Newport Beach, Cal 92660
INDUSTRIAL ELECTRONIC ENGINEERS INC.
7720-40 Lemona Ave, Van Nuys, Cal 91405
INFO-LITE CORP.
2337 Lemoine Ave, Fort Lee, N J 07024
INSTRUMENT DISPLAYS INC. SUB. KELTRON CORP.
223 Crescent St, Waltham, Mass 02154
KELTRON CORP.
225 Crescent St, Waltham, Mass 02154
LANDIS AND GYR INC.
4 Westchester Plaza, Elmsford, N Y 10523
LECROY RESEARCH SYSTEMS CORP.
126 N Rte 303, W Nyack, N Y 10994
LEHIGH VALLEY ELECTRONICS INC.
Po Box 125, Fogelsville, Pa 18051
LUMINETICS CORP.
P O Box 1943, Pompano Beach, Fla 33061
MAST DEVELOPMENT CO. SUB. AV ELECTRONICS INC.
2212 E 12th St, Davenport, Iowa 52803
MDC TECHNOLOGY CORP. SUB. MNGMNT. DATA CORP.
530 W St Rd, Warminster, Pa 18974
MEKONTROL INC.
56 Hudson St, Northboro, Mass 01532
MONSANTO CO. ELECTRONIC PDTS. & CONTROLS DIV.
11636 Administration, St Louis, Mo 63141
NANOSECOND SYSTEMS INC.
176 Linwood Ave, Fairfield, Conn 06430
NIGITRON CORP.
2544 W Main St, Norristown, Pa 19401
NON-LINEAR SYSTEMS INC.
P O Box N, Del Mar, Cal 92014
NOVATRONICS OF CANADA LTD.
677 Erie St, Stratford Ont, CANADA
PARABAM INC.
3017 E Las Hermanas, Compton, Cal 90221
PINLITES INC.
P O Box 453, Caldwell, N J 07006

2 Product Directory

PRACTICAL AUTOMATION

P O Box 313, Shelton, Conn 06484
RAMSAY ENGINEERING CO.

707 N Anaheim Blvd, Anaheim, Cal 92805
RANK PRECISION INDUSTRIES INC.

260 N Rt 303, W Nyack, N Y 10994
SANDERS ASSOCIATES INC. SYSTEMS DIV.

Daniel Webster Hwy S, Nashua, N H 03060
SCIENTIFIC MEASUREMENTS INC.

9701 N Kenton, Skokie, Ill 60076
SYSTEMS RESEARCH LABS, INC.

7001 Indian Ripple Rd, Dayton, Ohio 45440
TEC INC.

6700 S Wash Ave, Eden Prairie, Minn 55343
THETA INSTRUMENT CORP.

24 Dwight Pl, Fairfield, N J 07006
TYCO LABORATORIES INC.

16 Hickory Dr, Waltham, Mass 02154
VEEDER-ROOT

70 Sargeant St, Hartford, Conn 06102
WANG LABORATORIES INC.

836 N St, Tewksbury, Mass 01876

COUNTERS, STEPPING SWITCH

AUTOMATION DEVELOPMENT CO. DIV. AMER DIG
CORP.

9903 W Jefferson Blvd, Culver City, Cal 90230
DURANT DIGITAL INSTRUMENTS A CUTLER HAMMER
CO.

600 N Cass St, Milwaukee, Wis 53201
DYTRON CORP.

63 Tec St, Hicksville, N Y 11801
ELBIT COMPUTERS/SUB. CONTROL DATA CORP.

6 Tovim St, Haifa, ISRAEL
GENERAL INSTRUMENT CORP. MICROELECT. DIV.

600 W John St, Hicksville, N Y 11802
GUARDIAN ELECTRIC MANUFACTURING CO.

1550 W Carroll Ave, Chicago, Ill 60607
INSTRUMENT DISPLAYS INC. SUB. KELTRON CORP.

223 Crescent St, Waltham, Mass 02154
LANDIS AND GYR INC.

4 Westchester Plaza, Elmsford, N Y 10523
LEDEX INC.

123 Webster St, Dayton, Ohio 45401
LEHIGH VALLEY ELECTRONICS INC.

Po Box 125, Fogelsville, Pa 18051
NO. AMERICAN PHILIPS CORP. FREDERICK CONT. DIV

Frederick, Md 21701
PARABAM INC.

3017 E Las Hermanas, Compton, Cal 90221
RANK PRECISION INDUSTRIES INC.

260 N Rt 303, W Nyack, N Y 10994
STRUTHER-DUNN INC. SYSTEMS DIV.

1114 State St, Bettendorf, Iowa 52722

PLOTTERS, FILM EXPOSING

AUTO-TROL CORP.

6621 W 56th Ave, Arvada, Colo 80002
COMPUTERVISION CORP.

NW Ind Park S Ave, Burlington, Mass 01803
CONCORD CONTROL INC.

1282 Soldier Field Rd, Boston, Mass 02135
CURRAN COMPUTER CORP.

946 Main St, Hackensack, N J 07601
DACOM INC.

1060 Morse Ave, Sunnyvale, Cal 94086
DRESSER SYSTEMS INC.

P O Box 2928, Houston, Tex 77001
FELSENTHAL INSTRUMENTS CO.

7450 W Wilson Ave, Chicago, Ill 60656
FERRANTI PACKARD LTD., ELECTRONICS DIV.

121 Industry St, Toronto 15, CANADA
GEO SPACE CORP.

5803 Glenmont, Houston, Tex 77036
GERBER SCIENTIFIC INSTRUMENT CO. THE

P O Box 305, Hartford, Conn 06101
INFORMATION INTERNATIONAL INC.

12435 W Olympic Blvd, Los Angeles, Cal 90064
KONIGSBERG SYSTEMS INC.

10 De Angelo Dr, Bedford, Mass 01730
SINGER LINK DIV.

1077 E Arques, Sunnyvale, Cal 94086
STROMBERG DATAGRAPHIX INC.

P O Box 2449, San Diego, Cal 92112
SUPERIOR ELECTRIC CO., THE

383 Middle St, Bristol, Conn 06010
UNIVERSITY COMPUTING CO. GRAPHIC SYSTEMS DIV

14761 Califa St, Van Nuys, Cal 91401
XYNETICS INC.

6710 Variel Ave, Canoga Park, Cal 91303

COUNTERS, UP-DOWN

ADVANCED MICRO DEVICES INC.

901 Thompson Pl, Sunnyvale, Cal 94086
AMERICAN COMPUTER TECHNOLOGY INC.

8740 Shirley Ave, Northridge, Cal 91324
ANADIX INSTRUMENTS INC.

7833 Haskell Ave, Van Nuys, Cal 91406
APPLIED COMPUTER SYSTEMS INC.

P O Box 6479, Austin, Tex 78702
AUTOMATION DEVELOPMENT CO. DIV. AMER DIG
CORP.

9903 W Jefferson Blvd, Culver City, Cal 90230
AVCO CORP. ELECTRONICS DIV.

4807 Bradford, Huntsville, Ala 35805
CAMBRIDGE THERMIONIC CORP.

445 Concord Ave, Cambridge, Mass 02138
CLARE SYSTEMS DIV. C.P. CLARE & CO.

3101 W Pratt Ave, Chicago, Ill 60645
COMPUTER PRODUCTS, INC.

P O Box 23849, Ft Lauderdale, Fla 33307
CONTROL EQUIPMENT CORP.

32 Kearney Rd, Needham Heights, Mass 02194
CURTIS INSTRUMENTS INC.

200 Kisco Ave, Mt Kisco, N Y 10549
DATA GRAPHICS CORP.

8402 Speedway, San Antonio, Tex 78230
DATA TECHNOLOGY CORP.

1050 E Meadow Cir, Palo Alto, Cal 94303
DATA TECHNOLOGY INC.

65 Grove St, Watertown, Mass 02172
DIGITRON CORP.

2544 W Main St, Norristown, Pa 19401
DURANT DIGITAL INSTRUMENTS A CUTLER HAMMER
CO.

600 N Cass St, Milwaukee, Wis 53201
ELBIT COMPUTERS/SUB. CONTROL DATA CORP.

6 Tovim St, Haifa, ISRAEL
GAP INSTRUMENT CORP.

110 Marcus Blvd, Hauppauge, N Y 11787
GENERAL INSTRUMENT CORP. MICROELECT. DIV.

600 W John St, Hicksville, N Y 11802
HAYDON SWITCH&INSTRUMENT INC. SUB. TRI-TECH
INC.

1500 Meriden Rd, Waterbury, Conn 06720
HECON CORP.

31 Park Rd, New Shrewsbury, N J 07724
HEWLETT PACKARD CO.

1501 Page Mill Rd, Palo Alto, Cal 94304
HUGHES AIRCRAFT CO. M O S DIV.

500 Superior Ave, Newport Beach, Cal 92660
HYBRID SYSTEMS DIV. DIGITAL RESOURCES CORP.

4301 Dacoma Rd, Houston, Tex 77018
IKL INC.

4360 Campus Dr, Newport Beach, Cal 92660
INFO-LITE CORP.

2337 Lemoine Ave, Fort Lee, N J 07024
INSTRUMENT DISPLAYS INC. SUB. KELTRON CORP.

223 Crescent St, Waltham, Mass 02154
KELTRON CORP.

225 Crescent St, Waltham, Mass 02154
LANDIS AND GYR INC.

4 Westchester Plaza, Elmsford, N Y 10523
LEHIGH VALLEY ELECTRONICS INC.

Po Box 125, Fogelsville, Pa 18051
LUMINETICS CORP.

P O Box 1943, Pompano Beach, Fla 33061
MASSEY DICKINSON CO. INC.

9 Elm St, Saxonville, Mass 01701
MEASUREMENT SYSTEMS INC.

523 West Ave, Norwalk, Conn 06850
MEKONTROL INC.

56 Hudson St, Northboro, Mass 01532
METRIC SYSTEMS CORP.

736 N Beal St, Ft Walton Beach, Fla 32548
MONSANTO CO. ELECTRONIC PDTS. & CONTROLS
DIV.

11636 Administration, St Louis, Mo 63141
MOTOROLA SEMICONDUCTOR PRODUCTS INC.

5005 E Mc Dowell Rd, Phoenix, Ariz 85008
NANOSECOND SYSTEMS INC.

176 Linwood Ave, Fairfield, Conn 06430
NIGITRON CORP.

2544 W Main St, Norristown, Pa 19401
PARABAM INC.

3017 E Las Hermanas, Compton, Cal 90221
RANK PRECISION INDUSTRIES INC.

260 N Rt 303, W Nyack, N Y 10994
RAYTHEON COMPUTER

2700 S Fairview St, Santa Ana, Cal 92704
SCIENTIFIC MEASUREMENTS INC.

9701 N Kenton, Skokie, Ill 60076
SIGNETICS CORP. SUB. CORNING GLASS

811 E Arques Ave, Sunnyvale, Cal 94086

SPRAGUE ELECTRIC CO.

551 Marshall St, N Adams, Mass 01247
STERLING INSTRUMENT DIV. DESIGNATRONICS INC.

55 S Denton Ave, New Hyde Park, N Y 11040
STRUTHER-DUNN INC. SYSTEMS DIV.

1114 State St, Bettendorf, Iowa 52722
THETA INSTRUMENT CORP.

24 Dwight Pl, Fairfield, N J 07006
TYCO LABORATORIES INC.

16 Hickory Dr, Waltham, Mass 02154
VEEDER-ROOT

70 Sargeant St, Hartford, Conn 06102

COVERS, ACOUSTIC (FOR KEYBOARDS, TELETYPEWRITERS, ETC.)

BARRY-WRIGHT CORP. WRIGHT LINE DIV.

160 Gold Star Blvd, Worcester, Mass 01606
COMPUTER ACCESSORIES CO.

131 W 154th St, Gardena, Cal 90248
COMPUTER-LINK CORP.

14 Cambridge St, Burlington, Mass 01803
DELMARVA COMPUTER INDUSTRIES INC.

5865 Robert Oliver Pl, Columbia, Md 21043
ECCO BUSINESS SYSTEMS INC.

50 E 42nd St, New York, N Y 10017
MORLEY CO., THE

909 Islington St, Portsmouth, N H 03801
NUMERIDEX TAPE SYSTEMS INC.

4711 W North Ave, Chicago, Ill 60639
OCHMAN SYSTEMS, EDWARD

Po Box 141, Fairfield, Conn 06430
VISIBLE COMPUTER SUPPLY CORP.

9865 Derby Ln, Westchester, Ill 60153

CRT CONSOLES (SEE CONSOLES)

CRT DEFLECTION YOKES

CELCO.CONSTANTINE ENGINEERING LABS. CO.

70 Constantine Dr, Mahwah, N J 07430
CONSTANTINE ENGINEERING LABS CELCO

70 Constantine Dr, Mahwah, N J 07430

CRT FILM PROCESSORS (SEE PROCESSORS)

CRT HARD-COPY RECORDERS (SEE RECORDERS)

CRT MONITORS (SEE CONSOLES)

CRT SYMBOL GENERATORS (SEE GENERATORS)

CRYSTAL UNITS, QUARTZ (FOR FREQUENCY CONTROL)

ARVIN SYSTEMS INC.

1771 Springfield St, Dayton, Ohio 45403
BULOVA WATCH ELECTRONICS DIV.

6120 Woodside Ave, Woodside Li, N Y 11377
CTS CORP.

905 NW Blvd, Elkart, Ind 46514
CTS KNIGHTS INC.

Reimann Ave, Sandwich, Ill 60548
DYNAMICS CORP. OF AMERICA REEVES HOFFMAN
DIV.

400 W North St, Carlisle, Pa 17013
GIBBS MANUFACTURING & RESEARCH CORP.

450 N Main, Janesville, Wisc 53545
NYTRONICS INC.

3rd Ave, Alpha, N J 08865
TORTEL INC.

13402 S 71 Hwy, Grandview, Mo 64030
TRW SEMICONDUCTOR DIV.

14520 Aviation Blvd, Lawndale, Cal 90260
TYCO LABORATORIES INC.

16 Hickory Dr, Waltham, Mass 02154
VALPEY FISHER CORP.

1015 1st St, Holliston, Mass 01746
VALPEY FISHER CORP. DIV. CLARK CRYSTAL

344 Boston Post Rd, Marlboro, Mass 01752

2 Product Directory

CURVE TRACERS-DIGITIZERS, AUTOMATIC

AUTO-TROL CORP.
6621 W 56th Ave, Arvada, Colo 80002
BASIC COMPUTING ARTS INC.
2680 E Bayshore Frtge, Mt View, Cal 94040
CALIFORNIA COMPUTER PRODUCTS INC.
2411 W La Palma Ave, Anaheim, Cal 92801
CONCORD CONTROL INC.
1282 Soldier Field Rd, Boston, Mass 02135
DATA TECHNOLOGY INC.
65 Grove St, Watertown, Mass 02172
DIMENSIONAL SYSTEMS INC.
393 Totten Pond Rd, Waltham, Mass 02154
GERBER SCIENTIFIC INSTRUMENT CO., THE
P O Box 305, Hartford, Conn 06101
GRAPH DATA DIGITIZING
13834 S Prairie Ave, Hawthorne, Cal 90250
INFORMATION INTERNATIONAL INC.
12435 W Olympic Blvd, Los Angeles, Cal 90064
RESALAB INC. RESALAB SCIENTIFIC DIV.
4000 Campbell Ave, Menlo Park, Cal 94025
TRIDEA ELECTRONICS A SUB. OF CONDUCTRON CORP.
10581 Federal Dr, El Monte, Cal 91731
UNIVERSITY COMPUTING CO. GRAPHIC SYSTEMS DIV
14761 Califa St, Van Nuys, Cal 91401

CURVE TRACERS-DIGITIZERS, MANUAL

AUTO-TROL CORP.
6621 W 56th Ave, Arvada, Colo 80002
BENDIX COMPUTER GRAPHICS
23850 Freeway Park Dr, Farmington, Mich 48024
BOLT BERANEK & NEWMAN INC. DATA EQUIPMENT DIV.
1762 McGaw St, Santa Ana, Cal 92705
BOSTON DIGITAL CORP.
Main St, Ashland, Mass 01721
CALMA CO.
707 Kifer Rd, Sunnyvale, Cal 94086
COMPUTEK INC.
143 Albany St, Cambridge, Mass 02139
COMPUTER INC.
143 Albany St, Cambridge, Mass 02139
COMPUTERVISION CORP.
NW Ind Park S Ave, Burlington, Mass 01803
CONCORD CONTROL INC.
1282 Soldier Field Rd, Boston, Mass 02135
DATA GRAPHICS CORP.
8402 Speedway, San Antonio, Tex 78230
DATA TECHNOLOGY INC.
65 Grove St, Watertown, Mass 02172
DIMENSIONAL SYSTEMS INC.
393 Totten Pond Rd, Waltham, Mass 02154
DUPONT DE NEMOURS, & CO., E.I. CO., INC.
1007 Market St, Wilmington, Del 19898
GRAPH DATA DIGITIZING
13834 S Prairie Ave, Hawthorne, Cal 90250
KONGSBERG SYSTEMS INC.
10 De Angelo Dr, Bedford, Mass 01730
MEASUREMENT SYSTEMS INC.
523 West Ave, Norwalk, Conn 06850
PHOTON INC.
355 Middlesex Ave, Wilmington, Mass 01887
TRAID CORP., PHOTO INSTRUMENT DIV.
900 Grand Central, Glendale, Cal 91201
UNIVERSITY COMPUTING CO. GRAPHIC SYSTEMS DIV
14761 Califa St, Van Nuys, Cal 91401

DATA ACQUISITIONS SYSTEMS, AUTOMATIC

B&F INSTRUMENT INC.
Clermont Ave, Cornwell Height, Pa 19020
DATACOM INC.
40 Lincoln Dr, Ft Walton Beach, Fla 32548
HOUSTON ENGINEERING RESEARCH CORP.
P O Box 35495, Houston, Tex 77035
LARSE CORP.
1070 E Meadow Cir, Palo Alto, Cal 94303
SYMETRICS INDUSTRIES INC.
1227 S Patrick Dr, Satellite Beach, Fla 32935
TELEDYNE GEOTECH
P O Box 28277, Dallas, Tex 75228
VIDAR CORP.
77 Ortega Ave, Mountain View, Cal 94040

DATA ACQUISITION AND REDUCTION SYSTEMS

ADVANCED TERMINALS INC.
220 3rd Ave, Herkimer, N Y 13350
AMERICAN COMPUTER TECHNOLOGY INC.
8740 Shirley Ave, Northridge, Cal 91324
ANALOGIC CORP.
Audubon Rd, Wakefield, Mass 01880
APPLIED COMPUTER SYSTEMS INC.
P O Box 6479, Austin, Tex 78702
APPLIED DYNAMICS COMPUTER SYS DV RELIANCE ELEC CO
P O Box 1488, Ann Arbor, Mich 48106
APPLIED SYSTEMS CORP.
18325 W McNichols Ave, Detroit, Mich 48219
ASTROSYSTEMS INC.
6 Nevada Dr, Lake Success, N Y 11040
AVCO CORP. ELECTRONICS DIV.
4807 Bradford, Huntsville, Ala 35805
BAGANOFF ASSOCIATES INC.
6809 W Florissant, St Louis, Mo 63136
BASIC COMPUTING ARTS INC.
2680 E Bayshore Frtge, Mt View, Cal 94040
BFA CORP.
1309 S Inca, Denver, Colo 80223
CENTURY ELECTRONICS & INSTRUMENTS INC.
P O Box C Adm Sta, Tulsa, Okla 74115
COMPUTER CORP. OF AMERICA
6216 Evergreen St, Houston, Tex 77036
COMPUTER PRODUCTS, INC.
P O Box 23849, Ft Lauderdale, Fla 33307
CONTROL DATA CORP.
8100 34th Ave S, Minneapolis, Minn 55440
CUNNINGHAM CORP. SUB. GLEASON WORKS
10 Carriage St, Honeoye Falls, N Y 14472
DACOM INC.
1060 Morse Ave, Sunnyvale, Cal 94086
DACIONICS
925 Thompson Pl, Sunnyvale, Cal 94086
DATA CONTROL SYSTEMS INC.
Commerce Dr, Danbury, Conn 06810
DATA DISC INC.
686 W Maude Ave, Sunnyvale, Cal 94086
DATA GRAPHICS CORP.
8402 Speedway, San Antonio, Tex 78230
DATA TECHNOLOGY INC.
65 Grove St, Watertown, Mass 02172
DATATRON INC.
1562 Reynolds Ave, Santa Ana, Cal 92707
DATAWEST CORP.
7503 E Osborn Rd, Scottsdale, Ariz 85251
DATEL/VARADYNE
1020 Turnpike St, Canton, Mass 02021
DIGITAL APPLICATIONS INC.
6300 Westpark Ste 150, Houston, Tex 77027
DIGITAL DATA SYSTEMS
18819 Bryant St, Northridge, Cal 91324
DIGITAL EQUIPMENT CORP.
146 Main St, Maynard, Mass 01754
DIGITAL PRODUCTS
335 W 7th St, San Pedro, Cal 90733
DIMENSIONAL SYSTEMS INC.
393 Totten Pond Rd, Waltham, Mass 02154
DYNAMIC SYSTEM ELECTRONICS
1040 W Alameda Dr, Tempe, Ariz 85281
ELECTRONIC ASSOCIATES INC.
485 Monmouth Pkwy, W Long Branch, N J 07764
ELECTRONIC MICRO SYSTEMS INC.
1672 Kaiser Ave, Santa Ana, Cal 92705
ELPAC INC.
18651 Von Karman Ave, Irvine, Cal 92664
ESTERLINE ANGUS DIV., ESTERLINE CORP.
Po Box 24000, Indianapolis, Ind 46224
GENERAL DYNAMICS CORP. ELECTRONICS DIV.
P O Box 2566, Orlando, Fla 32802
GERBER SCIENTIFIC INSTRUMENT CO., THE
P O Box 305, Hartford, Conn 06101
GOULD INC. BRUSH DIV.
3631 Perkins Ave, Cleveland, Ohio 44114
GULTON INDUSTRIES INC.
212 Durham Ave, Metuchen, N J 08840
HATHAWAY INSTRUMENTS INC.
5250 E Evans Ave, Denver, Colo 80120
HEWLETT PACKARD CO.
1501 Page Mill Rd, Palo Alto, Cal 94304
HOUSTON ENGINEERING RESEARCH CORP.
P O Box 35495, Houston, Tex 77035
HOUSTON RESEARCH INC. SUB. SCI. ELECT.
6001 Gulf Fwy, Houston, Tex 77023
LANCER ELECTRONICS CORP.
1416 W Main St, Norristown, Penn 19041
LECROY RESEARCH SYSTEMS CORP.
126 N Rte 303, W Nyack, N Y 10994

BUY - RENT - LEASE DISPLAYS all types • all brands

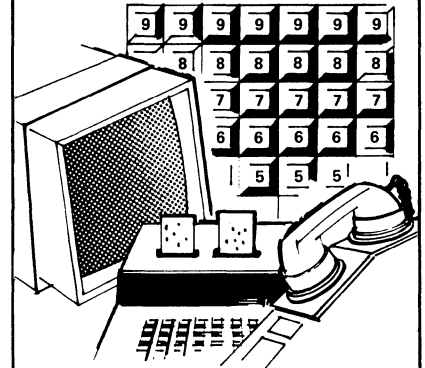

We are the West's largest, most experienced, best-stocked, factory-approved source for EDP terminals, peripherals and interfaces of every description

controllers • converters
processors • acoustic couplers
copiers • modems
display consoles
keyboards • transceivers
printers • teleprinters
readers • recorders
accessories • supplies

Our experienced EDP engineers analyze system requirements thoroughly, design and install custom turnkey systems, and provide expert consultation on system expansion or modification as requirements change.

We are thoroughly familiar with the capabilities and limitations of all reputable brands of EDP equipment, and are impartial in recommending and selecting equipment strictly on its merit for the application.

For more information on how to get the EDP system or equipment you need -- and get it on your terms -- see DataServ catalog insert.

DATA SERV

Burlingame, California
Denver • Salt Lake City • Seattle •
Phoenix • Los Angeles
One of the PURDY group of companies

2 Product Directory

UNIVERSITY COMPUTING CO.
P O Box 6228, Dallas, Tex 75222
UNIVERSITY COMPUTING CO.
888 N Sepulveda Blvd, El Segundo, Cal 90245

DATA TERMINALS, BLOCK-BY-BLOCK (MAGNETIC CARD)

WESTERN TELEMATIC INC.
5507 Peck Rd, Arcadia, Cal 91006

DATA TERMINALS, BLOCK-BY-BLOCK (MAGNETIC TAPE)

ADDO-X INC. ADP DIV.
437 Madison Ave, New York, N Y 10022
AMERICAN TOTALISATOR CO. UNI-TOTE DIV.
383 Hillen Rd, Towson, Md 21204
ANDERSON JACOBSON INC.
1065 Morse Ave., Sunnyvale, Cal 94086
APPLIED COMPUTER SYSTEMS INC.
P O Box 6479, Austin, Tex 78702
ATRON CORP.
1256 Trapp Rd, St Paul, Minn 55118
BECKMAN INSTRUMENTS INC. ELECT. INSTR. DIV.
2200 Wright Ave, Richmond, Cal 94804
COMMUNITYTYPE CORP.
767 Fifth Ave, New York, N Y 10022
COMPACE CORP.
7413 Washington Ave S, Edina-Minnepols, Minn 55435
COMPAT CORP.
177 Cantiguage Rock Rd, Westbury, N Y 11590
COMPERIPHERALS INC.
437 Madison Ave, New York, N Y 10022
COMPUTER CORP. OF AMERICA
6216 Evergreen St, Houston, Tex 77036
COMPUTER ENTRY SYSTEMS CORP.
2141 Industrial Pkwy, Silver Spring, Md 20904
COMPUTER USAGE CORP.
100 Putman Green, Greenwich, Conn 06830
CONTROL DATA CORP.
8100 34th Ave S, Minneapolis, Minn 55440
DACONICS
925 Thompson Pl, Sunnyvale, Cal 94086
DATA COMPUTER SYSTEMS INC.
17131 Daimler St, Santa Ana, Cal 92705
DATA GENERAL CORP.
Rte 9, Southboro, Mass 01772
DATA PACIFIC CORP.
116 E Ash, Fullerton, Cal 92631
DATA PATHING INC.
370 San Aleso Ave, Sunnyvale, Cal 94086
DATA TERMINAL SYSTEMS INC.
239 Main St, Maynard, Mass 01754
DATA TRENDS INC.
P O Box 82, Mt Lake, N J 07046
DATA 100 CORP.
7450 France Ave S, Minneapolis, Minn 55435
DATACOM INC.
40 Lincoln Dr, Ft Walton Beach, Fla 32548
DATASERV DIV., WILLIAM J. PURDY CORP.
770 Airport Blvd, Burlingame, Cal 94010
DESIGN ELEMENTS INC.
356 Norton Ave, Columbus, Ohio 43212
DIGITAL INFORMATION DEVICES INC.
210 Welsh Pool Rd, Lionville, Pa 19353
DIGITRONICS CORP.
1 Albertson Ave, Albertson, N Y 11507
DYNAMIC SYSTEM ELECTRONICS
1040 W Alameda Dr, Tempe, Ariz 85281
ELDORADO ELECTRODATA
601 Chalomar Rd, Concord, Cal 94520
ELECTRONIC INFORMATION SYSTEMS INC.
2400 Industrial Lane, Broomfield, Conn 80020
ELECTRONIC LABS, INC.
3726 Dacoma St, Houston, Tex 77018
FRIDEN DIV. THE SINGER CO.
97 Humboldt St, Rochester, N Y 14602
GULTON INDUSTRIES INC. COMPUTER SYS. DIV.
13041 Cerise Ave, Hawthorne, Cal 90250
HETRA
P O Box 970, Melbourne, Fla 32901
IAC COMPUTER SYSTEMS INC.
260 Newton Rd, Plainview, N Y 11803
IBM CORP., DATA PROCESSING DIV.
1133 Westchester Ave, White Plains, N Y 10604
INFOREX INC.
21 N Ave, Burlington, Mass 01803
INFORMATION MACHINES CORP.
8811 Cuyamaca St, Santee, Cal 92071
INFOTEC INC.
70 Newton Rd, Plainview, N Y 11803

ITT DEFENSE COMMUNICATIONS DIV.
492 River Rd, Nutley, N J 07110
LIVERMORE DATA SYSTEMS INC.
2050 Research Dr, Livermore, Cal 94550
LOGIC CORP.
21 Oldey Ave, Cherry Hill, N J 08034
LUNDY ELECTRONICS & SYSTEMS INC.
Robert Lane, Glen Head, N Y 11545
MADATRON CORP.
P O Box 172, Princeton, N J 08540
MARK COMPUTER SYSTEMS INC.
One Patterson Pl, Garden City, N Y 11530
MAXSON ELECTRONICS CORP. DIV. RIKKER MAXSON
Sunrise Hwy, Great River, N Y 11739
MICRODATA CORP.
644 E Young St, Santa Ana, Cal 92705
MICRODYNE INC. SUBBODINE ELEC.CO.
1600 S Micks Rd, Rolling Meadows, Ill 60008
MOHAWK DATA SCIENCES CORP.
Palisade St, Herkimer, N Y 13350
MSI DATA CORP.
4751 Holt Ave, Mont Clair, Cal 91763
NOLLER CONTROL SYSTEMS
150 E Standard Ave, Richmond, Cal 94804
NOVAR CORP.
2370 Charleston Rd, Mt View, Cal 94040
NYTRONICS INC.
3rd Ave, Alpha, N J 08865
OLIVETTI CORP. OF AMERICA
500 Park Ave, New York, N Y 10016
PERIPHERAL DATA MACHINES INC.
102 New S Rd, Hicksville, N Y 11801
POTTER INSTRUMENT CO. INC.
532 Broadhollow Rd, Melville, N Y 11746
PURDY CORP., WM. J.
770 Airport Blvd, Burlingame, Cal 94010
RAYCON INC.
218 Brunswick Blvd, Pointe Claire, CANADA
SINGER CO., THE, FRIDEN DIV.
2350 Washington St, San Leandro, Cal 94577
SYCOR INC.
100 Phoenix Dr, Ann Arbor, Mich 48104
SYS COMPUTER CORP.
17-25 Dicarolis Court, Hackensack, N J 07601
TALLY CORP.
8301 S 180th St, Kent, Wash 98031
TEAC CORPORATION OF AMERICA TECHNICAL PRODUCTS
2000 Colorado Ave, Santa Monica, Cal 90404
TELE-DATA CORP.
130 U S Hwy 22, N Plainfield, N J 07060
TERMINAL EQUIPMENT CORP.
750 Hamburg Tpk, Pompton Lakes, N J 07442
TEXAS INSTRUMENTS INC. DIGITAL SYSTEMS DIV
P O Box 66027, Houston, Tex 77006
TRANSITEL, DIV. OF SANGAMO ELECTRIC CO.
P O Box 7255, Denver, Colo 80207
UNIVERSITY COMPUTING CO.
P O Box 6228, Dallas, Tex 75222
UNIVERSITY COMPUTING CO.
888 N Sepulveda Blvd, El Segundo, Cal 90245
UNIVERSITY COMPUTING CO. DATA COMM. SYSTEMS
2659 Nova Dr, Dallas, Tex 75229
XEBEC SYSTEMS INC.
918 N Rengstorff Ave, Mountain View, Cal 94040

DATA TERMINALS, BLOCK-BY-BLOCK (MULTI-PURPOSE)

ADDO-X INC. ADP DIV.
437 Madison Ave, New York, N Y 10022
AMERICAN TOTALISATOR CO. UNI-TOTE DIV.
383 Hillen Rd, Towson, Md 21204
ANDERSON JACOBSON INC.
1065 Morse Ave., Sunnyvale, Cal 94086
APPLIED COMPUTER SYSTEMS INC.
P O Box 6479, Austin, Tex 78702
APPLIED SYSTEMS CORP.
18325 W McNichols Ave, Detroit, Mich 48219
ATRON CORP.
1256 Trapp Rd, St Paul, Minn 55118
BECKMAN INSTRUMENTS INC. ELECT. INSTR. DIV.
2200 Wright Ave, Richmond, Cal 94804
COMPAT CORP.
177 Cantiguage Rock Rd, Westbury, N Y 11590
COMPERIPHERALS INC.
437 Madison Ave, New York, N Y 10022
COMPUCORD INC.
225 Crescent St, Waltham, Mass 02154
COMPUTER COMMUNICATION INC.
701 W Manchester Blvd, Inglewood, Cal 90301
COMPUTER CORP. OF AMERICA
6216 Evergreen St, Houston, Tex 77036

COMPUTER DESIGN CORP.
12401 W Olympic Blvd, Los Angeles, Cal 90064
COMPUTER DEVICES INC.
10 Sonar Dr, Woburn, Mass 01801
COMPUTER USAGE CORP.
100 Putman Green, Greenwich, Conn 06830
CONTROL DATA CORP.
8100 34th Ave S, Minneapolis, Minn 55440
CYBERMATION INC.
P O Box 58 River Rd, Washngtn Xing, Pa 18977
DAEDALUS COMPUTER PRODUCTS INC.
P O Box 248, No Syracuse, N Y 13088
DATA ACCESS SYSTEMS INC.
503 Rte 10 Mt 19, Dover, N J 07801
DATA GENERAL CORP.
Rte 9, Southboro, Mass 01772
DATA PACIFIC CORP.
116 E Ash, Fullerton, Cal 92631
DATA PATHING INC.
370 San Aleso Ave, Sunnyvale, Cal 94086
DATA TERMINAL SYSTEMS INC.
239 Main St, Maynard, Mass 01754
DATA 100 CORP.
7450 France Ave S, Minneapolis, Minn 55435
DATASERV DIV., WILLIAM J. PURDY CORP.
770 Airport Blvd, Burlingame, Cal 94010
DECITRON COMMUNICATION SYSTEMS INC.
567 E 105 St, Brooklyn, N Y 11236
DELMARVA COMPUTER INDUSTRIES INC.
5865 Robert Oliver Pl, Columbia, Md 21043
DIGITAL INFORMATION DEVICES INC.
210 Welsh Pool Rd, Lionville, Pa 19353
DIVERSIFIED NUMERIC APPLICATIONS
9801 Logan Ave S, Minneapolis, Minn 55423
ELDORADO ELECTRODATA
601 Chalomar Rd, Concord, Cal 94520
ELECTRONIC INFORMATION SYSTEMS INC.
2400 Industrial Lane, Broomfield, Conn 80020
FEDDER DATA CENTERS INC.
307 S Sharp St, Baltimore, Md 21201
HETRA
P O Box 970, Melbourne, Fla 32901
IAC COMPUTER SYSTEMS INC.
260 Newton Rd, Plainview, N Y 11803
IBM CORP., DATA PROCESSING DIV.
1133 Westchester Ave, White Plains, N Y 10604
INFOREX INC.
21 N Ave, Burlington, Mass 01803
ITT DATA EQUIPMENT & SYSTEMS DIV.
187 E Union Ave, E Rutherford, N J 07073
ITT DEFENSE COMMUNICATIONS DIV.
492 River Rd, Nutley, N J 07110
KDI INTERACTIVE DATA SYSTEMS
17785 Skypark Circle, Irvine, Cal 92664
LITTON SYSTEMS INC. DATA SYSTEMS DIV.
8000 Woodley Ave, Van Nuys, Cal 91409
LOGIC CORP.
21 Oldey Ave, Cherry Hill, N J 08034
LUNDY ELECTRONICS & SYSTEMS INC.
Robert Lane, Glen Head, N Y 11545
MADATRON CORP.
P O Box 172, Princeton, N J 08540
MARK COMPUTER SYSTEMS INC.
One Patterson Pl, Garden City, N Y 11530
MARK/OPS DIV., NORTH EASTERN SYSTEMS ASSOC. INC.
475 Commonwealth Ave, Boston, Mass 02215
MAXSON ELECTRONICS CORP. DIV. RIKKER MAXSON
Sunrise Hwy, Great River, N Y 11739
MCA TECHNOLOGY INC. UDAC DIV.
P O Box 36166, Houston, Tex 77035
MICRODATA CORP.
644 E Young St, Santa Ana, Cal 92705
MOHAWK DATA SCIENCES CORP.
Palisade St, Herkimer, N Y 13350
NATIONAL MIDCO INDUSTRIES INC.
Box 5433, Trenton, N J 08638
NOLLER CONTROL SYSTEMS
150 E Standard Ave, Richmond, Cal 94804
NYTRONICS INC.
3rd Ave, Alpha, N J 08865
OKI ELECTRIC INDUSTRIES CO. LTD.
875 Ave of Americas, New York, N Y 10001
OLIVETTI CORP. OF AMERICA
500 Park Ave, New York, N Y 10016
PURDY CORP., WM. J.
770 Airport Blvd, Burlingame, Cal 94010
RCA COMPUTER SYSTEMS DIV.
200 Forest Ave, Marlboro, Mass 01752
SAGETEC CORP.
9177 Kelvin Ave, Chatsworth, Cal 91311
SYCOR INC.
100 Phoenix Dr, Ann Arbor, Mich 48104
TELE-DATA CORP.
130 U S Hwy 22, N Plainfield, N J 07060

2 Product Directory

TRACOR DATA SYSTEMS MARKETING
601 California St, San Francisco, Cal 94108
UNIVERSITY COMPUTING CO.
P O Box 6228, Dallas, Tex 75222
UNIVERSITY COMPUTING CO.
888 N Sepulveda Blvd, El Segundo, Cal 90245
UNIVERSITY COMPUTING CO. DATA COMM. SYSTEMS
2659 Nova Dr, Dallas, Tex 75229

DATA TERMINALS, BLOCK-BY-BLOCK (OPTICAL)

DATATYPE CORP.
1050 NW 163rd Dr, Miami, Fla 33169

DATA TERMINALS, BLOCK-BY-BLOCK (PAPER TAPE)

ADDO-X INC. ADP DIV.
437 Madison Ave, New York, N Y 10022
ANDERSON JACOBSON INC.
1065 Morse Ave., Sunnyvale, Cal 94086
APPLIED COMPUTER SYSTEMS INC.
P O Box 6479, Austin, Tex 78702
BECKMAN INSTRUMENTS INC. ELECT. INSTR. DIV.
2200 Wright Ave, Richmond, Cal 94804
BONNAR-VAWTER INC.
96 Dunbar St, Keene, N H 03431
COMPACE CORP.
7413 Washington Ave S, Edina-Minnepols, Minn 55435
COMPAT CORP.
177 Cantigue Rock Rd, Westbury, N Y 11590
COMPERIPHERALS INC.
437 Madison Ave, New York, N Y 10022
COMPUTER USAGE CORP.
100 Putman Green, Greenwich, Conn 06830
CONNECTICUT TECHNICAL CORP.
3000 Main St, Hartford, Conn 06120
CONTROL DATA CORP.
8100 34th Ave S, Minneapolis, Minn 55440
DATA COMPUTER SYSTEMS INC.
17131 Daimler St, Santa Ana, Cal 92705
DATA GENERAL CORP.
Rte 9, Southboro, Mass 01772
DATA PACIFIC CORP.
116 E Ash, Fullerton, Cal 92631
DATA PRODUCTS TELECOMMUNICATIONS
17 Amelia Place, Stamford, Conn 06902
DATA 100 CORP.
7450 France Ave S, Minneapolis, Minn 55435
DATACOM INC.
40 Lincoln Dr, Ft Walton Beach, Fla 32548
DATASERV DIV., WILLIAM J. PURDY CORP.
770 Airport Blvd, Burlingame, Cal 94010
DATATERM INC.
1671 Manning Blvd, Levittown, Pa 19057
DECITRON COMMUNICATION SYSTEMS INC.
567 E 105 St, Brooklyn, N Y 11236
DELMARVA COMPUTER INDUSTRIES INC.
5865 Robert Oliver Pl, Columbia, Md 21043
DIGITRONICS CORP.
1 Albertson Ave, Albertson, N Y 11507
ELDORADO ELECTRODATA
601 Chalomar Rd, Concord, Cal 94520
FARRINGTON MANUFACTURING CO.
6707 Electronics Dr, Springfield, Va 22151
FEDDER DATA CENTERS INC.
307 S Sharp St, Baltimore, Md 21201
FRIDEN DIV. THE SINGER CO.
97 Humboldt St, Rochester, N Y 14602
FUJITSU LTD. N.Y.LIAISON OFFICE
680 Fifth Ave, New York, N Y 10019
GENERAL ELECTRIC CO. COMM. SYS. DIV.
Mountain View Rd, Lynchburg, Va 24502
HI-G INC.
580 Spring St, Windsor Locks, Conn 06096
HONEYWELL INFORMATION SYSTEMS
P O Box 12313, Oklahoma City, Okla 73112
IAC COMPUTER SYSTEMS INC.
260 Newton Rd, Plainview, N Y 11803
IBM CORP..DATA PROCESSING DIV.
1133 Westchester Ave, White Plains, N Y 10604
INFORMATION MACHINES CORP.
8811 Cuyamaca St, Santee, Cal 92071
INSO ELECTRONIC PRODUCTS INC.
77 E Hawthorne Ave, Valley Stream, N Y 11580
INTERNATIONAL COMPUTERS LTD.
Icl House Putney, London S W 15, UNITED K
ITEL INFORMAMTION PRODUCTS DIV
2585 Bayshore, Palo Alto, Cal 94303
ITT DATA EQUIPMENT & SYSTEMS DIV.
187 E Union Ave, E Rutherford, N J 07073

ITT DEFENSE COMMUNICATIONS DIV.
492 River Rd, Nutley, N J 07110
KLEINSCHMIDT DIV., SCM CORP.
Lake-Cook Rd, Deerfield, Ill 60015
MADATRON CORP.
P O Box 172, Princeton, N J 08540
MARK COMPUTER SYSTEMS INC.
One Patterson Pl, Garden City, N Y 11530
MARK/OPS DIV., NORTH EASTERN SYSTEMS ASSOC.
INC.
475 Commonwealth Ave, Boston, Mass 02215
MAXSON ELECTRONICS CORP. DIV. RIXKER MAXSON
Sunrise Hwy, Great River, N Y 11739
MICRODATA CORP.
644 E Young St, Santa Ana, Cal 92705
MOHAWK DATA SCIENCES CORP.
Palisade St, Herkimer, N Y 13350
MSI DATA CORP.
4751 Holt Ave, Mont Clair, Cal 91763
NOLLER CONTROL SYSTEMS
150 E Standard Ave, Richmond, Cal 94804
NYTRONICS INC.
3rd Ave, Alpha, N J 08865
OKI ELECTRIC INDUSTRIES CO. LTD.
875 Ave of Americas, New York, N Y 10001
OLIVETTI CORP. OF AMERICA
500 Park Ave, New York, N Y 10016
PURDY CORP., WM. J.
770 Airport Blvd, Burlingame, Cal 94010
SINGER CO., THE, FRIDEN DIV.
2350 Washington St, San Leandro, Cal 94577
TALLY CORP.
8301 S 180th St, Kent, Wash 98031
TELETYPE CORP.
5555 W Touhy Ave, Skokie, Ill 60076
TERMINAL EQUIPMENT CORP.
750 Hamburg Tpk, Pompton Lakes, N J 07442
TEXAS INSTRUMENTS INC. DIGITAL SYSTEMS DIV
P O Box 66027, Houston, Tex 77006
TRANSCOM INC. SUB. OF HI-G INC.
12 Tobey Rd, Bloomfield, Conn 06002
TRANSMISSION MEASUREMENTS INC
1051 Clinton St, Buffalo, N Y 14206
UNIVERSITY COMPUTING CO.
P O Box 6228, Dallas, Tex 75222
UNIVERSITY COMPUTING CO.
888 N Sepulveda Blvd, El Segundo, Cal 90245
UNIVERSITY COMPUTING CO. DATA COMM. SYSTEMS
2659 Nova Dr, Dallas, Tex 75229
VISTATYPE CORP.
1226 E Pomona St, Santa Ana, Cal 92707

DATA TERMINALS, BLOCK-BY-BLOCK (PLOTTER)

APPLIED COMPUTER SYSTEMS INC.
P O Box 6479, Austin, Tex 78702
COMPUTER USAGE CORP.
100 Putman Green, Greenwich, Conn 06830
DATA ACCESS SYSTEMS INC.
503 Rte 10 Mt 19, Dover, N J 07801
DATA COMPUTER SYSTEMS INC.
17131 Daimler St, Santa Ana, Cal 92705
DATA GENERAL CORP.
Rte 9, Southboro, Mass 01772
DATA 100 CORP.
7450 France Ave S, Minneapolis, Minn 55435
DATASERV DIV., WILLIAM J. PURDY CORP.
770 Airport Blvd, Burlingame, Cal 94010
DELMARVA COMPUTER INDUSTRIES INC.
5865 Robert Oliver Pl, Columbia, Md 21043
ELDORADO ELECTRODATA
601 Chalomar Rd, Concord, Cal 94520
GOULD INC. BRUSH DIV.
3631 Perkins Ave, Cleveland, Ohio 44114
IAC COMPUTER SYSTEMS INC.
260 Newton Rd, Plainview, N Y 11803
IBM CORP..DATA PROCESSING DIV.
1133 Westchester Ave, White Plains, N Y 10604
INFO-MAX
1248 Alderwood, Sunnyvale, Cal 94086
MARK/OPS DIV., NORTH EASTERN SYSTEMS ASSOC.
INC.
475 Commonwealth Ave, Boston, Mass 02215
NYTRONICS INC.
3rd Ave, Alpha, N J 08865
PURDY CORP., WM. J.
770 Airport Blvd, Burlingame, Cal 94010
UNIVERSITY COMPUTING CO.
P O Box 6228, Dallas, Tex 75222
UNIVERSITY COMPUTING CO. DATA COMM. SYSTEMS
2659 Nova Dr, Dallas, Tex 75229

DATA TERMINALS, BLOCK-BY-BLOCK (HIGH SPEED PRINTER)

A.B. DICK CO.
5700 W Touhy, Chicago, Ill 60648
AMERICAN TOTALISATOR CO. UNI-TOTE DIV.
383 Hillen Rd, Towson, Md 21204
APPLIED COMPUTER SYSTEMS INC.
P O Box 6479, Austin, Tex 78702
ATRON CORP.
1256 Trapp Rd, St Paul, Minn 55118
BUNKER RAMO CORP., THE, BUSINESS & IND. DIV
445 Fairfield Ave, Stamford, Conn 06904
COMPAT CORP.
177 Cantigue Rock Rd, Westbury, N Y 11590
COMPUTER COMMUNICATION INC.
701 W Manchester Blvd, Inglewood, Cal 90301
COMPUTER ENTRY SYSTEMS CORP.
2141 Industrial Pkwy, Silver Spring, Md 20904
CONTROL DATA CORP.
8100 34th Ave S, Minneapolis, Minn 55440
CUSTOM COMPUTER SYSTEMS INC.
40 South Mall, Plainview, N Y 11803
DACONICS
925 Thompson Pl, Sunnyvale, Cal 94086
DATA COMPUTER SYSTEMS INC.
17131 Daimler St, Santa Ana, Cal 92705
DATA DIMENSIONS INC.
51 Weaver St, Greenwich, Conn 06830
DATA GENERAL CORP.
Rte 9, Southboro, Mass 01772
DATA PRODUCTS CORP.
16055 Ventura Blvd, Encino, Cal 91316
DATA PRODUCTS CORP. SYSTEMS DIV.
6219 Desoto Ave, Woodland Hills, Cal 91364
DATA 100 CORP.
7450 France Ave S, Minneapolis, Minn 55435
DATACOM INC.
40 Lincoln Dr, Ft Walton Beach, Fla 32548
DATASERV DIV., WILLIAM J. PURDY CORP.
770 Airport Blvd, Burlingame, Cal 94010
DI/AN CONTROLS INC.
944 Dorchester Ave, Boston, Mass 02125
DIGITRONICS CORP.
1 Albertson Ave, Albertson, N Y 11507
ELDORADO ELECTRODATA
601 Chalomar Rd, Concord, Cal 94520
GOULD INC. BRUSH DIV.
3631 Perkins Ave, Cleveland, Ohio 44114
HETRA
P O Box 970, Melbourne, Fla 32901
HONEYWELL INFORMATION SYSTEMS
P O Box 12313, Oklahoma City, Okla 73112
IAC COMPUTER SYSTEMS INC.
260 Newton Rd, Plainview, N Y 11803
IBM CORP..DATA PROCESSING DIV.
1133 Westchester Ave, White Plains, N Y 10604
INTERNATIONAL COMPUTERS LTD.
Icl House Putney, London S W 15, UNITED K
ITT DEFENSE COMMUNICATIONS DIV.
492 River Rd, Nutley, N J 07110
LITTON SYSTEMS INC. DATA SYSTEMS DIV.
8000 Woodley Ave, Van Nuys, Cal 91409
MARK COMPUTER SYSTEMS INC.
One Patterson Pl, Garden City, N Y 11530
MARK/OPS DIV., NORTH EASTERN SYSTEMS ASSOC.
INC.
475 Commonwealth Ave, Boston, Mass 02215
MICRODATA CORP.
644 E Young St, Santa Ana, Cal 92705
MOHAWK DATA SCIENCES CORP.
Palisade St, Herkimer, N Y 13350
NOLLER CONTROL SYSTEMS
150 E Standard Ave, Richmond, Cal 94804
NYTRONICS INC.
3rd Ave, Alpha, N J 08865
OKI ELECTRIC INDUSTRIES CO. LTD.
875 Ave of Americas, New York, N Y 10001
OLIVETTI CORP. OF AMERICA
500 Park Ave, New York, N Y 10016
PATH COMPUTER EQUIPMENT INC.
65 Commerce Rd, Stamford, Conn 06904
PERIPHERAL DATA MACHINES INC.
102 New S Rd, Hicksville, N Y 11801
PURDY CORP., WM. J.
770 Airport Blvd, Burlingame, Cal 94010
TRACOR DATA SYSTEMS MARKETING
601 California St, San Francisco, Cal 94108
ULTRONIC SYSTEMS CORP.
Mt Laurel Ind Pk, Moorestown, N J 08057
UNIVERSITY COMPUTING CO.
P O Box 6228, Dallas, Tex 75222
UNIVERSITY COMPUTING CO. DATA COMM. SYSTEMS
2659 Nova Dr, Dallas, Tex 75229

2 Product Directory

VOGUE INSTRUMENT CORP.

131st At Jamaica Ave, Richmond Hill, N Y 11418
XEBEC SYSTEMS INC.
918 N Rengstorff Ave, Mountain View, Cal 94040

DATA TERMINALS, BLOCK-BY-BLOCK (MEDIUM SPEED PRINTER)

A.B. DICK CO.

5700 W Touhy, Chicago, Ill 60648
AMERICAN TOTALISATOR CO. UNI-TOTE DIV.
383 Hillen Rd, Towson, Md 21204

ANDERSON JACOBSON INC.

1065 Morse Ave., Sunnyvale, Cal 94086
APPLIED COMPUTER SYSTEMS INC.
P O Box 6479, Austin, Tex 78702

APPLIED SYSTEMS CORP.

18325 W McNichols Ave, Detroit, Mich 48219
ATRON CORP.

1256 Trapp Rd, St Paul, Minn 55118
BECKMAN INSTRUMENTS INC. ELECT. INSTR. DIV.
2200 Wright Ave, Richmond, Cal 94804

BUNKER RAMO CORP., THE, BUSINESS & IND. DIV.
445 Fairfield Ave, Stamford, Conn 06904

COMPAT CORP.

177 Cantiague Rock Rd, Westbury, N Y 11590
COMPUTER COMMUNICATION INC.

701 W Manchester Blvd, Inglewood, Cal 90301
COMPUTER DEVICES INC.

10 Sonar Dr, Woburn, Mass 01801
COMPUTER USAGE CORP.

100 Putman Green, Greenwich, Conn 06830
CONTROL DATA CORP.

8100 34th Ave S, Minneapolis, Minn 55440
CYBERMATION INC.

P O Box 58 River Rd, Washngtn Xing, Pa 18977
DACONICS

925 Thompson Pl, Sunnyvale, Cal 94086
DATA COMPUTER SYSTEMS INC.

17131 Daimler St, Santa Ana, Cal 92705
DATA COMPUTING INC.

2219 W Shangri La Rd, Phoenix, Ariz 85029
DATA GENERAL CORP.

Rte 9, Southboro, Mass 01772
DATA PRINTER CORP.

225 Msgr O'Brien Hwy, Cambridge, Mass 02141
DATA PRODUCTS CORP.

16055 Ventura Blvd, Encino, Cal 91316
DATA PRODUCTS CORP. SYSTEMS DIV.

6219 Desoto Ave, Woodland Hills, Cal 91364
DATA 100 CORP.

7450 France Ave S, Minneapolis, Minn 55435
DATACOM INC.

40 Lincoln Dr, Ft Walton Beach, Fla 32548
DATASERV DIV., WILLIAM J. PURDY CORP.

770 Airport Blvd, Burlingame, Cal 94010
DI/AN CONTROLS INC.

944 Dorchester Ave, Boston, Mass 02125
ELDORADO ELECTRODATA

601 Chalomar Rd, Concord, Cal 94520
FUJITSU LTD. N.Y.LIAISON OFFICE

680 Fifth Ave, New York, N Y 10019
HETRA

P O Box 970, Melbourne, Fla 32901
HONEYWELL INFORMATION SYSTEMS

P O Box 12313, Oklahoma City, Okla 73112
IAC COMPUTER SYSTEMS INC.

260 Newton Rd, Plainview, N Y 11803
IBM CORP., DATA PROCESSING DIV.

1133 Westchester Ave, White Plains, N Y 10604
INFOREX INC.

21 N Ave, Burlington, Mass 01803
INTERNATIONAL COMPUTERS LTD.

lcl House Putney, London S W 15, UNITED K
ITT DEFENSE COMMUNICATIONS DIV.

492 River Rd, Nutley, N J 07110
KLEINSCHMIDT DIV., SCM CORP.

Lake-Cook Rd, Deerfield, Ill 60015
LOGIC CORP.

21 Oldey Ave, Cherry Hill, N J 08034
MARK/OPS DIV., NORTH EASTERN SYSTEMS ASSOC.
INC.

475 Commonwealth Ave, Boston, Mass 02215
MAXSON ELECTRONICS CORP. DIV. RIXKER MAXSON

Sunrise Hwy, Great River, N Y 11739
MEMOREX EQUIPMENT GROUP

San Tomas At Central, Santa Clara, Cal 95052
MICRODATA CORP.

644 E Young St, Santa Ana, Cal 92705
MOHAWK DATA SCIENCES CORP.

Palisade St, Herkimer, N Y 13350
NOLLER CONTROL SYSTEMS

150 E Standard Ave, Richmond, Cal 94804

NYTRONICS INC.

3rd Ave, Alpha, N J 08865
OKI ELECTRIC INDUSTRIES CO. LTD.

875 Ave of Americas, New York, N Y 10001
OLIVETTI CORP. OF AMERICA

500 Park Ave, New York, N Y 10016
PERIPHERAL DATA MACHINES INC.

102 New S Rd, Hicksville, N Y 11801
PRINTER TECHNOLOGY INC.

Sixth Rd, Woburn, Mass 01801
PURDY CORP., WM. J.

770 Airport Blvd, Burlingame, Cal 94010
SCIENTIFIC CONTROL CORP.

1215 Crosby Rd, Carrollton, Tex 75080
SYCOR INC.

100 Phoenix Dr, Ann Arbor, Mich 48104
SYSTEMS EQUIPMENT CORP.

458 Plasamour Dr, Atlanta, Ga 30324
TEXAS INSTRUMENTS INC. DIGITAL SYSTEMS DIV

P O Box 66027, Houston, Tex 77006
TRACOR DATA SYSTEMS INC.

4201 Ed Bluestein Blv, Austin, Tex 78721
TRANSITEL, DIV. OF SANGAMO ELECTRIC CO.

P O Box 7255, Denver, Colo 80207
UNIVERSITY COMPUTING CO.

P O Box 6228, Dallas, Tex 75222
UNIVERSITY COMPUTING CO. DATA COMM. SYSTEMS

2659 Nova Dr, Dallas, Tex 75229
VERSATEC

10100 Bubb Rd, Cupertino, Cal 95014
VOGUE INSTRUMENT CORP.

131st At Jamaica Ave, Richmond Hill, N Y 11418

DATA TERMINALS, BLOCK-BY-BLOCK (PUNCHED CARD)

AMP INC., SYSCOM DIV.

P O Box 3608, Harrisburg, Pa 17105
APPLIED COMPUTER SYSTEMS INC.

P O Box 6479, Austin, Tex 78702
APPLIED SYSTEMS CORP.

18325 W McNichols Ave, Detroit, Mich 48219
ATRON CORP.

1256 Trapp Rd, St Paul, Minn 55118
COMPACE CORP.

7413 Washington Ave S, Edina-Minnepols, Minn
55435

COMPAT CORP.

177 Cantiague Rock Rd, Westbury, N Y 11590
COMPUTER COMMUNICATION INC.

701 W Manchester Blvd, Inglewood, Cal 90301
COMPUTER USAGE CORP.

100 Putman Green, Greenwich, Conn 06830
CONTROL DATA CORP.

8100 34th Ave S, Minneapolis, Minn 55440
DATA COMPUTER SYSTEMS INC.

17131 Daimler St, Santa Ana, Cal 92705
DATA COMPUTING INC.

2219 W Shangri La Rd, Phoenix, Ariz 85029
DATA PACIFIC CORP.

116 E Ash, Fullerton, Cal 92631
DATA PATHING INC.

370 San Aleso Ave, Sunnyvale, Cal 94086
DATA 100 CORP.

7450 France Ave S, Minneapolis, Minn 55435
DATASERV DIV., WILLIAM J. PURDY CORP.

770 Airport Blvd, Burlingame, Cal 94010
DATRON SYSTEMS INC.

100 Rte 46, Mt Lakes, N J 07046
ELDORADO ELECTRODATA

601 Chalomar Rd, Concord, Cal 94520
FRIDEN DIV. THE SINGER CO.

97 Humboldt St, Rochester, N Y 14602
HETRA

P O Box 970, Melbourne, Fla 32901
HEWLETT PACKARD CO. CUPERTINO DIV.

1100 Wolfe Rd, Cupertino, Cal 95014
HICKOK ELECTRICAL INSTRUMENT CO.

10514 Dupont Ave, Cleveland, Ohio 44108
IAC COMPUTER SYSTEMS INC.

260 Newton Rd, Plainview, N Y 11803
IBM CORP., DATA PROCESSING DIV.

1133 Westchester Ave, White Plains, N Y 10604
INFORMATION MACHINES CORP.

8811 Cuyamaca St, Santee, Cal 92071
INTERNATIONAL COMPUTERS LTD.

lcl House Putney, London S W 15, UNITED K
INTERNATIONAL CONTROLS CORP.

200 Fairfield Rd, Fairfield, N J 07006
ITT DEFENSE COMMUNICATIONS DIV.

492 River Rd, Nutley, N J 07110
KLEINSCHMIDT DIV., SCM CORP.

Lake-Cook Rd, Deerfield, Ill 60015

MADATRON CORP.

P O Box 172, Princeton, N J 08540
MARK/OPS DIV., NORTH EASTERN SYSTEMS ASSOC.
INC.

475 Commonwealth Ave, Boston, Mass 02215
MOHAWK DATA SCIENCES CORP.

Palisade St, Herkimer, N Y 13350
NOLLER CONTROL SYSTEMS

150 E Standard Ave, Richmond, Cal 94804
NYTRONICS INC.

3rd Ave, Alpha, N J 08865
OKI ELECTRIC INDUSTRIES CO. LTD.

875 Ave of Americas, New York, N Y 10001
OLIVETTI CORP. OF AMERICA

500 Park Ave, New York, N Y 10016
PURDY CORP., WM. J.

770 Airport Blvd, Burlingame, Cal 94010
REPUBLIC INFORMATION SYSTEMS INC.

9732 Cozycroft Ave, Chatsworth, Cal 91311
SCIENTIFIC CONTROL CORP.

1215 Crosby Rd, Carrollton, Tex 75080
TRANSCOM INC. SUB. OF HI-G INC.

12 Tobey Rd, Bloomfield, Conn 06002
UNITED BUSINESS COMMUNICATIONS INC.

6405 Metcalf Ave, Shawnee Mission, Kans 66202
UNIVERSITY COMPUTING CO.

P O Box 6228, Dallas, Tex 75222
UNIVERSITY COMPUTING CO. DATA COMM. SYSTEMS

2659 Nova Dr, Dallas, Tex 75229
WESTERN TELEMATIC INC.

5507 Peck Rd, Arcadia, Cal 91006

DATA TERMINALS, BLOCK-BY-BLOCK (TELEPRINTER)

A.D. DATA SYSTEMS INC.

830 Linden Ave, Rochester, N Y 14625
AMERICAN DATA SYSTEMS

8851 Mason Ave, Canoga Park, Cal 91306
AMERICAN REGITEL CORP.

870 Industrial Way, San Carlos, Cal 94070
ANDERSON JACOBSON INC.

1065 Morse Ave., Sunnyvale, Cal 94086
APPLIED COMPUTER SYSTEMS INC.

P O Box 6479, Austin, Tex 78702
BEEHIVE MEDICAL ELECTRONICS INC.

1473 S 6th W, Salt Lake City, Utah 84104
BUNKER RAMO CORP., THE, BUSINESS & IND. DIV

445 Fairfield Ave, Stamford, Conn 06904
COMDATA CORP.

7544 W Oakton St, Niles, Ill 60648
COMPACE CORP.

7413 Washington Ave S, Edina-Minnepols, Minn
55435

COMPAT CORP.

177 Cantiague Rock Rd, Westbury, N Y 11590
COMPUTEK INC.

143 Albany St, Cambridge, Mass 02139
COMPUTER DEVICES INC.

10 Sonar Dr, Woburn, Mass 01801
COMPUTER INC.

143 Albany St, Cambridge, Mass 02139
COMPUTER TERMINALS OF MINNESOTA INC.

4815 W 77th St, Minneapolis, Minn 55435
CONNECTICUT TECHNICAL CORP.

3000 Main St, Hartford, Conn 06120
CONTROL DATA CORP.

8100 34th Ave S, Minneapolis, Minn 55440
DATA AUTOMATION COMMUNICATIONS INC.

7505 Carpenter Fwy, Dallas, Tex 75247
DATA COMPUTER SYSTEMS INC.

17131 Daimler St, Santa Ana, Cal 92705
DATA COMPUTING INC.

2219 W Shangri La Rd, Phoenix, Ariz 85029
DATA PATHING INC.

370 San Aleso Ave, Sunnyvale, Cal 94086
DATA PRODUCTS TELECOMMUNICATIONS

17 Amelia Place, Stamford, Conn 06902
DATA 100 CORP.

7450 France Ave S, Minneapolis, Minn 55435
DATACOM INC.

40 Lincoln Dr, Ft Walton Beach, Fla 32548
DATASERV DIV., WILLIAM J. PURDY CORP.

770 Airport Blvd, Burlingame, Cal 94010
DATATERM INC.

1671 Manning Blvd, Levittown, Pa 19057
DELMARVA COMPUTER INDUSTRIES INC.

5865 Robert Oliver Pl, Columbia, Md 21043
DESIGN ELEMENTS INC.

356 Norton Ave, Columbus, Ohio 43212
DI/AN CONTROLS INC.

944 Dorchester Ave, Boston, Mass 02125
DIGI-LOG SYSTEMS INC.

107 W Ridge Pike, Conshohocken, Pa 19428

2 Product Directory

DIVERSIFIED NUMERIC APPLICATIONS

9801 Logan Ave S, Minneapolis, Minn 55423
ELDORADO ELECTRODATA
601 Chalomar Rd, Concord, Cal 94520
ELECTRONIC INFORMATION SYSTEMS INC.
2400 Industrial Lane, Broomfield, Conn 80020
FUJITSU LTD. N.Y.LIAISON OFFICE
680 Fifth Ave, New York, N Y 10019
GENERAL ELECTRIC CO. COMM. SYS. DIV.
Mountain View Rd, Lynchburg, Va 24502
GULTON INDUSTRIES INC. COMPUTER SYS. DIV.
13041 Cerise Ave, Hawthorne, Cal 90250
HEWLETT PACKARD CO. CUPERTINO DIV.
1100 Wolfe Rd, Cupertino, Cal 95014
IBM CORP., DATA PROCESSING DIV.
1133 Westchester Ave, White Plains, N Y 10604
INTERNATIONAL COMPUTERS LTD.
Icl House Putney, London S W 15, UNITED K
ITEL INFORMAMTION PRODUCTS DIV
2585 Bayshore, Palo Alto, Cal 94303
ITI ELECTRONICS INC.
369 Lexington Ave, Clifton, N J 07015
ITT DATA EQUIPMENT & SYSTEMS DIV.
187 E Union Ave, E Rutherford, N J 07073
ITT DEFENSE COMMUNICATIONS DIV.
492 River Rd, Nutley, N J 07110
KLEINSCHMIDT DIV., SCM CORP.
Lake-Cook Rd, Deerfield, Ill 60015
MARK/OPS DIV., NORTH EASTERN SYSTEMS ASSOC.
INC.
475 Commonwealth Ave, Boston, Mass 02215
MAXSON ELECTRONICS CORP. DIV. RIXKER MAXSON
Sunrise Hwy, Great River, N Y 11739
MCA TECHNOLOGY INC. UDAC DIV.
P O Box 36166, Houston, Tex 77035
MICRODATA CORP.
644 E Young St, Santa Ana, Cal 92705
MULTIPLEX COMMUNICATIONS INC.
123 Marcus Blvd, Hauppauge, N Y 11787
NOLLER CONTROL SYSTEMS
150 E Standard Ave, Richmond, Cal 94804
NOVAR CORP.
2370 Charleston Rd, Mt View, Cal 94040
NYTRONICS INC.
3rd Ave, Alpha, N J 08865
OKI ELECTRIC INDUSTRIES CO. LTD.
875 Ave of Americas, New York, N Y 10001
OLIVETTI CORP. OF AMERICA
500 Park Ave, New York, N Y 10016
PRINTER TECHNOLOGY INC.
Sixth Rd, Woburn, Mass 01801
PURDY CORP., WM. J.
770 Airport Blvd, Burlingame, Cal 94010
TERMINAL EQUIPMENT CORP.
750 Hamburg Tpk, Pompton Lakes, N J 07442
TEXAS INSTRUMENTS INC. DIGITAL SYSTEMS DIV
P O Box 66027, Houston, Tex 77006
TIME-SHARING TERMINALS INC.
2351 Shady Grove Rd, Rockville, Md 20850
TREPAC CORP. OF AMERICA
30 W Hamilton Ave, Englewood, N J 07631
UNIVERSITY COMPUTING CO.
P O Box 6228, Dallas, Tex 75222
VERNITRON CORP. DATA DEVICE DIV.
176 Central Ave, Farmingdale, N Y 11735
WORLDWIDE COMPUTER SERVICES, INC.
280 N Central Pk Ave, Hartsdale, N Y 10530

DATA TERMINALS, INCREMENTAL (MAGNETIC TAPE)

TELETYPE CORP.
5555 W Touhy Ave, Skokie, Ill 60076
UNIVERSITY COMPUTING CO. DATEL DIV.
1 Tysons Corner Ctr, McLean, Va 22101

DATA TERMINALS, INQUIRY-RESPONSE (ALPHANUMERIC KEYBOARD)

AMERICAN DATA SYSTEMS
8851 Mason Ave, Canoga Park, Cal 91306
APPLIED COMPUTER SYSTEMS INC.
P O Box 6479, Austin, Tex 78702
APPLIED DIGITAL DATA SYSTEMS INC.
100 Marcus Blvd, Hauppauge, N Y 11787
BEEHIVE MEDICAL ELECTRONICS INC.
1473 S 6th W, Salt Lake City, Utah 84104
BUNKER RAMO CORP., THE BUSINESS & IND. DIV
445 Fairfield Ave, Stamford, Conn 06904
BURROUGHS CORP. BUSINESS MACHINES GROUP
6071 2nd Ave, Detroit, Mich 48232

CLARE-PENDAR CO.

P O Box 785, Post Falls, Ind 83854
COMMUNITYTYPE CORP.
767 Fifth Ave, New York, N Y 10022
COMPAT CORP.
177 Cantiague Rock Rd, Westbury, N Y 11590
COMPUTEK INC.
143 Albany St, Cambridge, Mass 02139
COMPUTER COMMUNICATION INC.
701 W Manchester Blvd, Inglewood, Cal 90301
COMPUTER DEVICES INC.
10 Sonar Dr, Woburn, Mass 01801
COMPUTER INC.
143 Albany St, Cambridge, Mass 02139
COMPUTER-OPTICS, INC.
Berkshire Ind Park, Bethel, Conn 06801
COMPUTER TASK GROUP INC.
5586 Main St, Buffalo, N Y 14221
COMPUTER TRANSCIEVER SYSTEMS INC.
317 Rte 17, Paramus, N J 07652
COMPUTER USAGE CORP.
100 Putnam Green, Greenwich, Conn 06830
CONNECTICUT TECHNICAL CORP.
3000 Main St, Hartford, Conn 06120
CONRAC CORP.
330 Madison Ave, New York, N Y 10017
CONTROL DATA CORP.
8100 34th Ave S, Minneapolis, Minn 55440
CONTROL DATA CORP. TERMINAL SUBSYS.DIV
2401 N Fairview Ave, St Paul, Minn 55113
DASH DATA SYSTEMS INC.
69 Jefferson St, Stamford, Conn 06902
DATA ACCESS SYSTEMS INC.
503 Rte 10 Mt 19, Dover, N J 07801
DATA COMPUTER SYSTEMS INC.
17131 Daimler St, Santa Ana, Cal 92705
DATA DIMENSIONS INC.
51 Weaver St, Greenwich, Conn 06830
DATA PACIFIC CORP.
116 E Ash, Fullerton, Cal 92631
DATA PATHING INC.
370 San Aleso Ave, Sunnyvale, Cal 94086
DATA PRODUCTS TELECOMMUNICATIONS
17 Amelia Place, Stamford, Conn 06902
DATA 100 CORP.
7450 France Ave S, Minneapolis, Minn 55435
DATALINE INC.
181 S Boro Line Rd, King of Prussia, Pa 19406
DATASERV DIV., WILLIAM J. PURDY CORP.
770 Airport Blvd, Burlingame, Cal 94010
DATATERM INC.
1671 Manning Blvd, Levittown, Pa 19057
DELTA DATA SYSTEMS CORP.
Woodhaven Ind Park, Cornwells Hgts, Pa 19020
DI/AN CONTROLS INC.
944 Dorchester Ave, Boston, Mass 02125
DIALOG COMPUTING INC.
1305 Post Rd, Fairfield, Conn 06430
DIGI-LOG SYSTEMS INC.
107 W Ridge Pike, Conshohocken, Pa 19428
DIGITRONICS CORP.
1 Albertson Ave, Albertson, N Y 11507
DIVERSIFIED NUMERIC APPLICATIONS
9801 Logan Ave S, Minneapolis, Minn 55423
ELDORADO ELECTRODATA
601 Chalomar Rd, Concord, Cal 94520
ELEC-TROL INC.
21018 Soledad Canyon, Saugus, Cal 91350
FEDDER DATA CENTERS INC.
307 S Sharp St, Baltimore, Md 21201
FERRANTI PACKARD LTD., ELECTRONICS DIV.
121 Industry St, Toronto 15, CANADA
FOUR-PHASE SYSTEMS INC.
10420 N Tantau Ave, Cupertino, Cal 95014
FRIDEN DIV. THE SINGER CO.
97 Humboldt St, Rochester, N Y 14602
FUJITSU LTD. N.Y.LIAISON OFFICE
680 Fifth Ave, New York, N Y 10019
GENERAL ELECTRIC CO. COMM. SYS. DIV.
Mountain View Rd, Lynchburg, Va 24502
GULTON INDUSTRIES INC. ~
212 Durham Ave, Metuchen, N J 08840
HI-G INC.
580 Spring St, Windsor Locks, Conn 06096
HONEYWELL INFORMATION SYSTEMS
P O Box 12313, Oklahoma City, Okla 73112
HONEYWELL INFORMATION SYSTEMS
60 Walnut St, Wellesley Hills, Mass 02181
HYPERTECH CORP.
7343 W Wilson Ave, Harwood Hgts, Ill 60656
IAC COMPUTER SYSTEMS INC.
260 Newton Rd, Plainview, N Y 11803
IBM CORP., DATA PROCESSING DIV.
1133 Westchester Ave, White Plains, N Y 10604

INTERNATIONAL COMPUTERS LTD.

Icl House Putney, London S W 15, UNITED K
ITEL INFORMAMTION PRODUCTS DIV
2585 Bayshore, Palo Alto, Cal 94303
ITT DATA EQUIPMENT & SYSTEMS DIV.
187 E Union Ave, E Rutherford, N J 07073
ITT DEFENSE COMMUNICATIONS DIV.
492 River Rd, Nutley, N J 07110
KLEINSCHMIDT DIV., SCM CORP.
Lake-Cook Rd, Deerfield, Ill 60015
LEAR SIEGLER INC., ELECTRONIC INSTRUMENTATION
DIV
714 N Brookhurst St, Anaheim, Cal 92803
LITTON SYSTEMS INC. DATA SYSTEMS DIV.
8000 Woodley Ave, Van Nuys, Cal 91409
LOGIC CORP.
21 Oldey Ave, Cherry Hill, N J 08034
MADATRON CORP.
P O Box 172, Princeton, N J 08540
MARK COMPUTER SYSTEMS INC.
One Patterson Pl, Garden City, N Y 11530
MARK/OPS DIV., NORTH EASTERN SYSTEMS ASSOC.
INC.
475 Commonwealth Ave, Boston, Mass 02215
MAXSON ELECTRONICS CORP. DIV. RIXKER MAXSON
Sunrise Hwy, Great River, N Y 11739
MEMOREX EQUIPMENT GROUP
San Tomas At Central, Santa Clara, Cal 95052
MICRODATA CORP.
644 E Young St, Santa Ana, Cal 92705
MICRODYNE INC. SUBBODINE ELEC.CO.
1600 S Micks Rd, Rolling Meadows, Ill 60008
MITE CORP. DATA EQUIPMENT DIV.
446 Blake St, New Haven, Conn 06514
NOVAR CORP.
2370 Charleston Rd, Mt View, Cal 94040
NYTRONICS INC.
3rd Ave, Alpha, N J 08865
OKI ELECTRIC INDUSTRIES CO. LTD.
875 Ave of Americas, New York, N Y 10001
OLIVETTI CORP. OF AMERICA
500 Park Ave, New York, N Y 10016
OMNITEC CORP. A NYTRONICS CORP.
903 N 2nd St, Phoenix, Ariz 85004
PHOTOPHYSICS
1601 Stierlin Rd, Mt View, Cal 94040
POTTER INSTRUMENT CO. INC.
532 Broadhollow Rd, Melville, N Y 11746
PRINTER TECHNOLOGY INC.
Sixth Rd, Woburn, Mass 01801
PURDY CORP., WM. J.
770 Airport Blvd, Burlingame, Cal 94010
RAYTHEON CO. CADPO OPERATION
1415 Providence Tpk, Norwood, Mass 02062
RAYTHEON CO. INDUSTRIAL COMPONENT
OPERATION
465 Centre St., Quincy, Mass 02169
RISK INDUSTRIES INC., GEORGE
P O Box 1035, Kimball, Nebr 69145
SCANTLIN ELECTRONICS, INC.
5454 Beethoven St, Los Angeles, Cal 90060
STROMBERG DATAGRAPHX INC.
P O Box 2449, San Diego, Cal 92112
SUGARMAN LABORATORIES INC.
295 Northern Blvd, Great Neck, N Y 11021
SYCOR INC.
100 Phoenix Dr, Ann Arbor, Mich 48104
SYS COMPUTER CORP.
17-25 Dicarolis Court, Hackensack, N J 07601
SYSTEMS EQUIPMENT CORP.
458 Plasamour Dr, Atlanta, Ga 30324
TEKTRONIX INC.
P O Box 500, Beaverton, Ore 97005
TELE-DATA CORP.
130 U S Hwy 22, N Plainfield, N J 07060
TELETYPE CORP.
5555 W Touhy Ave, Skokie, Ill 60076
TERMINAL EQUIPMENT CORP.
750 Hamburg Tpk, Pompton Lakes, N J 07442
TEXAS INSTRUMENTS INC. DIGITAL SYSTEMS DIV
P O Box 66027, Houston, Tex 77006
TRACOR DATA SYSTEMS INC.
4201 Ed Bluestein Blv, Austin, Tex 78721
TRANSCOM INC. SUB. OF HI-G INC.
12 Tobey Rd, Bloomfield, Conn 06002
ULTRONIC SYSTEMS CORP.
Mt Laurel Ind Pk, Moorestown, N J 08057
UNICOM INC.
1275 Bloomfield Ave, Fairfield, N J 07006
UNIMAX SWITCH CORP. SUB. RIKER-MAXSON
Ives Rd, Wallingford, Conn 06492
UNIVERSAL TECHNOLOGY INC.
3 Spielman Rd, Fairfield, N J 07006
UNIVERSITY COMPUTING CO.
P O Box 6228, Dallas, Tex 75222

2 Product Directory

UNIVERSITY COMPUTING CO. DATEL DIV.
1 Tysons Corner Ctr, McLean, Va 22101
WAVETEK DATA COMMUNICATIONS
9045 Balboa Ave, San Diego, Cal 92123
WYLE LABORATORIES
128 Maryland St, El Segundo, Cal 90245

DATA TERMINALS, INQUIRY-RESPONSE (AUDIO RESPONSE)

AMERICAN COMPUTER & COMMUNICATIONS CO.
2576 W Carson St, Torrance, Cal 90509
AMP INC., SYSCOM DIV.
P O Box 3608, Harrisburg, Pa 17105
APPLIED COMPUTER SYSTEMS INC.
P O Box 6479, Austin, Tex 78702
AUDAC CORP.
175 Bedford St, Burlington, Mass 01803
BUNKER RAMO CORP., THE, BUSINESS & IND. DIV
445 Fairfield Ave, Stamford, Conn 06904
BURROUGHS CORP., BUSINESS MACHINES GROUP
6071 2nd Ave, Detroit, Mich 48232
COGNITRONICS CORP.
333 Bedford Rd, Mt Kisco, N Y 10549
COMDATA CORP.
7544 W Oakton St, Niles, Ill 60648
COMPUTER SYSTEMS INC.
2042 Westmoreland St, Richmond, Va 23230
COMPUTONE SYSTEMS INC.
361 E Paces Ferry Rd, Atlanta, Ga 30305
CREDIT SYSTEMS INC.
P O Box 105, Colmar, Pa 18915
DASH DATA SYSTEMS INC.
69 Jefferson St, Stamford, Conn 06902
DATA PRODUCTS CORP.
16055 Ventura Blvd, Encino, Cal 91316
DATATERM INC.
1671 Manning Blvd, Levittown, Pa 19057
DATATROL INC.
Kane Industrial Dr, Hudson, Mass 01749
DATRON SYSTEMS INC.
100 Rte 46, Mt Lakes, N J 07046
DECITRON COMMUNICATION SYSTEMS INC.
567 E 105 St, Brooklyn, N Y 11236
HI-G INC.
580 Spring St, Windsor Locks, Conn 06096
HONEYWELL INFORMATION SYSTEMS
60 Walnut St, Wellesley Hills, Mass 02181
IBM CORP., DATA PROCESSING DIV.
1133 Westchester Ave, White Plains, N Y 10604
MARK COMPUTER SYSTEMS INC.
One Patterson Pl, Garden City, N Y 11530
MARK/OPS DIV., NORTH EASTERN SYSTEMS ASSOC.
INC.
475 Commonwealth Ave, Boston, Mass 02215
MAXSON ELECTRONICS CORP. DIV. RIXKER MAXSON
Sunrise Hwy, Great River, N Y 11739
METROPROCESSING CORP. OF AMERICA
64 Prospect St, White Plains, N Y 10606
NATIONAL MIDCO INDUSTRIES INC.
Box 5433, Trenton, N J 08638
NYTRONICS INC.
3rd Ave, Alpha, N J 08865
TECHNITREND INC.
7300 N Crescent Blvd, Pennsauken, N J 08110
TRANSCOM INC. SUB. OF HI-G INC.
12 Tobey Rd, Bloomfield, Conn 06002
TREPAC CORP. OF AMERICA
30 W Hamilton Ave, Englewood, N J 07631
VERNITRON CORP. DATA DEVICE DIV.
176 Central Ave, Farmingdale, N Y 11735
WAVETEK DATA COMMUNICATIONS
9045 Balboa Ave, San Diego, Cal 92123

DATA TERMINALS, INQUIRY-RESPONSE (BADGE-TOKEN READERS)

ADDO-X INC. ADP DIV.
437 Madison Ave, New York, N Y 10022
AMERICAN COMPUTER & COMMUNICATIONS CO.
2576 W Carson St, Torrance, Cal 90509
AMERICAN TOTALISATOR CO. UNI-TOTE DIV.
383 Hillen Rd, Towson, Md 21204
AMP INC.
Eisenhower Blvd, Harrisburg, Pa 17105
AMP INC., SYSCOM DIV.
P O Box 3608, Harrisburg, Pa 17105
APPLIED COMPUTER SYSTEMS INC.
P O Box 6479, Austin, Tex 78702

AUDAC CORP.
175 Bedford St, Burlington, Mass 01803
BUNKER RAMO CORP., THE, BUSINESS & IND. DIV
445 Fairfield Ave, Stamford, Conn 06904
CINCINNATI TIME RECORDER CO.
1733 Central Ave, Cincinnati, Ohio 45214
COMPERIPHERALS INC.
437 Madison Ave, New York, N Y 10022
CONTROL DATA CORP.
8100 34th Ave S, Minneapolis, Minn 55440
CONTROL DATA CORP. TERMINAL SUBSYS.DIV
2401 N Fairview Ave, St Paul, Minn 55113
CREDIT SYSTEMS INC.
P O Box 105, Colmar, Pa 18915
DASH DATA SYSTEMS INC.
69 Jefferson St, Stamford, Conn 06902
DATA PATHING INC.
370 San Aleso Ave, Sunnyvale, Cal 94086
DATA TERMINAL SYSTEMS INC.
239 Main St, Maynard, Mass 01754
DATASERV DIV., WILLIAM J. PURDY CORP.
770 Airport Blvd, Burlingame, Cal 94010
DATATERM INC.
1671 Manning Blvd, Levittown, Pa 19057
DECITRON COMMUNICATION SYSTEMS INC.
567 E 105 St, Brooklyn, N Y 11236
FERRANTI PACKARD LTD., ELECTRONICS DIV.
121 Industry St, Toronto 15, CANADA
FRIDEN DIV. THE SINGER CO.
97 Humboldt St, Rochester, N Y 14602
HICKOK ELECTRICAL INSTRUMENT CO.
10514 Dupont Ave, Cleveland, Ohio 44108
HI-G INC.
580 Spring St, Windsor Locks, Conn 06096
HONEYWELL INFORMATION SYSTEMS
P O Box 12313, Oklahoma City, Okla 73112
IBM CORP., DATA PROCESSING DIV.
1133 Westchester Ave, White Plains, N Y 10604
MADATRON CORP.
P O Box 172, Princeton, N J 08540
MARK COMPUTER SYSTEMS INC.
One Patterson Pl, Garden City, N Y 11530
NATIONAL MIDCO INDUSTRIES INC.
Box 5433, Trenton, N J 08638
NYTRONICS INC.
3rd Ave, Alpha, N J 08865
OLIVETTI CORP. OF AMERICA
500 Park Ave, New York, N Y 10016
PURDY CORP., WM. J.
770 Airport Blvd, Burlingame, Cal 94010
RAYTHEON CO. CADPO OPERATION
1415 Providence Tpk, Norwood, Mass 02062
SIERRA RESEARCH CORP. COMPUTER PROD. GRP.
167 Bedford St, Burlington, Mass 01803
STANDARD REGISTER CO., THE
626 Albany St, Dayton, Ohio 45401
SYS COMPUTER CORP.
17-25 Dicarolis Court, Hackensack, N J 07601
TRANSCOM INC. SUB. OF HI-G INC.
12 Tobey Rd, Bloomfield, Conn 06002
WORLD COMPUTER CORP.
1615 Stemmons Fwy, Dallas, Tex 75221

DATA TERMINALS, INQUIRY-RESPONSE (CRT WITH KEYBOARD)

ADDO-X INC. ADP DIV.
437 Madison Ave, New York, N Y 10022
AMERICAN TOTALISATOR CO. UNI-TOTE DIV.
383 Hillen Rd, Towson, Md 21204
ANN ARBOR TERMINALS INC.
918 Greene St, Ann Arbor, Mich 48104
APPLIED COMPUTER SYSTEMS INC.
P O Box 6479, Austin, Tex 78702
APPLIED DIGITAL DATA SYSTEMS INC.
100 Marcus Blvd, Hauppauge, N Y 11787
ATLANTIC TECHNOLOGY CORP.
505 W Hamilton Ave, Linwood, N J 08221
BALL BROTHERS MIRATEL DIV.
1633 Terrace Dr, Roseville, Minn 55113
BUNKER RAMO CORP., THE, BUSINESS & IND. DIV
445 Fairfield Ave, Stamford, Conn 06904
BUNKER-RAMO CORP.
Trumbull Ind Pk, Trumbull, Conn 06611
BURROUGHS CORP., BUSINESS MACHINES GROUP
6071 2nd Ave, Detroit, Mich 48232
COLLINS RADIO CO.
1200 N Alma Rd, Dallas, Tex 75207
COMMUNITY CORP.
767 Fifth Ave, New York, N Y 10022
COMPERIPHERALS INC.
437 Madison Ave, New York, N Y 10022

BUY - RENT - LEASE DATA TERMINALS all types • all brands

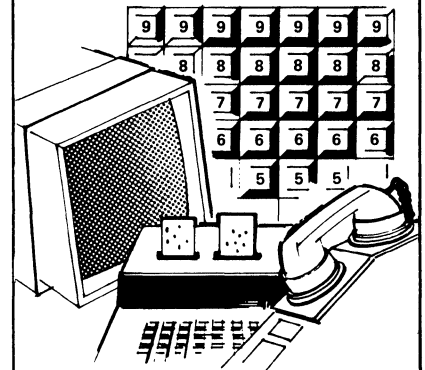

We are the West's largest, most experienced, best-stocked, factory-approved source for EDP terminals, peripherals and interfaces of every description

controllers • converters
processors • acoustic couplers
copiers • modems
display consoles
keyboards • transceivers
printers • teleprinters
readers • recorders
accessories • supplies

Our experienced EDP engineers analyze system requirements thoroughly, design and install custom turnkey systems, and provide expert consultation on system expansion or modification as requirements change.

We are thoroughly familiar with the capabilities and limitations of all reputable brands of EDP equipment, and are impartial in recommending and selecting equipment strictly on its merit for the application.

For more information on how to get the EDP system or equipment you need and get it on your terms see DataServ catalog insert.

DATA SERV

Burlingame, California
Denver • Salt Lake City • Seattle •
Phoenix • Los Angeles
One of the PURDY group of companies

2 Product Directory

COMPUTEK INC.
143 Albany St, Cambridge, Mass 02139
COMPUTER COMMUNICATION INC.
701 W Manchester Blvd, Inglewood, Cal 90301
COMPUTER DEVICES INC.
10 Sonar Dr, Woburn, Mass 01801
COMPUTER INC.
143 Albany St, Cambridge, Mass 02139
COMPUTER-OPTICS, INC.
Berkshire Ind Park, Bethel, Conn 06801
COMPUTER SYSTEMS INC.
2042 Westmoreland St, Richmond, Va 23230
COMPUTER TERMINAL CORP.
9725 Datapoint Dr, San Antonio, Tex 78229
COMPUTER USAGE CORP.
100 Putman Green, Greenwich, Conn 06830
CONRAC CORP.
330 Madison Ave, New York, N Y 10017
CONTROL DATA CORP.
8100 34th Ave S, Minneapolis, Minn 55440
CONTROL DATA CORP. TERMINAL SUBSYS.DIV
2401 N Fairview Ave, St Paul, Minn 55113
CORNING GLASS WORKS
Houghton Park, Corning, N Y 14830
DATA ACCESS SYSTEMS INC.
503 Rte 10 Mt 19, Dover, N J 07801
DATA AUTOMATION COMMUNICATIONS INC.
7505 Carpenter Fwy, Dallas, Tex 75247
DATA COMPUTER SYSTEMS INC.
17131 Daimier St, Santa Ana, Cal 92705
DATA DIMENSIONS INC.
51 Weaver St, Greenwich, Conn 06830
DATA DISC INC.
686 W Maude Ave, Sunnyvale, Cal 94086
DATA INPUT DEVICES INC.
Tinkham Ind Pk, Derry, N H 03038
DATA PACIFIC CORP.
116 E Ash, Fullerton, Cal 92631
DATA PATHING INC.
370 San Aleso Ave, Sunnyvale, Cal 94086
DATA 100 CORP.
7450 France Ave S, Minneapolis, Minn 55435
DATAC COMPUTER CORP.
7900 Computer Blvd, Minneapolis, Minn 55435
DATASERV DIV., WILLIAM J. PURDY CORP.
770 Airport Blvd, Burlingame, Cal 94010
DATRON SYSTEMS INC.
100 Rte 46, Mt Lakes, N J 07046
DELTA DATA SYSTEMS CORP.
Woodhaven Ind Park, Cornwells Hgts, Pa 19020
DIGI-LOG SYSTEMS INC.
107 W Ridge Pike, Conshohocken, Pa 19428
ELECTRONIC IDEAS INC.
Reading Sta, Wyncote, Pa 19095
ELECTRONIC INFORMATION SYSTEMS INC.
2400 Industrial Lane, Broomfield, Conn 80020
EVANS & SUTHERLAND COMPUTER CORP.
3 Research Rd, Salt Lake City, Utah 84112
FOUR-PHASE SYSTEMS INC.
10420 N Tantau Ave, Cupertino, Cal 95014
FUJITSU LTD. N.Y.LIAISON OFFICE
680 Fifth Ave, New York, N Y 10019
HARRIS-INTERTYPE CORP. INTERTYPE DIV.
Palm Bay Rd, Melbourne, Fla 32901
HAZELTINE CORP. INDUSTRIAL PRODUCTS DIV.
Greenlawn, N Y 11740
HEWLETT PACKARD CO. CUPERTINO DIV.
1100 Wolfe Rd, Cupertino, Cal 95014
HONEYWELL INFORMATION SYSTEMS
P O Box 12313, Oklahoma City, Okla 73112
HONEYWELL INFORMATION SYSTEMS
60 Walnut St, Wellesley Hills, Mass 02181
HYPERTECH CORP.
7343 W Wilson Ave, Harwood Hgts, Ill 60656
IBM CORP., DATA PROCESSING DIV.
1133 Westchester Ave, White Plains, N Y 10604
IMLAC CORP.
296 Newton St, Waltham, Mass 02154
INCOTERM CORP.
Hayes Memorial Dr, Marlboro, Mass 01752
INFOREX INC.
21 N Ave, Burlington, Mass 01803
INFOTON INC.
2nd Ave, Burlington, Mass 01803
INTERACTIVE TERMINALS CORP.
197 Albany St, Cambridge, Mass 02139
INTERNATIONAL COMPUTERS LTD.
Icl House Putney, London S W 15, UNITED K
INTERNATIONAL CONTROLS CORP.
200 Fairfield Rd, Fairfield, N J 07006
ITT DATA EQUIPMENT & SYSTEMS DIV.
187 E Union Ave, E Rutherford, N J 07073
ITT DEFENSE COMMUNICATIONS DIV.
492 River Rd, Nutley, N J 07110

LEAR SIEGLER INC., ELECTRONIC INSTRUMENTATION
DIV
714 N Brookhurst St, Anaheim, Cal 92803
MADATRON CORP.
P O Box 172, Princeton, N J 08540
MAI EQUIPMENT CORP.
300 E 44th St, New York, N Y 10017
MARK COMPUTER SYSTEMS INC.
One Patterson Pl, Garden City, N Y 11530
MARK/OPS DIV., NORTH EASTERN SYSTEMS ASSOC.
INC.
475 Commonwealth Ave, Boston, Mass 02215
MAXSON ELECTRONICS CORP. DIV. RIXKER MAXSON
Sunrise Hwy, Great River, N Y 11739
MICRODATA CORP.
644 E Young St, Santa Ana, Cal 92705
MULTIPLEX COMMUNICATIONS INC.
123 Marcus Blvd, Hauppauge, N Y 11787
OKI ELECTRIC INDUSTRIES CO. LTD.
875 Ave of Americas, New York, N Y 10001
OLIVETTI CORP. OF AMERICA
500 Park Ave, New York, N Y 10016
PHOTOPHYSICS
1601 Stierlin Rd, Mt View, Cal 94040
PRINCETON ELECTRONIC PRODUCTS INC.
P O Box 101, N Brunswick, N J 08902
PRINTER TECHNOLOGY INC.
Sixth Rd, Woburn, Mass 01801
PURDY CORP., WM. J.
770 Airport Blvd, Burlingame, Cal 94010
RAYTHEON CO. CADPO OPERATION
1415 Providence Tpk, Norwood, Mass 02062
SCANTLIN ELECTRONICS, INC.
5454 Beethoven St, Los Angeles, Cal 90060
SPIRAS SYSTEMS INC. AFFIL. USM CORP.
332 Second Ave, Waltham, Mass 02154
STROMBERG DATAGRAPHIX INC.
P O Box 2449, San Diego, Cal 92112
SUGARMAN LABORATORIES INC.
295 Northern Blvd, Great Neck, N Y 11021
SYCOR INC.
100 Phoenix Dr, Ann Arbor, Mich 48104
SYS COMPUTER CORP.
17-25 Dicarolis Court, Hackensack, N J 07601
TEC INC.
6700 S Wash Ave, Eden Prairie, Minn 55343
TECHNITREND INC.
7300 N Crescent Blvd, Pennsauken, N J 08110
TEKTRONIX INC.
P O Box 500, Beaverton, Ore 97005
TELE-DATA CORP.
130 U S Hwy 22, N Plainfield, N J 07060
TIME-SHARING TERMINALS INC.
2351 Shady Grove Rd, Rockville, Md 20850
ULTRONIC SYSTEMS CORP.
Mt Laurel Ind Pk, Moorestown, N J 08057
UNICOM INC.
1275 Bloomfield Ave, Fairfield, N J 07006
UNICOMP INC.
18219 Parthenia, Northridge, Cal 91324
UNIVERSAL TECHNOLOGY INC.
3 Spielman Rd, Fairfield, N J 07006
VERNITRON CORP. DATA DEVICE DIV.
176 Central Ave, Farmingdale, N Y 11735
VIDEO SYSTEMS CORP.
7300 N Crescent Blvd, Pennsauken, N J 08110

DATA TERMINALS, INQUIRY-RESPONSE (PORTABLE)

METROPROCESSING CORP. OF AMERICA
64 Prospect St, White Plains, N Y 10606

DATA TERMINALS, INQUIRY-RESPONSE (SPECIAL-PURPOSE)

AMERICAN COMPUTER & COMMUNICATIONS CO.
2576 W Carson St, Torrance, Cal 90509
AMERICAN TOTALISATOR CO. UNI-TOTE DIV.
383 Hillen Rd, Towson, Md 21204
AMP INC.
Eisenhower Blvd, Harrisburg, Pa 17105
AMP INC., SYSCOM DIV.
P O Box 3608, Harrisburg, Pa 17105
ANN ARBOR TERMINALS INC.
918 Greene St, Ann Arbor, Mich 48104
APPLIED COMPUTER SYSTEMS INC.
P O Box 6479, Austin, Tex 78702
APPLIED DIGITAL DATA SYSTEMS INC.
100 Marcus Blvd, Hauppauge, N Y 11787

APPLIED SYSTEMS CORP.
18325 W McNichols Ave, Detroit, Mich 48219
BUNKER RAMO CORP., THE, BUSINESS & IND. DIV
445 Fairfield Ave, Stamford, Conn 06904
BUNKER-RAMO CORP.
Trumbull Ind Pk, Trumbull, Conn 06611
CENTURY ELECTRONICS & INSTRUMENTS INC.
P O Box C Adm Sta, Tulsa, Okla 74115
COMPAT CORP.
177 Cantiague Rock Rd, Westbury, N Y 11590
COMPUTEK INC.
143 Albany St, Cambridge, Mass 02139
COMPUTER COMMUNICATION INC.
701 W Manchester Blvd, Inglewood, Cal 90301
COMPUTER DEVICES INC.
10 Sonar Dr, Woburn, Mass 01801
COMPUTER INC.
143 Albany St, Cambridge, Mass 02139
COMPUTER SYSTEMS INC.
2042 Westmoreland St, Richmond, Va 23230
COMPUTER TERMINAL CORP.
9725 Datapoint Dr, San Antonio, Tex 78229
COMPUTER USAGE CORP.
100 Putman Green, Greenwich, Conn 06830
COMPUTONE SYSTEMS INC.
361 E Paces Ferry Rd, Atlanta, Ga 30305
CONNECTICUT TECHNICAL CORP.
3000 Main St, Hartford, Conn 06120
CONTROL DATA CORP.
8100 34th Ave S, Minneapolis, Minn 55440
CREDIT SYSTEMS INC.
P O Box 105, Colmar, Pa 13915
DASH DATA SYSTEMS INC.
69 Jefferson St, Stamford, Conn 06902
DATA COMPUTING INC.
2219 W Shangri La Rd, Phoenix, Ariz 85029
DATA DISC INC.
686 W Maude Ave, Sunnyvale, Cal 94086
DATA PACIFIC CORP.
116 E Ash, Fullerton, Cal 92631
DATA PATHING INC.
370 San Aleso Ave, Sunnyvale, Cal 94086
DATA TERMINAL SYSTEMS INC.
239 Main St, Maynard, Mass 01754
DATA TRENDS INC.
P O Box 82, Mt Lake, N J 07046
DATA 100 CORP.
7450 France Ave S, Minneapolis, Minn 55435
DATALINE INC.
181 S Boro Line Rd, King of Prussia, Pa 19406
DATASERV DIV., WILLIAM J. PURDY CORP.
770 Airport Blvd, Burlingame, Cal 94010
DATATERM INC.
1671 Manning Blvd, Levittown, Pa 19057
DECITRON COMMUNICATION SYSTEMS INC.
567 E 105 St, Brooklyn, N Y 11236
DELTA DATA SYSTEMS CORP.
Woodhaven Ind Park, Cornwells Hgts, Pa 19020
DIGI-LOG SYSTEMS INC.
107 W Ridge Pike, Conshohocken, Pa 19428
DIGITAL APPLICATIONS INC.
6300 Westpark Ste 150, Houston, Tex 77027
DIGITAL PRODUCTS CORP.
6950 NW 12 Ave, Ft Lauderdale, Fla 33309
ELDORADO ELECTRODATA
601 Chalomar Rd, Concord, Cal 94520
ELPAC INC.
18651 Von Karman Ave, Irvine, Cal 92664
EVANS & SUTHERLAND COMPUTER CORP.
3 Research Rd, Salt Lake City, Utah 84112
FERRANTI PACKARD LTD., ELECTRONICS DIV.
121 Industry St, Toronto 15, CANADA
FOUR-PHASE SYSTEMS INC.
10420 N Tantau Ave, Cupertino, Cal 95014
FUJITSU LTD. N.Y.LIAISON OFFICE
680 Fifth Ave, New York, N Y 10019
HICKOK ELECTRICAL INSTRUMENT CO.
10514 Dupont Ave, Cleveland, Ohio 44108
HI-G INC.
580 Spring St, Windsor Locks, Conn 06096
HONEYWELL INFORMATION SYSTEMS
P O Box 12313, Oklahoma City, Okla 73112
I/O SYSTEMS INC.
P O Box 36, Natick, Mass 01760
IBM CORP., DATA PROCESSING DIV.
1133 Westchester Ave, White Plains, N Y 10604
INCOTERM CORP.
Hayes Memorial Dr, Marlboro, Mass 01752
LITTON SYSTEMS INC. DATA SYSTEMS DIV.
8000 Woodley Ave, Van Nuys, Cal 91409
LOGIC CORP.
21 Oldey Ave, Cherry Hill, N J 08034
MADATRON CORP.
P O Box 172, Princeton, N J 08540

2 Product Directory

MARK COMPUTER SYSTEMS INC.
One Patterson Pl, Garden City, N Y 11530
MAXSON ELECTRONICS CORP. DIV. RIKKER MAXSON
Sunrise Hwy, Great River, N Y 11739
MCA TECHNOLOGY INC. UDAC DIV.
P O Box 36166, Houston, Tex 77035
MICRO SYSTEMS INC.
644 E Young St, Santa Ana, Cal 92705
NATIONAL MIDCO INDUSTRIES INC.
Box 5433, Trenton, N J 08638
NYTRONICS INC.
3rd Ave, Alpha, N J 08865
OKI ELECTRIC INDUSTRIES CO. LTD.
875 Ave of Americas, New York, N Y 10001
OMNITEC CORP. A NYTRONICS CORP.
903 N 2nd St, Phoenix, Ariz 85004
PRINCETON APPLIED RESEARCH CORP.
P O Box 565, Princeton, N J 08540
PURDY CORP., WM. J.
770 Airport Blvd, Burlingame, Cal 94010
RAYCON INC.
218 Brunswick Blvd, Pointe Claire, CANADA
SCANTLIN ELECTRONICS, INC.
5454 Beethoven St, Los Angeles, Cal 90060
SIERRA RESEARCH CORP. COMPUTER PROD. GRP.
167 Bedford St, Burlington, Mass 01803
SINGER CO., THE, FRIDEN DIV.
2350 Washington St, San Leandro, Cal 94577
SPIRAS SYSTEMS INC. AFFIL. USM CORP.
332 Second Ave, Waltham, Mass 02154
STACOSWITCH INC.
1139 Baker St, Costa Mesa, Cal 92626
SYCOR INC.
100 Phoenix Dr, Ann Arbor, Mich 48104
SYLVANIA ELECTRONIC SYSTEMS EASTERN DIV.
77 A St, Needham Heights, Mass 02194
SYMETRICS INDUSTRIES INC.
1227 S Patrick Dr, Satellite Beach, Fla 32935
SYSTEMS EQUIPMENT CORP.
458 Plasamour Dr, Atlanta, Ga 30324
TEC INC.
6700 S Wash Ave, Eden Prairie, Minn 55343
TELECTRO SYSTEMS CORP.
96-18 43rd Ave, Corona, N Y 11368
ULTRONIC SYSTEMS CORP.
Mt Laurel Ind Pk, Moorestown, N J 08057
UNIVERSITY COMPUTING CO.
P O Box 6228, Dallas, Tex 75222
VERNITRON CORP. DATA DEVICE DIV.
176 Central Ave, Farmingdale, N Y 11735
WAVETEK DATA COMMUNICATIONS
9045 Balboa Ave, San Diego, Cal 92123
XEBEC SYSTEMS INC.
918 N Rengstorff Ave, Mountain View, Cal 94040

DATA TRANSMISSION SYSTEMS (SEE COMMUNICATIONS SYSTEMS)

DELAY LINES, ELECTROMAGNETIC

ALLEN AVIONICS INC.
255 E 2nd St, Mineola, N Y 11501
BELFUSE INC.
198 Van Vorst St, Jersey City, N J 07302
COLUMBIA COMPONENTS CORP.
60 Madison Ave, Hempstead, N Y 11550
GENERAL INSTRUMENT CORP., F W SICKLES DIV.
165 Front St, Chicopee, Mass 01014
MCGRAW-EDISON DAVEN DIV.
Grenier Field, Manchester, N H 03103

DELAY LINES, GLASS (ALSO SEE MEMORIES)

COMPUTER DEVICES CORP.
63 Austin Blvd, Commack, N Y 11725
CORNING GLASS WORKS
Houghton Park, Corning, N Y 14830
INTERNATIONAL CONTROLS CORP.
200 Fairfield Rd, Fairfield, N J 07006
MICROSONICS DIV. SANGAMO ELECTRIC CO
60 Winter St, Weymouth, Mass 02188
NYTRONICS INC.
3rd Ave, Alpha, N J 08865
RCL ELECTRONICS INC.
700 S 21 St, Irvington, N J 07111

DELAY LINES, GLASS (ALSO SEE MEMORIES)

DELAY LINES, MAGNETOSTRICTIVE (ALSO SEE MEMORIES)

ALADDIN ELECTRONICS DIV. ALADDIN INDUS.
701 Murfreesboro Rd, Nashville, Tenn 37202
BELFUSE INC.
198 Van Vorst St, Jersey City, N J 07302
COMPUTER DEVICES CORP.
63 Austin Blvd, Commack, N Y 11725
ENGINEERED COMPONENTS CO.
2134 W Rosecrans Ave, Gardena, Cal 90249
ESC ELECTRONICS
534 Bergen Blvd, Palisades Park, N J 07650
HELIPOT DIV. BECKMAN INSTRUMENTS INC.
2500 Harbor Blvd, Fullerton, Cal 92634
INTERNATIONAL CONTROLS CORP.
200 Fairfield Rd, Fairfield, N J 07006
MICROSONICS DIV. SANGAMO ELECTRIC CO
60 Winter St, Weymouth, Mass 02188
NORTH AMERICAN ROCKWELL CORP. AUTONETICS DIV.
3370 Miraloma Ave, Anaheim, Cal 92803
NYTRONICS INC.
3rd Ave, Alpha, N J 08865
RCL ELECTRONICS INC.
700 S 21 St, Irvington, N J 07111
TOKO N. Y. INC. SUB. OF TOKO INC. TOKYO
350 5th Ave, New York, N Y 10001
TYCO LABORATORIES INC.
16 Hickory Dr, Waltham, Mass 02154
TYCO LABORATORIES INC. DIGITAL DEVICES DIV
200 Michael Dr, Syosset, N Y 11791
VIDCOR CO. INC.
1251 W El Segundo Blv, Gardena, Cal 90247

DELAY LINES, MAGNETOSTRICTIVE (ALSO SEE MEMORIES)

DELAY LINES, SEMICONDUCTOR (SEE CIRCUITS)

DEMAGNETIZERS, MAGNETIC TAPE

AMPEX CORP. COMPUTER PRODUCTS DIV.
9937 W Jefferson Blvd, Culver City, Cal 90230
COMPUTER ACCESSORIES CO.
131 W 154th St, Gardena, Cal 90248
HEWLETT PACKARD CO.
1501 Page Mill Rd, Palo Alto, Cal 94304
HEWLETT PACKARD CO. MOUNTAIN VIEW DIV.
690 Middlefield Rd, Mtn View, Cal 94040
INDEL INC.
P O Box 15800, Tulsa, Okla 74115
MACS COMPUTER ACCESSORIES INC
104 Park Towne Pl, Philadelphia, Pa 19130
MAG-CON ENGINEERING CO.
85 Richardson St SE, St Paul, Minn 55112
MICROTRAN COMPANY INC.
145 E Mineola Ave, Valley Stream, N Y 11582
RFL INDUSTRIES INC. COMMUNICATION DIV.
Powerville Rd, Boonton, N J 07005

DEMONSTRATORS AND KITS, EDUCATIONAL (DIGITAL LOGIC)

APPLIED COMPUTER SYSTEMS INC.
P O Box 6479, Austin, Tex 78702
ASTRO MOBILE PRODUCTS CORP. MAGNAGRAPH DIV.
11-25 44 Rd, Long Island, N Y 11101
DATA DISPLAY SYSTEMS INC.
139 Terwood Rd, Willow Grove, Pa 19090
DENELCOR INC.
5975 Broadway, Denver, Colo 80216
DIGIAC CORP.
Ames Court, Plainville, N Y 11803
DIGITAL EQUIPMENT CORP.
146 Main St, Maynard, Mass 01754
DIGITAL PRODUCTS CORP.
6950 NW 12 Ave, Ft Lauderdale, Fla 33309
EL INSTRUMENTS INC.
61 1st St, Derby, Conn 06418
FABRI-TEK INC.
5901 S County Rd 18, Minneapolis, Minn 55436

INTRODUCING ...
DUAL-IN-LINE
"MINI"
SPIRADEL®
THE WORLD'S SMALLEST
DELAY LINE HAVING TIME DELAY
TO RISE TIME RATIO
GREATER THAN 5/1



FEATURES EXCELLENT PULSE FIDELITY
Exceptionally Fine Phase Linearity
Over Wide Frequency Range.
Operation from -55°C to $+105^{\circ}\text{C}$.
Units exhibit a change of less than
175 parts/million/ $^{\circ}\text{C}$
over its entire
temperature range.

ACTUAL SIZE
*Patented

Time Delay (Nano-seconds)	Rise Time (Nano-seconds)	Impedance (ohms)
10	2.5	125
20	4	200
30	6	250
40	8	300
50	10	350
60	12	400
70	14	400
80	16	475
90	18	500
100	20	500
125	25	500
150	30	1000
175	35	1000
200	40	1000

- Designed for dual-in-line mounting. Compatible with integrated circuits.
- Size: .780 x .460 x .250 inches.
- Standard delay tolerance 10%. (5% available).
- Minimum attenuation for all delays: 5%.
- Bandwidth DC to freq. $f = .35/\text{rise time}$.

SPIRADEL®
THE MOST COMPACT
"FIXED" & "TAPPED"
DISTRIBUTED DELAY LINES



Spiradel is a patented variety of Distributed Delay Lines, offering the highest delay to rise time ratios available. The units are extremely compact and are encapsulated for maximum environmental protection. Standard Spiradels are available within the following ranges:

	Fixed Lines	Tapped Lines
Delay to Rise Time Ratios..	Up to 30/1	Up to 21.3/1
Delay Range (nanoseconds)	20 to 6000	20 to 1000
Impedance (ohms)	50 to 1000	50 to 325
Standard height of all units:	5/16"	
Operation is from -55°C to 105°C .		
Bandwidth is from DC to frequency = $.35/\text{rise time}$.		

*Patented and patents applied for.

HIGHEST TIME DELAY RISE TIME RATIO EVER BUILT!

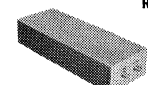

SERIES
"HF", "HR" & "VHR"

These units have the highest ratio of time delay to rise time that has ever been built in a Lumped Constant Line. Unlike other types of high ratio lines, the Lumped Constant Line has a passband from D.C. to its cutoff frequency and maintains a constant delay over these frequencies. These Lines offer relatively low insertion loss, tight time delay tolerances, low pulse distortion, excellent phase linearity and good temperature stability.

DECADE DELAY LINES
TYPE "D"



Range from 11.1 to 61,111 microseconds

These units provide variable time delays with absolute stability for accurate triggering and excellent reproduction of input pulse. They are completely passive. All models have a minimum of 1000 to 1 resolution and consist of 3 or more decade switches. Any delay output is the summation of individual lines, not the result of a tapped line. This feature eliminates undesirable reflections in the output pulse. Accuracy at any delay exceeding 1% of the unit's total delay is within 3%. These units have a characteristic impedance of 500 ohms in and out.

CUSTOM-BUILT DELAY LINES

We manufacture a wide variety of Delay Lines to customers' specifications. Delay times range from 3 nanoseconds through 61 milliseconds. Time Delay to Rise Time ratios are up to 300/1. Units are hermetically sealed in metal cans with glass to metal terminals or are epoxy encapsulated. Sizes start at 5/16" x 5/16" x .450".

CATALOG UPON REQUEST

ALLEN AVIONICS, INC.
MFR. OF FILTERS & DELAY LINES
224 E. 2nd STREET, MINEOLA, N. Y. 11501
Phone: 516-248-8080

2 Product Directory

HONEYWELL INFORMATION SYSTEMS INC. INFO. SERV.DIV

2701 4th Ave S, Minneapolis, Minn 55408
LEHIGH VALLEY ELECTRONICS INC.
Po Box 125, Fogelsville, Pa 18051
MASSEY DICKINSON CO. INC.
9 Elm St, Saxonville, Mass 01701
NATIONAL ELECTRO-MECHANICAL SYSTEMS INC.
32 Broad Ave, Binghamton, N Y 13904
SCIENTIFIC MEASUREMENTS INC.
9701 N Kenton, Skokie, Ill 60076
VECTOR ELECTRONIC CO. INC.
12460 Gladstone Ave, Sylmar, Cal 91342
WARREN ASSOCIATES
15 Royal Crest Dr, Marlboro, Mass 01752

DESIGN AND FEASIBILITY STUDIES (SEE CONSULTING)

DESKS, TABLES AND STANDS (FOR CALCULATORS)

AMCO ENGINEERING CO.
7333 W Ainslie, Chicago, Ill 60656
BARRY-WRIGHT CORP. WRIGHT LINE DIV.
160 Gold Star Blvd, Worcester, Mass 01606
BORG-WARNER/INGERSOLL PRODUCTS/EMCOR
1000 W 120th St, Chicago, Ill 60643
COMPUTER ACCESSORIES CO.
131 W 154th St, Gardena, Cal 90248
DEXION INC.
39-27 59th St, New York, N Y 11377
ECONOMET INC.
1033 W Kirkwall Rd, Azusa, Cal 91702
LYON METAL PRODUCTS INC.
P O Box 671, Aurora, Ill 60507
MONARCH METAL PRODUCTS INC.
Mac Arthur Ave, New Windsor, N Y 12550
OCHMAN SYSTEMS, EDWARD
Po Box 141, Fairfield, Conn 06430
ORIGINAL COMPUTER PRODUCTS INC.
204 Worcester St, Wellesley Hills, Mass 02181
SHAW-WALKER CO.
P O Box 208, Muskegon, Mich 49443
SMITH SYSTEM MANUFACTURING CO.
56 Emerald St SE, Minneapolis, Minn 55414
STINAFFS INC.
181 E Exchange St, Akron, Ohio 44304
TAB PRODUCTS
2690 Hanover St, Palo Alto, Cal 94304
TRANSITRON ELECTRONIC CORP.
168 Albion St, Wakefield, Mass 01880
VISIBLE COMPUTER SUPPLY CORP.
9865 Derby Ln, Westchester, Ill 60153
ZERO MANUFACTURING CO. ZERO-WEST DIV.
1121 Chestnut St, Burbank, Cal 91503
ZERO MFG. CO. ZERO-KRESKY DIV.
2nd & H St, Petaluma, Cal 94952

DESKS, TABLES AND STANDS (FOR KEYPUNCH UNITS)

AMCO ENGINEERING CO.
7333 W Ainslie, Chicago, Ill 60656
BARRY-WRIGHT CORP. WRIGHT LINE DIV.
160 Gold Star Blvd, Worcester, Mass 01606
BORG-WARNER/INGERSOLL PRODUCTS/EMCOR
1000 W 120th St, Chicago, Ill 60643
COMPUTER ACCESSORIES CO.
131 W 154th St, Gardena, Cal 90248
DEXION INC.
39-27 59th St, New York, N Y 11377
ECONOMET INC.
1033 W Kirkwall Rd, Azusa, Cal 91702
LYON METAL PRODUCTS INC.
P O Box 671, Aurora, Ill 60507
MONARCH METAL PRODUCTS INC.
Mac Arthur Ave, New Windsor, N Y 12550
OCHMAN SYSTEMS, EDWARD
Po Box 141, Fairfield, Conn 06430
ORIGINAL COMPUTER PRODUCTS INC.
204 Worcester St, Wellesley Hills, Mass 02181
SHAW-WALKER CO.
P O Box 208, Muskegon, Mich 49443
SINGER CO., THE, FRIDEN DIV.
2350 Washington St, San Leandro, Cal 94577
SMITH SYSTEM MANUFACTURING CO.
56 Emerald St SE, Minneapolis, Minn 55414
STINAFFS INC.
181 E Exchange St, Akron, Ohio 44304

TAB PRODUCTS

2690 Hanover St, Palo Alto, Cal 94304
VISIBLE COMPUTER SUPPLY CORP.
9865 Derby Ln, Westchester, Ill 60153
ZERO MANUFACTURING CO. ZERO-WEST DIV.
1121 Chestnut St, Burbank, Cal 91503
ZERO MFG. CO. ZERO-KRESKY DIV.
2nd & H St, Petaluma, Cal 94952

DESKS, TABLES AND STANDS (FOR PROGRAMMER STATIONS)

AMCO ENGINEERING CO.
7333 W Ainslie, Chicago, Ill 60656
BARRY-WRIGHT CORP. WRIGHT LINE DIV.
160 Gold Star Blvd, Worcester, Mass 01606
BORG-WARNER/INGERSOLL PRODUCTS/EMCOR
1000 W 120th St, Chicago, Ill 60643
COMPUTER ACCESSORIES CO.
131 W 154th St, Gardena, Cal 90248
DEXION INC.
39-27 59th St, New York, N Y 11377
ECONOMET INC.
1033 W Kirkwall Rd, Azusa, Cal 91702
LYON METAL PRODUCTS INC.
P O Box 671, Aurora, Ill 60507
MACS COMPUTER ACCESSORIES INC
104 Park Towne Pl, Philadelphia, Pa 19130
MONARCH METAL PRODUCTS INC.
Mac Arthur Ave, New Windsor, N Y 12550
OCHMAN SYSTEMS, EDWARD
Po Box 141, Fairfield, Conn 06430
ORIGINAL COMPUTER PRODUCTS INC.
204 Worcester St, Wellesley Hills, Mass 02181
SHAW-WALKER CO.
P O Box 208, Muskegon, Mich 49443
SINGER CO., THE, FRIDEN DIV.
2350 Washington St, San Leandro, Cal 94577
SMITH SYSTEM MANUFACTURING CO.
56 Emerald St SE, Minneapolis, Minn 55414
STINAFFS INC.
181 E Exchange St, Akron, Ohio 44304
TAB PRODUCTS
2690 Hanover St, Palo Alto, Cal 94304
VISIBLE COMPUTER SUPPLY CORP.
9865 Derby Ln, Westchester, Ill 60153
WESTERN MANUFACTURING CO.
P O Box 1266, Aurora, Ill 60507
ZERO MANUFACTURING CO. ZERO-WEST DIV.
1121 Chestnut St, Burbank, Cal 91503
ZERO MFG. CO. ZERO-KRESKY DIV.
2nd & H St, Petaluma, Cal 94952

DESKS, TABLES AND STANDS (FOR TYPEWRITERS)

AMCO ENGINEERING CO.
7333 W Ainslie, Chicago, Ill 60656
BARRY-WRIGHT CORP. WRIGHT LINE DIV.
160 Gold Star Blvd, Worcester, Mass 01606
COMPUTER ACCESSORIES CO.
131 W 154th St, Gardena, Cal 90248
DEXION INC.
39-27 59th St, New York, N Y 11377
ECONOMET INC.
1033 W Kirkwall Rd, Azusa, Cal 91702
FAIRCHILD GRAPHIC EQUIPMENT
221 Fairchild Ave, Plainview, N Y 11803
LYON METAL PRODUCTS INC.
P O Box 671, Aurora, Ill 60507
OCHMAN SYSTEMS, EDWARD
Po Box 141, Fairfield, Conn 06430
SHAW-WALKER CO.
P O Box 208, Muskegon, Mich 49443
SINGER CO., THE, FRIDEN DIV.
2350 Washington St, San Leandro, Cal 94577
SMITH SYSTEM MANUFACTURING CO.
56 Emerald St SE, Minneapolis, Minn 55414
STINAFFS INC.
181 E Exchange St, Akron, Ohio 44304
TAB PRODUCTS
2690 Hanover St, Palo Alto, Cal 94304
TRANSITRON ELECTRONIC CORP.
168 Albion St, Wakefield, Mass 01880
WARWICK PRODUCTS CO.
7909 Rockside Rd, Cleveland, Ohio 44131
WESTERN MANUFACTURING CO.
P O Box 1266, Aurora, Ill 60507
ZERO MANUFACTURING CO. ZERO-WEST DIV.
1121 Chestnut St, Burbank, Cal 91503
ZERO MFG. CO. ZERO-KRESKY DIV.
2nd & H St, Petaluma, Cal 94952

DIALERS, AUTOMATIC

G-V CONTROLS DIV. SOLA BASIC INDUSTRIES
101 Okner Pkwy, Livingston, N J 07039
TIMEPLEX INC.
65 Oak St, Norwood, N J 07648

DIGITAL ANALYZERS (SEE ANALYZERS)

DIGITAL COMPUTERS (SEE COMPUTERS)

DIGITAL INDICATORS (SEE INDICATORS AND READOUTS)

DIGITIZERS, PROGRAMMABLE

ALLEN-BRADLEY
1201 S 2nd St, Milwaukee, Wisc 53204
AMERICAN COMPUTER TECHNOLOGY INC.
8740 Shirley Ave, Northridge, Cal 91324
ANALOGIC CORP.
Audubon Rd, Wakefield, Mass 01880
APPLIED COMPUTER SYSTEMS INC.
P O Box 6479, Austin, Tex 78702
BECKMAN INSTRUMENTS INC. ELECT. INSTR. DIV.
2200 Wright Ave, Richmond, Cal 94804
BENDIX CORP., THE, ENVRNMNTL SCI. DIV.
1400 Taylor Ave, Baltimore, Md 21204
CALIFORNIA COMPUTER PRODUCTS INC.
2411 W La Palma Ave, Anaheim, Cal 92801
COMMUNICATIONS LOGIC INC.
6400 Westpark, Houston, Tex 77024
COMPUTER CONVERSIONS CORP.
6 Dunton Court, E Northport, N Y 11731
COMPUTER MICRO-IMAGE SYSTEMS INC.
9600 Desoto Ave, Chatsworth, Cal 91311
CONCORD CONTROL INC.
1282 Soldier Field Rd, Boston, Mass 02135
CONSOLIDATED OHMIC DEVICES INC.
115 Old Country Rd, Carle Place, N Y 11514
DATA CONTROL SYSTEMS INC.
Commerce Dr, Danbury, Conn 06810
DATA GENERAL CORP.
Rte 9, Southboro, Mass 01772
DATA GRAPHICS CORP.
8402 Speedway, San Antonio, Tex 78230
DATA TECHNOLOGY INC.
65 Grove St, Watertown, Mass 02172
DATACOM INC.
40 Lincoln Dr, Ft Walton Beach, Fla 32548
EDWIN INDUSTRIES CORP.
11933 Tech Rd, Silver Spring, Md 20904
GRAPH DATA DIGITIZING
13834 S Prairie Ave, Hawthorne, Cal 90250
IKL INC.
4360 Campus Dr, Newport Beach, Cal 92660
LITTON SYSTEMS INC. DATA SYSTEMS DIV.
8000 Woodley Ave, Van Nuys, Cal 91409
MEASUREMENT SYSTEMS INC.
523 West Ave, Norwalk, Conn 06850
NON-LINEAR SYSTEMS INC.
P O Box N, Del Mar, Cal 92014
NORDEN DIV., UNITED AIRCRAFT CORP.
Helen St, Norwalk, Conn 06850
NORTH AMERICAN ROCKWELL CORP. AUTONETICS DIV.
3370 Miraloma Ave, Anaheim, Cal 92803
RAYTHEON COMPUTER
2700 S Fairview St, Santa Ana, Cal 92704
SRC DIV. MOXON INC.
2222 Michelson Dr, Newport Beach, Cal 92664
SUPERIOR ELECTRIC CO., THE
383 Middle St, Bristol, Conn 06010
THETA INSTRUMENT CORP.
24 Dwight Pl, Fairfield, N J 07006
TRAID CORP., PHOTO INSTRUMENT DIV.
900 Grand Central, Glendale, Cal 91201
UNIVERSITY COMPUTING CO. GRAPHIC SYSTEMS DIV
14761 Califa St, Van Nuys, Cal 91401

2 Product Directory

DIODE MATRIX ENCODERS (SEE ENCODERS)

DIODE TESTERS, (SEE TESTERS)

DIODES, GERMANIUM

AMPEREX ELECTRONIC CORP. A NO AMERICAN PHILIPS CO
P O Box 98, Slatersville, R I 02876
ITT SEMICONDUCTORS
3301 Electronics Way, W Palm Beach, Fla 33407
ELCOM ELECTRONICS INC.
200 Allen Blvd, Farmingdale, N Y 11735
HARVEY INDUSTRIAL DIV.
60 Crossway Pk W, Woodbury Li, N Y 11797
HP ASSOCIATES
620 Page Mill Rd, Palo Alto, Cal 94304
INTERNATIONAL DIODE CORP.
90 Forrest St, Jersey City, N J 07304
NUCLEONIC PRODUCTS CO. INC.
6660 Variel Ave, Canoga Park, Cal 91303
RCA CORP. SOLID STATE DIV.
Rte 202, Somerville, N J 08876
SEVAN COMPUTER SERVICES INC.
Pollitt Dr S, Fair Lawn, N J 07410
SOLITRON DEVICES INC.
256 Oak Tree Rd, Tappan, N Y 10983
SOLITRON DEVICES INC.
8808 Balboa Ave, San Diego, Cal 92123
SOLITRON DEVICES INC. TRANSISTOR DIV.
1177 Blue Heron Blvd, Riviera Beach, Fla 33404
TRANSITRON ELECTRONIC CORP.
168 Albion St, Wakefield, Mass 01880

DIODES, NOT-CARRIER

ITT SEMICONDUCTORS
3301 Electronics Way, W Palm Beach, Fla 33407
FAIRCHILD SEMICONDUCTOR
464 Ellis St, Mt View, Cal 94040
HARVEY INDUSTRIAL DIV.
60 Crossway Pk W, Woodbury Li, N Y 11797
HEWLETT PACKARD CO.
1501 Page Mill Rd, Palo Alto, Cal 94304
HP ASSOCIATES
620 Page Mill Rd, Palo Alto, Cal 94304
INTERNATIONAL DIODE CORP.
90 Forrest St, Jersey City, N J 07304
MOTOROLA SEMICONDUCTOR PRODUCTS INC.
5005 E Mc Dowell Rd, Phoenix, Ariz 85008
NUCLEONIC PRODUCTS CO. INC.
6660 Variel Ave, Canoga Park, Cal 91303
SEVAN COMPUTER SERVICES INC.
Pollitt Dr S, Fair Lawn, N J 07410
SOLITRON DEVICES INC.
256 Oak Tree Rd, Tappan, N Y 10983
SOLITRON DEVICES INC.
8808 Balboa Ave, San Diego, Cal 92123
SOLITRON DEVICES INC. TRANSISTOR DIV.
1177 Blue Heron Blvd, Riviera Beach, Fla 33404

DIODES, LIGHT EMITTING

AMPEREX ELECTRONIC CORP. A NO AMERICAN PHILIPS CO
P O Box 98, Slatersville, R I 02876
BOWMAR CANADA LTD.
1257 Algoma Rd, Ottawa Ont, CANADA
CENTRALAB SEMICONDUCTOR GLOBE-UNION INC.
4501 N Arden Dr, El Monte, Cal 91734
FAIRCHILD SEMICONDUCTOR
464 Ellis St, Mt View, Cal 94040
HARVEY INDUSTRIAL DIV.
60 Crossway Pk W, Woodbury Li, N Y 11797
HEWLETT PACKARD CO.
1501 Page Mill Rd, Palo Alto, Cal 94304
HP ASSOCIATES
620 Page Mill Rd, Palo Alto, Cal 94304
MONSANTO CO. ELECTRONIC PDTS. & CONTROLS DIV.
11636 Administration, St Louis, Mo 63141
MOTOROLA SEMICONDUCTOR PRODUCTS INC.
5005 E Mc Dowell Rd, Phoenix, Ariz 85008
OPCOA INC.
330 Talmadge Rd, Edison, N J 08817
RCA CORP. SOLID STATE DIV.
Rte 202, Somerville, N J 08876
SEVAN COMPUTER SERVICES INC.
Pollitt Dr S, Fair Lawn, N J 07410

SKAN-A-MATIC CORP.
P O Drawer 68, Skaneateles, N Y 13152
SOLITRON DEVICES INC.
256 Oak Tree Rd, Tappan, N Y 10983
SPECTRONICS INC.
541 Sterling Dr, Richardson, Tex 75080

DIODES, SILICON

AMPEREX ELECTRONIC CORP. A NO AMERICAN PHILIPS CO
P O Box 98, Slatersville, R I 02876
ITT SEMICONDUCTORS
3301 Electronics Way, W Palm Beach, Fla 33407
BRADLEY SEMICONDUCTOR CORP.
275 Welton St, New Haven, Conn 06506
CENTRALAB ELECTRONICS, DIV.
5757 N Green Bay, Milwaukee, Wisc 53201
COMPUTER DIODE CORP.
Pollitt Dr S, Fair Lawn, N J 07410
CONTROL DATA CORP. CIRCUITS DIV.
7800 Computer Ave, Minneapolis, Minn 55435
DIONICS INC.
65 Rushmore St, Westburn, N Y 11590
EDGERTON GERMESHAUSEN GRIER INC.
Crosby Dr, Bedford, Mass 01730
ELCOM ELECTRONICS INC.
200 Allen Blvd, Farmingdale, N Y 11735
FAIRCHILD SEMICONDUCTOR
464 Ellis St, Mt View, Cal 94040
GENERAL SEMICONDUCTOR INDUSTRIES INC.
230 West 5th St, Tempe, Ariz 85281
HARVEY INDUSTRIAL DIV.
60 Crossway Pk W, Woodbury Li, N Y 11797
HEWLETT PACKARD CO.
1501 Page Mill Rd, Palo Alto, Cal 94304
HP ASSOCIATES
620 Page Mill Rd, Palo Alto, Cal 94304
INTERNATIONAL DIODE CORP.
90 Forrest St, Jersey City, N J 07304
MOTOROLA SEMICONDUCTOR PRODUCTS INC.
5005 E Mc Dowell Rd, Phoenix, Ariz 85008
NUCLEONIC PRODUCTS CO. INC.
6660 Variel Ave, Canoga Park, Cal 91303
POWER COMPONENTS INC.
P O Box 421, Scottsdale, Pa 15683
RCA CORP. SOLID STATE DIV.
Rte 202, Somerville, N J 08876
SEMICON INC.
10 N Ave, Burlington, Mass 01803
SEVAN COMPUTER SERVICES INC.
Pollitt Dr S, Fair Lawn, N J 07410
SKAN-A-MATIC CORP.
P O Drawer 68, Skaneateles, N Y 13152
SOLAR SYSTEMS INC.
8124 N Central Park, Skokie, Ill 60076
SOLITRON DEVICES INC.
256 Oak Tree Rd, Tappan, N Y 10983
SOLITRON DEVICES INC.
8808 Balboa Ave, San Diego, Cal 92123
SPECTRONICS INC.
541 Sterling Dr, Richardson, Tex 75080
TELEDYNE CRYSTALONICS
147 Sherman St, Cambridge, Mass 02140
TRANSITRON ELECTRONIC CORP.
168 Albion St, Wakefield, Mass 01880
TRW CAPACITOR DIV. SOLID STATE OPER.
71 Linden St, Lynn, Mass 01905
TRW SEMICONDUCTOR DIV.
14520 Aviation Blvd, Lawndale, Cal 90260
UNITRODE CORP.
580 Pleasant St, Watertown, Mass 02170
WAGNER ELECTRIC CORP.
630 W Mt Pleasant Ave, Livingston, N J 07039
WESTINGHOUSE ELECTRIC CORP.
Westinghouse Bldg, Pittsburgh, Pa 15222

DIODES, TUNNEL

AMPEREX ELECTRONIC CORP. A NO AMERICAN PHILIPS CO
P O Box 98, Slatersville, R I 02876
ITT SEMICONDUCTORS
3301 Electronics Way, W Palm Beach, Fla 33407
CENTRALAB ELECTRONICS, DIV.
5757 N Green Bay, Milwaukee, Wisc 53201
CENTRALAB SEMICONDUCTOR GLOBE-UNION INC.
4501 N Arden Dr, El Monte, Cal 91734
HEWLETT PACKARD CO.
1501 Page Mill Rd, Palo Alto, Cal 94304
RCA CORP. SOLID STATE DIV.
Rte 202, Somerville, N J 08876
SOLITRON DEVICES INC.
256 Oak Tree Rd, Tappan, N Y 10983

280	380	580	680	780
285	385	585	685	785

NEW MODEL 280 & 285 DIGITIZERS FOR GRAPHIC DATA INPUT THROUGH DIRECT INTERFACE TO A COMPUTER OR DATA TERMINAL

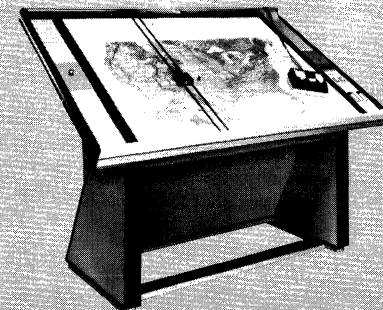

DIGITIZING IN THE 70's

The Model 280 and Model 285 are the first models of a new family of ten graphic data digitizers to be introduced by CALMA Company in 1970. Each of the new models will be tailored to a specific digitizer application, and will be provided with systems software.

TWO SIZES

Equipped with 32 x 42 inch tracing bed, the Model 280 is designed for fast and accurate input of such graphic data as oscillograms, photographs, and projected film images (with optional projector). The Model 285, illustrated above, is equipped with a 48 x 60 inch tracing bed for digitizing large charts and maps. Both digitizers are designed for direct on-line operation through an electronic interface to your computer or data terminal.

CALMA

COMPANY
707 Kifer Road • Sunnyvale
Calif. 94086 (408) 245-7522

2 Product Directory

SOLITRON DEVICES INC.
8808 Balboa Ave, San Diego, Cal 92123

DIODES, VARIABLE CAPACITANCE

TELEDYNE CRYSTALONICS
147 Sherman St, Cambridge, Mass 02140

DIODES, VIDEO DETECTOR

AMPEREX ELECTRONIC CORP. A NO AMERICAN PHILIPS CO

P O Box 98, Slatersville, R I 02876
COMPUTER DIODE CORP.

Pollitt Dr S, Fair Lawn, N J 07410

ELCOM ELECTRONICS INC.

200 Allen Blvd, Farmingdale, N Y 11735
HP ASSOCIATES

620 Page Mill Rd, Palo Alto, Cal 94304
NUCLEONIC PRODUCTS CO. INC.

6660 Variel Ave, Canoga Park, Cal 91303
SOLITRON DEVICES INC.

256 Oak Tree Rd, Tappan, N Y 10983
SOLITRON DEVICES INC.

8808 Balboa Ave, San Diego, Cal 92123

DIODES, ZENER

AMPEREX ELECTRONIC CORP. A NO AMERICAN PHILIPS CO

P O Box 98, Slatersville, R I 02876
ITT SEMICONDUCTORS

3301 Electronics Way, W Palm Beach, Fla 33407
CENTRALAB ELECTRONICS, DIV.

5757 N Green Bay, Milwaukee, Wisc 53201
CENTRALAB SEMICONDUCTOR GLOBE-UNION INC.

4501 N Arden Dr, El Monte, Cal 91734
CODI SEMICONDUCTOR DIV. COMPUTER DIODE

Pollitt Dr S, Fair Lawn, N J 07410
COMPONENTS INC.

Smith St, Biddeford, Me 04005
COMPUTER DIODE CORP.

Pollitt Dr S, Fair Lawn, N J 07410
DICKSON ELECTRONICS CORP.

P O Box 1390, Scottsdale, Ariz 85252
ELCOM ELECTRONICS INC.

200 Allen Blvd, Farmingdale, N Y 11735
FAIRCHILD SEMICONDUCTOR

464 Ellis St, Mt View, Cal 94040
GENERAL SEMICONDUCTOR INDUSTRIES INC.

230 West 5th St, Tempe, Ariz 85281
HARVEY INDUSTRIAL DIV.

60 Crossway Pk W, Woodbury Li, N Y 11797
INTERNATIONAL DIODE CORP.

90 Forrest St, Jersey City, N J 07304
MOTOROLA SEMICONDUCTOR PRODUCTS INC.

5005 E Mc Dowell Rd, Phoenix, Ariz 85008
NUCLEONIC PRODUCTS CO. INC.

6660 Variel Ave, Canoga Park, Cal 91303
POWER COMPONENTS INC.

P O Box 421, Scottdale, Pa 15683
SEMICON INC.

10 N Ave, Burlington, Mass 01803
SEVAN COMPUTER SERVICES INC.

Pollitt Dr S, Fair Lawn, N J 07410
SOLITRON DEVICES INC.

256 Oak Tree Rd, Tappan, N Y 10983
SOLITRON DEVICES INC.

8808 Balboa Ave, San Diego, Cal 92123
SOLITRON DEVICES INC. TRANSISTOR DIV.

1177 Blue Heron Blvd, Riviera Beach, Fla 33404
TRANSITRON ELECTRONIC CORP.

168 Albion St, Wakefield, Mass 01880
TRW INC. CAPACITOR DIV.

112 W 1st St, Oeallala, Neb 69153
TRW SEMICONDUCTOR DIV.

14520 Aviation Blvd, Lawndale, Cal 90260
UNITRODE CORP.

580 Pleasant St, Watertown, Mass 02170
WESTINGHOUSE ELECTRIC CORP.

Westinghouse Bldg, Pittsburgh, Pa 15222

DISC AND DRUM CONTROLLERS (SEE CONTROLLERS)

DISC DRIVES, FIXED HEAD (INCLUDING CONTROLLER)

ALPHA DATA INC.

8759 Remmet Ave, Canoga Park, Cal 91304
AMERICAN REGITEL CORP.

870 Industrial Way, San Carlos, Cal 94070
APPLIED MAGNETICS CORP. COMPUTER MEMORY DIV

75 Robin Hill Rd, Goleta, Cal 93017
BURROUGHS CORP., BUSINESS MACHINES GROUP

6071 2nd Ave, Detroit, Mich 48232
BURROUGHS CORP., OEM PRODUCT SALES

1649 Wilshire Blvd, Los Angeles, Cal 90017
CALIFORNIA COMPUTER PRODUCTS INC.

2411 W La Palma Ave, Anaheim, Cal 92801
DATA DISC INC.

686 W Maude Ave, Sunnyvale, Cal 94086
DATA GENERAL CORP.

Rte 9, Southboro, Mass 01772
DATA MEMORY INC.

1400 Terra Bella Ave, Mt View, Cal 94040
DATA PRODUCTS CORP.

16055 Ventura Blvd, Encino, Cal 91316
DATASERV DIV., WILLIAM J. PURDY CORP.

770 Airport Blvd, Burlingame, Cal 94010
DIGITAL INFORMATION STORAGE CORP.

100 Carter, Berlin, Mass 01503
DIGITAL SCIENTIFIC CORP.

11455 Sorrento Vly Rd, San Diego, Cal 92121
DISCOM INC., SUB. MAGNAFILE, COMDISK

P O Box 231, Mesa, Ariz 85201
ELDORADO ELECTRODATA

601 Chalmar Rd, Concord, Cal 94520
FUJITSU LTD. N.Y. LIAISON OFFICE

680 Fifth Ave, New York, N Y 10019
GENERAL INSTRUMENT CORP. MAGNE-HEAD DIV.

13040 Cerise Ave, Hawthorne, Cal 90250
HEWLETT PACKARD CO. CUPERTINO DIV.

1100 Wolfe Rd, Cupertino, Cal 95014
HONEYWELL INFORMATION SYS. INC. PERIPH. DEVICES DIV.

200 Smith St, Waltham, Mass 02154
IBM CORP., DATA PROCESSING DIV.

1133 Westchester Ave, White Plains, N Y 10604
INTERNATIONAL CONTROLS CORP.

200 Fairfield Rd, Fairfield, N J 07006
MAGNAFILE INC.

2602 E Magnolia, Phoenix, Ariz 85034
MICRO SYSTEMS INC.

644 E Young St, Santa Ana, Cal 92705
MICRODATA CORP.

644 E Young St, Santa Ana, Cal 92705
MULTIDATA INC.

7300 Bolsa Ave, Westminster, Cal 92683
NORTH AMERICAN ROCKWELL CORP. AUTONETICS DIV.

3370 Miraloma Ave, Anaheim, Cal 92803
PERIPHERAL DATA MACHINES INC.

102 New S Rd, Hicksville, N Y 11801
PURDY CORP., WM. J.

770 Airport Blvd, Burlingame, Cal 94010
RCA COMPUTER SYSTEMS DIV.

200 Forest Ave, Marlboro, Mass 01752
ROLM, CORP.

10300 N Tantau, Cupertino, Cal 95014
SYSTEMS ENGINEERING LABORATORIES INC.

P O Box 9148, Fort Lauderdale, Fla 33310
UNICOMP INC.

18219 Parthenia, Northridge, Cal 91324
WABASH COMPUTER CORP. PI DIV.

10202 N 19th St, Phoenix, Ariz 85021
WANG LABORATORIES INC.

836 N St, Tewksbury, Mass 01876

DISC DRIVES, MOVABLE HEAD (INCLUDING CONTROLLER)

BASF SYSTEMS INC.

Crosby Dr, Bedford, Mass 01730
BRYANT COMPUTER PRODUCTS DIV. EX-CELL-O CORP

850 Ladd Rd, Walled Lake, Mich 48088
CALIFORNIA COMPUTER PRODUCTS INC.

2411 W La Palma Ave, Anaheim, Cal 92801
CENTURY DATA SYSTEMS INC.

1630 S St Collg Blvd, Anaheim, Cal 92806
COLLINS RADIO CO.

1200 N Alma Rd, Dallas, Tex 75207
COMMUNITY COMPUTER CORP.

185 W Schoolhouse Ln, Philadelphia, Pa 17144
COMPUTER HARDWARE INC.

2550 Fair Oaks Blvd, Sacramento, Cal 95825
COMPUTER MEMORY DEVICES INC.

5170 W Bethany Home, Glendale, Ariz 85301

CONTROL DATA CORP.

8100 34th Ave S, Minneapolis, Minn 55440
DACIONIS

925 Thompson Pl, Sunnyvale, Cal 94086
DATA DISC INC.

686 W Maude Ave, Sunnyvale, Cal 94086
DATA GENERAL CORP.

Rte 9, Southboro, Mass 01772
DATA MEMORY INC.

1400 Terra Bella Ave, Mt View, Cal 94040
DATA PRODUCTS CORP. SYSTEMS DIV.

6219 Desoto Ave, Woodland Hills, Cal 91364
DATA SYSTEMS DESIGN INC.

1122 University Ave, Berkeley, Cal 94702
DATASERV DIV., WILLIAM J. PURDY CORP.

770 Airport Blvd, Burlingame, Cal 94010
ECLECTIC COMPUTER CORP.

3707 Rawlins Ste 301, Dallas, Tex 75219
FRIDEN DIV. THE SINGER CO.

97 Humboldt St, Rochester, N Y 14602
FUJITSU LTD. N.Y. LIAISON OFFICE

680 Fifth Ave, New York, N Y 10019
GENISCO TECHNOLOGY CORP.

18435 Susana Rd, Compton, Cal 90221
HEWLETT PACKARD CO. CUPERTINO DIV.

1100 Wolfe Rd, Cupertino, Cal 95014
HONEYWELL INFORMATION SYSTEMS

60 Walnut St, Wellesley Hills, Mass 02181
HONEYWELL INFORMATION SYS. INC. PERIPH. DEVICES DIV.

200 Smith St, Waltham, Mass 02154
IBM CORP., DATA PROCESSING DIV.

1133 Westchester Ave, White Plains, N Y 10604
INFORMATION STORAGE SYSTEMS

10435 N Tantau Ave, Cupertino, Cal 95014
INFOTECHNICS INC.

15730 Stage St, Van Nuys, Cal 91406
INTERNATIONAL CONTROLS CORP.

200 Fairfield Rd, Fairfield, N J 07006
IOMEC INC.

345 Mathew St, Santa Clara, Cal 95050
MARSHALL DATA SYSTEMS DIV. MARSHALL INDUSTRIES

2065 Huntington Dr, San Marino, Cal 91103
MEMOREX EQUIPMENT GROUP

San Tomas At Central, Santa Clara, Cal 95052
MICRO SYSTEMS INC.

644 E Young St, Santa Ana, Cal 92705
MICRODATA CORP.

644 E Young St, Santa Ana, Cal 92705
MULTIDATA INC.

7300 Bolsa Ave, Westminster, Cal 92683
NCR INDUSTRIAL PRODUCTS DIV.

Main And K St, Dayton, Ohio 45409
NORTH AMERICAN ROCKWELL CORP. AUTONETICS DIV.

3370 Miraloma Ave, Anaheim, Cal 92803
PERIPHERAL DATA MACHINES INC.

102 New S Rd, Hicksville, N Y 11801
PERIPHERALS GENERAL, INC.

Cherry Hill Ind Pk, Cherry Hill, N J 08034
POTTER INSTRUMENT CO. INC.

532 Broadhollow Rd, Melville, N Y 11746
PURDY CORP., WM. J.

770 Airport Blvd, Burlingame, Cal 94010
TALCOTT COMPUTER LEASING CO.

1290 Ave The Americas, New York, N Y 10019
TELEX COMPUTER PRODUCTS

6422 E 41st St, Tulsa, Okla 74135
TRACOR DATA SYSTEMS INC.

4201 Ed Bluestein Blv, Austin, Tex 78721
TRACOR DATA SYSTEMS MARKETING

601 California St, San Francisco, Cal 94108
UNICOMP INC.

18219 Parthenia, Northridge, Cal 91324
XEBEC SYSTEMS INC.

918 N Rengstorff Ave, Mountain View, Cal 94040

DISC DRIVES, REMOVABLE CARTRIDGE

BRYANT COMPUTER PRODUCTS DIV. EX-CELL-O CORP

850 Ladd Rd, Walled Lake, Mich 48088
CAELUS MEMORIES INC.

967 Maybury Rd, San Jose, Cal 95133
CALIFORNIA COMPUTER PRODUCTS INC.

2411 W La Palma Ave, Anaheim, Cal 92801
CENTURY DATA SYSTEMS INC.

1630 S St Collg Blvd, Anaheim, Cal 92806
COMPUTER MEMORY DEVICES INC.

5170 W Bethany Home, Glendale, Ariz 85301
CONTROL DATA CORP.

8100 34th Ave S, Minneapolis, Minn 55440

2 Product Directory

DACONICS

925 Thompson Pl, Sunnyvale, Cal 94086
DATA GENERAL CORP.
Rte 9, Southboro, Mass 01772
DATA SYSTEMS DESIGN INC.
1122 University Ave, Berkeley, Cal 94702
DATASERV DIV., WILLIAM J. PURDY CORP.
770 Airport Blvd, Burlingame, Cal 94010
DIABLO SYSTEMS INC.
24500 Industrial Blvd, Hayward, Cal 94545
DIGITAL INFORMATION STORAGE CORP.
100 Carter, Berlin, Mass 01503
DIGITAL SCIENTIFIC CORP.
11455 Sorrento Vly Rd, San Diego, Cal 92121
FUJITSU LTD. N.Y.LIAISON OFFICE
680 Fifth Ave, New York, N Y 10019
GENERAL INSTRUMENT CORP. MAGNE-HEAD DIV.
13040 Cerise Ave, Hawthorne, Cal 90250
HEWLETT PACKARD CO. CUPERTINO DIV.
1100 Wolfe Rd, Cupertino, Cal 95014
HONEYWELL INFORMATION SYSTEMS
P O Box 12313, Oklahoma City, Okla 73112
HONEYWELL INFORMATION SYSTEMS
60 Walnut St, Wellesley Hills, Mass 02181
HONEYWELL INFORMATION SYS.INC PERIPH.DEVICES DIV.
200 Smith St, Waltham, Mass 02154
IBM CORP.,DATA PROCESSING DIV.
1133 Westchester Ave, White Plains, N Y 10604
IOMEC INC.
345 Mathew St, Santa Clara, Cal 95050
MARSHALL DATA SYSTEMS DIV. MARSHALL INDUSTRIES
2065 Huntington Dr, San Marino, Cal 91103
MULTIDATA INC.
7300 Bolsa Ave, Westminster, Cal 92683
NCR INDUSTRIAL PRODUCTS DIV.
Main And K St, Dayton, Ohio 45409
NORTH AMERICAN ROCKWELL CORP. AUTONETICS DIV.
3370 Miraloma Ave, Anaheim, Cal 92803
PURDY CORP., WM. J.
770 Airport Blvd, Burlingame, Cal 94010
SINGER CO., THE, FRIDEN DIV.
2350 Washington St, San Leandro, Cal 94577
SYSTEM INDUSTRIES INC.
535 Del Rey Ave, Sunnyvale, Cal 94305
TELEX COMPUTER PRODUCTS
6422 E 41st St, Tulsa, Okla 74135
TRACOR DATA SYSTEMS INC.
4201 Ed Bluestein Blv, Austin, Tex 78721
UNICOMP INC.
18219 Parthenia, Northridge, Cal 91324
WABASH COMPUTER CORP. PI DIV.
10202 N 19th St, Phoenix, Ariz 85021
XEBEC SYSTEMS INC.
918 N Rengstorff Ave, Mountain View, Cal 94040

DISC MEMORIES (SEE MEMORIES)

DISC PACKS, MAGNETIC

BASF SYSTEMS INC.
Crosby Dr, Bedford, Mass 01730
BURTON MAGNEKOTE INC.
11334 Playa St, Culver City, Cal 90230
BUSINESS SUPPLIES CORP. OF AMERICA
475 5th Ave, New York, N Y 10017
CAELUS MEMORIES INC.
967 Maybury Rd, San Jose, Cal 95133
CERTRON CORP.
1701 State Collg Blvd, Anaheim, Cal 92806
COMPUTER ACCESSORIES CO.
131 W 154th St, Gardena, Cal 90248
COMPUTER RESOURCES INC.
5091 W 164th St, Cleveland, Ohio 44142
DATA FUNDING INC.
Station Square 2, Paoli, Pa 19301
DATA GENERAL CORP.
Rte 9, Southboro, Mass 01772
DATASERV DIV., WILLIAM J. PURDY CORP.
770 Airport Blvd, Burlingame, Cal 94010
FUJITSU LTD. N.Y.LIAISON OFFICE
680 Fifth Ave, New York, N Y 10019
GENERAL INSTRUMENT CORP. MAGNE-HEAD DIV.
13040 Cerise Ave, Hawthorne, Cal 90250
HACKETT CORP.
2100 W Fullerton Ave, Chicago, Ill 60647
HONEYWELL INFORMATION SYSTEMS
60 Walnut St, Wellesley Hills, Mass 02181
IBM CORP.,DATA PROCESSING DIV.
1133 Westchester Ave, White Plains, N Y 10604

INDEL INC.

P O Box 15800, Tulsa, Okla 74115
IOA DATA CORP.
383 Lafayette St, New York, N Y 10003
JERSEY TAB CARD CORP.
649 Rahway Ave, Union, N J 07083
3M CO. MAGNETIC PRODUCTS DIV.
3 M Ctr, St Paul, Minn 55101
MACPANEL CO. ADAMS-MILLIS CORP.
P O Box 5027, High Point, N C 27262
MACS COMPUTER ACCESSORIES INC
104 Park Towne Pl, Philadelphia, Pa 19130
NCR INDUSTRIAL PRODUCTS DIV.
Main And K St, Dayton, Ohio 45409
NORTH AMERICAN ROCKWELL CORP. AUTONETICS DIV.
3370 Miraloma Ave, Anaheim, Cal 92803
OCHMAN SYSTEMS, EDWARD
Po Box 141, Fairfield, Conn 06430
PURDY CORP., WM. J.
770 Airport Blvd, Burlingame, Cal 94010
RCA MAGNETIC PRODUCTS DIV.
201 E 50th St, New York, N Y 10022
RCA COMPUTER SYSTEMS DIV.
200 Forest Ave, Marlboro, Mass 01752
U. S. MAGNETIC TAPE CO. WABASH MAGNETICS
P O Box 128, Huntley, Ill 60142
XEROX DATA SYSTEMS
701 S Aviation, El Segundo, Cal 90245

DISC STORAGE SYSTEMS

ALPHA DATA INC.
8759 Remmet Ave, Canoga Park, Cal 91304
APPLIED MAGNETICS CORP. COMPUTER MEMORY DIV
75 Robin Hill Rd, Goleta, Cal 93017
BRYANT COMPUTER PRODUCTS DIV. EX-CELL-O CORP
850 Ladd Rd, Walled Lake, Mich 48088
BURROUGHS CORP.,BUSINESS MACHINES GROUP
6071 2nd Ave, Detroit, Mich 48232
BURROUGHS CORP., OEM PRODUCT SALES
1649 Wilshire Blvd, Los Angeles, Cal 90017
CALIFORNIA COMPUTER PRODUCTS INC.
2411 W La Palma Ave, Anaheim, Cal 92801
COLLINS RADIO CO.
1200 N Alma Rd, Dallas, Tex 75207
COMPUTER HARDWARE INC.
2550 Fair Oaks Blvd, Sacramento, Cal 95825
COMPUTER SPECIALTIES CORP.
87 Burlw Ct, Hackensack, N J 07601
CONTROL DATA CORP.
8100 34th Ave S, Minneapolis, Minn 55440
DACONICS
925 Thompson Pl, Sunnyvale, Cal 94086
DATA DISC INC.
686 W Maude Ave, Sunnyvale, Cal 94086
DATA GENERAL CORP.
Rte 9, Southboro, Mass 01772
DATA MEMORY INC.
1400 Terra Bella Ave, Mt View, Cal 94040
DATA PRODUCTS CORP.
16055 Ventura Blvd, Encino, Cal 91316
DATA RECORDING SYSTEMS.SUB. NEWELL IND.
795 Kifer Rd, Sunnyvale, Cal 94086
DATA SYSTEMS DESIGN INC.
1122 University Ave, Berkeley, Cal 94702
DATASERV DIV., WILLIAM J. PURDY CORP.
770 Airport Blvd, Burlingame, Cal 94010
DIGITAL INFORMATION STORAGE CORP.
100 Carter, Berlin, Mass 01503
DOLIN METAL PRODUCTS INC.
475 President St, Brooklyn, N Y 11215
DYNACOUSTICS INC.
1980 National Ave, Hayward, Cal 94545
ELECTIC COMPUTER CORP.
3707 Rawlins Ste 301, Dallas, Tex 75219
ENGINEERED DATA PERIPHERALS CORP.
1701 Colorado Ave, Santa Monica, Cal 90404
FUJITSU LTD. N.Y.LIAISON OFFICE
680 Fifth Ave, New York, N Y 10019
GENERAL INSTRUMENT CORP. MAGNE-HEAD DIV.
13040 Cerise Ave, Hawthorne, Cal 90250
GOULD INC. BRUSH DIV.
3631 Perkins Ave, Cleveland, Ohio 44114
HONEYWELL INFORMATION SYSTEMS
P O Box 12313, Oklahoma City, Okla 73112
HONEYWELL INFORMATION SYSTEMS
60 Walnut St, Wellesley Hills, Mass 02181
IBM CORP.,DATA PROCESSING DIV.
1133 Westchester Ave, White Plains, N Y 10604
INFORMATION DATA SYSTEMS INC.
7550 Walnut Lake Rd, Walled Lake, Mich 48088
INFORMATION STORAGE SYSTEMS
10435 N Tantau Ave, Cupertino, Cal 95014

INFOTECHNICS INC.

15730 Stage St, Van Nuys, Cal 91406
INTERDATA
2 Crescent Pl, Oceanport, N J 07757
IOMEC INC.
345 Mathew St, Santa Clara, Cal 95050
KDI INTERACTIVE DATA SYSTEMS
17785 Skypark Circle, Irvine, Cal 92664
KEMPER ENGINEERING CO.
9337 Shoshone Ave, Northridge, Cal 91324
LIBRASCOPE DIV. THE SINGER CO
808 Western Ave, Glendale, Cal 91201
MAGNAFILE INC.
2602 E Magnolia, Phoenix, Ariz 85034
MANZANO LABORATORIES INC.
146 Quincy N E, Albuquerque, N M 87108
MARK COMPUTER SYSTEMS INC.
One Patterson Pl, Garden City, N Y 11530
MARSHALL DATA SYSTEMS DIV. MARSHALL INDUSTRIES
2065 Huntington Dr, San Marino, Cal 91103
MEMOREX EQUIPMENT GROUP
San Tomas At Central, Santa Clara, Cal 95052
MICRO SYSTEMS INC.
644 E Young St, Santa Ana, Cal 92705
MOSLER SAFE CO., THE INFO. SYS. DIV.
1561 Grand Blvd., Hamilton, Ohio 45012
NCR INDUSTRIAL PRODUCTS DIV.
Main And K St, Dayton, Ohio 45409
NEWELL INDUSTRIES
795 Kifer Rd, Sunnyvale, Cal 94086
NORTH AMERICAN ROCKWELL CORP. AUTONETICS DIV.
3370 Miraloma Ave, Anaheim, Cal 92803
OCHMAN SYSTEMS, EDWARD
Po Box 141, Fairfield, Conn 06430
PER DATA
102 New South Rd, Hicksville, N Y 11801
POTTER INSTRUMENT CO. INC.
532 Broadhollow Rd, Melville, N Y 11746
PURDY CORP., WM. J.
770 Airport Blvd, Burlingame, Cal 94010
RCA COMPUTER SYSTEMS DIV.
200 Forest Ave, Marlboro, Mass 01752
SCIENTIFIC DATA SYSTEMS ISRAEL LTD.
Po Box 5101, Haifa, ISRAEL
SINGER CO., THE, FRIDEN DIV.
2350 Washington St, San Leandro, Cal 94577
SINGER-GENERAL PRECISION INC. LIBRASCOPE PROD.DIV
1100 Frances Ct, Glendale, Cal 91201
TALCOTT COMPUTER LEASING CO.
1290 Ave The Americas, New York, N Y 10019
TELEX COMPUTER PRODUCTS
6422 E 41st St, Tulsa, Okla 74135
UNICOMP INC.
18219 Parthenia, Northridge, Cal 91324
WABASH COMPUTER CORP. PI DIV.
10202 N 19th St, Phoenix, Ariz 85021
WEISMANTEL INC.
P O Box 1957, St Paul, Minn 55111
XEBEC SYSTEMS INC.
918 N Rengstorff Ave, Mountain View, Cal 94040
XEROX DATA SYSTEMS
701 S Aviation, El Segundo, Cal 90245

DISCS, MAGNETIC MEMORY

PLATEDATA DIV. CHEMPLATE CORP.
4355 E Sheila St, Los Angeles, Cal 90023

DISPLAY DRIVERS

AMPEREX ELECTRONIC CORP. A NO AMERICAN PHILIPS CO
P O Box 98, Slatersville, R I 02876
ANALOGIC CORP.
Audubon Rd, Wakefield, Mass 01880
ANN ARBOR TERMINALS INC.
918 Greene St, Ann Arbor, Mich 48104
BFA CORP.
1309 S Inca, Denver, Colo 80223
BURROUGHS CORP.,ELECTRONICS COMPONENTS DIV.
P O Box 1226, Plainfield, N J 07061
CELCO.CONSTANTINE ENGINEERING LABS. CO.
70 Constantine Dr, Mahwah, N J 07430
COMPUTER CORP. OF AMERICA
6216 Evergreen St, Houston, Tex 77036
COMPUTER SYSTEMS FOR MEDICINE INC.
340 Longwood Ave, Boston, Mass 02115
CONRAC CORP. DATEX DIV.
1600 S Mountain Ave, Duarte, Cal 91010
CONSTANTINE ENGINEERING LABS CELCO
70 Constantine Dr, Mahwah, N J 07430

2 Product Directory

DELTA DATA SYSTEMS CORP.

Woodhaven Ind Park, Cornwall Hgts, Pa 19020
DIALIGHT CORP.

60 Stewart Ave, Brooklyn, N Y 11237
DYNAMIC MEASUREMENTS CORP.

6 Lowell Ave, Winchester, Mass 01890
ELBIT COMPUTERS/SUB. CONTROL DATA CORP.
6 Tovim St, Haifa, ISRAEL

GENERAL INSTRUMENT CORP. MICROELECT. DIV.
600 W John St, Hicksville, N Y 11802

HELIPOT DIV. BECKMAN INSTRUMENTS INC.
2500 Harbor Blvd, Fullerton, Cal 92634

INDUSTRIAL ELECTRONIC ENGINEERS INC.
7720-40 Lemona Ave, Van Nuys, Cal 91405
INFO-LITE CORP.

2337 Lemoine Ave, Fort Lee, N J 07024
INSTRUMENT DISPLAYS INC. SUB. KELTRON CORP.

223 Crescent St, Waltham, Mass 02154
LECROY RESEARCH SYSTEMS CORP.

126 N Rte 303, W Nyack, N Y 10994
LUMINETICS CORP.

P O Box 1943, Pompano Beach, Fla 33061
MONSANTO CO. ELECTRONIC PDTS. & CONTROLS
DIV.

11636 Administration, St Louis, Mo 63141
MOTOROLA SEMICONDUCTOR PRODUCTS INC.

5005 E Mc Dowell Rd, Phoenix, Ariz 85008
RAYTHEON CO. EQUIPMENT DIV.

528 Boston Post Rd, Sudbury, Mass 01776
READOUTS INC.

P O Box 149, Del Mar, Cal 92014
SIGNETICS CORP. SUB. CORNING GLASS

811 E Arques Ave, Sunnyvale, Cal 94086
SYSTEMS RESEARCH LABS, INC.

7001 Indian Ripple Rd, Dayton, Ohio 45440
TEC INC.

6700 S Wash Ave, Eden Prairie, Minn 55343
TENNECOMP SYSTEMS INC.

795 Oak Ridge Tpk, Oak Ridge, Tenn 37830
THETA INSTRUMENT CORP.

24 Dwight Pl, Fairfield, N J 07006
TRANSITRON ELECTRONIC CORP.

168 Albion St, Wakefield, Mass 01880
UNICOMP INC.

18219 Parthenia, Northridge, Cal 91324

DISPLAY INDICATORS (SEE INDICATORS)

DISPLAYS, CRT (SEE CONSOLES)

DISPLAYS, MAGNETIC

AUTOMATION SCIENCES INTERNATIONAL CORP.
600 South St, Holbrook, Mass 02343

CELCO, CONSTANTINE ENGINEERING LABS. CO.
70 Constantine Dr, Mahwah, N J 07430

COMPUTER MICRO-IMAGE SYSTEMS INC.
9600 Desoto Ave, Chatsworth, Cal 91311

CONSTANTINE ENGINEERING LABS CELCO
70 Constantine Dr, Mahwah, N J 07430

CONTROL DATA CORP. MAGNETIC COMPONENTS DIV.
2300 Berkshire Lane, Minneapolis, Minn 55427

MARK COMPUTER SYSTEMS INC.
One Patterson Pl, Garden City, N Y 11530

NAYBOR LABORATORIES INC., E.V.
26 Manorhaved Blvd, Port Washington, N Y 11050

NOVATRONICS OF CANADA LTD.
677 Erie St, Stratford Ont, CANADA

OCHMAN SYSTEMS, EDWARD
Po Box 141, Fairfield, Conn 06430

SIGMATRON INC.
849 Ward Dr, Santa Barbara, Cal 93102

SYSTEMS RESEARCH LABS, INC.
7001 Indian Ripple Rd, Dayton, Ohio 45440

VERNITRON CORP. MOTOR PRODUCTS DIV.
300 Marcus Blvd, Deer Park, N Y 11729

DISPLAYS, THREE-DIMENSIONAL

ADAGE INC.
1079 Commonwealth Ave, Boston, Mass 02109

AMPEREX ELECTRONIC CORP. A NO AMERICAN
PHILIPS CO

P O Box 98, Slatersville, R I 02876
COMPUTEK INC.

143 Albany St, Cambridge, Mass 02139
COMPUTER INC.

143 Albany St, Cambridge, Mass 02139
COMPUTER MICRO-IMAGE SYSTEMS INC.

9600 Desoto Ave, Chatsworth, Cal 91311

EVANS & SUTHERLAND COMPUTER CORP.
3 Research Rd, Salt Lake City, Utah 84112

GOULD INC. BRUSH DIV.
3631 Perkins Ave, Cleveland, Ohio 44114

HP ASSOCIATES
620 Page Mill Rd, Palo Alto, Cal 94304

MACNEAL-SCHWENDLER CORP., THE
7442 N Figueroa St, Los Angeles, Cal 90041

OPTICAL ELECTRONICS INC.
P O Box 11140, Tucson, Ariz 85706

SPATIAL DATA SYSTEMS INC.
132 Aero Camino, Goleta, Cal 93017

DISPLAYS, PANELS, VIEWGRAPHS (FOR COMPUTER TRAINING)

ADTECH INC.

P O Box 10415, Honolulu, Haw 96816
ASTRO MOBILE PRODUCTS CORP. MAGNAGRAPH DIV.

11-25 44 Rd, Long Island, N Y 11101
CYTEK INFORMATION SYSTEMS CORP.

366 5th Ave, New York, N Y 10001
FELSETHAL INSTRUMENTS CO.

7450 W Wilson Ave, Chicago, Ill 60656
GTE DATA SERVICES INC.

5422 Bay Center Dr, Tampa, Fla 33609
HONEYWELL INFORMATION SYSTEMS INC. INFO.
SERV. DIV.

2701 4th Ave S, Minneapolis, Minn 55408
IAC COMPUTER SYSTEMS INC.

260 Newton Rd, Plainview, N Y 11803
INSTRUMENT DISPLAYS INC. SUB. KELTRON CORP.

223 Crescent St, Waltham, Mass 02154
MADATRON CORP.

P O Box 172, Princeton, N J 08540
PAYMENT SYSTEMS INC.

405 Lexington Ave, New York, N Y 10017
PROGRAMMING SCIENCES CORP.

1900 Ave of The Stars, Los Angeles, Cal 90067
VEMALINE PRODUCTS CO. INC.

P O Box 3, Wyckoff, N J 07481
WARREN ASSOCIATES

15 Royal Crest Dr, Marlboro, Mass 01752

DISPLAY TERMINALS (SEE DATA TERMINALS)

DOCUMENT READERS (SEE READERS)

DOCUMENTS, DCR/OMR

ACME VISIBLE RECORDS INC.

510 Allview Dr, Crozet, Va 22932
ADDRESSOGRAPH MULTIGRAPH CORP BRUNING DIV.

1200 Babbitt Rd, Cleveland, Ohio 44117
ALLISON COUPON COMPANY, INC.

200 S Capitol, Indianapolis, Ind 46206
AUDAC CORP.

175 Bedford St, Burlington, Mass 01803
BALTIMORE BUSINESS FORMS INC.

3132 Frederick Ave, Baltimore, Md 21229
SCM ALLIED EGRY BUSINESS SYSTEMS

P O Box 125 Wc Br, Dayton, Ohio 45449
STINAFFS INC.

181 E Exchange St, Akron, Ohio 44304

DRAFTING SYSTEMS, COMPUTER-CONTROLLED STORAGE

AUTO-TROL CORP.

6621 W 56th Ave, Arvada, Colo 80002
BOSTON DIGITAL CORP.

Main St, Ashland, Mass 01721
COMPUTERVISION CORP.

NW Ind Park S Ave, Burlington, Mass 01803
CONCORD CONTROL INC.

1282 Soldier Field Rd, Boston, Mass 02135
CURRAN COMPUTER CORP.

946 Main St, Hackensack, N J 07601
DIMENSIONAL SYSTEMS INC.

393 Totten Pond Rd, Waltham, Mass 02154
FERRANTI PACKARD LTD., ELECTRONICS DIV.

121 Industry St, Toronto 15, CANADA
GERBER SCIENTIFIC INSTRUMENT CO., THE

P O Box 305, Hartford, Conn 06101
INFORMATION DISPLAY INC.

333 N Bedford Rd, Mt Kisco, N Y 10549
KONGSBERG SYSTEMS INC.

10 De Angelo Dr, Bedford, Mass 01730

PHOTON INC.

355 Middlesex Ave, Wilmington, Mass 01887
SEACO COMPUTER-DISPLAY INC.

2826 W Kingsley Rd, Garland, Tex 75040
SINGER LINK DIV.

1077 E Arques, Sunnyvale, Cal 94086
SUPERIOR ELECTRIC CO., THE

383 Middle St, Bristol, Conn 06010
TELEDYNE FREDERICK POST

P O Box 803, Chicago, Ill 60690
TRIDEA ELECTRONICS A SUB. OF CONDUCTRON
CORP.

10581 Federal Dr, El Monte, Cal 91731
UNIVERSAL DRAFTING MACHINE CORP.

5200 Richmond Rd, Bedford Heights, Ohio 44146
UNIVERSITY COMPUTING CO. GRAPHIC SYSTEMS DIV

14761 Califa St, Van Nuys, Cal 91401
XYNETICS INC.

6710 Variel Ave, Canoga Park, Cal 91303

DRUM STORAGE EQUIPMENT, MAG-NETIC (INCLUDING CONTROLLER)

AMERICAN TOTALISATOR CO. UNI-TOTE DIV.
383 Hillen Rd, Towson, Md 21204

BRYANT COMPUTER PRODUCTS DIV. EX-CELL-O CORP
850 Ladd Rd, Walled Lake, Mich 48088

COMPUTER ACCESSORIES CO.
131 W 154th St, Gardena, Cal 90248

COMPUTER SPECIALTIES CORP.
87 Burlew Ct, Hackensack, N J 07601

CONTROL DATA CORP.
8100 34th Ave S, Minneapolis, Minn 55440

DACONICS
925 Thompson Pl, Sunnyvale, Cal 94086

DATA PRODUCTS CORP.
16055 Ventura Blvd, Encino, Cal 91316

DATASERV DIV., WILLIAM J. PURDY CORP.
770 Airport Blvd, Burlingame, Cal 94010

DATUM INC.
170 E Liberty Ave, Anaheim, Cal 92801

FUJITSU LTD. N.Y. LIAISON OFFICE
680 Fifth Ave, New York, N Y 10019

GENERAL INSTRUMENT CORP. MAGNE-HEAD DIV.
13040 Cerise Ave, Hawthorne, Cal 90250

IBM CORP. DATA PROCESSING DIV.
1133 Westchester Ave, White Plains, N Y 10604

INFORMATION DATA SYSTEMS INC.
7550 Walnut Lake Rd, Walled Lake, Mich 48088

MICRO SYSTEMS INC.
644 E Young St, Santa Ana, Cal 92705

OKI ELECTRIC INDUSTRIES CO. LTD.
875 Ave of Americas, New York, N Y 10001

PURDY CORP., WM. J.
770 Airport Blvd, Burlingame, Cal 94010

RCA COMPUTER SYSTEMS DIV.
200 Forest Ave, Marlboro, Mass 01752

SYSTEMS CONCEPTS INC.
524 2nd St, San Francisco, Cal 94107

SYSTEMS ENGINEERING LABORATORIES INC.
P O Box 9148, Fort Lauderdale, Fla 33310

UNICOMP INC.
18219 Parthenia, Northridge, Cal 91324

VERMONT RESEARCH CORP.
Precision Park, N Springfield, Vt 05150

DRUM MEMORIES (SEE MEMORIES)

DUPLICATORS-VERIFIERS, PAPER TAPE

CUSTOM DATA PROCESSING SERVICES
P O Box 14685, Phoenix, Ariz 85031

DATATERM INC.
1671 Manning Blvd, Levittown, Pa 19057

HRHRONICS INC., SUB MOHAWK DATA SCIENCES
CORP.

P O Box 406, King of Prussia, Pa 19406
OKI ELECTRIC INDUSTRIES CO. LTD.

875 Ave of Americas, New York, N Y 10001

EDUCATION (SEE TRAINING INSTITUTES)

2 Product Directory

ENCLOSURES, CUSTOM-DESIGNED (SEE CABINETS & ENCLOSURES)

ENCODERS, DIGITAL

ADVANCED MICRO DEVICES INC.
901 Thompson Pl, Sunnyvale, Cal 94086

AIRFLYTE ELECTRONICS CO.
56 New Hook Rd, Bayonne, N J 07002

ALLEN-BRADLEY
1201 S 2nd St, Milwaukee, Wisc 53204

AVCO CORP. ELECTRONICS DIV.
4807 Bradford, Huntsville, Ala 35805

BENDIX CORP., THE, ENVRNMNTL SCI. DIV.
1400 Taylor Ave, Baltimore, Md 21204

BFA CORP.
1309 S Inca, Denver, Colo 80223

COMPUTER CONVERSIONS CORP.
6 Dunton Court, E Northport, N Y 11731

CONNECTICUT TECHNICAL CORP.
3000 Main St, Hartford, Conn 06120

CONRAC CORP.
330 Madison Ave, New York, N Y 10017

CONRAC CORP. INSTRUMENT/ CONTROLS DIV.
1600 S Mountain Ave, Duarte, Cal 91010

DATA GRAPHICS CORP.
8402 Speedway, San Antonio, Tex 78230

DATA TECHNOLOGY INC.
65 Grove St, Watertown, Mass 02172

DISC INSTRUMENTS INC.
2701 So Halladay St, Santa Ana, Cal 92705

GENERAL DYNAMICS CORP. ELECTRONICS DIV.
P O Box 2566, Orlando, Fla 32802

GENERAL INSTRUMENT CORP. MICROELECT. DIV.
600 W John St, Hicksville, N Y 11802

HARRIS SEMICONDUCTOR A DIV.OF
HARRIS-INTERTYPE
P O Box 883, Melbourne, Fla 32901

HONEYWELL INFORMATION SYSTEMS
P O Box 12313, Oklahoma City, Okla 73112

HUGHES AIRCRAFT CO. M O S DIV.
500 Superior Ave, Newport Beach, Cal 92660

IKL INC.
4360 Campus Dr, Newport Beach, Cal 92660

ITEK CORP.
10 Maguire Rd, Lexington, Mass 02173

LANCER ELECTRONICS CORP.
1416 W Main St, Norristown, Penn 19401

LARSE CORP.
1070 E Meadow Cir, Palo Alto, Cal 94303

LEM INSTRUMENT CORP.
20 Sarah Dr, Farmingdale, N Y 11735

LIBRASCOPE DIV. THE SINGER CO
808 Western Ave, Glendale, Cal 91201

LITTON SYSTEMS INC. ENCODER DIV.
20745 Nordoff St, Chatsworth, Cal 91311

METROLOGICAL DATA CORP.
70 Plauderville Ave, Garfield, N J 07026

NORDEN DIV., UNITED AIRCRAFT CORP.
Helen St, Norwalk, Conn 06850

NUCLEONIC PRODUCTS CO. INC.
6660 Variel Ave, Canoga Park, Cal 91303

RAYTHEON CO. CADPO OPERATION
1415 Providence Tpk, Norwood, Mass 02062

REMEX ELECTRONICS
5250 W El Segundo Blv, Hawthorne, Cal 90250

RUCKER CO., THE, MOORE SYSTEMS DIV.
1212 Bordeaux Dr, Sunnyvale, Cal 94086

SINGER-GENERAL PRECISION INC. LIBRASCOPE
PROD.DIV
1100 Frances Ct, Glendale, Cal 91201

SPACETAC INC.
Burlington Rd, Bedford, Mass 01730

TEMPO INSTRUMENT DIV. ALLEN ELECTRIC&EQUIP.
CO.
9135 Independence Ave, Chatsworth, Cal 91311

THETA INSTRUMENT CORP.
24 Dwight Pl, Fairfield, N J 07006

WARLOCK COMPUTER CORP.
Rte 7, Georgetown, Conn 06829

ENCODERS, KEYBOARD (ALPHANUMERIC)

A.B. DICK CO.
5700 W Touhy, Chicago, Ill 60648

ADDRESSOGRAPH MULTIGRAPH CORP BRUNING DIV.
1200 Babbitt Rd, Cleveland, Ohio 44117

BRYANT DATA SERVICE INC.
319 Lynnway, Lynn, Mass 01901

CHERRY ELECTRICAL PRODUCTS CORP.
3600 Sunset Ave, Waukegan, Ill 60085

CLARE-PENDAR CO.
P O Box 785, Post Falls, Ind 83854

COMPUTER ENTRY SYSTEMS CORP.
2141 Industrial Pkwy, Silver Spring, Md 20904

CONNECTICUT TECHNICAL CORP.
3000 Main St, Hartford, Conn 06120

CONTROL DEVICES INC.
204 New Boston St, Woburn, Mass 01801

CONTROLS RESEARCH CORP.
2100 S Fairview, Santa Ana, Cal 92704

DATA ELECTRONICS CORP.
12 Cambridge St, Burlington, Mass 01803

DATA GRAPHICS CORP.
8402 Speedway, San Antonio, Tex 78230

DATA INPUT DEVICES INC.
Tinkham Ind Pk, Derry, N H 03038

DATAACON INTERNATIONAL INC.
2745 Bernice Rd, Lansing, Ill 60438

DATANETICS CORP.
2828 Spreckel Ln, Redondo Beach, Cal 90278

DATATERM INC.
1671 Manning Blvd, Levittown, Pa 19057

DIGITRONICS CORP.
1 Albertson Ave, Albertson, N Y 11507

ELDORADO ELECTRODATA
601 Chalomar Rd, Concord, Cal 94520

ELEC-TROL INC.
21018 Soledad Canyon, Saugus, Cal 91350

ELPAC INC.
18651 Von Karman Ave, Irvine, Cal 92664

FLEX KEY CORP.
1277 Main St, Waltham, Mass 02154

FRIDEN DIV. THE SINGER CO.
97 Humboldt St, Rochester, N Y 14602

GENERAL INSTRUMENT CORP. MICROELECT. DIV.
600 W John St, Hicksville, N Y 11802

HARRIS SEMICONDUCTOR A DIV.OF
HARRIS-INTERTYPE
P O Box 883, Melbourne, Fla 32901

IBM CORP.,DATA PROCESSING DIV.
1133 Westchester Ave, White Plains, N Y 10604

ILLINOIS TOOL WORKS INC. LICON DIV.
6615 W Irving Park, Chicago, Ill 60634

INFOREX INC.
21 N Ave, Burlington, Mass 01803

ITT DATA EQUIPMENT & SYSTEMS DIV.
187 E Union Ave, E Rutherford, N J 07073

ITT DEFENSE COMMUNICATIONS DIV.
492 River Rd, Nutley, N J 07110

KEYMATIC DATA SYSTEMS CORP.
56 Perataquit Ave, Bay Shore, N Y 11706

KLEINSCHMIDT DIV., SCM CORP.
Lake-Cook Rd, Deerfield, Ill 60015

LITTON ABS AUTOMATED BUSINESS SYSTEMS OEM
PRODUCT
600 Washington Ave, Carlstadt, N J 07072

LITTON SYSTEMS INC. DATA SYSTEMS DIV.
8000 Woodley Ave, Van Nuys, Cal 91409

LOGIC CORP.
21 Oldley Ave, Cherry Hill, N J 08034

MAXI SWITCH CO.
3125 Washington Ave, N, Minneapolis, Minn 55421

MECHANICAL ENTERPRISES INC.
5249 Duke St, Alexandria, Va 22304

MICRO SWITCH DIV. HONEYWELL INC.
11 W Spring St, Freeport, Ill 61032

MOSTEK CORP.
1400 Upfield Dr, Carrollton, Tex 75006

MSI DATA CORP.
4751 Holt Ave, Mont Clair, Cal 91763

NCR INDUSTRIAL PRODUCTS DIV.
Main And K St, Dayton, Ohio 45409

NUCLEONIC PRODUCTS CO. INC.
6660 Variel Ave, Canoga Park, Cal 91303

RAYTHEON CO. INDUSTRIAL COMPONENT
OPERATION
465 Centre St., Quincy, Mass 02169

RISK INDUSTRIES INC., GEORGE
P O Box 1035, Kimball, Nebr 69145

SCIENTIFIC MEASUREMENTS INC.
9701 N Kenton, Skokie, Ill 60076

SEVAN COMPUTER SERVICES INC.
Pollitt Dr S, Fair Lawn, N J 07410

SINGER CO., THE, FRIDEN DIV.
2350 Washington St, San Leandro, Cal 94577

STACOSWITCH INC.
1139 Baker St, Costa Mesa, Cal 92626

TEC INC.
6700 S Wash Ave, Eden Prarie, Minn 55343

TELETYPE CORP.
5555 W Touhy Ave, Skokie, Ill 60076

TRANSITEL, DIV. OF SANGAMO ELECTRIC CO.
P O Box 7255, Denver, Colo 80207

TREPAC CORP. OF AMERICA
30 W Hamilton Ave, Englewood, N J 07631

BUY - RENT - LEASE KEYBOARDS all types • all brands

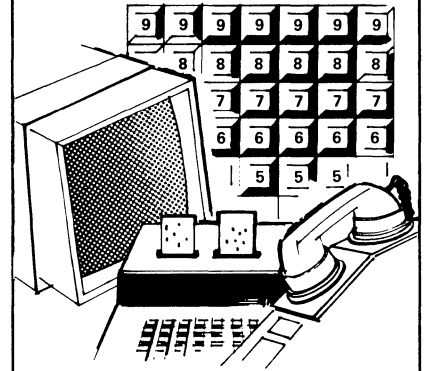

We are the West's largest, most experienced, best-stocked, factory-approved source for EDP terminals, peripherals and interfaces of every description

controllers • converters
processors • acoustic couplers
copiers • modems
display consoles
keyboards • transceivers
printers • teleprinters
readers • recorders
accessories • supplies

Our experienced EDP engineers analyze system requirements thoroughly, design and install custom turnkey systems, and provide expert consultation on system expansion or modification as requirements change.

We are thoroughly familiar with the capabilities and limitations of all reputable brands of EDP equipment, and are impartial in recommending and selecting equipment strictly on its merit for the application.

For more information on how to get the EDP system or equipment you need -- and get it on your terms -- see DataServ catalog insert.

DataSERV

Burlingame, California
Denver • Salt Lake City • Seattle •
Phoenix • Los Angeles
One of the PURDY group of companies

2 Product Directory

UNIMAX SWITCH CORP. SUB. RIKER-MAXSON
Ives Rd, Wallingford, Conn 06492
UNIVERSAL TECHNOLOGY INC.
3 Spielman Rd, Fairfield, N J 07006
VECTRONIX INC.
P O Box 209, Cozad, Nebr 69130

ENCODERS, KEYBOARD (NUMERIC)

ADDRESSOGRAPH MULTIGRAPH CORP BRUNING DIV.
1200 Babbitt Rd, Cleveland, Ohio 44117
CHERRY ELECTRICAL PRODUCTS CORP.
3600 Sunset Ave, Waukegan, Ill 60085
CLARE-PENDAR CO.
P O Box 785, Post Falls, Ind 83854
CONNECTICUT TECHNICAL CORP.
3000 Main St, Hartford, Conn 06120
CONTROL DEVICES INC.
204 New Boston St, Woburn, Mass 01801
CONTROLS RESEARCH CORP.
2100 S Fairview, Santa Ana, Cal 92704
DATA ELECTRONICS CORP.
12 Cambridge St, Burlington, Mass 01803
DATA GRAPHICS CORP.
8402 Speedway, San Antonio, Tex 78230
DATA INPUT DEVICES INC.
Tinkham Ind Pk, Derry, N H 03038
DATAACON INTERNATIONAL INC.
2745 Bernice Rd, Lansing, Ill 60438
DATANETICS CORP.
2828 Spreckel Ln, Redondo Beach, Cal 90278
DATATERM INC.
1671 Manning Blvd, Levittown, Pa 19057
ELDORADO ELECTRODATA
601 Chalomar Rd, Concord, Cal 94520
ELEC-TROL INC.
21018 Soledad Canyon, Saugus, Cal 91350
ELPAC INC.
18651 Von Karman Ave, Irvine, Cal 92664
FLEX KEY CORP.
1277 Main St, Waltham, Mass 02154
GENERAL INSTRUMENT CORP. MICROELECT. DIV.
600 W John St, Hicksville, N Y 11802
ITT DEFENSE COMMUNICATIONS DIV.
492 River Rd, Nutley, N J 07110
LOGIC CORP.
21 Oldey Ave, Cherry Hill, N J 08034
MAXI SWITCH CO.
3125 Washington Ave N, Minneapolis, Minn 55421
MECHANICAL ENTERPRISES INC.
5249 Duke St, Alexandria, Va 22304
MICRO SWITCH DIV. HONEYWELL INC.
11 W Spring St, Freeport, Ill 61032
MSI DATA CORP.
4751 Holt Ave, Mont Clair, Cal 91763
NUCLEONIC PRODUCTS CO. INC.
6660 Variel Ave, Canoga Park, Cal 91303
RAYTHEON CO. INDUSTRIAL COMPONENT
OPERATION
465 Centre St., Quincy, Mass 02169
RISK INDUSTRIES INC., GEORGE
P O Box 1035, Kimball, Nebr 69145
SCIENTIFIC MEASUREMENTS INC.
9701 N Kenton, Skokie, Ill 60076
SEVAN COMPUTER SERVICES INC.
Pollitt Dr S, Fair Lawn, N J 07410
SOURCE INFORMATION SYSTEMS INC.
P O Box 3088, Santa Monica, Cal 90403
STACOSWITCH INC.
1139 Baker St, Costa Mesa, Cal 92626
STANDARD REGISTER CO., THE
626 Albany St, Dayton, Ohio 45401
TEC INC.
6700 S Wash Ave, Eden Prarie, Minn 55343
TELETYPE CORP.
5555 W Touhy Ave, Skokie, Ill 60076
TREPAC CORP. OF AMERICA
30 W Hamilton Ave, Englewood, N J 07631
UNIMAX SWITCH CORP. SUB. RIKER-MAXSON
Ives Rd, Wallingford, Conn 06492
UNIVERSAL TECHNOLOGY INC.
3 Spielman Rd, Fairfield, N J 07006
VECTRONIX INC.
P O Box 209, Cozad, Nebr 69130

ENCODERS, KEYBOARD-TO-GRAPHIC DISPLAY

A.B. DICK CO.
5700 W Touhy, Chicago, Ill 60648
PRINTER TECHNOLOGY INC.
Sixth Rd, Woburn, Mass 01801

ENCODERS, KEYBOARD-TO-MAGNETIC DISC

CLARE-PENDAR CO.
P O Box 785, Post Falls, Ind 83854
CONSOLIDATED COMPUTER INTERNATIONAL INC.
235 Wyman St, Waltham, Mass 02154
DATA SYNTEKS CORP.
41 B St, Burlington, Mass 01803
DATANETICS CORP.
2828 Spreckel Ln, Redondo Beach, Cal 90278
ELDORADO ELECTRODATA
601 Chalomar Rd, Concord, Cal 94520
ENTREX INC.
113 Hartwell Ave, Lexington, Mass 02173
INFOREX INC.
21 N Ave, Burlington, Mass 01803
LOGIC CORP.
21 Oldey Ave, Cherry Hill, N J 08034
MICRO SWITCH DIV. HONEYWELL INC.
11 W Spring St, Freeport, Ill 61032
SYSTEMS ENGINEERING LABORATORIES INC.
P O Box 9148, Fort Lauderdale, Fla 33310

ENCODERS, KEYBOARD-TO-MAGNETIC DISC TAPE

ENTREX INC.
113 Hartwell Ave, Lexington, Mass 02173
GENERAL COMPUTER SYSTEMS INC.
12011 Colt Rd, Dallas, Tex 75230

ENCODERS, KEYBOARD-TO-MAGNETIC DRUM

AMERICAN TOTALISATOR CO. UNI-TOTE DIV.
383 Hillen Rd, Towson, Md 21204

ENCODERS, KEYBOARD-TO-MAGNETIC TAPE

ADDRESSOGRAPH MULTIGRAPH CORP BRUNING DIV
1200 Babbitt Rd, Cleveland, Ohio 44117
ANDERSON JACOBSON INC.
1065 Morse Ave., Sunnyvale, Cal 94086
BRYANT DATA SERVICE INC.
319 Lynnway, Lynn, Mass 01901
BURROUGHS CORP., BUSINESS MACHINES GROUP
6071 2nd Ave, Detroit, Mich 48232
CLARE-PENDAR CO.
P O Box 785, Post Falls, Ind 83854
COGAR CORP. INFORMATION SYS.DIV
Cosby Manor Rd, Utica, N Y 13502
COMPUTER ENTRY SYSTEMS CORP.
2141 Industrial Pkwy, Silver Spring, Md 20904
CONNECTICUT TECHNICAL CORP.
3000 Main St, Hartford, Conn 06120
CONSOLIDATED COMPUTER INTERNATIONAL INC.
235 Wyman St, Waltham, Mass 02154
DATA ACTION CORP.
4445 W 77th St, Minneapolis, Minn 55435
DATA GRAPHICS CORP.
8402 Speedway, San Antonio, Tex 78230
DATA PRODUCTS TELECOMMUNICATIONS
17 Amelia Place, Stamford, Conn 06902
DATA TRENDS INC.
P O Box 82, Mt Lake, N J 07046
DATAACON INTERNATIONAL INC.
2745 Bernice Rd, Lansing, Ill 60438
DATANETICS CORP.
2828 Spreckel Ln, Redondo Beach, Cal 90278
DESIGN ELEMENTS INC.
356 Norton Ave, Columbus, Ohio 43212
DIGITAL INFORMATION DEVICES INC.
210 Welsh Pool Rd, Lionville, Pa 19353
DIGITRONICS CORP.
1 Albertson Ave, Albertson, N Y 11507
DYNAMIC SYSTEM ELECTRONICS
1040 W Alameda Dr, Tempe, Ariz 85281
DYTRO CORP.
63 Tec St, Hicksville, N Y 11801
ELDORADO ELECTRODATA
601 Chalomar Rd, Concord, Cal 94520
ELECTRONIC DATA PREPARATION CORP.
P O Box 1446, Bradenton, Fla 33505
ELECTRONIC LABS, INC.
3726 Dacoma St, Houston, Tex 77018
FRIDEN DIV. THE SINGER CO.
97 Humboldt St, Rochester, N Y 14602
HYPERTECH CORP.
7343 W Wilson Ave, Harwood Hghts, Ill 60656

IBM CORP., DATA PROCESSING DIV.
1133 Westchester Ave, White Plains, N Y 10604
INFOREX INC.
21 N Ave, Burlington, Mass 01803
INTERNATIONAL DATA SCIENCES, INC.
100 Nashua St, Providence, R I 02904
KEY PUNCH SERVICE CO.
4 Smithfield St, Pittsburgh, Pa 15222
KEYMATIC DATA SYSTEMS CORP.
56 Perataquit Ave, Bay Shore, N Y 11706
LOGIC CORP.
21 Oldey Ave, Cherry Hill, N J 08034
MARK/OPS DIV., NORTH EASTERN SYSTEMS ASSOC.
INC.
475 Commonwealth Ave, Boston, Mass 02215
MICRO SWITCH DIV. HONEYWELL INC.
11 W Spring St, Freeport, Ill 61032
MICRODYNE INC. SUB.BODINE ELEC.CO.
1600 S Micks Rd, Rolling Meadows, Ill 60008
MOHAWK DATA SCIENCES CORP.
Palisade St, Herkimer, N Y 13350
POTTER INSTRUMENT CO. INC.
532 Broadhollow Rd, Melville, N Y 11746
SCHULTZ INSTRUMENTS INC.
P O Box 13385, Gainesville, Fla 32601
SINGER CO., THE, FRIDEN DIV.
2350 Washington St, San Leandro, Cal 94577
SYS COMPUTER CORP.
17-25 Dicarolis Court, Hackensack, N J 07601
SYSTEMS ENGINEERING LABORATORIES INC.
P O Box 9148, Fort Lauderdale, Fla 33310
TALLY CORP.
8301 S 180th St, Kent, Wash 98031
TELE-DATA CORP.
130 U S Hwy 22, N Plainfield, N J 07060
TELETYPE CORP.
5555 W Touhy Ave, Skokie, Ill 60076
TRANSITEL, DIV. OF SANGAMO ELECTRIC CO.
P O Box 7255, Denver, Colo 80207
TY-DATA INC.
109 NE Blvd, Nashua, N H 03060

ENCODERS, KEYBOARD-TO-PAPER TAPE

CONNECTICUT TECHNICAL CORP.
3000 Main St, Hartford, Conn 06120

ENCODERS, KEYBOARD-TO-PRINTED TAPE

CLARE-PENDAR CO.
P O Box 785, Post Falls, Ind 83854
CONNECTICUT TECHNICAL CORP.
3000 Main St, Hartford, Conn 06120
DATA GRAPHICS CORP.
8402 Speedway, San Antonio, Tex 78230
DATANETICS CORP.
2828 Spreckel Ln, Redondo Beach, Cal 90278
DI/AN CONTROLS INC.
944 Dorchester Ave, Boston, Mass 02125
ELDORADO ELECTRODATA
601 Chalomar Rd, Concord, Cal 94520
INTERFACE MECHANISMS INC.
5503 232nd St SW, Mount Lake Terr, Wash 98043
KLEINSCHMIDT DIV., SCM CORP.
Lake-Cook Rd, Deerfield, Ill 60015
MICRO SWITCH DIV. HONEYWELL INC.
11 W Spring St, Freeport, Ill 61032
SHIRAK TELEMETERING OF AMERICA
8926 Kester Ave, Van Nuys, Cal 91402
TELETYPE CORP.
5555 W Touhy Ave, Skokie, Ill 60076

ENCODERS, OPTICAL

ITEK CORP. WAYNE-GEORGE DIV.
Christina St, Newton, Mass 02161

ENCODERS, SHAFT ANGLE

AIRFLYTE ELECTRONICS CO.
56 New Hook Rd, Bayonne, N J 07002
ALLEN-BRADLEY
1201 S 2nd St, Milwaukee, Wisc 53204
BALDWIN ELECTRONICS INC.
1101 McAlmont St, Little Rock, Ark 72203
BENDIX CORP., THE, ENVRNMNTL SCI. DIV.
1400 Taylor Ave, Baltimore, Md 21204
COMPUTER CONVERSIONS CORP.
6 Dunton Court, E Northport, N Y 11731

2 Product Directory

CONRAC CORP.

330 Madison Ave, New York, N Y 10017
CONRAC CORP. INSTRUMENT/ CONTROLS DIV.
1600 S Mountain Ave, Duarte, Cal 91010
DATA GRAPHICS CORP.
8402 Speedway, San Antonio, Tex 78230
DATA TECHNOLOGY INC.
65 Grove St, Watertown, Mass 02172
DDC DIV. SOLID STATE SCIENTIFIC DEVICES
100 Tec St, Hicksville, N Y 11801
DEL ELECTRONIC CORP.
250 Sandford Blvd, Mt Vernon, N Y 10550
DISC INSTRUMENTS INC.
2701 So Halladay St, Santa Ana, Cal 92705
DYNAMICS RESEARCH CORP.
38 Montvale Ave, Stoneham, Mass 02180
HH CONTROLS CO. INC.
16 Frost St, Arlington, Mass 02174
ITEK CORP.

10 Maguire Rd, Lexington, Mass 02173
LEM INSTRUMENT CORP.
20 Sarah Dr, Farmingdale, N Y 11735
LIBRASCOPE DIV. THE SINGER CO
808 Western Ave, Glendale, Cal 91201
LITTON SYSTEMS INC. ENCODER DIV.
20745 Nordoff St, Chatsworth, Cal 91311
METROLOGICAL DATA CORP.
70 Plauderville Ave, Garfield, N J 07026
NORDEN DIV., UNITED AIRCRAFT CORP.
Helen St, Norwalk, Conn 06850
SEQUENTIAL INFORMATION SYSTEMS INC.
145 Palisade St, Dobbs Ferry, N Y 10522
SINGER-GENERAL PRECISION INC. LIBRASCOPE
PROD.DIV
1100 Frances Ct, Glendale, Cal 91201
TELEDYNE GURLEY
514 Fulton St, Troy, N Y 12181
THETA INSTRUMENT CORP.
24 Dwight Pl, Fairfield, N J 07006
TRUMP-ROSS INDUSTRIAL CONTROLS INC.
265 Boston Rd, N Billerica, Mass 01862
VERNITRON CORP. MOTOR PRODUCTS DIV.
300 Marcus Blvd, Deer Park, N Y 11729

ENVELOPES, CONTINUOUS

ACCURATE BUSINESS FORMS CO., INC.
P O Box 8339, Milwaukee, Wis 53225
AMERICAN BUSINESS FORMS INC.
114 S Canal St, Chicago, Ill 60606
BALTIMORE BUSINESS FORMS INC.
3132 Frederick Ave, Baltimore, Md 21229
BURROUGHS CORP., BUSINESS FORMS & SUPPLIES
1150 Univ Ave, Rochester, N Y 14607
CURTIS 1000 INC.
1000 Curtis Dr, Smyrna, Ga 30080
CYBERMATICS INC.
2460 Lemoine Ave, Fort Lee, N J 07024
ECCO BUSINESS SYSTEMS INC.
50 E 42nd St, New York, N Y 10017
GRECO ENTERPRISES INC. TSA DATA DIV.
2000 Texas, El Paso, Tex 79901
INTERNATIONAL SYSTEMS ASSOCIATES, LTD.
350 5th Ave, New York, N Y 10001
LABEL HOUSE INC., THE
155 W Wisconsin Ave, Pewaukee, Wisc 53072
MOORE BUSINESS FORMS INC.
110-112 Pkwy Inn Bldg, Niagara Falls, N Y 14302
SCM ALLIED EGRY BUSINESS SYSTEMS
P O Box 125 Wc Br, Dayton, Ohio 45449
SERVICE BUSINESS FORMS
815 E Second, Wichita, Kans 67202
STANDARD REGISTER CO., THE
626 Albany St, Dayton, Ohio 45401
STINAFFS INC.
181 E Exchange St, Akron, Ohio 44304
WALLACE BUSINESS FORMS INC.
4600 W Roosevelt Rd, Hillside, Ill 60162

ENVELOPES (FOR FILING TAPES)

ACME VISIBLE RECORDS INC.
510 Allview Dr, Crozet, Va 22932
AMES SAFETY ENVELOPE CO.
21 Properzi Way, Somerville, Mass 02145
DRESSER PRODUCTS INC.
P O Box 2035, Providence, R I 02905
ECCO BUSINESS SYSTEMS INC.
50 E 42nd St, New York, N Y 10017
FRIDEN DIV. THE SINGER CO.
97 Humboldt St, Rochester, N Y 14602
ICA CORP.
200 N 3rd St, Minneapolis, Minn 55401

OCHMAN SYSTEMS, EDWARD

Po Box 141, Fairfield, Conn 06430
ORIGINAL COMPUTER PRODUCTS INC.
204 Worcester St, Wellesley Hills, Mass 02181
SMEAD MANUFACTURING CO.
600 E 10th St, Hastings, Minn 55033
SMITH INC., JAY
292 E State St, Westport, Conn 06880
STINAFFS INC.
181 E Exchange St, Akron, Ohio 44304
VISIBLE COMPUTER SUPPLY CORP.
9865 Derby Ln, Westchester, Ill 60153

ERASERS, BULK (MAGNETIC TAPE)

AMPEX CORP. COMPUTER PRODUCTS DIV.
9937 W Jefferson Blvd, Culver City, Cal 90230
COMPUTER ACCESSORIES CO.
131 W 154th St, Gardena, Cal 90248
GENERAL KINETICS INC.
11425 Isaac Newt Sq S, Reston, Va 22070
HEWLETT PACKARD CO. MOUNTAIN VIEW DIV.
690 Middlefield Rd, Mtn View, Cal 94040
MACS COMPUTER ACCESSORIES INC
104 Park Towne Pl, Philadelphia, Pa 19130
MAG-CON ENGINEERING CO.
85 Richardson St SE, St Paul, Minn 55112
MICROTRAN COMPANY INC.
145 E Mineola Ave, Valley Stream, N Y 11582
TELECTRO SYSTEMS CORP.
96-18 43rd Ave, Corona, N Y 11368

ERROR DETECTORS (SEE TESTERS)

EXECUTIVE SOFTWARE (SEE PROG-RAMMING LANGUAGE DEVELOPMENT)

EXTRACTORS, CIRCUIT BOARD

BIRTCHEP CORP., THE, INDUSTRIAL DIV.
745 Monterey Pass Rd, Monterey Park, Cal 91754
CAMBRIDGE THERMIONIC CORP.
445 Concord Ave, Cambridge, Mass 02138
FLOTIRON INDUSTRIES INC.
2104 W Rosecrans Ave, Gardena, Cal 90249
VERO ELECTRONICS INC.
176 Central Ave, Farmingdale, N Y 11735

FACILITY MANAGEMENT SERVICES (SEE SERVICES)

FACSIMILE CONVERTERS (SEE CONVERTERS)

FACSIMILE RECORDERS (SEE RECORDERS)

FACSIMILE TRANSCEIVERS (SEE TRANSCEIVERS)

FASTENERS, EQUIPMENT

PANDUIT CORP.
17301 Ridgeland Ave, Tinley Park, Ill 60477
REX CHAINBELT INC. CAMLOC DIV.
22 Spring Valley Rd, Paramus, N J 07652
WECKESSER CO., INC.
4444 W Irving Pk Rd, Chicago, Ill 60641

FIBER OPTIC BUNDLES

AMERICAN OPTICAL CORP. FIBER OPTICS DIV.
14 Mechanic St, Southbridge, Mass 01550
BENDIX MOSAIC FABRICATIONS DIV.
Galileo Park, Sturbridge, Mass 01518
CORNING GLASS WORKS
Houghton Park, Corning, N Y 14830
DOLAN JENNER INDUSTRIES INC.
200 Ingall Court, Melrose, Mass 02176
DUPONT DE NEMOURS, & CO.E.I. CO., INC.
1007 Market St, Wilmington, Del 19898
DYONIC INC.
71 Pine St, Woburn, Mass 01801

ELECTRO FIBEROPTICS CORP.

99 Hartwell St, West Boylston, Mass 01583
FIBER PHOTICS INC.
2557 Soquel Dr, Santa Cruz, Cal 95060
FLEXI-OPTICS LABORATORY INC.
269 Mechanic St, Marlboro, Mass 01752
OPTICS TECHNOLOGY INC.
901 California Ave, Palo Alto, Cal 94304
POLY-OPTICS INC.
1815 E Carnegie, Santa Ana, Cal 92705
RANK PRECISION INDUSTRIES INC.
260 N Rt 303, W Nyack, N Y 10994
SKAN-A-MATIC CORP.
P O Drawer 68, Skaneateles, N Y 13152
WELCH ALLYN INC.
99 Jordan Rd, Skaneateles Fls, N Y 13153
ZIPPERTUBING CO.
13000 S Broadway, Los Angeles, Cal 90061

FIBER OPTICS ASSEMBLIES (FOR PUNCHED CODE READERS AND MARK SENSORS)

AMERICAN OPTICAL CORP. FIBER OPTICS DIV.
14 Mechanic St, Southbridge, Mass 01550
BENDIX MOSAIC FABRICATIONS DIV.
Galileo Park, Sturbridge, Mass 01518
COMPUTER IDENTICS CORP.
S W Park, Westwood, Mass 02090
CORNING GLASS WORKS
Houghton Park, Corning, N Y 14830
DOLAN JENNER INDUSTRIES INC.
200 Ingall Court, Melrose, Mass 02176
DYONIC INC.
71 Pine St, Woburn, Mass 01801
ELECTRO FIBEROPTICS CORP.
99 Hartwell St, West Boylston, Mass 01583
FIBER PHOTICS INC.
2557 Soquel Dr, Santa Cruz, Cal 95060
FLEXI-OPTICS LABORATORY INC.
269 Mechanic St, Marlboro, Mass 01752
OPTICS TECHNOLOGY INC.
901 California Ave, Palo Alto, Cal 94304
POLY-OPTICS INC.
1815 E Carnegie, Santa Ana, Cal 92705
RANK PRECISION INDUSTRIES INC.
260 N Rt 303, W Nyack, N Y 10994
SKAN-A-MATIC CORP.
P O Drawer 68, Skaneateles, N Y 13152
SOLAR SYSTEMS INC.
8124 N Central Park, Skokie, Ill 60076
SPECTRONICS INC.
541 Sterling Dr, Richardson, Tex 75080
WELCH ALLYN INC.
99 Jordan Rd, Skaneateles Fls, N Y 13153

FILES, PUNCHED CARD

ACME VISIBLE RECORDS INC.
510 Allview Dr, Crozet, Va 22932
AMES SAFETY ENVELOPE CO.
21 Properzi Way, Somerville, Mass 02145
BARRY-WRIGHT CORP. WRIGHT LINE DIV.
160 Gold Star Blvd, Worcester, Mass 01606
BUSINESS SUPPLIES CORP. OF AMERICA
475 5th Ave, New York, N Y 10017
COMPUTER ACCESSORIES CO.
131 W 154th St, Gardena, Cal 90248
DIEBOLD INC.
818 Mulberry Rd SE, Canton, Ohio 44702
DOLIN METAL PRODUCTS INC.
475 President St, Brooklyn, N Y 11215
INTERNATIONAL COMPUTER APPLIANCES CORP.
200 N Third St, Minneapolis, Minn 55401
LYON METAL PRODUCTS INC.
P O Box 671, Aurora, Ill 60507
MONARCH METAL PRODUCTS INC.
Mac Arthur Ave, New Windsor, N Y 12550
MOSLER SAFE CO., THE INFO. SYS. DIV.
1561 Grand Blvd., Hamilton, Ohio 45012
NUMERIDEX TAPE SYSTEMS INC.
4711 W North Ave, Chicago, Ill 60639
OCHMAN SYSTEMS, EDWARD
Po Box 141, Fairfield, Conn 06430
ORIGINAL COMPUTER PRODUCTS INC.
204 Worcester St, Wellesley Hills, Mass 02181
REMINGTON RAND OFFICE SYSTEMS DIV. SPERRY
RAND
P O Box 171, Marietta, Ohio 45750
SHAW-WALKER CO.
P O Box 208, Muskegon, Mich 49443
SMEAD MANUFACTURING CO.
600 E 10th St, Hastings, Minn 55033

2 Product Directory

TAB PRODUCTS
2690 Hanover St, Palo Alto, Cal 94304

FORMS HANDLING, CARBON DELEAVERS

ACRATOD COMPANY
Po Box 66847, Houston, Tex 77006
COMPUTER ACCESSORIES CO.
131 W 154th St, Gardena, Cal 90248
ECCO BUSINESS SYSTEMS INC.
50 E 42nd St, New York, N Y 10017
HACKETT CORP.
2100 W Fullerton Ave, Chicago, Ill 60647
INTERNATIONAL COMPUTERS LTD.
Icl House Putney, London S W 15, UNITED K
MACS COMPUTER ACCESSORIES INC
104 Park Towne Pl, Philadelphia, Pa 19130
MONARCH METAL PRODUCTS INC.
Mac Arthur Ave, New Windsor, N Y 12550
MOORE BUSINESS FORMS INC.
110-112 Pkwy Inn Bldg, Niagara Falls, N Y 14302
STANDARD REGISTER CO., THE
626 Albany St, Dayton, Ohio 45401
TAB PRODUCTS
2690 Hanover St, Palo Alto, Cal 94304

FORMS HANDLING, COLLATORS

COMPUTER ACCESSORIES CO.
131 W 154th St, Gardena, Cal 90248
MICHAEL BUSINESS MACHINES CORP.
145 W 45th St, New York, N Y 10036
MOORE BUSINESS FORMS INC.
110-112 Pkwy Inn Bldg, Niagara Falls, N Y 14302
STANDARD REGISTER CO., THE
626 Albany St, Dayton, Ohio 45401
TAB PRODUCTS
2690 Hanover St, Palo Alto, Cal 94304

FORMS HANDLING, DECOLLATORS

ACRATOD COMPANY
Po Box 66847, Houston, Tex 77006
COMPUTER ACCESSORIES CO.
131 W 154th St, Gardena, Cal 90248
COMPUTER-LINK CORP.
14 Cambridge St, Burlington, Mass 01803
ECCO BUSINESS SYSTEMS INC.
50 E 42nd St, New York, N Y 10017
HACKETT CORP.
2100 W Fullerton Ave, Chicago, Ill 60647
INTERNATIONAL COMPUTERS LTD.
Icl House Putney, London S W 15, UNITED K
MACS COMPUTER ACCESSORIES INC
104 Park Towne Pl, Philadelphia, Pa 19130
MONARCH METAL PRODUCTS INC.
Mac Arthur Ave, New Windsor, N Y 12550
MOORE BUSINESS FORMS INC.
110-112 Pkwy Inn Bldg, Niagara Falls, N Y 14302
OCHMAN SYSTEMS, EDWARD
Po Box 141, Fairfield, Conn 06430
STANDARD REGISTER CO., THE
626 Albany St, Dayton, Ohio 45401
TAB PRODUCTS
2690 Hanover St, Palo Alto, Cal 94304

FORMS HANDLING, DETACHERS

CURTIS 1000 INC.
1000 Curtis Dr, Smyrna, Ga 30080
ECCO BUSINESS SYSTEMS INC.
50 E 42nd St, New York, N Y 10017
MOORE BUSINESS FORMS INC.
110-112 Pkwy Inn Bldg, Niagara Falls, N Y 14302
STANDARD REGISTER CO., THE
626 Albany St, Dayton, Ohio 45401

FORMS HANDLING, DOCUMENT COUNTERS

CUMMINS-CHICAGO CORP.
4740 Ravenswood Ave, Chicago, Ill 60640
MOORE BUSINESS FORMS INC.
110-112 Pkwy Inn Bldg, Niagara Falls, N Y 14302

FORMS HANDLING, LABEL APPLICATORS

ADDRESSOGRAPH MULTIGRAPH CORP BRUNING DIV.
1200 Babbitt Rd, Cleveland, Ohio 44117
BALTIMORE BUSINESS FORMS INC.
3132 Frederick Ave, Baltimore, Md 21229
ECCO BUSINESS SYSTEMS INC.
50 E 42nd St, New York, N Y 10017
GRECO ENTERPRISES INC. TSA DATA DIV.
2000 Texas, El Paso, Tex 79901
NORMANDIE DATAFORMS
41-10 22nd St, Long Is Cy, N Y 11101
VISIBLE COMPUTER SUPPLY CORP.
9865 Derby Ln, Westchester, Ill 60153

FORMS HANDLING, OCR SOURCE DOCUMENT

COGNITRONICS CORP.
333 Bedford Rd, Mt Kisco, N Y 10549
ECCO BUSINESS SYSTEMS INC.
50 E 42nd St, New York, N Y 10017
INTERNATIONAL SYSTEMS ASSOCIATES, LTD.
350 5th Ave, New York, N Y 10001
MOORE BUSINESS FORMS INC.
110-112 Pkwy Inn Bldg, Niagara Falls, N Y 14302

FORMS HANDLING, PUNCHED CARD SOURCE

MOORE BUSINESS FORMS INC.
110-112 Pkwy Inn Bldg, Niagara Falls, N Y 14302
NUMERIDEX TAPE SYSTEMS INC.
4711 W North Ave, Chicago, Ill 60639
STANDARD REGISTER CO., THE
626 Albany St, Dayton, Ohio 45401

FORMS HANDLING, SLITTERS

ECCO BUSINESS SYSTEMS INC.
50 E 42nd St, New York, N Y 10017
MOORE BUSINESS FORMS INC.
110-112 Pkwy Inn Bldg, Niagara Falls, N Y 14302
STANDARD REGISTER CO., THE
626 Albany St, Dayton, Ohio 45401
TAB PRODUCTS
2690 Hanover St, Palo Alto, Cal 94304

FORMS HANDLING, STACKERS

ADVANCED TERMINALS INC.
220 3rd Ave, Herkimer, N Y 13350
COMPUTER-LINK CORP.
14 Cambridge St, Burlington, Mass 01803
ECCO BUSINESS SYSTEMS INC.
50 E 42nd St, New York, N Y 10017
MOORE BUSINESS FORMS INC.
110-112 Pkwy Inn Bldg, Niagara Falls, N Y 14302
STANDARD REGISTER CO., THE
626 Albany St, Dayton, Ohio 45401
TAB PRODUCTS
2690 Hanover St, Palo Alto, Cal 94304
UNIVERSITY COMPUTING CO. DATA COMM. SYSTEMS
2659 Nova Dr, Dallas, Tex 75229

FREQUENCY CONVERTERS (SEE CONVERTERS)

GEARS, PERIPHERAL EQUIPMENT

PERFECT GEAR&INSTRUMENT CORP.
18141 Napa St, Northbridge, Cal 91324

GENERATORS, BYTE

ADAR ASSOCIATES INC.
85 Bolton St, Cambridge, Mass 02140
BFA CORP.
1309 S Inca, Denver, Colo 80223
COMPUMATIC SYSTEMS CORP.
5303 Comercio Ln, Woodland Hills, Cal 91364
DATAPROBE INC.
290 Huyler St, S Hackensack, N J 07606
DIGITECH DATA INDUSTRIES INC.
66 Grove St, Ridgefield, Conn 06877
LIBRASCOPE DIV. THE SINGER CO
808 Western Ave, Glendale, Cal 91201

MONITOR DISPLAYS

401 Commerce Dr, Ft Washington, Pa 19034
SIGNETICS CORP. MEASUREMENT DATA DIV.
341 Moffett Blvd, Mountain View, Cal 94040
SONICRAFT INC.
8437 S Burley Ave, Chicago, Ill 60619
TAUTRON INC.
685 Lawrence St, Lowell, Mass 01852
TELEMODEM INC.
98-05 217 St, Queens Village, N Y 11429

GENERATORS, CHARACTER (CRT)

ADAR ASSOCIATES INC.
85 Bolton St, Cambridge, Mass 02140
BOWMAR INSTRUMENT CORP. ELECTRONIC SYS. DIV
800 Bluffton Rd, Fort Wayne, Ind 46809
DATA DISC INC.
686 W Maude Ave, Sunnyvale, Cal 94086
DIGITECH DATA INDUSTRIES INC.
66 Grove St, Ridgefield, Conn 06877
GENERAL INSTRUMENT CORP. MICROELECT. DIV.
600 W John St, Hicksville, N Y 11802
LECROY RESEARCH SYSTEMS CORP.
126 N Rte 303, W Nyack, N Y 10994
LIBRASCOPE DIV. THE SINGER CO
808 Western Ave, Glendale, Cal 91201
MARK COMPUTER SYSTEMS INC.
One Patterson Pl, Garden City, N Y 11530
MONITOR DISPLAYS
401 Commerce Dr, Ft Washington, Pa 19034
SYS COMPUTER CORP.
17-25 Dicarolis Court, Hackensack, N J 07601
TRANSMISSION MEASUREMENTS INC
1051 Clinton St, Buffalo, N Y 14206

GENERATORS, RANDOM NUMBER

COMPUMATIC SYSTEMS CORP.
5303 Comercio Ln, Woodland Hills, Cal 91364
DATAPROBE INC.
290 Huyler St, S Hackensack, N J 07606
LIBRASCOPE DIV. THE SINGER CO
808 Western Ave, Glendale, Cal 91201
MONITOR DISPLAYS
401 Commerce Dr, Ft Washington, Pa 19034
PIONEER ELECTRIC & RESEARCH DIV. JOHNSON SER.CO.
743 Circle Ave, Forest Park, Ill 60130
TAUTRON INC.
685 Lawrence St, Lowell, Mass 01852

GENERATORS, TIME CODE

A. W. HAYDON CO., THE
232 N Elm St, Waterbury, Conn 06720
BFA CORP.
1309 S Inca, Denver, Colo 80223
COMPUMATIC SYSTEMS CORP.
5303 Comercio Ln, Woodland Hills, Cal 91364
DATATRON INC.
1562 Reynolds Ave, Santa Ana, Cal 92707
GULTON INDUSTRIES INC.
212 Durham Ave, Metuchen, N J 08840
LIBRASCOPE DIV. THE SINGER CO
808 Western Ave, Glendale, Cal 91201
MONITOR DISPLAYS
401 Commerce Dr, Ft Washington, Pa 19034
NANOSECOND SYSTEMS INC.
176 Linwood Ave, Fairfield, Conn 06430
PIONEER ELECTRIC & RESEARCH DIV. JOHNSON SER.CO.
743 Circle Ave, Forest Park, Ill 60130
SRC DIV. MOXON INC.
2222 Michelson Dr, Newport Beach, Cal 92664
SYSTRON-DONNER CORP.
888 Galindo St, Concord, Cal 94520
TAUTRON INC.
685 Lawrence St, Lowell, Mass 01852

GRAPHIC PANELS AND DISPLAYS (SEE DISPLAYS, PANELS, VIEWGRAPHS)

2 Product Directory

CHICAGO MINIATURE LAMP WORKS
4433 N Ravenswood Ave, Chicago, Ill 60640
COMPUTER CONVERSIONS CORP.
6 Dunton Court, E Northport, N Y 11731
COMPUTER CORP. OF AMERICA
6216 Evergreen St, Houston, Tex 77036
CONRAC CORP. CONRAC DIV.
600 N Rimsdale Ave, Covina, Cal 91722
CONSOLIDATED CONTROLS CORP.
15 Durant Ave, Bethel, Conn 06801
CONTROL DATA CORP. MAGNETIC COMPONENTS DIV.
2300 Berkshire Lane, Minneapolis, Minn 55427
CONTROL TECHNOLOGY CO., INC.
41-16 29th St, Long Island Cty, N Y 11101
DATA GRAPHICS CORP.
8402 Speedway, San Antonio, Tex 78230
DIALIGHT CORP.
60 Stewart Ave, Brooklyn, N Y 11237
DIGITAL PRODUCTS CORP.
6950 NW 12 Ave, Ft Lauderdale, Fla 33309
DYTRO CORP.

63 Tec St, Hicksville, N Y 11801
ELECTRONIC RESEARCH CO., A TEXTRON CO.
10000 W 75th St, Shawnee Mission, Kan 66202
FERRANTI PACKARD LTD., ELECTRONICS DIV.
121 Industry St, Toronto 15, CANADA
GAP INSTRUMENT CORP.
110 Marcus Blvd, Hauppauge, N Y 11787
GENERAL ELECTRIC CO. TUBE DEPARTMENT
316 E 9th St, Owensboro, Ky 42301
GRALEX INDUSTRIES DIV. GENL. MICROWAVE CORP
155 Marine St, Farmingdale, N Y 11735
HAYDON SWITCH&INSTRUMENT INC. SUB. TRI-TECH
INC.

1500 Meriden Rd, Waterbury, Conn 06720
INFO-LITE CORP.
2337 Lemoine Ave, Fort Lee, N J 07024
INSTRULAB INC.
1205 Lamar St, Dayton, Ohio 45404
INSTRUMENT DISPLAYS INC. SUB. KELTRON CORP.
223 Crescent St, Waltham, Mass 02154
LEM INSTRUMENT CORP.
20 Sarah Dr, Farmingdale, N Y 11735
LUMINETICS CORP.

P O Box 1943, Pompano Beach, Fla 33061
MASTER SPECIALTIES CO.
1640 Monrovia, Costa Mesa, Cal 92627
NATIONWIDE ELECTRONIC SYSTEMS INC.
7, N 662 Rte 53, Itasca, Ill 60143
NOVATRONICS OF CANADA LTD.
677 Erie St, Stratford Ont, CANADA
PENN KEYSTONE CORP.
Division St, Ansonia, Conn 06401
RANK PRECISION INDUSTRIES INC.
260 N Rt 303, W Nyack, N Y 10994
RCA ELECTRONIC COMPONENTS DIV.
415 S 5th St, Harrison, N J 07029
READOUTS INC.

P O Box 149, Del Mar, Cal 92014
SIGMATRON INC.
849 Ward Dr, Santa Barbara, Cal 93102
SINGER-GENERAL PRECISION KEARFOTT DIV.
1150 McBride Ave, Little Falls, N J 07424
SYSTREX CORP.
303 Child St, Rochester, N Y 14611
TEC INC.
6700 S Wash Ave, Eden Prairie, Minn 55343
VEEDER-ROOT
70 Sargeant St, Hartford, Conn 06102
VERNITRON CORP. MOTOR PRODUCTS DIV.
300 Marcus Blvd, Deer Park, N Y 11729

INDICATORS, ELAPSED TIME

A. W. HAYDON CO., THE
232 N Elm St, Waterbury, Conn 06720
AVCO CORP. ELECTRONICS DIV.
4807 Bradford, Huntsville, Ala 35805
BAILEY METER CO. SUB. BABCOCK&WILCOX
29801 Euclid Ave, Wickliffe, Ohio 44092
BERGEN LABORATORIES INC. SUB. ZYROTRON INC.
60 Spruce St, Paterson, N J 07501
BOWMAR CANADA LTD.
1257 Algoma Rd, Ottawa Ont, CANADA
COMPUTER CORP. OF AMERICA
6216 Evergreen St, Houston, Tex 77036
CONRAC CORP.
330 Madison Ave, New York, N Y 10017
CONRAC CORP. CONRAC DIV.
600 N Rimsdale Ave, Covina, Cal 91722
CONRAC CORP. CRAMER DIV.
Mill Rock Rd, Old Saybrook, Conn 06475
CURTIS INSTRUMENTS INC.
200 Kisco Ave, Mt Kisco, N Y 10549

ELECTRONIC RESEARCH CO., A TEXTRON CO.
10000 W 75th St, Shawnee Mission, Kan 66202
GENERAL TIME CORP. IND. CONTROLS DIV.
Rte 8, Torrington, Conn 06790
HAYDON SWITCH&INSTRUMENT INC. SUB. TRI-TECH
INC.
1500 Meriden Rd, Waterbury, Conn 06720
INFO-LITE CORP.
2337 Lemoine Ave, Fort Lee, N J 07024
INSTRUMENT DISPLAYS INC. SUB. KELTRON CORP.
223 Crescent St, Waltham, Mass 02154
JEWELL ELECTRICAL INSTRUMENTS INC.
Grenier Field, Manchester, N H 03105
MASSEY DICKINSON CO. INC.
9 Elm St, Saxonville, Mass 01701
METRIC SYSTEMS CORP.
736 N Beal St, Ft Walton Beach, Fla 32548
NATIONWIDE ELECTRONIC SYSTEMS INC.
7 N 662 Rte 53, Itasca, Ill 60143
NON-LINEAR SYSTEMS INC.
P O Box N, Del Mar, Cal 92014

INDICATORS, ILLUMINATED

ALCO ELECTRONIC PRODUCTS INC.
8 Marblehead St, North Andover, Mass 01845
AMP INC.
Eisenhower Blvd, Harrisburg, Pa 17105
AMPEREX ELECTRONIC CORP. A NO AMERICAN
PHILIPS CO
P O Box 98, Slatersville, R I 02876
ANALOGIC CORP.
Audubon Rd, Wakefield, Mass 01880
AVCO CORP. ELECTRONICS DIV.
4807 Bradford, Huntsville, Ala 35805
BAILEY METER CO. SUB. BABCOCK&WILCOX
29801 Euclid Ave, Wickliffe, Ohio 44092
BENDIX MOSAIC FABRICATIONS DIV.
Galileo Park, Sturbridge, Mass 01518
BOWMAR CANADA LTD.
1257 Algoma Rd, Ottawa Ont, CANADA
CHICAGO MINIATURE LAMP WORKS
4433 N Ravenswood Ave, Chicago, Ill 60640
CLARE-PENDAR CO.
P O Box 785, Post Falls, Ind 83854
COMPU-LITE CORP.
17795 Sky Park Cir, Irvine, Cal 92664
COMPUTER CORP. OF AMERICA
6216 Evergreen St, Houston, Tex 77036
CONTROL TECHNOLOGY CO., INC.
41-16 29th St, Long Island Cty, N Y 11101
CONTROLS CO. AMERICA-SINGER CONTROL SWITCH
DIV.

1420 Delmar Dr, Folcroft, Pa 19032
CO-ORD SWITCH CO., DIV. LVC INDUSTRIES, INC.
102-48 43rd Ave, Corona, N Y 11368
DIALIGHT CORP.
60 Stewart Ave, Brooklyn, N Y 11237
DRAKE MANUFACTURING CO.
4626 N Olcott Ave, Harwood Heights, Ill 60656
GAP INSTRUMENT CORP.
110 Marcus Blvd, Hauppauge, N Y 11787
GENERAL ELECTRIC CO. TUBE DEPARTMENT
316 E 9th St, Owensboro, Ky 42301
GRAYHILL INC.
561 Hillgrove Ave, La Grande, Ill 60525
HARVEY INDUSTRIAL DIV.
60 Crossway Pk W, Woodbury Li, N Y 11797
HAYDON SWITCH&INSTRUMENT INC. SUB. TRI-TECH
INC.

1500 Meriden Rd, Waterbury, Conn 06720
ILLINOIS TOOL WORKS INC. LICON DIV.
6615 W Irving Park, Chicago, Ill 60634
INFO-LITE CORP.
2337 Lemoine Ave, Fort Lee, N J 07024
INSTRUMENT DISPLAYS INC. SUB. KELTRON CORP.
223 Crescent St, Waltham, Mass 02154
KORRY MANUFACTURING CO.
223-8th Ave N, Seattle, Wash 98109
LAMPS INC. SUB. OAK ELECTRO-NETICS CORP
19220 S Normandie Ave, Torrance, Cal 90502
NOVATRONICS OF CANADA LTD.
677 Erie St, Stratford Ont, CANADA
PENN KEYSTONE CORP.
Division St, Ansonia, Conn 06401
RCA ELECTRONIC COMPONENTS DIV.
415 S 5th St, Harrison, N J 07029
READOUTS INC.
P O Box 149, Del Mar, Cal 92014
RISK INDUSTRIES INC., GEORGE
P O Box 1035, Kimball, Nebr 69145
SIGMATRON INC.
849 Ward Dr, Santa Barbara, Cal 93102

SINGER-GENERAL PRECISION KEARFOTT DIV.
1150 McBride Ave, Little Falls, N J 07424
STACOSWITCH INC.
1139 Baker St, Costa Mesa, Cal 92626
TEC INC.
6700 S Wash Ave, Eden Prairie, Minn 55343
UNIMAX SWITCH CORP. SUB. RIKER-MAXSON
Ives Rd, Wallingford, Conn 06492
VEEDER-ROOT
70 Sargeant St, Hartford, Conn 06102
VEMALINE PRODUCTS CO. INC.
P O Box 3, Wyckoff, N J 07481

INFORMATION UTILITIES (SEE COMMERCIAL TIME SHARING SERVICES)

INPUT-OUTPUT CONVEYORS, PUNCHED CARD

ACME VISIBLE RECORDS INC.
510 Allview Dr, Crozet, Va 22932

INSTALLATION PLANNING (SEE CONSULTING)

INSTRUCTIONAL SYSTEMS, COMPUTER-BASED

ABT ASSOCIATES INC. TECHNOLOGY GROUP
55 Wheeler St, Cambridge, Mass 02138
ADTECH INC.
P O Box 10415, Honolulu, Haw 96816
APPLIED COMPUTER TIME SHARE INC.
29200 Southfield Rd, Southfield, Mich 48075
APPLIED DYNAMICS COMPUTER SYS DV RELIANCE
ELEC CO
P O Box 1488, Ann Arbor, Mich 48106
COMPUTER SYSTEMS CO. INC.
1470 St Charles Ave, Cleveland, Ohio 44107
CONSAD RESEARCH CORP.
5600 Forward Ave, Pittsburgh, Pa 15217
CTC COMPUTER CORP.
1000 Elwell Court, Palo Alto, Cal 94303
CYTEK INFORMATION SYSTEMS CORP.
366 5th Ave, New York, N Y 10001
DENELCOR INC.
5975 Broadway, Denver, Colo 80216
DIGITAL EQUIPMENT CORP.
146 Main St, Maynard, Mass 01754
DIGITAL PRODUCTS CORP.
6950 NW 12 Ave, Ft Lauderdale, Fla 33309
ENTELEK INC.
42 Pleasant St, Newburyport, Mass 01950
FRIDEN DIV. THE SINGER CO.
97 Humboldt St, Rochester, N Y 14602
HONEYWELL INFORMATION SYSTEMS INC. INFO.
SERV.DIV
2701 4th Ave S, Minneapolis, Minn 55408
HOUSTON ENGINEERING RESEARCH CORP.
P O Box 35495, Houston, Tex 77035
HOUSTON RESEARCH INC. SUB. SCI. ELECT.
6001 Gulf Fwy, Houston, Tex 77023
IAC COMPUTER SYSTEMS INC.
260 Newton Rd, Plainview, N Y 11803
INFOTON INC.
2nd Ave, Burlington, Mass 01803
MARK/OPS DIV., NORTH EASTERN SYSTEMS ASSOC.
INC.
475 Commonwealth Ave, Boston, Mass 02215
MICRO SYSTEMS INC.
644 E Young St, Santa Ana, Cal 92705
NATIONAL ELECTRO-MECHANICAL SYSTEMS INC.
32 Broad Ave, Binghamton, N Y 13904
PROGRAMMING SCIENCES CORP.
S E 42 St, New York, N Y 10016
PROGRAMMING SCIENCES CORP.
1900 Ave of The Stars, Los Angeles, Cal 90067
REL-QUAL ASSOCIATES INC.
18 Hamilton St, Bound Brook, N J 08805
SCIENTIFIC SYSTEMS SERVICES INC.
476 N Hwy A1a, Satellite Beach, Fla 32935
SCIENTIFIC TIME SHARING CORP.
2101 S St NW, Washington, D C 20008
SYSTEM DEVELOPMENT CORP.
2500 Colorado Ave, Santa Monica, Cal 90406
TIME SHARE CORP.
3 Lebanon St, Hanover, N H 03755
WANG LABORATORIES INC.
836 N St, Tewksbury, Mass 01876

2 Product Directory

WARREN ASSOCIATES
15 Royal Crest Dr, Marlboro, Mass 01752
WEISMANTEL INC.
P O Box 1957, St Paul, Minn 55111
WESTINGHOUSE ELECTRIC CORP.
Westinghouse Bldg, Pittsburgh, Pa 15222
WORLDWIDE COMPUTER SERVICES, INC.
280 N Central Pk Ave, Hartsdale, N Y 10530

INTEGRATED CIRCUIT MODULES (SEE MODULES)

INTEGRATED CIRCUITS (SEE CIRCUITS)

INVERTERS, DC-AC

A. W. HAYDON CO., THE
232 N Elm St, Waterbury, Conn 06720
ALTEC DIV., LTV LING ALTEC INC.
1515 So Manchester Av, Anaheim, Cal 92803
ANALOGIC CORP.
Audubon Rd, Wakefield, Mass 01880
ARNOLD MAGNETICS CORP.
P O Box K, Culver City, Cal 90230
AUSTRON, INC.
10214 N Interregional, Austin, Tex 78753
BASLER ELECTRIC CO.
Rte 143, Highland, Ill 62249
BULOVA WATCH ELECTRONICS DIV.
6120 Woodside Ave, Woodside Li, N Y 11377
CARTER MOTOR CO.
2711 W George St, Chicago, Ill 60618
COMPUTER LOGIC CORP.
1528 20th St, Santa Monica, Cal 90404
CONTROL TECHNOLOGY CO., INC.
41-16 29th St, Long Island City, N Y 11101
DEL ELECTRONIC CORP.
250 Sandford Blvd, Mt Vernon, N Y 10550
DYNAMIC INSTRUMENTS CORP.
115 W Bethpage Rd, Plainview, N Y 11803
ELECTRIC INDICATOR CO. INC.
195 Danbury Rd, Wilton, Conn 06897
ELGAR CORP.
8159 Engineer Rd, San Diego, Cal 92111
ELNETIC ELECTRONICS INC.
2100 Zeno Pl, Venice, Cal 90291
GULTON INDUSTRIES INC.
212 Durham Ave, Metuchen, N J 08840
LORAIN PRODUCTS CORP.
1122 F St, Lordin, Ohio 44052
MICROTRAN COMPANY INC.
145 E Mineola Ave, Valley Stream, N Y 11582
MIDEASTERN INDUSTRIES, INC. DIV. EANCO INC.
P O Box 186, Scotch Plains, N J 07076
RHO ENGINEERING CO.
2234 Colby Ave, Los Angeles, Cal 90064
SLOAN CO., THE
7704 San Fernando Rd, Sun Valley, Cal 91352
SPACETAC INC.
Burlington Rd, Bedford, Mass 01730
STATIC PRODUCTS INC.
2511 National Dr, Garland, Tex 75040
TECHNIPOWER INC. SUB. BENRUS CORP.
Benrus Center, Ridgefield, Conn 06877
TELEDYNE BROWN ENGINEERING
300 Sparkman Dr, Huntsville, Ala 35807
VARO INC. STATIC POWER DIV.
1600 Dallas Pkwy, Plano, Tex 75074
WANLASS ELECTRIC CO.
1815 S Ritohey St, Santa Ana, Cal 92705

I/O TERMINALS (SEE DATA TERMINALS)

JACKS, JACK PANELS, PLUGS, ASSEMBLIES

ADC PRODUCTS
4900 W 78th St, Minneapolis, Minn 55435
ALDEN PRODUCTS CO.
117 N Main St, Brockton, Mass 02401
AUGAT INC.
33 Perry Ave, Attleboro, Mass 02703
CAMBRIDGE THERMIONIC CORP.
445 Concord Ave, Cambridge, Mass 02138
ELECTRONIC MOLDING CORP.
96 Mill St, Woonsocket, R I 02895

FEDERAL SCREW PRODUCTS INC.
3917 N Kedzie Ave, Chicago, Ill 60618
GRAYHILL INC.
561 Hillgrove Ave, La Grande, Ill 60525
HARVEY INDUSTRIAL DIV.
60 Crossway Pk W, Woodbury Li, N Y 11797
HYPERTRONICS CORP.
50 Hunt St, Watertown, Mass 02172
INTERDYNE
2217 Purdue Ave, Los Angeles, Cal 90064
JOHNSON CO., E.F.
299 Tenth Ave SW, Waseca, Minn 56093
KEYSTONE ELECTRONICS CORP.
49 Bleecker St, New York, N Y 10012
LITTON PRECISION PRODUCTS USECO DIV.
13536 Saticoy St, Van Nuys, Cal 91409
MALLORY & CO. INC., P.R.
3029 E Washington, Indianapolis, Ind 46218
METHODE ELECTRONICS INC.
7447 W Wilson Ave, Chicago, Ill 60656
MICRODOT INC. CONNECTOR & CABLE DIV.
220 Pasadena Ave, S Pasadena, Cal 91030
MULTIPLEX COMMUNICATIONS INC.
123 Marcus Blvd, Hauppauge, N Y 11787
NATIONAL TEL-TRONICS
55 Northern Blvd, Great Neck, N Y 11021
NORRICH PLASTIC CORP.
200 Allen Blvd, Farmingdale, N Y 11575
POMONA ELECTRONICS CO. INC.
1500 E 9th St, Pomona, Cal 91766
RAYTHEON CO. INDUSTRIAL COMPONENT OPERATION
465 Centre St., Quincy, Mass 02169
ROBINSON-NUGENT INC.
800 E 8th St, New Albany, Ind 47150
SWITCHCRAFT INC.
5555 N Elston Ave, Chicago, Ill 60630
TRANSITRON ELECTRONIC CORP.
168 Albion St, Wakefield, Mass 01880
TROMPETER ELECTRONICS INC.
8936 Comanche Ave, Chatsworth, Cal 91311
VECTOR ELECTRONIC CO. INC.
12460 Gladstone Ave, Sylmar, Cal 91342
VIRGINIA ELECTRONICS CO. INC.
2901 Telestar Court, Falls Church, Va 22042
VIRGINIA PANEL CORP.
1400 N Hope Rd, Waynesboro, Va 22980

KEYBOARD ENCODERS (SEE ENCODERS)

KEYBOARD TELEPRINTERS (SEE DATA TERMINALS)

KEYPUNCH PERFORMANCE AIDS (SEE AIDS)

KEYBOARD-TO-TAPE/DISC DATA ENTRY EQUIPMENT (SEE ENCODERS)

KNOBS, DIALS (FOR COMPUTER CONSOLES)

ALCO ELECTRONIC PRODUCTS INC.
8 Marblehead St, North Andover, Mass 01845
FEDERAL SCREW PRODUCTS INC.
3917 N Kedzie Ave, Chicago, Ill 60618
HARVEY INDUSTRIAL DIV.
60 Crossway Pk W, Woodbury Li, N Y 11797
LITTON PRECISION PRODUCTS USECO DIV.
13536 Saticoy St, Van Nuys, Cal 91409
NORRICH PLASTIC CORP.
200 Allen Blvd, Farmingdale, N Y 11575
RAYTHEON CO. INDUSTRIAL COMPONENT OPERATION
465 Centre St., Quincy, Mass 02169
STACOSWITCH INC.
1139 Baker St, Costa Mesa, Cal 92626
STERLING INSTRUMENT DIV. DESIGNATRONICS INC.
55 S Denton Ave, New Hyde Park, N Y 11040
THETA INSTRUMENT CORP.
24 Dwight Pl, Fairfield, N J 07006
V.I.Z. MANUFACTURING CO.
335 E Price St, Philadelphia, Pa 19144

VEMALINE PRODUCTS CO. INC.
P O Box 3, Wyckoff, N J 07481

LABELS, CONTINUOUS AND GUMMED (MACHINE APPLICATION)

ACCURATE BUSINESS FORMS CO., INC.
P O Box 8339, Milwaukee, Wis 53225
ACME VISIBLE RECORDS INC.
510 Allview Dr, Crozet, Va 22932
ACRATOD COMPANY
Po Box 66847, Houston, Tex 77006
ALLEN HOLLANDER DIV. LITTON INDUS.
E 64 Midland Ave, Paramus, N J 07652
ALLISON COUPON COMPANY, INC.
200 S Capitol, Indianapolis, Ind 46206
AMERICAN BUSINESS FORMS INC.
114 S Canal St, Chicago, Ill 60606
AVERY LABEL CO.
777 E Foothill Blvd, Azusa, Cal 91702
BALTIMORE BUSINESS FORMS INC.
3132 Frederick Ave, Baltimore, Md 21229
BONNAR-VAWTER INC.
96 Dunbar St, Keene, N H 03431
BURROUGHS CORP., BUSINESS FORMS & SUPPLIES
1150 Univ Ave, Rochester, N Y 14607
BUSINESS SUPPLIES CORP. OF AMERICA
475 5th Ave, New York, N Y 10017
CHESHIRE INC. A XEROX CORP.
408 Washington Blvd, Mundelein, Ill 60060
COMPUTER ACCESSORIES CO.
131 W 154th St, Gardena, Cal 90248
CURTIS 1000 INC.
1000 Curtis Dr, Smyrna, Ga 30080
CYBERMATICS INC.
2460 Lemoine Ave, Fort Lee, N J 07024
DATA DOCUMENTS INC.
105 S 70th St, Omaha, Nebr 68132
DIAMOND SYSTEMS INC.
24638 NW Hwy, Southfield, Mich 48075
ECCO BUSINESS SYSTEMS INC.
50 E 42nd St, New York, N Y 10017
EUREKA CO. DIV. LITTON INDUS.
Dunham Dr, Dunmore, Pa 18512
FRIDEN DIV. THE SINGER CO.
97 Humboldt St, Rochester, N Y 14602
HACKETT CORP.
2100 W Fullerton Ave, Chicago, Ill 60647
HANO CO. INC., PHILIP
99 Guion St, Springfield, Mass 01104
INTERNATIONAL COMPUTERS LTD.
Icl House Putney, London S W 15, UNITED K
INTERNATIONAL SYSTEMS ASSOCIATES, LTD.
350 5th Ave, New York, N Y 10001
JERSEY TAB CARD CORP.
649 Rahway Ave, Union, N J 07083
KIMBALL SYSTEMS DIV. LITTON INDUS.
151 Cortlandt St, Belleville, N J 07109
LABEL HOUSE INC., THE
155 W Wisconsin Ave, Pewaukee, Wisc 53072
3M CO.
3m Center, St Paul, Minn 55101
MACS COMPUTER ACCESSORIES INC
104 Park Towne Pl, Philadelphia, Pa 19130
MONARCH MARKING SYSTEMS SUB. PITNEY-BOWES
Byers Rd, Dayton, Ohio 45401
MOORE BUSINESS FORMS INC.
110-112 Pkwy Inn Bldg, Niagara Falls, N Y 14302
NCR INDUSTRIA PRODUCTS DIV.
Main And K St, Dayton, Ohio 45409
NORMANDIE DATAFORMS
41-10 22nd St, Long Is Cy, N Y 11101
NUMERIDEX TAPE SYSTEMS INC.
4711 W North Ave, Chicago, Ill 60639
OCHMAN SYSTEMS, EDWARD
Po Box 141, Fairfield, Conn 06430
ORIGINAL COMPUTER PRODUCTS INC.
204 Worcester St, Wellesley Hills, Mass 02181
PAPER MANUFACTURERS CO.
9800 Bustleton Ave, Philadelphia, Pa 19115
PRYOR COMPUTER INDUSTRIES
400 N Michigan Ave, Chicago, Ill 60611
SCANFORMS INC.
312 Fox Pavilion, Jenkintown, Pa 19095
SMEAD MANUFACTURING CO.
600 E 10th St, Hastings, Minn 55033
STANDARD REGISTER CO., THE
626 Albany St, Dayton, Ohio 45401
STINAFFS INC.
181 E Exchange St, Akron, Ohio 44304
STURGIS NEWPORT BUSINESS FORMS INC.
P O Box 31, Sturgis, Mich 49091
VISIBLE COMPUTER SUPPLY CORP.
9865 Derby Ln, Westchester, Ill 60153

2 Product Directory

WALLACE BUSINESS FORMS INC.
4600 W Roosevelt Rd, Hillside, Ill 60162
WORKMAN BUSINESS FORMS INC.
7220 Wilson Ave, Chicago, Ill 60656

LABELS, CONTINUOUS AND PRESSURE SENSITIVE (MACHINE APPLICATION)

ACCURATE BUSINESS FORMS CO., INC.
P O Box 8339, Milwaukee, Wis 53225
ALLEN HOLLANDER DIV. LITTON INDUS.
E 64 Midland Ave, Paramus, N J 07652
AMERICAN BUSINESS FORMS INC.
114 S Canal St, Chicago, Ill 60606
AVERY LABEL CO.
777 E Foothill Blvd, Azusa, Cal 91702
BONNAR-VAWTER INC.
96 Dunbar St, Keene, N H 03431
BURROUGHS CORP., BUSINESS FORMS & SUPPLIES
1150 Univ Ave, Rochester, N Y 14607
DATA DOCUMENTS INC.
105 S 70th St, Omaha, Nebr 68132
ECCO BUSINESS SYSTEMS INC.
50 E 42nd St, New York, N Y 10017
EUREKA CO. DIV. LITTON INDUS.
Dunham Dr, Dunmore, Pa 18512
FRIDEN DIV. THE SINGER CO.
97 Humboldt St, Rochester, N Y 14602
HACKETT CORP.
2100 W Fullerton Ave, Chicago, Ill 60647
HANO CO. INC., PHILIP
99 Guion St, Springfield, Mass 01104
INFOTRAN INC.
860 Fifth Ave, New York, N Y 10021
INTERNATIONAL COMPUTERS LTD.
Ici House Putney, London S W 15, UNITED K
KIMBALL SYSTEMS DIV. LITTON INDUS.
151 Cortlandt St, Belleville, N J 07109
LABEL HOUSE INC., THE
155 W Wisconsin Ave, Pewaukee, Wisc 53072
MACS COMPUTER ACCESSORIES INC
104 Park Towne Pl, Philadelphia, Pa 19130
MONARCH MARKING SYSTEMS SUB. PITNEY-BOWES
Byers Rd, Dayton, Ohio 45401
MOORE BUSINESS FORMS INC.
110-112 Pkwy Inn Bldg, Niagara Falls, N Y 14302
MORLEY CO., THE
909 Islington St, Portsmouth, N H 03801
NCR INDUSTRIAL PRODUCTS DIV.
Main And K St, Dayton, Ohio 45409
NORMANDIE DATAFORMS
41-10 22nd St, Long Is Cy, N Y 11101
ORIGINAL COMPUTER PRODUCTS INC.
204 Worcester St, Wellesley Hills, Mass 02181
PRYOR COMPUTER INDUSTRIES
400 N Michigan Ave, Chicago, Ill 60611
STANDARD REGISTER CO., THE
626 Albany St, Dayton, Ohio 45401
VISIBLE COMPUTER SUPPLY CORP.
9865 Derby Ln, Westchester, Ill 60153
WALLACE BUSINESS FORMS INC.
4600 W Roosevelt Rd, Hillside, Ill 60162

LAMPS, GLOW

ALCO ELECTRONIC PRODUCTS INC.
8 Marblehead St, North Andover, Mass 01845
COMPU-LITE CORP.
17795 Sky Park Cir, Irvine, Cal 92664
CO-ORD SWITCH CO., DIV. LVC INDUSTRIES, INC.
102-48 43rd Ave, Corona, N Y 11368
DIALIGHT CORP.
60 Stewart Ave, Brooklyn, N Y 11237
DRAKE MANUFACTURING CO.
4626 N Olcott Ave, Harwood Heights, Ill 60656
INFO-LITE CORP.
2337 Lemoine Ave, Fort Lee, N J 07024
LAMPS INC. SUB. OAK ELECTRO-NETICS CORP
19220 S Normandie Ave, Torrance, Cal 90502
PENN KEYSTONE CORP.
Division St, Ansonia, Conn 06401
VEMALINE PRODUCTS CO. INC.
P O Box 3, Wyckoff, N J 07481

LAMPS-PANEL, PILOT AND DIAL (INCANDESCENT)

ALCO ELECTRONIC PRODUCTS INC.
8 Marblehead St, North Andover, Mass 01845
ALDEN PRODUCTS CO.
117 N Main St, Brockton, Mass 02401
AMP INC., SYSCOM DIV.
P O Box 3608, Harrisburg, Pa 17105
BENDIX MOSAIC FABRICATIONS DIV.
Galileo Park, Sturbridge, Mass 01518
CHICAGO MINIATURE LAMP WORKS
4433 N Ravenswood Ave, Chicago, Ill 60640
CLARE-PENDAR CO.
P O Box 785, Post Falls, Ind 83854
COMPU-LITE CORP.
17795 Sky Park Cir, Irvine, Cal 92664
CONTROLS CO. AMERICA-SINGER CONTROL SWITCH DIV.
1420 Delmar Dr, Folcroft, Pa 19032
CO-ORD SWITCH CO., DIV. LVC INDUSTRIES, INC.
102-48 43rd Ave, Corona, N Y 11368
DIALIGHT CORP.
60 Stewart Ave, Brooklyn, N Y 11237
DISPLAY DEVICES INC.
P O Box 667, Encinitas, Cal 92024
DRAKE MANUFACTURING CO.
4626 N Olcott Ave, Harwood Heights, Ill 60656
HARVEY INDUSTRIAL DIV.
60 Crossway Pk W, Woodbury Li, N Y 11797
HUDSON LAMP CO.
528 Elm St, Kearny, N J 07032
INDUSTRIAL DEVICES INC.
982 River Rd, Edgewater, N J 07020
INFO-LITE CORP.
2337 Lemoine Ave, Fort Lee, N J 07024
JOHNSON CO., E.F.
299 Tenth Ave SW, Waseca, Minn 56093
LAMPS INC. SUB. OAK ELECTRO-NETICS CORP
19220 S Normandie Ave, Torrance, Cal 90502
LEECRAFT MANUFACTURING CO.
21-16 44th Rd, Long Island, N Y 11378
NUCLEONIC PRODUCTS CO. INC.
6660 Variel Ave, Canoga Park, Cal 91303
PENN KEYSTONE CORP.
Division St, Ansonia, Conn 06401
PINLITES INC.
P O Box 453, Caldwell, N J 07006
SLOAN CO., THE
7704 San Ferrando Rd, Sun Valley, Cal 91352
STACOSWITCH INC.
1139 Baker St, Costa Mesa, Cal 92626
TEC INC.
6700 S Wash Ave, Eden Prairie, Minn 55343
TRANSITRON ELECTRONIC CORP.
168 Albion St, Wakefield, Mass 01880
VEMALINE PRODUCTS CO. INC.
P O Box 3, Wyckoff, N J 07481
WAGNER ELECTRIC CORP.
630 W Mt Pleasant Ave, Livingston, N J 07039
WELCH ALLYN INC.
99 Jordan Rd, Skaneateles Fls, N Y 13153

LANGUAGE PROCESSORS (SEE PROGRAMMING LANGUAGE DEVELOPMENT)

LARGE SCALE INTEGRATION (SEE CIRCUITS)

LEASING, EDP EQUIPMENT (OTHER THAN MFGRS)

AMERICAN COMPUTER LEASING CORP.
14 E 4th St, Cincinnati, Ohio 45202
AMERICAN COMPUTER SERVICES CORP.
14 E 4th St, Cincinnati, Ohio 45202
BUSINESS COMPUTERS INC.
10844 Shady Trail, Dallas, Tex 75220
CHANDLER LEASING CORP.
101 Hartwell Ave, Lexington, Mass 02173
CIT LEASING CORP.
650 Madison Ave, New York, N Y 10022
COMPUMATICS INC.
327 S Lasalle St, Chicago, Ill 60604
COMPUTE AMERICA CORP. DBA COMERICA
1515 Classen Blvd, Oklahoma City, Okla 73106
COMPUTER CENTER, INC.,
350 Royal Palm Way, Palm Beach, Fla 33480

BUY - RENT - LEASE EDP EQUIPMENT & COMPLETE SYSTEMS

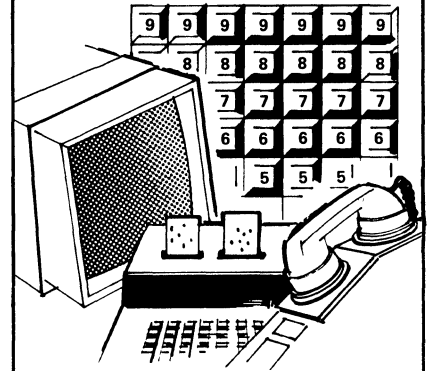

DataServ is the West's largest, best-stocked, factory-approved supplier of EDP terminals, peripherals, and interfaces of every description.

The DataServ staff of experienced equipment consultants and EDP system designers provides expert technical assistance, from completely objective advice on EDP equipment selection to the design and installation of complete EDP systems.

A complete array of support services are available to every DataServ customer at all times, from routine maintenance and operator training to the design and installation of complete turn-key systems. The specific support services required for any EDP installation may be determined and provided as a package that is incorporated into the overall financial arrangements.

DataServ provides EDP equipment, support services, and complete systems *on your terms*. . . lease, rental, or outright purchase.

For more information on how to get the EDP system or equipment you need — and get it on your terms — see DataServ catalog insert.

DATA SERV

Burlingame, California
Denver • Salt Lake City • Seattle •
Phoenix • Los Angeles.
One of the PURDY group of companies

2 Product Directory

COMPUTER EXCHANGE INC., THE
30 E 42nd St, New York, N Y 10017
COMPUTER INVESTMENTS & LEASING CORP.
9 Tanner St, Haddonfield, N J 08033
COMPUTER MEASUREMENTS CO.
12970 Bradley Ave, San Fernando, Cal 91342
COMPUTER PROCESSING INC.
200 Manhattan Bldg, Muskogee, Okla 74401
COMPUTER RESOURCES INC.
5091 W 164th St, Cleveland, Ohio 44142
COMPUTER SCIENCES CORP. INFO. NETWORK DIV.
1901 Building, Los Angeles, Cal 90067
COMPUTER USAGE CORP.
100 Putman Green, Greenwich, Conn 06830
CONDATA INC.
1809 Walnut St, Philadelphia, Pa 19103
CTM LEASING CORP.
4924 Hampden Lane, Bethesda, Md 20014
CURRAN COMPUTER CORP.
946 Main St, Hackensack, N J 07601
CUSTOM DATA PROCESSING SERVICES
P O Box 14685, Phoenix, Ariz 85031
CYBERMATICS INC.
2460 Lemoine Ave, Fort Lee, N J 07024
DASA CORP./CYBER-TRONICS SUB. DASA CORP.
15 Stevens St., Andover, Mass 01810
DATA DIMENSIONS INC.
51 Weaver St, Greenwich, Conn 06830
DATA FUNDING INC.
Station Square 2, Paoli, Pa 19301
DATA PROCESSING AND ACCOUNTING SERVICES
50 Van Ness Ave, San Francisco, Cal 94102
DATASERV DIV., WILLIAM J. PURDY CORP.
770 Airport Blvd, Burlingame, Cal 94010
DIEBOLD COMPUTER LEASING INC.
Park 80 Plaza E, Saddle Brook, N J 07667
DIRECT ACCESS COMPUTING CORP.
984 Livernois Rd, Troy, Mich 48084
DYNAMIC ACCESS CORP.
220 Park Ave S, New York, N Y 10003
EDP RESOURCES, INC.
One North Broadway, White Plains, N Y 10601
EICO ELECTRONIC INSTRUMENT CO INC.
283 Malta St, Brooklyn, N Y 11207
GMA COMPUTER CORP.
320 Yonker Ave, Yonkers, N Y 10701
GREYHOUND COMPUTER CORP.
130 S Canal St, Chicago, Ill 60606
GTE DATA SERVICES INC.
5422 Bay Center Dr, Tampa, Fla 33609
INFORMATION PROCESSING SYSTEMS INC.
467 Sylvan Ave, Englewood Cliff, N J 07632
LEASCO DATA PROCESSING EQUIPMENT CORP.
280 Park Ave, New York, N Y 10017
MACS COMPUTER ACCESSORIES INC
104 Park Towne Pl, Philadelphia, Pa 19130
MAI EQUIPMENT CORP.
300 E 44th St, New York, N Y 10017
MCLAUGHLIN ASSOC. INC./GEORGE
785 Springfield Ave, Summit, N J 07901
MULTITECH DATA PRODUCTS
583 Monterey Pass Rd, Monterey Park, Cal 91754
ORIGINAL COMPUTER PRODUCTS INC.
204 Worcester St, Wellesley Hills, Mass 02181
PENNDATA CORP.
1729 Cedar Ave, Scranton, Pa 18505
RANDOLPH COMPUTER CORP.
537 Steamboat Rd, Greenwich, Conn 06830
SCIENTIFIC LEASING INC.
77 Meadowgate, Wethersfield, Conn 06109
STANDARD PROCESSING CO. INC.
P O Box 703, Pharr, Tex 78577
SUMMIT COMPUTER CORP.
785 Springfield Ave, Summit, N J 07901
TIME BROKERS INC.
380 Lexington Ave, New York, N Y 10017
UNIVERSITY COMPUTING CO.
P O Box 6228, Dallas, Tex 75222
WORLD COMPUTER CORP.
1615 Stemmons Fwy, Dallas, Tex 75221

LIGHT PENS (FOR CRT TERMINAL INPUT/OUTPUT)

BENDIX MOSAIC FABRICATIONS DIV.
Galileo Park, Sturbridge, Mass 01518
COMPUTER COMMUNICATION INC.
701 W Manchester Blvd, Inglewood, Cal 90301
CONTROL DATA CORP.
8100 34th Ave S, Minneapolis, Minn 55440
DIGITAL EQUIPMENT CORP.
146 Main St, Maynard, Mass 01754
DOLAN JENNER INDUSTRIES INC.
200 Ingall Court, Melrose, Mass 02176

ELECTRO FIBEROPTICS CORP.
99 Hartwell St, West Boylston, Mass 01583
INFORMATION CONTROL CORP.
9610 Bellanca Ave, Los Angeles, Cal 90045
TENNECOMP SYSTEMS INC.
795 Oak Ridge Tpk, Oak Ridge, Tenn 37830
WELCH ALLYN INC.
99 Jordan Rd, Skaneateles Fls, N Y 13153

LINE PRINTERS (SEE PRINTERS)

LOGIC MODULES (SEE MODULES)

MAGNETIC CARD READERS (SEE READERS)

MAGNETIC DISCS & DRUMS

BURTON MAGNEKOTE INC.
11334 Playa St, Culver City, Cal 90230

MAGNETIC DISC CONTROLLERS (SEE CONTROLLERS)

MAGNETIC DISC DRIVES (SEE DISC DRIVES)

MAGNETIC DISC PACKS (SEE DISC PACKS)

MAGNETIC DRUM EQUIPMENT (SEE DRUM STORAGE EQUIPMENT AND MEMORIES)

MAGNETIC TAPE CONTROLLERS (SEE CONTROLLERS)

MAGNETIC TAPE DRIVES (SEE TAPE TRANSPORTS)

MAGNETIC TAPE STORAGE SYSTEMS (INCLUDES CONTROLLER)

ANDERSON JACOBSON INC.
1065 Morse Ave., Sunnyvale, Cal 94086
APPLIED COMPUTER SYSTEMS INC.
P O Box 6479, Austin, Tex 78702
ASTRO-SCIENCE CORP.
9700 Factorial Way, S El Monte, Cal 91734
BELL & HOWELL ELECTRONICS & INSTRUMENTS GROUP
360 Sierra Madre Vill, Pasadena, Cal 91109
BORG WARNER CONTROLS DIV. BORG WARNER
3300 S Halladan St, Santa Ana, Cal 92702
BRIGHT INDUSTRIES INC.
1 Maritime Plaza, San Francisco, Cal 94111
BUCODE INC.
175 Engineers Dr, Hauppauge, N Y 11787
COMPAT CORP.
177 Cantiague Rock Rd, Westbury, N Y 11590
COMPUCORD INC.
225 Crescent St, Waltham, Mass 02154
COMPUTER ACCESSORIES CO.
131 W 154th St, Gardena, Cal 90248
COMPUTER CORP. OF AMERICA
6216 Evergreen St, Houston, Tex 77036
COMPUTER OPERATIONS INC.
10774 Tucker St, Beltsville, Md 20705
CONTROL DATA CORP.
8100 34th Ave S, Minneapolis, Minn 55440
DACOM INC.
1060 Morse Ave, Sunnyvale, Cal 94086
DACIONIS
925 Thompson Pl, Sunnyvale, Cal 94086
DATA RECORDING SYSTEMS/SUB. NEWELL IND.
795 Kifer Rd, Sunnyvale, Cal 94086
DATA SYSTEMS DESIGN INC.
1122 University Ave, Berkeley, Cal 94702
DATACOM INC.
40 Lincoln Dr, Ft Walton Beach, Fla 32548

DATASONICS INC.
P O Box 4553, New York, N Y 10017
DATUM INC.
170 E Liberty Ave, Anaheim, Cal 92801
ECLECTIC COMPUTER CORP.
3707 Rawlins Ste 301, Dallas, Tex 75219
ELDORADO ELECTRODATA
601 Chalomar Rd, Concord, Cal 94520
FUJITSU LTD. N.Y.LIAISON OFFICE
680 Fifth Ave, New York, N Y 10019
HEWLETT PACKARD CO.
1501 Page Mill Rd, Palo Alto, Cal 94304
HEWLETT PACKARD CO. CUPERTINO DIV.
1100 Wolfe Rd, Cupertino, Cal 95014
HEWLETT PACKARD CO. MOUNTAIN VIEW DIV.
690 Middlefield Rd, Mtn View, Cal 94040
HONEYWELL INFORMATION SYSTEMS
P O Box 12313, Oklahoma City, Okla 73112
IBM CORP./DATA PROCESSING DIV.
1133 Westchester Ave, White Plains, N Y 10604
INFOTEC INC.
70 Newton Rd, Plainview, N Y 11803
INTERNATIONAL COMPUTER PRODUCTS INC.
P O Box 34484, Dallas, Tex 75234
K&M ELECTRONICS CO.
109 Hopkins Pl, Baltimore, Md 21201
KENNEDY CO.
540 W Woodbury Rd, Altadena, Cal 91001
LIVERMORE DATA SYSTEMS INC.
2050 Research Dr, Livermore, Cal 94550
3M CO.
3m Center, St Paul, Minn 55101
MACS COMPUTER ACCESSORIES INC
104 Park Towne Pl, Philadelphia, Pa 19130
MARK COMPUTER SYSTEMS INC.
One Patterson Pl, Garden City, N Y 11530
MICRODATA CORP.
644 E Young St, Santa Ana, Cal 92705
MOBARK INSTRUMENTS CORP.
1038 Evelyn, Sunnyvale, Cal 94086
NEWELL INDUSTRIES
795 Kifer Rd, Sunnyvale, Cal 94086
NEWMADE PRODUCTS CORP.
P O Box 568, Scarsdale, N Y 10583
PER DATA
102 New South Rd, Hicksville, N Y 11801
PERIPHERAL DATA MACHINES INC.
102 New S Rd, Hicksville, N Y 11801
POTTER INSTRUMENT CO. INC.
532 Broadhollow Rd, Melville, N Y 11746
RAYCON INC.
218 Brunswick Blvd, Pointe Claire, CANADA
RAYMOND ENGINEERING INC./DIV. RAYMOND PREC. INC.
217 Smith St, Middletown, Conn 06457
ROLM CORP.
10300 N Tantau, Cupertino, Cal 95014
SCHULTZ INSTRUMENTS INC.
P O Box 13385, Gainesville, Fla 32601
SYKES DATATRONICS INC.
375 Orchard St, Rochester, N Y 14606
SYNCOM INC. SHIELDATA DIV.
1914 Colvin Ave, Tonawanda, N Y 14150
SYSTEMS CONCEPTS INC.
524 2nd St, San Francisco, Cal 94107
TELECTRO SYSTEMS CORP.
96-18 43rd Ave, Corona, N Y 11368
TELEX COMPUTER PRODUCTS
6422 E 41st St, Tulsa, Okla 74135
TENNECOMP SYSTEMS INC.
795 Oak Ridge Tpk, Oak Ridge, Tenn 37830
TEXAS INSTRUMENTS INC. DIGITAL SYSTEMS DIV
P O Box 66027, Houston, Tex 77006
UNICOM INC.
1275 Bloomfield Ave, Fairfield, N J 07006
UNICOMP INC.
18219 Parthenia, Northridge, Cal 91324
WANG COMPUTER PRODUCTS INC.
2000 Stoner Ave, Los Angeles, Cal 90272
WEISMANTEL INC.
P O Box 1957, St Paul, Minn 55111
WESTERN TELEMATIC INC.
5507 Peck Rd, Arcadia, Cal 91006
WILTEK INC.
59 Danbury Rd, Wilton, Conn 06897

MAILERS, PUNCHED CARD

ACME VISIBLE RECORDS INC.
510 Allview Dr, Crozet, Va 22932
AMES SAFETY ENVELOPE CO.
21 Properzi Way, Somerville, Mass 02145
MOORE BUSINESS FORMS INC.
110-112 Pkwy Inn Bldg, Niagara Falls, N Y 14302

2 Product Directory

ORIGINAL COMPUTER PRODUCTS INC.
204 Worcester St, Wellesley Hills, Mass 02181
VISIBLE COMPUTER SUPPLY CORP.
9865 Derby Ln, Westchester, Ill 60153

MARK SENSING EQUIPMENT

ADDRESSOGRAPH MULTIGRAPH CORP BRUNING DIV.
1200 Babbitt Rd, Cleveland, Ohio 44117
BENDIX MOSAIC FABRICATIONS DIV.
Galileo Park, Sturbridge, Mass 01518
BOURNS INC.
1200 Columbia Ave., Riverside, Cal 92507
BRIDGE DATA PRODUCTS INC.
738 S 42nd St, Philadelphia, Pa 19104
COMPUTER-LINK CORP.
14 Cambridge St, Burlington, Mass 01803
DATA GENERAL CORP.
Rte 9, Southboro, Mass 01772
DATATYPE CORP.
1050 NW 163rd Dr, Miami, Fla 33169
DI/AN CONTROLS INC.
944 Dorchester Ave, Boston, Mass 02125
DOLAN JENNER INDUSTRIES INC.
200 Ingall Court, Melrose, Mass 02176
ELECTRONIC MICRO SYSTEMS INC.
1672 Kaiser Ave, Santa Ana, Cal 92705
FARRINGTON MANUFACTURING CO.
6707 Electronics Dr, Springfield, Va 22151
FERRANTI PACKARD LTD., ELECTRONICS DIV.
121 Industry St, Toronto 15, CANADA
FIBER PHOTICS INC.
2557 Soquel Dr, Santa Cruz, Cal 95060
FUJITSU LTD. N.Y. LIAISON OFFICE
680 Fifth Ave, New York, N Y 10019
HEWLETT PACKARD CO. CUPERTINO DIV.
1100 Wolfe Rd, Cupertino, Cal 95014
HICKOK ELECTRICAL INSTRUMENT CO.
10514 Dupont Ave, Cleveland, Ohio 44108
HYBRID SYSTEMS DIV. DIGITAL RESOURCES CORP.
4301 Dacoma Rd, Houston, Tex 77018
IBM CORP., DATA PROCESSING DIV.
1133 Westchester Ave, White Plains, N Y 10604
INFOTON INC.
2nd Ave, Burlington, Mass 01803
MEKONTROL INC.
56 Hudson St, Northboro, Mass 01532
NCR INDUSTRIAL PRODUCTS DIV.
Main And K St, Dayton, Ohio 45409
REPUBLIC INFORMATION SYSTEMS INC.
9732 Cozycroft Ave, Chatsworth, Cal 91311
SCAN-OPTICS INC.
22 Prestige Park, E Hartford, Conn 06108
SKAN-A-MATIC CORP.
P O Drawer 68, Skaneateles, N Y 13152
UNITED BUSINESS COMMUNICATIONS INC.
6405 Metcalf Ave, Shawnee Mission, Kans 66202

MARK SENSING SUPPLIES

ALLISON COUPON COMPANY, INC.
200 S Capitol, Indianapolis, Ind 46206
CURRAN COMPUTER CORP.
946 Main St, Hackensack, N J 07601
OCHMAN SYSTEMS, EDWARD
Po Box 141, Fairfield, Conn 06430
SPECTRONICS INC.
541 Sterling Dr, Richardson, Tex 75080
SYNCOM INC. SHIELDATA DIV.
1914 Colvin Ave, Tonawanda, N Y 14150

MEMORY CORES (SEE CORES)

MEMORY EXERCISERS (SEE TESTERS)

MEMORY PLANES AND STACKS, MAGNETIC CORE (W/O ELECTRONICS)

AMPEX CORP. COMPUTER PRODUCTS DIV.
9937 W Jefferson Blvd, Culver City, Cal 90230
BURROUGHS CORP., BUSINESS MACHINES GROUP
6071 2nd Ave, Detroit, Mich 48232
CORE MEMORIES INC.
2525 Charleston Rd, Mt View, Cal 94041
DATA PRODUCTS CORP.
16055 Ventura Blvd, Encino, Cal 91316
DATACRAFT CORP.
1200 NW 70 St, Ft Lauderdale, Fla 33307

DATARAM CORP.
Rte 206, Princeton, N J 08540
ELECTRONIC MEMORIES
12621 Chadron Ave, Hawthorne, Cal 90250
FABRI-TEK INC.
5901 S County Rd 18, Minneapolis, Minn 55436
FERROXCUBE CORP.
Po Box 359, Saugerties, N Y 12477
LOCKHEED ELECTRONICS CO. DATA PRODUCTS DIV.
6201 E Randolph St, Los Angeles, Cal 90650
LOCKHEED ELECTRONICS CO. DIV. LOCKHEED ACRTF CORP.
U S Hwy 22, Plainfield, N J 07060
MEMORY TECHNOLOGY INC.
83 Boston Post Rd, Sudbury, Mass 01776
NESS PACIFIC INC.
470 N San Antonio Rd, Palo Alto, Cal 94306
PLESSEY MEMORY PRODUCTS CORP.
1674 McGaw Ave, Santa Ana, Cal 92705
QUADRI CORP.
2959 W Fairmount, Phoenix, Ariz 85017
RAYTHEON CO. EQUIPMENT DIV.
528 Boston Post Rd, Sudbury, Mass 01776
RCA MEMORY PRODUCTS DIV.
150 A St, Needham Heights, Mass 02194
STANDARD MEMORIES INC.
15130 Ventura Blvd, Sherman Oak, Cal 91403
UNITED TELECONTROL ELEXS & INC. MEMORY SYS DIV.
3500 Sunset Ave, Asbury Park, N J 07712
WANG LABORATORIES INC.
836 N St, Tewksbury, Mass 01876
WEISMANTEL INC.
P O Box 1957, St Paul, Minn 55111

MEMORY PLANES AND STACKS, PLATED WIRE (W/O ELECTRONICS)

FERROXCUBE CORP.
Po Box 359, Saugerties, N Y 12477
FLEXIBLE CIRCUITS INC.
Paul Valley Ind Pk, Warrington, Pa 18976
FORTIN LAMINATING
1323 Truman St, San Fernando, Cal 91340
LOCKHEED ELECTRONICS CO. DATA PRODUCTS DIV.
6201 E Randolph St, Los Angeles, Cal 90650
LOCKHEED ELECTRONICS CO. DIV. LOCKHEED ACRTF CORP.
U S Hwy 22, Plainfield, N J 07060
MEMORY SYSTEMS INC.
3341 W El Segundo Blvd, Hawthorne, Cal 90250
NEMONIC DATA SYSTEMS INC.
1301 W 3rd Ave, Denver, Colo 80223
NORTH AMERICAN ROCKWELL CORP. AUTONETICS DIV.
3370 Miraloma Ave, Anaheim, Cal 92803
PLESSEY MEMORY PRODUCTS CORP.
1674 McGaw Ave, Santa Ana, Cal 92705
RAYTHEON CO. EQUIPMENT DIV.
528 Boston Post Rd, Sudbury, Mass 01776
WEISMANTEL INC.
P O Box 1957, St Paul, Minn 55111

MEMORY PLANES AND STACKS, THIN FILM

SIGNAL GALAXIES INC.
6955 Hayvenhurst Ave, Van Nuys, Cal 91406

MEMORY SYSTEMS, DELAY LINE

ALLEN AVIONICS INC.
255 E 2nd St, Mineola, N Y 11501
ANDERSEN LABS
Blue Hills Ave, Bloomfield, Conn 06002
BAGANOFF ASSOCIATES INC.
6809 W Florissant, St Louis, Mo 63136
BELFUSE INC.
198 Van Vorst St, Jersey City, N J 07302
COMPUTER DEVICES CORP.
63 Austin Blvd, Commack, N Y 11725
CORNING GLASS WORKS
Houghton Park, Corning, N Y 14830
ENGINEERED COMPONENTS CO.
2134 W Rosecrans Ave, Gardena, Cal 90249
GENERAL INSTRUMENT CORP., F W SICKLES DIV.
165 Front St, Chicopee, Mass 01014
MICROSONICS DIV. SANGAMO ELECTRIC CO
60 Winter St, Weymouth, Mass 02188
NORTH AMERICAN ROCKWELL CORP. AUTONETICS DIV.
3370 Miraloma Ave, Anaheim, Cal 92803

MEMORY PRODUCTS from United Telecontrol

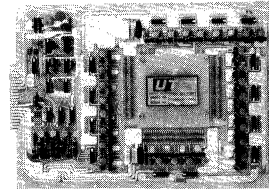

MODEL 5033
4K X 1

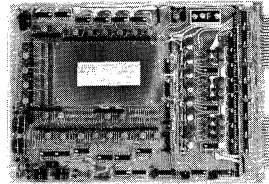

MODEL 5034
1K X 8

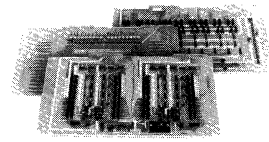

MODEL 5036
4K X 18

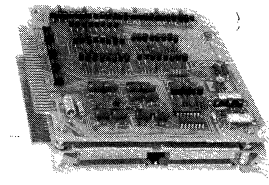

MODEL 5037
256 X 18

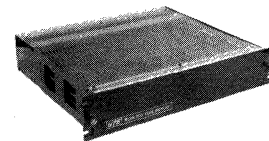

MODEL 1030
4K X 18

CUSTOM CORE ARRAYS

Commercial and Military

UTE UNITED TELECONTROL ELECTRONICS

3500 Sunset Ave., Asbury Park, N.J. 07712
201-922-1000

2 Product Directory

PLESSEY MEMORY PRODUCTS CORP.
1674 McGaw Ave, Santa Ana, Cal 92705
SPRAGUE ELECTRIC CO.
551 Marshall St, N Adams, Mass 01247
TYCO LABORATORIES INC.
16 Hickory Dr, Waltham, Mass 02154
TYCO LABORATORIES INC. DIGITAL DEVICES DIV
200 Michael Dr, Syosset, N Y 11791
UNIVERSAL AD-YU ELECTRONICS INC.
249-259 Terhune Ave, Passaic, N J 07055
VALOR ELECTRONICS INC.
3100 Pullman St, Costa Mesa, Cal 92627

MEMORY SYSTEMS, DIODE

DATAPAC INC.
3839 S Main St, Santa Ana, Cal 92702
DIONICS INC.
65 Rushmore St, Westburn, N Y 11590
MEMORY TECHNOLOGY INC.
83 Boston Post Rd, Sudbury, Mass 01776
MICRO SYSTEMS INC.
644 E Young St, Santa Ana, Cal 92705
MICRODATA CORP.
644 E Young St, Santa Ana, Cal 92705
SOLITRON DEVICES INC. TRANSISTOR DIV.
1177 Blue Heron Blvd, Riviera Beach, Fla 33404

MEMORY SYSTEMS, MAGNETIC CORE

AMPEX CORP. COMPUTER PRODUCTS DIV.
9937 W Jefferson Blvd, Culver City, Cal 90230
ATRON CORP.
1256 Trapp Rd, St Paul, Minn 55118
AZTEC DATA SYSTEMS
P O Box Cr, Irvine, Cal 92664
BURROUGHS CORP., BUSINESS MACHINES GROUP
6071 2nd Ave, Detroit, Mich 48232
CAMBRIDGE MEMORIES INC.
285 Newtonville Ave, Newton, Mass 02160
CORE MEMORIES INC.
2525 Charleston Rd, Mt View, Cal 94041
CUSTOM COMPUTER SYSTEMS INC.
40 South Mall, Plainville, N Y 11803
DATA GENERAL CORP.
Rte 9, Southboro, Mass 01772
DATA PRODUCTS CORP.
16055 Ventura Blvd, Encino, Cal 91316
DATACRAFT CORP.
1200 NW 70 St, Ft Lauderdale, Fla 33307
DATAPAC INC.
3839 S Main St, Santa Ana, Cal 92702
DATARAM CORP.
Rte 206, Princeton, N J 08540
DI/AN CONTROLS INC.
944 Dorchester Ave, Boston, Mass 02125
ELECTRONIC MEMORIES
12621 Chadron Ave, Hawthorne, Cal 90250
FABRI-TEK INC.
5901 S County Rd 18, Minneapolis, Minn 55436
FERROXUCUBE CORP.
Po Box 359, Saugerties, N Y 12477
IBM CORP., DATA PROCESSING DIV.
1133 Westchester Ave, White Plains, N Y 10604
INFORMATION CONTROL CORP.
9610 Bellanca Ave, Los Angeles, Cal 90045
LITTON SYSTEMS INC. GUIDANCE & CONTROL
SYS. DIV.
5500 Canoga Ave, Woodland Hills, Cal 91364
LOCKHEED ELECTRONICS CO. DATA PRODUCTS DIV.
6201 E Randolph St, Los Angeles, Cal 90650
LOCKHEED ELECTRONICS CO. DIV. LOCKHEED ACRFT
CORP
U S Hwy 22, Plainfield, N J 07060
MEMORY TECHNOLOGY INC.
83 Boston Post Rd, Sudbury, Mass 01776
MICRO SYSTEMS INC.
644 E Young St, Santa Ana, Cal 92705
MICRODATA CORP.
644 E Young St, Santa Ana, Cal 92705
PLESSEY MEMORY PRODUCTS CORP.
1674 McGaw Ave, Santa Ana, Cal 92705
QUADRI CORP.
2959 W Fairmount, Phoenix, Ariz 85017
RAYTHEON CO. EQUIPMENT DIV.
528 Boston Post Rd, Sudbury, Mass 01776
RCA MEMORY PRODUCTS DIV
150 A St, Needham Heights, Mass 02194
ROLM. CORP.
10300 N Tantau, Cupertino, Cal 95014
SANDERS ASSOCIATES INC. SYSTEMS DIV.
Daniel Webster Hwy S, Nashua, N H 03060
SINGER-GENERAL PRECISION KEARFOTT DIV.
1150 McBride Ave, Little Falls, N J 07424

SPACETAC INC.
Burlington Rd, Bedford, Mass 01730
STANDARD COMPUTER CORP.
633 Young St, Santa Ana, Cal 92705
STANDARD LOGIC INC.
1630 S Lyon St, Santa Ana, Cal 92705
STANDARD MEMORIES INC.
15130 Ventura Blvd, Sherman Oak, Cal 91403
UNICOM INC.
1275 Bloomfield Ave, Fairfield, N J 07006
UNICOMP INC.
18219 Parthenia, Northridge, Cal 91324
UNITED TELECOMM. ELEXS & INC. MEMORY SYS
DIV
3500 Sunset Ave, Asbury Park, N J 07712
WEISMANTEL INC.
P O Box 1957, St Paul, Minn 55111

MEMORY SYSTEMS, MAGNETIC DISC

ALPHA DATA INC.
8759 Remmet Ave, Canoga Park, Cal 91304
ANSLEY MANUFACTURING CO. SUB. THOMAS &
BETTS
4100 N Figueroa St, Los Angeles, Cal 90065
APPLIED MAGNETICS CORP. COMPUTER MEMORY DIV
75 Robin Hill Rd, Goleta, Cal 93017
BCD COMPUTING CORP.
100 E Industry Court, Deer Park, N Y 11729
BRYANT COMPUTER PRODUCTS DIV. EX-CELL-O CORP
850 Ladd Rd, Walled Lake, Mich 48088
BURROUGHS CORP., BUSINESS MACHINES GROUP
6071 2nd Ave, Detroit, Mich 48232
BURROUGHS CORP., OEM PRODUCT SALES
1649 Wilshire Blvd, Los Angeles, Cal 90017
BURTON MAGNEKOTE INC.
11334 Playa St, Culver City, Cal 90230
CALIFORNIA COMPUTER PRODUCTS INC.
2411 W La Palma Ave, Anaheim, Cal 92801
CENTURY DATA SYSTEMS INC.
1630 S St Collg Blvd, Anaheim, Cal 92806
COMPUTER PERIPHERALS CORP.
5037 Ruffner St, San Diego, Cal 92111
COMPUTER SPECIALTIES CORP.
87 Burlew Ct, Hackensack, N J 07601
CONTROL DATA CORP.
8100 34th Ave S, Minneapolis, Minn 55440
DATA DISC INC.
686 W Maude Ave, Sunnyvale, Cal 94086
DATA MEMORY INC.
1400 Terra Bella Ave, Mt View, Cal 94040
DATA PRODUCTS CORP.
16055 Ventura Blvd, Encino, Cal 91316
DATA SYSTEMS DESIGN INC.
1122 University Ave, Berkeley, Cal 94702
DIGITAL DEVELOPMENT CORP.
5575 Kearny Villa Rd, San Diego, Cal 92123
DIGITAL INFORMATION STORAGE CORP.
100 Carter, Berlin, Mass 01503
DYNACOUSTICS INC.
1980 National Ave, Hayward, Cal 94545
EDGERTON GERMESHAUSEN GRIER INC.
Crosby Dr, Bedford, Mass 01730
ENGINEERED DATA PERIPHERALS CORP.
1701 Colorado Ave, Santa Monica, Cal 90404
FRIDEN DIV. THE SINGER CO.
97 Humboldt St, Rochester, N Y 14602
IBM CORP., DATA PROCESSING DIV.
1133 Westchester Ave, White Plains, N Y 10604
INFORMATION DATA SYSTEMS INC.
7550 Walnut Lake Rd, Walled Lake, Mich 48088
INFOTECHNICS INC.
15730 Stage St, Van Nuys, Cal 91406
IOMEC INC.
345 Mathew St, Santa Clara, Cal 95050
KEMPER ENGINEERING CO.
9337 Shoshone Ave, Northridge, Cal 91324
LIBRASCOPE DIV. THE SINGER CO
808 Western Ave, Glendale, Cal 91201
MAGNAFILE INC.
2602 E Magnolia, Phoenix, Ariz 85034
MARSHALL DATA SYSTEMS DIV. MARSHALL
INDUSTRIES
2065 Huntington Dr, San Marino, Cal 91103
MICRO SYSTEMS INC.
644 E Young St, Santa Ana, Cal 92705
MICRODATA CORP.
644 E Young St, Santa Ana, Cal 92705
NCR INDUSTRIAL PRODUCTS DIV.
Main And K St, Dayton, Ohio 45409
NORTH AMERICAN ROCKWELL CORP. AUTONETICS
DIV.
3370 Miraloma Ave, Anaheim, Cal 92803

PER DATA
102 New South Rd, Hicksville, N Y 11801
SCIENTIFIC DATA SYSTEMS ISRAEL LTD.
Po Box 5101, Haifa, ISRAEL
SINGER-GENERAL PRECISION INC. LIBRASCOPE
PROD. DIV.
1100 Frances Ct, Glendale, Cal 91201
UNICOMP INC.
18219 Parthenia, Northridge, Cal 91324
WABASH COMPUTER CORP. PI DIV.
10202 N 19th St, Phoenix, Ariz 85021
WEISMANTEL INC.
P O Box 1957, St Paul, Minn 55111

MEMORY SYSTEMS, MAGNETIC DRUM

AMERICAN TOTALISATOR CO. UNI-TOTE DIV.
383 Hillen Rd, Towson, Md 21204
ANSLEY MANUFACTURING CO. SUB. THOMAS &
BETTS
4100 N Figueroa St, Los Angeles, Cal 90065
BRYANT COMPUTER PRODUCTS DIV. EX-CELL-O CORP
850 Ladd Rd, Walled Lake, Mich 48088
BURTON MAGNEKOTE INC.
11334 Playa St, Culver City, Cal 90230
COMPUTER SPECIALTIES CORP.
87 Burlew Ct, Hackensack, N J 07601
CONTROL DATA CORP.
8100 34th Ave S, Minneapolis, Minn 55440
DATUM INC.
170 E Liberty Ave, Anaheim, Cal 92801
IBM CORP., DATA PROCESSING DIV.
1133 Westchester Ave, White Plains, N Y 10604
IER CORP.
P O Box 5537, Arlington, Va 22205
INFORMATION DATA SYSTEMS INC.
7550 Walnut Lake Rd, Walled Lake, Mich 48088
MADATRON CORP.
P O Box 172, Princeton, N J 08540
MICRO SYSTEMS INC.
644 E Young St, Santa Ana, Cal 92705
UNICOMP INC.
18219 Parthenia, Northridge, Cal 91324
VERMONT RESEARCH CORP.
Precision Park, N Springfield, Vt 05150
WEISMANTEL INC.
P O Box 1957, St Paul, Minn 55111

MEMORY SYSTEMS, OPTICAL

ANDERSEN LABS
Blue Hills Ave, Bloomfield, Conn 06002
OPTICAL MEMORY SYSTEMS
1520 So Lyon St, Santa Ana, Cal 92705
PRECISION INSTRUMENT CO. UNICOM DIV.
3170 Porter Dr, Palo Alto, Cal 94304

MEMORY SYSTEMS, PLATED WIRE

ANSLEY MANUFACTURING CO. SUB. THOMAS &
BETTS
4100 N Figueroa St, Los Angeles, Cal 90065
COHN CORP., SIGMUND
1215 Columbus Ave, Mt Vernon, N Y 10553
COMPACE CORP.
7413 Washington Ave S, Edina-Minnepols, Minn
55435
LITTON SYSTEMS INC. DATA SYSTEMS DIV.
8000 Woodley Ave, Van Nuys, Cal 91409
LOCKHEED ELECTRONICS CO. DATA PRODUCTS DIV.
6201 E Randolph St, Los Angeles, Cal 90650
LOCKHEED ELECTRONICS CO. DIV. LOCKHEED ACRFT
CORP
U S Hwy 22, Plainfield, N J 07060
MEMORY SYSTEMS INC.
3341 W El Segundo Bld, Hawthorne, Cal 90250
MOTOROLA INC. GOVERNMENT ELECTRONICS DIV.
8201 E Mc Dowell Rd, Scottsdale, Ariz 85252
NEMONIC DATA SYSTEMS INC.
1301 W 3rd Ave, Denver, Colo 80223
NORTH AMERICAN ROCKWELL CORP. AUTONETICS
DIV.
3370 Miraloma Ave, Anaheim, Cal 92803
PLESSEY MEMORY PRODUCTS CORP.
1674 McGaw Ave, Santa Ana, Cal 92705
PRECISION MAGNETICS INC.
504 S 11th Ave, Minneapolis, Minn 55415
RAYTHEON CO. EQUIPMENT DIV.
528 Boston Post Rd, Sudbury, Mass 01776
SONICRAFT INC.
8437 S Burley Ave, Chicago, Ill 60619
SPACETAC INC.
Burlington Rd, Bedford, Mass 01730

2 Product Directory

STANDARD MEMORIES INC.
15130 Ventura Blvd, Sherman Oak, Cal 91403
TOKO N. Y. INC. SUB. OF TOKO INC. TOKYO
350 5th Ave, New York, N Y 10001
WEISMANTEL INC.
P O Box 1957, St Paul, Minn 55111

MEMORY SYSTEMS, READ-ONLY

ADVANCED MEMORY SYSTEMS INC.
1276 Hammerwood Ave, Sunnyvale, Cal 94086
AMPEX CORP. COMPUTER PRODUCTS DIV.
9937 W Jefferson Blvd, Culver City, Cal 90230
ATRON CORP.
1256 Trapp Rd, St Paul, Minn 55118
AZTEC DATA SYSTEMS
P O Box Cr, Irvine, Cal 92664
CLARE-PENDAR CO.
P O Box 785, Post Falls, Ind 83854
COGAR CORP. TECHNOLOGY DIV.
All Angels Rd, Wappinger Falls, N Y 12590
COLLINS RADIO CO.
19700 Jamboree Blvd, Newport Beach, Cal 92663
DATA GENERAL CORP.
Rte 9, Southboro, Mass 01772
DATAPAC INC.
3839 S Main St, Santa Ana, Cal 92702
EDGERTON GERMESHAUSEN GRIER INC.
Crosby Dr, Bedford, Mass 01730
ELECTRON OHIO INC.
1278 W 9th St, Cleveland, Ohio 44113
ELECTRONIC ARRAYS INC.
501 Ellis St, Mt View, Cal 94040
ELECTRONIC MEMORIES
12621 Chadron Ave, Hawthorne, Cal 90250
ENERGY CONVERSION DEVICES INC
1675 W Maple Rd, Troy, Mich 48084
GENERAL INSTRUMENT CORP. MICROELECT. DIV.
600 W. John St, Hicksville, N Y 11802
INTEGRAL DATA DEVICES INC.
35 Orville Dr, Bohemia, N Y 11716
INTERDATA
2 Crescent Pl, Oceanport, N J 07757
INTERSIL INC.
10900 N Tantu, Cupertino, Cal 95014
KENICS SYSTEMS CORP.
125 Harvard St, Cambridge, Mass 02139
LITTON SYSTEMS INC. DATA SYSTEMS DIV.
8000 Woodley Ave, Van Nuys, Cal 91409
LOCKHEED ELECTRONICS CO. DATA PRODUCTS DIV.
6201 E Randolph St, Los Angeles, Cal 90650
MARK COMPUTER SYSTEMS INC.
One Patterson Pl, Garden City, N Y 11530
MEMORY SYSTEMS INC.
3341 W El Segundo Bld, Hawthorne, Cal 90250
MEMORY TECHNOLOGY INC.
83 Boston Post Rd, Sudbury, Mass 01776
MICRO SYSTEMS INC.
644 E Young St, Santa Ana, Cal 92705
MICRODATA CORP.
644 E Young St, Santa Ana, Cal 92705
MOS TECHNOLOGY INC.
Valley Forge Ind Park, Valley Forge, Pa 19406
NATIONAL SEMICONDUCTOR CORP.
2900 Semicon Dr, Santa Clara, Cal 95051
NEMONIC DATA SYSTEMS INC.
1301 W 3rd Ave, Denver, Colo 80223
NORTH AMERICAN ROCKWELL CORP. AUTONETICS DIV.
3370 Miraloma Ave, Anaheim, Cal 92803
OPTICAL MEMORY SYSTEMS
1520 So Lyon St, Santa Ana, Cal 92705
PLESSEY MEMORY PRODUCTS CORP.
1674 McGaw Ave, Santa Ana, Cal 92705
PRECISION MAGNETICS INC.
504 S 11th Ave, Minneapolis, Minn 55415
QUADRI CORP.
2959 W Fairmount, Phoenix, Ariz 85017
ROLM. CORP.
10300 N Tantau, Cupertino, Cal 95014
SIGNETICS CORP. SUB. CORNING GLASS
811 E Arques Ave, Sunnyvale, Cal 94086
SOLITRON DEVICES INC.
256 Oak Tree Rd, Tappan, N Y 10983
SOLITRON DEVICES INC.
8808 Balboa Ave, San Diego, Cal 92123
SOLITRON DEVICES INC. TRANSISTOR DIV.
1177 Blue Heron Blvd, Riviera Beach, Fla 33404
SONICRAFT INC.
8437 S Burley Ave, Chicago, Ill 60619
SYS COMPUTER CORP.
17-25 Dicarolis Court, Hackensack, N J 07601
TOKO N. Y. INC. SUB. OF TOKO INC. TOKYO
350 5th Ave, New York, N Y 10001

ALPHA DATA HAS A 128 TRACK MIND.

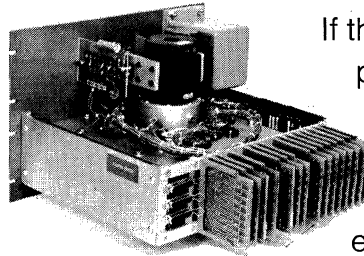

If that is too many for your present needs, we have a starter unit with only sixteen. If you need more later, it is easily expandable. With all of these features our magnetic disc memory is still the best buy in the industry:

- Head lifters to eliminate disc contact starts and stops.
- 8.4 milliseconds average access time.
- Sealed construction.
- Choice of interfaces — bit serial or parallel.



8759 Remmet Avenue, Canoga Park, California 91304 • (213) 882-6500

2 Product Directory

UNICOM INC.
1275 Bloomfield Ave, Fairfield, N J 07006
UNICOMP INC.
18219 Parthenia, Northridge, Cal 91324
VARIAN DATA MACHINES
2722 Michelson Dr, Irvine, Cal 92664

MEMORY SYSTEMS, SEMICONDUCTOR

ADVANCED MEMORY SYSTEMS INC.
1276 Hammerwood Ave, Sunnyvale, Cal 94086
ADVANCED MICRO DEVICES INC.
901 Thompson Pl, Sunnyvale, Cal 94086
AMPEX CORP. COMPUTER PRODUCTS DIV.
9937 W Jefferson Blvd, Culver City, Cal 90230
COGAR CORP. TECHNOLOGY DIV.
All Angels Rd, Wappinger Falls, N Y 12590
COMPUTER MICROTECHNOLOGY INC.
P O Box 7050, Sunnyvale, Cal 94086
DATAPAC INC.
3839 S Main St, Santa Ana, Cal 92702
DIONICS INC.
65 Rushmore St, Westburn, N Y 11590
FAIRCHILD SEMICONDUCTOR
464 Ellis St, Mt View, Cal 94040
HARRIS SEMICONDUCTOR A DIV. OF
HARRIS-INTERTYPE
P O Box 883, Melbourne, Fla 32901
INTEL CORP.
365 Middlefield Rd, Mt View, Cal 94040
INTERSIL INC.
10900 N Tantau, Cupertino, Cal 95014
KENICS SYSTEMS CORP.
125 Harvard St, Cambridge, Mass 02139
MARK COMPUTER SYSTEMS INC.
One Patterson Pl, Garden City, N Y 11530
MEMORY TECHNOLOGY INC.
83 Boston Post Rd, Sudbury, Mass 01776
MICRODATA CORP.
644 E Young St, Santa Ana, Cal 92705
QUADRI CORP.
2959 W Fairmount, Phoenix, Ariz 85017
ROLM, CORP.
10300 N Tantau, Cupertino, Cal 95014
SEMICONDUCTOR ELECTRONIC MEMORIES INC.
3883 N 28th Ave, Phoenix, Ariz 85017
SIGNETICS CORP. SUB. CORNING GLASS
811 E Arques Ave, Sunnyvale, Cal 94086
SOLITRON DEVICES INC.
256 Oak Tree Rd, Tappan, N Y 10983
SOLITRON DEVICES INC. TRANSISTOR DIV.
1177 Blue Heron Blvd, Riviera Beach, Fla 33404
SPRAGUE ELECTRIC CO.
551 Marshall St, N Adams, Mass 01247

MEMORY SYSTEMS, SEMICONDUCTOR (MOS)

ADVANCED MEMORY SYSTEMS INC.
1276 Hammerwood Ave, Sunnyvale, Cal 94086
AMERICAN ASTRONICS INC., SUB TECHNICOLOR INC.
855 No Cahuenga Blvd, Hollywood, Cal 90038
AMERICAN MICRO-SYSTEMS INC.
3800 Homestead Rd, Santa Clara, Cal 95051
AMPEX CORP. COMPUTER PRODUCTS DIV.
9937 W Jefferson Blvd, Culver City, Cal 90230
CAMBRIDGE MEMORIES INC.
285 Newtonville Ave, Newton, Mass 02160
COGAR CORP. TECHNOLOGY DIV.
All Angels Rd, Wappinger Falls, N Y 12590
COLLINS RADIO CO.
19700 Jamboree Blvd, Newport Beach, Cal 92663
COMPUTER DESIGN CORP.
12401 W Olympic Blvd, Los Angeles, Cal 90064
COMPUTER MICROTECHNOLOGY INC.
P O Box 7050, Sunnyvale, Cal 94086
COMPUTER SIGNAL PROCESSORS INC.
209 Middlesex Tpk, Burlington, Mass 01803
DATA GENERAL CORP.
Rte 9, Southboro, Mass 01772
DATAPAC INC.
3839 S Main St, Santa Ana, Cal 92702
ELECTRONIC ARRAYS INC.
501 Ellis St, Mt View, Cal 94040
FAIRCHILD SEMICONDUCTOR
464 Ellis St, Mt View, Cal 94040
GENERAL INSTRUMENT CORP. MAGNE-HEAD DIV.
13040 Cerise Ave, Hawthorne, Cal 90250
GENERAL INSTRUMENT CORP. MICROELECT. DIV.
600 W John St, Hicksville, N Y 11802
INTEL CORP.
365 Middlefield Rd, Mt View, Cal 94040

INTERNATIONAL DATA SYSTEMS INC.
162 Great Rd, Acton, Mass 01720
INTERSIL INC.
10900 N Tantau, Cupertino, Cal 95014
KENICS SYSTEMS CORP.
125 Harvard St, Cambridge, Mass 02139
LITTON SYSTEMS INC. DATA SYSTEMS DIV.
8000 Woodley Ave, Van Nuys, Cal 91409
MACRODATA CO.
20440 Corrisco St, Chatsworth, Cal 91311
MARK COMPUTER SYSTEMS INC.
One Patterson Pl, Garden City, N Y 11530
MEMORY TECHNOLOGY INC.
83 Boston Post Rd, Sudbury, Mass 01776
METRA INSTRUMENTS INC.
1340 Space Park Way, Mt View, Cal 94040
MICRODATA CORP.
644 E Young St, Santa Ana, Cal 92705
MOS TECHNOLOGY INC.
Valley Forge Ind Park, Valley Forge, Pa 19406
NATIONAL SEMICONDUCTOR CORP.
2900 Semicon Dr, Santa Clara, Cal 95051
NORTH AMERICAN ROCKWELL CORP. AUTONETICS DIV.
3370 Miraloma Ave, Anaheim, Cal 92803
ROLM, CORP.
10300 N Tantau, Cupertino, Cal 95014
SEMICONDUCTOR ELECTRONIC MEMORIES INC.
3883 N 28th Ave, Phoenix, Ariz 85017
SOLITRON DEVICES INC.
256 Oak Tree Rd, Tappan, N Y 10983
SOLITRON DEVICES INC.
8808 Balboa Ave, San Diego, Cal 92123
SOLITRON DEVICES INC. TRANSISTOR DIV.
1177 Blue Heron Blvd, Riviera Beach, Fla 33404
SPRAGUE ELECTRIC CO.
551 Marshall St, N Adams, Mass 01247
STANDARD LOGIC INC.
1630 S Lyon St, Santa Ana, Cal 92705

MEMORY SYSTEMS, THIN FILM

CAMBRIDGE MEMORIES INC.
285 Newtonville Ave, Newton, Mass 02160
DATAPAC INC.
3839 S Main St, Santa Ana, Cal 92702
INTERSIL INC.
10900 N Tantau, Cupertino, Cal 95014
LITTON SYSTEMS INC. DATA SYSTEMS DIV.
8000 Woodley Ave, Van Nuys, Cal 91409
NATIONAL SEMICONDUCTOR CORP.
2900 Semicon Dr, Santa Clara, Cal 95051
NORTH AMERICAN ROCKWELL CORP. AUTONETICS DIV.
3370 Miraloma Ave, Anaheim, Cal 92803
SIGNAL GALAXIES INC.
6955 Haynehurst Ave, Van Nuys, Cal 91406

MICROFICHE

ADDRESSOGRAPH MULTIGRAPH CORP
1800 W Central Rd, Mount Prospect, Ill 60056
APPLIED MICROFILM CORP.
107 Binney St, Watertown, Mass 02142
BRUNING CO., CHARLES
1800 W Central Rd, Mt Prospect, Ill 60005
COMPUTER MICRO-IMAGE SYSTEMS INC.
9600 Desoto Ave, Chatsworth, Cal 91311
COMPUTER SYSTEMS CO. INC.
1470 St Charles Ave, Cleveland, Ohio 44107
CYTEK INFORMATION SYSTEMS CORP.
366 5th Ave, New York, N Y 10001
DATA COPY INC.
760 Bryant St, San Francisco, Cal 94107
DIETZGEN CO., EUGENE
2425 N Sheffield, Chicago, Ill 60614
DUPONT DE NEMOURS, & CO., E.I. CO., INC.
1007 Market St, Wilmington, Del 19898
EASTMAN KODAK CO.
343 State St, Rochester, N Y 14650
ECCO BUSINESS SYSTEMS INC.
50 E 42nd St, New York, N Y 10017
ELLIOTT CO., B.K.
P O Box 3240, Pittsburg, Pa 15230
EXTEK MICROSYSTEMS INC.
15424 Cabrillo Rd, Van Nuys, Cal 91406
GORDON ENTERPRISES INC., ALAN
5362 Cahuenga Blvd, N Hollywood, Cal 91601
IMAGE SYSTEMS INC.
11244 Playa Ct, Culver City, Cal 90230
ITEK CORP.
10 Maguire Rd, Lexington, Mass 02173
KLEER-VU INDUSTRIES INC.
386 Park Ave S, New York, N Y 10016

3M CO.
3m Center, St Paul, Minn 55101
REPRODUCTION SYSTEMS DIV. TRANSAMERICA
COMP.
1 California St, San Francisco, Cal 94111
SEACO COMPUTER-DISPLAY INC.
2826 W Kingsley Rd, Garland, Tex 75040
SINGER LINK DIV.
1077 E Arques, Sunnyvale, Cal 94086
STINAFFS INC.
181 E Exchange St, Akron, Ohio 44304
STROMBERG DATAGRAPHIX INC.
P O Box 2449, San Diego, Cal 92112
TELEDYNE FREDERICK POST
P O Box 803, Chicago, Ill 60690
UNIVERSITY COMPUTING CO. GRAPHIC SYSTEMS DIV.
14761 Califa St, Van Nuys, Cal 91401
XIDEX CORP.
305 Soquel Way, Sunnyvale, Cal 94086

MICROFILM APERTURE CARDS (SEE CARDS)

MICROFILM DATA RETRIEVAL SYSTEMS, APERTURE CARDS

MICROSEAL CORP.
2222 Main St, Evanston, Ill 60204

MICROFILM DATA RETRIEVAL SYSTEMS, COMPUTER CONTROLLED

ALDEN ELECTRONIC & IMPULSE RECORDING EQUIP.
CO
Washington St, Westboro, Mass 01581
COMPUTER MICRO-IMAGE SYSTEMS INC.
9600 Desoto Ave, Chatsworth, Cal 91311
COMPUTER SYSTEMS CO. INC.
1470 St Charles Ave, Cleveland, Ohio 44107
CYTEK INFORMATION SYSTEMS CORP.
366 5th Ave, New York, N Y 10001
DATA COPY INC.
760 Bryant St, San Francisco, Cal 94107
DIEBOLD INC.
818 Mulberry Rd SE, Canton, Ohio 44702
DSI SYSTEMS INC.
2351 Shady Grove Rd, Rockville, Md 20854
EASTMAN KODAK CO.
343 State St, Rochester, N Y 14650
ECCO BUSINESS SYSTEMS INC.
50 E 42nd St, New York, N Y 10017
IMAGE SYSTEMS INC.
11244 Playa Ct, Culver City, Cal 90230
3M CO.
3m Center, St Paul, Minn 55101
MICROFORM DATA SYSTEMS INC.
830 Maude Ave, Mountain View, Cal 94040
MICROSEAL CORP.
2222 Main St, Evanston, Ill 60204
MOHAWK INDUSTRIAL LABORATORIES INC.
1 Ward St, Vernon, N Y 13476
MOSLER SAFE CO., THE INFO. SYS. DIV.
1561 Grand Blvd., Hamilton, Ohio 45012
RCA GRAPHIC SYSTEMS DIV.
Rte 130, Dayton, N J 08810
REPRODUCTION SYSTEMS DIV. TRANSAMERICA
COMP.
1 California St, San Francisco, Cal 94111
SANDERS ASSOCIATES INC. SYSTEMS DIV.
Daniel Webster Hwy S, Nashua, N H 03060
SYSTEMS CONCEPTS INC.
17-45 Clintonville St, Whitestone, N Y 11357
TRAID CORP., PHOTO INSTRUMENT DIV.
900 Grand Central, Glendale, Cal 91201

MICROFILM DATA RETRIEVAL SYSTEMS, COMPUTER CONTROLLED (GRAPHIC)

ALDEN ELECTRONIC & IMPULSE RECORDING EQUIP.
CO
Washington St, Westboro, Mass 01581
BENDIX COMPUTER GRAPHICS
23850 Freeway Park Dr, Farmington, Mich 48024
COMPUTER MICRO-IMAGE SYSTEMS INC.
9600 Desoto Ave, Chatsworth, Cal 91311
CURRAN COMPUTER CORP.
946 Main St, Hackensack, N J 07601
CYTEK INFORMATION SYSTEMS CORP.
366 5th Ave, New York, N Y 10001

2 Product Directory

DATA COPY INC.

760 Bryant St, San Francisco, Cal 94107
 DSI SYSTEMS INC.
 2351 Shady Grove Rd, Rockville, Md 20854
 EASTMAN KODAK CO.
 343 State St, Rochester, N Y 14650
 ECCO BUSINESS SYSTEMS INC.
 50 E 42nd St, New York, N Y 10017
 IMAGE SYSTEMS INC.
 11244 Playa Ct, Culver City, Cal 90230
 3M CO.

3m Center, St Paul, Minn 55101
 MICROFORM DATA SYSTEMS INC.
 830 Maude Ave, Mountain View, Cal 94040
 MOSLER SAFE CO., THE INFO. SYS. DIV.
 1561 Grand Blvd., Hamilton, Ohio 45012
 RCA GRAPHIC SYSTEMS DIV.
 Rte 130, Dayton, N J 08810
 REPRODUCTION SYSTEMS DIV. TRANSAMERICA
 COMP.
 1 California St, San Francisco, Cal 94111
 RESALAB INC. RESALAB SCIENTIFIC DIV.
 4000 Campbell Ave, Menlo Park, Cal 94025
 SANDERS ASSOCIATES INC. SYSTEMS DIV.
 Daniel Webster Hwy S, Nashua, N H 03060
 TERMINAL DATA CORP.
 16130 Stagg St, Van Nuys, Cal 91324
 TRAUD CORP., PHOTO INSTRUMENT DIV.
 900 Grand Central, Glendale, Cal 91201

MICROFILM ROLLS

ADDRESSOGRAPH MULTIGRAPH CORP
 1800 W Central Rd, Mount Prospect, Ill 60056
 APPLIED MICROFILM CORP.
 107 Binney St, Watertown, Mass 02142
 BRUNING CO., CHARLES
 1800 W Central Rd, Mt Prospect, Ill 60005
 COMPUTER MICRO-IMAGE SYSTEMS INC.
 9600 Desoto Ave, Chatsworth, Cal 91311
 DASA CORP./CYBER-TRONICS SUB. DASA CORP.
 15 Stevens St., Andover, Mass 01810
 DIETZGEN CO., EUGENE
 2425 N Sheffield, Chicago, Ill 60614
 DUPONT DE NEMOURS, & CO., E.I. CO., INC.
 1007 Market St, Wilmington, Del 19898
 EASTMAN KODAK CO.
 343 State St, Rochester, N Y 14650
 ELLIOTT CO., B.K.
 P O Box 3240, Pittsburg, Pa 15230
 EXTEK MICROSYSTEMS INC.
 15424 Cabrito Rd, Van Nuys, Cal 91406
 GORDON ENTERPRISES INC., ALAN
 5362 Cahuenga Blvd, N Hollywood, Cal 91601
 3M CO.
 3m Center, St Paul, Minn 55101
 REPRODUCTION SYSTEMS DIV. TRANSAMERICA
 COMP.
 1 California St, San Francisco, Cal 94111
 STROMBERG DATAGRAPHIX INC.
 P O Box 2449, San Diego, Cal 92112
 TELEDYNE FREDERICK POST
 P O Box 803, Chicago, Ill 60690
 XIDEX CORP.
 305 Soquel Way, Sunnyvale, Cal 94086

MICROSTRIPS (FOR MICROFILM)

EASTMAN KODAK CO.
 343 State St, Rochester, N Y 14650
 EXTEK MICROSYSTEMS INC.
 15424 Cabrito Rd, Van Nuys, Cal 91406
 KLEER-VU INDUSTRIES INC.
 386 Park Ave S, New York, N Y 10016
 3M CO.
 3m Center, St Paul, Minn 55101

MODEMS, ACOUSTIC

ANALOGIC CORP.
 Audubon Rd, Wakefield, Mass 01880
 ANDERSON JACOBSON INC.
 1065 Morse Ave., Sunnyvale, Cal 94086
 APPLIED DIGITAL DATA SYSTEMS INC.
 100 Marcus Blvd, Hauppauge, N Y 11787
 BUNKER-RAMO CORP.
 Trumbull Ind Pk, Trumbull, Conn 06611
 CARTERFONE COMMUNICATION CORP
 11710 E NW Hwy, Dallas, Tex 75218
 COMDATA CORP.
 7544 W Oakton St, Niles, Ill 60648
 COMMUNICATIONS LOGIC INC.
 6400 Westpark, Houston, Tex 77024

COMPUTER COMMUNICATION INC.

701 W Manchester Blvd, Inglewood, Cal 90301
 COMPUTER COMPLEX, INC.
 6400 Westpark, Houston, Tex 77027
 COMPUTER CONVERSIONS CORP.
 6 Dunton Court, E Northport, N Y 11731
 COMPUTER DEVICES INC.
 10 Sonar Dr, Woburn, Mass 01801
 CYBERMATION INC.
 P O Box 58 River Rd, Washngtn Xing, Pa 18977
 DATA ACCESS SYSTEMS INC.
 503 Rte 10 Mt 19, Dover, N J 07801
 DATA AUTOMATION COMMUNICATIONS INC.
 7505 Carpenter Fwy, Dallas, Tex 75247
 DATA PRODUCTS TELECOMMUNICATIONS
 17 Amelia Place, Stamford, Conn 06902
 DATALINE INC.
 181 6 Boro Line Rd, King of Prussia, Pa 19406
 DATAMAX CORP.
 3941 Research Park Dr, Ann Arbor, Mich 48104
 DATASERV DIV., WILLIAM J. PURDY CORP.
 770 Airport Blvd, Burlingame, Cal 94010
 DESIGN ELEMENTS INC.
 356 Norton Ave, Columbus, Ohio 43212
 DIGI-LOG SYSTEMS INC.
 107 W Ridge Pike, Conshohocken, Pa 19428
 DIGITAL TECHNIQUES CORP.
 4248 Delemere Court, Royal Oak, Mich 48073
 ELDORADO ELECTRODATA
 601 Chalomar Rd, Concord, Cal 94520
 ELECTRONIC INFORMATION SYSTEMS INC.
 2400 Industrial Lane, Broomfield, Conn 80020
 EMR COMPUTER
 8001 Bloomington Fwy, Minneapolis, Minn 55420
 FORD INDUSTRIES INC.
 5001 SE Johnson Ck, Portland, Ore 97206
 GENERAL DATACOMM INDUSTRIES
 537 Newton Ave, Norwalk, Conn 06851
 GENERAL ELECTRIC CO. COMM. SYS. DIV.
 Mountain View Rd, Lynchburg, Va 24502
 HI-G INC.
 580 Spring St, Windsor Locks, Conn 06096
 HYBRID SYSTEMS DIV. DIGITAL RESOURCES CORP.
 4301 Dacoma Rd, Houston, Tex 77018
 IONEX DIV. OF SONEX INC.
 20 E Herman St, Philadelphia, Pa 19144
 ITEL INFORMAMTION PRODUCTS DIV
 2585 Bayshore, Palo Alto, Cal 94303
 ITI ELECTRONICS INC.
 369 Lexington Ave, Clifton, N J 07015
 LIVERMORE DATA SYSTEMS INC.
 2050 Research Dr, Livermore, Cal 94550
 MARK/OPS DIV., NORTH EASTERN SYSTEMS ASSOC.
 INC.
 475 Commonwealth Ave, Boston, Mass 02215
 MICRODATA CORP.
 644 E Young St, Santa Ana, Cal 92705
 MICROTRAN COMPANY INC.
 145 E Mineola Ave, Valley Stream, N Y 11582
 MULTITECH DATA PRODUCTS
 583 Monterey Pass Rd, Monterey Park, Cal 91754
 NOVATION INC.
 18664 Topham, Tarzana, Cal 91356
 NYTRONICS INC.
 3rd Ave, Alpha, N J 08865
 OLIVETTI CORP. OF AMERICA
 500 Park Ave, New York, N Y 10016
 OMNITEC CORP. A NYTRONICS CORP.
 903 N 2nd St, Phoenix, Ariz 85004
 PURDY CORP., WM. J.
 770 Airport Blvd, Burlingame, Cal 94010
 RFL INDUSTRIES INC. COMMUNICATION DIV.
 Powerville Rd, Boonton, N J 07005
 SHIRAK TELEMETERING OF AMERICA
 8926 Kester Ave, Van Nuys, Cal 91402
 SINGER TELE-SIGNAL CORP.
 250 Crossway Park Dr, Woburn, N Y 11797
 TEL-TECH CORP.
 11810 Parklawn Dr, Rockville, Md 20852
 TELE-DATA CORP.
 130 U S Hwy 22, N Plainfield, N J 07060
 TELECTRO SYSTEMS CORP.
 96-18 43rd Ave, Corona, N Y 11368
 TIME-SHARING TERMINALS INC.
 2351 Shady Grove Rd, Rockville, Md 20850
 TUCK ELECTRONICS
 235 Market St, New Cumberland, Pa 17070
 TYMSHARE INC.
 525 University Ave, Palo Alto, Cal 94301
 ULTRONIC SYSTEMS CORP.
 Mt Laurel Ind Pk, Moorestown, N J 08057
 UNIVERSITY COMPUTING CO.
 P O Box 6228, Dallas, Tex 75222
 UNIVERSITY COMPUTING CO. DATEL DIV.
 1 Tysons Corner Ctr, McLean, Va 22101

BUY - RENT - LEASE MODEMS all types • all brands

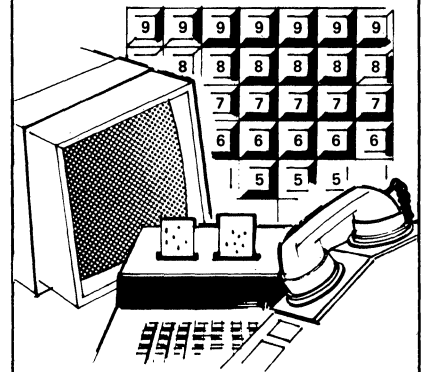

We are the West's largest, most experienced, best-stocked, factory-approved source for EDP terminals, peripherals and interfaces of every description

controllers • converters
 processors • acoustic couplers
 copiers • modems
 display consoles
 keyboards • transceivers
 printers • teleprinters
 readers • recorders
 accessories • supplies

Our experienced EDP engineers analyze system requirements thoroughly, design and install custom turnkey systems, and provide expert consultation on system expansion or modification as requirements change.

We are thoroughly familiar with the capabilities and limitations of all reputable brands of EDP equipment, and are impartial in recommending and selecting equipment strictly on its merit for the application.

For more information on how to get the EDP system or equipment you need and get it on your terms - see DataServ catalog insert.

DATA SERV

Burlingame, California
 Denver • Salt Lake City • Seattle •
 Phoenix • Los Angeles

One of the PURDY group of companies

2 Product Directory

VADIC CORP., THE
916 Commercial St, Palo Alto, Cal 94303
WAVETEK DATA COMMUNICATIONS
9045 Balboa Ave, San Diego, Cal 92123

MODEMS, HARD-WIRED

AMBAC INDUSTRIES INC. TELE-DYNAMICS DIV.
525 Virginia Dr, Ft Washington, Pa 19034
AMERICAN TOTALISATOR CO. UNI-TOTE DIV.
383 Hillen Rd, Towson, Md 21204
ANALOGIC CORP.
Audubon Rd, Wakefield, Mass 01880
ANDERSON JACOBSON INC.
1065 Morse Ave., Sunnyvale, Cal 94086
APPLIED DIGITAL DATA SYSTEMS INC.
100 Marcus Blvd, Hauppauge, N Y 11787
ASTROCOM CORP.
293 Commercial St, St Paul, Minn 55106
BONNAR-VAWTER INC.
96 Dunbar St, Keene, N H 03431
BUNKER RAMO CORP., THE, BUSINESS & IND. DIV
445 Fairfield Ave, Stamford, Conn 06904
BUNKER-RAMO CORP.
Trumbull Ind Pk, Trumbull, Conn 06611
CANTELTECH LTD.
1970 Ellesmere Rd, Scarbrough 722, CANADA
CARTERFONE COMMUNICATION CORP
11710 E NW Hwy, Dallas, Tex 75218
CODEX CORP.
15 Riverdale Ave, Newton, Mass 02195
COLLINS RADIO CO.
1200 N Alma Rd, Dallas, Tex 75207
COLLINS RADIO CO.
19700 Jamboree Blvd, Newport Beach, Cal 92663
COMDATA CORP.
7544 W Oakton St, Niles, Ill 60648
COMMUNICATIONS LOGIC INC.
6400 Westpark, Houston, Tex 77024
COMMUNICATIONS TECHNOLOGY INC.
1900 York Rd, Timonium, Md 21093
COMPU-SYSTEMS CO.
Audubon Rd, Wakefield, Mass 01880
COMPUTER COMPLEX, INC.
6400 Westpark, Houston, Tex 77027
COMPUTER CONVERSIONS CORP.
6 Dunton Court, E Northport, N Y 11731
COMPUTER DEVICES INC.
10 Sonar Dr, Woburn, Mass 01801
COMPUTER-LINK CORP.
14 Cambridge St, Burlington, Mass 01803
COMPUTER TRANSMISSION CORP.
1508 Cotner Ave, Los Angeles, Cal 90025
CONTROL DATA CORP.
8100 34th Ave S, Minneapolis, Minn 55440
CREDIT SYSTEMS INC.
P O Box 105, Colmar, Pa 18915
CYBERMATION INC.
P O Box 58 River Rd, Washngtn Xing, Pa 18977
DATA ACCESS SYSTEMS INC.
503 Rte 10 Mt 19, Dover, N J 07801
DATA AUTOMATION COMMUNICATIONS INC.
7505 Carpenter Fwy, Dallas, Tex 75247
DATA PRODUCTS TELECOMMUNICATIONS
17 Amelia Place, Stamford, Conn 06902
DATA 100 CORP.
7450 France Ave S, Minneapolis, Minn 55435
DATALINE INC.
181 S Boro Line Rd, King of Prussia, Pa 19406
DATAMAX CORP.
3941 Research Park Dr, Ann Arbor, Mich 48104
DATASERV DIV., WILLIAM J. PURDY CORP.
770 Airport Blvd, Burlingame, Cal 94010
DA-TEL RESEARCH CO.
930 N Park Ave, Montrose, Colo 81401
DESIGN ELEMENTS INC.
356 Norton Ave, Columbus, Ohio 43212
DIGI-LOG SYSTEMS INC.
107 W Ridge Pike, Conshohocken, Pa 19428
DIGITAL TECHNIQUES CORP.
4248 Delemere Court, Royal Oak, Mich 48073
EDGERTON GERMESHAUSEN GRIER INC.
Crosby Dr, Bedford, Mass 01730
ELDORADO ELECTRODATA
601 Chalomar Rd, Concord, Cal 94520
EMR COMPUTER
8001 Bloomington Fwy, Minneapolis, Minn 55420
FORD INDUSTRIES INC.
5001 SE Johnson Ck, Portland, Ore 97206
FUJITSU LTD. N.Y.LIAISON OFFICE
680 Fifth Ave, New York, N Y 10019
GENERAL ATRONICS CORP. SUB. OF MAGNAVOX
Mermaid Lane, Philadelphia, Pa 19118

GENERAL DATACOMM INDUSTRIES
537 Newton Ave, Norwalk, Conn 06851
GENERAL DYNAMICS CORP. ELECTRONICS DIV.
P O Box 2566, Orlando, Fla 32802
GENERAL ELECTRIC CO. COMM. SYS. DIV.
Mountain View Rd, Lynchburg, Va 24502
HI-G INC.
580 Spring St, Windsor Locks, Conn 06096
HONEYWELL INFORMATION SYS.INC PERIPH.DEVICES
DIV.
200 Smith St, Waltham, Mass 02154
INTERNATIONAL COMMUNICATIONS CORP.,SUB. OF
MILGO
7620 NW 36th Ave, Miami, Fla 33147
IONEX DIV. OF SONEX INC.
20 E Herman St, Philadelphia, Pa 19144
ITEL INFORAMTION PRODUCTS DIV
2585 Bayshore, Palo Alto, Cal 94303
ITI ELECTRONICS INC.
369 Lexington Ave, Clifton, N J 07015
ITT DATA EQUIPMENT & SYSTEMS DIV.
187 E Union Ave, E Rutherford, N J 07073
ITT DEFENSE COMMUNICATIONS DIV.
492 River Rd, Nutley, N J 07110
LENKURT ELECTRIC CO., INC. SUB. OF GT&E
1105 County Rd, San Carlos, Cal 94070
LITTON SYSTEMS INC. DATA SYSTEMS DIV.
8000 Woodley Ave, Van Nuys, Cal 91409
LIVERMORE DATA SYSTEMS INC.
2050 Research Dr, Livermore, Cal 94550
LYNCH COMMUNICATION SYSTEMS INC.
695 Bryant St, San Francisco, Cal 94107
MARQUETTA ELECTRONICS INC.
3712 W Elm St, Milwaukee, Wisc 53209
MEMOREX EQUIPMENT GROUP
San Tomas At Central, Santa Clara, Cal 95052
MICRODATA CORP.
644 E Young St, Santa Ana, Cal 92705
MILGO ELECTRONIC CORP.
7620 NW 36th Ave, Miami, Fla 33147
MULTITECH DATA PRODUCTS
583 Monterey Pass Rd, Monterey Park, Cal 91754
NATIONAL MIDCO INDUSTRIES INC.
Box 5433, Trenton, N J 08638
NOVATION INC.
18664 Topham, Tarzana, Cal 91356
NYTRONICS INC.
3rd Ave, Alpha, N J 08865
OKI ELECTRIC INDUSTRIES CO. LTD.
875 Ave of Americas, New York, N Y 10001
OLIVETTI CORP. OF AMERICA
500 Park Ave, New York, N Y 10016
OMNITEC CORP. A NYTRONICS CORP.
903 N 2nd St, Phoenix, Ariz 85004
PENRIL DATA COMMUNICATION INC
960 Thomas Ave, Rockville, Md 20852
PULSE COMMUNICATIONS INC.
5214 Columbia Pike, Falls Church, Va 22041
PURDY CORP., WM. J.
770 Airport Blvd, Burlingame, Cal 94010
RAYTHEON CO. CADPO OPERATION
1415 Providence Tpk, Norwood, Mass 02062
RAYTHEON COMPUTER
2700 S Fairview St, Santa Ana, Cal 92704
RFL INDUSTRIES INC. COMMUNICATION DIV.
Powerville Rd, Boonton, N J 07005
SANDERS ASSOCIATES DIGITAL COMMUNICATIONS
DEPT
Daniel Webster Hwy S, Nashua, N H 03060
SANDERS ASSOCIATES INC. SYSTEMS DIV.
Daniel Webster Hwy S, Nashua, N H 03060
SANGAMO ELECTRIC CO.
P O Box 3347, Springfield, Ill 62708
SHIRAK TELEMETERING OF AMERICA
8926 Kester Ave, Van Nuys, Cal 91402
SINGER TELE-SIGNAL CORP.
250 Crossway Park Dr, Woodbury, N Y 11797
TECHNICAL COMMUNICATIONS CORP.
442 Marrett Rd, Lexington, Mass 02173
TEL-TECH CORP.
11810 Parklawn Dr, Rockville, Md 20852
TELECTRO SYSTEMS CORP.
96-18 43rd Ave, Corona, N Y 11368
TELEMODEM INC.
98-05 217 St, Queens Village, N Y 11429
TIME-SHARING TERMINALS INC.
2351 Shady Grove Rd, Rockville, Md 20850
TREPAC CORP. OF AMERICA
30 W Hamilton Ave, Englewood, N J 07631
TUCK ELECTRONICS
235 Market St, New Cumberland, Pa 17070
ULTRONIC SYSTEMS CORP.
Mt Laurel Ind Pk, Moorestown, N J 08057
UNITED BUSINESS COMMUNICATIONS INC.
6405 Metcalf Ave, Shawnee Mission, Kans 66202

UNIVERSITY COMPUTING CO. DATEL DIV.
1 Tysons Corner Ctr, McLean, Va 22101
VADIC CORP., THE
916 Commercial St, Palo Alto, Cal 94303
VERNITRON CORP. DATA DEVICE DIV.
176 Central Ave, Farmingdale, N Y 11735
WAVETEK DATA COMMUNICATIONS
9045 Balboa Ave, San Diego, Cal 92123
WEISMANTEL INC.
P O Box 1957, St Paul, Minn 55111
WESTERN TELEMATIC INC.
5507 Peck Rd, Arcadia, Cal 91006

MODEMS, PC CARD

AMBAC INDUSTRIES INC. TELE-DYNAMICS DIV.
525 Virginia Dr, Ft Washington, Pa 19034
AMERICAN DATA SYSTEMS
8851 Mason Ave, Canoga Park, Cal 91306
AMERICAN TOTALISATOR CO. UNI-TOTE DIV.
383 Hillen Rd, Towson, Md 21204
ANALOGIC CORP.
Audubon Rd, Wakefield, Mass 01880
ANDERSON JACOBSON INC.
1065 Morse Ave., Sunnyvale, Cal 94086
APPLIED DIGITAL DATA SYSTEMS INC.
100 Marcus Blvd, Hauppauge, N Y 11787
ASTROCOM CORP.
293 Commercial St, St Paul, Minn 55106
BUNKER RAMO CORP., THE, BUSINESS & IND. DIV
445 Fairfield Ave, Stamford, Conn 06904
BUNKER-RAMO CORP.
Trumbull Ind Pk, Trumbull, Conn 06611
CANTELTECH LTD.
1970 Ellesmere Rd, Scarbrough 722, CANADA
CARTERFONE COMMUNICATION CORP
11710 E NW Hwy, Dallas, Tex 75218
CODEX CORP.
15 Riverdale Ave, Newton, Mass 02195
COLLINS RADIO CO.
1200 N Alma Rd, Dallas, Tex 75207
COLLINS RADIO CO.
19700 Jamboree Blvd, Newport Beach, Cal 92663
COMDATA CORP.
7544 W Oakton St, Niles, Ill 60648
COMMUNICATIONS LOGIC INC.
6400 Westpark, Houston, Tex 77024
COMPACE CORP.
7413 Washington Ave S, Edina-Minnepols, Minn
55435
COMPU-SYSTEMS CO.
Audubon Rd, Wakefield, Mass 01880
COMPUTER COMPLEX, INC.
6400 Westpark, Houston, Tex 77027
COMPUTER CONVERSIONS CORP.
6 Dunton Court, E Northport, N Y 11731
COMPUTER DEVICES INC.
10 Sonar Dr, Woburn, Mass 01801
CYBERMATION INC.
P O Box 58 River Rd, Washngtn Xing, Pa 18977
DATA ACCESS SYSTEMS INC.
503 Rte 10 Mt 19, Dover, N J 07801
DATA AUTOMATION COMMUNICATIONS INC.
7505 Carpenter Fwy, Dallas, Tex 75247
DATA PRODUCTS TELECOMMUNICATIONS
17 Amelia Place, Stamford, Conn 06902
DATALINE INC.
181 S Boro Line Rd, King of Prussia, Pa 19406
DATAMAX CORP.
3941 Research Park Dr, Ann Arbor, Mich 48104
DATASERV DIV., WILLIAM J. PURDY CORP.
770 Airport Blvd, Burlingame, Cal 94010
DA-TEL RESEARCH CO.
930 N Park Ave, Montrose, Colo 81401
DESIGN ELEMENTS INC.
356 Norton Ave, Columbus, Ohio 43212
DEVONSHIRE COMPUTER CORP.
377 Elliot St, Newton, Mass 02164
DIGI-LOG SYSTEMS INC.
107 W Ridge Pike, Conshohocken, Pa 19428
ELDORADO ELECTRODATA
601 Chalomar Rd, Concord, Cal 94520
FORD INDUSTRIES INC.
5001 SE Johnson Ck, Portland, Ore 97206
GENERAL DATACOMM INDUSTRIES
537 Newton Ave, Norwalk, Conn 06851
GENERAL ELECTRIC CO. COMM. SYS. DIV.
Mountain View Rd, Lynchburg, Va 24502
HYBRID SYSTEMS DIV. DIGITAL RESOURCES CORP.
4301 Dacoma Rd, Houston, Tex 77018
INTERNATIONAL COMMUNICATIONS CORP.,SUB. OF
MILGO
7620 NW 36th Ave, Miami, Fla 33147

2 Product Directory

IONEX DIV. OF SONEX INC.
20 E Herman St, Philadelphia, Pa 19144
ITEL INFORMATIION PRODUCTS DIV
2585 Bayshore, Palo Alto, Cal 94303
ITI ELECTRONICS INC.
369 Lexington Ave, Clifton, N J 07015
LENKURT ELECTRIC CO., INC. SUB. OF GT&E
1105 County Rd, San Carlos, Cal 94070
LIVERMORE DATA SYSTEMS INC.
2050 Research Dr, Livermore, Cal 94550
MARK COMPUTER SYSTEMS INC.
One Patterson Pl, Garden City, N Y 11530
MARQUETTA ELECTRONICS INC.
3712 W Elm St, Milwaukee, Wisc 53209
MCA TECHNOLOGY INC. UDAC DIV.
P O Box 36166, Houston, Tex 77035
MEMOREX EQUIPMENT GROUP
San Tomas At Central, Santa Clara, Cal 95052
MICRO SYSTEMS INC.
644 E Young St, Santa Ana, Cal 92705
MICRODATA CORP.
644 E Young St, Santa Ana, Cal 92705
MILGO ELECTRONIC CORP.
7620 NW 36th Ave, Miami, Fla 33147
MULTITECH DATA PRODUCTS
583 Monterey Pass Rd, Monterey Park, Cal 91754
NATIONAL MIDCO INDUSTRIES INC.
Box 5433, Trenton, N J 08638
NOVATION INC.
18664 Topham, Tarzana, Cal 91356
NYTRONICS INC.
3rd Ave, Alpha, N J 08865
OMNITEC CORP. A NYTRONICS CORP.
903 N 2nd St, Phoenix, Ariz 85004
PENRIL DATA COMMUNICATION INC
960 Thomas Ave, Rockville, Md 20852
PULSE COMMUNICATIONS INC.
5214 Columbia Pike, Falls Church, Va 22041
PURDY CORP., WM. J.
770 Airport Blvd, Burlingame, Cal 94010
RFL INDUSTRIES INC. COMMUNICATION DIV.
Powerville Rd, Boonton, N J 07005
ROBINTECH INC. E-M DIV.
P O Box 714, Binghamton, N Y 13902
SANDERS ASSOCIATES DIGITAL COMMUNICATIONS
DEPT
Daniel Webster Hwy S, Nashua, N H 03060
SANDERS ASSOCIATES INC. SYSTEMS DIV.
Daniel Webster Hwy S, Nashua, N H 03060
SANGAMO ELECTRIC CO.
P O Box 3347, Springfield, Ill 62708
SIERRA RESEARCH CORP. COMPUTER PROD. GRP.
167 Bedford St., Burlington, Mass 01803
SINGER TELE-SIGNAL CORP.
250 Crossway Park Dr, Woodbury, N Y 11797
SYSTEMS RESEARCH LABS. INC.
7001 Indian Ripple Rd, Dayton, Ohio 45440
TEL-TECH CORP.
11810 Parklawn Dr, Rockville, Md 20852
TELECTRO SYSTEMS CORP.
96-18 43rd Ave, Corona, N Y 11368
TELEMODEM INC.
98-05 217 St, Queens Village, N Y 11429
TUCK ELECTRONICS
235 Market St, New Cumberland, Pa 17070
UNITED BUSINESS COMMUNICATIONS INC.
6405 Metcalf Ave, Shawnee Mission, Kans 66202
VADIC CORP., THE
916 Commercial St, Palo Alto, Cal 94303
WESTERN TELEMEATIC INC.
5507 Peck Rd, Arcadia, Cal 91006

MODULES, DIGITAL LOGIC ENCAPSULATED (ALSO SEE CIRCUITS & CIRCUIT CARDS)

AMPEREX ELECTRONIC CORP. A NO AMERICAN
PHILIPS CO
P O Box 98, Slatersville, R I 02876
ANALOGIC CORP.
Audubon Rd, Wakefield, Mass 01880
AVCO CORP. ELECTRONICS DIV.
4807 Bradford, Huntsville, Ala 35805
ITT SEMICONDUCTORS
3301 Electronics Way, W Palm Beach, Fla 33407
CAMBRIDGE THERMIONIC CORP.
445 Concord Ave, Cambridge, Mass 02138
CENTRALAB ELECTRONICS, DIV.
5757 N Green Bay, Milwaukee, Wisc 53201
CERMETEK INC.
660 National Ave, Mt View, Cal 94040
CLAIREX CORP.
560 S 3rd Ave, Mount Vernon, N Y 10550

COMPUTER CONVERSIONS CORP.
6 Dunton Court, E Northport, N Y 11731
COMPUTER PRODUCTS, INC.
P O Box 23849, Ft Lauderdale, Fla 33307
CONTROL DATA CORP. CIRCUITS DIV.
7800 Computer Ave, Minneapolis, Minn 55435
CONTROL LOGIC INC.
3 Strathmore Rd, Natick, Mass 01760
DATA TECHNOLOGY CORP.
1050 E Meadow Cir, Palo Alto, Cal 94303
DI/AN CONTROLS INC.
944 Dorchester Ave, Boston, Mass 02125
DIGITRON CORP.
2544 W Main St, Norristown, Pa 19401
DYNAMIC MEASUREMENTS CORP.
6 Lowell Ave, Winchester, Mass 01890
ELECTRONIC ENGRG. CO. OF CAL. ELECTRONIC PRD.
DIV
1441 E Chestnut Ave, Santa Ana, Cal 92702
ELECTRONIC MODULES CORP.
P O Box 141, Timonium, Md 21093
ELPAC INC.
18651 Von Karman Ave, Irvine, Cal 92664
ERIE TECHNOLOGICAL PRODUCTS INC.
644 W 12th St, Erie, Pa 16512
GENERAL INSTRUMENT CORP. MICROELECT. DIV.
600 W John St, Hicksville, N Y 11802
GIBBS MANUFACTURING & RESEARCH CORP.
450 N Main, Janesville, Wisc 53545
INSTRUMENT DISPLAYS INC. SUB. KELTRON CORP.
223 Crescent St, Waltham, Mass 02154
INTERNATIONAL CONTROLS CORP.
200 Fairfield Rd, Fairfield, N J 07006
LECROY RESEARCH SYSTEMS CORP.
126 N Rte 303, W Nyack, N Y 10994
LEHIGH VALLEY ELECTRONICS INC.
Po Box 125, Fogelsville, Pa 18051
MASSEY DICKINSON CO. INC.
9 Elm St, Saxonville, Mass 01701
MCG ELECTRONICS INC.
279 Skidmore Rd, Deer Park, N Y 11729
MOTOROLA SEMICONDUCTOR PRODUCTS INC.
5005 E Mc Dowell Rd, Phoenix, Ariz 85008
NIGITRON CORP.
2544 W Main St, Norristown, Pa 19401
NORTH AMERICAN ROCKWELL CORP. AUTONETICS
DIV.
3370 Miraloma Ave, Anaheim, Cal 92803
NOVATRONICS OF CANADA LTD.
677 Erie St, Stratford Ont, CANADA
RAYTHEON CO. INDUSTRIAL COMPONENT
OPERATION
465 Centre St., Quincy, Mass 02169
REDCOR CORP.
21200 Victory, Woodland Hills, Cal 91364
ROLM. CORP.
10300 N Tantau, Cupertino, Cal 95014
SCIENTIFIC MEASUREMENTS INC.
9701 N Kenton, Skokie, Ill 60076
SIGNETICS CORP. SUB. CORNING GLASS
811 E Arques Ave, Sunnyvale, Cal 94086
SOLID STATE ELECTRONICS CORP.
15321 Rayen St, Sepulveda, Cal 91343
STELLARMETRICS AN AYDIN CO.
P O Box 719, Santa Barbara, Cal 93102
TOROIDAL COMPONENTS CO.
1374 E Walnut St, Pasadena, Cal 91106
TRANSMAGNETICS INC.
210 Adams Blvd, Farmingdale, N Y 11735
UNIVERSITY COMPUTING CO.
888 N Sepulveda Blvd, El Segundo, Cal 90245
VECTOR ELECTRONIC CO. INC.
12460 Gladstone Ave, Sylmar, Cal 91342

MODULES, DIGITAL LOGIC-ENCAPSULATED (SEE CIRCUITS AND CIRCUIT CARDS)

MODULES, LINEAR (ENCAPSULATED)

AMPEREX ELECTRONIC CORP. A NO AMERICAN
PHILIPS CO
P O Box 98, Slatersville, R I 02876
ANALOG DEVICES INC.
221 5th St, Cambridge, Mass 02142
ANALOGIC CORP.
Audubon Rd, Wakefield, Mass 01880
AVCO CORP. ELECTRONICS DIV.
4807 Bradford, Huntsville, Ala 35805
ITT SEMICONDUCTORS
3301 Electronics Way, W Palm Beach, Fla 33407
BURR-BROWN RESEARCH CORP.
6730 S Tucson Blvd, Tucson, Ariz 85706

CENTRALAB ELECTRONICS, DIV.
5757 N Green Bay, Milwaukee, Wisc 53201
COMPUTER CONVERSIONS CORP.
6 Dunton Court, E Northport, N Y 11731
DDC DIV. SOLID STATE SCIENTIFIC DEVICES
100 Tec St, Hicksville, N Y 11801
DYNAMIC MEASUREMENTS CORP.
6 Lowell Ave, Winchester, Mass 01890
ERIE TECHNOLOGICAL PRODUCTS INC.
644 W 12th St, Erie, Pa 16512
HELIPOT DIV. BECKMAN INSTRUMENTS INC.
2500 Harbor Blvd, Fullerton, Cal 92634
INCOR INSTRUMENTATION INC.
29 Newtown Rd, Plainview, N Y 11803
MAYBERRY ELECTRONICS CO.
1250 Industrial Ave, Escondido, Cal 92025
MOTOROLA SEMICONDUCTOR PRODUCTS INC.
5005 E Mc Dowell Rd, Phoenix, Ariz 85008
NORTH AMERICAN ROCKWELL CORP. AUTONETICS
DIV.
3370 Miraloma Ave, Anaheim, Cal 92803
OPTICAL ELECTRONICS INC.
P O Box 11140, Tucson, Ariz 85706
POWER/MATE CORP.
514 S River St, Hackensack, N J 07601
RAMSAY ENGINEERING CO.
707 N Anaheim Blvd, Anaheim, Cal 92805
SIGNETICS CORP. SUB. CORNING GLASS
811 E Arques Ave, Sunnyvale, Cal 94086
SOLID STATE ELECTRONICS CORP.
15321 Rayen St, Sepulveda, Cal 91343
SPRAGUE ELECTRIC CO.
551 Marshall St, N Adams, Mass 01247
TELEDYNE BROWN ENGINEERING
300 Sparkman Dr, Huntsville, Ala 35807
TELEDYNE PHILBRICK NEXUS
Allied Dr At Rte 128, Dedham, Mass 02026
TORTEL INC.
13402 S 71 Hwy, Grandview, Mo 64030
UNIVERSITY COMPUTING CO.
888 N Sepulveda Blvd, El Segundo, Cal 90245

MODULES, MEMORY (ENCAPSULATED)

AMPEREX ELECTRONIC CORP. A NO AMERICAN
PHILIPS CO
P O Box 98, Slatersville, R I 02876
AMPEX CORP. COMPUTER PRODUCTS DIV.
9937 W Jefferson Blvd, Culver City, Cal 90230
AVCO CORP. ELECTRONICS DIV.
4807 Bradford, Huntsville, Ala 35805
COMPUTER MICROTECHNOLOGY INC.
P O Box 7050, Sunnyvale, Cal 94086
DI/AN CONTROLS INC.
944 Dorchester Ave, Boston, Mass 02125
INSTRUMENT DISPLAYS INC. SUB. KELTRON CORP.
223 Crescent St, Waltham, Mass 02154
MICROSONICS DIV. SANGAMO ELECTRIC CO
60 Winter St, Weymouth, Mass 02188
NESS PACIFIC INC.
470 N San Antonio Rd, Palo Alto, Cal 94306
NORTH AMERICAN ROCKWELL CORP. AUTONETICS
DIV.
3370 Miraloma Ave, Anaheim, Cal 92803
RAYMOND ENGINEERING INC., DIV. RAYMOND PREC.
INC.
217 Smith St, Middletown, Conn 06457
RAYTHEON CO. EQUIPMENT DIV.
528 Boston Post Rd, Sudbury, Mass 01776
SIGNETICS CORP. SUB. CORNING GLASS
811 E Arques Ave, Sunnyvale, Cal 94086
SOLID STATE ELECTRONICS CORP.
15321 Rayen St, Sepulveda, Cal 91343
SPACETAC INC.
Burlington Rd, Bedford, Mass 01730
SPRAGUE ELECTRIC CO.
551 Marshall St, N Adams, Mass 01247
UNIVERSITY COMPUTING CO.
888 N Sepulveda Blvd, El Segundo, Cal 90245

MODULES, RESISTANCE NETWORKS (ENCAPSULATED)

AMPEREX ELECTRONIC CORP. A NO AMERICAN
PHILIPS CO
P O Box 98, Slatersville, R I 02876
AVCO CORP. ELECTRONICS DIV.
4807 Bradford, Huntsville, Ala 35805
BOURNS INC.
1200 Columbia Ave., Riverside, Cal 92507
CENTRALAB ELECTRONICS, DIV.
5757 N Green Bay, Milwaukee, Wisc 53201

URIEL 2 Product Directory

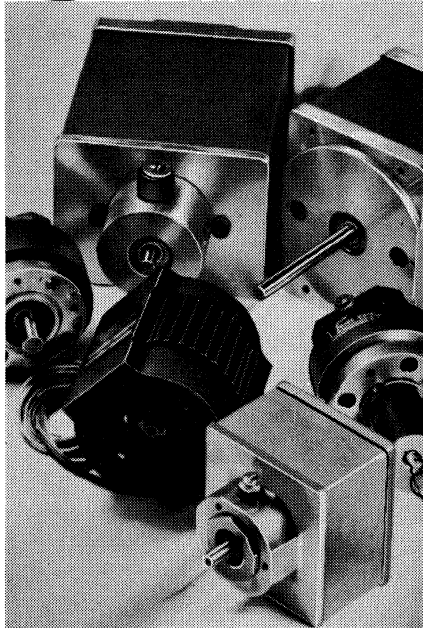

DELIVERS HIGH Performance RELIABLE PRECISION MOTORS D.C. SERVO A.C. TORQUER HYSTERESIS

Designed for direct drives in high speed printers, plotting machines, disc, drum and tape drives, film drives, incremental velocity and phase lock servo-systems, URIEL D.C. SERVO MOTORS provide the highest quality to cost ratio available today.

Low motor inertias, and high torque constants yield accelerations to 265,000 Rad/Sec²; time constants less than 2 ms; pulse torque capability over 1300 in/ozs. Reliability is ensured by unique construction techniques. Excellent heat dissipation capability ensures long life and consistent performance even under overload conditions. Available with integral tachometer generators and custom power supplies and controllers. A.C. Torque Motors and Hysteresis Synchronous motors also available from stock, in a wide range of sizes.

FOR ANALYSIS OF YOUR SYSTEM NEEDS,
CALL OR WRITE.

URIEL

CORPORATION

CALL 516
588-6010
53 Union Ave.
Ronkonkoma,
N. Y. 11779

COLUMBIA COMPONENTS CORP.

60 Madison Ave, Hempstead, N Y 11550
CONSOLIDATED OHMIC DEVICES INC.

115 Old Country Rd, Carle Place, N Y 11514
CONTROL DATA CORP. CIRCUITS DIV.

7800 Computer Ave, Minneapolis, Minn 55435
CTS CORP.

905 NW Blvd, Elkart, Ind 46514
DIGITAL PRODUCTS CORP.

6950 NW 12 Ave, Ft Lauderdale, Fla 33309
ERIE TECHNOLOGICAL PRODUCTS INC.

644 W 12th St, Erie, Pa 16512
HELIPOT DIV. BECKMAN INSTRUMENTS INC.

2500 Harbor Blvd, Fullerton, Cal 92634
INCOR INSTRUMENTATION INC.

29 Newtown Rd, Plainview, N Y 11803
JORDAN ELECTRIC CO.

14707 Keswick St, Van Nuys, Cal 91405
MICROTEK DIV. OF SPACETAC

Rte 62 Burlington Rd, Bedford, Mass 01730
NYTRONICS INC.

3rd Ave, Alpha, N J 08865
POWER/MATE CORP.

514 S River St, Hackensack, N J 07601
RAYTHEON CO. INDUSTRIAL COMPONENT

OPERATION
465 Centre St., Quincy, Mass 02169
ROLM, CORP.

10300 N Tantau, Cupertino, Cal 95014
SPRAGUE ELECTRIC CO.

551 Marshall St, N Adams, Mass 01247
TELEDYNE BROWN ENGINEERING

300 Sparkman Dr, Huntsville, Ala 35807
TORTEL INC.

13402 S 71 Hwy, Grandview, Mo 64030
TRW INC. IRC BOONE DIV.

P O Box 393, Boone, N C 28607
TRW INC. IRC BURLINGTON DIV.

P O Box 887, Burlington, Iowa 52601
UNIVERSITY COMPUTING CO.

888 N Sepulveda Blvd, El Segundo, Cal 90245

MONITORS, CRT (SEE CONSOLES AND DATA TERMINALS)

MONITORS, PARTICULATE

ROYCO INSTRUMENTS INC.

141 Jefferson Dr, Menlo Park, Cal 94025

MONITORS, SOFTWARE (SEE PROGRAMMING LANGUAGE DEVELOPMENT)

MONITORS, TV

BALL BROTHERS MIRATEL DIV.

1633 Terrace Dr, Roseville, Minn 55113
BALL BROTHERS RESEARCH CORP.

P O Box 1062, Boulder, Colo 80302
COHU ELECTRONICS INC. SAN DIEGO DIV.

P O Box 623, San Diego, Cal 92112
CONRAC CORP.

330 Madison Ave, New York, N Y 10017
CONRAC CORP. CONRAC DIV.

600 N Rimsdale Ave, Covina, Cal 91722
CONRAC CORP. INSTRUMENT/ CONTROLS DIV.

1600 S Mountain Ave, Duarte, Cal 91010
DACONICS

925 Thompson Pl, Sunnyvale, Cal 94086
DELTA DATA SYSTEMS CORP.

Woodhaven Ind Park, Cornwells Hgts, Pa 19020
DIAMOND POWER SPECIALTY CORP.

P O Box 415, Lancaster, Ohio 43130
MONITOR DISPLAYS

401 Commerce Dr, Ft Washington, Pa 19034
RANK PRECISION INDUSTRIES INC.

260 N Rt 303, W Nyack, N Y 10994
SYLVANIA ELECTRIC PRODUCTS ELECTRONIC TUBE

DIV
. Seneca Falls, N Y 13148
TREPAC CORP. OF AMERICA

30 W Hamilton Ave, Englewood, N J 07631

MOTORS, SERVO

AMETEK/LAMB ELECTRIC

627 Lake St, Kent, Ohio 44240
BODINE ELECTRIC CO.

2500 W Bradley Pl, Chicago, Ill 60618
BOWMAR CANADA LTD.

1257 Algoma Rd, Ottawa Ont, CANADA
CENTURY ELECTRONICS & INSTRUMENTS INC.

P O Box C Adm Sta, Tulsa, Okla 74115
CLIFTON DIV. LITTON SYSTEMS INC.

Marple At Broadway, Clifton Heights, Pa 19018
COMPUTER DEVICES CORP. OF CALIFORNIA

11925 Burke St, Santa Fe Spg, Cal 90670
CONTROL DATA CORP. MAGNETIC COMPONENTS DIV.

2300 Berkshire Lane, Minneapolis, Minn 55427
ELECTRIC INDICATOR CO. INC.

195 Danbury Rd, Wilton, Conn 06897
ELECTRO-CRAFT CORP.

1600 S 2nd St, Hopkins, Minn 55343
GEAR SYSTEMS DIV. OF USM CORP.

Rte 128, Wakefield, Mass 01880
GENERAL ELECTRIC CO. GENERAL PURPOSE MOTOR

DEPT.
200 Taylor St, Ft Wayne, Ind 46804
HAYDON SWITCH&INSTRUMENT INC. SUB. TRI-TECH

INC.
1500 Meriden Rd, Waterbury, Conn 06720
HELIPOT DIV. BECKMAN INSTRUMENTS INC.

2500 Harbor Blvd, Fullerton, Cal 92634
IMC MAGNETICS CORP. WESTERN DIV.

6058 Walker Ave, Maywood, Cal 90270
IMC MAGNETICS CORP. EASTERN DIV.

570 Main St, Westbury, N Y 11591
INDIANA GENERAL CORP. ELECTRO-MECH. PROD.

517 W Walnut St, Oglesby, Ill 61348
INSTRUMENT SYSTEMS CORP. ROTATING COMP. DIV.

1560 5th Ave, Bayshore, N Y 11706
INTERNATIONAL CONTROLS CORP.

200 Fairfield Rd, Fairfield, N J 07006
MICRO SWITCH DIV. HONEYWELL INC.

11 W Spring St, Freeport, Ill 61032
NOVATRONICS OF CANADA LTD.

677 Erie St, Stratford Ont, CANADA
OMNIACTION CONTROL SYSTEMS DIV. DYNAMIC

INSTR.
114 E Bethpage Rd, Plainview, N Y 11803
PORTESCAP US

730 5th Ave, New York, N Y 10019
RANK PRECISION INDUSTRIES INC.

260 N Rt 303, W Nyack, N Y 10994
ROBBINS & MYERS INC. ELECTRIC MOTOR DIV.

1345 Laconda Ave, Springfield, Ohio 45501
SEQUENTIAL INFORMATION SYSTEMS INC.

145 Palisade St, Dobbs Ferry, N Y 10522
SINGER CO., THE, DIEHL DIV.

Finderne Ave, Somerville, N J 08876
STETTNER-TRUSH INC.

67 Albany St, Cazenovia, N Y 13035
TRW INC. GLOBE DIV.

2275 Stanley Ave, Dayton, Ohio 45404
URIEL CORP.

53 Union Ave, Ronkonkoma, N Y 11779
USM CORP. GEAR SYSTEMS DIV.

101 Balch St, Beverly, Mass 01915
VERNITRON CORP. MOTOR PRODUCTS DIV.

300 Marcus Blvd, Deer Park, N Y 11729
WESTON-TRANSICOIL A SCHLUMBERGER CO.

Trooper Rd, Worcester, Pa 19490

MOTORS, STEPPING

A. W. HAYDON CO., THE

232 N Elm St, Waterbury, Conn 06720
ABRAMS INSTRUMENT CORP. J A MAURER INC.

606 E Shiawassee St, Lansing, Mich 48901
AUTOMATION DEVELOPMENT CO. DIV. AMER DIG

CORP.
9903 W Jefferson Blvd, Culver City, Cal 90230
BERGEN LABORATORIES INC. SUB. ZYROTRON INC.

60 Spruce St, Paterson, N J 07501
BOWMAR CANADA LTD.

1257 Algoma Rd, Ottawa Ont, CANADA
CITIZEN AMERICA CORP.

9201 Olympic Blvd, Beverly Hills, Cal 90212
CLIFTON DIV. LITTON SYSTEMS INC.

Marple At Broadway, Clifton Heights, Pa 19018
COMPUTER DEVICES CORP. OF CALIFORNIA

11925 Burke St, Santa Fe Spg, Cal 90670
CONRAC CORP.

330 Madison Ave, New York, N Y 10017
GAP INSTRUMENT CORP.

110 Marcus Blvd, Hauppauge, N Y 11787

2 Product Directory

GEAR SYSTEMS DIV. OF USM CORP.
Rte 128, Wakefield, Mass 01880
GENERAL ELECTRIC CO. GENERAL PURPOSE MOTOR DEPT.
200 Taylor St, Ft Wayne, Ind 46804
HAYDON SWITCH&INSTRUMENT INC. SUB. TRI-TECH INC.
1500 Meriden Rd, Waterbury, Conn 06720
HEINEMANN ELECTRIC CO.
Brunswick Pike Rte 1, Trenton, N J 08638
IMC MAGNETICS CORP. WESTERN DIV.
6058 Walker Ave, Maywood, Cal 90270
INDIANA GENERAL CORP. ELECTRO-MECH. PROD.
517 W Walnut St, Ogleby, Ill 61348
LEDEX INC.
123 Webster St, Dayton, Ohio 45401
MESUR-MATIC ELECTRONICS CORP.
Church St, Warner, N H 03278
MICRO SWITCH DIV. HONEYWELL INC.
11 W Spring St, Freeport, Ill 61032
NOVATRONICS OF CANADA LTD.
677 Erie St, Stratford Ont, CANADA
PORTESCAP US
730 5th Ave, New York, N Y 10019
SIGMA INSTRUMENTS INC.
170 Pearl St, Braintree, Mass 02185
SINGER CO., THE, DIEHL DIV.
FINDERNE AVE, SOMERVILLE, N J 08876
TRW INC. GLOBE DIV.
2275 Stanley Ave, Dayton, Ohio 45404
USM CORP. GEAR SYSTEMS DIV.
101 Balch St, Beverly, Mass 01915
USM CORP. ELECTRONIC CONTROL GROUP
140 Federal St, Boston, Mass 02107
VERNITRON CORP. MOTOR PRODUCTS DIV.
300 Marcus Blvd, Deer Park, N Y 11729
WARNER ELECTRIC BRAKE & CLUTCH CO.
Beloit, Wisc 53511
WESTON-TRANSCOCOIL A SCHLUMBERGER CO.
Trooper Rd, Worcester, Pa 19490

MOTORS, SYNCHRONOUS

A. W. HAYDON CO., THE
232 N Elm St, Waterbury, Conn 06720
ASHLAND ELECTRIC PRODUCTS INC
3202 Queens Blvd, Long Is Cy, N Y 11101
BARBER-COLMAN CO.
1300 Rock St, Rockford, Ill 61101
BERGEN LABORATORIES INC. SUB. ZYROTIRON INC.
60 Spruce St, Paterson, N J 07501
BODINE ELECTRIC CO.
2500 W Bradley Pl, Chicago, Ill 60618
CLIFTON DIV. LITTON SYSTEMS INC.
Marple At Broadway, Clifton Heights, Pa 19018
COMPUTER DEVICES CORP. OF CALIFORNIA
11925 Burke St, Santa Fe Spg, Cal 90670
CONRAC CORP.
330 Madison Ave, New York, N Y 10017
CONRAC CORP. CRAMER DIV.
Mill Rock Rd, Old Saybrook, Conn 06475
DALE ELECTRONICS INC. SUB. LIONEL CORP.
1360 28th Ave, Columbus, Nebr 68601
ELECTRIC INDICATOR CO. INC.
195 Danbury Rd, Wilton, Conn 06897
FREDERICK CONTROLS DIV., SUB. NO. AM. PHILIPS CORP.
E Church & Second Sts, Frederick, Md 21701
GEAR SYSTEMS DIV. OF USM CORP.
Rte 128, Wakefield, Mass 01880
GENERAL ELECTRIC CO. GENERAL PURPOSE MOTOR DEPT.
200 Taylor St, Ft Wayne, Ind 46804
GENERAL TIME CORP. IND. CONTROLS DIV.
Rte 8, Torrington, Conn 06790
HAYDON SWITCH&INSTRUMENT INC. SUB. TRI-TECH INC.
1500 Meriden Rd, Waterbury, Conn 06720
HOWARD INDUSTRIES
2420 18 St, Racine, Wisc 53403
HURST MANUFACTURING CO.
P O Box 326, Princeton, Ind 47570
IMC MAGNETICS CORP. WESTERN DIV.
6058 Walker Ave, Maywood, Cal 90270
IMC MAGNETICS CORP., EASTERN DIV.
570 Main St, Westbury, N Y 11591
INDIANA GENERAL CORP. ELECTRO-MECH. PROD.
517 W Walnut St, Ogleby, Ill 61348
INSTRUMENT SYSTEMS CORP. ROTATING COMP. DIV.
1560 5th Ave, Bayshore, N Y 11706
INTERNATIONAL CONTROLS CORP.
200 Fairfield Rd, Fairfield, N J 07006
MALLORY & CO. INC., P.R.
3029 E Washington, Indianapolis, Ind 46218

MALLORY TIMERS CO.
3029 E Washington St, Indianapolis, Ind 46206
MCLEAN ENGINEERING LABS.
70 Washington Rd, Princeton Jct, N J 08550
MILLETRON INC.
540 Alpha Dr, Pittsburgh, Pa 15238
NOVATRONICS OF CANADA LTD.
677 Erie St, Stratford Ont, CANADA
OMNIACTION CONTROL SYSTEMS DIV. DYNAMIC INSTR.
114 E Bethpage Rd, Plainview, N Y 11803
PORTESCAP US
730 5th Ave, New York, N Y 10019
ROBBINS & MYERS INC. ELECTRIC MOTOR DIV.
1345 Laconda Ave, Springfield, Ohio 45501
SEQUENTIAL INFORMATION SYSTEMS INC.
145 Palisade St, Dobbs Ferry, N Y 10522
SIGMA INSTRUMENTS INC.
170 Pearl St, Braintree, Mass 02185
SINGER CO., THE, DIEHL DIV.
FINDERNE AVE, SOMERVILLE, N J 08876
TRW INC. GLOBE DIV.
2275 Stanley Ave, Dayton, Ohio 45404
URIEL CORP.
53 Union Ave, Ronkonkoma, N Y 11779
USM CORP. GEAR SYSTEMS DIV.
101 Balch St, Beverly, Mass 01915
USM CORP. ELECTRONIC CONTROL GROUP
140 Federal St, Boston, Mass 02107
VERNITRON CORP. MOTOR PRODUCTS DIV.
300 Marcus Blvd, Deer Park, N Y 11729
WESTERN GEAR CORP. ELECTRO PRDTS. DIV.
75 W Green St, Pasadena, Cal 91101
WESTON-TRANSCOCOIL A SCHLUMBERGER CO.
Trooper Rd, Worcester, Pa 19490

MOTORS, TORQUE

CLIFTON DIV. LITTON SYSTEMS INC.
Marple At Broadway, Clifton Heights, Pa 19018
URIEL CORP.
53 Union Ave, Ronkonkoma, N Y 11779

MULTIPLEXER-CONVERTER (SINGLE UNIT WITH MULTIPLEXER, SAMPLE & HOLD AMPLIFIER & A-T-O-D CONVERTER)

A.D. DATA SYSTEMS INC.
830 Linden Ave, Rochester, N Y 14625
AMERICAN ASTRONICS INC., SUB TECHNICOLOM INC.
855 No Cauhuenga Blvd, Hollywood, Cal 90038
ANALOG DEVICES INC. PASTORIZA DIV.
221 5th St, Cambridge, Mass 02142
ANALOGIC CORP.
Audubon Rd, Wakefield, Mass 01880
ASTROSYSTEMS INC.
6 Nevada Dr, Lake Success, N Y 11040
AVCO CORP. ELECTRONICS DIV.
4807 Bradford, Huntsville, Ala 35805
BECKMAN INSTRUMENTS INC. ELECT. INSTR. DIV.
2200 Wright Ave, Richmond, Cal 94804
BENDIX CORP., THE, ENVRNMNTL SCI. DIV.
1400 Taylor Ave, Baltimore, Md 21204
BFA CORP.
1309 S Inca, Denver, Colo 80223
BOWMAR INSTRUMENT CORP. ELECTRONIC SYS. DIV.
800 Bluffton Rd, Fort Wayne, Ind 46809
COMPU DYNE CORP. CONTROLS DIV.
P O Box 247, Hatboro, Pa 19040
COMPUTER PRODUCTS, INC.
P O Box 23849, Ft Lauderdale, Fla 33307
DASH DATA SYSTEMS INC.
69 Jefferson St, Stamford, Conn 06902
DATA CONTROL SYSTEMS INC.
Commerce Dr, Danbury, Conn 06810
DATAWEST CORP.
7503 E Osborn Rd, Scottsdale, Ariz 85251
DATUM INC.
170 E Liberty Ave, Anaheim, Cal 92801
DIGITRON CORP.
2544 W Main St, Norristown, Pa 19401
DYNALIX INC.
885 Front St, Burbank, Cal 91502
DYNAMIC MEASUREMENTS CORP.
6 Lowell Ave, Winchester, Mass 01890
ELECTRONIC SYSTEM ELECTRONICS
1040 W Alameda Dr, Tempe, Ariz 85281
ELECTRONIC ENGRG. CO. OF CAL. ELECTRONIC PRD. DIV.
1441 E Chestnut Ave, Santa Ana, Cal 92702

FAIRCHILD SEMICONDUCTOR
464 Ellis St, Mt View, Cal 94040
GAP INSTRUMENT CORP.
110 Marcus Blvd, Hauppauge, N Y 11787
GENERAL DEVICES INC.
P O Box 253, Princeton, N J 08540
GENERAL DYNAMICS CORP. ELECTRONICS DIV.
P O Box 2566, Orlando, Fla 32802
GULTON INDUSTRIES INC.
212 Durham Ave, Metuchen, N J 08840
HUGHES AIRCRAFT CO. M O S DIV.
500 Superior Ave, Newport Beach, Cal 92660
LOGICON INC.
Del Amo Financial Ctr, Torrance, Cal 90503
MB ELECTRONICS DIV. TEXTRON INC.
781 Whalley Ave, New Haven, Conn 06515
MICROWAVE MAGNETICS INC. MMI INSTRUMENT DIV.
Rte 1, Danvers, Mass 01923
NATIONAL SEMICONDUCTOR CORP.
2900 Semicon Dr, Santa Clara, Cal 95051
NEFF INSTRUMENT CORP.
1088 E Hamilton Rd, Duarte, Cal 91010
NIGITRON CORP.
2544 W Main St, Norristown, Pa 19401
NON-LINEAR SYSTEMS INC.
P O Box N, Del Mar, Cal 92014
NORTH AMERICAN ROCKWELL CORP. AUTONETICS DIV.
3370 Miraloma Ave, Anaheim, Cal 92803
NYTRONICS INC.
3rd Ave, Alpha, N J 08865
PHOENIX DATA INC.
3384 W Osborn Rd, Phoenix, Ariz 85017
PRESTON SCIENTIFIC INC.
805 E Cerritos Ave, Anaheim, Cal 92805
RAYTHEON CO. CADPO OPERATION
1415 Providence Tpk, Norwood, Mass 02062
RAYTHEON CO. EQUIPMENT DIV.
528 Boston Post Rd, Sudbury, Mass 01776
RC-95 INC.
2 Westchester Plaza, Elmsford, N Y 10523
REDCOR CORP.
21200 Victory, Woodland Hills, Cal 91364
SINGER-GENERAL PRECISION KEARFOTT DIV.
1150 McBride Ave, Little Falls, N J 07424
SOLID STATE ELECTRONICS CORP.
15321 Rayen St, Sepulveda, Cal 91343
SPACETAC INC.
Burlington Rd, Bedford, Mass 01730
SRC DIV. MOXON INC.
2222 Michelson Dr, Newport Beach, Cal 92664
STELLARMETRICS AN AYDIN CO.
P O Box 719, Santa Barbara, Cal 93102
STRUTHER-DUNN INC. SYSTEMS DIV.
1114 State St, Bettendorf, Iowa 52722
SYSTEMS CONCEPTS INC.
524 2nd St, San Francisco, Cal 94107
TAFT ELECTROSYSTEMS, INC.
P O Box 43, Metuchen, N J 08840
TIME ZERO CORP.
3530 Torrance Blvd, Torrance, Cal 90510
TRANSMAGNETICS INC.
210 Adams Blvd, Farmingdale, N Y 11735
TUSTIN ELECTRONICS CO.
17942 E Main St, Tustin, Cal 92680
UNICOMP INC.
18219 Parthenia, Northridge, Cal 91324
VARIAN ASSOCIATES GRAPHICS & DATA SYSTEMS DIV.
611 Hansen Way, Palo Alto, Cal 94303
ZELTEX INC.
1000 Chalmor Rd, Concord, Cal 94520

MULTIPLEXERS, ANALOG-RELAY (SEQUENTIAL SAMPLING)

A.D. DATA SYSTEMS INC.
830 Linden Ave, Rochester, N Y 14625
APPLIED COMPUTER SYSTEMS INC.
P O Box 6479, Austin, Tex 78702
ASTROSYSTEMS INC.
6 Nevada Dr, Lake Success, N Y 11040
AVCO CORP. ELECTRONICS DIV.
4807 Bradford, Huntsville, Ala 35805
B&F INSTRUMENT INC.
Clarmont Ave, Cornwell Height, Pa 19020
BENDIX CORP., THE, ENVRNMNTL SCI. DIV.
1400 Taylor Ave, Baltimore, Md 21204
BRISTOL CO., DIV AMERICAN CHAIN & CABLE CO.
Bristol Rd, Waterbury, Conn 06720
CLARE SYSTEMS DIV. C.P. CLARE & CO.
3101 W Pratt Ave, Chicago, Ill 60645
COMPUTER PRODUCTS, INC.
P O Box 23849, Ft Lauderdale, Fla 33307

2 Product Directory

CONTROL EQUIPMENT CORP.
32 Kearney Rd, Needham Heights, Mass 02194
CUNNINGHAM CORP. SUB. GLEASON WORKS
10 Carriage St, Honeoye Falls, N Y 14472
DATA CONTROL SYSTEMS INC.
Commerce Dr, Danbury, Conn 06810
DATUM INC.
170 E Liberty Ave, Anaheim, Cal 92801
DIGITAL AUTOMATION CO, INC.
1018 Whitehead Rd Ext, Trenton, N J 08638
DIGITRON CORP.
2544 W Main St, Norristown, Pa 19401
ELECTRONIC MODULES CORP.
P O Box 141, Timonium, Md 21093
ELECTRONIC RESEARCH CO., A TEXTRON CO.
10000 W 75th St, Shawnee Mission, Kan 66202
FAIRCHILD SEMICONDUCTOR
464 Ellis St, Mt View, Cal 94040
GENERAL DEVICES INC.
P O Box 253, Princeton, N J 08540
INTEGRAL DATA DEVICES INC.
35 Orville Dr, Bohemia, N Y 11716
JULIE RESEARCH LABORATORIES INC.
211 West 161 St, New York, N Y 10023
LANCER ELECTRONICS CORP.
1416 W Main St, Norristown, Penn 19401
LOGICON INC.
Del Amo Financial Ctr, Torrance, Cal 90503
METRA INSTRUMENTS INC.
1340 Space Park Way, Mt View, Cal 94040
MONITOR LABS INC.
10451 Roselle, San Diego, Cal 92121
NATIONWIDE ELECTRONIC SYSTEMS INC.
7 N 662 Rte 53, Itasca, Ill 60143
NIGITRON CORP.
2544 W Main St, Norristown, Pa 19401
NON-LINEAR SYSTEMS INC.
P O Box N, Del Mar, Cal 92014
NYTRONICS INC.
3rd Ave, Alpha, N J 08865
PRINCETON APPLIED RESEARCH CORP.
P O Box 565, Princeton, N J 08540
RAYCON INC.
218 Brunswick Blvd, Pointe Claire, CANADA
REO DATA PRODUCTS INC.
7346 Bolsa Ave, Westminster, Cal 92683
SINGER-GENERAL PRECISION KEARFOTT DIV.
1150 McBride Ave, Little Falls, N J 07424
SOLID STATE ELECTRONICS CORP.
15321 Rayen St, Sepulveda, Cal 91343
SRC DIV. MOXON INC.
2222 Michelson Dr, Newport Beach, Cal 92664
STRUTHER-DUNN INC. SYSTEMS DIV.
1114 State St, Bettendorf, Iowa 52722
SYMETRICS INDUSTRIES INC.
1227 S Patrick Dr, Satellite Beach, Fla 32935
SYSTEMS DATA, INC.
1951 W Market St, Akron, Ohio 44313
SYSTEMS ENGINEERING LABORATORIES INC.
P O Box 9148, Fort Lauderdale, Fla 33310
TRANSMATION INC.
977 Mount Read Blvd, Rochester, N Y 14606
TUSTIN ELECTRONICS CO.
17942 E Main St, Tustin, Cal 92680
VIDAR CORP.
77 Ortega Ave, Mountain View, Cal 94040

MULTIPLEXERS, ANALOG-SOLID STATE (SEQUENTIAL SAMPLING)

A.D. DATA SYSTEMS INC.
830 Linden Ave, Rochester, N Y 14625
AMERICAN MICRO-SYSTEMS INC.
3800 Homestead Rd, Santa Clara, Cal 95051
ANALOG DEVICES INC. PASTORIZA DIV.
221 5th St, Cambridge, Mass 02142
ANALOGIC CORP.
Audubon Rd, Wakefield, Mass 01880
APPLIED COMPUTER SYSTEMS INC.
P O Box 6479, Austin, Tex 78702
ASTROSYSTEMS INC.
6 Nevada Dr, Lake Success, N Y 11040
AVCO CORP. ELECTRONICS DIV.
4807 Bradford, Huntsville, Ala 35805
BENDIX CORP., THE, ENVRNMNTL SCI. DIV.
1400 Taylor Ave, Baltimore, Md 21204
BOWMAR INSTRUMENT CORP. ELECTRONIC SYS. DIV.
800 Bluffton Rd, Fort Wayne, Ind 46809
BURR-BROWN RESEARCH CORP.
6730 S Tucson Blvd, Tucson, Ariz 85706
COMPUDYNE CORP. CONTROLS DIV.
P O Box 247, Hatboro, Pa 19040
COMPUTER CONVERSIONS CORP.
6 Dunton Court, E Northport, N Y 11731

COMPUTER LABS INC.
1109 S Chapman St, Greensboro, N C 27403
COMPUTER PRODUCTS, INC.
P O Box 23849, Ft Lauderdale, Fla 33307
DATA CONTROL SYSTEMS INC.
Commerce Dr, Danbury, Conn 06810
DATAWEST CORP.
7503 E Osborn Rd, Scottsdale, Ariz 85251
DATEL/VARADYNE
1020 Turnpike St, Canton, Mass 02021
DATUM INC.
170 E Liberty Ave, Anaheim, Cal 92801
DDC DIV. SOLID STATE SCIENTIFIC DEVICES
100 Tec St, Hicksville, N Y 11801
DIGITAL AUTOMATION CO, INC.
1018 Whitehead Rd Ext, Trenton, N J 08638
DIGITRON CORP.
2544 W Main St, Norristown, Pa 19401
DYNALOX INC.
885 Front St, Burbank, Cal 91502
DYNAMIC MEASUREMENTS CORP.
6 Lowell Ave, Winchester, Mass 01890
DYNAMIC SYSTEM ELECTRONICS
1040 W Alameda Dr, Tempe, Ariz 85281
ELECTRONIC MODULES CORP.
P O Box 141, Timonium, Md 21093
ELECTRONIC RESEARCH CO., A TEXTRON CO.
10000 W 75th St, Shawnee Mission, Kan 66202
FAIRCHILD SEMICONDUCTOR
464 Ellis St, Mt View, Cal 94040
GAP INSTRUMENT CORP.
110 Marcus Blvd, Hauppauge, N Y 11787
GENERAL ATRONICS CORP. SUB. OF MAGNAVOX
Mermaid Lane, Philadelphia, Pa 19118
GENERAL AUTOMATION INC.
1055 S East St, Anaheim, Cal 92805
GENERAL DEVICES INC.
P O Box 253, Princeton, N J 08540
GENERAL DYNAMICS CORP. ELECTRONICS DIV.
P O Box 2566, Orlando, Fla 32802
HARRIS SEMICONDUCTOR A DIV. OF
HARRIS-INTERTYPE
P O Box 883, Melbourne, Fla 32901
INTEGRAL DATA DEVICES INC.
35 Orville Dr, Bohemia, N Y 11716
LANCER ELECTRONICS CORP.
1416 W Main St, Norristown, Penn 19401
LEAR SIEGLER INC., ELECTRONIC INSTRUMENTATION
DIV
714 N Brookhurst St, Anaheim, Cal 92803
LENKURT ELECTRIC CO., INC. SUB. OF GT&E
1105 County Rd, San Carlos, Cal 94070
LOGICON INC.
Del Amo Financial Ctr, Torrance, Cal 90503
MACNEAL-SCHWENDLER CORP., THE
7442 N Figueroa St, Los Angeles, Cal 90041
METRA INSTRUMENTS INC.
1340 Space Park Way, Mt View, Cal 94040
MONITOR LABS INC.
10451 Roselle, San Diego, Cal 92121
MOTOROLA INC. CONTROL SYSTEMS DIV
P O Box 5409, Phoenix, Ariz 85010
NATIONAL SEMICONDUCTOR CORP.
2900 Semicon Dr, Santa Clara, Cal 95051
NATIONWIDE ELECTRONIC SYSTEMS INC.
7 N 662 Rte 53, Itasca, Ill 60143
NEFF INSTRUMENT CORP.
1088 E Hamilton Rd, Duarte, Cal 91010
NIGITRON CORP.
2544 W Main St, Norristown, Pa 19401
NON-LINEAR SYSTEMS INC.
P O Box N, Del Mar, Cal 92014
NYTRONICS INC.
3rd Ave, Alpha, N J 08865
OPTICAL ELECTRONICS INC.
P O Box 11140, Tucson, Ariz 85706
PHOENIX DATA INC.
3384 W Osborn Rd, Phoenix, Ariz 85017
PRESTON SCIENTIFIC INC.
805 E Cerritos Ave, Anaheim, Cal 92805
RAYCON INC.
218 Brunswick Blvd, Pointe Claire, CANADA
RAYTHEON COMPUTER
2700 S Fairview St, Santa Ana, Cal 92704
REDCOR CORP.
21200 Victory, Woodland Hills, Cal 91364
SILCONIX INC.
2201 Laurelwood Rd, Santa Clara, Cal 95054
SINGER-GENERAL PRECISION KEARFOTT DIV.
1150 McBride Ave, Little Falls, N J 07424
SOLID STATE ELECTRONICS CORP.
15321 Rayen St, Sepulveda, Cal 91343
SPACETAC INC.
Burlington Rd, Bedford, Mass 01730

SRC DIV. MOXON INC.
2222 Michelson Dr, Newport Beach, Cal 92664
STELLARMETRICS AN AYDIN CO.
P O Box 719, Santa Barbara, Cal 93102
STRUTHER-DUNN INC. SYSTEMS DIV.
1114 State St, Bettendorf, Iowa 52722
SYSTEMS ENGINEERING LABORATORIES INC.
P O Box 9148, Fort Lauderdale, Fla 33310
TAFT ELECTROSYSTEMS, INC.
P O Box 43, Metuchen, N J 08840
TELEDYNE BROWN ENGINEERING
300 Sparkman Dr, Huntsville, Ala 35807
TELEDYNE CRYSTALONICS
147 Sherman St, Cambridge, Mass 02140
TRANSMAGNETICS INC.
210 Adams Blvd, Farmingdale, N Y 11735
TREPAC CORP. OF AMERICA
30 W Hamilton Ave, Englewood, N J 07631
TUSTIN ELECTRONICS CO.
17942 E Main St, Tustin, Cal 92680
XEROX DATA SYSTEMS
701 S Aviation, El Segundo, Cal 90245
ZELTEC INC.
1000 Chalamar Rd, Concord, Cal 94520

MULTIPLEXERS, DIGITAL

A.D. DATA SYSTEMS INC.
830 Linden Ave, Rochester, N Y 14625
ADVANCED MICRO DEVICES INC.
901 Thompson Pl, Sunnyvale, Cal 94086
AMERICAN COMPUTER TECHNOLOGY INC.
8740 Shirley Ave, Northridge, Cal 91324
AMERICAN MICRO-SYSTEMS INC.
3800 Homestead Rd, Santa Clara, Cal 95051
AMERICAN REGITEL CORP.
870 Industrial Way, San Carlos, Cal 94070
AMP INC., SYSCOM DIV.
P O Box 3608, Harrisburg, Pa 17105
ANALOGIC CORP.
Audubon Rd, Wakefield, Mass 01880
APPLIED COMPUTER SYSTEMS INC.
P O Box 6479, Austin, Tex 78702
ASTROSYSTEMS INC.
6 Nevada Dr, Lake Success, N Y 11040
AVCO CORP. ELECTRONICS DIV.
4807 Bradford, Huntsville, Ala 35805
BASIC COMPUTING ARTS INC.
2680 E Bayshore Frtge, Mt View, Cal 94040
BECKMAN INSTRUMENTS INC. ELECT. INSTR. DIV.
2200 Wright Ave, Richmond, Cal 94804
BENDIX CORP., THE, ENVRNMNTL SCI. DIV.
1400 Taylor Ave, Baltimore, Md 21204
BFA CORP.
1309 S Inca, Denver, Colo 80223
CLARE SYSTEMS DIV. C.P. CLARE & CO.
3101 W Pratt Ave, Chicago, Ill 60645
CODEX CORP.
15 Riverdale Ave, Newton, Mass 02195
COLLINS RADIO CO.
1970 Jamboree Blvd, Newport Beach, Cal 92663
COMDATA CORP.
7544 W Oakton St, Niles, Ill 60648
COMMUNICATIONS LOGIC INC.
6400 Westpark, Houston, Tex 77024
COMPUDYNE CORP. CONTROLS DIV.
P O Box 247, Hatboro, Pa 19040
COMPUTER CONVERSIONS CORP.
6 Dunton Court, E Northport, N Y 11731
COMPUTER DEVICES INC.
10 Sonar Dr, Woburn, Mass 01801
COMPUTER PRODUCTS, INC.
P O Box 23849, Ft Lauderdale, Fla 33307
COMPUTER TRANSMISSION CORP.
1508 Cotner Ave, Los Angeles, Cal 90025
CONTROL EQUIPMENT CORP.
32 Kearney Rd, Needham Heights, Mass 02194
DASH DATA SYSTEMS INC.
69 Jefferson St, Stamford, Conn 06902
DATA CONTROL SYSTEMS INC.
Commerce Dr, Danbury, Conn 06810
DATA PRODUCTS TELECOMMUNICATIONS
17 Amelia Place, Stamford, Conn 06902
DATACOM INC.
40 Lincoln Dr, Ft Walton Beach, Fla 32548
DATASERV DIV., WILLIAM J. PURDY CORP.
770 Airport Blvd, Burlingame, Cal 94010
DATAWEST CORP.
7503 E Osborn Rd, Scottsdale, Ariz 85251
DATUM INC.
170 E Liberty Ave, Anaheim, Cal 92801
DIGITAL AUTOMATION CO, INC.
1018 Whitehead Rd Ext, Trenton, N J 08638

2 Product Directory

DIGITAL EQUIPMENT CORP.
146 Main St, Maynard, Mass 01754

DIGITRON CORP.
2544 W Main St, Norristown, Pa 19401

DYNALEX INC.
885 Front St, Burbank, Cal 91502

DYNAMIC SYSTEM ELECTRONICS
1040 W Alameda Dr, Tempe, Ariz 85281

ELBIT COMPUTERS/SUB. CONTROL DATA CORP.
6 Tovim St, Haifa, ISRAEL

ELECTRONIC RESEARCH CO., A TEXTRON CO.
10000 W 75th St, Shawnee Mission, Kan 66202

ELPAC INC.
18651 Von Karman Ave, Irvine, Cal 92664

FAIRCHILD SEMICONDUCTOR
464 Ellis St, Mt View, Cal 94040

GAP INSTRUMENT CORP.
110 Marcus Blvd, Hauppauge, N.Y 11787

GENERAL DATACOMM INDUSTRIES
537 Newton Ave, Norwalk, Conn 06851

GENERAL DEVICES INC.
P O Box 253, Princeton, N J 08540

GENERAL DYNAMICS CORP. ELECTRONICS DIV.
P O Box 2566, Orlando, Fla 32802

GENERAL ELECTRIC CO. COMM. SYS. DIV.
Mountain View Rd, Lynchburg, Va 24502

GENERAL INSTRUMENT CORP. MICROELECT. DIV.
600 W John St, Hicksville, N Y 11802

GULTON INDUSTRIES INC.
212 Durham Ave, Metuchen, N J 08840

HEWLETT PACKARD CO. CUPERTINO DIV.
1100 Wolfe Rd, Cupertino, Cal 95014

HUGHES AIRCRAFT CO. M O S DIV.
500 Superior Ave, Newport Beach, Cal 92660

I/O SYSTEMS INC.
P O Box 36, Natick, Mass 01760

IBM CORP., DATA PROCESSING DIV.
1133 Westchester Ave, White Plains, N Y 10604

INCRE-DATA CORP.
6401 Acoma Rd SE, Albuquerque, N M 87108

INFORMATION CONTROL CORP.
9610 Bellanca Ave, Los Angeles, Cal 90045

INFOTON INC.
2nd Ave, Burlington, Mass 01803

IONEX DIV. OF SONEX INC.
20 E Herman St, Philadelphia, Pa 19144

LANCER ELECTRONICS CORP.
1416 W Main St, Norristown, Penn 19401

LARSE CORP.
1070 E Meadow Cir, Palo Alto, Cal 94303

LEHIGH VALLEY ELECTRONICS INC.
Po Box 125, Fogelsville, Pa 18051

LENKURT ELECTRIC CO., INC. SUB. OF GT&E
1105 County Rd, San Carlos, Cal 94070

LITTON SYSTEMS INC. DATA SYSTEMS DIV.
8000 Woodley Ave, Van Nuys, Cal 91409

LOGICON INC.
Del Amo Financial Ctr, Torrance, Cal 90503

METRA INSTRUMENTS INC.
1340 Space Park Way, Mt View, Cal 94040

MICRO SYSTEMS INC.
644 E Young St, Santa Ana, Cal 92705

MICRODATA CORP.
644 E Young St, Santa Ana, Cal 92705

MICROWAVE MAGNETICS INC. MMI INSTRUMENT DIV.
Rte 1, Danvers, Mass 01923

MONITOR LABS INC.
10451 Roselle, San Diego, Cal 92121

MOTOROLA SEMICONDUCTOR PRODUCTS INC.
5005 E Mc Dowell Rd, Phoenix, Ariz 85008

NANOSECOND SYSTEMS INC.
176 Linwood Ave, Fairfield, Conn 06430

NATIONAL SEMICONDUCTOR CORP.
2900 Semicon Dr, Santa Clara, Cal 95051

NATIONWIDE ELECTRONIC SYSTEMS INC.
7 N 662 Rte 53, Itasca, Ill 60143

NIGITRON CORP.
2544 W Main St, Norristown, Pa 19401

NON-LINEAR SYSTEMS INC.
P O Box N, Del Mar, Cal 92014

NORTH AMERICAN ROCKWELL CORP. AUTONETICS DIV.
3370 Miraloma Ave, Anaheim, Cal 92803

NYTRONICS INC.
3rd Ave, Alpha, N J 08865

PRINCETON APPLIED RESEARCH CORP.
P O Box 565, Princeton, N J 08540

PURDY CORP., WM. J.
770 Airport Blvd, Burlingame, Cal 94010

RAYCON INC.
218 Brunswick Blvd, Pointe Claire, CANADA

RAYTHEON CO. CADPO OPERATION
1415 Providence Tpk, Norwood, Mass 02062

RAYTHEON CO. EQUIPMENT DIV.
528 Boston Post Rd, Sudbury, Mass 01776

RAYTHEON COMPUTER
2700 S Fairview St, Santa Ana, Cal 92704

REO DATA PRODUCTS INC.
7346 Bolsa Ave, Westminster, Cal 92683

RUCKER CO., THE, MOORE SYSTEMS DIV.
1212 Bordeaux Dr, Sunnyvale, Cal 94086

SAGETEC CORP.
9177 Kelvin Ave, Chatsworth, Cal 91311

SCIENTIFIC CONTROL CORP.
1215 Crosby Rd, Carrollton, Tex 75080

SIERRA RESEARCH CORP. COMPUTER PROD. GRP.
167 Bedford St., Burlington, Mass 01803

SIGNETICS CORP. SUB. CORNING GLASS
811 E Arques Ave, Sunnyvale, Cal 94086

SINGER-GENERAL PRECISION KEARFOTT DIV.
1150 McBride Ave, Little Falls, N J 07424

SOLID STATE ELECTRONICS CORP.
15321 Rayen St, Sepulveda, Cal 91343

SPACETAC INC.
Burlington Rd, Bedford, Mass 01730

SRC DIV. MOXON INC.
2222 Michelson Dr, Newport Beach, Cal 92664

STELLARMETRICS AN AYDIN CO.
P O Box 719, Santa Barbara, Cal 93102

STRUTHER-DUNN INC. SYSTEMS DIV.
1114 State St, Bettendorf, Iowa 52722

SYNERGISTICS INC. IKON DATA SYS. DIV.
2619 2nd Ave, Seattle, Wash 98121

SYSTEM INDUSTRIES INC.
535 Del Rey Ave, Sunnyvale, Cal 94305

TAFT ELECTROSYSTEMS, INC.
P O Box 43, Metuchen, N J 08840

TELEDYNE BROWN ENGINEERING
300 Sparkman Dr, Huntsville, Ala 35807

TIME ZERO CORP.
3530 Torrance Blvd, Torrance, Cal 90510

TRANSMAGNETICS INC.
210 Adams Blvd, Farmingdale, N Y 11735

WEISMANTEL INC.
P O Box 1957, St Paul, Minn 55111

WELLS TP SCIENCES INC. SUB. WELLS MGT CORP
1450 Broadway, Laurence Levine, Vp 10018

WESTERN TELEOMATIC INC.
5507 Peck Rd, Arcadia, Cal 91006

MULTIPLEXERS, TIME DIVISION

INTERNATIONAL COMMUNICATIONS CORP., SUB. OF MILGO
7620 NW 36th Ave, Miami, Fla 33147

MILGO ELECTRONIC CORP.
7620 NW 36th Ave, Miami, Fla 33147

ON LINE COMPUTER CORP.
370 Ludlow St, Stamford, Conn 06902

PAPER (FOR FACSIMILE)

TEL AUTOGRAPH CORP.
8700 Bellanca Ave, Los Angeles, Cal 90045

OCR/OMR DOCUMENTS (SEE DOCUMENTS)

OPERATIONS RESEARCH (SEE CONSULTING)

OSCILLATORS, MAGNETIC

SCANBE MANUFACTURING CO.
3445 Fletcher Ave, El Monte, Cal 91750

SOLID STATE ELECTRONICS CORP.
15321 Rayen St, Sepulveda, Cal 91343

TORTEL INC.
13402 S 71 Hwy, Grandview, Mo 64030

OSCILLATORS, VOLTAGE CONTROLLED

ARVIN SYSTEMS INC.
1771 Springfield St, Dayton, Ohio 45403

AUSTRON, INC.
10214 N Interregional, Austin, Tex 78753

BECKMAN INSTRUMENTS INC. ELECT. INSTR. DIV.
2200 Wright Ave, Richmond, Cal 94804

BFA CORP.
1309 S Inca, Denver, Colo 80223

BULOVA WATCH ELECTRONICS DIV.
6120 Woodside Ave, Woodside Li, N Y 11377

COLUMBIA COMPONENTS CORP.
60 Madison Ave, Hempstead, N Y 11550

CTS CORP.
905 NW Blvd, Elkart, Ind 46514

CTS KNIGHTS INC.
Reimann Ave, Sandwich, Ill 60548

DATA CONTROL SYSTEMS INC.
Commerce Dr, Danbury, Conn 06810

DYNAMICS CORP. OF AMERICA REEVES HOFFMAN DIV.
400 W North St, Carlisle, Pa 17013

EDWIN INDUSTRIES CORP.
11933 Tech Rd, Silver Spring, Md 20904

GENERAL DEVICES INC.
P O Box 253, Princeton, N J 08540

GENERAL RADIO CO.
300 Baker Ave, Concord, Mass 01742

GIBBS MANUFACTURING & RESEARCH CORP.
450 N Main, Janesville, Wisc 53545

INDUSTRIAL TEST EQUIPMENT CO INC.
20 Beechwood Ave, Pt Washington, N Y 11050

LEHIGH VALLEY ELECTRONICS INC.
Po Box 125, Fogelsville, Pa 18051

LORCH ELECTRONICS, LORCH ADRET CORP.
105 Cedar Ln, Englewood, N J 07631

MARQUETTA ELECTRONICS INC.
3712 W Elm St, Milwaukee, Wisc 53209

MB ELECTRONICS DIV. TEXTRON INC.
781 Whalley Ave, New Haven, Conn 06515

MULTITECH DATA PRODUCTS
583 Monterey Pass Rd, Monterey Park, Cal 91754

OPTICAL ELECTRONICS INC.
P O Box 11140, Tucson, Ariz 85706

OVENAIRE INC.
706 Forrest St, Charlottesville, Va 22901

SIGNETICS CORP. SUB. CORNING GLASS
811 E Arques Ave, Sunnyvale, Cal 94086

SOLID STATE ELECTRONICS CORP.
15321 Rayen St, Sepulveda, Cal 91343

TORTEL INC.
13402 S 71 Hwy, Grandview, Mo 64030

VIDAR CORP.
77 Ortega Ave, Mountain View, Cal 94040

WISE INSTRUMENTATION & CONTROLS INC.
3568 Amherst Court, Mt View, Cal 94040

PACKAGING SYSTEMS

SCANBE MANUFACTURING CO.
3445 Fletcher Ave, El Monte, Cal 91750

PANEL METERS (SEE METERS)

PANELS, POWER DISTRIBUTION

AMCO ENGINEERING CO.
7333 W Ainslie, Chicago, Ill 60656

BABCOCK & WILCOX AUTOMTD MACHINE DIV
950 S Rochester Rd, Rochester, Mich 48063

BAILEY METER CO. SUB. BABCOCK&WILCOX
29801 Euclid Ave, Wickliffe, Ohio 44092

BORG-WARNER/INGERSOLL PRODUCTS/EMCOR
1000 W 120th St, Chicago, Ill 60643

BUSSCO ENGINEERING INC.
122 Penn St, El Segundo, Cal 90245

CONTROL DATA CORP. CONNECTOR OPERATION
31829 W Latienda Dr, Westlake Vii, Cal 91360

KEYSTONE ELECTRONICS CORP.
49 Bleecker St, New York, N Y 10012

METHODE ELECTRONICS INC.
7447 W Wilson Ave, Chicago, Ill 60656

TELEDYNE BROWN ENGINEERING
300 Sparkman Dr, Huntsville, Ala 35807

WESTINGHOUSE ELECTRIC CORP.
Westinghouse Bldg, Pittsburgh, Pa 15222

PAPER (FOR MICR EQUIPMENT)-

ACCURATE BUSINESS FORMS CO., INC.
P O Box 8339, Milwaukee, Wis 53225

ACME DATAGRAPHIC BUSINESS SYSTEMS INC.
45 E Wesley St, S Hackensack, N J 07606

AMERICAN BUSINESS FORMS INC.
114 S Canal St, Chicago, Ill 60606

BALTIMORE BUSINESS FORMS INC.
3132 Frederick Ave, Baltimore, Md 21229

BONNAR-VAWTER INC.
96 Dunbar St, Keene, N H 03431

BURROUGHS CORP., BUSINESS FORMS & SUPPLIES
1150 Univ Ave, Rochester, N Y 14607

INTERNATIONAL SYSTEMS ASSOCIATES, LTD.
350 5th Ave, New York, N Y 10001

2 Product Directory

LEWIS BUSINESS FORMS INC.
P O Box M, Jacksonville, Fla 32203
3M CO.
3m Center, St Paul, Minn 55101
MOORE BUSINESS FORMS INC.
110-112 Pkwy Inn Bldg, Niagara Falls, N Y 14302
SCANFORMS INC.
312 Fox Pavilion, Jenkintown, Pa 19095
SCM ALLIED EGRY BUSINESS SYSTEMS
P O Box 125 Wc Br, Dayton, Ohio 45449
SERVICE BUSINESS FORMS
815 E Second, Wichita, Kans 67202
STANDARD REGISTER CO., THE
626 Albany St, Dayton, Ohio 45401
STINAFFS INC.
181 E Exchange St, Akron, Ohio 44304
STURGIS NEWPORT BUSINESS FORMS INC.
P O Box 31, Sturgis, Mich 49091
WALLACE BUSINESS FORMS INC.
4600 W Roosevelt Rd, Hillside, Ill 60162

PAPER (FOR OCR EQUIPMENT)

ACCURATE BUSINESS FORMS CO., INC.
P O Box 8339, Milwaukee, Wis 53225
ACME DATAGRAPHIC BUSINESS SYSTEMS INC.
45 E Wesley St, S Hackensack, N J 07606
ACME VISIBLE RECORDS INC.
510 Allview Dr, Crozet, Va 22932
ADDRESSOGRAPH MULTIGRAPH CORP BRUNING DIV.
1200 Babbitt Rd, Cleveland, Ohio 44117
AMERICAN BUSINESS FORMS INC.
114 S Canal St, Chicago, Ill 60606
BALTIMORE BUSINESS FORMS INC.
3132 Frederick Ave, Baltimore, Md 21229
BONNAR-VAWTER INC.
96 Dunbar St, Keene, N H 03431
BURROUGHS CORP., BUSINESS FORMS & SUPPLIES
1150 Univ Ave, Rochester, N Y 14607
COLUMBIA RIBBON & CARBON MFG. CO. INC.
Herb Hill Rd, Glen Cove, N Y 11542
FRYE MANUFACTURING CO.
P O Box 854, Des Moines, Iowa 50304
INPUT DATA CO. INC.
1187 Valley Rd, Stirling, N J 07980
INTERNATIONAL SYSTEMS ASSOCIATES, LTD.
350 5th Ave, New York, N Y 10001
LEWIS BUSINESS FORMS INC.
P O Box M, Jacksonville, Fla 32203
MOORE BUSINESS FORMS INC.
110-112 Pkwy Inn Bldg, Niagara Falls, N Y 14302
SCANFORMS INC.
312 Fox Pavilion, Jenkintown, Pa 19095
SCM ALLIED EGRY BUSINESS SYSTEMS
P O Box 125 Wc Br, Dayton, Ohio 45449
SERVICE BUSINESS FORMS
815 E Second, Wichita, Kans 67202
STANDARD REGISTER CO., THE
626 Albany St, Dayton, Ohio 45401
STINAFFS INC.
181 E Exchange St, Akron, Ohio 44304
STURGIS NEWPORT BUSINESS FORMS INC.
P O Box 31, Sturgis, Mich 49091
WALLACE BUSINESS FORMS INC.
4600 W Roosevelt Rd, Hillside, Ill 60162

PAPER (FOR PRINTERS)

ACCURATE BUSINESS FORMS CO., INC.
P O Box 8339, Milwaukee, Wis 53225
ACME DATAGRAPHIC BUSINESS SYSTEMS INC.
45 E Wesley St, S Hackensack, N J 07606
ALDEN ELECTRONIC & IMPULSE RECORDING EQUIP.
CO
Washington St, Westboro, Mass 01581
AMERICAN BUSINESS FORMS INC.
114 S Canal St, Chicago, Ill 60606
APPLIED MICROFILM CORP.
107 Binney St, Watertown, Mass 02142
BALTIMORE BUSINESS FORMS INC.
3132 Frederick Ave, Baltimore, Md 21229
BONNAR-VAWTER INC.
96 Dunbar St, Keene, N H 03431
BURROUGHS CORP., BUSINESS FORMS & SUPPLIES
1150 Univ Ave, Rochester, N Y 14607
CONTINENTAL DATA PROCESSING INC.
300 Market St, Kingston, Pa 18704
CYBERMATICS INC.
2460 Lemoine Ave, Fort Lee, N J 07024
DATASERV DIV., WILLIAM J. PURDY CORP.
770 Airport Blvd, Burlingame, Cal 94010
DI/AN CONTROLS INC.
944 Dorchester Ave, Boston, Mass 02125

DIGITAL EQUIPMENT CORP.
146 Main St, Maynard, Mass 01754
FRYE MANUFACTURING CO.
P O Box 854, Des Moines, Iowa 50304
GOULD INC. BRUSH DIV.
3631 Perkins Ave, Cleveland, Ohio 44114
INTERNATIONAL COMPUTERS LTD.
Icl House Putney, London S W 15, UNITED K
INTERNATIONAL SYSTEMS ASSOCIATES, LTD.
350 5th Ave, New York, N Y 10001
ITEK BUSINESS PRODUCTS
1001 Jefferson Rd, Rochester, N Y 14603
LEWIS BUSINESS FORMS INC.
P O Box M, Jacksonville, Fla 32203
3M CO.
3m Center, St Paul, Minn 55101
MOORE BUSINESS FORMS INC.
110-112 Pkwy Inn Bldg, Niagara Falls, N Y 14302
NUMERIDEX TAPE SYSTEMS INC.
4711 W North Ave, Chicago, Ill 60639
ORIGINAL COMPUTER PRODUCTS INC.
204 Worcester St, Wellesley Hills, Mass 02181
PURDY CORP., WM. J.
770 Airport Blvd, Burlingame, Cal 94010
RCA COMPUTER SYSTEMS DIV.
200 Forest Ave, Marlboro, Mass 01752
SCANFORMS INC.
312 Fox Pavilion, Jenkintown, Pa 19095
SCM ALLIED EGRY BUSINESS SYSTEMS
P O Box 125 Wc Br, Dayton, Ohio 45449
SERVICE BUSINESS FORMS
815 E Second, Wichita, Kans 67202
STANDARD REGISTER CO., THE
626 Albany St, Dayton, Ohio 45401
STURGIS NEWPORT BUSINESS FORMS INC.
P O Box 31, Sturgis, Mich 49091
WALLACE BUSINESS FORMS INC.
4600 W Roosevelt Rd, Hillside, Ill 60162

PAPER (FOR RECORDERS AND PLOTTERS)

ACCURATE BUSINESS FORMS CO., INC.
P O Box 8339, Milwaukee, Wis 53225
ADDRESSOGRAPH MULTIGRAPH CORP BRUNING DIV.
1200 Babbitt Rd, Cleveland, Ohio 44117
ALDEN ELECTRONIC & IMPULSE RECORDING EQUIP.
CO
Washington St, Westboro, Mass 01581
AMERICAN BUSINESS FORMS INC.
114 S Canal St, Chicago, Ill 60606
BFA CORP.
1309 S Inca, Denver, Colo 80223
BONNAR-VAWTER INC.
96 Dunbar St, Keene, N H 03431
CALIFORNIA COMPUTER PRODUCTS INC.
2411 W La Palma Ave, Anaheim, Cal 92801
CURRAN COMPUTER CORP.
946 Main St, Hackensack, N J 07601
EDGERTON GERMESHAUSEN GRIER INC.
Crosby Dr, Bedford, Mass 01730
ESTERLINE ANGUS DIV., ESTERLINE CORP.
Po Box 24000, Indianapolis, Ind 46224
GOULD INC. BRUSH DIV.
3631 Perkins Ave, Cleveland, Ohio 44114
INFO-MAX
1248 Alderwood, Sunnyvale, Cal 94086
INSO ELECTRONIC PRODUCTS INC.
77 E Hawthorne Ave, Valley Stream, N Y 11580
INTERNATIONAL SYSTEMS ASSOCIATES, LTD.
350 5th Ave, New York, N Y 10001
MOORE BUSINESS FORMS INC.
110-112 Pkwy Inn Bldg, Niagara Falls, N Y 14302
MUIRHEAD INC.
1101 Bristol Rd, Mountainside, N J 07092
SCM ALLIED EGRY BUSINESS SYSTEMS
P O Box 125 Wc Br, Dayton, Ohio 45449
TRACOR DATA SYSTEMS INC.
4201 Ed Bluestein Blv, Austin, Tex 78721
VARIAN ASSOCIATES GRAPHICS & DATA SYSTEMS
DIV.
611 Hansen Way, Palo Alto, Cal 94303

PATTERN RECOGNITION EQUIPMENT

SYSTEMATICS GENERAL CORP.
6825 Redmond Dr, McLean, Va 22101

PAYMENT COUPON BOOKS, MACHINE READABLE

ACCURATE BUSINESS FORMS CO., INC.
P O Box 8339, Milwaukee, Wis 53225
ALLISON COUPON COMPANY, INC.
200 S Capitol, Indianapolis, Ind 46206
BURROUGHS CORP., BUSINESS FORMS & SUPPLIES
1150 Univ Ave, Rochester, N Y 14607
INTERNATIONAL COMPUTERS LTD.
Icl House Putney, London S W 15, UNITED K
MOORE BUSINESS FORMS INC.
110-112 Pkwy Inn Bldg, Niagara Falls, N Y 14302
STANDARD REGISTER CO., THE
626 Albany St, Dayton, Ohio 45401
WALLACE BUSINESS FORMS INC.
4600 W Roosevelt Rd, Hillside, Ill 60162

PAYROLL PROCESSING (SEE MACHINE TIME RENTAL/PROCESSING SERVICES)

PERFORATED DOCUMENT READERS (SEE READERS)

PERFORATORS, DOCUMENT

BOURNS INC.
1200 Columbia Ave., Riverside, Cal 92507
FRIDEN DIV. THE SINGER CO.
97 Humboldt St, Rochester, N Y 14602
MICHAEL BUSINESS MACHINES CORP.
145 W 45th St, New York, N Y 10036

PERFORATORS, PAPER TAPE

ADVANCED SPACE AGE PRODUCTS
4308 Wheeler Ave, Alexandria, Va 22313
ANDERSON JACOBSON INC.
1065 Morse Ave., Sunnyvale, Cal 94086
BFA CORP.
1309 S Inca, Denver, Colo 80223
BONNAR-VAWTER INC.
96 Dunbar St, Keene, N H 03431
BURROUGHS CORP., OEM PRODUCT SALES
1649 Wilshire Blvd, Los Angeles, Cal 90017
CHALCO ENGINEERING CORP.
15126 S Broadway, Gardena, Cal 90248
COMPUTER ACCESSORIES CO.
131 W 154th St, Gardena, Cal 90248
CONNECTICUT TECHNICAL CORP.
3000 Main St, Hartford, Conn 06120
DATA GRAPHICS CORP.
8402 Speedway, San Antonio, Tex 78230
DATATERM INC.
1671 Manning Blvd, Levittown, Pa 19057
DIGITRONICS CORP.
1 Albertson Ave, Albertson, N Y 11507
FRIDEN DIV. THE SINGER CO.
97 Humboldt St, Rochester, N Y 14602
FUJITSU LTD. N.Y.LIAISON OFFICE
680 Fifth Ave, New York, N Y 10019
ITT DATA EQUIPMENT & SYSTEMS DIV.
187 E Union Ave, E Rutherford, N J 07073
KLEINSCHMIDT DIV., SCM CORP.
Lake-Cook Rd, Deerfield, Ill 60015
LEHIGH VALLEY ELECTRONICS INC.
Po Box 125, Fogelsville, Pa 18051
MICRODATA CORP.
644 E Young St, Santa Ana, Cal 92705
NCR INDUSTRIAL PRODUCTS DIV.
Main And K St, Dayton, Ohio 45409
OCHMAN SYSTEMS, EDWARD
Po Box 141, Fairfield, Conn 06430
OHRTRONICS INC., SUB MOHAWK DATA SCIENCES
CORP.
P O Box 406, King of Prussia, Pa 19406
OKI ELECTRIC INDUSTRIES CO. LTD.
875 Ave of Americas, New York, N Y 10001
OLIVETTI CORP. OF AMERICA
500 Park Ave, New York, N Y 10016
PHOTON INC.
355 Middlesex Ave, Wilmington, Mass 01887
QANTELE CORP.
3474 Investment Blvd, Hayward, Cal 94545
REMX ELECTRONICS
5250 W El Segundo Blv, Hawthorne, Cal 90250
SHIRAK TELEMETERING OF AMERICA
8926 Kester Ave, Van Nuys, Cal 91402

2 Product Directory

SINGER CO., THE, FRIDEN DIV.
2350 Washington St, San Leandro, Cal 94577
TALLY CORP.
8301 S 180th St, Kent, Wash 98031
TELETYPE CORP.
5555 W Touhy Ave, Skokie, Ill 60076
TEXAS INSTRUMENTS INC. DIGITAL SYSTEMS DIV
P O Box 66027, Houston, Tex 77006

PHOTOCONDUCTIVE CELLS (SEE CELLS)

PHOTOTRANSISTORS (SEE TRANSISTORS)

PLATED WIRE

COHN CORP., SIGMUND
1215 Columbus Ave, Mt Vernon, N Y 10553
INSTRUTECH CORP. INSTRUMENT WIRE DIV
7 Just Rd, Fairfield, N J 07006
LOCKHEED ELECTRONICS CO. DATA PRODUCTS DIV.
6201 E Randolph St, Los Angeles, Cal 90650
LOCKHEED ELECTRONICS CO. DIV. LOCKHEED ACRFT CORP
U S Hwy 22, Plainfield, N J 07060
MEMORY SYSTEMS INC.
3341 W El Segundo Blvd, Hawthorne, Cal 90250
NEMONIC DATA SYSTEMS INC.
1301 W 3rd Ave, Denver, Colo 80223
NORTH AMERICAN ROCKWELL CORP. AUTONETICS DIV.
3370 Miraloma Ave, Anaheim, Cal 92803
PLESSEY MEMORY PRODUCTS CORP.
1674 McGaw Ave, Santa Ana, Cal 92705
RAYTHEON CO. EQUIPMENT DIV.
528 Boston Post Rd, Sudbury, Mass 01776
STANDARD WIRE AND CABLE CO.
3440 Overland Ave, Los Angeles, Cal 90034
TOKO N. Y. INC. SUB. OF TOKO INC. TOKYO
350 5th Ave, New York, N Y 10001

PLOTTERS, MOVING PEN (ANALOG CONTROLLER)

ARGONAUT ASSOCIATES INC.
P O Box K, Beaverton, Ore 97005
ARVIN SYSTEMS INC.
1771 Springfield St, Dayton, Ohio 45403
BFA CORP.
1309 S Inca, Denver, Colo 80223
BOLT BERANEK & NEWMAN INC. DATA EQUIPMENT DIV.
1762 McGaw St, Santa Ana, Cal 92705
BRISTOL CO., DIV AMERICAN CHAIN & CABLE CO.
Bristol Rd, Waterbury, Conn 06720
COMPUTER GRAPHICS CORP. DIV. MILGO ELECTRONIC
7620 NW 36th Ave, Miami, Fla 33147
ELECTRONIC ASSOCIATES INC.
485 Monmouth Pkwy, W Long Branch, N J 07764
GOULD INC. BRUSH DIV.
3631 Perkins Ave, Cleveland, Ohio 44114
HEWLETT PACKARD CO.
1501 Page Mill Rd, Palo Alto, Cal 94304
HONEYWELL INC. TEST INSTRUMENTS DIV.
P O Box 5227, Denver, Colo 80217
HOUSTON INSTRUMENT INC. DIV. BAUSCH & LOMB INC.
4950 Terminal Ave, Bellaire, Tex 77401
I/O SYSTEMS INC.
P O Box 36, Natick, Mass 01760
LEEDS & NORTHRUP CO.
Sumney Town Pike, North Wales, Pa 19454
MARK/OPS DIV., NORTH EASTERN SYSTEMS ASSOC. INC.
475 Commonwealth Ave, Boston, Mass 02215
MILGO ELECTRONIC CORP.
7620 NW 36th Ave, Miami, Fla 33147
OMEGA-T SYSTEMS INC.
300 Terrace Village, Richardson, Tex 75080
UNIVERSITY COMPUTING CO. GRAPHIC SYSTEMS DIV
14761 Califa St, Van Nuys, Cal 91401

PLOTTERS, MOVING PEN (DIGITAL CONTROLLER)

ARVIN SYSTEMS INC.
1771 Springfield St, Dayton, Ohio 45403
AUTO-TROL CORP.
6621 W 56th Ave, Arvada, Colo 80002
BENDIX COMPUTER GRAPHICS
23850 Freeway Park Dr, Farmington, Mich 48024
BOSTON DIGITAL CORP.
Main St, Ashland, Mass 01721
CALIFORNIA COMPUTER PRODUCTS INC.
2411 W La Palma Ave, Anaheim, Cal 92801
COMPUTER DESIGN CORP.
12401 W Olympic Blvd, Los Angeles, Cal 90064
COMPUTER DEVICES INC.
10 Sonar Dr, Woburn, Mass 01801
COMPUTER GRAPHICS CORP. DIV. MILGO ELECTRONIC
7620 NW 36th Ave, Miami, Fla 33147
COMPUTER-LINK CORP.
14 Cambridge St, Burlington, Mass 01803
COMPUTERVISION CORP.
NW Ind Park S Ave, Burlington, Mass 01803
CONCORD CONTROL INC.
1282 Soldier Field Rd, Boston, Mass 02135
CONTROL DATA CORP.
8100 34th Ave S, Minneapolis, Minn 55440
CURRAN COMPUTER CORP.
946 Main St, Hackensack, N J 07601
DELMARVA COMPUTER INDUSTRIES INC.
5865 Robert Oliver Pl, Columbia, Md 21043
DIGITAL EQUIPMENT CORP.
146 Main St, Maynard, Mass 01754
DIGITAL SCIENTIFIC CORP.
11455 Sorrento Vly Rd, San Diego, Cal 92121
DIMENSIONAL SYSTEMS INC.
393 Totten Pond Rd, Waltham, Mass 02154
ELECTRONIC ASSOCIATES INC.
485 Monmouth Pkwy, W Long Branch, N J 07764
GERBER SCIENTIFIC INSTRUMENT CO., THE
P O Box 305, Hartford, Conn 06101
GOULD INC. BRUSH DIV.
3631 Perkins Ave, Cleveland, Ohio 44114
HEWLETT PACKARD CO.
1501 Page Mill Rd, Palo Alto, Cal 94304
HOUSTON INSTRUMENT INC. DIV. BAUSCH & LOME INC.
4950 Terminal Ave, Bellaire, Tex 77401
IBM CORP., DATA PROCESSING DIV.
1133 Westchester Ave, White Plains, N Y 10604
KONGSBERG SYSTEMS INC.
10 De Angelo Dr, Bedford, Mass 01730
MILGO ELECTRONIC CORP.
7620 NW 36th Ave, Miami, Fla 33147
RC-95 INC.
2 Westchester Plaza, Elmsford, N Y 10523
TIME SHARE PERIPHERALS CORP.
P O Box 361, Wilton, Conn 06897
TIMESHARE DEVICES INC.
225 Crescent St, Waltham, Mass 02154
UNIVERSITY COMPUTING CO. GRAPHIC SYSTEMS DIV
14761 Califa St, Van Nuys, Cal 91401
XYNETICS INC.
6710 Variel Ave, Canoga Park, Cal 91303

PLOTTERS, NON-IMPACT

GRAPHIC DATA INC.
169 Bedford St, Burlington, Mass 01803
RC-95 INC.
2 Westchester Plaza, Elmsford, N Y 10523
VERSATEC
10100 Bubb Rd, Cupertino, Cal 95014

PLUGBOARDS, PROGRAMMING

AMP INC.
Eisenhower Blvd, Harrisburg, Pa 17105
COMPUTER ACCESSORIES CO.
131 W 154th St, Gardena, Cal 90248
INFO-LITE CORP.
2337 Lemoine Ave, Fort Lee, N J 07024
INTERSWITCH DIV. WILLIAM J. PURDY CORP.
770 Airport Blvd, Burlingame, Cal 94010
KEYSTONE ELECTRONICS CORP.
49 Bleecker St, New York, N Y 10012
MACPANEL CO. ADAMS-MILLIS CORP.
P O Box 5027, High Point, N C 27262
PROGRAM DATA CO.
739 E 223 St, Torrance, Cal 90502
PURDY CORP., WM. J.
770 Airport Blvd, Burlingame, Cal 94010

Logic too dense for ordinary hardware? Switch to INTERSWITCH Optimized Man/Machine Interfaces

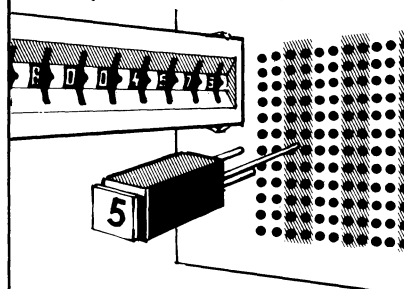

Use INTERSWITCH Data Programming Modules and INTERSWITCH Matrix Boards for more interconnections per unit of space, and for more options in choosing interconnection logic and programming means.

INTERSWITCH Matrix Boards offer important advantages — design simplicity, programming ease and flexibility, visual presentation of the circuit linkage, high package density — over other programming methods (punched cards, magnetic or paper tapes, crossbar switches, hard-wired matrices, etc.). They may be used both as patchboards, connecting circuits to circuits on a one-to-one basis, and as logic-performing devices (e.g., encoding, decoding, programming). Standard one-level and multi-level boards are available in a wide choice of formats.

The Matrix Board line includes a broad selection of Programming Elements with which to satisfy almost any combination of circuit, display, and logic requirements — shorting pins, diode plugs, dummy plugs, plug-in lamps, cable plugs, and custom accessories.

INTERSWITCH Data Programming Modules accomplish BCD (or hexadecimal) programming by simple insertion of appropriate decimal-numbered keys into a standard switch body mounted on, or plugged into, a Matrix Board or conventional printed circuit board. For quick, error-free programming of many characters at once, program-storing templates are available for inserting or removing a complete program simultaneously. For further error-free simplicity, modules may be color-coded — seven standard colors available.

We simplify the man/machine interface. For more technical data on our thumbwheel switches, see the INTERSWITCH catalog insert.

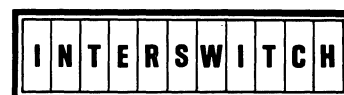

One of the PURDY group of companies
770 Airport Boulevard
Burlingame, California 94010
(415) 347-8217

2 Product Directory

SRC DIV. MOXON INC.
2222 Michelson Dr, Newport Beach, Cal 92664
SYSTRON-DONNER CORP.
888 Galindo St, Concord, Cal 94520
VECTOR ELECTRONIC CO. INC.
12460 Gladstone Ave, Sylmar, Cal 91342
VIRGINIA ELECTRONICS CO. INC.
2901 Telear Court, Falls Church, Va 22042
VIRGINIA PANEL CORP.
1400 N Hope Rd, Waynesboro, Va 22980

POLE PIECES, FERRITE

COUNTIS INDUSTRIES
Po Box 1444, San Luis Obispo, Cal 93401
DATA MAGNETICS CORP.
355 Maple Ave, Torrance, Cal 90503
FERROXICUBE CORP.
Po Box 359, Saugerties, N Y 12477
GOULD INC. BRUSH DIV.
3631 Perkins Ave, Cleveland, Ohio 44114
INDIANA GENERAL CORP. ELECT. PRDTS. GRP.
Crows Mill Rd, Keasbey, N J 08832
LIPPS INC.
1630 Euclid St, Santa Monica, Cal 90404
MAGNETIC ARTS CORP.
1310 Industrial Ave, Escondido, Cal 92025
MICRONETICS INC.
Rte 28, W Hurley, N Y 12491

POOLERS, MAGNETIC TAPE

ANDERSON JACOBSON INC.
1065 Morse Ave., Sunnyvale, Cal 94086
BRIGHT INDUSTRIES INC.
1 Maritime Plaza, San Francisco, Cal 94111
COGAR CORP. INFORMATION SYS.DIV
Cosby Manor Rd, Utica, N Y 13502
COMPUCORD INC.
225 Crescent St, Waltham, Mass 02154
COMPUTER ENTRY SYSTEMS CORP.
2141 Industrial Pkwy, Silver Spring, Md 20904
DATA ACTION CORP.
4445 W 77th St, Minneapolis, Minn 55435
DATA INPUT DEVICES INC.
Tinkham Ind Pk, Derry, N H 03038
DATA TRENDS INC.
P O Box 82, Mt Lake, N J 07046
DIGITAL INFORMATION DEVICES INC.
210 Welsh Pool Rd, Lionville, Pa 19353
FORET, P. G.
60 Union Ave, Sudbury, Mass 01776
FRIDEN DIV. THE SINGER CO.
97 Humboldt St, Rochester, N Y 14602
HEWLETT PACKARD CO. MOUNTAIN VIEW DIV.
690 Middlefield Rd, Mtn View, Cal 94040
HONEYWELL INFORMATION SYSTEMS
60 Walnut St, Wellesley Hills, Mass 02181
HYPERTECH CORP.
7343 W Wilson Ave, Harwood Hghts, Ill 60656
INTERNATIONAL COMPUTER PRODUCTS INC.
P O Box 34484, Dallas, Tex 75234
LEACH CORP. CONTROLS DIV.
717 N Coney Ave, Azusa, Cal 91702
MOHAWK DATA SCIENCES CORP.
Palisade St, Herkimer, N Y 13350
MSI DATA CORP.
4751 Holt Ave, Mont Clair, Cal 91763
SINGER CO., THE, FRIDEN DIV.
2350 Washington St, San Leandro, Cal 94577
TELECTRO SYSTEMS CORP.
96-18 43rd Ave, Corona, N Y 11368
TRANSITEL, DIV. OF SANGAMO ELECTRIC CO.
P O Box 7255, Denver, Colo 80207

POTENTIOMETERS, TRIM (FILM)

AIRCO SPEER ELECTRONICS, DIV. OF AIR REDUCTION CO
800 Theresia St, St Marys, Pa 15857
AUTOMATION SCIENCES INTERNATIONAL CORP.
600 South St, Holbrook, Mass 02343
BOURNS INC.
1200 Columbia Ave., Riverside, Cal 92507
BOWMAR/TIC INC.
850 Lawrence Dr, Newbury Park, Cal 91320
CLAROSTAT MANUFACTURING CO. INC.
Washington St, Dover, N H 03820
CTS CORP.
905 NW Blvd, Elkart, Ind 46514
DALE ELECTRONICS INC. SUB. LIONEL CORP.
1360 28th Ave, Columbus, Nebr 68601

DUNCAN ELECTRONICS, INC.
2865 Fairview Rd, Costa Mesa, Cal 92626
ELCOM ELECTRONICS INC.
200 Allen Blvd, Farmingdale, N Y 11735
FAIRCHILD CAMERA & INST. CO. FAIRCHILD CONT. DIV
225 Park Ave, Hicksville, N Y 11802
HELIPOT DIV. BECKMAN INSTRUMENTS INC.
2500 Harbor Blvd, Fullerton, Cal 92634
MALLORY CONTROLS CO.
P O Box 327, Frankfort, Ind 46041
MINELCO, SUB. GENERAL TIME CORP.
600 South St, Holbrook, Mass 02343
NUCLEONIC PRODUCTS CO. INC.
6660 Variel Ave, Canoga Park, Cal 91303
SPECTROL ELECTRONICS CORP.
17070 E Gale Ave, Industry, Cal 91745
TECHNO-COMPONENTS CORP. SUB
OAK/ELECTRONETICS
7803 Lemona Ave, Van Nuys, Cal 91405
TRW INC. IRC ST. PETERSBURG DIV.
2801 72nd St N, St Petersburg, Fla 33733
VIRGINIA ELECTRONICS CO. INC.
2901 Telear Court, Falls Church, Va 22042
VISHAY RESISTOR PRODUCTS INC.
63 Lincoln Hwy, Maluern, Pa 19355

POTENTIOMETERS, TRIM (WIRE-WOUND)

AMPHENOL CONTROLS DIV. BUNKER RAMO CORP.
120 S Main St, Janesville, Wisc 53545
AUTOMATION SCIENCES INTERNATIONAL CORP.
600 South St, Holbrook, Mass 02343
BOURNS INC.
1200 Columbia Ave., Riverside, Cal 92507
BOWMAR/TIC INC.
850 Lawrence Dr, Newbury Park, Cal 91320
CLAROSTAT MANUFACTURING CO. INC.
Washington St, Dover, N H 03820
DALE ELECTRONICS INC. SUB. LIONEL CORP.
1360 28th Ave, Columbus, Nebr 68601
DUNCAN ELECTRONICS, INC.
2865 Fairview Rd, Costa Mesa, Cal 92626
ELCOM ELECTRONICS INC.
200 Allen Blvd, Farmingdale, N Y 11735
FAIRCHILD CAMERA & INST. CO. FAIRCHILD CONT. DIV
225 Park Ave, Hicksville, N Y 11802
MALLORY & CO. INC., P.R.
3029 E Washington, Indianapolis, Ind 46218
MINELCO, SUB. GENERAL TIME CORP.
600 South St, Holbrook, Mass 02343
OHMITE MANUFACTURING CO.
3601 Howard St, Skokie, Ill 60076
SPECTROL ELECTRONICS CORP.
17070 E Gale Ave, Industry, Cal 91745
TECHNO-COMPONENTS CORP. SUB
OAK/ELECTRONETICS
7803 Lemona Ave, Van Nuys, Cal 91405
TRANSITRON ELECTRONIC CORP.
168 Albion St, Wakefield, Mass 01880
TRW INC. IRC ST. PETERSBURG DIV.
2801 72nd St N, St Petersburg, Fla 33733
VISHAY RESISTOR PRODUCTS INC.
63 Lincoln Hwy, Maluern, Pa 19355

POWER SUPPLIES, AC

ABBOTT TRANSISTOR LABORATORIES INC.
5200 W Jefferson Blvd, Los Angeles, Cal 90016
ACME ELECTRIC CORP.
20 Water St, Cuba, N Y 14727
ALTEC DIV., LTV LING ALTEC INC.
1515 So Manchester Av, Anaheim, Cal 92803
AMBAC INDUSTRIES INC. WANLASS DIV.
525 Virginia Dr, Ft Washington, Pa 19034
AMPHENOL CONTROLS DIV. BUNKER RAMO CORP.
120 S Main St, Janesville, Wisc 53545
ANALOGIC CORP.
Audubon Rd, Wakefield, Mass 01880
ARNOLD MAGNETICS CORP.
P O Box K, Culver City, Cal 90230
AUSTRON, INC.
10214 N Interregional, Austin, Tex 78753
AVTEL CORP.
1130 E Cypress St, Covina, Cal 91722
BASLER ELECTRIC CO.
Rte 143, Highland, Ill 62249
BERGEN LABORATORIES INC. SUB. ZYROTRON INC.
60 Spruce St, Paterson, N J 07501
BOWMAR INSTRUMENT CORP. ELECTRONIC SYS. DIV
800 Bluffton Rd, Fort Wayne, Ind 46809

BULOVA WATCH ELECTRONICS DIV.
6120 Woodside Ave, Woodside Li, N Y 11377
CALIFORNIA INSTRUMENTS CO.
5150 Conroy St, San Diego, Cal 92111
CLARE SYSTEMS DIV. C.P. CLARE & CO.
3101 W Pratt Ave, Chicago, Ill 60645
COMPUTER CORP. OF AMERICA
6216 Evergreen St, Houston, Tex 77036
COMPUTER DIODE CORP.
Pollitt Dr S, Fair Lawn, N J 07410
COMPUTER LOGIC CORP.
1528 20th St, Santa Monica, Cal 90404
CONTROL DATA CORP. MAGNETIC COMPONENTS DIV.
2300 Berkshire Lane, Minneapolis, Minn 55427
DEL ELECTRONIC CORP.
250 Sandford Blvd, Mt Vernon, N Y 10550
DELTRON INC.
Wissahickon Ave, No Wales, Pa 19454
DYNAMIC INSTRUMENTS CORP.
115 W Bethpage Rd, Plainview, N Y 11803
ELASCO EASTERN INC.
5 Northwood Rd, Bloomfield, Conn 06002
ELBIT COMPUTERS/SUB. CONTROL DATA CORP.
6 Tovim St, Haifa, ISRAEL
ELECTRO PRODUCTS LABORATORIES INC.
6125 W Howard St, Chicago, Ill 60648
ELECTRONIC DEVELOPMENT CORP.
11 Hamlin St, Boston, Mass 02127
ELEXON INC.
1422 E St Gertrude, Santa Ana, Cal 92705
ELGAR CORP.
8159 Engineer Rd, San Diego, Cal 92111
ERA TRANSPAC CORP.
67 Sand Park Rd, Cedar Grove, N J 07009
GEORATOR CORP.
9016 Prince Wm St, Manassas, Va 22110
GLENTRONICS INC.
748 E Alosta Ave, Glendora, Cal 91740
GULTON INDUSTRIES INC.
212 Durham Ave, Metuchen, N J 08840
HARVEY INDUSTRIAL DIV.
60 Crossway Pk W, Woodbury Li, N Y 11797
HI-G INC.
580 Spring St, Windsor Locks, Conn 06096
HOLT INSTRUMENT LABS.
Po Box 230, Oconto, Wis 54153
HONEYWELL INC. TEST INSTRUMENTS DIV.
P O Box 5227, Denver, Colo 80217
HOWARD INDUSTRIES
2420 18 St, Racine, Wisc 53403
INDUSTRIAL TEST EQUIPMENT CO INC.
20 Beechwood Ave, Pt Washington, N Y 11050
INTERNATIONAL CONTROLS CORP.
200 Fairfield Rd, Fairfield, N J 07006
ITI ELECTRONICS INC.
369 Lexington Ave, Clifton, N J 07015
LITTON SYSTEMS INC. DATA SYSTEMS DIV.
8000 Woodley Ave, Van Nuys, Cal 91409
LORAIN PRODUCTS CORP.
1122 F St, Lordin, Ohio 44052
MAG-COM ENGINEERING CO.
85 Richardson St SE, St Paul, Minn 55112
MASTER ELECTRONIC CONTROLS
1553 17 St, Santa Monica, Cal 90404
MICROTRAN COMPANY INC.
145 E Mineola Ave, Valley Stream, N Y 11582
MIDEASTERN INDUSTRIES, INC. DIV. EANCO INC.
P O Box 186, Scotch Plains, N J 07076
MODULAR DEVICES INC.
1265 W 135 St, Gardena, Cal 90247
MOTOROLA INC. CONTROL SYSTEMS DIV
P O Box 5409, Phoenix, Ariz 85010
NORTH ELECTRIC CO. ELECTRONETICS DIV.
Galion, Ohio 44833
NYTRONICS INC.
3rd Ave, Alpha, N J 08865
PEERLESS ELECTRICAL PRODUCTS DIV.
1515 S Manchester Ave, Anaheim, Cal 92803
PIONEER MAGNETICS INC.
1745 Berkeley St, Santa Monica, Cal 90404
PLASTIC CAPACITORS INC.
2620 N Clybourn Ave, Chicago, Ill 60614
POWER/MATE CORP.
514 S River St, Hackensack, N J 07601
POWERTEC
9168 Desoto St, Chatsworth, Cal 91311
RAYCON INC.
218 Brunswick Blvd, Pointe Claire, CANADA
RHO ENGINEERING CO.
2234 Colby Ave, Los Angeles, Cal 90064
SBD ELECTRONIC SYSTEMS INC.
275 Dixon Ave, Amityville, N Y 11701
SCIENTIFIC ELECTRIC INC.
111 Monroe St, Garfield, N J 07026

2 Product Directory

SIERRA SYSTEMS INC.

2255 Old Midfield Way, Mountain View, Cal 94040
SOLA BASIC INDUSTRIES SOLA ELECTRIC DIV.

1717 Busse Rd, Elk Grove Vilge, Ill 60007
TECHNIPOWER INC. SUB. BENRUS CORP.

Benrus Center, Ridgefield, Conn 06877
TELEDYNE BROWN ENGINEERING

300 Sparkman Dr, Huntsville, Ala 35807
ULTRONIX INC.

P O Box 1090, Grand Junction, Colo 81501
VARO INC. STATIC POWER DIV.

1600 Dallas Pkwy, Plano, Tex 75074
VARO INC., TEXAS DIV.

Po Box 828, Garland, Tex 75040
VENUS SCIENTIFIC INC.

399 Smith St, Farmingdale, N Y 11735
VIDCOR CO. INC.

1251 W El Segundo Blv, Gardena, Cal 90247
VIRGINIA ELECTRONICS CO. INC.

2901 Telestar Court, Falls Church, Va 22042
VOLTEX CO. INC.

115 Marine St, Farmingdale, N Y 11735
WAGNER ELECTRIC CORP.

630 W Mt Pleasant Ave, Livingston, N J 07039
WANLASS ELECTRIC CO.

1815 S Ritohey St, Santa Ana, Cal 92705

POWER SUPPLIES, DC

ABBOTT TRANSISTOR LABORATORIES INC.

5200 W Jefferson Blvd, Los Angeles, Cal 90016
ACDC ELECTRONICS INC.

Oceanside Ind Center, Oceanside, Cal 92054
ACME ELECTRIC CORP.

20 Water St, Cuba, N Y 14727
ADVANCED DEVELOPMENT CORP.

2014 W 139th St, Gardena, Cal 90249
ALTEC DIV., LTV LING ALTEC INC.

1515 So Manchester Av, Anaheim, Cal 92803
AMBAC INDUSTRIES INC. WANLASS DIV.

525 Virginia Dr, Ft Washington, Pa 19034
AMP INC.

Eisenhower Blvd, Harrisburg, Pa 17105
AMP INC. CAPITRON DIV.

1595 S Mount Joy St, Elizabethtown, Pa 17022
ANALOG DEVICES INC.

221 5th St, Cambridge, Mass 02142
ANALOG DEVICES INC. PASTORIZA DIV.

221 5th St, Cambridge, Mass 02142
ANALOGIC CORP.

Audubon Rd, Wakefield, Mass 01880
APPLIED COMPUTER SYSTEMS INC.

P O Box 6479, Austin, Tex 78702
ARNOLD MAGNETICS CORP.

P O Box K, Culver City, Cal 90230
ASTRO-SPACE LABS., INC.

110 Wynn Drive NW, Huntsville, Ala 35806
AUL INSTRUMENT INC.

139-30 34th Rd, Flushing, N Y 11354
AUSTRON, INC.

10214 N Interregional, Austin, Tex 78753
B&F INSTRUMENT INC.

Clarmont Ave, Cornwell Height, Pa 19020
BASLER ELECTRIC CO.

Rte 143, Highland, Ill 62249
BERGEN LABORATORIES INC. SUB. ZYROTRON INC.

60 Spruce St, Paterson, N J 07501
BERTAN ASSOCIATES INC.

15 Newtown Rd, Plainview, N Y 11803
BFA CORP.

1309 S Inca, Denver, Colo 80223
BOWMAR INSTRUMENT CORP. ELECTRONIC SYS. DIV

800 Bluffton Rd, Fort Wayne, Ind 46809
BULOVA WATCH ELECTRONICS DIV.

6120 Woodside Ave, Woodside Li, N Y 11377
BURR-BROWN RESEARCH CORP.

6730 S Tucson Blvd, Tucson, Ariz 85706
CAL POWER CORP.

140 Kansas St, El Segundo, Cal 90245
CEA DIV. BERKLEONICS INC.

1221 S Shamrock Ave, Monrovia, Cal 91016
CHALCO ENGINEERING CORP.

15126 S Broadway, Gardena, Cal 90248
CLARE SYSTEMS DIV. C.P. CLARE & CO.

3101 W Pratt Ave, Chicago, Ill 60645
CODI SEMICONDUCTOR DIV. COMPUTER DIODE

Pollitt Dr S, Fair Lawn, N J 07410
COMPONENTS CORP.

106 Main St, Denville, N J 07834
COMPUTER CORP. OF AMERICA

6216 Evergreen St, Houston, Tex 77036
COMPUTER DIODE CORP.

Pollitt Dr S, Fair Lawn, N J 07410

COMPUTER LOGIC CORP.

1528 20th St, Santa Monica, Cal 90404
COMPUTER PRODUCTS, INC.

P O Box 23849, Ft Lauderdale, Fla 33307
CONTROL DATA CORP. MAGNETIC COMPONENTS DIV.

2300 Berkshire Lane, Minneapolis, Minn 55427
DATA DISPLAY SYSTEMS INC.

139 Terwood Rd, Willow Grove, Pa 19090
DDC DIV. SOLID STATE SCIENTIFIC DEVICES

100 Tec St, Hicksville, N Y 11801
DEL ELECTRONIC CORP.

250 Sandford Blvd, Mt Vernon, N Y 10550
DELTRON INC.

Wissahickon Ave, No Wales, Pa 19454
DESIGN ELEMENTS INC.

356 Norton Ave, Columbus, Ohio 43212
DIGITAL EQUIPMENT CORP.

146 Main St, Maynard, Mass 01754
DYNAGE INC.

1331 Blue Hills Ave, Bloomfield, Conn 06002
DYNAMIC INSTRUMENTS CORP.

115 W Bethpage Rd, Plainview, N Y 11803
DYNAMIC MEASUREMENTS CORP.

6 Lowell Ave, Winchester, Mass 01890
EL INSTRUMENTS INC.

61 1st St, Derby, Conn 06418
ELASCO EASTERN INC.

5 Northwood Rd, Bloomfield, Conn 06002
ELBIT COMPUTERS/SUB. CONTROL DATA CORP.

6 Tovim St, Haifa, ISRAEL
ELECTRO PRODUCTS LABORATORIES INC.

6125 W Howard St, Chicago, Ill 60648
ELECTRONIC DEVELOPMENT CORP.

11 Hamlin St, Boston, Mass 02127
ELECTRONIC MEASUREMENTS INC.

405 Essex Rd, New Shrewsbury, N J 07753
ELECTROSTATICS INC.

7718 Clairemont Mesa, San Diego, Cal 92111
ELEXON INC.

1422 E St Gertrude, Santa Ana, Cal 92705
ERA TRANSPAC CORP.

67 Sand Park Rd, Cedar Grove, N J 07009
FLUKE, JOHN MFG. CO. INC.

P O Box 7428, Seattle, Wash 98133
GAP INSTRUMENT CORP.

110 Marcus Blvd, Hauppauge, N Y 11787
GEAR SYSTEMS DIV. OF USM CORP.

Rte 128, Wakefield, Mass 01880
GENERAL DEVICES INC.

P O Box 253, Princeton, N J 08540
GEORATOR CORP.

9016 Prince Wm St, Manassas, Va 22110
GLENTRONICS INC.

748 E Alosta Ave, Glendora, Cal 91740
GULTON INDUSTRIES INC.

212 Durham Ave, Metuchen, N J 08840
HARVEY INDUSTRIAL DIV.

60 Crossway Pk W, Woodbury Li, N Y 11797
HELIPOT DIV. BECKMAN INSTRUMENTS INC.

2500 Harbor Blvd, Fullerton, Cal 92634
HEWLETT PACKARD NEW JERSEY DIV.

100 Locust Ave, Berkeley Heights, N J 07922
HEWLETT PACKARD CO.

1501 Page Mill Rd, Palo Alto, Cal 94304
HEXEM INC.

1015 Corporation Way, Palo Alto, Cal 94303
HI-G INC.

580 Spring St, Windsor Locks, Conn 06096
INCOR INSTRUMENTATION INC.

29 Newtown Rd, Plainview, N Y 11803
INSTRUMENT DISPLAYS INC. SUB. KELTRON CORP.

223 Crescent St, Waltham, Mass 02154
INTERNATIONAL CONTROLS CORP.

200 Fairfield Rd, Fairfield, N J 07006
ITI ELECTRONICS INC.

369 Lexington Ave, Clifton, N J 07015
JULIE RESEARCH LABORATORIES INC.

211 West 161 St, New York, N Y 10023
KELTRON CORP.

225 Crescent St, Waltham, Mass 02154
KEPCO INC.

131 38 Sanford Ave, Flushing, N Y 11352
KRATOS PRECISION PRODUCTS

11161 W Pico Blvd, Los Angeles, Cal 90064
LEHIGH VALLEY ELECTRONICS INC.

Po Box 125, Fogelsville, Pa 18051
LITTON SYSTEMS INC. DATA SYSTEMS DIV.

8000 Woodley Ave, Van Nuys, Cal 91409
LORAIN PRODUCTS CORP.

1122 F St, Lordin, Ohio 44052
MAG-CON ENGINEERING CO.

85 Richardson St SE, St Paul, Minn 55112
MASTER ELECTRONIC CONTROLS

1553 17 St, Santa Monica, Cal 90404

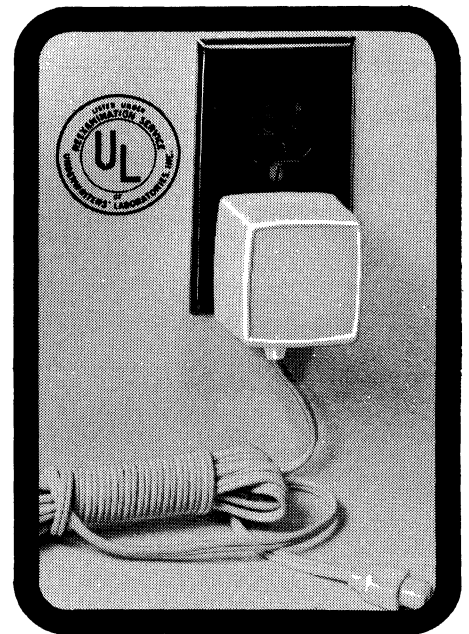

WALL PLUG-IN POWER SUPPLIES

DESIGNED FOR LISTING
UNDER U/L #114 and/or EDP #478
SPECIFICATIONS

MODEL 3-1743 is a closely filtered transistor regulated, low-voltage, U/L listed converter presently in production for use with keyboard logic circuits, calculators, minicomputers, remote CRT terminals and hundreds of other applications. A wall plug-in power supply eliminates the possible need for U/L listed computer wiring, removes a major heat source, reduces size and weight, increases design flexibility and avoids the need for U/L investigation of your product.

**POWER CONVERSION
AC/DC CONVERSION/
CHARGING
TRANSFORMERS** **SECONDARY
BATTERY CHARGING
FAST CHARGING
DEVICES**

THE TRANSFORMATION OF POWER

A unique brochure explaining the many advantages and application possibilities of Dynamic's patented U/L listed transformers, converters, chargers and power supplies, technical data sheets and bulletins are available on specific products. A request on your letterhead or phone our Sales Engineering Department.

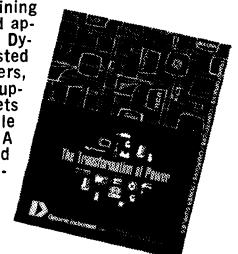

**DYNAMIC INSTRUMENT
CORP.**

115 E. BETHPAGE RD., PLAINVIEW, N. Y. 11803

2 Product Directory

MCG ELECTRONICS INC.
279 Skidmore Rd, Deer Park, N Y 11729
MICRODATA CORP.
644 E Young St, Santa Ana, Cal 92705
MICROTRAN COMPANY INC.
145 E Mineola Ave, Valley Stream, N Y 11582
MIDEASTERN INDUSTRIES, INC. DIV. EANCO INC.
P O Box 186, Scotch Plains, N J 07076
MODULAR DEVICES INC.
1265 W 135 St, Gardena, Cal 90247
MYLEE DIGITAL SCIENCES INC.
16 Progress Pkwy, Maryland Hts, Mo 63043
NJE SUB. OF CONDEC
20 Boright Ave, Kenilworth, N J 07033
NORTH ELECTRIC CO. ELECTRONETICS DIV.
Galion, Ohio 44833
NYTRONICS INC.
3rd Ave, Alpha, N J 08865
OPTICAL ELECTRONICS INC.
P O Box 11140, Tucson, Ariz 85706
OVEN INDUSTRIES INC. METRIC ENGINEERING DIV.
P O Box 229, Mechanicsburg, Pa 17055
PEERLESS ELECTRICAL PRODUCTS DIV.
1515 S Manchester Ave, Anaheim, Cal 92803
PIONEER MAGNETICS INC.
1745 Berkeley St, Santa Monica, Cal 90404
PLASTIC CAPACITORS INC.
2620 N Clybourn Ave, Chicago, Ill 60614
POWER DESIGNS INC.
1700 S Hames Dr, Westbury, N Y 11590
POWER/MATE CORP.
514 S River St, Hackensack, N J 07601
POWERTEC
9168 Desoto St, Chatsworth, Cal 91311
PRECISION PRODUCTS DIV. OF KRATOS
11161 W Pico Blvd, Los Angeles, Cal 90064
RAYCON INC.
218 Brunswick Blvd, Pointe Claire, CANADA
RAYTHEON COMPANY, SORENSEN OPERATION
676 Island Pond, Manchester, N H 03103
RAYTHEON COMPUTER
2700 S Fairview St, Santa Ana, Cal 92704
RHO ENGINEERING CO.
2234 Colby Ave, Los Angeles, Cal 90064
RO ASSOCIATES INC.
3705 Haven Ave, Menlo Park, Cal 94025
ROSEMOUNT PLUG-IN INC.
P O Box 107, Nashville, Tenn 37202
SCIENTIFIC ELECTRIC INC.
111 Monroe St, Garfield, N J 07026
SCIENTIFIC MEASUREMENTS INC.
9701 N Kenton, Skokie, Ill 60076
SIERRA SYSTEMS INC.
2255 Old Midfield Way, Mountain View, Cal 94040
SIMCO CO. INC., THE
920 Walnut St, Lansdale, Pa 19446
SOLA BASIC INDUSTRIES SOLA ELECTRIC DIV.
1717 Busse Rd, Elk Grove Village, Ill 60007
SOLID STATE ELECTRONICS CORP.
15321 Rayen St, Sepulveda, Cal 91343
SPACETAC INC.
Burlington Rd, Bedford, Mass 01730
SRC DIV. MOXON INC.
2222 Michelson Dr, Newport Beach, Cal 92664
TECHNIPOWER INC. SUB. BENRUS CORP.
Benrus Center, Ridgefield, Conn 06877
TELEDYNE BROWN ENGINEERING
300 Sparkman Dr, Huntsville, Ala 35807
TELEDYNE PHILBRICK NEXUS
Allied Dr At Rte 128, Dedham, Mass 02026
TRIO LABORATORIES INC.
80 Dupont St, Plainview, N Y 11803
TRYGON ELECTRONICS
111 Pleasant Ave, Roosevelt, N Y 11575
ULTRONIX INC.
P O Box 1090, Grand Junction, Colo 81501
UNICOMP INC.
18219 Parthenia, Northridge, Cal 91324
VALOR INSTRUMENTS INC.
2430 Amsler, Torrance, Cal 90505
VARO INC. STATIC POWER DIV.
1600 Dallas Pkwy, Plano, Tex 75074
VARO INC., TEXAS DIV.
Po Box 828, Garland, Tex 75040
VENUS SCIENTIFIC INC.
399 Smith St, Farmingdale, N Y 11735
VIDCOR CO. INC.
1251 W El Segundo Blv, Gardena, Cal 90247
VIRGINIA ELECTRONICS CO. INC.
2901 Telesar Court, Falls Church, Va 22042
VOLTEX CO. INC.
115 Marine St, Farmingdale, N Y 11735
WAGNER ELECTRIC CORP.
630 W Mt Pleasant Ave, Livingston, N J 07039

WALDEN ELECTRONICS CORP.
223 Crescent St, Waltham, Mass 02154
WANLASS ELECTRIC CO.
1815 S Ritohey St, Santa Ana, Cal 92705
WISE INSTRUMENTATION & CONTROLS INC.
3568 Amherst Court, Mt View, Cal 94040
ZELTEX INC.
1000 Chalomar Rd, Concord, Cal 94520

POWER SUPPLIES, DIGITALLY-CONTROLLED

ALTEC DIV., LTV LING ALTEC INC.
1515 So Manchester Av, Anaheim, Cal 92803
AMERICAN COMPUTER TECHNOLOGY INC.
8740 Shirley Ave, Northridge, Cal 91324
ANALOGIC CORP.
Audubon Rd, Wakefield, Mass 01880
AUL INSTRUMENT INC.
139-30 34th Rd, Flushing, N Y 11354
BERTAN ASSOCIATES INC.
15 Newtown Rd, Plainview, N Y 11803
BFA CORP.
1309 S Inca, Denver, Colo 80223
BOWMAR INSTRUMENT CORP. ELECTRONIC SYS. DIV
800 Bluffton Rd, Fort Wayne, Ind 46809
CALIFORNIA INSTRUMENTS CO.
5150 Convooy St, San Diego, Cal 92111
COMPU-SYSTEMS CO.
Audubon Rd, Wakefield, Mass 01880
COMPUTER DIODE CORP.
Pollitt Dr S, Fair Lawn, N J 07410
DEL ELECTRONIC CORP.
250 Sandford Blvd, Mt Vernon, N Y 10550
DYNAMIC INSTRUMENTS CORP.
115 W Bethpage Rd, Plainview, N Y 11803
DYNAMIC SYSTEM ELECTRONICS
1040 W Alameda Dr, Tempe, Ariz 85281
ELBIT COMPUTERS/SUB. CONTROL DATA CORP.
6 Tovim St, Haifa, ISRAEL
ELECTRONIC DEVELOPMENT CORP.
11 Hamlin St, Boston, Mass 02127
ELEXON INC.
1422 E St Gertrude, Santa Ana, Cal 92705
ELGAR CORP.
8159 Engineer Rd, San Diego, Cal 92111
ERA TRANSPAC CORP.
67 Sand Park Rd, Cedar Grove, N J 07009
FLUKE, JOHN MFG. CO. INC.
P O Box 7428, Seattle, Wash 98133
GAP INSTRUMENT CORP.
110 Marcus Blvd, Hauppauge, N Y 11787
GENERAL DEVICES INC.
P O Box 253, Princeton, N J 08540
GLENTRONICS INC.
748 E Alosta Ave, Glendora, Cal 91740
HEWLETT PACKARD NEW JERSEY DIV.
100 Locust Ave, Berkley Heights, N J 07922
HI-G INC.
580 Spring St, Windsor Locks, Conn 06096
INCOR INSTRUMENTATION INC.
29 Newtown Rd, Plainview, N Y 11803
INDUSTRIAL TEST EQUIPMENT CO INC.
20 Beechwood Ave, Pt Washington, N Y 11050
INSTRUMENT DISPLAYS INC. SUB. KELTRON CORP.
223 Crescent St, Waltham, Mass 02154
KELTRON CORP.
225 Crescent St, Waltham, Mass 02154
KEPCO INC.
131 38 Sanford Ave, Flushing, N Y 11352
LORCH ELECTRONICS, LORCH ADRET CORP.
105 Cedar Ln, Englewood, N J 07631
MODULAR DEVICES INC.
1265 W 135 St, Gardena, Cal 90247
NORTH ELECTRIC CO. ELECTRONETICS DIV.
Galion, Ohio 44833
NYTRONICS INC.
3rd Ave, Alpha, N J 08865
POWER DESIGNS INC.
1700 S Hames Dr, Westbury, N Y 11590
POWER/MATE CORP.
514 S River St, Hackensack, N J 07601
POWERTEC
9168 Desoto St, Chatsworth, Cal 91311
RAYTHEON COMPANY, SORENSEN OPERATION
676 Island Pond, Manchester, N H 03103
RHO ENGINEERING CO.
2234 Colby Ave, Los Angeles, Cal 90064
SPACETAC INC.
Burlington Rd, Bedford, Mass 01730
SRC DIV. MOXON INC.
2222 Michelson Dr, Newport Beach, Cal 92664
VENUS SCIENTIFIC INC.
399 Smith St, Farmingdale, N Y 11735

VIDCOR CO. INC.
1251 W El Segundo Blv, Gardena, Cal 90247
VOLTEX CO. INC.
115 Marine St, Farmingdale, N Y 11735
WANLASS ELECTRIC CO.
1815 S Ritohey St, Santa Ana, Cal 92705
WISE INSTRUMENTATION & CONTROLS INC.
3568 Amherst Court, Mt View, Cal 94040

POWER SUPPLIES, UNINTERRUPTABLE

AIROYAL MANUFACTURING CO.
19 Gloria Ln, Fairfield, N J 07006
AVTEL CORP.
1130 E Cypress St, Covina, Cal 91722
CLARE SYSTEMS DIV. C.P. CLARE & CO.
3101 W Pratt Ave, Chicago, Ill 60645
ESB INC. POWER SYSTEMS DIV.
P O Box 5723, Philadelphia, Pa 19120
IDEAL ELECTRIC AND MFG. CO.
330 E 1st St, Mansfield, Ohio 44903
POWER SYSTEMS & CONTROLS INC.
3206 Lanvale Ave, Richmond, Va 23213
STATIC PRODUCTS INC.
2511 National Dr, Garland, Tex 75040

PRINTED CABLE (SEE CABLE)

PRINTED CIRCUIT BOARDS (SEE BOARDS)

PRINTER/PUNCH, PAPER TAPE

ANDERSON JACOBSON INC.
1065 Morse Ave., Sunnyvale, Cal 94086
BFA CORP.
1309 S Inca, Denver, Colo 80223
CITIZEN AMERICA CORP.
9201 Olympic Blvd, Beverly Hills, Cal 90212
CLARY CORP.
320 W Clary Ave, San Gabriel, Cal 91011
CONNECTICUT TECHNICAL CORP.
3000 Main St, Hartford, Conn 06120
CORNING GLASS WORKS
Houghton Park, Corning, N Y 14830
DATA ACCESS SYSTEMS INC.
503 Rte 10 Mt 19, Dover, N J 07801
DATA GRAPHICS CORP.
8402 Speedway, San Antonio, Tex 78230
DATATERM INC.
1671 Manning Blvd, Levittown, Pa 19057
ELECTRONIC MICRO SYSTEMS INC.
1672 Kaiser Ave, Santa Ana, Cal 92705
FRIDEN DIV. THE SINGER CO.
97 Humboldt St, Rochester, N Y 14602
FUJITSU LTD. N.Y. LIAISON OFFICE
680 Fifth Ave, New York, N Y 10019
ITEL INFORAMTION PRODUCTS DIV
2585 Bayshore, Palo Alto, Cal 94303
ITT DATA EQUIPMENT & SYSTEMS DIV.
187 E Union Ave, E Rutherford, N J 07073
KLEINSCHMIDT DIV., SCM CORP.
Lake-Cook Rd, Deerfield, Ill 60015
LEHIGH VALLEY ELECTRONICS INC.
Po Box 125, Fogelsville, Pa 18051
MICRO SYSTEMS INC.
644 E Young St, Santa Ana, Cal 92705
MICRODATA CORP.
644 E Young St, Santa Ana, Cal 92705
OCHMAN SYSTEMS, EDWARD
Po Box 141, Fairfield, Conn 06430
OKI ELECTRIC INDUSTRIES CO. LTD.
875 Ave of Americas, New York, N Y 10001
ROHDE & SCHWARZ SALES CO. USA INC.
111 Lexington Ave, Passaic, N J 07055
ROLM, CORP.
10300 N Tantau, Cupertino, Cal 95014
SHIRAK TELEMETERING OF AMERICA
8926 Kester Ave, Van Nuys, Cal 91402
SINGER CO., THE, FRIDEN DIV.
2350 Washington St, San Leandro, Cal 94577
SYNER-DATA, INC.
138 Brimbal Ave, Beverly, Mass 01915
TELETYPE CORP.
5555 W Touhy Ave, Skokie, Ill 60076
TEXAS INSTRUMENTS INC. DIGITAL SYSTEMS DIV
P O Box 66027, Houston, Tex 77006
WEISMANTEL INC.
P O Box 1957, St Paul, Minn 55111

2 Product Directory

XEROX DATA SYSTEMS
701 S Aviation, El Segundo, Cal 90245

PRINTERS, DIGITAL STRIP RECORDING

AUSTRON, INC.
10214 N Interregional, Austin, Tex 78753

CLARY CORP.
320 W Clary Ave, San Gabriel, Cal 91011

CLEVITE DIV. GOULD INC.
3631 Perkins Ave, Cleveland, Ohio 44114

CONNECTICUT TECHNICAL CORP.
3000 Main St, Hartford, Conn 06120

DATA TRENDS INC.
P O Box 82, Mt Lake, N J 07046

DATADYNE CORP.
Valley Forge Ctr, King of Prussia, Pa 19406

DATALINE INC.
181 S Boro Line Rd, King of Prussia, Pa 19406

DATALOG DIV. LITTON SYSTEMS INC.
1 Executive Pk, Englewood, Colo 80110

DATAMETRIC CORP.
7630 Gloria Ave, Van Nuys, Cal 91406

DI/AN CONTROLS INC.
944 Dorchester Ave, Boston, Mass 02125

DIGITRON CORP.
2544 W Main St, Norristown, Pa 19401

DYTRO CORP.
63 Tec St, Hicksville, N Y 11801

ELECTRONIC LABS, INC.
3726 Dacoma St, Houston, Tex 77018

FACIT-ODHNER INC.
501 Winsor Dr, Secaucus, N J 07094

HEWLETT PACKARD CO.
1501 Page Mill Rd, Palo Alto, Cal 94304

INSTRUMENT DISPLAYS INC. SUB. KELTRON CORP.
223 Crescent St, Waltham, Mass 02154

INTERFACE MECHANISMS INC.
5503 232nd St SW, Mount Lake Terr, Wash 98043

JOHNSON WAX SERV. PRODUCTS DIV.
1525 Howe St, Racine, Wis 53403

KDI ADTROL INC.
700 Abbott Dr, Broomall, Pa 19008

MITE CORP. DATA EQUIPMENT DIV.
446 Blake St, New Haven, Conn 06514

MOHAWK DATA SCIENCES CORP.
Palisade St, Herkimer, N Y 13350

MOHAWK DATA SCIENCES CORP. FRANKLIN ELECT. DIV.
P O Box 406, King of Prussia, Pa 19406

NIGITRON CORP.
2544 W Main St, Norristown, Pa 19401

OMNITEC CORP. A NYTRONICS CORP.
903 N 2nd St, Phoenix, Ariz 85004

REO DATA PRODUCTS INC.
7346 Bolsa Ave, Westminster, Cal 92683

TRANSCOM INC. SUB. OF HI-G INC.
12 Tobey Rd, Bloomfield, Conn 06002

PRINTERS, KEYBOARD

ABINGTON KEYPUNCH INC.
920 Fox Chase Rd, Rockledge, Pa 19111

AMERICAN DATA SYSTEMS
8851 Mason Ave, Canoga Park, Cal 91306

ANDERSON JACOBSON INC.
1065 Morse Ave., Sunnyvale, Cal 94086

BRIGHT INDUSTRIES INC.
1 Maritime Plaza, San Francisco, Cal 94111

BUNKER RAMO CORP., THE, BUSINESS & IND. DIV
445 Fairfield Ave, Stamford, Conn 06904

CLARY CORP.
320 W Clary Ave, San Gabriel, Cal 91011

COMPACE CORP.
7413 Washington Ave S, Edina-Minnepols, Minn 55435

CONNECTICUT TECHNICAL CORP.
3000 Main St, Hartford, Conn 06120

DATACON INTERNATIONAL INC.
2745 Bernice Rd, Lansing, Ill 60438

DATALINE INC.
181 S Boro Line Rd, King of Prussia, Pa 19406

DATALOG DIV. LITTON SYSTEMS INC.
1 Executive Pk, Englewood, Colo 80110

DELTA DATA SYSTEMS CORP.
Woodhaven Ind Park, Cornwells Hgts, Pa 19020

DI/AN CONTROLS INC.
944 Dorchester Ave, Boston, Mass 02125

DIGI-LOG SYSTEMS INC.
107 W Ridge Pike, Conshohocken, Pa 19428

DIGITAL SCIENTIFIC CORP.
11455 Sorrento Vly Rd, San Diego, Cal 92121

ELDORADO ELECTRODATA
601 Chalomar Rd, Concord, Cal 94520

ELECTRONIC INFORMATION SYSTEMS INC.
2400 Industrial Lane, Broomfield, Conn 80020

FRIDEN DIV. THE SINGER CO.
97 Humboldt St, Rochester, N Y 14602

GENERAL ELECTRIC CO. COMM&CONT DEV DEPT.
General Electric Dr, Waynesboro, Va 22980

GULTON INDUSTRIES INC. COMPUTER SYS. DIV.
13041 Cerise Ave, Hawthorne, Cal 90250

ITEL INFORAMTION PRODUCTS DIV
2585 Bayshore, Palo Alto, Cal 94303

ITT DATA EQUIPMENT & SYSTEMS DIV.
187 E Union Ave, E Rutherford, N J 07073

JOHNSON WAX SERV. PRODUCTS DIV.
1525 Howe St, Racine, Wis 53403

KDI ADTROL INC.
700 Abbott Dr, Broomall, Pa 19008

KELTRON CORP.
225 Crescent St, Waltham, Mass 02154

KLEINSCHMIDT DIV., SCM CORP.
Lake-Cook Rd, Deerfield, Ill 60015

MICRODATA CORP.
644 E Young St, Santa Ana, Cal 92705

MITE CORP. DATA EQUIPMENT DIV.
446 Blake St, New Haven, Conn 06514

NCR INDUSTRIAL PRODUCTS DIV.
Main And K St, Dayton, Ohio 45409

OKI ELECTRIC INDUSTRIES CO. LTD.
875 Ave of Americas, New York, N Y 10001

PRINTER TECHNOLOGY INC.
Sixth Rd, Woburn, Mass 01801

RCA COMPUTER SYSTEMS DIV.
200 Forest Ave, Marlboro, Mass 01752

REO DATA PRODUCTS INC.
7346 Bolsa Ave, Westminster, Cal 92683

SHIRAK TELEMETERING OF AMERICA
8926 Kester Ave, Van Nuys, Cal 91402

SYNER-DATA, INC.
138 Brimbal Ave, Beverly, Mass 01915

TELETYPE CORP.
5555 W Touhy Ave, Skokie, Ill 60076

TERMINAL EQUIPMENT CORP.
750 Hamburg Tpk, Pompton Lakes, N J 07442

TRANSCOM INC. SUB. OF HI-G INC.
12 Tobey Rd, Bloomfield, Conn 06002

WEISMANTEL INC.
P O Box 1957, St Paul, Minn 55111

XEROX DATA SYSTEMS
701 S Aviation, El Segundo, Cal 90245

PRINTERS, LINE (LOW & MEDIUM SPEED)

A. B. DICK CO.
5700 W Touhy, Chicago, Ill 60648

ABINGTON KEYPUNCH INC.
920 Fox Chase Rd, Rockledge, Pa 19111

ADDRESSOGRAPH MULTIGRAPH CORP BRUNING DIV.
1200 Babbitt Rd, Cleveland, Ohio 44117

AMERICAN REGITEL CORP.
870 Industrial Way, San Carlos, Cal 94070

ANADEX INSTRUMENTS INC.
7833 Haskell Ave, Van Nuys, Cal 91406

BECKMAN INSTRUMENTS INC. ELECT. INSTR. DIV.
2200 Wright Ave, Richmond, Cal 94804

BRIGHT INDUSTRIES INC.
1 Maritime Plaza, San Francisco, Cal 94111

BUNKER RAMO CORP., THE, BUSINESS & IND. DIV
445 Fairfield Ave, Stamford, Conn 06904

BUNKER-RAMO CORP.
Trumbull Ind Pk, Trumbull, Conn 06611

BURROUGHS CORP. BUSINESS MACHINES GROUP
6071 2nd Ave, Detroit, Mich 48232

CITIZEN AMERICA CORP.
9201 Olympic Blvd, Beverly Hills, Cal 90212

CLARY CORP.
320 W Clary Ave, San Gabriel, Cal 91011

CLEVITE DIV. GOULD INC.
3631 Perkins Ave, Cleveland, Ohio 44114

COMPUTER COMMUNICATION INC.
701 W Manchester Blvd, Inglewood, Cal 90301

COMPUTER DESIGN CORP.
12401 W Olympic Blvd, Los Angeles, Cal 90064

COMPUTER MACHINERY CORP.
2231 S Barrington Ave, Los Angeles, Cal 90064

COMPUTER MEASUREMENTS CO.
12970 Bradley Ave, San Fernando, Cal 91342

COMPUTER SYSTEMS INC.
2042 Westmoreland St, Richmond, Va 23230

CONNECTICUT TECHNICAL CORP.
3000 Main St, Hartford, Conn 06120

CUSTOM COMPUTER SYSTEMS INC.
40 South Mall, Plainview, N Y 11803

DATA COMPUTING INC.
2219 W Shangri La Rd, Phoenix, Ariz 85029

DATA GENERAL CORP.
Rte 9, Southboro, Mass 01772

DATA GRAPHICS CORP.
8402 Speedway, San Antonio, Tex 78230

DATA PRINTER CORP.
225 Msgr O Brien Hwy, Cambridge, Mass 02141

DATA PRODUCTS CORP.
16055 Ventura Blvd, Encino, Cal 91316

DATA 100 CORP.
7450 France Ave S, Minneapolis, Minn 55435

DATADYNE CORP.
Valley Forge Ctr, King of Prussia, Pa 19406

DATALINE INC.
181 S Boro Line Rd, King of Prussia, Pa 19406

DATALOG DIV. LITTON SYSTEMS INC.
1 Executive Pk, Englewood, Colo 80110

DATAMARK INC.
Cantiague Rd, Westbury, N Y 11590

DATAMETRIC CORP.
7630 Gloria Ave, Van Nuys, Cal 91406

DATASERV DIV., WILLIAM J. PURDY CORP.
770 Airport Blvd, Burlingame, Cal 94010

DI/AN CONTROLS INC.
944 Dorchester Ave, Boston, Mass 02125

DIGITAL EQUIPMENT CORP.
146 Main St, Maynard, Mass 01754

DIGITRON CORP.
2544 W Main St, Norristown, Pa 19401

ECLECTIC COMPUTER CORP.
3707 Rawlins Ste 301, Dallas, Tex 75219

ESTERLINE ANGUS DIV., ESTERLINE CORP.
Po Box 24000, Indianapolis, Ind 46224

FRIDEN DIV. THE SINGER CO.
97 Humboldt St, Rochester, N Y 14602

FUJITSU LTD. N.Y.LIAISON OFFICE
680 Fifth Ave, New York, N Y 10019

HAZELTINE CORP. INDUSTRIAL PRODUCTS DIV.
Greenlawn, N Y 11740

HEWLETT PACKARD CO. CUPERTINO DIV.
1100 Wolfe Rd, Cupertino, Cal 95014

HICKOK ELECTRICAL INSTRUMENT CO.
10514 Dupont Ave, Cleveland, Ohio 44108

HONEYWELL INFORMATION SYSTEMS
P O Box 12313, Oklahoma City, Okla 73112

HONEYWELL INFORMATION SYSTEMS
60 Walnut St, Wellesley Hills, Mass 02181

HONEYWELL INFORMATION SYS.INC PERIPH.DEVICES DIV.
200 Smith St, Waltham, Mass 02154

INCOTERM CORP.
Hayes Memorial Dr, Marlboro, Mass 01752

INSTRUMENT DISPLAYS INC. SUB. KELTRON CORP.
223 Crescent St, Waltham, Mass 02154

INTERNATIONAL DATA SCIENCES, INC.
100 Nashua St, Providence, R I 02904

JOHNSON WAX SERV. PRODUCTS DIV.
1525 Howe St, Racine, Wis 53403

KDI ADTROL INC.
700 Abbott Dr, Broomall, Pa 19008

KELTRON CORP.
225 Crescent St, Waltham, Mass 02154

KLEINSCHMIDT DIV., SCM CORP.
Lake-Cook Rd, Deerfield, Ill 60015

LANDIS AND GYR INC.
4 Westchester Plaza, Elmsford, N Y 10523

LEIGH INSTRUMENTS LTD. COMPUTER EQUIP. DIV
P O Box 2323 Sta D, Ottawa 4, ONT CAN

LITTON ABS AUTOMATED BUSINESS SYSTEMS OEM PRODUCT
600 Washington Ave, Carlstadt, N J 07072

MICRODATA CORP.
644 E Young St, Santa Ana, Cal 92705

MOHAWK DATA SCIENCES CORP.
Palisade St, Herkimer, N Y 13350

MONITOR LABS INC.
10451 Roselle, San Diego, Cal 92121

MONSANTO CO. ELECTRONIC PDTS. & CONTROLS DIV.
11636 Administration, St Louis, Mo 63141

MOTOROLA INC. CONTROL SYSTEMS DIV
P O Box 5409, Phoenix, Ariz 85010

MOTOROLA INC. GOVERNMENT ELECTRONICS DIV.
8201 E Mc Dowell Rd, Scottsdale, Ariz 85252

MULTIDATA INC.
7300 Bolsa Ave, Westminster, Cal 92683

NCR INDUSTRIAL PRODUCTS DIV.
Main And K St, Dayton, Ohio 45409

NIGITRON CORP.
2544 W Main St, Norristown, Pa 19401

NORTEC COMPUTER DEVICES INC. AC&T CO.
Rte 9, Southboro, Mass 01772

ODEC COMPUTER SYSTEMS, INC.
871 Waterman Ave, E Providence, R I 02914

OKI ELECTRIC INDUSTRIES CO. LTD.
875 Ave of Americas, New York, N Y 10001

2 Product Directory

PATH COMPUTER EQUIPMENT INC.
65 Commerce Rd, Stamford, Conn 06904
PER DATA
102 New South Rd, Hicksville, N Y 11801
PERIPHERAL DATA MACHINES INC.
102 New S Rd, Hicksville, N Y 11801
PERIPHERAL DYNAMICS INC.
1030 W Germantown Pk, Norristown, Pa 19401
PHOTON INC.
355 Middlesex Ave, Wilmington, Mass 01887
POTTER INSTRUMENT CO. INC.
532 Broadhollow Rd, Melville, N Y 11746
PRACTICAL AUTOMATION
P O Box 313, Shelton, Conn 06484
PRINTER TECHNOLOGY INC.
Sixth Rd, Woburn, Mass 01801
PURDY CORP., WM. J.
770 Airport Blvd, Burlingame, Cal 94010
QANTEL CORP.
3474 Investment Blvd, Hayward, Cal 94545
RANK PRECISION INDUSTRIES INC.
260 N Rt 303, W Nyack, N Y 10994
RCA COMPUTER SYSTEMS DIV.
200 Forest Ave, Marlboro, Mass 01752
REO DATA PRODUCTS INC.
7346 Bolsa Ave, Westminster, Cal 92683
SINGER CO., THE, FRIDEN DIV.
2350 Washington St, San Leandro, Cal 94577
SYNER-DATA, INC.
138 Brimbal Ave, Beverly, Mass 01915
SYSTRON-DONNER CORP.
888 Galindo St, Concord, Cal 94520
TALCOTT COMPUTER LEASING CO.
1290 Ave The Americas, New York, N Y 10019
TEXAS INSTRUMENTS INC. DIGITAL SYSTEMS DIV
P O Box 66027, Houston, Tex 77006
TRACOR DATA SYSTEMS INC.
4201 Ed Bluestein Blv, Austin, Tex 78721
TRANSITEL, DIV. OF SANGAMO ELECTRIC CO.
P O Box 7255, Denver, Colo 80207
UNICOM INC.
1275 Bloomfield Ave, Fairfield, N J 07006
UNICOMP INC.
18219 Parthenia, Northridge, Cal 91324
UNITED BUSINESS COMMUNICATIONS INC.
6405 Metcalf Ave, Shawnee Mission, Kans 66202
UNITED SYSTEMS CORP.
918 Woodley Rd, Dayton, Ohio 45403
VERSATEC
10100 Bubb Rd, Cupertino, Cal 95014
VOGUE INSTRUMENT CORP.
131st At Jamaica Ave, Richmond Hill, N Y 11418
WEISMANTEL INC.
P O Box 1957, St Paul, Minn 55111
XEROX DATA SYSTEMS
701 S Aviation, El Segundo, Cal 90245

PRINTERS, LINE (HIGH SPEED)

A.B. DICK CO.
5700 W Touhy, Chicago, Ill 60648
BUNKER-RAMO CORP.
Trumbull Ind Pk, Trumbull, Conn 06611
BURROUGHS CORP. BUSINESS MACHINES GROUP
6071 2nd Ave, Detroit, Mich 48232
BURROUGHS CORP., OEM PRODUCT SALES
1649 Wilshire Blvd, Los Angeles, Cal 90017
CLEVITE DIV. GOULD INC.
3631 Perkins Ave, Cleveland, Ohio 44114
COMPUTER HARDWARE INC.
2550 Fair Oaks Blvd, Sacramento, Cal 95825
CONTROL DATA CORP.
8100 34th Ave S, Minneapolis, Minn 55440
DACONICS
925 Thompson Pl, Sunnyvale, Cal 94086
DATA GENERAL CORP.
Rte 9, Southboro, Mass 01772
DATA PRODUCTS CORP.
16055 Ventura Blvd, Encino, Cal 91316
DATA PRODUCTS CORP. SYSTEMS DIV.
6219 Desoto Ave, Woodland Hills, Cal 91364
DATADYNE CORP.
Valley Forge Ctr, King of Prussia, Pa 19406
DATALINE INC.
181 S Boro Line Rd, King of Prussia, Pa 19406
DATALOG DIV. LITTON SYSTEMS INC.
1 Executive Pk, Englewood, Colo 80110
DATAMARK INC.
Cantiague Rd, Westbury, N Y 11590
DATAMETRIC CORP.
7630 Gloria Ave, Van Nuys, Cal 91406
DATASERV DIV., WILLIAM J. PURDY CORP.
770 Airport Blvd, Burlingame, Cal 94010

DATASONICS INC.
P O Box 4553, New York, N Y 10017
DI/AN CONTROLS INC.
944 Dorchester Ave, Boston, Mass 02125
DIGITAL SCIENTIFIC CORP.
11455 Sorrento Vly Rd, San Diego, Cal 92121
DIGITRONICS CORP.
1 Albertson Ave, Albertson, N Y 11507
ELDORADO ELECTRODATA
601 Chalomar Rd, Concord, Cal 94520
FUJITSU LTD. N.Y. LIAISON OFFICE
680 Fifth Ave, New York, N Y 10019
GOULD INC. BRUSH DIV.
3631 Perkins Ave, Cleveland, Ohio 44114
HONEYWELL INFORMATION SYSTEMS
P O Box 12313, Oklahoma City, Okla 73112
HONEYWELL INFORMATION SYSTEMS
60 Walnut St, Wellesley Hills, Mass 02181
HONEYWELL INFORMATION SYS. INC PERIPH. DEVICES DIV.
200 Smith St, Waltham, Mass 02154
INFO-MAX
1248 Alderwood, Sunnyvale, Cal 94086
INTERNATIONAL DATA SCIENCES, INC.
100 Nashua St, Providence, R I 02904
JOHNSON WAX SERV. PRODUCTS DIV.
1525 Howe St, Racine, Wis 53403
KDI ADTROL INC.
700 Abbott Dr, Broomall, Pa 19008
MOHAWK DATA SCIENCES CORP.
Palisade St, Herkimer, N Y 13350
NCR INDUSTRIAL PRODUCTS DIV.
Main And K St, Dayton, Ohio 45409
OKI ELECTRIC INDUSTRIES CO. LTD.
875 Ave of Americas, New York, N Y 10001
PATH COMPUTER EQUIPMENT INC.
65 Commerce Rd, Stamford, Conn 06904
PERIPHERAL DATA MACHINES INC.
102 New S Rd, Hicksville, N Y 11801
PRINTER TECHNOLOGY INC.
Sixth Rd, Woburn, Mass 01801
PURDY CORP., WM. J.
770 Airport Blvd, Burlingame, Cal 94010
RCA COMPUTER SYSTEMS DIV.
200 Forest Ave, Marlboro, Mass 01752
UNICOMP INC.
18219 Parthenia, Northridge, Cal 91324
VARIAN ASSOCIATES GRAPHICS & DATA SYSTEMS DIV.
611 Hansen Way, Palo Alto, Cal 94303
VERSATEC
10100 Bubb Rd, Cupertino, Cal 95014
VOGUE INSTRUMENT CORP.
131st At Jamaica Ave, Richmond Hill, N Y 11418
WEISMANTEL INC.
P O Box 1957, St Paul, Minn 55111
XEROX DATA SYSTEMS
701 S Aviation, El Segundo, Cal 90245

PRINTERS, MICROFILM/MICROFICHE

A.B. DICK CO.
5700 W Touhy, Chicago, Ill 60648
ALLEN PRODUCTS INC.
180 Wampus Ln, Milford, Conn 06460
CALIFORNIA COMPUTER PRODUCTS INC.
2411 W La Palma Ave, Anaheim, Cal 92801
COMPUTER MICRO-IMAGE SYSTEMS INC.
9600 Desoto Ave, Chatsworth, Cal 91311
EXTEK MICROSYSTEMS INC.
15424 Cabrillo Rd, Van Nuys, Cal 91406
GORDON ENTERPRISES INC., ALAN
5362 Cahuenga Blvd, N Hollywood, Cal 91601
ITEK BUSINESS PRODUCTS
1001 Jefferson Rd, Rochester, N Y 14603
ITEK CORP.
10 Maguire Rd, Lexington, Mass 02173
MEMOREX EQUIPMENT GROUP
San Tomas At Central, Santa Clara, Cal 95052
MOSLER SAFE CO., THE INFO. SYS. DIV.
1561 Grand Blvd., Hamilton, Ohio 45012
NCR INDUSTRIAL PRODUCTS DIV.
Main And K St, Dayton, Ohio 45409
PERIPHERAL TECHNOLOGY INC.
757 N Pastoria Ave, Sunnyvale, Cal 94086
SANDERS ASSOCIATES INC. SYSTEMS DIV.
Daniel Webster Hwy S, Nashua, N H 03060
SINGER LINK DIV.
1077 E Arques, Sunnyvale, Cal 94086
STROMBERG DATAGRAPHIX INC.
P O Box 2449, San Diego, Cal 92112
TELEDYNE FREDERICK POST
P O Box 803, Chicago, Ill 60690

XIDEX CORP.
305 Soquel Way, Sunnyvale, Cal 94086

PRINTERS, NON-IMPACT, SPECIAL PURPOSE

A.B. DICK CO.
5700 W Touhy, Chicago, Ill 60648
INFO-MAX
1248 Alderwood, Sunnyvale, Cal 94086

PROCESS CONTROL COMPUTERS (SEE COMPUTERS)

PROCESSORS, MICROFILM

ADDRESSOGRAPH MULTIGRAPH CORP
1800 W Central Rd, Mount Prospect, Ill 60056
ALLEN PRODUCTS INC.
180 Wampus Ln, Milford, Conn 06460
BENDIX COMPUTER GRAPHICS
23850 Freeway Park Dr, Farmington, Mich 48024
BRUNING CO., CHARLES
1800 W Central Rd, Mt Prospect, Ill 60005
CANON U.S.A. INC.
64-10 Queens Blvd, Woodside, N Y 11377
CINTEL CORP. SUB. TECHNOLOGY INC
11801 W Olympic Blvd., Los Angeles, Cal 90064
COMPUTER MICRO-IMAGE SYSTEMS INC.
9600 Desoto Ave, Chatsworth, Cal 91311
CORNELL ENGINEERING INC.
210 Broadway, Everett, Mass 02149
CURRAN COMPUTER CORP.
946 Main St, Hackensack, N J 07601
DACOM INC.
1060 Morse Ave, Sunnyvale, Cal 94086
EASTMAN KODAK CO.
343 State St, Rochester, N Y 14650
ELLIOTT CO., B.K.
P O Box 3240, Pittsburg, Pa 15230
GORDON ENTERPRISES INC., ALAN
5362 Cahuenga Blvd, N Hollywood, Cal 91601
IMAGE SYSTEMS INC.
11244 Playa Ct, Culver City, Cal 90230
ITEK BUSINESS PRODUCTS
1001 Jefferson Rd, Rochester, N Y 14603
3M CO.
3m Center, St Paul, Minn 55101
MEMOREX EQUIPMENT GROUP
San Tomas At Central, Santa Clara, Cal 95052
REMINGTON RAND OFFICE SYSTEMS DIV. SPERRY RAND
P O Box 171, Marietta, Ohio 45750
STROMBERG DATAGRAPHIX INC.
P O Box 2449, San Diego, Cal 92112
TERMINAL DATA CORP.
16130 Stagg St, Van Nuys, Cal 91324

PRODUCT PLANNING (SEE CONSULTING)

PROGRAMMERS, PUNCHED CARD

AMP INC., SYSCOM DIV.
P O Box 3608, Harrisburg, Pa 17105
COMPUTER CONVERSIONS CORP.
6 Dunton Court, E Northport, N Y 11731
COMPUTER DESIGN CORP.
12401 W Olympic Blvd, Los Angeles, Cal 90064
DATA PROCESSING AND ACCOUNTING SERVICES
50 Van Ness Ave, San Francisco, Cal 94102
HICKOK ELECTRICAL INSTRUMENT CO.
10514 Dupont Ave, Cleveland, Ohio 44108
SYSTEMS ANALYSIS INC.
11110 N E 8th, Bellevue, Wash 98004

PROGRAMMING LANGUAGE DEVELOPMENT (CONSULTANTS)

ABT ASSOCIATES INC. TECHNOLOGY GROUP
55 Wheeler St, Cambridge, Mass 02138
ACADEMY COMPUTING CORP.
5005 N Lincoln Blvd, Oklahoma City, Okla 73105
ADAPT INC.
624 S 62nd St, Philadelphia, Pa 19143
ADVANCED COMPUTER SYSTEMS INC
3131 S Dixie Dr, Dayton, Ohio 45305
ADVANCED COMPUTER TECHNIQUES CORP.
437 Madison Ave, New York, N Y 10022

2 Product Directory

ADVANCED MANAGEMENT SYSTEMS INC.
3310 Richmond Ave, Houston, Tex 77006
ALLEN-BABCOCK COMPUTING INC.
1800 Ave of The Stars, Los Angeles, Cal 90067
ANALYTICS INC.
179 Washington Lane, Jenkintown, Pa 19046
ANCOM SYSTEMS, DIV. GENERAL ANALYTICS CORP.
9841 Airport Blvd, Los Angeles, Cal 90045
APPLIED COMPUTER TIME SHARE INC.
29200 Southfield Rd, Southfield, Mich 48075
APPLIED CYBERNETICS CORP.
1285 Forgewood Ave, Sunnyvale, Cal 94086
APPLIED DIGITAL SYSTEMS INC.
3848 Campus Dr 112, Newport Beach, Cal 92660
APPLIED LOGIC CORP.
One Palmer Sq, Princeton, N J 08540
APPLIED PROGRAMMING TECHNOLOGY CORP.
275 D Cox St, Hudson, Mass 01749
APPLIED SYSTEMS CORP.
18325 W McNichols Ave, Detroit, Mich 48219
AUERBACH ASSOCIATES INC.
121 W Broad St, Philadelphia, Pa 19107
AVCO CORP. ELECTRONICS DIV.
4807 Bradford, Huntsville, Ala 35805
AZREX INC.
105 Terrace Hall Ave, Burlington, Mass 01803
BASIC COMPUTING ARTS INC.
2680 E Bayshore Frtge, Mt View, Cal 94040
BONNER&MOORE ASSOCIATES INC.
500 Jefferson Bldg, Houston, Tex 77002
BOOTHE DATA SYSTEMS INC.
485 Lexington Ave, New York, N Y 10001
BURLINGTON MANAGEMENT SERVICES CO.
P O Box 21207, Greensboro, N C 27420
C&C COMPUTER SYSTEMS INC.
1006 S E Grand, Portland, Ore 97214
CALL-A-COMPUTER INC.
633 Young St, Santa Ana, Cal 92702
CAMBRIDGE COMPUTER ASSOCIATES INC.
220 Alewife Brook Pky, Cambridge, Mass 02138
CODE INC.
8939 Sepulveda Blvd, Los Angeles, Cal 90045
CODON CORP.
400 Totten Pond Rd, Waltham, Mass 02154
COMPAC COMPUTER SYSTEMS INC.
911 Hennepin, Minneapolis, Minn 55403
COMPU-MEDIC CONTROLS CORP.
432 Park Ave S, New York, N Y 10016
COMPU-TIME INC.
327 Orange Ave, Daytona, Fla 32014
COMPUTATION AND SYSTEMS CORP.
12061 Wilshire Blvd, Los Angeles, Cal 90025
COMPUTER & APPLIED SCIENCES INC.
1401 Dekalb St, Norristown, Pa 19401
COMPUTER COMMAND AND CONTROLS COMPANY
4025 Chestnut St, Philadelphia, Pa 19104
COMPUTER CONSULTANTS CORP.
U S Rte 46 E, Denville, N J 07834
COMPUTER DYNAMICS INC.
1760 Solano Ave, Berkeley, Cal 94707
COMPUTERIA INC.
14 Wood Rd, Braintree, Mass 02143
COMPUTER LEARNING & SYSTEMS CORP.
5530 Wisconsin Ave, Chevy Chase, Md 20015
COMPUTER MANAGEMENT INC.
3101 Eullid Ave, Cleveland, Ohio 44115
COMPUTER METHODS CORP.
470 Mamaroneck Ave, White Plains, N Y 10605
COMPUTER PROCESSING INC.
300 6th Ave, Pittsburgh, Pa 15222
COMPUTER PROGRAMMING CONCEPTS INC.
101 Atkinson Sq, Cincinnati, Ohio 45246
COMPUTER SCIENCES CORP. INFO. NETWORK DIV.
1901 Building, Los Angeles, Cal 90067
COMPUTER SYSTEM TECHNOLOGY INC.
700-42 Fox Pavilion, Jenkintown, Pa 19046
COMPUTER SYSTEMS CO. INC.
1470 St Charles Ave, Cleveland, Ohio 44107
COMPUTER TECHNOLOGY INC. SUB. UNIV.
COMPUTING CO.
P O Box 47911, Dallas, Tex 75247
COMPUTER USAGE CO.
387 Elliot St, Newton Uppr Fis, Mass 02164
COMPUTER USAGE CO.
3181 Porter Dr, Palo Alto, Cal 94304
COMPUTER USAGE CORP.
100 Putman Green, Greenwich, Conn 06830
COMPUTER USAGE CORP.,
8939 S Sepulveda Blvd, Los Angeles, Cal 90045
COMPUTING & SOFTWARE INC., EAST COAST DIV.
3700 Mt Vernon Ave, Alexandria, Va 22305
COMPUTING EFFICIENCY INC. COMPUTING EFF. DIV.
35 Orville Dr, Bohemia, N Y 11716
COMPUVISOR INC.
P O Box 381, Ithaca, N Y 14850

COMTEK ASSOCIATES
2077 Center Ave, Fort Lee, N J 07024
CONDATA INC.
1809 Walnut St, Philadelphia, Pa 19103
CONSAD RESEARCH CORP.
5600 Forward Ave, Pittsburgh, Pa 15217
CONSUMER SYSTEMS CORP.
15 Spinning Wheel Rd, Hinsdale, Ill 60521
CONTROL TECHNOLOGY INC.
3450 E Spring St, Long Beach, Cal 90806
CTC COMPUTER CORP.
1000 Elwell Court, Palo Alto, Cal 94303
CYBERMATICS INC.
2460 Lemoine Ave, Fort Lee, N J 07024
D.P.&W. INC.
1107 Commonwealth Ave, Boston, Mass 02215
DAILEY INC., R.N.
300 Madison Ave, New York, N Y 10017
DATA COMPUTING CORP.
229 Baldwin Rd, Hempstead, N Y 11551
DATA DIMENSIONS INC.
51 Weaver St, Greenwich, Conn 06830
DATA USAGE CORP.,
2460 Lemoine Ave, Fort Lee, N J 07024
DECISION SYSTEMS INC.
E 66 Midland Ave, Paramus, N J 07652
DELMARVA COMPUTER INDUSTRIES INC.
5865 Robert Oliver Pl, Columbia, Md 21043
DELTA SYSTEMS CORP.
Edens Exective Ctr, Wilmette, Ill 60091
DESIGNERS & BUILDERS OF INFORMATION SYSTEMS
35 W 53 St, New York, N Y 10019
DEUSSEN ASSOCIATES INC.
576 Hyannis Dr, Sunnyvale, Cal 94087
DIGITAL PROGRAMMING SERVICES INC.
60 Hickory Dr, Waltham, Mass 02154
DIRECT ACCESS COMPUTING CORP.
984 Livernois Rd, Troy, Mich 48084
DYNAMIC ACCESS CORP.
220 Park Ave S, New York, N Y 10003
EASTERN COMPUTER SERVICES INC
920 Fox Chase Rd, Rockledge, Pa 19111
EDUCATION AND TRAINING CONSULTANTS CO.
P O Box 49899, Los Angeles, Cal 90049
ELECTRONIC DATA PREPARATION CORP.
P O Box 1446, Bradenton, Fla 33505
FEDDER DATA CENTERS MANAGEMENT INC.
1654 Central Ave, Albany, N Y 12205
FIRST BUSINESS COMPUTING
1020 Houston Bk&Tr Tr, Houston, Tex 77002
FLORES ASSOCIATES
108 8th Ave, Brooklyn, N Y 11215
GENASYS CORP.
2011 Gye St NW, Washington, D C 20006
GENERAL AUTOMATION INC.
1055 S East St, Anaheim, Cal 92805
GRECO ENTERPRISES INC. TSA DATA DIV.
2000 Texas, El Paso, Tex 79901
GTE DATA SERVICES INC.
5422 Bay Center Dr, Tampa, Fla 33609
HAVERLY SYSTEMS INC.
4 2nd Ave, Denville, N J 07834
HOLLANDER ASSOCIATES
P O Box 2276, Fullerton, Cal 92633
HONEYWELL INFORMATION SYSTEMS INC. INFO.
SERV.DIV
2701 4th Ave S, Minneapolis, Minn 55408
HOUSTON RESEARCH INC. SUB. SCI. ELECT.
6001 Gulf Fwy, Houston, Tex 77023
HUB RATLIFF CONSULTANT
P O Box 22487, Houston, Tex 77027
HYDRA COMPUTER CORP.
P O Box 17883, Raleigh, N C 27609
INFODATA SYSTEMS INC.
680 Ridge Rd, Webster, N Y 14580
INFONET SYSTEMS INC.
358 McKinley Blvd, Paramus, N J 07652
INFORMATICS INC.
21050 Vanover St, Canoga Park, Cal 91303
INFORMATION DEVELOPMENT ASSOCIATES INC.
P O Box 2285, Bethlehem, Pa 18018
INFORMATION MANAGEMENT INC.
447 Battery St, San Francisco, Cal 94111
INFORMATION SCIENCES INC.
14 Jefferson Blvd, Warwick, R I 02888
INFORMATION SYSTEMS MANAGEMENT
120 Montgomery St, San Francisco, Cal 94104
INFOSCI INC.
P O Box 464, Menlo Park, Cal 94025
INNOVATIVE SOFTWARE INC.
486 Totten Pond Rd, Waltham, Mass 02154
INPUT INC.
500 Old Elm Rd, Highland Park, Ill 60035
INTECH INC.
2915 Wayzata Blvd, Minneapolis, Minn 55405

INTERACTIVE SCIENCES CORP.
60 Brook Dr, Braintree, Mass 02184
INTERACTIVE SYSTEMS INC.
327 S Fourth Ave, Ann Arbor, Mich 48108
INTERACTIVE TECHNICAL SERVICES INC.
486 Totten Pond Rd, Waltham, Mass 02154
INTERNATIONAL COMPUTER CORP.
1 N Broadway, White Plains, N Y 10601
JACKSON ASSOCIATES
4663 Executive Dr, Columbus, Ohio 43220
KEYSTONE COMPUTER ASSOCIATES INC.
1055 Virginia Dr, Ft Washington, Pa 19034
LAHEY COMPUTER SYSTEMS INC.
4747 N 16th St, Phoenix, Ariz 85016
LEASCO DATA PROCESSING EQUIPMENT CORP.
280 Park Ave, New York, N Y 10017
LIMITED FOURS LIMITED
1030 13th St, Boulder, Colo 80302
LITTON SYSTEMS INC. MELLONICS DIV.
1001 W Maude Ave, Sunnyvale, Cal 94086
LOCKHEED ELECTRONICS DATA MANAGEMENT
SERVICES
16811 El Camino Real, Houston, Tex 77058
LOGIC INC.
1712 Commerce St, Dallas, Tex 75201
LOGICON INC.
Del Amo Financial Ctr, Torrance, Cal 90503
LOWENTHAL PROGRAMMING CO.
30 Rock Ridge Dr, Pt Chester, N Y 10573
MACNEAL-SCHWENDLER CORP., THE
7442 N Figueroa St, Los Angeles, Cal 90041
MACRO CORP.
1260 Virginia Dr, Ft Washington, Pa 19034
MANAGEMENT & COMPUTER SERVICES INC.
104 Park Towne Pl E, Philadelphia, Pa 19130
MANAGEMENT SCIENCE SYSTEMS INC.
1530 E Jefferson St, Rockville, Md 20852
MARK COMPUTER SYSTEMS INC.
One Patterson Pl, Garden City, N Y 11530
MASTECH COMPUTER SYSTEMS INC.
7026 W North Ave, Chicago, Ill 60635
MCDONNELL AUTOMATION CO.
P O Box 516, St Louis, Mo 63166
METROPROCESSING CORP. OF AMERICA
64 Prospect St, White Plains, N Y 10606
MICRO SYSTEMS INC.
644 E Young St, Santa Ana, Cal 92705
MILNEE BROTHERS PRODUCTS
8000 Blackburn Ave, Los Angeles, Cal 90048
NATIONAL C.S.S.
460 Summer St, Stamford, Conn 06901
NATIONAL COMPUTER ANALYSTS INC.
Us Hwy 1, Princeton, N J 08540
NEOTERIC INC.
2800 Euclid Ave, Cleveland, Ohio 44115
NORDEN DIV., UNITED AIRCRAFT CORP.
Helen St, Norwalk, Conn 06850
ON-LINE SYSTEMS INC.
4721 Mc Knight Rd, Pittsburg, Pa 15237
PANSOPHC SYSTEMS INC.
230 Roosevelt Rd, Lombard, Ill 60148
PENNDATA CORP.
1729 Cedar Ave, Scranton, Pa 18505
PHI COMPUTER SERVICES INC.
800 Massachusetts Ave, Arlington, Mass 02174
PIONEER DATA SYSTEMS INC.
606 Merle Hay Tower, Des Moines, Iowa 50310
PLANNING RESEARCH CORP.
1100 Glendon Ave, Los Angeles, Cal 90024
PRINCETON TIME SHARING SERVICES, INC.
Us Hwy 1, Princeton, N J 08540
PROGRAMMATICS INC.
11661 San Vicente Blv, Los Angeles, Cal 90049
PROGRAMMING SCIENCES CORP.
S E 42 St, New York, N Y 10016
QUIKDATA INTERNATIONAL INC.
8444 Wilshire Blvd, Beverly Hills, Cal 90211
RAYTHEON CO. EQUIPMENT DIV.
528 Boston Post Rd, Sudbury, Mass 01776
REL-QUAL ASSOCIATES INC.
18 Hamilton St, Bound Brook, N J 08805
REMOTE COMPUTING CORP.
A40 Palo Alto Off Ctr, Palo Alto, Cal 94301
REPUBLIC SYSTEMS INC.
100 Plaza Centre, Secaucus, N J 07094
REPUBLIC SYSTEMS INC.
715 Park Ave, E Orange, N J 07017
REPUBLIC SYSTEMS OF CONNECTICUT INC.
350 S Main St, Cheshire, Conn 06410
RIDGWOOD ASSOCIATES INC.
10 Wilsey Sq, Ridgewood, N J 07450
SARNA ASSOCIATES INC.
22 Russell St, Brookline, Mass 02146
SCIENTIFIC CALCULATIONS INC.
110 Allens Creek Rd, Rochester, N Y 14618

2 Product Directory

SCIENTIFIC COMPUTERS, INC.,
919 Second Ave S, Minneapolis, Minn 55402
SCIENTIFIC SOFTWARE CORP.
5300 S Ulster, Englewood, Colo 80110
SCIENTIFIC SYSTEMS SERVICES INC.
476 N Hwy A1a, Satellite Beach, Fla 32935
SCIENTIFIC TIME SHARING CORP.
2101 S St NW, Washington, D C 20008
SCI-TEK COMPUTER CENTER INC.
1707 Gilpin Ave, Wilmington, Del 19806
SIERRA RESEARCH CORP. COMPUTER PROD. GRP.
167 Bedford St., Burlington, Mass 01803
SINGER-GENERAL PRECISION KEARFOTT DIV.
1150 McBride Ave, Little Falls, N J 07424
SOFTECH INC.
391 Totten Pond Rd, Waltham, Mass 02154
SOFTWARE GUIDANCE ASSOCIATES INC.
432 Park Ave S, New York, N Y 10016
SOFTWARE PROGRAMMING ASSOCIATES INC.
1209 Tropic St, Titusville, Fla 32780
SYSTEM DEVELOPMENT CORP.
2500 Colorado Ave, Santa Monica, Cal 90406
SYSTEM IMPLEMENTATION CORP.
18 E 48th St, New York, N Y 10017
SYSTEMS & PROGRAMMING SERVICES
1001 Daniel Bldg, Greenville, S C 29602
SYSTEMS ANALYSIS INC.
11110 N E 8th, Bellevue, Wash 98004
SYSTEMS ASSOCIATES INC.
356 Penn St, Reading, Pa 19602
SYSTEMS CONCEPTS INC.
524 2nd St, San Francisco, Cal 94107
SYSTEMS PROGRAMMING INC.
175 Main St, White Plains, N Y 10601
SYSTEMS, SCIENCE & SOFTWARE INC.
Po Box 1620, La Jolla, Cal 92037
TECHNOLOGY FOR INFORMATION MANAGEMENT INC.
1654 Central Ave, Albany, N Y 12205
THEORY ANALYSIS GROUP
22 E Elm St, Chicago, Ill 60611
TIME SHARE CORP.
3 Lebanon St, Hanover, N H 03755
TIME SHARING SCIENCES INC.
1180 Ave Americas, New York, N Y 10036
TRACOR COMPUTING CORP.
1705 Guadalupe St, Austin, Tex 78701
TRILOG ASSOCIATES INC.
1700 Market St, Philadelphia, Pa 19103
TURNKEY SYSTEMS INC.
111 E Ave, Norwalk, Conn 06851
UNITED COMPUTING CORP.
22500 S Avalon Blvd, Carson, Cal 90744
UNITED COMPUTING SYSTEMS INC.
3130 Broadway, Kansas City, Mo 64111
UNITED SYSTEMS INC.
1020 Kings Hwy N, Cherry Hill, N J 08034
UNIVERSAL DATA SYSTEMS INC.
14482 Beach Blvd, Westminster, Cal 92626
UNIVERSITY COMPUTING CO.
P O Box 6228, Dallas, Tex 75222
URBAN DATA PROCESSING INC.
552 Massachusetts Ave, Cambridge, Mass 02139
URS DATA SCIENCE CO.
155 Bovet Rd, San Mateo, Cal 94402
VIRTUAL COMPUTER SERVICES INC
1119 Springfield Rd, Union, N J 07083
WANG LABORATORIES INC.
836 N St, Tewksbury, Mass 01876
WARREN ASSOCIATES
15 Royal Crest Dr, Marlboro, Mass 01752
WELLINGTON COMPUTER SYSTEMS CORP.
405 Lexington Ave, New York, N Y 10017
WESTERN OPERATIONS INC.
120 Montgomery St, San Francisco, Cal 94104
WORLDWIDE COMPUTER SERVICES, INC.
280 N Central Pk Ave, Hartsdale, N Y 10530

PROGRAMMING LANGUAGE DEVELOPMENT (CONTRACT PROGRAMMING)

ABINGTON KEYPUNCH INC.
920 Fox Chase Rd, Rockledge, Pa 19111
ABT ASSOCIATES INC. TECHNOLOGY GROUP
55 Wheeler St, Cambridge, Mass 02138
ACADEMY COMPUTING CORP.
5005 N Lincoln Blvd, Oklahoma City, Okla 73105
ADAPT INC.
624 S 62nd St, Philadelphia, Pa 19143
ADVANCED COMPUTER SYSTEMS INC
3131 S Dixie Dr, Dayton, Ohio 45305
ADVANCED COMPUTER TECHNIQUES CORP.
437 Madison Ave, New York, N Y 10022

ADVANCED MANAGEMENT SYSTEMS INC.
3310 Richmond Ave, Houston, Tex 77006
ALLEN-BABCOCK COMPUTING INC.
1800 Ave of The Stars, Los Angeles, Cal 90067
AMERICAN COMPUTER LEASING CORP.
14 E 4th St, Cincinnati, Ohio 45202
AMERICAN COMPUTER SERVICES CORP.
14 E 4th St, Cincinnati, Ohio 45202
ANCOM SYSTEMS, DIV. GENERAL ANALYTICS CORP.
9841 Airport Blvd, Los Angeles, Cal 90045
APPLIED COMPUTER TIME SHARE INC.
29200 Southfield Rd, Southfield, Mich 48075
APPLIED CYBERNETICS CORP.
1285 Forgeood Ave, Sunnyvale, Cal 94086
APPLIED DIGITAL SYSTEMS INC.
3848 Campus Dr 112, Newport Beach, Cal 92660
APPLIED LOGIC CORP.
One Palmer Sq, Princeton, N J 08540
APPLIED PROGRAMMING TECHNOLOGY CORP.
275 D Cox St, Hudson, Mass 01749
AUERBACH ASSOCIATES INC.
121 W Broad St, Philadelphia, Pa 19107
AUTOMATION SERVICES CORP.
182 Forbes Rd, Braintree, Mass 02184
AVCO CORP. ELECTRONICS DIV.
4807 Bradford, Huntsville, Ala 35805
AZREX INC.
105 Terrace Hall Ave, Burlington, Mass 01803
BASIC COMPUTING ARTS INC.
2680 E Bayshore Frige, Mt View, Cal 94040
BONNER&MOORE ASSOCIATES INC.
500 Jefferson Bldg, Houston, Tex 77002
BOOTHE DATA SYSTEMS INC.
485 Lexington Ave, New York, N Y 10001
BOOTHE RESOURCES INTERNATIONAL INC.
3435 Wilshire Blvd, Los Angeles, Cal 90005
BOSTON COMPUTER SYSTEMS CORP.
15 School St, Boston, Mass 02108
BRADDOCK, DUNN & MCDONALD INC.
8027 Leesburg Pike, Mc Lean, Va 22101
BURLINGTON MANAGEMENT SERVICES CO.
P O Box 21207, Greensboro, N C 27420
C&C COMPUTER SYSTEMS INC.
1006 S E Grand, Portland, Ore 97214
CAMBRIDGE COMPUTER ASSOCIATES INC.
220 Alewife Brook Pky, Cambridge, Mass 02138
CENTURY DATA PROCESSING INC.
1006 Coronado Towers, El Paso, Tex 79912
CGA COMPUTER ASSOCIATES INC.
715 Park Ave, East Orange, N J 07017
CODE INC.
8939 Sepulveda Blvd, Los Angeles, Cal 90045
CODON CORP.
400 Totten Pond Rd, Waltham, Mass 02154
COMPAC COMPUTER SYSTEMS INC.
911 Hennepin, Minneapolis, Minn 55403
COMPU-MEDIC CONTROLS CORP.
432 Park Ave S, New York, N Y 10016
COMPU-TIME INC.
327 Orange Ave, Daytona, Fla 32014
COMPUTATION AND SYSTEMS CORP.
12061 Wilshire Blvd, Los Angeles, Cal 90025
COMPUTER & APPLIED SCIENCES INC.
1401 Dekalb St, Norristown, Pa 19401
COMPUTER ADVISORS TO MANAGEMENT
120 S Riverside Plaza, Chicago, Ill 60606
COMPUTER AMERICA CORP.
818 Roeder Rd, Silver Spring, Md 20910
COMPUTER COMMAND AND CONTROLS COMPANY
4025 Chestnut St, Philadelphia, Pa 19104
COMPUTER COMMUNICATION INC.
701 W Manchester Blvd, Inglewood, Cal 90301
COMPUTER CONSULTANTS CORP.
U S Rte 46 E, Denville, N J 07834
COMPUTER DYNAMICS INC.
1760 Solano Ave, Berkeley, Cal 94707
COMPUTERIA INC.
14 Wood Rd, Braintree, Mass 02143
COMPUTER LEARNING & SYSTEMS CORP.
5530 Wisconsin Ave, Chevy Chase, Md 20015
COMPUTER MANAGEMENT INC.
3101 Euclid Ave, Cleveland, Ohio 44115
COMPUTER METHODS CORP.
470 Mamaroneck Ave, White Plains, N Y 10605
COMPUTER PROCESSING INC.
300 6th Ave, Pittsburgh, Pa 15222
COMPUTER PROGRAMMING CONCEPTS INC.
101 Atkinson Sq, Cincinnati, Ohio 45246
COMPUTER SCIENCES CORP. INFO. NETWORK DIV.
1901 Building, Los Angeles, Cal 90067
COMPUTER SYSTEM TECHNOLOGY INC.
700-42 Fox Pavilion, Jenkintown, Pa 19046
COMPUTER SYSTEMS CO. INC.
1470 St Charles Ave, Cleveland, Ohio 44107

COMPUTER TECHNOLOGY INC. SUB. UNIV.
COMPUTING CO.
P O Box 47911, Dallas, Tex 75247
COMPUTER USAGE CO.
387 Elliot St, Newton Uppr Fls, Mass 02164
COMPUTER USAGE CO.
3181 Porter Dr, Palo Alto, Cal 94304
COMPUTER USAGE CORP.
100 Putman Green, Greenwich, Conn 06830
COMPUTER USAGE CORP.,
8939 S Sepulveda Blvd, Los Angeles, Cal 90045
COMPUTING & SOFTWARE INC., EAST COAST DIV.
3700 Mt Vernon Ave, Alexandria, Va 22305
COMPUTING EFFICIENCY INC. COMPUTING EFF. DIV.
35 Orville Dr, Bohemia, N Y 11716
COMTEK ASSOCIATES
2077 Center Ave, Fort Lee, N J 07024
CONDATA INC.
1809 Walnut St, Philadelphia, Pa 19103
CONSAD RESEARCH CORP.
5600 Forward Ave, Pittsburgh, Pa 15217
CONSULTANTS ASSOCIATED INC.
Lakeside Office Park, Wakefield, Mass 01880
CONSUMER SYSTEMS CORP.
15 Spinning Wheel Rd, Hinsdale, Ill 60521
CONTROL TECHNOLOGY INC.
3450 E Spring St, Long Beach, Cal 90806
CORPORATE DATA PROCESSING
1724 Silver Lake Blvd, Los Angeles, Cal 90026
CTC COMPUTER CORP.
1000 Elwell Court, Palo Alto, Cal 94303
CYBERMATICS INC.
2460 Lemoine Ave, Fort Lee, N J 07024
D.P.&W. INC.
1107 Commonwealth Ave, Boston, Mass 02215
DAILEY INC., R.N.
300 Madison Ave, New York, N Y 10017
DATA COMPUTING CORP.
229 Baldwin Rd, Hempsted, N Y 11551
DATA DIMENSIONS INC.
51 Weaver St, Greenwich, Conn 06830
DATA USAGE CORP.,
2460 Lemoine Ave, Fort Lee, N J 07024
DATAMATION SERVICES INC.
461 Eighth Ave, New York, N Y 10001
DECISION SYSTEMS INC.
E 66 Midland Ave, Paramus, N J 07652
DELMARVA COMPUTER INDUSTRIES INC.
5865 Robert Oliver Pl, Columbia, Md 21043
DELTA SYSTEMS CORP.
Edens Exective Ctr, Wilmette, Ill 60091
DESIGNERS & BUILDERS OF INFORMATION SYSTEMS
35 W 53 St, New York, N Y 10019
DEUSSEN ASSOCIATES INC.
576 Hyannis Dr, Sunnyvale, Cal 94087
DIGITAL APPLICATIONS INC.
6300 Westpark Ste 150, Houston, Tex 77027
DIGITAL EQUIPMENT CORP.
146 Main St, Maynard, Mass 01754
DIGITAL PROGRAMMING SERVICES INC.
60 Hickory Dr, Waltham, Mass 02154
DIRECT ACCESS COMPUTING CORP.
984 Livernois Rd, Troy, Mich 48084
DYNAMIC ACCESS CORP.
220 Park Ave S, New York, N Y 10003
EASTERN COMPUTER SERVICES INC
920 Fox Chase Rd, Rockledge, Pa 19111
EDUCATION AND TRAINING CONSULTANTS CO.
P O Box 49899, Los Angeles, Cal 90049
ELECTRONIC DATA PREPARATION CORP.
P O Box 1446, Bradenton, Fla 33505
FEDDER DATA CENTERS MANAGEMENT INC.
1654 Central Ave, Albany, N Y 12205
FIRST BUSINESS COMPUTING
1020 Houston Bk&Tr Tr, Houston, Tex 77002
FLORES ASSOCIATES
108 8th Ave, Brooklyn, N Y 11215
GENASYS CORP.
2011 Gye St NW, Washington, D C 20006
GENERAL AUTOMATION INC.
1055 S East St, Anaheim, Cal 92805
GENERAL ELECTRIC CO. PROCESS COMPUTER DEPT.
2255 W Desert Cove Rd, Phoenix, Ariz 85029
GRAY & ASSOCIATES INC., H.J.
2501 Cedar Springs Rd, Dallas, Tex 75201
GRECO ENTERPRISES INC. TSA DATA DIV.
2000 Texas, El Paso, Tex 79901
GREYHOUND COMPUTER CORP.
130 S Canal St, Chicago, Ill 60606
GTE DATA SERVICES INC.
5422 Bay Center Dr, Tampa, Fla 33609
HAVERLY SYSTEMS INC.
4 2nd Ave, Denville, N J 07834
HOLLANDER ASSOCIATES
P O Box 2276, Fullerton, Cal 92633

2 Product Directory

HONEYWELL INFORMATION SYSTEMS INC. INFO. SERV.DIV

2701 4th Ave S, Minneapolis, Minn 55408
HOUSTON RESEARCH INC. SUB. SCI. ELECT.
6001 Gulf Fwy, Houston, Tex 77023
HUB RATLIFF CONSULTANT
P O Box 22487, Houston, Tex 77027
HYDRA COMPUTER CORP.
P O Box 17883, Raleigh, N C 27609
INDECON INC.
30 N Lasalle St, Chicago, Ill 60602
INFODATA SYSTEMS INC.
680 Ridge Rd, Webster, N Y 14580
INFONET SYSTEMS INC.
358 McKinley Blvd, Paramus, N J 07652
INFORMATICS INC.
21050 Vanower St, Canoga Park, Cal 91303
INFORMATION DEVELOPMENT ASSOCIATES INC.
P O Box 2285, Bethlehem, Pa 18018
INFORMATION MANAGEMENT INC.
447 Battery St, San Francisco, Cal 94111
INFORMATION SCIENCES INC.
14 Jefferson Blvd, Warwick, R I 02888
INFOTON INC.
2nd Ave, Burlington, Mass 01803
INNOVATIVE SOFTWARE INC.
486 Totten Pond Rd, Waltham, Mass 02154
INPUT INC.
500 Old Elm Rd, Highland Park, Ill 60035
INTECH INC.
2915 Wayzata Blvd, Minneapolis, Minn 55405
INTERACTIVE SCIENCES CORP.
60 Brook Dr, Braintree, Mass 02184
INTERACTIVE SYSTEMS INC.
327 S Fourth Ave, Ann Arbor, Mich 48108
INTERACTIVE TECHNICAL SERVICES INC.
486 Totten Pond Rd, Waltham, Mass 02154
INTERNATIONAL COMPUTER CORP.
1 N Broadway, White Plains, N Y 10601
INTERNATIONAL SYSTEMS ASSOCIATES, LTD.
350 5th Ave, New York, N Y 10001
INTERNATIONAL TELECONTROL CORP.
4300 Pine St, Wilmington, Del 19802
JACKSON ASSOCIATES
4663 Executive Dr, Columbus, Ohio 43220
KEYSTONE COMPUTER ASSOCIATES INC.
1055 Virginia Dr, Ft Washington, Pa 19034
KRANZLEY & CO. INC. ARTHUR S.
1010 S Kings Hwy, Cherry Hill, N J 08034
LAHEY COMPUTER SYSTEMS INC.
4747 N 16th St, Phoenix, Ariz 85016
LEASCO DATA PROCESSING EQUIPMENT CORP.
280 Park Ave, New York, N Y 10017
LITTON SYSTEMS INC. DATA SYSTEMS DIV.
8000 Woodley Ave, Van Nuys, Cal 91409
LITTON SYSTEMS INC. MELLONICS DIV.
1001 W Maude Ave, Sunnyvale, Cal 94086
LOCKHEED ELECTRONICS DATA MANAGEMENT SERVICES
16811 El Camino Real, Houston, Tex 77058
LOCKHEED ELECTRONICS CO. DIV. LOCKHEED ACRFT CORP
U S Hwy 22, Plainfield, N J 07060
LOGIC INC.
1712 Commerce St, Dallas, Tex 75201
LOGICON INC.
Del Amo Financial Ctr, Torrance, Cal 90503
LOWENTHAL PROGRAMMING CO.
30 Rock Ridge Dr, Pt Chester, N Y 10573
MACNEAL-SCHWENDLER CORP., THE
7442 N Figueroa St, Los Angeles, Cal 90041
MACRO CORP.
1260 Virginia Dr, Ft Washington, Pa 19034
MANAGEMENT & COMPUTER SERVICES INC.
104 Park Towne Pl E, Philadelphia, Pa 19130
MANAGEMENT SCIENCE SYSTEMS INC.
1530 E Jefferson St, Rockville, Md 20852
MARK COMPUTER SYSTEMS INC.
One Patterson Pl, Garden City, N Y 11530
MARK/OPS DIV., NORTH EASTERN SYSTEMS ASSOC. INC.
475 Commonwealth Ave, Boston, Mass 02215
MASTECH COMPUTER SYSTEMS INC.
7026 W North Ave, Chicago, Ill 60635
MCDONNELL AUTOMATION CO.
P O Box 516, St Louis, Mo 63166
MEGASYSTEMS INC.
1 Bala Ave, Bala-Cynwyd, Pa 19004
MEGASYSTEMS INC.
640 W 40th St, New York, N Y 10018
MELPAR DIV. LTV ELECTROSYSTEMS INC.
7700 Arlington Blvd, Falls Church, Va 22046
MICRO SYSTEMS INC.
644 E Young St, Santa Ana, Cal 92705

MILNEE BROTHERS PRODUCTS

8000 Blackburn Ave, Los Angeles, Cal 90048
MULTICOMP INC.
36 Washington St, Wellesley Hills, Mass 02181
MULTIDATA INC.
7300 Bolsa Ave, Westminster, Cal 92683
NATIONAL C.S.S.
460 Summer St, Stamford, Conn 06901
NATIONAL COMPUTER ANALYSTS INC.
Us Hwy 1, Princeton, N J 08540
NEOTERIC INC.
2800 Euclid Ave, Cleveland, Ohio 44115
NETWORK DATA PROCESSING CORP.
823 Commerce Dr, Oak Brook, Ill 60521
NORDEN DIV., UNITED AIRCRAFT CORP.
Helen St, Norwalk, Conn 06850
OLIVETTI CORP. OF AMERICA
500 Park Ave, New York, N Y 10016
ON-LINE SYSTEMS INC.
4721 Mc Knight Rd, Pittsburg, Pa 15237
PANSOPHIC SYSTEMS INC.
230 Roosevelt Rd, Lombard, Ill 60148
PAPERWORK DATA COMM. SERVICES INC.
1703 S Ave, Syracuse, N Y 13207
PENNDATA CORP.
1729 Cedar Ave, Scranton, Pa 18505
PHI COMPUTER SERVICES INC.
800 Massachusetts Ave, Arlington, Mass 02174
PIONEER DATA SYSTEMS INC.
606 Merle Hay Tower, Des Moines, Iowa 50310
PLANNING RESEARCH CORP.
1100 Glendon Ave, Los Angeles, Cal 90024
PRINCETON TIME SHARING SERVICES, INC.
Us Hwy 1, Princeton, N J 08540
PROGRAMMATIC INC.
11661 San Vicente Blv, Los Angeles, Cal 90049
PROGRAMMING SCIENCES CORP.
S E 42 St, New York, N Y 10016
QUIKDATA INTERNATIONAL INC.
8444 Wilshire Blvd, Beverly Hills, Cal 90211
RAPIDATA INC.
20 New Dutch Lane, Fairfield, N J 07006
REL-QUAL ASSOCIATES INC.
18 Hamilton St, Bound Brook, N J 08805
REMOTE COMPUTING CORP.
A40 Palo Alto Off Ctr, Palo Alto, Cal 94301
REPUBLIC SYSTEMS INC.
100 Plaza Centre, Secaucus, N J 07094
REPUBLIC SYSTEMS INC.
715 Park Ave, E Orange, N J 07017
REPUBLIC SYSTEMS OF CONNECTICUT INC.
350 S Main St, Cheshire, Conn 06410
RIDGEWOOD ASSOCIATES INC.
10 Wilsley Sq, Ridgewood, N J 07450
SARNA ASSOCIATES INC.
22 Russell St, Brookline, Mass 02146
SCIENTIFIC CALCULATIONS INC.
110 Allens Creek Rd, Rochester, N Y 14618
SCIENTIFIC COMPUTERS, INC.,
919 Second Ave S, Minneapolis, Minn 55402
SCIENTIFIC SOFTWARE CORP.
5300 S Ulster, Englewood, Colo 80110
SCIENTIFIC SYSTEMS SERVICES INC.
476 N Hwy A1a, Satellite Beach, Fla 32935
SCIENTIFIC TIME SHARING CORP.
2101 S St NW, Washington, D C 20008
SCI-TEK COMPUTER CENTER INC.
1707 Gilpin Ave, Wilmington, Del 19806
SINGER-GENERAL PRECISION KEARFOTT DIV.
1150 McBride Ave, Little Falls, N J 07424
SMITHSONIAN ASTROPHYSICAL OBSERVATORY
60 Garden St, Cambridge, Mass 02138
SOFTECH INC.
391 Totten Pond Rd, Waltham, Mass 02154
SOFTWARE GUIDANCE ASSOCIATES INC.
432 Park Ave S, New York, N Y 10016
SOFTWARE PROGRAMMING ASSOCIATES INC.
1209 Tropic St, Titusville, Fla 32780
SYLVANIA ELECTRONIC SYSTEMS EASTERN DIV.
77 A St, Needham Heights, Mass 02194
SYSTEM DEVELOPMENT CORP.
2500 Colorado Ave, Santa Monica, Cal 90406
SYSTEM IMPLEMENTATION CORP.
18 E 48th St, New York, N Y 10017
SYSTEMS & PROGRAMMING SERVICES
1001 Daniel Bldg, Greenville, S C 29602
SYSTEMS ANALYSIS INC.
11110 N E 8th, Bellevue, Wash 98004
SYSTEMS ASSOCIATES INC.
356 Penn St, Reading, Pa 19602
SYSTEMS DATA, INC.
1951 W Market St, Akron, Ohio 44313
SYSTEMS PROGRAMMING INC.
175 Main St, White Plains, N Y 10601

SYSTEMS RESEARCH LABS, INC.

7001 Indian Ripple Rd, Dayton, Ohio 45440
SYSTEMS, SCIENCE & SOFTWARE INC.
Po Box 1620, La Jolla, Cal 92037
TECHNOLOGY FOR INFORMATION MANAGEMENT INC.
1654 Central Ave, Albany, N Y 122C5
TELEDYNE BROWN ENGINEERING
300 Sparkman Dr, Huntsville, Ala 35807
THEORY ANALYSIS GROUP
22 E Elm St, Chicago, Ill 60611
TIME SHARE CORP.
3 Lebanon St, Hanover, N H 03755
TIME SHARING SCIENCES INC.
1180 Ave Americas, New York, N Y 10036
TRACOR COMPUTING CORP.
1705 Guadalupe St, Austin, Tex 78701
TRACOR DATA SYSTEMS INC.
4201 Ed Bluestein Blv, Austin, Tex 78721
TRIOLOG ASSOCIATES INC.
1700 Market St, Philadelphia, Pa 19103
UNITED COMPUTING CORP.
22500 S Avalon Blvd, Carson, Cal 90744
UNITED COMPUTING SYSTEMS INC.
3130 Broadway, Kansas City, Mo 64111
UNITED SYSTEMS INC.
1020 Kings Hwy N, Cherry Hill, N J 08034
UNIVERSAL DATA SYSTEMS INC.
14482 Beach Blvd, Westminster, Cal 92626
UNIVERSITY COMPUTING CO.
P O Box 6228, Dallas, Tex 75222
URBAN DATA PROCESSING INC.
552 Massachusetts Ave, Cambridge, Mass 02139
URS DATA SCIENCE CO.
155 Bovet Rd, San Mateo, Cal 94402
VIRTUAL COMPUTER SERVICES INC
1119 Springfield Rd, Union, N J 07083
WANG LABORATORIES INC.
836 N St, Tewksbury, Mass 01876
WARREN ASSOCIATES
15 Royal Crest Dr, Marlboro, Mass 01752
WELLINGTON COMPUTER SYSTEMS CORP.
405 Lexington Ave, New York, N Y 10017
WESTERN OPERATIONS INC.
120 Montgomery St, San Francisco, Cal 94104
WESTINGHOUSE TELE-COMPUTER SYSTEMS CORP.
2040 Ardmore Blvd, Pittsburgh, Pa 15221
WORLDWIDE COMPUTER SERVICES, INC.
280 N Central Pk Ave, Hartsdale, N Y 10530
ZENITH INTEGRATED-DATA PROCESSING INC.
950 Fulton Ave, Sacramento, Cal 95825

PROGRAMMING LANGUAGE DEVELOPMENT (DEDICATED APPLICATION SYSTEMS)

A.B. DICK CO.
5700 W Touhy, Chicago, Ill 60648
ABT ASSOCIATES INC. TECHNOLOGY GROUP
55 Wheeler St, Cambridge, Mass 02138
ACADEMY COMPUTING CORP.
5005 N Lincoln Blvd, Oklahoma City, Okla 73105
ADAPT INC.
624 S 62nd St, Philadelphia, Pa 19143
ADVANCED COMPUTER SYSTEMS INC
3131 S Dixie Dr, Dayton, Ohio 45305
ADVANCED COMPUTER TECHNIQUES CORP.
437 Madison Ave, New York, N Y 10022
ADVANCED MANAGEMENT SYSTEMS INC.
3310 Richmond Ave, Houston, Tex 77006
AERO TECHNICAL APPLICATIONS INC.
8011 Clayton Rd, St Louis, Mo 63117
ALLEN-BABCOCK COMPUTING INC.
1800 Ave of The Stars, Los Angeles, Cal 90067
ANALYTICS INC.
179 Washington Lane, Jenkintown, Pa 19046
ANCOM SYSTEMS, DIV. GENERAL ANALYTICS CORP.
9841 Airport Blvd, Los Angeles, Cal 90045
APPLIED COMPUTER TIME SHARE INC.
29200 Southfield Rd, Southfield, Mich 48075
APPLIED CYBERNETICS CORP.
1285 Forgewood Ave, Sunnyvale, Cal 94086
APPLIED DIGITAL SYSTEMS INC.
3848 Campus Dr 112, Newport Beach, Cal 92660
APPLIED PROGRAMMING TECHNOLOGY CORP.
275 D Cox St, Hudson, Mass 01749
AUERBACH ASSOCIATES INC.
121 W Broad St, Philadelphia, Pa 19107
AUTOMATION SERVICES CORP.
182 Forbes Rd, Braintree, Mass 02184
AVCO CORP. ELECTRONICS DIV.
4807 Bradford, Huntsville, Ala 35805
BASIC COMPUTING ARTS INC.
2680 E Bayshore Frtge, Mt View, Cal 94040

2 Product Directory

- BERKELEY COMPUTER CORP.
2398 4th St, Berkeley, Cal 94710
- BONNER&MOORE ASSOCIATES INC.
500 Jefferson Bldg, Houston, Tex 77002
- BOOTHE DATA SYSTEMS INC.
485 Lexington Ave, New York, N Y 10001
- BOOTHE RESOURCES INTERNATIONAL INC.
3435 Wilshire Blvd, Los Angeles, Cal 90005
- BOSTON COMPUTER SYSTEMS CORP.
15 School St, Boston, Mass 02108
- BURLINGTON MANAGEMENT SERVICES CO.
P O Box 21207, Greensboro, N C 27420
- BURROUGHS CORP..BUSINESS MACHINES GROUP
6071 2nd Ave, Detroit, Mich 48232
- C&C COMPUTER SYSTEMS INC.
1006 S E Grand, Portland, Ore 97214
- CALL-A-COMPUTER INC.
633 Young St, Santa Ana, Cal 92702
- CAMBRIDGE COMPUTER ASSOCIATES INC.
220 Alewife Brook Pky, Cambridge, Mass 02138
- CENTURY DATA PROCESSING INC.
1006 Coronado Towers, El Paso, Tex 79912
- CINCINNATI MILACRON
State Rte 48, Lebanon, Ohio 45036
- CODE INC.
8939 Sepulveda Blvd, Los Angeles, Cal 90045
- CODON CORP.
400 Totten Pond Rd, Waltham, Mass 02154
- COMPAC COMPUTER SYSTEMS INC.
911 Hennepin, Minneapolis, Minn 55403
- COMPUMEDIC CONTROLS CORP.
432 Park Ave S, New York, N Y 10016
- COMPU-TIME INC.
327 Orange Ave, Daytona, Fla 32014
- COMPUTATION AND SYSTEMS CORP.
12061 Wilshire Blvd, Los Angeles, Cal 90025
- COMPUTER ADVISORS TO MANAGEMENT
120 S Riverside Plaza, Chicago, Ill 60606
- COMPUTER COMMUNICATION INC.
701 W Manchester Blvd, Inglewood, Cal 90301
- COMPUTER CONSULTANTS CORP.
U S Rte 46 E, Denville, N J 07834
- COMPUTER DESIGN CORP.
12401 W Olympic Blvd, Los Angeles, Cal 90064
- COMPUTER DYNAMICS INC.
1760 Solano Ave, Berkeley, Cal 94707
- COMPUTERIA INC.
14 Wood Rd, Braintree, Mass 02143
- COMPUTER LEARNING & SYSTEMS CORP.
5530 Wisconsin Ave, Chevy Chase, Md 20015
- COMPUTER MANAGEMENT INC.
3101 Euclid Ave, Cleveland, Ohio 44115
- COMPUTER METHODS CORP.
470 Mamaroneck Ave, White Plains, N Y 10605
- COMPUTER PROGRAMMING CONCEPTS INC.
101 Atkinson Sq, Cincinnati, Ohio 45246
- COMPUTER SCIENCES CORP. INFO. NETWORK DIV.
1901 Building, Los Angeles, Cal 90067
- COMPUTER SYSTEM TECHNOLOGY INC.
700-42 Fox Pavilion, Jenkintown, Pa 19046
- COMPUTER SYSTEMS CO. INC.
1470 St Charles Ave, Cleveland, Ohio 44107
- COMPUTER TECHNOLOGY INC. SUB. UNIV.
COMPUTING CO.
P O Box 47911, Dallas, Tex 75247
- COMPUTER USAGE CO.
387 Elliot St, Newton Uppr Fls, Mass 02164
- COMPUTER USAGE CO.
3181 Porter Dr, Palo Alto, Cal 94304
- COMPUTER USAGE CORP.
100 Putman Green, Greenwich, Conn 06830
- COMPUTER USAGE CORP..
8939 S Sepulveda Blvd, Los Angeles, Cal 90045
- COMPUTING & SOFTWARE INC., EAST COAST DIV.
3700 Mt Vernon Ave, Alexandria, Va 22305
- COMPUTING EFFICIENCY INC. COMPUTING EFF. DIV.
35 Orville Dr, Bohemia, N Y 11716
- COMTEK ASSOCIATES
2077 Center Ave, Fort Lee, N J 07024
- CONSAD RESEARCH CORP.
5600 Forward Ave, Pittsburgh, Pa 15217
- CONSOLIDATED COMPUTER LTD.
48 Yonge St, Toronto, CANADA
- CONSUMER SYSTEMS CORP.
15 Spinning Wheel Rd, Hinsdale, Ill 60521
- CONTROL TECHNOLOGY INC.
3450 E Spring St, Long Beach, Cal 90806
- CORPORATE DATA PROCESSING
1724 Silver Lake Blvd, Los Angeles, Cal 90026
- CTC COMPUTER CORP.
1000 Elwell Court, Palo Alto, Cal 94303
- CYBERMATICS INC.
2460 Lemoine Ave, Fort Lee, N J 07024
- D.P.&W. INC.
1107 Commonwealth Ave, Boston, Mass 02215
- DAILEY INC., R.N.
300 Madison Ave, New York, N Y 10017
- DATA COMPUTING CORP.
229 Baldwin Rd, Hempsted, N Y 11551
- DATA DIMENSIONS INC.
51 Weaver St, Greenwich, Conn 06830
- DATA TECHNOLOGY INC.
65 Grove St, Watertown, Mass 02172
- DATA USAGE CORP..
2460 Lemoine Ave, Fort Lee, N J 07024
- DATACAP INTERNATIONAL INC.
37 W 2950 S, Salt Lake City, Utah 84101
- DECISION SYSTEMS INC.
E 66 Midland Ave, Paramus, N J 07652
- DELMARVA COMPUTER INDUSTRIES INC.
5865 Robert Oliver Pl, Columbia, Md 21043
- DELTA SYSTEMS CORP.
Edens Executive Ctr, Wilmette, Ill 60091
- DEUSSEN ASSOCIATES INC.
576 Hyannis Dr, Sunnyvale, Cal 94087
- DIGITAL APPLICATIONS INC.
6300 Westpark Ste 150, Houston, Tex 77027
- DIGITAL EQUIPMENT CORP.
146 Main St, Maynard, Mass 01754
- DIGITAL PRODUCTS
335 W 7th St, San Pedro, Cal 90733
- DIGITAL PROGRAMMING SERVICES INC.
60 Hickory Dr, Waltham, Mass 02154
- DIRECT ACCESS COMPUTING CORP.
984 Livernois Rd, Troy, Mich 48084
- DYNAMIC ACCESS CORP.
220 Park Ave S, New York, N Y 10003
- EASTERN COMPUTER SERVICES INC
920 Fox Chase Rd, Rockledge, Pa 19111
- ELECTRONIC ASSOCIATES INC.
485 Monmouth Pkwy, W Long Branch, N J 07764
- EMR COMPUTER
8001 Bloomington Fwy, Minneapolis, Minn 55420
- ENTREKIN COMPUTERS INC. SUB. THE CROSS CO.
9475 Center Rd, Fenton, Mich 48430
- FEDDER DATA CENTERS MANAGEMENT INC.
1654 Central Ave, Albany, N Y 12205
- FIRST BUSINESS COMPUTING
1020 Houston Bk&Tr Tr, Houston, Tex 77002
- GENERAL AUTOMATION INC.
1055 S East St, Anaheim, Cal 92805
- GTE DATA SERVICES INC.
5422 Bay Center Dr, Tampa, Fla 33609
- HAVERLY SYSTEMS INC.
4 2nd Ave, Denville, N J 07834
- HONEYWELL INFORMATION SYSTEMS INC. INFO.
SERV.DIV
2701 4th Ave S, Minneapolis, Minn 55408
- HOUSTON RESEARCH INC. SUB. SCI. ELECT.
6001 Gulf Fwy, Houston, Tex 77023
- HUB RATLIFF CONSULTANT
P O Box 22487, Houston, Tex 77027
- HYDRA COMPUTER CORP.
P O Box 17883, Raleigh, N C 27609
- IAC COMPUTER SYSTEMS INC.
260 Newton Rd, Plainview, N Y 11803
- INFODATA SYSTEMS INC.
680 Ridge Rd, Webster, N Y 14580
- INFONET SYSTEMS INC.
358 McKinley Blvd, Paramus, N J 07652
- INFORMATION DEVELOPMENT ASSOCIATES INC.
P O Box 2285, Bethlehem, Pa 18018
- INFORMATION MANAGEMENT INC.
447 Battery St, San Francisco, Cal 94111
- INFORMATION SCIENCES INC.
14 Jefferson Blvd, Warwick, R I 02888
- INFOTON INC.
2nd Ave, Burlington, Mass 01803
- INNOVATIVE SOFTWARE INC.
486 Totten Pond Rd, Waltham, Mass 02154
- INTECH INC.
2915 Wayzata Blvd, Minneapolis, Minn 55405
- INTERACTIVE SCIENCES CORP.
60 Brook Dr, Braintree, Mass 02184
- INTERACTIVE SYSTEMS INC.
327 S Fourth Ave, Ann Arbor, Mich 48108
- INTERACTIVE TECHNICAL SERVICES INC.
486 Totten Pond Rd, Waltham, Mass 02154
- INTERNATIONAL COMPUTER CORP.
1 N Broadway, White Plains, N Y 10601
- INTERNATIONAL SYSTEMS ASSOCIATES, LTD.
350 5th Ave, New York, N Y 10001
- ITT DEFENSE COMMUNICATIONS DIV.
492 River Rd, Nutley, N J 07110
- JACKSON ASSOCIATES
4663 Executive Dr, Columbus, Ohio 43220
- KEYSTONE COMPUTER ASSOCIATES INC.
1055 Virginia Dr, Ft Washington, Pa 19034
- KONIGSBERG SYSTEMS INC.
10 De Angelo Dr, Bedford, Mass 01730
- KRANZLEY & CO. INC. ARTHUR S.
1010 S Kings Hwy, Cherry Hill, N J 08034
- LAHEY COMPUTER SYSTEMS INC.
4747 N 16th St, Phoenix, Ariz 85016
- LEASCO DATA PROCESSING EQUIPMENT CORP.
280 Park Ave, New York, N Y 10017
- LIMITED FOURS UNLIMITED
1030 13th St, Boulder, Colo 80302
- LITTON SYSTEMS INC. DATA SYSTEMS DIV.
8000 Woodley Ave, Van Nuys, Cal 91409
- LITTON SYSTEMS INC. MELLONICS DIV.
1001 W Maude Ave, Sunnyvale, Cal 94086
- LOCKHEED ELECTRONICS DATA MANAGEMENT SERVICES
16811 El Camino Real, Houston, Tex 77058
- LOGIC INC.
1712 Commerce St, Dallas, Tex 75201
- LOWENTHAL PROGRAMMING CO.
30 Rock Ridge Dr, Pt Chester, N Y 10573
- MACNEAL-SCHWENDLER CORP., THE
7442 N Figueroa St, Los Angeles, Cal 90041
- MACRO CORP.
1260 Virginia Dr, Ft Washington, Pa 19034
- MANAGEMENT SCIENCE SYSTEMS INC.
1530 E Jefferson St, Rockville, Md 20852
- MARK COMPUTER SYSTEMS INC.
One Patterson Pl, Garden City, N Y 11530
- MARK/OPS DIV., NORTH EASTERN SYSTEMS ASSOC.
INC.
475 Commonwealth Ave, Boston, Mass 02215
- MASTECH COMPUTER SYSTEMS INC.
7026 W North Ave, Chicago, Ill 60635
- MCDONNELL AUTOMATION CO.
P O Box 516, St Louis, Mo 63166
- MICRO SYSTEMS INC.
644 E Young St, Santa Ana, Cal 92705
- MILNEE BROTHERS PRODUCTS
8000 Blackburn Ave, Los Angeles, Cal 90048
- MULTIDATA INC.
7300 Bolsa Ave, Westminster, Cal 92683
- NATIONAL C.S.S.
460 Summer St, Stamford, Conn 06901
- NATIONAL COMPUTER ANALYSTS INC.
Us Hwy 1, Princeton, N J 08540
- NEOTERICS INC.
2800 Euclid Ave, Cleveland, Ohio 44115
- NORDEN DIV., UNITED AIRCRAFT CORP.
Helen St, Norwalk, Conn 06850
- OLIVETTI CORP. OF AMERICA
500 Park Ave, New York, N Y 10016
- ON-LINE SYSTEMS INC.
4721 Mc Knight Rd, Pittsburg, Pa 15237
- PANSOPHIC SYSTEMS INC.
230 Roosevelt Rd, Lombard, Ill 60148
- PAPERWORK DATA COMM. SERVICES INC.
1703 S Ave, Syracuse, N Y 13207
- PENNDATA CORP.
1729 Cedar Ave, Scranton, Pa 18505
- PHI COMPUTER SERVICES INC.
800 Massachusetts Ave, Arlington, Mass 02174
- PIONEER DATA SYSTEMS INC.
606 Merle Hay Tower, Des Moines, Iowa 50310
- PLANNING RESEARCH CORP.
1100 Glendon Ave, Los Angeles, Cal 90024
- PRINCETON TIME SHARING SERVICES, INC.
Us Hwy 1, Princeton, N J 08540
- PROCESS SYSTEMS INC.
3061 Sheridan St, Las Vegas, Nev 89102
- PROGRAMMATICS INC.
11661 San Vicente Blv, Los Angeles, Cal 90049
- PROGRAMMING SCIENCES CORP.
S E 42 St, New York, N Y 10016
- QUICKDATA INTERNATIONAL INC.
8444 Wilshire Blvd, Beverly Hills, Cal 90211
- RAPIDATA INC.
20 New Dutch Lane, Fairfield, N J 07006
- RAYTHEON CO. EQUIPMENT DIV.
528 Boston Post Rd, Sudbury, Mass 01776
- RCA GRAPHIC SYSTEMS DIV.
Rte 130, Dayton, N J 08810
- REMOTE COMPUTING CORP.
A40 Palo Alto Off Ctr, Palo Alto, Cal 94301
- REPUBLIC SYSTEMS INC.
100 Plaza Centre, Secaucus, N J 07094
- REPUBLIC SYSTEMS INC.
715 Park Ave, E Orange, N J 07017
- REPUBLIC SYSTEMS OF CONNECTICUT INC.
350 S Main St, Cheshire, Conn 06410
- RIDGEWOOD ASSOCIATES INC.
10 Wilsey Sq, Ridgewood, N J 07450
- SARNA ASSOCIATES INC.
22 Russell St, Brookline, Mass 02146
- SCI ELECTRONICS INC.
7705 La Porte Fwy, Houston, Tex 77012

2 Product Directory

SCIENTIFIC CALCULATIONS INC.
110 Allens Creek Rd, Rochester, N Y 14618
SCIENTIFIC COMPUTER APPLICATIONS INC.
2310 4th Natl Bank Bg, Tulsa, Okla 74119
SCIENTIFIC COMPUTERS, INC.,
919 Second Ave S, Minneapolis, Minn 55402
SCIENTIFIC SOFTWARE CORP.
5300 S Ulster, Englewood, Colo 88110
SCIENTIFIC SYSTEMS SERVICES INC.
476 N Hwy A1a, Satelilite Beach, Fla 32935
SCIENTIFIC TIME SHARING CORP.
2101 S St NW, Washington, D C 20008
SCI-TEK COMPUTER CENTER INC.
1707 Gilpin Ave, Wilmington, Del 19806
SIERRA RESEARCH CORP. COMPUTER PROD. GRP.
167 Bedford St, Burlington, Mass 01803
SINGER-GENERAL PRECISION KEARFOTT DIV.
1150 McBride Ave, Little Falls, N J 07424
SOFTTECH INC.
391 Totten Pond Rd, Waltham, Mass 02154
SOFTWARE GUIDANCE ASSOCIATES INC.
432 Park Ave S, New York, N Y 10016
SOFTWARE PROGRAMMING ASSOCIATES INC.
1209 Tropic St, Titusville, Fla 32780
STANDARD COMPUTER CORP.
633 Young St, Santa Ana, Cal 92705
SYLVANIA ELECTRONIC SYSTEMS EASTERN DIV.
77 A St, Needham Heights, Mass 02194
SYNERGISTIC SOFTWARE SYSTEMS, INC.
Po Box 36097, Houston, Tex 77036
SYSTEM DEVELOPMENT CORP.
2500 Colorado Ave, Santa Monica, Cal 90406
SYSTEM IMPLEMENTATION CORP.
18 E 48th St, New York, N Y 10017
SYSTEMS ANALYSIS INC.
11110 N E 8th, Bellevue, Wash 98004
SYSTEMS DATA, INC.
1951 W Market St, Akron, Ohio 44313
SYSTEMS RESEARCH LABS, INC.
7001 Indian Ripple Rd, Dayton, Ohio 45440
SYSTEMS, SCIENCE & SOFTWARE INC.
Po Box 1620, La Jolla, Cal 92037
TECHNOLOGY FOR INFORMATION MANAGEMENT INC.
1654 Central Ave, Albany, N Y 12205
TELEDYNE BROWN ENGINEERING
300 Sparkman Dr, Huntsville, Ala 35807
TIME SHARE CORP.
3 Lebanon St, Hanover, N H 03755
TIME SHARING SCIENCES INC.
1180 Ave Americas, New York, N Y 10036
TRACOR COMPUTING CORP.
1705 Guadalupe St, Austin, Tex 78701
TRACOR DATA SYSTEMS INC.
4201 Ed Bluestein Biv, Austin, Tex 78721
TRILOG ASSOCIATES INC.
1700 Market St, Philadelphia, Pa 19103
TURNKEY SYSTEMS INC.
111 E Ave, Norwalk, Conn 06851
UNICOMP INC.
18219 Parthenia, Northridge, Cal 91324
UNITED COMPUTING CORP.
22500 S Avalon Blvd, Carson, Cal 90744
UNITED COMPUTING SYSTEMS INC.
3130 Broadway, Kansas City, Mo 64111
UNITED SYSTEMS INC.
1020 Kings Hwy N, Cherry Hill, N J 08034
UNIVERSAL DATA SYSTEMS INC.
14482 Beach Blvd, Westminster, Cal 92626
UNIVERSITY COMPUTING CO.
P O Box 6228, Dallas, Tex 75222
URBAN DATA PROCESSING INC.
552 Massachusetts Ave, Cambridge, Mass 02139
URS DATA SCIENCE CO.
155 Bovet Rd, San Mateo, Cal 94402
VARIAN ASSOCIATES GRAPHICS & DATA SYSTEMS
DIV.
611 Hansen Way, Palo Alto, Cal 94303
VIRTUAL COMPUTER SERVICES INC
1119 Springfield Rd, Union, N J 07083
WANG LABORATORIES INC.
836 N St, Tewksbury, Mass 01876
WARREN ASSOCIATES
15 Royal Crest Dr, Marlboro, Mass 01752
WELLINGTON COMPUTER SYSTEMS CORP.
405 Lexington Ave, New York, N Y 10017
WESTERN OPERATIONS INC.
120 Montgomery St, San Francisco, Cal 94104
WESTINGHOUSE TELE-COMPUTER SYSTEMS CORP.
2040 Ardmore Blvd, Pittsburgh, Pa 15221
WORLDWIDE COMPUTER SERVICES, INC.
280 N Central Pk Ave, Hartsdale, N Y 10530
XEROX DATA SYSTEMS
701 S Aviation, El Segundo, Cal 90245

PROGRAMMING LANGUAGE DEVELOPMENT (PROPRIETARY SOFTWARE PRODUCTS)

ACADEMY COMPUTING CORP.
5005 N Lincoln Blvd, Oklahoma City, Okla 73105
ADAPT INC.
624 S 62nd St, Philadelphia, Pa 19143
ADVANCED COMPUTER SYSTEMS INC
3131 S Dixie Dr, Dayton, Ohio 45305
ADVANCED COMPUTER TECHNIQUES CORP.
437 Madison Ave, New York, N Y 10022
ADVANCED MANAGEMENT SYSTEMS INC.
3310 Richmond Ave, Houston, Tex 77006
AERO TECHNICAL APPLICATIONS INC.
8011 Clayton Rd, St Louis, Mo 63117
ALLEN-BABCOCK COMPUTING INC.
1800 Ave of The Stars, Los Angeles, Cal 90067
AMERICAN COMPUTER LEASING CORP.
14 E 4th St, Cincinnati, Ohio 45202
AMERICAN COMPUTER SERVICES CORP.
14 E 4th St, Cincinnati, Ohio 45202
ANALYTICS INC.
179 Washington Lane, Jenkintown, Pa 19046
ANCOM SYSTEMS, DIV. GENERAL ANALYTICS CORP.
9841 Airport Blvd, Los Angeles, Cal 90045
APPLIED COMPUTER TIME SHARE INC.
29200 Southfield Rd, Southfield, Mich 48075
APPLIED CYBERNETICS CORP.
1285 Forgewood Ave, Sunnyvale, Cal 94086
APPLIED GEODATA SYSTEMS INC.
675 Massachusetts Ave, Cambridge, Mass 02139
APPLIED PROGRAMMING TECHNOLOGY CORP.
275 D Cox St, Hudson, Mass 01749
APPLIED SYSTEMS CORP.
18325 W McNichols Ave, Detroit, Mich 48219
ATLANTIC SOFTWARE INC.
5th & Chestnut St, Philadelphia, Pa 19106
AUERBACH ASSOCIATES INC.
121 W Broad St, Philadelphia, Pa 19107
AUSTIN SYSTEMS CO., INC.
87 Terrace Hall Ave, Burlington, Mass 01803
AUTOMATED INFORMATION AND MANAGEMENT
SYSTEMS
705 Transptation Bldg, Cincinnati, Ohio 45202
AUTOMATION SERVICES CORP.
182 Forbes Rd, Braintree, Mass 02184
AVCO CORP. ELECTRONICS DIV.
4807 Bradford, Huntsville, Ala 35805
AZREX INC.
105 Terrace Hall Ave, Burlington, Mass 01803
BASIC COMPUTING ARTS INC.
2680 E Bayshore Frtge, Mt View, Cal 94040
BERKELEY COMPUTER CORP.
2398 4th St, Berkeley, Cal 94710
BONNER&MOORE ASSOCIATES INC.
500 Jefferson Bldg, Houston, Tex 77002
BOOTHE DATA SYSTEMS INC.
485 Lexington Ave, New York, N Y 10001
BOOTHE RESOURCES INTERNATIONAL INC.
3435 Wilshire Blvd, Los Angeles, Cal 90005
BOSTON COMPUTER SYSTEMS CORP.
15 School St, Boston, Mass 02108
BURLINGTON MANAGEMENT SERVICES CO.
P O Box 21207, Greensboro, N C 27420
BURROUGHS CORP. BUSINESS MACHINES GROUP
6071 2nd Ave, Detroit, Mich 48232
C&C COMPUTER SYSTEMS INC.
1006 S E Grand, Portland, Ore 97214
CALIFORNIA COMPUTER PRODUCTS INC.
2411 W La Palma Ave, Anaheim, Cal 92801
CAMBRIDGE COMPUTER ASSOCIATES INC.
220 Alewife Brook Pky, Cambridge, Mass 02138
CGA COMPUTER ASSOCIATES INC.
715 Park Ave, East Orange, N J 07017
CODE INC.
8939 Sepulveda Blvd, Los Angeles, Cal 90045
CODON CORP.
400 Totten Pond Rd, Waltham, Mass 02154
COMPAC COMPUTER SYSTEMS INC.
911 Hennepin, Minneapolis, Minn 55403
COMPU-MEDIC CONTROLS CORP.
432 Park Ave S, New York, N Y 10016
COMPU-TIME INC.
327 Orange Ave, Daytona, Fla 32014
COMPUTATION AND SYSTEMS CORP.
12061 Wilshire Blvd, Los Angeles, Cal 90025
COMPUTER COMMAND AND CONTROLS COMPANY
4025 Chestnut St, Philadelphia, Pa 19104
COMPUTER COMMUNICATION INC.
701 W Manchester Blvd, Inglewood, Cal 90301
COMPUTER CORP. OF AMERICA
6216 Evergreen St, Houston, Tex 77036

COMPUTER DESIGN CORP.
12401 W Olympic Blvd, Los Angeles, Cal 90064
COMPUTER DYNAMICS INC.
1760 Solano Ave, Berkeley, Cal 94707
COMPUTER GUILD INC.
12 Mercer Rd, Natick, Mass 01760
COMPUTERIA INC.
14 Wood Rd, Braintree, Mass 02143
COMPUTER LEARNING & SYSTEMS CORP.
5530 Wisconsin Ave, Chevy Chase, Md 20015
COMPUTER MANAGEMENT INC.
3101 Eullid Ave, Cleveland, Ohio 44115
COMPUTER METHODS CORP.
470 Mamaroneck Ave, White Plains, N Y 10605
COMPUTER PROCESSING INC.
300 6th Ave, Pittsburgh, Pa 15222
COMPUTER PROGRAMMING CONCEPTS INC.
101 Atkinson Sq, Cincinnati, Ohio 45246
COMPUTER SCIENCES CORP. INFO. NETWORK DIV.
1901 Building, Los Angeles, Cal 90067
COMPUTER SYSTEM TECHNOLOGY INC.
700-42 Fox Pavilion, Jenkintown, Pa 19046
COMPUTER SYSTEMS CO. INC.
1470 St Charles Ave, Cleveland, Ohio 44107
COMPUTER TECHNOLOGY INC. SUB. UNIV.
COMPUTING CO.
P O Box 47911, Dallas, Tex 75247
COMPUTER USAGE CO.
3181 Porter Dr, Palo Alto, Cal 94304
COMPUTER USAGE CORP.
100 Putnam Green, Greenwich, Conn 06830
COMPUTER USAGE CORP.,
8939 S Sepulveda Blvd, Los Angeles, Cal 90045
COMPUTING & SOFTWARE INC., EAST COAST DIV.
3700 Mt Vernon Ave, Alexandria, Va 22305
COMPUTING EFFICIENCY INC. COMPUTING EFF. DIV.
35 Orville Dr, Bohemia, N Y 11716
COMPUVISOR INC.
P O Box 381, Ithaca, N Y 14850
COMTEK ASSOCIATES
2077 Center Ave, Fort Lee, N J 07024
CONDATA INC.
1809 Walnut St, Philadelphia, Pa 19103
CONSAD RESEARCH CORP.
5600 Forward Ave, Pittsburgh, Pa 15217
CONSOLIDATED ANALYSIS CENTERS, INC.,
225 Santa Monica Blvd, Santa Monica, Cal 90401
CONSULTANTS ASSOCIATED INC.
Lakeside Office Park, Wakefield, Mass 01880
CONSUMER SYSTEMS CORP.
15 Spinning Wheel Rd, Hinsdale, Ill 60521
CONTROL TECHNOLOGY INC.
3450 E Spring St, Long Beach, Cal 90806
CORPORATE DATA PROCESSING
1724 Silver Lake Blvd, Los Angeles, Cal 90026
CTC COMPUTER CORP.
1000 Elwell Court, Palo Alto, Cal 94303
CULLINANE CORP.
60 State St, Boston, Mass 02109
CYBERMATICS INC.
2460 Lemoine Ave, Fort Lee, N J 07024
D.P.&W. INC.
1107 Commonwealth Ave, Boston, Mass 02215
DAILEY INC., R.N.
300 Madison Ave, New York, N Y 10017
DATA DIMENSIONS INC.
51 Weaver St, Greenwich, Conn 06830
DATA TECHNOLOGY INC.
65 Grove St, Watertown, Mass 02172
DATA USAGE CORP.,
2460 Lemoine Ave, Fort Lee, N J 07024
DATACAP INTERNATIONAL INC.
37 W 2950 S, Salt Lake City, Utah 84101
DATAMATION SERVICES INC.
461 Eighth Ave, New York, N Y 10001
DATASONICS INC.
P O Box 4553, New York, N Y 10017
DECISION SYSTEMS INC.
E 66 Midland Ave, Paramus, N J 07652
DELMARVA COMPUTER INDUSTRIES INC.
5865 Robert Oliver Pl, Columbia, Md 21043
DELTA SYSTEMS CORP.
Edens Exective Ctr, Wilmette, Ill 60091
DEUSSEN ASSOCIATES INC.
576 Hyannis Dr, Sunnyvale, Cal 94087
DIGITAL PRODUCTS
335 W 7th St, San Pedro, Cal 90733
DIGITAL PROGRAMMING SERVICES INC.
60 Hickory Dr, Waltham, Mass 02154
DIKEWOOD CORP., THE
1009 Bradbury Dr SE, Albuquerque, N M 87106
DIRECT ACCESS COMPUTING CORP.
984 Livernois Rd, Troy, Mich 48084
DYNAMIC ACCESS CORP.
220 Park Ave S, New York, N Y 10003

2 Product Directory

EASTERN COMPUTER SERVICES INC
920 Fox Chase Rd, Rockledge, Pa 19111
ELECTRONIC ASSOCIATES INC.
485 Monmouth Pkwy, W Long Branch, N J 07764
ELECTRONIC DATA PREPARATION CORP.
P O Box 1446, Bradenton, Fla 33505
EMR COMPUTER
8001 Bloomington Fwy, Minneapolis, Minn 55420
ENTREKIN COMPUTERS INC. SUB. THE CROSS CO.
9475 Center Rd, Fenton, Mich 48430
EXPRESS SOFTWARE SYSTEMS INC.
342 Madison Ave, New York, N Y 10017
FEDDER DATA CENTERS MANAGEMENT INC.
1654 Central Ave, Albany, N Y 12205
FIRST BUSINESS COMPUTING
1020 Houston Bk&Tr Tr, Houston, Tex 77002
GENASY CORP.
2011 Gye St NW, Washington, D C 20006
GENERAL AUTOMATION INC.
1055 S East St, Anaheim, Cal 92805
GRAY & ASSOCIATES INC., H.J.
2501 Cedar Springs Rd, Dallas, Tex 75201
GRECO ENTERPRISES INC. TSA DATA DIV.
2000 Texas, El Paso, Tex 79901
GROWTH INDUSTRY COMPUTING INC.
1111 Wilshire Blvd, Los Angeles, Cal 90017
GTE DATA SERVICES INC.
5422 Bay Center Dr, Tampa, Fla 33609
HAVERLY SYSTEMS INC.
4 2nd Ave, Denville, N J 07834
HOLLANDER ASSOCIATES
P O Box 2276, Fullerton, Cal 92633
HONEYWELL INFORMATION SYSTEMS INC. INFO.
SERV.DIV
2701 4th Ave S, Minneapolis, Minn 55408
HOUSTON RESEARCH INC. SUB. SCI. ELECT.
6001 Gulf Fwy, Houston, Tex 77023
HUB RATLIFF CONSULTANT
P O Box 22487, Houston, Tex 77027
HYDRA COMPUTER CORP.
P O Box 17883, Raleigh, N C 27609
IAC COMPUTER SYSTEMS INC.
260 Newton Rd, Plainview, N Y 11803
INDECON INC.
30 N Lasalle St, Chicago, Ill 60602
INFODATA SYSTEMS INC.
680 Ridge Rd, Webster, N Y 14580
INFONET SYSTEMS INC.
358 McKinley Blvd, Paramus, N J 07652
INFORMATICS INC.
21050 Vanover St, Canoga Park, Cal 91303
INFORMATION DEVELOPMENT ASSOCIATES INC.
P O Box 2285, Bethlehem, Pa 18018
INFORMATION MANAGEMENT INC.
447 Battery St, San Francisco, Cal 94111
INFORMATION SCIENCES INC.
14 Jefferson Blvd, Warwick, R I 02888
INFORMATION STORAGE SYSTEMS
10435 N Tantau Ave, Cupertino, Cal 95014
INFORMATION SYSTEMS MANAGEMENT
120 Montgomery St, San Francisco, Cal 94104
INPUT INC.
500 Old Elm Rd, Highland Park, Ill 60035
INTECH INC.
2915 Wayzata Blvd, Minneapolis, Minn 55405
INTERACTIVE SCIENCES CORP.
60 Brook Dr, Braintree, Mass 02184
INTERACTIVE SYSTEMS INC.
327 S Fourth Ave, Ann Arbor, Mich 48108
INTERACTIVE TECHNICAL SERVICES INC.
486 Totten Pond Rd, Waltham, Mass 02154
INTERDATA
2 Crescent Pl, Oceanport, N J 07757
INTERNATIONAL COMPUTER CORP.
1 N Broadway, White Plains, N Y 10601
INTERNATIONAL DATA APPLICATIONS INC.
100 Main St, Reading, Mass 08167
INTERNATIONAL SYSTEMS ASSOCIATES, LTD.
350 5th Ave, New York, N Y 10001
INTERNATIONAL TELECOMPUTER NETWORK CORP.
4919 Fairmont Ave, Bethesda, Md 20014
JACKSON ASSOCIATES
4663 Executive Dr, Columbus, Ohio 43220
KEYSTONE COMPUTER ASSOCIATES INC.
1055 Virginia Dr, Ft Washington, Pa 19034
KRANZLEY & CO. INC. ARTHUR S.
1010 S Kings Hwy, Cherry Hill, N J 08034
LAHEY COMPUTER SYSTEMS INC.
4747 N 16th St, Phoenix, Ariz 85016
LEASCO DATA PROCESSING EQUIPMENT CORP.
280 Park Ave, New York, N Y 10017
LEEDS & NORTHRUP CO.
Sumney Town Pike, North Wales, Pa 19454
LEHIGH VALLEY ELECTRONICS INC.
Po Box 125, Fogelsville, Pa 18051

LITTON SYSTEMS INC. DATA SYSTEMS DIV.
8000 Woodley Ave, Van Nuys, Cal 91409
LITTON SYSTEMS INC. MELLONICS DIV.
1001 W Maude Ave, Sunnyvale, Cal 94086
LOCKHEED ELECTRONICS DATA MANAGEMENT
SERVICES
16811 El Camino Real, Houston, Tex 77058
LOGIC INC.
1712 Commerce St, Dallas, Tex 75201
MACNEAL-SCHWENDLER CORP., THE
7442 N Figueroa St, Los Angeles, Cal 90041
MACRO CORP.
1260 Virginia Dr, Ft Washington, Pa 19034
MACRODATA CO.
20440 Corisco St, Chatsworth, Cal 91311
MANAGEMENT & COMPUTER SERVICES INC.
104 Park Towne Pl E, Philadelphia, Pa 19130
MANAGEMENT SCIENCE SYSTEMS INC.
1530 E Jefferson St, Rockville, Md 20852
MARK COMPUTER SYSTEMS INC.
One Patterson Pl, Garden City, N Y 11530
MASTECH COMPUTER SYSTEMS INC.
7026 W North Ave, Chicago, Ill 60635
MCDONNELL AUTOMATION CO.
P O Box 516, St Louis, Mo 63166
MEGASYSTEMS INC.
1 Bala Ave, Bala-Cynwyd, Pa 19004
META-LANGUAGE PRODUCTS INC.
4 E 43 St, New York, N Y 10017
MICRO SYSTEMS INC.
644 E Young St, Santa Ana, Cal 92705
MILNEE BROTHERS PRODUCTS
8000 Blackburn Ave, Los Angeles, Cal 90048
NATIONAL C.S.S.
460 Summer St, Stamford, Conn 06901
NATIONAL COMPUTER ANALYSTS INC.
Us Hwy 1, Princeton, N J 08540
NATIONAL COMPUTING INDUSTRIES INC.
One Jackson Pl, San Francisco, Cal 94111
NEOTERIC INC.
2800 Euclid Ave, Cleveland, Ohio 44115
NETWORK DATA PROCESSING CORP.
823 Commerce Dr, Oak Brook, Ill 60521
NORDEN DIV., UNITED AIRCRAFT CORP.
Helen St, Norwalk, Conn 06850
OLIVETTI CORP. OF AMERICA
500 Park Ave, New York, N Y 10016
ON-LINE SYSTEMS INC.
4721 Mc Knight Rd, Pittsburg, Pa 15237
OPTICAL MEMORY SYSTEMS
1520 So Lyon St, Santa Ana, Cal 92705
PANSOPHIC SYSTEMS INC.
230 Roosevelt Rd, Lombard, Ill 60148
PAPERWORK DATA COMM. SERVICES INC.
1703 S Ave, Syracuse, N Y 13207
PENNDATA CORP.
1729 Cedar Ave, Scranton, Pa 18505
PHI COMPUTER SERVICES INC.
800 Massachusetts Ave, Arlington, Mass 02174
PHILCO-FORD CORP., COMPUTER SERVICES NETWORK
Tioga & C Sts, Philadelphia, Pa 19134
PIONEER DATA SYSTEMS INC.
606 Merle Hay Tower, Des Moines, Iowa 50310
PRINCETON TIME SHARING SERVICES, INC.
Us Hwy 1, Princeton, N J 08540
PROGRAMMATICS INC.
11661 San Vicente Blv, Los Angeles, Cal 90049
PROGRAMMING SCIENCES CORP.
S E 42 St, New York, N Y 10016
QUICKDATA INTERNATIONAL INC.
8444 Wilshire Blvd, Beverly Hills, Cal 90211
RAPIDATA INC.
20 New Dutch Lane, Fairfield, N J 07006
RCA GRAPHIC SYSTEMS DIV.
Rte 130, Dayton, N J 08810
REMOTE COMPUTING CORP.
A40 Palo Alto Off Ctr, Palo Alto, Cal 94301
REPUBLIC SYSTEMS INC.
100 Plaza Centre, Secaucus, N J 07094
REPUBLIC SYSTEMS INC.
715 Park Ave, E Orange, N J 07017
REPUBLIC SYSTEMS OF CONNECTICUT INC.
350 S Main St, Cheshire, Conn 06410
RESALAB INC. RESALAB SCIENTIFIC DIV.
4000 Campbell Ave, Menlo Park, Cal 94025
RIDGEWOOD ASSOCIATES INC.
10 Wilsey Sq, Ridgewood, N J 07450
SARNA ASSOCIATES INC.
22 Russell St, Brookline, Mass 02146
SCANFORMS INC.
312 Fox Pavilion, Jenkintown, Pa 19095
SCI ELECTRONICS INC.
7705 La Porte Fwy, Houston, Tex 77012
SCIENTIFIC CALCULATIONS INC.
110 Allens Creek Rd, Rochester, N Y 14618

SCIENTIFIC COMPUTER APPLICATIONS INC.
2310 4th Natl Bank Bg, Tulsa, Okla 74119
SCIENTIFIC COMPUTERS, INC.,
919 Second Ave S, Minneapolis, Minn 55402
SCIENTIFIC SOFTWARE CORP.
5300 S Ulster, Englewood, Colo 81110
SCIENTIFIC SYSTEMS SERVICES INC.
476 N Hwy A1a, Satellite Beach, Fla 32935
SCIENTIFIC TIME SHARING CORP.
2101 S St NW, Washington, D C 20008
SCI-TEK COMPUTER CENTER INC.
1707 Gilpin Ave, Wilmington, Del 19806
SIERRA RESEARCH CORP. COMPUTER PROD. GRP.
167 Bedford St., Burlington, Mass 01803
SOFTTECH INC.
391 Totten Pond Rd, Waltham, Mass 02154
SOFTWARE GUIDANCE ASSOCIATES INC.
432 Park Ave S, New York, N Y 10016
SOFTWARE PROGRAMMING ASSOCIATES INC.
1209 Tropic St, Titusville, Fla 32780
SYNERGISTIC SOFTWARE SYSTEMS, INC.
Po Box 36097, Houston, Tex 77036
SYSTEM DEVELOPMENT CORP.
2500 Colorado Ave, Santa Monica, Cal 90406
SYSTEM IMPLEMENTATION CORP.
18 E 48th St, New York, N Y 10017
SYSTEMS & PROGRAMMING SERVICES
1001 Daniel Bldg, Greenville, S C 29602
SYSTEMS ANALYSIS INC.
11110 N E 8th, Bellevue, Wash 98004
SYSTEMS ASSOCIATES INC.
356 Penn St, Reading, Pa 19602
SYSTEMS PROGRAMMING INC.
175 Main St, White Plains, N Y 10601
SYSTEMS RESEARCH LABS, INC.
7001 Indian Ripple Rd, Dayton, Ohio 45440
SYSTEMS, SCIENCE & SOFTWARE INC.
Po Box 1620, La Jolla, Cal 92037
TECHNOLOGY FOR INFORMATION MANAGEMENT INC
1654 Central Ave, Albany, N Y 12205
TELEDYNE BROWN ENGINEERING
300 Sparkman Dr, Huntsville, Ala 35807
THEORY ANALYSIS GROUP
22 E Elm St, Chicago, Ill 60611
TIME SHARE CORP.
3 Lebanon St, Hanover, N H 03755
TIME SHARING SCIENCES INC.
1180 Ave Americas, New York, N Y 10036
TRACOR COMPUTING CORP.
1705 Guadalupe St, Austin, Tex 78701
TRILOG ASSOCIATES INC.
1700 Market St, Philadelphia, Pa 19103
TURNKEY SYSTEMS INC.
111 E Ave, Norwalk, Conn 06851
U.S. TIME-SHARING INC.
1831 Michael Faraday, Reston, Va 22070
UNITED COMPUTING CORP.
22500 S Avalon Blvd, Carson, Cal 90744
UNITED COMPUTING SYSTEMS INC.
3130 Broadway, Kansas City, Mo 64111
UNITED SYSTEMS INC.
1020 Kings Hwy N, Cherry Hill, N J 08034
UNIVERSAL DATA SYSTEMS INC.
14482 Beach Blvd, Westminster, Cal 92626
UNIVERSITY COMPUTING CO.
P O Box 6228, Dallas, Tex 75222
URBAN DATA PROCESSING INC.
552 Massachusetts Ave, Cambridge, Mass 02139
URS DATA SCIENCE CO.
155 Bovet Rd, San Mateo, Cal 94402
UTILITY CONSULTING SERVICES CO.
888 N Sepulveda Blvd, El Segundo, Cal 90245
VARIAN ASSOCIATES GRAPHICS & DATA SYSTEMS
DIV.
611 Hansen Way, Palo Alto, Cal 94303
VIRTUAL COMPUTER SERVICES INC.
1119 Springfield Rd, Union, N J 07083
WANG LABORATORIES INC.
836 N St, Tewksbury, Mass 01876
WARREN ASSOCIATES
15 Royal Crest Dr, Marlboro, Mass 01752
WELLINGTON COMPUTER SYSTEMS CORP.
405 Lexington Ave, New York, N Y 10017
WESTERN OPERATIONS INC.
120 Montgomery St, San Francisco, Cal 94104
WESTINGHOUSE TELE-COMPUTER SYSTEMS CORP.
2040 Ardmore Blvd, Pittsburgh, Pa 15221
WORLDWIDE COMPUTER SERVICES, INC.
280 N Central Pk Ave, Hartsdale, N Y 10530

2 Product Directory

PROJECTORS, OPTICAL (COMPUTER CONTROLLED SLIDE SELECTING)

APPLIED COMPUTER SYSTEMS INC.
P O Box 6479, Austin, Tex 78702
COMPUTER SYSTEMS FOR MEDICINE INC.
340 Longwood Ave, Boston, Mass 02115
IMAGE SYSTEMS INC.
11244 Playa Ct, Culver City, Cal 90230
MASSEY DICKINSON CO. INC.
9 Elm St, Saxonville, Mass 01701
MAST DEVELOPMENT CO. SUB. AV ELECTRONICS INC.
2212 E 12th St, Davenport, Iowa 52803
PHOTON INC.
355 Middlesex Ave, Wilmington, Mass 01887
SPINDLER AND SAUPPE INC.
1329 Grand Central Av, Glendale, Cal 91201

PROJECTORS, OPTICAL (COMPUTER CONTROLLED SCRIBING)

KONGSBERG SYSTEMS INC.
10 De Angelo Dr, Bedford, Mass 01730
TELECTRO SYSTEMS CORP.
96-18 43rd Ave, Corona, N Y 11368

PROTECTORS, CIRCUIT AND EQUIPMENT OVERLOAD

AIRPAX ELECTRONICS INC.
P O Box 8488, Ft Lauderdale, Fla 33310
AVTEL CORP.
1130 E Cypress St, Covina, Cal 91722
CLARE SYSTEMS DIV. C.P. CLARE & CO.
3101 W Pratt Ave, Chicago, Ill 60645
ERA TRANSPAC CORP.
67 Sand Park Rd, Cedar Grove, N J 07009
GENERAL SEMICONDUCTOR INDUSTRIES INC.
230 West 5th St, Tempe, Ariz 85281
GLENTRONICS INC.
748 E Alosta Ave, Glendora, Cal 91740
HALMAR ELECTRONICS INC.
1544 W Mound St, Columbus, Ohio 43223
HEINEMANN ELECTRIC CO.
Brunswick Pike Rte 1, Trenton, N J 08638
HELIPOT DIV. BECKMAN INSTRUMENTS INC.
2500 Harbor Blvd, Fullerton, Cal 92634
JOSLYN ELECTRONIC SYSTEMS DIV.
6868 Cortona Dr, Goleta, Cal 93017
KEPCO INC.
131 38 Sanford Ave, Flushing, N Y 11352
LITTLEFUZE INC.
800 E NW Highway, Des Plaines, Ill 60016
MCG ELECTRONICS INC.
279 Skidmore Rd, Deer Park, N Y 11729
MODULAR DEVICES INC.
1265 W 135 St, Gardena, Cal 90247
RAYTHEON COMPANY, SORENSON OPERATION
676 Island Pond, Manchester, N H 03103
SYSTEMS RESEARCH LABS, INC.
7001 Indian Ripple Rd, Dayton, Ohio 45440
TECHNIPOWER INC. SUB. BENRUS CORP.
Benrus Center, Ridgefield, Conn 06877
TEXAS INSTRUMENTS INC. CONTROLS DIV.
34 Forest St, Attleboro, Mass 02703

PUNCHED CARD COLLATORS (SEE COLLATORS)

PUNCHED CARD HOLDERS (SEE HOLDERS)

PUNCHED CARD-TO-TAPE CONVERTERS (SEE CONVERTERS)

PUNCHED CARD READERS (SEE READERS)

PUNCHED TAPE READERS (SEE READERS)

PUNCHES, CARD (EDGE-PUNCHING)

COMPUTER ACCESSORIES CO.
131 W 154th St, Gardena, Cal 90248
CUSTOM DATA PROCESSING SERVICES
P O Box 14685, Phoenix, Ariz 85031
FRIDEN DIV. THE SINGER CO.
97 Humboldt St, Rochester, N Y 14602
LITTON ABS AUTOMATED BUSINESS SYSTEMS OEM PRODUCT
600 Washington Ave, Carlstadt, N J 07072
ROBIN INDUSTRIES CORP. DATA PRODUCTS DIV.
15-58 127 St, Flushing, N Y 11356
SINGER CO., THE, FRIDEN DIV.
2350 Washington St, San Leandro, Cal 94577

PUNCHES, CARD (OVER 100 CPM)

BRIDGE DATA PRODUCTS INC.
738 S 42nd St, Philadelphia, Pa 19104
BURROUGHS CORP., BUSINESS MACHINES GROUP
6071 2nd Ave, Detroit, Mich 48232
BURROUGHS CORP., OEM PRODUCT SALES
1649 Wilshire Blvd, Los Angeles, Cal 90017
CUSTOM DATA PROCESSING SERVICES
P O Box 14685, Phoenix, Ariz 85031
DATA GENERAL CORP.
Rte 9, Southboro, Mass 01772
DATA PROCESSING AND ACCOUNTING SERVICES
50 Van Ness Ave, San Francisco, Cal 94102
DATA PRODUCTS CORP.
16055 Ventura Blvd, Encino, Cal 91316
DECISION DATA CORP.
300 Jacksonville Rd, Warminster, Penn 18974
HONEYWELL INFORMATION SYSTEMS
P O Box 12313, Oklahoma City, Okla 73112
HONEYWELL INFORMATION SYSTEMS
60 Walnut St, Wellesley Hills, Mass 02181
HONEYWELL INFORMATION SYS. INC PERIPH. DEVICES DIV.
200 Smith St, Waltham, Mass 02154
MAI EQUIPMENT CORP.
300 E 44th St, New York, N Y 10017
MOHAWK DATA SCIENCES CORP.
Palisade St, Herkimer, N Y 13350
OKI ELECTRIC INDUSTRIES CO. LTD.
875 Ave of Americas, New York, N Y 10001
RCA COMPUTER SYSTEMS DIV.
200 Forest Ave, Marlboro, Mass 01752
TAB PRODUCTS
2690 Hanover St, Palo Alto, Cal 94304
UNICOMP INC.
18219 Parthenia, Northridge, Cal 91324
UNIVERSITY COMPUTING CO.
P O Box 6228, Dallas, Tex 75222
WEISMANTEL INC.
P O Box 1957, St Paul, Minn 55111
XEROX DATA SYSTEMS
701 S Aviation, El Segundo, Cal 90245

PUNCHES, CARD (PORTABLE)

BARRY-WRIGHT CORP. WRIGHT LINE DIV.
160 Gold Star Blvd, Worcester, Mass 01606
BUSINESS SUPPLIES CORP. OF AMERICA
475 5th Ave, New York, N Y 10017
DATA DEVICES INC. SUB. DATA PROD. CORP
18360 Topham St, Tarzana, Cal 91356
DATA GENERAL CORP.
Rte 9, Southboro, Mass 01772
DATAACON INTERNATIONAL INC.
2745 Bernice Rd, Lansing, Ill 60438
LITTON REVENUE CONTROL SYSTEMS
4000 Hadley Rd, So Plainfield, N J 07080
ROBIN INDUSTRIES CORP. DATA PRODUCTS DIV.
15-58 127 St, Flushing, N Y 11356
SOURCE INFORMATION SYSTEMS INC.
P O Box 3088, Santa Monica, Cal 90403
STANDARD REGISTER CO., THE
626 Albany St, Dayton, Ohio 45401
VARIFAB INC. SUB. CONDEC CORP.
1700 E Putnam Ave, Old Greenwich, Conn 06880
XEROX DATA SYSTEMS
701 S Aviation, El Segundo, Cal 90245

PUNCHES, CARD (UP TO 100 CPM)

ABINGTON KEYPUNCH INC.
920 Fox Chase Rd, Rockledge, Pa 19111
BRIDGE DATA PRODUCTS INC.
738 S 42nd St, Philadelphia, Pa 19104
BRYANT DATA SERVICE INC.
319 Lynnway, Lynn, Mass 01901
DATA GENERAL CORP.
Rte 9, Southboro, Mass 01772
DATA PROCESSING AND ACCOUNTING SERVICES
50 Van Ness Ave, San Francisco, Cal 94102
DATA PRODUCTS CORP. CARD EQUIPMENT DIV.
8455 E Prentice Ave, Englewood, Colo 80110
DATRON SYSTEMS INC.
100 Rte 46, Mt Lakes, N J 07046
DATRON SYSTEMS INC.
100 Rte 46, Mt Lakes, N J 07046
DECISION DATA CORP.
300 Jacksonville Rd, Warminster, Penn 18974
HONEYWELL INFORMATION SYSTEMS
P O Box 12313, Oklahoma City, Okla 73112
HONEYWELL INFORMATION SYSTEMS
60 Walnut St, Wellesley Hills, Mass 02181
HONEYWELL INFORMATION SYS. INC PERIPH. DEVICES DIV.
200 Smith St, Waltham, Mass 02154
IOA DATA CORP.
383 Lafayette St, New York, N Y 10003
MAI EQUIPMENT CORP.
300 E 44th St, New York, N Y 10017
MOHAWK DATA SCIENCES CORP.
Palisade St, Herkimer, N Y 13350
OKI ELECTRIC INDUSTRIES CO. LTD.
875 Ave of Americas, New York, N Y 10001
REN ELECTRONICS
775 New Ludlow Rd, So Hadley, Mass 01075
SINGER CO., THE, FRIDEN DIV.
2350 Washington St, San Leandro, Cal 94577
TAB PRODUCTS
2690 Hanover St, Palo Alto, Cal 94304
UNITED BUSINESS COMMUNICATIONS INC.
6405 Metcalf Ave, Shawnee Mission, Kans 66202
UNIVERSITY COMPUTING CO.
P O Box 6228, Dallas, Tex 75222

PUNCHES, PAPER TAPE

ADDO-X INC. ADP DIV.
437 Madison Ave, New York, N Y 10022
ADDO-X INC. OEM DIV.
437 Madison Ave, New York, N Y 10022
ANDERSON JACOBSON INC.
1065 Morse Ave., Sunnyvale, Cal 94086
BUNKER-RAMO CORP.
Trumbull Ind Pk, Trumbull, Conn 06611
BURROUGHS CORP., BUSINESS MACHINES GROUP
6071 2nd Ave, Detroit, Mich 48232
BURROUGHS CORP., OEM PRODUCT SALES
1649 Wilshire Blvd, Los Angeles, Cal 90017
CHALCO ENGINEERING CORP.
15126 S Broadway, Gardena, Cal 90248
COMPACE CORP.
7413 Washington Ave S, Edina-Minnepols, Minn 55435
DATA ACCESS SYSTEMS INC.
503 Rte 10 Mt 19, Dover, N J 07801
DATA DEVICES INC. SUB. DATA PROD. CORP
18360 Topham St, Tarzana, Cal 91356
DATA GENERAL CORP.
Rte 9, Southboro, Mass 01772
DATA GRAPHICS CORP.
8402 Speedway, San Antonio, Tex 78230
DATAACON INTERNATIONAL INC.
2745 Bernice Rd, Lansing, Ill 60438
DATATERM INC.
1671 Manning Blvd, Levittown, Pa 19057
DIGITAL EQUIPMENT CORP.
146 Main St, Maynard, Mass 01754
DIGITAL SCIENTIFIC CORP.
11455 Sorrento Vly Rd, San Diego, Cal 92121
DIGITRONICS CORP.
1 Albertson Ave, Albertson, N Y 11507
DONAULD INC.
P O Box 104, Ridgewood, N J 07451
ENDLESS TAPE REEL CO.
81 Haven St, Reading, Mass 01867
FACIT-ODHNER INC.
501 Winsor Dr, Secaucus, N J 07094
FRIDEN DIV. THE SINGER CO.
97 Humboldt St, Rochester, N Y 14602
FUJITSU LTD. N.Y. LIAISON OFFICE
680 Fifth Ave, New York, N Y 10019

2 Product Directory

HONEYWELL INFORMATION SYSTEMS
60 Walnut St, Wellesley Hills, Mass 02181
ICA CORP.
200 N 3rd St, Minneapolis, Minn 55401
INDUSTRIAL TIMER DIV., THE SINGER CO.
Us Hwy 287, Parsippany, N J 07054
INSO ELECTRONIC PRODUCTS INC.
77 E Hawthorne Ave, Valley Stream, N Y 11580
INTERNATIONAL COMPUTER APPLIANCES CORP.
200 N Third St, Minneapolis, Minn 55401
ITEL INFORMATION PRODUCTS DIV
2585 Bayshore, Palo Alto, Cal 94303
KLEINSCHMIDT DIV., SCM CORP.
Lake-Cook Rd, Deerfield, Ill 60015
LITTON ABS AUTOMATED BUSINESS SYSTEMS OEM
PRODUCT
600 Washington Ave, Carlstadt, N J 07072
MICRO SYSTEMS INC.
644 E Young St, Santa Ana, Cal 92705
MICRODATA CORP.
644 E Young St, Santa Ana, Cal 92705
MOHAWK DATA SCIENCES CORP.
Palisade St, Herkimer, N Y 13350
MULTIDATA INC.
7300 Bolsa Ave, Westminster, Cal 92683
NCR INDUSTRIAL PRODUCTS DIV.
Main And K St, Dayton, Ohio 45409
NUMERIDEX TAPE SYSTEMS INC.
4711 W North Ave, Chicago, Ill 60639
OCHMAN SYSTEMS, EDWARD
Po Box 141, Fairfield, Conn 06430
OHRTRONICS INC., SUB MOHAWK DATA SCIENCES
CORP.
P O Box 406, King of Prussia, Pa 19406
OKI ELECTRIC INDUSTRIES CO. LTD.
875 Ave of Americas, New York, N Y 10001
OLIVETTI CORP. OF AMERICA
500 Park Ave, New York, N Y 10016
REMAX ELECTRONICS
5250 W El Segundo Blv, Hawthorne, Cal 90250
ROBIN INDUSTRIES CORP. DATA PRODUCTS DIV.
15-58 127 St, Flushing, N Y 11356
ROLM, CORP.
10300 N Tantau, Cupertino, Cal 95014
SHIRAK TELEMETERING OF AMERICA
8926 Kester Ave, Van Nuys, Cal 91402
SINGER CO., THE, FRIDEN DIV.
2350 Washington St, San Leandro, Cal 94577
SMITH INC., JAY
292 E State St, Westport, Conn 06880
TALLY CORP.
8301 S 180th St, Kent, Wash 98031
TELETYPE CORP.
5555 W Touhy Ave, Skokie, Ill 60076
TEXAS INSTRUMENTS INC. DIGITAL SYSTEMS DIV
P O Box 66027, Houston, Tex 77006
UNICOMP INC.
18219 Parthenia, Northridge, Cal 91324
VISTATYPE CORP.
1226 E Pomona St, Santa Ana, Cal 92707

RACKS, PAPER TAPE

AMCO ENGINEERING CO.
7333 W Ainslie, Chicago, Ill 60656
DATATERM INC.
1671 Manning Blvd, Levittown, Pa 19057
DELMARVA COMPUTER INDUSTRIES INC.
5865 Robert Oliver Pl, Columbia, Md 21043
INTERNATIONAL COMPUTER APPLIANCES CORP.
200 N Third St, Minneapolis, Minn 55401
NCR INDUSTRIAL PRODUCTS DIV.
Main And K St, Dayton, Ohio 45409
OCHMAN SYSTEMS, EDWARD
Po Box 141, Fairfield, Conn 06430

READER/PRINTER, MICROFILM/MICROFICHE

ADDRESSOGRAPH MULTIGRAPH CORP
1800 W Central Rd, Mount Prospect, Ill 60056
APPLIED MICROFILM CORP.
107 Binney St, Watertown, Mass 02142
BRUNING CO., CHARLES
1800 W Central Rd, Mt Prospect, Ill 60005
CALIFORNIA COMPUTER PRODUCTS INC.
2411 W La Palma Ave, Anaheim, Cal 92801
COMPUTER MICRO-IMAGE SYSTEMS INC.
9600 Desoto Ave, Chatsworth, Cal 91311
CURRAN COMPUTER CORP.
946 Main St, Hackensack, N J 07601
CYTEK INFORMATION SYSTEMS CORP.
366 5th Ave, New York, N Y 10001

DASA CORP./CYBER-TRONICS SUB. DASA CORP.
15 Stevens St., Andover, Mass 01810
DATA COPY INC.
760 Bryant St, San Francisco, Cal 94107
EASTMAN KODAK CO.
343 State St, Rochester, N Y 14650
ELLIOTT CO., B.K.
P O Box 3240, Pittsburg, Pa 15230
GORDON ENTERPRISES INC., ALAN
5362 Cahuenga Blvd, N Hollywood, Cal 91601
IMAGE SYSTEMS INC.
11244 Playa Ct, Culver City, Cal 90230
ITEK BUSINESS PRODUCTS
1001 Jefferson Rd, Rochester, N Y 14603
ITEK CORP.
10 Maguire Rd, Lexington, Mass 02173
3M CO.
3m Center, St Paul, Minn 55101
MEMOREX EQUIPMENT GROUP
San Tomas At Central, Santa Clara, Cal 95052
MICROFORM DATA SYSTEMS INC.
830 Maude Ave, Mountain View, Cal 94040
MOSLER SAFE CO., THE INFO. SYS. DIV.
1561 Grand Blvd., Hamilton, Ohio 45012
NCR INDUSTRIAL PRODUCTS DIV.
Main And K St, Dayton, Ohio 45409
REPRODUCTION SYSTEMS DIV. TRANSAMERICA
COMP.
1 California St, San Francisco, Cal 94111
SANDERS ASSOCIATES INC. SYSTEMS DIV.
Daniel Webster Hwy S, Nashua, N H 03060
STROMBERG DATAGRAPHIX INC.
P O Box 2449, San Diego, Cal 92112
WASHINGTON SCIENTIFIC INDUS. INC. MICROFILM
PROD
Hwy 12, Longlake, Minn 55356

READER/PUNCHES, PUNCHED CARD

BRIDGE DATA PRODUCTS INC.
738 S 42nd St, Philadelphia, Pa 19104
DATA GENERAL CORP.
Rte 9, Southboro, Mass 01772
DATA PROCESSING AND ACCOUNTING SERVICES
50 Van Ness Ave, San Francisco, Cal 94102
DECISION DATA CORP.
300 Jacksonville Rd, Warminster, Penn 18974
DIGITAL SCIENTIFIC CORP.
11455 Sorrento Vly Rd, San Diego, Cal 92121
HONEYWELL INFORMATION SYSTEMS
60 Walnut St, Wellesley Hills, Mass 02181
INTERNATIONAL CONTROLS CORP.
200 Fairfield Rd, Fairfield, N J 07006
MOHAWK DATA SCIENCES CORP.
Palisade St, Herkimer, N Y 13350
OKI ELECTRIC INDUSTRIES CO. LTD.
875 Ave of Americas, New York, N Y 10001
POTTER INSTRUMENT CO. INC.
532 Broadhollow Rd, Melville, N Y 11746
RCA COMPUTER SYSTEMS DIV.
200 Forest Ave, Marlboro, Mass 01752
SONICRAFT INC.
8437 S Burley Ave, Chicago, Ill 60619

READERS, EDGE-PUNCHED CARD

BURROUGHS CORP., BUSINESS MACHINES GROUP
6071 2nd Ave, Detroit, Mich 48232
DATATERM INC.
1671 Manning Blvd, Levittown, Pa 19057
FRIDEN DIV. THE SINGER CO.
97 Humboldt St, Rochester, N Y 14602
GENERAL INSTRUMENT CORP. MAGNE-HEAD DIV.
13040 Cerise Ave, Hawthorne, Cal 90250
IOA DATA CORP.
383 Lafayette St, New York, N Y 10003
LITTON ABS AUTOMATED BUSINESS SYSTEMS OEM
PRODUCT
600 Washington Ave, Carlstadt, N J 07072
OHRTRONICS INC., SUB MOHAWK DATA SCIENCES
CORP.
P O Box 406, King of Prussia, Pa 19406
OKI ELECTRIC INDUSTRIES CO. LTD.
875 Ave of Americas, New York, N Y 10001
PANASONIC INDUSTRIAL DIV.
200 Park Ave, New York, N Y 10017
WESTERN TELEMATIC INC.
5507 Peck Rd, Arcadia, Cal 91006

READERS, MAGNETIC CARD

AMERICAN COMPUTER & COMMUNICATIONS CO.
2576 W Carson St, Torrance, Cal 90509
AMP INC.
Eisenhower Blvd, Harrisburg, Pa 17105
AMP INC., SYSCOM DIV.
P O Box 3608, Harrisburg, Pa 17105
DIGITAL INFORMATION DEVICES INC.
210 Welsh Pool Rd, Lionville, Pa 19353
HICKOK ELECTRICAL INSTRUMENT CO.
10514 Dupont Ave, Cleveland, Ohio 44108
HONEYWELL INFORMATION SYSTEMS
P O Box 12313, Oklahoma City, Okla 73112
INTERNATIONAL CONTROLS CORP.
200 Fairfield Rd, Fairfield, N J 07006
LUNDY ELECTRONICS & SYSTEMS INC.
Robert Lane, Glen Head, N Y 11545
NCR INDUSTRIAL PRODUCTS DIV.
Main And K St, Dayton, Ohio 45409
NORTH AMERICAN ROCKWELL CORP. AUTONETICS
DIV.
3370 Miraloma Ave, Anaheim, Cal 92803
NYTRONICS INC.
3rd Ave, Alpha, N J 08865
POTTER INSTRUMENT CO. INC.
532 Broadhollow Rd, Melville, N Y 11746
WESTERN TELEMATIC INC.
5507 Peck Rd, Arcadia, Cal 91006

READERS, MAGNETIC INK CHARACTER

BURROUGHS CORP., BUSINESS MACHINES GROUP
6071 2nd Ave, Detroit, Mich 48232
BURROUGHS CORP., OEM PRODUCT SALES
1649 Wilshire Blvd, Los Angeles, Cal 90017
FARRINGTON MANUFACTURING CO.
6707 Electronics Dr, Springfield, Va 22151
HONEYWELL INFORMATION SYSTEMS
60 Walnut St, Wellesley Hills, Mass 02181
IBM CORP., DATA PROCESSING DIV.
1133 Westchester Ave, White Plains, N Y 10604
INFOTON INC.
2nd Ave, Burlington, Mass 01803
LUNDY ELECTRONICS & SYSTEMS INC.
Robert Lane, Glen Head, N Y 11545
NCR INDUSTRIAL PRODUCTS DIV.
Main And K St, Dayton, Ohio 45409
POTTER INSTRUMENT CO. INC.
532 Broadhollow Rd, Melville, N Y 11746
SCAN-OPTICS INC.
22 Prestige Park, E Hartford, Conn 06108

READERS, MICROFILM/MICROFICHE

ADDRESSOGRAPH MULTIGRAPH CORP
1800 W Central Rd, Mount Prospect, Ill 60056
APPLIED MICROFILM CORP.
107 Binney St, Watertown, Mass 02142
BRUNING CO., CHARLES
1800 W Central Rd, Mt Prospect, Ill 60005
CANON U.S.A. INC.
64-10 Queens Blvd, Woodside, N Y 11377
COMPUTER MICRO-IMAGE SYSTEMS INC.
9600 Desoto Ave, Chatsworth, Cal 91311
CYTEK INFORMATION SYSTEMS CORP.
366 5th Ave, New York, N Y 10001
DASA CORP./CYBER-TRONICS SUB. DASA CORP.
15 Stevens St., Andover, Mass 01810
DATA COPY INC.
760 Bryant St, San Francisco, Cal 94107
DIETZGEN CO., EUGENE
2425 N Sheffield, Chicago, Ill 60614
DIOPTRIX INC.
1020 Prospect St, La Jolla, Cal 92037
EASTMAN KODAK CO.
343 State St, Rochester, N Y 14650
ELLIOTT CO., B.K.
P O Box 3240, Pittsburg, Pa 15230
GORDON ENTERPRISES INC., ALAN
5362 Cahuenga Blvd, N Hollywood, Cal 91601
IMAGE SYSTEMS INC.
11244 Playa Ct, Culver City, Cal 90230
ITEK BUSINESS PRODUCTS
1001 Jefferson Rd, Rochester, N Y 14603
ITEK CORP.
10 Maguire Rd, Lexington, Mass 02173
KLEER-VU INDUSTRIES INC.
386 Park Ave S, New York, N Y 10016
3M CO.
3m Center, St Paul, Minn 55101

2 Product Directory

MEMOREX EQUIPMENT GROUP

San Tomas At Central, Santa Clara, Cal 95052
MICRO DESIGN INC.
235 S Johnson St, Hartford, Wisc 53027
MICROFORM DATA SYSTEMS INC.
830 Maude Ave, Mountain View, Cal 94040
MICROSEAL CORP.
2222 Main St, Evanston, Ill 60204
MOSLER SAFE CO., THE INFO. SYS. DIV.
1561 Grand Blvd., Hamilton, Ohio 45012
NCR INDUSTRIAL PRODUCTS DIV.
Main And K St, Dayton, Ohio 45409
REPRODUCTION SYSTEMS DIV. TRANSAMERICA COMP.
1 California St, San Francisco, Cal 94111
SANDERS ASSOCIATES INC. SYSTEMS DIV.
Daniel Webster Hwy S, Nashua, N H 03060
STROMBERG DATAGRAPHIC INC.
P O Box 2449, San Diego, Cal 92112
TAYLOR MERCHANT CORP.
25 W 45 St, New York, N Y 10013
TELEDYNE FREDERICK POST
P O Box 803, Chicago, Ill 60690
WASHINGTON SCIENTIFIC INDUS. INC. MICROFILM PROD
Hwy 12, Longlake, Minn 55356

READERS, OPTICAL CHARACTER SCANNING

BASIC COMPUTING ARTS INC.
2680 E Bayshore Frtge, Mt View, Cal 94040
BENDIX MOSAIC FABRICATIONS DIV.
Galileo Park, Sturbridge, Mass 01518
BOURNS INC.
1200 Columbia Ave., Riverside, Cal 92507
BURROUGHS CORP., BUSINESS MACHINES GROUP
6071 2nd Ave, Detroit, Mich 48232
COGNITRONICS CORP.
333 Bedford Rd, Mt Kisco, N Y 10549
DATA PRODUCTS CORP.
16055 Ventura Blvd, Encino, Cal 91316
DATA RECOGNITION CORP.
908 Industrial Ave, Palo Alto, Cal 94303
DATATYPE CORP.
1050 NW 163rd Dr, Miami, Fla 33169
DI/AN CONTROLS INC.
944 Dorchester Ave, Boston, Mass 02125
DIGITRONICS CORP.
1 Albertson Ave, Albertson, N Y 11507
ELECTRONIC MICRO SYSTEMS INC.
1672 Kaiser Ave, Santa Ana, Cal 92705
FARRINGTON MANUFACTURING CO.
6707 Electronics Dr, Springfield, Va 22151
FIBER PHOTICS INC.
2557 Soquel Dr, Santa Cruz, Cal 95060
FLEXI-OPTICS LABORATORY INC.
269 Mechanic St, Marlboro, Mass 01752
FUJITSU LTD. N.Y. LIAISON OFFICE
680 Fifth Ave, New York, N Y 10019
HEWLETT PACKARD CO.
1501 Page Mill Rd, Palo Alto, Cal 94304
HONEYWELL INFORMATION SYSTEMS
60 Walnut St, Wellesley Hills, Mass 02181
IBM CORP., DATA PROCESSING DIV.
1133 Westchester Ave, White Plains, N Y 10604
INFORMATION INTERNATIONAL INC.
12435 W Olympic Blvd, Los Angeles, Cal 90064
INFOTON INC.
2nd Ave, Burlington, Mass 01803
LITTON SYSTEMS INC. DATA SYSTEMS DIV.
8000 Woodley Ave, Van Nuys, Cal 91409
NCR INDUSTRIAL PRODUCTS DIV.
Main And K St, Dayton, Ohio 45409
OPTICAL SCANNING CORP.
P O Box 40, Newton, Pa 18940
ORBITAL SYSTEMS INC.
Church & Fellowship, Moorestown, N J 08057
RECOGNITION EQUIPMENT INC.
1500 W Mockingbird L, Dallas, Tex 75222
SCAN-DATA CORP.
800 E Main St, Norristown, Pa 19401
SCAN-OPTICS INC.
22 Prestige Park, E Hartford, Conn 06108

READERS, OPTICAL MARK SENSING

MOTOROLA INC. CONTROL SYSTEMS DIV
P O Box 5409, Phoenix, Ariz 85010
OKI ELECTRIC INDUSTRIES CO. LTD.
875 Ave of Americas, New York, N Y 10001

READERS, PAPER TAPE

ADDRESSOGRAPH MULTIGRAPH CORP BRUNING DIV.
1200 Babbitt Rd, Cleveland, Ohio 44117
ANDERSON JACOBSON INC.
1065 Morse Ave., Sunnyvale, Cal 94086
BFA CORP.
1309 S Inca, Denver, Colo 80223
BONNAR-VAWTER INC.
96 Dunbar St, Keene, N H 03431
BUNKER-RAMO CORP.
Trumbull Ind Pk, Trumbull, Conn 06611
BURROUGHS CORP., BUSINESS MACHINES GROUP
6071 2nd Ave, Detroit, Mich 48232
CHALCO ENGINEERING CORP.
15126 S Broadway, Gardena, Cal 90248
COMPACE CORP.
7413 Washington Ave S, Edina-Minnepols, Minn 55435
COMPUTER MECHANISMS CORP.
493 Washington Dr, Carlstadt, N J 07072
COOK ELECTRIC CO. DATA-STOR DIV.
6201 W Oakton St, Morton Grove, Ill 60053
CORNING GLASS WORKS
Houghton Park, Corning, N Y 14830
DATA GENERAL CORP.
Rte 9, Southboro, Mass 01772
DATA PRODUCTS TELECOMMUNICATIONS
17 Amelia Place, Stamford, Conn 06902
DATASCAN INC.
1111 Paulison Ave, Clifton, N J 07013
DATATERM INC.
1671 Manning Blvd, Levittown, Pa 19057
DIGITAL EQUIPMENT CORP.
146 Main St, Maynard, Mass 01754
DIGITAL SCIENTIFIC CORP.
11455 Sorrento Vly Rd, San Diego, Cal 92121
DIGITRONICS CORP.
1 Albertson Ave, Albertson, N Y 11507
ECLECTIC COMPUTER CORP.
3707 Rawlins Ste 301, Dallas, Tex 75219
ELECTRONIC ENGRG. CO. OF CAL. ELECTRONIC PRD. DIV.
1441 E Chestnut Ave, Santa Ana, Cal 92702
ELECTRONIC MICRO SYSTEMS INC.
1672 Kaiser Ave, Santa Ana, Cal 92705
FACIT-ODHNER INC.
501 Winsor Dr, Secaucus, N J 07094
FERRANTI PACKARD LTD., ELECTRONICS DIV.
121 Industry St, Toronto 15, CANADA
FIBER PHOTICS INC.
2557 Soquel Dr, Santa Cruz, Cal 95060
FRIDEN DIV. THE SINGER CO.
97 Humboldt St, Rochester, N Y 14602
FUJITSU LTD. N.Y. LIAISON OFFICE
680 Fifth Ave, New York, N Y 10019
HEWLETT PACKARD CO.
1501 Page Mill Rd, Palo Alto, Cal 94304
HEWLETT PACKARD CO. CUPERTINO DIV.
1100 Wolfe Rd, Cupertino, Cal 95014
HONEYWELL INFORMATION SYSTEMS
P O Box 12313, Oklahoma City, Okla 73112
HONEYWELL INFORMATION SYSTEMS
60 Walnut St, Wellesley Hills, Mass 02181
HONEYWELL INFORMATION SYS. INC PERIPH. DEVICES DIV.
200 Smith St, Waltham, Mass 02154
INDUSTRIAL TIMER DIV., THE SINGER CO.
Us Hwy 287, Parsippany, N J 07054
ITEL INFORMATION PRODUCTS DIV
2585 Bayshore, Palo Alto, Cal 94303
JAMESBURY CORP. DECITEK DIV.
15 Sagamore Rd, Worcester, Mass 01605
JOHNSON ASSOCIATES INC.
108 Lyster Rd, Oreland, Pa 19075
LEHIGH VALLEY ELECTRONICS INC.
Po Box 125, Fogelsville, Pa 18051
LITTON ABS AUTOMATED BUSINESS SYSTEMS OEM PRODUCT
600 Washington Ave, Carlstadt, N J 07072
3M CO.
3m Center, St Paul, Minn 55101
MICRO SYSTEMS INC.
644 E Young St, Santa Ana, Cal 92705
MICRODATA CORP.
644 E Young St, Santa Ana, Cal 92705
MOHAWK DATA SCIENCES CORP.
Palisade St, Herkimer, N Y 13350
MULTIDATA INC.
7300 Bolsa Ave, Westminster, Cal 92683
NCR INDUSTRIAL PRODUCTS DIV.
Main And K St, Dayton, Ohio 45409
OHRTRONICS INC., SUB MOHAWK DATA SCIENCES CORP.
P O Box 406, King of Prussia, Pa 19406

OKI ELECTRIC INDUSTRIES CO. LTD.

875 Ave of Americas, New York, N Y 10001
OLIVETTI CORP. OF AMERICA
500 Park Ave, New York, N Y 10016
REMEX ELECTRONICS
5250 W El Segundo Blv, Hawthorne, Cal 90250
ROHDE & SCHWARZ SALES CO. USA INC.
111 Lexington Ave, Passaic, N J 07055
SHIRAK TELEMETERING OF AMERICA
8926 Kester Ave, Van Nuys, Cal 91402
SINGER CO., THE, FRIDEN DIV.
2350 Washington St, San Leandro, Cal 94577
SUPERIOR ELECTRIC CO., THE
383 Middle St, Bristol, Conn 06010
TALLY CORP.
8301 S 180th St, Kent, Wash 98031
TELETYPE CORP.
5555 W Touhy Ave, Skokie, Ill 60076
TEXAS INSTRUMENTS INC. DIGITAL SYSTEMS DIV
P O Box 66027, Houston, Tex 77006
TRANSCOM INC. SUB. OF HI-G INC.
12 Tobey Rd, Bloomfield, Conn 06002
TRANSMISSION MEASUREMENTS INC
1051 Clinton St, Buffalo, N Y 14206
UNICOMP INC.
18219 Parthenia, Northridge, Cal 91324
VISTATYPE CORP.
1226 E Pomona St, Santa Ana, Cal 92707
WANG LABORATORIES INC.
836 N St, Tewksbury, Mass 01876

READERS, PAYMENT COUPONS

CONTROL DATA CORP.
8100 34th Ave S, Minneapolis, Minn 55440
DATA PRODUCTS CORP.
16055 Ventura Blvd, Encino, Cal 91316
HICKOK ELECTRICAL INSTRUMENT CO.
10514 Dupont Ave, Cleveland, Ohio 44108
NYTRONICS INC.
3rd Ave, Alpha, N J 08865
REPUBLIC INFORMATION SYSTEMS INC.
9732 Cozycroft Ave, Chatsworth, Cal 91311

READERS, PERFORATED DOCUMENT

BENDIX MOSAIC FABRICATIONS DIV.
Galileo Park, Sturbridge, Mass 01518
BFA CORP.
1309 S Inca, Denver, Colo 80223
BURROUGHS CORP., BUSINESS MACHINES GROUP
6071 2nd Ave, Detroit, Mich 48232
BURROUGHS CORP., OEM PRODUCT SALES
1649 Wilshire Blvd, Los Angeles, Cal 90017
CENTRALAB ELECTRONICS, DIV.
5757 N Green Bay, Milwaukee, Wisc 53201
DATA PRODUCTS CORP.
16055 Ventura Blvd, Encino, Cal 91316
DATATERM INC.
1671 Manning Blvd, Levittown, Pa 19057
DECISION DATA CORP.
300 Jacksonville Rd, Warminster, Penn 18974
DIGITAL EQUIPMENT CORP.
146 Main St, Maynard, Mass 01754
FERRANTI PACKARD LTD., ELECTRONICS DIV.
121 Industry St, Toronto 15, CANADA
FRIDEN DIV. THE SINGER CO.
97 Humboldt St, Rochester, N Y 14602
HICKOK ELECTRICAL INSTRUMENT CO.
10514 Dupont Ave, Cleveland, Ohio 44108
HONEYWELL INFORMATION SYSTEMS
P O Box 12313, Oklahoma City, Okla 73112
INTERNATIONAL CONTROLS CORP.
200 Fairfield Rd, Fairfield, N J 07006
INTERSWITCH DIV. WILLIAM J. PURDY CORP.
770 Airport Blvd, Burlington, Cal 94010
LEHIGH VALLEY ELECTRONICS INC.
Po Box 125, Fogelsville, Pa 18051
NYTRONICS INC.
3rd Ave, Alpha, N J 08865
OKI ELECTRIC INDUSTRIES CO. LTD.
875 Ave of Americas, New York, N Y 10001
POTTER INSTRUMENT CO. INC.
532 Broadhollow Rd, Melville, N Y 11746
REPUBLIC INFORMATION SYSTEMS INC.
9732 Cozycroft Ave, Chatsworth, Cal 91311
TAURAS CORP.
Academy Hill, Lambertville, N J 08530
WESTERN TELEMATIC INC.
5507 Peck Rd, Arcadia, Cal 91006

2 Product Directory

READERS, PUNCHED CARD (UP TO 100 CPM)

BRIDGE DATA PRODUCTS INC.
738 S 42nd St, Philadelphia, Pa 19104
BURROUGHS CORP., BUSINESS MACHINES GROUP
6071 2nd Ave, Detroit, Mich 48232
COMPACT CORP.
7413 Washington Ave S, Edina-Minnepols, Minn 55435
COMPUTER DESIGN CORP.
12401 W Olympic Blvd, Los Angeles, Cal 90064
DATA COMPUTING INC.
2219 W Shangri La Rd, Phoenix, Ariz 85029
DATA GENERAL CORP.
Rte 9, Southboro, Mass 01772
DATRON SYSTEMS INC.
100 Rte 46, Mt Lakes, N J 07046
DEMEX INC.
2130 Jefferson, Kansas City, Mo 64108
DOCUMENTATION INC.
841 E New Haven Ave, Melbourne, Fla 32901
HICKOK ELECTRICAL INSTRUMENT CO.
10514 Dupont Ave, Cleveland, Ohio 44108
HONEYWELL INFORMATION SYSTEMS
P O Box 12313, Oklahoma City, Okla 73112
HONEYWELL INFORMATION SYSTEMS
60 Walnut St, Wellesley Hills, Mass 02181
HONEYWELL INFORMATION SYS. INC PERIPH. DEVICES DIV.
200 Smith St, Waltham, Mass 02154
INTERNATIONAL CONTROLS CORP.
200 Fairfield Rd, Fairfield, N J 07006
MICRO SYSTEMS INC.
644 E Young St, Santa Ana, Cal 92705
MOHAWK DATA SCIENCES CORP.
Palisade St, Herkimer, N Y 13350
NCR INDUSTRIAL PRODUCTS DIV.
Main And K St, Dayton, Ohio 45409
PANASONIC INDUSTRIAL DIV.
200 Park Ave, New York, N Y 10017

READERS, PUNCHED CARD (100 TO 300 CPM)

BRIDGE DATA PRODUCTS INC.
738 S 42nd St, Philadelphia, Pa 19104
BURROUGHS CORP., BUSINESS MACHINES GROUP
6071 2nd Ave, Detroit, Mich 48232
BURROUGHS CORP., OEM PRODUCT SALES
1649 Wilshire Blvd, Los Angeles, Cal 90017
DATA GENERAL CORP.
Rte 9, Southboro, Mass 01772
DATA PRODUCTS CORP.
16055 Ventura Blvd, Encino, Cal 91316
DATA PRODUCTS CORP. CARD EQUIPMENT DIV.
8455 E Prentice Ave, Englewood, Colo 80110
DECISION DATA CORP.
300 Jacksonville Rd, Warminster, Penn 18974
DIGITAL EQUIPMENT CORP.
146 Main St, Maynard, Mass 01754
DIGITAL SCIENTIFIC CORP.
11455 Sorrento Vly Rd, San Diego, Cal 92121
DOCUMENTATION INC.
841 E New Haven Ave, Melbourne, Fla 32901
ELDORADO ELECTRODATA
601 Chalomar Rd, Concord, Cal 94520
FUJITSU LTD. N.Y. LIAISON OFFICE
680 Fifth Ave, New York, N Y 10019
HONEYWELL INFORMATION SYSTEMS
P O Box 12313, Oklahoma City, Okla 73112
HONEYWELL INFORMATION SYSTEMS
60 Walnut St, Wellesley Hills, Mass 02181
HONEYWELL INFORMATION SYS. INC PERIPH. DEVICES DIV.
200 Smith St, Waltham, Mass 02154
INTERNATIONAL CONTROLS CORP.
200 Fairfield Rd, Fairfield, N J 07006
LITTON ABS AUTOMATED BUSINESS SYSTEMS OEM PRODUCT
600 Washington Ave, Carlstadt, N J 07072
MICRO SYSTEMS INC.
644 E Young St, Santa Ana, Cal 92705
MOHAWK DATA SCIENCES CORP.
Palisade St, Herkimer, N Y 13350
NCR INDUSTRIAL PRODUCTS DIV.
Main And K St, Dayton, Ohio 45409
OKI ELECTRIC INDUSTRIES CO. LTD.
875 Ave of Americas, New York, N Y 10001
OMNITEC CORP. A NYTRONICS CORP.
903 N 2nd St, Phoenix, Ariz 85004
PERIPHERAL DYNAMICS INC.
1030 W Germantown Pk, Norristown, Pa 19401

QANTEL CORP.
3474 Investment Blvd, Hayward, Cal 94545
UNITED BUSINESS COMMUNICATIONS INC.
6405 Metcalf Ave, Shawnee Mission, Kans 66202
UNIVERSITY COMPUTING CO.
P O Box 6228, Dallas, Tex 75222
WEISMANTEL INC.
P O Box 1957, St Paul, Minn 55111
XEROX DATA SYSTEMS
701 S Aviation, El Segundo, Cal 90245

READERS, PUNCHED CARD (OVER 300 CPM)

BRIDGE DATA PRODUCTS INC.
738 S 42nd St, Philadelphia, Pa 19104
BURROUGHS CORP., BUSINESS MACHINES GROUP
6071 2nd Ave, Detroit, Mich 48232
BURROUGHS CORP., OEM PRODUCT SALES
1649 Wilshire Blvd, Los Angeles, Cal 90017
DATA GENERAL CORP.
Rte 9, Southboro, Mass 01772
DATA PRODUCTS CORP.
16055 Ventura Blvd, Encino, Cal 91316
DATA PRODUCTS CORP. CARD EQUIPMENT DIV.
8455 E Prentice Ave, Englewood, Colo 80110
DECISION DATA CORP.
300 Jacksonville Rd, Warminster, Penn 18974
DIGITAL SCIENTIFIC CORP.
11455 Sorrento Vly Rd, San Diego, Cal 92121
DOCUMENTATION INC.
841 E New Haven Ave, Melbourne, Fla 32901
FUJITSU LTD. N.Y. LIAISON OFFICE
680 Fifth Ave, New York, N Y 10019
HONEYWELL INFORMATION SYSTEMS
P O Box 12313, Oklahoma City, Okla 73112
HONEYWELL INFORMATION SYSTEMS
60 Walnut St, Wellesley Hills, Mass 02181
HONEYWELL INFORMATION SYS. INC PERIPH. DEVICES DIV.
200 Smith St, Waltham, Mass 02154
MOHAWK DATA SCIENCES CORP.
Palisade St, Herkimer, N Y 13350
MULTIDATA INC.
7300 Bolsa Ave, Westminster, Cal 92683
OKI ELECTRIC INDUSTRIES CO. LTD.
875 Ave of Americas, New York, N Y 10001
PERIPHERAL DYNAMICS INC.
1030 W Germantown Pk, Norristown, Pa 19401
POTTER INSTRUMENT CO. INC.
532 Broadhollow Rd, Melville, N Y 11746
RCA COMPUTER SYSTEMS DIV.
200 Forest Ave, Marlboro, Mass 01752
UNICOMP INC.
18219 Parthenia, Northridge, Cal 91324
UNITED BUSINESS COMMUNICATIONS INC.
6405 Metcalf Ave, Shawnee Mission, Kans 66202
UNIVERSITY COMPUTING CO.
P O Box 6228, Dallas, Tex 75222
WEISMANTEL INC.
P O Box 1957, St Paul, Minn 55111
XEROX DATA SYSTEMS
701 S Aviation, El Segundo, Cal 90245

READERS, PUNCHED CARD (STATIC)

AMP INC.
Eisenhower Blvd, Harrisburg, Pa 17105

READERS, PUNCHED TAG

KIMBALL SYSTEMS DIV. LITTON INDUS.
151 Cortlandt St, Belleville, N J 07109
MOHAWK DATA SCIENCES CORP.
Palisade St, Herkimer, N Y 13350
OHRTRONICS INC., SUB MOHAWK DATA SCIENCES CORP.
P O Box 406, King of Prussia, Pa 19406
PANASONIC INDUSTRIAL DIV.
200 Park Ave, New York, N Y 10017

READERS, STATIC

ADDO-X INC. ADP DIV.
437 Madison Ave, New York, N Y 10022
AMP INC.
Eisenhower Blvd, Harrisburg, Pa 17105
AMP INC., SYSCOM DIV.
P O Box 3608, Harrisburg, Pa 17105
COMPERIPHERALS INC.
437 Madison Ave, New York, N Y 10022

HICKOK ELECTRICAL INSTRUMENT CO.
10514 Dupont Ave, Cleveland, Ohio 44108
NCR INDUSTRIAL PRODUCTS DIV.
Main And K St, Dayton, Ohio 45409
NYTRONICS INC.
3rd Ave, Alpha, N J 08865
OKI ELECTRIC INDUSTRIES CO. LTD.
875 Ave of Americas, New York, N Y 10001
SEAELECTRO CORP.
225 Hoyt St, Mamaroneck, N Y 10543
TAURAS CORP.
Academy Hill, Lambertville, N J 08530

READOUTS AND DISPLAYS, NUMERIC AND ALPHANUMERIC (OTHER THAN CRT)

ALCO ELECTRONIC PRODUCTS INC.
8 Marblehead St, North Andover, Mass 01845
ALDEN ELECTRONIC & IMPULSE RECORDING EQUIP. CO
Washington St, Westboro, Mass 01581
AMERICAN COMPUTER TECHNOLOGY INC.
8740 Shirley Ave, Northridge, Cal 91324
ANALOGIC CORP.
Audubon Rd, Wakefield, Mass 01880
ARVIN SYSTEMS INC.
1771 Springfield St, Dayton, Ohio 45403
AUSTRON, INC.
10214 N Interregional, Austin, Tex 78753
AUTO-TROL CORP.
6621 W 56th Ave, Arvada, Colo 80002
BASIC COMPUTING ARTS INC.
2680 E Bayshore Frtge, Mt View, Cal 94040
BURROUGHS CORP. ELECTRONICS COMPONENTS DIV.
P O Box 1226, Plainfield, N J 07061
CHICAGO MINIATURE LAMP WORKS
4433 N Ravenswood Ave, Chicago, Ill 60640
CITIZEN AMERICA CORP.
9201 Olympic Blvd, Beverly Hills, Cal 90212
COMPUDYNE CORP. CONTROLS DIV.
P O Box 247, Hatboro, Pa 19040
COMPUTER MICRO-IMAGE SYSTEMS INC.
9600 Desoto Ave, Chatsworth, Cal 91311
COMPUTER PRODUCTS, INC.
P O Box 23849, Ft Lauderdale, Fla 33307
CONRAC CORP.
330 Madison Ave, New York, N Y 10017
CONRAC CORP. CONRAC DIV.
600 N Rimsdale Ave, Covina, Cal 91722
CONRAC CORP. CRAMER DIV.
Mill Rock Rd, Old Saybrook, Conn 06475
CONRAC CORP. DATEX DIV.
1600 S Mountain Ave, Duarte, Cal 91010
CO-ORD SWITCH CO., DIV. LVC INDUSTRIES, INC.
102-48 43rd Ave, Corona, N Y 11368
DATALOG DIV. LITTON SYSTEMS INC.
1 Executive Pk, Englewood, Colo 80110
DIGITAL AUTOMATION CO. INC.
1018 Whitehead Rd Ext, Trenton, N J 08638
DISPLAY DEVICES INC.
P O Box 667, Encinitas, Cal 92024
ELBIT COMPUTERS/SUB. CONTROL DATA CORP.
6 Tovim St, Haifa, ISRAEL
FERRANTI PACKARD LTD., ELECTRONICS DIV.
121 Industry St, Toronto 15, CANADA
FIBER PHOTICS INC.
2557 Soquel Dr, Santa Cruz, Cal 95060
FLEXI-OPTICS LABORATORY INC.
269 Mechanic St, Marlboro, Mass 01752
GOULD INC. BRUSH DIV.
3631 Perkins Ave, Cleveland, Ohio 44114
GRALEX INDUSTRIES DIV. GENL. MICROWAVE CORP
155 Marine St, Farmingdale, N Y 11735
HEWLETT PACKARD CO.
1501 Page Mill Rd, Palo Alto, Cal 94304
HP ASSOCIATES
620 Page Mill Rd, Palo Alto, Cal 94304
I/O SYSTEMS INC.
P O Box 36, Natick, Mass 01760
IKL INC.
4360 Campus Dr, Newport Beach, Cal 92660
INDUSTRIAL ELECTRONIC ENGINEERS INC.
7720-40 Lemoona Ave, Van Nuys, Cal 91405
INFO-LITE CORP.
2337 Lemoine Ave, Fort Lee, N J 07024
INSTRUMENT DISPLAYS INC. SUB. KELTRON CORP.
223 Crescent St, Waltham, Mass 02154
LANDIS AND GYR INC.
4 Westchester Plaza, Elmsford, N Y 10523
LEGI ELECTRONICS CORP.
3118-A W Jefferson Bl, Los Angeles, Cal 90018
LEM INSTRUMENT CORP.
20 Sarah Dr, Farmingdale, N Y 11735

2 Product Directory

LITTON SYSTEMS INC. DATA SYSTEMS DIV.
8000 Woodley Ave, Van Nuys, Cal 91409
LORCH ELECTRONICS, LORCH ADRET CORP.
105 Cedar Ln, Englewood, N J 07631
LUMINETICS CORP.
P O Box 1943, Pompano Beach, Fla 33061
MASTER SPECIALTIES CO.
1640 Monrovia, Costa Mesa, Cal 92627
MONITOR LABS INC.
10451 Roselle, San Diego, Cal 92121
MONSANTO CO. ELECTRONIC PDTS. & CONTROLS DIV.
11636 Administration, St Louis, Mo 63141
NCR INDUSTRIA PRODUCTS DIV.
Main And K St, Dayton, Ohio 45409
NOVATRONICS OF CANADA LTD.
677 Erie St, Stratford Ont, CANADA
OKI ELECTRIC INDUSTRIES CO. LTD.,
875 Ave of Americas, New York, N Y 10001
OPCOA INC.
330 Talmadge Rd, Edison, N J 08817
PINLITES INC.
P O Box 453, Caldwell, N J 07006
RANK PRECISION INDUSTRIES INC.
260 N Rt 303, W Nyack, N Y 10994
RCA ELECTRONIC COMPONENTS DIV.
415 S 5th St, Harrison, N J 07029
READOUTS INC.
P O Box 149, Del Mar, Cal 92014
SIERRA RESEARCH CORP. COMPUTER PROD. GRP.
167 Bedford St., Burlington, Mass 01803
SIGMA INSTRUMENTS INC.
170 Pearl St, Braintree, Mass 02185
SIGMATRON INC.
849 Ward Dr, Santa Barbara, Cal 93102
SINGER-GENERAL PRECISION KEARFOTT DIV.
1150 McBride Ave, Little Falls, N J 07424
SINGER-GENERAL PRECISION INC. LIBRASCOPE PROD.DIV
1100 Frances Ct, Glendale, Cal 91201
TEC INC.
6700 S Wash Ave, Eden Prarie, Minn 55343
TYCO INSTRUMENT DIV. TYCO LABS. INC
Waltham, Mass 02154
VEMALINE PRODUCTS CO. INC.
P O Box 3, Wyckoff, N J 07481
VERNITRON CORP. MOTOR PRODUCTS DIV.
300 Marcus Blvd, Deer Park, N Y 11729
WAGNER ELECTRIC CORP.
630 W Mt Pleasant Ave, Livingston, N J 07039

READOUTS, CRT

ANN ARBOR TERMINALS INC.
918 Greene St, Ann Arbor, Mich 48104
APPLIED DIGITAL DATA SYSTEMS INC.
100 Marcus Blvd, Hauppauge, N Y 11787
ASTRONAUTICS CORPORATION OF AMERICA
907 S First St, Milwaukee, Wis 53204
CELCO,CONSTANTINE ENGINEERING LABS. CO.
70 Constantine Dr, Mahwah, N J 07430
COMPUTER DEVICES INC.
10 Sonar Dr, Woburn, Mass 01801
COMPUTER MICRO-IMAGE SYSTEMS INC.
9600 Desoto Ave, Chatsworth, Cal 91311
CONRAC CORP.
330 Madison Ave, New York, N Y 10017
CONSTANTINE ENGINEERING LABS CELCO
70 Constantine Dr, Mahwah, N J 07430
CONTROL DATA CORP.
8100 34th Ave S, Minneapolis, Minn 55440
DATA DISC INC.
686 W Maude Ave, Sunnyvale, Cal 94086
DELTA DATA SYSTEMS CORP.
Woodhaven Ind Park, Cornwells Hgts, Pa 19020
DIAMOND POWER SPECIALTY CORP.
P O Box 415, Lancaster, Ohio 43130
DIGI-LOG SYSTEMS INC.
107 W Ridge Pike, Conshohocken, Pa 19428
FAIRCHILD DUMONT ELECTRON TUBES
750 Bloomfield Ave, Clifton, N J 07015
HEWLETT PACKARD CO.
1501 Page Mill Rd, Palo Alto, Cal 94304
HONEYWELL INFORMATION SYSTEMS
P O Box 12313, Oklahoma City, Okla 73112
INDUSTRIAL ELECTRONIC ENGINEERS INC.
7720-40 Lemona Ave, Van Nuys, Cal 91405
INFODEX INC.
7 Cherry Ave, Waterbury, Conn 06702
INFOREX INC.
21 N Ave, Burlington, Mass 01803
INTERNATIONAL CONTROLS CORP.
200 Fairfield Rd, Fairfield, N J 07006

LECROY RESEARCH SYSTEMS CORP.
126 N Rte 303, W Nyack, N Y 10994
LEGI ELECTRONICS CORP.
3118-A W Jefferson Bl, Los Angeles, Cal 90018
MARK COMPUTER SYSTEMS INC.
One Patterson Pl, Garden City, N Y 11530
METRA INSTRUMENTS INC.
1340 Space Park Way, Mt View, Cal 94040
MOTOROLA INC. GOVERNMENT ELECTRONICS DIV.
8201 E Mc Dowell Rd, Scottsdale, Ariz 85252
OPTIMATION, INC.
9421 Telfair Ave, Sunn Valley, Cal 91352
PRINCETON ELECTRONIC PRODUCTS INC.
P O Box 101, N Brunswick, N J 08902
RANK PRECISION INDUSTRIES INC.
260 N Rt 303, W Nyack, N Y 10994
RAYTHEON CO. CADPO OPERATION
1415 Providence Tpk, Norwood, Mass 02062
RAYTHEON CO. INDUSTRIAL COMPONENT OPERATION
465 Centre St., Quincy, Mass 02169
SIGMATRON INC.
849 Ward Dr, Santa Barbara, Cal 93102
STROMBERG DATAGRAPHIX INC.
P O Box 2449, San Diego, Cal 92112
TEC INC.
6700 S Wash Ave, Eden Prarie, Minn 55343
TEKTRONIX INC.
P O Box 500, Beaverton, Ore 97005
UNIVERSAL TECHNOLOGY INC.
3 Spielman Rd, Fairfield, N J 07006
WESTINGHOUSE ELECTRIC CORP.
Westinghouse Bldg, Pittsburgh, Pa 15222

RECONDITIONING EQUIPMENT, MAGNETIC TAPE

COMPUTER-LINK CORP.
14 Cambridge St, Burlington, Mass 01803
GENERAL KINETICS INC.
11425 Isaac Newt Sq S, Reston, Va 22070
GRAHAM MAGNETICS INC.
Graham, Tex 76046
INDEL INC.
P O Box 15800, Tulsa, Okla 74115
KYBE CORP.
132 Calvary St, Waltham, Mass 02154
3M CO.
3m Center, St Paul, Minn 55101
VIRGINIA PANEL CORP.
1400 N Hope Rd, Waynesboro, Va 22980

RECONDITIONING EQUIPMENT, PUNCHED CARD

CUMMINS-CHICAGO CORP.
4740 Ravenswood Ave, Chicago, Ill 60640
DATACON INTERNATIONAL INC.
2745 Bernice Rd, Lansing, Ill 60438
GMA COMPUTER CORP.
320 Yonker Ave, Yonkers, N Y 10701
IOA DATA CORP.
383 Lafayette St, New York, N Y 10003
REN ELECTRONICS
775 New Ludlow Rd, So Hadley, Mass 01075
UNIVERSITY COMPUTING CO.
P O Box 6228, Dallas, Tex 75222

RECORDERS, DIGITAL CASSETTE

A.D. DATA SYSTEMS INC.
830 Linden Ave, Rochester, N Y 14625
ADDO-X INC. ADP DIV.
437 Madison Ave, New York, N Y 10022
ADDO-X INC. OEM DIV.
437 Madison Ave, New York, N Y 10022
AMPEX CORP. COMPUTER PRODUCTS DIV.
9937 W Jefferson Blvd, Culver City, Cal 90230
ANDERSON JACOBSON INC.
1065 Morse Ave., Sunnyvale, Cal 94086
APPLIED COMPUTER SYSTEMS INC.
P O Box 6479, Austin, Tex 78702
ASTRO-SCIENCE CORP.
9700 Factorial Way, S El Monte, Cal 91734
AURICORD DIV., SCOVILL MFG. CO.
35-41 29 St, Long Isl City, N Y 11106
BELL & HOWELL ELECTRONICS & INSTRUMENTS GROUP
360 Sierra Madre Vill, Pasadena, Cal 91109
BFA CORP.
1309 S Inca, Denver, Colo 80223

BORG WARNER CONTROLS DIV. BORG WARNER
3300 S Halladan St, Santa Ana, Cal 92702
CIPHER DATA PRODUCTS INC.
7655 Convoct Ct, San Diego, Cal 92111
COGAR CORP. INFORMATION SYS.DIV
Cosby Manor Rd, Utica, N Y 13502
COMPUCORD INC.
225 Crescent St, Waltham, Mass 02154
COMPUTER ACCESS SYSTEMS INC.
3050 W Clarendon Ave, Phoenix, Ariz 85017
COMPUTER DEVICES INC.
10 Sonar Dr, Woburn, Mass 01801
DACOM INC.
1060 Morse Ave, Sunnyvale, Cal 94086
DATA INPUT DEVICES INC.
Tinkham Ind Pk, Derry, N H 03038
DATA PRODUCTS TELECOMMUNICATIONS
17 Amelia Place, Stamford, Conn 06902
DESIGN ELEMENTS INC.
356 Norton Ave, Columbus, Ohio 43212
DICOM INDUSTRIES
684 W Maude Ave, Sunnyvale, Cal 94086
DYTRO CORP.
63 Tec St, Hicksville, N Y 11801
ELECTRONIC LABS. INC.
3726 Dacoma St, Houston, Tex 77018
FORD INDUSTRIES INC.
5001 SE Johnson Ck, Portland, Ore 97206
GULTON INDUSTRIES INC. COMPUTER SYS. DIV.
13041 Cerise Ave, Hawthorne, Cal 90250
HAZELTINE CORP. INDUSTRIAL PRODUCTS DIV.
. Greenlawn, N Y 11740
INTERDATA
2 Crescent Pl, Oceanport, N J 07757
INTERNATIONAL COMPUTER PRODUCTS INC.
P O Box 34484, Dallas, Tex 75234
LEACH CORP. CONTROLS DIV.
717 N Coney Ave, Azusa, Cal 91702
LIVERMORE DATA SYSTEMS INC.
2050 Research Dr, Livermore, Cal 94550
LOCKHEED ELECTRONICS CO. DIV. LOCKHEED ACRFT CORP
U S Hwy 22, Plainfield, N J 07060
3M CO.
3m Center, St Paul, Minn 55101
MCA TECHNOLOGY INC. UDAC DIV.
P O Box 36166, Houston, Tex 77035
MICRODYNE INC. SUB.BODINE ELEC.CO.
1600 S Micks Rd, Rolling Meadows, Ill 60008
MOBARK INSTRUMENTS CORP.
1038 Evelyn, Sunnyvale, Cal 94086
RAYMOND ENGINEERING INC.,DIV. RAYMOND PREC. INC.
217 Smith St, Middletown, Conn 06457
ROLM, CORP.
10300 N Tantau, Cupertino, Cal 95014
SYCOR INC.
100 Phoenix Dr, Ann Arbor, Mich 48104
SYKES DATATRONICS INC.
375 Orchard St, Rochester, N Y 14606
TEAC CORPORATION OF AMERICA TECHNICAL PRODUCTS
2000 Colorado Ave, Santa Monica, Cal 90404
TELE-DATA CORP.
130 U S Hwy 22, N Plainfield, N J 07060
TELECTRO SYSTEMS CORP.
96-18 43rd Ave, Corona, N Y 11368
TELEX COMMUNICATIONS DIV.
9600 Aldrich Ave S, Minneapolis, Minn 55420
TELEX COMPUTER PRODUCTS
6422 E 41st St, Tulsa, Okla 74135
TENNECOMP SYSTEMS INC.
795 Oak Ridge Tpk, Oak Ridge, Tenn 37830
TRI-DATA CORP.
800 Maude Ave, Mt View, Cal 94040
WANG COMPUTER PRODUCTS INC.
2000 Stoner Ave, Los Angeles, Cal 90272
WANG LABORATORIES INC.
836 N St, Tewksbury, Mass 01876
WESTERN TELEMATIC INC.
5507 Peck Rd, Arcadia, Cal 91006

RECORDERS, FACSIMILE

CENTURY ELECTRONICS & INSTRUMENTS INC.
P O Box C Adm Sta, Tulsa, Okla 74115
EDGERTON GERMESHAUSEN GRIER INC.
Crosby Dr, Bedford, Mass 01730

2 Product Directory

RECORDERS, FACSIMILE (SEE TRANSCIVERS)

RECORDERS, GRAPHIC

A.B. DICK CO.
5700 W Touhy, Chicago, Ill 60648
ALDEN ELECTRONIC & IMPULSE RECORDING EQUIP. CO.
Washington St, Westboro, Mass 01581
ARGONAUT ASSOCIATES INC.
P O Box K, Beaverton, Ore 97005
BFA CORP.
1309 S Inca, Denver, Colo 80223
BOLT BERANEK & NEWMAN INC. DATA EQUIPMENT DIV.
1762 McGaw St, Santa Ana, Cal 92705
CALIFORNIA COMPUTER PRODUCTS INC.
2411 W La Palma Ave, Anaheim, Cal 92801
CENTURY ELECTRONICS & INSTRUMENTS INC.
P O Box C Adm Sta, Tulsa, Okla 74115
COMPUTER MICRO-IMAGE SYSTEMS INC.
9600 Desoto Ave, Chatsworth, Cal 91311
CONCORD CONTROL INC.
1282 Soldier Field Rd, Boston, Mass 02135
CONTROL DATA CORP.
8100 34th Ave S, Minneapolis, Minn 55440
DASA CORP./CYBER-TRONICS SUB. DASA CORP.
15 Stevens St., Andover, Mass 01810
EDGERTON GERMESHAUSEN GRIER INC.
Crosby Dr, Bedford, Mass 01730
ESTERLINE ANGUS DIV., ESTERLINE CORP.
Po Box 24000, Indianapolis, Ind 46224
GOULD INC. BRUSH DIV.
3631 Perkins Ave, Cleveland, Ohio 44114
HEWLETT PACKARD CO.
1501 Page Mill Rd, Palo Alto, Cal 94304
HONEYWELL INC. TEST INSTRUMENTS DIV.
P O Box 5227, Denver, Colo 80217
INFO-MAX
1248 Alderwood, Sunnyvale, Cal 94086
KDI ADTROL INC.
700 Abbott Dr, Broomall, Pa 19008
LEEDS & NORTHRUP CO.
Sumney Town Pike, North Wales, Pa 19454
LEIGH INSTRUMENTS LTD. COMPUTER EQUIP. DIV.
P O Box 2323 Sta D, Ottawa 4, ONT CAN
MANDREL INDUSTRIES ELECTRO TECHNICAL LABS DIV.
P O Box 36306, Houston, Tex 77036
PHOTRON INSTRUMENT CO.
6516 Detroit Ave, Cleveland, Ohio 44102
SEACO COMPUTER-DISPLAY INC.
2826 W Kingsley Rd, Garland, Tex 75040
SINGER LINK DIV.
1077 E Arques, Sunnyvale, Cal 94086
STROMBERG DATAGRAPHIX INC.
P O Box 2449, San Diego, Cal 92112
TEKTRONIX INC.
P O Box 500, Beaverton, Ore 97005
TEXAS INSTRUMENTS INC. DIGITAL SYSTEMS DIV.
P O Box 66027, Houston, Tex 77006
VARIAN ASSOCIATES GRAPHICS & DATA SYSTEMS DIV.
611 Hansen Way, Palo Alto, Cal 94303

RECORDERS, HARD-COPY (WITH CRT)

A.B. DICK CO.
5700 W Touhy, Chicago, Ill 60648
ALDEN ELECTRONIC & IMPULSE RECORDING EQUIP. CO.
Washington St, Westboro, Mass 01581
BENDIX MOSAIC FABRICATIONS DIV.
Galileo Park, Sturbridge, Mass 01518
CALIFORNIA COMPUTER PRODUCTS INC.
2411 W La Palma Ave, Anaheim, Cal 92801
CENTURY ELECTRONICS & INSTRUMENTS INC.
P O Box C Adm Sta, Tulsa, Okla 74115
CONTROL DATA CORP.
8100 34th Ave S, Minneapolis, Minn 55440
CONTROL DATA CORP. TERMINAL SUBSYS.DIV
2401 N Fairview Ave, St Paul, Minn 55113
DASA CORP./CYBER-TRONICS SUB. DASA CORP.
15 Stevens St., Andover, Mass 01810
ELECTRONIC ASSOCIATES INC.
485 Monmouth Pkwy, W Long Branch, N J 07764
KDI ADTROL INC.
700 Abbott Dr, Broomall, Pa 19008
LEIGH INSTRUMENTS LTD. COMPUTER EQUIP. DIV.
P O Box 2323 Sta D, Ottawa 4, ONT CAN
MICROFORM DATA SYSTEMS INC.
830 Maude Ave, Mountain View, Cal 94040

PRINTER TECHNOLOGY INC.
Sixth Rd, Woburn, Mass 01801
TEKTRONIX INC.
P O Box 500, Beaverton, Ore 97005
VARIAN ASSOCIATES GRAPHICS & DATA SYSTEMS DIV.
611 Hansen Way, Palo Alto, Cal 94303

RECORDERS, MAGNETIC TAPE

AMPEX CORP. COMPUTER PRODUCTS DIV.
9937 W Jefferson Blvd, Culver City, Cal 90230
ANDERSON JACOBSON INC.
1065 Morse Ave., Sunnyvale, Cal 94086
ASTRO-SCIENCE CORP.
9700 Factorial Way, S El Monte, Cal 91734
AURICORD DIV., SCOVILL MFG. CO.
35-41 29 St, Long Isl City, N Y 11106
BFA CORP.
1309 S Inca, Denver, Colo 80223
BORG WARNER CONTROLS DIV. BORG WARNER
3300 S Halladan St, Santa Ana, Cal 92702
BRIGHT INDUSTRIES INC.
1 Maritime Plaza, San Francisco, Cal 94111
BUCCODE INC.
175 Engineers Dr, Hauppauge, N Y 11787
BURROUGHS CORP. BUSINESS MACHINES GROUP
6071 2nd Ave, Detroit, Mich 48232
CALIFORNIA COMPUTER PRODUCTS INC.
2411 W La Palma Ave, Anaheim, Cal 92801
CALMA CO.
707 Kifer Rd, Sunnyvale, Cal 94086
CIPHER DATA PRODUCTS INC.
7655 Conroy Ct, San Diego, Cal 92111
COOK ELECTRIC CO. DATA-STOR DIV.
6201 W Oakton St, Morton Grove, Ill 60053
DACOM INC.
1060 Morse Ave, Sunnyvale, Cal 94086
DATA RECORDING SYSTEMS SUB. NEWELL IND.
795 Kifer Rd, Sunnyvale, Cal 94086
DATRAN CORP.
179 W Rocks Rd, Norwalk, Conn 06851
DIGI-DATA CORP.
4315 Baltimore Ave, Bladensburg, Md 20710
ELECTRIC COMPUTER CORP.
3707 Rawlins Ste 301, Dallas, Tex 75219
FACIT-ODHNER INC.
501 Winsor Dr, Secaucus, N J 07094
FORD INDUSTRIES INC.
5001 SE Johnson Ck, Portland, Ore 97206
FRIDEN DIV. THE SINGER CO.
97 Humboldt St, Rochester, N Y 14602
GENERAL RADIO CO.
300 Baker Ave, Concord, Mass 01742
GULTON INDUSTRIES INC. COMPUTER SYS. DIV.
13041 Cerise Ave, Hawthorne, Cal 90250
HEWLETT PACKARD CO. MOUNTAIN VIEW DIV.
690 Middlefield Rd, Mtn View, Cal 94040
HONEYWELL INC. TEST INSTRUMENTS DIV.
P O Box 5227, Denver, Colo 80217
IBM CORP./DATA PROCESSING DIV.
1133 Westchester Ave, White Plains, N Y 10604
INCOR CORP.
P O Box 156, Feasterville, Pa 19046
INCRE-DATA CORP.
6401 Acoma Rd SE, Albuquerque, N M 87108
INFOTEC INC.
70 Newton Rd, Plainview, N Y 11803
LEACH CORP. CONTROLS DIV.
717 N Coney Ave, Azusa, Cal 91702
LOCKHEED ELECTRONICS CO. DIV. LOCKHEED ACRFT CORP.
U S Hwy 22, Plainfield, N J 07060
LOGIC SCIENCE INC.
P O Box 10096, San Diego, Cal 92110
MOHAWK DATA SCIENCES CORP.
Palisade St, Herkimer, N Y 13350
MSI DATA CORP.
4751 Holt Ave, Mont Clair, Cal 91763
NEWELL INDUSTRIES
795 Kifer Rd, Sunnyvale, Cal 94086
PERIPHERAL DATA MACHINES INC.
102 New S Rd, Hicksville, N Y 11801
PERIPHERAL EQUIPMENT CORP.
9600 Irondale Ave, Chatsworth, Cal 91311
PRECISION INSTRUMENT CO. UNICON DIV.
3170 Porter Dr, Palo Alto, Cal 94304
RAYMOND ENGINEERING INC./DIV. RAYMOND PREC. INC.
217 Smith St, Middletown, Conn 06457
ROLM CORP.
10300 N Tantau, Cupertino, Cal 95014
SANGAMO ELECTRIC CO.
P O Box 3347, Springfield, Ill 62708

SINGER CO., THE, FRIDEN DIV.
2350 Washington St, San Leandro, Cal 94577
SRC DIV. MOXON INC.
2222 Michelson Dr, Newport Beach, Cal 92664
STORAGE TECHNOLOGY CORP.
P O Box 3524, Boulder, Colo 80303
TALLY CORP.
8301 S 180th St, Kent, Wash 98031
TEAC CORPORATION OF AMERICA TECHNICAL PRODUCTS
2000 Colorado Ave, Santa Monica, Cal 90404
TELECTRO SYSTEMS CORP.
96-18 43rd Ave, Corona, N Y 11368
TELEX COMMUNICATIONS DIV.
9600 Aldrich Ave S, Minneapolis, Minn 55420
TELEX COMPUTER PRODUCTS
6422 E 41st St, Tulsa, Okla 74135
TENNECOMP SYSTEMS INC.
795 Oak Ridge Tpk, Oak Ridge, Tenn 37830
TEXAS INSTRUMENTS INC. DIGITAL SYSTEMS DIV.
P O Box 66027, Houston, Tex 77006
UNIVERSITY COMPUTING CO. DATEL DIV.
1 Tysons Corner Ctr, McLean, Va 22101
WANG COMPUTER PRODUCTS INC.
2000 Stoner Ave, Los Angeles, Cal 90272
WILTEK INC.
59 Danbury Rd, Wilton, Conn 06897

RECORDERS, MICROFILM/MICROFICHE

BETA INSTRUMENT CORP.
20 Ossipee Rd, Newton Upr Fls, Mass 02164
CALIFORNIA COMPUTER PRODUCTS INC.
2411 W La Palma Ave, Anaheim, Cal 92801
CANON U.S.A. INC.
64-10 Queens Blvd, Woodside, N Y 11377
COMPUTER MICRO-IMAGE SYSTEMS INC.
9600 Desoto Ave, Chatsworth, Cal 91311
CONTROL DATA CORP.
8100 34th Ave S, Minneapolis, Minn 55440
CONTROL DATA CORP. TERMINAL SUBSYS.DIV
2401 N Fairview Ave, St Paul, Minn 55113
DASA CORP./CYBER-TRONICS SUB. DASA CORP.
15 Stevens St., Andover, Mass 01810
DIETZGEN CO., EUGENE
2425 N Sheffield, Chicago, Ill 60614
EASTMAN KODAK CO.
343 State St, Rochester, N Y 14650
GORDON ENTERPRISES INC., ALAN
5362 Cahuenga Blvd, N Hollywood, Cal 91601
INFORMATION INTERNATIONAL INC.
12435 W Olympic Blvd, Los Angeles, Cal 90064
INPUT DATA CO. INC.
1187 Valley Rd, Stirling, N J 07980
ITEK CORP.
10 Maguire Rd, Lexington, Mass 02173
3M CO.
3m Center, St Paul, Minn 55101
MICROFORM DATA SYSTEMS INC.
830 Maude Ave, Mountain View, Cal 94040
NCR INDUSTRIA PRODUCTS DIV.
Main And K St, Dayton, Ohio 45409
PERIPHERAL TECHNOLOGY INC.
757 N Pastoria Ave, Sunnyvale, Cal 94086
SEACO COMPUTER-DISPLAY INC.
2826 W Kingsley Rd, Garland, Tex 75040
SEQUENTIAL INFORMATION SYSTEMS INC.
145 Palisade St, Dobbs Ferry, N Y 10522
SINGER LINK DIV.
1077 E Arques, Sunnyvale, Cal 94086
STROMBERG DATAGRAPHIX INC.
P O Box 2449, San Diego, Cal 92112
TRAID CORP., PHOTO INSTRUMENT DIV.
900 Grand Central, Glendale, Cal 91201
UNIVERSITY COMPUTING CO. GRAPHIC SYSTEMS DIV
14761 Califa St, Van Nuys, Cal 91401

RECORDERS, PAPER TAPE

BRISTOL CO., DIV AMERICAN CHAIN & CABLE CO.
Bristol Rd, Waterbury, Conn 06720
DATA GRAPHICS CORP.
8402 Speedway, San Antonio, Tex 78230
ESTERLINE ANGUS DIV., ESTERLINE CORP.
Po Box 24000, Indianapolis, Ind 46224
FACIT-ODHNER INC.
501 Winsor Dr, Secaucus, N J 07094
INSO ELECTRONIC PRODUCTS INC.
77 E Hawthorne Ave, Valley Stream, N Y 11580
VARIFAB INC. SUB. CONDEC CORP.
1700 E Putnam Ave, Old Greenwich, Conn 06880

2 Product Directory

RECORDERS, STRIP CHART

AMPROBE INSTRUMENT DIV. SOS CONSOLIDATED INC.
630 Merrick Rd. Lynbrook, N Y 11563

RECORDING HEADS, MAGNETIC CARD

NORTRONICS CO. INC.
8101 10th Ave W, Minneapolis, Minn 55427

RECORDING HEADS, MAGNETIC DISC

ALPHA DATA INC.
8759 Remmet Ave, Canoga Park, Cal 91304
APPLIED MAGNETICS CORP. MAG. TAPE HEAD DIV.
75 Robin Hill Rd, Goleta, Cal 93017
ARVIN MAGNETICS
6950 Washington Ave S, Eden Prairie, Minn 55343
BURTON MAGNEKOTE INC.
11334 Playa St, Culver City, Cal 90230
CHEMICAL MICRO MILLING CO.
1601 Hylton Rd, Pennsauken, N J 08101
CREATIVE MAGNETICS INC.
210 Blydenburgh Rd, Central Islip, N Y 11722
DATA INDUSTRIES INC.
12624 Daphne, Hawthorne, Cal 90250
DATA MAGNETICS CORP.
355 Maple Ave, Torrance, Cal 90503
DATA PRODUCTS CORP.
16055 Ventura Blvd, Encino, Cal 91316
FERROXCUBE CORP.
Po Box 359, Saugerties, N Y 12477
GENERAL INSTRUMENT CORP. MAGNE-HEAD DIV.
13040 Cerise Ave, Hawthorne, Cal 90250
GOULD INC. BRUSH DIV.
3631 Perkins Ave, Cleveland, Ohio 44114
HONEYWELL INFORMATION SYSTEMS
P O Box 12313, Oklahoma City, Okla 73112
INTERNATIONAL ELECTRO- MAGNETICS INC.
Eric Dr & Cornell Ave, Palatine, Ill 60067
IOMEC INC.
345 Mathew St, Santa Clara, Cal 95050
LIPPS INC.
1630 Euclid St, Santa Monica, Cal 90404
MAGNETIC ARTS CORP.
1310 Industrial Ave, Escondido, Cal 92025
MICHIGAN MAGNETICS DIV. VSI CORP.
203 W Third St, Vermontville, Mich 49096
NORTRONICS CO. INC.
8101 10th Ave W, Minneapolis, Minn 55427
TELECTRO SYSTEMS CORP.
96-18 43rd Ave, Corona, N Y 11368

RECORDING HEADS, MAGNETIC DRUM

APPLIED MAGNETICS CORP. MAG. TAPE HEAD DIV.
75 Robin Hill Rd, Goleta, Cal 93017
ARVIN MAGNETICS
6950 Washington Ave S, Eden Prairie, Minn 55343
BURTON MAGNEKOTE INC.
11334 Playa St, Culver City, Cal 90230
CREATIVE MAGNETICS INC.
210 Blydenburgh Rd, Central Islip, N Y 11722
DATA INDUSTRIES INC.
12624 Daphne, Hawthorne, Cal 90250
DATA MAGNETICS CORP.
355 Maple Ave, Torrance, Cal 90503
DATA PRODUCTS CORP.
16055 Ventura Blvd, Encino, Cal 91316
FERROXCUBE CORP.
Po Box 359, Saugerties, N Y 12477
GENERAL INSTRUMENT CORP. MAGNE-HEAD DIV.
13040 Cerise Ave, Hawthorne, Cal 90250
INTERNATIONAL ELECTRO- MAGNETICS INC.
Eric Dr & Cornell Ave, Palatine, Ill 60067
LIPPS INC.
1630 Euclid St, Santa Monica, Cal 90404
MAGNETIC ARTS CORP.
1310 Industrial Ave, Escondido, Cal 52025
MICHIGAN MAGNETICS DIV. VSI CORP.
203 W Third St, Vermontville, Mich 49096
NORTRONICS CO. INC.
8101 10th Ave W, Minneapolis, Minn 55427
TELECTRO SYSTEMS CORP.
96-18 43rd Ave, Corona, N Y 11368

RECORDING HEADS, MAGNETIC TAPE

APPLIED MAGNETICS CORP. MAG. TAPE HEAD DIV.
75 Robin Hill Rd, Goleta, Cal 93017
ARVIN MAGNETICS
6950 Washington Ave S, Eden Prairie, Minn 55343
CHEMICAL MICRO MILLING CO.
1601 Hylton Rd, Pennsauken, N J 08101
CREATIVE MAGNETICS INC.
210 Blydenburgh Rd, Central Islip, N Y 11722
DATA PRODUCTS CORP.
16055 Ventura Blvd, Encino, Cal 91316
DIAMOND POWER SPECIALTY CORP.
P O Box 415, Lancaster, Ohio 43130
FERROXCUBE CORP.
Po Box 359, Saugerties, N Y 12477
GENERAL INSTRUMENT CORP. MAGNE-HEAD DIV.
13040 Cerise Ave, Hawthorne, Cal 90250
GOULD INC. BRUSH DIV.
3631 Perkins Ave, Cleveland, Ohio 44114
HONEYWELL INFORMATION SYSTEMS
P O Box 12313, Oklahoma City, Okla 73112
INTERNATIONAL ELECTRO- MAGNETICS INC.
Eric Dr & Cornell Ave, Palatine, Ill 60067
LIPPS INC.
1630 Euclid St, Santa Monica, Cal 90404
MAGNUSONIC DEVICES INC.
124 Duffy Ave, Hicksville, N Y 11801
MCA TECHNOLOGY INC. UDAC DIV.
P O Box 36166, Houston, Tex 77035
MICHIGAN MAGNETICS DIV. VSI CORP.
203 W Third St, Vermontville, Mich 49096
NORTON ASSOCIATES INC.
10 Ditomas Court, Copiague, N Y 11726
NORTRONICS CO. INC.
8101 10th Ave W, Minneapolis, Minn 55427
TEAC CORPORATION OF AMERICA TECHNICAL PRODUCTS
2000 Colorado Ave, Santa Monica, Cal 90404
TELECTRO SYSTEMS CORP.
96-18 43rd Ave, Corona, N Y 11368
WESTERN MAGNETICS INC.
1733 Flower St, Glendale, Cal 91201

RECTIFIERS, SILICON CONTROLLED

AMPEREX ELECTRONIC CORP. A NO AMERICAN PHILIPS CO
P O Box 98, Slatersville, R I 02876
BERGEN LABORATORIES INC. SUB. ZYROTROTRON INC.
60 Spruce St, Paterson, N J 07501
CENTRALAB ELECTRONICS, DIV.
5757 N Green Bay, Milwaukee, Wisc 53201
ELCOM ELECTRONICS INC.
200 Allen Blvd, Farmingdale, N Y 11735
ERIE TECHNOLOGICAL PRODUCTS INC.
644 W 12th St, Erie, Pa 16512
FAIRCHILD SEMICONDUCTOR
464 Ellis St, Mt View, Cal 94040
HARVEY INDUSTRIAL DIV.
60 Crossway Pk W, Woodbury Li, N Y 11797
LORAIN PRODUCTS CORP.
1122 F St, Lordin, Ohio 44052
MOTOROLA SEMICONDUCTOR PRODUCTS INC.
5005 E Mc Dowell Rd, Phoenix, Ariz 85008
NUCLEONIC PRODUCTS CO. INC.
6660 Variel Ave, Canoga Park, Cal 91303
POWER/MATE CORP.
514 S River St, Hackensack, N J 07601
RCA CORP. SOLID STATE DIV.
Rte 202, Somerville, N J 08876
SEMICON INC.
10 N Ave, Burlington, Mass 01803
SOLITRON DEVICES INC.
256 Oak Tree Rd, Tappan, N Y 10983
TRANSITRON ELECTRONIC CORP.
168 Albion St, Wakefield, Mass 01880
TRW CAPACITOR DIV. SOLID STATE OPER.
71 Linden St, Lynn, Mass 01905
TRW INC. CAPACITOR DIV.
112 W 1st St, Oeallala, Nev 69153
TRW SEMICONDUCTOR DIV.
14520 Aviation Blvd, Lawndale, Cal 90260
WESTINGHOUSE ELECTRIC CORP.
Westinghouse Bldg, Pittsburgh, Pa 15222

TAKE A HARD LOOK AT A HARD HEAD!

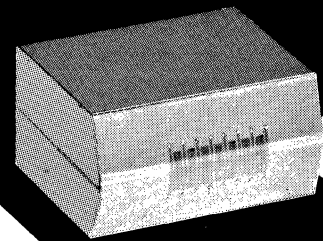
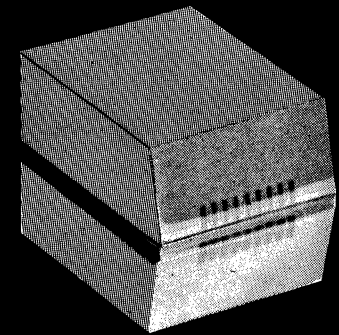

WHY A HARD HEAD?

For greater abrasive resistance, that's why. New materials, plus new techniques enable Creative Magnetics to manufacture the hardest and longest lasting tape heads made.

The Company designs and manufactures Digital Tape Heads to the rigid tolerances required by the computer industry.

CMI will supply prototype heads for engineering evaluation.

For performance and reliability take a hard look at.....



**CREATIVE
MAGNETICS INC.**
Manufacturers of
Digital Magnetic Devices

210 BLYDENBURGH ROAD,
CENTRAL ISLIP, NEW YORK 11722
516 - 234 - 6300 582 - 4481

2 Product Directory

REEL CLIPS AND BELTS, MAGNETIC TAPE

AMPEX CORP. MAGNETIC TAPE DIV.
401 Broadway, Redwood City, Cal 94063
BARRY-WRIGHT CORP. WRIGHT LINE DIV.
160 Gold Star Blvd, Worcester, Mass 01606
COMPUTER ACCESSORIES CO.
131 W 154th St, Gardena, Cal 90248
CTM LEASING CORP.
4924 Hampden Lane, Bethesda, Md 20014
DATA TECHNOLOGY CORP., PLASTRONICS DIV.
1600 Las Plumas Ave, San Jose, Cal 95133
GENERAL KINETICS INC.
11425 Isaac Newt Sq S, Reston, Va 22070
INDEL INC.
P O Box 15800, Tulsa, Okla 74115
MONARCH METAL PRODUCTS INC.
Mac Arthur Ave, New Windsor, N Y 12550
OCHMAN SYSTEMS, EDWARD
Po Box 141, Fairfield, Conn 06430
ORIGINAL COMPUTER PRODUCTS INC.
204 Worcester St, Wellesley Hills, Mass 02181
SYNCOM INC. SHIELDATA DIV.
1914 Colvin Ave, Tonawanda, N Y 14150

REELS, MAGNETIC TAPE

ACRATOD COMPANY
Po Box 66847, Houston, Tex 77006
AMPEX CORP. MAGNETIC TAPE DIV.
401 Broadway, Redwood City, Cal 94063
AUDIO DEVICES INC. A CAPITOL INDUSTRIES CO.
100 Research Dr, Glenbrook, Conn 06906
CERTRON CORP.
1701 State Collg Blvd, Anaheim, Cal 92806
CERTRON CORP. COMPUTER TAPE DIV.
2060 Brentwood St, High Point, N C 27262
COMPUTER ACCESSORIES CO.
131 W 154th St, Gardena, Cal 90248
CORNING GLASS WORKS
Houghton Park, Corning, N Y 14830
CTM LEASING CORP.
4924 Hampden Lane, Bethesda, Md 20014
DATA PACKAGING CORP.
205 Broadway, Cambridge, Mass 02139
DATA TECHNOLOGY CORP., PLASTRONICS DIV.
1600 Las Plumas Ave, San Jose, Cal 95133
DIGITAL EQUIPMENT CORP.
146 Main St, Maynard, Mass 01754
FRIDEN DIV. THE SINGER CO.
97 Humboldt St, Rochester, N Y 14602
GENERAL KINETICS INC.
11425 Isaac Newt Sq S, Reston, Va 22070
HACKETT CORP.
2100 W Fullerton Ave, Chicago, Ill 60647
INDEL INC.
P O Box 15800, Tulsa, Okla 74115
3M CO. MAGNETIC PRODUCTS DIV.
3 M Ctr, St Paul, Minn 55101
MACPANEL CO. ADAMS-MILLIS CORP.
P O Box 5027, High Point, N C 27262
MACS COMPUTER ACCESSORIES INC
104 Park Towne Pl, Philadelphia, Pa 19130
MONARCH METAL PRODUCTS INC.
Mac Arthur Ave, New Windsor, N Y 12550
MORLEY CO., THE
909 Islington St, Portsmouth, N H 03801
NUMERIDEX TAPE SYSTEMS INC.
4711 W North Ave, Chicago, Ill 60639
O. K. DATA SERVICES
P O Box 3001, Darien, Conn 06820
OCHMAN SYSTEMS, EDWARD
Po Box 141, Fairfield, Conn 06430
ORIGINAL COMPUTER PRODUCTS INC.
204 Worcester St, Wellesley Hills, Mass 02181
SYNCOM INC. SHIELDATA DIV.
1914 Colvin Ave, Tonawanda, N Y 14150
U. S. MAGNETIC TAPE CO. WABASH MAGNETICS
P O Box 128, Huntley, Ill 60142
VIRGINIA PANEL CORP.
1400 N Hope Rd, Waynesboro, Va 22980

REELS, PAPER TAPE

ACRATOD COMPANY
Po Box 66847, Houston, Tex 77006
AMPEX CORP. MAGNETIC TAPE DIV.
401 Broadway, Redwood City, Cal 94063
COMPUTER ACCESSORIES CO.
131 W 154th St, Gardena, Cal 90248
COMPUTER ACCESSORIES CORP.
211 New York Ave, Huntington, N Y 11743

CYCLE EQUIPMENT CO.
P O Box 307, Los Gatos, Cal 95030
DATA-LINK CORP.
P O Box 2792, San Diego, Cal 92112
DATA TECHNOLOGY CORP., PLASTRONICS DIV.
1600 Las Plumas Ave, San Jose, Cal 95133
DATASERV DIV., WILLIAM J. PURDY CORP.
770 Airport Blvd, Burlingame, Cal 94010
ENDLESS TAPE REEL CO.
81 Haven St, Reading, Mass 01867
FRIDEN DIV. THE SINGER CO.
97 Humboldt St, Rochester, N Y 14602
NUMERIDEX TAPE SYSTEMS INC.
4711 W North Ave, Chicago, Ill 60639
OCHMAN SYSTEMS, EDWARD
Po Box 141, Fairfield, Conn 06430
ORIGINAL COMPUTER PRODUCTS INC.
204 Worcester St, Wellesley Hills, Mass 02181
PAPER MANUFACTURERS CO.
9800 Bustleton Ave, Philadelphia, Pa 19115
PURDY CORP., WM. J.
770 Airport Blvd, Burlingame, Cal 94010
REMAX ELECTRONICS
5250 W El Segundo Blv, Hawthorne, Cal 90250
SHIRAK TELEMETERING OF AMERICA
8926 Kester Ave, Van Nuys, Cal 91402
VISIBLE COMPUTER SUPPLY CORP.
9865 Derby Ln, Westchester, Ill 60153

REGULATORS, CURRENT

AMPEREX ELECTRONIC CORP. A NO AMERICAN PHILIPS CO
P O Box 98, Slatersville, R I 02876
ANALOGIC CORP.
Audubon Rd, Wakefield, Mass 01880
AUL INSTRUMENT INC.
139-30 34th Rd, Flushing, N Y 11354
CENTRALAB ELECTRONICS, DIV.
5757 N Green Bay, Milwaukee, Wisc 53201
ERA TRANSPAC CORP.
67 Sand Park Rd, Cedar Grove, N J 07009
FAIRCHILD SEMICONDUCTOR
464 Ellis St, Mt View, Cal 94040
GULTON INDUSTRIES INC.
212 Durham Ave, Metuchen, N J 08840
HALMAR ELECTRONICS INC.
1544 W Mound St, Columbus, Ohio 43223
HELIPOT DIV. BECKMAN INSTRUMENTS INC.
2500 Harbor Blvd, Fullerton, Cal 92634
HEXEM INC.
1015 Corporation Way, Palo Alto, Cal 94303
INDUSTRIAL TEST EQUIPMENT CO INC.
20 Beechwood Ave, Pt Washington, N Y 11050
KEPCO INC.
131 38 Sanford Ave, Flushing, N Y 11352
MIDEASTERN INDUSTRIES, INC. DIV. EANCO INC.
P O Box 186, Scotch Plains, N J 07076
MOTOROLA SEMICONDUCTOR PRODUCTS INC.
5005 E Mc Dowell Rd, Phoenix, Ariz 85008
NATIONAL SEMICONDUCTOR CORP.
2900 Semicon Dr, Santa Clara, Cal 95051
OPTICAL ELECTRONICS INC.
P O Box 11140, Tucson, Ariz 85706
POWER COMPONENTS INC.
P O Box 421, Scottsdale, Pa 15683
POWER/MATE CORP.
514 S River St, Hackensack, N J 07601
POWERTEC
9168 Desoto St, Chatsworth, Cal 91311
RHO ENGINEERING CO.
2234 Colby Ave, Los Angeles, Cal 90064
SOLA BASIC INDUSTRIES SOLA ELECTRIC DIV.
1717 Busse Rd, Elk Grove Vllge, Ill 60007
SPACETAC INC.
Burlington Rd, Bedford, Mass 01730
TELEDYNE BROWN ENGINEERING
300 Sparkman Dr, Huntsville, Ala 35807
TROTTE ELECTRONICS INC.
30 Ridgeland Rd, Rochester, N Y 14623
VARO INC. STATIC POWER DIV.
1600 Dallas Pkwy, Plano, Tex 75074
WANLASS ELECTRIC CO.
1815 S Ritohey St, Santa Ana, Cal 92705
WESTINGHOUSE ELECTRIC CORP.
Westinghouse Bldg, Pittsburgh, Pa 15222

REGULATORS, FREQUENCY

BASLER ELECTRIC CO.
Rte 143, Highland, Ill 62249
ELGAR CORP.
8159 Engineer Rd, San Diego, Cal 92111
FAIRCHILD SEMICONDUCTOR
464 Ellis St, Mt View, Cal 94040
LORAIN PRODUCTS CORP.
1122 F St, Lordin, Ohio 44052
MIDEASTERN INDUSTRIES, INC. DIV. EANCO INC.
P O Box 186, Scotch Plains, N J 07076
NYTRONICS INC.
3rd Ave, Alpha, N J 08865
VARO INC. STATIC POWER DIV.
1600 Dallas Pkwy, Plano, Tex 75074
WANLASS ELECTRIC CO.
1815 S Ritohey St, Santa Ana, Cal 92705

REGULATORS, VOLTAGE

ABBOTT TRANSISTOR LABORATORIES INC.
5200 W Jefferson Blvd, Los Angeles, Cal 90016
AMBAC INDUSTRIES INC. WANLASS DIV.
525 Virginia Dr, Ft Washington, Pa 19034
AMPEREX ELECTRONIC CORP. A NO AMERICAN PHILIPS CO
P O Box 98, Slatersville, R I 02876
ANALOGIC CORP.
Audubon Rd, Wakefield, Mass 01880
AUL INSTRUMENT INC.
139-30 34th Rd, Flushing, N Y 11354
BASLER ELECTRIC CO.
Rte 143, Highland, Ill 62249
BECKMAN INSTRUMENTS INC. HELIPOT DIV.
Fullerton, Cal 92634
BERTAN ASSOCIATES INC.
15 Newtown Rd, Plainview, N Y 11803
CALIFORNIA INSTRUMENTS CO.
5150 Convoy St, San Diego, Cal 92111
CAL POWER CORP.
140 Kansas St, El Segundo, Cal 90245
CENTRALAB ELECTRONICS, DIV.
5757 N Green Bay, Milwaukee, Wisc 53201
CENTRALAB SEMICONDUCTOR GLOBE-UNION INC.
4501 N Arden Dr, El Monte, Cal 91734
COMPUTER DIODE CORP.
Pollitt Dr S, Fair Lawn, N J 07410
COMPUTER LOGIC CORP.
1528 20th St, Santa Monica, Cal 90404
CTS CORP.
905 NW Blvd, Elkart, Ind 46514
DATA DISPLAY SYSTEMS INC.
139 Terwood Rd, Willow Grove, Pa 19090
DICKSON ELECTRONICS CORP.
P O Box 1390, Scottsdale, Ariz 85252
ELASCO EASTERN INC.
5 Northwood Rd, Bloomfield, Conn 06002
ELGAR CORP.
8159 Engineer Rd, San Diego, Cal 92111
ERA TRANSPAC CORP.
67 Sand Park Rd, Cedar Grove, N J 07009
FAIRCHILD SEMICONDUCTOR
464 Ellis St, Mt View, Cal 94040
GENERAL RADIO CO.
300 Baker Ave, Concord, Mass 01742
GULTON INDUSTRIES INC.
212 Durham Ave, Metuchen, N J 08840
HALMAR ELECTRONICS INC.
1544 W Mound St, Columbus, Ohio 43223
HELIPOT DIV. BECKMAN INSTRUMENTS INC.
2500 Harbor Blvd, Fullerton, Cal 92634
INDUSTRIAL TEST EQUIPMENT CO INC.
20 Beechwood Ave, Pt Washington, N Y 11050
INSTRULAB INC.
1205 Lamar St, Dayton, Ohio 45404
KEPCO INC.
131 38 Sanford Ave, Flushing, N Y 11352
LITTON SYSTEMS INC. DATA SYSTEMS DIV.
8000 Woodley Ave, Van Nuys, Cal 91409
LORAIN PRODUCTS CORP.
1122 F St, Lordin, Ohio 44052
METRIC ENGINEERING DIV. GREENRAY INDUS. INC
P O Box 290, Mechanicsburg, Pa 17055
MOTOROLA SEMICONDUCTOR PRODUCTS INC.
5005 E Mc Dowell Rd, Phoenix, Ariz 85008
NATIONAL SEMICONDUCTOR CORP.
2900 Semicon Dr, Santa Clara, Cal 95051
NYTRONICS INC.
3rd Ave, Alpha, N J 08865
OPTICAL ELECTRONICS INC.
P O Box 11140, Tucson, Ariz 85706
PEERLESS ELECTRICAL PRODUCTS DIV.
1515 S Manchester Ave, Anaheim, Cal 92803

2 Product Directory

POWER COMPONENTS INC.
P O Box 421, Scottdale, Pa 15683
POWER/MATE CORP.
514 S River St, Hackensack, N J 07601
POWERTEC
9168 Desoto St, Chatsworth, Cal 91311
RAYTHEON CO. INDUSTRIAL COMPONENT
OPERATION
465 Centre St., Quincy, Mass 02169
RAYTHEON COMPANY, SORENSEN OPERATION
676 Island Pond, Manchester, N H 03103
RHO ENGINEERING CO.
2234 Colby Ave, Los Angeles, Cal 90064
SIGNETICS CORP. SUB. CORNING GLASS
811 E Arques Ave, Sunnyvale, Cal 94086
SILICON GENERAL INC.
7382 Bolsa Ave, Westminster, Cal 92683
SOLA BASIC INDUSTRIES SOLA ELECTRIC DIV.
1717 Busse Rd, Elk Grove Village, Ill 60007
SOLITRON DEVICES INC.
256 Oak Tree Rd, Tappan, N Y 10983
SOLITRON DEVICES INC. TRANSISTOR DIV.
1177 Blue Heron Blvd, Riviera Beach, Fla 33404
SPACETAC INC.
Burlington Rd, Bedford, Mass 01730
TECHNIPOWER INC. SUB. BENRUS CORP.
Benrus Center, Ridgefield, Conn 06877
TELEDYNE PHILBRICK NEXUS
Allied Dr At Rte 128, Dedham, Mass 02026
TRANSITRON ELECTRONIC CORP.
168 Albion St, Wakefield, Mass 01880
TRIO LABORATORIES INC.
80 Dupont St, Plainview, N Y 11803
TROTT ELECTRONICS INC.
30 Ridgeland Rd, Rochester, N Y 14623
VARO INC. STATIC POWER DIV.
1600 Dallas Pkwy, Plano, Tex 75074
VICTOREEN INSTRUMENT CO.
10101 Woodlawn Ave, Cleveland, Ohio 44104
WANLASS ELECTRIC CO.
1815 S Ritohey St, Santa Ana, Cal 92705
WESTINGHOUSE ELECTRIC CORP.
Westinghouse Bldg, Pittsburgh, Pa 15222

RELAYS, DRY REED (COMPUTER GRADE)

ADAMS & WESTLAKE, SUB. ALLIED PRODUCTS
1025 N Michigan, Elkhart, Ind 46514
ALLEN-BRADLEY
1201 S 2nd St, Milwaukee, Wisc 53204
ALLIED CONTROL CO. INC.
100 Relay Rd, Plantsville, Conn 60479
ASTRO-SPACE LABS., INC.
110 Wynn Drive NW, Huntsville, Ala 35806
BABCOCK ELECTRONICS CORP.
3501 Harbor Blvd, Costa Mesa, Cal 92626
COMPAC ENGINEERING INC.
845 Commercial St, San Jose, Cal 95112
COMPUTER COMPONENTS INC.
88-06 Van Wyck Expwy, Jamaica, N Y 11418
COMPUTER PRODUCTS, INC.
P O Box 23849, Ft Lauderdale, Fla 33307
ELEC-TROL INC.
21018 Soledad Canyon, Saugus, Cal 91350
ELECTRONIC CONTROLS INC. T-BAR SWITCHING TECH
DIV.
141 Danbury Rd, Milton, Conn 06897
ESSEX WIRE & CABLE CO.
1601 Wall St, Ft Wayne, Ind 46804
FIFTH DIMENSION INC.
P O Box 483, Princeton, N J 08540
FREDERICK CONTROLS DIV., SUB. NO. AM. PHILIPS
CORP.
E Church & Second Sts, Frederick, Md 21701
FROST ELECTRONICS CORP.
Pearl St, Caryville, Mass 02024
GORDOS CORP.
250 Glenwood Ave, Bloomfield, N J 07003
GRIGSBY BARTON INC.
3800 Industrial Pkwy, Rolling Meadows, Ill 60008
HARVEY INDUSTRIAL DIV.
60 Crossway Pk W, Woodbury Li, N Y 11797
HATHAWAY INSTRUMENTS INC.
5250 E Evans Ave, Denver, Colo 80120
INRESCO INC.
503 Adamston Rd, Bricktown, N J 08723
INTERNATIONAL CONTROLS CORP.
200 Fairfield Rd, Fairfield, N J 07006
JAMES ELECTRONICS INC.
4050 N Rockwell St, Chicago, Ill 60618
KRATOS PRECISION PRODUCTS
11161 W Pico Blvd, Los Angeles, Cal 90064

LIBERTY LEASING CO., LIBERTY CONTROLS DIV.
R F D 5, Joliet, Ill 60431
MAGNECRAFT ELECTRIC CO.
5575 N Lynch Ave, Chicago, Ill 60630
MASTER ELECTRONIC CONTROLS
1553 17 St, Santa Monica, Cal 90404
NEW PRODUCT ENGINEERING
1 St & Webster St, Wabash, Ind 46992
NO. AMERICAN PHILIPS CORP. FREDERICK CONT. DIV.
Frederick, Md 21701
NORTH AMERICAN ROCKWELL CORP. AUTONETICS
DIV.
3370 Miraloma Ave, Anaheim, Cal 92803
POTTER & BRUMFIELD DIV. OF AMF INC.
1200 E Broadway, Princeton, Ind 47570
PRECISION PRODUCTS DIV. OF KRATOS
11161 W Pico Blvd, Los Angeles, Cal 90064
SELF-ORGANIZING SYSTEMS INC.
P O Box 9918, Dallas, Tex 75214
SIGMA INSTRUMENTS INC.
170 Pearl St, Braintree, Mass 02185
SOLID STATE ELECTRONICS CORP.
15321 Rayen St, Sepulveda, Cal 91343
STRUTHER-DUNN INC. SYSTEMS DIV.
1114 State St, Bettendorf, Iowa 52722
THERMOSEN INC.
375 Fairfield Ave, Stamford, Conn 06904
TROMPETER ELECTRONICS INC.
8936 Comanche Ave, Chatsworth, Cal 91311
UNIVERSAL RELAY CORP.
42 White St, New York, N Y 10013
WHEELLOCK SIGNALS INC.
273 Branchport Ave, Long Beach, N J 07740

RELAYS, MERCURY WETTED (COMPUTER GRADE)

ADAMS & WESTLAKE, SUB. ALLIED PRODUCTS
1025 N Michigan, Elkhart, Ind 46514
ALLIED CONTROL CO. INC.
100 Relay Rd, Plantsville, Conn 60479
BABCOCK ELECTRONICS CORP.
3501 Harbor Blvd, Costa Mesa, Cal 92626
COMPAC ENGINEERING INC.
845 Commercial St, San Jose, Cal 95112
COMPUTER COMPONENTS INC.
88-06 Van Wyck Expwy, Jamaica, N Y 11418
COMPUTER PRODUCTS, INC.
P O Box 23849, Ft Lauderdale, Fla 33307
ELEC-TROL INC.
21018 Soledad Canyon, Saugus, Cal 91350
FIFTH DIMENSION INC.
P O Box 483, Princeton, N J 08540
FROST ELECTRONICS CORP.
Pearl St, Caryville, Mass 02024
GORDOS CORP.
250 Glenwood Ave, Bloomfield, N J 07003
GRIGSBY BARTON INC.
3800 Industrial Pkwy, Rolling Meadows, Ill 60008
HARVEY INDUSTRIAL DIV.
60 Crossway Pk W, Woodbury Li, N Y 11797
HATHAWAY INSTRUMENTS INC.
5250 E Evans Ave, Denver, Colo 80120
INTERNATIONAL CONTROLS CORP.
200 Fairfield Rd, Fairfield, N J 07006
JAMES ELECTRONICS INC.
4050 N Rockwell St, Chicago, Ill 60618
KRATOS PRECISION PRODUCTS
11161 W Pico Blvd, Los Angeles, Cal 90064
MAGNECRAFT ELECTRIC CO.
5575 N Lynch Ave, Chicago, Ill 60630
NEW PRODUCT ENGINEERING
1 St & Webster St, Wabash, Ind 46992
POTTER & BRUMFIELD DIV. OF AMF INC.
1200 E Broadway, Princeton, Ind 47570
PRECISION PRODUCTS DIV. OF KRATOS
11161 W Pico Blvd, Los Angeles, Cal 90064
SELF-ORGANIZING SYSTEMS INC.
P O Box 9918, Dallas, Tex 75214
STRUTHER-DUNN INC. SYSTEMS DIV.
1114 State St, Bettendorf, Iowa 52722
TROMPETER ELECTRONICS INC.
8936 Comanche Ave, Chatsworth, Cal 91311
UNIVERSAL RELAY CORP.
42 White St, New York, N Y 10013
WHEELLOCK SIGNALS INC.
273 Branchport Ave, Long Beach, N J 07740

RELAYS, SOLID-STATE (COMPUTER GRADE)

A. W. HAYDON CO., THE
232 N Elm St, Waterbury, Conn 06720
ADAMS & WESTLAKE, SUB. ALLIED PRODUCTS
1025 N Michigan, Elkhart, Ind 46514
ARTISAN ELECTRONICS CORP.
5 Eastman Rd, Parsippany, N J 07054
AUTRONICS CORP.
180 N Vinedo Ave, Pasadena, Cal 91107
BULOVA WATCH ELECTRONICS DIV.
6120 Woodside Ave, Woodside Li, N Y 11377
COMPUTER PRODUCTS, INC.
P O Box 23849, Ft Lauderdale, Fla 33307
DATA PRODUCTS TELECOMMUNICATIONS
17 Amelia Place, Stamford, Conn 06902
ESSEX WIRE & CABLE CO.
1601 Wall St, Ft Wayne, Ind 46804
GRIGSBY BARTON INC.
3800 Industrial Pkwy, Rolling Meadows, Ill 60008
GUARDIAN ELECTRIC MANUFACTURING CO.
1550 W Carroll Ave, Chicago, Ill 60607
HAMLIN ELECTRONICS INC.
3066 W Clarendon, Phoenix, Ariz 85017
HART-ADVANCE RELAY DIV. OAK ELECTRO-NETICS
CORP.
Crystal Lake, Ill 60014
HARVEY INDUSTRIAL DIV.
60 Crossway Pk W, Woodbury Li, N Y 11797
HI-G INC.
580 Spring St, Windsor Locks, Conn 06096
INTEGRAL DATA DEVICES INC.
35 Orville Dr, Bohemia, N Y 11716
INTERNATIONAL CONTROLS CORP.
200 Fairfield Rd, Fairfield, N J 07006
JAMES ELECTRONICS INC.
4050 N Rockwell St, Chicago, Ill 60618
LIBERTY LEASING CO., LIBERTY CONTROLS DIV.
R F D 5, Joliet, Ill 60431
LOGITEK INC.
42 Central Dr, Farmingdale, N Y 11735
MAG-CON ENGINEERING CO.
85 Richardson St SE, St Paul, Minn 55112
MAGNECRAFT ELECTRIC CO.
5575 N Lynch Ave, Chicago, Ill 60630
MASTER ELECTRONIC CONTROLS
1553 17 St, Santa Monica, Cal 90404
MULTIPLEX COMMUNICATIONS INC.
123 Marcus Blvd, Hauppauge, N Y 11787
NATIONAL SEMICONDUCTOR CORP.
2900 Semicon Dr, Santa Clara, Cal 95051
NEW PRODUCT ENGINEERING
1 St & Webster St, Wabash, Ind 46992
NO. AMERICAN PHILIPS CORP. FREDERICK CONT. DIV.
Frederick, Md 21701
NUCLEONIC PRODUCTS CO. INC.
6660 Variel Ave, Canoga Park, Cal 91303
OHMITE MANUFACTURING CO.
3601 Howard St, Skokie, Ill 60076
OKI ELECTRIC INDUSTRIES CO. LTD.
875 Ave of Americas, New York, N Y 10001
POTTER & BRUMFIELD DIV. OF AMF INC.
1200 E Broadway, Princeton, Ind 47570
RHO ENGINEERING CO.
2234 Colby Ave, Los Angeles, Cal 90064
ROWAN CONTROLLER INC.
P O Box 306, Westminster, Md 21157
SELF-ORGANIZING SYSTEMS INC.
P O Box 9918, Dallas, Tex 75214
SIGMA INSTRUMENTS INC.
170 Pearl St, Braintree, Mass 02185
SOLID STATE ELECTRONICS CORP.
15321 Rayen St, Sepulveda, Cal 91343
STRUTHER-DUNN INC. SYSTEMS DIV.
1114 State St, Bettendorf, Iowa 52722
TELEDYNE CRYSTALONICS
147 Sherman St, Cambridge, Mass 02140
TELEDYNE RELAYS
3155 W El Segundo Blv, Hawthorne, Cal 90250
TEMPO INSTRUMENT DIV. ALLEN ELECTRIC & EQUIP.
CO.
9135 Independence Ave, Chatsworth, Cal 91311
TEXAS INSTRUMENTS INC. CONTROLS DIV.
34 Forest St, Attleboro, Mass 02703
TREPAC CORP. OF AMERICA
30 W Hamilton Ave, Englewood, N J 07631
UNIVERSAL RELAY CORP.
42 White St, New York, N Y 10013
VECTROL INC.
1010 Westmore Ave, Rockville, Md 20850

2 Product Directory

REMOTE JOB ENTRY TERMINALS (SEE DATA TERMINALS)

REMOTE TERMINAL MULTIPLEXERS (SEE MULTIPLEXERS)

REPRODUCERS, PAPER TAPE (AUTOMATIC)

FRIDEN DIV. THE SINGER CO.
97 Humboldt St, Rochester, N Y 14602
INDUSTRIAL TIMER DIV., THE SINGER CO.
Us Hwy 287, Parsippany, N J 07054
OHRTRONICS INC., SUB MOHAWK DATA SCIENCES CORP.
P O Box 406, King of Prussia, Pa 19406
TELECTRO SYSTEMS CORP.
96-18 43rd Ave, Corona, N Y 11368

REPRODUCERS, PUNCHED CARD (AUTOMATIC)

ABINGTON KEYPUNCH INC.
920 Fox Chase Rd, Rockledge, Pa 19111
CUSTOM DATA PROCESSING SERVICES
P O Box 14685, Phoenix, Ariz 85031
DATA PROCESSING AND ACCOUNTING SERVICES
50 Van Ness Ave, San Francisco, Cal 94102
DECISION DATA CORP.
300 Jacksonville Rd, Warminster, Penn 18974
DYNAMIC ACCESS CORP.
220 Park Ave S, New York, N Y 10003
MAI EQUIPMENT CORP.
300 E 44th St, New York, N Y 10017
REN ELECTRONICS
775 New Ludlow Rd, So Hadley, Mass 01075

RESISTORS, PRECISION

AIRCO SPEER ELECTRONICS, DIV. OF AIR REDUCTION CO
800 Theresia St, St Marys, Pa 15857
AMERICAN COMPONENTS INC.
8th Ave And Harry St, Conshohocken, Pa 19428
DALE ELECTRONICS INC. SUB. LIONEL CORP.
1360 28th Ave, Columbus, Nebr 68601
JORDAN ELECTRIC CO.
14707 Keswick St, Van Nuys, Cal 91405
KELVIN
5919 Noble Ave, Van Nuys, Cal 91401
LTV ELECTROSYSTEMS INC. MEMCOR DIV.
1320 Flaxmill Rd, Huntington, Ind 46750
OMTRONICS MANUFACTURING INC.
2406 Leavenworth St, Omaha, Nebr 68105
RCL ELECTRONICS INC.
700 S 21 St, Irvington, N J 07111
TEL LABS INC.
1050 2nd St, Manchester, N H 03102
VISHAY RESISTOR PRODUCTS INC.
63 Lincoln Hwy, Malvern, Pa 19355

RETRIEVAL UNITS, PUNCHED CARD (RANDOM ACCESS)

MOHAWK INDUSTRIAL LABORATORIES INC.
1 Ward St, Vernon, N Y 13476
RANDOMATIC DATA SYSTEMS INC.
344 W State St, Trenton, N J 08618
STINAFFS INC.
181 E Exchange St, Akron, Ohio 44304

RIBBON CABLE (SEE CABLE)

RIBBONS, INK (FOR PRINTERS AND TAB EQUIPMENT)

ACRATOD COMPANY
Po Box 66847, Houston, Tex 77006
ADDRESSOGRAPH MULTIGRAPH CORP BRUNING DIV.
1200 Babbitt Rd, Cleveland, Ohio 44117
ADVANCED COMPUTER SUPPLIES INC.
Bldg 529 Raritan Ctr, Edison, N J 08817
AETNA PRODUCTS CO., INC.
11 Commercial St, Hicksville, N Y 11802
BURROUGHS CORP. BUSINESS MACHINES GROUP
6071 2nd Ave, Detroit, Mich 48232

BUSINESS SUPPLIES CORP. OF AMERICA
475 5th Ave, New York, N Y 10017
CLOPAY CORP. COPYING PROD. DIV.
417 E 7th St, Cincinnati, Ohio 45202
CODO MANUFACTURING CO. INC. DIV. BEMIS CO. INC.
P O Box 36, Leetsdale, Pa 15056
COLUMBIA GREAT LAKES CORP.
Po Box 945, Dayton, Ohio 45401
COLUMBIA RIBBON & CARBON MFG. CO. INC.
Herb Hill Rd, Glen Cove, N Y 11542
COMPUTER ACCESSORIES CO.
131 W 154th St, Gardena, Cal 90248
COPYING PRODUCTS DIV., CLOPAY CORP.
417 E Seventh St, Cincinnati, Ohio 45201
CTM LEASING CORP.
4924 Hampden Lane, Bethesda, Md 20814
DATA DEVICES INC. SUB. DATA PROD. CORP
18360 Topham St, Tarzana, Cal 91356
DATA DOCUMENTS INC.
105 S 70th St, Omaha, Nebr 68132
FRANKLIN RIBBON & CARBON CO., INC.
225 Charlotte Ave, Hicksville, N Y 11802
FRIDEN DIV. THE SINGER CO.
97 Humboldt St, Rochester, N Y 14602
HACKETT CORP.
2100 W Fullerton Ave, Chicago, Ill 60647
JERSEY TAB CARD CORP.
649 Rahway Ave, Union, N J 07083
MACS COMPUTER ACCESSORIES INC
104 Park Towne Pl, Philadelphia, Pa 19130
MORLEY CO., THE
909 Islington St, Portsmouth, N H 03801
NUMERIDEX TAPE SYSTEMS INC.
4711 W North Ave, Chicago, Ill 60639
OCHMAN SYSTEMS, EDWARD
Po Box 141, Fairfield, Conn 06430
OLD TOWN CORP.
750 Pacific St, Brooklyn, N Y 11238
OLIVETTI CORP. OF AMERICA
500 Park Ave, New York, N Y 10016
ORIGINAL COMPUTER PRODUCTS INC.
204 Worcester St, Wellesley Hills, Mass 02181
PAPER MANUFACTURERS CO.
9800 Bustleton Ave, Philadelphia, Pa 19115
PRYOR COMPUTER INDUSTRIES
400 N Michigan Ave, Chicago, Ill 60611
SHIRAK TELEMETERING OF AMERICA
8926 Kester Ave, Van Nuys, Cal 91402
SINGER CO., THE, FRIDEN DIV.
2350 Washington St, San Leandro, Cal 94577
VISIBLE COMPUTER SUPPLY CORP.
9865 Derby Ln, Westchester, Ill 60153
WHITE INC.
178 Wade St, Bridgeport, Conn 06601

SAFES, MAGNETIC TAPE STORAGE

ACRATOD COMPANY
Po Box 66847, Houston, Tex 77006
BARRY-WRIGHT CORP. WRIGHT LINE DIV.
160 Gold Star Blvd, Worcester, Mass 01606
COMPUTER ACCESSORIES CO.
131 W 154th St, Gardena, Cal 90248
DIEBOLD INC.
818 Mulberry Rd SE, Canton, Ohio 44702
ECCO BUSINESS SYSTEMS INC.
50 E 42nd St, New York, N Y 10017
INTERNATIONAL COMPUTER APPLIANCES CORP.
200 N Third St, Minneapolis, Minn 55401
MACS COMPUTER ACCESSORIES INC
104 Park Towne Pl, Philadelphia, Pa 19130
MOSLER SAFE CO., THE INFO. SYS. DIV.
1561 Grand Blvd., Hamilton, Ohio 45012
OCHMAN SYSTEMS, EDWARD
Po Box 141, Fairfield, Conn 06430
ORIGINAL COMPUTER PRODUCTS INC.
204 Worcester St, Wellesley Hills, Mass 02181
PERFECTION MICA CO. MAGNETIC SHIELD DIV
748 Thomas Dr, Bensenville, Ill 60106
REMINGTON RAND OFFICE SYSTEMS DIV. SPERRY RAND
P O Box 171, Marietta, Ohio 45750
SCHWAB SAFE CO. INC.
3000 Main St, Lafayette, Ind 47902
SHAW-WALKER CO.
P O Box 208, Muskegon, Mich 49443
STINAFFS INC.
181 E Exchange St, Akron, Ohio 44304

SCAN CONVERTER (SEE CONVERTERS)

SCANNERS, IMAGE

ADDRESSOGRAPH MULTIGRAPH CORP BRUNING DIV.
1200 Babbitt Rd, Cleveland, Ohio 44117
ALDEN ELECTRONIC & IMPULSE RECORDING EQUIP. CO
Washington St, Westboro, Mass 01581
BENDIX MOSAIC FABRICATIONS DIV.
Galileo Park, Sturbridge, Mass 01518
COMPUTER MICRO-IMAGE SYSTEMS INC.
9600 Desoto Ave, Chatsworth, Cal 91311
COMPUTER SYSTEMS FOR MEDICINE INC.
340 Longwood Ave, Boston, Mass 02115
DATA DISC INC.
686 W Maude Ave, Sunnyvale, Cal 94086
EDGERTON GERMESHAUSEN GRIER INC.
Crosby Dr, Bedford, Mass 01730
FARRINGTON MANUFACTURING CO.
6707 Electronics Dr, Springfield, Va 22151
GENERAL DEVICES INC.
P O Box 253, Princeton, N J 08540
SINGER LINK DIV.
1077 E Arques, Sunnyvale, Cal 94086
SKAN-A-MATIC CORP.
P O Drawer 68, Skaneateles, N Y 13152

SCANNERS, INPUT

A.D. DATA SYSTEMS INC.
830 Linden Ave, Rochester, N Y 14625
ALDEN ELECTRONIC & IMPULSE RECORDING EQUIP. CO
Washington St, Westboro, Mass 01581
AMERICAN COMPUTER TECHNOLOGY INC.
8740 Shirley Ave, Northridge, Cal 91324
AMP INC., SYSCOM DIV.
P O Box 3608, Harrisburg, Pa 17105
APPLIED COMPUTER SYSTEMS INC.
P O Box 6479, Austin, Tex 78702
AUSTRON, INC.
10214 N Interregional, Austin, Tex 78753
BECKMAN INSTRUMENTS INC. ELECT. INSTR. DIV.
2200 Wright Ave, Richmond, Cal 94804
BFA CORP.
1309 S Inca, Denver, Colo 80223
CLARE SYSTEMS DIV. C.P. CLARE & CO.
3101 W Pratt Ave, Chicago, Ill 60645
COMPUDYNE CORP. CONTROLS DIV.
P O Box 247, Hatboro, Pa 19040
COMPUTER MICRO-IMAGE SYSTEMS INC.
9600 Desoto Ave, Chatsworth, Cal 91311
COMPUTER PRODUCTS, INC.
P O Box 23849, Ft Lauderdale, Fla 33307
DIGITAL AUTOMATION CO, INC.
1018 Whitehead Rd Ext, Trenton, N J 08638
DIGITAL PRODUCTS CORP.
6950 NW 12 Ave, Ft Lauderdale, Fla 33309
DIGITRON CORP.
2544 W Main St, Norristown, Pa 19401
DOLAN JENNER INDUSTRIES INC.
200 Ingall Court, Melrose, Mass 02176
DYNAMIC SYSTEM ELECTRONICS
1040 W Alameda Dr, Tempe, Ariz 85281
EDGERTON GERMESHAUSEN GRIER INC.
Crosby Dr, Bedford, Mass 01730
ELBIT COMPUTERS/SUB. CONTROL DATA CORP.
6 Tovim St, Haifa, ISRAEL
ELECTRONIC MODULES CORP.
P O Box 141, Timonium, Md 21093
ELECTRONIC RESEARCH CO., A TEXTRON CO.
10000 W 75th St, Shawnee Mission, Kan 66202
FARRINGTON MANUFACTURING CO.
6707 Electronics Dr, Springfield, Va 22151
GENERAL DEVICES INC.
P O Box 253, Princeton, N J 08540
GENERAL RADIO CO.
300 Baker Ave, Concord, Mass 01742
HEWLETT PACKARD CO.
1501 Page Mill Rd, Palo Alto, Cal 94304
INTEGRAL DATA DEVICES INC.
35 Orville Dr, Bohemia, N Y 11716
KAYE INSTRUMENTS INC.
737 Concord Ave, Cambridge, Mass 02138
LARSE CORP.
1070 E Meadow Cir, Palo Alto, Cal 94303
MASSEY DICKINSON CO. INC.
9 Elm St, Saxonville, Mass 01701
METRIC SYSTEMS CORP.
736 N Beal St, Ft Walton Beach, Fla 32548

2 Product Directory

MICRODATA CORP.
644 E Young St, Santa Ana, Cal 92705
NIGITRON CORP.
2544 W Main St, Norristown, Pa 19401
NON-LINEAR SYSTEMS INC.
P O Box N, Del Mar, Cal 92014
RAMSAY ENGINEERING CO.
707 N Anaheim Blvd, Anaheim, Cal 92805
RC-95 INC.
2 Westchester Plaza, Elmsford, N Y 10523
REO DATA PRODUCTS INC.
7346 Bolsa Ave, Westminster, Cal 92683
SAGETEC CORP.
9177 Kelvin Ave, Chatsworth, Cal 91311
SINGER LINK DIV.
1077 E Arques, Sunnyvale, Cal 94086
TREPAC CORP. OF AMERICA
30 W Hamilton Ave, Englewood, N J 07631
UNICOMP INC.
18219 Parthenia, Northridge, Cal 91324

SCANNERS, FACSIMILE

ADDRESSOGRAPH MULTIGRAPH CORP BRUNING DIV.
1200 Babbitt Rd, Cleveland, Ohio 44117
ALDEN ELECTRONIC & IMPULSE RECORDING EQUIP. CO
Washington St, Westboro, Mass 01581
COLORADO VIDEO INC.
P O Box 928, Boulder, Colo 80302
DACOM INC.
1060 Morse Ave, Sunnyvale, Cal 94086
DATA DISC INC.
686 W Maude Ave, Sunnyvale, Cal 94086
DATA PATHING INC.
370 San Aleso Ave, Sunnyvale, Cal 94086
EDGERTON GERMESHAUSEN GRIER INC.
Crosby Dr, Bedford, Mass 01730
KDI INTERACTIVE DATA SYSTEMS
17785 SkyPark Circle, Irvine, Cal 92664
NATIONAL MIDCO INDUSTRIES INC.
Box 5433, Trenton, N J 08638
STEWART WARNER CORP./DATAFAH
1300 N Kostner Ave, Chicago, Ill 60651
TEL AUTOGRAPH CORP.
8700 Bellanca Ave, Los Angeles, Cal 90045

SCANNERS, OPTICAL

ADDRESSOGRAPH MULTIGRAPH CORP BRUNING DIV.
1200 Babbitt Rd, Cleveland, Ohio 44117
ALDEN ELECTRONIC & IMPULSE RECORDING EQUIP. CO
Washington St, Westboro, Mass 01581
ANDERSEN LABS
Blue Hills Ave, Bloomfield, Conn 06002
AUDAC CORP.
175 Bedford St, Burlington, Mass 01803
BASIC COMPUTING ARTS INC.
2680 E Bayside Frtge, Mt View, Cal 94040
BENDIX MOSAIC FABRICATIONS DIV.
Galileo Park, Sturbridge, Mass 01518
BOURNS INC.
1200 Columbia Ave., Riverside, Cal 92507
BULOVA WATCH ELECTRONICS DIV.
6120 Woodside Ave, Woodside Li, N Y 11377
CHEMICAL MICRO MILLING CO.
1601 Hylton Rd, Pennsauken, N J 08101
CINCINNATI TIME RECORDER CO.
1733 Central Ave, Cincinnati, Ohio 45214
COGNITRONICS CORP.
333 Bedford Rd, Mt Kisco, N Y 10549
COMPUSCAN INC.
125 Ft Lee Rd, Leonia, N J 07605
COMPUTER IDENTICS CORP.
S W Park, Westwood, Mass 02090
COMPUTER MICRO-IMAGE SYSTEMS INC.
9600 Desoto Ave, Chatsworth, Cal 91311
COMPUTER SYSTEMS FOR MEDICINE INC.
340 Longwood Ave, Boston, Mass 02115
CONTROL LOGIC INC.
3 Strathmore Rd, Natick, Mass 01760
CUMMINS-CHICAGO CORP.
4740 Ravenswood Ave, Chicago, Ill 60640
DATATYPE CORP.
1050 NW 163rd Dr, Miami, Fla 33169
DECITRON COMMUNICATION SYSTEMS INC.
567 E 105 St, Brooklyn, N Y 11236
DOLAN JENNER INDUSTRIES INC.
200 Ingall Court, Melrose, Mass 02176
ELECTRONIC MICRO SYSTEMS INC.
1672 Kaiser Ave, Santa Ana, Cal 92705
FARRINGTON MANUFACTURING CO.
6707 Electronics Dr, Springfield, Va 22151

FERRANTI PACKARD LTD., ELECTRONICS DIV.
121 Industry St, Toronto 15, CANADA
FIBER PHOTICS INC.
2557 Soquel Dr, Santa Cruz, Cal 95060
FLEXI-OPTICS LABORATORY INC.
269 Mechanic St, Marlboro, Mass 01752
INFORMATION INTERNATIONAL INC.
12435 W Olympic Blvd, Los Angeles, Cal 90064
INFOTON INC.
2nd Ave, Burlington, Mass 01803
LITTON SYSTEMS INC. DATA SYSTEMS DIV.
8000 Woodley Ave, Van Nuys, Cal 91409
MONARCH MARKING SYSTEMS SUB. PITNEY-BOWES
Byers Rd, Dayton, Ohio 45401
NATIONAL COMPUTER SYSTEMS
4401 W 76th St, Minneapolis, Minn 55435
NCR INDUSTRIAL PRODUCTS DIV.
Main And K St, Dayton, Ohio 45409
OPTICAL SCANNING CORP.
P O Box 40, Newton, Pa 18940
RCA GRAPHIC SYSTEMS DIV.
Rte 130, Dayton, N J 08810
REPUBLIC INFORMATION SYSTEMS INC.
9732 Cozycroft Ave, Chatsworth, Cal 91311
RESALAB INC. RESALAB SCIENTIFIC DIV.
4000 Campbell Ave, Menlo Park, Cal 94025
SCAN-DATA CORP.
800 E Main St, Norristown, Pa 19401
SCAN-OPTICS INC.
22 Prestige Park, E Hartford, Conn 06108
SINGER LINK DIV.
1077 E Arques, Sunnyvale, Cal 94086
SKAN-A-MATIC CORP.
P O Drawer 68, Skaneateles, N Y 13152
TRANSITEL, DIV. OF SANGAMO ELECTRIC CO.
P O Box 7255, Denver, Colo 80207

SERVICES, COMPUTER-AIDED DESIGN

ACADEMY COMPUTING CORP.
5005 N Lincoln Blvd, Oklahoma City, Okla 73105
AMERICAN COMPUTER SERVICES CORP.
14 E 4th St, Cincinnati, Ohio 45202
AMERICAN COMPUTER TECHNOLOGY INC.
8740 Shirley Ave, Northridge, Cal 91324
ANDROCOR INC.
5949 Hohman Ave, Hammond, Ind 46320
APPLIED COMPUTER TIME SHARE INC.
29200 Southfield Rd, Southfield, Mich 48075
AUERBACH ASSOCIATES INC.
121 W Broad St, Philadelphia, Pa 19107
AUTOMATION SERVICES CORP.
182 Forbes Rd, Braintree, Mass 02184
BECK & ASSOCIATES, R.W.
200 Tower Bldg, Seattle, Wash 98101
BRADDOCK, DUNN & MCDONALD INC.
8027 Leesburg Pike, Mc Lean, Va 22101
C&C COMPUTER SYSTEMS INC.
1006 S E Grand, Portland, Ore 97214
CENTRAL COMPUTING CORP.
180 N Mich Ave, Chicago, Ill 60601
CHAPARRAL SYSTEMS INC. MANAGEMENT,
Po Box 5755, Bethesda, Md 20014
CHICAGO TABULATING SERV. INC.
425 N Michigan, Chicago, Ill 60611
COLLINS RADIO CO.
1200 N Alma Rd, Dallas, Tex 75207
COMPAC COMPUTER SYSTEMS INC.
911 Hennepin, Minneapolis, Minn 55403
COMPU-MATIC SYSTEMS CORP.
5303 Comercio Ln, Woodland Hills, Cal 91364
COMPUMEDIC CONTROLS CORP.
432 Park Ave S, New York, N Y 10016
COMPUTER ART SERVICES CO. DIV. OF AGARD
40 Nassau Terminal Rd, New Hyde Park, N J 11040
COMPUTER CONSULTING SERVICES
1176 Iowa, Dubuque, Iowa 52001
COMPUTER FULFILLMENT
225 East St, Winchester, Mass 01890
COMPUTER GUILD INC.
12 Mercer Rd, Natick, Mass 01760
COMPUTERIA INC.
14 Wood Rd, Braintree, Mass 02143
COMPUTER INVESTMENTS & LEASING CORP.
9 Tanner St, Haddonfield, N J 08033
COMPUTER NETWORK CORP.
5185 MacArthur Blvd, Washington, D C 20016
COMPUTER SCIENCES CORP. INFO. NETWORK DIV.
1901 Building, Los Angeles, Cal 90067
COMPUTER SYSTEMS CO. INC.
1470 St Charles Ave, Cleveland, Ohio 44107
COMPUTER TUTOR, THE, DIV. COMPTUT INC.
12 Emerald Court, Commack, N Y 11725

COMPUTER USAGE CORP.,
8939 S Sepulveda Blvd, Los Angeles, Cal 90045
COM-SHARE INC.
P O Box 1588, Ann Arbor, Mich 48106
CONSUMER SYSTEMS CORP.
15 Spinning Wheel Rd, Hinsdale, Ill 60521
CONTROL TECHNOLOGY INC.
3450 E Spring St, Long Beach, Cal 90806
CURRAN COMPUTER CORP.
946 Main St, Hackensack, N J 07601
CYBERMATICS INC.
2460 Lemoine Ave, Fort Lee, N J 07024
CYPHERNETICS CORP., THE
333 Maple Village Ctr, Ann Arbor, Mich 48103
DATA MANAGEMENT SERVICES INC.
1845 Walnut St, Philadelphia, Pa 19103
DATA PROCESSING AND ACCOUNTING SERVICES
50 Van Ness Ave, San Francisco, Cal 94102
DATA TECHNOLOGY CORP.
1050 E Meadow Cir, Palo Alto, Cal 94303
DATA-TRONICS CORP. SUB. ARKANSAS BEST CORP.
310 Townson Ave, Fort Smith, Ark 72901
DATACAP INTERNATIONAL INC.
37 W 2950 S, Salt Lake City, Utah 84101
DATAROYAL INC.
Simon St, Nashua, N H 03060
DESIGN AUTOMATION INC.
809 Massachusetts Ave, Lexington, Mass 02173
DIGITRON INC.
P O Box 5836, Columbus, S C 29205
DIMENSIONAL SYSTEMS INC.
393 Totten Pond Rd, Waltham, Mass 02154
DIPIETRO & WILSON INC.
1107 Commonwealth Ave, Boston, Mass 02215
DYNAMIC ACCESS CORP.
220 Park Ave S, New York, N Y 10003
ELECTRONIC ENGRG. CO. OF CAL. ELECTRONIC PRD. DIV.
1441 E Chestnut Ave, Santa Ana, Cal 92702
ELECTRONIC GRAPHICS INC.
2834 W Kingsley Rd, Garland, Tex 75040
ELECTRONIC TABULATING SERVICE INC.
P O Box 85, Atlanta, Ga 30301
EPEC INDUSTRIES INC.
Industrial Pk, New Bedford, Mass 02745
FAIRCHILD SEMICONDUCTOR
464 Ellis St, Mt View, Cal 94040
FEDDER DATA CENTERS MANAGEMENT INC.
1654 Central Ave, Albany, N Y 12205
HONEYWELL INFORMATION SYSTEMS INC. INFO. SERV. DIV.
2701 4th Ave S, Minneapolis, Minn 55408
HOUSTON ENGINEERING RESEARCH CORP.
P O Box 35495, Houston, Tex 77035
HUB RATLIFF CONSULTANT
P O Box 22487, Houston, Tex 77027
IAC COMPUTER SYSTEMS INC.
260 Newton Rd, Plainview, N Y 11803
ICM COMPUTER CORP.
P O Box 7220, Tulsa, Okla 74105
INFONET SYSTEMS INC.
358 McKinley Blvd, Paramus, N J 07652
INFORMATION DEVELOPMENT ASSOCIATES INC.
P O Box 2285, Bethlehem, Pa 18018
INTECH INC.
2915 Wayzata Blvd, Minneapolis, Minn 55405
INTERACTIVE SCIENCES CORP.
60 Brook Dr, Braintree, Mass 02184
INTERNATIONAL COMPUTER CORP.
1 N Broadway, White Plains, N Y 10601
INTERSTATE COMPUTER SERVICES
754 4th Ave, Brooklyn, N Y 11232
JONES & CO., GAYLE W.
3846 E 14th St, Oakland, Cal 94601
LEASCO DATA PROCESSING EQUIPMENT CORP.
280 Park Ave, New York, N Y 10017
LITTON SYSTEMS INC. CIRCUITRY DIV.
4811 W Kearney St, Springfield, Mo 65803
MACRODATA CO.
20440 Corisco St, Chatsworth, Cal 91311
MATHEMATICAL APPLICATIONS GROUP INC.
180 S Broadway, White Plains, N Y 10605
MCDONNELL AUTOMATION CO.
500 Jefferson Bldg, Houston, Tex 27002
MCDONNELL AUTOMATION CO.
P O Box 516, St Louis, Mo 63166
MDC TECHNOLOGY CORP. SUB. MNGMNT. DATA CORP.
530 W St Rd, Westminster, Pa 18974
MELPAR DIV. LTV ELECTROSYSTEMS INC.
7700 Arlington Blvd, Falls Church, Va 22046
MNEOTECH COMPUTER SYSTEMS
55 Liberty St, New York, N Y 10005
NATIONAL C.S.S.
460 Summer St, Stamford, Conn 06901

2 Product Directory

NORDEN DIV., UNITED AIRCRAFT CORP.
Helen St, Norwalk, Conn 06850

OPTICAL MEMORY SYSTEMS
1520 So Lyon St, Santa Ana, Cal 92705

PENNDATA CORP.
1729 Cedar Ave, Scranton, Pa 18505

PHILCO-FORD CORP., COMPUTER SERVICES NETWORK
Tioga & C Sts, Philadelphia, Pa 19134

PRINCETON TIME SHARING SERVICES, INC.
Us Hwy 1, Princeton, N J 08540

PTSS SYSTEMETRICS DIV.
Martinsville Center, Martinsville, N J 08836

REL-QUAL ASSOCIATES INC.
18 Hamilton St, Bound Brook, N J 08805

REMOTE COMPUTING CORP.
440 Palo Alto Off Ctr, Palo Alto, Cal 94301

REPUBLIC STEEL CORP. MANUFACTURING DIV.
1315 Albert St, Youngstown, Ohio 44505

RESALAB INC. RESALAB SCIENTIFIC DIV.
4000 Campbell Ave, Menlo Park, Cal 94025

SAGE ACTION INC.
P O Box 416, Ithaca, N Y 14850

SCANBE MANUFACTURING CO.
3445 Fletcher Ave, El Monte, Cal 91750

SCHULTZ INSTRUMENTS INC.
P O Box 13385, Gainesville, Fla 32601

SCIENTIFIC CALCULATIONS INC.
110 Allens Creek Rd, Rochester, N Y 14618

SCIENTIFIC COMPUTERS, INC.
919 Second Ave S, Minneapolis, Minn 55402

SCI-TEK COMPUTER CENTER INC.
1707 Gilpin Ave, Wilmington, Del 19806

SEVAN COMPUTER SERVICES INC.
Pollitt Dr S, Fair Lawn, N J 07410

SOFTTECH INC.
391 Totten Pond Rd, Waltham, Mass 02154

SOFTWARE PROGRAMMING ASSOCIATES INC.
1209 Tropic St, Titusville, Fla 32780

SYSTEMS ANALYSIS INC.
11110 N E 8th, Bellevue, Wash 98004

SYSTEMS, SCIENCE & SOFTWARE INC.
Po Box 1620, La Jolla, Cal 92037

TECHNOLOGY FOR INFORMATION MANAGEMENT INC.
1654 Central Ave, Albany, N Y 12205

TIME-SHARING SYSTEMS, INC.
1840 N Farwell Ave, Milwaukee, Wis 53202

TRACOR COMPUTING CORP.
1705 Guadalupe St, Austin, Tex 78701

TRW SYSTEMS GROUP SOFTWARE & INFORMATION
SYS DIV.
1 Space Park, Redondo Beach, Cal 90278

UNIVERSITY COMPUTING CO.
P O Box 6228, Dallas, Tex 75222

VIKING INDUSTRIES INC.
21001 Nordhoff St, Chatsworth, Cal 91311

VITRO LABORATORIES, DIV. VITRO CORP. OF AMERICA
14000 Georgia Ave, Silver Spring, Md 20910

WESTINGHOUSE ELECTRIC CORP.
Westinghouse Bldg, Pittsburgh, Pa 15222

WESTINGHOUSE TELE-COMPUTER SYSTEMS CORP.
2040 Ardmore Blvd, Pittsburgh, Pa 15221

SERVICES, COMPUTER OUTPUT MICROFILM

COMPUTER MANAGEMENT INC.
3101 Euclid Ave, Cleveland, Ohio 44115

COMPUTER MICROFILM CORP.
70 Charlton St, New York, N Y 10014

COMPUTER MICROGRAPHICS INC.
5345 W 102nd, Los Angeles, Cal 90045

DATA COPY INC.
760 Bryant St, San Francisco, Cal 94107

DATAFLOW SYSTEMS INC.
7758 Wilconsin Ave, Bethesda, Md 20014

REMINGTON RAND OFFICE SYSTEMS DIV. SPERRY
RAND
P O Box 171, Marietta, Ohio 45750

SERVICES, FACILITY MANAGEMENT

ACADEMY COMPUTING CORP.
5005 N Lincoln Blvd, Oklahoma City, Okla 73105

ADAPT INC.
624 S 62nd St, Philadelphia, Pa 19143

ADVANCED COMPUTER SYSTEMS INC
3131 S Dixie Dr, Dayton, Ohio 45305

ADVANCED COMPUTER TECHNIQUES CORP.
437 Madison Ave, New York, N Y 10022

ADVANCED MANAGEMENT SYSTEMS INC.
3310 Richmond Ave, Houston, Tex 77006

AGRICULTURAL COMPUTING CO. DBA
ASSOCIOMETRICS
P O Box 1259, Grand Prairie, Tex 75050

ALLEN-BABCOCK COMPUTING INC.
1800 Ave of The Stars, Los Angeles, Cal 90067

AMERICAN COMPUTER LEASING CORP.
14 E 4th St, Cincinnati, Ohio 45202

AMERICAN COMPUTER SERVICES CORP.
14 E 4th St, Cincinnati, Ohio 45202

ANDROCOR INC.
5949 Hohman Ave, Hammond, Ind 46320

APPLIED COMPUTER SCIENCES INC.
361 Park Rd, W Hartford, Conn 06107

APPLIED COMPUTER TIME SHARE INC.
29200 Southfield Rd, Southfield, Mich 48075

APPLIED CYBERNETICS CORP.
1285 Forgeood Ave, Sunnyvale, Cal 94086

APT COMPUTER CENTER
5309 W Touhy, Skokie, Ill 60076

ARIES CORP.
1651 Old Meadow Rd, Mc Lean, Va 22101

ARISTA INFORMATION SYSTEMS INC.
P O Box 4775, Winston-Salem, N C 27107

AUERBACH ASSOCIATES INC.
121 W Broad St, Philadelphia, Pa 19107

AUTOMATED CONCEPTS INC.
477 Madison Ave, New York, N Y 10017

AUTOMATED INFORMATION SYSTEMS INC.
1064 River Rd, Edgewater, N J 07020

AUTOMATED SYSTEMS CORP.
600 Houst Nat Gas Bid, Houston, Tex 77002

AUTOMATION SERVICES CORP.
182 Forbes Rd, Braintree, Mass 02184

AZREX INC.
105 Terrace Hall Ave, Burlington, Mass 01803

BIZ-MATIC DATA CONTROL CENTERS INC.
232 Summer St, Boston, Mass 02210

BOOTHIE RESOURCES INTERNATIONAL INC.
3435 Wilshire Blvd, Los Angeles, Cal 90005

BOSTON COMPUTER SYSTEMS CORP.
15 School St, Boston, Mass 02108

BRADDOCK, DUNN & MCDONALD INC.
8027 Leesburg Pike, Mc Lean, Va 22101

BRANDON APPLIED SYSTEMS INC.
1700 Broadway, New York, N Y 10019

BRANDON APPLIED SYSTEMS INC.
1611 N Kent St, Arlington, Va 22209

BURLINGTON MANAGEMENT SERVICES CO.
P O Box 21207, Greensboro, N C 27420

C&C COMPUTER SYSTEMS INC.
1006 S E Grand, Portland, Ore 97214

CALL-A-COMPUTER INC.
633 Young St, Santa Ana, Cal 92702

CENTRAL COMPUTING CORP.
749 Water P O Box 681, Decatur, Ill 62525

CENTRAL COMPUTING CORP.
180 N Mich Ave, Chicago, Ill 60601

CENTRAL COMPUTING, INC.
2627 E Central, Wichita, Kans 67214

CENTRAL DATA SYSTEMS INC.
1215 Valley Belt Rd, Cleveland, Ohio 44131

CENTRAL PROCESSING CENTER OF SAN ANTONIO
INC.
P O Box 1416, San Antonio, Tex 78206

CENTURY DATA PROCESSING INC.
1006 Coronado Towers, El Paso, Tex 79912

CGA COMPUTER ASSOCIATES INC.
715 Park Ave, East Orange, N J 07017

COLLINS RADIO CO.
1200 N Alma Rd, Dallas, Tex 75207

COMMERCIAL TECHNOLOGY INC.
P O Box 10616, Knoxville, Tenn 37919

COMMUNICATIONS LOGIC INC.
6400 Westpark, Houston, Tex 77024

COMPAC COMPUTER SYSTEMS INC.
911 Hennepin, Minneapolis, Minn 55403

COMPUMATICS INC.
327 S Lasalle St, Chicago, Ill 60604

COMPUMEDIC CONTROLS CORP.
432 Park Ave S, New York, N Y 10016

COMPU SYS INC.
Po Box 11104, Albuquerque, N M 87112

COMPU-TIME INC.
327 Orange Ave, Daytona, Fla 32014

COMPUTATION AND SYSTEMS CORP.
12061 Wilshire Blvd, Los Angeles, Cal 90025

COMPUTE AMERICA CORP. DBA COMERICA
1515 Classen Blvd, Oklahoma City, Okla 73106

COMPUTER ADVISORS TO MANAGEMENT
120 S Riverside Plaza, Chicago, Ill 60606

COMPUTER ASSISTANCE INC.
298 Park Rd, West Hartford, Conn 06119

COMPUTER AUDIT SYSTEMS, INC.
725 Park Ave, E Orange, N J 07017

COMPUTER CENTER, INC.,
350 Royal Palm Way, Palm Beach, Fla 33480

COMPUTER CENTER OF ATLANTA DIV. COMP. CNTRS
INC
2695 Buford Hwy NE, Atlanta, Ga 30324

COMPUTER COMMAND AND CONTROLS COMPANY
4025 Chestnut St, Philadelphia, Pa 19104

COMPUTER COMPLEX, INC.
6400 Westpark, Houston, Tex 77027

COMPUTER CONSULTANTS CORP.
U S Rte 46 E, Denville, N J 07834

COMPUTER CONSULTING SERVICES
1176 Iowa, Dubuque, Iowa 52001

COMPUTER DIMENSIONS, INC.
511 Akard, Dallas, Tex 75201

COMPUTER DYNAMICS INC.
100 Hegeberger Rd, Oakland, Cal 94621

COMPUTER EXCHANGE INC., THE
30 E 42nd St, New York, N Y 10017

COMPUTERIA INC.
14 Wood Rd, Braintree, Mass 02143

COMPUTER INVESTMENTS & LEASING CORP.
9 Tanner St, Haddonfield, N J 08033

COMPUTER MANAGEMENT INC.
3101 Euclid Ave, Cleveland, Ohio 44115

COMPUTER NETWORK CORP.
5185 Macarthur Blvd, Washington, D C 20016

COMPUTER POWER INC.
30 S Laura St, Jacksonville, Fla 32202

COMPUTER PROCESSING INC.
200 Manhattan Bldg, Muskogee, Okla 74401

COMPUTER PROCESSING INC.
300 6th Ave, Pittsburgh, Pa 15222

COMPUTER SCIENCES CORP. INFO. NETWORK DIV.
1901 Building, Los Angeles, Cal 90067

COMPUTER SERVICENTER CORP.
16 Maple St, Latham, N Y 12110

COMPUTER SERVICES CORP.
200 Bank Savings Bldg, Birmingham, Ala 35203

COMPUTER SERVICES INC.
47 Congress St, Salem, Mass 01970

COMPUTER SERVICES OF INDIANA, INC.
214 S 13 1/2 St, Terre Haute, Ind 47808

COMPUTER SHARING SERVICES
2492 W 2nd Ave, Denver, Colo 80223

COMPUTER SYSTEM TECHNOLOGY INC.
700-42 Fox Pavilion, Jenkintown, Pa 19046

COMPUTER SYSTEMS CO. INC.
1470 St Charles Ave, Cleveland, Ohio 44107

COMPUTER SYSTEMS CORP. U.S. INDUSTRIES INC
P O Box 64400, Dallas, Tex 75206

COMPUTER SYSTEMS INC.
19619 81st Ave S, Kent, Wash 98031

COMPUTER TASK GROUP INC.
5586 Main St, Buffalo, N Y 14221

COMPUTER TECHNOLOGY INC. SUB. UNIV.
COMPUTING CO.
P O Box 47911, Dallas, Tex 75247

COMPUTER UNIVERSAL CORP.
1641 Universal Rd, Columbus, Ohio 43207

COMPUTER USAGE CO.
7315 Wisconsin Ave Nw, Washington, D C 20014

COMPUTER USAGE CO.
387 Elliot St, Newton Uppr Fls, Mass 02164

COMPUTER USAGE CO.
3181 Porter Dr, Palo Alto, Cal 94304

COMPUTER USAGE CORP.
100 Putman Green, Greenwich, Conn 06830

COMPUTER USAGE CORP.,
8939 S Sepulveda Blvd, Los Angeles, Cal 90045

COMPUTING & SOFTWARE INC. EAST COAST DIV.
3700 Mt Vernon Ave, Alexandria, Va 22305

COMSI INC.
1211 W 22 St, Oakbrook, Ill 60521

CONDATA INC.
1809 Walnut St, Philadelphia, Pa 19103

CONSULTANTS ASSOCIATED INC.
Lakeside Office Park, Wakefield, Mass 01880

CONSUMER SYSTEMS CORP.
15 Spinning Wheel Rd, Hinsdale, Ill 60521

CONTINENTAL DATA PROCESSING INC.
300 Market St., Kingston, Pa 18704

CORPORATE DATA PROCESSING
1724 Silver Lake Blvd, Los Angeles, Cal 90026

CTC COMPUTER CORP.
1000 Elwell Court, Palo Alto, Cal 94303

CYBERMATICS INC.
2460 Lemoine Ave, Fort Lee, N J 07024

CYPHERNETICS CORP., THE
333 Maple Village Ctr, Ann Arbor, Mich 48103

D.P.&W. INC.
1107 Commonwealth Ave, Boston, Mass 02215

DATA ARCHITECTS INC.
213 3rd Ave, Waltham, Mass 02154

2 Product Directory

- DATA CENTER CORP.
3002 Midvale St, Los Angeles, Cal 90034
- DATA COPY INC.
760 Bryant St, San Francisco, Cal 94107
- DATA CORP., THE
1111 W 6th St, Los Angeles, Cal 90017
- DATA DIMENSIONS INC.
51 Weaver St, Greenwich, Conn 06830
- DATA MANAGEMENT SERVICES INC.
1845 Walnut St, Philadelphia, Pa 19103
- DATA PROCESSING AND ACCOUNTING SERVICES
50 Van Ness Ave, San Francisco, Cal 94102
- DATA PROCESSORS INC.
2703 W 28th Ave, Pine Bluff, Ark 71601
- DATA SYSTEMS INC.
434 Stinson Blvd, Minneapolis, Minn 55413
- DATA-TRONICS CORP. SUB. ARKANSAS BEST CORP.
310 Townson Ave, Fort Smith, Ark 72901
- DATA USAGE CORP.,
2460 Lemoine Ave, Fort Lee, N J 07024
- DATALOGICS INC.
12025 Shakee Blvd, Cleveland, Ohio 44120
- DATAMATION SERVICES INC.
461 Eighth Ave, New York, N Y 10001
- DATAROYAL INC.
Simon St, Nashua, N H 03060
- DATASONICS INC.
P O Box 4553, New York, N Y 10017
- DECISION SYSTEMS INC.
E 66 Midland Ave, Paramus, N J 07652
- DELMARVA COMPUTER INDUSTRIES INC.
5865 Robert Oliver Pl, Columbia, Md 21043
- DELTA AUTOMATED SYSTEMS INC.
816 Thayer Ave, Silver Spring, Md 20910
- DELTA SYSTEMS CORP.
Edens Exective Ctr, Wilmette, Ill 60091
- DEUSSEN ASSOCIATES INC.
576 Hyannis Dr, Sunnyvale, Cal 94087
- DIGITAL PROGRAMMING SERVICES INC.
60 Hickory Dr, Waltham, Mass 02154
- DIGITAL RESOURCES CORP.
6250 W Park Suite 100, Houston, Tex 77027
- DIPIETRO & WILSON INC.
1107 Commonwealth Ave, Boston, Mass 02215
- DIRECT ACCESS COMPUTING CORP.
984 Livernois Rd, Troy, Mich 48084
- DIVERSIFIED COMPUTER APPLICATIONS
2525 E Bayshore Rd, Palo Alto, Cal 94302
- DYNAMIC ACCESS CORP.
220 Park Ave S, New York, N Y 10003
- EASTERN COMPUTER SERVICES INC
920 Fox Chase Rd, Rockledge, Pa 19111
- ELECTROMECH COMPUTING & TECH. SERVICES CO.
2964 Peachtree Rd NW, Atlanta, Ga 30305
- ELECTRONIC ACCOUNTING SYSTEMS INC.
255 Alexander St, Rochester, N Y 14607
- ELECTRONIC DATA PREPARATION CORP.
P O Box 1446, Bradenton, Fla 33505
- ELMIRA DATA PROCESSING CO.
221 E Church St, Elmira, N Y 14902
- FABRI-TEK INFORMATION MANAGEMENT, INC.
5901 S County Rd 18, Edina, Minn 55436
- FEDDER DATA CENTERS INC.
307 S Sharp St, Baltimore, Md 21201
- GANNETT, FLEMING, CORDDRY & CARPENTER INC.
P O Box 1963, Harrisburg, Pa 17105
- GENERAL COMPUTER SERVICES INC.
1332 Meridan St NE, Huntsville, Ala 35801
- GOODHEW, J.W. & ASSOCIATES INC.
11600 Nebel St, Rockville, Md 20854
- GRAPHICAL TECHNOLOGY CORP.
47-34 33rd St, Long Is Cy, N Y 11101
- GREYHOUND COMPUTER CORP.
130 S Canal St, Chicago, Ill 60606
- GTE DATA SERVICES INC.
5422 Bay Center Dr, Tampa, Fla 33609
- HOBBS ASSOCIATES, INC.
Po Box 686, Corona Del Mar, Cal 92625
- HONEYWELL INFORMATION SYSTEMS INC. INFO. SERV.DIV
2701 4th Ave S, Minneapolis, Minn 55408
- HOUSING DATA CORP.
29433 Southfield Rd, Southfield, Mich 48075
- HOUSING DATA CORP.
23400 Michigan, Dearborn, Mich 48124
- HOUSTON ENGINEERING RESEARCH CORP.
P O Box 35495, Houston, Tex 77035
- HUB RATLIFF CONSULTANT
P O Box 22487, Houston, Tex 77027
- ICM COMPUTER CORP.
P O Box 7220, Tulsa, Okla 74105
- INDECON INC.
30 N Lasalle St, Chicago, Ill 60602
- INFONET SYSTEMS INC.
358 McKinley Blvd, Paramus, N J 07652
- INFORMATICS INC.
21050 Vanover St, Canoga Park, Cal 91303
- INFORMATION DEVELOPMENT ASSOCIATES INC.
P O Box 2285, Bethlehem, Pa 18018
- INFORMATION MANAGEMENT INC.
447 Battery St, San Francisco, Cal 94111
- INFORMATION SCIENCES INC.
14 Jefferson Blvd, Warwick, R I 02888
- INPUT DATA CO. INC.
1187 Valley Rd, Stirling, N J 07980
- INPUT INC.
500 Old Elm Rd, Highland Park, Ill 60035
- INSTITUTE FOR CYBERNETIC DEVELOPMENT
3031 Bateman St, Berkeley, Cal 94705
- INTECH INC.
2915 Wayzata Blvd, Minneapolis, Minn 55405
- INTERACTIVE SCIENCES CORP.
60 Brook Dr, Braintree, Mass 02184
- INTERNATIONAL COMPUTER CORP.
1 N Broadway, White Plains, N Y 10601
- INTERNATIONAL SYSTEMS ASSOCIATES, LTD.
350 5th Ave, New York, N Y 10001
- INTERNATIONAL TELECOMPUTER NETWORK CORP.
4919 Fairmont Ave, Bethesda, Md 20014
- INTERNATIONAL TIMESHARING CORP.
Its Bldg Jonathan Ind, Chaska, Minn 55318
- ITT DATA SERVICES DIV.
P O Box 402, Paramus, N J 07652
- KEYSTONE COMPUTER ASSOCIATES INC.
1055 Virginia Dr, Ft Washington, Pa 19034
- LEASCO DATA PROCESSING EQUIPMENT CORP.
280 Park Ave, New York, N Y 10017
- LITTON SYSTEMS INC. MELLONICS DIV.
1001 W Maude Ave, Sunnyvale, Cal 94086
- LOCKHEED ELECTRONICS DATA MANAGEMENT SERVICES
16811 El Camino Real, Houston, Tex 77058
- LOGIC INC.
1712 Commerce St, Dallas, Tex 75201
- LOGICON INC.
Del Amo Financial Ctr, Torrance, Cal 90503
- LYNCH & CO., JOHN G.
245 Briargate Rd, Cary, Ill 60013
- MANAGEMENTATICS INC.
2 Pennsylvania Plaza, New York, N Y 10001
- MANAGEMENT & COMPUTER SERVICES INC.
104 Park Towne Pl E, Philadelphia, Pa 19130
- MANAGEMENT DATA PROCESSING SYSTEMS
385 Lakeview Ave, Clifton, N J 07011
- MANAGEMENT SCIENCE AMERICA INC.
1389 Peachtree St NE, Atlanta, Ga 30309
- MANAGEMENT SERVICES INC.
1538 Dunex Hill Ln Ne, Atlanta, Ga 30324
- MANAGEMENT SYSTEMS CORP.
7007 Preston Rd, Dallas, Tex 75205
- MASTECH COMPUTER SYSTEMS INC.
7026 W North Ave, Chicago, Ill 60635
- MATRIX CORP., THE
931 S Douglas St, El Segundo, Cal 90245
- MCDILL CORP.
P O Box 98, Montgomery, Ala 36101
- MCDONNELL AUTOMATION CO.
500 Jefferson Bldg, Houston, Tex 27002
- MCDONNELL AUTOMATION CO.
360 W Federal Savings, Denver, Colo 80202
- MCDONNELL AUTOMATION CO.
P O Box 516, St Louis, Mo 63166
- MEGASYSTEMS INC.
640 W 40th St, New York, N Y 10018
- METRIDATA COMPUTING INC.
6600 Grade Lane, Louisville, Ky 40221
- MICHIANA LEASING CORP.
1814 S Main St, St Bend, Ind 46613
- MICROMATON SYSTEMS INC.
3610 East St, Landover, Md 20785
- MILNEE BROTHERS PRODUCTS
8000 Blackburn Ave, Los Angeles, Cal 90048
- MNEMOTECH COMPUTER SYSTEMS
55 Liberty St, New York, N Y 10005
- MOBILITY SYSTEMS D P SERVICES DEPT.
3530 De La Cruz Blvd, Santa Clara, Cal 95050
- NATIONAL C.S.S.
460 Summer St, Stamford, Conn 06901
- NATIONAL INFORMATION SYSTEMS CORP.
150 Allendale Rd, Valley Forge, Pa 19481
- NEOTERIC INC.
2800 Euclid Ave, Cleveland, Ohio 44115
- NETWORK DATA PROCESSING CORP.
823 Commerce Dr, Oak Brook, Ill 60521
- NETWORK DATA PROCESSING CORP.
118 2nd Ave SE, Cedar Rapids, Iowa 52407
- OGDEN TECHNOLOGY LABORATORIES FULLERTON DIV.
1536 E Valencia Dr, Fullerton, Cal 92631
- OPERATIONS RESEARCH INC.
1400 Spring St, Silver Spring, Md 20910
- PANSOPHIC SYSTEMS INC.
230 Roosevelt Rd, Lombard, Ill 60148
- PAPERWORK DATA COMM. SERVICES INC.
1703 S Ave, Syracuse, N Y 13207
- PAYMENT SYSTEMS INC.
405 Lexington Ave, New York, N Y 10017
- PENNDATA CORP.
1729 Cedar Ave, Scranton, Pa 18505
- PG DATA CENTER INC.
P O Box 11, Garrettsville, Ohio 44231
- PHILCO-FORD CORP., COMPUTER SERVICES NETWORK
Tioga & C Sts, Philadelphia, Pa 19134
- PIONEER DATA SYSTEMS INC.
606 Merle Hay Tower, Des Moines, Iowa 50310
- PLANNING RESEARCH CORP.
1100 Glendon Ave, Los Angeles, Cal 90024
- PRC COMPUTER CENTER INC. PLANNING RSCH CORP.
7670 Old Springhouse, McLean, Va 22101
- PRINCETON TIME SHARING SERVICES, INC.
Us Hwy 1, Princeton, N J 08540
- PROGRAMMING SCIENCES CORP.
S E 42 St, New York, N Y 10016
- PROGRAMMING SCIENCES CORP.
1900 Ave of The Stars, Los Angeles, Cal 90067
- PRYOR COMPUTER INDUSTRIES
400 N Michigan Ave, Chicago, Ill 60611
- PUBLIC DATA PROCESSING CORP.
640 N Lasalle St, Chicago, Ill 60610
- RAPIDATA INC.
20 New Dutch Lane, Fairfield, N J 07006
- REALTIME SYSTEMS INC.
866 3rd Ave, New York, N Y 10022
- REILAND, PAGE & ASSOCIATES INC.
1521 E Broad St, Columbus, Ohio 43205
- REL-QUAL ASSOCIATES INC.
18 Hamilton St, Bound Brook, N J 08805
- REMOTE COMPUTING CORP.
A40 Palo Alto Off Ctr, Palo Alto, Cal 94301
- REN ELECTRONICS
775 New Ludlow Rd, So Hadley, Mass 01075
- REPRODUCTION SYSTEMS DIV. TRANSAMERICA COMP.
1 California St, San Francisco, Cal 94111
- REPUBLIC SYSTEMS INC.
100 Plaza Centre, Secaucus, N J 07094
- REPUBLIC SYSTEMS INC.
715 Park Ave, E Orange, N J 07017
- REPUBLIC SYSTEMS OF CONNECTICUT INC.
350 S Main St, Cheshire, Conn 06410
- RIDGEWOOD ASSOCIATES INC.
10 Wilsey Sq, Ridgewood, N J 07450
- SAGE ACTION INC.
P O Box 416, Ithaca, N Y 14850
- SAID INC.
1243 W Broad St, Falls Church, Va 22046
- SARNA ASSOCIATES INC.
22 Russell St, Brookline, Mass 02146
- SC DATA CENTER, INC.
1112 7th Ave, Monroe, Wis 53566
- SCANFORMS INC.
312 Fox Pavilion, Jenkintown, Pa 19095
- SCIENTIFIC COMPUTERS, INC.,
919 Second Ave S, Minneapolis, Minn 55402
- SCI-TEK COMPUTER CENTER INC.
1707 Gilpin Ave, Wilmington, Del 19806
- SEGALL ASSOCIATES, M. HARVEY
1019 Rust Bldg, Tacoma, Wash 98402
- SEVAN COMPUTER SERVICES INC.
Pollitt Dr S, Fair Lawn, N J 07410
- SMITH CORP., A.O. DATA SYSTEMS DIV.
3533 N 27 St, Milwaukee, Wisc 53201
- SOFTWARE METHODS INC.
10 E 40th St, New York, N Y 10016
- SOFTWARE PROGRAMMING ASSOCIATES INC.
1209 Tropic St, Titusville, Fla 32780
- SOUTHERN DATA PROCESSING SERVICE INC.
P O Box 123, Augusta, Ga 30903
- SPACETRONICS CO.
43 Hassemer Ave, Cherry Hill, N J 08034
- SPS INC.
4485 N W 36th St, Miami, Fla 33166
- SYSTEM DEVELOPMENT CORP.
2500 Colorado Ave, Santa Monica, Cal 90406
- SYSTEM IMPLEMENTATION CORP.
18 E 48th St, New York, N Y 10017
- SYSTEMATICS GENERAL CORP.
6825 Redmond Dr, McLean, Va 22101
- SYSTEMATICS INC.
411 Victory, Little Rock, Ark 72201
- SYSTEMS & PROGRAMMING SERVICES
1001 Daniel Bldg, Greenville, S C 29602
- SYSTEMS ANALYSIS INC.
11110 N E 8th, Bellevue, Wash 98004

2 Product Directory

SYSTEMS ASSOCIATES INC.
356 Penn St, Reading, Pa 19602
SYSTEMS DATA PROCESSING CO.
920 23rd St, Sacramento, Cal 95816
SYSTEMS EQUIPMENT CORP.
458 Plasamour Dr, Atlanta, Ga 30324
SYSTEMS GENERAL CORP.
10889 Wilshire Blvd, Los Angeles, Cal 90024
SYSTEMS, SCIENCE & SOFTWARE INC.
Po Box 1620, La Jolla, Cal 92037
TELE-DATA CORP.
130 U S Hwy 22, N Plainfield, N J 07060
TIME SHARE CORP.
3 Lebanon St, Hanover, N H 03755
TIME-SHARING SYSTEMS INC.,
1840 N Farwell Ave, Milwaukee, Wis 53202
TRACOR COMPUTING CORP.
1705 Guadalupe St, Austin, Tex 78701
TRAVCOM INC.
1425 E McMillan, Cincinnati, Ohio 45206
TRAVCOM INC. UNITED DATA PROC DV
70 E 14th St, Eugene, Oreg 97401
TRILOG ASSOCIATES INC.
1700 Market St, Philadelphia, Pa 19103
TRIPLE C COMPUTER SERVICE
432 Park Ave S, New York, N Y 10016
TRW SYSTEMS GROUP SOFTWARE & INFORMATION
SYS DIV
1 Space Park, Redondo Beach, Cal 90278
TURNKEY SYSTEMS INC.
111 E Ave, Norwalk, Conn 06851
UNITED COMPUTING SYSTEMS INC.
3130 Broadway, Kansas City, Mo 64111
UNITED DATA CENTERS INC.
100 Putnam Green, Greenwich, Conn 06830
UNITED SYSTEMS INC.
1020 Kings Hwy N, Cherry Hill, N J 08034
UNIVAC DATA PROCESSING SRVCS. DIV. SPERRY
RAND
60 Herricks Rd, Mineola, N Y 11501
UNIVERSAL INFORMATION SYSTEMS INC.
S-10 Rte 17 At Rte 4, Paramus, N J 07652
UNIVERSITY COMPUTING CO.
P O Box 6228, Dallas, Tex 75222
UNIVERSITY COMPUTING CO. GRAPHIC SYSTEMS DIV
14761 Califa St, Van Nuys, Cal 91401
URS DATA SCIENCE CO.
155 Bovet Rd, San Mateo, Cal 94402
VIRTUAL COMPUTER SERVICES INC
1119 Springfield Rd, Union, N J 07083
WARREN ASSOCIATES
15 Royal Crest Dr, Marlboro, Mass 01752
WELLINGTON COMPUTER SYSTEMS CORP.
405 Lexington Ave, New York, N Y 10017
WENGEL SERVICE CORP.
1101 State Rd, Princeton, N J 08540
WESTERN OPERATIONS INC.
120 Montgomery St, San Francisco, Cal 94104
WESTERN UNION TELEPROCESSING CO.
82 McKee Dr, Mahwah, N J 07436
WESTINGHOUSE ELECTRIC CORP.
Westinghouse Bldg, Pittsburgh, Pa 15222
WESTINGHOUSE TELE-COMPUTER SYSTEMS CORP.
2040 Ardmore Blvd, Pittsburgh, Pa 15221
WORLD COMPUTER CORP.
1615 Stemmons Fwy, Dallas, Tex 75221
ZENITH INTEGRATED-DATA PROCESSING INC.
950 Fulton Ave, Sacramento, Cal 95825

SERVICES, LIST MAINTENANCE

HOUSING DATA CORP.
23400 Michigan, Dearborn, Mich 48124
MATHEMATICAL APPLICATIONS GROUP INC.
180 S Broadway, White Plains, N Y 10605
PTSS SYSTEMETRICS DIV.
Martinsville Center, Martinsville, N J 08836

SERVICES, MAGNETIC TAPE CERTIFICATION

AURICORD DIV., SCOVILL MFG. CO.
35-41 29 St, Long Isl City, N Y 11106
C&C COMPUTER SYSTEMS INC.
1006 S E Grand, Portland, Ore 97214
CERTRON CORP. COMPUTER TAPE DIV.
2060 Brentwood St, High Point, N C 27262
COMPUMEDIC CONTROLS CORP.
432 Park Ave S, New York, N Y 10016
COMPUTER CONSULTING SERVICES
1176 Iowa, Dubuque, Iowa 52001
COMPUTER-LINK CORP.
14 Cambridge St, Burlington, Mass 01803

COMPUTER SCIENCES CORP. INFO. NETWORK DIV.
1901 Building, Los Angeles, Cal 90067
DATA MANAGEMENT SERVICES INC.
1845 Walnut St, Philadelphia, Pa 19103
DATA PROCESSING AND ACCOUNTING SERVICES
50 Van Ness Ave, San Francisco, Cal 94102
GENERAL KINETICS INC.
11425 Isaac Newt Sq S, Reston, Va 22070
INDEL INC.
P O Box 15800, Tulsa, Okla 74115
INTERACTIVE SCIENCES CORP.
60 Brook Dr, Braintree, Mass 02184
KYBE CORP.
132 Calvary St, Waltham, Mass 02154
MACS COMPUTER ACCESSORIES INC
104 Park Towne Pl, Philadelphia, Pa 19130
PENNDATA CORP.
1729 Cedar Ave, Scranton, Pa 18505
PRYOR COMPUTER INDUSTRIES
400 N Michigan Ave, Chicago, Ill 60611
SYNCOM INC. SHIELDATA DIV.
1914 Colvin Ave, Tonawanda, N Y 14150
TIME BROKERS INC.
380 Lexington Ave, New York, N Y 10017
TRACOR COMPUTING CORP.
1705 Guadalupe St, Austin, Tex 78701

SERVICES, MANAGEMENT INFORMATION SYSTEMS

ACADEMY COMPUTING CORP.
5005 N Lincoln Blvd, Oklahoma City, Okla 73105
ADAPT INC.
624 S 62nd St, Philadelphia, Pa 19143
ADATACO
1475 N Broadway, Walnut Creek, Cal 94596
ADVANCED COMPUTER SYSTEMS INC
3131 S Dixie Dr, Dayton, Ohio 45305
ADVANCED COMPUTER TECHNIQUES CORP.
437 Madison Ave, New York, N Y 10022
AERO TECHNICAL APPLICATIONS INC.
8011 Clayton Rd, St Louis, Mo 63117
AHART & ASSOC. INC., JAMES R.
225 S Main St, Dayton, Ohio 45402
ALLEN-BABCOCK COMPUTING INC.
1800 Ave of The Stars, Los Angeles, Cal 90067
ANALYTIC SCIENCES CORP., THE
6 Jacob Way, Reading, Mass 01867
ANALYTICS INC.
179 Washington Lane, Jenkintown, Pa 19046
ANCOM SYSTEMS, DIV. GENERAL ANALYTICS CORP.
9841 Airport Blvd, Los Angeles, Cal 90045
ANDROCOR INC.
5949 Hohman Ave, Hammond, Ind 46320
APPLIED COMPUTER SCIENCES INC.
361 Park Rd, W Hartford, Conn 06107
APPLIED COMPUTER TIME SHARE INC.
29200 Southfield Rd, Southfield, Mich 48075
ARIES CORP.
1651 Old Meadow Rd, Mc Lean, Va 22101
AUERBACH ASSOCIATES INC.
121 W Broad St, Philadelphia, Pa 19107
AUTOCOMP INC.
4720 Montgomery Ln, Bethesda, Md 20014
AUTOMATED INFORMATION SYSTEMS INC.
1064 River Rd, Edgewater, N J 07020
AUTOMATION, INC.
1904 Farnam St, Omaha, Nebr 68102
AUTOMATION SERVICES CORP.
182 Forbes Rd, Braintree, Mass 02184
BERKELEY COMPUTER CORP.
2398 4th St, Berkeley, Cal 94710
BIZ-MATIC DATA CONTROL CENTERS INC.
232 Summer St, Boston, Mass 02210
BOOTH THE RESOURCES INTERNATIONAL INC.
3435 Wilshire Blvd, Los Angeles, Cal 90005
BOSTON COMPUTER SYSTEMS CORP.
15 School St, Boston, Mass 02108
BRADDOCK, DUNN & MCDONALD INC.
8027 Leesburg Pike, Mc Lean, Va 22101
BRANDON APPLIED SYSTEMS INC.
1611 N Kent St, Arlington, Va 22209
BUNKER RAMO CORP., THE, BUSINESS & IND. DIV
445 Fairfield Ave, Stamford, Conn 06904
BURLINGTON MANAGEMENT SERVICES CO.
P O Box 21207, Greensboro, N C 27420
C&C COMPUTER SYSTEMS INC.
1006 S E Grand, Portland, Ore 97214
CALTEC INC.
1931 Sylvania Ave, Toledo, Ohio 43613
CENTRAL COMPUTING CORP.
180 N Mich Ave, Chicago, Ill 60601
CENTRAL COMPUTING, INC.
2627 E Central, Wichita, Kans 67214

CENTRAL DATA SYSTEMS INC.
1215 Valley Belt Rd, Cleveland, Ohio 44131
CENTURY DATA PROCESSING INC.
1006 Coronado Towers, El Paso, Tex 79912
CHICAGO TABULATING SERV. INC.
425 N Michigan, Chicago, Ill 60611
COLORADO INSTRUMENTS INC.
1 Park St, Broomfield, Colo 80020
COMPAC COMPUTER SYSTEMS INC.
911 Hennepin, Minneapolis, Minn 55403
COMPUMEDIC CONTROLS CORP.
432 Park Ave S, New York, N Y 10016
COMPU SYS INC.
Po Box 11104, Albuquerque, N M 87112
COMPUTATION AND SYSTEMS CORP.
12061 Wilshire Blvd, Los Angeles, Cal 90025
COMPUTE AMERICA CORP. DBA COMERICA
1515 Classen Blvd, Oklahoma City, Okla 73106
COMPUTER AMERICA CORP.
818 Roeder Rd, Silver Spring, Md 20910
COMPUTER ASSISTANCE INC.
298 Park Rd, West Hartford, Conn 06119
COMPUTER CENTER OF ATLANTA DIV. COMP. CNTRS
INC
2695 Buford Hwy NE, Atlanta, Ga 30324
COMPUTER COMMAND & CONTROL CO
1717 Penn Ave NW, Washington, D C 20006
COMPUTER COMMAND AND CONTROLS COMPANY
4025 Chestnut St, Philadelphia, Pa 19104
COMPUTER CONSULTANTS CORP.
U S Rte 46 E, Denville, N J 07834
COMPUTER DIMENSIONS, INC.
511 Akard, Dallas, Tex 75201
COMPUTER DYNAMICS INC.
100 Hegenberger Rd, Oakland, Cal 94621
COMPUTER FULFILLMENT
225 East St, Winchester, Mass 01890
COMPUTERIA INC.
14 Wood Rd, Braintree, Mass 02143
COMPUTER IDENTICS CORP.
S W Park, Westwood, Mass 02090
COMPUTER MANAGEMENT INC.
3101 Euclid Ave, Cleveland, Ohio 44115
COMPUTER NETWORK CORP.
5185 Macarthur Blvd, Washington, D C 20016
COMPUTER POWER INC.
30 S Laura St, Jacksonville, Fla 32202
COMPUTER PROCESSING INC.
300 6th Ave, Pittsburgh, Pa 15222
COMPUTER SCIENCES CORP. INFO. NETWORK DIV.
1901 Building, Los Angeles, Cal 90067
COMPUTER SERVICENTER CORP.
16 Maple St, Latham, N Y 12110
COMPUTER SERVICES CORP.
200 Bank Savings Bldg, Birmingham, Ala 35203
COMPUTER SERVICES INC.
47 Congress St, Salem, Mass 01970
COMPUTER SERVICES OF INDIANA, INC.
214 S 13 1/2 St, Terre Haute, Ind 47808
COMPUTER SYSTEM TECHNOLOGY INC.
700-42 Fox Pavilion, Jenkintown, Pa 19046
COMPUTER SYSTEMS
400 Wing Bldg, Grants Pass, Oreg 97526
COMPUTER SYSTEMS CO. INC.
1470 St Charles Ave, Cleveland, Ohio 44107
COMPUTER SYSTEMS CORP. U.S. INDUSTRIES INC
P O Box 64400, Dallas, Tex 75206
COMPUTER TASK GROUP INC.
5586 Main St, Buffalo, N Y 14221
COMPUTER TECHNOLOGY INC. SUB. UNIV.
COMPUTING CO.
P O Box 47911, Dallas, Tex 75247
COMPUTER UNIVERSAL CORP.
1641 Universal Rd, Columbus, Ohio 43207
COMPUTER USAGE CO.
7315 Wisconsin Ave Nw, Washington, D C 20014
COMPUTER USAGE CO.
387 Elliot St, Newton Uppr Fls, Mass 02164
COMPUTER USAGE CO.
3181 Porter Dr, Palo Alto, Cal 94304
COMPUTER USAGE CORP.
100 Putnam Green, Greenwich, Conn 06830
COMPUTER USAGE CORP.
8939 S Sepulveda Blvd, Los Angeles, Cal 90045
COMPUTING & SOFTWARE INC., EAST COAST DIV.
3700 Mt Vernon Ave, Alexandria, Va 22305
COMPUTING EFFICIENCY INC. COMPUTING EFF. DIV.
35 Orville Dr, Bohemia, N Y 11716
COMPUVISOR INC.
P O Box 381, Ithaca, N Y 14850
COMSERV CORP.
4025 Chestnut St, Philadelphia, Pa 19104
COMTECH NEW ENGLAND INC.
534 Boston Post Rd, Wayland, Mass 01778

2 Product Directory

- COMTEK ASSOCIATES
2077 Center Ave, Fort Lee, N J 07024
CONSAD RESEARCH CORP.
5600 Forward Ave, Pittsburgh, Pa 15217
CONSENTIVE INC.
3525 Lancaster Ave, Philadelphia, Pa 19104
CONSUMER SYSTEMS CORP.
15 Spinning Wheel Rd, Hinsdale, Ill 60521
CONTINENTAL DATA PROCESSING INC.
300 Market St., Kingston, Pa 18704
CONTROL DATA CORP. CEIR PROF. SERV. DIV.
5272 River Rd, Washington, D C 20016
CONTROL TECHNOLOGY INC.
3450 E Spring St, Long Beach, Cal 90806
CSI COMPUTER SYSTEMS INC.
P O Box 75008, Cincinnati, Ohio 45275
CTC COMPUTER CORP.
1000 Elwell Court, Palo Alto, Cal 94303
CYBERMATICS INC.
2460 Lemoine Ave, Fort Lee, N J 07024
D.P.&W. INC.
1107 Commonwealth Ave, Boston, Mass 02215
DATA ARCHITECTS INC.
213 3rd Ave, Waltham, Mass 02154
DATA COMPUTING CORP.
229 Baldwin Rd, Hempsted, N Y 11551
DATA CONTROL CO.
405 E Easterday Ave, Sault Ste Marie, Mich 49783
DATA COPY INC.
760 Bryant St, San Francisco, Cal 94107
DATA CORP., THE PENINSULA COMPUTER CENTER
DIV
1190 Coleman Ave, San Jose, Cal 95110
DATA MANAGEMENT SERVICES INC.
1845 Walnut St, Philadelphia, Pa 19103
DATA PROCESSING AND ACCOUNTING SERVICES
50 Van Ness Ave, San Francisco, Cal 94102
DATA SERVICE CORP.
1907 Division St, Nashville, Tenn 37203
DATA SYSTEMS INC.
434 Stinson Blvd, Minneapolis, Minn 55413
DATA-TRONICS CORP. SUB. ARKANSAS BEST CORP.
310 Townson Ave, Fort Smith, Ark 72901
DATACAP INTERNATIONAL INC.
37 W 2950 S, Salt Lake City, Utah 84101
DATAMATION SERVICES INC.
461 Eighth Ave, New York, N Y 10001
DATASONICS INC.
P O Box 4553, New York, N Y 10017
DELMARVA COMPUTER INDUSTRIES INC.
5865 Robert Oliver Pl, Columbia, Md 21043
DEUSSEN ASSOCIATES INC.
576 Hyannis Dr, Sunnyvale, Cal 94087
DIGITAL PROGRAMMING SERVICES INC.
60 Hickory Dr, Waltham, Mass 02154
DIGITRON INC.
P O Box 5836, Columbus, S C 29205
DIKEWOOD CORP., THE
1009 Bradbury Dr SE, Albuquerque, N M 87106
DIPIETRO & WILSON INC.
1107 Commonwealth Ave, Boston, Mass 02215
DIRECT ACCESS COMPUTING CORP.
984 Livernois Rd, Troy, Mich 48084
DIVERSIFIED COMPUTER APPLICATIONS
2525 E Bayshore Rd, Palo Alto, Cal 94302
DYNAMIC ACCESS CORP.
220 Park Ave S, New York, N Y 10003
EASTERN COMPUTER SERVICES INC
920 Fox Chase Rd, Rockledge, Pa 19111
ECONOMIC INFORMATION SYSTEMS INC.
21 W 38 St, New York, N Y 10018
ELECTROMECH COMPUTING & TECH. SERVICES CO.
2964 Peachtree Rd NW, Atlanta, Ga 30305
ELECTRONIC DATA PREPARATION CORP.
P O Box 1446, Bradenton, Fla 33505
ELMIRA DATA PROCESSING CO.
221 E Church St, Elmira, N Y 14902
ENTREKIN COMPUTERS INC. SUB. THE CROSS CO.
9475 Center Rd, Fenton, Mich 48430
EXPRESS SOFTWARE SYSTEMS INC.
342 Madison Ave, New York, N Y 10017
FABRI-TEK INFORMATION MANAGEMENT, INC.
5901 S County Rd 18, Edina, Minn 55436
FEDDER DATA CENTERS MANAGEMENT INC.
1654 Central Ave, Albany, N Y 12205
FEDDER DATA CENTERS INC.
307 S Sharp St, Baltimore, Md 21201
FIRST BUSINESS COMPUTING
1020 Houston Bk& Tr, Houston, Tex 77002
FLORES ASSOCIATES
108 8th Ave, Brooklyn, N Y 11215
GANNETT, FLEMING, CORDRY & CARPENTER INC.
P O Box 1963, Harrisburg, Pa 17105
GENASYS CORP.
2011 Gye St NW, Washington, D C 20006
GOODHEW, J.W. & ASSOCIATES INC.
11600 Nebel St, Rockville, Md 20854
GRAPHIC IMAGE CORP.
612 S Clinton St, Chicago, Ill 60607
GREYHOUND COMPUTER CORP.
130 S Canal St, Chicago, Ill 60606
GTE DATA SERVICES INC.
5422 Bay Center Dr, Tampa, Fla 33609
GULLEY, DALE L. & ASSOCIATES, INC.
2300 E 14th St, Tulsa, Okla 74104
HAVERLY SYSTEMS INC.
4 2nd Ave, Denville, N J 07834
HOLLANDER ASSOCIATES
P O Box 2276, Fullerton, Cal 92633
HONEYWELL INFORMATION SYSTEMS INC. INFO.
SERV.DIV
2701 4th Ave S, Minneapolis, Minn 55408
HOUSING DATA CORP.
29433 Southfield Rd, Southfield, Mich 48075
HOUSING DATA CORP.
23400 Michigan, Dearborn, Mich 48124
HOWARD ASSOC. INC., DANIEL D.
307 N Michigan Ave, Chicago, Ill 60601
HRB-SINGER INC.
Science Park, State College, Pa 16801
HUB RATLIFF CONSULTANT
P O Box 22487, Houston, Tex 77027
ICM COMPUTER CORP.
P O Box 7220, Tulsa, Okla 74105
INDECON INC.
30 N LaSalle St, Chicago, Ill 60602
INFODATA SYSTEMS INC.
680 Ridge Rd, Webster, N Y 14580
INFONET SYSTEMS INC.
358 McKinley Blvd, Paramus, N J 07652
INFORMATICS INC.
21050 Vanover St, Canoga Park, Cal 91303
INFORMATION DEVELOPMENT ASSOCIATES INC.
P O Box 2285, Bethlehem, Pa 18018
INFORMATION DISPLAY INC.
333 N Bedford Rd, Mt Kisco, N Y 10549
INFORMATION MANAGEMENT INC.
447 Battery St, San Francisco, Cal 94111
INFORMATION SCIENCES INC.
14 Jefferson Blvd, Warwick, R I 02888
INFORMATION SERVICES INC.
90 Broad St, Babson Park, Mass 02157
INFORMATION SYSTEMS MANAGEMENT
120 Montgomery St, San Francisco, Cal 94104
INFORMATION SYSTEMS CORP.
1701 K St, Washington, D C 20006
INFOTON INC.
2nd Ave, Burlington, Mass 01803
INNOVATIVE SOFTWARE INC.
486 Totten Pond Rd, Waltham, Mass 02154
INPUT INC.
500 Old Elm Rd, Highland Park, Ill 60035
INSTITUTE FOR CYBERNETIC DEVELOPMENT
3031 Bateman St, Berkeley, Cal 94705
INTECH INC.
2915 Wayzata Blvd, Minneapolis, Minn 55405
INTERACTIVE DATA CORP.
486 Totten Pond Rd, Waltham, Mass 02154
INTERACTIVE SCIENCES CORP.
60 Brook Dr, Braintree, Mass 02184
INTERNATIONAL COMPUTER CORP.
1 N Broadway, White Plains, N Y 10601
INTERNATIONAL TELECOMPUTER NETWORK CORP.
4919 Fairmont Ave, Bethesda, Md 20014
INTERNATIONAL TIMESHARING CORP.
Its Bldg Jonathan Ind, Chaska, Minn 55318
ITT DATA SERVICES
7822 Bonhomme, St Louis, Mo 63105
ITT DATA SERVICES DIV.
P O Box 402, Paramus, N J 07652
KEYSTONE COMPUTER ASSOCIATES INC.
1055 Virginia Dr, Ft Washington, Pa 19034
LEASCO DATA PROCESSING EQUIPMENT CORP.
280 Park Ave, New York, N Y 10017
LITTON SYSTEMS INC. MELLONICS DIV.
1001 W Maude Ave, Sunnyvale, Cal 94086
LOCKHEED ELECTRONICS DATA MANAGEMENT
SERVICES
16811 El Camino Real, Houston, Tex 77058
MANAGEMENTICS INC.
2 Pennsylvania Plaza, New York, N Y 10001
MANAGEMENT & COMPUTER SERVICES INC.
104 Park Towne Pl E, Philadelphia, Pa 19130
MANAGEMENT COMPUTER CONTROLS INC.
3385 Airway Blvd., Memphis, Tenn 38116
MANAGEMENT CONCEPTS INC.
2 Decker Sq, Bala-Cynwyd, Pa 19004
MANAGEMENT REPORTING SERVICES INC.
5929 E 38th Ave, Denver, Colo 80207
MANAGEMENT SCIENCE AMERICA INC.
1389 Peachtree St NE, Atlanta, Ga 30309
MANAGEMENT SYSTEMS CORP.
7007 Preston Rd, Dallas, Tex 75205
MANAGEMENT SYSTEMS INC.
420 W Campbell Ave., Roanoke, Va 24016
MASTECH COMPUTER SYSTEMS INC.
7026 W North Ave, Chicago, Ill 60635
MATHEMATICAL APPLICATIONS GROUP INC.
180 S Broadway, White Plains, N Y 10605
MATRIX CORP., THE
931 S Douglas St, El Segundo, Cal 90245
MCAULIFFE ASSOC. INC., JOHN INC.
1181 Broadway, New York, N Y 10001
MCDILL CORP.
P O Box 98, Montgomery, Ala 36101
MCDONNELL AUTOMATION CO.
500 Jefferson Bldg, Houston, Tex 27002
MCDONNELL AUTOMATION CO.
360 W Federal Savings, Denver, Colo 80202
MCDONNELL AUTOMATION CO.
P O Box 516, St Louis, Mo 63166
META-LANGUAGE PRODUCTS INC.
4 E 43 St, New York, N Y 10017
METRIDATA COMPUTING INC.
6600 Grade Lane, Louisville, Ky 40221
MICROMATON SYSTEMS INC.
3610 East St, Landover, Md 20785
MILNEE BROTHERS PRODUCTS
8000 Blackburn Ave, Los Angeles, Cal 90048
MNEMOTECH COMPUTER SYSTEMS
55 Liberty St, New York, N Y 10005
MOORE BUSINESS FORMS INC.
110-112 Pkwy Inn Bldg, Niagara Falls, N Y 14302
NATIONAL C.S.S.
460 Summer St, Stamford, Conn 06901
NEOTERIC INC.
2800 Euclid Ave, Cleveland, Ohio 44115
NETWORK DATA PROCESSING CORP.
823 Commerce Dr, Oak Brook, Ill 60521
NORDEN DIV., UNITED AIRCRAFT CORP.
Helen St, Norwalk, Conn 06850
OPERATIONS RESEARCH INC.
1400 Spring St, Silver Spring, Md 20910
PANSOPHIC SYSTEMS INC.
230 Roosevelt Rd, Lombard, Ill 60148
PAYMENT SYSTEMS INC.
405 Lexington Ave, New York, N Y 10017
PENNDATA CORP.
1729 Cedar Ave, Scranton, Pa 18505
PHI COMPUTER SERVICES INC.
800 Massachusetts Ave, Arlington, Mass 02174
PHILCO-FORD CORP., COMPUTER SERVICES NETWORK
Tioga & C Sts, Philadelphia, Pa 19134
PIONEER DATA SYSTEMS INC.
606 Merle Hay Tower, Des Moines, Iowa 50310
PLANNING RESEARCH CORP.
1100 Glendon Ave, Los Angeles, Cal 90024
PRC COMPUTER CENTER INC. PLANNING RSCH CORP.
7670 Old Springhouse, McLean, Va 22101
PRINCETON INFORMATIX INC.
1 Palmer Sq, Princeton, N J 08540
PRINCETON TIME SHARING SERVICES, INC.
Us Hwy 1, Princeton, N J 08540
PROFIMATICS INC.
6355 Topanga Canyon, Woodland Hills, Cal 91364
PROGRAMMING SCIENCES CORP.
S E 42 St, New York, N Y 10016
PTSS SYSTEMMETRICS DIV.
Martinsville Center, Martinsville, N J 08836
PUBLIC DATA PROCESSING CORP.
640 N LaSalle St, Chicago, Ill 60610
QUICKDATA INTERNATIONAL INC.
8444 Wilshire Blvd, Beverly Hills, Cal 90211
RAPIDATA INC.
20 New Dutch Lane, Fairfield, N J 07006
REALTIME SYSTEMS INC.
866 3rd Ave, New York, N Y 10022
REMOTE COMPUTING CORP.
A40 Palo Alto Off Ctr, Palo Alto, Cal 94301
REPRODUCTION SYSTEMS DIV. TRANSAMERICA
COMP.
1 California St, San Francisco, Cal 94111
REPUBLIC STEEL CORP. MANUFACTURING DIV.
1315 Albert St, Youngstown, Ohio 44505
REPUBLIC SYSTEMS INC.
100 Plaza Centre, Secaucus, N J 07094
REPUBLIC SYSTEMS INC.
715 Park Ave, E Orange, N J 07017
REPUBLIC SYSTEMS OF CONNECTICUT INC.
350 S Main St, Cheshire, Conn 06410
RIDGWOOD ASSOCIATES INC.
10 Wilsey Sq, Ridgewood, N J 07450
SAID INC.
1243 W Broad St, Falls Church, Va 22046

2 Product Directory

SARNA ASSOCIATES INC.
22 Russell St, Brookline, Mass 02146
SCANTLIN ELECTRONICS, INC.
5454 Beethoven St, Los Angeles, Cal 90060
SCIENTIFIC CALCULATIONS INC.
10 Allens Creek Rd, Rochester, N Y 14618
SCIENTIFIC COMPUTERS, INC.,
919 Second Ave S, Minneapolis, Minn 55402
SCIENTIFIC SOFTWARE CORP.
5300 S Ulster, Englewood, Colo 80110
SCI-TEK COMPUTER CENTER INC.
1707 Gilpin Ave, Wilmington, Del 19806
SIERRA RESEARCH CORP. COMPUTER PROD. GRP.
167 Bedford St., Burlington, Mass 01803
SMITH CORP., A.O. DATA SYSTEMS DIV.
3533 N 27 St, Milwaukee, Wisc 53201
SOFTTECH INC.
391 Totten Pond Rd, Waltham, Mass 02154
SOFTWARE METHODS INC.
10 E 40th St, New York, N Y 10016
SOFTWARE PROGRAMMING ASSOCIATES INC.
1209 Tropic St, Titusville, Fla 32780
SOUTHERN DATA PROCESSING SERVICE INC.
P O Box 123, Augusta, Ga 30903
SPACETRONICS CO.
43 Hassemer Ave, Cherry Hill, N J 08034
SPS INC.
4485 N W 36th St, Miami, Fla 33166
STANDARD PROCESSING CO. INC.
P O Box 703, Pharr, Tex 78577
SYNERGISTIC SOFTWARE SYSTEMS, INC.
Po Box 36097, Houston, Tex 77036
SYSTEM DEVELOPMENT CORP.
2500 Colorado Ave, Santa Monica, Cal 90406
SYSTEM IMPLEMENTATION CORP.
18 E 48th St, New York, N Y 10017
SYSTEMATICS GENERAL CORP.
6825 Redmond Dr, McLean, Va 22101
SYSTEMATICS INC.
411 Victory, Little Rock, Ark 72201
SYSTEMS ANALYSIS INC.
11110 N E 8th, Bellevue, Wash 98004
SYSTEMS ASSOCIATES INC.
356 Penn St, Reading, Pa 19602
SYSTEMS DATA, INC.
1951 W Market St, Akron, Ohio 44313
SYSTEMS GENERAL CORP.
10889 Wilshire Blvd, Los Angeles, Cal 90024
SYSTEMS, SCIENCE & SOFTWARE INC.
Po Box 1620, La Jolla, Cal 92037
TECHNOLOGY FOR INFORMATION MANAGEMENT INC.
1654 Central Ave, Albany, N Y 12205
TECHNOMETRICS INC.
6000 Telegraph Ave, Oakland, Cal 94609
TELEDYNE BROWN ENGINEERING
300 Sparkman Dr, Huntsville, Ala 35807
TIME SHARING SCIENCES INC.
1180 Ave Americas, New York, N Y 10036
TIME-SHARING SYSTEMS, INC.,
1840 N Farwell Ave, Milwaukee, Wis 53202
TRACOR COMPUTING CORP.
1705 Guadalupe St, Austin, Tex 78701
TRAVCOM INC.
1425 E McMillan, Cincinnati, Ohio 45206
TRAVCOM INC. UNITED DATA PROC DV
70 E 14th St, Eugene, Oreg 97401
TRILOG ASSOCIATES INC.
1700 Market St, Philadelphia, Pa 19103
TRIPLE C COMPUTER SERVICE
432 Park Ave S, New York, N Y 10016
TRW SYSTEMS GROUP SOFTWARE & INFORMATION
SYS DIV
1 Space Park, Redondo Beach, Cal 90278
U.S. TIME-SHARING INC.
1831 Michael Faraday, Reston, Va 22070
UNITED COMPUTING SYSTEMS INC.
3130 Broadway, Kansas City, Mo 64111
UNITED SYSTEMS INC.
1020 Kings Hwy N, Cherry Hill, N J 08034
UNIVERSAL DATA SYSTEMS INC.
14482 Beach Blvd, Westminster, Cal 92626
BANKERS DATA SERVICES INC.
P O Box 6228, Dallas, Tex 75222
URS DATA SCIENCE CO.
155 Boveet Rd, San Mateo, Cal 94402
VITRO LABORATORIES, DIV. VITRO CORP. OF AMERICA
14000 Georgia Ave, Silver Spring, Md 20910
WARREN ASSOCIATES
15 Royal Crest Dr, Marlboro, Mass 01752
WELLINGTON COMPUTER SYSTEMS CORP.
405 Lexington Ave, New York, N Y 10017
WENGEL SERVICE CORP.
1101 State Rd, Princeton, N J 08540
WESTERN OPERATIONS INC.
120 Montgomery St, San Francisco, Cal 94104

WESTINGHOUSE ELECTRIC CORP.
Westinghouse Bldg, Pittsburgh, Pa 15222
WESTINGHOUSE TELE-COMPUTER SYSTEMS CORP.
2040 Ardmore Blvd, Pittsburgh, Pa 15221
WORLD COMPUTER CORP.
1615 Stemmons Fwy, Dallas, Tex 75221
ZENITH INTEGRATED-DATA PROCESSING INC.
950 Fulton Ave, Sacramento, Cal 95825

SERVICES, PROCESSING (COMMERCIAL EDP)

ABINGTON KEYPUNCH INC.
920 Fox Chase Rd, Rockledge, Pa 19111
ACADEMY COMPUTING CORP.
5005 N Lincoln Blvd, Oklahoma City, Okla 73105
ADAPT INC.
624 S 62nd St, Philadelphia, Pa 19143
ADATACO
1475 N Broadway, Walnut Creek, Cal 94596
ADMINISTRATIVE SYSTEMS INC.
131 Mineola Blvd, Mineola, N Y 11501
ADP-AUTOMATIC DATA PROCESSING OF SF INC.
4250 W Williams Rd, San Jose, Cal 95129
ADVANCE DATA
221 Hughes Dr, Jonesboro, Ark 72401
ADVANCED AUTOMATION ASSOCIATES
192 Worcester St, Wellesley Hills, Mass 02181
ADVANCED COMPUTER TECHNIQUES CORP.
437 Madison Ave, New York, N Y 10022
AGRICULTURAL COMPUTING CO. DBA
ASSOCIOMETRICS
P O Box 1259, Grand Prairie, Tex 75050
ALPHA COMPUTER SERVICE CORP.
226 W 37th St, New York, N Y 10018
AMERICAN COMPUTER LEASING CORP.
14 E 4th St, Cincinnati, Ohio 45202
AMERICAN COMPUTER SERVICES CORP.
14 E 4th St, Cincinnati, Ohio 45202
AMERICAN KEY PUNCH CO.
204 Wow Bldg, Omaha, Nebr 68104
ANACOMP INC.
6161 Hillside Ave, Indianapolis, Ind 46220
ANALYTIC SCIENCES CORP., THE
6 Jacob Way, Reading, Mass 01867
ANCOM SYSTEMS, DIV. GENERAL ANALYTICS CORP.
9841 Airport Blvd, Los Angeles, Cal 90045
ANDROCOR INC.
5949 Hohman Ave, Hammond, Ind 46320
APPLIED COMPUTER TIME SHARE INC.
29200 Southfield Rd, Southfield, Mich 48075
APPLIED CYBERNETICS CORP.
1285 Forgewood Ave, Sunnyvale, Cal 94086
APT COMPUTER CENTER
5309 W Touhy, Skokie, Ill 60076
ARISTA INFORMATION SYSTEMS INC.
P O Box 4775, Winston-Salem, N C 27107
ASC TABULATING CORP.
1080 Green Bay Rd, Lake Bluff, Ill 60044
AUDITEK INC.
866 6th Ave, New York, N Y 10001
AUTOCOMP INC.
4720 Montgomery Ln, Bethesda, Md 20014
AUTOMATED COMPUTER SERVICES INC.
517 W Grace St, Richmond, Va 23220
AUTOMATED DATA ASSOCIATES INC.
1333 Lawrence St, Rahway, N J 07065
AUTOMATED FACTS & FIGURES CO.
4551 S Racine Ave, Chicago, Ill 60609
AUTOMATED INFORMATION SYSTEMS INC.
1064 River Rd, Edgewater, N J 07020
AUTOMATED SYSTEMS CORP.
600 Houst Nat Gas Bld, Houston, Tex 77002
AUTOMATIC DATA PROCESSING, INC.
405 Route 3, Clifton, N J 07015
AUTOMATION, INC.
1904 Farnam St, Omaha, Nebr 68102
AUTOMATION SERVICES CORP.
182 Forbes Rd, Braintree, Mass 02184
BANKERS DATA SERVICES INC.
430 Lamar, Houston, Tex 77002
BENDIX CORP., THE, ELECTRODYNAMICS DIV
11600 Sherman Way, No Hollywood, Cal 91605
BIZ-MATIC DATA CONTROL CENTERS INC.
232 Summer St, Boston, Mass 02210
BMS DATA PROCESSING CORP.
415 E Paces Ferry Rd, Atlanta, Ga 30305
BONNER&MOORE ASSOCIATES INC.
500 Jefferson Bldg, Houston, Tex 77002
BOOTHE RESOURCES INTERNATIONAL INC.
3435 Wilshire Blvd, Los Angeles, Cal 90005
BRADDOCK, DUNN & McDONALD INC.
8027 Leesburg Pike, Mc Lean, Va 22101

BURLINGTON MANAGEMENT SERVICES CO.
P O Box 21207, Greensboro, N C 27420
BURROUGHS CORP., BUSINESS MACHINES GROUP
6071 2nd Ave, Detroit, Mich 48232
C&C COMPUTER SYSTEMS INC.
1006 S E Grand, Portland, Ore 97214
CALL-A-COMPUTER INC.
633 Young St, Santa Ana, Cal 92702
CALTEC INC.
1931 Sylvania Ave, Toledo, Ohio 43613
CAL-WESTERN DATA SYSTEMS INC.
13517 Ventura Blvd, Sherman Oaks, Cal 91403
CENTRAL COMPUTING CORP.
749 Water P O Box 681, Decatur, Ill 62525
CENTRAL COMPUTING CORP.
180 N Mich Ave, Chicago, Ill 60601
CENTRAL COMPUTING, INC.
2627 E Central, Wichita, Kans 67214
CENTRAL DATA SYSTEMS INC.
1215 Valley Belt Rd, Cleveland, Ohio 44131
CENTRAL PROCESSING CENTER OF SAN ANTONIO
INC.
P O Box 1416, San Antonio, Tex 78206
CENTURY DATA PROCESSING INC.
1006 Coronado Towers, El Paso, Tex 79912
CGA COMPUTER ASSOCIATES INC.
715 Park Ave, East Orange, N J 07017
CHAPARRAL SYSTEMS INC. MANAGEMENT,
Po Box 5755, Bethesda, Md 20014
CHI CORP.
11000 Cedar Ave, Cleveland, Ohio 44106
CHICAGO TABULATING SERV. INC.
425 N Michigan, Chicago, Ill 60611
COMMERCIAL TECHNOLOGY INC.
P O Box 10616, Knoxville, Tenn 37919
COMPAC COMPUTER SYSTEMS INC.
911 Hennepin, Minneapolis, Minn 55403
COM PU DAT DIV. SOUTHEASTERN NEWSPAPERS
CORP.
P O Box 3806, Augusta, Ga 30904
COMPUTATICS INC.
327 S LaSalle St, Chicago, Ill 60604
COMPU-MEDIC CONTROLS CORP.
432 Park Ave S, New York, N Y 10016
COMPU SYS INC.
Po Box 11104, Albuquerque, N M 87112
COMPU-TIME INC.
327 Orange Ave, Daytona, Fla 32014
COMPUTATION AND SYSTEMS CORP.
12061 Wilshire Blvd, Los Angeles, Cal 90025
COMPUTE AMERICA CORP. DBA COMERICA
1515 Classen Blvd, Oklahoma City, Okla 73106
COMPUTER AMERICA CORP.
818 Roeder Rd, Silver Spring, Md 20910
COMPUTER APPLICATIONS CENTER, INC.
516 Hutton Pl, Columbus, Ohio 43215
COMPUTER CENTER, INC.,
350 Royal Palm Way, Palm Beach, Fla 33480
COMPUTER CENTER OF ATLANTA DIV. COMP. CNTRS
INC
2695 Buford Hwy NE, Atlanta, Ga 30324
COMPUTER COMMAND AND CONTROLS COMPANY
4025 Chestnut St, Philadelphia, Pa 19104
COMPUTER CONSULTING SERVICES
1176 Iowa, Dubuque, Iowa 52001
COMPUTER CONVERSIONS INC.
140 Weldon Pkwy, Maryland Hts, Mo 63044
COMPUTER DATA SERVICES INC.
P O Box 1431, Fayetteville, N C 28302
COMPUTER DIMENSIONS, INC.
511 Akard, Dallas, Tex 75201
COMPUTER DYNAMICS INC.
1760 Solano Ave, Berkeley, Cal 94707
COMPUTER DYNAMICS INC.
100 Heegenberger Rd, Oakland, Cal 94621
COMPUTER FULFILLMENT
225 East St, Winchester, Mass 01890
COMPUTER INFORMATION SERVICES INC.
6701 N Broad St, Philadelphia, Pa 19126
COMPUTER INFORMATION CORP.
3645 Wrrnsville Ctr Rd, Cleveland, Ohio 44122
COMPUTER INVESTMENTS & LEASING CORP.
9 Tanner St, Haddonfield, N J 08033
COMPUTER MANAGEMENT INC.
3101 Eullid Ave, Cleveland, Ohio 44115
COMPUTER MEASUREMENTS CO.
12970 Bradley Ave, San Fernando, Cal 91342
COMPUTER NETWORK CORP.
5185 Macarthur Blvd, Washington, D C 20016
COMPUTER POWER INC.
30 S Laura St, Jacksonville, Fla 32202
COMPUTER PROCESSING INC.
200 Manhattan Bldg, Muskogee, Okla 74401
COMPUTER PROCESSING INC.
300 6th Ave, Pittsburgh, Pa 15222

2 Product Directory

- COMPUTER RESOURCES INC.
5091 W 164th St, Cleveland, Ohio 44142
- COMPUTER SCIENCES CORP. INFO. NETWORK DIV.
1901 Building, Los Angeles, Cal 90067
- COMPUTER SERVICENTER CORP.
16 Maple St, Latham, N Y 12110
- COMPUTER SERVICE OF E. TEXAS
P O Box 5981, Jasper, Tex 75951
- COMPUTER SERVICES CORP.
200 Bank Savings Bldg, Birmingham, Ala 35203
- COMPUTER SERVICES INC.
500 Clark St, Paducah, Ky 42001
- COMPUTER SERVICES INC.
47 Congress St, Salem, Mass 01970
- COMPUTER SERVICES OF INDIANA, INC.
214 S 13 1/2 St, Terre Haute, Ind 47808
- COMPUTER SHARING SERVICES
2492 W 2nd Ave, Denver, Colo 80223
- COMPUTER SYSTEMS
400 Wing Bldg, Grants Pass, Oreg 97526
- COMPUTER SYSTEMS CORP. U.S. INDUSTRIES INC
P O Box 64400, Dallas, Tex 75206
- COMPUTER SYSTEMS INC.
19619 81st Ave S, Kent, Wash 98031
- COMPUTER TABULATING CORP.
136 Main St, Hemstead, N Y 11550
- COMPUTER TASK GROUP INC.
5586 Main St, Buffalo, N Y 14221
- COMPUTER TECHNOLOGY INC. SUB. UNIV.
COMPUTING CO.
P O Box 47911, Dallas, Tex 75247
- COMPUTER TIME
368 Village Sq, Orinda, Cal 94563
- COMPUTER UNIVERSAL CORP.
1641 Universal Rd, Columbus, Ohio 43207
- COMPUTING & SOFTWARE INC., EAST COAST DIV.
3700 Mt Vernon Ave, Alexandria, Va 22305
- COMPUTING EFFICIENCY INC. COMPUTING EFF. DIV.
35 Orville Dr, Bohemia, N Y 11716
- COMPUTONE SYSTEMS INC.
361 E Paces Ferry Rd, Atlanta, Ga 30305
- COMSERV CORP.
4025 Chestnut St, Philadelphia, Pa 19104
- COMSI INC.
1211 W 22 St, Oakbrook, Ill 60521
- COMTECH NEW ENGLAND INC.
534 Boston Post Rd, Wayland, Mass 01778
- CONDATA INC.
1809 Walnut St, Philadelphia, Pa 19103
- CONSENTIVE INC.
3525 Lancaster Ave, Philadelphia, Pa 19104
- CONSUMER SYSTEMS CORP.
15 Spinning Wheel Rd, Hinsdale, Ill 60521
- CONTINENTAL DATA PROCESSING INC.
300 Market St., Kingston, Pa 18704
- CONTROL TECHNOLOGY INC.
3450 E Spring St, Long Beach, Cal 90806
- COOPER DATA SYSTEMS INC.
826 Union St, New Orleans, La 70112
- CORPORATE DATA PROCESSING
1724 Silver Lake Blvd, Los Angeles, Cal 90026
- CTC COMPUTER CORP.
1000 Elwell Court, Palo Alto, Cal 94303
- CUSTOM DATA PROCESSING SERVICES
P O Box 14685, Phoenix, Ariz 85031
- D.P.&W. INC.
1107 Commonwealth Ave, Boston, Mass 02215
- DATA CENTER CORP.
3002 Midvale St, Los Angeles, Cal 90034
- DATA COMPUTING CORP.
229 Baldwin Rd, Hempstead, N Y 11551
- DATA CONTROL CO.
405 E Easterday Ave, Sault Ste Marie, Mich 49783
- DATA CORP., THE
1111 W 6th St, Los Angeles, Cal 90017
- DATA CORP., THE PENINSULA COMPUTER CENTER
DIV
1190 Coleman Ave, San Jose, Cal 95110
- DATA MANAGEMENT SERVICES INC.
1845 Walnut St, Philadelphia, Pa 19103
- DATA-PACK INC.
269 Brookside Rd, Waterbury, Conn 06720
- DATA PROCESSING AND ACCOUNTING SERVICES
50 Van Ness Ave, San Francisco, Cal 94102
- DATA PROCESSING CENTER DIV FROST REALTY CO
P O Box 1600, San Antonio, Tex 78206
- DATA PROCESSING SERVICE INC.
270 Main St, Painesville, Ohio 44077
- DATA PROCESSORS INC.
2703 W 28th Ave, Pine Bluff, Ark 71601
- DATA SERVICE CORP.
1907 Division St, Nashville, Tenn 37203
- DATA SERVICE OF TEXAS INC.
1415 W 5th, Plainview, Tex 79072
- DATA SYSTEMS INC.
434 Stinson Blvd, Minneapolis, Minn 55413
- DATA SYSTEMS INC.
707 S E Belmont St, Portland, Ore 97214
- DATA-TRONICS CORP. SUB. ARKANSAS BEST CORP.
310 Townson Ave, Fort Smith, Ark 72901
- DATA USAGE CORP.,
2460 Lemoine Ave, Fort Lee, N J 07024
- DATACAP INTERNATIONAL INC.
37 W 2950 S, Salt Lake City, Utah 84101
- DATACON INTERNATIONAL INC.
2745 Bernice Rd, Lansing, Ill 60438
- DATAGRAPHICS INC.
740 N Rush St, Chicago, Ill 60611
- DATAMATION SERVICES INC.
461 Eighth Ave, New York, N Y 10001
- DATAROYAL INC.
Simon St, Nashua, N H 03060
- DATASONICS INC.
P O Box 4553, New York, N Y 10017
- DATATAB
740 N Rush St, Chicago, Ill 60611
- DATATRONIC SERVICE CO.
1250 Guardian Blvd, Detroit, Mich 48226
- DA-TRONICS INC.
2962 Market Ave N, Canton, Ohio 44714
- DELMARVA COMPUTER INDUSTRIES INC.
5865 Robert Oliver Pl, Columbia, Md 21043
- DELTA AUTOMATED SYSTEMS INC.
816 Thayer Ave, Silver Spring, Md 20910
- DELTA SYSTEMS CORP.
Edens Executive Ctr, Wilmette, Ill 60091
- DIGITAL PROGRAMMING SERVICES INC.
60 Hickory Dr, Waltham, Mass 02154
- DIGITRON INC.
P O Box 5836, Columbus, S C 29205
- DIPIETRO & WILSON INC.
1107 Commonwealth Ave, Boston, Mass 02215
- DIRECT ACCESS COMPUTING CORP.
984 Livernois Rd, Troy, Mich 48084
- DIVERSIFIED COMPUTER APPLICATIONS
2525 E Bayshore Rd, Palo Alto, Cal 94302
- DYNAMIC ACCESS CORP.
220 Park Ave S, New York, N Y 10003
- EASTERN COMPUTER SERVICES INC
920 Fox Chase Rd, Rockledge, Pa 19111
- ELECTROMECH COMPUTING & TECH. SERVICES CO.
2964 Peachtree Rd NW, Atlanta, Ga 30305
- ELECTRONIC ACCOUNTING SYSTEMS INC.
255 Alexander St, Rochester, N Y 14607
- ELECTRONIC BUSINESS SERVICE
P O Box 368, Visalia, Cal 93277
- ELECTRONIC COMPUTER PROG. INSTITUTE
49 N Progress Ave, Harrisburg, Pa 17109
- ELECTRONIC DATA PREPARATION CORP.
P O Box 1446, Bradenton, Fla 33505
- ELECTRONIC DATA SERVICE INC.
18 Germay Dr, Wilmington, Del 19804
- ELECTRONIC TABULATING SERVICE INC.
P O Box 85, Atlanta, Ga 30301
- ELMIRA DATA PROCESSING CO.
221 E Church St, Elmira, N Y 14902
- ENNIS BRANDON COMPUTER SERVICES INC.
2840 Walnut Hill Ln, Dallas, Tex 75229
- EXPRESS SOFTWARE SYSTEMS INC.
342 Madison Ave, New York, N Y 10017
- FABRI-TEK INFORMATION MANAGEMENT, INC.
5901 S County Rd 18, Edina, Minn 55436
- FARRINGTON MANUFACTURING CO.
6707 Electronics Dr, Springfield, Va 22151
- FEDDER DATA CENTERS INC.
307 S Sharp St, Baltimore, Md 21201
- FISHER-STEVENSON INC.
120 Brighton Rd, Clifton, N J 07012
- GANNETT, FLEMING, CORDRY & CARPENTER INC.
P O Box 1963, Harrisburg, Pa 17105
- GENASYS CORP.
2011 Gye St NW, Washington, D C 20006
- GENERAL COMPUTER SERVICES INC.
1332 Meridan St NE, Huntsville, Ala 35801
- GENESEE COMPUTER CENTER INC.
20 University Ave, Rochester, N Y 14605
- GOODHEW, J.W. & ASSOCIATES INC.
11600 Nebel St, Rockville, Md 20854
- GRAY & ASSOCIATES INC., H.J.
2501 Cedar Springs Rd, Dallas, Tex 75201
- GREYHOUND COMPUTER CORP.
130 S Canal St, Chicago, Ill 60606
- GROWTH INDUSTRY COMPUTING INC.
1111 Wilshire Blvd, Los Angeles, Cal 90017
- GTE DATA SERVICES INC.
5422 Bay Center Dr, Tampa, Fla 33609
- GULLEY, DALE L. & ASSOCIATES, INC.
2300 E 14th St, Tulsa, Okla 74104
- HELM DATA PROCESSING INC.
P O Box 147, Arcata, Cal 95521
- HOBBS ASSOCIATES, INC.
Po Box 686, Corona Del Mar, Cal 92625
- HONEYWELL INFORMATION SYSTEMS INC. INFO.
SERV.DIV
2701 4th Ave S, Minneapolis, Minn 55408
- HOOVER INC., J.K.
2720 1st Ave NE, Cedar Rapids, Iowa 52402
- HOUSING DATA CORP.
29433 Southfield Rd, Southfield, Mich 48075
- HOUSING DATA CORP.
23400 Michigan, Dearborn, Mich 48124
- HYDRA COMPUTER CORP.
P O Box 17883, Raleigh, N C 27609
- IAC COMPUTER SYSTEMS INC.
260 Newton Rd, Plainview, N Y 11803
- ICM COMPUTER CORP.
P O Box 7220, Tulsa, Okla 74105
- INFODATA SYSTEMS INC.
680 Ridge Rd, Webster, N Y 14580
- INFONET SYSTEMS INC.
358 McKinley Blvd, Paramus, N J 07652
- INFORMATICS INC.
21050 Vanover St, Canoga Park, Cal 91303
- INFORMATION DEVELOPMENT ASSOCIATES INC.
P O Box 2285, Bethlehem, Pa 18018
- INFORMATION SCIENCES INC.
14 Jefferson Blvd, Warwick, R I 02888
- INPUT INC.
500 Old Elm Rd, Highland Park, Ill 60035
- INTECH INC.
2915 Wayzata Blvd, Minneapolis, Minn 55405
- INTEL CORP. DATA PROCESSING DIV.
1120 Ave of Americas, New York, N Y 10036
- INTERACTIVE DATA CORP.
486 Totten Pond Rd, Waltham, Mass 02154
- INTERACTIVE SCIENCES CORP.
60 Brook Dr, Braintree, Mass 02184
- INTERNATIONAL COMPUTER CORP.
1 N Broadway, White Plains, N Y 10601
- INTERNATIONAL SYSTEMS ASSOCIATES, LTD.
350 5th Ave, New York, N Y 10001
- INTERNATIONAL TELECOMPUTER NETWORK CORP.
4919 Fairmont Ave, Bethesda, Md 20014
- INTERSTATE COMPUTER SERVICES
754 4th Ave, Brooklyn, N Y 11232
- ITT DATA SERVICES DIV.
P O Box 402, Paramus, N J 07652
- KEY PUNCH SERVICE CO.
4 Smithfield St, Pittsburgh, Pa 15222
- KEYDATA CORP.
108 Water St, Watertown, Mass 02172
- LEASCO DATA PROCESSING EQUIPMENT CORP.
280 Park Ave, New York, N Y 10017
- LEVER DATA PROCESSING SERVICES, INC.
390 Park Ave, New York, N Y 10022
- LITTON SYSTEMS INC. MELLONICS DIV.
1001 W Maude Ave, Sunnyvale, Cal 94086
- LOGIC INC.
1712 Commerce St, Dallas, Tex 75201
- LOHMAN DATA PROCESSING INC.
1818 State St, Quincy, Ill 62301
- LYNCH & CO., JOHN G.
245 Briarcliff Rd, Cary, Ill 60013
- MANAGEMENT & COMPUTER SERVICES INC.
104 Park Towne Pl E, Philadelphia, Pa 19130
- MANAGEMENT COMPUTER CONTROLS INC.
3385 Airway Blvd., Memphis, Tenn 38116
- MANAGEMENT DATA PROCESSING SYSTEMS
P O Box 466, Warsaw, N C 28398
- MANAGEMENT DATA PROCESSING SYSTEMS
385 Lakeview Ave, Clifton, N J 07011
- MANAGEMENT REPORTING SERVICES INC.
5929 E 38th Ave, Denver, Colo 80207
- MANAGEMENT SCIENCE AMERICA INC.
1389 Peachtree St NE, Atlanta, Ga 30309
- MANAGEMENT SERVICES INC.
1538 Dunex Hill Ln Ne, Atlanta, Ga 30324
- MANAGEMENT SYSTEMS CORP.
7007 Preston Rd, Dallas, Tex 75205
- MANAGEMENT SYSTEMS INC.
420 W Campbell Ave., Roanoke, Va 24016
- MARK/OPS DIV., NORTH EASTERN SYSTEMS ASSOC.
INC.
475 Commonwealth Ave, Boston, Mass 02215
- MATHEMATICAL APPLICATIONS GROUP INC.
180 S Broadway, White Plains, N Y 10605
- MATRIX CORP., THE
931 S Douglas St, El Segundo, Cal 90245
- MCAULIFFE ASSOC. INC., JOHN INC.
1181 Broadway, New York, N Y 10001
- MC DILL CORP.
P O Box 98, Montgomery, Ala 36101

2 Product Directory

MCDONNELL AUTOMATION CO.
500 Jefferson Bldg, Houston, Tex 27002
MCDONNELL AUTOMATION CO.
360 W Federal Savings, Denver, Colo 80202
MCDONNELL AUTOMATION CO.
P O Box 516, St Louis, Mo 63166
MEMPHIS METHODS & TABULATING SERVICE INC.
56 N Main St, Memphis, Tenn 38103
METRIDATA COMPUTING INC.
6600 Grade Lane, Louisville, Ky 40221
MICHIANA LEASING CORP.
1814 S Main St, S Bend, Ind 46613
MILNEE BROTHERS PRODUCTS
8000 Blackburn Ave, Los Angeles, Cal 90048
MNEMOTECH COMPUTER SYSTEMS
55 Liberty St, New York, N Y 10005
MOBILITY SYSTEMS D P SERVICES DEPT.
3530 De La Cruz Blvd, Santa Clara, Cal 95050
MODERN BUSINESS RECORDS
6030 Chase, Dearborn, Mich 48126
MOORE BUSINESS FORMS INC.
110-112 Pkwy Inn Bldg, Niagara Falls, N Y 14302
NATIONAL COMPUTER ANALYSTS INC.
Us Hwy 1, Princeton, N J 08540
NATIONAL DATA PROCESSING INC.
P O Box 3393, Wilmington, N C 28401
NETWORK DATA PROCESSING CORP.
823 Commerce Dr, Oak Brook, Ill 60521
NORTHWEST MANAGEMENT SERVICES INC.
2300 Elake Ave E, Seattle, Wash 98102
O. K. DATA SERVICES
P O Box 3001, Darien, Conn 06820
OFFICE SERVICES, INC.
2919 Allen Parkway, Houston, Tex 77019
OPERATIONS RESEARCH INC.
1400 Spring St, Silver Spring, Md 20910
OPTICAL SCANNING CORP.
P O Box 40, Newton, Pa 18940
PAPERWORK DATA COMM. SERVICES INC.
1703 S Ave, Syracuse, N Y 13207
PAYMENT SYSTEMS INC.
405 Lexington Ave, New York, N Y 10017
PG DATA CENTER INC.
P O Box 11, Garrettsville, Ohio 44231
PHI COMPUTER SERVICES INC.
800 Massachusetts Ave, Arlington, Mass 02174
PHILCO-FORD CORP., COMPUTER SERVICES NETWORK
Tioga & C Sts, Philadelphia, Pa 19134
PIONEER DATA SYSTEMS INC.
606 Merle Hay Tower, Des Moines, Iowa 50310
PLANNING RESEARCH CORP.
1100 Glendon Ave, Los Angeles, Cal 90024
PRC COMPUTER CENTER INC. PLANNING RSCH CORP.
7670 Old Springhouse, McLean, Va 22101
PRINCETON INFORMATRIX INC.
1 Palmer Sq, Princeton, N J 08540
PRINCETON TIME SHARING SERVICES, INC.
Us Hwy 1, Princeton, N J 08540
PROGRAMMING SCIENCES CORP.
S E 42 St, New York, N Y 10016
PROGRAMMING SCIENCES CORP.
1900 Ave of The Stars, Los Angeles, Cal 90067
PRYOR COMPUTER INDUSTRIES
400 N Michigan Ave, Chicago, Ill 60611
PUBLIC DATA PROCESSING CORP.
640 N Lasalle St, Chicago, Ill 60610
QUIKDATA INTERNATIONAL INC.
8444 Wilshire Blvd, Beverly Hills, Cal 90211
REALTIME SYSTEMS INC.
866 3rd Ave, New York, N Y 10022
REMOTE COMPUTING CORP.
440 Palo Alto Off Ctr, Palo Alto, Cal 94301
RESALAB INC. RESALAB SCIENTIFIC DIV.
4000 Campbell Ave, Menlo Park, Cal 94025
RIDGEWOOD ASSOCIATES INC.
10 Wilsey Sq, Ridgewood, N J 07450
ROSS & CO. INC., ROBERT H.
22 Main St Rear, Denver, Pa-17517
SAGE ACTION INC.
P O Box 416, Ithaca, N Y 14850
SAID INC.
1243 W Broad St, Falls Church, Va 22046
SARNA ASSOCIATES INC.
22 Russell St, Brookline, Mass 02146
SC DATA CENTER, INC.
1112 7th Ave, Monroe, Wis 53566
SCANFORMS INC.
312 Fox Pavilion, Jenkintown, Pa 19095
SCIENTIFIC COMPUTERS, INC.,
919 Second Ave S, Minneapolis, Minn 55402
SCIENTIFIC SOFTWARE CORP.
5300 S Ulster, Englewood, Colo 80110
SCI-TEK COMPUTER CENTER INC.
1707 Gilpin Ave, Wilmington, Del 19806

SERVICE BUREAU CORP., THE
1350 Ave Americas, New York, N Y 10019
SHARED COMPUTER SYSTEMS CORP.
176 W Adams St, Chicago, Ill 60603
SINTAB INC. SUB. UNITED DATA CENTERS
6563 Ridings Rd, Syracuse, N Y 13206
SMITH CORP., A.O. DATA SYSTEMS DIV.
3533 N 27 St, Milwaukee, Wisc 53201
SMITHSONIAN ASTROPHYSICAL OBSERVATORY
60 Garden St, Cambridge, Mass 02138
SOFTWARE METHODS INC.
10 E 40th St, New York, N Y 10016
SOFTWARE PROGRAMMING ASSOCIATES INC.
1209 Tropic St, Titusville, Fla 32780
SOUTHERN DATA PROCESSING SERVICE INC.
P O Box 123, Augusta, Ga 30903
SOUTHERN VERMONT COMPUTER CENTER&DATA
SCHOOL
219 Belmont Ave, Bennington, Vt 05201
SOUTHWEST COMPUTER COLLEGE INC.
136 Louisiana NE, Albuquerque, N M 87108
STANDARD PROCESSING CO. INC.
P O Box 703, Pharr, Tex 78577
SYMETRICS INDUSTRIES INC.
1227 S Patrick Dr, Satellite Beach, Fla 32935
SYSTEM DEVELOPMENT CORP.
2500 Colorado Ave, Santa Monica, Cal 90406
SYSTEMATICS INC.
411 Victory, Little Rock, Ark 72201
SYSTEMS & ELECTRONICS, INC.
223 Park Ave, Rutherford, N J 07070
SYSTEMS ANALYSIS INC.
11110 N E 8th, Bellevue, Wash 98004
SYSTEMS ASSOCIATES INC.
356 Penn St, Reading, Pa 19602
SYSTEMS DATA PROCESSING CO.
920 23rd St, Sacramento, Cal 95816
SYSTEMS GENERAL CORP.
10889 Wilshire Blvd, Los Angeles, Cal 90024
SYSTEMS, SCIENCE & SOFTWARE INC.
Po Box 1620, La Jolla, Cal 92037
TAB DATA SYSTEMS INC.
4833 Everett Ave, Los Angeles, Cal 90058
TABULATING CONSULTANTS INC.
1011 W Alameda Ave, Burbank, Cal 91506
TEL-DATA SERVICE CORP.
1221 4th Ave, San Diego, Cal 92101
TELE-DATA CORP.
130 U S Hwy 22, N Plainfield, N J 07060
TIME-SHARING SYSTEMS, INC.,
1840 N Farwell Ave, Milwaukee, Wis 53202
TRACOR COMPUTING CORP.
1705 Guadalupe St, Austin, Tex 78701
TRAVCOM INC.
1425 E McMillan, Cincinnati, Ohio 45206
TRAVCOM INC. UNITED DATA PROC DIV
70 E 14th St, Eugene, Oreg 97401
TRILOG ASSOCIATES INC.
1700 Market St, Philadelphia, Pa 19103
TRIPLE C COMPUTER SERVICE
432 Park Ave S, New York, N Y 10016
U.S. TIME-SHARING INC.
1831 Michael Faraday, Reston, Va 22070
UNITAB CO. OF ABILENE
418 Chestnut St, Abilene, Tex 79604
UNITED COMPUTING SYSTEMS INC.
3130 Broadway, Kansas City, Mo 64111
UNITED DATA CENTERS INC.
100 Putnam Green, Greenwich, Conn 06830
UNITED SYSTEMS INC.
1020 Kings Hwy N, Cherry Hill, N J 08034
UNIVAC DATA PROCESSING SRVCS. DIV. SPERRY
RAND
60 Herricks Rd, Mineola, N Y 11501
UNIVERSAL INFORMATION SYSTEMS INC.
S-10 Rte 17 At Rte 4, Paramus, N J 07652
UNIVERSITY COMPUTING CO.
P O Box 6228, Dallas, Tex 75222
URS DATA SCIENCE CO.
155 Bovet Rd, San Mateo, Cal 94402
VIRTUAL COMPUTER SERVICES INC
1119 Springfield Rd, Union, N J 07083
WELLINGTON COMPUTER SYSTEMS CORP.
405 Lexington Ave, New York, N Y 10017
WENGEL SERVICE CORP.
1101 State Rd, Princeton, N J 08540
WEST FLORIDA DATA PROCESSING CENTER INC.
P O Box 1460, Panama City, Fla 32401
WESTERN OPERATIONS INC.
120 Montgomery St, San Francisco, Cal 94104
WESTERN UNION TELEPROCESSING CO.
82 McKee Dr, Mahwah, N J 07436
WESTINGHOUSE TELE-COMPUTER SYSTEMS CORP.
2040 Ardmore Blvd, Pittsburgh, Pa 15221

WESTLEY MODERN METHODS
214 S Michigan Ave, Big Rapids, Mich 49307
WORLD COMPUTER CORP.
1615 Stemmons Fwy, Dallas, Tex 75221
ZENITH INTEGRATED-DATA PROCESSING INC.
950 Fulton Ave, Sacramento, Cal 95825

SERVICES, PROCESSING (ANALOG OR HYBRID, SCIENTIFIC)

BAGANOFF ASSOCIATES INC.
6809 W Florissant, St Louis, Mo 63136
BENDIX CORP., THE, ELECTRODYNAMICS DIV
11600 Sherman Way, No Hollywood, Cal 91605
CENTRAL COMPUTING, INC.
2627 E Central, Wichita, Kans 67214
CHICAGO TABULATING SERV. INC.
425 N Michigan, Chicago, Ill 60611
COMPUMEDIC CONTROLS CORP.
432 Park Ave S, New York, N Y 10016
COMPUTER CORP. OF AMERICA
6216 Evergreen St, Houston, Tex 77036
COMPUTERIA INC.
14 Wood Rd, Braintree, Mass 02143
COMPUTER NETWORK CORP.
5185 Macarthur Blvd, Washington, D C 20016
COMPUTER PRODUCTS, INC.
P O Box 23849, Ft Lauderdale, Fla 33307
COMPUTER SCIENCES CORP. INFO. NETWORK DIV.
1901 Building, Los Angeles, Cal 90067
COMPUTER SERVICENTER CORP.
16 Maple St, Latham, N Y 12110
COMPUTER TECHNOLOGY INC. SUB. UNIV.
COMPUTING CO.
P O Box 47911, Dallas, Tex 75247
COMSERV CORP.
4025 Chestnut St, Philadelphia, Pa 19104
CONTROL TECHNOLOGY INC.
3450 E Spring St, Long Beach, Cal 90806
ELECTRONIC ASSOCIATES INC.
485 Monmouth Pkwy, W Long Branch, N J 07764
GANNETT, FLEMING, CORDDRY & CARPENTER INC.
P O Box 1963, Harrisburg, Pa 17105
ICM COMPUTER CORP.
P O Box 7220, Tulsa, Okla 74105
INFORMATICS INC.
21050 Vanover St, Canoga Park, Cal 91303
LEASCO DATA PROCESSING EQUIPMENT CORP.
280 Park Ave, New York, N Y 10017
MCDONNELL AUTOMATION CO.
500 Jefferson Bldg, Houston, Tex 27002
MCDONNELL AUTOMATION CO.
P O Box 516, St Louis, Mo 63166
MDC TECHNOLOGY CORP. SUB. MNGMNT. DATA
CORP.
530 W St Rd, Warminster, Pa 18974
MELPAR DIV. LTV ELECTROSYSTEMS INC.
7700 Arlington Blvd, Falls Church, Va 22046
MILLETRON INC.
540 Alpha Dr, Pittsburgh, Pa 15238
PENNDATA CORP.
1729 Cedar Ave, Scranton, Pa 18505
PHILCO-FORD CORP., COMPUTER SERVICES NETWORK
Tioga & C Sts, Philadelphia, Pa 19134
PROGRAMMING SCIENCES CORP.
S E 42 St, New York, N Y 10016
PROGRAMMING SCIENCES CORP.
1900 Ave of The Stars, Los Angeles, Cal 90067
RESALAB INC. RESALAB SCIENTIFIC DIV.
4000 Campbell Ave, Menlo Park, Cal 94025
SAID INC.
1243 W Broad St, Falls Church, Va 22046
SCIENTIFIC CALCULATIONS INC.
110 Allens Creek Rd, Rochester, N Y 14618
SCIENTIFIC SYSTEMS SERVICES INC.
476 N Hwy A1a, Satellite Beach, Fla 32935
SEISMOGRAPH SERVICE CORP.
P O Box 1590, Tulsa, Okla 74102
TRACOR COMPUTING CORP.
1705 Guadalupe St, Austin, Tex 78701
WESTINGHOUSE TELE-COMPUTER SYSTEMS CORP.
2040 Ardmore Blvd, Pittsburgh, Pa 15221

SERVICES, PROCESSING (DIGITAL SCIENTIFIC)

ABINGTON KEYPUNCH INC.
920 Fox Chase Rd, Rockledge, Pa 19111
ACADEMY COMPUTING CORP.
5005 N Lincoln Blvd, Oklahoma City, Okla 73105
ADAPT INC.
624 S 62nd St, Philadelphia, Pa 19143

2 Product Directory

ADVANCED COMPUTER TECHNIQUES CORP.

437 Madison Ave, New York, N Y 10022
AMERICAN COMPUTER LEASING CORP.
14 E 4th St, Cincinnati, Ohio 45202
AMERICAN COMPUTER SERVICES CORP.
14 E 4th St, Cincinnati, Ohio 45202
ANDROCOR INC.
5949 Hohman Ave, Hammond, Ind 46320
APPLIED COMPUTER TIME SHARE INC.
29200 Southfield Rd, Southfield, Mich 48075
AUTOMATED INFORMATION SYSTEMS INC.
1064 River Rd, Edgewater, N J 07020
AUTOMATION SERVICES CORP.
182 Forbes Rd, Braintree, Mass 02184
BAGANOFF ASSOCIATES INC.
6809 W Florissant, St Louis, Mo 63136
BECK & ASSOCIATES, R.W.
200 Tower Bldg, Seattle, Wash 98101
BENDIX CORP., THE, ELECTRODYNAMICS DIV
11600 Sherman Way, No Hollywood, Cal 91605
BERKELEY COMPUTER CORP.
2398 4th St, Berkeley, Cal 94710
BONNER&MOORE ASSOCIATES INC.
500 Jefferson Bldg, Houston, Tex 77002
BOOTHE RESOURCES INTERNATIONAL INC.
3435 Wilshire Blvd, Los Angeles, Cal 90005
BRADDOCK, DUNN & MCDONALD INC.
8027 Leesburg Pike, Mc Lean, Va 22101
BURLINGTON MANAGEMENT SERVICES CO.
P O Box 21207, Greensboro, N C 27420
C&C COMPUTER SYSTEMS INC.
1006 S E Grand, Portland, Ore 97214
CALTEC INC.
1931 Sylvania Ave, Toledo, Ohio 43613
CENTRAL COMPUTING, INC.
2627 E Central, Wichita, Kans 67214
CHI CORP.
11000 Cedar Ave, Cleveland, Ohio 44106
CHICAGO TABULATING SERV. INC.
425 N Michigan, Chicago, Ill 60611
COLLINS RADIO CO.
1200 N Alma Rd, Dallas, Tex 75207
COMPUMEDIC CONTROLS CORP.
432 Park Ave S, New York, N Y 10016
COMPU-TIME INC.
327 Orange Ave, Daytona, Fla 32014
COMPUTER APPLICATIONS CENTER, INC.
516 Hutton Pl, Columbus, Ohio 43215
COMPUTER CONSULTANTS CORP.
U S Rte 46 E, Denville, N J 07834
COMPUTER CORP. OF AMERICA
6216 Evergreen St, Houston, Tex 77036
COMPUTER NETWORK CORP.
5185 Macarthur Blvd, Washington, D C 20016
COMPUTER PRODUCTS, INC.
P O Box 23849, Ft Lauderdale, Fla 33307
COMPUTER SCIENCES CORP. INFO. NETWORK DIV.
1901 Building, Los Angeles, Cal 90067
COMPUTER SERVICENTER CORP.
16 Maple St, Latham, N Y 12110
COMPUTER SERVICES INC.
500 Clark St, Paducah, Ky 42001
COMPUTER SHARING SERVICES
2492 W 2nd Ave, Denver, Colo 80223
COMPUTER SYSTEMS CORP. U.S. INDUSTRIES INC
P O Box 64400, Dallas, Tex 75206
COMPUTER TASK GROUP INC.
5586 Main St, Buffalo, N Y 14221
COMPUTER TECHNOLOGY INC. SUB. UNIV.
COMPUTING CO.
P O Box 47911, Dallas, Tex 75247
COMPUTER UNIVERSAL CORP.
1641 Universal Rd, Columbus, Ohio 43207
COMPUTING & SOFTWARE INC., EAST COAST DIV.
3700 Mt Vernon Ave, Alexandria, Va 22305
COMPUTONE SYSTEMS INC.
361 E Paces Ferry Rd, Atlanta, Ga 30305
COMSERV CORP.
4025 Chestnut St, Philadelphia, Pa 19104
CONTROL TECHNOLOGY INC.
3450 E Spring St, Long Beach, Cal 90806
CTC COMPUTER CORP.
1000 Elwell Court, Palo Alto, Cal 94303
CURRAN COMPUTER CORP.
946 Main St, Hackensack, N J 07601
CUSTOM DATA PROCESSING SERVICES
P O Box 14685, Phoenix, Ariz 85031
DATA MANAGEMENT SERVICES INC.
1845 Walnut St, Philadelphia, Pa 19103
DATA SYSTEMS INC.
707 S E Belmont St, Portland, Ore 97214
DATA USAGE CORP.,
2460 Lemoine Ave, Fort Lee, N J 07024
DATACAP INTERNATIONAL INC.
37 W 2950 S, Salt Lake City, Utah 84101

DATAROYAL INC.

Simon St, Nashua, N H 03060
DESIGN AUTOMATION INC.
809 Massachusetts Ave, Lexington, Mass 02173
DIGITAL PROGRAMMING SERVICES INC.
60 Hickory Dr, Waltham, Mass 02154
DIMENSIONAL SYSTEMS INC.
393 Totten Pond Rd, Waltham, Mass 02154
DIRECT ACCESS COMPUTING CORP.
984 Livernois Rd, Troy, Mich 48084
DYNAMIC ACCESS CORP.
220 Park Ave S, New York, N Y 10003
EASTERN COMPUTER SERVICES INC
920 Fox Chase Rd, Rockledge, Pa 19111
ELECTRONIC ASSOCIATES INC.
485 Monmouth Pkwy, W Long Branch, N J 07764
ENTREKIN COMPUTERS INC. SUB. THE CROSS CO.
9475 Center Rd, Fenton, Mich 48430
GANNETT, FLEMING, CORDDRY & CARPENTER INC.
P O Box 1963, Harrisburg, Pa 17105
GENERAL AUTOMATION INC.
1055 S East St, Anaheim, Cal 92805
GENESEE COMPUTER CENTER INC.
20 University Ave, Rochester, N Y 14605
GRAPHICAL TECHNOLOGY CORP.
47-34 33rd St, Long Is Cy, N Y 11101
GREYHOUND COMPUTER CORP.
130 S Canal St, Chicago, Ill 60606
GULLEY, DALE L. & ASSOCIATES, INC.
2300 E 14th St, Tulsa, Okla 74104
HAVERLY SYSTEMS INC.
4 2nd Ave, Denville, N J 07834
HOBBS ASSOCIATES, INC.
Po Box 686, Corona Del Mar, Cal 92625
HONEYWELL INFORMATION SYSTEMS INC. INFO.
SERV.DIV
2701 4th Ave S, Minneapolis, Minn 55408
HOOVER INC., J.K.
2720 1st Ave NE, Cedar Rapids, Iowa 52402
HOUSING DATA CORP.
29433 Southfield Rd, Southfield, Mich 48075
HOUSING DATA CORP.
23400 Michigan, Dearborn, Mich 48124
HRB-SINGER INC.
Science Park, State College, Pa 16801
HYDRA COMPUTER CORP.
P O Box 17883, Raleigh, N C 27609
ICM COMPUTER CORP.
P O Box 7220, Tulsa, Okla 74105
INFONET SYSTEMS INC.
358 McKinley Blvd, Paramus, N J 07652
INFORMATION DEVELOPMENT ASSOCIATES INC.
P O Box 2285, Bethlehem, Pa 18018
INTECH INC.
2915 Wayzata Blvd, Minneapolis, Minn 55405
INTERACTIVE SCIENCES CORP.
60 Brook Dr, Braintree, Mass 02184
INTERACTIVE SYSTEMS INC.
327 S Fourth Ave, Ann Arbor, Mich 48108
INTERNATIONAL TELECOMPUTER NETWORK CORP.
4919 Fairmont Ave, Bethesda, Md 20014
ITT DATA SERVICES DIV.
P O Box 402, Paramus, N J 07652
LEASCO DATA PROCESSING EQUIPMENT CORP.
280 Park Ave, New York, N Y 10017
LITTON SYSTEMS INC. MELLONICS DIV.
1001 W Maude Ave, Sunnyvale, Cal 94086
MACRO CORP.
1260 Virginia Dr, Ft Washington, Pa 19034
MANAGEMENT COMPUTER CONTROLS INC.
3385 Airway Blvd., Memphis, Tenn 38116
MATRIX CORP., THE
931 S Douglas St, El Segundo, Cal 90245
MCDONNELL AUTOMATION CO.
500 Jefferson Bldg, Houston, Tex 27002
MCDONNELL AUTOMATION CO.
360 W Federal Savings, Denver, Colo 80202
MCDONNELL AUTOMATION CO.
P O Box 516, St Louis, Mo 63166
MELPAR DIV. LTV ELECTROSYSTEMS INC.
7700 Arlington Blvd, Falls Church, Va 22046
MNEMOTECH COMPUTER SYSTEMS
55 Liberty St, New York, N Y 10005
NATIONAL C.S.S.
460 Summer St, Stamford, Conn 06901
PENNDATA CORP.
1729 Cedar Ave, Scranton, Pa 18505
PENNDATA CORP.
1729 Cedar Ave, Scranton, Pa 18505
PHI COMPUTER SERVICES INC.
800 Massachusetts Ave, Arlington, Mass 02174
PHILCO-FORD CORP., COMPUTER SERVICES NETWORK
Tioga & C Sts, Philadelphia, Pa 19134
PLANNING RESEARCH CORP.
1100 Glendon Ave, Los Angeles, Cal 90024

PRC COMPUTER CENTER INC. PLANNING RSCH CORP.

7670 Old Springhouse, McLean, Va 22101
PRINCETON INFORMATRIX INC.
1 Palmer Sq, Princeton, N J 08540
PROGRAMMING SCIENCES INC.
S E 42 St, New York, N Y 10016
PROGRAMMING SCIENCES CORP.
1900 Ave of The Stars, Los Angeles, Cal 90067
QUIKDATA INTERNATIONAL INC.
8444 Wilshire Blvd, Beverly Hills, Cal 90211
REALTIME SYSTEMS INC.
866 3rd Ave, New York, N Y 10022
REMOTE COMPUTING CORP.
A40 Palo Alto Off Ctr, Palo Alto, Cal 94301
RESALAB INC. RESALAB SCIENTIFIC DIV.
4000 Campbell Ave, Menlo Park, Cal 94025
SAGE ACTION INC.
P O Box 416, Ithaca, N Y 14850
SAID INC.
1243 W Broad St, Falls Church, Va 22046
SCANFORMS INC.
312 Fox Pavilion, Jenkintown, Pa 19095
SCHULTZ INSTRUMENTS INC.
P O Box 13385, Gainesville, Fla 32601
SCIENTIFIC CALCULATIONS INC.
110 Allens Creek Rd, Rochester, N Y 14618
SCIENTIFIC COMPUTERS, INC.,
919 Second Ave S, Minneapolis, Minn 55402
SCIENTIFIC SOFTWARE CORP.
5300 S Ulster, Englewood, Colo 80110
SCIENTIFIC SYSTEMS SERVICES INC.
476 N Hwy A1a, Satellite Beach, Fla 32935
SCI-TEK COMPUTER CENTER INC.
1707 Gilpin Ave, Wilmington, Del 19806
SEISMOGRAPH SERVICE CORP.
P O Box 1590, Tulsa, Okla 74102
SHARED COMPUTER SYSTEMS CORP.
176 W Adams St, Chicago, Ill 60603
SMITH CORP., A.O. DATA SYSTEMS DIV.
3533 N 27 St, Milwaukee, Wisc 53201
SMITHSONIAN ASTROPHYSICAL OBSERVATORY
60 Garden St, Cambridge, Mass 02138
SOFTWARE PROGRAMMING ASSOCIATES INC.
1209 Tropic St, Titusville, Fla 32780
SYSTEMS ANALYSIS INC.
11110 N E 8th, Bellevue, Wash 98004
SYSTEMS, SCIENCE & SOFTWARE INC.
Po Box 1620, La Jolla, Cal 92037
TECHNICAL ADVISORS INC.
4455 Fletcher St, Wayne, Mich 48184
TIME-SHARING SYSTEMS, INC.,
1840 N Farwell Ave, Milwaukee, Wis 53202
TRACOR COMPUTING CORP.
1705 Guadalupe St, Austin, Tex 78701
TRILOG ASSOCIATES INC.
1700 Market St, Philadelphia, Pa 19103
UNITED COMPUTING SYSTEMS INC.
3130 Broadway, Kansas City, Mo 64111
UNIVERSITY COMPUTING CO.
P O Box 6228, Dallas, Tex 75222
VIRTUAL COMPUTER SERVICES INC
1119 Springfield Rd, Union, N J 07083
VITRO LABORATORIES, DIV. VITRO CORP. OF AMERICA
14000 Georgia Ave, Silver Spring, Md 20910
WESTINGHOUSE TELE-COMPUTER SYSTEMS CORP.
2040 Ardmore Blvd, Pittsburgh, Pa 15221

SERVICES, TIME SHARING (COMMERCIAL)

ACADEMY COMPUTING CORP.
5005 N Lincoln Blvd, Oklahoma City, Okla 73105
AHART & ASSOC. INC., JAMES R.
225 S Main St, Dayton, Ohio 45402
ALLEN-BABCOCK COMPUTING INC.
1800 Ave of The Stars, Los Angeles, Cal 90067
AMERICAN COMPUTER LEASING CORP.
14 E 4th St, Cincinnati, Ohio 45202
AMERICAN COMPUTER SERVICES CORP.
14 E 4th St, Cincinnati, Ohio 45202
ANCOM SYSTEMS, DIV. GENERAL ANALYTICS CORP.
9841 Airport Blvd, Los Angeles, Cal 90045
APPLIED COMPUTER TIME SHARE INC.
29200 Southfield Rd, Southfield, Mich 48075
APPLIED GEODATA SYSTEMS INC.
675 Massachusetts Ave, Cambridge, Mass 02139
APPLIED LOGIC CORP.
One Palmer Sq, Princeton, N J 08540
AUTOMATED SYSTEMS CORP.
600 Houst Nat Gas Bld, Houston, Tex 77002
AUTOMATION SERVICES CORP.
182 Forbes Rd, Braintree, Mass 02184
BERKELEY COMPUTER CORP.
2398 4th St, Berkeley, Cal 94710

2 Product Directory

BURLINGTON MANAGEMENT SERVICES CO.
P O Box 21207, Greensboro, N C 27420
BURROUGHS CORP., BUSINESS MACHINES GROUP
6071 2nd Ave, Detroit, Mich 48232
C&C COMPUTER SYSTEMS INC.
1006 S E Grand, Portland, Ore 97214
CALL-A-COMPUTER INC.
633 Young St, Santa Ana, Cal 92702
CENTRAL COMPUTING CORP.
180 N Mich Ave, Chicago, Ill 60601
CENTRAL COMPUTING, INC.
2627 E Central, Wichita, Kans 67214
CENTRAL PROCESSING CENTER OF SAN ANTONIO INC.
P O Box 1416, San Antonio, Tex 78206
CENTURY DATA PROCESSING INC.
1006 Coronado Towers, El Paso, Tex 79912
CHAPARRAL SYSTEMS INC. MANAGEMENT,
Po Box 5755, Bethesda, Md 20014
CHI CORP.
11000 Cedar Ave, Cleveland, Ohio 44106
CHICAGO TABULATING SERV. INC.
425 N Michigan, Chicago, Ill 60611
COMMUNITY COMPUTER CORP.
185 W Schoolhouse Ln, Philadelphia, Pa 17144
COMPAC COMPUTER SYSTEMS INC.
911 Hennepin, Minneapolis, Minn 55403
COMPUMEDIC CONTROLS CORP.
432 Park Ave S, New York, N Y 10016
COMPU-TIME INC.
327 Orange Ave, Daytona, Fla 32014
COMPUTATION AND SYSTEMS CORP.
12061 Wilshire Blvd, Los Angeles, Cal 90025
COMPUTER CENTER, INC.,
350 Royal Palm Way, Palm Beach, Fla 33480
COMPUTER COMMAND AND CONTROLS COMPANY
4025 Chestnut St, Philadelphia, Pa 19104
COMPUTER COMPLEX, INC.
6400 Westpark, Houston, Tex 77027
COMPUTER DIMENSIONS, INC.
511 Akard, Dallas, Tex 75201
COMPUTERIA INC.
14 Wood Rd, Braintree, Mass 02143
COMPUTER NETWORK CORP.
5185 Macarthur Blvd, Washington, D C 20016
COMPUTER PROCESSING INC.
300 6th Ave, Pittsburgh, Pa 15222
COMPUTER SCIENCES CORP. INFO. NETWORK DIV.
1901 Building, Los Angeles, Cal 90067
COMPUTER SERVICENTER CORP.
16 Maple St, Latham, N Y 12110
COMPUTER SHARING SERVICES
2492 W 2nd Ave, Denver, Colo 80223
COMPUTER TASK GROUP INC.
5586 Main St, Buffalo, N Y 14221
COMPUTER UNIVERSAL CORP.
1641 Universal Rd, Columbus, Ohio 43207
COMP/UTILITY INC.
1 Center Plaza, Boston, Mass 02108
COMPUTONE SYSTEMS INC.
361 E Paces Ferry Rd, Atlanta, Ga 30305
COMSERV CORP.
4025 Chestnut St, Philadelphia, Pa 19104
COM-SHARE INC.
P O Box 1588, Ann Arbor, Mich 48106
COMSONIC CORP., THE
123 Pleasant Ave, Upper Saddle R, N J 07458
CONSENTIVE INC.
3525 Lancaster Ave, Philadelphia, Pa 19104
CONSOLIDATED COMPUTER INTERNATIONAL INC.
235 Wyman St, Waltham, Mass 02154
CONSOLIDATED COMPUTER LTD.
48 Yonge St, Toronto, CANADA
CORPORATE DATA PROCESSING
1724 Silver Lake Blvd, Los Angeles, Cal 90026
CTC COMPUTER CORP.
1000 Elwell Court, Palo Alto, Cal 94303
CUSTOM DATA PROCESSING SERVICES
P O Box 14685, Phoenix, Ariz 85031
CYPHERNETICS CORP., THE
333 Maple Village Ctr, Ann Arbor, Mich 48103
DATA PROCESSING AND ACCOUNTING SERVICES
50 Van Ness Ave, San Francisco, Cal 94102
DATA SYSTEMS INC.
434 Stinson Blvd, Minneapolis, Minn 55413
DATAGRAPHICS INC.
740 N Rush St, Chicago, Ill 60611
DATALOGICS INC.
12025 Shakee Blvd, Cleveland, Ohio 44120
DATASONICS INC.
P O Box 4553, New York, N Y 10017
DELMARVA COMPUTER INDUSTRIES INC.
5865 Robert Oliver Pl, Columbia, Md 21043
DIALOG COMPUTING INC.
1305 Post Rd, Fairfield, Conn 06430

DIGITEK TIMESHARE INC.
4818 Lincoln Blvd, Marina Del Rey, Cal 90291
DIRECT ACCESS COMPUTING CORP.
984 Livernois Rd, Troy, Mich 48084
DIVERSIFIED COMPUTER APPLICATIONS
2525 E Bayshore Rd, Palo Alto, Cal 94302
DYNAMIC ACCESS CORP.
220 Park Ave S, New York, N Y 10003
EDP RESOURCES, INC.
One North Broadway, White Plains, N Y 10601
ELECTRONIC TABULATING SERVICE INC.
P O Box 85, Atlanta, Ga 30301
ENNIS BRANDON COMPUTER SERVICES INC.
2840 Walnut Hill Ln, Dallas, Tex 75229
EXPRESS SOFTWARE SYSTEMS INC.
342 Madison Ave, New York, N Y 10017
FEDDER DATA CENTERS MANAGEMENT INC.
1654 Central Ave, Albany, N Y 12205
GENERAL COMPUTER SERVICES INC.
1332 Meridan St NE, Huntsville, Ala 35801
GENESEE COMPUTER CENTER INC.
20 University Ave, Rochester, N Y 14605
HOBBS ASSOCIATES, INC.
Po Box 686, Corona Del Mar, Cal 92625
HONEYWELL INFORMATION SYSTEMS INC. INFO.
SERV.DIV
2701 4th Ave S, Minneapolis, Minn 55408
HOUSING DATA CORP.
29433 Southfield Rd, Southfield, Mich 48075
HOUSING DATA CORP.
23400 Michigan, Dearborn, Mich 48124
ICM COMPUTER CORP.
P O Box 7220, Tulsa, Okla 74105
INFONET SYSTEMS INC.
358 McKinley Blvd, Paramus, N J 07652
INFORMATION DEVELOPMENT ASSOCIATES INC.
P O Box 2285, Bethlehem, Pa 18018
INTERACTIVE DATA CORP.
486 Totten Pond Rd, Waltham, Mass 02154
INTERACTIVE SCIENCES CORP.
60 Brook Dr, Braintree, Mass 02184
INTERACTIVE TECHNICAL SERVICES INC.
486 Totten Pond Rd, Waltham, Mass 02154
INTERNATIONAL TELECOMPUTER NETWORK CORP.
4919 Fairmont Ave, Bethesda, Md 20014
INTERNATIONAL TIMESHARING CORP.
Its Bldg Jonathan Ind, Chaska, Minn 55318
ITT DATA SERVICES DIV.
P O Box 402, Paramus, N J 07652
KEYDATA CORP.
108 Water St, Watertown, Mass 02172
LEASCO DATA PROCESSING EQUIPMENT CORP.
280 Park Ave, New York, N Y 10017
MANAGEMENT SYSTEMS CORP.
7007 Preston Rd, Dallas, Tex 75205
MARK/OPS DIV., NORTH EASTERN SYSTEMS ASSOC.
INC.
475 Commonwealth Ave, Boston, Mass 02215
MATRIX CORP., THE
931 S Douglas St, El Segundo, Cal 90245
MCDILL CORP.
P O Box 98, Montgomery, Ala 36101
MCDONNELL AUTOMATION CO.
500 Jefferson Bldg, Houston, Tex 27002
MCDONNELL AUTOMATION CO.
360 W Federal Savings, Denver, Colo 80202
MCDONNELL AUTOMATION CO.
P O Box 516, St Louis, Mo 63166
MEGASYSTEMS INC.
1 Bala Ave, Bala-Cynwyd, Pa 19004
MEGASYSTEMS INC.
640 W 40th St, New York, N Y 10018
MELPAR DIV. LTV ELECTROSYSTEMS INC.
7700 Arlington Blvd, Falls Church, Va 22046
METRIDATA COMPUTING INC.
6600 Grade Lane, Louisville, Ky 40221
MICROWAVE MAGNETICS INC. MMI INSTRUMENT DIV.
Rte 1, Danvers, Mass 01923
MILNEE BROTHERS PRODUCTS
8000 Blackburn Ave, Los Angeles, Cal 90048
MNEMOTECH COMPUTER SYSTEMS
55 Liberty St, New York, N Y 10005
MOBILITY SYSTEMS D P SERVICES DEPT.
3530 De La Cruz Blvd, Santa Clara, Cal 95050
MULTICOMP INC.
36 Washington St, Wellesley Hills, Mass 02181
NATIONAL C.S.S.
460 Summer St, Stamford, Conn 06901
NORDEN DIV., UNITED AIRCRAFT CORP.
Helen St, Norwalk, Conn 06850
NORTHWEST MANAGEMENT SERVICES INC.
2300 Elake Ave E, Seattle, Wash 98102
ON-LINE SYSTEMS INC.
4721 Mc Knight Rd, Pittsburg, Pa 15237

PENNDATA CORP.
1729 Cedar Ave, Scranton, Pa 18505
PHI COMPUTER SERVICES INC.
800 Massachusetts Ave, Arlington, Mass 02174
PHILCO-FORD CORP., COMPUTER SERVICES NETWORK
Tioga & C Sts, Philadelphia, Pa 19134
PRINCETON INFORMATIX INC.
1 Palmer Sq, Princeton, N J 08540
PRINCETON TIME SHARING SERVICES, INC.
Us Hwy 1, Princeton, N J 08540
PROGRAMS & ANALYSIS INC.
21 Ray Ave, Burlington, Mass 01803
PRYOR COMPUTER INDUSTRIES
400 N Michigan Ave, Chicago, Ill 60611
QUICKDATA INTERNATIONAL INC.
8444 Wilshire Blvd, Beverly Hills, Cal 90211
RAPIDATA INC.
20 New Dutch Lane, Fairfield, N J 07006
REALTIME SYSTEMS INC.
866 3rd Ave, New York, N Y 10022
REMOTE COMPUTING CORP.
A40 Palo Alto Off Ctr, Palo Alto, Cal 94301
SARNA ASSOCIATES INC.
22 Russell St, Brookline, Mass 02146
SCANTLIN ELECTRONICS, INC.
5454 Beethoven St, Los Angeles, Cal 90060
SCIENTIFIC SYSTEMS SERVICES INC.
476 N Hwy A1a, Satellite Beach, Fla 32935
SCIENTIFIC TIME SHARING CORP.
2101 S St NW, Washington, D C 20008
SCI-TEK COMPUTER CENTER INC.
1707 Gilpin Ave, Wilmington, Del 19806
SERVICE BUREAU CORP., THE
1350 Ave Americas, New York, N Y 10019
SHARED COMPUTER SYSTEMS CORP.
176 W Adams St, Chicago, Ill 60603
SMITH CORP., A.O. DATA SYSTEMS DIV.
3533 N 27 St, Milwaukee, Wisc 53201
SOFTWARE METHODS INC.
10 E 40th St, New York, N Y 10016
SYSTEMS ANALYSIS INC.
11110 N E 8th, Bellevue, Wash 98004
SYSTEMS, SCIENCE & SOFTWARE INC.
Po Box 1620, La Jolla, Cal 92037
TECHNICAL ADVISORS INC.
4455 Fletcher St, Wayne, Mich 48184
TECHNOLOGY FOR INFORMATION MANAGEMENT INC.
1654 Central Ave, Albany, N Y 12205
TEL-DATA SERVICE CORP.
1221 4th Ave, San Diego, Cal 92101
TELCOMP CORP. OF AMERICA SUB. BBN
50 Moulton St, Cambridge, Mass 02138
TIME SHARE CORP.
3 Lebanon St, Hanover, N H 03755
TIME-SHARING SYSTEMS, INC.,
1840 N Farwell Ave, Milwaukee, Wis 53202
TRACOR COMPUTING CORP.
1705 Guadalupe St, Austin, Tex 78701
TYMSHARE INC.
525 University Ave, Palo Alto, Cal 94301
TYMSHARE INC.
1001 Watertown St, West Newton, Mass 02165
U.S. TIME-SHARING INC.
1831 Michael Faraday, Reston, Va 22070
UNITED COMPUTING SYSTEMS INC.
3130 Broadway, Kansas City, Mo 64111
UNITED SYSTEMS INC.
1020 Kings Hwy N, Cherry Hill, N J 08034
UNIVAC DATA PROCESSING SRVCS. DIV. SPERRY
RAND
60 Herricks Rd, Mineola, N Y 11501
UNIVERSITY COMPUTING CO.
P O Box 6228, Dallas, Tex 75222
URS DATA SCIENCE CO.
155 Bovet Rd, San Mateo, Cal 94402
VIRTUAL COMPUTER SERVICES INC
1119 Springfield Rd, Union, N J 07083
VITRO LABORATORIES, DIV. VITRO CORP. OF AMERICA
14000 Georgia Ave, Silver Spring, Md 20910
WALSH ASSOC., RICHARD M.
310 Jefferson Ave, Scranton, Pa 18503
WANG LABORATORIES INC.
836 N St, Tewksbury, Mass 01876
WESTERN UNION TELEPROCESSING CO.
82 McKee Dr, Mahwah, N J 07436
WORLDWIDE TIME SHARING INC.
180 N Michigan, Chicago, Ill 60601

2 Product Directory

SERVICES, TIME SHARING (RESEARCH)

ALLEN-BABCOCK COMPUTING INC.
1800 Ave of The Stars, Los Angeles, Cal 90067
AMERICAN COMPUTER LEASING CORP.
14 E 4th St, Cincinnati, Ohio 45202
AMERICAN COMPUTER SERVICES CORP.
14 E 4th St, Cincinnati, Ohio 45202
APPLIED COMPUTER TIME SHARE INC.
29200 Southfield Rd, Southfield, Mich 48075
APPLIED LOGIC CORP.
One Palmer Sq, Princeton, N J 08540
AUTOMATION SERVICES CORP.
182 Forbes Rd, Braintree, Mass 02184
BERKELEY COMPUTER CORP.
2398 4th St, Berkeley, Cal 94710
BRADDOCK, DUNN & MCDONALD INC.
8027 Leesburg Pike, Mc Lean, Va 22101
BURLINGTON MANAGEMENT SERVICES CO.
P O Box 21207, Greensboro, N C 27420
C&C COMPUTER SYSTEMS INC.
1006 S E Grand, Portland, Ore 97214
CALL-A-COMPUTER INC.
633 Young St, Santa Ana, Cal 92702
CENTRAL COMPUTING, INC.
2627 E Central, Wichita, Kans 67214
CHI CORP.
11000 Cedar Ave, Cleveland, Ohio 44106
CHICAGO TABULATING SERV. INC.
425 N Michigan, Chicago, Ill 60611
COMPU-MEDIC CONTROLS CORP.
432 Park Ave S, New York, N Y 10016
COMPU-TIME INC.
327 Orange Ave, Daytona, Fla 32014
COMPUTATION AND SYSTEMS CORP.
12061 Wilshire Blvd, Los Angeles, Cal 90025
COMPUTER CENTER, INC.
350 Royal Palm Way, Palm Beach, Fla 33480
COMPUTER COMPLEX, INC.
6400 Westpark, Houston, Tex 77027
COMPUTER NETWORK CORP.
5185 Macarthur Blvd, Washington, D C 20016
COMPUTER SCIENCES CORP. INFO. NETWORK DIV.
1901 Building, Los Angeles, Cal 90067
COMPUTER SYSTEM TECHNOLOGY INC.
700-42 Fox Pavilion, Jenkintown, Pa 19046
COMPUTER UNIVERSAL CORP.
1641 Universal Rd, Columbus, Ohio 43207
COMP/UTILITY INC.
1 Center Plaza, Boston, Mass 02108
COMSERV CORP.
4025 Chestnut St, Philadelphia, Pa 19104
CONSENTIVE INC.
3525 Lancaster Ave, Philadelphia, Pa 19104
CUSTOM DATA PROCESSING SERVICES
P O Box 14685, Phoenix, Ariz 85031
CYPHERNETICS CORP., THE
333 Maple Village Ctr, Ann Arbor, Mich 48103
DATA PROCESSING AND ACCOUNTING SERVICES
50 Van Ness Ave, San Francisco, Cal 94102
DATA LOGICS INC.
12025 Shakee Blvd, Cleveland, Ohio 44120
DELMARVA COMPUTER INDUSTRIES INC.
5865 Robert Oliver Pl, Columbia, Md 21043
DIALOG COMPUTING INC.
1305 Post Rd, Fairfield, Conn 06430
DIRECT ACCESS COMPUTING CORP.
984 Livernois Rd, Troy, Mich 48084
DYNAMIC ACCESS CORP.
220 Park Ave S, New York, N Y 10003
EDP RESOURCES, INC.
One North Broadway, White Plains, N Y 10601
FEDDER DATA CENTERS MANAGEMENT INC.
1654 Central Ave, Albany, N Y 12205
GENESEE COMPUTER CENTER INC.
20 University Ave, Rochester, N Y 14605
HOBBS ASSOCIATES, INC.
Po Box 686, Corona Del Mar, Cal 92625
HONEYWELL INFORMATION SYSTEMS INC. INFO.
SERV. DIV.
2701 4th Ave S, Minneapolis, Minn 55408
HOUSING DATA CORP.
29433 Southfield Rd, Southfield, Mich 48075
HOUSING DATA CORP.
23400 Michigan, Dearborn, Mich 48124
ICM COMPUTER CORP.
P O Box 7220, Tulsa, Okla 74105
INFONET SYSTEMS INC.
358 McKinley Blvd, Paramus, N J 07652
INFORMATION DEVELOPMENT ASSOCIATES INC.
P O Box 2285, Bethlehem, Pa 18018
INTERACTIVE DATA CORP.
486 Totten Pond Rd, Waltham, Mass 02154

INTERACTIVE SCIENCES CORP.
60 Brook Dr, Braintree, Mass 02184
INTERACTIVE TECHNICAL SERVICES INC.
486 Totten Pond Rd, Waltham, Mass 02154
INTERNATIONAL TELECOMPUTER NETWORK CORP.
4919 Fairmont Ave, Bethesda, Md 20014
ITT DATA SERVICES DIV.
P O Box 402, Paramus, N J 07652
LEASCO DATA PROCESSING EQUIPMENT CORP.
280 Park Ave, New York, N Y 10017
LITTON SYSTEMS INC. MELLONICS DIV.
1001 W Maude Ave, Sunnyvale, Cal 94086
MARK/OPS DIV., NORTH EASTERN SYSTEMS ASSOC.
INC.
475 Commonwealth Ave, Boston, Mass 02215
MATRIX CORP., THE
931 S Douglas St, El Segundo, Cal 90245
MCDONNELL AUTOMATION CO.
500 Jefferson Bldg, Houston, Tex 27002
MCDONNELL AUTOMATION CO.
360 W Federal Savings, Denver, Colo 80202
MCDONNELL AUTOMATION CO.
P O Box 516, St Louis, Mo 63166
MEGASYSTEMS INC.
1 Bala Ave, Bala-Cynwyd, Pa 19004
MEGASYSTEMS INC.
640 W 40th St, New York, N Y 10018
METRIDATA COMPUTING INC.
6600 Grade Lane, Louisville, Ky 40221
MICROWAVE MAGNETICS INC. MMI INSTRUMENT DIV.
Rte 1, Danvers, Mass 01923
MNEMOTECH COMPUTER SYSTEMS
55 Liberty St, New York, N Y 10005
MOBILITY SYSTEMS D P SERVICES DEPT.
3530 De La Cruz Blvd, Santa Clara, Cal 95050
MULTICOMP INC.
36 Washington St, Wellesley Hills, Mass 02181
NATIONAL C.S.S.
460 Summer St, Stamford, Conn 06901
NORDEN DIV., UNITED AIRCRAFT CORP.
Helen St, Norwalk, Conn 06850
ON-LINE SYSTEMS INC.
4721 Mc Knight Rd, Pittsburg, Pa 15237
PENNDATA CORP.
1729 Cedar Ave, Scranton, Pa 18505
PHILCO-FORD CORP., COMPUTER SERVICES NETWORK
Tioga & C Sts, Philadelphia, Pa 19134
PIONEER DATA SYSTEMS INC.
606 Merle Hay Tower, Des Moines, Iowa 50310
PRINCETON INFORMATIX INC.
1 Palmer Sq, Princeton, N J 08540
PROGRAMS & ANALYSIS INC.
21 Ray Ave, Burlington, Mass 01803
PRYOR COMPUTER INDUSTRIES
400 N Michigan Ave, Chicago, Ill 60611
RAPIDATA INC.
20 New Dutch Lane, Fairfield, N J 07006
REALTIME SYSTEMS INC.
866 3rd Ave, New York, N Y 10022
REMOTE COMPUTING CORP.
440 Palo Alto Off Ctr, Palo Alto, Cal 94301
SARNA ASSOCIATES INC.
22 Russell St, Brookline, Mass 02146
SCIENTIFIC CALCULATIONS INC.
110 Allens Creek Rd, Rochester, N Y 14618
SCIENTIFIC TIME SHARING CORP.
2101 S St NW, Washington, D C 20008
SCI-TEK COMPUTER CENTER INC.
1707 Gilpin Ave, Wilmington, Del 19806
SHARED COMPUTER SYSTEMS CORP.
176 W Adams St, Chicago, Ill 60603
SMITH CORP., A.O. DATA SYSTEMS DIV.
3533 N 27 St, Milwaukee, Wisc 53201
SYSTEMS ANALYSIS CO.
9 Office Park Cir, Birmingham, Ala 35223
SYSTEMS, SCIENCE & SOFTWARE INC.
Po Box 1620, La Jolla, Cal 92037
TECHNICAL INFORMATION PROCESSING INC.
108 N Main St, Wheaton, Ill 60187
TECHNOLOGY FOR INFORMATION MANAGEMENT INC.
1654 Central Ave, Albany, N Y 12205
THEORY ANALYSIS GROUP
22 E Elm St, Chicago, Ill 60611
TIME SHARING SCIENCES INC.
1180 Ave Americas, New York, N Y 10036
TIME-SHARING SYSTEMS, INC.
1840 N Farwell Ave, Milwaukee, Wis 53202
TRACOR COMPUTING CORP.
1705 Guadalupe St, Austin, Tex 78701
TYMSHARE INC.
1001 Watertown St, West Newton, Mass 02165
U.S. TIME-SHARING INC.
1831 Michael Faraday, Reston, Va 22070
UNITED COMPUTING SYSTEMS INC.
3130 Broadway, Kansas City, Mo 64111

UNIVERSITY COMPUTING CO.
P O Box 6228, Dallas, Tex 75222
URS DATA SCIENCE CO.
155 Bovet Rd, San Mateo, Cal 94402
VIRTUAL COMPUTER SERVICES INC
1119 Springfield Rd, Union, N J 07083
WANG LABORATORIES INC.
836 N St, Tewksbury, Mass 01876
WORLDWIDE COMPUTER SERVICES, INC.
280 N Central Pk Ave, Hartsdale, N Y 10530

SERVICES, AUTOMATED WIRE-WRAPPING

AMERICAN COMPUTER TECHNOLOGY INC.
8740 Shirley Ave, Northridge, Cal 91324
APPLIED COMPUTER SYSTEMS INC.
P O Box 6479, Austin, Tex 78702
AUTOMATION SERVICES CORP.
182 Forbes Rd, Braintree, Mass 02184
BAIRD-ATOMIC INC.
125 Middlesex Tpk, Bedford, Mass 01730
COMPAT CORP.
177 Cantiague Rock Rd, Westbury, N Y 11590
COMPUTER GUILD INC.
12 Mercer Rd, Natick, Mass 01760
CONTACT SYSTEMS INC.
97 Golden Hill Rd, Danbury, Conn 06810
CONTROL LOGIC INC.
3 Strathmore Rd, Natick, Mass 01760
DATA NUMERICS INC.
141a Central Ave, Farmingdale, N Y 11735
DATA TECHNOLOGY CORP.
1050 E Meadow Cir, Palo Alto, Cal 94303
DATAROYAL INC.
Simon St, Nashua, N H 03060
DIMENSIONAL SYSTEMS INC.
393 Totten Pond Rd, Waltham, Mass 02154
ELCO CORP.
Maryland Rd, Willow Grove, Pa 19090
ELECTRONIC ENGRG. CO. OF CAL. ELECTRONIC PRD.
DIV.
1441 E Chestnut Ave, Santa Ana, Cal 92702
ELECTRONIC MOLDING CORP.
96 Mill St, Woonsocket, R I 02895
GARDNER-DENVER CO.
Gardner Expwy, Quincy, Ill 62301
GARDNER-DENVER CO. WIRE-WRAP DIV.
1333 Fulton, Grand Haven, Mich 49417
GENERAL AUTOMATION INC.
1055 S East St, Anaheim, Cal 92805
GENESEE COMPUTER CENTER INC.
20 University Ave, Rochester, N Y 14605
IAC COMPUTER SYSTEMS INC.
260 Newton Rd, Plainview, N Y 11803
INFODATA SYSTEMS INC.
680 Ridge Rd, Webster, N Y 14580
INFORMATION DISPLAY INC.
333 N Bedford Rd, Mt Kisco, N Y 10549
INFORMATION INSTRUMENT INC.
62 Enterprise Dr, Ann Arbor, Mich 48106
INTECH INC.
2915 Wayzata Blvd, Minneapolis, Minn 55405
INTERACTIVE SCIENCES CORP.
60 Brook Dr, Braintree, Mass 02184
LANE INDUSTRIES ELECTRONICS DIV.
7254 Atoll Ave, North Hollywood, Cal 91605
MICROSYSTEMS TECHNOLOGY CORP.
55 B St, Burlington, Mass 01803
PENNDATA CORP.
1729 Cedar Ave, Scranton, Pa 18505
RAYTHEON CO. CADPO OPERATION
1415 Providence Tpk, Norwood, Mass 02062
RAYTHEON COMPUTER
2700 S Fairview St, Santa Ana, Cal 92704
REMOTE COMPUTING CORP.
440 Palo Alto Off Ctr, Palo Alto, Cal 94301
SCANBE MANUFACTURING CO.
3445 Fletcher Ave, El Monte, Cal 91750
SCIENTIFIC CALCULATIONS INC.
110 Allens Creek Rd, Rochester, N Y 14618
SUPERIOR ELECTRIC CO., THE
383 Middle St, Bristol, Conn 06010
SYSTEMS, SCIENCE & SOFTWARE INC.
Po Box 1620, La Jolla, Cal 92037
VIKING INDUSTRIES INC.
21001 Nordhoff St, Chatsworth, Cal 91311
WINCHESTER ELECTRONICS DIV. LITTON INDUS.
Main St & Hillside, Oakville, Conn 06779
XEROX DATA SYSTEMS
701 S Aviation, El Segundo, Cal 90245

2 Product Directory

SERVICES, HARDWARE MAINTENANCE

ANDERSON JACOBSON INC.
1065 Morse Ave., Sunnyvale, Cal 94086
APPLIED COMPUTER SYSTEMS INC.
P O Box 6479, Austin, Tex 78702
BUSINESS COMPUTERS INC.
10844 Shady Trail, Dallas, Tex 75220
COMPAT CORP.
177 Cantigue Rock Rd, Westbury, N Y 11590
COMPU-MEDIC CONTROLS CORP.
432 Park Ave S, New York, N Y 10016
COMPUTER COMPLEX, INC.
6400 Westpark, Houston, Tex 77027
COMPUTER HARDWARE CONSULTANTS & SERVICES
1409 Easton Rd, Warrington, Pa 18976
COMPUTER SCIENCES CORP. INFO. NETWORK DIV.
1901 Building, Los Angeles, Cal 90067
COMSONIC CORP., THE
123 Pleasant Ave, Upper Saddle R, N J 07458
DASA CORP./CYBER-TRONICS SUB. DASA CORP.
15 Stevens St., Andover, Mass 01810
DATA ACCESS SYSTEMS INC.
503 Rte 10 Mt 19, Dover, N J 07801
DATA PROCESSING AND ACCOUNTING SERVICES
50 Van Ness Ave, San Francisco, Cal 94102
DIMENSIONAL SYSTEMS INC.
393 Totten Pond Rd, Waltham, Mass 02154
ELECTRONIC MOLDING CORP.
96 Mill St, Woonsocket, R I 02895
GENERAL AUTOMATION INC.
1055 S East St, Anaheim, Cal 92805
GMA COMPUTER CORP.
320 Yonker Ave, Yonkers, N Y 10701
HOUSTON ENGINEERING RESEARCH CORP.
P O Box 35495, Houston, Tex 77035
INTERACTIVE SYSTEMS INC.
327 S Fourth Ave, Ann Arbor, Mich 48108
ITT DATA EQUIPMENT & SYSTEMS DIV.
187 E Union Ave, E Rutherford, N J 07073
LEASCO DATA PROCESSING EQUIPMENT CORP.
280 Park Ave, New York, N Y 10017
MAI-EQUIPMENT CORP.
300 E 44th St, New York, N Y 10017
PENNDATA CORP.
1729 Cedar Ave, Scranton, Pa 18505
SCHULTZ INSTRUMENTS INC.
P O Box 13385, Gainesville, Fla 32601
SHIRAK TELEMETERING OF AMERICA
8926 Kester Ave, Van Nuys, Cal 91402
SIERRA RESEARCH CORP. COMPUTER PROD. GRP.
167 Bedford St., Burlington, Mass 01803
SORBUS
875 First Ave, King of Prussia, Pa 19406
SYSTEMS RESEARCH LABS, INC.
7001 Indian Ripple Rd, Dayton, Ohio 45440
TELETYPE CORP.
5555 W Touhy Ave, Skokie, Ill 60076
TIME-SHARING TERMINALS INC.
2351 Shady Grove Rd, Rockville, Md 20850
TROTT ELECTRONICS INC.
30 Ridgeland Rd, Rochester, N Y 14623
UNIVERSITY COMPUTING CO.
P O Box 6228, Dallas, Tex 75222
WEISMANTEL INC.
P O Box 1957, St Paul, Minn 55111
WESTERN UNION TELEPROCESSING CO.
82 McKee Dr, Mahwah, N J 07436

SERVICES, SYSTEMS ANALYSIS

ACADEMY COMPUTING CORP.
5005 N Lincoln Blvd, Oklahoma City, Okla 73105
ADAPT INC.
624 S 62nd St, Philadelphia, Pa 19143
ADMINISTRATIVE SYSTEMS INC.
131 Mineola Blvd, Mineola, N Y 11501
ADP-AUTOMATIC DATA PROCESSING OF SF INC.
4250 W Williams Rd, San Jose, Cal 95129
ADVANCED-COMPUTER SYSTEMS INC
3131 S Dixie Dr, Dayton, Ohio 45305
ADVANCED COMPUTER TECHNIQUES CORP.
437 Madison Ave, New York, N Y 10022
AERO TECHNICAL APPLICATIONS INC.
8011 Clayton Rd, St Louis, Mo 63117
AHART & ASSOC. INC., JAMES R.
225 S Main St, Dayton, Ohio 45402
ALLEN-BABCOCK COMPUTING INC.
1800 Ave of The Stars, Los Angeles, Cal 90067
ALPHA COMPUTER SERVICE CORP.
226 W 37th St, New York, N Y 10018
AMBAC INDUSTRIES INC. TELE-DYNAMICS DIV.
525 Virginia Dr, Ft Washington, Pa 19034

AMERICAN COMPUTER LEASING CORP.
14 E 4th St, Cincinnati, Ohio 45202
AMERICAN COMPUTER SERVICES CORP.
14 E 4th St, Cincinnati, Ohio 45202
ANACOMP INC.
6161 Hillside Ave, Indianapolis, Ind 46220
ANALYTIC SCIENCES CORP., THE
6 Jacob Way, Reading, Mass 01867
ANALYTICS INC.
179 Washington Lane, Jenkintown, Pa 19046
ANCOM SYSTEMS, DIV. GENERAL ANALYTICS CORP.
9841 Airport Blvd, Los Angeles, Cal 90045
ANDROCOR INC.
5949 Hohman Ave, Hammond, Ind 46320
APPLIED COMPUTER SCIENCES INC.
361 Park Rd, W Hartford, Conn 06107
APPLIED COMPUTER SYSTEMS INC.
P O Box 6479, Austin, Tex 78702
APPLIED COMPUTER TIME SHARE INC.
29200 Southfield Rd, Southfield, Mich 48075
APPLIED CYBERNETICS CORP.
1285 Forgewood Ave, Sunnyvale, Cal 94086
APPLIED DIGITAL SYSTEMS INC.
3848 Campus Dr 112, Newport Beach, Cal 92660
ARIES CORP.
1651 Old Meadow Rd, Mc Lean, Va 22101
ASC TABULATING CORP.
1080 Green Bay Rd, Lake Bluff, Ill 60044
AUERBACH ASSOCIATES INC.
121 W Broad St, Philadelphia, Pa 19107
AUTOCOMP INC.
4720 Montgomery Ln, Bethesda, Md 20014
AUTOMATED CONCEPTS INC.
477 Madison Ave, New York, N Y 10017
AUTOMATED DATA ASSOCIATES INC.
1333 Lawrence St, Rahway, N J 07065
AUTOMATED FACTS & FIGURES CO.
4551 S Racine Ave, Chicago, Ill 60609
AUTOMATED INFORMATION SYSTEMS INC.
1064 River Rd, Edgewater, N J 07020
AUTOMATED SYSTEMS CORP.
600 Houst Nat Gas Bld, Houston, Tex 77002
AUTOMATION, INC.
1904 Farnam St, Omaha, Nebr 68102
AUTOMATION SERVICES CORP.
182 Forbes Rd, Braintree, Mass 02184
BANKERS DATA SERVICES, INC.
430 Lamar, Houston, Tex 77002
BEDFORD ASSOCIATES INC.
P O Box 327, Bedford, Mass 01730
BENDIX CORP., THE. ELECTRODYNAMICS DIV
11600 Sherman Way, No Hollywood, Cal 91605
BIZ-MATIC DATA CONTROL CENTERS INC.
232 Summer St, Boston, Mass 02210
BOOTHE RESOURCES INTERNATIONAL INC.
3435 Wilshire Blvd, Los Angeles, Cal 90005
BOSTON COMPUTER SYSTEMS CORP.
15 School St, Boston, Mass 02108
BRADDOCK, DUNN & MCDONALD INC.
8027 Leesburg Pike, Mc Lean, Va 22101
BRANDON APPLIED SYSTEMS INC.
1611 N Kent St, Arlington, Va 22209
BUNKER RAMO CORP., THE, BUSINESS & IND. DIV
445 Fairfield Ave, Stamford, Conn 06904
BURLINGTON MANAGEMENT SERVICES CO.
P O Box 21207, Greensboro, N C 27420
C&C COMPUTER SYSTEMS INC.
1006 S E Grand, Portland, Ore 97214
CALTEC INC.
1931 Sylvania Ave, Toledo, Ohio 43613
CAMBRIDGE COMPUTER ASSOCIATES INC.
220 Alewife Brook Pky, Cambridge, Mass 02138
CENTRAL COMPUTING CORP.
180 N Mich Ave, Chicago, Ill 60601
CENTRAL COMPUTING, INC.
2627 E Central, Wichita, Kans 67214
CENTRAL DATA SYSTEMS INC.
1215 Valley Belt Rd, Cleveland, Ohio 44131
CENTRAL PROCESSING CENTER OF SAN ANTONIO INC.
P O Box 1416, San Antonio, Tex 78206
CENTURY DATA PROCESSING INC.
1006 Coronado Towers, El Paso, Tex 79912
CGA COMPUTER ASSOCIATES INC.
715 Park Ave, East Orange, N J 07017
CHICAGO TABULATING SERV. INC.
425 N Michigan, Chicago, Ill 60611
COMMERCIAL TECHNOLOGY INC.
P O Box 10616, Knoxville, Tenn 37919
COMPAC COMPUTER SYSTEMS INC.
911 Hennepin, Minneapolis, Minn 55403
COM PU DAT DIV. SOUTHEASTERN NEWSPAPERS CORP.
P O Box 3806, Augusta, Ga 30904

COMPU-MATIC SYSTEMS CORP.
5303 Comercio Ln, Woodland Hills, Cal 91364
COMPU-MEDIC CONTROLS CORP.
432 Park Ave S, New York, N Y 10016
COMPU-SYS INC.
Po Box 11104, Albuquerque, N M 87112
COMPU-TIME INC.
327 Orange Ave, Daytona, Fla 32014
COMPUTATION AND SYSTEMS CORP.
12061 Wilshire Blvd, Los Angeles, Cal 90025
COMPUTE AMERICA CORP. DBA COMERICA
1515 Classen Blvd, Oklahoma City, Okla 73106
COMPUTER & PROGRAMMING ANALYSIS INC.
1 Wynnewood Rd, Wynnewood, Pa 19096
COMPUTER AID COMPANIES INC.
5925 Forest Lane, Dallas, Tex 75201
COMPUTER AMERICA CORP.
818 Roeder Rd, Silver Spring, Md 20910
COMPUTER ASSISTANCE INC.
298 Park Rd, West Hartford, Conn 06119
COMPUTER CENTER, INC..
350 Royal Palm Way, Palm Beach, Fla 33480
COMPUTER CENTER OF ATLANTA DIV. COMP. CNTRS INC
2695 Buford Hwy NE, Atlanta, Ga 30324
COMPUTER COMMAND & CONTROL CO
1717 Penn Ave NW, Washington, D C 20006
COMPUTER COMMAND AND CONTROLS COMPANY
4025 Chestnut St, Philadelphia, Pa 19104
COMPUTER COMMUNICATION INC.
701 W Manchester Blvd, Inglewood, Cal 90301
COMPUTER COMPLEX, INC.
6400 Westpark, Houston, Tex 77027
COMPUTER CONSULTANTS CORP.
U S Rte 46 E, Denville, N J 07834
COMPUTER DYNAMICS INC.
1760 Solano Ave, Berkeley, Cal 94707
COMPUTER DYNAMICS INC.
100 Hegenberger Rd, Oakland, Cal 94621
COMPUTER FULFILLMENT
225 East St, Winchester, Mass 01890
COMPUTER INFORMATION SERVICES INC.
6701 N Broad St, Philadelphia, Pa 19126
COMPUTER INVESTMENTS & LEASING CORP.
9 Tanner St, Haddonfield, N J 08033
COMPUTER MANAGEMENT INC.
3101 Euclid Ave, Cleveland, Ohio 44115
COMPUTER NETWORK CORP.
5185 MacArthur Blvd, Washington, D C 20016
COMPUTER PROCESSING INC.
200 Manhattan Bldg, Muskogee, Okla 74401
COMPUTER PROCESSING INC.
300 6th Ave, Pittsburgh, Pa 15222
COMPUTER PRODUCTS, INC.
P O Box 23849, Ft Lauderdale, Fla 33307
COMPUTER SCIENCES CORP. INFO. NETWORK DIV.
1901 Building, Los Angeles, Cal 90067
COMPUTER SERVICE OF E. TEXAS
P O Box 5981, Jasper, Tex 75951
COMPUTER SERVICES INC.
500 Clark St, Paducah, Ky 42001
COMPUTER SERVICES INC.
47 Congress St, Salem, Mass 01970
COMPUTER SERVICES OF INDIANA, INC.
214 S 13 1/2 St, Terre Haute, Ind 47808
COMPUTER SHARING SERVICES
2492 W 2nd Ave, Denver, Colo 80223
COMPUTER SYSTEM TECHNOLOGY INC.
700-42 Fox Pavilion, Jenkintown, Pa 19046
COMPUTER SYSTEMS
400 Wing Bldg, Grants Pass, Ore 97526
COMPUTER SYSTEMS CORP. U.S. INDUSTRIES INC
P O Box 64400, Dallas, Tex 75206
COMPUTER SYSTEMS INC.
19619 81st Ave S, Kent, Wash 98031
COMPUTER TABULATING CORP.
136 Main St, Hemstead, N Y 11550
COMPUTER TECHNOLOGY INC. SUB. UNIV. COMPUTING CO.
P O Box 47911, Dallas, Tex 75247
COMPUTER TIME
368 Village Sq, Orinda, Cal 94563
COMPUTER TUTOR, THE, DIV. COMPUTUT INC.
12 Emerald Court, Commack, N Y 11725
COMPUTER UNIVERSAL CORP.
1641 Universal Rd, Columbus, Ohio 43207
COMPUTER USAGE CO.
7315 Wisconsin Ave Nw, Washington, D C 20014
COMPUTER USAGE CO.
387 Elliot St, Newton Uppr Fis, Mass 02164
COMPUTER USAGE CO.
3181 Porter Dr, Palo Alto, Cal 94304
COMPUTER USAGE CORP..
8939 S Sepulveda Blvd, Los Angeles, Cal 90045

2 Product Directory

COMPUTING & SOFTWARE INC., EAST COAST DIV.
3700 Mt Vernon Ave, Alexandria, Va 22305
COMPUTING EFFICIENCY INC. COMPUTING EFF. DIV.
35 Orville Dr, Bohemia, N Y 11716
COMSONIC CORP., THE
123 Pleasant Ave, Upper Saddle R, N J 07458
COMTEK ASSOCIATES
2077 Center Ave, Fort Lee, N J 07024
CONDATA INC.
1809 Walnut St, Philadelphia, Pa 19103
CONSENTIVE INC.
3525 Lancaster Ave, Philadelphia, Pa 19104
CONSULTANTS ASSOCIATED INC.
Lakeside Office Park, Wakefield, Mass 01880
CONSUMER SYSTEMS CORP.
15 Spinning Wheel Rd, Hinsdale, Ill 60521
CONTINENTAL DATA PROCESSING INC.
300 Market St., Kingston, Pa 18704
CONTROL DATA CORP. CEIR PROF. SERV. DIV.
5272 River Rd, Washington, D C 20016
CONTROL TECHNOLOGY INC.
3450 E Spring St, Long Beach, Cal 90806
COOPER DATA SYSTEMS INC.
826 Union St, New Orleans, La 70112
CORPORATE DATA PROCESSING
1724 Silver Lake Blvd, Los Angeles, Cal 90026
CTC COMPUTER CORP.
1000 Elwell Court, Palo Alto, Cal 94303
CURRAN COMPUTER CORP.
946 Main St, Hackensack, N J 07601
CYBERMATICS INC.
2460 Lemoine Ave, Fort Lee, N J 07024
D.P.&W. INC.
1107 Commonwealth Ave, Boston, Mass 02215
DATA ARCHITECTS INC.
213 3rd Ave, Waltham, Mass 02154
DATA CENTER CORP.
3002 Midvale St, Los Angeles, Cal 90034
DATA COMPUTING CORP.
229 Baldwin Rd, Hempstead, N Y 11551
DATA CONTROL CO.
405 E Easterday Ave, Sault Ste Marie, Mich 49783
DATA COPY INC.
760 Bryant St, San Francisco, Cal 94107
DATA CORP., THE
1111 W 6th St, Los Angeles, Cal 90017
DATA CORP., THE PENINSULA COMPUTER CENTER
DIV
1190 Coleman Ave, San Jose, Cal 95110
DATA DIMENSIONS INC.
51 Weaver St, Greenwich, Conn 06830
DATA MANAGEMENT SERVICES INC.
1845 Walnut St, Philadelphia, Pa 19103
DATA PROCESSING AND ACCOUNTING SERVICES
50 Van Ness Ave, San Francisco, Cal 94102
DATA PROCESSING CENTER DIV FROST REALTY CO
P O Box 1600, San Antonio, Tex 78206
DATA PROCESSORS INC.
2703 W 28th Ave, Pine Bluff, Ark 71601
DATA SERVICE OF TEXAS INC.
1415 W 5th, Plainview, Tex 79072
DATA SYSTEMS INC.
434 Stinson Blvd, Minneapolis, Minn 55413
DATA SYSTEMS INC.
707 S E Belmont St, Portland, Ore 97214
DATA TECHNOLOGY CORP.
1050 E Meadow Cir, Palo Alto, Cal 94303
DATA-TRONICS CORP. SUB. ARKANSAS BEST.CORP.
310 Townson Ave, Fort Smith, Ark 72901
DATA USAGE CORP.
2460 Lemoine Ave, Fort Lee, N J 07024
DATACAP INTERNATIONAL INC.
37 W 2950 S, Salt Lake City, Utah 84101
DATACOM INC.
40 Lincoln Dr, Ft Walton Beach, Fla 32548
DATALOGICS INC.
12025 Shakee Blvd, Cleveland, Ohio 44120
DATAMATION SERVICES INC.
461 Eighth Ave, New York, N Y 10001
DATAROYAL INC.
Simon St, Nashua, N H 03060
DATASERV DIV., WILLIAM J. PURDY CORP.
770 Airport Blvd, Burlingame, Cal 94010
DATASONICS INC.
P O Box 4553, New York, N Y 10017
DATATRONIC SERVICE CO.
1250 Guardian Blvd, Detroit, Mich 48226
DECISION SYSTEMS INC.
E 66 Midland Ave, Paramus, N J 07652
DELMARVA COMPUTER INDUSTRIES INC.
5865 Robert Oliver Pl, Columbia, Md 21043
DELTA AUTOMATED SYSTEMS INC.
816 Thayer Ave, Silver Spring, Md 20910
DESIGN AUTOMATION INC.
809 Massachusetts Ave, Lexington, Mass 02173

DEUSSEN ASSOCIATES INC.
576 Hyannis Dr, Sunnyvale, Cal 94087
DIGITAL APPLICATIONS INC.
6300 Westpark Ste 150, Houston, Tex 77027
DIGITAL RESOURCES CORP.
6250 W Park Suite 100, Houston, Tex 77027
DIGITRON INC.
P O Box 5836, Columbus, S C 29205
DIKEWOOD CORP., THE
1009 Bradbury Dr SE, Albuquerque, N M 87106
DIPIETRO & WILSON INC.
1107 Commonwealth Ave, Boston, Mass 02215
DIRECT ACCESS COMPUTING CORP.
984 Livernois Rd, Troy, Mich 48084
DIVERSIFIED COMPUTER APPLICATIONS
2525 E Bayshore Rd, Palo Alto, Cal 94302
DYNAMIC ACCESS CORP.
220 Park Ave S, New York, N Y 10003
EASTERN COMPUTER SERVICES INC
920 Fox Chase Rd, Rockledge, Pa 19111
ECCO BUSINESS SYSTEMS INC.
50 E 42nd St, New York, N Y 10017
ELECTROMECH COMPUTING & TECH. SERVICES CO.
2964 Peachtree Rd NW, Atlanta, Ga 30305
ELECTRONIC ASSOCIATES INC.
485 Monmouth Pkwy, W Long Branch, N J 07764
ELECTRONIC COMPUTER PROG. INSTITUTE
49 N Progress Ave, Harrisburg, Pa 17109
ELECTRONIC DATA PREPARATION CORP.
P O Box 1446, Bradenton, Fla 33505
ELMIRA DATA PROCESSING CO.
221 E Church St, Elmira, N Y 14902
ENNIS BRANDON COMPUTER SERVICES INC.
2840 Walnut Hill Ln, Dallas, Tex 75229
ENTREKIN COMPUTERS INC. SUB. THE CROSS CO.
9475 Center Rd, Fenton, Mich 48430
FABRI-TEK INFORMATION MANAGEMENT, INC.
5901 S County Rd 18, Edina, Minn 55436
FEDDER DATA CENTERS MANAGEMENT INC.
1654 Central Ave, Albany, N Y 12205
FLORES ASSOCIATES
108 8th Ave, Brooklyn, N Y 11215
GAMS & ASSOCIATES INC., T.C.
2222 Morris Ave, Union, N J 07083
GENASYS CORP.
2011 Gye St NW, Washington, D C 20006
GENERAL AUTOMATION INC.
1055 S East St, Anaheim, Cal 92805
GENERAL COMPUTER SERVICES INC.
1332 Meridan St NE, Huntsville, Ala 35801
GENESEEC COMPUTER CENTER INC.
20 University Ave, Rochester, N Y 14605
GRAY & ASSOCIATES INC., H.J.
2501 Cedar Springs Rd, Dallas, Tex 75201
GREYHOUND COMPUTER CORP.
130 S Canal St, Chicago, Ill 60606
GTE DATA SERVICES INC.
5422 Bay Center Dr, Tampa, Fla 33609
GULLEY, DALE L. & ASSOCIATES, INC.
2300 E 14th St, Tulsa, Okla 74104
HAVERLY SYSTEMS INC.
4 2nd Ave, Denville, N J 07834
HOBBS ASSOCIATES, INC.
Po Box 686, Corona Del Mar, Cal 92625
HOLLANDER ASSOCIATES
P O Box 2276, Fullerton, Cal 92633
HONEYWELL INFORMATION SYSTEMS INC. INFO.
SERV.DIV
2701 4th Ave S, Minneapolis, Minn 55408
HOOVER INC., J.K.
2720 1st Ave NE, Cedar Rapids, Iowa 52402
HOUSING DATA CORP.
29433 Southfield Rd, Southfield, Mich 48075
HOUSING DATA CORP.
23400 Michigan, Dearborn, Mich 48124
HOUSTON ENGINEERING RESEARCH CORP.
P O Box 35495, Houston, Tex 77035
HOUSTON RESEARCH INC. SUB. SCI. ELECT.
6001 Gulf Fwy, Houston, Tex 77023
HOWARD ASSOC. INC., DANIEL D.
307 N Michigan Ave, Chicago, Ill 60601
HRB-SINGER INC.
Science Park, State College, Pa 16801
HUB RATLIFF CONSULTANT
P O Box 22487, Houston, Tex 77027
HYDRA COMPUTER CORP.
P O Box 17883, Raleigh, N C 27609
ICM COMPUTER CORP.
P O Box 7220, Tulsa, Okla 74105
INFODATA SYSTEMS INC.
680 Ridge Rd, Webster, N Y 14580
INFONET SYSTEMS INC.
358 McKinley Blvd, Paramus, N J 07652
INFORMATICS INC.
21050 Vanover St, Canoga Park, Cal 91303

INFORMATION DEVELOPMENT ASSOCIATES INC.
P O Box 2285, Bethlehem, Pa 18018
INFORMATION MANAGEMENT INC.
447 Battery St, San Francisco, Cal 94111
INFORMATION SCIENCES INC.
14 Jefferson Blvd, Warwick, R I 02888
INFORMATION SERVICES INC.
90 Broad St, Babson Park, Mass 02157
INFOSCI INC.
P O Box 464, Menlo Park, Cal 94025
INFOTON INC.
2nd Ave, Burlington, Mass 01803
INNOVATIVE SOFTWARE INC.
486 Totten Pond Rd, Waltham, Mass 02154
INPUT INC.
500 Old Elm Rd, Highland Park, Ill 60035
INSTITUTE FOR CYBERNETIC DEVELOPMENT
3031 Bateman St, Berkeley, Cal 94705
INTECH INC.
2915 Wayzata Blvd, Minneapolis, Minn 55405
INTERACTIVE SCIENCES CORP.
60 Brook Dr, Braintree, Mass 02184
INTERACTIVE SYSTEMS INC.
327 S Fourth Ave, Ann Arbor, Mich 48108
INTERNATIONAL COMPUTER CORP.
1 N Broadway, White Plains, N Y 10601
INTERNATIONAL SYSTEMS ASSOCIATES, LTD.
350 5th Ave, New York, N Y 10001
INTERNATIONAL TELECOMPUTER NETWORK CORP.
4919 Fairmont Ave, Bethesda, Md 20014
INTERNATIONAL TELECONTROL CORP.
4300 Pine St, Wilmington, Del 19802
KENICS SYSTEMS CORP.
125 Harvard St, Cambridge, Mass 02139
LAHEY COMPUTER SYSTEMS INC.
4747 N 16th St, Phoenix, Ariz 85016
LEASCO DATA PROCESSING EQUIPMENT CORP.
280 Park Ave, New York, N Y 10017
LITTON SYSTEMS INC. DATA SYSTEMS DIV.
8000 Woodley Ave, Van Nuys, Cal 91409
LITTON SYSTEMS INC. MELLONICS DIV.
1001 W Maude Ave, Sunnyvale, Cal 94086
LOCKHEED ELECTRONICS DATA MANAGEMENT
SERVICES
16811 El Camino Real, Houston, Tex 77058
LOGIC INC.
1712 Commerce St, Dallas, Tex 75201
LOGICON INC.
Del Amo Financial Ctr, Torrance, Cal 90503
LOWENTHAL PROGRAMMING CO.
30 Rock Ridge Dr, Pt Chester, N Y 10573
MANAGEMENTICS INC.
2 Pennsylvania Plaza, New York, N Y 10001
MANAGEMENT CONCEPTS INC.
2 Decker Sq, Bala-Cynwyd, Pa 19004
MANAGEMENT SERVICES INC.
1538 Dunex Hill Ln Ne, Atlanta, Ga 30324
MANAGEMENT SYSTEMS CORP.
7007 Preston Rd, Dallas, Tex 75205
MASTECH COMPUTER SYSTEMS INC.
7026 W North Ave, Chicago, Ill 60635
MATHEMATICAL APPLICATIONS GROUP INC.
180 S Broadway, White Plains, N Y 10605
MATRIX CORP., THE
931 S Douglas St, El Segundo, Cal 90245
MCAULIFFE ASSOC. INC., JOHN INC.
1181 Broadway, New York, N Y 10001
MCDILL CORP.
P O Box 98, Montgomery, Ala 36101
MCDONNELL AUTOMATION CO.
500 Jefferson Bldg, Houston, Tex 27002
MCDONNELL AUTOMATION CO.
360 W Federal Savings, Denver, Colo 80202
MCDONNELL AUTOMATION CO.
P O Box 516, St Louis, Mo 63166
MDC TECHNOLOGY CORP. SUB. MNGMNT. DATA
CORP.
530 W St Rd, Warminster, Pa 18974
MELPAR DIV. LTV ELECTROSYSTEMS INC.
7700 Arlington Blvd, Falls Church, Va 22046
MICHIANA LEASING CORP.
1814 S Main St, S Bend, Ind 46613
MILNEE BROTHERS PRODUCTS
8000 Blackburn Ave, Los Angeles, Cal 90048
MNEMOTECH COMPUTER SYSTEMS
55 Liberty St, New York, N Y 10005
MOBILITY SYSTEMS D P SERVICES DEPT.
3530 De La Cruz Blvd, Santa Clara, Cal 95050
MOORE BUSINESS FORMS INC.
110-112 Pkwy Inn Bldg, Niagara Falls, N Y 14302
MULTICOMP INC.
36 Washington St, Wellesley Hills, Mass 02181
NATIONAL C.S.S.
460 Summer St, Stamford, Conn 06901

2 Product Directory

NATIONAL COMPUTER ANALYSTS INC.

Us Hwy 1, Princeton, N J 08540
NATIONAL INFORMATION RESEARCH INSTITUTE
8444 Wilshire Blvd, Beverly Hills, Cal 90211
NEOTERIC INC.
2800 Euclid Ave, Cleveland, Ohio 44115
NORDEN DIV., UNITED AIRCRAFT CORP.
Helen St, Norwalk, Conn 06850
NORTHWEST MANAGEMENT SERVICES INC.
2300 Elake Ave E, Seattle, Wash 98102
OFFICE SERVICES, INC.
2919 Allen Parkway, Houston, Tex 77019
OPERATIONS RESEARCH INC.
1400 Spring St, Silver Spring, Md 20910
PANSOPHIC SYSTEMS INC.
230 Roosevelt Rd, Lombard, Ill 60148
PAPERWORK DATA COMM. SERVICES INC.
1703 S Ave, Syracuse, N Y 13207
PAYMENT SYSTEMS INC.
405 Lexington Ave, New York, N Y 10017
PENNDATA CORP.
1729 Cedar Ave, Scranton, Pa 18505
PERIPHERAL DATA MACHINES INC.
102 New S Rd, Hicksville, N Y 11801
PG DATA CENTER INC.
P O Box 11, Garrettsville, Ohio 44231
PHI COMPUTER SERVICES INC.
800 Massachusetts Ave, Arlington, Mass 02174
PHILCO-FORD CORP., COMPUTER SERVICES NETWORK
Tioga & C Sts, Philadelphia, Pa 19134
PIONEER DATA SYSTEMS INC.
606 Merle Hay Tower, Des Moines, Iowa 50310
PLANNING RESEARCH CORP.
1100 Glendon Ave, Los Angeles, Cal 90024
PRC COMPUTER CENTER INC. PLANNING RSCH CORP.
7670 Old Springhouse, McLean, Va 22101
PRINCETON INFORMATIX INC.
1 Palmer Sq, Princeton, N J 08540
PRINCETON TIME SHARING SERVICES, INC.
Us Hwy 1, Princeton, N J 08540
PROFIMATICS INC.
6355 Topanga Canyon, Woodland Hills, Cal 91364
PROGRAMMING SCIENCES CORP.
S E 42 St, New York, N Y 10016
PROGRAMMING SCIENCES CORP.
1900 Ave of The Stars, Los Angeles, Cal 90067
PROGRAMS & ANALYSIS INC.
21 Ray Ave, Burlington, Mass 01803
PRYOR COMPUTER INDUSTRIES
400 N Michigan Ave, Chicago, Ill 60611
PUBLIC DATA PROCESSING CORP.
640 N Lasalle St, Chicago, Ill 60610
QUIKDATA INTERNATIONAL INC.
8444 Wilshire Blvd, Beverly Hills, Cal 90211
RAYTHEON CO. CADPO OPERATION
1415 Providence Tpk, Norwood, Mass 02062
REALTIME SYSTEMS INC.
866 3rd Ave, New York, N Y 10022
REILAND, PAGE & ASSOCIATES INC.
1521 E Broad St, Columbus, Ohio 43205
REL-QUAL ASSOCIATES INC.
18 Hamilton St, Bound Brook, N J 08805
REMOTE COMPUTING CORP.
A40 Palo Alto Off Ctr, Palo Alto, Cal 94301
REPRODUCTION SYSTEMS DIV. TRANSAMERICA
COMP.
1 California St, San Francisco, Cal 94111
REPUBLIC STEEL CORP. MANUFACTURING DIV.
1315 Albert St, Youngstown, Ohio 44505
REPUBLIC SYSTEMS INC.
100 Plaza Centre, Secaucus, N J 07094
REPUBLIC SYSTEMS INC.
715 Park Ave, E Orange, N J 07017
REPUBLIC SYSTEMS OF CONNECTICUT INC
350 S Main St, Cheshire, Conn 06410
RESALAB INC. RESALAB SCIENTIFIC DIV.
4000 Campbell Ave, Menlo Park, Cal 94025
RIDGWOOD ASSOCIATES INC.
10 Wilsley Sq, Ridgewood, N J 07450
SAGE ACTION INC.
P O Box 416, Ithaca, N Y 14850
SAID INC.
1243 W Broad St, Falls Church, Va 22046
SARNA ASSOCIATES INC.
22 Russell St, Brookline, Mass 02146
SC DATA CENTER, INC.
1112 7th Ave, Monroe, Wis 53566
SCANFORMS INC.
312 Fox Pavilion, Jenkintown, Pa 19095
SCHULTZ INSTRUMENTS INC.
P O Box 13385, Gainesville, Fla 32601
SCIENTIFIC CALCULATIONS INC.
110 Allens Creek Rd, Rochester, N Y 14618
SCIENTIFIC COMPUTERS, INC.,
919 Second Ave S, Minneapolis, Minn 55402

SCIENTIFIC SOFTWARE CORP.

5300 S Ulster, Englewood, Colo 08110
SCIENTIFIC SYSTEMS SERVICES INC.
476 N Hwy A1a, Satellite Beach, Fla 32935
SEGALL ASSOCIATES, M. HARVEY
1019 Rust Bldg, Tacoma, Wash 98402
SERVICE BUREAU CORP., THE
1350 Ave Americas, New York, N Y 10019
SEVAN COMPUTER SERVICES INC.
Pollitt Dr S, Fair Lawn, N J 07410
SMITH CORP., A.O. DATA SYSTEMS DIV.
3533 N 27 St, Milwaukee, Wisc 53201
SOFTTECH INC.
391 Totten Pond Rd, Waltham, Mass 02154
SOFTWARE METHODS INC.
10 E 40th St, New York, N Y 10016
SOFTWARE PROGRAMMING ASSOCIATES INC.
1209 Tropic St, Titusville, Fla 32780
SOUTHERN DATA PROCESSING SERVICE INC.
P O Box 123, Augusta, Ga 30903
SOUTHERN SIMULATION SERVICES INC.
P O Box 1155, Tampa, Fla 33601
SOUTHERN VERMONT COMPUTER CENTER&DATA
SCHOOL
219 Belmont Ave, Bennington, Vt 05201
SPACETRONICS CO.
43 Hassemer Ave, Cherry Hill, N J 08034
SYSTEM DEVELOPMENT CORP.
2500 Colorado Ave, Santa Monica, Cal 90406
SYSTEM IMPLEMENTATION CORP.
18 E 48th St, New York, N Y 10017
SYSTEMATICS GENERAL CORP.
6825 Redmond Dr, McLean, Va 22101
SYSTEMATICS INC.
411 Victory, Little Rock, Ark 72201
SYSTEMS & ELECTRONICS, INC.
223 Park Ave, Rutherford, N J 07070
SYSTEMS ANALYSIS CO.
9 Office Park Cir, Birmingham, Ala 35223
SYSTEMS ANALYSIS INC.
11110 N E 8th, Bellevue, Wash 98004
SYSTEMS ASSOCIATES INC.
356 Penn St, Reading, Pa 19602
SYSTEMS DATA, INC.
1951 W Market St, Akron, Ohio 44313
SYSTEMS EQUIPMENT CORP.
458 Plasamour Dr, Atlanta, Ga 30324
SYSTEMS GENERAL CORP.
10889 Wilshire Blvd, Los Angeles, Cal 90024
SYSTEMS PROGRAMMING INC.
175 Main St, White Plains, N Y 10601
SYSTEMS RESEARCH LABS, INC.
7001 Indian Ripple Rd, Dayton, Ohio 45440
SYSTEMS, SCIENCE & SOFTWARE INC.
Po Box 1620, La Jolla, Cal 92037
TAYLOR INSTRUMENT PROCESS CONTROL DIV
95 Ames, Rochester, N Y 14601
TECHNOLOGY FOR INFORMATION MANAGEMENT INC.
1654 Central Ave, Albany, N Y 12205
TELE-DATA CORP.
130 U S Hwy 22, N Plainfield, N J 07060
TELEDYNE BROWN ENGINEERING
300 Sparkman Dr, Huntsville, Ala 35807
TIME SHARING SCIENCES INC.
1180 Ave Americas, New York, N Y 10036
TIME-SHARING SYSTEMS, INC.,
1840 N Farwell Ave, Milwaukee, Wis 53202
TRACOR COMPUTING CORP.
1705 Guadalupe St, Austin, Tex 78701
TRANS-DATA SYSTEMS
6394 Freeport B, Sacramento, Cal 95822
TRAVCOM INC.
1425 E McMillan, Cincinnati, Ohio 45206
TRAVCOM INC. UNITED DATA PROC DV
70 E 14th St, Eugene, Oreg 97401
TRILOG ASSOCIATES INC.
1700 Market St, Philadelphia, Pa 19103
TRIPLE C COMPUTER SERVICE
432 Park Ave S, New York, N Y 10016
TRW SYSTEMS GROUP SOFTWARE & INFORMATION
SYS DIV
1 Space Park, Redondo Beach, Cal 90278
TURNKEY SYSTEMS INC.
111 E Ave, Norwalk, Conn 06851
U.S. TIME-SHARING INC.
1831 Michael Faraday, Reston, Va 22070
UNITED COMPUTING SYSTEMS INC.
3130 Broadway, Kansas City, Mo 64111
UNITED DATA CENTERS INC.
100 Putnam Green, Greenwich, Conn 06830
UNITED SYSTEMS INC.
1020 Kings Hwy N, Cherry Hill, N J 08034
UNIVERSAL DATA SYSTEMS INC.
14482 Beach Blvd, Westminster, Cal 92626

UNIVERSITY COMPUTING CO.

P O Box 6228, Dallas, Tex 75222
URS DATA SCIENCE CO.
155 Bovet Rd, San Mateo, Cal 94402
VIRTUAL COMPUTER SERVICES INC
1119 Springfield Rd, Union, N J 07083
VITRO LABORATORIES, DIV. VITRO CORP. OF AMERICA
14000 Georgia Ave, Silver Spring, Md 20910
WARREN ASSOCIATES
15 Royal Crest Dr, Marlboro, Mass 01752
WELLINGTON COMPUTER SYSTEMS CORP.
405 Lexington Ave, New York, N Y 10017
WENGEL SERVICE CORP.
1101 State Rd, Princeton, N J 08540
WEST FLORIDA DATA PROCESSING CENTER INC.
P O Box 1460, Panama City, Fla 32401
WESTERN OPERATIONS INC.
120 Montgomery St, San Francisco, Cal 94104
WESTERN UNION TELEPROCESSING CO.
82 McKee Dr, Mahwah, N J 07436
WESTINGHOUSE ELECTRIC CORP.
Westinghouse Bldg, Pittsburgh, Pa 15222
WESTINGHOUSE TELE-COMPUTER SYSTEMS CORP.
2040 Ardmore Blvd, Pittsburgh, Pa 15221
WORLD COMPUTER CORP.
1615 Stemmons Fwy, Dallas, Tex 75221
WORLDWIDE COMPUTER SERVICES, INC.
280 N Central Pk Ave, Hartsdale, N Y 10530
ZENITH INTEGRATED-DATA PROCESSING INC.
950 Fulton Ave, Sacramento, Cal 95825

SERVOS, COMPUTER

BERGEN LABORATORIES INC. SUB. ZYROTRON INC.
60 Spruce St, Paterson, N J 07501
CLIFTON DIV. LITTON SYSTEMS INC.
Marple At Broadway, Clifton Heights, Pa 19018
COMPUTER CONVERSIONS CORP.
6 Dunton Court, E Northport, N Y 11731
COMPUTER DEVICES CORP. OF CALIFORNIA
11925 Burke St, Santa Fe Spg, Cal 90670
ELECTRO-CRAFT CORP.
1600 S 2nd St, Hopkins, Minn 55343
GAP INSTRUMENT CORP.
110 Marcus Blvd, Hauppauge, N Y 11787
IMC MAGNETICS CORP. WESTERN DIV.
6058 Walker Ave, Maywood, Cal 90270
INDIANA GENERAL CORP. ELECTRO-MECH. PROD.
517 W Walnut St, Ogleby, Ill 61348
INTERNATIONAL CONTROLS CORP.
200 Fairfield Rd, Fairfield, N J 07006
LEM INSTRUMENT CORP.
20 Sarah Dr, Farmingdale, N Y 11735
OMNIACTION CONTROL SYSTEMS DIV. DYNAMIC
INSTR.
114 E Bethpage Rd, Plainview, N Y 11803
SEQUENTIAL INFORMATION SYSTEMS INC.
145 Palisade St, Dobbs Ferry, N Y 10522
SINGER CO., THE, DIEHL DIV.
Finderne Ave, Somerville, N J 08876
SINGER-GENERAL PRECISION KEARFOTT DIV.
1150 McBride Ave, Little Falls, N J 07424
URIEL CORP.
53 Union Ave, Ronkonkoma, N Y 11779
USM CORP. GEAR SYSTEMS DIV.
101 Balch St, Beverly, Mass 01915
VERNITRON CORP. MOTOR PRODUCTS DIV.
300 Marcus Blvd, Deer Park, N Y 11729
WESTON-TRANSCOIDAL A SCHLUMBERGER CO.
Trooper Rd, Worcester, Pa 19490

SHIELDED CABLES (SEE CABLES)

SHIFT REGISTERS (SEE CIRCUITS)

SIGNAL CONDITIONERS

AMERICAN COMPUTER TECHNOLOGY INC.
8740 Shirley Ave, Northridge, Cal 91324
AUSTRON, INC.
10214 N Interregional, Austin, Tex 78753
AVCO CORP. ELECTRONICS DIV.
4807 Bradford, Huntsville, Ala 35805
B&F INSTRUMENT INC.
Clarmont Ave, Cornwell Height, Pa 19020
BAGANOFF ASSOCIATES INC.
6809 W Florissant, St Louis, Mo 63136
BENDIX CORP., THE, ENVRNMENTL SCI. DIV.
1400 Taylor Ave, Baltimore, Md 21204
BERGEN LABORATORIES INC. SUB. ZYROTRON INC.
60 Spruce St, Paterson, N J 07501

2 Product Directory

BFA CORP.

1309 S Inca, Denver, Colo 80223
BULOVA WATCH ELECTRONICS DIV.
6120 Woodside Ave, Woodside Li, N Y 11377
COMPUDYNE CORP. CONTROLS DIV.
P O Box 247, Hatboro, Pa 19040
COMPUTER CONVERSIONS CORP.
6 Dunton Court, E Northport, N Y 11731
COMPUTER DEVICES INC.
10 Sonar Dr, Woburn, Mass 01801
CONSOLIDATED OHMIC DEVICES INC.
115 Old Country Rd, Carle Place, N Y 11514
DATA CONTROL SYSTEMS INC.
Commerce Dr, Danbury, Conn 06810
DDC DIV. SOLID STATE SCIENTIFIC DEVICES
100 Tec St, Hicksville, N Y 11801
DIGITRON CORP.

2544 W Main St, Norristown, Pa 19401
ELBIT COMPUTERS/SUB. CONTROL DATA CORP.
6 Tovim St, Haifa, ISRAEL
GENERAL DEVICES INC.
P O Box 253, Princeton, N J 08540
GENERAL DYNAMICS CORP. ELECTRONICS DIV.
P O Box 2566, Orlando, Fla 32802
GOULD INC. BRUSH DIV.
3631 Perkins Ave, Cleveland, Ohio 44114
INCOR INSTRUMENTATION INC.
29 Newtown Rd, Plainview, N Y 11803
LITTON SYSTEMS INC. DATA SYSTEMS DIV.
8000 Woodley Ave, Van Nuys, Cal 91409
MB ELECTRONICS DIV. TEXTRON INC.
781 Whalley Ave, New Haven, Conn 06515
NATEL ENGINEERING CO. INC.
8944 Mason Ave, Canoga Park, Cal 91306
NIGITRON CORP.
2544 W Main St, Norristown, Pa 19401
NON-LINEAR SYSTEMS INC.
P O Box N, Del Mar, Cal 92014
PIONEER ELECTRIC & RESEARCH DIV. JOHNSON SER.CO.

743 Circle Ave, Forest Park, Ill 60130
ROCKLAND SYSTEMS CORP.
131 Erie St E, Blaauvelt, N Y 10913
SRC DIV. MOXON INC.
2222 Michelson Dr, Newport Beach, Cal 92664
SYSTEMS RESEARCH LABS, INC.
7001 Indian Ripple Rd, Dayton, Ohio 45440
TELEDYNE BROWN ENGINEERING
300 Sparkman Dr, Huntsville, Ala 35807
TRANSMAGNETICS INC.
210 Adams Blvd, Farmingdale, N Y 11735
WISE INSTRUMENTATION & CONTROLS INC.
3568 Amherst Court, Mt View, Cal 94040

SKREW METERS, MAGNETIC TAPE

BFA CORP.
1309 S Inca, Denver, Colo 80223
TALLY CORP.
8301 S 180th St, Kent, Wash 98031
TELECTRO SYSTEMS CORP.
96-18 43rd Ave, Corona, N Y 11368

SOCKETS, IC MOUNTING

AMP INC.
Eisenhower Blvd, Harrisburg, Pa 17105
AMP INC., SYSCOM DIV.
P O Box 3608, Harrisburg, Pa 17105
ANSLEY ELECTRONICS CORP. SUB. THOMAS & BETTS
Old Easton Rd, Doylestown, Pa 18901
BARNES CORP.
24 N Lansdowne Ave, Lansdowne, Pa 19050
CHEMELEC PRODUCTS INC.
8 Fellowship Rd, Cherryhill, N J 08034
CURTIS DEVELOPMENT & MANUFACTURING CO.
3266 N 33rd St, Milwaukee, Wis 53216
ELCO CORP.
Maryland Rd, Willow Grove, Pa 19090
ELCOM ELECTRONICS INC.
200 Allen Blvd, Farmingdale, N Y 11735
ELECTRONIC MOLDING CORP.
96 Mill St, Woonsocket, R I 02895
ELFAB CORP.
P O Box 34555, Dallas, Tex 75234
FABRI-TEK INC. NATIONAL CONNECTOR DIV.
9210 Science Ctr, Minneapolis, Minn 55428
HARVEY INDUSTRIAL DIV.
60 Crossway Pk W, Woodbury Li, N Y 11797
HYPERTRONICS CORP.
50 Hunt St, Watertown, Mass 02172
JOHNSON CO., E.F.
299 Tenth Ave SW, Waseca, Minn 56093

LITTON PRECISION PRODUCTS USECO DIV.
13536 Saticoy St, Van Nuys, Cal 91409
MALCO MANUFACTURING CO. INC.
5150 W Roosevelt Rd, Chicago, Ill 60650
METHODE ELECTRONICS INC.
7447 W Wilson Ave, Chicago, Ill 60656
MICRODATA CORP.
644 E Young St, Santa Ana, Cal 92705
MOLEX PRODUCTS CO.
5224 Katrine, Downers Grove, Ill 60515
ROBINSON-NUGENT INC.
800 E 8th St, New Albany, Ind 47150
SAE ADVANCED PACKAGING INC.
2165 S Grand Ave, Santa Ana, Cal 92705
SCANBE MANUFACTURING CO.
3445 Fletcher Ave, El Monte, Cal 91750
SEAELECTRO CORP.
225 Hoyt St, Mamaroneck, N Y 10543
VECTOR ELECTRONIC CO. INC.
12460 Gladstone Ave, Sylmar, Cal 91342
VIKING INDUSTRIES INC.
21001 Nordhoff St, Chatsworth, Cal 91311

SOCKETS, PCB MOUNTING

AMP INC.
Eisenhower Blvd, Harrisburg, Pa 17105
AMP INC., SYSCOM DIV.
P O Box 3608, Harrisburg, Pa 17105
CHEMELEC PRODUCTS INC.
8 Fellowship Rd, Cherryhill, N J 08034
CURTIS DEVELOPMENT & MANUFACTURING CO.
3266 N 33rd St, Milwaukee, Wis 53216
ELCO CORP.
Maryland Rd, Willow Grove, Pa 19090
ELECTRONIC MOLDING CORP.
96 Mill St, Woonsocket, R I 02895
FABRI-TEK INC. NATIONAL CONNECTOR DIV.
9210 Science Ctr, Minneapolis, Minn 55428
HARVEY INDUSTRIAL DIV.
60 Crossway Pk W, Woodbury Li, N Y 11797
HUGHES AIRCRAFT CO. CONNECTING DEV. DIV
500 Superior Ave, Newport Beach, Cal 92663
HYPERTRONICS CORP.
50 Hunt St, Watertown, Mass 02172
JOHNSON CO., E.F.
299 Tenth Ave SW, Waseca, Minn 56093
LITTON PRECISION PRODUCTS USECO DIV.
13536 Saticoy St, Van Nuys, Cal 91409
METHODE ELECTRONICS INC.
7447 W Wilson Ave, Chicago, Ill 60656
MICRODATA CORP.
644 E Young St, Santa Ana, Cal 92705
MOLEX PRODUCTS CO.
5224 Katrine, Downers Grove, Ill 60515
NORRICH PLASTIC CORP.
200 Allen Blvd, Farmingdale, N Y 11757
ROBINSON-NUGENT INC.
800 E 8th St, New Albany, Ind 47150
SAE ADVANCED PACKAGING INC.
2165 S Grand Ave, Santa Ana, Cal 92705
SCANBE MANUFACTURING CO.
3445 Fletcher Ave, El Monte, Cal 91750
VECTOR ELECTRONIC CO. INC.
12460 Gladstone Ave, Sylmar, Cal 91342

SOCKETS, SEMICONDUCTOR MOUNTING

AMP INC., SYSCOM DIV.
P O Box 3608, Harrisburg, Pa 17105
BARNES CORP.
24 N Lansdowne Ave, Lansdowne, Pa 19050
CHEMELEC PRODUCTS INC.
8 Fellowship Rd, Cherryhill, N J 08034
ELECTRONIC MOLDING CORP.
96 Mill St, Woonsocket, R I 02895
HARVEY INDUSTRIAL DIV.
60 Crossway Pk W, Woodbury Li, N Y 11797
LITTON PRECISION PRODUCTS USECO DIV.
13536 Saticoy St, Van Nuys, Cal 91409
METHODE ELECTRONICS INC.
7447 W Wilson Ave, Chicago, Ill 60656
MOLEX PRODUCTS CO.
5224 Katrine, Downers Grove, Ill 60515
ROBINSON-NUGENT INC.
800 E 8th St, New Albany, Ind 47150
SAE ADVANCED PACKAGING INC.
2165 S Grand Ave, Santa Ana, Cal 92705
THERMALLOY CO.
8717 Diplomacy Row, Dallas, Tex 75247

SOFTWARE SERVICES (SEE PRO-GRAMMING LANGUAGE DEVELOPMENT)

SOLENOIDS

DETROIT COIL CO.
2435 Hilton Rd, Ferndale, Mich 48220
DORMEYER INDUSTRIES INC.
3418 N Milwaukee Ave, Chicago, Ill 60641
FEMA CORP.
11023 Glenoaks Blvd, Pacoima, Cal 91331
GUARDIAN ELECTRIC MANUFACTURING CO.
1550 W Carroll Ave, Chicago, Ill 60607
HI-G INC.
580 Spring St, Windsor Locks, Conn 06096

SORTERS, PUNCHED CARD

ABINGTON KEYPUNCH INC.
920 Fox Chase Rd, Rockledge, Pa 19111
BRIDGE DATA PRODUCTS INC.
738 S 42nd St, Philadelphia, Pa 19104
BURROUGHS CORP. BUSINESS MACHINES GROUP
6071 2nd Ave, Detroit, Mich 48232
COMPUTER ACCESSORIES CO.
131 W 154th St, Gardena, Cal 90248
CUSTOM DATA PROCESSING SERVICES
P O Box 14685, Phoenix, Ariz 85031
DATA PROCESSING AND ACCOUNTING SERVICES
50 Van Ness Ave, San Francisco, Cal 94102
DECISION DATA CORP.
300 Jacksonville Rd, Warminster, Penn 18974
DYNAMIC ACCESS CORP.
220 Park Ave S, New York, N Y 10003
IOA DATA CORP.
383 Lafayette St, New York, N Y 10003
MAI EQUIPMENT CORP.
300 E 44th St, New York, N Y 10017
RANDOMATIC DATA SYSTEMS INC.
344 W State St, Trenton, N J 08618
REN ELECTRONICS
775 New Ludlow Rd, So Hadley, Mass 01075

SPINDLES

MPB CORP.
Precision Park, Keene, N H 03431
SPINDLE SALES EX-CELL-O CORP.
Po Box 386, Detroit, Mich 48232

SPLICERS, MAGNETIC TAPE

COMPUTER ACCESSORIES CO.
131 W 154th St, Gardena, Cal 90248
CTM LEASING CORP.
4924 Hampden Lane, Bethesda, Md 20014
HEWLETT PACKARD CO. MOUNTAIN VIEW DIV.
690 Middlefield Rd, Mtn View, Cal 94040
PRESTOSEAL MANUFACTURING CO.
37-12 108 St, Corona, N Y 11368
TELECTRO SYSTEMS CORP.
96-18 43rd Ave, Corona, N Y 11368

SPLICERS, PAPER TAPE

ANDERSON JACOBSON INC.
1065 Morse Ave., Sunnyvale, Cal 94086
ARNDT ASSOCIATES
727 Howard St, Evanston, Ill 60202
COMPUTER ACCESSORIES CORP.
211 New York Ave, Huntington, N Y 11743
DATA-LINK CORP.
P O Box 2792, San Diego, Cal 92112
DELMARVA COMPUTER INDUSTRIES INC.
5865 Robert Oliver Pl, Columbia, Md 21043
DONAULD INC.
P O Box 104, Ridgewood, N J 07451
DRESSER PRODUCTS INC.
P O Box 2035, Providence, R I 02905
ENDLESS TAPE REEL CO.
81 Haven St, Reading, Mass 01867
FRIDEN DIV. THE SINGER CO.
97 Humboldt St, Rochester, N Y 14602
ICA CORP.
200 N 3rd St, Minneapolis, Minn 55401
INTERNATIONAL COMPUTER APPLIANCES CORP.
200 N Third St, Minneapolis, Minn 55401
ITEL INFORMATION PRODUCTS DIV
2585 Bayshore, Palo Alto, Cal 94303

**AT
LAST!**

**- a truly
high efficiency
STATIC
ELIMINATOR
at low cost!**

Simco's new Shockless Static Eliminator is guaranteed effective on all data processing and office/business machines. Manufacturers of computer printers, duplicator presses, electrostatic copier/duplicators and other machines, now have the benefit of truly effective static elimination at extremely low cost, when purchasing the equipment in quantity. The static bars are available in any desired length, with cable exiting straight out the end of the bar or at right angles. They are designed to mount easily, even where space is limited. The compact Power Unit operates one or more static bars, is listed by UL and CSA. Write for facts.

the SIMCO company INC.
920 Walnut Street, Lansdale, Pa. 19446
WORLD'S LARGEST MANUFACTURER OF STATIC
ELIMINATORS, DETECTORS AND GENERATORS

2 Product Directory

JOHNSON ASSOCIATES INC.
108 Lyster Rd. Orelan, Pa 19075
NUMERIDEX TAPE SYSTEMS INC.
4711 W North Ave, Chicago, Ill 60639
OCHMAN SYSTEMS, EDWARD
Po Box 141, Fairfield, Conn 06430
PAPER MANUFACTURERS CO.
9800 Bustleton Ave, Philadelphia, Pa 19115
PRESTOSEAL MANUFACTURING CO.
37-12 108 St, Corona, N Y 11368
ROBIN INDUSTRIES CORP. DATA PRODUCTS DIV.
15-58 127 St, Flushing, N Y 11356
SHIRAK TELEMETERING OF AMERICA
8926 Kester Ave, Van Nuys, Cal 91402
SMITH INC., JAY
292 E State St, Westport, Conn 06880
TELETYPE CORP.
5555 W Touhy Ave, Skokie, Ill 60076

SPOOLERS, PAPER TAPE

ANDERSON JACOBSON INC.
1065 Morse Ave., Sunnyvale, Cal 94086
CHALCO ENGINEERING CORP.
15126 S Broadway, Gardena, Cal 90248
CYCLE EQUIPMENT CO.
P O Box 307, Los Gatos, Cal 95030
DATASCAN INC.
1111 Paulson Ave, Clifton, N J 07013
DATATERM INC.
1671 Manning Blvd, Levittown, Pa 19057
DIGITRONICS CORP.
1 Albertson Ave, Albertson, N Y 11507
DRESSER PRODUCTS INC.
P O Box 2035, Providence, R I 02905
ENDLESS TAPE REEL CO.
81 Haven St, Reading, Mass 01867
FACIT-ODHNER INC.
501 Winsor Dr, Secaucus, N J 07094
FRIDEN DIV. THE SINGER CO.
97 Humboldt St, Rochester, N Y 14602
ITEL INFORMATION PRODUCTS DIV
2585 Bayshore, Palo Alto, Cal 94303
JAMESBURY CORP. DECITEK DIV.
15 Sagamore Rd, Worcester, Mass 01605
NEWMADE PRODUCTS CORP.
P O Box 568, Scarsdale, N Y 10583
NUMERIDEX TAPE SYSTEMS INC.
4711 W North Ave, Chicago, Ill 60639
OCHMAN SYSTEMS, EDWARD
Po Box 141, Fairfield, Conn 06430
PAPER MANUFACTURERS CO.
9800 Bustleton Ave, Philadelphia, Pa 19115
REMEM ELECTRONICS
5250 W El Segundo Blv, Hawthorne, Cal 90250
ROBIN INDUSTRIES CORP. DATA PRODUCTS DIV.
15-58 127 St, Flushing, N Y 11356
ROHDE & SCHWARZ SALES CO. USA INC.
111 Lexington Ave, Passaic, N J 07055
SHIRAK TELEMETERING OF AMERICA
8926 Kester Ave, Van Nuys, Cal 91402
SMITH INC., JAY
292 E State St, Westport, Conn 06880
WHITEFORD LABORATORY
258 Broad St, Lynn, Mass 01901

STATIC ELIMINATION EQUIPMENT

CUSTOM MATERIALS INC.
Alpha Industrial Park, Chelmsford, Mass 01824
HERBERT PRODUCTS INC.
180 Linden Ave, Westbury, N Y 11590
SIMCO CO. INC., THE
920 Walnut St, Lansdale, Pa 19446

SWITCH ARRAYS, ENCODED

CHOMERICS, INC. SERVICE INC.
77 Dragon Court, Woburn, Mass 01801
INTEGRAL DATA DEVICES INC.
35 Orville Dr, Bohemia, N Y 11716

SWITCHES, COAXIAL

TROMPETER ELECTRONICS INC.
8936 Comanche Ave, Chatsworth, Cal 91311

SWITCHES, CODE BAR

C&K COMPONENTS INC.
103 Morse St, Watertown, Mass 02172
CHERRY ELECTRICAL PRODUCTS CORP.
3600 Sunset Ave, Waukegan, Ill 60085
DATANETICS CORP.
2828 Spreckel Ln, Redondo Beach, Cal 90278
ELECTRONIC CONTROLS INC. T-BAR SWITCHING TECH
DIV.
141 Danbury Rd, Milton, Conn 06897
MAXI SWITCH CO.
3125 Washington Ave N, Minneapolis, Minn 55421
RCL ELECTRONICS INC.
700 S 21 St, Irvington, N J 07111

SWITCHES, DRY REED

ADAMS & WESTLAKE, SUB. ALLIED PRODUCTS
1025 N Michigan, Elkhart, Ind 46514
ALLEN-BRADLEY
1201 S 2nd St, Milwaukee, Wisc 53204
CHERRY ELECTRICAL PRODUCTS CORP.
3600 Sunset Ave, Waukegan, Ill 60085
CLARE-PENDAR CO.
P O Box 785, Post Falls, Ind 83854
COMPU-LITE CORP.
17795 Sky Park Cir, Irvine, Cal 92664
COMPUTER COMPONENTS INC.
88-06 Van Wyck Expwy, Jamaica, N Y 11418
CONTROLS RESEARCH CORP.
2100 S Fairview, Santa Ana, Cal 92704
ELECTRONIC CONTROLS INC. T-BAR SWITCHING TECH
DIV.
141 Danbury Rd, Milton, Conn 06897
FREDERICK CONTROLS DIV., SUB. NO. AM. PHILIPS
CORP.
E Church & Second Sts, Frederick, Md 21701
GORDOS CORP.
250 Glenwood Ave, Bloomfield, N J 07003
HAMLIN, INC.
Lake & Grove Sts, Lake Mills, Wis 53551
HATHAWAY INSTRUMENTS INC.
5250 E Evans Ave, Denver, Colo 80120
INTEGRAL DATA DEVICES INC.
35 Orville Dr, Bohemia, N Y 11716
JAMES ELECTRONICS INC.
4050 N Rockwell St, Chicago, Ill 60618
MAXI SWITCH CO.
3125 Washington Ave N, Minneapolis, Minn 55421
NEW PRODUCT ENGINEERING
1 St & Webster St, Wabash, Ind 46992
NO. AMERICAN PHILIPS CORP. FREDERICK CONT. DIV
Frederick, Md 21701
NON-LINEAR SYSTEMS INC.
P O Box N, Del Mar, Cal 92014
POTTER & BRUMFIELD DIV. OF AMF INC.
1200 E Broadway, Princeton, Ind 47570
RAYTHEON CO. INDUSTRIAL COMPONENT
OPERATION
465 Centre St., Quincy, Mass 02169
SELF-ORGANIZING SYSTEMS INC.
P O Box 9918, Dallas, Tex 75214
SIGMA INSTRUMENTS INC.
170 Pearl St, Braintree, Mass 02185
TROMPETER ELECTRONICS INC.
8936 Comanche Ave, Chatsworth, Cal 91311
UNIVERSAL RELAY CORP.
42 White St, New York, N Y 10013
VECTRONIX INC.
P O Box 209, Cozad, Nebr 69130

SWITCHES, KEYBOARD

ALCO ELECTRONIC PRODUCTS INC.
8 Marblehead St, North Andover, Mass 01845
GORDOS CORP.
250 Glenwood Ave, Bloomfield, N J 07003

SWITCHES, LEVER

DIGITRAN CO., THE BECTON, DICKINSON & CO
855 S Arroyo Pkwy, Pasadena, Cal 91105

SWITCHES, PUSHBUTTON

ALCO ELECTRONIC PRODUCTS INC.
8 Marblehead St, North Andover, Mass 01845
ALLEN-BRADLEY
1201 S 2nd St, Milwaukee, Wisc 53204
AMERICAN ZETTLER INC.
697 Randolph Ave, Costa Mesa, Cal 92626

2 Product Directory

CAPITOL MACHINE & SWITCH CO., THE
87 Newtown Rd, Danbury, Conn 06810
CENTRALAB ELECTRONICS, DIV.
5757 N Green Bay, Milwaukee, Wisc 53201
CHERRY ELECTRICAL PRODUCTS CORP.
3600 Sunset Ave, Waukegan, Ill 60085
CHICAGO DYNAMIC INDUSTRIES PRECISION PROD. DIV
1725 Diversey Blvd, Chicago, Ill 60614
CLARE-PENDAR CO.
P O Box 785, Post Falls, Ind 83854
CONTROLS CO. AMERICA-SINGER CONTROL SWITCH
DIV.
1420 Delmar Dr, Folcroft, Pa 19032
CONTROLS RESEARCH CORP.
2100 S Fairview, Santa Ana, Cal 92704
CUTLER-HAMMER, SPECIALTY PRODUCTS DIV.
4201 N 27th St, Milwaukee, Wisc 53216
DIALIGHT CORP.
60 Stewart Ave, Brooklyn, N Y 11237
ELEC-TROL INC.
21018 Soledad Canyon, Saugus, Cal 91350
ELECTRONIC CONTROLS INC. T-BAR SWITCHING TECH
DIV.
141 Danbury Rd, Milton, Conn 06897
GORDOS CORP.
250 Glenwood Ave, Bloomfield, N J 07003
GRAYHILL INC.
561 Hillgrove Ave, La Grande, Ill 60525
GUARDIAN ELECTRIC MANUFACTURING CO.
1550 W Carroll Ave, Chicago, Ill 60607
HARVEY INDUSTRIAL DIV.
60 Crossway Pk W, Woodbury Li, N Y 11797
HAYDON SWITCH&INSTRUMENT INC. SUB. TRI-TECH
INC.
1500 Meriden Rd, Waterbury, Conn 06720
ILLINOIS TOOL WORKS INC. LICON DIV.
6615 W Irving Park, Chicago, Ill 60634
JANCO CORP.
311 Winona Ave, Burbank, Cal 91504
MASTER SPECIALTIES CO.
1640 Monrovia, Costa Mesa, Cal 92627
MAXI SWITCH CO.
3125 Washington Ave N, Minneapolis, Minn 55421
METHODE ELECTRONICS INC.
7447 W Wilson Ave, Chicago, Ill 60656
MICRO SWITCH DIV. HONEYWELL INC.
11 W Spring St, Freeport, Ill 61032
MOLEX PRODUCTS CO.
5224 Katrine, Downers Grove, Ill 60515
NUCLEONIC PRODUCTS CO. INC.
6660 Variel Ave, Canoga Park, Cal 91303
OAK ELECTRO/NETICS CORP. OAK MFG. CO.
Main St, Crystal Lake, Ill 60014
RAYTHEON CO. INDUSTRIAL COMPONENT
OPERATION
465 Centre St., Quincy, Mass 02169
RCL ELECTRONICS INC.
700 S 21 St, Irvington, N J 07111
RISK INDUSTRIES INC., GEORGE
P O Box 1035, Kimball, Nebr 69145
RODALE MANUFACTURING CO.
6th & Minor St, Emmaus, Pa 18049
ROWAN CONTROLLER INC.
P O Box 306, Westminster, Md 21157
STACOSWITCH INC.
1139 Baker St, Costa Mesa, Cal 92626
STETTNER-TRUSH INC.
67 Albany St, Cazenovia, N Y 13035
SWITCHCRAFT INC.
5555 N Elston Ave, Chicago, Ill 60630
TEC INC.
6700 S Wash Ave, Eden Prairie, Minn 55343
TEXAS INSTRUMENTS INC. CONTROLS DIV.
34 Forest St, Attleboro, Mass 02703
TROMPETER ELECTRONICS INC.
8936 Comanche Ave, Chatsworth, Cal 91311
UNIMAX SWITCH CORP. SUB. RIKER-MAXSON
Ives Rd, Wallingford, Conn 06492
UNIVERSAL RELAY CORP.
42 White St, New York, N Y 10013
VECTRONIX INC.
P O Box 209, Cozad, Nebr 69130

SWITCHES, PUSHBUTTON (ILLUMINATED)

ALCO ELECTRONIC PRODUCTS INC.
8 Marblehead St, North Andover, Mass 01845
ALLEN-BRADLEY
1201 S 2nd St, Milwaukee, Wisc 53204
AMERICAN ZETTLER INC.
697 Randolph Ave, Costa Mesa, Cal 92626
C&K COMPONENTS INC.
103 Morse St, Watertown, Mass 02172

CAPITOL MACHINE & SWITCH CO., THE
87 Newtown Rd, Danbury, Conn 06810
CENTRALAB ELECTRONICS, DIV.
5757 N Green Bay, Milwaukee, Wisc 53201
CLARE-PENDAR CO.
P O Box 785, Post Falls, Ind 83854
COMPU-LITE CORP.
17795 Sky Park Cir, Irvine, Cal 92664
CONTROLS CO. AMERICA-SINGER CONTROL SWITCH
DIV.
1420 Delmar Dr, Folcroft, Pa 19032
CONTROLS RESEARCH CORP.
2100 S Fairview, Santa Ana, Cal 92704
CO-ORD SWITCH CO., DIV. LVC INDUSTRIES, INC.
102-48 43rd Ave, Corona, N Y 11368
CUTLER-HAMMER, SPECIALTY PRODUCTS DIV.
4201 N 27th St, Milwaukee, Wisc 53216
DIALIGHT CORP.
60 Stewart Ave, Brooklyn, N Y 11237
DRAKE MANUFACTURING CO.
4626 N Olcott Ave, Harwood Heights, Ill 60656
GORDOS CORP.
250 Glenwood Ave, Bloomfield, N J 07003
GRAYHILL INC.
561 Hillgrove Ave, La Grande, Ill 60525
GUARDIAN ELECTRIC MANUFACTURING CO.
1550 W Carroll Ave, Chicago, Ill 60607
HARVEY INDUSTRIAL DIV.
60 Crossway Pk W, Woodbury Li, N Y 11797
HAYDON SWITCH&INSTRUMENT INC. SUB. TRI-TECH
INC.
1500 Meriden Rd, Waterbury, Conn 06720
ILLINOIS TOOL WORKS INC. LICON DIV.
6615 W Irving Park, Chicago, Ill 60634
INDUSTRIAL DEVICES INC.
982 River Rd, Edgewater, N J 07020
INDUSTRIAL ELECTRONIC ENGINEERS INC.
7720-40 Lemona Ave, Van Nuys, Cal 91405
MASTER SPECIALTIES CO.
1640 Monrovia, Costa Mesa, Cal 92627
MAXI SWITCH CO.
3125 Washington Ave N, Minneapolis, Minn 55421
MICRO SWITCH DIV. HONEYWELL INC.
11 W Spring St, Freeport, Ill 61032
MOLEX PRODUCTS CO.
5224 Katrine, Downers Grove, Ill 60515
NUCLEONIC PRODUCTS CO. INC.
6660 Variel Ave, Canoga Park, Cal 91303
OAK ELECTRO/NETICS CORP. OAK MFG. CO.
Main St, Crystal Lake, Ill 60014
RAYTHEON CO. INDUSTRIAL COMPONENT
OPERATION
465 Centre St., Quincy, Mass 02169
RISK INDUSTRIES INC., GEORGE
P O Box 1035, Kimball, Nebr 69145
RODALE MANUFACTURING CO.
6th & Minor St, Emmaus, Pa 18049
ROWAN CONTROLLER INC.
P O Box 306, Westminster, Md 21157
STACOSWITCH INC.
1139 Baker St, Costa Mesa, Cal 92626
STETTNER-TRUSH INC.
67 Albany St, Cazenovia, N Y 13035
SWITCHCRAFT INC.
5555 N Elston Ave, Chicago, Ill 60630
TEC INC.
6700 S Wash Ave, Eden Prairie, Minn 55343
TEXAS INSTRUMENTS INC. CONTROLS DIV.
34 Forest St, Attleboro, Mass 02703
TROMPETER ELECTRONICS INC.
8936 Comanche Ave, Chatsworth, Cal 91311
UNIMAX SWITCH CORP. SUB. RIKER-MAXSON
Ives Rd, Wallingford, Conn 06492
UNIVERSAL RELAY CORP.
42 White St, New York, N Y 10013
VECTRONIX INC.
P O Box 209, Cozad, Nebr 69130

SWITCHES, ROTARY

AIRFLYTE ELECTRONICS CO.
56 New Hook Rd, Bayonne, N J 07002
ALCO ELECTRONIC PRODUCTS INC.
8 Marblehead St, North Andover, Mass 01845
ALLEN-BRADLEY
1201 S 2nd St, Milwaukee, Wisc 53204
AMP INC.
Eisenhower Blvd, Harrisburg, Pa 17105
AMP INC., SYSCOM DIV.
P O Box 3608, Harrisburg, Pa 17105
ANSLEY ELECTRONICS CORP. SUB. THOMAS & BETTS
Old Easton Rd, Doylestown, Pa 18901
AUTOMATION SCIENCES INTERNATIONAL CORP.
600 South St, Holbrook, Mass 02343

BOURNS INC.
1200 Columbia Ave., Riverside, Cal 92507
CENTRALAB ELECTRONICS, DIV.
5757 N Green Bay, Milwaukee, Wisc 53201
CHERRY ELECTRICAL PRODUCTS CORP.
3600 Sunset Ave, Waukegan, Ill 60085
CHICAGO DYNAMIC INDUSTRIES PRECISION PROD. DIV
1725 Diversey Blvd, Chicago, Ill 60614
CTS CORP.
905 NW Blvd, Elkart, Ind 46514
CUTLER-HAMMER, SPECIALTY PRODUCTS DIV.
4201 N 27th St, Milwaukee, Wisc 53216
ESSEX WIRE & CABLE CO.
1601 Wall St, Ft Wayne, Ind 46804
FIFTH DIMENSION INC.
P O Box 483, Princeton, N J 08540
GENERAL DEVICES INC.
P O Box 253, Princeton, N J 08540
GRAYHILL INC.
561 Hillgrove Ave, La Grande, Ill 60525
HARVEY INDUSTRIAL DIV.
60 Crossway Pk W, Woodbury Li, N Y 11797
HAYDON SWITCH&INSTRUMENT INC. SUB. TRI-TECH
INC.
1500 Meriden Rd, Waterbury, Conn 06720
HEINEMANN ELECTRIC CO.
Brunswick Pike Rte 1, Trenton, N J 08638
HELIPOT DIV. BECKMAN INSTRUMENTS INC.
2500 Harbor Blvd, Fullerton, Cal 92634
ILLINOIS TOOL WORKS INC. LICON DIV.
6615 W Irving Park, Chicago, Ill 60634
JANCO CORP.
311 Winona Ave, Burbank, Cal 91504
LEDEX INC.
123 Webster St, Dayton, Ohio 45401
LEEDS & NORTHRUP CO.
Sumney Town Pike, North Wales, Pa 19454
MALLORY & CO. INC., P.R.
3029 E Washington, Indianapolis, Ind 46218
MALLORY CONTROLS CO.
P O Box 327, Frankfort, Ind 46041
MCGRAW-EDISON DAVEN DIV.
Grenier Field, Manchester, N H 03103
MICRO SWITCH DIV. HONEYWELL INC.
11 W Spring St, Freeport, Ill 61032
MINELCO, SUB. GENERAL TIME CORP.
600 South St, Holbrook, Mass 02343
NOVATRONICS OF CANADA LTD.
677 Erie St, Stratford Ont, CANADA
OAK ELECTRO/NETICS CORP. OAK MFG. CO.
Main St, Crystal Lake, Ill 60014
OHMITE MANUFACTURING CO.
3601 Howard St, Skokie, Ill 60076
RCL ELECTRONICS INC.
700 S 21 St, Irvington, N J 07111
RODALE MANUFACTURING CO.
6th & Minor St, Emmaus, Pa 18049
SEAELECTRO CORP.
225 Hoyt St, Mamaroneck, N Y 10543
SIGMA INSTRUMENTS INC.
170 Pearl St, Braintree, Mass 02185
SPECTROL ELECTRONICS CORP.
17070 E Gale Ave, Industry, Cal 91745
STACKPOLE CARBON CO.
Stackpole, St Marys, Pa 15857
STACOSWITCH INC.
1139 Baker St, Costa Mesa, Cal 92626
SWITCHCRAFT INC.
5555 N Elston Ave, Chicago, Ill 60630
TECH LABORATORIES INC.
Bergen & Edsall Blvd, Palisades Park, N J 07650
VECTRONIX INC.
P O Box 209, Cozad, Nebr 69130
VEEDER-ROOT
70 Sargeant St, Hartford, Conn 06102

SWITCHES, SNAP ACTION

ALCO ELECTRONIC PRODUCTS INC.
8 Marblehead St, North Andover, Mass 01845
ALLEN-BRADLEY
1201 S 2nd St, Milwaukee, Wisc 53204
C&K COMPONENTS INC.
103 Morse St, Watertown, Mass 02172
CHERRY ELECTRICAL PRODUCTS CORP.
3600 Sunset Ave, Waukegan, Ill 60085
CHOMERICS, INC. SERVICE INC.
77 Dragon Court, Woburn, Mass 01801
CLARE-PENDAR CO.
P O Box 785, Post Falls, Ind 83854
CLAROSTAT MANUFACTURING CO. INC.
Washington St, Dover, N H 03820

Thumbwheel Switches for EDP LEGERDEMAIN & PRESTIDIGITATION

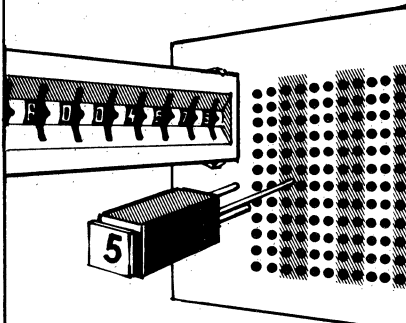

(Thumbwheel switches that are really finger-wheel switches.)

For the nimble-fingered and the light-of-hand — as well as for operators who are all thumbs — **INTERSWITCH** thumbwheel switches perform **sleight-of-hand** switching. Here's why you should switch to **INTERSWITCH**:

- featherweight action
- positive detent
- highly legible readout
- 2 to 16 positions
- 158 standard codes
- custom characters unlimited
- 6 colors for coding.

All this and **smallest size too!** What's more, we assemble your own custom switch requirements from over a million standard switch-component **in-stock designs**.

These superior characteristics make **INTERSWITCH** Thumbwheel Switches your best choice for any application in which instantly identifiable, split-second settings are necessary — particularly when those settings must convert decimal values to machine-language codes or formats.

We simplify the man/machine interface. For technical data on Matrix Boards and Data Programming Modules, see the **INTERSWITCH** catalog insert.



One of the **PURDY** group of companies.
770 Airport Boulevard
Burlingame, California 94010
(415) 347-8217

2 Product Directory

CONTROLS CO. AMERICA-SINGER CONTROL SWITCH DIV.

1420 Delmar Dr. Folcroft, Pa 19032
CTS CORP.

905 NW Blvd. Elkart, Ind 46514
CUTLER-HAMMER, SPECIALTY PRODUCTS DIV.
4201 N 27th St. Milwaukee, Wisc 53216
ESSEX WIRE & CABLE CO.

1601 Wall St. Ft Wayne, Ind 46804
FREDERICK CONTROLS DIV., SUB. NO. AM. PHILIPS CORP.

E Church & Second Sts. Frederick, Md 21701
GENERAL EQUIPMENT & MANUFACTURING CO.
3300 Fern Valley Rd. Louisville, Ky 40213
GRAYHILL INC.

561 Hillgrove Ave. La Grande, Ill 60525
GUARDIAN ELECTRIC MANUFACTURING CO.
1550 W Carroll Ave. Chicago, Ill 60607
HARVEY INDUSTRIAL DIV.

60 Crossway Pk W. Woodbury Li. N Y 11797
HAYDON SWITCH&INSTRUMENT INC. SUB. TRI-TECH INC.

1500 Meriden Rd. Waterbury, Conn 06720
ILLINOIS TOOL WORKS INC. LICON DIV.

6615 W Irving Park, Chicago, Ill 60634
MALLORY & CO. INC., P.R.

3029 E Washington, Indianapolis, Ind 46218
MASTER SPECIALTIES CO.

1640 Monrovia, Costa Mesa, Cal 92627
MICRO SWITCH DIV. HONEYWELL INC.

11 W Spring St. Freeport, Ill 61032
NO. AMERICAN PHILIPS CORP. FREDERICK CONT. DIV.
Frederick, Md 21701

POTTER & BRUMFIELD DIV. OF AMF INC.
1200 E Broadway, Princeton, Ind 47570

RCL ELECTRONICS INC.
700 S 21 St. Irvington, N J 07111

RODALE MANUFACTURING CO.
6th & Minor St. Emmaus, Pa 18049

SEAELECTRO CORP.
225 Hoyt St. Mamaroneck, N Y 10543

SIGMA INSTRUMENTS INC.
170 Pearl St. Braintree, Mass 02185

STACOSWITCH INC.
1139 Baker St. Costa Mesa, Cal 92626

SWITCHCRAFT INC.
5555 N Elston Ave. Chicago, Ill 60630

TEC INC.
6700 S Wash Ave. Eden Prarie, Minn 55343

TECH LABORATORIES INC.
Bergen & Edsall Blvd, Palisades Park, N J 07650

TEXAS INSTRUMENTS INC. CONTROLS DIV.
34 Forest St. Attleboro, Mass 02703

UNIMAX SWITCH CORP. SUB. RIKER-MAXSON
Ives Rd. Wallingford, Conn 06492

UNIVERSAL RELAY CORP.
42 White St. New York, N Y 10013

VECTRONIX INC.
P O Box 209, Cozad, Nebr 69130

SWITCHES, SOLID STATE

BURR-BROWN RESEARCH CORP.
6730 S Tucson Blvd, Tucson, Ariz 85706

NUCLEONIC PRODUCTS CO. INC.
6660 Variel Ave. Canoga Park, Cal 91303

SWITCHES, THUMBWHEEL

A. W. HAYDON CO., THE
232 N Elm St. Waterbury, Conn 06720

AIRPAX ELECTRONICS INC.
P O Box 8488, Ft Lauderdale, Fla 33310

AMP INC., SYSCOM DIV.
P O Box 3608, Harrisburg, Pa 17105

CHERRY ELECTRICAL PRODUCTS CORP.
3600 Sunset Ave. Waukegan, Ill 60085

CHICAGO DYNAMIC INDUSTRIES PRECISION PROD. DIV.
1725 Diversey Blvd. Chicago, Ill 60614

CO-ORD SWITCH CO., DIV. LVC INDUSTRIES, INC.
102-48 43rd Ave. Corona, N Y 11368

DIGITRAN CO., THE BECTON, DICKINSON & CO
855 S Arroyo Pkwy, Pasadena, Cal 91105

ELECTRONIC ENGRG. CO. OF CAL. ELECTRONIC PRD. DIV.

1441 E Chestnut Ave. Santa Ana, Cal 92702
HAYDON SWITCH&INSTRUMENT INC. SUB. TRI-TECH INC.

1500 Meriden Rd. Waterbury, Conn 06720
INTERSWITCH DIV. WILLIAM J. PURDY CORP.

770 Airport Blvd, Burlingame, Cal 94010
MCGRAW-EDISON DAVEN DIV.

Grenier Field, Manchester, N H 03103

OAK ELECTRO/NETICS CORP. OAK MFG. CO.
Main St. Crystal Lake, Ill 60014

PURDY CORP., WM. J.
770 Airport Blvd, Burlingame, Cal 94010

SEAELECTRO CORP.
225 Hoyt St. Mamaroneck, N Y 10543

TECH LABORATORIES INC.
Bergen & Edsall Blvd, Palisades Park, N J 07650

UNIVERSAL RELAY CORP.
42 White St. New York, N Y 10013

VECTRONIX INC.
P O Box 209, Cozad, Nebr 69130

SWITCHES, TOGGLE (MINIATURE)

ALCO ELECTRONIC PRODUCTS INC.
8 Marblehead St. North Andover, Mass 01845

C&K COMPONENTS INC.
103 Morse St. Watertown, Mass 02172

CONTROLS CO. AMERICA-SINGER CONTROL SWITCH DIV.

1420 Delmar Dr. Folcroft, Pa 19032
CUTLER-HAMMER, SPECIALTY PRODUCTS DIV.

4201 N 27th St. Milwaukee, Wisc 53216
HARVEY INDUSTRIAL DIV.

60 Crossway Pk W. Woodbury Li. N Y 11797
HAYDON SWITCH&INSTRUMENT INC. SUB. TRI-TECH INC.

1500 Meriden Rd. Waterbury, Conn 06720
HEINEMANN ELECTRIC CO.

Brunswick Pike Rte 1, Trenton, N J 08638
ILLINOIS TOOL WORKS INC. LICON DIV.

6615 W Irving Park, Chicago, Ill 60634
MALLORY & CO. INC., P.R.

3029 E Washington, Indianapolis, Ind 46218
MICRO SWITCH DIV. HONEYWELL INC.

11 W Spring St. Freeport, Ill 61032
NO. AMERICAN PHILIPS CORP. FREDERICK CONT. DIV.

Frederick, Md 21701
RODALE MANUFACTURING CO.

6th & Minor St. Emmaus, Pa 18049
SWITCHCRAFT INC.

5555 N Elston Ave. Chicago, Ill 60630
TEXAS INSTRUMENTS INC. CONTROLS DIV.

34 Forest St. Attleboro, Mass 02703
UNIMAX SWITCH CORP. SUB. RIKER-MAXSON

Ives Rd. Wallingford, Conn 06492
UNIVERSAL RELAY CORP.

42 White St. New York, N Y 10013
VECTRONIX INC.

P O Box 209, Cozad, Nebr 69130

SYNCHROS-RESOLVERS, CONTROL TRANSFORMERS

BOWMAR CANADA LTD.
1257 Algoma Rd. Ottawa Ont, CANADA

DDC DIV. SOLID STATE SCIENTIFIC DEVICES
100 Tec St. Hicksville, N Y 11801

ELECTRIC INDICATOR CO. INC.
195 Danbury Rd. Wilton, Conn 06897

FARRAND CONTROLS INC.
99 Wall St. Valhalla, N Y 10595

IMC MAGNETICS CORP. WESTERN DIV.
6058 Walker Ave. Maywood, Cal 90270

NOVATRONICS OF CANADA LTD.
677 Erie St. Stratford Ont, CANADA

USM CORP. GEAR SYSTEMS DIV.
101 Balch St. Beverly, Mass 01915

WESTON-TRANSICOIL A SCHLUMBERGER CO.
Trooper Rd. Worcester, Pa 19490

TAGS (FOR EDP PROCESSING)

ACCURATE BUSINESS FORMS CO., INC.
P O Box 8339, Milwaukee, Wis 53225

ALLISON COUPON COMPANY, INC.
200 S Capitol. Indianapolis, Ind 46206

DATASERV DIV., WILLIAM J. PURDY CORP.
770 Airport Blvd, Burlingame, Cal 94010

ECCO BUSINESS SYSTEMS INC.
50 E 42nd St. New York, N Y 10017

KIMBALL SYSTEMS DIV. LITTON INDUS.
151 Cortlandt St. Belleville, N J 07109

NORMANDIE DATAFORMS
41-10 22nd St. Long Is Cy, N Y 11101

OCHMAN SYSTEMS, EDWARD
Po Box 141, Fairfield, Conn 06430

ORIGINAL COMPUTER PRODUCTS INC.
204 Worcester St. Wellesley Hills, Mass 02181

PURDY CORP., WM. J.
770 Airport Blvd, Burlingame, Cal 94010

2 Product Directory

STINAFFS INC.
181 E Exchange St, Akron, Ohio 44304
VISIBLE COMPUTER SUPPLY CORP.
9865 Derby Ln, Westchester, Ill 60153

TAPE DRIVES (SEE TAPE TRANSPORTS)

TAPE ERASERS (SEE ERASERS)

TAPE, MAGNETIC (CARTRIDGE)

TELETYPE CORP.
5555 W Touhy Ave, Skokie, Ill 60076
TRI-DATA CORP.
800 Maude Ave, Mt View, Cal 94040

TAPE, MAGNETIC (CASSETTE)

AMPEX CORP. MAGNETIC TAPE DIV.
401 Broadway, Redwood City, Cal 94063
ASTRO-SCIENCE CORP.
9700 Factorial Way, S El Monte, Cal 91734
AURICORD DIV., SCOVILL MFG. CO.
35-41 29 St, Long Isl City, N Y 11106
BASF SYSTEMS INC.
Crosby Dr, Bedford, Mass 01730
CERTRON CORP.
1701 State Collg Blvd, Anaheim, Cal 92806
CERTRON CORP. COMPUTER TAPE DIV.
2060 Brentwood St, High Point, N C 27262
COMPUTER ACCESSORIES CO.
131 W 154th St, Gardena, Cal 90248
DATA PACKAGING CORP.
205 Broadway, Cambridge, Mass 02139
DATASERV DIV., WILLIAM J. PURDY CORP.
770 Airport Blvd, Burlingame, Cal 94010
FRIDEN DIV. THE SINGER CO.
97 Humboldt St, Rochester, N Y 14602
GRAHAM MAGNETICS INC.
Graham, Tex 76046
K/TRONIC INC.
10601 Saratoga Rd, Cupertino, Cal 95014
3M CO.
3m Center, St Paul, Minn 55101
3M CO. MAGNETIC PRODUCTS DIV.
3 M Ctr, St Paul, Minn 55101
MCA TECHNOLOGY INC. UDAC DIV.
P O Box 36166, Houston, Tex 77035
NUMERIDEX TAPE SYSTEMS INC.
4711 W North Ave, Chicago, Ill 60639
OCHMAN SYSTEMS, EDWARD
Po Box 141, Fairfield, Conn 06430
ORIGINAL COMPUTER PRODUCTS INC.
204 Worcester St, Wellesley Hills, Mass 02181
PURDY CORP., WM. J.
770 Airport Blvd, Burlingame, Cal 94010
RCA MAGNETIC PRODUCTS DIV.
201 E 50th St, New York, N Y 10022
RCA ELECTRONIC COMPONENTS DIV.
415 S 5th St, Harrison, N J 07029
SCOVILL MANUFACTURING CO. AURICORD DIV.
35-41 29 St, Long Island, N Y 11106
SYCOR INC.
100 Phoenix Dr, Ann Arbor, Mich 48104
TEAC CORPORATION OF AMERICA TECHNICAL PRODUCTS
2000 Colorado Ave, Santa Monica, Cal 90404
TELE-DATA CORP.
130 U S Hwy 22, N Plainfield, N J 07060
UNIVERSITY COMPUTING CO. DATEL DIV.
1 Tysons Corner Ctr, McLean, Va 22101

TAPE, MAGNETIC (REELS)

ACRATOD COMPANY
Po Box 66847, Houston, Tex 77006
AMPEX CORP. MAGNETIC TAPE DIV.
401 Broadway, Redwood City, Cal 94063
ASTRO-SCIENCE CORP.
9700 Factorial Way, S El Monte, Cal 91734
BASF SYSTEMS INC.
Crosby Dr, Bedford, Mass 01730
BURROUGHS CORP..BUSINESS MACHINES GROUP
6071 2nd Ave, Detroit, Mich 48232
BUSINESS SUPPLIES CORP. OF AMERICA
475 5th Ave, New York, N Y 10017
CERTRON CORP.
1701 State Collg Blvd, Anaheim, Cal 92806
CERTRON CORP. COMPUTER TAPE DIV.
2060 Brentwood St, High Point, N C 27262

COMPUTER ACCESSORIES CO.
131 W 154th St, Gardena, Cal 90248
CTM LEASING CORP.
4924 Hampden Lane, Bethesda, Md 20014
DATA DOCUMENTS INC.
105 S 70th St, Omaha, Nebr 68132
DATASERV DIV., WILLIAM J. PURDY CORP.
770 Airport Blvd, Burlingame, Cal 94010
DIAMOND POWER SPECIALTY CORP.
P O Box 415, Lancaster, Ohio 43130
DIGITAL EQUIPMENT CORP.
146 Main St, Maynard, Mass 01754
DUPONT DE NEMOURS, & CO.,E.I. CO., INC.
1007 Market St, Wilmington, Del 19898
FACIT-ODHNER INC.
501 Winsor Dr, Secaucus, N J 07094
FRIDEN DIV. THE SINGER CO.
97 Humboldt St, Rochester, N Y 14602
GENERAL KINETICS INC.
11425 Isaac Newt Sq S, Reston, Va 22070
GRAHAM MAGNETICS INC.
Graham, Tex 76046
HACKETT CORP.
2100 W Fullerton Ave, Chicago, Ill 60647
INDEL INC.
P O Box 15800, Tulsa, Okla 74115
INTERNATIONAL SYSTEMS ASSOCIATES, LTD.
350 5th Ave, New York, N Y 10001
JERSEY TAB CARD CORP.
649 Rahway Ave, Union, N J 07083
3M CO.
3m Center, St Paul, Minn 55101
3M CO. MAGNETIC PRODUCTS DIV.
3 M Ctr, St Paul, Minn 55101
MACPANEL CO. ADAMS-MILLIS CORP.
P O Box 5027, High Point, N C 27262
MACS COMPUTER ACCESSORIES INC
104 Park Towne Pl, Philadelphia, Pa 19130
MORLEY CO. THE
909 Islington St, Portsmouth, N H 03801
NUMERIDEX TAPE SYSTEMS INC.
4711 W North Ave, Chicago, Ill 60639
OCHMAN SYSTEMS, EDWARD
Po Box 141, Fairfield, Conn 06430
ORIGINAL COMPUTER PRODUCTS INC.
204 Worcester St, Wellesley Hills, Mass 02181
PRYOR COMPUTER INDUSTRIES
400 N Michigan Ave, Chicago, Ill 60611
PURDY CORP., WM. J.
770 Airport Blvd, Burlingame, Cal 94010
RCA MAGNETIC PRODUCTS DIV.
201 E 50th St, New York, N Y 10022
RCA COMPUTER SYSTEMS DIV.
200 Forest Ave, Marlboro, Mass 01752
RCA CORP. SOLID STATE DIV.
Rte 202, Somerville, N J 08876
RCA ELECTRONIC COMPONENTS DIV.
415 S 5th St, Harrison, N J 07029
SYNCOM INC. SHIELDATA DIV.
1914 Colvin Ave, Tonawanda, N Y 14150

TAPE, PUNCH (MYLAR)

ACRATOD COMPANY
Po Box 66847, Houston, Tex 77006
CHASE-FOSTER DIV. OF KEENE CORP.
199 Amaral St, E Providence, R I 02914
COMPUTER ACCESSORIES CO.
131 W 154th St, Gardena, Cal 90248
DATA DEVICES INC. SUB. DATA PROD.CORP
18360 Topham St, Tarzana, Cal 91356
DATASERV DIV., WILLIAM J. PURDY CORP.
770 Airport Blvd, Burlingame, Cal 94010
DATATERM INC.
1671 Manning Blvd, Levittown, Pa 19057
DONAULD INC.
P O Box 104, Ridgewood, N J 07451
EASTERN SPECIALTIES CO. INC.
5 Appleton Ave, Holyoke, Mass 01040
ENDLESS TAPE REEL CO.
81 Haven St, Reading, Mass 01867
FAIRCHILD GRAPHIC EQUIPMENT
221 Fairchild Ave, Plainview, N Y 11803
FRIDEN DIV. THE SINGER CO.
97 Humboldt St, Rochester, N Y 14602
ICA CORP.
200 N 3rd St, Minneapolis, Minn 55401
INTERNATIONAL COMPUTER APPLIANCES CORP.
200 N Third St, Minneapolis, Minn 55401
ITEL INFORMAMTION PRODUCTS DIV
2585 Bayshore, Palo Alto, Cal 94303
JOHNSON ASSOCIATES INC.
108 Lyster Rd, Oreland, Pa 19075

MOORE BUSINESS FORMS INC.
110-112 Pkwy Inn Bldg, Niagara Falls, N Y 14302
NUMERIDEX TAPE SYSTEMS INC.
4711 W North Ave, Chicago, Ill 60639
OCHMAN SYSTEMS, EDWARD
Po Box 141, Fairfield, Conn 06430
ORIGINAL COMPUTER PRODUCTS INC.
204 Worcester St, Wellesley Hills, Mass 02181
PAPER MANUFACTURERS CO.
9800 Bustleton Ave, Philadelphia, Pa 19115
PURDY CORP., WM. J.
770 Airport Blvd, Burlingame, Cal 94010
REMAX ELECTRONICS
5250 W El Segundo Blv, Hawthorne, Cal 90250
SHIRAK TELEMETERING OF AMERICA
8926 Kester Ave, Van Nuys, Cal 91402

TAPE, PUNCH (MYLAR-COATED FOIL)

ACRATOD COMPANY
Po Box 66847, Houston, Tex 77006
CHASE-FOSTER DIV. OF KEENE CORP.
199 Amaral St, E Providence, R I 02914
COMPUTER ACCESSORIES CO.
131 W 154th St, Gardena, Cal 90248
DATATERM INC.
1671 Manning Blvd, Levittown, Pa 19057
DONAULD INC.
P O Box 104, Ridgewood, N J 07451
EASTERN SPECIALTIES CO. INC.
5 Appleton Ave, Holyoke, Mass 01040
ENDLESS TAPE REEL CO.
81 Haven St, Reading, Mass 01867
FRIDEN DIV. THE SINGER CO.
97 Humboldt St, Rochester, N Y 14602
HAMMER MILL PAPER CO. PAPERTRONICS DIV.
P O Box 56 Mitchell, Oswego, N Y 13126
ICA CORP.
200 N 3rd St, Minneapolis, Minn 55401
INTERNATIONAL COMPUTER APPLIANCES CORP.
200 N Third St, Minneapolis, Minn 55401
ITEL INFORMAMTION PRODUCTS DIV
2585 Bayshore, Palo Alto, Cal 94303
JOHNSON ASSOCIATES INC.
108 Lyster Rd, Oreland, Pa 19075
NUMERIDEX TAPE SYSTEMS INC.
4711 W North Ave, Chicago, Ill 60639
OCHMAN SYSTEMS, EDWARD
Po Box 141, Fairfield, Conn 06430
ORIGINAL COMPUTER PRODUCTS INC.
204 Worcester St, Wellesley Hills, Mass 02181
PAPER MANUFACTURERS CO.
9800 Bustleton Ave, Philadelphia, Pa 19115
REMAX ELECTRONICS
5250 W El Segundo Blv, Hawthorne, Cal 90250
SHIRAK TELEMETERING OF AMERICA
8926 Kester Ave, Van Nuys, Cal 91402
STINAFFS INC.
181 E Exchange St, Akron, Ohio 44304

TAPE, PUNCH (PAPER)

ACCURATE BUSINESS FORMS CO., INC.
P O Box 8339, Milwaukee, Wis 53225
ACRATOD COMPANY
Po Box 66847, Houston, Tex 77006
ADDO-X INC. ADP DIV.
437 Madison Ave, New York, N Y 10022
BEMIS CO. INC.
800 Northstar Ctr., Minneapolis, Minn 55402
BFA CORP.
1309 S Inca, Denver, Colo 80223
BONNAR-VAWTER INC.
96 Dunbar St, Keene, N H 03431
COMPUTER ACCESSORIES CO.
131 W 154th St, Gardena, Cal 90248
DATASERV DIV., WILLIAM J. PURDY CORP.
770 Airport Blvd, Burlingame, Cal 94010
DATATERM INC.
1671 Manning Blvd, Levittown, Pa 19057
DELMARVA COMPUTER INDUSTRIES INC.
5865 Robert Oliver Pl, Columbia, Md 21043
DIGITAL EQUIPMENT CORP.
146 Main St, Maynard, Mass 01754
DONAULD INC.
P O Box 104, Ridgewood, N J 07451
EASTERN SPECIALTIES CO. INC.
5 Appleton Ave, Holyoke, Mass 01040
ENDLESS TAPE REEL CO.
81 Haven St, Reading, Mass 01867
FAIRCHILD GRAPHIC EQUIPMENT
221 Fairchild Ave, Plainview, N Y 11803
FRIDEN DIV. THE SINGER CO.
97 Humboldt St, Rochester, N Y 14602

2 Product Directory

HAMMER MILL PAPER CO. PAPERTRONICS DIV.
P O Box 56 Mitchell, Oswego, N Y 13126
ICA CORP.
200 N 3rd St, Minneapolis, Minn 55401
INTERNATIONAL COMPUTER APPLIANCES CORP.
200 N Third St, Minneapolis, Minn 55401
ITEL INFORMAMTION PRODUCTS DIV
2585 Bayshore, Palo Alto, Cal 94303
JOHNSON ASSOCIATES INC.
108 Lyster Rd, Oreland, Pa 19075
MOORE BUSINESS FORMS INC.
110-112 Pkwy Inn Bldg, Niagara Falls, N Y 14302
NUMERIDEX TAPE SYSTEMS INC.
4711 W North Ave, Chicago, Ill 60639
OCHMAN SYSTEMS, EDWARD
Po Box 141, Fairfield, Conn 06430
ORIGINAL COMPUTER PRODUCTS INC.
204 Worcester St, Wellesley Hills, Mass 02181
PAPER MANUFACTURERS CO.
9800 Bustleton Ave, Philadelphia, Pa 19115
PURDY CORP., WM, J.
770 Airport Blvd, Burlingame, Cal 94010
REMAX ELECTRONICS
5250 W El Segundo Blv, Hawthorne, Cal 90250
SHIRAK TELEMETERING OF AMERICA
8926 Kester Ave, Van Nuys, Cal 91402
SINGER CO., THE, FRIDEN DIV.
2350 Washington St, San Leandro, Cal 94577
STINAFFS INC.
181 E Exchange St, Akron, Ohio 44304
TALLY CORP.
8301 S 180th St, Kent, Wash 98031
VISIBLE COMPUTER SUPPLY CORP.
9865 Derby Ln, Westchester, Ill 60153

TAPE, PUNCH (PAPER-COATED MYLAR)

ACRATOD COMPANY
Po Box 66847, Houston, Tex 77006
CHASE-FOSTER DIV. OF KEENE CORP.
199 Amaral St, E Providence, R I 02914
COMPUTER ACCESSORIES CO.
131 W 154th St, Gardena, Cal 90248
DATATERM INC.
1671 Manning Blvd, Levittown, Pa 19057
DONAULD INC.
P O Box 104, Ridgewood, N J 07451
EASTERN SPECIALTIES CO. INC.
5 Appleton Ave, Holyoke, Mass 01040
ENDLESS TAPE REEL CO.
81 Haven St, Reading, Mass 01867
FAIRCHILD GRAPHIC EQUIPMENT
221 Fairchild Ave, Plainview, N Y 11803
FRIDEN DIV. THE SINGER CO.
97 Humboldt St, Rochester, N Y 14602
HAMMER MILL PAPER CO. PAPERTRONICS DIV.
P O Box 56 Mitchell, Oswego, N Y 13126
ICA CORP.
200 N 3rd St, Minneapolis, Minn 55401
INDUSTRIAL TIMER DIV., THE SINGER CO.
Us Hwy 287, Parsippany, N J 07054
INTERNATIONAL COMPUTER APPLIANCES CORP.
200 N Third St, Minneapolis, Minn 55401
ITEL INFORMAMTION PRODUCTS DIV
2585 Bayshore, Palo Alto, Cal 94303
JOHNSON ASSOCIATES INC.
108 Lyster Rd, Oreland, Pa 19075
NUMERIDEX TAPE SYSTEMS INC.
4711 W North Ave, Chicago, Ill 60639
OCHMAN SYSTEMS, EDWARD
Po Box 141, Fairfield, Conn 06430
ORIGINAL COMPUTER PRODUCTS INC.
204 Worcester St, Wellesley Hills, Mass 02181
PAPER MANUFACTURERS CO.
9800 Bustleton Ave, Philadelphia, Pa 19115
REMAX ELECTRONICS
5250 W El Segundo Blv, Hawthorne, Cal 90250
SHIRAK TELEMETERING OF AMERICA
8926 Kester Ave, Van Nuys, Cal 91402
STINAFFS INC.
181 E Exchange St, Akron, Ohio 44304

TAPE, PUNCH (PAPER-COATED ALUMINUM)

ACRATOD COMPANY
Po Box 66847, Houston, Tex 77006
CHASE-FOSTER DIV. OF KEENE CORP.
199 Amaral St, E Providence, R I 02914
COMPUTER ACCESSORIES CO.
131 W 154th St, Gardena, Cal 90248

DATATERM INC.
1671 Manning Blvd, Levittown, Pa 19057
DONAULD INC.
P O Box 104, Ridgewood, N J 07451
EASTERN SPECIALTIES CO. INC.
5 Appleton Ave, Holyoke, Mass 01040
ENDLESS TAPE REEL CO.
81 Haven St, Reading, Mass 01867
FRIDEN DIV. THE SINGER CO.
97 Humboldt St, Rochester, N Y 14602
ICA CORP.
200 N 3rd St, Minneapolis, Minn 55401
INTERNATIONAL COMPUTER APPLIANCES CORP.
200 N Third St, Minneapolis, Minn 55401
ITEL INFORMAMTION PRODUCTS DIV
2585 Bayshore, Palo Alto, Cal 94303
JOHNSON ASSOCIATES INC.
108 Lyster Rd, Oreland, Pa 19075
NUMERIDEX TAPE SYSTEMS INC.
4711 W North Ave, Chicago, Ill 60639
OCHMAN SYSTEMS, EDWARD
Po Box 141, Fairfield, Conn 06430
ORIGINAL COMPUTER PRODUCTS INC.
204 Worcester St, Wellesley Hills, Mass 02181
PAPER MANUFACTURERS CO.
9800 Bustleton Ave, Philadelphia, Pa 19115
REMAX ELECTRONICS
5250 W El Segundo Blv, Hawthorne, Cal 90250
SHIRAK TELEMETERING OF AMERICA
8926 Kester Ave, Van Nuys, Cal 91402
STINAFFS INC.
181 E Exchange St, Akron, Ohio 44304

TAPE READERS (SEE READERS)

TAPE TRANSPORTS, MAGNETIC (DIGITAL-EXCL. CASSETTE)

AMPEX CORP. COMPUTER PRODUCTS DIV.
9937 W Jefferson Blvd, Culver City, Cal 90230
ASTRO-SCIENCE CORP.
9700 Factorial Way, S El Monte, Cal 91734
AURICORD DIV., SCOVILL MFG. CO.
35-41 29 St, Long Isl City, N Y 11106
BFA CORP.
1309 S Inca, Denver, Colo 80223
BORG WARNER CONTROLS DIV. BORG WARNER
3300 S Halladan St, Santa Ana, Cal 92702
BRIGHT INDUSTRIES INC.
1 Maritine Plaza, San Francisco, Cal 94111
BUCODE INC.
175 Engineers Dr, Hauppauge, N Y 11787
BURROUGHS CORP., BUSINESS MACHINES GROUP
6071 2nd Ave, Detroit, Mich 48232
BURROUGHS CORP., OEM PRODUCT SALES
1649 Wilshire Blvd, Los Angeles, Cal 90017
CIPHER DATA PRODUCTS INC.
7655 Convoy Ct, San Diego, Cal 92111
COMPUTER ACCESSORIES CO.
131 W 154th St, Gardena, Cal 90248
COMPUTER CORP. OF AMERICA
6216 Evergreen St, Houston, Tex 77036
COMPUTER ENTRY SYSTEMS CORP.
2141 Industrial Pkwy, Silver Spring, Md 20904
COMPUTER OPERATIONS INC.
10774 Tucker St, Beltsville, Md 20705
CONTROL DATA CORP.
8100 34th Ave S, Minneapolis, Minn 55440
COOK ELECTRIC CO. DATA-STOR DIV.
6201 W Oakton St, Morton Grove, Ill 60053
DACONICS
925 Thompson Pl, Sunnyvale, Cal 94086
DATA ACTION CORP.
4445 W 77th St, Minneapolis, Minn 55435
DATA RECORDING SYSTEMS, SUB. NEWELL IND.
795 Kifer Rd, Sunnyvale, Cal 94086
DATASONICS INC.
P O Box 4553, New York, N Y 10017
DATRAN CORP.
179 W Rocks Rd, Norwalk, Conn 06851
DIGITAL EQUIPMENT CORP.
146 Main St, Maynard, Mass 01754
DIGITAL INFORMATION DEVICES INC.
210 Welsh Pool Rd, Lionville, Pa 19353
DIGITAL SCIENTIFIC CORP.
11455 Sorrento Vly Rd, San Diego, Cal 92121
ECLECTIC COMPUTER CORP.
3707 Rawlins Ste 301, Dallas, Tex 75219
HEWLETT PACKARD CO. MOUNTAIN VIEW DIV.
690 Middlefield Rd, Mtn View, Cal 94040
HONEYWELL INFORMATION SYSTEMS
P O Box 12313, Oklahoma City, Okla 73112

INCRE-DATA CORP.
6401 Acoma Rd SE, Albuquerque, N M 87108
INFORMATION TERMINALS CORP.
1160 Terra Bella Ave, Mountain View, Cal 94040
INFOTEC INC.
70 Newton Rd, Plainview, N Y 11803
INTERNATIONAL ELECTRO- MAGNETICS INC.
Eric Dr & Cornell Ave, Palatine, Ill 60067
KENNEDY CO.
540 W Woodbury Rd, Altadena, Cal 91001
LEACH CORP. CONTROLS DIV.
717 N Coney Ave, Azusa, Cal 91702
LOCKHEED ELECTRONICS CO. DIV. LOCKHEED ACRFT CORP
U S Hwy 22, Plainfield, N J 07060
3M CO. INSTRUMENT & DATA PRODUCTS
300 So Lewis Rd, Camarillo, Cal 93010
MAI EQUIPMENT CORP.
300 E 44th St, New York, N Y 10017
MICRODATA CORP.
644 E Young St, Santa Ana, Cal 92705
MOHAWK DATA SCIENCES CORP.
Palisade St, Herkimer, N Y 13350
MOHAWK DATA SCIENCES CORP. FRANKLIN ELECT. DIV
P O Box 406, King of Prussia, Pa 19406
MULTIDATA INC.
7300 Bolsa Ave, Westminster, Cal 92683
NEWELL INDUSTRIES
795 Kifer Rd, Sunnyvale, Cal 94086
OCHMAN SYSTEMS, EDWARD
Po Box 141, Fairfield, Conn 06430
PER DATA
102 New South Rd, Hicksville, N Y 11801
PERIPHERAL DATA MACHINES INC.
102 New S Rd, Hicksville, N Y 11801
PERIPHERAL EQUIPMENT CORP.
9600 Irondale Ave, Chatsworth, Cal 91311
POTTER INSTRUMENT CO. INC.
532 Broadhollow Rd, Melville, N Y 11746
PRECISION INSTRUMENT CO. UNICOM DIV.
3170 Porter Dr, Palo Alto, Cal 94304
QANTEL CORP.
3474 Investment Blvd, Hayward, Cal 94545
RCA COMPUTER SYSTEMS DIV.
200 Forest Ave, Marlboro, Mass 01752
RECORTEC INC.
162 S Whisman, Mt View, Cal 94040
S-I ELECTRONICS INC.
5 Industrial Rd, Fairfield, N J 07006
SANGAMO ELECTRIC CO.
P O Box 3347, Springfield, Ill 62708
SCOVILL MANUFACTURING CO. AURICORD DIV.
35-41 29 St, Long Island, N Y 11106
STORAGE TECHNOLOGY CORP.
P O Box 3524, Boulder, Colo 80303
STROMBERG DATAGRAPHIX INC.
P O Box 2449, San Diego, Cal 92112
TEAC CORPORATION OF AMERICA TECHNICAL PRODUCTS
2000 Colorado Ave, Santa Monica, Cal 90404
TELECTRO SYSTEMS CORP.
96-18 43rd Ave, Corona, N Y 11368
TELEX COMPUTER PRODUCTS
6422 E 41st St, Tulsa, Okla 74135
TEXAS INSTRUMENTS INC. DIGITAL SYSTEMS DIV
P O Box 66027, Houston, Tex 77006
UNICOMP INC.
18219 Parthenia, Northridge, Cal 91324

TAPE TRANSPORTS, MAGNETIC (DIGITAL CASSETTE)

AMPEX CORP. COMPUTER PRODUCTS DIV.
9937 W Jefferson Blvd, Culver City, Cal 90230
ANDERSON JACOBSON INC.
1065 Morse Ave., Sunnyvale, Cal 94086
ASTRO-SCIENCE CORP.
9700 Factorial Way, S El Monte, Cal 91734
AURICORD DIV., SCOVILL MFG. CO.
35-41 29 St, Long Isl City, N Y 11106
BELL & HOWELL ELECTRONICS & INSTRUMENTS GROUP
360 Sierra Madre Vill, Pasadena, Cal 91109
BFA CORP.
1309 S Inca, Denver, Colo 80223
BORG WARNER CONTROLS DIV. BORG WARNER
3300 S Halladan St, Santa Ana, Cal 92702
BURROUGHS CORP., OEM PRODUCT SALES
1649 Wilshire Blvd, Los Angeles, Cal 90017
CERTRON CORP.
1701 State Collg Blvd, Anaheim, Cal 92806
CHALCO ENGINEERING CORP.
15126 S Broadway, Gardena, Cal 90248

2 Product Directory

CIPHER DATA PRODUCTS INC.
7655 Convoy Ct. San Diego, Cal 92111
COGAR CORP. INFORMATION SYS.DIV
Cosby Manor Rd, Utica, N Y 13502
COMPUCORD INC.
225 Crescent St. Waltham, Mass 02154
COMPUTER ACCESS SYSTEMS INC.
3050 W Clarendon Ave, Phoenix, Ariz 85017
COMPUTER CORP. OF AMERICA
6216 Evergreen St, Houston, Tex 77036
COMPUTER DESIGN CORP.
12401 W Olympic Blvd, Los Angeles, Cal 90064
COMPUTER DEVICES INC.
10 Sonar Dr, Woburn, Mass 01801
COMPUTER DISPLAY INC.
223 Cresent St, Waltham, Mass 02154
COMPUTER ENTRY SYSTEMS CORP.
2141 Industrial Pkwy, Silver Spring, Md 20904
CONTROL DATA CORP.
8100 34th Ave S, Minneapolis, Minn 55440
DESIGN ELEMENTS INC.
356 Norton Ave, Columbus, Ohio 43212
DICOM INDUSTRIES
684 W Maude Ave, Sunnyvale, Cal 94086
ELDORADO ELECTRODATA
601 Chalomar Rd, Concord, Cal 94520
FORD INDUSTRIES INC.
5001 SE Johnson Ck, Portland, Ore 97206
GENISCO TECHNOLOGY CORP.
18435 Susana Rd, Compton, Cal 90221
HETRA
P O Box 970, Melbourne, Fla 32901
INFORMATION TERMINALS CORP.
1160 Terra Bella Ave, Mountain View, Cal 94040
INTERNATIONAL COMPUTER PRODUCTS INC.
P O Box 34484, Dallas, Tex 75234
INTERNATIONAL ELECTRO- MAGNETICS INC.
Eric Dr & Cornell Ave, Palatine, Ill 60067
KENNEDY CO.
540 W Woodbury Rd, Altadena, Cal 91001
LEACH CORP. CONTROLS DIV.
717 N Coney Ave, Azusa, Cal 91702
LOCKHEED ELECTRONICS CO. DIV. LOCKHEED ACRFT
CORP
U S Hwy 22, Plainfield, N J 07060
3M CO.
3m Center, St Paul, Minn 55101
3M CO. INSTRUMENT & DATA PRODUCTS
300 So Lewis Rd, Camarillo, Cal 93010
MCA TECHNOLOGY INC. UDAC DIV.
P O Box 36166, Houston, Tex 77035
MICRODATA CORP.
644 E Young St, Santa Ana, Cal 92705
MICRODYNE INC. SUB.BODINE ELEC.CO.
1600 S Micks Rd, Rolling Meadows, Ill 60008
MULTIDATA INC.
7300 Bolsa Ave, Westminster, Cal 92683
SCOVILL MANUFACTURING CO. AURICORD DIV.
35-41 29 St, Long Island, N Y 11106
SYCOR INC.
100 Phoenix Dr, Ann Arbor, Mich 48104
SYKES DATATRONICS INC.
375 Orchard St, Rochester, N Y 14606
SYS COMPUTER CORP.
17-25 Dicarolis Court, Hackensack, N J 07601
TEAC CORPORATION OF AMERICA TECHNICAL
PRODUCTS
2000 Colorado Ave, Santa Monica, Cal 90404
TELE-DATA CORP.
130 U S Hwy 22, N Plainfield, N J 07060
TELECTRO SYSTEMS CORP.
96-18 43rd Ave, Corona, N Y 11368
TELEX COMMUNICATIONS DIV.
9600 Aldrich Ave S, Minneapolis, Minn 55420
TELEX COMPUTER PRODUCTS
6422 E 41st St, Tulsa, Okla 74135
TENNECOMP SYSTEMS INC.
795 Oak Ridge Tpk, Oak Ridge, Tenn 37830
UNICOMP INC.
18219 Parthenia, Northridge, Cal 91324

TAPE TRANSPORTS, MAGNETIC (INCREMENTAL)

AMPEX CORP. COMPUTER PRODUCTS DIV.
9937 W Jefferson Blvd, Culver City, Cal 90230
ANDERSON JACOBSON INC.
1065 Morse Ave., Sunnyvale, Cal 94086
ASTRO-SCIENCE CORP.
9700 Factorial Way, S El Monte, Cal 91734
BELL & HOWELL ELECTRONICS & INSTRUMENTS
GROUP
360 Sierra Madre Vill, Pasadena, Cal 91109

BFA CORP.
1309 S Inca, Denver, Colo 80223
BRIGHT INDUSTRIES INC.
1 Maritime Plaza, San Francisco, Cal 94111
CIPHER DATA PRODUCTS INC.
7655 Convoy Ct, San Diego, Cal 92111
COMPUTER ACCESSORIES CO.
131 W 154th St, Gardena, Cal 90248
COMPUTER CORP. OF AMERICA
6216 Evergreen St, Houston, Tex 77036
DATA RECORDING SYSTEMS, SUB. NEWELL IND.
795 Kifer Rd, Sunnyvale, Cal 94086
DATA TRENDS INC.
P O Box 82, Mt Lake, N J 07046
DATRAN CORP.
179 W Rocks Rd, Norwalk, Conn 06851
DIGI-DATA CORP.
4315 Baltimore Ave, Bladensburg, Md 20710
DIGITAL SCIENTIFIC CORP.
11455 Sorrento Vly Rd, San Diego, Cal 92121
DIGITRONICS CORP.
1 Albertson Ave, Albertson, N Y 11507
ELDORADO ELECTRODATA
601 Chalomar Rd, Concord, Cal 94520
GRAPHIC DATA INC.
169 Bedford St, Burlington, Mass 01803
HEWLETT PACKARD CO. MOUNTAIN VIEW DIV.
690 Middlefield Rd, Mtn View, Cal 94040
HONEYWELL INFORMATION SYSTEMS
P O Box 12313, Oklahoma City, Okla 73112
HONEYWELL INFORMATION SYS. INC PERIPH. DEVICES
DIV.
200 Smith St, Waltham, Mass 02154
INCOR CORP.
P O Box 156, Feasterville, Pa 19046
INCRE-DATA CORP.
6401 Acoma Rd SE, Albuquerque, N M 87108
KENNEDY CO.
540 W Woodbury Rd, Altadena, Cal 91001
LEACH CORP. CONTROLS DIV.
717 N Coney Ave, Azusa, Cal 91702
LOCKHEED ELECTRONICS CO. DIV. LOCKHEED ACRFT
CORP
U S Hwy 22, Plainfield, N J 07060
MCA TECHNOLOGY INC. UDAC DIV.
P O Box 36166, Houston, Tex 77035
MOBARK INSTRUMENTS CORP.
1038 Evelyn, Sunnyvale, Cal 94086
MOHAWK DATA SCIENCES CORP. FRANKLIN ELECT.
DIV
P O Box 406, King of Prussia, Pa 19406
NEWELL INDUSTRIES
795 Kifer Rd, Sunnyvale, Cal 94086
PERIPHERAL EQUIPMENT CORP.
9600 Irondale Ave, Chatsworth, Cal 91311
PRECISION INSTRUMENT CO. UNICON DIV.
3170 Porter Dr, Palo Alto, Cal 94304
TALLY CORP.
8301 S 180th St, Kent, Wash 98031
TEAC CORPORATION OF AMERICA TECHNICAL
PRODUCTS
2000 Colorado Ave, Santa Monica, Cal 90404
TELECTRO SYSTEMS CORP.
96-18 43rd Ave, Corona, N Y 11368
TELEX COMMUNICATIONS DIV.
9600 Aldrich Ave S, Minneapolis, Minn 55420
TELEX COMPUTER PRODUCTS
6422 E 41st St, Tulsa, Okla 74135
UNIVERSITY COMPUTING CO. DATEL DIV.
1 Tysons Corner Ctr, McLean, Va 22101
XEROX DATA SYSTEMS
701 S Aviation, El Segundo, Cal 90245

TAPE TRANSPORTS, MAGNETIC (WITH KEYBOARD INPUT)

BURROUGHS CORP. BUSINESS MACHINES GROUP
6071 2nd Ave, Detroit, Mich 48232
DIGITAL INFORMATION DEVICES INC.
210 Welsh Pool Rd, Lionville, Pa 19353
ELDORADO ELECTRODATA
601 Chalomar Rd, Concord, Cal 94520
HEWLETT PACKARD CO. MOUNTAIN VIEW DIV.
690 Middlefield Rd, Mtn View, Cal 94040
MAI EQUIPMENT CORP.
300 E 44th St, New York, N Y 10017
MCA TECHNOLOGY INC. UDAC DIV.
P O Box 36166, Houston, Tex 77035
MICRODYNE INC. SUB.BODINE ELEC.CO.
1600 S Micks Rd, Rolling Meadows, Ill 60008
MOHAWK DATA SCIENCES CORP.
Palisade St, Herkimer, N Y 13350
POTTER INSTRUMENT CO. INC.
532 Broadholow Rd, Melville, N Y 11746

RCA COMPUTER SYSTEMS DIV.
200 Forest Ave, Marlboro, Mass 01752
SYCOR INC.
100 Phoenix Dr, Ann Arbor, Mich 48104
SYS COMPUTER CORP.
17-25 Dicarolis Court, Hackensack, N J 07601
TELE-DATA CORP.
130 U S Hwy 22, N Plainfield, N J 07060
TELECTRO SYSTEMS CORP.
96-18 43rd Ave, Corona, N Y 11368
TELEX COMMUNICATIONS DIV.
9600 Aldrich Ave S, Minneapolis, Minn 55420
TRANSITEL, DIV. OF SANGAMO ELECTRIC CO.
P O Box 7255, Denver, Colo 80207
UNIVERSITY COMPUTING CO. DATEL DIV.
1 Tysons Corner Ctr, McLean, Va 22101

TELEPRINTERS (SEE DATA TERMINALS)

TELETYPEWRITERS (SEE DATA TERMINALS)

TEMPERATURE DETECTORS AND ALARMS (SEE DETECTORS)

TEMPLATES, FLOW CHART

FELSENTAL INSTRUMENTS CO.
7450 W Wilson Ave, Chicago, Ill 60656
FISHER AND CROME INC.
2427 N Mascher St, Philadelphia, Pa 19133
FRIDEN DIV. THE SINGER CO.
97 Humboldt St, Rochester, N Y 14602
INFOSCI INC.
P O Box 464, Menlo Park, Cal 94025
OCHMAN SYSTEMS, EDWARD
Po Box 141, Fairfield, Conn 06430
PLASTIGRAPH RULES
5530 State Rd, Cleveland, Ohio 44134
PRYOR MARKING PRODUCTS INC.
21 E Hubbard St, Chicago, Ill 60611
VISIBLE COMPUTER SUPPLY CORP.
9865 Derby Ln, Westchester, Ill 60153

TERMINAL BLOCKS, STRIPS, BOARDS

ALCO ELECTRONIC PRODUCTS INC.
8 Marblehead St, North Andover, Mass 01845
ALLEN-BRADLEY
1201 S 2nd St, Milwaukee, Wisc 53204
AMP INC.
Eisenhower Blvd, Harrisburg, Pa 17105
AUGAT INC.
33 Perry Ave, Attleboro, Mass 02703
BUCHANAN ELECTRICAL PRODUCTS CORP.
1065 Floral Ave, Union, N J 07083
BURNDY CORP.
Richard Ave, Norwalk, Conn 06852
CAMBRIDGE THERMIONIC CORP.
445 Concord Ave, Cambridge, Mass 02138
CONTINENTAL CONNECTOR CORP.
34-63 56th St, Woodside, N Y 11377
CONTROL DATA CORP. CONNECTOR OPERATION
31829 W Latienda Dr, Westlake Vil, Cal 91360
CO-ORD SWITCH CO., DIV. LVC INDUSTRIES, INC.
102-48 43rd Ave, Corona, N Y 11368
ELECTRONIC MOLDING CORP.
96 Mill St, Woonsocket, R I 02895
ELETROVERT INC.
86 Hartford Ave, Mt Vernon, N Y 10553
FEDERAL SCREW PRODUCTS INC.
3917 N Kedzie Ave, Chicago, Ill 60618
JOHNSON CO., E.F.
299 Tenth Ave SW, Waseca, Minn 56093
KEYSTONE ELECTRONICS CORP.
49 Bleecker St, New York, N Y 10012
LITTON PRECISION PRODUCTS USECO DIV.
13536 Saticoy St, Van Nuys, Cal 91409
MOLEX PRODUCTS CO.
5224 Katrine, Downers Grove, Ill 60515
NORRICH PLASTIC CORP.
200 Allen Blvd, Farmingdale, N Y 11575
PRECISION METAL PRODUCTS CO.
41 Elm St, Stoneham, Mass 02180
SEASTROM MANUFACTURING CO.
701 Sonora Ave, Glendale, Cal 91201
THOMAS & BETTS CO., THE
36 Butler St, Elizabeth, N J 07207

2 Product Directory

V.I.Z. MANUFACTURING CO.
335 E Price St, Philadelphia, Pa 19144
VECTOR ELECTRONIC CO. INC.
12460 Gladstone Ave, Sylmar, Cal 91342
VERNITRON ELEC. COMPONENTS BEAU PRODUCTS
DIV.
117 Union Ave, Laconia, N H 03246
VERO ELECTRONICS INC.
176 Central Ave, Farmingdale, N Y 11735

TERMINALS, DATA ENTRY (SEE DATA TERMINALS AND ENCODERS)

TEST SYSTEMS, COMPUTER PERFORMANCE

AMERICAN COMPUTER TECHNOLOGY INC.
8740 Shirley Ave, Northridge, Cal 91324
ANALOGIC CORP.
Audubon Rd, Wakefield, Mass 01880
ATLANTIC RESEARCH CORP.
Shirley Hwy/Edsall Rd, Alexandria, Va 22304
BOOLE & BABBAGE INC.
18990 Homestead Rd, Cupertino, Cal 95014
COMPUMATIC SYSTEMS CORP.
5303 Comercio Ln, Woodland Hills, Cal 91364
COMRESS INC.
No 2 Research Court, Rockville, Md 20850
CUSTOM COMPUTER SYSTEMS INC.
40 South Mall, Plainview, N Y 11803
DATAPROBE INC.
290 Huyler St, S Hackensack, N J 07606
DATAWEST CORP.
7503 E Osborn Rd, Scottsdale, Ariz 85251
DIGITAL PRODUCTS
335 W 7th St, San Pedro, Cal 90733
FEDERAL SCIENTIFIC CORP.
615 W 131st St, New York, N Y 10027
KEMPER ENGINEERING CO.
9337 Shoshone Ave, Northridge, Cal 91324
LIBRASCOPE DIV. THE SINGER CO
808 Western Ave, Glendale, Cal 91201
MICRO SYSTEMS INC.
644 E Young St, Santa Ana, Cal 92705
MINELCO, SUB. GENERAL TIME CORP.
600 South St, Holbrook, Mass 02343
NATIONAL ELECTRO-MECHANICAL SYSTEMS INC.
32 Broad Ave, Binghamton, N Y 13904
NON-LINEAR SYSTEMS INC.
P O Box N, Del Mar, Cal 92014
TRANSMISSION MEASUREMENTS INC
1051 Clinton St, Buffalo, N Y 14206

TEST SYSTEMS, CRT TERMINALS

KDI INTERACTIVE DATA SYSTEMS
17785 Skypark Circle, Irvine, Cal 92664

TEST SYSTEMS, DISC DRIVES

AIR TECHNIQUES INC.
1717 Whitehead Rd, Baltimore, Md 21207
KDI INTERACTIVE DATA SYSTEMS
17785 Skypark Circle, Irvine, Cal 92664

TESTERS, CIRCUIT

AAI CORP.
P O Box 6767, Baltimore, Md 21204
ACRON CORP.
1209 River Ave, Lakewood, N J 08701
ADAR ASSOCIATES INC.
85 Bolton St, Cambridge, Mass 02140
AMERICAN COMPUTER TECHNOLOGY INC.
8740 Shirley Ave, Northridge, Cal 91324
ANALOGIC CORP.
Audubon Rd, Wakefield, Mass 01880
ASTRONAUTICS CORPORATION OF AMERICA
907 S First St, Milwaukee, Wis 53204
ASTROSYSTEMS INC.
6 Nevada Dr, Lake Success, N Y 11040
AUTOMATED CONTROL TECHNOLOGY INC.
745 Distel Dr, Los Altos, Cal 94022
BECKMAN INSTRUMENTS INC. ELECT. INSTR. DIV.
2200 Wright Ave, Richmond, Cal 94804
BERGEN LABORATORIES INC. SUB. ZYROTROIN INC.
60 Spruce St, Paterson, N J 07501
BFA CORP.
1309 S Inca, Denver, Colo 80223

COLLINS RADIO CO.
1200 N Alma Rd, Dallas, Tex 75207
COMPU-SYSTEMS CO.
Audubon Rd, Wakefield, Mass 01880
COMPUTER AUTOMATION INC.
895 W 16th St, Newport Beach, Cal 92660
DATA DISPLAY SYSTEMS INC.
139 Terwood Rd, Willow Grove, Pa 19090
DATAPROBE INC.
290 Huyler St, S Hackensack, N J 07606
DIGITAL PRODUCTS
335 W 7th St, San Pedro, Cal 90733
DIGITECH DATA INDUSTRIES INC.
66 Grove St, Ridgefield, Conn 06877
DIMENSIONAL SYSTEMS INC.
393 Totten Pond Rd, Waltham, Mass 02154
DIT-MCO INTERNATIONAL
5612 Brighton Terr, Kansas City, Mo 64130
EDWIN INDUSTRIES CORP.
11933 Tech Rd, Silver Spring, Md 20904
EICO ELECTRONIC INSTRUMENT CO INC.
283 Malta St, Brooklyn, N Y 11207
FAIRCHILD SYSTEMS TECHNOLOGY
974 E Arques Ave, Sunnyvale, Cal 94086
GENERAL RADIO CO.
300 Baker Ave, Concord, Mass 01742
IAC COMPUTER SYSTEMS INC.
260 Newton Rd, Plainview, N Y 11803
INDUSTRIAL INVENTIONS INC.
Rd 2 463 Us 1, Monmouth Jct, N J 08852
JENSEN TOOLS AND ALLOYS
4117 N 44th St, Phoenix, Ariz 85018
LIBRASCOPE DIV. THE SINGER CO
808 Western Ave, Glendale, Cal 91201
LITTON SYSTEMS INC. DATA SYSTEMS DIV.
8000 Woodley Ave, Van Nuys, Cal 91409
MICRO METRICS INC.
253 Crooks Ave, Clifton, N J 07011
MICRO SYSTEMS INC.
644 E Young St, Santa Ana, Cal 92705
NATIONAL ELECTRO-MECHANICAL SYSTEMS INC.
32 Broad Ave, Binghamton, N Y 13904
NON-LINEAR SYSTEMS INC.
P O Box N, Del Mar, Cal 92014
OPTIMIZED DEVICES INC.
220 Marble Ave, Pleasantville, N Y 10570
PACIFIC MEASUREMENTS INC.
940 Industrial Ave, Palo Alto, Cal 94303
PRD ELECTRONICS INC., SUB. HARRIS-INTERTYPE
6801 Jericho Tpk, Syosset, N Y 11791
PROGRAM DATA CO.
739 E 223 St, Torrance, Cal 90502
RESALAB INC. AUTOMATION DYNAMICS DIV.
35 Industrial Pky, Northvale, N J 07647
SANDERS ASSOCIATES INC. SYSTEMS DIV.
Daniel Webster Hwy S, Nashua, N H 03060
SCIENTIFIC MEASUREMENT SYSTEMS INC.
351 New Albany Rd, Moorestown, N J 08057
SIMPSON ELECTRIC CO.
5200 W Kinzie St, Chicago, Ill 60644
SRC DIV. MOXON INC.
2222 Michelson Dr, Newport Beach, Cal 92664
SYSTEMATION INC.
Clifton Park, Elnora, N Y 12065
TAUTRON INC.
685 Lawrence St, Lowell, Mass 01852
TEKTRONIX INC.
P O Box 500, Beaverton, Ore 97005
TELESCIENCES INC.
351 New Albany Rd, Moorestown, N J 08057
TEST EQUIPMENT CORP.
2925 Merrell Rd, Dallas, Tex 75220
TEXAS INSTRUMENTS INC. DIGITAL SYSTEMS DIV
P O Box 66027, Houston, Tex 77006
TRIPLETT CORP.
286 Harmon Rd, Bluffton, Ohio 45817
VARADYNE INC.
320-B Martina Ave, Santa Clara, Cal 95050
WILLARD LABORATORIES INC.
4221 Redwood Ave, Los Angeles, Cal 90066
WISE INSTRUMENTATION & CONTROLS INC.
3568 Amherst Court, Mt View, Cal 94040
XINTEL CORP.
20931 Nordhoff, Chatsworth, Cal 91311
ZEHNTEL, INC., AFFIL. EM&M INC.
1450 6th St, Berkeley, Cal 94810

TESTERS, DATA INTERFACE

PERIPHERALS GENERAL, INC.
Cherry Hill Ind Pk, Cherry Hill, N J 08034
PULSE COMMUNICATIONS INC.
5214 Columbia Pike, Falls Church, Va 22041

TESTERS, DIGITAL DATA TRANSMISSION

AMERICAN DATA SYSTEMS
8851 Mason Ave, Canoga Park, Cal 91306
ATLANTIC RESEARCH CORP.
Shirley Hwy/Edsall Rd, Alexandria, Va 22304
COLLINS RADIO CO.
1200 N Alma Rd, Dallas, Tex 75207
COMDATA CORP.
7544 W Oakton St, Niles, Ill 60648
COMMUNICATIONS LOGIC INC.
6400 Westpark, Houston, Tex 77024
COMMUNICATIONS TECHNOLOGY INC.
1900 York Rd, Timonium, Md 21093
COMPUTER COMPLEX, INC.
6400 Westpark, Houston, Tex 77027
DATA DISPLAY SYSTEMS INC.
139 Terwood Rd, Willow Grove, Pa 19090
DATA PRODUCTS TELECOMMUNICATIONS
17 Amelia Place, Stamford, Conn 06902
DATAPROBE INC.
290 Huyler St, S Hackensack, N J 07606
DIGITAL PRODUCTS
335 W 7th St, San Pedro, Cal 90733
DIGITECH DATA INDUSTRIES INC.
66 Grove St, Ridgefield, Conn 06877
DIMENSIONAL SYSTEMS INC.
393 Totten Pond Rd, Waltham, Mass 02154
EDWIN INDUSTRIES CORP.
11933 Tech Rd, Silver Spring, Md 20904
FEDERAL SCIENTIFIC CORP.
615 W 131st St, New York, N Y 10027
GENERAL DYNAMICS CORP. ELECTRONICS DIV.
P O Box 2566, Orlando, Fla 32802
GULTON INDUSTRIES INC. COMPUTER SYS. DIV.
13041 Cerise Ave, Hawthorne, Cal 90250
INTERNATIONAL COMMUNICATIONS CORP. SUB. OF
MILGO
7620 NW 36th Ave, Miami, Fla 33147
INTERNATIONAL DATA SCIENCES, INC.
100 Nashua St, Providence, R I 02904
ITI ELECTRONICS INC.
369 Lexington Ave, Clifton, N J 07015
LIBRASCOPE DIV. THE SINGER CO
808 Western Ave, Glendale, Cal 91201
LITTON SYSTEMS INC. DATA SYSTEMS DIV.
8000 Woodley Ave, Van Nuys, Cal 91409
MILGO ELECTRONIC CORP.
7620 NW 36th Ave, Miami, Fla 33147
NATIONAL ELECTRO-MECHANICAL SYSTEMS INC.
32 Broad Ave, Binghamton, N Y 13904
NOLLER CONTROL SYSTEMS
150 E Standard Ave, Richmond, Cal 94804
RENTAL ELECTRONICS INC. SUB. PEPSI CO.
16600 Oakmont Ave, Gaithersburg, Md 20760
RFL INDUSTRIES INC. COMMUNICATION DIV.
Powerville Rd, Boonton, N J 07005
SANDERS ASSOCIATES DIGITAL COMMUNICATIONS
DEPT
Daniel Webster Hwy S, Nashua, N H 03060
SANDERS ASSOCIATES INC. SYSTEMS DIV.
Daniel Webster Hwy S, Nashua, N H 03060
SINGER TELE-SIGNAL CORP.
250 Crossway Park Dr, Woodbury, N Y 11797
SPECTRON CORP.
10060 Kings Hwy N, Cherry Hill, N J 08034
SRC DIV. MOXON INC.
2222 Michelson Dr, Newport Beach, Cal 92664
TALLY CORP.
8301 S 180th St, Kent, Wash 98031
TAUTRON INC.
685 Lawrence St, Lowell, Mass 01852
TELEMODEM INC.
98-05 217 St, Queens Village, N Y 11429
TRANSMISSION MEASUREMENTS INC
1051 Clinton St, Buffalo, N Y 14206
TROTT ELECTRONICS INC.
30 Ridgeland Rd, Rochester, N Y 14623

2 Product Directory

TESTERS, DIGITAL LOGIC MODULES AND CARDS

AAI CORP.

P O Box 6767, Baltimore, Md 21204

ACRON CORP.

1209 River Ave, Lakewood, N J 08701

ADAR ASSOCIATES INC.

85 Bolton St, Cambridge, Mass 02140

AMERICAN COMPUTER TECHNOLOGY INC.

8740 Shirley Ave, Northridge, Cal 91324

ASTRONAUTICS CORPORATION OF AMERICA

907 S First St, Milwaukee, Wis 53204

AUTOMATED CONTROL TECHNOLOGY INC.

745 Distel Dr, Los Altos, Cal 94022

COLLINS RADIO CO.

1200 N Alma Rd, Dallas, Tex 75207

COMPU-MATIC SYSTEMS CORP.

5303 Comercio Ln, Woodland Hills, Cal 91364

COMPU-SYSTEMS CO.

Audubon Rd, Wakefield, Mass 01880

COMPUTER AUTOMATION INC.

895 W 16th St, Newport Beach, Cal 92660

COMPUTER DESIGN CORP.

12401 W Olympic Blvd, Los Angeles, Cal 90064

CONTROL LOGIC INC.

3 Strathmore Rd, Natick, Mass 01760

CREDIT SYSTEMS INC.

P O Box 105, Colmar, Pa 18915

DATA DISPLAY SYSTEMS INC.

139 Terwood Rd, Willow Grove, Pa 19090

DATAPROBE INC.

290 Huyler St, S Hackensack, N J 07606

DATATRON INC.

1562 Reynolds Ave, Santa Ana, Cal 92707

DIGITAL GENERAL CORP.

11000 Cedar Ave, Cleveland, Ohio 44107

DIGITAL PRODUCTS

335 W 7th St, San Pedro, Cal 90733

DIMENSIONAL SYSTEMS INC.

393 Totten Pond Rd, Waltham, Mass 02154

E-H RESEARCH LABORATORIES INC

P O Box 1289, Oakland, Cal 94604

ELECTRONIC DEVELOPMENT CORP.

11 Hamlin St, Boston, Mass 02127

FAIRCHILD SYSTEMS TECHNOLOGY

974 E Arques Ave, Sunnyvale, Cal 94086

GENERAL DYNAMICS CORP. ELECTRONICS DIV.

P O Box 2566, Orlando, Fla 32802

GENERAL RADIO CO.

300 Baker Ave, Concord, Mass 01742

INDUSTRIAL INVENTIONS INC.

Rd2 463 Us 1, Monmouth Jct, N J 08852

INSTRUMENT DISPLAYS INC. SUB. KELTRON CORP.

223 Crescent St, Waltham, Mass 02154

INSTRUMENTATION ENGINEERING INC.

269 Susquehanna Ave, Franklin Lakes, N J 07417

LECROY RESEARCH SYSTEMS CORP.

126 N Rte 303, W Nyack, N Y 10994

LIBRASCOPE DIV. THE SINGER CO

808 Western Ave, Glendale, Cal 91201

LITTON SYSTEMS INC. GUIDANCE & CONTROL SYS.DIV.

5500 Canoga Ave, Woodland Hills, Cal 91364

MICRO METRICS INC.

253 Crooks Ave, Clifton, N J 07011

MICRO SYSTEMS INC.

644 E Young St, Santa Ana, Cal 92705

NATIONAL ELECTRO-MECHANICAL SYSTEMS INC.

32 Broad Ave, Binghamton, N Y 13904

NON-LINEAR SYSTEMS INC.

P O Box N, Del Mar, Cal 92014

OPTIMIZED DEVICES INC.

220 Marble Ave, Pleasantville, N Y 10570

RAYTHEON COMPUTER

2700 S Fairview St, Santa Ana, Cal 92704

RESALAB INC. AUTOMATION DYNAMICS DIV.

35 Industrial Pky, Northvale, N J 07647

SANGAMO ELECTRIC CO.

P O Box 3347, Springfield, Ill 62708

SCIENTIFIC MEASUREMENT SYSTEMS INC.

351 New Albany Rd, Moorestown, N J 08057

SINGER-GENERAL PRECISION KEARFOTT DIV.

1150 McBride Ave, Little Falls, N J 07424

SRC DIV. MOXON INC.

2222 Michelson Dr, Newport Beach, Cal 92664

SYSTEMATION INC.

Clifton Park, Elnora, N Y 12065

TAUTRON INC.

685 Lawrence St, Lowell, Mass 01852

TEKTRONIX INC.

P O Box 500, Beaverton, Ore 97005

TELESCIENCES INC.

351 New Albany Rd, Moorestown, N J 08057

Is The Modem Working ?

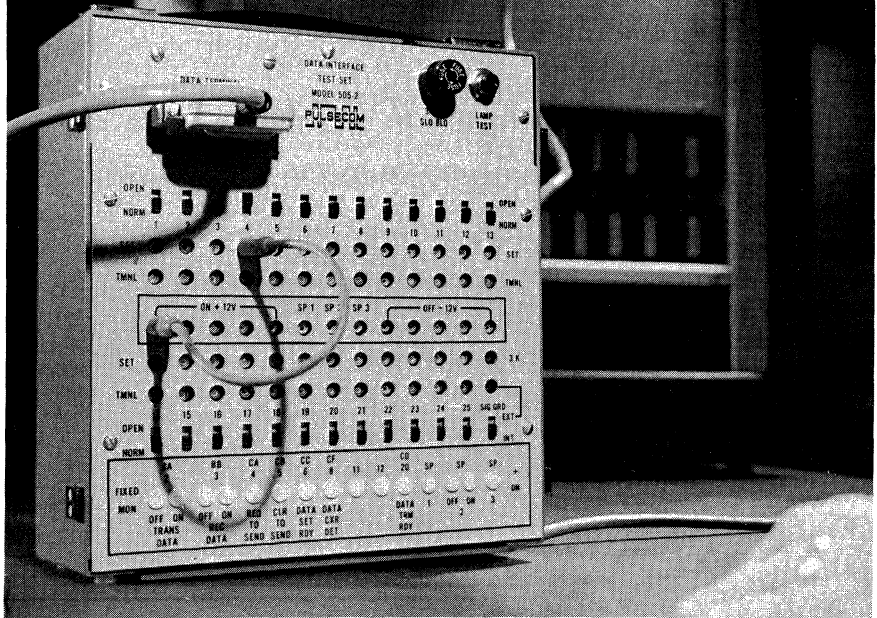

Or has the terminal failed?

Down time is money lost. Prompt failure isolation is a must. Today's on-line systems, employing modems and multiplexers in ever increasing complexity, present new problems. Maintenance responsibility is often divided; operating personnel waste time calling the wrong people; failure isolation is complex.

The Pulsecom 505 Data Interface Test Set helps operators isolate problems; helps maintainers fix them. It provides access to the RS-232 interface.....it simulates inputs.....monitors outputs.....provides answers.....fast.

For more information contact Pulse Communications

PULSECOM

5714 COLUMBIA PIKE, FALLS CHURCH, VIRGINIA 22041
TELEPHONE 703/820-0652 TELEX 89-9423

2 Product Directory

TERADYNE INC.

183 Essex St, Boston, Mass 02111
TEST EQUIPMENT CORP.
2925 Merrell Rd, Dallas, Tex 75220
TEXAS INSTRUMENTS INC. DIGITAL SYSTEMS DIV
P O Box 66027, Houston, Tex 77006
TROTT ELECTRONICS INC.
30 Ridgeland Rd, Rochester, N Y 14623
VARADYNE INC.
320-B Martina Ave, Santa Clara, Cal 95050
WILLARD LABORATORIES INC.
4221 Redwood Ave, Los Angeles, Cal 90066
XINTEL CORP.
20931 Nordhoff, Chatsworth, Cal 91311
ZEHNTEL, INC., AFFIL. EM&M INC.
1450 6th St, Berkeley, Cal 94810

TESTERS, DISC HEADS

DATA INDUSTRIES INC.
12624 Daphne, Hawthorne, Cal 90250
DAVIDSON OPTRONICS INC.
2223 Ramona Blvd, West Covina, Cal 91790

TESTERS, INTEGRATED CIRCUIT

AAI CORP.
P O Box 6767, Baltimore, Md 21204
ACRON CORP.
1209 River Ave, Lakewood, N J 08701
ASTROSYSTEMS INC.
6 Nevada Dr, Lake Success, N Y 11040
AUTOMATED CONTROL TECHNOLOGY INC.
745 Distel Dr, Los Altos, Cal 94022
BARNES CORP.
24 N Lansdowne Ave, Lansdowne, Pa 19050
BECKMAN INSTRUMENTS INC. ELECT. INSTR. DIV.
2200 Wright Ave, Richmond, Cal 94804
COLLINS RADIO CO.
1200 N Alma Rd, Dallas, Tex 75207
COMPU-SYSTEMS CO.
Audubon Rd, Wakefield, Mass 01880
COMPUTER DESIGN CORP.
12401 W Olympic Blvd, Los Angeles, Cal 90064
CYBERMATION INC.
P O Box 58 River Rd, Washngtn Xing, Pa 18977
DATA DISPLAY SYSTEMS INC.
139 Terwood Rd, Willow Grove, Pa 19090
DATACON INTERNATIONAL INC.
2745 Bernice Rd, Lansing, Ill 60438
DATAPROBE INC.
290 Huyler St, S Hackensack, N J 07606
DATATRON INC.
1562 Reynolds Ave, Santa Ana, Cal 92707
DIGITAL GENERAL CORP.
11000 Cedar Ave, Cleveland, Ohio 44107
DIGITAL PRODUCTS
335 W 7th St, San Pedro, Cal 90733
DIMENSIONAL SYSTEMS INC.
393 Totten Pond Rd, Waltham, Mass 02154
E-H RESEARCH LABORATORIES INC
P O Box 1289, Oakland, Cal 94604
EL INSTRUMENTS INC.
61 1st St, Derby, Conn 06418
ELECTRONIC DEVELOPMENT CORP.
11 Hamlin St, Boston, Mass 02127
FAIRCHILD SYSTEMS TECHNOLOGY
974 E Arques Ave, Sunnyvale, Cal 94086
GENERAL RADIO CO.
300 Baker Ave, Concord, Mass 01742
HEWLETT PACKARD CO.
1501 Page Mill Rd, Palo Alto, Cal 94304
INSTRUMENTATION ENGINEERING INC.
269 Susquehanna Ave, Franklin Lakes, N J 07417
KENICS SYSTEMS CORP.
125 Harvard St, Cambridge, Mass 02139
LIBRASCOPE DIV. THE SINGER CO
808 Western Ave, Glendale, Cal 91201
LITTON SYSTEMS INC. DATA SYSTEMS DIV.
8000 Woodley Ave, Van Nuys, Cal 91409
MICRO METRICS INC.
253 Crooks Ave, Clifton, N J 07011
NATIONAL ELECTRO-MECHANICAL SYSTEMS INC.
32 Broad Ave, Binghamton, N Y 13904
NON-LINEAR SYSTEMS INC.
P O Box N, Del Mar, Cal 92014
OPTIMIZED DEVICES INC.
220 Marble Ave, Pleasantville, N Y 10570
REDCOR CORP.
21200 Victory, Woodland Hills, Cal 91364
RENTAL ELECTRONICS INC. SUB. PEPSI CO.
16600 Oakmont Ave, Gaithersburg, Md 20760
ROHDE & SCHWARZ SALES CO. USA INC.
111 Lexington Ave, Passaic, N J 07055

SCI ELECTRONICS INC.

7705 La Porte Fwy, Houston, Tex 77012
SCIENTIFIC MEASUREMENT SYSTEMS INC.
351 New Albany Rd, Moorestown, N J 08057
SIGNETICS CORP. SUB. CORNING GLASS
811 E Arques Ave, Sunnyvale, Cal 94086
SIGNETICS CORP. MEASUREMENT DATA DIV.
341 Moffett Blvd, Mountain View, Cal 94040
SIMPSON ELECTRIC CO.
5200 W Kinzie St, Chicago, Ill 60644
SPECTRUM DYNAMICS INC.
P O Box 23699, Ft Lauderdale, Fla 33308
SRC DIV. MOXON INC.
2222 Michelson Dr, Newport Beach, Cal 92664
SYSTREX CORP.
303 Child St, Rochester, N Y 14611
TAUTRON INC.
685 Lawrence St, Lowell, Mass 01852
TEKTRONIX INC.
P O Box 500, Beaverton, Ore 97005
TELECTRO SYSTEMS CORP.
96-18 43rd Ave, Corona, N Y 11368
TELEDYNE PHILBRICK NEXUS
Allied Dr At Rte 128, Dedham, Mass 02026
TELESCIENCES INC.
351 New Albany Rd, Moorestown, N J 08057
TELVAC INSTRUMENT CO.
18531 Ventura Blvd, Tarzana, Cal 91356
TERADYNE INC.
183 Essex St, Boston, Mass 02111
TEST EQUIPMENT CORP.
2925 Merrell Rd, Dallas, Tex 75220
TEXAS INSTRUMENTS INC. DIGITAL SYSTEMS DIV
P O Box 66027, Houston, Tex 77006
VARADYNE INC.
320-B Martina Ave, Santa Clara, Cal 95050
VISHAY RESISTOR PRODUCTS INC.
63 Lincoln Hwy, Malvern, Pa 19355
WILLARD LABORATORIES INC.
4221 Redwood Ave, Los Angeles, Cal 90066
XINTEL CORP.
20931 Nordhoff, Chatsworth, Cal 91311
ZEHNTEL, INC., AFFIL. EM&M INC.
1450 6th St, Berkeley, Cal 94810

TESTERS, MAGNETIC DISC

AIR TECHNIQUES INC.
1717 Whitehead Rd, Baltimore, Md 21207
DAVIDSON OPTRONICS INC.
2223 Ramona Blvd, West Covina, Cal 91790
DISKOS ELECTRONICS CORP.
201 Lane Tree Court, Milpitas, Cal 95035
PIONEER MAGNETICS INC.
1745 Berkeley St, Santa Monica, Cal 90404
SCIENTIFIC MEASUREMENT SYSTEMS INC.
351 New Albany Rd, Moorestown, N J 08057
WABASH COMPUTER CORP. PI DIV.
10202 N 19th St, Phoenix, Ariz 85021

TESTERS, MAGNETIC DRUM

NUCLEONIC DATA SYSTEMS INC.
7461 Lorge Cir, Huntington Bch, Cal 92647
PIONEER MAGNETICS INC.
1745 Berkeley St, Santa Monica, Cal 90404
SCIENTIFIC MEASUREMENT SYSTEMS INC.
351 New Albany Rd, Moorestown, N J 08057

TESTERS, MAGNETIC TAPE (CASSETTE)

MINNETECH LABS INC.
8115 10th Ave N, Minneapolis, Minn 55427

TESTERS, MAGNETIC TAPE TRANSPORTS

COOK ELECTRIC CO. DATA-STOR DIV.
6201 W Oakton St, Morton Grove, Ill 60053

TESTERS, MEMORY PLANES, STACKS AND SYSTEMS

AMERICAN COMPUTER TECHNOLOGY INC.
8740 Shirley Ave, Northridge, Cal 91324
AMPEX CORP. COMPUTER PRODUCTS DIV.
9937 W Jefferson Blvd, Culver City, Cal 90230
CHRONETICS INC.
500 Nuber Ave, Mount Vernon, N Y 10550

COMPUMATIC SYSTEMS CORP.

5303 Comercio Ln, Woodland Hills, Cal 91364
COMPUTER TEST CORP.
3 Computer Dr, Cherry Hill, N J 08034
DATARAM CORP.
Rte 206, Princeton, N J 08540
DIGITAL PRODUCTS
335 W 7th St, San Pedro, Cal 90733
DIMENSIONAL SYSTEMS INC.
393 Totten Pond Rd, Waltham, Mass 02154
DISKOS ELECTRONICS CORP.
201 Lane Tree Court, Milpitas, Cal 95035
E-H RESEARCH LABORATORIES INC
P O Box 1289, Oakland, Cal 94604
FAIRCHILD SYSTEMS TECHNOLOGY
974 E Arques Ave, Sunnyvale, Cal 94086
HEIDEX CORP.
Stuart Rd, Chelmsford, Mass 01824
KENICS SYSTEMS CORP.
125 Harvard St, Cambridge, Mass 02139
LIBRASCOPE DIV. THE SINGER CO
808 Western Ave, Glendale, Cal 91201
MICRO SYSTEMS INC.
644 E Young St, Santa Ana, Cal 92705
MINNETECH LABS INC.
8115 10th Ave N, Minneapolis, Minn 55427
NATIONAL ELECTRO-MECHANICAL SYSTEMS INC.
32 Broad Ave, Binghamton, N Y 13904
PRECISION MAGNETICS INC.
504 S 11th Ave, Minneapolis, Minn 55415
QUADRI CORP.
2959 W Fairmount, Phoenix, Ariz 85017
REDCOR CORP.
21200 Victory, Woodland Hills, Cal 91364
SCIENTIFIC MEASUREMENT SYSTEMS INC.
351 New Albany Rd, Moorestown, N J 08057
SONICRAFT INC.
8437 S Burley Ave, Chicago, Ill 60619
SRC DIV. MOXON INC.
2222 Michelson Dr, Newport Beach, Cal 92664
STANDARD MEMORIES INC.
15130 Ventura Blvd, Sherman Oak, Cal 91403
TAUTRON INC.
685 Lawrence St, Lowell, Mass 01852
TEKTRONIX INC.
P O Box 500, Beaverton, Ore 97005
WILLARD LABORATORIES INC.
4221 Redwood Ave, Los Angeles, Cal 90066
ZEHNTEL, INC., AFFIL. EM&M INC.
1450 6th St, Berkeley, Cal 94810

TESTERS, SEMICONDUCTOR

AAI CORP.
P O Box 6767, Baltimore, Md 21204
ADAR ASSOCIATES INC.
85 Bolton St, Cambridge, Mass 02140
AUTOMATED CONTROL TECHNOLOGY INC.
745 Distel Dr, Los Altos, Cal 94022
COMPONENTS CORP.
106 Main St, Denville, N J 07834
DAYMARC CORP.
40 Bear Hill Rd, Waltham, Mass 02154
DIGITAL PRODUCTS
335 W 7th St, San Pedro, Cal 90733
E-H RESEARCH LABORATORIES INC
P O Box 1289, Oakland, Cal 94604
ELECTRONIC DEVELOPMENT CORP.
11 Hamlin St, Boston, Mass 02127
FAIRCHILD SYSTEMS TECHNOLOGY
974 E Arques Ave, Sunnyvale, Cal 94086
HEXEM INC.
1015 Corporation Way, Palo Alto, Cal 94303
HICKOK ELECTRICAL INSTRUMENT CO.
10514 Dupont Ave, Cleveland, Ohio 44108
INSTRUMENTATION ENGINEERING INC.
269 Susquehanna Ave, Franklin Lakes, N J 07417
J-OMEGA CO.
2271 Mora Dr, Mt View, Cal 94040
JULIE RESEARCH LABORATORIES INC.
211 West 161 St, New York, N Y 10023
LECROY RESEARCH SYSTEMS CORP.
126 N Rte 303, W Nyack, N Y 10994
LIBRASCOPE DIV. THE SINGER CO
808 Western Ave, Glendale, Cal 91201
MACRODATA CO.
20440 Corrisco St, Chatsworth, Cal 91311
NATIONAL ELECTRO-MECHANICAL SYSTEMS INC.
32 Broad Ave, Binghamton, N Y 13904
OPTIMIZED DEVICES INC.
220 Marble Ave, Pleasantville, N Y 10570
QUADRI CORP.
2959 W Fairmount, Phoenix, Ariz 85017

2 Product Directory

RENTAL ELECTRONICS INC. SUB. PEPSI CO.
16600 Oakmont Ave, Gaithersburg, Md 20760
ROHDE & SCHWARZ SALES CO. USA INC.
111 Lexington Ave, Passaic, N J 07055
SCIENTIFIC MEASUREMENT SYSTEMS INC.
351 New Albany Rd, Moorestown, N J 08057
SIMPSON ELECTRIC CO.
5200 W Kinzie St, Chicago, Ill 60644
SOLITRON DEVICES INC.
256 Oak Tree Rd, Tappan, N Y 10983
SYS COMPUTER CORP.
17-25 Dicarolis Court, Hackensack, N J 07601
TAUTRON INC.
685 Lawrence St, Lowell, Mass 01852
TEKTRONIX INC.
P O Box 500, Beaverton, Ore 97005
TERADYNE INC.
183 Essex St, Boston, Mass 02111
TEST EQUIPMENT CORP.
2925 Merrell Rd, Dallas, Tex 75220
TEXAS INSTRUMENTS INC. DIGITAL SYSTEMS DIV
P O Box 66027, Houston, Tex 77006
TRIPLETT CORP.
286 Harmon Rd, Bluffton, Ohio 45817
VARADYNE INC.
320-B Martina Ave, Santa Clara, Cal 95050
WAKEFIELD ENGINEERING INC.
Audubon Rd, Wakefield, Mass 01880
WISE INSTRUMENTATION & CONTROLS INC.
3568 Amherst Court, Mt View, Cal 94040
XINTEL CORP.
20931 Nordhoff, Chatsworth, Cal 91311
ZEHNTEL, INC., AFFIL. EM&M INC.
1450 6th St, Berkeley, Cal 94810

THERMISTORS

FENWAL ELECTRONICS INC.
63 Fountain St, Framingham, Mass 01701
VICTORY ENGINEERING CORP.
Victory Rd, Springfield, N J 07081

THERMOCOUPLE REFERENCE SYSTEMS

APPLIED COMPUTER SYSTEMS INC.
P O Box 6479, Austin, Tex 78702
ASTROSYSTEMS INC.
6 Nevada Dr, Lake Success, N Y 11040
AUSTRON, INC.
10214 N Interregional, Austin, Tex 78753
AVCO CORP. ELECTRONICS DIV.
4807 Bradford, Huntsville, Ala 35805
BRISTOL CO., DIV AMERICAN CHAIN & CABLE CO.
Bristol Rd, Waterbury, Conn 06720
CHRONETICS INC.
500 Nuber Ave, Mount Vernon, N Y 10550
CONSOLIDATED OHMIC DEVICES INC.
115 Old Country Rd, Carle Place, N Y 11514
DYNASCIENCES CORP. INSTRUMENT SYSTEMS DIV.
9601 Canoga Ave, Chatsworth, Cal 91311
EDWIN INDUSTRIES CORP.
11933 Tech Rd, Silver Spring, Md 20904
GULTON INDUSTRIES INC.
212 Durham Ave, Metuchen, N J 08840
KAYE INSTRUMENTS INC.
737 Concord Ave, Cambridge, Mass 02138
LEEDS & NORTHRUP CO.
Sumney Town Pike, North Wales, Pa 19454
NON-LINEAR SYSTEMS INC.
P O Box N, Del Mar, Cal 92014
TEXAS INSTRUMENTS INC. CONTROLS DIV.
34 Forest St, Attleboro, Mass 02703

TIME RECORDERS (SEE INDICATORS)

TIMERS, EVENT (IMPULSE)

A. W. HAYDON CO., THE
232 N Elm St, Waterbury, Conn 06720
ADAMS & WESTLAKE, SUB. ALLIED PRODUCTS
1025 N Michigan, Elkhart, Ind 46514
ALLIED CONTROL CO. INC.
100 Relay Rd, Plantsville, Conn 60479
ARTISAN ELECTRONICS CORP.
5 Eastman Rd, Parsippany, N J 07054
AUTRONICS CORP.
180 N Vinedo Ave, Pasadena, Cal 91107
BABCOCK ELECTRONICS CORP.
3501 Harbor Blvd, Costa Mesa, Cal 92626
BAILEY METER CO. SUB. BABCOCK&WILCOX
29801 Euclid Ave, Wickliffe, Ohio 44092

BECKMAN INSTRUMENTS INC. ELECT. INSTR. DIV.
2200 Wright Ave, Richmond, Cal 94804
BFA CORP.
1309 S Inca, Denver, Colo 80223
CHRONO-LOG CORP.
2583 W Chester Pike, Broomall, Pa 19008
COMPUTER PRODUCTS, INC.
P O Box 23849, Ft Lauderdale, Fla 33307
CONRAC CORP.
330 Madison Ave, New York, N Y 10017
CONRAC CORP. CRAMER DIV.
Mill Rock Rd, Old Saybrook, Conn 06475
DIGITAL PRODUCTS CORP.
6950 NW 12 Ave, Ft Lauderdale, Fla 33309
DURANT DIGITAL INSTRUMENTS A CUTLER HAMMER CO.
600 N Cass St, Milwaukee, Wisc 53201
ELECTRONIC RESEARCH CO., A TEXTRON CO.
10000 W 75th St, Shawnee Mission, Kan 66202
FREDERICK CONTROLS DIV., SUB. NO.AM.PHILIPS CORP.
E Church & Second Sts, Frederick, Md 21701
GIBBS MANUFACTURING & RESEARCH CORP.
450 N Main, Janesville, Wisc 53545
GULTON INDUSTRIES INC.
212 Durham Ave, Metuchen, N J 08840
HAYDON SWITCH&INSTRUMENT INC. SUB. TRI-TECH INC.
1500 Meriden Rd, Waterbury, Conn 06720
HECON CORP.
31 Park Rd, New Shrewsbury, N J 07724
HUGHES AIRCRAFT CO. M O S DIV.
500 Superior Ave, Newport Beach, Cal 92660
INSTRUMENT DISPLAYS INC. SUB. KELTRON CORP.
223 Crescent St, Waltham, Mass 02154
JANCO CORP.
311 Winona Ave, Burbank, Cal 91504
LANDIS AND GYR INC.
4 Westchester Plaza, Elmsford, N Y 10523
LEHIGH VALLEY ELECTRONICS INC.
Po Box 125, Fogelsville, Pa 18051
MAGNECRAFT ELECTRIC CO.
5575 N Lynch Ave, Chicago, Ill 60630
MALLORY TIMERS CO.
3029 E Washington St, Indianapolis, Ind 46206
MASSEY DICKINSON CO. INC.
9 Elm St, Saxonville, Mass 01701
MASTER ELECTRONIC CONTROLS
1553 17 St, Santa Monica, Cal 90404
MEKONTROL INC.
56 Hudson St, Northboro, Mass 01532
METRIC SYSTEMS CORP.
736 N Beal St, Ft Walton Beach, Fla 32548
MONITOR LABS INC.
10451 Roselle, San Diego, Cal 92121
MONSANTO CO. ELECTRONIC PDTS. & CONTROLS DIV.
11636 Administration, St Louis, Mo 63141
NO. AMERICAN PHILIPS CORP. FREDERICK CONT. DIV.
Frederick, Md 21701
PARABAM INC.
3017 E Las Hermanas, Compton, Cal 90221
RELAY SPECIALTIES INC.
3 Godwin Ave, Fair Lawn, N J 07410
SINGER-GENERAL PRECISION KEARFOTT DIV.
1150 McBride Ave, Little Falls, N J 07424
STRUTHER-DUNN INC. SYSTEMS DIV.
1114 State St, Bettendorf, Iowa 52722
TEMPO INSTRUMENT DIV. ALLEN ELECTRIC&EQUIP. CO.
9135 Independence Ave, Chatsworth, Cal 91311
THETA INSTRUMENT CORP.
24 Dwight Pl, Fairfield, N J 07006
TROTT ELECTRONICS INC.
30 Ridgeland Rd, Rochester, N Y 14623

TIMERS, INTERVAL

A. W. HAYDON CO., THE
232 N Elm St, Waterbury, Conn 06720
ADAMS & WESTLAKE, SUB. ALLIED PRODUCTS
1025 N Michigan, Elkhart, Ind 46514
ALLEN-BRADLEY
1201 S 2nd St, Milwaukee, Wisc 53204
ALLIED CONTROL CO. INC.
100 Relay Rd, Plantsville, Conn 60479
ARTISAN ELECTRONICS CORP.
5 Eastman Rd, Parsippany, N J 07054
AUTRONICS CORP.
180 N Vinedo Ave, Pasadena, Cal 91107
BABCOCK ELECTRONICS CORP.
3501 Harbor Blvd, Costa Mesa, Cal 92626
BAILEY METER CO. SUB. BABCOCK&WILCOX
29801 Euclid Ave, Wickliffe, Ohio 44092

BECKMAN INSTRUMENTS INC. ELECT. INSTR. DIV.
2200 Wright Ave, Richmond, Cal 94804
BFA CORP.
1309 S Inca, Denver, Colo 80223
CHRONO-LOG CORP.
2583 W Chester Pike, Broomall, Pa 19008
COMPUTER MEASUREMENTS CO.
12970 Bradley Ave, San Fernando, Cal 91342
COMPUTER PRODUCTS, INC.
P O Box 23849, Ft Lauderdale, Fla 33307
CONRAC CORP.
330 Madison Ave, New York, N Y 10017
CONRAC CORP. CRAMER DIV.
Mill Rock Rd, Old Saybrook, Conn 06475
DI/AN CONTROLS INC.
944 Dorchester Ave, Boston, Mass 02125
DIGITAL PRODUCTS CORP.
6950 NW 12 Ave, Ft Lauderdale, Fla 33309
DIGITRON CORP.
2544 W Main St, Norristown, Pa 19401
DURANT DIGITAL INSTRUMENTS A CUTLER HAMMER CO.
600 N Cass St, Milwaukee, Wisc 53201
ELECTRONIC RESEARCH CO., A TEXTRON CO.
10000 W 75th St, Shawnee Mission, Kan 66202
FREDERICK CONTROLS DIV., SUB. NO.AM.PHILIPS CORP.
E Church & Second Sts, Frederick, Md 21701
GENERAL RADIO CO.
300 Baker Ave, Concord, Mass 01742
GENERAL TIME CORP. IND. CONTROLS DIV.
Rte 8, Torrington, Conn 06790
GIBBS MANUFACTURING & RESEARCH CORP.
450 N Main, Janesville, Wisc 53545
GULTON INDUSTRIES INC.
212 Durham Ave, Metuchen, N J 08840
HAYDON SWITCH&INSTRUMENT INC. SUB. TRI-TECH INC.
1500 Meriden Rd, Waterbury, Conn 06720
HECON CORP.
31 Park Rd, New Shrewsbury, N J 07724
HEINEMANN ELECTRIC CO.
Brunswick Pike Rte 1, Trenton, N J 08638
HI-G INC.
580 Spring St, Windsor Locks, Conn 06096
HYBRID SYSTEMS DIV. DIGITAL RESOURCES CORP.
4301 Dacoma Rd, Houston, Tex 77018
INDUSTRIAL TIMER DIV., THE SINGER CO.
Us Hwy 287, Parsippany, N J 07054
INSTRUMENT DISPLAYS INC. SUB. KELTRON CORP.
223 Crescent St, Waltham, Mass 02154
LANDIS AND GYR INC.
4 Westchester Plaza, Elmsford, N Y 10523
LEACH CORP. RELAY DIV.
5915 Avalon, Los Angeles, Cal 90003
LEHIGH VALLEY ELECTRONICS INC.
Po Box 125, Fogelsville, Pa 18051
MAGNECRAFT ELECTRIC CO.
5575 N Lynch Ave, Chicago, Ill 60630
MALLORY & CO. INC., P.R.
3029 E Washington, Indianapolis, Ind 46218
MALLORY TIMERS CO.
3029 E Washington St, Indianapolis, Ind 46206
MASSEY DICKINSON CO. INC.
9 Elm St, Saxonville, Mass 01701
MASTER ELECTRONIC CONTROLS
1553 17 St, Santa Monica, Cal 90404
METRIC SYSTEMS CORP.
736 N Beal St, Ft Walton Beach, Fla 32548
MONSANTO CO. ELECTRONIC PDTS. & CONTROLS DIV.
11636 Administration, St Louis, Mo 63141
NAYBOR LABORATORIES INC.E.V.
26 Manorhaved Blvd, Port Washington, N Y 11050
NIGITRON CORP.
2544 W Main St, Norristown, Pa 19401
NO. AMERICAN PHILIPS CORP. FREDERICK CONT. DIV.
Frederick, Md 21701
PARABAM INC.
3017 E Las Hermanas, Compton, Cal 90221
RELAY SPECIALTIES INC.
3 Godwin Ave, Fair Lawn, N J 07410
SEALLECTRO CORP.
225 Hoyt St, Mamaroneck, N Y 10543
SINGER-GENERAL PRECISION KEARFOTT DIV.
1150 McBride Ave, Little Falls, N J 07424
SKAN-A-MATIC CORP.
P O Drawer 68, Skaneateles, N Y 13152
STRUTHER-DUNN INC. SYSTEMS DIV.
1114 State St, Bettendorf, Iowa 52722
TEMPO INSTRUMENT DIV. ALLEN ELECTRIC&EQUIP. CO.
9135 Independence Ave, Chatsworth, Cal 91311
THETA INSTRUMENT CORP.
24 Dwight Pl, Fairfield, N J 07006

2 Product Directory

TRAID CORP., PHOTO INSTRUMENT DIV.
900 Grand Central, Glendale, Cal 91201
TREPAC CORP. OF AMERICA
30 W Hamilton Ave, Englewood, N J 07631

TIME SHARING SERVICES (SEE SERVICES)

TRAINING INSTITUTES, COMMERCIAL COMPUTER COURSES, SEMINARS, CORRESPONDENCE COURSES

ACADEMY OF COMPUTER TECHNOLOGY, THE
1940 Hi-Line Dr, Dallas, Tex 75207
ADAPT INC.
624 S 62nd St, Philadelphia, Pa 19143
ADTECH INC.
P O Box 10415, Honolulu, Haw 96816
ADVANCED COMPUTER SYSTEMS INC
3131 S Dixie Dr, Dayton, Ohio 45305
ADVANCED COMPUTER TECHNIQUES CORP.
437 Madison Ave, New York, N Y 10022
ADVANCED MANAGEMENT SYSTEMS INC.
3310 Richmond Ave, Houston, Tex 77006
ADVANCED SYSTEMS INC.
1100 W NW Hwy, Mt Prospec, Ill 60056
AMERICAN COMPUTER LEASING CORP.
14 E 4th St, Cincinnati, Ohio 45202
AMERICAN COMPUTER SERVICES CORP.
14 E 4th St, Cincinnati, Ohio 45202
AMPEX CORP. COMPUTER PRODUCTS DIV.
9937 W Jefferson Blvd, Culver City, Cal 90230
APPLIED COMPUTER SCIENCES INC.
361 Park Rd, W Hartford, Conn 06107
APPLIED COMPUTER TIME SHARE INC.
29200 Southfield Rd, Southfield, Mich 48075
AUTOMATED DATA ASSOCIATES INC.
1333 Lawrence St, Rahway, N J 07065
AUTOMATED INFORMATION SYSTEMS INC.
1064 River Rd, Edgewater, N J 07020
BERGLUND ASSOCIATES INC.
1060 Kings Hwy N, Cherry Hill, N J 08034
BOOTHE DATA SYSTEMS INC.
485 Lexington Ave, New York, N Y 10001
BOOTHE RESOURCES INTERNATIONAL INC.
3435 Wilshire Blvd, Los Angeles, Cal 90005
BRADDOCK, DUNN & MCDONALD INC.
8027 Leesburg Pike, Mc Lean, Va 22101
BRANDON APPLIED SYSTEMS INC.
1700 Broadway, New York, N Y 10019
BRANDON APPLIED SYSTEMS INC.
1611 N Kent St, Arlington, Va 22209
CHI CORP.
11000 Cedar Ave, Cleveland, Ohio 44106
COMPUTATION AND SYSTEMS CORP.
12061 Wilshire Blvd, Los Angeles, Cal 90025
COMPUTER & BUSINESS SKILLS INSTITUTE
17 N State St, Chicago, Ill 60602
COMPUTER AGE INDUSTRIES INC.
8800 Arlington Blvd, Fairfax, Va 22030
COMPUTER ASSISTANCE INC.
298 Park Rd, West Hartford, Conn 06119
COMPUTER COMMAND & CONTROL CO
1717 Penn Ave NW, Washington, D C 20006
COMPUTER COMMAND AND CONTROLS COMPANY
4025 Chestnut St, Philadelphia, Pa 19104
COMPUTER LEARNING & SYSTEMS CORP.
5530 Wisconsin Ave, Chevy Chase, Md 20015
COMPUTER PROCESSING INC.
300 6th Ave, Pittsburgh, Pa 15222
COMPUTER PROCESSING INSTITUTE
111 Ash St, East Hartford, Conn 06108
COMPUTER SCIENCES CORP. INFO. NETWORK DIV.
1901 Building, Los Angeles, Cal 90067
COMPUTER SERVICENTER CORP.
16 Maple St, Latham, N Y 12110
COMPUTER SYSTEM TECHNOLOGY INC.
700-42 Fox Pavilion, Jenkintown, Pa 19046
COMPUTER SYSTEMS CO. INC.
1470 St Charles Ave, Cleveland, Ohio 44107
COMPUTER TECHNOLOGY INC. SUB. UNIV.
COMPUTING CO.
P O Box 47911, Dallas, Tex 75247
COMPUTER TUTOR, THE, DIV. COMPTUT INC.
12 Emerald Court, Commack, N Y 11725
COMPUTER USAGE CO.
3181 Porter Dr, Palo Alto, Cal 94304
COMPUTER USAGE CORP.
100 Putman Green, Greenwich, Conn 06830
COMPUTER USAGE CORP.,
8939 S Sepulveda Blvd, Los Angeles, Cal 90045

COMPUTING & SOFTWARE INC., EAST COAST DIV.
3700 Mt Vernon Ave, Alexandria, Va 22305
COMSI INC.
1211 W 22 St, Oakbrook, Ill 60521
CONSOLIDATED ANALYSIS CENTERS, INC.,
225 Santa Monica Blvd, Santa Monica, Cal 90401
CONSULTANTS ASSOCIATED INC.
Lakeside Office Park, Wakefield, Mass 01880
CONTINENTAL DATA PROCESSING INC.
300 Market St, Kingston, Pa 18704
CONTROL TECHNOLOGY INC.
3450 E Spring St, Long Beach, Cal 90806
CTC COMPUTER CORP.
1000 Elwell Court, Palo Alto, Cal 94303
CYBERMATICS INC.
2460 Lemoine Ave, Fort Lee, N J 07024
DATA ENGINEERING ASSOC. INC.
300 Kings Hwy E, Haddonfield, N J 08033
DATA PROCESSORS INC.
2703 W 28th Ave, Pine Bluff, Ark 71601
DATA-TRONICS CORP. SUB. ARKANSAS BEST CORP.
310 Townson Ave, Fort Smith, Ark 72901
DATAFLOW SYSTEMS INC.
7758 Wilconsin Ave, Bethesda, Md 20014
DELMARVA COMPUTER INDUSTRIES INC.
5865 Robert Oliver Pl, Columbia, Md 21043
DELTA SYSTEMS CORP.
Edens Executive Ctr, Wilmette, Ill 60091
DESIGN AUTOMATION INC.
809 Massachusetts Ave, Lexington, Mass 02173
DUPONT DE NEMOURS, & CO. E.I. CO., INC.
1007 Market St, Wilmington, Del 19898
DYNAMIC ACCESS CORP.
220 Park Ave S, New York, N Y 10003
EDUCATION AND TRAINING CONSULTANTS CO.
P O Box 49899, Los Angeles, Cal 90049
ELECTRONIC COMPUTER PROG. INSTITUTE
49 N Progress Ave, Harrisburg, Pa 17109
ENGINEERING TECHNOLOGY ANALYSTS INC.
3310 Richmond Ave, Houston, Tex 77006
ENTELEK INC.
42 Pleasant St, Newburyport, Mass 01950
FIRST BUSINESS COMPUTING
1020 Houston Bk&Tr Tr, Houston, Tex 77002
FLORES ASSOCIATES
108 8th Ave, Brooklyn, N Y 11215
GENERAL INSTRUMENT CORP. MICROELECT. DIV.
600 W John St, Hicksville, N Y 11802
GOODHEW, J.W. & ASSOCIATES INC.
11600 Nebel St, Rockville, Md 20854
GTE DATA SERVICES INC.
5422 Bay Center Dr, Tampa, Fla 33609
HAVERLY SYSTEMS INC.
4 2nd Ave, Denville, N J 07834
HONEYWELL INFORMATION SYSTEMS
60 Walnut St, Wellesley Hills, Mass 02181
HONEYWELL INFORMATION SYSTEMS INC. INFO.
SERV.DIV
2701 4th Ave S, Minneapolis, Minn 55408
HOWARD ASSOC. INC., DANIEL D.
307 N Michigan Ave, Chicago, Ill 60601
ICM COMPUTER CORP.
P O Box 7220, Tulsa, Okla 74105
INFONET SYSTEMS INC.
358 McKinley Blvd, Paramus, N J 07652
INFORMATION MANAGEMENT INC.
447 Battery St, San Francisco, Cal 94111
INFOSCI INC.
P O Box 464, Menlo Park, Cal 94025
INPUT INC.
500 Old Elm Rd, Highland Park, Ill 60035
INSTITUTE FOR ADVANCED TECHNOLOGY, THE CDC
5272 River Rd, Washington, D C 20016
INSTITUTE FOR CYBERNETIC DEVELOPMENT
3031 Bateman St, Berkeley, Cal 94705
INTERACTIVE SYSTEMS INC.
327 S Fourth Ave, Ann Arbor, Mich 48108
INTERNATIONAL COMPUTER CORP.
1 N Broadway, White Plains, N Y 10601
ITT DATA EQUIPMENT & SYSTEMS DIV.
187 E Union Ave, E Rutherford, N J 07073
LEASCO DATA PROCESSING EQUIPMENT CORP.
280 Park Ave, New York, N Y 10017
MALT KEYBOARD DYNAMICS INC.
540 Frontage Rd, Northfield, Ill 60093
MANAGEMENTICS INC.
2 Pennsylvania Plaza, New York, N Y 10001
MANAGEMENT & COMPUTER SERVICES INC.
104 Park Towne Pl E, Philadelphia, Pa 19130
MANAGEMENT SCIENCE SYSTEMS INC.
1530 E Jefferson St, Rockville, Md 20852
MARK/OPS DIV., NORTH EASTERN SYSTEMS ASSOC.
INC.
475 Commonwealth Ave, Boston, Mass 02215

MCDONNELL AUTOMATION CO.
500 Jefferson Bldg, Houston, Tex 27002
MELPAR DIV. LTV ELECTROSYSTEMS INC.
7700 Arlington Blvd, Falls Church, Va 22046
MEMPHIS METHODS & TABULATING SERVICE INC.
56 N Main St, Memphis, Tenn 38103
METRIDATA COMPUTING INC.
6600 Grade Lane, Louisville, Ky 40221
MICHIANA LEASING CORP.
1814 S Main St, S Bend, Ind 46613
MNMOTECH COMPUTER SYSTEMS
55 Liberty St, New York, N Y 10005
MTI BUSINESS SCHOOLS OF SACRAMENTO INC.
2731 Capitol Ave, Sacramento, Cal 95816
NATIONAL C.S.S.
460 Summer St, Stamford, Conn 06901
NATIONAL INFORMATION RESEARCH INSTITUTE
8444 Wilshire Blvd, Beverly Hills, Cal 90211
NORTHEASTERN COMPUTER INSTITUTE
16 Maple St, Latham, N Y 12110
ON-LINE SYSTEMS INC.
4721 Mc Knight Rd, Pittsburg, Pa 15237
PANSOPHIC SYSTEMS INC.
230 Roosevelt Rd, Lombard, Ill 60148
PAYMENT SYSTEMS INC.
405 Lexington Ave, New York, N Y 10017
PENNDATA CORP.
1729 Cedar Ave, Scranton, Pa 18505
PHILCO-FORD CORP., COMPUTER SERVICES NETWORK
Tioga & C Sts, Philadelphia, Pa 19134
PIONEER DATA SYSTEMS INC.
606 Merle Hay Tower, Des Moines, Iowa 50310
PROFIMATICS INC.
6355 Topanga Canyon, Woodland Hills, Cal 91364
PROGRAMMING SCIENCES CORP.
S E 42 St, New York, N Y 10016
PROGRAMMING SCIENCES CORP.
1900 Ave of The Stars, Los Angeles, Cal 90067
PRYOR COMPUTER INDUSTRIES
400 N Michigan Ave, Chicago, Ill 60611
PUBLIC DATA PROCESSING CORP.
640 N LaSalle St, Chicago, Ill 60610
QUIKDATA INTERNATIONAL INC.
8444 Wilshire Blvd, Beverly Hills, Cal 90211
RCA INSTITUTE FOR PROFSNL. DEVELOPMENT
P O Box 962, Clark, N J 07066
REL-QUAL ASSOCIATES INC.
18 Hamilton St, Bound Brook, N J 08805
REMOTE COMPUTING CORP.
440 Palo Alto Off Ctr, Palo Alto, Cal 94301
REPUBLIC SYSTEMS INC.
100 Plaza Centre, Secaucus, N J 07094
REPUBLIC SYSTEMS INC.
715 Park Ave, E Orange, N J 07017
REPUBLIC SYSTEMS OF CONNECTICUT INC.
350 S Main St, Cheshire, Conn 06410
RIDGEWOOD ASSOCIATES INC.
10 Wilsey Sq, Ridgewood, N J 07450
SARNA ASSOCIATES INC.
22 Russell St, Brookline, Mass 02146
SCIENTIFIC SYSTEMS SERVICES INC.
476 N Hwy A1a, Satellite Beach, Fla 32935
SEGALL ASSOCIATES, M. HARVEY
1019 Rust Bldg, Tacoma, Wash 98402
SINGER CO., THE, FRIDEN DIV.
2350 Washington St, San Leandro, Cal 94577
SOFTTECH INC.
391 Totten Pond Rd, Waltham, Mass 02154
SOUTHERN SIMULATION SERVICES INC.
P O Box 1155, Tampa, Fla 33601
SOUTHERN VERMONT COMPUTER CENTER&DATA
SCHOOL
219 Belmont Ave, Bennington, Vt 05201
SOUTHWEST COMPUTER COLLEGE INC.
136 Louisiana NE, Albuquerque, N M 87108
SYSTEM DEVELOPMENT CORP.
2500 Colorado Ave, Santa Monica, Cal 90406
SYSTEM IMPLEMENTATION CORP.
18 E 48th St, New York, N Y 10017
SYSTEMATICS INC.
411 Victory, Little Rock, Ark 72201
SYSTEMS ASSOCIATES INC.
356 Penn St, Reading, Pa 19602
SYSTEMS GENERAL CORP.
10889 Wilshire Blvd, Los Angeles, Cal 90024
TELETYPE CORP.
5555 W Touhy Ave, Skokie, Ill 60076
THEORY ANALYSIS GROUP
22 E Elm St, Chicago, Ill 60611
TIME SHARE CORP.
3 Lebanon St, Hanover, N H 03755
TRACOR COMPUTING CORP.
1705 Guadalupe St, Austin, Tex 78701
TRILOG ASSOCIATES INC.
1700 Market St, Philadelphia, Pa 19103

2 Product Directory

U.S. TIME-SHARING INC.
1831 Michael Faraday, Reston, Va 22070
UNGERLEIDER & CO.
P O Box 1180, Alexandria, Va 22313
UNITED COMPUTING SYSTEMS INC.
3130 Broadway, Kansas City, Mo 64111
UNIVERSAL DATA SYSTEMS INC.
14482 Beach Blvd, Westminster, Cal 92626
UNIVERSAL INFORMATION SYSTEMS INC.
S-10 Rte 17 At Rte 4, Paramus, N J 07652
WALSH ASSOC., RICHARD M.
310 Jefferson Ave, Scranton, Pa 18503
WARREN ASSOCIATES
15 Royal Crest Dr, Marlboro, Mass 01752
WESTINGHOUSE ELECTRIC CORP.
Westinghouse Bldg, Pittsburgh, Pa 15222
WILEY SYSTEMS INC.
7942 Wisconsin Ave, Bethesda, Md 20014

TRAINING SYSTEMS, CARD PUNCH

CTC COMPUTER CORP.
1000 Elwell Court, Palo Alto, Cal 94303
DATA COMPUTING INC.
2219 W Shangri La Rd, Phoenix, Ariz 85029
DECISION DATA CORP.
300 Jacksonville Rd, Warminster, Penn 18974
EL INSTRUMENTS INC.
61 1st St, Derby, Conn 06418
HOUSTON ENGINEERING RESEARCH CORP.
P O Box 35495, Houston, Tex 77035
INPUT DATA CO. INC.
1187 Valley Rd, Stirling, N J 07980
LEHIGH VALLEY ELECTRONICS INC.
Po Box 125, Fogelsville, Pa 18051
WARREN ASSOCIATES
15 Royal Crest Dr, Marlboro, Mass 01752

TRAINING SYSTEMS, COMPUTER SERVICE

ADTECH INC.
P O Box 10415, Honolulu, Haw 96816
ADVANCED COMPUTER TECHNIQUES CORP.
437 Madison Ave, New York, N Y 10022
ADVANCED SYSTEMS INC.
1100 W NW Hwy, Mt Prospec, Ill 60056
APPLIED COMPUTER SCIENCES INC.
361 Park Rd, W Hartford, Conn 06107
BRANDON APPLIED SYSTEMS INC.
1611 N Kent St, Arlington, Va 22209
BURLINGTON MANAGEMENT SERVICES CO.
P O Box 21207, Greensboro, N C 27420
C&C COMPUTER SYSTEMS INC.
1006 S E Grand, Portland, Ore 97214
CALTEC INC.
1931 Sylvania Ave, Toledo, Ohio 43613
CENTRAL COMPUTING CORP.
180 N Mich Ave, Chicago, Ill 60601
CGA COMPUTER ASSOCIATES INC.
715 Park Ave, East Orange, N J 07017
COMPU-TIME INC.
327 Orange Ave, Daytona, Fla 32014
COMPUTER AGE INDUSTRIES INC.
8800 Arlington Blvd, Fairfax, Va 22030
COMPUTER PRODUCTS, INC.
P O Box 23849, Ft Lauderdale, Fla 33307
COMPUTER SCIENCES CORP. INFO. NETWORK DIV.
1901 Building, Los Angeles, Cal 90067
COMPUTER SYSTEMS CORP. U.S. INDUSTRIES INC
P O Box 64400, Dallas, Tex 75206
COMPUTER TECHNOLOGY INC. SUB. UNIV.
COMPUTING CO.
P O Box 47911, Dallas, Tex 75247
COMPUTER TUTOR, THE, DIV. COMPUTUT INC.
12 Emerald Court, Commack, N Y 11725
COMPUTER USAGE CORP.
100 Putman Green, Greenwich, Conn 06830
COMPUTER USAGE CORP.,
8939 S Sepulveda Blvd, Los Angeles, Cal 90045
CONDATA INC.
1809 Walnut St, Philadelphia, Pa 19103
CTC COMPUTER CORP.
1000 Elwell Court, Palo Alto, Cal 94303
DIGITAL EQUIPMENT CORP.
146 Main St, Maynard, Mass 01754
ELECTROMECH COMPUTING & TECH. SERVICES CO.
2964 Peachtree Rd NW, Atlanta, Ga 30305
FLORES ASSOCIATES
108 8th Ave, Brooklyn, N Y 11215
HAVERLY SYSTEMS INC.
4 2nd Ave, Denville, N J 07834

HONEYWELL INFORMATION SYSTEMS INC. INFO.
SERV.DIV.
2701 4th Ave S, Minneapolis, Minn 55408
ICM COMPUTER CORP.
P O Box 7220, Tulsa, Okla 74105
INFONET SYSTEMS INC.
358 McKinley Blvd, Paramus, N J 07652
INTERACTIVE SYSTEMS INC.
327 S Fourth Ave, Ann Arbor, Mich 48108
INTERNATIONAL COMPUTER CORP.
1 N Broadway, White Plains, N Y 10601
LEASCO DATA PROCESSING EQUIPMENT CORP.
280 Park Ave, New York, N Y 10017
LITTON SYSTEMS INC. MELLONICS DIV.
1001 W Maude Ave, Sunnyvale, Cal 94086
MANAGEMENTICS INC.
2 Pennsylvania Plaza, New York, N Y 10001
MICRO SYSTEMS INC.
644 E Young St, Santa Ana, Cal 92705
MNEMOTECH COMPUTER SYSTEMS
55 Liberty St, New York, N Y 10005
PANSOPHIC SYSTEMS INC.
230 Roosevelt Rd, Lombard, Ill 60148
PENNDATA CORP.
1729 Cedar Ave, Scranton, Pa 18505
PHILCO-FORD CORP., COMPUTER SERVICES NETWORK
Tioga & C Sts, Philadelphia, Pa 19134
PIONEER DATA SYSTEMS INC.
606 Merle Hay Tower, Des Moines, Iowa 50310
PROGRAMMING SCIENCES CORP.
S E 42 St, New York, N Y 10016
PROGRAMMING SCIENCES CORP.
1900 Ave of The Stars, Los Angeles, Cal 90067
PRYOR COMPUTER INDUSTRIES
400 N Michigan Ave, Chicago, Ill 60611
QUIKDATA INTERNATIONAL INC.
8444 Wilshire Blvd, Beverly Hills, Cal 90211
RIDGEWOOD ASSOCIATES INC.
10 Wilsey Sq, Ridgewood, N J 07450
SARNA ASSOCIATES INC.
22 Russell St, Brookline, Mass 02146
SCIENTIFIC SYSTEMS SERVICES INC.
476 N Hwy A1a, Satellite Beach, Fla 32935
SOFTWARE METHODS INC.
10 E 40th St, New York, N Y 10016
SORBUS
875 First Ave, King of Prussia, Pa 19406
SOUTHERN VERMONT COMPUTER CENTER&DATA
SCHOOL
219 Belmont Ave, Bennington, Vt 05201
SYSTEMS CONCEPTS INC.
17-45 Clintonville St, Whitestone, N Y 11357
SYSTEMS GENERAL CORP.
10889 Wilshire Blvd, Los Angeles, Cal 90024
UNITED COMPUTING SYSTEMS INC.
3130 Broadway, Kansas City, Mo 64111
WALSH ASSOC., RICHARD M.
310 Jefferson Ave, Scranton, Pa 18503

TRANSCIVERS, FACSIMILE

ADDRESSOGRAPH MULTIGRAPH CORP BRUNING DIV.
1200 Babbitt Rd, Cleveland, Ohio 44117
ALDEN ELECTRONIC & IMPULSE RECORDING EQUIP.
CO
Washington St, Westboro, Mass 01581
BENDIX MOSAIC FABRICATIONS DIV.
Galileo Park, Sturbridge, Mass 01518
DACOM INC.
1060 Morse Ave, Sunnyvale, Cal 94086
DATA DISC INC.
686 W Maude Ave, Sunnyvale, Cal 94086
DATAMAX CORP.
3941 Research Park Dr, Ann Arbor, Mich 48104
DECITRON COMMUNICATION SYSTEMS INC.
567 E 105 St, Brooklyn, N Y 11236
LENKURT ELECTRIC CO., INC. SUB. OF GT&E
1105 County Rd, San Carlos, Cal 94070
STEWART WARNER CORP./DATAFAX
1300 N Kostner Ave, Chicago, Ill 60651
TECHNICAL MATERIAL CORP.
700 Fenimore Rd, Mamaroneck, N Y 10543
TEL AUTOGRAPH CORP.
8700 Bellanca Ave, Los Angeles, Cal 90045

TRANSDUCERS, DIGITAL

BALDWIN ELECTRONICS INC.
1101 McAlmont St, Little Rock, Ark 72203
BENDIX CORP., THE, ENVRNMENTL SCI. DIV.
1400 Taylor Ave, Baltimore, Md 21204
BFA CORP.
1309 S Inca, Denver, Colo 80223

BOURNS INC.
1200 Columbia Ave., Riverside, Cal 92507
COMPUTER CONVERSIONS CORP.
6 Dunton Court, E Northport, N Y 11731
CONRAC CORP. INSTRUMENT/ CONTROLS DIV.
1600 S Mountain Ave, Duarte, Cal 91010
DATA TECHNOLOGY INC.
65 Grove St, Watertown, Mass 02172
DYNASCIENCES CORP. INSTRUMENT SYSTEMS DIV.
9601 Canoga Ave, Chatsworth, Cal 91311
ELECTRO PRODUCTS LABORATORIES INC.
6125 W Howard St, Chicago, Ill 60648
FARRAND CONTROLS INC.
99 Wall St, Valhalla, N Y 10595
GULTON INDUSTRIES INC.
212 Durham Ave, Metuchen, N J 08840
LEM INSTRUMENT CORP.
20 Sarah Dr, Farmingdale, N Y 11735
MB ELECTRONICS DIV. TEXTRON INC.
781 Whalley Ave, New Haven, Conn 06515
MEASUREMENT SYSTEMS INC.
523 West Ave, Norwalk, Conn 06850
METROLOGICAL DATA CORP.
70 Plauderville Ave, Garfield, N J 07026
RANK PRECISION INDUSTRIES INC.
260 N Rt 303, W Nyack, N Y 10994
SOLID STATE ELECTRONICS CORP.
15321 Rayen St, Sepulveda, Cal 91343
SRC DIV. MOXON INC.
2222 Michelson Dr, Newport Beach, Cal 92664
TELEDYNE GURLEY
514 Fulton St, Troy, N Y 12181
TEMPO INSTRUMENT DIV. ALLEN ELECTRIC&EQUIP.
CO.
9135 Independence Ave, Chatsworth, Cal 91311
THETA INSTRUMENT CORP.
24 Dwight Pl, Fairfield, N J 07006
TROTTELECTRONICS INC.
30 Ridgeland Rd, Rochester, N Y 14623

TRANSFORMERS, POWER (COMPUTER GRADE)

ABBOTT TRANSISTOR LABORATORIES INC.
5200 W Jefferson Blvd, Los Angeles, Cal 90016
ACDC ELECTRONICS INC.
Oceanside Ind Center, Oceanside, Cal 92054
ACME ELECTRIC CORP.
20 Water St, Cuba, N Y 14727
ADC PRODUCTS
4900 W 78th St, Minneapolis, Minn 55435
ARNOLD MAGNETICS CORP.
P O Box K, Culver City, Cal 90230
BASLER ELECTRIC CO.
Rte 143, Highland, Ill 62249
BOURNS INC.
1200 Columbia Ave., Riverside, Cal 92507
CLARE SYSTEMS DIV. C.P. CLARE & CO.
3101 W Pratt Ave, Chicago, Ill 60645
COLLINS RADIO CO.
19700 Jamboree Blvd, Newport Beach, Cal 92663
DEL ELECTRONIC CORP.
250 Sandford Blvd, Mt Vernon, N Y 10550
DORMEYER INDUSTRIES INC.
3418 N Milwaukee Ave, Chicago, Ill 60641
ELECTRONIC TRANSFORMER CORP.
460 Totowa Ave, Paterson, N J 07509
ELNETIC ELECTRONICS INC.
2100 Zeno Pl, Venice, Cal 90291
ESSEX WIRE & CABLE CO.
1601 Wall St, Ft Wayne, Ind 46804
GLENTRONICS INC.
748 E Alosta Ave, Glendora, Cal 91740
GULTON INDUSTRIES INC.
212 Durham Ave, Metuchen, N J 08840
HARVEY INDUSTRIAL DIV.
60 Crossway Pk W, Woodbury Li, N Y 11797
HI-G INC.
580 Spring St, Windsor Locks, Conn 06096
INTERNATIONAL CONTROLS CORP.
200 Fairfield Rd, Fairfield, N J 07006
JAMES ELECTRONICS INC.
4050 N Rockwell St, Chicago, Ill 60618
MAG-CON ENGINEERING CO.
85 Richardson St SE, St Paul, Minn 55112
MICROTRAN COMPANY INC.
145 E Mineola Ave, Valley Stream, N Y 11582
NESS PACIFIC INC.
470 N San Antonio Rd, Palo Alto, Cal 94306
NYTRONICS INC.
3rd Ave, Alpha, N J 08865
PEERLESS ELECTRICAL PRODUCTS DIV.
1515 S Manchester Ave, Anaheim, Cal 92803

2 Product Directory

POLYPHASE COMPONENTS DIV.

E 4th, Bridgeport, Penn 19405
RHO ENGINEERING CO.

2234 Colby Ave, Los Angeles, Cal 90064
SOLA BASIC INDUSTRIES SOLA ELECTRIC DIV.
1717 Busse Rd, Elk Grove Vilge, Ill 60007
TELEDYNE BROWN ENGINEERING
300 Sparkman Dr, Huntsville, Ala 35807
TRANSITRON ELECTRONIC CORP.
168 Albion St, Wakefield, Mass 01880
TRIAD DISTRIBUTOR DIV. LITTON INDUS.
305 N Briant St, Huntington, Ind 46750
TRUELINE INSTRUMENTS INC.
4002 S Clay, Englewood, Colo 80110
UNITED TRANSFORMER CO. DIV. OF TRW INC.
150 Varick St, New York, N Y 10013
VECTROL INC.

1010 Westmore Ave, Rockville, Md 20850
WANLASS ELECTRIC CO.
1815 S Ritohey St, Santa Ana, Cal 92705
WESTINGHOUSE ELECTRIC CORP.
Westinghouse Bldg, Pittsburgh, Pa 15222

TRANSFORMERS, PULSE (COMPUTER GRADE)

ACDC ELECTRONICS INC.

Oceanside Ind Center, Oceanside, Cal 92054
ALADDIN ELECTRONICS DIV. ALADDIN INDUS.
701 Murfreesboro Rd, Nashville, Tenn 37202
ARIES TECHNOLOGY DIV. UNIDEX INC.
3475 Victor St, Santa Clara, Cal 95050
ARTRONIC INSTRUMENT CORP.
11232 Triangle Ln, Silver Spring, Md 20902
BOURNS INC.

1200 Columbia Ave., Riverside, Cal 92507
COLLINS RADIO CO.

19700 Jamboree Blvd, Newport Beach, Cal 92663
COMPUTER CONVERSIONS CORP.
6 Dunton Court, E Northport, N Y 11731
DEL ELECTRONIC CORP.

250 Sandford Blvd, Mt Vernon, N Y 10550
ELECTRONIC TRANSFORMER CORP.

460 Totowa Ave, Paterson, N J 07509
ELNETIC ELECTRONICS INC.

2100 Zeno Pl, Venice, Cal 90291
INTERNATIONAL CONTROLS CORP.

200 Fairfield Rd, Fairfield, N J 07006
JAMES ELECTRONICS INC.

4050 N Rockwell St, Chicago, Ill 60618
MICROTRAN COMPANY INC.

145 E Mineola Ave, Valley Stream, N Y 11582
NESS PACIFIC INC.

470 N San Antonio Rd, Palo Alto, Cal 94306
NYTRONICS INC.

3rd Ave, Alpha, N J 08865

PLASTIC CAPACITORS INC.
2620 N Clybourn Ave, Chicago, Ill 60614

POLYPHASE COMPONENTS DIV.
E 4th, Bridgeport, Penn 19405

POWER DESIGNS INC.
1700 S Hames Dr, Westbury, N Y 11590

PULSE ENGINEERING INC.
P O Box 12235, San Diego, Cal 92112

RHO ENGINEERING CO.
2234 Colby Ave, Los Angeles, Cal 90064
SPRAGUE ELECTRIC CO.

551 Marshall St, N Adams, Mass 01247
TOKO N. Y. INC. SUB. OF TOKO INC. TOKYO
350 5th Ave, New York, N Y 10001
TOROIDAL COMPONENTS CO.

1374 E Walnut St, Pasadena, Cal 91106
TORTEL INC.

13402 S 71 Hwy, Grandview, Mo 64030
TRANSITRON ELECTRONIC CORP.

168 Albion St, Wakefield, Mass 01880
TRIAD DISTRIBUTOR DIV. LITTON INDUS.

305 N Briant St, Huntington, Ind 46750
TRUELINE INSTRUMENTS INC.

4002 S Clay, Englewood, Colo 80110
UNITED TRANSFORMER CO. DIV. OF TRW INC.

150 Varick St, New York, N Y 10013
VALOR ELECTRONICS INC.

3100 Pullman St, Costa Mesa, Cal 92627
VIDCOR CO. INC.

1251 W El Segundo Blv, Gardena, Cal 90247

TRANSISTORS, FIELD EFFECT

DIONICS INC.

65 Rushmore St, Westburn, N Y 11590
ELCOM ELECTRONICS INC.
200 Allen Blvd, Farmingdale, N Y 11735
FAIRCHILD SEMICONDUCTOR
464 Ellis St, Mt View, Cal 94040
HARVEY INDUSTRIAL DIV.
60 Crossway Pk W, Woodbury Li, N Y 11797
HUGHES AIRCRAFT CO. M O S DIV.
500 Superior Ave, Newport Beach, Cal 92660
INTERSIL INC.

10900 N Tantu, Cupertino, Cal 95014
JAMES ELECTRONICS INC.

4050 N Rockwell St, Chicago, Ill 60618
MOTOROLA SEMICONDUCTOR PRODUCTS INC.
5005 E Mc Dowell Rd, Phoenix, Ariz 85008
NATIONAL SEMICONDUCTOR CORP.

2900 Semicon Dr, Santa Clara, Cal 95051
NESS PACIFIC INC.
470 N San Antonio Rd, Palo Alto, Cal 94306
NUCLEONIC PRODUCTS CO. INC.

6660 Variel Ave, Canoga Park, Cal 91303
RCA CORP. SOLID STATE DIV.
Rte 202, Somerville, N J 08876

SILCONIX INC.
2201 Laurelwood Rd, Santa Clara, Cal 95054
SOLITRON DEVICES INC.

256 Oak Tree Rd, Tappan, N Y 10983
SOLITRON DEVICES INC. TRANSISTOR DIV.
1177 Blue Heron Blvd, Riviera Beach, Fla 33404
SPRAGUE ELECTRIC CO.
551 Marshall St, N Adams, Mass 01247

TELEDYNE CRYSTALONICS
147 Sherman St, Cambridge, Mass 02140

TRANSISTORS, GERMANIUM

AMPEREX ELECTRONIC CORP. A NO AMERICAN PHILIPS CO

P O Box 98, Slatersville, R I 02876
ELCOM ELECTRONICS INC.
200 Allen Blvd, Farmingdale, N Y 11735
HARVEY INDUSTRIAL DIV.

60 Crossway Pk W, Woodbury Li, N Y 11797
INTERNATIONAL DIODE CORP.

90 Forrest St, Jersey City, N J 07304
LANSDALE TRANSISTOR & ELECTRONICS, INC.
19 Jenkins Ave, Lansdale, Pa 19446

MOTOROLA SEMICONDUCTOR PRODUCTS INC.
5005 E Mc Dowell Rd, Phoenix, Ariz 85008
NESS PACIFIC INC.

470 N San Antonio Rd, Palo Alto, Cal 94306
NUCLEONIC PRODUCTS CO. INC.

6660 Variel Ave, Canoga Park, Cal 91303
POWER PHYSICS CORP.

P O Box 626 Indus Way, Eatontown, N J 07724
RCA CORP. SOLID STATE DIV.
Rte 202, Somerville, N J 08876

SOLITRON DEVICES INC.
256 Oak Tree Rd, Tappan, N Y 10983
SOLITRON DEVICES INC. TRANSISTOR DIV.

1177 Blue Heron Blvd, Riviera Beach, Fla 33404

TRANSISTORS, PHOTO

AMPEREX ELECTRONIC CORP. A NO AMERICAN PHILIPS CO

P O Box 98, Slatersville, R I 02876
CLAIREX CORP.
560 S 3rd Ave, Mount Vernon, N Y 10550
ELCOM ELECTRONICS INC.

200 Allen Blvd, Farmingdale, N Y 11735
ELECTRONIC MICRO SYSTEMS INC.
1672 Kaiser Ave, Santa Ana, Cal 92705
FAIRCHILD SEMICONDUCTOR
464 Ellis St, Mt View, Cal 94040

HEWLETT PACKARD CO.
1501 Page Mill Rd, Palo Alto, Cal 94304
MOTOROLA SEMICONDUCTOR PRODUCTS INC.

5005 E Mc Dowell Rd, Phoenix, Ariz 85008
NUCLEONIC PRODUCTS CO. INC.

6660 Variel Ave, Canoga Park, Cal 91303
RCA CORP. SOLID STATE DIV.
Rte 202, Somerville, N J 08876

SILCONIX INC.
2201 Laurelwood Rd, Santa Clara, Cal 95054
SKAN-A-MATIC CORP.
P O Drawer 68, Skaneateles, N Y 13152

SOLAR SYSTEMS INC.
8124 N Central Park, Skokie, Ill 60076

TELEDYNE CRYSTALONICS
147 Sherman St, Cambridge, Mass 02140

TRANSITRON ELECTRONIC CORP.

168 Albion St, Wakefield, Mass 01880

TRANSISTORS, SILICON

AMPEREX ELECTRONIC CORP. A NO AMERICAN PHILIPS CO

P O Box 98, Slatersville, R I 02876
ITT SEMICONDUCTORS
3301 Electronics Way, W Palm Beach, Fla 33407
CONTROL DATA CORP. CIRCUITS DIV.

7800 Computer Ave, Minneapolis, Minn 55435
DIONICS INC.

65 Rushmore St, Westburn, N Y 11590
ELCOM ELECTRONICS INC.

200 Allen Blvd, Farmingdale, N Y 11735
FAIRCHILD SEMICONDUCTOR
464 Ellis St, Mt View, Cal 94040

GENERAL SEMICONDUCTOR INDUSTRIES INC.
230 West 5th St, Tempe, Ariz 85281

HARVEY INDUSTRIAL DIV.
60 Crossway Pk W, Woodbury Li, N Y 11797

INTERNATIONAL DIODE CORP.
90 Forrest St, Jersey City, N J 07304

INTERSIL INC.
10900 N Tantu, Cupertino, Cal 95014

LANSDALE TRANSISTOR & ELECTRONICS, INC.
19 Jenkins Ave, Lansdale, Pa 19446

MOTOROLA SEMICONDUCTOR PRODUCTS INC.
5005 E Mc Dowell Rd, Phoenix, Ariz 85008

NATIONAL SEMICONDUCTOR CORP.
2900 Semicon Dr, Santa Clara, Cal 95051

NATIONAL SEMICONDUCTOR CORP. TRANSISTOR DIV.
Commerce Pk, Danbury, Conn 06810

NESS PACIFIC INC.
470 N San Antonio Rd, Palo Alto, Cal 94306

NUCLEONIC PRODUCTS CO. INC.
6660 Variel Ave, Canoga Park, Cal 91303

POWER PHYSICS CORP.
P O Box 626 Indus Way, Eatontown, N J 07724

PURDY CORP., WM. J.
770 Airport Blvd, Burlingame, Cal 94010

RCA CORP. SOLID STATE DIV.
Rte 202, Somerville, N J 08876

SILICON TRANSISTOR CORP.
E Gate Blvd, Garden City, N Y 11532

SOLITRON DEVICES INC.
256 Oak Tree Rd, Tappan, N Y 10983

SOLITRON DEVICES INC. TRANSISTOR DIV.
1177 Blue Heron Blvd, Riviera Beach, Fla 33404

TELEDYNE CRYSTALONICS
147 Sherman St, Cambridge, Mass 02140

TRANSITRON ELECTRONIC CORP.
168 Albion St, Wakefield, Mass 01880

TRW SEMICONDUCTOR DIV.
14520 Aviation Blvd, Lawndale, Cal 90260

UNITRODE CORP.
580 Pleasant St, Watertown, Mass 02170

WESTINGHOUSE ELECTRIC CORP.
Westinghouse Bldg, Pittsburgh, Pa 15222

TRANSMISSION TEST SGTS (SEE TESTERS)

TUBES, CATHODE RAY

GENERAL ATRONICS CORP. SUB. OF MAGNAVOC
Mermaid Lane, Philadelphia, Pa 19118

GENERAL ELECTRIC CO. TUBE DEPARTMENT
316 E 9th St, Owensboro, Ky 42301

INDUSTRIAL ELECTRONIC ENGINEERS INC.
7720-40 Lemona Ave, Van Nuys, Cal 91405

LITTON SYSTEMS INC. ELECTRON TUBE DIV.
960 Industrial Rd, San Carlos, Cal 94070

RAYTHEON CO. INDUSTRIAL COMPONENT
OPERATION
465 Centre St., Quincy, Mass 02169

RCA ELECTRONIC COMPONENTS DIV.
415 S 5th St, Harrison, N J 07029

SIGMATRON INC.
849 Ward Dr, Santa Barbara, Cal 93102

SYLVANIA ELECTRIC PRODUCTS ELECTRONIC TUBE
DIV.
Seneca Falls, N Y 13148

THOMAS ELECTRONICS INC.
100 Riverview Dr, Wayne, N J 07470

WESTINGHOUSE ELECTRIC CORP.
Westinghouse Bldg, Pittsburgh, Pa 15222

2 Product Directory

TYPEWRITERS, COMPUTER INPUT-OUTPUT

AMERICAN DATA SYSTEMS
8851 Mason Ave, Canoga Park, Cal 91306
ANDERSON JACOBSON INC.
1065 Morse Ave., Sunnyvale, Cal 94086
CLARE-PENDAR CO.
P O Box 785, Post Falls, Ind 83854
COMDATA CORP.
7544 W Oakton St, Niles, Ill 60648
COMPACE CORP.
7413 Washington Ave S, Edina-Minnepols, Minn 55435
COMPUTER DEVICES INC.
10 Sonar Dr, Woburn, Mass 01801
COMPUTER TERMINALS OF MINNESOTA INC.
4815 W 77th St, Minneapolis, Minn 55435
CONNECTICUT TECHNICAL CORP.
3000 Main St, Hartford, Conn 06120
DACONICS
925 Thompson Pl, Sunnyvale, Cal 94086
DATA ACCESS SYSTEMS INC.
503 Rte 10 Mt 19, Dover, N J 07801
DATA ACTION CORP.
4445 W 77th St, Minneapolis, Minn 55435
DATA PRODUCTS TELECOMMUNICATIONS
17 Amelia Place, Stamford, Conn 06902
DATACON INTERNATIONAL INC.
2745 Bernice Rd, Lansing, Ill 60438
DATANETICS CORP.
2828 Spreckel Ln, Redondo Beach, Cal 90278
DESIGN ELEMENTS INC.
356 Norton Ave, Columbus, Ohio 43212
DI/AN CONTROLS INC.
944 Dorchester Ave, Boston, Mass 02125
DIGI-LOG SYSTEMS INC.
107 W Ridge Pike, Conshohocken, Pa 19428
DIGITAL EQUIPMENT CORP.
146 Main St, Maynard, Mass 01754
DIGITAL SCIENTIFIC CORP.
11455 Sorrento Vly Rd, San Diego, Cal 92121
ELECTRONIC INFORMATION SYSTEMS INC.
2400 Industrial Lane, Broomfield, Conn 80020
FACIT-ODHNER INC.
501 Winsor Dr, Secaucus, N J 07094
FAIRCHILD GRAPHIC EQUIPMENT
221 Fairchild Ave, Plainview, N Y 11803
FRIDEN DIV. THE SINGER CO.
97 Humboldt St, Rochester, N Y 14602
FUJITSU LTD. N.Y.LIAISON OFFICE
680 Fifth Ave, New York, N Y 10019
GULTON INDUSTRIES INC. COMPUTER SYS. DIV.
13041 Cerise Ave, Hawthorne, Cal 90250
IBM CORP., DATA PROCESSING DIV.
1133 Westchester Ave, White Plains, N Y 10604
INFORMATION CONTROL SYSTEMS INC.
109 E Madison Ave, Ann Arbor, Mich 48104
ITEL INFORMAMTION PRODUCTS DIV
2585 Bayshore, Palo Alto, Cal 94303
ITT DATA EQUIPMENT & SYSTEMS DIV.
187 E Union Ave, E Rutherford, N J 07073
KLEINSCHMIDT DIV., SCM CORP.
Lake-Cook Rd, Deerfield, Ill 60015
MICRO SWITCH DIV. HONEYWELL INC.
11 W Spring St, Freeport, Ill 61032
MICRODYNE INC. SUB.BODINE ELEC.CO.
1600 S Micks Rd, Rolling Meadows, Ill 60008
OKI ELECTRIC INDUSTRIES CO. LTD.
875 Ave of Americas, New York, N Y 10001
PURDY CORP., WM. J.
770 Airport Blvd, Burlingame, Cal 94010
RCA COMPUTER SYSTEMS DIV.
200 Forest Ave, Marlboro, Mass 01752
ROYAL TYPEWRITER CO. DIV. LITTON INDUS.
150 New Park Ave, Hartford, Conn 06106
SEVAN COMPUTER SERVICES INC.
Pollitt Dr S, Fair Lawn, N J 07410
SHIRAK TELEMETERING OF AMERICA
8926 Kester Ave, Van Nuys, Cal 91402
SYNER-DATA, INC.
138 Brimbal Ave, Beverly, Mass 01915
TELETYPE CORP.
5555 W Touhy Ave, Skokie, Ill 60076
TERMINAL EQUIPMENT CORP.
750 Hamburg Tpk, Pompton Lakes, N J 07442
TEXAS INSTRUMENTS INC. DIGITAL SYSTEMS DIV
P O Box 66027, Houston, Tex 77006
UNICOMP INC.
18219 Parthenia, Northridge, Cal 91324
UNIVERSITY COMPUTING CO. DATEL DIV.
1 Tysons Corner Ctr, McLean, Va 22101
WANG LABORATORIES INC.
836 N St. Tewksbury, Mass 01876

USED EQUIPMENT (BUYING, SELLING, LEASING)

ALL DATA PROCESSING MACHINES
105 Hinricher St, Willow Springs, Ill 60480
AMERICAN COMPUTER LEASING CORP.
14 E 4th St, Cincinnati, Ohio 45202
AMERICAN COMPUTER SERVICES CORP.
14 E 4th St, Cincinnati, Ohio 45202
ANDERSON JACOBSON INC.
1065 Morse Ave., Sunnyvale, Cal 94086
BECKMAN INSTRUMENTS INC. ELECT. INSTR. DIV.
2200 Wright Ave, Richmond, Cal 94804
BUSINESS COMPUTERS INC.
10844 Shady Trail, Dallas, Tex 75220
BUSINESS SUPPLIES CORP. OF AMERICA
475 5th Ave, New York, N Y 10017
CHANDLER LEASING CORP.
101 Hartwell Ave, Lexington, Mass 02173
COMPUMATICS INC.
327 S Lasalle St, Chicago, Ill 60604
COMPUTE AMERICA CORP. DBA COMERICA
1515 Classen Blvd, Oklahoma City, Okla 73106
COMPUTER EXCHANGE INC., THE
30 E 42nd St, New York, N Y 10017
COMPUTER INVESTMENTS & LEASING CORP.
9 Tanner St, Haddonfield, N J 08033
COMPUTER MEASUREMENTS CO.
12970 Bradley Ave, San Fernando, Cal 91342
COMPUTER TABULATING CORP.
136 Main St, Hemstead, N Y 11550
CURRAN COMPUTER CORP.
946 Main St, Hackensack, N J 07601
CUSTOM DATA PROCESSING SERVICES
P O Box 14685, Phoenix, Ariz 85031
DA-PEX DATA PROCESSING EQUIPMENT EXCHANGE
334 Lincoln Fed Bldg, Louisville, Ky 40202
DASA CORP./CYBER-TRONICS SUB. DASA CORP.
15 Stevens St., Andover, Mass 01810
DATA ACCESS SYSTEMS INC.
503 Rte 10 Mt 19, Dover, N J 07801
DATA AUTOMATION COMMUNICATIONS INC.
7505 Carpenter Fwy, Dallas, Tex 75247
DATA CONTROL CO.
405 E Easterday Ave, Sault Ste Marie, Mich 49783
DATA FUNDING INC.
Station Square 2, Paoli, Pa 19301
DATA PROCESSING AND ACCOUNTING SERVICES
50 Van Ness Ave, San Francisco, Cal 94102
DATA PROCESSING FINANCIAL & GENERAL CORP.
141 Central Park Ave, Hartsdale, N Y 10530
DATASERV DIV., WILLIAM J. PURDY CORP.
770 Airport Blvd, Burlingame, Cal 94010
DUPONT DE NEMOURS, & CO., E.I. CO., INC.
1007 Market St, Wilmington, Del 19898
DYNAMIC ACCESS CORP.
220 Park Ave S, New York, N Y 10003
ELECTRONIC DATA PREPARATION CORP.
P O Box 1446, Bradenton, Fla 33505
EMR COMPUTER
8001 Bloomington Fwy, Minneapolis, Minn 55420
GMA COMPUTER CORP.
320 Yonker Ave, Yonkers, N Y 10701
GTE DATA SERVICES INC.
5422 Bay Center Dr, Tampa, Fla 33609
INFORMATION PROCESSING SYSTEMS INC.
467 Sylvan Ave, Englewood Cliff, N J 07632
LEASCO DATA PROCESSING EQUIPMENT CORP.
280 Park Ave, New York, N Y 10017
MAI EQUIPMENT CORP.
300 E 44th St, New York, N Y 10017
MCLAUGHLIN ASSOC. INC. GEORGE
785 Springfield Ave, Summit, N J 07901
MICHIANA LEASING CORP.
1814 S Main St, S Bend, Ind 46613
O. K. DATA SERVICES
P O Box 3001, Darien, Conn 06820
ORIGINAL COMPUTER PRODUCTS INC.
204 Worcester St, Wellesley Hills, Mass 02181
PENNDATA CORP.
1729 Cedar Ave, Scranton, Pa 18505
REN ELECTRONICS
775 New Ludlow Rd, So Hadley, Mass 01075
SCIENTIFIC LEASING INC.
77 Meadowgate, Wethersfield, Conn 06109
SHIRAK TELEMETERING OF AMERICA
8926 Kester Ave, Van Nuys, Cal 91402
STANDARD PROCESSING CO. INC.
P O Box 703, Pharr, Tex 78577
SUMMIT COMPUTER CORP.
785 Springfield Ave, Summit, N J 07901
SYNCOM INC. SHIELDATA DIV.
1914 Colvin Ave, Tonawanda, N Y 14150
TIME BROKERS INC.
380 Lexington Ave, New York, N Y 10017

TRANSITRON ELECTRONIC CORP.
168 Albion St, Wakefield, Mass 01880
UNIVERSITY COMPUTING CO.
P O Box 6228, Dallas, Tex 75222
WESPAC
2445 Chico Ave, So El Monte, Cal 91733
WORLD COMPUTER CORP.
1615 Stemmons Fwy, Dallas, Tex 75221
WORLDWIDE COMPUTER SERVICES, INC.
280 N Central Pk Ave, Hartsdale, N Y 10530
XEROX DATA SYSTEMS
701 S Aviation, El Segundo, Cal 90245

VERIFIERS, PAPER TAPE

ADDO-X INC. ADP DIV.
437 Madison Ave, New York, N Y 10022

VERIFIERS, PUNCHED CARD

ABINGTON KEYPUNCH INC.
920 Fox Chase Rd, Rockledge, Pa 19111
BRYANT DATA SERVICE INC.
319 Lynnway, Lynn, Mass 01901
CUSTOM DATA PROCESSING SERVICES
P O Box 14685, Phoenix, Ariz 85031
DATA PROCESSING AND ACCOUNTING SERVICES
50 Van Ness Ave, San Francisco, Cal 94102
DECISION DATA CORP.
300 Jacksonville Rd, Warminster, Penn 18974
DYNAMIC ACCESS CORP.
220 Park Ave S, New York, N Y 10003
IOA DATA CORP.
383 Lafayette St, New York, N Y 10003
KEY PUNCH SERVICE CO.
4 Smithfield St, Pittsburgh, Pa 15222
MAI EQUIPMENT CORP.
300 E 44th St, New York, N Y 10017
OKI ELECTRIC INDUSTRIES CO. LTD.
875 Ave of Americas, New York, N Y 10001
REN ELECTRONICS
775 New Ludlow Rd, So Hadley, Mass 01075
TAB PRODUCTS
2690 Hanover St, Palo Alto, Cal 94304

VOICE RESPONSE SYSTEMS (SEE DATA TERMINALS)

VOLTAGE DIVIDERS

AMP INC. CAPITRON DIV.
1595 S Mount Joy St, Elizabethtown, Pa 17022
AUL INSTRUMENT INC.
139-30 34th Rd, Flushing, N Y 11354
CARTER MANUFACTURING CORP.
8 Washington St, Hudson, Mass 01749
CHRONETICS INC.
500 Nuber Ave, Mount Vernon, N Y 10550
DEL ELECTRONIC CORP.
250 Sandford Blvd, Mt Vernon, N Y 10550
DIGITRAN CO., THE BECTON, DICKINSON & CO
855 S Arroyo Pkwy, Pasadena, Cal 91105
DYNAGE INC.
1331 Blue Hills Ave, Bloomfield, Conn 06002
FAIRCHILD CAMERA & INST. CO. FAIRCHILD CONT. DIV
225 Park Ave, Hicksville, N Y 11802
INSTRULAB INC.
1205 Lamar St, Dayton, Ohio 45404
JULIE RESEARCH LABORATORIES INC.
211 West 161 St, New York, N Y 10023
MICRO METRICS INC.
253 Crooks Ave, Clifton, N J 07011
MICROTEK DIV. OF SPACETAC
Rte 62 Burlington Rd, Bedford, Mass 01730
NORTH ELECTRIC CO. ELECTRONETICS DIV.
Galion, Ohio 44833
OHMITE MANUFACTURING CO.
3601 Howard St, Skokie, Ill 60076
POWER DESIGNS INC.
1700 S Hames Dr, Westbury, N Y 11590
SPACETAC INC.
Burlington Rd, Bedford, Mass 01730
TECH LABORATORIES INC.
Bergen & Edsall Blvd, Palisades Park, N J 07650
VARO INC. STATIC POWER DIV.
1600 Dallas Pkwy, Plano, Tex 75074

2 Product Directory

VOLTMETERS, AC, DC, DIFFERENTIAL

AMMON INSTRUMENTS, INC.
345 Kelley St, Manchester, N H 03105
B&K INSTRUMENTS INC.
5111 W 164th St, Cleveland, Ohio 44142
BEENE ELECTRICAL INSTRUMENT CO. INC.
P O Box 100, Penacook, N H 03301
DATA TECHNOLOGY CORP.
1050 E Meadow Cir, Palo Alto, Cal 94303
DYTRONICS CO. INC.
4800 Evanswood Dr, Columbus, Ohio 43229
ELECTRONIC DEVELOPMENT CORP.
11 Hamlin St, Boston, Mass 02127
ESTERLINE ANGUS DIV., ESTERLINE CORP.
Po Box 24000, Indianapolis, Ind 46224
FLUKE, JOHN MFG. CO. INC.
P O Box 7428, Seattle, Wash 98133
GARRETT ELECTRONICS & CABLE CO.
24 Central Dr, Farmingdale, N Y 11735
GENERAL RADIO CO.
300 Baker Ave, Concord, Mass 01742
HEWLETT PACKARD CO.
1501 Page Mill Rd, Palo Alto, Cal 94304
HEXEM INC.
1015 Corporation Way, Palo Alto, Cal 94303
HICKOK ELECTRICAL INSTRUMENT CO.
10514 Dupont Ave, Cleveland, Ohio 44108
HOLT INSTRUMENT LABS.
Po Box 230, Oconto, Wis 54153
HONEYWELL INC. TEST INSTRUMENTS DIV.
P O Box 5227, Denver, Colo 80217
JEWELL ELECTRICAL INSTRUMENTS INC.
Grenier Field, Manchester, N H 03105
JULIE RESEARCH LABORATORIES INC.
211 West 161 St, New York, N Y 10023
MICRO INSTRUMENT CO.
12901 Crenshaw Blvd, Hawthorne, Cal 90250
MULTITECH DATA PRODUCTS
583 Monterey Pass Rd, Monterey Park, Cal 91754
NORTH ATLANTIC INDUSTRIES INC.
200 Terminal Dr, Plainview, N Y 11803
PACIFIC MEASUREMENTS INC.
940 Industrial Ave, Palo Alto, Cal 94303
RCA ELECTRONIC COMPONENTS DIV.
415 S 5th St, Harrison, N J 07029
RENTAL ELECTRONICS INC. SUB. PEPSI CO.
16600 Oakmont Ave, Gaithersburg, Md 20760
SIMPSON ELECTRIC CO.
5200 W Kinzie St, Chicago, Ill 60644
SOLITRON DEVICES INC.
256 Oak Tree Rd, Tappan, N Y 10983
SOLITRON DEVICES INC. TRANSISTOR DIV.
1177 Blue Heron Blvd, Riviera Beach, Fla 33404
SYSTEMATION INC.
Clifton Park, Elnora, N Y 12065
TELEDYNE PHILBRICK NEXUS
Allied Dr At Rte 128, Dedham, Mass 02026
TRIPLETT CORP.
286 Harmon Rd, Bluffton, Ohio 45817
TROTTE ELECTRONICS INC.
30 Ridgeland Rd, Rochester, N Y 14623

VOLTMETERS, DIGITAL

ALCO ELECTRONIC PRODUCTS INC.
8 Marblehead St, North Andover, Mass 01845
AMP INC. CAPITRON DIV.
1595 S Mount Joy St, Elizabethtown, Pa 17022
BECKMAN INSTRUMENTS INC. ELECT. INSTR. DIV.
2200 Wright Ave, Richmond, Cal 94804
BEENE ELECTRICAL INSTRUMENT CO. INC.
P O Box 100, Penacook, N H 03301
BFA CORP.
1309 S Inca, Denver, Colo 80223
CALIFORNIA INSTRUMENTS CO.
5150 Conroy St, San Diego, Cal 92111
CONSOLIDATED CONTROLS CORP.
15 Durant Ave, Bethel, Conn 06801
DATA TECHNOLOGY CORP.
1050 E Meadow Cir, Palo Alto, Cal 94303
DENELCOR INC.
5975 Broadway, Denver, Colo 80216
DIGILIN, INC.
1007 Air Way, Glendale, Cal 91201
ELECTRONIC RESEARCH CO., A TETRAN CO.
10000 W 75th St, Shawnee Mission, Kan 66202
EPIC INC.
150 Nassau St, New York, N Y 10038
ESTERLINE ANGUS DIV., ESTERLINE CORP.
Po Box 24000, Indianapolis, Ind 46224
FLUKE, JOHN MFG. CO. INC.
P O Box 7428, Seattle, Wash 98133

GRALEX INDUSTRIES DIV. GENL.MICROWAVE CORP
155 Marine St, Farmingdale, N Y 11735
HEWLETT PACKARD CO.
1501 Page Mill Rd, Palo Alto, Cal 94304
HICKOK ELECTRICAL INSTRUMENT CO.
10514 Dupont Ave, Cleveland, Ohio 44108
HONEYWELL INC. TEST INSTRUMENTS DIV.
P O Box 5227, Denver, Colo 80217
INSTRUMENT DISPLAYS INC. SUB. KELTRON CORP.
223 Crescent St, Waltham, Mass 02154
J-OMEGA CO.
2271 Mora Dr, Mt View, Cal 94040
LEAR SIEGLER INC. CIMRON DIV.
1152 Morena Blvd, San Diego, Cal 92110
MICRO INSTRUMENT CO.
12901 Crenshaw Blvd, Hawthorne, Cal 90250
MILLETRON INC.
540 Alpha Dr, Pittsburgh, Pa 15238
MINONICS INC.
2993 Los Feliz Dr, Thousand Oaks, Cal 91360
MONITOR LABS INC.
10451 Roselle, San Diego, Cal 92121
MONSANTO CO. ELECTRONIC PDTS. & CONTROLS DIV.
11636 Administration, St Louis, Mo 63141
NON-LINEAR SYSTEMS INC.
P O Box N, Del Mar, Cal 92014
PACIFIC MEASUREMENTS INC.
940 Industrial Ave, Palo Alto, Cal 94303
PRACTICAL AUTOMATION
P O Box 313, Shelton, Conn 06484
PRESTON SCIENTIFIC INC.
805 E Cerritos Ave, Anaheim, Cal 92805
RENTAL ELECTRONICS INC. SUB. PEPSI CO.
16600 Oakmont Ave, Gaithersburg, Md 20760
RFL INDUSTRIES INC. COMMUNICATION DIV.
Powerville Rd, Boonton, N J 07005
ROHDE & SCHWARZ SALES CO. USA INC.
111 Lexington Ave, Passaic, N J 07055
SIMPSON ELECTRIC CO.
5200 W Kinzie St, Chicago, Ill 60644
SOLITRON DEVICES INC. TRANSISTOR DIV.
1177 Blue Heron Blvd, Riviera Beach, Fla 33404
SYSTRON-DONNER CORP.
888 Galindo St, Concord, Cal 94520
TRIPLETT CORP.
286 Harmon Rd, Bluffton, Ohio 45817
TROTTE ELECTRONICS INC.
30 Ridgeland Rd, Rochester, N Y 14623
TRYGON ELECTRONICS
111 Pleasant Ave, Roosevelt, N Y 11575
TUSTIN ELECTRONICS CO.
17942 E Main St, Tustin, Cal 92680
TYCO INSTRUMENT DIV. TYCO LABS. INC
., Waltham, Mass 02154
TYCO LABORATORIES INC.
16 Hickory Dr, Waltham, Mass 02154
UNITED SYSTEMS CORP.
918 Woodley Rd, Dayton, Ohio 45403
VIDAR CORP.
77 Ortega Ave, Mountain View, Cal 94040

VOLTMETERS, PRINTING

DYTRO CORP.
63 Tec St, Hicksville, N Y 11801
HICKOK ELECTRICAL INSTRUMENT CO.
10514 Dupont Ave, Cleveland, Ohio 44108
MICRO INSTRUMENT CO.
12901 Crenshaw Blvd, Hawthorne, Cal 90250
NON-LINEAR SYSTEMS INC.
P O Box N, Del Mar, Cal 92014
PRACTICAL AUTOMATION
P O Box 313, Shelton, Conn 06484
RENTAL ELECTRONICS INC. SUB. PEPSI CO.
16600 Oakmont Ave, Gaithersburg, Md 20760
REO DATA PRODUCTS INC.
7346 Bolsa Ave, Westminster, Cal 92683
TOWNER SYSTEMS CO.
1829 Clement Ave, Alameda, Cal 94501
VIDAR CORP.
77 Ortega Ave, Mountain View, Cal 94040

WAVE ANALYZERS (SEE ANALYZERS)

WINDERS, MAGNETIC TAPE

AURICORD DIV., SCOVILL MFG. CO.
35-41 29 St, Long Isl City, N Y 11106
COMPUTER ACCESSORIES CO.
131 W 154th St, Gardena, Cal 90248
COMPUTER-LINK CORP.
14 Cambridge St, Burlington, Mass 01803
CTM LEASING CORP.
4924 Hampden Lane, Bethesda, Md 20014
DATA DEVICES INC. SUB. DATA PROD.CORP
18360 Topham St, Tarzana, Cal 91356
FORET, P. G.
60 Union Ave, Sudbury, Mass 01776
GENERAL KINETICS INC.
11425 Isaac Newt Sq S, Reston, Va 22070
HEWLETT PACKARD CO. MOUNTAIN VIEW DIV.
690 Middlefield Rd, Mtn View, Cal 94040
INCRE-DATA CORP.
6401 Acoma Rd SE, Albuquerque, N M 87108
INDEL INC.
P O Box 15800, Tulsa, Okla 74115
INDUSTRIAL WINDING MACHINERY CORP.
P O Box 45, River Edge, N J 07661
INSO ELECTRONIC PRODUCTS INC.
77 E Hawthorne Ave, Valley Stream, N Y 11580
KYBE CORP.
132 Calvary St, Waltham, Mass 02154
3M CO.
3m Center, St Paul, Minn 55101
NEWMADE PRODUCTS CORP.
P O Box 568, Scarsdale, N Y 10583
OCHMAN SYSTEMS, EDWARD
Po Box 141, Fairfield, Conn 06430
RECORTEC INC.
162 S Whisman, Mt View, Cal 94040
TELECTRO SYSTEMS CORP.
96-18 43rd Ave, Corona, N Y 11368
VIRGINIA PANEL CORP.
1400 N Hope Rd, Waynesboro, Va 22980

WINDERS, PAPER TAPE

ADDO-X INC. ADP DIV.
437 Madison Ave, New York, N Y 10022
ADDO-X INC. OEM DIV.
437 Madison Ave, New York, N Y 10022
ANDERSON JACOBSON INC.
1065 Morse Ave., Sunnysvale, Cal 94086
ARNDT ASSOCIATES
727 Howard St, Evanston, Ill 60202
CHALCO ENGINEERING CORP.
15126 S Broadway, Gardena, Cal 90248
COMPUTER ACCESSORIES CORP.
211 New York Ave, Huntington, N Y 11743
CYCLE EQUIPMENT CO.
P O Box 307, Los Gatos, Cal 95030
DATA-LINK CORP.
P O Box 2792, San Diego, Cal 92112
DATATERM INC.
1671 Manning Blvd, Levittown, Pa 19057
DELMARVA COMPUTER INDUSTRIES INC.
5865 Robert Oliver Pl, Columbia, Md 21043
DRESSER PRODUCTS INC.
P O Box 2035, Providence, R I 02905
ENDLESS TAPE REEL CO.
81 Haven St, Reading, Mass 01867
FRIDEN DIV. THE SINGER CO.
97 Humboldt St, Rochester, N Y 14602
HONEYWELL INFORMATION SYSTEMS
P O Box 12313, Oklahoma City, Okla 73112
ICA CORP.
200 N 3rd St, Minneapolis, Minn 55401
INSO ELECTRONIC PRODUCTS INC.
77 E Hawthorne Ave, Valley Stream, N Y 11580
INTERNATIONAL COMPUTER APPLIANCES CORP.
200 N Third St, Minneapolis, Minn 55401
ITEL INFORMATION PRODUCTS DIV
2585 Bayshore, Palo Alto, Cal 94303
JOHNSON ASSOCIATES INC.
108 Lyster Rd, Oreland, Pa 19075
NEWMADE PRODUCTS CORP.
P O Box 568, Scarsdale, N Y 10583
NUMERIDEX TAPE SYSTEMS INC.
4711 W North Ave, Chicago, Ill 60639
PAPER MANUFACTURERS CO.
9800 Bustleton Ave, Philadelphia, Pa 19115
PRESTOSEAL MANUFACTURING CO.
37-12 108 St, Corona, N Y 11368
ROBIN INDUSTRIES CORP. DATA PRODUCTS DIV.
15-58 127 St, Flushing, N Y 11356
SHIRAK TELEMETERING OF AMERICA
8926 Kester Ave, Van Nuys, Cal 91402
TALLY CORP.
8301 S 180th St, Kent, Wash 98031

PART 3
Manufacturers'
Directory

3 Manufacturers' Directory

A.B. DICK CO.
5700 W Touhy, Chicago, Ill 60648

312-763-1900

AUDIO/VISUAL TRAINING AIDS
DATA TERMINALS, BLOCK-BY-BLOCK (HIGH SPEED PRINTER)
DATA TERMINALS, BLOCK-BY-BLOCK (MEDIUM SPEED PRINTER)
ENCODERS, KEYBOARD (ALPHANUMERIC)
ENCODERS, KEYBOARD-TO-GRAPHIC DISPLAY
PRINTERS, LINE (LOW & MEDIUM SPEED)
PRINTERS, LINE (HIGH SPEED)
PRINTERS, MICROFILM/MICROFICHE
PRINTERS, NON-IMPACT, SPECIAL PURPOSE
PROGRAMMING LANGUAGE DEVELOPMENT (DEDICATED APPLICATION SYSTEMS)
RECORDERS, GRAPHIC
RECORDERS, HARD-COPY (WITH CRT),

A.C. MANUFACTURING CO.
Old Cuthbert & Deer, Cherry Hill, N J 08034
AIR CONDITIONERS (FOR EDP INSTALLATIONS)

609-428-9800
TWX 710-896-0998

A.D. CIRCUITS INC.
Panorama Creek Dr, Rochester, N Y 14625

716-381-2370

BOARDS, PRINTED CIRCUIT (WITHOUT COMPONENTS)
BREARDBOARDS
CABLE ASSEMBLIES (WITH CONNECTORS)

A.D. DATA SYSTEMS INC.
830 Linden Ave, Rochester, N Y 14625

716-381-2370

BOARDS, PRINTED CIRCUIT (WITHOUT COMPONENTS)
COMMUTATORS, SWITCHING (ELECTRIC)
CONVERTERS, ANALOG-TO-DIGITAL
DATA TERMINALS, BLOCK-BY-BLOCK (TELEPRINTER)
FORMATTERS, MAGNETIC TAPE
MULTIPLEXER-CONVERTER (SINGLE UNIT WITH MULTIPLEXER, SAMPLE & HOLD
AMPLIFIER & A-TO-D CONVERTER)
MULTIPLEXERS, ANALOG-RELAY (SEQUENTIAL SAMPLING)
MULTIPLEXERS, ANALOG-SOLID STATE (SEQUENTIAL SAMPLING)
MULTIPLEXERS, DIGITAL
RECORDERS, DIGITAL CASSETTE
SCANNERS, INPUT

A. W. HAYDON CO., THE
232 N Elm St, Waterbury, Conn 06720

203-756-4481
TWX 710-477-3141

CLOCKS, DIGITAL (REAL-TIME)
COUNTERS, DIGITAL READOUT
GENERATORS, TIME CODE
INDICATORS, DIGITAL
INDICATORS, ELAPSED TIME
INVERTERS, DC-AC
MOTORS, STEPPING
MOTORS, SYNCHRONOUS
RELAYS, SOLID-STATE (COMPUTER GRADE)
SWITCHES, THUMBWHEEL
TIMERS, EVENT (IMPULSE)
TIMERS, INTERVAL

AAI CORP.
P O Box 6767, Baltimore, Md 21204

301-666-1400
TWX 710-232-1800

TESTERS, CIRCUIT
TESTERS, DIGITAL LOGIC MODULES AND CARDS
TESTERS, INTEGRATED CIRCUIT
TESTERS, SEMICONDUCTOR

ABBOTT TRANSISTOR LABORATORIES INC.
5200 W Jefferson Blvd, Los Angeles, Cal 90016

213-936-8185

POWER SUPPLIES, AC
POWER SUPPLIES, DC
REGULATORS, VOLTAGE
TRANSFORMERS, POWER (COMPUTER GRADE)

ABINGTON KEYPUNCH INC.
920 Fox Chase Rd, Rockledge, Pa 19111

215-379-3991

CARDS, CONVENTIONAL PUNCH
HOLDERS, PUNCHED CARD
PRINTERS, KEYBOARD
PRINTERS, LINE (LOW & MEDIUM SPEED)
PROGRAMMING LANGUAGE DEVELOPMENT (CONTRACT PROGRAMMING)
PUNCHES, CARD (UP TO 100 CPM)
REPRODUCERS, PUNCHED CARD (AUTOMATIC)
SERVICES, PROCESSING (COMMERCIAL EDP)
SERVICES, PROCESSING (DIGITAL SCIENTIFIC)
CONTINUED

SORTERS, PUNCHED CARD
VERIFIERS, PUNCHED CARD

ABRAMS INSTRUMENT CORP. J A MAURER INC.
606 E Shiawassee St, Lansing, Mich 48901
COUNTERS, DIGITAL READOUT
MOTORS, STEPPING

517-484-9441
TWX 810-251-0785

ABT ASSOCIATES INC. TECHNOLOGY GROUP
55 Wheeler St, Cambridge, Mass 02138

617-492-7100
TWX 710-320-6367

BOARDS, VISUAL CONTROL (GRAPHIC)
CONSULTING (SCIENTIFIC APPLICATIONS)
INSTRUCTIONAL SYSTEMS, COMPUTER-BASED
PROGRAMMING LANGUAGE DEVELOPMENT (CONSULTANTS)
PROGRAMMING LANGUAGE DEVELOPMENT (CONTRACT PROGRAMMING)
PROGRAMMING LANGUAGE DEVELOPMENT (DEDICATED APPLICATION SYSTEMS)

ACADEMY OF COMPUTER TECHNOLOGY, THE
1940 Hi-Line Dr, Dallas, Tex 75207

214-741-5551

TRAINING INSTITUTES, COMMERCIAL COMPUTER COURSES, SEMINARS,
CORRESPONDENCE COURSES

ACADEMY COMPUTING CORP.
5005 N Lincoln Blvd, Oklahoma City, Okla 73105

405-528-2861

CONSULTING (ACCOUNTING, BUSINESS AND COMMERCIAL APPLICATIONS)
CONSULTING (ADVANCED COMPUTER EQUIPMENT DESIGN AND FEASIBILITY
STUDIES)
CONSULTING (COMPUTER EVALUATIONS, SELECTIONS, INSTALLATION
PLANNING)
CONSULTING (DATA COMMUNICATIONS SYSTEMS PLANNING)
CONSULTING (COMPUTER PRODUCT PLANNING SURVEYS, MARKET RESEARCH
STUDIES)
CONSULTING (MANAGEMENT INFORMATION SYSTEMS PLANNING)
CONSULTING (SCIENTIFIC APPLICATIONS)
PROGRAMMING LANGUAGE DEVELOPMENT (CONSULTANTS)
PROGRAMMING LANGUAGE DEVELOPMENT (CONTRACT PROGRAMMING)
PROGRAMMING LANGUAGE DEVELOPMENT (DEDICATED APPLICATION SYSTEMS)
PROGRAMMING LANGUAGE DEVELOPMENT (PROPRIETARY SOFTWARE
PRODUCTS)
SERVICES, COMPUTER-AIDED DESIGN
SERVICES, FACILITY MANAGEMENT
SERVICES, MANAGEMENT INFORMATION SYSTEMS
SERVICES, PROCESSING (COMMERCIAL EDP)
SERVICES, PROCESSING (DIGITAL SCIENTIFIC)
SERVICES, TIME SHARING (COMMERCIAL)
SERVICES, SYSTEMS ANALYSIS

ACCURATE BUSINESS FORMS CO., INC.
P O Box 8339, Milwaukee, Wis 53225

414-781-2310

ENVELOPES, CONTINUOUS
FORMS, CONTINUOUS (MACHINE PROCESSED)
LABELS, CONTINUOUS AND GUMMED (MACHINE APPLICATION)
LABELS, CONTINUOUS AND PRESSURE SENSITIVE (MACHINE APPLICATION)
PAPER (FOR MICR EQUIPMENT)
PAPER (FOR OCR EQUIPMENT)
PAPER (FOR PRINTERS)
PAPER (FOR RECORDERS AND PLOTTERS)
PAYMENT COUPON BOOKS, MACHINE READABLE
TAGS (FOR EDP PROCESSING)
TAPE, PUNCH (PAPER)

ACCURIDE DIV. SUB. STANDARD PRECISION INC.
12311 S Shoemaker, Santa Fe Spgs, Cal 90670

213-944-6236

CHASSIS, SLIDES, RACKS
GUIDES, CIRCUIT CARDS

ACDC ELECTRONICS INC.
Oceanside Ind Center, Oceanside, Cal 92054

714-757-1880
TWX 910-322-1470

POWER SUPPLIES, DC
TRANSFORMERS, POWER (COMPUTER GRADE)
TRANSFORMERS, PULSE (COMPUTER GRADE)

ACE-SYCAMORE INC.
448 Dekalb Ave, Sycamore, Ill 60178

815-895-4573

BLOWERS, FANS, COOLING ASSEMBLIES

3 Manufacturers' Directory

ACME DATAGRAPHIC BUSINESS SYSTEMS INC.
45 E Wesley St, S Hackensack, N J 07606

201-489-6500

FORMS, CONTINUOUS (MACHINE PROCESSED)
PAPER (FOR MICR EQUIPMENT)
PAPER (FOR OCR EQUIPMENT)
PAPER (FOR PRINTERS)

ACME ELECTRIC CORP.
20 Water St, Cuba, N Y 14727

716-968-2400
TWX 510-245-2700

POWER SUPPLIES, AC
POWER SUPPLIES, DC
TRANSFORMERS, POWER (COMPUTER GRADE)

ACME VISIBLE RECORDS INC.
510 Allview Dr, Crozet, Va 22932

703-823-4351
TWX 510-587-5451

BOARDS, VISUAL CONTROL (GRAPHIC)
CARDS, EDGE-PUNCH
CARDS, MAGNETIC
CLEANER/CERTIFIERS, MAGNETIC TAPE
CONSULTING (ACCOUNTING, BUSINESS AND COMMERCIAL APPLICATIONS)
CONTAINERS, PAPER TAPE STORAGE
DOCUMENTS, DCR/OMR
ENVELOPES (FOR FILING TAPES)
FILES, PUNCHED CARD
INPUT-OUTPUT CONVEYORS, PUNCHED CARD
LABELS, CONTINUOUS AND GUMMED (MACHINE APPLICATION)
MAILERS, PUNCHED CARD
PAPER (FOR OCR EQUIPMENT)

ACRATOD COMPANY

713-524-3111

Po Box 66847, Houston, Tex 77006

CABINETS, RACKS, VAULTS (FOR MAGNETIC TAPE STORAGE)
CABINETS, TRAYS (FOR PUNCHED CARD STORAGE)
CANNISTERS, MAGNETIC TAPE
CERTIFIERS, MAGNETIC TAPE
CLEANER/CERTIFIERS, MAGNETIC TAPE
CLEANERS, MAGNETIC TAPE
CLEANERS, MAGNETIC TAPE HEADS
CONTAINERS, DISK PACK STORAGE
CONTAINERS, PAPER TAPE STORAGE
CORRECTION SEALS, MICR DOCUMENTS
CORRECTION SEALS, PUNCH CARD
CORRECTION SEALS, PAPER TAPE
FORMS HANDLING, BURSTERS
FORMS HANDLING, CARBON DELEAVERS
FORMS HANDLING, DECOLLATORS
LABELS, CONTINUOUS AND GUMMED (MACHINE APPLICATION)
REELS, MAGNETIC TAPE
REELS, PAPER TAPE
RIBBONS, INK (FOR PRINTERS AND TAB EQUIPMENT)
SAFEES, MAGNETIC TAPE STORAGE
TAPE, MAGNETIC (REELS)
TAPE, PUNCH (MYLAR)
TAPE, PUNCH (MYLAR-COATED FOIL)
TAPE, PUNCH (PAPER)
TAPE, PUNCH (PAPER-COATED MYLAR)
TAPE, PUNCH (PAPER-COATED ALUMINUM)

ACRON CORP.

1209 River Ave, Lakewood, N J 08701

201-364-7200

TESTERS, CIRCUIT
TESTERS, DIGITAL LOGIC MODULES AND CARDS
TESTERS, INTEGRATED CIRCUIT

ADAGE INC.

1079 Commonwealth Ave, Boston, Mass 02109

617-783-1100

AMPLIFIERS, OPERATIONAL
COMPUTERS, DIGITAL (GENERAL-PURPOSE, MEDIUM-SCALE)
COMPUTERS, HYBRID
CONSOLES, CRT (ALPHANUMERIC AND GRAPHIC)
CONSOLES, CRT (COLOR-ALPHANUMERIC AND GRAPHIC)
CONSOLES, CRT (GRAPHIC)
CONVERTERS, ANALOG-TO-DIGITAL
CONVERTERS, DIGITAL-TO-ANALOG
DISPLAYS, THREE-DIMENSIONAL

ADAMS & WESTLAKE, SUB. ALLIED PRODUCTS
1025 N Michigan, Elkhart, Ind 46514

219-264-1141
TWX 219-522-3102

RELAYS, DRY REED (COMPUTER GRADE)
RELAYS, MERCURY WETTED (COMPUTER GRADE)
RELAYS, SOLID-STATE (COMPUTER GRADE)
SWITCHES, DRY REED
CONTINUED

TIMERS, EVENT (IMPULSE)
TIMERS, INTERVAL

ADAPT INC.

624 S 62nd St, Philadelphia, Pa 19143

215-474-5567

CONSULTING (ACCOUNTING, BUSINESS AND COMMERCIAL APPLICATIONS)
CONSULTING (COMPUTER PRODUCT PLANNING SURVEYS, MARKET RESEARCH STUDIES)
CONSULTING (MANAGEMENT INFORMATION SYSTEMS PLANNING)
CONSULTING (SCIENTIFIC APPLICATIONS)
PROGRAMMING LANGUAGE DEVELOPMENT (CONSULTANTS)
PROGRAMMING LANGUAGE DEVELOPMENT (CONTRACT PROGRAMMING)
PROGRAMMING LANGUAGE DEVELOPMENT (DEDICATED APPLICATION SYSTEMS)
PROGRAMMING LANGUAGE DEVELOPMENT (PROPRIETARY SOFTWARE PRODUCTS)
SERVICES, FACILITY MANAGEMENT
SERVICES, MANAGEMENT INFORMATION SYSTEMS
SERVICES, PROCESSING (COMMERCIAL EDP)
SERVICES, PROCESSING (DIGITAL SCIENTIFIC)
SERVICES, SYSTEMS ANALYSIS
TRAINING INSTITUTES, COMMERCIAL COMPUTER COURSES, SEMINARS, CORRESPONDENCE COURSES

ADAR ASSOCIATES INC.

85 Bolton St, Cambridge, Mass 02140

617-492-7110

GENERATORS, BYTE
GENERATORS, CHARACTER (CRT)
TESTERS, CIRCUIT
TESTERS, DIGITAL LOGIC MODULES AND CARDS
TESTERS, SEMICONDUCTOR

ADATACO

1475 N Broadway, Walnut Creek, Cal 94596

415-932-2121

CONSULTING (ACCOUNTING, BUSINESS AND COMMERCIAL APPLICATIONS)
CONSULTING (MANAGEMENT INFORMATION SYSTEMS PLANNING)
SERVICES, MANAGEMENT INFORMATION SYSTEMS
SERVICES, PROCESSING (COMMERCIAL EDP)

ADC PRODUCTS

4900 W 78th St, Minneapolis, Minn 55435
JACKS, JACK PANELS, PLUGS, ASSEMBLIES
TRANSFORMERS, POWER (COMPUTER GRADE)

612-929-7881
TWX 910-576-2832

ADDO-X INC. ADP DIV.

437 Madison Ave, New York, N Y 10022

212-758-9171

ACCOUNTING MACHINES, CARD-PROGRAMMED
ACCOUNTING MACHINES, PAPER TAPE PROGRAMMED
COMMUNICATION SYSTEMS, DATA TRANSMISSION
DATA TERMINALS, BLOCK-BY-BLOCK (MAGNETIC TAPE)
DATA TERMINALS, BLOCK-BY-BLOCK (MULTI-PURPOSE)
DATA TERMINALS, BLOCK-BY-BLOCK (PAPER TAPE)
DATA TERMINALS, INQUIRY-RESPONSE (BADGE-TOKEN READERS)
DATA TERMINALS, INQUIRY-RESPONSE (CRT WITH KEYBOARD)
PUNCHES, PAPER TAPE
READERS, STATIC
RECORDERS, DIGITAL CASSETTE
TAPE, PUNCH (PAPER)
VERIFIERS, PAPER TAPE
WINDERS, PAPER TAPE

ADDO-X INC. OEM DIV.

437 Madison Ave, New York, N Y 10022

212-758-9171

CONVERTERS, BINARY-TO-DECIMAL
PUNCHES, PAPER TAPE
RECORDERS, DIGITAL CASSETTE
WINDERS, PAPER TAPE

ADDRESSOGRAPH MULTIGRAPH CORP

1800 W Central Rd, Mount Prospect, Ill 60056

312-255-1900

MICROFICHE
MICROFILM ROLLS
PROCESSORS, MICROFILM
READER/PRINTER, MICROFILM/MICROFICHE
READERS, MICROFILM/MICROFICHE

3 Manufacturers' Directory

ADDRESSOGRAPH MULTIGRAPH CORP BRUNING DIV. 216-731-8000
 1200 Babbitt Rd, Cleveland, Ohio 44117 TWX 810-421-8456
 AUDIO/VISUAL TRAINING AIDS
 COMMUNICATION SYSTEMS, DATA TRANSMISSION
 COMMUNICATION SYSTEMS, FACSIMILE
 CONVERTERS, DOCUMENT-TO-MAGNETIC TAPE
 CONVERTERS, DOCUMENT-TO-PAPER TAPE
 CONVERTERS, DOCUMENT-TO-UNIT RECORDS
 CONVERTERS, MAGNETIC TAPE-TO-PRINTER
 CONVERTERS, PUNCHED CARD-TO-MAGNETIC TAPE
 DOCUMENTS, DCR/OMR
 ENCODERS, KEYBOARD (ALPHANUMERIC)
 ENCODERS, KEYBOARD (NUMERIC)
 ENCODERS, KEYBOARD-TO-MAGNETIC TAPE
 FORMS HANDLING, LABEL APPLICATORS
 IMPRINTERS, MAGNETIC INK CHARACTER
 IMPRINTERS, OPTICALLY-SENSSED CHARACTER
 MARK SENSING EQUIPMENT
 PAPER (FOR OCR EQUIPMENT)
 PAPER (FOR RECORDERS AND PLOTTERS)
 PRINTERS, LINE (LOW & MEDIUM SPEED)
 READERS, PAPER TAPE
 RIBBONS, INK (FOR PRINTERS AND TAB EQUIPMENT)
 SCANNERS, IMAGE
 SCANNERS, FACSIMILE
 SCANNERS, OPTICAL
 TRANSCEIVERS, FACSIMILE

ADMINISTRATIVE SYSTEMS INC. 516-248-5237
 131 Mineola Blvd, Mineola, N Y 11501

CONSULTING (ACCOUNTING, BUSINESS AND COMMERCIAL APPLICATIONS)
 CONSULTING (COMPUTER EVALUATIONS, SELECTIONS, INSTALLATION
 PLANNING)
 SERVICES, PROCESSING (COMMERCIAL EDP)
 SERVICES, SYSTEMS ANALYSIS

ADP-AUTOMATIC DATA PROCESSING OF SF INC. 408-253-0947
 4250 W Williams Rd, San Jose, Cal 95129

CONSULTING (ACCOUNTING, BUSINESS AND COMMERCIAL APPLICATIONS)
 SERVICES, PROCESSING (COMMERCIAL EDP)
 SERVICES, SYSTEMS ANALYSIS

ADTECH INC.

P O Box 10415, Honolulu, Haw 96816

COMPUTERS, DIGITAL (EDUCATIONAL)
 DISPLAYS, PANELS, VIEWGRAPHS (FOR COMPUTER TRAINING)
 INSTRUCTIONAL SYSTEMS, COMPUTER-BASED
 TRAINING INSTITUTES, COMMERCIAL COMPUTER COURSES, SEMINARS,
 CORRESPONDENCE COURSES
 TRAINING SYSTEMS, COMPUTER SERVICE

ADVANCE DATA 501-932-8341
 221 Hughes Dr, Jonesboro, Ark 72401

CONSULTING (ACCOUNTING, BUSINESS AND COMMERCIAL APPLICATIONS)
 SERVICES, PROCESSING (COMMERCIAL EDP)

ADVANCED AUTOMATION ASSOCIATES 617-237-0212
 192 Worcester St, Wellesley Hills, Mass 02181

SERVICES, PROCESSING (COMMERCIAL EDP)

ADVANCED COMPUTER SUPPLIES INC. 201-225-1200
 Bldg 529 Raritan Ctr, Edison, N J 08817

CARDS, CONVENTIONAL PUNCH
 RIBBONS, INK (FOR PRINTERS AND TAB EQUIPMENT)

ADVANCED COMPUTER SYSTEMS INC 513-294-0586
 3131 S Dixie Dr, Dayton, Ohio 45305

CONSULTING (ACCOUNTING, BUSINESS AND COMMERCIAL APPLICATIONS)
 CONSULTING (DATA COMMUNICATIONS SYSTEMS PLANNING)
 CONSULTING (MANAGEMENT INFORMATION SYSTEMS PLANNING)
 PROGRAMMING LANGUAGE DEVELOPMENT (CONSULTANTS)
 PROGRAMMING LANGUAGE DEVELOPMENT (CONTRACT PROGRAMMING)
 PROGRAMMING LANGUAGE DEVELOPMENT (DEDICATED APPLICATION SYSTEMS)
 PROGRAMMING LANGUAGE DEVELOPMENT (PROPRIETARY SOFTWARE
 PRODUCTS)
 SERVICES, FACILITY MANAGEMENT
 SERVICES, MANAGEMENT INFORMATION SYSTEMS
 CONTINUED

SERVICES, SYSTEMS ANALYSIS
 TRAINING INSTITUTES, COMMERCIAL COMPUTER COURSES, SEMINARS,
 CORRESPONDENCE COURSES

ADVANCED COMPUTER TECHNIQUES CORP. 212-421-4688
 437 Madison Ave, New York, N Y 10022

CONSULTING (ACCOUNTING, BUSINESS AND COMMERCIAL APPLICATIONS)
 CONSULTING (ADVANCED COMPUTER EQUIPMENT DESIGN AND FEASIBILITY
 STUDIES)
 CONSULTING (COMPUTER EVALUATIONS, SELECTIONS, INSTALLATION
 PLANNING)
 CONSULTING (DATA COMMUNICATIONS SYSTEMS PLANNING)
 CONSULTING (COMPUTER PRODUCT PLANNING SURVEYS, MARKET RESEARCH
 STUDIES)
 CONSULTING (MANAGEMENT INFORMATION SYSTEMS PLANNING)
 CONSULTING (SCIENTIFIC APPLICATIONS)
 PROGRAMMING LANGUAGE DEVELOPMENT (CONSULTANTS)
 PROGRAMMING LANGUAGE DEVELOPMENT (CONTRACT PROGRAMMING)
 PROGRAMMING LANGUAGE DEVELOPMENT (DEDICATED APPLICATION SYSTEMS)
 PROGRAMMING LANGUAGE DEVELOPMENT (PROPRIETARY SOFTWARE
 PRODUCTS)
 SERVICES, FACILITY MANAGEMENT
 SERVICES, MANAGEMENT INFORMATION SYSTEMS
 SERVICES, PROCESSING (COMMERCIAL EDP)
 SERVICES, PROCESSING (DIGITAL SCIENTIFIC)
 SERVICES, SYSTEMS ANALYSIS
 TRAINING INSTITUTES, COMMERCIAL COMPUTER COURSES, SEMINARS,
 CORRESPONDENCE COURSES
 TRAINING SYSTEMS, COMPUTER SERVICE

ADVANCED DEVELOPMENT CORP. 213-770-1143
 2014 W 139th St, Gardena, Cal 90249

POWER SUPPLIES, DC

ADVANCED MANAGEMENT SYSTEMS INC. 713-529-3459
 3310 Richmond Ave, Houston, Tex 77006

CONSULTING (ACCOUNTING, BUSINESS AND COMMERCIAL APPLICATIONS)
 CONSULTING (ADVANCED COMPUTER EQUIPMENT DESIGN AND FEASIBILITY
 STUDIES)
 CONSULTING (COMPUTER EVALUATIONS, SELECTIONS, INSTALLATION
 PLANNING)
 CONSULTING (COMPUTER PRODUCT PLANNING SURVEYS, MARKET RESEARCH
 STUDIES)
 CONSULTING (MANAGEMENT INFORMATION SYSTEMS PLANNING)
 PROGRAMMING LANGUAGE DEVELOPMENT (CONSULTANTS)
 PROGRAMMING LANGUAGE DEVELOPMENT (CONTRACT PROGRAMMING)
 PROGRAMMING LANGUAGE DEVELOPMENT (DEDICATED APPLICATION SYSTEMS)
 PROGRAMMING LANGUAGE DEVELOPMENT (PROPRIETARY SOFTWARE
 PRODUCTS)
 SERVICES, FACILITY MANAGEMENT
 TRAINING INSTITUTES, COMMERCIAL COMPUTER COURSES, SEMINARS,
 CORRESPONDENCE COURSES

ADVANCED MEMORY SYSTEMS INC. 408-734-4330
 1276 Hammerwood Ave, Sunnyvale, Cal 94086

CIRCUITS, MONOLITHIC (LSI-BIPOLAR)
 CIRCUITS, MONOLITHIC (LSI-MOS)
 MEMORY SYSTEMS, READ-ONLY
 MEMORY SYSTEMS, SEMICONDUCTOR
 MEMORY SYSTEMS, SEMICONDUCTOR (MOS)

ADVANCED MICRO DEVICES INC. 408-732-2400
 901 Thompson Pl, Sunnyvale, Cal 94086 TWX 910-339-9280

AMPLIFIERS, INSTRUMENTATION
 AMPLIFIERS, OPERATIONAL
 AMPLIFIERS, VIDEO
 CIRCUITS, MONOLITHIC (DIGITAL LOGIC)
 CIRCUITS, MONOLITHIC (LINEAR-EXCL. OP AMPS)
 CIRCUITS, MONOLITHIC (LSI-BIPOLAR)
 CIRCUITS, MONOLITHIC (OP AMPS)
 COUNTERS, DECADE
 COUNTERS, UP-DOWN
 ENCODERS, DIGITAL
 MEMORY SYSTEMS, SEMICONDUCTOR
 MULTIPLEXERS, DIGITAL

ADVANCED SPACE AGE PRODUCTS 703-751-3320
 4308 Wheeler Ave, Alexandria, Va 22313

CONVERTERS, BINARY-TO-DECIMAL
 CONVERTERS, MAGNETIC TAPE-TO-PAPER TAPE
 CONVERTERS, MAGNETIC TAPE-TO-PRINTER
 CONTINUED

3 Manufacturers' Directory

CONVERTERS, MAGNETIC TAPE-TO-PUNCHED CARD
 CONVERTERS, PAPER TAPE-TO-MAGNETIC TAPE
 CONVERTERS, PAPER TAPE-TO-PAPER TAPE
 CONVERTERS, PAPER TAPE-TO-PRINTER
 CONVERTERS, PAPER TAPE-TO-PUNCHED CARD
 CONVERTERS, PUNCHED CARD-TO-MAGNETIC TAPE
 CONVERTERS, PUNCHED CARD-TO-PAPER TAPE
 CONVERTERS, PUNCHED TAG-TO-MAGNETIC TAPE
 CONVERTERS, PUNCHED TAG-TO-PUNCHED CARD
 PERFORATORS, PAPER TAPE

ADVANCED SYSTEMS INC. 312-394-3443
 1100 W NW Hwy, Mt Prospec, Ill 60056

AUDIO/VISUAL TRAINING AIDS
 COMPUTERS, DIGITAL (EDUCATIONAL)
 TRAINING INSTITUTES, COMMERCIAL COMPUTER COURSES, SEMINARS,
 CORRESPONDENCE COURSES
 TRAINING SYSTEMS, COMPUTER SERVICE

ADVANCED TERMINALS INC. 315-866-6900
 220 3rd Ave, Herkimer, N Y 13350

CAMERAS, DATA RECORDING (EXCL. OSCILLOSCOPES)
 DATA ACQUISITION AND REDUCTION SYSTEMS
 FORMS HANDLING, STACKERS

AERO TECHNICAL APPLICATIONS INC. 314-862-5666
 8011 Clayton Rd, St Louis, Mo 63117

CONSULTING (ACCOUNTING, BUSINESS AND COMMERCIAL APPLICATIONS)
 CONSULTING (COMPUTER EVALUATIONS, SELECTIONS, INSTALLATION
 PLANNING)
 CONSULTING (DATA COMMUNICATIONS SYSTEMS PLANNING)
 CONSULTING (MANAGEMENT INFORMATION SYSTEMS PLANNING)
 PROGRAMMING LANGUAGE DEVELOPMENT (DEDICATED APPLICATION SYSTEMS)
 PROGRAMMING LANGUAGE DEVELOPMENT (PROPRIETARY SOFTWARE
 PRODUCTS)
 SERVICES, MANAGEMENT INFORMATION SYSTEMS
 SERVICES, SYSTEMS ANALYSIS

AEROVOX CORP. 617-994-9661
 740 Belleville Ave, New Bedford, Mass 02741 TWX 710-344-6985

AETNA PRODUCTS CO., INC. 516-931-3120
 11 Commercial St, Hicksville, N Y 11802
 RIBBONS, INK (FOR PRINTERS AND TAB EQUIPMENT)

AGNEW-HIGGINS, INC. 714-893-1301
 7532 Anthony Ave, Garden Grove, Cal 92641
 AIR CONDITIONERS (FOR EDP INSTALLATIONS)

AGRICULTURAL COMPUTING CO. DBA ASSOCIOMETRICS 214-264-2536
 P O Box 1259, Grand Prairie, Tex 75050
 CONSULTING (ACCOUNTING, BUSINESS AND COMMERCIAL APPLICATIONS)
 SERVICES, FACILITY MANAGEMENT
 SERVICES, PROCESSING (COMMERCIAL EDP)

AHART & ASSOC. INC., JAMES R. 513-224-7261
 225 S Main St, Dayton, Ohio 45402

CONSULTING (ACCOUNTING, BUSINESS AND COMMERCIAL APPLICATIONS)
 CONSULTING (MANAGEMENT INFORMATION SYSTEMS PLANNING)
 CONSULTING (SCIENTIFIC APPLICATIONS)
 SERVICES, MANAGEMENT INFORMATION SYSTEMS
 SERVICES, TIME SHARING (COMMERCIAL)
 SERVICES, SYSTEMS ANALYSIS

AIRBORN INC. 214-357-0274
 2618 Manana, Dallas, Tex 75220

CONNECTORS, COAXIAL (COMPUTER-GRADE)
 CONNECTORS, MINIATURE AND SUB-MINIATURE (COMPUTER-GRADE)
 CONNECTORS, PC AND IC BOARD (COMPUTER-GRADE)
 CONNECTORS, RACK AND PANEL (COMPUTER-GRADE)

AIRCO SPEER ELECTRONICS, DIV. OF AIR REDUCTION CO 814-834-2801
 800 Theresia St, St Marys, Pa 15857 TWX 510-693-4516
 CAPACITORS, COMPUTER GRADE
 POTENTIOMETERS, TRIM (FILM)
 RESISTORS, PRECISION

AIRFLYTE ELECTRONICS CO. 201-436-2230
 56 New Hook Rd, Bayonne, N J 07002 TWX 710-729-4489
 COMMUTATORS, SWITCHING (ELECTRIC)
 ENCODERS, DIGITAL
 ENCODERS, SHAFT ANGLE
 SWITCHES, ROTARY

AIROYAL MANUFACTURING CO. 201-227-4280
 19 Gloria Ln, Fairfield, N J 07006
 POWER SUPPLIES, UNINTERRUPTABLE

AIRPAX ELECTRONICS INC. 305-587-1100
 P O Box 8488, Ft Lauderdale, Fla 33310 TWX 510-955-9866
 CONVERTERS, ANALOG-TO-DIGITAL
 CONVERTERS, DC-TO-FREQUENCY
 CONVERTERS, DIGITAL-TO-ANALOG
 CONVERTERS, FREQUENCY-TO-DC
 CONVERTERS, VOLTAGE-TO-FREQUENCY
 PROTECTORS, CIRCUIT AND EQUIPMENT OVERLOAD
 SWITCHES, THUMBWHEEL

AIR TECHNIQUES INC. 301-944-6037
 1717 Whitehead Rd, Baltimore, Md 21207 TELEX 87-894
 TEST SYSTEMS, DISC DRIVES
 TESTERS, MAGNETIC DISC

ALADDIN ELECTRONICS DIV. ALADDIN INDUS. 615-242-3411
 701 Murfreesboro Rd, Nashville, Tenn 37202
 DELAY LINES, MAGNETOSTRICTIVE (ALSO SEE MEMORIES)
 TRANSFORMERS, PULSE (COMPUTER GRADE)

ALCO ELECTRONIC PRODUCTS INC. 617-686-3887
 8 Marblehead St, North Andover, Mass 01845 TWX 710-342-0552
 COUNTERS, DECADE
 COUNTERS, DIGITAL READOUT
 INDICATORS, DIGITAL
 INDICATORS, ILLUMINATED
 KNOBS, DIALS (FOR COMPUTER CONSOLES)
 LAMPS, GLOW
 LAMPS-PANEL, PILOT AND DIAL (INCANDESCENT)
 READOUTS AND DISPLAYS, NUMERIC AND ALPHANUMERIC (OTHER THAN CRT)
 SWITCHES, KEYBOARD
 SWITCHES, PUSHBUTTON
 SWITCHES, PUSHBUTTON (ILLUMINATED)
 SWITCHES, ROTARY
 SWITCHES, SNAP ACTION
 SWITCHES, TOGGLE (MINIATURE)
 TERMINAL BLOCKS, STRIPS, BOARDS
 VOLTMETERS, DIGITAL

ALCOR INC. 607-273-4242
 215 S Tioga St, Ithaca, N Y 14050
 AMPLIFIERS, VIDEO
 AUDIO/VISUAL TRAINING AIDS
 CABLE, COAXIAL (FLEXIBLE)

ALDEN ELECTRONIC & IMPULSE RECORDING EQUIP. CO 617-366-8851
 Washington St, Westboro, Mass 01581

COMMUNICATION SYSTEMS, DATA TRANSMISSION
 COMMUNICATION SYSTEMS, FACSIMILE
 DATA RETRIEVAL SYSTEMS, MICRO-FILM (COMPUTER-CONTROLLED)
 FILM SCANNERS
 MICROFILM DATA RETRIEVAL SYSTEMS, COMPUTER CONTROLLED
 MICROFILM DATA RETRIEVAL SYSTEMS, COMPUTER CONTROLLED (GRAPHIC)
 PAPER (FOR PRINTERS)
 PAPER (FOR RECORDERS AND PLOTTERS)
 READOUTS AND DISPLAYS, NUMERIC AND ALPHANUMERIC (OTHER THAN CRT)
 RECORDERS, GRAPHIC
 RECORDERS, HARD-COPY (WITH CRT)
 SCANNERS, IMAGE
 SCANNERS, INPUT
 SCANNERS, FACSIMILE
 SCANNERS, OPTICAL
 CONTINUED

3 Manufacturers' Directory

TRANSCEIVERS, FACSIMILE

ALDEN PRODUCTS CO. 617-583-0160
117 N Main St, Brockton, Mass 02401

CABINETS, ENCLOSURES, CONSOLES, ELECTRONIC (FOR GENERAL EQUIPMENT)
CABLE ASSEMBLIES (WITH CONNECTORS)
CHASSIS, SLIDES, RACKS
CORDS, PATCH
JACKS, JACK PANELS, PLUGS, ASSEMBLIES
LAMPS-PANEL, PILOT AND DIAL (INCANDESCENT)

ALL DATA PROCESSING MACHINES 312-839-5164
105 Hinricher St, Willow Springs, Ill 60480

USED EQUIPMENT (BUYING, SELLING, LEASING)

ALLEN AVIONICS INC. 516-248-8080
255 E 2nd St, Mineola, N Y 11501

DELAY LINES, ELECTROMAGNETIC
FILTERS (ACTIVE, LC, NOISE, ETC.)
MEMORY SYSTEMS, DELAY LINE

ALLEN-BABCOCK COMPUTING INC. 213-277-1600
1800 Ave of The Stars, Los Angeles, Cal 90067

CONSULTING (ACCOUNTING, BUSINESS AND COMMERCIAL APPLICATIONS)
CONSULTING (MANAGEMENT INFORMATION SYSTEMS PLANNING)
CONSULTING (SCIENTIFIC APPLICATIONS)
PROGRAMMING LANGUAGE DEVELOPMENT (CONSULTANTS)
PROGRAMMING LANGUAGE DEVELOPMENT (CONTRACT PROGRAMMING)
PROGRAMMING LANGUAGE DEVELOPMENT (DEDICATED APPLICATION SYSTEMS)
PROGRAMMING LANGUAGE DEVELOPMENT (PROPRIETARY SOFTWARE PRODUCTS)
SERVICES, FACILITY MANAGEMENT
SERVICES, MANAGEMENT INFORMATION SYSTEMS
SERVICES, TIME SHARING (COMMERCIAL)
SERVICES, TIME SHARING (RESEARCH)
SERVICES, SYSTEMS ANALYSIS

ALLEN-BRADLEY 414-671-2000
1201 S 2nd St, Milwaukee, Wisc 53204 TWX 910-262-3451

CIRCUIT CARDS, LOGIC (WITH DISCRETE COMPONENTS)
CIRCUIT CARDS, LOGIC (WITH IC'S)
CIRCUITS, HYBRID (IC AND DISCRETE-DIGITAL)
CONTROLLERS, MOTOR
COUNTERS, DIGITAL READOUT
DIGITIZERS, PROGRAMMABLE
ENCODERS, DIGITAL
ENCODERS, SHAFT ANGLE
RELAYS, DRY REED (COMPUTER GRADE)
SWITCHES, DRY REED
SWITCHES, PUSHBUTTON
SWITCHES, PUSHBUTTON (ILLUMINATED)
SWITCHES, ROTARY
SWITCHES, SNAP ACTION
TERMINAL BLOCKS, STRIPS, BOARDS
TIMERS, INTERVAL

ALLEN HOLLANDER DIV. LITTON INDUS. 201-265-7000
E 64 Midland Ave, Paramus, N J 07652

LABELS, CONTINUOUS AND GUMMED (MACHINE APPLICATION)
LABELS, CONTINUOUS AND PRESSURE SENSITIVE (MACHINE APPLICATION)

ALLEN PRODUCTS INC. 203-874-2563
180 Wampus Ln, Milford, Conn 06460

PRINTERS, MICROFILM/MICROFICHE
PROCESSORS, MICROFILM

ALLIED COMPUTER TECHNOLOGY INC. 213-828-7471
1610 26 St, Santa Monica, Cal 90404

ANALYZERS, COMPUTER PERFORMANCE
CONSULTING (COMPUTER EVALUATIONS, SELECTIONS, INSTALLATION PLANNING)

ALLIED CONTROL CO. INC. 203-628-9654
100 Relay Rd, Plantsville, Conn 60479 TWX 710-473-0079

RELAYS, DRY REED (COMPUTER GRADE)
RELAYS, MERCURY WETTED (COMPUTER GRADE)
CONTINUED

TIMERS, EVENT (IMPULSE)
TIMERS, INTERVAL

ALLISON COUPON COMPANY, INC. 317-632-2403
200 S Capitol, Indianapolis, Ind 46206

DOCUMENTS, DCR/OMR
LABELS, CONTINUOUS AND GUMMED (MACHINE APPLICATION)
MARK SENSING SUPPLIES
PAYMENT COUPON BOOKS, MACHINE READABLE
TAGS (FOR EDP PROCESSING)

ALL-TRONICS INC. 516-333-3090
45 Bond St, Westbury, N Y 11590

FILTERS (ACTIVE, LC, NOISE, ETC.)

ALPHA COMPUTER SERVICE CORP. 312-695-1824
226 W 37th St, New York, N Y 10018

CONSULTING (ACCOUNTING, BUSINESS AND COMMERCIAL APPLICATIONS)
CONSULTING (MANAGEMENT INFORMATION SYSTEMS PLANNING)
SERVICES, PROCESSING (COMMERCIAL EDP)
SERVICES, SYSTEMS ANALYSIS

ALPHA DATA INC. 213-882-6500
8759 Remmet Ave, Canoga Park, Cal 91304

DISC DRIVES, FIXED HEAD (INCLUDING CONTROLLER)
DISC STORAGE SYSTEMS
MEMORY SYSTEMS, MAGNETIC DISC
RECORDING HEADS, MAGNETIC DISC

ALTEC DIV., LTV LING ALTEC INC. 714-774-2900
1515 So Manchester Av, Anaheim, Cal 92803 TWX 910-591-1142

AMPLIFIERS, D.C.
AMPLIFIERS, OPERATIONAL
ATTENUATORS, DECADE DIGITAL
CONVERTERS, DC-TO-FREQUENCY
CONVERTERS, FREQUENCY-TO-DC
CONVERTERS, VOLTAGE-TO-FREQUENCY
INVERTERS, DC-AC
POWER SUPPLIES, AC
POWER SUPPLIES, DC
POWER SUPPLIES, DIGITALLY-CONTROLLED

AMBAC INDUSTRIES INC. TELE-DYNAMICS DIV. 215-643-3900
525 Virginia Dr, Ft Washington, Pa 19034 TWX 510-661-0654

COMMUNICATION SYSTEMS, DATA TRANSMISSION
CONSULTING (DATA COMMUNICATIONS SYSTEMS PLANNING)
DATA CONCENTRATORS
MODEMS, HARD-WIRED
MODEMS, PC CARD
SERVICES, SYSTEMS ANALYSIS

AMBAC INDUSTRIES INC. WANLASS DIV. 215-643-6161
525 Virginia Dr, Ft Washington, Pa 19034 TWX 510-661-0654

POWER SUPPLIES, AC
POWER SUPPLIES, DC
REGULATORS, VOLTAGE

AMCO ENGINEERING CO. 312-867-8500
7333 W Ainslie, Chicago, Ill 60656 TWX 910-221-5192

CABINETS AND ENCLOSURES (FOR KEYPUNCHES, PRINTERS)
CABINETS, ENCLOSURES, CONSOLES, ELECTRONIC (FOR GENERAL EQUIPMENT)
CABINETS, RACKS, VAULTS (FOR MAGNETIC TAPE STORAGE)
CONSOLES, COMPUTER CONTROL (WIRED)
DESKS, TABLES AND STANDS (FOR CALCULATORS)
DESKS, TABLES AND STANDS (FOR KEYPUNCH UNITS)
DESKS, TABLES AND STANDS (FOR PROGRAMMER STATIONS)
DESKS, TABLES AND STANDS (FOR TYPEWRITERS)
PANELS, POWER DISTRIBUTION
RACKS, PAPER TAPE

AMERICAN ASTRONICS INC., SUB TECHNICOLOR INC. 213-466-9741
855 No Cahuenga Blvd, Hollywood, Cal 90038

AMPLIFIERS, VIDEO
CONVERTERS, ANALOG-TO-DIGITAL
CONVERTERS, DIGITAL-TO-ANALOG
CONVERTERS, PULSE-TO-DIGITAL
MEMORY SYSTEMS, SEMICONDUCTOR (MOS)
MULTIPLEXER-CONVERTER (SINGLE UNIT WITH MULTIPLEXER, SAMPLE & HOLD AMPLIFIER & A-TO-D CONVERTER)

3 Manufacturers' Directory

AMERICAN BUSINESS FORMS INC.
114 S Canal St, Chicago, Ill 60606

312-782-4588

CARDS, EDGE-PUNCH
ENVELOPES, CONTINUOUS
FORMS, CONTINUOUS (MACHINE PROCESSED)
LABELS, CONTINUOUS AND GUMMED (MACHINE APPLICATION)
LABELS, CONTINUOUS AND PRESSURE SENSITIVE (MACHINE APPLICATION)
PAPER (FOR MICR EQUIPMENT)
PAPER (FOR OCR EQUIPMENT)
PAPER (FOR PRINTERS)
PAPER (FOR RECORDERS AND PLOTTERS)

AMERICAN COMPONENTS INC.
8th Ave And Harry St, Conshohocken, Pa 19428
CAPACITORS, COMPUTER GRADE
RESISTORS, PRECISION

215-828-6240
TWX 510-660-9268

AMERICAN COMPUTER & COMMUNICATIONS CO.
2576 W Carson St, Torrance, Cal 90509

213-320-8810

CARDS, MAGNETIC
DATA TERMINALS, INQUIRY-RESPONSE (AUDIO RESPONSE)
DATA TERMINALS, INQUIRY-RESPONSE (BADGE-TOKEN READERS)
DATA TERMINALS, INQUIRY-RESPONSE (SPECIAL-PURPOSE)
READERS, MAGNETIC CARD

AMERICAN COMPUTER LEASING CORP.
14 E 4th St, Cincinnati, Ohio 45202

513-579-2244

CONSULTING (ACCOUNTING, BUSINESS AND COMMERCIAL APPLICATIONS)
LEASING, EDP EQUIPMENT (OTHER THAN MFGRS)
PROGRAMMING LANGUAGE DEVELOPMENT (CONTRACT PROGRAMMING)
PROGRAMMING LANGUAGE DEVELOPMENT (PROPRIETARY SOFTWARE PRODUCTS)
SERVICES, FACILITY MANAGEMENT
SERVICES, PROCESSING (COMMERCIAL EDP)
SERVICES, PROCESSING (DIGITAL SCIENTIFIC)
SERVICES, TIME SHARING (COMMERCIAL)
SERVICES, TIME SHARING (RESEARCH)
SERVICES, SYSTEMS ANALYSIS
TRAINING INSTITUTES, COMMERCIAL COMPUTER COURSES, SEMINARS,
CORRESPONDENCE COURSES
USED EQUIPMENT (BUYING, SELLING, LEASING)

AMERICAN COMPUTER SERVICES CORP.
14 E 4th St, Cincinnati, Ohio 45202

513-579-2090

CONSULTING (ACCOUNTING, BUSINESS AND COMMERCIAL APPLICATIONS)
CONSULTING (SCIENTIFIC APPLICATIONS)
LEASING, EDP EQUIPMENT (OTHER THAN MFGRS)
PROGRAMMING LANGUAGE DEVELOPMENT (CONTRACT PROGRAMMING)
PROGRAMMING LANGUAGE DEVELOPMENT (PROPRIETARY SOFTWARE PRODUCTS)
SERVICES, COMPUTER-AIDED DESIGN
SERVICES, FACILITY MANAGEMENT
SERVICES, PROCESSING (COMMERCIAL EDP)
SERVICES, PROCESSING (DIGITAL SCIENTIFIC)
SERVICES, TIME SHARING (COMMERCIAL)
SERVICES, TIME SHARING (RESEARCH)
SERVICES, SYSTEMS ANALYSIS
TRAINING INSTITUTES, COMMERCIAL COMPUTER COURSES, SEMINARS,
CORRESPONDENCE COURSES
USED EQUIPMENT (BUYING, SELLING, LEASING)

AMERICAN COMPUTER TECHNOLOGY INC.
8740 Shirley Ave, Northridge, Cal 91324

213-886-7440

ANALYZERS, COMPUTER PERFORMANCE
ANALYZERS, CONTINUITY
BREADBOARDS
CIRCUIT CARDS, LOGIC (WITH DISCRETE COMPONENTS)
CIRCUIT CARDS, LOGIC (WITH IC'S)
COMMUNICATION SYSTEMS, DATA TRANSMISSION
COMMUTATORS, SWITCHING (ELECTRIC)
CONSOLES, COMPUTER CONTROL (WIRED)
CONTROLLERS, MAGNETIC DISC
CONTROLLERS, MAGNETIC DRUM
CONVERTERS, BINARY-TO-DECIMAL
COUNTERS, DECADE
COUNTERS, DIGITAL READOUT
COUNTERS, UP-DOWN
DATA ACQUISITION AND REDUCTION SYSTEMS
DIGITIZERS, PROGRAMMABLE
MULTIPLEXERS, DIGITAL
POWER SUPPLIES, DIGITALLY-CONTROLLED
READOUTS AND DISPLAYS, NUMERIC AND ALPHANUMERIC (OTHER THAN CRT)
CONTINUED

SCANNERS, INPUT
SERVICES, COMPUTER-AIDED DESIGN
SERVICES, AUTOMATED WIRE-WRAPPING
SIGNAL CONDITIONERS
TEST SYSTEMS, COMPUTER PERFORMANCE
TESTERS, CIRCUIT
TESTERS, DIGITAL LOGIC MODULES AND CARDS
TESTERS, MEMORY PLANES, STACKS AND SYSTEMS

AMERICAN DATA SYSTEMS
8851 Mason Ave, Canoga Park, Cal 91306

213-882-0020

COMMUNICATIONS-ORIENTED PROCESSORS, MULTIPLE CHANNEL CONTROLLERS
COMPUTERS, DIGITAL (GENERAL-PURPOSE, MEDIUM-SCALE)
CONVERTERS, ANALOG-TO-DIGITAL
CONVERTERS, DIGITAL-TO-ANALOG
DATA TERMINALS, BLOCK-BY-BLOCK (TELEPRINTER)
DATA TERMINALS, INQUIRY-RESPONSE (ALPHANUMERIC KEYBOARD)
MODEMS, PC CARD
PRINTERS, KEYBOARD
TESTERS, DIGITAL DATA TRANSMISSION
TYPEWRITERS, COMPUTER INPUT-OUTPUT

AMERICAN KEY PUNCH CO.
204 Wow Bldg, Omaha, Nebr 68104

402-345-0500

SERVICES, PROCESSING (COMMERCIAL EDP)

AMERICAN LAVA CORP. SUB. OF 3M CO.
Manufacturer's Rd, Chattanooga, Tenn 37405
CAPACITORS, COMPUTER GRADE
GUIDES, CIRCUIT CARDS

615-265-3411
TWX 810-573-5216

AMERICAN MICRO-SYSTEMS INC.
3800 Homestead Rd, Santa Clara, Cal 95051

408-246-0330
TWX 910-338-0018

CIRCUITS, MONOLITHIC (DIGITAL LOGIC)
CIRCUITS, MONOLITHIC (LSI-MOS)
MEMORY SYSTEMS, SEMICONDUCTOR (MOS)
MULTIPLEXERS, ANALOG-SOLID STATE (SEQUENTIAL SAMPLING)
MULTIPLEXERS, DIGITAL

AMERICAN OPTICAL CORP. FIBER OPTICS DIV.
14 Mechanic St, Southbridge, Mass 01550

617-764-3211

FIBER OPTIC BUNDLES
FIBER OPTICS ASSEMBLIES (FOR PUNCHED CODE READERS AND MARK SENSORS)

AMERICAN PRECISION INDUSTRIES INC. DELEVAN DIV.
270 Quaker Rd, E Aurora, N Y 14052
BRAKES AND CLUTCHES

716-652-3600
TELEX 09-1293

AMERICAN REGITEL CORP.
870 Industrial Way, San Carlos, Cal 94070

415-593-1016

COMMUNICATION SYSTEMS, TELEPRINTER
CONTROLLERS, MAGNETIC DISC
DATA TERMINALS, BLOCK-BY-BLOCK (TELEPRINTER)
DISC DRIVES, FIXED HEAD (INCLUDING CONTROLLER)
MULTIPLEXERS, DIGITAL
PRINTERS, LINE (LOW & MEDIUM SPEED)

AMERICAN TOTALISATOR CO. UNI-TOTE DIV.
383 Hillen Rd, Towson, Md 21204

301-825-5500

COMMUNICATIONS-ORIENTED PROCESSORS, MULTIPLE CHANNEL CONTROLLERS
COMMUNICATIONS-ORIENTED PROCESSORS, SINGLE CHANNEL CONTROLLERS
COMMUNICATIONS-ORIENTED PROCESSORS, STORED PROGRAM
COMMUNICATION SYSTEMS, DATA TRANSMISSION
CONTROLLERS, MAGNETIC DRUM
CONTROLLERS, MODEM
DATA CONCENTRATORS
DATA TERMINALS, BLOCK-BY-BLOCK (MAGNETIC TAPE)
DATA TERMINALS, BLOCK-BY-BLOCK (MULTI-PURPOSE)
DATA TERMINALS, BLOCK-BY-BLOCK (HIGH SPEED PRINTER)
DATA TERMINALS, BLOCK-BY-BLOCK (MEDIUM SPEED PRINTER)
DATA TERMINALS, INQUIRY-RESPONSE (BADGE-TOKEN READERS)
DATA TERMINALS, INQUIRY-RESPONSE (CRT WITH KEYBOARD)
DATA TERMINALS, INQUIRY-RESPONSE (SPECIAL-PURPOSE)
DRUM STORAGE EQUIPMENT, MAGNETIC (INCLUDING CONTROLLER)
ENCODERS, KEYBOARD-TO-MAGNETIC DRUM
MEMORY SYSTEMS, MAGNETIC DRUM
MODEMS, HARD-WIRED
MODEMS, PC CARD

3 Manufacturers' Directory

- AMERICAN ZETTLER INC.** 714-540-4190
 697 Randolph Ave, Costa Mesa, Cal 92626
 SWITCHES, PUSHBUTTON
 SWITCHES, PUSHBUTTON (ILLUMINATED)
 TELEX 67-8472
- AMES SAFETY ENVELOPE CO.** 617-776-3360
 21 Properzi Way, Somerville, Mass 02145
 ENVELOPES (FOR FILING TAPES)
 FILES, PUNCHED CARD
 MAILERS, PUNCHED CARD
- AMETEK/LAMB ELECTRIC** 216-673-3451
 627 Lake St, Kent, Ohio 44240
 BLOWERS, FANS, COOLING ASSEMBLIES
 MOTORS, SERVO
 TWX 810-437-2332
- AMF INC.** 212-687-3100
 261 Madison Ave, New York, N Y 10016
 COMPUTERS, ANALOG (EDUCATIONAL)
- AMMON INSTRUMENTS, INC.** 603-669-1531
 345 Kelley St, Manchester, N H 03105
 VOLTMETERS, AC, DC, DIFFERENTIAL
- AMP INC.** 717-564-0101
 Eisenhower Blvd, Harrisburg, Pa 17105
 BUS BAR SYSTEMS
 CONNECTORS, COAXIAL (COMPUTER-GRADE)
 CONNECTORS, MINIATURE AND SUB-MINIATURE (COMPUTER-GRADE)
 CONNECTORS, PC AND IC BOARD (COMPUTER-GRADE)
 CONNECTORS, RACK AND PANEL (COMPUTER-GRADE)
 CORDS, PATCH
 DATA TERMINALS, INQUIRY-RESPONSE (BADGE-TOKEN READERS)
 DATA TERMINALS, INQUIRY-RESPONSE (SPECIAL-PURPOSE)
 INDICATORS, ILLUMINATED
 PLUGBOARDS, PROGRAMMING
 POWER SUPPLIES, DC
 READERS, MAGNETIC CARD
 READERS, PUNCHED CARD (STATIC)
 READERS, STATIC
 SOCKETS, IC MOUNTING
 SOCKETS, PCB MOUNTING
 SWITCHES, ROTARY
 TERMINAL BLOCKS, STRIPS, BOARDS
- AMP INC. CAPITRON DIV.** 717-367-1105
 1595 S Mount Joy St, Elizabethtown, Pa 17022
 BUS BAR SYSTEMS
 POWER SUPPLIES, DC
 VOLTAGE DIVIDERS
 VOLTMETERS, DIGITAL
 TWX 510-657-4561
- AMP INC., SYSCOM DIV.** 717-565-0101
 P O Box 3608, Harrisburg, Pa 17105
 CONNECTORS, PC AND IC BOARD (COMPUTER-GRADE)
 CONNECTORS, POWER (COMPUTER-GRADE)
 CONNECTORS, RACK AND PANEL (COMPUTER-GRADE)
 DATA TERMINALS, BLOCK-BY-BLOCK (PUNCHED CARD)
 DATA TERMINALS, INQUIRY-RESPONSE (AUDIO RESPONSE)
 DATA TERMINALS, INQUIRY-RESPONSE (BADGE-TOKEN READERS)
 DATA TERMINALS, INQUIRY-RESPONSE (SPECIAL-PURPOSE)
 LAMPS-PANEL, PILOT AND DIAL (INCANDESCENT)
 MULTIPLEXERS, DIGITAL
 PROGRAMMERS, PUNCHED CARD
 READERS, MAGNETIC CARD
 READERS, STATIC
 SCANNERS, INPUT
 SOCKETS, IC MOUNTING
 SOCKETS, PCB MOUNTING
 SOCKETS, SEMICONDUCTOR MOUNTING
 SWITCHES, ROTARY
 SWITCHES, THUMBWHEEL
 TWX 510-657-4110
- AMPEREX ELECTRONIC CORP. A NO AMERICAN PHILIPS CO** 401-762-9000
 P O Box 98, Slatersville, R I 02876
 AMPLIFIERS, D.C.
 AMPLIFIERS, INSTRUMENTATION
 AMPLIFIERS, OPERATIONAL
 CONTINUED
 TWX 710-387-1591
- AMPLIFIERS, VIDEO**
 CIRCUITS, HYBRID (IC AND DISCRETE-DIGITAL)
 CIRCUITS, MONOLITHIC (DIGITAL LOGIC)
 CIRCUITS, MONOLITHIC (DIODE MATRICES)
 CIRCUITS, MONOLITHIC (LINEAR-EXCL. OP AMPS)
 CIRCUITS, MONOLITHIC (LSI-BIPOLAR)
 CIRCUITS, MONOLITHIC (OP AMPS)
 CIRCUITS, THICK FILM (DIGITAL)
 CIRCUITS, THIN FILM (DIGITAL)
 DIODES, GERMANIUM
 DIODES, LIGHT EMITTING
 DIODES, SILICON
 DIODES, TUNNEL
 DIODES, VIDEO DETECTOR
 DIODES, ZENER
 DISPLAY DRIVERS
 DISPLAYS, THREE-DIMENSIONAL
 HEAT SINKS, CIRCUIT BOARD MOUNTING
 INDICATORS, ALPHANUMERIC
 INDICATORS, DIGITAL
 INDICATORS, ILLUMINATED
 MODULES, DIGITAL LOGIC ENCAPSULATED (ALSO SEE CIRCUITS & CIRCUIT CARDS)
 MODULES, LINEAR (ENCAPSULATED)
 MODULES, MEMORY (ENCAPSULATED)
 MODULES, RESISTANCE NETWORKS (ENCAPSULATED)
 RECTIFIERS, SILICON CONTROLLED
 REGULATORS, CURRENT
 REGULATORS, VOLTAGE
 TRANSISTORS, GERMANIUM
 TRANSISTORS, PHOTO
 TRANSISTORS, SILICON
- AMPEX CORP. COMPUTER PRODUCTS DIV.** 213-836-5000
 9937 W Jefferson Blvd, Culver City, Cal 90230
 TWX 910-340-6767
 CORES, FERRITE MEMORY
 DEMAGNETIZERS, MAGNETIC TAPE
 ERASERS, BULK (MAGNETIC TAPE)
 MEMORY PLANES AND STACKS, MAGNETIC CORE (W/O ELECTRONICS)
 MEMORY SYSTEMS, MAGNETIC CORE
 MEMORY SYSTEMS, READ-ONLY
 MEMORY SYSTEMS, SEMICONDUCTOR
 MEMORY SYSTEMS, SEMICONDUCTOR (MOS)
 MODULES, MEMORY (ENCAPSULATED)
 RECORDERS, DIGITAL CASSETTE
 RECORDERS, MAGNETIC TAPE
 TAPE TRANSPORTS, MAGNETIC (DIGITAL-EXCL. CASSETTE)
 TAPE TRANSPORTS, MAGNETIC (DIGITAL CASSETTE)
 TAPE TRANSPORTS, MAGNETIC (INCREMENTAL)
 TESTERS, MEMORY PLANES, STACKS AND SYSTEMS
 TRAINING INSTITUTES, COMMERCIAL COMPUTER COURSES, SEMINARS,
 CORRESPONDENCE COURSES
- AMPEX CORP. MAGNETIC TAPE DIV.** 415-367-3883
 401 Broadway, Redwood City, Cal 94063
 TWX 910-378-5920
 CANNISTERS, MAGNETIC TAPE
 CLEANERS, MAGNETIC TAPE HEADS
 REEL CLIPS AND BELTS, MAGNETIC TAPE
 REELS, MAGNETIC TAPE
 REELS, PAPER TAPE
 TAPE, MAGNETIC (CASSETTE)
 TAPE, MAGNETIC (REELS)
- AMPHENOL CONTROLS DIV. BUNKER RAMO CORP.** 608-754-2211
 120 S Main St, Janesville, Wisc 53545
 TWX 910-288-2924
 COUNTERS, DIGITAL READOUT
 POTENTIOMETERS, TRIM (WIRE-WOUND)
 POWER SUPPLIES, AC
- AMPHENOL INDUSTRIAL DIV. BUNKER-RAMO CORP.** 312-242-1000
 1830 S 54 Ave, Chicago, Ill 60650
 TWX 910-229-1541
 CONNECTORS, MINIATURE AND SUB-MINIATURE (COMPUTER-GRADE)
 CONNECTORS, PC AND IC BOARD (COMPUTER-GRADE)
 CONNECTORS, POWER (COMPUTER-GRADE)
 CONNECTORS, RACK AND PANEL (COMPUTER-GRADE)
- AMPROBE INSTRUMENT DIV. SOS CONSOLIDATED INC.** 516-593-5600
 630 Merrick Rd, Lynbrook, N Y 11563
 RECORDERS, STRIP CHART
- ANACOMP INC.** 317-257-6555
 6161 Hillside Ave, Indianapolis, Ind 46220
 CONSULTING (ACCOUNTING, BUSINESS AND COMMERCIAL APPLICATIONS)
 CONSULTING (SCIENTIFIC APPLICATIONS)
 CONTINUED

3 Manufacturers' Directory

SERVICES, PROCESSING (COMMERCIAL EDP)
SERVICES, SYSTEMS ANALYSIS

ANADIX INSTRUMENTS INC.
7833 Haskell Ave, Van Nuys, Cal 91406
CONVERTERS, FREQUENCY-TO-DC
CONVERTERS, VOLTAGE-TO-FREQUENCY
COUNTERS, DECADE
COUNTERS, DIGITAL READOUT
COUNTERS, UP-DOWN
PRINTERS, LINE (LOW & MEDIUM SPEED)

213-782-9527
TWX 910-495-1762

ANALOG DEVICES INC.
221 5th St, Cambridge, Mass 02142
AMPLIFIERS, D.C.
AMPLIFIERS, INSTRUMENTATION
AMPLIFIERS, OPERATIONAL
AMPLIFIERS, VIDEO
CIRCUITS, MONOLITHIC (LINEAR-EXCL. OP AMPS)
CIRCUITS, MONOLITHIC (OP AMPS)
MODULES, LINEAR (ENCAPSULATED)
POWER SUPPLIES, DC

617-492-6000
TWX 710-320-0326

ANALOG DEVICES INC. PASTORIZA DIV.
221 5th St, Cambridge, Mass 02142
CIRCUITS, HYBRID (IC AND DISCRETE-DIGITAL)
CIRCUITS, MONOLITHIC (OP AMPS)
CIRCUITS, THICK FILM (DIGITAL)
CIRCUITS, THIN FILM (DIGITAL)
CONVERTERS, ANALOG-TO-DIGITAL
CONVERTERS, DIGITAL-TO-ANALOG
CONVERTERS, DIGITAL-TO-SYNCHRO
CONVERTERS, SYNCHRO-TO-DIGITAL
MULTIPLEXER-CONVERTER (SINGLE UNIT WITH MULTIPLEXER, SAMPLE & HOLD
AMPLIFIER & A-TO-D CONVERTER)
MULTIPLEXERS, ANALOG-SOLID STATE (SEQUENTIAL SAMPLING)
POWER SUPPLIES, DC

617-492-6000
TWX 710-320-0326

ANALOGIC CORP.
Audubon Rd, Wakefield, Mass 01880
AMPLIFIERS, D.C.
AMPLIFIERS, INSTRUMENTATION
AMPLIFIERS, OPERATIONAL
CIRCUIT CARDS, LINEAR (WITH DISCRETE COMPONENTS)
CIRCUIT CARDS, LINEAR (WITH IC'S)
CIRCUIT CARDS, LOGIC (WITH DISCRETE COMPONENTS)
CIRCUIT CARDS, LOGIC (WITH IC'S)
CONTROLLERS, MODEM
CONVERTERS, ANALOG-TO-DIGITAL
CONVERTERS, BINARY-TO-DECIMAL
CONVERTERS, DC-TO-FREQUENCY
CONVERTERS, DIGITAL-TO-ANALOG
CONVERTERS, DIGITAL-TO-SYNCHRO
CONVERTERS, FREQUENCY-TO-DC
CONVERTERS, SYNCHRO-TO-DIGITAL
CONVERTERS, VOLTAGE-TO-FREQUENCY
COUNTERS, DECADE
COUNTERS, DIGITAL READOUT
DATA ACQUISITION AND REDUCTION SYSTEMS
DIGITIZERS, PROGRAMMABLE
DISPLAY DRIVERS
INDICATORS, ALPHANUMERIC
INDICATORS, DIGITAL
INDICATORS, ILLUMINATED
INVERTERS, DC-AC
MODEMS, ACOUSTIC
MODEMS, HARD-WIRED
MODEMS, PC CARD
MODULES, DIGITAL LOGIC ENCAPSULATED (ALSO SEE CIRCUITS & CIRCUIT
CARDS)
MODULES, LINEAR (ENCAPSULATED)
MULTIPLEXER-CONVERTER (SINGLE UNIT WITH MULTIPLEXER, SAMPLE & HOLD
AMPLIFIER & A-TO-D CONVERTER)
MULTIPLEXERS, ANALOG-SOLID STATE (SEQUENTIAL SAMPLING)
MULTIPLEXERS, DIGITAL
POWER SUPPLIES, AC
POWER SUPPLIES, DC
POWER SUPPLIES, DIGITALLY-CONTROLLED
READOUTS AND DISPLAYS, NUMERIC AND ALPHANUMERIC (OTHER THAN CRT)
REGULATORS, CURRENT
REGULATORS, VOLTAGE
TEST SYSTEMS, COMPUTER PERFORMANCE
TESTERS, CIRCUIT

617-246-0300
TWX 710-348-0425

ANALYTIC SCIENCES CORP., THE
6 Jacob Way, Reading, Mass 01867

617-944-6850

CONSULTING (MANAGEMENT INFORMATION SYSTEMS PLANNING)
CONSULTING (SCIENTIFIC APPLICATIONS)
SERVICES, MANAGEMENT INFORMATION SYSTEMS
SERVICES, PROCESSING (COMMERCIAL EDP)
SERVICES, SYSTEMS ANALYSIS

ANALYTICS INC.
179 Washington Lane, Jenkintown, Pa 19046

215-885-4242

CONSULTING (ACCOUNTING, BUSINESS AND COMMERCIAL APPLICATIONS)
CONSULTING (ADVANCED COMPUTER EQUIPMENT DESIGN AND FEASIBILITY
STUDIES)
CONSULTING (COMPUTER EVALUATIONS, SELECTIONS, INSTALLATION
PLANNING)
CONSULTING (DATA COMMUNICATIONS SYSTEMS PLANNING)
CONSULTING (MANAGEMENT INFORMATION SYSTEMS PLANNING)
CONSULTING (SCIENTIFIC APPLICATIONS)
PROGRAMMING LANGUAGE DEVELOPMENT (CONSULTANTS)
PROGRAMMING LANGUAGE DEVELOPMENT (DEDICATED APPLICATION SYSTEMS)
PROGRAMMING LANGUAGE DEVELOPMENT (PROPRIETARY SOFTWARE
PRODUCTS)
SERVICES, MANAGEMENT INFORMATION SYSTEMS
SERVICES, SYSTEMS ANALYSIS

ANCOM SYSTEMS, DIV. GENERAL ANALYTICS CORP.
9841 Airport Blvd, Los Angeles, Cal 90045

213-776-6810

CONSULTING (ACCOUNTING, BUSINESS AND COMMERCIAL APPLICATIONS)
CONSULTING (COMPUTER EVALUATIONS, SELECTIONS, INSTALLATION
PLANNING)
CONSULTING (DATA COMMUNICATIONS SYSTEMS PLANNING)
CONSULTING (MANAGEMENT INFORMATION SYSTEMS PLANNING)
PROGRAMMING LANGUAGE DEVELOPMENT (CONSULTANTS)
PROGRAMMING LANGUAGE DEVELOPMENT (CONTRACT PROGRAMMING)
PROGRAMMING LANGUAGE DEVELOPMENT (DEDICATED APPLICATION SYSTEMS)
PROGRAMMING LANGUAGE DEVELOPMENT (PROPRIETARY SOFTWARE
PRODUCTS)
SERVICES, MANAGEMENT INFORMATION SYSTEMS
SERVICES, PROCESSING (COMMERCIAL EDP)
SERVICES, TIME SHARING (COMMERCIAL)
SERVICES, SYSTEMS ANALYSIS

ANDERSEN LABS
Blue Hills Ave, Bloomfield, Conn 06002
MEMORY SYSTEMS, DELAY LINE
MEMORY SYSTEMS, OPTICAL
SCANNERS, OPTICAL

203-242-0761
TWX 710-425-2390

ANDERSON JACOBSON INC.
1065 Morse Ave., Sunnyvale, Cal 94086

408-734-4030

ACOUSTIC COUPLERS
COMMUNICATION SYSTEMS, DATA TRANSMISSION
COMMUNICATION SYSTEMS, TELEPRINTER
DATA TERMINALS, BLOCK-BY-BLOCK (MAGNETIC TAPE)
DATA TERMINALS, BLOCK-BY-BLOCK (MULTI-PURPOSE)
DATA TERMINALS, BLOCK-BY-BLOCK (PAPER TAPE)
DATA TERMINALS, BLOCK-BY-BLOCK (MEDIUM SPEED PRINTER)
DATA TERMINALS, BLOCK-BY-BLOCK (TELEPRINTER)
ENCODERS, KEYBOARD-TO-MAGNETIC TAPE
MAGNETIC TAPE STORAGE SYSTEMS (INCLUDES CONTROLLER)
MODEMS, ACOUSTIC
MODEMS, HARD-WIRED
MODEMS, PC CARD
PERFORATORS, PAPER TAPE
POOLERS, MAGNETIC TAPE
PRINTER/PUNCH, PAPER TAPE
PRINTERS, KEYBOARD
PUNCHES, PAPER TAPE
READERS, PAPER TAPE
RECORDERS, DIGITAL CASSETTE
RECORDERS, MAGNETIC TAPE
SERVICES, HARDWARE MAINTENANCE
SPLICERS, PAPER TAPE
SPOOLERS, PAPER TAPE
TAPE TRANSPORTS, MAGNETIC (DIGITAL CASSETTE)
TAPE TRANSPORTS, MAGNETIC (INCREMENTAL)
TYPEWRITERS, COMPUTER INPUT-OUTPUT
USED EQUIPMENT (BUYING, SELLING, LEASING)
WINDERS, PAPER TAPE

3 Manufacturers' Directory

ANDROCOR INC.

5949 Hohman Ave, Hammond, Ind 46320

219-931-0750

CONSULTING (ACCOUNTING, BUSINESS AND COMMERCIAL APPLICATIONS)
CONSULTING (ADVANCED COMPUTER EQUIPMENT DESIGN AND FEASIBILITY STUDIES)
CONSULTING (COMPUTER EVALUATIONS, SELECTIONS, INSTALLATION PLANNING)
CONSULTING (DATA COMMUNICATIONS SYSTEMS PLANNING)
CONSULTING (MANAGEMENT INFORMATION SYSTEMS PLANNING)
CONSULTING (SCIENTIFIC APPLICATIONS)
SERVICES, COMPUTER-AIDED DESIGN
SERVICES, FACILITY MANAGEMENT
SERVICES, MANAGEMENT INFORMATION SYSTEMS
SERVICES, PROCESSING (COMMERCIAL EDP)
SERVICES, PROCESSING (DIGITAL SCIENTIFIC)
SERVICES, SYSTEMS ANALYSIS

ANETSBERGER BROTHERS INC. SYS. ENCLOSURES DIV

200 Anets Dr, Northbrook, Ill 60062

312-272-0787

CABINETS, ENCLOSURES, CONSOLES, ELECTRONIC (FOR GENERAL EQUIPMENT)

ANN ARBOR TERMINALS INC.

918 Greene St, Ann Arbor, Mich 48104

313-769-0926

DATA TERMINALS, INQUIRY-RESPONSE (CRT WITH KEYBOARD)
DATA TERMINALS, INQUIRY-RESPONSE (SPECIAL-PURPOSE)
DISPLAY DRIVERS
READOUTS, CRT

ANSLEY ELECTRONICS CORP. SUB. THOMAS & BETTS

Old Easton Rd, Doylestown, Pa 18901

215-345-1800

TWX 510-665-8105

BOARDS, PRINTED CIRCUIT (WITHOUT COMPONENTS)
CABLE ASSEMBLIES (WITH CONNECTORS)
CABLE, FLAT, PRINTED AND RIBBON
CABLE, MULTICONDUCTOR
CABLE, SHIELDED (NOT COAXIAL)
CONNECTORS, RACK AND PANEL (COMPUTER-GRADE)
SOCKETS, IC MOUNTING
SWITCHES, ROTARY

ANSLEY MANUFACTURING CO. SUB. THOMAS & BETTS

4100 N Figueroa St, Los Angeles, Cal 90065

213-223-2331

TWX 910-321-3938

CABLE ASSEMBLIES (WITH CONNECTORS)
CABLE, FLAT, PRINTED AND RIBBON
CABLE, MULTICONDUCTOR
CABLE, SHIELDED (NOT COAXIAL)
CONNECTORS, MINIATURE AND SUB-MINIATURE (COMPUTER-GRADE)
CONNECTORS, PC AND IC BOARD (COMPUTER-GRADE)
CONNECTORS, RACK AND PANEL (COMPUTER-GRADE)
MEMORY SYSTEMS, MAGNETIC DISC
MEMORY SYSTEMS, MAGNETIC DRUM
MEMORY SYSTEMS, PLATED WIRE

APOLLO COMPUTER ROOM INSTALLATIONS INC.

P O Box 32, Bellmore, N Y 11710

516-781-5776

AIR CONDITIONERS (FOR EDP INSTALLATIONS)
FLOORING (FOR EDP ROOMS)
FLOOR PLANNING AIDS (FOR EDP ROOMS)

APPLIED COMPUTER SCIENCES INC.

361 Park Rd, W Hartford, Conn 06107

203-233-8503

CONSULTING (ACCOUNTING, BUSINESS AND COMMERCIAL APPLICATIONS)
CONSULTING (COMPUTER EVALUATIONS, SELECTIONS, INSTALLATION PLANNING)
CONSULTING (DATA COMMUNICATIONS SYSTEMS PLANNING)
CONSULTING (MANAGEMENT INFORMATION SYSTEMS PLANNING)
SERVICES, FACILITY MANAGEMENT
SERVICES, MANAGEMENT INFORMATION SYSTEMS
SERVICES, SYSTEMS ANALYSIS
TRAINING INSTITUTES, COMMERCIAL COMPUTER COURSES, SEMINARS, CORRESPONDENCE COURSES
TRAINING SYSTEMS, COMPUTER SERVICE

APPLIED COMPUTER SYSTEMS INC.

P O Box 6479, Austin, Tex 78702

512-926-1536

AMPLIFIERS, D.C.
AMPLIFIERS, INSTRUMENTATION
AUDIO/VISUAL TRAINING AIDS
CIRCUIT CARDS, LINEAR (WITH DISCRETE COMPONENTS)
CIRCUIT CARDS, LINEAR (WITH IC'S)
CONTINUED

CIRCUIT CARDS, LOGIC (WITH DISCRETE COMPONENTS)
CIRCUIT CARDS, LOGIC (WITH IC'S)
CLOCKS, DIGITAL (REAL-TIME)
COMPUTERS, DIGITAL (EDUCATIONAL)
CONSULTING (DATA COMMUNICATIONS SYSTEMS PLANNING)
CONSULTING (SCIENTIFIC APPLICATIONS)
CONTROLLERS, MAGNETIC TAPE
CONTROLLERS, PLOTTING
CONVERTERS, ANALOG-TO-DIGITAL
CONVERTERS, BINARY-TO-DECIMAL
CONVERTERS, DIGITAL-TO-ANALOG
COUNTERS, DECADE
COUNTERS, UP-DOWN
DATA ACQUISITION AND REDUCTION SYSTEMS
DATA CONCENTRATORS
DATA TERMINALS, BLOCK-BY-BLOCK (GRAPHIC DIGITIZERS)
DATA TERMINALS, BLOCK-BY-BLOCK (MAGNETIC TAPE)
DATA TERMINALS, BLOCK-BY-BLOCK (MULTI-PURPOSE)
DATA TERMINALS, BLOCK-BY-BLOCK (PAPER TAPE)
DATA TERMINALS, BLOCK-BY-BLOCK (PLOTTER)
DATA TERMINALS, BLOCK-BY-BLOCK (HIGH SPEED PRINTER)
DATA TERMINALS, BLOCK-BY-BLOCK (MEDIUM SPEED PRINTER)
DATA TERMINALS, BLOCK-BY-BLOCK (PUNCHED CARD)
DATA TERMINALS, BLOCK-BY-BLOCK (TELEPRINTER)
DATA TERMINALS, INQUIRY-RESPONSE (ALPHANUMERIC KEYBOARD)
DATA TERMINALS, INQUIRY-RESPONSE (AUDIO RESPONSE)
DATA TERMINALS, INQUIRY-RESPONSE (BADGE-TOKEN READERS)
DATA TERMINALS, INQUIRY-RESPONSE (CRT WITH KEYBOARD)
DATA TERMINALS, INQUIRY-RESPONSE (SPECIAL-PURPOSE)
DEMONSTRATORS AND KITS, EDUCATIONAL (DIGITAL LOGIC)
DIGITIZERS, PROGRAMMABLE
MAGNETIC TAPE STORAGE SYSTEMS (INCLUDES CONTROLLER)
MULTIPLEXERS, ANALOG-RELAY (SEQUENTIAL SAMPLING)
MULTIPLEXERS, ANALOG-SOLID STATE (SEQUENTIAL SAMPLING)
MULTIPLEXERS, DIGITAL
POWER SUPPLIES, DC
PROJECTORS, OPTICAL (COMPUTER CONTROLLED SLIDE SELECTING)
RECORDERS, DIGITAL CASSETTE
SCANNERS, INPUT
SERVICES, AUTOMATED WIRE-WRAPPING
SERVICES, HARDWARE MAINTENANCE
SERVICES, SYSTEMS ANALYSIS
THERMOCOUPLE REFERENCE SYSTEMS

APPLIED COMPUTER TIME SHARE INC.

29200 Southfield Rd, Southfield, Mich 48075

313-352-6800

COMPUTERS, DIGITAL (EDUCATIONAL)
CONSULTING (ACCOUNTING, BUSINESS AND COMMERCIAL APPLICATIONS)
CONSULTING (ADVANCED COMPUTER EQUIPMENT DESIGN AND FEASIBILITY STUDIES)
CONSULTING (COMPUTER EVALUATIONS, SELECTIONS, INSTALLATION PLANNING)
CONSULTING (DATA COMMUNICATIONS SYSTEMS PLANNING)
CONSULTING (COMPUTER PRODUCT PLANNING SURVEYS, MARKET RESEARCH STUDIES)
CONSULTING (MANAGEMENT INFORMATION SYSTEMS PLANNING)
CONSULTING (SCIENTIFIC APPLICATIONS)
INSTRUCTIONAL SYSTEMS, COMPUTER-BASED
PROGRAMMING LANGUAGE DEVELOPMENT (CONSULTANTS)
PROGRAMMING LANGUAGE DEVELOPMENT (CONTRACT PROGRAMMING)
PROGRAMMING LANGUAGE DEVELOPMENT (DEDICATED APPLICATION SYSTEMS)
PROGRAMMING LANGUAGE DEVELOPMENT (PROPRIETARY SOFTWARE PRODUCTS)
SERVICES, COMPUTER-AIDED DESIGN
SERVICES, FACILITY MANAGEMENT
SERVICES, MANAGEMENT INFORMATION SYSTEMS
SERVICES, PROCESSING (COMMERCIAL EDP)
SERVICES, PROCESSING (DIGITAL SCIENTIFIC)
SERVICES, TIME SHARING (COMMERCIAL)
SERVICES, TIME SHARING (RESEARCH)
SERVICES, SYSTEMS ANALYSIS
TRAINING INSTITUTES, COMMERCIAL COMPUTER COURSES, SEMINARS, CORRESPONDENCE COURSES

APPLIED CYBERNETICS CORP.

1285 Forgewood Ave, Sunnyvale, Cal 94086

408-734-1900

CONSULTING (ACCOUNTING, BUSINESS AND COMMERCIAL APPLICATIONS)
CONSULTING (COMPUTER EVALUATIONS, SELECTIONS, INSTALLATION PLANNING)
CONSULTING (COMPUTER PRODUCT PLANNING SURVEYS, MARKET RESEARCH STUDIES)
CONSULTING (MANAGEMENT INFORMATION SYSTEMS PLANNING)
CONSULTING (SCIENTIFIC APPLICATIONS)
PROGRAMMING LANGUAGE DEVELOPMENT (CONSULTANTS)
PROGRAMMING LANGUAGE DEVELOPMENT (CONTRACT PROGRAMMING)
PROGRAMMING LANGUAGE DEVELOPMENT (DEDICATED APPLICATION SYSTEMS)
PROGRAMMING LANGUAGE DEVELOPMENT (PROPRIETARY SOFTWARE PRODUCTS)
SERVICES, FACILITY MANAGEMENT
CONTINUED

3 Manufacturers' Directory

SERVICES, PROCESSING (COMMERCIAL EDP)
SERVICES, SYSTEMS ANALYSIS

APPLIED DIGITAL DATA SYSTEMS INC. 516-231-5400
100 Marcus Blvd, Hauppauge, N Y 11787

ACOUSTIC COUPLERS
DATA TERMINALS, INQUIRY-RESPONSE (ALPHANUMERIC KEYBOARD)
DATA TERMINALS, INQUIRY-RESPONSE (CRT WITH KEYBOARD)
DATA TERMINALS, INQUIRY-RESPONSE (SPECIAL-PURPOSE)
MODEMS, ACOUSTIC
MODEMS, HARD-WIRED
MODEMS, PC CARD
READOUTS, CRT

APPLIED DIGITAL SYSTEMS INC. 714-540-4350
3848 Campus Dr 112, Newport Beach, Cal 92660

CONSULTING (ACCOUNTING, BUSINESS AND COMMERCIAL APPLICATIONS)
CONSULTING (COMPUTER EVALUATIONS, SELECTIONS, INSTALLATION PLANNING)
CONSULTING (DATA COMMUNICATIONS SYSTEMS PLANNING)
CONSULTING (MANAGEMENT INFORMATION SYSTEMS PLANNING)
CONSULTING (SCIENTIFIC APPLICATIONS)
PROGRAMMING LANGUAGE DEVELOPMENT (CONSULTANTS)
PROGRAMMING LANGUAGE DEVELOPMENT (CONTRACT PROGRAMMING)
PROGRAMMING LANGUAGE DEVELOPMENT (DEDICATED APPLICATION SYSTEMS)
SERVICES, SYSTEMS ANALYSIS

APPLIED DYNAMICS COMPUTER SYS DV RELIANCE ELEC CO 313-971-4444
P O Box 1488, Ann Arbor, Mich 48106 TWX 810-223-6050

COMPUTERS, ANALOG (EDUCATIONAL)
COMPUTERS, ANALOG (GENERAL-PURPOSE)
COMPUTERS, HYBRID
DATA ACQUISITION AND REDUCTION SYSTEMS
INSTRUCTIONAL SYSTEMS, COMPUTER-BASED

APPLIED GEODATA SYSTEMS INC. 617-868-8168
675 Massachusetts Ave, Cambridge, Mass 02139

CONSULTING (SCIENTIFIC APPLICATIONS)
PROGRAMMING LANGUAGE DEVELOPMENT (PROPRIETARY SOFTWARE PRODUCTS)
SERVICES, TIME SHARING (COMMERCIAL)

APPLIED LOGIC CORP. 609-924-7800
One Palmer Sq, Princeton, N J 08540

PROGRAMMING LANGUAGE DEVELOPMENT (CONSULTANTS)
PROGRAMMING LANGUAGE DEVELOPMENT (CONTRACT PROGRAMMING)
SERVICES, TIME SHARING (COMMERCIAL)
SERVICES, TIME SHARING (RESEARCH)

APPLIED MAGNETICS CORP. COMPUTER MEMORY DIV 805-964-4881
75 Robin Hill Rd, Goleta, Cal 93017 TWX 910-334-1195

DISC DRIVES, FIXED HEAD (INCLUDING CONTROLLER)
DISC STORAGE SYSTEMS
MEMORY SYSTEMS, MAGNETIC DISC

APPLIED MAGNETICS CORP. MAG. TAPE HEAD DIV. 805-964-4881
75 Robin Hill Rd, Goleta, Cal 93017 TWX 910-334-1195

RECORDING HEADS, MAGNETIC DISC
RECORDING HEADS, MAGNETIC DRUM
RECORDING HEADS, MAGNETIC TAPE

APPLIED MICROFILM CORP. 617-491-0838
107 Binney St, Watertown, Mass 02142

CARDS, MICORFILM APERTURE
MICROFICHE
MICROFILM ROLLS
PAPER (FOR PRINTERS)
READER/PRINTER, MICROFILM/MICROFICHE
READERS, MICROFILM/MICROFICHE

APPLIED PROGRAMMING TECHNOLOGY CORP. 617-562-9573
275 D Cox St, Hudson, Mass 01749

CONSULTING (COMPUTER EVALUATIONS, SELECTIONS, INSTALLATION PLANNING)
CONSULTING (COMPUTER PRODUCT PLANNING SURVEYS, MARKET RESEARCH STUDIES)
CONTINUED

CONSULTING (SCIENTIFIC APPLICATIONS)
PROGRAMMING LANGUAGE DEVELOPMENT (CONSULTANTS)
PROGRAMMING LANGUAGE DEVELOPMENT (CONTRACT PROGRAMMING)
PROGRAMMING LANGUAGE DEVELOPMENT (DEDICATED APPLICATION SYSTEMS)
PROGRAMMING LANGUAGE DEVELOPMENT (PROPRIETARY SOFTWARE PRODUCTS)

APPLIED SYSTEMS CORP. 313-535-5800
18325 W McNichols Ave, Detroit, Mich 48219

COMMUNICATIONS-ORIENTED PROCESSORS, MULTIPLE CHANNEL CONTROLLERS
COMMUNICATIONS-ORIENTED PROCESSORS, STORED PROGRAM
COMPUTERS, DIGITAL (GENERAL-PURPOSE, SMALL-SCALE)
COMPUTERS, MINI GENERAL PURPOSE (ALSO SEE CALCULATORS)
COMPUTERS, PROCESS CONTROL
CONSULTING (ADVANCED COMPUTER EQUIPMENT DESIGN AND FEASIBILITY STUDIES)
CONSULTING (DATA COMMUNICATIONS SYSTEMS PLANNING)
DATA ACQUISITION AND REDUCTION SYSTEMS
DATA CONCENTRATORS
DATA TERMINALS, BLOCK-BY-BLOCK (MULTI-PURPOSE)
DATA TERMINALS, BLOCK-BY-BLOCK (MEDIUM SPEED PRINTER)
DATA TERMINALS, BLOCK-BY-BLOCK (PUNCHED CARD)
DATA TERMINALS, INQUIRY-RESPONSE (SPECIAL-PURPOSE)
PROGRAMMING LANGUAGE DEVELOPMENT (CONSULTANTS)
PROGRAMMING LANGUAGE DEVELOPMENT (PROPRIETARY SOFTWARE PRODUCTS)

APT COMPUTER CENTER 314-267-3540
5309 W Touhy, Skokie, Ill 60076

CONSULTING (ACCOUNTING, BUSINESS AND COMMERCIAL APPLICATIONS)
CONSULTING (COMPUTER EVALUATIONS, SELECTIONS, INSTALLATION PLANNING)
SERVICES, FACILITY MANAGEMENT
SERVICES, PROCESSING (COMMERCIAL EDP)

ARGONAUT ASSOCIATES INC. 503-292-3149
P O Box K, Beaverton, Ore 97005

AMPLIFIERS, D.C.
AMPLIFIERS, INSTRUMENTATION
PLOTTERS, MOVING PEN (ANALOG CONTROLLER)
RECORDERS, GRAPHIC

ARIES CORP. 703-893-4400
1651 Old Meadow Rd, Mc Lean, Va 22101

CONSULTING (ACCOUNTING, BUSINESS AND COMMERCIAL APPLICATIONS)
CONSULTING (ADVANCED COMPUTER EQUIPMENT DESIGN AND FEASIBILITY STUDIES)
CONSULTING (COMPUTER EVALUATIONS, SELECTIONS, INSTALLATION PLANNING)
CONSULTING (DATA COMMUNICATIONS SYSTEMS PLANNING)
CONSULTING (MANAGEMENT INFORMATION SYSTEMS PLANNING)
CONSULTING (SCIENTIFIC APPLICATIONS)
SERVICES, FACILITY MANAGEMENT
SERVICES, MANAGEMENT INFORMATION SYSTEMS
SERVICES, SYSTEMS ANALYSIS

ARIES TECHNOLOGY DIV. UNIDEX INC. 408-244-9366
3475 Victor St, Santa Clara, Cal 95050

BOARDS, PRINTED CIRCUIT (WITHOUT COMPONENTS)
TRANSFORMERS, PULSE (COMPUTER GRADE)

ARISTA INFORMATION SYSTEMS INC. 919-722-5167
P O Box 4775, Winston-Salem, N C 27107

CONSULTING (ACCOUNTING, BUSINESS AND COMMERCIAL APPLICATIONS)
CONSULTING (COMPUTER EVALUATIONS, SELECTIONS, INSTALLATION PLANNING)
SERVICES, FACILITY MANAGEMENT
SERVICES, PROCESSING (COMMERCIAL EDP)

ARNDT ASSOCIATES 312-864-1999
727 Howard St, Evanston, Ill 60202

CARDS, EDGE-PUNCH
SPLICERS, PAPER TAPE
WINDERS, PAPER TAPE

3 Manufacturers' Directory

ARNOLD MAGNETICS CORP. P O Box K, Culver City, Cal 90230 CONVERTERS, DC-TO-FREQUENCY CONVERTERS, FREQUENCY-TO-DC CONVERTERS, VOLTAGE-TO-FREQUENCY INVERTERS, DC-AC POWER SUPPLIES, AC POWER SUPPLIES, DC TRANSFORMERS, POWER (COMPUTER GRADE)	213-870-7014 TWX 910-343-6468	COMPUTERS, AEROSPACE COMPUTERS, NAVIGATION CONSOLES, CRT (ALPHANUMERIC AND GRAPHIC) CONVERTERS, SYNCHRO-TO-DIGITAL INDICATORS, ALPHANUMERIC READOUTS, CRT TESTERS, CIRCUIT TESTERS, DIGITAL LOGIC MODULES AND CARDS
ARROW BUS BAR CORP. 23 A Dana St, Malden, Mass 02148 BUS BAR SYSTEMS	617-322-2244	ASTRO-SCIENCE CORP. 9700 Factorial Way, S El Monte, Cal 91734 MAGNETIC TAPE STORAGE SYSTEMS (INCLUDES CONTROLLER) RECORDERS, DIGITAL CASSETTE RECORDERS, MAGNETIC TAPE TAPE, MAGNETIC (CASSETTE) TAPE, MAGNETIC (REELS) TAPE TRANSPORTS, MAGNETIC (DIGITAL-EXCL. CASSETTE) TAPE TRANSPORTS, MAGNETIC (DIGITAL CASSETTE) TAPE TRANSPORTS, MAGNETIC (INCREMENTAL)
ARTISAN ELECTRONICS CORP. 5 Eastman Rd, Parsippany, N J 07054 CABLE ASSEMBLIES (WITH CONNECTORS) CLOCKS, DIGITAL (REAL-TIME) RELAYS, SOLID-STATE (COMPUTER GRADE) TIMERS, EVENT (IMPULSE) TIMERS, INTERVAL	201-887-7100	ASTRO-SPACE LABS., INC. 110 Wynn Drive NW, Huntsville, Ala 35806 CABLE ASSEMBLIES (WITH CONNECTORS) CIRCUITS, THICK FILM (DIGITAL) POWER SUPPLIES, DC RELAYS, DRY REED (COMPUTER GRADE)
ARTRONIC INSTRUMENT CO. 11232 Triangle Ln, Silver Spring, Md 20902 TRANSFORMERS, PULSE (COMPUTER GRADE)	301-949-1131	ASTROSYSTEMS INC. 6 Nevada Dr, Lake Success, N Y 11040 CONVERTERS, ANALOG-TO-DIGITAL CONVERTERS, BINARY-TO-DECIMAL CONVERTERS, DC-TO-FREQUENCY CONVERTERS, DIGITAL-TO-ANALOG CONVERTERS, DIGITAL-TO-SYNCHRO CONVERTERS, PULSE-TO-DIGITAL CONVERTERS, SCAN CONVERTERS, SYNCHRO-TO-DIGITAL CONVERTERS, VOLTAGE-TO-FREQUENCY DATA ACQUISITION AND REDUCTION SYSTEMS MULTIPLEXER-CONVERTER (SINGLE UNIT WITH MULTIPLEXER, SAMPLE & HOLD AMPLIFIER & A-TO-D CONVERTER) MULTIPLEXERS, ANALOG-RELAY (SEQUENTIAL SAMPLING) MULTIPLEXERS, ANALOG-SOLID STATE (SEQUENTIAL SAMPLING) MULTIPLEXERS, DIGITAL TESTERS, CIRCUIT TESTERS, INTEGRATED CIRCUIT THERMOCOUPLE REFERENCE SYSTEMS
ARVIN MAGNETICS 6950 Washington Ave S, Eden Prairie, Minn 55343 RECORDING HEADS, MAGNETIC DISC RECORDING HEADS, MAGNETIC DRUM RECORDING HEADS, MAGNETIC TAPE	612-941-6700	ATLANTIC RESEARCH CORP. Shirley Hwy/Edsall Rd, Alexandria, Va 22304 TEST SYSTEMS, COMPUTER PERFORMANCE TESTERS, DIGITAL DATA TRANSMISSION
ARVIN SYSTEMS INC. 1771 Springfield St, Dayton, Ohio 45403 AUDIO/VISUAL TRAINING AIDS CRYSTAL UNITS, QUARTZ (FOR FREQUENCY CONTROL) OSCILLATORS, VOLTAGE CONTROLLED PLOTTERS, MOVING PEN (ANALOG CONTROLLER) PLOTTERS, MOVING PEN (DIGITAL CONTROLLER) READOUTS AND DISPLAYS, NUMERIC AND ALPHANUMERIC (OTHER THAN CRT)	513-254-6177 TELEX 28-8207	ATLANTIC SOFTWARE INC. 5th & Chestnut St, Philadelphia, Pa 19106 PROGRAMMING LANGUAGE DEVELOPMENT (PROPRIETARY SOFTWARE PRODUCTS)
ASC TABULATING CORP. 1080 Green Bay Rd, Lake Bluff, Ill 60044 SERVICES, PROCESSING (COMMERCIAL EDP) SERVICES, SYSTEMS ANALYSIS	312-234-9550	ATLANTIC TECHNOLOGY CORP. 505 W Hamilton Ave, Linwood, N J 08221 CONSOLES, CRT (ALPHANUMERIC AND GRAPHIC) DATA TERMINALS, INQUIRY-RESPONSE (CRT WITH KEYBOARD)
ASHLAND ELECTRIC PRODUCTS INC 3202 Queens Blvd, Long Is Cy, N Y 11101 BLOWERS, FANS, COOLING ASSEMBLIES MOTORS, SYNCHRONOUS	212-392-4010	ATRON CORP. 1256 Trapp Rd, St Paul, Minn 55118 COMMUNICATIONS-ORIENTED PROCESSORS, STORED PROGRAM COMPUTERS, DIGITAL (GENERAL-PURPOSE, SMALL-SCALE) COMPUTERS, MINI GENERAL PURPOSE (ALSO SEE CALCULATORS) CONVERTERS, MAGNETIC TAPE-TO-MAGNETIC TAPE CONVERTERS, MAGNETIC TAPE-TO-PRINTER CONVERTERS, PUNCHED CARD-TO-MAGNETIC TAPE DATA TERMINALS, BLOCK-BY-BLOCK (MAGNETIC TAPE) DATA TERMINALS, BLOCK-BY-BLOCK (MULTI-PURPOSE) DATA TERMINALS, BLOCK-BY-BLOCK (HIGH SPEED PRINTER) DATA TERMINALS, BLOCK-BY-BLOCK (MEDIUM SPEED PRINTER) DATA TERMINALS, BLOCK-BY-BLOCK (PUNCHED CARD) MEMORY SYSTEMS, MAGNETIC CORE MEMORY SYSTEMS, READ-ONLY
ASTROCOM CORP. 293 Commercial St, St Paul, Minn 55106 MODEMS, HARD-WIRED MODEMS, PC CARD	612-227-8991	
ASTRODYNE INC. 353 Middlesex Ave, Wilmington, Mass 01887 BLOWERS, FANS, COOLING ASSEMBLIES HEAT SINKS, CIRCUIT BOARD MOUNTING	617-272-3850 TWX 710-347-0704	
ASTRO MOBILE PRODUCTS CORP. MAGNAGRAPH DIV. 11-25 44 Rd, Long Island, N Y 11101 AUDIO/VISUAL TRAINING AIDS BOARDS, VISUAL CONTROL (GRAPHIC) DEMONSTRATORS AND KITS, EDUCATIONAL (DIGITAL LOGIC) DISPLAYS, PANELS, VIEWGRAPHS (FOR COMPUTER TRAINING)	212-784-9044	
ASTRONAUTICS CORPORATION OF AMERICA 907 S First St, Milwaukee, Wis 53204 AMPLIFIERS, INSTRUMENTATION AMPLIFIERS, VIDEO CONTINUED	414-671-5500 TWX 262-3153-910	

3 Manufacturers' Directory

- AUDAC CORP.** 617-272-6720
175 Bedford St, Burlington, Mass 01803
DATA TERMINALS, INQUIRY-RESPONSE (AUDIO RESPONSE)
DATA TERMINALS, INQUIRY-RESPONSE (BADGE-TOKEN READERS)
DOCUMENTS, DCR/OMR
SCANNERS, OPTICAL
- AUDIO DEVICES INC. A CAPITOL INDUSTRIES CO.** 203-324-6761
100 Research Dr, Glenbrook, Conn 06906 TWX 710-474-2045
REELS, MAGNETIC TAPE
- AUDIO SUTTLE CORP. SUB.OF RAY PROOF** 203-838-4596
50 Keeler Ave, Norwalk, Conn 06856
CABINETS AND ENCLOSURES (FOR KEYPUNCHES, PRINTERS)
CABINETS, ENCLOSURES, CONSOLES, ELECTRONIC (FOR GENERAL EQUIPMENT)
CABINETS, RACKS, VAULTS (FOR MAGNETIC TAPE STORAGE)
- AUDITEK INC.** 212-689-8999
866 6th Ave, New York, N Y 10001
CONSULTING (ACCOUNTING, BUSINESS AND COMMERCIAL APPLICATIONS)
SERVICES, PROCESSING (COMMERCIAL EDP)
- AUERBACH ASSOCIATES INC.** 215-491-8200
121 W Broad St, Philadelphia, Pa 19107
CONSULTING (ACCOUNTING, BUSINESS AND COMMERCIAL APPLICATIONS)
CONSULTING (ADVANCED COMPUTER EQUIPMENT DESIGN AND FEASIBILITY STUDIES)
CONSULTING (COMPUTER EVALUATIONS, SELECTIONS, INSTALLATION PLANNING)
CONSULTING (DATA COMMUNICATIONS SYSTEMS PLANNING)
CONSULTING (COMPUTER PRODUCT PLANNING SURVEYS, MARKET RESEARCH STUDIES)
CONSULTING (MANAGEMENT INFORMATION SYSTEMS PLANNING)
CONSULTING (SCIENTIFIC APPLICATIONS)
PROGRAMMING LANGUAGE DEVELOPMENT (CONSULTANTS)
PROGRAMMING LANGUAGE DEVELOPMENT (CONTRACT PROGRAMMING)
PROGRAMMING LANGUAGE DEVELOPMENT (DEDICATED APPLICATION SYSTEMS)
PROGRAMMING LANGUAGE DEVELOPMENT (PROPRIETARY SOFTWARE PRODUCTS)
SERVICES, COMPUTER-AIDED DESIGN
SERVICES, FACILITY MANAGEMENT
SERVICES, MANAGEMENT INFORMATION SYSTEMS
SERVICES, SYSTEMS ANALYSIS
- AUGAT INC.** 617-222-2202
33 Perry Ave, Attleboro, Mass 02703 TWX 710-391-0644
CABINETS, ENCLOSURES, CONSOLES, ELECTRONIC (FOR GENERAL EQUIPMENT)
CABLE ASSEMBLIES (WITH CONNECTORS)
CABLE, FLAT, PRINTED AND RIBBON
CONNECTORS, MINIATURE AND SUB-MINIATURE (COMPUTER-GRADE)
CONNECTORS, PC AND IC BOARD (COMPUTER-GRADE)
HEAT SINKS, CIRCUIT BOARD MOUNTING
JACKS, JACK PANELS, PLUGS, ASSEMBLIES
TERMINAL BLOCKS, STRIPS, BOARDS
- AUL INSTRUMENT INC.** 212-886-0600
139-30 34th Rd, Flushing, N Y 11354
POWER SUPPLIES, DC
POWER SUPPLIES, DIGITALLY-CONTROLLED
REGULATORS, CURRENT
REGULATORS, VOLTAGE
VOLTAGE DIVIDERS
- AURICORD DIV., SCOVILL MFG. CO.** 212-361-7400
35-41 29 St, Long Isl City, N Y 11106
RECORDERS, DIGITAL CASSETTE
RECORDERS, MAGNETIC TAPE
SERVICES, MAGNETIC TAPE CERTIFICATION
TAPE, MAGNETIC (CASSETTE)
TAPE TRANSPORTS, MAGNETIC (DIGITAL-EXCL. CASSETTE)
TAPE TRANSPORTS, MAGNETIC (DIGITAL CASSETTE)
WINDERS, MAGNETIC TAPE
- AUSTIN SYSTEMS CO., INC.** 617-272-7308
87 Terrace Hall Ave, Burlington, Mass 01803
PROGRAMMING LANGUAGE DEVELOPMENT (PROPRIETARY SOFTWARE PRODUCTS)
- AUSTRON, INC.** 512-836-3523
10214 N Interregional, Austin, Tex 78753 TWX 910-874-1356
CLOCKS, DIGITAL (REAL-TIME)
COMPUTERS, NAVIGATION
INVERTERS, DC-AC
OSCILLATORS, VOLTAGE CONTROLLED
POWER SUPPLIES, AC
POWER SUPPLIES, DC
PRINTERS, DIGITAL STRIP RECORDING
READOUTS AND DISPLAYS, NUMERIC AND ALPHANUMERIC (OTHER THAN CRT)
SCANNERS, INPUT
SIGNAL CONDITIONERS
THERMOCOUPLE REFERENCE SYSTEMS
- AUTOCOMP INC.** 301-654-8023
4720 Montgomery Ln, Bethesda, Md 20014
CONSULTING (ACCOUNTING, BUSINESS AND COMMERCIAL APPLICATIONS)
CONSULTING (COMPUTER EVALUATIONS, SELECTIONS, INSTALLATION PLANNING)
SERVICES, MANAGEMENT INFORMATION SYSTEMS
SERVICES, PROCESSING (COMMERCIAL EDP)
SERVICES, SYSTEMS ANALYSIS
- AUTOMATED COMPUTER SERVICES INC.** 703-643-5315
517 W Grace St, Richmond, Va 23220
CONSULTING (ACCOUNTING, BUSINESS AND COMMERCIAL APPLICATIONS)
CONSULTING (COMPUTER EVALUATIONS, SELECTIONS, INSTALLATION PLANNING)
CONSULTING (DATA COMMUNICATIONS SYSTEMS PLANNING)
SERVICES, PROCESSING (COMMERCIAL EDP)
- AUTOMATED CONCEPTS INC.** 212-688-8440
477 Madison Ave, New York, N Y 10017
CONSULTING (ACCOUNTING, BUSINESS AND COMMERCIAL APPLICATIONS)
CONSULTING (COMPUTER EVALUATIONS, SELECTIONS, INSTALLATION PLANNING)
CONSULTING (DATA COMMUNICATIONS SYSTEMS PLANNING)
CONSULTING (MANAGEMENT INFORMATION SYSTEMS PLANNING)
SERVICES, FACILITY MANAGEMENT
SERVICES, SYSTEMS ANALYSIS
- AUTOMATED CONTROL TECHNOLOGY INC.** 415-964-4860
745 Distel Dr, Los Altos, Cal 94022
TESTERS, CIRCUIT
TESTERS, DIGITAL LOGIC MODULES AND CARDS
TESTERS, INTEGRATED CIRCUIT
TESTERS, SEMICONDUCTOR
- AUTOMATED DATA ASSOCIATES INC.** 201-382-3900
1333 Lawrence St, Rahway, N J 07065
SERVICES, PROCESSING (COMMERCIAL EDP)
SERVICES, SYSTEMS ANALYSIS
TRAINING INSTITUTES, COMMERCIAL COMPUTER COURSES, SEMINARS,
CORRESPONDENCE COURSES
- AUTOMATED FACTS & FIGURES CO.** 312-927-4466
4551 S Racine Ave, Chicago, Ill 60609
CONSULTING (ACCOUNTING, BUSINESS AND COMMERCIAL APPLICATIONS)
CONSULTING (COMPUTER EVALUATIONS, SELECTIONS, INSTALLATION PLANNING)
CONSULTING (DATA COMMUNICATIONS SYSTEMS PLANNING)
SERVICES, PROCESSING (COMMERCIAL EDP)
SERVICES, SYSTEMS ANALYSIS
- AUTOMATED INFORMATION AND MANAGEMENT SYSTEMS** 513-621-9721
705 Transpation Bldg, Cincinnati, Ohio 45202
PROGRAMMING LANGUAGE DEVELOPMENT (PROPRIETARY SOFTWARE PRODUCTS)
- AUTOMATED INFORMATION SYSTEMS INC.** 201-945-0871
1064 River Rd, Edgewater, N J 07020
CONSULTING (ACCOUNTING, BUSINESS AND COMMERCIAL APPLICATIONS)
CONSULTING (DATA COMMUNICATIONS SYSTEMS PLANNING)
CONSULTING (MANAGEMENT INFORMATION SYSTEMS PLANNING)
CONSULTING (SCIENTIFIC APPLICATIONS)
CONTINUED

3 Manufacturers' Directory

SERVICES, FACILITY MANAGEMENT
 SERVICES, MANAGEMENT INFORMATION SYSTEMS
 SERVICES, PROCESSING (COMMERCIAL EDP)
 SERVICES, PROCESSING (DIGITAL SCIENTIFIC)
 SERVICES, SYSTEMS ANALYSIS
 TRAINING INSTITUTES, COMMERCIAL COMPUTER COURSES, SEMINARS,
 CORRESPONDENCE COURSES

AUTOMATED SYSTEMS CORP. 713-225-2281
600 Houst Nat Gas Bld, Houston, Tex 77002

COMMUNICATIONS-ORIENTED PROCESSORS, STORED PROGRAM
 CONSULTING (ACCOUNTING, BUSINESS AND COMMERCIAL APPLICATIONS)
 CONSULTING (COMPUTER EVALUATIONS, SELECTIONS, INSTALLATION
 PLANNING)
 CONSULTING (DATA COMMUNICATIONS SYSTEMS PLANNING)
 CONSULTING (MANAGEMENT INFORMATION SYSTEMS PLANNING)
 SERVICES, FACILITY MANAGEMENT
 SERVICES, PROCESSING (COMMERCIAL EDP)
 SERVICES, TIME SHARING (COMMERCIAL)
 SERVICES, SYSTEMS ANALYSIS

AUTOMATIC DATA PROCESSING, INC. 201-472-1000
405 Route 3, Clifton, N J 07015

SERVICES, PROCESSING (COMMERCIAL EDP)

AUTOMATIC ELECTRIC SUB. GT&E 312-562-7100
400 No Wolf Rd, North Lake, Ill 60164

COMMUNICATION SYSTEMS, DATA TRANSMISSION

AUTOMATION DEVELOPMENT CO. DIV. AMER DIG CORP. 213-838-7346
9903 W Jefferson Blvd, Culver City, Cal 90230

CONTROLLERS, MODEM
 COUNTERS, DIGITAL READOUT
 COUNTERS, STEPPING SWITCH
 COUNTERS, UP-DOWN
 INDICATORS, DIGITAL
 MOTORS, STEPPING

AUTOMATION, INC. 402-342-3346
1904 Farnam St, Omaha, Nebr 68102

SERVICES, MANAGEMENT INFORMATION SYSTEMS
 SERVICES, PROCESSING (COMMERCIAL EDP)
 SERVICES, SYSTEMS ANALYSIS

AUTOMATION SCIENCE INTL CORP. SUB AUTO. SCI. INC. 212-489-1380
15 Columbus Cir, New York, N Y 10023

COMPUTERS, DIGITAL (GENERAL-PURPOSE, SMALL-SCALE)
 COMPUTERS, DIGITAL (GENERAL-PURPOSE, MEDIUM-SCALE)
 COMPUTERS, DIGITAL (GENERAL-PURPOSE, LARGE SCALE)

AUTOMATION SCIENCES INTERNATIONAL CORP. 617-963-7717
600 South St, Holbrook, Mass 02343 TWX 710-348-0451

DISPLAYS, MAGNETIC
 POTENTIOMETERS, TRIM (FILM)
 POTENTIOMETERS, TRIM (WIRE-WOUND)
 SWITCHES, ROTARY

AUTOMATION SERVICES CORP. 617-843-0290
182 Forbes Rd, Braintree, Mass 02184

CONSULTING (ACCOUNTING, BUSINESS AND COMMERCIAL APPLICATIONS)
 CONSULTING (COMPUTER EVALUATIONS, SELECTIONS, INSTALLATION
 PLANNING)
 CONSULTING (DATA COMMUNICATIONS SYSTEMS PLANNING)
 CONSULTING (MANAGEMENT INFORMATION SYSTEMS PLANNING)
 CONSULTING (SCIENTIFIC APPLICATIONS)
 PROGRAMMING LANGUAGE DEVELOPMENT (CONTRACT PROGRAMMING)
 PROGRAMMING LANGUAGE DEVELOPMENT (DEDICATED APPLICATION SYSTEMS)
 PROGRAMMING LANGUAGE DEVELOPMENT (PROPRIETARY SOFTWARE
 PRODUCTS)
 SERVICES, COMPUTER-AIDED DESIGN
 SERVICES, FACILITY MANAGEMENT
 SERVICES, MANAGEMENT INFORMATION SYSTEMS
 SERVICES, PROCESSING (COMMERCIAL EDP)
 SERVICES, PROCESSING (DIGITAL SCIENTIFIC)
 SERVICES, TIME SHARING (COMMERCIAL)
 SERVICES, TIME SHARING (RESEARCH)
 SERVICES, AUTOMATED WIRE-WRAPPING
 CONTINUED

SERVICES, SYSTEMS ANALYSIS

AUTO-TROL CORP. 303-421-5670
6621 W 56th Ave, Arvada, Colo 80002

CONVERTERS, ANALOG-TO-DIGITAL
 PLOTTERS, FILM EXPOSING
 CURVE TRACERS-DIGITIZERS, AUTOMATIC
 CURVE TRACERS-DIGITIZERS, MANUAL
 DRAFTING SYSTEMS, COMPUTER-CONTROLLED STORAGE
 GRAPHIC TABLETS
 PLOTTERS, MOVING PEN (DIGITAL CONTROLLER)
 READOUTS AND DISPLAYS, NUMERIC AND ALPHANUMERIC (OTHER THAN CRT)

AUTRONICS CORP. 213-681-3545
180 N Vinedo Ave, Pasadena, Cal 91107 TWX 213-449-2854

RELAYS, SOLID-STATE (COMPUTER GRADE)
 TIMERS, EVENT (IMPULSE)
 TIMERS, INTERVAL

AVCO CORP. ELECTRONICS DIV. 205-837-6500
4807 Bradford, Huntsville, Ala 35805 TWX 810-726-2241

AMPLIFIERS, D.C.
 AMPLIFIERS, INSTRUMENTATION
 AMPLIFIERS, OPERATIONAL
 AUDIO/VISUAL TRAINING AIDS
 BOARDS, PRINTED CIRCUIT (WITHOUT COMPONENTS)
 CABLE ASSEMBLIES (WITH CONNECTORS)
 CIRCUIT CARDS, LINEAR (WITH DISCRETE COMPONENTS)
 CIRCUIT CARDS, LINEAR (WITH IC'S)
 CIRCUIT CARDS, LOGIC (WITH DISCRETE COMPONENTS)
 CIRCUIT CARDS, LOGIC (WITH IC'S)
 CIRCUITS, HYBRID (IC AND DISCRETE-DIGITAL)
 CIRCUITS, MONOLITHIC (DIGITAL LOGIC)
 CIRCUITS, MONOLITHIC (DIODE MATRICES)
 CIRCUITS, MONOLITHIC (LINEAR-EXCL. OP AMPS)
 CIRCUITS, MONOLITHIC (LSI-BIPOLAR)
 CIRCUITS, MONOLITHIC (LSI-MOS)
 CIRCUITS, MONOLITHIC (OP AMPS)
 CONSULTING (ADVANCED COMPUTER EQUIPMENT DESIGN AND FEASIBILITY
 STUDIES)
 CONSULTING (COMPUTER EVALUATIONS, SELECTIONS, INSTALLATION
 PLANNING)
 CONVERTERS, ANALOG-TO-DIGITAL
 CONVERTERS, BINARY-TO-DECIMAL
 CONVERTERS, DIGITAL-TO-ANALOG
 CORDS, PATCH
 COUNTERS, DECADE
 COUNTERS, UP-DOWN
 DATA ACQUISITION AND REDUCTION SYSTEMS
 ENCODERS, DIGITAL
 INDICATORS, ALPHANUMERIC
 INDICATORS, DIGITAL
 INDICATORS, ELAPSED TIME
 INDICATORS, ILLUMINATED
 MODULES, DIGITAL LOGIC ENCAPSULATED (ALSO SEE CIRCUITS & CIRCUIT
 CARDS)
 MODULES, LINEAR (ENCAPSULATED)
 MODULES, MEMORY (ENCAPSULATED)
 MODULES, RESISTANCE NETWORKS (ENCAPSULATED)
 MULTIPLEXER-CONVERTER (SINGLE UNIT WITH MULTIPLEXER, SAMPLE & HOLD
 AMPLIFIER & A-TO-D CONVERTER)
 MULTIPLEXERS, ANALOG-RELAY (SEQUENTIAL SAMPLING)
 MULTIPLEXERS, ANALOG-SOLID STATE (SEQUENTIAL SAMPLING)
 MULTIPLEXERS, DIGITAL
 PROGRAMMING LANGUAGE DEVELOPMENT (CONSULTANTS)
 PROGRAMMING LANGUAGE DEVELOPMENT (CONTRACT PROGRAMMING)
 PROGRAMMING LANGUAGE DEVELOPMENT (DEDICATED APPLICATION SYSTEMS)
 PROGRAMMING LANGUAGE DEVELOPMENT (PROPRIETARY SOFTWARE
 PRODUCTS)
 SIGNAL CONDITIONERS
 THERMOCOUPLE REFERENCE SYSTEMS

AVERY LABEL CO. 213-969-3311
777 E Foothill Blvd, Azusa, Cal 91702 TWX 910-584-1825
 LABELS, CONTINUOUS AND GUMMED (MACHINE APPLICATION)
 LABELS, CONTINUOUS AND PRESSURE SENSITIVE (MACHINE APPLICATION)

AVTEL CORP. 213-331-0661
1130 E Cypress St, Covina, Cal 91722

CONVERTERS, DC-TO-FREQUENCY
 POWER SUPPLIES, AC
 POWER SUPPLIES, UNINTERRUPTABLE
 PROTECTORS, CIRCUIT AND EQUIPMENT OVERLOAD

3 Manufacturers' Directory

- AZREX INC.** 617-272-8750
105 Terrace Hall Ave, Burlington, Mass 01803
CONSULTING (ACCOUNTING, BUSINESS AND COMMERCIAL APPLICATIONS)
CONSULTING (ADVANCED COMPUTER EQUIPMENT DESIGN AND FEASIBILITY STUDIES)
CONSULTING (COMPUTER EVALUATIONS, SELECTIONS, INSTALLATION PLANNING)
CONSULTING (DATA COMMUNICATIONS SYSTEMS PLANNING)
CONSULTING (MANAGEMENT INFORMATION SYSTEMS PLANNING)
CONSULTING (SCIENTIFIC APPLICATIONS)
PROGRAMMING LANGUAGE DEVELOPMENT (CONSULTANTS)
PROGRAMMING LANGUAGE DEVELOPMENT (CONTRACT PROGRAMMING)
PROGRAMMING LANGUAGE DEVELOPMENT (PROPRIETARY SOFTWARE PRODUCTS)
SERVICES, FACILITY MANAGEMENT
- AZTEC DATA SYSTEMS** 714-557-6366
P O Box Cr, Irvine, Cal 92664
MEMORY SYSTEMS, MAGNETIC CORE
MEMORY SYSTEMS, READ-ONLY
- B&F INSTRUMENT INC.** 215-639-7100
Clarmont Ave, Cornwell Height, Pa 19020 TWX 510-667-1516
DATA ACQUISITIONS SYSTEMS, AUTOMATIC
MULTIPLEXERS, ANALOG-RELAY (SEQUENTIAL SAMPLING)
POWER SUPPLIES, DC
SIGNAL CONDITIONERS
- B&K INSTRUMENTS INC.** 216-267-4800
5111 W 164th St, Cleveland, Ohio 44142 TWX 810-421-8266
VOLTMETERS, AC, DC, DIFFER-ENTIAL
- BABCOCK & WILCOX AUTOMTD MACHINE DIV** 313-651-9211
950 S Rochester Rd, Rochester, Mich 48063
AMPLIFIERS, INSTRUMENTATION
CONTROLLERS, MOTOR
PANELS, POWER DISTRIBUTION
- BABCOCK & WILCOX LTD.** 519-621-2130
Coronahon Blvd, Galt Ontario, CANADA
CAMERAS, COM
- BABCOCK ELECTRONICS CORP.** 714-540-1234
3501 Harbor Blvd, Costa Mesa, Cal 92626 TWX 910-595-1517
RELAYS, DRY REED (COMPUTER GRADE)
RELAYS, MERCURY WETTED (COMPUTER GRADE)
TIMERS, EVENT (IMPULSE)
TIMERS, INTERVAL
- BAGANOFF ASSOCIATES INC.** 314-383-2432
6809 W Florissant, St Louis, Mo 63136
AMPLIFIERS, INSTRUMENTATION
COMMUNICATION SYSTEMS, DATA TRANSMISSION
CONSULTING (ADVANCED COMPUTER EQUIPMENT DESIGN AND FEASIBILITY STUDIES)
CONSULTING (DATA COMMUNICATIONS SYSTEMS PLANNING)
CONSULTING (SCIENTIFIC APPLICATIONS)
DATA ACQUISITION AND REDUCTION SYSTEMS
DATA RETREIVAL SYSTEMS, MICRO-FILM (COMPUTER-CONTROLLED)
MEMORY SYSTEMS, DELAY LINE
SERVICES, PROCESSING (ANALOG OR HYBRID, SCIENTIFIC)
SERVICES, PROCESSING (DIGITAL SCIENTIFIC)
SIGNAL CONDITIONERS
- BAILEY METER CO. SUB. BABCOCK & WILCOX** 216-943-5500
29801 Euclid Ave, Wickliffe, Ohio 44092
COMPUTERS, ANALOG (GENERAL-PURPOSE)
COMPUTERS, DIGITAL (GENERAL-PURPOSE, SMALL-SCALE)
COMPUTERS, DIGITAL (GENERAL-PURPOSE, MEDIUM-SCALE)
COMPUTERS, DIGITAL (GENERAL-PURPOSE, LARGE SCALE)
COMPUTERS, PROCESS CONTROL
INDICATORS, ALPHANUMERIC
INDICATORS, DIGITAL
INDICATORS, ELAPSED TIME
INDICATORS, ILLUMINATED
PANELS, POWER DISTRIBUTION
TIMERS, EVENT (IMPULSE)
TIMERS, INTERVAL
- BAIRD-ATOMIC INC.** 617-276-6000
125 Middlesex Tpk, Bedford, Mass 01730
CONSULTING (SCIENTIFIC APPLICATIONS)
SERVICES, AUTOMATED WIRE-WRAPPING
- BALDWIN ELECTRONICS INC.** 501-375-7351
1101 McAlmont St, Little Rock, Ark 72203 TELEX 053-6433
CELLS, PHOTOCONDUCTIVE
CONVERTERS, ANALOG-TO-DIGITAL
ENCODERS, SHAFT ANGLE
TRANSDUCERS, DIGITAL
- BALL BROTHERS MIRATEL DIV.** 612-633-1742
1633 Terrace Dr, Roseville, Minn 55113 TWX 910-563-3552
DATA TERMINALS, INQUIRY-RESPONSE (CRT WITH KEYBOARD)
MONITORS, TV
- BALL BROTHERS RESEARCH CORP.** 303-444-5300
P O Box 1062, Boulder, Colo 80302 TWX 910-940-3241
AMPLIFIERS, VIDEO
CONSOLES, CRT (ALPHANUMERIC AND GRAPHIC)
CONSOLES, CRT (COLOR-ALPHANUMERIC AND GRAPHIC)
CONSOLES, CRT (GRAPHIC)
MONITORS, TV
- BALTIMORE BUSINESS FORMS INC.** 301-233-8000
3132 Frederick Ave, Baltimore, Md 21229 TELEX 8-7913
DOCUMENTS, DCR/OMR
ENVELOPES, CONTINUOUS
FORMS, CONTINUOUS (MACHINE PROCESSED)
FORMS HANDLING, LABEL APPLICATORS
LABELS, CONTINUOUS AND GUMMED (MACHINE APPLICATION)
PAPER (FOR MICR EQUIPMENT)
PAPER (FOR OCR EQUIPMENT)
PAPER (FOR PRINTERS)
- BANKERS DATA SERVICES, INC.** 713-225-0731
430 Lamar, Houston, Tex 77002
CONSULTING (ACCOUNTING, BUSINESS AND COMMERCIAL APPLICATIONS)
CONSULTING (COMPUTER EVALUATIONS, SELECTIONS, INSTALLATION PLANNING)
SERVICES, PROCESSING (COMMERCIAL EDP)
SERVICES, SYSTEMS ANALYSIS
- BARBER-COLMAN CO.** 815-877-0241
1300 Rock St, Rockford, Ill 61101 TWX 815-398-0341
MOTORS, SYNCHRONOUS
- BARNES CORP.** 215-622-1525
24 N Lansdowne Ave, Lansdowne, Pa 19050 TWX 510-669-9977
CONNECTORS, PC AND IC BOARD (COMPUTER-GRADE)
SOCKETS, IC MOUNTING
SOCKETS, SEMICONDUCTOR MOUNTING
TESTERS, INTEGRATED CIRCUIT
- BARRY-WRIGHT CORP. WRIGHT LINE DIV.** 617-791-0931
160 Gold Star Blvd, Worcester, Mass 01606
CABINETS AND ENCLOSURES (FOR KEYPUNCHES, PRINTERS)
CABINETS, ENCLOSURES, CONSOLES, ELECTRONIC (FOR GENERAL EQUIPMENT)
CABINETS, RACKS, VAULTS (FOR MAGNETIC TAPE STORAGE)
CABINETS, TRAYS (FOR PUNCHED CARD STORAGE)
CANNISTERS, MAGNETIC TAPE
CLEANERS, MAGNETIC TAPE
CONTAINERS, DISK PACK STORAGE
CONTAINERS, PAPER TAPE STORAGE
COVERS, ACOUSTIC (FOR KEYBOARDS, TELETYPEWRITERS, ETC.)
DESKS, TABLES AND STANDS (FOR CALCULATORS)
DESKS, TABLES AND STANDS (FOR KEYPUNCH UNITS)
DESKS, TABLES AND STANDS (FOR PROGRAMMER STATIONS)
DESKS, TABLES AND STANDS (FOR TYPEWRITERS)
FILES, PUNCHED CARD
PUNCHES, CARD (PORTABLE)
REEL CLIPS AND BELTS, MAGNETIC TAPE
SAFES, MAGNETIC TAPE STORAGE
- BASF SYSTEMS INC.** 617-271-4000
Crosby Dr, Bedford, Mass 01730
DISC DRIVES, MOVABLE HEAD (INCLUDING CONTROLLER)
CONTINUED

3 Manufacturers' Directory

DISC PACKS, MAGNETIC
TAPE, MAGNETIC (CASSETTE)
TAPE, MAGNETIC (REELS)

BASIC COMPUTING ARTS INC. 415-964-3138
2680 E Bayshore Frtge, Mt View, Cal 94040

COMPUTERS, ANALOG (EDUCATIONAL)
COMPUTERS, PROCESS CONTROL
CONSOLES, CRT (GRAPHIC)
CONSULTING (ADVANCED COMPUTER EQUIPMENT DESIGN AND FEASIBILITY STUDIES)
CONSULTING (COMPUTER EVALUATIONS, SELECTIONS, INSTALLATION PLANNING)
CONSULTING (SCIENTIFIC APPLICATIONS)
CONVERTERS, ANALOG-TO-DIGITAL
CONVERTERS, DIGITAL-TO-ANALOG
CURVE TRACERS-DIGITIZERS, AUTOMATIC
DATA ACQUISITION AND REDUCTION SYSTEMS
MULTIPLEXERS, DIGITAL
PROGRAMMING LANGUAGE DEVELOPMENT (CONSULTANTS)
PROGRAMMING LANGUAGE DEVELOPMENT (CONTRACT PROGRAMMING)
PROGRAMMING LANGUAGE DEVELOPMENT (DEDICATED APPLICATION SYSTEMS)
PROGRAMMING LANGUAGE DEVELOPMENT (PROPRIETARY SOFTWARE PRODUCTS)
READERS, OPTICAL CHARACTER SCANNING
READOUTS AND DISPLAYS, NUMERIC AND ALPHANUMERIC (OTHER THAN CRT)
SCANNERS, OPTICAL

BASLER ELECTRIC CO. 618-654-2341
Rte 143, Highland, Ill 62249 TWX 910-996-2522

INVERTERS, DC-AC
POWER SUPPLIES, AC
POWER SUPPLIES, DC
REGULATORS, FREQUENCY
REGULATORS, VOLTAGE
TRANSFORMERS, POWER (COMPUTER GRADE)

BCD COMPUTING CORP. 516-586-6133
100 E Industry Court, Deer Park, N Y 11729

CONSULTING (ACCOUNTING, BUSINESS AND COMMERCIAL APPLICATIONS)
CONSULTING (ADVANCED COMPUTER EQUIPMENT DESIGN AND FEASIBILITY STUDIES)
MEMORY SYSTEMS, MAGNETIC DISC

BECK & ASSOCIATES, R.W. 206-622-5000
200 Tower Bldg, Seattle, Wash 98101 TWX 910-444-1388

CONSULTING (COMPUTER EVALUATIONS, SELECTIONS, INSTALLATION PLANNING)
CONSULTING (SCIENTIFIC APPLICATIONS)
SERVICES, COMPUTER-AIDED DESIGN
SERVICES, PROCESSING (DIGITAL SCIENTIFIC)

BECKMAN INSTRUMENTS INC. ELECT. INSTR. DIV. 415-526-7730
2200 Wright Ave, Richmond, Cal 94804 TWX 910-382-8125

CLOCKS, DIGITAL (REAL-TIME)
CONVERTERS, ANALOG-TO-DIGITAL
CONVERTERS, BINARY-TO-DECIMAL
CONVERTERS, VOLTAGE-TO-FREQUENCY
COUNTERS, DIGITAL READOUT
DATA TERMINALS, BLOCK-BY-BLOCK (MAGNETIC TAPE)
DATA TERMINALS, BLOCK-BY-BLOCK (MULTI-PURPOSE)
DATA TERMINALS, BLOCK-BY-BLOCK (PAPER TAPE)
DATA TERMINALS, BLOCK-BY-BLOCK (MEDIUM SPEED PRINTER)
DIGITIZERS, PROGRAMMABLE
MULTIPLEXER-CONVERTER (SINGLE UNIT WITH MULTIPLEXER, SAMPLE & HOLD AMPLIFIER & A-TO-D CONVERTER)
MULTIPLEXERS, DIGITAL
OSCILLATORS, VOLTAGE CONTROLLED
PRINTERS, LINE (LOW & MEDIUM SPEED)
SCANNERS, INPUT
TESTERS, CIRCUIT
TESTERS, INTEGRATED CIRCUIT
TIMERS, EVENT (IMPULSE)
TIMERS, INTERVAL
USED EQUIPMENT (BUYING, SELLING, LEASING)
VOLTMETERS, DIGITAL

BECKMAN INSTRUMENTS INC. HELIPOT DIV.

Fullerton, Cal 92634

REGULATORS, VOLTAGE

BEDFORD ASSOCIATES INC. 617-275-0740
P O Box 327, Bedford, Mass 01730

CONSULTING (ADVANCED COMPUTER EQUIPMENT DESIGN AND FEASIBILITY STUDIES)
CONSULTING (COMPUTER EVALUATIONS, SELECTIONS, INSTALLATION PLANNING)
CONSULTING (DATA COMMUNICATIONS SYSTEMS PLANNING)
CONSULTING (MANAGEMENT INFORMATION SYSTEMS PLANNING)
CONTROLLERS, MAGNETIC DISC
SERVICES, SYSTEMS ANALYSIS

BEEHIVE MEDICAL ELECTRONICS INC. 801-487-0741
1473 S 6th W, Salt Lake City, Utah 84104 TWX 910-925-5271

CLOCKS, DIGITAL (REAL-TIME)
DATA TERMINALS, BLOCK-BY-BLOCK (TELEPRINTER)
DATA TERMINALS, INQUIRY-RESPONSE (ALPHANUMERIC KEYBOARD)

BEE MAK PLASTICS 213-876-1770
7424 Santa Monica Blv, Los Angeles, Cal 91406

HOLDERS, PUNCHED CARD

BEENE ELECTRICAL INSTRUMENT CO. INC. 603-753-6362
P O Box 100, Penacook, N H 03301 TWX 710-364-6977

VOLTMETERS, AC, DC, DIFFERENTIAL
VOLTMETERS, DIGITAL

BELFUSE INC. 201-432-0463
198 Van Vorst St, Jersey City, N J 07302

DELAY LINES, ELECTROMAGNETIC
DELAY LINES, MAGNETOSTRICTIVE (ALSO SEE MEMORIES)
MEMORY SYSTEMS, DELAY LINE

BELL & HOWELL ELECTRONICS & INSTRUMENTS GROUP 213-681-8421
360 Sierra Madre Vill, Pasadena, Cal 91109 TELEX 67-5415

MAGNETIC TAPE STORAGE SYSTEMS (INCLUDES CONTROLLER)
RECORDERS, DIGITAL CASSETTE
TAPE TRANSPORTS, MAGNETIC (DIGITAL CASSETTE)
TAPE TRANSPORTS, MAGNETIC (INCREMENTAL)

BEMIS CO. INC. 612-332-7151
800 Northstar Ctr., Minneapolis, Minn 55402

TAPE, PUNCH (PAPER)

BENDIX COMPUTER GRAPHICS 313-477-3700
23850 Freeway Park Dr, Farmington, Mich 48024

CURVE TRACERS-DIGITIZERS, MANUAL
DATA RETRIEVAL SYSTEMS, MICRO-FILM (COMPUTER-CONTROLLED)
MICROFILM DATA RETRIEVAL SYSTEMS, COMPUTER CONTROLLED (GRAPHIC)
PLOTTERS, MOVING PEN (DIGITAL CONTROLLER)
PROCESSORS, MICROFILM

BENDIX CORP., THE, ELECTRODYNAMICS DIV 213-877-2881
11600 Sherman Way, No Hollywood, Cal 91605 TWX 910-499-2151

CONSULTING (ACCOUNTING, BUSINESS AND COMMERCIAL APPLICATIONS)
SERVICES, PROCESSING (COMMERCIAL EDP)
SERVICES, PROCESSING (ANALOG OR HYBRID, SCIENTIFIC)
SERVICES, PROCESSING (DIGITAL SCIENTIFIC)
SERVICES, SYSTEMS ANALYSIS

BENDIX CORP., THE, ENVRNMNTL SCI. DIV. 301-825-5200
1400 Taylor Ave, Baltimore, Md 21204 TWX 710-232-1805

COMMUNICATION SYSTEMS, DATA TRANSMISSION
COMMUTATORS, SWITCHING (ELECTRIC)
CONVERTERS, ANALOG-TO-DIGITAL
CONVERTERS, DIGITAL-TO-ANALOG
CONVERTERS, DIGITAL-TO-SYNCHRO
CONVERTERS, SYNCHRO-TO-DIGITAL
DIGITIZERS, PROGRAMMABLE
ENCODERS, DIGITAL
ENCODERS, SHAFT ANGLE
MULTIPLEXER-CONVERTER (SINGLE UNIT WITH MULTIPLEXER, SAMPLE & HOLD AMPLIFIER & A-TO-D CONVERTER)
MULTIPLEXERS, ANALOG-RELAY (SEQUENTIAL SAMPLING)
MULTIPLEXERS, ANALOG-SOLID STATE (SEQUENTIAL SAMPLING)
MULTIPLEXERS, DIGITAL
SIGNAL CONDITIONERS
TRANSDUCERS, DIGITAL

3 Manufacturers' Directory

BENDIX CORP., THE ELECTRICAL COMPONENTS DIV.

Sherman Ave, Sidney, N Y 13838

607-563-9511

TWX 510-261-7550

ANALYZERS, WAVEFORM
CABLE ASSEMBLIES (WITH CONNECTORS)
CABLE, COAXIAL (FLEXIBLE)
CABLE, COAXIAL (SEMI/RIGID)
CABLE, FINE LEAD
CABLE, MULTICONDUCTOR
CABLE, SHIELDED (NOT COAXIAL)
CONNECTORS, COAXIAL (COMPUTER-GRADE)
CONNECTORS, MINIATURE AND SUB-MINIATURE (COMPUTER-GRADE)
CONNECTORS, PC AND IC BOARD (COMPUTER-GRADE)
CONNECTORS, RACK AND PANEL (COMPUTER-GRADE)

BENDIX MOSAIC FABRICATIONS DIV.

Galileo Park, Sturbridge, Mass 01518

617-347-9191

TWX 710-347-1190

FIBER OPTIC BUNDLES
FIBER OPTICS ASSEMBLIES (FOR PUNCHED CODE READERS AND MARK SENSORS)
FILM SCANNERS
INDICATORS, ILLUMINATED
LAMPS-PANEL, PILOT AND DIAL (INCANDESCENT)
LIGHT PENS (FOR CRT TERMINAL INPUT/OUTPUT)
MARK SENSING EQUIPMENT
READERS, OPTICAL CHARACTER SCANNING
READERS, PERFORATED DOCUMENT
RECORDERS, HARD-COPY (WITH CRT)
SCANNERS, IMAGE
SCANNERS, OPTICAL
TRANSCIEVERS, FACSIMILE

BERGEN LABORATORIES INC. SUB. ZYROTRON INC.

60 Spruce St, Paterson, N J 07501

201-278-3020

AMPLIFIERS, D.C.
AMPLIFIERS, INSTRUMENTATION
CIRCUIT CARDS, LINEAR (WITH DISCRETE COMPONENTS)
CIRCUIT CARDS, LINEAR (WITH IC'S)
CIRCUIT CARDS, LOGIC (WITH DISCRETE COMPONENTS)
CIRCUIT CARDS, LOGIC (WITH IC'S)
CONVERTERS, VOLTAGE-TO-FREQUENCY
INDICATORS, ELAPSED TIME
MOTORS, STEPPING
MOTORS, SYNCHRONOUS
POWER SUPPLIES, AC
POWER SUPPLIES, DC
RECTIFIERS, SILICON CONTROLLED
SERVOS, COMPUTER
SIGNAL CONDITIONERS
TESTERS, CIRCUIT

BERGLUND ASSOCIATES INC.

1060 Kings Hwy N, Cherry Hill, N J 08034

609-667-4700

TELEX 83-4763

CONSULTING (COMPUTER EVALUATIONS, SELECTIONS, INSTALLATION PLANNING)
CONSULTING (DATA COMMUNICATIONS SYSTEMS PLANNING)
CONSULTING (COMPUTER PRODUCT PLANNING SURVEYS, MARKET RESEARCH STUDIES)
TRAINING INSTITUTES, COMMERCIAL COMPUTER COURSES, SEMINARS, CORRESPONDENCE COURSES

BERKELEY COMPUTER CORP.

2398 4th St, Berkeley, Cal 94710

415-549-3630

COMMUNICATIONS-ORIENTED PROCESSORS, MULTIPLE CHANNEL CONTROLLERS
COMMUNICATIONS-ORIENTED PROCESSORS, STORED PROGRAM
COMMUNICATION SYSTEMS, DATA TRANSMISSION
COMPUTERS, DIGITAL (GENERAL-PURPOSE, LARGE SCALE)
PROGRAMMING LANGUAGE DEVELOPMENT (DEDICATED APPLICATION SYSTEMS)
PROGRAMMING LANGUAGE DEVELOPMENT (PROPRIETARY SOFTWARE PRODUCTS)
SERVICES, MANAGEMENT INFORMATION SYSTEMS
SERVICES, PROCESSING (DIGITAL SCIENTIFIC)
SERVICES, TIME SHARING (COMMERCIAL)
SERVICES, TIME SHARING (RESEARCH)

BERTAN ASSOCIATES INC.

15 Newtown Rd, Plainview, N Y 11803

516-293-5340

POWER SUPPLIES, DC
POWER SUPPLIES, DIGITALLY-CONTROLLED
REGULATORS, VOLTAGE

BETA INSTRUMENT CORP.

20 Ossipee Rd, Newton Upr Flls, Mass 02164

617-969-6510

TWX 710-335-6973

CONVERTERS, MAGNETIC TAPE-TO-MICROFILM
RECORDERS, MICROFILM/MICROFICHE

BFA CORP.

1309 S Inca, Denver, Colo 80223

303-744-3301

AMPLIFIERS, D.C.
AMPLIFIERS, INSTRUMENTATION
AMPLIFIERS, OPERATIONAL
CAMERAS, DATA RECORDING (EXCL. OSCILLOSCOPES)
CLOCKS, DIGITAL (REAL-TIME)
COMPUTERS, DIGITAL (GENERAL-PURPOSE, SMALL-SCALE)
CONTROLLERS, MAGNETIC DISC
CONTROLLERS, MAGNETIC DRUM
CONVERTERS, ANALOG-TO-DIGITAL
CONVERTERS, BINARY-TO-DECIMAL
CONVERTERS, DC-TO-FREQUENCY
CONVERTERS, DIGITAL-TO-ANALOG
CONVERTERS, DIGITAL-TO-SYNCHRO
CONVERTERS, MAGNETIC TAPE-TO-PAPER TAPE
CONVERTERS, MAGNETIC TAPE-TO-PRINTER
CONVERTERS, MAGNETIC TAPE-TO-PUNCHED CARD
CONVERTERS, SYNCHRO-TO-DIGITAL
COUNTERS, DECADE
COUNTERS, DIGITAL READOUT
DATA ACQUISITION AND REDUCTION SYSTEMS
DISPLAY DRIVERS
ENCODERS, DIGITAL
GENERATORS, BYTE
GENERATORS, TIME CODE
MULTIPLEXER-CONVERTER (SINGLE UNIT WITH MULTIPLEXER, SAMPLE & HOLD AMPLIFIER & A-TO-D CONVERTER)
MULTIPLEXERS, DIGITAL
OSCILLATORS, VOLTAGE CONTROLLED
PAPER (FOR RECORDERS AND PLOTTERS)
PERFORATORS, PAPER TAPE
PLOTTERS, MOVING PEN (ANALOG CONTROLLER)
POWER SUPPLIES, DC
POWER SUPPLIES, DIGITALLY-CONTROLLED
PRINTER/PUNCH, PAPER TAPE
READERS, PAPER TAPE
READERS, PERFORATED DOCUMENT
RECORDERS, DIGITAL CASSETTE
RECORDERS, GRAPHIC
RECORDERS, MAGNETIC TAPE
SCANNERS, INPUT
SIGNAL CONDITIONERS
SKEW METERS, MAGNETIC TAPE
TAPE, PUNCH (PAPER)
TAPE TRANSPORTS, MAGNETIC (DIGITAL-EXCL. CASSETTE)
TAPE TRANSPORTS, MAGNETIC (DIGITAL CASSETTE)
TAPE TRANSPORTS, MAGNETIC (INCREMENTAL)
TESTERS, CIRCUIT
TIMERS, EVENT (IMPULSE)
TIMERS, INTERVAL
TRANSDUCERS, DIGITAL
VOLTMETERS, DIGITAL

BIRTCHE CORP., THE INDUSTRIAL DIV.

745 Monterey Pass Rd, Monterey Park, Cal 91754

213-268-8584

TWX 910-321-3076

EXTRACTORS, CIRCUIT BOARD
GUIDES, CIRCUIT CARDS
HEAT SINKS, CIRCUIT BOARD MOUNTING

ITT SEMICONDUCTORS

3301 Electronics Way, W Palm Beach, Fla 33407

305-842-2411

TWX 510-952-6667

CAPACITORS, COMPUTER GRADE
CIRCUITS, MONOLITHIC (DIGITAL LOGIC)
CIRCUITS, MONOLITHIC (DIODE MATRICES)
CIRCUITS, MONOLITHIC (LINEAR-EXCL. OP AMPS)
CIRCUITS, MONOLITHIC (LSI-BIPOLAR)
CIRCUITS, MONOLITHIC (LSI-MOS)
CIRCUITS, MONOLITHIC (OP AMPS)
DIODES, GERMANIUM
DIODES, NOT-CARRIER
DIODES, SILICON
DIODES, TUNNEL
DIODES, ZENER
MODULES, DIGITAL LOGIC ENCAPSULATED (ALSO SEE CIRCUITS & CIRCUIT CARDS)
MODULES, LINEAR (ENCAPSULATED)
TRANSISTORS, SILICON

BIZ-MATIC DATA CONTROL CENTERS INC.

232 Summer St, Boston, Mass 02210

617-426-6863

CONSULTING (ACCOUNTING, BUSINESS AND COMMERCIAL APPLICATIONS)
CONSULTING (COMPUTER EVALUATIONS, SELECTIONS, INSTALLATION PLANNING)
CONSULTING (MANAGEMENT INFORMATION SYSTEMS PLANNING)
SERVICES, FACILITY MANAGEMENT
SERVICES, MANAGEMENT INFORMATION SYSTEMS
SERVICES, PROCESSING (COMMERCIAL EDP)
CONTINUED

3 Manufacturers' Directory

SERVICES, SYSTEMS ANALYSIS

BLAIR & ASSOCIATES, NEIL F. 602-272-7763
4026 N 48th Dr, Phoenix, Ariz 85031

CONSULTING (ACCOUNTING, BUSINESS AND COMMERCIAL APPLICATIONS)
CONSULTING (ADVANCED COMPUTER EQUIPMENT DESIGN AND FEASIBILITY STUDIES)
CONSULTING (COMPUTER EVALUATIONS, SELECTIONS, INSTALLATION PLANNING)
CONSULTING (DATA COMMUNICATIONS SYSTEMS PLANNING)
CONSULTING (COMPUTER PRODUCT PLANNING SURVEYS, MARKET RESEARCH STUDIES)
CONSULTING (MANAGEMENT INFORMATION SYSTEMS PLANNING)

BLAZER CORP. 201-933-1111
400 Paterson Plank Rd, E Rutherford, N J 07073

AIR CONDITIONERS (FOR EDP INSTALLATIONS)

BMS DATA PROCESSING CORP. 404-233-8252
415 E Paces Ferry Rd, Atlanta, Ga 30305

CONSULTING (ACCOUNTING, BUSINESS AND COMMERCIAL APPLICATIONS)
SERVICES, PROCESSING (COMMERCIAL EDP)

BODINE ELECTRIC CO. 312-478-3515
2500 W Bradley Pl, Chicago, Ill 60618
TELEX 25-3646
MOTORS, SERVO
MOTORS, SYNCHRONOUS

BOLT BERANEK & NEWMAN INC. DATA EQUIPMENT DIV. 714-546-5300
1762 McGaw St, Santa Ana, Cal 92705

AUDIO/VISUAL TRAINING AIDS
CURVE TRACERS-DIGITIZERS, MANUAL
DATA TERMINALS, BLOCK-BY-BLOCK (GRAPHIC DIGITIZERS)
GRAPHIC TABLETS
PLOTTERS, MOVING PEN (ANALOG CONTROLLER)
RECORDERS, GRAPHIC

BONNER&MOORE ASSOCIATES INC. 713-228-0871
500 Jefferson Bldg, Houston, Tex 77002

CONSULTING (ACCOUNTING, BUSINESS AND COMMERCIAL APPLICATIONS)
CONSULTING (ADVANCED COMPUTER EQUIPMENT DESIGN AND FEASIBILITY STUDIES)
CONSULTING (COMPUTER EVALUATIONS, SELECTIONS, INSTALLATION PLANNING)
CONSULTING (DATA COMMUNICATIONS SYSTEMS PLANNING)
CONSULTING (COMPUTER PRODUCT PLANNING SURVEYS, MARKET RESEARCH STUDIES)
CONSULTING (MANAGEMENT INFORMATION SYSTEMS PLANNING)
CONSULTING (SCIENTIFIC APPLICATIONS)
PROGRAMMING LANGUAGE DEVELOPMENT (CONSULTANTS)
PROGRAMMING LANGUAGE DEVELOPMENT (CONTRACT PROGRAMMING)
PROGRAMMING LANGUAGE DEVELOPMENT (DEDICATED APPLICATION SYSTEMS)
PROGRAMMING LANGUAGE DEVELOPMENT (PROPRIETARY SOFTWARE PRODUCTS)
SERVICES, PROCESSING (COMMERCIAL EDP)
SERVICES, PROCESSING (DIGITAL SCIENTIFIC)

BONNAR-VAWTER INC. 603-352-4335
96 Dunbar St, Keene, N H 03431
TWX 710-366-1804

COMMUNICATION SYSTEMS, DATA TRANSMISSION
DATA TERMINALS, BLOCK-BY-BLOCK (PAPER TAPE)
FORMS, CONTINUOUS (MACHINE PROCESSED)
LABELS, CONTINUOUS AND GUMMED (MACHINE APPLICATION)
LABELS, CONTINUOUS AND PRESSURE SENSITIVE (MACHINE APPLICATION)
MODEMS, HARD-WIRED
PAPER (FOR MICR EQUIPMENT)
PAPER (FOR OCR EQUIPMENT)
PAPER (FOR PRINTERS)
PAPER (FOR RECORDERS AND PLOTTERS)
PERFORATORS, PAPER TAPE
READERS, PAPER TAPE
TAPE, PUNCH (PAPER)

BOOLE & BABBAGE INC. 408-255-1200
18990 Homestead Rd, Cupertino, Cal 95014

ANALYZERS, COMPUTER PERFORMANCE
TEST SYSTEMS, COMPUTER PERFORMANCE

BOOTHE DATA SYSTEMS INC. 212-972-0550
485 Lexington Ave, New York, N Y 10001

CONSULTING (ACCOUNTING, BUSINESS AND COMMERCIAL APPLICATIONS)
CONSULTING (COMPUTER EVALUATIONS, SELECTIONS, INSTALLATION PLANNING)
CONSULTING (DATA COMMUNICATIONS SYSTEMS PLANNING)
CONSULTING (COMPUTER PRODUCT PLANNING SURVEYS, MARKET RESEARCH STUDIES)
CONSULTING (MANAGEMENT INFORMATION SYSTEMS PLANNING)
CONSULTING (SCIENTIFIC APPLICATIONS)
PROGRAMMING LANGUAGE DEVELOPMENT (CONSULTANTS)
PROGRAMMING LANGUAGE DEVELOPMENT (CONTRACT PROGRAMMING)
PROGRAMMING LANGUAGE DEVELOPMENT (DEDICATED APPLICATION SYSTEMS)
PROGRAMMING LANGUAGE DEVELOPMENT (PROPRIETARY SOFTWARE PRODUCTS)
TRAINING INSTITUTES, COMMERCIAL COMPUTER COURSES, SEMINARS, CORRESPONDENCE COURSES

BOOTHE RESOURCES INTERNATIONAL INC. 213-380-5700
3435 Wilshire Blvd, Los Angeles, Cal 90005
TWX 910-321-4210

CONSULTING (ACCOUNTING, BUSINESS AND COMMERCIAL APPLICATIONS)
CONSULTING (COMPUTER EVALUATIONS, SELECTIONS, INSTALLATION PLANNING)
CONSULTING (DATA COMMUNICATIONS SYSTEMS PLANNING)
CONSULTING (COMPUTER PRODUCT PLANNING SURVEYS, MARKET RESEARCH STUDIES)
CONSULTING (MANAGEMENT INFORMATION SYSTEMS PLANNING)
CONSULTING (SCIENTIFIC APPLICATIONS)
PROGRAMMING LANGUAGE DEVELOPMENT (CONTRACT PROGRAMMING)
PROGRAMMING LANGUAGE DEVELOPMENT (DEDICATED APPLICATION SYSTEMS)
PROGRAMMING LANGUAGE DEVELOPMENT (PROPRIETARY SOFTWARE PRODUCTS)
SERVICES, FACILITY MANAGEMENT
SERVICES, MANAGEMENT INFORMATION SYSTEMS
SERVICES, PROCESSING (COMMERCIAL EDP)
SERVICES, PROCESSING (DIGITAL SCIENTIFIC)
SERVICES, SYSTEMS ANALYSIS
TRAINING INSTITUTES, COMMERCIAL COMPUTER COURSES, SEMINARS, CORRESPONDENCE COURSES

BORG WARNER CONTROLS DIV. BORG WARNER 714-545-5584
3300 S Halladan St, Santa Ana, Cal 92702
TELEX 67-8460

MAGNETIC TAPE STORAGE SYSTEMS (INCLUDES CONTROLLER)
RECORDERS, DIGITAL CASSETTE
RECORDERS, MAGNETIC TAPE
TAPE TRANSPORTS, MAGNETIC (DIGITAL-EXCL. CASSETTE)
TAPE TRANSPORTS, MAGNETIC (DIGITAL CASSETTE)

BORG-WARNER/INGERSOLL PRODUCTS/EMCOR 312-264-7800
1000 W 120th St, Chicago, Ill 60643

CABINETS, ENCLOSURES, CONSOLES, ELECTRONIC (FOR GENERAL EQUIPMENT)
CABINETS, TRAYS (FOR PUNCHED CARD STORAGE)
CHASSIS, SLIDES, RACKS
DESKS, TABLES AND STANDS (FOR CALCULATORS)
DESKS, TABLES AND STANDS (FOR KEYPUNCH UNITS)
DESKS, TABLES AND STANDS (FOR PROGRAMMER STATIONS)
PANELS, POWER DISTRIBUTION

BOSTON COMPUTER SYSTEMS CORP. 617-227-8634
15 School St, Boston, Mass 02108

CONSULTING (ACCOUNTING, BUSINESS AND COMMERCIAL APPLICATIONS)
CONSULTING (ADVANCED COMPUTER EQUIPMENT DESIGN AND FEASIBILITY STUDIES)
CONSULTING (COMPUTER EVALUATIONS, SELECTIONS, INSTALLATION PLANNING)
CONSULTING (DATA COMMUNICATIONS SYSTEMS PLANNING)
CONSULTING (COMPUTER PRODUCT PLANNING SURVEYS, MARKET RESEARCH STUDIES)
CONSULTING (MANAGEMENT INFORMATION SYSTEMS PLANNING)
PROGRAMMING LANGUAGE DEVELOPMENT (CONTRACT PROGRAMMING)
PROGRAMMING LANGUAGE DEVELOPMENT (DEDICATED APPLICATION SYSTEMS)
PROGRAMMING LANGUAGE DEVELOPMENT (PROPRIETARY SOFTWARE PRODUCTS)
SERVICES, FACILITY MANAGEMENT
SERVICES, MANAGEMENT INFORMATION SYSTEMS
SERVICES, SYSTEMS ANALYSIS

BOSTON DIGITAL CORP. 617-881-1600
Main St, Ashland, Mass 01721

CONTROLLERS, PLOTTING
CURVE TRACERS-DIGITIZERS, MANUAL
DRAFTING SYSTEMS, COMPUTER-CONTROLLED STORAGE
PLOTTERS, MOVING PEN (DIGITAL CONTROLLER)

3 Manufacturers' Directory

BOSTON INSULATED WIRE AND CABLE CO. INC. 617-265-2104
 65 Bay St, Boston, Mass 02102 TELEX 09-4540
 CABLE ASSEMBLIES (WITH CONNECTORS)
 CABLE, COAXIAL (FLEXIBLE)
 CABLE, MULTICONDUCTOR
 CABLE, SHIELDED (NOT COAXIAL)

BOSWORTH & ASSOCIATES, S. 516-938-8223
 9 Forest Dr, Plainview, N Y 11803
 CONSULTING (ACCOUNTING, BUSINESS AND COMMERCIAL APPLICATIONS)
 CONSULTING (COMPUTER EVALUATIONS, SELECTIONS, INSTALLATION PLANNING)
 CONSULTING (DATA COMMUNICATIONS SYSTEMS PLANNING)
 CONSULTING (MANAGEMENT INFORMATION SYSTEMS PLANNING)

BOURNS/CAI INC. PACIFIC OPTICAL DIV 213-670-4902
 5221 W 102nd St, Los Angeles, Cal 90045 TWX 910-328-6158
 CAMERAS, COM

BOURNS INC. 714-684-1700
 1200 Columbia Ave., Riverside, Cal 92507 TWX 910-332-1252
 CIRCUITS, HYBRID (IC AND DISCRETE-DIGITAL)
 CIRCUITS, MONOLITHIC (LINEAR-EXCL. OP AMPS)
 CIRCUITS, MONOLITHIC (LSI-MOS)
 CIRCUITS, MONOLITHIC (OP AMPS)
 CIRCUITS, THICK FILM (DIGITAL)
 MARK SENSING EQUIPMENT
 MODULES, RESISTANCE NETWORKS (ENCAPSULATED)
 PERFORATORS, DOCUMENT
 POTENTIOMETERS, TRIM (FILM)
 POTENTIOMETERS, TRIM (WIRE-WOUND)
 READERS, OPTICAL CHARACTER SCANNING
 SCANNERS, OPTICAL
 SWITCHES, ROTARY
 TRANSDUCERS, DIGITAL
 TRANSFORMERS, POWER (COMPUTER GRADE)
 TRANSFORMERS, PULSE (COMPUTER GRADE)

BOWMAR CANADA LTD. 613-746-3100
 1257 Algoma Rd, Ottawa Ont, CANADA TWX 610-562-1916
 DIODES, LIGHT EMITTING
 INDICATORS, ALPHANUMERIC
 INDICATORS, DIGITAL
 INDICATORS, ELAPSED TIME
 INDICATORS, ILLUMINATED
 MOTORS, SERVO
 MOTORS, STEPPING
 SYNCHROS-RESOLVERS, CONTROL TRANSFORMERS

BOWMAR INSTRUMENT CORP. ELECTRONIC SYS. DIV 219-747-3121
 800 Bluffton Rd, Fort Wayne, Ind 46809 TWX 810-332-1510
 AMPLIFIERS, D.C.
 AMPLIFIERS, VIDEO
 COMPUTERS, NAVIGATION
 COMPUTERS, SPECIAL PURPOSE
 CONVERTERS, ANALOG-TO-DIGITAL
 CONVERTERS, BINARY-TO-DECIMAL
 CONVERTERS, DIGITAL-TO-ANALOG
 CONVERTERS, DIGITAL-TO-SYNCHRO
 GENERATORS, CHARACTER (CRT)
 MULTIPLEXER-CONVERTER (SINGLE UNIT WITH MULTIPLEXER, SAMPLE & HOLD AMPLIFIER & A-TO-D CONVERTER)
 MULTIPLEXERS, ANALOG-SOLID STATE (SEQUENTIAL SAMPLING)
 POWER SUPPLIES, AC
 POWER SUPPLIES, DC
 POWER SUPPLIES, DIGITALLY-CONTROLLED

BOWMAR/TIC INC. 805-498-2161
 850 Lawrence Dr, Newbury Park, Cal 91320 TWX 910-336-1265
 POTENTIOMETERS, TRIM (FILM)
 POTENTIOMETERS, TRIM (WIRE-WOUND)

BRADDOCK,DUNN&MCDONALD INC. 703-893-7885
 8027 Leesburg Pike, Mc Lean, Va 22101 TWX 710-833-9892
 CONSULTING (ACCOUNTING, BUSINESS AND COMMERCIAL APPLICATIONS)
 CONSULTING (COMPUTER EVALUATIONS, SELECTIONS, INSTALLATION PLANNING)
 CONSULTING (DATA COMMUNICATIONS SYSTEMS PLANNING)
 CONSULTING (MANAGEMENT INFORMATION SYSTEMS PLANNING)
 CONSULTING (SCIENTIFIC APPLICATIONS)
 PROGRAMMING LANGUAGE DEVELOPMENT (CONTRACT PROGRAMMING)
 SERVICES, COMPUTER-AIDED DESIGN
 SERVICES, FACILITY MANAGEMENT
 CONTINUED

SERVICES, MANAGEMENT INFORMATION SYSTEMS
 SERVICES, PROCESSING (COMMERCIAL EDP)
 SERVICES, PROCESSING (DIGITAL SCIENTIFIC)
 SERVICES, TIME SHARING (RESEARCH)
 SERVICES, SYSTEMS ANALYSIS
 TRAINING INSTITUTES, COMMERCIAL COMPUTER COURSES, SEMINARS,
 CORRESPONDENCE COURSES

BRADLEY SEMICONDUCTOR CORP. 203-787-7181
 275 Welton St, New Haven, Conn 06506
 DIODES, SILICON

BRAMCO CONTROLS DIV. LEDEX INC. 513-773-8271
 College & South St, Piqua, Ohio 45356
 COMMUNICATION SYSTEMS, DATA TRANSMISSION

BRANDON APPLIED SYSTEMS INC. 212-757-2100
 1700 Broadway, New York, N Y 10019
 CONSULTING (ACCOUNTING, BUSINESS AND COMMERCIAL APPLICATIONS)
 CONSULTING (ADVANCED COMPUTER EQUIPMENT DESIGN AND FEASIBILITY STUDIES)
 CONSULTING (COMPUTER EVALUATIONS, SELECTIONS, INSTALLATION PLANNING)
 CONSULTING (DATA COMMUNICATIONS SYSTEMS PLANNING)
 CONSULTING (COMPUTER PRODUCT PLANNING SURVEYS, MARKET RESEARCH STUDIES)
 CONSULTING (MANAGEMENT INFORMATION SYSTEMS PLANNING)
 SERVICES, FACILITY MANAGEMENT
 TRAINING INSTITUTES, COMMERCIAL COMPUTER COURSES, SEMINARS,
 CORRESPONDENCE COURSES

BRANDON APPLIED SYSTEMS INC. 703-525-2620
 1611 N Kent St, Arlington, Va 22209
 CONSULTING (ACCOUNTING, BUSINESS AND COMMERCIAL APPLICATIONS)
 CONSULTING (ADVANCED COMPUTER EQUIPMENT DESIGN AND FEASIBILITY STUDIES)
 CONSULTING (COMPUTER EVALUATIONS, SELECTIONS, INSTALLATION PLANNING)
 CONSULTING (DATA COMMUNICATIONS SYSTEMS PLANNING)
 CONSULTING (COMPUTER PRODUCT PLANNING SURVEYS, MARKET RESEARCH STUDIES)
 CONSULTING (MANAGEMENT INFORMATION SYSTEMS PLANNING)
 SERVICES, FACILITY MANAGEMENT
 SERVICES, MANAGEMENT INFORMATION SYSTEMS
 SERVICES, SYSTEMS ANALYSIS
 TRAINING INSTITUTES, COMMERCIAL COMPUTER COURSES, SEMINARS,
 CORRESPONDENCE COURSES
 TRAINING SYSTEMS, COMPUTER SERVICE

BRAND-REX SUB. AKZONA 203-423-7771
 P O Box 498, Willimantic, Conn 06226 TWX 710-440-2247
 CABLE, COAXIAL (FLEXIBLE)
 CABLE, COAXIAL (SEMI/RIGID)
 CABLE, FINE LEAD
 CABLE, FLAT, PRINTED AND RIBBON
 CABLE, MULTICONDUCTOR
 CABLE, SHIELDED (NOT COAXIAL)

BRIDGE DATA PRODUCTS INC. 215-382-8700
 738 S 42nd St, Philadelphia, Pa 19104
 MARK SENSING EQUIPMENT
 PUNCHES, CARD (OVER 100 CPM)
 PUNCHES, CARD (UP TO 100 CPM)
 READER/PUNCHES, PUNCHED CARD
 READERS, PUNCHED CARD (UP TO 100 CPM)
 READERS, PUNCHED CARD (100 TO 300 CPM)
 READERS, PUNCHED CARD (OVER 300 CPM)
 SORTERS, PUNCHED CARD

BRIGHT INDUSTRIES INC. 415-391-9794
 1 Maritime Plaza, San Francisco, Cal 94111
 CONTROLLERS, MAGNETIC TAPE
 FORMATTERS, MAGNETIC TAPE
 MAGNETIC TAPE STORAGE SYSTEMS (INCLUDES CONTROLLER)
 POOLERS, MAGNETIC TAPE
 PRINTERS, KEYBOARD
 PRINTERS, LINE (LOW & MEDIUM SPEED)
 RECORDERS, MAGNETIC TAPE
 TAPE TRANSPORTS, MAGNETIC (DIGITAL-EXCL. CASSETTE)
 CONTINUED

3 Manufacturers' Directory

TAPE TRANSPORTS, MAGNETIC (INCREMENTAL)

BRISTOL CO., DIV AMERICAN CHAIN & CABLE CO. 203-756-4451
 Bristol Rd, Waterbury, Conn 06720

AMPLIFIERS, INSTRUMENTATION
 COMPUTERS, HYBRID
 COMPUTERS, PROCESS CONTROL
 CONTROLLERS, PLOTTING
 MULTIPLEXERS, ANALOG-RELAY (SEQUENTIAL SAMPLING)
 PLOTTERS, MOVING PEN (ANALOG CONTROLLER)
 RECORDERS, PAPER TAPE
 THERMOCOUPLE REFERENCE SYSTEMS

BRUNING CO., CHARLES 312-255-1900
 1800 W Central Rd, Mt Prospect, Ill 60005

MICROFICHE
 MICROFILM ROLLS
 PROCESSORS, MICROFILM
 READER/PRINTER, MICROFILM/MICROFICHE
 READERS, MICROFILM/MICROFICHE

BRYANT COMPUTER PRODUCTS DIV. EX-CELL-O CORP 313-624-4571
 850 Ladd Rd, Walled Lake, Mich 48088 TWX 810-232-1550

CONTROLLERS, MAGNETIC DISC
 CONTROLLERS, MAGNETIC DRUM
 DISC DRIVES, MOVABLE HEAD (INCLUDING CONTROLLER)
 DISC DRIVES, REMOVABLE CARTRIDGE
 DISC STORAGE SYSTEMS
 DRUM STORAGE EQUIPMENT, MAGNETIC (INCLUDING CONTROLLER)
 MEMORY SYSTEMS, MAGNETIC DISC
 MEMORY SYSTEMS, MAGNETIC DRUM

BRYANT DATA SERVICE INC. 617-592-3308
 319 Lynnway, Lynn, Mass 01901

ENCODERS, KEYBOARD (ALPHANUMERIC)
 ENCODERS, KEYBOARD-TO-MAGNETIC TAPE
 PUNCHES, CARD (UP TO 100 CPM)
 VERIFIERS, PUNCHED CARD

BUCHANAN ELECTRICAL PRODUCTS CORP. 201-289-8200
 1065 Floral Ave, Union, N J 07083 TELEX 13-8214
 TERMINAL BLOCKS, STRIPS, BOARDS

BUCODE INC. 516-273-2100
 175 Engineers Dr, Hauppauge, N Y 11787 TWX 510-227-6236
 CONTROLLERS, MAGNETIC TAPE
 FORMATTERS, MAGNETIC TAPE
 MAGNETIC TAPE STORAGE SYSTEMS (INCLUDES CONTROLLER)
 RECORDERS, MAGNETIC TAPE
 TAPE TRANSPORTS, MAGNETIC (DIGITAL-EXCL. CASSETTE)

BULOVA WATCH ELECTRONICS DIV. 212-335-6000
 6120 Woodside Ave, Woodside Li, N Y 11377 TWX 710-582-2637

AMPLIFIERS, D.C.
 AMPLIFIERS, INSTRUMENTATION
 AMPLIFIERS, OPERATIONAL
 CLOCKS, DIGITAL (REAL-TIME)
 CONTROLLERS, MOTOR
 CONVERTERS, DC-TO-FREQUENCY
 CONVERTERS, FREQUENCY-TO-DC
 CONVERTERS, VOLTAGE-TO-FREQUENCY
 CRYSTAL UNITS, QUARTZ (FOR FREQUENCY CONTROL)
 INVERTERS, DC-AC
 OSCILLATORS, VOLTAGE CONTROLLED
 POWER SUPPLIES, AC
 POWER SUPPLIES, DC
 RELAYS, SOLID-STATE (COMPUTER GRADE)
 SCANNERS, OPTICAL
 SIGNAL CONDITIONERS

BUNKER RAMO CORP., THE, BUSINESS & IND. DIV 203-348-4291
 445 Fairfield Ave, Stamford, Conn 06904 TWX 710-474-1725

COMMUNICATION SYSTEMS, DATA TRANSMISSION
 COMMUNICATION SYSTEMS, TELEPRINTER
 CONTROLLERS, MODEM
 DATA CONCENTRATORS
 DATA TERMINALS, BLOCK-BY-BLOCK (HIGH SPEED PRINTER)
 DATA TERMINALS, BLOCK-BY-BLOCK (MEDIUM SPEED PRINTER)
 DATA TERMINALS, BLOCK-BY-BLOCK (TELEPRINTER)
 DATA TERMINALS, INQUIRY-RESPONSE (ALPHANUMERIC KEYBOARD)
 DATA TERMINALS, INQUIRY-RESPONSE (AUDIO RESPONSE)
 CONTINUED

DATA TERMINALS, INQUIRY-RESPONSE (BADGE-TOKEN READERS)
 DATA TERMINALS, INQUIRY-RESPONSE (CRT WITH KEYBOARD)
 DATA TERMINALS, INQUIRY-RESPONSE (SPECIAL-PURPOSE)
 MODEMS, HARD-WIRED
 MODEMS, PC CARD
 PRINTERS, KEYBOARD
 PRINTERS, LINE (LOW & MEDIUM SPEED)
 SERVICES, MANAGEMENT INFORMATION SYSTEMS
 SERVICES, SYSTEMS ANALYSIS

BUNKER-RAMO CORP. 203-377-4141
 Trumbull Ind Pk, Trumbull, Conn 06611

DATA TERMINALS, INQUIRY-RESPONSE (CRT WITH KEYBOARD)
 DATA TERMINALS, INQUIRY-RESPONSE (SPECIAL-PURPOSE)
 MODEMS, ACOUSTIC
 MODEMS, HARD-WIRED
 MODEMS, PC CARD
 PRINTERS, LINE (LOW & MEDIUM SPEED)
 PRINTERS, LINE (HIGH SPEED)
 PUNCHES, PAPER TAPE
 READERS, PAPER TAPE

BUREAU OF ENGRAVING INC. INDUSTRIAL DIV. 612-339-8001
 219 N 2nd St, Minneapolis, Minn 55401 TWX 910-576-2733

BOARDS, PRINTED CIRCUIT (WITHOUT COMPONENTS)
 CIRCUIT CARDS, LINEAR (WITH DISCRETE COMPONENTS)
 CIRCUIT CARDS, LINEAR (WITH IC'S)
 CIRCUIT CARDS, LOGIC (WITH DISCRETE COMPONENTS)
 CIRCUIT CARDS, LOGIC (WITH IC'S)

BURLINGTON MANAGEMENT SERVICES CO. 919-379-2174
 P O Box 21207, Greensboro, N C 27420

AUDIO/VISUAL TRAINING AIDS
 COMPUTERS, DIGITAL (EDUCATIONAL)
 CONSULTING (ACCOUNTING, BUSINESS AND COMMERCIAL APPLICATIONS)
 CONSULTING (ADVANCED COMPUTER EQUIPMENT DESIGN AND FEASIBILITY STUDIES)
 CONSULTING (COMPUTER EVALUATIONS, SELECTIONS, INSTALLATION PLANNING)
 CONSULTING (DATA COMMUNICATIONS SYSTEMS PLANNING)
 CONSULTING (COMPUTER PRODUCT PLANNING SURVEYS, MARKET RESEARCH STUDIES)
 CONSULTING (MANAGEMENT INFORMATION SYSTEMS PLANNING)
 CONSULTING (SCIENTIFIC APPLICATIONS)
 PROGRAMMING LANGUAGE DEVELOPMENT (CONSULTANTS)
 PROGRAMMING LANGUAGE DEVELOPMENT (CONTRACT PROGRAMMING)
 PROGRAMMING LANGUAGE DEVELOPMENT (DEDICATED APPLICATION SYSTEMS)
 PROGRAMMING LANGUAGE DEVELOPMENT (PROPRIETARY SOFTWARE PRODUCTS)
 SERVICES, FACILITY MANAGEMENT
 SERVICES, MANAGEMENT INFORMATION SYSTEMS
 SERVICES, PROCESSING (COMMERCIAL EDP)
 SERVICES, PROCESSING (DIGITAL SCIENTIFIC)
 SERVICES, TIME SHARING (COMMERCIAL)
 SERVICES, TIME SHARING (RESEARCH)
 SERVICES, SYSTEMS ANALYSIS
 TRAINING SYSTEMS, COMPUTER SERVICE

BURNDY CORP. 203-838-4444
 Richard Ave, Norwalk, Conn 06852 TWX 710-468-2546

CABLE, FLAT, PRINTED AND RIBBON
 CONNECTORS, COAXIAL (COMPUTER-GRADE)
 CONNECTORS, MINIATURE AND SUB-MINIATURE (COMPUTER-GRADE)
 CONNECTORS, PC AND IC BOARD (COMPUTER-GRADE)
 CONNECTORS, POWER (COMPUTER-GRADE)
 CONNECTORS, RACK AND PANEL (COMPUTER-GRADE)
 TERMINAL BLOCKS, STRIPS, BOARDS

BURR-BROWN RESEARCH CORP. 602-294-1431
 6730 S Tucson Blvd, Tucson, Ariz 85706 TWX 910-952-1111

AMPLIFIERS, D.C.
 AMPLIFIERS, INSTRUMENTATION
 AMPLIFIERS, OPERATIONAL
 AMPLIFIERS, VIDEO
 CIRCUITS, HYBRID (IC AND DISCRETE-DIGITAL)
 CIRCUITS, MONOLITHIC (OP AMPS)
 COMPUTERS, ANALOG (EDUCATIONAL)
 CONVERTERS, ANALOG-TO-DIGITAL
 CONVERTERS, DIGITAL-TO-ANALOG
 MODULES, LINEAR (ENCAPSULATED)
 MULTIPLEXERS, ANALOG-SOLID STATE (SEQUENTIAL SAMPLING)
 POWER SUPPLIES, DC
 SWITCHES, SOLID STATE

3 Manufacturers' Directory

BURROUGHS CORP., BUSINESS FORMS & SUPPLIES 1150 Univ Ave, Rochester, N Y 14607 CARDS, EDGE-PUNCH ENVELOPES, CONTINUOUS FORMS, CONTINUOUS (MACHINE PROCESSED) LABELS, CONTINUOUS AND GUMMED (MACHINE APPLICATION) LABELS, CONTINUOUS AND PRESSURE SENSITIVE (MACHINE APPLICATION) PAPER (FOR MICR EQUIPMENT) PAPER (FOR OCR EQUIPMENT) PAPER (FOR PRINTERS) PAYMENT COUPON BOOKS, MACHINE READABLE	716-271-3400 TELEX 97-8228	MEMORY SYSTEMS, MAGNETIC DISC MEMORY SYSTEMS, MAGNETIC DRUM RECORDING HEADS, MAGNETIC DISC RECORDING HEADS, MAGNETIC DRUM	
BURROUGHS CORP., BUSINESS MACHINES GROUP 6071 2nd Ave, Detroit, Mich 48232 ACCOUNTING MACHINES, PAPER TAPE PROGRAMMED CALCULATORS, PROGRAMMABLE (ALSO SEE COMPUTERS) CAMERAS, COM COMMUNICATIONS-ORIENTED PROCESSORS, MULTIPLE CHANNEL CONTROLLERS COMMUNICATIONS-ORIENTED PROCESSORS, SINGLE CHANNEL CONTROLLERS COMMUNICATIONS-ORIENTED PROCESSORS, STORED PROGRAM COMPUTERS, DIGITAL (GENERAL-PURPOSE, SMALL-SCALE) COMPUTERS, DIGITAL (GENERAL-PURPOSE, MEDIUM-SCALE) COMPUTERS, DIGITAL (GENERAL-PURPOSE, LARGE SCALE) CONTROLLERS, MODEM CORES, FERRITE MEMORY DATA TERMINALS, INQUIRY-RESPONSE (ALPHANUMERIC KEYBOARD) DATA TERMINALS, INQUIRY-RESPONSE (AUDIO RESPONSE) DATA TERMINALS, INQUIRY-RESPONSE (CRT WITH KEYBOARD) DISC DRIVES, FIXED HEAD (INCLUDING CONTROLLER) DISC STORAGE SYSTEMS ENCODERS, KEYBOARD-TO-MAGNETIC TAPE IMPRINTERS, MAGNETIC INK CHARACTER MEMORY PLANES AND STACKS, MAGNETIC CORE (W/O ELECTRONICS) MEMORY SYSTEMS, MAGNETIC CORE MEMORY SYSTEMS, MAGNETIC DISC PRINTERS, LINE (LOW & MEDIUM SPEED) PRINTERS, LINE (HIGH SPEED) PROGRAMMING LANGUAGE DEVELOPMENT (DEDICATED APPLICATION SYSTEMS) PROGRAMMING LANGUAGE DEVELOPMENT (PROPRIETARY SOFTWARE PRODUCTS) PUNCHES, CARD (OVER 100 CPM) PUNCHES, PAPER TAPE READERS, EDGE-PUNCHED CARD READERS, MAGNETIC INK CHARACTER READERS, OPTICAL CHARACTER SCANNING READERS, PAPER TAPE READERS, PERFORATED DOCUMENT READERS, PUNCHED CARD (UP TO 100 CPM) READERS, PUNCHED CARD (100 TO 300 CPM) READERS, PUNCHED CARD (OVER 300 CPM) RECORDERS, MAGNETIC TAPE RIBBONS, INK (FOR PRINTERS AND TAB EQUIPMENT) SERVICES, PROCESSING (COMMERCIAL EDP) SERVICES, TIME SHARING (COMMERCIAL) SORTERS, PUNCHED CARD TAPE, MAGNETIC (REELS) TAPE TRANSPORTS, MAGNETIC (DIGITAL-EXCL. CASSETTE) TAPE TRANSPORTS, MAGNETIC (WITH KEYBOARD INPUT)	313-972-7000 TWX 810-221-6175	BUSCOM U.S.A. INC. 31 E 28th St, New York, N Y 10016 CALCULATORS, PROGRAMMABLE (ALSO SEE COMPUTERS)	212-689-4925
BURROUGHS CORP., ELECTRONICS COMPONENTS DIV. P O Box 1226, Plainfield, N J 07061 COUNTERS, DECADE COUNTERS, DIGITAL READOUT DISPLAY DRIVERS READOUTS AND DISPLAYS, NUMERIC AND ALPHANUMERIC (OTHER THAN CRT)	201-757-5000 TWX 710-997-9539	BUSINESS COMPUTER SERVICE INC 1027 Virginia St E, Charleston, W Va 25301 COMPUTERS, ANALOG (GENERAL-PURPOSE)	304-343-9471
BURROUGHS CORP., OEM PRODUCT SALES 1649 Wilshire Blvd, Los Angeles, Cal 90017 CONTROLLERS, MAGNETIC DISC DISC DRIVES, FIXED HEAD (INCLUDING CONTROLLER) DISC STORAGE SYSTEMS MEMORY SYSTEMS, MAGNETIC DISC PERFORATORS, PAPER TAPE PRINTERS, LINE (HIGH SPEED) PUNCHES, CARD (OVER 100 CPM) PUNCHES, PAPER TAPE READERS, MAGNETIC INK CHARACTER READERS, PERFORATED DOCUMENT READERS, PUNCHED CARD (100 TO 300 CPM) READERS, PUNCHED CARD (OVER 300 CPM) TAPE TRANSPORTS, MAGNETIC (DIGITAL-EXCL. CASSETTE) TAPE TRANSPORTS, MAGNETIC (DIGITAL CASSETTE)	213-483-1425 TWX 910-321-2494	BUSINESS COMPUTERS INC. 10844 Shady Trail, Dallas, Tex 75220 LEASING, EDP EQUIPMENT (OTHER THAN MFGRS) SERVICES, HARDWARE MAINTENANCE USED EQUIPMENT (BUYING, SELLING, LEASING)	214-358-0235 TELEX 73-0355
BURTON MAGNEKOTE INC. 11334 Playa St, Culver City, Cal 90230 DISC PACKS, MAGNETIC MAGNETIC DISCS & DRUMS CONTINUED	213-391-0535	BUSINESS SUPPLIES CORP. OF AMERICA 475 5th Ave, New York, N Y 10017 CABINETS, TRAYS (FOR PUNCHED CARD STORAGE) CARDS, CONVENTIONAL PUNCH DISC PACKS, MAGNETIC FILES, PUNCHED CARD FORMS, CONTINUOUS (MACHINE PROCESSED) LABELS, CONTINUOUS AND GUMMED (MACHINE APPLICATION) PUNCHES, CARD (PORTABLE) RIBBONS, INK (FOR PRINTERS AND TAB EQUIPMENT) TAPE, MAGNETIC (REELS) USED EQUIPMENT (BUYING, SELLING, LEASING)	212-689-6363
		BUSSCO ENGINEERING INC. 122 Penn St, El Segundo, Cal 90245 BUS BAR SYSTEMS PANELS, POWER DISTRIBUTION	213-322-6580 TWX 910-348-6295
		C&C COMPUTER SYSTEMS INC. 1006 S E Grand, Portland, Ore 97214 CONSULTING (ACCOUNTING, BUSINESS AND COMMERCIAL APPLICATIONS) CONSULTING (COMPUTER EVALUATIONS, SELECTIONS, INSTALLATION PLANNING) CONSULTING (DATA COMMUNICATIONS SYSTEMS PLANNING) CONSULTING (MANAGEMENT INFORMATION SYSTEMS PLANNING) CONSULTING (SCIENTIFIC APPLICATIONS) PROGRAMMING LANGUAGE DEVELOPMENT (CONSULTANTS) PROGRAMMING LANGUAGE DEVELOPMENT (CONTRACT PROGRAMMING) PROGRAMMING LANGUAGE DEVELOPMENT (DEDICATED APPLICATION SYSTEMS) PROGRAMMING LANGUAGE DEVELOPMENT (PROPRIETARY SOFTWARE PRODUCTS) SERVICES, COMPUTER-AIDED DESIGN SERVICES, FACILITY MANAGEMENT SERVICES, MAGNETIC TAPE CERTIFICATION SERVICES, MANAGEMENT INFORMATION SYSTEMS SERVICES, PROCESSING (COMMERCIAL EDP) SERVICES, PROCESSING (DIGITAL SCIENTIFIC) SERVICES, TIME SHARING (COMMERCIAL) SERVICES, TIME SHARING (RESEARCH) SERVICES, SYSTEMS ANALYSIS TRAINING SYSTEMS, COMPUTER SERVICE	503-233-2541
		C&K COMPONENTS INC. 103 Morse St, Watertown, Mass 02172 SWITCHES, CODE BAR SWITCHES, PUSHBUTTON (ILLUMINATED) SWITCHES, SNAP ACTION SWITCHES, TOGGLE (MINIATURE)	617-926-0800
		C-O-M SYSTEMS INC. 75 Maiden Lane, New York, N Y 10038 CONSULTING (ACCOUNTING, BUSINESS AND COMMERCIAL APPLICATIONS) CONSULTING (MANAGEMENT INFORMATION SYSTEMS PLANNING)	212-483-0850
		CABLE-TECH INC. P O Box 177, Staffordville, Conn 06077 CABLE, FLAT, PRINTED AND RIBBON CABLE, MULTICONDUCTOR	315-637-3144 TWX 710-545-0242

3 Manufacturers' Directory

CABTRON CORP. 312-829-4282
1900 W Kinzie St, Chicago, Ill 60622

CABINETS, ENCLOSURES, CONSOLES, ELECTRONIC (FOR GENERAL EQUIPMENT)
CHASSIS, SLIDES, RACKS

CAELUS MEMORIES INC. 408-298-7080
967 Maybury Rd, San Jose, Cal 95133 TWX 910-338-0261
DISC DRIVES, REMOVABLE CARTRIDGE
DISC PACKS, MAGNETIC

CAIG LABORATORIES INC. 516-334-1940
455a Union Ave, Westbury, N Y 11590
CLEANERS, MAGNETIC TAPE HEADS

CALABRO PLASTICS INC. UNITRACK DIV. 215-789-3820
8738 W Chester Pike, Upper Darby, Pa 19082
CABINETS, ENCLOSURES, CONSOLES, ELECTRONIC (FOR GENERAL EQUIPMENT)
CHASSIS, SLIDES, RACKS
GUIDES, CIRCUIT CARDS

CALIFORNIA COMPUTER PRODUCTS INC. 714-821-2011
2411 W La Palma Ave, Anaheim, Cal 92801 TWX 910-591-1154
CONTROLLERS, MAGNETIC DISC
CONTROLLERS, MAGNETIC TAPE
CONTROLLERS, PLOTTING
CURVE TRACERS-DIGITIZERS, AUTOMATIC
DIGITIZERS, PROGRAMMABLE
DISC DRIVES, FIXED HEAD (INCLUDING CONTROLLER)
DISC DRIVES, MOVABLE HEAD (INCLUDING CONTROLLER)
DISC DRIVES, REMOVABLE CARTRIDGE
DISC STORAGE SYSTEMS
MEMORY SYSTEMS, MAGNETIC DISC
PAPER (FOR RECORDERS AND PLOTTERS)
PLOTTERS, MOVING PEN (DIGITAL CONTROLLER)
PRINTERS, MICROFILM/MICROFICHE
PROGRAMMING LANGUAGE DEVELOPMENT (PROPRIETARY SOFTWARE
PRODUCTS)
READER/PRINTER, MICROFILM/MICROFICHE
RECORDERS, GRAPHIC
RECORDERS, HARD-COPY (WITH CRT)
RECORDERS, MAGNETIC TAPE
RECORDERS, MICROFILM/MICROFICHE

CALIFORNIA INSTRUMENTS CO. 714-279-8620
5150 Convoy St, San Diego, Cal 92111
COUNTERS, DIGITAL READOUT
POWER SUPPLIES, AC
POWER SUPPLIES, DIGITALLY-CONTROLLED
REGULATORS, VOLTAGE
VOLTMETERS, DIGITAL

CALL-A-COMPUTER INC. 714-540-2464
633 Young St, Santa Ana, Cal 92702
CONSULTING (ACCOUNTING, BUSINESS AND COMMERCIAL APPLICATIONS)
CONSULTING (DATA COMMUNICATIONS SYSTEMS PLANNING)
CONSULTING (MANAGEMENT INFORMATION SYSTEMS PLANNING)
CONSULTING (SCIENTIFIC APPLICATIONS)
PROGRAMMING LANGUAGE DEVELOPMENT (CONSULTANTS)
PROGRAMMING LANGUAGE DEVELOPMENT (DEDICATED APPLICATION SYSTEMS)
SERVICES, FACILITY MANAGEMENT
SERVICES, PROCESSING (COMMERCIAL EDP)
SERVICES, TIME SHARING (COMMERCIAL)
SERVICES, TIME SHARING (RESEARCH)

CALMA CO. 408-245-7522
707 Kifer Rd, Sunnyvale, Cal 94086
CURVE TRACERS-DIGITIZERS, MANUAL
RECORDERS, MAGNETIC TAPE

CALMONT ENGINEERING & ELECTRONICS CORP. 714-549-0336
420 E Alton St, Santa Ana, Cal 92707
CABLE, COAXIAL (FLEXIBLE)
CABLE, FINE LEAD
CABLE, FLAT, PRINTED AND RIBBON
CABLE, MULTICONDUCTOR
CABLE, SHIELDED (NOT COAXIAL)

CAL POWER CORP. 213-772-2171
140 Kansas St, El Segundo, Cal 90245 TWX 910-348-6678
POWER SUPPLIES, DC
REGULATORS, VOLTAGE

CAL-R INC. DIV. OF CAP-TECH. 213-451-9761
1601 Olympic Blvd, Santa Monica, Cal 90404 TWX 910-343-6966
CAPACITORS, COMPUTER GRADE
CIRCUITS, THICK FILM (DIGITAL)

CALTEC INC. 419-475-3501
1931 Sylvania Ave, Toledo, Ohio 43613
CONSULTING (ACCOUNTING, BUSINESS AND COMMERCIAL APPLICATIONS)
CONSULTING (ADVANCED COMPUTER EQUIPMENT DESIGN AND FEASIBILITY
STUDIES)
CONSULTING (COMPUTER PRODUCT PLANNING SURVEYS, MARKET RESEARCH
STUDIES)
CONSULTING (MANAGEMENT INFORMATION SYSTEMS PLANNING)
CONSULTING (SCIENTIFIC APPLICATIONS)
SERVICES, MANAGEMENT INFORMATION SYSTEMS
SERVICES, PROCESSING (COMMERCIAL EDP)
SERVICES, PROCESSING (DIGITAL SCIENTIFIC)
SERVICES, SYSTEMS ANALYSIS
TRAINING SYSTEMS, COMPUTER SERVICE

CAL-WESTERN DATA SYSTEMS INC. 213-872-2592
13517 Ventura Blvd, Sherman Oaks, Cal 91403
CONSULTING (ACCOUNTING, BUSINESS AND COMMERCIAL APPLICATIONS)
SERVICES, PROCESSING (COMMERCIAL EDP)

CAMBRIDGE COMPUTER ASSOCIATES INC. 617-868-1111
220 Alewife Brook Pky, Cambridge, Mass 02138
CONSULTING (ACCOUNTING, BUSINESS AND COMMERCIAL APPLICATIONS)
CONSULTING (ADVANCED COMPUTER EQUIPMENT DESIGN AND FEASIBILITY
STUDIES)
CONSULTING (COMPUTER EVALUATIONS, SELECTIONS, INSTALLATION
PLANNING)
CONSULTING (DATA COMMUNICATIONS SYSTEMS PLANNING)
CONSULTING (COMPUTER PRODUCT PLANNING SURVEYS, MARKET RESEARCH
STUDIES)
CONSULTING (MANAGEMENT INFORMATION SYSTEMS PLANNING)
CONSULTING (SCIENTIFIC APPLICATIONS)
PROGRAMMING LANGUAGE DEVELOPMENT (CONSULTANTS)
PROGRAMMING LANGUAGE DEVELOPMENT (CONTRACT PROGRAMMING)
PROGRAMMING LANGUAGE DEVELOPMENT (DEDICATED APPLICATION SYSTEMS)
PROGRAMMING LANGUAGE DEVELOPMENT (PROPRIETARY SOFTWARE
PRODUCTS)
SERVICES, SYSTEMS ANALYSIS

CAMBRIDGE MEMORIES INC. 617-969-0050
285 Newtonville Ave, Newton, Mass 02160
MEMORY SYSTEMS, MAGNETIC CORE
MEMORY SYSTEMS, SEMICONDUCTOR (MOS)
MEMORY SYSTEMS, THIN FILM

CAMBRIDGE THERMIONIC CORP. 617-491-5400
445 Concord Ave, Cambridge, Mass 02138 TWX 710-320-6399
BREADBOARDS
CIRCUIT CARDS, LINEAR (WITH DISCRETE COMPONENTS)
CIRCUIT CARDS, LINEAR (WITH IC'S)
CIRCUIT CARDS, LOGIC (WITH DISCRETE COMPONENTS)
CIRCUIT CARDS, LOGIC (WITH IC'S)
CIRCUITS, HYBRID (IC AND DISCRETE-DIGITAL)
CONNECTORS, MINIATURE AND SUB-MINIATURE (COMPUTER-GRADE)
CONNECTORS, PC AND IC BOARD (COMPUTER-GRADE)
CONNECTORS, RACK AND PANEL (COMPUTER-GRADE)
CONVERTERS, ANALOG-TO-DIGITAL
CONVERTERS, BINARY-TO-DECIMAL
CONVERTERS, DC-TO-FREQUENCY
CONVERTERS, DIGITAL-TO-ANALOG
CORDS, PATCH
COUNTERS, DECADE
COUNTERS, UP-DOWN
EXTRACTORS, CIRCUIT BOARD
HANDLES, TEST POINT STRIPS (FOR CIRCUIT CARDS)
JACKS, JACK PANELS, PLUGS, ASSEMBLIES
MODULES, DIGITAL LOGIC ENCAPSULATED (ALSO SEE CIRCUITS & CIRCUIT
CARDS)
TERMINAL BLOCKS, STRIPS, BOARDS

3 Manufacturers' Directory

CANOGA DIGITAL SYSTEMS 8851 Mason Ave, Canoga Park, Cal 93106	213-341-6744	RECTIFIERS, SILICON CONTROLLED REGULATORS, CURRENT REGULATORS, VOLTAGE SWITCHES, PUSHBUTTON SWITCHES, PUSHBUTTON (ILLUMINATED) SWITCHES, ROTARY
ANALYZERS, COMPUTER PERFORMANCE ANALYZERS, CONTINUITY ANALYZERS, DIFFERENTIAL ANALYZERS, PULSE HEIGHT ANALYZERS, WAVEFORM		
CANON U.S.A. INC. 64-10 Queens Blvd, Woodside, N Y 11377	212-478-5600	CENTRALAB SEMICONDUCTOR GLOBE-UNION INC. 4501 N Arden Dr, El Monte, Cal 91734
CALCULATORS, PROGRAMMABLE (ALSO SEE COMPUTERS) CAMERAS, COM PROCESSORS, MICROFILM READERS, MICROFILM/MICROFICHE RECORDERS, MICROFILM/MICROFICHE		CELLS, PHOTOCONDUCTIVE DIODES, LIGHT EMITTING DIODES, TUNNEL DIODES, ZENER REGULATORS, VOLTAGE
CANTELTECH LTD. 1970 Ellesmere Rd, Scarborough 722, CANADA	416-291-8151	CENTRAL COMPUTING CORP. 749 Water P O Box 681, Decatur, Ill 62525
COMMUNICATION SYSTEMS, DATA TRANSMISSION MODEMS, HARD-WIRED MODEMS, PC CARD		CONSULTING (ACCOUNTING, BUSINESS AND COMMERCIAL APPLICATIONS) CONSULTING (DATA COMMUNICATIONS SYSTEMS PLANNING) CONSULTING (MANAGEMENT INFORMATION SYSTEMS PLANNING) SERVICES, FACILITY MANAGEMENT SERVICES, PROCESSING (COMMERCIAL EDP)
CAPITOL MACHINE & SWITCH CO., THE 87 Newtown Rd, Danbury, Conn 06810	203-744-3300 TWX 710-456-0365	CENTRAL COMPUTING CORP. 180 N Mich Ave, Chicago, Ill 60601
SWITCHES, PUSHBUTTON SWITCHES, PUSHBUTTON (ILLUMINATED)		CONSULTING (ACCOUNTING, BUSINESS AND COMMERCIAL APPLICATIONS) CONSULTING (COMPUTER EVALUATIONS, SELECTIONS, INSTALLATION PLANNING) CONSULTING (MANAGEMENT INFORMATION SYSTEMS PLANNING) SERVICES, COMPUTER-AIDED DESIGN SERVICES, FACILITY MANAGEMENT SERVICES, MANAGEMENT INFORMATION SYSTEMS SERVICES, PROCESSING (COMMERCIAL EDP) SERVICES, TIME SHARING (COMMERCIAL) SERVICES, SYSTEMS ANALYSIS TRAINING SYSTEMS, COMPUTER SERVICE
CARROLL GRAPHICS INC. 5301 Michigan Ave, Rosemont, Ill 60018	312-678-5392 TWX 910-227-4632	CENTRAL COMPUTING, INC. 2627 E Central, Wichita, Kans 67214
COMMUNICATION SYSTEMS, DATA TRANSMISSION CONSULTING (DATA COMMUNICATIONS SYSTEMS PLANNING)		CONSULTING (ACCOUNTING, BUSINESS AND COMMERCIAL APPLICATIONS) CONSULTING (ADVANCED COMPUTER EQUIPMENT DESIGN AND FEASIBILITY STUDIES) CONSULTING (COMPUTER EVALUATIONS, SELECTIONS, INSTALLATION PLANNING) CONSULTING (DATA COMMUNICATIONS SYSTEMS PLANNING) CONSULTING (COMPUTER PRODUCT PLANNING SURVEYS, MARKET RESEARCH STUDIES) CONSULTING (MANAGEMENT INFORMATION SYSTEMS PLANNING) SERVICES, FACILITY MANAGEMENT SERVICES, MANAGEMENT INFORMATION SYSTEMS SERVICES, PROCESSING (COMMERCIAL EDP) SERVICES, PROCESSING (ANALOG OR HYBRID, SCIENTIFIC) SERVICES, PROCESSING (DIGITAL SCIENTIFIC) SERVICES, TIME SHARING (COMMERCIAL) SERVICES, TIME SHARING (RESEARCH) SERVICES, SYSTEMS ANALYSIS
CARTERFONE COMMUNICATION CORP 11710 E NW Hwy, Dallas, Tex 75218	214-328-8511	CENTRAL DATA SYSTEMS INC. 1215 Valley Belt Rd, Cleveland, Ohio 44131
ACOUSTIC COUPLERS MODEMS, ACOUSTIC MODEMS, HARD-WIRED MODEMS, PC CARD		CONSULTING (ACCOUNTING, BUSINESS AND COMMERCIAL APPLICATIONS) CONSULTING (COMPUTER EVALUATIONS, SELECTIONS, INSTALLATION PLANNING) CONSULTING (MANAGEMENT INFORMATION SYSTEMS PLANNING) SERVICES, FACILITY MANAGEMENT SERVICES, MANAGEMENT INFORMATION SYSTEMS SERVICES, PROCESSING (COMMERCIAL EDP) SERVICES, PROCESSING (ANALOG OR HYBRID, SCIENTIFIC) SERVICES, PROCESSING (DIGITAL SCIENTIFIC) SERVICES, TIME SHARING (COMMERCIAL) SERVICES, TIME SHARING (RESEARCH) SERVICES, SYSTEMS ANALYSIS
CARTER MANUFACTURING CORP. 8 Washington St, Hudson, Mass 01749	617-562-6987	CENTRAL PROCESSING CENTER OF SAN ANTONIO INC. P O Box 1416, San Antonio, Tex 78206
VOLTAGE DIVIDERS		SERVICES, FACILITY MANAGEMENT SERVICES, PROCESSING (COMMERCIAL EDP) SERVICES, TIME SHARING (COMMERCIAL) SERVICES, SYSTEMS ANALYSIS
CARTER MOTOR CO. 2711 W George St, Chicago, Ill 60618	312-588-7700	CENTURY DATA PROCESSING INC. 1006 Coronado Towers, El Paso, Tex 79912
CONVERTERS, DC-TO-FREQUENCY INVERTERS, DC-AC		CONSULTING (ACCOUNTING, BUSINESS AND COMMERCIAL APPLICATIONS) CONSULTING (COMPUTER EVALUATIONS, SELECTIONS, INSTALLATION PLANNING) CONSULTING (MANAGEMENT INFORMATION SYSTEMS PLANNING) SERVICES, FACILITY MANAGEMENT SERVICES, MANAGEMENT INFORMATION SYSTEMS SERVICES, PROCESSING (COMMERCIAL EDP) SERVICES, SYSTEMS ANALYSIS
CEA DIV. BERKLEONICS INC. 1221 S Shamrock Ave, Monrovia, Cal 91016	213-359-9261	CENTURY DATA PROCESSING INC. 1006 Coronado Towers, El Paso, Tex 79912
POWER SUPPLIES, DC		CONSULTING (ACCOUNTING, BUSINESS AND COMMERCIAL APPLICATIONS) CONSULTING (COMPUTER EVALUATIONS, SELECTIONS, INSTALLATION PLANNING) CONSULTING (MANAGEMENT INFORMATION SYSTEMS PLANNING) SERVICES, FACILITY MANAGEMENT SERVICES, MANAGEMENT INFORMATION SYSTEMS SERVICES, PROCESSING (COMMERCIAL EDP) SERVICES, SYSTEMS ANALYSIS
CELCO, CONSTANTINE ENGINEERING LABS. CO. 70 Constantine Dr, Mahwah, N J 07430	201-327-1123 TWX 710-988-1018	CENTRALAB ELECTRONICS, DIV. 5757 N Green Bay, Milwaukee, Wisc 53201
AMPLIFIERS, D.C. AMPLIFIERS, VIDEO CRT DEFLECTION YOKES DISPLAY DRIVERS DISPLAYS, MAGNETIC READOUTS, CRT		CIRCUIT CARDS, LINEAR (WITH DISCRETE COMPONENTS) CIRCUIT CARDS, LINEAR (WITH IC'S) CIRCUITS, THICK FILM (DIGITAL) DIODES, SILICON DIODES, TUNNEL DIODES, ZENER MODULES, DIGITAL LOGIC ENCAPSULATED (ALSO SEE CIRCUITS & CIRCUIT CARDS) MODULES, LINEAR (ENCAPSULATED) MODULES, RESISTANCE NETWORKS (ENCAPSULATED) READERS, PERFORATED DOCUMENT
CENTRALAB ELECTRONICS, DIV. 5757 N Green Bay, Milwaukee, Wisc 53201	414-228-1200 TWX 910-262-3084	CONTINUED
CIRCUIT CARDS, LINEAR (WITH DISCRETE COMPONENTS) CIRCUIT CARDS, LINEAR (WITH IC'S) CIRCUITS, THICK FILM (DIGITAL) DIODES, SILICON DIODES, TUNNEL DIODES, ZENER MODULES, DIGITAL LOGIC ENCAPSULATED (ALSO SEE CIRCUITS & CIRCUIT CARDS) MODULES, LINEAR (ENCAPSULATED) MODULES, RESISTANCE NETWORKS (ENCAPSULATED) READERS, PERFORATED DOCUMENT		CONTINUED

3 Manufacturers' Directory

CONSULTING (MANAGEMENT INFORMATION SYSTEMS PLANNING)
PROGRAMMING LANGUAGE DEVELOPMENT (CONTRACT PROGRAMMING)
PROGRAMMING LANGUAGE DEVELOPMENT (DEDICATED APPLICATION SYSTEMS)
SERVICES, FACILITY MANAGEMENT
SERVICES, MANAGEMENT INFORMATION SYSTEMS
SERVICES, PROCESSING (COMMERCIAL EDP)
SERVICES, TIME SHARING (COMMERCIAL)
SERVICES, SYSTEMS ANALYSIS

CENTURY DATA SYSTEMS INC. 714-639-4910
1630 S St Collg Blvd, Anaheim, Cal 92806

CONTROLLERS, MAGNETIC DISC
DISC DRIVES, MOVABLE HEAD (INCLUDING CONTROLLER)
DISC DRIVES, REMOVABLE CARTRIDGE
MEMORY SYSTEMS, MAGNETIC DISC

CENTURY ELECTRONICS & INSTRUMENTS INC. 918-835-9951
P O Box C Adm Sta, Tulsa, Okla 74115 TWX 918-923-3407

AMPLIFIERS, D.C.
AMPLIFIERS, INSTRUMENTATION
COMPUTERS, ANALOG (GENERAL-PURPOSE)
DATA ACQUISITION AND REDUCTION SYSTEMS
DATA TERMINALS, INQUIRY-RESPONSE (SPECIAL-PURPOSE)
MOTORS, SERVO
RECORDERS, FACSIMILE
RECORDERS, GRAPHIC
RECORDERS, HARD-COPY (WITH CRT)

CERMETEK INC. 415-969-9433
660 National Ave, Mt View, Cal 94040 TWX 910-379-6931

CIRCUITS, HYBRID (IC AND DISCRETE-DIGITAL)
CIRCUITS, MONOLITHIC (DIGITAL LOGIC)
CIRCUITS, THICK FILM (DIGITAL)
CONVERTERS, PULSE-TO-DIGITAL
MODULES, DIGITAL LOGIC ENCAPSULATED (ALSO SEE CIRCUITS & CIRCUIT CARDS)

CERTRON CORP. 714-633-4280
1701 State Collg Blvd, Anaheim, Cal 92806

DISC PACKS, MAGNETIC
REELS, MAGNETIC TAPE
TAPE, MAGNETIC (CASSETTE)
TAPE, MAGNETIC (REELS)
TAPE TRANSPORTS, MAGNETIC (DIGITAL CASSETTE)

CERTRON CORP. COMPUTER TAPE DIV. 919-882-8138
2060 Brentwood St, High Point, N C 27262 TWX 510-926-1840

REELS, MAGNETIC TAPE
SERVICES, MAGNETIC TAPE CERTIFICATION
TAPE, MAGNETIC (CASSETTE)
TAPE, MAGNETIC (REELS)

CGA COMPUTER ASSOCIATES INC. 201-678-6100
715 Park Ave, East Orange, N J 07017

COMPUTERS, DIGITAL (EDUCATIONAL)
CONSULTING (ACCOUNTING, BUSINESS AND COMMERCIAL APPLICATIONS)
CONSULTING (COMPUTER EVALUATIONS, SELECTIONS, INSTALLATION PLANNING)
CONSULTING (MANAGEMENT INFORMATION SYSTEMS PLANNING)
PROGRAMMING LANGUAGE DEVELOPMENT (CONTRACT PROGRAMMING)
PROGRAMMING LANGUAGE DEVELOPMENT (PROPRIETARY SOFTWARE PRODUCTS)
SERVICES, FACILITY MANAGEMENT
SERVICES, PROCESSING (COMMERCIAL EDP)
SERVICES, SYSTEMS ANALYSIS
TRAINING SYSTEMS, COMPUTER SERVICE

CHALCO ENGINEERING CORP. 213-321-0121
15126 S Broadway, Gardena, Cal 90248 TWX 213-327-0167

PERFORATORS, PAPER TAPE
POWER SUPPLIES, DC
PUNCHES, PAPER TAPE
READERS, PAPER TAPE
SPOOLERS, PAPER TAPE
TAPE TRANSPORTS, MAGNETIC (DIGITAL CASSETTE)
WINDERS, PAPER TAPE

CHANDLER LEASING CORP. 617-861-0676
101 Hartwell Ave, Lexington, Mass 02173

LEASING, EDP EQUIPMENT (OTHER THAN MFGRS)
CONTINUED

USED EQUIPMENT (BUYING, SELLING, LEASING)

CHAPARRAL SYSTEMS INC. MANAGEMENT, 301-654-4317
P O Box 5755, Bethesda, Md 20014

CONSULTING (ACCOUNTING, BUSINESS AND COMMERCIAL APPLICATIONS)
CONSULTING (DATA COMMUNICATIONS SYSTEMS PLANNING)
CONSULTING (COMPUTER PRODUCT PLANNING SURVEYS, MARKET RESEARCH STUDIES)
CONSULTING (MANAGEMENT INFORMATION SYSTEMS PLANNING)
SERVICES, COMPUTER-AIDED DESIGN
SERVICES, PROCESSING (COMMERCIAL EDP)
SERVICES, TIME SHARING (COMMERCIAL)

CHASE-FOSTER DIV. OF KEENE CORP. 401-434-2340
199 Amarat St, E Providence, R I 02914 TELEX 92-7524

TAPE, PUNCH (MYLAR)
TAPE, PUNCH (MYLAR-COATED FOIL)
TAPE, PUNCH (PAPER-COATED MYLAR)
TAPE, PUNCH (PAPER-COATED ALUMINUM)

CHEM ACRO INC. 213-775-2581
231 E Lomita Blvd, Wilmington, Cal 90744 TWX 910-345-6297

BUS BAR SYSTEMS
HEAT SINKS, CIRCUIT BOARD MOUNTING

CHEMELEC PRODUCTS INC. 609-424-1470
8 Fellowship Rd, Cherryhill, N J 08034

SOCKETS, IC MOUNTING
SOCKETS, PCB MOUNTING
SOCKETS, SEMICONDUCTOR MOUNTING

CHEMICAL MICRO MILLING CO. 609-964-2030
1601 Hylton Rd, Pennsauken, N J 08101 TWX 710-892-0731

BUS BAR SYSTEMS
CONSULTING (SCIENTIFIC APPLICATIONS)
RECORDING HEADS, MAGNETIC DISC
RECORDING HEADS, MAGNETIC TAPE
SCANNERS, OPTICAL

CHERRY ELECTRICAL PRODUCTS CORP. 312-689-7600
3600 Sunset Ave, Waukegan, Ill 60085 TWX 910-235-1572

ENCODERS, KEYBOARD (ALPHANUMERIC)
ENCODERS, KEYBOARD (NUMERIC)
SWITCHES, CODE BAR
SWITCHES, DRY REED
SWITCHES, PUSHBUTTON
SWITCHES, ROTARY
SWITCHES, SNAP ACTION
SWITCHES, THUMBWHEEL

CHESHIRE INC. A XEROX CORP. 312-566-7880
408 Washington Blvd, Mundelein, Ill 60060 TELEX 25-4693

LABELS, CONTINUOUS AND GUMMED (MACHINE APPLICATION)

CHESTER CABLE OPERATION CITIES SERVICE CO. 914-469-2141
Oakland Ave, Chester, N Y 10918 TWX 914-469-9801

CABLE, COAXIAL (FLEXIBLE)
CABLE, COAXIAL (SEMI/RIGID)
CABLE, FLAT, PRINTED AND RIBBON
CABLE, MULTICONDUCTOR
CABLE, SHIELDED (NOT COAXIAL)

CHI CORP. 216-229-6400
11000 Cedar Ave, Cleveland, Ohio 44106

CONSULTING (ACCOUNTING, BUSINESS AND COMMERCIAL APPLICATIONS)
CONSULTING (SCIENTIFIC APPLICATIONS)
SERVICES, PROCESSING (COMMERCIAL EDP)
SERVICES, PROCESSING (DIGITAL SCIENTIFIC)
SERVICES, TIME SHARING (COMMERCIAL)
SERVICES, TIME SHARING (RESEARCH)
TRAINING INSTITUTES, COMMERCIAL COMPUTER COURSES, SEMINARS,
CORRESPONDENCE COURSES

CHICAGO DYNAMIC INDUSTRIES PRECISION PROD. DIV 312-935-4600
1725 Diversey Blvd, Chicago, Ill 60614 TELEX 41-6041

SWITCHES, PUSHBUTTON
SWITCHES, ROTARY
SWITCHES, THUMBWHEEL

3 Manufacturers' Directory

CHICAGO MINIATURE LAMP WORKS 4433 N Ravenswood Ave, Chicago, Ill 60640 INDICATORS, DIGITAL INDICATORS, ILLUMINATED LAMPS-PANEL, PILOT AND DIAL (INCANDESCENT) READOUTS AND DISPLAYS, NUMERIC AND ALPHANUMERIC (OTHER THAN CRT)	312-784-1020 TWX 910-221-5445	CIPHER DATA PRODUCTS INC. 7655 Convoy Ct, San Diego, Cal 92111 RECORDERS, DIGITAL CASSETTE RECORDERS, MAGNETIC TAPE TAPE TRANSPORTS, MAGNETIC (DIGITAL-EXCL. CASSETTE) TAPE TRANSPORTS, MAGNETIC (DIGITAL CASSETTE) TAPE TRANSPORTS, MAGNETIC (INCREMENTAL)	714-277-8070 TWX 910-335-1251
CHICAGO TABULATING SERV. INC. 425 N Michigan, Chicago, Ill 60611 CONSULTING (ACCOUNTING, BUSINESS AND COMMERCIAL APPLICATIONS) CONSULTING (ADVANCED COMPUTER EQUIPMENT DESIGN AND FEASIBILITY STUDIES) CONSULTING (COMPUTER EVALUATIONS, SELECTIONS, INSTALLATION PLANNING) CONSULTING (DATA COMMUNICATIONS SYSTEMS PLANNING) CONSULTING (COMPUTER PRODUCT PLANNING SURVEYS, MARKET RESEARCH STUDIES) CONSULTING (MANAGEMENT INFORMATION SYSTEMS PLANNING) CONSULTING (SCIENTIFIC APPLICATIONS) SERVICES, COMPUTER-AIDED DESIGN SERVICES, MANAGEMENT INFORMATION SYSTEMS SERVICES, PROCESSING (COMMERCIAL EDP) SERVICES, PROCESSING (ANALOG OR HYBRID, SCIENTIFIC) SERVICES, PROCESSING (DIGITAL SCIENTIFIC) SERVICES, TIME SHARING (COMMERCIAL) SERVICES, TIME SHARING (RESEARCH) SERVICES, SYSTEMS ANALYSIS	312-828-0620	CIRCUIT SCIENCE INC. 615 N County Rd 18, Minneapolis, Minn 55427 BOARDS, PRINTED CIRCUIT (WITHOUT COMPONENTS) BREADBOARDS	612-544-8635
CHOMERICS, INC. SERVICE INC. 77 Dragon Court, Woburn, Mass 01801 SWITCH ARRAYS, ENCODED SWITCHES, SNAP ACTION	617-935-4850 TWX 710-393-0173	CIRCUIT-STIK INC. 1518 W 132nd, Gardena, Cal 90249 BOARDS, PRINTED CIRCUIT (WITHOUT COMPONENTS) BREADBOARDS	213-532-1450
CHRONETICS INC. 500 Nuber Ave, Mount Vernon, N Y 10550 AMPLIFIERS, D.C. ANALYZERS, PULSE HEIGHT ANALYZERS, WAVEFORM TESTERS, MEMORY PLANES, STACKS AND SYSTEMS THERMOCOUPLE REFERENCE SYSTEMS VOLTAGE DIVIDERS	914-699-4400 TWX 710-560-0014	CIRCUITS INC. 59 Deming Rd, Berlin, Conn 06037 BOARDS, PRINTED CIRCUIT (WITHOUT COMPONENTS)	203-828-3526
CHRONO-LOG CORP. 2583 W Chester Pike, Broomall, Pa 19008 CLOCKS, DIGITAL (REAL-TIME) COUNTERS, DIGITAL READOUT TIMERS, EVENT (IMPULSE) TIMERS, INTERVAL	215-356-6771	CIT LEASING CORP. 650 Madison Ave, New York, N Y 10022 LEASING, EDP EQUIPMENT (OTHER THAN MFGRS)	212-572-6615
CICOIL CORP. 9324 Topanga Cyn Blvd, Chatsworth, Cal 91311 CABLE, COAXIAL (FLEXIBLE) CABLE, FINE LEAD CABLE, FLAT, PRINTED AND RIBBON CABLE, MULTICONDUCTOR CABLE, SHIELDED (NOT COAXIAL)	213-882-2021 TWX 910-494-1921	CITIZEN AMERICA CORP. 9201 Olympic Blvd, Beverly Hills, Cal 90212 CALCULATORS, PROGRAMMABLE (ALSO SEE COMPUTERS) COUNTERS, DIGITAL READOUT IMPRINTERS, OPTICALLY-SENSED CHARACTER MOTORS, STEPPING PRINTER/PUNCH, PAPER TAPE PRINTERS, LINE (LOW & MEDIUM SPEED) READOUTS AND DISPLAYS, NUMERIC AND ALPHANUMERIC (OTHER THAN CRT)	213-278-8320
CINCH-GRAPIK DIV. OF TRW 200 S Turnbull Canyon, Cy of Industry, Cal 91744 BOARDS, PRINTED CIRCUIT (WITHOUT COMPONENTS)	213-333-1201 TWX 910-584-1861	CLAIREX CORP. 560 S 3rd Ave, Mount Vernon, N Y 10550 CELLS, PHOTOCONDUCTIVE CIRCUIT CARDS, LINEAR (WITH DISCRETE COMPONENTS) CIRCUIT CARDS, LOGIC (WITH DISCRETE COMPONENTS) MODULES, DIGITAL LOGIC ENCAPSULATED (ALSO SEE CIRCUITS & CIRCUIT CARDS) TRANSISTORS, PHOTO	914-664-6602 TELEX 13-7308
CINCINNATI MILACRON State Rte 48, Lebanon, Ohio 45036 COMPUTERS, DIGITAL (GENERAL-PURPOSE, SMALL-SCALE) COMPUTERS, DIGITAL (GENERAL-PURPOSE, MEDIUM-SCALE) COMPUTERS, PROCESS CONTROL PROGRAMMING LANGUAGE DEVELOPMENT (DEDICATED APPLICATION SYSTEMS)	513-494-5444 TWX 810-450-2840	CLARE-PENDAR CO. P O Box 785, Post Falls, Ind 83854 DATA TERMINALS, INQUIRY-RESPONSE (ALPHANUMERIC KEYBOARD) ENCODERS, KEYBOARD (ALPHANUMERIC) ENCODERS, KEYBOARD (NUMERIC) ENCODERS, KEYBOARD-TO-MAGNETIC DISC ENCODERS, KEYBOARD-TO-MAGNETIC TAPE ENCODERS, KEYBOARD-TO-PRINTED TAPE INDICATORS, ILLUMINATED LAMPS-PANEL, PILOT AND DIAL (INCANDESCENT) MEMORY SYSTEMS, READ-ONLY SWITCHES, DRY REED SWITCHES, PUSHBUTTON SWITCHES, PUSHBUTTON (ILLUMINATED) SWITCHES, SNAP ACTION TYPEWRITERS, COMPUTER INPUT-OUTPUT	208-773-4541 TELEX 32-6448
CINCINNATI TIME RECORDER CO. 1733 Central Ave, Cincinnati, Ohio 45214 DATA TERMINALS, INQUIRY-RESPONSE (BADGE-TOKEN READERS) SCANNERS, OPTICAL	513-241-5500	CLARE SYSTEMS DIV. C.P. CLARE & CO. 3101 W Pratt Ave, Chicago, Ill 60645 CONSOLES, COMPUTER CONTROL (WIRED) COUNTERS, DECADE COUNTERS, UP-DOWN MULTIPLEXERS, ANALOG-RELAY (SEQUENTIAL SAMPLING) MULTIPLEXERS, DIGITAL POWER SUPPLIES, AC POWER SUPPLIES, DC POWER SUPPLIES, UNINTERRUPTABLE PROTECTORS, CIRCUIT AND EQUIPMENT OVERLOAD SCANNERS, INPUT TRANSFORMERS, POWER (COMPUTER GRADE)	312-262-7700 TELEX 25-3775
CINTEL CORP. SUB. TECHNOLOGY INC 11801 W Olympic Blvd., Los Angeles, Cal 90064 PROCESSORS, MICROFILM	213-272-4331 TWX 910-342-6899		

3 Manufacturers' Directory

CLAROSTAT MANUFACTURING CO. INC. Washington St, Dover, N H 03820 POTENTIOMETERS, TRIM (FILM) POTENTIOMETERS, TRIM (WIRE-WOUND) SWITCHES, SNAP ACTION	603-742-1120 TWX 710-366-1616	COGAR CORP. INFORMATION SYS.DIV Cosby Manor Rd, Utica, N Y 13502 CONVERTERS, MAGNETIC TAPE-TO-MAGNETIC TAPE ENCODERS, KEYBOARD-TO-MAGNETIC TAPE POOLERS, MAGNETIC TAPE RECORDERS, DIGITAL CASSETTE TAPE TRANSPORTS, MAGNETIC (DIGITAL CASSETTE)	315-797-5750
CLARY CORP. 320 W Clary Ave, San Gabriel, Cal 91011 PRINTER/PUNCH, PAPER TAPE PRINTERS, DIGITAL STRIP RECORDING PRINTERS, KEYBOARD PRINTERS, LINE (LOW & MEDIUM SPEED)	213-287-6111 TELEX 67-4604	COGAR CORP. TECHNOLOGY DIV. All Angels Rd, Wappinger Falls, N Y 12590 MEMORY SYSTEMS, READ-ONLY MEMORY SYSTEMS, SEMICONDUCTOR MEMORY SYSTEMS, SEMICONDUCTOR (MOS)	914-297-4323
CLARY DATACOMP SYSTEMS INC. 404 Junipero Serra, San Gabriel, Cal 91776 COMPUTERS, DIGITAL (GENERAL-PURPOSE, SMALL-SCALE)	213-283-9485 TELEX 67-4604	COGNITRONICS CORP. 333 Bedford Rd, Mt Kisco, N Y 10549 COMMUNICATION SYSTEMS, DATA TRANSMISSION DATA TERMINALS, INQUIRY-RESPONSE (AUDIO RESPONSE) FORMS HANDLING, OCR SOURCE DOCUMENT READERS, OPTICAL CHARACTER SCANNING SCANNERS, OPTICAL	914-666-2941 TWX 710-571-2177
CLEVITE DIV. GOULD INC. 3631 Perkins Ave, Cleveland, Ohio 44114 PRINTERS, DIGITAL STRIP RECORDING PRINTERS, LINE (LOW & MEDIUM SPEED) PRINTERS, LINE (HIGH SPEED)	216-361-3315 TWX 216-574-9080	COHN CORP., SIGMUND 1215 Columbus Ave, Mt Vernon, N Y 10553 MEMORY SYSTEMS, PLATED WIRE PLATED WIRE	914-664-5300 TWX 710-562-0112
CLIFTON DIV. LITTON SYSTEMS INC. Marple At Broadway, Clifton Heights, Pa 19018 CONVERTERS, ANALOG-TO-DIGITAL CONVERTERS, BINARY-TO-DECIMAL CONVERTERS, DC-TO-FREQUENCY CONVERTERS, DIGITAL-TO-ANALOG CONVERTERS, DIGITAL-TO-SYNCHRO CONVERTERS, SYNCHRO-TO-DIGITAL MOTORS, SERVO MOTORS, STEPPING MOTORS, SYNCHRONOUS MOTORS, TORQUE SERVOS, COMPUTER	215-622-1000 TWX 510-669-9782	COHU ELECTRONICS INC. SAN DIEGO DIV. P O Box 623, San Diego, Cal 92112 AMPLIFIERS, INSTRUMENTATION AMPLIFIERS, VIDEO COMMUNICATION SYSTEMS, DATA TRANSMISSION MONITORS, TV	714-277-6700 TWX 910-335-1244
CLOPAY CORP. COPYING PROD. DIV. 417 E 7th St, Cincinnati, Ohio 45202 RIBBONS, INK (FOR PRINTERS AND TAB EQUIPMENT)	513-421-5200	COLLINS RADIO CO. 1200 N Alma Rd, Dallas, Tex 75207 BOARDS, PRINTED CIRCUIT (WITHOUT COMPONENTS) CIRCUITS, MONOLITHIC (LSI-MOS) CIRCUITS, THICK FILM (DIGITAL) CIRCUITS, THIN FILM (DIGITAL) COMMUNICATIONS-ORIENTED PROCESSORS, MULTIPLE CHANNEL CONTROLLERS COMMUNICATIONS-ORIENTED PROCESSORS, STORED PROGRAM COMMUNICATION SYSTEMS, DATA TRANSMISSION COMPUTERS, DIGITAL (GENERAL-PURPOSE, SMALL-SCALE) COMPUTERS, DIGITAL (GENERAL-PURPOSE, MEDIUM-SCALE) COMPUTERS, NAVIGATION COMPUTERS, PROCESS CONTROL CONNECTORS, PC AND IC BOARD (COMPUTER-GRADE) CONSULTING (DATA COMMUNICATIONS SYSTEMS PLANNING) CONVERTERS, ANALOG-TO-DIGITAL CONVERTERS, DIGITAL-TO-ANALOG DATA TERMINALS, INQUIRY-RESPONSE (CRT WITH KEYBOARD) DISC DRIVES, MOVABLE HEAD (INCLUDING CONTROLLER) DISC STORAGE SYSTEMS MODEMS, HARD-WIRED MODEMS, PC CARD SERVICES, COMPUTER-AIDED DESIGN SERVICES, FACILITY MANAGEMENT SERVICES, PROCESSING (DIGITAL SCIENTIFIC) TESTERS, CIRCUIT TESTERS, DIGITAL DATA TRANSMISSION TESTERS, DIGITAL LOGIC MODULES AND CARDS TESTERS, INTEGRATED CIRCUIT	214-235-9511 TWX 214-231-1495
CODE INC. 8939 Sepulveda Blvd, Los Angeles, Cal 90045 PROGRAMMING LANGUAGE DEVELOPMENT (CONSULTANTS) PROGRAMMING LANGUAGE DEVELOPMENT (CONTRACT PROGRAMMING) PROGRAMMING LANGUAGE DEVELOPMENT (DEDICATED APPLICATION SYSTEMS) PROGRAMMING LANGUAGE DEVELOPMENT (PROPRIETARY SOFTWARE PRODUCTS)	213-670-8329	COLLINS RADIO CO. 19700 Jamboree Blvd, Newport Beach, Cal 92663 CIRCUITS, MONOLITHIC (LSI-MOS) CIRCUITS, THIN FILM (DIGITAL) COMMUNICATION SYSTEMS, DATA TRANSMISSION CONTROLLERS, MODEM FILTERS (ACTIVE, LC, NOISE, ETC.) MEMORY SYSTEMS, READ-ONLY MEMORY SYSTEMS, SEMICONDUCTOR (MOS) MODEMS, HARD-WIRED MODEMS, PC CARD MULTIPLEXERS, DIGITAL TRANSFORMERS, POWER (COMPUTER GRADE) TRANSFORMERS, PULSE (COMPUTER GRADE)	714-833-0600 TWX 714-546-0430
CODEX CORP. 15 Riverdale Ave, Newton, Mass 02195 COMMUNICATION SYSTEMS, DATA TRANSMISSION CONSULTING (DATA COMMUNICATIONS SYSTEMS PLANNING) MODEMS, HARD-WIRED MODEMS, PC CARD MULTIPLEXERS, DIGITAL	617-926-3000 TELEX 92-2443	CODI SEMICONDUCTOR DIV. COMPUTER DIODE Pollitt Dr S, Fair Lawn, N J 07410 DIODES, ZENER POWER SUPPLIES, DC	201-797-3900 TWX 710-988-241
CODO MANUFACTURING CO. INC. DIV. BEMIS CO. INC. P O Box 36, Leetsdale, Pa 15056 FORMS, CONTINUOUS (MACHINE PROCESSED) RIBBONS, INK (FOR PRINTERS AND TAB EQUIPMENT)	412-766-1155	CODON CORP. 400 Totten Pond Rd, Waltham, Mass 02154 PROGRAMMING LANGUAGE DEVELOPMENT (CONSULTANTS) PROGRAMMING LANGUAGE DEVELOPMENT (CONTRACT PROGRAMMING) PROGRAMMING LANGUAGE DEVELOPMENT (DEDICATED APPLICATION SYSTEMS) PROGRAMMING LANGUAGE DEVELOPMENT (PROPRIETARY SOFTWARE PRODUCTS)	617-891-1700
COLORADO INSTRUMENTS INC. 1 Park St, Broomfield, Colo 80020 COMMUNICATION SYSTEMS, DATA TRANSMISSION CONTINUED	303-466-1881		

3 Manufacturers' Directory

CONTROLLERS, MODEM
SERVICES, MANAGEMENT INFORMATION SYSTEMS

COLORADO VIDEO INC. 303-444-3972
P O Box 928, Boulder, Colo 80302

COMMUNICATION SYSTEMS, FACSIMILE
SCANNERS, FACSIMILE

COLUMBIA COMPONENTS CORP. 516-483-8200
60 Madison Ave, Hempstead, N Y 11550 TWX 510-222-4189

AMPLIFIERS, D.C.
AMPLIFIERS, OPERATIONAL
AMPLIFIERS, VIDEO
CIRCUITS, HYBRID (IC AND DISCRETE-DIGITAL)
CIRCUITS, THICK FILM (DIGITAL)
CONVERTERS, ANALOG-TO-DIGITAL
CONVERTERS, DIGITAL-TO-ANALOG
DELAY LINES, ELECTROMAGNETIC
MODULES, RESISTANCE NETWORKS (ENCAPSULATED)
OSCILLATORS, VOLTAGE CONTROLLED

COLUMBIA GREAT LAKES CORP. 513-224-1167
P O Box 945, Dayton, Ohio 45401

RIBBONS, INK (FOR PRINTERS AND TAB EQUIPMENT)

COLUMBIA RIBBON & CARBON MFG. CO. INC. 516-676-2730
Herb Hill Rd, Glen Cove, N Y 11542 TWX 510-223-0627

PAPER (FOR OCR EQUIPMENT)
RIBBONS, INK (FOR PRINTERS AND TAB EQUIPMENT)

COMCET 301-948-8700
2 Research Court, Rockville, Md 20850

COMMUNICATIONS-ORIENTED PROCESSORS, STORED PROGRAM
DATA CONCENTRATORS

COMCET INC. 612-633-8130
1950 W County Rd, St Paul, Minn 55113

CIRCUIT CARDS, LOGIC (WITH IC'S)
COMMUNICATIONS-ORIENTED PROCESSORS, MULTIPLE CHANNEL CONTROLLERS
CONNECTORS, PC AND IC BOARD (COMPUTER-GRADE)
GUIDES, CIRCUIT CARDS

COMDATA CORP. 312-692-6107
7544 W Oakton St, Niles, Ill 60648

ACOUSTIC COUPLERS
COMMUNICATIONS-ORIENTED PROCESSORS, MULTIPLE CHANNEL CONTROLLERS
COMMUNICATIONS-ORIENTED PROCESSORS, SINGLE CHANNEL CONTROLLERS
COMMUNICATIONS-ORIENTED PROCESSORS, STORED PROGRAM
COMMUNICATION SYSTEMS, DATA TRANSMISSION
COMMUNICATION SYSTEMS, TELEPRINTER
CONTROLLERS, MODEM
DATA CONCENTRATORS
DATA TERMINALS, BLOCK-BY-BLOCK (TELEPRINTER)
DATA TERMINALS, INQUIRY-RESPONSE (AUDIO RESPONSE)
MODEMS, ACOUSTIC
MODEMS, HARD-WIRED
MODEMS, PC CARD
MULTIPLEXERS, DIGITAL
TESTERS, DIGITAL DATA TRANSMISSION
TYPEWRITERS, COMPUTER INPUT-OUTPUT

COMMERCIAL SCIENCES CORP. 305-942-0387
P O Box 5328, Pompano Beach, Fla 33064

CONSULTING (COMPUTER PRODUCT PLANNING SURVEYS, MARKET RESEARCH
STUDIES)

COMMERCIAL TECHNOLOGY INC. 615-584-9121
P O Box 10616, Knoxville, Tenn 37919

CONSULTING (ACCOUNTING, BUSINESS AND COMMERCIAL APPLICATIONS)
CONSULTING (COMPUTER EVALUATIONS, SELECTIONS, INSTALLATION
PLANNING)
SERVICES, FACILITY MANAGEMENT
SERVICES, PROCESSING (COMMERCIAL EDP)
SERVICES, SYSTEMS ANALYSIS

COMM/SCOPE CORP. A SUPERIOR CONTINENTAL CO. 704-328-5271
P O Box 2406, Hickory, N Y 28601 TWX 510-934-1569
CABLE, COAXIAL (FLEXIBLE)
CABLE, COAXIAL (SEMI/RIGID)

COMMUNICATIONS LOGIC INC. 713-785-3865
6400 Westpark, Houston, Tex 77024

ACOUSTIC COUPLERS
COMMUNICATIONS-ORIENTED PROCESSORS, MULTIPLE CHANNEL CONTROLLERS
COMMUNICATIONS-ORIENTED PROCESSORS, SINGLE CHANNEL CONTROLLERS
COMMUNICATION SYSTEMS, DATA TRANSMISSION
CONSULTING (DATA COMMUNICATIONS SYSTEMS PLANNING)
CONTROLLERS, MODEM
DATA CONCENTRATORS
DIGITIZERS, PROGRAMMABLE
MODEMS, ACOUSTIC
MODEMS, HARD-WIRED
MODEMS, PC CARD
MULTIPLEXERS, DIGITAL
SERVICES, FACILITY MANAGEMENT
TESTERS, DIGITAL DATA TRANSMISSION

COMMUNICATIONS TECHNOLOGY INC. 301-252-4313
1900 York Rd, Timonium, Md 21093

COMMUNICATIONS-ORIENTED PROCESSORS, MULTIPLE CHANNEL CONTROLLERS
COMMUNICATIONS-ORIENTED PROCESSORS, STORED PROGRAM
COMMUNICATION SYSTEMS, DATA TRANSMISSION
DATA CONCENTRATORS
MODEMS, HARD-WIRED
TESTERS, DIGITAL DATA TRANSMISSION

COMMUNITY COMPUTER CORP. 215-849-1200
185 W Schoolhouse Ln, Philadelphia, Pa 17144

DISC DRIVES, MOVABLE HEAD (INCLUDING CONTROLLER)
SERVICES, TIME SHARING (COMMERCIAL)

COMMUNITYTYPE CORP. 212-758-4230
767 Fifth Ave, New York, N Y 10022

COMMUNICATION SYSTEMS, DATA TRANSMISSION
COMPUTERS, MINI GENERAL PURPOSE (ALSO SEE CALCULATORS)
CONVERTERS, MAGNETIC TAPE-TO-MAGNETIC TAPE
DATA TERMINALS, BLOCK-BY-BLOCK (MAGNETIC TAPE)
DATA TERMINALS, INQUIRY-RESPONSE (ALPHANUMERIC KEYBOARD)
DATA TERMINALS, INQUIRY-RESPONSE (CRT WITH KEYBOARD)

COMPAC COMPUTER SYSTEMS INC. 612-335-5211
911 Hennepin, Minneapolis, Minn 55403

CONSULTING (ACCOUNTING, BUSINESS AND COMMERCIAL APPLICATIONS)
CONSULTING (COMPUTER EVALUATIONS, SELECTIONS, INSTALLATION
PLANNING)
CONSULTING (DATA COMMUNICATIONS SYSTEMS PLANNING)
CONSULTING (MANAGEMENT INFORMATION SYSTEMS PLANNING)
CONSULTING (SCIENTIFIC APPLICATIONS)
PROGRAMMING LANGUAGE DEVELOPMENT (CONSULTANTS)
PROGRAMMING LANGUAGE DEVELOPMENT (CONTRACT PROGRAMMING)
PROGRAMMING LANGUAGE DEVELOPMENT (DEDICATED APPLICATION SYSTEMS)
PROGRAMMING LANGUAGE DEVELOPMENT (PROPRIETARY SOFTWARE
PRODUCTS)
SERVICES, COMPUTER-AIDED DESIGN
SERVICES, FACILITY MANAGEMENT
SERVICES, MANAGEMENT INFORMATION SYSTEMS
SERVICES, PROCESSING (COMMERCIAL EDP)
SERVICES, TIME SHARING (COMMERCIAL)
SERVICES, SYSTEMS ANALYSIS

COMPAC ENGINEERING INC. 408-286-4844
845 Commercial St, San Jose, Cal 95112

RELAYS, DRY REED (COMPUTER GRADE)
RELAYS, MERCURY WETTED (COMPUTER GRADE)

COMPACE CORP. 612-941-6330
7413 Washington Ave S, Edina-Minnepols, Minn 55435

CIRCUIT CARDS, LOGIC (WITH IC'S)
COMMUNICATION SYSTEMS, TELEPRINTER
COMPUTERS, PROCESS CONTROL
CONSULTING (SCIENTIFIC APPLICATIONS)
CONTROLLERS, MODEM
COUNTERS, DIGITAL READOUT
CONTINUED

3 Manufacturers' Directory

DATA TERMINALS, BLOCK-BY-BLOCK (MAGNETIC TAPE)
 DATA TERMINALS, BLOCK-BY-BLOCK (PAPER TAPE)
 DATA TERMINALS, BLOCK-BY-BLOCK (PUNCHED CARD)
 DATA TERMINALS, BLOCK-BY-BLOCK (TELEPRINTER)
 MEMORY SYSTEMS, PLATED WIRE
 MODEMS, PC CARD
 PRINTERS, KEYBOARD
 PUNCHES, PAPER TAPE
 READERS, PAPER TAPE
 READERS, PUNCHED CARD (UP TO 100 CPM)
 TYPEWRITERS, COMPUTER INPUT-OUTPUT

COMPAT CORP. 516-822-1320
 177 Cantiague Rock Rd, Westbury, N Y 11590 TWX 510-221-1821

COMMUNICATIONS-ORIENTED PROCESSORS, STORED PROGRAM
 COMMUNICATION SYSTEMS, DATA TRANSMISSION
 COMMUNICATION SYSTEMS, TELEPRINTER
 COMPUTERS, DIGITAL (GENERAL-PURPOSE, SMALL-SCALE)
 DATA CONCENTRATORS
 DATA TERMINALS, BLOCK-BY-BLOCK (MAGNETIC TAPE)
 DATA TERMINALS, BLOCK-BY-BLOCK (MULTI-PURPOSE)
 DATA TERMINALS, BLOCK-BY-BLOCK (PAPER TAPE)
 DATA TERMINALS, BLOCK-BY-BLOCK (HIGH SPEED PRINTER)
 DATA TERMINALS, BLOCK-BY-BLOCK (MEDIUM SPEED PRINTER)
 DATA TERMINALS, BLOCK-BY-BLOCK (PUNCHED CARD)
 DATA TERMINALS, BLOCK-BY-BLOCK (TELEPRINTER)
 DATA TERMINALS, INQUIRY-RESPONSE (ALPHANUMERIC KEYBOARD)
 DATA TERMINALS, INQUIRY-RESPONSE (SPECIAL-PURPOSE)
 MAGNETIC TAPE STORAGE SYSTEMS (INCLUDES CONTROLLER)
 SERVICES, AUTOMATED WIRE-WRAPPING
 SERVICES, HARDWARE MAINTENANCE

COMPERIPHERALS INC. 212-758-9192
 437 Madison Ave, New York, N Y 10022

COMMUNICATION SYSTEMS, DATA TRANSMISSION
 DATA TERMINALS, BLOCK-BY-BLOCK (MAGNETIC TAPE)
 DATA TERMINALS, BLOCK-BY-BLOCK (MULTI-PURPOSE)
 DATA TERMINALS, BLOCK-BY-BLOCK (PAPER TAPE)
 DATA TERMINALS, INQUIRY-RESPONSE (BADGE-TOKEN READERS)
 DATA TERMINALS, INQUIRY-RESPONSE (CRT WITH KEYBOARD)
 READERS, STATIC

COMPILER SYSTEMS INC. 203-438-0488
 P O Box 366, Ridgefield, Conn 06877

COMPUTERS, DIGITAL (GENERAL-PURPOSE, SMALL-SCALE)
 COMPUTERS, DIGITAL (GENERAL-PURPOSE, MEDIUM-SCALE)
 COMPUTERS, DIGITAL (GENERAL-PURPOSE, LARGE SCALE)
 COMPUTERS, MINI GENERAL PURPOSE (ALSO SEE CALCULATORS)
 COMPUTERS, PROCESS CONTROL

COMPONENT RESEARCH CO. INC. 213-393-3755
 1719 19 St, Santa Monica, Cal 90404 TWX 910-343-6864

CAPACITORS, COMPUTER GRADE

COMPONENTS CORP. 201-627-0290
 106 Main St, Denville, N J 07834

CONNECTORS, MINIATURE AND SUB-MINIATURE (COMPUTER-GRADE)
 CONNECTORS, PC AND IC BOARD (COMPUTER-GRADE)
 COUNTERS, DECADE
 POWER SUPPLIES, DC
 TESTERS, SEMICONDUCTOR

COMPONENTS INC. 207-282-5111
 Smith St, Biddeford, Me 04005 TWX 710-229-1559

CAPACITORS, COMPUTER GRADE
 DIODES, ZENER

COMPUCORD INC. 617-891-0080
 225 Crescent St, Waltham, Mass 02154

DATA TERMINALS, BLOCK-BY-BLOCK (MULTI-PURPOSE)
 MAGNETIC TAPE STORAGE SYSTEMS (INCLUDES CONTROLLER)
 POOLERS, MAGNETIC TAPE
 RECORDERS, DIGITAL CASSETTE
 TAPE TRANSPORTS, MAGNETIC (DIGITAL CASSETTE)

COM PU DAT DIV. SOUTHEASTERN NEWSPAPERS CORP. 404-722-1283
 P O Box 3806, Augusta, Ga 30904

CONSULTING (ACCOUNTING, BUSINESS AND COMMERCIAL APPLICATIONS)
 CONSULTING (COMPUTER EVALUATIONS, SELECTIONS, INSTALLATION
 PLANNING)
 CONTINUED

SERVICES, PROCESSING (COMMERCIAL EDP)
 SERVICES, SYSTEMS ANALYSIS

COMPUDYNE CORP. CONTROLS DIV. 215-675-4100
 P O Box 247, Hatboro, Pa 19040

DATA CONCENTRATORS
 MULTIPLEXER-CONVERTER (SINGLE UNIT WITH MULTIPLEXER, SAMPLE & HOLD
 AMPLIFIER & A-TO-D CONVERTER)
 MULTIPLEXERS, ANALOG-SOLID STATE (SEQUENTIAL SAMPLING)
 MULTIPLEXERS, DIGITAL
 READOUTS AND DISPLAYS, NUMERIC AND ALPHANUMERIC (OTHER THAN CRT)
 SCANNERS, INPUT
 SIGNAL CONDITIONERS

COMPU-FLOOR CORP. 212-868-1407
 16 W 40th St, New York, N Y 10018

FLOORING (FOR EDP ROOMS)

COMPU-LITE CORP. 714-546-9045
 17795 Sky Park Cir, Irvine, Cal 92664

INDICATORS, ILLUMINATED
 LAMPS, GLOW
 LAMPS-PANEL, PILOT AND DIAL (INCANDESCENT)
 SWITCHES, DRY REED
 SWITCHES, PUSHBUTTON (ILLUMINATED)

COMPUMATIC SYSTEMS CORP. 213-346-7062
 5303 Comercio Ln, Woodland Hills, Cal 91364

ANALYZERS, COMPUTER PERFORMANCE
 ANALYZERS, PULSE HEIGHT
 CONSULTING (ADVANCED COMPUTER EQUIPMENT DESIGN AND FEASIBILITY
 STUDIES)
 CONSULTING (COMPUTER EVALUATIONS, SELECTIONS, INSTALLATION
 PLANNING)
 CONSULTING (COMPUTER PRODUCT PLANNING SURVEYS, MARKET RESEARCH
 STUDIES)
 CONSULTING (MANAGEMENT INFORMATION SYSTEMS PLANNING)
 CONSULTING (SCIENTIFIC APPLICATIONS)
 GENERATORS, BYTE
 GENERATORS, RANDOM NUMBER
 GENERATORS, TIME CODE
 SERVICES, COMPUTER-AIDED DESIGN
 SERVICES, SYSTEMS ANALYSIS
 TEST SYSTEMS, COMPUTER PERFORMANCE
 TESTERS, DIGITAL LOGIC MODULES AND CARDS
 TESTERS, MEMORY PLANES, STACKS AND SYSTEMS

COMPUMATICS INC. 312-922-9422
 327 S Lasalle St, Chicago, Ill 60604

CONSULTING (ACCOUNTING, BUSINESS AND COMMERCIAL APPLICATIONS)
 CONSULTING (ADVANCED COMPUTER EQUIPMENT DESIGN AND FEASIBILITY
 STUDIES)
 CONSULTING (COMPUTER EVALUATIONS, SELECTIONS, INSTALLATION
 PLANNING)
 CONSULTING (DATA COMMUNICATIONS SYSTEMS PLANNING)
 LEASING, EDP EQUIPMENT (OTHER THAN MFGRS)
 SERVICES, FACILITY MANAGEMENT
 SERVICES, PROCESSING (COMMERCIAL EDP)
 USED EQUIPMENT (BUYING, SELLING, LEASING)

COMPUMEDIC CONTROLS CORP. 212-889-0440
 432 Park Ave S, New York, N Y 10016

CONSULTING (ACCOUNTING, BUSINESS AND COMMERCIAL APPLICATIONS)
 CONSULTING (ADVANCED COMPUTER EQUIPMENT DESIGN AND FEASIBILITY
 STUDIES)
 CONSULTING (COMPUTER EVALUATIONS, SELECTIONS, INSTALLATION
 PLANNING)
 CONSULTING (DATA COMMUNICATIONS SYSTEMS PLANNING)
 CONSULTING (COMPUTER PRODUCT PLANNING SURVEYS, MARKET RESEARCH
 STUDIES)
 CONSULTING (MANAGEMENT INFORMATION SYSTEMS PLANNING)
 CONSULTING (SCIENTIFIC APPLICATIONS)
 PROGRAMMING LANGUAGE DEVELOPMENT (CONSULTANTS)
 PROGRAMMING LANGUAGE DEVELOPMENT (CONTRACT PROGRAMMING)
 PROGRAMMING LANGUAGE DEVELOPMENT (DEDICATED APPLICATION SYSTEMS)
 PROGRAMMING LANGUAGE DEVELOPMENT (PROPRIETARY SOFTWARE
 PRODUCTS)
 SERVICES, COMPUTER-AIDED DESIGN
 SERVICES, FACILITY MANAGEMENT
 SERVICES, MAGNETIC TAPE CERTIFICATION
 SERVICES, MANAGEMENT INFORMATION SYSTEMS
 CONTINUED

3 Manufacturers' Directory

SERVICES, PROCESSING (COMMERCIAL EDP)
 SERVICES, PROCESSING (ANALOG OR HYBRID, SCIENTIFIC)
 SERVICES, PROCESSING (DIGITAL SCIENTIFIC)
 SERVICES, TIME SHARING (COMMERCIAL)
 SERVICES, TIME SHARING (RESEARCH)
 SERVICES, HARDWARE MAINTENANCE
 SERVICES, SYSTEMS ANALYSIS

COMPUSCAN INC. 201-947-9148
 125 Ft Lee Rd, Leonia, N J 07605

SCANNERS, OPTICAL

COMPU SYS INC. 505-255-2165
 Po Box 11104, Albuquerque, N M 87112

CONSULTING (ACCOUNTING, BUSINESS AND COMMERCIAL APPLICATIONS)
 CONSULTING (ADVANCED COMPUTER EQUIPMENT DESIGN AND FEASIBILITY STUDIES)
 CONSULTING (COMPUTER EVALUATIONS, SELECTIONS, INSTALLATION PLANNING)
 CONSULTING (DATA COMMUNICATIONS SYSTEMS PLANNING)
 CONSULTING (MANAGEMENT INFORMATION SYSTEMS PLANNING)
 CONSULTING (SCIENTIFIC APPLICATIONS)
 SERVICES, FACILITY MANAGEMENT
 SERVICES, MANAGEMENT INFORMATION SYSTEMS
 SERVICES, PROCESSING (COMMERCIAL EDP)
 SERVICES, SYSTEMS ANALYSIS

COMPU-SYSTEMS CO. 617-245-8800
 Audubon Rd, Wakefield, Mass 01880 TWX 710-348-0425

MODEMS, HARD-WIRED
 MODEMS, PC CARD
 POWER SUPPLIES, DIGITALLY-CONTROLLED
 TESTERS, CIRCUIT
 TESTERS, DIGITAL LOGIC MODULES AND CARDS
 TESTERS, INTEGRATED CIRCUIT

COMPU-TIME INC. 904-255-7511
 327 Orange Ave, Daytona, Fla 32014

CONSULTING (ACCOUNTING, BUSINESS AND COMMERCIAL APPLICATIONS)
 CONSULTING (ADVANCED COMPUTER EQUIPMENT DESIGN AND FEASIBILITY STUDIES)
 CONSULTING (COMPUTER EVALUATIONS, SELECTIONS, INSTALLATION PLANNING)
 CONSULTING (COMPUTER PRODUCT PLANNING SURVEYS, MARKET RESEARCH STUDIES)
 CONSULTING (MANAGEMENT INFORMATION SYSTEMS PLANNING)
 PROGRAMMING LANGUAGE DEVELOPMENT (CONSULTANTS)
 PROGRAMMING LANGUAGE DEVELOPMENT (CONTRACT PROGRAMMING)
 PROGRAMMING LANGUAGE DEVELOPMENT (DEDICATED APPLICATION SYSTEMS)
 PROGRAMMING LANGUAGE DEVELOPMENT (PROPRIETARY SOFTWARE PRODUCTS)
 SERVICES, FACILITY MANAGEMENT
 SERVICES, PROCESSING (COMMERCIAL EDP)
 SERVICES, PROCESSING (DIGITAL SCIENTIFIC)
 SERVICES, TIME SHARING (COMMERCIAL)
 SERVICES, TIME SHARING (RESEARCH)
 SERVICES, SYSTEMS ANALYSIS
 TRAINING SYSTEMS, COMPUTER SERVICE

COMPUTATION AND SYSTEMS CORP. 213-478-9741
 12061 Wilshire Blvd, Los Angeles, Cal 90025

CONSULTING (COMPUTER EVALUATIONS, SELECTIONS, INSTALLATION PLANNING)
 CONSULTING (MANAGEMENT INFORMATION SYSTEMS PLANNING)
 CONSULTING (SCIENTIFIC APPLICATIONS)
 PROGRAMMING LANGUAGE DEVELOPMENT (CONSULTANTS)
 PROGRAMMING LANGUAGE DEVELOPMENT (CONTRACT PROGRAMMING)
 PROGRAMMING LANGUAGE DEVELOPMENT (DEDICATED APPLICATION SYSTEMS)
 PROGRAMMING LANGUAGE DEVELOPMENT (PROPRIETARY SOFTWARE PRODUCTS)
 SERVICES, FACILITY MANAGEMENT
 SERVICES, MANAGEMENT INFORMATION SYSTEMS
 SERVICES, PROCESSING (COMMERCIAL EDP)
 SERVICES, TIME SHARING (COMMERCIAL)
 SERVICES, TIME SHARING (RESEARCH)
 SERVICES, SYSTEMS ANALYSIS
 TRAINING INSTITUTES, COMMERCIAL COMPUTER COURSES, SEMINARS, CORRESPONDENCE COURSES

COMPUTE AMERICA CORP. DBA COMERICA 405-524-2361
 1515 Classen Blvd, Oklahoma City, Okla 73106

CONSULTING (ACCOUNTING, BUSINESS AND COMMERCIAL APPLICATIONS)
 CONSULTING (MANAGEMENT INFORMATION SYSTEMS PLANNING)
 LEASING, EDP EQUIPMENT (OTHER THAN MFGRS)
 SERVICES, FACILITY MANAGEMENT
 SERVICES, MANAGEMENT INFORMATION SYSTEMS
 SERVICES, PROCESSING (COMMERCIAL EDP)
 SERVICES, SYSTEMS ANALYSIS
 USED EQUIPMENT (BUYING, SELLING, LEASING)

COMPUTEK INC. 617-864-5140
 143 Albany St, Cambridge, Mass 02139

CONSOLES, CRT (ALPHANUMERIC AND GRAPHIC)
 CONSOLES, CRT (COLOR-ALPHANUMERIC AND GRAPHIC)
 CONSOLES, CRT (GRAPHIC)
 CURVE TRACERS-DIGITIZERS, MANUAL
 DATA TERMINALS, BLOCK-BY-BLOCK (GRAPHIC DIGITIZERS)
 DATA TERMINALS, BLOCK-BY-BLOCK (TELEPRINTER)
 DATA TERMINALS, INQUIRY-RESPONSE (ALPHANUMERIC KEYBOARD)
 DATA TERMINALS, INQUIRY-RESPONSE (CRT WITH KEYBOARD)
 DATA TERMINALS, INQUIRY-RESPONSE (SPECIAL-PURPOSE)
 DISPLAYS, THREE-DIMENSIONAL
 GRAPHIC TABLETS

COMPUTER & APPLIED SCIENCES INC. 215-275-8891
 1401 Dekalb St, Norristown, Pa 19401

PROGRAMMING LANGUAGE DEVELOPMENT (CONSULTANTS)
 PROGRAMMING LANGUAGE DEVELOPMENT (CONTRACT PROGRAMMING)

COMPUTER & BUSINESS SKILLS INSTITUTE 312-641-6700
 17 N State St, Chicago, Ill 60602

TRAINING INSTITUTES, COMMERCIAL COMPUTER COURSES, SEMINARS, CORRESPONDENCE COURSES

COMPUTER & PROGRAMMING ANALYSIS INC. 215-649-7700
 1 Wynnewood Rd, Wynnewood, Pa 19096

ANALYZERS, COMPUTER PERFORMANCE
 CONSULTING (COMPUTER EVALUATIONS, SELECTIONS, INSTALLATION PLANNING)
 CONSULTING (COMPUTER PRODUCT PLANNING SURVEYS, MARKET RESEARCH STUDIES)
 SERVICES, SYSTEMS ANALYSIS

COMPUTER ACCESS SYSTEMS INC. 602-279-5591
 3050 W Clarendon Ave, Phoenix, Ariz 85017

RECORDERS, DIGITAL CASSETTE
 TAPE TRANSPORTS, MAGNETIC (DIGITAL CASSETTE)

COMPUTER ACCESSORIES CO. 213-321-3421
 131 W 154th St, Gardena, Cal 90248

CABINETS AND ENCLOSURES (FOR KEYPUNCHES, PRINTERS)
 CABINETS, ENCLOSURES, CONSOLES, ELECTRONIC (FOR GENERAL EQUIPMENT)
 CABINETS, RACKS, VAULTS (FOR MAGNETIC TAPE STORAGE)
 CABINETS, TRAYS (FOR PUNCHED CARD STORAGE)
 CANNISTERS, MAGNETIC TAPE
 CARDS, CONVENTIONAL PUNCH
 CARDS, EDGE-PUNCH
 CONTAINERS, DISK PACK STORAGE
 CONTAINERS, PAPER TAPE STORAGE
 CORDS, PATCH
 CORRECTION SEALS, PUNCH CARD
 CORRECTION SEALS, PAPER TAPE
 COVERS, ACOUSTIC (FOR KEYBOARDS, TELETYPEWRITERS, ETC.)
 DEMAGNETIZERS, MAGNETIC TAPE
 DESKS, TABLES AND STANDS (FOR CALCULATORS)
 DESKS, TABLES AND STANDS (FOR KEYPUNCH UNITS)
 DESKS, TABLES AND STANDS (FOR PROGRAMMER STATIONS)
 DESKS, TABLES AND STANDS (FOR TYPEWRITERS)
 DISC PACKS, MAGNETIC
 DRUM STORAGE EQUIPMENT, MAGNETIC (INCLUDING CONTROLLER)
 ERASERS, BULK (MAGNETIC TAPE)
 FILES, PUNCHED CARD
 FLOORING (FOR EDP ROOMS)
 FORMS HANDLING, BURSTERS
 FORMS HANDLING, CARBON DELEAVERS
 FORMS HANDLING, COLLATORS
 FORMS HANDLING, DECOLLATORS
 HOLDERS, BINDER
CONTINUED

3 Manufacturers' Directory

LABELS, CONTINUOUS AND GUMMED (MACHINE APPLICATION)
MAGNETIC TAPE STORAGE SYSTEMS (INCLUDES CONTROLLER)
PERFORATORS, PAPER TAPE
PLUGBOARDS, PROGRAMMING
PUNCHES, CARD (EDGE-PUNCHING)
REEL CLIPS AND BELTS, MAGNETIC TAPE
REELS, MAGNETIC TAPE
REELS, PAPER TAPE
RIBBONS, INK (FOR PRINTERS AND TAB EQUIPMENT)
SAFES, MAGNETIC TAPE STORAGE
SORTERS, PUNCHED CARD
SPLICERS, MAGNETIC TAPE
TAPE, MAGNETIC (CASSETTE)
TAPE, MAGNETIC (REELS)
TAPE, PUNCH (MYLAR)
TAPE, PUNCH (MYLAR-COATED FOIL)
TAPE, PUNCH (PAPER)
TAPE, PUNCH (PAPER-COATED MYLAR)
TAPE, PUNCH (PAPER-COATED ALUMINUM)
TAPE TRANSPORTS, MAGNETIC (DIGITAL-EXCL. CASSETTE)
TAPE TRANSPORTS, MAGNETIC (INCREMENTAL)
WINDERS, MAGNETIC TAPE

COMPUTER ACCESSORIES CORP. 516-421-0929
211 New York Ave, Huntington, N Y 11743

REELS, PAPER TAPE
SPLICERS, PAPER TAPE
WINDERS, PAPER TAPE

COMPUTER ADVISORS TO MANAGEMENT 312-782-7395
120 S Riverside Plaza, Chicago, Ill 60606

CONSULTING (ACCOUNTING, BUSINESS AND COMMERCIAL APPLICATIONS)
CONSULTING (ADVANCED COMPUTER EQUIPMENT DESIGN AND FEASIBILITY STUDIES)
CONSULTING (COMPUTER EVALUATIONS, SELECTIONS, INSTALLATION PLANNING)
CONSULTING (DATA COMMUNICATIONS SYSTEMS PLANNING)
CONSULTING (MANAGEMENT INFORMATION SYSTEMS PLANNING)
PROGRAMMING LANGUAGE DEVELOPMENT (CONTRACT PROGRAMMING)
PROGRAMMING LANGUAGE DEVELOPMENT (DEDICATED APPLICATION SYSTEMS)
SERVICES, FACILITY MANAGEMENT

COMPUTER AGE INDUSTRIES INC. 703-573-1600
8800 Arlington Blvd, Fairfax, Va 22030

CONSULTING (ACCOUNTING, BUSINESS AND COMMERCIAL APPLICATIONS)
TRAINING INSTITUTES, COMMERCIAL COMPUTER COURSES, SEMINARS,
CORRESPONDENCE COURSES
TRAINING SYSTEMS, COMPUTER SERVICE

COMPUTER AID COMPANIES INC. 214-233-4111
5925 Forest Lane, Dallas, Tex 75201

CONSULTING (ACCOUNTING, BUSINESS AND COMMERCIAL APPLICATIONS)
CONSULTING (COMPUTER EVALUATIONS, SELECTIONS, INSTALLATION PLANNING)
CONSULTING (DATA COMMUNICATIONS SYSTEMS PLANNING)
CONSULTING (COMPUTER PRODUCT PLANNING SURVEYS, MARKET RESEARCH STUDIES)
CONSULTING (MANAGEMENT INFORMATION SYSTEMS PLANNING)
CONSULTING (SCIENTIFIC APPLICATIONS)
SERVICES, SYSTEMS ANALYSIS

COMPUTER AMERICA CORP. 301-587-3210
818 Roeder Rd, Silver Spring, Md 20910

CONSULTING (ACCOUNTING, BUSINESS AND COMMERCIAL APPLICATIONS)
PROGRAMMING LANGUAGE DEVELOPMENT (CONTRACT PROGRAMMING)
SERVICES, MANAGEMENT INFORMATION SYSTEMS
SERVICES, PROCESSING (COMMERCIAL EDP)
SERVICES, SYSTEMS ANALYSIS

COMPUTER APPLICATIONS CENTER, INC. 614-224-8139
516 Hutton Pl, Columbus, Ohio 43215

CONSULTING (ACCOUNTING, BUSINESS AND COMMERCIAL APPLICATIONS)
CONSULTING (MANAGEMENT INFORMATION SYSTEMS PLANNING)
CONSULTING (SCIENTIFIC APPLICATIONS)
SERVICES, PROCESSING (COMMERCIAL EDP)
SERVICES, PROCESSING (DIGITAL SCIENTIFIC)

COMPUTER ART SERVICES CO. DIV. OF AGARD 516-328-1905
40 Nassau Terminal Rd, New Hyde Park, N J 11040

CONSULTING (ADVANCED COMPUTER EQUIPMENT DESIGN AND FEASIBILITY STUDIES)
SERVICES, COMPUTER-AIDED DESIGN

COMPUTER ASSISTANCE INC. 203-233-9848
298 Park Rd, West Hartford, Conn 06119

CONSULTING (ACCOUNTING, BUSINESS AND COMMERCIAL APPLICATIONS)
CONSULTING (COMPUTER EVALUATIONS, SELECTIONS, INSTALLATION PLANNING)
CONSULTING (DATA COMMUNICATIONS SYSTEMS PLANNING)
CONSULTING (MANAGEMENT INFORMATION SYSTEMS PLANNING)
SERVICES, FACILITY MANAGEMENT
SERVICES, MANAGEMENT INFORMATION SYSTEMS
SERVICES, SYSTEMS ANALYSIS
TRAINING INSTITUTES, COMMERCIAL COMPUTER COURSES, SEMINARS,
CORRESPONDENCE COURSES

COMPUTER AUDIT SYSTEMS, INC. 203-676-8320
725 Park Ave, E Orange, N J 07017

CONSULTING (ACCOUNTING, BUSINESS AND COMMERCIAL APPLICATIONS)
SERVICES, FACILITY MANAGEMENT

COMPUTER AUTOMATION INC. 714-642-9630
895 W 16th St, Newport Beach, Cal 92660 TWX 910-596-1377

CALCULATORS, PROGRAMMABLE (ALSO SEE COMPUTERS)
COMMUNICATIONS-ORIENTED PROCESSORS, MULTIPLE CHANNEL CONTROLLERS
COMMUNICATIONS-ORIENTED PROCESSORS, STORED PROGRAM
COMPUTERS, DIGITAL (GENERAL-PURPOSE, SMALL-SCALE)
COMPUTERS, MINI GENERAL PURPOSE (ALSO SEE CALCULATORS)
COMPUTERS, PROCESS CONTROL
CONTROLLERS, MODEM
CONTROLLERS, PLOTTING
DATA CONCENTRATORS
TESTERS, CIRCUIT
TESTERS, DIGITAL LOGIC MODULES AND CARDS

COMPUTER CENTER, INC., 305-655-3711
350 Royal Palm Way, Palm Beach, Fla 33480

CONSULTING (ACCOUNTING, BUSINESS AND COMMERCIAL APPLICATIONS)
CONSULTING (COMPUTER EVALUATIONS, SELECTIONS, INSTALLATION PLANNING)
CONSULTING (DATA COMMUNICATIONS SYSTEMS PLANNING)
LEASING, EDP EQUIPMENT (OTHER THAN MFGRS)
SERVICES, FACILITY MANAGEMENT
SERVICES, PROCESSING (COMMERCIAL EDP)
SERVICES, TIME SHARING (COMMERCIAL)
SERVICES, TIME SHARING (RESEARCH)
SERVICES, SYSTEMS ANALYSIS

COMPUTER CENTER OF ATLANTA DIV.COMP. CNTRS INC 404-633-6245
2695 Buford Hwy NE, Atlanta, Ga 30324

CONSULTING (ACCOUNTING, BUSINESS AND COMMERCIAL APPLICATIONS)
CONSULTING (COMPUTER EVALUATIONS, SELECTIONS, INSTALLATION PLANNING)
CONSULTING (MANAGEMENT INFORMATION SYSTEMS PLANNING)
SERVICES, FACILITY MANAGEMENT
SERVICES, MANAGEMENT INFORMATION SYSTEMS
SERVICES, PROCESSING (COMMERCIAL EDP)
SERVICES, SYSTEMS ANALYSIS

COMPUTER COMMAND & CONTROL CO 202-298-8300
1717 Penn Ave NW, Washington, D C 20006

CONSULTING (ACCOUNTING, BUSINESS AND COMMERCIAL APPLICATIONS)
CONSULTING (ADVANCED COMPUTER EQUIPMENT DESIGN AND FEASIBILITY STUDIES)
CONSULTING (COMPUTER EVALUATIONS, SELECTIONS, INSTALLATION PLANNING)
CONSULTING (DATA COMMUNICATIONS SYSTEMS PLANNING)
CONSULTING (COMPUTER PRODUCT PLANNING SURVEYS, MARKET RESEARCH STUDIES)
CONSULTING (MANAGEMENT INFORMATION SYSTEMS PLANNING)
CONSULTING (SCIENTIFIC APPLICATIONS)
SERVICES, MANAGEMENT INFORMATION SYSTEMS
SERVICES, SYSTEMS ANALYSIS
TRAINING INSTITUTES, COMMERCIAL COMPUTER COURSES, SEMINARS,
CORRESPONDENCE COURSES

3 Manufacturers' Directory

COMPUTER COMMAND AND CONTROLS COMPANY 215-387-1500
4025 Chestnut St, Philadelphia, Pa 19104

CONSULTING (ACCOUNTING, BUSINESS AND COMMERCIAL APPLICATIONS)
CONSULTING (ADVANCED COMPUTER EQUIPMENT DESIGN AND FEASIBILITY STUDIES)
CONSULTING (COMPUTER EVALUATIONS, SELECTIONS, INSTALLATION PLANNING)
CONSULTING (DATA COMMUNICATIONS SYSTEMS PLANNING)
CONSULTING (COMPUTER PRODUCT PLANNING SURVEYS, MARKET RESEARCH STUDIES)
CONSULTING (MANAGEMENT INFORMATION SYSTEMS PLANNING)
CONSULTING (SCIENTIFIC APPLICATIONS)
PROGRAMMING LANGUAGE DEVELOPMENT (CONSULTANTS)
PROGRAMMING LANGUAGE DEVELOPMENT (CONTRACT PROGRAMMING)
PROGRAMMING LANGUAGE DEVELOPMENT (PROPRIETARY SOFTWARE PRODUCTS)
SERVICES, FACILITY MANAGEMENT
SERVICES, MANAGEMENT INFORMATION SYSTEMS
SERVICES, PROCESSING (COMMERCIAL EDP)
SERVICES, TIME SHARING (COMMERCIAL)
SERVICES, SYSTEMS ANALYSIS
TRAINING INSTITUTES, COMMERCIAL COMPUTER COURSES, SEMINARS, CORRESPONDENCE COURSES

COMPUTER COMMUNICATION INC. 213-674-5300
701 W Manchester Blvd, Inglewood, Cal 90301

ACOUSTIC COUPLERS
COMMUNICATIONS-ORIENTED PROCESSORS, MULTIPLE CHANNEL CONTROLLERS
COMMUNICATIONS-ORIENTED PROCESSORS, SINGLE CHANNEL CONTROLLERS
COMMUNICATIONS-ORIENTED PROCESSORS, STORED PROGRAM
COMMUNICATION SYSTEMS, DATA TRANSMISSION
COMMUNICATION SYSTEMS, TELEPRINTER
COMPUTERS, MINI GENERAL PURPOSE (ALSO SEE CALCULATORS)
CONSOLES, CRT (ALPHANUMERIC AND GRAPHIC)
CONSOLES, CRT (COLOR-ALPHANUMERIC AND GRAPHIC)
DATA CONCENTRATORS
DATA TERMINALS, BLOCK-BY-BLOCK (MULTI-PURPOSE)
DATA TERMINALS, BLOCK-BY-BLOCK (HIGH SPEED PRINTER)
DATA TERMINALS, BLOCK-BY-BLOCK (MEDIUM SPEED PRINTER)
DATA TERMINALS, BLOCK-BY-BLOCK (PUNCHED CARD)
DATA TERMINALS, INQUIRY-RESPONSE (ALPHANUMERIC KEYBOARD)
DATA TERMINALS, INQUIRY-RESPONSE (CRT WITH KEYBOARD)
DATA TERMINALS, INQUIRY-RESPONSE (SPECIAL-PURPOSE)
LIGHT PENS (FOR CRT TERMINAL INPUT/OUTPUT)
MODEMS, ACOUSTIC
PRINTERS, LINE (LOW & MEDIUM SPEED)
PROGRAMMING LANGUAGE DEVELOPMENT (CONTRACT PROGRAMMING)
PROGRAMMING LANGUAGE DEVELOPMENT (DEDICATED APPLICATION SYSTEMS)
PROGRAMMING LANGUAGE DEVELOPMENT (PROPRIETARY SOFTWARE PRODUCTS)
SERVICES, SYSTEMS ANALYSIS

COMPUTER COMPLEX, INC. 713-785-8100
6400 Westpark, Houston, Tex 77027

ACOUSTIC COUPLERS
DATA CONCENTRATORS
MODEMS, ACOUSTIC
MODEMS, HARD-WIRED
MODEMS, PC CARD
SERVICES, FACILITY MANAGEMENT
SERVICES, TIME SHARING (COMMERCIAL)
SERVICES, TIME SHARING (RESEARCH)
SERVICES, HARDWARE MAINTENANCE
SERVICES, SYSTEMS ANALYSIS
TESTERS, DIGITAL DATA TRANSMISSION

COMPUTER COMPONENTS INC. 212-291-3500
88-06 Van Wyck Expwy, Jamaica, N Y 11418

RELAYS, DRY REED (COMPUTER GRADE)
RELAYS, MERCURY WETTED (COMPUTER GRADE)
SWITCHES, DRY REED

COMPUTER CONSULTANTS CORP. 201-625-1213
U S Rte 46 E, Denville, N J 07834

COMMUNICATIONS-ORIENTED PROCESSORS, MULTIPLE CHANNEL CONTROLLERS
COMMUNICATIONS-ORIENTED PROCESSORS, STORED PROGRAM
COMMUNICATION SYSTEMS, DATA TRANSMISSION
CONSULTING (ACCOUNTING, BUSINESS AND COMMERCIAL APPLICATIONS)
CONSULTING (ADVANCED COMPUTER EQUIPMENT DESIGN AND FEASIBILITY STUDIES)
CONSULTING (COMPUTER EVALUATIONS, SELECTIONS, INSTALLATION PLANNING)
CONSULTING (DATA COMMUNICATIONS SYSTEMS PLANNING)
CONSULTING (MANAGEMENT INFORMATION SYSTEMS PLANNING)
CONTINUED

CONSULTING (SCIENTIFIC APPLICATIONS)
DATA CONCENTRATORS
PROGRAMMING LANGUAGE DEVELOPMENT (CONSULTANTS)
PROGRAMMING LANGUAGE DEVELOPMENT (CONTRACT PROGRAMMING)
PROGRAMMING LANGUAGE DEVELOPMENT (DEDICATED APPLICATION SYSTEMS)
SERVICES, FACILITY MANAGEMENT
SERVICES, MANAGEMENT INFORMATION SYSTEMS
SERVICES, PROCESSING (DIGITAL SCIENTIFIC)
SERVICES, SYSTEMS ANALYSIS

COMPUTER CONSULTING SERVICES 319-583-3225
1176 Iowa, Dubuque, Iowa 52001

CONSULTING (ACCOUNTING, BUSINESS AND COMMERCIAL APPLICATIONS)
SERVICES, COMPUTER-AIDED DESIGN
SERVICES, FACILITY MANAGEMENT
SERVICES, MAGNETIC TAPE CERTIFICATION
SERVICES, PROCESSING (COMMERCIAL EDP)

COMPUTER CONTROL SYSTEMS INC. 214-369-7681
6116 N Central Expwy, Dallas, Tex 75206

COMMUNICATION SYSTEMS, DATA TRANSMISSION
COMMUNICATION SYSTEMS, TELEPRINTER

COMPUTER CONVERSIONS CORP. 516-261-3300
6 Dunton Court, E Northport, N Y 11731

CIRCUIT CARDS, LINEAR (WITH DISCRETE COMPONENTS)
CIRCUIT CARDS, LINEAR (WITH IC'S)
CIRCUIT CARDS, LOGIC (WITH DISCRETE COMPONENTS)
CIRCUIT CARDS, LOGIC (WITH IC'S)
COMMUNICATION SYSTEMS, DATA TRANSMISSION
CONTROLLERS, MODEM
CONVERTERS, ANALOG-TO-DIGITAL
CONVERTERS, BINARY-TO-DECIMAL
CONVERTERS, DC-TO-FREQUENCY
CONVERTERS, DIGITAL-TO-ANALOG
CONVERTERS, DIGITAL-TO-SYNCHRO
CONVERTERS, FREQUENCY-TO-DC
CONVERTERS, POLAR-TO-RECTANGULAR
CONVERTERS, PULSE-TO-DIGITAL
CONVERTERS, SYNCHRO-TO-DIGITAL
CONVERTERS, VOLTAGE-TO-FREQUENCY
COUNTERS, DIGITAL READOUT
DATA CONCENTRATORS
DIGITIZERS, PROGRAMMABLE
ENCODERS, DIGITAL
ENCODERS, SHAFT ANGLE
INDICATORS, DIGITAL
MODEMS, ACOUSTIC
MODEMS, HARD-WIRED
MODEMS, PC CARD
MODULES, DIGITAL LOGIC ENCAPSULATED (ALSO SEE CIRCUITS & CIRCUIT CARDS)
MODULES, LINEAR (ENCAPSULATED)
MULTIPLEXERS, ANALOG-SOLID STATE (SEQUENTIAL SAMPLING)
MULTIPLEXERS, DIGITAL
PROGRAMMERS, PUNCHED CARD
SERVOS, COMPUTER
SIGNAL CONDITIONERS
TRANSDUCERS, DIGITAL
TRANSFORMERS, PULSE (COMPUTER GRADE)

COMPUTER CONVERSIONS INC. 314-872-8750
140 Weldon Pkwy, Maryland Hts, Mo 63044

SERVICES, PROCESSING (COMMERCIAL EDP)

COMPUTER CORP. OF AMERICA 713-771-5821
6216 Evergreen St, Houston, Tex 77036

AMPLIFIERS, INSTRUMENTATION
AMPLIFIERS, OPERATIONAL
ANALYZERS, PULSE HEIGHT
CIRCUIT CARDS, LINEAR (WITH DISCRETE COMPONENTS)
CIRCUIT CARDS, LINEAR (WITH IC'S)
CIRCUIT CARDS, LOGIC (WITH IC'S)
CLOCKS, DIGITAL (REAL-TIME)
COMPUTERS, DIGITAL (GENERAL-PURPOSE, SMALL-SCALE)
COMPUTERS, DIGITAL (GENERAL-PURPOSE, MEDIUM-SCALE)
COMPUTERS, MINI GENERAL PURPOSE (ALSO SEE CALCULATORS)
CONSULTING (ADVANCED COMPUTER EQUIPMENT DESIGN AND FEASIBILITY STUDIES)
CONSULTING (COMPUTER EVALUATIONS, SELECTIONS, INSTALLATION PLANNING)
CONSULTING (SCIENTIFIC APPLICATIONS)
CONVERTERS, ANALOG-TO-DIGITAL
CONTINUED

3 Manufacturers' Directory

CONVERTERS, BINARY-TO-DECIMAL
 CONVERTERS, DC-TO-FREQUENCY
 CONVERTERS, DIGITAL-TO-ANALOG
 CONVERTERS, FREQUENCY-TO-DC
 CONVERTERS, PULSE-TO-DIGITAL
 CONVERTERS, VOLTAGE-TO-FREQUENCY

COUNTERS, DECADE
 COUNTERS, DIGITAL READOUT
 DATA ACQUISITION AND REDUCTION SYSTEMS
 DATA TERMINALS, BLOCK-BY-BLOCK (MAGNETIC TAPE)
 DATA TERMINALS, BLOCK-BY-BLOCK (MULTI-PURPOSE)
 DISPLAY DRIVERS
 INDICATORS, ALPHANUMERIC
 INDICATORS, DIGITAL
 INDICATORS, ELAPSED TIME
 INDICATORS, ILLUMINATED
 MAGNETIC TAPE STORAGE SYSTEMS (INCLUDES CONTROLLER)
 POWER SUPPLIES, AC
 POWER SUPPLIES, DC
 PROGRAMMING LANGUAGE DEVELOPMENT (PROPRIETARY SOFTWARE PRODUCTS)
 SERVICES, PROCESSING (ANALOG OR HYBRID, SCIENTIFIC)
 SERVICES, PROCESSING (DIGITAL, SCIENTIFIC)
 TAPE TRANSPORTS, MAGNETIC (DIGITAL-EXCL. CASSETTE)
 TAPE TRANSPORTS, MAGNETIC (DIGITAL CASSETTE)
 TAPE TRANSPORTS, MAGNETIC (INCREMENTAL)

COMPUTER DATA SERVICES INC. 919-483-4064
 P O Box 1431, Fayetteville, N C 28302

SERVICES, PROCESSING (COMMERCIAL EDP)

COMPUTER DESIGN CORP. 213-478-9761
 12401 W Olympic Blvd, Los Angeles, Cal 90064

CALCULATORS, PROGRAMMABLE (ALSO SEE COMPUTERS)
 COMPUTERS, DIGITAL (EDUCATIONAL)
 COMPUTERS, DIGITAL (GENERAL-PURPOSE, SMALL-SCALE)
 DATA TERMINALS, BLOCK-BY-BLOCK (MULTI-PURPOSE)
 MEMORY SYSTEMS, SEMICONDUCTOR (MOS)
 PLOTTERS, MOVING PEN (DIGITAL CONTROLLER)
 PRINTERS, LINE (LOW & MEDIUM SPEED)
 PROGRAMMERS, PUNCHED CARD
 PROGRAMMING LANGUAGE DEVELOPMENT (DEDICATED APPLICATION SYSTEMS)
 PROGRAMMING LANGUAGE DEVELOPMENT (PROPRIETARY SOFTWARE PRODUCTS)
 READERS, PUNCHED CARD (UP TO 100 CPM)
 TAPE TRANSPORTS, MAGNETIC (DIGITAL CASSETTE)
 TESTERS, DIGITAL LOGIC MODULES AND CARDS
 TESTERS, INTEGRATED CIRCUIT

COMPUTER DEVICES CORP. 516-543-4220
 63 Austin Blvd, Commack, N Y 11725

DELAY LINES, GLASS (ALSO SEE MEMORIES)
 DELAY LINES, MAGNETOSTRICTIVE (ALSO SEE MEMORIES)
 MEMORY SYSTEMS, DELAY LINE

COMPUTER DEVICES CORP. OF CALIFORNIA 213-698-2595
 11925 Burke St, Santa Fe Spg, Cal 90670

MOTORS, SERVO
 MOTORS, STEPPING
 MOTORS, SYNCHRONOUS
 SERVOS, COMPUTER

COMPUTER DEVICES INC. 617-729-7436
 10 Sonar Dr, Woburn, Mass 01801

ACOUSTIC COUPLERS
 COMMUNICATION SYSTEMS, DATA TRANSMISSION
 COMMUNICATION SYSTEMS, TELEPRINTER
 CONSOLES, COMPUTER CONTROL (WIRED)
 CONSOLES, CRT (ALPHANUMERIC AND GRAPHIC)
 CONTROLLERS, MODEM
 CONTROLLERS, PLOTTING
 DATA CONCENTRATORS
 DATA TERMINALS, BLOCK-BY-BLOCK (MULTI-PURPOSE)
 DATA TERMINALS, BLOCK-BY-BLOCK (MEDIUM SPEED PRINTER)
 DATA TERMINALS, BLOCK-BY-BLOCK (TELEPRINTER)
 DATA TERMINALS, INQUIRY-RESPONSE (ALPHANUMERIC KEYBOARD)
 DATA TERMINALS, INQUIRY-RESPONSE (CRT WITH KEYBOARD)
 DATA TERMINALS, INQUIRY-RESPONSE (SPECIAL-PURPOSE)
 MODEMS, ACOUSTIC
 MODEMS, HARD-WIRED
 MODEMS, PC CARD
 MULTIPLEXERS, DIGITAL
 PLOTTERS, MOVING PEN (DIGITAL CONTROLLER)
 CONTINUED

READOUTS, CRT
 RECORDERS, DIGITAL CASSETTE
 SIGNAL CONDITIONERS
 TAPE TRANSPORTS, MAGNETIC (DIGITAL CASSETTE)
 TYPEWRITERS, COMPUTER INPUT-OUTPUT

COMPUTER DIMENSIONS, INC. 214-742-2131
 511 Akard, Dallas, Tex 75201

CONSULTING (ACCOUNTING, BUSINESS AND COMMERCIAL APPLICATIONS)
 SERVICES, FACILITY MANAGEMENT
 SERVICES, MANAGEMENT INFORMATION SYSTEMS
 SERVICES, PROCESSING (COMMERCIAL EDP)
 SERVICES, TIME SHARING (COMMERCIAL)

COMPUTER DIODE CORP. 201-797-3900
 Pollitt Dr S, Fair Lawn, N J 07410 TWX 710-988-2241

CONSULTING (SCIENTIFIC APPLICATIONS)
 DIODES, SILICON
 DIODES, VIDEO DETECTOR
 DIODES, ZENER
 POWER SUPPLIES, AC
 POWER SUPPLIES, DC
 POWER SUPPLIES, DIGITALLY-CONTROLLED
 REGULATORS, VOLTAGE

COMPUTER DISPLAY INC. 617-899-0480
 223 Cresent St, Waltham, Mass 02154 TWX 710-324-7596

CONSOLES, CRT (ALPHANUMERIC AND GRAPHIC)
 CONSOLES, CRT (GRAPHIC)
 GRAPHIC TABLETS
 TAPE TRANSPORTS, MAGNETIC (DIGITAL CASSETTE)

COMPUTER DYNAMICS INC. 415-527-3737
 1760 Solano Ave, Berkeley, Cal 94707

CONSULTING (ACCOUNTING, BUSINESS AND COMMERCIAL APPLICATIONS)
 CONSULTING (DATA COMMUNICATIONS SYSTEMS PLANNING)
 CONSULTING (MANAGEMENT INFORMATION SYSTEMS PLANNING)
 PROGRAMMING LANGUAGE DEVELOPMENT (CONSULTANTS)
 PROGRAMMING LANGUAGE DEVELOPMENT (CONTRACT PROGRAMMING)
 PROGRAMMING LANGUAGE DEVELOPMENT (DEDICATED APPLICATION SYSTEMS)
 PROGRAMMING LANGUAGE DEVELOPMENT (PROPRIETARY SOFTWARE PRODUCTS)
 SERVICES, PROCESSING (COMMERCIAL EDP)
 SERVICES, SYSTEMS ANALYSIS

COMPUTER DYNAMICS INC. 415-635-5800
 100 Hegenberger Rd, Oakland, Cal 94621

CONSULTING (ACCOUNTING, BUSINESS AND COMMERCIAL APPLICATIONS)
 CONSULTING (COMPUTER EVALUATIONS, SELECTIONS, INSTALLATION PLANNING)
 CONSULTING (DATA COMMUNICATIONS SYSTEMS PLANNING)
 CONSULTING (MANAGEMENT INFORMATION SYSTEMS PLANNING)
 SERVICES, FACILITY MANAGEMENT
 SERVICES, MANAGEMENT INFORMATION SYSTEMS
 SERVICES, PROCESSING (COMMERCIAL EDP)
 SERVICES, SYSTEMS ANALYSIS

COMPUTER ENTRY SYSTEMS CORP. 301-622-3500
 2141 Industrial Pkwy, Silver Spring, Md 20904

COMMUNICATION SYSTEMS, DATA TRANSMISSION
 DATA TERMINALS, BLOCK-BY-BLOCK (MAGNETIC TAPE)
 DATA TERMINALS, BLOCK-BY-BLOCK (HIGH SPEED PRINTER)
 ENCODERS, KEYBOARD (ALPHANUMERIC)
 ENCODERS, KEYBOARD-TO-MAGNETIC TAPE
 POOLERS, MAGNETIC TAPE
 TAPE TRANSPORTS, MAGNETIC (DIGITAL-EXCL. CASSETTE)
 TAPE TRANSPORTS, MAGNETIC (DIGITAL CASSETTE)

COMPUTER EXCHANGE INC., THE 212-661-5870
 30 E 42nd St, New York, N Y 10017

CONSULTING (ACCOUNTING, BUSINESS AND COMMERCIAL APPLICATIONS)
 CONSULTING (COMPUTER EVALUATIONS, SELECTIONS, INSTALLATION PLANNING)
 CONSULTING (DATA COMMUNICATIONS SYSTEMS PLANNING)
 CONSULTING (MANAGEMENT INFORMATION SYSTEMS PLANNING)
 LEASING, EDP EQUIPMENT (OTHER THAN MFGRS)
 SERVICES, FACILITY MANAGEMENT
 USED EQUIPMENT (BUYING, SELLING, LEASING)

3 Manufacturers' Directory

COMPUTERFILES INC. 617-369-6660
 Prof Bldg Baker Ave, Concord, Mass 01742

CONSULTING (COMPUTER PRODUCT PLANNING SURVEYS, MARKET RESEARCH STUDIES)

COMPUTER FULFILLMENT 617-729-4650
 225 East St, Winchester, Mass 01890

SERVICES, COMPUTER-AIDED DESIGN
 SERVICES, MANAGEMENT INFORMATION SYSTEMS
 SERVICES, PROCESSING (COMMERCIAL EDP)
 SERVICES, SYSTEMS ANALYSIS

COMPUTER GRAPHICS CORP. DIV. MILGO ELECTRONIC 305-691-1220
 7620 NW 36th Ave, Miami, Fla 33147 TWX 810-848-6588

PLOTTERS, MOVING PEN (ANALOG CONTROLLER)
 PLOTTERS, MOVING PEN (DIGITAL CONTROLLER)

COMPUTER GUILD INC. 617-655-3667
 12 Mercer Rd, Natick, Mass 01760 TWX 710-386-6677

CONSULTING (ADVANCED COMPUTER EQUIPMENT DESIGN AND FEASIBILITY STUDIES)
 CONSULTING (SCIENTIFIC APPLICATIONS)
 PROGRAMMING LANGUAGE DEVELOPMENT (PROPRIETARY SOFTWARE PRODUCTS)
 SERVICES, COMPUTER-AIDED DESIGN
 SERVICES, AUTOMATED WIRE-WRAPPING

COMPUTER HARDWARE CONSULTANTS & SERVICES 215-343-1430
 1409 Easton Rd, Warrington, Pa 18976 TWX 510-667-2341

CONSULTING (COMPUTER EVALUATIONS, SELECTIONS, INSTALLATION PLANNING)
 SERVICES, HARDWARE MAINTENANCE

COMPUTER HARDWARE INC. 916-481-7723
 2550 Fair Oaks Blvd, Sacramento, Cal 95825

CONSULTING (ADVANCED COMPUTER EQUIPMENT DESIGN AND FEASIBILITY STUDIES)
 DISC DRIVES, MOVABLE HEAD (INCLUDING CONTROLLER)
 DISC STORAGE SYSTEMS
 PRINTERS, LINE (HIGH SPEED)

COMPUTERIA INC. 617-848-2511
 14 Wood Rd, Braintree, Mass 02143

CONSULTING (ACCOUNTING, BUSINESS AND COMMERCIAL APPLICATIONS)
 CONSULTING (ADVANCED COMPUTER EQUIPMENT DESIGN AND FEASIBILITY STUDIES)
 CONSULTING (COMPUTER EVALUATIONS, SELECTIONS, INSTALLATION PLANNING)
 CONSULTING (DATA COMMUNICATIONS SYSTEMS PLANNING)
 CONSULTING (MANAGEMENT INFORMATION SYSTEMS PLANNING)
 PROGRAMMING LANGUAGE DEVELOPMENT (CONSULTANTS)
 PROGRAMMING LANGUAGE DEVELOPMENT (CONTRACT PROGRAMMING)
 PROGRAMMING LANGUAGE DEVELOPMENT (DEDICATED APPLICATION SYSTEMS)
 PROGRAMMING LANGUAGE DEVELOPMENT (PROPRIETARY SOFTWARE PRODUCTS)
 SERVICES, COMPUTER-AIDED DESIGN
 SERVICES, FACILITY MANAGEMENT
 SERVICES, MANAGEMENT INFORMATION SYSTEMS
 SERVICES, PROCESSING (ANALOG OR HYBRID, SCIENTIFIC)
 SERVICES, TIME SHARING (COMMERCIAL)

COMPUTER IDENTICS CORP. 617-326-8960
 S W Park, Westwood, Mass 02090

FIBER OPTICS ASSEMBLIES (FOR PUNCHED CODE READERS AND MARK SENSORS)
 SCANNERS, OPTICAL
 SERVICES, MANAGEMENT INFORMATION SYSTEMS

COMPUTER INC. 617-864-5140
 143 Albany St, Cambridge, Mass 02139

CONSOLES, CRT (ALPHANUMERIC AND GRAPHIC)
 CONSOLES, CRT (COLOR-ALPHANUMERIC AND GRAPHIC)
 CONSOLES, CRT (GRAPHIC)
 CURVE TRACERS-DIGITIZERS, MANUAL
 DATA TERMINALS, BLOCK-BY-BLOCK (GRAPHIC DIGITIZERS)
 DATA TERMINALS, BLOCK-BY-BLOCK (TELEPRINTER)
 DATA TERMINALS, INQUIRY-RESPONSE (ALPHANUMERIC KEYBOARD)
 DATA TERMINALS, INQUIRY-RESPONSE (CRT WITH KEYBOARD)
 DATA TERMINALS, INQUIRY-RESPONSE (SPECIAL-PURPOSE)
 CONTINUED

DISPLAYS, THREE-DIMENSIONAL
 GRAPHIC TABLETS

COMPUTER INFORMATION SERVICES INC. 215-927-7080
 6701 N Broad St, Philadelphia, Pa 19126

CONSULTING (ACCOUNTING, BUSINESS AND COMMERCIAL APPLICATIONS)
 CONSULTING (SCIENTIFIC APPLICATIONS)
 SERVICES, PROCESSING (COMMERCIAL EDP)
 SERVICES, SYSTEMS ANALYSIS

COMPUTER INFORMATION CORP. 216-283-1340
 3645 Wrrnsville Ctr Rd, Cleveland, Ohio 44122

CONSULTING (ACCOUNTING, BUSINESS AND COMMERCIAL APPLICATIONS)
 SERVICES, PROCESSING (COMMERCIAL EDP)

COMPUTER INVESTMENTS & LEASING CORP. 609-428-7040
 9 Tanner St, Haddonfield, N J 08033

CONSULTING (ACCOUNTING, BUSINESS AND COMMERCIAL APPLICATIONS)
 CONSULTING (ADVANCED COMPUTER EQUIPMENT DESIGN AND FEASIBILITY STUDIES)
 CONSULTING (COMPUTER EVALUATIONS, SELECTIONS, INSTALLATION PLANNING)
 CONSULTING (DATA COMMUNICATIONS SYSTEMS PLANNING)
 CONSULTING (MANAGEMENT INFORMATION SYSTEMS PLANNING)
 LEASING, EDP EQUIPMENT (OTHER THAN MFGRS)
 SERVICES, COMPUTER-AIDED DESIGN
 SERVICES, FACILITY MANAGEMENT
 SERVICES, PROCESSING (COMMERCIAL EDP)
 SERVICES, SYSTEMS ANALYSIS
 USED EQUIPMENT (BUYING, SELLING, LEASING)

COMPUTER LABS INC. 919-292-6427
 1109 S Chapman St, Greensboro, N C 27403 TWX 510-922-7954

AMPLIFIERS, OPERATIONAL
 CONVERTERS, ANALOG-TO-DIGITAL
 CONVERTERS, DIGITAL-TO-ANALOG
 MULTIPLEXERS, ANALOG-SOLID STATE (SEQUENTIAL SAMPLING)

COMPUTER LEARNING & SYSTEMS CORP. 301-652-9220
 5530 Wisconsin Ave, Chevy Chase, Md 20015

ANALYZERS, COMPUTER PERFORMANCE
 CONSULTING (COMPUTER EVALUATIONS, SELECTIONS, INSTALLATION PLANNING)
 CONSULTING (MANAGEMENT INFORMATION SYSTEMS PLANNING)
 PROGRAMMING LANGUAGE DEVELOPMENT (CONSULTANTS)
 PROGRAMMING LANGUAGE DEVELOPMENT (CONTRACT PROGRAMMING)
 PROGRAMMING LANGUAGE DEVELOPMENT (DEDICATED APPLICATION SYSTEMS)
 PROGRAMMING LANGUAGE DEVELOPMENT (PROPRIETARY SOFTWARE PRODUCTS)
 TRAINING INSTITUTES, COMMERCIAL COMPUTER COURSES, SEMINARS,
 CORRESPONDENCE COURSES

COMPUTER-LINK CORP. 617-272-7400
 14 Cambridge St, Burlington, Mass 01803

ACOUSTIC COUPLERS
 CABINETS AND ENCLOSURES (FOR KEYPUNCHES, PRINTERS)
 CERTIFIERS, DISC PACK
 CERTIFIERS, MAGNETIC TAPE
 CLEANER/CERTIFIERS, MAGNETIC TAPE
 CLEANERS, MAGNETIC TAPE
 CLEANERS, MAGNETIC TAPE HEADS
 COVERS, ACOUSTIC (FOR KEYBOARDS, TELETYPEWRITERS, ETC.)
 FLOOR PLANNING AIDS (FOR EDP ROOMS)
 FORMS HANDLING, DECOLLATORS
 FORMS HANDLING, STACKERS
 MARK SENSING EQUIPMENT
 MODEMS, HARD-WIRED
 PLOTTERS, MOVING PEN (DIGITAL CONTROLLER)
 RECONDITIONING EQUIPMENT, MAGNETIC TAPE
 SERVICES, MAGNETIC TAPE CERTIFICATION
 WINDERS, MAGNETIC TAPE

COMPUTER LOGIC CORP. 213-451-9754
 1528 20th St, Santa Monica, Cal 90404

INVERTERS, DC-AC
 POWER SUPPLIES, AC
 POWER SUPPLIES, DC
 REGULATORS, VOLTAGE

3 Manufacturers' Directory

COMPUTER LOGIC SYSTEMS INC. 617-893-3032
225 Crescent St, Waltham, Mass 02154

COMPUTERS, DIGITAL (GENERAL-PURPOSE, SMALL-SCALE)
COMPUTERS, DIGITAL (GENERAL-PURPOSE, MEDIUM-SCALE)
COMPUTERS, MINI GENERAL PURPOSE (ALSO SEE CALCULATORS)
COMPUTERS, PROCESS CONTROL

COMPUTER MACHINERY CORP. 213-477-1585
2231 S Barrington Ave, Los Angeles, Cal 90064 TWX 910-342-6989
PRINTERS, LINE (LOW & MEDIUM SPEED)

COMPUTER MANAGEMENT INC. 216-881-9180
3101 Eullid Ave, Cleveland, Ohio 44115

CONSULTING (ACCOUNTING, BUSINESS AND COMMERCIAL APPLICATIONS)
CONSULTING (ADVANCED COMPUTER EQUIPMENT DESIGN AND FEASIBILITY STUDIES)
CONSULTING (COMPUTER EVALUATIONS, SELECTIONS, INSTALLATION PLANNING)
CONSULTING (DATA COMMUNICATIONS SYSTEMS PLANNING)
CONSULTING (COMPUTER PRODUCT PLANNING SURVEYS, MARKET RESEARCH STUDIES)
CONSULTING (MANAGEMENT INFORMATION SYSTEMS PLANNING)
CONSULTING (SCIENTIFIC APPLICATIONS)
PROGRAMMING LANGUAGE DEVELOPMENT (CONSULTANTS)
PROGRAMMING LANGUAGE DEVELOPMENT (CONTRACT PROGRAMMING)
PROGRAMMING LANGUAGE DEVELOPMENT (DEDICATED APPLICATION SYSTEMS)
PROGRAMMING LANGUAGE DEVELOPMENT (PROPRIETARY SOFTWARE PRODUCTS)
SERVICES, COMPUTER OUTPUT MICROFILM
SERVICES, FACILITY MANAGEMENT
SERVICES, MANAGEMENT INFORMATION SYSTEMS
SERVICES, PROCESSING (COMMERCIAL EDP)
SERVICES, SYSTEMS ANALYSIS

COMPUTER MEASUREMENTS CO. 213-367-2161
12970 Bradley Ave, San Fernando, Cal 91342 TWX 910-496-1487

CONSULTING (MANAGEMENT INFORMATION SYSTEMS PLANNING)
COUNTERS, DIGITAL READOUT
LEASING, EDP EQUIPMENT (OTHER THAN MFGRS)
PRINTERS, LINE (LOW & MEDIUM SPEED)
SERVICES, PROCESSING (COMMERCIAL EDP)
TIMERS, INTERVAL
USED EQUIPMENT (BUYING, SELLING, LEASING)

COMPUTER MECHANISMS CORP. 201-438-1770
493 Washington Dr, Carlstadt, N J 07072 TWX 710-989-0111
READERS, PAPER TAPE

COMPUTER MEMORY DEVICES INC. 602-939-9444
5170 W Bethany Home, Glendale, Ariz 85301 TWX 910-950-1244
DISC DRIVES, MOVABLE HEAD (INCLUDING CONTROLLER)
DISC DRIVES, REMOVABLE CARTRIDGE

COMPUTER METHODS CORP. 914-428-0400
470 Mamaroneck Ave, White Plains, N Y 10605

AUDIO/VISUAL TRAINING AIDS
CONSULTING (ACCOUNTING, BUSINESS AND COMMERCIAL APPLICATIONS)
CONSULTING (ADVANCED COMPUTER EQUIPMENT DESIGN AND FEASIBILITY STUDIES)
CONSULTING (MANAGEMENT INFORMATION SYSTEMS PLANNING)
PROGRAMMING LANGUAGE DEVELOPMENT (CONSULTANTS)
PROGRAMMING LANGUAGE DEVELOPMENT (CONTRACT PROGRAMMING)
PROGRAMMING LANGUAGE DEVELOPMENT (DEDICATED APPLICATION SYSTEMS)
PROGRAMMING LANGUAGE DEVELOPMENT (PROPRIETARY SOFTWARE PRODUCTS)

COMPUTER MICROFILM CORP. 212-255-5202
70 Charlton St, New York, N Y 10014

SERVICES, COMPUTER OUTPUT MICROFILM

COMPUTER MICROGRAPHICS INC. 213-776-6820
5345 W 102nd, Los Angeles, Cal 90045

SERVICES, COMPUTER OUTPUT MICROFILM

COMPUTER MICRO-IMAGE SYSTEMS INC. 213-882-8900
9600 Desoto Ave, Chatsworth, Cal 91311

CAMERAS, COM
CAMERAS, DATA RECORDING (EXCL. OSCILLOSCOPES)
COMPUTERS, DIGITAL (GENERAL-PURPOSE, SMALL-SCALE)
COMPUTERS, DIGITAL (GENERAL-PURPOSE, MEDIUM-SCALE)
COMPUTERS, MINI GENERAL PURPOSE (ALSO SEE CALCULATORS)
CONSOLES, CRT (ALPHANUMERIC AND GRAPHIC)
CONSOLES, CRT (COLOR-ALPHANUMERIC AND GRAPHIC)
CONSOLES, CRT (GRAPHIC)
CONTROLLERS, PLOTTING
CONVERTERS, DOCUMENT-TO-UNIT RECORDS
CONVERTERS, MAGNETIC TAPE-TO-MICROFILM
CONVERTERS, SCAN
DATA RETRIEVAL SYSTEMS, MICRO-FILM (COMPUTER-CONTROLLED)
DIGITIZERS, PROGRAMMABLE
DISPLAYS, MAGNETIC
DISPLAYS, THREE-DIMENSIONAL
FILM SCANNERS
MICROFICHE
MICROFILM DATA RETRIEVAL SYSTEMS, COMPUTER CONTROLLED
MICROFILM DATA RETRIEVAL SYSTEMS, COMPUTER CONTROLLED (GRAPHIC)
MICROFILM ROLLS
PRINTERS, MICROFILM/MICROFICHE
PROCESSORS, MICROFILM
READER/PRINTER, MICROFILM/MICROFICHE
READERS, MICROFILM/MICROFICHE
READOUTS AND DISPLAYS, NUMERIC AND ALPHANUMERIC (OTHER THAN CRT)
READOUTS, CRT
RECORDERS, GRAPHIC
RECORDERS, MICROFILM/MICROFICHE
SCANNERS, IMAGE
SCANNERS, INPUT
SCANNERS, OPTICAL

COMPUTER MICROTECHNOLOGY INC. 408-736-0300
P O Box 7050, Sunnyvale, Cal 94086 TWX 910-339-9236

CIRCUITS, MONOLITHIC (LSI-BIPOLAR)
CIRCUITS, MONOLITHIC (LSI-MOS)
MEMORY SYSTEMS, SEMICONDUCTOR
MEMORY SYSTEMS, SEMICONDUCTOR (MOS)
MODULES, MEMORY (ENCAPSULATED)

COMPUTER NETWORK CORP. 202-244-9250
5185 Macarthur Blvd, Washington, D C 20016

CONSULTING (ACCOUNTING, BUSINESS AND COMMERCIAL APPLICATIONS)
CONSULTING (ADVANCED COMPUTER EQUIPMENT DESIGN AND FEASIBILITY STUDIES)
CONSULTING (COMPUTER EVALUATIONS, SELECTIONS, INSTALLATION PLANNING)
CONSULTING (DATA COMMUNICATIONS SYSTEMS PLANNING)
CONSULTING (COMPUTER PRODUCT PLANNING SURVEYS, MARKET RESEARCH STUDIES)
CONSULTING (MANAGEMENT INFORMATION SYSTEMS PLANNING)
CONSULTING (SCIENTIFIC APPLICATIONS)
SERVICES, COMPUTER-AIDED DESIGN
SERVICES, FACILITY MANAGEMENT
SERVICES, MANAGEMENT INFORMATION SYSTEMS
SERVICES, PROCESSING (COMMERCIAL EDP)
SERVICES, PROCESSING (ANALOG OR HYBRID, SCIENTIFIC)
SERVICES, PROCESSING (DIGITAL SCIENTIFIC)
SERVICES, TIME SHARING (COMMERCIAL)
SERVICES, TIME SHARING (RESEARCH)
SERVICES, SYSTEMS ANALYSIS

COMPUTER OPERATIONS INC. 301-345-5377
10774 Tucker St, Beltsville, Md 20705

MAGNETIC TAPE STORAGE SYSTEMS (INCLUDES CONTROLLER)
TAPE TRANSPORTS, MAGNETIC (DIGITAL-EXCL. CASSETTE)

COMPUTER-OPTICS, INC. 203-744-6720
Berkshire Ind Park, Bethel, Conn 06801

DATA TERMINALS, INQUIRY-RESPONSE (ALPHANUMERIC KEYBOARD)
DATA TERMINALS, INQUIRY-RESPONSE (CRT WITH KEYBOARD)

COMPUTER PERIPHERALS CORP. 714-279-7500
5037 Ruffner St, San Diego, Cal 92111 TWX 910-335-1257

CONTROLLERS, MAGNETIC DISC
MEMORY SYSTEMS, MAGNETIC DISC

3 Manufacturers' Directory

COMPUTER POWER INC. 904-353-0953
30 S Laura St, Jacksonville, Fla 32202

CONSULTING (ACCOUNTING, BUSINESS AND COMMERCIAL APPLICATIONS)
CONSULTING (COMPUTER EVALUATIONS, SELECTIONS, INSTALLATION PLANNING)
CONSULTING (MANAGEMENT INFORMATION SYSTEMS PLANNING)
SERVICES, FACILITY MANAGEMENT
SERVICES, MANAGEMENT INFORMATION SYSTEMS
SERVICES, PROCESSING (COMMERCIAL EDP)

COMPUTER PREPARATIONS INC. 201-569-8750
112 S Dean St, Englewood, N J 07631

AIR CONDITIONERS (FOR EDP INSTALLATIONS)
CABINETS AND ENCLOSURES (FOR KEYPUNCHES, PRINTERS)
FLOORING (FOR EDP ROOMS)
FLOOR PLANNING AIDS (FOR EDP ROOMS)

COMPUTER PROCESSING INC. 918-683-3231
200 Manhattan Bldg, Muskogee, Okla 74401

CONSULTING (ACCOUNTING, BUSINESS AND COMMERCIAL APPLICATIONS)
CONSULTING (COMPUTER EVALUATIONS, SELECTIONS, INSTALLATION PLANNING)
LEASING, EDP EQUIPMENT (OTHER THAN MFGRS)
SERVICES, FACILITY MANAGEMENT
SERVICES, PROCESSING (COMMERCIAL EDP)
SERVICES, SYSTEMS ANALYSIS

COMPUTER PROCESSING INC. 412-261-4625
300 6th Ave, Pittsburgh, Pa 15222

CONSULTING (ACCOUNTING, BUSINESS AND COMMERCIAL APPLICATIONS)
CONSULTING (ADVANCED COMPUTER EQUIPMENT DESIGN AND FEASIBILITY STUDIES)
CONSULTING (COMPUTER EVALUATIONS, SELECTIONS, INSTALLATION PLANNING)
CONSULTING (DATA COMMUNICATIONS SYSTEMS PLANNING)
CONSULTING (COMPUTER PRODUCT PLANNING SURVEYS, MARKET RESEARCH STUDIES)
CONSULTING (MANAGEMENT INFORMATION SYSTEMS PLANNING)
CONSULTING (SCIENTIFIC APPLICATIONS)
PROGRAMMING LANGUAGE DEVELOPMENT (CONSULTANTS)
PROGRAMMING LANGUAGE DEVELOPMENT (CONTRACT PROGRAMMING)
PROGRAMMING LANGUAGE DEVELOPMENT (PROPRIETARY SOFTWARE PRODUCTS)
SERVICES, FACILITY MANAGEMENT
SERVICES, MANAGEMENT INFORMATION SYSTEMS
SERVICES, PROCESSING (COMMERCIAL EDP)
SERVICES, TIME SHARING (COMMERCIAL)
SERVICES, SYSTEMS ANALYSIS
TRAINING INSTITUTES, COMMERCIAL COMPUTER COURSES, SEMINARS, CORRESPONDENCE COURSES

COMPUTER PROCESSING INSTITUTE 203-528-9211
111 Ash St, East Hartford, Conn 06108

TRAINING INSTITUTES, COMMERCIAL COMPUTER COURSES, SEMINARS, CORRESPONDENCE COURSES

COMPUTER PRODUCTS, INC. 305-565-9565
P O Box 23849, Ft Lauderdale, Fla 33307

CIRCUIT CARDS, LINEAR (WITH IC'S)
CIRCUIT CARDS, LOGIC (WITH IC'S)
CLOCKS, DIGITAL (REAL-TIME)
CONSULTING (SCIENTIFIC APPLICATIONS)
CONVERTERS, ANALOG-TO-DIGITAL
CONVERTERS, DIGITAL-TO-ANALOG
COUNTERS, DECADE
COUNTERS, UP-DOWN
DATA ACQUISITION AND REDUCTION SYSTEMS
MODULES, DIGITAL LOGIC ENCAPSULATED (ALSO SEE CIRCUITS & CIRCUIT CARDS)
MULTIPLEXER-CONVERTER (SINGLE UNIT WITH MULTIPLEXER, SAMPLE & HOLD AMPLIFIER & A-TO-D CONVERTER)
MULTIPLEXERS, ANALOG-RELAY (SEQUENTIAL SAMPLING)
MULTIPLEXERS, ANALOG-SOLID STATE (SEQUENTIAL SAMPLING)
MULTIPLEXERS, DIGITAL
POWER SUPPLIES, DC
READOUTS AND DISPLAYS, NUMERIC AND ALPHANUMERIC (OTHER THAN CRT)
RELAYS, DRY REED (COMPUTER GRADE)
RELAYS, MERCURY WETTED (COMPUTER GRADE)
RELAYS, SOLID-STATE (COMPUTER GRADE)
SCANNERS, INPUT
SERVICES, PROCESSING (ANALOG OR HYBRID, SCIENTIFIC)
SERVICES, PROCESSING (DIGITAL SCIENTIFIC)
CONTINUED

SERVICES, SYSTEMS ANALYSIS
TIMERS, EVENT (IMPULSE)
TIMERS, INTERVAL
TRAINING SYSTEMS, COMPUTER SERVICE

COMPUTER PROGRAMMING CONCEPTS INC. 513-771-5551
101 Atkinson Sq, Cincinnati, Ohio 45246

CONSULTING (ACCOUNTING, BUSINESS AND COMMERCIAL APPLICATIONS)
CONSULTING (SCIENTIFIC APPLICATIONS)
PROGRAMMING LANGUAGE DEVELOPMENT (CONSULTANTS)
PROGRAMMING LANGUAGE DEVELOPMENT (CONTRACT PROGRAMMING)
PROGRAMMING LANGUAGE DEVELOPMENT (DEDICATED APPLICATION SYSTEMS)
PROGRAMMING LANGUAGE DEVELOPMENT (PROPRIETARY SOFTWARE PRODUCTS)

COMPUTER RESOURCES INC. 216-267-6400
5091 W 164th St, Cleveland, Ohio 44142

CONSULTING (ACCOUNTING, BUSINESS AND COMMERCIAL APPLICATIONS)
DISC PACKS, MAGNETIC
LEASING, EDP EQUIPMENT (OTHER THAN MFGRS)
SERVICES, PROCESSING (COMMERCIAL EDP)

COMPUTER SCIENCES CORP. INFO. NETWORK DIV. 213-277-9000
1901 Building, Los Angeles, Cal 90067 TWX 910-490-2550

COMPUTERS, DIGITAL (EDUCATIONAL)
CONSULTING (ACCOUNTING, BUSINESS AND COMMERCIAL APPLICATIONS)
CONSULTING (ADVANCED COMPUTER EQUIPMENT DESIGN AND FEASIBILITY STUDIES)
CONSULTING (COMPUTER EVALUATIONS, SELECTIONS, INSTALLATION PLANNING)
CONSULTING (DATA COMMUNICATIONS SYSTEMS PLANNING)
CONSULTING (MANAGEMENT INFORMATION SYSTEMS PLANNING)
CONSULTING (SCIENTIFIC APPLICATIONS)
LEASING, EDP EQUIPMENT (OTHER THAN MFGRS)
PROGRAMMING LANGUAGE DEVELOPMENT (CONSULTANTS)
PROGRAMMING LANGUAGE DEVELOPMENT (CONTRACT PROGRAMMING)
PROGRAMMING LANGUAGE DEVELOPMENT (DEDICATED APPLICATION SYSTEMS)
PROGRAMMING LANGUAGE DEVELOPMENT (PROPRIETARY SOFTWARE PRODUCTS)
SERVICES, COMPUTER-AIDED DESIGN
SERVICES, FACILITY MANAGEMENT
SERVICES, MAGNETIC TAPE CERTIFICATION
SERVICES, MANAGEMENT INFORMATION SYSTEMS
SERVICES, PROCESSING (COMMERCIAL EDP)
SERVICES, PROCESSING (ANALOG OR HYBRID, SCIENTIFIC)
SERVICES, PROCESSING (DIGITAL SCIENTIFIC)
SERVICES, TIME SHARING (COMMERCIAL)
SERVICES, TIME SHARING (RESEARCH)
SERVICES, HARDWARE MAINTENANCE
SERVICES, SYSTEMS ANALYSIS
TRAINING INSTITUTES, COMMERCIAL COMPUTER COURSES, SEMINARS, CORRESPONDENCE COURSES
TRAINING SYSTEMS, COMPUTER SERVICE

COMPUTER SERVICENTER CORP. 518-785-3333
16 Maple St, Latham, N Y 12110

CONSULTING (ACCOUNTING, BUSINESS AND COMMERCIAL APPLICATIONS)
CONSULTING (MANAGEMENT INFORMATION SYSTEMS PLANNING)
SERVICES, FACILITY MANAGEMENT
SERVICES, MANAGEMENT INFORMATION SYSTEMS
SERVICES, PROCESSING (COMMERCIAL EDP)
SERVICES, PROCESSING (ANALOG OR HYBRID, SCIENTIFIC)
SERVICES, PROCESSING (DIGITAL SCIENTIFIC)
SERVICES, TIME SHARING (COMMERCIAL)
TRAINING INSTITUTES, COMMERCIAL COMPUTER COURSES, SEMINARS, CORRESPONDENCE COURSES

COMPUTER SERVICE OF E. TEXAS 713-384-3718
P O Box 5981, Jasper, Tex 75951

CONSULTING (ACCOUNTING, BUSINESS AND COMMERCIAL APPLICATIONS)
CONSULTING (SCIENTIFIC APPLICATIONS)
SERVICES, PROCESSING (COMMERCIAL EDP)
SERVICES, SYSTEMS ANALYSIS

COMPUTER SERVICES CORP. 205-328-2974
200 Bank Savings Bldg, Birmingham, Ala 35203

CONSULTING (ACCOUNTING, BUSINESS AND COMMERCIAL APPLICATIONS)
CONSULTING (COMPUTER EVALUATIONS, SELECTIONS, INSTALLATION PLANNING)
SERVICES, FACILITY MANAGEMENT
SERVICES, MANAGEMENT INFORMATION SYSTEMS
CONTINUED

3 Manufacturers' Directory

SERVICES, PROCESSING (COMMERCIAL EDP)

COMPUTER SERVICES INC. 502-444-9646
 500 Clark St, Paducah, Ky 42001 TWX 510-546-1171
 CONSULTING (ACCOUNTING, BUSINESS AND COMMERCIAL APPLICATIONS)
 CONSULTING (COMPUTER EVALUATIONS, SELECTIONS, INSTALLATION
 PLANNING)
 SERVICES, PROCESSING (COMMERCIAL EDP)
 SERVICES, PROCESSING (DIGITAL SCIENTIFIC)
 SERVICES, SYSTEMS ANALYSIS

COMPUTER SERVICES INC. 617-745-3550
 47 Congress St, Salem, Mass 01970

CONSULTING (ACCOUNTING, BUSINESS AND COMMERCIAL APPLICATIONS)
 CONSULTING (COMPUTER EVALUATIONS, SELECTIONS, INSTALLATION
 PLANNING)
 CONSULTING (MANAGEMENT INFORMATION SYSTEMS PLANNING)
 SERVICES, FACILITY MANAGEMENT
 SERVICES, MANAGEMENT INFORMATION SYSTEMS
 SERVICES, PROCESSING (COMMERCIAL EDP)
 SERVICES, SYSTEMS ANALYSIS

COMPUTER SERVICES OF INDIANA, INC. 812-232-1385
 214 S 13 1/2 St, Terre Haute, Ind 47808

CONSULTING (ACCOUNTING, BUSINESS AND COMMERCIAL APPLICATIONS)
 CONSULTING (COMPUTER EVALUATIONS, SELECTIONS, INSTALLATION
 PLANNING)
 SERVICES, FACILITY MANAGEMENT
 SERVICES, MANAGEMENT INFORMATION SYSTEMS
 SERVICES, PROCESSING (COMMERCIAL EDP)
 SERVICES, SYSTEMS ANALYSIS

COMPUTER SHARING SERVICES 303-934-5747
 2492 W 2nd Ave, Denver, Colo 80223

CONSULTING (ACCOUNTING, BUSINESS AND COMMERCIAL APPLICATIONS)
 CONSULTING (SCIENTIFIC APPLICATIONS)
 SERVICES, FACILITY MANAGEMENT
 SERVICES, PROCESSING (COMMERCIAL EDP)
 SERVICES, PROCESSING (DIGITAL SCIENTIFIC)
 SERVICES, TIME SHARING (COMMERCIAL)
 SERVICES, SYSTEMS ANALYSIS

COMPUTER SIGNAL PROCESSORS INC. 617-272-6020
 209 Middlesex Tpk, Burlington, Mass 01803 TWX 710-332-1352

CIRCUIT CARDS, LINEAR (WITH IC'S)
 CIRCUIT CARDS, LOGIC (WITH IC'S)
 COMMUNICATIONS-ORIENTED PROCESSORS, MULTIPLE CHANNEL CONTROLLERS
 COMMUNICATIONS-ORIENTED PROCESSORS, STORED PROGRAM
 COMPUTERS, DIGITAL (GENERAL-PURPOSE, SMALL-SCALE)
 COMPUTERS, DIGITAL (GENERAL-PURPOSE, MEDIUM-SCALE)
 COMPUTERS, NAVIGATION
 COMPUTERS, PROCESS CONTROL
 MEMORY SYSTEMS, SEMICONDUCTOR (MOS)

COMPUTER SPECIALTIES CORP. 201-487-4116
 87 Burlaw Ct, Hackensack, N J 07601

DISC STORAGE SYSTEMS
 DRUM STORAGE EQUIPMENT, MAG-NETIC (INCLUDING CONTROLLER)
 MEMORY SYSTEMS, MAGNETIC DISC
 MEMORY SYSTEMS, MAGNETIC DRUM

COMPUTER SYNECTICS INC. 408-247-0200
 283 Brokaw Rd, Santa Clara, Cal 95050 TWX 910-338-0256

ANALYZERS, COMPUTER PERFORMANCE
 CONSULTING (COMPUTER EVALUATIONS, SELECTIONS, INSTALLATION
 PLANNING)

COMPUTER SYSTEM TECHNOLOGY INC. 215-886-2100
 700-42 Fox Pavilion, Jenkintown, Pa 19046

CONSULTING (ACCOUNTING, BUSINESS AND COMMERCIAL APPLICATIONS)
 CONSULTING (ADVANCED COMPUTER EQUIPMENT DESIGN AND FEASIBILITY
 STUDIES)
 CONSULTING (COMPUTER EVALUATIONS, SELECTIONS, INSTALLATION
 PLANNING)
 CONSULTING (DATA COMMUNICATIONS SYSTEMS PLANNING)
 CONSULTING (MANAGEMENT INFORMATION SYSTEMS PLANNING)
 PROGRAMMING LANGUAGE DEVELOPMENT (CONSULTANTS)
 PROGRAMMING LANGUAGE DEVELOPMENT (CONTRACT PROGRAMMING)
 PROGRAMMING LANGUAGE DEVELOPMENT (DEDICATED APPLICATION SYSTEMS)
 CONTINUED

PROGRAMMING LANGUAGE DEVELOPMENT (PROPRIETARY SOFTWARE
 PRODUCTS)
 SERVICES, FACILITY MANAGEMENT
 SERVICES, MANAGEMENT INFORMATION SYSTEMS
 SERVICES, TIME SHARING (RESEARCH)
 SERVICES, SYSTEMS ANALYSIS
 TRAINING INSTITUTES, COMMERCIAL COMPUTER COURSES, SEMINARS,
 CORRESPONDENCE COURSES

COMPUTER SYSTEMS 503-476-6557
 400 Wing Bldg, Grants Pass, Oreg 97526

CONSULTING (ACCOUNTING, BUSINESS AND COMMERCIAL APPLICATIONS)
 CONSULTING (COMPUTER EVALUATIONS, SELECTIONS, INSTALLATION
 PLANNING)
 CONSULTING (MANAGEMENT INFORMATION SYSTEMS PLANNING)
 SERVICES, MANAGEMENT INFORMATION SYSTEMS
 SERVICES, PROCESSING (COMMERCIAL EDP)
 SERVICES, SYSTEMS ANALYSIS

COMPUTER SYSTEMS CO. INC. 216-228-4100
 1470 St Charles Ave, Cleveland, Ohio 44107

CONSULTING (ACCOUNTING, BUSINESS AND COMMERCIAL APPLICATIONS)
 CONSULTING (ADVANCED COMPUTER EQUIPMENT DESIGN AND FEASIBILITY
 STUDIES)
 CONSULTING (COMPUTER EVALUATIONS, SELECTIONS, INSTALLATION
 PLANNING)
 CONSULTING (DATA COMMUNICATIONS SYSTEMS PLANNING)
 CONSULTING (COMPUTER PRODUCT PLANNING SURVEYS, MARKET RESEARCH
 STUDIES)
 CONSULTING (MANAGEMENT INFORMATION SYSTEMS PLANNING)
 CONSULTING (SCIENTIFIC APPLICATIONS)
 INSTRUCTIONAL SYSTEMS, COMPUTER-BASED
 MICROFICHE
 MICROFILM DATA RETRIEVAL SYSTEMS, COMPUTER CONTROLLED
 PROGRAMMING LANGUAGE DEVELOPMENT (CONSULTANTS)
 PROGRAMMING LANGUAGE DEVELOPMENT (CONTRACT PROGRAMMING)
 PROGRAMMING LANGUAGE DEVELOPMENT (DEDICATED APPLICATION SYSTEMS)
 PROGRAMMING LANGUAGE DEVELOPMENT (PROPRIETARY SOFTWARE
 PRODUCTS)
 SERVICES, COMPUTER-AIDED DESIGN
 SERVICES, FACILITY MANAGEMENT
 SERVICES, MANAGEMENT INFORMATION SYSTEMS
 TRAINING INSTITUTES, COMMERCIAL COMPUTER COURSES, SEMINARS,
 CORRESPONDENCE COURSES

COMPUTER SYSTEMS CORP. U.S. INDUSTRIES INC 214-369-6211
 P O Box 64400, Dallas, Tex 75206

CONSULTING (ACCOUNTING, BUSINESS AND COMMERCIAL APPLICATIONS)
 CONSULTING (COMPUTER EVALUATIONS, SELECTIONS, INSTALLATION
 PLANNING)
 CONSULTING (COMPUTER PRODUCT PLANNING SURVEYS, MARKET RESEARCH
 STUDIES)
 CONSULTING (MANAGEMENT INFORMATION SYSTEMS PLANNING)
 CONSULTING (SCIENTIFIC APPLICATIONS)
 SERVICES, FACILITY MANAGEMENT
 SERVICES, MANAGEMENT INFORMATION SYSTEMS
 SERVICES, PROCESSING (COMMERCIAL EDP)
 SERVICES, PROCESSING (DIGITAL SCIENTIFIC)
 SERVICES, SYSTEMS ANALYSIS
 TRAINING SYSTEMS, COMPUTER SERVICE

COMPUTER SYSTEMS FOR MEDICINE INC. 617-731-6616
 340 Longwood Ave, Boston, Mass 02115

CONSULTING (ADVANCED COMPUTER EQUIPMENT DESIGN AND FEASIBILITY
 STUDIES)
 CONSULTING (SCIENTIFIC APPLICATIONS)
 DATA RETRIEVAL SYSTEMS, MICRO-FILM (COMPUTER-CONTROLLED)
 DISPLAY DRIVERS
 FILM SCANNERS
 PROJECTORS, OPTICAL (COMPUTER CONTROLLED SLIDE SELECTING)
 SCANNERS, IMAGE
 SCANNERS, OPTICAL

COMPUTER SYSTEMS INC. 703-353-7856
 2042 Westmoreland St, Richmond, Va 23230

DATA TERMINALS, INQUIRY-RESPONSE (AUDIO RESPONSE)
 DATA TERMINALS, INQUIRY-RESPONSE (CRT WITH KEYBOARD)
 DATA TERMINALS, INQUIRY-RESPONSE (SPECIAL-PURPOSE)
 PRINTERS, LINE (LOW & MEDIUM SPEED)

3 Manufacturers' Directory

- COMPUTER SYSTEMS INC.** 206-854-3650
19619 81st Ave S, Kent, Wash 98031
- CONSULTING (ACCOUNTING, BUSINESS AND COMMERCIAL APPLICATIONS)
CONSULTING (COMPUTER EVALUATIONS, SELECTIONS, INSTALLATION PLANNING)
SERVICES, FACILITY MANAGEMENT
SERVICES, PROCESSING (COMMERCIAL EDP)
SERVICES, SYSTEMS ANALYSIS
- COMPUTER TABULATING CORP.** 516-489-7481
136 Main St, Hemstead, N Y 11550
- CONSULTING (ACCOUNTING, BUSINESS AND COMMERCIAL APPLICATIONS)
SERVICES, PROCESSING (COMMERCIAL EDP)
SERVICES, SYSTEMS ANALYSIS
USED EQUIPMENT (BUYING, SELLING, LEASING)
- COMPUTER TASK GROUP INC.** 716-634-9090
5586 Main St, Buffalo, N Y 14221
- CONSULTING (ACCOUNTING, BUSINESS AND COMMERCIAL APPLICATIONS)
CONSULTING (COMPUTER EVALUATIONS, SELECTIONS, INSTALLATION PLANNING)
CONSULTING (DATA COMMUNICATIONS SYSTEMS PLANNING)
CONSULTING (COMPUTER PRODUCT PLANNING SURVEYS, MARKET RESEARCH STUDIES)
CONSULTING (MANAGEMENT INFORMATION SYSTEMS PLANNING)
DATA TERMINALS, INQUIRY-RESPONSE (ALPHANUMERIC KEYBOARD)
SERVICES, FACILITY MANAGEMENT
SERVICES, MANAGEMENT INFORMATION SYSTEMS
SERVICES, PROCESSING (COMMERCIAL EDP)
SERVICES, PROCESSING (DIGITAL SCIENTIFIC)
SERVICES, TIME SHARING (COMMERCIAL)
- COMPUTER TECHNOLOGY INC. SUB. UNIV. COMPUTING CO.** 214-638-7555
P O Box 47911, Dallas, Tex 75247
- CONSULTING (ACCOUNTING, BUSINESS AND COMMERCIAL APPLICATIONS)
CONSULTING (ADVANCED COMPUTER EQUIPMENT DESIGN AND FEASIBILITY STUDIES)
CONSULTING (COMPUTER EVALUATIONS, SELECTIONS, INSTALLATION PLANNING)
CONSULTING (DATA COMMUNICATIONS SYSTEMS PLANNING)
CONSULTING (COMPUTER PRODUCT PLANNING SURVEYS, MARKET RESEARCH STUDIES)
CONSULTING (MANAGEMENT INFORMATION SYSTEMS PLANNING)
CONSULTING (SCIENTIFIC APPLICATIONS)
PROGRAMMING LANGUAGE DEVELOPMENT (CONSULTANTS)
PROGRAMMING LANGUAGE DEVELOPMENT (CONTRACT PROGRAMMING)
PROGRAMMING LANGUAGE DEVELOPMENT (DEDICATED APPLICATION SYSTEMS)
PROGRAMMING LANGUAGE DEVELOPMENT (PROPRIETARY SOFTWARE PRODUCTS)
SERVICES, FACILITY MANAGEMENT
SERVICES, MANAGEMENT INFORMATION SYSTEMS
SERVICES, PROCESSING (COMMERCIAL EDP)
SERVICES, PROCESSING (ANALOG OR HYBRID, SCIENTIFIC)
SERVICES, PROCESSING (DIGITAL SCIENTIFIC)
SERVICES, SYSTEMS ANALYSIS
TRAINING INSTITUTES, COMMERCIAL COMPUTER COURSES, SEMINARS, CORRESPONDENCE COURSES
TRAINING SYSTEMS, COMPUTER SERVICE
- COMPUTER TERMINAL CORP.** 512-342-5217
9725 Datapoint Dr, San Antonio, Tex 78229
- COMPUTERS, MINI GENERAL PURPOSE (ALSO SEE CALCULATORS)
DATA TERMINALS, INQUIRY-RESPONSE (CRT WITH KEYBOARD)
DATA TERMINALS, INQUIRY-RESPONSE (SPECIAL-PURPOSE)
- COMPUTER TERMINALS OF MINNESOTA INC.** 612-920-2784
4815 W 77th St, Minneapolis, Minn 55435
- COMMUNICATIONS-ORIENTED PROCESSORS, MULTIPLE CHANNEL CONTROLLERS
COMMUNICATIONS-ORIENTED PROCESSORS, SINGLE CHANNEL CONTROLLERS
COMMUNICATIONS-ORIENTED PROCESSORS, STORED PROGRAM
DATA CONCENTRATORS
DATA TERMINALS, BLOCK-BY-BLOCK (TELEPRINTER)
TYPEWRITERS, COMPUTER INPUT-OUTPUT
- COMPUTER TEST CORP.** 609-424-2400
3 Computer Dr, Cherry Hill, N J 08034
TELEX 84-5120
- TESTERS, MEMORY PLANES, STACKS AND SYSTEMS
- COMPUTER TIME** 415-254-6202
368 Village Sq, Orinda, Cal 94563
- CONSULTING (ACCOUNTING, BUSINESS AND COMMERCIAL APPLICATIONS)
SERVICES, PROCESSING (COMMERCIAL EDP)
SERVICES, SYSTEMS ANALYSIS
- COMPUTER TRANSCEIVER SYSTEMS INC.** 201-261-6800
317 Rte 17, Paramus, N J 07652
- DATA TERMINALS, INQUIRY-RESPONSE (ALPHANUMERIC KEYBOARD)
- COMPUTER TRANSMISSION CORP.** 213-477-5020
1508 Cotner Ave, Los Angeles, Cal 90025
- COMMUNICATION SYSTEMS, DATA TRANSMISSION
MODEMS, HARD-WIRED
MULTIPLEXERS, DIGITAL
- COMPUTER TUTOR, THE, DIV. COMPTUT INC.** 516-368-3332
12 Emerald Court, Commack, N Y 11725
- CONSULTING (ACCOUNTING, BUSINESS AND COMMERCIAL APPLICATIONS)
CONSULTING (ADVANCED COMPUTER EQUIPMENT DESIGN AND FEASIBILITY STUDIES)
CONSULTING (COMPUTER EVALUATIONS, SELECTIONS, INSTALLATION PLANNING)
CONSULTING (DATA COMMUNICATIONS SYSTEMS PLANNING)
CONSULTING (COMPUTER PRODUCT PLANNING SURVEYS, MARKET RESEARCH STUDIES)
CONSULTING (MANAGEMENT INFORMATION SYSTEMS PLANNING)
CONSULTING (SCIENTIFIC APPLICATIONS)
SERVICES, COMPUTER-AIDED DESIGN
SERVICES, SYSTEMS ANALYSIS
TRAINING INSTITUTES, COMMERCIAL COMPUTER COURSES, SEMINARS, CORRESPONDENCE COURSES
TRAINING SYSTEMS, COMPUTER SERVICE
- COMPUTER UNIVERSAL CORP.** 614-443-7654
1641 Universal Rd, Columbus, Ohio 43207
- CONSULTING (ACCOUNTING, BUSINESS AND COMMERCIAL APPLICATIONS)
CONSULTING (COMPUTER EVALUATIONS, SELECTIONS, INSTALLATION PLANNING)
CONSULTING (DATA COMMUNICATIONS SYSTEMS PLANNING)
CONSULTING (MANAGEMENT INFORMATION SYSTEMS PLANNING)
CONSULTING (SCIENTIFIC APPLICATIONS)
SERVICES, FACILITY MANAGEMENT
SERVICES, MANAGEMENT INFORMATION SYSTEMS
SERVICES, PROCESSING (COMMERCIAL EDP)
SERVICES, PROCESSING (DIGITAL SCIENTIFIC)
SERVICES, TIME SHARING (COMMERCIAL)
SERVICES, TIME SHARING (RESEARCH)
SERVICES, SYSTEMS ANALYSIS
- COMPUTER USAGE CO.** 301-656-0200
7315 Wisconsin Ave Nw, Washington, D C 20014
- CONSULTING (ACCOUNTING, BUSINESS AND COMMERCIAL APPLICATIONS)
CONSULTING (ADVANCED COMPUTER EQUIPMENT DESIGN AND FEASIBILITY STUDIES)
CONSULTING (COMPUTER EVALUATIONS, SELECTIONS, INSTALLATION PLANNING)
CONSULTING (DATA COMMUNICATIONS SYSTEMS PLANNING)
CONSULTING (COMPUTER PRODUCT PLANNING SURVEYS, MARKET RESEARCH STUDIES)
CONSULTING (MANAGEMENT INFORMATION SYSTEMS PLANNING)
CONSULTING (SCIENTIFIC APPLICATIONS)
SERVICES, FACILITY MANAGEMENT
SERVICES, MANAGEMENT INFORMATION SYSTEMS
SERVICES, SYSTEMS ANALYSIS
- COMPUTER USAGE CO.** 617-969-4000
387 Elliot St, Newton Uppr Fls, Mass 02164
- CONSULTING (ACCOUNTING, BUSINESS AND COMMERCIAL APPLICATIONS)
CONSULTING (ADVANCED COMPUTER EQUIPMENT DESIGN AND FEASIBILITY STUDIES)
CONSULTING (COMPUTER EVALUATIONS, SELECTIONS, INSTALLATION PLANNING)
CONSULTING (DATA COMMUNICATIONS SYSTEMS PLANNING)
CONSULTING (MANAGEMENT INFORMATION SYSTEMS PLANNING)
CONSULTING (SCIENTIFIC APPLICATIONS)
PROGRAMMING LANGUAGE DEVELOPMENT (CONSULTANTS)
PROGRAMMING LANGUAGE DEVELOPMENT (CONTRACT PROGRAMMING)
PROGRAMMING LANGUAGE DEVELOPMENT (DEDICATED APPLICATION SYSTEMS)
CONTINUED

3 Manufacturers' Directory

SERVICES, FACILITY MANAGEMENT
SERVICES, MANAGEMENT INFORMATION SYSTEMS
SERVICES, SYSTEMS ANALYSIS

COMPUTER USAGE CO. 415-321-6754
3181 Porter Dr, Palo Alto, Cal 94304

CONSULTING (ACCOUNTING, BUSINESS AND COMMERCIAL APPLICATIONS)
CONSULTING (ADVANCED COMPUTER EQUIPMENT DESIGN AND FEASIBILITY STUDIES)
CONSULTING (COMPUTER EVALUATIONS, SELECTIONS, INSTALLATION PLANNING)
CONSULTING (DATA COMMUNICATIONS SYSTEMS PLANNING)
CONSULTING (COMPUTER PRODUCT PLANNING SURVEYS, MARKET RESEARCH STUDIES)
CONSULTING (MANAGEMENT INFORMATION SYSTEMS PLANNING)
CONSULTING (SCIENTIFIC APPLICATIONS)
PROGRAMMING LANGUAGE DEVELOPMENT (CONSULTANTS)
PROGRAMMING LANGUAGE DEVELOPMENT (CONTRACT PROGRAMMING)
PROGRAMMING LANGUAGE DEVELOPMENT (DEDICATED APPLICATION SYSTEMS)
PROGRAMMING LANGUAGE DEVELOPMENT (PROPRIETARY SOFTWARE PRODUCTS)
SERVICES, FACILITY MANAGEMENT
SERVICES, MANAGEMENT INFORMATION SYSTEMS
SERVICES, SYSTEMS ANALYSIS
TRAINING INSTITUTES, COMMERCIAL COMPUTER COURSES, SEMINARS, CORRESPONDENCE COURSES

COMPUTER USAGE CORP. 203-661-4100
100 Putnam Green, Greenwich, Conn 06830

COMPUTERS, DIGITAL (GENERAL-PURPOSE, SMALL-SCALE)
COMPUTERS, MINI GENERAL PURPOSE (ALSO SEE CALCULATORS)
CONSULTING (ACCOUNTING, BUSINESS AND COMMERCIAL APPLICATIONS)
CONSULTING (ADVANCED COMPUTER EQUIPMENT DESIGN AND FEASIBILITY STUDIES)
CONSULTING (COMPUTER EVALUATIONS, SELECTIONS, INSTALLATION PLANNING)
CONSULTING (DATA COMMUNICATIONS SYSTEMS PLANNING)
CONSULTING (COMPUTER PRODUCT PLANNING SURVEYS, MARKET RESEARCH STUDIES)
CONSULTING (MANAGEMENT INFORMATION SYSTEMS PLANNING)
CONSULTING (SCIENTIFIC APPLICATIONS)
DATA TERMINALS, BLOCK-BY-BLOCK (MAGNETIC TAPE)
DATA TERMINALS, BLOCK-BY-BLOCK (MULTI-PURPOSE)
DATA TERMINALS, BLOCK-BY-BLOCK (PAPER TAPE)
DATA TERMINALS, BLOCK-BY-BLOCK (PLOTTER)
DATA TERMINALS, BLOCK-BY-BLOCK (MEDIUM SPEED PRINTER)
DATA TERMINALS, BLOCK-BY-BLOCK (PUNCHED CARD)
DATA TERMINALS, INQUIRY-RESPONSE (ALPHANUMERIC KEYBOARD)
DATA TERMINALS, INQUIRY-RESPONSE (CRT WITH KEYBOARD)
DATA TERMINALS, INQUIRY-RESPONSE (SPECIAL-PURPOSE)
LEASING, EDP EQUIPMENT (OTHER THAN MFGRS)
PROGRAMMING LANGUAGE DEVELOPMENT (CONSULTANTS)
PROGRAMMING LANGUAGE DEVELOPMENT (CONTRACT PROGRAMMING)
PROGRAMMING LANGUAGE DEVELOPMENT (DEDICATED APPLICATION SYSTEMS)
PROGRAMMING LANGUAGE DEVELOPMENT (PROPRIETARY SOFTWARE PRODUCTS)
SERVICES, FACILITY MANAGEMENT
SERVICES, MANAGEMENT INFORMATION SYSTEMS
TRAINING INSTITUTES, COMMERCIAL COMPUTER COURSES, SEMINARS, CORRESPONDENCE COURSES
TRAINING SYSTEMS, COMPUTER SERVICE

COMPUTER USAGE CORP.,
8939 S Sepulveda Blvd, Los Angeles, Cal 90045

CONSULTING (ACCOUNTING, BUSINESS AND COMMERCIAL APPLICATIONS)
CONSULTING (ADVANCED COMPUTER EQUIPMENT DESIGN AND FEASIBILITY STUDIES)
CONSULTING (COMPUTER EVALUATIONS, SELECTIONS, INSTALLATION PLANNING)
CONSULTING (DATA COMMUNICATIONS SYSTEMS PLANNING)
CONSULTING (COMPUTER PRODUCT PLANNING SURVEYS, MARKET RESEARCH STUDIES)
CONSULTING (MANAGEMENT INFORMATION SYSTEMS PLANNING)
CONSULTING (SCIENTIFIC APPLICATIONS)
PROGRAMMING LANGUAGE DEVELOPMENT (CONSULTANTS)
PROGRAMMING LANGUAGE DEVELOPMENT (CONTRACT PROGRAMMING)
PROGRAMMING LANGUAGE DEVELOPMENT (DEDICATED APPLICATION SYSTEMS)
PROGRAMMING LANGUAGE DEVELOPMENT (PROPRIETARY SOFTWARE PRODUCTS)
SERVICES, COMPUTER-AIDED DESIGN
SERVICES, FACILITY MANAGEMENT
SERVICES, MANAGEMENT INFORMATION SYSTEMS
SERVICES, SYSTEMS ANALYSIS
TRAINING INSTITUTES, COMMERCIAL COMPUTER COURSES, SEMINARS, CORRESPONDENCE COURSES
TRAINING SYSTEMS, COMPUTER SERVICE

COMPUTERVISION CORP. 617-272-7240
NW Ind Park S Ave, Burlington, Mass 01803

CONSOLES, CRT (ALPHANUMERIC AND GRAPHIC)
PLOTTERS, FILM EXPOSING
CURVE TRACERS-DIGITIZERS, MANUAL
DRAFTING SYSTEMS, COMPUTER-CONTROLLED STORAGE
PLOTTERS, MOVING PEN (DIGITAL CONTROLLER)

COMP/UTILITY INC. 617-227-4640
1 Center Plaza, Boston, Mass 02108

CONSULTING (ACCOUNTING, BUSINESS AND COMMERCIAL APPLICATIONS)
CONSULTING (COMPUTER EVALUATIONS, SELECTIONS, INSTALLATION PLANNING)
SERVICES, TIME SHARING (COMMERCIAL)
SERVICES, TIME SHARING (RESEARCH)

COMPUTING & SOFTWARE INC., EAST COAST DIV. 703-683-5330
3700 Mt Vernon Ave, Alexandria, Va 22305

CONSULTING (ACCOUNTING, BUSINESS AND COMMERCIAL APPLICATIONS)
CONSULTING (COMPUTER EVALUATIONS, SELECTIONS, INSTALLATION PLANNING)
CONSULTING (DATA COMMUNICATIONS SYSTEMS PLANNING)
CONSULTING (MANAGEMENT INFORMATION SYSTEMS PLANNING)
CONSULTING (SCIENTIFIC APPLICATIONS)
PROGRAMMING LANGUAGE DEVELOPMENT (CONSULTANTS)
PROGRAMMING LANGUAGE DEVELOPMENT (CONTRACT PROGRAMMING)
PROGRAMMING LANGUAGE DEVELOPMENT (DEDICATED APPLICATION SYSTEMS)
PROGRAMMING LANGUAGE DEVELOPMENT (PROPRIETARY SOFTWARE PRODUCTS)
SERVICES, FACILITY MANAGEMENT
SERVICES, MANAGEMENT INFORMATION SYSTEMS
SERVICES, PROCESSING (COMMERCIAL EDP)
SERVICES, PROCESSING (DIGITAL SCIENTIFIC)
SERVICES, SYSTEMS ANALYSIS
TRAINING INSTITUTES, COMMERCIAL COMPUTER COURSES, SEMINARS, CORRESPONDENCE COURSES

COMPUTING EFFICIENCY INC. COMPUTING EFF. DIV. 516-567-3600
35 Orville Dr, Bohemia, N Y 11716

CONSULTING (ACCOUNTING, BUSINESS AND COMMERCIAL APPLICATIONS)
CONSULTING (ADVANCED COMPUTER EQUIPMENT DESIGN AND FEASIBILITY STUDIES)
CONSULTING (COMPUTER EVALUATIONS, SELECTIONS, INSTALLATION PLANNING)
CONSULTING (DATA COMMUNICATIONS SYSTEMS PLANNING)
CONSULTING (MANAGEMENT INFORMATION SYSTEMS PLANNING)
CONSULTING (SCIENTIFIC APPLICATIONS)
PROGRAMMING LANGUAGE DEVELOPMENT (CONSULTANTS)
PROGRAMMING LANGUAGE DEVELOPMENT (CONTRACT PROGRAMMING)
PROGRAMMING LANGUAGE DEVELOPMENT (DEDICATED APPLICATION SYSTEMS)
PROGRAMMING LANGUAGE DEVELOPMENT (PROPRIETARY SOFTWARE PRODUCTS)
SERVICES, MANAGEMENT INFORMATION SYSTEMS
SERVICES, PROCESSING (COMMERCIAL EDP)
SERVICES, SYSTEMS ANALYSIS

COMPUTONE SYSTEMS INC. 404-261-0070
361 E Paces Ferry Rd, Atlanta, Ga 30305

CONSULTING (ACCOUNTING, BUSINESS AND COMMERCIAL APPLICATIONS)
CONSULTING (DATA COMMUNICATIONS SYSTEMS PLANNING)
CONSULTING (SCIENTIFIC APPLICATIONS)
DATA TERMINALS, INQUIRY-RESPONSE (AUDIO RESPONSE)
DATA TERMINALS, INQUIRY-RESPONSE (SPECIAL-PURPOSE)
SERVICES, PROCESSING (COMMERCIAL EDP)
SERVICES, PROCESSING (DIGITAL SCIENTIFIC)
SERVICES, TIME SHARING (COMMERCIAL)

COMPUVISOR INC. 607-272-3269
P O Box 381, Ithaca, N Y 14850

CONSULTING (MANAGEMENT INFORMATION SYSTEMS PLANNING)
PROGRAMMING LANGUAGE DEVELOPMENT (CONSULTANTS)
PROGRAMMING LANGUAGE DEVELOPMENT (PROPRIETARY SOFTWARE PRODUCTS)
SERVICES, MANAGEMENT INFORMATION SYSTEMS

COMRESS INC. 301-948-8000
No 2 Research Court, Rockville, Md 20850
TELEX 89-2454

ANALYZERS, COMPUTER PERFORMANCE
CONSULTING (ACCOUNTING, BUSINESS AND COMMERCIAL APPLICATIONS)
CONSULTING (ADVANCED COMPUTER EQUIPMENT DESIGN AND FEASIBILITY STUDIES)
CONTINUED

3 Manufacturers' Directory

CONSULTING (COMPUTER EVALUATIONS, SELECTIONS, INSTALLATION PLANNING)
 CONSULTING (DATA COMMUNICATIONS SYSTEMS PLANNING)
 CONSULTING (COMPUTER PRODUCT PLANNING SURVEYS, MARKET RESEARCH STUDIES)
 CONSULTING (MANAGEMENT INFORMATION SYSTEMS PLANNING)
 TEST SYSTEMS, COMPUTER PERFORMANCE

COMSERV CORP. 215-387-3600
 4025 Chestnut St, Philadelphia, Pa 19104

CONSULTING (ACCOUNTING, BUSINESS AND COMMERCIAL APPLICATIONS)
 CONSULTING (MANAGEMENT INFORMATION SYSTEMS PLANNING)
 CONSULTING (SCIENTIFIC APPLICATIONS)
 SERVICES, MANAGEMENT INFORMATION SYSTEMS
 SERVICES, PROCESSING (COMMERCIAL EDP)
 SERVICES, PROCESSING (ANALOG OR HYBRID, SCIENTIFIC)
 SERVICES, PROCESSING (DIGITAL SCIENTIFIC)
 SERVICES, TIME SHARING (COMMERCIAL)
 SERVICES, TIME SHARING (RESEARCH)

COM-SHARE INC. 313-761-4040
 P O Box 1588, Ann Arbor, Mich 48106

SERVICES, COMPUTER-AIDED DESIGN
 SERVICES, TIME SHARING (COMMERCIAL)

COMSI INC. 312-654-4262
 1211 W 22 St, Oakbrook, Ill 60521

CONSULTING (ACCOUNTING, BUSINESS AND COMMERCIAL APPLICATIONS)
 CONSULTING (ADVANCED COMPUTER EQUIPMENT DESIGN AND FEASIBILITY STUDIES)
 CONSULTING (COMPUTER EVALUATIONS, SELECTIONS, INSTALLATION PLANNING)
 CONSULTING (DATA COMMUNICATIONS SYSTEMS PLANNING)
 SERVICES, FACILITY MANAGEMENT
 SERVICES, PROCESSING (COMMERCIAL EDP)
 TRAINING INSTITUTES, COMMERCIAL COMPUTER COURSES, SEMINARS, CORRESPONDENCE COURSES

COMSONIC CORP., THE 201-825-1800
 123 Pleasant Ave, Upper Saddle R, N J 07458

CONSULTING (ACCOUNTING, BUSINESS AND COMMERCIAL APPLICATIONS)
 CONSULTING (ADVANCED COMPUTER EQUIPMENT DESIGN AND FEASIBILITY STUDIES)
 CONSULTING (DATA COMMUNICATIONS SYSTEMS PLANNING)
 SERVICES, TIME SHARING (COMMERCIAL)
 SERVICES, HARDWARE MAINTENANCE
 SERVICES, SYSTEMS ANALYSIS

COMTECH NEW ENGLAND INC. 617-899-5560
 534 Boston Post Rd, Wayland, Mass 01778

CONSULTING (ACCOUNTING, BUSINESS AND COMMERCIAL APPLICATIONS)
 CONSULTING (MANAGEMENT INFORMATION SYSTEMS PLANNING)
 SERVICES, MANAGEMENT INFORMATION SYSTEMS
 SERVICES, PROCESSING (COMMERCIAL EDP)

COMTEK ASSOCIATES 201-944-9266
 2077 Center Ave, Fort Lee, N J 07024

CONSULTING (ACCOUNTING, BUSINESS AND COMMERCIAL APPLICATIONS)
 CONSULTING (DATA COMMUNICATIONS SYSTEMS PLANNING)
 CONSULTING (MANAGEMENT INFORMATION SYSTEMS PLANNING)
 CONSULTING (SCIENTIFIC APPLICATIONS)
 PROGRAMMING LANGUAGE DEVELOPMENT (CONSULTANTS)
 PROGRAMMING LANGUAGE DEVELOPMENT (CONTRACT PROGRAMMING)
 PROGRAMMING LANGUAGE DEVELOPMENT (DEDICATED APPLICATION SYSTEMS)
 PROGRAMMING LANGUAGE DEVELOPMENT (PROPRIETARY SOFTWARE PRODUCTS)
 SERVICES, MANAGEMENT INFORMATION SYSTEMS
 SERVICES, SYSTEMS ANALYSIS

CONCORD CONTROL INC. 617-254-5106
 1282 Soldier Field Rd, Boston, Mass 02135

PLOTTERS, FILM EXPOSING
 CURVE TRACERS-DIGITIZERS, AUTOMATIC
 CURVE TRACERS-DIGITIZERS, MANUAL
 DIGITIZERS, PROGRAMMABLE
 DRAFTING SYSTEMS, COMPUTER-CONTROLLED STORAGE
 PLOTTERS, MOVING PEN (DIGITAL CONTROLLER)
 RECORDERS, GRAPHIC

CONDATA INC. 215-569-4240
 1809 Walnut St, Philadelphia, Pa 19103

CONSULTING (ACCOUNTING, BUSINESS AND COMMERCIAL APPLICATIONS)
 CONSULTING (DATA COMMUNICATIONS SYSTEMS PLANNING)
 LEASING, EDP EQUIPMENT (OTHER THAN MFGRS)
 PROGRAMMING LANGUAGE DEVELOPMENT (CONSULTANTS)
 PROGRAMMING LANGUAGE DEVELOPMENT (CONTRACT PROGRAMMING)
 PROGRAMMING LANGUAGE DEVELOPMENT (PROPRIETARY SOFTWARE PRODUCTS)
 SERVICES, FACILITY MANAGEMENT
 SERVICES, PROCESSING (COMMERCIAL EDP)
 SERVICES, SYSTEMS ANALYSIS
 TRAINING SYSTEMS, COMPUTER SERVICE

CONDUCTORLAB, INC. 617-448-5922
 Main St, Groton, Mass 01450

BOARDS, PRINTED CIRCUIT (WITHOUT COMPONENTS)
 CIRCUIT CARDS, LINEAR (WITH DISCRETE COMPONENTS)
 CIRCUIT CARDS, LINEAR (WITH IC'S)
 CIRCUIT CARDS, LOGIC (WITH DISCRETE COMPONENTS)
 CIRCUIT CARDS, LOGIC (WITH IC'S)

CONNECTICUT TECHNICAL CORP. 203-522-6167
 3000 Main St, Hartford, Conn 06120

CONVERTERS, MAGNETIC TAPE-TO-PAPER TAPE
 CONVERTERS, PAPER TAPE-TO-MAGNETIC TAPE
 CONVERTERS, PAPER TAPE-TO-PAPER TAPE
 CONVERTERS, PAPER TAPE-TO-PRINTER
 DATA TERMINALS, BLOCK-BY-BLOCK (PAPER TAPE)
 DATA TERMINALS, BLOCK-BY-BLOCK (TELEPRINTER)
 DATA TERMINALS, INQUIRY-RESPONSE (ALPHANUMERIC KEYBOARD)
 DATA TERMINALS, INQUIRY-RESPONSE (SPECIAL-PURPOSE)
 ENCODERS, DIGITAL
 ENCODERS, KEYBOARD (ALPHANUMERIC)
 ENCODERS, KEYBOARD (NUMERIC)
 ENCODERS, KEYBOARD-TO-MAGNETIC TAPE
 ENCODERS, KEYBOARD-TO-PAPER TAPE
 ENCODERS, KEYBOARD-TO-PRINTED TAPE
 PERFORATORS, PAPER TAPE
 PRINTER/PUNCH, PAPER TAPE
 PRINTERS, DIGITAL STRIP RECORDING
 PRINTERS, KEYBOARD
 PRINTERS, LINE (LOW & MEDIUM SPEED)
 TYPEWRITERS, COMPUTER INPUT-OUTPUT

CONRAC CORP. 212-687-3330
 330 Madison Ave, New York, N Y 10017

COMMUNICATION SYSTEMS, DATA TRANSMISSION
 CONVERTERS, SYNCHRO-TO-DIGITAL
 COUNTERS, DIGITAL READOUT
 DATA TERMINALS, INQUIRY-RESPONSE (ALPHANUMERIC KEYBOARD)
 DATA TERMINALS, INQUIRY-RESPONSE (CRT WITH KEYBOARD)
 ENCODERS, DIGITAL
 ENCODERS, SHAFT ANGLE
 INDICATORS, ALPHANUMERIC
 INDICATORS, ELAPSED TIME
 MONITORS, TV
 MOTORS, STEPPING
 MOTORS, SYNCHRONOUS
 READOUTS AND DISPLAYS, NUMERIC AND ALPHANUMERIC (OTHER THAN CRT)
 READOUTS, CRT
 TIMERS, EVENT (IMPULSE)
 TIMERS, INTERVAL

CONRAC CORP. CONRAC DIV. 213-966-3511
 600 N Rimsdale Ave, Covina, Cal 91722

INDICATORS, ALPHANUMERIC
 INDICATORS, DIGITAL
 INDICATORS, ELAPSED TIME
 MONITORS, TV
 READOUTS AND DISPLAYS, NUMERIC AND ALPHANUMERIC (OTHER THAN CRT)

CONRAC CORP. CRAMER DIV. 203-388-3574
 Mill Rock Rd, Old Saybrook, Conn 06475

COUNTERS, DIGITAL READOUT
 INDICATORS, ELAPSED TIME
 MOTORS, SYNCHRONOUS
 READOUTS AND DISPLAYS, NUMERIC AND ALPHANUMERIC (OTHER THAN CRT)
 TIMERS, EVENT (IMPULSE)
 TIMERS, INTERVAL

3 Manufacturers' Directory

CONRAC CORP. DATEX DIV. 213-359-5381
 1600 S Mountain Ave, Duarte, Cal 91010

COMMUNICATION SYSTEMS, DATA TRANSMISSION
 COMMUNICATION SYSTEMS, TELEPRINTER
 DISPLAY DRIVERS
 READOUTS AND DISPLAYS, NUMERIC AND ALPHANUMERIC (OTHER THAN CRT)

CONRAC CORP. NEW JERSEY DIV. 201-226-7777
 Sherwood Ln, Fairfield, N J 07006 TWX 710-734-4356
 COMPUTERS, SPECIAL PURPOSE
 CONVERTERS, ANALOG-TO-DIGITAL

CONRAC CORP. INSTRUMENT/ CONTROLS DIV. 213-359-9141
 1600 S Mountain Ave, Duarte, Cal 91010 TWX 910-585-3247
 CONVERTERS, ANALOG-TO-DIGITAL
 ENCODERS, DIGITAL
 ENCODERS, SHAFT ANGLE
 MONITORS, TV
 TRANSDUCERS, DIGITAL

CONSAD RESEARCH CORP. 412-521-9600
 5600 Forward Ave, Pittsburgh, Pa 15217

CONSULTING (ACCOUNTING, BUSINESS AND COMMERCIAL APPLICATIONS)
 CONSULTING (COMPUTER EVALUATIONS, SELECTIONS, INSTALLATION PLANNING)
 CONSULTING (DATA COMMUNICATIONS SYSTEMS PLANNING)
 CONSULTING (MANAGEMENT INFORMATION SYSTEMS PLANNING)
 CONSULTING (SCIENTIFIC APPLICATIONS)
 INSTRUCTIONAL SYSTEMS, COMPUTER-BASED
 PROGRAMMING LANGUAGE DEVELOPMENT (CONSULTANTS)
 PROGRAMMING LANGUAGE DEVELOPMENT (CONTRACT PROGRAMMING)
 PROGRAMMING LANGUAGE DEVELOPMENT (DEDICATED APPLICATION SYSTEMS)
 PROGRAMMING LANGUAGE DEVELOPMENT (PROPRIETARY SOFTWARE PRODUCTS)
 SERVICES, MANAGEMENT INFORMATION SYSTEMS

CONSENTIVE INC. 215-382-6715
 3525 Lancaster Ave, Philadelphia, Pa 19104

CONSULTING (ACCOUNTING, BUSINESS AND COMMERCIAL APPLICATIONS)
 CONSULTING (COMPUTER EVALUATIONS, SELECTIONS, INSTALLATION PLANNING)
 CONSULTING (COMPUTER PRODUCT PLANNING SURVEYS, MARKET RESEARCH STUDIES)
 CONSULTING (MANAGEMENT INFORMATION SYSTEMS PLANNING)
 CONSULTING (SCIENTIFIC APPLICATIONS)
 SERVICES, MANAGEMENT INFORMATION SYSTEMS
 SERVICES, PROCESSING (COMMERCIAL EDP)
 SERVICES, TIME SHARING (COMMERCIAL)
 SERVICES, TIME SHARING (RESEARCH)
 SERVICES, SYSTEMS ANALYSIS

CONSOLIDATED ANALYSIS CENTERS, INC., 213-451-5771
 225 Santa Monica Blvd, Santa Monica, Cal 90401 TWX 910-343-6446

CONSULTING (COMPUTER EVALUATIONS, SELECTIONS, INSTALLATION PLANNING)
 CONSULTING (MANAGEMENT INFORMATION SYSTEMS PLANNING)
 PROGRAMMING LANGUAGE DEVELOPMENT (PROPRIETARY SOFTWARE PRODUCTS)
 TRAINING INSTITUTES, COMMERCIAL COMPUTER COURSES, SEMINARS, CORRESPONDENCE COURSES

CONSOLIDATED COMPUTER INTERNATIONAL INC. 617-891-7100
 235 Wyman St, Waltham, Mass 02154

ENCODERS, KEYBOARD-TO-MAGNETIC DISC
 ENCODERS, KEYBOARD-TO-MAGNETIC TAPE
 SERVICES, TIME SHARING (COMMERCIAL)

CONSOLIDATED COMPUTER LTD. 416-366-7643
 48 Yonge St, Toronto, CANADA TWX 610-491-4213
 PROGRAMMING LANGUAGE DEVELOPMENT (DEDICATED APPLICATION SYSTEMS)
 SERVICES, TIME SHARING (COMMERCIAL)

CONSOLIDATED CONTROLS CORP. 203-743-6721
 15 Durant Ave, Bethel, Conn 06801 TWX 710-456-0446
 INDICATORS, DIGITAL
 VOLTMETERS, DIGITAL

CONSOLIDATED WIRE AND ASSOCIATED CORPS. 312-421-4441
 1635 S Clinton St, Chicago, Ill 60616

CABLE, COAXIAL (FLEXIBLE)
 CABLE, COAXIAL (SEMI/RIGID)
 CABLE, FINE LEAD
 CABLE, FLAT, PRINTED AND RIBBON
 CABLE, MULTICONDUCTOR
 CABLE, SHIELDED (NOT COAXIAL)

CONSOLIDATED OHMIC DEVICES INC. 516-741-1500
 115 Old Country Rd, Carle Place, N Y 11514 TWX 510-222-3789

AMPLIFIERS, D.C.
 AMPLIFIERS, INSTRUMENTATION
 CIRCUIT CARDS, LOGIC (WITH DISCRETE COMPONENTS)
 CIRCUIT CARDS, LOGIC (WITH IC'S)
 DIGITIZERS, PROGRAMMABLE
 MODULES, RESISTANCE NETWORKS (ENCAPSULATED)
 SIGNAL CONDITIONERS
 THERMOCOUPLE REFERENCE SYSTEMS

CONSTANTINE ENGINEERING LABS CELCO 201-327-1123
 70 Constantine Dr, Mahwah, N J 07430 TWX 710-988-1018

AMPLIFIERS, D.C.
 AMPLIFIERS, VIDEO
 CRT DEFLECTION YOKES
 DISPLAY DRIVERS
 DISPLAYS, MAGNETIC
 READOUTS, CRT

CONSULTANTS ASSOCIATED INC. 617-245-0148
 Lakeside Office Park, Wakefield, Mass 01880

CONSULTING (ACCOUNTING, BUSINESS AND COMMERCIAL APPLICATIONS)
 CONSULTING (ADVANCED COMPUTER EQUIPMENT DESIGN AND FEASIBILITY STUDIES)
 CONSULTING (COMPUTER EVALUATIONS, SELECTIONS, INSTALLATION PLANNING)
 CONSULTING (DATA COMMUNICATIONS SYSTEMS PLANNING)
 CONSULTING (MANAGEMENT INFORMATION SYSTEMS PLANNING)
 PROGRAMMING LANGUAGE DEVELOPMENT (CONTRACT PROGRAMMING)
 PROGRAMMING LANGUAGE DEVELOPMENT (PROPRIETARY SOFTWARE PRODUCTS)
 SERVICES, FACILITY MANAGEMENT
 SERVICES, SYSTEMS ANALYSIS
 TRAINING INSTITUTES, COMMERCIAL COMPUTER COURSES, SEMINARS, CORRESPONDENCE COURSES

CONSUMER SYSTEMS CORP. 312-325-2102
 15 Spinning Wheel Rd, Hinsdale, Ill 60521

CONSULTING (ACCOUNTING, BUSINESS AND COMMERCIAL APPLICATIONS)
 CONSULTING (ADVANCED COMPUTER EQUIPMENT DESIGN AND FEASIBILITY STUDIES)
 CONSULTING (COMPUTER EVALUATIONS, SELECTIONS, INSTALLATION PLANNING)
 CONSULTING (DATA COMMUNICATIONS SYSTEMS PLANNING)
 CONSULTING (COMPUTER PRODUCT PLANNING SURVEYS, MARKET RESEARCH STUDIES)
 CONSULTING (MANAGEMENT INFORMATION SYSTEMS PLANNING)
 CONSULTING (SCIENTIFIC APPLICATIONS)
 PROGRAMMING LANGUAGE DEVELOPMENT (CONSULTANTS)
 PROGRAMMING LANGUAGE DEVELOPMENT (CONTRACT PROGRAMMING)
 PROGRAMMING LANGUAGE DEVELOPMENT (DEDICATED APPLICATION SYSTEMS)
 PROGRAMMING LANGUAGE DEVELOPMENT (PROPRIETARY SOFTWARE PRODUCTS)
 SERVICES, COMPUTER-AIDED DESIGN
 SERVICES, FACILITY MANAGEMENT
 SERVICES, MANAGEMENT INFORMATION SYSTEMS
 SERVICES, PROCESSING (COMMERCIAL EDP)
 SERVICES, SYSTEMS ANALYSIS

CONTACT SYSTEMS INC. 203-743-3837
 97 Golden Hill Rd, Danbury, Conn 06810

SERVICES, AUTOMATED WIRE-WRAPPING

CONTINENTAL CONNECTOR CORP. 212-899-4422
 34-63 56th St, Woodside, N Y 11377 TWX 710-582-2565

CONNECTORS, MINIATURE AND SUB-MINIATURE (COMPUTER-GRADE)
 CONNECTORS, PC AND IC BOARD (COMPUTER-GRADE)
 CONNECTORS, POWER (COMPUTER-GRADE)
 CONNECTORS, RACK AND PANEL (COMPUTER-GRADE)
 TERMINAL BLOCKS, STRIPS, BOARDS

3 Manufacturers' Directory

CONTINENTAL DATA PROCESSING INC. 717-288-1461
300 Market St., Kingston, Pa 18704

CONSULTING (ACCOUNTING, BUSINESS AND COMMERCIAL APPLICATIONS)
CONSULTING (COMPUTER EVALUATIONS, SELECTIONS, INSTALLATION PLANNING)
CONSULTING (COMPUTER PRODUCT PLANNING SURVEYS, MARKET RESEARCH STUDIES)
CONSULTING (MANAGEMENT INFORMATION SYSTEMS PLANNING)
FORMS, CONTINUOUS (MACHINE PROCESSED)
PAPER (FOR PRINTERS)
SERVICES, FACILITY MANAGEMENT
SERVICES, MANAGEMENT INFORMATION SYSTEMS
SERVICES, PROCESSING (COMMERCIAL EDP)
SERVICES, SYSTEMS ANALYSIS
TRAINING INSTITUTES, COMMERCIAL COMPUTER COURSES, SEMINARS, CORRESPONDENCE COURSES

CONTROL DATA CORP. 612-888-5555
8100 34th Ave S, Minneapolis, Minn 55440 TWX 910-576-2408

CAMERAS, COM
CERTIFIERS, MAGNETIC TAPE
COMMUNICATIONS-ORIENTED PROCESSORS, MULTIPLE CHANNEL CONTROLLERS
COMMUNICATIONS-ORIENTED PROCESSORS, SINGLE CHANNEL CONTROLLERS
COMMUNICATIONS-ORIENTED PROCESSORS, STORED PROGRAM
COMMUNICATION SYSTEMS, DATA TRANSMISSION
COMMUNICATION SYSTEMS, TELEPRINTER
COMPUTERS, DIGITAL (GENERAL-PURPOSE, SMALL-SCALE)
COMPUTERS, DIGITAL (GENERAL-PURPOSE, MEDIUM-SCALE)
COMPUTERS, DIGITAL (GENERAL-PURPOSE, LARGE SCALE)
COMPUTERS, FIRE CONTROL
COMPUTERS, NAVIGATION
COMPUTERS, PROCESS CONTROL
CONSOLES, CRT (ALPHANUMERIC AND GRAPHIC)
CONSOLES, CRT (GRAPHIC)
CONTROLLERS, MAGNETIC TAPE
CONTROLLERS, MODEM
CONVERTERS, ANALOG-TO-DIGITAL
CONVERTERS, DIGITAL-TO-ANALOG
DATA ACQUISITION AND REDUCTION SYSTEMS
DATA TERMINALS, BLOCK-BY-BLOCK (MAGNETIC TAPE)
DATA TERMINALS, BLOCK-BY-BLOCK (MULTI-PURPOSE)
DATA TERMINALS, BLOCK-BY-BLOCK (PAPER TAPE)
DATA TERMINALS, BLOCK-BY-BLOCK (HIGH SPEED PRINTER)
DATA TERMINALS, BLOCK-BY-BLOCK (MEDIUM SPEED PRINTER)
DATA TERMINALS, BLOCK-BY-BLOCK (PUNCHED CARD)
DATA TERMINALS, BLOCK-BY-BLOCK (TELEPRINTER)
DATA TERMINALS, INQUIRY-RESPONSE (ALPHANUMERIC KEYBOARD)
DATA TERMINALS, INQUIRY-RESPONSE (BADGE-TOKEN READERS)
DATA TERMINALS, INQUIRY-RESPONSE (CRT WITH KEYBOARD)
DATA TERMINALS, INQUIRY-RESPONSE (SPECIAL-PURPOSE)
DISC DRIVES, MOVABLE HEAD (INCLUDING CONTROLLER)
DISC DRIVES, REMOVABLE CARTRIDGE
DISC STORAGE SYSTEMS
DRUM STORAGE EQUIPMENT, MAGNETIC (INCLUDING CONTROLLER)
FLOOR PLANNING AIDS (FOR EDP ROOMS)
LIGHT PENS (FOR CRT TERMINAL INPUT/OUTPUT)
MAGNETIC TAPE STORAGE SYSTEMS (INCLUDES CONTROLLER)
MEMORY SYSTEMS, MAGNETIC DISC
MEMORY SYSTEMS, MAGNETIC DRUM
MODEMS, HARD-WIRED
PLOTTERS, MOVING PEN (DIGITAL CONTROLLER)
PRINTERS, LINE (HIGH SPEED)
READERS, PAYMENT COUPONS
READOUTS, CRT
RECORDERS, GRAPHIC
RECORDERS, HARD-COPY (WITH CRT)
RECORDERS, MICROFILM/MICROFICHE
TAPE TRANSPORTS, MAGNETIC (DIGITAL-EXCL. CASSETTE)
TAPE TRANSPORTS, MAGNETIC (DIGITAL CASSETTE)

CONTROL DATA CORP. CEIR PROF. SERV. DIV. 301-652-2268
5272 River Rd, Washington, D C 20016 TWX 710-824-9610

CONSULTING (ACCOUNTING, BUSINESS AND COMMERCIAL APPLICATIONS)
CONSULTING (COMPUTER EVALUATIONS, SELECTIONS, INSTALLATION PLANNING)
CONSULTING (DATA COMMUNICATIONS SYSTEMS PLANNING)
CONSULTING (MANAGEMENT INFORMATION SYSTEMS PLANNING)
CONSULTING (SCIENTIFIC APPLICATIONS)
SERVICES, MANAGEMENT INFORMATION SYSTEMS
SERVICES, SYSTEMS ANALYSIS

CONTROL DATA CORP. CIRCUITS DIV. 612-920-8600
7800 Computer Ave, Minneapolis, Minn 55435 TWX 910-576-2852

BOARDS, PRINTED CIRCUIT (WITHOUT COMPONENTS)
CIRCUITS, HYBRID (IC AND DISCRETE-DIGITAL)
CIRCUITS, MONOLITHIC (DIGITAL LOGIC)
CIRCUITS, MONOLITHIC (DIODE MATRICES)
CIRCUITS, MONOLITHIC (LSI-BIPOLAR)
CONTINUED

CIRCUITS, THICK FILM (DIGITAL)
CIRCUITS, THIN FILM (DIGITAL)
DIODES, SILICON
MODULES, DIGITAL LOGIC ENCAPSULATED (ALSO SEE CIRCUITS & CIRCUIT CARDS)
MODULES, RESISTANCE NETWORKS (ENCAPSULATED)
TRANSISTORS, SILICON

CONTROL DATA CORP. CONNECTOR OPERATION 213-889-3535
31829 W Latienda Dr, Westlake Vil, Cal 91360

BUS BAR SYSTEMS
CABLE ASSEMBLIES (WITH CONNECTORS)
CONNECTORS, COAXIAL (COMPUTER-GRADE)
CONNECTORS, MINIATURE AND SUB-MINIATURE (COMPUTER-GRADE)
CONNECTORS, PC AND IC BOARD (COMPUTER-GRADE)
CONNECTORS, POWER (COMPUTER-GRADE)
CONNECTORS, RACK AND PANEL (COMPUTER-GRADE)
PANELS, POWER DISTRIBUTION
TERMINAL BLOCKS, STRIPS, BOARDS

CONTROL DATA CORP. MAGNETIC COMPONENTS DIV. 612-545-2851
2300 Berkshire Lane, Minneapolis, Minn 55427 TWX 910-576-3434

DISPLAYS, MAGNETIC
INDICATORS, DIGITAL
MOTORS, SERVO
POWER SUPPLIES, AC
POWER SUPPLIES, DC

CONTROL DATA CORP. TERMINAL SUBSYS.DIV 612-633-0371
2401 N Fairview Ave, St Paul, Minn 55113

CONSOLES, CRT (ALPHANUMERIC AND GRAPHIC)
CONSOLES, CRT (GRAPHIC)
DATA TERMINALS, INQUIRY-RESPONSE (ALPHANUMERIC KEYBOARD)
DATA TERMINALS, INQUIRY-RESPONSE (BADGE-TOKEN READERS)
DATA TERMINALS, INQUIRY-RESPONSE (CRT WITH KEYBOARD)
RECORDERS, HARD-COPY (WITH CRT)
RECORDERS, MICROFILM/MICROFICHE

CONTROL DEVICES INC. 617-935-1105
204 New Boston St, Woburn, Mass 01801

ENCODERS, KEYBOARD (ALPHANUMERIC)
ENCODERS, KEYBOARD (NUMERIC)

CONTROL EQUIPMENT CORP. 617-444-7550
32 Kearney Rd, Needham Heights, Mass 02194

CLOCKS, DIGITAL (REAL-TIME)
COMMUTATORS, SWITCHING (ELECTRIC)
CONVERTERS, ANALOG-TO-DIGITAL
CONVERTERS, BINARY-TO-DECIMAL
CONVERTERS, DC-TO-FREQUENCY
CONVERTERS, VOLTAGE-TO-FREQUENCY
COUNTERS, DECADE
COUNTERS, DIGITAL READOUT
COUNTERS, UP-DOWN
MULTIPLEXERS, ANALOG-RELAY (SEQUENTIAL SAMPLING)
MULTIPLEXERS, DIGITAL

CONTROL LOGIC INC. 617-655-1170
3 Strathmore Rd, Natick, Mass 01760 TWX 710-786-6677

CIRCUIT CARDS, LOGIC (WITH DISCRETE COMPONENTS)
CIRCUIT CARDS, LOGIC (WITH IC'S)
CONVERTERS, ANALOG-TO-DIGITAL
CONVERTERS, DIGITAL-TO-ANALOG
HANDLES, TEST POINT STRIPS (FOR CIRCUIT CARDS)
MODULES, DIGITAL LOGIC ENCAPSULATED (ALSO SEE CIRCUITS & CIRCUIT CARDS)
SCANNERS, OPTICAL
SERVICES, AUTOMATED WIRE-WRAPPING
TESTERS, DIGITAL LOGIC MODULES AND CARDS

CONTROL TECHNOLOGY CO., INC. 212-361-2133
41-16 29th St, Long Island Cty, N Y 11101

AMPLIFIERS, D.C.
AMPLIFIERS, INSTRUMENTATION
CONTROLLERS, MOTOR
CONVERTERS, ANALOG-TO-DIGITAL
CONVERTERS, DC-TO-FREQUENCY
CONVERTERS, DIGITAL-TO-ANALOG
CONVERTERS, DIGITAL-TO-SYNCHRO
INDICATORS, DIGITAL
CONTINUED

3 Manufacturers' Directory

INDICATORS, ILLUMINATED
INVERTERS, DC-AC

CONTROL TECHNOLOGY INC. 213-426-4587
3450 E Spring St, Long Beach, Cal 90806

CONSULTING (ACCOUNTING, BUSINESS AND COMMERCIAL APPLICATIONS)
CONSULTING (ADVANCED COMPUTER EQUIPMENT DESIGN AND FEASIBILITY STUDIES)
CONSULTING (COMPUTER EVALUATIONS, SELECTIONS, INSTALLATION PLANNING)
CONSULTING (DATA COMMUNICATIONS SYSTEMS PLANNING)
CONSULTING (MANAGEMENT INFORMATION SYSTEMS PLANNING)
CONSULTING (SCIENTIFIC APPLICATIONS)
PROGRAMMING LANGUAGE DEVELOPMENT (CONSULTANTS)
PROGRAMMING LANGUAGE DEVELOPMENT (CONTRACT PROGRAMMING)
PROGRAMMING LANGUAGE DEVELOPMENT (DEDICATED APPLICATION SYSTEMS)
PROGRAMMING LANGUAGE DEVELOPMENT (PROPRIETARY SOFTWARE PRODUCTS)
SERVICES, COMPUTER-AIDED DESIGN
SERVICES, MANAGEMENT INFORMATION SYSTEMS
SERVICES, PROCESSING (COMMERCIAL EDP)
SERVICES, PROCESSING (ANALOG OR HYBRID, SCIENTIFIC)
SERVICES, PROCESSING (DIGITAL SCIENTIFIC)
SERVICES, SYSTEMS ANALYSIS
TRAINING INSTITUTES, COMMERCIAL COMPUTER COURSES, SEMINARS, CORRESPONDENCE COURSES

CONTROLS CO. AMERICA-SINGER CONTROL SWITCH DIV. 215-586-7500
1420 Delmar Dr, Folcroft, Pa 19032 TWX 510-669-2136

INDICATORS, ILLUMINATED
LAMPS-PANEL, PILOT AND DIAL (INCANDESCENT)
SWITCHES, PUSHBUTTON
SWITCHES, PUSHBUTTON (ILLUMINATED)
SWITCHES, SNAP ACTION
SWITCHES, TOGGLE (MINIATURE)

CONTROLS RESEARCH CORP. 714-557-7161
2100 S Fairview, Santa Ana, Cal 92704

ENCODERS, KEYBOARD (ALPHANUMERIC)
ENCODERS, KEYBOARD (NUMERIC)
SWITCHES, DRY REED
SWITCHES, PUSHBUTTON
SWITCHES, PUSHBUTTON (ILLUMINATED)

COOK ELECTRIC CO. DATA-STOR DIV. 312-967-6600
6201 W Oakton St, Morton Grove, Ill 60053 TWX 910-223-3654

READERS, PAPER TAPE
RECORDERS, MAGNETIC TAPE
TAPE TRANSPORTS, MAGNETIC (DIGITAL-EXCL. CASSETTE)
TESTERS, MAGNETIC TAPE TRANSPORTS

COOPER DATA SYSTEMS INC. 504-525-3352
826 Union St, New Orleans, La 70112

CONSULTING (ACCOUNTING, BUSINESS AND COMMERCIAL APPLICATIONS)
SERVICES, PROCESSING (COMMERCIAL EDP)
SERVICES, SYSTEMS ANALYSIS

CO-ORD SWITCH CO., DIV. LVC INDUSTRIES, INC. 212-899-5588
102-48 43rd Ave, Corona, N Y 11368

INDICATORS, ILLUMINATED
LAMPS, GLOW
LAMPS-PANEL, PILOT AND DIAL (INCANDESCENT)
READOUTS AND DISPLAYS, NUMERIC AND ALPHANUMERIC (OTHER THAN CRT)
SWITCHES, PUSHBUTTON (ILLUMINATED)
SWITCHES, THUMBWHEEL
TERMINAL BLOCKS, STRIPS, BOARDS

COPYING PRODUCTS DIV., CLOPAY CORP. 513-421-5200
417 E Seventh St, Cincinnati, Ohio 45201

RIBBONS, INK (FOR PRINTERS AND TAB EQUIPMENT)

CORE MEMORIES INC. 415-964-4000
2525 Charleston Rd, Mt View, Cal 94041 TELEX 34-8396

CORES, FERRITE MEMORY
MEMORY PLANES AND STACKS, MAG-NETIC CORE (W/O ELECTRONICS)
MEMORY SYSTEMS, MAGNETIC CORE

CORNELL ENGINEERING INC. 617-289-4200
210 Broadway, Everett, Mass 02149

PROCESSORS, MICROFILM

CORNELL-DUBILIER ELECTRONICS 201-589-7500
150 Avenue L, Newark, N J 07101 TELEX 03-8366
CAPACITORS, COMPUTER GRADE

CORNING GLASS WORKS 607-962-4444
Houghton Park, Corning, N Y 14830 TWX 510-252-1384

CAPACITORS, COMPUTER GRADE
CONSOLES, CRT (ALPHANUMERIC AND GRAPHIC)
DATA TERMINALS, INQUIRY-RESPONSE (CRT WITH KEYBOARD)
DELAY LINES, GLASS (ALSO SEE MEMORIES)
FIBER OPTIC BUNDLES
FIBER OPTICS ASSEMBLIES (FOR PUNCHED CODE READERS AND MARK SENSORS)
MEMORY SYSTEMS, DELAY LINE
PRINTER/PUNCH, PAPER TAPE
READERS, PAPER TAPE
REELS, MAGNETIC TAPE

CORPORATE DATA PROCESSING 213-666-1957
1724 Silver Lake Blvd, Los Angeles, Cal 90026

CONSULTING (ACCOUNTING, BUSINESS AND COMMERCIAL APPLICATIONS)
CONSULTING (MANAGEMENT INFORMATION SYSTEMS PLANNING)
PROGRAMMING LANGUAGE DEVELOPMENT (CONTRACT PROGRAMMING)
PROGRAMMING LANGUAGE DEVELOPMENT (DEDICATED APPLICATION SYSTEMS)
PROGRAMMING LANGUAGE DEVELOPMENT (PROPRIETARY SOFTWARE PRODUCTS)
SERVICES, FACILITY MANAGEMENT
SERVICES, PROCESSING (COMMERCIAL EDP)
SERVICES, TIME SHARING (COMMERCIAL)
SERVICES, SYSTEMS ANALYSIS

COUNTIS INDUSTRIES 805-544-1770
Po Box 1444, San Luis Obispo, Cal 93401

POLE PIECES, FERRITE

CREATED SPACE INC. 212-594-3970
16 W 40th St, New York, N Y 10018

AIR CONDITIONERS (FOR EDP INSTALLATIONS)

CREATIVE MAGNETICS INC. 516-234-6300
210 Blydenburgh Rd, Central Islip, N Y 11722

RECORDING HEADS, MAGNETIC DISC
RECORDING HEADS, MAGNETIC DRUM
RECORDING HEADS, MAGNETIC TAPE

CREDIT SYSTEMS INC. 215-822-3371
P O Box 105, Colmar, Pa 18915

COMMUNICATION SYSTEMS, DATA TRANSMISSION
COMPUTERS, DIGITAL (GENERAL-PURPOSE, SMALL-SCALE)
CONSULTING (ACCOUNTING, BUSINESS AND COMMERCIAL APPLICATIONS)
CONTROLLERS, MODEM
DATA TERMINALS, INQUIRY-RESPONSE (AUDIO RESPONSE)
DATA TERMINALS, INQUIRY-RESPONSE (BADGE-TOKEN READERS)
DATA TERMINALS, INQUIRY-RESPONSE (SPECIAL-PURPOSE)
MODEMS, HARD-WIRED
TESTERS, DIGITAL LOGIC MODULES AND CARDS

CSI COMPUTER SYSTEMS INC. 606-371-5005
P O Box 75008, Cincinnati, Ohio 45275

CONSULTING (ACCOUNTING, BUSINESS AND COMMERCIAL APPLICATIONS)
SERVICES, MANAGEMENT INFORMATION SYSTEMS

CTC COMPUTER CORP. 415-961-6352
1000 Elwell Court, Palo Alto, Cal 94303

COMPUTERS, DIGITAL (EDUCATIONAL)
CONSULTING (ACCOUNTING, BUSINESS AND COMMERCIAL APPLICATIONS)
CONSULTING (ADVANCED COMPUTER EQUIPMENT DESIGN AND FEASIBILITY STUDIES)
CONSULTING (COMPUTER EVALUATIONS, SELECTIONS, INSTALLATION PLANNING)
CONSULTING (DATA COMMUNICATIONS SYSTEMS PLANNING)
CONSULTING (MANAGEMENT INFORMATION SYSTEMS PLANNING)
CONTINUED

3 Manufacturers' Directory

CONSULTING (SCIENTIFIC APPLICATIONS)
 INSTRUCTIONAL SYSTEMS, COMPUTER-BASED
 PROGRAMMING LANGUAGE DEVELOPMENT (CONSULTANTS)
 PROGRAMMING LANGUAGE DEVELOPMENT (CONTRACT PROGRAMMING)
 PROGRAMMING LANGUAGE DEVELOPMENT (DEDICATED APPLICATION SYSTEMS)
 PROGRAMMING LANGUAGE DEVELOPMENT (PROPRIETARY SOFTWARE PRODUCTS)
 SERVICES, FACILITY MANAGEMENT
 SERVICES, MANAGEMENT INFORMATION SYSTEMS
 SERVICES, PROCESSING (COMMERCIAL EDP)
 SERVICES, PROCESSING (DIGITAL SCIENTIFIC)
 SERVICES, TIME SHARING (COMMERCIAL)
 SERVICES, SYSTEMS ANALYSIS
 TRAINING INSTITUTES, COMMERCIAL COMPUTER COURSES, SEMINARS,
 CORRESPONDENCE COURSES
 TRAINING SYSTEMS, CARD PUNCH
 TRAINING SYSTEMS, COMPUTER SERVICE

CTM LEASING CORP. 301-656-6374
 4924 Hampden Lane, Bethesda, Md 20014

CERTIFIERS, MAGNETIC TAPE
 CLEANER/CERTIFIERS, MAGNETIC TAPE
 LEASING, EDP EQUIPMENT (OTHER THAN MFGRS)
 REEL CLIPS AND BELTS, MAGNETIC TAPE
 REELS, MAGNETIC TAPE
 RIBBONS, INK (FOR PRINTERS AND TAB EQUIPMENT)
 SPLICERS, MAGNETIC TAPE
 TAPE, MAGNETIC (REELS)
 WINDERS, MAGNETIC TAPE

CTS CORP. 219-293-7511
 905 NW Blvd, Elkart, Ind 46514 TWX 810-294-2256

CIRCUITS, THICK FILM (DIGITAL)
 CRYSTAL UNITS, QUARTZ (FOR FREQUENCY CONTROL)
 MODULES, RESISTANCE NETWORKS (ENCAPSULATED)
 OSCILLATORS, VOLTAGE CONTROLLED
 POTENTIOMETERS, TRIM (FILM)
 REGULATORS, VOLTAGE
 SWITCHES, ROTARY
 SWITCHES, SNAP ACTION

CTS KNIGHTS INC. 815-786-8411
 Reimann Ave, Sandwich, Ill 60548 TWX 910-642-0860

CRYSTAL UNITS, QUARTZ (FOR FREQUENCY CONTROL)
 OSCILLATORS, VOLTAGE CONTROLLED

CULLINANE CORP. 617-742-8656
 60 State St, Boston, Mass 02109

PROGRAMMING LANGUAGE DEVELOPMENT (PROPRIETARY SOFTWARE PRODUCTS)

CUMMINS ASSOCIATES, J.J. 716-377-0509
 29 Towpath Trail, Fairport, N Y 14450

CONSULTING (ACCOUNTING, BUSINESS AND COMMERCIAL APPLICATIONS)
 CONSULTING (DATA COMMUNICATIONS SYSTEMS PLANNING)
 CONSULTING (COMPUTER PRODUCT PLANNING SURVEYS, MARKET RESEARCH STUDIES)
 CONSULTING (MANAGEMENT INFORMATION SYSTEMS PLANNING)

CUMMINS-CHICAGO CORP. 312-561-6600
 4740 Ravenswood Ave, Chicago, Ill 60640

FORMS HANDLING, DOCUMENT COUNTERS
 RECONDITIONING EQUIPMENT, PUNCHED CARD
 SCANNERS, OPTICAL

CUNNINGHAM CORP. SUB. GLEASON WORKS 716-624-2000
 10 Carriage St, Honeoye Falls, N Y 14472 TWX 510-254-2402

COMMUTATORS, SWITCHING (ELECTRIC)
 DATA ACQUISITION AND REDUCTION SYSTEMS
 MULTIPLEXERS, ANALOG-RELAY (SEQUENTIAL SAMPLING)

CURRAN COMPUTER CORP. 201-343-3760
 946 Main St, Hackensack, N J 07601

CONSOLES, CRT (ALPHANUMERIC AND GRAPHIC)
 PLOTTERS, FILM EXPOSING
 DRAFTING SYSTEMS, COMPUTER-CONTROLLED STORAGE
 LEASING, EDP EQUIPMENT (OTHER THAN MFGRS)
 MARK SENSING SUPPLIES
 MICROFILM DATA RETRIEVAL SYSTEMS, COMPUTER CONTROLLED (GRAPHIC)
 CONTINUED

PAPER (FOR RECORDERS AND PLOTTERS)
 PLOTTERS, MOVING PEN (DIGITAL CONTROLLER)
 PROCESSORS, MICROFILM
 READER/PRINTER, MICROFILM/MICROFICHE
 SERVICES, COMPUTER-AIDED DESIGN
 SERVICES, PROCESSING (DIGITAL SCIENTIFIC)
 SERVICES, SYSTEMS ANALYSIS
 USED EQUIPMENT (BUYING, SELLING, LEASING)

CURTIS DEVELOPMENT & MANUFACTURING CO. 414-445-1817
 3266 N 33rd St, Milwaukee, Wis 53216 TWX 910-262-3125

CONNECTORS, MINIATURE AND SUB-MINIATURE (COMPUTER-GRADE)
 CONNECTORS, PC AND IC BOARD (COMPUTER-GRADE)
 CONNECTORS, POWER (COMPUTER-GRADE)
 CONNECTORS, RACK AND PANEL (COMPUTER-GRADE)
 SOCKETS, IC MOUNTING
 SOCKETS, PCB MOUNTING

CURTIS INSTRUMENTS INC. 914-666-2971
 200 Kisco Ave, Mt Kisco, N Y 10549

COUNTERS, UP-DOWN
 INDICATORS, ELAPSED TIME

CURTIS 1000 INC. 404-436-6155
 1000 Curtis Dr, Smyrna, Ga 30080 TWX 810-766-4899

AUDIO/VISUAL TRAINING AIDS
 CARDS, MAGNETIC
 ENVELOPES, CONTINUOUS
 FORMS, CONTINUOUS (MACHINE PROCESSED)
 FORMS HANDLING, DETACHERS
 LABELS, CONTINUOUS AND GUMMED (MACHINE APPLICATION)

CUSTOM COMPUTER SYSTEMS INC. 516-293-5353
 40 South Mall, Plainview, N Y 11803

COMPUTERS, DIGITAL (EDUCATIONAL)
 DATA TERMINALS, BLOCK-BY-BLOCK (HIGH SPEED PRINTER)
 MEMORY SYSTEMS, MAGNETIC CORE
 PRINTERS, LINE (LOW & MEDIUM SPEED)
 TEST SYSTEMS, COMPUTER PERFORMANCE

CUSTOM DATA PROCESSING SERVICES 602-272-3867
 P O Box 14685, Phoenix, Ariz 85031

ACCOUNTING MACHINES, CARD-PROGRAMMED
 ACCOUNTING MACHINES, PAPER TAPE PROGRAMMED
 COLLATORS, PUNCHED CARD
 CONSULTING (ACCOUNTING, BUSINESS AND COMMERCIAL APPLICATIONS)
 DUPLICATORS-VERIFIERS, PAPER TAPE
 LEASING, EDP EQUIPMENT (OTHER THAN MFGRS)
 PUNCHES, CARD (EDGE-PUNCHING)
 PUNCHES, CARD (OVER 100 CPM)
 REPRODUCERS, PUNCHED CARD (AUTOMATIC)
 SERVICES, PROCESSING (COMMERCIAL EDP)
 SERVICES, PROCESSING (DIGITAL SCIENTIFIC)
 SERVICES, TIME SHARING (COMMERCIAL)
 SERVICES, TIME SHARING (RESEARCH)
 SORTERS, PUNCHED CARD
 USED EQUIPMENT (BUYING, SELLING, LEASING)
 VERIFIERS, PUNCHED CARD

CUSTOM MATERIALS INC. 617-256-3911
 Alpha Industrial Park, Chelmsford, Mass 01824 TWX 710-343-6929

COATINGS, ANTI-STATIC
 CONTAINERS, DISK PACK STORAGE
 CONTAINERS, PAPER TAPE STORAGE
 FLOORING (FOR EDP ROOMS)
 STATIC ELIMINATION EQUIPMENT

CUTLER-HAMMER, SPECIALTY PRODUCTS DIV. 414-442-7800
 4201 N 27th St, Milwaukee, Wisc 53216 TWX 910-262-3089

SWITCHES, PUSHBUTTON
 SWITCHES, PUSHBUTTON (ILLUMINATED)
 SWITCHES, ROTARY
 SWITCHES, SNAP ACTION
 SWITCHES, TOGGLE (MINIATURE)

CYBERMATICS INC. 201-461-6171
 2460 Lemoine Ave, Fort Lee, N J 07024

CARDS, CONVENTIONAL PUNCH
 CARDS, EDGE-PUNCH
 CARDS, MAGNETIC
 CONTINUED

3 Manufacturers' Directory

CONSULTING (ACCOUNTING, BUSINESS AND COMMERCIAL APPLICATIONS)
 CONSULTING (ADVANCED COMPUTER EQUIPMENT DESIGN AND FEASIBILITY STUDIES)
 CONSULTING (COMPUTER EVALUATIONS, SELECTIONS, INSTALLATION PLANNING)
 CONSULTING (DATA COMMUNICATIONS SYSTEMS PLANNING)
 CONSULTING (MANAGEMENT INFORMATION SYSTEMS PLANNING)
 CONSULTING (SCIENTIFIC APPLICATIONS)
 ENVELOPES, CONTINUOUS
 FORMS, CONTINUOUS (MACHINE PROCESSED)
 FORMS HANDLING, BURSTERS
 LABELS, CONTINUOUS AND GUMMED (MACHINE APPLICATION)
 LEASING, EDP EQUIPMENT (OTHER THAN MFGRS)
 PAPER (FOR PRINTERS)
 PROGRAMMING LANGUAGE DEVELOPMENT (CONSULTANTS)
 PROGRAMMING LANGUAGE DEVELOPMENT (CONTRACT PROGRAMMING)
 PROGRAMMING LANGUAGE DEVELOPMENT (DEDICATED APPLICATION SYSTEMS)
 PROGRAMMING LANGUAGE DEVELOPMENT (PROPRIETARY SOFTWARE PRODUCTS)
 SERVICES, COMPUTER-AIDED DESIGN
 SERVICES, FACILITY MANAGEMENT
 SERVICES, MANAGEMENT INFORMATION SYSTEMS
 SERVICES, SYSTEMS ANALYSIS
 TRAINING INSTITUTES, COMMERCIAL COMPUTER COURSES, SEMINARS, CORRESPONDENCE COURSES

CYBERMATION INC. 215-493-3686
 P O Box 58 River Rd, Washngtn Xing, Pa 18977

ACOUSTIC COUPLERS
 COMMUNICATIONS-ORIENTED PROCESSORS, MULTIPLE CHANNEL CONTROLLERS
 COMMUNICATIONS-ORIENTED PROCESSORS, SINGLE CHANNEL CONTROLLERS
 COMMUNICATIONS-ORIENTED PROCESSORS, STORED PROGRAM
 COMMUNICATION SYSTEMS, DATA TRANSMISSION
 COMPUTERS, MINI GENERAL PURPOSE (ALSO SEE CALCULATORS)
 CONSULTING (ADVANCED COMPUTER EQUIPMENT DESIGN AND FEASIBILITY STUDIES)
 CONTROLLERS, MAGNETIC DISC
 CONVERTERS, PULSE-TO-DIGITAL
 DATA TERMINALS, BLOCK-BY-BLOCK (MULTI-PURPOSE)
 DATA TERMINALS, BLOCK-BY-BLOCK (MEDIUM SPEED PRINTER)
 MODEMS, ACOUSTIC
 MODEMS, HARD-WIRED
 MODEMS, PC CARD
 TESTERS, INTEGRATED CIRCUIT

CYCLE EQUIPMENT CO. 408-356-5555
 P O Box 307, Los Gatos, Cal 95030

REELS, PAPER TAPE
 SPOOLERS, PAPER TAPE
 WINDERS, PAPER TAPE

CYPHERNETICS CORP., THE 313-769-6800
 333 Maple Village Ctr, Ann Arbor, Mich 48103

CONSULTING (SCIENTIFIC APPLICATIONS)
 SERVICES, COMPUTER-AIDED DESIGN
 SERVICES, FACILITY MANAGEMENT
 SERVICES, TIME SHARING (COMMERCIAL)
 SERVICES, TIME SHARING (RESEARCH)

CYPRUS MINES CORP. ROME CABLE DIV. 315-337-3000
 421 Ridge St, Rome, N Y 13440 TWX 510-243-9732

CABLE ASSEMBLIES (WITH CONNECTORS)
 CABLE, COAXIAL (FLEXIBLE)
 CABLE, COAXIAL (SEMI/RIGID)
 CABLE, FINE LEAD
 CABLE, MULTICONDUCTOR
 CABLE, SHIELDED (NOT COAXIAL)

CYTEK INFORMATION SYSTEMS CORP. 212-594-8870
 366 5th Ave, New York, N Y 10001

DATA RETREIVAL SYSTEMS, MICRO-FILM (COMPUTER-CONTROLLED)
 DISPLAYS, PANELS, VIEWGRAPHS (FOR COMPUTER TRAINING)
 INSTRUCTIONAL SYSTEMS, COMPUTER-BASED
 MICROFICHE
 MICROFILM DATA RETRIEVAL SYSTEMS, COMPUTER CONTROLLED
 MICROFILM DATA RETRIEVAL SYSTEMS, COMPUTER CONTROLLED (GRAPHIC)
 READER/PRINTER, MICROFILM/MICROFICHE
 READERS, MICROFILM/MICROFICHE

D.P.&W. INC. 617-783-1024
 1107 Commonwealth Ave, Boston, Mass 02215

CONSULTING (ACCOUNTING, BUSINESS AND COMMERCIAL APPLICATIONS)
 CONSULTING (COMPUTER EVALUATIONS, SELECTIONS, INSTALLATION PLANNING)
 CONSULTING (DATA COMMUNICATIONS SYSTEMS PLANNING)
 CONSULTING (MANAGEMENT INFORMATION SYSTEMS PLANNING)
 PROGRAMMING LANGUAGE DEVELOPMENT (CONSULTANTS)
 PROGRAMMING LANGUAGE DEVELOPMENT (CONTRACT PROGRAMMING)
 PROGRAMMING LANGUAGE DEVELOPMENT (DEDICATED APPLICATION SYSTEMS)
 PROGRAMMING LANGUAGE DEVELOPMENT (PROPRIETARY SOFTWARE PRODUCTS)
 SERVICES, FACILITY MANAGEMENT
 SERVICES, MANAGEMENT INFORMATION SYSTEMS
 SERVICES, PROCESSING (COMMERCIAL EDP)
 SERVICES, SYSTEMS ANALYSIS

DACOM INC. 408-734-3710
 1060 Morse Ave, Sunnyvale, Cal 94086

COMMUNICATIONS-ORIENTED PROCESSORS, MULTIPLE CHANNEL CONTROLLERS
 COMMUNICATION SYSTEMS, DATA TRANSMISSION
 COMMUNICATION SYSTEMS, FACSIMILE
 PLOTTERS, FILM EXPOSING
 DATA ACQUISITION AND REDUCTION SYSTEMS
 FILM SCANNERS
 MAGNETIC TAPE STORAGE SYSTEMS (INCLUDES CONTROLLER)
 PROCESSORS, MICROFILM
 RECORDERS, DIGITAL CASSETTE
 RECORDERS, MAGNETIC TAPE
 SCANNERS, FACSIMILE
 TRANSCEIVERS, FACSIMILE

DACONICS 408-732-2634
 925 Thompson Pl, Sunnyvale, Cal 94086

CONSOLES, CRT (ALPHANUMERIC AND GRAPHIC)
 CONSOLES, CRT (COLOR-ALPHANUMERIC AND GRAPHIC)
 CONSULTING (ACCOUNTING, BUSINESS AND COMMERCIAL APPLICATIONS)
 CONSULTING (MANAGEMENT INFORMATION SYSTEMS PLANNING)
 CONSULTING (SCIENTIFIC APPLICATIONS)
 CONTROLLERS, MAGNETIC DISC
 CONTROLLERS, MAGNETIC DRUM
 CONTROLLERS, MODEM
 DATA ACQUISITION AND REDUCTION SYSTEMS
 DATA TERMINALS, BLOCK-BY-BLOCK (MAGNETIC TAPE)
 DATA TERMINALS, BLOCK-BY-BLOCK (HIGH SPEED PRINTER)
 DATA TERMINALS, BLOCK-BY-BLOCK (MEDIUM SPEED PRINTER)
 DISC DRIVES, MOVABLE HEAD (INCLUDING CONTROLLER)
 DISC DRIVES, REMOVABLE CARTRIDGE
 DISC STORAGE SYSTEMS
 DRUM STORAGE EQUIPMENT, MAG-NETIC (INCLUDING CONTROLLER)
 MAGNETIC TAPE STORAGE SYSTEMS (INCLUDES CONTROLLER)
 MONITORS, TV
 PRINTERS, LINE (HIGH SPEED)
 TAPE TRANSPORTS, MAGNETIC (DIGITAL-EXCL. CASSETTE)
 TYPEWRITERS, COMPUTER INPUT-OUTPUT

DAEDALUS COMPUTER PRODUCTS INC. 315-699-2631
 P O Box 248, No Syracuse, N Y 13088

DATA TERMINALS, BLOCK-BY-BLOCK (MULTI-PURPOSE)

DAHLSTROM MANUFACTURING CORP. 716-487-0111
 443 Buffalo St, Jamestown, N Y 14701

CABINETS, ENCLOSURES, CONSOLES, ELECTRONIC (FOR GENERAL EQUIPMENT)

DAILEY INC., R.N. 201-986-6742
 300 Madison Ave, New York, N Y 10017

CONSULTING (ACCOUNTING, BUSINESS AND COMMERCIAL APPLICATIONS)
 CONSULTING (ADVANCED COMPUTER EQUIPMENT DESIGN AND FEASIBILITY STUDIES)
 CONSULTING (COMPUTER EVALUATIONS, SELECTIONS, INSTALLATION PLANNING)
 CONSULTING (DATA COMMUNICATIONS SYSTEMS PLANNING)
 PROGRAMMING LANGUAGE DEVELOPMENT (CONSULTANTS)
 PROGRAMMING LANGUAGE DEVELOPMENT (CONTRACT PROGRAMMING)
 PROGRAMMING LANGUAGE DEVELOPMENT (DEDICATED APPLICATION SYSTEMS)
 PROGRAMMING LANGUAGE DEVELOPMENT (PROPRIETARY SOFTWARE PRODUCTS)

3 Manufacturers' Directory

- DALE ELECTRONICS INC. SUB. LIONEL CORP.** 402-564-3131
 1360 28th Ave, Columbus, Nebr 68601 TWX 910-626-8314
 CIRCUITS, THICK FILM (DIGITAL)
 CONNECTORS, MINIATURE AND SUB-MINIATURE (COMPUTER-GRADE)
 CONNECTORS, PC AND IC BOARD (COMPUTER-GRADE)
 CONNECTORS, POWER (COMPUTER-GRADE)
 CONNECTORS, RACK AND PANEL (COMPUTER-GRADE)
 MOTORS, SYNCHRONOUS
 POTENTIOMETERS, TRIM (FILM)
 POTENTIOMETERS, TRIM (WIRE-WOUND)
 RESISTORS, PRECISION
- DA-PEX DATA PROCESSING EQUIPMENT EXCHANGE** 502-585-5454
 334 Lincoln Fed Bldg, Louisville, Ky 40202
 USED EQUIPMENT (BUYING, SELLING, LEASING)
- DASA CORP./CYBER-TRONICS SUB. DASA CORP.** 617-475-4940
 15 Stevens St., Andover, Mass 01810 TWX 710-347-0331
 CONSULTING (ADVANCED COMPUTER EQUIPMENT DESIGN AND FEASIBILITY STUDIES)
 CONSULTING (COMPUTER EVALUATIONS, SELECTIONS, INSTALLATION PLANNING)
 LEASING, EDP EQUIPMENT (OTHER THAN MFGRS)
 MICROFILM ROLLS
 READER/PRINTER, MICROFILM/MICROFICHE
 READERS, MICROFILM/MICROFICHE
 RECORDERS, GRAPHIC
 RECORDERS, HARD-COPY (WITH CRT)
 RECORDERS, MICROFILM/MICROFICHE
 SERVICES, HARDWARE MAINTENANCE
 USED EQUIPMENT (BUYING, SELLING, LEASING)
- DASH DATA SYSTEMS INC.** 203-324-3186
 69 Jefferson St, Stamford, Conn 06902
 COMMUNICATIONS-ORIENTED PROCESSORS, MULTIPLE CHANNEL CONTROLLERS
 COMMUNICATIONS-ORIENTED PROCESSORS, STORED PROGRAM
 COMMUNICATION SYSTEMS, DATA TRANSMISSION
 COMMUNICATION SYSTEMS, TELEPRINTER
 CONSULTING (DATA COMMUNICATIONS SYSTEMS PLANNING)
 CONTROLLERS, MODEM
 DATA CONCENTRATORS
 DATA TERMINALS, INQUIRY-RESPONSE (ALPHANUMERIC KEYBOARD)
 DATA TERMINALS, INQUIRY-RESPONSE (AUDIO RESPONSE)
 DATA TERMINALS, INQUIRY-RESPONSE (BADGE-TOKEN READERS)
 DATA TERMINALS, INQUIRY-RESPONSE (SPECIAL-PURPOSE)
 MULTIPLEXER-CONVERTER (SINGLE UNIT WITH MULTIPLEXER, SAMPLE & HOLD AMPLIFIER & A-TO-D CONVERTER)
 MULTIPLEXERS, DIGITAL
- DASHEW BUSINESS MACHINES INC.** 213-392-3981
 2219 Main St, Santa Monica, Cal 90406
 IMPRINTERS, OPTICALLY-SENSED CHARACTER
- DATA ACCESS SYSTEMS INC.** 201-361-2345
 503 Rte 10 Mt 19, Dover, N J 07801
 ACOUSTIC COUPLERS
 COMMUNICATION SYSTEMS, DATA TRANSMISSION
 COMMUNICATION SYSTEMS, TELEPRINTER
 CONSOLES, CRT (ALPHANUMERIC AND GRAPHIC)
 CONTROLLERS, MODEM
 DATA TERMINALS, BLOCK-BY-BLOCK (MULTI-PURPOSE)
 DATA TERMINALS, BLOCK-BY-BLOCK (PLOTTER)
 DATA TERMINALS, INQUIRY-RESPONSE (ALPHANUMERIC KEYBOARD)
 DATA TERMINALS, INQUIRY-RESPONSE (CRT WITH KEYBOARD)
 MODEMS, ACOUSTIC
 MODEMS, HARD-WIRED
 MODEMS, PC CARD
 PRINTER/PUNCH, PAPER TAPE
 PUNCHES, PAPER TAPE
 SERVICES, HARDWARE MAINTENANCE
 TYPEWRITERS, COMPUTER INPUT-OUTPUT
 USED EQUIPMENT (BUYING, SELLING, LEASING)
- DATA ACTION CORP.** 612-920-9200
 4445 W 77th St, Minneapolis, Minn 55435
 ENCODERS, KEYBOARD-TO-MAGNETIC TAPE
 POOLERS, MAGNETIC TAPE
 TAPE TRANSPORTS, MAGNETIC (DIGITAL-EXCL. CASSETTE)
 TYPEWRITERS, COMPUTER INPUT-OUTPUT
- DATA ARCHITECTS INC.** 617-891-7730
 213 3rd Ave, Waltham, Mass 02154
 CONSULTING (ACCOUNTING, BUSINESS AND COMMERCIAL APPLICATIONS)
 CONSULTING (ADVANCED COMPUTER EQUIPMENT DESIGN AND FEASIBILITY STUDIES)
 CONSULTING (COMPUTER EVALUATIONS, SELECTIONS, INSTALLATION PLANNING)
 CONSULTING (DATA COMMUNICATIONS SYSTEMS PLANNING)
 CONSULTING (COMPUTER PRODUCT PLANNING SURVEYS, MARKET RESEARCH STUDIES)
 CONSULTING (MANAGEMENT INFORMATION SYSTEMS PLANNING)
 CONSULTING (SCIENTIFIC APPLICATIONS)
 SERVICES, FACILITY MANAGEMENT
 SERVICES, MANAGEMENT INFORMATION SYSTEMS
 SERVICES, SYSTEMS ANALYSIS
- DATA AUTOMATION COMMUNICATIONS INC.** 214-637-2403
 7505 Carpenter Fwy, Dallas, Tex 75247
 ACOUSTIC COUPLERS
 COMMUNICATION SYSTEMS, TELEPRINTER
 DATA TERMINALS, BLOCK-BY-BLOCK (TELEPRINTER)
 DATA TERMINALS, INQUIRY-RESPONSE (CRT WITH KEYBOARD)
 MODEMS, ACOUSTIC
 MODEMS, HARD-WIRED
 MODEMS, PC CARD
 USED EQUIPMENT (BUYING, SELLING, LEASING)
- DATA CENTER CORP.** 213-475-4444
 3002 Midvale St, Los Angeles, Cal 90034
 CONSULTING (ACCOUNTING, BUSINESS AND COMMERCIAL APPLICATIONS)
 CONSULTING (COMPUTER EVALUATIONS, SELECTIONS, INSTALLATION PLANNING)
 SERVICES, FACILITY MANAGEMENT
 SERVICES, PROCESSING (COMMERCIAL EDP)
 SERVICES, SYSTEMS ANALYSIS
- DATA COMPUTER SYSTEMS INC.** 714-546-7610
 17131 Daimler St, Santa Ana, Cal 92705
 DATA TERMINALS, BLOCK-BY-BLOCK (MAGNETIC TAPE)
 DATA TERMINALS, BLOCK-BY-BLOCK (PAPER TAPE)
 DATA TERMINALS, BLOCK-BY-BLOCK (PLOTTER)
 DATA TERMINALS, BLOCK-BY-BLOCK (HIGH SPEED PRINTER)
 DATA TERMINALS, BLOCK-BY-BLOCK (MEDIUM SPEED PRINTER)
 DATA TERMINALS, BLOCK-BY-BLOCK (PUNCHED CARD)
 DATA TERMINALS, BLOCK-BY-BLOCK (TELEPRINTER)
 DATA TERMINALS, INQUIRY-RESPONSE (ALPHANUMERIC KEYBOARD)
 DATA TERMINALS, INQUIRY-RESPONSE (CRT WITH KEYBOARD)
- DATA COMPUTING CORP.** 516-481-7344
 229 Baldwin Rd, Hempsted, N Y 11551
 CONSULTING (ACCOUNTING, BUSINESS AND COMMERCIAL APPLICATIONS)
 CONSULTING (COMPUTER PRODUCT PLANNING SURVEYS, MARKET RESEARCH STUDIES)
 CONSULTING (MANAGEMENT INFORMATION SYSTEMS PLANNING)
 PROGRAMMING LANGUAGE DEVELOPMENT (CONSULTANTS)
 PROGRAMMING LANGUAGE DEVELOPMENT (CONTRACT PROGRAMMING)
 PROGRAMMING LANGUAGE DEVELOPMENT (DEDICATED APPLICATION SYSTEMS)
 SERVICES, MANAGEMENT INFORMATION SYSTEMS
 SERVICES, PROCESSING (COMMERCIAL EDP)
 SERVICES, SYSTEMS ANALYSIS
- DATA COMPUTING INC.** 602-944-4491
 2219 W Shangri La Rd, Phoenix, Ariz 85029 TWX 910-957-1618
 ACOUSTIC COUPLERS
 COMMUNICATION SYSTEMS, TELEPRINTER
 DATA TERMINALS, BLOCK-BY-BLOCK (MEDIUM SPEED PRINTER)
 DATA TERMINALS, BLOCK-BY-BLOCK (PUNCHED CARD)
 DATA TERMINALS, BLOCK-BY-BLOCK (TELEPRINTER)
 DATA TERMINALS, INQUIRY-RESPONSE (SPECIAL-PURPOSE)
 PRINTERS, LINE (LOW & MEDIUM SPEED)
 READERS, PUNCHED CARD (UP TO 100 CPM)
 TRAINING SYSTEMS, CARD PUNCH
- DATA CONTROL CO.** 906-635-1515
 405 E Easterday Ave, Sault Ste Marie, Mich 49783
 CONSULTING (ACCOUNTING, BUSINESS AND COMMERCIAL APPLICATIONS)
 SERVICES, MANAGEMENT INFORMATION SYSTEMS
 SERVICES, PROCESSING (COMMERCIAL EDP)
 SERVICES, SYSTEMS ANALYSIS
 USED EQUIPMENT (BUYING, SELLING, LEASING)

3 Manufacturers' Directory

DATA CONTROL SYSTEMS INC.
Commerce Dr, Danbury, Conn 06810

203-743-9241
TWX 710-456-2596

AMPLIFIERS, D.C.
AMPLIFIERS, INSTRUMENTATION
AMPLIFIERS, OPERATIONAL
CIRCUIT CARDS, LINEAR (WITH DISCRETE COMPONENTS)
CIRCUIT CARDS, LINEAR (WITH IC'S)
CIRCUIT CARDS, LOGIC (WITH DISCRETE COMPONENTS)
CIRCUIT CARDS, LOGIC (WITH IC'S)
CIRCUITS, HYBRID (IC AND DISCRETE-DIGITAL)
CLOCKS, DIGITAL (REAL-TIME)
COMMUNICATIONS-ORIENTED PROCESSORS, MULTIPLE CHANNEL CONTROLLERS
COMMUNICATIONS-ORIENTED PROCESSORS, SINGLE CHANNEL CONTROLLERS
COMMUNICATIONS-ORIENTED PROCESSORS, STORED PROGRAM
COMMUNICATION SYSTEMS, DATA TRANSMISSION
CONTROLLERS, MODEM
CONVERTERS, DIGITAL-TO-ANALOG
DATA ACQUISITION AND REDUCTION SYSTEMS
DIGITIZERS, PROGRAMMABLE
MULTIPLEXER-CONVERTER (SINGLE UNIT WITH MULTIPLEXER, SAMPLE & HOLD
AMPLIFIER & A-TO-D CONVERTER)
MULTIPLEXERS, ANALOG-RELAY (SEQUENTIAL SAMPLING)
MULTIPLEXERS, ANALOG-SOLID STATE (SEQUENTIAL SAMPLING)
MULTIPLEXERS, DIGITAL
OSCILLATORS, VOLTAGE CONTROLLED
SIGNAL CONDITIONERS

DATA COPY INC.
760 Bryant St, San Francisco, Cal 94107

415-391-1811

CONSULTING (ACCOUNTING, BUSINESS AND COMMERCIAL APPLICATIONS)
CONSULTING (MANAGEMENT INFORMATION SYSTEMS PLANNING)
DATA RETRIEVAL SYSTEMS, MICRO-FILM (COMPUTER-CONTROLLED)
MICROFICHE
MICROFILM DATA RETRIEVAL SYSTEMS, COMPUTER CONTROLLED
MICROFILM DATA RETRIEVAL SYSTEMS, COMPUTER CONTROLLED (GRAPHIC)
READER/PRINTER, MICROFILM/MICROFICHE
READERS, MICROFILM/MICROFICHE
SERVICES, COMPUTER OUTPUT MICROFILM
SERVICES, FACILITY MANAGEMENT
SERVICES, MANAGEMENT INFORMATION SYSTEMS
SERVICES, SYSTEMS ANALYSIS

DATA CORP., THE
1111 W 6th St, Los Angeles, Cal 90017

213-482-1300

CONSULTING (ACCOUNTING, BUSINESS AND COMMERCIAL APPLICATIONS)
SERVICES, FACILITY MANAGEMENT
SERVICES, PROCESSING (COMMERCIAL EDP)
SERVICES, SYSTEMS ANALYSIS

DATA CORP., THE PENINSULA COMPUTER CENTER DIV
1190 Coleman Ave, San Jose, Cal 95110

408-244-2200

CONSULTING (ACCOUNTING, BUSINESS AND COMMERCIAL APPLICATIONS)
CONSULTING (COMPUTER EVALUATIONS, SELECTIONS, INSTALLATION
PLANNING)
CONSULTING (MANAGEMENT INFORMATION SYSTEMS PLANNING)
SERVICES, MANAGEMENT INFORMATION SYSTEMS
SERVICES, PROCESSING (COMMERCIAL EDP)
SERVICES, SYSTEMS ANALYSIS

DATA DEVICES INC. SUB. DATA PROD.CORP
18360 Topham St, Tarzana, Cal 91356

213-345-7013

CLEANER/CERTIFIERS, MAGNETIC TAPE
CLEANERS, MAGNETIC TAPE
PUNCHES, CARD (PORTABLE)
PUNCHES, PAPER TAPE
RIBBONS, INK (FOR PRINTERS AND TAB EQUIPMENT)
TAPE, PUNCH (MYLAR)
WINDERS, MAGNETIC TAPE

DATA DIMENSIONS INC.
51 Weaver St, Greenwich, Conn 06830

203-661-1700
TWX 203-661-1700

COMMUNICATION SYSTEMS, TELEPRINTER
CONSULTING (ACCOUNTING, BUSINESS AND COMMERCIAL APPLICATIONS)
CONSULTING (ADVANCED COMPUTER EQUIPMENT DESIGN AND FEASIBILITY
STUDIES)
CONSULTING (COMPUTER EVALUATIONS, SELECTIONS, INSTALLATION
PLANNING)
CONSULTING (DATA COMMUNICATIONS SYSTEMS PLANNING)
CONSULTING (COMPUTER PRODUCT PLANNING SURVEYS, MARKET RESEARCH
STUDIES)
CONSULTING (MANAGEMENT INFORMATION SYSTEMS PLANNING)
DATA TERMINALS, BLOCK-BY-BLOCK (HIGH SPEED PRINTER)
DATA TERMINALS, INQUIRY-RESPONSE (ALPHANUMERIC KEYBOARD)
CONTINUED

DATA TERMINALS, INQUIRY-RESPONSE (CRT WITH KEYBOARD)
LEASING, EDP EQUIPMENT (OTHER THAN MFGRS)
PROGRAMMING LANGUAGE DEVELOPMENT (CONSULTANTS)
PROGRAMMING LANGUAGE DEVELOPMENT (CONTRACT PROGRAMMING)
PROGRAMMING LANGUAGE DEVELOPMENT (DEDICATED APPLICATION SYSTEMS)
PROGRAMMING LANGUAGE DEVELOPMENT (PROPRIETARY SOFTWARE
PRODUCTS)
SERVICES, FACILITY MANAGEMENT
SERVICES, SYSTEMS ANALYSIS

DATA DISC INC.
686 W Maude Ave, Sunnyvale, Cal 94086

408-732-7330
TWX 910-339-9244

ANALYZERS, WAVEFORM
CONSOLES, CRT (ALPHANUMERIC AND GRAPHIC)
CONSOLES, CRT (COLOR-ALPHANUMERIC AND GRAPHIC)
CONSOLES, CRT (GRAPHIC)
CONTROLLERS, MAGNETIC DISC
CONVERTERS, MAGNETIC TAPE-TO-FACSIMILE
CONVERTERS, PULSE-TO-DIGITAL
CONVERTERS, SCAN
DATA ACQUISITION AND REDUCTION SYSTEMS
DATA TERMINALS, INQUIRY-RESPONSE (CRT WITH KEYBOARD)
DATA TERMINALS, INQUIRY-RESPONSE (SPECIAL-PURPOSE)
DISC DRIVES, FIXED HEAD (INCLUDING CONTROLLER)
DISC DRIVES, MOVABLE HEAD (INCLUDING CONTROLLER)
DISC STORAGE SYSTEMS
GENERATORS, CHARACTER (CRT)
MEMORY SYSTEMS, MAGNETIC DISC
READOUTS, CRT
SCANNERS, IMAGE
SCANNERS, FACSIMILE
TRANSCIVERS, FACSIMILE

DATA DISPLAY SYSTEMS INC.
139 Terwood Rd, Willow Grove, Pa 19090

215-659-6900

ANALYZERS, COMPUTER PERFORMANCE
ANALYZERS, WAVEFORM
CIRCUIT CARDS, LOGIC (WITH IC'S)
DEMONSTRATORS AND KITS, EDUCATIONAL (DIGITAL LOGIC)
POWER SUPPLIES, DC
REGULATORS, VOLTAGE
TESTERS, CIRCUIT
TESTERS, DIGITAL DATA TRANSMISSION
TESTERS, DIGITAL LOGIC MODULES AND CARDS
TESTERS, INTEGRATED CIRCUIT

DATA DOCUMENTS INC.
105 S 70th St, Omaha, Nebr 68132

402-558-5700

CARDS, CONVENTIONAL PUNCH
FORMS, CONTINUOUS (MACHINE PROCESSED)
LABELS, CONTINUOUS AND GUMMED (MACHINE APPLICATION)
LABELS, CONTINUOUS AND PRESSURE SENSITIVE (MACHINE APPLICATION)
RIBBONS, INK (FOR PRINTERS AND TAB EQUIPMENT)
TAPE, MAGNETIC (REELS)

DATA ELECTRONICS CORP.
12 Cambridge St, Burlington, Mass 01803

617-272-7460

ENCODERS, KEYBOARD (ALPHANUMERIC)
ENCODERS, KEYBOARD (NUMERIC)

DATA ENGINEERING ASSOC. INC.
300 Kings Hwy E, Haddonfield, N J 08033

609-428-3308

CONSULTING (ADVANCED COMPUTER EQUIPMENT DESIGN AND FEASIBILITY
STUDIES)
CONSULTING (COMPUTER PRODUCT PLANNING SURVEYS, MARKET RESEARCH
STUDIES)
CONSULTING (SCIENTIFIC APPLICATIONS)
TRAINING INSTITUTES, COMMERCIAL COMPUTER COURSES, SEMINARS,
CORRESPONDENCE COURSES

DATA FUNDING INC.
Station Square 2, Paoli, Pa 19301

215-647-2333

DISC PACKS, MAGNETIC
LEASING, EDP EQUIPMENT (OTHER THAN MFGRS)
USED EQUIPMENT (BUYING, SELLING, LEASING)

DATA GENERAL CORP.
Rte 9, Southboro, Mass 01772

617-485-9100

ANALYZERS, DIFFERENTIAL
CONTINUED

3 Manufacturers' Directory

ANALYZERS, PULSE HEIGHT
 CALCULATORS, PROGRAMMABLE (ALSO SEE COMPUTERS)
 COMMUNICATIONS-ORIENTED PROCESSORS, MULTIPLE CHANNEL CONTROLLERS
 COMMUNICATIONS-ORIENTED PROCESSORS, SINGLE CHANNEL CONTROLLERS
 COMMUNICATIONS-ORIENTED PROCESSORS, STORED PROGRAM
 COMMUNICATION SYSTEMS, DATA TRANSMISSION
 COMMUNICATION SYSTEMS, TELEPRINTER
 COMPUTERS, DIGITAL (GENERAL-PURPOSE, SMALL-SCALE)
 COMPUTERS, MINI GENERAL PURPOSE (ALSO SEE CALCULATORS)
 COMPUTERS, PROCESS CONTROL
 CONTROLLERS, MAGNETIC DISC
 CONTROLLERS, MAGNETIC DRUM
 CONTROLLERS, MODEM
 CONVERTERS, ANALOG-TO-DIGITAL
 CONVERTERS, DIGITAL-TO-ANALOG
 DATA CONCENTRATORS
 DATA TERMINALS, BLOCK-BY-BLOCK (GRAPHIC DIGITIZERS)
 DATA TERMINALS, BLOCK-BY-BLOCK (MAGNETIC TAPE)
 DATA TERMINALS, BLOCK-BY-BLOCK (MULTI-PURPOSE)
 DATA TERMINALS, BLOCK-BY-BLOCK (PAPER TAPE)
 DATA TERMINALS, BLOCK-BY-BLOCK (PLOTTER)
 DATA TERMINALS, BLOCK-BY-BLOCK (HIGH SPEED PRINTER)
 DATA TERMINALS, BLOCK-BY-BLOCK (MEDIUM SPEED PRINTER)
 DIGITIZERS, PROGRAMMABLE
 DISC DRIVES, FIXED HEAD (INCLUDING CONTROLLER)
 DISC DRIVES, MOVABLE HEAD (INCLUDING CONTROLLER)
 DISC DRIVES, REMOVABLE CARTRIDGE
 DISC PACKS, MAGNETIC
 DISC STORAGE SYSTEMS
 MARK SENSING EQUIPMENT
 MEMORY SYSTEMS, MAGNETIC CORE
 MEMORY SYSTEMS, READ-ONLY
 MEMORY SYSTEMS, SEMICONDUCTOR (MOS)
 PRINTERS, LINE (LOW & MEDIUM SPEED)
 PRINTERS, LINE (HIGH SPEED)
 PUNCHES, CARD (OVER 100 CPM)
 PUNCHES, CARD (PORTABLE)
 PUNCHES, CARD (UP TO 100 CPM)
 PUNCHES, PAPER TAPE
 READER/PUNCHES, PUNCHED CARD
 READERS, PAPER TAPE
 READERS, PUNCHED CARD (UP TO 100 CPM)
 READERS, PUNCHED CARD (100 TO 300 CPM)
 READERS, PUNCHED CARD (OVER 300 CPM)

DATA GRAPHICS CORP. 512-342-9486
 8402 Speedway, San Antonio, Tex 78230

CIRCUIT CARDS, LOGIC (WITH IC'S)
 CONTROLLERS, MAGNETIC TAPE
 CONTROLLERS, MODEM
 CONVERTERS, BINARY-TO-DECIMAL
 CONVERTERS, DOCUMENT-TO-MAGNETIC TAPE
 CONVERTERS, DOCUMENT-TO-PAPER TAPE
 COUNTERS, DECADE
 COUNTERS, DIGITAL READOUT
 COUNTERS, UP-DOWN
 CURVE TRACERS-DIGITIZERS, MANUAL
 DATA ACQUISITION AND REDUCTION SYSTEMS
 DIGITIZERS, PROGRAMMABLE
 ENCODERS, DIGITAL
 ENCODERS, KEYBOARD (ALPHANUMERIC)
 ENCODERS, KEYBOARD (NUMERIC)
 ENCODERS, KEYBOARD-TO-MAGNETIC TAPE
 ENCODERS, KEYBOARD-TO-PRINTED TAPE
 ENCODERS, SHAFT ANGLE
 FORMATTERS, MAGNETIC TAPE
 INDICATORS, DIGITAL
 PERFORATORS, PAPER TAPE
 PRINTER/PUNCH, PAPER TAPE
 PRINTERS, LINE (LOW & MEDIUM SPEED)
 PUNCHES, PAPER TAPE
 RECORDERS, PAPER TAPE

DATA INDUSTRIES INC. 213-757-8383
 12624 Daphne, Hawthorne, Cal 90250 TWX 910-321-4470
 RECORDING HEADS, MAGNETIC DISC
 RECORDING HEADS, MAGNETIC DRUM
 TESTERS, DISC HEADS

DATA INPUT DEVICES INC. 603-434-4551
 Tinkham Ind Pk, Derry, N H 03038

COMMUNICATION SYSTEMS, DATA TRANSMISSION
 DATA TERMINALS, INQUIRY-RESPONSE (CRT WITH KEYBOARD)
 ENCODERS, KEYBOARD (ALPHANUMERIC)
 ENCODERS, KEYBOARD (NUMERIC)
 POOLERS, MAGNETIC TAPE
 RECORDERS, DIGITAL CASSETTE

DATA-LINK CORP. 714-279-5430
 P O Box 2792, San Diego, Cal 92112

REELS, PAPER TAPE
 SPLICERS, PAPER TAPE
 WINDERS, PAPER TAPE

DATA MAGNETICS CORP. 213-320-8260
 355 Maple Ave, Torrance, Cal 90503

POLE PIECES, FERRITE
 RECORDING HEADS, MAGNETIC DISC
 RECORDING HEADS, MAGNETIC DRUM

DATA MANAGEMENT SERVICES INC. 215-561-6400
 1845 Walnut St, Philadelphia, Pa 19103

CONSULTING (ACCOUNTING, BUSINESS AND COMMERCIAL APPLICATIONS)
 CONSULTING (ADVANCED COMPUTER EQUIPMENT DESIGN AND FEASIBILITY STUDIES)
 CONSULTING (COMPUTER EVALUATIONS, SELECTIONS, INSTALLATION PLANNING)
 CONSULTING (DATA COMMUNICATIONS SYSTEMS PLANNING)
 CONSULTING (COMPUTER PRODUCT PLANNING SURVEYS, MARKET RESEARCH STUDIES)
 CONSULTING (MANAGEMENT INFORMATION SYSTEMS PLANNING)
 CONSULTING (SCIENTIFIC APPLICATIONS)
 SERVICES, COMPUTER-AIDED DESIGN
 SERVICES, FACILITY MANAGEMENT
 SERVICES, MAGNETIC TAPE CERTIFICATION
 SERVICES, MANAGEMENT INFORMATION SYSTEMS
 SERVICES, PROCESSING (COMMERCIAL EDP)
 SERVICES, PROCESSING (DIGITAL SCIENTIFIC)
 SERVICES, SYSTEMS ANALYSIS

DATA MEMORY INC. 415-961-9440
 1400 Terra Bella Ave, Mt View, Cal 94040 TWX 910-379-6474
 DISC DRIVES, FIXED HEAD (INCLUDING CONTROLLER)
 DISC DRIVES, MOVABLE HEAD (INCLUDING CONTROLLER)
 DISC STORAGE SYSTEMS
 MEMORY SYSTEMS, MAGNETIC DISC

DATA NUMERICS INC. 516-293-6600
 141a Central Ave, Farmingdale, N Y 11735
 SERVICES, AUTOMATED WIRE-WRAPPING

DATA PACIFIC CORP. 714-879-8730
 116 E Ash, Fullerton, Cal 92631

CARDS, CONVENTIONAL PUNCH
 COMMUNICATIONS-ORIENTED PROCESSORS, MULTIPLE CHANNEL CONTROLLERS
 COMMUNICATIONS-ORIENTED PROCESSORS, SINGLE CHANNEL CONTROLLERS
 COMMUNICATIONS-ORIENTED PROCESSORS, STORED PROGRAM
 COMMUNICATION SYSTEMS, DATA TRANSMISSION
 CONTROLLERS, MODEM
 CONVERTERS, PUNCHED CARD-TO-MAGNETIC TAPE
 CONVERTERS, PUNCHED CARD-TO-PAPER TAPE
 DATA CONCENTRATORS
 DATA TERMINALS, BLOCK-BY-BLOCK (MAGNETIC TAPE)
 DATA TERMINALS, BLOCK-BY-BLOCK (MULTI-PURPOSE)
 DATA TERMINALS, BLOCK-BY-BLOCK (PAPER TAPE)
 DATA TERMINALS, BLOCK-BY-BLOCK (PUNCHED CARD)
 DATA TERMINALS, INQUIRY-RESPONSE (ALPHANUMERIC KEYBOARD)
 DATA TERMINALS, INQUIRY-RESPONSE (CRT WITH KEYBOARD)
 DATA TERMINALS, INQUIRY-RESPONSE (SPECIAL-PURPOSE)

DATA PACKAGING CORP. 617-868-6200
 205 Broadway, Cambridge, Mass 02139 TWX 710-320-0740
 CANNISTERS, MAGNETIC TAPE
 CONTAINERS, DISK PACK STORAGE
 REELS, MAGNETIC TAPE
 TAPE, MAGNETIC (CASSETTE)

DATA-PACK INC. 203-756-7077
 269 Brookside Rd, Waterbury, Conn 06720

CONSULTING (ACCOUNTING, BUSINESS AND COMMERCIAL APPLICATIONS)
 CONSULTING (MANAGEMENT INFORMATION SYSTEMS PLANNING)
 SERVICES, PROCESSING (COMMERCIAL EDP)

3 Manufacturers' Directory

DATA PATHING INC. 408-734-0100
 370 San Aleso Ave, Sunnyvale, Cal 94086 TWX 910-339-9262
 COMMUNICATIONS-ORIENTED PROCESSORS, MULTIPLE CHANNEL CONTROLLERS
 COMMUNICATIONS-ORIENTED PROCESSORS, STORED PROGRAM
 COMMUNICATION SYSTEMS, DATA TRANSMISSION
 COMMUNICATION SYSTEMS, TELEPRINTER
 DATA CONCENTRATORS
 DATA TERMINALS, BLOCK-BY-BLOCK (MAGNETIC TAPE)
 DATA TERMINALS, BLOCK-BY-BLOCK (MULTI-PURPOSE)
 DATA TERMINALS, BLOCK-BY-BLOCK (PUNCHED CARD)
 DATA TERMINALS, BLOCK-BY-BLOCK (TELEPRINTER)
 DATA TERMINALS, INQUIRY-RESPONSE (ALPHANUMERIC KEYBOARD)
 DATA TERMINALS, INQUIRY-RESPONSE (BADGE-TOKEN READERS)
 DATA TERMINALS, INQUIRY-RESPONSE (CRT WITH KEYBOARD)
 DATA TERMINALS, INQUIRY-RESPONSE (SPECIAL-PURPOSE)
 SCANNERS, FACSIMILE

DATA PRINTER CORP. 617-492-7484
 225 Msgr O Brien Hwy, Cambridge, Mass 02141

DATA TERMINALS, BLOCK-BY-BLOCK (MEDIUM SPEED PRINTER)
 PRINTERS, LINE (LOW & MEDIUM SPEED)

DATA PROCESSING AND ACCOUNTING SERVICES 415-621-2888
 50 Van Ness Ave, San Francisco, Cal 94102

ACCOUNTING MACHINES, CARD-PROGRAMMED
 COLLATORS, PUNCHED CARD
 CONSULTING (ACCOUNTING, BUSINESS AND COMMERCIAL APPLICATIONS)
 CONSULTING (ADVANCED COMPUTER EQUIPMENT DESIGN AND FEASIBILITY STUDIES)
 CONSULTING (COMPUTER EVALUATIONS, SELECTIONS, INSTALLATION PLANNING)
 CONSULTING (DATA COMMUNICATIONS SYSTEMS PLANNING)
 CONSULTING (COMPUTER PRODUCT PLANNING SURVEYS, MARKET RESEARCH STUDIES)
 CONSULTING (MANAGEMENT INFORMATION SYSTEMS PLANNING)
 LEASING, EDP EQUIPMENT (OTHER THAN MFGRS)
 PROGRAMMERS, PUNCHED CARD
 PUNCHES, CARD (OVER 100 CPM)
 PUNCHES, CARD (UP TO 100 CPM)
 READER/PUNCHES, PUNCHED CARD
 REPRODUCERS, PUNCHED CARD (AUTOMATIC)
 SERVICES, COMPUTER-AIDED DESIGN
 SERVICES, FACILITY MANAGEMENT
 SERVICES, MAGNETIC TAPE CERTIFICATION
 SERVICES, MANAGEMENT INFORMATION SYSTEMS
 SERVICES, PROCESSING (COMMERCIAL EDP)
 SERVICES, TIME SHARING (COMMERCIAL)
 SERVICES, TIME SHARING (RESEARCH)
 SERVICES, HARDWARE MAINTENANCE
 SERVICES, SYSTEMS ANALYSIS
 SORTERS, PUNCHED CARD
 USED EQUIPMENT (BUYING, SELLING, LEASING)
 VERIFIERS, PUNCHED CARD

DATA PROCESSING CENTER DIV FROST REALTY CO 512-226-6391
 P O Box 1600, San Antonio, Tex 78206

CONSULTING (ACCOUNTING, BUSINESS AND COMMERCIAL APPLICATIONS)
 SERVICES, PROCESSING (COMMERCIAL EDP)
 SERVICES, SYSTEMS ANALYSIS

DATA PROCESSING FINANCIAL & GENERAL CORP. 914-428-5000
 141 Central Park Ave, Hartsdale, N Y 10530

USED EQUIPMENT (BUYING, SELLING, LEASING)

DATA PROCESSING SERVICE INC. 216-354-3548
 270 Main St, Painesville, Ohio 44077

CONSULTING (ACCOUNTING, BUSINESS AND COMMERCIAL APPLICATIONS)
 CONSULTING (ADVANCED COMPUTER EQUIPMENT DESIGN AND FEASIBILITY STUDIES)
 CONSULTING (COMPUTER EVALUATIONS, SELECTIONS, INSTALLATION PLANNING)
 CONSULTING (DATA COMMUNICATIONS SYSTEMS PLANNING)
 CONSULTING (COMPUTER PRODUCT PLANNING SURVEYS, MARKET RESEARCH STUDIES)
 CONSULTING (MANAGEMENT INFORMATION SYSTEMS PLANNING)
 SERVICES, PROCESSING (COMMERCIAL EDP)

DATA PROCESSORS INC. 501-535-4820
 2703 W 28th Ave, Pine Bluff, Ark 71601

CONSULTING (ACCOUNTING, BUSINESS AND COMMERCIAL APPLICATIONS)
 CONTINUED

CONSULTING (ADVANCED COMPUTER EQUIPMENT DESIGN AND FEASIBILITY STUDIES)
 CONSULTING (COMPUTER EVALUATIONS, SELECTIONS, INSTALLATION PLANNING)
 CONSULTING (DATA COMMUNICATIONS SYSTEMS PLANNING)
 SERVICES, FACILITY MANAGEMENT
 SERVICES, PROCESSING (COMMERCIAL EDP)
 SERVICES, SYSTEMS ANALYSIS
 TRAINING INSTITUTES, COMMERCIAL COMPUTER COURSES, SEMINARS, CORRESPONDENCE COURSES

DATA PRODUCTS CORP. 213-981-9600
 16055 Ventura Blvd, Encino, Cal 91316 TELEX 67-3407

CERTIFIERS, MAGNETIC TAPE
 CLEANER/CERTIFIERS, MAGNETIC TAPE
 COMMUNICATION SYSTEMS, DATA TRANSMISSION
 CONTROLLERS, MAGNETIC DISC
 CONVERTERS, MAGNETIC TAPE-TO-PRINTER
 CORES, FERRITE MEMORY
 DATA TERMINALS, BLOCK-BY-BLOCK (HIGH SPEED PRINTER)
 DATA TERMINALS, BLOCK-BY-BLOCK (MEDIUM SPEED PRINTER)
 DATA TERMINALS, INQUIRY-RESPONSE (AUDIO RESPONSE)
 DISC DRIVES, FIXED HEAD (INCLUDING CONTROLLER)
 DISC STORAGE SYSTEMS
 DRUM STORAGE EQUIPMENT, MAG-NETIC (INCLUDING CONTROLLER)
 MEMORY PLANES AND STACKS, MAG-NETIC CORE (W/O ELECTRONICS)
 MEMORY SYSTEMS, MAGNETIC CORE
 MEMORY SYSTEMS, MAGNETIC DISC
 PRINTERS, LINE (LOW & MEDIUM SPEED)
 PRINTERS, LINE (HIGH SPEED)
 PUNCHES, CARD (OVER 100 CPM)
 READERS, OPTICAL CHARACTER SCANNING
 READERS, PAYMENT COUPONS
 READERS, PERFORATED DOCUMENT
 READERS, PUNCHED CARD (100 TO 300 CPM)
 READERS, PUNCHED CARD (OVER 300 CPM)
 RECORDING HEADS, MAGNETIC DISC
 RECORDING HEADS, MAGNETIC DRUM
 RECORDING HEADS, MAGNETIC TAPE

DATA PRODUCTS CORP. CARD EQUIPMENT DIV. 303-771-1230
 8455 E Prentice Ave, Englewood, Colo 80110

PUNCHES, CARD (UP TO 100 CPM)
 READERS, PUNCHED CARD (100 TO 300 CPM)
 READERS, PUNCHED CARD (OVER 300 CPM)

DATA PRODUCTS CORP. SYSTEMS DIV. 213-887-8000
 6219 Desoto Ave, Woodland Hills, Cal 91364 TELEX 67-4734

CONTROLLERS, MAGNETIC DISC
 DATA TERMINALS, BLOCK-BY-BLOCK (HIGH SPEED PRINTER)
 DATA TERMINALS, BLOCK-BY-BLOCK (MEDIUM SPEED PRINTER)
 DISC DRIVES, MOVABLE HEAD (INCLUDING CONTROLLER)
 PRINTERS, LINE (HIGH SPEED)

DATA PRODUCTS TELECOMMUNICATIONS 203-325-4161
 17 Amelia Place, Stamford, Conn 06902 TWX 710-474-0698

ACOUSTIC COUPLERS
 COMMUNICATION SYSTEMS, DATA TRANSMISSION
 COMMUNICATION SYSTEMS, TELEPRINTER
 DATA CONCENTRATORS
 DATA TERMINALS, BLOCK-BY-BLOCK (PAPER TAPE)
 DATA TERMINALS, BLOCK-BY-BLOCK (TELEPRINTER)
 DATA TERMINALS, INQUIRY-RESPONSE (ALPHANUMERIC KEYBOARD)
 ENCODERS, KEYBOARD-TO-MAGNETIC TAPE
 MODEMS, ACOUSTIC
 MODEMS, HARD-WIRED
 MODEMS, PC CARD
 MULTIPLEXERS, DIGITAL
 READERS, PAPER TAPE
 RECORDERS, DIGITAL CASSETTE
 RELAYS, SOLID-STATE (COMPUTER GRADE)
 TESTERS, DIGITAL DATA TRANSMISSION
 TYPEWRITERS, COMPUTER INPUT-OUTPUT

DATA RECOGNITION CORP. 415-326-4810
 908 Industrial Ave, Palo Alto, Cal 94303

READERS, OPTICAL CHARACTER SCANNING

DATA RECORDING SYSTEMS, SUB. NEWELL IND. 408-732-2000
 795 Kifer Rd, Sunnyvale, Cal 94086

DISC STORAGE SYSTEMS
 MAGNETIC TAPE STORAGE SYSTEMS (INCLUDES CONTROLLER)
 RECORDERS, MAGNETIC TAPE
 CONTINUED

3 Manufacturers' Directory

TAPE TRANSPORTS, MAGNETIC (DIGITAL-EXCL. CASSETTE)
TAPE TRANSPORTS, MAGNETIC (INCREMENTAL)

DATA SERVICE CORP. 615-327-4471
1907 Division St, Nashville, Tenn 37203

CONSULTING (ACCOUNTING, BUSINESS AND COMMERCIAL APPLICATIONS)
SERVICES, MANAGEMENT INFORMATION SYSTEMS
SERVICES, PROCESSING (COMMERCIAL EDP)

DATA SERVICE OF TEXAS INC. 806-293-3217
1415 W 5th, Plainview, Tex 79072

CONSULTING (ACCOUNTING, BUSINESS AND COMMERCIAL APPLICATIONS)
SERVICES, PROCESSING (COMMERCIAL EDP)
SERVICES, SYSTEMS ANALYSIS

DATA SYNTEKS CORP. 617-272-1020
41 B St, Burlington, Mass 01803

ENCODERS, KEYBOARD-TO-MAGNETIC DISC

DATA SYSTEMS ANALYSTS INC. 609-665-6088
N Park Dr, Pennsauken, N J 08109 TELEX 84-5133

CONSULTING (ACCOUNTING, BUSINESS AND COMMERCIAL APPLICATIONS)
CONSULTING (COMPUTER EVALUATIONS, SELECTIONS, INSTALLATION
PLANNING)
CONSULTING (DATA COMMUNICATIONS SYSTEMS PLANNING)
CONSULTING (MANAGEMENT INFORMATION SYSTEMS PLANNING)

DATA SYSTEMS DESIGN INC. 415-849-1102
1122 University Ave, Berkeley, Cal 94702

CONTROLLERS, MAGNETIC DISC
DISC DRIVES, MOVABLE HEAD (INCLUDING CONTROLLER)
DISC DRIVES, REMOVABLE CARTRIDGE
DISC STORAGE SYSTEMS
MAGNETIC TAPE STORAGE SYSTEMS (INCLUDES CONTROLLER)
MEMORY SYSTEMS, MAGNETIC DISC

DATA SYSTEMS ENGINEERING INC. 714-835-1123
1505 E 17th St, Santa Ana, Cal 92701

CONSULTING (ADVANCED COMPUTER EQUIPMENT DESIGN AND FEASIBILITY
STUDIES)

DATA SYSTEMS INC. 612-331-9435
434 Stinson Blvd, Minneapolis, Minn 55413

CONSULTING (ACCOUNTING, BUSINESS AND COMMERCIAL APPLICATIONS)
CONSULTING (ADVANCED COMPUTER EQUIPMENT DESIGN AND FEASIBILITY
STUDIES)
CONSULTING (COMPUTER EVALUATIONS, SELECTIONS, INSTALLATION
PLANNING)
CONSULTING (DATA COMMUNICATIONS SYSTEMS PLANNING)
CONSULTING (COMPUTER PRODUCT PLANNING SURVEYS, MARKET RESEARCH
STUDIES)
CONSULTING (MANAGEMENT INFORMATION SYSTEMS PLANNING)
CONSULTING (SCIENTIFIC APPLICATIONS)
SERVICES, FACILITY MANAGEMENT
SERVICES, MANAGEMENT INFORMATION SYSTEMS
SERVICES, PROCESSING (COMMERCIAL EDP)
SERVICES, TIME SHARING (COMMERCIAL)
SERVICES, SYSTEMS ANALYSIS

DATA SYSTEMS INC. 503-233-5126
707 S E Belmont St, Portland, Ore 97214

CONSULTING (ACCOUNTING, BUSINESS AND COMMERCIAL APPLICATIONS)
SERVICES, PROCESSING (COMMERCIAL EDP)
SERVICES, PROCESSING (DIGITAL SCIENTIFIC)
SERVICES, SYSTEMS ANALYSIS

DATA TECHNOLOGY CORP. 415-321-0551
1050 E Meadow Cir, Palo Alto, Cal 94303 TWX 910-373-1186

BOARDS, PRINTED CIRCUIT (WITHOUT COMPONENTS)
BRE ADBOARDS
BUS BAR SYSTEMS
CIRCUIT CARDS, LINEAR (WITH DISCRETE COMPONENTS)
CIRCUIT CARDS, LINEAR (WITH IC'S)
CIRCUIT CARDS, LOGIC (WITH DISCRETE COMPONENTS)
CIRCUIT CARDS, LOGIC (WITH IC'S)
CONSULTING (ADVANCED COMPUTER EQUIPMENT DESIGN AND FEASIBILITY
STUDIES)

CONTINUED

CONSULTING (DATA COMMUNICATIONS SYSTEMS PLANNING)
CONVERTERS, ANALOG-TO-DIGITAL
CONVERTERS, BINARY-TO-DECIMAL
CONVERTERS, DIGITAL-TO-ANALOG
COUNTERS, UP-DOWN
MODULES, DIGITAL LOGIC ENCAPSULATED (ALSO SEE CIRCUITS & CIRCUIT
CARDS)
SERVICES, COMPUTER-AIDED DESIGN
SERVICES, AUTOMATED WIRE-WRAPPING
SERVICES, SYSTEMS ANALYSIS
VOLTMETERS, AC, DC, DIFFER-ENTIAL
VOLTMETERS, DIGITAL

DATA TECHNOLOGY CORP., PLASTRONICS DIV. 408-272-0300
1600 Las Plumas Ave, San Jose, Cal 95133

CONTAINERS, DISK PACK STORAGE
REEL CLIPS AND BELTS, MAGNETIC TAPE
REELS, MAGNETIC TAPE
REELS, PAPER TAPE

DATA TECHNOLOGY INC. 617-924-1773
65 Grove St, Watertown, Mass 02172 TWX 710-329-0607

CONVERTERS, DOCUMENT-TO-PAPER TAPE
COUNTERS, DIGITAL READOUT
COUNTERS, UP-DOWN
CURVE TRACERS-DIGITIZERS, AUTOMATIC
CURVE TRACERS-DIGITIZERS, MANUAL
DATA ACQUISITION AND REDUCTION SYSTEMS
DIGITIZERS, PROGRAMMABLE
ENCODERS, DIGITAL
ENCODERS, SHAFT ANGLE
PROGRAMMING LANGUAGE DEVELOPMENT (DEDICATED APPLICATION SYSTEMS)
PROGRAMMING LANGUAGE DEVELOPMENT (PROPRIETARY SOFTWARE
PRODUCTS)
TRANSDUCERS, DIGITAL

DATA TERMINAL SYSTEMS INC. 617-897-2978
239 Main St, Maynard, Mass 01754

DATA TERMINALS, BLOCK-BY-BLOCK (MAGNETIC TAPE)
DATA TERMINALS, BLOCK-BY-BLOCK (MULTI-PURPOSE)
DATA TERMINALS, INQUIRY-RESPONSE (BADGE-TOKEN READERS)
DATA TERMINALS, INQUIRY-RESPONSE (SPECIAL-PURPOSE)

DATA TRENDS INC. 201-334-1515
P O Box 82, Mt Lake, N J 07046

COMMUNICATIONS-ORIENTED PROCESSORS, STORED PROGRAM
CONTROLLERS, MODEM
DATA TERMINALS, BLOCK-BY-BLOCK (MAGNETIC TAPE)
DATA TERMINALS, INQUIRY-RESPONSE (SPECIAL-PURPOSE)
ENCODERS, KEYBOARD-TO-MAGNETIC TAPE
POOLERS, MAGNETIC TAPE
PRINTERS, DIGITAL STRIP RECORDING
TAPE TRANSPORTS, MAGNETIC (INCREMENTAL)

DATA-TRONICS CORP. SUB. ARKANSAS BEST CORP. 501-782-8987
310 Townson Ave, Fort Smith, Ark 72901

CONSULTING (ACCOUNTING, BUSINESS AND COMMERCIAL APPLICATIONS)
CONSULTING (ADVANCED COMPUTER EQUIPMENT DESIGN AND FEASIBILITY
STUDIES)
CONSULTING (COMPUTER EVALUATIONS, SELECTIONS, INSTALLATION
PLANNING)
CONSULTING (DATA COMMUNICATIONS SYSTEMS PLANNING)
CONSULTING (COMPUTER PRODUCT PLANNING SURVEYS, MARKET RESEARCH
STUDIES)
CONSULTING (MANAGEMENT INFORMATION SYSTEMS PLANNING)
SERVICES, COMPUTER-AIDED DESIGN
SERVICES, FACILITY MANAGEMENT
SERVICES, MANAGEMENT INFORMATION SYSTEMS
SERVICES, PROCESSING (COMMERCIAL EDP)
SERVICES, SYSTEMS ANALYSIS
TRAINING INSTITUTES, COMMERCIAL COMPUTER COURSES, SEMINARS,
CORRESPONDENCE COURSES

DATA USAGE CORP., 201-461-6242
2460 Lemoine Ave, Fort Lee, N J 07024

CONSULTING (ACCOUNTING, BUSINESS AND COMMERCIAL APPLICATIONS)
CONSULTING (COMPUTER EVALUATIONS, SELECTIONS, INSTALLATION
PLANNING)
PROGRAMMING LANGUAGE DEVELOPMENT (CONSULTANTS)
PROGRAMMING LANGUAGE DEVELOPMENT (CONTRACT PROGRAMMING)
PROGRAMMING LANGUAGE DEVELOPMENT (DEDICATED APPLICATION SYSTEMS)
CONTINUED

3 Manufacturers' Directory

PROGRAMMING LANGUAGE DEVELOPMENT (PROPRIETARY SOFTWARE PRODUCTS)
 SERVICES, FACILITY MANAGEMENT
 SERVICES, PROCESSING (COMMERCIAL EDP)
 SERVICES, PROCESSING (DIGITAL SCIENTIFIC)
 SERVICES, SYSTEMS ANALYSIS

DATA 100 CORP. 612-920-8800
 7450 France Ave S, Minneapolis, Minn 55435

COMMUNICATIONS-ORIENTED PROCESSORS, MULTIPLE CHANNEL CONTROLLERS
 COMMUNICATIONS-ORIENTED PROCESSORS, STORED PROGRAM
 COMMUNICATION SYSTEMS, DATA TRANSMISSION
 COMMUNICATION SYSTEMS, TELEPRINTER
 CONSULTING (DATA COMMUNICATIONS SYSTEMS PLANNING)
 CONTROLLERS, MODEM
 DATA CONCENTRATORS
 DATA TERMINALS, BLOCK-BY-BLOCK (MAGNETIC TAPE)
 DATA TERMINALS, BLOCK-BY-BLOCK (MULTI-PURPOSE)
 DATA TERMINALS, BLOCK-BY-BLOCK (PAPER TAPE)
 DATA TERMINALS, BLOCK-BY-BLOCK (PLOTTER)
 DATA TERMINALS, BLOCK-BY-BLOCK (HIGH SPEED PRINTER)
 DATA TERMINALS, BLOCK-BY-BLOCK (MEDIUM SPEED PRINTER)
 DATA TERMINALS, BLOCK-BY-BLOCK (PUNCHED CARD)
 DATA TERMINALS, BLOCK-BY-BLOCK (TELEPRINTER)
 DATA TERMINALS, INQUIRY-RESPONSE (ALPHANUMERIC KEYBOARD)
 DATA TERMINALS, INQUIRY-RESPONSE (CRT WITH KEYBOARD)
 DATA TERMINALS, INQUIRY-RESPONSE (SPECIAL-PURPOSE)
 MODEMS, HARD-WIRED
 PRINTERS, LINE (LOW & MEDIUM SPEED)

DATAC COMPUTER CORP. 612-920-9020
 7900 Computer Blvd, Minneapolis, Minn 55435

COMPUTERS, DIGITAL (GENERAL-PURPOSE, SMALL-SCALE)
 DATA TERMINALS, INQUIRY-RESPONSE (CRT WITH KEYBOARD)

DATACAP INTERNATION INC. 801-487-1641
 37 W 2950 S, Salt Lake City, Utah 84101

CARDS, EDGE-PUNCH
 COMPUTERS, DIGITAL (EDUCATIONAL)
 COMPUTERS, MINI GENERAL PURPOSE (ALSO SEE CALCULATORS)
 CONSULTING (ACCOUNTING, BUSINESS AND COMMERCIAL APPLICATIONS)
 CONSULTING (COMPUTER EVALUATIONS, SELECTIONS, INSTALLATION PLANNING)
 PROGRAMMING LANGUAGE DEVELOPMENT (DEDICATED APPLICATION SYSTEMS)
 PROGRAMMING LANGUAGE DEVELOPMENT (PROPRIETARY SOFTWARE PRODUCTS)
 SERVICES, COMPUTER-AIDED DESIGN
 SERVICES, MANAGEMENT INFORMATION SYSTEMS
 SERVICES, PROCESSING (COMMERCIAL EDP)
 SERVICES, PROCESSING (DIGITAL SCIENTIFIC)
 SERVICES, SYSTEMS ANALYSIS

DATACOM INC. 904-242-3113
 40 Lincoln Dr, Ft Walton Beach, Fla 32548 TWX 510-730-7693

CIRCUIT CARDS, LOGIC (WITH IC'S)
 COMMUNICATION SYSTEMS, DATA TRANSMISSION
 CONTROLLERS, MAGNETIC TAPE
 CONVERTERS, ANALOG-TO-DIGITAL
 CONVERTERS, MAGNETIC TAPE-TO-MAGNETIC TAPE
 CONVERTERS, PAPER TAPE-TO-MAGNETIC TAPE
 DATA ACQUISITIONS SYSTEMS, AUTOMATIC
 DATA TERMINALS, BLOCK-BY-BLOCK (MAGNETIC TAPE)
 DATA TERMINALS, BLOCK-BY-BLOCK (PAPER TAPE)
 DATA TERMINALS, BLOCK-BY-BLOCK (HIGH SPEED PRINTER)
 DATA TERMINALS, BLOCK-BY-BLOCK (MEDIUM SPEED PRINTER)
 DATA TERMINALS, BLOCK-BY-BLOCK (TELEPRINTER)
 DIGITIZERS, PROGRAMMABLE
 FORMATTERS, MAGNETIC TAPE
 MAGNETIC TAPE STORAGE SYSTEMS (INCLUDES CONTROLLER)
 MULTIPLEXERS, DIGITAL
 SERVICES, SYSTEMS ANALYSIS

DATACON INTERNATIONAL INC. 312-474-5100
 2745 Bernice Rd, Lansing, Ill 60438

CONVERTERS, PAPER TAPE-TO-MAGNETIC TAPE
 CONVERTERS, PAPER TAPE-TO-PAPER TAPE
 CONVERTERS, PAPER TAPE-TO-PRINTER
 CONVERTERS, PAPER TAPE-TO-PUNCHED CARD
 CONVERTERS, PUNCHED CARD-TO-MAGNETIC TAPE
 CONVERTERS, PUNCHED CARD-TO-PAPER TAPE
 ENCODERS, KEYBOARD (ALPHANUMERIC)
 ENCODERS, KEYBOARD (NUMERIC)
 ENCODERS, KEYBOARD-TO-MAGNETIC TAPE
 PRINTERS, KEYBOARD
 CONTINUED

PUNCHES, CARD (PORTABLE)
 PUNCHES, PAPER TAPE
 RECONDITIONING EQUIPMENT, PUNCHED CARD
 SERVICES, PROCESSING (COMMERCIAL EDP)
 TESTERS, INTEGRATED CIRCUIT
 TYPEWRITERS, COMPUTER INPUT-OUTPUT

DATACRAFT CORP. 305-933-2651
 1200 NW 70 St, Ft Lauderdale, Fla 33307 TWX 510-956-3096

COMPUTERS, DIGITAL (GENERAL-PURPOSE, MEDIUM-SCALE)
 COMPUTERS, PROCESS CONTROL
 MEMORY PLANES AND STACKS, MAG-NETIC CORE (W/O ELECTRONICS)
 MEMORY SYSTEMS, MAGNETIC CORE

DATADYNE CORP. 215-265-1793
 Valley Forge Ctr, King of Prussia, Pa 19406

PRINTERS, DIGITAL STRIP RECORDING
 PRINTERS, LINE (LOW & MEDIUM SPEED)
 PRINTERS, LINE (HIGH SPEED)

DATAFLOW SYSTEMS INC. 301-654-9133
 7758 Wilconsin Ave, Bethesda, Md 20014

CONSULTING (MANAGEMENT INFORMATION SYSTEMS PLANNING)
 SERVICES, COMPUTER OUTPUT MICROFILM
 TRAINING INSTITUTES, COMMERCIAL COMPUTER COURSES, SEMINARS,
 CORRESPONDENCE COURSES

DATAGRAPHICS INC. 312-944-2166
 740 N Rush St, Chicago, Ill 60611

SERVICES, PROCESSING (COMMERCIAL EDP)
 SERVICES, TIME SHARING (COMMERCIAL)

DATALINE INC. 215-265-6340
 181 S Boro Line Rd, King of Prussia, Pa 19406

DATA TERMINALS, INQUIRY-RESPONSE (ALPHANUMERIC KEYBOARD)
 DATA TERMINALS, INQUIRY-RESPONSE (SPECIAL-PURPOSE)
 MODEMS, ACOUSTIC
 MODEMS, HARD-WIRED
 MODEMS, PC CARD
 PRINTERS, DIGITAL STRIP RECORDING
 PRINTERS, KEYBOARD
 PRINTERS, LINE (LOW & MEDIUM SPEED)
 PRINTERS, LINE (HIGH SPEED)

DATALOG DIV. LITTON SYSTEMS INC. 303-771-2010
 1 Executive Pk, Englewood, Colo 80110 TWX 910-935-0707

COMMUNICATION SYSTEMS, TELEPRINTER
 PRINTERS, DIGITAL STRIP RECORDING
 PRINTERS, KEYBOARD
 PRINTERS, LINE (LOW & MEDIUM SPEED)
 PRINTERS, LINE (HIGH SPEED)
 READOUTS AND DISPLAYS, NUMERIC AND ALPHANUMERIC (OTHER THAN CRT)

DATALOGICS INC. 216-721-9035
 12025 Shakee Blvd, Cleveland, Ohio 44120

CONSULTING (ACCOUNTING, BUSINESS AND COMMERCIAL APPLICATIONS)
 CONSULTING (COMPUTER EVALUATIONS, SELECTIONS, INSTALLATION PLANNING)
 CONSULTING (DATA COMMUNICATIONS SYSTEMS PLANNING)
 CONSULTING (MANAGEMENT INFORMATION SYSTEMS PLANNING)
 CONSULTING (SCIENTIFIC APPLICATIONS)
 SERVICES, FACILITY MANAGEMENT
 SERVICES, TIME SHARING (COMMERCIAL)
 SERVICES, TIME SHARING (RESEARCH)
 SERVICES, SYSTEMS ANALYSIS

DATAMARK INC. 516-333-8910
 Cantiague Rd, Westbury, N Y 11590

PRINTERS, LINE (LOW & MEDIUM SPEED)
 PRINTERS, LINE (HIGH SPEED)

DATAMATE COMPUTER SYSTEMS SUB. SIBONEY CORP. 503-263-6863
 P O Box 310, Big Spring, Tex 79720

COMPUTERS, DIGITAL (GENERAL-PURPOSE, SMALL-SCALE)
 COMPUTERS, DIGITAL (GENERAL-PURPOSE, MEDIUM-SCALE)
 COMPUTERS, MINI GENERAL PURPOSE (ALSO SEE CALCULATORS)
 CONTINUED

3 Manufacturers' Directory

COMPUTERS, PROCESS CONTROL

DATAMATION SERVICES INC.

461 Eighth Ave, New York, N Y 10001

CONSULTING (ACCOUNTING, BUSINESS AND COMMERCIAL APPLICATIONS)
CONSULTING (COMPUTER PRODUCT PLANNING SURVEYS, MARKET RESEARCH STUDIES)
CONSULTING (MANAGEMENT INFORMATION SYSTEMS PLANNING)
PROGRAMMING LANGUAGE DEVELOPMENT (CONTRACT PROGRAMMING)
PROGRAMMING LANGUAGE DEVELOPMENT (PROPRIETARY SOFTWARE PRODUCTS)
SERVICES, FACILITY MANAGEMENT
SERVICES, MANAGEMENT INFORMATION SYSTEMS
SERVICES, PROCESSING (COMMERCIAL EDP)
SERVICES, SYSTEMS ANALYSIS

DATAMAX CORP.

313-769-0900

3941 Research Park Dr, Ann Arbor, Mich 48104

CONSULTING (DATA COMMUNICATIONS SYSTEMS PLANNING)
MODEMS, ACOUSTIC
MODEMS, HARD-WIRED
MODEMS, PC CARD
TRANSCEIVERS, FACSIMILE

DATAMETRIC CORP.

213-989-3840

7630 Gloria Ave, Van Nuys, Cal 91406

COMMUNICATION SYSTEMS, TELEPRINTER
PRINTERS, DIGITAL STRIP RECORDING
PRINTERS, LINE (LOW & MEDIUM SPEED)
PRINTERS, LINE (HIGH SPEED)

DATANETICS CORP.

213-542-4355

2828 Spreckel Ln, Redondo Beach, Cal 90278

TWX 910-344-7356

ENCODERS, KEYBOARD (ALPHANUMERIC)
ENCODERS, KEYBOARD (NUMERIC)
ENCODERS, KEYBOARD-TO-MAGNETIC DISC
ENCODERS, KEYBOARD-TO-MAGNETIC TAPE
ENCODERS, KEYBOARD-TO-PRINTED TAPE
SWITCHES, CODE BAR
TYPEWRITERS, COMPUTER INPUT-OUTPUT

DATAPAC INC.

714-549-7781

3839 S Main St, Santa Ana, Cal 92702

TWX 910-595-1791

CORES, FERRITE MEMORY
MEMORY SYSTEMS, DIODE
MEMORY SYSTEMS, MAGNETIC CORE
MEMORY SYSTEMS, READ-ONLY
MEMORY SYSTEMS, SEMICONDUCTOR
MEMORY SYSTEMS, SEMICONDUCTOR (MOS)
MEMORY SYSTEMS, THIN FILM

DATAPRO RESEARCH CORP.

215-564-3600

2204 Walnut St, Philadelphia, Pa 19103

CONSULTING (COMPUTER EVALUATIONS, SELECTIONS, INSTALLATION PLANNING)
CONSULTING (COMPUTER PRODUCT PLANNING SURVEYS, MARKET RESEARCH STUDIES)

DATAPROBE INC.

201-489-5588

290 Huyler St, S Hackensack, N J 07606

ANALYZERS, COMPUTER PERFORMANCE
ANALYZERS, CONTINUITY
GENERATORS, BYTE
GENERATORS, RANDOM NUMBER
TEST SYSTEMS, COMPUTER PERFORMANCE
TESTERS, CIRCUIT
TESTERS, DIGITAL DATA TRANSMISSION
TESTERS, DIGITAL LOGIC MODULES AND CARDS
TESTERS, INTEGRATED CIRCUIT

DATARAM CORP.

609-924-3331

Rte 206, Princeton, N J 08540

TWX 510-685-9285

CORES, FERRITE MEMORY
MEMORY PLANES AND STACKS, MAG-NETIC CORE (W/O ELECTRONICS)
MEMORY SYSTEMS, MAGNETIC CORE
TESTERS, MEMORY PLANES, STACKS AND SYSTEMS

DATAROYAL INC.

603-889-2192

Simon St, Nashua, N H 03060

CONSULTING (ADVANCED COMPUTER EQUIPMENT DESIGN AND FEASIBILITY STUDIES)
CONSULTING (COMPUTER EVALUATIONS, SELECTIONS, INSTALLATION PLANNING)
CONSULTING (DATA COMMUNICATIONS SYSTEMS PLANNING)
CONSULTING (MANAGEMENT INFORMATION SYSTEMS PLANNING)
CONSULTING (SCIENTIFIC APPLICATIONS)
SERVICES, COMPUTER-AIDED DESIGN
SERVICES, FACILITY MANAGEMENT
SERVICES, PROCESSING (COMMERCIAL EDP)
SERVICES, PROCESSING (DIGITAL SCIENTIFIC)
SERVICES, AUTOMATED WIRE-WRAPPING
SERVICES, SYSTEMS ANALYSIS

DATASERV DIV., WILLIAM J. PURDY CORP.

415-342-0877

770 Airport Blvd, Burlingame, Cal 94010

ACOUSTIC COUPLERS
CERTIFIERS, MAGNETIC TAPE
CLEANER/CERTIFIERS, MAGNETIC TAPE
CONSULTING (COMPUTER EVALUATIONS, SELECTIONS, INSTALLATION PLANNING)
CONTROLLERS, MAGNETIC DISC
CONTROLLERS, MAGNETIC DRUM
CONTROLLERS, MODEM
CONVERTERS, MAGNETIC TAPE-TO-PRINTER
CONVERTERS, PAPER TAPE-TO-PRINTER
CONVERTERS, SCAN
DATA CONCENTRATORS
DATA TERMINALS, BLOCK-BY-BLOCK (GRAPHIC DIGITIZERS)
DATA TERMINALS, BLOCK-BY-BLOCK (MAGNETIC TAPE)
DATA TERMINALS, BLOCK-BY-BLOCK (MULTI-PURPOSE)
DATA TERMINALS, BLOCK-BY-BLOCK (PAPER TAPE)
DATA TERMINALS, BLOCK-BY-BLOCK (PLOTTER)
DATA TERMINALS, BLOCK-BY-BLOCK (HIGH SPEED PRINTER)
DATA TERMINALS, BLOCK-BY-BLOCK (MEDIUM SPEED PRINTER)
DATA TERMINALS, BLOCK-BY-BLOCK (PUNCHED CARD)
DATA TERMINALS, BLOCK-BY-BLOCK (TELEPRINTER)
DATA TERMINALS, INQUIRY-RESPONSE (ALPHANUMERIC KEYBOARD)
DATA TERMINALS, INQUIRY-RESPONSE (BADGE-TOKEN READERS)
DATA TERMINALS, INQUIRY-RESPONSE (CRT WITH KEYBOARD)
DATA TERMINALS, INQUIRY-RESPONSE (SPECIAL-PURPOSE)
DISC DRIVES, FIXED HEAD (INCLUDING CONTROLLER)
DISC DRIVES, MOVABLE HEAD (INCLUDING CONTROLLER)
DISC DRIVES, REMOVABLE CARTRIDGE
DISC PACKS, MAGNETIC
DISC STORAGE SYSTEMS
DRUM STORAGE EQUIPMENT, MAG-NETIC (INCLUDING CONTROLLER)
LEASING, EDP EQUIPMENT (OTHER THAN MFGRS)
MODEMS, ACOUSTIC
MODEMS, HARD-WIRED
MODEMS, PC CARD
MULTIPLEXERS, DIGITAL
PAPER (FOR PRINTERS)
PRINTERS, LINE (LOW & MEDIUM SPEED)
PRINTERS, LINE (HIGH SPEED)
REELS, PAPER TAPE
SERVICES, SYSTEMS ANALYSIS
TAGS (FOR EDP PROCESSING)
TAPE, MAGNETIC (CASSETTE)
TAPE, MAGNETIC (REELS)
TAPE, PUNCH (MYLAR)
TAPE, PUNCH (PAPER)
USED EQUIPMENT (BUYING, SELLING, LEASING)

DATASCAN INC.

201-478-2800

1111 Paulison Ave, Clifton, N J 07013

CIRCUIT CARDS, LOGIC (WITH DISCRETE COMPONENTS)
CIRCUIT CARDS, LOGIC (WITH IC'S)
CONVERTERS, ANALOG-TO-DIGITAL
CONVERTERS, BINARY-TO-DECIMAL
CONVERTERS, PAPER TAPE-TO-MAGNETIC TAPE
READERS, PAPER TAPE
SPOOLERS, PAPER TAPE

DATASONICS INC.

212-682-0326

P O Box 4553, New York, N Y 10017

COMMUNICATION SYSTEMS, DATA TRANSMISSION
CONSULTING (ACCOUNTING, BUSINESS AND COMMERCIAL APPLICATIONS)
CONSULTING (COMPUTER PRODUCT PLANNING SURVEYS, MARKET RESEARCH STUDIES)
CONSULTING (MANAGEMENT INFORMATION SYSTEMS PLANNING)
CONTROLLERS, MAGNETIC TAPE
MAGNETIC TAPE STORAGE SYSTEMS (INCLUDES CONTROLLER)
PRINTERS, LINE (HIGH SPEED)
CONTINUED

3 Manufacturers' Directory

PROGRAMMING LANGUAGE DEVELOPMENT (PROPRIETARY SOFTWARE PRODUCTS)

SERVICES, FACILITY MANAGEMENT
 SERVICES, MANAGEMENT INFORMATION SYSTEMS
 SERVICES, PROCESSING (COMMERCIAL EDP)
 SERVICES, TIME SHARING (COMMERCIAL)
 SERVICES, SYSTEMS ANALYSIS
 TAPE TRANSPORTS, MAGNETIC (DIGITAL-EXCL. CASSETTE)

DATATAB 312-943-1323
 740 N Rush St, Chicago, Ill 60611

CONSULTING (ACCOUNTING, BUSINESS AND COMMERCIAL APPLICATIONS)
 CONSULTING (COMPUTER PRODUCT PLANNING SURVEYS, MARKET RESEARCH STUDIES)
 SERVICES, PROCESSING (COMMERCIAL EDP)

DATATERM INC. 215-949-1910
 1671 Manning Blvd, Levittown, Pa 19057

COMMUNICATION SYSTEMS, DATA TRANSMISSION
 COMMUNICATION SYSTEMS, TELEPRINTER
 CONVERTERS, DOCUMENT-TO-PAPER TAPE
 CONVERTERS, MAGNETIC TAPE-TO-PAPER TAPE
 CONVERTERS, PAPER TAPE-TO-MAGNETIC TAPE
 CONVERTERS, PAPER TAPE-TO-PAPER TAPE
 CONVERTERS, PAPER TAPE-TO-PRINTER
 CONVERTERS, PAPER TAPE-TO-PUNCHED CARD
 DATA TERMINALS, BLOCK-BY-BLOCK (PAPER TAPE)
 DATA TERMINALS, BLOCK-BY-BLOCK (TELEPRINTER)
 DATA TERMINALS, INQUIRY-RESPONSE (ALPHANUMERIC KEYBOARD)
 DATA TERMINALS, INQUIRY-RESPONSE (AUDIO RESPONSE)
 DATA TERMINALS, INQUIRY-RESPONSE (BADGE-TOKEN READERS)
 DATA TERMINALS, INQUIRY-RESPONSE (SPECIAL-PURPOSE)
 DUPLICATORS-VERIFIERS, PAPER TAPE
 ENCODERS, KEYBOARD (ALPHANUMERIC)
 ENCODERS, KEYBOARD (NUMERIC)
 PERFORATORS, PAPER TAPE
 PRINTER/PUNCH, PAPER TAPE
 PUNCHES, PAPER TAPE
 RACKS, PAPER TAPE
 READERS, EDGE-PUNCHED CARD
 READERS, PAPER TAPE
 READERS, PERFORATED DOCUMENT
 SPOOLERS, PAPER TAPE
 TAPE, PUNCH (MYLAR)
 TAPE, PUNCH (MYLAR-COATED FOIL)
 TAPE, PUNCH (PAPER)
 TAPE, PUNCH (PAPER-COATED MYLAR)
 TAPE, PUNCH (PAPER-COATED ALUMINUM)
 WINDERS, PAPER TAPE

DATATROL INC. 617-562-3422
 Kane Industrial Dr, Hudson, Mass 01749

CONSOLES, CRT (GRAPHIC)
 DATA CONCENTRATORS
 DATA TERMINALS, INQUIRY-RESPONSE (AUDIO RESPONSE)

DATATRON INC. 714-540-9330
 1562 Reynolds Ave, Santa Ana, Cal 92707 TWX 910-595-1589

CLOCKS, DIGITAL (REAL-TIME)
 DATA ACQUISITION AND REDUCTION SYSTEMS
 GENERATORS, TIME CODE
 TESTERS, DIGITAL LOGIC MODULES AND CARDS
 TESTERS, INTEGRATED CIRCUIT

DATATRONIC SERVICE CO. 313-965-3855
 1250 Guardian Blvd, Detroit, Mich 48226

CONSULTING (ACCOUNTING, BUSINESS AND COMMERCIAL APPLICATIONS)
 SERVICES, PROCESSING (COMMERCIAL EDP)
 SERVICES, SYSTEMS ANALYSIS

DATATYPE CORP. 305-625-2489
 1050 NW 163rd Dr, Miami, Fla 33169

DATA TERMINALS, BLOCK-BY-BLOCK (OPTICAL)
 MARK SENSING EQUIPMENT
 READERS, OPTICAL CHARACTER SCANNING
 SCANNERS, OPTICAL

DATAWEST CORP. 602-947-4295
 7503 E Osborn Rd, Scottsdale, Ariz 85251

CONVERTERS, ANALOG-TO-DIGITAL
 CONVERTERS, BINARY-TO-DECIMAL
 CONVERTERS, DIGITAL-TO-ANALOG
 DATA ACQUISITION AND REDUCTION SYSTEMS
 FORMATTERS, MAGNETIC TAPE
 MULTIPLEXER-CONVERTER (SINGLE UNIT WITH MULTIPLEXER, SAMPLE & HOLD AMPLIFIER & A-TO-D CONVERTER)
 MULTIPLEXERS, ANALOG-SOLID STATE (SEQUENTIAL SAMPLING)
 MULTIPLEXERS, DIGITAL
 TEST SYSTEMS, COMPUTER PERFORMANCE

DA-TEL RESEARCH CO. 303-249-6129
 930 N Park Ave, Montrose, Colo 81401

COMMUNICATION SYSTEMS, DATA TRANSMISSION
 COMMUNICATION SYSTEMS, TELEPRINTER
 CONVERTERS, DC-TO-FREQUENCY
 MODEMS, HARD-WIRED
 MODEMS, PC CARD

DATEL/VARADYNE 617-828-6395
 1020 Turnpike St, Canton, Mass 02021

CIRCUITS, THICK FILM (DIGITAL)
 CONVERTERS, ANALOG-TO-DIGITAL
 CONVERTERS, DIGITAL-TO-ANALOG
 DATA ACQUISITION AND REDUCTION SYSTEMS
 MULTIPLEXERS, ANALOG-SOLID STATE (SEQUENTIAL SAMPLING)

DATRAN CORP. 203-847-9669
 179 W Rocks Rd, Norwalk, Conn 06851

COMMUNICATION SYSTEMS, DATA TRANSMISSION
 RECORDERS, MAGNETIC TAPE
 TAPE TRANSPORTS, MAGNETIC (DIGITAL-EXCL. CASSETTE)
 TAPE TRANSPORTS, MAGNETIC (INCREMENTAL)

DA-TRONICS INC. 216-455-5363
 2962 Market Ave N, Canton, Ohio 44714

CONSULTING (ACCOUNTING, BUSINESS AND COMMERCIAL APPLICATIONS)
 SERVICES, PROCESSING (COMMERCIAL EDP)

DATRON SYSTEMS INC. 201-334-4521
 100 Rte 46, Mt Lakes, N J 07046

DATA TERMINALS, BLOCK-BY-BLOCK (PUNCHED CARD)
 DATA TERMINALS, INQUIRY-RESPONSE (AUDIO RESPONSE)
 DATA TERMINALS, INQUIRY-RESPONSE (CRT WITH KEYBOARD)
 PUNCHES, CARD (UP TO 100 CPM)
 PUNCHES, CARD (UP TO 100 CPM)
 READERS, PUNCHED CARD (UP TO 100 CPM)

DATUM INC. 714-879-3070
 170 E Liberty Ave, Anaheim, Cal 92801 TWX 910-592-1289

AMPLIFIERS, D.C.
 AMPLIFIERS, INSTRUMENTATION
 CONTROLLERS, MAGNETIC DRUM
 CONTROLLERS, MAGNETIC TAPE
 CONVERTERS, ANALOG-TO-DIGITAL
 CONVERTERS, DIGITAL-TO-ANALOG
 CONVERTERS, MAGNETIC TAPE-TO-PRINTER
 DRUM STORAGE EQUIPMENT, MAGNETIC (INCLUDING CONTROLLER)
 MAGNETIC TAPE STORAGE SYSTEMS (INCLUDES CONTROLLER)
 MEMORY SYSTEMS, MAGNETIC DRUM
 MULTIPLEXER-CONVERTER (SINGLE UNIT WITH MULTIPLEXER, SAMPLE & HOLD AMPLIFIER & A-TO-D CONVERTER)
 MULTIPLEXERS, ANALOG-RELAY (SEQUENTIAL SAMPLING)
 MULTIPLEXERS, ANALOG-SOLID STATE (SEQUENTIAL SAMPLING)
 MULTIPLEXERS, DIGITAL

DAVIDSON OPTRONICS INC. 213-962-5181
 2223 Ramona Blvd, West Covina, Cal 91790

TESTERS, DISC HEADS
 TESTERS, MAGNETIC DISC

DAYMARC CORP. 617-894-2105
 40 Bear Hill Rd, Waltham, Mass 02154 TWX 710-324-6469

TESTERS, SEMICONDUCTOR

3 Manufacturers' Directory

DDC DIV. SOLID STATE SCIENTIFIC DEVICES

100 Tec St, Hicksville, N Y 11801

516-433-5330
TWX 510-221-1874

AMPLIFIERS, D.C.
AMPLIFIERS, OPERATIONAL
CONVERTERS, ANALOG-TO-DIGITAL
CONVERTERS, DIGITAL-TO-ANALOG
CONVERTERS, DIGITAL-TO-SYNCHRO
CONVERTERS, SYNCHRO-TO-DIGITAL
ENCODERS, SHAFT ANGLE
MODULES, LINEAR (ENCAPSULATED)
MULTIPLEXERS, ANALOG-SOLID STATE (SEQUENTIAL SAMPLING)
POWER SUPPLIES, DC
SIGNAL CONDITIONERS
SYNCHROS-RESOLVERS, CONTROL TRANSFORMERS

DECISION DATA CORP.

300 Jacksonville Rd, Warminster, Penn 18974

215-672-9410

AIDS, KEYPUNCH PERFORMANCE
PUNCHES, CARD (OVER 100 CPM)
PUNCHES, CARD (UP TO 100 CPM)
READER/PUNCHES, PUNCHED CARD
READERS, PERFORATED DOCUMENT
READERS, PUNCHED CARD (100 TO 300 CPM)
READERS, PUNCHED CARD (OVER 300 CPM)
REPRODUCERS, PUNCHED CARD (AUTOMATIC)
SORTERS, PUNCHED CARD
TRAINING SYSTEMS, CARD PUNCH
VERIFIERS, PUNCHED CARD

DECISION SYSTEMS INC.

E 66 Midland Ave, Paramus, N J 07652

201-261-8900

AUDIO/VISUAL TRAINING AIDS
CONSULTING (ACCOUNTING, BUSINESS AND COMMERCIAL APPLICATIONS)
CONSULTING (COMPUTER EVALUATIONS, SELECTIONS, INSTALLATION PLANNING)
CONSULTING (MANAGEMENT INFORMATION SYSTEMS PLANNING)
CONSULTING (SCIENTIFIC APPLICATIONS)
PROGRAMMING LANGUAGE DEVELOPMENT (CONSULTANTS)
PROGRAMMING LANGUAGE DEVELOPMENT (CONTRACT PROGRAMMING)
PROGRAMMING LANGUAGE DEVELOPMENT (DEDICATED APPLICATION SYSTEMS)
PROGRAMMING LANGUAGE DEVELOPMENT (PROPRIETARY SOFTWARE PRODUCTS)
SERVICES, FACILITY MANAGEMENT
SERVICES, SYSTEMS ANALYSIS

DECITRON COMMUNICATION SYSTEMS INC.

567 E 105 St, Brooklyn, N Y 11236

212-649-8110

DATA TERMINALS, BLOCK-BY-BLOCK (MULTI-PURPOSE)
DATA TERMINALS, BLOCK-BY-BLOCK (PAPER TAPE)
DATA TERMINALS, INQUIRY-RESPONSE (AUDIO RESPONSE)
DATA TERMINALS, INQUIRY-RESPONSE (BADGE-TOKEN READERS)
DATA TERMINALS, INQUIRY-RESPONSE (SPECIAL-PURPOSE)
SCANNERS, OPTICAL
TRANSCIVERS, FACSIMILE

DEFIANCE CIRCUIT CORP. SUB. HI-G INC.

12 Shepard St, Lawrence, Mass 01843
BOARDS, PRINTED CIRCUIT (WITHOUT COMPONENTS)

617-688-1856
TWX 710-342-1246

DEL ELECTRONIC CORP.

250 Sandford Blvd, Mt Vernon, N Y 10550

914-699-2000
TWX 710-562-0130

CAPACITORS, COMPUTER GRADE
CONVERTERS, DC-TO-FREQUENCY
CONVERTERS, FREQUENCY-TO-DC
ENCODERS, SHAFT ANGLE
INVERTERS, DC-AC
POWER SUPPLIES, AC
POWER SUPPLIES, DC
POWER SUPPLIES, DIGITALLY-CONTROLLED
TRANSFORMERS, POWER (COMPUTER GRADE)
TRANSFORMERS, PULSE (COMPUTER GRADE)
VOLTAGE DIVIDERS

DELCO ELECTRONICS DIV., SUB. GENERAL MOTORS CORP

7929 S Howell Ave, Milwaukee, Wisc 53201

414-762-7000
TELEX 1-112

COMPUTERS, FIRE CONTROL
COMPUTERS, NAVIGATION

DELMARVA COMPUTER INDUSTRIES INC.

5865 Robert Oliver Pl, Columbia, Md 21043

301-730-5950

ACOUSTIC COUPLERS
CONTINUED

CONSOLES, CRT (ALPHANUMERIC AND GRAPHIC)

CONSOLES, CRT (GRAPHIC)

CONSULTING (ACCOUNTING, BUSINESS AND COMMERCIAL APPLICATIONS)

CONSULTING (COMPUTER EVALUATIONS, SELECTIONS, INSTALLATION PLANNING)

CONSULTING (MANAGEMENT INFORMATION SYSTEMS PLANNING)

CONSULTING (SCIENTIFIC APPLICATIONS)

CORRECTION SEALS, PAPER TAPE

COVERS, ACOUSTIC (FOR KEYBOARDS, TELETYPEWRITERS, ETC.)

DATA TERMINALS, BLOCK-BY-BLOCK (MULTI-PURPOSE)

DATA TERMINALS, BLOCK-BY-BLOCK (PAPER TAPE)

DATA TERMINALS, BLOCK-BY-BLOCK (PLOTTER)

DATA TERMINALS, BLOCK-BY-BLOCK (TELEPRINTER)

PLOTTERS, MOVING PEN (DIGITAL CONTROLLER)

PROGRAMMING LANGUAGE DEVELOPMENT (CONSULTANTS)

PROGRAMMING LANGUAGE DEVELOPMENT (CONTRACT PROGRAMMING)

PROGRAMMING LANGUAGE DEVELOPMENT (DEDICATED APPLICATION SYSTEMS)

PROGRAMMING LANGUAGE DEVELOPMENT (PROPRIETARY SOFTWARE PRODUCTS)

RACKS, PAPER TAPE

SERVICES, FACILITY MANAGEMENT

SERVICES, MANAGEMENT INFORMATION SYSTEMS

SERVICES, PROCESSING (COMMERCIAL EDP)

SERVICES, TIME SHARING (COMMERCIAL)

SERVICES, TIME SHARING (RESEARCH)

SERVICES, SYSTEMS ANALYSIS

SPLICERS, PAPER TAPE

TAPE, PUNCH (PAPER)

TRAINING INSTITUTES, COMMERCIAL COMPUTER COURSES, SEMINARS,

CORRESPONDENCE COURSES

WINDERS, PAPER TAPE

DELTA AUTOMATED SYSTEMS INC.

816 Thayer Ave, Silver Spring, Md 20910

301-588-3265

COMPUTERS, DIGITAL (EDUCATIONAL)

CONSULTING (ACCOUNTING, BUSINESS AND COMMERCIAL APPLICATIONS)

SERVICES, FACILITY MANAGEMENT

SERVICES, PROCESSING (COMMERCIAL EDP)

SERVICES, SYSTEMS ANALYSIS

DELTA DATA SYSTEMS CORP.

Woodhaven Ind Park, Cornwells Hgts, Pa 19020

215-639-9400

TWX 510-667-1650

ACOUSTIC COUPLERS

COMMUNICATIONS-ORIENTED PROCESSORS, MULTIPLE CHANNEL CONTROLLERS

COMMUNICATIONS-ORIENTED PROCESSORS, SINGLE CHANNEL CONTROLLERS

COMMUNICATIONS-ORIENTED PROCESSORS, STORED PROGRAM

COMMUNICATION SYSTEMS, DATA TRANSMISSION

CONSOLES, CRT (ALPHANUMERIC AND GRAPHIC)

CONSOLES, CRT (COLOR-ALPHANUMERIC AND GRAPHIC)

CONSOLES, CRT (GRAPHIC)

CONTROLLERS, MODEM

DATA TERMINALS, INQUIRY-RESPONSE (ALPHANUMERIC KEYBOARD)

DATA TERMINALS, INQUIRY-RESPONSE (CRT WITH KEYBOARD)

DATA TERMINALS, INQUIRY-RESPONSE (SPECIAL-PURPOSE)

DISPLAY DRIVERS

MONITORS, TV

PRINTERS, KEYBOARD

READOUTS, CRT

DELTA SYSTEMS CORP.

Edens Exective Ctr, Wilmette, Ill 60091

312-256-5100

CONSULTING (ACCOUNTING, BUSINESS AND COMMERCIAL APPLICATIONS)

CONSULTING (COMPUTER EVALUATIONS, SELECTIONS, INSTALLATION PLANNING)

CONSULTING (DATA COMMUNICATIONS SYSTEMS PLANNING)

CONSULTING (COMPUTER PRODUCT PLANNING SURVEYS, MARKET RESEARCH STUDIES)

CONSULTING (MANAGEMENT INFORMATION SYSTEMS PLANNING)

PROGRAMMING LANGUAGE DEVELOPMENT (CONSULTANTS)

PROGRAMMING LANGUAGE DEVELOPMENT (CONTRACT PROGRAMMING)

PROGRAMMING LANGUAGE DEVELOPMENT (DEDICATED APPLICATION SYSTEMS)

PROGRAMMING LANGUAGE DEVELOPMENT (PROPRIETARY SOFTWARE PRODUCTS)

SERVICES, FACILITY MANAGEMENT

SERVICES, PROCESSING (COMMERCIAL EDP)

TRAINING INSTITUTES, COMMERCIAL COMPUTER COURSES, SEMINARS,

CORRESPONDENCE COURSES

DELTRON INC.

Wissahickon Ave, No Wales, Pa 19454

215-699-9261

TWX 510-661-8061

POWER SUPPLIES, AC

POWER SUPPLIES, DC

3 Manufacturers' Directory

DEMEX INC. 816-421-3181
 2130 Jefferson, Kansas City, Mo 64108 TWX 910-771-2067
 COMMUNICATION SYSTEMS, DATA TRANSMISSION
 READERS, PUNCHED CARD (UP TO 100 CPM)

DENELCOR INC. 303-892-0987
 5975 Broadway, Denver, Colo 80216

AMPLIFIERS, D.C.
 AMPLIFIERS, OPERATIONAL
 COMPUTERS, ANALOG (EDUCATIONAL)
 COMPUTERS, DIGITAL (EDUCATIONAL)
 COMPUTERS, HYBRID
 DEMONSTRATORS AND KITS, EDUCATIONAL (DIGITAL LOGIC)
 INSTRUCTIONAL SYSTEMS, COMPUTER-BASED
 VOLTMETERS, DIGITAL

DESIGN AUTOMATION INC. 617-862-8998
 809 Massachusetts Ave, Lexington, Mass 02173

CONSULTING (ADVANCED COMPUTER EQUIPMENT DESIGN AND FEASIBILITY STUDIES)
 CONSULTING (SCIENTIFIC APPLICATIONS)
 SERVICES, COMPUTER-AIDED DESIGN
 SERVICES, PROCESSING (DIGITAL SCIENTIFIC)
 SERVICES, SYSTEMS ANALYSIS
 TRAINING INSTITUTES, COMMERCIAL COMPUTER COURSES, SEMINARS, CORRESPONDENCE COURSES

DESIGN ELEMENTS INC. 614-294-2694
 356 Norton Ave, Columbus, Ohio 43212

ACOUSTIC COUPLERS
 COMMUNICATION SYSTEMS, DATA TRANSMISSION
 CONVERTERS, DOCUMENT-TO-MAGNETIC TAPE
 DATA TERMINALS, BLOCK-BY-BLOCK (MAGNETIC TAPE)
 DATA TERMINALS, BLOCK-BY-BLOCK (TELEPRINTER)
 ENCODERS, KEYBOARD-TO-MAGNETIC TAPE
 MODEMS, ACOUSTIC
 MODEMS, HARD-WIRED
 MODEMS, PC CARD
 POWER SUPPLIES, DC
 RECORDERS, DIGITAL CASSETTE
 TAPE TRANSPORTS, MAGNETIC (DIGITAL CASSETTE)
 TYPEWRITERS, COMPUTER INPUT-OUTPUT

DESIGNERS & BUILDERS OF INFORMATION SYSTEMS 212-581-2490
 35 W 53 St, New York, N Y 10019

CONSULTING (ACCOUNTING, BUSINESS AND COMMERCIAL APPLICATIONS)
 CONSULTING (SCIENTIFIC APPLICATIONS)
 PROGRAMMING LANGUAGE DEVELOPMENT (CONSULTANTS)
 PROGRAMMING LANGUAGE DEVELOPMENT (CONTRACT PROGRAMMING)

DETROIT COIL CO. 313-566-3950
 2435 Hilton Rd, Ferndale, Mich 48220

SOLENOIDS

DEUSSEN ASSOCIATES INC. 408-739-5024
 576 Hyannis Dr, Sunnyvale, Cal 94087

CONSULTING (ACCOUNTING, BUSINESS AND COMMERCIAL APPLICATIONS)
 CONSULTING (ADVANCED COMPUTER EQUIPMENT DESIGN AND FEASIBILITY STUDIES)
 CONSULTING (COMPUTER EVALUATIONS, SELECTIONS, INSTALLATION PLANNING)
 CONSULTING (DATA COMMUNICATIONS SYSTEMS PLANNING)
 CONSULTING (COMPUTER PRODUCT PLANNING SURVEYS, MARKET RESEARCH STUDIES)
 CONSULTING (MANAGEMENT INFORMATION SYSTEMS PLANNING)
 CONSULTING (SCIENTIFIC APPLICATIONS)
 PROGRAMMING LANGUAGE DEVELOPMENT (CONSULTANTS)
 PROGRAMMING LANGUAGE DEVELOPMENT (CONTRACT PROGRAMMING)
 PROGRAMMING LANGUAGE DEVELOPMENT (DEDICATED APPLICATION SYSTEMS)
 PROGRAMMING LANGUAGE DEVELOPMENT (PROPRIETARY SOFTWARE PRODUCTS)
 SERVICES, FACILITY MANAGEMENT
 SERVICES, MANAGEMENT INFORMATION SYSTEMS
 SERVICES, SYSTEMS ANALYSIS

DEVONSHIRE COMPUTER CORP. 617-969-0650
 377 Elliot St, Newton, Mass 02164

COMMUNICATIONS-ORIENTED PROCESSORS, MULTIPLE CHANNEL CONTROLLERS
 CONTINUED

COMMUNICATION SYSTEMS, DATA TRANSMISSION
 DATA CONCENTRATORS
 MODEMS, PC CARD

DEXION INC. 212-335-3636
 39-27 59th St, New York, N Y 11377

CABINETS, RACKS, VAULTS (FOR MAGNETIC TAPE STORAGE)
 DESKS, TABLES AND STANDS (FOR CALCULATORS)
 DESKS, TABLES AND STANDS (FOR KEYPUNCH UNITS)
 DESKS, TABLES AND STANDS (FOR PROGRAMMER STATIONS)
 DESKS, TABLES AND STANDS (FOR TYPEWRITERS)

DI/AN CONTROLS INC. 617-288-7700
 944 Dorchester Ave, Boston, Mass 02125 TWX 710-333-0174

CLOCKS, DIGITAL (REAL-TIME)
 DATA TERMINALS, BLOCK-BY-BLOCK (HIGH SPEED PRINTER)
 DATA TERMINALS, BLOCK-BY-BLOCK (MEDIUM SPEED PRINTER)
 DATA TERMINALS, BLOCK-BY-BLOCK (TELEPRINTER)
 DATA TERMINALS, INQUIRY-RESPONSE (ALPHANUMERIC KEYBOARD)
 ENCODERS, KEYBOARD-TO-PRINTED TAPE
 MARK SENSING EQUIPMENT
 MEMORY SYSTEMS, MAGNETIC CORE
 MODULES, DIGITAL LOGIC ENCAPSULATED (ALSO SEE CIRCUITS & CIRCUIT CARDS)
 MODULES, MEMORY (ENCAPSULATED)
 PAPER (FOR PRINTERS)
 PRINTERS, DIGITAL STRIP RECORDING
 PRINTERS, KEYBOARD
 PRINTERS, LINE (LOW & MEDIUM SPEED)
 PRINTERS, LINE (HIGH SPEED)
 READERS, OPTICAL CHARACTER SCANNING
 TIMERS, INTERVAL
 TYPEWRITERS, COMPUTER INPUT-OUTPUT

DIABLO SYSTEMS INC. 415-783-3910
 24500 Industrial Blvd, Hayward, Cal 94545 TWX 910-383-0225
 DISC DRIVES, REMOVABLE CARTRIDGE

DIALIGHT CORP. 212-497-7600
 60 Stewart Ave, Brooklyn, N Y 11237 TWX 212-366-5420

DISPLAY DRIVERS
 INDICATORS, ALPHANUMERIC
 INDICATORS, DIGITAL
 INDICATORS, ILLUMINATED
 LAMPS, GLOW
 LAMPS-PANEL, PILOT AND DIAL (INCANDESCENT)
 SWITCHES, PUSHBUTTON
 SWITCHES, PUSHBUTTON (ILLUMINATED)

DIALOG COMPUTING INC. 203-255-3571
 1305 Post Rd, Fairfield, Conn 06430

DATA TERMINALS, INQUIRY-RESPONSE (ALPHANUMERIC KEYBOARD)
 SERVICES, TIME SHARING (COMMERCIAL)
 SERVICES, TIME SHARING (RESEARCH)

DIAMOND POWER SPECIALTY CORP. 614-653-6540
 P O Box 415, Lancaster, Ohio 43130

BLOWERS, FANS, COOLING ASSEMBLIES
 COMMUNICATION SYSTEMS, DATA TRANSMISSION
 COMMUNICATION SYSTEMS, FACSIMILE
 COMMUNICATION SYSTEMS, TELEPRINTER
 CONSOLES, CRT (GRAPHIC)
 MONITORS, TV
 READOUTS, CRT
 RECORDING HEADS, MAGNETIC TAPE
 TAPE, MAGNETIC (REELS)

DIAMOND SYSTEMS INC. 313-442-5866
 24638 NW Hwy, Southfield, Mich 48075

LABELS, CONTINUOUS AND GUMMED (MACHINE APPLICATION)

DICKSON ELECTRONICS CORP. 602-947-2231
 P O Box 1390, Scottsdale, Ariz 85252

AMPLIFIERS, OPERATIONAL
 CIRCUITS, HYBRID (IC AND DISCRETE-DIGITAL)
 DIODES, ZENER
 REGULATORS, VOLTAGE

3 Manufacturers' Directory

DICOM INDUSTRIES 684 W Maude Ave, Sunnyvale, Cal 94086	408-732-1060	DIGITAL APPLICATIONS INC. 6300 Westpark Ste 150, Houston, Tex 77027	713-781-6760
RECORDERS, DIGITAL CASSETTE TAPE TRANSPORTS, MAGNETIC (DIGITAL CASSETTE)		CABLE ASSEMBLIES (WITH CONNECTORS) CONSULTING (COMPUTER EVALUATIONS, SELECTIONS, INSTALLATION PLANNING) CONSULTING (SCIENTIFIC APPLICATIONS) DATA ACQUISITION AND REDUCTION SYSTEMS DATA CONCENTRATORS DATA TERMINALS, INQUIRY-RESPONSE (SPECIAL-PURPOSE) PROGRAMMING LANGUAGE DEVELOPMENT (CONTRACT PROGRAMMING) PROGRAMMING LANGUAGE DEVELOPMENT (DEDICATED APPLICATION SYSTEMS) SERVICES, SYSTEMS ANALYSIS	
DICOMED CORP. 7600 Parklawn Ave, Minneapolis, Minn 55435	612-920-8980	DIGITAL AUTOMATION CO, INC. 1018 Whitehead Rd Ext, Trenton, N J 08638	609-883-1400
CONSOLES, CRT (GRAPHIC) FILM SCANNERS		COMMUNICATION SYSTEMS, DATA TRANSMISSION COMMUNICATION SYSTEMS, TELEPRINTER CONVERTERS, PAPER TAPE-TO-PUNCHED CARD CONVERTERS, PUNCHED CARD-TO-MAGNETIC TAPE CONVERTERS, PUNCHED CARD-TO-PAPER TAPE MULTIPLEXERS, ANALOG-RELAY (SEQUENTIAL SAMPLING) MULTIPLEXERS, ANALOG-SOLID STATE (SEQUENTIAL SAMPLING) MULTIPLEXERS, DIGITAL READOUTS AND DISPLAYS, NUMERIC AND ALPHANUMERIC (OTHER THAN CRT) SCANNERS, INPUT	
DIEBOLD COMPUTER LEASING INC. Park 80 Plaza E, Saddle Brook, N J 07667	201-845-4774	DIGITAL COMPUTER CONTROLS INC 23 Just Rd, Fairfield, N J 07006	201-227-4861
COMPUTERS, DIGITAL (GENERAL-PURPOSE, MEDIUM-SCALE) COMPUTERS, DIGITAL (GENERAL-PURPOSE, LARGE SCALE) CONSULTING (COMPUTER EVALUATIONS, SELECTIONS, INSTALLATION PLANNING) LEASING, EDP EQUIPMENT (OTHER THAN MFGRS)		COMMUNICATIONS-ORIENTED PROCESSORS, MULTIPLE CHANNEL CONTROLLERS COMMUNICATIONS-ORIENTED PROCESSORS, STORED PROGRAM COMPUTERS, DIGITAL (GENERAL-PURPOSE, SMALL-SCALE) COMPUTERS, MINI GENERAL PURPOSE (ALSO SEE CALCULATORS) CONSULTING (ADVANCED COMPUTER EQUIPMENT DESIGN AND FEASIBILITY STUDIES)	
DIEBOLD INC. 818 Mulberry Rd SE, Canton, Ohio 44702	216-453-4592	DIGITAL DATA SYSTEMS 18819 Bryant St, Northridge, Cal 91324	213-886-5711
CABINETS, RACKS, VAULTS (FOR MAGNETIC TAPE STORAGE) CABINETS, TRAYS (FOR PUNCHED CARD STORAGE) DATA RETRIEVAL SYSTEMS, MICRO-FILM (COMPUTER-CONTROLLED) FILES, PUNCHED CARD MICROFILM DATA RETRIEVAL SYSTEMS, COMPUTER CONTROLLED SAFES, MAGNETIC TAPE STORAGE		CIRCUIT CARDS, LOGIC (WITH DISCRETE COMPONENTS) CIRCUIT CARDS, LOGIC (WITH IC'S) CLOCKS, DIGITAL (REAL-TIME) DATA ACQUISITION AND REDUCTION SYSTEMS	
DIETZGEN CO., EUGENE 2425 N Sheffield, Chicago, Ill 60614	312-549-3300	DIGITAL DEVELOPMENT CORP. 5575 Kearny Villa Rd, San Diego, Cal 92123	714-278-9920 TELEX 69-5430
CALCULATORS, PROGRAMMABLE (ALSO SEE COMPUTERS) COMPUTERS, DIGITAL (GENERAL-PURPOSE, SMALL-SCALE) MICROFICHE MICROFILM ROLLS READERS, MICROFILM/MICROFICHE RECORDERS, MICROFILM/MICROFICHE		MEMORY SYSTEMS, MAGNETIC DISC	
DIGI-DATA CORP. 4315 Baltimore Ave, Bladensburg, Md 20710	301-277-9378	DIGITAL EQUIPMENT CORP. 146 Main St, Maynard, Mass 01754	617-897-5111 TWX 710-347-0212
COMMUNICATION SYSTEMS, DATA TRANSMISSION CONVERTERS, MAGNETIC TAPE-TO-MAGNETIC TAPE CONVERTERS, MAGNETIC TAPE-TO-PAPER TAPE CONVERTERS, PAPER TAPE-TO-MAGNETIC TAPE RECORDERS, MAGNETIC TAPE TAPE TRANSPORTS, MAGNETIC (INCREMENTAL)		AMPLIFIERS, OPERATIONAL ANALYZERS, PULSE HEIGHT BOARDS, PRINTED CIRCUIT (WITHOUT COMPONENTS) CABINETS, ENCLOSURES, CONSOLES, ELECTRONIC (FOR GENERAL EQUIPMENT) CIRCUIT CARDS, LOGIC (WITH DISCRETE COMPONENTS) CIRCUIT CARDS, LOGIC (WITH IC'S) CIRCUITS, HYBRID (IC AND DISCRETE-DIGITAL) CLOCKS, DIGITAL (REAL-TIME) COMMUNICATION SYSTEMS, DATA TRANSMISSION COMPUTERS, DIGITAL (GENERAL-PURPOSE, SMALL-SCALE) COMPUTERS, DIGITAL (GENERAL-PURPOSE, MEDIUM-SCALE) COMPUTERS, DIGITAL (GENERAL-PURPOSE, LARGE SCALE) COMPUTERS, MINI GENERAL PURPOSE (ALSO SEE CALCULATORS) COMPUTERS, PROCESS CONTROL CONNECTORS, PC AND IC BOARD (COMPUTER-GRADE) CONNECTORS, POWER (COMPUTER-GRADE) CONSOLES, CRT (ALPHANUMERIC AND GRAPHIC) CONSOLES, CRT (GRAPHIC) CONTROLLERS, MODEM CONVERTERS, ANALOG-TO-DIGITAL CONVERTERS, DIGITAL-TO-ANALOG CORES, FERRITE MEMORY DATA ACQUISITION AND REDUCTION SYSTEMS DEMONSTRATORS AND KITS, EDUCATIONAL (DIGITAL LOGIC) INSTRUCTIONAL SYSTEMS, COMPUTER-BASED LIGHT PENS (FOR CRT TERMINAL INPUT/OUTPUT) MULTIPLEXERS, DIGITAL PAPER (FOR PRINTERS) PLOTTERS, MOVING PEN (DIGITAL CONTROLLER) POWER SUPPLIES, DC PRINTERS, LINE (LOW & MEDIUM SPEED) PROGRAMMING LANGUAGE DEVELOPMENT (CONTRACT PROGRAMMING) PROGRAMMING LANGUAGE DEVELOPMENT (DEDICATED APPLICATION SYSTEMS) PUNCHES, PAPER TAPE READERS, PAPER TAPE	
DIGI-LOG SYSTEMS INC. 107 W Ridge Pike, Conshohocken, Pa 19428	215-825-1440	DIGILIN, INC. 1007 Air Way, Glendale, Cal 91201	213-240-1200 TWX 910-497-2085
ACOUSTIC COUPLERS COMPUTERS, HYBRID COMPUTERS, PROCESS CONTROL CONTROLLERS, MODEM CONTROLLERS, MOTOR DATA TERMINALS, BLOCK-BY-BLOCK (TELEPRINTER) DATA TERMINALS, INQUIRY-RESPONSE (ALPHANUMERIC KEYBOARD) DATA TERMINALS, INQUIRY-RESPONSE (CRT WITH KEYBOARD) DATA TERMINALS, INQUIRY-RESPONSE (SPECIAL-PURPOSE) MODEMS, ACOUSTIC MODEMS, HARD-WIRED MODEMS, PC CARD PRINTERS, KEYBOARD READOUTS, CRT TYPEWRITERS, COMPUTER INPUT-OUTPUT		CONVERTERS, ANALOG-TO-DIGITAL CONVERTERS, DIGITAL-TO-ANALOG CORES, FERRITE MEMORY DATA ACQUISITION AND REDUCTION SYSTEMS DEMONSTRATORS AND KITS, EDUCATIONAL (DIGITAL LOGIC) INSTRUCTIONAL SYSTEMS, COMPUTER-BASED LIGHT PENS (FOR CRT TERMINAL INPUT/OUTPUT) MULTIPLEXERS, DIGITAL PAPER (FOR PRINTERS) PLOTTERS, MOVING PEN (DIGITAL CONTROLLER) POWER SUPPLIES, DC PRINTERS, LINE (LOW & MEDIUM SPEED) PROGRAMMING LANGUAGE DEVELOPMENT (CONTRACT PROGRAMMING) PROGRAMMING LANGUAGE DEVELOPMENT (DEDICATED APPLICATION SYSTEMS) PUNCHES, PAPER TAPE READERS, PAPER TAPE	
DIGIAC CORP. Ames Court, Plainview, N Y 11803	516-433-7800	CONTINUED	
COMPUTERS, DIGITAL (EDUCATIONAL) DEMONSTRATORS AND KITS, EDUCATIONAL (DIGITAL LOGIC)			

3 Manufacturers' Directory

READERS, PERFORATED DOCUMENT
 READERS, PUNCHED CARD (100 TO 300 CPM)
 REELS, MAGNETIC TAPE
 TAPE, MAGNETIC (REELS)
 TAPE, PUNCH (PAPER)
 TAPE TRANSPORTS, MAGNETIC (DIGITAL-EXCL. CASSETTE)
 TRAINING SYSTEMS, COMPUTER SERVICE
 TYPEWRITERS, COMPUTER INPUT-OUTPUT

DIGITAL GENERAL CORP. 216-721-0440
 11000 Cedar Ave, Cleveland, Ohio 44107

TESTERS, DIGITAL LOGIC MODULES AND CARDS
 TESTERS, INTEGRATED CIRCUIT

DIGITAL INFORMATION DEVICES INC. 215-647-3700
 210 Welsh Pool Rd, Lionville, Pa 19353

CONTROLLERS, MAGNETIC TAPE
 DATA TERMINALS, BLOCK-BY-BLOCK (MAGNETIC TAPE)
 DATA TERMINALS, BLOCK-BY-BLOCK (MULTI-PURPOSE)
 ENCODERS, KEYBOARD-TO-MAGNETIC TAPE
 FORMATTERS, MAGNETIC TAPE
 POOLERS, MAGNETIC TAPE
 READERS, MAGNETIC CARD
 TAPE TRANSPORTS, MAGNETIC (DIGITAL-EXCL. CASSETTE)
 TAPE TRANSPORTS, MAGNETIC (WITH KEYBOARD INPUT)

DIGITAL INFORMATION STORAGE CORP. 617-368-8544
 100 Carter, Berlin, Mass 01503

DISC DRIVES, FIXED HEAD (INCLUDING CONTROLLER)
 DISC DRIVES, REMOVABLE CARTRIDGE
 DISC STORAGE SYSTEMS
 MEMORY SYSTEMS, MAGNETIC DISC

DIGITAL PRODUCTS

335 W 7th St, San Pedro, Cal 90733

COMMUNICATION SYSTEMS, DATA TRANSMISSION
 COMPUTERS, DIGITAL (GENERAL-PURPOSE, SMALL-SCALE)
 COMPUTERS, MINI GENERAL PURPOSE (ALSO SEE CALCULATORS)
 COMPUTERS, PROCESS CONTROL
 DATA ACQUISITION AND REDUCTION SYSTEMS
 PROGRAMMING LANGUAGE DEVELOPMENT (DEDICATED APPLICATION SYSTEMS)
 PROGRAMMING LANGUAGE DEVELOPMENT (PROPRIETARY SOFTWARE PRODUCTS)
 TEST SYSTEMS, COMPUTER PERFORMANCE
 TESTERS, CIRCUIT
 TESTERS, DIGITAL DATA TRANSMISSION
 TESTERS, DIGITAL LOGIC MODULES AND CARDS
 TESTERS, INTEGRATED CIRCUIT
 TESTERS, MEMORY PLANES, STACKS AND SYSTEMS
 TESTERS, SEMICONDUCTOR

DIGITAL PRODUCTS CORP. 305-933-7151
 6950 NW 12 Ave, Ft Lauderdale, Fla 33309

BOARDS, PRINTED CIRCUIT (WITHOUT COMPONENTS)
 CIRCUIT CARDS, LINEAR (WITH DISCRETE COMPONENTS)
 CIRCUIT CARDS, LINEAR (WITH IC'S)
 CIRCUIT CARDS, LOGIC (WITH DISCRETE COMPONENTS)
 CIRCUIT CARDS, LOGIC (WITH IC'S)
 CLOCKS, DIGITAL (REAL-TIME)
 CONVERTERS, ANALOG-TO-DIGITAL
 CONVERTERS, BINARY-TO-DECIMAL
 CONVERTERS, DIGITAL-TO-ANALOG
 CONVERTERS, DOCUMENT-TO-MAGNETIC TAPE
 CONVERTERS, DOCUMENT-TO-PAPER TAPE
 DATA TERMINALS, INQUIRY-RESPONSE (SPECIAL-PURPOSE)
 DEMONSTRATORS AND KITS, EDUCATIONAL (DIGITAL LOGIC)
 INDICATORS, DIGITAL
 INSTRUCTIONAL SYSTEMS, COMPUTER-BASED
 MODULES, RESISTANCE NETWORKS (ENCAPSULATED)
 SCANNERS, INPUT
 TIMERS, EVENT (IMPULSE)
 TIMERS, INTERVAL

DIGITAL PROGRAMMING SERVICES INC. 617-893-4445
 60 Hickory Dr, Waltham, Mass 02154

CONSULTING (ACCOUNTING, BUSINESS AND COMMERCIAL APPLICATIONS)
 CONSULTING (COMPUTER EVALUATIONS, SELECTIONS, INSTALLATION PLANNING)
 CONSULTING (DATA COMMUNICATIONS SYSTEMS PLANNING)
 CONSULTING (MANAGEMENT INFORMATION SYSTEMS PLANNING)
 CONTINUED

CONSULTING (SCIENTIFIC APPLICATIONS)
 PROGRAMMING LANGUAGE DEVELOPMENT (CONSULTANTS)
 PROGRAMMING LANGUAGE DEVELOPMENT (CONTRACT PROGRAMMING)
 PROGRAMMING LANGUAGE DEVELOPMENT (DEDICATED APPLICATION SYSTEMS)
 PROGRAMMING LANGUAGE DEVELOPMENT (PROPRIETARY SOFTWARE PRODUCTS)
 SERVICES, FACILITY MANAGEMENT
 SERVICES, MANAGEMENT INFORMATION SYSTEMS
 SERVICES, PROCESSING (COMMERCIAL EDP)
 SERVICES, PROCESSING (DIGITAL SCIENTIFIC)

DIGITAL RESOURCES CORP. 713-781-7062
 6250 W Park Suite 100, Houston, Tex 77027
 CONSOLES, CRT (GRAPHIC)
 CONVERTERS, ANALOG-TO-DIGITAL
 CONVERTERS, DIGITAL-TO-ANALOG
 SERVICES, FACILITY MANAGEMENT
 SERVICES, SYSTEMS ANALYSIS
 TELEX 76-2495

DIGITAL SCIENTIFIC CORP. 714-453-6050
 11455 Sorrento Vly Rd, San Diego, Cal 92121
 TWX 910-322-1136

COMMUNICATIONS-ORIENTED PROCESSORS, STORED PROGRAM
 COMPUTERS, DIGITAL (GENERAL-PURPOSE, SMALL-SCALE)
 COMPUTERS, DIGITAL (GENERAL-PURPOSE, MEDIUM-SCALE)
 CONTROLLERS, MAGNETIC DISC
 CONTROLLERS, MAGNETIC DRUM
 DISC DRIVES, FIXED HEAD (INCLUDING CONTROLLER)
 DISC DRIVES, REMOVABLE CARTRIDGE
 PLOTTERS, MOVING PEN (DIGITAL CONTROLLER)
 PRINTERS, KEYBOARD
 PRINTERS, LINE (HIGH SPEED)
 PUNCHES, PAPER TAPE
 READER/PUNCHES, PUNCHED CARD
 READERS, PAPER TAPE
 READERS, PUNCHED CARD (100 TO 300 CPM)
 READERS, PUNCHED CARD (OVER 300 CPM)
 TAPE TRANSPORTS, MAGNETIC (DIGITAL-EXCL. CASSETTE)
 TAPE TRANSPORTS, MAGNETIC (INCREMENTAL)
 TYPEWRITERS, COMPUTER INPUT-OUTPUT

DIGITAL SYSTEMS DESIGN 516-747-6561
 P O Box 305 Fdr Sta, New York, N Y 10022

CONSULTING (ACCOUNTING, BUSINESS AND COMMERCIAL APPLICATIONS)
 CONSULTING (ADVANCED COMPUTER EQUIPMENT DESIGN AND FEASIBILITY STUDIES)
 CONSULTING (COMPUTER EVALUATIONS, SELECTIONS, INSTALLATION PLANNING)
 CONSULTING (DATA COMMUNICATIONS SYSTEMS PLANNING)
 CONSULTING (COMPUTER PRODUCT PLANNING SURVEYS, MARKET RESEARCH STUDIES)
 CONSULTING (MANAGEMENT INFORMATION SYSTEMS PLANNING)
 CONSULTING (SCIENTIFIC APPLICATIONS)

DIGITAL TECHNIQUES CORP. 313-549-8663
 4248 Delemere Court, Royal Oak, Mich 48073
 TWX 810-232-1506
 ACOUSTIC COUPLERS
 CLOCKS, DIGITAL (REAL-TIME)
 MODEMS, ACOUSTIC
 MODEMS, HARD-WIRED

DIGITECH DATA INDUSTRIES INC. 203-438-3731
 66 Grove St, Ridgefield, Conn 06877
 TELEX 96-9623
 ANALYZERS, WAVEFORM
 GENERATORS, BYTE
 GENERATORS, CHARACTER (CRT)
 TESTERS, CIRCUIT
 TESTERS, DIGITAL DATA TRANSMISSION

DIGITEK TIMESHARE INC. 213-823-6379
 4818 Lincoln Blvd, Marina Del Rey, Cal 90291
 SERVICES, TIME SHARING (COMMERCIAL)

DIGITRAN CO., THE BECTON, DICKINSON & CO 213-449-3110
 855 S Arroyo Pkwy, Pasadena, Cal 91105
 TWX 910-588-3794
 SWITCHES, LEVER
 SWITCHES, THUMBWHEEL
 VOLTAGE DIVIDERS

DIGITRON CORP. 215-277-5800
 2544 W Main St, Norristown, Pa 19401
 CONTROLLERS, MAGNETIC DISC
 CONTINUED

3 Manufacturers' Directory

CONTROLLERS, MAGNETIC DRUM
 CONVERTERS, ANALOG-TO-DIGITAL
 CONVERTERS, BINARY-TO-DECIMAL
 CONVERTERS, DC-TO-FREQUENCY
 CONVERTERS, DIGITAL-TO-ANALOG
 CONVERTERS, FREQUENCY-TO-DC
 CONVERTERS, MAGNETIC TAPE-TO-MAGNETIC TAPE
 CONVERTERS, MAGNETIC TAPE-TO-PAPER TAPE
 CONVERTERS, MAGNETIC TAPE-TO-PRINTER
 CONVERTERS, MAGNETIC TAPE-TO-PUNCHED CARD
 CONVERTERS, PAPER TAPE-TO-MAGNETIC TAPE
 CONVERTERS, PAPER TAPE-TO-PAPER TAPE
 CONVERTERS, PAPER TAPE-TO-PRINTER
 CONVERTERS, PAPER TAPE-TO-PUNCHED CARD
 CONVERTERS, PUNCHED CARD-TO-MAGNETIC TAPE
 CONVERTERS, PUNCHED CARD-TO-PAPER TAPE
 CONVERTERS, VOLTAGE-TO-FREQUENCY
 COUNTERS, DECADE
 COUNTERS, DIGITAL READOUT
 COUNTERS, UP-DOWN
 FORMATTERS, MAGNETIC TAPE
 MODULES, DIGITAL LOGIC ENCAPSULATED (ALSO SEE CIRCUITS & CIRCUIT CARDS)
 MULTIPLEXER-CONVERTER (SINGLE UNIT WITH MULTIPLEXER, SAMPLE & HOLD AMPLIFIER & A-TO-D CONVERTER)
 MULTIPLEXERS, ANALOG-RELAY (SEQUENTIAL SAMPLING)
 MULTIPLEXERS, ANALOG-SOLID STATE (SEQUENTIAL SAMPLING)
 MULTIPLEXERS, DIGITAL
 PRINTERS, DIGITAL STRIP RECORDING
 PRINTERS, LINE (LOW & MEDIUM SPEED)
 SCANNERS, INPUT
 SIGNAL CONDITIONERS
 TIMERS, INTERVAL

DIGITRON INC. 803-779-5060
 P O Box 5836, Columbus, S C 29205

CONSULTING (ACCOUNTING, BUSINESS AND COMMERCIAL APPLICATIONS)
 CONSULTING (MANAGEMENT INFORMATION SYSTEMS PLANNING)
 SERVICES, COMPUTER-AIDED DESIGN
 SERVICES, MANAGEMENT INFORMATION SYSTEMS
 SERVICES, PROCESSING (COMMERCIAL EDP)
 SERVICES, SYSTEMS ANALYSIS

DIGITRONICS CORP. 516-484-1000
 1 Albertson Ave, Albertson, N Y 11507 TWX 510-223-0607

COMMUNICATION SYSTEMS, DATA TRANSMISSION
 DATA TERMINALS, BLOCK-BY-BLOCK (MAGNETIC TAPE)
 DATA TERMINALS, BLOCK-BY-BLOCK (PAPER TAPE)
 DATA TERMINALS, BLOCK-BY-BLOCK (HIGH SPEED PRINTER)
 DATA TERMINALS, INQUIRY-RESPONSE (ALPHANUMERIC KEYBOARD)
 ENCODERS, KEYBOARD (ALPHANUMERIC)
 ENCODERS, KEYBOARD-TO-MAGNETIC TAPE
 PERFORATORS, PAPER TAPE
 PRINTERS, LINE (HIGH SPEED)
 PUNCHES, PAPER TAPE
 READERS, OPTICAL CHARACTER SCANNING
 READERS, PAPER TAPE
 SPOOLERS, PAPER TAPE
 TAPE TRANSPORTS, MAGNETIC (INCREMENTAL)

DIKEWOOD CORP.,THE 505-243-9781
 1009 Bradbury Dr SE, Albuquerque, N M 87106 TWX 910-989-1163

CONSULTING (MANAGEMENT INFORMATION SYSTEMS PLANNING)
 CONSULTING (SCIENTIFIC APPLICATIONS)
 PROGRAMMING LANGUAGE DEVELOPMENT (PROPRIETARY SOFTWARE PRODUCTS)
 SERVICES, MANAGEMENT INFORMATION SYSTEMS
 SERVICES, SYSTEMS ANALYSIS

DIMENSIONAL SYSTEMS INC. 617-891-5533
 393 Totten Pond Rd, Waltham, Mass 02154

ANALYZERS, CONTINUITY
 COMPUTERS, DIGITAL (GENERAL-PURPOSE, SMALL-SCALE)
 COMPUTERS, DIGITAL (GENERAL-PURPOSE, MEDIUM-SCALE)
 COMPUTERS, MINI GENERAL PURPOSE (ALSO SEE CALCULATORS)
 COMPUTERS, NAVIGATION
 COMPUTERS, PROCESS CONTROL
 CONSOLES, CRT (GRAPHIC)
 CONSULTING (ADVANCED COMPUTER EQUIPMENT DESIGN AND FEASIBILITY STUDIES)
 CONSULTING (COMPUTER EVALUATIONS, SELECTIONS, INSTALLATION PLANNING)
 CONSULTING (MANAGEMENT INFORMATION SYSTEMS PLANNING)
 CONSULTING (SCIENTIFIC APPLICATIONS)
 CONTROLLERS, PLOTTING
 CURVE TRACERS-DIGITIZERS, AUTOMATIC
 CURVE TRACERS-DIGITIZERS, MANUAL
 CONTINUED

DATA ACQUISITION AND REDUCTION SYSTEMS
 DRAFTING SYSTEMS, COMPUTER-CONTROLLED STORAGE
 GRAPHIC TABLETS
 PLOTTERS, MOVING PEN (DIGITAL CONTROLLER)
 SERVICES, COMPUTER-AIDED DESIGN
 SERVICES, PROCESSING (DIGITAL SCIENTIFIC)
 SERVICES, AUTOMATED WIRE-WRAPPING
 SERVICES, HARDWARE MAINTENANCE
 TESTERS, CIRCUIT
 TESTERS, DIGITAL DATA TRANSMISSION
 TESTERS, DIGITAL LOGIC MODULES AND CARDS
 TESTERS, INTEGRATED CIRCUIT
 TESTERS, MEMORY PLANES, STACKS AND SYSTEMS

DIONICS INC. 516-997-7474
 65 Rushmore St, Westburn, N Y 11590 TWX 510-222-0974

CIRCUITS, MONOLITHIC (DIGITAL LOGIC)
 CIRCUITS, MONOLITHIC (DIODE MATRICES)
 CIRCUITS, MONOLITHIC (LINEAR-EXCL. OP AMPS)
 CIRCUITS, MONOLITHIC (LSI-BIPOLAR)
 DIODES, SILICON
 MEMORY SYSTEMS, DIODE
 MEMORY SYSTEMS, SEMICONDUCTOR
 TRANSISTORS, FIELD EFFECT
 TRANSISTORS, SILICON

DIOPTRIX INC. 714-459-4226
 1020 Prospect St, La Jolla, Cal 92037

READERS, MICROFILM/MICROFICHE

DIPIETRO & WILSON INC. 617-783-1024
 1107 Commonwealth Ave, Boston, Mass 02215

CONSULTING (ACCOUNTING, BUSINESS AND COMMERCIAL APPLICATIONS)
 CONSULTING (ADVANCED COMPUTER EQUIPMENT DESIGN AND FEASIBILITY STUDIES)
 CONSULTING (COMPUTER EVALUATIONS, SELECTIONS, INSTALLATION PLANNING)
 CONSULTING (DATA COMMUNICATIONS SYSTEMS PLANNING)
 CONSULTING (COMPUTER PRODUCT PLANNING SURVEYS, MARKET RESEARCH STUDIES)
 CONSULTING (MANAGEMENT INFORMATION SYSTEMS PLANNING)
 SERVICES, COMPUTER-AIDED DESIGN
 SERVICES, FACILITY MANAGEMENT
 SERVICES, MANAGEMENT INFORMATION SYSTEMS
 SERVICES, PROCESSING (COMMERCIAL EDP)
 SERVICES, SYSTEMS ANALYSIS

DIRECT ACCESS COMPUTING CORP. 313-585-7000
 984 Livernois Rd, Troy, Mich 48084

ACOUSTIC COUPLERS
 CONSULTING (ACCOUNTING, BUSINESS AND COMMERCIAL APPLICATIONS)
 CONSULTING (COMPUTER EVALUATIONS, SELECTIONS, INSTALLATION PLANNING)
 CONSULTING (DATA COMMUNICATIONS SYSTEMS PLANNING)
 CONSULTING (COMPUTER PRODUCT PLANNING SURVEYS, MARKET RESEARCH STUDIES)
 CONSULTING (MANAGEMENT INFORMATION SYSTEMS PLANNING)
 CONSULTING (SCIENTIFIC APPLICATIONS)
 LEASING, EDP EQUIPMENT (OTHER THAN MFGRS)
 PROGRAMMING LANGUAGE DEVELOPMENT (CONSULTANTS)
 PROGRAMMING LANGUAGE DEVELOPMENT (CONTRACT PROGRAMMING)
 PROGRAMMING LANGUAGE DEVELOPMENT (DEDICATED APPLICATION SYSTEMS)
 PROGRAMMING LANGUAGE DEVELOPMENT (PROPRIETARY SOFTWARE PRODUCTS)
 SERVICES, FACILITY MANAGEMENT
 SERVICES, MANAGEMENT INFORMATION SYSTEMS
 SERVICES, PROCESSING (COMMERCIAL EDP)
 SERVICES, PROCESSING (DIGITAL SCIENTIFIC)
 SERVICES, TIME SHARING (COMMERCIAL)
 SERVICES, TIME SHARING (RESEARCH)
 SERVICES, SYSTEMS ANALYSIS

DISC INSTRUMENTS INC. 714-549-0343
 2701 So Halladay St, Santa Ana, Cal 92705 TWX 714-546-0434

ENCODERS, DIGITAL
 ENCODERS, SHAFT ANGLE

DISCOM INC., SUB. MAGNAFILE, COMDISK 602-964-2981
 P O Box 231, Mesa, Ariz 85201 TWX 910-953-1681

CONTROLLERS, MAGNETIC DISC
 DISC DRIVES, FIXED HEAD (INCLUDING CONTROLLER)

3 Manufacturers' Directory

DISKOS ELECTRONICS CORP. 201 Lane Tree Court, Milpitas, Cal 95035	408-263-2170	DRAKE MANUFACTURING CO. 4626 N Olcott Ave, Harwood Heights, Ill 60656	312-867-7227 TWX 910-221-0236
TESTERS, MAGNETIC DISC TESTERS, MEMORY PLANES, STACKS AND SYSTEMS		INDICATORS, ILLUMINATED LAMPS, GLOW LAMPS-PANEL, PILOT AND DIAL (INCANDESCENT) SWITCHES, PUSHBUTTON (ILLUMINATED)	
DISPLAY DEVICES INC. P O Box 667, Encinitas, Cal 92024	714-753-0113	DRESSER PRODUCTS INC. P O Box 2035, Providence, R I 02905	401-781-4430
LAMPS-PANEL, PILOT AND DIAL (INCANDESCENT) READOUTS AND DISPLAYS, NUMERIC AND ALPHANUMERIC (OTHER THAN CRT)		ENVELOPES (FOR FILING TAPES) SPLICERS, PAPER TAPE SPOOLERS, PAPER TAPE WINDERS, PAPER TAPE	
DIT-MCO INTERNATIONAL 5612 Brighton Terr, Kansas City, Mo 64130	816-363-6288	DRESSER SYSTEMS INC. P O Box 2928, Houston, Tex 77001	713-781-5900
ANALYZERS, CONTINUITY TESTERS, CIRCUIT		PLOTTERS, FILM EXPOSING	
DIVERSIFIED COMPUTER APPLICATIONS 2525 E Bayshore Rd, Palo Alto, Cal 94302	415-324-2523	DSI SYSTEMS INC. 2351 Shady Grove Rd, Rockville, Md 20854	301-926-2800
CONSULTING (ACCOUNTING, BUSINESS AND COMMERCIAL APPLICATIONS) CONSULTING (COMPUTER EVALUATIONS, SELECTIONS, INSTALLATION PLANNING) CONSULTING (DATA COMMUNICATIONS SYSTEMS PLANNING) CONSULTING (MANAGEMENT INFORMATION SYSTEMS PLANNING) SERVICES, FACILITY MANAGEMENT SERVICES, MANAGEMENT INFORMATION SYSTEMS SERVICES, PROCESSING (COMMERCIAL EDP) SERVICES, TIME SHARING (COMMERCIAL) SERVICES, SYSTEMS ANALYSIS		MICROFILM DATA RETRIEVAL SYSTEMS, COMPUTER CONTROLLED MICROFILM DATA RETRIEVAL SYSTEMS, COMPUTER CONTROLLED (GRAPHIC)	
DIVERSIFIED NUMERIC APPLICATIONS 9801 Logan Ave S, Minneapolis, Minn 55423	612-884-4777	DUMEY, ARNOLD I. 641 Mt Lucas Rd, Princeton, N J 08540	609-924-3592
DATA TERMINALS, BLOCK-BY-BLOCK (MULTI-PURPOSE) DATA TERMINALS, BLOCK-BY-BLOCK (TELEPRINTER) DATA TERMINALS, INQUIRY-RESPONSE (ALPHANUMERIC KEYBOARD)		CONSULTING (ACCOUNTING, BUSINESS AND COMMERCIAL APPLICATIONS) CONSULTING (COMPUTER EVALUATIONS, SELECTIONS, INSTALLATION PLANNING) CONSULTING (DATA COMMUNICATIONS SYSTEMS PLANNING) CONSULTING (MANAGEMENT INFORMATION SYSTEMS PLANNING)	
DOCUMATION INC. 841 E New Haven Ave, Melbourne, Fla 32901	305-724-1111	DUNCAN ELECTRONICS, INC. 2865 Fairview Rd, Costa Mesa, Cal 92626	714-545-8261 TWX 910-595-1128
READERS, PUNCHED CARD (UP TO 100 CPM) READERS, PUNCHED CARD (100 TO 300 CPM) READERS, PUNCHED CARD (OVER 300 CPM)		POTENTIOMETERS, TRIM (FILM) POTENTIOMETERS, TRIM (WIRE-WOUND)	
DOLAN JENNER INDUSTRIES INC. 200 Ingall Court, Melrose, Mass 02176	617-662-8200	DUPONT DE NEMOURS, & CO.,E.I. CO., INC. 1007 Market St, Wilmington, Del 19898	302-774-2421
FIBER OPTIC BUNDLES FIBER OPTICS ASSEMBLIES (FOR PUNCHED CODE READERS AND MARK SENSORS) LIGHT PENS (FOR CRT TERMINAL INPUT/OUTPUT) MARK SENSING EQUIPMENT SCANNERS, INPUT SCANNERS, OPTICAL		ANALYZERS, DIFFERENTIAL CURVE TRACERS-DIGITIZERS, MANUAL FIBER OPTIC BUNDLES MICROFICHE MICROFILM ROLLS TAPE, MAGNETIC (REELS) TRAINING INSTITUTES, COMMERCIAL COMPUTER COURSES, SEMINARS, CORRESPONDENCE COURSES USED EQUIPMENT (BUYING, SELLING, LEASING)	
DOLIN METAL PRODUCTS INC. 475 President St, Brooklyn, N Y 11215	212-596-1400	DURANT DIGITAL INSTRUMENTS A CUTLER HAMMER CO. 600 N Cass St, Milwaukee, Wisc 53201	414-271-9300 TWX 910-262-3307
CABINETS, ENCLOSURES, CONSOLES, ELECTRONIC (FOR GENERAL EQUIPMENT) CABINETS, RACKS, VAULTS (FOR MAGNETIC TAPE STORAGE) CABINETS, TRAYS (FOR PUNCHED CARD STORAGE) DISC STORAGE SYSTEMS FILES, PUNCHED CARD		COUNTERS, DECADE COUNTERS, DIGITAL READOUT COUNTERS, STEPPING SWITCH COUNTERS, UP-DOWN TIMERS, EVENT (IMPULSE) TIMERS, INTERVAL	
DONALD INC. P O Box 104, Ridgewood, N J 07451	201-444-6573 TWX 710-988-5612	DYNACOOOL MANUFACTURING CO INC 1 Russell St, Saugerties, N Y 12477	914-246-4902
CORRECTION SEALS, PAPER TAPE PUNCHES, PAPER TAPE SPLICERS, PAPER TAPE TAPE, PUNCH (MYLAR) TAPE, PUNCH (MYLAR-COATED FOIL) TAPE, PUNCH (PAPER) TAPE, PUNCH (PAPER-COATED MYLAR) TAPE, PUNCH (PAPER-COATED ALUMINUM)		BLOWERS, FANS, COOLING ASSEMBLIES	
DORMEYER INDUSTRIES INC. 3418 N Milwaukee Ave, Chicago, Ill 60641	312-283-4000	DYNACOUSTICS INC. 1980 National Ave, Hayward, Cal 94545	415-783-5614
SOLENOIDS TRANSFORMERS, POWER (COMPUTER GRADE)		CONTROLLERS, MAGNETIC DISC CONTROLLERS, MAGNETIC DRUM CONTROLLERS, MAGNETIC TAPE DISC STORAGE SYSTEMS FORMATTERS, MAGNETIC TAPE MEMORY SYSTEMS, MAGNETIC DISC	
DORMEYER INDUSTRIES INC. 3418 N Milwaukee Ave, Chicago, Ill 60641	312-283-4000	DYNAGE INC. 1331 Blue Hills Ave, Bloomfield, Conn 06002	203-243-0315 TWX 710-425-6063
SOLENOIDS TRANSFORMERS, POWER (COMPUTER GRADE)		CIRCUIT CARDS, LOGIC (WITH DISCRETE COMPONENTS) CIRCUIT CARDS, LOGIC (WITH IC'S) CONTINUED	

3 Manufacturers' Directory

POWER SUPPLIES, DC
VOLTAGE DIVIDERS

DYNAIR ELECTRONICS INC. 714-582-9211
6360 Federal Blvd, San Diego, Cal 92114 TWX 910-335-2040
AMPLIFIERS, VIDEO

DYNALEX INC. 213-849-2221
885 Front St, Burbank, Cal 91502

COMMUNICATIONS-ORIENTED PROCESSORS, MULTIPLE CHANNEL CONTROLLERS
COMMUNICATIONS-ORIENTED PROCESSORS, STORED PROGRAM
COMPUTERS, DIGITAL (GENERAL-PURPOSE, SMALL-SCALE)
COMPUTERS, FIRE CONTROL
CONTROLLERS, MAGNETIC DISC
CONTROLLERS, MAGNETIC DRUM
CONTROLLERS, MAGNETIC TAPE
CONVERTERS, ANALOG-TO-DIGITAL
CONVERTERS, DIGITAL-TO-ANALOG
CONVERTERS, DIGITAL-TO-SYNCHRO
CONVERTERS, SYNCHRO-TO-DIGITAL
DATA CONCENTRATORS
MULTIPLEXER-CONVERTER (SINGLE UNIT WITH MULTIPLEXER, SAMPLE & HOLD
AMPLIFIER & A-TO-D CONVERTER)
MULTIPLEXERS, ANALOG-SOLID STATE (SEQUENTIAL SAMPLING)
MULTIPLEXERS, DIGITAL

DYNAMIC ACCESS CORP. 212-475-1850
220 Park Ave S, New York, N Y 10003

ACCOUNTING MACHINES, CARD-PROGRAMMED
COLLATORS, PUNCHED CARD
CONSULTING (ACCOUNTING, BUSINESS AND COMMERCIAL APPLICATIONS)
CONSULTING (ADVANCED COMPUTER EQUIPMENT DESIGN AND FEASIBILITY
STUDIES)
CONSULTING (COMPUTER EVALUATIONS, SELECTIONS, INSTALLATION
PLANNING)
CONSULTING (DATA COMMUNICATIONS SYSTEMS PLANNING)
CONSULTING (COMPUTER PRODUCT PLANNING SURVEYS, MARKET RESEARCH
STUDIES)
CONSULTING (MANAGEMENT INFORMATION SYSTEMS PLANNING)
CONSULTING (SCIENTIFIC APPLICATIONS)
LEASING, EDP EQUIPMENT (OTHER THAN MFGRS)
PROGRAMMING LANGUAGE DEVELOPMENT (CONSULTANTS)
PROGRAMMING LANGUAGE DEVELOPMENT (CONTRACT PROGRAMMING)
PROGRAMMING LANGUAGE DEVELOPMENT (DEDICATED APPLICATION SYSTEMS)
PROGRAMMING LANGUAGE DEVELOPMENT (PROPRIETARY SOFTWARE
PRODUCTS)
REPRODUCERS, PUNCHED CARD (AUTOMATIC)
SERVICES, COMPUTER-AIDED DESIGN
SERVICES, FACILITY MANAGEMENT
SERVICES, MANAGEMENT INFORMATION SYSTEMS
SERVICES, PROCESSING (COMMERCIAL EDP)
SERVICES, PROCESSING (DIGITAL SCIENTIFIC)
SERVICES, TIME SHARING (COMMERCIAL)
SERVICES, TIME SHARING (RESEARCH)
SERVICES, SYSTEMS ANALYSIS
SORTERS, PUNCHED CARD
TRAINING INSTITUTES, COMMERCIAL COMPUTER COURSES, SEMINARS,
CORRESPONDENCE COURSES
USED EQUIPMENT (BUYING, SELLING, LEASING)
VERIFIERS, PUNCHED CARD

DYNAMIC INSTRUMENTS CORP. 516-694-6000
115 W Bethpage Rd, Plainview, N Y 11803

INVERTERS, DC-AC
POWER SUPPLIES, AC
POWER SUPPLIES, DC
POWER SUPPLIES, DIGITALLY-CONTROLLED

DYNAMIC MEASUREMENTS CORP. 617-729-7870
6 Lowell Ave, Winchester, Mass 01890

AMPLIFIERS, D.C.
AMPLIFIERS, INSTRUMENTATION
AMPLIFIERS, OPERATIONAL
CIRCUIT CARDS, LINEAR (WITH DISCRETE COMPONENTS)
CIRCUIT CARDS, LINEAR (WITH IC'S)
CIRCUIT CARDS, LOGIC (WITH DISCRETE COMPONENTS)
CIRCUIT CARDS, LOGIC (WITH IC'S)
CONVERTERS, ANALOG-TO-DIGITAL
CONVERTERS, DIGITAL-TO-ANALOG
DISPLAY DRIVERS
MODULES, DIGITAL LOGIC ENCAPSULATED (ALSO SEE CIRCUITS & CIRCUIT
CARDS)
MODULES, LINEAR (ENCAPSULATED)
MULTIPLEXER-CONVERTER (SINGLE UNIT WITH MULTIPLEXER, SAMPLE & HOLD
AMPLIFIER & A-TO-D CONVERTER)

MULTIPLEXERS, ANALOG-SOLID STATE (SEQUENTIAL SAMPLING)
POWER SUPPLIES, DC

DYNAMIC SYSTEM ELECTRONICS 602-967-8644
1040 W Alameda Dr, Tempe, Ariz 85281 TWX 910-950-1941

CONVERTERS, ANALOG-TO-DIGITAL
CONVERTERS, DOCUMENT-TO-MAGNETIC TAPE
CONVERTERS, MAGNETIC TAPE-TO-MAGNETIC TAPE
DATA ACQUISITION AND REDUCTION SYSTEMS
DATA TERMINALS, BLOCK-BY-BLOCK (MAGNETIC TAPE)
ENCODERS, KEYBOARD-TO-MAGNETIC TAPE
MULTIPLEXER-CONVERTER (SINGLE UNIT WITH MULTIPLEXER, SAMPLE & HOLD
AMPLIFIER & A-TO-D CONVERTER)
MULTIPLEXERS, ANALOG-SOLID STATE (SEQUENTIAL SAMPLING)
MULTIPLEXERS, DIGITAL
POWER SUPPLIES, DIGITALLY-CONTROLLED
SCANNERS, INPUT

DYNAMICS CORP. OF AMERICA REEVES HOFFMAN DIV. 717-243-5929
400 W North St, Carlisle, Pa 17013 TWX 510-650-3510
CRYSTAL UNITS, QUARTZ (FOR FREQUENCY CONTROL)
OSCILLATORS, VOLTAGE CONTROLLED

DYNAMICS RESEARCH CORP. 617-438-3900
38 Montvale Ave, Stoneham, Mass 02180 TWX 710-348-0769
COUNTERS, DIGITAL READOUT
ENCODERS, SHAFT ANGLE

DYNAPHONICS INC. 513-294-0347
2975 Far Hill, Dayton, Ohio 45419

AUDIO/VISUAL TRAINING AIDS

DYNASCIENCES CORP. INSTRUMENT SYSTEMS DIV. 213-341-0800
9601 Canoga Ave, Chatsworth, Cal 91311 TWX 910-494-1951
THERMOCOUPLE REFERENCE SYSTEMS
TRANSDUCERS, DIGITAL

DYONIC INC. 617-935-5900
71 Pine St, Woburn, Mass 01801

COUNTERS, DECADE
FIBER OPTIC BUNDLES
FIBER OPTICS ASSEMBLIES (FOR PUNCHED CODE READERS AND MARK SENSORS)

DYTRO CORP. 516-822-2130
63 Tec St, Hicksville, N Y 11801

CERTIFIERS, MAGNETIC TAPE
CONVERTERS, ANALOG-TO-DIGITAL
CONVERTERS, MAGNETIC TAPE-TO-MAGNETIC TAPE
CONVERTERS, MAGNETIC TAPE-TO-PAPER TAPE
CONVERTERS, MAGNETIC TAPE-TO-PRINTER
COUNTERS, STEPPING SWITCH
ENCODERS, KEYBOARD-TO-MAGNETIC TAPE
INDICATORS, DIGITAL
PRINTERS, DIGITAL STRIP RECORDING
RECORDERS, DIGITAL CASSETTE
VOLTMETERS, PRINTING

DYTRONICS CO. INC. 614-885-3303
4800 Evanswood Dr, Columbus, Ohio 43229

VOLTMETERS, AC, DC, DIFFERENTIAL

E-H RESEARCH LABORATORIES INC 415-834-3030
P O Box 1289, Oakland, Cal 94604 TWX 910-366-7258

ANALYZERS, WAVEFORM
TESTERS, DIGITAL LOGIC MODULES AND CARDS
TESTERS, INTEGRATED CIRCUIT
TESTERS, MEMORY PLANES, STACKS AND SYSTEMS
TESTERS, SEMICONDUCTOR

EASTERN COMPUTER SERVICES INC 215-378-8100
920 Fox Chase Rd, Rockledge, Pa 19111

CONSULTING (ACCOUNTING, BUSINESS AND COMMERCIAL APPLICATIONS)
CONSULTING (ADVANCED COMPUTER EQUIPMENT DESIGN AND FEASIBILITY
STUDIES)
CONSULTING (COMPUTER EVALUATIONS, SELECTIONS, INSTALLATION
PLANNING)
CONTINUED

3 Manufacturers' Directory

CONSULTING (DATA COMMUNICATIONS SYSTEMS PLANNING)
 CONSULTING (COMPUTER PRODUCT PLANNING SURVEYS, MARKET RESEARCH STUDIES)
 CONSULTING (MANAGEMENT INFORMATION SYSTEMS PLANNING)
 CONSULTING (SCIENTIFIC APPLICATIONS)
 PROGRAMMING LANGUAGE DEVELOPMENT (CONSULTANTS)
 PROGRAMMING LANGUAGE DEVELOPMENT (CONTRACT PROGRAMMING)
 PROGRAMMING LANGUAGE DEVELOPMENT (DEDICATED APPLICATION SYSTEMS)
 PROGRAMMING LANGUAGE DEVELOPMENT (PROPRIETARY SOFTWARE PRODUCTS)
 SERVICES, FACILITY MANAGEMENT
 SERVICES, MANAGEMENT INFORMATION SYSTEMS
 SERVICES, PROCESSING (COMMERCIAL EDP)
 SERVICES, PROCESSING (DIGITAL SCIENTIFIC)
 SERVICES, SYSTEMS ANALYSIS

EASTERN SPECIALTIES CO. INC. 413-533-7171
 5 Appleton Ave, Holyoke, Mass 01040

TAPE, PUNCH (MYLAR)
 TAPE, PUNCH (MYLAR-COATED FOIL)
 TAPE, PUNCH (PAPER)
 TAPE, PUNCH (PAPER-COATED MYLAR)
 TAPE, PUNCH (PAPER-COATED ALUMINUM)

EASTMAN KODAK CO. 716-325-2000
 343 State St, Rochester, N Y 14650

DATA RETRIEVAL SYSTEMS, MICRO-FILM (COMPUTER-CONTROLLED)
 MICROFICHE
 MICROFILM DATA RETRIEVAL SYSTEMS, COMPUTER CONTROLLED
 MICROFILM DATA RETRIEVAL SYSTEMS, COMPUTER CONTROLLED (GRAPHIC)
 MICROFILM ROLLS
 MICROSTRIPS (FOR MICROFILM)
 PROCESSORS, MICROFILM
 READER/PRINTER, MICROFILM/MICROFICHE
 READERS, MICROFILM/MICROFICHE
 RECORDERS, MICROFILM/MICROFICHE

EBY CO., HUGH H. DIV. REDM CORP. 215-314-7000
 4701 Germantown Ave, Philadelphia, Pa 19104 TWX 710-670-0452
 CONNECTORS, MINIATURE AND SUB-MINIATURE (COMPUTER-GRADE)
 CONNECTORS, PC AND IC BOARD (COMPUTER-GRADE)
 CONNECTORS, RACK AND PANEL (COMPUTER-GRADE)

ECCO BUSINESS SYSTEMS INC. 212-682-3244
 50 E 42nd St, New York, N Y 10017

CABINETS AND ENCLOSURES (FOR KEYPUNCHES, PRINTERS)
 CARDS, EDGE-PUNCH
 CONSULTING (ACCOUNTING, BUSINESS AND COMMERCIAL APPLICATIONS)
 COVERS, ACOUSTIC (FOR KEYBOARDS, TELETYPEWRITERS, ETC.)
 DATA RETRIEVAL SYSTEMS, MICRO-FILM (COMPUTER-CONTROLLED)
 ENVELOPES, CONTINUOUS
 ENVELOPES (FOR FILING TAPES)
 FORMS, CONTINUOUS (MACHINE PROCESSED)
 FORMS HANDLING, BURSTERS
 FORMS HANDLING, CARBON DELEAVERS
 FORMS HANDLING, DECOLLATORS
 FORMS HANDLING, DETACHERS
 FORMS HANDLING, LABEL APPLICATORS
 FORMS HANDLING, OCR SOURCE DOCUMENT
 FORMS HANDLING, SLITTERS
 FORMS HANDLING, STACKERS
 LABELS, CONTINUOUS AND GUMMED (MACHINE APPLICATION)
 LABELS, CONTINUOUS AND PRESSURE SENSITIVE (MACHINE APPLICATION)
 MICROFICHE
 MICROFILM DATA RETRIEVAL SYSTEMS, COMPUTER CONTROLLED
 MICROFILM DATA RETRIEVAL SYSTEMS, COMPUTER CONTROLLED (GRAPHIC)
 SAFES, MAGNETIC TAPE STORAGE
 SERVICES, SYSTEMS ANALYSIS
 TAGS (FOR EDP PROCESSING)

ECCLECTIC COMPUTER CORP. 214-522-3624
 3707 Rawlins Ste 301, Dallas, Tex 75219

COMPUTERS, DIGITAL (GENERAL-PURPOSE, SMALL-SCALE)
 DISC DRIVES, MOVABLE HEAD (INCLUDING CONTROLLER)
 DISC STORAGE SYSTEMS
 MAGNETIC TAPE STORAGE SYSTEMS (INCLUDES CONTROLLER)
 PRINTERS, LINE (LOW & MEDIUM SPEED)
 READERS, PAPER TAPE
 RECORDERS, MAGNETIC TAPE
 TAPE TRANSPORTS, MAGNETIC (DIGITAL-EXCL. CASSETTE)

ECONOMET INC. 213-334-4971
 1033 W Kirkwall Rd, Azusa, Cal 91702

CABINETS AND ENCLOSURES (FOR KEYPUNCHES, PRINTERS)
 CABINETS, ENCLOSURES, CONSOLES, ELECTRONIC (FOR GENERAL EQUIPMENT)
 CABINETS, RACKS, VAULTS (FOR MAGNETIC TAPE STORAGE)
 CABINETS, TRAYS (FOR PUNCHED CARD STORAGE)
 CHASSIS, SLIDES, RACKS
 CONSOLES, CRT (ALPHANUMERIC AND GRAPHIC)
 CONSOLES, CRT (COLOR-ALPHANUMERIC AND GRAPHIC)
 CONSOLES, CRT (GRAPHIC)
 DESKS, TABLES AND STANDS (FOR CALCULATORS)
 DESKS, TABLES AND STANDS (FOR KEYPUNCH UNITS)
 DESKS, TABLES AND STANDS (FOR PROGRAMMER STATIONS)
 DESKS, TABLES AND STANDS (FOR TYPEWRITERS)

ECONOMIC INFORMATION SYSTEMS INC. 212-239-7090
 21 W 38 St, New York, N Y 10018

CONSULTING (MANAGEMENT INFORMATION SYSTEMS PLANNING)
 SERVICES, MANAGEMENT INFORMATION SYSTEMS

EDGERTON GERMESHAUSEN GRIER INC. 617-271-5129
 Crosby Dr, Bedford, Mass 01730

COMMUNICATION SYSTEMS, FACSIMILE
 CONVERTERS, MAGNETIC TAPE-TO-FACSIMILE
 DIODES, SILICON
 MEMORY SYSTEMS, MAGNETIC DISC
 MEMORY SYSTEMS, READ-ONLY
 MODEMS, HARD-WIRED
 PAPER (FOR RECORDERS AND PLOTTERS)
 RECORDERS, FACSIMILE
 RECORDERS, GRAPHIC
 SCANNERS, IMAGE
 SCANNERS, INPUT
 SCANNERS, FACSIMILE

EDP RESOURCES, INC. 914-428-3804
 One North Broadway, White Plains, N Y 10601 TWX 710-568-1332
 LEASING, EDP EQUIPMENT (OTHER THAN MFGRS)
 SERVICES, TIME SHARING (COMMERCIAL)
 SERVICES, TIME SHARING (RESEARCH)

EDUCATION AND TRAINING CONSULTANTS CO. 213-472-2444
 P O Box 49899, Los Angeles, Cal 90049

AUDIO/VISUAL TRAINING AIDS
 CONSULTING (ADVANCED COMPUTER EQUIPMENT DESIGN AND FEASIBILITY STUDIES)
 CONSULTING (MANAGEMENT INFORMATION SYSTEMS PLANNING)
 PROGRAMMING LANGUAGE DEVELOPMENT (CONSULTANTS)
 PROGRAMMING LANGUAGE DEVELOPMENT (CONTRACT PROGRAMMING)
 TRAINING INSTITUTES, COMMERCIAL COMPUTER COURSES, SEMINARS, CORRESPONDENCE COURSES

EDWIN INDUSTRIES CORP. 301-622-0700
 11933 Tech Rd, Silver Spring, Md 20904 TWX 710-825-0436
 DIGITIZERS, PROGRAMMABLE
 OSCILLATORS, VOLTAGE CONTROLLED
 TESTERS, CIRCUIT
 TESTERS, DIGITAL DATA TRANSMISSION
 THERMOCOUPLE REFERENCE SYSTEMS

EICO ELECTRONIC INSTRUMENT CO INC. 212-949-1100
 283 Malta St, Brooklyn, N Y 11207

CONSULTING (ACCOUNTING, BUSINESS AND COMMERCIAL APPLICATIONS)
 LEASING, EDP EQUIPMENT (OTHER THAN MFGRS)
 TESTERS, CIRCUIT

EL INSTRUMENTS INC. 203-735-8774
 61 1st St, Derby, Conn 06418

ANALYZERS, PULSE HEIGHT
 BREADBOARDS
 CLOCKS, DIGITAL (REAL-TIME)
 CONVERTERS, PULSE-TO-DIGITAL
 COUNTERS, DIGITAL READOUT
 DEMONSTRATORS AND KITS, EDUCATIONAL (DIGITAL LOGIC)
 POWER SUPPLIES, DC
 TESTERS, INTEGRATED CIRCUIT
 TRAINING SYSTEMS, CARD PUNCH

3 Manufacturers' Directory

ELASCO EASTERN INC.
5 Northwood Rd, Bloomfield, Conn 06002

203-242-0708

POWER SUPPLIES, AC
POWER SUPPLIES, DC
REGULATORS, VOLTAGE

ELBIT COMPUTERS/SUB. CONTROL DATA CORP.

6 Tovim St, Haifa, ISRAEL

TELEX 4-744

CIRCUIT CARDS, LINEAR (WITH DISCRETE COMPONENTS)
CIRCUIT CARDS, LINEAR (WITH IC'S)
CIRCUIT CARDS, LOGIC (WITH DISCRETE COMPONENTS)
CIRCUIT CARDS, LOGIC (WITH IC'S)
CIRCUITS, HYBRID (IC AND DISCRETE-DIGITAL)
CIRCUITS, THICK FILM (DIGITAL)
CLOCKS, DIGITAL (REAL-TIME)
COMMUNICATION SYSTEMS, DATA TRANSMISSION
COMMUNICATION SYSTEMS, TELEPRINTER
COMPUTERS, MINI GENERAL PURPOSE (ALSO SEE CALCULATORS)
CONVERTERS, ANALOG-TO-DIGITAL
CONVERTERS, BINARY-TO-DECIMAL
CONVERTERS, DC-TO-FREQUENCY
CONVERTERS, DIGITAL-TO-ANALOG
CONVERTERS, DIGITAL-TO-SYNCHRO
CONVERTERS, DOCUMENT-TO-MAGNETIC TAPE
CONVERTERS, DOCUMENT-TO-PAPER TAPE
CONVERTERS, DOCUMENT-TO-UNIT RECORDS
CONVERTERS, FREQUENCY-TO-DC
CONVERTERS, MAGNETIC TAPE-TO-FACSIMILE
CONVERTERS, MAGNETIC TAPE-TO-MAGNETIC TAPE
CONVERTERS, MAGNETIC TAPE-TO-MICROFILM
CONVERTERS, MAGNETIC TAPE-TO-PAPER TAPE
CONVERTERS, MAGNETIC TAPE-TO-PRINTER
CONVERTERS, MAGNETIC TAPE-TO-PUNCHED CARD
CONVERTERS, PAPER TAPE-TO-MAGNETIC TAPE
CONVERTERS, PAPER TAPE-TO-PAPER TAPE
CONVERTERS, PAPER TAPE-TO-PRINTER
CONVERTERS, PAPER TAPE-TO-PUNCHED CARD
CONVERTERS, POLAR-TO-RECTANGULAR
CONVERTERS, PULSE-TO-DIGITAL
CONVERTERS, PUNCHED CARD-TO-MAGNETIC TAPE
CONVERTERS, PUNCHED CARD-TO-PAPER TAPE
CONVERTERS, PUNCHED TAG-TO-MAGNETIC TAPE
CONVERTERS, PUNCHED TAG-TO-PUNCHED CARD
CONVERTERS, SCAN
CONVERTERS, SYNCHRO-TO-DIGITAL
CONVERTERS, VOLTAGE-TO-FREQUENCY
COUNTERS, DECADE
COUNTERS, DIGITAL READOUT
COUNTERS, STEPPING SWITCH
COUNTERS, UP-DOWN
DISPLAY DRIVERS
MULTIPLEXERS, DIGITAL
POWER SUPPLIES, AC
POWER SUPPLIES, DC
POWER SUPPLIES, DIGITALLY-CONTROLLED
READOUTS AND DISPLAYS, NUMERIC AND ALPHANUMERIC (OTHER THAN CRT)
SCANNERS, INPUT
SIGNAL CONDITIONERS

ELCO CORP.
Maryland Rd, Willow Grove, Pa 19090

215-659-7000
TWX 510-665-5573

AUDIO/VISUAL TRAINING AIDS
BUS BAR SYSTEMS
CABINETS, ENCLOSURES, CONSOLES, ELECTRONIC (FOR GENERAL EQUIPMENT)
CONNECTORS, MINIATURE AND SUB-MINIATURE (COMPUTER-GRADE)
CONNECTORS, PC AND IC BOARD (COMPUTER-GRADE)
CONNECTORS, POWER (COMPUTER-GRADE)
CONNECTORS, RACK AND PANEL (COMPUTER-GRADE)
GUIDES, CIRCUIT CARDS
SERVICES, AUTOMATED WIRE-WRAPPING
SOCKETS, IC MOUNTING
SOCKETS, PCB MOUNTING

ELCOM ELECTRONICS INC.
200 Allen Blvd, Farmingdale, N Y 11735

516-249-7262

AMPLIFIERS, OPERATIONAL
BLOWERS, FANS, COOLING ASSEMBLIES
CIRCUITS, MONOLITHIC (DIGITAL LOGIC)
CIRCUITS, MONOLITHIC (LINEAR-EXCL. OP AMPS)
CIRCUITS, MONOLITHIC (LSI-BIPOLAR)
CIRCUITS, MONOLITHIC (OP AMPS)
CONNECTORS, COAXIAL (COMPUTER-GRADE)
DIODES, GERMANIUM
DIODES, SILICON
DIODES, VIDEO DETECTOR
DIODES, ZENER
HEAT SINKS, CIRCUIT BOARD MOUNTING
CONTINUED

POTENTIOMETERS, TRIM (FILM)
POTENTIOMETERS, TRIM (WIRE-WOUND)
RECTIFIERS, SILICON CONTROLLED
SOCKETS, IC MOUNTING
TRANSISTORS, FIELD EFFECT
TRANSISTORS, GERMANIUM
TRANSISTORS, PHOTO
TRANSISTORS, SILICON

ELDORADO ELECTRODATA
601 Chalomar Rd, Concord, Cal 94520

415-686-4200

CARDS, CONVENTIONAL PUNCH
CARDS, EDGE-PUNCH
CERTIFIERS, DISC PACK
COMMUNICATIONS-ORIENTED PROCESSORS, MULTIPLE CHANNEL CONTROLLERS
COMMUNICATIONS-ORIENTED PROCESSORS, STORED PROGRAM
COMMUNICATION SYSTEMS, DATA TRANSMISSION
CONTROLLERS, MAGNETIC DISC
CONTROLLERS, MODEM
CONVERTERS, DOCUMENT-TO-PAPER TAPE
CONVERTERS, MAGNETIC TAPE-TO-MAGNETIC TAPE
CONVERTERS, MAGNETIC TAPE-TO-PAPER TAPE
CONVERTERS, MAGNETIC TAPE-TO-PRINTER
CONVERTERS, MAGNETIC TAPE-TO-PUNCHED CARD
CONVERTERS, PAPER TAPE-TO-MAGNETIC TAPE
CONVERTERS, PAPER TAPE-TO-PAPER TAPE
CONVERTERS, PAPER TAPE-TO-PRINTER
CONVERTERS, PAPER TAPE-TO-PUNCHED CARD
CONVERTERS, PUNCHED CARD-TO-MAGNETIC TAPE
CONVERTERS, PUNCHED CARD-TO-PAPER TAPE
CONVERTERS, PUNCHED TAG-TO-MAGNETIC TAPE
CONVERTERS, PUNCHED TAG-TO-PUNCHED CARD
DATA CONCENTRATORS
DATA TERMINALS, BLOCK-BY-BLOCK (MAGNETIC TAPE)
DATA TERMINALS, BLOCK-BY-BLOCK (MULTI-PURPOSE)
DATA TERMINALS, BLOCK-BY-BLOCK (PAPER TAPE)
DATA TERMINALS, BLOCK-BY-BLOCK (PLOTTER)
DATA TERMINALS, BLOCK-BY-BLOCK (HIGH SPEED PRINTER)
DATA TERMINALS, BLOCK-BY-BLOCK (MEDIUM SPEED PRINTER)
DATA TERMINALS, BLOCK-BY-BLOCK (PUNCHED CARD)
DATA TERMINALS, BLOCK-BY-BLOCK (TELEPRINTER)
DATA TERMINALS, INQUIRY-RESPONSE (ALPHANUMERIC KEYBOARD)
DATA TERMINALS, INQUIRY-RESPONSE (SPECIAL-PURPOSE)
DISC DRIVES, FIXED HEAD (INCLUDING CONTROLLER)
ENCODERS, KEYBOARD (ALPHANUMERIC)
ENCODERS, KEYBOARD (NUMERIC)
ENCODERS, KEYBOARD-TO-MAGNETIC DISC
ENCODERS, KEYBOARD-TO-MAGNETIC TAPE
ENCODERS, KEYBOARD-TO-PRINTED TAPE
FORMATTERS, MAGNETIC TAPE
MAGNETIC TAPE STORAGE SYSTEMS (INCLUDES CONTROLLER)
MODEMS, ACOUSTIC
MODEMS, HARD-WIRED
MODEMS, PC CARD
PRINTERS, KEYBOARD
PRINTERS, LINE (HIGH SPEED)
READERS, PUNCHED CARD (100 TO 300 CPM)
TAPE TRANSPORTS, MAGNETIC (DIGITAL CASSETTE)
TAPE TRANSPORTS, MAGNETIC (INCREMENTAL)
TAPE TRANSPORTS, MAGNETIC (WITH KEYBOARD INPUT)

ELDRE COMPONENTS INC.
1239 University Ave, Rochester, N Y 14607

716-244-2570
TWX 510-253-4347

ELEC-TROL INC.
21018 Soledad Canyon, Saugus, Cal 91350

805-252-8330
TWX 910-336-1556

DATA TERMINALS, INQUIRY-RESPONSE (ALPHANUMERIC KEYBOARD)
ENCODERS, KEYBOARD (ALPHANUMERIC)
ENCODERS, KEYBOARD (NUMERIC)
RELAYS, DRY REED (COMPUTER GRADE)
RELAYS, MERCURY WETTED (COMPUTER GRADE)
SWITCHES, PUSHBUTTON

ELECTRALAB DIV. TYCO LABORATORIES INC.
P O Box 548, Encinitas, Cal 92024

714-753-6261
TWX 910-322-3130

BOARDS, PRINTED CIRCUIT (WITHOUT COMPONENTS)
CABLE, FLAT, PRINTED AND RIBBON
CABLE, MULTICONDUCTOR

ELECTRIC INDICATOR CO. INC.
195 Danbury Rd, Wilton, Conn 06897

203-762-8655
TELEX 96-5945

CONVERTERS, DC-TO-FREQUENCY
CONVERTERS, FREQUENCY-TO-DC
CONVERTERS, VOLTAGE-TO-FREQUENCY
INVERTERS, DC-AC
CONTINUED

3 Manufacturers' Directory

MOTORS, SERVO
MOTORS, SYNCHRONOUS
SYNCHROS-RESOLVERS, CONTROL TRANSFORMERS

ELECTRO FIBEROPTICS CORP. 617-835-6082
99 Hartwell St, West Boylston, Mass 01583

CONVERTERS, SCAN
FIBER OPTIC BUNDLES
FIBER OPTICS ASSEMBLIES (FOR PUNCHED CODE READERS AND MARK SENSORS)
LIGHT PENS (FOR CRT TERMINAL INPUT/OUTPUT)

ELECTRO MOTIVE MANUFACTURING CO. INC. 203-423-9231
South Park St, Willimantic, Conn 06226 TWX 701-440-0601
CAPACITORS, COMPUTER GRADE

ELECTRO PRODUCTS LABORATORIES INC. 312-647-8744
6125 W Howard St, Chicago, Ill 60648

CONVERTERS, DC-TO-FREQUENCY
CONVERTERS, FREQUENCY-TO-DC
POWER SUPPLIES, AC
POWER SUPPLIES, DC
TRANSDUCERS, DIGITAL

ELECTRO-CRAFT CORP. 612-935-8226
1600 S 2nd St, Hopkins, Minn 55343 TWX 910-576-3469

AMPLIFIERS, D.C.
AMPLIFIERS, OPERATIONAL
AMPLIFIERS, SERVO
MOTORS, SERVO
SERVOS, COMPUTER

ELECTROID CO. 201-686-8290
119 Progress St, Union, N J 07083

BRAKES AND CLUTCHES

ELECTROMECH COMPUTING & TECH. SERVICES CO. 404-261-4891
2964 Peachtree Rd NW, Atlanta, Ga 30305 TWX 810-751-8421

CONSULTING (ACCOUNTING, BUSINESS AND COMMERCIAL APPLICATIONS)
CONSULTING (ADVANCED COMPUTER EQUIPMENT DESIGN AND FEASIBILITY STUDIES)
CONSULTING (MANAGEMENT INFORMATION SYSTEMS PLANNING)
CONSULTING (SCIENTIFIC APPLICATIONS)
SERVICES, FACILITY MANAGEMENT
SERVICES, MANAGEMENT INFORMATION SYSTEMS
SERVICES, PROCESSING (COMMERCIAL EDP)
SERVICES, SYSTEMS ANALYSIS
TRAINING SYSTEMS, COMPUTER SERVICE

ELECTRON OHIO INC. 216-621-5377
1278 W 9th St, Cleveland, Ohio 44113

CONSULTING (MANAGEMENT INFORMATION SYSTEMS PLANNING)
MEMORY SYSTEMS, READ-ONLY

ELECTRONIC ACCOUNTING SYSTEMS INC. 716-546-8237
255 Alexander St, Rochester, N Y 14607

CONSULTING (ACCOUNTING, BUSINESS AND COMMERCIAL APPLICATIONS)
SERVICES, FACILITY MANAGEMENT
SERVICES, PROCESSING (COMMERCIAL EDP)

ELECTRONIC ARRAYS INC. 415-964-4321
501 Ellis St, Mt View, Cal 94040 TWX 910-379-6985

CIRCUITS, MONOLITHIC (DIGITAL LOGIC)
CIRCUITS, MONOLITHIC (LSI-MOS)
MEMORY SYSTEMS, READ-ONLY
MEMORY SYSTEMS, SEMICONDUCTOR (MOS)

ELECTRONIC ASSOCIATES INC. 201-229-1100
485 Monmouth Pkwy, W Long Branch, N J 07764

AMPLIFIERS, D.C.
AMPLIFIERS, INSTRUMENTATION
AMPLIFIERS, OPERATIONAL
ATTENUATORS, DECADE DIGITAL
AUDIO/VISUAL TRAINING AIDS
CAPACITORS, COMPUTER GRADE
COMPUTERS, ANALOG (GENERAL-PURPOSE)
CONTINUED

COMPUTERS, DIGITAL (GENERAL-PURPOSE, SMALL-SCALE)
COMPUTERS, DIGITAL (GENERAL-PURPOSE, MEDIUM-SCALE)
COMPUTERS, HYBRID
COMPUTERS, PROCESS CONTROL
CONSULTING (SCIENTIFIC APPLICATIONS)
DATA ACQUISITION AND REDUCTION SYSTEMS
PLOTTERS, MOVING PEN (ANALOG CONTROLLER)
PLOTTERS, MOVING PEN (DIGITAL CONTROLLER)
PROGRAMMING LANGUAGE DEVELOPMENT (DEDICATED APPLICATION SYSTEMS)
PROGRAMMING LANGUAGE DEVELOPMENT (PROPRIETARY SOFTWARE PRODUCTS)
RECORDERS, HARD-COPY (WITH CRT)
SERVICES, PROCESSING (ANALOG OR HYBRID, SCIENTIFIC)
SERVICES, PROCESSING (DIGITAL SCIENTIFIC)
SERVICES, SYSTEMS ANALYSIS

ELECTRONIC BUSINESS SERVICE 209-732-8601
P O Box 368, Visalia, Cal 93277

CONSULTING (ACCOUNTING, BUSINESS AND COMMERCIAL APPLICATIONS)
SERVICES, PROCESSING (COMMERCIAL EDP)

ELECTRONIC COMPUTER PROG. INSTITUTE 717-545-4231
49 N Progress Ave, Harrisburg, Pa 17109

CONSULTING (ACCOUNTING, BUSINESS AND COMMERCIAL APPLICATIONS)
CONSULTING (COMPUTER EVALUATIONS, SELECTIONS, INSTALLATION PLANNING)
SERVICES, PROCESSING (COMMERCIAL EDP)
SERVICES, SYSTEMS ANALYSIS
TRAINING INSTITUTES, COMMERCIAL COMPUTER COURSES, SEMINARS, CORRESPONDENCE COURSES

ELECTRONIC CONTROLS INC. T-BAR SWITCHING TECH DIV. 203-762-8351
141 Danbury Rd, Milton, Conn 06897

RELAYS, DRY REED (COMPUTER GRADE)
SWITCHES, CODE BAR
SWITCHES, DRY REED
SWITCHES, PUSHBUTTON

ELECTRONIC DATA PREPARATION CORP. 813-755-8030
P O Box 1446, Bradenton, Fla 33505

CONSULTING (ACCOUNTING, BUSINESS AND COMMERCIAL APPLICATIONS)
CONSULTING (COMPUTER EVALUATIONS, SELECTIONS, INSTALLATION PLANNING)
CONSULTING (MANAGEMENT INFORMATION SYSTEMS PLANNING)
ENCODERS, KEYBOARD-TO-MAGNETIC TAPE
PROGRAMMING LANGUAGE DEVELOPMENT (CONSULTANTS)
PROGRAMMING LANGUAGE DEVELOPMENT (CONTRACT PROGRAMMING)
PROGRAMMING LANGUAGE DEVELOPMENT (PROPRIETARY SOFTWARE PRODUCTS)
SERVICES, FACILITY MANAGEMENT
SERVICES, MANAGEMENT INFORMATION SYSTEMS
SERVICES, PROCESSING (COMMERCIAL EDP)
SERVICES, SYSTEMS ANALYSIS
USED EQUIPMENT (BUYING, SELLING, LEASING)

ELECTRONIC DATA SERVICE INC. 302-652-3901
18 Germay Dr, Wilmington, Del 19804

CONSULTING (ACCOUNTING, BUSINESS AND COMMERCIAL APPLICATIONS)
CONSULTING (ADVANCED COMPUTER EQUIPMENT DESIGN AND FEASIBILITY STUDIES)
CONSULTING (COMPUTER EVALUATIONS, SELECTIONS, INSTALLATION PLANNING)
SERVICES, PROCESSING (COMMERCIAL EDP)

ELECTRONIC DEVELOPMENT CORP. 617-268-9696
11 Hamlin St, Boston, Mass 02127

POWER SUPPLIES, AC
POWER SUPPLIES, DC
POWER SUPPLIES, DIGITALLY-CONTROLLED
TESTERS, DIGITAL LOGIC MODULES AND CARDS
TESTERS, INTEGRATED CIRCUIT
TESTERS, SEMICONDUCTOR
VOLTMETERS, AC, DC, DIFFERENTIAL

ELECTRONIC ENGRG. CO. OF CAL. COMPUTER EQUIP. DIV 714-547-5501
1601 E Chestnut Ave, Santa Ana, Cal 92702 TWX 910-595-1550
CONTROLLERS, MAGNETIC DISC

3 Manufacturers' Directory

ELECTRONIC ENGRG. CO. OF CAL. ELECTRONIC PRD. DIV 714-547-5651
1441 E Chestnut Ave, Santa Ana, Cal 92702 TWX 910-595-1550

CIRCUIT CARDS, LOGIC (WITH DISCRETE COMPONENTS)
 CIRCUIT CARDS, LOGIC (WITH IC'S)
 CIRCUITS, HYBRID (IC AND DISCRETE-DIGITAL)
 CONVERTERS, ANALOG-TO-DIGITAL
 CONVERTERS, BINARY-TO-DECIMAL
 CONVERTERS, DIGITAL-TO-ANALOG
 MODULES, DIGITAL LOGIC ENCAPSULATED (ALSO SEE CIRCUITS & CIRCUIT CARDS)
 MULTIPLEXER-CONVERTER (SINGLE UNIT WITH MULTIPLEXER, SAMPLE & HOLD AMPLIFIER & A-TO-D CONVERTER)
 READERS, PAPER TAPE
 SERVICES, COMPUTER-AIDED DESIGN
 SERVICES, AUTOMATED WIRE-WRAPPING
 SWITCHES, THUMBWHEEL

ELECTRONIC GRAPHICS INC. 214-271-2585
2834 W Kingsley Rd, Garland, Tex 75040

CONSULTING (DATA COMMUNICATIONS SYSTEMS PLANNING)
 CONSULTING (SCIENTIFIC APPLICATIONS)
 SERVICES, COMPUTER-AIDED DESIGN

ELECTRONIC IDEAS INC. 215-886-4770
Reading Sta, Wyncote, Pa 19095

DATA TERMINALS, INQUIRY-RESPONSE (CRT WITH KEYBOARD)

ELECTRONIC INFORMATION SYSTEMS INC. 303-466-1985
2400 Industrial Lane, Broomfield, Conn 80020

ACOUSTIC COUPLERS
 DATA TERMINALS, BLOCK-BY-BLOCK (MAGNETIC TAPE)
 DATA TERMINALS, BLOCK-BY-BLOCK (MULTI-PURPOSE)
 DATA TERMINALS, BLOCK-BY-BLOCK (TELEPRINTER)
 DATA TERMINALS, INQUIRY-RESPONSE (CRT WITH KEYBOARD)
 MODEMS, ACOUSTIC
 PRINTERS, KEYBOARD
 TYPEWRITERS, COMPUTER INPUT-OUTPUT

ELECTRONIC LABS, INC. 713-686-8656
3726 Dacoma St, Houston, Tex 77018

COMMUNICATION SYSTEMS, DATA TRANSMISSION
 CONVERTERS, MAGNETIC TAPE-TO-MAGNETIC TAPE
 DATA TERMINALS, BLOCK-BY-BLOCK (MAGNETIC TAPE)
 ENCODERS, KEYBOARD-TO-MAGNETIC TAPE
 PRINTERS, DIGITAL STRIP RECORDING
 RECORDERS, DIGITAL CASSETTE

ELECTRONIC MEASUREMENTS INC. 201-922-9300
405 Essex Rd, New Shrewsbury, N J 07753

POWER SUPPLIES, DC

ELECTRONIC MEMORIES 213-772-5201
12621 Chadron Ave, Hawthorne, Cal 90250 TWX 910-325-6213

CORES, FERRITE MEMORY
 MEMORY PLANES AND STACKS, MAG-NETIC CORE (W/O ELECTRONICS)
 MEMORY SYSTEMS, MAGNETIC CORE
 MEMORY SYSTEMS, READ-ONLY

ELECTRONIC MICRO SYSTEMS INC. 714-549-2295
1672 Kaiser Ave, Santa Ana, Cal 92705

CELLS, PHOTOCONDUCTIVE
 CIRCUITS, THICK FILM (DIGITAL)
 CIRCUITS, THIN FILM (DIGITAL)
 DATA ACQUISITION AND REDUCTION SYSTEMS
 MARK SENSING EQUIPMENT
 PRINTER/PUNCH, PAPER TAPE
 READERS, OPTICAL CHARACTER SCANNING
 READERS, PAPER TAPE
 SCANNERS, OPTICAL
 TRANSISTORS, PHOTO

ELECTRONIC MODULES CORP. 301-666-3300
P O Box 141, Timonium, Md 21093 TWX 710-862-2638

AMPLIFIERS, D.C.
 AMPLIFIERS, INSTRUMENTATION
 CIRCUIT CARDS, LINEAR (WITH DISCRETE COMPONENTS)
 CIRCUIT CARDS, LINEAR (WITH IC'S)
 CIRCUIT CARDS, LOGIC (WITH DISCRETE COMPONENTS)
 CONTINUED

CIRCUIT CARDS, LOGIC (WITH IC'S)
 CIRCUITS, HYBRID (IC AND DISCRETE-DIGITAL)
 CIRCUITS, THICK FILM (DIGITAL)
 CONVERTERS, ANALOG-TO-DIGITAL
 MODULES, DIGITAL LOGIC ENCAPSULATED (ALSO SEE CIRCUITS & CIRCUIT CARDS)
 MULTIPLEXERS, ANALOG-RELAY (SEQUENTIAL SAMPLING)
 MULTIPLEXERS, ANALOG-SOLID STATE (SEQUENTIAL SAMPLING)
 SCANNERS, INPUT

ELECTRONIC MOLDING CORP. 401-769-3800
96 Mill St, Woonsocket, R I 02895

CABLE ASSEMBLIES (WITH CONNECTORS)
 CONNECTORS, PC AND IC BOARD (COMPUTER-GRADE)
 GUIDES, CIRCUIT CARDS
 JACKS, JACK PANELS, PLUGS, ASSEMBLIES
 SERVICES, AUTOMATED WIRE-WRAPPING
 SERVICES, HARDWARE MAINTENANCE
 SOCKETS, IC MOUNTING
 SOCKETS, PCB MOUNTING
 SOCKETS, SEMICONDUCTOR MOUNTING
 TERMINAL BLOCKS, STRIPS, BOARDS

ELECTRONIC PROCESSORS INC. SUB. SAMSONITE CORP 303-798-9305
5050 S Federal Blvd, Englewood, Colo 80110 TWX 910-935-0874

COMPUTERS, DIGITAL (GENERAL-PURPOSE, SMALL-SCALE)
 COMPUTERS, DIGITAL (GENERAL-PURPOSE, MEDIUM-SCALE)
 COMPUTERS, MINI GENERAL PURPOSE (ALSO SEE CALCULATORS)

ELECTRONIC RESEARCH CO., A TEXTRON CO. 913-631-6700
10000 W 75th St, Shawnee Mission, Kan 66202 TWX 910-749-6477

CLOCKS, DIGITAL (REAL-TIME)
 CONVERTERS, ANALOG-TO-DIGITAL
 INDICATORS, DIGITAL
 INDICATORS, ELAPSED TIME
 MULTIPLEXERS, ANALOG-RELAY (SEQUENTIAL SAMPLING)
 MULTIPLEXERS, ANALOG-SOLID STATE (SEQUENTIAL SAMPLING)
 MULTIPLEXERS, DIGITAL
 SCANNERS, INPUT
 TIMERS, EVENT (IMPULSE)
 TIMERS, INTERVAL
 VOLTMETERS, DIGITAL

ELECTRONIC SYSTEMS & PROGRAMMING INC. 213-674-0233
7320 S Lacienega Blvd, Inglewood, Cal 90302

ANALYZERS, CONTINUITY

ELECTRONIC TABULATING SERVICE INC. 404-523-8411
P O Box 85, Atlanta, Ga 30301

CONSULTING (ACCOUNTING, BUSINESS AND COMMERCIAL APPLICATIONS)
 SERVICES, COMPUTER-AIDED DESIGN
 SERVICES, PROCESSING (COMMERCIAL EDP)
 SERVICES, TIME SHARING (COMMERCIAL)

ELECTRONIC TRANSFORMER CORP. 201-279-4445
460 Totowa Ave, Paterson, N J 07509

TRANSFORMERS, POWER (COMPUTER GRADE)
 TRANSFORMERS, PULSE (COMPUTER GRADE)

ELECTRONIZED CHEMICALS CORP. 617-272-2850
S Bedford St, Burlington, Mass 01803 TWX 710-332-0502

BOARDS, PRINTED CIRCUIT (WITHOUT COMPONENTS)
 CABLE ASSEMBLIES (WITH CONNECTORS)
 CABLE, COAXIAL (FLEXIBLE)
 CABLE, COAXIAL (SEMI/RIGID)
 CABLE, FINE LEAD
 CABLE, FLAT, PRINTED AND RIBBON
 CABLE, MULTICONDUCTOR
 CABLE, SHIELDED (NOT COAXIAL)

ELECTRONIZED CHEMICALS CORP. JUDD WIRE DIV. 413-863-4357
50 Turnpike Rd, Turners Falls, Mass 01376 TWX 710-332-0502

CABLE, COAXIAL (FLEXIBLE)
 CABLE, COAXIAL (SEMI/RIGID)
 CABLE, FINE LEAD
 CABLE, FLAT, PRINTED AND RIBBON
 CABLE, MULTICONDUCTOR
 CABLE, SHIELDED (NOT COAXIAL)

3 Manufacturers' Directory

ELECTRORACK PRODUCTS CO. 714-776-5420
1742 S Clementine St, Anaheim, Cal 92802

CABINETS AND ENCLOSURES (FOR KEYPUNCHES, PRINTERS)
CABINETS, ENCLOSURES, CONSOLES, ELECTRONIC (FOR GENERAL EQUIPMENT)
CABINETS, RACKS, VAULTS (FOR MAGNETIC TAPE STORAGE)
CHASSIS, SLIDES, RACKS

ELECTROSTATICS INC. 714-274-1414
7718 Clairemont Mesa, San Diego, Cal 92111

POWER SUPPLIES, DC

ELETROVERT INC. 914-664-6090
86 Hartford Ave, Mt Vernon, N Y 10553
CABLE ASSEMBLIES (WITH CONNECTORS)
TERMINAL BLOCKS, STRIPS, BOARDS
TELEX 13-7483

ELEXON INC. 714-540-9510
1422 E St Gertrude, Santa Ana, Cal 92705

POWER SUPPLIES, AC
POWER SUPPLIES, DC
POWER SUPPLIES, DIGITALLY-CONTROLLED

ELFAB CORP. 214-239-7181
P O Box 34555, Dallas, Tex 75234
TWX 910-860-5137

BOARDS, PRINTED CIRCUIT (WITHOUT COMPONENTS)
BREADBOARDS
CONNECTORS, PC AND IC BOARD (COMPUTER-GRADE)
SOCKETS, IC MOUNTING

ELGAR CORP. 714-279-0800
8159 Engineer Rd, San Diego, Cal 92111
TWX 910-335-1246

INVERTERS, DC-AC
POWER SUPPLIES, AC
POWER SUPPLIES, DIGITALLY-CONTROLLED
REGULATORS, FREQUENCY
REGULATORS, VOLTAGE

ELLIOTT CO., B.K. 412-471-3660
P O Box 3240, Pittsburg, Pa 15230

MICROFICHE
MICROFILM ROLLS
PROCESSORS, MICROFILM
READER/PRINTER, MICROFILM/MICROFICHE
READERS, MICROFILM/MICROFICHE

ELMIRA DATA PROCESSING CO. 607-734-2077
221 E Church St, Elmira, N Y 14902

CONSULTING (ACCOUNTING, BUSINESS AND COMMERCIAL APPLICATIONS)
CONSULTING (ADVANCED COMPUTER EQUIPMENT DESIGN AND FEASIBILITY STUDIES)
CONSULTING (COMPUTER EVALUATIONS, SELECTIONS, INSTALLATION PLANNING)
CONSULTING (DATA COMMUNICATIONS SYSTEMS PLANNING)
CONSULTING (COMPUTER PRODUCT PLANNING SURVEYS, MARKET RESEARCH STUDIES)
CONSULTING (MANAGEMENT INFORMATION SYSTEMS PLANNING)
SERVICES, FACILITY MANAGEMENT
SERVICES, MANAGEMENT INFORMATION SYSTEMS
SERVICES, PROCESSING (COMMERCIAL EDP)
SERVICES, SYSTEMS ANALYSIS

ELNETIC ELECTRONICS INC. 213-821-3447
2100 Zeno Pl, Venice, Cal 90291

CAPACITORS, COMPUTER GRADE
INVERTERS, DC-AC
TRANSFORMERS, POWER (COMPUTER GRADE)
TRANSFORMERS, PULSE (COMPUTER GRADE)

ELPAC INC. 714-833-1717
18651 Von Karman Ave, Irvine, Cal 92664
TWX 910-595-1513

COMMUNICATIONS-ORIENTED PROCESSORS, MULTIPLE CHANNEL CONTROLLERS
COMMUNICATIONS-ORIENTED PROCESSORS, SINGLE CHANNEL CONTROLLERS
COMMUNICATIONS-ORIENTED PROCESSORS, STORED PROGRAM
CONVERTERS, BINARY-TO-DECIMAL
CONVERTERS, DIGITAL-TO-ANALOG
CONVERTERS, PULSE-TO-DIGITAL
CONTINUED

DATA ACQUISITION AND REDUCTION SYSTEMS
DATA CONCENTRATORS
DATA TERMINALS, INQUIRY-RESPONSE (SPECIAL-PURPOSE)
ENCODERS, KEYBOARD (ALPHANUMERIC)
ENCODERS, KEYBOARD (NUMERIC)
MODULES, DIGITAL LOGIC ENCAPSULATED (ALSO SEE CIRCUITS & CIRCUIT CARDS)
MULTIPLEXERS, DIGITAL

EMR COMPUTER 612-888-9581
8001 Bloomington Fwy, Minneapolis, Minn 55420
TELEX 29-0316

ACOUSTIC COUPLERS
COMMUNICATIONS-ORIENTED PROCESSORS, MULTIPLE CHANNEL CONTROLLERS
COMMUNICATIONS-ORIENTED PROCESSORS, SINGLE CHANNEL CONTROLLERS
COMMUNICATIONS-ORIENTED PROCESSORS, STORED PROGRAM
COMMUNICATION SYSTEMS, DATA TRANSMISSION
COMPUTERS, DIGITAL (GENERAL-PURPOSE, SMALL-SCALE)
COMPUTERS, DIGITAL (GENERAL-PURPOSE, MEDIUM-SCALE)
CONTROLLERS, MODEM
DATA CONCENTRATORS
MODEMS, ACOUSTIC
MODEMS, HARD-WIRED
PROGRAMMING LANGUAGE DEVELOPMENT (DEDICATED APPLICATION SYSTEMS)
PROGRAMMING LANGUAGE DEVELOPMENT (PROPRIETARY SOFTWARE PRODUCTS)
USED EQUIPMENT (BUYING, SELLING, LEASING)

ENDLESS TAPE REEL CO. 617-944-1346
81 Haven St, Reading, Mass 01867

CABINETS, ENCLOSURES, CONSOLES, ELECTRONIC (FOR GENERAL EQUIPMENT)
CONTAINERS, PAPER TAPE STORAGE
PUNCHES, PAPER TAPE
REELS, PAPER TAPE
SPLICERS, PAPER TAPE
SPOOLERS, PAPER TAPE
TAPE, PUNCH (MYLAR)
TAPE, PUNCH (MYLAR-COATED FOIL)
TAPE, PUNCH (PAPER)
TAPE, PUNCH (PAPER-COATED MYLAR)
TAPE, PUNCH (PAPER-COATED ALUMINUM)
WINDERS, PAPER TAPE

ENERGY CONVERSION DEVICES INC 313-547-7300
1675 W Maple Rd, Troy, Mich 48084
TELEX 23-3448

MEMORY SYSTEMS, READ-ONLY

ENGINEERED COMPONENTS CO. 213-321-6565
2134 W Rosecrans Ave, Gardena, Cal 90249

CAPACITORS, COMPUTER GRADE
DELAY LINES, MAGNETOSTRICTIVE (ALSO SEE MEMORIES)
MEMORY SYSTEMS, DELAY LINE

ENGINEERED DATA PERIPHERALS CORP. 213-451-5406
1701 Colorado Ave, Santa Monica, Cal 90404

DISC STORAGE SYSTEMS
MEMORY SYSTEMS, MAGNETIC DISC

ENGINEERING TECHNOLOGY ANALYSTS INC. 713-523-2050
3310 Richmond Ave, Houston, Tex 77006

CONSULTING (ACCOUNTING, BUSINESS AND COMMERCIAL APPLICATIONS)
CONSULTING (ADVANCED COMPUTER EQUIPMENT DESIGN AND FEASIBILITY STUDIES)
CONSULTING (COMPUTER EVALUATIONS, SELECTIONS, INSTALLATION PLANNING)
CONSULTING (COMPUTER PRODUCT PLANNING SURVEYS, MARKET RESEARCH STUDIES)
CONSULTING (MANAGEMENT INFORMATION SYSTEMS PLANNING)
CONSULTING (SCIENTIFIC APPLICATIONS)
TRAINING INSTITUTES, COMMERCIAL COMPUTER COURSES, SEMINARS, CORRESPONDENCE COURSES

ENNIS BRANDON COMPUTER SERVICES INC. 214-357-7386
2840 Walnut Hill Ln, Dallas, Tex 75229

SERVICES, PROCESSING (COMMERCIAL EDP)
SERVICES, TIME SHARING (COMMERCIAL)
SERVICES, SYSTEMS ANALYSIS

3 Manufacturers' Directory

ENTELEK INC. 42 Pleasant St, Newburyport, Mass 01950	617-465-3000	ESB INC. POWER SYSTEMS DIV. P O Box 5723, Philadelphia, Pa 19120	215-342-8000
AIDS, KEYPUNCH PERFORMANCE INSTRUCTIONAL SYSTEMS, COMPUTER-BASED TRAINING INSTITUTES, COMMERCIAL COMPUTER COURSES, SEMINARS, CORRESPONDENCE COURSES		POWER SUPPLIES, UNINTERRUPTABLE	
ENTREKIN COMPUTERS INC. SUB. THE CROSS CO. 9475 Center Rd, Fenton, Mich 48430	313-629-5361	ESC ELECTRONICS 534 Bergen Blvd, Palisades Park, N J 07650 DELAY LINES, MAGNETOSTRICTIVE (ALSO SEE MEMORIES) FILTERS (ACTIVE, LC, NOISE, ETC.)	201-947-0400 TWX 410-991-9780
COMPUTERS, DIGITAL (GENERAL-PURPOSE, SMALL-SCALE) COMPUTERS, DIGITAL (GENERAL-PURPOSE, MEDIUM-SCALE) COMPUTERS, PROCESS CONTROL CONSULTING (COMPUTER EVALUATIONS, SELECTIONS, INSTALLATION PLANNING) CONSULTING (MANAGEMENT INFORMATION SYSTEMS PLANNING) PROGRAMMING LANGUAGE DEVELOPMENT (DEDICATED APPLICATION SYSTEMS) PROGRAMMING LANGUAGE DEVELOPMENT (PROPRIETARY SOFTWARE PRODUCTS) SERVICES, MANAGEMENT INFORMATION SYSTEMS SERVICES, PROCESSING (DIGITAL SCIENTIFIC) SERVICES, SYSTEMS ANALYSIS		ESSEX INTERNATIONAL IND. WIRE PDTS. DIV 6235 S Harlem Ave, Chicago, Ill 60638 CABLE, COAXIAL (FLEXIBLE) CABLE, COAXIAL (SEMI/RIGID) CABLE, FINE LEAD CABLE, MULTICONDUCTOR CABLE, SHIELDED (NOT COAXIAL)	
ENTREX INC. 113 Hartwell Ave, Lexington, Mass 02173	617-862-7230	ESSEX SYSTEMS CO. INC. 24 Forge St, Jamesburg, N J 08831	201-521-2360
CONSULTING (DATA COMMUNICATIONS SYSTEMS PLANNING) ENCODERS, KEYBOARD-TO-MAGNETIC DISC ENCODERS, KEYBOARD-TO-MAGNETIC DISC TAPE		CONSULTING (MANAGEMENT INFORMATION SYSTEMS PLANNING) FORMS, CONTINUOUS (MACHINE PROCESSED)	
EPEC INDUSTRIES INC. Industrial Pk, New Bedford, Mass 02745	617-995-5171	ESSEX WIRE & CABLE CO. 1601 Wall St, Ft Wayne, Ind 46804	219-743-0311
BOARDS, PRINTED CIRCUIT (WITHOUT COMPONENTS) SERVICES, COMPUTER-AIDED DESIGN		CABLE, COAXIAL (FLEXIBLE) CABLE, COAXIAL (SEMI/RIGID) CABLE, FLAT, PRINTED AND RIBBON CABLE, MULTICONDUCTOR CABLE, SHIELDED (NOT COAXIAL) RELAYS, DRY REED (COMPUTER GRADE) RELAYS, SOLID-STATE (COMPUTER GRADE) SWITCHES, ROTARY SWITCHES, SNAP ACTION TRANSFORMERS, POWER (COMPUTER GRADE)	
EPIC INC. 150 Nassau St, New York, N Y 10038	212-349-2470	ESTERLINE ANGUS DIV., ESTERLINE CORP. Po Box 24000, Indianapolis, Ind 46224	317-244-7611 TELEX 02-7419
VOLTMETERS, DIGITAL		AMPLIFIERS, D.C. AMPLIFIERS, INSTRUMENTATION DATA ACQUISITION AND REDUCTION SYSTEMS PAPER (FOR RECORDERS AND PLOTTERS) PRINTERS, LINE (LOW & MEDIUM SPEED) RECORDERS, GRAPHIC RECORDERS, PAPER TAPE VOLTMETERS, AC, DC, DIFFERENTIAL VOLTMETERS, DIGITAL	
EQUIPTO ELECTRONICS CORP. 435 Woodlawn Ave, Aurora, Ill 60537	312-897-4691	EUREKA CO. DIV. LITTON INDUS. Dunham Dr, Dunmore, Pa 18512	717-346-6511 TWX 510-659-5036
BLOWERS, FANS, COOLING ASSEMBLIES CABINETS, ENCLOSURES, CONSOLES, ELECTRONIC (FOR GENERAL EQUIPMENT)		LABELS, CONTINUOUS AND GUMMED (MACHINE APPLICATION) LABELS, CONTINUOUS AND PRESSURE SENSITIVE (MACHINE APPLICATION)	
ERA TRANSPAC CORP. 67 Sand Park Rd, Cedar Grove, N J 07009	201-239-3000 TWX 710-994-5789	EVANS & SUTHERLAND COMPUTER CORP. 3 Research Rd, Salt Lake City, Utah 84112	801-322-5847
CONVERTERS, VOLTAGE-TO-FREQUENCY POWER SUPPLIES, AC POWER SUPPLIES, DC POWER SUPPLIES, DIGITALLY-CONTROLLED PROTECTORS, CIRCUIT AND EQUIPMENT OVERLOAD REGULATORS, CURRENT REGULATORS, VOLTAGE		CIRCUIT CARDS, LOGIC (WITH DISCRETE COMPONENTS) CIRCUIT CARDS, LOGIC (WITH IC'S) CONSOLES, CRT (ALPHANUMERIC AND GRAPHIC) CONSOLES, CRT (GRAPHIC) DATA TERMINALS, INQUIRY-RESPONSE (CRT WITH KEYBOARD) DATA TERMINALS, INQUIRY-RESPONSE (SPECIAL-PURPOSE) DISPLAYS, THREE-DIMENSIONAL	
ERIE TECHNOLOGICAL PRODUCTS INC. 644 W 12th St, Erie, Pa 16512	814-453-5611 TWX 510-696-6607	EXPRESS SOFTWARE SYSTEMS INC. 342 Madison Ave, New York, N Y 10017	212-682-0011
CAPACITORS, COMPUTER GRADE CIRCUITS, HYBRID (IC AND DISCRETE-DIGITAL) CIRCUITS, THICK FILM (DIGITAL) MODULES, DIGITAL LOGIC ENCAPSULATED (ALSO SEE CIRCUITS & CIRCUIT CARDS) MODULES, LINEAR (ENCAPSULATED) MODULES, RESISTANCE NETWORKS (ENCAPSULATED) RECTIFIERS, SILICON CONTROLLED		CONSULTING (MANAGEMENT INFORMATION SYSTEMS PLANNING) PROGRAMMING LANGUAGE DEVELOPMENT (PROPRIETARY SOFTWARE PRODUCTS) SERVICES, MANAGEMENT INFORMATION SYSTEMS SERVICES, PROCESSING (COMMERCIAL EDP) SERVICES, TIME SHARING (COMMERCIAL)	
ESAN ELECTRONIC LABORATORIES INC. 2653 E 14th St, Brooklyn, N Y 11235	212-332-0388	EXTEK MICROSYSTEMS INC. 15424 Cabrito Rd, Van Nuys, Cal 91406	213-989-2630
COMPUTERS, HYBRID COMPUTERS, SPECIAL PURPOSE CONSULTING (ACCOUNTING, BUSINESS AND COMMERCIAL APPLICATIONS) CONSULTING (ADVANCED COMPUTER EQUIPMENT DESIGN AND FEASIBILITY STUDIES) CONSULTING (COMPUTER EVALUATIONS, SELECTIONS, INSTALLATION PLANNING)		MICROFICHE MICROFILM ROLLS MICROSTRIPS (FOR MICROFILM) CONTINUED	

3 Manufacturers' Directory

PRINTERS, MICROFILM/MICROFICHE

FABRI-TEK INC.

5901 S County Rd 18, Minneapolis, Minn 55436
ANALYZERS, DIFFERENTIAL
ANALYZERS, PULSE HEIGHT
ANALYZERS, WAVEFORM
BOARDS, PRINTED CIRCUIT (WITHOUT COMPONENTS)
COMPUTERS, DIGITAL (EDUCATIONAL)
CONNECTORS, PC AND IC BOARD (COMPUTER-GRADE)
CONNECTORS, POWER (COMPUTER-GRADE)
CONNECTORS, RACK AND PANEL (COMPUTER-GRADE)
CORES, FERRITE MEMORY
DEMONSTRATORS AND KITS, EDUCATIONAL (DIGITAL LOGIC)
MEMORY PLANES AND STACKS, MAGNETIC CORE (W/O ELECTRONICS)
MEMORY SYSTEMS, MAGNETIC CORE

612-935-8811
TWX 910-576-2913

FABRI-TEK INC. NATIONAL CONNECTOR DIV.

9210 Science Ctr, Minneapolis, Minn 55428
CONNECTORS, MINIATURE AND SUB-MINIATURE (COMPUTER-GRADE)
CONNECTORS, PC AND IC BOARD (COMPUTER-GRADE)
CONNECTORS, POWER (COMPUTER-GRADE)
CONNECTORS, RACK AND PANEL (COMPUTER-GRADE)
GUIDES, CIRCUIT CARDS
SOCKETS, IC MOUNTING
SOCKETS, PCB MOUNTING

612-533-5361
TWX 910-576-2866

FABRI-TEK INFORMATION MANAGEMENT, INC.

5901 S County Rd 18, Edina, Minn 55436
CONSULTING (ACCOUNTING, BUSINESS AND COMMERCIAL APPLICATIONS)
CONSULTING (COMPUTER EVALUATIONS, SELECTIONS, INSTALLATION PLANNING)
CONSULTING (MANAGEMENT INFORMATION SYSTEMS PLANNING)
SERVICES, FACILITY MANAGEMENT
SERVICES, MANAGEMENT INFORMATION SYSTEMS
SERVICES, PROCESSING (COMMERCIAL EDP)
SERVICES, SYSTEMS ANALYSIS

612-935-8811
TWX 910-576-2913

FACIT-ODHNER INC.

501 Winsor Dr, Secaucus, N J 07094
ACCOUNTING MACHINES, PAPER TAPE PROGRAMMED
PRINTERS, DIGITAL STRIP RECORDING
PUNCHES, PAPER TAPE
READERS, PAPER TAPE
RECORDERS, MAGNETIC TAPE
RECORDERS, PAPER TAPE
SPOOLERS, PAPER TAPE
TAPE, MAGNETIC (REELS)
TYPEWRITERS, COMPUTER INPUT-OUTPUT

201-866-5111

FAIRCHILD CAMERA & INST. CO. FAIRCHILD CONT. DIV

225 Park Ave, Hicksville, N Y 11802
AMPLIFIERS, D.C.
AMPLIFIERS, INSTRUMENTATION
AMPLIFIERS, OPERATIONAL
POTENTIOMETERS, TRIM (FILM)
POTENTIOMETERS, TRIM (WIRE-WOUND)
VOLTAGE DIVIDERS

516-938-5600
TWX 510-221-1854

FAIRCHILD DUMONT ELECTRON TUBES

750 Bloomfield Ave, Clifton, N J 07015
CONVERTERS, SCAN
READOUTS, CRT

201-773-2000
TWX 710-989-7149

FAIRCHILD/ELECTRO-METRICS CORP.

100 Church St, Amsterdam, N Y 12010
ANALYZERS, COMPUTER PERFORMANCE
ANALYZERS, WAVEFORM

518-843-2600
TELEX 14-5336

FAIRCHILD GRAPHIC EQUIPMENT

221 Fairchild Ave, Plainview, N Y 11803
COMPUTERS, DIGITAL (GENERAL-PURPOSE, SMALL-SCALE)
DESKS, TABLES AND STANDS (FOR TYPEWRITERS)
TAPE, PUNCH (MYLAR)
TAPE, PUNCH (PAPER)
TAPE, PUNCH (PAPER-COATED MYLAR)
TYPEWRITERS, COMPUTER INPUT-OUTPUT

516-938-9600
TWX 510-221-1868

FAIRCHILD SEMICONDUCTOR

464 Ellis St, Mt View, Cal 94040
CIRCUITS, HYBRID (IC AND DISCRETE-DIGITAL)
CIRCUITS, MONOLITHIC (DIGITAL LOGIC)
CIRCUITS, MONOLITHIC (DIODE MATRICES)
CIRCUITS, MONOLITHIC (LINEAR-EXCL. OP AMPS)
CIRCUITS, MONOLITHIC (LSI-BIPOLAR)
CIRCUITS, MONOLITHIC (LSI-MOS)
CIRCUITS, MONOLITHIC (OP AMPS)
DIODES, NOT-CARRIER
DIODES, LIGHT EMITTING
DIODES, SILICON
DIODES, ZENER
MEMORY SYSTEMS, SEMICONDUCTOR
MEMORY SYSTEMS, SEMICONDUCTOR (MOS)
MULTIPLEXER-CONVERTER (SINGLE UNIT WITH MULTIPLEXER, SAMPLE & HOLD AMPLIFIER & A-TO-D CONVERTER)
MULTIPLEXERS, ANALOG-RELAY (SEQUENTIAL SAMPLING)
MULTIPLEXERS, ANALOG-SOLID STATE (SEQUENTIAL SAMPLING)
MULTIPLEXERS, DIGITAL
RECTIFIERS, SILICON CONTROLLED
REGULATORS, CURRENT
REGULATORS, FREQUENCY
REGULATORS, VOLTAGE
SERVICES, COMPUTER-AIDED DESIGN
TRANSISTORS, FIELD EFFECT
TRANSISTORS, PHOTO
TRANSISTORS, SILICON

415-962-5011
TWX 910-379-6435

FAIRCHILD SYSTEMS TECHNOLOGY

974 E Arques Ave, Sunnyvale, Cal 94086
BOARDS, PRINTED CIRCUIT (WITHOUT COMPONENTS)
COMPUTERS, PROCESS CONTROL
TESTERS, CIRCUIT
TESTERS, DIGITAL LOGIC MODULES AND CARDS
TESTERS, INTEGRATED CIRCUIT
TESTERS, MEMORY PLANES, STACKS AND SYSTEMS
TESTERS, SEMICONDUCTOR

408-735-5011
TWX 910-339-9217

FARRAND CONTROLS INC.

99 Wall St, Valhalla, N Y 10595
CONVERTERS, ANALOG-TO-DIGITAL
CONVERTERS, DIGITAL-TO-ANALOG
CONVERTERS, DIGITAL-TO-SYNCHRO
CONVERTERS, SYNCHRO-TO-DIGITAL
SYNCHRO-RESOLVERS, CONTROL TRANSFORMERS
TRANSDUCERS, DIGITAL

914-761-2600

FARRINGTON MANUFACTURING CO.

6707 Electronics Dr, Springfield, Va 22151
BOARDS, PRINTED CIRCUIT (WITHOUT COMPONENTS)
CABLE ASSEMBLIES (WITH CONNECTORS)
COMPUTERS, DIGITAL (GENERAL-PURPOSE, SMALL-SCALE)
DATA TERMINALS, BLOCK-BY-BLOCK (PAPER TAPE)
IMPRINTERS, MAGNETIC INK CHARACTER
IMPRINTERS, OPTICALLY-SENSED CHARACTER
MARK SENSING EQUIPMENT
READERS, MAGNETIC INK CHARACTER
READERS, OPTICAL CHARACTER SCANNING
SCANNERS, IMAGE
SCANNERS, INPUT
SCANNERS, OPTICAL
SERVICES, PROCESSING (COMMERCIAL EDP)

703-354-5000
TELEX 89-9447

FEDDER DATA CENTERS MANAGEMENT INC.

1654 Central Ave, Albany, N Y 12205
CONSULTING (ACCOUNTING, BUSINESS AND COMMERCIAL APPLICATIONS)
CONSULTING (MANAGEMENT INFORMATION SYSTEMS PLANNING)
CONSULTING (SCIENTIFIC APPLICATIONS)
PROGRAMMING LANGUAGE DEVELOPMENT (CONSULTANTS)
PROGRAMMING LANGUAGE DEVELOPMENT (CONTRACT PROGRAMMING)
PROGRAMMING LANGUAGE DEVELOPMENT (DEDICATED APPLICATION SYSTEMS)
PROGRAMMING LANGUAGE DEVELOPMENT (PROPRIETARY SOFTWARE PRODUCTS)
SERVICES, COMPUTER-AIDED DESIGN
SERVICES, MANAGEMENT INFORMATION SYSTEMS
SERVICES, TIME SHARING (COMMERCIAL)
SERVICES, TIME SHARING (RESEARCH)
SERVICES, SYSTEMS ANALYSIS

518-869-0928

FEDDER DATA CENTERS INC.

307 S Sharp St, Baltimore, Md 21201
COMMUNICATIONS-ORIENTED PROCESSORS, STORED PROGRAM
COMPUTERS, MINI GENERAL PURPOSE (ALSO SEE CALCULATORS)
CONTINUED

301-685-6773

3 Manufacturers' Directory

CONSULTING (ACCOUNTING, BUSINESS AND COMMERCIAL APPLICATIONS)
 DATA TERMINALS, BLOCK-BY-BLOCK (MULTI-PURPOSE)
 DATA TERMINALS, BLOCK-BY-BLOCK (PAPER TAPE)
 DATA TERMINALS, INQUIRY-RESPONSE (ALPHANUMERIC KEYBOARD)
 SERVICES, FACILITY MANAGEMENT
 SERVICES, MANAGEMENT INFORMATION SYSTEMS
 SERVICES, PROCESSING (COMMERCIAL EDP)

FEDERAL SCIENTIFIC CORP. 212-286-4400
 615 W 131st St, New York, N Y 10027

ANALYZERS, COMPUTER PERFORMANCE
 ANALYZERS, PULSE HEIGHT
 ANALYZERS, WAVEFORM
 TEST SYSTEMS, COMPUTER PERFORMANCE
 TESTERS, DIGITAL DATA TRANSMISSION

FEDERAL SCREW PRODUCTS INC. 312-478-5744
 3917 N Kedzie Ave, Chicago, Ill 60618
 JACKS, JACK PANELS, PLUGS, ASSEMBLIES
 KNOBS, DIALS (FOR COMPUTER CONSOLES)
 TERMINAL BLOCKS, STRIPS, BOARDS
 TELEX 25-3677

FELSENTHAL INSTRUMENTS CO. 312-867-7450
 7450 W Wilson Ave, Chicago, Ill 60656
 AUDIO/VISUAL TRAINING AIDS
 COMPUTERS, FIRE CONTROL
 COMPUTERS, NAVIGATION
 PLOTTERS, FILM EXPOSING
 DISPLAYS, PANELS, VIEWGRAPHS (FOR COMPUTER TRAINING)
 TEMPLATES, FLOW CHART
 TWX 910-221-1302

FEMA CORP. 213-899-5910
 11023 Glenoaks Blvd, Pacoima, Cal 91331
 SOLENOIDS

FENWAL ELECTRONICS INC. 617-872-8841
 63 Fountain St, Framingham, Mass 01701
 THERMISTORS
 TWX 710-346-0678

FERRANTI PACKARD LTD., ELECTRONICS DIV. 416-762-3661
 121 Industry St, Toronto 15, CANADA
 BOARDS, VISUAL CONTROL (GRAPHIC)
 CONSULTING (ADVANCED COMPUTER EQUIPMENT DESIGN AND FEASIBILITY
 STUDIES)
 PLOTTERS, FILM EXPOSING
 DATA TERMINALS, INQUIRY-RESPONSE (ALPHANUMERIC KEYBOARD)
 DATA TERMINALS, INQUIRY-RESPONSE (BADGE-TOKEN READERS)
 DATA TERMINALS, INQUIRY-RESPONSE (SPECIAL-PURPOSE)
 DRAFTING SYSTEMS, COMPUTER-CONTROLLED STORAGE
 FILM SCANNERS
 INDICATORS, ALPHANUMERIC
 INDICATORS, DIGITAL
 MARK SENSING EQUIPMENT
 READERS, PAPER TAPE
 READERS, PERFORATED DOCUMENT
 READOUTS AND DISPLAYS, NUMERIC AND ALPHANUMERIC (OTHER THAN CRT)
 SCANNERS, OPTICAL
 TWX 610-491-1434

FERROXCUBE CORP. 914-246-2811
 Po Box 359, Saugerties, N Y 12477
 CORES, FERRITE MEMORY
 MEMORY PLANES AND STACKS, MAG-NETIC CORE (W/O ELECTRONICS)
 MEMORY PLANES AND STACKS, PLATED WIRE (W/O ELECTRONICS)
 MEMORY SYSTEMS, MAGNETIC CORE
 POLE PIECES, FERRITE
 RECORDING HEADS, MAGNETIC DISC
 RECORDING HEADS, MAGNETIC DRUM
 RECORDING HEADS, MAGNETIC TAPE
 TWX 510-247-5410

FIBER PHOTICS INC. 408-475-5242
 2557 Soquel Dr, Santa Cruz, Cal 95060

FIBER OPTIC BUNDLES
 FIBER OPTICS ASSEMBLIES (FOR PUNCHED CODE READERS AND MARK SENSORS)
 FILM SCANNERS
 MARK SENSING EQUIPMENT
 READERS, OPTICAL CHARACTER SCANNING
 READERS, PAPER TAPE
 READOUTS AND DISPLAYS, NUMERIC AND ALPHANUMERIC (OTHER THAN CRT)
 SCANNERS, OPTICAL

FIELDTEC INC. 714-540-4000
 4262 Campus Dr, Newport Beach, Cal 92660
 BLOWERS, FANS, COOLING ASSEMBLIES
 CIRCUITS, THIN FILM (DIGITAL)
 TWX 213-860-4000

FIFTH DIMENSION INC. 609-924-5990
 P O Box 483, Princeton, N J 08540
 RELAYS, DRY REED (COMPUTER GRADE)
 RELAYS, MERCURY WETTED (COMPUTER GRADE)
 SWITCHES, ROTARY
 TWX 510-685-9294

FILM MICROELECTRONICS INC. 617-272-5650
 17 A St, Burlington, Mass 01803
 CIRCUITS, HYBRID (IC AND DISCRETE-DIGITAL)
 CIRCUITS, THIN FILM (DIGITAL)

FIMACO INC. 212-565-3814
 2 Pennsylvania Plaza, New York, N Y 10001
 CONSULTING (COMPUTER EVALUATIONS, SELECTIONS, INSTALLATION
 PLANNING)

FIRST BUSINESS COMPUTING 713-227-3429
 1020 Houston Bk&Tr Tr, Houston, Tex 77002

CONSULTING (ACCOUNTING, BUSINESS AND COMMERCIAL APPLICATIONS)
 CONSULTING (COMPUTER EVALUATIONS, SELECTIONS, INSTALLATION
 PLANNING)
 CONSULTING (MANAGEMENT INFORMATION SYSTEMS PLANNING)
 CONSULTING (SCIENTIFIC APPLICATIONS)
 PROGRAMMING LANGUAGE DEVELOPMENT (CONSULTANTS)
 PROGRAMMING LANGUAGE DEVELOPMENT (CONTRACT PROGRAMMING)
 PROGRAMMING LANGUAGE DEVELOPMENT (DEDICATED APPLICATION SYSTEMS)
 PROGRAMMING LANGUAGE DEVELOPMENT (PROPRIETARY SOFTWARE
 PRODUCTS)
 SERVICES, MANAGEMENT INFORMATION SYSTEMS
 TRAINING INSTITUTES, COMMERCIAL COMPUTER COURSES, SEMINARS,
 CORRESPONDENCE COURSES

FISHER AND CROME INC. 215-426-3232
 2427 N Mascher St, Philadelphia, Pa 19133
 TEMPLATES, FLOW CHART

FISHER-STEVENS INC. 201-471-4000
 120 Brighton Rd, Clifton, N J 07012
 CONSULTING (MANAGEMENT INFORMATION SYSTEMS PLANNING)
 SERVICES, PROCESSING (COMMERCIAL EDP)

FLEX KEY CORP. 617-891-1320
 1277 Main St, Waltham, Mass 02154
 ENCODERS, KEYBOARD (ALPHANUMERIC)
 ENCODERS, KEYBOARD (NUMERIC)

FLEXIBLE CIRCUITS INC. 215-343-2300
 Paul Valley Ind Pk, Warrington, Pa 18976

BOARDS, PRINTED CIRCUIT (WITHOUT COMPONENTS)
 BREADBOARDS
 BUS BAR SYSTEMS
 CABLE ASSEMBLIES (WITH CONNECTORS)
 CABLE, COAXIAL (FLEXIBLE)
 CABLE, FLAT, PRINTED AND RIBBON
 CABLE, SHIELDED (NOT COAXIAL)
 CIRCUIT CARDS, LINEAR (WITH DISCRETE COMPONENTS)
 CIRCUIT CARDS, LINEAR (WITH IC'S)
 CIRCUIT CARDS, LOGIC (WITH DISCRETE COMPONENTS)
 CIRCUIT CARDS, LOGIC (WITH IC'S)
 MEMORY PLANES AND STACKS, PLATED WIRE (W/O ELECTRONICS)

FLEXI-OPTICS LABORATORY INC. 617-485-2265
 269 Mechanic St, Marlboro, Mass 01752

FIBER OPTIC BUNDLES
 FIBER OPTICS ASSEMBLIES (FOR PUNCHED CODE READERS AND MARK SENSORS)
 READERS, OPTICAL CHARACTER SCANNING
 READOUTS AND DISPLAYS, NUMERIC AND ALPHANUMERIC (OTHER THAN CRT)
 SCANNERS, OPTICAL

3 Manufacturers' Directory

FLOATING FLOORS INC. SUB. NATIONAL LEAD CO.
5400 N Detroit Ave, Tpledo, Ohio 43612
 AIR CONDITIONERS (FOR EDP INSTALLATIONS)

419-479-0721
 TWX 419-442-1709

FLORES ASSOCIATES
108 8th Ave, Brooklyn, N Y 11215

212-789-1312

CONSULTING (ACCOUNTING, BUSINESS AND COMMERCIAL APPLICATIONS)
 CONSULTING (ADVANCED COMPUTER EQUIPMENT DESIGN AND FEASIBILITY STUDIES)
 CONSULTING (COMPUTER EVALUATIONS, SELECTIONS, INSTALLATION PLANNING)
 CONSULTING (COMPUTER PRODUCT PLANNING SURVEYS, MARKET RESEARCH STUDIES)
 CONSULTING (MANAGEMENT INFORMATION SYSTEMS PLANNING)
 CONSULTING (SCIENTIFIC APPLICATIONS)
 PROGRAMMING LANGUAGE DEVELOPMENT (CONSULTANTS)
 PROGRAMMING LANGUAGE DEVELOPMENT (CONTRACT PROGRAMMING)
 SERVICES, MANAGEMENT INFORMATION SYSTEMS
 SERVICES, SYSTEMS ANALYSIS
 TRAINING INSTITUTES, COMMERCIAL COMPUTER COURSES, SEMINARS, CORRESPONDENCE COURSES
 TRAINING SYSTEMS, COMPUTER SERVICE

FLOTRON INDUSTRIES INC.
2104 W Rosecrans Ave, Gardena, Cal 90249

213-532-8302

EXTRACTORS, CIRCUIT BOARD

FLUKE, JOHN MFG. CO. INC.
P O Box 7428, Seattle, Wash 98133

206-774-2211
 TWX 910-449-2850

ATTENUATORS, DECADE DIGITAL
 CONVERTERS, ANALOG-TO-DIGITAL
 CONVERTERS, DIGITAL-TO-ANALOG
 POWER SUPPLIES, DC
 POWER SUPPLIES, DIGITALLY-CONTROLLED
 VOLTMETERS, AC, DC, DIFFERENTIAL
 VOLTMETERS, DIGITAL

FORD INDUSTRIES INC.
5001 SE Johnson Ck, Portland, Ore 97206

503-774-1104
 TELEX 3-6520

ACOUSTIC COUPLERS
 MODEMS, ACOUSTIC
 MODEMS, HARD-WIRED
 MODEMS, PC CARD
 RECORDERS, DIGITAL CASSETTE
 RECORDERS, MAGNETIC TAPE
 TAPE TRANSPORTS, MAGNETIC (DIGITAL CASSETTE)

FORET, P. G.
60 Union Ave, Sudbury, Mass 01776

617-443-9958

CLEANER/CERTIFIERS, MAGNETIC TAPE
 POOLERS, MAGNETIC TAPE
 WINDERS, MAGNETIC TAPE

FORTIN LAMINATING
1323 Truman St, San Fernando, Cal 91340

213-365-9651

MEMORY PLANES AND STACKS, PLATED WIRE (W/O ELECTRONICS)

FOUR-PHASE SYSTEMS INC.
10420 N Tantau Ave, Cupertino, Cal 95014

408-255-0900

COMPUTERS, DIGITAL (EDUCATIONAL)
 COMPUTERS, DIGITAL (GENERAL-PURPOSE, SMALL-SCALE)
 COMPUTERS, DIGITAL (GENERAL-PURPOSE, MEDIUM-SCALE)
 CONSOLES, CRT (ALPHANUMERIC AND GRAPHIC)
 DATA TERMINALS, INQUIRY-RESPONSE (ALPHANUMERIC KEYBOARD)
 DATA TERMINALS, INQUIRY-RESPONSE (CRT WITH KEYBOARD)
 DATA TERMINALS, INQUIRY-RESPONSE (SPECIAL-PURPOSE)

FOXBORO CO., THE
Neponset Ave, Foxboro, Mass 02035

617-543-8750
 TELEX 92-7602

COMPUTERS, ANALOG (GENERAL-PURPOSE)
 COMPUTERS, DIGITAL (GENERAL-PURPOSE, SMALL-SCALE)
 COMPUTERS, DIGITAL (GENERAL-PURPOSE, MEDIUM-SCALE)
 COMPUTERS, PROCESS CONTROL
 CONSOLES, COMPUTER CONTROL (WIRED)
 CONVERTERS, ANALOG-TO-DIGITAL
 CONVERTERS, DC-TO-FREQUENCY
 CONVERTERS, DIGITAL-TO-ANALOG
 CONVERTERS, FREQUENCY-TO-DC
 CONVERTERS, PULSE-TO-DIGITAL
 CONTINUED

CONVERTERS, VOLTAGE-TO-FREQUENCY

FRANKLIN RIBBON & CARBON CO., INC.
225 Charlotte Ave, Hicksville, N Y 11802

516-433-3010

RIBBONS, INK (FOR PRINTERS AND TAB EQUIPMENT)

FREDERICK CONTROLS DIV., SUB. NO.AM.PHILIPS CORP.
E Church & Second Sts, Frederick, Md 21701

301-663-5141

MOTORS, SYNCHRONOUS
 RELAYS, DRY REED (COMPUTER GRADE)
 SWITCHES, DRY REED
 SWITCHES, SNAP ACTION
 TIMERS, EVENT (IMPULSE)
 TIMERS, INTERVAL

FRIDEN DIV. THE SINGER CO.
97 Humboldt St, Rochester, N Y 14602

716-288-7400

AUDIO/VISUAL TRAINING AIDS
 CARDS, EDGE-PUNCH
 CLEANERS, MAGNETIC TAPE HEADS
 COMMUNICATION SYSTEMS, DATA TRANSMISSION
 CONVERTERS, DOCUMENT-TO-PAPER TAPE
 CONVERTERS, MAGNETIC TAPE-TO-MAGNETIC TAPE
 CONVERTERS, PAPER TAPE-TO-MAGNETIC TAPE
 CONVERTERS, PAPER TAPE-TO-PRINTER
 CONVERTERS, PUNCHED CARD-TO-PAPER TAPE
 DATA TERMINALS, BLOCK-BY-BLOCK (MAGNETIC TAPE)
 DATA TERMINALS, BLOCK-BY-BLOCK (PAPER TAPE)
 DATA TERMINALS, BLOCK-BY-BLOCK (PUNCHED CARD)
 DATA TERMINALS, INQUIRY-RESPONSE (ALPHANUMERIC KEYBOARD)
 DATA TERMINALS, INQUIRY-RESPONSE (BADGE-TOKEN READERS)
 DISC DRIVES, MOVABLE HEAD (INCLUDING CONTROLLER)
 ENCODERS, KEYBOARD (ALPHANUMERIC)
 ENCODERS, KEYBOARD-TO-MAGNETIC TAPE
 ENVELOPES (FOR FILING TAPES)
 INSTRUCTIONAL SYSTEMS, COMPUTER-BASED
 LABELS, CONTINUOUS AND GUMMED (MACHINE APPLICATION)
 LABELS, CONTINUOUS AND PRESSURE SENSITIVE (MACHINE APPLICATION)
 MEMORY SYSTEMS, MAGNETIC DISC
 PERFORATORS, DOCUMENT
 PERFORATORS, PAPER TAPE
 POOLERS, MAGNETIC TAPE
 PRINTER/PUNCH, PAPER TAPE
 PRINTERS, KEYBOARD
 PRINTERS, LINE (LOW & MEDIUM SPEED)
 PUNCHES, CARD (EDGE-PUNCHING)
 PUNCHES, PAPER TAPE
 READERS, EDGE-PUNCHED CARD
 READERS, PAPER TAPE
 READERS, PERFORATED DOCUMENT
 RECORDERS, MAGNETIC TAPE
 REELS, MAGNETIC TAPE
 REELS, PAPER TAPE
 REPRODUCERS, PAPER TAPE (AUTOMATIC)
 RIBBONS, INK (FOR PRINTERS AND TAB EQUIPMENT)
 SPLICERS, PAPER TAPE
 SPOOLERS, PAPER TAPE
 TAPE, MAGNETIC (CASSETTE)
 TAPE, MAGNETIC (REELS)
 TAPE, PUNCH (MYLAR)
 TAPE, PUNCH (MYLAR-COATED FOIL)
 TAPE, PUNCH (PAPER)
 TAPE, PUNCH (PAPER-COATED MYLAR)
 TAPE, PUNCH (PAPER-COATED ALUMINUM)
 TEMPLATES, FLOW CHART
 TYPEWRITERS, COMPUTER INPUT-OUTPUT
 WINDERS, PAPER TAPE

FROST ELECTRONICS CORP.
Pearl St, Caryville, Mass 02024

617-966-1590

RELAYS, DRY REED (COMPUTER GRADE)
 RELAYS, MERCURY WETTED (COMPUTER GRADE)

FRYE MANUFACTURING CO.
P O Box 854, Des Moines, Iowa 50304

515-262-8233

PAPER (FOR OCR EQUIPMENT)
 PAPER (FOR PRINTERS)

FUJITSU LTD. N.Y.LIAISON OFFICE
680 Fifth Ave, New York, N Y 10019

212-265-5360

COMMUNICATION SYSTEMS, DATA TRANSMISSION
 CONTINUED

3 Manufacturers' Directory

COMMUNICATION SYSTEMS, TELEPRINTER
 COMPUTERS, DIGITAL (GENERAL-PURPOSE, SMALL-SCALE)
 COMPUTERS, DIGITAL (GENERAL-PURPOSE, MEDIUM-SCALE)
 COMPUTERS, DIGITAL (GENERAL-PURPOSE, LARGE SCALE)
 COMPUTERS, MINI GENERAL PURPOSE (ALSO SEE CALCULATORS)
 COMPUTERS, PROCESS CONTROL
 CONTROLLERS, MODEM
 DATA TERMINALS, BLOCK-BY-BLOCK (PAPER TAPE)
 DATA TERMINALS, BLOCK-BY-BLOCK (MEDIUM SPEED PRINTER)
 DATA TERMINALS, BLOCK-BY-BLOCK (TELEPRINTER)
 DATA TERMINALS, INQUIRY-RESPONSE (ALPHANUMERIC KEYBOARD)
 DATA TERMINALS, INQUIRY-RESPONSE (CRT WITH KEYBOARD)
 DATA TERMINALS, INQUIRY-RESPONSE (SPECIAL-PURPOSE)
 DISC DRIVES, FIXED HEAD (INCLUDING CONTROLLER)
 DISC DRIVES, MOVABLE HEAD (INCLUDING CONTROLLER)
 DISC DRIVES, REMOVABLE CARTRIDGE
 DISC PACKS, MAGNETIC
 DISC STORAGE SYSTEMS
 DRUM STORAGE EQUIPMENT, MAG-NETIC (INCLUDING CONTROLLER)
 MAGNETIC TAPE STORAGE SYSTEMS (INCLUDES CONTROLLER)
 MARK SENSING EQUIPMENT
 MODEMS, HARD-WIRED
 PERFORATORS, PAPER TAPE
 PRINTER/PUNCH, PAPER TAPE
 PRINTERS, LINE (LOW & MEDIUM SPEED)
 PRINTERS, LINE (HIGH SPEED)
 PUNCHES, PAPER TAPE
 READERS, OPTICAL CHARACTER SCANNING
 READERS, PAPER TAPE
 READERS, PUNCHED CARD (100 TO 300 CPM)
 READERS, PUNCHED CARD (OVER 300 CPM)
 TYPEWRITERS, COMPUTER INPUT-OUTPUT

G-V CONTROLS DIV. SOLA BASIC INDUSTRIES 201-992-6200
 101 Okner Pkwy, Livingston, N J 07039 TWX 710-994-4852
 DIALERS, AUTOMATIC

GAF CORP. OFFICE SYSTEMS DIV. 419-342-3515
 40 High School Ave, Shelby, Ohio 44875
 FORMS, CONTINUOUS (MACHINE PROCESSED)

GAMS & ASSOCIATES INC., T.C. 201-687-2501
 2222 Morris Ave, Union, N J 07083

CONSULTING (COMPUTER PRODUCT PLANNING SURVEYS, MARKET RESEARCH STUDIES)
 CONSULTING (SCIENTIFIC APPLICATIONS)
 SERVICES, SYSTEMS ANALYSIS

GANNETT, FLEMING, CORDDRY & CARPENTER INC. 717-238-0451
 P O Box 1963, Harrisburg, Pa 17105

CONSULTING (ACCOUNTING, BUSINESS AND COMMERCIAL APPLICATIONS)
 CONSULTING (COMPUTER EVALUATIONS, SELECTIONS, INSTALLATION PLANNING)
 CONSULTING (SCIENTIFIC APPLICATIONS)
 SERVICES, FACILITY MANAGEMENT
 SERVICES, MANAGEMENT INFORMATION SYSTEMS
 SERVICES, PROCESSING (COMMERCIAL EDP)
 SERVICES, PROCESSING (ANALOG OR HYBRID, SCIENTIFIC)
 SERVICES, PROCESSING (DIGITAL SCIENTIFIC)

GAP INSTRUMENT CORP. 516-273-0909
 110 Marcus Blvd, Hauppauge, N Y 11787 TWX 510-227-6237

AMPLIFIERS, INSTRUMENTATION
 BREADBOARDS
 CABLE ASSEMBLIES (WITH CONNECTORS)
 COMPUTERS, FIRE CONTROL
 COMPUTERS, NAVIGATION
 COMPUTERS, PROCESS CONTROL
 CONVERTERS, ANALOG-TO-DIGITAL
 CONVERTERS, BINARY-TO-DECIMAL
 CONVERTERS, DC-TO-FREQUENCY
 CONVERTERS, DIGITAL-TO-ANALOG
 CONVERTERS, DIGITAL-TO-SYNCHRO
 CONVERTERS, POLAR-TO-RECTANGULAR
 CONVERTERS, PULSE-TO-DIGITAL
 CONVERTERS, SYNCHRO-TO-DIGITAL
 CONVERTERS, VOLTAGE-TO-FREQUENCY
 COUNTERS, DIGITAL READOUT
 COUNTERS, UP-DOWN
 INDICATORS, DIGITAL
 INDICATORS, ILLUMINATED
 MOTORS, STEPPING
 MULTIPLEXER-CONVERTER (SINGLE UNIT WITH MULTIPLEXER, SAMPLE & HOLD AMPLIFIER & A-TO-D CONVERTER)

CONTINUED

MULTIPLEXERS, ANALOG-SOLID STATE (SEQUENTIAL SAMPLING)
 MULTIPLEXERS, DIGITAL
 POWER SUPPLIES, DC
 POWER SUPPLIES, DIGITALLY-CONTROLLED
 SERVOS, COMPUTER

GARDNER-DENVER CO. 616-84200200
 Gardner Expwy, Quincy, Ill 62301

SERVICES, AUTOMATED WIRE-WRAPPING

GARDNER-DENVER CO. WIRE-WRAP DIV. 616-842-0200
 1333 Fulton, Grand Haven, Mich 49417

SERVICES, AUTOMATED WIRE-WRAPPING

GARRETT ELECTRONICS & CABLE CO. 516-249-0180
 24 Central Dr, Farmingdale, N Y 11735

BUS BAR SYSTEMS
 CABLE, COAXIAL (FLEXIBLE)
 CABLE, COAXIAL (SEMI/RIGID)
 CABLE, FINE LEAD
 VOLTMETERS, AC, DC, DIFFERENTIAL

GARRETT GRUNER 517-787-5710
 1204 First, Jackson, Mich 49203

CONSULTING (ACCOUNTING, BUSINESS AND COMMERCIAL APPLICATIONS)
 CONSULTING (COMPUTER EVALUATIONS, SELECTIONS, INSTALLATION PLANNING)
 CONSULTING (MANAGEMENT INFORMATION SYSTEMS PLANNING)
 CONSULTING (SCIENTIFIC APPLICATIONS)

GARY INDUSTRIES INC. ACCO DIV. 312-282-6800
 5150 Northwest Hwy, Chicago, Ill 60630 TWX 910-221-4222
 HOLDERS, BINDER

GATES ACOUSTINET INC. 707-544-2711
 P O Box 1406, Santa Rosa, Cal 95403

CABINETS AND ENCLOSURES (FOR KEYPUNCHES, PRINTERS)

GEAR SYSTEMS DIV. OF USM CORP. 617-245-4900
 Rte 128, Wakefield, Mass 01880 TWX 710-348-0426

COUNTERS, DECADE
 MOTORS, SERVO
 MOTORS, STEPPING
 MOTORS, SYNCHRONOUS
 POWER SUPPLIES, DC

GENASYS CORP. 202-293-1166
 2011 Gye St NW, Washington, D C 20006

CONSULTING (ACCOUNTING, BUSINESS AND COMMERCIAL APPLICATIONS)
 CONSULTING (ADVANCED COMPUTER EQUIPMENT DESIGN AND FEASIBILITY STUDIES)
 CONSULTING (COMPUTER EVALUATIONS, SELECTIONS, INSTALLATION PLANNING)
 CONSULTING (DATA COMMUNICATIONS SYSTEMS PLANNING)
 CONSULTING (MANAGEMENT INFORMATION SYSTEMS PLANNING)
 PROGRAMMING LANGUAGE DEVELOPMENT (CONSULTANTS)
 PROGRAMMING LANGUAGE DEVELOPMENT (CONTRACT PROGRAMMING)
 PROGRAMMING LANGUAGE DEVELOPMENT (PROPRIETARY SOFTWARE PRODUCTS)
 SERVICES, MANAGEMENT INFORMATION SYSTEMS
 SERVICES, PROCESSING (COMMERCIAL EDP)
 SERVICES, SYSTEMS ANALYSIS

GENERAL APPLIED SCIENCE LABORATORIES INC. 516-333-6960
 Merrick & Stewart Ave, Westbury, N Y 11590 TWX 510-222-4136
 CONSULTING (SCIENTIFIC APPLICATIONS)

GENERAL ATRONICS CORP. SUB. OF MAGNAVOX 215-248-3700
 Mermaid Lane, Philadelphia, Pa 19118 TWX 710-670-0636

COMMUNICATION SYSTEMS, DATA TRANSMISSION
 CONSULTING (DATA COMMUNICATIONS SYSTEMS PLANNING)
 MODEMS, HARD-WIRED
 MULTIPLEXERS, ANALOG-SOLID STATE (SEQUENTIAL SAMPLING)
 TUBES, CATHODE RAY

3 Manufacturers' Directory

GENERAL AUTOMATION INC.
1055 S East St, Anaheim, Cal 92805

714-778-4800
TWX 910-591-1695

CIRCUIT CARDS, LOGIC (WITH IC'S)
COMMUNICATIONS-ORIENTED PROCESSORS, STORED PROGRAM COMPUTERS, DIGITAL (GENERAL-PURPOSE, SMALL-SCALE)
COMPUTERS, MINI GENERAL PURPOSE (ALSO SEE CALCULATORS)
COMPUTERS, PROCESS CONTROL
CONSULTING (COMPUTER EVALUATIONS, SELECTIONS, INSTALLATION PLANNING)
CONSULTING (DATA COMMUNICATIONS SYSTEMS PLANNING)
CONSULTING (SCIENTIFIC APPLICATIONS)
CONTROLLERS, MAGNETIC DISC
CONTROLLERS, MAGNETIC DRUM
CONTROLLERS, MAGNETIC TAPE
CONTROLLERS, MODEM
CONTROLLERS, PLOTTING
CONVERTERS, ANALOG-TO-DIGITAL
CONVERTERS, DIGITAL-TO-ANALOG
MULTIPLEXERS, ANALOG-SOLID STATE (SEQUENTIAL SAMPLING)
PROGRAMMING LANGUAGE DEVELOPMENT (CONSULTANTS)
PROGRAMMING LANGUAGE DEVELOPMENT (CONTRACT PROGRAMMING)
PROGRAMMING LANGUAGE DEVELOPMENT (DEDICATED APPLICATION SYSTEMS)
PROGRAMMING LANGUAGE DEVELOPMENT (PROPRIETARY SOFTWARE PRODUCTS)
SERVICES, PROCESSING (DIGITAL SCIENTIFIC)
SERVICES, AUTOMATED WIRE-WRAPPING
SERVICES, HARDWARE MAINTENANCE
SERVICES, SYSTEMS ANALYSIS

GENERAL CABLE CORP.
730 3rd Ave, New York, N Y 10017

212-986-3800

BLOWERS, FANS, COOLING ASSEMBLIES
CABLE, COAXIAL (FLEXIBLE)
CABLE, COAXIAL (SEMI/RIGID)
CABLE, FINE LEAD
CABLE, MULTICONDUCTOR
CABLE, SHIELDED (NOT COAXIAL)

GENERAL CIRCUITS INC.
95 Mt Read Blvd, Rochester, N Y 14611

716-235-2880

BOARDS, PRINTED CIRCUIT (WITHOUT COMPONENTS)
CABLE, FLAT, PRINTED AND RIBBON
CABLE, MULTICONDUCTOR
CIRCUIT CARDS, LINEAR (WITH DISCRETE COMPONENTS)
CIRCUIT CARDS, LINEAR (WITH IC'S)
CIRCUIT CARDS, LOGIC (WITH DISCRETE COMPONENTS)
CIRCUIT CARDS, LOGIC (WITH IC'S)

GENERAL COMPUTER SERVICES INC.
1332 Meridan St NE, Huntsville, Ala 35801

205-539-9492

COMPUTERS, DIGITAL (GENERAL-PURPOSE, LARGE SCALE)
CONSULTING (ACCOUNTING, BUSINESS AND COMMERCIAL APPLICATIONS)
CONSULTING (COMPUTER EVALUATIONS, SELECTIONS, INSTALLATION PLANNING)
CONSULTING (DATA COMMUNICATIONS SYSTEMS PLANNING)
SERVICES, FACILITY MANAGEMENT
SERVICES, PROCESSING (COMMERCIAL EDP)
SERVICES, TIME SHARING (COMMERCIAL)
SERVICES, SYSTEMS ANALYSIS

GENERAL COMPUTER SYSTEMS INC.
12011 Colt Rd, Dallas, Tex 75230

214-239-0375

ENCODERS, KEYBOARD-TO-MAGNETIC DISC TAPE

GENERAL COMPUTERS INC.
5990 W Pico Blvd, Los Angeles, Cal 90035

213-939-7687

COMPUTERS, HYBRID

GENERAL DATACOMM INDUSTRIES
537 Newton Ave, Norwalk, Conn 06851

203-847-2445

MODEMS, ACOUSTIC
MODEMS, HARD-WIRED
MODEMS, PC CARD
MULTIPLEXERS, DIGITAL

GENERAL DEVICES CO. INC.
525 S Webster Ave, Indianapolis, Ind 46219

317-359-5407

BLOWERS, FANS, COOLING ASSEMBLIES
CONTINUED

CABINETS AND ENCLOSURES (FOR KEYPUNCHES, PRINTERS)
CABINETS, ENCLOSURES, CONSOLES, ELECTRONIC (FOR GENERAL EQUIPMENT)
CHASSIS, SLIDES, RACKS
HANDLES, TEST POINT STRIPS (FOR CIRCUIT CARDS)

GENERAL DEVICES CO. INC. CHASSIS-TRAK DIV. 317-359-5407
525 S Webster Ave, Indianapolis, Ind 46219

CHASSIS, SLIDES, RACKS

GENERAL DEVICES CO. INC. VENT-RAK DIV. 317-359-5407
525 S Webster Ave, Indianapolis, Ind 46219

CABINETS, ENCLOSURES, CONSOLES, ELECTRONIC (FOR GENERAL EQUIPMENT)

GENERAL DEVICES INC. 609-924-2500
P O Box 253, Princeton, N J 08540 TWX 510-236-5624

AMPLIFIERS, D.C.
CONVERTERS, ANALOG-TO-DIGITAL
CONVERTERS, DIGITAL-TO-ANALOG
MULTIPLEXER-CONVERTER (SINGLE UNIT WITH MULTIPLEXER, SAMPLE & HOLD AMPLIFIER & A-TO-D CONVERTER)
MULTIPLEXERS, ANALOG-RELAY (SEQUENTIAL SAMPLING)
MULTIPLEXERS, ANALOG-SOLID STATE (SEQUENTIAL SAMPLING)
MULTIPLEXERS, DIGITAL
OSCILLATORS, VOLTAGE CONTROLLED
POWER SUPPLIES, DC
POWER SUPPLIES, DIGITALLY-CONTROLLED
SCANNERS, IMAGE
SCANNERS, INPUT
SIGNAL CONDITIONERS
SWITCHES, ROTARY

GENERAL DYNAMICS CORP. ELECTRONICS DIV. 305-323-1260
P O Box 2566, Orlando, Fla 32802 TWX 810-853-0262

CIRCUIT CARDS, LOGIC (WITH IC'S)
COMMUNICATIONS-ORIENTED PROCESSORS, MULTIPLE CHANNEL CONTROLLERS
COMMUNICATIONS-ORIENTED PROCESSORS, SINGLE CHANNEL CONTROLLERS
COMMUNICATIONS-ORIENTED PROCESSORS, STORED PROGRAM COMMUNICATION SYSTEMS, DATA TRANSMISSION
CONVERTERS, ANALOG-TO-DIGITAL
CONVERTERS, DIGITAL-TO-ANALOG
DATA ACQUISITION AND REDUCTION SYSTEMS
ENCODERS, DIGITAL
MODEMS, HARD-WIRED
MULTIPLEXER-CONVERTER (SINGLE UNIT WITH MULTIPLEXER, SAMPLE & HOLD AMPLIFIER & A-TO-D CONVERTER)
MULTIPLEXERS, ANALOG-SOLID STATE (SEQUENTIAL SAMPLING)
MULTIPLEXERS, DIGITAL
SIGNAL CONDITIONERS
TESTERS, DIGITAL DATA TRANSMISSION
TESTERS, DIGITAL LOGIC MODULES AND CARDS

GENERAL ELECTRIC CO. COMM. SYS. DIV. 703-846-7311
Mountain View Rd, Lynchburg, Va 24502

ACOUSTIC COUPLERS
COMMUNICATIONS-ORIENTED PROCESSORS, STORED PROGRAM COMMUNICATION SYSTEMS, DATA TRANSMISSION
COMMUNICATION SYSTEMS, TELEPRINTER
CONTROLLERS, MODEM
DATA CONCENTRATORS
DATA TERMINALS, BLOCK-BY-BLOCK (PAPER TAPE)
DATA TERMINALS, BLOCK-BY-BLOCK (TELEPRINTER)
DATA TERMINALS, INQUIRY-RESPONSE (ALPHANUMERIC KEYBOARD)
MODEMS, ACOUSTIC
MODEMS, HARD-WIRED
MODEMS, PC CARD
MULTIPLEXERS, DIGITAL

GENERAL ELECTRIC CO. COMM&CONT DEV DEPT. 703-942-8161
General Electric Dr, Waynesboro, Va 22980

PRINTERS, KEYBOARD

GENERAL ELECTRIC CO. TUBE DEPARTMENT 502-683-2401
316 E 9th St, Owensboro, Ky 42301

INDICATORS, ALPHANUMERIC
INDICATORS, DIGITAL
INDICATORS, ILLUMINATED
TUBES, CATHODE RAY

3 Manufacturers' Directory

GENERAL ELECTRIC CO. WIRE & CABLE DEPT. 1285 Boston Ave, Bridgeport, Conn 06602	203-334-1012	GENERAL KINETICS INC. 11425 Isaac Newt Sq S, Reston, Va 22070	703-471-7522
CABLE, COAXIAL (FLEXIBLE) CABLE, COAXIAL (SEMI/RIGID) CABLE, FINE LEAD CABLE, MULTICONDUCTOR CABLE, SHIELDED (NOT COAXIAL)		CERTIFIERS, MAGNETIC TAPE CLEANER/CERTIFIERS, MAGNETIC TAPE CLEANERS, MAGNETIC TAPE ERASERS, BULK (MAGNETIC TAPE) RECONDITIONING EQUIPMENT, MAGNETIC TAPE REEL CLIPS AND BELTS, MAGNETIC TAPE REELS, MAGNETIC TAPE SERVICES, MAGNETIC TAPE CERTIFICATION TAPE, MAGNETIC (REELS) WINDERS, MAGNETIC TAPE	
GENERAL ELECTRIC CO. GENERAL PURPOSE MOTOR DEPT. 200 Taylor St, Ft Wayne, Ind 46804	219-743-7431		
BLOWERS, FANS, COOLING ASSEMBLIES MOTORS, SERVO MOTORS, STEPPING MOTORS, SYNCHRONOUS		GENERAL RADIO CO. 300 Baker Ave, Concord, Mass 01742	617-369-4400 TWX 710-347-1051
GENERAL ELECTRIC CO. PROCESS COMPUTER DEPT. 2255 W Desert Cove Rd, Phoenix, Ariz 85029	602-943-2341	AMPLIFIERS, INSTRUMENTATION CONNECTORS, COAXIAL (COMPUTER-GRADE) COUNTERS, DECADE COUNTERS, DIGITAL READOUT OSCILLATORS, VOLTAGE CONTROLLED RECORDERS, MAGNETIC TAPE REGULATORS, VOLTAGE SCANNERS, INPUT- TESTERS, CIRCUIT TESTERS, DIGITAL LOGIC MODULES AND CARDS TESTERS, INTEGRATED CIRCUIT TIMERS, INTERVAL VOLTMETERS, AC, DC, DIFFER-ENTIAL	
COMPUTERS, MINI GENERAL PURPOSE (ALSO SEE CALCULATORS) COMPUTERS, PROCESS CONTROL CONSULTING (ADVANCED COMPUTER EQUIPMENT DESIGN AND FEASIBILITY STUDIES) PROGRAMMING LANGUAGE DEVELOPMENT (CONTRACT PROGRAMMING)			
GENERAL EQUIPMENT & MANUFACTURING CO. 3300 Fern Valley Rd, Louisville, Ky 40213	502-969-2386		
COUNTERS, DECADE COUNTERS, DIGITAL READOUT SWITCHES, SNAP ACTION		GENERAL SEMICONDUCTOR INDUSTRIES INC. 230 West 5th St, Tempe, Ariz 85281	602-966-7263 TWX 910-950-1942
GENERAL INSTRUMENT CORP. MAGNE-HEAD DIV. 13040 Cerise Ave, Hawthorne, Cal 90250	213-679-3377 TWX 910-325-6203		
CONTROLLERS, MAGNETIC DISC CONTROLLERS, MAGNETIC DRUM CONVERTERS, PAPER TAPE-TO-PAPER TAPE CONVERTERS, PAPER TAPE-TO-PUNCHED CARD CONVERTERS, PUNCHED CARD-TO-PAPER TAPE DISC DRIVES, FIXED HEAD (INCLUDING CONTROLLER) DISC DRIVES, REMOVABLE CARTRIDGE DISC PACKS, MAGNETIC DISC STORAGE SYSTEMS DRUM STORAGE EQUIPMENT, MAG-NETIC (INCLUDING CONTROLLER) MEMORY SYSTEMS, SEMICONDUCTOR (MOS) READERS, EDGE-PUNCHED CARD RECORDING HEADS, MAGNETIC DISC RECORDING HEADS, MAGNETIC DRUM RECORDING HEADS, MAGNETIC TAPE		GENERAL TIME CORP. IND. CONTROLS DIV. Rte 8, Torrington, Conn 06790	203-482-4481 TELEX 96-2445
GENERAL INSTRUMENT CORP. MICROELECT. DIV. 600 W John St, Hicksville, N Y 11802	516-733-3247 TWX 510-221-1866	INDICATORS, ELAPSED TIME MOTORS, SYNCHRONOUS TIMERS, INTERVAL	
CIRCUITS, HYBRID (IC AND DISCRETE-DIGITAL) CIRCUITS, MONOLITHIC (DIGITAL LOGIC) CIRCUITS, MONOLITHIC (LSI-MOS) CIRCUITS, THICK FILM (DIGITAL) CIRCUITS, THIN FILM (DIGITAL) CONVERTERS, BINARY-TO-DECIMAL COUNTERS, DECADE COUNTERS, DIGITAL READOUT COUNTERS, STEPPING SWITCH COUNTERS, UP-DOWN DISPLAY DRIVERS ENCODERS, DIGITAL ENCODERS, KEYBOARD (ALPHANUMERIC) ENCODERS, KEYBOARD (NUMERIC) GENERATORS, CHARACTER (CRT) MEMORY SYSTEMS, READ-ONLY MEMORY SYSTEMS, SEMICONDUCTOR (MOS) MODULES, DIGITAL LOGIC ENCAPSULATED (ALSO SEE CIRCUITS & CIRCUIT CARDS) MULTIPLEXERS, DIGITAL TRAINING INSTITUTES, COMMERCIAL COMPUTER COURSES, SEMINARS, CORRESPONDENCE COURSES		GENESEE COMPUTER CENTER INC. 20 University Ave, Rochester, N Y 14605	716-232-7050
		CONSULTING (ACCOUNTING, BUSINESS AND COMMERCIAL APPLICATIONS) CONSULTING (DATA COMMUNICATIONS SYSTEMS PLANNING) CONSULTING (MANAGEMENT INFORMATION SYSTEMS PLANNING) CONSULTING (SCIENTIFIC APPLICATIONS) SERVICES, PROCESSING (COMMERCIAL EDP) SERVICES, PROCESSING (DIGITAL SCIENTIFIC) SERVICES, TIME SHARING (COMMERCIAL) SERVICES, TIME SHARING (RESEARCH) SERVICES, AUTOMATED WIRE-WRAPPING SERVICES, SYSTEMS ANALYSIS	
		GENISCO TECHNOLOGY CORP. 18435 Susana Rd, Compton, Cal 90221	213-774-1850 TWX 910-346-6773
		GEO SPACE CORP. 5803 Glenmont, Houston, Tex 77036	713-666-1611 TELEX 07-7374
		PLOTTERS, FILM EXPOSING FORMATTERS, MAGNETIC TAPE	
		GEORATOR CORP. 9016 Prince Wm St, Manassas, Va 22110	703-368-2101 TELEX 89-402
		POWER SUPPLIES, AC POWER SUPPLIES, DC	
		GERBER SCIENTIFIC INSTRUMENT CO., THE P O Box 305, Hartford, Conn 06101	203-644-1551 TWX 710-427-2218
		CONTROLLERS, PLOTTING PLOTTERS, FILM EXPOSING CURVE TRACERS-DIGITIZERS, AUTOMATIC DATA ACQUISITION AND REDUCTION SYSTEMS DRAFTING SYSTEMS, COMPUTER-CONTROLLED STORAGE PLOTTERS, MOVING PEN (DIGITAL CONTROLLER)	

3 Manufacturers' Directory

GIBBS MANUFACTURING & RESEARCH CORP. 608-756-1261
 450 N Main, Janesville, Wisc 53545 TWX 910-288-2927
 COMMUNICATION SYSTEMS, FACSIMILE
 COUNTERS, DIGITAL READOUT
 CRYSTAL UNITS, QUARTZ (FOR FREQUENCY CONTROL)
 MODULES, DIGITAL LOGIC ENCAPSULATED (ALSO SEE CIRCUITS & CIRCUIT
 CARDS)
 OSCILLATORS, VOLTAGE CONTROLLED
 TIMERS, EVENT (IMPULSE)
 TIMERS, INTERVAL

GILLOTTE, ROBERT P. & CO. INC 803-254-8452
 2230 Commerce Dr, Columbia, S C 29205
 BOARDS, VISUAL CONTROL (GRAPHIC)

GLETRONICS INC. 213-963-1676
 748 E Alosta Ave, Glendora, Cal 91740 TELEX 67-0466
 POWER SUPPLIES, AC
 POWER SUPPLIES, DC
 POWER SUPPLIES, DIGITALLY-CONTROLLED
 PROTECTORS, CIRCUIT AND EQUIPMENT OVERLOAD
 TRANSFORMERS, POWER (COMPUTER GRADE)

GMA COMPUTER CORP. 914-969-0807
 320 Yonker Ave, Yonkers, N Y 10701
 LEASING, EDP EQUIPMENT (OTHER THAN MFGRS)
 RECONDITIONING EQUIPMENT, PUNCHED CARD
 SERVICES, HARDWARE MAINTENANCE
 USED EQUIPMENT (BUYING, SELLING, LEASING)

GOODHEW, J.W. & ASSOCIATES INC. 301-881-5752
 11600 Nebel St, Rockville, Md 20854
 CONSULTING (ACCOUNTING, BUSINESS AND COMMERCIAL APPLICATIONS)
 CONSULTING (COMPUTER EVALUATIONS, SELECTIONS, INSTALLATION
 PLANNING)
 CONSULTING (DATA COMMUNICATIONS SYSTEMS PLANNING)
 CONSULTING (COMPUTER PRODUCT PLANNING SURVEYS, MARKET RESEARCH
 STUDIES)
 CONSULTING (MANAGEMENT INFORMATION SYSTEMS PLANNING)
 CONSULTING (SCIENTIFIC APPLICATIONS)
 SERVICES, FACILITY MANAGEMENT
 SERVICES, MANAGEMENT INFORMATION SYSTEMS
 SERVICES, PROCESSING (COMMERCIAL EDP)
 TRAINING INSTITUTES, COMMERCIAL COMPUTER COURSES, SEMINARS,
 CORRESPONDENCE COURSES

GORDON ENTERPRISES INC., ALAN 213-985-5500
 5362 Cahuenga Blvd, N Hollywood, Cal 91601
 AUDIO/VISUAL TRAINING AIDS
 CAMERAS, COM
 CAMERAS, DATA RECORDING (EXCL. OSCILLOSCOPES)
 FILM SCANNERS
 MICROFICHE
 MICROFILM ROLLS
 PRINTERS, MICROFILM/MICROFICHE
 PROCESSORS, MICROFILM
 READER/PRINTER, MICROFILM/MICROFICHE
 READERS, MICROFILM/MICROFICHE
 RECORDERS, MICROFILM/MICROFICHE

GORDOS CORP. 201-743-6800
 250 Glenwood Ave, Bloomfield, N J 07003 TELEX 13-8209
 RELAYS, DRY REED (COMPUTER GRADE)
 RELAYS, MERCURY WETTED (COMPUTER GRADE)
 SWITCHES, DRY REED
 SWITCHES, KEYBOARD
 SWITCHES, PUSHBUTTON
 SWITCHES, PUSHBUTTON (ILLUMINATED)

GORE & ASSOCIATES INC., W.L. 302-738-4880
 555 Papermill Rd, Newark, Del 19711 TWX 510-666-0825
 CABLE ASSEMBLIES (WITH CONNECTORS)
 CABLE, COAXIAL (FLEXIBLE)
 CABLE, FINE LEAD
 CABLE, FLAT, PRINTED AND RIBBON
 CABLE, MULTICONDUCTOR
 CABLE, SHIELDED (NOT COAXIAL)

GOULD INC. BRUSH DIV. 216-361-3315
 3631 Perkins Ave, Cleveland, Ohio 44114 TWX 810-421-8580
 AMPLIFIERS, INSTRUMENTATION
 COMMUNICATION SYSTEMS, TELEPRINTER
 CONSOLES, CRT (GRAPHIC)
 DATA ACQUISITION AND REDUCTION SYSTEMS
 DATA TERMINALS, BLOCK-BY-BLOCK (GRAPHIC DIGITIZERS)
 DATA TERMINALS, BLOCK-BY-BLOCK (PLOTTER)
 DATA TERMINALS, BLOCK-BY-BLOCK (HIGH SPEED PRINTER)
 DISC STORAGE SYSTEMS
 DISPLAYS, THREE-DIMENSIONAL
 PAPER (FOR PRINTERS)
 PAPER (FOR RECORDERS AND PLOTTERS)
 PLOTTERS, MOVING PEN (ANALOG CONTROLLER)
 PLOTTERS, MOVING PEN (DIGITAL CONTROLLER)
 POLE PIECES, FERRITE
 PRINTERS, LINE (HIGH SPEED)
 READOUTS AND DISPLAYS, NUMERIC AND ALPHANUMERIC (OTHER THAN CRT)
 RECORDERS, GRAPHIC
 RECORDING HEADS, MAGNETIC DISC
 RECORDING HEADS, MAGNETIC TAPE
 SIGNAL CONDITIONERS

GPS CORP. 617-875-0607
 14 Burr St, Framingham, Mass 01701 TELEX 94-8471
 AMPLIFIERS, OPERATIONAL
 CIRCUITS, MONOLITHIC (OP AMPS)
 COMPUTERS, ANALOG (GENERAL-PURPOSE)

GRAHAM MAGNETICS INC. 817-549-3211
 Graham, Tex 76046
 CLEANER/CERTIFIERS, MAGNETIC TAPE
 RECONDITIONING EQUIPMENT, MAGNETIC TAPE
 TAPE, MAGNETIC (CASSETTE)
 TAPE, MAGNETIC (REELS)

GRALEX INDUSTRIES DIV. GENL. MICROWAVE CORP 516-694-3600
 155 Marine St, Farmingdale, N Y 11735
 CONVERTERS, ANALOG-TO-DIGITAL
 CONVERTERS, BINARY-TO-DECIMAL
 CONVERTERS, DIGITAL-TO-ANALOG
 COUNTERS, DIGITAL READOUT
 INDICATORS, DIGITAL
 READOUTS AND DISPLAYS, NUMERIC AND ALPHANUMERIC (OTHER THAN CRT)
 VOLTMETERS, DIGITAL

GRANT PULLEY & HARDWARE CO. DIV INST. SYS. CORP 914-358-4400
 582 High St, West Nyack, N Y 10994 TWX 914-358-3541
 CHASSIS, SLIDES, RACKS

GRAPH DATA DIGITIZING 213-676-9335
 13834 S Prairie Ave, Hawthorne, Cal 90250
 CURVE TRACERS-DIGITIZERS, AUTOMATIC
 CURVE TRACERS-DIGITIZERS, MANUAL
 DIGITIZERS, PROGRAMMABLE

GRAPHIC DATA INC. 617-272-4445
 169 Bedford St, Burlington, Mass 01803
 PLOTTERS, NON-IMPACT
 TAPE TRANSPORTS, MAGNETIC (INCREMENTAL)

GRAPHIC IMAGE CORP. 312-922-3922
 612 S Clinton St, Chicago, Ill 60607
 CONSULTING (ACCOUNTING, BUSINESS AND COMMERCIAL APPLICATIONS)
 SERVICES, MANAGEMENT INFORMATION SYSTEMS

GRAPHICAL TECHNOLOGY CORP. 212-786-6931
 47-34 33rd St, Long Is Cy, N Y 11101
 CONSULTING (SCIENTIFIC APPLICATIONS)
 SERVICES, FACILITY MANAGEMENT
 SERVICES, PROCESSING (DIGITAL SCIENTIFIC)

GRAY & ASSOCIATES INC., H.J. 214-742-1421
 2501 Cedar Springs Rd, Dallas, Tex 75201
 CONSULTING (ACCOUNTING, BUSINESS AND COMMERCIAL APPLICATIONS)
 CONSULTING (COMPUTER PRODUCT PLANNING SURVEYS, MARKET RESEARCH
 STUDIES)

3 Manufacturers' Directory

CONSULTING (SCIENTIFIC APPLICATIONS)
PROGRAMMING LANGUAGE DEVELOPMENT (CONTRACT PROGRAMMING)
PROGRAMMING LANGUAGE DEVELOPMENT (PROPRIETARY SOFTWARE PRODUCTS)
SERVICES, PROCESSING (COMMERCIAL EDP)
SERVICES, SYSTEMS ANALYSIS

GRAYHILL INC. 312-354-1040
561 Hillgrove Ave, La Grande, Ill 60525 TWX 910-683-1850
INDICATORS, ILLUMINATED
JACKS, JACK PANELS, PLUGS, ASSEMBLIES
SWITCHES, PUSHBUTTON
SWITCHES, PUSHBUTTON (ILLUMINATED)
SWITCHES, ROTARY
SWITCHES, SNAP ACTION

GRECO ENTERPRISES INC. TSA DATA DIV. 915-532-8121
2000 Texas, El Paso, Tex 79901

ACOUSTIC COUPLERS
CARDS, CONVENTIONAL PUNCH
CARDS, MAGNETIC
CARDS, MICORFILM APERTURE
ENVELOPES, CONTINUOUS
FORMS, CONTINUOUS (MACHINE PROCESSED)
FORMS HANDLING, LABEL APPLICATORS
PROGRAMMING LANGUAGE DEVELOPMENT (CONSULTANTS)
PROGRAMMING LANGUAGE DEVELOPMENT (CONTRACT PROGRAMMING)
PROGRAMMING LANGUAGE DEVELOPMENT (PROPRIETARY SOFTWARE PRODUCTS)

GREYHOUND COMPUTER CORP. 312-782-2680
130 S Canal St, Chicago, Ill 60606

CONSULTING (ACCOUNTING, BUSINESS AND COMMERCIAL APPLICATIONS)
CONSULTING (ADVANCED COMPUTER EQUIPMENT DESIGN AND FEASIBILITY STUDIES)
CONSULTING (COMPUTER EVALUATIONS, SELECTIONS, INSTALLATION PLANNING)
CONSULTING (DATA COMMUNICATIONS SYSTEMS PLANNING)
CONSULTING (MANAGEMENT INFORMATION SYSTEMS PLANNING)
CONSULTING (SCIENTIFIC APPLICATIONS)
LEASING, EDP EQUIPMENT (OTHER THAN MFGRS)
PROGRAMMING LANGUAGE DEVELOPMENT (CONTRACT PROGRAMMING)
SERVICES, FACILITY MANAGEMENT
SERVICES, MANAGEMENT INFORMATION SYSTEMS
SERVICES, PROCESSING (COMMERCIAL EDP)
SERVICES, PROCESSING (DIGITAL SCIENTIFIC)
SERVICES, SYSTEMS ANALYSIS

GRI COMPUTER CORP. 617-969-0800
320 Needham St, Newton, Mass 02164

COMPUTERS, DIGITAL (GENERAL-PURPOSE, SMALL-SCALE)
COMPUTERS, MINI GENERAL PURPOSE (ALSO SEE CALCULATORS)
COMPUTERS, PROCESS CONTROL

GRIGSBY BARTON INC. 312-392-5900
3800 Industrial Pkwy, Rolling Meadows, Ill 60008

RELAYS, DRY REED (COMPUTER GRADE)
RELAYS, MERCURY WETTED (COMPUTER GRADE)
RELAYS, SOLID-STATE (COMPUTER GRADE)

GROWTH INDUSTRY COMPUTING INC. 213-481-1110
1111 Wilshire Blvd, Los Angeles, Cal 90017

CONSULTING (ACCOUNTING, BUSINESS AND COMMERCIAL APPLICATIONS)
PROGRAMMING LANGUAGE DEVELOPMENT (PROPRIETARY SOFTWARE PRODUCTS)
SERVICES, PROCESSING (COMMERCIAL EDP)

GRUYE VOGT OPPERMAN INC. 415-324-2544
439 Tasso St, Palo Alto, Cal 94301

CONSULTING (ADVANCED COMPUTER EQUIPMENT DESIGN AND FEASIBILITY STUDIES)

GTE DATA SERVICES INC. 813-877-8021
5422 Bay Center Dr, Tampa, Fla 33609 TWX 810-876-0645
AUDIO/VISUAL TRAINING AIDS
CONSULTING (ACCOUNTING, BUSINESS AND COMMERCIAL APPLICATIONS)
CONSULTING (COMPUTER EVALUATIONS, SELECTIONS, INSTALLATION PLANNING)
CONTINUED

CONSULTING (DATA COMMUNICATIONS SYSTEMS PLANNING)
CONSULTING (COMPUTER PRODUCT PLANNING SURVEYS, MARKET RESEARCH STUDIES)

CONSULTING (MANAGEMENT INFORMATION SYSTEMS PLANNING)
DISPLAYS, PANELS, VIEWGRAPHS (FOR COMPUTER TRAINING)
LEASING, EDP EQUIPMENT (OTHER THAN MFGRS)
PROGRAMMING LANGUAGE DEVELOPMENT (CONSULTANTS)
PROGRAMMING LANGUAGE DEVELOPMENT (CONTRACT PROGRAMMING)
PROGRAMMING LANGUAGE DEVELOPMENT (DEDICATED APPLICATION SYSTEMS)
PROGRAMMING LANGUAGE DEVELOPMENT (PROPRIETARY SOFTWARE PRODUCTS)
SERVICES, FACILITY MANAGEMENT
SERVICES, MANAGEMENT INFORMATION SYSTEMS
SERVICES, PROCESSING (COMMERCIAL EDP)
SERVICES, SYSTEMS ANALYSIS
TRAINING INSTITUTES, COMMERCIAL COMPUTER COURSES, SEMINARS, CORRESPONDENCE COURSES
USED EQUIPMENT (BUYING, SELLING, LEASING)

GUARDIAN ELECTRIC MANUFACTURING CO. 312-243-1100
1550 W Carroll Ave, Chicago, Ill 60607 TWX 910-221-5073

COUNTERS, STEPPING SWITCH
RELAYS, SOLID-STATE (COMPUTER GRADE)
SOLENOIDS
SWITCHES, PUSHBUTTON
SWITCHES, PUSHBUTTON (ILLUMINATED)
SWITCHES, SNAP ACTION

GULLEY, DALE L. & ASSOCIATES, INC. 918-932-3628
2300 E 14th St, Tulsa, Okla 74104

CONSULTING (ACCOUNTING, BUSINESS AND COMMERCIAL APPLICATIONS)
CONSULTING (MANAGEMENT INFORMATION SYSTEMS PLANNING)
CONSULTING (SCIENTIFIC APPLICATIONS)
SERVICES, MANAGEMENT INFORMATION SYSTEMS
SERVICES, PROCESSING (COMMERCIAL EDP)
SERVICES, PROCESSING (DIGITAL SCIENTIFIC)
SERVICES, SYSTEMS ANALYSIS

GULTON INDUSTRIES INC. 201-548-2800
212 Durham Ave, Metuchen, N J 08840 TWX 710-998-0592

COMMUNICATION SYSTEMS, DATA TRANSMISSION
CONVERTERS, ANALOG-TO-DIGITAL
CONVERTERS, DIGITAL-TO-ANALOG
DATA ACQUISITION AND REDUCTION SYSTEMS
DATA TERMINALS, INQUIRY-RESPONSE (ALPHANUMERIC KEYBOARD)
GENERATORS, TIME CODE
INVERTERS, DC-AC
MULTIPLEXER-CONVERTER (SINGLE UNIT WITH MULTIPLEXER, SAMPLE & HOLD AMPLIFIER & A-TO-D CONVERTER)
MULTIPLEXERS, DIGITAL
POWER SUPPLIES, AC
POWER SUPPLIES, DC
REGULATORS, CURRENT
REGULATORS, VOLTAGE
THERMOCOUPLE REFERENCE SYSTEMS
TIMERS, EVENT (IMPULSE)
TIMERS, INTERVAL
TRANSDUCERS, DIGITAL
TRANSFORMERS, POWER (COMPUTER GRADE)

GULTON INDUSTRIES INC. COMPUTER SYS. DIV. 213-679-0111
13041 Cerise Ave, Hawthorne, Cal 90250 TWX 910-325-6208

COMMUNICATION SYSTEMS, TELEPRINTER
DATA TERMINALS, BLOCK-BY-BLOCK (MAGNETIC TAPE)
DATA TERMINALS, BLOCK-BY-BLOCK (TELEPRINTER)
PRINTERS, KEYBOARD
RECORDERS, DIGITAL CASSETTE
RECORDERS, MAGNETIC TAPE
TESTERS, DIGITAL DATA TRANSMISSION
TYPEWRITERS, COMPUTER INPUT-OUTPUT

GULTON INDUSTRIES INC. GUEDEMAN DIV. 312-337-7400
340 W Huron St, Chicago, Ill 60610 TWX 910-221-3863
CAPACITORS, COMPUTER GRADE

HACKETT CORP. 312-227-7714
2100 W Fullerton Ave, Chicago, Ill 60647

CARDS, CONVENTIONAL PUNCH
DISC PACKS, MAGNETIC
FORMS HANDLING, BURSTERS
FORMS HANDLING, CARBON DELEAVERS
FORMS HANDLING, DECOLLATORS
LABELS, CONTINUOUS AND GUMMED (MACHINE APPLICATION)
LABELS, CONTINUOUS AND PRESSURE SENSITIVE (MACHINE APPLICATION)
CONTINUED

3 Manufacturers' Directory

REELS, MAGNETIC TAPE
RIBBONS, INK (FOR PRINTERS AND TAB EQUIPMENT)
TAPE, MAGNETIC (REELS)

HALEX INC. 213-542-3555
3500 W Torrance Blvd, Torrance, Cal 90509
TELEX 65-3442
CIRCUITS, HYBRID (IC AND DISCRETE-DIGITAL)
CIRCUITS, THIN FILM (DIGITAL)
CONVERTERS, ANALOG-TO-DIGITAL
CONVERTERS, DIGITAL-TO-ANALOG

HALMAR ELECTRONICS INC. 614-276-0131
1544 W Mound St, Columbus, Ohio 43223
CONSULTING (SCIENTIFIC APPLICATIONS)
CONVERTERS, ANALOG-TO-DIGITAL
PROTECTORS, CIRCUIT AND EQUIPMENT OVERLOAD
REGULATORS, CURRENT
REGULATORS, VOLTAGE

HAMILTON WATCH CO. PRECISION METALS DV 717-394-7161
Lancaster, Pa 17604
GUIDES, CIRCUIT CARDS

HAMLIN ELECTRONICS INC. 602-277-4834
3066 W Clarendon, Phoenix, Ariz 85017
TWX 910-951-1535
RELAYS, SOLID-STATE (COMPUTER GRADE)

HAMLIN, INC. 414-648-2361
Lake & Grove Sts, Lake Mills, Wis 53551
TWX 910-260-3740
SWITCHES, DRY REED

HAMMER MILL PAPER CO. PAPERTRONICS DIV. 315-343-5010
P O Box 56 Mitchell, Oswego, N Y 13126
TWX 710-547-0651
TAPE, PUNCH (MYLAR-COATED FOIL)
TAPE, PUNCH (PAPER)
TAPE, PUNCH (PAPER-COATED MYLAR)

HANO CO. INC., PHILIP 413-781-7800
99 Guion St, Springfield, Mass 01104
TELEX 95-5445
FORMS, CONTINUOUS (MACHINE PROCESSED)
LABELS, CONTINUOUS AND GUMMED (MACHINE APPLICATION)
LABELS, CONTINUOUS AND PRESSURE SENSITIVE (MACHINE APPLICATION)

HARRIS SEMICONDUCTOR A DIV OF HARRIS-INTERTYPE 305-727-5430
P O Box 883, Melbourne, Fla 32901
TWX 510-959-6259
CIRCUITS, MONOLITHIC (DIODE MATRICES)
CIRCUITS, MONOLITHIC (LINEAR-EXCL. OP AMPS)
CIRCUITS, MONOLITHIC (LSI-BIPOLAR)
CIRCUITS, MONOLITHIC (OP AMPS)
CONVERTERS, DIGITAL-TO-ANALOG
ENCODERS, DIGITAL
ENCODERS, KEYBOARD (ALPHANUMERIC)
MEMORY SYSTEMS, SEMICONDUCTOR
MULTIPLEXERS, ANALOG-SOLID STATE (SEQUENTIAL SAMPLING)

HARRIS-INTERTYPE CORP. INTERTYPE DIV. 305-727-4790
Palm Bay Rd, Melbourne, Fla 32901
CONSOLES, CRT (ALPHANUMERIC AND GRAPHIC)
DATA TERMINALS, INQUIRY-RESPONSE (CRT WITH KEYBOARD)

HART-ADVANCE RELAY DIV. OAK ELECTRO-NETICS CORP 815-459-5000
Crystal Lake, Ill 60014
TWX 910-634-3353
RELAYS, SOLID-STATE (COMPUTER GRADE)

HARVEY INDUSTRIAL DIV. 516-921-8700
60 Crossway Pk W, Woodbury LI, N Y 11797
AMPLIFIERS, OPERATIONAL
BLOWERS, FANS, COOLING ASSEMBLIES
CELLS, PHOTOCONDUCTIVE
CIRCUITS, HYBRID (IC AND DISCRETE-DIGITAL)
CIRCUITS, MONOLITHIC (DIGITAL LOGIC)
CIRCUITS, MONOLITHIC (LINEAR-EXCL. OP AMPS)
CIRCUITS, MONOLITHIC (LSI-BIPOLAR)
CIRCUITS, MONOLITHIC (LSI-MOS)
CIRCUITS, MONOLITHIC (OP AMPS)
CONNECTORS, COAXIAL (COMPUTER-GRADE)
CONTINUED

CONNECTORS, MINIATURE AND SUB-MINIATURE (COMPUTER-GRADE)
CONNECTORS, PC AND IC BOARD (COMPUTER-GRADE)
CONNECTORS, POWER (COMPUTER-GRADE)
CONNECTORS, RACK AND PANEL (COMPUTER-GRADE)
DIODES, GERMANIUM
DIODES, NOT-CARRIER
DIODES, LIGHT EMITTING
DIODES, SILICON
DIODES, ZENER
HEAT SINKS, CIRCUIT BOARD MOUNTING
INDICATORS, ILLUMINATED
JACKS, JACK PANELS, PLUGS, ASSEMBLIES
KNOBS, DIALS (FOR COMPUTER CONSOLES)
LAMPS-PANEL, PILOT AND DIAL (INCANDESCENT)
POWER SUPPLIES, AC
POWER SUPPLIES, DC
RECTIFIERS, SILICON CONTROLLED
RELAYS, DRY REED (COMPUTER GRADE)
RELAYS, MERCURY WETTED (COMPUTER GRADE)
RELAYS, SOLID-STATE (COMPUTER GRADE)
SOCKETS, IC MOUNTING
SOCKETS, PCB MOUNTING
SOCKETS, SEMICONDUCTOR MOUNTING
SWITCHES, PUSHBUTTON
SWITCHES, PUSHBUTTON (ILLUMINATED)
SWITCHES, ROTARY
SWITCHES, SNAP ACTION
SWITCHES, TOGGLE (MINIATURE)
TRANSFORMERS, POWER (COMPUTER GRADE)
TRANSISTORS, FIELD EFFECT
TRANSISTORS, GERMANIUM
TRANSISTORS, SILICON

HATHAWAY INSTRUMENTS INC. 303-756-8301
5250 E Evans Ave, Denver, Colo 80120
TWX 910-931-0568
CLOCKS, DIGITAL (REAL-TIME)
COMMUNICATION SYSTEMS, DATA TRANSMISSION
DATA ACQUISITION AND REDUCTION SYSTEMS
RELAYS, DRY REED (COMPUTER GRADE)
RELAYS, MERCURY WETTED (COMPUTER GRADE)
SWITCHES, DRY REED

HAYERLY SYSTEMS INC. 201-627-1424
4 2nd Ave, Denville, N J 07834
CONSULTING (ACCOUNTING, BUSINESS AND COMMERCIAL APPLICATIONS)
CONSULTING (COMPUTER EVALUATIONS, SELECTIONS, INSTALLATION
PLANNING)
CONSULTING (DATA COMMUNICATIONS SYSTEMS PLANNING)
CONSULTING (MANAGEMENT INFORMATION SYSTEMS PLANNING)
CONSULTING (SCIENTIFIC APPLICATIONS)
PROGRAMMING LANGUAGE DEVELOPMENT (CONSULTANTS)
PROGRAMMING LANGUAGE DEVELOPMENT (CONTRACT PROGRAMMING)
PROGRAMMING LANGUAGE DEVELOPMENT (DEDICATED APPLICATION SYSTEMS)
PROGRAMMING LANGUAGE DEVELOPMENT (PROPRIETARY SOFTWARE
PRODUCTS)
SERVICES, MANAGEMENT INFORMATION SYSTEMS
SERVICES, PROCESSING (DIGITAL SCIENTIFIC)
SERVICES, SYSTEMS ANALYSIS
TRAINING INSTITUTES, COMMERCIAL COMPUTER COURSES, SEMINARS,
CORRESPONDENCE COURSES
TRAINING SYSTEMS, COMPUTER SERVICE

HAYDON SWITCH&INSTRUMENT INC. SUB. TRI-TECH INC. 203-756-7441
1500 Meriden Rd, Waterbury, Conn 06720
TWX 710-477-2580
COUNTERS, DIGITAL READOUT
COUNTERS, UP-DOWN
INDICATORS, DIGITAL
INDICATORS, ELAPSED TIME
INDICATORS, ILLUMINATED
MOTORS, SERVO
MOTORS, STEPPING
MOTORS, SYNCHRONOUS
SWITCHES, PUSHBUTTON
SWITCHES, PUSHBUTTON (ILLUMINATED)
SWITCHES, ROTARY
SWITCHES, SNAP ACTION
SWITCHES, THUMBWHEEL
SWITCHES, TOGGLE (MINIATURE)
TIMERS, EVENT (IMPULSE)
TIMERS, INTERVAL

HAZELTINE CORP. INDUSTRIAL PRODUCTS DIV. 516-261-7000
Greenlawn, N Y 11740
TWX 212-428-0092
DATA TERMINALS, INQUIRY-RESPONSE (CRT WITH KEYBOARD)
PRINTERS, LINE (LOW & MEDIUM SPEED)
RECORDERS, DIGITAL CASSETTE

3 Manufacturers' Directory

<p>HECON CORP. 31 Park Rd, New Shrewsbury, N J 07724 COUNTERS, DECADE COUNTERS, DIGITAL READOUT COUNTERS, UP-DOWN TIMERS, EVENT (IMPULSE) TIMERS, INTERVAL</p>	<p>201-542-9200 TWX 710-722-6620</p>	<p>HEWLETT PACKARD CO. 1501 Page Mill Rd, Palo Alto, Cal 94304 AMPLIFIERS, INSTRUMENTATION ANALYZERS, PULSE HEIGHT ANALYZERS, WAVEFORM CALCULATORS, PROGRAMMABLE (ALSO SEE COMPUTERS) COMPUTERS, DIGITAL (EDUCATIONAL) COMPUTERS, DIGITAL (GENERAL-PURPOSE, SMALL-SCALE) COMPUTERS, DIGITAL (GENERAL-PURPOSE, MEDIUM-SCALE) COMPUTERS, MINI GENERAL PURPOSE (ALSO SEE CALCULATORS) CONSOLES, CRT (ALPHANUMERIC AND GRAPHIC) CONVERTERS, ANALOG-TO-DIGITAL CONVERTERS, DIGITAL-TO-ANALOG CONVERTERS, VOLTAGE-TO-FREQUENCY COUNTERS, DIGITAL READOUT COUNTERS, UP-DOWN DATA ACQUISITION AND REDUCTION SYSTEMS DEMAGNETIZERS, MAGNETIC TAPE DIODES, NOT-CARRIER DIODES, LIGHT EMITTING DIODES, SILICON DIODES, TUNNEL MAGNETIC TAPE STORAGE SYSTEMS (INCLUDES CONTROLLER) PLOTTERS, MOVING PEN (ANALOG CONTROLLER) PLOTTERS, MOVING PEN (DIGITAL CONTROLLER) POWER SUPPLIES, DC PRINTERS, DIGITAL STRIP RECORDING READERS, OPTICAL CHARACTER SCANNING READERS, PAPER TAPE READOUTS AND DISPLAYS, NUMERIC AND ALPHANUMERIC (OTHER THAN CRT) READOUTS, CRT RECORDERS, GRAPHIC SCANNERS, INPUT TESTERS, INTEGRATED CIRCUIT TRANSISTORS, PHOTO VOLTMETERS, AC, DC, DIFFER-ENTIAL VOLTMETERS, DIGITAL</p>	<p>414-326-7000 TWX 910-373-1267</p>
<p>HEFFELFINGER ASSOCIATES INC. 888 Washington St, Dedham, Mass 02026 CONSULTING (COMPUTER PRODUCT PLANNING SURVEYS, MARKET RESEARCH STUDIES)</p>	<p>617-329-1040</p>		
<p>HEIDELEX CORP. Stuart Rd, Chelmsford, Mass 01824 TESTERS, MEMORY PLANES, STACKS AND SYSTEMS</p>	<p>617-256-3921</p>		
<p>HEINEMANN ELECTRIC CO. Brunswick Pike Rte 1, Trenton, N J 08638 MOTORS, STEPPING PROTECTORS, CIRCUIT AND EQUIPMENT OVERLOAD SWITCHES, ROTARY SWITCHES, TOGGLE (MINIATURE) TIMERS, INTERVAL</p>	<p>609-882-4800 TELEX 84-3431</p>		
<p>HELIPOT DIV. BECKMAN INSTRUMENTS INC. 2500 Harbor Blvd, Fullerton, Cal 92634 AMPLIFIERS, D.C. CIRCUITS, HYBRID (IC AND DISCRETE-DIGITAL) CIRCUITS, MONOLITHIC (DIODE MATRICES) CIRCUITS, MONOLITHIC (LINEAR-EXCL. OP AMPS) CIRCUITS, THICK FILM (DIGITAL) CONVERTERS, ANALOG-TO-DIGITAL CONVERTERS, DIGITAL-TO-ANALOG DELAY LINES, MAGNETOSTRICTIVE (ALSO SEE MEMORIES) DISPLAY DRIVERS HEAT SINKS, CIRCUIT BOARD MOUNTING MODULES, LINEAR (ENCAPSULATED) MODULES, RESISTANCE NETWORKS (ENCAPSULATED) MOTORS, SERVO POTENTIOMETERS, TRIM (FILM) POWER SUPPLIES, DC PROTECTORS, CIRCUIT AND EQUIPMENT OVERLOAD REGULATORS, CURRENT REGULATORS, VOLTAGE SWITCHES, ROTARY</p>	<p>714-871-4848</p>		
<p>HELM DATA PROCESSING INC. P O Box 147, Arcata, Cal 95521 SERVICES, PROCESSING (COMMERCIAL EDP)</p>	<p>707-822-0386</p>		
<p>HERBERT PRODUCTS INC. 180 Linden Ave, Westbury, N Y 11590 STATIC ELIMINATION EQUIPMENT</p>	<p>516-334-6500</p>		
<p>HETRA P O Box 970, Melbourne, Fla 32901 COMPUTERS, DIGITAL (GENERAL-PURPOSE, SMALL-SCALE) COMPUTERS, MINI GENERAL PURPOSE (ALSO SEE CALCULATORS) CONVERTERS, MAGNETIC TAPE-TO-PRINTER CONVERTERS, MAGNETIC TAPE-TO-PUNCHED CARD CONVERTERS, PUNCHED CARD-TO-MAGNETIC TAPE DATA CONCENTRATORS DATA TERMINALS, BLOCK-BY-BLOCK (MAGNETIC TAPE) DATA TERMINALS, BLOCK-BY-BLOCK (MULTI-PURPOSE) DATA TERMINALS, BLOCK-BY-BLOCK (HIGH SPEED PRINTER) DATA TERMINALS, BLOCK-BY-BLOCK (MEDIUM SPEED PRINTER) DATA TERMINALS, BLOCK-BY-BLOCK (PUNCHED CARD) TAPE TRANSPORTS, MAGNETIC (DIGITAL CASSETTE)</p>	<p>305-723-7731</p>		
<p>HEWLETT PACKARD NEW JERSEY DIV. 100 Locust Ave, Berkeley Heights, N J 07922 AMPLIFIERS, D.C. AMPLIFIERS, INSTRUMENTATION CONVERTERS, DIGITAL-TO-ANALOG POWER SUPPLIES, DC POWER SUPPLIES, DIGITALLY-CONTROLLED</p>	<p>201-464-1234</p>	<p>HEWLETT PACKARD CO. CUPERTINO DIV. 1100 Wolfe Rd, Cupertino, Cal 95014 BREADBOARDS CLOCKS, DIGITAL (REAL-TIME) COMMUNICATION SYSTEMS, DATA TRANSMISSION COMPUTERS, DIGITAL (EDUCATIONAL) COMPUTERS, DIGITAL (GENERAL-PURPOSE, MEDIUM-SCALE) COMPUTERS, MINI GENERAL PURPOSE (ALSO SEE CALCULATORS) COMPUTERS, TIME SHARING CONTROLLERS, MAGNETIC DISC CONTROLLERS, MAGNETIC DRUM CONVERTERS, ANALOG-TO-DIGITAL DATA TERMINALS, BLOCK-BY-BLOCK (PUNCHED CARD) DATA TERMINALS, BLOCK-BY-BLOCK (TELEPRINTER) DATA TERMINALS, INQUIRY-RESPONSE (CRT WITH KEYBOARD) DISC DRIVES, FIXED HEAD (INCLUDING CONTROLLER) DISC DRIVES, MOVABLE HEAD (INCLUDING CONTROLLER) DISC DRIVES, REMOVABLE CARTRIDGE MAGNETIC TAPE STORAGE SYSTEMS (INCLUDES CONTROLLER) MARK SENSING EQUIPMENT MULTIPLEXERS, DIGITAL PRINTERS, LINE (LOW & MEDIUM SPEED) READERS, PAPER TAPE</p>	<p>408-257-7000 TWX 910-338-0221</p>
		<p>HEWLETT PACKARD CO. MOUNTAIN VIEW DIV. 690 Middlefield Rd, Mtn View, Cal 94040 CERTIFIERS, MAGNETIC TAPE CLEANER/CERTIFIERS, MAGNETIC TAPE CONTROLLERS, MAGNETIC TAPE DEMAGNETIZERS, MAGNETIC TAPE ERASERS, BULK (MAGNETIC TAPE) MAGNETIC TAPE STORAGE SYSTEMS (INCLUDES CONTROLLER) POOLERS, MAGNETIC TAPE RECORDERS, MAGNETIC TAPE SPLICERS, MAGNETIC TAPE TAPE TRANSPORTS, MAGNETIC (DIGITAL-EXCL. CASSETTE) TAPE TRANSPORTS, MAGNETIC (INCREMENTAL) TAPE TRANSPORTS, MAGNETIC (WITH KEYBOARD INPUT) WINDERS, MAGNETIC TAPE</p>	<p>415-968-7291 TWX 910-379-6441</p>
		<p>HEXEM INC. 1015 Corporation Way, Palo Alto, Cal 94303 POWER SUPPLIES, DC REGULATORS, CURRENT TESTERS, SEMICONDUCTOR VOLTMETERS, AC, DC, DIFFER-ENTIAL</p>	<p>415-964-3113</p>

3 Manufacturers' Directory

HH CONTROLS CO. INC.
16 Frost St, Arlington, Mass 02174

617-272-3298

ENCODERS, SHAFT ANGLE

HICKOK ELECTRICAL INSTRUMENT CO.
10514 Dupont Ave, Cleveland, Ohio 44108

216-541-8060
TWX 810-421-8286

ANALYZERS, WAVEFORM
CONVERTERS, ANALOG-TO-DIGITAL
CONVERTERS, DC-TO-FREQUENCY
CONVERTERS, VOLTAGE-TO-FREQUENCY
COUNTERS, DIGITAL READOUT
DATA TERMINALS, BLOCK-BY-BLOCK (PUNCHED CARD)
DATA TERMINALS, INQUIRY-RESPONSE (BADGE-TOKEN READERS)
DATA TERMINALS, INQUIRY-RESPONSE (SPECIAL-PURPOSE)
MARK SENSING EQUIPMENT
PRINTERS, LINE (LOW & MEDIUM SPEED)
PROGRAMMERS, PUNCHED CARD
READERS, MAGNETIC CARD
READERS, PAYMENT COUPONS
READERS, PERFORATED DOCUMENT
READERS, PUNCHED CARD (UP TO 100 CPM)
READERS, STATIC
TESTERS, SEMICONDUCTOR
VOLTMETERS, AC, DC, DIFFER-ENTIAL
VOLTMETERS, DIGITAL
VOLTMETERS, PRINTING

HI-G INC.
580 Spring St, Windsor Locks, Conn 06096

203-623-2481
TWX 710-420-0592

ACOUSTIC COUPLERS
BOARDS, PRINTED CIRCUIT (WITHOUT COMPONENTS)
CIRCUITS, THICK FILM (DIGITAL)
COMMUNICATION SYSTEMS, DATA TRANSMISSION
COMMUNICATION SYSTEMS, TELEPRINTER
COUNTERS, DECADE
DATA TERMINALS, BLOCK-BY-BLOCK (PAPER TAPE)
DATA TERMINALS, INQUIRY-RESPONSE (ALPHANUMERIC KEYBOARD)
DATA TERMINALS, INQUIRY-RESPONSE (AUDIO RESPONSE)
DATA TERMINALS, INQUIRY-RESPONSE (BADGE-TOKEN READERS)
DATA TERMINALS, INQUIRY-RESPONSE (SPECIAL-PURPOSE)
MODEMS, ACOUSTIC
MODEMS, HARD-WIRED
POWER SUPPLIES, AC
POWER SUPPLIES, DC
POWER SUPPLIES, DIGITALLY-CONTROLLED
RELAYS, SOLID-STATE (COMPUTER GRADE)
SOLENOIDS
TIMERS, INTERVAL
TRANSFORMERS, POWER (COMPUTER GRADE)

HITEMP WIRES INC.
12 Morris Ave., Glen Cove, N Y 11542

516-671-6100

CABLE ASSEMBLIES (WITH CONNECTORS)
CABLE, COAXIAL (FLEXIBLE)
CABLE, COAXIAL (SEMI/RIGID)
CABLE, FINE LEAD
CABLE, FLAT, PRINTED AND RIBBON
CABLE, MULTICONDUCTOR
CABLE, SHIELDED (NOT COAXIAL)

HOBBS ASSOCIATES, INC.
Po Box 686, Corona Del Mar, Cal 92625

714-644-8000

CONSULTING (ACCOUNTING, BUSINESS AND COMMERCIAL APPLICATIONS)
CONSULTING (ADVANCED COMPUTER EQUIPMENT DESIGN AND FEASIBILITY STUDIES)
CONSULTING (COMPUTER EVALUATIONS, SELECTIONS, INSTALLATION PLANNING)
CONSULTING (DATA COMMUNICATIONS SYSTEMS PLANNING)
CONSULTING (COMPUTER PRODUCT PLANNING SURVEYS, MARKET RESEARCH STUDIES)
SERVICES, FACILITY MANAGEMENT
SERVICES, PROCESSING (COMMERCIAL EDP)
SERVICES, PROCESSING (DIGITAL SCIENTIFIC)
SERVICES, TIME SHARING (COMMERCIAL)
SERVICES, TIME SHARING (RESEARCH)
SERVICES, SYSTEMS ANALYSIS

HOFFMAN ENGINEERING CO.
9th And Tyler, Anoka, Minn 55303

612-421-2240
TWX 910-578-2211

CABINETS, ENCLOSURES, CONSOLES, ELECTRONIC (FOR GENERAL EQUIPMENT)

HOLLANDER ASSOCIATES
P O Box 2276, Fullerton, Cal 92633

714-879-9000

CONSULTING (ADVANCED COMPUTER EQUIPMENT DESIGN AND FEASIBILITY STUDIES)
CONSULTING (COMPUTER EVALUATIONS, SELECTIONS, INSTALLATION PLANNING)
CONSULTING (DATA COMMUNICATIONS SYSTEMS PLANNING)
CONSULTING (COMPUTER PRODUCT PLANNING SURVEYS, MARKET RESEARCH STUDIES)
CONSULTING (MANAGEMENT INFORMATION SYSTEMS PLANNING)
PROGRAMMING LANGUAGE DEVELOPMENT (CONSULTANTS)
PROGRAMMING LANGUAGE DEVELOPMENT (CONTRACT PROGRAMMING)
PROGRAMMING LANGUAGE DEVELOPMENT (PROPRIETARY SOFTWARE PRODUCTS)
SERVICES, MANAGEMENT INFORMATION SYSTEMS
SERVICES, SYSTEMS ANALYSIS

HOLT INSTRUMENT LABS.
Po Box 230, Oconto, Wis 54153

414-834-2222

POWER SUPPLIES, AC
VOLTMETERS, AC, DC, DIFFER-ENTIAL

HONEYWELL INC. TEST INSTRUMENTS DIV.
P O Box 5227, Denver, Colo 80217

303-771-4700
TELEX 45-793

AMPLIFIERS, D.C.
AMPLIFIERS, INSTRUMENTATION
PLOTTERS, MOVING PEN (ANALOG CONTROLLER)
POWER SUPPLIES, AC
RECORDERS, GRAPHIC
RECORDERS, MAGNETIC TAPE
VOLTMETERS, AC, DC, DIFFER-ENTIAL
VOLTMETERS, DIGITAL

HONEYWELL INFORMATION SYSTEMS
P O Box 12313, Oklahoma City, Okla 73112

405-946-5421

CONTROLLERS, MAGNETIC DISC
CONTROLLERS, MAGNETIC TAPE
DATA TERMINALS, BLOCK-BY-BLOCK (PAPER TAPE)
DATA TERMINALS, BLOCK-BY-BLOCK (HIGH SPEED PRINTER)
DATA TERMINALS, BLOCK-BY-BLOCK (MEDIUM SPEED PRINTER)
DATA TERMINALS, INQUIRY-RESPONSE (ALPHANUMERIC KEYBOARD)
DATA TERMINALS, INQUIRY-RESPONSE (BADGE-TOKEN READERS)
DATA TERMINALS, INQUIRY-RESPONSE (CRT WITH KEYBOARD)
DATA TERMINALS, INQUIRY-RESPONSE (SPECIAL-PURPOSE)
DISC DRIVES, REMOVABLE CARTRIDGE
DISC STORAGE SYSTEMS
ENCODERS, DIGITAL
MAGNETIC TAPE STORAGE SYSTEMS (INCLUDES CONTROLLER)
PRINTERS, LINE (LOW & MEDIUM SPEED)
PRINTERS, LINE (HIGH SPEED)
PUNCHES, CARD (OVER 100 CPM)
PUNCHES, CARD (UP TO 100 CPM)
READERS, MAGNETIC CARD
READERS, PAPER TAPE
READERS, PERFORATED DOCUMENT
READERS, PUNCHED CARD (UP TO 100 CPM)
READERS, PUNCHED CARD (100 TO 300 CPM)
READERS, PUNCHED CARD (OVER 300 CPM)
READOUTS, CRT
RECORDING HEADS, MAGNETIC DISC
RECORDING HEADS, MAGNETIC TAPE
TAPE TRANSPORTS, MAGNETIC (DIGITAL-EXCL. CASSETTE)
TAPE TRANSPORTS, MAGNETIC (INCREMENTAL)
WINDERS, PAPER TAPE

HONEYWELL INFORMATION SYSTEMS
60 Walnut St, Wellesley Hills, Mass 02181

617-237-4100

AUDIO/VISUAL TRAINING AIDS
COMMUNICATIONS-ORIENTED PROCESSORS, MULTIPLE CHANNEL CONTROLLERS
COMMUNICATIONS-ORIENTED PROCESSORS, SINGLE CHANNEL CONTROLLERS
COMMUNICATION SYSTEMS, DATA TRANSMISSION
COMMUNICATION SYSTEMS, FACSIMILE
COMPUTERS, ANALOG (GENERAL-PURPOSE)
COMPUTERS, DIGITAL (GENERAL-PURPOSE, SMALL-SCALE)
COMPUTERS, DIGITAL (GENERAL-PURPOSE, MEDIUM-SCALE)
COMPUTERS, DIGITAL (GENERAL-PURPOSE, LARGE SCALE)
COMPUTERS, MINI GENERAL PURPOSE (ALSO SEE CALCULATORS)
COMPUTERS, PROCESS CONTROL
CONTROLLERS, MAGNETIC TAPE
CONVERTERS, ANALOG-TO-DIGITAL
CONVERTERS, DIGITAL-TO-ANALOG
DATA TERMINALS, INQUIRY-RESPONSE (ALPHANUMERIC KEYBOARD)
DATA TERMINALS, INQUIRY-RESPONSE (AUDIO RESPONSE)
DATA TERMINALS, INQUIRY-RESPONSE (CRT WITH KEYBOARD)
DISC DRIVES, MOVABLE HEAD (INCLUDING CONTROLLER)
CONTINUED

3 Manufacturers' Directory

DISC DRIVES, REMOVABLE CARTRIDGE
DISC PACKS, MAGNETIC
DISC STORAGE SYSTEMS
POOLERS, MAGNETIC TAPE
PRINTERS, LINE (LOW & MEDIUM SPEED)
PRINTERS, LINE (HIGH SPEED)
PUNCHES, CARD (OVER 100 CPM)
PUNCHES, CARD (UP TO 100 CPM)
PUNCHES, PAPER TAPE
READER/PUNCHES, PUNCHED CARD
READERS, MAGNETIC INK CHARACTER
READERS, OPTICAL CHARACTER SCANNING
READERS, PAPER TAPE
READERS, PUNCHED CARD (UP TO 100 CPM)
READERS, PUNCHED CARD (100 TO 300 CPM)
READERS, PUNCHED CARD (OVER 300 CPM)
TRAINING INSTITUTES, COMMERCIAL COMPUTER COURSES, SEMINARS,
CORRESPONDENCE COURSES

HONEYWELL INFORMATION SYS.INC PERIPH.DEVICES DIV. 617-891-8400
200 Smith St, Waltham, Mass 02154 TWX 910-496-1531

DISC DRIVES, FIXED HEAD (INCLUDING CONTROLLER)
DISC DRIVES, MOVABLE HEAD (INCLUDING CONTROLLER)
DISC DRIVES, REMOVABLE CARTRIDGE
MODEMS, HARD-WIRED
PRINTERS, LINE (LOW & MEDIUM SPEED)
PRINTERS, LINE (HIGH SPEED)
PUNCHES, CARD (OVER 100 CPM)
PUNCHES, CARD (UP TO 100 CPM)
READERS, PAPER TAPE
READERS, PUNCHED CARD (UP TO 100 CPM)
READERS, PUNCHED CARD (100 TO 300 CPM)
READERS, PUNCHED CARD (OVER 300 CPM)
TAPE TRANSPORTS, MAGNETIC (INCREMENTAL)

HONEYWELL INFORMATION SYSTEMS INC. INFO. SERV.DIV 612-332-5200
2701 4th Ave S, Minneapolis, Minn 55408

CONSULTING (ACCOUNTING, BUSINESS AND COMMERCIAL APPLICATIONS)
CONSULTING (ADVANCED COMPUTER EQUIPMENT DESIGN AND FEASIBILITY STUDIES)
CONSULTING (COMPUTER EVALUATIONS, SELECTIONS, INSTALLATION PLANNING)
CONSULTING (DATA COMMUNICATIONS SYSTEMS PLANNING)
CONSULTING (MANAGEMENT INFORMATION SYSTEMS PLANNING)
CONSULTING (SCIENTIFIC APPLICATIONS)
DEMONSTRATORS AND KITS, EDUCATIONAL (DIGITAL LOGIC)
DISPLAYS, PANELS, VIEWGRAPHS (FOR COMPUTER TRAINING)
INSTRUCTIONAL SYSTEMS, COMPUTER-BASED
PROGRAMMING LANGUAGE DEVELOPMENT (CONSULTANTS)
PROGRAMMING LANGUAGE DEVELOPMENT (CONTRACT PROGRAMMING)
PROGRAMMING LANGUAGE DEVELOPMENT (DEDICATED APPLICATION SYSTEMS)
PROGRAMMING LANGUAGE DEVELOPMENT (PROPRIETARY SOFTWARE PRODUCTS)
SERVICES, COMPUTER-AIDED DESIGN
SERVICES, FACILITY MANAGEMENT
SERVICES, MANAGEMENT INFORMATION SYSTEMS
SERVICES, PROCESSING (COMMERCIAL EDP)
SERVICES, PROCESSING (DIGITAL SCIENTIFIC)
SERVICES, TIME SHARING (COMMERCIAL)
SERVICES, TIME SHARING (RESEARCH)
SERVICES, SYSTEMS ANALYSIS
TRAINING INSTITUTES, COMMERCIAL COMPUTER COURSES, SEMINARS,
CORRESPONDENCE COURSES
TRAINING SYSTEMS, COMPUTER SERVICE

HOOVER INC., J.K. 319-366-1876
2720 1st Ave NE, Cedar Rapids, Iowa 52402

FORMS, CONTINUOUS (MACHINE PROCESSED)
SERVICES, PROCESSING (COMMERCIAL EDP)
SERVICES, PROCESSING (DIGITAL SCIENTIFIC)
SERVICES, SYSTEMS ANALYSIS

HOPKINS ENGINEERING CO. 213-361-8691
12900 Foothill Blvd, San Fernando, Cal 91342 TWX 910-496-1531
FILTERS (ACTIVE, LC, NOISE, ETC.)

HOUSING DATA CORP. 313-352-5887
29433 Southfield Rd, Southfield, Mich 48075

CONSULTING (ACCOUNTING, BUSINESS AND COMMERCIAL APPLICATIONS)
CONSULTING (COMPUTER EVALUATIONS, SELECTIONS, INSTALLATION PLANNING)
CONSULTING (DATA COMMUNICATIONS SYSTEMS PLANNING)
CONSULTING (COMPUTER PRODUCT PLANNING SURVEYS, MARKET RESEARCH STUDIES)
CONTINUED

CONSULTING (MANAGEMENT INFORMATION SYSTEMS PLANNING)
SERVICES, FACILITY MANAGEMENT
SERVICES, MANAGEMENT INFORMATION SYSTEMS
SERVICES, PROCESSING (COMMERCIAL EDP)
SERVICES, PROCESSING (DIGITAL SCIENTIFIC)
SERVICES, TIME SHARING (COMMERCIAL)
SERVICES, TIME SHARING (RESEARCH)
SERVICES, SYSTEMS ANALYSIS

HOUSING DATA CORP. 313-565-6400
23400 Michigan, Dearborn, Mich 48124

CONSULTING (ACCOUNTING, BUSINESS AND COMMERCIAL APPLICATIONS)
CONSULTING (ADVANCED COMPUTER EQUIPMENT DESIGN AND FEASIBILITY STUDIES)
CONSULTING (COMPUTER EVALUATIONS, SELECTIONS, INSTALLATION PLANNING)
CONSULTING (DATA COMMUNICATIONS SYSTEMS PLANNING)
CONSULTING (COMPUTER PRODUCT PLANNING SURVEYS, MARKET RESEARCH STUDIES)
CONSULTING (MANAGEMENT INFORMATION SYSTEMS PLANNING)
CONSULTING (SCIENTIFIC APPLICATIONS)
SERVICES, FACILITY MANAGEMENT
SERVICES, LIST MAINTENANCE
SERVICES, MANAGEMENT INFORMATION SYSTEMS
SERVICES, PROCESSING (COMMERCIAL EDP)
SERVICES, PROCESSING (DIGITAL SCIENTIFIC)
SERVICES, TIME SHARING (COMMERCIAL)
SERVICES, TIME SHARING (RESEARCH)
SERVICES, SYSTEMS ANALYSIS

HOUSTON ENGINEERING RESEARCH CORP. 713-522-9703
P O Box 35495, Houston, Tex 77035 TELEX 76-2263

CONSOLES, CRT (ALPHANUMERIC AND GRAPHIC)
CONSULTING (ADVANCED COMPUTER EQUIPMENT DESIGN AND FEASIBILITY STUDIES)
CONSULTING (COMPUTER EVALUATIONS, SELECTIONS, INSTALLATION PLANNING)
CONSULTING (DATA COMMUNICATIONS SYSTEMS PLANNING)
CONSULTING (MANAGEMENT INFORMATION SYSTEMS PLANNING)
CONSULTING (SCIENTIFIC APPLICATIONS)
DATA ACQUISITIONS SYSTEMS, AUTOMATIC
DATA ACQUISITION AND REDUCTION SYSTEMS
INSTRUCTIONAL SYSTEMS, COMPUTER-BASED
SERVICES, COMPUTER-AIDED DESIGN
SERVICES, FACILITY MANAGEMENT
SERVICES, HARDWARE MAINTENANCE
SERVICES, SYSTEMS ANALYSIS
TRAINING SYSTEMS, CARD PUNCH

HOUSTON INSTRUMENT INC. DIV. BAUSCH & LOMB INC. 713-667-7403
4950 Terminal Ave, Bellaire, Tex 77401 TWX 910-881-5782

PLOTTERS, MOVING PEN (ANALOG CONTROLLER)
PLOTTERS, MOVING PEN (DIGITAL CONTROLLER)

HOUSTON RESEARCH INC. SUB. SCI. ELECT. 713-928-5001
6001 Gulf Fwy, Houston, Tex 77023 TWX 910-881-5542

COMMUNICATION SYSTEMS, DATA TRANSMISSION
CONSULTING (ADVANCED COMPUTER EQUIPMENT DESIGN AND FEASIBILITY STUDIES)
CONSULTING (COMPUTER EVALUATIONS, SELECTIONS, INSTALLATION PLANNING)
CONSULTING (DATA COMMUNICATIONS SYSTEMS PLANNING)
CONSULTING (SCIENTIFIC APPLICATIONS)
DATA ACQUISITION AND REDUCTION SYSTEMS
INSTRUCTIONAL SYSTEMS, COMPUTER-BASED
PROGRAMMING LANGUAGE DEVELOPMENT (CONSULTANTS)
PROGRAMMING LANGUAGE DEVELOPMENT (CONTRACT PROGRAMMING)
PROGRAMMING LANGUAGE DEVELOPMENT (DEDICATED APPLICATION SYSTEMS)
PROGRAMMING LANGUAGE DEVELOPMENT (PROPRIETARY SOFTWARE PRODUCTS)
SERVICES, SYSTEMS ANALYSIS

HOWARD ASSOC. INC., DANIEL D. 312-372-7041
307 N Michigan Ave, Chicago, Ill 60601

CONSULTING (ACCOUNTING, BUSINESS AND COMMERCIAL APPLICATIONS)
CONSULTING (COMPUTER EVALUATIONS, SELECTIONS, INSTALLATION PLANNING)
CONSULTING (DATA COMMUNICATIONS SYSTEMS PLANNING)
CONSULTING (COMPUTER PRODUCT PLANNING SURVEYS, MARKET RESEARCH STUDIES)
CONSULTING (MANAGEMENT INFORMATION SYSTEMS PLANNING)
SERVICES, MANAGEMENT INFORMATION SYSTEMS
SERVICES, SYSTEMS ANALYSIS
TRAINING INSTITUTES, COMMERCIAL COMPUTER COURSES, SEMINARS,
CORRESPONDENCE COURSES

3 Manufacturers' Directory

HOWARD INDUSTRIES 414-632-2731
 2420 18 St, Racine, Wisc 53403 TWX 910-271-2387
 BLOWERS, FANS, COOLING ASSEMBLIES
 MOTORS, SYNCHRONOUS
 POWER SUPPLIES, AC

HP ASSOCIATES 415-321-8510
 620 Page Mill Rd, Palo Alto, Cal 94304 TWX 910-373-1751
 DIODES, GERMANIUM
 DIODES, NOT-CARRIER
 DIODES, LIGHT EMITTING
 DIODES, SILICON
 DIODES, VIDEO DETECTOR
 DISPLAYS, THREE-DIMENSIONAL
 READOUTS AND DISPLAYS, NUMERIC AND ALPHANUMERIC (OTHER THAN CRT)

HRB-SINGER INC. 814-238-4311
 Science Park, State College, Pa 16801 TWX 510-691-2610
 CONSULTING (COMPUTER EVALUATIONS, SELECTIONS, INSTALLATION
 PLANNING)
 CONSULTING (MANAGEMENT INFORMATION SYSTEMS PLANNING)
 CONSULTING (SCIENTIFIC APPLICATIONS)
 SERVICES, MANAGEMENT INFORMATION SYSTEMS
 SERVICES, PROCESSING (DIGITAL SCIENTIFIC)
 SERVICES, SYSTEMS ANALYSIS

HUB RATLIFF CONSULTANT 713-622-1192
 P O Box 22487, Houston, Tex 77027
 CONSULTING (ADVANCED COMPUTER EQUIPMENT DESIGN AND FEASIBILITY
 STUDIES)
 CONSULTING (COMPUTER EVALUATIONS, SELECTIONS, INSTALLATION
 PLANNING)
 CONSULTING (DATA COMMUNICATIONS SYSTEMS PLANNING)
 CONSULTING (COMPUTER PRODUCT PLANNING SURVEYS, MARKET RESEARCH
 STUDIES)
 CONSULTING (MANAGEMENT INFORMATION SYSTEMS PLANNING)
 CONSULTING (SCIENTIFIC APPLICATIONS)
 PROGRAMMING LANGUAGE DEVELOPMENT (CONSULTANTS)
 PROGRAMMING LANGUAGE DEVELOPMENT (CONTRACT PROGRAMMING)
 PROGRAMMING LANGUAGE DEVELOPMENT (DEDICATED APPLICATION SYSTEMS)
 PROGRAMMING LANGUAGE DEVELOPMENT (PROPRIETARY SOFTWARE
 PRODUCTS)
 SERVICES, COMPUTER-AIDED DESIGN
 SERVICES, FACILITY MANAGEMENT
 SERVICES, MANAGEMENT INFORMATION SYSTEMS
 SERVICES, SYSTEMS ANALYSIS

HUDSON LAMP CO. 201-997-1850
 528 Elm St, Kearny, N J 07032 TWX 710-995-4764
 LAMPS-PANEL, PILOT AND DIAL (INCANDESCENT)

HUGHES AIRCRAFT CO. CONNECTING DEV. DIV 714-548-0671
 500 Superior Ave, Newport Beach, Cal 92663 TWX 910-596-1374
 CABLE ASSEMBLIES (WITH CONNECTORS)
 CABLE, FLAT, PRINTED AND RIBBON
 CONNECTORS, MINIATURE AND SUB-MINIATURE (COMPUTER-GRADE)
 CONNECTORS, PC AND IC BOARD (COMPUTER-GRADE)
 CONNECTORS, POWER (COMPUTER-GRADE)
 CONNECTORS, RACK AND PANEL (COMPUTER-GRADE)
 SOCKETS, PCB MOUNTING

HUGHES AIRCRAFT CO. INDUS. PRDTS. DIV. 714-757-1200
 2020 Oceanside Blvd, Oceanside, Cal 92054
 CONVERTERS, SCAN

HUGHES AIRCRAFT CO. M O S DIV. 714-548-0671
 500 Superior Ave, Newport Beach, Cal 92660 TWX 910-596-1374
 CIRCUITS, MONOLITHIC (DIGITAL LOGIC)
 CIRCUITS, MONOLITHIC (LSI-MOS)
 CONVERTERS, ANALOG-TO-DIGITAL
 COUNTERS, DIGITAL READOUT
 COUNTERS, UP-DOWN
 ENCODERS, DIGITAL
 MULTIPLEXER-CONVERTER (SINGLE UNIT WITH MULTIPLEXER, SAMPLE & HOLD
 AMPLIFIER & A-TO-D CONVERTER)
 MULTIPLEXERS, DIGITAL
 TIMERS, EVENT (IMPULSE)
 TRANSISTORS, FIELD EFFECT

HURST MANUFACTURING CO. 812-385-2564
 P O Box 326, Princeton, Ind 47570 TWX 810-350-2341
 MOTORS, SYNCHRONOUS

HYBRID SYSTEMS DIV. DIGITAL RESOURCES CORP. 713-681-3581
 4301 Dacoma Rd, Houston, Tex 77018 TWX 910-881-1556
 ACOUSTIC COUPLERS
 AMPLIFIERS, OPERATIONAL
 ATTENUATORS, DECADE DIGITAL
 COMPUTERS, ANALOG (GENERAL-PURPOSE)
 COMPUTERS, HYBRID
 CONVERTERS, DIGITAL-TO-ANALOG
 COUNTERS, UP-DOWN
 MARK SENSING EQUIPMENT
 MODEMS, ACOUSTIC
 MODEMS, PC CARD
 TIMERS, INTERVAL

HYCOMP INC. 617-897-4578
 146 Main St, Maynard, Mass 01754
 AMPLIFIERS, INSTRUMENTATION
 CIRCUITS, HYBRID (IC AND DISCRETE-DIGITAL)
 CONVERTERS, ANALOG-TO-DIGITAL
 CONVERTERS, DIGITAL-TO-ANALOG

HYDRA COMPUTER CORP. 919-782-1051
 P O Box 17883, Raleigh, N C 27609 TWX 510-928-1850
 CONSULTING (ACCOUNTING, BUSINESS AND COMMERCIAL APPLICATIONS)
 CONSULTING (DATA COMMUNICATIONS SYSTEMS PLANNING)
 CONSULTING (COMPUTER PRODUCT PLANNING SURVEYS, MARKET RESEARCH
 STUDIES)
 CONSULTING (SCIENTIFIC APPLICATIONS)
 PROGRAMMING LANGUAGE DEVELOPMENT (CONSULTANTS)
 PROGRAMMING LANGUAGE DEVELOPMENT (CONTRACT PROGRAMMING)
 PROGRAMMING LANGUAGE DEVELOPMENT (DEDICATED APPLICATION SYSTEMS)
 PROGRAMMING LANGUAGE DEVELOPMENT (PROPRIETARY SOFTWARE
 PRODUCTS)
 SERVICES, PROCESSING (COMMERCIAL EDP)
 SERVICES, PROCESSING (DIGITAL SCIENTIFIC)
 SERVICES, SYSTEMS ANALYSIS

HYPERTECH CORP. 312-867-4200
 7343 W Wilson Ave, Harwood Hghts, Ill 60656
 COMMUNICATION SYSTEMS, DATA TRANSMISSION
 DATA TERMINALS, INQUIRY-RESPONSE (ALPHANUMERIC KEYBOARD)
 DATA TERMINALS, INQUIRY-RESPONSE (CRT WITH KEYBOARD)
 ENCODERS, KEYBOARD-TO-MAGNETIC TAPE
 POOLERS, MAGNETIC TAPE

HYPERTRONICS CORP. 617-926-2401
 50 Hunt St, Watertown, Mass 02172
 CONNECTORS, MINIATURE AND SUB-MINIATURE (COMPUTER-GRADE)
 CONNECTORS, PC AND IC BOARD (COMPUTER-GRADE)
 CONNECTORS, POWER (COMPUTER-GRADE)
 CONNECTORS, RACK AND PANEL (COMPUTER-GRADE)
 JACKS, JACK PANELS, PLUGS, ASSEMBLIES
 SOCKETS, IC MOUNTING
 SOCKETS, PCB MOUNTING

I/O SYSTEMS INC. 617-235-4404
 P O Box 36, Natick, Mass 01760
 CONVERTERS, MAGNETIC TAPE-TO-PAPER TAPE
 CONVERTERS, MAGNETIC TAPE-TO-PRINTER
 CONVERTERS, PAPER TAPE-TO-MAGNETIC TAPE
 CONVERTERS, PAPER TAPE-TO-PAPER TAPE
 CONVERTERS, PAPER TAPE-TO-PRINTER
 DATA TERMINALS, INQUIRY-RESPONSE (SPECIAL-PURPOSE)
 MULTIPLEXERS, DIGITAL
 PLOTTERS, MOVING PEN (ANALOG CONTROLLER)
 READOUTS AND DISPLAYS, NUMERIC AND ALPHANUMERIC (OTHER THAN CRT)

IAC COMPUTER SYSTEMS INC. 516-694-8690
 260 Newton Rd, Plainview, N Y 11803
 ANALYZERS, COMPUTER PERFORMANCE
 COMPUTERS, DIGITAL (GENERAL-PURPOSE, SMALL-SCALE)
 CONSULTING (ACCOUNTING, BUSINESS AND COMMERCIAL APPLICATIONS)
 CONSULTING (COMPUTER EVALUATIONS, SELECTIONS, INSTALLATION
 PLANNING)
 CONSULTING (DATA COMMUNICATIONS SYSTEMS PLANNING)
 CONSULTING (SCIENTIFIC APPLICATIONS)
 CONTINUED

3 Manufacturers' Directory

DATA TERMINALS, BLOCK-BY-BLOCK (MAGNETIC TAPE)
 DATA TERMINALS, BLOCK-BY-BLOCK (MULTI-PURPOSE)
 DATA TERMINALS, BLOCK-BY-BLOCK (PAPER TAPE)
 DATA TERMINALS, BLOCK-BY-BLOCK (PLOTTER)
 DATA TERMINALS, BLOCK-BY-BLOCK (HIGH SPEED PRINTER)
 DATA TERMINALS, BLOCK-BY-BLOCK (MEDIUM SPEED PRINTER)
 DATA TERMINALS, BLOCK-BY-BLOCK (PUNCHED CARD)
 DATA TERMINALS, INQUIRY-RESPONSE (ALPHANUMERIC KEYBOARD)
 DISPLAYS, PANELS, VIEWGRAPHS (FOR COMPUTER TRAINING)
 INSTRUCTIONAL SYSTEMS, COMPUTER-BASED
 PROGRAMMING LANGUAGE DEVELOPMENT (DEDICATED APPLICATION SYSTEMS)
 PROGRAMMING LANGUAGE DEVELOPMENT (PROPRIETARY SOFTWARE PRODUCTS)
 SERVICES, COMPUTER-AIDED DESIGN
 SERVICES, PROCESSING (COMMERCIAL EDP)
 SERVICES, AUTOMATED WIRE-WRAPPING
 TESTERS, CIRCUIT

IBM CORP., DATA PROCESSING DIV. 914-696-9100
 1133 Westchester Ave, White Plains, N Y 10604

CALCULATORS, PROGRAMMABLE (ALSO SEE COMPUTERS)
 COMMUNICATIONS-ORIENTED PROCESSORS, MULTIPLE CHANNEL CONTROLLERS
 COMMUNICATIONS-ORIENTED PROCESSORS, SINGLE CHANNEL CONTROLLERS
 COMMUNICATIONS-ORIENTED PROCESSORS, STORED PROGRAM
 COMMUNICATION SYSTEMS, DATA TRANSMISSION
 COMMUNICATION SYSTEMS, TELEPRINTER
 COMPUTERS, DIGITAL (GENERAL-PURPOSE, SMALL-SCALE)
 COMPUTERS, DIGITAL (GENERAL-PURPOSE, MEDIUM-SCALE)
 COMPUTERS, DIGITAL (GENERAL-PURPOSE, LARGE SCALE)
 COMPUTERS, PROCESS CONTROL
 CONSOLES, CRT (ALPHANUMERIC AND GRAPHIC)
 CONSOLES, CRT (GRAPHIC)
 CONTROLLERS, MAGNETIC DISC
 CONTROLLERS, MAGNETIC DRUM
 DATA TERMINALS, BLOCK-BY-BLOCK (GRAPHIC DIGITIZERS)
 DATA TERMINALS, BLOCK-BY-BLOCK (MAGNETIC TAPE)
 DATA TERMINALS, BLOCK-BY-BLOCK (MULTI-PURPOSE)
 DATA TERMINALS, BLOCK-BY-BLOCK (PAPER TAPE)
 DATA TERMINALS, BLOCK-BY-BLOCK (PLOTTER)
 DATA TERMINALS, BLOCK-BY-BLOCK (HIGH SPEED PRINTER)
 DATA TERMINALS, BLOCK-BY-BLOCK (MEDIUM SPEED PRINTER)
 DATA TERMINALS, BLOCK-BY-BLOCK (PUNCHED CARD)
 DATA TERMINALS, BLOCK-BY-BLOCK (TELEPRINTER)
 DATA TERMINALS, INQUIRY-RESPONSE (ALPHANUMERIC KEYBOARD)
 DATA TERMINALS, INQUIRY-RESPONSE (AUDIO RESPONSE)
 DATA TERMINALS, INQUIRY-RESPONSE (BADGE-TOKEN READERS)
 DATA TERMINALS, INQUIRY-RESPONSE (CRT WITH KEYBOARD)
 DATA TERMINALS, INQUIRY-RESPONSE (SPECIAL-PURPOSE)
 DISC DRIVES, FIXED HEAD (INCLUDING CONTROLLER)
 DISC DRIVES, MOVABLE HEAD (INCLUDING CONTROLLER)
 DISC DRIVES, REMOVABLE CARTRIDGE
 DISC PACKS, MAGNETIC
 DISC STORAGE SYSTEMS
 DRUM STORAGE EQUIPMENT, MAGNETIC (INCLUDING CONTROLLER)
 ENCODERS, KEYBOARD (ALPHANUMERIC)
 ENCODERS, KEYBOARD-TO-MAGNETIC TAPE
 HANDWRITING SYSTEMS, ELECTRONIC
 IMPRINTERS, MAGNETIC INK CHARACTER
 IMPRINTERS, OPTICALLY-SENSED CHARACTER
 MAGNETIC TAPE STORAGE SYSTEMS (INCLUDES CONTROLLER)
 MARK SENSING EQUIPMENT
 MEMORY SYSTEMS, MAGNETIC CORE
 MEMORY SYSTEMS, MAGNETIC DISC
 MEMORY SYSTEMS, MAGNETIC DRUM
 MULTIPLEXERS, DIGITAL
 PLOTTERS, MOVING PEN (DIGITAL CONTROLLER)
 READERS, MAGNETIC INK CHARACTER
 READERS, OPTICAL CHARACTER SCANNING
 RECORDERS, MAGNETIC TAPE
 TYPEWRITERS, COMPUTER INPUT-OUTPUT

ICA CORP. 612-338-5821
 200 N 3rd St, Minneapolis, Minn 55401

CABINETS, RACKS, VAULTS (FOR MAGNETIC TAPE STORAGE)
 CONTAINERS, PAPER TAPE STORAGE
 ENVELOPES (FOR FILING TAPES)
 HOLDERS, PUNCHED CARD
 PUNCHES, PAPER TAPE
 SPLICERS, PAPER TAPE
 TAPE, PUNCH (MYLAR)
 TAPE, PUNCH (MYLAR-COATED FOIL)
 TAPE, PUNCH (PAPER)
 TAPE, PUNCH (PAPER-COATED MYLAR)
 TAPE, PUNCH (PAPER-COATED ALUMINUM)
 WINDERS, PAPER TAPE

ICM COMPUTER CORP. 918-587-2333
 P O Box 7220, Tulsa, Okla 74105

CONSULTING (ACCOUNTING, BUSINESS AND COMMERCIAL APPLICATIONS)
 CONSULTING (ADVANCED COMPUTER EQUIPMENT DESIGN AND FEASIBILITY STUDIES)
 CONSULTING (COMPUTER EVALUATIONS, SELECTIONS, INSTALLATION PLANNING)
 CONSULTING (DATA COMMUNICATIONS SYSTEMS PLANNING)
 CONSULTING (COMPUTER PRODUCT PLANNING SURVEYS, MARKET RESEARCH STUDIES)
 CONSULTING (MANAGEMENT INFORMATION SYSTEMS PLANNING)
 CONSULTING (SCIENTIFIC APPLICATIONS)
 SERVICES, COMPUTER-AIDED DESIGN
 SERVICES, FACILITY MANAGEMENT
 SERVICES, MANAGEMENT INFORMATION SYSTEMS
 SERVICES, PROCESSING (COMMERCIAL EDP)
 SERVICES, PROCESSING (ANALOG OR HYBRID, SCIENTIFIC)
 SERVICES, PROCESSING (DIGITAL SCIENTIFIC)
 SERVICES, TIME SHARING (COMMERCIAL)
 SERVICES, TIME SHARING (RESEARCH)
 SERVICES, SYSTEMS ANALYSIS
 TRAINING INSTITUTES, COMMERCIAL COMPUTER COURSES, SEMINARS, CORRESPONDENCE COURSES
 TRAINING SYSTEMS, COMPUTER SERVICE

ICORE ELECTRO-PLASTICS INC. 408-732-5400
 3015 Copper Rd, Santa Clara, Cal 95051 TWX 910-339-9293

CABLE ASSEMBLIES (WITH CONNECTORS)
 CABLE, COAXIAL (FLEXIBLE)
 CABLE, SHIELDED (NOT COAXIAL)

IDEAL ELECTRIC AND MFG. CO. 419-522-3611
 330 E 1st St, Mansfield, Ohio 44903 TWX 810-448-2808

POWER SUPPLIES, UNINTERRUPTABLE

IDEAS INC. 307-742-6668
 118 Grand Ave, Laramie, Wyo 82070

CABLE, FLAT, PRINTED AND RIBBON
 CABLE, MULTICONDUCTOR

IER CORP. 703-527-3400
 P O Box 5537, Arlington, Va 22205

MEMORY SYSTEMS, MAGNETIC DRUM

IKL INC. 714-540-1301
 4360 Campus Dr, Newport Beach, Cal 92660

COUNTERS, DIGITAL READOUT
 COUNTERS, UP-DOWN
 DIGITIZERS, PROGRAMMABLE
 ENCODERS, DIGITAL
 READOUTS AND DISPLAYS, NUMERIC AND ALPHANUMERIC (OTHER THAN CRT)

ILLINOIS TOOL WORKS INC. LICON DIV. 312-282-4040
 6615 W Irving Park, Chicago, Ill 60634 TWX 910-221-0275

ENCODERS, KEYBOARD (ALPHANUMERIC)
 INDICATORS, ILLUMINATED
 SWITCHES, PUSHBUTTON
 SWITCHES, PUSHBUTTON (ILLUMINATED)
 SWITCHES, ROTARY
 SWITCHES, SNAP ACTION
 SWITCHES, TOGGLE (MINIATURE)

IMAGE SYSTEMS INC. 213-390-3378
 11244 Playa Ct, Culver City, Cal 90230 TWX 910-343-6465

DATA RETRIEVAL SYSTEMS, MICRO-FILM (COMPUTER-CONTROLLED)
 MICROFICHE
 MICROFILM DATA RETRIEVAL SYSTEMS, COMPUTER CONTROLLED
 MICROFILM DATA RETRIEVAL SYSTEMS, COMPUTER CONTROLLED (GRAPHIC)
 PROCESSORS, MICROFILM
 PROJECTORS, OPTICAL (COMPUTER CONTROLLED SLIDE SELECTING)
 READER/PRINTER, MICROFILM/MICROFICHE
 READERS, MICROFILM/MICROFICHE

IMC MAGNETICS CORP. WESTERN DIV. 213-583-4785
 6058 Walker Ave, Maywood, Cal 90270 TWX 910-321-3089

MOTORS, SERVO
 MOTORS, STEPPING
 MOTORS, SYNCHRONOUS
 SERVOS, COMPUTER
 CONTINUED

3 Manufacturers' Directory

SYNCHROS-RESOLVERS, CONTROL TRANSFORMERS

IMC MAGNETICS CORP., EASTERN DIV. 516-334-7070
 570 Main St, Westbury, N Y 11591 TWX 510-222-4469
 BLOWERS, FANS, COOLING ASSEMBLIES
 MOTORS, SERVO
 MOTORS, SYNCHRONOUS

IMC MAGNETICS CORP., NEW HAMPSHIRE DIV. 603-332-5300
 Route 16b, Rochester, N H 03867

BLOWERS, FANS, COOLING ASSEMBLIES

IME SALES CORP. 201-861-3900
 7800 River, North Bergen, N J 07047

CALCULATORS, PROGRAMMABLE (ALSO SEE COMPUTERS)

IMLAC CORP. 617-891-1600
 296 Newton St, Waltham, Mass 02154

ACOUSTIC COUPLERS
 CONSOLES, CRT (ALPHANUMERIC AND GRAPHIC)
 CONSOLES, CRT (GRAPHIC)
 DATA TERMINALS, INQUIRY-RESPONSE (CRT WITH KEYBOARD)

INCOR CORP. 215-357-8838
 P O Box 156, Feasterville, Pa 19046

FORMATTERS, MAGNETIC TAPE
 RECORDERS, MAGNETIC TAPE
 TAPE TRANSPORTS, MAGNETIC (INCREMENTAL)

INCOR INSTRUMENTATION INC. 516-293-8717
 29 Newtown Rd, Plainview, N Y 11803

AMPLIFIERS, D.C.
 AMPLIFIERS, INSTRUMENTATION
 AMPLIFIERS, OPERATIONAL
 CIRCUIT CARDS, LINEAR (WITH DISCRETE COMPONENTS)
 MODULES, LINEAR (ENCAPSULATED)
 MODULES, RESISTANCE NETWORKS (ENCAPSULATED)
 POWER SUPPLIES, DC
 POWER SUPPLIES, DIGITALLY-CONTROLLED
 SIGNAL CONDITIONERS

INCOTERM CORP. 617-481-2000
 Hayes Memorial Dr, Marlboro, Mass 01752 TELEX 94-8402
 DATA TERMINALS, INQUIRY-RESPONSE (CRT WITH KEYBOARD)
 DATA TERMINALS, INQUIRY-RESPONSE (SPECIAL-PURPOSE)
 PRINTERS, LINE (LOW & MEDIUM SPEED)

INCRE-DATA CORP. 505-265-9575
 6401 Acoma Rd SE, Albuquerque, N M 87108 TWX 910-989-1178

MULTIPLEXERS, DIGITAL
 RECORDERS, MAGNETIC TAPE
 TAPE TRANSPORTS, MAGNETIC (DIGITAL-EXCL. CASSETTE)
 TAPE TRANSPORTS, MAGNETIC (INCREMENTAL)
 WINDERS, MAGNETIC TAPE

INDECON INC. 312-641-6397
 30 N Lasalle St, Chicago, Ill 60602

CONSULTING (ACCOUNTING, BUSINESS AND COMMERCIAL APPLICATIONS)
 CONSULTING (COMPUTER EVALUATIONS, SELECTIONS, INSTALLATION PLANNING)
 CONSULTING (MANAGEMENT INFORMATION SYSTEMS PLANNING)
 PROGRAMMING LANGUAGE DEVELOPMENT (CONTRACT PROGRAMMING)
 PROGRAMMING LANGUAGE DEVELOPMENT (PROPRIETARY SOFTWARE PRODUCTS)
 SERVICES, FACILITY MANAGEMENT
 SERVICES, MANAGEMENT INFORMATION SYSTEMS

INDEL INC. 918-835-9568
 P O Box 15800, Tulsa, Okla 74115 TWX 910-845-2234

BOARDS, PRINTED CIRCUIT (WITHOUT COMPONENTS)
 CANNISTERS, MAGNETIC TAPE
 CERTIFIERS, MAGNETIC TAPE
 CLEANER/CERTIFIERS, MAGNETIC TAPE
 CLEANERS, MAGNETIC TAPE
 CLEANERS, MAGNETIC TAPE HEADS
 CONTINUED

DEMAGNETIZERS, MAGNETIC TAPE
 DISC PACKS, MAGNETIC
 RECONDITIONING EQUIPMENT, MAGNETIC TAPE
 REEL CLIPS AND BELTS, MAGNETIC TAPE
 REELS, MAGNETIC TAPE
 SERVICES, MAGNETIC TAPE CERTIFICATION
 TAPE, MAGNETIC (REELS)
 WINDERS, MAGNETIC TAPE

INDIANA GENERAL CORP. ELECT. PRDTS. GRP. 201-826-5100
 Crows Mill Rd, Keasbey, N J 08832 TWX 710-998-8877
 POLE PIECES, FERRITE

INDIANA GENERAL CORP. ELECTRO-MECH. PROD. 815-883-8453
 517 W Walnut St, Oglesby, Ill 61348 TWX 910-642-2370

MOTORS, SERVO
 MOTORS, STEPPING
 MOTORS, SYNCHRONOUS
 SERVOS, COMPUTER

INDUSTRIAL CONDENSER CORP. 312-463-2200
 3243 N California Ave, Chicago, Ill 60618

CAPACITORS, COMPUTER GRADE

INDUSTRIAL DEVICES INC. 201-943-4084
 982 River Rd, Edgewater, N J 07020

LAMPS-PANEL, PILOT AND DIAL (INCANDESCENT)
 SWITCHES, PUSHBUTTON (ILLUMINATED)

INDUSTRIAL ELECTRONIC ENGINEERS INC. 213-787-0311
 7720-40 Lemona Ave, Van Nuys, Cal 91405 TWX 910-495-1707

COUNTERS, DECADE
 COUNTERS, DIGITAL READOUT
 DISPLAY DRIVERS
 READOUTS AND DISPLAYS, NUMERIC AND ALPHANUMERIC (OTHER THAN CRT)
 READOUTS, CRT
 SWITCHES, PUSHBUTTON (ILLUMINATED)
 TUBES, CATHODE RAY

INDUSTRIAL INVENTIONS INC. 201-329-6000
 Rd2 463 Us 1, Monmouth Jct, N J 08852

TESTERS, CIRCUIT
 TESTERS, DIGITAL LOGIC MODULES AND CARDS

INDUSTRIAL TEST EQUIPMENT CO INC. 516-767-5253
 20 Beechwood Ave, Pt Washington, N Y 11050

CONVERTERS, VOLTAGE-TO-FREQUENCY
 OSCILLATORS, VOLTAGE CONTROLLED
 POWER SUPPLIES, AC
 POWER SUPPLIES, DIGITALLY-CONTROLLED
 REGULATORS, CURRENT
 REGULATORS, VOLTAGE

INDUSTRIAL TIMER DIV., THE SINGER CO. 201-887-2200
 Us Hwy 287, Parsippany, N J 07054

PUNCHES, PAPER TAPE
 READERS, PAPER TAPE
 REPRODUCERS, PAPER TAPE (AUTOMATIC)
 TAPE, PUNCH (PAPER-COATED MYLAR)
 TIMERS, INTERVAL

INDUSTRIAL WINDING MACHINERY CORP. 201-488-4492
 P O Box 45, River Edge, N J 07661

WINDERS, MAGNETIC TAPE

INFODATA SYSTEMS INC. 716-671-7700
 680 Ridge Rd, Webster, N Y 14580

CONSULTING (ACCOUNTING, BUSINESS AND COMMERCIAL APPLICATIONS)
 CONSULTING (COMPUTER PRODUCT PLANNING SURVEYS, MARKET RESEARCH STUDIES)
 CONSULTING (MANAGEMENT INFORMATION SYSTEMS PLANNING)
 PROGRAMMING LANGUAGE DEVELOPMENT (CONSULTANTS)
 PROGRAMMING LANGUAGE DEVELOPMENT (CONTRACT PROGRAMMING)
 PROGRAMMING LANGUAGE DEVELOPMENT (DEDICATED APPLICATION SYSTEMS)
 PROGRAMMING LANGUAGE DEVELOPMENT (PROPRIETARY SOFTWARE PRODUCTS)

3 Manufacturers' Directory

SERVICES, MANAGEMENT INFORMATION SYSTEMS
 SERVICES, PROCESSING (COMMERCIAL EDP)
 SERVICES, AUTOMATED WIRE-WRAPPING
 SERVICES, SYSTEMS ANALYSIS

INFODEX INC. 203-757-9291
 7 Cherry Ave, Waterbury, Conn 06702

READOUTS, CRT

INFO-LITE CORP. 201-947-6646
 2337 Lemoine Ave, Fort Lee, N J 07024

CORDS, PATCH
 COUNTERS, DIGITAL READOUT
 COUNTERS, UP-DOWN
 DISPLAY DRIVERS
 INDICATORS, ALPHANUMERIC
 INDICATORS, DIGITAL
 INDICATORS, ELAPSED TIME
 INDICATORS, ILLUMINATED
 LAMPS, GLOW
 LAMPS-PANEL, PILOT AND DIAL (INCANDESCENT)
 PLUGBOARDS, PROGRAMMING
 READOUTS AND DISPLAYS, NUMERIC AND ALPHANUMERIC (OTHER THAN CRT)

INFO-MAX 408-734-3444
 1248 Alderwood, Sunnyvale, Cal 94086

ACOUSTIC COUPLERS
 DATA TERMINALS, BLOCK-BY-BLOCK (PLOTTER)
 PAPER (FOR RECORDERS AND PLOTTERS)
 PRINTERS, LINE (HIGH SPEED)
 PRINTERS, NON-IMPACT, SPECIAL PURPOSE
 RECORDERS, GRAPHIC

INFONET SYSTEMS INC. 201-488-4829
 358 McKinley Blvd, Paramus, N J 07652

CONSULTING (ACCOUNTING, BUSINESS AND COMMERCIAL APPLICATIONS)
 CONSULTING (ADVANCED COMPUTER EQUIPMENT DESIGN AND FEASIBILITY STUDIES)
 CONSULTING (COMPUTER EVALUATIONS, SELECTIONS, INSTALLATION PLANNING)
 CONSULTING (DATA COMMUNICATIONS SYSTEMS PLANNING)
 CONSULTING (COMPUTER PRODUCT PLANNING SURVEYS, MARKET RESEARCH STUDIES)
 CONSULTING (MANAGEMENT INFORMATION SYSTEMS PLANNING)
 CONSULTING (SCIENTIFIC APPLICATIONS)
 PROGRAMMING LANGUAGE DEVELOPMENT (CONSULTANTS)
 PROGRAMMING LANGUAGE DEVELOPMENT (CONTRACT PROGRAMMING)
 PROGRAMMING LANGUAGE DEVELOPMENT (DEDICATED APPLICATION SYSTEMS)
 PROGRAMMING LANGUAGE DEVELOPMENT (PROPRIETARY SOFTWARE PRODUCTS)
 SERVICES, COMPUTER-AIDED DESIGN
 SERVICES, FACILITY MANAGEMENT
 SERVICES, MANAGEMENT INFORMATION SYSTEMS
 SERVICES, PROCESSING (COMMERCIAL EDP)
 SERVICES, PROCESSING (DIGITAL SCIENTIFIC)
 SERVICES, TIME SHARING (COMMERCIAL)
 SERVICES, TIME SHARING (RESEARCH)
 SERVICES, SYSTEMS ANALYSIS
 TRAINING INSTITUTES, COMMERCIAL COMPUTER COURSES, SEMINARS, CORRESPONDENCE COURSES
 TRAINING SYSTEMS, COMPUTER SERVICE

INFOREX INC. 617-272-6420
 21 N Ave, Burlington, Mass 01803

COMMUNICATION SYSTEMS, DATA TRANSMISSION
 DATA TERMINALS, BLOCK-BY-BLOCK (MAGNETIC TAPE)
 DATA TERMINALS, BLOCK-BY-BLOCK (MULTI-PURPOSE)
 DATA TERMINALS, BLOCK-BY-BLOCK (MEDIUM SPEED PRINTER)
 DATA TERMINALS, INQUIRY-RESPONSE (CRT WITH KEYBOARD)
 ENCODERS, KEYBOARD (ALPHANUMERIC)
 ENCODERS, KEYBOARD-TO-MAGNETIC DISC
 ENCODERS, KEYBOARD-TO-MAGNETIC TAPE
 READOUTS, CRT

INFORMATICS INC. 213-887-9121
 21050 Vanower St, Canoga Park, Cal 91303

CONSULTING (ACCOUNTING, BUSINESS AND COMMERCIAL APPLICATIONS)
 CONSULTING (ADVANCED COMPUTER EQUIPMENT DESIGN AND FEASIBILITY STUDIES)
 CONSULTING (COMPUTER EVALUATIONS, SELECTIONS, INSTALLATION PLANNING)
 CONTINUED

CONSULTING (DATA COMMUNICATIONS SYSTEMS PLANNING)
 CONSULTING (COMPUTER PRODUCT PLANNING SURVEYS, MARKET RESEARCH STUDIES)
 CONSULTING (MANAGEMENT INFORMATION SYSTEMS PLANNING)
 CONSULTING (SCIENTIFIC APPLICATIONS)
 PROGRAMMING LANGUAGE DEVELOPMENT (CONSULTANTS)
 PROGRAMMING LANGUAGE DEVELOPMENT (CONTRACT PROGRAMMING)
 PROGRAMMING LANGUAGE DEVELOPMENT (PROPRIETARY SOFTWARE PRODUCTS)
 SERVICES, FACILITY MANAGEMENT
 SERVICES, MANAGEMENT INFORMATION SYSTEMS
 SERVICES, PROCESSING (COMMERCIAL EDP)
 SERVICES, PROCESSING (ANALOG OR HYBRID, SCIENTIFIC)
 SERVICES, SYSTEMS ANALYSIS

INFORMATION CONTROL SYSTEMS INC. 313-761-1600
 109 E Madison Ave, Ann Arbor, Mich 48104

TYPEWRITERS, COMPUTER INPUT-OUTPUT

INFORMATION CONTROL CORP. 213-641-8520
 9610 Bellanca Ave, Los Angeles, Cal 90045 TWX 910-328-7234

CHASSIS, SLIDES, RACKS
 CIRCUIT CARDS, LINEAR (WITH DISCRETE COMPONENTS)
 CIRCUIT CARDS, LINEAR (WITH IC'S)
 CIRCUIT CARDS, LOGIC (WITH DISCRETE COMPONENTS)
 CIRCUIT CARDS, LOGIC (WITH IC'S)
 CIRCUITS, HYBRID (IC AND DISCRETE-DIGITAL)
 CONVERTERS, ANALOG-TO-DIGITAL
 CONVERTERS, BINARY-TO-DECIMAL
 CONVERTERS, DIGITAL-TO-ANALOG
 LIGHT PENS (FOR CRT TERMINAL INPUT/OUTPUT)
 MEMORY SYSTEMS, MAGNETIC CORE
 MULTIPLEXERS, DIGITAL

INFORMATION DATA SYSTEMS INC. 313-624-5525
 7550 Walnut Lake Rd, Walled Lake, Mich 48088

CONTROLLERS, MAGNETIC DISC
 CONTROLLERS, MAGNETIC DRUM
 DISC STORAGE SYSTEMS
 DRUM STORAGE EQUIPMENT, MAG-NETIC (INCLUDING CONTROLLER)
 MEMORY SYSTEMS, MAGNETIC DISC
 MEMORY SYSTEMS, MAGNETIC DRUM

INFORMATION DEVELOPMENT ASSOCIATES INC. 215-437-3084
 P O Box 2285, Bethlehem, Pa 18018

CONSULTING (ACCOUNTING, BUSINESS AND COMMERCIAL APPLICATIONS)
 CONSULTING (ADVANCED COMPUTER EQUIPMENT DESIGN AND FEASIBILITY STUDIES)
 CONSULTING (COMPUTER EVALUATIONS, SELECTIONS, INSTALLATION PLANNING)
 CONSULTING (DATA COMMUNICATIONS SYSTEMS PLANNING)
 CONSULTING (COMPUTER PRODUCT PLANNING SURVEYS, MARKET RESEARCH STUDIES)
 CONSULTING (MANAGEMENT INFORMATION SYSTEMS PLANNING)
 CONSULTING (SCIENTIFIC APPLICATIONS)
 PROGRAMMING LANGUAGE DEVELOPMENT (CONSULTANTS)
 PROGRAMMING LANGUAGE DEVELOPMENT (CONTRACT PROGRAMMING)
 PROGRAMMING LANGUAGE DEVELOPMENT (DEDICATED APPLICATION SYSTEMS)
 PROGRAMMING LANGUAGE DEVELOPMENT (PROPRIETARY SOFTWARE PRODUCTS)
 SERVICES, COMPUTER-AIDED DESIGN
 SERVICES, FACILITY MANAGEMENT
 SERVICES, MANAGEMENT INFORMATION SYSTEMS
 SERVICES, PROCESSING (COMMERCIAL EDP)
 SERVICES, PROCESSING (DIGITAL SCIENTIFIC)
 SERVICES, TIME SHARING (COMMERCIAL)
 SERVICES, TIME SHARING (RESEARCH)
 SERVICES, SYSTEMS ANALYSIS

INFORMATION DISPLAY INC. 914-241-1000
 333 N Bedford Rd, Mt Kisco, N Y 10549 TWX 710-571-2179

CONSOLES, CRT (ALPHANUMERIC AND GRAPHIC)
 CONSOLES, CRT (COLOR-ALPHANUMERIC AND GRAPHIC)
 CONSOLES, CRT (GRAPHIC)
 DRAFTING SYSTEMS, COMPUTER-CONTROLLED STORAGE
 SERVICES, MANAGEMENT INFORMATION SYSTEMS
 SERVICES, AUTOMATED WIRE-WRAPPING

INFORMATION INSTRUMENT INC. 313-761-2255
 62 Enterprise Dr, Ann Arbor, Mich 48106

COMPUTERS, PROCESS CONTROL
 CONTROLLERS, MOTOR
 CONTINUED

3 Manufacturers' Directory

SERVICES, AUTOMATED WIRE-WRAPPING

INFORMATION INTERNATIONAL INC. 213-478-2571
12435 W Olympic Blvd, Los Angeles, Cal 90064 TWX 910-342-6346
 CONSOLES, CRT (ALPHANUMERIC AND GRAPHIC)
 CONSOLES, CRT (GRAPHIC)
 PLOTTERS, FILM EXPOSING
 CURVE TRACERS-DIGITIZERS, AUTOMATIC
 READERS, OPTICAL CHARACTER SCANNING
 RECORDERS, MICROFILM/MICROFICHE
 SCANNERS, OPTICAL

INFORMATION MACHINES CORP. 714-448-8811
8811 Cuyamaca St, Santee, Cal 92071
 CONSULTING (MANAGEMENT INFORMATION SYSTEMS PLANNING)
 DATA TERMINALS, BLOCK-BY-BLOCK (MAGNETIC TAPE)
 DATA TERMINALS, BLOCK-BY-BLOCK (PAPER TAPE)
 DATA TERMINALS, BLOCK-BY-BLOCK (PUNCHED CARD)

INFORMATION MANAGEMENT INC. 415-981-2645
447 Battery St, San Francisco, Cal 94111
 CONSULTING (ACCOUNTING, BUSINESS AND COMMERCIAL APPLICATIONS)
 CONSULTING (ADVANCED COMPUTER EQUIPMENT DESIGN AND FEASIBILITY STUDIES)
 CONSULTING (COMPUTER EVALUATIONS, SELECTIONS, INSTALLATION PLANNING)
 CONSULTING (DATA COMMUNICATIONS SYSTEMS PLANNING)
 CONSULTING (MANAGEMENT INFORMATION SYSTEMS PLANNING)
 PROGRAMMING LANGUAGE DEVELOPMENT (CONSULTANTS)
 PROGRAMMING LANGUAGE DEVELOPMENT (CONTRACT PROGRAMMING)
 PROGRAMMING LANGUAGE DEVELOPMENT (DEDICATED APPLICATION SYSTEMS)
 PROGRAMMING LANGUAGE DEVELOPMENT (PROPRIETARY SOFTWARE PRODUCTS)
 SERVICES, FACILITY MANAGEMENT
 SERVICES, MANAGEMENT INFORMATION SYSTEMS
 SERVICES, SYSTEMS ANALYSIS
 TRAINING INSTITUTES, COMMERCIAL COMPUTER COURSES, SEMINARS, CORRESPONDENCE COURSES

INFORMATION PROCESSING SYSTEMS INC. 201-871-4200
467 Sylvan Ave, Englewood Cliff, N J 07632
 LEASING, EDP EQUIPMENT (OTHER THAN MFGRS)
 USED EQUIPMENT (BUYING, SELLING, LEASING)

INFORMATION SCIENCES INC. 401-467-9313
14 Jefferson Blvd, Warwick, R I 02888
 CONSULTING (ACCOUNTING, BUSINESS AND COMMERCIAL APPLICATIONS)
 CONSULTING (ADVANCED COMPUTER EQUIPMENT DESIGN AND FEASIBILITY STUDIES)
 CONSULTING (COMPUTER EVALUATIONS, SELECTIONS, INSTALLATION PLANNING)
 CONSULTING (DATA COMMUNICATIONS SYSTEMS PLANNING)
 CONSULTING (COMPUTER PRODUCT PLANNING SURVEYS, MARKET RESEARCH STUDIES)
 CONSULTING (MANAGEMENT INFORMATION SYSTEMS PLANNING)
 PROGRAMMING LANGUAGE DEVELOPMENT (CONSULTANTS)
 PROGRAMMING LANGUAGE DEVELOPMENT (CONTRACT PROGRAMMING)
 PROGRAMMING LANGUAGE DEVELOPMENT (DEDICATED APPLICATION SYSTEMS)
 PROGRAMMING LANGUAGE DEVELOPMENT (PROPRIETARY SOFTWARE PRODUCTS)
 SERVICES, FACILITY MANAGEMENT
 SERVICES, MANAGEMENT INFORMATION SYSTEMS
 SERVICES, PROCESSING (COMMERCIAL EDP)
 SERVICES, SYSTEMS ANALYSIS

INFORMATION SERVICES INC. 617-234-4700
90 Broad St, Babson Park, Mass 02157
 CONSULTING (ACCOUNTING, BUSINESS AND COMMERCIAL APPLICATIONS)
 CONSULTING (MANAGEMENT INFORMATION SYSTEMS PLANNING)
 SERVICES, MANAGEMENT INFORMATION SYSTEMS
 SERVICES, SYSTEMS ANALYSIS

INFORMATION STORAGE SYSTEMS 408-257-6220
10435 N Tantau Ave, Cupertino, Cal 95014 TWX 910-338-0280
 CONTROLLERS, MAGNETIC DISC
 DISC DRIVES, MOVABLE HEAD (INCLUDING CONTROLLER)
 DISC STORAGE SYSTEMS
 PROGRAMMING LANGUAGE DEVELOPMENT (PROPRIETARY SOFTWARE PRODUCTS)

INFORMATION SYSTEMS MANAGEMENT 415-434-0583
120 Montgomery St, San Francisco, Cal 94104

CONSULTING (MANAGEMENT INFORMATION SYSTEMS PLANNING)
 PROGRAMMING LANGUAGE DEVELOPMENT (CONSULTANTS)
 PROGRAMMING LANGUAGE DEVELOPMENT (PROPRIETARY SOFTWARE PRODUCTS)
 SERVICES, MANAGEMENT INFORMATION SYSTEMS

INFORMATION SYSTEMS CORP. 202-638-5575
1701 K St, Washington, D C 20006
 SERVICES, MANAGEMENT INFORMATION SYSTEMS

INFORMATION TERMINALS CORP. 415-964-3600
1160 Terra Bella Ave, Mountain View, Cal 94040
 TAPE TRANSPORTS, MAGNETIC (DIGITAL-EXCL. CASSETTE)
 TAPE TRANSPORTS, MAGNETIC (DIGITAL CASSETTE)

INFORONICS INC. 617-897-8815
146 Main St, Maynard, Mass 01754 TWX 710-347-7690
 CONSULTING (SCIENTIFIC APPLICATIONS)

INFOSCI INC. 415-365-5811
P O Box 464, Menlo Park, Cal 94025
 CONSULTING (ACCOUNTING, BUSINESS AND COMMERCIAL APPLICATIONS)
 CONSULTING (ADVANCED COMPUTER EQUIPMENT DESIGN AND FEASIBILITY STUDIES)
 CONSULTING (COMPUTER EVALUATIONS, SELECTIONS, INSTALLATION PLANNING)
 CONSULTING (DATA COMMUNICATIONS SYSTEMS PLANNING)
 CONSULTING (COMPUTER PRODUCT PLANNING SURVEYS, MARKET RESEARCH STUDIES)
 CONSULTING (MANAGEMENT INFORMATION SYSTEMS PLANNING)
 PROGRAMMING LANGUAGE DEVELOPMENT (CONSULTANTS)
 SERVICES, SYSTEMS ANALYSIS
 TEMPLATES, FLOW CHART
 TRAINING INSTITUTES, COMMERCIAL COMPUTER COURSES, SEMINARS, CORRESPONDENCE COURSES

INFOTEC INC. 516-694-9633
70 Newton Rd, Plainview, N Y 11803
 COMMUNICATION SYSTEMS, DATA TRANSMISSION
 COMMUNICATION SYSTEMS, TELEPRINTER
 CONSULTING (DATA COMMUNICATIONS SYSTEMS PLANNING)
 DATA TERMINALS, BLOCK-BY-BLOCK (MAGNETIC TAPE)
 MAGNETIC TAPE STORAGE SYSTEMS (INCLUDES CONTROLLER)
 RECORDERS, MAGNETIC TAPE
 TAPE TRANSPORTS, MAGNETIC (DIGITAL-EXCL. CASSETTE)

INFOTECHNICS INC. 213-780-3615
15730 Stage St, Van Nuys, Cal 91406
 DISC DRIVES, MOVABLE HEAD (INCLUDING CONTROLLER)
 DISC STORAGE SYSTEMS
 MEMORY SYSTEMS, MAGNETIC DISC

INFOTON INC. 617-272-6660
2nd Ave, Burlington, Mass 01803
 CONSULTING (DATA COMMUNICATIONS SYSTEMS PLANNING)
 CONSULTING (MANAGEMENT INFORMATION SYSTEMS PLANNING)
 CONSULTING (SCIENTIFIC APPLICATIONS)
 DATA TERMINALS, INQUIRY-RESPONSE (CRT WITH KEYBOARD)
 INSTRUCTIONAL SYSTEMS, COMPUTER-BASED
 MARK SENSING EQUIPMENT
 MULTIPLEXERS, DIGITAL
 PROGRAMMING LANGUAGE DEVELOPMENT (CONTRACT PROGRAMMING)
 PROGRAMMING LANGUAGE DEVELOPMENT (DEDICATED APPLICATION SYSTEMS)
 READERS, MAGNETIC INK CHARACTER
 READERS, OPTICAL CHARACTER SCANNING
 SCANNERS, OPTICAL
 SERVICES, MANAGEMENT INFORMATION SYSTEMS
 SERVICES, SYSTEMS ANALYSIS

INFOTRAN INC. 212-535-7500
860 Fifth Ave, New York, N Y 10021
 CONSULTING (ACCOUNTING, BUSINESS AND COMMERCIAL APPLICATIONS)
 CONSULTING (ADVANCED COMPUTER EQUIPMENT DESIGN AND FEASIBILITY STUDIES)
 CONTINUED

3 Manufacturers' Directory

CONSULTING (COMPUTER EVALUATIONS, SELECTIONS, INSTALLATION PLANNING)
CONSULTING (DATA COMMUNICATIONS SYSTEMS PLANNING)
CONSULTING (SCIENTIFIC APPLICATIONS)
LABELS, CONTINUOUS AND PRESSURE SENSITIVE (MACHINE APPLICATION)

INFOTRONICS CORP. 512-454-3521
8500 Cameron Rd, Austin, Tex 78753 TWX 910-874-1323
COMPUTERS, DIGITAL (GENERAL-PURPOSE, SMALL-SCALE)
COMPUTERS, DIGITAL (GENERAL-PURPOSE, MEDIUM-SCALE)
COMPUTERS, MINI GENERAL PURPOSE (ALSO SEE CALCULATORS)

INGERSOLL PRODUCTS DIV. BORG- WARNER CORP. 312-264-7800
1000 W 120th St, Chicago, Ill 60643 TWX 910-221-5081
CABINETS AND ENCLOSURES (FOR KEYPUNCHES, PRINTERS)
CABINETS, ENCLOSURES, CONSOLES, ELECTRONIC (FOR GENERAL EQUIPMENT)
CABINETS, RACKS, VAULTS (FOR MAGNETIC TAPE STORAGE)
CABINETS, TRAYS (FOR PUNCHED CARD STORAGE)
CHASSIS, SLIDES, RACKS

INNOVATEK ENTERPRISE 914-373-9122
Smithfield Rd, Millerton, N Y 12546
CIRCUIT CARDS, LINEAR (WITH DISCRETE COMPONENTS)
CIRCUIT CARDS, LINEAR (WITH IC'S)
CIRCUIT CARDS, LOGIC (WITH DISCRETE COMPONENTS)
CIRCUIT CARDS, LOGIC (WITH IC'S)
CONSULTING (SCIENTIFIC APPLICATIONS)
CONVERTERS, ANALOG-TO-DIGITAL

INNOVATIVE SOFTWARE INC. 617-891-6250
486 Totten Pond Rd, Waltham, Mass 02154
CONSULTING (ACCOUNTING, BUSINESS AND COMMERCIAL APPLICATIONS)
CONSULTING (COMPUTER EVALUATIONS, SELECTIONS, INSTALLATION PLANNING)
CONSULTING (MANAGEMENT INFORMATION SYSTEMS PLANNING)
PROGRAMMING LANGUAGE DEVELOPMENT (CONSULTANTS)
PROGRAMMING LANGUAGE DEVELOPMENT (CONTRACT PROGRAMMING)
PROGRAMMING LANGUAGE DEVELOPMENT (DEDICATED APPLICATION SYSTEMS)
SERVICES, MANAGEMENT INFORMATION SYSTEMS
SERVICES, SYSTEMS ANALYSIS

INPUT DATA CO. INC. 201-647-5788
1187 Valley Rd, Stirling, N J 07980
CONSULTING (ACCOUNTING, BUSINESS AND COMMERCIAL APPLICATIONS)
PAPER (FOR OCR EQUIPMENT)
RECORDERS, MICROFILM/MICROFICHE
SERVICES, FACILITY MANAGEMENT
TRAINING SYSTEMS, CARD PUNCH

INPUT INC. 312-433-4450
500 Old Elm Rd, Highland Park, Ill 60035
CONSULTING (ACCOUNTING, BUSINESS AND COMMERCIAL APPLICATIONS)
CONSULTING (COMPUTER EVALUATIONS, SELECTIONS, INSTALLATION PLANNING)
CONSULTING (MANAGEMENT INFORMATION SYSTEMS PLANNING)
CONSULTING (SCIENTIFIC APPLICATIONS)
PROGRAMMING LANGUAGE DEVELOPMENT (CONSULTANTS)
PROGRAMMING LANGUAGE DEVELOPMENT (CONTRACT PROGRAMMING)
PROGRAMMING LANGUAGE DEVELOPMENT (PROPRIETARY SOFTWARE PRODUCTS)
SERVICES, FACILITY MANAGEMENT
SERVICES, MANAGEMENT INFORMATION SYSTEMS
SERVICES, PROCESSING (COMMERCIAL EDP)
SERVICES, SYSTEMS ANALYSIS
TRAINING INSTITUTES, COMMERCIAL COMPUTER COURSES, SEMINARS, CORRESPONDENCE COURSES

INRESCO INC. 201-477-5454
503 Adamston Rd, Bricktown, N J 08723
RELAYS, DRY REED (COMPUTER GRADE)

INSO ELECTRONIC PRODUCTS INC. 516-825-6670
77 E Hawthorne Ave, Valley Stream, N Y 11580
DATA TERMINALS, BLOCK-BY-BLOCK (PAPER TAPE)
PAPER (FOR RECORDERS AND PLOTTERS)
PUNCHES, PAPER TAPE
RECORDERS, PAPER TAPE
WINDERS, MAGNETIC TAPE
CONTINUED

WINDERS, PAPER TAPE

INSTITUTE FOR ADVANCED TECHNOLOGY, THE CDC 301-652-2268
5272 River Rd, Washington, D C 20016

TRAINING INSTITUTES, COMMERCIAL COMPUTER COURSES, SEMINARS, CORRESPONDENCE COURSES

INSTITUTE FOR CYBERNETIC DEVELOPMENT 415-843-9854
3031 Bateman St, Berkeley, Cal 94705

CONSULTING (ACCOUNTING, BUSINESS AND COMMERCIAL APPLICATIONS)
CONSULTING (DATA COMMUNICATIONS SYSTEMS PLANNING)
CONSULTING (MANAGEMENT INFORMATION SYSTEMS PLANNING)
SERVICES, FACILITY MANAGEMENT
SERVICES, MANAGEMENT INFORMATION SYSTEMS
SERVICES, SYSTEMS ANALYSIS
TRAINING INSTITUTES, COMMERCIAL COMPUTER COURSES, SEMINARS, CORRESPONDENCE COURSES

INSTRULAB INC. 513-223-2241
1205 Lamar St, Dayton, Ohio 45404

INDICATORS, DIGITAL
REGULATORS, VOLTAGE
VOLTAGE DIVIDERS

INSTRUMENT DISPLAYS INC. SUB. KELTRON CORP. 617-894-1577
223 Crescent St, Waltham, Mass 02154

COUNTERS, DECADE
COUNTERS, DIGITAL READOUT
COUNTERS, STEPPING SWITCH
COUNTERS, UP-DOWN
DISPLAY DRIVERS
DISPLAYS, PANELS, VIEWGRAPHS (FOR COMPUTER TRAINING)
INDICATORS, DIGITAL
INDICATORS, ELAPSED TIME
INDICATORS, ILLUMINATED
MODULES, DIGITAL LOGIC ENCAPSULATED (ALSO SEE CIRCUITS & CIRCUIT CARDS)
MODULES, MEMORY (ENCAPSULATED)
POWER SUPPLIES, DC
POWER SUPPLIES, DIGITALLY-CONTROLLED
PRINTERS, DIGITAL STRIP RECORDING
PRINTERS, LINE (LOW & MEDIUM SPEED)
READOUTS AND DISPLAYS, NUMERIC AND ALPHANUMERIC (OTHER THAN CRT)
TESTERS, DIGITAL LOGIC MODULES AND CARDS
TIMERS, EVENT (IMPULSE)
TIMERS, INTERVAL
VOLTMETERS, DIGITAL

INSTRUMENT SYSTEMS CORP. ROTATING COMP. DIV. 516-666-8500
1560 5th Ave, Bayshore, N Y 11706 TWX 516-666-7047
BLOWERS, FANS, COOLING ASSEMBLIES
MOTORS, SERVO
MOTORS, SYNCHRONOUS

INSTRUMENTATION ENGINEERING INC. 201-891-9300
269 Susquehanna Ave, Franklin Lakes, N J 07417
TESTERS, DIGITAL LOGIC MODULES AND CARDS
TESTERS, INTEGRATED CIRCUIT
TESTERS, SEMICONDUCTOR

INSTRUTEC CORP. INSTRUMENT WIRE DIV 201-227-4050
7 Just Rd, Fairfield, N J 07006

CABLE, FLAT, PRINTED AND RIBBON
PLATED WIRE

INTECH INC. 612-377-0151
2915 Wayzata Blvd, Minneapolis, Minn 55405

CONSULTING (ACCOUNTING, BUSINESS AND COMMERCIAL APPLICATIONS)
CONSULTING (COMPUTER EVALUATIONS, SELECTIONS, INSTALLATION PLANNING)
CONSULTING (DATA COMMUNICATIONS SYSTEMS PLANNING)
CONSULTING (MANAGEMENT INFORMATION SYSTEMS PLANNING)
CONSULTING (SCIENTIFIC APPLICATIONS)
PROGRAMMING LANGUAGE DEVELOPMENT (CONSULTANTS)
PROGRAMMING LANGUAGE DEVELOPMENT (CONTRACT PROGRAMMING)
PROGRAMMING LANGUAGE DEVELOPMENT (DEDICATED APPLICATION SYSTEMS)
PROGRAMMING LANGUAGE DEVELOPMENT (PROPRIETARY SOFTWARE PRODUCTS)
CONTINUED

3 Manufacturers' Directory

SERVICES, COMPUTER-AIDED DESIGN
SERVICES, FACILITY MANAGEMENT
SERVICES, MANAGEMENT INFORMATION SYSTEMS
SERVICES, PROCESSING (COMMERCIAL EDP)
SERVICES, PROCESSING (DIGITAL SCIENTIFIC)
SERVICES, AUTOMATED WIRE-WRAPPING
SERVICES, SYSTEMS ANALYSIS

INTEGRAL DATA DEVICES INC. 516-567-3400
35 Orville Dr, Bohemia, N Y 11716

COMMUTATORS, SWITCHING (ELECTRIC)
CONSULTING (DATA COMMUNICATIONS SYSTEMS PLANNING)
MEMORY SYSTEMS, READ-ONLY
MULTIPLEXERS, ANALOG-RELAY (SEQUENTIAL SAMPLING)
MULTIPLEXERS, ANALOG-SOLID STATE (SEQUENTIAL SAMPLING)
RELAYS, SOLID-STATE (COMPUTER GRADE)
SCANNERS, INPUT
SWITCH ARRAYS, ENCODED
SWITCHES, DRY REED

INTEL CORP. 415-969-1670
365 Middlefield Rd, Mt View, Cal 94040 TWX 910-379-6476
MEMORY SYSTEMS, SEMICONDUCTOR
MEMORY SYSTEMS, SEMICONDUCTOR (MOS)

INTEL CORP. DATA PROCESSING DIV. 212-687-7630
1120 Ave of Americas, New York, N Y 10036
SERVICES, PROCESSING (COMMERCIAL EDP)

INTERACTIVE DATA CORP. 617-891-6250
486 Totten Pond Rd, Waltham, Mass 02154
SERVICES, MANAGEMENT INFORMATION SYSTEMS
SERVICES, PROCESSING (COMMERCIAL EDP)
SERVICES, TIME SHARING (COMMERCIAL)
SERVICES, TIME SHARING (RESEARCH)

INTERACTIVE SCIENCES CORP. 617-848-2660
60 Brook Dr, Braintree, Mass 02184
CONSULTING (ACCOUNTING, BUSINESS AND COMMERCIAL APPLICATIONS)
CONSULTING (DATA COMMUNICATIONS SYSTEMS PLANNING)
CONSULTING (MANAGEMENT INFORMATION SYSTEMS PLANNING)
CONSULTING (SCIENTIFIC APPLICATIONS)
PROGRAMMING LANGUAGE DEVELOPMENT (CONSULTANTS)
PROGRAMMING LANGUAGE DEVELOPMENT (CONTRACT PROGRAMMING)
PROGRAMMING LANGUAGE DEVELOPMENT (DEDICATED APPLICATION SYSTEMS)
PROGRAMMING LANGUAGE DEVELOPMENT (PROPRIETARY SOFTWARE PRODUCTS)
SERVICES, COMPUTER-AIDED DESIGN
SERVICES, FACILITY MANAGEMENT
SERVICES, MAGNETIC TAPE CERTIFICATION
SERVICES, MANAGEMENT INFORMATION SYSTEMS
SERVICES, PROCESSING (COMMERCIAL EDP)
SERVICES, PROCESSING (DIGITAL SCIENTIFIC)
SERVICES, TIME SHARING (COMMERCIAL)
SERVICES, TIME SHARING (RESEARCH)
SERVICES, AUTOMATED WIRE-WRAPPING
SERVICES, SYSTEMS ANALYSIS

INTERACTIVE SYSTEMS INC. 313-769-0355
327 S Fourth Ave, Ann Arbor, Mich 48108
CONSULTING (ADVANCED COMPUTER EQUIPMENT DESIGN AND FEASIBILITY STUDIES)
CONSULTING (COMPUTER EVALUATIONS, SELECTIONS, INSTALLATION PLANNING)
PROGRAMMING LANGUAGE DEVELOPMENT (CONSULTANTS)
PROGRAMMING LANGUAGE DEVELOPMENT (CONTRACT PROGRAMMING)
PROGRAMMING LANGUAGE DEVELOPMENT (DEDICATED APPLICATION SYSTEMS)
PROGRAMMING LANGUAGE DEVELOPMENT (PROPRIETARY SOFTWARE PRODUCTS)
SERVICES, PROCESSING (DIGITAL SCIENTIFIC)
SERVICES, HARDWARE MAINTENANCE
SERVICES, SYSTEMS ANALYSIS
TRAINING INSTITUTES, COMMERCIAL COMPUTER COURSES, SEMINARS, CORRESPONDENCE COURSES
TRAINING SYSTEMS, COMPUTER SERVICE

INTERACTIVE TECHNICAL SERVICES INC. 617-891-6250
486 Totten Pond Rd, Waltham, Mass 02154
PROGRAMMING LANGUAGE DEVELOPMENT (CONSULTANTS)
CONTINUED

PROGRAMMING LANGUAGE DEVELOPMENT (CONTRACT PROGRAMMING)
PROGRAMMING LANGUAGE DEVELOPMENT (DEDICATED APPLICATION SYSTEMS)
PROGRAMMING LANGUAGE DEVELOPMENT (PROPRIETARY SOFTWARE PRODUCTS)
SERVICES, TIME SHARING (COMMERCIAL)
SERVICES, TIME SHARING (RESEARCH)

INTERACTIVE TERMINALS CORP. 617-868-5670
197 Albany St, Cambridge, Mass 02139 TWX 710-320-1502
DATA TERMINALS, INQUIRY-RESPONSE (CRT WITH KEYBOARD)

INTERDATA 201-229-4040
2 Crescent Pl, Oceanport, N J 07757 TWX 710-722-6532
COMMUNICATIONS-ORIENTED PROCESSORS, MULTIPLE CHANNEL CONTROLLERS
COMMUNICATIONS-ORIENTED PROCESSORS, SINGLE CHANNEL CONTROLLERS
COMPUTERS, DIGITAL (GENERAL-PURPOSE, SMALL-SCALE)
COMPUTERS, DIGITAL (GENERAL-PURPOSE, MEDIUM-SCALE)
COMPUTERS, MINI GENERAL PURPOSE (ALSO SEE CALCULATORS)
COMPUTERS, PROCESS CONTROL
DATA CONCENTRATORS
DISC STORAGE SYSTEMS
MEMORY SYSTEMS, READ-ONLY
PROGRAMMING LANGUAGE DEVELOPMENT (PROPRIETARY SOFTWARE PRODUCTS)
RECORDERS, DIGITAL CASSETTE

INTERDYNE 213-477-6051
2217 Purdue Ave, Los Angeles, Cal 90064 TWX 910-342-6490
CABLE ASSEMBLIES (WITH CONNECTORS)
CONNECTORS, MINIATURE AND SUB-MINIATURE (COMPUTER-GRADE)
CONNECTORS, PC AND IC BOARD (COMPUTER-GRADE)
CORDS, PATCH
JACKS, JACK PANELS, PLUGS, ASSEMBLIES

INTERFACE MECHANISMS INC. 206-774-3511
5503 232nd St SW, Mount Lake Terr, Wash 98043
ENCODERS, KEYBOARD-TO-PRINTED TAPE
PRINTERS, DIGITAL STRIP RECORDING

INTERNATIONAL COMMUNICATIONS CORP., SUB. OF MILGO 305-691-1220
7620 NW 36th Ave, Miami, Fla 33147 TWX 810-848-6588
COMMUNICATION SYSTEMS, DATA TRANSMISSION
COMMUNICATION SYSTEMS, FACSIMILE
COMMUNICATION SYSTEMS, TELEPRINTER
CONSULTING (DATA COMMUNICATIONS SYSTEMS PLANNING)
CONTROLLERS, MODEM
MODEMS, HARD-WIRED
MODEMS, PC CARD
MULTIPLEXERS, TIME DIVISION
TESTERS, DIGITAL DATA TRANSMISSION

INTERNATIONAL COMPUTER APPLIANCES CORP. 612-338-5821
200 N Third St, Minneapolis, Minn 55401
CABINETS, RACKS, VAULTS (FOR MAGNETIC TAPE STORAGE)
CABINETS, TRAYS (FOR PUNCHED CARD STORAGE)
CONTAINERS, PAPER TAPE STORAGE
CORRECTION SEALS, PAPER TAPE
FILES, PUNCHED CARD
PUNCHES, PAPER TAPE
RACKS, PAPER TAPE
SAFES, MAGNETIC TAPE STORAGE
SPLICERS, PAPER TAPE
TAPE, PUNCH (MYLAR)
TAPE, PUNCH (MYLAR-COATED FOIL)
TAPE, PUNCH (PAPER)
TAPE, PUNCH (PAPER-COATED MYLAR)
TAPE, PUNCH (PAPER-COATED ALUMINUM)
WINDERS, PAPER TAPE

INTERNATIONAL COMPUTER CORP. 914-946-1847
1 N Broadway, White Plains, N Y 10601
CONSULTING (ACCOUNTING, BUSINESS AND COMMERCIAL APPLICATIONS)
CONSULTING (ADVANCED COMPUTER EQUIPMENT DESIGN AND FEASIBILITY STUDIES)
CONSULTING (COMPUTER EVALUATIONS, SELECTIONS, INSTALLATION PLANNING)
CONSULTING (DATA COMMUNICATIONS SYSTEMS PLANNING)
CONSULTING (COMPUTER PRODUCT PLANNING SURVEYS, MARKET RESEARCH STUDIES)
CONSULTING (MANAGEMENT INFORMATION SYSTEMS PLANNING)
CONSULTING (SCIENTIFIC APPLICATIONS)
CONTINUED

3 Manufacturers' Directory

PROGRAMMING LANGUAGE DEVELOPMENT (CONSULTANTS)
 PROGRAMMING LANGUAGE DEVELOPMENT (CONTRACT PROGRAMMING)
 PROGRAMMING LANGUAGE DEVELOPMENT (DEDICATED APPLICATION SYSTEMS)
 PROGRAMMING LANGUAGE DEVELOPMENT (PROPRIETARY SOFTWARE PRODUCTS)
 SERVICES, COMPUTER-AIDED DESIGN
 SERVICES, FACILITY MANAGEMENT
 SERVICES, MANAGEMENT INFORMATION SYSTEMS
 SERVICES, PROCESSING (COMMERCIAL EDP)
 SERVICES, SYSTEMS ANALYSIS
 TRAINING INSTITUTES, COMMERCIAL COMPUTER COURSES, SEMINARS, CORRESPONDENCE COURSES
 TRAINING SYSTEMS, COMPUTER SERVICE

INTERNATIONAL COMPUTER PRODUCTS INC. 214-239-5381
 P O Box 34484, Dallas, Tex 75234

CONTROLLERS, MAGNETIC TAPE
 CONVERTERS, MAGNETIC TAPE-TO-MAGNETIC TAPE
 MAGNETIC TAPE STORAGE SYSTEMS (INCLUDES CONTROLLER)
 POOLERS, MAGNETIC TAPE
 RECORDERS, DIGITAL CASSETTE
 TAPE TRANSPORTS, MAGNETIC (DIGITAL CASSETTE)

INTERNATIONAL COMPUTER PROGRAMS INC. 317-545-7265
 2511 E 46th St, Indianapolis, Ind 46205

CONSULTING (ACCOUNTING, BUSINESS AND COMMERCIAL APPLICATIONS)
 CONSULTING (COMPUTER PRODUCT PLANNING SURVEYS, MARKET RESEARCH STUDIES)

INTERNATIONAL COMPUTERS LTD. 01-788-7272
 Icl House Putney, London S W 15, UNITED K

CABINETS AND ENCLOSURES (FOR KEYPUNCHES, PRINTERS)
 CABINETS, RACKS, VAULTS (FOR MAGNETIC TAPE STORAGE)
 CABINETS, TRAYS (FOR PUNCHED CARD STORAGE)
 CANNISTERS, MAGNETIC TAPE
 CARDS, CONVENTIONAL PUNCH
 CARDS, MICORFILM APERTURE
 COMMUNICATIONS-ORIENTED PROCESSORS, MULTIPLE CHANNEL CONTROLLERS
 COMMUNICATIONS-ORIENTED PROCESSORS, SINGLE CHANNEL CONTROLLERS
 COMMUNICATIONS-ORIENTED PROCESSORS, STORED PROGRAM
 COMMUNICATION SYSTEMS, DATA TRANSMISSION
 COMMUNICATION SYSTEMS, TELEPRINTER
 COMPUTERS, DIGITAL (GENERAL-PURPOSE, SMALL-SCALE)
 COMPUTERS, DIGITAL (GENERAL-PURPOSE, MEDIUM-SCALE)
 COMPUTERS, DIGITAL (GENERAL-PURPOSE, LARGE SCALE)
 CONVERTERS, PAPER TAPE-TO-PUNCHED CARD
 CONVERTERS, PUNCHED CARD-TO-PAPER TAPE
 DATA TERMINALS, BLOCK-BY-BLOCK (PAPER TAPE)
 DATA TERMINALS, BLOCK-BY-BLOCK (HIGH SPEED PRINTER)
 DATA TERMINALS, BLOCK-BY-BLOCK (MEDIUM SPEED PRINTER)
 DATA TERMINALS, BLOCK-BY-BLOCK (PUNCHED CARD)
 DATA TERMINALS, BLOCK-BY-BLOCK (TELEPRINTER)
 DATA TERMINALS, INQUIRY-RESPONSE (ALPHANUMERIC KEYBOARD)
 DATA TERMINALS, INQUIRY-RESPONSE (CRT WITH KEYBOARD)
 FORMS HANDLING, BURSTERS
 FORMS HANDLING, CARBON DELEAVERS
 FORMS HANDLING, DECOLLATORS
 LABELS, CONTINUOUS AND GUMMED (MACHINE APPLICATION)
 LABELS, CONTINUOUS AND PRESSURE SENSITIVE (MACHINE APPLICATION)
 PAPER (FOR PRINTERS)
 PAYMENT COUPON BOOKS, MACHINE READABLE

INTERNATIONAL CONTROLS CORP. 201-227-4600
 200 Fairfield Rd, Fairfield, N J 07006 TWX 710-734-4340

CABINETS, ENCLOSURES, CONSOLES, ELECTRONIC (FOR GENERAL EQUIPMENT)
 CLOCKS, DIGITAL (REAL-TIME)
 DATA TERMINALS, BLOCK-BY-BLOCK (PUNCHED CARD)
 DATA TERMINALS, INQUIRY-RESPONSE (CRT WITH KEYBOARD)
 DELAY LINES, GLASS (ALSO SEE MEMORIES)
 DELAY LINES, MAGNETOSTRICTIVE (ALSO SEE MEMORIES)
 DISC DRIVES, FIXED HEAD (INCLUDING CONTROLLER)
 DISC DRIVES, MOVABLE HEAD (INCLUDING CONTROLLER)
 MODULES, DIGITAL LOGIC ENCAPSULATED (ALSO SEE CIRCUITS & CIRCUIT CARDS)
 MOTORS, SERVO
 MOTORS, SYNCHRONOUS
 POWER SUPPLIES, AC
 POWER SUPPLIES, DC
 READER/PUNCHES, PUNCHED CARD
 READERS, MAGNETIC CARD
 READERS, PERFORATED DOCUMENT
 READERS, PUNCHED CARD (UP TO 100 CPM)
 READERS, PUNCHED CARD (100 TO 300 CPM)
 READOUTS, CRT
 RELAYS, DRY REED (COMPUTER GRADE)
 RELAYS, MERCURY WETTED (COMPUTER GRADE)
 CONTINUED

RELAYS, SOLID-STATE (COMPUTER GRADE)
 SERVOS, COMPUTER
 TRANSFORMERS, POWER (COMPUTER GRADE)
 TRANSFORMERS, PULSE (COMPUTER GRADE)

INTERNATIONAL DATA APPLICATIONS INC. 617-944-7595
 100 Main St, Reading, Mass 08167

CONSULTING (ACCOUNTING, BUSINESS AND COMMERCIAL APPLICATIONS)
 CONSULTING (COMPUTER EVALUATIONS, SELECTIONS, INSTALLATION PLANNING)
 CONSULTING (COMPUTER PRODUCT PLANNING SURVEYS, MARKET RESEARCH STUDIES)
 CONSULTING (MANAGEMENT INFORMATION SYSTEMS PLANNING)
 PROGRAMMING LANGUAGE DEVELOPMENT (PROPRIETARY SOFTWARE PRODUCTS)

INTERNATIONAL DATA CORP. 617-969-4020
 60 Austin St, Newtonville, Mass 02160

CONSULTING (COMPUTER PRODUCT PLANNING SURVEYS, MARKET RESEARCH STUDIES)

INTERNATIONAL DATA SCIENCES, INC. 401-274-5100
 100 Nashua St, Providence, R I 02904

ENCODERS, KEYBOARD-TO-MAGNETIC TAPE
 PRINTERS, LINE (LOW & MEDIUM SPEED)
 PRINTERS, LINE (HIGH SPEED)
 TESTERS, DIGITAL DATA TRANSMISSION

INTERNATIONAL DATA SYSTEMS INC. 617-263-3792
 162 Great Rd, Acton, Mass 01720

MEMORY SYSTEMS, SEMICONDUCTOR (MOS)

INTERNATIONAL DIODE CORP. 201-432-7151
 90 Forrest St, Jersey City, N J 07304

DIODES, GERMANIUM
 DIODES, NOT-CARRIER
 DIODES, SILICON
 DIODES, ZENER
 TRANSISTORS, GERMANIUM
 TRANSISTORS, SILICON

INTERNATIONAL ELECTRO- MAGNETICS INC. 312-358-4622
 Eric Dr & Cornell Ave, Palatine, Ill 60067

RECORDING HEADS, MAGNETIC DISC
 RECORDING HEADS, MAGNETIC DRUM
 RECORDING HEADS, MAGNETIC TAPE
 TAPE TRANSPORTS, MAGNETIC (DIGITAL-EXCL. CASSETTE)
 TAPE TRANSPORTS, MAGNETIC (DIGITAL CASSETTE)

INTERNATIONAL ELECTRONIC RESEARCH CORP. 213-849-2481
 135 W Magnolia Blvd, Burbank, Cal 91502 TWX 910-498-2206

BLOWERS, FANS, COOLING ASSEMBLIES
 BOARDS, PRINTED CIRCUIT (WITHOUT COMPONENTS)
 CHASSIS, SLIDES, RACKS
 GUIDES, CIRCUIT CARDS
 HEAT SINKS, CIRCUIT BOARD MOUNTING

INTERNATIONAL SYSTEMS ASSOCIATES, LTD. 212-736-2924
 350 5th Ave, New York, N Y 10001 TELEX 62-0483

CONSULTING (ACCOUNTING, BUSINESS AND COMMERCIAL APPLICATIONS)
 CONSULTING (COMPUTER EVALUATIONS, SELECTIONS, INSTALLATION PLANNING)
 CONSULTING (MANAGEMENT INFORMATION SYSTEMS PLANNING)
 ENVELOPES, CONTINUOUS
 FORMS, CONTINUOUS (MACHINE PROCESSED)
 FORMS HANDLING, OCR SOURCE DOCUMENT
 LABELS, CONTINUOUS AND GUMMED (MACHINE APPLICATION)
 PAPER (FOR MICR EQUIPMENT)
 PAPER (FOR OCR EQUIPMENT)
 PAPER (FOR PRINTERS)
 PAPER (FOR RECORDERS AND PLOTTERS)
 PROGRAMMING LANGUAGE DEVELOPMENT (CONTRACT PROGRAMMING)
 PROGRAMMING LANGUAGE DEVELOPMENT (DEDICATED APPLICATION SYSTEMS)
 PROGRAMMING LANGUAGE DEVELOPMENT (PROPRIETARY SOFTWARE PRODUCTS)
 SERVICES, FACILITY MANAGEMENT
 SERVICES, PROCESSING (COMMERCIAL EDP)
 SERVICES, SYSTEMS ANALYSIS
 CONTINUED

3 Manufacturers' Directory

TAPE, MAGNETIC (REELS)

INTERNATIONAL TELECOMPUTER NETWORK CORP. 301-654-2335
4919 Fairmont Ave, Bethesda, Md 20014

CONSULTING (ACCOUNTING, BUSINESS AND COMMERCIAL APPLICATIONS)
CONSULTING (COMPUTER EVALUATIONS, SELECTIONS, INSTALLATION PLANNING)
CONSULTING (DATA COMMUNICATIONS SYSTEMS PLANNING)
CONSULTING (MANAGEMENT INFORMATION SYSTEMS PLANNING)
PROGRAMMING LANGUAGE DEVELOPMENT (PROPRIETARY SOFTWARE PRODUCTS)
SERVICES, FACILITY MANAGEMENT
SERVICES, MANAGEMENT INFORMATION SYSTEMS
SERVICES, PROCESSING (COMMERCIAL EDP)
SERVICES, PROCESSING (DIGITAL SCIENTIFIC)
SERVICES, TIME SHARING (COMMERCIAL)
SERVICES, TIME SHARING (RESEARCH)
SERVICES, SYSTEMS ANALYSIS

INTERNATIONAL TELECONTROL CORP. 302-762-5605
4300 Pine St, Wilmington, Del 19802

CONSULTING (ACCOUNTING, BUSINESS AND COMMERCIAL APPLICATIONS)
CONSULTING (COMPUTER EVALUATIONS, SELECTIONS, INSTALLATION PLANNING)
CONSULTING (DATA COMMUNICATIONS SYSTEMS PLANNING)
CONSULTING (MANAGEMENT INFORMATION SYSTEMS PLANNING)
PROGRAMMING LANGUAGE DEVELOPMENT (CONTRACT PROGRAMMING)
SERVICES, SYSTEMS ANALYSIS

INTERNATIONAL TIMESHARING CORP. 612-448-3061
Its Bldg Jonathan Ind, Chaska, Minn 55318

CONSULTING (MANAGEMENT INFORMATION SYSTEMS PLANNING)
SERVICES, FACILITY MANAGEMENT
SERVICES, MANAGEMENT INFORMATION SYSTEMS
SERVICES, TIME SHARING (COMMERCIAL)

INTERSCAN INC. 405-787-5180
407 N Rockwell Ave, Oklahoma City, Okla 73127

CERTIFIERS, DISC PACK
CLEANERS, DISC PACK

INTERSIL INC. 408-257-5450
10900 N Tantu, Cupertino, Cal 95014 TWX 910-338-0228

AMPLIFIERS, D.C.
AMPLIFIERS, INSTRUMENTATION
AMPLIFIERS, OPERATIONAL
AMPLIFIERS, VIDEO
CIRCUITS, MONOLITHIC (DIGITAL LOGIC)
CIRCUITS, MONOLITHIC (LINEAR-EXCL. OP AMPS)
CIRCUITS, MONOLITHIC (LSI-BIPOLAR)
CIRCUITS, MONOLITHIC (LSI-MOS)
CIRCUITS, MONOLITHIC (OP AMPS)
CIRCUITS, THICK FILM (DIGITAL)
CIRCUITS, THIN FILM (DIGITAL)
CONVERTERS, DIGITAL-TO-ANALOG
MEMORY SYSTEMS, READ-ONLY
MEMORY SYSTEMS, SEMICONDUCTOR
MEMORY SYSTEMS, SEMICONDUCTOR (MOS)
MEMORY SYSTEMS, THIN FILM
TRANSISTORS, FIELD EFFECT
TRANSISTORS, SILICON

INTERSTATE COMPUTER SERVICES 212-788-2115
754 4th Ave, Brooklyn, N Y 11232

SERVICES, COMPUTER-AIDED DESIGN
SERVICES, PROCESSING (COMMERCIAL EDP)

INTERSWITCH DIV. WILLIAM J. PURDY CORP. 415-347-8217
770 Airport Blvd, Burlington, Cal 94010 TELEX 34-9373

CORDS, PATCH
PLUGBOARDS, PROGRAMMING
READERS, PERFORATED DOCUMENT
SWITCHES, THUMBWHEEL

IOA DATA CORP. 216-673-9300
383 Lafayette St, New York, N Y 10003

ACCOUNTING MACHINES, CARD-PROGRAMMED
CALCULATORS, PROGRAMMABLE (ALSO SEE COMPUTERS)
CONTINUED

COLLATORS, PUNCHED CARD
COMPUTERS, DIGITAL (GENERAL-PURPOSE, MEDIUM-SCALE)
DISC PACKS, MAGNETIC
PUNCHES, CARD (UP TO 100 CPM)
READERS, EDGE-PUNCHED CARD
RECONDITIONING EQUIPMENT, PUNCHED CARD
SORTERS, PUNCHED CARD
VERIFIERS, PUNCHED CARD

IOMEC INC. 408-246-2950
345 Mathew St, Santa Clara, Cal 95050

CONTROLLERS, MAGNETIC DISC
DISC DRIVES, MOVABLE HEAD (INCLUDING CONTROLLER)
DISC DRIVES, REMOVABLE CARTRIDGE
DISC STORAGE SYSTEMS
MEMORY SYSTEMS, MAGNETIC DISC
RECORDING HEADS, MAGNETIC DISC

IONEX DIV. OF SONEX INC. 215-843-6400
20 E Herman St, Philadelphia, Pa 19144 TWX 710-670-6372

ACOUSTIC COUPLERS
MODEMS, ACOUSTIC
MODEMS, HARD-WIRED
MODEMS, PC CARD
MULTIPLEXERS, DIGITAL

ISEC 609-924-3366
206 Center, Princeton, N J 08540

COMPUTERS, ANALOG (GENERAL-PURPOSE)

ITEK BUSINESS PRODUCTS 716-244-5600
1001 Jefferson Rd, Rochester, N Y 14603 TELEX 97-8431

CARDS, MICROFILM APERTURE
PAPER (FOR PRINTERS)
PRINTERS, MICROFILM/MICROFICHE
PROCESSORS, MICROFILM
READER/PRINTER, MICROFILM/MICROFICHE
READERS, MICROFILM/MICROFICHE

ITEK CORP. 617-276-2000
10 Maguire Rd, Lexington, Mass 02173

CAMERAS, DATA RECORDING (EXCL. OSCILLOSCOPES)
ENCODERS, DIGITAL
ENCODERS, SHAFT ANGLE
FILM SCANNERS
MICROFICHE
PRINTERS, MICROFILM/MICROFICHE
READER/PRINTER, MICROFILM/MICROFICHE
READERS, MICROFILM/MICROFICHE
RECORDERS, MICROFILM/MICROFICHE

ITEK CORP. WAYNE-GEORGE DIV. 617-969-7300
Christina St, Newton, Mass 02161 TWX 710-335-6783

ITEL INFORMATION PRODUCTS DIV 415-328-5660
2585 Bayshore, Palo Alto, Cal 94303 TEXEL 34-8386

ACOUSTIC COUPLERS
CARDS, EDGE-PUNCH
COMMUNICATION SYSTEMS, DATA TRANSMISSION
COMMUNICATION SYSTEMS, TELEPRINTER
CONTROLLERS, MODEM
CONVERTERS, PAPER TAPE-TO-PRINTER
DATA TERMINALS, BLOCK-BY-BLOCK (PAPER TAPE)
DATA TERMINALS, BLOCK-BY-BLOCK (TELEPRINTER)
DATA TERMINALS, INQUIRY-RESPONSE (ALPHANUMERIC KEYBOARD)
MODEMS, ACOUSTIC
MODEMS, HARD-WIRED
MODEMS, PC CARD
PRINTER/PUNCH, PAPER TAPE
PRINTERS, KEYBOARD
PUNCHES, PAPER TAPE
READERS, PAPER TAPE
SPLICERS, PAPER TAPE
SPOOLERS, PAPER TAPE
TAPE, PUNCH (MYLAR)
TAPE, PUNCH (MYLAR-COATED FOIL)
TAPE, PUNCH (PAPER)
TAPE, PUNCH (PAPER-COATED MYLAR)
TAPE, PUNCH (PAPER-COATED ALUMINUM)
TYPEWRITERS, COMPUTER INPUT-OUTPUT
WINDERS, PAPER TAPE

3 Manufacturers' Directory

- ITI ELECTRONICS INC.** 201-473-0900
369 Lexington Ave, Clifton, N J 07015
- DATA TERMINALS, BLOCK-BY-BLOCK (TELEPRINTER)
 MODEMS, ACOUSTIC
 MODEMS, HARD-WIRED
 MODEMS, PC CARD
 POWER SUPPLIES, AC
 POWER SUPPLIES, DC
 TESTERS, DIGITAL DATA TRANSMISSION
- ITT CANNON ELECTRIC DIV. ITT CORP.** 213-225-1251
3208 Humboldt St, Los Angeles, Cal 90031 TWX 910-321-4267
- CABLE ASSEMBLIES (WITH CONNECTORS)
 CABLE, FLAT, PRINTED AND RIBBON
 CONNECTORS, MINIATURE AND SUB-MINIATURE (COMPUTER-GRADE)
 CONNECTORS, PC AND IC BOARD (COMPUTER-GRADE)
 CONNECTORS, POWER (COMPUTER-GRADE)
 CONNECTORS, RACK AND PANEL (COMPUTER-GRADE)
- ITT DATA EQUIPMENT & SYSTEMS DIV.** 201-935-3900
187 E Union Ave, E Rutherford, N J 07073 TWX 710-989-0291
- COMMUNICATIONS-ORIENTED PROCESSORS, MULTIPLE CHANNEL CONTROLLERS
 COMMUNICATIONS-ORIENTED PROCESSORS, SINGLE CHANNEL CONTROLLERS
 COMMUNICATIONS-ORIENTED PROCESSORS, STORED PROGRAM
 COMMUNICATION SYSTEMS, DATA TRANSMISSION
 COMMUNICATION SYSTEMS, TELEPRINTER
 CONSOLES, CRT (ALPHANUMERIC AND GRAPHIC)
 CONSULTING (DATA COMMUNICATIONS SYSTEMS PLANNING)
 DATA CONCENTRATORS
 DATA TERMINALS, BLOCK-BY-BLOCK (MULTI-PURPOSE)
 DATA TERMINALS, BLOCK-BY-BLOCK (PAPER TAPE)
 DATA TERMINALS, BLOCK-BY-BLOCK (TELEPRINTER)
 DATA TERMINALS, INQUIRY-RESPONSE (ALPHANUMERIC KEYBOARD)
 DATA TERMINALS, INQUIRY-RESPONSE (CRT WITH KEYBOARD)
 ENCODERS, KEYBOARD (ALPHANUMERIC)
 MODEMS, HARD-WIRED
 PERFORATORS, PAPER TAPE
 PRINTER/PUNCH, PAPER TAPE
 PRINTERS, KEYBOARD
 SERVICES, HARDWARE MAINTENANCE
 TRAINING INSTITUTES, COMMERCIAL COMPUTER COURSES, SEMINARS,
 CORRESPONDENCE COURSES
 TYPEWRITERS, COMPUTER INPUT-OUTPUT
- ITT DATA SERVICES** 314-862-7700
7822 Bonhomme, St Louis, Mo 63105
- CONSULTING (ACCOUNTING, BUSINESS AND COMMERCIAL APPLICATIONS)
 CONSULTING (DATA COMMUNICATIONS SYSTEMS PLANNING)
 CONSULTING (MANAGEMENT INFORMATION SYSTEMS PLANNING)
 SERVICES, MANAGEMENT INFORMATION SYSTEMS
- ITT DATA SERVICES DIV.** 201-229-6700
P O Box 402, Paramus, N J 07652 TWX 710-990-6618
- CONSULTING (ACCOUNTING, BUSINESS AND COMMERCIAL APPLICATIONS)
 CONSULTING (ADVANCED COMPUTER EQUIPMENT DESIGN AND FEASIBILITY
 STUDIES)
 CONSULTING (DATA COMMUNICATIONS SYSTEMS PLANNING)
 CONSULTING (MANAGEMENT INFORMATION SYSTEMS PLANNING)
 CONSULTING (SCIENTIFIC APPLICATIONS)
 SERVICES, FACILITY MANAGEMENT
 SERVICES, MANAGEMENT INFORMATION SYSTEMS
 SERVICES, PROCESSING (COMMERCIAL EDP)
 SERVICES, PROCESSING (DIGITAL SCIENTIFIC)
 SERVICES, TIME SHARING (COMMERCIAL)
 SERVICES, TIME SHARING (RESEARCH)
- ITT DEFENSE COMMUNICATIONS DIV.** 201-284-3710
492 River Rd, Nutley, N J 07110 TWX 710-989-1427
- COMMUNICATIONS-ORIENTED PROCESSORS, MULTIPLE CHANNEL CONTROLLERS
 COMMUNICATIONS-ORIENTED PROCESSORS, SINGLE CHANNEL CONTROLLERS
 COMMUNICATIONS-ORIENTED PROCESSORS, STORED PROGRAM
 COMMUNICATION SYSTEMS, DATA TRANSMISSION
 COMMUNICATION SYSTEMS, TELEPRINTER
 CONSULTING (DATA COMMUNICATIONS SYSTEMS PLANNING)
 CONTROLLERS, MAGNETIC TAPE
 CONTROLLERS, MODEM
 DATA CONCENTRATORS
 DATA TERMINALS, BLOCK-BY-BLOCK (MAGNETIC TAPE)
 DATA TERMINALS, BLOCK-BY-BLOCK (MULTI-PURPOSE)
 DATA TERMINALS, BLOCK-BY-BLOCK (PAPER TAPE)
 DATA TERMINALS, BLOCK-BY-BLOCK (HIGH SPEED PRINTER)
 DATA TERMINALS, BLOCK-BY-BLOCK (MEDIUM SPEED PRINTER)
 DATA TERMINALS, BLOCK-BY-BLOCK (PUNCHED CARD)
 DATA TERMINALS, BLOCK-BY-BLOCK (TELEPRINTER)
 DATA TERMINALS, INQUIRY-RESPONSE (ALPHANUMERIC KEYBOARD)
 CONTINUED
- DATA TERMINALS, INQUIRY-RESPONSE (CRT WITH KEYBOARD)
 ENCODERS, KEYBOARD (ALPHANUMERIC)
 ENCODERS, KEYBOARD (NUMERIC)
 MODEMS, HARD-WIRED
 PROGRAMMING LANGUAGE DEVELOPMENT (DEDICATED APPLICATION SYSTEMS)
- J-OMEGA CO.** 415-961-2000
2271 Mora Dr, Mt View, Cal 94040
- TESTERS, SEMICONDUCTOR
 VOLTMETERS, DIGITAL
- JACKSON ASSOCIATES** 614-451-1330
4663 Executive Dr, Columbus, Ohio 43220
- COMPUTERS, MINI GENERAL PURPOSE (ALSO SEE CALCULATORS)
 CONSULTING (ACCOUNTING, BUSINESS AND COMMERCIAL APPLICATIONS)
 CONSULTING (ADVANCED COMPUTER EQUIPMENT DESIGN AND FEASIBILITY
 STUDIES)
 CONSULTING (COMPUTER EVALUATIONS, SELECTIONS, INSTALLATION
 PLANNING)
 CONSULTING (DATA COMMUNICATIONS SYSTEMS PLANNING)
 CONSULTING (COMPUTER PRODUCT PLANNING SURVEYS, MARKET RESEARCH
 STUDIES)
 CONSULTING (MANAGEMENT INFORMATION SYSTEMS PLANNING)
 CONSULTING (SCIENTIFIC APPLICATIONS)
 PROGRAMMING LANGUAGE DEVELOPMENT (CONSULTANTS)
 PROGRAMMING LANGUAGE DEVELOPMENT (CONTRACT PROGRAMMING)
 PROGRAMMING LANGUAGE DEVELOPMENT (DEDICATED APPLICATION SYSTEMS)
 PROGRAMMING LANGUAGE DEVELOPMENT (PROPRIETARY SOFTWARE
 PRODUCTS)
- JAMES ELECTRONICS INC.** 312-463-6500
4050 N Rockwell St, Chicago, Ill 60618
- RELAYS, DRY REED (COMPUTER GRADE)
 RELAYS, MERCURY WETTED (COMPUTER GRADE)
 RELAYS, SOLID-STATE (COMPUTER GRADE)
 SWITCHES, DRY REED
 TRANSFORMERS, POWER (COMPUTER GRADE)
 TRANSFORMERS, PULSE (COMPUTER GRADE)
 TRANSISTORS, FIELD EFFECT
- JAMESBURY CORP. DECITEK DIV.** 617-757-4577
15 Sagamore Rd, Worcester, Mass 01605
- READERS, PAPER TAPE
 SPOOLERS, PAPER TAPE
- JANCO CORP.** 213-845-7473
311 Winona Ave, Burbank, Cal 91504 TWX 910-498-2701
- BUS BAR SYSTEMS
 SWITCHES, PUSHBUTTON
 SWITCHES, ROTARY
 TIMERS, EVENT (IMPULSE)
- JENSEN TOOLS AND ALLOYS** 602-959-2210
4117 N 44th St, Phoenix, Ariz 85018
- TESTERS, CIRCUIT
- JERSEY TAB CARD CORP.** 201-688-1700
649 Rahway Ave, Union, N J 07083
- CARDS, CONVENTIONAL PUNCH
 CLEANER/CERTIFIERS, MAGNETIC TAPE
 CLEANERS, MAGNETIC TAPE
 CONVERTERS, MAGNETIC TAPE-TO-MICROFILM
 DISC PACKS, MAGNETIC
 LABELS, CONTINUOUS AND GUMMED (MACHINE APPLICATION)
 RIBBONS, INK (FOR PRINTERS AND TAB EQUIPMENT)
 TAPE, MAGNETIC (REELS)
- JEWELL ELECTRICAL INSTRUMENTS INC.** 603-669-6400
Grenier Field, Manchester, N H 03105
- INDICATORS, ELAPSED TIME
 VOLTMETERS, AC, DC, DIFFERENTIAL
- JOBBINS INC., WILLIAM F.** 312-897-8648
Aurora, Ill 60507
- CABINETS AND ENCLOSURES (FOR KEYPUNCHES, PRINTERS)
 CONTINUED

3 Manufacturers' Directory

CABINETS, ENCLOSURES, CONSOLES, ELECTRONIC (FOR GENERAL EQUIPMENT)

JOHNSON ASSOCIATES INC. 215-885-0290
108 Lyster Rd, Oreland, Pa 19075

READERS, PAPER TAPE
SPLICERS, PAPER TAPE
TAPE, PUNCH (MYLAR)
TAPE, PUNCH (MYLAR-COATED FOIL)
TAPE, PUNCH (PAPER)
TAPE, PUNCH (PAPER-COATED MYLAR)
TAPE, PUNCH (PAPER-COATED ALUMINUM)
WINDERS, PAPER TAPE

JOHNSON CO., E.F. 507-835-2050
299 Tenth Ave SW, Waseca, Minn 56093
TELEX 295-5221

CABLE ASSEMBLIES (WITH CONNECTORS)
CONNECTORS, COAXIAL (COMPUTER-GRADE)
CONNECTORS, MINIATURE AND SUB-MINIATURE (COMPUTER-GRADE)
CORDS, PATCH
JACKS, JACK PANELS, PLUGS, ASSEMBLIES
LAMPS-PANEL, PILOT AND DIAL (INCANDESCENT)
SOCKETS, IC MOUNTING
SOCKETS, PCB MOUNTING
TERMINAL BLOCKS, STRIPS, BOARDS

JOHNSON WAX SERV. PRODUCTS DIV. 414-632-1611
1525 Howe St, Racine, Wis 53403

CONSULTING (ACCOUNTING, BUSINESS AND COMMERCIAL APPLICATIONS)
PRINTERS, DIGITAL STRIP RECORDING
PRINTERS, KEYBOARD
PRINTERS, LINE (LOW & MEDIUM SPEED)
PRINTERS, LINE (HIGH SPEED)

JONES & CO., GAYLE W. 415-532-5166
3846 E 14th St, Oakland, Cal 94601

CONSULTING (ACCOUNTING, BUSINESS AND COMMERCIAL APPLICATIONS)
CONSULTING (COMPUTER EVALUATIONS, SELECTIONS, INSTALLATION PLANNING)
CONSULTING (DATA COMMUNICATIONS SYSTEMS PLANNING)
CONSULTING (MANAGEMENT INFORMATION SYSTEMS PLANNING)
SERVICES, COMPUTER-AIDED DESIGN

JORDAN ELECTRIC CO. 213-873-5782
14707 Keswick St, Van Nuys, Cal 91405

MODULES, RESISTANCE NETWORKS (ENCAPSULATED)
RESISTORS, PRECISION

JOSLYN ELECTRONIC SYSTEMS DIV. 805-968-3551
6868 Cortona Dr, Goleta, Cal 93017

PROTECTORS, CIRCUIT AND EQUIPMENT OVERLOAD

JULIE RESEARCH LABORATORIES INC.

211 West 161 St, New York, N Y 10023

AMPLIFIERS, D.C.
MULTIPLEXERS, ANALOG-RELAY (SEQUENTIAL SAMPLING)
POWER SUPPLIES, DC
TESTERS, SEMICONDUCTOR
VOLTAGE DIVIDERS
VOLTMETERS, AC, DC, DIFFERENTIAL

K&M ELECTRONICS CO. 301-685-3140
109 Hopkins Pl, Baltimore, Md 21201
TWX 710-234-2317

COMPUTERS, DIGITAL (GENERAL-PURPOSE, SMALL-SCALE)
MAGNETIC TAPE STORAGE SYSTEMS (INCLUDES CONTROLLER)

K/TRONIC INC. 408-253-7100
10601 Saratoga Rd, Cupertino, Cal 95014

TAPE, MAGNETIC (CASSETTE)

KAYE INSTRUMENTS INC. 617-868-7080
737 Concord Ave, Cambridge, Mass 02138

SCANNERS, INPUT
THERMOCOUPLE REFERENCE SYSTEMS

KDI ADTROL INC. 215-544-6906
700 Abbott Dr, Broomall, Pa 19008

FILM SCANNERS
PRINTERS, DIGITAL STRIP RECORDING
PRINTERS, KEYBOARD
PRINTERS, LINE (LOW & MEDIUM SPEED)
PRINTERS, LINE (HIGH SPEED)
RECORDERS, GRAPHIC
RECORDERS, HARD-COPY (WITH CRT)

KDI INTERACTIVE DATA SYSTEMS 714-557-6660
17785 Skypark Circle, Irvine, Cal 92664

CABLE ASSEMBLIES (WITH CONNECTORS)
CIRCUIT CARDS, LINEAR (WITH DISCRETE COMPONENTS)
CIRCUIT CARDS, LINEAR (WITH IC'S)
CIRCUIT CARDS, LOGIC (WITH DISCRETE COMPONENTS)
CIRCUIT CARDS, LOGIC (WITH IC'S)
COMMUNICATIONS-ORIENTED PROCESSORS, MULTIPLE CHANNEL CONTROLLERS
COMMUNICATIONS-ORIENTED PROCESSORS, SINGLE CHANNEL CONTROLLERS
COMMUNICATION SYSTEMS, DATA TRANSMISSION
COMMUNICATION SYSTEMS, FACSIMILE
CONSULTING (ADVANCED COMPUTER EQUIPMENT DESIGN AND FEASIBILITY STUDIES)
CONSULTING (DATA COMMUNICATIONS SYSTEMS PLANNING)
CONTROLLERS, MAGNETIC DISC
DATA CONCENTRATORS
DATA TERMINALS, BLOCK-BY-BLOCK (MULTI-PURPOSE)
DISC STORAGE SYSTEMS
SCANNERS, FACSIMILE
TEST SYSTEMS, CRT TERMINALS
TEST SYSTEMS, DISC DRIVES

KELTRON CORP. 617-894-0525
225 Crescent St, Waltham, Mass 02154

COUNTERS, DIGITAL READOUT
COUNTERS, UP-DOWN
POWER SUPPLIES, DC
POWER SUPPLIES, DIGITALLY-CONTROLLED
PRINTERS, KEYBOARD
PRINTERS, LINE (LOW & MEDIUM SPEED)

KELVIN 213-782-6662
5919 Noble Ave, Van Nuys, Cal 91401
TELEX 65-1417

RESISTORS, PRECISION

KEMPER ENGINEERING CO. 213-886-0121
9337 Shoshone Ave, Northridge, Cal 91324

CONSULTING (ADVANCED COMPUTER EQUIPMENT DESIGN AND FEASIBILITY STUDIES)
CONSULTING (DATA COMMUNICATIONS SYSTEMS PLANNING)
CONSULTING (SCIENTIFIC APPLICATIONS)
CONTROLLERS, MAGNETIC DISC
DISC STORAGE SYSTEMS
MEMORY SYSTEMS, MAGNETIC DISC
TEST SYSTEMS, COMPUTER PERFORMANCE

KENICS SYSTEMS CORP. 617-868-5100
125 Harvard St, Cambridge, Mass 02139

CIRCUITS, MONOLITHIC (DIGITAL LOGIC)
CIRCUITS, MONOLITHIC (LSI-BIPOLAR)
CIRCUITS, MONOLITHIC (LSI-MOS)
CONSULTING (ADVANCED COMPUTER EQUIPMENT DESIGN AND FEASIBILITY STUDIES)
CONSULTING (SCIENTIFIC APPLICATIONS)
MEMORY SYSTEMS, READ-ONLY
MEMORY SYSTEMS, SEMICONDUCTOR
MEMORY SYSTEMS, SEMICONDUCTOR (MOS)
SERVICES, SYSTEMS ANALYSIS
TESTERS, INTEGRATED CIRCUIT
TESTERS, MEMORY PLANES, STACKS AND SYSTEMS

KENNEDY CO. 213-798-0953
540 W Woodbury Rd, Altadena, Cal 91001
TWX 910-588-3751

FORMATTERS, MAGNETIC TAPE
MAGNETIC TAPE STORAGE SYSTEMS (INCLUDES CONTROLLER)
TAPE TRANSPORTS, MAGNETIC (DIGITAL-EXCL. CASSETTE)
TAPE TRANSPORTS, MAGNETIC (DIGITAL CASSETTE)
TAPE TRANSPORTS, MAGNETIC (INCREMENTAL)

3 Manufacturers' Directory

<p>KEPCO INC. 131 38 Sanford Ave, Flushing, N Y 11352 AMPLIFIERS, D.C. AMPLIFIERS, INSTRUMENTATION AMPLIFIERS, OPERATIONAL CONVERTERS, DIGITAL-TO-ANALOG POWER SUPPLIES, DC POWER SUPPLIES, DIGITALLY-CONTROLLED PROTECTORS, CIRCUIT AND EQUIPMENT OVERLOAD REGULATORS, CURRENT REGULATORS, VOLTAGE</p>	<p>212-461-7000 TWX 710-582-2631</p>	<p>KLEER-VU INDUSTRIES INC. 386 Park Ave S, New York, N Y 10016 MICROFICHE MICROSTRIPS (FOR MICROFILM) READERS, MICROFILM/MICROFICHE</p>	<p>679-212-5900 TWX 710-581-3735</p>
<p>KERN INDUSTRIES 22 Tannery St, Ayer, Mass 01432 CONSULTING (ADVANCED COMPUTER EQUIPMENT DESIGN AND FEASIBILITY STUDIES) CONSULTING (SCIENTIFIC APPLICATIONS)</p>	<p>617-772-3362</p>	<p>KLEINSCHMIDT DIV., SCM CORP. Lake-Cook Rd, Deerfield, Ill 60015 CABINETS AND ENCLOSURES (FOR KEYPUNCHES, PRINTERS) COMMUNICATION SYSTEMS, DATA TRANSMISSION COMMUNICATION SYSTEMS, TELEPRINTER CONVERTERS, PAPER TAPE-TO-PAPER TAPE CONVERTERS, PAPER TAPE-TO-PRINTER CONVERTERS, PAPER TAPE-TO-PUNCHED CARD CONVERTERS, PUNCHED CARD-TO-PAPER TAPE DATA TERMINALS, BLOCK-BY-BLOCK (PAPER TAPE) DATA TERMINALS, BLOCK-BY-BLOCK (MEDIUM SPEED PRINTER) DATA TERMINALS, BLOCK-BY-BLOCK (PUNCHED CARD) DATA TERMINALS, BLOCK-BY-BLOCK (TELEPRINTER) DATA TERMINALS, INQUIRY-RESPONSE (ALPHANUMERIC KEYBOARD) ENCODERS, KEYBOARD (ALPHANUMERIC) ENCODERS, KEYBOARD-TO-PRINTED TAPE PERFORATORS, PAPER TAPE PRINTER/PUNCH, PAPER TAPE PRINTERS, KEYBOARD PRINTERS, LINE (LOW & MEDIUM SPEED) PUNCHES, PAPER TAPE TYPEWRITERS, COMPUTER INPUT-OUTPUT</p>	<p>312-945-1000 TWX 910-692-2151</p>
<p>KEY PUNCH SERVICE CO. 4 Smithfield St, Pittsburgh, Pa 15222 ENCODERS, KEYBOARD-TO-MAGNETIC TAPE SERVICES, PROCESSING (COMMERCIAL EDP) VERIFIERS, PUNCHED CARD</p>	<p>412-471-0636</p>	<p>KONGSBERG SYSTEMS INC. 10 De Angelo Dr, Bedford, Mass 01730 PLOTTERS, FILM EXPOSING CURVE TRACERS-DIGITIZERS, MANUAL DRAFTING SYSTEMS, COMPUTER-CONTROLLED STORAGE PLOTTERS, MOVING PEN (DIGITAL CONTROLLER) PROGRAMMING LANGUAGE DEVELOPMENT (DEDICATED APPLICATION SYSTEMS) PROJECTORS, OPTICAL (COMPUTER CONTROLLED SCRIBING)</p>	<p>617-275-9606 TWX 710-326-1289</p>
<p>KEYDATA CORP. 108 Water St, Watertown, Mass 02172 CONSULTING (ADVANCED COMPUTER EQUIPMENT DESIGN AND FEASIBILITY STUDIES) CONSULTING (COMPUTER PRODUCT PLANNING SURVEYS, MARKET RESEARCH STUDIES) SERVICES, PROCESSING (COMMERCIAL EDP) SERVICES, TIME SHARING (COMMERCIAL)</p>	<p>617-924-1200</p>	<p>KOOLTRONIC FAN CO. P O Box 504, Princeton, N J 08540 BLOWERS, FANS, COOLING ASSEMBLIES</p>	<p>609-799-1466</p>
<p>KEYMATIC DATA SYSTEMS CORP. 56 Perataquit Ave, Bay Shore, N Y 11706 ENCODERS, KEYBOARD (ALPHANUMERIC) ENCODERS, KEYBOARD-TO-MAGNETIC TAPE</p>	<p>516-666-4008</p>	<p>KORRY MANUFACTURING CO. 223-8th Ave N, Seattle, Wash 98109 INDICATORS, ILLUMINATED</p>	<p>206-624-4066 TWX 910-444-2295</p>
<p>KEYSTONE COMPUTER ASSOCIATES INC. 1055 Virginia Dr, Ft Washington, Pa 19034 CONSULTING (ACCOUNTING, BUSINESS AND COMMERCIAL APPLICATIONS) CONSULTING (ADVANCED COMPUTER EQUIPMENT DESIGN AND FEASIBILITY STUDIES) CONSULTING (COMPUTER EVALUATIONS, SELECTIONS, INSTALLATION PLANNING) CONSULTING (DATA COMMUNICATIONS SYSTEMS PLANNING) CONSULTING (COMPUTER PRODUCT PLANNING SURVEYS, MARKET RESEARCH STUDIES) CONSULTING (MANAGEMENT INFORMATION SYSTEMS PLANNING) CONSULTING (SCIENTIFIC APPLICATIONS) PROGRAMMING LANGUAGE DEVELOPMENT (CONSULTANTS) PROGRAMMING LANGUAGE DEVELOPMENT (CONTRACT PROGRAMMING) PROGRAMMING LANGUAGE DEVELOPMENT (DEDICATED APPLICATION SYSTEMS) PROGRAMMING LANGUAGE DEVELOPMENT (PROPRIETARY SOFTWARE PRODUCTS) SERVICES, FACILITY MANAGEMENT SERVICES, MANAGEMENT INFORMATION SYSTEMS</p>	<p>215-643-3800</p>	<p>KRANZLEY & CO. INC. ARTHUR S. 1010 S Kings Hwy, Cherry Hill, N J 08034 CONSULTING (ACCOUNTING, BUSINESS AND COMMERCIAL APPLICATIONS) CONSULTING (ADVANCED COMPUTER EQUIPMENT DESIGN AND FEASIBILITY STUDIES) CONSULTING (COMPUTER EVALUATIONS, SELECTIONS, INSTALLATION PLANNING) CONSULTING (DATA COMMUNICATIONS SYSTEMS PLANNING) CONSULTING (COMPUTER PRODUCT PLANNING SURVEYS, MARKET RESEARCH STUDIES) CONSULTING (MANAGEMENT INFORMATION SYSTEMS PLANNING) PROGRAMMING LANGUAGE DEVELOPMENT (CONTRACT PROGRAMMING) PROGRAMMING LANGUAGE DEVELOPMENT (DEDICATED APPLICATION SYSTEMS) PROGRAMMING LANGUAGE DEVELOPMENT (PROPRIETARY SOFTWARE PRODUCTS)</p>	<p>609-795-1515</p>
<p>KEYSTONE ELECTRONICS CORP. 49 Bleecker St, New York, N Y 10012 BOARDS, PRINTED CIRCUIT (WITHOUT COMPONENTS) BREADBOARDS JACKS, JACK PANELS, PLUGS, ASSEMBLIES PANELS, POWER DISTRIBUTION PLUGBOARDS, PROGRAMMING TERMINAL BLOCKS, STRIPS, BOARDS</p>	<p>212-475-4600</p>	<p>KRATOS PRECISION PRODUCTS 11161 W Pico Blvd, Los Angeles, Cal 90064 POWER SUPPLIES, DC RELAYS, DRY REED (COMPUTER GRADE) RELAYS, MERCURY WETTED (COMPUTER GRADE)</p>	<p>213-478-0635</p>
<p>KIMBALL SYSTEMS DIV. LITTON INDUS. 151 Cortlandt St, Belleville, N J 07109 COMMUNICATION SYSTEMS, DATA TRANSMISSION CONVERTERS, PUNCHED TAG-TO-MAGNETIC TAPE CONVERTERS, PUNCHED TAG-TO-PUNCHED CARD LABELS, CONTINUOUS AND GUMMED (MACHINE APPLICATION) LABELS, CONTINUOUS AND PRESSURE SENSITIVE (MACHINE APPLICATION) READERS, PUNCHED TAG TAGS (FOR EDP PROCESSING)</p>	<p>201-759-6500 TWX 201-759-1556</p>	<p>KYBE CORP. 132 Calvary St, Waltham, Mass 02154 CERTIFIERS, MAGNETIC TAPE CLEANER/CERTIFIERS, MAGNETIC TAPE CLEANERS, DISC PACK CLEANERS, MAGNETIC TAPE RECONDITIONING EQUIPMENT, MAGNETIC TAPE SERVICES, MAGNETIC TAPE CERTIFICATION WINDERS, MAGNETIC TAPE</p>	<p>617-899-0012</p>

3 Manufacturers' Directory

KYROS CORP. 608-238-3587
P O Box 406, Madison, Wisc 53701

CERTIFIERS, MAGNETIC TAPE
 CLEANER/CERTIFIERS, MAGNETIC TAPE

LABEL HOUSE INC., THE 414-691-3220
155 W Wisconsin Ave, Pewaukee, Wisc 53072

ENVELOPES, CONTINUOUS
 FORMS, CONTINUOUS (MACHINE PROCESSED)
 LABELS, CONTINUOUS AND GUMMED (MACHINE APPLICATION)
 LABELS, CONTINUOUS AND PRESSURE SENSITIVE (MACHINE APPLICATION)

LAHEY COMPUTER SYSTEMS INC. 602-264-9586
4747 N 16th St, Phoenix, Ariz 85016

CONSULTING (ACCOUNTING, BUSINESS AND COMMERCIAL APPLICATIONS)
 CONSULTING (ADVANCED COMPUTER EQUIPMENT DESIGN AND FEASIBILITY STUDIES)
 CONSULTING (COMPUTER EVALUATIONS, SELECTIONS, INSTALLATION PLANNING)
 CONSULTING (DATA COMMUNICATIONS SYSTEMS PLANNING)
 CONSULTING (SCIENTIFIC APPLICATIONS)
 PROGRAMMING LANGUAGE DEVELOPMENT (CONSULTANTS)
 PROGRAMMING LANGUAGE DEVELOPMENT (CONTRACT PROGRAMMING)
 PROGRAMMING LANGUAGE DEVELOPMENT (DEDICATED APPLICATION SYSTEMS)
 PROGRAMMING LANGUAGE DEVELOPMENT (PROPRIETARY SOFTWARE PRODUCTS)
 SERVICES, SYSTEMS ANALYSIS

LAMPS INC. SUB. OAK ELECTRO-NETICS CORP 213-323-7578
19220 S Normandie Ave, Torrance, Cal 90502 TWX 910-346-7038

INDICATORS, ILLUMINATED
 LAMPS, GLOW
 LAMPS-PANEL, PILOT AND DIAL (INCANDESCENT)

LANCER ELECTRONICS CORP. 215-277-4410
1416 W Main St, Norristown, Penn 19401

AMPLIFIERS, OPERATIONAL
 BOARDS, PRINTED CIRCUIT (WITHOUT COMPONENTS)
 CONVERTERS, ANALOG-TO-DIGITAL
 CONVERTERS, DIGITAL-TO-ANALOG
 DATA ACQUISITION AND REDUCTION SYSTEMS
 ENCODERS, DIGITAL
 MULTIPLEXERS, ANALOG-RELAY (SEQUENTIAL SAMPLING)
 MULTIPLEXERS, ANALOG-SOLID STATE (SEQUENTIAL SAMPLING)
 MULTIPLEXERS, DIGITAL

LANDIS AND GYR INC. 914-592-4400
4 Westchester Plaza, Elmsford, N Y 10523 TWX 710-567-1219

COUNTERS, DECADE
 COUNTERS, DIGITAL READOUT
 COUNTERS, STEPPING SWITCH
 COUNTERS, UP-DOWN
 PRINTERS, LINE (LOW & MEDIUM SPEED)
 READOUTS AND DISPLAYS, NUMERIC AND ALPHANUMERIC (OTHER THAN CRT)
 TIMERS, EVENT (IMPULSE)
 TIMERS, INTERVAL

LANE INDUSTRIES ELECTRONICS DIV. 213-765-6125
7254 Atoll Ave, North Hollywood, Cal 91605

CABLE ASSEMBLIES (WITH CONNECTORS)
 CABLE, FINE LEAD
 CABLE, FLAT, PRINTED AND RIBBON
 CABLE, MULTICONDUCTOR
 SERVICES, AUTOMATED WIRE-WRAPPING

LANSDALE TRANSISTOR & ELECTRONICS, INC. 215-855-9002
19 Jenkins Ave, Lansdale, Pa 19446 TWX 510-661-6715

TRANSISTORS, GERMANIUM
 TRANSISTORS, SILICON

LARSE CORP. 415-493-0700
1070 E Meadow Cir, Palo Alto, Cal 94303

COMMUNICATION SYSTEMS, DATA TRANSMISSION
 DATA ACQUISITIONS SYSTEMS, AUTOMATIC
 ENCODERS, DIGITAL
 MULTIPLEXERS, DIGITAL
 SCANNERS, INPUT

LEACH CORP. CONTROLS DIV. 213-334-8211
717 N Coney Ave, Azusa, Cal 91702 TWX 910-584-1855

POOLERS, MAGNETIC TAPE
 RECORDERS, DIGITAL CASSETTE
 RECORDERS, MAGNETIC TAPE
 TAPE TRANSPORTS, MAGNETIC (DIGITAL-EXCL. CASSETTE)
 TAPE TRANSPORTS, MAGNETIC (DIGITAL CASSETTE)
 TAPE TRANSPORTS, MAGNETIC (INCREMENTAL)

LEACH CORP. RELAY DIV. 213-232-8221
5915 Avalon, Los Angeles, Cal 90003 TWX 910-321-2303

TIMERS, INTERVAL

LEAR SIEGLER INC. CIMRON DIV. 714-276-3200
1152 Morena Blvd, San Diego, Cal 92110 TWX 910-335-1196

CONVERTERS, ANALOG-TO-DIGITAL
 VOLTMETERS, DIGITAL

LEAR SIEGLER INC., ELECTRONIC INSTRUMENTATION DIV 714-774-1010
714 N Brookhurst St, Anaheim, Cal 92803 TWX 910-591-1157

BUS BAR SYSTEMS
 DATA TERMINALS, INQUIRY-RESPONSE (ALPHANUMERIC KEYBOARD)
 DATA TERMINALS, INQUIRY-RESPONSE (CRT WITH KEYBOARD)
 MULTIPLEXERS, ANALOG-SOLID STATE (SEQUENTIAL SAMPLING)

LEAR SIEGLER INC. POWER EQUIPMENT DIV 216-662-1000
P O Box 6719, Cleveland, Ohio 44101 TWX 810-422-2213

BRAKES AND CLUTCHES

LEASCO DATA PROCESSING EQUIPMENT CORP. 212-682-8300
280 Park Ave, New York, N Y 10017 TELEX 12-6346

CONSULTING (ACCOUNTING, BUSINESS AND COMMERCIAL APPLICATIONS)
 CONSULTING (ADVANCED COMPUTER EQUIPMENT DESIGN AND FEASIBILITY STUDIES)
 CONSULTING (COMPUTER EVALUATIONS, SELECTIONS, INSTALLATION PLANNING)
 CONSULTING (DATA COMMUNICATIONS SYSTEMS PLANNING)
 CONSULTING (COMPUTER PRODUCT PLANNING SURVEYS, MARKET RESEARCH STUDIES)
 CONSULTING (MANAGEMENT INFORMATION SYSTEMS PLANNING)
 CONSULTING (SCIENTIFIC APPLICATIONS)
 LEASING, EDP EQUIPMENT (OTHER THAN MFGRS)
 PROGRAMMING LANGUAGE DEVELOPMENT (CONSULTANTS)
 PROGRAMMING LANGUAGE DEVELOPMENT (CONTRACT PROGRAMMING)
 PROGRAMMING LANGUAGE DEVELOPMENT (DEDICATED APPLICATION SYSTEMS)
 PROGRAMMING LANGUAGE DEVELOPMENT (PROPRIETARY SOFTWARE PRODUCTS)
 SERVICES, COMPUTER-AIDED DESIGN
 SERVICES, FACILITY MANAGEMENT
 SERVICES, MANAGEMENT INFORMATION SYSTEMS
 SERVICES, PROCESSING (COMMERCIAL EDP)
 SERVICES, PROCESSING (ANALOG OR HYBRID, SCIENTIFIC)
 SERVICES, PROCESSING (DIGITAL SCIENTIFIC)
 SERVICES, TIME SHARING (COMMERCIAL)
 SERVICES, TIME SHARING (RESEARCH)
 SERVICES, HARDWARE MAINTENANCE
 SERVICES, SYSTEMS ANALYSIS
 TRAINING INSTITUTES, COMMERCIAL COMPUTER COURSES, SEMINARS, CORRESPONDENCE COURSES
 TRAINING SYSTEMS, COMPUTER SERVICE
 USED EQUIPMENT (BUYING, SELLING, LEASING)

LECROY RESEARCH SYSTEMS CORP. 914-358-7900
126 N Rte 303, W Nyack, N Y 10994

AMPLIFIERS, INSTRUMENTATION
 AMPLIFIERS, VIDEO
 ANALYZERS, WAVEFORM
 CONVERTERS, ANALOG-TO-DIGITAL
 CONVERTERS, BINARY-TO-DECIMAL
 CONVERTERS, DIGITAL-TO-ANALOG
 CONVERTERS, PULSE-TO-DIGITAL
 COUNTERS, DIGITAL READOUT
 DATA ACQUISITION AND REDUCTION SYSTEMS
 DISPLAY DRIVERS
 GENERATORS, CHARACTER (CRT)
 MODULES, DIGITAL LOGIC ENCAPSULATED (ALSO SEE CIRCUITS & CIRCUIT CARDS)
 READOUTS, CRT
 TESTERS, DIGITAL LOGIC MODULES AND CARDS
 TESTERS, SEMICONDUCTOR

3 Manufacturers' Directory

- LEDEX INC.** 513-224-9819
 123 Webster St, Dayton, Ohio 45401 TWX 513-944-0286
 AMPLIFIERS, OPERATIONAL
 CIRCUITS, HYBRID (IC AND DISCRETE-DIGITAL)
 CIRCUITS, THICK FILM (DIGITAL)
 COUNTERS, STEPPING SWITCH
 MOTORS, STEPPING
 SWITCHES, ROTARY
- LEECRAFT MANUFACTURING CO.** 212-392-8800
 21-16 44th Rd, Long Island, N Y 11378 TELEX 12-6977
 LAMPS-PANEL, PILOT AND DIAL (INCANDESCENT)
- LEEDS & NORTHRUP CO.** 215-643-2000
 Sumney Town Pike, North Wales, Pa 19454
 COMPUTERS, PROCESS CONTROL
 CONTROLLERS, PLOTTING
 CONVERTERS, ANALOG-TO-DIGITAL
 DATA ACQUISITION AND REDUCTION SYSTEMS
 PLOTTERS, MOVING PEN (ANALOG CONTROLLER)
 PROGRAMMING LANGUAGE DEVELOPMENT (PROPRIETARY SOFTWARE PRODUCTS)
 RECORDERS, GRAPHIC
 SWITCHES, ROTARY
 THERMOCOUPLE REFERENCE SYSTEMS
- LEGI ELECTRONICS CORP.** 213-733-1521
 3118-A W Jefferson Bl, Los Angeles, Cal 90018
 READOUTS AND DISPLAYS, NUMERIC AND ALPHANUMERIC (OTHER THAN CRT)
 READOUTS, CRT
- LEHIGH VALLEY ELECTRONICS INC.** 215-285-4221
 Po Box 125, Fogelsville, Pa 18051
 AUDIO/VISUAL TRAINING AIDS
 CIRCUIT CARDS, LOGIC (WITH DISCRETE COMPONENTS)
 CIRCUIT CARDS, LOGIC (WITH IC'S)
 CONSULTING (COMPUTER EVALUATIONS, SELECTIONS, INSTALLATION PLANNING)
 CONSULTING (SCIENTIFIC APPLICATIONS)
 COUNTERS, DECADE
 COUNTERS, DIGITAL READOUT
 COUNTERS, STEPPING SWITCH
 COUNTERS, UP-DOWN
 DEMONSTRATORS AND KITS, EDUCATIONAL (DIGITAL LOGIC)
 MODULES, DIGITAL LOGIC ENCAPSULATED (ALSO SEE CIRCUITS & CIRCUIT CARDS)
 MULTIPLEXERS, DIGITAL
 OSCILLATORS, VOLTAGE CONTROLLED
 PERFORATORS, PAPER TAPE
 POWER SUPPLIES, DC
 PRINTER/PUNCH, PAPER TAPE
 PROGRAMMING LANGUAGE DEVELOPMENT (PROPRIETARY SOFTWARE PRODUCTS)
 READERS, PAPER TAPE
 READERS, PERFORATED DOCUMENT
 TIMERS, EVENT (IMPULSE)
 TIMERS, INTERVAL
 TRAINING SYSTEMS, CARD PUNCH
- LEIGH INSTRUMENTS LTD. COMPUTER EQUIP. DIV** 613-829-6161
 P O Box 2323 Sta D, Ottawa 4, ONT CAN
 PRINTERS, LINE (LOW & MEDIUM SPEED)
 RECORDERS, GRAPHIC
 RECORDERS, HARD-COPY (WITH CRT)
- LEM INSTRUMENT CORP.** 516-293-7240
 20 Sarah Dr, Farmingdale, N Y 11735
 BRAKES AND CLUTCHES
 CONVERTERS, ANALOG-TO-DIGITAL
 CONVERTERS, BINARY-TO-DECIMAL
 ENCODERS, DIGITAL
 ENCODERS, SHAFT ANGLE
 INDICATORS, DIGITAL
 READOUTS AND DISPLAYS, NUMERIC AND ALPHANUMERIC (OTHER THAN CRT)
 SERVOS, COMPUTER
 TRANSDUCERS, DIGITAL
- LENKURT ELECTRIC CO., INC. SUB. OF GT&E** 415-591-8461
 1105 County Rd, San Carlos, Cal 94070 TWX 910-376-4891
 COMMUNICATION SYSTEMS, DATA TRANSMISSION
 COMMUNICATION SYSTEMS, FACSIMILE
 COMMUNICATION SYSTEMS, TELEPRINTER
 DATA CONCENTRATORS
 MODEMS, HARD-WIRED
 MODEMS, PC CARD
 MULTIPLEXERS, ANALOG-SOLID STATE (SEQUENTIAL SAMPLING)
 MULTIPLEXERS, DIGITAL
 TRANSCEIVERS, FACSIMILE
- LENZ ELECTRIC MANUFACTURING CO.** 312-276-4454
 1751 N Western Ave, Chicago, Ill 60647
 CABLE, COAXIAL (FLEXIBLE)
 CABLE, MULTICONDUCTOR
 CABLE, SHIELDED (NOT COAXIAL)
- LEVER DATA PROCESSING SERVICES, INC.** 212-688-6000
 390 Park Ave, New York, N Y 10022
 CONSULTING (MANAGEMENT INFORMATION SYSTEMS PLANNING)
 SERVICES, PROCESSING (COMMERCIAL EDP)
- LEWIS BUSINESS FORMS INC.** 904-781-7200
 P O Box M, Jacksonville, Fla 32203
 CARDS, CONVENTIONAL PUNCH
 FORMS, CONTINUOUS (MACHINE PROCESSED)
 PAPER (FOR MICR EQUIPMENT)
 PAPER (FOR OCR EQUIPMENT)
 PAPER (FOR PRINTERS)
- LIBERTY LEASING CO., LIBERTY CONTROLS DIV.** 815-725-2241
 R F D 5, Joliet, Ill 60431
 RELAYS, DRY REED (COMPUTER GRADE)
 RELAYS, SOLID-STATE (COMPUTER GRADE)
- LIBRASCOPE DIV. THE SINGER CO** 213-245-8711
 808 Western Ave, Glendale, Cal 91201 TWX 910-497-2266
 ANALYZERS, COMPUTER PERFORMANCE
 ANALYZERS, CONTINUITY
 ANALYZERS, DIFFERENTIAL
 ANALYZERS, PULSE HEIGHT
 ANALYZERS, WAVEFORM
 CONSOLES, CRT (COLOR-ALPHANUMERIC AND GRAPHIC)
 DISC STORAGE SYSTEMS
 ENCODERS, DIGITAL
 ENCODERS, SHAFT ANGLE
 GENERATORS, BYTE
 GENERATORS, CHARACTER (CRT)
 GENERATORS, RANDOM NUMBER
 GENERATORS, TIME CODE
 MEMORY SYSTEMS, MAGNETIC DISC
 TEST SYSTEMS, COMPUTER PERFORMANCE
 TESTERS, CIRCUIT
 TESTERS, DIGITAL DATA TRANSMISSION
 TESTERS, DIGITAL LOGIC MODULES AND CARDS
 TESTERS, INTEGRATED CIRCUIT
 TESTERS, MEMORY PLANES, STACKS AND SYSTEMS
 TESTERS, SEMICONDUCTOR
- LIMITED FOURS UNLIMITED**
 1030 13th St, Boulder, Colo 80302
 CONSULTING (ACCOUNTING, BUSINESS AND COMMERCIAL APPLICATIONS)
 CONSULTING (ADVANCED COMPUTER EQUIPMENT DESIGN AND FEASIBILITY STUDIES)
 CONSULTING (COMPUTER EVALUATIONS, SELECTIONS, INSTALLATION PLANNING)
 CONSULTING (DATA COMMUNICATIONS SYSTEMS PLANNING)
 CONSULTING (MANAGEMENT INFORMATION SYSTEMS PLANNING)
 PROGRAMMING LANGUAGE DEVELOPMENT (CONSULTANTS)
 PROGRAMMING LANGUAGE DEVELOPMENT (DEDICATED APPLICATION SYSTEMS)
- LIPPS INC.** 213-393-0449
 1630 Euclid St, Santa Monica, Cal 90404
 POLE PIECES, FERRITE
 RECORDING HEADS, MAGNETIC DISC
 RECORDING HEADS, MAGNETIC DRUM
 RECORDING HEADS, MAGNETIC TAPE

3 Manufacturers' Directory

LITTLEFUSE INC. 312-824-1188
 800 E NW Highway, Des Plaines, Ill 60016 TWX 910-233-3598
 PROTECTORS, CIRCUIT AND EQUIPMENT OVERLOAD

LITTON ABS AUTOMATED BUSINESS SYSTEMS OEM PRODUCT 201-935-2200
 600 Washington Ave, Carlstadt, N J 07072

ENCODERS, KEYBOARD (ALPHANUMERIC)
 PRINTERS, LINE (LOW & MEDIUM SPEED)
 PUNCHES, CARD (EDGE-PUNCHING)
 PUNCHES, PAPER TAPE
 READERS, EDGE-PUNCHED CARD
 READERS, PAPER TAPE
 READERS, PUNCHED CARD (100 TO 300 CPM)

LITTON PRECISION PRODUCTS USECO DIV. 213-786-9381
 13536 Saticoy St, Van Nuys, Cal 91409 TWX 910-495-1700
 JACKS, JACK PANELS, PLUGS, ASSEMBLIES
 KNOBS, DIALS (FOR COMPUTER CONSOLES)
 SOCKETS, IC MOUNTING
 SOCKETS, PCB MOUNTING
 SOCKETS, SEMICONDUCTOR MOUNTING
 TERMINAL BLOCKS, STRIPS, BOARDS

LITTON REVENUE CONTROL SYSTEMS 201-561-5800
 4000 Hadley Rd, So Plainfield, N J 07080 TWX 710-997-9543
 PUNCHES, CARD (PORTABLE)

LITTON SYSTEMS INC. CIRCUITRY DIV. 417-862-0751
 4811 W Kearney St, Springfield, Mo 65803 TWX 910-775-4705
 BOARDS, PRINTED CIRCUIT (WITHOUT COMPONENTS)
 BREADBOARDS
 SERVICES, COMPUTER-AIDED DESIGN

LITTON SYSTEMS INC. DATA SYSTEMS DIV. 213-781-8211
 8000 Woodley Ave, Van Nuys, Cal 91409 TWX 910-495-1708
 CIRCUIT CARDS, LOGIC (WITH IC'S)
 COMMUNICATIONS-ORIENTED PROCESSORS, MULTIPLE CHANNEL CONTROLLERS
 COMMUNICATIONS-ORIENTED PROCESSORS, STORED PROGRAM
 COMMUNICATION SYSTEMS, DATA TRANSMISSION
 COMPUTERS, DIGITAL (GENERAL-PURPOSE, SMALL-SCALE)
 COMPUTERS, DIGITAL (GENERAL-PURPOSE, MEDIUM-SCALE)
 COMPUTERS, FIRE CONTROL
 COMPUTERS, MINI GENERAL PURPOSE (ALSO SEE CALCULATORS)
 CONSOLES, COMPUTER CONTROL (WIRED)
 CONSOLES, CRT (ALPHANUMERIC AND GRAPHIC)
 CONSULTING (ADVANCED COMPUTER EQUIPMENT DESIGN AND FEASIBILITY STUDIES)
 CONSULTING (DATA COMMUNICATIONS SYSTEMS PLANNING)
 CONTROLLERS, MODEM
 CONVERTERS, ANALOG-TO-DIGITAL
 DATA CONCENTRATORS
 DATA TERMINALS, BLOCK-BY-BLOCK (MULTI-PURPOSE)
 DATA TERMINALS, BLOCK-BY-BLOCK (HIGH SPEED PRINTER)
 DATA TERMINALS, INQUIRY-RESPONSE (ALPHANUMERIC KEYBOARD)
 DATA TERMINALS, INQUIRY-RESPONSE (SPECIAL-PURPOSE)
 DIGITIZERS, PROGRAMMABLE
 ENCODERS, KEYBOARD (ALPHANUMERIC)
 FILM SCANNERS
 MEMORY SYSTEMS, PLATED WIRE
 MEMORY SYSTEMS, READ-ONLY
 MEMORY SYSTEMS, SEMICONDUCTOR (MOS)
 MEMORY SYSTEMS, THIN FILM
 MODEMS, HARD-WIRED
 MULTIPLEXERS, DIGITAL
 POWER SUPPLIES, AC
 POWER SUPPLIES, DC
 PROGRAMMING LANGUAGE DEVELOPMENT (CONTRACT PROGRAMMING)
 PROGRAMMING LANGUAGE DEVELOPMENT (DEDICATED APPLICATION SYSTEMS)
 PROGRAMMING LANGUAGE DEVELOPMENT (PROPRIETARY SOFTWARE PRODUCTS)
 READERS, OPTICAL CHARACTER SCANNING
 READOUTS AND DISPLAYS, NUMERIC AND ALPHANUMERIC (OTHER THAN CRT)
 REGULATORS, VOLTAGE
 SCANNERS, OPTICAL
 SERVICES, SYSTEMS ANALYSIS
 SIGNAL CONDITIONERS
 TESTERS, CIRCUIT
 TESTERS, DIGITAL DATA TRANSMISSION
 TESTERS, INTEGRATED CIRCUIT

LITTON SYSTEMS INC. ELECTRON TUBE DIV. 415-591-8411
 960 Industrial Rd, San Carlos, Cal 94070
 TUBES, CATHODE RAY

LITTON SYSTEMS INC. ENCODER DIV. 213-341-6161
 20745 Nordoff St, Chatsworth, Cal 91311 TWX 910-494-1229
 CONVERTERS, ANALOG-TO-DIGITAL
 ENCODERS, DIGITAL
 ENCODERS, SHAFT ANGLE

LITTON SYSTEMS INC. MELLONICS DIV. 408-245-0795
 1001 W Maude Ave, Sunnyvale, Cal 94086 TWX 910-339-9264
 AUDIO/VISUAL TRAINING AIDS
 CONSULTING (ACCOUNTING, BUSINESS AND COMMERCIAL APPLICATIONS)
 CONSULTING (ADVANCED COMPUTER EQUIPMENT DESIGN AND FEASIBILITY STUDIES)
 CONSULTING (COMPUTER EVALUATIONS, SELECTIONS, INSTALLATION PLANNING)
 CONSULTING (DATA COMMUNICATIONS SYSTEMS PLANNING)
 CONSULTING (MANAGEMENT INFORMATION SYSTEMS PLANNING)
 CONSULTING (SCIENTIFIC APPLICATIONS)
 CONVERTERS, MAGNETIC TAPE-TO-MAGNETIC TAPE
 PROGRAMMING LANGUAGE DEVELOPMENT (CONSULTANTS)
 PROGRAMMING LANGUAGE DEVELOPMENT (CONTRACT PROGRAMMING)
 PROGRAMMING LANGUAGE DEVELOPMENT (DEDICATED APPLICATION SYSTEMS)
 PROGRAMMING LANGUAGE DEVELOPMENT (PROPRIETARY SOFTWARE PRODUCTS)
 SERVICES, FACILITY MANAGEMENT
 SERVICES, MANAGEMENT INFORMATION SYSTEMS
 SERVICES, PROCESSING (COMMERCIAL EDP)
 SERVICES, PROCESSING (DIGITAL SCIENTIFIC)
 SERVICES, TIME SHARING (RESEARCH)
 SERVICES, SYSTEMS ANALYSIS
 TRAINING SYSTEMS, COMPUTER SERVICE

LITTON SYSTEMS INC. GUIDANCE & CONTROL SYS.DIV. 213-887-4989
 5500 Canoga Ave, Woodland Hills, Cal 91364 TWX 910-494-2091
 COMPUTERS, FIRE CONTROL
 COMPUTERS, MINI GENERAL PURPOSE (ALSO SEE CALCULATORS)
 COMPUTERS, NAVIGATION
 MEMORY SYSTEMS, MAGNETIC CORE
 TESTERS, DIGITAL LOGIC MODULES AND CARDS

LIVERMORE DATA SYSTEMS INC. 415-447-2252
 2050 Research Dr, Livermore, Cal 94550
 ACOUSTIC COUPLERS
 DATA TERMINALS, BLOCK-BY-BLOCK (MAGNETIC TAPE)
 MAGNETIC TAPE STORAGE SYSTEMS (INCLUDES CONTROLLER)
 MODEMS, ACOUSTIC
 MODEMS, HARD-WIRED
 MODEMS, PC CARD
 RECORDERS, DIGITAL CASSETTE

LOCKHEED ELECTRONICS DATA MANAGEMENT SERVICES 713-488-0080
 16811 El Camino Real, Houston, Tex 77058

CONSULTING (ACCOUNTING, BUSINESS AND COMMERCIAL APPLICATIONS)
 CONSULTING (COMPUTER EVALUATIONS, SELECTIONS, INSTALLATION PLANNING)
 CONSULTING (DATA COMMUNICATIONS SYSTEMS PLANNING)
 CONSULTING (MANAGEMENT INFORMATION SYSTEMS PLANNING)
 CONSULTING (SCIENTIFIC APPLICATIONS)
 PROGRAMMING LANGUAGE DEVELOPMENT (CONSULTANTS)
 PROGRAMMING LANGUAGE DEVELOPMENT (CONTRACT PROGRAMMING)
 PROGRAMMING LANGUAGE DEVELOPMENT (DEDICATED APPLICATION SYSTEMS)
 PROGRAMMING LANGUAGE DEVELOPMENT (PROPRIETARY SOFTWARE PRODUCTS)
 SERVICES, FACILITY MANAGEMENT
 SERVICES, MANAGEMENT INFORMATION SYSTEMS
 SERVICES, SYSTEMS ANALYSIS

LOCKHEED ELECTRONICS CO. DATA PRODUCTS DIV. 213-722-6810
 6201 E Randolph St, Los Angeles, Cal 90650 TWX 910-580-3623
 BOARDS, PRINTED CIRCUIT (WITHOUT COMPONENTS)
 COMPUTERS, DIGITAL (GENERAL-PURPOSE, SMALL-SCALE)
 COMPUTERS, MINI GENERAL PURPOSE (ALSO SEE CALCULATORS)
 COMPUTERS, PROCESS CONTROL
 CORES, FERRITE MEMORY
 MEMORY PLANES AND STACKS, MAG-NETIC CORE (W/O ELECTRONICS)
 MEMORY PLANES AND STACKS, PLATED WIRE (W/O ELECTRONICS)
 MEMORY SYSTEMS, MAGNETIC CORE
 MEMORY SYSTEMS, PLATED WIRE
 MEMORY SYSTEMS, READ-ONLY
 PLATED WIRE

3 Manufacturers' Directory

**LOCKHEED ELECTRONICS CO. DIV. LOCKHEED ACRFT
CORP****U S Hwy 22, Plainfield, N J 07060****201-757-1600
TWX 710-997-9541**

CIRCUIT CARDS, LINEAR (WITH DISCRETE COMPONENTS)
CIRCUIT CARDS, LINEAR (WITH IC'S)
CIRCUIT CARDS, LOGIC (WITH DISCRETE COMPONENTS)
CIRCUIT CARDS, LOGIC (WITH IC'S)
COMPUTERS, DIGITAL (GENERAL-PURPOSE, SMALL-SCALE)
COMPUTERS, MINI GENERAL PURPOSE (ALSO SEE CALCULATORS)
COMPUTERS, PROCESS CONTROL
CONSULTING (COMPUTER EVALUATIONS, SELECTIONS, INSTALLATION
PLANNING)
CONSULTING (MANAGEMENT INFORMATION SYSTEMS PLANNING)
CORES, FERRITE MEMORY
MEMORY PLANES AND STACKS, MAG-NETIC CORE (W/O ELECTRONICS)
MEMORY PLANES AND STACKS, PLATED WIRE (W/O ELECTRONICS)
MEMORY SYSTEMS, MAGNETIC CORE
MEMORY SYSTEMS, PLATED WIRE
PLATED WIRE
PROGRAMMING LANGUAGE DEVELOPMENT (CONTRACT PROGRAMMING)
RECORDERS, DIGITAL CASSETTE
RECORDERS, MAGNETIC TAPE
TAPE TRANSPORTS, MAGNETIC (DIGITAL-EXCL. CASSETTE)
TAPE TRANSPORTS, MAGNETIC (DIGITAL CASSETTE)
TAPE TRANSPORTS, MAGNETIC (INCREMENTAL)

LOGIC CORP.**21 Oldey Ave, Cherry Hill, N J 08034****609-424-3150**

CLOCKS, DIGITAL (REAL-TIME)
COMMUNICATION SYSTEMS, DATA TRANSMISSION
COMMUNICATION SYSTEMS, FACSIMILE
DATA CONCENTRATORS
DATA TERMINALS, BLOCK-BY-BLOCK (MAGNETIC TAPE)
DATA TERMINALS, BLOCK-BY-BLOCK (MULTI-PURPOSE)
DATA TERMINALS, BLOCK-BY-BLOCK (MEDIUM SPEED PRINTER)
DATA TERMINALS, INQUIRY-RESPONSE (ALPHANUMERIC KEYBOARD)
DATA TERMINALS, INQUIRY-RESPONSE (SPECIAL-PURPOSE)
ENCODERS, KEYBOARD (ALPHANUMERIC)
ENCODERS, KEYBOARD (NUMERIC)
ENCODERS, KEYBOARD-TO-MAGNETIC DISC
ENCODERS, KEYBOARD-TO-MAGNETIC TAPE

LOGIC INC.**1712 Commerce St, Dallas, Tex 75201****214-741-2465**

CONSULTING (ADVANCED COMPUTER EQUIPMENT DESIGN AND FEASIBILITY
STUDIES)
CONSULTING (COMPUTER EVALUATIONS, SELECTIONS, INSTALLATION
PLANNING)
CONSULTING (DATA COMMUNICATIONS SYSTEMS PLANNING)
CONSULTING (COMPUTER PRODUCT PLANNING SURVEYS, MARKET RESEARCH
STUDIES)
CONSULTING (MANAGEMENT INFORMATION SYSTEMS PLANNING)
CONSULTING (SCIENTIFIC APPLICATIONS)
PROGRAMMING LANGUAGE DEVELOPMENT (CONSULTANTS)
PROGRAMMING LANGUAGE DEVELOPMENT (CONTRACT PROGRAMMING)
PROGRAMMING LANGUAGE DEVELOPMENT (DEDICATED APPLICATION SYSTEMS)
PROGRAMMING LANGUAGE DEVELOPMENT (PROPRIETARY SOFTWARE
PRODUCTS)
SERVICES, FACILITY MANAGEMENT
SERVICES, PROCESSING (COMMERCIAL EDP)
SERVICES, SYSTEMS ANALYSIS

LOGIC SCIENCE INC.**P O Box 10096, San Diego, Cal 92110****714-276-1464**

AUDIO/VISUAL TRAINING AIDS
CIRCUIT CARDS, LOGIC (WITH DISCRETE COMPONENTS)
CIRCUIT CARDS, LOGIC (WITH IC'S)
RECORDERS, MAGNETIC TAPE

LOGICON INC.**Del Amo Financial Ctr, Torrance, Cal 90503****213-831-0611
TWX 910-345-7452**

COMMUNICATIONS-ORIENTED PROCESSORS, MULTIPLE CHANNEL CONTROLLERS
COMMUNICATIONS-ORIENTED PROCESSORS, STORED PROGRAM
COMMUNICATION SYSTEMS, DATA TRANSMISSION
COMPUTERS, DIGITAL (GENERAL-PURPOSE, MEDIUM-SCALE)
COMPUTERS, PROCESS CONTROL
CONSULTING (ACCOUNTING, BUSINESS AND COMMERCIAL APPLICATIONS)
CONSULTING (ADVANCED COMPUTER EQUIPMENT DESIGN AND FEASIBILITY
STUDIES)
CONSULTING (COMPUTER EVALUATIONS, SELECTIONS, INSTALLATION
PLANNING)
CONSULTING (DATA COMMUNICATIONS SYSTEMS PLANNING)
CONSULTING (MANAGEMENT INFORMATION SYSTEMS PLANNING)
CONSULTING (SCIENTIFIC APPLICATIONS)
MULTIPLEXER-CONVERTER (SINGLE UNIT WITH MULTIPLEXER, SAMPLE & HOLD
AMPLIFIER & A-TO-D CONVERTER)
CONTINUED

MULTIPLEXERS, ANALOG-RELAY (SEQUENTIAL SAMPLING)
MULTIPLEXERS, ANALOG-SOLID STATE (SEQUENTIAL SAMPLING)
MULTIPLEXERS, DIGITAL
PROGRAMMING LANGUAGE DEVELOPMENT (CONSULTANTS)
PROGRAMMING LANGUAGE DEVELOPMENT (CONTRACT PROGRAMMING)
SERVICES, FACILITY MANAGEMENT
SERVICES, SYSTEMS ANALYSIS

LOGITEK INC.**42 Central Dr, Farmingdale, N Y 11735****516-694-3080**

RELAYS, SOLID-STATE (COMPUTER GRADE)

LOHMAN DATA PROCESSING INC.**1818 State St, Quincy, Ill 62301****217-222-4410**

CONSULTING (ACCOUNTING, BUSINESS AND COMMERCIAL APPLICATIONS)
SERVICES, PROCESSING (COMMERCIAL EDP)

LORAIN PRODUCTS CORP.**1122 F St, Lordin, Ohio 44052****216-288-9191
TWX 810-426-2130**

CONVERTERS, DC-TO-FREQUENCY
CONVERTERS, FREQUENCY-TO-DC
CONVERTERS, VOLTAGE-TO-FREQUENCY
INVERTERS, DC-AC
POWER SUPPLIES, AC
POWER SUPPLIES, DC
RECTIFIERS, SILICON CONTROLLED
REGULATORS, FREQUENCY
REGULATORS, VOLTAGE

LORCH ELECTRONICS, LORCH ADRET CORP.**105 Cedar Ln, Englewood, N J 07631****201-569-8282
TWX 710-991-9718**

AMPLIFIERS, VIDEO
ATTENUATORS, DECADE DIGITAL
CONVERTERS, DIGITAL-TO-ANALOG
CONVERTERS, FREQUENCY-TO-DC
OSCILLATORS, VOLTAGE CONTROLLED
POWER SUPPLIES, DIGITALLY-CONTROLLED
READOUTS AND DISPLAYS, NUMERIC AND ALPHANUMERIC (OTHER THAN CRT)

LOWENTHAL PROGRAMMING CO.**30 Rock Ridge Dr, Pt Chester, N Y 10573****914-939-8298**

CONSULTING (ACCOUNTING, BUSINESS AND COMMERCIAL APPLICATIONS)
CONSULTING (COMPUTER EVALUATIONS, SELECTIONS, INSTALLATION
PLANNING)
PROGRAMMING LANGUAGE DEVELOPMENT (CONSULTANTS)
PROGRAMMING LANGUAGE DEVELOPMENT (CONTRACT PROGRAMMING)
PROGRAMMING LANGUAGE DEVELOPMENT (DEDICATED APPLICATION SYSTEMS)
SERVICES, SYSTEMS ANALYSIS

LTV ELECTROSYSTEMS INC. MEMCOR DIV.**1320 Flaxmill Rd, Huntington, Ind 46750****219-356-4300
TWX 810-333-1531**

RESISTORS, PRECISION

LUMINETICS CORP.**P O Box 1943, Pompano Beach, Fla 33061****305-933-4551**

COUNTERS, DECADE
COUNTERS, DIGITAL READOUT
COUNTERS, UP-DOWN
DISPLAY DRIVERS
INDICATORS, DIGITAL
READOUTS AND DISPLAYS, NUMERIC AND ALPHANUMERIC (OTHER THAN CRT)

LUNDY ELECTRONICS & SYSTEMS INC.**Robert Lane, Glen Head, N Y 11545****516-676-1440
TWX 510-223-0605**

COMMUNICATION SYSTEMS, DATA TRANSMISSION
CONSOLES, CRT (ALPHANUMERIC AND GRAPHIC)
CONSOLES, CRT (GRAPHIC)
DATA TERMINALS, BLOCK-BY-BLOCK (MAGNETIC TAPE)
DATA TERMINALS, BLOCK-BY-BLOCK (MULTI-PURPOSE)
READERS, MAGNETIC CARD
READERS, MAGNETIC INK CHARACTER

LYNCH & CO., JOHN G.**245 Briargate Rd, Cary, Ill 60013****312-639-3137**

SERVICES, FACILITY MANAGEMENT
SERVICES, PROCESSING (COMMERCIAL EDP)

3 Manufacturers' Directory

LYNCH COMMUNICATION SYSTEMS INC. 415-397-1471
695 Bryant St, San Francisco, Cal 94107 TELEX 3-4421
 COMMUNICATION SYSTEMS, DATA TRANSMISSION
 MODEMS, HARD-WIRED

LYON METAL PRODUCTS INC. 312-892-8941
P O Box 671, Aurora, Ill 60507

CABINETS, TRAYS (FOR PUNCHED CARD STORAGE)
 DESKS, TABLES AND STANDS (FOR CALCULATORS)
 DESKS, TABLES AND STANDS (FOR KEYPUNCH UNITS)
 DESKS, TABLES AND STANDS (FOR PROGRAMMER STATIONS)
 DESKS, TABLES AND STANDS (FOR TYPEWRITERS)
 FILES, PUNCHED CARD

3M CO. 612-733-1110
3m Center, St Paul, Minn 55101 TWX 910-563-3712

AUDIO/VISUAL TRAINING AIDS
 CABLE, FLAT, PRINTED AND RIBBON
 CAPACITORS, COMPUTER GRADE
 COMMUNICATIONS-ORIENTED PROCESSORS, STORED PROGRAM
 LABELS, CONTINUOUS AND GUMMED (MACHINE APPLICATION)
 MAGNETIC TAPE STORAGE SYSTEMS (INCLUDES CONTROLLER)
 MICROFICHE
 MICROFILM DATA RETRIEVAL SYSTEMS, COMPUTER CONTROLLED
 MICROFILM DATA RETRIEVAL SYSTEMS, COMPUTER CONTROLLED (GRAPHIC)
 MICROFILM ROLLS
 MICROSTRIPS (FOR MICROFILM)
 PAPER (FOR MICR EQUIPMENT)
 PAPER (FOR PRINTERS)
 PROCESSORS, MICROFILM
 READER/PRINTER, MICROFILM/MICROFICHE
 READERS, MICROFILM/MICROFICHE
 READERS, PAPER TAPE
 RECONDITIONING EQUIPMENT, MAGNETIC TAPE
 RECORDERS, DIGITAL CASSETTE
 RECORDERS, MICROFILM/MICROFICHE
 TAPE, MAGNETIC (CASSETTE)
 TAPE, MAGNETIC (REELS)
 TAPE TRANSPORTS, MAGNETIC (DIGITAL CASSETTE)
 WINDERS, MAGNETIC TAPE

3M CO. MAGNETIC PRODUCTS DIV. 612-733-1110
3 M Ctr, St Paul, Minn 55101 TWX 910-563-3712

CANNISTERS, MAGNETIC TAPE
 DISC PACKS, MAGNETIC
 REELS, MAGNETIC TAPE
 TAPE, MAGNETIC (CASSETTE)
 TAPE, MAGNETIC (REELS)

3M CO. INSTRUMENT & DATA PRODUCTS 805-482-1911
300 So Lewis Rd, Camarillo, Cal 93010 TWX 910-336-1676

TAPE TRANSPORTS, MAGNETIC (DIGITAL-EXCL. CASSETTE)
 TAPE TRANSPORTS, MAGNETIC (DIGITAL CASSETTE)

MACNEAL-SCHWENDLER CORP., THE 213-254-3456
7442 N Figueroa St, Los Angeles, Cal 90041

COMPUTERS, SPECIAL PURPOSE
 CONSULTING (ADVANCED COMPUTER EQUIPMENT DESIGN AND FEASIBILITY
 STUDIES)
 CONSULTING (COMPUTER EVALUATIONS, SELECTIONS, INSTALLATION
 PLANNING)
 CONSULTING (SCIENTIFIC APPLICATIONS)
 CONVERTERS, DIGITAL-TO-ANALOG
 CONVERTERS, VOLTAGE-TO-FREQUENCY
 DISPLAYS, THREE-DIMENSIONAL
 MULTIPLEXERS, ANALOG-SOLID STATE (SEQUENTIAL SAMPLING)
 PROGRAMMING LANGUAGE DEVELOPMENT (CONSULTANTS)
 PROGRAMMING LANGUAGE DEVELOPMENT (CONTRACT PROGRAMMING)
 PROGRAMMING LANGUAGE DEVELOPMENT (DEDICATED APPLICATION SYSTEMS)
 PROGRAMMING LANGUAGE DEVELOPMENT (PROPRIETARY SOFTWARE
 PRODUCTS)

MACPANEL CO. ADAMS-MILLIS CORP. 919-882-8138
P O Box 5027, High Point, N C 27262

CONSOLES, COMPUTER CONTROL (WIRED)
 CORDS, PATCH
 DISC PACKS, MAGNETIC
 PLUGBOARDS, PROGRAMMING
 REELS, MAGNETIC TAPE
 TAPE, MAGNETIC (REELS)

MACRO CORP. 215-646-9510
1260 Virginia Dr, Ft Washington, Pa 19034

CONSULTING (COMPUTER EVALUATIONS, SELECTIONS, INSTALLATION
 PLANNING)
 CONSULTING (DATA COMMUNICATIONS SYSTEMS PLANNING)
 CONSULTING (MANAGEMENT INFORMATION SYSTEMS PLANNING)
 PROGRAMMING LANGUAGE DEVELOPMENT (CONSULTANTS)
 PROGRAMMING LANGUAGE DEVELOPMENT (CONTRACT PROGRAMMING)
 PROGRAMMING LANGUAGE DEVELOPMENT (DEDICATED APPLICATION SYSTEMS)
 PROGRAMMING LANGUAGE DEVELOPMENT (PROPRIETARY SOFTWARE
 PRODUCTS)
 SERVICES, PROCESSING (DIGITAL SCIENTIFIC)

MACRODATA CO. 213-882-8880
20440 Corrisco St, Chatsworth, Cal 91311

CIRCUITS, MONOLITHIC (LSI-MOS)
 MEMORY SYSTEMS, SEMICONDUCTOR (MOS)
 PROGRAMMING LANGUAGE DEVELOPMENT (PROPRIETARY SOFTWARE
 PRODUCTS)
 SERVICES, COMPUTER-AIDED DESIGN
 TESTERS, SEMICONDUCTOR

MACS COMPUTER ACCESSORIES INC 215-568-6860
104 Park Towne Pl, Philadelphia, Pa 19130

AIR CONDITIONERS (FOR EDP INSTALLATIONS)
 CABINETS AND ENCLOSURES (FOR KEYPUNCHES, PRINTERS)
 CABINETS, RACKS, VAULTS (FOR MAGNETIC TAPE STORAGE)
 CABINETS, TRAYS (FOR PUNCHED CARD STORAGE)
 CANNISTERS, MAGNETIC TAPE
 CERTIFIERS, MAGNETIC TAPE
 CLEANER/CERTIFIERS, MAGNETIC TAPE
 CLEANERS, MAGNETIC TAPE
 DEMAGNETIZERS, MAGNETIC TAPE
 DESKS, TABLES AND STANDS (FOR PROGRAMMER STATIONS)
 DISC PACKS, MAGNETIC
 ERASERS, BULK (MAGNETIC TAPE)
 FLOORING (FOR EDP ROOMS)
 FORMS, CONTINUOUS (MACHINE PROCESSED)
 FORMS HANDLING, BURSTERS
 FORMS HANDLING, CARBON DELEAVERS
 FORMS HANDLING, DECOLLATORS
 LABELS, CONTINUOUS AND GUMMED (MACHINE APPLICATION)
 LABELS, CONTINUOUS AND PRESSURE SENSITIVE (MACHINE APPLICATION)
 LEASING, EDP EQUIPMENT (OTHER THAN MFGRS)
 MAGNETIC TAPE STORAGE SYSTEMS (INCLUDES CONTROLLER)
 REELS, MAGNETIC TAPE
 RIBBONS, INK (FOR PRINTERS AND TAB EQUIPMENT)
 SAFES, MAGNETIC TAPE STORAGE
 SERVICES, MAGNETIC TAPE CERTIFICATION
 TAPE, MAGNETIC (REELS)

MADATRON CORP. 609-921-9262
P O Box 172, Princeton, N J 08540

AUDIO/VISUAL TRAINING AIDS
 DATA TERMINALS, BLOCK-BY-BLOCK (MAGNETIC TAPE)
 DATA TERMINALS, BLOCK-BY-BLOCK (MULTI-PURPOSE)
 DATA TERMINALS, BLOCK-BY-BLOCK (PAPER TAPE)
 DATA TERMINALS, BLOCK-BY-BLOCK (PUNCHED CARD)
 DATA TERMINALS, INQUIRY-RESPONSE (ALPHANUMERIC KEYBOARD)
 DATA TERMINALS, INQUIRY-RESPONSE (BADGE-TOKEN READERS)
 DATA TERMINALS, INQUIRY-RESPONSE (CRT WITH KEYBOARD)
 DATA TERMINALS, INQUIRY-RESPONSE (SPECIAL-PURPOSE)
 DISPLAYS, PANELS, VIEWGRAPHS (FOR COMPUTER TRAINING)
 MEMORY SYSTEMS, MAGNETIC DRUM

MAG-CON ENGINEERING CO. 612-633-8820
85 Richardson St SE, St Paul, Minn 55112

DEMAGNETIZERS, MAGNETIC TAPE
 ERASERS, BULK (MAGNETIC TAPE)
 POWER SUPPLIES, AC
 POWER SUPPLIES, DC
 RELAYS, SOLID-STATE (COMPUTER GRADE)
 TRANSFORMERS, POWER (COMPUTER GRADE)

MAGNAFILE INC. 602-275-3607
2602 E Magnolia, Phoenix, Ariz 85034

CONTROLLERS, MAGNETIC DISC
 DISC DRIVES, FIXED HEAD (INCLUDING CONTROLLER)
 DISC STORAGE SYSTEMS
 MEMORY SYSTEMS, MAGNETIC DISC

3 Manufacturers' Directory

MAGNECRAFT ELECTRIC CO. 5575 N Lynch Ave, Chicago, Ill 60630 RELAYS, DRY REED (COMPUTER GRADE) RELAYS, MERCURY WETTED (COMPUTER GRADE) RELAYS, SOLID-STATE (COMPUTER GRADE) TIMERS, EVENT (IMPULSE) TIMERS, INTERVAL	312-282-5500 TWX 910-221-5221	MANAGEMATICS INC. 2 Pennsylvania Plaza, New York, N Y 10001 CONSULTING (ACCOUNTING, BUSINESS AND COMMERCIAL APPLICATIONS) CONSULTING (COMPUTER EVALUATIONS, SELECTIONS, INSTALLATION PLANNING) CONSULTING (DATA COMMUNICATIONS SYSTEMS PLANNING) CONSULTING (COMPUTER PRODUCT PLANNING SURVEYS, MARKET RESEARCH STUDIES) CONSULTING (MANAGEMENT INFORMATION SYSTEMS PLANNING) CONSULTING (SCIENTIFIC APPLICATIONS) SERVICES, FACILITY MANAGEMENT SERVICES, MANAGEMENT INFORMATION SYSTEMS SERVICES, SYSTEMS ANALYSIS TRAINING INSTITUTES, COMMERCIAL COMPUTER COURSES, SEMINARS, CORRESPONDENCE COURSES TRAINING SYSTEMS, COMPUTER SERVICE	212-594-7199
MAGNETIC AIDS INC. 11 W 42nd St, New York, N Y 10036 BOARDS, VISUAL CONTROL (GRAPHIC)	212-244-4661		
MAGNETIC ARTS CORP. 1310 Industrial Ave, Escondido, Cal 92025 CONSULTING (SCIENTIFIC APPLICATIONS) POLE PIECES, FERRITE RECORDING HEADS, MAGNETIC DISC RECORDING HEADS, MAGNETIC DRUM	714-746-8386		
MAGNUSONIC DEVICES INC. 124 Duffy Ave, Hicksville, N Y 11801 RECORDING HEADS, MAGNETIC TAPE	516-938-4700		
MAI EQUIPMENT CORP. 300 E 44th St, New York, N Y 10017 ACCOUNTING MACHINES, CARD-PROGRAMMED COLLATORS, PUNCHED CARD COMPUTERS, DIGITAL (GENERAL-PURPOSE, SMALL-SCALE) COMPUTERS, DIGITAL (GENERAL-PURPOSE, MEDIUM-SCALE) COMPUTERS, DIGITAL (GENERAL-PURPOSE, LARGE SCALE) DATA TERMINALS, INQUIRY-RESPONSE (CRT WITH KEYBOARD) LEASING, EDP EQUIPMENT (OTHER THAN MFGRS) PUNCHES, CARD (OVER 100 CPM) PUNCHES, CARD (UP TO 100 CPM) REPRODUCERS, PUNCHED CARD (AUTOMATIC) SERVICES, HARDWARE MAINTENANCE SORTERS, PUNCHED CARD TAPE TRANSPORTS, MAGNETIC (DIGITAL-EXCL, CASSETTE) TAPE TRANSPORTS, MAGNETIC (WITH KEYBOARD INPUT) USED EQUIPMENT (BUYING, SELLING, LEASING) VERIFIERS, PUNCHED CARD	212-557-3500 TWX 710-581-2910		
MALCO MANUFACTURING CO. INC. 5150 W Roosevelt Rd, Chicago, Ill 60650 BUS BAR SYSTEMS CONNECTORS, PC AND IC BOARD (COMPUTER-GRADE) CONNECTORS, POWER (COMPUTER-GRADE) CONNECTORS, RACK AND PANEL (COMPUTER-GRADE) SOCKETS, IC MOUNTING	312-287-6700	MANAGEMENT COMPUTER CONTROLS INC. 3385 Airway Blvd., Memphis, Tenn 38116 CONSULTING (ACCOUNTING, BUSINESS AND COMMERCIAL APPLICATIONS) CONSULTING (MANAGEMENT INFORMATION SYSTEMS PLANNING) CONSULTING (SCIENTIFIC APPLICATIONS) SERVICES, MANAGEMENT INFORMATION SYSTEMS SERVICES, PROCESSING (COMMERCIAL EDP) SERVICES, PROCESSING (DIGITAL SCIENTIFIC)	901-332-7820
MALLORY & CO. INC., P.R. 3029 E Washington, Indianapolis, Ind 46218 CAPACITORS, COMPUTER GRADE JACKS, JACK PANELS, PLUGS, ASSEMBLIES MOTORS, SYNCHRONOUS POTENTIOMETERS, TRIM (WIRE-WOUND) SWITCHES, ROTARY SWITCHES, SNAP ACTION SWITCHES, TOGGLE (MINIATURE) TIMERS, INTERVAL	317-636-5353	MANAGEMENT CONCEPTS INC. 2 Decker Sq, Bala-Cynwyd, Pa 19004 CONSULTING (ACCOUNTING, BUSINESS AND COMMERCIAL APPLICATIONS) CONSULTING (ADVANCED COMPUTER EQUIPMENT DESIGN AND FEASIBILITY STUDIES) CONSULTING (COMPUTER PRODUCT PLANNING SURVEYS, MARKET RESEARCH STUDIES) CONSULTING (MANAGEMENT INFORMATION SYSTEMS PLANNING) SERVICES, MANAGEMENT INFORMATION SYSTEMS SERVICES, SYSTEMS ANALYSIS	215-667-1690
MALLORY CONTROLS CO. P O Box 327, Frankfort, Ind 46041 POTENTIOMETERS, TRIM (FILM) SWITCHES, ROTARY	317-654-6149 TWX 317-634-4214	MANAGEMENT DATA PROCESSING SYSTEMS P O Box 466, Warsaw, N C 28398 SERVICES, PROCESSING (COMMERCIAL EDP)	919-293-7136
MALLORY TIMERS CO. 3029 E Washington St, Indianapolis, Ind 46206 MOTORS, SYNCHRONOUS TIMERS, EVENT (IMPULSE) TIMERS, INTERVAL	317-636-5353 TWX 810-341-3243	MANAGEMENT DATA PROCESSING SYSTEMS 385 Lakeview Ave, Clifton, N J 07011 CONSULTING (ACCOUNTING, BUSINESS AND COMMERCIAL APPLICATIONS) SERVICES, FACILITY MANAGEMENT SERVICES, PROCESSING (COMMERCIAL EDP)	201-478-3400
MALT KEYBOARD DYNAMICS INC. 540 Frontage Rd, Northfield, Ill 60093 TRAINING INSTITUTES, COMMERCIAL COMPUTER COURSES, SEMINARS, CORRESPONDENCE COURSES	312-446-9480	MANAGEMENT REPORTING SERVICES INC. 5929 E 38th Ave, Denver, Colo 80207 CONSULTING (ACCOUNTING, BUSINESS AND COMMERCIAL APPLICATIONS) CONSULTING (MANAGEMENT INFORMATION SYSTEMS PLANNING) SERVICES, MANAGEMENT INFORMATION SYSTEMS SERVICES, PROCESSING (COMMERCIAL EDP)	303-333-5495
		MANAGEMENT SCIENCE AMERICA INC. 1389 Peachtree St NE, Atlanta, Ga 30309 CONSULTING (ACCOUNTING, BUSINESS AND COMMERCIAL APPLICATIONS) CONSULTING (ADVANCED COMPUTER EQUIPMENT DESIGN AND FEASIBILITY STUDIES) CONTINUED	404-892-3390

3 Manufacturers' Directory

CONSULTING (COMPUTER EVALUATIONS, SELECTIONS, INSTALLATION PLANNING)
 CONSULTING (DATA COMMUNICATIONS SYSTEMS PLANNING)
 CONSULTING (COMPUTER PRODUCT PLANNING SURVEYS, MARKET RESEARCH STUDIES)
 CONSULTING (MANAGEMENT INFORMATION SYSTEMS PLANNING)
 SERVICES, FACILITY MANAGEMENT
 SERVICES, MANAGEMENT INFORMATION SYSTEMS
 SERVICES, PROCESSING (COMMERCIAL EDP)

MANAGEMENT SCIENCE SYSTEMS INC. 301-881-0400
 1530 E Jefferson St, Rockville, Md 20852

CONSULTING (ACCOUNTING, BUSINESS AND COMMERCIAL APPLICATIONS)
 CONSULTING (MANAGEMENT INFORMATION SYSTEMS PLANNING)
 CONSULTING (SCIENTIFIC APPLICATIONS)
 PROGRAMMING LANGUAGE DEVELOPMENT (CONSULTANTS)
 PROGRAMMING LANGUAGE DEVELOPMENT (CONTRACT PROGRAMMING)
 PROGRAMMING LANGUAGE DEVELOPMENT (DEDICATED APPLICATION SYSTEMS)
 PROGRAMMING LANGUAGE DEVELOPMENT (PROPRIETARY SOFTWARE PRODUCTS)
 TRAINING INSTITUTES, COMMERCIAL COMPUTER COURSES, SEMINARS, CORRESPONDENCE COURSES

MANAGEMENT SERVICES INC. 404-636-8621
 1538 Dunex Hill Ln Ne, Atlanta, Ga 30324

SERVICES, FACILITY MANAGEMENT
 SERVICES, PROCESSING (COMMERCIAL EDP)
 SERVICES, SYSTEMS ANALYSIS

MANAGEMENT SYSTEMS CORP. 214-521-0370
 7007 Preston Rd, Dallas, Tex 75205

CONSULTING (ACCOUNTING, BUSINESS AND COMMERCIAL APPLICATIONS)
 CONSULTING (COMPUTER EVALUATIONS, SELECTIONS, INSTALLATION PLANNING)
 CONSULTING (DATA COMMUNICATIONS SYSTEMS PLANNING)
 CONSULTING (MANAGEMENT INFORMATION SYSTEMS PLANNING)
 SERVICES, FACILITY MANAGEMENT
 SERVICES, MANAGEMENT INFORMATION SYSTEMS
 SERVICES, PROCESSING (COMMERCIAL EDP)
 SERVICES, TIME SHARING (COMMERCIAL)
 SERVICES, SYSTEMS ANALYSIS

MANAGEMENT SYSTEMS INC. 703-344-6263
 420 W Campbell Ave., Roanoke, Va 24016

COMMUNICATION SYSTEMS, DATA TRANSMISSION
 SERVICES, MANAGEMENT INFORMATION SYSTEMS
 SERVICES, PROCESSING (COMMERCIAL EDP)

MANDREL INDUSTRIES ELECTRO TECHNICAL LABS DIV. 713-774-7561
 P O Box 36306, Houston, Tex 77036
 RECORDERS, GRAPHIC
 TELEX 07-7252

MANZANO LABORATORIES INC. 505-265-7511
 146 Quincy N E, Albuquerque, N M 87108

CONTROLLERS, MAGNETIC DISC
 CONTROLLERS, MAGNETIC TAPE
 DISC STORAGE SYSTEMS

MARCOM INC. 212-697-7185
 30 E 42nd St, New York, N Y 10017

CONSULTING (ACCOUNTING, BUSINESS AND COMMERCIAL APPLICATIONS)
 CONSULTING (ADVANCED COMPUTER EQUIPMENT DESIGN AND FEASIBILITY STUDIES)
 CONSULTING (COMPUTER EVALUATIONS, SELECTIONS, INSTALLATION PLANNING)
 CONSULTING (DATA COMMUNICATIONS SYSTEMS PLANNING)
 CONSULTING (COMPUTER PRODUCT PLANNING SURVEYS, MARKET RESEARCH STUDIES)
 CONSULTING (MANAGEMENT INFORMATION SYSTEMS PLANNING)
 CONSULTING (SCIENTIFIC APPLICATIONS)

MARK COMPUTER SYSTEMS INC. 516-746-5885
 One Patterson Pl, Garden City, N Y 11530

BREARDBOARDS
 CIRCUIT CARDS, LINEAR (WITH DISCRETE COMPONENTS)
 CIRCUIT CARDS, LINEAR (WITH IC'S)
 CIRCUIT CARDS, LOGIC (WITH DISCRETE COMPONENTS)
 CONTINUED

CIRCUIT CARDS, LOGIC (WITH IC'S)
 COMMUNICATION SYSTEMS, DATA TRANSMISSION
 CONSULTING (ADVANCED COMPUTER EQUIPMENT DESIGN AND FEASIBILITY STUDIES)
 CONSULTING (COMPUTER EVALUATIONS, SELECTIONS, INSTALLATION PLANNING)
 CONSULTING (DATA COMMUNICATIONS SYSTEMS PLANNING)
 CONSULTING (COMPUTER PRODUCT PLANNING SURVEYS, MARKET RESEARCH STUDIES)
 CONSULTING (MANAGEMENT INFORMATION SYSTEMS PLANNING)
 DATA TERMINALS, BLOCK-BY-BLOCK (MAGNETIC TAPE)
 DATA TERMINALS, BLOCK-BY-BLOCK (MULTI-PURPOSE)
 DATA TERMINALS, BLOCK-BY-BLOCK (PAPER TAPE)
 DATA TERMINALS, BLOCK-BY-BLOCK (HIGH SPEED PRINTER)
 DATA TERMINALS, INQUIRY-RESPONSE (ALPHANUMERIC KEYBOARD)
 DATA TERMINALS, INQUIRY-RESPONSE (AUDIO RESPONSE)
 DATA TERMINALS, INQUIRY-RESPONSE (BADGE-TOKEN READERS)
 DATA TERMINALS, INQUIRY-RESPONSE (CRT WITH KEYBOARD)
 DATA TERMINALS, INQUIRY-RESPONSE (SPECIAL-PURPOSE)
 DISC STORAGE SYSTEMS
 DISPLAYS, MAGNETIC
 GENERATORS, CHARACTER (CRT)
 MAGNETIC TAPE STORAGE SYSTEMS (INCLUDES CONTROLLER)
 MEMORY SYSTEMS, READ-ONLY
 MEMORY SYSTEMS, SEMICONDUCTOR
 MEMORY SYSTEMS, SEMICONDUCTOR (MOS)
 MODEMS, PC CARD
 PROGRAMMING LANGUAGE DEVELOPMENT (CONSULTANTS)
 PROGRAMMING LANGUAGE DEVELOPMENT (CONTRACT PROGRAMMING)
 PROGRAMMING LANGUAGE DEVELOPMENT (DEDICATED APPLICATION SYSTEMS)
 PROGRAMMING LANGUAGE DEVELOPMENT (PROPRIETARY SOFTWARE PRODUCTS)
 READOUTS, CRT

MARKEL AND SONS, L. FRANK 215-272-8960
 School Lane, Norristown, Pa 19404
 TWX 510-660-0190

CABLE, COAXIAL (FLEXIBLE)
 CABLE, COAXIAL (SEMI/RIGID)
 CABLE, MULTICONDUCTOR
 CABLE, SHIELDED (NOT COAXIAL)

MARKET DATA SYSTEMS CORP. 212-826-2966
 919 3rd Ave, New York, N Y 10022

CONSULTING (ACCOUNTING, BUSINESS AND COMMERCIAL APPLICATIONS)

MARK/OPS DIV., NORTH EASTERN SYSTEMS ASSOC. INC. 617-266-1930
 475 Commonwealth Ave, Boston, Mass 02215

ACOUSTIC COUPLERS
 CONSULTING (ACCOUNTING, BUSINESS AND COMMERCIAL APPLICATIONS)
 CONSULTING (COMPUTER EVALUATIONS, SELECTIONS, INSTALLATION PLANNING)
 CONSULTING (DATA COMMUNICATIONS SYSTEMS PLANNING)
 DATA TERMINALS, BLOCK-BY-BLOCK (MULTI-PURPOSE)
 DATA TERMINALS, BLOCK-BY-BLOCK (PAPER TAPE)
 DATA TERMINALS, BLOCK-BY-BLOCK (PLOTTER)
 DATA TERMINALS, BLOCK-BY-BLOCK (HIGH SPEED PRINTER)
 DATA TERMINALS, BLOCK-BY-BLOCK (MEDIUM SPEED PRINTER)
 DATA TERMINALS, BLOCK-BY-BLOCK (PUNCHED CARD)
 DATA TERMINALS, BLOCK-BY-BLOCK (TELEPRINTER)
 DATA TERMINALS, INQUIRY-RESPONSE (ALPHANUMERIC KEYBOARD)
 DATA TERMINALS, INQUIRY-RESPONSE (AUDIO RESPONSE)
 DATA TERMINALS, INQUIRY-RESPONSE (CRT WITH KEYBOARD)
 ENCODERS, KEYBOARD-TO-MAGNETIC TAPE
 INSTRUCTIONAL SYSTEMS, COMPUTER-BASED
 MODEMS, ACOUSTIC
 PLOTTERS, MOVING PEN (ANALOG CONTROLLER)
 PROGRAMMING LANGUAGE DEVELOPMENT (CONTRACT PROGRAMMING)
 PROGRAMMING LANGUAGE DEVELOPMENT (DEDICATED APPLICATION SYSTEMS)
 SERVICES, PROCESSING (COMMERCIAL EDP)
 SERVICES, TIME SHARING (COMMERCIAL)
 SERVICES, TIME SHARING (RESEARCH)
 TRAINING INSTITUTES, COMMERCIAL COMPUTER COURSES, SEMINARS, CORRESPONDENCE COURSES

MARQUETTA ELECTRONICS INC. 414-352-3500
 3712 W Elm St, Milwaukee, Wisc 53209

CARDS, MAGNETIC
 CARDS, MICORFILM APERTURE
 COMMUNICATION SYSTEMS, DATA TRANSMISSION
 CONVERTERS, FREQUENCY-TO-DC
 CONVERTERS, VOLTAGE-TO-FREQUENCY
 DATA ACQUISITION AND REDUCTION SYSTEMS
 MODEMS, HARD-WIRED
 MODEMS, PC CARD
 OSCILLATORS, VOLTAGE CONTROLLED

3 Manufacturers' Directory

MARSHALL DATA SYSTEMS DIV. MARSHALL INDUSTRIES 213-684-1530
2065 Huntington Dr, San Marino, Cal 91103

DISC DRIVES, MOVABLE HEAD (INCLUDING CONTROLLER)
DISC DRIVES, REMOVABLE CARTRIDGE
DISC STORAGE SYSTEMS
MEMORY SYSTEMS, MAGNETIC DISC

MASSEY DICKINSON CO. INC. 617-877-2511
9 Elm St, Saxonville, Mass 01701

CIRCUIT CARDS, LOGIC (WITH DISCRETE COMPONENTS)
COUNTERS, DECADE
COUNTERS, UP-DOWN
DATA ACQUISITION AND REDUCTION SYSTEMS
DEMONSTRATORS AND KITS, EDUCATIONAL (DIGITAL LOGIC)
INDICATORS, ELAPSED TIME
MODULES, DIGITAL LOGIC ENCAPSULATED (ALSO SEE CIRCUITS & CIRCUIT CARDS)
PROJECTORS, OPTICAL (COMPUTER CONTROLLED SLIDE SELECTING)
SCANNERS, INPUT
TIMERS, EVENT (IMPULSE)
TIMERS, INTERVAL

MAST DEVELOPMENT CO. SUB. AV ELECTRONICS INC. 319-326-0141
2212 E 12th St, Davenport, Iowa 52803

AUDIO/VISUAL TRAINING AIDS
COUNTERS, DIGITAL READOUT
PROJECTORS, OPTICAL (COMPUTER CONTROLLED SLIDE SELECTING)

MASTECH COMPUTER SYSTEMS INC. 312-622-9444
7026 W North Ave, Chicago, Ill 60635

CONSULTING (ACCOUNTING, BUSINESS AND COMMERCIAL APPLICATIONS)
CONSULTING (ADVANCED COMPUTER EQUIPMENT DESIGN AND FEASIBILITY STUDIES)
CONSULTING (COMPUTER EVALUATIONS, SELECTIONS, INSTALLATION PLANNING)
CONSULTING (DATA COMMUNICATIONS SYSTEMS PLANNING)
CONSULTING (MANAGEMENT INFORMATION SYSTEMS PLANNING)
PROGRAMMING LANGUAGE DEVELOPMENT (CONSULTANTS)
PROGRAMMING LANGUAGE DEVELOPMENT (CONTRACT PROGRAMMING)
PROGRAMMING LANGUAGE DEVELOPMENT (DEDICATED APPLICATION SYSTEMS)
PROGRAMMING LANGUAGE DEVELOPMENT (PROPRIETARY SOFTWARE PRODUCTS)
SERVICES, FACILITY MANAGEMENT
SERVICES, MANAGEMENT INFORMATION SYSTEMS
SERVICES, SYSTEMS ANALYSIS

MASTER ELECTRONIC CONTROLS 213-393-3177
1553 17 St, Santa Monica, Cal 90404

POWER SUPPLIES, AC
POWER SUPPLIES, DC
RELAYS, DRY REED (COMPUTER GRADE)
RELAYS, SOLID-STATE (COMPUTER GRADE)
TIMERS, EVENT (IMPULSE)
TIMERS, INTERVAL

MASTER SPECIALTIES CO. 714-642-2427
1640 Monrovia, Costa Mesa, Cal 92627
TELEX 67-8433

INDICATORS, ALPHANUMERIC
INDICATORS, DIGITAL
READOUTS AND DISPLAYS, NUMERIC AND ALPHANUMERIC (OTHER THAN CRT)
SWITCHES, PUSHBUTTON
SWITCHES, PUSHBUTTON (ILLUMINATED)
SWITCHES, SNAP ACTION

MASTERITE INDUSTRIES INC. 213-534-0962
2841 Lomita Blvd, Torrance, Cal 90505

CONNECTORS, MINIATURE AND SUB-MINIATURE (COMPUTER-GRADE)
CONNECTORS, PC AND IC BOARD (COMPUTER-GRADE)

MATHATRONICS OF PENNSYLVANIA INC. 617-893-1630
241 Crescent St, Waltham, Mass 02154

CALCULATORS, PROGRAMMABLE (ALSO SEE COMPUTERS)

MATHEMATICAL APPLICATIONS GROUP INC. 914-428-2350
180 S Broadway, White Plains, N Y 10605

SERVICES, COMPUTER-AIDED DESIGN
CONTINUED

SERVICES, LIST MAINTENANCE
SERVICES, MANAGEMENT INFORMATION SYSTEMS
SERVICES, PROCESSING (COMMERCIAL EDP)
SERVICES, SYSTEMS ANALYSIS

MATRIX CORP., THE 213-679-8211
931 S Douglas St, El Segundo, Cal 90245

CONSULTING (ACCOUNTING, BUSINESS AND COMMERCIAL APPLICATIONS)
CONSULTING (COMPUTER PRODUCT PLANNING SURVEYS, MARKET RESEARCH STUDIES)
CONSULTING (MANAGEMENT INFORMATION SYSTEMS PLANNING)
CONSULTING (SCIENTIFIC APPLICATIONS)
SERVICES, FACILITY MANAGEMENT
SERVICES, MANAGEMENT INFORMATION SYSTEMS
SERVICES, PROCESSING (COMMERCIAL EDP)
SERVICES, PROCESSING (DIGITAL SCIENTIFIC)
SERVICES, TIME SHARING (COMMERCIAL)
SERVICES, TIME SHARING (RESEARCH)
SERVICES, SYSTEMS ANALYSIS

MAXI SWITCH CO. 612-529-7601
3125 Washington Ave N, Minneapolis, Minn 55421

ENCODERS, KEYBOARD (ALPHANUMERIC)
ENCODERS, KEYBOARD (NUMERIC)
SWITCHES, CODE BAR
SWITCHES, DRY REED
SWITCHES, PUSHBUTTON
SWITCHES, PUSHBUTTON (ILLUMINATED)

MAXSON ELECTRONICS CORP. DIV. RIXKER MAXSON 516-362-2000
Sunrise Hwy, Great River, N Y 11739

COMMUNICATIONS-ORIENTED PROCESSORS, MULTIPLE CHANNEL CONTROLLERS
COMMUNICATION SYSTEMS, DATA TRANSMISSION
COMMUNICATION SYSTEMS, TELEPRINTER
DATA TERMINALS, BLOCK-BY-BLOCK (MAGNETIC TAPE)
DATA TERMINALS, BLOCK-BY-BLOCK (MULTI-PURPOSE)
DATA TERMINALS, BLOCK-BY-BLOCK (PAPER TAPE)
DATA TERMINALS, BLOCK-BY-BLOCK (MEDIUM SPEED PRINTER)
DATA TERMINALS, BLOCK-BY-BLOCK (TELEPRINTER)
DATA TERMINALS, INQUIRY-RESPONSE (ALPHANUMERIC KEYBOARD)
DATA TERMINALS, INQUIRY-RESPONSE (AUDIO RESPONSE)
DATA TERMINALS, INQUIRY-RESPONSE (CRT WITH KEYBOARD)
DATA TERMINALS, INQUIRY-RESPONSE (SPECIAL-PURPOSE)

MAYBERRY ELECTRONICS CO. 714-747-4940
1250 Industrial Ave, Escondido, Cal 92025

AMPLIFIERS, D.C.
AMPLIFIERS, INSTRUMENTATION
CONVERTERS, FREQUENCY-TO-DC
MODULES, LINEAR (ENCAPSULATED)

MB ELECTRONICS DIV. TEXTRON INC. 203-387-5700
781 Whalley Ave, New Haven, Conn 06515
TWX 710-465-3283

AMPLIFIERS, D.C.
AMPLIFIERS, INSTRUMENTATION
CONTROLLERS, MOTOR
CONVERTERS, ANALOG-TO-DIGITAL
CONVERTERS, DIGITAL-TO-ANALOG
MULTIPLEXER-CONVERTER (SINGLE UNIT WITH MULTIPLEXER, SAMPLE & HOLD AMPLIFIER & A-TO-D CONVERTER)
OSCILLATORS, VOLTAGE CONTROLLED
SIGNAL CONDITIONERS
TRANSDUCERS, DIGITAL

MCA TECHNOLOGY INC. UDAC DIV. 713-621-4381
P O Box 36166, Houston, Tex 77035

CONVERTERS, MAGNETIC TAPE-TO-MAGNETIC TAPE
DATA ACQUISITION AND REDUCTION SYSTEMS
DATA TERMINALS, BLOCK-BY-BLOCK (MULTI-PURPOSE)
DATA TERMINALS, BLOCK-BY-BLOCK (TELEPRINTER)
DATA TERMINALS, INQUIRY-RESPONSE (SPECIAL-PURPOSE)
MODEMS, PC CARD
RECORDERS, DIGITAL CASSETTE
RECORDING HEADS, MAGNETIC TAPE
TAPE, MAGNETIC (CASSETTE)
TAPE TRANSPORTS, MAGNETIC (DIGITAL CASSETTE)
TAPE TRANSPORTS, MAGNETIC (INCREMENTAL)
TAPE TRANSPORTS, MAGNETIC (WITH KEYBOARD INPUT)

3 Manufacturers' Directory

MCAULIFFE ASSOC. INC., JOHN INC.
1181 Broadway, New York, N Y 10001

212-889-1640

CONSULTING (ACCOUNTING, BUSINESS AND COMMERCIAL APPLICATIONS)
CONSULTING (COMPUTER EVALUATIONS, SELECTIONS, INSTALLATION PLANNING)
CONSULTING (MANAGEMENT INFORMATION SYSTEMS PLANNING)
SERVICES, MANAGEMENT INFORMATION SYSTEMS
SERVICES, PROCESSING (COMMERCIAL EDP)
SERVICES, SYSTEMS ANALYSIS

MCDILL CORP.
P O Box 98, Montgomery, Ala 36101

205-262-6401

CONSULTING (COMPUTER EVALUATIONS, SELECTIONS, INSTALLATION PLANNING)
CONSULTING (DATA COMMUNICATIONS SYSTEMS PLANNING)
CONSULTING (MANAGEMENT INFORMATION SYSTEMS PLANNING)
SERVICES, FACILITY MANAGEMENT
SERVICES, MANAGEMENT INFORMATION SYSTEMS
SERVICES, PROCESSING (COMMERCIAL EDP)
SERVICES, TIME SHARING (COMMERCIAL)
SERVICES, SYSTEMS ANALYSIS

MCDONNELL AUTOMATION CO.
500 Jefferson Bldg, Houston, Tex 27002

713-224-5921

CONSULTING (ACCOUNTING, BUSINESS AND COMMERCIAL APPLICATIONS)
CONSULTING (ADVANCED COMPUTER EQUIPMENT DESIGN AND FEASIBILITY STUDIES)
CONSULTING (COMPUTER EVALUATIONS, SELECTIONS, INSTALLATION PLANNING)
CONSULTING (DATA COMMUNICATIONS SYSTEMS PLANNING)
CONSULTING (MANAGEMENT INFORMATION SYSTEMS PLANNING)
CONSULTING (SCIENTIFIC APPLICATIONS)
SERVICES, COMPUTER-AIDED DESIGN
SERVICES, FACILITY MANAGEMENT
SERVICES, MANAGEMENT INFORMATION SYSTEMS
SERVICES, PROCESSING (COMMERCIAL EDP)
SERVICES, PROCESSING (ANALOG OR HYBRID, SCIENTIFIC)
SERVICES, PROCESSING (DIGITAL SCIENTIFIC)
SERVICES, TIME SHARING (COMMERCIAL)
SERVICES, TIME SHARING (RESEARCH)
SERVICES, SYSTEMS ANALYSIS
TRAINING INSTITUTES, COMMERCIAL COMPUTER COURSES, SEMINARS, CORRESPONDENCE COURSES

MCDONNELL AUTOMATION CO.
360 W Federal Savings, Denver, Colo 80202

303-534-6291

CONSULTING (ACCOUNTING, BUSINESS AND COMMERCIAL APPLICATIONS)
CONSULTING (MANAGEMENT INFORMATION SYSTEMS PLANNING)
CONSULTING (SCIENTIFIC APPLICATIONS)
SERVICES, FACILITY MANAGEMENT
SERVICES, MANAGEMENT INFORMATION SYSTEMS
SERVICES, PROCESSING (COMMERCIAL EDP)
SERVICES, PROCESSING (DIGITAL SCIENTIFIC)
SERVICES, TIME SHARING (COMMERCIAL)
SERVICES, TIME SHARING (RESEARCH)
SERVICES, SYSTEMS ANALYSIS

MCDONNELL AUTOMATION CO.
P O Box 516, St Louis, Mo 63166

314-232-8021
TELEX 04-4857

CONSULTING (ACCOUNTING, BUSINESS AND COMMERCIAL APPLICATIONS)
CONSULTING (ADVANCED COMPUTER EQUIPMENT DESIGN AND FEASIBILITY STUDIES)
CONSULTING (COMPUTER EVALUATIONS, SELECTIONS, INSTALLATION PLANNING)
CONSULTING (DATA COMMUNICATIONS SYSTEMS PLANNING)
CONSULTING (MANAGEMENT INFORMATION SYSTEMS PLANNING)
CONSULTING (SCIENTIFIC APPLICATIONS)
PROGRAMMING LANGUAGE DEVELOPMENT (CONSULTANTS)
PROGRAMMING LANGUAGE DEVELOPMENT (CONTRACT PROGRAMMING)
PROGRAMMING LANGUAGE DEVELOPMENT (DEDICATED APPLICATION SYSTEMS)
PROGRAMMING LANGUAGE DEVELOPMENT (PROPRIETARY SOFTWARE PRODUCTS)
SERVICES, COMPUTER-AIDED DESIGN
SERVICES, FACILITY MANAGEMENT
SERVICES, MANAGEMENT INFORMATION SYSTEMS
SERVICES, PROCESSING (COMMERCIAL EDP)
SERVICES, PROCESSING (ANALOG OR HYBRID, SCIENTIFIC)
SERVICES, PROCESSING (DIGITAL SCIENTIFIC)
SERVICES, TIME SHARING (COMMERCIAL)
SERVICES, TIME SHARING (RESEARCH)
SERVICES, SYSTEMS ANALYSIS

MCG ELECTRONICS INC.
279 Skidmore Rd, Deer Park, N Y 11729

516-586-4388

CIRCUIT CARDS, LOGIC (WITH DISCRETE COMPONENTS)
CIRCUIT CARDS, LOGIC (WITH IC'S)
CIRCUITS, HYBRID (IC AND DISCRETE-DIGITAL)
MODULES, DIGITAL LOGIC ENCAPSULATED (ALSO SEE CIRCUITS & CIRCUIT CARDS)
POWER SUPPLIES, DC
PROTECTORS, CIRCUIT AND EQUIPMENT OVERLOAD

MCGRAW-EDISON DAVEN DIV.
Grenier Field, Manchester, N H 03103

603-669-0940
TWX 710-220-1747

ATTENUATORS, DECADE DIGITAL
DELAY LINES, ELECTROMAGNETIC
SWITCHES, ROTARY
SWITCHES, THUMBWHEEL

MCLAUGHLIN ASSOC. INC., GEORGE
785 Springfield Ave, Summit, N J 07901

201-273-5464

LEASING, EDP EQUIPMENT (OTHER THAN MFGRS)
USED EQUIPMENT (BUYING, SELLING, LEASING)

MCLEAN ENGINEERING LABS.
70 Washington Rd, Princeton Jct, N J 08550

609-799-0100

BLOWERS, FANS, COOLING ASSEMBLIES
MOTORS, SYNCHRONOUS

MDC TECHNOLOGY CORP. SUB. MNGMNT. DATA CORP.
530 W St Rd, Warminster, Pa 18974

215-672-9220

CONSULTING (SCIENTIFIC APPLICATIONS)
COUNTERS, DIGITAL READOUT
SERVICES, COMPUTER-AIDED DESIGN
SERVICES, PROCESSING (ANALOG OR HYBRID, SCIENTIFIC)
SERVICES, SYSTEMS ANALYSIS

MEASUREMENT SYSTEMS INC.
523 West Ave, Norwalk, Conn 06850

203-838-5561

CONTROLLERS, MOTOR
CONTROLLERS, PLOTTING
CONVERTERS, ANALOG-TO-DIGITAL
COUNTERS, UP-DOWN
CURVE TRACERS-DIGITIZERS, MANUAL
DIGITIZERS, PROGRAMMABLE
TRANSDUCERS, DIGITAL

MECHANICAL ENTERPRISES INC.
5249 Duke St, Alexandria, Va 22304

703-751-3030
TWX 710-832-9810

ENCODERS, KEYBOARD (ALPHANUMERIC)
ENCODERS, KEYBOARD (NUMERIC)

MEGASYSTEMS INC.
1 Bala Ave, Bala-Cynwyd, Pa 19004

215-667-1700

PROGRAMMING LANGUAGE DEVELOPMENT (CONTRACT PROGRAMMING)
PROGRAMMING LANGUAGE DEVELOPMENT (PROPRIETARY SOFTWARE PRODUCTS)
SERVICES, TIME SHARING (COMMERCIAL)
SERVICES, TIME SHARING (RESEARCH)

MEGASYSTEMS INC.
640 W 40th St, New York, N Y 10018

212-594-2500

PROGRAMMING LANGUAGE DEVELOPMENT (CONTRACT PROGRAMMING)
SERVICES, FACILITY MANAGEMENT
SERVICES, TIME SHARING (COMMERCIAL)
SERVICES, TIME SHARING (RESEARCH)

MEIER ASSOCIATES
46 White Birch Rd, Ridgefield, Conn 06877

203-438-8324

CONSULTING (DATA COMMUNICATIONS SYSTEMS PLANNING)
CONSULTING (SCIENTIFIC APPLICATIONS)
DATA ACQUISITION AND REDUCTION SYSTEMS

3 Manufacturers' Directory

- MEKONTROL INC.** 617-393-2451
 56 Hudson St, Northboro, Mass 01532
 TELEX 92-0437
 COUNTERS, DECADE
 COUNTERS, DIGITAL READOUT
 COUNTERS, UP-DOWN
 MARK SENSING EQUIPMENT
 TIMERS, EVENT (IMPULSE)
- MELPAR DIV. LTV ELECTROSYSTEMS INC.** 703-560-5000
 7700 Arlington Blvd, Falls Church, Va 22046
 TWX 710-831-9802
 CONSULTING (COMPUTER EVALUATIONS, SELECTIONS, INSTALLATION
 PLANNING)
 CONSULTING (DATA COMMUNICATIONS SYSTEMS PLANNING)
 CONSULTING (SCIENTIFIC APPLICATIONS)
 PROGRAMMING LANGUAGE DEVELOPMENT (CONTRACT PROGRAMMING)
 SERVICES, COMPUTER-AIDED DESIGN
 SERVICES, PROCESSING (ANALOG OR HYBRID, SCIENTIFIC)
 SERVICES, PROCESSING (DIGITAL SCIENTIFIC)
 SERVICES, TIME SHARING (COMMERCIAL)
 SERVICES, SYSTEMS ANALYSIS
 TRAINING INSTITUTES, COMMERCIAL COMPUTER COURSES, SEMINARS,
 CORRESPONDENCE COURSES
- MEMOREX EQUIPMENT GROUP** 408-987-1000
 San Tomas At Central, Santa Clara, Cal 95052
 CONTROLLERS, MAGNETIC DISC
 CONTROLLERS, MODEM
 DATA TERMINALS, BLOCK-BY-BLOCK (MEDIUM SPEED PRINTER)
 DATA TERMINALS, INQUIRY-RESPONSE (ALPHANUMERIC KEYBOARD)
 DISC DRIVES, MOVABLE HEAD (INCLUDING CONTROLLER)
 DISC STORAGE SYSTEMS
 MODEMS, HARD-WIRED
 MODEMS, PC CARD
 PRINTERS, MICROFILM/MICROFICHE
 PROCESSORS, MICROFILM
 READER/PRINTER, MICROFILM/MICROFICHE
 READERS, MICROFILM/MICROFICHE
- MEMORY SYSTEMS INC.** 213-772-4229
 3341 W El Segundo Bld, Hawthorne, Cal 90250
 MEMORY PLANES AND STACKS, PLATED WIRE (W/O ELECTRONICS)
 MEMORY SYSTEMS, PLATED WIRE
 MEMORY SYSTEMS, READ-ONLY
 PLATED WIRE
- MEMORY TECHNOLOGY INC.** 617-891-8465
 83 Boston Post Rd, Sudbury, Mass 01776
 CONTROLLERS, MAGNETIC DISC
 CONTROLLERS, PLOTTING
 MEMORY PLANES AND STACKS, MAG-NETIC CORE (W/O ELECTRONICS)
 MEMORY SYSTEMS, DIODE
 MEMORY SYSTEMS, MAGNETIC CORE
 MEMORY SYSTEMS, READ-ONLY
 MEMORY SYSTEMS, SEMICONDUCTOR
 MEMORY SYSTEMS, SEMICONDUCTOR (MOS)
- MEMPHIS METHODS & TABULATING SERVICE INC.** 901-527-4913
 56 N Main St, Memphis, Tenn 38103
 CONSULTING (ACCOUNTING, BUSINESS AND COMMERCIAL APPLICATIONS)
 CONSULTING (ADVANCED COMPUTER EQUIPMENT DESIGN AND FEASIBILITY
 STUDIES)
 CONSULTING (SCIENTIFIC APPLICATIONS)
 SERVICES, PROCESSING (COMMERCIAL EDP)
 TRAINING INSTITUTES, COMMERCIAL COMPUTER COURSES, SEMINARS,
 CORRESPONDENCE COURSES
- MEPCO INC.** 201-539-2000
 Columbia Rd, Morristown, N J 07960
 TWX 710-986-7437
 CIRCUITS, HYBRID (IC AND DISCRETE-DIGITAL)
 CIRCUITS, THICK FILM (DIGITAL)
 CONNECTORS, PC AND IC BOARD (COMPUTER-GRADE)
- MERIX CHEMICAL CO.** 312-221-8242
 2234 E 75th St, Chicago, Ill 60649
 CLEANER/CERTIFIERS, MAGNETIC TAPE
 CLEANERS, MAGNETIC TAPE
 CLEANERS, MAGNETIC TAPE HEADS
 COATINGS, ANTI-STATIC
 FLOORING (FOR EDP ROOMS)
 FLOOR PLANNING AIDS (FOR EDP ROOMS)
- MESUR-MATIC ELECTRONICS CORP.** 603-456-2285
 Church St, Warner, N H 03278
 CIRCUIT CARDS, LOGIC (WITH DISCRETE COMPONENTS)
 CIRCUIT CARDS, LOGIC (WITH IC'S)
 CIRCUITS, HYBRID (IC AND DISCRETE-DIGITAL)
 MOTORS, STEPPING
- META-LANGUAGE PRODUCTS INC.** 212-869-1160
 4 E 43 St, New York, N Y 10017
 CONSULTING (MANAGEMENT INFORMATION SYSTEMS PLANNING)
 PROGRAMMING LANGUAGE DEVELOPMENT (PROPRIETARY SOFTWARE
 PRODUCTS)
 SERVICES, MANAGEMENT INFORMATION SYSTEMS
- METHODE ELECTRONICS INC.** 312-867-9600
 7447 W Wilson Ave, Chicago, Ill 60656
 TWX 910-221-2468
 BREADBOARDS
 BUS BAR SYSTEMS
 CABINETS AND ENCLOSURES (FOR KEYPUNCHES, PRINTERS)
 CABINETS, ENCLOSURES, CONSOLES, ELECTRONIC (FOR GENERAL EQUIPMENT)
 CABLE ASSEMBLIES (WITH CONNECTORS)
 CABLE, FINE LEAD
 CABLE, FLAT, PRINTED AND RIBBON
 CIRCUIT CARDS, LINEAR (WITH DISCRETE COMPONENTS)
 CIRCUIT CARDS, LINEAR (WITH IC'S)
 CIRCUIT CARDS, LOGIC (WITH DISCRETE COMPONENTS)
 CIRCUIT CARDS, LOGIC (WITH IC'S)
 CONNECTORS, PC AND IC BOARD (COMPUTER-GRADE)
 CONNECTORS, POWER (COMPUTER-GRADE)
 CONNECTORS, RACK AND PANEL (COMPUTER-GRADE)
 HANDLES, TEST POINT STRIPS (FOR CIRCUIT CARDS)
 JACKS, JACK PANELS, PLUGS, ASSEMBLIES
 PANELS, POWER DISTRIBUTION
 SOCKETS, IC MOUNTING
 SOCKETS, PCB MOUNTING
 SOCKETS, SEMICONDUCTOR MOUNTING
 SWITCHES, PUSHBUTTON
- METHODS RESEARCH CORP.** 212-442-4900
 105 Willow Ave, Staten Island, N Y 10305
 BOARDS, VISUAL CONTROL (GRAPHIC)
- METRA INSTRUMENTS INC.** 415-961-7249
 1340 Space Park Way, Mt View, Cal 94040
 AMPLIFIERS, INSTRUMENTATION
 CONSOLES, CRT (ALPHANUMERIC AND GRAPHIC)
 CONSOLES, CRT (GRAPHIC)
 DATA ACQUISITION AND REDUCTION SYSTEMS
 MEMORY SYSTEMS, SEMICONDUCTOR (MOS)
 MULTIPLEXERS, ANALOG-RELAY (SEQUENTIAL SAMPLING)
 MULTIPLEXERS, ANALOG-SOLID STATE (SEQUENTIAL SAMPLING)
 MULTIPLEXERS, DIGITAL
 READOUTS, CRT
- METRIC ENGINEERING DIV. GREENRAY INDUS. INC** 717-766-0741
 P O Box 290, Mechanicsburg, Pa 17055
 REGULATORS, VOLTAGE
- METRIC SYSTEMS CORP.** 904-242-2111
 736 N Beal St, Ft Walton Beach, Fla 32548
 BOARDS, PRINTED CIRCUIT (WITHOUT COMPONENTS)
 CIRCUIT CARDS, LINEAR (WITH DISCRETE COMPONENTS)
 CIRCUIT CARDS, LINEAR (WITH IC'S)
 CIRCUIT CARDS, LOGIC (WITH DISCRETE COMPONENTS)
 CIRCUIT CARDS, LOGIC (WITH IC'S)
 CIRCUITS, HYBRID (IC AND DISCRETE-DIGITAL)
 CIRCUITS, MONOLITHIC (DIGITAL LOGIC)
 CIRCUITS, MONOLITHIC (DIODE MATRICES)
 CIRCUITS, MONOLITHIC (LINEAR-EXCL. OP AMPS)
 CIRCUITS, MONOLITHIC (LSI-BIPOLAR)
 CLOCKS, DIGITAL (REAL-TIME)
 COMMUNICATION SYSTEMS, DATA TRANSMISSION
 CONTROLLERS, MODEM
 CONVERTERS, BINARY-TO-DECIMAL
 CONVERTERS, DIGITAL-TO-ANALOG
 CONVERTERS, DIGITAL-TO-SYNCHRO
 CONVERTERS, DOCUMENT-TO-MAGNETIC TAPE
 CONVERTERS, SYNCHRO-TO-DIGITAL
 COUNTERS, UP-DOWN
 INDICATORS, ELAPSED TIME
 CONTINUED

3 Manufacturers' Directory

SCANNERS, INPUT
TIMERS, EVENT (IMPULSE)
TIMERS, INTERVAL

METRADATA COMPUTING INC. 502-361-7161
6600 Grade Lane, Louisville, Ky 40221

CONSULTING (ACCOUNTING, BUSINESS AND COMMERCIAL APPLICATIONS)
CONSULTING (ADVANCED COMPUTER EQUIPMENT DESIGN AND FEASIBILITY STUDIES)
CONSULTING (COMPUTER EVALUATIONS, SELECTIONS, INSTALLATION PLANNING)
CONSULTING (DATA COMMUNICATIONS SYSTEMS PLANNING)
CONSULTING (MANAGEMENT INFORMATION SYSTEMS PLANNING)
CONSULTING (SCIENTIFIC APPLICATIONS)
SERVICES, FACILITY MANAGEMENT
SERVICES, MANAGEMENT INFORMATION SYSTEMS
SERVICES, PROCESSING (COMMERCIAL EDP)
SERVICES, TIME SHARING (COMMERCIAL)
SERVICES, TIME SHARING (RESEARCH)
TRAINING INSTITUTES, COMMERCIAL COMPUTER COURSES, SEMINARS, CORRESPONDENCE COURSES

METROLOGICAL DATA CORP. 201-772-6720
70 Plauderville Ave, Garfield, N J 07026

ENCODERS, DIGITAL
ENCODERS, SHAFT ANGLE
TRANSDUCERS, DIGITAL

METROPROCESSING CORP. OF AMERICA 914-969-0890
64 Prospect St, White Plains, N Y 10606

ACOUSTIC COUPLERS
CONSULTING (DATA COMMUNICATIONS SYSTEMS PLANNING)
DATA TERMINALS, INQUIRY-RESPONSE (AUDIO RESPONSE)
DATA TERMINALS, INQUIRY-RESPONSE (PORTABLE)
PROGRAMMING LANGUAGE DEVELOPMENT (CONSULTANTS)

MICA CORP. 213-870-6861
4031 Elenda St, Culver City, Cal 90230 TWX 910-340-6365
BOARDS, PRINTED CIRCUIT (WITHOUT COMPONENTS)

MICHAEL BUSINESS MACHINES CORP. 212-582-2900
145 W 45th St, New York, N Y 10036

FORMS HANDLING, COLLATORS
PERFORATORS, DOCUMENT

MICHIANA LEASING CORP. 219-288-1431
1814 S Main St, S Bend, Ind 46613

CONSULTING (ACCOUNTING, BUSINESS AND COMMERCIAL APPLICATIONS)
CONSULTING (COMPUTER EVALUATIONS, SELECTIONS, INSTALLATION PLANNING)
SERVICES, FACILITY MANAGEMENT
SERVICES, PROCESSING (COMMERCIAL EDP)
SERVICES, SYSTEMS ANALYSIS
TRAINING INSTITUTES, COMMERCIAL COMPUTER COURSES, SEMINARS, CORRESPONDENCE COURSES
USED EQUIPMENT (BUYING, SELLING, LEASING)

MICHIGAN MAGNETICS DIV. VSI CORP. 517-726-0590
203 W Third St, Vermontville, Mich 49096

RECORDING HEADS, MAGNETIC DISC
RECORDING HEADS, MAGNETIC DRUM
RECORDING HEADS, MAGNETIC TAPE

MICRO DESIGN INC. 414-673-3920
235 S Johnson St, Hartford, Wisc 53027

READERS, MICROFILM/MICROFICHE

MICRO INSTRUMENT CO. 213-772-1275
12901 Crenshaw Blvd, Hawthorne, Cal 90250 TWX 910-325-6631

ANALYZERS, PULSE HEIGHT
VOLTMETERS, AC, DC, DIFFERENTIAL
VOLTMETERS, DIGITAL
VOLTMETERS, PRINTING

MICRO METRICS INC. 201-478-8440
253 Crooks Ave, Clifton, N J 07011

ANALYZERS, CONTINUITY
CABLE ASSEMBLIES (WITH CONNECTORS)
COUNTERS, DECADE
TESTERS, CIRCUIT
TESTERS, DIGITAL LOGIC MODULES AND CARDS
TESTERS, INTEGRATED CIRCUIT
VOLTAGE DIVIDERS

MICRO SWITCH DIV. HONEYWELL INC. 815-232-1122
11 W Spring St, Freeport, Ill 61032 TWX 910-642-0922

ENCODERS, KEYBOARD (ALPHANUMERIC)
ENCODERS, KEYBOARD (NUMERIC)
ENCODERS, KEYBOARD-TO-MAGNETIC DISC
ENCODERS, KEYBOARD-TO-MAGNETIC TAPE
ENCODERS, KEYBOARD-TO-PRINTED TAPE
MOTORS, SERVO
MOTORS, STEPPING
SWITCHES, PUSHBUTTON
SWITCHES, PUSHBUTTON (ILLUMINATED)
SWITCHES, ROTARY
SWITCHES, SNAP ACTION
SWITCHES, TOGGLE (MINIATURE)
TYPEWRITERS, COMPUTER INPUT-OUTPUT

MICRO SYSTEMS INC. 714-540-6730
644 E Young St, Santa Ana, Cal 92705 TWX 910-595-1764

CABLE ASSEMBLIES (WITH CONNECTORS)
CABLE, FLAT, PRINTED AND RIBBON
CIRCUIT CARDS, LOGIC (WITH IC'S)
COMMUNICATIONS-ORIENTED PROCESSORS, MULTIPLE CHANNEL CONTROLLERS
COMMUNICATIONS-ORIENTED PROCESSORS, SINGLE CHANNEL CONTROLLERS
COMMUNICATIONS-ORIENTED PROCESSORS, STORED PROGRAM
COMMUNICATION SYSTEMS, DATA TRANSMISSION
COMMUNICATION SYSTEMS, TELEPRINTER
COMPUTERS, DIGITAL (EDUCATIONAL)
COMPUTERS, DIGITAL (GENERAL-PURPOSE, SMALL-SCALE)
COMPUTERS, MINI GENERAL PURPOSE (ALSO SEE CALCULATORS)
COMPUTERS, PROCESS CONTROL
CONSULTING (ACCOUNTING, BUSINESS AND COMMERCIAL APPLICATIONS)
CONSULTING (ADVANCED COMPUTER EQUIPMENT DESIGN AND FEASIBILITY STUDIES)
CONSULTING (COMPUTER EVALUATIONS, SELECTIONS, INSTALLATION PLANNING)
CONSULTING (DATA COMMUNICATIONS SYSTEMS PLANNING)
CONSULTING (MANAGEMENT INFORMATION SYSTEMS PLANNING)
CONSULTING (SCIENTIFIC APPLICATIONS)
CONTROLLERS, MAGNETIC DISC
CONTROLLERS, MODEM
CORES, FERRITE MEMORY
DATA CONCENTRATORS
DATA TERMINALS, INQUIRY-RESPONSE (SPECIAL-PURPOSE)
DISC DRIVES, FIXED HEAD (INCLUDING CONTROLLER)
DISC DRIVES, MOVABLE HEAD (INCLUDING CONTROLLER)
DISC STORAGE SYSTEMS
DRUM STORAGE EQUIPMENT, MAGNETIC (INCLUDING CONTROLLER)
INSTRUCTIONAL SYSTEMS, COMPUTER-BASED
MEMORY SYSTEMS, DIODE
MEMORY SYSTEMS, MAGNETIC CORE
MEMORY SYSTEMS, MAGNETIC DISC
MEMORY SYSTEMS, MAGNETIC DRUM
MEMORY SYSTEMS, READ-ONLY
MODEMS, PC CARD
MULTIPLEXERS, DIGITAL
PRINTER/PUNCH, PAPER TAPE
PROGRAMMING LANGUAGE DEVELOPMENT (CONSULTANTS)
PROGRAMMING LANGUAGE DEVELOPMENT (CONTRACT PROGRAMMING)
PROGRAMMING LANGUAGE DEVELOPMENT (DEDICATED APPLICATION SYSTEMS)
PROGRAMMING LANGUAGE DEVELOPMENT (PROPRIETARY SOFTWARE PRODUCTS)
PUNCHES, PAPER TAPE
READERS, PAPER TAPE
READERS, PUNCHED CARD (UP TO 100 CPM)
READERS, PUNCHED CARD (100 TO 300 CPM)
TEST SYSTEMS, COMPUTER PERFORMANCE
TESTERS, CIRCUIT
TESTERS, DIGITAL LOGIC MODULES AND CARDS
TESTERS, MEMORY PLANES, STACKS AND SYSTEMS
TRAINING SYSTEMS, COMPUTER SERVICE

MICRODATA CORP. 714-540-6730
644 E Young St, Santa Ana, Cal 92705 TWX 910-595-1764

BOARDS, PRINTED CIRCUIT (WITHOUT COMPONENTS)
BREADBOARDS
CABLE ASSEMBLIES (WITH CONNECTORS)
CABLE, FLAT, PRINTED AND RIBBON
CABLE, MULTICONDUCTOR
CONTINUED

3 Manufacturers' Directory

COMMUNICATIONS-ORIENTED PROCESSORS, MULTIPLE CHANNEL CONTROLLERS
 COMMUNICATIONS-ORIENTED PROCESSORS, SINGLE CHANNEL CONTROLLERS
 COMMUNICATIONS-ORIENTED PROCESSORS, STORED PROGRAM
 COMMUNICATION SYSTEMS, DATA TRANSMISSION
 COMMUNICATION SYSTEMS, TELEPRINTER
 COMPUTERS, DIGITAL (GENERAL-PURPOSE, SMALL-SCALE)
 COMPUTERS, DIGITAL (GENERAL-PURPOSE, MEDIUM-SCALE)
 COMPUTERS, MINI GENERAL PURPOSE (ALSO SEE CALCULATORS)
 CONTROLLERS, MAGNETIC DISC
 CONTROLLERS, MODEM
 DATA CONCENTRATORS
 DATA TERMINALS, BLOCK-BY-BLOCK (MAGNETIC TAPE)
 DATA TERMINALS, BLOCK-BY-BLOCK (MULTI-PURPOSE)
 DATA TERMINALS, BLOCK-BY-BLOCK (PAPER TAPE)
 DATA TERMINALS, BLOCK-BY-BLOCK (HIGH SPEED PRINTER)
 DATA TERMINALS, BLOCK-BY-BLOCK (MEDIUM SPEED PRINTER)
 DATA TERMINALS, BLOCK-BY-BLOCK (TELEPRINTER)
 DATA TERMINALS, INQUIRY-RESPONSE (ALPHANUMERIC KEYBOARD)
 DATA TERMINALS, INQUIRY-RESPONSE (CRT WITH KEYBOARD)
 DISC DRIVES, FIXED HEAD (INCLUDING CONTROLLER)
 DISC DRIVES, MOVABLE HEAD (INCLUDING CONTROLLER)
 FORMATTERS, MAGNETIC TAPE
 MAGNETIC TAPE STORAGE SYSTEMS (INCLUDES CONTROLLER)
 MEMORY SYSTEMS, DIODE
 MEMORY SYSTEMS, MAGNETIC CORE
 MEMORY SYSTEMS, MAGNETIC DISC
 MEMORY SYSTEMS, READ-ONLY
 MEMORY SYSTEMS, SEMICONDUCTOR
 MEMORY SYSTEMS, SEMICONDUCTOR (MOS)
 MODEMS, ACOUSTIC
 MODEMS, HARD-WIRED
 MODEMS, PC CARD
 MULTIPLEXERS, DIGITAL
 PERFORATORS, PAPER TAPE
 POWER SUPPLIES, DC
 PRINTER/PUNCH, PAPER TAPE
 PRINTERS, KEYBOARD
 PRINTERS, LINE (LOW & MEDIUM SPEED)
 PUNCHES, PAPER TAPE
 READERS, PAPER TAPE
 SCANNERS, INPUT
 SOCKETS, IC MOUNTING
 SOCKETS, PCB MOUNTING
 TAPE TRANSPORTS, MAGNETIC (DIGITAL-EXCL. CASSETTE)
 TAPE TRANSPORTS, MAGNETIC (DIGITAL CASSETTE)

MICRODOT INC. CONNECTOR & CABLE DIV. 213-682-3351
 220 Pasadena Ave, S Pasadena, Cal 91030 TWX 910-588-3768

AMPLIFIERS, D.C.
 CABLE ASSEMBLIES (WITH CONNECTORS)
 CABLE, COAXIAL (FLEXIBLE)
 CABLE, COAXIAL (SEMI/RIGID)
 CABLE, MULTICONDUCTOR
 CONNECTORS, COAXIAL (COMPUTER-GRADE)
 CONNECTORS, MINIATURE AND SUB-MINIATURE (COMPUTER-GRADE)
 CONNECTORS, PC AND IC BOARD (COMPUTER-GRADE)
 CONNECTORS, POWER (COMPUTER-GRADE)
 CONNECTORS, RACK AND PANEL (COMPUTER-GRADE)
 CONVERTERS, FREQUENCY-TO-DC
 JACKS, JACK PANELS, PLUGS, ASSEMBLIES

MICRODYNE INC. SUB.BODINE ELEC.CO. 312-774-9022
 1600 S Micks Rd, Rolling Meadows, Ill 60008

DATA TERMINALS, BLOCK-BY-BLOCK (MAGNETIC TAPE)
 DATA TERMINALS, INQUIRY-RESPONSE (ALPHANUMERIC KEYBOARD)
 ENCODERS, KEYBOARD-TO-MAGNETIC TAPE
 RECORDERS, DIGITAL CASSETTE
 TAPE TRANSPORTS, MAGNETIC (DIGITAL CASSETTE)
 TAPE TRANSPORTS, MAGNETIC (WITH KEYBOARD INPUT)
 TYPEWRITERS, COMPUTER INPUT-OUTPUT

MICROFORM DATA SYSTEMS INC. 415-964-4635
 830 Maude Ave, Mountain View, Cal 94040

CONSOLES, CRT (ALPHANUMERIC AND GRAPHIC)
 CONSULTING (MANAGEMENT INFORMATION SYSTEMS PLANNING)
 DATA RETRIEVAL SYSTEMS, MICRO-FILM (COMPUTER-CONTROLLED)
 MICROFILM DATA RETRIEVAL SYSTEMS, COMPUTER CONTROLLED
 MICROFILM DATA RETRIEVAL SYSTEMS, COMPUTER CONTROLLED (GRAPHIC)
 READER/PRINTER, MICROFILM/MICROFICHE
 READERS, MICROFILM/MICROFICHE
 RECORDERS, HARD-COPY (WITH CRT)
 RECORDERS, MICROFILM/MICROFICHE

MICROMATON SYSTEMS INC. 301-772-1700
 3610 East St, Landover, Md 20785

CONSULTING (MANAGEMENT INFORMATION SYSTEMS PLANNING)
 CONTINUED

SERVICES, FACILITY MANAGEMENT
 SERVICES, MANAGEMENT INFORMATION SYSTEMS

MICRONETICS INC. 914-338-0333
 Rte 28, W Hurley, N Y 12491

POLE PIECES, FERRITE

MICROSEAL CORP. 312-328-7100
 2222 Main St, Evanston, Ill 60204

MICROFILM DATA RETRIEVAL SYSTEMS, APERTURE CARDS
 MICROFILM DATA RETRIEVAL SYSTEMS, COMPUTER CONTROLLED
 READERS, MICROFILM/MICROFICHE

MICROSONICS DIV. SANGAMO ELECTRIC CO 617-337-4200
 60 Winter St, Weymouth, Mass 02188

DELAY LINES, GLASS (ALSO SEE MEMORIES)
 DELAY LINES, MAGNETOSTRICTIVE (ALSO SEE MEMORIES)
 MEMORY SYSTEMS, DELAY LINE
 MODULES, MEMORY (ENCAPSULATED)

MICROSYSTEMS TECHNOLOGY CORP. 617-272-5517
 55 B St, Burlington, Mass 01803

SERVICES, AUTOMATED WIRE-WRAPPING

MICROTEK DIV. OF SPACETAC 617-275-1040
 Rte 62 Burlington Rd, Bedford, Mass 01730 TWX 710-326-7567

CIRCUITS, THICK FILM (DIGITAL)
 MODULES, RESISTANCE NETWORKS (ENCAPSULATED)
 VOLTAGE DIVIDERS

MICROTRAN COMPANY INC. 516-561-6050
 145 E Mineola Ave, Valley Stream, N Y 11582 TWX 510-225-8412

CONVERTERS, DC-TO-FREQUENCY
 DEMAGNETIZERS, MAGNETIC TAPE
 ERASERS, BULK (MAGNETIC TAPE)
 INVERTERS, DC-AC
 MODEMS, ACOUSTIC
 POWER SUPPLIES, AC
 POWER SUPPLIES, DC
 TRANSFORMERS, POWER (COMPUTER GRADE)
 TRANSFORMERS, PULSE (COMPUTER GRADE)

MICROWAVE MAGNETICS INC. MMI INSTRUMENT DIV. 617-774-1072
 Rte 1, Danvers, Mass 01923

CLOCKS, DIGITAL (REAL-TIME)
 COMMUNICATION SYSTEMS, DATA TRANSMISSION
 CONSULTING (SCIENTIFIC APPLICATIONS)
 CONVERTERS, ANALOG-TO-DIGITAL
 DATA ACQUISITION AND REDUCTION SYSTEMS
 MULTIPLEXER-CONVERTER (SINGLE UNIT WITH MULTIPLEXER, SAMPLE & HOLD
 AMPLIFIER & A-TO-D CONVERTER)
 MULTIPLEXERS, DIGITAL
 SERVICES, TIME SHARING (COMMERCIAL)
 SERVICES, TIME SHARING (RESEARCH)

MIDEASTERN INDUSTRIES, INC. DIV. EANCO INC. 201-233-5900
 P O Box 186, Scotch Plains, N J 07076 TWX 510-665-6752

INVERTERS, DC-AC
 POWER SUPPLIES, AC
 POWER SUPPLIES, DC
 REGULATORS, CURRENT
 REGULATORS, FREQUENCY

MILGO ELECTRONIC CORP. 305-691-1220
 7620 NW 36th Ave, Miami, Fla 33147 TWX 810-848-6588

COMMUNICATION SYSTEMS, DATA TRANSMISSION
 COMMUNICATION SYSTEMS, FACSIMILE
 COMMUNICATION SYSTEMS, TELEPRINTER
 CONSULTING (DATA COMMUNICATIONS SYSTEMS PLANNING)
 CONTROLLERS, MODEM
 MODEMS, HARD-WIRED
 MODEMS, PC CARD
 MULTIPLEXERS, TIME DIVISION
 PLOTTERS, MOVING PEN (ANALOG CONTROLLER)
 PLOTTERS, MOVING PEN (DIGITAL CONTROLLER)
 TESTERS, DIGITAL DATA TRANSMISSION

3 Manufacturers' Directory

MILLETRON INC.

540 Alpha Dr, Pittsburgh, Pa 15238

412-781-5300

AMPLIFIERS, D.C.
AMPLIFIERS, INSTRUMENTATION
AMPLIFIERS, OPERATIONAL
CABLE, MULTICONDUCTOR
CABLE, SHIELDED (NOT COAXIAL)
CELLS, PHOTOCONDUCTIVE
CIRCUIT CARDS, LINEAR (WITH DISCRETE COMPONENTS)
CIRCUIT CARDS, LINEAR (WITH IC'S)
CIRCUIT CARDS, LOGIC (WITH DISCRETE COMPONENTS)
CIRCUIT CARDS, LOGIC (WITH IC'S)
CIRCUITS, HYBRID (IC AND DISCRETE-DIGITAL)
CONTROLLERS, MOTOR
CONVERTERS, ANALOG-TO-DIGITAL
CONVERTERS, DIGITAL-TO-ANALOG
COUNTERS, DECADE
MOTORS, SYNCHRONOUS
SERVICES, PROCESSING (ANALOG OR HYBRID, SCIENTIFIC)
VOLTMETERS, DIGITAL

MILNEE BROTHERS PRODUCTS

8000 Blackburn Ave, Los Angeles, Cal 90048

213-936-4919

CONSULTING (ACCOUNTING, BUSINESS AND COMMERCIAL APPLICATIONS)
CONSULTING (COMPUTER EVALUATIONS, SELECTIONS, INSTALLATION PLANNING)
CONSULTING (DATA COMMUNICATIONS SYSTEMS PLANNING)
CONSULTING (COMPUTER PRODUCT PLANNING SURVEYS, MARKET RESEARCH STUDIES)
CONSULTING (MANAGEMENT INFORMATION SYSTEMS PLANNING)
CONSULTING (SCIENTIFIC APPLICATIONS)
PROGRAMMING LANGUAGE DEVELOPMENT (CONSULTANTS)
PROGRAMMING LANGUAGE DEVELOPMENT (CONTRACT PROGRAMMING)
PROGRAMMING LANGUAGE DEVELOPMENT (DEDICATED APPLICATION SYSTEMS)
PROGRAMMING LANGUAGE DEVELOPMENT (PROPRIETARY SOFTWARE PRODUCTS)
SERVICES, FACILITY MANAGEMENT
SERVICES, MANAGEMENT INFORMATION SYSTEMS
SERVICES, PROCESSING (COMMERCIAL EDP)
SERVICES, TIME SHARING (COMMERCIAL)
SERVICES, SYSTEMS ANALYSIS

MINELCO, SUB. GENERAL TIME CORP.

600 South St, Holbrook, Mass 02343

617-963-7716
TWX 710-348-0451

POTENTIOMETERS, TRIM (FILM)
POTENTIOMETERS, TRIM (WIRE-WOUND)
SWITCHES, ROTARY
TEST SYSTEMS, COMPUTER PERFORMANCE

MINNESOTA ELECTRIC TECHNOLOGY INC.

304 Main N, Winnebago, Minn 56098

507-893-3181

BLOWERS, FANS, COOLING ASSEMBLIES

MINNETECH LABS INC.

8115 10th Ave N, Minneapolis, Minn 55427

612-544-4431

TESTERS, MAGNETIC TAPE (CASSETTE)
TESTERS, MEMORY PLANES, STACKS AND SYSTEMS

MINONICS INC.

2993 Los Feliz Dr, Thousand Oaks, Cal 91360

805-495-6618

VOLTMETERS, DIGITAL

MITE CORP. DATA EQUIPMENT DIV.

446 Blake St, New Haven, Conn 06514

203-387-2572

COMMUNICATION SYSTEMS, TELEPRINTER
DATA TERMINALS, INQUIRY-RESPONSE (ALPHANUMERIC KEYBOARD)
PRINTERS, DIGITAL STRIP RECORDING
PRINTERS, KEYBOARD

MNEMOTECH COMPUTER SYSTEMS

55 Liberty St, New York, N Y 10005

212-267-8762

CONSULTING (ACCOUNTING, BUSINESS AND COMMERCIAL APPLICATIONS)
CONSULTING (ADVANCED COMPUTER EQUIPMENT DESIGN AND FEASIBILITY STUDIES)
CONSULTING (COMPUTER EVALUATIONS, SELECTIONS, INSTALLATION PLANNING)
CONSULTING (DATA COMMUNICATIONS SYSTEMS PLANNING)
CONSULTING (COMPUTER PRODUCT PLANNING SURVEYS, MARKET RESEARCH STUDIES)
CONTINUED

CONSULTING (MANAGEMENT INFORMATION SYSTEMS PLANNING)
CONSULTING (SCIENTIFIC APPLICATIONS)
SERVICES, COMPUTER-AIDED DESIGN
SERVICES, FACILITY MANAGEMENT
SERVICES, MANAGEMENT INFORMATION SYSTEMS
SERVICES, PROCESSING (COMMERCIAL EDP)
SERVICES, PROCESSING (DIGITAL SCIENTIFIC)
SERVICES, TIME SHARING (COMMERCIAL)
SERVICES, TIME SHARING (RESEARCH)
SERVICES, SYSTEMS ANALYSIS
TRAINING INSTITUTES, COMMERCIAL COMPUTER COURSES, SEMINARS,
CORRESPONDENCE COURSES
TRAINING SYSTEMS, COMPUTER SERVICE

MOBARK INSTRUMENTS CORP.

1038 Evelyn, Sunnyvale, Cal 94086

408-735-8540

CONTROLLERS, MAGNETIC TAPE
MAGNETIC TAPE STORAGE SYSTEMS (INCLUDES CONTROLLER)
RECORDERS, DIGITAL CASSETTE
TAPE TRANSPORTS, MAGNETIC (INCREMENTAL)

MOBILITY SYSTEMS D P SERVICES DEPT.

3530 De La Cruz Blvd, Santa Clara, Cal 95050

408-246-5000

TWX 910-338-0186

CONSULTING (ACCOUNTING, BUSINESS AND COMMERCIAL APPLICATIONS)
CONSULTING (COMPUTER EVALUATIONS, SELECTIONS, INSTALLATION PLANNING)
CONSULTING (MANAGEMENT INFORMATION SYSTEMS PLANNING)
CONSULTING (SCIENTIFIC APPLICATIONS)
SERVICES, FACILITY MANAGEMENT
SERVICES, PROCESSING (COMMERCIAL EDP)
SERVICES, TIME SHARING (COMMERCIAL)
SERVICES, TIME SHARING (RESEARCH)
SERVICES, SYSTEMS ANALYSIS

MODERN BUSINESS RECORDS

6030 Chase, Dearborn, Mich 48126

313-584-7330

CONSULTING (ACCOUNTING, BUSINESS AND COMMERCIAL APPLICATIONS)
SERVICES, PROCESSING (COMMERCIAL EDP)

MODULAR COMPUTER SYSTEMS

2709 N Dixie Hwy, Ft Lauderdale, Fla 33308

305-563-4392

COMPUTERS, DIGITAL (GENERAL-PURPOSE, SMALL-SCALE)
COMPUTERS, DIGITAL (GENERAL-PURPOSE, MEDIUM-SCALE)
COMPUTERS, MINI GENERAL PURPOSE (ALSO SEE CALCULATORS)
COMPUTERS, PROCESS CONTROL
CONVERTERS, ANALOG-TO-DIGITAL
CONVERTERS, DIGITAL-TO-ANALOG

MODULAR DEVICES INC.

1265 W 135 St, Gardena, Cal 90247

213-327-5546

POWER SUPPLIES, AC
POWER SUPPLIES, DC
POWER SUPPLIES, DIGITALLY-CONTROLLED
PROTECTORS, CIRCUIT AND EQUIPMENT OVERLOAD

MOHAWK DATA SCIENCES CORP.

Palisade St, Herkimer, N Y 13350

315-867-6000

ACOUSTIC COUPLERS
COMMUNICATIONS-ORIENTED PROCESSORS, STORED PROGRAM
COMMUNICATION SYSTEMS, DATA TRANSMISSION
DATA TERMINALS, BLOCK-BY-BLOCK (MAGNETIC TAPE)
DATA TERMINALS, BLOCK-BY-BLOCK (MULTI-PURPOSE)
DATA TERMINALS, BLOCK-BY-BLOCK (PAPER TAPE)
DATA TERMINALS, BLOCK-BY-BLOCK (HIGH SPEED PRINTER)
DATA TERMINALS, BLOCK-BY-BLOCK (MEDIUM SPEED PRINTER)
DATA TERMINALS, BLOCK-BY-BLOCK (PUNCHED CARD)
ENCODERS, KEYBOARD-TO-MAGNETIC TAPE
POOLERS, MAGNETIC TAPE
PRINTERS, DIGITAL STRIP RECORDING
PRINTERS, LINE (LOW & MEDIUM SPEED)
PRINTERS, LINE (HIGH SPEED)
PUNCHES, CARD (OVER 100 CPM)
PUNCHES, CARD (UP TO 100 CPM)
PUNCHES, PAPER TAPE
READER/PUNCHES, PUNCHED CARD
READERS, PAPER TAPE
READERS, PUNCHED CARD (UP TO 100 CPM)
READERS, PUNCHED CARD (100 TO 300 CPM)
READERS, PUNCHED CARD (OVER 300 CPM)
READERS, PUNCHED TAG
RECORDERS, MAGNETIC TAPE
CONTINUED

3 Manufacturers' Directory

TAPE TRANSPORTS, MAGNETIC (DIGITAL-EXCL. CASSETTE)
TAPE TRANSPORTS, MAGNETIC (WITH KEYBOARD INPUT)

MOHAWK DATA SCIENCES CORP. FRANKLIN ELECT. DIV 215-265-7700
P O Box 406, King of Prussia, Pa 19406 TELEX 84-5206
ACOUSTIC COUPLERS
PRINTERS, DIGITAL STRIP RECORDING
TAPE TRANSPORTS, MAGNETIC (DIGITAL-EXCL. CASSETTE)
TAPE TRANSPORTS, MAGNETIC (INCREMENTAL)

MOHAWK INDUSTRIAL LABORATORIES INC. 315-829-2781
1 Ward St, Vernon, N Y 13476

DATA RETRIEVAL SYSTEMS, MICRO-FILM (COMPUTER-CONTROLLED)
MICROFILM DATA RETRIEVAL SYSTEMS, COMPUTER CONTROLLED
RETRIEVAL UNITS, PUNCHED CARD (RANDOM ACCESS)

MOLEX PRODUCTS CO. 319-969-4550
5224 Katrine, Downers Grove, Ill 60515

CONNECTORS, COAXIAL (COMPUTER-GRADE)
CONNECTORS, MINIATURE AND SUB-MINIATURE (COMPUTER-GRADE)
CONNECTORS, PC AND IC BOARD (COMPUTER-GRADE)
CONNECTORS, POWER (COMPUTER-GRADE)
CONNECTORS, RACK AND PANEL (COMPUTER-GRADE)
SOCKETS, IC MOUNTING
SOCKETS, PCB MOUNTING
SOCKETS, SEMICONDUCTOR MOUNTING
SWITCHES, PUSHBUTTON
SWITCHES, PUSHBUTTON (ILLUMINATED)
TERMINAL BLOCKS, STRIPS, BOARDS

MONARCH MARKING SYSTEMS SUB. PITNEY-BOWES 513-866-7401
Byers Rd, Dayton, Ohio 45401 TELEX 28-8284

IMPRINTERS, OPTICALLY-SENSED CHARACTER
LABELS, CONTINUOUS AND GUMMED (MACHINE APPLICATION)
LABELS, CONTINUOUS AND PRESSURE SENSITIVE (MACHINE APPLICATION)
SCANNERS, OPTICAL

MONARCH METAL PRODUCTS INC. 914-562-3100
Mac Arthur Ave, New Windsor, N Y 12550

CABINETS, RACKS, VAULTS (FOR MAGNETIC TAPE STORAGE)
CABINETS, TRAYS (FOR PUNCHED CARD STORAGE)
CANNISTERS, MAGNETIC TAPE
CONTAINERS, DISK PACK STORAGE
DESKS, TABLES AND STANDS (FOR CALCULATORS)
DESKS, TABLES AND STANDS (FOR KEYPUNCH UNITS)
DESKS, TABLES AND STANDS (FOR PROGRAMMER STATIONS)
FILES, PUNCHED CARD
FORMS HANDLING, BURSTERS
FORMS HANDLING, CARBON DELEAVERS
FORMS HANDLING, DECOLLATORS
REEL CLIPS AND BELTS, MAGNETIC TAPE
REELS, MAGNETIC TAPE

MONITOR DISPLAYS 215-646-8100
401 Commerce Dr, Ft Washington, Pa 19034 TWX 215-646-9399

CONSOLES, CRT (GRAPHIC)
GENERATORS, BYTE
GENERATORS, CHARACTER (CRT)
GENERATORS, RANDOM NUMBER
GENERATORS, TIME CODE
MONITORS, TV

MONITOR LABS INC.

10451 Roselle, San Diego, Cal 92121

CLOCKS, DIGITAL (REAL-TIME)
CONVERTERS, ANALOG-TO-DIGITAL
FORMATTERS, MAGNETIC TAPE
MULTIPLEXERS, ANALOG-RELAY (SEQUENTIAL SAMPLING)
MULTIPLEXERS, ANALOG-SOLID STATE (SEQUENTIAL SAMPLING)
MULTIPLEXERS, DIGITAL
PRINTERS, LINE (LOW & MEDIUM SPEED)
READOUTS AND DISPLAYS, NUMERIC AND ALPHANUMERIC (OTHER THAN CRT)
TIMERS, EVENT (IMPULSE)
VOLTMETERS, DIGITAL

MONOLITHIC DIELECTRICS INC. 213-848-4465
P O Box 647, Burbank, Cal 91503

CAPACITORS, COMPUTER GRADE

MONOLITHIC DIELECTRICS INC. 213-848-4465
P O Box 647, Burbank, Cal 91503

CAPACITORS, COMPUTER GRADE

MONROE, THE CALCULATOR CO. DIV. LITTON INDUS. 201-673-6600
550 Central Ave, Orange, N J 07051 TWX 910-994-5840
CALCULATORS, PROGRAMMABLE (ALSO SEE COMPUTERS)

MONSANTO CO. ELECTRONIC PDTS. & CONTROLS DIV. 314-694-1000
11636 Administration, St Louis, Mo 63141 TWX 910-764-0824

CONVERTERS, ANALOG-TO-DIGITAL
COUNTERS, DIGITAL READOUT
COUNTERS, UP-DOWN
DIODES, LIGHT EMITTING
DISPLAY DRIVERS
PRINTERS, LINE (LOW & MEDIUM SPEED)
READOUTS AND DISPLAYS, NUMERIC AND ALPHANUMERIC (OTHER THAN CRT)
TIMERS, EVENT (IMPULSE)
TIMERS, INTERVAL
VOLTMETERS, DIGITAL

MOORE & CO., SAMUEL 216-274-2276
Main & Orchard, Mantua, Ohio 44255 TWX 810-437-2430

CABLE, MULTICONDUCTOR
CABLE, SHIELDED (NOT COAXIAL)

MOORE BUSINESS FORMS INC. 716-285-7891
110-112 Pkwy Inn Bldg, Niagara Falls, N Y 14302

CARDS, CONVENTIONAL PUNCH
ENVELOPES, CONTINUOUS
FORMS, CONTINUOUS (MACHINE PROCESSED)
FORMS HANDLING, BURSTERS
FORMS HANDLING, CARBON DELEAVERS
FORMS HANDLING, COLLATORS
FORMS HANDLING, DECOLLATORS
FORMS HANDLING, DETACHERS
FORMS HANDLING, DOCUMENT COUNTERS
FORMS HANDLING, OCR SOURCE DOCUMENT
FORMS HANDLING, PUNCHED CARD SOURCE
FORMS HANDLING, SLITTERS
FORMS HANDLING, STACKERS
LABELS, CONTINUOUS AND GUMMED (MACHINE APPLICATION)
LABELS, CONTINUOUS AND PRESSURE SENSITIVE (MACHINE APPLICATION)
MAILERS, PUNCHED CARD
PAPER (FOR MICR EQUIPMENT)
PAPER (FOR OCR EQUIPMENT)
PAPER (FOR PRINTERS)
PAPER (FOR RECORDERS AND PLOTTERS)
PAYMENT COUPON BOOKS, MACHINE READABLE
SERVICES, MANAGEMENT INFORMATION SYSTEMS
SERVICES, PROCESSING (COMMERCIAL EDP)
SERVICES, SYSTEMS ANALYSIS
TAPE, PUNCH (MYLAR)
TAPE, PUNCH (PAPER)

MORLEY CO., THE 603-436-5430
909 Islington St, Portsmouth, N H 03801

CARDS, CONVENTIONAL PUNCH
CERTIFIERS, MAGNETIC TAPE
CLEANER/CERTIFIERS, MAGNETIC TAPE
CLEANERS, MAGNETIC TAPE
COVERS, ACOUSTIC (FOR KEYBOARDS, TELETYPEWRITERS, ETC.)
FORMS, CONTINUOUS (MACHINE PROCESSED)
LABELS, CONTINUOUS AND PRESSURE SENSITIVE (MACHINE APPLICATION)
REELS, MAGNETIC TAPE
RIBBONS, INK (FOR PRINTERS AND TAB EQUIPMENT)
TAPE, MAGNETIC (REELS)

MOS TECHNOLOGY INC. 215-666-7950
Valley Forge Ind Park, Valley Forge, Pa 19406

CIRCUITS, MONOLITHIC (LSI-MOS)
MEMORY SYSTEMS, READ-ONLY
MEMORY SYSTEMS, SEMICONDUCTOR (MOS)

MOSLER SAFE CO., THE INFO. SYS. DIV. 513-867-4000
1561 Grand Blvd., Hamilton, Ohio 45012

CABINETS, RACKS, VAULTS (FOR MAGNETIC TAPE STORAGE)
CABINETS, TRAYS (FOR PUNCHED CARD STORAGE)
CONSULTING (ACCOUNTING, BUSINESS AND COMMERCIAL APPLICATIONS)
CONSULTING (MANAGEMENT INFORMATION SYSTEMS PLANNING)
CONTINUED

3 Manufacturers' Directory

CONTAINERS, DISK PACK STORAGE
 DATA RETRIEVAL SYSTEMS, MICRO-FILM (COMPUTER-CONTROLLED)
 DISC STORAGE SYSTEMS
 FILES, PUNCHED CARD
 MICROFILM DATA RETRIEVAL SYSTEMS, COMPUTER CONTROLLED
 MICROFILM DATA RETRIEVAL SYSTEMS, COMPUTER CONTROLLED (GRAPHIC)
 PRINTERS, MICROFILM/MICROFICHE
 READER/PRINTER, MICROFILM/MICROFICHE
 READERS, MICROFILM/MICROFICHE
 SAFES, MAGNETIC TAPE STORAGE

MOSTEK CORP. 214-242-1494
 1400 Upfield Dr, Carrollton, Tex 75006

CIRCUITS, MONOLITHIC (LSI-MOS)
 ENCODERS, KEYBOARD (ALPHANUMERIC)

MOTOROLA INC. CONTROL SYSTEMS DIV 602-959-1000
 P O Box 5409, Phoenix, Ariz 85010 TWX 910-950-0088

CABLE ASSEMBLIES (WITH CONNECTORS)
 CIRCUIT CARDS, LOGIC (WITH IC'S)
 COMPUTERS, MINI GENERAL PURPOSE (ALSO SEE CALCULATORS)
 CONVERTERS, ANALOG-TO-DIGITAL
 CONVERTERS, DIGITAL-TO-ANALOG
 MULTIPLEXERS, ANALOG-SOLID STATE (SEQUENTIAL SAMPLING)
 POWER SUPPLIES, AC
 PRINTERS, LINE (LOW & MEDIUM SPEED)
 READERS, OPTICAL MARK SENSING

MOTOROLA INC. GOVERNMENT ELECTRONICS DIV. 602-949-3033
 8201 E Mc Dowell Rd, Scottsdale, Ariz 85252 TWX 910-950-1286

MEMORY SYSTEMS, PLATED WIRE
 PRINTERS, LINE (LOW & MEDIUM SPEED)
 READOUTS, CRT

MOTOROLA SEMICONDUCTOR PRODUCTS INC. 602-273-6900
 5005 E Mc Dowell Rd, Phoenix, Ariz 85008 TWX 910-951-1334

CIRCUITS, HYBRID (IC AND DISCRETE-DIGITAL)
 CIRCUITS, MONOLITHIC (DIGITAL LOGIC)
 CIRCUITS, MONOLITHIC (LINEAR-EXCL. OP AMPS)
 CIRCUITS, MONOLITHIC (LSI-BIPOLAR)
 CIRCUITS, MONOLITHIC (LSI-MOS)
 CIRCUITS, MONOLITHIC (OP AMPS)
 CIRCUITS, THICK FILM (DIGITAL)
 CIRCUITS, THIN FILM (DIGITAL)
 COUNTERS, DECADE
 COUNTERS, UP-DOWN
 DIODES, NOT-CARRIER
 DIODES, LIGHT EMITTING
 DIODES, SILICON
 DIODES, ZENER
 DISPLAY DRIVERS
 MODULES, DIGITAL LOGIC ENCAPSULATED (ALSO SEE CIRCUITS & CIRCUIT CARDS)
 MODULES, LINEAR (ENCAPSULATED)
 MULTIPLEXERS, DIGITAL
 RECTIFIERS, SILICON CONTROLLED
 REGULATORS, CURRENT
 REGULATORS, VOLTAGE
 TRANSISTORS, FIELD EFFECT
 TRANSISTORS, GERMANIUM
 TRANSISTORS, PHOTO
 TRANSISTORS, SILICON

MPB CORP. 603-352-0310
 Precision Park, Keene, N H 03431

CAPSTANS, IDLERS, AND GUIDES (FOR TAPE DRIVES)
 SPINDLES

MSI DATA CORP. 714-626-2451
 4751 Holt Ave, Mont Clair, Cal 91763 TWX 910-581-2791

ACOUSTIC COUPLERS
 COMMUNICATION SYSTEMS, DATA TRANSMISSION
 DATA CONCENTRATORS
 DATA TERMINALS, BLOCK-BY-BLOCK (MAGNETIC TAPE)
 DATA TERMINALS, BLOCK-BY-BLOCK (PAPER TAPE)
 ENCODERS, KEYBOARD (ALPHANUMERIC)
 ENCODERS, KEYBOARD (NUMERIC)
 POOLERS, MAGNETIC TAPE
 RECORDERS, MAGNETIC TAPE

MTI BUSINESS SCHOOLS OF SACRAMENTO INC. 916-442-8933
 2731 Capitol Ave, Sacramento, Cal 95816

CONSULTING (ACCOUNTING, BUSINESS AND COMMERCIAL APPLICATIONS)
 CONSULTING (COMPUTER EVALUATIONS, SELECTIONS, INSTALLATION PLANNING)
 TRAINING INSTITUTES, COMMERCIAL COMPUTER COURSES, SEMINARS, CORRESPONDENCE COURSES

MUIRHEAD INC. 201-233-6010
 1101 Bristol Rd, Mountainside, N J 07092

COMMUNICATION SYSTEMS, FACSIMILE
 PAPER (FOR RECORDERS AND PLOTTERS)

MULTICOMP INC. 617-237-2910
 36 Washington St, Wellesley Hills, Mass 02181

CONSULTING (ACCOUNTING, BUSINESS AND COMMERCIAL APPLICATIONS)
 CONSULTING (DATA COMMUNICATIONS SYSTEMS PLANNING)
 CONSULTING (MANAGEMENT INFORMATION SYSTEMS PLANNING)
 CONSULTING (SCIENTIFIC APPLICATIONS)
 PROGRAMMING LANGUAGE DEVELOPMENT (CONTRACT PROGRAMMING)
 SERVICES, TIME SHARING (COMMERCIAL)
 SERVICES, TIME SHARING (RESEARCH)
 SERVICES, SYSTEMS ANALYSIS

MULTIDATA INC. 213-598-1377
 7300 Bolsa Ave, Westminster, Cal 92683

COMPUTERS, DIGITAL (GENERAL-PURPOSE, SMALL-SCALE)
 CONSULTING (ADVANCED COMPUTER EQUIPMENT DESIGN AND FEASIBILITY STUDIES)
 CONSULTING (SCIENTIFIC APPLICATIONS)
 CONTROLLERS, MAGNETIC DISC
 CONTROLLERS, MAGNETIC DRUM
 CONTROLLERS, MAGNETIC TAPE
 DISC DRIVES, FIXED HEAD (INCLUDING CONTROLLER)
 DISC DRIVES, MOVABLE HEAD (INCLUDING CONTROLLER)
 DISC DRIVES, REMOVABLE CARTRIDGE
 PRINTERS, LINE (LOW & MEDIUM SPEED)
 PROGRAMMING LANGUAGE DEVELOPMENT (CONTRACT PROGRAMMING)
 PROGRAMMING LANGUAGE DEVELOPMENT (DEDICATED APPLICATION SYSTEMS)
 PUNCHES, PAPER TAPE
 READERS, PAPER TAPE
 READERS, PUNCHED CARD (OVER 300 CPM)
 TAPE TRANSPORTS, MAGNETIC (DIGITAL-EXCL. CASSETTE)
 TAPE TRANSPORTS, MAGNETIC (DIGITAL CASSETTE)

MULTIPLEX COMMUNICATIONS INC. 516-231-5350
 123 Marcus Blvd, Hauppauge, N Y 11787

BOARDS, PRINTED CIRCUIT (WITHOUT COMPONENTS)
 BREADBOARDS
 CABLE ASSEMBLIES (WITH CONNECTORS)
 CIRCUIT CARDS, LINEAR (WITH DISCRETE COMPONENTS)
 CIRCUIT CARDS, LINEAR (WITH IC'S)
 CIRCUIT CARDS, LOGIC (WITH DISCRETE COMPONENTS)
 CIRCUIT CARDS, LOGIC (WITH IC'S)
 COMMUNICATION SYSTEMS, DATA TRANSMISSION
 COMMUNICATION SYSTEMS, TELEPRINTER
 DATA TERMINALS, BLOCK-BY-BLOCK (TELEPRINTER)
 DATA TERMINALS, INQUIRY-RESPONSE (CRT WITH KEYBOARD)
 JACKS, JACK PANELS, PLUGS, ASSEMBLIES
 RELAYS, SOLID-STATE (COMPUTER GRADE)

MULTITECH DATA PRODUCTS 213-283-7773
 583 Monterey Pass Rd, Monterey Park, Cal 91754

ACOUSTIC COUPLERS
 AMPLIFIERS, D.C.
 AMPLIFIERS, INSTRUMENTATION
 AMPLIFIERS, OPERATIONAL
 CIRCUIT CARDS, LINEAR (WITH DISCRETE COMPONENTS)
 CIRCUIT CARDS, LINEAR (WITH IC'S)
 CIRCUIT CARDS, LOGIC (WITH DISCRETE COMPONENTS)
 CIRCUIT CARDS, LOGIC (WITH IC'S)
 CIRCUITS, HYBRID (IC AND DISCRETE-DIGITAL)
 CIRCUITS, THICK FILM (DIGITAL)
 COMMUNICATION SYSTEMS, DATA TRANSMISSION
 DATA CONCENTRATORS
 LEASING, EDP EQUIPMENT (OTHER THAN MFGRS)
 MODEMS, ACOUSTIC
 MODEMS, HARD-WIRED
 MODEMS, PC CARD
 OSCILLATORS, VOLTAGE CONTROLLED
 VOLTMETERS, AC, DC, DIFFERENTIAL

3 Manufacturers' Directory

- MYLEE DIGITAL SCIENCES INC.** 314-542-4525
16 Progress Pkwy, Maryland Hts, Mo 63043
- COMPUTERS, DIGITAL (GENERAL-PURPOSE, MEDIUM-SCALE)
POWER SUPPLIES, DC
- NANOSECOND SYSTEMS INC.** 203-255-1008
176 Linwood Ave, Fairfield, Conn 06430
- COUNTERS, DECADE
COUNTERS, DIGITAL READOUT
COUNTERS, UP-DOWN
GENERATORS, TIME CODE
MULTIPLEXERS, DIGITAL
- NATEL ENGINEERING CO. INC.** 213-882-9620
8944 Mason Ave, Canoga Park, Cal 91306 TWX 910-494-1959
- AMPLIFIERS, INSTRUMENTATION
CONVERTERS, DIGITAL-TO-SYNCHRO
CONVERTERS, FREQUENCY-TO-DC
CONVERTERS, POLAR-TO-RECTANGULAR
CONVERTERS, SCAN
CONVERTERS, SYNCHRO-TO-DIGITAL
SIGNAL CONDITIONERS
- NATIONAL C.S.S.** 203-327-9100
460 Summer St, Stamford, Conn 06901
- CONSULTING (ACCOUNTING, BUSINESS AND COMMERCIAL APPLICATIONS)
CONSULTING (ADVANCED COMPUTER EQUIPMENT DESIGN AND FEASIBILITY STUDIES)
CONSULTING (COMPUTER EVALUATIONS, SELECTIONS, INSTALLATION PLANNING)
CONSULTING (MANAGEMENT INFORMATION SYSTEMS PLANNING)
CONSULTING (SCIENTIFIC APPLICATIONS)
PROGRAMMING LANGUAGE DEVELOPMENT (CONSULTANTS)
PROGRAMMING LANGUAGE DEVELOPMENT (CONTRACT PROGRAMMING)
PROGRAMMING LANGUAGE DEVELOPMENT (DEDICATED APPLICATION SYSTEMS)
PROGRAMMING LANGUAGE DEVELOPMENT (PROPRIETARY SOFTWARE PRODUCTS)
SERVICES, COMPUTER-AIDED DESIGN
SERVICES, FACILITY MANAGEMENT
SERVICES, MANAGEMENT INFORMATION SYSTEMS
SERVICES, PROCESSING (DIGITAL SCIENTIFIC)
SERVICES, TIME SHARING (COMMERCIAL)
SERVICES, TIME SHARING (RESEARCH)
SERVICES, SYSTEMS ANALYSIS
TRAINING INSTITUTES, COMMERCIAL COMPUTER COURSES, SEMINARS, CORRESPONDENCE COURSES
- NATIONAL COMPUTER ANALYSTS INC.** 609-452-2800
Us Hwy 1, Princeton, N J 08540 TELEX 84-3476
- CONSULTING (ACCOUNTING, BUSINESS AND COMMERCIAL APPLICATIONS)
CONSULTING (ADVANCED COMPUTER EQUIPMENT DESIGN AND FEASIBILITY STUDIES)
CONSULTING (COMPUTER EVALUATIONS, SELECTIONS, INSTALLATION PLANNING)
CONSULTING (DATA COMMUNICATIONS SYSTEMS PLANNING)
CONSULTING (MANAGEMENT INFORMATION SYSTEMS PLANNING)
CONSULTING (SCIENTIFIC APPLICATIONS)
PROGRAMMING LANGUAGE DEVELOPMENT (CONSULTANTS)
PROGRAMMING LANGUAGE DEVELOPMENT (CONTRACT PROGRAMMING)
PROGRAMMING LANGUAGE DEVELOPMENT (DEDICATED APPLICATION SYSTEMS)
PROGRAMMING LANGUAGE DEVELOPMENT (PROPRIETARY SOFTWARE PRODUCTS)
SERVICES, PROCESSING (COMMERCIAL EDP)
SERVICES, SYSTEMS ANALYSIS
- NATIONAL COMPUTER SYSTEMS** 612-920-3670
4401 W 76th St, Minneapolis, Minn 55435
- SCANNERS, OPTICAL
- NATIONAL COMPUTING INDUSTRIES INC.** 415-989-1790
One Jackson Pl, San Francisco, Cal 94111
- PROGRAMMING LANGUAGE DEVELOPMENT (PROPRIETARY SOFTWARE PRODUCTS)
- NATIONAL DATA PROCESSING INC.** 919-763-1559
P O Box 3393, Wilmington, N C 28401
- CONSULTING (ACCOUNTING, BUSINESS AND COMMERCIAL APPLICATIONS)
SERVICES, PROCESSING (COMMERCIAL EDP)
- NATIONAL ELECTRO-MECHANICAL SYSTEMS INC.** 607-723-9561
32 Broad Ave, Binghamton, N Y 13904
- COMPUTERS, ANALOG (EDUCATIONAL)
COMPUTERS, ANALOG (GENERAL-PURPOSE)
COMPUTERS, DIGITAL (EDUCATIONAL)
COMPUTERS, DIGITAL (GENERAL-PURPOSE, SMALL-SCALE)
DEMONSTRATORS AND KITS, EDUCATIONAL (DIGITAL LOGIC)
INSTRUCTIONAL SYSTEMS, COMPUTER-BASED
TEST SYSTEMS, COMPUTER PERFORMANCE
TESTERS, CIRCUIT
TESTERS, DIGITAL DATA TRANSMISSION
TESTERS, DIGITAL LOGIC MODULES AND CARDS
TESTERS, INTEGRATED CIRCUIT
TESTERS, MEMORY PLANES, STACKS AND SYSTEMS
TESTERS, SEMICONDUCTOR
- NATIONAL INFORMATION RESEARCH INSTITUTE** 213-653-1992
8444 Wilshire Blvd, Beverly Hills, Cal 90211
- CONSULTING (COMPUTER EVALUATIONS, SELECTIONS, INSTALLATION PLANNING)
SERVICES, SYSTEMS ANALYSIS
TRAINING INSTITUTES, COMMERCIAL COMPUTER COURSES, SEMINARS, CORRESPONDENCE COURSES
- NATIONAL INFORMATION SYSTEMS CORP.** 215-265-5000
150 Allendale Rd, Valley Forge, Pa 19481
- CONSULTING (ACCOUNTING, BUSINESS AND COMMERCIAL APPLICATIONS)
CONSULTING (ADVANCED COMPUTER EQUIPMENT DESIGN AND FEASIBILITY STUDIES)
CONSULTING (COMPUTER EVALUATIONS, SELECTIONS, INSTALLATION PLANNING)
CONSULTING (DATA COMMUNICATIONS SYSTEMS PLANNING)
CONSULTING (MANAGEMENT INFORMATION SYSTEMS PLANNING)
SERVICES, FACILITY MANAGEMENT
- NATIONAL MIDCO INDUSTRIES INC.** 215-943-7010
Box 5433, Trenton, N J 08638
- ACOUSTIC COUPLERS
COMMUNICATION SYSTEMS, DATA TRANSMISSION
CONTROLLERS, MODEM
DATA TERMINALS, BLOCK-BY-BLOCK (MULTI-PURPOSE)
DATA TERMINALS, INQUIRY-RESPONSE (AUDIO RESPONSE)
DATA TERMINALS, INQUIRY-RESPONSE (BADGE-TOKEN READERS)
DATA TERMINALS, INQUIRY-RESPONSE (SPECIAL-PURPOSE)
MODEMS, HARD-WIRED
MODEMS, PC CARD
SCANNERS, FACSIMILE
- NATIONAL SEMICONDUCTOR CORP.** 408-732-5000
2900 Semicon Dr, Santa Clara, Cal 95051 TWX 910-339-9240
- AMPLIFIERS, D.C.
AMPLIFIERS, INSTRUMENTATION
AMPLIFIERS, OPERATIONAL
AMPLIFIERS, VIDEO
CIRCUITS, HYBRID (IC AND DISCRETE-DIGITAL)
CIRCUITS, MONOLITHIC (DIGITAL LOGIC)
CIRCUITS, MONOLITHIC (LINEAR-EXCL. OP AMPS)
CIRCUITS, MONOLITHIC (LSI-BIPOLAR)
CIRCUITS, MONOLITHIC (LSI-MOS)
CIRCUITS, MONOLITHIC (OP AMPS)
CIRCUITS, THIN FILM (DIGITAL)
CLOCKS, DIGITAL (REAL-TIME)
CONVERTERS, ANALOG-TO-DIGITAL
CONVERTERS, DIGITAL-TO-ANALOG
MEMORY SYSTEMS, READ-ONLY
MEMORY SYSTEMS, SEMICONDUCTOR (MOS)
MEMORY SYSTEMS, THIN FILM
MULTIPLEXER-CONVERTER (SINGLE UNIT WITH MULTIPLEXER, SAMPLE & HOLD AMPLIFIER & A-TO-D CONVERTER)
MULTIPLEXERS, ANALOG-SOLID STATE (SEQUENTIAL SAMPLING)
MULTIPLEXERS, DIGITAL
REGULATORS, CURRENT
REGULATORS, VOLTAGE
RELAYS, SOLID-STATE (COMPUTER GRADE)
TRANSISTORS, FIELD EFFECT
TRANSISTORS, SILICON
- NATIONAL SEMICONDUCTOR CORP. TRANSISTOR DIV.** 203-744-0060
Commerce Pk, Danbury, Conn 06810 TWX 710-456-1142
- TRANSISTORS, SILICON

3 Manufacturers' Directory

NATIONAL TECHNOLOGY 714-546-6186
220 W Central Ave, Santa Ana, Cal 92707

BOARDS, PRINTED CIRCUIT (WITHOUT COMPONENTS)

NATIONAL TEL-TRONICS 516-466-5100
55 Northern Blvd, Great Neck, N Y 11021

BOARDS, PRINTED CIRCUIT (WITHOUT COMPONENTS)
CONNECTORS, COAXIAL (COMPUTER-GRADE)
CONNECTORS, MINIATURE AND SUB-MINIATURE (COMPUTER-GRADE)
CONNECTORS, POWER (COMPUTER-GRADE)
CORDS, PATCH
JACKS, JACK PANELS, PLUGS, ASSEMBLIES

NATIONWIDE ELECTRONIC SYSTEMS INC. 312-773-0370
7 N 662 Rte 53, Itasca, Ill 60143 TWX 910-651-4713

CLOCKS, DIGITAL (REAL-TIME)
COMPUTERS, DIGITAL (GENERAL-PURPOSE, SMALL-SCALE)
COMPUTERS, PROCESS CONTROL
CONVERTERS, ANALOG-TO-DIGITAL
CONVERTERS, BINARY-TO-DECIMAL
CONVERTERS, DIGITAL-TO-ANALOG
CONVERTERS, DOCUMENT-TO-MAGNETIC TAPE
CONVERTERS, DOCUMENT-TO-PAPER TAPE
CONVERTERS, DOCUMENT-TO-UNIT RECORDS
CONVERTERS, MAGNETIC TAPE-TO-MAGNETIC TAPE
CONVERTERS, MAGNETIC TAPE-TO-PAPER TAPE
CONVERTERS, MAGNETIC TAPE-TO-PRINTER
CONVERTERS, MAGNETIC TAPE-TO-PUNCHED CARD
CONVERTERS, PAPER TAPE-TO-MAGNETIC TAPE
CONVERTERS, PAPER TAPE-TO-PAPER TAPE
CONVERTERS, PAPER TAPE-TO-PRINTER
CONVERTERS, PAPER TAPE-TO-PUNCHED CARD
CONVERTERS, PUNCHED CARD-TO-MAGNETIC TAPE
CONVERTERS, PUNCHED CARD-TO-PAPER TAPE
CONVERTERS, PUNCHED TAG-TO-MAGNETIC TAPE
CONVERTERS, PUNCHED TAG-TO-PUNCHED CARD
DATA ACQUISITION AND REDUCTION SYSTEMS
INDICATORS, DIGITAL
INDICATORS, ELAPSED TIME
MULTIPLEXERS, ANALOG-RELAY (SEQUENTIAL SAMPLING)
MULTIPLEXERS, ANALOG-SOLID STATE (SEQUENTIAL SAMPLING)
MULTIPLEXERS, DIGITAL

NAYBOR LABORATORIES INC., E.V. 516-767-4300
26 Manorhaved Blvd, Port Washington, N Y 11050

DISPLAYS, MAGNETIC
TIMERS, INTERVAL

NCR INDUSTRILA PRODUCTS DIV. 513-449-8316
Main And K St, Dayton, Ohio 45409

CARDS, CONVENTIONAL PUNCH
CARDS, MAGNETIC
CERTIFIERS, DISC PACK
COMMUNICATION SYSTEMS, TELEPRINTER
CONTROLLERS, MAGNETIC DISC
DISC DRIVES, MOVABLE HEAD (INCLUDING CONTROLLER)
DISC DRIVES, REMOVABLE CARTRIDGE
DISC PACKS, MAGNETIC
DISC STORAGE SYSTEMS
ENCODERS, KEYBOARD (ALPHANUMERIC)
IMPRINTERS, MAGNETIC INK CHARACTER
IMPRINTERS, OPTICALLY-SENSED CHARACTER
LABELS, CONTINUOUS AND GUMMED (MACHINE APPLICATION)
LABELS, CONTINUOUS AND PRESSURE SENSITIVE (MACHINE APPLICATION)
MARK SENSING EQUIPMENT
MEMORY SYSTEMS, MAGNETIC DISC
PERFORATORS, PAPER TAPE
PRINTERS, KEYBOARD
PRINTERS, LINE (LOW & MEDIUM SPEED)
PRINTERS, LINE (HIGH SPEED)
PRINTERS, MICROFILM/MICROFICHE
PUNCHES, PAPER TAPE
RACKS, PAPER TAPE
READER/PRINTER, MICROFILM/MICROFICHE
READERS, MAGNETIC CARD
READERS, MAGNETIC INK CHARACTER
READERS, MICROFILM/MICROFICHE
READERS, OPTICAL CHARACTER SCANNING
READERS, PAPER TAPE
READERS, PUNCHED CARD (UP TO 100 CPM)
READERS, PUNCHED CARD (100 TO 300 CPM)
READERS, STATIC
READOUTS AND DISPLAYS, NUMERIC AND ALPHANUMERIC (OTHER THAN CRT)
RECORDERS, MICROFILM/MICROFICHE
SCANNERS, OPTICAL

NEFF INSTRUMENT CORP. 213-357-2281
1088 E Hamilton Rd, Duarte, Cal 91010 TWX 910-585-1833

AMPLIFIERS, D.C.
AMPLIFIERS, INSTRUMENTATION
MULTIPLEXER-CONVERTER (SINGLE UNIT WITH MULTIPLEXER, SAMPLE & HOLD AMPLIFIER & A-TO-D CONVERTER)
MULTIPLEXERS, ANALOG-SOLID STATE (SEQUENTIAL SAMPLING)

NELLISSIN INC., ALBERT 212-759-1720
510 Madison Ave, New York, N Y 10022

CONSULTING (COMPUTER EVALUATIONS, SELECTIONS, INSTALLATION PLANNING)

NEMONIC DATA SYSTEMS INC. 303-892-7012
1301 W 3rd Ave, Denver, Colo 80223

MEMORY PLANES AND STACKS, PLATED WIRE (W/O ELECTRONICS)
MEMORY SYSTEMS, PLATED WIRE
MEMORY SYSTEMS, READ-ONLY
PLATED WIRE

NEOTERIC INC. 216-861-3990
2800 Euclid Ave, Cleveland, Ohio 44115

CONSULTING (ACCOUNTING, BUSINESS AND COMMERCIAL APPLICATIONS)
CONSULTING (COMPUTER EVALUATIONS, SELECTIONS, INSTALLATION PLANNING)
CONSULTING (DATA COMMUNICATIONS SYSTEMS PLANNING)
CONSULTING (MANAGEMENT INFORMATION SYSTEMS PLANNING)
PROGRAMMING LANGUAGE DEVELOPMENT (CONSULTANTS)
PROGRAMMING LANGUAGE DEVELOPMENT (CONTRACT PROGRAMMING)
PROGRAMMING LANGUAGE DEVELOPMENT (DEDICATED APPLICATION SYSTEMS)
PROGRAMMING LANGUAGE DEVELOPMENT (PROPRIETARY SOFTWARE PRODUCTS)
SERVICES, FACILITY MANAGEMENT
SERVICES, MANAGEMENT INFORMATION SYSTEMS
SERVICES, SYSTEMS ANALYSIS

NESS PACIFIC INC. 415-328-7036
470 N San Antonio Rd, Palo Alto, Cal 94306 TWX 910-373-1177

CIRCUITS, HYBRID (IC AND DISCRETE-DIGITAL)
MEMORY PLANES AND STACKS, MAG-NETIC CORE (W/O ELECTRONICS)
MODULES, MEMORY (ENCAPSULATED)
TRANSFORMERS, POWER (COMPUTER GRADE)
TRANSFORMERS, PULSE (COMPUTER GRADE)
TRANSISTORS, FIELD EFFECT
TRANSISTORS, GERMANIUM
TRANSISTORS, SILICON

NETWORK DATA PROCESSING CORP. 312-325-3464
823 Commerce Dr, Oak Brook, Ill 60521

CONSULTING (ACCOUNTING, BUSINESS AND COMMERCIAL APPLICATIONS)
CONSULTING (MANAGEMENT INFORMATION SYSTEMS PLANNING)
PROGRAMMING LANGUAGE DEVELOPMENT (CONTRACT PROGRAMMING)
PROGRAMMING LANGUAGE DEVELOPMENT (PROPRIETARY SOFTWARE PRODUCTS)
SERVICES, FACILITY MANAGEMENT
SERVICES, MANAGEMENT INFORMATION SYSTEMS
SERVICES, PROCESSING (COMMERCIAL EDP)

NETWORK DATA PROCESSING CORP. 319-365-8691
118 2nd Ave SE, Cedar Rapids, Iowa 52407

CONSULTING (ACCOUNTING, BUSINESS AND COMMERCIAL APPLICATIONS)
CONSULTING (COMPUTER EVALUATIONS, SELECTIONS, INSTALLATION PLANNING)
SERVICES, FACILITY MANAGEMENT

NEW PRODUCT ENGINEERING 219-563-2191
1 St & Webster St, Wabash, Ind 46992 TWX 810-290-2722

RELAYS, DRY REED (COMPUTER GRADE)
RELAYS, MERCURY WETTED (COMPUTER GRADE)
RELAYS, SOLID-STATE (COMPUTER GRADE)
SWITCHES, DRY REED

NEWELL INDUSTRIES 408-732-2000
795 Kifer Rd, Sunnyvale, Cal 94086

DISC STORAGE SYSTEMS
MAGNETIC TAPE STORAGE SYSTEMS (INCLUDES CONTROLLER)
RECORDERS, MAGNETIC TAPE
TAPE TRANSPORTS, MAGNETIC (DIGITAL-EXCL. CASSETTE)
CONTINUED

3 Manufacturers' Directory

TAPE TRANSPORTS, MAGNETIC (INCREMENTAL)

NEWMADE PRODUCTS CORP.
P O Box 568, Scarsdale, N Y 10583

914-725-4900

AUDIO/VISUAL TRAINING AIDS
CABINETS, RACKS, VAULTS (FOR MAGNETIC TAPE STORAGE)
MAGNETIC TAPE STORAGE SYSTEMS (INCLUDES CONTROLLER)
SPOOLERS, PAPER TAPE
WINDERS, MAGNETIC TAPE
WINDERS, PAPER TAPE

NIGITRON CORP.
2544 W Main St, Norristown, Pa 19401

215-277-5800

CONTROLLERS, MAGNETIC DISC
CONTROLLERS, MAGNETIC DRUM
CONVERTERS, ANALOG-TO-DIGITAL
CONVERTERS, BINARY-TO-DECIMAL
CONVERTERS, DC-TO-FREQUENCY
CONVERTERS, DIGITAL-TO-ANALOG
CONVERTERS, FREQUENCY-TO-DC
CONVERTERS, MAGNETIC TAPE-TO-MAGNETIC TAPE
CONVERTERS, MAGNETIC TAPE-TO-PAPER TAPE
CONVERTERS, MAGNETIC TAPE-TO-PRINTER
CONVERTERS, MAGNETIC TAPE-TO-PUNCHED CARD
CONVERTERS, PAPER TAPE-TO-MAGNETIC TAPE
CONVERTERS, PAPER TAPE-TO-PAPER TAPE
CONVERTERS, PAPER TAPE-TO-PRINTER
CONVERTERS, PAPER TAPE-TO-PUNCHED CARD
CONVERTERS, PUNCHED CARD-TO-MAGNETIC TAPE
CONVERTERS, PUNCHED CARD-TO-PAPER TAPE
CONVERTERS, VOLTAGE-TO-FREQUENCY
COUNTERS, DECADE
COUNTERS, DIGITAL READOUT
COUNTERS, UP-DOWN
FORMATTERS, MAGNETIC TAPE
MODULES, DIGITAL LOGIC ENCAPSULATED (ALSO SEE CIRCUITS & CIRCUIT CARDS)
MULTIPLEXER-CONVERTER (SINGLE UNIT WITH MULTIPLEXER, SAMPLE & HOLD AMPLIFIER & A-TO-D CONVERTER)
MULTIPLEXERS, ANALOG-RELAY (SEQUENTIAL SAMPLING)
MULTIPLEXERS, ANALOG-SOLID STATE (SEQUENTIAL SAMPLING)
MULTIPLEXERS, DIGITAL
PRINTERS, DIGITAL STRIP RECORDING
PRINTERS, LINE (LOW & MEDIUM SPEED)
SCANNERS, INPUT
SIGNAL CONDITIONERS
TIMERS, INTERVAL

NJE SUB. OF CONDEC
20 Boright Ave, Kenilworth, N J 07033
POWER SUPPLIES, DC

201-272-6000
TWX 201-276-7630

NO. AMERICAN PHILIPS CORP. FREDERICK CONT. DIV
Frederick, Md 21701

301-663-5141
TWX 710-862-0901

COUNTERS, STEPPING SWITCH
RELAYS, DRY REED (COMPUTER GRADE)
RELAYS, SOLID-STATE (COMPUTER GRADE)
SWITCHES, DRY REED
SWITCHES, SNAP ACTION
SWITCHES, TOGGLE (MINIATURE)
TIMERS, EVENT (IMPULSE)
TIMERS, INTERVAL

NOLLER CONTROL SYSTEMS
150 E Standard Ave, Richmond, Cal 94804

415-233-8220
TWX 910-382-8143

DATA TERMINALS, BLOCK-BY-BLOCK (MAGNETIC TAPE)
DATA TERMINALS, BLOCK-BY-BLOCK (MULTI-PURPOSE)
DATA TERMINALS, BLOCK-BY-BLOCK (PAPER TAPE)
DATA TERMINALS, BLOCK-BY-BLOCK (HIGH SPEED PRINTER)
DATA TERMINALS, BLOCK-BY-BLOCK (MEDIUM SPEED PRINTER)
DATA TERMINALS, BLOCK-BY-BLOCK (PUNCHED CARD)
DATA TERMINALS, BLOCK-BY-BLOCK (TELEPRINTER)
TESTERS, DIGITAL DATA TRANSMISSION

NON-LINEAR SYSTEMS INC.
P O Box N, Del Mar, Cal 92014

714-755-1134
TWX 910-322-1132

CONVERTERS, ANALOG-TO-DIGITAL
CONVERTERS, DIGITAL-TO-ANALOG
COUNTERS, DIGITAL READOUT
DATA ACQUISITION AND REDUCTION SYSTEMS
DIGITIZERS, PROGRAMMABLE
INDICATORS, ELAPSED TIME
MULTIPLEXER-CONVERTER (SINGLE UNIT WITH MULTIPLEXER, SAMPLE & HOLD AMPLIFIER & A-TO-D CONVERTER)
CONTINUED

MULTIPLEXERS, ANALOG-RELAY (SEQUENTIAL SAMPLING)
MULTIPLEXERS, ANALOG-SOLID STATE (SEQUENTIAL SAMPLING)
MULTIPLEXERS, DIGITAL
SCANNERS, INPUT
SIGNAL CONDITIONERS
SWITCHES, DRY REED
TEST SYSTEMS, COMPUTER PERFORMANCE
TESTERS, CIRCUIT
TESTERS, DIGITAL LOGIC MODULES AND CARDS
TESTERS, INTEGRATED CIRCUIT
THERMOCOUPLE REFERENCE SYSTEMS
VOLTMETERS, DIGITAL
VOLTMETERS, PRINTING

NORDEN DIV., UNITED AIRCRAFT CORP.
Helen St, Norwalk, Conn 06850

203-838-4471
TWX 710-468-0788

COMPUTERS, ANALOG (GENERAL-PURPOSE)
COMPUTERS, SPECIAL PURPOSE
CONSULTING (ACCOUNTING, BUSINESS AND COMMERCIAL APPLICATIONS)
CONSULTING (ADVANCED COMPUTER EQUIPMENT DESIGN AND FEASIBILITY STUDIES)
CONSULTING (COMPUTER EVALUATIONS, SELECTIONS, INSTALLATION PLANNING)
CONSULTING (COMPUTER PRODUCT PLANNING SURVEYS, MARKET RESEARCH STUDIES)
CONSULTING (MANAGEMENT INFORMATION SYSTEMS PLANNING)
CONSULTING (SCIENTIFIC APPLICATIONS)
CONVERTERS, ANALOG-TO-DIGITAL
CONVERTERS, BINARY-TO-DECIMAL
CONVERTERS, DIGITAL-TO-ANALOG
CONVERTERS, DIGITAL-TO-SYNCHRO
CONVERTERS, POLAR-TO-RECTANGULAR
CONVERTERS, SYNCHRO-TO-DIGITAL
DIGITIZERS, PROGRAMMABLE
ENCODERS, DIGITAL
ENCODERS, SHAFT ANGLE
PROGRAMMING LANGUAGE DEVELOPMENT (CONSULTANTS)
PROGRAMMING LANGUAGE DEVELOPMENT (CONTRACT PROGRAMMING)
PROGRAMMING LANGUAGE DEVELOPMENT (DEDICATED APPLICATION SYSTEMS)
PROGRAMMING LANGUAGE DEVELOPMENT (PROPRIETARY SOFTWARE PRODUCTS)
SERVICES, COMPUTER-AIDED DESIGN
SERVICES, MANAGEMENT INFORMATION SYSTEMS
SERVICES, TIME SHARING (COMMERCIAL)
SERVICES, TIME SHARING (RESEARCH)
SERVICES, SYSTEMS ANALYSIS

NORMANDIE DATAFORMS
41-10 22nd St, Long Is Cy, N Y 11101

212-392-7200

FORMS, CONTINUOUS (MACHINE PROCESSED)
FORMS HANDLING, LABEL APPLICATORS
LABELS, CONTINUOUS AND GUMMED (MACHINE APPLICATION)
LABELS, CONTINUOUS AND PRESSURE SENSITIVE (MACHINE APPLICATION)
TAGS (FOR EDP PROCESSING)

NORRICH PLASTIC CORP.
200 Allen Blvd, Farmingdale, N Y 11575

516-249-7245

BOARDS, PRINTED CIRCUIT (WITHOUT COMPONENTS)
CABLE ASSEMBLIES (WITH CONNECTORS)
CHASSIS, SLIDES, RACKS
CONNECTORS, MINIATURE AND SUB-MINIATURE (COMPUTER-GRADE)
HANDLES, TEST POINT STRIPS (FOR CIRCUIT CARDS)
HEAT SINKS, CIRCUIT BOARD MOUNTING
JACKS, JACK PANELS, PLUGS, ASSEMBLIES
KNOBS, DIALS (FOR COMPUTER CONSOLES)
SOCKETS, PCB MOUNTING
TERMINAL BLOCKS, STRIPS, BOARDS

NORTEC COMPUTER DEVICES INC. AC&T CO.
Rte 9, Southboro, Mass 01772

617-481-2500

PRINTERS, LINE (LOW & MEDIUM SPEED)

NORTH AMERICAN ROCKWELL CORP. AUTONETICS DIV.
3370 Miraloma Ave, Anaheim, Cal 92803

714-632-0955
TWX 910-591-1654

BREADBOARDS
CIRCUIT CARDS, LINEAR (WITH DISCRETE COMPONENTS)
CIRCUIT CARDS, LINEAR (WITH IC'S)
CIRCUIT CARDS, LOGIC (WITH DISCRETE COMPONENTS)
CIRCUIT CARDS, LOGIC (WITH IC'S)
CIRCUITS, HYBRID (IC AND DISCRETE-DIGITAL)
CIRCUITS, MONOLITHIC (DIGITAL LOGIC)
CIRCUITS, MONOLITHIC (DIODE MATRICES)
CIRCUITS, MONOLITHIC (LINEAR-EXCL. OP AMPS)
CIRCUITS, MONOLITHIC (LSI-BIPOLAR)
CONTINUED

3 Manufacturers' Directory

CIRCUITS, MONOLITHIC (LSI-MOS)
 COMMUNICATIONS-ORIENTED PROCESSORS, MULTIPLE CHANNEL CONTROLLERS
 COMMUNICATIONS-ORIENTED PROCESSORS, SINGLE CHANNEL CONTROLLERS
 COMMUNICATIONS-ORIENTED PROCESSORS, STORED PROGRAM
 COMMUNICATION SYSTEMS, DATA TRANSMISSION
 COMPUTERS, DIGITAL (GENERAL-PURPOSE, SMALL-SCALE)
 COMPUTERS, DIGITAL (GENERAL-PURPOSE, MEDIUM-SCALE)
 COMPUTERS, NAVIGATION
 COMPUTERS, PROCESS CONTROL
 CONSOLES, COMPUTER CONTROL (WIRED)
 CONTROLLERS, MAGNETIC DISC
 CONTROLLERS, MODEM
 CONVERTERS, ANALOG-TO-DIGITAL
 CONVERTERS, BINARY-TO-DECIMAL
 CONVERTERS, DIGITAL-TO-ANALOG
 CONVERTERS, DIGITAL-TO-SYNCHRO
 CONVERTERS, PULSE-TO-DIGITAL
 CONVERTERS, SYNCHRO-TO-DIGITAL
 DELAY LINES, MAGNETOSTRICTIVE (ALSO SEE MEMORIES)
 DIGITIZERS, PROGRAMMABLE
 DISC DRIVES, FIXED HEAD (INCLUDING CONTROLLER)
 DISC DRIVES, MOVABLE HEAD (INCLUDING CONTROLLER)
 DISC DRIVES, REMOVABLE CARTRIDGE
 DISC PACKS, MAGNETIC
 DISC STORAGE SYSTEMS
 MEMORY PLANES AND STACKS, PLATED WIRE (W/O ELECTRONICS)
 MEMORY SYSTEMS, DELAY LINE
 MEMORY SYSTEMS, MAGNETIC DISC
 MEMORY SYSTEMS, PLATED WIRE
 MEMORY SYSTEMS, READ-ONLY
 MEMORY SYSTEMS, SEMICONDUCTOR (MOS)
 MEMORY SYSTEMS, THIN FILM
 MODULES, DIGITAL LOGIC ENCAPSULATED (ALSO SEE CIRCUITS & CIRCUIT CARDS)
 MODULES, LINEAR (ENCAPSULATED)
 MODULES, MEMORY (ENCAPSULATED)
 MULTIPLEXER-CONVERTER (SINGLE UNIT WITH MULTIPLEXER, SAMPLE & HOLD AMPLIFIER & A-TO-D CONVERTER)
 MULTIPLEXERS, DIGITAL
 PLATED WIRE
 READERS, MAGNETIC CARD
 RELAYS, DRY REED (COMPUTER GRADE)

NORTH ATLANTIC INDUSTRIES INC. 516-681-8600
 200 Terminal Dr, Plainview, N Y 11803 TWX 510-221-1879
 CONVERTERS, DIGITAL-TO-SYNCHRO
 CONVERTERS, SYNCHRO-TO-DIGITAL
 VOLTMETERS, AC, DC, DIFFERENTIAL

NORTH ELECTRIC CO. ELECTRONETICS DIV. 419-468-8244
 Galion, Ohio 44833 TWX 419-468-4860
 POWER SUPPLIES, AC
 POWER SUPPLIES, DC
 POWER SUPPLIES, DIGITALLY-CONTROLLED
 VOLTAGE DIVIDERS

NORTHEASTERN COMPUTER INSTITUTE 518-785-3333
 16 Maple St, Latham, N Y 12110

TRAINING INSTITUTES, COMMERCIAL COMPUTER COURSES, SEMINARS,
 CORRESPONDENCE COURSES

NORTHERN RESEARCH AND ENGINEERING CORP. 617-491-2770
 219 Vassar St, Cambridge, Mass 02139
 CONSULTING (SCIENTIFIC APPLICATIONS)

NORTHWEST MANAGEMENT SERVICES INC. 206-329-9990
 2300 Elake Ave E, Seattle, Wash 98102
 CONSULTING (DATA COMMUNICATIONS SYSTEMS PLANNING)
 SERVICES, PROCESSING (COMMERCIAL EDP)
 SERVICES, TIME SHARING (COMMERCIAL)
 SERVICES, SYSTEMS ANALYSIS

NORTON ASSOCIATES INC. 516-598-1600
 10 Ditomas Court, Copiague, N Y 11726
 RECORDING HEADS, MAGNETIC TAPE

NORTONICS CO. INC. 612-545-0401
 8101 10th Ave W, Minneapolis, Minn 55427
 RECORDING HEADS, MAGNETIC CARD
 RECORDING HEADS, MAGNETIC DISC
 CONTINUED

RECORDING HEADS, MAGNETIC DRUM
 RECORDING HEADS, MAGNETIC TAPE

NOVAR CORP. 415-964-3900
 2370 Charleston Rd, Mt View, Cal 94040

COMMUNICATION SYSTEMS, TELEPRINTER
 DATA TERMINALS, BLOCK-BY-BLOCK (MAGNETIC TAPE)
 DATA TERMINALS, BLOCK-BY-BLOCK (TELEPRINTER)
 DATA TERMINALS, INQUIRY-RESPONSE (ALPHANUMERIC KEYBOARD)

NOVATION INC. 213-344-7191
 18664 Topham, Tarzana, Cal 91356

ACOUSTIC COUPLERS
 MODEMS, ACOUSTIC
 MODEMS, HARD-WIRED
 MODEMS, PC CARD

NOVATRONICS OF CANADA LTD. 519-271-3880
 677 Erie St, Stratford Ont, CANADA TWX 610-355-8717

COUNTERS, DIGITAL READOUT
 DISPLAYS, MAGNETIC
 INDICATORS, DIGITAL
 INDICATORS, ILLUMINATED
 MODULES, DIGITAL LOGIC ENCAPSULATED (ALSO SEE CIRCUITS & CIRCUIT CARDS)
 MOTORS, SERVO
 MOTORS, STEPPING
 MOTORS, SYNCHRONOUS
 READOUTS AND DISPLAYS, NUMERIC AND ALPHANUMERIC (OTHER THAN CRT)
 SWITCHES, ROTARY
 SYNCHROS-RESOLVERS, CONTROL TRANSFORMERS

NUCLEAR DATA INC. 312-529-4600
 P O Box 451, Palatine, Ill 60067 TELEX 25-4774

AMPLIFIERS, INSTRUMENTATION
 BOARDS, PRINTED CIRCUIT (WITHOUT COMPONENTS)
 COMPUTERS, DIGITAL (GENERAL-PURPOSE, SMALL-SCALE)
 COMPUTERS, MINI GENERAL PURPOSE (ALSO SEE CALCULATORS)
 COMPUTERS, PROCESS CONTROL
 CONVERTERS, ANALOG-TO-DIGITAL

NUCLEAR SYSTEMS INC. 214-276-0543
 406 S Yale St, Garland, Tex 75040

BLOWERS, FANS, COOLING ASSEMBLIES

NUCLEONIC DATA SYSTEMS INC. 714-842-1408
 7461 Lorge Cir, Huntington Bch, Cal 92647

TESTERS, MAGNETIC DRUM

NUCLEONIC PRODUCTS CO. INC. 213-887-1010
 6660 Variel Ave, Canoga Park, Cal 91303 TWX 910-494-1954

CAPACITORS, COMPUTER GRADE
 CIRCUITS, HYBRID (IC AND DISCRETE-DIGITAL)
 CIRCUITS, MONOLITHIC (DIGITAL LOGIC)
 CIRCUITS, MONOLITHIC (LINEAR-EXCL. OP AMPS)
 CIRCUITS, MONOLITHIC (LSI-MOS)
 CIRCUITS, MONOLITHIC (OP AMPS)
 CIRCUITS, THICK FILM (DIGITAL)
 CIRCUITS, THIN FILM (DIGITAL)
 COUNTERS, DECADE
 DIODES, GERMANIUM
 DIODES, NOT-CARRIER
 DIODES, SILICON
 DIODES, VIDEO DETECTOR
 DIODES, ZENER
 ENCODERS, DIGITAL
 ENCODERS, KEYBOARD (ALPHANUMERIC)
 ENCODERS, KEYBOARD (NUMERIC)
 LAMPS-PANEL, PILOT AND DIAL (INCANDESCENT)
 POTENTIOMETERS, TRIM (FILM)
 RECTIFIERS, SILICON CONTROLLED
 RELAYS, SOLID-STATE (COMPUTER GRADE)
 SWITCHES, PUSHBUTTON
 SWITCHES, PUSHBUTTON (ILLUMINATED)
 SWITCHES, SOLID STATE
 TRANSISTORS, FIELD EFFECT
 TRANSISTORS, GERMANIUM
 TRANSISTORS, PHOTO
 TRANSISTORS, SILICON

3 Manufacturers' Directory

NUMERIDEX TAPE SYSTEMS INC.

312-772-6400

4711 W North Ave, Chicago, Ill 60639

CABINETS AND ENCLOSURES (FOR KEYPUNCHES, PRINTERS)
 CABINETS, RACKS, VAULTS (FOR MAGNETIC TAPE STORAGE)
 CABINETS, TRAYS (FOR PUNCHED CARD STORAGE)
 CARDS, EDGE-PUNCH
 CARDS, MAGNETIC
 CONTAINERS, PAPER TAPE STORAGE
 CORRECTION SEALS, PAPER TAPE
 COVERS, ACOUSTIC (FOR KEYBOARDS, TELETYPEWRITERS, ETC.)
 FILES, PUNCHED CARD
 FORMS, CONTINUOUS (MACHINE PROCESSED)
 FORMS HANDLING, PUNCHED CARD SOURCE
 LABELS, CONTINUOUS AND GUMMED (MACHINE APPLICATION)
 PAPER (FOR PRINTERS)
 PUNCHES, PAPER TAPE
 REELS, MAGNETIC TAPE
 REELS, PAPER TAPE
 RIBBONS, INK (FOR PRINTERS AND TAB EQUIPMENT)
 SPLICERS, PAPER TAPE
 SPOOLERS, PAPER TAPE
 TAPE, MAGNETIC (CASSETTE)
 TAPE, MAGNETIC (REELS)
 TAPE, PUNCH (MYLAR)
 TAPE, PUNCH (MYLAR-COATED FOIL)
 TAPE, PUNCH (PAPER)
 TAPE, PUNCH (PAPER-COATED MYLAR)
 TAPE, PUNCH (PAPER-COATED ALUMINUM)
 WINDERS, PAPER TAPE

NYTRONICS INC.

201-454-1143

3rd Ave, Alpha, N J 08865

TWX 510-235-2918

ACOUSTIC COUPLERS
 CABINETS AND ENCLOSURES (FOR KEYPUNCHES, PRINTERS)
 CABINETS, ENCLOSURES, CONSOLES, ELECTRONIC (FOR GENERAL EQUIPMENT)
 CABINETS, RACKS, VAULTS (FOR MAGNETIC TAPE STORAGE)
 CABINETS, TRAYS (FOR PUNCHED CARD STORAGE)
 CABLE, COAXIAL (FLEXIBLE)
 CABLE, COAXIAL (SEMI/RIGID)
 CABLE, FINE LEAD
 CABLE, MULTICONDUCTOR
 CABLE, SHIELDED (NOT COAXIAL)
 CAPACITORS, COMPUTER GRADE
 CHASSIS, SLIDES, RACKS
 CIRCUITS, HYBRID (IC AND DISCRETE-DIGITAL)
 CIRCUITS, THICK FILM (DIGITAL)
 CRYSTAL UNITS, QUARTZ (FOR FREQUENCY CONTROL)
 DATA TERMINALS, BLOCK-BY-BLOCK (GRAPHIC DIGITIZERS)
 DATA TERMINALS, BLOCK-BY-BLOCK (MAGNETIC TAPE)
 DATA TERMINALS, BLOCK-BY-BLOCK (MULTI-PURPOSE)
 DATA TERMINALS, BLOCK-BY-BLOCK (PAPER TAPE)
 DATA TERMINALS, BLOCK-BY-BLOCK (PLOTTER)
 DATA TERMINALS, BLOCK-BY-BLOCK (HIGH SPEED PRINTER)
 DATA TERMINALS, BLOCK-BY-BLOCK (MEDIUM SPEED PRINTER)
 DATA TERMINALS, BLOCK-BY-BLOCK (PUNCHED CARD)
 DATA TERMINALS, BLOCK-BY-BLOCK (TELEPRINTER)
 DATA TERMINALS, INQUIRY-RESPONSE (ALPHANUMERIC KEYBOARD)
 DATA TERMINALS, INQUIRY-RESPONSE (AUDIO RESPONSE)
 DATA TERMINALS, INQUIRY-RESPONSE (BADGE-TOKEN READERS)
 DATA TERMINALS, INQUIRY-RESPONSE (SPECIAL-PURPOSE)
 DELAY LINES, GLASS (ALSO SEE MEMORIES)
 DELAY LINES, MAGNETOSTRICTIVE (ALSO SEE MEMORIES)
 MODEMS, ACOUSTIC
 MODEMS, HARD-WIRED
 MODEMS, PC CARD
 MODULES, RESISTANCE NETWORKS (ENCAPSULATED)
 MULTIPLEXER-CONVERTER (SINGLE UNIT WITH MULTIPLEXER, SAMPLE & HOLD
 AMPLIFIER & A-TO-D CONVERTER)
 MULTIPLEXERS, ANALOG-RELAY (SEQUENTIAL SAMPLING)
 MULTIPLEXERS, ANALOG-SOLID STATE (SEQUENTIAL SAMPLING)
 MULTIPLEXERS, DIGITAL
 POWER SUPPLIES, AC
 POWER SUPPLIES, DC
 POWER SUPPLIES, DIGITALLY-CONTROLLED
 READERS, MAGNETIC CARD
 READERS, PAYMENT COUPONS
 READERS, PERFORATED DOCUMENT
 READERS, STATIC
 REGULATORS, FREQUENCY
 REGULATORS, VOLTAGE
 TRANSFORMERS, POWER (COMPUTER GRADE)
 TRANSFORMERS, PULSE (COMPUTER GRADE)

O. K. DATA SERVICES

203-323-0607

P O Box 3001, Darien, Conn 06820

CONSULTING (ACCOUNTING, BUSINESS AND COMMERCIAL APPLICATIONS)
 REELS, MAGNETIC TAPE
 SERVICES, PROCESSING (COMMERCIAL EDP)
 USED EQUIPMENT (BUYING, SELLING, LEASING)

OAK ELECTRO/NETICS CORP. OAK MFG. CO.

815-459-5000

Main St, Crystal Lake, Ill 60014

TWX 910-634-3353

SWITCHES, PUSHBUTTON
 SWITCHES, PUSHBUTTON (ILLUMINATED)
 SWITCHES, ROTARY
 SWITCHES, THUMBWHEEL

OCHMAN SYSTEMS, EDWARD

203-259-1927

Po Box 141, Fairfield, Conn 06430

BOARDS, VISUAL CONTROL (GRAPHIC)
 CABINETS AND ENCLOSURES (FOR KEYPUNCHES, PRINTERS)
 CABINETS, ENCLOSURES, CONSOLES, ELECTRONIC (FOR GENERAL EQUIPMENT)
 CABINETS, RACKS, VAULTS (FOR MAGNETIC TAPE STORAGE)
 CABINETS, TRAYS (FOR PUNCHED CARD STORAGE)
 CANNISTERS, MAGNETIC TAPE
 CLEANERS, MAGNETIC TAPE HEADS
 CONTAINERS, DISK PACK STORAGE
 CONTAINERS, PAPER TAPE STORAGE
 CORDS, PATCH
 CORRECTION SEALS, MICR DOCUMENTS
 CORRECTION SEALS, PUNCH CARD
 CORRECTION SEALS, PAPER TAPE
 COVERS, ACOUSTIC (FOR KEYBOARDS, TELETYPEWRITERS, ETC.)
 DESKS, TABLES AND STANDS (FOR CALCULATORS)
 DESKS, TABLES AND STANDS (FOR KEYPUNCH UNITS)
 DESKS, TABLES AND STANDS (FOR PROGRAMMER STATIONS)
 DESKS, TABLES AND STANDS (FOR TYPEWRITERS)
 DISC PACKS, MAGNETIC
 DISC STORAGE SYSTEMS
 DISPLAYS, MAGNETIC
 ENVELOPES (FOR FILING TAPES)
 FILES, PUNCHED CARD
 FLOOR PLANNING AIDS (FOR EDP ROOMS)
 FORMS HANDLING, DECOLLATORS
 HOLDERS, BINDER
 LABELS, CONTINUOUS AND GUMMED (MACHINE APPLICATION)
 MARK SENSING SUPPLIES
 PERFORATORS, PAPER TAPE
 PRINTER/PUNCH, PAPER TAPE
 PUNCHES, PAPER TAPE
 RACKS, PAPER TAPE
 REEL CLIPS AND BELTS, MAGNETIC TAPE
 REELS, MAGNETIC TAPE
 REELS, PAPER TAPE
 RIBBONS, INK (FOR PRINTERS AND TAB EQUIPMENT)
 SAFES, MAGNETIC TAPE STORAGE
 SPLICERS, PAPER TAPE
 SPOOLERS, PAPER TAPE
 TAGS (FOR EDP PROCESSING)
 TAPE, MAGNETIC (CASSETTE)
 TAPE, MAGNETIC (REELS)
 TAPE, PUNCH (MYLAR)
 TAPE, PUNCH (MYLAR-COATED FOIL)
 TAPE, PUNCH (PAPER)
 TAPE, PUNCH (PAPER-COATED MYLAR)
 TAPE, PUNCH (PAPER-COATED ALUMINUM)
 TAPE TRANSPORTS, MAGNETIC (DIGITAL-EXCL. CASSETTE)
 TEMPLATES, FLOW CHART
 WINDERS, MAGNETIC TAPE

ODEC COMPUTER SYSTEMS, INC.

401-438-0220

871 Waterman Ave, E Providence, R I 02914

PRINTERS, LINE (LOW & MEDIUM SPEED)

OFFICE SERVICES, INC.

713-526-1841

2919 Allen Parkway, Houston, Tex 77019

CONSULTING (ACCOUNTING, BUSINESS AND COMMERCIAL APPLICATIONS)
 SERVICES, PROCESSING (COMMERCIAL EDP)
 SERVICES, SYSTEMS ANALYSIS

OGDEN TECHNOLOGY LABORATORIES FULLERTON DIV.

714-879-6110

1536 E Valencia Dr, Fullerton, Cal 92631

SERVICES, FACILITY MANAGEMENT

OHMITE MANUFACTURING CO.

312-675-2600

3601 Howard St, Skokie, Ill 60076

TWX 910-223-0805

CONTROLLERS, MOTOR
 POTENTIOMETERS, TRIM (WIRE-WOUND)
 RELAYS, SOLID-STATE (COMPUTER GRADE)
 SWITCHES, ROTARY
 VOLTAGE DIVIDERS

3 Manufacturers' Directory

OHTRONICS INC., SUB MOHAWK DATA SCIENCES CORP. 215-265-7700
P O Box 406, King of Prussia, Pa 19406 TELEX 84-5206
 CARDS, EDGE-PUNCH
 DUPLICATORS-VERIFIERS, PAPER TAPE
 PERFORATORS, PAPER TAPE
 PUNCHES, PAPER TAPE
 READERS, EDGE-PUNCHED CARD
 READERS, PAPER TAPE
 READERS, PUNCHED TAG
 REPRODUCERS, PAPER TAPE (AUTOMATIC)

OKI ELECTRIC INDUSTRIES CO. LTD. 212-868-9540
875 Ave of Americas, New York, N Y 10001

COMMUNICATIONS-ORIENTED PROCESSORS, MULTIPLE CHANNEL CONTROLLERS
 COMMUNICATIONS-ORIENTED PROCESSORS, SINGLE CHANNEL CONTROLLERS
 COMMUNICATIONS-ORIENTED PROCESSORS, STORED PROGRAM
 COMMUNICATION SYSTEMS, DATA TRANSMISSION
 COMMUNICATION SYSTEMS, TELEPRINTER
 COMPUTERS, DIGITAL (GENERAL-PURPOSE, SMALL-SCALE)
 COMPUTERS, DIGITAL (GENERAL-PURPOSE, MEDIUM-SCALE)
 COMPUTERS, DIGITAL (GENERAL-PURPOSE, LARGE SCALE)
 COMPUTERS, PROCESS CONTROL
 CONTROLLERS, MAGNETIC DRUM
 CONTROLLERS, MODEM
 CONVERTERS, MAGNETIC TAPE-TO-PAPER TAPE
 CONVERTERS, MAGNETIC TAPE-TO-PRINTER
 CONVERTERS, MAGNETIC TAPE-TO-PUNCHED CARD
 CONVERTERS, PAPER TAPE-TO-PAPER TAPE
 CONVERTERS, PUNCHED CARD-TO-PAPER TAPE
 DATA CONCENTRATORS
 DATA TERMINALS, BLOCK-BY-BLOCK (MULTI-PURPOSE)
 DATA TERMINALS, BLOCK-BY-BLOCK (PAPER TAPE)
 DATA TERMINALS, BLOCK-BY-BLOCK (HIGH SPEED PRINTER)
 DATA TERMINALS, BLOCK-BY-BLOCK (MEDIUM SPEED PRINTER)
 DATA TERMINALS, BLOCK-BY-BLOCK (PUNCHED CARD)
 DATA TERMINALS, BLOCK-BY-BLOCK (TELEPRINTER)
 DATA TERMINALS, INQUIRY-RESPONSE (ALPHANUMERIC KEYBOARD)
 DATA TERMINALS, INQUIRY-RESPONSE (CRT WITH KEYBOARD)
 DATA TERMINALS, INQUIRY-RESPONSE (SPECIAL-PURPOSE)
 DRUM STORAGE EQUIPMENT, MAGNETIC (INCLUDING CONTROLLER)
 DUPLICATORS-VERIFIERS, PAPER TAPE
 MODEMS, HARD-WIRED
 PERFORATORS, PAPER TAPE
 PRINTER/PUNCH, PAPER TAPE
 PRINTERS, KEYBOARD
 PRINTERS, LINE (LOW & MEDIUM SPEED)
 PRINTERS, LINE (HIGH SPEED)
 PUNCHES, CARD (OVER 100 CPM)
 PUNCHES, CARD (UP TO 100 CPM)
 PUNCHES, PAPER TAPE
 READER/PUNCHES, PUNCHED CARD
 READERS, EDGE-PUNCHED CARD
 READERS, OPTICAL MARK SENSING
 READERS, PAPER TAPE
 READERS, PERFORATED DOCUMENT
 READERS, PUNCHED CARD (100 TO 300 CPM)
 READERS, PUNCHED CARD (OVER 300 CPM)
 READERS, STATIC
 READOUTS AND DISPLAYS, NUMERIC AND ALPHANUMERIC (OTHER THAN CRT)
 RELAYS, SOLID-STATE (COMPUTER GRADE)
 TYPEWRITERS, COMPUTER INPUT-OUTPUT
 VERIFIERS, PUNCHED CARD

OKONITE CO., THE, WIRE & CABLE DIV. 201-825-0300
P O Box 340, Ramsey, N J 07446
 CABLE, MULTICONDUCTOR
 CABLE, SHIELDED (NOT COAXIAL)

OLD TOWN CORP. 212-622-2600
750 Pacific St, Brooklyn, N Y 11238 TELEX 62-561
 RIBBONS, INK (FOR PRINTERS AND TAB EQUIPMENT)

OLIVETTI CORP. OF AMERICA 212-679-3400
500 Park Ave, New York, N Y 10016

ACOUSTIC COUPLERS
 CALCULATORS, PROGRAMMABLE (ALSO SEE COMPUTERS)
 CARDS, MAGNETIC
 COMMUNICATIONS-ORIENTED PROCESSORS, MULTIPLE CHANNEL CONTROLLERS
 COMMUNICATIONS-ORIENTED PROCESSORS, STORED PROGRAM
 COMMUNICATION SYSTEMS, DATA TRANSMISSION
 COMMUNICATION SYSTEMS, TELEPRINTER
 COMPUTERS, DIGITAL (GENERAL-PURPOSE, SMALL-SCALE)
 CONTROLLERS, MODEM
 DATA CONCENTRATORS
 DATA TERMINALS, BLOCK-BY-BLOCK (MAGNETIC TAPE)
 CONTINUED

DATA TERMINALS, BLOCK-BY-BLOCK (MULTI-PURPOSE)
 DATA TERMINALS, BLOCK-BY-BLOCK (PAPER TAPE)
 DATA TERMINALS, BLOCK-BY-BLOCK (HIGH SPEED PRINTER)
 DATA TERMINALS, BLOCK-BY-BLOCK (MEDIUM SPEED PRINTER)
 DATA TERMINALS, BLOCK-BY-BLOCK (PUNCHED CARD)
 DATA TERMINALS, BLOCK-BY-BLOCK (TELEPRINTER)
 DATA TERMINALS, INQUIRY-RESPONSE (ALPHANUMERIC KEYBOARD)
 DATA TERMINALS, INQUIRY-RESPONSE (BADGE-TOKEN READERS)
 DATA TERMINALS, INQUIRY-RESPONSE (CRT WITH KEYBOARD)
 IMPRINTERS, MAGNETIC INK CHARACTER
 IMPRINTERS, OPTICALLY-SENSED CHARACTER
 MODEMS, ACOUSTIC
 MODEMS, HARD-WIRED
 PERFORATORS, PAPER TAPE
 PROGRAMMING LANGUAGE DEVELOPMENT (CONTRACT PROGRAMMING)
 PROGRAMMING LANGUAGE DEVELOPMENT (DEDICATED APPLICATION SYSTEMS)
 PROGRAMMING LANGUAGE DEVELOPMENT (PROPRIETARY SOFTWARE PRODUCTS)
 PUNCHES, PAPER TAPE
 READERS, PAPER TAPE
 RIBBONS, INK (FOR PRINTERS AND TAB EQUIPMENT)

OMEGA-T SYSTEMS INC. 214-231-5121
300 Terrace Village, Richardson, Tex 75080
 PLOTTERS, MOVING PEN (ANALOG CONTROLLER)

OMNIACTION CONTROL SYSTEMS DIV. DYNAMIC INSTR. 516-694-6000
114 E Bethpage Rd, Plainview, N Y 11803
 MOTORS, SERVO
 MOTORS, SYNCHRONOUS
 SERVOS, COMPUTER

OMNITEC CORP. A NYTRONICS CORP. 602-258-8246
903 N 2nd St, Phoenix, Ariz 85004 TWX 910-951-4247
 ACOUSTIC COUPLERS
 CARDS, CONVENTIONAL PUNCH
 DATA TERMINALS, INQUIRY-RESPONSE (ALPHANUMERIC KEYBOARD)
 DATA TERMINALS, INQUIRY-RESPONSE (SPECIAL-PURPOSE)
 MODEMS, ACOUSTIC
 MODEMS, HARD-WIRED
 MODEMS, PC CARD
 PRINTERS, DIGITAL STRIP RECORDING
 READERS, PUNCHED CARD (100 TO 300 CPM)

OMTRONICS MANUFACTURING INC. 402-348-9500
2406 Leavenworth St, Omaha, Nebr 68105 TWX 910-622-8220
 RESISTORS, PRECISION

ON LINE COMPUTER CORP. 203-327-7354
370 Ludlow St, Stamford, Conn 06902
 CIRCUITS, MONOLITHIC (LSI-MOS)
 MULTIPLEXERS, TIME DIVISION

ON-LINE SYSTEMS INC. 412-931-7600
4721 Mc Knight Rd, Pittsburg, Pa 15237

COMMUNICATIONS-ORIENTED PROCESSORS, MULTIPLE CHANNEL CONTROLLERS
 CONSULTING (ADVANCED COMPUTER EQUIPMENT DESIGN AND FEASIBILITY STUDIES)
 CONSULTING (MANAGEMENT INFORMATION SYSTEMS PLANNING)
 CONSULTING (SCIENTIFIC APPLICATIONS)
 PROGRAMMING LANGUAGE DEVELOPMENT (CONSULTANTS)
 PROGRAMMING LANGUAGE DEVELOPMENT (CONTRACT PROGRAMMING)
 PROGRAMMING LANGUAGE DEVELOPMENT (DEDICATED APPLICATION SYSTEMS)
 PROGRAMMING LANGUAGE DEVELOPMENT (PROPRIETARY SOFTWARE PRODUCTS)
 SERVICES, TIME SHARING (COMMERCIAL)
 SERVICES, TIME SHARING (RESEARCH)
 TRAINING INSTITUTES, COMMERCIAL COMPUTER COURSES, SEMINARS,
 CORRESPONDENCE COURSES

OPCOA INC. 201-287-0355
330 Talmadge Rd, Edison, N J 08817 TWX 710-988-0555
 DIODES, LIGHT EMITTING
 READOUTS AND DISPLAYS, NUMERIC AND ALPHANUMERIC (OTHER THAN CRT)

OPERATIONS RESEARCH INC. 301-588-6180
1400 Spring St, Silver Spring, Md 20910
 CONSULTING (ACCOUNTING, BUSINESS AND COMMERCIAL APPLICATIONS)
 CONSULTING (ADVANCED COMPUTER EQUIPMENT DESIGN AND FEASIBILITY STUDIES)
 CONTINUED

3 Manufacturers' Directory

CONSULTING (COMPUTER EVALUATIONS, SELECTIONS, INSTALLATION PLANNING)
 CONSULTING (DATA COMMUNICATIONS SYSTEMS PLANNING)
 CONSULTING (COMPUTER PRODUCT PLANNING SURVEYS, MARKET RESEARCH STUDIES)
 CONSULTING (MANAGEMENT INFORMATION SYSTEMS PLANNING)
 CONSULTING (SCIENTIFIC APPLICATIONS)
 SERVICES, FACILITY MANAGEMENT
 SERVICES, MANAGEMENT INFORMATION SYSTEMS
 SERVICES, PROCESSING (COMMERCIAL EDP)
 SERVICES, SYSTEMS ANALYSIS

OPTICAL ELECTRONICS INC. 602-624-8358
 P O Box 11140, Tucson, Ariz 85706

AMPLIFIERS, D.C.
 AMPLIFIERS, INSTRUMENTATION
 AMPLIFIERS, OPERATIONAL
 AMPLIFIERS, VIDEO
 CIRCUITS, MONOLITHIC (LINEAR-EXCL. OP AMPS)
 CIRCUITS, MONOLITHIC (OP AMPS)
 CONVERTERS, ANALOG-TO-DIGITAL
 CONVERTERS, DC-TO-FREQUENCY
 CONVERTERS, DIGITAL-TO-ANALOG
 CONVERTERS, FREQUENCY-TO-DC
 CONVERTERS, POLAR-TO-RECTANGULAR
 CONVERTERS, VOLTAGE-TO-FREQUENCY
 DISPLAYS, THREE-DIMENSIONAL
 MODULES, LINEAR (ENCAPSULATED)
 MULTIPLEXERS, ANALOG-SOLID STATE (SEQUENTIAL SAMPLING)
 OSCILLATORS, VOLTAGE CONTROLLED
 POWER SUPPLIES, DC
 REGULATORS, CURRENT
 REGULATORS, VOLTAGE

OPTICAL MEMORY SYSTEMS 714-542-3548
 1520 So Lyon St, Santa Ana, Cal 92705

MEMORY SYSTEMS, OPTICAL
 MEMORY SYSTEMS, READ-ONLY
 PROGRAMMING LANGUAGE DEVELOPMENT (PROPRIETARY SOFTWARE PRODUCTS)
 SERVICES, COMPUTER-AIDED DESIGN

OPTICAL SCANNING CORP. 215-968-4611
 P O Box 40, Newton, Pa 18940

FORMS, CONTINUOUS (MACHINE PROCESSED)
 READERS, OPTICAL CHARACTER SCANNING
 SCANNERS, OPTICAL
 SERVICES, PROCESSING (COMMERCIAL EDP)

OPTICS TECHNOLOGY INC. 415-327-6600
 901 California Ave, Palo Alto, Cal 94304 TWX 415-492-9241
 FIBER OPTIC BUNDLES
 FIBER OPTICS ASSEMBLIES (FOR PUNCHED CODE READERS AND MARK SENSORS)

OPTIMATION, INC. 213-768-0830
 9421 Telfair Ave, Sunn Valley, Cal 91352 TWX 910-498-2710

AMPLIFIERS, D.C.
 AMPLIFIERS, INSTRUMENTATION
 AMPLIFIERS, OPERATIONAL
 CONSOLES, CRT (ALPHANUMERIC AND GRAPHIC)
 CONSOLES, CRT (COLOR-ALPHANUMERIC AND GRAPHIC)
 CONSOLES, CRT (GRAPHIC)
 READOUTS, CRT

OPTIMIZED DEVICES INC. 914-769-6100
 220 Marble Ave, Pleasantville, N Y 10570

TESTERS, CIRCUIT
 TESTERS, DIGITAL LOGIC MODULES AND CARDS
 TESTERS, INTEGRATED CIRCUIT
 TESTERS, SEMICONDUCTOR

ORBITAL SYSTEMS INC. 609-234-1700
 Church & Fellowship, Moorestown, N J 08057

READERS, OPTICAL CHARACTER SCANNING

ORIGINAL COMPUTER PRODUCTS INC. 617-235-6588
 204 Worcester St, Wellesley Hills, Mass 02181

CABINETS AND ENCLOSURES (FOR KEYPUNCHES, PRINTERS)
 CONTINUED

CABINETS, ENCLOSURES, CONSOLES, ELECTRONIC (FOR GENERAL EQUIPMENT)
 CABINETS, RACKS, VAULTS (FOR MAGNETIC TAPE STORAGE)
 CABINETS, TRAYS (FOR PUNCHED CARD STORAGE)
 CANNISTERS, MAGNETIC TAPE
 CARDS, EDGE-PUNCH
 CERTIFIERS, MAGNETIC TAPE
 CLEANER/CERTIFIERS, MAGNETIC TAPE
 CLEANERS, MAGNETIC TAPE
 CONSULTING (ACCOUNTING, BUSINESS AND COMMERCIAL APPLICATIONS)
 CONSULTING (COMPUTER EVALUATIONS, SELECTIONS, INSTALLATION PLANNING)
 CONSULTING (COMPUTER PRODUCT PLANNING SURVEYS, MARKET RESEARCH STUDIES)

CONTAINERS, DISK PACK STORAGE
 CONTAINERS, PAPER TAPE STORAGE
 CORRECTION SEALS, PAPER TAPE
 DESKS, TABLES AND STANDS (FOR CALCULATORS)
 DESKS, TABLES AND STANDS (FOR KEYPUNCH UNITS)
 DESKS, TABLES AND STANDS (FOR PROGRAMMER STATIONS)
 ENVELOPES (FOR FILING TAPES)
 FILES, PUNCHED CARD
 FORMS, CONTINUOUS (MACHINE PROCESSED)
 HOLDERS, BINDER
 LABELS, CONTINUOUS AND GUMMED (MACHINE APPLICATION)
 LABELS, CONTINUOUS AND PRESSURE SENSITIVE (MACHINE APPLICATION)
 LEASING, EDP EQUIPMENT (OTHER THAN MFGRS)
 MAILERS, PUNCHED CARD
 PAPER (FOR PRINTERS)
 REEL CLIPS AND BELTS, MAGNETIC TAPE
 REELS, MAGNETIC TAPE
 REELS, PAPER TAPE
 RIBBONS, INK (FOR PRINTERS AND TAB EQUIPMENT)
 SAFES, MAGNETIC TAPE STORAGE
 TAGS (FOR EDP PROCESSING)
 TAPE, MAGNETIC (CASSETTE)
 TAPE, MAGNETIC (REELS)
 TAPE, PUNCH (MYLAR)
 TAPE, PUNCH (MYLAR-COATED FOIL)
 TAPE, PUNCH (PAPER)
 TAPE, PUNCH (PAPER-COATED MYLAR)
 TAPE, PUNCH (PAPER-COATED ALUMINUM)
 USED EQUIPMENT (BUYING, SELLING, LEASING)

OVEN INDUSTRIES INC. METRIC ENGINEERING DIV. 717-766-0721
 P O Box 229, Mechanicsburg, Pa 17055

POWER SUPPLIES, DC

OVENAIRE INC. 703-293-5148
 706 Forrest St, Charlottesville, Va 22901 TWX 510-587-5461
 OSCILLATORS, VOLTAGE CONTROLLED

PACIFIC MEASUREMENTS INC. 415-328-0300
 940 Industrial Ave, Palo Alto, Cal 94303 TWX 910-373-1171
 TESTERS, CIRCUIT
 VOLTMETERS, AC, DC, DIFFERENTIAL
 VOLTMETERS, DIGITAL

PAIGE ELECTRIC CORP. 201-643-4445
 10 Commerce Court, Newark, N J 07102 TELEX 13-8121
 CABLE, COAXIAL (FLEXIBLE)
 CABLE, COAXIAL (SEMI/RIGID)
 CABLE, FINE LEAD
 CABLE, FLAT, PRINTED AND RIBBON
 CABLE, MULTICONDUCTOR
 CABLE, SHIELDED (NOT COAXIAL)

PAKTRON, DIV. ILLINOIS TOOL WORKS, INC. 703-548-4400
 1321 Leslie Ave, Alexandria, Va 22301 TWX 710-832-9811
 CAPACITORS, COMPUTER GRADE

PAMOTOR INC., WILLIAM J. PURDY CORP. 415-347-8217
 770 Airport Blvd, Burlingame, Cal 94010 TELEX 34-9373
 AIR CONDITIONERS (FOR EDP INSTALLATIONS)
 BLOWERS, FANS, COOLING ASSEMBLIES

PANASONIC INDUSTRIAL DIV. 212-973-8907
 200 Park Ave, New York, N Y 10017

READERS, EDGE-PUNCHED CARD
 READERS, PUNCHED CARD (UP TO 100 CPM)
 READERS, PUNCHED TAG

3 Manufacturers' Directory

PANDUIT CORP. 312-532-1800
17301 Ridgeland Ave, Tinley Park, Ill 60477
FASTENERS, EQUIPMENT
TELEX 25-4560

PANSOPHC SYSTEMS INC. 312-629-6200
230 Roosevelt Rd, Lombard, Ill 60148

CONSULTING (ACCOUNTING, BUSINESS AND COMMERCIAL APPLICATIONS)
CONSULTING (ADVANCED COMPUTER EQUIPMENT DESIGN AND FEASIBILITY STUDIES)
CONSULTING (COMPUTER EVALUATIONS, SELECTIONS, INSTALLATION PLANNING)
CONSULTING (DATA COMMUNICATIONS SYSTEMS PLANNING)
CONSULTING (COMPUTER PRODUCT PLANNING SURVEYS, MARKET RESEARCH STUDIES)
CONSULTING (MANAGEMENT INFORMATION SYSTEMS PLANNING)
PROGRAMMING LANGUAGE DEVELOPMENT (CONSULTANTS)
PROGRAMMING LANGUAGE DEVELOPMENT (CONTRACT PROGRAMMING)
PROGRAMMING LANGUAGE DEVELOPMENT (DEDICATED APPLICATION SYSTEMS)
PROGRAMMING LANGUAGE DEVELOPMENT (PROPRIETARY SOFTWARE PRODUCTS)
SERVICES, FACILITY MANAGEMENT
SERVICES, MANAGEMENT INFORMATION SYSTEMS
SERVICES, SYSTEMS ANALYSIS
TRAINING INSTITUTES, COMMERCIAL COMPUTER COURSES, SEMINARS, CORRESPONDENCE COURSES
TRAINING SYSTEMS, COMPUTER SERVICE

PAPER MANUFACTURERS CO. 215-673-4500
9800 Bustleton Ave, Philadelphia, Pa 19115
FORMS, CONTINUOUS (MACHINE PROCESSED)
LABELS, CONTINUOUS AND GUMMED (MACHINE APPLICATION)
REELS, PAPER TAPE
RIBBONS, INK (FOR PRINTERS AND TAB EQUIPMENT)
SPLICERS, PAPER TAPE
SPOOLERS, PAPER TAPE
TAPE, PUNCH (MYLAR)
TAPE, PUNCH (MYLAR-COATED FOIL)
TAPE, PUNCH (PAPER)
TAPE, PUNCH (PAPER-COATED MYLAR)
TAPE, PUNCH (PAPER-COATED ALUMINUM)
WINDERS, PAPER TAPE
TWX 710-670-0595

PAPERWORK DATA COMM. SERVICES INC. 315-475-2126
1703 S Ave, Syracuse, N Y 13207

CONSULTING (ACCOUNTING, BUSINESS AND COMMERCIAL APPLICATIONS)
CONSULTING (MANAGEMENT INFORMATION SYSTEMS PLANNING)
PROGRAMMING LANGUAGE DEVELOPMENT (CONTRACT PROGRAMMING)
PROGRAMMING LANGUAGE DEVELOPMENT (DEDICATED APPLICATION SYSTEMS)
PROGRAMMING LANGUAGE DEVELOPMENT (PROPRIETARY SOFTWARE PRODUCTS)
SERVICES, FACILITY MANAGEMENT
SERVICES, PROCESSING (COMMERCIAL EDP)
SERVICES, SYSTEMS ANALYSIS

PARABAM INC. 213-537-1771
3017 E Las Hermanas, Compton, Cal 90221

CLOCKS, DIGITAL (REAL-TIME)
COUNTERS, DECADE
COUNTERS, DIGITAL READOUT
COUNTERS, STEPPING SWITCH
COUNTERS, UP-DOWN
TIMERS, EVENT (IMPULSE)
TIMERS, INTERVAL

PARSONS & WILLIAMS, INC.
Nyrupsgade 43, 1602 Copenhagen, DENMARK

CONSULTING (ACCOUNTING, BUSINESS AND COMMERCIAL APPLICATIONS)
CONSULTING (ADVANCED COMPUTER EQUIPMENT DESIGN AND FEASIBILITY STUDIES)
CONSULTING (DATA COMMUNICATIONS SYSTEMS PLANNING)
CONSULTING (COMPUTER PRODUCT PLANNING SURVEYS, MARKET RESEARCH STUDIES)
CONSULTING (MANAGEMENT INFORMATION SYSTEMS PLANNING)

PATH COMPUTER EQUIPMENT INC. 203-348-4244
65 Commerce Rd, Stamford, Conn 06904

COMMUNICATION SYSTEMS, TELEPRINTER
DATA TERMINALS, BLOCK-BY-BLOCK (HIGH SPEED PRINTER)
PRINTERS, LINE (LOW & MEDIUM SPEED)
PRINTERS, LINE (HIGH SPEED)

PAYMENT SYSTEMS INC. 212-867-4690
405 Lexington Ave, New York, N Y 10017

AUDIO/VISUAL TRAINING AIDS
CONSULTING (ACCOUNTING, BUSINESS AND COMMERCIAL APPLICATIONS)
CONSULTING (ADVANCED COMPUTER EQUIPMENT DESIGN AND FEASIBILITY STUDIES)
CONSULTING (COMPUTER EVALUATIONS, SELECTIONS, INSTALLATION PLANNING)
CONSULTING (DATA COMMUNICATIONS SYSTEMS PLANNING)
CONSULTING (COMPUTER PRODUCT PLANNING SURVEYS, MARKET RESEARCH STUDIES)
CONSULTING (MANAGEMENT INFORMATION SYSTEMS PLANNING)
DISPLAYS, PANELS, VIEWGRAPHS (FOR COMPUTER TRAINING)
SERVICES, FACILITY MANAGEMENT
SERVICES, MANAGEMENT INFORMATION SYSTEMS
SERVICES, PROCESSING (COMMERCIAL EDP)
SERVICES, SYSTEMS ANALYSIS
TRAINING INSTITUTES, COMMERCIAL COMPUTER COURSES, SEMINARS, CORRESPONDENCE COURSES

PAYROLL SPECIALISTS INC. 216-486-7474
714 E 200th St, Cleveland, Ohio 44119

CONSULTING (ACCOUNTING, BUSINESS AND COMMERCIAL APPLICATIONS)

PEERLESS ELECTRICAL PRODUCTS DIV. 714-774-5373
1515 S Manchester Ave, Anaheim, Cal 92803
CONVERTERS, FREQUENCY-TO-DC
CONVERTERS, VOLTAGE-TO-FREQUENCY
POWER SUPPLIES, AC
POWER SUPPLIES, DC
REGULATORS, VOLTAGE
TRANSFORMERS, POWER (COMPUTER GRADE)
TWX 910-591-1142

PENN KEYSTONE CORP. 203-734-3301
Division St, Ansonia, Conn 06401

INDICATORS, ALPHANUMERIC
INDICATORS, DIGITAL
INDICATORS, ILLUMINATED
LAMPS, GLOW
LAMPS-PANEL, PILOT AND DIAL (INCANDESCENT)

PENNDATA CORP. 717-346-7348
1729 Cedar Ave, Scranton, Pa 18505

CONSULTING (ACCOUNTING, BUSINESS AND COMMERCIAL APPLICATIONS)
CONSULTING (ADVANCED COMPUTER EQUIPMENT DESIGN AND FEASIBILITY STUDIES)
CONSULTING (COMPUTER EVALUATIONS, SELECTIONS, INSTALLATION PLANNING)
CONSULTING (DATA COMMUNICATIONS SYSTEMS PLANNING)
CONSULTING (COMPUTER PRODUCT PLANNING SURVEYS, MARKET RESEARCH STUDIES)
CONSULTING (MANAGEMENT INFORMATION SYSTEMS PLANNING)
CONSULTING (SCIENTIFIC APPLICATIONS)
LEASING, EDP EQUIPMENT (OTHER THAN MFGRS)
PROGRAMMING LANGUAGE DEVELOPMENT (CONSULTANTS)
PROGRAMMING LANGUAGE DEVELOPMENT (CONTRACT PROGRAMMING)
PROGRAMMING LANGUAGE DEVELOPMENT (DEDICATED APPLICATION SYSTEMS)
PROGRAMMING LANGUAGE DEVELOPMENT (PROPRIETARY SOFTWARE PRODUCTS)
SERVICES, COMPUTER-AIDED DESIGN
SERVICES, FACILITY MANAGEMENT
SERVICES, MAGNETIC TAPE CERTIFICATION
SERVICES, MANAGEMENT INFORMATION SYSTEMS
SERVICES, PROCESSING (ANALOG OR HYBRID, SCIENTIFIC)
SERVICES, PROCESSING (DIGITAL SCIENTIFIC)
SERVICES, PROCESSING (DIGITAL SCIENTIFIC)
SERVICES, TIME SHARING (COMMERCIAL)
SERVICES, TIME SHARING (RESEARCH)
SERVICES, AUTOMATED WIRE-WRAPPING
SERVICES, HARDWARE MAINTENANCE
SERVICES, SYSTEMS ANALYSIS
TRAINING INSTITUTES, COMMERCIAL COMPUTER COURSES, SEMINARS, CORRESPONDENCE COURSES
TRAINING SYSTEMS, COMPUTER SERVICE
USED EQUIPMENT (BUYING, SELLING, LEASING)

PENNWALT CORP. 215-587-7000
3 Penn Ctr, Philadelphia, Pa 19102

CABLE, SHIELDED (NOT COAXIAL)

3 Manufacturers' Directory

PENRIL DATA COMMUNICATION INC 301-881-8151
 960 Thomas Ave, Rockville, Md 20852

MODEMS, HARD-WIRED
 MODEMS, PC CARD

PER DATA 516-938-2851
 102 New South Rd, Hicksville, N Y 11801 TWX 510-222-4555

CABLE, MULTICONDUCTOR
 CABLE, SHIELDED (NOT COAXIAL)
 CONTROLLERS, MAGNETIC TAPE
 DISC STORAGE SYSTEMS
 MAGNETIC TAPE STORAGE SYSTEMS (INCLUDES CONTROLLER)
 MEMORY SYSTEMS, MAGNETIC DISC
 PRINTERS, LINE (LOW & MEDIUM SPEED)
 TAPE TRANSPORTS, MAGNETIC (DIGITAL-EXCL. CASSETTE)

PERFECT GEAR&INSTRUMENT CORP. 213-885-1781
 18141 Napa St, Northridge, Cal 91324

GEARS, PERIPHERAL EQUIPMENT

PERFECTION MICA CO. MAGNETIC SHIELD DIV 312-766-7800
 748 Thomas Dr, Bensenville, Ill 60106 TWX 910-256-4815

CABLE, SHIELDED (NOT COAXIAL)
 SAFES, MAGNETIC TAPE STORAGE

PERIPHERAL DATA MACHINES INC. 516-938-2851
 102 New S Rd, Hicksville, N Y 11801

COMPUTERS, DIGITAL (GENERAL-PURPOSE, SMALL-SCALE)
 CONTROLLERS, MAGNETIC DISC
 CONTROLLERS, MODEM
 DATA CONCENTRATORS
 DATA TERMINALS, BLOCK-BY-BLOCK (MAGNETIC TAPE)
 DATA TERMINALS, BLOCK-BY-BLOCK (HIGH SPEED PRINTER)
 DATA TERMINALS, BLOCK-BY-BLOCK (MEDIUM SPEED PRINTER)
 DISC DRIVES, FIXED HEAD (INCLUDING CONTROLLER)
 DISC DRIVES, MOVABLE HEAD (INCLUDING CONTROLLER)
 FORMATTERS, MAGNETIC TAPE
 MAGNETIC TAPE STORAGE SYSTEMS (INCLUDES CONTROLLER)
 PRINTERS, LINE (LOW & MEDIUM SPEED)
 PRINTERS, LINE (HIGH SPEED)
 RECORDERS, MAGNETIC TAPE
 SERVICES, SYSTEMS ANALYSIS
 TAPE TRANSPORTS, MAGNETIC (DIGITAL-EXCL. CASSETTE)

PERIPHERAL DYNAMICS INC. 215-539-5500
 1030 W Germantown Pk, Norristown, Pa 19401

PRINTERS, LINE (LOW & MEDIUM SPEED)
 READERS, PUNCHED CARD (100 TO 300 CPM)
 READERS, PUNCHED CARD (OVER 300 CPM)

PERIPHERAL EQUIPMENT CORP. 213-882-0030
 9600 Irondale Ave, Chatsworth, Cal 91311 TWX 910-494-2093

FORMATTERS, MAGNETIC TAPE
 RECORDERS, MAGNETIC TAPE
 TAPE TRANSPORTS, MAGNETIC (DIGITAL-EXCL. CASSETTE)
 TAPE TRANSPORTS, MAGNETIC (INCREMENTAL)

PERIPHERAL TECHNOLOGY INC. 405-732-4940
 757 N Pastoria Ave, Sunnyvale, Cal 94086

PRINTERS, MICROFILM/MICROFICHE
 RECORDERS, MICROFILM/MICROFICHE

PERIPHERALS GENERAL, INC. 609-424-2010
 Cherry Hill Ind Pk, Cherry Hill, N J 08034 TELEX 83-4343

CONTROLLERS, MAGNETIC DISC
 DISC DRIVES, MOVABLE HEAD (INCLUDING CONTROLLER)
 TESTERS, DATA INTERFACE

PFC MFG. DIV. ARCO/DIV. LORAL 516-487-0500
 Community Dr, Great Neck, N Y 11022 TWX 510-223-0888

CAPACITORS, COMPUTER GRADE

PG DATA CENTER INC. 216-527-2108
 P O Box 11, Garrettsville, Ohio 44231

CONSULTING (ACCOUNTING, BUSINESS AND COMMERCIAL APPLICATIONS)
 CONTINUED

SERVICES, FACILITY MANAGEMENT
 SERVICES, PROCESSING (COMMERCIAL EDP)
 SERVICES, SYSTEMS ANALYSIS

PHALO CORP. A TRANSITRON GROUP CO. 617-844-4021
 530 Boston Tpk, Shrewsbury, Mass 01545 TWX 710-392-1383

CABLE ASSEMBLIES (WITH CONNECTORS)
 CABLE, COAXIAL (FLEXIBLE)
 CABLE, COAXIAL (SEMI/RIGID)
 CABLE, FINE LEAD
 CABLE, FLAT, PRINTED AND RIBBON
 CABLE, MULTICONDUCTOR
 CABLE, SHIELDED (NOT COAXIAL)

PHI COMPUTER SERVICES INC. 617-648-8550
 800 Massachusetts Ave, Arlington, Mass 02174

CONSULTING (ACCOUNTING, BUSINESS AND COMMERCIAL APPLICATIONS)
 CONSULTING (ADVANCED COMPUTER EQUIPMENT DESIGN AND FEASIBILITY STUDIES)
 CONSULTING (COMPUTER EVALUATIONS, SELECTIONS, INSTALLATION PLANNING)
 CONSULTING (DATA COMMUNICATIONS SYSTEMS PLANNING)
 CONSULTING (COMPUTER PRODUCT PLANNING SURVEYS, MARKET RESEARCH STUDIES)
 CONSULTING (MANAGEMENT INFORMATION SYSTEMS PLANNING)
 CONSULTING (SCIENTIFIC APPLICATIONS)
 PROGRAMMING LANGUAGE DEVELOPMENT (CONSULTANTS)
 PROGRAMMING LANGUAGE DEVELOPMENT (CONTRACT PROGRAMMING)
 PROGRAMMING LANGUAGE DEVELOPMENT (DEDICATED APPLICATION SYSTEMS)
 PROGRAMMING LANGUAGE DEVELOPMENT (PROPRIETARY SOFTWARE PRODUCTS)
 SERVICES, MANAGEMENT INFORMATION SYSTEMS
 SERVICES, PROCESSING (COMMERCIAL EDP)
 SERVICES, PROCESSING (DIGITAL SCIENTIFIC)
 SERVICES, TIME SHARING (COMMERCIAL)
 SERVICES, SYSTEMS ANALYSIS

PHILCO-FORD CORP., COMPUTER SERVICES NETWORK 215-443-5500
 Tioga & C Sts, Philadelphia, Pa 19134

AUDIO/VISUAL TRAINING AIDS
 CONSULTING (ACCOUNTING, BUSINESS AND COMMERCIAL APPLICATIONS)
 CONSULTING (COMPUTER EVALUATIONS, SELECTIONS, INSTALLATION PLANNING)
 CONSULTING (MANAGEMENT INFORMATION SYSTEMS PLANNING)
 CONSULTING (SCIENTIFIC APPLICATIONS)
 PROGRAMMING LANGUAGE DEVELOPMENT (PROPRIETARY SOFTWARE PRODUCTS)
 SERVICES, COMPUTER-AIDED DESIGN
 SERVICES, FACILITY MANAGEMENT
 SERVICES, MANAGEMENT INFORMATION SYSTEMS
 SERVICES, PROCESSING (COMMERCIAL EDP)
 SERVICES, PROCESSING (ANALOG OR HYBRID, SCIENTIFIC)
 SERVICES, PROCESSING (DIGITAL SCIENTIFIC)
 SERVICES, TIME SHARING (COMMERCIAL)
 SERVICES, TIME SHARING (RESEARCH)
 SERVICES, SYSTEMS ANALYSIS
 TRAINING INSTITUTES, COMMERCIAL COMPUTER COURSES, SEMINARS, CORRESPONDENCE COURSES
 TRAINING SYSTEMS, COMPUTER SERVICE

PHOENIX DATA INC. 602-278-8528
 3384 W Osborn Rd, Phoenix, Ariz 85017

CONVERTERS, ANALOG-TO-DIGITAL
 CONVERTERS, DIGITAL-TO-ANALOG
 CONVERTERS, DIGITAL-TO-SYNCHRO
 CONVERTERS, SYNCHRO-TO-DIGITAL
 MULTIPLEXER-CONVERTER (SINGLE UNIT WITH MULTIPLEXER, SAMPLE & HOLD AMPLIFIER & A-TO-D CONVERTER)
 MULTIPLEXERS, ANALOG-SOLID STATE (SEQUENTIAL SAMPLING)

PHOTO TECHNICAL PRODUCTS INC. SUB. EPOI 516-248-5200
 623 Stewart Ave, Garden City, N Y 11530 TELEX 12-5855

CAMERAS, DATA RECORDING (EXCL. OSCILLOSCOPES)

PHOTON INC. 617-933-7000
 355 Middlesex Ave, Wilmington, Mass 01887

CURVE TRACERS-DIGITIZERS, MANUAL
 DRAFTING SYSTEMS, COMPUTER-CONTROLLED STORAGE
 PERFORATORS, PAPER TAPE
 PRINTERS, LINE (LOW & MEDIUM SPEED)
 PROJECTORS, OPTICAL (COMPUTER CONTROLLED SLIDE SELECTING)

3 Manufacturers' Directory

PHOTOPHYSICS 415-969-9500
1601 Stierlin Rd, Mt View, Cal 94040

DATA TERMINALS, INQUIRY-RESPONSE (ALPHANUMERIC KEYBOARD)
DATA TERMINALS, INQUIRY-RESPONSE (CRT WITH KEYBOARD)

PHOTRON INSTRUMENT CO. 216-281-7020
6516 Detroit Ave, Cleveland, Ohio 44102

RECORDERS, GRAPHIC

PINLITES INC. 201-226-7724
P O Box 453, Caldwell, N J 07006

CONNECTORS, MINIATURE AND SUB-MINIATURE (COMPUTER-GRADE)
COUNTERS, DIGITAL READOUT
LAMPS-PANEL, PILOT AND DIAL (INCANDESCENT)
READOUTS AND DISPLAYS, NUMERIC AND ALPHANUMERIC (OTHER THAN CRT)

PINS INC. 714-531-3503
P O Box 6409, Santa Ana, Cal 92706

CONNECTORS, MINIATURE AND SUB-MINIATURE (COMPUTER-GRADE)
CONNECTORS, PC AND IC BOARD (COMPUTER-GRADE)

PIONEER ALUMINUM 213-263-7211
3800 E 26th St, Los Angeles, Cal 90023

CABINETS AND ENCLOSURES (FOR KEYPUNCHES, PRINTERS)
CABINETS, ENCLOSURES, CONSOLES, ELECTRONIC (FOR GENERAL EQUIPMENT)
CHASSIS, SLIDES, RACKS

PIONEER DATA SYSTEMS INC. 515-276-6746
606 Merle Hay Tower, Des Moines, Iowa 50310

CONSULTING (ACCOUNTING, BUSINESS AND COMMERCIAL APPLICATIONS)
CONSULTING (COMPUTER EVALUATIONS, SELECTIONS, INSTALLATION PLANNING)
CONSULTING (DATA COMMUNICATIONS SYSTEMS PLANNING)
CONSULTING (COMPUTER PRODUCT PLANNING SURVEYS, MARKET RESEARCH STUDIES)
CONSULTING (MANAGEMENT INFORMATION SYSTEMS PLANNING)
CONSULTING (SCIENTIFIC APPLICATIONS)
PROGRAMMING LANGUAGE DEVELOPMENT (CONSULTANTS)
PROGRAMMING LANGUAGE DEVELOPMENT (CONTRACT PROGRAMMING)
PROGRAMMING LANGUAGE DEVELOPMENT (DEDICATED APPLICATION SYSTEMS)
PROGRAMMING LANGUAGE DEVELOPMENT (PROPRIETARY SOFTWARE PRODUCTS)
SERVICES, FACILITY MANAGEMENT
SERVICES, MANAGEMENT INFORMATION SYSTEMS
SERVICES, PROCESSING (COMMERCIAL EDP)
SERVICES, TIME SHARING (RESEARCH)
SERVICES, SYSTEMS ANALYSIS
TRAINING INSTITUTES, COMMERCIAL COMPUTER COURSES, SEMINARS, CORRESPONDENCE COURSES
TRAINING SYSTEMS, COMPUTER SERVICE

PIONEER ELECTRIC & RESEARCH DIV. JOHNSON SER.CO. 312-771-8242
743 Circle Ave, Forest Park, Ill 60130

CELLS, PHOTOCONDUCTIVE
CLOCKS, DIGITAL (REAL-TIME)
COMMUNICATION SYSTEMS, DATA TRANSMISSION
COMMUNICATION SYSTEMS, TELEPRINTER
CONVERTERS, PAPER TAPE-TO-PAPER TAPE
CONVERTERS, PAPER TAPE-TO-PRINTER
CONVERTERS, PULSE-TO-DIGITAL
GENERATORS, RANDOM NUMBER
GENERATORS, TIME CODE
SIGNAL CONDITIONERS

PIONEER MAGNETICS INC. 213-393-0136
1745 Berkeley St, Santa Monica, Cal 90404

POWER SUPPLIES, AC
POWER SUPPLIES, DC
TESTERS, MAGNETIC DISC
TESTERS, MAGNETIC DRUM

PLANNING RESEARCH CORP. 213-479-7725
1100 Glendon Ave, Los Angeles, Cal 90024 TWX 910-342-6893

CONSULTING (ACCOUNTING, BUSINESS AND COMMERCIAL APPLICATIONS)
CONSULTING (ADVANCED COMPUTER EQUIPMENT DESIGN AND FEASIBILITY STUDIES)
CONTINUED

CONSULTING (COMPUTER EVALUATIONS, SELECTIONS, INSTALLATION PLANNING)
CONSULTING (DATA COMMUNICATIONS SYSTEMS PLANNING)
CONSULTING (COMPUTER PRODUCT PLANNING SURVEYS, MARKET RESEARCH STUDIES)
CONSULTING (MANAGEMENT INFORMATION SYSTEMS PLANNING)
CONSULTING (SCIENTIFIC APPLICATIONS)
PROGRAMMING LANGUAGE DEVELOPMENT (CONSULTANTS)
PROGRAMMING LANGUAGE DEVELOPMENT (CONTRACT PROGRAMMING)
PROGRAMMING LANGUAGE DEVELOPMENT (DEDICATED APPLICATION SYSTEMS)
SERVICES, FACILITY MANAGEMENT
SERVICES, MANAGEMENT INFORMATION SYSTEMS
SERVICES, PROCESSING (COMMERCIAL EDP)
SERVICES, PROCESSING (DIGITAL SCIENTIFIC)
SERVICES, SYSTEMS ANALYSIS

PLASTIC CAPACITORS INC. 312-348-3735
2620 N Clybourn Ave, Chicago, Ill 60614

CAPACITORS, COMPUTER GRADE
CONVERTERS, DC-TO-FREQUENCY
CONVERTERS, FREQUENCY-TO-DC
POWER SUPPLIES, AC
POWER SUPPLIES, DC
TRANSFORMERS, PULSE (COMPUTER GRADE)

PLASTIGRAPH RULES 216-749-4088
5530 State Rd, Cleveland, Ohio 44134

TEMPLATES, FLOW CHART

PLATEDATA DIV. CHEMPLATE CORP. 213-268-9265
4355 E Sheila St, Los Angeles, Cal 90023

DISCS, MAGNETIC MEMORY

PLESSEY MEMORY PRODUCTS CORP. 714-540-9945
1674 McGaw Ave, Santa Ana, Cal 92705

MEMORY PLANES AND STACKS, MAGNETIC CORE (W/O ELECTRONICS)
MEMORY PLANES AND STACKS, PLATED WIRE (W/O ELECTRONICS)
MEMORY SYSTEMS, DELAY LINE
MEMORY SYSTEMS, MAGNETIC CORE
MEMORY SYSTEMS, PLATED WIRE
MEMORY SYSTEMS, READ-ONLY
PLATED WIRE

POLY CABLE CO. 312-671-1640
5235 N Rose St, Rosemont, Ill 60018

BOARDS, PRINTED CIRCUIT (WITHOUT COMPONENTS)
CABLE ASSEMBLIES (WITH CONNECTORS)
CABLE, FLAT, PRINTED AND RIBBON
CABLE, SHIELDED (NOT COAXIAL)

POLY-OPTICS INC. 714-546-2250
1815 E Carnegie, Santa Ana, Cal 92705

FIBER OPTIC BUNDLES
FIBER OPTICS ASSEMBLIES (FOR PUNCHED CODE READERS AND MARK SENSORS)

POLYPHASE COMPONENTS DIV. 215-279-4660
E 4th, Bridgeport, Penn 19405

FILTERS (ACTIVE, LC, NOISE, ETC.)
TRANSFORMERS, POWER (COMPUTER GRADE)
TRANSFORMERS, PULSE (COMPUTER GRADE)

POMONA ELECTRONICS CO. INC. 714-623-3463
1500 E 9th St, Pomona, Cal 91766 TWX 910-581-3822

CABLE ASSEMBLIES (WITH CONNECTORS)
CONNECTORS, MINIATURE AND SUB-MINIATURE (COMPUTER-GRADE)
JACKS, JACK PANELS, PLUGS, ASSEMBLIES

PORTESCAP US 212-245-7716
730 5th Ave, New York, N Y 10019

MOTORS, SERVO
MOTORS, STEPPING
MOTORS, SYNCHRONOUS

3 Manufacturers' Directory

POTTER & BRUMFIELD DIV. OF AMF INC. 1200 E Broadway, Princeton, Ind 47570 RELAYS, DRY REED (COMPUTER GRADE) RELAYS, MERCURY WETTED (COMPUTER GRADE) RELAYS, SOLID-STATE (COMPUTER GRADE) SWITCHES, DRY REED SWITCHES, SNAP ACTION	812-385-5251 TWX 810-350-2343	VOLTMETERS, DIGITAL VOLTMETERS, PRINTING
POTTER INSTRUMENT CO. INC. 532 Broadhollow Rd, Melville, N Y 11746 DATA TERMINALS, BLOCK-BY-BLOCK (MAGNETIC TAPE) DATA TERMINALS, INQUIRY-RESPONSE (ALPHANUMERIC KEYBOARD) DISC DRIVES, MOVABLE HEAD (INCLUDING CONTROLLER) DISC STORAGE SYSTEMS ENCODERS, KEYBOARD-TO-MAGNETIC TAPE MAGNETIC TAPE STORAGE SYSTEMS (INCLUDES CONTROLLER) PRINTERS, LINE (LOW & MEDIUM SPEED) READER/PUNCHES, PUNCHED CARD READERS, MAGNETIC CARD READERS, MAGNETIC INK CHARACTER READERS, PERFORATED DOCUMENT READERS, PUNCHED CARD (OVER 300 CPM) TAPE TRANSPORTS, MAGNETIC (DIGITAL-EXCL. CASSETTE) TAPE TRANSPORTS, MAGNETIC (WITH KEYBOARD INPUT)	516-694-9000 TWX 510-224-6485	PRC COMPUTER CENTER INC. PLANNING RSCH CORP. 703-893-7880 7670 Old Springhouse, McLean, Va 22101 CONSULTING (COMPUTER EVALUATIONS, SELECTIONS, INSTALLATION PLANNING) CONSULTING (DATA COMMUNICATIONS SYSTEMS PLANNING) CONSULTING (SCIENTIFIC APPLICATIONS) SERVICES, FACILITY MANAGEMENT SERVICES, MANAGEMENT INFORMATION SYSTEMS SERVICES, PROCESSING (COMMERCIAL EDP) SERVICES, PROCESSING (DIGITAL SCIENTIFIC) SERVICES, SYSTEMS ANALYSIS
POWER COMPONENTS INC. P O Box 421, Scottsdale, Pa 15683 DIODES, SILICON DIODES, ZENER REGULATORS, CURRENT REGULATORS, VOLTAGE	412-887-6600	PRD ELECTRONICS INC., SUB. HARRIS-INTERTYPE 516-364-0400 6801 Jericho Tpk, Syosset, N Y 11791 TWX 510-221-2130 TESTERS, CIRCUIT
POWER DESIGNS INC. 1700 S Hames Dr, Westbury, N Y 11590 POWER SUPPLIES, DC POWER SUPPLIES, DIGITALLY-CONTROLLED TRANSFORMERS, PULSE (COMPUTER GRADE) VOLTAGE DIVIDERS	516-333-6200 TWX 510-222-6561	PRECISION CIRCUITS INC. DIV. HARVARD INDUS. 201-922-1910 P O Box 605, Farmingdale, N J 07727 BOARDS, PRINTED CIRCUIT (WITHOUT COMPONENTS)
POWER PHYSICS CORP. P O Box 626 Indus Way, Eatontown, N J 07724 CIRCUITS, THICK FILM (DIGITAL) TRANSISTORS, GERMANIUM TRANSISTORS, SILICON	201-542-1393 TWX 710-722-6646	PRECISION INSTRUMENT CO. UNICON DIV. 415-321-5615 3170 Porter Dr, Palo Alto, Cal 94304 TWX 910-373-1752 MEMORY SYSTEMS, OPTICAL RECORDERS, MAGNETIC TAPE TAPE TRANSPORTS, MAGNETIC (DIGITAL-EXCL. CASSETTE) TAPE TRANSPORTS, MAGNETIC (INCREMENTAL)
POWER SYSTEMS & CONTROLS INC. 3206 Lanvale Ave, Richmond, Va 23213 POWER SUPPLIES, UNINTERRUPTABLE	703-355-2803	PRECISION MAGNETICS INC. 612-339-1489 504 S 11th Ave, Minneapolis, Minn 55415 MEMORY SYSTEMS, PLATED WIRE MEMORY SYSTEMS, READ-ONLY TESTERS, MEMORY PLANES, STACKS AND SYSTEMS
POWER/MATE CORP. 514 S River St, Hackensack, N J 07601 CIRCUIT CARDS, LINEAR (WITH DISCRETE COMPONENTS) CIRCUIT CARDS, LINEAR (WITH IC'S) MODULES, LINEAR (ENCAPSULATED) MODULES, RESISTANCE NETWORKS (ENCAPSULATED) POWER SUPPLIES, AC POWER SUPPLIES, DC POWER SUPPLIES, DIGITALLY-CONTROLLED RECTIFIERS, SILICON CONTROLLED REGULATORS, CURRENT REGULATORS, VOLTAGE	201-343-6294 TWX 710-990-5023	PRECISION METAL PRODUCTS CO. 617-438-3650 41 Elm St, Stoneham, Mass 02180 TWX 710-393-0113 TERMINAL BLOCKS, STRIPS, BOARDS
POWERTEC 9168 Desoto St, Chatsworth, Cal 91311 CIRCUIT CARDS, LOGIC (WITH DISCRETE COMPONENTS) CIRCUIT CARDS, LOGIC (WITH IC'S) CIRCUITS, HYBRID (IC AND DISCRETE-DIGITAL) CLOCKS, DIGITAL (REAL-TIME) POWER SUPPLIES, AC POWER SUPPLIES, DC POWER SUPPLIES, DIGITALLY-CONTROLLED REGULATORS, CURRENT REGULATORS, VOLTAGE	213-882-0004	PRECISION MONOLITHICS INC. 408-246-9225 1500 Space Park Dr, Santa Clara, Cal 95050 TWX 910-338-0528 AMPLIFIERS, D.C. AMPLIFIERS, INSTRUMENTATION AMPLIFIERS, OPERATIONAL CIRCUIT CARDS, LINEAR (WITH IC'S) CIRCUIT CARDS, LOGIC (WITH IC'S) CIRCUITS, HYBRID (IC AND DISCRETE-DIGITAL) CIRCUITS, MONOLITHIC (DIGITAL LOGIC) CIRCUITS, MONOLITHIC (LINEAR-EXCL. OP AMPS) CIRCUITS, MONOLITHIC (LSI-BIPOLAR) CIRCUITS, MONOLITHIC (OP AMPS) CONVERTERS, ANALOG-TO-DIGITAL CONVERTERS, DIGITAL-TO-ANALOG
PRACTICAL AUTOMATION P O Box 313, Shelton, Conn 06484 COUNTERS, DECADE COUNTERS, DIGITAL READOUT PRINTERS, LINE (LOW & MEDIUM SPEED) CONTINUED	203-929-1495	PRECISION PRODUCTS DIV. OF KRATOS 213-478-0635 11161 W Pico Blvd, Los Angeles, Cal 90064 POWER SUPPLIES, DC RELAYS, DRY REED (COMPUTER GRADE) RELAYS, MERCURY WETTED (COMPUTER GRADE)
		PRECISION TUBE CO. INC. 215-699-5801 P O Box 176, North Wales, Pa 19454 TWX 510-661-8427 CABLE ASSEMBLIES (WITH CONNECTORS) CABLE, COAXIAL (SEMI/RIGID)
		PREMIER METAL PRODUCTS CO. 212-991-6600 337 Manjida St, Bronx, N Y 10474 BLOWERS, FANS, COOLING ASSEMBLIES CABINETS, ENCLOSURES, CONSOLES, ELECTRONIC (FOR GENERAL EQUIPMENT) CHASSIS, SLIDES, RACKS

3 Manufacturers' Directory

PRESTON SCIENTIFIC INC.
805 E Cerritos Ave, Anaheim, Cal 92805

714-776-6400

AMPLIFIERS, D.C.
AMPLIFIERS, INSTRUMENTATION
CONVERTERS, ANALOG-TO-DIGITAL
CONVERTERS, DIGITAL-TO-ANALOG
MULTIPLEXER-CONVERTER (SINGLE UNIT WITH MULTIPLEXER, SAMPLE & HOLD
AMPLIFIER & A-TO-D CONVERTER)
MULTIPLEXERS, ANALOG-SOLID STATE (SEQUENTIAL SAMPLING)
VOLTMETERS, DIGITAL

PRESTOSEAL MANUFACTURING CO.
37-12 108 St, Corona, N Y 11368

212-457-5566

SPLICERS, MAGNETIC TAPE
SPLICERS, PAPER TAPE
WINDERS, PAPER TAPE

PRINCETON APPLIED RESEARCH CORP.
P O Box 565, Princeton, N J 08540

609-924-6835

AMPLIFIERS, D.C.
AMPLIFIERS, INSTRUMENTATION
AMPLIFIERS, OPERATIONAL
ANALYZERS, WAVEFORM
DATA TERMINALS, INQUIRY-RESPONSE (SPECIAL-PURPOSE)
MULTIPLEXERS, ANALOG-RELAY (SEQUENTIAL SAMPLING)
MULTIPLEXERS, DIGITAL

PRINCETON ELECTRONIC PRODUCTS INC.
P O Box 101, N Brunswick, N J 08902

201-297-4448

CONVERTERS, SCAN
DATA TERMINALS, INQUIRY-RESPONSE (CRT WITH KEYBOARD)
READOUTS, CRT

PRINCETON INFORMATRIX INC.
1 Palmer Sq, Princeton, N J 08540

609-924-1279

CONSULTING (ACCOUNTING, BUSINESS AND COMMERCIAL APPLICATIONS)
CONSULTING (MANAGEMENT INFORMATION SYSTEMS PLANNING)
CONSULTING (SCIENTIFIC APPLICATIONS)
SERVICES, MANAGEMENT INFORMATION SYSTEMS
SERVICES, PROCESSING (COMMERCIAL EDP)
SERVICES, PROCESSING (DIGITAL SCIENTIFIC)
SERVICES, TIME SHARING (COMMERCIAL)
SERVICES, TIME SHARING (RESEARCH)
SERVICES, SYSTEMS ANALYSIS

PRINCETON TIME SHARING SERVICES, INC.
Us Hwy 1, Princeton, N J 08540

609-452-7877

CONSULTING (ACCOUNTING, BUSINESS AND COMMERCIAL APPLICATIONS)
CONSULTING (COMPUTER EVALUATIONS, SELECTIONS, INSTALLATION
PLANNING)
CONSULTING (DATA COMMUNICATIONS SYSTEMS PLANNING)
CONSULTING (MANAGEMENT INFORMATION SYSTEMS PLANNING)
PROGRAMMING LANGUAGE DEVELOPMENT (CONSULTANTS)
PROGRAMMING LANGUAGE DEVELOPMENT (CONTRACT PROGRAMMING)
PROGRAMMING LANGUAGE DEVELOPMENT (DEDICATED APPLICATION SYSTEMS)
PROGRAMMING LANGUAGE DEVELOPMENT (PROPRIETARY SOFTWARE
PRODUCTS)
SERVICES, COMPUTER-AIDED DESIGN
SERVICES, FACILITY MANAGEMENT
SERVICES, MANAGEMENT INFORMATION SYSTEMS
SERVICES, PROCESSING (COMMERCIAL EDP)
SERVICES, TIME SHARING (COMMERCIAL)
SERVICES, SYSTEMS ANALYSIS

PRINTED CIRCUIT CORP.
180 Elm St, Waltham, Mass 02154

617-899-0380
TWX 617-324-1619

BOARDS, PRINTED CIRCUIT (WITHOUT COMPONENTS)
CIRCUIT CARDS, LINEAR (WITH DISCRETE COMPONENTS)
CIRCUIT CARDS, LINEAR (WITH IC'S)
CIRCUIT CARDS, LOGIC (WITH DISCRETE COMPONENTS)
CIRCUIT CARDS, LOGIC (WITH IC'S)

PRINTER TECHNOLOGY INC.
Sixth Rd, Woburn, Mass 01801

617-935-4246

COMMUNICATION SYSTEMS, DATA TRANSMISSION
COMMUNICATION SYSTEMS, TELEPRINTER
CONVERTERS, MAGNETIC TAPE-TO-PRINTER
CONVERTERS, PAPER TAPE-TO-PRINTER
CONTINUED

DATA TERMINALS, BLOCK-BY-BLOCK (MEDIUM SPEED PRINTER)
DATA TERMINALS, BLOCK-BY-BLOCK (TELEPRINTER)
DATA TERMINALS, INQUIRY-RESPONSE (ALPHANUMERIC KEYBOARD)
DATA TERMINALS, INQUIRY-RESPONSE (CRT WITH KEYBOARD)
ENCODERS, KEYBOARD-TO-GRAPHIC DISPLAY
PRINTERS, KEYBOARD
PRINTERS, LINE (LOW & MEDIUM SPEED)
PRINTERS, LINE (HIGH SPEED)
RECORDERS, HARD-COPY (WITH CRT)

PRINTEX CORP.
1911 Plymouth St, Mt View, Cal 94040

415-964-5000

BOARDS, PRINTED CIRCUIT (WITHOUT COMPONENTS)

PROCESS SYSTEMS INC.
3061 Sheridan St, Las Vegas, Nev 89102

702-870-8081

COMPUTERS, PROCESS CONTROL
PROGRAMMING LANGUAGE DEVELOPMENT (DEDICATED APPLICATION SYSTEMS)

PROFIMATICS INC.
6355 Topanga Canyon, Woodland Hills, Cal 91364

213-883-6530

CONSULTING (ACCOUNTING, BUSINESS AND COMMERCIAL APPLICATIONS)
CONSULTING (COMPUTER EVALUATIONS, SELECTIONS, INSTALLATION
PLANNING)
CONSULTING (MANAGEMENT INFORMATION SYSTEMS PLANNING)
SERVICES, MANAGEMENT INFORMATION SYSTEMS
SERVICES, SYSTEMS ANALYSIS
TRAINING INSTITUTES, COMMERCIAL COMPUTER COURSES, SEMINARS,
CORRESPONDENCE COURSES

PROGRAM DATA CO.
739 E 223 St, Torrance, Cal 90502

213-830-3016

CONNECTORS, COAXIAL (COMPUTER-GRADE)
CONNECTORS, MINIATURE AND SUB-MINIATURE (COMPUTER-GRADE)
CONNECTORS, PC AND IC BOARD (COMPUTER-GRADE)
PLUGBOARDS, PROGRAMMING
TESTERS, CIRCUIT

PROGRAMMATICS INC.
11661 San Vicente Blv, Los Angeles, Cal 90049

213-826-6503

PROGRAMMING LANGUAGE DEVELOPMENT (CONSULTANTS)
PROGRAMMING LANGUAGE DEVELOPMENT (CONTRACT PROGRAMMING)
PROGRAMMING LANGUAGE DEVELOPMENT (DEDICATED APPLICATION SYSTEMS)
PROGRAMMING LANGUAGE DEVELOPMENT (PROPRIETARY SOFTWARE
PRODUCTS)

PROGRAMMING SCIENCES CORP.
S E 42 St, New York, N Y 10016

212-869-1600

AUDIO/VISUAL TRAINING AIDS
CONSULTING (ACCOUNTING, BUSINESS AND COMMERCIAL APPLICATIONS)
CONSULTING (ADVANCED COMPUTER EQUIPMENT DESIGN AND FEASIBILITY
STUDIES)
CONSULTING (COMPUTER EVALUATIONS, SELECTIONS, INSTALLATION
PLANNING)
CONSULTING (DATA COMMUNICATIONS SYSTEMS PLANNING)
CONSULTING (COMPUTER PRODUCT PLANNING SURVEYS, MARKET RESEARCH
STUDIES)
CONSULTING (MANAGEMENT INFORMATION SYSTEMS PLANNING)
CONSULTING (SCIENTIFIC APPLICATIONS)
INSTRUCTIONAL SYSTEMS, COMPUTER-BASED
PROGRAMMING LANGUAGE DEVELOPMENT (CONSULTANTS)
PROGRAMMING LANGUAGE DEVELOPMENT (CONTRACT PROGRAMMING)
PROGRAMMING LANGUAGE DEVELOPMENT (DEDICATED APPLICATION SYSTEMS)
PROGRAMMING LANGUAGE DEVELOPMENT (PROPRIETARY SOFTWARE
PRODUCTS)
SERVICES, FACILITY MANAGEMENT
SERVICES, MANAGEMENT INFORMATION SYSTEMS
SERVICES, PROCESSING (COMMERCIAL EDP)
SERVICES, PROCESSING (ANALOG OR HYBRID, SCIENTIFIC)
SERVICES, PROCESSING (DIGITAL SCIENTIFIC)
SERVICES, SYSTEMS ANALYSIS
TRAINING INSTITUTES, COMMERCIAL COMPUTER COURSES, SEMINARS,
CORRESPONDENCE COURSES
TRAINING SYSTEMS, COMPUTER SERVICE

PROGRAMMING SCIENCES CORP.
1900 Ave of The Stars, Los Angeles, Cal 90067

213-277-4965

AUDIO/VISUAL TRAINING AIDS
CONTINUED

3 Manufacturers' Directory

COMPUTERS, DIGITAL (EDUCATIONAL)
 CONSULTING (ACCOUNTING, BUSINESS AND COMMERCIAL APPLICATIONS)
 CONSULTING (ADVANCED COMPUTER EQUIPMENT DESIGN AND FEASIBILITY STUDIES)
 CONSULTING (COMPUTER EVALUATIONS, SELECTIONS, INSTALLATION PLANNING)
 CONSULTING (DATA COMMUNICATIONS SYSTEMS PLANNING)
 CONSULTING (COMPUTER PRODUCT PLANNING SURVEYS, MARKET RESEARCH STUDIES)
 CONSULTING (MANAGEMENT INFORMATION SYSTEMS PLANNING)
 CONSULTING (SCIENTIFIC APPLICATIONS)
 DISPLAYS, PANELS, VIEWGRAPHS (FOR COMPUTER TRAINING)
 INSTRUCTIONAL SYSTEMS, COMPUTER-BASED SERVICES, FACILITY MANAGEMENT SERVICES, PROCESSING (COMMERCIAL EDP)
 SERVICES, PROCESSING (ANALOG OR HYBRID, SCIENTIFIC)
 SERVICES, PROCESSING (DIGITAL SCIENTIFIC)
 SERVICES, SYSTEMS ANALYSIS
 TRAINING INSTITUTES, COMMERCIAL COMPUTER COURSES, SEMINARS, CORRESPONDENCE COURSES
 TRAINING SYSTEMS, COMPUTER SERVICE

PROGRAMS & ANALYSIS INC. 617-272-7723
 21 Ray Ave, Burlington, Mass 01803

CONSULTING (ACCOUNTING, BUSINESS AND COMMERCIAL APPLICATIONS)
 SERVICES, TIME SHARING (COMMERCIAL)
 SERVICES, TIME SHARING (RESEARCH)
 SERVICES, SYSTEMS ANALYSIS

PROTOTYPE ASSEMBLIES INC. 617-244-5183
 70 Jaconnet St, Newton Hglds, Mass 02161

CABLE, COAXIAL (FLEXIBLE)
 CABLE, COAXIAL (SEMI/RIGID)
 CABLE, FINE LEAD
 CABLE, FLAT, PRINTED AND RIBBON
 CABLE, MULTICONDUCTOR
 CABLE, SHIELDED (NOT COAXIAL)
 CONNECTORS, COAXIAL (COMPUTER-GRADE)
 CONNECTORS, MINIATURE AND SUB-MINIATURE (COMPUTER-GRADE)
 CONNECTORS, PC AND IC BOARD (COMPUTER-GRADE)

PRYOR COMPUTER INDUSTRIES 312-644-5650
 400 N Michigan Ave, Chicago, Ill 60611

CABINETS, RACKS, VAULTS (FOR MAGNETIC TAPE STORAGE)
 CANNISTERS, MAGNETIC TAPE
 CARDS, CONVENTIONAL PUNCH
 CLEANERS, MAGNETIC TAPE
 CONSULTING (ACCOUNTING, BUSINESS AND COMMERCIAL APPLICATIONS)
 CONSULTING (ADVANCED COMPUTER EQUIPMENT DESIGN AND FEASIBILITY STUDIES)
 CONSULTING (COMPUTER EVALUATIONS, SELECTIONS, INSTALLATION PLANNING)
 CONSULTING (DATA COMMUNICATIONS SYSTEMS PLANNING)
 CONSULTING (MANAGEMENT INFORMATION SYSTEMS PLANNING)
 CONSULTING (SCIENTIFIC APPLICATIONS)
 FLOORING (FOR EDP ROOMS)
 FORMS, CONTINUOUS (MACHINE PROCESSED)
 HOLDERS, BINDER
 LABELS, CONTINUOUS AND GUMMED (MACHINE APPLICATION)
 LABELS, CONTINUOUS AND PRESSURE SENSITIVE (MACHINE APPLICATION)
 RIBBONS, INK (FOR PRINTERS AND TAB EQUIPMENT)
 SERVICES, FACILITY MANAGEMENT
 SERVICES, MAGNETIC TAPE CERTIFICATION
 SERVICES, PROCESSING (COMMERCIAL EDP)
 SERVICES, TIME SHARING (COMMERCIAL)
 SERVICES, TIME SHARING (RESEARCH)
 SERVICES, SYSTEMS ANALYSIS
 TAPE, MAGNETIC (REELS)
 TRAINING INSTITUTES, COMMERCIAL COMPUTER COURSES, SEMINARS, CORRESPONDENCE COURSES
 TRAINING SYSTEMS, COMPUTER SERVICE

PRYOR MARKING PRODUCTS INC. 312-527-2048
 21 E Hubbard St, Chicago, Ill 60611

BOARDS, VISUAL CONTROL (GRAPHIC)
 FLOOR PLANNING AIDS (FOR EDP ROOMS)
 TEMPLATES, FLOW CHART

PTSS SYSTEMETRICS DIV. 201-356-7374
 Martinsville Center, Martinsville, N J 08836

SERVICES, COMPUTER-AIDED DESIGN
 SERVICES, LIST MAINTENANCE
 SERVICES, MANAGEMENT INFORMATION SYSTEMS

PUBLIC DATA PROCESSING CORP. 312-751-0100
 640 N Lasalle St, Chicago, Ill 60610 TWX 910-221-3117

CONSULTING (ACCOUNTING, BUSINESS AND COMMERCIAL APPLICATIONS)
 CONSULTING (COMPUTER EVALUATIONS, SELECTIONS, INSTALLATION PLANNING)
 CONSULTING (MANAGEMENT INFORMATION SYSTEMS PLANNING)
 SERVICES, FACILITY MANAGEMENT
 SERVICES, MANAGEMENT INFORMATION SYSTEMS
 SERVICES, PROCESSING (COMMERCIAL EDP)
 SERVICES, SYSTEMS ANALYSIS
 TRAINING INSTITUTES, COMMERCIAL COMPUTER COURSES, SEMINARS, CORRESPONDENCE COURSES

PULSE COMMUNICATIONS INC. 703-820-0652
 5214 Columbia Pike, Falls Church, Va 22041 TELEX 89-9423

COMMUNICATION SYSTEMS, DATA TRANSMISSION
 CONTROLLERS, MODEM
 DATA CONCENTRATORS
 MODEMS, HARD-WIRED
 MODEMS, PC CARD
 TESTERS, DATA INTERFACE

PULSE ENGINEERING INC. 714-453-6010
 P O Box 12235, San Diego, Cal 92112 TWX 910-322-1134

TRANSFORMERS, PULSE (COMPUTER GRADE)

PURDY CORP., WM. J. 415-347-8217
 770 Airport Blvd, Burlingame, Cal 94010 TELEX 34-9373

ACOUSTIC COUPLERS
 AIR CONDITIONERS (FOR EDP INSTALLATIONS)
 BLOWERS, FANS, COOLING ASSEMBLIES
 CAPACITORS, COMPUTER GRADE
 CERTIFIERS, MAGNETIC TAPE
 CLEANER/CERTIFIERS, MAGNETIC TAPE
 CONSULTING (COMPUTER EVALUATIONS, SELECTIONS, INSTALLATION PLANNING)
 CONTROLLERS, MAGNETIC DISC
 CONTROLLERS, MAGNETIC DRUM
 CONTROLLERS, MODEM
 CONVERTERS, MAGNETIC TAPE-TO-PRINTER
 CONVERTERS, PAPER TAPE-TO-PRINTER
 CONVERTERS, SCAN
 DATA CONCENTRATORS
 DATA TERMINALS, BLOCK-BY-BLOCK (GRAPHIC DIGITIZERS)
 DATA TERMINALS, BLOCK-BY-BLOCK (MAGNETIC TAPE)
 DATA TERMINALS, BLOCK-BY-BLOCK (MULTI-PURPOSE)
 DATA TERMINALS, BLOCK-BY-BLOCK (PAPER TAPE)
 DATA TERMINALS, BLOCK-BY-BLOCK (PLOTTER)
 DATA TERMINALS, BLOCK-BY-BLOCK (HIGH SPEED PRINTER)
 DATA TERMINALS, BLOCK-BY-BLOCK (MEDIUM SPEED PRINTER)
 DATA TERMINALS, BLOCK-BY-BLOCK (PUNCHED CARD)
 DATA TERMINALS, BLOCK-BY-BLOCK (TELEPRINTER)
 DATA TERMINALS, INQUIRY-RESPONSE (ALPHANUMERIC KEYBOARD)
 DATA TERMINALS, INQUIRY-RESPONSE (BADGE-TOKEN READERS)
 DATA TERMINALS, INQUIRY-RESPONSE (CRT WITH KEYBOARD)
 DATA TERMINALS, INQUIRY-RESPONSE (SPECIAL-PURPOSE)
 DISC DRIVES, FIXED HEAD (INCLUDING CONTROLLER)
 DISC DRIVES, MOVABLE HEAD (INCLUDING CONTROLLER)
 DISC DRIVES, REMOVABLE CARTRIDGE
 DISC PACKS, MAGNETIC
 DISC STORAGE SYSTEMS
 DRUM STORAGE EQUIPMENT, MAGNETIC (INCLUDING CONTROLLER)
 MODEMS, ACOUSTIC
 MODEMS, HARD-WIRED
 MODEMS, PC CARD
 MULTIPLEXERS, DIGITAL
 PAPER (FOR PRINTERS)
 PLUGBOARDS, PROGRAMMING
 PRINTERS, LINE (LOW & MEDIUM SPEED)
 PRINTERS, LINE (HIGH SPEED)
 REELS, PAPER TAPE
 SWITCHES, THUMBWHEEL
 TAGS (FOR EDP PROCESSING)
 TAPE, MAGNETIC (CASSETTE)
 TAPE, MAGNETIC (REELS)
 TAPE, PUNCH (MYLAR)
 TAPE, PUNCH (PAPER)
 TRANSISTORS, SILICON
 TYPEWRITERS, COMPUTER INPUT-OUTPUT

QANTEL CORP. 415-783-3410
 3474 Investment Blvd, Hayward, Cal 94545

ACCOUNTING MACHINES, PAPER TAPE PROGRAMMED
 COMMUNICATIONS-ORIENTED PROCESSORS, STORED PROGRAM
 COMPUTERS, DIGITAL (GENERAL-PURPOSE, SMALL-SCALE)
 PERFORATORS, PAPER TAPE
 PRINTERS, LINE (LOW & MEDIUM SPEED)
 CONTINUED

3 Manufacturers' Directory

READERS, PUNCHED CARD (100 TO 300 CPM)
TAPE TRANSPORTS, MAGNETIC (DIGITAL-EXCL. CASSETTE)

QUADRI CORP. 602-263-9555
2959 W Fairmount, Phoenix, Ariz 85017 TWX 910-957-1616

CORES, FERRITE MEMORY
MEMORY PLANES AND STACKS, MAG-NETIC CORE (W/O ELECTRONICS)
MEMORY SYSTEMS, MAGNETIC CORE
MEMORY SYSTEMS, READ-ONLY
MEMORY SYSTEMS, SEMICONDUCTOR
TESTERS, MEMORY PLANES, STACKS AND SYSTEMS
TESTERS, SEMICONDUCTOR

QUALIDYNE 408-738-0120
3699 Tahoe Way, Santa Clara, Cal 95051 TWX 910-339-9273

CIRCUITS, MONOLITHIC (DIGITAL LOGIC)
CIRCUITS, MONOLITHIC (DIODE MATRICES)
CIRCUITS, MONOLITHIC (LINEAR-EXCL. OP AMPS)
CIRCUITS, MONOLITHIC (LSI-BIPOLAR)
CIRCUITS, MONOLITHIC (LSI-MOS)
CIRCUITS, MONOLITHIC (OP AMPS)
CIRCUITS, THIN FILM (DIGITAL)

QUANTUM SCIENCE CORP. SUB. SAMSON ASSOC. 212-986-4410
245 Park Ave, New York, N Y 10017

CONSULTING (ADVANCED COMPUTER EQUIPMENT DESIGN AND FEASIBILITY STUDIES)
CONSULTING (COMPUTER PRODUCT PLANNING SURVEYS, MARKET RESEARCH STUDIES)

QUIKDATA INTERNATIONAL INC. 213-653-1992
8444 Wilshire Blvd, Beverly Hills, Cal 90211

CONSULTING (ACCOUNTING, BUSINESS AND COMMERCIAL APPLICATIONS)
CONSULTING (COMPUTER EVALUATIONS, SELECTIONS, INSTALLATION PLANNING)
CONSULTING (MANAGEMENT INFORMATION SYSTEMS PLANNING)
CONSULTING (SCIENTIFIC APPLICATIONS)
PROGRAMMING LANGUAGE DEVELOPMENT (CONSULTANTS)
PROGRAMMING LANGUAGE DEVELOPMENT (CONTRACT PROGRAMMING)
PROGRAMMING LANGUAGE DEVELOPMENT (DEDICATED APPLICATION SYSTEMS)
PROGRAMMING LANGUAGE DEVELOPMENT (PROPRIETARY SOFTWARE PRODUCTS)
SERVICES, MANAGEMENT INFORMATION SYSTEMS
SERVICES, PROCESSING (COMMERCIAL EDP)
SERVICES, PROCESSING (DIGITAL SCIENTIFIC)
SERVICES, TIME SHARING (COMMERCIAL)
SERVICES, SYSTEMS ANALYSIS
TRAINING INSTITUTES, COMMERCIAL COMPUTER COURSES, SEMINARS, CORRESPONDENCE COURSES
TRAINING SYSTEMS, COMPUTER SERVICE

RAMSAY ENGINEERING CO. 714-774-5511
707 N Anaheim Blvd, Anaheim, Cal 92805

CONSULTING (SCIENTIFIC APPLICATIONS)
CONVERTERS, FREQUENCY-TO-DC
COUNTERS, DIGITAL READOUT
DATA ACQUISITION AND REDUCTION SYSTEMS
MODULES, LINEAR (ENCAPSULATED)
SCANNERS, INPUT

RANDOLPH COMPUTER CORP. 203-661-4200
537 Steamboat Rd, Greenwich, Conn 06830 TWX 710-579-2920

LEASING, EDP EQUIPMENT (OTHER THAN MFGRS)

RANDOMATIC DATA SYSTEMS INC. 609-695-3447
344 W State St, Trenton, N J 08618

RETRIEVAL UNITS, PUNCHED CARD (RANDOM ACCESS)
SORTERS, PUNCHED CARD

RANK PRECISION INDUSTRIES INC. 914-358-4450
260 N Rt 303, W Nyack, N Y 10994

AUDIO/VISUAL TRAINING AIDS
CABLE ASSEMBLIES (WITH CONNECTORS)
COUNTERS, DECADE
COUNTERS, DIGITAL READOUT
COUNTERS, STEPPING SWITCH
COUNTERS, UP-DOWN
FIBER OPTIC BUNDLES
FIBER OPTICS ASSEMBLIES (FOR PUNCHED CODE READERS AND MARK SENSORS)
CONTINUED

FILM SCANNERS
INDICATORS, DIGITAL
MONITORS, TV
MOTORS, SERVO
PRINTERS, LINE (LOW & MEDIUM SPEED)
READOUTS AND DISPLAYS, NUMERIC AND ALPHANUMERIC (OTHER THAN CRT)
READOUTS, CRT
TRANSDUCERS, DIGITAL

RAPIDATA INC. 201-227-0035
20 New Dutch Lane, Fairfield, N J 07006

PROGRAMMING LANGUAGE DEVELOPMENT (CONTRACT PROGRAMMING)
PROGRAMMING LANGUAGE DEVELOPMENT (DEDICATED APPLICATION SYSTEMS)
PROGRAMMING LANGUAGE DEVELOPMENT (PROPRIETARY SOFTWARE PRODUCTS)
SERVICES, FACILITY MANAGEMENT
SERVICES, MANAGEMENT INFORMATION SYSTEMS
SERVICES, TIME SHARING (COMMERCIAL)
SERVICES, TIME SHARING (RESEARCH)

RAY PROOF CORP. 203-838-4555
50 Keller Ave, Norwalk, Conn 06856

CABINETS AND ENCLOSURES (FOR KEYPUNCHES, PRINTERS)
CABINETS, ENCLOSURES, CONSOLES, ELECTRONIC (FOR GENERAL EQUIPMENT)
CABINETS, RACKS, VAULTS (FOR MAGNETIC TAPE STORAGE)

RAYCON INC. 514-695-7725
218 Brunswick Blvd, Pointe Claire, CANADA

CIRCUIT CARDS, LOGIC (WITH DISCRETE COMPONENTS)
CLOCKS, DIGITAL (REAL-TIME)
COMPUTERS, PROCESS CONTROL
CONSOLES, COMPUTER CONTROL (WIRED)
DATA TERMINALS, BLOCK-BY-BLOCK (MAGNETIC TAPE)
DATA TERMINALS, INQUIRY-RESPONSE (SPECIAL-PURPOSE)
MAGNETIC TAPE STORAGE SYSTEMS (INCLUDES CONTROLLER)
MULTIPLEXERS, ANALOG-RELAY (SEQUENTIAL SAMPLING)
MULTIPLEXERS, ANALOG-SOLID STATE (SEQUENTIAL SAMPLING)
MULTIPLEXERS, DIGITAL
POWER SUPPLIES, AC
POWER SUPPLIES, DC

RAYMOND ENGINEERING INC., DIV. RAYMOND PREC. INC. 203-347-5611
217 Smith St, Middletown, Conn 06457

MAGNETIC TAPE STORAGE SYSTEMS (INCLUDES CONTROLLER)
MODULES, MEMORY (ENCAPSULATED)
RECORDERS, DIGITAL CASSETTE
RECORDERS, MAGNETIC TAPE

RAYTHEON CO. CADPO OPERATION 617-762-6700
1415 Providence Tpk, Norwood, Mass 02062 TWX 710-337-6879

COMMUNICATIONS-ORIENTED PROCESSORS, MULTIPLE CHANNEL CONTROLLERS
COMMUNICATIONS-ORIENTED PROCESSORS, SINGLE CHANNEL CONTROLLERS
COMMUNICATIONS-ORIENTED PROCESSORS, STORED PROGRAM
COMMUNICATION SYSTEMS, DATA TRANSMISSION
CONSULTING (DATA COMMUNICATIONS SYSTEMS PLANNING)
CONSULTING (MANAGEMENT INFORMATION SYSTEMS PLANNING)
CONTROLLERS, MODEM
CONVERTERS, PULSE-TO-DIGITAL
DATA CONCENTRATORS
DATA TERMINALS, INQUIRY-RESPONSE (ALPHANUMERIC KEYBOARD)
DATA TERMINALS, INQUIRY-RESPONSE (BADGE-TOKEN READERS)
DATA TERMINALS, INQUIRY-RESPONSE (CRT WITH KEYBOARD)
ENCODERS, DIGITAL
MODEMS, HARD-WIRED
MULTIPLEXER-CONVERTER (SINGLE UNIT WITH MULTIPLEXER, SAMPLE & HOLD AMPLIFIER & A-TO-D CONVERTER)
MULTIPLEXERS, DIGITAL
READOUTS, CRT
SERVICES, AUTOMATED WIRE-WRAPPING
SERVICES, SYSTEMS ANALYSIS

RAYTHEON CO. EQUIPMENT DIV. 617-443-3211
528 Boston Post Rd, Sudbury, Mass 01776 TWX 710-347-0384

AMPLIFIERS, D.C.
AMPLIFIERS, OPERATIONAL
CIRCUITS, MONOLITHIC (LSI-BIPOLAR)
CIRCUITS, MONOLITHIC (LSI-MOS)
CIRCUITS, THICK FILM (DIGITAL)
CIRCUITS, THIN FILM (DIGITAL)
COMMUNICATIONS-ORIENTED PROCESSORS, MULTIPLE CHANNEL CONTROLLERS
COMMUNICATIONS-ORIENTED PROCESSORS, STORED PROGRAM
COMMUNICATION SYSTEMS, DATA TRANSMISSION
CONTINUED

3 Manufacturers' Directory

COMMUNICATION SYSTEMS, FACSIMILE
 COMPUTERS, DIGITAL (GENERAL-PURPOSE, SMALL-SCALE)
 COMPUTERS, DIGITAL (GENERAL-PURPOSE, MEDIUM-SCALE)
 COMPUTERS, DIGITAL (GENERAL-PURPOSE, LARGE SCALE)
 COMPUTERS, HYBRID
 COMPUTERS, MINI GENERAL PURPOSE (ALSO SEE CALCULATORS)
 COMPUTERS, NAVIGATION
 CONSULTING (ADVANCED COMPUTER EQUIPMENT DESIGN AND FEASIBILITY STUDIES)
 CONSULTING (COMPUTER EVALUATIONS, SELECTIONS, INSTALLATION PLANNING)
 CONSULTING (DATA COMMUNICATIONS SYSTEMS PLANNING)
 CONSULTING (SCIENTIFIC APPLICATIONS)
 CONVERTERS, ANALOG-TO-DIGITAL
 CONVERTERS, DIGITAL-TO-ANALOG
 DISPLAY DRIVERS
 MEMORY PLANES AND STACKS, MAG-NETIC CORE (W/O ELECTRONICS)
 MEMORY PLANES AND STACKS, PLATED WIRE (W/O ELECTRONICS)
 MEMORY SYSTEMS, MAGNETIC CORE
 MEMORY SYSTEMS, PLATED WIRE
 MODULES, MEMORY (ENCAPSULATED)
 MULTIPLEXER-CONVERTER (SINGLE UNIT WITH MULTIPLEXER, SAMPLE & HOLD AMPLIFIER & A-TO-D CONVERTER)
 MULTIPLEXERS, DIGITAL
 PLATED WIRE
 PROGRAMMING LANGUAGE DEVELOPMENT (CONSULTANTS)
 PROGRAMMING LANGUAGE DEVELOPMENT (DEDICATED APPLICATION SYSTEMS)

RAYTHEON CO. INDUSTRIAL COMPONENT OPERATION 617-479-5300
 465 Centre St., Quincy, Mass 02169 TWX 710-337-6879

CELLS, PHOTOCONDUCTIVE
 CIRCUITS, HYBRID (IC AND DISCRETE-DIGITAL)
 CIRCUITS, THICK FILM (DIGITAL)
 DATA TERMINALS, INQUIRY-RESPONSE (ALPHANUMERIC KEYBOARD)
 ENCODERS, KEYBOARD (ALPHANUMERIC)
 ENCODERS, KEYBOARD (NUMERIC)
 JACKS, JACK PANELS, PLUGS, ASSEMBLIES
 KNOBS, DIALS (FOR COMPUTER CONSOLES)
 MODULES, DIGITAL LOGIC ENCAPSULATED (ALSO SEE CIRCUITS & CIRCUIT CARDS)
 MODULES, RESISTANCE NETWORKS (ENCAPSULATED)
 READOUTS, CRT
 REGULATORS, VOLTAGE
 SWITCHES, DRY REED
 SWITCHES, PUSHBUTTON
 SWITCHES, PUSHBUTTON (ILLUMINATED)
 TUBES, CATHODE RAY

RAYTHEON COMPANY, SORENSEN OPERATION 603-668-1600
 676 Island Pond, Manchester, N H 03103 TWX 710-220-1339

POWER SUPPLIES, DC
 POWER SUPPLIES, DIGITALLY-CONTROLLED
 PROTECTORS, CIRCUIT AND EQUIPMENT OVERLOAD
 REGULATORS, VOLTAGE

RAYTHEON COMPUTER 714-546-7160
 2700 S Fairview St, Santa Ana, Cal 92704 TWX 910-595-1570

AMPLIFIERS, INSTRUMENTATION
 CIRCUIT CARDS, LOGIC (WITH DISCRETE COMPONENTS)
 CIRCUIT CARDS, LOGIC (WITH IC'S)
 CIRCUITS, HYBRID (IC AND DISCRETE-DIGITAL)
 COMPUTERS, DIGITAL (GENERAL-PURPOSE, SMALL-SCALE)
 COMPUTERS, MINI GENERAL PURPOSE (ALSO SEE CALCULATORS)
 CONVERTERS, ANALOG-TO-DIGITAL
 CONVERTERS, BINARY-TO-DECIMAL
 CONVERTERS, DIGITAL-TO-ANALOG
 COUNTERS, DECADE
 COUNTERS, UP-DOWN
 DIGITIZERS, PROGRAMMABLE
 MODEMS, HARD-WIRED
 MULTIPLEXERS, ANALOG-SOLID STATE (SEQUENTIAL SAMPLING)
 MULTIPLEXERS, DIGITAL
 POWER SUPPLIES, DC
 SERVICES, AUTOMATED WIRE-WRAPPING
 TESTERS, DIGITAL LOGIC MODULES AND CARDS

RC-95 INC. 914-592-4500
 2 Westchester Plaza, Elmsford, N Y 10523 TWX 710-567-1218

CONSOLES, CRT (ALPHANUMERIC AND GRAPHIC)
 CONVERTERS, ANALOG-TO-DIGITAL
 CONVERTERS, BINARY-TO-DECIMAL
 CONVERTERS, DC-TO-FREQUENCY
 CONVERTERS, DIGITAL-TO-ANALOG
 CONVERTERS, DIGITAL-TO-SYNCHRO
 CONVERTERS, FREQUENCY-TO-DC
 CONVERTERS, PULSE-TO-DIGITAL
 CONVERTERS, SYNCHRO-TO-DIGITAL
 CONVERTERS, VOLTAGE-TO-FREQUENCY
 CONTINUED

MULTIPLEXER-CONVERTER (SINGLE UNIT WITH MULTIPLEXER, SAMPLE & HOLD AMPLIFIER & A-TO-D CONVERTER)
 PLOTTERS, MOVING PEN (DIGITAL CONTROLLER)
 PLOTTERS, NON-IMPACT
 SCANNERS, INPUT

RCA MEMORY PRODUCTS DIV 617-444-7200
 150 A St, Needham Heights, Mass 02194 TWX 710-325-0378

CORES, FERRITE MEMORY
 MEMORY PLANES AND STACKS, MAG-NETIC CORE (W/O ELECTRONICS)
 MEMORY SYSTEMS, MAGNETIC CORE

RCA MAGNETIC PRODUCTS DIV. 201-586-3000
 201 E 50th St, New York, N Y 10022

DISC PACKS, MAGNETIC
 TAPE, MAGNETIC (CASSETTE)
 TAPE, MAGNETIC (REELS)

RCA COMPUTER SYSTEMS DIV. 617-485-6000
 200 Forest Ave, Marlboro, Mass 01752

COMPUTERS, DIGITAL (GENERAL-PURPOSE, SMALL-SCALE)
 COMPUTERS, DIGITAL (GENERAL-PURPOSE, MEDIUM-SCALE)
 COMPUTERS, DIGITAL (GENERAL-PURPOSE, LARGE SCALE)
 COMPUTERS, MINI GENERAL PURPOSE (ALSO SEE CALCULATORS)
 COMPUTERS, PROCESS CONTROL
 CONSOLES, CRT (ALPHANUMERIC AND GRAPHIC)
 CONTROLLERS, MAGNETIC DISC
 CONTROLLERS, MAGNETIC DRUM
 CONTROLLERS, MAGNETIC TAPE
 DATA TERMINALS, BLOCK-BY-BLOCK (MULTI-PURPOSE)
 DISC DRIVES, FIXED HEAD (INCLUDING CONTROLLER)
 DISC PACKS, MAGNETIC
 DISC STORAGE SYSTEMS
 DRUM STORAGE EQUIPMENT, MAG-NETIC (INCLUDING CONTROLLER)
 PAPER (FOR PRINTERS)
 PRINTERS, KEYBOARD
 PRINTERS, LINE (LOW & MEDIUM SPEED)
 PRINTERS, LINE (HIGH SPEED)
 PUNCHES, CARD (OVER 100 CPM)
 READER/PUNCHES, PUNCHED CARD
 READERS, PUNCHED CARD (OVER 300 CPM)
 TAPE, MAGNETIC (REELS)
 TAPE TRANSPORTS, MAGNETIC (DIGITAL-EXCL. CASSETTE)
 TAPE TRANSPORTS, MAGNETIC (WITH KEYBOARD INPUT)
 TYPEWRITERS, COMPUTER INPUT-OUTPUT

RCA CORP. SOLID STATE DIV. 201-722-3200
 Rte 202, Somerville, N J 08876 TWX 710-480-9333

CIRCUITS, HYBRID (IC AND DISCRETE-DIGITAL)
 CIRCUITS, MONOLITHIC (DIGITAL LOGIC)
 CIRCUITS, MONOLITHIC (LINEAR-EXCL. OP AMPS)
 CIRCUITS, MONOLITHIC (LSI-BIPOLAR)
 CIRCUITS, MONOLITHIC (LSI-MOS)
 CIRCUITS, MONOLITHIC (OP AMPS)
 DIODES, GERMANIUM
 DIODES, LIGHT EMITTING
 DIODES, SILICON
 DIODES, TUNNEL
 RECTIFIERS, SILICON CONTROLLED
 TAPE, MAGNETIC (REELS)
 TRANSISTORS, FIELD EFFECT
 TRANSISTORS, GERMANIUM
 TRANSISTORS, PHOTO
 TRANSISTORS, SILICON

RCA ELECTRONIC COMPONENTS DIV. 201-485-3900
 415 S 5th St, Harrison, N J 07029 TWX 211-621-7846

INDICATORS, ALPHANUMERIC
 INDICATORS, DIGITAL
 INDICATORS, ILLUMINATED
 READOUTS AND DISPLAYS, NUMERIC AND ALPHANUMERIC (OTHER THAN CRT)
 TAPE, MAGNETIC (CASSETTE)
 TAPE, MAGNETIC (REELS)
 TUBES, CATHODE RAY
 VOLTMETERS, AC, DC, DIFFERENTIAL

RCA GRAPHIC SYSTEMS DIV. 609-655-2400
 Rte 130, Dayton, N J 08810

DATA RETRIEVAL SYSTEMS, MICRO-FILM (COMPUTER-CONTROLLED)
 FILM SCANNERS
 MICROFILM DATA RETRIEVAL SYSTEMS, COMPUTER CONTROLLED
 MICROFILM DATA RETRIEVAL SYSTEMS, COMPUTER CONTROLLED (GRAPHIC)
 PROGRAMMING LANGUAGE DEVELOPMENT (DEDICATED APPLICATION SYSTEMS)
 CONTINUED

3 Manufacturers' Directory

PROGRAMMING LANGUAGE DEVELOPMENT (PROPRIETARY SOFTWARE PRODUCTS)
SCANNERS, OPTICAL

RCA INSTITUTE FOR PROFSNL. DEVELOPMENT 201-485-3900
P O Box 962, Clark, N J 07066 TELEX 13-8307
TRAINING INSTITUTES, COMMERCIAL COMPUTER COURSES, SEMINARS,
CORRESPONDENCE COURSES

RCL ELECTRONICS INC. 201-374-3311
700 S 21 St, Irvington, N J 07111

DELAY LINES, GLASS (ALSO SEE MEMORIES)
DELAY LINES, MAGNETOSTRICTIVE (ALSO SEE MEMORIES)
RESISTORS, PRECISION
SWITCHES, CODE BAR
SWITCHES, PUSHBUTTON
SWITCHES, ROTARY
SWITCHES, SNAP ACTION

READOUTS INC. 714-755-2641
P O Box 149, Del Mar, Cal 92014 TWX 910-322-1137
DISPLAY DRIVERS
INDICATORS, DIGITAL
INDICATORS, ILLUMINATED
READOUTS AND DISPLAYS, NUMERIC AND ALPHANUMERIC (OTHER THAN CRT)

REALTIME SYSTEMS INC. 212-421-2250
866 3rd Ave, New York, N Y 10022

CONSULTING (ACCOUNTING, BUSINESS AND COMMERCIAL APPLICATIONS)
CONSULTING (COMPUTER EVALUATIONS, SELECTIONS, INSTALLATION PLANNING)
CONSULTING (DATA COMMUNICATIONS SYSTEMS PLANNING)
CONSULTING (COMPUTER PRODUCT PLANNING SURVEYS, MARKET RESEARCH STUDIES)
CONSULTING (MANAGEMENT INFORMATION SYSTEMS PLANNING)
SERVICES, FACILITY MANAGEMENT
SERVICES, MANAGEMENT INFORMATION SYSTEMS
SERVICES, PROCESSING (COMMERCIAL EDP)
SERVICES, PROCESSING (DIGITAL SCIENTIFIC)
SERVICES, TIME SHARING (COMMERCIAL)
SERVICES, TIME SHARING (RESEARCH)
SERVICES, SYSTEMS ANALYSIS

RECOGNITION EQUIPMENT INC. 214-637-2210
1500 W Mockingbird L, Dallas, Tex 75222
READERS, OPTICAL CHARACTER SCANNING

RECORTEC INC. 415-961-8821
162 S Whisman, Mt View, Cal 94040

CERTIFIERS, MAGNETIC TAPE
CLEANER/CERTIFIERS, MAGNETIC TAPE
TAPE TRANSPORTS, MAGNETIC (DIGITAL-EXCL. CASSETTE)
WINDERS, MAGNETIC TAPE

REDCOR CORP. 213-348-5892
21200 Victory, Woodland Hills, Cal 91364 TWX 910-494-1228

COMPUTERS, DIGITAL (GENERAL-PURPOSE, SMALL-SCALE)
CONVERTERS, ANALOG-TO-DIGITAL
CONVERTERS, DIGITAL-TO-ANALOG
MODULES, DIGITAL LOGIC ENCAPSULATED (ALSO SEE CIRCUITS & CIRCUIT CARDS)
MULTIPLEXER-CONVERTER (SINGLE UNIT WITH MULTIPLEXER, SAMPLE & HOLD AMPLIFIER & A-TO-D CONVERTER)
MULTIPLEXERS, ANALOG-SOLID STATE (SEQUENTIAL SAMPLING)
TESTERS, INTEGRATED CIRCUIT
TESTERS, MEMORY PLANES, STACKS AND SYSTEMS

REILAND, PAGE & ASSOCIATES INC. 614-258-3903
1521 E Broad St, Columbus, Ohio 43205

CONSULTING (ACCOUNTING, BUSINESS AND COMMERCIAL APPLICATIONS)
CONSULTING (COMPUTER EVALUATIONS, SELECTIONS, INSTALLATION PLANNING)
CONSULTING (MANAGEMENT INFORMATION SYSTEMS PLANNING)
CONSULTING (SCIENTIFIC APPLICATIONS)
SERVICES, FACILITY MANAGEMENT
SERVICES, SYSTEMS ANALYSIS

REL-QUAL ASSOCIATES INC. 201-356-8168
18 Hamilton St, Bound Brook, N J 08805

BOARDS, VISUAL CONTROL (GRAPHIC)
CONSULTING (ACCOUNTING, BUSINESS AND COMMERCIAL APPLICATIONS)
CONSULTING (ADVANCED COMPUTER EQUIPMENT DESIGN AND FEASIBILITY STUDIES)
CONSULTING (COMPUTER EVALUATIONS, SELECTIONS, INSTALLATION PLANNING)
CONSULTING (DATA COMMUNICATIONS SYSTEMS PLANNING)
CONSULTING (COMPUTER PRODUCT PLANNING SURVEYS, MARKET RESEARCH STUDIES)
CONSULTING (MANAGEMENT INFORMATION SYSTEMS PLANNING)
CONSULTING (SCIENTIFIC APPLICATIONS)
INSTRUCTIONAL SYSTEMS, COMPUTER-BASED
PROGRAMMING LANGUAGE DEVELOPMENT (CONSULTANTS)
PROGRAMMING LANGUAGE DEVELOPMENT (CONTRACT PROGRAMMING)
SERVICES, COMPUTER-AIDED DESIGN
SERVICES, FACILITY MANAGEMENT
SERVICES, SYSTEMS ANALYSIS
TRAINING INSTITUTES, COMMERCIAL COMPUTER COURSES, SEMINARS,
CORRESPONDENCE COURSES

RELAY SPECIALTIES INC. 201-797-3313
3 Godwin Ave, Fair Lawn, N J 07410

TIMERS, EVENT (IMPULSE)
TIMERS, INTERVAL

REMAX ELECTRONICS 213-772-5321
5250 W El Segundo Blv, Hawthorne, Cal 90250 TWX 910-325-6219

ENCODERS, DIGITAL
PERFORATORS, PAPER TAPE
PUNCHES, PAPER TAPE
READERS, PAPER TAPE
REELS, PAPER TAPE
SPOOLERS, PAPER TAPE
TAPE, PUNCH (MYLAR)
TAPE, PUNCH (MYLAR-COATED FOIL)
TAPE, PUNCH (PAPER)
TAPE, PUNCH (PAPER-COATED MYLAR)
TAPE, PUNCH (PAPER-COATED ALUMINUM)

REMINGTON RAND OFFICE SYSTEMS DIV. SPERRY RAND 614-374-9300
P O Box 171, Marietta, Ohio 45750

BOARDS, VISUAL CONTROL (GRAPHIC)
CABINETS, RACKS, VAULTS (FOR MAGNETIC TAPE STORAGE)
CARDS, MICROFILM APERTURE
FILES, PUNCHED CARD
PROCESSORS, MICROFILM
SAFES, MAGNETIC TAPE STORAGE
SERVICES, COMPUTER OUTPUT MICROFILM

REMOTE COMPUTING CORP. 213-629-2532
A40 Palo Alto Off Ctr, Palo Alto, Cal 94301

CONSULTING (ACCOUNTING, BUSINESS AND COMMERCIAL APPLICATIONS)
CONSULTING (ADVANCED COMPUTER EQUIPMENT DESIGN AND FEASIBILITY STUDIES)
CONSULTING (COMPUTER EVALUATIONS, SELECTIONS, INSTALLATION PLANNING)
CONSULTING (DATA COMMUNICATIONS SYSTEMS PLANNING)
CONSULTING (COMPUTER PRODUCT PLANNING SURVEYS, MARKET RESEARCH STUDIES)
CONSULTING (MANAGEMENT INFORMATION SYSTEMS PLANNING)
PROGRAMMING LANGUAGE DEVELOPMENT (CONSULTANTS)
PROGRAMMING LANGUAGE DEVELOPMENT (CONTRACT PROGRAMMING)
PROGRAMMING LANGUAGE DEVELOPMENT (DEDICATED APPLICATION SYSTEMS)
PROGRAMMING LANGUAGE DEVELOPMENT (PROPRIETARY SOFTWARE PRODUCTS)
SERVICES, COMPUTER-AIDED DESIGN
SERVICES, FACILITY MANAGEMENT
SERVICES, MANAGEMENT INFORMATION SYSTEMS
SERVICES, PROCESSING (COMMERCIAL EDP)
SERVICES, PROCESSING (DIGITAL SCIENTIFIC)
SERVICES, TIME SHARING (COMMERCIAL)
SERVICES, TIME SHARING (RESEARCH)
SERVICES, AUTOMATED WIRE-WRAPPING
SERVICES, SYSTEMS ANALYSIS
TRAINING INSTITUTES, COMMERCIAL COMPUTER COURSES, SEMINARS,
CORRESPONDENCE COURSES

REN ELECTRONICS 413-536-1800
775 New Ludlow Rd, So Hadley, Mass 01075

ACCOUNTING MACHINES, CARD-PROGRAMMED
CONTINUED

3 Manufacturers' Directory

COLLATORS, PUNCHED CARD
PUNCHES, CARD (UP TO 100 CPM)
RECONDITIONING EQUIPMENT, PUNCHED CARD
REPRODUCERS, PUNCHED CARD (AUTOMATIC)
SERVICES, FACILITY MANAGEMENT
SORTERS, PUNCHED CARD
USED EQUIPMENT (BUYING, SELLING, LEASING)
VERIFIERS, PUNCHED CARD

RENTAL ELECTRONICS INC. SUB. PEPSI CO. 301-948-0620
16600 Oakmont Ave, Gaithersburg, Md 20760

ANALYZERS, WAVEFORM
TESTERS, DIGITAL DATA TRANSMISSION
TESTERS, INTEGRATED CIRCUIT
TESTERS, SEMICONDUCTOR
VOLTMETERS, AC, DC, DIFFERENTIAL
VOLTMETERS, DIGITAL
VOLTMETERS, PRINTING

REO DATA PRODUCTS INC. 714-892-3396
7346 Bolsa Ave, Westminster, Cal 92683

CONVERTERS, ANALOG-TO-DIGITAL
MULTIPLEXERS, ANALOG-RELAY (SEQUENTIAL SAMPLING)
MULTIPLEXERS, DIGITAL
PRINTERS, DIGITAL STRIP RECORDING
PRINTERS, KEYBOARD
PRINTERS, LINE (LOW & MEDIUM SPEED)
SCANNERS, INPUT
VOLTMETERS, PRINTING

REPRODUCTION SYSTEMS DIV. TRANSAMERICA COMP. 415-397-6428
1 California St, San Francisco, Cal 94111

MICROFICHE
MICROFILM DATA RETRIEVAL SYSTEMS, COMPUTER CONTROLLED
MICROFILM DATA RETRIEVAL SYSTEMS, COMPUTER CONTROLLED (GRAPHIC)
MICROFILM ROLLS
READER/PRINTER, MICROFILM/MICROFICHE
READERS, MICROFILM/MICROFICHE
SERVICES, FACILITY MANAGEMENT
SERVICES, MANAGEMENT INFORMATION SYSTEMS
SERVICES, SYSTEMS ANALYSIS

REPUBLIC ELECTRONICS CORP. 201-279-0300
176 E 7th St, Paterson, N J 07524 TWX 710-988-5908
CAPACITORS, COMPUTER GRADE

REPUBLIC INFORMATION SYSTEMS INC. 213-341-9200
9732 Cozycroft Ave, Chatsworth, Cal 91311

DATA TERMINALS, BLOCK-BY-BLOCK (PUNCHED CARD)
MARK SENSING EQUIPMENT
READERS, PAYMENT COUPONS
READERS, PERFORATED DOCUMENT
SCANNERS, OPTICAL

REPUBLIC STEEL CORP. MANUFACTURING DIV. 216-746-7211
1315 Albert St, Youngstown, Ohio 44505

CABINETS AND ENCLOSURES (FOR KEYPUNCHES, PRINTERS)
CABINETS, ENCLOSURES, CONSOLES, ELECTRONIC (FOR GENERAL EQUIPMENT)
CABINETS, RACKS, VAULTS (FOR MAGNETIC TAPE STORAGE)
CABINETS, TRAYS (FOR PUNCHED CARD STORAGE)
SERVICES, COMPUTER-AIDED DESIGN
SERVICES, MANAGEMENT INFORMATION SYSTEMS
SERVICES, SYSTEMS ANALYSIS

REPUBLIC SYSTEMS INC. 201-865-2000
100 Plaza Centre, Secaucus, N J 07094

CONSULTING (ACCOUNTING, BUSINESS AND COMMERCIAL APPLICATIONS)
CONSULTING (ADVANCED COMPUTER EQUIPMENT DESIGN AND FEASIBILITY STUDIES)
CONSULTING (COMPUTER EVALUATIONS, SELECTIONS, INSTALLATION PLANNING)
CONSULTING (DATA COMMUNICATIONS SYSTEMS PLANNING)
CONSULTING (COMPUTER PRODUCT PLANNING SURVEYS, MARKET RESEARCH STUDIES)
CONSULTING (MANAGEMENT INFORMATION SYSTEMS PLANNING)
PROGRAMMING LANGUAGE DEVELOPMENT (CONSULTANTS)
PROGRAMMING LANGUAGE DEVELOPMENT (CONTRACT PROGRAMMING)
PROGRAMMING LANGUAGE DEVELOPMENT (DEDICATED APPLICATION SYSTEMS)
PROGRAMMING LANGUAGE DEVELOPMENT (PROPRIETARY SOFTWARE PRODUCTS)
CONTINUED

SERVICES, FACILITY MANAGEMENT
SERVICES, MANAGEMENT INFORMATION SYSTEMS
SERVICES, SYSTEMS ANALYSIS
TRAINING INSTITUTES, COMMERCIAL COMPUTER COURSES, SEMINARS, CORRESPONDENCE COURSES

REPUBLIC SYSTEMS INC. 201-675-5300
715 Park Ave, E Orange, N J 07017

CONSULTING (ACCOUNTING, BUSINESS AND COMMERCIAL APPLICATIONS)
CONSULTING (ADVANCED COMPUTER EQUIPMENT DESIGN AND FEASIBILITY STUDIES)
CONSULTING (COMPUTER EVALUATIONS, SELECTIONS, INSTALLATION PLANNING)
CONSULTING (DATA COMMUNICATIONS SYSTEMS PLANNING)
CONSULTING (COMPUTER PRODUCT PLANNING SURVEYS, MARKET RESEARCH STUDIES)
CONSULTING (MANAGEMENT INFORMATION SYSTEMS PLANNING)
PROGRAMMING LANGUAGE DEVELOPMENT (CONSULTANTS)
PROGRAMMING LANGUAGE DEVELOPMENT (CONTRACT PROGRAMMING)
PROGRAMMING LANGUAGE DEVELOPMENT (DEDICATED APPLICATION SYSTEMS)
PROGRAMMING LANGUAGE DEVELOPMENT (PROPRIETARY SOFTWARE PRODUCTS)
SERVICES, FACILITY MANAGEMENT
SERVICES, MANAGEMENT INFORMATION SYSTEMS
SERVICES, SYSTEMS ANALYSIS
TRAINING INSTITUTES, COMMERCIAL COMPUTER COURSES, SEMINARS, CORRESPONDENCE COURSES

REPUBLIC SYSTEMS OF CONNECTICUT INC. 203-272-5363
350 S Main St, Cheshire, Conn 06410

CONSULTING (ACCOUNTING, BUSINESS AND COMMERCIAL APPLICATIONS)
CONSULTING (COMPUTER EVALUATIONS, SELECTIONS, INSTALLATION PLANNING)
CONSULTING (DATA COMMUNICATIONS SYSTEMS PLANNING)
CONSULTING (MANAGEMENT INFORMATION SYSTEMS PLANNING)
PROGRAMMING LANGUAGE DEVELOPMENT (CONSULTANTS)
PROGRAMMING LANGUAGE DEVELOPMENT (CONTRACT PROGRAMMING)
PROGRAMMING LANGUAGE DEVELOPMENT (DEDICATED APPLICATION SYSTEMS)
PROGRAMMING LANGUAGE DEVELOPMENT (PROPRIETARY SOFTWARE PRODUCTS)
SERVICES, FACILITY MANAGEMENT
SERVICES, MANAGEMENT INFORMATION SYSTEMS
SERVICES, SYSTEMS ANALYSIS
TRAINING INSTITUTES, COMMERCIAL COMPUTER COURSES, SEMINARS, CORRESPONDENCE COURSES

RESALAB INC. RESALAB SCIENTIFIC DIV. 415-329-0260
4000 Campbell Ave, Menlo Park, Cal 94025

AMPLIFIERS, INSTRUMENTATION
AMPLIFIERS, VIDEO
CURVE TRACERS-DIGITIZERS, AUTOMATIC
DATA ACQUISITION AND REDUCTION SYSTEMS
DATA RETRIEVAL SYSTEMS, MICRO-FILM (COMPUTER-CONTROLLED)
FILM SCANNERS
MICROFILM DATA RETRIEVAL SYSTEMS, COMPUTER CONTROLLED (GRAPHIC)
PROGRAMMING LANGUAGE DEVELOPMENT (PROPRIETARY SOFTWARE PRODUCTS)
SCANNERS, OPTICAL
SERVICES, COMPUTER-AIDED DESIGN
SERVICES, PROCESSING (COMMERCIAL EDP)
SERVICES, PROCESSING (ANALOG OR HYBRID, SCIENTIFIC)
SERVICES, PROCESSING (DIGITAL SCIENTIFIC)
SERVICES, SYSTEMS ANALYSIS

RESALAB INC. AUTOMATION DYNAMICS DIV. 201-768-9200
35 Industrial Pky, Northvale, N J 07647

ANALYZERS, CONTINUITY
TESTERS, CIRCUIT
TESTERS, DIGITAL LOGIC MODULES AND CARDS

REX CHAINBELT INC. CAMLOC DIV. 201-845-6900
22 Spring Valley Rd, Paramus, N J 07652

FASTENERS, EQUIPMENT

RFL INDUSTRIES INC. COMMUNICATION DIV. 201-334-3100
Powerville Rd, Boonton, N J 07005 TWX 710-987-8352

ACOUSTIC COUPLERS
DEMAGNETIZERS, MAGNETIC TAPE
MODEMS, ACOUSTIC
MODEMS, HARD-WIRED
MODEMS, PC CARD
CONTINUED

3 Manufacturers' Directory

TESTERS, DIGITAL DATA TRANSMISSION
VOLTMETERS, DIGITAL

RHO ENGINEERING CO.
2234 Colby Ave, Los Angeles, Cal 90064

213-272-1163

CONVERTERS, DC-TO-FREQUENCY
CONVERTERS, FREQUENCY-TO-DC
CONVERTERS, VOLTAGE-TO-FREQUENCY
INVERTERS, DC-AC
POWER SUPPLIES, AC
POWER SUPPLIES, DC
POWER SUPPLIES, DIGITALLY-CONTROLLED
REGULATORS, CURRENT
REGULATORS, VOLTAGE
RELAYS, SOLID-STATE (COMPUTER GRADE)
TRANSFORMERS, POWER (COMPUTER GRADE)
TRANSFORMERS, PULSE (COMPUTER GRADE)

RIDGEWOOD ASSOCIATES INC.
10 Wilsey Sq, Ridgewood, N J 07450

201-652-7100

CONSULTING (ACCOUNTING, BUSINESS AND COMMERCIAL APPLICATIONS)
CONSULTING (ADVANCED COMPUTER EQUIPMENT DESIGN AND FEASIBILITY STUDIES)
CONSULTING (COMPUTER EVALUATIONS, SELECTIONS, INSTALLATION PLANNING)
CONSULTING (DATA COMMUNICATIONS SYSTEMS PLANNING)
CONSULTING (MANAGEMENT INFORMATION SYSTEMS PLANNING)
PROGRAMMING LANGUAGE DEVELOPMENT (CONSULTANTS)
PROGRAMMING LANGUAGE DEVELOPMENT (CONTRACT PROGRAMMING)
PROGRAMMING LANGUAGE DEVELOPMENT (DEDICATED APPLICATION SYSTEMS)
PROGRAMMING LANGUAGE DEVELOPMENT (PROPRIETARY SOFTWARE PRODUCTS)
SERVICES, FACILITY MANAGEMENT
SERVICES, MANAGEMENT INFORMATION SYSTEMS
SERVICES, PROCESSING (COMMERCIAL EDP)
SERVICES, SYSTEMS ANALYSIS
TRAINING INSTITUTES, COMMERCIAL COMPUTER COURSES, SEMINARS, CORRESPONDENCE COURSES
TRAINING SYSTEMS, COMPUTER SERVICE

RISK INDUSTRIES INC., GEORGE
P O Box 1035, Kimball, Nebr 69145
DATA TERMINALS, INQUIRY-RESPONSE (ALPHANUMERIC KEYBOARD)
ENCODERS, KEYBOARD (ALPHANUMERIC)
ENCODERS, KEYBOARD (NUMERIC)
HEAT SINKS, CIRCUIT BOARD MOUNTING
INDICATORS, ALPHANUMERIC
INDICATORS, ILLUMINATED
SWITCHES, PUSHBUTTON
SWITCHES, PUSHBUTTON (ILLUMINATED)

308-235-4645
TWX 910-620-9040

RO ASSOCIATES INC.
3705 Haven Ave, Menlo Park, Cal 94025
POWER SUPPLIES, DC

415-322-5321
TWX 910-378-5929

ROBBINS & MYERS INC. ELECTRIC MOTOR DIV.
1345 Laconda Ave, Springfield, Ohio 45501
MOTORS, SERVO
MOTORS, SYNCHRONOUS

513-323-6461
TELEX 20-5416

ROBIN INDUSTRIES CORP. DATA PRODUCTS DIV.
15-58 127 St, Flushing, N Y 11356

212-445-7200

PUNCHES, CARD (EDGE-PUNCHING)
PUNCHES, CARD (PORTABLE)
PUNCHES, PAPER TAPE
SPLICERS, PAPER TAPE
SPOOLERS, PAPER TAPE
WINDERS, PAPER TAPE

ROBINSON-NUGENT INC.
800 E 8th St, New Albany, Ind 47150

812-945-0211
TWX 810-540-4082

BOARDS, PRINTED CIRCUIT (WITHOUT COMPONENTS)
BREADBOARDS
CABLE ASSEMBLIES (WITH CONNECTORS)
CABLE, COAXIAL (FLEXIBLE)
JACKS, JACK PANELS, PLUGS, ASSEMBLIES
SOCKETS, IC MOUNTING
SOCKETS, PCB MOUNTING
SOCKETS, SEMICONDUCTOR MOUNTING

ROBINTECH INC. E-M DIV.
P O Box 714, Binghamton, N Y 13902
BOARDS, PRINTED CIRCUIT (WITHOUT COMPONENTS)
BREADBOARDS
CABLE ASSEMBLIES (WITH CONNECTORS)
MODEMS, PC CARD

607-798-5011
TWX 510-252-0189

ROCKLAND SYSTEMS CORP.
131 Erie St E, Blauvelt, N Y 10913

914-359-1818

ANALYZERS, WAVEFORM
FILTERS (ACTIVE, LC, NOISE, ETC.)
SIGNAL CONDITIONERS

RODALE MANUFACTURING CO.
6th & Minor St, Emmaus, Pa 18049

215-965-9071
TELEX 84-7431

SWITCHES, PUSHBUTTON
SWITCHES, PUSHBUTTON (ILLUMINATED)
SWITCHES, ROTARY
SWITCHES, SNAP ACTION
SWITCHES, TOGGLE (MINIATURE)

ROGERS CORP.
Rogers, Conn 06263

203-774-9605
TWX 718-448-0047

BUS BAR SYSTEMS
CABLE ASSEMBLIES (WITH CONNECTORS)
CABLE, FLAT, PRINTED AND RIBBON
CABLE, SHIELDED (NOT COAXIAL)
COMMUTATORS, SWITCHING (ELECTRIC)

ROHDE & SCHWARZ SALES CO. USA INC.
111 Lexington Ave, Passaic, N J 07055

201-773-8010

ANALYZERS, WAVEFORM
PRINTER/PUNCH, PAPER TAPE
READERS, PAPER TAPE
SPOOLERS, PAPER TAPE
TESTERS, INTEGRATED CIRCUIT
TESTERS, SEMICONDUCTOR
VOLTMETERS, DIGITAL

ROLM, CORP.
10300 N Tantau, Cupertino, Cal 95014

408-257-6440
TWX 910-338-0247

CABLE ASSEMBLIES (WITH CONNECTORS)
CIRCUIT CARDS, LOGIC (WITH IC'S)
COMMUNICATIONS-ORIENTED PROCESSORS, SINGLE CHANNEL CONTROLLERS
COMMUNICATIONS-ORIENTED PROCESSORS, STORED PROGRAM
COMPUTERS, DIGITAL (GENERAL-PURPOSE, SMALL-SCALE)
COMPUTERS, FIRE CONTROL
COMPUTERS, MINI GENERAL PURPOSE (ALSO SEE CALCULATORS)
COMPUTERS, NAVIGATION
COMPUTERS, PROCESS CONTROL
CONVERTERS, ANALOG-TO-DIGITAL
CONVERTERS, BINARY-TO-DECIMAL
CONVERTERS, DIGITAL-TO-ANALOG
CONVERTERS, DIGITAL-TO-SYNCHRO
CONVERTERS, SYNCHRO-TO-DIGITAL
DISC DRIVES, FIXED HEAD (INCLUDING CONTROLLER)
MAGNETIC TAPE STORAGE SYSTEMS (INCLUDES CONTROLLER)
MEMORY SYSTEMS, MAGNETIC CORE
MEMORY SYSTEMS, READ-ONLY
MEMORY SYSTEMS, SEMICONDUCTOR
MEMORY SYSTEMS, SEMICONDUCTOR (MOS)
MODULES, DIGITAL LOGIC ENCAPSULATED (ALSO SEE CIRCUITS & CIRCUIT CARDS)
MODULES, RESISTANCE NETWORKS (ENCAPSULATED)
PRINTER/PUNCH, PAPER TAPE
PUNCHES, PAPER TAPE
RECORDERS, DIGITAL CASSETTE
RECORDERS, MAGNETIC TAPE

ROSEMOUNT PLUG-IN INC.
P O Box 107, Nashville, Tenn 37202

615-244-1330
TWX 810-371-1699

BREADBOARDS
CABINETS, ENCLOSURES, CONSOLES, ELECTRONIC (FOR GENERAL EQUIPMENT)
POWER SUPPLIES, DC

ROSENBERG ASSOCIATES, PAUL
330 5th Ave, Pelham, N Y 10803

914-738-2266

CONSULTING (ADVANCED COMPUTER EQUIPMENT DESIGN AND FEASIBILITY STUDIES)
CONSULTING (DATA COMMUNICATIONS SYSTEMS PLANNING)
CONSULTING (SCIENTIFIC APPLICATIONS)

3 Manufacturers' Directory

ROSS & CO. INC., ROBERT H. 215-267-5508
22 Main St Rear, Denver, Pa 17517

SERVICES, PROCESSING (COMMERCIAL EDP)

ROTRON INC. 914-679-2401
Hasbrouck Ln, Woodstock, N Y 12498 TWX 510-247-9033
BLOWERS, FANS, COOLING ASSEMBLIES

ROWAN CONTROLLER INC. 301-848-8181
P O Box 306, Westminster, Md 21157 TWX 710-862-0845
RELAYS, SOLID-STATE (COMPUTER GRADE)
SWITCHES, PUSHBUTTON
SWITCHES, PUSHBUTTON (ILLUMINATED)

ROWE INDUSTRIES INC. 419-382-5666
1702 Airport Hwy, Toledo, Ohio 43609 TWX 810-442-1734
CABLE ASSEMBLIES (WITH CONNECTORS)
CABLE, COAXIAL (FLEXIBLE)
CABLE, COAXIAL (SEMI/RIGID)
CABLE, FINE LEAD
CABLE, FLAT, PRINTED AND RIBBON
CABLE, MULTICONDUCTOR
CABLE, SHIELDED (NOT COAXIAL)
CORDS, PATCH

ROYAL TYPEWRITER CO. DIV. LITTON INDUS. 203-233-2621
150 New Park Ave, Hartford, Conn 06106 TWX 710-425-0062
TYPEWRITERS, COMPUTER INPUT-OUTPUT

ROYCO INSTRUMENTS INC. 415-325-7811
141 Jefferson Dr, Menlo Park, Cal 94025 TELEX 34-8323
MONITORS, PARTICULATE

RUCKER CO., THE, MOORE SYSTEMS DIV. 408-738-3141
1212 Bordeaux Dr, Sunnyvale, Cal 94086 TWX 910-339-9209
ENCODERS, DIGITAL
MULTIPLEXERS, DIGITAL

S-I ELECTRONICS INC. 201-228-1237
5 Industrial Rd, Fairfield, N J 07006
TAPE TRANSPORTS, MAGNETIC (DIGITAL-EXCL. CASSETTE)

SAE ADVANCED PACKAGING INC. 714-540-9256
2165 S Grand Ave, Santa Ana, Cal 92705 TWX 910-595-1122
SOCKETS, IC MOUNTING
SOCKETS, PCB MOUNTING
SOCKETS, SEMICONDUCTOR MOUNTING

SAGE ACTION INC. 607-844-8448
P O Box 416, Ithaca, N Y 14850

CONSULTING (ACCOUNTING, BUSINESS AND COMMERCIAL APPLICATIONS)
CONSULTING (ADVANCED COMPUTER EQUIPMENT DESIGN AND FEASIBILITY STUDIES)
CONSULTING (COMPUTER EVALUATIONS, SELECTIONS, INSTALLATION PLANNING)
CONSULTING (DATA COMMUNICATIONS SYSTEMS PLANNING)
CONSULTING (COMPUTER PRODUCT PLANNING SURVEYS, MARKET RESEARCH STUDIES)
CONSULTING (MANAGEMENT INFORMATION SYSTEMS PLANNING)
CONSULTING (SCIENTIFIC APPLICATIONS)
SERVICES, COMPUTER-AIDED DESIGN
SERVICES, FACILITY MANAGEMENT
SERVICES, PROCESSING (COMMERCIAL EDP)
SERVICES, PROCESSING (DIGITAL SCIENTIFIC)
SERVICES, SYSTEMS ANALYSIS

SAGE ELECTRONICS CORP. SUB. NYTRONICS INC. 716-586-8010
P O Box 3926, Rochester, N Y 14610 TWX 510-254-2861
CIRCUITS, HYBRID (IC AND DISCRETE-DIGITAL)
CIRCUITS, THICK FILM (DIGITAL)

SAGETEC CORP. 213-341-2407
9177 Kelvin Ave, Chatsworth, Cal 91311

CONVERTERS, MAGNETIC TAPE-TO-MAGNETIC TAPE
DATA TERMINALS, BLOCK-BY-BLOCK (MULTI-PURPOSE)
MULTIPLEXERS, DIGITAL
CONTINUED

SCANNERS, INPUT

SAID INC. 703-532-9190
1243 W Broad St, Falls Church, Va 22046

CONSULTING (ACCOUNTING, BUSINESS AND COMMERCIAL APPLICATIONS)
CONSULTING (COMPUTER EVALUATIONS, SELECTIONS, INSTALLATION PLANNING)
CONSULTING (DATA COMMUNICATIONS SYSTEMS PLANNING)
CONSULTING (COMPUTER PRODUCT PLANNING SURVEYS, MARKET RESEARCH STUDIES)
DATA ACQUISITION AND REDUCTION SYSTEMS
SERVICES, FACILITY MANAGEMENT
SERVICES, MANAGEMENT INFORMATION SYSTEMS
SERVICES, PROCESSING (COMMERCIAL EDP)
SERVICES, PROCESSING (ANALOG OR HYBRID, SCIENTIFIC)
SERVICES, PROCESSING (DIGITAL SCIENTIFIC)
SERVICES, SYSTEMS ANALYSIS

SANDERS ASSOCIATES DIGITAL COMMUNICATIONS DEPT 603-885-2811
Daniel Webster Hwy S, Nashua, N H 03060 TWX 710-228-1894
CONSULTING (DATA COMMUNICATIONS SYSTEMS PLANNING)
MODEMS, HARD-WIRED
MODEMS, PC CARD
TESTERS, DIGITAL DATA TRANSMISSION

SANDERS ASSOCIATES INC. SYSTEMS DIV. 603-885-6660
Daniel Webster Hwy S, Nashua, N H 03060 TWX 710-228-1894

BLOWERS, FANS, COOLING ASSEMBLIES
CABLE, FLAT, PRINTED AND RIBBON
COMMUNICATIONS-ORIENTED PROCESSORS, MULTIPLE CHANNEL CONTROLLERS
COMMUNICATION SYSTEMS, DATA TRANSMISSION
CONSULTING (DATA COMMUNICATIONS SYSTEMS PLANNING)
CONSULTING (MANAGEMENT INFORMATION SYSTEMS PLANNING)
COUNTERS, DIGITAL READOUT
DATA RETRIEVAL SYSTEMS, MICRO-FILM (COMPUTER-CONTROLLED)
MEMORY SYSTEMS, MAGNETIC CORE
MICROFILM DATA RETRIEVAL SYSTEMS, COMPUTER CONTROLLED
MICROFILM DATA RETRIEVAL SYSTEMS, COMPUTER CONTROLLED (GRAPHIC)
MODEMS, HARD-WIRED
MODEMS, PC CARD
PRINTERS, MICROFILM/MICROFICHE
READER/PRINTER, MICROFILM/MICROFICHE
READERS, MICROFILM/MICROFICHE
TESTERS, CIRCUIT
TESTERS, DIGITAL DATA TRANSMISSION

SANGAMO ELECTRIC CO. 217-544-6411
P O Box 3347, Springfield, Ill 62708 TWX 910-242-0533
CAPACITORS, COMPUTER GRADE
MODEMS, HARD-WIRED
MODEMS, PC CARD
RECORDERS, MAGNETIC TAPE
TAPE TRANSPORTS, MAGNETIC (DIGITAL-EXCL. CASSETTE)
TESTERS, DIGITAL LOGIC MODULES AND CARDS

SARNA ASSOCIATES INC. 617-734-2313
22 Russell St, Brookline, Mass 02146

CONSULTING (ACCOUNTING, BUSINESS AND COMMERCIAL APPLICATIONS)
CONSULTING (ADVANCED COMPUTER EQUIPMENT DESIGN AND FEASIBILITY STUDIES)
CONSULTING (COMPUTER EVALUATIONS, SELECTIONS, INSTALLATION PLANNING)
CONSULTING (DATA COMMUNICATIONS SYSTEMS PLANNING)
CONSULTING (COMPUTER PRODUCT PLANNING SURVEYS, MARKET RESEARCH STUDIES)
CONSULTING (MANAGEMENT INFORMATION SYSTEMS PLANNING)
CONSULTING (SCIENTIFIC APPLICATIONS)
PROGRAMMING LANGUAGE DEVELOPMENT (CONSULTANTS)
PROGRAMMING LANGUAGE DEVELOPMENT (CONTRACT PROGRAMMING)
PROGRAMMING LANGUAGE DEVELOPMENT (DEDICATED APPLICATION SYSTEMS)
PROGRAMMING LANGUAGE DEVELOPMENT (PROPRIETARY SOFTWARE PRODUCTS)
SERVICES, FACILITY MANAGEMENT
SERVICES, MANAGEMENT INFORMATION SYSTEMS
SERVICES, PROCESSING (COMMERCIAL EDP)
SERVICES, TIME SHARING (COMMERCIAL)
SERVICES, TIME SHARING (RESEARCH)
SERVICES, SYSTEMS ANALYSIS
TRAINING INSTITUTES, COMMERCIAL COMPUTER COURSES, SEMINARS, CORRESPONDENCE COURSES
TRAINING SYSTEMS, COMPUTER SERVICE

3 Manufacturers' Directory

SAUNDERS MANUFACTURING CO. INC.
P O Box 243, Winthrop, Me 04364

207-685-3385

HOLDERS, PUNCHED CARD

SBD ELECTRONIC SYSTEMS INC.
275 Dixon Ave, Armitville, N Y 11701
CONVERTERS, DC-TO-FREQUENCY
CONVERTERS, FREQUENCY-TO-DC
POWER SUPPLIES, AC

516-598-0100
TWX 510-224-6697

SC DATA CENTER, INC.
1112 7th Ave, Monroe, Wis 53566

608-325-7191

CONSULTING (ACCOUNTING, BUSINESS AND COMMERCIAL APPLICATIONS)
SERVICES, FACILITY MANAGEMENT
SERVICES, PROCESSING (COMMERCIAL EDP)
SERVICES, SYSTEMS ANALYSIS

SCANBE MANUFACTURING CO.
3445 Fletcher Ave, El Monte, Cal 91750

213-579-2300
TWX 910-587-3437

CABINETS, ENCLOSURES, CONSOLES, ELECTRONIC (FOR GENERAL EQUIPMENT)
CHASSIS, SLIDES, RACKS
CONNECTORS, PC AND IC BOARD (COMPUTER-GRADE)
GUIDES, CIRCUIT CARDS
OSCILLATORS, MAGNETIC
PACKAGING SYSTEMS
SERVICES, COMPUTER-AIDED DESIGN
SERVICES, AUTOMATED WIRE-WRAPPING
SOCKETS, IC MOUNTING
SOCKETS, PCB MOUNTING

SCAN-DATA CORP.
800 E Main St, Norristown, Pa 19401

215-277-0500

READERS, OPTICAL CHARACTER SCANNING
SCANNERS, OPTICAL

SCANFORMS INC.
312 Fox Pavilion, Jenkintown, Pa 19095

215-886-0600

CONSULTING (ACCOUNTING, BUSINESS AND COMMERCIAL APPLICATIONS)
CONSULTING (ADVANCED COMPUTER EQUIPMENT DESIGN AND FEASIBILITY STUDIES)
CONSULTING (COMPUTER EVALUATIONS, SELECTIONS, INSTALLATION PLANNING)
CONSULTING (MANAGEMENT INFORMATION SYSTEMS PLANNING)
CONSULTING (SCIENTIFIC APPLICATIONS)
FORMS, CONTINUOUS (MACHINE PROCESSED)
LABELS, CONTINUOUS AND GUMMED (MACHINE APPLICATION)
PAPER (FOR MICR EQUIPMENT)
PAPER (FOR OCR EQUIPMENT)
PAPER (FOR PRINTERS)
PROGRAMMING LANGUAGE DEVELOPMENT (PROPRIETARY SOFTWARE PRODUCTS)
SERVICES, FACILITY MANAGEMENT
SERVICES, PROCESSING (COMMERCIAL EDP)
SERVICES, PROCESSING (DIGITAL SCIENTIFIC)
SERVICES, SYSTEMS ANALYSIS

SCAN-OPTICS INC.
22 Prestige Park, E Hartford, Conn 06108

203-289-6001

HANDWRITING SYSTEMS, ELECTRONIC
MARK SENSING EQUIPMENT
READERS, MAGNETIC INK CHARACTER
READERS, OPTICAL CHARACTER SCANNING
SCANNERS, OPTICAL

SCANTLIN ELECTRONICS, INC.
5454 Beethoven St, Los Angeles, Cal 90060

213-398-2761
TELEX 65-2455

COMMUNICATIONS-ORIENTED PROCESSORS, MULTIPLE CHANNEL CONTROLLERS
COMMUNICATIONS-ORIENTED PROCESSORS, SINGLE CHANNEL CONTROLLERS
COMMUNICATIONS-ORIENTED PROCESSORS, STORED PROGRAM
COMMUNICATION SYSTEMS, DATA TRANSMISSION
COMPUTERS, DIGITAL (GENERAL-PURPOSE, SMALL-SCALE)
DATA CONCENTRATORS
DATA TERMINALS, INQUIRY-RESPONSE (ALPHANUMERIC KEYBOARD)
DATA TERMINALS, INQUIRY-RESPONSE (CRT WITH KEYBOARD)
DATA TERMINALS, INQUIRY-RESPONSE (SPECIAL-PURPOSE)
SERVICES, MANAGEMENT INFORMATION SYSTEMS
SERVICES, TIME SHARING (COMMERCIAL)

SCHAEVITZ ENGINEERING
Rte 130 & Union Ave, Pennsauken, N J 08110
AMPLIFIERS, INSTRUMENTATION
COMPUTERS, PROCESS CONTROL

609-662-8000
TWX 710-892-0714

SCHULTZ INSTRUMENTS INC.
P O Box 13385, Gainesville, Fla 32601

904-378-1750

CONSULTING (ADVANCED COMPUTER EQUIPMENT DESIGN AND FEASIBILITY STUDIES)
CONSULTING (COMPUTER EVALUATIONS, SELECTIONS, INSTALLATION PLANNING)
CONSULTING (DATA COMMUNICATIONS SYSTEMS PLANNING)
CONSULTING (SCIENTIFIC APPLICATIONS)
ENCODERS, KEYBOARD-TO-MAGNETIC TAPE
MAGNETIC TAPE STORAGE SYSTEMS (INCLUDES CONTROLLER)
SERVICES, COMPUTER-AIDED DESIGN
SERVICES, PROCESSING (DIGITAL SCIENTIFIC)
SERVICES, HARDWARE MAINTENANCE
SERVICES, SYSTEMS ANALYSIS

SCHWAB SAFE CO. INC.
3000 Main St, Lafayette, Ind 47902

317-447-2178

CABINETS, RACKS, VAULTS (FOR MAGNETIC TAPE STORAGE)
CONTAINERS, DISK PACK STORAGE
CONTAINERS, PAPER TAPE STORAGE
SAFES, MAGNETIC TAPE STORAGE

SCI ELECTRONICS INC.
7705 La Porte Fwy, Houston, Tex 77012

713-644-3213
TWX 910-881-5542

ANALYZERS, CONTINUITY
COMMUNICATION SYSTEMS, DATA TRANSMISSION
PROGRAMMING LANGUAGE DEVELOPMENT (DEDICATED APPLICATION SYSTEMS)
PROGRAMMING LANGUAGE DEVELOPMENT (PROPRIETARY SOFTWARE PRODUCTS)
TESTERS, INTEGRATED CIRCUIT

SCIENTIFIC CONTROL CORP.
1215 Crosby Rd, Carrollton, Tex 75080

214-242-6555
TWX 910-860-5509

CLOCKS, DIGITAL (REAL-TIME)
COMMUNICATIONS-ORIENTED PROCESSORS, STORED PROGRAM
COMMUNICATION SYSTEMS, DATA TRANSMISSION
COMPUTERS, DIGITAL (GENERAL-PURPOSE, SMALL-SCALE)
COMPUTERS, DIGITAL (GENERAL-PURPOSE, MEDIUM-SCALE)
COMPUTERS, PROCESS CONTROL
DATA ACQUISITION AND REDUCTION SYSTEMS
DATA CONCENTRATORS
DATA TERMINALS, BLOCK-BY-BLOCK (MEDIUM SPEED PRINTER)
DATA TERMINALS, BLOCK-BY-BLOCK (PUNCHED CARD)
MULTIPLEXERS, DIGITAL

SCIENTIFIC ATLANTA INC.
P O Box 16345, Atlanta, Ga 30345

404-938-2930
TWX 810-766-4912

CABINETS, ENCLOSURES, CONSOLES, ELECTRONIC (FOR GENERAL EQUIPMENT)
CHASSIS, SLIDES, RACKS

SCIENTIFIC CALCULATIONS INC.
110 Allens Creek Rd, Rochester, N Y 14618

716-442-7660

CONSULTING (COMPUTER EVALUATIONS, SELECTIONS, INSTALLATION PLANNING)
CONSULTING (DATA COMMUNICATIONS SYSTEMS PLANNING)
CONSULTING (COMPUTER PRODUCT PLANNING SURVEYS, MARKET RESEARCH STUDIES)
CONSULTING (MANAGEMENT INFORMATION SYSTEMS PLANNING)
CONSULTING (SCIENTIFIC APPLICATIONS)
PROGRAMMING LANGUAGE DEVELOPMENT (CONSULTANTS)
PROGRAMMING LANGUAGE DEVELOPMENT (CONTRACT PROGRAMMING)
PROGRAMMING LANGUAGE DEVELOPMENT (DEDICATED APPLICATION SYSTEMS)
PROGRAMMING LANGUAGE DEVELOPMENT (PROPRIETARY SOFTWARE PRODUCTS)
SERVICES, COMPUTER-AIDED DESIGN
SERVICES, MANAGEMENT INFORMATION SYSTEMS
SERVICES, PROCESSING (ANALOG OR HYBRID, SCIENTIFIC)
SERVICES, PROCESSING (DIGITAL SCIENTIFIC)
SERVICES, TIME SHARING (RESEARCH)
SERVICES, AUTOMATED WIRE-WRAPPING
SERVICES, SYSTEMS ANALYSIS

SCIENTIFIC COMPUTER APPLICATIONS INC.
2310 4th Natl Bank Bg, Tulsa, Okla 74119

918-584-6197

CONSULTING (SCIENTIFIC APPLICATIONS)
PROGRAMMING LANGUAGE DEVELOPMENT (DEDICATED APPLICATION SYSTEMS)
CONTINUED

3 Manufacturers' Directory

PROGRAMMING LANGUAGE DEVELOPMENT (PROPRIETARY SOFTWARE PRODUCTS)

SCIENTIFIC COMPUTERS, INC., 612-339-0544
919 Second Ave S, Minneapolis, Minn 55402

CONSULTING (ACCOUNTING, BUSINESS AND COMMERCIAL APPLICATIONS)
CONSULTING (COMPUTER EVALUATIONS, SELECTIONS, INSTALLATION PLANNING)
CONSULTING (DATA COMMUNICATIONS SYSTEMS PLANNING)
CONSULTING (COMPUTER PRODUCT PLANNING SURVEYS, MARKET RESEARCH STUDIES)
CONSULTING (MANAGEMENT INFORMATION SYSTEMS PLANNING)
PROGRAMMING LANGUAGE DEVELOPMENT (CONSULTANTS)
PROGRAMMING LANGUAGE DEVELOPMENT (CONTRACT PROGRAMMING)
PROGRAMMING LANGUAGE DEVELOPMENT (DEDICATED APPLICATION SYSTEMS)
PROGRAMMING LANGUAGE DEVELOPMENT (PROPRIETARY SOFTWARE PRODUCTS)
SERVICES, COMPUTER-AIDED DESIGN
SERVICES, FACILITY MANAGEMENT
SERVICES, MANAGEMENT INFORMATION SYSTEMS
SERVICES, PROCESSING (COMMERCIAL EDP)
SERVICES, PROCESSING (DIGITAL SCIENTIFIC)
SERVICES, SYSTEMS ANALYSIS

SCIENTIFIC DATA SYSTEMS ISRAEL LTD.

Po Box 5101, Haifa, ISRAEL

DISC STORAGE SYSTEMS
MEMORY SYSTEMS, MAGNETIC DISC

SCIENTIFIC ELECTRIC INC. 201-478-7050
111 Monroe St, Garfield, N J 07026

POWER SUPPLIES, AC
POWER SUPPLIES, DC

SCIENTIFIC LEASING INC. 203-565-7686
77 Meadowgate, Wethersfield, Conn 06109

CONSULTING (COMPUTER EVALUATIONS, SELECTIONS, INSTALLATION PLANNING)
CONSULTING (SCIENTIFIC APPLICATIONS)
LEASING, EDP EQUIPMENT (OTHER THAN MFGRS)
USED EQUIPMENT (BUYING, SELLING, LEASING)

SCIENTIFIC MEASUREMENT SYSTEMS INC. 609-234-0200
351 New Albany Rd, Moorestown, N J 08057

CERTIFIERS, DISC PACK
TESTERS, CIRCUIT
TESTERS, DIGITAL LOGIC MODULES AND CARDS
TESTERS, INTEGRATED CIRCUIT
TESTERS, MAGNETIC DISC
TESTERS, MAGNETIC DRUM
TESTERS, MEMORY PLANES, STACKS AND SYSTEMS
TESTERS, SEMICONDUCTOR

SCIENTIFIC MEASUREMENTS INC. 312-676-1044
9701 N Kenton, Skokie, Ill 60076

AMPLIFIERS, D.C.
AMPLIFIERS, INSTRUMENTATION
AMPLIFIERS, OPERATIONAL
CIRCUIT CARDS, LINEAR (WITH DISCRETE COMPONENTS)
CIRCUIT CARDS, LINEAR (WITH IC'S)
CIRCUIT CARDS, LOGIC (WITH IC'S)
CLOCKS, DIGITAL (REAL-TIME)
COMPUTERS, ANALOG (EDUCATIONAL)
COMPUTERS, DIGITAL (EDUCATIONAL)
CONSULTING (DATA COMMUNICATIONS SYSTEMS PLANNING)
CONSULTING (SCIENTIFIC APPLICATIONS)
CONVERTERS, ANALOG-TO-DIGITAL
CONVERTERS, BINARY-TO-DECIMAL
CONVERTERS, DIGITAL-TO-ANALOG
COUNTERS, DECADE
COUNTERS, DIGITAL READOUT
COUNTERS, UP-DOWN
DEMONSTRATORS AND KITS, EDUCATIONAL (DIGITAL LOGIC)
ENCODERS, KEYBOARD (ALPHANUMERIC)
ENCODERS, KEYBOARD (NUMERIC)
MODULES, DIGITAL LOGIC ENCAPSULATED (ALSO SEE CIRCUITS & CIRCUIT CARDS)
POWER SUPPLIES, DC

SCIENTIFIC SOFTWARE CORP. 303-771-6220
5300 S Ulster, Englewood, Colo 08110

CONSULTING (ACCOUNTING, BUSINESS AND COMMERCIAL APPLICATIONS)
CONSULTING (COMPUTER EVALUATIONS, SELECTIONS, INSTALLATION PLANNING)
CONSULTING (MANAGEMENT INFORMATION SYSTEMS PLANNING)
CONSULTING (SCIENTIFIC APPLICATIONS)
PROGRAMMING LANGUAGE DEVELOPMENT (CONSULTANTS)
PROGRAMMING LANGUAGE DEVELOPMENT (CONTRACT PROGRAMMING)
PROGRAMMING LANGUAGE DEVELOPMENT (DEDICATED APPLICATION SYSTEMS)
PROGRAMMING LANGUAGE DEVELOPMENT (PROPRIETARY SOFTWARE PRODUCTS)
SERVICES, MANAGEMENT INFORMATION SYSTEMS
SERVICES, PROCESSING (COMMERCIAL EDP)
SERVICES, PROCESSING (DIGITAL SCIENTIFIC)
SERVICES, SYSTEMS ANALYSIS

SCIENTIFIC SYSTEMS SERVICES INC. 305-262-7527
476 N Hwy A 1a, Satellite Beach, Fla 32935

CONSULTING (ADVANCED COMPUTER EQUIPMENT DESIGN AND FEASIBILITY STUDIES)
CONSULTING (COMPUTER EVALUATIONS, SELECTIONS, INSTALLATION PLANNING)
CONSULTING (DATA COMMUNICATIONS SYSTEMS PLANNING)
CONSULTING (COMPUTER PRODUCT PLANNING SURVEYS, MARKET RESEARCH STUDIES)
CONSULTING (MANAGEMENT INFORMATION SYSTEMS PLANNING)
CONSULTING (SCIENTIFIC APPLICATIONS)
INSTRUCTIONAL SYSTEMS, COMPUTER-BASED
PROGRAMMING LANGUAGE DEVELOPMENT (CONSULTANTS)
PROGRAMMING LANGUAGE DEVELOPMENT (CONTRACT PROGRAMMING)
PROGRAMMING LANGUAGE DEVELOPMENT (DEDICATED APPLICATION SYSTEMS)
PROGRAMMING LANGUAGE DEVELOPMENT (PROPRIETARY SOFTWARE PRODUCTS)
SERVICES, PROCESSING (ANALOG OR HYBRID, SCIENTIFIC)
SERVICES, PROCESSING (DIGITAL SCIENTIFIC)
SERVICES, TIME SHARING (COMMERCIAL)
SERVICES, SYSTEMS ANALYSIS
TRAINING INSTITUTES, COMMERCIAL COMPUTER COURSES, SEMINARS, CORRESPONDENCE COURSES
TRAINING SYSTEMS, COMPUTER SERVICE

SCIENTIFIC TIME SHARING CORP. 202-462-4620
2101 S St NW, Washington, D C 20008

CONSULTING (MANAGEMENT INFORMATION SYSTEMS PLANNING)
INSTRUCTIONAL SYSTEMS, COMPUTER-BASED
PROGRAMMING LANGUAGE DEVELOPMENT (CONSULTANTS)
PROGRAMMING LANGUAGE DEVELOPMENT (CONTRACT PROGRAMMING)
PROGRAMMING LANGUAGE DEVELOPMENT (DEDICATED APPLICATION SYSTEMS)
PROGRAMMING LANGUAGE DEVELOPMENT (PROPRIETARY SOFTWARE PRODUCTS)
SERVICES, TIME SHARING (COMMERCIAL)
SERVICES, TIME SHARING (RESEARCH)

SCI-TEK COMPUTER CENTER INC. 302-658-2431
1707 Gilpin Ave, Wilmington, Del 19806

COMMUNICATIONS-ORIENTED PROCESSORS, MULTIPLE CHANNEL CONTROLLERS
COMMUNICATIONS-ORIENTED PROCESSORS, SINGLE CHANNEL CONTROLLERS
COMMUNICATIONS-ORIENTED PROCESSORS, STORED PROGRAM
COMMUNICATION SYSTEMS, DATA TRANSMISSION
COMMUNICATION SYSTEMS, FACSIMILE
CONSULTING (ACCOUNTING, BUSINESS AND COMMERCIAL APPLICATIONS)
CONSULTING (ADVANCED COMPUTER EQUIPMENT DESIGN AND FEASIBILITY STUDIES)
CONSULTING (COMPUTER EVALUATIONS, SELECTIONS, INSTALLATION PLANNING)
CONSULTING (DATA COMMUNICATIONS SYSTEMS PLANNING)
CONSULTING (COMPUTER PRODUCT PLANNING SURVEYS, MARKET RESEARCH STUDIES)
CONSULTING (MANAGEMENT INFORMATION SYSTEMS PLANNING)
CONSULTING (SCIENTIFIC APPLICATIONS)
DATA CONCENTRATORS
PROGRAMMING LANGUAGE DEVELOPMENT (CONSULTANTS)
PROGRAMMING LANGUAGE DEVELOPMENT (CONTRACT PROGRAMMING)
PROGRAMMING LANGUAGE DEVELOPMENT (DEDICATED APPLICATION SYSTEMS)
PROGRAMMING LANGUAGE DEVELOPMENT (PROPRIETARY SOFTWARE PRODUCTS)
SERVICES, COMPUTER-AIDED DESIGN
SERVICES, FACILITY MANAGEMENT
SERVICES, MANAGEMENT INFORMATION SYSTEMS
SERVICES, PROCESSING (COMMERCIAL EDP)
SERVICES, PROCESSING (DIGITAL SCIENTIFIC)
SERVICES, TIME SHARING (COMMERCIAL)
SERVICES, TIME SHARING (RESEARCH)

3 Manufacturers' Directory

SCM ALLIED EGRY BUSINESS SYSTEMS P O Box 125 Wc Br, Dayton, Ohio 45449 CARDS, CONVENTIONAL PUNCH DOCUMENTS, DCR/OMR ENVELOPES, CONTINUOUS FORMS, CONTINUOUS (MACHINE PROCESSED) PAPER (FOR MICR EQUIPMENT) PAPER (FOR OCR EQUIPMENT) PAPER (FOR PRINTERS) PAPER (FOR RECORDERS AND PLOTTERS)	513-866-7421 TWX 810-473-2978	SEMICONDUCTOR ELECTRONIC MEMORIES INC. 3883 N 28th Ave, Phoenix, Ariz 85017 MEMORY SYSTEMS, SEMICONDUCTOR MEMORY SYSTEMS, SEMICONDUCTOR (MOS)	602-263-0202
SCM CORP. SMITH CORONA MARCHANT DIV. 299 Park Ave, New York, N Y 10017 CALCULATORS, PROGRAMMABLE (ALSO SEE COMPUTERS) COMPUTERS, MINI GENERAL PURPOSE (ALSO SEE CALCULATORS)	212-752-2700 TWX 710-581-5311	SEQUENTIAL INFORMATION SYSTEMS INC. 145 Palisade St, Dobbs Ferry, N Y 10522 CONVERTERS, MAGNETIC TAPE-TO-MICROFILM ENCODERS, SHAFT ANGLE MOTORS, SERVO MOTORS, SYNCHRONOUS RECORDERS, MICROFILM/MICROFICHE SERVOS, COMPUTER	914-693-6800 TWX 710-564-0809
SCOVILL MANUFACTURING CO. AURICORD DIV. 35-41 29 St, Long Island, N Y 11106 TAPE, MAGNETIC (CASSETTE) TAPE TRANSPORTS, MAGNETIC (DIGITAL-EXCL. CASSETTE) TAPE TRANSPORTS, MAGNETIC (DIGITAL CASSETTE)	212-361-7400	SERVICE BUREAU CORP., THE 1350 Ave Americas, New York, N Y 10019 CONSULTING (DATA COMMUNICATIONS SYSTEMS PLANNING) CONSULTING (MANAGEMENT INFORMATION SYSTEMS PLANNING) SERVICES, PROCESSING (COMMERCIAL EDP) SERVICES, TIME SHARING (COMMERCIAL) SERVICES, SYSTEMS ANALYSIS	212-262-5000
SEACO COMPUTER-DISPLAY INC. 2826 W Kingsley Rd, Garland, Tex 75040 DRAFTING SYSTEMS, COMPUTER-CONTROLLED STORAGE MICROFICHE RECORDERS, GRAPHIC RECORDERS, MICROFILM/MICROFICHE	214-271-2431	SERVICE BUSINESS FORMS 815 E Second, Wichita, Kans 67202 ENVELOPES, CONTINUOUS FORMS, CONTINUOUS (MACHINE PROCESSED) PAPER (FOR MICR EQUIPMENT) PAPER (FOR OCR EQUIPMENT) PAPER (FOR PRINTERS)	316-264-4315
SEAELECTRO CORP. 225 Hoyt St, Mamaroneck, N Y 10543 CABLE ASSEMBLIES (WITH CONNECTORS) CONNECTORS, COAXIAL (COMPUTER-GRADE) CONNECTORS, MINIATURE AND SUB-MINIATURE (COMPUTER-GRADE) READERS, STATIC SOCKETS, IC MOUNTING SWITCHES, ROTARY SWITCHES, SNAP ACTION SWITCHES, THUMBWHEEL TIMERS, INTERVAL	914-698-5600 TWX 710-566-1110	SEVAN COMPUTER SERVICES INC. Pollitt Dr S, Fair Lawn, N J 07410 CONSULTING (ACCOUNTING, BUSINESS AND COMMERCIAL APPLICATIONS) CONSULTING (COMPUTER EVALUATIONS, SELECTIONS, INSTALLATION PLANNING) CONSULTING (DATA COMMUNICATIONS SYSTEMS PLANNING) CONSULTING (MANAGEMENT INFORMATION SYSTEMS PLANNING) CONSULTING (SCIENTIFIC APPLICATIONS) DIODES, GERMANIUM DIODES, NOT-CARRIER DIODES, LIGHT EMITTING DIODES, SILICON DIODES, ZENER ENCODERS, KEYBOARD (ALPHANUMERIC) ENCODERS, KEYBOARD (NUMERIC) SERVICES, COMPUTER-AIDED DESIGN SERVICES, FACILITY MANAGEMENT SERVICES, SYSTEMS ANALYSIS TYPEWRITERS, COMPUTER INPUT-OUTPUT	201-797-0073 TWX 710-988-2241
SEASTROM MANUFACTURING CO. 701 Sonora Ave, Glendale, Cal 91201 BUS BAR SYSTEMS TERMINAL BLOCKS, STRIPS, BOARDS	213-245-9121 TWX 910-497-2271	SHARED COMPUTER SYSTEMS CORP. 176 W Adams St, Chicago, Ill 60603 SERVICES, PROCESSING (COMMERCIAL EDP) SERVICES, PROCESSING (DIGITAL SCIENTIFIC) SERVICES, TIME SHARING (COMMERCIAL) SERVICES, TIME SHARING (RESEARCH)	312-372-5350
SEGALL ASSOCIATES, M. HARVEY 1019 Rust Bldg, Tacoma, Wash 98402 CONSULTING (ACCOUNTING, BUSINESS AND COMMERCIAL APPLICATIONS) CONSULTING (COMPUTER EVALUATIONS, SELECTIONS, INSTALLATION PLANNING) CONSULTING (MANAGEMENT INFORMATION SYSTEMS PLANNING) SERVICES, FACILITY MANAGEMENT SERVICES, SYSTEMS ANALYSIS TRAINING INSTITUTES, COMMERCIAL COMPUTER COURSES, SEMINARS, CORRESPONDENCE COURSES	206-383-4848	SHAW-WALKER CO. P O Box 208, Muskegon, Mich 49443 CABINETS, RACKS, VAULTS (FOR MAGNETIC TAPE STORAGE) CABINETS, TRAYS (FOR PUNCHED CARD STORAGE) DESKS, TABLES AND STANDS (FOR CALCULATORS) DESKS, TABLES AND STANDS (FOR KEYPUNCH UNITS) DESKS, TABLES AND STANDS (FOR PROGRAMMER STATIONS) DESKS, TABLES AND STANDS (FOR TYPEWRITERS) FILES, PUNCHED CARD SAFES, MAGNETIC TAPE STORAGE	616-722-7211
SEISMOGRAPH SERVICE CORP. P O Box 1590, Tulsa, Okla 74102 SERVICES, PROCESSING (ANALOG OR HYBRID, SCIENTIFIC) SERVICES, PROCESSING (DIGITAL SCIENTIFIC)	918-627-3330	SHINTRON CO INC. 144 Rogers St, Cambridge, Mass 02142 ACOUSTIC COUPLERS COMMUNICATION SYSTEMS, FACSIMILE GRAPHIC TABLETS	617-491-8700
SELF-ORGANIZING SYSTEMS INC. P O Box 9918, Dallas, Tex 75214 RELAYS, DRY REED (COMPUTER GRADE) RELAYS, MERCURY WETTED (COMPUTER GRADE) RELAYS, SOLID-STATE (COMPUTER GRADE) SWITCHES, DRY REED	214-276-9487	SHIRAK TELEMETERING OF AMERICA 8926 Kester Ave, Van Nuys, Cal 91402 ACOUSTIC COUPLERS CONTINUED	213-894-3638
SEMICON INC. 10 N Ave, Burlington, Mass 01803 BOARDS, PRINTED CIRCUIT (WITHOUT COMPONENTS) CIRCUIT CARDS, LINEAR (WITH DISCRETE COMPONENTS) CIRCUIT CARDS, LOGIC (WITH DISCRETE COMPONENTS) DIODES, SILICON DIODES, ZENER RECTIFIERS, SILICON CONTROLLED	617-272-9015 TWX 710-332-1919		

3 Manufacturers' Directory

COMMUNICATION SYSTEMS, DATA TRANSMISSION
 COMMUNICATION SYSTEMS, TELEPRINTER
 CONSULTING (DATA COMMUNICATIONS SYSTEMS PLANNING)
 CONVERTERS, PAPER TAPE-TO-PAPER TAPE
 CONVERTERS, PAPER TAPE-TO-PRINTER
 ENCODERS, KEYBOARD-TO-PRINTED TAPE
 MODEMS, ACOUSTIC
 MODEMS, HARD-WIRED
 PERFORATORS, PAPER TAPE
 PRINTER/PUNCH, PAPER TAPE
 PRINTERS, KEYBOARD
 PUNCHES, PAPER TAPE
 READERS, PAPER TAPE
 REELS, PAPER TAPE
 RIBBONS, INK (FOR PRINTERS AND TAB EQUIPMENT)
 SERVICES, HARDWARE MAINTENANCE
 SPLICERS, PAPER TAPE
 SPOOLERS, PAPER TAPE
 TAPE, PUNCH (MYLAR)
 TAPE, PUNCH (MYLAR-COATED FOIL)
 TAPE, PUNCH (PAPER)
 TAPE, PUNCH (PAPER-COATED MYLAR)
 TAPE, PUNCH (PAPER-COATED ALUMINUM)
 TYPEWRITERS, COMPUTER INPUT-OUTPUT
 USED EQUIPMENT (BUYING, SELLING, LEASING)
 WINDERS, PAPER TAPE

SIERRA RESEARCH CORP. COMPUTER PROD. GRP. 617-272-6534
 167 Bedford St., Burlington, Mass 01803 TWX 710-523-1864

COMMUNICATIONS-ORIENTED PROCESSORS, MULTIPLE CHANNEL CONTROLLERS
 COMMUNICATIONS-ORIENTED PROCESSORS, SINGLE CHANNEL CONTROLLERS
 COMMUNICATION SYSTEMS, DATA TRANSMISSION
 CONSULTING (MANAGEMENT INFORMATION SYSTEMS PLANNING)
 DATA TERMINALS, INQUIRY-RESPONSE (BADGE-TOKEN READERS)
 DATA TERMINALS, INQUIRY-RESPONSE (SPECIAL-PURPOSE)
 MODEMS, PC CARD
 MULTIPLEXERS, DIGITAL
 PROGRAMMING LANGUAGE DEVELOPMENT (CONSULTANTS)
 PROGRAMMING LANGUAGE DEVELOPMENT (DEDICATED APPLICATION SYSTEMS)
 PROGRAMMING LANGUAGE DEVELOPMENT (PROPRIETARY SOFTWARE PRODUCTS)
 READOUTS AND DISPLAYS, NUMERIC AND ALPHANUMERIC (OTHER THAN CRT)
 SERVICES, MANAGEMENT INFORMATION SYSTEMS
 SERVICES, HARDWARE MAINTENANCE

SIERRA SYSTEMS INC. 415-969-3056
 2255 Old Mdfld Way, Mountain View, Cal 94040

AMPLIFIERS, VIDEO
 POWER SUPPLIES, AC
 POWER SUPPLIES, DC

SIGMA INSTRUMENTS INC. 617-843-5000
 170 Pearl St, Braintree, Mass 02185 TWX 617-848-0845

AMPLIFIERS, INSTRUMENTATION
 CELLS, PHOTOCONDUCTIVE
 MOTORS, STEPPING
 MOTORS, SYNCHRONOUS
 READOUTS AND DISPLAYS, NUMERIC AND ALPHANUMERIC (OTHER THAN CRT)
 RELAYS, DRY REED (COMPUTER GRADE)
 RELAYS, SOLID-STATE (COMPUTER GRADE)
 SWITCHES, DRY REED
 SWITCHES, ROTARY
 SWITCHES, SNAP ACTION

SIGMATRON INC. 805-967-0131
 849 Ward Dr, Santa Barbara, Cal 93102

DISPLAYS, MAGNETIC
 INDICATORS, ALPHANUMERIC
 INDICATORS, DIGITAL
 INDICATORS, ILLUMINATED
 READOUTS AND DISPLAYS, NUMERIC AND ALPHANUMERIC (OTHER THAN CRT)
 READOUTS, CRT
 TUBES, CATHODE RAY

SIGNAL ANALYSIS INDUSTRIES CORP. 516-234-5700
 595 Old Willets Path, Hauppauge, N Y 11787

ANALYZERS, WAVEFORM

SIGNAL GALAXIES INC. 213-988-1570
 6955 Hayvenhurst Ave, Van Nuys, Cal 91406

MEMORY PLANES AND STACKS, THIN FILM
 MEMORY SYSTEMS, THIN FILM

SIGNETICS CORP. SUB. CORNING GLASS 408-739-7700
 811 E Arques Ave, Sunnyvale, Cal 94086 TWX 910-339-9220

AMPLIFIERS, OPERATIONAL
 AMPLIFIERS, VIDEO
 CIRCUITS, MONOLITHIC (DIGITAL LOGIC)
 CIRCUITS, MONOLITHIC (LINEAR-EXCL. OP AMPS)
 CIRCUITS, MONOLITHIC (LSI-BIPOLAR)
 CIRCUITS, MONOLITHIC (LSI-MOS)
 CIRCUITS, MONOLITHIC (OP AMPS)
 COUNTERS, DECADE
 COUNTERS, UP-DOWN
 DISPLAY DRIVERS
 MEMORY SYSTEMS, READ-ONLY
 MEMORY SYSTEMS, SEMICONDUCTOR
 MODULES, DIGITAL LOGIC ENCAPSULATED (ALSO SEE CIRCUITS & CIRCUIT CARDS)
 MODULES, LINEAR (ENCAPSULATED)
 MODULES, MEMORY (ENCAPSULATED)
 MULTIPLEXERS, DIGITAL
 OSCILLATORS, VOLTAGE CONTROLLED
 REGULATORS, VOLTAGE
 TESTERS, INTEGRATED CIRCUIT

SIGNETICS CORP. MEASUREMENT DATA DIV. 415-961-9383
 341 Moffett Blvd, Mountain View, Cal 94040 TWX 910-379-6939

GENERATORS, BYTE
 TESTERS, INTEGRATED CIRCUIT

SILCONIX INC. 408-246-8000
 2201 Laurelwood Rd, Santa Clara, Cal 95054 TWX 910-338-0227

CIRCUITS, MONOLITHIC (DIGITAL LOGIC)
 CIRCUITS, MONOLITHIC (LINEAR-EXCL. OP AMPS)
 CIRCUITS, MONOLITHIC (OP AMPS)
 MULTIPLEXERS, ANALOG-SOLID STATE (SEQUENTIAL SAMPLING)
 TRANSISTORS, FIELD EFFECT
 TRANSISTORS, PHOTO

SILICON GENERAL INC. 714-839-6200
 7382 Bolsa Ave, Westminster, Cal 92683 TWX 910-596-1804

AMPLIFIERS, OPERATIONAL
 AMPLIFIERS, VIDEO
 CIRCUITS, MONOLITHIC (LINEAR-EXCL. OP AMPS)
 CIRCUITS, MONOLITHIC (OP AMPS)
 REGULATORS, VOLTAGE

SILICON TRANSISTOR CORP. 516-742-4100
 E Gate Blvd, Garden City, N Y 11532 TWX 510-222-8258

TRANSISTORS, SILICON

SIMCO CO. INC.,THE 215-368-2220
 920 Walnut St, Lansdale, Pa 19446

CLEANERS, MAGNETIC TAPE
 COATINGS, ANTI-STATIC
 POWER SUPPLIES, DC
 STATIC ELIMINATION EQUIPMENT

SIMPLEX TIME RECORDER CO. 617-632-2500
 26 South Lincoln St, Gardner, Mass 01440

CLOCKS, DIGITAL (REAL-TIME)
 COMPUTERS, FIRE CONTROL

SIMPSON ELECTRIC CO. 312-379-1121
 5200 W Kinzie St, Chicago, Ill 60644

TESTERS, CIRCUIT
 TESTERS, INTEGRATED CIRCUIT
 TESTERS, SEMICONDUCTOR
 VOLTMETERS, AC, DC, DIFFER-ENTIAL
 VOLTMETERS, DIGITAL

SIMTAB INC. SUB. UNITED DATA CENTERS 315-437-2927
 6563 Ridings Rd, Syracuse, N Y 13206

SERVICES, PROCESSING (COMMERCIAL EDP)

SIMULATORS, INC. 312-593-6340
 95 Randall St, Elk Grove Vill, Ill 60007

ACOUSTIC COUPLERS
 COMPUTERS, ANALOG (GENERAL-PURPOSE)

3 Manufacturers' Directory

SINGER CO., THE, FRIDEN DIV.
2350 Washington St, San Leandro, Cal 94577

415-357-6800

ACCOUNTING MACHINES, CARD-PROGRAMMED
ACCOUNTING MACHINES, PAPER TAPE PROGRAMMED
CALCULATORS, PROGRAMMABLE (ALSO SEE COMPUTERS)
COMMUNICATION SYSTEMS, DATA TRANSMISSION
COMPUTERS, DIGITAL (GENERAL-PURPOSE, SMALL-SCALE)
CONTROLLERS, PUNCHES CARD
CONVERTERS, PAPER TAPE-TO-MAGNETIC TAPE
DATA TERMINALS, BLOCK-BY-BLOCK (MAGNETIC TAPE)
DATA TERMINALS, BLOCK-BY-BLOCK (PAPER TAPE)
DATA TERMINALS, INQUIRY-RESPONSE (SPECIAL-PURPOSE)
DESKS, TABLES AND STANDS (FOR KEYPUNCH UNITS)
DESKS, TABLES AND STANDS (FOR PROGRAMMER STATIONS)
DESKS, TABLES AND STANDS (FOR TYPEWRITERS)
DISC DRIVES, REMOVABLE CARTRIDGE
DISC STORAGE SYSTEMS
ENCODERS, KEYBOARD (ALPHANUMERIC)
ENCODERS, KEYBOARD-TO-MAGNETIC TAPE
PERFORATORS, PAPER TAPE
POOLERS, MAGNETIC TAPE
PRINTER/PUNCH, PAPER TAPE
PRINTERS, LINE (LOW & MEDIUM SPEED)
PUNCHES, CARD (EDGE-PUNCHING)
PUNCHES, CARD (UP TO 100 CPM)
PUNCHES, PAPER TAPE
READERS, PAPER TAPE
RECORDERS, MAGNETIC TAPE
RIBBONS, INK (FOR PRINTERS AND TAB EQUIPMENT)
TAPE, PUNCH (PAPER)
TRAINING INSTITUTES, COMMERCIAL COMPUTER COURSES, SEMINARS,
CORRESPONDENCE COURSES

SINGER CO., THE, DIEHL DIV.
Finderne Ave, Somerville, N J 08876

201-725-2200
TWX 710-480-9325

AMPLIFIERS, D.C.
BLOWERS, FANS, COOLING ASSEMBLIES
MOTORS, SERVO
MOTORS, STEPPING
MOTORS, SYNCHRONOUS
SERVOS, COMPUTER

SINGER-GENERAL PRECISION KEARFOTT DIV.
1150 McBride Ave, Little Falls, N J 07424

201-256-4000
TWX 710-988-5700

COMPUTERS, DIGITAL (GENERAL-PURPOSE, SMALL-SCALE)
COMPUTERS, DIGITAL (GENERAL-PURPOSE, MEDIUM-SCALE)
COMPUTERS, FIRE CONTROL
COMPUTERS, HYBRID
COMPUTERS, NAVIGATION
CONSULTING (ADVANCED COMPUTER EQUIPMENT DESIGN AND FEASIBILITY STUDIES)
CONSULTING (SCIENTIFIC APPLICATIONS)
CONVERTERS, ANALOG-TO-DIGITAL
CONVERTERS, BINARY-TO-DECIMAL
CONVERTERS, DC-TO-FREQUENCY
CONVERTERS, DIGITAL-TO-ANALOG
CONVERTERS, DIGITAL-TO-SYNCHRO
CONVERTERS, POLAR-TO-RECTANGULAR
CONVERTERS, PULSE-TO-DIGITAL
CONVERTERS, SCAN
CONVERTERS, SYNCHRO-TO-DIGITAL
INDICATORS, ALPHANUMERIC
INDICATORS, DIGITAL
INDICATORS, ILLUMINATED
MEMORY SYSTEMS, MAGNETIC CORE
MULTIPLEXER-CONVERTER (SINGLE UNIT WITH MULTIPLEXER, SAMPLE & HOLD AMPLIFIER & A-TO-D CONVERTER)
MULTIPLEXERS, ANALOG-RELAY (SEQUENTIAL SAMPLING)
MULTIPLEXERS, ANALOG-SOLID STATE (SEQUENTIAL SAMPLING)
MULTIPLEXERS, DIGITAL
PROGRAMMING LANGUAGE DEVELOPMENT (CONSULTANTS)
PROGRAMMING LANGUAGE DEVELOPMENT (CONTRACT PROGRAMMING)
PROGRAMMING LANGUAGE DEVELOPMENT (DEDICATED APPLICATION SYSTEMS)
READOUTS AND DISPLAYS, NUMERIC AND ALPHANUMERIC (OTHER THAN CRT)
SERVOS, COMPUTER
TESTERS, DIGITAL LOGIC MODULES AND CARDS
TIMERS, EVENT (IMPULSE)
TIMERS, INTERVAL

SINGER-GENERAL PRECISION INC. LIBRASCOPE PROD.DIV
1100 Frances Ct, Glendale, Cal 91201

213-246-7231
TWX 910-497-2267

DISC STORAGE SYSTEMS
ENCODERS, DIGITAL
ENCODERS, SHAFT ANGLE
MEMORY SYSTEMS, MAGNETIC DISC
READOUTS AND DISPLAYS, NUMERIC AND ALPHANUMERIC (OTHER THAN CRT)

SINGER LINK DIV.
1077 E Arques, Sunnyvale, Cal 94086

408-732-3800
TWX 910-339-9204

PLOTTERS, FILM EXPOSING
DRAFTING SYSTEMS, COMPUTER-CONTROLLED STORAGE
FILM SCANNERS
MICROFICHE
PRINTERS, MICROFILM/MICROFICHE
RECORDERS, GRAPHIC
RECORDERS, MICROFILM/MICROFICHE
SCANNERS, IMAGE
SCANNERS, INPUT
SCANNERS, OPTICAL

SINGER TELE-SIGNAL CORP.
250 Crossway Park Dr, Woodbury, N Y 11797

516-921-9400
TELEX 96-1468

CONSULTING (DATA COMMUNICATIONS SYSTEMS PLANNING)
DATA CONCENTRATORS
MODEMS, ACOUSTIC
MODEMS, HARD-WIRED
MODEMS, PC CARD
TESTERS, DIGITAL DATA TRANSMISSION

SKAN-A-MATIC CORP.
P O Drawer 68, Skaneateles, N Y 13152

315-685-3473

DIODES, LIGHT EMITTING
DIODES, SILICON
FIBER OPTIC BUNDLES
FIBER OPTICS ASSEMBLIES (FOR PUNCHED CODE READERS AND MARK SENSORS)
FILM SCANNERS
MARK SENSING EQUIPMENT
SCANNERS, IMAGE
SCANNERS, OPTICAL
TIMERS, INTERVAL
TRANSISTORS, PHOTO

SKOTTIE ELECTRONICS, INC.
Line St, Archbald, Pa 18403

717-876-1686
TELEX 83-7434

CAPACITORS, COMPUTER GRADE

SLOAN CO., THE
7704 San Fernando Rd, Sun Valley, Cal 91352

213-875-1123
TWX 910-498-2250

INVERTERS, DC-AC
LAMPS-PANEL, PILOT AND DIAL (INCANDESCENT)

SMEAD MANUFACTURING CO.
600 E 10th St, Hastings, Minn 55033

612-437-4111
TWX 910-578-3813

ENVELOPES (FOR FILING TAPES)
FILES, PUNCHED CARD
GUIDES, CIRCUIT CARDS
LABELS, CONTINUOUS AND GUMMED (MACHINE APPLICATION)

SMITH CORP., A.O. DATA SYSTEMS DIV.
3533 N 27 St, Milwaukee, Wisc 53201

414-873-3000

CONSULTING (ACCOUNTING, BUSINESS AND COMMERCIAL APPLICATIONS)
CONSULTING (SCIENTIFIC APPLICATIONS)
SERVICES, FACILITY MANAGEMENT
SERVICES, MANAGEMENT INFORMATION SYSTEMS
SERVICES, PROCESSING (COMMERCIAL EDP)
SERVICES, PROCESSING (DIGITAL SCIENTIFIC)
SERVICES, TIME SHARING (COMMERCIAL)
SERVICES, TIME SHARING (RESEARCH)
SERVICES, SYSTEMS ANALYSIS

SMITH INC., JAY
292 E State St, Westport, Conn 06880

203-227-8484

CONTAINERS, PAPER TAPE STORAGE
ENVELOPES (FOR FILING TAPES)
PUNCHES, PAPER TAPE
SPLICERS, PAPER TAPE
SPOOLERS, PAPER TAPE
WINDERS, PAPER TAPE

SMITH SYSTEM MANUFACTURING CO.
56 Emerald St SE, Minneapolis, Minn 55414

612-336-1784

CABINETS, RACKS, VAULTS (FOR MAGNETIC TAPE STORAGE)
CHASSIS, SLIDES, RACKS
DESKS, TABLES AND STANDS (FOR CALCULATORS)
DESKS, TABLES AND STANDS (FOR KEYPUNCH UNITS)
DESKS, TABLES AND STANDS (FOR PROGRAMMER STATIONS)
CONTINUED

3 Manufacturers' Directory

DESKS, TABLES AND STANDS (FOR TYPEWRITERS)

SMITHSONIAN ASTROPHYSICAL OBSERVATORY 617-864-7910
60 Garden St, Cambridge, Mass 02138 TWX 617-499-9111
PROGRAMMING LANGUAGE DEVELOPMENT (CONTRACT PROGRAMMING)
SERVICES, PROCESSING (COMMERCIAL EDP)
SERVICES, PROCESSING (DIGITAL SCIENTIFIC)

SOFTECH INC. 617-899-6900
391 Totten Pond Rd, Waltham, Mass 02154

CONSULTING (ACCOUNTING, BUSINESS AND COMMERCIAL APPLICATIONS)
CONSULTING (ADVANCED COMPUTER EQUIPMENT DESIGN AND FEASIBILITY STUDIES)
CONSULTING (DATA COMMUNICATIONS SYSTEMS PLANNING)
CONSULTING (MANAGEMENT INFORMATION SYSTEMS PLANNING)
CONSULTING (SCIENTIFIC APPLICATIONS)
PROGRAMMING LANGUAGE DEVELOPMENT (CONSULTANTS)
PROGRAMMING LANGUAGE DEVELOPMENT (CONTRACT PROGRAMMING)
PROGRAMMING LANGUAGE DEVELOPMENT (DEDICATED APPLICATION SYSTEMS)
PROGRAMMING LANGUAGE DEVELOPMENT (PROPRIETARY SOFTWARE PRODUCTS)
SERVICES, COMPUTER-AIDED DESIGN
SERVICES, MANAGEMENT INFORMATION SYSTEMS
SERVICES, SYSTEMS ANALYSIS
TRAINING INSTITUTES, COMMERCIAL COMPUTER COURSES, SEMINARS, CORRESPONDENCE COURSES

SOFTWARE ASSOCIATES INC. 213-445-1164
501 S 1st Ave Ste 0, Arcadia, Cal 91006

CONSULTING (COMPUTER EVALUATIONS, SELECTIONS, INSTALLATION PLANNING)
CONSULTING (DATA COMMUNICATIONS SYSTEMS PLANNING)
CONSULTING (SCIENTIFIC APPLICATIONS)

SOFTWARE GUIDANCE ASSOCIATES INC. 212-725-1555
432 Park Ave S, New York, N Y 10016

CONSULTING (ACCOUNTING, BUSINESS AND COMMERCIAL APPLICATIONS)
CONSULTING (ADVANCED COMPUTER EQUIPMENT DESIGN AND FEASIBILITY STUDIES)
CONSULTING (COMPUTER EVALUATIONS, SELECTIONS, INSTALLATION PLANNING)
CONSULTING (MANAGEMENT INFORMATION SYSTEMS PLANNING)
CONSULTING (SCIENTIFIC APPLICATIONS)
PROGRAMMING LANGUAGE DEVELOPMENT (CONSULTANTS)
PROGRAMMING LANGUAGE DEVELOPMENT (CONTRACT PROGRAMMING)
PROGRAMMING LANGUAGE DEVELOPMENT (DEDICATED APPLICATION SYSTEMS)
PROGRAMMING LANGUAGE DEVELOPMENT (PROPRIETARY SOFTWARE PRODUCTS)

SOFTWARE METHODS INC. 212-689-0669
10 E 40th St, New York, N Y 10016

CONSULTING (ACCOUNTING, BUSINESS AND COMMERCIAL APPLICATIONS)
CONSULTING (ADVANCED COMPUTER EQUIPMENT DESIGN AND FEASIBILITY STUDIES)
CONSULTING (COMPUTER EVALUATIONS, SELECTIONS, INSTALLATION PLANNING)
CONSULTING (DATA COMMUNICATIONS SYSTEMS PLANNING)
CONSULTING (MANAGEMENT INFORMATION SYSTEMS PLANNING)
SERVICES, FACILITY MANAGEMENT
SERVICES, MANAGEMENT INFORMATION SYSTEMS
SERVICES, PROCESSING (COMMERCIAL EDP)
SERVICES, TIME SHARING (COMMERCIAL)
SERVICES, SYSTEMS ANALYSIS
TRAINING SYSTEMS, COMPUTER SERVICE

SOFTWARE PROGRAMMING ASSOCIATES INC. 305-267-4870
1209 Tropic St, Titusville, Fla 32780

CONSULTING (ACCOUNTING, BUSINESS AND COMMERCIAL APPLICATIONS)
CONSULTING (ADVANCED COMPUTER EQUIPMENT DESIGN AND FEASIBILITY STUDIES)
CONSULTING (COMPUTER EVALUATIONS, SELECTIONS, INSTALLATION PLANNING)
CONSULTING (DATA COMMUNICATIONS SYSTEMS PLANNING)
CONSULTING (COMPUTER PRODUCT PLANNING SURVEYS, MARKET RESEARCH STUDIES)
CONSULTING (MANAGEMENT INFORMATION SYSTEMS PLANNING)
CONSULTING (SCIENTIFIC APPLICATIONS)
PROGRAMMING LANGUAGE DEVELOPMENT (CONSULTANTS)
PROGRAMMING LANGUAGE DEVELOPMENT (CONTRACT PROGRAMMING)
PROGRAMMING LANGUAGE DEVELOPMENT (DEDICATED APPLICATION SYSTEMS)
PROGRAMMING LANGUAGE DEVELOPMENT (PROPRIETARY SOFTWARE PRODUCTS)
CONTINUED

SERVICES, COMPUTER-AIDED DESIGN
SERVICES, FACILITY MANAGEMENT
SERVICES, MANAGEMENT INFORMATION SYSTEMS
SERVICES, PROCESSING (COMMERCIAL EDP)
SERVICES, PROCESSING (DIGITAL SCIENTIFIC)
SERVICES, SYSTEMS ANALYSIS

SOLA BASIC INDUSTRIES SOLA ELECTRIC DIV. 312-439-2800
1717 Busse Rd, Elk Grove Vilge, Ill 60007 TELEX 25-3395

POWER SUPPLIES, AC
POWER SUPPLIES, DC
REGULATORS, CURRENT
REGULATORS, VOLTAGE
TRANSFORMERS, POWER (COMPUTER GRADE)

SOLAR SYSTEMS INC. 312-676-2040
8124 N Central Park, Skokie, Ill 60076 TWX 910-223-3642

CELLS, PHOTOCONDUCTIVE
DIODES, SILICON
FIBER OPTICS ASSEMBLIES (FOR PUNCHED CODE READERS AND MARK SENSORS)
TRANSISTORS, PHOTO

SOLID STATE ELECTRONICS CORP. 213-894-2271
15321 Rayen St, Sepulveda, Cal 91343

AMPLIFIERS, D.C.
AMPLIFIERS, INSTRUMENTATION
AMPLIFIERS, OPERATIONAL
CIRCUIT CARDS, LINEAR (WITH IC'S)
CLOCKS, DIGITAL (REAL-TIME)
COMMUTATORS, SWITCHING (ELECTRIC)
CONVERTERS, ANALOG-TO-DIGITAL
CONVERTERS, DC-TO-FREQUENCY
CONVERTERS, FREQUENCY-TO-DC
CONVERTERS, VOLTAGE-TO-FREQUENCY
MODULES, DIGITAL LOGIC ENCAPSULATED (ALSO SEE CIRCUITS & CIRCUIT CARDS)
MODULES, LINEAR (ENCAPSULATED)
MODULES, MEMORY (ENCAPSULATED)
MULTIPLEXER-CONVERTER (SINGLE UNIT WITH MULTIPLEXER, SAMPLE & HOLD AMPLIFIER & A-TO-D CONVERTER)
MULTIPLEXERS, ANALOG-RELAY (SEQUENTIAL SAMPLING)
MULTIPLEXERS, ANALOG-SOLID STATE (SEQUENTIAL SAMPLING)
MULTIPLEXERS, DIGITAL
OSCILLATORS, MAGNETIC
OSCILLATORS, VOLTAGE CONTROLLED
POWER SUPPLIES, DC
RELAYS, DRY REED (COMPUTER GRADE)
RELAYS, SOLID-STATE (COMPUTER GRADE)
TRANSDUCERS, DIGITAL

SOLITRON DEVICES INC. 914-245-3243
256 Oak Tree Rd, Tappan, N Y 10983 TWX 710-576-2654

CABLE ASSEMBLIES (WITH CONNECTORS)
CABLE, COAXIAL (FLEXIBLE)
CABLE, COAXIAL (SEMI/RIGID)
CIRCUITS, MONOLITHIC (DIODE MATRICES)
CIRCUITS, MONOLITHIC (LINEAR-EXCL. OP AMPS)
CIRCUITS, MONOLITHIC (LSI-BIPOLAR)
CIRCUITS, MONOLITHIC (LSI-MOS)
CIRCUITS, MONOLITHIC (OP AMPS)
CIRCUITS, THICK FILM (DIGITAL)
CONNECTORS, COAXIAL (COMPUTER-GRADE)
CONNECTORS, RACK AND PANEL (COMPUTER-GRADE)
DIODES, GERMANIUM
DIODES, NOT-CARRIER
DIODES, LIGHT EMITTING
DIODES, SILICON
DIODES, TUNNEL
DIODES, VIDEO DETECTOR
DIODES, ZENER
MEMORY SYSTEMS, READ-ONLY
MEMORY SYSTEMS, SEMICONDUCTOR
MEMORY SYSTEMS, SEMICONDUCTOR (MOS)
RECTIFIERS, SILICON CONTROLLED
REGULATORS, VOLTAGE
TESTERS, SEMICONDUCTOR
TRANSISTORS, FIELD EFFECT
TRANSISTORS, GERMANIUM
TRANSISTORS, SILICON
VOLTMETERS, AC, DC, DIFFERENTIAL

SOLITRON DEVICES INC. 714-278-8780
8808 Balboa Ave, San Diego, Cal 92123 TWX 910-335-1221

AMPLIFIERS, OPERATIONAL
CIRCUITS, MONOLITHIC (LSI-MOS)
CIRCUITS, MONOLITHIC (OP AMPS)
CONTINUED

3 Manufacturers' Directory

CONVERTERS, ANALOG-TO-DIGITAL
 DIODES, GERMANIUM
 DIODES, NOT-CARRIER
 DIODES, SILICON
 DIODES, TUNNEL
 DIODES, VIDEO DETECTOR
 DIODES, ZENER
 MEMORY SYSTEMS, READ-ONLY
 MEMORY SYSTEMS, SEMICONDUCTOR (MOS)

SOLITRON DEVICES INC. TRANSISTOR DIV. 305-848-4311
 1177 Blue Heron Blvd, Riviera Beach, Fla 33404

CABLE, COAXIAL (FLEXIBLE)
 CABLE, COAXIAL (SEMI/RIGID)
 CONNECTORS, COAXIAL (COMPUTER-GRADE)
 CONNECTORS, MINIATURE AND SUB-MINIATURE (COMPUTER-GRADE)
 CONNECTORS, PC AND IC BOARD (COMPUTER-GRADE)
 CONNECTORS, POWER (COMPUTER-GRADE)
 CONNECTORS, RACK AND PANEL (COMPUTER-GRADE)
 DIODES, GERMANIUM
 DIODES, NOT-CARRIER
 DIODES, ZENER
 MEMORY SYSTEMS, DIODE
 MEMORY SYSTEMS, READ-ONLY
 MEMORY SYSTEMS, SEMICONDUCTOR
 MEMORY SYSTEMS, SEMICONDUCTOR (MOS)
 REGULATORS, VOLTAGE
 TRANSISTORS, FIELD EFFECT
 TRANSISTORS, GERMANIUM
 TRANSISTORS, SILICON
 VOLTMETERS, AC, DC, DIFFERENTIAL
 VOLTMETERS, DIGITAL

SONICRAFT INC. 312-374-3000
 8437 S Burley Ave, Chicago, Ill 60619

GENERATORS, BYTE
 MEMORY SYSTEMS, PLATED WIRE
 MEMORY SYSTEMS, READ-ONLY
 READER/PUNCHES, PUNCHED CARD
 TESTERS, MEMORY PLANES, STACKS AND SYSTEMS

SORBUS 215-265-6700
 875 First Ave, King of Prussia, Pa 19406 TWX 510-660-1043

CONSULTING (COMPUTER EVALUATIONS, SELECTIONS, INSTALLATION PLANNING)
 SERVICES, HARDWARE MAINTENANCE
 TRAINING SYSTEMS, COMPUTER SERVICE

SOURCE INFORMATION SYSTEMS INC. 213-451-1628
 P O Box 3088, Santa Monica, Cal 90403

ENCODERS, KEYBOARD (NUMERIC)
 PUNCHES, CARD (PORTABLE)

SOUTHERN DATA PROCESSING SERVICE INC. 404-724-4217
 P O Box 123, Augusta, Ga 30903

CONSULTING (ACCOUNTING, BUSINESS AND COMMERCIAL APPLICATIONS)
 CONSULTING (COMPUTER EVALUATIONS, SELECTIONS, INSTALLATION PLANNING)
 CONSULTING (DATA COMMUNICATIONS SYSTEMS PLANNING)
 CONSULTING (MANAGEMENT INFORMATION SYSTEMS PLANNING)
 SERVICES, FACILITY MANAGEMENT
 SERVICES, MANAGEMENT INFORMATION SYSTEMS
 SERVICES, PROCESSING (COMMERCIAL EDP)
 SERVICES, SYSTEMS ANALYSIS

SOUTHERN SIMULATION SERVICES INC. 813-839-5201
 P O Box 1155, Tampa, Fla 33601

CONSULTING (ACCOUNTING, BUSINESS AND COMMERCIAL APPLICATIONS)
 CONSULTING (SCIENTIFIC APPLICATIONS)
 SERVICES, SYSTEMS ANALYSIS
 TRAINING INSTITUTES, COMMERCIAL COMPUTER COURSES, SEMINARS,
 CORRESPONDENCE COURSES

SOUTHERN VERMONT COMPUTER CENTER&DATA SCHOOL 802-447-7528
 219 Belmont Ave, Bennington, Vt 05201

CONSULTING (ACCOUNTING, BUSINESS AND COMMERCIAL APPLICATIONS)
 CONSULTING (COMPUTER EVALUATIONS, SELECTIONS, INSTALLATION PLANNING)
 CONTINUED

CONSULTING (DATA COMMUNICATIONS SYSTEMS PLANNING)
 CONSULTING (COMPUTER PRODUCT PLANNING SURVEYS, MARKET RESEARCH STUDIES)
 CONSULTING (MANAGEMENT INFORMATION SYSTEMS PLANNING)
 SERVICES, PROCESSING (COMMERCIAL EDP)
 SERVICES, SYSTEMS ANALYSIS
 TRAINING INSTITUTES, COMMERCIAL COMPUTER COURSES, SEMINARS,
 CORRESPONDENCE COURSES
 TRAINING SYSTEMS, COMPUTER SERVICE

SOUTHWEST COMPUTER COLLEGE INC. 505-265-5906
 136 Louisiana NE, Albuquerque, N M 87108

SERVICES, PROCESSING (COMMERCIAL EDP)
 TRAINING INSTITUTES, COMMERCIAL COMPUTER COURSES, SEMINARS,
 CORRESPONDENCE COURSES

SPACETAC INC. 617-275-1710
 Burlington Rd, Bedford, Mass 01730 TWX 710-326-7567

ANALYZERS, PULSE HEIGHT
 CIRCUITS, HYBRID (IC AND DISCRETE-DIGITAL)
 CIRCUITS, THICK FILM (DIGITAL)
 CIRCUITS, THIN FILM (DIGITAL)
 COMPUTERS, AEROSPACE
 COMPUTERS, NAVIGATION
 CONVERTERS, ANALOG-TO-DIGITAL
 CONVERTERS, BINARY-TO-DECIMAL
 CONVERTERS, DIGITAL-TO-ANALOG
 CONVERTERS, DIGITAL-TO-SYNCHRO
 CONVERTERS, SYNCHRO-TO-DIGITAL
 ENCODERS, DIGITAL
 INVERTERS, DC-AC
 MEMORY SYSTEMS, MAGNETIC CORE
 MEMORY SYSTEMS, PLATED WIRE
 MODULES, MEMORY (ENCAPSULATED)
 MULTIPLEXER-CONVERTER (SINGLE UNIT WITH MULTIPLEXER, SAMPLE & HOLD AMPLIFIER & A-TO-D CONVERTER)
 MULTIPLEXERS, ANALOG-SOLID STATE (SEQUENTIAL SAMPLING)
 MULTIPLEXERS, DIGITAL
 POWER SUPPLIES, DC
 POWER SUPPLIES, DIGITALLY-CONTROLLED
 REGULATORS, CURRENT
 REGULATORS, VOLTAGE
 VOLTAGE DIVIDERS

SPACETRONICS CO. 609-667-2355
 43 Hassemer Ave, Cherry Hill, N J 08034

CONSULTING (ACCOUNTING, BUSINESS AND COMMERCIAL APPLICATIONS)
 CONSULTING (COMPUTER EVALUATIONS, SELECTIONS, INSTALLATION PLANNING)
 CONSULTING (MANAGEMENT INFORMATION SYSTEMS PLANNING)
 CONSULTING (SCIENTIFIC APPLICATIONS)
 SERVICES, FACILITY MANAGEMENT
 SERVICES, MANAGEMENT INFORMATION SYSTEMS
 SERVICES, SYSTEMS ANALYSIS

SPATIAL DATA SYSTEMS INC. 805-968-3594
 132 Aero Camino, Goleta, Cal 93017

CONSOLES, CRT (GRAPHIC)
 DISPLAYS, THREE-DIMENSIONAL
 FILM SCANNERS

SPECTRA-STRIP CORP. 714-892-3361
 7100 Lampson Ave, Garden Grove, Cal 92642 TWX 910-596-1314

CABLE, FLAT, PRINTED AND RIBBON
 CABLE, MULTICONDUCTOR

SPECTROL ELECTRONICS CORP. 213-964-6565
 17070 E Gale Ave, Industry, Cal 91745 TWX 910-584-1314

POTENTIOMETERS, TRIM (FILM)
 POTENTIOMETERS, TRIM (WIRE-WOUND)
 SWITCHES, ROTARY

SPECTRON CORP. 609-667-5700
 10060 Kings Hwy N, Cherry Hill, N J 08034 TELEX 83-4763

COMMUNICATION SYSTEMS, DATA TRANSMISSION
 COMMUNICATION SYSTEMS, TELEPRINTER
 CONSULTING (ADVANCED COMPUTER EQUIPMENT DESIGN AND FEASIBILITY STUDIES)
 TESTERS, DIGITAL DATA TRANSMISSION

3 Manufacturers' Directory

- SPECTRONICS INC.** 214-231-9381
541 Sterling Dr, Richardson, Tex 75080
- DIODES, LIGHT EMITTING
DIODES, SILICON
FIBER OPTICS ASSEMBLIES (FOR PUNCHED CODE READERS AND MARK SENSORS)
INDICATORS, ALPHANUMERIC
MARK SENSING SUPPLIES
- SPECTRUM DYNAMICS INC.** 305-566-2547
P O Box 23699, Ft Lauderdale, Fla 33308
- TESTERS, INTEGRATED CIRCUIT
- SPINDLE SALES EX-CELL-O CORP.** 313-541-3833
Po Box 386, Detroit, Mich 48232
- SPINDLES
- SPINDLER AND SAUPPE INC.** 213-247-1610
1329 Grand Central Av, Glendale, Cal 91201
- PROJECTORS, OPTICAL (COMPUTER CONTROLLED SLIDE SELECTING)
- SPIRAS SYSTEMS INC. AFFIL. USM CORP.** 617-893-7100
332 Second Ave, Waltham, Mass 02154 TWX 710-324-6699
- COMPUTERS, DIGITAL (EDUCATIONAL)
COMPUTERS, DIGITAL (GENERAL-PURPOSE, SMALL-SCALE)
COMPUTERS, DIGITAL (GENERAL-PURPOSE, MEDIUM-SCALE)
COMPUTERS, MINI GENERAL PURPOSE (ALSO SEE CALCULATORS)
COMPUTERS, PROCESS CONTROL
DATA TERMINALS, INQUIRY-RESPONSE (CRT WITH KEYBOARD)
DATA TERMINALS, INQUIRY-RESPONSE (SPECIAL-PURPOSE)
- SPRAGUE ELECTRIC CO.** 413-664-4411
551 Marshall St, N Adams, Mass 01247 TWX 413-663-3581
- AMPLIFIERS, OPERATIONAL
AMPLIFIERS, VIDEO
CAPACITORS, COMPUTER GRADE
CIRCUITS, HYBRID (IC AND DISCRETE-DIGITAL)
CIRCUITS, MONOLITHIC (DIGITAL LOGIC)
CIRCUITS, MONOLITHIC (LINEAR-EXCL. OP AMPS)
CIRCUITS, MONOLITHIC (LSI-BIPOLAR)
CIRCUITS, MONOLITHIC (LSI-MOS)
CIRCUITS, MONOLITHIC (OP AMPS)
CIRCUITS, THICK FILM (DIGITAL)
CIRCUITS, THIN FILM (DIGITAL)
CONVERTERS, ANALOG-TO-DIGITAL
CONVERTERS, BINARY-TO-DECIMAL
COUNTERS, DECADE
COUNTERS, UP-DOWN
MEMORY SYSTEMS, DELAY LINE
MEMORY SYSTEMS, SEMICONDUCTOR
MEMORY SYSTEMS, SEMICONDUCTOR (MOS)
MODULES, LINEAR (ENCAPSULATED)
MODULES, MEMORY (ENCAPSULATED)
MODULES, RESISTANCE NETWORKS (ENCAPSULATED)
TRANSFORMERS, PULSE (COMPUTER GRADE)
TRANSISTORS, FIELD EFFECT
- SPS INC.** 305-885-6455
4485 N W 36th St, Miami, Fla 33166
- CONSULTING (MANAGEMENT INFORMATION SYSTEMS PLANNING)
SERVICES, FACILITY MANAGEMENT
SERVICES, MANAGEMENT INFORMATION SYSTEMS
- SRC DIV. MOXON INC.** 714-833-2000
2222 Michelson Dr, Newport Beach, Cal 92664 TWX 910-596-1362
- AMPLIFIERS, D.C.
AMPLIFIERS, INSTRUMENTATION
CLOCKS, DIGITAL (REAL-TIME)
CONVERTERS, ANALOG-TO-DIGITAL
CONVERTERS, BINARY-TO-DECIMAL
CONVERTERS, DIGITAL-TO-ANALOG
CONVERTERS, MAGNETIC TAPE-TO-PAPER TAPE
DIGITIZERS, PROGRAMMABLE
GENERATORS, TIME CODE
MULTIPLEXER-CONVERTER (SINGLE UNIT WITH MULTIPLEXER, SAMPLE & HOLD AMPLIFIER & A-TO-D CONVERTER)
MULTIPLEXERS, ANALOG-RELAY (SEQUENTIAL SAMPLING)
MULTIPLEXERS, ANALOG-SOLID STATE (SEQUENTIAL SAMPLING)
MULTIPLEXERS, DIGITAL
PLUGBOARDS, PROGRAMMING
POWER SUPPLIES, DC
CONTINUED
- POWER SUPPLIES, DIGITALLY-CONTROLLED
RECORDERS, MAGNETIC TAPE
SIGNAL CONDITIONERS
TESTERS, CIRCUIT
TESTERS, DIGITAL DATA TRANSMISSION
TESTERS, DIGITAL LOGIC MODULES AND CARDS
TESTERS, INTEGRATED CIRCUIT
TESTERS, MEMORY PLANES, STACKS AND SYSTEMS
TRANSDUCERS, DIGITAL
- STACKPOLE CARBON CO.** 814-834-1521
Stackpole, St Marys, Pa 15857
- SWITCHES, ROTARY
- STACOSWITCH INC.** 714-549-3041
1139 Baker St, Costa Mesa, Cal 92626 TWX 910-595-1507
- CONSOLES, COMPUTER CONTROL (WIRED)
DATA TERMINALS, INQUIRY-RESPONSE (SPECIAL-PURPOSE)
ENCODERS, KEYBOARD (ALPHANUMERIC)
ENCODERS, KEYBOARD (NUMERIC)
INDICATORS, ILLUMINATED
KNOBS, DIALS (FOR COMPUTER CONSOLES)
LAMPS-PANEL, PILOT AND DIAL (INCANDESCENT)
SWITCHES, PUSHBUTTON
SWITCHES, PUSHBUTTON (ILLUMINATED)
SWITCHES, ROTARY
SWITCHES, SNAP ACTION
- STANDARD COMPUTER CORP.** 714-540-2464
633 Young St, Santa Ana, Cal 92705
- COMPUTERS, DIGITAL (GENERAL-PURPOSE, MEDIUM-SCALE)
MEMORY SYSTEMS, MAGNETIC CORE
PROGRAMMING LANGUAGE DEVELOPMENT (DEDICATED APPLICATION SYSTEMS)
- STANDARD LOGIC INC.** 714-835-5466
1630 S Lyon St, Santa Ana, Cal 92705 TWX 910-595-1707
- CIRCUIT CARDS, LOGIC (WITH DISCRETE COMPONENTS)
CIRCUIT CARDS, LOGIC (WITH IC'S)
CONVERTERS, ANALOG-TO-DIGITAL
CONVERTERS, DIGITAL-TO-ANALOG
MEMORY SYSTEMS, MAGNETIC CORE
MEMORY SYSTEMS, SEMICONDUCTOR (MOS)
- STANDARD MEMORIES INC.** 213-788-3010
15130 Ventura Blvd, Sherman Oak, Cal 91403 TWX 910-495-1738
- CORES, FERRITE MEMORY
MEMORY PLANES AND STACKS, MAGNETIC CORE (W/O ELECTRONICS)
MEMORY SYSTEMS, MAGNETIC CORE
MEMORY SYSTEMS, PLATED WIRE
TESTERS, MEMORY PLANES, STACKS AND SYSTEMS
- STANDARD PROCESSING CO. INC.** 512-787-1717
P O Box 703, Pharr, Tex 78577
- CONSULTING (ACCOUNTING, BUSINESS AND COMMERCIAL APPLICATIONS)
CONSULTING (COMPUTER EVALUATIONS, SELECTIONS, INSTALLATION PLANNING)
CONSULTING (DATA COMMUNICATIONS SYSTEMS PLANNING)
CONSULTING (MANAGEMENT INFORMATION SYSTEMS PLANNING)
LEASING, EDP EQUIPMENT (OTHER THAN MFGRS)
SERVICES, MANAGEMENT INFORMATION SYSTEMS
SERVICES, PROCESSING (COMMERCIAL EDP)
USED EQUIPMENT (BUYING, SELLING, LEASING)
- STANDARD REGISTER CO., THE** 513-223-6181
626 Albany St, Dayton, Ohio 45401 TWX 810-459-1694
- DATA TERMINALS, INQUIRY-RESPONSE (BADGE-TOKEN READERS)
ENCODERS, KEYBOARD (NUMERIC)
ENVELOPES, CONTINUOUS
FORMS, CONTINUOUS (MACHINE PROCESSED)
FORMS HANDLING, BURSTERS
FORMS HANDLING, CARBON DELEAVERS
FORMS HANDLING, COLLATORS
FORMS HANDLING, DECOLLATORS
FORMS HANDLING, DETACHERS
FORMS HANDLING, PUNCHED CARD SOURCE
FORMS HANDLING, SLITTERS
FORMS HANDLING, STACKERS
LABELS, CONTINUOUS AND GUMMED (MACHINE APPLICATION)
LABELS, CONTINUOUS AND PRESSURE SENSITIVE (MACHINE APPLICATION)
PAPER (FOR MICR EQUIPMENT)
PAPER (FOR OCR EQUIPMENT)
PAPER (FOR PRINTERS)
CONTINUED

3 Manufacturers' Directory

PAYMENT COUPON BOOKS, MACHINE READABLE
PUNCHES, CARD (PORTABLE)

STANDARD WIRE AND CABLE CO.
3440 Overland Ave, Los Angeles, Cal 90034
CABLE ASSEMBLIES (WITH CONNECTORS)
CABLE, COAXIAL (FLEXIBLE)
CABLE, COAXIAL (SEMI/RIGID)
CABLE, FINE LEAD
CABLE, FLAT, PRINTED AND RIBBON
CABLE, MULTICONDUCTOR
CABLE, SHIELDED (NOT COAXIAL)
CORDS, PATCH
PLATED WIRE

213-870-9231
TWX 910-340-6758

STATIC PRODUCTS INC.
2511 National Dr, Garland, Tex 75040

214-271-3631

CONVERTERS, DC-TO-FREQUENCY
INVERTERS, DC-AC
POWER SUPPLIES, UNINTERRUPTABLE

STEARNS ELECTRIC CORP.
120 N Broadway, Milwaukee, Wisc 53202
BRAKES AND CLUTCHES

414-272-1100
TWX 414-322-8412

STELLARMETRICS AN AYDIN CO.
P O Box 719, Santa Barbara, Cal 93102

805-963-3566
TWX 910-334-1187

BOARDS, PRINTED CIRCUIT (WITHOUT COMPONENTS)
CIRCUIT CARDS, LOGIC (WITH DISCRETE COMPONENTS)
CIRCUIT CARDS, LOGIC (WITH IC'S)
COMMUTATORS, SWITCHING (ELECTRIC)
CONNECTORS, PC AND IC BOARD (COMPUTER-GRADE)
CONVERTERS, ANALOG-TO-DIGITAL
CONVERTERS, DIGITAL-TO-ANALOG
MODULES, DIGITAL LOGIC ENCAPSULATED (ALSO SEE CIRCUITS & CIRCUIT
CARDS)
MULTIPLEXER-CONVERTER (SINGLE UNIT WITH MULTIPLEXER, SAMPLE & HOLD
AMPLIFIER & A-TO-D CONVERTER)
MULTIPLEXERS, ANALOG-SOLID STATE (SEQUENTIAL SAMPLING)
MULTIPLEXERS, DIGITAL

STERLING INSTRUMENT DIV. DESIGNATRONICS INC.
55 S Denton Ave, New Hyde Park, N Y 11040

516-328-3300
TWX 510-222-5889

COUNTERS, UP-DOWN
KNOBS, DIALS (FOR COMPUTER CONSOLES)

STETTNER-TRUSH INC.
67 Albany St, Cazenovia, N Y 13035

315-655-8141
TELEX 93-7204

CAPACITORS, COMPUTER GRADE
MOTORS, SERVO
SWITCHES, PUSHBUTTON
SWITCHES, PUSHBUTTON (ILLUMINATED)

STEWART CO., WM A. ROL-A-CHART DIV.
P O Box 67, Somerset, Cal 95684

916-622-2437

BOARDS, VISUAL CONTROL (GRAPHIC)

STEWART WARNER CORP./DATAFAX
1300 N Kostner Ave, Chicago, Ill 60651

312-292-3000

COMMUNICATION SYSTEMS, FACSIMILE
SCANNERS, FACSIMILE
TRANSCIVERS, FACSIMILE

STEWART WARNER MICROCIRCUITS
824 E Evelyn Ave, Sunnyvale, Cal 94086
CIRCUITS, MONOLITHIC (DIGITAL LOGIC)

408-245-9200
TWX 910-339-9210

STINAFPS INC.
181 E Exchange St, Akron, Ohio 44304

216-434-2106

CABINETS AND ENCLOSURES (FOR KEYPUNCHES, PRINTERS)
CABINETS, RACKS, VAULTS (FOR MAGNETIC TAPE STORAGE)
CABINETS, TRAYS (FOR PUNCHED CARD STORAGE)
CARDS, CONVENTIONAL PUNCH
CARDS, EDGE-PUNCH
CARDS, MAGNETIC
CONTAINERS, DISK PACK STORAGE
CONTAINERS, PAPER TAPE STORAGE
CONTINUED

DATA RETRIEVAL SYSTEMS, MICRO-FILM (COMPUTER-CONTROLLED)
DESKS, TABLES AND STANDS (FOR CALCULATORS)
DESKS, TABLES AND STANDS (FOR KEYPUNCH UNITS)
DESKS, TABLES AND STANDS (FOR PROGRAMMER STATIONS)
DESKS, TABLES AND STANDS (FOR TYPEWRITERS)
DOCUMENTS, DCR/OMR
ENVELOPES, CONTINUOUS
ENVELOPES (FOR FILING TAPES)
FILES, PUNCHED CARD
FORMS, CONTINUOUS (MACHINE PROCESSED)
HOLDERS, BINDER
LABELS, CONTINUOUS AND GUMMED (MACHINE APPLICATION)
MICROFICHE
PAPER (FOR MICR EQUIPMENT)
PAPER (FOR OCR EQUIPMENT)
RETRIEVAL UNITS, PUNCHED CARD (RANDOM ACCESS)
SAFES, MAGNETIC TAPE STORAGE
TAGS (FOR EDP PROCESSING)
TAPE, PUNCH (MYLAR-COATED FOIL)
TAPE, PUNCH (PAPER)
TAPE, PUNCH (PAPER-COATED MYLAR)
TAPE, PUNCH (PAPER-COATED ALUMINUM)

STORAGE TECHNOLOGY CORP.
P O Box 3524, Boulder, Colo 80303

303-449-4950

CONTROLLERS, MAGNETIC TAPE
RECORDERS, MAGNETIC TAPE
TAPE TRANSPORTS, MAGNETIC (DIGITAL-EXCL. CASSETTE)

STRATOJET CORP.
P O Box 909, Azusa, Cal 91702

213-969-1703

CAPSTANS, IDLERS, AND GUIDES (FOR TAPE DRIVES)

STROMBERG DATAGRAPHIX INC.
P O Box 2449, San Diego, Cal 92112

714-283-6531
TWX 910-335-2058

CONVERTERS, MAGNETIC TAPE-TO-MICROFILM
PLOTTERS, FILM EXPOSING
DATA TERMINALS, INQUIRY-RESPONSE (ALPHANUMERIC KEYBOARD)
DATA TERMINALS, INQUIRY-RESPONSE (CRT WITH KEYBOARD)
MICROFICHE
MICROFILM ROLLS
PRINTERS, MICROFILM/MICROFICHE
PROCESSORS, MICROFILM
READER/PRINTER, MICROFILM/MICROFICHE
READERS, MICROFILM/MICROFICHE
READOUTS, CRT
RECORDERS, GRAPHIC
RECORDERS, MICROFILM/MICROFICHE
TAPE TRANSPORTS, MAGNETIC (DIGITAL-EXCL. CASSETTE)

STRUTHER-DUNN INC. SYSTEMS DIV.
1114 State St, Bettendorf, Iowa 52722

319-359-0318
TWX 910-525-1176

CIRCUIT CARDS, LINEAR (WITH DISCRETE COMPONENTS)
CIRCUIT CARDS, LINEAR (WITH IC'S)
CIRCUIT CARDS, LOGIC (WITH DISCRETE COMPONENTS)
CIRCUIT CARDS, LOGIC (WITH IC'S)
CIRCUITS, HYBRID (IC AND DISCRETE-DIGITAL)
CLOCKS, DIGITAL (REAL-TIME)
COMPUTERS, PROCESS CONTROL
CONTROLLERS, MOTOR
CONVERTERS, ANALOG-TO-DIGITAL
CONVERTERS, BINARY-TO-DECIMAL
CONVERTERS, DIGITAL-TO-ANALOG
CONVERTERS, DOCUMENT-TO-PAPER TAPE
CONVERTERS, DOCUMENT-TO-UNIT RECORDS
COUNTERS, STEPPING SWITCH
COUNTERS, UP-DOWN
MULTIPLEXER-CONVERTER (SINGLE UNIT WITH MULTIPLEXER, SAMPLE & HOLD
AMPLIFIER & A-TO-D CONVERTER)
MULTIPLEXERS, ANALOG-RELAY (SEQUENTIAL SAMPLING)
MULTIPLEXERS, ANALOG-SOLID STATE (SEQUENTIAL SAMPLING)
MULTIPLEXERS, DIGITAL
RELAYS, DRY REED (COMPUTER GRADE)
RELAYS, MERCURY WETTED (COMPUTER GRADE)
RELAYS, SOLID-STATE (COMPUTER GRADE)
TIMERS, EVENT (IMPULSE)
TIMERS, INTERVAL

STURGIS NEWPORT BUSINESS FORMS INC.
P O Box 31, Sturgis, Mich 49091

616-651-2301
TWX 510-398-5130

FORMS, CONTINUOUS (MACHINE PROCESSED)
LABELS, CONTINUOUS AND GUMMED (MACHINE APPLICATION)
PAPER (FOR MICR EQUIPMENT)
PAPER (FOR OCR EQUIPMENT)
PAPER (FOR PRINTERS)

3 Manufacturers' Directory

SUGARMAN LABORATORIES INC. 295 Northern Blvd, Great Neck, N Y 11021	516-466-0080	SYLVANIA ELECTRIC PRODUCTS ELECTRONIC TUBE DIV Seneca Falls, N Y 13148	315-568-5881
DATA TERMINALS, INQUIRY-RESPONSE (ALPHANUMERIC KEYBOARD) DATA TERMINALS, INQUIRY-RESPONSE (CRT WITH KEYBOARD)		MONITORS, TV TUBES, CATHODE RAY	
SUMMIT COMPUTER CORP. 785 Springfield Ave, Summit, N J 07901	201-273-6900	SYLVANIA ELECTRONIC SYSTEMS EASTERN DIV. 77 A St, Needham Heights, Mass 02194	617-449-2000 TWX 617-444-3364
LEASING, EDP EQUIPMENT (OTHER THAN MFGRS) USED EQUIPMENT (BUYING, SELLING, LEASING)		COMMUNICATION SYSTEMS, DATA TRANSMISSION COMMUNICATION SYSTEMS, TELEPRINTER COMPUTERS, DIGITAL (GENERAL-PURPOSE, SMALL-SCALE) COMPUTERS, DIGITAL (GENERAL-PURPOSE, MEDIUM-SCALE) COMPUTERS, PROCESS CONTROL CONSOLES, CRT (ALPHANUMERIC AND GRAPHIC) CONSOLES, CRT (COLOR-ALPHANUMERIC AND GRAPHIC) CONSOLES, CRT (GRAPHIC) DATA TERMINALS, BLOCK-BY-BLOCK (GRAPHIC DIGITIZERS) DATA TERMINALS, INQUIRY-RESPONSE (SPECIAL-PURPOSE) GRAPHIC TABLETS PROGRAMMING LANGUAGE DEVELOPMENT (CONTRACT PROGRAMMING) PROGRAMMING LANGUAGE DEVELOPMENT (DEDICATED APPLICATION SYSTEMS)	
SUPERIOR CABLE & EQUIPMENT DIV. SUPERIOR CONT. P O Box 489, Hickory, N C 28601	704-328-2171 TWX 510-934-1422		
CABLE, MULTICONDUCTOR CABLE, SHIELDED (NOT COAXIAL)			
SUPERIOR CIRCUITS DIV. RESALAB INC. 2200 Ladybird Ln, Dallas, Tex 75220	214-358-4181		
BOARDS, PRINTED CIRCUIT (WITHOUT COMPONENTS)			
SUPERIOR ELECTRIC CO., THE 383 Middle St, Bristol, Conn 06010	203-582-9561 TWX 710-454-0682		
PLOTTERS, FILM EXPOSING DIGITIZERS, PROGRAMMABLE DRAFTING SYSTEMS, COMPUTER-CONTROLLED STORAGE READERS, PAPER TAPE SERVICES, AUTOMATED WIRE-WRAPPING			
SUPREME EQUIPMENT & SYSTEMS CORP. 170 53rd St, Brooklyn, N Y 11232	212-492-7777		
CABINETS, RACKS, VAULTS (FOR MAGNETIC TAPE STORAGE) CABINETS, TRAYS (FOR PUNCHED CARD STORAGE) CHASSIS, SLIDES, RACKS FILES, PUNCHED CARD			
SWITCHCRAFT INC. 5555 N Elston Ave, Chicago, Ill 60630	312-792-2700 TWX 910-221-5199		
CABLE ASSEMBLIES (WITH CONNECTORS) CABLE, SHIELDED (NOT COAXIAL) CONNECTORS, MINIATURE AND SUB-MINIATURE (COMPUTER-GRADE) CONNECTORS, PC AND IC BOARD (COMPUTER-GRADE) CONNECTORS, RACK AND PANEL (COMPUTER-GRADE) JACKS, JACK PANELS, PLUGS, ASSEMBLIES SWITCHES, PUSHBUTTON SWITCHES, PUSHBUTTON (ILLUMINATED) SWITCHES, ROTARY SWITCHES, SNAP ACTION SWITCHES, TOGGLE (MINIATURE)			
SYCOR INC. 100 Phoenix Dr, Ann Arbor, Mich 48104	313-971-0900		
DATA TERMINALS, BLOCK-BY-BLOCK (MAGNETIC TAPE) DATA TERMINALS, BLOCK-BY-BLOCK (MULTI-PURPOSE) DATA TERMINALS, BLOCK-BY-BLOCK (MEDIUM SPEED PRINTER) DATA TERMINALS, INQUIRY-RESPONSE (ALPHANUMERIC KEYBOARD) DATA TERMINALS, INQUIRY-RESPONSE (CRT WITH KEYBOARD) DATA TERMINALS, INQUIRY-RESPONSE (SPECIAL-PURPOSE) RECORDERS, DIGITAL CASSETTE TAPE, MAGNETIC (CASSETTE) TAPE TRANSPORTS, MAGNETIC (DIGITAL CASSETTE) TAPE TRANSPORTS, MAGNETIC (WITH KEYBOARD INPUT)			
SYKES DATATRONICS INC. 375 Orchard St, Rochester, N Y 14606	716-458-8000		
CONSULTING (ACCOUNTING, BUSINESS AND COMMERCIAL APPLICATIONS) CONSULTING (ADVANCED COMPUTER EQUIPMENT DESIGN AND FEASIBILITY STUDIES) CONSULTING (COMPUTER EVALUATIONS, SELECTIONS, INSTALLATION PLANNING) CONSULTING (DATA COMMUNICATIONS SYSTEMS PLANNING) CONSULTING (COMPUTER PRODUCT PLANNING SURVEYS, MARKET RESEARCH STUDIES) CONSULTING (MANAGEMENT INFORMATION SYSTEMS PLANNING) CONSULTING (SCIENTIFIC APPLICATIONS) MAGNETIC TAPE STORAGE SYSTEMS (INCLUDES CONTROLLER) RECORDERS, DIGITAL CASSETTE TAPE TRANSPORTS, MAGNETIC (DIGITAL CASSETTE)			
		SYNERGISTIC SOFTWARE SYSTEMS, INC. Po Box 36097, Houston, Tex 77036	713-771-2463
		CONSULTING (MANAGEMENT INFORMATION SYSTEMS PLANNING) PROGRAMMING LANGUAGE DEVELOPMENT (DEDICATED APPLICATION SYSTEMS) PROGRAMMING LANGUAGE DEVELOPMENT (PROPRIETARY SOFTWARE PRODUCTS) SERVICES, MANAGEMENT INFORMATION SYSTEMS	
		SYNERGISTICS INC. IKON DATA SYS. DIV. 2619 2nd Ave, Seattle, Wash 98121	206-624-3410
		CONSULTING (DATA COMMUNICATIONS SYSTEMS PLANNING) CONTROLLERS, MODEM MULTIPLEXERS, DIGITAL	
		SYS COMPUTER CORP. 17-25 Dicarolis Court, Hackensack, N J 07601	201-488-0300
		COMMUNICATIONS-ORIENTED PROCESSORS, MULTIPLE CHANNEL CONTROLLERS COMMUNICATION SYSTEMS, DATA TRANSMISSION COMPUTERS, DIGITAL (GENERAL-PURPOSE, SMALL-SCALE) COMPUTERS, MINI GENERAL PURPOSE (ALSO SEE CALCULATORS) CONTROLLERS, MAGNETIC TAPE CONVERTERS, MAGNETIC TAPE-TO-MAGNETIC TAPE CONVERTERS, MAGNETIC TAPE-TO-PAPER TAPE CONVERTERS, PAPER TAPE-TO-MAGNETIC TAPE DATA ACQUISITION AND REDUCTION SYSTEMS DATA TERMINALS, BLOCK-BY-BLOCK (MAGNETIC TAPE) DATA TERMINALS, INQUIRY-RESPONSE (ALPHANUMERIC KEYBOARD) DATA TERMINALS, INQUIRY-RESPONSE (BADGE-TOKEN READERS) DATA TERMINALS, INQUIRY-RESPONSE (CRT WITH KEYBOARD) ENCODERS, KEYBOARD-TO-MAGNETIC TAPE GENERATORS, CHARACTER (CRT) MEMORY SYSTEMS, READ-ONLY CONTINUED	

3 Manufacturers' Directory

TAPE TRANSPORTS, MAGNETIC (DIGITAL CASSETTE)
TAPE TRANSPORTS, MAGNETIC (WITH KEYBOARD INPUT)
TESTERS, SEMICONDUCTOR

SYSTEM DEVELOPMENT CORP. 213-393-9411
2500 Colorado Ave, Santa Monica, Cal 90406

CONSULTING (ACCOUNTING, BUSINESS AND COMMERCIAL APPLICATIONS)
CONSULTING (ADVANCED COMPUTER EQUIPMENT DESIGN AND FEASIBILITY STUDIES)
CONSULTING (COMPUTER EVALUATIONS, SELECTIONS, INSTALLATION PLANNING)
CONSULTING (MANAGEMENT INFORMATION SYSTEMS PLANNING)
DATA ACQUISITION AND REDUCTION SYSTEMS
INSTRUCTIONAL SYSTEMS, COMPUTER-BASED
PROGRAMMING LANGUAGE DEVELOPMENT (CONSULTANTS)
PROGRAMMING LANGUAGE DEVELOPMENT (CONTRACT PROGRAMMING)
PROGRAMMING LANGUAGE DEVELOPMENT (DEDICATED APPLICATION SYSTEMS)
PROGRAMMING LANGUAGE DEVELOPMENT (PROPRIETARY SOFTWARE PRODUCTS)
SERVICES, FACILITY MANAGEMENT
SERVICES, MANAGEMENT INFORMATION SYSTEMS
SERVICES, PROCESSING (COMMERCIAL EDP)
SERVICES, SYSTEMS ANALYSIS
TRAINING INSTITUTES, COMMERCIAL COMPUTER COURSES, SEMINARS, CORRESPONDENCE COURSES

SYSTEM IMPLEMENTATION CORP. 212-838-1600
18 E 48th St, New York, N Y 10017

CONSULTING (ACCOUNTING, BUSINESS AND COMMERCIAL APPLICATIONS)
CONSULTING (ADVANCED COMPUTER EQUIPMENT DESIGN AND FEASIBILITY STUDIES)
CONSULTING (COMPUTER EVALUATIONS, SELECTIONS, INSTALLATION PLANNING)
CONSULTING (DATA COMMUNICATIONS SYSTEMS PLANNING)
CONSULTING (MANAGEMENT INFORMATION SYSTEMS PLANNING)
PROGRAMMING LANGUAGE DEVELOPMENT (CONSULTANTS)
PROGRAMMING LANGUAGE DEVELOPMENT (CONTRACT PROGRAMMING)
PROGRAMMING LANGUAGE DEVELOPMENT (DEDICATED APPLICATION SYSTEMS)
PROGRAMMING LANGUAGE DEVELOPMENT (PROPRIETARY SOFTWARE PRODUCTS)
SERVICES, FACILITY MANAGEMENT
SERVICES, MANAGEMENT INFORMATION SYSTEMS
SERVICES, SYSTEMS ANALYSIS
TRAINING INSTITUTES, COMMERCIAL COMPUTER COURSES, SEMINARS, CORRESPONDENCE COURSES

SYSTEM INDUSTRIES INC. 408-732-1650
535 Del Rey Ave, Sunnyvale, Cal 94305

CONTROLLERS, MAGNETIC DISC
CONTROLLERS, MAGNETIC TAPE
DATA CONCENTRATORS
DISC DRIVES, REMOVABLE CARTRIDGE
MULTIPLEXERS, DIGITAL

SYSTEMATICS GENERAL CORP. 703-356-0550
6825 Redmond Dr, McLean, Va 22101

PATTERN RECOGNITION EQUIPMENT
SERVICES, FACILITY MANAGEMENT
SERVICES, MANAGEMENT INFORMATION SYSTEMS
SERVICES, SYSTEMS ANALYSIS

SYSTEMATICS INC. 501-372-7158
411 Victory, Little Rock, Ark 72201

CONSULTING (ACCOUNTING, BUSINESS AND COMMERCIAL APPLICATIONS)
CONSULTING (COMPUTER EVALUATIONS, SELECTIONS, INSTALLATION PLANNING)
CONSULTING (DATA COMMUNICATIONS SYSTEMS PLANNING)
CONSULTING (COMPUTER PRODUCT PLANNING SURVEYS, MARKET RESEARCH STUDIES)
CONSULTING (MANAGEMENT INFORMATION SYSTEMS PLANNING)
SERVICES, FACILITY MANAGEMENT
SERVICES, MANAGEMENT INFORMATION SYSTEMS
SERVICES, PROCESSING (COMMERCIAL EDP)
SERVICES, SYSTEMS ANALYSIS
TRAINING INSTITUTES, COMMERCIAL COMPUTER COURSES, SEMINARS, CORRESPONDENCE COURSES

SYSTEMS & ELECTRONICS, INC. 201-933-6660
223 Park Ave, Rutherford, N J 07070

CONSULTING (ACCOUNTING, BUSINESS AND COMMERCIAL APPLICATIONS)
CONSULTING (COMPUTER EVALUATIONS, SELECTIONS, INSTALLATION PLANNING)

SERVICES, PROCESSING (COMMERCIAL EDP)
SERVICES, SYSTEMS ANALYSIS

SYSTEMS & PROGRAMMING SERVICES 803-242-4180
1001 Daniel Bldg, Greenville, S C 29602

CONSULTING (ACCOUNTING, BUSINESS AND COMMERCIAL APPLICATIONS)
CONSULTING (COMPUTER EVALUATIONS, SELECTIONS, INSTALLATION PLANNING)
CONSULTING (DATA COMMUNICATIONS SYSTEMS PLANNING)
PROGRAMMING LANGUAGE DEVELOPMENT (CONSULTANTS)
PROGRAMMING LANGUAGE DEVELOPMENT (CONTRACT PROGRAMMING)
PROGRAMMING LANGUAGE DEVELOPMENT (PROPRIETARY SOFTWARE PRODUCTS)
SERVICES, FACILITY MANAGEMENT

SYSTEMS ANALYSIS CO. 205-871-9554
9 Office Park Cir, Birmingham, Ala 35223

CONSULTING (MANAGEMENT INFORMATION SYSTEMS PLANNING)
CONSULTING (SCIENTIFIC APPLICATIONS)
SERVICES, TIME SHARING (RESEARCH)
SERVICES, SYSTEMS ANALYSIS

SYSTEMS ANALYSIS INC. 206-455-1440
11110 N E 8th, Bellevue, Wash 98004

ACCOUNTING MACHINES, CARD-PROGRAMMED
CONSULTING (ACCOUNTING, BUSINESS AND COMMERCIAL APPLICATIONS)
CONSULTING (ADVANCED COMPUTER EQUIPMENT DESIGN AND FEASIBILITY STUDIES)
CONSULTING (COMPUTER EVALUATIONS, SELECTIONS, INSTALLATION PLANNING)
CONSULTING (DATA COMMUNICATIONS SYSTEMS PLANNING)
CONSULTING (COMPUTER PRODUCT PLANNING SURVEYS, MARKET RESEARCH STUDIES)
CONSULTING (MANAGEMENT INFORMATION SYSTEMS PLANNING)
CONSULTING (SCIENTIFIC APPLICATIONS)
PROGRAMMERS, PUNCHED CARD
PROGRAMMING LANGUAGE DEVELOPMENT (CONSULTANTS)
PROGRAMMING LANGUAGE DEVELOPMENT (CONTRACT PROGRAMMING)
PROGRAMMING LANGUAGE DEVELOPMENT (DEDICATED APPLICATION SYSTEMS)
PROGRAMMING LANGUAGE DEVELOPMENT (PROPRIETARY SOFTWARE PRODUCTS)
SERVICES, COMPUTER-AIDED DESIGN
SERVICES, FACILITY MANAGEMENT
SERVICES, MANAGEMENT INFORMATION SYSTEMS
SERVICES, PROCESSING (COMMERCIAL EDP)
SERVICES, PROCESSING (DIGITAL SCIENTIFIC)
SERVICES, TIME SHARING (COMMERCIAL)
SERVICES, SYSTEMS ANALYSIS

SYSTEMS ASSOCIATES INC. 215-376-7221
356 Penn St, Reading, Pa 19602

CONSULTING (ACCOUNTING, BUSINESS AND COMMERCIAL APPLICATIONS)
CONSULTING (ADVANCED COMPUTER EQUIPMENT DESIGN AND FEASIBILITY STUDIES)
CONSULTING (COMPUTER EVALUATIONS, SELECTIONS, INSTALLATION PLANNING)
CONSULTING (COMPUTER PRODUCT PLANNING SURVEYS, MARKET RESEARCH STUDIES)
CONSULTING (MANAGEMENT INFORMATION SYSTEMS PLANNING)
PROGRAMMING LANGUAGE DEVELOPMENT (CONSULTANTS)
PROGRAMMING LANGUAGE DEVELOPMENT (CONTRACT PROGRAMMING)
PROGRAMMING LANGUAGE DEVELOPMENT (PROPRIETARY SOFTWARE PRODUCTS)
SERVICES, FACILITY MANAGEMENT
SERVICES, MANAGEMENT INFORMATION SYSTEMS
SERVICES, PROCESSING (COMMERCIAL EDP)
SERVICES, SYSTEMS ANALYSIS
TRAINING INSTITUTES, COMMERCIAL COMPUTER COURSES, SEMINARS, CORRESPONDENCE COURSES

SYSTEMS CONCEPTS INC. 212-353-5000
17-45 Clintonville St, Whitestone, N Y 11357

COMMUNICATIONS-ORIENTED PROCESSORS, SINGLE CHANNEL CONTROLLERS
COMMUNICATIONS-ORIENTED PROCESSORS, STORED PROGRAM
COMMUNICATION SYSTEMS, DATA TRANSMISSION
COMMUNICATION SYSTEMS, FACSIMILE
CONSOLES, COMPUTER CONTROL (WIRED)
CONSULTING (ADVANCED COMPUTER EQUIPMENT DESIGN AND FEASIBILITY STUDIES)
CONSULTING (COMPUTER EVALUATIONS, SELECTIONS, INSTALLATION PLANNING)
CONSULTING (DATA COMMUNICATIONS SYSTEMS PLANNING)
CONSULTING (COMPUTER PRODUCT PLANNING SURVEYS, MARKET RESEARCH STUDIES)

3 Manufacturers' Directory

CONSULTING (MANAGEMENT INFORMATION SYSTEMS PLANNING)
 CONVERTERS, DOCUMENT-TO-MAGNETIC TAPE
 CONVERTERS, DOCUMENT-TO-PAPER TAPE
 CONVERTERS, DOCUMENT-TO-UNIT RECORDS
 CONVERTERS, MAGNETIC TAPE-TO-MAGNETIC TAPE
 CONVERTERS, MAGNETIC TAPE-TO-PAPER TAPE
 CONVERTERS, MAGNETIC TAPE-TO-PRINTER
 CONVERTERS, MAGNETIC TAPE-TO-PUNCHED CARD
 CONVERTERS, PAPER TAPE-TO-MAGNETIC TAPE
 CONVERTERS, PAPER TAPE-TO-PAPER TAPE
 CONVERTERS, PAPER TAPE-TO-PRINTER
 CONVERTERS, PAPER TAPE-TO-PUNCHED CARD
 CONVERTERS, PUNCHED CARD-TO-MAGNETIC TAPE
 CONVERTERS, PUNCHED CARD-TO-PAPER TAPE
 CONVERTERS, PUNCHED TAG-TO-MAGNETIC TAPE
 CONVERTERS, PUNCHED TAG-TO-PUNCHED CARD
 DATA CONCENTRATORS
 DATA RETRIEVAL SYSTEMS, MICRO-FILM (COMPUTER-CONTROLLED)
 MICROFILM DATA RETRIEVAL SYSTEMS, COMPUTER CONTROLLED
 TRAINING SYSTEMS, COMPUTER SERVICE

SYSTEMS CONCEPTS INC. 415-433-5400
 524 2nd St, San Francisco, Cal 94107 TWX 910-372-6062

COMPUTERS, DIGITAL (GENERAL-PURPOSE, SMALL-SCALE)
 COMPUTERS, DIGITAL (GENERAL-PURPOSE, MEDIUM-SCALE)
 COMPUTERS, DIGITAL (GENERAL-PURPOSE, LARGE SCALE)
 CONSOLES, CRT (ALPHANUMERIC AND GRAPHIC)
 CONSOLES, CRT (GRAPHIC)
 CONTROLLERS, MAGNETIC DISC
 CONTROLLERS, MAGNETIC DRUM
 CONTROLLERS, MAGNETIC TAPE
 CONVERTERS, ANALOG-TO-DIGITAL
 CONVERTERS, DIGITAL-TO-ANALOG
 DRUM STORAGE EQUIPMENT, MAG-NETIC (INCLUDING CONTROLLER)
 MAGNETIC TAPE STORAGE SYSTEMS (INCLUDES CONTROLLER)
 MULTIPLEXER-CONVERTER (SINGLE UNIT WITH MULTIPLEXER, SAMPLE & HOLD
 AMPLIFIER & A-TO-D CONVERTER)
 PROGRAMMING LANGUAGE DEVELOPMENT (CONSULTANTS)

SYSTEMS DATA PROCESSING CO. 916-444-0152
 920 23rd St, Sacramento, Cal 95816

SERVICES, FACILITY MANAGEMENT
 SERVICES, PROCESSING (COMMERCIAL EDP)

SYSTEMS DATA, INC. 216-867-2197
 1951 W Market St, Akron, Ohio 44313

CIRCUIT CARDS, LOGIC (WITH IC'S)
 CIRCUITS, HYBRID (IC AND DISCRETE-DIGITAL)
 CONVERTERS, ANALOG-TO-DIGITAL
 CONVERTERS, DIGITAL-TO-ANALOG
 MULTIPLEXERS, ANALOG-RELAY (SEQUENTIAL SAMPLING)
 PROGRAMMING LANGUAGE DEVELOPMENT (CONTRACT PROGRAMMING)
 PROGRAMMING LANGUAGE DEVELOPMENT (DEDICATED APPLICATION SYSTEMS)
 SERVICES, MANAGEMENT INFORMATION SYSTEMS
 SERVICES, SYSTEMS ANALYSIS

SYSTEMS ENGINEERING LABORATORIES INC. 305-587-2900
 P O Box 9148, Fort Lauderdale, Fla 33310

BOARDS, PRINTED CIRCUIT (WITHOUT COMPONENTS)
 COMPUTERS, DIGITAL (GENERAL-PURPOSE, SMALL-SCALE)
 COMPUTERS, DIGITAL (GENERAL-PURPOSE, MEDIUM-SCALE)
 COMPUTERS, MINI GENERAL PURPOSE (ALSO SEE CALCULATORS)
 COMPUTERS, PROCESS CONTROL
 CONSOLES, CRT (ALPHANUMERIC AND GRAPHIC)
 CONSOLES, CRT (COLOR-ALPHANUMERIC AND GRAPHIC)
 CONSOLES, CRT (GRAPHIC)
 DATA ACQUISITION AND REDUCTION SYSTEMS
 DISC DRIVES, FIXED HEAD (INCLUDING CONTROLLER)
 DRUM STORAGE EQUIPMENT, MAG-NETIC (INCLUDING CONTROLLER)
 ENCODERS, KEYBOARD-TO-MAGNETIC DISC
 ENCODERS, KEYBOARD-TO-MAGNETIC TAPE
 MULTIPLEXERS, ANALOG-RELAY (SEQUENTIAL SAMPLING)
 MULTIPLEXERS, ANALOG-SOLID STATE (SEQUENTIAL SAMPLING)

SYSTEMS EQUIPMENT CORP. 404-873-6571
 458 Plasamour Dr, Atlanta, Ga 30324

COMMUNICATIONS-ORIENTED PROCESSORS, STORED PROGRAM
 COMPUTERS, DIGITAL (GENERAL-PURPOSE, SMALL-SCALE)
 COMPUTERS, MINI GENERAL PURPOSE (ALSO SEE CALCULATORS)
 CONSULTING (ACCOUNTING, BUSINESS AND COMMERCIAL APPLICATIONS)
 DATA TERMINALS, BLOCK-BY-BLOCK (MEDIUM SPEED PRINTER)
 DATA TERMINALS, INQUIRY-RESPONSE (ALPHANUMERIC KEYBOARD)
 DATA TERMINALS, INQUIRY-RESPONSE (SPECIAL-PURPOSE)
 SERVICES, FACILITY MANAGEMENT
 CONTINUED

SERVICES, SYSTEMS ANALYSIS

SYSTEMS GENERAL CORP. 213-477-5573
 10889 Wilshire Blvd, Los Angeles, Cal 90024

CONSULTING (ACCOUNTING, BUSINESS AND COMMERCIAL APPLICATIONS)
 CONSULTING (COMPUTER EVALUATIONS, SELECTIONS, INSTALLATION
 PLANNING)
 CONSULTING (COMPUTER PRODUCT PLANNING SURVEYS, MARKET RESEARCH
 STUDIES)
 CONSULTING (MANAGEMENT INFORMATION SYSTEMS PLANNING)
 SERVICES, FACILITY MANAGEMENT
 SERVICES, MANAGEMENT INFORMATION SYSTEMS
 SERVICES, PROCESSING (COMMERCIAL EDP)
 SERVICES, SYSTEMS ANALYSIS
 TRAINING INSTITUTES, COMMERCIAL COMPUTER COURSES, SEMINARS,
 CORRESPONDENCE COURSES
 TRAINING SYSTEMS, COMPUTER SERVICE

SYSTEMS INSTRUMENT RESEARCH INC. 404-525-2434
 331 Luckie St, Atlanta, Ga 30313

DATA ACQUISITION AND REDUCTION SYSTEMS

SYSTEMS PROGRAMMING INC. 914-428-0494
 175 Main St, White Plains, N Y 10601

CONSULTING (ACCOUNTING, BUSINESS AND COMMERCIAL APPLICATIONS)
 PROGRAMMING LANGUAGE DEVELOPMENT (CONSULTANTS)
 PROGRAMMING LANGUAGE DEVELOPMENT (CONTRACT PROGRAMMING)
 PROGRAMMING LANGUAGE DEVELOPMENT (PROPRIETARY SOFTWARE
 PRODUCTS)
 SERVICES, SYSTEMS ANALYSIS

SYSTEMS RESEARCH ASSOCIATES, INC. 212-874-5151
 27 W 67th St, New York, N Y 10023

CONSULTING (ACCOUNTING, BUSINESS AND COMMERCIAL APPLICATIONS)
 CONSULTING (COMPUTER EVALUATIONS, SELECTIONS, INSTALLATION
 PLANNING)
 CONSULTING (COMPUTER PRODUCT PLANNING SURVEYS, MARKET RESEARCH
 STUDIES)
 CONSULTING (SCIENTIFIC APPLICATIONS)

SYSTEMS RESEARCH LABS, INC. 513-426-6000
 7001 Indian Ripple Rd, Dayton, Ohio 45440

AMPLIFIERS, INSTRUMENTATION
 AMPLIFIERS, VIDEO
 BOARDS, PRINTED CIRCUIT (WITHOUT COMPONENTS)
 BREARDBOARDS
 CONSULTING (COMPUTER EVALUATIONS, SELECTIONS, INSTALLATION
 PLANNING)
 CONSULTING (SCIENTIFIC APPLICATIONS)
 COUNTERS, DIGITAL READOUT
 DATA ACQUISITION AND REDUCTION SYSTEMS
 DISPLAY DRIVERS
 DISPLAYS, MAGNETIC
 MODEMS, PC CARD
 PROGRAMMING LANGUAGE DEVELOPMENT (CONTRACT PROGRAMMING)
 PROGRAMMING LANGUAGE DEVELOPMENT (DEDICATED APPLICATION SYSTEMS)
 PROGRAMMING LANGUAGE DEVELOPMENT (PROPRIETARY SOFTWARE
 PRODUCTS)
 PROTECTORS, CIRCUIT AND EQUIPMENT OVERLOAD
 SERVICES, HARDWARE MAINTENANCE
 SERVICES, SYSTEMS ANALYSIS
 SIGNAL CONDITIONERS

SYSTEMS, SCIENCE & SOFTWARE INC. 714-453-0060
 Po Box 1620, La Jolla, Cal 92037

CONSULTING (ACCOUNTING, BUSINESS AND COMMERCIAL APPLICATIONS)
 CONSULTING (ADVANCED COMPUTER EQUIPMENT DESIGN AND FEASIBILITY
 STUDIES)
 CONSULTING (COMPUTER EVALUATIONS, SELECTIONS, INSTALLATION
 PLANNING)
 CONSULTING (DATA COMMUNICATIONS SYSTEMS PLANNING)
 CONSULTING (COMPUTER PRODUCT PLANNING SURVEYS, MARKET RESEARCH
 STUDIES)
 CONSULTING (MANAGEMENT INFORMATION SYSTEMS PLANNING)
 CONSULTING (SCIENTIFIC APPLICATIONS)
 PROGRAMMING LANGUAGE DEVELOPMENT (CONSULTANTS)
 PROGRAMMING LANGUAGE DEVELOPMENT (CONTRACT PROGRAMMING)
 PROGRAMMING LANGUAGE DEVELOPMENT (DEDICATED APPLICATION SYSTEMS)
 PROGRAMMING LANGUAGE DEVELOPMENT (PROPRIETARY SOFTWARE
 PRODUCTS)
 SERVICES, COMPUTER-AIDED DESIGN
 CONTINUED

3 Manufacturers' Directory

SERVICES, FACILITY MANAGEMENT
 SERVICES, MANAGEMENT INFORMATION SYSTEMS
 SERVICES, PROCESSING (COMMERCIAL EDP)
 SERVICES, PROCESSING (DIGITAL SCIENTIFIC)
 SERVICES, TIME SHARING (COMMERCIAL)
 SERVICES, TIME SHARING (RESEARCH)
 SERVICES, AUTOMATED WIRE-WRAPPING
 SERVICES, SYSTEMS ANALYSIS

SYSTEMATION INC. 518-393-3638
 Clifton Park, Elnora, N Y 12065

TESTERS, CIRCUIT
 TESTERS, DIGITAL LOGIC MODULES AND CARDS
 VOLTMETERS, AC, DC, DIFFERENTIAL

SYSTREX CORP. 716-235-3753
 303 Child St, Rochester, N Y 14611

BOARDS, PRINTED CIRCUIT (WITHOUT COMPONENTS)
 BREADBOARDS
 COMPUTERS, DIGITAL (EDUCATIONAL)
 CONSULTING (SCIENTIFIC APPLICATIONS)
 CONVERTERS, ANALOG-TO-DIGITAL
 INDICATORS, DIGITAL
 TESTERS, INTEGRATED CIRCUIT

SYSTRON-DONNER CORP. 415-682-6161
 888 Galindo St, Concord, Cal 94520 TWX 910-481-9479

AMPLIFIERS, OPERATIONAL
 CLOCKS, DIGITAL (REAL-TIME)
 COMPUTERS, ANALOG (GENERAL-PURPOSE)
 COMPUTERS, HYBRID
 CONSOLES, COMPUTER CONTROL (WIRED)
 CORDS, PATCH
 GENERATORS, TIME CODE
 PLUGBOARDS, PROGRAMMING
 PRINTERS, LINE (LOW & MEDIUM SPEED)
 VOLTMETERS, DIGITAL

SYSTRON-DONNER CORP. DATAPULSE DIV. 213-836-6100
 10150 W Jefferson Blv, Culver City, Cal 90230 TWX 910-340-6766

ANALYZERS, PULSE HEIGHT

TAB DATA SYSTEMS INC. 213-583-1015
 4833 Everett Ave, Los Angeles, Cal 90058

CONSULTING (ACCOUNTING, BUSINESS AND COMMERCIAL APPLICATIONS)
 SERVICES, PROCESSING (COMMERCIAL EDP)

TAB PRODUCTS 415-328-5790
 2690 Hanover St, Palo Alto, Cal 94304

CABINETS AND ENCLOSURES (FOR KEYPUNCHES, PRINTERS)
 CABINETS, ENCLOSURES, CONSOLES, ELECTRONIC (FOR GENERAL EQUIPMENT)
 CABINETS, RACKS, VAULTS (FOR MAGNETIC TAPE STORAGE)
 CABINETS, TRAYS (FOR PUNCHED CARD STORAGE)
 CANNISTERS, MAGNETIC TAPE
 COMPUTERS, MINI GENERAL PURPOSE (ALSO SEE CALCULATORS)
 CONTAINERS, DISK PACK STORAGE
 CONTAINERS, PAPER TAPE STORAGE
 DESKS, TABLES AND STANDS (FOR CALCULATORS)
 DESKS, TABLES AND STANDS (FOR KEYPUNCH UNITS)
 DESKS, TABLES AND STANDS (FOR PROGRAMMER STATIONS)
 DESKS, TABLES AND STANDS (FOR TYPEWRITERS)
 FILES, PUNCHED CARD
 FLOOR PLANNING AIDS (FOR EDP ROOMS)
 FORMS HANDLING, BURSTERS
 FORMS HANDLING, CARBON DELEAVERS
 FORMS HANDLING, COLLATORS
 FORMS HANDLING, DECOLLATORS
 FORMS HANDLING, SLITTERS
 FORMS HANDLING, STACKERS
 HOLDERS, BINDER
 PUNCHES, CARD (OVER 100 CPM)
 PUNCHES, CARD (UP TO 100 CPM)
 VERIFIERS, PUNCHED CARD

TABULATING CONSULTANTS INC. 213-843-3043
 1011 W Alameda Ave, Burbank, Cal 91506

CONSULTING (ACCOUNTING, BUSINESS AND COMMERCIAL APPLICATIONS)
 SERVICES, PROCESSING (COMMERCIAL EDP)

TAFT ELECTROSYSTEMS, INC. 201-549-9200
 P O Box 43, Metuchen, N J 08840 TWX 710-998-0593

COMMUTATORS, SWITCHING (ELECTRIC)
 MULTIPLEXER-CONVERTER (SINGLE UNIT WITH MULTIPLEXER, SAMPLE & HOLD
 AMPLIFIER & A-TO-D CONVERTER)
 MULTIPLEXERS, ANALOG-SOLID STATE (SEQUENTIAL SAMPLING)
 MULTIPLEXERS, DIGITAL

TALCOTT COMPUTER LEASING CO. 212-956-3000
 1290 Ave The Americas, New York, N Y 10019

CONTROLLERS, MAGNETIC DISC
 DISC DRIVES, MOVABLE HEAD (INCLUDING CONTROLLER)
 DISC STORAGE SYSTEMS
 PRINTERS, LINE (LOW & MEDIUM SPEED)

TALLY CORP. 206-251-5500
 8301 S 180th St, Kent, Wash 98031 TWX 910-423-0895

COMMUNICATION SYSTEMS, DATA TRANSMISSION
 CONVERTERS, MAGNETIC TAPE-TO-PAPER TAPE
 CONVERTERS, PAPER TAPE-TO-MAGNETIC TAPE
 DATA TERMINALS, BLOCK-BY-BLOCK (MAGNETIC TAPE)
 DATA TERMINALS, BLOCK-BY-BLOCK (PAPER TAPE)
 ENCODERS, KEYBOARD-TO-MAGNETIC TAPE
 PERFORATORS, PAPER TAPE
 PUNCHES, PAPER TAPE
 READERS, PAPER TAPE
 RECORDERS, MAGNETIC TAPE
 SKEW METERS, MAGNETIC TAPE
 TAPE, PUNCH (PAPER)
 TAPE TRANSPORTS, MAGNETIC (INCREMENTAL)
 TESTERS, DIGITAL DATA TRANSMISSION
 WINDERS, PAPER TAPE

TANSITOR ELECTRONICS INC. 802-442-5473
 West Rd, Bennington, Vt 05201 TWX 710-360-1782

CAPACITORS, COMPUTER GRADE

TATE ARCHITECTURAL PRODUCTS INC. 301-799-4200
 Box 349c Montevideo, Jessup, Md 20794

AIR CONDITIONERS (FOR EDP INSTALLATIONS)
 FLOORING (FOR EDP ROOMS)

TAURAS CORP. 609-397-2390
 Academy Hill, Lambertville, N J 08530

READERS, PERFORATED DOCUMENT
 READERS, STATIC

TAUTRON INC. 617-458-6871
 685 Lawrence St, Lowell, Mass 01852

GENERATORS, BYTE
 GENERATORS, RANDOM NUMBER
 GENERATORS, TIME CODE
 TESTERS, CIRCUIT
 TESTERS, DIGITAL DATA TRANSMISSION
 TESTERS, DIGITAL LOGIC MODULES AND CARDS
 TESTERS, INTEGRATED CIRCUIT
 TESTERS, MEMORY PLANES, STACKS AND SYSTEMS
 TESTERS, SEMICONDUCTOR

TAYLOR INSTRUMENT PROCESS CONTROL DIV 716-235-5000
 95 Ames, Rochester, N Y 14601

COMPUTERS, PROCESS CONTROL
 CONSULTING (COMPUTER EVALUATIONS, SELECTIONS, INSTALLATION
 PLANNING)
 SERVICES, SYSTEMS ANALYSIS

TAYLOR MERCHANT CORP. 212-757-7700
 25 W 45 St, New York, N Y 10013

AUDIO/VISUAL TRAINING AIDS
 READERS, MICROFILM/MICROFICHE

TEAC CORPORATION OF AMERICA TECHNICAL PRODUCTS 213-394-0240
 2000 Colorado Ave, Santa Monica, Cal 90404

DATA TERMINALS, BLOCK-BY-BLOCK (MAGNETIC TAPE)
 RECORDERS, DIGITAL CASSETTE
 CONTINUED

3 Manufacturers' Directory

RECORDERS, MAGNETIC TAPE
 RECORDING HEADS, MAGNETIC TAPE
 TAPE, MAGNETIC (CASSETTE)
 TAPE TRANSPORTS, MAGNETIC (DIGITAL-EXCL. CASSETTE)
 TAPE TRANSPORTS, MAGNETIC (DIGITAL CASSETTE)
 TAPE TRANSPORTS, MAGNETIC (INCREMENTAL)

TEC INC. 612-941-1100
 6700 S Wash Ave, Eden Prairie, Minn 55343 TWX 910-576-2860

COMMUNICATIONS-ORIENTED PROCESSORS, MULTIPLE CHANNEL CONTROLLERS
 COMMUNICATIONS-ORIENTED PROCESSORS, SINGLE CHANNEL CONTROLLERS
 COMMUNICATIONS-ORIENTED PROCESSORS, STORED PROGRAM
 COMPUTERS, MINI GENERAL PURPOSE (ALSO SEE CALCULATORS)
 COUNTERS, DIGITAL READOUT
 DATA TERMINALS, INQUIRY-RESPONSE (CRT WITH KEYBOARD)
 DATA TERMINALS, INQUIRY-RESPONSE (SPECIAL-PURPOSE)
 DISPLAY DRIVERS
 ENCODERS, KEYBOARD (ALPHANUMERIC)
 ENCODERS, KEYBOARD (NUMERIC)
 INDICATORS, ALPHANUMERIC
 INDICATORS, DIGITAL
 INDICATORS, ILLUMINATED
 LAMPS-PANEL, PILOT AND DIAL (INCANDESCENT)
 READOUTS AND DISPLAYS, NUMERIC AND ALPHANUMERIC (OTHER THAN CRT)
 READOUTS, CRT
 SWITCHES, PUSHBUTTON
 SWITCHES, PUSHBUTTON (ILLUMINATED)
 SWITCHES, SNAP ACTION

TECH LABORATORIES INC. 201-944-2221
 Bergen & Edsall Blvd, Palisades Park, N J 07650 TWX 201-947-0825

ATTENUATORS, DECADE DIGITAL
 AUDIO/VISUAL TRAINING AIDS
 SWITCHES, ROTARY
 SWITCHES, SNAP ACTION
 SWITCHES, THUMBWHEEL
 VOLTAGE DIVIDERS

TECHMAR CORP. 213-478-0046
 2232 S Cotner Ave, Los Angeles, Cal 90064

CABINETS, ENCLOSURES, CONSOLES, ELECTRONIC (FOR GENERAL EQUIPMENT)
 CHASSIS, SLIDES, RACKS

TECHNICAL ADVISORS INC. 313-722-5010
 4455 Fletcher St, Wayne, Mich 48184

CALCULATORS, PROGRAMMABLE (ALSO SEE COMPUTERS)
 SERVICES, PROCESSING (DIGITAL SCIENTIFIC)
 SERVICES, TIME SHARING (COMMERCIAL)

TECHNICAL COMMUNICATIONS CORP. 617-862-6035
 442 Marrett Rd, Lexington, Mass 02173

MODEMS, HARD-WIRED

TECHNICAL INFORMATION PROCESSING INC. 312-668-6131
 108 N Main St, Wheaton, Ill 60187

SERVICES, TIME SHARING (RESEARCH)

TECHNICAL MATERIAL CORP. 914-698-4800
 700 Fenimore Rd, Mamaroneck, N Y 10543

CIRCUIT CARDS, LINEAR (WITH DISCRETE COMPONENTS)
 CIRCUIT CARDS, LINEAR (WITH IC'S)
 CIRCUIT CARDS, LOGIC (WITH DISCRETE COMPONENTS)
 CIRCUIT CARDS, LOGIC (WITH IC'S)
 COMMUNICATION SYSTEMS, DATA TRANSMISSION
 COMMUNICATION SYSTEMS, FACSIMILE
 CONNECTORS, MINIATURE AND SUB-MINIATURE (COMPUTER-GRADE)
 CONSULTING (DATA COMMUNICATIONS SYSTEMS PLANNING)
 TRANSCEIVERS, FACSIMILE

TECHNIPOWER INC. SUB. BENRUS CORP. 203-438-0333
 Benrus Center, Ridgefield, Conn 06877 TWX 710-467-0666

CONVERTERS, DC-TO-FREQUENCY
 HEAT SINKS, CIRCUIT BOARD MOUNTING
 INVERTERS, DC-AC
 POWER SUPPLIES, AC
 POWER SUPPLIES, DC
 PROTECTORS, CIRCUIT AND EQUIPMENT OVERLOAD
 REGULATORS, VOLTAGE

TECHNITREND INC. 609-665-4910
 7300 N Crescent Blvd, Pennsauken, N J 08110

COMMUNICATIONS-ORIENTED PROCESSORS, MULTIPLE CHANNEL CONTROLLERS
 COMMUNICATIONS-ORIENTED PROCESSORS, SINGLE CHANNEL CONTROLLERS
 DATA TERMINALS, INQUIRY-RESPONSE (AUDIO RESPONSE)
 DATA TERMINALS, INQUIRY-RESPONSE (CRT WITH KEYBOARD)

TECHNO-COMPONENTS CORP. SUB OAK/ELECTRONETICS 213-781-1642
 7803 Lemona Ave, Van Nuys, Cal 91405 TWX 910-495-2015

POTENTIOMETERS, TRIM (FILM)
 POTENTIOMETERS, TRIM (WIRE-WOUND)

TECHNOLOGY FOR INFORMATION MANAGEMENT INC. 518-869-0928
 1654 Central Ave, Albany, N Y 12205

CONSULTING (ACCOUNTING, BUSINESS AND COMMERCIAL APPLICATIONS)
 CONSULTING (MANAGEMENT INFORMATION SYSTEMS PLANNING)
 CONSULTING (SCIENTIFIC APPLICATIONS)
 PROGRAMMING LANGUAGE DEVELOPMENT (CONSULTANTS)
 PROGRAMMING LANGUAGE DEVELOPMENT (CONTRACT PROGRAMMING)
 PROGRAMMING LANGUAGE DEVELOPMENT (DEDICATED APPLICATION SYSTEMS)
 PROGRAMMING LANGUAGE DEVELOPMENT (PROPRIETARY SOFTWARE PRODUCTS)
 SERVICES, COMPUTER-AIDED DESIGN
 SERVICES, MANAGEMENT INFORMATION SYSTEMS
 SERVICES, TIME SHARING (COMMERCIAL)
 SERVICES, TIME SHARING (RESEARCH)
 SERVICES, SYSTEMS ANALYSIS

TECHNOMETRICS INC. 415-653-4812
 6000 Telegraph Ave, Oakland, Cal 94609

CONSULTING (DATA COMMUNICATIONS SYSTEMS PLANNING)
 CONSULTING (COMPUTER PRODUCT PLANNING SURVEYS, MARKET RESEARCH STUDIES)
 CONSULTING (MANAGEMENT INFORMATION SYSTEMS PLANNING)
 CONSULTING (SCIENTIFIC APPLICATIONS)
 SERVICES, MANAGEMENT INFORMATION SYSTEMS

TECHRON CORP. 617-445-2150
 20 Simmons St, Boston, Mass 02120

BOARDS, PRINTED CIRCUIT (WITHOUT COMPONENTS)

TEKTRONIX INC. 503-644-0161
 P O Box 500, Beaverton, Ore 97005 TWX 503-291-6805

ANALYZERS, WAVEFORM
 CAMERAS, COM
 CONSOLES, CRT (ALPHANUMERIC AND GRAPHIC)
 CONSOLES, CRT (COLOR-ALPHANUMERIC AND GRAPHIC)
 CONSOLES, CRT (GRAPHIC)
 CONTROLLERS, PLOTTING
 DATA TERMINALS, INQUIRY-RESPONSE (ALPHANUMERIC KEYBOARD)
 DATA TERMINALS, INQUIRY-RESPONSE (CRT WITH KEYBOARD)
 READOUTS, CRT
 RECORDERS, GRAPHIC
 RECORDERS, HARD-COPY (WITH CRT)
 TESTERS, CIRCUIT
 TESTERS, DIGITAL LOGIC MODULES AND CARDS
 TESTERS, INTEGRATED CIRCUIT
 TESTERS, MEMORY PLANES, STACKS AND SYSTEMS
 TESTERS, SEMICONDUCTOR

TEL AUTOGRAPH CORP. 213-641-3690
 8700 Bellanca Ave, Los Angeles, Cal 90045 TWX 910-328-6117

COMMUNICATION SYSTEMS, FACSIMILE
 HANDWRITING SYSTEMS, ELECTRONIC
 PAPER (FOR FACSIMILE)
 SCANNERS, FACSIMILE
 TRANSCEIVERS, FACSIMILE

TEL-DATA SERVICE CORP. 714-239-3881
 1221 4th Ave, San Diego, Cal 92101

CONSULTING (ACCOUNTING, BUSINESS AND COMMERCIAL APPLICATIONS)
 SERVICES, PROCESSING (COMMERCIAL EDP)
 SERVICES, TIME SHARING (COMMERCIAL)

TEL LABS INC. 603-625-8994
 1050 2nd St, Manchester, N H 03102 TWX 710-220-1844

RESISTORS, PRECISION

3 Manufacturers' Directory

TEL-TECH CORP. 301-933-8170
 11810 Parklawn Dr, Rockville, Md 20852

ACOUSTIC COUPLERS
 COMMUNICATION SYSTEMS, DATA TRANSMISSION
 CONSULTING (DATA COMMUNICATIONS SYSTEMS PLANNING)
 DATA CONCENTRATORS
 MODEMS, ACOUSTIC
 MODEMS, HARD-WIRED
 MODEMS, PC CARD

TELCOMP CORP. OF AMERICA SUB. BBN 617-491-1850
 50 Moulton St, Cambridge, Mass 02138

SERVICES, TIME SHARING (COMMERCIAL)

TELE-DATA CORP. 201-755-1124
 130 U S Hwy 22, N Plainfield, N J 07060

ACOUSTIC COUPLERS
 COMMUNICATIONS-ORIENTED PROCESSORS, STORED PROGRAM
 COMMUNICATION SYSTEMS, DATA TRANSMISSION
 COMPUTERS, MINI GENERAL PURPOSE (ALSO SEE CALCULATORS)
 CONSULTING (ACCOUNTING, BUSINESS AND COMMERCIAL APPLICATIONS)
 CONSULTING (COMPUTER EVALUATIONS, SELECTIONS, INSTALLATION
 PLANNING)
 CONSULTING (DATA COMMUNICATIONS SYSTEMS PLANNING)
 CONSULTING (MANAGEMENT INFORMATION SYSTEMS PLANNING)
 CONVERTERS, MAGNETIC TAPE-TO-PUNCHED CARD
 CONVERTERS, PUNCHED CARD-TO-MAGNETIC TAPE
 DATA CONCENTRATORS
 DATA TERMINALS, BLOCK-BY-BLOCK (MAGNETIC TAPE)
 DATA TERMINALS, BLOCK-BY-BLOCK (MULTI-PURPOSE)
 DATA TERMINALS, INQUIRY-RESPONSE (ALPHANUMERIC KEYBOARD)
 DATA TERMINALS, INQUIRY-RESPONSE (CRT WITH KEYBOARD)
 ENCODERS, KEYBOARD-TO-MAGNETIC TAPE
 MODEMS, ACOUSTIC
 RECORDERS, DIGITAL CASSETTE
 SERVICES, FACILITY MANAGEMENT
 SERVICES, PROCESSING (COMMERCIAL EDP)
 SERVICES, SYSTEMS ANALYSIS
 TAPE, MAGNETIC (CASSETTE)
 TAPE TRANSPORTS, MAGNETIC (DIGITAL CASSETTE)
 TAPE TRANSPORTS, MAGNETIC (WITH KEYBOARD INPUT)

TELECTRO SYSTEMS CORP. 212-651-8900
 96-18 43rd Ave, Corona, N Y 11368

ACOUSTIC COUPLERS
 AUDIO/VISUAL TRAINING AIDS
 CERTIFIERS, MAGNETIC TAPE
 CIRCUITS, HYBRID (IC AND DISCRETE-DIGITAL)
 CLEANER/CERTIFIERS, MAGNETIC TAPE
 COMMUNICATION SYSTEMS, DATA TRANSMISSION
 DATA TERMINALS, INQUIRY-RESPONSE (SPECIAL-PURPOSE)
 ERASERS, BULK (MAGNETIC TAPE)
 HEAT SINKS, CIRCUIT BOARD MOUNTING
 MAGNETIC TAPE STORAGE SYSTEMS (INCLUDES CONTROLLER)
 MODEMS, ACOUSTIC
 MODEMS, HARD-WIRED
 MODEMS, PC CARD
 POOLERS, MAGNETIC TAPE
 PROJECTORS, OPTICAL (COMPUTER CONTROLLED SCRIBING)
 RECORDERS, DIGITAL CASSETTE
 RECORDERS, MAGNETIC TAPE
 RECORDING HEADS, MAGNETIC DISC
 RECORDING HEADS, MAGNETIC DRUM
 RECORDING HEADS, MAGNETIC TAPE
 REPRODUCERS, PAPER TAPE (AUTOMATIC)
 SKEW METERS, MAGNETIC TAPE
 SPLICERS, MAGNETIC TAPE
 TAPE TRANSPORTS, MAGNETIC (DIGITAL-EXCL. CASSETTE)
 TAPE TRANSPORTS, MAGNETIC (DIGITAL CASSETTE)
 TAPE TRANSPORTS, MAGNETIC (INCREMENTAL)
 TAPE TRANSPORTS, MAGNETIC (WITH KEYBOARD INPUT)
 TESTERS, INTEGRATED CIRCUIT
 WINDERS, MAGNETIC TAPE

TELEDYNE BROWN ENGINEERING 205-532-1208
 300 Sparkman Dr, Huntsville, Ala 35807 TWX 810-726-2103

AMPLIFIERS, INSTRUMENTATION
 CABLE ASSEMBLIES (WITH CONNECTORS)
 CIRCUIT CARDS, LINEAR (WITH IC'S)
 CIRCUIT CARDS, LOGIC (WITH IC'S)
 CONSULTING (ADVANCED COMPUTER EQUIPMENT DESIGN AND FEASIBILITY
 STUDIES)
 CONSULTING (COMPUTER EVALUATIONS, SELECTIONS, INSTALLATION
 PLANNING)
 CONSULTING (MANAGEMENT INFORMATION SYSTEMS PLANNING)
 CONTINUED

DATA ACQUISITION AND REDUCTION SYSTEMS
 INVERTERS, DC-AC
 MODULES, LINEAR (ENCAPSULATED)
 MODULES, RESISTANCE NETWORKS (ENCAPSULATED)
 MULTIPLEXERS, ANALOG-SOLID STATE (SEQUENTIAL SAMPLING)
 MULTIPLEXERS, DIGITAL
 PANELS, POWER DISTRIBUTION
 POWER SUPPLIES, AC
 POWER SUPPLIES, DC
 PROGRAMMING LANGUAGE DEVELOPMENT (CONTRACT PROGRAMMING)
 PROGRAMMING LANGUAGE DEVELOPMENT (DEDICATED APPLICATION SYSTEMS)
 PROGRAMMING LANGUAGE DEVELOPMENT (PROPRIETARY SOFTWARE
 PRODUCTS)
 REGULATORS, CURRENT
 SERVICES, MANAGEMENT INFORMATION SYSTEMS
 SERVICES, SYSTEMS ANALYSIS
 SIGNAL CONDITIONERS
 TRANSFORMERS, POWER (COMPUTER GRADE)

TELEDYNE CRYSTALONICS 617-491-1670
 147 Sherman St, Cambridge, Mass 02140 TWX 710-320-1196

CIRCUITS, HYBRID (IC AND DISCRETE-DIGITAL)
 CIRCUITS, MONOLITHIC (LINEAR-EXCL. OP AMPS)
 CIRCUITS, THIN FILM (DIGITAL)
 COMMUTATORS, SWITCHING (ELECTRIC)
 CONVERTERS, DIGITAL-TO-ANALOG
 DIODES, SILICON
 DIODES, VARIABLE CAPACITANCE
 MULTIPLEXERS, ANALOG-SOLID STATE (SEQUENTIAL SAMPLING)
 RELAYS, SOLID-STATE (COMPUTER GRADE)
 TRANSISTORS, FIELD EFFECT
 TRANSISTORS, PHOTO
 TRANSISTORS, SILICON

TELEDYNE FRÉDERICK POST 312-299-1111
 P O Box 803, Chicago, Ill 60690 TWX 910-490-2533

AUDIO/VISUAL TRAINING AIDS
 CARDS, MICROFILM APERTURE
 DRAFTING SYSTEMS, COMPUTER-CONTROLLED STORAGE
 MICROFICHE
 MICROFILM ROLLS
 PRINTERS, MICROFILM/MICROFICHE
 READERS, MICROFILM/MICROFICHE

TELEDYNE GEOTECH 214-271-2561
 P O Box 28277, Dallas, Tex 75228 TWX 214-278-9516

COMMUNICATION SYSTEMS, DATA TRANSMISSION
 DATA ACQUISITIONS SYSTEMS, AUTOMATIC

TELEDYNE GURLEY 518-272-6300
 514 Fulton St, Troy, N Y 12181 TWX 710-443-8156

ENCODERS, SHAFT ANGLE
 TRANSDUCERS, DIGITAL

TELEDYNE KINETICS SUB. TELEDYNE INC. 714-755-1181
 410 S Cedros St, Solana Beach, Cal 92075 TWX 910-322-1135

CONNECTORS, PC AND IC BOARD (COMPUTER-GRADE)

TELEDYNE PHILBRICK NEXUS 617-329-1600
 Allied Dr At Rte 128, Dedham, Mass 02026 TWX 710-348-6276

AMPLIFIERS, D.C.
 AMPLIFIERS, INSTRUMENTATION
 AMPLIFIERS, OPERATIONAL
 CIRCUITS, MONOLITHIC (OP AMPS)
 COMPUTERS, ANALOG (EDUCATIONAL)
 CONVERTERS, ANALOG-TO-DIGITAL
 CONVERTERS, DIGITAL-TO-ANALOG
 MODULES, LINEAR (ENCAPSULATED)
 POWER SUPPLIES, DC
 REGULATORS, VOLTAGE
 TESTERS, INTEGRATED CIRCUIT
 VOLTMETERS, AC, DC, DIFFER-ENTIAL

TELEDYNE RELAYS 213-772-4357
 3155 W El Segundo Blv, Hawthorne, Cal 90250 TWX 910-325-6600

RELAYS, SOLID-STATE (COMPUTER GRADE)

TELEMODEM INC. 212-479-0099
 98-05 217 St, Queens Village, N Y 11429

ANALYZERS, COMPUTER PERFORMANCE
 COMMUNICATION SYSTEMS, DATA TRANSMISSION
 GENERATORS, BYTE
 CONTINUED

3 Manufacturers' Directory

MODEMS, HARD-WIRED
MODEMS, PC CARD
TESTERS, DIGITAL DATA TRANSMISSION

TELESCIENCES INC. 609-235-6227
351 New Albany Rd, Moorestown, N J 08057

ANALYZERS, CONTINUITY
TESTERS, CIRCUIT
TESTERS, DIGITAL LOGIC MODULES AND CARDS
TESTERS, INTEGRATED CIRCUIT

TELETYPE CORP. 312-982-2000
5555 W Touhy Ave, Skokie, Ill 60076 TWX 910-223-3611

COMMUNICATION SYSTEMS, DATA TRANSMISSION
COMMUNICATION SYSTEMS, TELEPRINTER
DATA TERMINALS, BLOCK-BY-BLOCK (PAPER TAPE)
DATA TERMINALS, INCREMENTAL (MAGNETIC TAPE)
DATA TERMINALS, INQUIRY-RESPONSE (ALPHANUMERIC KEYBOARD)
ENCODERS, KEYBOARD (ALPHANUMERIC)
ENCODERS, KEYBOARD (NUMERIC)
ENCODERS, KEYBOARD-TO-MAGNETIC TAPE
ENCODERS, KEYBOARD-TO-PRINTED TAPE
PERFORATORS, PAPER TAPE
PRINTER/PUNCH, PAPER TAPE
PRINTERS, KEYBOARD
PUNCHES, PAPER TAPE
READERS, PAPER TAPE
SERVICES, HARDWARE MAINTENANCE
SPLICERS, PAPER TAPE
TAPE, MAGNETIC (CARTRIDGE)
TRAINING INSTITUTES, COMMERCIAL COMPUTER COURSES, SEMINARS,
CORRESPONDENCE COURSES
TYPEWRITERS, COMPUTER INPUT-OUTPUT
WINDERS, PAPER TAPE

TELEX COMMUNICATIONS DIV. 612-884-4051
9600 Aldrich Ave S, Minneapolis, Minn 55420 TELEX 29-7053

RECORDERS, DIGITAL CASSETTE
RECORDERS, MAGNETIC TAPE
TAPE TRANSPORTS, MAGNETIC (DIGITAL CASSETTE)
TAPE TRANSPORTS, MAGNETIC (INCREMENTAL)
TAPE TRANSPORTS, MAGNETIC (WITH KEYBOARD INPUT)

TELEX COMPUTER PRODUCTS 918-627-1111
6422 E 41st St, Tulsa, Okla 74135 TWX 918-627-6030

CERTIFIERS, MAGNETIC TAPE
CONTROLLERS, MAGNETIC DISC
DISC DRIVES, MOVABLE HEAD (INCLUDING CONTROLLER)
DISC DRIVES, REMOVABLE CARTRIDGE
DISC STORAGE SYSTEMS
MAGNETIC TAPE STORAGE SYSTEMS (INCLUDES CONTROLLER)
RECORDERS, DIGITAL CASSETTE
RECORDERS, MAGNETIC TAPE
TAPE TRANSPORTS, MAGNETIC (DIGITAL-EXCL. CASSETTE)
TAPE TRANSPORTS, MAGNETIC (DIGITAL CASSETTE)
TAPE TRANSPORTS, MAGNETIC (INCREMENTAL)

TELVAC INSTRUMENT CO. 714-494-9401
18531 Ventura Blvd, Tarzana, Cal 91356 TWX 910-596-1320

TESTERS, INTEGRATED CIRCUIT

TEMPO COMPUTERS INC. 714-633-3660
1550 S St College Blv, Anaheim, Cal 92806 TWX 910-223-3611

COMMUNICATIONS-ORIENTED PROCESSORS, STORED PROGRAM
COMMUNICATION SYSTEMS, DATA TRANSMISSION
COMPUTERS, DIGITAL (GENERAL-PURPOSE, SMALL-SCALE)
COMPUTERS, DIGITAL (GENERAL-PURPOSE, MEDIUM-SCALE)
CONTROLLERS, MAGNETIC DISC
CONTROLLERS, MAGNETIC DRUM
CONTROLLERS, MAGNETIC TAPE
DATA CONCENTRATORS

TEMPO INSTRUMENT DIV. ALLEN ELECTRIC&EQUIP. CO. 213-882-2500
9135 Independence Ave, Chatsworth, Cal 91311 TELEX 65-1439

CIRCUIT CARDS, LINEAR (WITH DISCRETE COMPONENTS)
CIRCUIT CARDS, LINEAR (WITH IC'S)
CIRCUIT CARDS, LOGIC (WITH DISCRETE COMPONENTS)
CONTINUED

CIRCUIT CARDS, LOGIC (WITH IC'S)
CONVERTERS, ANALOG-TO-DIGITAL
CONVERTERS, DIGITAL-TO-ANALOG
CONVERTERS, FREQUENCY-TO-DC
ENCODERS, DIGITAL
RELAYS, SOLID-STATE (COMPUTER GRADE)
TIMERS, EVENT (IMPULSE)
TIMERS, INTERVAL
TRANSDUCERS, DIGITAL

TENET INC. 408-245-8751
927 Thompson Pl, Sunnyvale, Cal 94086

COMMUNICATIONS-ORIENTED PROCESSORS, MULTIPLE CHANNEL CONTROLLERS
COMPUTERS, DIGITAL (GENERAL-PURPOSE, MEDIUM-SCALE)

TENNECOMP SYSTEMS INC. 615-482-3491
795 Oak Ridge Tpk, Oak Ridge, Tenn 37830

ANALYZERS, PULSE HEIGHT
DISPLAY DRIVERS
LIGHT PENS (FOR CRT TERMINAL INPUT/OUTPUT)
MAGNETIC TAPE STORAGE SYSTEMS (INCLUDES CONTROLLER)
RECORDERS, DIGITAL CASSETTE
RECORDERS, MAGNETIC TAPE
TAPE TRANSPORTS, MAGNETIC (DIGITAL CASSETTE)

TERADYNE INC. 617-426-6560
183 Essex St, Boston, Mass 02111 TWX 710-321-1055

CONNECTORS, PC AND IC BOARD (COMPUTER-GRADE)
TESTERS, DIGITAL LOGIC MODULES AND CARDS
TESTERS, INTEGRATED CIRCUIT
TESTERS, SEMICONDUCTOR

TERMINAL DATA CORP. 213-988-4301
16130 Stagg St, Van Nuys, Cal 91324

CAMERAS, COM
CAMERAS, OCR
DATA RETRIEVAL SYSTEMS, MICRO-FILM (COMPUTER-CONTROLLED)
MICROFILM DATA RETRIEVAL SYSTEMS, COMPUTER CONTROLLED (GRAPHIC)
PROCESSORS, MICROFILM

TERMINAL EQUIPMENT CORP. 201-839-3000
750 Hamburg Tpk, Pompton Lakes, N J 07442

COMMUNICATION SYSTEMS, TELEPRINTER
DATA TERMINALS, BLOCK-BY-BLOCK (MAGNETIC TAPE)
DATA TERMINALS, BLOCK-BY-BLOCK (PAPER TAPE)
DATA TERMINALS, BLOCK-BY-BLOCK (TELEPRINTER)
DATA TERMINALS, INQUIRY-RESPONSE (ALPHANUMERIC KEYBOARD)
PRINTERS, KEYBOARD
TYPEWRITERS, COMPUTER INPUT-OUTPUT

TEST EQUIPMENT CORP. 214-357-6271
2925 Merrell Rd, Dallas, Tex 75220

TESTERS, CIRCUIT
TESTERS, DIGITAL LOGIC MODULES AND CARDS
TESTERS, INTEGRATED CIRCUIT
TESTERS, SEMICONDUCTOR

TEVCO INC. 916-441-6977
3260 J St, Sacramento, Cal 95816

CONSULTING (ACCOUNTING, BUSINESS AND COMMERCIAL APPLICATIONS)
CONSULTING (SCIENTIFIC APPLICATIONS)

TEXAS INSTRUMENTS INC. CONTROLS DIV. 617-222-2800
34 Forest St, Attleboro, Mass 02703

CONTROLLERS, MOTOR
PROTECTORS, CIRCUIT AND EQUIPMENT OVERLOAD
RELAYS, SOLID-STATE (COMPUTER GRADE)
SWITCHES, PUSHBUTTON
SWITCHES, PUSHBUTTON (ILLUMINATED)
SWITCHES, SNAP ACTION
SWITCHES, TOGGLE (MINIATURE)
THERMOCOUPLE REFERENCE SYSTEMS

3 Manufacturers' Directory

TEXAS INSTRUMENTS INC. DIGITAL SYSTEMS DIV 713-526-1411
P O Box 66027, Houston, Tex 77006 TWX 910-867-4702
 COMMUNICATIONS-ORIENTED PROCESSORS, MULTIPLE CHANNEL CONTROLLERS
 COMMUNICATION SYSTEMS, DATA TRANSMISSION
 COMMUNICATION SYSTEMS, TELEPRINTER
 COMPUTERS, DIGITAL (GENERAL-PURPOSE, SMALL-SCALE)
 COMPUTERS, MINI GENERAL PURPOSE (ALSO SEE CALCULATORS)
 COMPUTERS, PROCESS CONTROL
 DATA TERMINALS, BLOCK-BY-BLOCK (MAGNETIC TAPE)
 DATA TERMINALS, BLOCK-BY-BLOCK (PAPER TAPE)
 DATA TERMINALS, BLOCK-BY-BLOCK (MEDIUM SPEED PRINTER)
 DATA TERMINALS, BLOCK-BY-BLOCK (TELEPRINTER)
 DATA TERMINALS, INQUIRY-RESPONSE (ALPHANUMERIC KEYBOARD)
 MAGNETIC TAPE STORAGE SYSTEMS (INCLUDES CONTROLLER)
 PERFORATORS, PAPER TAPE
 PRINTER/PUNCH, PAPER TAPE
 PRINTERS, LINE (LOW & MEDIUM SPEED)
 PUNCHES, PAPER TAPE
 READERS, PAPER TAPE
 RECORDERS, GRAPHIC
 RECORDERS, MAGNETIC TAPE
 TAPE TRANSPORTS, MAGNETIC (DIGITAL-EXCL. CASSETTE)
 TESTERS, CIRCUIT
 TESTERS, DIGITAL LOGIC MODULES AND CARDS
 TESTERS, INTEGRATED CIRCUIT
 TESTERS, SEMICONDUCTOR
 TYPEWRITERS, COMPUTER INPUT-OUTPUT

TEXWIPE COMPANY, THE 201-664-0555
51 Prospect Place, Hillsdale, N J 07642

CLEANER/CERTIFIERS, MAGNETIC TAPE
 CLEANERS, MAGNETIC TAPE
 CLEANERS, MAGNETIC TAPE HEADS

THEORY ANALYSIS GROUP 312-337-3035
22 E Elm St, Chicago, Ill 60611

CONSULTING (ADVANCED COMPUTER EQUIPMENT DESIGN AND FEASIBILITY STUDIES)
 CONSULTING (SCIENTIFIC APPLICATIONS)
 PROGRAMMING LANGUAGE DEVELOPMENT (CONSULTANTS)
 PROGRAMMING LANGUAGE DEVELOPMENT (CONTRACT PROGRAMMING)
 PROGRAMMING LANGUAGE DEVELOPMENT (PROPRIETARY SOFTWARE PRODUCTS)
 SERVICES, TIME SHARING (RESEARCH)
 TRAINING INSTITUTES, COMMERCIAL COMPUTER COURSES, SEMINARS, CORRESPONDENCE COURSES

THERMALLOY CO. 214-637-3333
8717 Diplomacy Row, Dallas, Tex 75247 TWX 910-861-4410

BLOWERS, FANS, COOLING ASSEMBLIES
 GUIDES, CIRCUIT CARDS
 HEAT SINKS, CIRCUIT BOARD MOUNTING
 SOCKETS, SEMICONDUCTOR MOUNTING

THERMOSEN INC. 203-324-6125
375 Fairfield Ave, Stamford, Conn 06904

RELAYS, DRY REED (COMPUTER GRADE)

THETA INSTRUMENT CORP. 201-227-1700
24 Dwight Pl, Fairfield, N J 07006

CONTROLLERS, MOTOR
 CONVERTERS, ANALOG-TO-DIGITAL
 CONVERTERS, BINARY-TO-DECIMAL
 CONVERTERS, DC-TO-FREQUENCY
 CONVERTERS, DIGITAL-TO-ANALOG
 CONVERTERS, DIGITAL-TO-SYNCHRO
 CONVERTERS, PULSE-TO-DIGITAL
 CONVERTERS, SYNCHRO-TO-DIGITAL
 CONVERTERS, VOLTAGE-TO-FREQUENCY
 COUNTERS, DECADE
 COUNTERS, DIGITAL READOUT
 COUNTERS, UP-DOWN
 DIGITIZERS, PROGRAMMABLE
 DISPLAY DRIVERS
 ENCODERS, DIGITAL
 ENCODERS, SHAFT ANGLE
 KNOBS, DIALS (FOR COMPUTER CONSOLES)
 TIMERS, EVENT (IMPULSE)
 TIMERS, INTERVAL
 TRANSDUCERS, DIGITAL

THOMAS & BETTS CO., THE 201-354-4321
36 Butler St, Elizabeth, N J 07207 TELEX 13-8236
 TERMINAL BLOCKS, STRIPS, BOARDS

THOMAS ELECTRONICS INC. 201-696-5200
100 Riverview Dr, Wayne, N J 07470 TWX 710-988-5836
 TUBES, CATHODE RAY

TIME BROKERS INC. 212-661-7712
380 Lexington Ave, New York, N Y 10017

LEASING, EDP EQUIPMENT (OTHER THAN MFGRS)
 SERVICES, MAGNETIC TAPE CERTIFICATION
 USED EQUIPMENT (BUYING, SELLING, LEASING)

TIME SHARE CORP. 603-643-3640
3 Lebanon St, Hanover, N H 03755

CONSULTING (ACCOUNTING, BUSINESS AND COMMERCIAL APPLICATIONS)
 INSTRUCTIONAL SYSTEMS, COMPUTER-BASED
 PROGRAMMING LANGUAGE DEVELOPMENT (CONSULTANTS)
 PROGRAMMING LANGUAGE DEVELOPMENT (CONTRACT PROGRAMMING)
 PROGRAMMING LANGUAGE DEVELOPMENT (DEDICATED APPLICATION SYSTEMS)
 PROGRAMMING LANGUAGE DEVELOPMENT (PROPRIETARY SOFTWARE PRODUCTS)
 SERVICES, FACILITY MANAGEMENT
 SERVICES, TIME SHARING (COMMERCIAL)
 TRAINING INSTITUTES, COMMERCIAL COMPUTER COURSES, SEMINARS, CORRESPONDENCE COURSES

TIME SHARE PERIPHERALS CORP. 203-762-3348
P O Box 361, Wilton, Conn 06897 TWX 710-479-3219

CONTROLLERS, PLOTTING
 PLOTTERS, MOVING PEN (DIGITAL CONTROLLER)

TIME SHARING SCIENCES INC. 212-765-1711
1180 Ave Americas, New York, N Y 10036

CONSULTING (ACCOUNTING, BUSINESS AND COMMERCIAL APPLICATIONS)
 CONSULTING (COMPUTER EVALUATIONS, SELECTIONS, INSTALLATION PLANNING)
 CONSULTING (DATA COMMUNICATIONS SYSTEMS PLANNING)
 CONSULTING (MANAGEMENT INFORMATION SYSTEMS PLANNING)
 CONSULTING (SCIENTIFIC APPLICATIONS)
 PROGRAMMING LANGUAGE DEVELOPMENT (CONSULTANTS)
 PROGRAMMING LANGUAGE DEVELOPMENT (CONTRACT PROGRAMMING)
 PROGRAMMING LANGUAGE DEVELOPMENT (DEDICATED APPLICATION SYSTEMS)
 PROGRAMMING LANGUAGE DEVELOPMENT (PROPRIETARY SOFTWARE PRODUCTS)
 SERVICES, MANAGEMENT INFORMATION SYSTEMS
 SERVICES, TIME SHARING (RESEARCH)
 SERVICES, SYSTEMS ANALYSIS

TIME ZERO CORP. 213-371-3501
3530 Torrance Blvd, Torrance, Cal 90510

COMMUNICATIONS-ORIENTED PROCESSORS, MULTIPLE CHANNEL CONTROLLERS
 COMMUNICATIONS-ORIENTED PROCESSORS, SINGLE CHANNEL CONTROLLERS
 COMMUNICATIONS-ORIENTED PROCESSORS, STORED PROGRAM
 CONSULTING (DATA COMMUNICATIONS SYSTEMS PLANNING)
 CONSULTING (SCIENTIFIC APPLICATIONS)
 CONTROLLERS, MAGNETIC DISC
 CONTROLLERS, MAGNETIC DRUM
 DATA CONCENTRATORS
 MULTIPLEXER-CONVERTER (SINGLE UNIT WITH MULTIPLEXER, SAMPLE & HOLD AMPLIFIER & A-TO-D CONVERTER)
 MULTIPLEXERS, DIGITAL

TIME-SHARING SYSTEMS, INC., 414-272-8580
1840 N Farwell Ave, Milwaukee, Wis 53202

CONSULTING (ACCOUNTING, BUSINESS AND COMMERCIAL APPLICATIONS)
 CONSULTING (ADVANCED COMPUTER EQUIPMENT DESIGN AND FEASIBILITY STUDIES)
 CONSULTING (MANAGEMENT INFORMATION SYSTEMS PLANNING)
 CONSULTING (SCIENTIFIC APPLICATIONS)
 SERVICES, COMPUTER-AIDED DESIGN
 SERVICES, FACILITY MANAGEMENT
 SERVICES, MANAGEMENT INFORMATION SYSTEMS
 SERVICES, PROCESSING (COMMERCIAL EDP)
 SERVICES, PROCESSING (DIGITAL SCIENTIFIC)
 SERVICES, TIME SHARING (COMMERCIAL)
 SERVICES, TIME SHARING (RESEARCH)
 SERVICES, SYSTEMS ANALYSIS

3 Manufacturers' Directory

TIME-SHARING TERMINALS INC. 2351 Shady Grove Rd, Rockville, Md 20850 ACOUSTIC COUPLERS COMMUNICATION SYSTEMS, TELEPRINTER DATA TERMINALS, BLOCK-BY-BLOCK (TELEPRINTER) DATA TERMINALS, INQUIRY-RESPONSE (CRT WITH KEYBOARD) MODEMS, ACOUSTIC MODEMS, HARD-WIRED SERVICES, HARDWARE MAINTENANCE	301-948-0700 TWX 710-828-0087	CONSULTING (SCIENTIFIC APPLICATIONS) PROGRAMMING LANGUAGE DEVELOPMENT (CONSULTANTS) PROGRAMMING LANGUAGE DEVELOPMENT (CONTRACT PROGRAMMING) PROGRAMMING LANGUAGE DEVELOPMENT (DEDICATED APPLICATION SYSTEMS) PROGRAMMING LANGUAGE DEVELOPMENT (PROPRIETARY SOFTWARE PRODUCTS) SERVICES, COMPUTER-AIDED DESIGN SERVICES, FACILITY MANAGEMENT SERVICES, MAGNETIC TAPE CERTIFICATION SERVICES, MANAGEMENT INFORMATION SYSTEMS SERVICES, PROCESSING (COMMERCIAL EDP) SERVICES, PROCESSING (ANALOG OR HYBRID, SCIENTIFIC) SERVICES, PROCESSING (DIGITAL SCIENTIFIC) SERVICES, TIME SHARING (COMMERCIAL) SERVICES, TIME SHARING (RESEARCH) SERVICES, SYSTEMS ANALYSIS TRAINING INSTITUTES, COMMERCIAL COMPUTER COURSES, SEMINARS, CORRESPONDENCE COURSES
TIME/DATA CORP. SUB. GENL. RADIO CO 490 San Antonio Rd, Palo Alto, Cal 94306	415-327-8322	
COMPUTERS, SPECIAL PURPOSE		
TIMEPLEX INC. 65 Oak St, Norwood, N J 07648 COMMUNICATION SYSTEMS, DATA TRANSMISSION CONSULTING (DATA COMMUNICATIONS SYSTEMS PLANNING) DATA CONCENTRATORS DIALERS, AUTOMATIC	201-539-1842 TWX 710-991-9759	
TIMES WIRE & CABLE CO. SUB. INSILCO CORP. 358 Hall Ave, Wallingford, Conn 06492 CABLE ASSEMBLIES (WITH CONNECTORS) CABLE, COAXIAL (FLEXIBLE) CABLE, COAXIAL (SEMI/RIGID) CABLE, MULTICONDUCTOR CABLE, SHIELDED (NOT COAXIAL)	203-269-3385 TWX 710-476-0763	
TIMESHARE DEVICES INC. 225 Crescent St, Waltham, Mass 02154 ACOUSTIC COUPLERS COMMUNICATION SYSTEMS, TELEPRINTER CONTROLLERS, PLOTTING PLOTTERS, MOVING PEN (DIGITAL CONTROLLER)	617-899-3560	
TOKO N. Y. INC. SUB. OF TOKO INC. TOKYO 350 5th Ave, New York, N Y 10001 DELAY LINES, MAGNETOSTRICTIVE (ALSO SEE MEMORIES) MEMORY SYSTEMS, PLATED WIRE MEMORY SYSTEMS, READ-ONLY PLATED WIRE TRANSFORMERS, PULSE (COMPUTER GRADE)	212-565-3767 TELEX 22-4114	
TORIN CORP. 100 Franklin Dr, Torrington, Conn 06790 BLOWERS, FANS, COOLING ASSEMBLIES	203-482-4422 TWX 710-439-2343	
TOROIDAL COMPONENTS CO. 1374 E Walnut St, Pasadena, Cal 91106 MODULES, DIGITAL LOGIC ENCAPSULATED (ALSO SEE CIRCUITS & CIRCUIT CARDS) TRANSFORMERS, PULSE (COMPUTER GRADE)	713-795-7123	
TORTEL INC. 13402 S 71 Hwy, Grandview, Mo 64030 CRYSTAL UNITS, QUARTZ (FOR FREQUENCY CONTROL) MODULES, LINEAR (ENCAPSULATED) MODULES, RESISTANCE NETWORKS (ENCAPSULATED) OSCILLATORS, MAGNETIC OSCILLATORS, VOLTAGE CONTROLLED TRANSFORMERS, PULSE (COMPUTER GRADE)	816-761-6314 TWX 910-777-7037	
TOWNER SYSTEMS CO. 1829 Clement Ave, Alameda, Cal 94501 CONVERTERS, ANALOG-TO-DIGITAL DATA ACQUISITION AND REDUCTION SYSTEMS VOLTMETERS, PRINTING	415-521-3373	
TRACOR COMPUTING CORP. 1705 Guadalupe St, Austin, Tex 78701 CONSULTING (ACCOUNTING, BUSINESS AND COMMERCIAL APPLICATIONS) CONSULTING (ADVANCED COMPUTER EQUIPMENT DESIGN AND FEASIBILITY STUDIES) CONSULTING (DATA COMMUNICATIONS SYSTEMS PLANNING) CONSULTING (MANAGEMENT INFORMATION SYSTEMS PLANNING) CONTINUED	512-476-7771	
TRACOR DATA SYSTEMS INC. 4201 Ed Bluestein Blv, Austin, Tex 78721 COMPUTERS, DIGITAL (GENERAL-PURPOSE, SMALL-SCALE) COMPUTERS, HYBRID CONSULTING (SCIENTIFIC APPLICATIONS) CONTROLLERS, MAGNETIC DISC DATA TERMINALS, BLOCK-BY-BLOCK (MEDIUM SPEED PRINTER) DATA TERMINALS, INQUIRY-RESPONSE (ALPHANUMERIC KEYBOARD) DISC DRIVES, MOVABLE HEAD (INCLUDING CONTROLLER) DISC DRIVES, REMOVABLE CARTRIDGE PAPER (FOR RECORDERS AND PLOTTERS) PRINTERS, LINE (LOW & MEDIUM SPEED) PROGRAMMING LANGUAGE DEVELOPMENT (CONTRACT PROGRAMMING) PROGRAMMING LANGUAGE DEVELOPMENT (DEDICATED APPLICATION SYSTEMS)	512-926-9111	
TRACOR DATA SYSTEMS MARKETING 601 California St, San Francisco, Cal 94108 CONTROLLERS, MAGNETIC DISC DATA TERMINALS, BLOCK-BY-BLOCK (MULTI-PURPOSE) DATA TERMINALS, BLOCK-BY-BLOCK (HIGH SPEED PRINTER) DISC DRIVES, MOVABLE HEAD (INCLUDING CONTROLLER)	415-781-5450 TWX 910-372-6676	
TRAFFIC & DISTRIBUTION SERVICES INC. 30 Boylston St, Cambridge, Mass 02138 CONSULTING (MANAGEMENT INFORMATION SYSTEMS PLANNING)	617-547-3514	
TRAIID CORP., PHOTO INSTRUMENT DIV. 900 Grand Central, Glendale, Cal 91201 AUDIO/VISUAL TRAINING AIDS CAMERAS, COM CAMERAS, DATA RECORDING (EXCL. OSCILLOSCOPES) CURVE TRACERS-DIGITIZERS, MANUAL DATA ACQUISITION AND REDUCTION SYSTEMS DATA RETREIVAL SYSTEMS, MICRO-FILM (COMPUTER-CONTROLLED) DIGITIZERS, PROGRAMMABLE FILM SCANNERS MICROFILM DATA RETRIEVAL SYSTEMS, COMPUTER CONTROLLED MICROFILM DATA RETRIEVAL SYSTEMS, COMPUTER CONTROLLED (GRAPHIC) RECORDERS, MICROFILM/MICROFICHE TIMERS, INTERVAL	213-247-3000	
TRANS-DATA SYSTEMS 6394 Freeport B, Sacramento, Cal 95822 CONSULTING (DATA COMMUNICATIONS SYSTEMS PLANNING) CONSULTING (SCIENTIFIC APPLICATIONS) SERVICES, SYSTEMS ANALYSIS	916-421-8253	
TRANSCOM INC. SUB. OF HI-G INC. 12 Tobey Rd, Bloomfield, Conn 06002 COMMUNICATION SYSTEMS, DATA TRANSMISSION DATA TERMINALS, BLOCK-BY-BLOCK (PAPER TAPE) DATA TERMINALS, BLOCK-BY-BLOCK (PUNCHED CARD) DATA TERMINALS, INQUIRY-RESPONSE (ALPHANUMERIC KEYBOARD) DATA TERMINALS, INQUIRY-RESPONSE (AUDIO RESPONSE) DATA TERMINALS, INQUIRY-RESPONSE (BADGE-TOKEN READERS) PRINTERS, DIGITAL STRIP RECORDING PRINTERS, KEYBOARD READERS, PAPER TAPE	203-243-1486	

3 Manufacturers' Directory

TRANSITEL, DIV. OF SANGAMO ELECTRIC CO. 303-399-2263
P O Box 7255, Denver, Colo 80207

COMMUNICATION SYSTEMS, DATA TRANSMISSION
 DATA TERMINALS, BLOCK-BY-BLOCK (MAGNETIC TAPE)
 DATA TERMINALS, BLOCK-BY-BLOCK (MEDIUM SPEED PRINTER)
 ENCODERS, KEYBOARD (ALPHANUMERIC)
 ENCODERS, KEYBOARD-TO-MAGNETIC TAPE
 POOLERS, MAGNETIC TAPE
 PRINTERS, LINE (LOW & MEDIUM SPEED)
 SCANNERS, OPTICAL
 TAPE TRANSPORTS, MAGNETIC (WITH KEYBOARD INPUT)

TRANSITRON ELECTRONIC CORP. 617-245-4500
168 Albion St, Wakefield, Mass 01880 TWX 710-348-6718

AMPLIFIERS, OPERATIONAL
 CABLE ASSEMBLIES (WITH CONNECTORS)
 CABLE, COAXIAL (FLEXIBLE)
 CABLE, COAXIAL (SEMI/RIGID)
 CABLE, FINE LEAD
 CABLE, FLAT, PRINTED AND RIBBON
 CABLE, MULTICONDUCTOR
 CABLE, SHIELDED (NOT COAXIAL)
 CIRCUITS, MONOLITHIC (DIGITAL LOGIC)
 CIRCUITS, MONOLITHIC (LSI-MOS)
 CIRCUITS, MONOLITHIC (OP AMPS)
 CIRCUITS, THICK FILM (DIGITAL)
 CIRCUITS, THIN FILM (DIGITAL)
 CONNECTORS, PC AND IC BOARD (COMPUTER-GRADE)
 CONNECTORS, RACK AND PANEL (COMPUTER-GRADE)
 COUNTERS, DECADE
 DESKS, TABLES AND STANDS (FOR CALCULATORS)
 DESKS, TABLES AND STANDS (FOR TYPEWRITERS)
 DIODES, GERMANIUM
 DIODES, SILICON
 DIODES, ZENER
 DISPLAY DRIVERS
 INDICATORS, ALPHANUMERIC
 JACKS, JACK PANELS, PLUGS, ASSEMBLIES
 LAMPS-PANEL, PILOT AND DIAL (INCANDESCENT)
 POTENTIOMETERS, TRIM (WIRE-WOUND)
 RECTIFIERS, SILICON CONTROLLED
 REGULATORS, VOLTAGE
 TRANSFORMERS, POWER (COMPUTER GRADE)
 TRANSFORMERS, PULSE (COMPUTER GRADE)
 TRANSISTORS, PHOTO
 TRANSISTORS, SILICON
 USED EQUIPMENT (BUYING, SELLING, LEASING)

TRANSMAGNETICS INC. 516-293-3100
210 Adams Blvd, Farmingdale, N Y 11735 TWX 510-224-6420

CIRCUIT CARDS, LOGIC (WITH DISCRETE COMPONENTS)
 CIRCUIT CARDS, LOGIC (WITH IC'S)
 CONVERTERS, ANALOG-TO-DIGITAL
 CONVERTERS, DIGITAL-TO-ANALOG
 CONVERTERS, DIGITAL-TO-SYNCHRO
 CONVERTERS, POLAR-TO-RECTANGULAR
 CONVERTERS, SYNCHRO-TO-DIGITAL
 MODULES, DIGITAL LOGIC ENCAPSULATED (ALSO SEE CIRCUITS & CIRCUIT CARDS)
 MULTIPLEXER-CONVERTER (SINGLE UNIT WITH MULTIPLEXER, SAMPLE & HOLD AMPLIFIER & A-TO-D CONVERTER)
 MULTIPLEXERS, ANALOG-SOLID STATE (SEQUENTIAL SAMPLING)
 MULTIPLEXERS, DIGITAL
 SIGNAL CONDITIONERS

TRANSMATION INC. 716-254-9000
977 Mount Read Blvd, Rochester, N Y 14606 TELEX 97-8314
 MULTIPLEXERS, ANALOG-RELAY (SEQUENTIAL SAMPLING)

TRANSMISSION MEASUREMENTS INC 716-852-4500
1051 Clinton St, Buffalo, N Y 14206 TWX 610-492-2712

ANALYZERS, COMPUTER PERFORMANCE
 DATA TERMINALS, BLOCK-BY-BLOCK (PAPER TAPE)
 GENERATORS, CHARACTER (CRT)
 READERS, PAPER TAPE
 TEST SYSTEMS, COMPUTER PERFORMANCE
 TESTERS, DIGITAL DATA TRANSMISSION
 WINDERS, PAPER TAPE

TRAVCOM INC. 513-961-5400
1425 E McMillan, Cincinnati, Ohio 45206 TWX 810-461-2301

CONSULTING (ACCOUNTING, BUSINESS AND COMMERCIAL APPLICATIONS)
 CONSULTING (MANAGEMENT INFORMATION SYSTEMS PLANNING)
 SERVICES, FACILITY MANAGEMENT
 SERVICES, MANAGEMENT INFORMATION SYSTEMS
 SERVICES, PROCESSING (COMMERCIAL EDP)
 CONTINUED

SERVICES, SYSTEMS ANALYSIS

TRAVCOM INC. UNITED DATA PROC DV 503-342-1871
70 E 14th St, Eugene, Oreg 97401

CONSULTING (ACCOUNTING, BUSINESS AND COMMERCIAL APPLICATIONS)
 CONSULTING (COMPUTER EVALUATIONS, SELECTIONS, INSTALLATION PLANNING)
 CONSULTING (MANAGEMENT INFORMATION SYSTEMS PLANNING)
 SERVICES, FACILITY MANAGEMENT
 SERVICES, MANAGEMENT INFORMATION SYSTEMS
 SERVICES, PROCESSING (COMMERCIAL EDP)
 SERVICES, SYSTEMS ANALYSIS

TREPAC CORP. OF AMERICA 201-567-3810
30 W Hamilton Ave, Englewood, N J 07631 TWX 710-991-9685

COMMUNICATIONS-ORIENTED PROCESSORS, MULTIPLE CHANNEL CONTROLLERS
 COMMUNICATION SYSTEMS, DATA TRANSMISSION
 COMMUNICATION SYSTEMS, TELEPRINTER
 COMMUTATORS, SWITCHING (ELECTRIC)
 CONSULTING (DATA COMMUNICATIONS SYSTEMS PLANNING)
 CONTROLLERS, MODEM
 CONTROLLERS, MOTOR
 CONVERTERS, SCAN
 DATA TERMINALS, BLOCK-BY-BLOCK (TELEPRINTER)
 DATA TERMINALS, INQUIRY-RESPONSE (AUDIO RESPONSE)
 ENCODERS, KEYBOARD (ALPHANUMERIC)
 ENCODERS, KEYBOARD (NUMERIC)
 MODEMS, HARD-WIRED
 MONITORS, TV
 MULTIPLEXERS, ANALOG-SOLID STATE (SEQUENTIAL SAMPLING)
 RELAYS, SOLID-STATE (COMPUTER GRADE)
 SCANNERS, INPUT
 TIMERS, INTERVAL

TRI-DATA CORP. 415-969-3700
800 Maude Ave, Mt View, Cal 94040 TWX 910-379-6978
 RECORDERS, DIGITAL CASSETTE
 TAPE, MAGNETIC (CARTRIDGE)

TRI-DEX DATA SERVICES 209-732-7415
2146 E Main St, Visalia, Cal 93277

CONSULTING (ACCOUNTING, BUSINESS AND COMMERCIAL APPLICATIONS)
 CONSULTING (DATA COMMUNICATIONS SYSTEMS PLANNING)

TRIAD DISTRIBUTOR DIV. LITTON INDUS. 219-356-6500
305 N Briant St, Huntington, Ind 46750 TWX 213-390-3571
 TRANSFORMERS, POWER (COMPUTER GRADE)
 TRANSFORMERS, PULSE (COMPUTER GRADE)

TRIDEA ELECTRONICS A SUB. OF CONDUCTRON CORP. 213-686-1740
10581 Federal Dr, El Monte, Cal 91731 TWX 910-587-3530
 CURVE TRACERS-DIGITIZERS, AUTOMATIC
 DRAFTING SYSTEMS, COMPUTER-CONTROLLED STORAGE

TRILOG ASSOCIATES INC. 215-564-3404
1700 Market St, Philadelphia, Pa 19103

CONSULTING (ACCOUNTING, BUSINESS AND COMMERCIAL APPLICATIONS)
 CONSULTING (COMPUTER EVALUATIONS, SELECTIONS, INSTALLATION PLANNING)
 CONSULTING (DATA COMMUNICATIONS SYSTEMS PLANNING)
 CONSULTING (MANAGEMENT INFORMATION SYSTEMS PLANNING)
 PROGRAMMING LANGUAGE DEVELOPMENT (CONSULTANTS)
 PROGRAMMING LANGUAGE DEVELOPMENT (CONTRACT PROGRAMMING)
 PROGRAMMING LANGUAGE DEVELOPMENT (DEDICATED APPLICATION SYSTEMS)
 PROGRAMMING LANGUAGE DEVELOPMENT (PROPRIETARY SOFTWARE PRODUCTS)
 SERVICES, FACILITY MANAGEMENT
 SERVICES, MANAGEMENT INFORMATION SYSTEMS
 SERVICES, PROCESSING (COMMERCIAL EDP)
 SERVICES, PROCESSING (DIGITAL SCIENTIFIC)
 SERVICES, SYSTEMS ANALYSIS
 TRAINING INSTITUTES, COMMERCIAL COMPUTER COURSES, SEMINARS,
 CORRESPONDENCE COURSES

TRIO LABORATORIES INC. 516-681-0400
80 Dupont St, Plainview, N Y 11803 TWX 510-221-1861
 POWER SUPPLIES, DC
 REGULATORS, VOLTAGE

3 Manufacturers' Directory

TRIPLE C COMPUTER SERVICE 212-725-0170
432 Park Ave S, New York, N Y 10016

SERVICES, FACILITY MANAGEMENT
 SERVICES, MANAGEMENT INFORMATION SYSTEMS
 SERVICES, PROCESSING (COMMERCIAL EDP)
 SERVICES, SYSTEMS ANALYSIS

TRIPLETT CORP. 419-358-5015
286 Harmon Rd, Bluffton, Ohio 45817 TWX 810-490-2400

TESTERS, CIRCUIT
 TESTERS, SEMICONDUCTOR
 VOLTMETERS, AC, DC, DIFFERENTIAL
 VOLTMETERS, DIGITAL

TROMPETER ELECTRONICS INC. 213-882-1020
8936 Comanche Ave, Chatsworth, Cal 91311 TWX 910-494-1210

CABLE ASSEMBLIES (WITH CONNECTORS)
 CABLE, COAXIAL (FLEXIBLE)
 CONNECTORS, COAXIAL (COMPUTER-GRADE)
 CONNECTORS, MINIATURE AND SUB-MINIATURE (COMPUTER-GRADE)
 JACKS, JACK PANELS, PLUGS, ASSEMBLIES
 RELAYS, DRY REED (COMPUTER GRADE)
 RELAYS, MERCURY WETTED (COMPUTER GRADE)
 SWITCHES, COAXIAL
 SWITCHES, DRY REED
 SWITCHES, PUSHBUTTON
 SWITCHES, PUSHBUTTON (ILLUMINATED)

TROTT ELECTRONICS INC. 716-473-8010
30 Ridgeland Rd, Rochester, N Y 14623

BREADBOARDS
 CONTROLLERS, MOTOR
 CONVERTERS, ANALOG-TO-DIGITAL
 REGULATORS, CURRENT
 REGULATORS, VOLTAGE
 SERVICES, HARDWARE MAINTENANCE
 TESTERS, DIGITAL DATA TRANSMISSION
 TESTERS, DIGITAL LOGIC MODULES AND CARDS
 TIMERS, EVENT (IMPULSE)
 TRANSDUCERS, DIGITAL
 VOLTMETERS, AC, DC, DIFFERENTIAL
 VOLTMETERS, DIGITAL

TRUELINE INSTRUMENTS INC. 303-781-6621
4002 S Clay, Englewood, Colo 80110

TRANSFORMERS, POWER (COMPUTER GRADE)
 TRANSFORMERS, PULSE (COMPUTER GRADE)

TRUMP-ROSS INDUSTRIAL CONTROLS INC. 617-663-3451
265 Boston Rd, N Billerica, Mass 01862

ENCODERS, SHAFT ANGLE

TRW AND CABLE DIV. 413-533-3961
720 Main St, Holyoke, Mass 01040

CABLE, COAXIAL (FLEXIBLE)
 CABLE, COAXIAL (SEMI/RIGID)
 CABLE, FINE LEAD
 CABLE, FLAT, PRINTED AND RIBBON
 CABLE, MULTICONDUCTOR
 CABLE, SHIELDED (NOT COAXIAL)

TRW CAPACITOR DIV. SOLID STATE OPER. 617-598-4800
71 Linden St, Lynn, Mass 01905 TWX 710-334-0254

DIODES, SILICON
 RECTIFIERS, SILICON CONTROLLED

TRW INC. CAPACITOR DIV. 308-284-3611
112 W 1st St, Oeallala, Neb 69153 TWX 910-620-0321

CAPACITORS, COMPUTER GRADE
 DIODES, ZENER
 RECTIFIERS, SILICON CONTROLLED

TRW INC. GLOBE DIV. 513-228-3171
2275 Stanley Ave, Dayton, Ohio 45404 TWX 810-459-1642

BLOWERS, FANS, COOLING ASSEMBLIES
 MOTORS, SERVO
 MOTORS, STEPPING
 CONTINUED

MOTORS, SYNCHRONOUS

TRW INC. IRC BOONE DIV. 704-264-8861
P O Box 393, Boone, N C 28607 TWX 510-936-3241
 MODULES, RESISTANCE NETWORKS (ENCAPSULATED)

TRW INC. IRC BURLINGTON DIV. 319-754-8491
P O Box 887, Burlington, Iowa 52601 TWX 910-525-1135
 MODULES, RESISTANCE NETWORKS (ENCAPSULATED)

TRW INC. IRC ST. PETERSBURG DIV. 813-347-2181
2801 72nd St N, St Petersburg, Fla 33733 TWX 810-863-0357
 POTENTIOMETERS, TRIM (FILM)
 POTENTIOMETERS, TRIM (WIRE-WOUND)

TRW SEMICONDUCTOR DIV. 213-679-4561
14520 Aviation Blvd, Lawndale, Cal 90260 TWX 910-325-6206

CIRCUITS, HYBRID (IC AND DISCRETE-DIGITAL)
 CIRCUITS, MONOLITHIC (OP AMPS)
 CIRCUITS, THIN FILM (DIGITAL)
 CRYSTAL UNITS, QUARTZ (FOR FREQUENCY CONTROL)
 DIODES, SILICON
 DIODES, ZENER
 RECTIFIERS, SILICON CONTROLLED
 TRANSISTORS, SILICON

TRW SYSTEMS GROUP SOFTWARE & INFORMATION SYS DIV 213-536-2385
1 Space Park, Redondo Beach, Cal 90278

CONSULTING (ACCOUNTING, BUSINESS AND COMMERCIAL APPLICATIONS)
 CONSULTING (COMPUTER EVALUATIONS, SELECTIONS, INSTALLATION PLANNING)
 CONSULTING (DATA COMMUNICATIONS SYSTEMS PLANNING)
 CONSULTING (MANAGEMENT INFORMATION SYSTEMS PLANNING)
 CONSULTING (SCIENTIFIC APPLICATIONS)
 SERVICES, COMPUTER-AIDED DESIGN
 SERVICES, FACILITY MANAGEMENT
 SERVICES, MANAGEMENT INFORMATION SYSTEMS
 SERVICES, SYSTEMS ANALYSIS

TRYGON ELECTRONICS 516-378-2800
111 Pleasant Ave, Roosevelt, N Y 11575 TWX 510-225-3664

POWER SUPPLIES, DC
 VOLTMETERS, DIGITAL

TUCK ELECTRONICS 717-232-3431
235 Market St, New Cumberland, Pa 17070

ACOUSTIC COUPLERS
 COMMUNICATION SYSTEMS, DATA TRANSMISSION
 COMMUNICATION SYSTEMS, TELEPRINTER
 CONTROLLERS, MODEM
 MODEMS, ACOUSTIC
 MODEMS, HARD-WIRED
 MODEMS, PC CARD

TURNKEY SYSTEMS INC. 203-838-4581
111 E Ave, Norwalk, Conn 06851

CONSULTING (ACCOUNTING, BUSINESS AND COMMERCIAL APPLICATIONS)
 CONSULTING (COMPUTER EVALUATIONS, SELECTIONS, INSTALLATION PLANNING)
 CONSULTING (DATA COMMUNICATIONS SYSTEMS PLANNING)
 CONSULTING (MANAGEMENT INFORMATION SYSTEMS PLANNING)
 CONSULTING (SCIENTIFIC APPLICATIONS)
 PROGRAMMING LANGUAGE DEVELOPMENT (CONSULTANTS)
 PROGRAMMING LANGUAGE DEVELOPMENT (DEDICATED APPLICATION SYSTEMS)
 PROGRAMMING LANGUAGE DEVELOPMENT (PROPRIETARY SOFTWARE PRODUCTS)
 SERVICES, FACILITY MANAGEMENT
 SERVICES, SYSTEMS ANALYSIS

TUSTIN ELECTRONICS CO. 714-544-9570
17942 E Main St, Tustin, Cal 92680

AMPLIFIERS, D.C.
 AMPLIFIERS, INSTRUMENTATION
 CLOCKS, DIGITAL (REAL-TIME)
 CONVERTERS, ANALOG-TO-DIGITAL
 CONVERTERS, DC-TO-FREQUENCY
 CONVERTERS, DIGITAL-TO-ANALOG
 CONTINUED

3 Manufacturers' Directory

CONVERTERS, FREQUENCY-TO-DC
 CONVERTERS, VOLTAGE-TO-FREQUENCY
 MULTIPLEXER-CONVERTER (SINGLE UNIT WITH MULTIPLEXER, SAMPLE & HOLD
 AMPLIFIER & A-TO-D CONVERTER)
 MULTIPLEXERS, ANALOG-RELAY (SEQUENTIAL SAMPLING)
 MULTIPLEXERS, ANALOG-SOLID STATE (SEQUENTIAL SAMPLING)
 VOLTMETERS, DIGITAL

TY-DATA INC. 603-889-1155
 109 NE Blvd, Nashua, N H 03060

ENCODERS, KEYBOARD-TO-MAGNETIC TAPE

TYCO INSTRUMENT DIV. TYCO LABS. INC. 617-899-5600
 Waltham, Mass 02154 TWX 710-324-6988

CIRCUIT CARDS, LOGIC (WITH DISCRETE COMPONENTS)
 CIRCUIT CARDS, LOGIC (WITH IC'S)
 CLOCKS, DIGITAL (REAL-TIME)
 READOUTS AND DISPLAYS, NUMERIC AND ALPHANUMERIC (OTHER THAN CRT)
 VOLTMETERS, DIGITAL

TYCO LABORATORIES INC. 617-899-2400
 16 Hickory Dr, Waltham, Mass 02154

BOARDS, PRINTED CIRCUIT (WITHOUT COMPONENTS)
 CABINETS AND ENCLOSURES (FOR KEYPUNCHES, PRINTERS)
 CABINETS, ENCLOSURES, CONSOLES, ELECTRONIC (FOR GENERAL EQUIPMENT)
 CABINETS, RACKS, VAULTS (FOR MAGNETIC TAPE STORAGE)
 CELLS, PHOTOCONDUCTIVE
 COUNTERS, DIGITAL READOUT
 COUNTERS, UP-DOWN
 CRYSTAL UNITS, QUARTZ (FOR FREQUENCY CONTROL)
 DELAY LINES, MAGNETOSTRICTIVE (ALSO SEE MEMORIES)
 MEMORY SYSTEMS, DELAY LINE
 VOLTMETERS, DIGITAL

TYCO LABORATORIES INC. DIGITAL DEVICES DIV 516-921-2400
 200 Michael Dr, Syosset, N Y 11791 TWX 510-221-2187
 DELAY LINES, MAGNETOSTRICTIVE (ALSO SEE MEMORIES)
 MEMORY SYSTEMS, DELAY LINE

TYMSHARE INC. 415-328-5990
 525 University Ave, Palo Alto, Cal 94301

ACOUSTIC COUPLERS
 COMMUNICATION SYSTEMS, DATA TRANSMISSION
 COMPUTERS, MINI GENERAL PURPOSE (ALSO SEE CALCULATORS)
 MODEMS, ACOUSTIC
 SERVICES, TIME SHARING (COMMERCIAL)

TYMSHARE INC. 617-969-1800
 1001 Watertown St, West Newton, Mass 02165

CONSULTING (ACCOUNTING, BUSINESS AND COMMERCIAL APPLICATIONS)
 CONSULTING (MANAGEMENT INFORMATION SYSTEMS PLANNING)
 CONSULTING (SCIENTIFIC APPLICATIONS)
 SERVICES, TIME SHARING (COMMERCIAL)
 SERVICES, TIME SHARING (RESEARCH)

TYROTEK INC. 415-376-7095
 P O Box 254, Moraga, Cal 94556

COMPUTERS, ANALOG (GENERAL-PURPOSE)

U.S. CAPACITOR CORP. 213-843-4222
 2151 N Lincoln St, Burbank, Cal 91504 TWX 910-498-2222
 CAPACITORS, COMPUTER GRADE
 FILTERS (ACTIVE, LC, NOISE, ETC.)

U.S. COMPONENTS INC. 212-824-1600
 1320 Zerega Ave, Bronx, N Y 10462 TWX 710-593-2141

CABLE ASSEMBLIES (WITH CONNECTORS)
 CONNECTORS, COAXIAL (COMPUTER-GRADE)
 CONNECTORS, MINIATURE AND SUB-MINIATURE (COMPUTER-GRADE)
 CONNECTORS, PC AND IC BOARD (COMPUTER-GRADE)
 CONNECTORS, POWER (COMPUTER-GRADE)
 CONNECTORS, RACK AND PANEL (COMPUTER-GRADE)

U. S. MAGNETIC TAPE CO. WABASH MAGNETICS 312-669-5181
 P O Box 128, Huntley, Ill 60142 TWX 910-651-1800
 DISC PACKS, MAGNETIC
 REELS, MAGNETIC TAPE

U.S. TIME-SHARING INC. 703-471-9000
 1831 Michael Faraday, Reston, Va 22070

CONSULTING (ACCOUNTING, BUSINESS AND COMMERCIAL APPLICATIONS)
 CONSULTING (ADVANCED COMPUTER EQUIPMENT DESIGN AND FEASIBILITY
 STUDIES)
 CONSULTING (DATA COMMUNICATIONS SYSTEMS PLANNING)
 CONSULTING (SCIENTIFIC APPLICATIONS)
 PROGRAMMING LANGUAGE DEVELOPMENT (PROPRIETARY SOFTWARE
 PRODUCTS)
 SERVICES, MANAGEMENT INFORMATION SYSTEMS
 SERVICES, PROCESSING (COMMERCIAL EDP)
 SERVICES, TIME SHARING (COMMERCIAL)
 SERVICES, TIME SHARING (RESEARCH)
 SERVICES, SYSTEMS ANALYSIS
 TRAINING INSTITUTES, COMMERCIAL COMPUTER COURSES, SEMINARS,
 CORRESPONDENCE COURSES

ULTRONIC SYSTEMS CORP. 609-235-7300
 Mt Laurel Ind Pk, Moorestown, N J 08057

ACOUSTIC COUPLERS
 COMMUNICATIONS-ORIENTED PROCESSORS, MULTIPLE CHANNEL CONTROLLERS
 COMMUNICATIONS-ORIENTED PROCESSORS, SINGLE CHANNEL CONTROLLERS
 COMMUNICATIONS-ORIENTED PROCESSORS, STORED PROGRAM
 COMMUNICATION SYSTEMS, DATA TRANSMISSION
 COMMUNICATION SYSTEMS, TELEPRINTER
 CONTROLLERS, MODEM
 DATA CONCENTRATORS
 DATA TERMINALS, BLOCK-BY-BLOCK (HIGH SPEED PRINTER)
 DATA TERMINALS, INQUIRY-RESPONSE (ALPHANUMERIC KEYBOARD)
 DATA TERMINALS, INQUIRY-RESPONSE (CRT WITH KEYBOARD)
 DATA TERMINALS, INQUIRY-RESPONSE (SPECIAL-PURPOSE)
 MODEMS, ACOUSTIC
 MODEMS, HARD-WIRED

ULTRONIX INC. 303-242-0810
 P O Box 1090, Grand Junction, Colo 81501 TWX 910-929-6965
 POWER SUPPLIES, AC
 POWER SUPPLIES, DC

UNGERLEIDER & CO. 703-360-4400
 P O Box 1180, Alexandria, Va 22313 TWX 301-369-4414

CONSULTING (ACCOUNTING, BUSINESS AND COMMERCIAL APPLICATIONS)
 CONSULTING (COMPUTER PRODUCT PLANNING SURVEYS, MARKET RESEARCH
 STUDIES)
 FLOORING (FOR EDP ROOMS)
 TRAINING INSTITUTES, COMMERCIAL COMPUTER COURSES, SEMINARS,
 CORRESPONDENCE COURSES

UNICOM INC. 201-228-1696
 1275 Bloomfield Ave, Fairfield, N J 07006

ACOUSTIC COUPLERS
 COMPUTERS, MINI GENERAL PURPOSE (ALSO SEE CALCULATORS)
 COMPUTERS, PROCESS CONTROL
 DATA TERMINALS, INQUIRY-RESPONSE (ALPHANUMERIC KEYBOARD)
 DATA TERMINALS, INQUIRY-RESPONSE (CRT WITH KEYBOARD)
 MAGNETIC TAPE STORAGE SYSTEMS (INCLUDES CONTROLLER)
 MEMORY SYSTEMS, MAGNETIC CORE
 MEMORY SYSTEMS, READ-ONLY
 PRINTERS, LINE (LOW & MEDIUM SPEED)

UNICOMP INC. 213-886-7722
 18219 Parthenia, Northridge, Cal 91324

CLOCKS, DIGITAL (REAL-TIME)
 COMMUNICATIONS-ORIENTED PROCESSORS, MULTIPLE CHANNEL CONTROLLERS
 COMMUNICATIONS-ORIENTED PROCESSORS, STORED PROGRAM
 COMMUNICATION SYSTEMS, DATA TRANSMISSION
 COMMUNICATION SYSTEMS, TELEPRINTER
 COMPUTERS, DIGITAL (EDUCATIONAL)
 COMPUTERS, DIGITAL (GENERAL-PURPOSE, SMALL-SCALE)
 COMPUTERS, MINI GENERAL PURPOSE (ALSO SEE CALCULATORS)
 COMPUTERS, NAVIGATION
 COMPUTERS, PROCESS CONTROL
 CONTROLLERS, MAGNETIC DISC
 CONTROLLERS, MAGNETIC DRUM
 CONTROLLERS, MODEM
 CONVERTERS, ANALOG-TO-DIGITAL
 CONVERTERS, BINARY-TO-DECIMAL
 CONTINUED

3 Manufacturers' Directory

CONVERTERS, DIGITAL-TO-ANALOG
 CONVERTERS, DIGITAL-TO-SYNCHRO
 CONVERTERS, MAGNETIC TAPE-TO-PUNCHED CARD
 CONVERTERS, PAPER TAPE-TO-MAGNETIC TAPE
 CONVERTERS, PUNCHED CARD-TO-MAGNETIC TAPE
 CONVERTERS, SYNCHRO-TO-DIGITAL
 DATA ACQUISITION AND REDUCTION SYSTEMS
 DATA CONCENTRATORS
 DATA TERMINALS, INQUIRY-RESPONSE (CRT WITH KEYBOARD)
 DISC DRIVES, FIXED HEAD (INCLUDING CONTROLLER)
 DISC DRIVES, MOVABLE HEAD (INCLUDING CONTROLLER)
 DISC DRIVES, REMOVABLE CARTRIDGE
 DISC STORAGE SYSTEMS
 DISPLAY DRIVERS
 DRUM STORAGE EQUIPMENT, MAG-NETIC (INCLUDING CONTROLLER)
 MAGNETIC TAPE STORAGE SYSTEMS (INCLUDES CONTROLLER)
 MEMORY SYSTEMS, MAGNETIC CORE
 MEMORY SYSTEMS, MAGNETIC DISC
 MEMORY SYSTEMS, MAGNETIC DRUM
 MEMORY SYSTEMS, READ-ONLY
 MULTIPLEXER-CONVERTER (SINGLE UNIT WITH MULTIPLEXER, SAMPLE & HOLD
 AMPLIFIER & A-TO-D CONVERTER)
 POWER SUPPLIES, DC
 PRINTERS, LINE (LOW & MEDIUM SPEED)
 PRINTERS, LINE (HIGH SPEED)
 PROGRAMMING LANGUAGE DEVELOPMENT (DEDICATED APPLICATION SYSTEMS)
 PUNCHES, CARD (OVER 100 CPM)
 PUNCHES, PAPER TAPE
 READERS, PAPER TAPE
 READERS, PUNCHED CARD (OVER 300 CPM)
 SCANNERS, INPUT
 TAPE TRANSPORTS, MAGNETIC (DIGITAL-EXCL. CASSETTE)
 TAPE TRANSPORTS, MAGNETIC (DIGITAL CASSETTE)
 TYPEWRITERS, COMPUTER INPUT-OUTPUT

UNIMAX SWITCH CORP. SUB. RIKER-MAXSON 203-269-8701
Ives Rd, Wallingford, Conn 06492 TWX 710-476-1397

DATA TERMINALS, INQUIRY-RESPONSE (ALPHANUMERIC KEYBOARD)
 ENCODERS, KEYBOARD (ALPHANUMERIC)
 ENCODERS, KEYBOARD (NUMERIC)
 INDICATORS, ILLUMINATED
 SWITCHES, PUSHBUTTON
 SWITCHES, PUSHBUTTON (ILLUMINATED)
 SWITCHES, SNAP ACTION
 SWITCHES, TOGGLE (MINIATURE)

UNION CARBIDE CORP. COMPONENTS DEPT. 803-963-7421
P O Box 5928, Greenville, S C 29606 TWX 810-287-2536
 CAPACITORS, COMPUTER GRADE

UNITAB CO. OF ABILENE 915-673-3779
418 Chestnut St, Abilene, Tex 79604

SERVICES, PROCESSING (COMMERCIAL EDP)

UNITED BUSINESS COMMUNICATIONS INC. 913-362-5300
6405 Metcalf Ave, Shawnee Mission, Kans 66202 TWX 910-743-6819

COMMUNICATION SYSTEMS, DATA TRANSMISSION
 CONTROLLERS, MODEM
 DATA TERMINALS, BLOCK-BY-BLOCK (PUNCHED CARD)
 MARK SENSING EQUIPMENT
 MODEMS, HARD-WIRED
 MODEMS, PC CARD
 PRINTERS, LINE (LOW & MEDIUM SPEED)
 PUNCHES, CARD (UP TO 100 CPM)
 READERS, PUNCHED CARD (100 TO 300 CPM)
 READERS, PUNCHED CARD (OVER 300 CPM)

UNITED COMPUTING CORP. 213-830-7720
22500 S Avalon Blvd, Carson, Cal 90744

CONSULTING (ACCOUNTING, BUSINESS AND COMMERCIAL APPLICATIONS)
 CONSULTING (COMPUTER EVALUATIONS, SELECTIONS, INSTALLATION
 PLANNING)
 CONSULTING (MANAGEMENT INFORMATION SYSTEMS PLANNING)
 PROGRAMMING LANGUAGE DEVELOPMENT (CONSULTANTS)
 PROGRAMMING LANGUAGE DEVELOPMENT (CONTRACT PROGRAMMING)
 PROGRAMMING LANGUAGE DEVELOPMENT (DEDICATED APPLICATION SYSTEMS)
 PROGRAMMING LANGUAGE DEVELOPMENT (PROPRIETARY SOFTWARE
 PRODUCTS)

UNITED COMPUTING SYSTEMS INC. 816-753-4500
3130 Broadway, Kansas City, Mo 64111

CONSULTING (DATA COMMUNICATIONS SYSTEMS PLANNING)
 CONSULTING (MANAGEMENT INFORMATION SYSTEMS PLANNING)
 CONTINUED

PROGRAMMING LANGUAGE DEVELOPMENT (CONSULTANTS)
 PROGRAMMING LANGUAGE DEVELOPMENT (CONTRACT PROGRAMMING)
 PROGRAMMING LANGUAGE DEVELOPMENT (DEDICATED APPLICATION SYSTEMS)
 PROGRAMMING LANGUAGE DEVELOPMENT (PROPRIETARY SOFTWARE
 PRODUCTS)
 SERVICES, FACILITY MANAGEMENT
 SERVICES, MANAGEMENT INFORMATION SYSTEMS
 SERVICES, PROCESSING (COMMERCIAL EDP)
 SERVICES, PROCESSING (DIGITAL SCIENTIFIC)
 SERVICES, TIME SHARING (COMMERCIAL)
 SERVICES, TIME SHARING (RESEARCH)
 SERVICES, SYSTEMS ANALYSIS
 TRAINING INSTITUTES, COMMERCIAL COMPUTER COURSES, SEMINARS,
 CORRESPONDENCE COURSES
 TRAINING SYSTEMS, COMPUTER SERVICE

UNITED DATA CENTERS INC. 203-531-8200
100 Putnam Green, Greenwich, Conn 06830

CONSULTING (ACCOUNTING, BUSINESS AND COMMERCIAL APPLICATIONS)
 SERVICES, FACILITY MANAGEMENT
 SERVICES, PROCESSING (COMMERCIAL EDP)
 SERVICES, SYSTEMS ANALYSIS

UNITED SYSTEMS CORP. 513-254-6251
918 Woodley Rd, Dayton, Ohio 45403 TWX 810-459-1728
 PRINTERS, LINE (LOW & MEDIUM SPEED)
 VOLTMETERS, DIGITAL

UNITED SYSTEMS INC. 609-667-6565
1020 Kings Hwy N, Cherry Hill, N J 08034

CONSULTING (ACCOUNTING, BUSINESS AND COMMERCIAL APPLICATIONS)
 CONSULTING (COMPUTER EVALUATIONS, SELECTIONS, INSTALLATION
 PLANNING)
 CONSULTING (DATA COMMUNICATIONS SYSTEMS PLANNING)
 CONSULTING (MANAGEMENT INFORMATION SYSTEMS PLANNING)
 PROGRAMMING LANGUAGE DEVELOPMENT (CONSULTANTS)
 PROGRAMMING LANGUAGE DEVELOPMENT (CONTRACT PROGRAMMING)
 PROGRAMMING LANGUAGE DEVELOPMENT (DEDICATED APPLICATION SYSTEMS)
 PROGRAMMING LANGUAGE DEVELOPMENT (PROPRIETARY SOFTWARE
 PRODUCTS)
 SERVICES, FACILITY MANAGEMENT
 SERVICES, MANAGEMENT INFORMATION SYSTEMS
 SERVICES, PROCESSING (COMMERCIAL EDP)
 SERVICES, TIME SHARING (COMMERCIAL)
 SERVICES, SYSTEMS ANALYSIS

UNITED TELECONTROL ELEXS & INC. MEMORY SYS DIV 201-922-1000
3500 Sunset Ave, Asbury Park, N J 07712 TWX 710-723-8638
 MEMORY PLANES AND STACKS, MAG-NETIC CORE (W/O ELECTRONICS)
 MEMORY SYSTEMS, MAGNETIC CORE

UNITED TRANSFORMER CO. DIV. OF TRW INC. 212-255-3500
150 Varick St, New York, N Y 10013 TWX 710-581-2722
 TRANSFORMERS, POWER (COMPUTER GRADE)
 TRANSFORMERS, PULSE (COMPUTER GRADE)

UNITRODE CORP. 617-926-0404
580 Pleasant St, Watertown, Mass 02170 TWX 710-327-1296
 DIODES, SILICON
 DIODES, ZENER
 TRANSISTORS, SILICON

UNIVAC DATA PROCESSING SRVCS. DIV. SPERRY RAND 516-248-5544
60 Herricks Rd, Mineola, N Y 11501

SERVICES, FACILITY MANAGEMENT
 SERVICES, PROCESSING (COMMERCIAL EDP)
 SERVICES, TIME SHARING (COMMERCIAL)

UNIVERSAL AD-YU ELECTRONICS INC. 201-472-5622
249-259 Terhune Ave, Passaic, N J 07055

AMPLIFIERS, INSTRUMENTATION
 ANALYZERS, WAVEFORM
 MEMORY SYSTEMS, DELAY LINE

UNIVERSAL DATA SYSTEMS INC. 714-897-1033
14482 Beach Blvd, Westminster, Cal 92626

CONSULTING (ACCOUNTING, BUSINESS AND COMMERCIAL APPLICATIONS)
 CONSULTING (ADVANCED COMPUTER EQUIPMENT DESIGN AND FEASIBILITY
 STUDIES)

3 Manufacturers' Directory

CONSULTING (COMPUTER EVALUATIONS, SELECTIONS, INSTALLATION PLANNING)
 CONSULTING (DATA COMMUNICATIONS SYSTEMS PLANNING)
 CONSULTING (COMPUTER PRODUCT PLANNING SURVEYS, MARKET RESEARCH STUDIES)
 CONSULTING (MANAGEMENT INFORMATION SYSTEMS PLANNING)
 CONSULTING (SCIENTIFIC APPLICATIONS)
 PROGRAMMING LANGUAGE DEVELOPMENT (CONSULTANTS)
 PROGRAMMING LANGUAGE DEVELOPMENT (CONTRACT PROGRAMMING)
 PROGRAMMING LANGUAGE DEVELOPMENT (DEDICATED APPLICATION SYSTEMS)
 PROGRAMMING LANGUAGE DEVELOPMENT (PROPRIETARY SOFTWARE PRODUCTS)
 SERVICES, MANAGEMENT INFORMATION SYSTEMS
 SERVICES, SYSTEMS ANALYSIS
 TRAINING INSTITUTES, COMMERCIAL COMPUTER COURSES, SEMINARS, CORRESPONDENCE COURSES

UNIVERSAL DRAFTING MACHINE CORP. 216-292-7550
 5200 Richmond Rd, Bedford Heights, Ohio 44146

DRAFTING SYSTEMS, COMPUTER-CONTROLLED STORAGE

UNIVERSAL INFORMATION SYSTEMS INC. 201-845-7444
 S-10 Rte 17 At Rte 4, Paramus, N J 07652

CONSULTING (ACCOUNTING, BUSINESS AND COMMERCIAL APPLICATIONS)
 CONSULTING (COMPUTER EVALUATIONS, SELECTIONS, INSTALLATION PLANNING)
 SERVICES, FACILITY MANAGEMENT
 SERVICES, PROCESSING (COMMERCIAL EDP)
 TRAINING INSTITUTES, COMMERCIAL COMPUTER COURSES, SEMINARS, CORRESPONDENCE COURSES

UNIVERSAL INSTRUMENTS CORP. 607-772-1710
 E Frederick St, Binghamton, N Y 13902 TWX 510-252-1990

BOARDS, PRINTED CIRCUIT (WITHOUT COMPONENTS)
 BREADBOARDS

UNIVERSAL RELAY CORP. 212-925-6900
 42 White St, New York, N Y 10013 TWX 710-581-4461

RELAYS, DRY REED (COMPUTER GRADE)
 RELAYS, MERCURY WETTED (COMPUTER GRADE)
 RELAYS, SOLID-STATE (COMPUTER GRADE)
 SWITCHES, DRY REED
 SWITCHES, PUSHBUTTON
 SWITCHES, PUSHBUTTON (ILLUMINATED)
 SWITCHES, SNAP ACTION
 SWITCHES, THUMBWHEEL
 SWITCHES, TOGGLE (MINIATURE)

UNIVERSAL TECHNOLOGY INC. 201-227-2118
 3 Spielman Rd, Fairfield, N J 07006

CONSOLES, CRT (ALPHANUMERIC AND GRAPHIC)
 CONSOLES, CRT (GRAPHIC)
 DATA TERMINALS, INQUIRY-RESPONSE (ALPHANUMERIC KEYBOARD)
 DATA TERMINALS, INQUIRY-RESPONSE (CRT WITH KEYBOARD)
 ENCODERS, KEYBOARD (ALPHANUMERIC)
 ENCODERS, KEYBOARD (NUMERIC)
 READOUTS, CRT

UNIVERSITY COMPUTING CO. 214-350-1211
 P O Box 6228, Dallas, Tex 75222 TWX 910-861-4990

ACOUSTIC COUPLERS
 COMMUNICATIONS-ORIENTED PROCESSORS, MULTIPLE CHANNEL CONTROLLERS
 COMMUNICATIONS-ORIENTED PROCESSORS, SINGLE CHANNEL CONTROLLERS
 COMMUNICATIONS-ORIENTED PROCESSORS, STORED PROGRAM
 COMMUNICATION SYSTEMS, DATA TRANSMISSION
 CONSULTING (ACCOUNTING, BUSINESS AND COMMERCIAL APPLICATIONS)
 CONSULTING (ADVANCED COMPUTER EQUIPMENT DESIGN AND FEASIBILITY STUDIES)
 CONSULTING (COMPUTER EVALUATIONS, SELECTIONS, INSTALLATION PLANNING)
 CONSULTING (DATA COMMUNICATIONS SYSTEMS PLANNING)
 CONSULTING (COMPUTER PRODUCT PLANNING SURVEYS, MARKET RESEARCH STUDIES)
 CONSULTING (MANAGEMENT INFORMATION SYSTEMS PLANNING)
 CONSULTING (SCIENTIFIC APPLICATIONS)
 CONTROLLERS, MODEM
 DATA CONCENTRATORS
 DATA TERMINALS, BLOCK-BY-BLOCK (GRAPHIC DIGITIZERS)
 DATA TERMINALS, BLOCK-BY-BLOCK (MAGNETIC TAPE)
 DATA TERMINALS, BLOCK-BY-BLOCK (MULTI-PURPOSE)
 DATA TERMINALS, BLOCK-BY-BLOCK (PAPER TAPE)
 DATA TERMINALS, BLOCK-BY-BLOCK (PLOTTER)
 DATA TERMINALS, BLOCK-BY-BLOCK (HIGH SPEED PRINTER)
 CONTINUED

DATA TERMINALS, BLOCK-BY-BLOCK (MEDIUM SPEED PRINTER)
 DATA TERMINALS, BLOCK-BY-BLOCK (PUNCHED CARD)
 DATA TERMINALS, BLOCK-BY-BLOCK (TELEPRINTER)
 DATA TERMINALS, INQUIRY-RESPONSE (ALPHANUMERIC KEYBOARD)
 DATA TERMINALS, INQUIRY-RESPONSE (SPECIAL-PURPOSE)
 LEASING, EDP EQUIPMENT (OTHER THAN MFGRS)
 MODEMS, ACOUSTIC
 PROGRAMMING LANGUAGE DEVELOPMENT (CONSULTANTS)
 PROGRAMMING LANGUAGE DEVELOPMENT (CONTRACT PROGRAMMING)
 PROGRAMMING LANGUAGE DEVELOPMENT (DEDICATED APPLICATION SYSTEMS)
 PROGRAMMING LANGUAGE DEVELOPMENT (PROPRIETARY SOFTWARE PRODUCTS)
 PUNCHES, CARD (OVER 100 CPM)
 PUNCHES, CARD (UP TO 100 CPM)
 READERS, PUNCHED CARD (100 TO 300 CPM)
 READERS, PUNCHED CARD (OVER 300 CPM)
 RECONDITIONING EQUIPMENT, PUNCHED CARD
 SERVICES, COMPUTER-AIDED DESIGN
 SERVICES, FACILITY MANAGEMENT
 SERVICES, MANAGEMENT INFORMATION SYSTEMS
 SERVICES, PROCESSING (COMMERCIAL EDP)
 SERVICES, PROCESSING (DIGITAL SCIENTIFIC)
 SERVICES, TIME SHARING (COMMERCIAL)
 SERVICES, TIME SHARING (RESEARCH)
 SERVICES, HARDWARE MAINTENANCE
 SERVICES, SYSTEMS ANALYSIS
 USED EQUIPMENT (BUYING, SELLING, LEASING)

UNIVERSITY COMPUTING CO. 213-322-3093
 888 N Sepulveda Blvd, El Segundo, Cal 90245 TWX 910-348-6289

ACOUSTIC COUPLERS
 BREADBOARDS
 CABLE, COAXIAL (FLEXIBLE)
 CABLE, COAXIAL (SEMI/RIGID)
 CALCULATORS, PROGRAMMABLE (ALSO SEE COMPUTERS)
 CIRCUIT CARDS, LINEAR (WITH DISCRETE COMPONENTS)
 CIRCUIT CARDS, LINEAR (WITH IC'S)
 CIRCUITS, MONOLITHIC (DIGITAL LOGIC)
 CIRCUITS, THICK FILM (DIGITAL)
 CLOCKS, DIGITAL (REAL-TIME)
 COMMUNICATIONS-ORIENTED PROCESSORS, MULTIPLE CHANNEL CONTROLLERS
 COMMUNICATIONS-ORIENTED PROCESSORS, SINGLE CHANNEL CONTROLLERS
 COMMUNICATIONS-ORIENTED PROCESSORS, STORED PROGRAM
 COMMUNICATION SYSTEMS, DATA TRANSMISSION
 COMMUNICATION SYSTEMS, FACSIMILE
 COMPUTERS, DIGITAL (GENERAL-PURPOSE, SMALL-SCALE)
 COMPUTERS, DIGITAL (GENERAL-PURPOSE, MEDIUM-SCALE)
 COMPUTERS, DIGITAL (GENERAL-PURPOSE, LARGE SCALE)
 COMPUTERS, PROCESS CONTROL
 CONVERTERS, DOCUMENT-TO-PAPER TAPE
 CONVERTERS, MAGNETIC TAPE-TO-MICROFILM
 DATA TERMINALS, BLOCK-BY-BLOCK (GRAPHIC DIGITIZERS)
 DATA TERMINALS, BLOCK-BY-BLOCK (MAGNETIC TAPE)
 DATA TERMINALS, BLOCK-BY-BLOCK (MULTI-PURPOSE)
 DATA TERMINALS, BLOCK-BY-BLOCK (PAPER TAPE)
 GUIDES, CIRCUIT CARDS
 MODULES, DIGITAL LOGIC ENCAPSULATED (ALSO SEE CIRCUITS & CIRCUIT CARDS)
 MODULES, LINEAR (ENCAPSULATED)
 MODULES, MEMORY (ENCAPSULATED)
 MODULES, RESISTANCE NETWORKS (ENCAPSULATED)

UNIVERSITY COMPUTING CO. DATA COMM. SYSTEMS 214-241-3501
 2659 Nova Dr, Dallas, Tex 75229 TWX 910-860-5503

COMMUNICATIONS-ORIENTED PROCESSORS, MULTIPLE CHANNEL CONTROLLERS
 COMMUNICATIONS-ORIENTED PROCESSORS, SINGLE CHANNEL CONTROLLERS
 COMMUNICATIONS-ORIENTED PROCESSORS, STORED PROGRAM
 COMMUNICATION SYSTEMS, DATA TRANSMISSION
 DATA CONCENTRATORS
 DATA TERMINALS, BLOCK-BY-BLOCK (MAGNETIC TAPE)
 DATA TERMINALS, BLOCK-BY-BLOCK (MULTI-PURPOSE)
 DATA TERMINALS, BLOCK-BY-BLOCK (PAPER TAPE)
 DATA TERMINALS, BLOCK-BY-BLOCK (PLOTTER)
 DATA TERMINALS, BLOCK-BY-BLOCK (HIGH SPEED PRINTER)
 DATA TERMINALS, BLOCK-BY-BLOCK (MEDIUM SPEED PRINTER)
 DATA TERMINALS, BLOCK-BY-BLOCK (PUNCHED CARD)
 FORMS HANDLING, STACKERS

UNIVERSITY COMPUTING CO. DATEL DIV. 703-893-3700
 1 Tysons Corner Ctr, McLean, Va 22101 TWX 710-833-9899

ACOUSTIC COUPLERS
 DATA TERMINALS, INCREMENTAL (MAGNETIC TAPE)
 DATA TERMINALS, INQUIRY-RESPONSE (ALPHANUMERIC KEYBOARD)
 MODEMS, ACOUSTIC
 MODEMS, HARD-WIRED
 RECORDERS, MAGNETIC TAPE
 TAPE, MAGNETIC (CASSETTE)
 TAPE TRANSPORTS, MAGNETIC (INCREMENTAL)
 TAPE TRANSPORTS, MAGNETIC (WITH KEYBOARD INPUT)
 TYPEWRITERS, COMPUTER INPUT-OUTPUT

3 Manufacturers' Directory

UNIVERSITY COMPUTING CO. GRAPHIC SYSTEMS DIV 14761 Califa St, Van Nuys, Cal 91401	213-781-7100	V.I.Z. MANUFACTURING CO. 335 E Price St, Philadelphia, Pa 19144	215-844-2626
CAMERAS, COM CONVERTERS, DOCUMENT-TO-MAGNETIC TAPE CONVERTERS, DOCUMENT-TO-PAPER TAPE CONVERTERS, DOCUMENT-TO-UNIT RECORDS PLOTTERS, FILM EXPOSING CURVE TRACERS-DIGITIZERS, AUTOMATIC CURVE TRACERS-DIGITIZERS, MANUAL DIGITIZERS, PROGRAMMABLE DRAFTING SYSTEMS, COMPUTER-CONTROLLED STORAGE MICROFICHE PLOTTERS, MOVING PEN (ANALOG CONTROLLER) PLOTTERS, MOVING PEN (DIGITAL CONTROLLER) RECORDERS, MICROFILM/MICROFICHE SERVICES, FACILITY MANAGEMENT		BOARDS, PRINTED CIRCUIT (WITHOUT COMPONENTS) COMMUTATORS, SWITCHING (ELECTRIC) CONNECTORS, PC AND IC BOARD (COMPUTER-GRADE) KNOBS, DIALS (FOR COMPUTER CONSOLES) TERMINAL BLOCKS, STRIPS, BOARDS	
URAY PROOF CORP. 50 Keeler Ave, Norwalk, Conn 06856	203-838-4555	VADIC CORP., THE 916 Commercial St, Palo Alto, Cal 94303	415-321-6201
CABINETS AND ENCLOSURES (FOR KEYPUNCHES, PRINTERS) CABINETS, ENCLOSURES, CONSOLES, ELECTRONIC (FOR GENERAL EQUIPMENT) CABINETS, RACKS, VAULTS (FOR MAGNETIC TAPE STORAGE)		ACOUSTIC COUPLERS MODEMS, ACOUSTIC MODEMS, HARD-WIRED MODEMS, PC CARD	
URBAN DATA PROCESSING INC. 552 Massachusetts Ave, Cambridge, Mass 02139	617-868-8720	VALOR ELECTRONICS INC. 3100 Pullman St, Costa Mesa, Cal 92627	714-540-9261
CONSULTING (MANAGEMENT INFORMATION SYSTEMS PLANNING) PROGRAMMING LANGUAGE DEVELOPMENT (CONSULTANTS) PROGRAMMING LANGUAGE DEVELOPMENT (CONTRACT PROGRAMMING) PROGRAMMING LANGUAGE DEVELOPMENT (DEDICATED APPLICATION SYSTEMS) PROGRAMMING LANGUAGE DEVELOPMENT (PROPRIETARY SOFTWARE PRODUCTS)		MEMORY SYSTEMS, DELAY LINE TRANSFORMERS, PULSE (COMPUTER GRADE)	
URIEL CORP. 53 Union Ave, Ronkonkoma, N Y 11779	516-588-6010	VALOR INSTRUMENTS INC. 2430 Amsler, Torrance, Cal 90505	213-534-2533
MOTORS, SERVO MOTORS, SYNCHRONOUS MOTORS, TORQUE SERVOS, COMPUTER		POWER SUPPLIES, DC	
URS DATA SCIENCE CO. 155 Bovet Rd, San Mateo, Cal 94402	415-574-5000 TWX 910-375-3380	VALPEY FISHER CORP. 1015 1st St, Holliston, Mass 01746	617-429-4392
CONSULTING (ACCOUNTING, BUSINESS AND COMMERCIAL APPLICATIONS) CONSULTING (COMPUTER EVALUATIONS, SELECTIONS, INSTALLATION PLANNING) CONSULTING (DATA COMMUNICATIONS SYSTEMS PLANNING) CONSULTING (MANAGEMENT INFORMATION SYSTEMS PLANNING) PROGRAMMING LANGUAGE DEVELOPMENT (CONSULTANTS) PROGRAMMING LANGUAGE DEVELOPMENT (CONTRACT PROGRAMMING) PROGRAMMING LANGUAGE DEVELOPMENT (DEDICATED APPLICATION SYSTEMS) PROGRAMMING LANGUAGE DEVELOPMENT (PROPRIETARY SOFTWARE PRODUCTS) SERVICES, FACILITY MANAGEMENT SERVICES, MANAGEMENT INFORMATION SYSTEMS SERVICES, PROCESSING (COMMERCIAL EDP) SERVICES, TIME SHARING (COMMERCIAL) SERVICES, TIME SHARING (RESEARCH) SERVICES, SYSTEMS ANALYSIS		CRYSTAL UNITS, QUARTZ (FOR FREQUENCY CONTROL)	
USM CORP. GEAR SYSTEMS DIV. 101 Balch St, Beverly, Mass 01915	617-927-4200	VALPEY FISHER CORP. DIV. CLARK CRYSTAL 344 Boston Post Rd, Marlboro, Mass 01752	617-481-0821
MOTORS, SERVO MOTORS, STEPPING MOTORS, SYNCHRONOUS SERVOS, COMPUTER SYNCHROS-RESOLVERS, CONTROL TRANSFORMERS		CRYSTAL UNITS, QUARTZ (FOR FREQUENCY CONTROL)	
USM CORP. ELECTRONIC CONTROL GROUP 140 Federal St, Boston, Mass 02107	617-542-9100	VARADYNE INC. 320-B Martina Ave, Santa Clara, Cal 95050	408-296-1730
COMPUTERS, DIGITAL (GENERAL-PURPOSE, SMALL-SCALE) COMPUTERS, MINI GENERAL PURPOSE (ALSO SEE CALCULATORS) CONTROLLERS, MOTOR MOTORS, STEPPING MOTORS, SYNCHRONOUS		TESTERS, CIRCUIT TESTERS, DIGITAL LOGIC MODULES AND CARDS TESTERS, INTEGRATED CIRCUIT TESTERS, SEMICONDUCTOR	
UTILITY CONSULTING SERVICES CO. 888 N Sepulveda Blvd, El Segundo, Cal 90245	213-322-9217	VARIAN ASSOCIATES GRAPHICS & DATA SYSTEMS DIV. 611 Hansen Way, Palo Alto, Cal 94303	415-326-4000 TWX 910-373-1731
CONSULTING (SCIENTIFIC APPLICATIONS) PROGRAMMING LANGUAGE DEVELOPMENT (PROPRIETARY SOFTWARE PRODUCTS)		AMPLIFIERS, INSTRUMENTATION CIRCUIT CARDS, LINEAR (WITH IC'S) CIRCUIT CARDS, LOGIC (WITH IC'S) CONVERTERS, ANALOG-TO-DIGITAL CONVERTERS, DIGITAL-TO-ANALOG MULTIPLEXER-CONVERTER (SINGLE UNIT WITH MULTIPLEXER, SAMPLE & HOLD AMPLIFIER & A-TO-D CONVERTER) PAPER (FOR RECORDERS AND PLOTTERS) PRINTERS, LINE (HIGH SPEED) PROGRAMMING LANGUAGE DEVELOPMENT (DEDICATED APPLICATION SYSTEMS) PROGRAMMING LANGUAGE DEVELOPMENT (PROPRIETARY SOFTWARE PRODUCTS) RECORDERS, GRAPHIC RECORDERS, HARD-COPY (WITH CRT)	
		VARIAN DATA MACHINES 2722 Michelson Dr, Irvine, Cal 92664	714-833-2400 TWX 910-596-1358
		COMMUNICATIONS-ORIENTED PROCESSORS, MULTIPLE CHANNEL CONTROLLERS COMMUNICATIONS-ORIENTED PROCESSORS, SINGLE CHANNEL CONTROLLERS COMMUNICATIONS-ORIENTED PROCESSORS, STORED PROGRAM COMMUNICATION SYSTEMS, DATA TRANSMISSION COMPUTERS, DIGITAL (GENERAL-PURPOSE, SMALL-SCALE) COMPUTERS, MINI GENERAL PURPOSE (ALSO SEE CALCULATORS) CONTROLLERS, MODEM DATA CONCENTRATORS MEMORY SYSTEMS, READ-ONLY	
		VARIFAB INC. SUB. CONDEC CORP. 1700 E Putnam Ave, Old Greenwich, Conn 06880	203-637-1434
		PUNCHES, CARD (PORTABLE) RECORDERS, PAPER TAPE	

3 Manufacturers' Directory

VARO INC. STATIC POWER DIV.
1600 Dallas Pkwy, Plano, Tex 75074
 CONVERTERS, DC-TO-FREQUENCY
 CONVERTERS, FREQUENCY-TO-DC
 CONVERTERS, VOLTAGE-TO-FREQUENCY
 INVERTERS, DC-AC
 POWER SUPPLIES, AC
 POWER SUPPLIES, DC
 REGULATORS, CURRENT
 REGULATORS, FREQUENCY
 REGULATORS, VOLTAGE
 VOLTAGE DIVIDERS

214-424-5621
TWX 910-860-5640

VARO INC., TEXAS DIV.
Po Box 828, Garland, Tex 75040
 POWER SUPPLIES, AC
 POWER SUPPLIES, DC

214-276-6141
TWX 910-860-5093

VECTOR ELECTRONIC CO. INC.
12460 Gladstone Ave, Sylmar, Cal 91342
 BOARDS, PRINTED CIRCUIT (WITHOUT COMPONENTS)
 BREADBOARDS
 CABINETS, ENCLOSURES, CONSOLES, ELECTRONIC (FOR GENERAL EQUIPMENT)
 CONNECTORS, MINIATURE AND SUB-MINIATURE (COMPUTER-GRADE)
 CONNECTORS, PC AND IC BOARD (COMPUTER-GRADE)
 CORDS, PATCH
 DEMONSTRATORS AND KITS, EDUCATIONAL (DIGITAL LOGIC)
 GUIDES, CIRCUIT CARDS
 HANDLES, TEST POINT STRIPS (FOR CIRCUIT CARDS)
 JACKS, JACK PANELS, PLUGS, ASSEMBLIES
 MODULES, DIGITAL LOGIC ENCAPSULATED (ALSO SEE CIRCUITS & CIRCUIT CARDS)
 PLUGBOARDS, PROGRAMMING
 SOCKETS, IC MOUNTING
 SOCKETS, PCB MOUNTING
 TERMINAL BLOCKS, STRIPS, BOARDS

213-365-9661
TWX 910-496-1539

VECTROL INC.
1010 Westmore Ave, Rockville, Md 20850

301-424-6900

AMPLIFIERS, D.C.
 CONTROLLERS, MOTOR
 RELAYS, SOLID-STATE (COMPUTER GRADE)
 TRANSFORMERS, POWER (COMPUTER GRADE)

VECTRONIX INC.
P O Box 209, Cozad, Nebr 69130

308-784-4000

ENCODERS, KEYBOARD (ALPHANUMERIC)
 ENCODERS, KEYBOARD (NUMERIC)
 SWITCHES, DRY REED
 SWITCHES, PUSHBUTTON
 SWITCHES, PUSHBUTTON (ILLUMINATED)
 SWITCHES, ROTARY
 SWITCHES, SNAP ACTION
 SWITCHES, THUMBWHEEL
 SWITCHES, TOGGLE (MINIATURE)

VEEDER-ROOT
70 Sargeant St, Hartford, Conn 06102

203-527-7201

COUNTERS, DECADE
 COUNTERS, DIGITAL READOUT
 COUNTERS, UP-DOWN
 INDICATORS, ALPHANUMERIC
 INDICATORS, DIGITAL
 INDICATORS, ILLUMINATED
 SWITCHES, ROTARY

VEMALINE PRODUCTS CO. INC.
P O Box 3, Wyckoff, N J 07481

201-891-3200

DISPLAYS, PANELS, VIEWGRAPHS (FOR COMPUTER TRAINING)
 HEAT SINKS, CIRCUIT BOARD MOUNTING
 INDICATORS, ILLUMINATED
 KNOBS, DIALS (FOR COMPUTER CONSOLES)
 LAMPS, GLOW
 LAMPS-PANEL, PILOT AND DIAL (INCANDESCENT)
 READOUTS AND DISPLAYS, NUMERIC AND ALPHANUMERIC (OTHER THAN CRT)

VENUS SCIENTIFIC INC.
399 Smith St, Farmingdale, N Y 11735

516-293-4100

POWER SUPPLIES, AC
 POWER SUPPLIES, DC
 CONTINUED

POWER SUPPLIES, DIGITALLY-CONTROLLED

VERMONT RESEARCH CORP.

Precision Park, N Springfield, Vt 05150
 DRUM STORAGE EQUIPMENT, MAG-NETIC (INCLUDING CONTROLLER)
 MEMORY SYSTEMS, MAGNETIC DRUM

802-886-2256
TWX 710-363-6533

VERNITRON CORP. DATA DEVICE DIV.
176 Central Ave, Farmingdale, N Y 11735

516-694-5002

ACOUSTIC COUPLERS
 DATA TERMINALS, BLOCK-BY-BLOCK (TELEPRINTER)
 DATA TERMINALS, INQUIRY-RESPONSE (AUDIO RESPONSE)
 DATA TERMINALS, INQUIRY-RESPONSE (CRT WITH KEYBOARD)
 DATA TERMINALS, INQUIRY-RESPONSE (SPECIAL-PURPOSE)
 MODEMS, HARD-WIRED

VERNITRON CORP. MOTOR PRODUCTS DIV.
300 Marcus Blvd, Deer Park, N Y 11729

516-586-5100
TWX 510-227-6079

CONVERTERS, ANALOG-TO-DIGITAL
 CONVERTERS, BINARY-TO-DECIMAL
 CONVERTERS, DIGITAL-TO-ANALOG
 CONVERTERS, DIGITAL-TO-SYNCHRO
 CONVERTERS, SYNCHRO-TO-DIGITAL
 DISPLAYS, MAGNETIC
 ENCODERS, SHAFT ANGLE
 INDICATORS, ALPHANUMERIC
 INDICATORS, DIGITAL
 MOTORS, SERVO
 MOTORS, STEPPING
 MOTORS, SYNCHRONOUS
 READOUTS AND DISPLAYS, NUMERIC AND ALPHANUMERIC (OTHER THAN CRT)
 SERVOS, COMPUTER

VERNITRON ELEC. COMPONENTS BEAU PRODUCTS DIV.
117 Union Ave, Laconia, N H 03246

603-524-5101
TWX 710-364-1843

CONNECTORS, MINIATURE AND SUB-MINIATURE (COMPUTER-GRADE)
 CONNECTORS, POWER (COMPUTER-GRADE)
 CONNECTORS, RACK AND PANEL (COMPUTER-GRADE)
 TERMINAL BLOCKS, STRIPS, BOARDS

VERO ELECTRONICS INC.
176 Central Ave, Farmingdale, N Y 11735

516-694-6550
TWX 510-224-6425

BOARDS, PRINTED CIRCUIT (WITHOUT COMPONENTS)
 BREADBOARDS
 CABINETS, ENCLOSURES, CONSOLES, ELECTRONIC (FOR GENERAL EQUIPMENT)
 CHASSIS, SLIDES, RACKS
 CONNECTORS, PC AND IC BOARD (COMPUTER-GRADE)
 EXTRACTORS, CIRCUIT BOARD
 GUIDES, CIRCUIT CARDS
 TERMINAL BLOCKS, STRIPS, BOARDS

VERSATEC
10100 Bubb Rd, Cupertino, Cal 95014

408-257-9900
TWX 910-338-0243

DATA TERMINALS, BLOCK-BY-BLOCK (MEDIUM SPEED PRINTER)
 PLOTTERS, NON-IMPACT
 PRINTERS, LINE (LOW & MEDIUM SPEED)
 PRINTERS, LINE (HIGH SPEED)

VIBRAC CORP. AFFILIATE USM CORP.
11 Alpha Rd, Chelmsford, Mass 01824

617-256-6581

BRAKES AND CLUTCHES

VICTOREEN INSTRUMENT CO.
10101 Woodlawn Ave, Cleveland, Ohio 44104

216-795-8200
TWX 810-421-8287

ANALYZERS, PULSE HEIGHT
 REGULATORS, VOLTAGE

VICTORY ENGINEERING CORP.
Victory Rd, Springfield, N J 07081

201-379-5900
TWX 710-983-4430

THERMISTORS

VIDAR CORP.
77 Ortega Ave, Mountain View, Cal 94040

415-961-1000
TWX 910-379-6933

CLOCKS, DIGITAL (REAL-TIME)
 CONVERTERS, ANALOG-TO-DIGITAL
 CONVERTERS, DC-TO-FREQUENCY
 CONVERTERS, DIGITAL-TO-ANALOG
 CONVERTERS, FREQUENCY-TO-DC
 CONVERTERS, VOLTAGE-TO-FREQUENCY
 CONTINUED

3 Manufacturers' Directory

DATA ACQUISITIONS SYSTEMS, AUTOMATIC
MULTIPLEXERS, ANALOG-RELAY (SEQUENTIAL SAMPLING)
OSCILLATORS, VOLTAGE CONTROLLED
VOLT METERS, DIGITAL
VOLT METERS, PRINTING

VIDCOR CO. INC. 213-757-0110
1251 W El Segundo Blv, Gardena, Cal 90247

DELAY LINES, MAGNETOSTRICTIVE (ALSO SEE MEMORIES)
POWER SUPPLIES, AC
POWER SUPPLIES, DC
POWER SUPPLIES, DIGITALLY-CONTROLLED
TRANSFORMERS, PULSE (COMPUTER GRADE)

VIDEO SYSTEMS CORP. 609-665-6688
7300 N Crescent Blvd, Pennsauken, N J 08110 TWX 710-892-0818
DATA TERMINALS, INQUIRY-RESPONSE (CRT WITH KEYBOARD)

VIKING INDUSTRIES INC. 213-341-4330
21001 Nordhoff St, Chatsworth, Cal 91311 TWX 910-494-2094

CABLE ASSEMBLIES (WITH CONNECTORS)
CONNECTORS, PC AND IC BOARD (COMPUTER-GRADE)
CONNECTORS, POWER (COMPUTER-GRADE)
CONNECTORS, RACK AND PANEL (COMPUTER-GRADE)
SERVICES, COMPUTER-AIDED DESIGN
SERVICES, AUTOMATED WIRE-WRAPPING
SOCKETS, IC MOUNTING

VIRGINIA ELECTRONICS CO. INC. 703-560-6500
2901 Telestar Court, Falls Church, Va 22042

AMPLIFIERS, D.C.
AMPLIFIERS, VIDEO
CABLE ASSEMBLIES (WITH CONNECTORS)
CONNECTORS, COAXIAL (COMPUTER-GRADE)
CONNECTORS, POWER (COMPUTER-GRADE)
CONNECTORS, RACK AND PANEL (COMPUTER-GRADE)
CORDS, PATCH
JACKS, JACK PANELS, PLUGS, ASSEMBLIES
PLUGBOARDS, PROGRAMMING
POTENTIOMETERS, TRIM (FILM)
POWER SUPPLIES, AC
POWER SUPPLIES, DC

VIRGINIA PANEL CORP. 703-942-8376
1400 N Hope Rd, Waynesboro, Va 22980

CERTIFIERS, MAGNETIC TAPE
CLEANER/CERTIFIERS, MAGNETIC TAPE
CONNECTORS, RACK AND PANEL (COMPUTER-GRADE)
CORDS, PATCH
JACKS, JACK PANELS, PLUGS, ASSEMBLIES
PLUGBOARDS, PROGRAMMING
RECONDITIONING EQUIPMENT, MAGNETIC TAPE
REELS, MAGNETIC TAPE
WINDERS, MAGNETIC TAPE

VIRTUAL COMPUTER SERVICES INC 201-688-0020
1119 Springfield Rd, Union, N J 07083

CONSULTING (ACCOUNTING, BUSINESS AND COMMERCIAL APPLICATIONS)
CONSULTING (ADVANCED COMPUTER EQUIPMENT DESIGN AND FEASIBILITY STUDIES)
CONSULTING (COMPUTER EVALUATIONS, SELECTIONS, INSTALLATION PLANNING)
CONSULTING (COMPUTER PRODUCT PLANNING SURVEYS, MARKET RESEARCH STUDIES)
CONSULTING (MANAGEMENT INFORMATION SYSTEMS PLANNING)
CONSULTING (SCIENTIFIC APPLICATIONS)
PROGRAMMING LANGUAGE DEVELOPMENT (CONSULTANTS)
PROGRAMMING LANGUAGE DEVELOPMENT (CONTRACT PROGRAMMING)
PROGRAMMING LANGUAGE DEVELOPMENT (DEDICATED APPLICATION SYSTEMS)
PROGRAMMING LANGUAGE DEVELOPMENT (PROPRIETARY SOFTWARE PRODUCTS)
SERVICES, FACILITY MANAGEMENT
SERVICES, PROCESSING (COMMERCIAL EDP)
SERVICES, PROCESSING (DIGITAL SCIENTIFIC)
SERVICES, TIME SHARING (COMMERCIAL)
SERVICES, TIME SHARING (RESEARCH)
SERVICES, SYSTEMS ANALYSIS

VISHAY RESISTOR PRODUCTS INC. 215-644-1300
63 Lincoln Hwy, Malvern, Pa 19355

POTENTIOMETERS, TRIM (FILM)
POTENTIOMETERS, TRIM (WIRE-WOUND)
RESISTORS, PRECISION
TESTERS, INTEGRATED CIRCUIT

VISIBLE COMPUTER SUPPLY CORP. 312-681-6080
9865 Derby Ln, Westchester, Ill 60153

CABINETS AND ENCLOSURES (FOR KEYPUNCHES, PRINTERS)
CABINETS, RACKS, VAULTS (FOR MAGNETIC TAPE STORAGE)
CABINETS, TRAYS (FOR PUNCHED CARD STORAGE)
CORRECTION SEALS, MICRO DOCUMENTS
CORRECTION SEALS, PUNCH CARD
CORRECTION SEALS, PAPER TAPE
COVERS, ACOUSTIC (FOR KEYBOARDS, TELETYPEWRITERS, ETC.)
DESKS, TABLES AND STANDS (FOR CALCULATORS)
DESKS, TABLES AND STANDS (FOR KEYPUNCH UNITS)
DESKS, TABLES AND STANDS (FOR PROGRAMMER STATIONS)
ENVELOPES (FOR FILING TAPES)
FILES, PUNCHED CARD
FORMS HANDLING, LABEL APPLICATORS
HOLDERS, PUNCHED CARD
HOLDERS, BINDER
LABELS, CONTINUOUS AND GUMMED (MACHINE APPLICATION)
LABELS, CONTINUOUS AND PRESSURE SENSITIVE (MACHINE APPLICATION)
MAILERS, PUNCHED CARD
REELS, PAPER TAPE
RIBBONS, INK (FOR PRINTERS AND TAB EQUIPMENT)
TAGS (FOR EDP PROCESSING)
TAPE, PUNCH (PAPER)
TEMPLATES, FLOW CHART

VISIRECORD 516-264-4900
54 Railroad Ave, Copiague, N Y 11726

BOARDS, VISUAL CONTROL (GRAPHIC)
CABINETS, TRAYS (FOR PUNCHED CARD STORAGE)
CARDS, CONVENTIONAL PUNCH
CARDS, EDGE-PUNCH

VISTATYPE CORP. 714-547-0007
1226 E Pomona St, Santa Ana, Cal 92707

DATA TERMINALS, BLOCK-BY-BLOCK (PAPER TAPE)
PUNCHES, PAPER TAPE
READERS, PAPER TAPE

VITRO LABORATORIES, DIV. VITRO CORP. OF AMERICA 301-871-7200
14000 Georgia Ave, Silver Spring, Md 20910 TWX 710-825-9642

SERVICES, COMPUTER-AIDED DESIGN
SERVICES, MANAGEMENT INFORMATION SYSTEMS
SERVICES, PROCESSING (DIGITAL SCIENTIFIC)
SERVICES, TIME SHARING (COMMERCIAL)
SERVICES, SYSTEMS ANALYSIS

VOGUE INSTRUMENT CORP. 212-641-8800
131st At Jamaica Ave, Richmond Hill, N Y 11418 TWX 710-582-4796

DATA TERMINALS, BLOCK-BY-BLOCK (HIGH SPEED PRINTER)
DATA TERMINALS, BLOCK-BY-BLOCK (MEDIUM SPEED PRINTER)
PRINTERS, LINE (LOW & MEDIUM SPEED)
PRINTERS, LINE (HIGH SPEED)

VOICEPRINT LABORATORIES DIV. OF FARRINGTON 201-722-7391
68 FINDERNE AVE, SOMERVILLE, N J 08876

CONSULTING (DATA COMMUNICATIONS SYSTEMS PLANNING)
CONSULTING (SCIENTIFIC APPLICATIONS)

VOLTEX CO. INC. 516-249-2336
115 Marine St, Farmingdale, N Y 11735

POWER SUPPLIES, AC
POWER SUPPLIES, DC
POWER SUPPLIES, DIGITALLY-CONTROLLED

WABASH COMPUTER CORP. PI DIV. 602-943-2311
10202 N 19th St, Phoenix, Ariz 85021 TELEX 66-8447

CERTIFIERS, DISC PACK
CONTROLLERS, MAGNETIC DISC
DISC DRIVES, FIXED HEAD (INCLUDING CONTROLLER)
DISC DRIVES, REMOVABLE CARTRIDGE
CONTINUED

3 Manufacturers' Directory

DISC STORAGE SYSTEMS
MEMORY SYSTEMS, MAGNETIC DISC
TESTERS, MAGNETIC DISC

WAGNER ELECTRIC CORP. 201-992-1100
630 W Mt Pleasant Ave, Livingston, N J 07039 TWX 710-994-4865

DIODES, SILICON
LAMPS-PANEL, PILOT AND DIAL (INCANDESCENT)
POWER SUPPLIES, AC
POWER SUPPLIES, DC
READOUTS AND DISPLAYS, NUMERIC AND ALPHANUMERIC (OTHER THAN CRT)

WAKEFIELD ENGINEERING INC. 617-245-5900
Audubon Rd, Wakefield, Mass 01880 TWX 710-348-6713

HEAT SINKS, CIRCUIT BOARD MOUNTING
TESTERS, SEMICONDUCTOR

WALDEN ELECTRONICS CORP. 617-899-0510
223 Crescent St, Waltham, Mass 02154

POWER SUPPLIES, DC

WALLACE BUSINESS FORMS INC. 312-449-8600
4600 W Roosevelt Rd, Hillside, Ill 60162 TWX 910-234-2070

ENVELOPES, CONTINUOUS
FORMS, CONTINUOUS (MACHINE PROCESSED)
LABELS, CONTINUOUS AND GUMMED (MACHINE APPLICATION)
LABELS, CONTINUOUS AND PRESSURE SENSITIVE (MACHINE APPLICATION)
PAPER (FOR MICR EQUIPMENT)
PAPER (FOR OCR EQUIPMENT)
PAPER (FOR PRINTERS)
PAYMENT COUPON BOOKS, MACHINE READABLE

WALSH ASSOC., RICHARD M. 717-346-3856
310 Jefferson Ave, Scranton, Pa 18503

CONSULTING (ACCOUNTING, BUSINESS AND COMMERCIAL APPLICATIONS)
CONSULTING (ADVANCED COMPUTER EQUIPMENT DESIGN AND FEASIBILITY STUDIES)
CONSULTING (COMPUTER EVALUATIONS, SELECTIONS, INSTALLATION PLANNING)
CONSULTING (DATA COMMUNICATIONS SYSTEMS PLANNING)
SERVICES, TIME SHARING (COMMERCIAL)
TRAINING INSTITUTES, COMMERCIAL COMPUTER COURSES, SEMINARS, CORRESPONDENCE COURSES
TRAINING SYSTEMS, COMPUTER SERVICE

WANG COMPUTER PRODUCTS INC. 213-478-7727
2000 Stoner Ave, Los Angeles, Cal 90272

FORMATTERS, MAGNETIC TAPE
MAGNETIC TAPE STORAGE SYSTEMS (INCLUDES CONTROLLER)
RECORDERS, DIGITAL CASSETTE
RECORDERS, MAGNETIC TAPE

WANG LABORATORIES INC. 617-851-7311
836 N St, Tewksbury, Mass 01876 TELEX 94-7421

ACOUSTIC COUPLERS
CALCULATORS, PROGRAMMABLE (ALSO SEE COMPUTERS)
COMMUNICATIONS-ORIENTED PROCESSORS, MULTIPLE CHANNEL CONTROLLERS
COMPUTERS, DIGITAL (EDUCATIONAL)
COMPUTERS, MINI GENERAL PURPOSE (ALSO SEE CALCULATORS)
CONSULTING (ACCOUNTING, BUSINESS AND COMMERCIAL APPLICATIONS)
CORES, FERRITE MEMORY
COUNTERS, DIGITAL READOUT
DISC DRIVES, FIXED HEAD (INCLUDING CONTROLLER)
INSTRUCTIONAL SYSTEMS, COMPUTER-BASED
MEMORY PLANES AND STACKS, MAG-NETIC CORE (W/O ELECTRONICS)
PROGRAMMING LANGUAGE DEVELOPMENT (CONSULTANTS)
PROGRAMMING LANGUAGE DEVELOPMENT (CONTRACT PROGRAMMING)
PROGRAMMING LANGUAGE DEVELOPMENT (DEDICATED APPLICATION SYSTEMS)
PROGRAMMING LANGUAGE DEVELOPMENT (PROPRIETARY SOFTWARE PRODUCTS)
READERS, PAPER TAPE
RECORDERS, DIGITAL CASSETTE
SERVICES, TIME SHARING (COMMERCIAL)
SERVICES, TIME SHARING (RESEARCH)
TYPEWRITERS, COMPUTER INPUT-OUTPUT

WANLASS ELECTRIC CO. 714-546-8990
1815 S Ritohey St, Santa Ana, Cal 92705 TWX 910-596-1526

CONVERTERS, DC-TO-FREQUENCY
CONVERTERS, FREQUENCY-TO-DC
INVERTERS, DC-AC
CONTINUED

POWER SUPPLIES, AC
POWER SUPPLIES, DC
POWER SUPPLIES, DIGITALLY-CONTROLLED
REGULATORS, CURRENT
REGULATORS, FREQUENCY
REGULATORS, VOLTAGE
TRANSFORMERS, POWER (COMPUTER GRADE)

WARLOCK COMPUTER CORP. 203-544-8308
Rte 7, Georgetown, Conn 06829

CIRCUIT CARDS, LINEAR (WITH DISCRETE COMPONENTS)
CIRCUIT CARDS, LINEAR (WITH IC'S)
CIRCUIT CARDS, LOGIC (WITH DISCRETE COMPONENTS)
CIRCUIT CARDS, LOGIC (WITH IC'S)
CONVERTERS, MAGNETIC TAPE-TO-PUNCHED CARD
ENCODERS, DIGITAL

WARNER ELECTRIC BRAKE & CLUTCH CO. 815-389-3771
Beloit, Wisc 53511 TWX 815-389-2208

BRAKES AND CLUTCHES
MOTORS, STEPPING

WARREN ASSOCIATES 617-481-1320
15 Royal Crest Dr, Marlboro, Mass 01752

AUDIO/VISUAL TRAINING AIDS
BOARDS, VISUAL CONTROL (GRAPHIC)
COMPUTERS, ANALOG (EDUCATIONAL)
COMPUTERS, DIGITAL (EDUCATIONAL)
CONSULTING (ACCOUNTING, BUSINESS AND COMMERCIAL APPLICATIONS)
CONSULTING (ADVANCED COMPUTER EQUIPMENT DESIGN AND FEASIBILITY STUDIES)
CONSULTING (COMPUTER EVALUATIONS, SELECTIONS, INSTALLATION PLANNING)
CONSULTING (DATA COMMUNICATIONS SYSTEMS PLANNING)
CONSULTING (COMPUTER PRODUCT PLANNING SURVEYS, MARKET RESEARCH STUDIES)
CONSULTING (MANAGEMENT INFORMATION SYSTEMS PLANNING)
CONSULTING (SCIENTIFIC APPLICATIONS)
DEMONSTRATORS AND KITS, EDUCATIONAL (DIGITAL LOGIC)
DISPLAYS, PANELS, VIEWGRAPHS (FOR COMPUTER TRAINING)
INSTRUCTIONAL SYSTEMS, COMPUTER-BASED
PROGRAMMING LANGUAGE DEVELOPMENT (CONSULTANTS)
PROGRAMMING LANGUAGE DEVELOPMENT (CONTRACT PROGRAMMING)
PROGRAMMING LANGUAGE DEVELOPMENT (DEDICATED APPLICATION SYSTEMS)
PROGRAMMING LANGUAGE DEVELOPMENT (PROPRIETARY SOFTWARE PRODUCTS)
SERVICES, FACILITY MANAGEMENT
SERVICES, MANAGEMENT INFORMATION SYSTEMS
SERVICES, SYSTEMS ANALYSIS
TRAINING INSTITUTES, COMMERCIAL COMPUTER COURSES, SEMINARS, CORRESPONDENCE COURSES
TRAINING SYSTEMS, CARD PUNCH

WARWICK PRODUCTS CO. 216-524-4404
7909 Rockside Rd, Cleveland, Ohio 44131

CABINETS AND ENCLOSURES (FOR KEYPUNCHES, PRINTERS)
CABINETS, ENCLOSURES, CONSOLES, ELECTRONIC (FOR GENERAL EQUIPMENT)
CABINETS, RACKS, VAULTS (FOR MAGNETIC TAPE STORAGE)
CABINETS, TRAYS (FOR PUNCHED CARD STORAGE)
DESKS, TABLES AND STANDS (FOR TYPEWRITERS)

WASHINGTON ALUMINUM CO. INC. DIV. OF ELASCO 301-242-1000
Knecht Ave & Penn Rd, Baltimore, Md 21229 TELEX 87-814

FLOORING (FOR EDP ROOMS)
FLOOR PLANNING AIDS (FOR EDP ROOMS)

WASHINGTON SCIENTIFIC INDUS. INC. MICROFILM PROD 612-473-1271
Hwy 12, Longlake, Minn 55356

READER/PRINTER, MICROFILM/MICROFICHE
READERS, MICROFILM/MICROFICHE

WAVETEK DATA COMMUNICATIONS 714-279-2200
9045 Balboa Ave, San Diego, Cal 92123 TWX 910-335-2007

DATA CONCENTRATORS
DATA TERMINALS, INQUIRY-RESPONSE (ALPHANUMERIC KEYBOARD)
DATA TERMINALS, INQUIRY-RESPONSE (AUDIO RESPONSE)
DATA TERMINALS, INQUIRY-RESPONSE (SPECIAL-PURPOSE)
MODEMS, ACOUSTIC
MODEMS, HARD-WIRED

3 Manufacturers' Directory

WEBER TECHNICAL PRODUCTS DIV. WALTER KIDDE & CO.

616-361-7341

1340 Monroe Ave NW, Grand Rapids, Mich 49502

AIR CONDITIONERS (FOR EDP INSTALLATIONS)
FLOORING (FOR EDP ROOMS)

WECKESSER CO., INC.

312-282-8626

4444 W Irving Pk Rd, Chicago, Ill 60641

TWX 312-265-1322

FASTENERS, EQUIPMENT

WEISMANTEL INC.

612-454-6200

P O Box 1957, St Paul, Minn 55111

CIRCUIT CARDS, LINEAR (WITH DISCRETE COMPONENTS)
CIRCUIT CARDS, LINEAR (WITH IC'S)
CIRCUIT CARDS, LOGIC (WITH DISCRETE COMPONENTS)
CIRCUIT CARDS, LOGIC (WITH IC'S)
COMMUNICATIONS-ORIENTED PROCESSORS, MULTIPLE CHANNEL CONTROLLERS
COMMUNICATIONS-ORIENTED PROCESSORS, SINGLE CHANNEL CONTROLLERS
COMMUNICATIONS-ORIENTED PROCESSORS, STORED PROGRAM
COMMUNICATION SYSTEMS, DATA TRANSMISSION
COMMUNICATION SYSTEMS, FACSIMILE
COMPUTERS, DIGITAL (EDUCATIONAL)
COMPUTERS, DIGITAL (GENERAL-PURPOSE, SMALL-SCALE)
COMPUTERS, DIGITAL (GENERAL-PURPOSE, MEDIUM-SCALE)
COMPUTERS, DIGITAL (GENERAL-PURPOSE, LARGE SCALE)
CONSOLES, COMPUTER CONTROL (WIRED)
CONSULTING (DATA COMMUNICATIONS SYSTEMS PLANNING)
CONTROLLERS, PLOTTING
DATA CONCENTRATORS
DISC STORAGE SYSTEMS
INSTRUCTIONAL SYSTEMS, COMPUTER-BASED
MAGNETIC TAPE STORAGE SYSTEMS (INCLUDES CONTROLLER)
MEMORY PLANES AND STACKS, MAG-NETIC CORE (W/O ELECTRONICS)
MEMORY PLANES AND STACKS, PLATED WIRE (W/O ELECTRONICS)
MEMORY SYSTEMS, MAGNETIC CORE
MEMORY SYSTEMS, MAGNETIC DISC
MEMORY SYSTEMS, MAGNETIC DRUM
MEMORY SYSTEMS, PLATED WIRE
MODEMS, HARD-WIRED
MULTIPLEXERS, DIGITAL
PRINTER/PUNCH, PAPER TAPE
PRINTERS, KEYBOARD
PRINTERS, LINE (LOW & MEDIUM SPEED)
PRINTERS, LINE (HIGH SPEED)
PUNCHES, CARD (OVER 100 CPM)
READERS, PUNCHED CARD (100 TO 300 CPM)
READERS, PUNCHED CARD (OVER 300 CPM)
SERVICES, HARDWARE MAINTENANCE

WELCH ALLYN INC.

315-685-5788

99 Jordan Rd, Skaneateles Fls, N Y 13153

FIBER OPTIC BUNDLES
FIBER OPTICS ASSEMBLIES (FOR PUNCHED CODE READERS AND MARK SENSORS)
LAMPS-PANEL, PILOT AND DIAL (INCANDESCENT)
LIGHT PENS (FOR CRT TERMINAL INPUT/OUTPUT)

WELLINGTON COMPUTER SYSTEMS CORP.

212-986-2580

405 Lexington Ave, New York, N Y 10017

CONSULTING (ACCOUNTING, BUSINESS AND COMMERCIAL APPLICATIONS)
CONSULTING (COMPUTER EVALUATIONS, SELECTIONS, INSTALLATION PLANNING)
CONSULTING (DATA COMMUNICATIONS SYSTEMS PLANNING)
CONSULTING (COMPUTER PRODUCT PLANNING SURVEYS, MARKET RESEARCH STUDIES)
CONSULTING (MANAGEMENT INFORMATION SYSTEMS PLANNING)
CONSULTING (SCIENTIFIC APPLICATIONS)
PROGRAMMING LANGUAGE DEVELOPMENT (CONSULTANTS)
PROGRAMMING LANGUAGE DEVELOPMENT (CONTRACT PROGRAMMING)
PROGRAMMING LANGUAGE DEVELOPMENT (DEDICATED APPLICATION SYSTEMS)
PROGRAMMING LANGUAGE DEVELOPMENT (PROPRIETARY SOFTWARE PRODUCTS)
SERVICES, FACILITY MANAGEMENT
SERVICES, MANAGEMENT INFORMATION SYSTEMS
SERVICES, PROCESSING (COMMERCIAL EDP)
SERVICES, SYSTEMS ANALYSIS

WELLS TP SCIENCES INC. SUB. WELLS MGT CORP

212-736-2315

1450 Broadway, Laurence Levine, Vp 10018

COMMUNICATIONS-ORIENTED PROCESSORS, MULTIPLE CHANNEL CONTROLLERS
COMMUNICATIONS-ORIENTED PROCESSORS, STORED PROGRAM
COMMUNICATION SYSTEMS, DATA TRANSMISSION
DATA CONCENTRATORS
CONTINUED

MULTIPLEXERS, DIGITAL

WENGEL SERVICE CORP.

609-924-4900

1101 State Rd, Princeton, N J 08540

CONSULTING (ACCOUNTING, BUSINESS AND COMMERCIAL APPLICATIONS)
CONSULTING (MANAGEMENT INFORMATION SYSTEMS PLANNING)
SERVICES, FACILITY MANAGEMENT
SERVICES, MANAGEMENT INFORMATION SYSTEMS
SERVICES, PROCESSING (COMMERCIAL EDP)
SERVICES, SYSTEMS ANALYSIS

WESCO ELECTRICAL CO. INC.

413-774-4358

27 Olive St, Greenfield, Mass 01301

CAPACITORS, COMPUTER GRADE

WESPAC

213-579-5555

2445 Chico Ave, So El Monte, Cal 91733

USED EQUIPMENT (BUYING, SELLING, LEASING)

WEST FLORIDA DATA PROCESSING CENTER INC.

904-763-6510

P O Box 1460, Panama City, Fla 32401

CONSULTING (ACCOUNTING, BUSINESS AND COMMERCIAL APPLICATIONS)
CONSULTING (COMPUTER EVALUATIONS, SELECTIONS, INSTALLATION PLANNING)
SERVICES, PROCESSING (COMMERCIAL EDP)
SERVICES, SYSTEMS ANALYSIS

WESTAMP INC.

213-393-0401

1542 15th St, Santa Monica, Cal 90404

AMPLIFIERS, D.C.

WESTERN GEAR CORP. ELECTRO PRDTS. DIV.

213-796-4395

75 W Green St, Pasadena, Cal 91101

TWX 213-639-6541

MOTORS, SYNCHRONOUS

WESTERN MAGNETICS INC.

213-245-7311

1733 Flower St, Glendale, Cal 91201

RECORDING HEADS, MAGNETIC TAPE

WESTERN MANUFACTURING CO.

312-897-8458

P O Box 1266, Aurora, Ill 60507

DESKS, TABLES AND STANDS (FOR PROGRAMMER STATIONS)
DESKS, TABLES AND STANDS (FOR TYPEWRITERS)

WESTERN OPERATIONS INC.

415-981-1131

120 Montgomery St, San Francisco, Cal 94104

CONSULTING (ACCOUNTING, BUSINESS AND COMMERCIAL APPLICATIONS)
CONSULTING (COMPUTER EVALUATIONS, SELECTIONS, INSTALLATION PLANNING)
CONSULTING (DATA COMMUNICATIONS SYSTEMS PLANNING)
CONSULTING (MANAGEMENT INFORMATION SYSTEMS PLANNING)
PROGRAMMING LANGUAGE DEVELOPMENT (CONSULTANTS)
PROGRAMMING LANGUAGE DEVELOPMENT (CONTRACT PROGRAMMING)
PROGRAMMING LANGUAGE DEVELOPMENT (DEDICATED APPLICATION SYSTEMS)
PROGRAMMING LANGUAGE DEVELOPMENT (PROPRIETARY SOFTWARE PRODUCTS)
SERVICES, FACILITY MANAGEMENT
SERVICES, MANAGEMENT INFORMATION SYSTEMS
SERVICES, PROCESSING (COMMERCIAL EDP)
SERVICES, SYSTEMS ANALYSIS

WESTERN TELEMATIC INC.

213-442-1862

5507 Peck Rd, Arcadia, Cal 91006

COMMUNICATION SYSTEMS, DATA TRANSMISSION
CONVERTERS, PUNCHED CARD-TO-MAGNETIC TAPE
CONVERTERS, PUNCHED CARD-TO-PAPER TAPE
DATA TERMINALS, BLOCK-BY-BLOCK (MAGNETIC CARD)
DATA TERMINALS, BLOCK-BY-BLOCK (PUNCHED CARD)
MAGNETIC TAPE STORAGE SYSTEMS (INCLUDES CONTROLLER)
MODEMS, HARD-WIRED
MODEMS, PC CARD
MULTIPLEXERS, DIGITAL
READERS, EDGE-PUNCHED CARD
CONTINUED

3 Manufacturers' Directory

READERS, MAGNETIC CARD
READERS, PERFORATED DOCUMENT
RECORDERS, DIGITAL CASSETTE

WESTERN UNION TELEPROCESSING CO. 201-529-4600
82 McKee Dr, Mahwah, N J 07436

COMMUNICATION SYSTEMS, TELEPRINTER
CONSULTING (ACCOUNTING, BUSINESS AND COMMERCIAL APPLICATIONS)
CONSULTING (ADVANCED COMPUTER EQUIPMENT DESIGN AND FEASIBILITY STUDIES)
CONSULTING (COMPUTER EVALUATIONS, SELECTIONS, INSTALLATION PLANNING)
CONSULTING (DATA COMMUNICATIONS SYSTEMS PLANNING)
CONSULTING (COMPUTER PRODUCT PLANNING SURVEYS, MARKET RESEARCH STUDIES)
CONSULTING (MANAGEMENT INFORMATION SYSTEMS PLANNING)
SERVICES, FACILITY MANAGEMENT
SERVICES, PROCESSING (COMMERCIAL EDP)
SERVICES, TIME SHARING (COMMERCIAL)
SERVICES, HARDWARE MAINTENANCE
SERVICES, SYSTEMS ANALYSIS

WESTINGHOUSE COMPUTER & INSTRUMENTATION DIV 412-782-1730
100 Beta Dr, Pittsburgh, Pa 15238 TELEX 86-6234

COMPUTERS, DIGITAL (GENERAL-PURPOSE, SMALL-SCALE)
COMPUTERS, DIGITAL (GENERAL-PURPOSE, MEDIUM-SCALE)
COMPUTERS, MINI GENERAL PURPOSE (ALSO SEE CALCULATORS)
COMPUTERS, PROCESS CONTROL

WESTINGHOUSE ELECTRIC CORP. 412-255-3319
Westinghouse Bldg, Pittsburgh, Pa 15222

AIR CONDITIONERS (FOR EDP INSTALLATIONS)
BOARDS, PRINTED CIRCUIT (WITHOUT COMPONENTS)
COMPUTERS, DIGITAL (GENERAL-PURPOSE, SMALL-SCALE)
COMPUTERS, DIGITAL (GENERAL-PURPOSE, MEDIUM-SCALE)
COMPUTERS, MINI GENERAL PURPOSE (ALSO SEE CALCULATORS)
COMPUTERS, PROCESS CONTROL
CONNECTORS, POWER (COMPUTER-GRADE)
CONSULTING (ACCOUNTING, BUSINESS AND COMMERCIAL APPLICATIONS)
CONSULTING (ADVANCED COMPUTER EQUIPMENT DESIGN AND FEASIBILITY STUDIES)
CONSULTING (COMPUTER EVALUATIONS, SELECTIONS, INSTALLATION PLANNING)
CONSULTING (DATA COMMUNICATIONS SYSTEMS PLANNING)
CONSULTING (MANAGEMENT INFORMATION SYSTEMS PLANNING)
CONSULTING (SCIENTIFIC APPLICATIONS)
DIODES, SILICON
DIODES, ZENER
FLOORING (FOR EDP ROOMS)
INSTRUCTIONAL SYSTEMS, COMPUTER-BASED
PANELS, POWER DISTRIBUTION
READOUTS, CRT
RECTIFIERS, SILICON CONTROLLED
REGULATORS, CURRENT
REGULATORS, VOLTAGE
SERVICES, COMPUTER-AIDED DESIGN
SERVICES, FACILITY MANAGEMENT
SERVICES, MANAGEMENT INFORMATION SYSTEMS
SERVICES, SYSTEMS ANALYSIS
TRAINING INSTITUTES, COMMERCIAL COMPUTER COURSES, SEMINARS, CORRESPONDENCE COURSES
TRANSFORMERS, POWER (COMPUTER GRADE)
TRANSISTORS, SILICON
TUBES, CATHODE RAY

WESTINGHOUSE ELECTRIC CORP. ARCHITECTURAL SYS. 616-949-1050
4300 36th St SE, Grand Rapids, Mich 49508

AIR CONDITIONERS (FOR EDP INSTALLATIONS)
FLOORING (FOR EDP ROOMS)

WESTINGHOUSE TELE-COMPUTER SYSTEMS CORP. 412-256-7793
2040 Ardmore Blvd, Pittsburgh, Pa 15221

CONSULTING (ACCOUNTING, BUSINESS AND COMMERCIAL APPLICATIONS)
CONSULTING (COMPUTER EVALUATIONS, SELECTIONS, INSTALLATION PLANNING)
CONSULTING (DATA COMMUNICATIONS SYSTEMS PLANNING)
CONSULTING (MANAGEMENT INFORMATION SYSTEMS PLANNING)
CONSULTING (SCIENTIFIC APPLICATIONS)
PROGRAMMING LANGUAGE DEVELOPMENT (CONTRACT PROGRAMMING)
PROGRAMMING LANGUAGE DEVELOPMENT (DEDICATED APPLICATION SYSTEMS)
PROGRAMMING LANGUAGE DEVELOPMENT (PROPRIETARY SOFTWARE PRODUCTS)
SERVICES, COMPUTER-AIDED DESIGN
SERVICES, FACILITY MANAGEMENT
CONTINUED

SERVICES, MANAGEMENT INFORMATION SYSTEMS
SERVICES, PROCESSING (COMMERCIAL EDP)
SERVICES, PROCESSING (ANALOG OR HYBRID, SCIENTIFIC)
SERVICES, PROCESSING (DIGITAL SCIENTIFIC)
SERVICES, SYSTEMS ANALYSIS

WESTLEY MODERN METHODS 616-796-5767
214 S Michigan Ave, Big Rapids, Mich 49307

SERVICES, PROCESSING (COMMERCIAL EDP)

WESTON-TRANSICOIL A SCHLUMBERGER CO. 215-277-1300
Trooper Rd, Worcester, Pa 19490 TWX 510-660-0132

COMPUTERS, NAVIGATION
CONVERTERS, DIGITAL-TO-SYNCHRO
CONVERTERS, SYNCHRO-TO-DIGITAL
MOTORS, SERVO
MOTORS, STEPPING
MOTORS, SYNCHRONOUS
SERVOS, COMPUTER
SYNCHROS-RESOLVERS, CONTROL TRANSFORMERS

WHELDDEX INC. 914-737-6800
1000 N Division St, Peekskill, N Y 10566

CABINETS, TRAYS (FOR PUNCHED CARD STORAGE)
CARDS, MICORFILM APERTURE
FILES, PUNCHED CARD
FORMS, CONTINUOUS (MACHINE PROCESSED)

WHELOCK SIGNALS INC. 201-222-6880
273 Branchport Ave, Long Beach, N J 07740 TWX 201-222-7091

RELAYS, DRY REED (COMPUTER GRADE)
RELAYS, MERCURY WETTED (COMPUTER GRADE)

WHITE INC. 203-367-7491
178 Wade St, Bridgeport, Conn 06601

RIBBONS, INK (FOR PRINTERS AND TAB EQUIPMENT)

WHITEFORD LABORATORY 617-598-9119
258 Broad St, Lynn, Mass 01901

SPOOLERS, PAPER TAPE
WINDERS, PAPER TAPE

WILEY SYSTEMS INC. 301-654-5274
7942 Wisconsin Ave, Bethesda, Md 20014

TRAINING INSTITUTES, COMMERCIAL COMPUTER COURSES, SEMINARS,
CORRESPONDENCE COURSES

WILLARD LABORATORIES INC. 213-390-3626
4221 Redwood Ave, Los Angeles, Cal 90066

ANALYZERS, WAVEFORM
CONSULTING (ADVANCED COMPUTER EQUIPMENT DESIGN AND FEASIBILITY STUDIES)
CONSULTING (COMPUTER EVALUATIONS, SELECTIONS, INSTALLATION PLANNING)
CONSULTING (DATA COMMUNICATIONS SYSTEMS PLANNING)
CONSULTING (COMPUTER PRODUCT PLANNING SURVEYS, MARKET RESEARCH STUDIES)
TESTERS, CIRCUIT
TESTERS, DIGITAL LOGIC MODULES AND CARDS
TESTERS, INTEGRATED CIRCUIT
TESTERS, MEMORY PLANES, STACKS AND SYSTEMS

WILSON CO., W.E., COMPUTER AUTOMATION GROUP 213-378-8461
2564 Via Tejon, Palos Vrd Est, Cal 90274

CONSULTING (ACCOUNTING, BUSINESS AND COMMERCIAL APPLICATIONS)
CONSULTING (COMPUTER PRODUCT PLANNING SURVEYS, MARKET RESEARCH STUDIES)

WILTEK INC. 203-762-5521
59 Danbury Rd, Wilton, Conn 06897

MAGNETIC TAPE STORAGE SYSTEMS (INCLUDES CONTROLLER)
RECORDERS, MAGNETIC TAPE

3 Manufacturers' Directory

WINCHESTER ELECTRONICS DIV. LITTON INDUS. 203-274-8891
Main St & Hillside, Oakville, Conn 06779 TWX 710-478-3392
 CONNECTORS, COAXIAL (COMPUTER-GRADE)
 CONNECTORS, MINIATURE AND SUB-MINIATURE (COMPUTER-GRADE)
 CONNECTORS, PC AND IC BOARD (COMPUTER-GRADE)
 CONNECTORS, POWER (COMPUTER-GRADE)
 CONNECTORS, RACK AND PANEL (COMPUTER-GRADE)
 SERVICES, AUTOMATED WIRE-WRAPPING

WISE INSTRUMENTATION & CONTROLS INC. 415-967-1159
3568 Amherst Court, Mt View, Cal 94040

AMPLIFIERS, D.C.
 AMPLIFIERS, VIDEO
 CONSULTING (ADVANCED COMPUTER EQUIPMENT DESIGN AND FEASIBILITY STUDIES)
 OSCILLATORS, VOLTAGE CONTROLLED
 POWER SUPPLIES, DC
 POWER SUPPLIES, DIGITALLY-CONTROLLED
 SIGNAL CONDITIONERS
 TESTERS, CIRCUIT
 TESTERS, SEMICONDUCTOR

WORKMAN BUSINESS FORMS INC. 312-867-7575
7220 Wilson Ave, Chicago, Ill 60656

FORMS, CONTINUOUS (MACHINE PROCESSED)
 LABELS, CONTINUOUS AND GUMMED (MACHINE APPLICATION)

WORLD COMPUTER CORP. 214-742-1841
1615 Stemmons Fwy, Dallas, Tex 75221

COMMUNICATION SYSTEMS, DATA TRANSMISSION
 CONSULTING (ACCOUNTING, BUSINESS AND COMMERCIAL APPLICATIONS)
 CONSULTING (COMPUTER EVALUATIONS, SELECTIONS, INSTALLATION PLANNING)
 CONSULTING (MANAGEMENT INFORMATION SYSTEMS PLANNING)
 DATA TERMINALS, INQUIRY-RESPONSE (BADGE-TOKEN READERS)
 LEASING, EDP EQUIPMENT (OTHER THAN MFGRS)
 SERVICES, FACILITY MANAGEMENT
 SERVICES, MANAGEMENT INFORMATION SYSTEMS
 SERVICES, PROCESSING (COMMERCIAL EDP)
 SERVICES, SYSTEMS ANALYSIS
 USED EQUIPMENT (BUYING, SELLING, LEASING)

WORLDWIDE COMPUTER SERVICES, INC. 914-428-0284
280 N Central Pk Ave, Hartsdale, N Y 10530

CONSULTING (ACCOUNTING, BUSINESS AND COMMERCIAL APPLICATIONS)
 CONSULTING (ADVANCED COMPUTER EQUIPMENT DESIGN AND FEASIBILITY STUDIES)
 CONSULTING (COMPUTER EVALUATIONS, SELECTIONS, INSTALLATION PLANNING)
 CONSULTING (DATA COMMUNICATIONS SYSTEMS PLANNING)
 CONSULTING (COMPUTER PRODUCT PLANNING SURVEYS, MARKET RESEARCH STUDIES)
 CONSULTING (MANAGEMENT INFORMATION SYSTEMS PLANNING)
 CONSULTING (SCIENTIFIC APPLICATIONS)
 DATA TERMINALS, BLOCK-BY-BLOCK (TELEPRINTER)
 INSTRUCTIONAL SYSTEMS, COMPUTER-BASED
 PROGRAMMING LANGUAGE DEVELOPMENT (CONSULTANTS)
 PROGRAMMING LANGUAGE DEVELOPMENT (CONTRACT PROGRAMMING)
 PROGRAMMING LANGUAGE DEVELOPMENT (DEDICATED APPLICATION SYSTEMS)
 PROGRAMMING LANGUAGE DEVELOPMENT (PROPRIETARY SOFTWARE PRODUCTS)
 SERVICES, TIME SHARING (RESEARCH)
 SERVICES, SYSTEMS ANALYSIS
 USED EQUIPMENT (BUYING, SELLING, LEASING)

WORLDWIDE TIME SHARING INC. 312-263-4270
180 N Michigan, Chicago, Ill 60601

CONSULTING (ACCOUNTING, BUSINESS AND COMMERCIAL APPLICATIONS)
 SERVICES, TIME SHARING (COMMERCIAL)

WYLE LABORATORIES 213-322-1763
128 Maryland St, El Segundo, Cal 90245 TWX 910-348-6283

CIRCUIT CARDS, LINEAR (WITH DISCRETE COMPONENTS)
 CIRCUIT CARDS, LINEAR (WITH IC'S)
 CIRCUIT CARDS, LOGIC (WITH DISCRETE COMPONENTS)
 CIRCUIT CARDS, LOGIC (WITH IC'S)
 CONSOLES, CRT (ALPHANUMERIC AND GRAPHIC)
 DATA TERMINALS, INQUIRY-RESPONSE (ALPHANUMERIC KEYBOARD)

XEBEC SYSTEMS INC. 415-964-4263
918 N Rengstorff Ave, Mountain View, Cal 94040 TWX 910-379-6942

CONTROLLERS, MAGNETIC DISC
 CONTROLLERS, MAGNETIC TAPE
 DATA TERMINALS, BLOCK-BY-BLOCK (MAGNETIC TAPE)
 DATA TERMINALS, BLOCK-BY-BLOCK (HIGH SPEED PRINTER)
 DATA TERMINALS, INQUIRY-RESPONSE (SPECIAL-PURPOSE)
 DISC DRIVES, MOVABLE HEAD (INCLUDING CONTROLLER)
 DISC DRIVES, REMOVABLE CARTRIDGE
 DISC STORAGE SYSTEMS
 FORMATTERS, MAGNETIC TAPE

XEROX DATA SYSTEMS 213-679-4511
701 S Aviation, El Segundo, Cal 90245 TWX 910-325-6908

CABINETS, ENCLOSURES, CONSOLES, ELECTRONIC (FOR GENERAL EQUIPMENT)
 CIRCUIT CARDS, LINEAR (WITH DISCRETE COMPONENTS)
 CIRCUIT CARDS, LINEAR (WITH IC'S)
 CIRCUIT CARDS, LOGIC (WITH DISCRETE COMPONENTS)
 CIRCUIT CARDS, LOGIC (WITH IC'S)
 COMPUTERS, DIGITAL (GENERAL-PURPOSE, SMALL-SCALE)
 COMPUTERS, DIGITAL (GENERAL-PURPOSE, MEDIUM-SCALE)
 COMPUTERS, DIGITAL (GENERAL-PURPOSE, LARGE SCALE)
 COMPUTERS, HYBRID
 COMPUTERS, MINI GENERAL PURPOSE (ALSO SEE CALCULATORS)
 COMPUTERS, PROCESS CONTROL
 CONSOLES, CRT (ALPHANUMERIC AND GRAPHIC)
 CONSULTING (ACCOUNTING, BUSINESS AND COMMERCIAL APPLICATIONS)
 CONSULTING (DATA COMMUNICATIONS SYSTEMS PLANNING)
 CONSULTING (MANAGEMENT INFORMATION SYSTEMS PLANNING)
 CONSULTING (SCIENTIFIC APPLICATIONS)
 CONTROLLERS, MAGNETIC DISC
 CONVERTERS, ANALOG-TO-DIGITAL
 CONVERTERS, DIGITAL-TO-ANALOG
 DATA ACQUISITION AND REDUCTION SYSTEMS
 DISC PACKS, MAGNETIC
 DISC STORAGE SYSTEMS
 MULTIPLEXERS, ANALOG-SOLID STATE (SEQUENTIAL SAMPLING)
 PRINTER/PUNCH, PAPER TAPE
 PRINTERS, KEYBOARD
 PRINTERS, LINE (LOW & MEDIUM SPEED)
 PRINTERS, LINE (HIGH SPEED)
 PROGRAMMING LANGUAGE DEVELOPMENT (DEDICATED APPLICATION SYSTEMS)
 PUNCHES, CARD (OVER 100 CPM)
 PUNCHES, CARD (PORTABLE)
 READERS, PUNCHED CARD (100 TO 300 CPM)
 READERS, PUNCHED CARD (OVER 300 CPM)
 SERVICES, AUTOMATED WIRE-WRAPPING
 TAPE TRANSPORTS, MAGNETIC (INCREMENTAL)
 USED EQUIPMENT (BUYING, SELLING, LEASING)

XIDEX CORP. 408-739-4120
305 Soquel Way, Sunnyvale, Cal 94086 TWX 910-339-9299

MICROFICHE
 MICROFILM ROLLS
 PRINTERS, MICROFILM/MICROFICHE

XINTEL CORP. 213-882-8811
20931 Nordhoff, Chatsworth, Cal 91311

TESTERS, CIRCUIT
 TESTERS, DIGITAL LOGIC MODULES AND CARDS
 TESTERS, INTEGRATED CIRCUIT
 TESTERS, SEMICONDUCTOR

XYNETICS INC. 213-887-1022
6710 Variel Ave, Canoga Park, Cal 91303

PLOTTERS, FILM EXPOSING
 DRAFTING SYSTEMS, COMPUTER-CONTROLLED STORAGE
 PLOTTERS, MOVING PEN (DIGITAL CONTROLLER)

ZEHNTEL, INC., AFFIL. EM&M INC. 415-527-5440
1450 6th St, Berkeley, Cal 94810 TWX 910-366-7047

TESTERS, CIRCUIT
 TESTERS, DIGITAL LOGIC MODULES AND CARDS
 TESTERS, INTEGRATED CIRCUIT
 TESTERS, MEMORY PLANES, STACKS AND SYSTEMS
 TESTERS, SEMICONDUCTOR

ZELTEX INC. 415-686-6660
1000 Chalomar Rd, Concord, Cal 94520 TWX 910-481-9477

AMPLIFIERS, D.C.
 AMPLIFIERS, INSTRUMENTATION
 AMPLIFIERS, OPERATIONAL
 AMPLIFIERS, VIDEO
 CONVERTERS, ANALOG-TO-DIGITAL
 CONTINUED

3 Manufacturers' Directory

CONVERTERS, DIGITAL-TO-ANALOG
MULTIPLEXER-CONVERTER (SINGLE UNIT WITH MULTIPLEXER, SAMPLE & HOLD
AMPLIFIER & A-TO-D CONVERTER)
MULTIPLEXERS, ANALOG-SOLID STATE (SEQUENTIAL SAMPLING)
POWER SUPPLIES, DC

ZENITH INTEGRATED-DATA PROCESSING INC. 916-483-5511
950 Fulton Ave, Sacramento, Cal 95825

CONSULTING (ACCOUNTING, BUSINESS AND COMMERCIAL APPLICATIONS)
CONSULTING (MANAGEMENT INFORMATION SYSTEMS PLANNING)
PROGRAMMING LANGUAGE DEVELOPMENT (CONTRACT PROGRAMMING)
SERVICES, FACILITY MANAGEMENT
SERVICES, MANAGEMENT INFORMATION SYSTEMS
SERVICES, PROCESSING (COMMERCIAL EDP)
SERVICES, SYSTEMS ANALYSIS

ZERO MANUFACTURING CO. ZERO-WEST DIV. 213-846-4191
1121 Chestnut St, Burbank, Cal 91503 TWX 910-498-2237

AIR CONDITIONERS (FOR EDP INSTALLATIONS)
CABINETS AND ENCLOSURES (FOR KEYPUNCHES, PRINTERS)
CABINETS, ENCLOSURES, CONSOLES, ELECTRONIC (FOR GENERAL EQUIPMENT)
CABINETS, RACKS, VAULTS (FOR MAGNETIC TAPE STORAGE)
CABINETS, TRAYS (FOR PUNCHED CARD STORAGE)
CHASSIS, SLIDES, RACKS
DESKS, TABLES AND STANDS (FOR CALCULATORS)
DESKS, TABLES AND STANDS (FOR KEYPUNCH UNITS)
DESKS, TABLES AND STANDS (FOR PROGRAMMER STATIONS)
DESKS, TABLES AND STANDS (FOR TYPEWRITERS)
FILES, PUNCHED CARD

ZERO MFG. CO. ZERO-KRESKY DIV. 707-762-4554
2nd & H St, Petaluma, Cal 94952

CABINETS AND ENCLOSURES (FOR KEYPUNCHES, PRINTERS)
CABINETS, ENCLOSURES, CONSOLES, ELECTRONIC (FOR GENERAL EQUIPMENT)
CABINETS, RACKS, VAULTS (FOR MAGNETIC TAPE STORAGE)
CABINETS, TRAYS (FOR PUNCHED CARD STORAGE)
CHASSIS, SLIDES, RACKS
DESKS, TABLES AND STANDS (FOR CALCULATORS)
DESKS, TABLES AND STANDS (FOR KEYPUNCH UNITS)
DESKS, TABLES AND STANDS (FOR PROGRAMMER STATIONS)
DESKS, TABLES AND STANDS (FOR TYPEWRITERS)

ZIPPERTUBING CO. 213-321-3901
13000 S Broadway, Los Angeles, Cal 90061 TWX 910-346-6713

CABLE ASSEMBLIES (WITH CONNECTORS)
CABLE, COAXIAL (FLEXIBLE)
CABLE, COAXIAL (SEMI/RIGID)
CABLE, FLAT, PRINTED AND RIBBON
CABLE, MULTICONDUCTOR
CABLE, SHIELDED (NOT COAXIAL)
FIBER OPTIC BUNDLES

Advertisers' Index

Allen Avionics	377	General Radio	4
Alpha Data, Inc.	395	Harvey Industrial Div.	2
Analog Devices, Inc.. ..	10	Incoterm Corp.	75
Brand-Rex	Cover 4	Interswitch	313-316, 405, 444
Calma	379	Information Control Corp.	181
Cambridge Memories	166	ITT-Cannon	612
Clifton Div., Litton Industries	222	Lockheed Electronics	182
Computer Fulfillment	307	Micro Switch Div. of Honeywell	202
Constantine Engineering Labs (CELCO) ...	145	Nortronics Company	240
Control Devices	210	Nuclear Data	Cover 3
Creative Magnetics	423	Pamotor	229-232, 321, 324, 326
DataRam Corp.	178	Pulse Communications	449
Data Recording Systems, Newell Industries.....	241	Quadri Corp.	184, 185
Datascan, Inc.	251, 254	RCA Information Systems	159
DataServ	65-68, 320, 351, 369, 375, 383, 391, 397	Sanders Associates	91
Digitran Company	11	Sangamo Electric Co.	126
Dynamic Instruments	407	Signal Galaxies	183
Electronic Memories	179	Simco Company	442
Electronic Processors, Inc.	24	Standard Memories	186, 187
Fabri-Tek, Inc.....	Cover 2	United Telecontrol Electronics	393
Ferroxcube Corp.	180, 239	Uriel Corp.	400
General Instrument Corp., Systematics/Magne-Head Div.	190	Varian Data Machines	14
		Vermont Research	198

If you don't know Cannon means EDP connectors, look at all you're missing:

Printed Circuit.

Backplane Assemblies. Low-cost, versatile and flexible. Accept 1/16" PC boards. Utilize preloaded, removable bifurcated .025" square tail contacts for wire-wrapping termination. Adjacent contacts on .100" centers, opposing contacts on .200" centers.

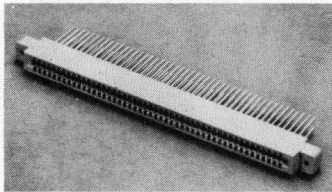
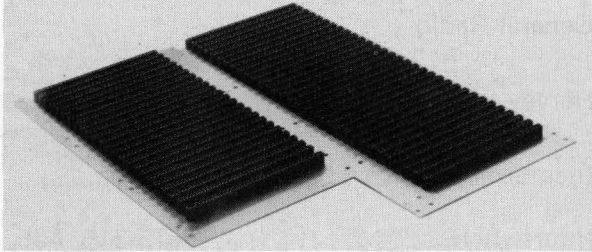
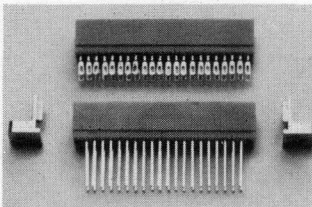
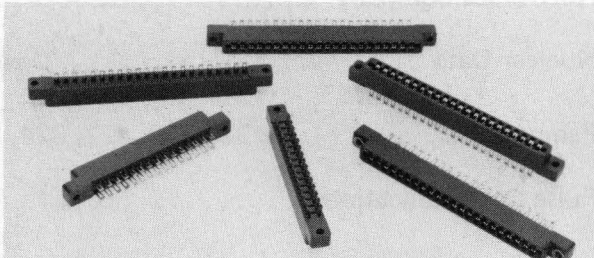

Plate Connectors. With bottom preload for constant contact force. Single beam bifurcated contacts on .125" centers for use with 1/16" printed circuit boards.

Edgecard Connectors. .156" center edgecard connectors designed to meet MIL-C-21097. Rack or panel mounted. Available in thru-hole, threaded bushing and float-mounted styles.



Variable length Edgecard. Available in any length from 1 to 100 contact positions with solder pin termination or up to 70 contact positions for solder eyelet or wire-wrapping post termination. Single or dual readout contacts.

Microminiature.

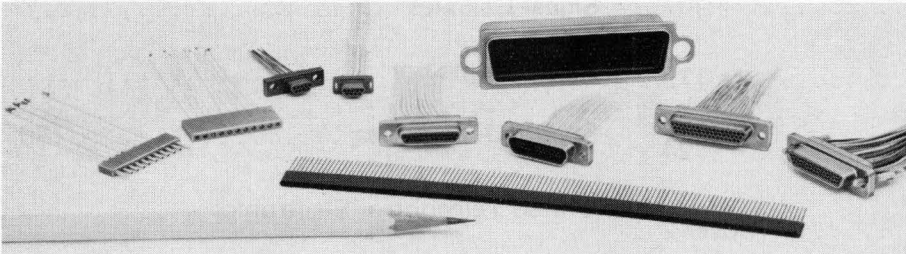

Microminiature. Space-saving rectangular, circular and strip configurations available featuring MICROPIN/MICROSOCKET contacts.

For more information write ITT Cannon, 666 E. Dyer Rd., Santa Ana, Calif. 92702. Division of International Telephone and Telegraph Corporation.

Input/Output.

Burgun-D. Subminiature rectangular connectors for use where space and weight are prime considerations. Rear release, crimp removable contacts.

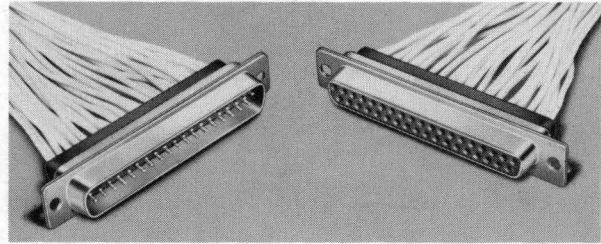

DL. Multiple-wire connectors with cam-actuated spring contacts. For cable to cable, cable to panel and cable to backplane applications. Crimp and wire-wrapping terminations. Low mating forces, low contact wear, low cost.

CL. Low cost circular connector that provides low mating force and high contact force with cam-actuated spring contacts. Cable to cable and cable to panel applications.

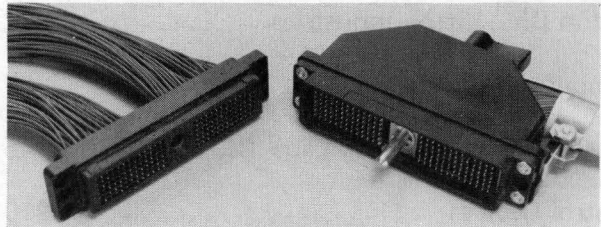

Flexible Cable.

FLEX-LOC. FCBL connectors enable you to terminate all flat cable conductors in one operation by an actuating slide on the plug side. Receptacle uses .025" square post contacts for crimp termination of round wire. Wire wrapping adapters available.

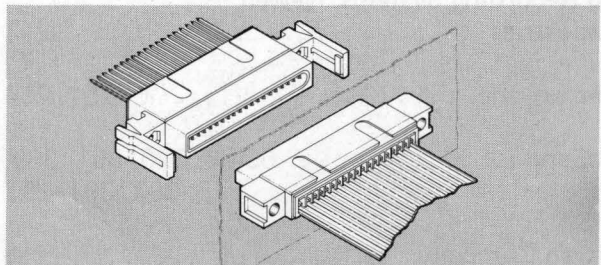

CANNON ITT

ND 812

ND 815

INTRODUCING THE ND 812 — GENERAL PURPOSE COMPUTER

Offering more core and instruction capability . . . dollar for dollar . . . than any other computer on the market.

Nuclear Data started making special purpose computers in 1959.

Recently Nuclear Data announced several new computer systems incorporating the new ND 812. These systems include a computer controlled disc display system; a computer cassette system with automatic editing and assembling using a high speed line printer; and a computer controlled data on line program acquisition and display system.



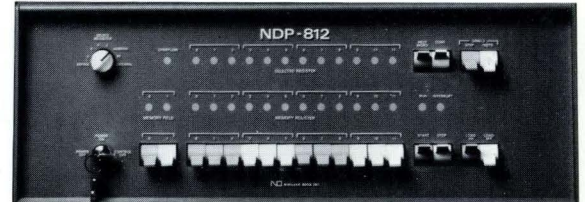

As a systems company, Nuclear Data has strong capability in all phases of computer system design — hardware, software, and peripheral interfaces.

Some typical ND 812 system configurations and prices are shown below. The prices are for single system orders. Quantity discount schedules are available.

If you would like assistance in solving your systems requirements, please contact us.

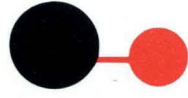
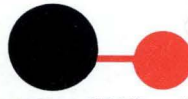

ND 812 SYSTEMS

- | | | |
|---|--|-----------------|
| <p>1</p>  <p>4096 Word ND 812 TT</p> | <p>The 4096 word ND 812 operates with a variety of software packages. Included are; assembler and editors, floating point package, and our NUTRAN Compiler. The NUTRAN Compiler allows an operator without prior programming experience to generate his own programs in an on-line conversational mode.</p> | <p>\$8,400</p> |
| <p>2</p>  <p>8192 Word ND 812 TT</p> | <p>The memory of the ND 812 is field expandable to 8192, 12,288 or 16,384 words. In the expanded memory configuration, two word instructions and hardware multiple field control provide easy transit across 4K field boundaries.</p> | <p>\$11,050</p> |
| <p>3</p>  <p>Dual Cassette Unit 8192 Word ND 812 TT</p> | <p>One of the peripheral devices that can be added to the ND 812 (any memory size) is a Nuclear Data Cassette Unit. This is available with a single, dual, or triple transport unit. The triple cassette unit provides the user with a full cassette operating system. The system operates at about 500 characters per second.</p> | <p>\$14,650</p> |
| <p>4</p>  <p>Disc Pack or Fixed Head Storage 8192 Word ND 812 TT</p> | <p>Nuclear Data offers two disc operating systems.</p> | <p>\$21,000</p> |
| <p>5</p>  <p>Line Printer Fixed Head or Disc Pack 8192 Word ND 812 TT</p> | <p>The addition of a high speed line printer provides the user with a rapid printout of the program listing or processed data.</p> | <p>\$30,950</p> |

FOB Palatine. Quantity discount schedule available on request.

EXAMPLES OF SYSTEM CAPABILITY

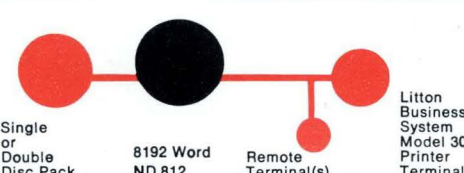
- | | | |
|--|---|--------------------------|
| <p>6</p>  <p>Oscilloscope
Analog and/or Digital Acquisition Unit(s)
Control Module</p> <p>4096 Word ND 812 TT</p> | <p>SYSTEM 4410 — Data acquisition and display system acquires and processes data from various analog to digital converters or digital output devices. The Data may be stored in 1024 twenty-four (24) bit words, or 2048 twelve (12) bit words. The remaining portion of the computer memory is used to store programs for handling the data. Software and hardware are provided to display or readout to any peripheral device, or process selected portions of the acquired data. The full line of accessories and software will operate with the ND 812 used in this system. Special system software may also be provided upon request.</p> | <p>Prices on Request</p> |
| <p>7</p>  <p>Single or Double Disc Pack 8192 Word ND 812 Remote Terminal(s) Litton Business System Model 30 Printer Terminal</p> | <p>Business oriented computer system
This system configuration performs many business functions such as inventory control, pay records, accounts receivable and payable, etc. The system is provided with a commercially oriented compiler and a disc operating system, thus enabling application programming with little technical programming knowledge. Specialized system software may also be provided on request.</p> | <p>Prices on Request</p> |

ND
NUCLEAR DATA INC.
Post Office Box 451
Palatine, Illinois 60067

Nuclear Data GmbH
Frankfurt, Germany

Nuclear Data U.K.
Bourne End, Bucks, U.K.

Nuclear Data Scandinavia
Stockholm, Sweden



OK.

Brand-Rex didn't become the industry's largest supplier of computer wire and cable by overlooking U.L. approvals. In fact, we have more U.L. ok's for EDP products than any other wire and cable manufacturer. American Enka Corporation, Brand-Rex Division, Willimantic, Connecticut 06226. Phone 203-423-7771.

Make wire the easiest part of your next design by making connections now with

BRAND-REX