

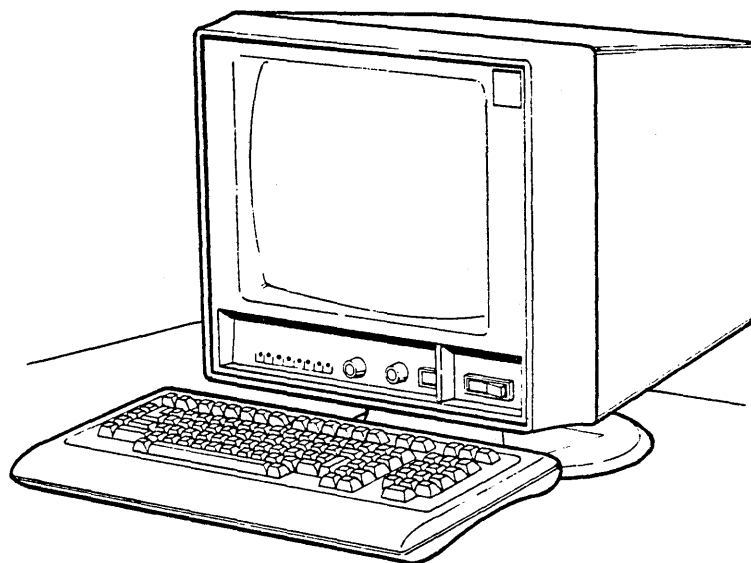

---

**CDC® 721 - X0  
DISPLAY TERMINAL**



REVISION RECORD

REVISION	DESCRIPTION
A (05-03-82)	Manual released. This edition obsoletes all previous editions.
B (08-10-82)	Manual revised to incorporate ECO/FCO 15337. Also includes various technical and editorial changes.
C (11-20-82)	Manual revised to incorporate ECO 15371 and technical/editorial changes.
D (01-24-83)	Manual revised to incorporate editorial changes.

Publication No.

62940020

Address comments concerning this manual to:

Control Data Corporation  
 Publications and Graphics Div.  
 2401 North Fairview Avenue  
 St. Paul, Minnesota 55113

REVISION LETTERS I, O, Q AND X ARE NOT USED

©1981, 1982, 1983

by Control Data Corporation  
 Printed in the United States of America

or use Comment Sheet in  
 the back of this manual.

LIST OF EFFECTIVE PAGES

New features, as well as changes, deletions, and additions to information in this manual are indicated by bars in the margins or by a dot near the page number if the entire page is affected. A bar by the page number indicates pagination rather than content has changed.

PAGE	REV	PAGE	REV	PAGE	REV
Cover	-	B-25/B-26	A		
Title Page	-	B-27/B-28	B		
ii thru iv	D	B-29 thru B-34	A		
v/vi	C	B-35	D		
vii thru x	B	B-36	A		
xi	C	B-37	D		
1-1 thru 1-3	B	C-1 thru C-3	A		
1-4	C	D-1	B		
1-5 thru 1-7	A	D-2 thru D-5	A		
2-1/2-2	A	D-6	B		
2-3/2-4	B	D-7 thru D-41	A		
2-5	A	Comment Sheet	D		
2-6	B	Mailer	-		
2-7	A	Back Cover	-		
2-8/2-9	B				
2-10/2-11	A				
2-12/2-13	B				
2-14 thru 2-17	A				
2-18/2-19	B				
3-1/3-2	B				
3-3	A				
3-4	B				
3-5 thru 3-8	C				
3-9	B				
3-10/3-11	A				
4-1 thru 4-7	B				
4-8	A				
4-9 thru 4-46	B				
4-47	C				
4-48 thru 4-93	B				
A-1 thru A-6	B				
A-7	A				
A-8	B				
B-1/B-2	A				
B-3 thru B-5	B				
B-6 thru B-9	A				
B-10/B-11	B				
B-12	A				
B-13	B				
B-14	A				
B-15	B				
B-16	A				
B-17	B				
B-18 thru B-21	A				
B-22 thru B-24	B				





## PREFACE

---

This manual contains hardware reference information for the CDC® 721 Display Terminal. This information consists of functional descriptions, parameter and mode selections, as well as a description of operator controls, indicators, and keysets.

This information provides an overview of the terminal and specifically covers its operation in CYBER mode. That mode is for operations with computer systems of the CDC CYBER 120 or 170 series. In addition, an appendix covers a 401X/graphics mode that can be run when the terminal is connected to the Control Data Shared Network.

Other associated manuals include the:

<u>Title</u>	<u>Publication Number</u>
721 Display Terminal Unpacking/Packing Instructions	62940038
721 Display Terminal Operator's Guide Installation Instructions	62940019

All manuals may be ordered from:

Control Data Corporation  
Literature and Distribution Services  
308 North Dale Street  
St. Paul, Minnesota 55103



# CONTENTS

## 1. GENERAL DESCRIPTION

Terminal Features . . . . .	1-2
Basic Terminal Features . . . . .	1-2
Optional Terminal Features . . . . .	1-3
Terminal Configuration . . . . .	1-3
Equipment Specifications . . . . .	1-6
Physical Specifications . . . . .	1-6
Electrical Specifications . . . . .	1-6
Environmental Specifications . . . . .	1-7

## 2. FUNCTIONAL DESCRIPTION

CRT Monitor . . . . .	2-1
Microprocessor . . . . .	2-1
Memory . . . . .	2-3
Display Refresh Logic . . . . .	2-3
Symbol Generators . . . . .	2-4
ROM-Based Generator . . . . .	2-4
Loadable Symbol Generator . . . . .	2-4
Character Attributes . . . . .	2-6
Display Timing . . . . .	2-6
Symbol Generation . . . . .	2-6
Cursor . . . . .	2-6
Host Interface . . . . .	2-17
Keyboard Interface . . . . .	2-17
Optional Features . . . . .	2-17
Touchpanel Option . . . . .	2-17
Graphics Display Option . . . . .	2-18
Parallel Channel Option . . . . .	2-18
Memory Module (ROM Pack) Option . . . . .	2-18
Dual Asynchronous Interface Option . . . . .	2-18
Foreign Keycap Options . . . . .	2-19

## 3. OPERATOR CONTROLS AND INDICATORS

Cabinet-Mounted Controls and Indicators . . . . .	3-1
Keyboard Configurations . . . . .	3-4
Keyboard Operation . . . . .	3-8

## 4. OPERATION

Parameter Selection . . . . .	4-1
Terminal Installation Parameters . . . . .	4-3
F1 Return . . . . .	4-5
F2 CONFIG (Configuration) . . . . .	4-5
F3 CONFIG (Configuration) . . . . .	4-5
F4 CONFIG (Configuration) . . . . .	4-6
F5 CONFIG (Configuration) . . . . .	4-6

F6 AS, X or Y . . . . .	4-6
F7 L, ID . . . . .	4-7
F8 (PORT A) . . . . .	4-7
F9 (PORT B) . . . . .	4-9
F10 [Instl Mode n (Installation Mode n)] . . . . .	4-9
Mode Installation Parameters . . . . .	4-10
F1 Return . . . . .	4-10
F2 CONFIG (Configuration) . . . . .	4-10
F3 CONFIG (Configuration) . . . . .	4-11
F4 CONFIG (Configuration) . . . . .	4-12
F5 CONFIG (Configuration) . . . . .	4-13
F6 OPR DF (Operator Default) . . . . .	4-14
Mode Operator Parameters . . . . .	4-17
Printer . . . . .	4-20
Baud Rate . . . . .	4-20
Default Parameters . . . . .	4-20
Load Source Selection . . . . .	4-22
Interfaces . . . . .	4-22
Aborts and Recovery . . . . .	4-23
Performance . . . . .	4-23
Errors . . . . .	4-24
Installation Parameters . . . . .	4-24
Load File Selection . . . . .	4-24
Interfaces . . . . .	4-24
Aborts and Recovery . . . . .	4-26
Performance . . . . .	4-26
ASCII Network Loader . . . . .	4-26
Description . . . . .	4-26
Autoload Message Formats . . . . .	4-27
Load Block . . . . .	4-28
Load Request . . . . .	4-29
NAK Sequence . . . . .	4-29
Load Complete . . . . .	4-30
Autoload Sequence . . . . .	4-30
Interfaces . . . . .	4-31
Aborts and Recovery . . . . .	4-32
Errors . . . . .	4-32
Performance . . . . .	4-33
Installation Parameters . . . . .	4-33
ROM Pack Loader . . . . .	4-33
Description . . . . .	4-33
Aborts and Recovery . . . . .	4-34
Performance . . . . .	4-34
Installation Parameters . . . . .	4-35
Interfaces . . . . .	4-35
Errors . . . . .	4-35
CYBER Mode Operation . . . . .	4-35
General Information . . . . .	4-36
Cursor . . . . .	4-36
Character Attributes . . . . .	4-36
Parity Errors . . . . .	4-37
Keyboard Operation . . . . .	4-37
↑ (Shift) Keys . . . . .	4-38
⊕ (Lock) Key/Indicator . . . . .	4-38
CTRL (Control) Key . . . . .	4-38
RESET Switch . . . . .	4-39

Validation Bits . . . . .	4-39
Host Multiple Code Sequences . . . . .	4-40
Prologue Code . . . . .	4-40
Printer Operation . . . . .	4-41
Character-Transmit Mode . . . . .	4-50
PRINT Key . . . . .	4-51
SETUP Key . . . . .	4-52
Special Function Keys . . . . .	4-52
L/INSRT/C Key . . . . .	4-53
ERASE Key . . . . .	4-53
L/DLETE/C Key . . . . .	4-54
P/CLEAR/EOL (Erase Page/Erase End of Line) Key . . . . .	4-54
LF/ESC (Line Feed/Escape) Key . . . . .	4-55
M REL/BREAK Key . . . . .	4-55
NEXT/ (New Line/Carriage Return) . . . . .	4-55
(Tab Forward) Key . . . . .	4-55
(Tab Backward) Key . . . . .	4-56
Cursor Control Keys (Up ), (Down ), (Left ), (Right ) and (HOME Key) . . . . .	4-56
CR/DEL (Carriage Return/Delete) Key . . . . .	4-57
Special Action Keys (+, -, x, , HELP, ERASE, EDIT BACK, LAB, DATA, STOP) . . . . .	4-57
Block-Transmit Mode . . . . .	4-57
Initiating/Terminating Block Mode . . . . .	4-58
Block Mode Operation . . . . .	4-59
Keyboard Operation in Block Mode . . . . .	4-59
Special-Action and Function Keys . . . . .	4-60
L/INSRT and L/DLETE/C Keys . . . . .	4-60
Protect Operation . . . . .	4-60
Host Communications . . . . .	4-61
Protect System Disabled . . . . .	4-61
Protect System Enabled (Keyboard Operation) . . . . .	4-61
Alphanumeric and Control Code Entry . . . . .	4-62
, (Forward Tab and Back Tab) Keys . . . . .	4-62
NEXT/ (New Line) Key . . . . .	4-62
PRINT Key . . . . .	4-62
Protect System Active Display Operation . . . . .	4-63
Touchpanel Operation . . . . .	4-63
Line Display . . . . .	4-64
Host Communications . . . . .	4-64
Terminal Operation . . . . .	4-64
CYBER Mode Host Received Commands . . . . .	4-65
Host-Specified Code Sequence/Controlware . . . . .	4-84
Model Report Request . . . . .	4-88
Host Select Bidirectional Port . . . . .	4-91
X-Off/X-On . . . . .	4-92
Write New Mode Parameters . . . . .	4-92

## APPENDIXES

A.	RESIDENT DIAGNOSTICS	A-1
B.	INTERFACES TO SOFTWARE	B-1
C.	RESIDENT HOST INTERFACE	C-1
D.	401X/GRAPHICS MODE	D-1

## FIGURES

### 1. GENERAL DESCRIPTION

1-1	721-X0 Display Terminal . . . . .	1-1
1-2	Basic Terminal Configuration . . . . .	1-4
1-3	Expanded Terminal Configuration . . . . .	1-5

### 2. FUNCTIONAL DESCRIPTION

2-1	Microprocessor CPU Block Diagram . . . . .	2-2
2-2	Display Refresh Logic - Alphanumeric Mode . . . . .	2-3
2-3	Symbol Generator Addressing . . . . .	2-5

### 3. OPERATOR CONTROLS AND INDICATORS

3-1	Location of Controls and Indicators . . . . .	3-2
3-2	Keyboard with Standard English Keycaps . . . . .	3-4
3-3	Keyboard with British Keycap Option . . . . .	3-5
3-4	Keyboard with Spanish Keycap Option . . . . .	3-6
3-5	Keyboard with German Keycap Option . . . . .	3-6
3-6	Keyboard with French Keycap Option . . . . .	3-7
3-7	Keyboard with Swedish/Finnish Option . . . . .	3-7
3-8	Keyboard with Danish/Norwegian Option . . . . .	3-8
3-9	Keyboard Keystation Assignments . . . . .	3-9

### 4. OPERATION

4-1	Parameters . . . . .	4-2
4-2	Mode Selection Menu . . . . .	4-2
4-3	Terminal Installation Parameters . . . . .	4-4
4-4	Mode Installation Parameters . . . . .	4-11
4-5	CYBER Mode Operator Parameters . . . . .	4-21
4-6	Load Source/File Selection . . . . .	4-25

## TABLES

### 2. FUNCTIONAL DESCRIPTION

2-1	American Alphanumeric Character Codes . . . . .	2-7
2-2	British Alphanumeric Character Codes . . . . .	2-8
2-3	Spanish Alphanumeric Character Codes . . . . .	2-9
2-4	German Alphanumeric Character Codes . . . . .	2-10
2-5	French Alphanumeric Character Codes . . . . .	2-11
2-6	Swedish/Finnish Alphanumeric Character Codes . . . . .	2-12
2-7	Danish/Norwegian Alphanumeric Character Codes . . . . .	2-13
2-8	Control Character Codes . . . . .	2-14
2-9	Line Drawing Symbol Codes . . . . .	2-15
2-10	Foreign Character Codes . . . . .	2-16

### 3. OPERATOR CONTROLS AND INDICATORS

3-1	Keyboard Keystation Coding (Hexadecimal) . . . . .	3-9
-----	--	-----

### 4. OPERATION

4-1	Keycodes and Legends of Standard Keyboard . . . . .	4-42
4-1.1	Keycode and Legend Addendum for British Keycap Kit . . . . .	4-46
4-1.2	Keycode and Legend Addendum for Spanish Keycap Kit . . . . .	4-47
4-1.3	Keycode and Legend Addendum for German Keycap Kit . . . . .	4-47
4-1.4	Keycode and Legend Addendum for French Keycap Kit . . . . .	4-48
4-1.5	Keycode and Legend Addendum for Swedish/ Finnish Keycap Kit . . . . .	4-49
4-1.6	Keycode and Legend Addendum for Danish/ Norwegian Keycap Kit . . . . .	4-50
4-2	CYBER Mode Receive and I/O Responses . . . . .	4-65
4-3	Read Parameter Data Word Format . . . . .	4-84





---

The CDC® 721-X0 Display Terminal (figure 1-1) is a locally or remotely located input/output device capable of supporting several modes of operation. This capability is accomplished through use of a microprocessor and common bus based scheme that supports a large, loadable memory (loadable via the communications line, an attached flexible disk, or operator plug-in memory module). The basic resident terminal mode supports CYBER mode (722-10 TTY compatible advanced mode with enhancements and additional edit features) and a Control Data Shared Network (CDSN) downline load capability. Optional modes require optional hardware and include, Tektronix\* 401X mode, graphics mode, and IST-III mode (operating controlware loaded from the host network or from a program module).

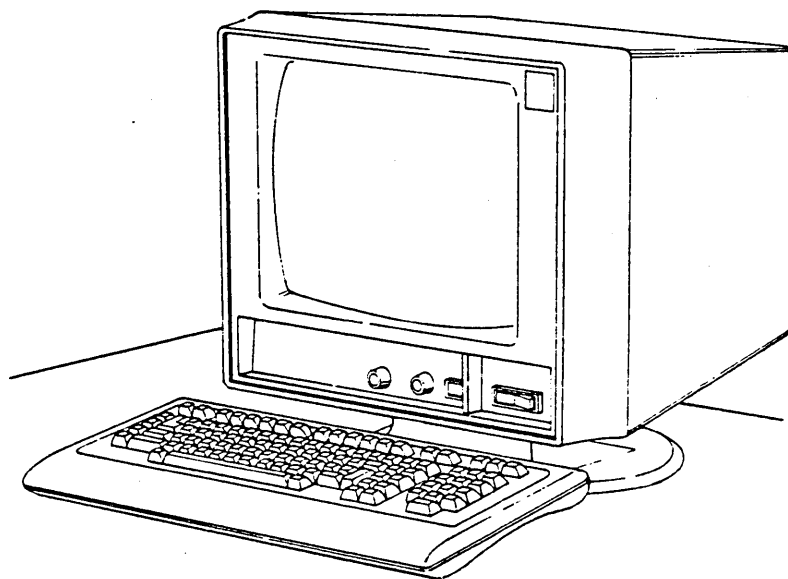

Figure 1-1. 721-X0 Display Terminal

---

\*Tektronix is a registered trademark of Tektronix Inc.

## TERMINAL FEATURES

The following tabulations highlight the basic and optional features of the terminal.

### BASIC TERMINAL FEATURES

The basic terminal features include the following:

- Tilttable display module with a 380 mm (15 in diagonal measurement) cathode-ray tube (CRT) and associated drive electronics
- Symbol generation circuits - 256 symbols in ROM, 64 loadable RAM symbols
- 20K ROM and 64K RAM, 256 x 4K nonvolatile memory (NVM), and 1K character generation RAM
- Nonvolatile memory (NVM) for parameter retention
- Detached alphanumeric keyboard
- Asynchronous RS-232-C/CCITT V.24 interface with selectable transmission speeds up to 19 200 bps (receive and transmit speeds may differ)
- ASCII downline load (CDSN compatible) capability
- 80- or 132-characters per line with up to 30 lines of data entry
- Window scroll, character attributes (inverse, dim, blink, blank, underscore, and protected data)
- Memory module capability (16K maximum)
- Parameter selection performed via keyboard (no selection switches)
- Switch selectable 115/220 V ac operation
- Foreign character ROM

## OPTIONAL TERMINAL FEATURES

Optional terminal features include:

- Full-vector graphic displays within either a 512- by 480-dot array or a 512- by 512-dot array
- 16- by 16-position touchpanel
- 16K memory module
- Peripheral options to support:
  - An alphanumeric character printer (dual asynchronous RS-232-C interface required)
  - An asynchronous RS-232-C peripheral device interface with two ports with transmission speeds up to 19 200 bps
  - Parallel peripheral interface

## TERMINAL CONFIGURATION

The terminal may be configured as a basic terminal as shown in figure 1-2 or as an expanded terminal as shown in figure 1-3. The basic terminal configuration supports CYBER mode operation and CDSN-compatible downline load, while the expanded configuration supports optional modes that allow emulation of several terminal products.

The minimum configuration is a single PC board with 64K bytes of RAM and 20K bytes of ROM. The maximum configuration is limited by PC board space and power requirements. The terminal can be configured with a basic terminal control PC board, two large

optional PC board modules, and three small optional PC board modules. The large modules (approximately 515 square centimeters) connect to the basic terminal control PC board via ribbon cables. The large option modules are factory and field service center installable. The small modules (approximately 160 square centimeters) plug directly into a backpanel that connects into the basic terminal. The small option modules are customer installable.

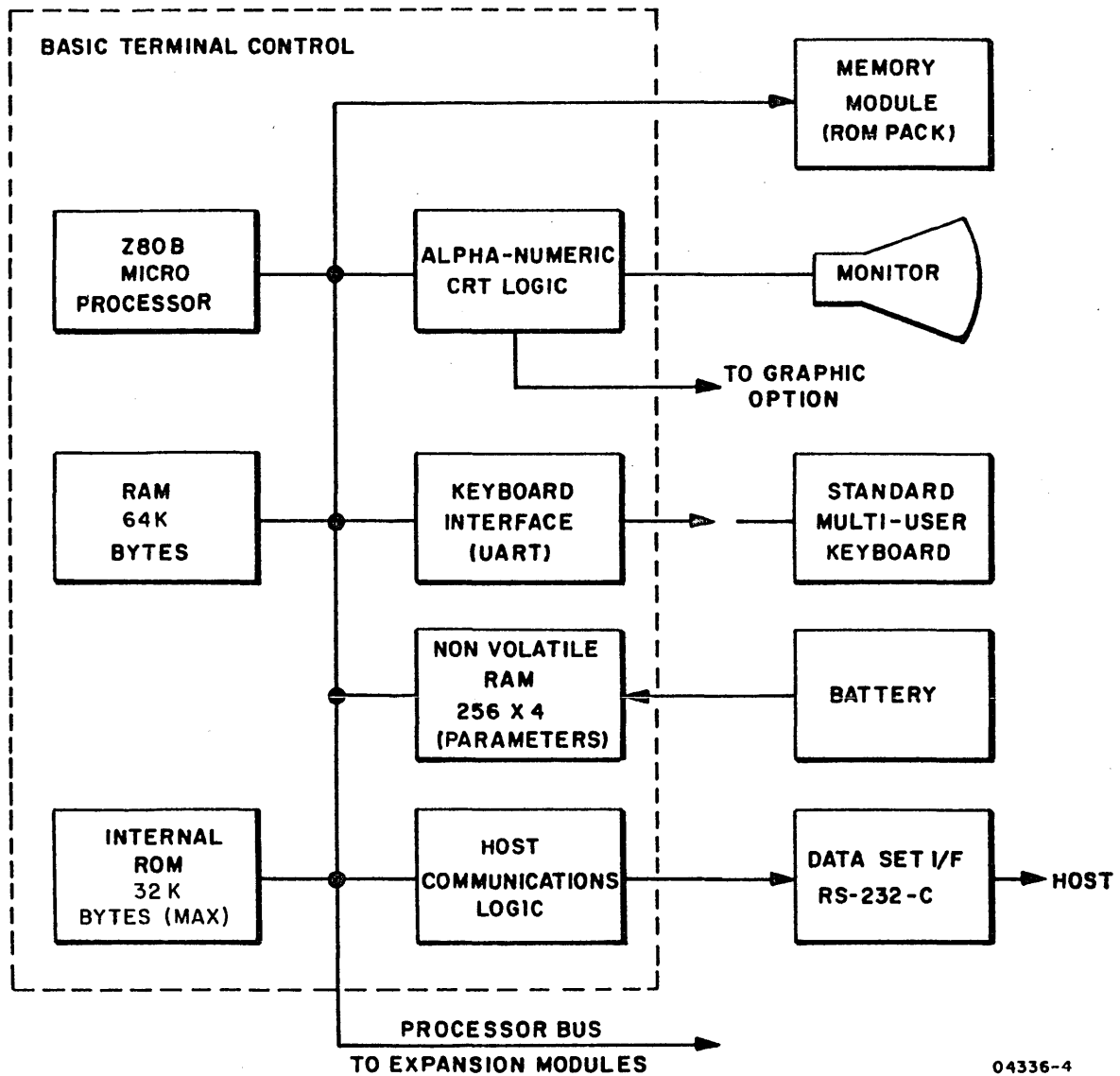

\*SHOWN FOR REFERENCE, NOT INCLUDED IN BASIC TERMINAL CONFIGURATION.

Figure 1-2. Basic Terminal Configuration

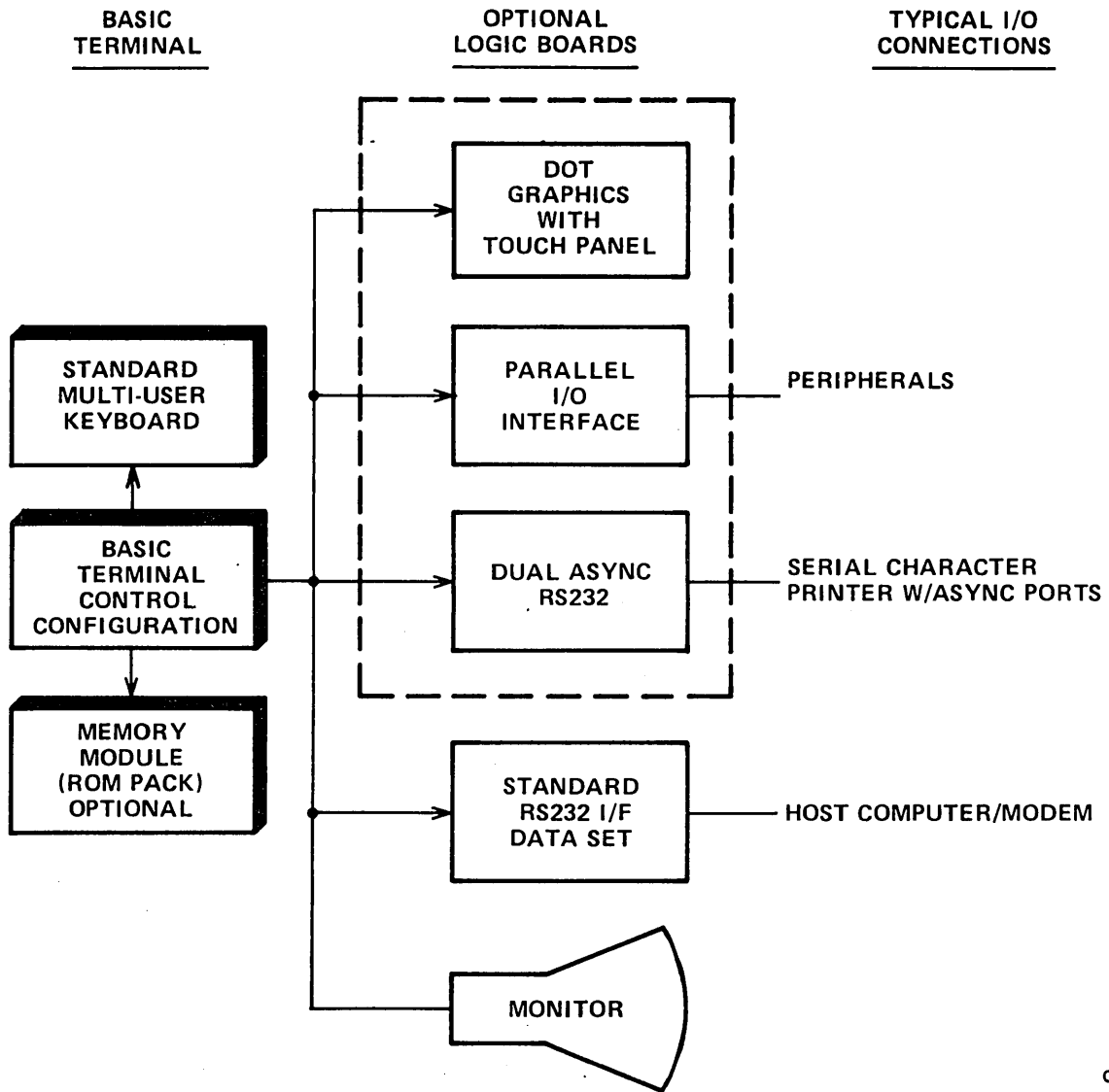

04337-2

Figure 1-3. Expanded Terminal Configuration

## EQUIPMENT SPECIFICATIONS

The following paragraphs describe the physical, electrical, and environmental specifications for the display terminal.

### PHYSICAL SPECIFICATIONS

The size and weight of the monitor and control module and detached keyboard module are as follows:

- o Monitor and control logic module
  - Height: 440 mm (17.3 in) nominal position
  - Width: 430 mm (16.9 in) maximum
  - Depth: 430 mm (17.0 in) maximum
  - Weight: 19.5 kg (43 lb) maximum
  - Weight (packaged): 22.2 kg (49 lb) maximum
  
- o Keyboard module
  - Height: 51 mm (2.0 in) maximum  
80 mm (3.1 in) maximum (raised position)
  - Width: 490 mm (19.3 in) maximum
  - Depth: 230 mm (9.0 in) maximum
  - Weight: 3.0 kg (8 lb)
  - Weight (packaged): 4.5 kg (10 lb) maximum

### ELECTRICAL SPECIFICATIONS

The display terminal has the following electrical power requirements:

	<u>Basic Configuration</u>	<u>Full Configuration</u>
o 120V ac, 50/60 Hz, at 1.0 A, nominal;		1.30 A, maximum
o 220V ac, 50/60 Hz, at 0.5 A, nominal;		0.71 A, maximum
o 240V ac, 50/60 Hz, at 0.5 A, nominal;		0.65 A, maximum
o 85 W (290 Btu/hr), heat dissipation configuration without options		

## ENVIRONMENTAL SPECIFICATIONS

The display terminal has the following environmental requirements:

- OPERATING:

Temperature range: 10°C(50°F) to 40°C(104°F)

Temperature change: 10°C(18°F)/60 minutes

Relative humidity range: 20 to 80 percent

Humidity change: 10 percent/60 minutes

Altitude: 3000m (9850 ft) maximum

- NONOPERATING:

Temperature range: -40°C(-40°F) to 60°C(140°F)

Temperature change: 20°C(36°F)/60 minutes

Relative humidity range: 5 to 100 percent

Humidity change: 10 percent/60 minutes





---

This section provides a brief description of the major functional areas and the optional features that may be configured with the display terminal:

- CRT Monitor
- Microprocessor
- Memory
- Display Refresh logic
- Host Interface
- Keyboard Interface
- Optional Features

#### CRT MONITOR

The terminal crt measures 380 mm (15 in) diagonally with an approximate 203 mm (8 in) by 262 mm (10.3 in) viewable area. A green phosphor is used to optimize performance in the interlaced mode of operation. A reduced-glare green faceplate is standard.

#### MICROPROCESSOR

The terminal uses a type Z80B programmable microprocessor. It is an 8-bit parallel central processor unit (CPU) contained in one large scale integration (LSI) microcircuit chip. The microprocessor controls all operations inside the terminal as well as directing the operation of associated peripheral equipments, such as printers, disk drives, and modems. See figure 2-1 for a block diagram of primary microprocessor functions.

There are six general purpose registers which are used individually either as 8-bit or 16-bit register-pairs. There are two sets of accumulator and flag registers. A group of exchange instructions designates each of the sets as main or alternate registers. The alternate set allows the programmer to operate in foreground-background mode or it may be reserved for very fast interrupt response. The microprocessor also contains a stack pointer, program counter, two index registers, a refresh counter, and an interrupt register.

The instruction set contains the following categories of operations and the type of action performed by each category.

<u>Category</u>	<u>Type of Action</u>
8-Bit loads	Miscellaneous
16-Bit loads	Rotates and shifts
Exchanges	Bit set, reset and test
Memory block moves	Input and output
Memory block searches	Jumps
8-Bit arithmetic and logic	Calls
16-Bit arithmetic	Restarts
General purpose accumulator and flag operations	Returns

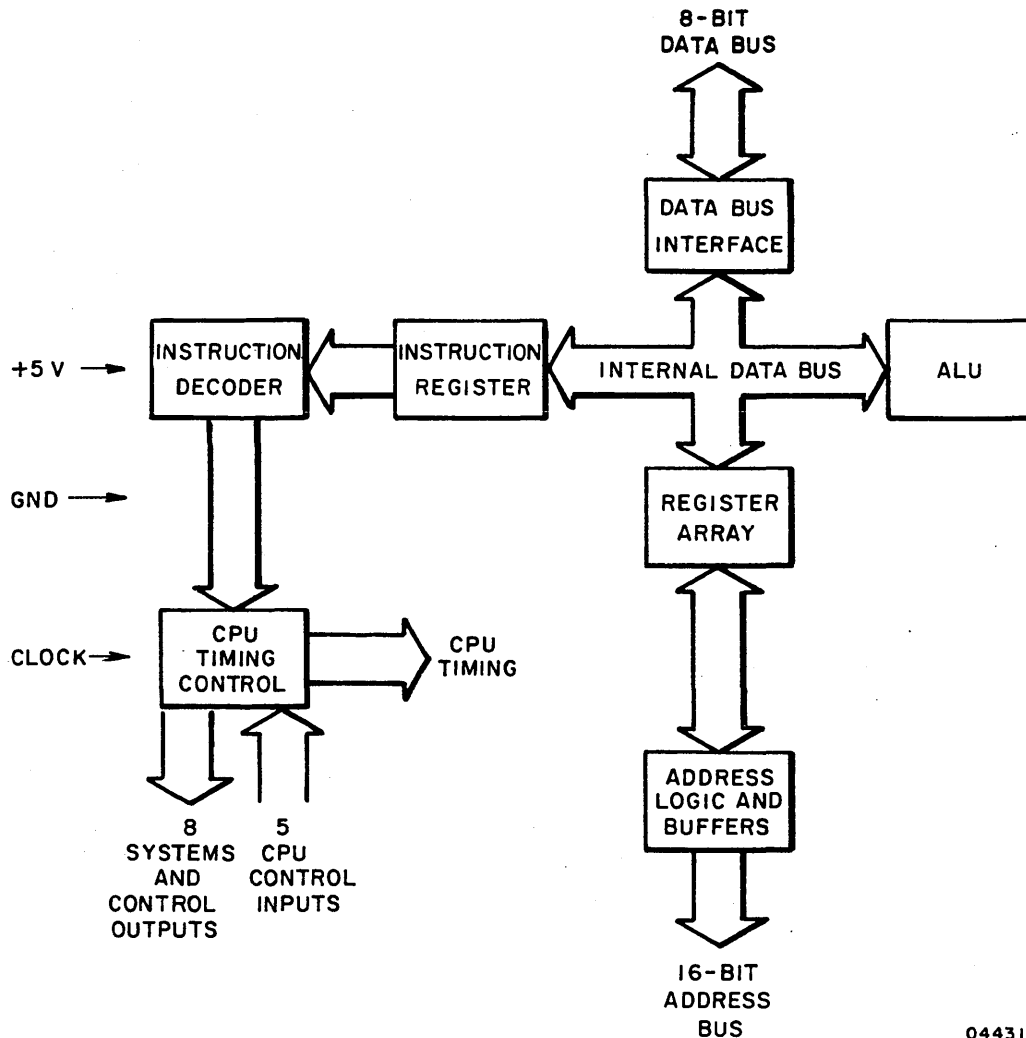

04431

Figure 2-1. Microprocessor CPU Block Diagram

## MEMORY

The terminal uses a 16-bit address bus that allows for a maximum of 64K bytes of direct memory addressing. However, since the terminal has more than 64K bytes of RAM and ROM, memory mapping is required. Refer to figure B-1 (in Appendix B) to see how the memory is divided into 16K banks. The memory mapping scheme used structures these banks into four blocks forming 64K of addressable memory locations as shown in figure B-2 (in Appendix B). Block 0 starts at address 0000, block 4 starts at address 4000, block 8 starts at address 8000, and block C starts at address C000.

## DISPLAY REFRESH LOGIC

A block diagram of the display refresh logic is shown in figure 2-2. The display is refreshed from executable 64K RAM memory via dual-line buffers and a symbol generator. Each line buffer stores one line of displayable characters and character attributes. Line addresses, resident at fixed-byte locations in executable RAM, are read by the refresh hardware and used to define locations in the RAM where the strings of character and attribute codes are stored.

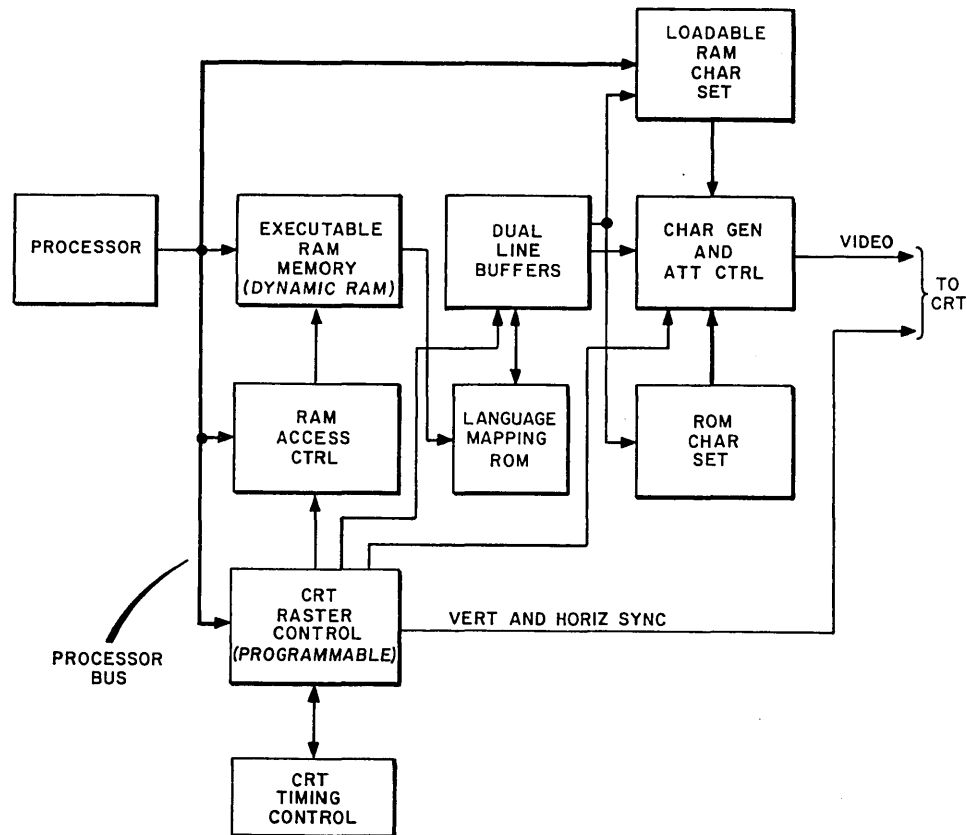

03976-2

Figure 2-2. Display Refresh Logic - Alphanumeric Mode

## SYMBOL GENERATORS

The codes received from memory with conversion by foreign character ROM, determine what symbol is to be generated. If the most significant 2 bits are ones, the loadable symbol generator symbols are used. If either of the most significant 2 bits are a zero, the ROM based symbol generator is used.

### ROM-Based Generator

The ROM-based generator provides the following symbols:

- 95 ANSI X3.4 Alphanumeric Characters (tables 2-1 through 2-7).
- 32 ANSI X3.4 Control Code Symbols and one special parity error symbol (table 2-8).
- 32 Line Drawing Symbols (table 2-9).
- 32 Foreign Language Symbols (table 2-10).

A ROM symbol-generator IC allows the terminal to accommodate foreign and special character sets. The 32 foreign language symbols accommodate character sets in British, German, French, Spanish, Swedish/Finnish, and Danish/Norwegian.\*

### Loadable Symbol Generator

The loadable symbol generator uses bit patterns that have been loaded into RAM from an external source. A maximum of 64 symbols can be stored. These symbols are host accessed by character codes  $40_{16}$  thru  $7F_{16}$  when preceded by an extended character command code. The symbol generator addressing scheme is shown in figure 2-3.

---

\*Requires parameter selection and keycap kit option.

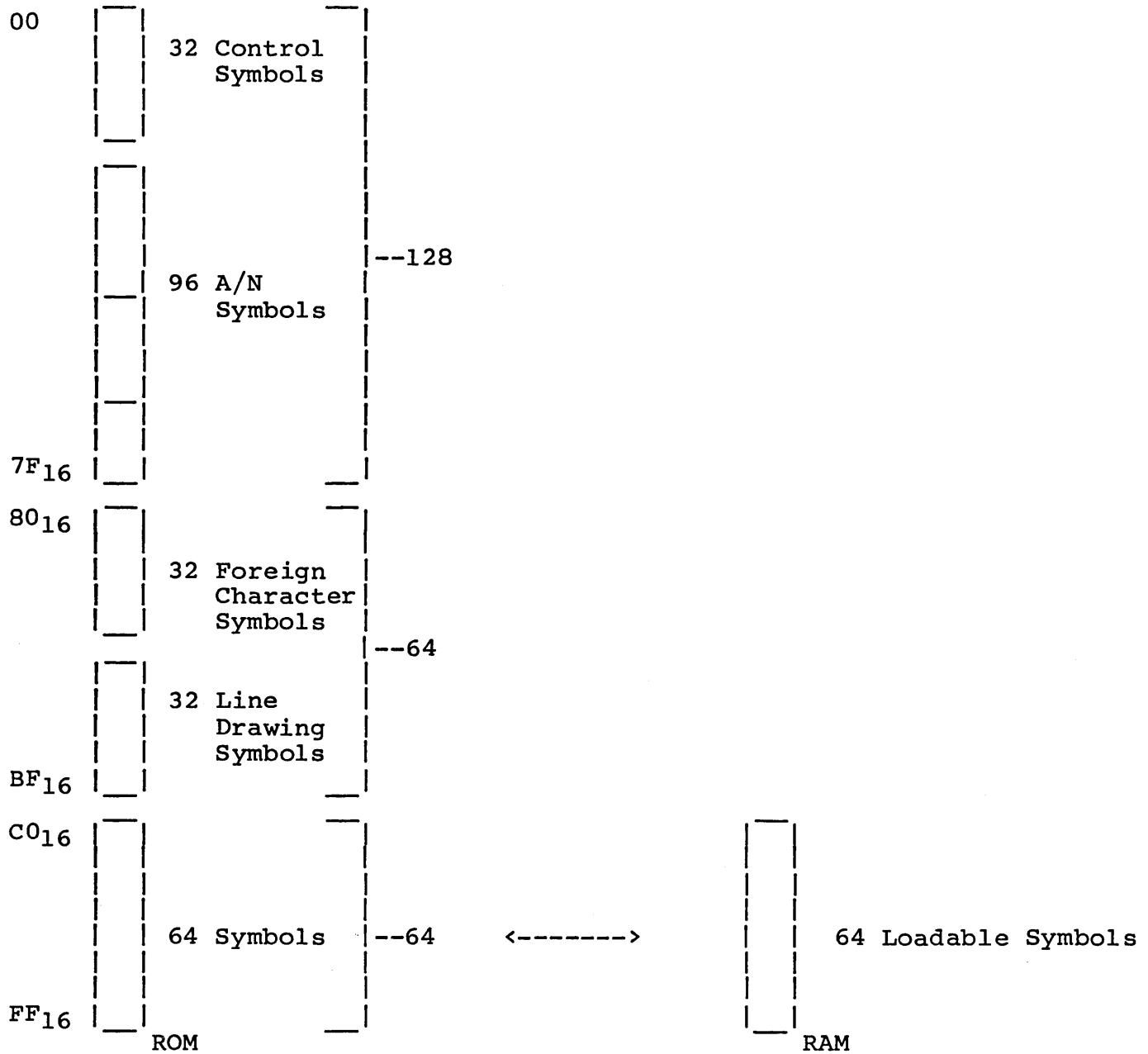

Eight memory bits address 256 symbols in ROM/RAM. An I/O bit controls overlay selection of 64 symbols.

Figure 2-3. Symbol Generator Addressing

## CHARACTER ATTRIBUTES

A character attribute code (background) is loaded into the line buffer for every character display code (foreground). Of the eight bits available, five are used by the hardware. These are:

<u>Bit No.</u>	<u>Feature</u>
0	Blank
1	Underscore
2	Inverse
3	Blink
4	Dim
5 thru 7	Available for program control (these may be used for marking modified fields, programmed fields, protected field, and so forth).

## DISPLAY TIMING

A crystal controlled oscillator provides the basic CRT timing. This method of timing, in conjunction with a programmable CRT controller IC allows flexibility in display modes of operation; that is, interlaced, 80- or 132-characters per row. A programmable bit allows this timing to be driven by an external source.

## SYMBOL GENERATION

Two methods of symbol generation are provided. In the first method, used for 80-column display format, the characters are formed via a 8- by 16-dot symbol generator. The dot array for all characters normally occupies a 7 by 12 subset within the generator. In the second method, used for 132-column display format, the characters are formed on the screen in a 5- by 16-dot space with half-dot step positioning. The same character generator bit pattern is used for both methods.

## CURSOR

The cursor indicates the current entry position. This position is represented on the screen in one of the following manners:

- Constant underline
- Blinking underline
- Solid block
- Blinking solid block

The type of cursor is determined by two operator selectable parameter bits.

TABLE 2-1. AMERICAN ALPHANUMERIC CHARACTER CODES

BITS					0	0	1	1	1	1
					0	1	0	0	1	1
					0	1	0	1	0	1
b4	b3	b2	b1	COLUMN ↓ ROW	2	3	4	5	6	7
0	0	0	0	0	SP	0	@	P	'	p
0	0	0	1	1	!	1	A	Q	a	q
0	0	1	0	2	"	2	B	R	b	r
0	0	1	1	3	#	3	C	S	c	s
0	1	0	0	4	\$	4	D	T	d	t
0	1	0	1	5	%	5	E	U	e	u
0	1	1	0	6	&	6	F	V	f	v
0	1	1	1	7	'	7	G	W	g	w
1	0	0	0	8	(	8	H	X	h	x
1	0	0	1	9	)	9	I	Y	i	y
1	0	1	0	10(A)	*	:	J	Z	j	z
1	0	1	1	11(B)	+	;	K	[	k	}
1	1	0	0	12(C)	,	<	L	\	l	
1	1	0	1	13(D)	-	=	M	]	m	}
1	1	1	0	14(E)	.	>	N	^	n	~
1	1	1	1	15(F)	/	?	O	_	o	

02015

TABLE 2-2. BRITISH ALPHANUMERIC CHARACTER CODES

BITS					0	0	1	1	1	1
b4	b3	b2	b1	COLUMN ROW	2	3	4	5	6	7
0	0	0	0	0	SP	0	@	P	'	p
0	0	0	1	1	!	1	A	Q	a	q
0	0	1	0	2	"	2	B	R	b	r
0	0	1	1	3	£	3	C	S	c	s
0	1	0	0	4	\$	4	D	T	d	t
0	1	0	1	5	%	5	E	U	e	u
0	1	1	0	6	&	6	F	V	f	v
0	1	1	1	7	'	7	G	W	g	w
1	0	0	0	8	(	8	H	X	h	x
1	0	0	1	9	)	9	I	Y	i	y
1	0	1	0	10(A)	*	:	J	Z	j	z
1	0	1	1	11(B)	+	;	K	[	k	}
1	1	0	0	12(C)	,	<	L	\	l	!
1	1	0	1	13(D)	-	=	M	]	m	}
1	1	1	0	14(E)	.	>	N	^	n	-
1	1	1	1	15(F)	/	?	O	_	o	

02015-8



TABLE 2-3. SPANISH ALPHANUMERIC CHARACTER CODES

BITS					0	0	1	1	1	1
					0	0	1	1	1	1
					0	1	0	0	1	1
					0	1	0	1	0	1
b7	b6	b5			0	0	1	1	1	1
b4	b3	b2	b1	COLUMN	2	3	4	5	6	7
				ROW						
0	0	0	0	0	SP	0	Ç	P	'	p
0	0	0	1	1	!	1	A	Q	a	q
0	0	1	0	2	"	2	B	R	b	r
0	0	1	1	3	£	3	C	S	c	s
0	1	0	0	4	\$	4	D	T	d	t
0	1	0	1	5	%	5	E	U	e	u
0	1	1	0	6	&	6	F	V	f	v
0	1	1	1	7	'	7	G	W	g	w
1	0	0	0	8	(	8	H	X	h	x
1	0	0	1	9	)	9	I	Y	i	y
1	0	1	0	10(A)	*	:	J	Z	j	z
1	0	1	1	11(B)	+	;	K	i	k	°
1	1	0	0	12(C)	,	<	L	Ñ	l	ñ
1	1	0	1	13(D)	-	=	M	ç	m	ç
1	1	1	0	14(E)	.	>	N	^	n	~
1	1	1	1	15(F)	/	?	O	_	o	

02015-9

TABLE 2-4. GERMAN ALPHANUMERIC CHARACTER CODES

BITS					0	0	1	1	1	1
					0	1	0	0	1	1
					0	1	0	1	0	1
b4	b3	b2	b1	COLUMN ↓ ROW	2	3	4	5	6	7
0	0	0	0	0	SP	0	§	P	'	p
0	0	0	1	1	!	1	A	Q	a	q
0	0	1	0	2	"	2	B	R	b	r
0	0	1	1	3	#	3	C	S	c	s
0	1	0	0	4	\$	4	D	T	d	t
0	1	0	1	5	%	5	E	U	e	u
0	1	1	0	6	&	6	F	V	f	v
0	1	1	1	7	'	7	G	W	g	w
1	0	0	0	8	(	8	H	X	h	x
1	0	0	1	9	)	9	I	Y	i	y
1	0	1	0	10(A)	*	:	J	Z	j	z
1	0	1	1	11(B)	+	;	K	Ä	k	ä
1	1	0	0	12(C)	,	<	L	Ö	l	ö
1	1	0	1	13(D)	-	=	M	Ü	m	ü
1	1	1	0	14(E)	.	>	N	^	n	β
1	1	1	1	15(F)	/	?	O	_	o	

02015-2

TABLE 2-5. FRENCH ALPHANUMERIC CHARACTER CODES

BITS					0	0	1	1	1	1
					0	1	0	0	1	1
b4	b3	b2	b1	COLUMN ROW	2	3	4	5	6	7
0	0	0	0	0	SP	0	à	P	`	p
0	0	0	1	1	!	1	A	Q	a	q
0	0	1	0	2	"	2	B	R	b	r
0	0	1	1	3	£	3	C	S	c	s
0	1	0	0	4	\$	4	D	T	d	t
0	1	0	1	5	%	5	E	U	e	u
0	1	1	0	6	&	6	F	V	f	v
0	1	1	1	7	'	7	G	W	g	w
1	0	0	0	8	(	8	H	X	h	x
1	0	0	1	9	)	9	I	Y	i	y
1	0	1	0	10(A)	*	:	J	Z	j	z
1	0	1	1	11(B)	+	;	K	°	k	é
1	1	0	0	12(C)	,	<	L	ç	l	ù
1	1	0	1	13(D)	-	=	M	§	m	è
1	1	1	0	14(E)	.	>	N	^	n	..
1	1	1	1	15(F)	/	?	O	_	o	

Q2015-1

TABLE 2-6. SWEDISH/FINNISH ALPHANUMERIC CHARACTER CODES

BITS					0	0	1	1	1	1
					0	0	1	0	1	1
					0	1	0	1	0	1
b7	b6	b5			2	3	4	5	6	7
b4	b3	b2	b1	COLUMN						
↓	↓	↓	↓	↓	ROW					
0	0	0	0	0	SP	0	É	P	é	p
0	0	0	1	1	!	1	A	Q	a	q
0	0	1	0	2	"	2	B	R	b	r
0	0	1	1	3	#	3	C	S	c	s
0	1	0	0	4	Ø	4	D	T	d	t
0	1	0	1	5	%	5	E	U	e	u
0	1	1	0	6	&	6	F	V	f	v
0	1	1	1	7	'	7	G	W	g	w
1	0	0	0	8	(	8	H	X	h	x
1	0	0	1	9	)	9	I	Y	i	y
1	0	1	0	10(A)	*	:	J	Z	j	z
1	0	1	1	11(B)	+	;	K	Ä	k	ä
1	1	0	0	12(C)	,	<	L	Ö	l	ö
1	1	0	1	13(D)	-	=	M	Å	m	å
1	1	1	0	14(E)	.	>	N	Ü	n	ü
1	1	1	1	15(F)	/	?	O	_	o	

02015-7

TABLE 2-7. DANISH/NORWEGIAN ALPHANUMERIC CHARACTER CODES

BITS					0	0	1	1	1	1
					0	0	1	1	1	1
					0	1	0	0	1	1
b4	b3	b2	b1	COLUMN	2	3	4	5	6	7
↓	↓	↓	↓	↓ ROW						
0	0	0	0	0	SP	0	@	P	`	p
0	0	0	1	1	!	1	A	Q	a	q
0	0	1	0	2	"	2	B	R	b	r
0	0	1	1	3	#	3	C	S	c	s
0	1	0	0	4	\$	4	D	T	d	t
0	1	0	1	5	%	5	E	U	e	u
0	1	1	0	6	&	6	F	V	f	v
0	1	1	1	7	'	7	G	W	g	w
1	0	0	0	8	(	8	H	X	h	x
1	0	0	1	9	)	9	I	Y	i	y
1	0	1	0	10(A)	*	:	J	Z	j	z
1	0	1	1	11(B)	+	;	K	Æ	k	æ
1	1	0	0	12(C)	,	<	L	Ø	l	ø
1	1	0	1	13(D)	-	=	M	Å	m	å
1	1	1	0	14(E)	.	>	N	^	n	-
1	1	1	1	15(F)	/	?	O	_	o	

02015-10

TABLE 2-8. CONTROL CHARACTER CODES

BITS					0	0	1
b4	b3	b2	b1	COLUMN	0	1	7
				ROW			
0	0	0	0	0	NUL	DLE	
0	0	0	1	1	SOH	DC1	
0	0	1	0	2	STX	DC2	
0	0	1	1	3	ETX	DC3	
0	1	0	0	4	EOT	DC4	
0	1	0	1	5	ENQ	NAK	
0	1	1	0	6	ACK	SYN	
0	1	1	1	7	BEL	ETB	
1	0	0	0	8	BS	CAN	
1	0	0	1	9	HT	EM	
1	0	1	0	10 (A)	LF	SUB	
1	0	1	1	11 (B)	VT	ESC	
1	1	0	0	12 (C)	FF	FS	
1	1	0	1	13 (D)	CR	GS	
1	1	1	0	14 (E)	SO	RS	
1	1	1	1	15 (F)	SI	US	DEL <sup>(1)</sup>

02016

(1) This character code is used to denote a parity error.

TABLE 2-9. LINE DRAWING SYMBOL CODES

BITS					0	0
b7 →						
b6 →						
b5 →						
b4	b3	b2	b1	COLUMN → ROW	2	3
0	0	0	0	0	—	┘
0	0	0	1	1		┐
0	0	1	0	2	┌	└
0	0	1	1	3	┌	┐
0	1	0	0	4	└	┐
0	1	0	1	5	┘	┐
0	1	1	0	6	┐	└
0	1	1	1	7	└	└
1	0	0	0	8	┐	┘
1	0	0	1	9	┐	┌
1	0	1	0	10 (A)	┐	┘
1	0	1	1	11 (B)	—	└
1	1	0	0	12 (C)		■
1	1	0	1	13 (D)	┌	■
1	1	1	0	14 (E)	┌	
1	1	1	1	15 (F)	└	■

02016-2

TABLE 2-10. FOREIGN CHARACTER CODES

BITS					0	0
b7 →					0	0
b6 →					0	0
b5 →					0	1
b4 ↓	b3 ↓	b2 ↓	b1 ↓	COLUMN → ROW ↓	0	1
0	0	0	0	0	£	¤
0	0	0	1	1	à	É
0	0	1	0	2	è	Å
0	0	1	1	3	ù	â
0	1	0	0	4	e'	é
0	1	0	1	5	ç	ı
0	1	1	0	6	°	—
0	1	1	1	7	§	
1	0	0	0	8	Ä	Ö
1	0	0	1	9	Ö	Æ
1	0	1	0	10 (A)	Ü	Ø
1	0	1	1	11 (B)	ä	æ
1	1	0	0	12 (C)	ö	ø
1	1	0	1	13 (D)	ü	
1	1	1	0	14 (E)	ß	Ñ
1	1	1	1	15 (F)	••	ñ

020167



## HOST INTERFACE

The only method of interfacing to the host system is through the interface conforming to RS-232-C/CCITT V.24 (data set interface). In asynchronous RS-232-C operation, a different send and receive data rate may be provided. The data rate and several other communication parameters are entered via the keyboard. The interface selection is operator program selectable.

The RS-232-C/CCITT V.24 interface is described in Appendix C.

## KEYBOARD INTERFACE

A serial keyboard interface is provided with a single, standard-length cable to allow 1 metre (39.4 in) keyboard to monitor separation.

## OPTIONAL FEATURES

The following paragraphs describe the functions of the optional features that may be configured with the system:

### TOUCHPANEL OPTION

The touchpanel option is part of the graphics display option. The touchpanel array size is 16 by 16 providing a 12.7 mm square grid on the monitor. Each square grid covers 4 characters by 2 lines in 80 character/line mode. Control logic for the touchpanel is located on the graphics option module. Touchpanel operation is used with the graphic-display operation. In modes supporting touchpanel input, pressure applied to the touchpanel surface interrupts an X/Y scanning mechanism. When a touch is detected, the terminal captures the intersecting X/Y coordinates for processing and produces an audible tone, except in CYBER mode. In CYBER mode, the cursor moves to the area touched.

## GRAPHICS DISPLAY OPTION

The standard graphics display capability allows the terminal to display a 512- by 480- full-vector dot array on the monitor. The refresh memory is contained in a separate independent 32K bytes of dynamic RAM. This memory is mapped into processor memory space by the display driver when required. All bit patterns are written under normal processor-to-memory, operations.

A graphics mode selection allows full IST compatibility to display a 512- by 512- full-vector dot array. Both capabilities are provided on the same basic graphics module (program selectable). Refer to appendix D.

## PARALLEL CHANNEL OPTION

In the graphics operations described in appendix D, the parallel channel interface supports a graphics printer. The graphics printer provides a 115 LPM capability. The parallel channel interface control logic is contained on a small customer-installable option module.

## MEMORY MODULE (ROM PACK) OPTION

The ROM pack plugs into the terminal via an external slot accessible on the back of the display cabinet. Each ROM pack provides a maximum of 16K bytes of memory. Firmware in the basic terminal allows the ROM pack code to supersede resident mode and parameter selection. The ROM pack is packaged in a hand-sized module that has its connector contacts protected when not inserted in the terminal.

## DUAL ASYNCHRONOUS INTERFACE OPTION

The dual bidirectional asynchronous interface can connect to two RS-232-C-compatible devices. The dual interface supports the same data rate for both send and receive data on each port. Data rate and other communication parameters can be entered on the keyboard. The interface supports local devices with cable lengths less than 15 metres (50 ft). This interface is provided on a small customer-installable option module.

## FOREIGN KEYCAP OPTIONS

Foreign keycap kits are available for the following languages:

- German
- French
- British
- Spanish
- Swedish/Finnish
- Danish/Norwegian

A language selection in the terminal installation parameters (described in section 4) allows displayed characters to be changed to match the installed keycap kit.



---

This section describes the operator-accessible controls and indicators of the display terminal including the various keyboard configurations. Refer to section 4 for information on parameter selection and terminal operation.

#### CABINET-MOUNTED CONTROLS AND INDICATORS

All of the following items are mounted on the terminal cabinet (figure 3-1).

- POWER 0/1 (off/on) Switch - Allows the operator to control primary power application to the terminal. This switch is located at the front of the terminal.
- CBI Circuit Breaker - Provides line circuit over-current protection for the terminal. CBI is located at the rear of the terminal and can be reset when the over-current fault condition is cleared.
- TEST Switch - This slide switch allows maintenance loopback of the resident host interface (RS232C) and keyboard I/F for fault isolation capability. It is in the TEST (looped) position when the actuator is pulled out. This switch is located at the rear of the terminal
- RESET Switch - Allows operator to reset the terminal to a normal restart condition (provides a clear function to the terminal). Terminal activity is program dependent. This switch is located on the front of the terminal.
- BRIGHTNESS (Intensity) Control - Allows the operator to adjust the video intensity to the ambient lighting conditions. This control is located on the front of the terminal.
- CONTRAST Control - Allows the operator to adjust the intensity variation between the normal characters and background. This control is located at the front of the terminal.
- LINE VOLTAGE Switch - Allows for selection of the appropriate line voltage range (115/220 V ac) for terminal operation. This switch is located at the rear of the terminal. CAUTION: This switch must be set to equal line voltage.
- M REL (Manual Release) - This key will perform a firmware manual release. Any print or host operation is aborted.

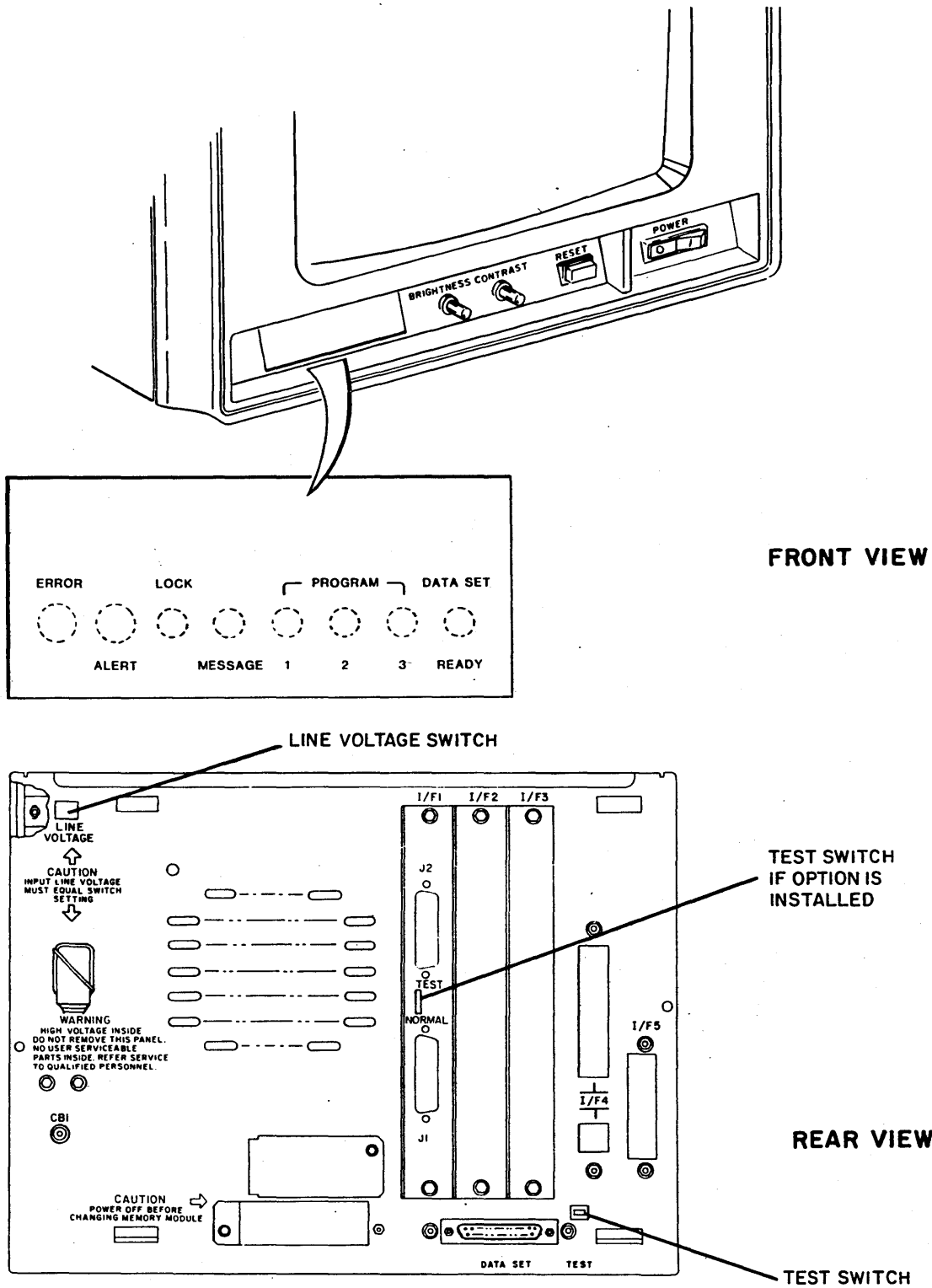

04218-3

Figure 3-1. Location of Controls and Indicators

- DATA SET READY Indicator - Illuminates if the Data Set Ready signal at the modem (host) interface is present. The DATA SET READY indicator is located at the front of the terminal.

- LOCK (Keyboard Locked) Indicator - Illuminates during a page print operation. The keyboard is also locked and the LOCK indicator is lit if the terminal is unable to transmit data due to loss of modem control signals such as CTS or DATA SET READY while the terminal is online and ready to send, or if the terminal is disabled by host command. Also, the keyboard is locked out during block mode communication with the host or when a disk operation is active. The LOCK indicator is located at the front of the terminal.
- MESSAGE (Message Waiting) Indicator - This indicator is under program control. The MESSAGE indicator is located on the front of the terminal.
- ALERT Indicator - Used as an alternate visible alert when the audible alarm is disabled or cannot be heard. It is controlled by a programmable bit. The Alert indicator is located at the front of the terminal.
- ERROR Indicator - Illuminates when a terminal subsystem or mode dependent error condition is detected. It is controlled by a programmable bit. The Error indicator is located at the front of the terminal.
- PROGRAM 1/PROGRAM 2/PROGRAM 3 (Programmable) Indicators - These three indicators are under programmable control, and are illuminated when certain conditions are present as defined by the program. The Programmable indicator is located at the front of the terminal.
- Audible Alarm - Provides a two-level (loud/soft intensity) audible alarm signal. Operation is under firmware control and is also operator parameter bit controlled. The following conditions cause an audible alarm to occur:

After power on or RESET has run test 1

- Improper key depressions during MODE selection.
- Host code sequence
- Entry of certain key while the cursor is in a protected position
- Entry on keyboard while the keyboard is locked
- Entry of the cursor by the keyboard into the 8th position from end of line or into the last line caused by keyboard entry and margin alert enabled.

## KEYBOARD CONFIGURATIONS

Figure 3-2 shows the standard keyboard. Figures 3-3 through 3-8 show the keyboard with foreign keycap kits installed. The symbols on the keys support standard alphanumeric requirements and mode dependent special functions. The keyboard function keys can be labeled with application-unique legends through use of special overlay templates.

All keys - including special functions such as Shift and Control - are under firmware control. If a foreign keycap kit is installed, the only change necessary is to specify the language in the terminal installation parameters. The foreign character sets supported are:

- German
- French
- British
- Spanish
- Swedish/Finnish
- Danish/Norwegian

Each keycap option consists of a user-installed keycap kit. The corresponding characters are displayed by changing the factory-set language in the terminal installation parameters. For changing terminal installation parameters, refer to appendix A of the CDC 721 Display Terminal Operator's Guide/Installation Instructions Manual (publication number is listed in preface).

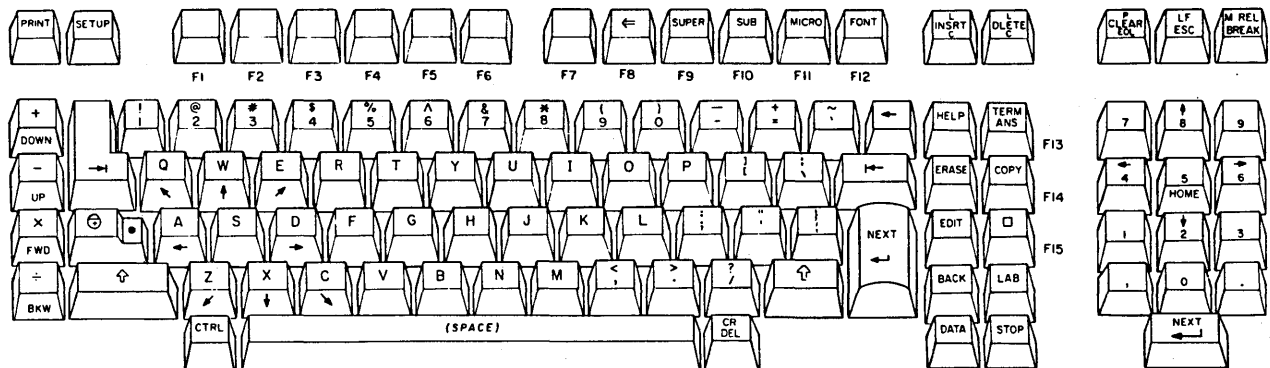

03942-6

Figure 3-2. Keyboard with Standard English Keycaps



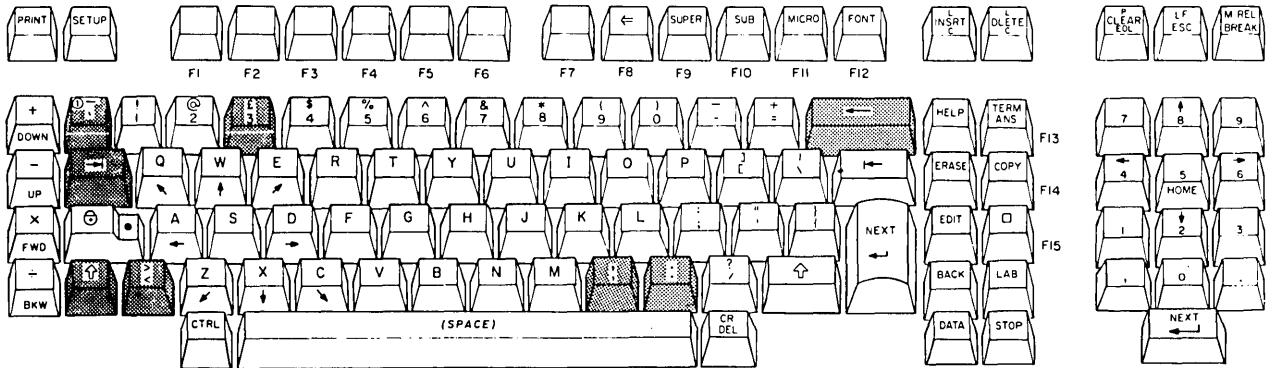

NOTES:  
 OPTIONAL KEYCAPS ARE SHADED FOR ILLUSTRATING PURPOSES

03942-19

⊖ UPPER-OVER BAR  
 ⊕ LOWER-GRAVE ACCENT

Figure 3-3. Keyboard with British Keycap Option

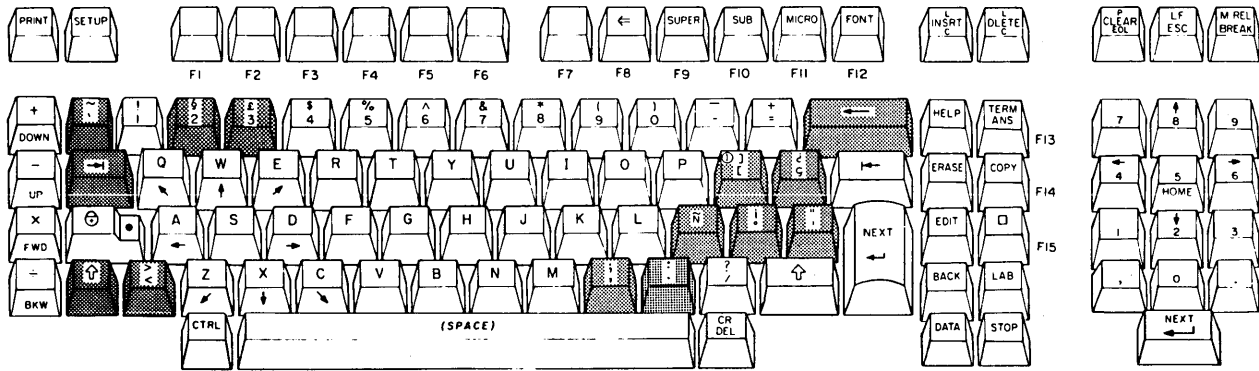

NOTES:  
OPTIONAL KEYCAPS ARE SHADED FOR ILLUSTRATING PURPOSES

03942-30

Figure 3-4. Keyboard with Spanish Keycap Option

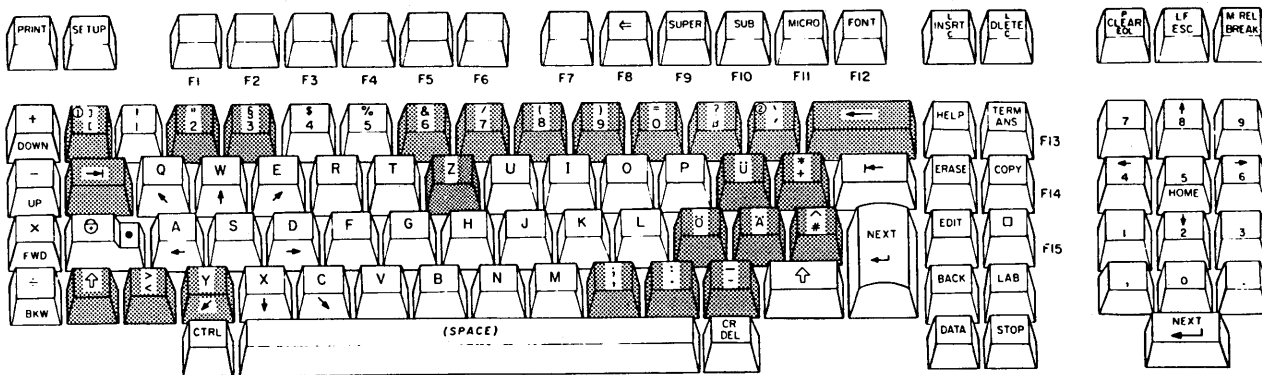

NOTES:  
OPTIONAL KEYCAPS ARE SHADED FOR ILLUSTRATING PURPOSES

03942-27

⓪ PROVIDED FOR PLATO USAGE  
Ⓛ UPPER-GRAVE ACCENT  
Ⓜ LOWER-APOSTROPHE, ACUTE ACCENT

Figure 3-5. Keyboard with German Keycap Option

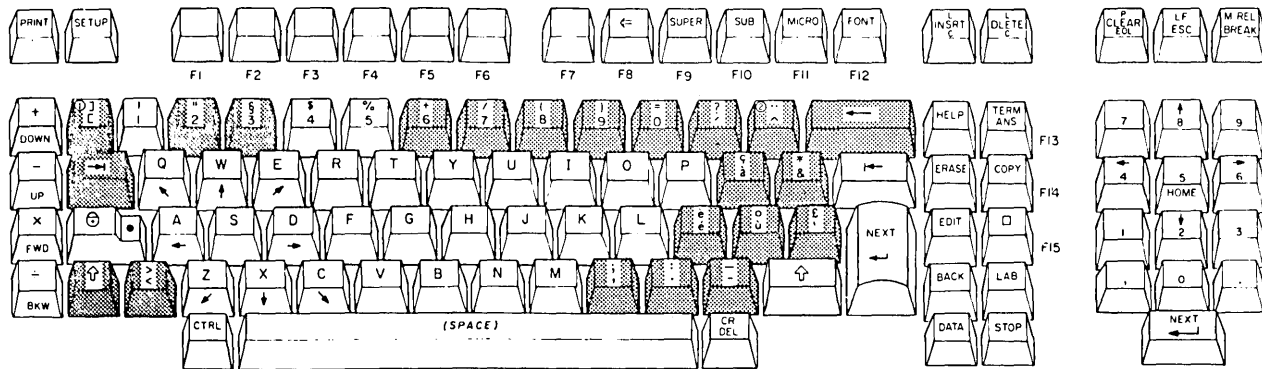

NOTES:  
OPTIONAL KEYCAPS ARE SHADED FOR ILLUSTRATING PURPOSES

⊕ PROVIDED FOR PLATO USAGE.  
⊙ UPPER-UMLAUT

03942-18

Figure 3-6. Keyboard with French Keycap Option

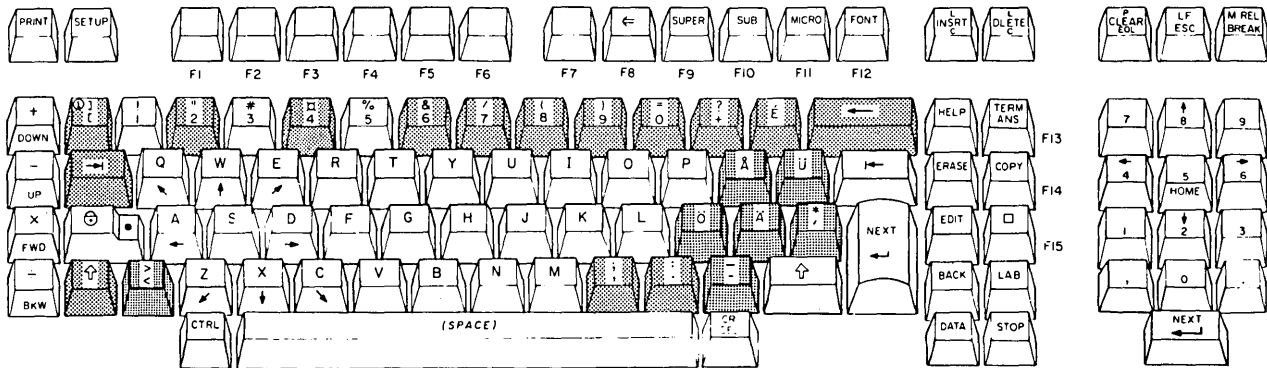

NOTES:  
OPTIONAL KEYCAPS ARE SHADED FOR ILLUSTRATING PURPOSES

03942-28

Figure 3-7. Keyboard with Swedish/Finnish Keycap Option

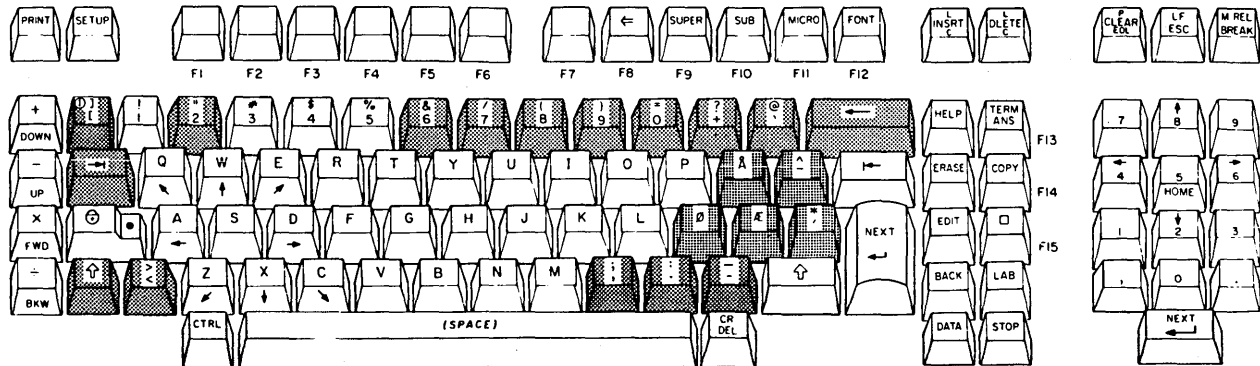

NOTES:  
OPTIONAL KEYCAPS ARE SHADED FOR ILLUSTRATING PURPOSES

03942-29

Figure 3-8. Keyboard with Danish/Norwegian Keycap Option

### KEYBOARD OPERATION

The keyboard provides for operator entry of desired symbols/commands. Figure 3-9 shows the keyboard keystation assignments. Each keystation, when pressed, sends an 8-bit serial code and parity to the terminal. A similar code is sent to the terminal when each keystation is released. This allows the terminal program to monitor the exact state of the keyboard and assign/define the resultant activity as desired. Refer to table 3-1 for keystation coding.

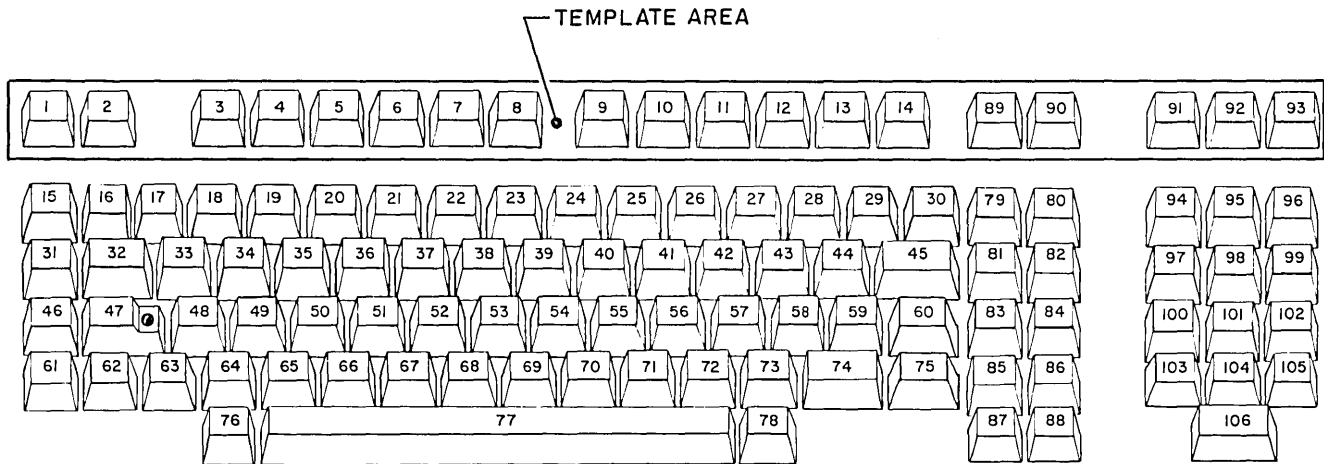

03942-11

Figure 3-9 Keyboard Keystation Assignments

TABLE 3-1. KEYBOARD KEYSTATION CODING (HEXIDECIMAL)

KEY STATION NUMBER	OUTPUT CODE	
	DOWN	UP
1	10	90
2	18	98
3	20	A0
4	28	A8
5	30	B0
6	38	B8
7	40	C0
8	48	C8
9	50	D0
10	58	D8
11	60	E0
12	68	E8
13	70	F0
14	78	F8
15	11	91
16	19	99
17	21	A1
18	29	A9
19	31	B1
20	39	B9

TABLE 3-1. KEYBOARD KEYSTATION CODING (HEX) (CONTD)

KEY STATION NUMBER	OUTPUT CODE	
	DOWN	UP
21	41	C1
22	49	C9
23	51	D1
24	59	D9
25	61	E1
26	69	E9
27	71	F1
28	79	F9
29	7E	FE
30	76	F6
31	13	93
32	1B	9B
33	23	A3
34	2B	AB
35	33	B3
36	3B	BB
37	43	C3
38	4B	CB
39	53	D3
40	5B	DB
41	63	E3
42	6B	EB
43	73	F3
44	7B	FB
45	7F	FF
46	12	92
47	1A	9A
48	22	A2
49	2A	AA
50	32	B2
51	3A	BA
52	42	C2
53	4A	CA
54	52	D2
55	5A	DA
56	62	E2
57	6A	EA
58	72	F2
59	7A	FA
60	67	E7
61	14	94
62	1C	9C
63	24	A4
64	2C	AC
65	34	B4

TABLE 3-1. KEYBOARD KEYSTATION CODING (HEX) (CONTD)

KEY STATION NUMBER	OUTPUT CODE	
	DOWN	UP
66	3C	BC
67	44	C4
68	4C	CC
69	54	D4
70	5C	DC
71	64	E4
72	6C	EC
73	74	F4
74	7C	FC
75	66	E6
76	25	A5
77	2D	AD
78	35	B5
79	6E	EE
80	36	B6
81	77	F7
82	6F	EF
83	5F	DF
84	55	D5
85	5D	DD
86	56	D6
87	45	C5
88	4D	CD
89	7D	FD
90	75	F5
91	6D	ED
92	37	B7
93	1D	9D
94	16	96
95	1E	9E
96	26	A6
97	17	97
98	1F	9F
99	27	A7
100	4F	CF
101	47	C7
102	3F	BF
103	4E	CE
104	46	C6
105	3E	BE
106	3D	BD





---

This section describes the method of parameter selection and operation of the terminal in CYBER mode.

### PARAMETER SELECTION

The terminal has no operator parameter switches that can be sensed by the processor. Instead, parameters are entered into a nonvolatile memory (NVM) and read by the processor. The NVM retains the parameters when power is off via the use of a battery. These parameters should be set/changed only by terminal installation personnel or their equivalent. No provision has been made for a nontechnical operator to have the capability to change the installation parameters.

The parameters consist of the following three groups:

- Terminal Installation Parameters
- Mode Installation Parameters
- Mode Operator Parameters

There is one set of terminal installation parameters, six sets of mode installation and operator parameters (see figure 4-1). The terminal installation parameters are viewed and changed by simultaneously pressing the CTRL and SETUP keys prior to operator mode selection. The mode installation parameters (figure 4-2) can then be viewed and changed by pressing F10 and the desired mode number. Parameters are changed in NVM by making change on screen and pressing COPY. The mode operator parameters are viewed and temporarily changed by pressing SETUP while in an active mode.

ADDRESS	NONVOLATILE MEMORY		MEMORY
4000 HEX	TERMINAL	ACTIVE IN ALL MODES*	MODE #
	INSTALLATION		↓
4020 HEX	MODE 1	> CYBER MODE	1
	OPERATOR		
4040 HEX	MODE 2	> PLATO MODE	2
	OPERATOR		
4060 HEX	MODE 3	> CP/M**	3
	OPERATOR		
4080 HEX	MODE 4	> DISK**	4
	OPERATOR		
40A0 HEX	MODE 5	> C120**	5
	OPERATOR		
40C0 HEX	MODE 6	>	6
	OPERATOR		
40E0 HEX		USED TO RETAIN THE NAMES > ENTERED FOR MODES 3-6	

\*ANY MODE CAN BE ASSIGNED TO ANY BLOCK, EXCEPT 1 IS RESERVED FOR RESIDENT CYBER MODE AND 2 IS RESERVED FOR PLATO MODE.

\*\*DEFAULT NAMES

Figure 4-1. Parameters

CONVENTIONS:

1. LOWERCASE LABELS INDICATE A BRANCHING FUNCTION.
2. ALPHA CAPS LABELS INDICATE A DIRECT FUNCTION SELECTION.
3. "BOXES" ARE DISPLAYED IN INVERSE VIDEO.
4. F1 THROUGH F10 ARE SELECTED BY PRESSING (OPERATOR) FUNCTION KEYS F1 THROUGH F10.
5. AN \* WILL APPEAR IN THE LOWER RIGHT CORNER OF THE BOX THAT IS THE AUTO SELECT MODE.

(\*A CUSTOMER OR APPLICATION DEFINED 4 ALPHANUMERIC CHARACTER LABEL FOR MODES 3 THROUGH 6 AND OPERATOR DEFINED AT MODE INSTALLATION TIME. THE DEFAULT VALUES ARE SHOWN.)

F   MODE 1	F   MODE 2	F   MODE 3	F   MODE 4	F   MODE 5	F   MODE 6	F   MODE 7	F   TERMNL	F	F
1   CYBER	2   PLATO	3   CP/M	4   DISK	5   C120	6   XXXX	7   PACK	8   TEST	9	10
		*	*	*	*				

0            10            20            30            40            50            60            70            80

LAST TWO ROWS DISPLAY (VIRTUAL LINES) AFTER POWER ON OR RESET

Figure 4-2. Mode Selection Menu

## TERMINAL INSTALLATION PARAMETERS

The terminal installation parameters are used in all modes. They can be viewed by simultaneously pressing the CTRL and SETUP keys prior to operator mode selection. To change any installation parameter, the cursor must be positioned under the item to be changed and COPY must be pressed prior to displaying different information. Only the following keys are operable for changing parameters.

- Space - Moves cursor to next changeable parameter. If cursor is under the last changeable parameter, it will wrap around and reposition again under the first changeable parameter.
- Backspace - Moves cursor back to next changeable parameter. If cursor is under the first changeable parameter, it will stop.
- 0 - 7 - Enters 0 or 7 at cursor if field requires an octal value.
- 0 - 1 - Enters 0 or 1 at cursor if field requires a binary value.
- 0 - 9, A - F - Enters 0 to 9 or A to F at cursor if field requires a hexadecimal value.
- COPY - Stores the current line of parameters displayed in NVM (non-volatile memory).
- F1 (Return) - Exits to terminate installation mode (Returns to mode selection menu).
- F2 - F9 - Moves cursor under first changeable parameter in the associated field.
- F10 - Goes to mode installation parameters.

The cursor advances to next changeable location after each data entry. Cursor movement is not limited to the selected function key group; a new function group may be selected as required. See figure 4-3 for terminal installation parameters.

F	return	F	CONFIG	F	CONFIG	F	CONFIG	F	CONFIG	F	AS X Y	F	L ID	F	PORT A	F	PORT B	F	instl
1		2	123456	3	123456	4	123456	5	123456	6	O O H	7	O HHH	8	H H	9	H H	10	mode n

1-6 = BINARY  
 O = OCTAL  
 H = HEX

F2 CONFIGURATION (BINARY)

- 1 1 = SPARE
- 2 1 = TOUCHPANEL OPTION IN
- 3 1 = DUAL SERIAL INTERFACE OPTION IN
- 4 1 = GRAPHIC PRINTER OPTION IN
- 5 1 = FLEXIBLE DISK OPTION IN
- 6 1 = SPARE

F3 CONFIGURATION

- 1 1 = 1200/1200 INTERNAL MODEM OPTION IN
- 2 1 = A KEYCAP OPTION INSTALLED
- 3 1 = GRAPHIC OPTION IN
- 4 1 = PARALLEL PORT OPTION IN
- 5 1 = SPARE
- 6 1 = FIXED DISK OPTION IN

F4 CONFIGURATION (BINARY)

- 1 1 = AUTO SELECT ENABLED 0 = AUTO SELECT DISABLED
- 2 1 = USE PRINTER SRTS 0 = IGNORE PRINTER SRTS
- 3 1 = SPARE
- 4 1 = SPARE
- 5 1 = SPARE
- 6 1 = SPARE

F5 CONFIGURATION (BINARY)

- 1 1 = SPARE
- 2 1 = SPARE
- 3 1 = SPARE
- 4 1 = SPARE
- 5 1 = SPARE
- 6 1 = SPARE

F6 AS AUTO SELECT (MODE NUMBER) (OCTAL)

- 0 = CYBER MODE
- 1 = CYBER MODE
- 2 = PLATO MODE
- 3 = MODE 3
- 4 = MODE 4
- 5 = MODE 5
- 6 = MODE 6
- 7 = ROM PACK FUNCTION

F6 X DISPLAY DISPLACEMENT RIGHT/LEFT (OCTAL)

- |                       |                      |
|-----------------------|----------------------|
| 0 = NO DISPLACEMENT   | 4 = NO DISPLACEMENT  |
| 1 = RIGHT 1 CHARACTER | 5 = LEFT 1 CHARACTER |
| 2 = RIGHT 2 CHARACTER | 6 = LEFT 2 CHARACTER |
| 3 = RIGHT 3 CHARACTER | 7 = LEFT 3 CHARACTER |

F6 Y DISPLAY DISPLACEMENT UP/DOWN (HEXADECIMAL)

- |                     |                     |
|---------------------|---------------------|
| 0 = NO DISPLACEMENT | 8 = NO DISPLACEMENT |
| 1 = UP 1 SCANS      | 9 = DOWN 1 SCANS    |
| 2 = UP 2 SCANS      | A = DOWN 2 SCANS    |
| 3 = UP 3 SCANS      | B = DOWN 3 SCANS    |
| 4 = UP 4 SCANS      | C = DOWN 4 SCANS    |
| 5 = UP 5 SCANS      | D = DOWN 5 SCANS    |
| 6 = UP 6 SCANS      | E = DOWN 6 SCANS    |
| 7 = UP 7 SCANS      | F = DOWN 7 SCANS    |

Figure 4-3. Terminal Installation Parameters

F7 L LANGUAGE (OCTAL)

0 = ENGLISH  
1 = ENGLISH  
2 = FRENCH  
3 = GERMAN  
4 = SWEDISH/FINNISH  
5 = BRITISH  
6 = SPANISH  
7 = DANISH/NORWEGIAN

F7 ID TERMINAL IDENTIFICATION

F8 PORT A (HEXADECIMAL)

1ST VALUE

B3 0 = PORT A PRINTER	1 = PORT A BI-DIRECTIONAL
B2 0 = PORT A PARITY ENABLED	1 = PORT A PARITY DISABLE
B1 0 = PORT A PARITY ODD/SPACE	1 = PORT A PARITY EVEN/MARK
B0 0 = PORT A STOP BITS 1	1 = A STOP BITS 2

2ND VALUE - BAUD RATE (HEXADECIMAL)

0 = 75 BAUD	4 = 300	8 = 2400
1 = 110	5 = 600	9 = 4800
2 = 150	6 = 1200	A = 9600
3 = 200	7 = 1800	B-F = 19.2K

F9 PORT B

Same as PORT A

F10 INSTALLATION PARAMETERS FOR MODE n

THE FOLLOWING MESSAGE WILL BE DISPLAYED

ENTER MODE n

ENTER MODE NAME  (FOR MODES 3-6)

Figure 4-3. Terminal Installation Parameters (Contd)

The meaning of the displayed blocks is further described in the following paragraphs.

F1 Return

Indicates that pressing the F1 key returns control to Mode Selection Menu.

F2 CONFIG (Configuration)

Each parameter bit in this block must be set to 1 for each option present. If an option is not present or disabled, the corresponding bit must be set to 0.

F3 CONFIG (Configuration)

Each parameter bit of the F3 block must be set to 1 for each option present or set to 0 if the option is not present or disabled.

## F4 CONFIG (Configuration)

The F4 parameters defines the following:

- F4-1 - AUTO SELECT ENABLE/DISABLE - If this bit is set to a 1, the mode selected in the Auto Select (AS) field (F6) will automatically load if Test 1 detected no errors. If this bit is set to 0, the Mode Selection Menu appears after Test 1 is run.
- F4-2 - USE/IGNORE PRINTER SRTS - If this bit is set to 1, a 200-millisecond delay will follow every carriage return and line feed sent to the serial printer when its Secondary Request To Send (STRS) line is in a marking or open condition. If this bit is set to 0, no delays will be used when sending data to a serial printer.

## F5 CONFIG (Configuration)

All bits in this parameter block are spare at this time.

## F6 AS, X or Y

The F6 parameters are:

- AS (AUTO SELECT) - This parameter allows the entry of a number between 0 and 7. The parameter value is used as the mode number if auto select enable is selected.
  - 0-1 - Executes CYBER mode.
  - 2-6 - Executes the appropriate mode.
  - 7 - Executes function in a ROM pack.
- X (Screen Move in X Direction) - As the CRT ages, the picture raster may drift. This parameter will allow the installer to move the raster left or right up to 3 characters in width. It is set to 0 when aligned at factory.

To move the raster left or right see the following listing:

0 = No move	4 = No move
1 = Move right 1 character	5 = Move left 1 character
2 = Move right 2 characters	6 = Move left 2 characters
3 = Move right 3 characters	7 = Move left 3 characters

- Y-Screen Move in Y Direction - As the CRT ages, the picture raster may drift. This parameter will allow the installer to move the raster up or down, up to 7 scans. It is set to 0 when aligned at factory. To move the raster up or down see the following listing:

0 = No move	8 = No move
1 = Move up 1 scans	9 = Move down 1 scans
2 = Move up 2 scans	A = Move down 2 scans
3 = Move up 3 scans	B = Move down 3 scans
4 = Move up 4 scans	C = Move down 4 scans
5 = Move up 5 scans	D = Move down 5 scans
6 = Move up 6 scans	E = Move down 6 scans
7 = Move up 7 scans	F = Move down 7 scans

### F7 L, ID

Allows selection of language characters and the terminal identification code.

- L - Language - This parameter allows the display of special foreign characters; only the numbers 0 through 7 are allowed. The unit must be reset after changing this parameter.

0 = English
1 = English
2 = French
3 = German
4 = Swedish/Finnish
5 = British
6 = Spanish
7 = Danish/Norwegian

- ID - (Terminal Identification Code) - The ID code is broken up into 4 codes. Each code can be set between 0 and F. This code can be used as a physical or logical identifier (host defined). They will be sent to the host with the Model Report Request in CYBER mode.

### F8 (PORT A)

This block establishes the data transmission parameters for port A of the dual asynchronous interface option.

- 1st Value - This is an encoded value to select different parameters for Port A.

- Bit 3 Printer/Bi-Directional - This parameter is used by the firmware to determine if an ASCII type printer is connected to the terminal. In order to connect an ASCII printer, the Dual Serial RS232/Serial Interface Option must be installed. This option has two serial I/O Ports, A and B. This parameter must be set to 1 if the printer is connected to Port A. Otherwise, it must be set to 0 for a bi-directional port, which is supported by the resident firmware.

NOTE

The firmware tests for a printer on Port A first. If both ports are sent for a printer, Port A will be used.

- Bit 2 (Parity Enabled/Disabled) - If this parameter is set to Parity Enable, even or odd parity is transmitted with each code and tested for on each code received. If this parameter is set to Parity Disabled, the parity checking logic is disabled and the terminal will transmit either a mark or space condition in the parity position of each code. Transmission of either mark or space parity is determined by the setting of the Port A Parity Odd/Even.
- Bit 1 (Parity Odd/Even) - This parameter interacts with Port A Parity Enabled/Disabled. If Channel A Parity Enabled is selected and:
  - This parameter is set to Parity Odd - The terminal will transmit and test for odd parity.
  - This parameter is set to Parity Even - The terminal will transmit and test for even party.

If Port A Parity Disabled is selected and:

- This parameter is set to Parity Odd - The terminal will transmit a space in place of the parity bit.
- This parameter is set to Parity Even - The terminal will transmit a mark in place of the parity bit.
- Bit 0 (1/2 Stop Bits) - If this parameter is set to 1 stop bit, only 1 stop bit is transmitted with each code. If this parameter is set to 2 stop bits, 2 stop bits are transmitted with each code. Received data may have one or two stop bits regardless of the parameter setting.
- 2nd Value (PORT A Baud Rate) - This parameter will be used to select the baud rate (send and receive) of PORT A. The value is encoded; 0 through F may be entered. (See figure 4-3).



## F9 (PORT B)

This block establishes data transmission parameters for port B of the dual asynchronous interface option.

### NOTE

The same descriptions apply, except substitute port B for port A.

- 1st Value - This is an encoded value to select different parameters for PORT B.
  - Bit 3 (Printer/Bidirectional) - Same as described for port A.
  - Bit 2 (Parity Enabled/Disabled) - Same as described for port A.
  - Bit 1 (Parity Odd/Even - Same as described for port A.
  - Bit 0 (1/2 Stop Bits - Same as described for port A.
- 2nd Value (PORT B Baud Rate) - Same as described for A baud rate.

## F10 [Instl Mode n (Installation Mode n)]

Mode installation parameters are entered as follows.

When F10 is pressed the following message will be displayed on line 27:

ENTER MODE n (1-6) |  |

The number 1 through 6 must be entered. It will be displayed where the inverse box is, and the inverse will go to normal intensity. If any other key is pressed, the alarm will sound and the key is ignored.

If mode 3 through 6 are selected, the following message will be displayed on line 28:

ENTER MODE NAME |  |

The current mode name will be displayed in the inverse boxes. If no change is desired, the NEXT key can be pressed. A change can be made by entering the new codes. When all four codes are entered (or the NEXT key pressed) control will transfer to mode installation parameter entry

## MODE INSTALLATION PARAMETERS

There are six sets of mode installation parameters, one set for each mode the terminal is to operate in. Modes 1 through 5 have factory-assigned, default, mode installation parameters. These parameters automatically load into NVM when no parameters have been stored (further details are given later in this section under Default Parameters). The default parameters establish mode 3 as CP/M mode, mode 4 as disk mode, and mode 5 as CI20 mode. If desired, the names for these mode numbers may be changed (previously covered in this section under F10 Instl Mode n) and new modes assigned by entering new mode installation parameters. The mode installation parameters for mode 1 (CYBER mode) and mode 2 (PLATO mode) may be changed as needed but not the names. Mode 6 is for a user assigned mode.

A set of mode installation parameters is shown in figure 4-4. To make a change, the cursor must be positioned under the item to be changed. The keys that are operable for mode parameter changes are the same as described earlier under Terminal Installation Parameters. To view the set of parameters for another mode, requires that the F1 key be pressed, then the CTRL and SETUP keys. This displays the message ENTER MODE n (1-6) ||.

The meaning of the displayed blocks is further described in the following paragraphs.

### F1 Return

Return control to Mode Selection Menu.

### F2 CONFIG (Configuration)

- F2-1 Mode Disabled/Enabled - When this parameter is set to 0, the mode is disabled and will not be executed. All the other parameters in the block can be set to perform a given load. This could allow a supervisor to simply disable or enable a mode. When this parameter is set to 1, the mode is enabled and can be executed.

ENTER MODE n(1-6)1

F	return	F	CONFIG	F	CONFIG	F	CONFIG	F	CONFIG	F	OPR DF	F	A-DIAL	F	A-DIAL	F	DF T R	F	ACCESS
1		2	123456	3	123456	4	123456	5	123456	6	HHHH	7	HHHHHH	8	HHHHHH	9	OH H H	10	HHHH

F2 CONFIGURATION (BINARY)

1 0 = MODE DISABLED	1 = MODE ENABLED
2 0 = ACCESS DISABLED	1 = ACCESS ENABLED
*3 0 = USE DEFAULT SOURCE/FILE/ PHONE NUMBER	1 = OPERATOR SELECT SOURCE/FILE/PHONE NUMBER
*4 0 = RUN INTERNAL	1 = LOAD EXTERNAL
*5 0 = LOAD FROM HOST	1 = LOAD FROM FLEXIBLE DISK
6 0 = RESIDENT HOST INTERFACE	1 = 1200/1200 INTERNAL MODEM INTERFACE

F3 CONFIGURATION (BINARY)

1 0 = SPARE	1 = SPARE
2 0 = AUTO DIAL DISABLED	1 = AUTO DIAL ENABLED
3 0 = HOST 7 BITS (DATA)	1 = HOST 8 BITS (DATA)
4 0 = HOST PARITY DISABLE	1 = HOST PARITY ENABLE
5 0 = HOST PARITY ODD	1 = HOST PARITY EVEN
6 0 = HOST 1 STOP BIT	1 = HOST 2 STOP BITS

F4 CONFIGURATION (BINARY)

1 0 = DTR CONSTANT	1 - DTR SWITCHED
2 0 = RTS CONSTANT	1 - RTS SWITCHED
3 0 = TYPAMATIC ON	1 = TYPAMATIC OFF
4 0 = DATA ONLY OFF	1 = DATA ONLY ON
5 0 = HOME UPPER LEFT	1 = HOME LOWER LEFT
6 0 = AUTO LF OFF	1 = AUTO LF ON

F5 CONFIGURATION (BINARY)

1 0 = PACING DISABLED	1 = PACING ENABLED
2 0 = BIAS DISABLED	1 = BIAS ENABLED
3 0 = SPARE	
4 0 = SPARE	
5 0 = SPARE	
6 0 = CYBER MODE	1 = LOAD FROM ROM PACK

F6 OPERATOR DEFAULT PARAMETERS (HEXADECIMAL)

1ST VALUE

B0 0 = ONLINE	1 = LOCAL
B1 0 = PRINTER DESELECTED	1 = PRINTER SELECTED
B2 0 = MARGIN ALERT OFF	1 = MARGIN ALERT ON
B3 0 = ALERT SOFT	1 = ALERT LOUD

2ND VALUE (HEXADECIMAL)

B0 0 = ALPHA LOCK	1 = SHIFT LOCK
B1 0 = NUMERIC PAD NORMAL	1 = NUMERIC PAD SHIFT
B2 0 = PAGE SCREEN	1 = ROLL SCREEN
B3 0 = ADV. / SMALL CYBER	1 = NATIVE / LARGE CYBER

Figure 4-4. Mode Installation Parameters

3RD VALUE (HEXADECIMAL)

B0 0 = BACKGROUND DARK	1 = BACKGROUND LIGHT
B1 0 = CURSOR LINE	1 = CURSOR BOX
B2 0 = CURSOR BLINK	1 = CURSOR SOLID ON
B3 0 = NOT USABLE	1 = NOT USABLE

4TH VALUE (HEXADECIMAL)

B0 0 = HALF DUPLEX	1 = FULL DUPLEX
B1 0 = 80 CHARACTERS/LINE	1 = 132 CHARACTERS/LINE
B2 0 = 24 LINES	1 = 30 LINES
B3 0 = TRANSPARENT OFF	1 = TRANSPARENT ON

F7 A-DIAL AUTO DIAL NUMBER PART 1 (HEXADECIMAL)

F8 A-DIAL AUTO DIAL NUMBER PART 2 (HEXADECIMAL)

F9

DF DEFAULT FILE NUMBER (HEXADECIMAL)

T TRANSMIT BAUD RATE (HEXADECIMAL)

0 = 75	4 = 300	8 = 2400	C = 19.2K
1 = 110	5 = 600	9 = 4800	D = 19.2K
2 = 150	6 = 1200	A = 9600	E = 19.2K
3 = 200	7 = 1800	B = 19.2 K	F = 19.2K

R RECEIVE BAUD RATE

SAME AS TRANSMIT BAUD RATE

F10 ACCESS CODE HEXADECIMAL

\*THESE PARAMETERS ARE IGNORED IN CYBER MODE.

Figure 4-4. Mode Installation Parameters (Contd)

- F2-2 Access Off/On - If this parameter is set to 1 (Access On), the operator will be required to enter the proper access code before the mode is loaded. If this parameter is set to 0 (Access Off), the load will commence immediately after mode selection.
- F2-3 Load Default/Operator Selected Source/File/Phone Number - If the host load has been selected and this parameter is set to 0, the default source and file parameters will be used to select the load source and file. If the parameter is set to 1, the operator will be allowed to select the source and phone number (phone number is to be used with 1200/1200 auto dial modem).
- F2-4 RUN Internal/Load External - This parameter must be set to 0 to execute CYBER mode or a mode from ROM pack. This parameter must be set to 1 to load a mode from host or disk.

- F2-5 Load From Host/Disk - This parameter works in conjunction with the Run Internal/Load External parameter. If the Load External (1) is selected and this parameter is set to 0, a load from host will be initiated. If this parameter is set to 1, a load from disk is initiated.
- F2-6 Use Resident Host/Internal Modem Interface - This parameter works in conjunction with LOAD FROM HOST/DISK. If LOAD FROM HOST is selected and this parameter is set to 0, the Resident Host interface is used. If this parameter is set to 1, the internal 1200/1200 modem is used.

### F3 CONFIG (Configuration)

- F3-1 Spare -
- F3-2 Auto Dial Off/On - This parameter is not used by the resident firmware; only the intent is described here. If the host load has been selected, the internal modem option is installed, and this parameter is a 1, the auto dial number will be used. If this parameter is a 0, the operator will be requested to make an external phone connection.
- F3-3 Host 7/8 Bits, F3-4 Host Parity Enabled/Disabled, F3-5 Host Parity Odd/Even, and F3-6 Host 1/2 Stop Bits - These four parameters work together to select the proper word format to the host. If 8 bits are selected, 8 data bits are sent. The parity bit is dependent upon Parity Enabled/ Disabled and Parity Odd/Even. If 7 bits are selected, only 7 data bits are sent.

If 8 bits are selected and parity is disabled, the Even/Odd parameter is used to select a mark or space in place of the parity bit 8th bit.

The following example is to aid in selecting the proper word format:

	<u>7/8</u>	<u>Enabled/ Disabled</u>	<u>Odd/ Even</u>	<u>Stop 1/2</u>
8 data bits with parity	1	1	X	X
7 data bits with odd parity	0	1	0	X
7 data bits with even parity	0	1	1	X
7 data bits with space parity (bit 8)	1	0	0	X
7 data bits with mark parity (bit 8)	1	0	1	X
7 data bits with no parity	0	0	X	X
Where X can be either 0 or 1.	0=7 1=8	0=DIS 1=ENA	0=ODD 1=EVEN	0=1 STOP BIT 1=2 STOP BITS

## F4 CONFIG (Configuration)

- F4-1 DTR Constant/Switched - If this parameter is set to 0 (DTR Constant), the DTR (Data Terminal Ready) signal on the host connector will be held on at all times. If this parameter is set to 1 (DTR Switched), the DTR signal on the host connector will be switched off if the mode is in local operation. DTR is maintained in the on condition at all other times. Received data is ignored if DTR is off.
- F4-2 RTS Constant/Switched - If this parameter is set to 0 (RTS Constant), the RTS (Request to Send) signal will be on whenever DSR and DTR are on. If this parameter is set to 1 (RTS Switched), the RTS signal will operate as follows if DSR and DTR are on, and Data Only Off:
  - Half Duplex - RTS is on with the first keystroke and is switched off a minimum of 1 millisecond, maximum of 16 milliseconds following transmission of a CR, LF, ACK, or LF. RTS will be placed to off if a break is received, or local operation is selected. Automatic responses to the host will cause RTS to be on for the duration of the response and switched off 1 to 16 milliseconds following the last word transmitted.
  - Full Duplex - RTS is on until local operation is selected.
- F4-3 TYPAMATIC On/Off - If TYPAMATIC is on, the keys shown in table 4-1 will repeat at a rate of 15 +3 characters per second if held down longer than 1 second. If TYPAMATIC is off, no keys will repeat when held down.
- F4-4 Data Only Off/On - If this parameter is set to 0 (Data Only Off), the terminal honors the DSR and DTR when sending and CO when receiving. If this parameter is set to 1 (Data Only On), the terminal will disregard the RS-232-C modem control signals. Data is transmitted without regard to the presence of DSR or CTS. Received data is acted upon without regard to CO or DSR. DTR operates normally.
- F4-5 Home Upper/Lower Left - If this parameter is set to 0, the home position for the cursor will be at the upper-left corner of the screen. If this parameter is set to 1, the home position for the cursor will be at the lower left corner. In CYBER mode, Upper-Left selection is applicable if compatibility with a CDC 722-10 (CC628) TTY Display Terminal is desired.

- F4-6 Auto LF Off/On - This parameter may be ignored in some modes. In the resident CYBER mode it is operational. If this parameter is set to a 0 (Auto LF Off), it is intended that a carriage return operation position the cursor to the beginning of the current line. If this parameter is set to a 1 (Auto LF On), it is intended that a line feed operation in addition to a carriage return operation be performed upon actuation of the CR key or receipt of the carriage return code.

#### F5 CONFIG (Configuration)

- F5-1 Pacing Disabled/Enabled - When this parameter is set to 1, the rate of data being sent to the host will be limited to one code every 8 milliseconds regardless of the baud rate. This gives an effective throughput of 1200 baud. If the parameter is set to 0, no limiting is performed.
- F5-2 Code Bias Off/On - This parameter may be ignored in some modes. In the resident CYBER mode it is operational. If this parameter is set to a 0 (Code Bias Off, no bias is added to the cursor address when sending or receiving X/Y positioning information or set-scroll field information. If this parameter is set to a 1 (Code Bias On), a bias of 20 hex is added to the cursor address when sending or receiving X/Y positioning information or set-scroll field information.
- F5-3 Spare
- F5-4 Spare
- F5-5 Spare
- F5-6 CYBER MODE/ROM PACK - If the Run Internal parameter is selected in F2, this parameter will be tested to determine if control is passed to CYBER mode or to the ROM pack.

#### F6 OPR DF (Operator Default)

All of the Mode Operator Parameter default values are encoded in hex digits. They are the initial operator parameters when a mode is selected. The initial value is moved from NVM into an active RAM table to allow temporary changes by the operator or host.

- F6 1st Digit

- Bit 0 Online/Local - This parameter may be ignored in some modes. In the resident advanced mode it determines the initial state. If this parameter is set to 1 (Local), the transmit portion of the terminal is disabled and data originating at the keyboard is displayed. Modem interface circuits are also affected. If this parameter is set to 0 (Online), data originating at the keyboard is transmitted in character mode and block mode transmission is enabled. It is possible to receive data while in local mode if Constant DTR is selected.
- Bit 1 Printer Off/On - This parameter may be ignored in some modes. In the resident CYBER mode it is operational. If this parameter is set to 1 (Printer On), the initial condition will have the printer interface active. The host can also change the active value. If this parameter is set to 0 (Printer Off), the initial condition will have the printer interface disabled. When the printer is enabled, all data sent or received in character mode will be printed while it is being displayed.
- Bit 2 Margin Alert Off/On - This parameter may be ignored by some modes. In the resident CYBER mode, it is operational. If this parameter is set to 1 (Margin Alert On), the audible alarm will sound whenever the cursor is advanced into the eighth position from the end of a line during keyboard entry. The audible alarm will also sound when the cursor is moved into the last line from the previous line during keyboard entry. If this parameter is set to 0 (Margin Alert Off), the audible alarm will not sound due to cursor movement from the keyboard.
- Bit 3 Alert Soft/Loud - This parameter may be ignored in some modes. In the resident CYBER mode, it is operational. If this parameter is set to 0 (Alert Loud), the audible alarm will be at a louder level. If this parameter is set to 1 (Alert Soft), the audible alarm will be at a lower level.

- F6 2nd Digit

- Bit 0 Shift/Alpha Lock - When this parameter is set to 1, the lock key will be a shift lock (all keys used as shifted). If the parameter is set to 0, the lock key will lock only alphabetical keys.



- Bit 1 Numeric Pad - When this parameter is set to 0 (normal), the 13-key numeric pad group on right side of keyboard operates in both lowercase and uppercase. When the parameter is set to 1 (shift), the 13-key numeric pad group operates in uppercase only.
  - Bit 2 Roll/Page Screen - This parameter may be ignored in some modes. In the resident CYBER mode, it is operational. If this parameter is set to 1 (Roll Screen), the scroll feature is enabled; the field scroll feature is unaffected. It is recommended to set this parameter to Roll Screen to be compatible with the CC628 TTY Display Terminal. The host has the capability to switch the active value. If this parameter is set to 0 (Page Screen), the initial value will disable the scroll feature.
  - Bit 3 Advanced/Native Operation - This parameter will determine which code is sent as keys are pressed and reaction to received codes (see table 4-1).
- o F6 3rd Digit
- Bit 0 Background Dark/Light - This parameter may be ignored in some modes. In the resident CYBER mode, it is operational. If this parameter is set to 0 (Background Dark), characters will be displayed as light characters on a dark background. If this parameter is set to 1 (Background Light), characters will be displayed as dark characters on a light background (inverse video).
  - Bit 1 Cursor Line/Block - This parameter may be ignored in some modes. In the resident CYBER mode, it is operational. If this parameter is set to 0 (Cursor Line), the cursor will appear as an underline. It may be blinking or solid depending upon the next parameter. If this parameter is set to 1 (Cursor Block), the cursor will appear as a solid box. It may be blinking or solid depending upon the next parameter.
  - Bit 2 Cursor Blink/Solid On - This parameter may be ignored by some modes. In the resident CYBER mode, it is operational. If this parameter is set to 0 (Cursor Blink), the cursor will blink. If this parameter is set to 1 (Cursor Solid On), the cursor will be always on.
  - Bit 3 Not Used

- F6 4th Digit
  - Bit 0 - Half/Full Duplex - This parameter may be ignored in some modes. In the resident CYBER mode, a 0 selects Half Duplex and a 1 selects Full Duplex. In half-duplex operation, data is displayed, printed (if enabled), and sent to the host as it is typed. In full-duplex operation, data is only sent to the host as it is typed. In either operation, data will be displayed and printed (if enabled) as data is received from the host. This parameter is ignored if the terminal is in local or block mode operations.
  - Bit 1 80/132 Characters/Line - This parameter may be ignored by some modes. In the resident CYBER mode, it is operational. If this parameter is set to 0 (80 Characters/Line), 80 characters will be the maximum number per line. If this parameter is set to 1 (132 Characters/line), 132 characters will be the maximum number per line.
  - Bit 2 24/30 Lines - This parameter is ignored by some modes. In the resident CYBER mode, it is operational. If this parameter is set to 0 (24 Lines), there will be a maximum of 24 lines displayed. If this parameter is set to 1 (30 Lines), there will be a maximum of 30 lines displayed.
  - Bit 3 Transparent - This parameter may be ignored by some modes. In the resident CYBER mode, it is operational. If this parameter is set to 1 (transparent on), all control codes received and entered on the keyboard will be displayed and not acted upon. When set to 0 (off), control functions will be performed.
- F7 A-DIAL Auto Dial number part 1.
- F8 A-DIAL Auto Dial number part 2. - This will be supported by the resident firmware when it becomes available, for now, its intent is described here. This parameter is used if auto dial is selected. It contains up to 12 digits. If less than 12 digits are used, they must be left justified with any letter A to F after the last digit to denote terminational digits.
- F9 - DF - Default File Number - This parameter may be used when requesting a downline load (see the Load File Selection section, for when it is used).
- T - Host Transmit Baud Rate - This parameter will be used to select the host transmit baud rate. It can be set to a value between 0 and F hex, which represents baud rates between 75 and 19.2K baud (see figure 4-4).

- R - Host Receive Baud Rate - This parameter will be used to select the host receive baud rate. It can be set to a value between 0 and F hex, which represents baud rates between 75 and 19.2K baud (see figure 4-4).

#### NOTE

The Transmit and Receive baud rate may be set to different rates when selected here. If the operator changes the rate in Operator Parameter Entry mode, the Transmit and Receive rates will be forced to the same rate.

- F10 ACCESS - Access Code - This parameter is used if the Access On parameter is selected. It contains four hexadecimal digits. The operator is required to type in the same four digits before the mode is entered. If the Access Disabled parameter is selected, this parameter is ignored.

#### MODE OPERATOR PARAMETERS

Operator parameters are mode dependent. The initial state of each operator parameter is set in the mode installation parameters. The operator parameters are moved into an active RAM section and can only be changed temporarily by the operator. The operator cannot change the NVM values.

To change the operator parameters, the SETUP key must be pressed while in an operating mode. Eight parameters will be written on the bottom line. To change any parameter, the operator must press the Function key number that precedes the block. The alternate state will then be displayed. If there are more parameters, F10 will indicate MORE SELECT. Pressing F10 key will display eight new parameters. If there are no more parameters, F10 will say MODE SELECT. Pressing F1 at any time will exit the operation.

If the operator does not change the 80/132 Characters/Line parameter or 24/30 lines parameter, displayed data is not lost. If either parameters are changed, the screen will clear and cursor will return to home.

CYBER mode will interface to a host using the RS-232 interface and to an operator using the keyboard or touchpanel.

If an unallowable key is pressed, the alarm will sound. The only keys operational in this mode are:

- F1 (Return) - Returns to original operating mode.
- F2 to F9 - Except for the printer and baud rate parameters described below, alternates the selected parameters.
- F10 (More Select) - When first set of parameters are on screen, displays second set of parameters.  
  
(Mode Select) - When second set of parameters are on screen, displays the mode selection menu.

See figure 4-5 for CYBER Mode Operator Parameters.

### Printer

When the first line of CYBER Mode Operator Parameters is being displayed, block F3 shows the printer selection. If both ports on the dual serial interface option are set to bidirectional operation (no printer assigned), the printer parameter field will remain blank and no changes can be made to it.

### Baud Rate

When the second line of CYBER Mode Operator Parameters is being displayed, block F5 shows the transmit baud rate. If the F5 key is pressed, both the transmit and receive baud rates will be set to the next faster rate. When the parameter shows 19.2, the next operation of the F5 key sets the value to the slowest rate, 75 baud.

### DEFAULT PARAMETERS

If the terminal is ever turned off and the battery removed, default parameters will be forced into NVM. The default values are as follows:

F1	return	F2	LINE (OFF) (ON)	F3	PRINTR (OFF) (ON)	F4	MARGIN (OFF) (ON)	F5	ALERT (SOFT) (LOUD)	F6	LOCK (ALPHA) (SHIFT)	F7	N PAD NORMAL SHIFT	F8	SCREEN (ROLL) (PAGE)	F9	CYBER (SMALL) (LARGE)	F10	MORE SELECT
----	--------	----	-----------------------	----	-------------------------	----	-------------------------	----	---------------------------	----	----------------------------	----	--------------------------	----	----------------------------	----	-----------------------------	-----	----------------

0            10            20            30            40            50            60            70            80

SETUP #1

1. OPERATOR SELECTED AFTER MODE ACTIVE BY PRESSING SETUP KEY.
2. F(N) KEY SELECTION ACTIVATES ALTERNATE SPECIFIED FUNCTION.

F1	return	F2	BACKGD (DARK) (LIGHT)	F3	CURSOR (LINE) (BLOCK)	F4	CURSOR (BLINK) (SOLID)	F5	BAUD (75-19.2)	F6	DUPLEX HALF (FULL)	F7	CH/LN (80) (132)	F8	LINES (24) (30)	F9	XPARNT (OFF) (ON)	F10	mode select
----	--------	----	-----------------------------	----	-----------------------------	----	------------------------------	----	-------------------	----	--------------------------	----	------------------------	----	-----------------------	----	-------------------------	-----	----------------

0            10            20            30            40            50            60            70            80

Character  
Position

SETUP #2

1. OPERATOR SELECTED VIA F10 = more select IN SETUP #1.
2. F(N) KEY SELECTION ACTIVATES ALTERNATE SPECIFIED FUNCTION.

Figure 4-5. CYBER Mode Operator Parameters

Terminal Installation Parameters

Block	721-20 (CC634-A) Terminals	721-30 (CC638-A) Terminals
F2	000000	010000
F3	000000	001000
F4	000000	000000
F5	000000	000000
F6	0 0 0	0 0 0
F7	0 0000	0 0000
F8	0 6	0 6
F9	A 6	A 6

Mode Names and Installation Parameters

Block	CYBER	PLATO	CP/M	Disk	C120
F2	100000	100100	100110	100110	100000
F3	000110	000110	000100	000110	001010
F4	000000	000001	000000	000001	000000
F5	010000	000000	000000	000000	000000
F6	4C04	6C24	6C25	6C24	4421
F7	000000	000000	000000	000000	000000
F8	000000	000000	000000	000000	000000
F9	00 6 6	08 6 6	00 6 6	00 6 6	00 9 9
F10	0000	0000	0000	0000	0000

## LOAD SOURCE SELECTION

If the operator selects a mode 2 through 6 and has met the security requirement, or the host selects a mode change, the resident firmware must determine which load source is to be used. This is accomplished through the preset mode installation parameters.

This feature allows automatic selection of the load source. Either of the following load sources can be selected if present:

- o Resident Host
- o Optional ROM Pack

Automatic selection of the load source is determined by the following mode installation parameters:

- o Use-Default/Operator-Select Source/File/Phone Number
- o Run Internal/Load External
- o Load From Host/Load from Disk\*
- o Resident Host/1200/1200 Internal Modem
- o CYBER Mode/ROM Pack

## INTERFACES

Activity is generated to select the load source if:

- o The auto select enable parameter is a 1 and auto select number is 2-6.
- o If F2-F6 keys (modes 2 through 6) are pressed while displaying the mode selection menu.

---

\*Loading from a disk is not supported in the 721 usage of the terminal.

The USE-DEFAULT/OPERATOR-SELECT parameter will be tested first.

- o If USE-DEFAULT SOURCE/FILE is selected, the parameters RUN INTERNAL/LOAD EXTERNAL, CYBER MODE/ROM PACK, and LOAD FROM HOST/LOAD FROM DISK are checked.
- o If OPERATOR-SELECT SOURCE/FILE/PHONE NUMBER is selected, the following prompt is displayed:

```
SELECT LOAD SOURCE > DISK HOST ROM
```

Selection of the source is done from the keyboard by pressing H or R. Pressing the NEXT key results in automatic selection of the default load source specified in the installation parameters.

#### NOTE

The mode installation parameters must be preset to the desired load source.

If ROM pack is selected as the load source, the ROM pack load is performed (refer to ROM Pack Loader later in this section).

If Load External is selected, the firmware then checks the Load From Host/Disk parameter.\* If Load From Host is selected, the firmware checks if communications are to be via the resident host interface or the 1200/1200 internal modem.

#### ABORTS AND RECOVERY

If an operator error is made during the number entry, the ERASE key will clear all entries.

#### PERFORMANCE

The time required to make entries is operator-dependent.

---

\*Loading from a disk is not supported in the 721 usage of the terminal.

## ERRORS

If an internal modem is not present and erroneously specified in parameters for host communications, the error message FAILURE LOADING MODE will appear along with the mode selection menu.

## INSTALLATION PARAMETERS

Parameter entries are described under Mode Installation Parameters.

## LOAD FILE SELECTION

When the communications host has been selected, this feature allows selection of a controlware load file to be loaded into the terminal. This can be done either automatically or manually. One default value can be used in the mode installation parameters or one of 64 different files may be selected manually.

### NOTE

A suggested scheme for setting up Load File Parameters is shown in figure 4-6.

## INTERFACES

Automatic selection of a load file is done if the use Default Source/File/Phone Number parameter is selected in the mode installation parameters. Manual selection is done if the operator selected parameter is selected. The terminal requests the load file selection with the following prompt:

SELECT LOAD FILE\_

The operator then selects the desired load file by using the keyboard. Entry is done by entering one or two hexadecimal digits followed by pressing the NEXT key. The file number entered must be less than 40 hexadecimal. If an error is made during entry, the ERASE key may be pressed to start over. Other keyboard keys are ignored.



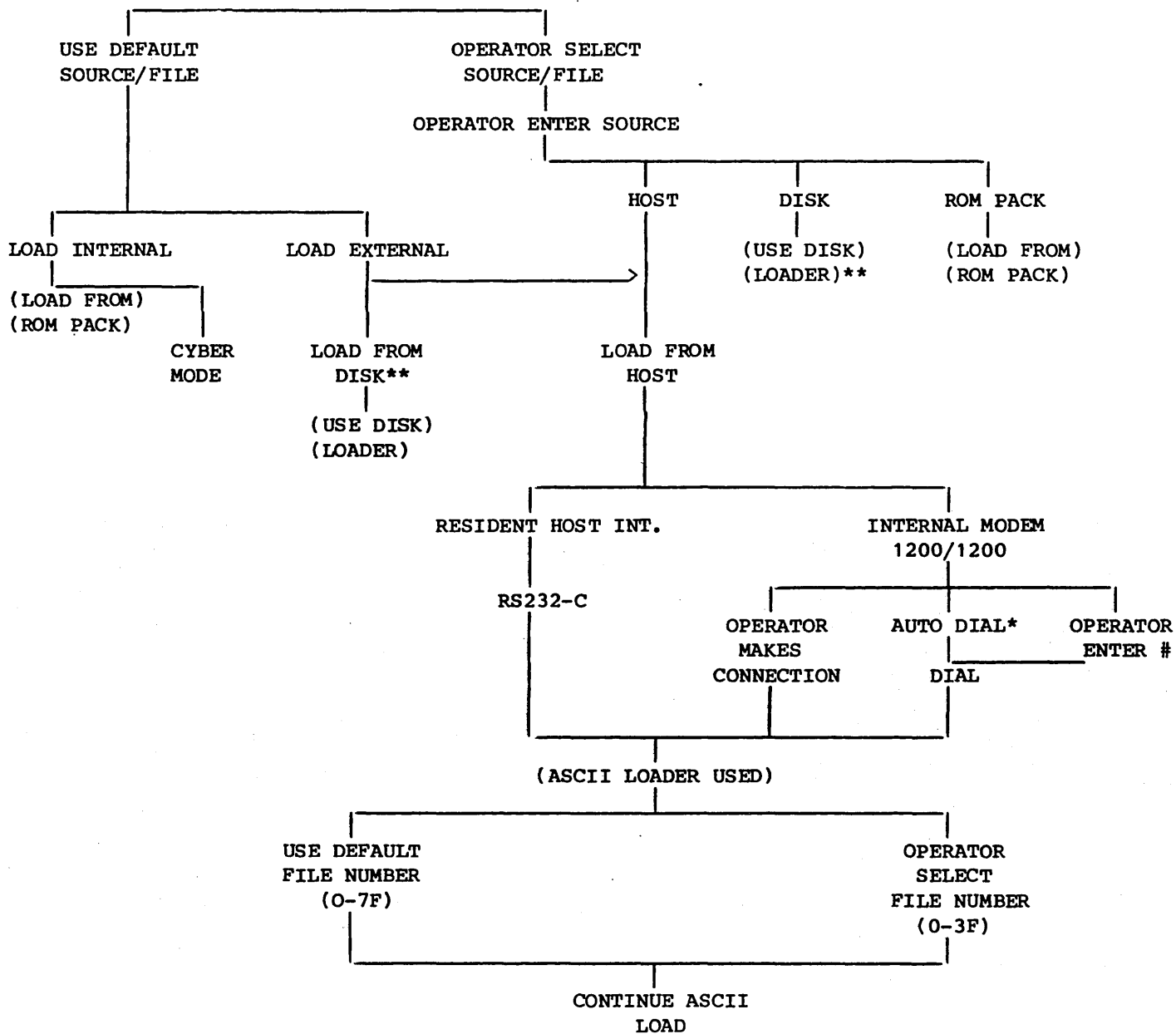

\*THE INTERNAL MODEM WITH AUTO DIAL HAS NOT BEEN DEFINED AT THIS TIME, SO THIS IS ONLY THE INTENDED PROCEDURE. THIS IS THE 1200/1200 BAUD MODEM.

\*\*LOADING FROM A DISK IS NOT SUPPORTED IN THE 721 USAGE OF THE TERMINAL.

Figure 4-6. Load Source/File Selection

If the file number entered is 40 hexadecimal or more, the program will force entry to start over; the same as if ERASE had been pressed.

If the NEXT key is pressed before any other entry is made, the program will select the automatic default file; the same as if the Load Default File parameter were selected.

#### ABORTS AND RECOVERY

If an operator error is made during a number entry, the ERASE key will clear all entries.

#### PERFORMANCE

The time required to make entries is operator-dependent.

#### ASCII NETWORK LOADER

The ASCII network loader allows the terminal to load a selected controlware program from an ASCII communications network that supports the protocol described in the following paragraphs.

#### DESCRIPTION

The ASCII communications loader loads a selected controlware file into the RAM of the terminal. Once the load file is selected, the load process proceeds automatically until control is transferred to the loaded controlware or until an unrecoverable error situation occurs. This section describes the communications protocol for loading the terminal from the ASCII communications network.

The protocol contains the following features:

- All data transmitted to the terminal from the network is in blocks and a cyclic redundancy check is associated with each block (transmit and receive data is automatically switched to 8 bits of data and no parity).
- The load process generates a memory checksum of the loaded controlware. It is intended that the loaded controlware have a routine that utilizes this checksum for checking the integrity of the loaded controlware during operation.
- The RESET switch can be used to exit from operation on the ASCII network if other techniques are ineffective.
- Automatic error recovery during loading is limited to three attempts. After three unsuccessful load attempts, the terminal aborts the load.
- Partial loading of selected blocks is not supported. If a checksum error occurs or a load is aborted, a full load is then performed.
- The maximum number of production load files is 64. Block lengths are variable with a maximum number of 240 data characters per block. The maximum number of host blocks in a file is 65536.
- The first block is loaded starting at a host-defined memory address and all succeeding blocks are loaded contiguously after this block. No auxiliary block loading table is used. The host is restricted from using hexadecimal addresses 0000 through 3FFF and D870 through FFFF.
- If no carrier is detected within 30 seconds of load initialization, the message HOST NOT CONNECTED is displayed.

#### AUTOLOAD MESSAGE FORMATS

The following message formats are utilized by the host communications line autoload routine (currently supported on the DSN). Unless otherwise specified, communications characters are those in the ASCII character set with even parity.

- Load Block
- Load Request
- NAK Sequence
- Load Complete

## Load Block

Each Load Block received from the host (CDSN-compatible) is formatted as follows:

D	S	HEADING	DATA	D	E	E	CRC	
L	T			L	T	or		T
E	X			E	B	X		

The heading is formatted as follows:

SEQ1	SEQ2	LDN	A1	A2	A3
------	------	-----	----	----	----

Each block begins with a DLE STX character sequence and ends with either a DLE ETB or DLE ETX character sequence followed by a block cyclic redundancy check. The DLE ETB sequence is used on all blocks except for the last one. In this case, a DLE ETX sequence is used, signifying to the terminal that this is the last block of the load. The CRC is a 2-character, 16-bit cyclic redundancy check; that is, the remainder after polynomial division modulo two. The polynomial divisor is  $X^{16}+X^{15}+X^2+1$ . The end of the block occurs immediately after the CRC characters. The division is performed on all characters except the initial DLE STX sequence and the first DLE of any DLE DLE sequence in the block.

The heading and data parts of the block can be comprised of any 8-bit character sequences. If any character happens to be a DLE, it is prefixed by another DLE.

SEQ1 SEQ2 is a 2-character, 16-bit binary number which uniquely identifies each load block being transmitted. SEQ1 SEQ2 = 0 for the first load block and is incremented by one for each subsequent load block initially transmitted.

LDN is a single 8-bit character which uniquely identifies the particular load file. The load file can be selected by the operator if desired.

A1 A2 A3 is a three-character, 24-bit binary number which identifies the absolute starting address of the load data in the present block. The address sequence must be in sequential ascending order with all load data being loaded contiguously in memory. Only the lower 16 bits are used.

The data portion of the block may be variable in length from 1 to 240 8-bit load-data characters.

### Load Request

The down-line load operation from the host is initiated by the terminal sending the following character sequence, termed a Load Request.

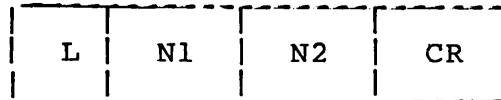

The sequence begins with an upper case ASCII L and ends with an ASCII CR. The N1 N2 sequence is an ASCII representation of the desired load file. Each N is a hexadecimal number represented by the corresponding ASCII character (upper case for the numbers A through F). N1 N2 corresponds to the LDN binary number in the resulting load blocks. All four ASCII characters have even parity.

### NAK Sequence

If the terminal detects an error during the load process that can be corrected by retransmitting the load block, it sends a 5-character NAK Sequence indicating the block to be retransmitted.

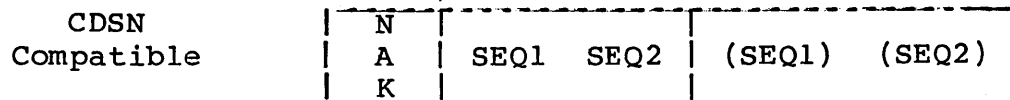

The NAK is the corresponding ASCII NAK character. SEQ1 SEQ2 is a 2-character sequence identifying the load block from which point retransmission is to occur. This sequence corresponds to the SEQ1 SEQ2 16-bit binary number in the load block where the error occurred. (SEQ1) (SEQ2) is a one's complement of SEQ1 SEQ2 and is used for error detection.

The use of NAK does not alter the sequence of alternating acknowledgements. The same positive reply (ACK 0 or ACK 1) is used for successful retransmission as would have been used if the previous transmission of the unaccepted block had been successful.

### Load Complete

Upon successful receipt of the last load block, the terminal sends the following Load Complete message to the CDSN.

D	E
L	O
E	T

The characters are the corresponding ASCII characters with even parity.

### AUTOLOAD SEQUENCE

After the host autoload routine is initiated, the following sequence occurs:

1. The terminal transmits a Load Request upon detection of the network sign-on message (ASCII "/"). If the default file is not selected, the terminal waits for the operator to select the desired load file from the keyboard before transmitting the load request. The message LOADING FILE MM is also displayed to indicate that file number MM is the selected load file.
2. The network must then send Load Blocks to the terminal. As it receives the load blocks, the terminal checks for valid SEQ1 and SEQ2 characters. If they are too large, a NAK sequence is sent and the terminal waits for successful retransmission of the desired block. If they are too small, the terminal ignores the block. The terminal also checks the LDN and A1 A2 A3 characters to see if they match the values expected by the terminal. If not, the terminal sends a NAK sequence and awaits retransmission of the block. After the header has been verified, the terminal stores data characters at sequentially-increasing RAM addresses. When the end of the block is encountered, the received CRC characters are compared to the CRC calculated by the terminal on the received data. If they do not agree, the terminal sends a NAK sequence to request retransmission of the load block.

3. If the two CRC values agree, the block has been received successfully. If this was not the last load block for CDSN operation, the terminal then updates the expected values for the header and awaits receipt of the next block (no positive acknowledgement is sent). If this was the last load block, the terminal sends a Load Complete message signaling a positive acknowledgement of completing the load process.
4. The network then returns to its sign-on phase and awaits operator action. The loader, upon detection of the sign-on phase, turns control over to the loaded controlware.
5. During the load process, the loader program calculates an 8-bit arithmetic-sum checksum of the loaded RAM controlware and saves it for use by the memory checksum routine.

While each block is being loaded the message LOADING FILE MM BLOCK NN is displayed to indicate that block number NN of load file MM is being loaded.

During the load, various timeout conditions can occur. When this happens, the ERROR light is turned on and error recovery is attempted.

If no response to a NAK sequence has been received, the NAK sequence is resent. After three tries without success, the load is aborted with a load-failure message being displayed.

If no response to a load request has been received, the load request is retried up to three times. If there is still no success, the load is aborted with a load-failure message being displayed.

If the network does not return to the sign-on phase after the load-complete message has been sent, the load-complete message is resent. After three retries without success, the load is aborted with a load-failure message.

## INTERFACES

The operator interface consists of a series of displays on the CRT screen indicating progress of the load operation. The load process is automatic and does not require any operator interaction.

The message LOADING FILE MM is displayed whenever the terminal sends a load request to the network, indicating that a load of controlware file number MM has been initiated.

The message LOADING FILE MM BLOCK NN is displayed to indicate that block NN of controlware load file MM is being loaded. Error messages are listed below in the Errors paragraph.

At the end of a completed ASCII load, the following common variables are present:

LINFO is set to X1 (ASCII loader used)

#### ABORTS AND RECOVERY

If the load is unsuccessful due to checksum errors, or no response from the network for 30 seconds, or loss of carrier on the selected RS-232-C communications interface, the ASCII loader displays a HOST LOAD FAIL, FAILURE LOADING MODE message and then returns to the mode selection routine.

Pressing the RESET switch on the terminal front panel results in the terminal aborting the load and running diagnostics again.

#### ERRORS

The following error messages can be generated on the CRT screen during the course of the load process.

NO REPLY - Indicates that the load operation has not progressed for 30 seconds due to no response or incorrect response from the network. The terminal then sends a new load request and tries loading again up to three times.

HOST LOAD FAIL - Indicates that the load process has been aborted after three unsuccessful load attempts or that host carrier has been lost. The terminal will return to load file selection after momentarily displaying this message.

HOST NOT CONNECTED - Indicates no initial carrier signal was detected within 30 seconds of load initialization.



In addition, the ERROR light on the front panel lights whenever a load error has occurred and remains lit until the error has been recovered or the load has been aborted.

## PERFORMANCE

The ASCII loader program in the terminal is capable of loading programs from the ASCII network at communication line rates specified by the send and receive parameters in the mode installation parameters. A typical controlware load will take about 3 to 4 minutes at 1200 bps.

## INSTALLATION PARAMETERS

Transmit and receive rates are selectable in the mode installation parameters. These rates must be set to the desired value at installation (see Parameter Selection at the beginning of this section). The last transmit and receive is forced to 8 data bits and no parity.

## ROM PACK LOADER

The ROM pack loader transfers control to a program in an internal ROM pack option if the option is present. When a ROM pack is selected as the load source, control is transferred to the ROM pack loader. The presence of a ROM pack is tested first by sensing status. If the status check indicates the presence of a ROM pack, a memory read is performed on the ROM pack to verify its presence. If the ROM pack is present, control is then transferred to the ROM pack. If the ROM pack is not present, a loading failure message appears on the CRT screen.

The ROM pack can contain diagnostics or special functions.

## DESCRIPTION

The ROM pack has a name, revision level, and three entry points, as follows.

<u>ADDRESS</u>	<u>DATA</u>	<u>DESCRIPTION</u>
8000	C3	Entry point to mode
8003	C3	Entry point to diagnostic
8006	C3	Entry point to function
800A	X X X	3 ASCII codes of pack name
800D	X X X	3 ASCII codes of pack version

- Mode Entry - When ROM pack is selected as the load source (see Load Source Selection section), control will be transferred to address 8000, if that address contains a C3 with mode parameters loaded in RAM. If the C3 is not read, a message FAILURE LOADING MODE will be displayed.
- Diagnostic Entry - When test 1 is complete, it will test address 8003 for a C3. If a C3 is read, control will be transferred to 8003. If a C3 is not read, control is not transferred and test 1 will be completed. The ROM pack should contain a checksum of its own ROM, test any special hardware it uses, and display its name and revision.
- Function Entry - When the terminal is displaying the Mode Selection Menu and the F7 key is pressed, or if Auto Select mode 7 is selected, control will be transferred to address 8006 if it contains a C3. If the C3 is not read, the alarm will sound, the message FAILURE LOADING MODE will be displayed, and control transferred to the Mode Selection Menu.

#### ABORTS AND RECOVERY

See ERRORS paragraph that follows.

#### PERFORMANCE

The ROM pack load requires the presence of a ROM pack option at address 8000 hexadecimal, bank 5, with the entry table containing a C3 for each entry that is enabled. The operation of the ROM pack load takes less than one second to execute.

## INSTALLATION PARAMETERS

A ROM pack option must be installed. See the Load Source Selection section to select the proper parameter for using the ROM as the load source. The ROM pack must contain the proper format (the format is contained in the Description paragraph for the the ROM Pack Loader).

## INTERFACES

Selection of the ROM pack is described in the Load Source Selection section. Once selected, loading proceeds automatically without operator intervention. If the ROM pack option is not present, the FAILURE LOADING MODE message is displayed.

The common variables are set as follows before the jump to ROM:

- LINFO is set to a value of X4 hexadecimal (ROM loader used).

## ERRORS

If the ROM pack option is not present, the message FAILURE LOADING MODE is displayed on the screen.

## CYBER MODE OPERATION

The basic terminal mode is CYBER mode. CYBER mode consists of two operating submodes. Small CYBER mode is referred to as Advanced (ADV) mode and is functional on CYBER-C120 series systems. Large CYBER Mode is referred to as Advanced Native (ADV N) mode and is functional on CYBER C170 series systems. Small CYBER mode emulates an enhanced Advanced Mode operation compatible with the CC628 TTY Display Terminal. Small CYBER and Large CYBER submodes are host and operator selectable. The differences are covered by tables 4-1 and 4-2. See table 4-2 for CYBER control codes and escape sequences.

CYBER mode supports character transmissions and block transmissions and protected and unprotected data operations.

## GENERAL INFORMATION

### Cursor

The cursor indicates the current entry position. It is represented on the screen in one of the following manners:

- Constant underline
- Blinking underline
- Solid block
- Blinking solid block

The type of cursor is determined by two operator-selectable parameter bits.

### Character Attributes

A character attribute code (background) is loaded into the display memory for every character display code (foreground). These are:

<u>Bit No.</u>	<u>Feature</u>	
0	Blank	} Used by Hardware
1	Underscore	
2	Inverse	
3	Blink	
4	Dim	
5	Modified	
6	Validate	
7	Protect	

The code is stored along with the displayable character in the following manner:

1. The modified bit is always set if displayable character came from the keyboard and cleared if from host (common input).
2. With Protect disabled, the new attribute code will be stored with each keyboard input and common input.

3. With Protect enabled, the old attribute is reused if common input and the modified bits set, if keyboard-input.
4. The validate bit is not changed with keyboard input.

### Parity Errors

If parity errors are received while alphanumeric display information is being received from the keyboard, the code is ignored.

### KEYBOARD OPERATION

In CYBER mode, the keyboard operates all 128 ASCII codes. Table 4-1 contains a listing of the keyboard codes and legends. Refer to section 3 for figures of keycap options and for a figure showing keystation assignments.

All code generation is controlled by the terminal firmware. Also, the terminal firmware provides typamatic action on all keys. This typamatic action provides a repeat rate of 15 +3 characters per second after a 1-second delay when the operator holds a key pressed. Typamatic action can be disabled by host command or by mode installation parameter selection. All terminal code generation is controlled by the terminal firmware.

The transmission of keyboard input is governed by the transmission mode being used, which is host controlled. As described later under Character-Transmit Mode and Block-Transmit Mode, transmission may occur immediately as a key is pressed (character mode) or input may be stored until the operator initiates transmission (block mode).

For protected character locations, actuation of any alphanumeric or control code key causes the alarm to sound with no other action taken. The cursor does not move when this condition occurs. Cursor control operation, however, is always allowed when the keyboard is enabled.

The codes of the keyboard can function three different ways:

- Normal - Pressing a key causes the corresponding code in table 4-1 to be sent to the host (immediately in character mode or subsequently in block mode).
- Host-Loaded Code Sequence - If the host has loaded an code sequence for that key (table 4-1 indicates the keys which are loadable), those codes will be sent to the host instead of the codes in the table. If the terminal is in half-duplex routing, the codes will not be acted upon by the terminal.
- Host-Loaded Controlware - If the host has loaded Z80 code controlware for that key, a call will be made to the controlware.

The following paragraphs describe the function of basic keys and basic operations.



### (Shift) Keys

When two symbols share the same key, the upper symbol or control function is active only while either one of the two Shift keys is actuated.

Actuating the Shift key in conjunction with a key labeled with a single legend causes the transmission of the uppercase code for the symbol shown on the key as indicated in table 4-1.



### (LOCK) Key/Indicator

The Lock key is operator-parameter selectable to perform a shift-lock or alpha-lock function. In shift-lock mode, all function, control and alpha/numeric keys unconditionally transmit the level two column shifted keycode definition shown in table 4-1. Operator care must be exercised to ensure intended operation of all keys when shift-lock mode is active. Shift lock is provided for single key activation ease of use.

In alpha-lock mode, this key, when pressed, causes all alphabetic keys to transmit only the uppercase code until pressed a second time. The alpha-lock mode is provided to disable the generation of lowercase codes. If this key is in the lock position, uppercase characters are generated in place of the lowercase characters. Special function, control, and numeric keys are unaffected. This key contains an indicator that is illuminated when in lock mode.

## CTRL (Control) Key

Actuation of the CTRL key in conjunction with any data key or combination of data key and Shift key causes the generation of the codes outlined in the level three and level four columns of table 4-1, respectively.

For protected locations and block mode operation, actuation of the CTRL key in conjunction with any data key causes an audible alarm and no action is taken.

## RESET Switch

When the RESET switch is activated, a power-on reset function is executed. This function causes the terminal to reinitialize and perform a self-test routine. At the completion of the self-test routine, the terminal checks terminal installation parameters to determine whether to display the mode menu (manual-mode selection) or to load/enter the designated mode (automatic-mode selection).

Activating the RESET switch halts any data transfer to or from the terminal. This includes display to host and display to printer transfers.

## Validation Bits

The host has the ability to load validation code, (see the Host Specified Code Sequence/Controlware) and start/stop validation.

As the host is entering data on the screen, the start validation will store the validate bit in background memory for each code stored while the start validation is active.

As keys are pressed on the keyboard, the following conditions are tested against the question: Is the key a host-loadable key?

- YES-perform loadable key function
- NO-is current position a validate position?
  - NO-perform normal function
  - YES-has host loaded validation code?
    - NO-perform normal function
    - YES-call host loaded validation code. When control is returned, the normal function will be performed if the ZERO flag is clear. Nothing will be done if the ZERO flag is set.

## Host Multiple Code Sequences

There are many host-initiated functions which have multiple-code sequences. (See table 4-2.) These sequences contain either two codes (RS, X) or three codes (RS, DC2, X). When the terminal receives the RS code, keyboard inputs will be ignored until one of the following conditions is met:

- The next code is processed (unless it is a DC2 code).
- The next code is DC2 and keyboard inputs are ignored until one more code is received.

### NOTE

If the RS code or RS, DC2 codes are received without another code following, the keyboard may be hung up. The manual release (M REL) function re-enables the keyboard.

## Prologue Code

The user is able to down-load a series of characters to be used as a screen prologue. In block mode, the screen prologue characters, if active, will be sent back to the host prior to sending the unprotected fields on the screen. The primary use of the prologue characters is as a screen or transaction identifier which would be unknown, not modifiable, and not displayable by the terminal operator. Prologue characters are down-loaded using the following command:

RS, HT, (V), (W), (X), (Y), (Z)

where:

V = 5F (the prologue command identifier)  
W = 31 (the host code sequence)  
X = the address in RAM where the code is to be loaded  
Y = the prologue character sequence (same as the host code sequence)  
Z = termination code (CR)



To clear the prologue characters, the user sends the following command:

RS, HT, (V), (W), (X), (Y), (Z)

where:

V = 5F (the prologue command identifier)  
W = 30 (to clear the function)  
X = not required  
Y = not required  
Z = termination code

### Printer Operation

Both of the CYBER modes support a serial printer which may be connected to either port on the optional dual asynchronous interface board. As data is received from the host, it is sent to the printer port if the Printer-On parameter is selected. As data is entered from the keyboard, it is sent to the printer port only if the Printer-On parameter is selected and half-duplex data routing is in effect (with full-duplex routing, keyboard entered data is echoed back from host for printing).

The printer X-ON/X-OFF condition is supported. If the printer sends an X-OFF signal to the terminal, the terminal will stop taking data from the buffer and sending it to the printer. When the X-ON signal is received from the printer, data transfer is resumed.

When the common input buffer reaches three-quarter capacity, an X-OFF signal is sent to the host. If it is desired to communicate with the host after the printer has sent an X-OFF signal, the manual release operation will send an X-ON signal to the host and will resume sending data to the printer even if it cannot accept it.

TABLE 4-1. KEYCODES AND LEGENDS OF STANDARD KEYBOARD



KEY NO.	NOTES*	KEY LEGENDS			PRESSED WITH KEY ... GENERATE			
		LOWER	CENTER	UPPER			CTRL	 .CTRL
1	DS, L		PRINT					
			ADV Mode (Small)		1E, 11	1E, 01	1E, 11	1E, 01
			ADV N Mode (Large)		1E, 02	1E, 01	1E, 02	1E, 01
2			SETUP					
3	D, L		(F1)		1E, 71	1E, 61	1E, 31	1E, 21
4	D, L		(F2)		1E, 72	1E, 62	1E, 32	1E, 22
5	D, L		(F3)		1E, 73	1E, 63	1E, 33	1E, 23
6	D, L		(F4)		1E, 74	1E, 64	1E, 34	1E, 24
7	D, L		(F5)		1E, 75	1E, 65	1E, 35	1E, 25
8	D, L		(F6)		1E, 76	1E, 66	1E, 36	1E, 26
9	D, L		(F7)		1E, 77	1E, 67	1E, 37	1E, 27
								
10	D, L		(F8)		1E, 78	1E, 68	1E, 38	1E, 28
			SUPER					
11	D, L		(F9)		1E, 79	1E, 69	1E, 39	1E, 29
			SUB					
12	D, L		(F10)		1E, 7A	1E, 6A	1E, 3A	1E, 2A
			MICRO					
13	D, L		(F11)		1E, 7B	1E, 6B	1E, 3B	1E, 2B
			FONT					
14	D, L		(F12)		1E, 7C	1E, 6C	1E, 3C	1E, 2C
15	L, D		+	DOWN**	1E, 12, 20	1E, 12, 21	1E, 12, 22	1E, 12, 23
16	R, L				NOT USED			
17	R	1		!	31	21	31	21
18	R	2		@	32	40	00	00
19	R	3		#	33	23	33	23
20	R	4		\$	34	24	34	24
21	R	5		%	35	25	35	25
22	R	6		^	36	5E	36	5E
23	R	7		&	37	26	37	26
24	R	8		*	38	2A	38	2A

TABLE 4-1. KEYCODES AND LEGENDS OF STANDARD KEYBOARD (CONTD)











KEY NO.	NOTES*	KEY LEGENDS			PRESSED WITH KEY ... GENERATE			
		LOWER	CENTER	UPPER			CTRL	 . CTRL
25	R	9		(	39	28	39	28
26	R	0		)	30	29	30	29
27	R	-		_	2D	5F	1F	1F
28	R	=		+	3D	2B	1E	1E
29	R	`		~	60	7E	60	7E
30	R							
			ADV MODE (Small)		19	19	19	19
			ADV N MODE (Large)		08	08	08	08
31	L, D		-	UP**	1E, 12, 24	1E, 12, 25	1E, 12, 26	1E, 12, 27
32	R, L, DS				09	09	1E, 12, 57	1E, 12, 57
33	R		Q	 **	71	51	11	11
34	R		W	 **	77	57	17	17
35	R		E	 **	65	45	05	05
36	R		R		72	52	12	12
37	R		T		74	54	14	14
38	R		Y		79	59	19	19
39	R		U		75	55	15	15
40	R		I		69	49	09	09
41	R		O		6F	4F	0F	0F
42	R		P		70	50	10	10
43	R	[		]	5B	5D	1D	1D
44	R	`		!	5C	7C	1C	1C
45	R, L, DS				1E, 0B	1E, 0B	1E, 12, 58	1E, 12, 58
46	D, L		X	FWD**	1E, 12, 28	1E, 12, 29	1E, 12, 2A	1E, 12, 2B
47								
48	R		A	**	61	41	01	01
49	R		S		73	53	13	13
50	R		D	**	64	44	04	04
51	R		F		66	46	06	06

TABLE 4-1. KEYCODES AND LEGENDS OF STANDARD KEYBOARD (CONTD)









KEY NO.	NOTES*	KEY LEGENDS			PRESSED WITH KEY ... GENERATE			
		LOWER	CENTER	UPPER			CTRL	 .CTRL
52	R		G		67	47	07	07
53	R		H		68	48	08	08
54	R		J		6A	4A	0A	0A
55	R		K		6B	4B	0B	0B
56	R		L		6C	4C	0C	0C
57	R	;		:	3B	3A	3B	3A
58	R	'		"	27	22	27	22
59	R	{		}	7B	7D	7B	7D
60	See Key 75				-	-	-	-
61	D, L		+	BKW**	1E, 12, 2C	1E, 12, 2D	1E, 12, 2E	1E, 12, 2F
62								
63	R				NOT USED			
64	R		Z	 **	7A	5A	1A	1A
65	R		X	 **	78	58	18	18
66	R		C	 **	63	43	03	03
67	R		V		76	56	16	16
68	R		B		62	42	02	02
69	R		N		6E	4E	0E	0E
70	R		M		6D	4D	0D	0D
71	R		'	<	2C	3C	2C	3C
72	R		.	>	2E	3E	2E	3E
73	R		/	?	2F	3F	2F	3F
74								
75	L			NEXT				
			ADV MODE (Small)		0A	0A	0A	0A
			ADV N MODE (Large)		0D	0D	0D	0D
76			CTRL					
77	R		(Space)		20	20	20	20
78			DEL	CR	7F	0D	7F	0D
79	D, L		HELP		1E, 5C	1E, 58	1E, 5C	1E, 58
80	D, L		ANS (F13)	TERM	1E, 7D	1E, 6D	1E, 3D	1E, 2D

TABLE 4-1. KEYCODES AND LEGENDS OF STANDARD KEYBOARD (CONTD)

KEY NO.	NOTES*	KEY LEGENDS			PRESSED WITH KEY ... GENERATE			
		LOWER	CENTER	UPPER		↑	CTRL	↑ .CTRL
81	DS, L		ERASE					
			ADV MODE (Small)		1E,5D	1E,59	1E,5D	1E,59
			ADV N MODE (Large)		1F	1E,5D	1E,5D	1E,59
			COPY					
82			(F14)		1E,7E	1E,6E	1E,3E	1E,2E
83	D, L		EDIT		1E,5E	1E,5A	1E,5E	1E,5A
			□					
84	D, L		(F15)		1E,70	1E,60	1E,30	1E,20
85	D, L		BACK		1E,5F	1E,5B	1E,5F	1E,5B
86	D, L		LAB		1E,12,31	1E,12,32	1E,12,33	1E,12,33
87	D, L		DATA		1E,12,35	1E,12,36		
88	D, L		STOP		1E,49	1E,4A	1E,49	1E,4A
89	DS, L, R	C	INSRT	L	1E,4F	1E,52	1E,4F	1E,52
90	DS, L, R	C	DLETE	L	1E,4E	1E,51	1E,4E	1E,51
91	L	EOL	CLEAR	P	0B	0C	0B	0C
92		ESC		LF	1B	0A	1B	0A
93		BREAK		M REL	BREAK		BREAK	
94	R, L, N		7		37		37	
95	R, L, N	8		↑	38	17	38	17
96	R, L, N		9		39		39	
97	R, L, N	4		←				
	D		ADV MODE (Small)		34	19	19	1E,19
			ADV N MODE (Large)		34	08	34	08
98	R, L, N	5		HOME**				
	D		ADV MODE (Small)		35	08	08	1E,08
			ADV N MODE (Large)		35	19	35	19
99	R, L, N	6		→				
			ADV MODE (Small)		36	18	18	1E,18
			ADV N MODE (Large)		36	18	36	18
100	R, L, N	1			31		31	

TABLE 4-1. KEYCODES AND LEGENDS OF STANDARD KEYBOARD (CONTD)

KEY NO.	NOTES*	KEY LEGENDS			PRESSED WITH KEY ... GENERATE			
		LOWER	CENTER	UPPER		↑	CTRL	↑ .CTRL
101	R, L, N	2		↓				
	D	ADV MODE (Small)		32	1A	1A	1E, 1A	
		ADV N MODE (Large)		32	1A	32	1A	
102	R, L, N	3				33		
103	R, L, N	,				2C		
104	R, L, N	0				30		
105	R, L, N	.				2E		
106	L, N	←		NEXT				
		ADV MODE (Small)		0A	0A	0A	0A	
		ADV N MODE (Large)		0D	0D	0D	0D	

\*Key to Notes:

N - Modified if the numeric pad parameter set to SHIFT.

R - Auto repeat if TYPAMATIC is on.

L - Host loadable.

D - Delimiter. CR sent when enabled by host.

DS - Delimiter. CR sent when enabled by host in small CYBER mode.

- - No function performed.

\*\* - Labeled on skirt of key cap.

TABLE 4-1.1. KEYCODE AND LEGEND ADDENDUM FOR BRITISH KEYCAP KIT

KEY NO.	KEY LEGENDS			PRESSED WITH KEY ... GENERATE			
	LOWER	CENTER	UPPER		↑	CTRL	↑ .CTRL
16	`		-	60	7E	60	7E
19	3		£	33	23	33	23
29				-	-	-	-
63	<		>	3C	3E	3C	3E
71	,		,	2C	2C	2C	2C
72	.		.	2E	2E	2E	2E

TABLE 4-1.2. KEYCODE AND LEGEND ADDENDUM FOR SPANISH KEYCAP KIT

KEY NO.	KEY LEGENDS			PRESSED WITH KEY ... GENERATE			
	LOWER	CENTER	UPPER		↑	CTRL	↑ .CTRL
16	\		~	60	7E	60	7E
18	2		§	32	40	00	00
19	3		£	33	23	33	23
29				-	-	-	-
43	]		[	1E, 4B	1E, 4D	1D	1D
44	§		¿	7D	5D	1C	1C
57		Ñ		7C	5C	7C	5C
58	.		i	7B	5B	7B	5B
59	'		"	27	22	27	22
63	<		>	3C	3E	3C	3E
71	,		;	2C	3B	2C	3B
72	.		:	2E	3A	2E	3A

TABLE 4-1.3. KEYCODE AND LEGEND ADDENDUM FOR GERMAN KEYCAP KIT

KEY NO.	KEY LEGENDS			PRESSED WITH KEY ... GENERATE			
	LOWER	CENTER	UPPER		↑	CTRL	↑ .CTRL
16	[		]	1E, 4B	1E, 4D	1E, 4B	1E, 4D
18	2		"	32	22	00	00
19	3		§	33	40	33	40
22	6		&	36	26	36	26
23	7		/	37	2F	37	3F
24	8		(	38	28	38	28
25	9		)	39	29	39	29
26	0		=	30	3D	30	3D
27	B		?	7E	3F	1F	1F
28	'		\	27	60	1E	1E
29				-	-	-	-
38		Z		7A	5A	19	19
43		ü		7D	5D	1D	1D

TABLE 4-1.3. KEYCODE AND LEGEND ADDENDUM FOR GERMAN KEYCAP KIT (CONTD)

KEY NO.	KEY LEGENDS			PRESSED WITH KEY ... GENERATE			
	LOWER	CENTER	UPPER		↑	CTRL	↑ .CTRL
44	+	Ü	*	2B	2A	1C	1C
57		ö		7C	5C	7C	5C
58		ä		7B	5B	7B	5B
59	#		^	23	5E	23	5E
63	<		>	3C	3E	3C	3E
64		y		79	59	1A	1A
71	,		;	2C	3B	2C	3B
72	.		:	2E	3A	2E	3A
73	-		_	2D	5F	2D	5F

TABLE 4-1.4. KEYCODE AND LEGEND ADDENDUM FOR FRENCH KEYCAP KIT

KEY NO.	KEY LEGENDS			PRESSED WITH KEY ... GENERATE			
	LOWER	CENTER	UPPER		↑	CTRL	↑ .CTRL
16	[		]	1E, 4B	1E, 4D	1E, 4B	1E, 4D
18	2		"	32	22	00	00
19	3		§	33	5D	33	5D
22	6		+	36	2B	36	2B
23	7		/	37	2F	37	2F
24	8		(	38	28	38	28
25	9		)	39	29	39	29
26	0		=	30	3D	30	3D
27	'		?	27	3F	1F	1F
28	^		..	5E	7E	1E	1E
29				-	-	-	-
43	à		g	40	5C	1D	1D
44	&		*	26	2A	1C	1C
57	é		e	7B	7D	7B	7D
58	ù		o	7C	5B	7C	5B
59	'		£	60	23	60	23



TABLE 4-1.4. KEYCODE AND LEGEND ADDENDUM FOR FRENCH KEYCAP KIT (CONTD)

KEY NO.	KEY LEGENDS			PRESSED WITH KEY ... GENERATE			
	LOWER	CENTER	UPPER		↑	CTRL	↑ .CTRL
63	<		>	3C	3E	3C	3E
71	,		;	2C	3B	2C	3B
72	.		:	2E	3A	2E	3A
73	-		_	2D	5F	2D	5F

TABLE 4-1.5. KEYCODE AND LEGEND ADDENDUM FOR SWEDISH/FINNISH KEYCAP KIT

KEY NO.	KEY LEGENDS			PRESSED WITH KEY ... GENERATE			
	LOWER	CENTER	UPPER		↑	CTRL	↑ .CTRL
16	[		]	1E, 4B	1E, 4D	1E, 4B	1E, 4D
18	2		"	32	22	00	00
19	3		#	33	23	33	23
20	4		Å	34	24	34	24
22	6		&	36	26	36	26
23	7		/	37	2F	37	2F
24	8		(	38	28	38	28
25	9		)	39	29	39	29
26	0		=	30	3D	30	3D
27	+		?	2B	3F	1F	1F
28		É		60	40	1E	1E
29				-	-	-	-
43		Å		7D	5D	1D	1D
44		Ü		7E	5E	1C	1C
57		Ö		7C	5C	7C	5C
58		Ä		7B	5B	7B	5B
59	'		*	27	2A	27	2A
63	<		>	3C	3E	3C	3E
71	,		;	2C	3B	2C	3B
72	.		:	2E	3A	2E	3A
73	-		_	2D	5F	2D	5F

TABLE 4-1.6. KEYCODE AND LEGEND ADDENDUM FOR DANISH/NORWEGIAN KEYCAP KIT

KEY NO.	KEY LEGENDS			PRESSED WITH KEY ... GENERATE			
	LOWER	CENTER	UPPER		↑	CTRL	↑ .CTRL
16	[		]	1E, 4B	1E, 4D	1E, 4B	1E, 4D
18	2		"	32	22	00	00
22	6		&	36	26	36	26
23	7		/	37	2F	37	2F
24	8		(	38	28	38	28
25	9		)	39	29	39	29
26	0		=	30	3D	30	3D
27	+		?	2B	3F	1F	1F
28	`		@	60	40	1E	1E
29				-	-	-	-
43		A		7D	5D	1D	1D
44	-		^	7E	5E	1C	1C
57		ø		7C	5C	7C	5C
58		Æ		7B	5B	7B	5B
59	'		*	27	2A	27	2A
63	<		>	3C	3E	3C	3E
71	,		;	2C	3B	2C	3B
72	.		:	2E	3A	2E	3A
73	-		_	2D	5F	2D	5F

CHARACTER-TRANSMIT MODE

The basic type of transmission in CYBER mode is character transmission which emulates the operation of the CC628 TTY Display Terminal. This type of transmission is in effect unless a command to enter block mode is received from the host.

In character mode, the code for a pressed key is transmitted immediately. That is if operations are online and the cursor was in an unprotected position. In addition, the character for the pressed key displays immediately if half-duplex routing is being used or displays when the code is echoed back by the host if full-duplex routing is being used. As characters are displayed, the attribute word is stored in back-ground memory with the modified bit set. If the cursor occupied a protected position, and the key pressed is a displayable code, nothing is sent and the alarm sounds. When a function requiring the clearing of data is performed, the modified attribute bit is cleared for each position cleared.

The following paragraphs describe the operation of keys in character mode.

### PRINT Key

Activation of this key in the unshifted position causes the transmission of a page print code sequence. If half-duplex is selected, the terminal causes all data to be printed as it appears on the screen from the current line to end of page. Preceding the transfer, the terminal issues a form feed. During the transfer, all codes 7F through FF hexadecimal are replaced by spaces and a carriage return/line feed is inserted at the start of the page and at the end of each line. When online, all incoming codes are ignored (not lost) until completion of the print transmission. Print completion is signaled by the terminal transmitting a print complete code (ACK) or if the operation is aborted by actuating SHIFT/M REL; transmission of an abnormal completion sequence (RS, NAK). No response is sent in large CYBER mode.

#### NOTE

Pressing the Shift and M REL keys sends a X-ON signal (DC1) to the host.

If the PRINT key is actuated in conjunction with the shift key, a print form code sequence is generated. If half-duplex is selected, the terminal sends all data as previously described except dimmed data is replaced with space codes for transfer to the printer.

Any data received during the print operation is ignored. The keyboard is locked during the print operation. A 250-ms delay is inserted after each CR, LF, FF if the SRTS is off and Use Printer SRTS parameter is in effect. If the printer is not ready, DTR off, or goes not ready, nothing will be sent to the printer until DTR goes on.

### SETUP Key

Activating the SETUP key causes the terminal to display the operator mode status (eight parameters) at the bottom two lines of the display. The bottom lines are not lost. When displayed, mode operating parameters can be changed. Activating the F1 (Return) key causes deletion of the status line and returns screen data to its original position. If data is received from the host, it is placed into the 992 character COMM INPUT BUFFER. If the buffer ever reaches 768 characters, an X-OFF is sent to the host (if online).

#### NOTE

If the mode is exited by pressing F10, F10, the host may be left with the X-OFF active.

### Special Function Keys

Fifteen four-level special function keys (F1 through F15) are contained on the keyboard. When pressed, these keys cause the transmission of a 2-character sequence. The first character is an 1E<sub>16</sub>, the second character is unique to the individual function key whether it is shifted, unshifted, or activated in conjunction with the CTRL (Control) key (refer to table 4-1).

The following additional host-defined actions are also available:

- A host-selectable CR (0D<sub>16</sub>) code delimiter added to the code sequence defined in table 4-1.
- A host-specified code sequence or a host defined controlware sequence executed in response to a key activation. The host-specified action includes a key identifier, a code sequence or controlware sequence selector, and the actual code sequence or controlware sequence.

### L/INSRT/C Key

When unshifted, activation of the L/INSRT/C key causes entry of a space code at the current cursor position. The character that occupied that position and all characters to the right of the cursor are moved one position to the right. This character shifting to the right is continued to the end of the line, or to the end of the unprotected field, whichever occurs first. The rightmost character is then lost. This key is ignored and the audible alarm is activated if the cursor currently occupies a protected position.

When shifted, activation of this key causes a line of space codes to be entered into the display line presently occupied by the cursor. The line of data that occupied the cursor line is then moved down one line position. This line shifting continues until either the bottom line, or a line with protected data is encountered. The data in the bottom line, or just above the line with any protected data is lost. This shifted key is ignored and the audible alarm is activated if the cursor currently occupies a line with any protected character positions. For character and protect mode, the modified attribute bit is cleared for all character locations changed.

### ERASE Key

The ERASE key causes entry of a space code into all unprotected display positions in the current unprotected field. This includes all unprotected positions from the current cursor position to the beginning of the field or the beginning of the line, and all unprotected positions from the current cursor position to the end of the field, or end of the line, whichever comes first. The cursor is moved to the beginning of the field. For character or protect mode, the modified attribute bit is cleared for all locations cleared. In half-duplex operation, this key performs a line clear and carriage return or destructive backspace.

If the cursor currently occupies a protected position, an audible alarm is activated, the cursor is left unchanged, and no additional action is taken.

## L/DLETE/C Key

When activated in the unshifted position, the L/DLETE/C key deletes the character code at the present cursor position. The character code to the right of the cursor moves one position to the left and this character shift to the left continues to the end of the unprotected field, or to the end of the line, whichever occurs first. The rightmost position shifted left is then replaced with a space code. If the cursor currently occupies a protected position, the function of this key is ignored and the audible alarm is activated.

When activated in the shifted position, this key deletes the entire line of codes in the line presently occupied by the cursor. The lines below this line are then shifted up one line position. This shifting continues until the bottom line, or until a line with any protected data is encountered. The line position of the last line shifted up is then replaced with space codes. If the cursor currently occupies a line with any protected position, the function of this key is ignored and the audible alarm is activated.

For character and protect mode, the modified attribute bit is cleared for all character locations changed.

## P/CLEAR/EOL (Erase Page/Erase End of Line) Key

When activated in the unshifted position, the P/CLEAR/EOL key causes entry of space codes into all unprotected display positions, from and including the current cursor position to the end of the current unprotected field or to the end of the line, whichever occurs first. The cursor is not moved. The modified attribute bit is cleared for all character locations cleared.

When activated in the shifted position, this key causes the entry of a space code into all unprotected display positions, from the home position to the end of the display position. The cursor is moved to the home position. The modified attribute bit is cleared for all character locations cleared.

### LF/ESC (Line Feed/Escape) Key

When actuated in the unshifted position, this key causes an ESC code to be sent to the host. The LF/ESC key for unprotected character locations performs an escape function. For protected locations, an audible alarm is generated and no action taken. Actuation of this key in the shifted position performs a line feed function and causes an LF code to be sent to the host.

### M REL/BREAK Key

Actuation of the M REL/BREAK key in the unshifted position causes the transmitted data signal to be held to a space (logical 0) condition for approximately 250 milliseconds. If a break is received, a parity error symbol is entered at the cursor position and the audible alarm is actuated.

Actuation of this key in the shifted position causes a manual release operation to be executed. This provides a controlware/firmware break function and sends an X-ON signal to the host. If a print operation is active, it will be aborted and the keyboard unlocked.

### NEXT/ (New Line/Carriage Return)

Activation of this key causes a new line code ( $0A_{16}$ ) to be transmitted in Advanced mode or a carriage return code ( $0D_{16}$ ) to be transmitted in Advanced native mode.

### (Tab Forward) Key

Activation of this key causes the transmission of the tab sequence. If pressed in conjunction with the Control key it will set the current column as a tab stop. If protect is not enabled, the key will move the cursor to the first position following the low intensity field or next column tab, whichever comes first. If none are present, the cursor moves to the top of page. If protect is enabled, this key will cause the cursor to move right to the beginning of the next unprotected field or the next column tab that is set. If the cursor is at the beginning of an unprotected field or at a protected character position, the cursor will move to the beginning of the previous unprotected field or upper-left position, if neither is found.

## ← (Tab Backward) Key

Activation of this key causes the transmission of the back tab sequence. See the protect operation section if protect is enabled. If protect is not enabled, the key will move the cursor backwards to the start of the current or next non-dim field or to the next column tab position, whichever comes first. If none are present, the cursor moves to the top of the page. If pressed in conjunction with the CTRL key, it clears the current column as a tab stop.

## Cursor Control Keys (Up ↑ , Down ↓ , Left ← , Right → and HOME Keys)

Five keys in the numeric cluster are used to enable cursor movement. The cursor control keys must be used in conjunction with the Shift key or the Shift and CTRL keys. The numeric pad keys are also affected by the N PAD NORMAL/SHIFT parameter. Key functions are described as follows:

- Cursor Up - The shifted numeric 8 key moves the cursor up one line. If the cursor up key is activated in the top line, the cursor moves to the current column position in the last line. If the character position that the cursor is to occupy is protected, the cursor moves to the protected position.
- Cursor Down - The shifted numeric 2 key moves the cursor down one line. If the cursor down key is activated and the cursor is in the bottom line, the cursor moves to the current column position in top line. If the character position that the cursor is to occupy is protected, the cursor moves to the protected position.
- Cursor Left - The shifted numeric 4 key or Backspace key moves the cursor left one character position. If the cursor is in column 1 when the key is activated, the cursor moves to the last column position (80 or 132) of the previous line. If the cursor is at upper-left, it will move to the last column of the bottom line. If the position the cursor is to occupy is protected, the cursor moves to the protected position.
- Cursor Right - The shifted numeric 6 key moves the cursor right one character position. If the cursor is in the last column position (80 or 132) when the key is activated, the cursor moves to column 1 of the next line. If the cursor is at the last column of the bottom line, it moves to upper-left if page operation is selected or causes the screen to scroll in roll operation. If the position the cursor is to occupy is protected, the cursor moves to the protected position.



- Home - The shifted numeric 5 key moves the cursor to the home position. If the position the cursor is to occupy is protected, the cursor moves to the protected position following the home position.

### CR/DEL (Carriage Return/Delete) Key

Unshifted, the CR/DEL key transmits a delete (DEL) code.  
Shifted, the CR/DEL key transmits a carriage return (CR) code.

### Special Action Keys (+, -, x, ÷, HELP, ERASE, EDIT, BACK, LAB, DATA, STOP)

Eleven special action keys are available on the keyboard. Action keycodes and code sequences as defined by table 4-1 are transmitted to the host.

All keys identified in table 4-1 that are not function keys and support a host-specified optional code sequence or controlware sequence support the additional host defined action:

- A host-specified code sequence or a host-defined controlware sequence is executed in response to a key activation. The host-specified action includes a key identifying a code sequence or controlware sequence selector and the actual code sequence or controlware sequence.
- ERASE - This key performs a LINE CLEAR and carriage return or a destructive backspace in half-duplex. See Protect Operation later in this section.

### BLOCK-TRANSMIT MODE

CYBER mode includes the capability to perform operator entry and editing on a page basis offline to the host. When the operator completes an activity, a block transmission is initiated by the operator to the host.

When alphanumeric keys are pressed in block mode, the associated 7-bit code is stored in display memory. Bit 27 in display memory is not modified. Therefore, a graphic, PLATO, RAM generator character will be displayed if the previous code stored there was a graphic, PLATO, or RAM generator character. The attribute word for an alphanumeric entry is stored in background memory with the modified bit set. However, if the cursor occupied a protected position, no action is performed and the alarm will sound. If the operator initiates a function which requires the clearing of data, the modified attribute bit will be set for each position cleared.

If alphanumeric codes are received from the host while in block mode, they will be stored along with new attribute words and the modified bit will be cleared. If protect is enabled, the attributes will not be stored with received data, and if the cursor is at a protected position when data is received, a tab will be performed before storing the data.

#### Initiating/Terminating Block Mode

The host uses two commands to initiate and terminate block mode transmission:

- Enter Block Mode - When block mode is active, the operator enters and/or changes data locally at the terminal on a page basis without host intervention. Block transmission is initiated by the operator when the current page activity is completed.
- Exit Block Mode - Terminates local terminal activity.
- Block mode selection can only be activated by host command (not an installation parameter). When the block mode operation is active, the host utilizes the following commands to properly support block mode operation.
  - Enable/Disable Keyboard - Enables/disables operator keyboard entry during block mode transmission activity.
  - Load/Define Function Keys - This allows the host to define any or all function keys to perform desired block mode code sequence or controlware sequence.

## Block Mode Operation

When an enter block mode command is received, the terminal disables immediate communications with the host. It performs all allowed operator actions, such as data-entry and editing functions locally (offline to the host). These actions are performed on a page basis.

The terminal remains in this state until the operator initiates a send function by activating anyone of the 15 function keys or ten special action keys (does not include the ERASE key, the L/INSRT/C key, or the L/DLETE/C key). This indicates to the terminal that the operator has completed the current page activity and requests transmission to the host. The terminal then performs the following:

- Enables communications with the host
- Disables keyboard to the operator
- Saves the current cursor position
- Resets cursor to upper left
- Sends prologue codes if loaded
- Sends all unprotected data in each field. Modified bits are cleared as codes are sent.
- Restores the cursor to original position
- Sends the function code sequence for the key that started transmission
- Sends current cursor XY position
- Sends a page block terminator (CR)
- Disables communications
- Enables the keyboard

## Keyboard Operation in Block Mode

The special-action and function keys and the L/INSRT/C and L/DLETE/C keys generate different operations in block mode than they do in character mode. These differences are described in the following paragraphs. The other keys operate the same as if in character mode but offline from the host.

## Special-Action and Function Keys

Function keys F1 through F15 and special action keys (+, -, X, ÷, HELP, EDIT, BACK, LAB, DATA, STOP) are used by the operator to initiate a block transfer to the host. The significance of any or all function keys is dependent upon the host or host application.

## L/INSRT/C and L/DLETE/C Keys

Unshifted, the insert-character and delete-character actions of these keys perform the same as for character and/or protect mode operations.

Shifted, these keys:

- Send an insert-line or delete-line keycode sequence
- Do not perform the insert-line or delete-line operation until the codes are echoed or sent back by the host

## PROTECT OPERATION

Protect operation in CYBER mode allows areas of the screen to be protected from operator entry. These areas are designated by the protect attribute bit. Each character position has a protect attribute bit which allows the host to select individual character positions for protection. The operator cannot alter these positions, but can move the cursor through them.

As alphanumeric codes are received from the host, they are displayed at the cursor position if protect is disabled. If protect is enabled and the current position is protected, a tab is performed before displaying the data. The host must disable the protect system to perform clear functions. The host can store data over protected positions.

## Host Communications

The host uses two commands to specify desired protect attribute bit conditions:

- Start Protect - Store protect bit for each succeeding character received.
- Clear Protect - Clear protect bit for each succeeding character received.

The state of the protect attribute bit by itself has no effect on normal terminal operation. The protect system active condition must be present before the terminal uses the protect attribute bit. The host uses two additional commands to select desired protect system conditions.

- Enable Protect System - All protected characters (protect attribute set) are protected from operator action and can only be changed by the host. Any operator alphanumeric or Control key entry causes an audible alarm to be generated and no operation is performed.
- Disable Protect System - All character positions can be entered/changed by operator action. If an operator changes a character location with its protect bit set, the character is entered and its associated bit is stored.

## Protect System Disabled

With the protect system off, all character positions can be entered/changed via the terminal keyboard.

## Protect System Enabled (Keyboard Operation)

Keyboard operation with the protect system enabled is described as follows. Operation of the keys is the same as for Character-Transmit Mode unless otherwise specified.

## Alphanumeric and Control Code Entry

For unprotected character locations, actuation of the alphanumeric or control code key causes the code for that key to be processed the same as for the current mode operation.

For protected character locations, actuation of any alphanumeric key causes an audible alarm to be generated with no additional terminal action taken. The cursor does not move when this condition occurs.

### →, ← (Forward Tab and Back Tab) Keys

The → (Forward Tab) key moves the cursor to the beginning of the next unprotected field next column tab that is set or the home position if found.

The ← (Back Tab) key causes the cursor to move left to the beginning of the current unprotected field or next column tab that is set. If the cursor is at the beginning of an unprotected field or at a protected character location, the cursor will move to the beginning of the previous unprotected field or upper-left position if neither is found.

### NEXT/ ← (New Line) Key

In Advanced mode, the NEXT/New Line key moves the cursor to the first location of the next line.

In Advanced N mode, the NEXT/New Line key moves the cursor to the first location of the current line. If the Auto LF option is enabled, a line feed is also performed.

### PRINT Key

Unshifted this key operates the same as standard character mode operation.

Shifted this key operation is the same as previously defined except that dimmed or protected characters are replaced with space codes.

## Protect System Active Display Operation

When the protect system is enabled, all character attributes remain unchanged. Display operation is controlled by the character attributes (blink, protect, underscore, dim, inverse, and blank), and the character set and edit control commands (line drawing, external loadable characters, scroll/page field, line length and format).

The character attribute commands enable the video display characteristic named with the protect system active. The line drawing and extended character commands cause the display to substitute the selected character set for part of the standard ASCII set.

The line length command selects 80- or 132-character line operation. All other functions are not affected.

### TOUCHPANEL OPERATION

CYBER mode supports touchpanel operation. This support is as follows:

- With graphics and touchpanel option installed, an 80-character-per-line display format must be in effect for graphics use. Therefore, only that format is referred to here.
- The touchpanel has 16 vertical and 16 horizontal strips. Each strip is 0.5 inches wide. Where the vertical and horizontal strips intersect is a 0.5-inch square cell. With 80 characters per line, the cell covers two lines by four characters.
- Touchpanel activated selection to a defined single character position located within the activated cell. Normally, this is intended to be the bottom center character located in the touchpanel cell.

## Line Display

When 30 lines are displayed, the top line is under the bottom half of the top strip of the touchpanel, and the last line is under the top half of the bottom strip. When 24 lines are displayed, the top 2 and bottom 2 strips of the touchpanel have no data under them.

### NOTE

The displayable area of 30 lines by 80 characters is 7.5-inches high by 10-inches wide. The area covered by the touchpanel is 8 inches by 8 inches. This means 1 inch (8 characters) on each side is not covered by the touchpanel and 0.25-inches on top and bottom are not covered by the touchpanel.

The following charts show the X and Y positions (decimal) used when positioning the cursor.

Char/ Line	TOUCHPANEL STRIPS LEFT TO RIGHT															
	1	2	3	4	5	6	7	8	9	10	11	12	13	14	15	16
80	11	15	19	23	27	31	35	39	43	47	51	54	58	62	66	70

Lines/ Screen	TOUCHPANEL STRIPS LEFT TO RIGHT															
	1	2	3	4	5	6	7	8	9	10	11	12	13	14	15	16
24	1	1	2	4	6	8	10	12	14	16	18	20	22	24	24	24
30	1	3	5	7	9	11	13	15	17	19	21	23	25	27	29	30

## Host Communications

The host utilizes two special commands to support touchpanel operation. The host can enable or disable the function. If enabled, it is supported by operator initiated selection input to the host. The host can request terminal configuration status to determine if the touchpanel option is present.

## Terminal Operation

When a touchpanel operation is active, the following occurs:

1. The operator determines desired selection or position.
2. The operator touches the touchpanel at the desired position.



3. The terminal computes X/Y position activated.
4. The terminal moves cursor to X/Y position activated.
5. The terminal sends a Select function (RS, M code sequence) to the host.
6. The terminal sends a Read Cursor Address function to the host to specify the X/Y cursor position. Refer to table 4-2 for a definition. The terminal then sends a CR (OD) termination character.

CYBER MODE HOST RECEIVED COMMANDS

Table 4-2 summarizes all host-received commands and I/O responses. Table 4-3 provides read parameter data word formats.

NOTE

Multiple word responses made by the terminal are subject to the Pacing parameter in mode installation parameters.

TABLE 4-2. CYBER MODE RECEIVE AND I/O RESPONSES

COMMAND NAME	ASCII MNEMONIC	HEX CODE	TERMINAL RESPONSE
NOOP	NUL	00	No operation performed.
Print Form	SOH	01	Transfers all nondimmed displayed data to printer from beginning of current line to end of page. Dimmed data is sent as space code (20). Keyboard locks, comm data is received but ignored until end of operation (not lost). Printing may be aborted by actuation of SHIFT/M REL. Print completion is signaled by terminal transmitting an 06 (ACK) or, if the operation is aborted due to actuating SHIFT/M REL, by transmission of an 1E, 15 (RS, NAK) sequence. If there is no printer DTR when the Print Form command is received, an RS,NAK is sent. There is no completion response in large CYBER mode.

TABLE 4-2. CYBER MODE RECEIVE AND I/O RESPONSES (CONTD)

COMMAND NAME	ASCII MNEMONIC	HEX CODE	TERMINAL RESPONSE
NOOP ADV Mode (small)	STX	02	No operation.
Write Cursor Address ADV N Mode (large)	STX	02	See Write Cursor Address (DLE).
Enable Blink	ETX	03	Blinks characters whose blink bit is set to 1 (refer to Start Blink command). Following power up or page erase, blink is automatically enabled.
Disable Blink	EOT	04	Disables character blinking on display page.
Read Cursor Address	ENQ	05	Causes terminal to send cursor address header code (1F) followed by codes containing column and row address. Column position transfers first and is numbered from left to right (00 through 4F) for 80-column mode. In 132-column mode, a 7E code precedes the column position address, producing a code sequence of 7E, 00, 00 through 4F for the first 80 columns: 01, 00 through 34 for columns 81 through 132. The next code is line position numbering from top to bottom (00 through 1D). Row/column addresses may be biased to avoid codes 00 through 1F by enabling code bias parameter selection. When CODE BIAS is enabled, cursor position 00 equals 20. Addressing continues in normal binary progression through 6F for 80-column mode. The 132-column mode sequence is 7E, 20, 20 through 7E, 21, 44 for columns 0 through 132, respectively. The line position address is 20 through 3D for both 80- and 132-column modes.
NOOP ADV Mode (small)	ACK	06	No operation.
Start Underline ADV N Mode (large)	ACK	06	Sets the underline attribute bit to 1.
Alarm	BEL	07	Sounds audible alarm for 250 milliseconds.

TABLE 4-2. CYBER MODE RECEIVE AND I/O RESPONSES (CONTD)

COMMAND NAME	ASCII MNEMONIC	HEX CODE	TERMINAL RESPONSE
Home ADV Mode (small)	BS	08	Moves cursor to home position as defined by parameter setting.
Cursor Left ADV N Mode (large)	BS	08	Moves cursor left one character position.
NOOP ADV Mode (small)	HT	09	No operation.
TAB ADV N Mode (large)	HT	09	Causes cursor to be advanced to the first position following the next low intensity field or next column tab (whichever comes first) if protect is not enabled. Causes cursor to be advanced to the next unprotected field or next column tab (whichever comes first) if protect is enabled. Cursor will move to top of page if none present. Completion response is identical to Read Status response. No response sent in large CYBER mode.
New Line ADV Mode (small)	LF	0A	Moves cursor to first character position in next line.
Cursor Down ADV N Mode (large)	LF	0A	Moves cursor down one line while remaining in the same position. If on the last line, screen will scroll if roll enabled; cursor moves to top line if page enabled.
EOL (Erase to End of Line)	VT	0B	Erases all unprotected characters from and including current cursor position to end of current unprotected field or the end of that line. Enters 20 in affected positions. Modified attribute bit for all cleared character positions are cleared.

TABLE 4-2. CYBER MODE RECEIVE AND I/O RESPONSES (CONTD)

COMMAND NAME	ASCII MNEMONIC	HEX CODE	TERMINAL RESPONSE
EP (Erase Page)	FF	0C	Erases all unprotected characters on screen. Cursor moves to home position. Enters 20 in affected positions. Clears background memory and enables blink if previously disabled. Return to enter normal data (clears enter blink, underscore, reduced intensity, dim, and blank). Modified attribute bits are cleared in character mode, set in block mode.
Carriage Return ADV Mode (small)	CR	0D	Moves cursor to first character position in line that it is on. If the Auto Line Feed parameter is selected, a LF is performed.
Start Blink	SO	0E	Sets blink bit to 1 in those succeeding characters received and stored in terminal memory.
Stop Blink	SI	0F	Sets blink bit to 0 in succeeding characters received.
Write Cursor Address ADV Mode (small)	DLE	10	Interprets next characters as cursor column and row address. Cursor moves to position defined by addresses. Column address is numbered from left to right (00 through 4F) for 80-column mode. In 132-column mode, a 7E code precedes the column position address, producing a code sequence of 7E, 20, 00 through 4F for columns 0 through 80, and 7E, 21, 00 through 33 for columns 81 through 132. Line position is numbered from top to bottom (00 through 1D). If column position code is greater than 4F in 80-column mode or 01, 33 in 132-column mode, cursor control logic wraps around. Line position operates in a similar manner (e.g., 1F equals 01). Row and column addresses may be biased in same manner as described for Read Cursor Address.
NOOP ADV N Mode (large)	DLE	10	No operation.

TABLE 4-2. CYBER MODE RECEIVE AND I/O RESPONSES (CONTD)

COMMAND NAME	ASCII MNEMONIC	HEX CODE	TERMINAL RESPONSE
Page Print ADV Mode (small)	DC1	11	Transfers to printer all displayed data from current line to end of page. Keyboard is locked and received data ignored until end of operation (not lost). Printing may be aborted by pressing SHIFT/M REL. Print completion is signaled by terminal transmitting an 06, or if the operation is aborted by actuating SHIFT/M REL, transmission of an RS,NAK (1E,15) sequence. If there is no printer DTR when the Page Print command is received, an RS,NAK is sent. No completion response is sent in large CYBER mode.
X-On ADV N Mode (large)	DC1	11	Enables transmission to the host or initiates continuation of suspended transmission from the host.
Roll Enable	DC2	12	Enables roll mode; screen scrolls up one line each time cursor overflows bottom line or if a new line code is received when cursor is on bottom line, cursor moves to first character position on bottom line. Bottom line clears; top line is lost. Powering on terminal enables scroll feature.
Roll Disable ADV Mode (small)	DC3	13	Enables page mode; moves cursor to home position when new line code is received and cursor is on bottom line.
X-Off ADV N Mode (large)	DC3	13	Causes the terminal to temporarily halt transmission to the host until the X-On is received. When sent to the host, means data cannot be acted upon.
			NOTE
			This code cannot be placed inside a multiple code sequence.
Start Underscore ADV Mode (small)	DC4	14	Sets underscore bit to 1. Each succeeding displayed character received is underlined on the screen.

TABLE 4-2. CYBER MODE RECEIVE AND I/O RESPONSES (CONTD)

COMMAND NAME	ASCII MNEMONIC	HEX CODE	TERMINAL RESPONSE
NOOP ADV N Mode (large)	DC4	14	No operation.
End Underscore	NAK	15	Sets underscore bit to 0. Each succeeding displayed character received is not underlined.
NOOP ADV Mode (small)	SYN	16	No operation.
Roll Disable ADV N Mode (large)	SYN	16	Roll disable (see DC3).
Cursor Up	ETB	17	Moves cursor up one line while remaining in same column (character) position. Stored data is not affected.
Skip	CAN	18	Moves cursor right one character position. Stored data is not affected.
Cursor Left ADV Mode (small)	EM	19	Moves cursor left one character position. Stored data is not affected.
Home ADV N Mode (large)	EM	19	Moves cursor to home as determined by the parameter bit.
Cursor Down	SUB	1A	Moves cursor down one line while remaining in same column (character) position. If cursor is on the last line it will wrap around to the top. Stored data is not affected.
NOOP	ESC	1B	No operation.
Start Dim	FS	1C	Sets dim bit to 1. Each succeeding displayed character received is dimmed on the screen.
End Dim	GS	1D	Sets dim bit to 0. Each succeeding displayed character received is displayed at full intensity on the screen.
NOOP ADV Mode (small)	US	1F	No operation.

TABLE 4-2. CYBER MODE RECEIVE AND I/O RESPONSES (CONTD)

COMMAND NAME	ASCII MNEMONIC	HEX CODE	TERMINAL RESPONSE
Backspace ADV N Mode (large)	US	1F	Move data left one position and clears the data. Protected data is not cleared.
NOOP	DEL	7F	No operation.
Print Form	RS, SOH	1E, 01	See Print Form (SOH)
Page Print	RS, STX	1E, 02	See Page Print (DC1)
Tab ADV Mode (small)	RS, EOT	1E, 04	If protect is not active, this will cause the cursor to advance to the first position following next low-intensity field or next column tab (whichever comes first). If none are present, moves to top of page. If protect is active, moves to the next unprotected area or column tab (whichever comes first). If none are present, moves to top of page. Completion response is identical to Read Status response. No response is sent in large CYBER mode.
NOOP ADV N Mode (large)	RS, EOT	1E, 04	No operation.
Enable CR Delimiter	RS, ENQ,	1E, 05	Caused a CR delimiter (0D) to be added to certain host responses.
Home	RS, BS	1E, 08	See Home BS, (08)
Define Function or Action Key Code Sequence or Con- trolware Sequence	RS, HT, (V), (W) (X), (Y...), (Z)	1E, 09, (V), (W) (X), (Y...), (Z)	Causes a code sequence or controlware sequence to be defined by the host. V = Key identifier and address pointer W = Function X = Address Y = Code sequence or controlware Z = Specified delimiter The terminal will respond with an ACK if all codes are received okay and an RS,NAK if not. No response is sent in large CYBER mode.

TABLE 4-2. CYBER MODE RECEIVE AND I/O RESPONSES (CONTD)

COMMAND NAME	ASCII MNEMONIC	HEX CODE	TERMINAL RESPONSE
Back Tab	RS, VT	1E, 0B	Causes the cursor to move back to the first position following a preceding low-intensity field, following a preceding protected field position at preceding column tab or to Home position, if none are encountered. See Back Tab key for more detailed definition. Completion response is identical to Read Status response. No response is sent in large CYBER mode.
Read Attribute	RS, SO (X), (Y)	1E, 0E (X) (Y)	Causes terminal to respond with two words that indicate the attributes of character at cursor position. Cursor is not advanced; stored data is not affected. Data word one bit significance is: $2^0$ - internal program use; $2^1$ - underscore; $2^2$ - blink; $2^3$ - reduced intensity; $2^4$ and $2^5$ - set to logical 1. If data bit $2^6$ is logical 1, character displayed at cursor position is not an alphanumeric or control character. Refer to tables 2-1 through 2-8. If $2^6$ a logical 1 and data word at cursor-position falls in columns 4, 5, 6, or 7, symbol is extended character. If data word falls in columns 2 or 3, symbol is one of line drawing set (table 2-9). Data word two bit significance is: $2^0$ - modified position; $2^1$ - protected position; $2^2$ - blank; $2^3$ - inverse; $2^4$ and $2^5$ - set to logical 1; $2^6$ - set to logical 0.
Read Parameter	RS, SI	1E, 1F	See RS, DC3
Read Data	RS, DLE	1E, 10	Causes data word stored in memory at cursor position to be transferred to interface. Cursor is not advanced. Seven data bits are transferred. Determining if the code represents an alphanumeric character, line drawing, extended character, or control code requires that the attribute character be read. Refer to read attribute command and buffer mode operation.



TABLE 4-2. CYBER MODE RECEIVE AND I/O RESPONSES (CONTD)

COMMAND NAME	ASCII MNEMONIC	HEX CODE	TERMINAL RESPONSE
Page Print ADV Mode (Small)	RS, DC1	1E, 11	See Page Print (DC1).
X-ON ADV N Mode (large)	RS, DC1	1E, 11	This is not a normal sequence. If the DC1 is following an RS, the X-ON function will be performed (see DC1) but the next code received will be acted upon as if an RS preceded it.
Read Parameter ADV Mode (small)	RS, DC3	1E, 13	Causes terminal to transmit settings of terminal operating parameters. Settings are sent out in data words preceded by sequence 02, 06, 25 and terminated with a Read Status response. See table 4-4. No response sent in large CYBER mode.
X-OFF ADV N Mode (large)	RS, DC3	1E, 13	This is not a normal sequence. If the DC1 is following an RS, the X-ON function will be performed (see DC1) but the next code received will be acted upon as if an RS preceded it.
Read Status	RS, DC4	1E, 14	Causes terminal to respond 02, 06, 06 (STX, ACK, ACK), if all preceding self-test operations were completed successfully. The response 02, 06, 15 (STX, ACK, NAK) is transferred if any self test failed.
Initiate Test	RS, SYN	1E, 16	Causes terminal to perform self-test (Test 2) operation; no response to further commands until self test is completed. Terminal signals completion of self test by automatically sending a Read Status response. Refer to Self-Test Routines paragraph for further description.
Skip	RS, CAN	1E, 18	See Skip (CAN, 18)
Backspace	RS, EM	1E, 19	See Backspace (EM, 19)
Cursor Down	RS, SUB	1E, 1A	See Cursor Down (SUB, 1A)

TABLE 4-2. CYBER MODE RECEIVE AND I/O RESPONSES (CONTD)

COMMAND NAME	ASCII MNEMONIC	HEX CODE	TERMINAL RESPONSE
Line Drawing	RS, FS	1E, 1C	Causes terminal to interpret any following data words received from 20 to 3F as line drawing characters. Refer to table 2-9 for codes.
Basic Char	RS, GS	1E, 1D	Causes terminal to interpret received data as normal characters.
NOOP	RS, SP thru RS, .	1E, 20 thru 1E, 2E	No operation.
NOOP	RS, $\phi$ thru RS, >	1E, 3 $\phi$ thru 1E, 3E	No operation
Clear field			
• Low Intensity	RS, ?	1E, 3F	Causes terminal to clear all unprotected data from cursor position to end of page for all data or only unprotected high- or low-intensity areas as selected. No response is provided to I/O commands during operation. Modified attribute bits for all cleared character positions are cleared. The Read Status is sent back to indicate operation complete. No response is sent in large CYBER mode.
• High Intensity	RS, @	1E, 40	
• All Data	RS, P	1E, 50	
Initiate Host DLL	RS, A	1E, 41	Initiates a host specified downline load (DLL). The host DLL command is followed by standard load blocks until all load blocks are loaded or an uncorrectable error occurs. If the load completes successfully, control is transferred to the loaded controlware. If unsuccessful, terminal responds with RS, NAK (1E, 05).
Exit Host DLL	RS, B	1E, 42	Reserved for host command to loaded controlware.

TABLE 4-2. CYBER MODE RECEIVE AND I/O RESPONSES (CONTD)

COMMAND NAME	ASCII MNEMONIC	HEX CODE	TERMINAL RESPONSE
Model Report Request	RS, C, (n)	1E, 43, (n)	<p>n = 30 Terminal installation parameters  n = 31-36 Requesting that modes NVM only  n = 37 Active status from RAM  The terminal sends the following code sequence to the host system:</p> <p>1E Header Code  6F Header Code  23 Indicates model report request data follows  21 Indicates a Viking X terminal  XXX Configuration Code; See Model Report Request  YYY Firmware code  ZZZ Termination code</p> <p style="text-align: center;">NOTE</p> <p>Terminal and NVM data is only valid while running in CYBER mode (Mode 1).</p>
Start Inverse	RS, D	1E, 44	Set inverse bit of each succeeding character received to 1.
End Inverse	RS, E	1E, 45	Clear inverse bit of each succeeding character received.
Print I/O	RS, F	1E, 46	Causes terminal to direct all received data, and transmitted data in half duplex, or local, to printer interface. Completion response is identical to Read Status. No response is sent in large CYBER mode.
Set All Protect Bits	RS, G	1E, 47	<p>This command will disable Protect and set the protected bit in the attribute code for every character position.</p> <p style="text-align: center;">NOTE</p> <p>If the Protect Enable Command is received before any unprotected data is displayed, the terminal will lock up.</p>
NOOP	RS, I thru M	1E, 49 thru 4D	No operation.

TABLE 4-2. CYBER MODE RECEIVE AND I/O RESPONSES (CONTD)

COMMAND NAME	ASCII MNEMONIC	HEX CODE	TERMINAL RESPONSE
Delete Character	RS, N	1E, 4E	Deletes one character. All characters to the right of the cursor are shifted left one position. If protect enable is active, shift occurs only up to protected data.
Insert Character	RS, O	1E, 4F	Inserts one space character. Character in cursor position and all characters to the right of the cursor are shifted right one position. If protect enable is active, shift occurs only up to protected data.
Clear All Data	RS, P	1E, 50	See Clear Fields.
Delete Line	RS, Q	1E, 51	Causes all unprotected line data and associated highlight fields below cursor and within the logical page or unprotected area limits to be moved up one position; current line is lost; bottom line is cleared. No response to I/O commands during operation. Completion response is identical to Read Status response. No response is sent in large CYBER mode. Modified attribute bits for all cleared character positions are cleared.
Insert Line	RS, R	1E, 52	Causes all unprotected line data and associated highlight field on current line to be relocated one line down; bottom line within logical page or unprotected area is lost; current line is cleared. No response to I/O commands is provided during operation. Insert line timing and completion response are identical to delete line. Modified attribute bits for all cleared character positions are cleared.

TABLE 4-2. CYBER MODE RECEIVE AND I/O RESPONSES (CONTD)

COMMAND NAME	ASCII MNEMONIC	HEX CODE	TERMINAL RESPONSE
Load RAM Extended Character Generator*	RS,S,(W), (X), (Y), (Z)	1E, 53,(W) (X), (Y), (Z)	<p>Causes the terminal to interpret the characters following the RS, S, [1E, 53 command (W) (X), (Y), (Z)] as information concerning the RAM character generator. Loading the generator requires the character be specified (40 through 7F, six bits, 64 characters). It also requires the starting scan be specified (one of sixteen numbered top to bottom, four bits). The dot patterns may then be specified (eight possible dots); left to right, lowest to highest order bit position. The data words are formatted as follows:</p> <ul style="list-style-type: none"> <li>● Word 1 (W) - Character Code. Code must be between 40 through 7F. Codes outside this field cause an RS NAK to be sent to the host.</li> <li>● Word 2 (X) - Start Scan Count. Bits <math>2^0</math> through <math>2^3</math> contain the start count. <math>2^4</math> must be 0, <math>2^5</math> must be 1, <math>2^6</math> must be 0.</li> <li>● Word 3 (Y) - Dot Pattern. Dot Patterns are sent in groups of 2. Bits <math>2^0</math> through <math>2^3</math> of the first word are the upper 4 dots and <math>2^0</math> through <math>2^3</math> of the second word are the lower 4 dots. Bit <math>2^4</math> must be 0, <math>2^5</math> must be 1, <math>2^6</math> must be 0 for first word and 1 for the second word. If words have an error, an RS, NAK will be sent to host when the termination code is received.</li> <li>● Word 4 (Z) - Termination Code CR. An ACK will be sent to host if no errors were encountered, otherwise an RS, NAK is returned. No response is sent in large CYBER mode.</li> </ul>

\*Resequence per dual hexadecimal code.

TABLE 4-2. CYBER MODE RECEIVE AND I/O RESPONSES (CONTD)

COMMAND NAME	ASCII MNEMONIC	HEX CODE	TERMINAL RESPONSE
Extended Character*	RS, T, (X)	1E, 54, (X)	Causes terminal to interpret (X) as character to be displayed from RAM character generator. Code must be in field 40 through 7F. Codes outside of this field cause entry of parity error symbol.
Field Scroll Up	RS, U	1E, 55	Causes each line to be relocated down one position between upper- and lower-field delimiters. Uppermost line in scroll field is lost; bottom line in scroll field is cleared. If protect enable is active, only lines containing unprotected data will be moved. No response to I/O commands is provided during operation. Completion response is identical to Read Status. No response is sent in large CYBER mode.
Field Scroll Down	RS, V	1E, 56	Causes each line to be relocated down one position between upper- and lower-field delimiters. Lowest line is lost; uppermost line in scroll field is cleared. If protect enable is active, only lines containing unprotected data will be moved. No response to I/O commands is provided during operation. Completion response is identical to Read Status. No response is sent in large CYBER mode.
Set Scroll Field	RS, W, (U,) (L)	1E, 57, U, L	Causes terminal to store upper- and lower-line addresses of scroll page field. Refer to X/Y position command for line addressing definition. Receipt of line numbers other than 1 through 30 causes entry of line 30 and 1. Address biasing is supported if selected.
			NOTE
			This works in conjunction with Field Scroll Up and Down.

\*Resequenece per dual hexadecimal code.

TABLE 4-2. CYBER MODE RECEIVE AND I/O RESPONSES (CONTD)

COMMAND NAME	ASCII MNEMONIC	HEX CODE	TERMINAL RESPONSE
NOOP	RS, X	1E, 58	No operation.
Erase	RS, Y	1E, 59	See RS,] 1E, 5D
NOOP	RS, Z	1E, 5A	No operation.
NOOP	RS, [	1E, 5B	No operation.
NOOP	RS, \	1E, 5C	No operation.
Erase	RS, ]	1E, 5D	All character locations in the current unprotected field are cleared to spaces and the cursor is moved to the beginning of the unprotected field.
NOOP	RS, ^	1E, 5E	No operation.
NOOP	RS, _	1E, 5F	No operation.
Blind Printer	RS, DEL	1E, 7F	Causes terminal to stop transferring received and transmitted data to printer. Initial value selected by parameter. RS, DEL is transmitted to printer. The completion response is identical to Read Status. No response is sent in large CYBER mode.
NOOP	RS,DC2,SP thru RS,DC2,?	1E, 12, 20 thru 1E, 12, 3F	No operation.
Enter ADV mode (small)	RS, DC2, A	1E, 12, 41	Enter advanced (ADV) mode of operation.
Enter ADV N mode (large)	RS, DC2, B	1E, 12, 42	Enter Advanced Native (ADV N) mode operation.
NOOP	RS, DC2, C	1E, 12, 43	No operation.

TABLE 4-2. CYBER MODE RECEIVE AND I/O RESPONSES (CONTD)

COMMAND NAME	ASCII MNEMONIC	HEX CODE	TERMINAL RESPONSE
Start Block Mode Send	RS, DC2, D	1E, 12, 44	The terminal sends all unprotected data characters. See Block-Transmit Mode for format of data. A delimiter indicates the end of operation.
Reserved	RS, DC2, E	1E, 12, 45	No operation.
Reserved	RS, DC2, F	1E, 12, 46	No operation.
Set 132 Character Line	RS, DC2, G	1E, 12, 47	Causes the terminal to display 132 characters/line. If the initial line length is 80 characters per line, the display is cleared and cursor is moved to Home.
Set 80 Character Line	RS, DC2, H	1E, 12, 48	Causes the terminal to display 80 characters/line. If the initial line length is 132 characters per line, the display is cleared and cursor is moved to Home.
Start Protect	RS, DC2, I	1E, 12, 49	Set Protect bit of each succeeding character received to a 1.
Clear Protect	RS, DC2, J	1E, 12, 4A	Clear Protect bit of each succeeding character received to a 0.
Enable Protect	RS, DC2, K	1E, 12, 4B	Protected characters (with their protect bit set) are protected from operator action and can only be changed by host action.
Disable Protect	RS, DC2, L	1E, 12, 4C	Disables protected characters on the display page. If an operator changes a character location, its protect bit is determined by the state of the start/clear protect bit flag.
Disable Keyboard Display	RS, DC2, M	1E, 12, 4D	Disable keyboard entry, until reenabled by host or a reset condition.



TABLE 4-2. CYBER MODE RECEIVE AND I/O RESPONSES (CONTD)

COMMAND NAME	ASCII MNEMONIC	HEX CODE	TERMINAL RESPONSE
Enable Keyboard Display	RS, DC2, N	1E, 12, 4E	Enable keyboard entry.
Disable Display	RS, DC2, O	1E, 12, 4F	Disables change to display refresh memory for normal terminal operation. All incoming commands are ignored until the Enable Display is received.
Enable Display	RS, DC2, P	1E, 12, 50	Enables normal display operation.
Disable Touchpanel	RS, DC2, Q	1E, 12, 51	Disables input from the touchpanel.
Enable Touchpanel	RS, DC2, R	1E, 12, 52	Enables input from the touchpanel.
Mode Select	RS, DC2, S, (n)	1E, 12, 53, (n)	Selects mode n = 30-37 (0-7) and transfers control to selected mode. Mode enable and mode security are bypassed. See Auto-Select parameter in Terminal Installation parameter. If n is outside of range, an RS, NAK is returned.
Select Bidirectional Port N	RS, DC2, U, (N)	1E, 12, 55, (N)	Selects bidirectional port N where N = 0-1. When selected, the port can transmit transparent bidirectional data until a deselect is issued. See Host Select Bidirectional port.
Write New Mode Parameters	RS, DC2, V, (Y), (Z)	1E, 12, 56, (Y), (Z)	Causes the terminal to write the RAM (dynamic) parameter memory specified. Y = Write data to parameter memory in format specified by Write New Parameters section. Z = CR Delimiter.

NOTE

To change NMV, see RS, DC2, 0

TABLE 4-2. CYBER MODE RECEIVE AND I/O RESPONSES (CONTD)

COMMAND NAME	ASCII MNEMONIC	HEX CODE	TERMINAL RESPONSE
Set Column Tab	RS,DC2,W,	1E, 12, 57	Causes the terminal to set a column tab for the current column.
Clear Column Tab	RS,DC2,X,	1E, 12, 58	Causes the terminal to clear the column tab position of current column.
Clear All Tabs	RS,DC2,Y	1E, 12, 59	Clear all column tabs.
Disable CR Delimiter	RS, DC2, Z	1E, 12, 5A	Disables the CR delimiter for multiple code and controlware sequences.
Start Blank	RS,DC2,[	1E, 12, 5B	Set the blank attribute bit.
End Blank	RS,DC2,\	1E, 12, 5C	Clear the blank attribute bit.
Select 24 lines	RS,DC2,]	1E, 12, 5D	Set 24 lines.
Select 30 lines	RS,DC2,^	1E, 12, 5E	Set 30 lines.
NOOP	RS,DC2,_	1E, 12, 5F	No operation.
NOOP	RS,DC2,`	1E, 12, 60	No operation.
Enter Block Mode	RS, DC2, a	1E, 12, 61	Enter block mode operation.
Exit Block Mode	RS, DC2, b	1E, 12, 62	Exit block mode operation.
NOOP	RS, DC2, c	1E, 12, 63	No operation.
NOOP	RS,DC2, d	1E, 12, 64	No operation.
Turn On Indicator	RS, DC2, e, (N)	1E, 12, 65, (N)	Causes terminal to turn on indicator specified by (N). N = 30: Alert indicator N = 31: Programmable indicator 1 N = 32: Programmable indicator 2 N = 33: Programmable indicator 3 N = 34: Message indicator

TABLE 4-2. CYBER MODE RECEIVE AND I/O RESPONSES (CONTD)

COMMAND NAME	ASCII MNEMONIC	HEX CODE	TERMINAL RESPONSE
Turn Off Indicator	RS, DC2, f, (N)	1E, 12, 66, (N)	Causes terminal to turn off indicator specified by (N). N = 30: Alert indicator N = 31: Programmable indicator 1 N = 32: Programmable indicator 2 N = 33: Programmable indicator 3 N = 34: Message indicator
NOOP	RS, DC2, g	1E, 12, 67	No operation.
Driver Request	RS, DC2, h	1E, 12, 68	Causes the terminal to test for presence of a driver. A Status response is sent to the host and control is passed to the driver: RS, NAK if transfer not successful.
Enable Typamatic	RS, DC2, i	1E, 12, 69	Enable typamatic keys defined by table 4-1.
Disable Typamatic	RS, DC2, j	1E, 12, 6A	Disable typamatic keys defined by table 4-1.
SHIFT Numeric Pad	RS, DC2, k	1E, 12, 6B	Causes the numeric keypad to operate as if the Shift key were active.
Normal Numeric Pad	RS, DC2, l	1E, 12, 6C	Returns the numeric keypad to normal operation.
Start Validation	RS, DC2, m	1E, 12, 6D	Sets the character validation attribute bit for each character stored.
End Validation	RS, DC2, n	1E, 12, 6E	Clear the character validation attribute bit for each character stored.
Store Mode Parameters in NVM	RS,DC2, o	1E, 12, 6F	Causes the active mode parameters in RAM to be stored into the NVM memory as the new default parameters.
Host Execute Loaded Controlware	RS,DC2, p-DEL	1E, 12, 70-7F	If the host has loaded controlware for the appropriate function, a call will be made to the starting address. If the host has not loaded any controlware for the appropriate function, this will be a no operation.

TABLE 4-3. READ PARAMETER DATA WORD FORMAT

	WORD 1	WORD 2	WORD 3	WORD 4	WORD 5
b0	0 = PAGE 1 = ROLL	0 = EOL BELL 1 = DISABLE BELL	0 = PAR ODD 1 = PAR EVEN	Baud Rate $2^3$	1
b1	0 = HALF DUP 1 = FULL DUP	0 = AUTO LF 1 = Normal	0 = 2 STOP BITS 1 = 1 STOP BIT	Baud Rate $2^2$	1
b2	Printer DSR (READY)	1	0 = PARITY DISABLE 1 = PARITY ENABLE	Baud Rate $2^1$	0 = DTR SWITCHED 1 = DTR CONSTANT
b3	Bidirec- tional Port DSR (READY)	1	0 = DATA ONLY 1 = NORMAL	Baud Rate $2^0$	0 = RTS SWITCHED 1 = RTS CONSTANT
b4	1	1	1	1	1
b5	1	1	1	1	1
b6	1	1	1	1	1

Host-Specified Code Sequence/Controlware

The keyboard has 45 keys that can be redefined by the host. The host can specify if a key is to act as previously defined, send a different code sequence, or execute loaded controlware. A 2K block of RAM is reserved for this function (D000 to D8FF bank 4). If the disk controlware is not going to be used, the next 4K (C000 to CFFF) can be used for defining the keys. The first 240 locations make up a table used by the firmware to determine which operation is to be performed on each key.

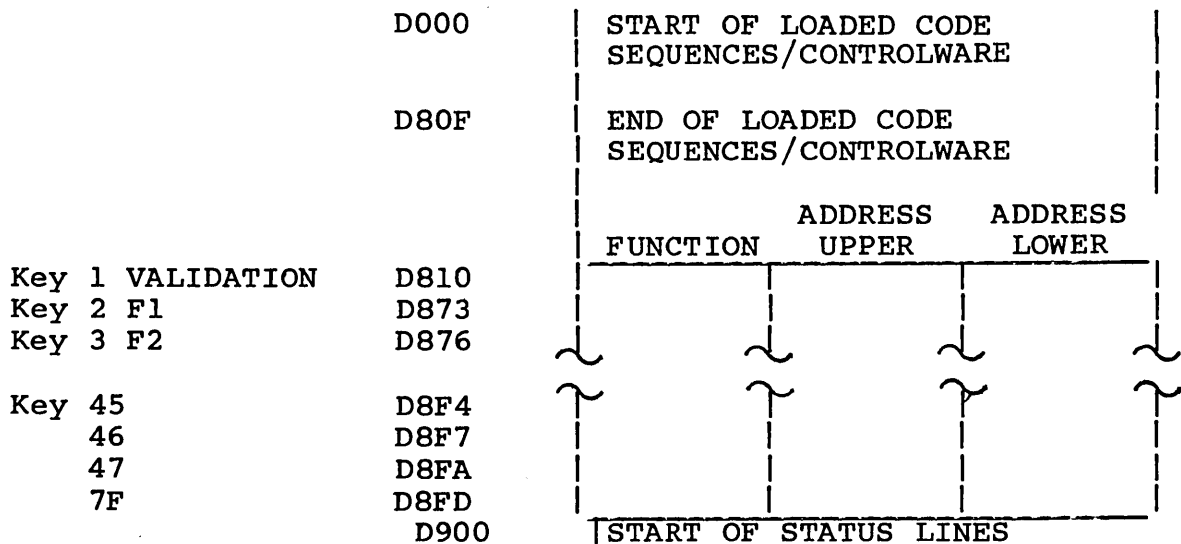

- Host Interface - The host can specify keys and load code sequences or controlware in the following manner.

RS, HT, (V), (W), (X), (Y...), Z

V = Key identifier  
W = Function  
X = Address  
Y = Code sequence or controlware code  
Z = Terminator code

- V (Key Identifier)

30	VALIDATION				
31	F1	3E	F14 COPY	4B	LAB
32	F2	3F	F15 □	4C	DATA
33	F3	40	TAB →	4D	STOP
34	F4	41	TAB ←	4E	INSRT
35	F5	42	NEXT ↵	4F	DLETE
36	F6	43	+	50	CLEAR
37	F7	44	-	51	PRINT
38	F8 ←	45	X	52	1
39	F9 SUPER	46	÷	53	2 ↓
3A	F10 SUB	47	HELP	54	3
3B	F11 MICRO	48	ERASE	55	4 ←
3C	F12 FONT	49	EDIT	56	5 HOME
3D	F13 TERM	4A	BACK	57	6 →
				58	7
				59	8 ↑
				5A	9
				5B	0
				5C	,
				5D	.
				5E	
				5F	PROLOGUE
				60-6F	NOT USED
				70-7F	HOST CONTROL-WARE FUNCTIONS

- W (Function)

30 = Disable - send normal code - default value  
 31 = Host specified code sequence  
 32 = Host defined controlware  
 33 = Host validation controlware  
 Default for all keys is 30.

- X (Address)

NOTE: This parameter is not required if W = 30.

This parameter is four codes wide. It contains the address where the code sequence/controlware starts. The address is converted to a modified hex value for each digit sending the highest digit first. The modified hex value is:

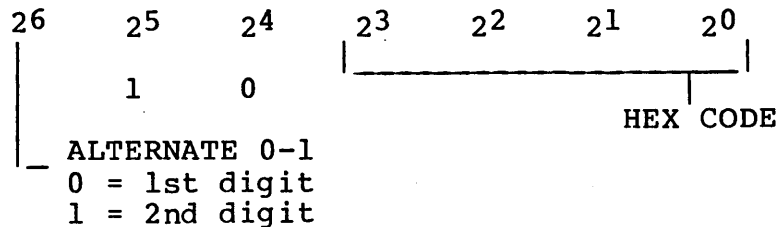

Example: Address D090 - RS, HT, V, W, 2D, 60, 29, 60

- Y (Code Sequence/Controlware Code)

Note: This parameter is not required if W = 30. This is the information that is stored in RAM starting at the address previously loaded. These words are formatted like the address.

- If information being loaded is a code sequence, the first word (two codes) will be FF. The following example indicates how the host would change F1 to send a code of 7F with the ESC key when pressed (store code at D090). The byte count and codes are stored in memory.

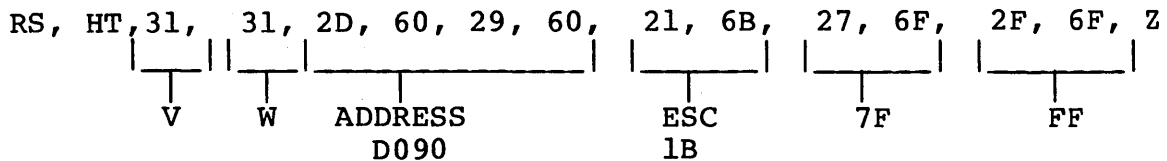

- If the information being loaded is controlware, the FF is not needed. Information is stored until the termination code is detected.

If a parity error, framing error, or improper bit 6 occurs, data will be ignored until the termination code is received at which time an RS, NAK will be sent back to the host. If no error occurred, an ACK will be returned. No response will be returned in CYBER mode.

-Z (Termination Code)

CR (0D) is the termination code.

- Keyboard Operation Character Mode

As each key is pressed, it will be tested first to see if it is a key that the host can modify. If it is, the firmware will next test the function code in the table.

- If it is a disable code (30), the normal operation will be performed.
- If it is a host-specified code sequence (31), the controlware will go to the address specified and send codes until the FF is found.
- If it is a host-defined controlware (32), a call will be made to the address specified.

- Keyboard Operation Block Mode

As each key is pressed, it will be tested first to see if it is a key that the host can modify. If it is, the firmware will next test the function code in the table.

- If it is a disable code (30), the normal operation will be performed.
- If it is a host-specified code sequence (31), the block send is initiated. The host-specified code sequence will be sent in place of the normal function keycode.
- If it is a host-defined controlware (32), a call will be made to the address specified.





- Word 4

20 = Not Used  
21 = Not Used  
22 = Not Used  
23 = Not Used

The next 32 words are determined by the n value.

If n = 30, the Terminal Installation Parameters from NVM are sent.

If n = 31-36, the Mode Installation Parameters from NVM are sent.

If n = 37, the Active Mode Parameters from RAM are sent.

For n = 30, the Terminal Installation Parameters are sent as follows:

- Word 5 - See F2, 1 through 4, of Terminal Installation Parameters
- Word 6 - See F2, 5 and 6, and F3, 1 and 2, of Terminal Installation Parameters
- Word 7 - See F3, 3 through 6, of Terminal Installation Parameters
- Word 8 - See F4, 1 through 4, of Terminal Installation Parameters
- Word 9 - See F4, 5 and 6, and F5, 1 and 2, of Terminal Installation Parameters
- Word 10 - See F5, 3 through 6, of Terminal Installation Parameters
- Word 11 - See AS-AUTO SELECT of Terminal Installation Parameters
- Word 12 - See X - Delta X of Terminal Installation Parameters
- Word 13 - See Y - Delta Y of Terminal Installation Parameters
- Word 14 - See L - Language of Terminal Installation Parameters
- Word 15-18 - See ID = Identification of Terminal Installation Parameters
- Word 19 - See PORT A - Parameters of Terminal Installation Parameters

- Word 20 - See PORT A Baud of Terminal Installation Parameters
- Word 21 - See PORT B - Parameter of Terminal Installation Parameters
- Word 22 - See PORT B - Baud of Terminal Installation Parameters
- Word 23-36 - Not Used

If n = 31 to 36, only that mode's parameters are sent from NVM.

If n = 37, the active Mode Parameters are sent from RAM as follows:.

- Word 5 - See F2, 1 through 4, of Mode Installation Parameter
- Word 6 - See F2, 5 and 6, F3, 1 and 2, of Mode Installation Parameter
- Word 7 - See F3, 3 through 6, of Mode Installation Parameter
- Word 8 - See F4, 1 through 4, of Mode Installation Parameter
- Word 9 - See F4, 5 and 6, F5, 1 and 2, of Mode Installation Parameter
- Word 10 - See F5, 3 through 6, of Mode Installation Parameter
- Word 11-14 - See OPR-DF of Mode Installation Parameter
- Word 15-26 - See A-DIAL of Mode Installation Parameter
- Word 27-28 - See DF of Mode Installation Parameter
- Word 29 - See T of Mode Installation Parameter
- Word 30 - See R of Mode Installation Parameter
- Word 31-34 - See ACCESS of Mode Installation Parameter
- Word 35-36 - Not Used
- Y Firmware Revision Level - Two codes will be sent:
  - 1st code 1 to F = Release level
  - 2nd code 1 to F = Revision level
- Z Termination Code
  - CR (0D)

## Host Select Bidirectional Port

In CYBER mode, the host can select and send or receive information to either Port A or Port B of the optional bidirectional RS-232-C ports. The parameter bits for both ports must be set up before entering CYBER mode. The host must make certain that the transmit buffer is empty by ensuring X-On is active. When the terminal receives the host select bidirectional port sequence, it will interpret the next code (port and word size) as follows:

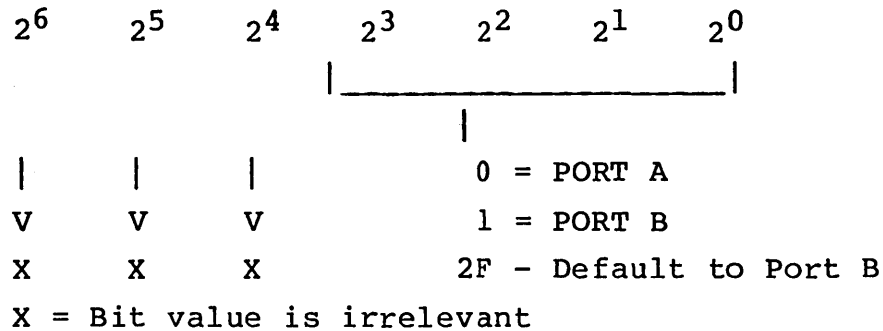

Ports A and B have no parameters to select word size. The default word size is 7 bits. The terminal will return an ACK to the host to indicate end of terminal data. The keyboard will be locked. DTR, RTS and CO will be sent to the selected port. At this time all data received from the host will be sent to the selected port and will not be acted upon by the display. As data is received from the port, it is placed into the comm output buffer to be sent to the host. The standard host communication protocol is used to send the data as if it came from the keyboard (Full/Half duplex, Constant/Switched RTS, Data Only).

If an RS is received from the host, it is not sent to the port. The next code is examined as follows.

- If it is an RS, a single RS will be sent to the port. This allows the host to send an RS to the port.
- If it is a DC2, the bidirectional port will be deselected and the host interface will be returned to the parameter setting for word size and parity.
- If it is anything except the DC2, the code will be sent to the port and the previous RS ignored.
- If a parity error is received from the host, a 7F is sent to the port.

## X-Off/X-On

- Receiving X-OFF/X-ON - Transmit off/Transmit on (X-Off/X-On) is supported by large CYBER mode. Each operating mode is defined in the following text.
- Character mode - When the X-Off is received from the host, all codes being sent to the host will be placed in the comm output buffer until the buffer becomes full. At this time, the keyboard is locked. When the X-On is received, the buffer will send and the keyboard unlocked.
- Block mode - When the X-Off is received from the host, no information will be sent to the host. Keyboard entry is still allowed. If a send function is initiated, the comm output buffer will be filled and no other operations will be performed until the X-On is received. When X-On is received, transmission will continue. The keyboard will remain locked until cleared by the completion of the block send.
- Bidirection Port - When the bidirectional port is selected, X-On must be active. In large CYBER mode, the X-ON and X-OFF can be placed anywhere in the data stream.
- Sending X-OFF/X-ON - This feature is supported in both large and small CYBER modes. The terminal has a receive buffer of 992 characters. If this buffer ever reaches 768 characters, the X-OFF will be sent to the host and the X-ON sent when the count goes down to 256.

## Write New Mode Parameters

The host can temporarily override the CYBER mode installation parameters by changing them in the active RAM table.

### NOTE

The host cannot change the Nonvolatile Memory (NVM) table.

When CYBER mode receives the write new mode parameter command, it will input up to 32 codes and replace the active mode parameter words with them. The 32 words correspond to the 32 groups which are contained in the Mode Installation Parameters section. The 32 codes are received in the following format.

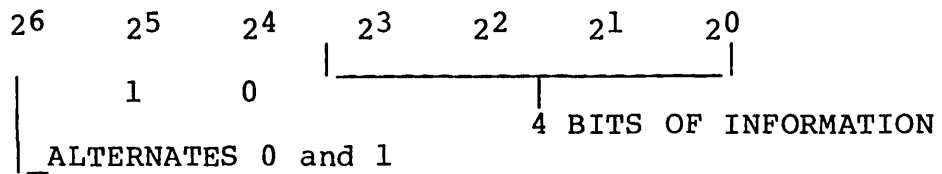

The first code received should have  $2^6 = 0$ . If an error is received during the 32-code sequence, data will be ignored until the termination code is received. At this time, an RS, NAK is sent to the host. If no errors are detected, an ACK is sent to the host and control will be sent back to cause the new codes to be implemented. This will clear the screen and reset the cursor. Note: No response is sent in large CYBER mode.



## APPENDIXES





---

The resident diagnostics contain three tests. Test 1 runs after a power up or RESET and requires no operator verification or intervention. It should take less than 6 seconds to run. Test 2 is a host-initiated RAM test. Test 3 contains a setup raster and other tests that require operator verification or intervention. Resident diagnostics test the basic hardware and some options. In test 1, if any failure occurs, a message will be displayed, an error flag will be set and the MODE SELECTION MENU displayed. If no errors are detected, no messages will be displayed and the mode selection process will begin.

### DESCRIPTION

#### TEST 1 (QUICKLOOK)

Test 1 runs after power on or by pressing the RESET switch. It is also run if test 2 is run, but the RAM test is replaced by a shifting pattern test. Test 1 contains the following subtests:

- Character RAM Test - A 55 hex and AA hex are written, read and compared throughout the RAM Character Generator memory. A failure of this test results in displaying CHARACTER RAM FAIL on the next line of the CRT. Nothing will be displayed if there is no failure.
- RAM Test - 55 hex and AA hex are written, read, and compared throughout the 64K resident RAM. A failure of this test results in displaying RAM FAIL XXXX AA EE on the next line of the CRT (assuming a failure mode does not prevent display) where: XXXX = failing address; AA = actual data read; EE = expected data read. Nothing will be displayed if there are no failures. Parity error interrupts are enabled during the RAM test, and a failure will be reported if a parity error is detected.
- Graphics RAM Test - If this option is present, the graphics RAM will be selected and a 55 hex and AA hex pattern will be stored and tested. A failure of the test will result in a display of GRAPHICS FAIL XXXX, AA EE on the next line. Nothing will be displayed if there are no failures.

- Graphics Bulk Write Test - If this option is present, a bulk write function will be performed, writing all zeros into the graphics RAM. If the bulk write busy status does not set and clear, the message GRAPHICS FAIL will be displayed. The same message will be displayed if the graphics RAM does not contain all zeros after the completion of the bulk write function.
- ROM Test - A checksum is run on each memory chip of the resident ROM. A failure of this test results in a display of ROM FAIL XX XX XX. The first value is ROM 1, the second is ROM 2, and the third is ROM 3. A value other than 00 indicates a failure. A checksum will be run on the nonvolatile memory (NVM). A failure of this test results in a display of NVM FAIL on the next line of the CRT. Nothing will be displayed if there are no failures.
- Loopback Test - The test transfers 128 characters from the processor to the communications UART which is conditioned to echo rather than transmit all data. The data is tested as it is received. Transmitter speed is fixed at 9600 baud. A failure of the test results in a display of COMM FAIL on the next line of the CRT. The same test is conducted on the UART to the keyboard. A failure of this test results in a display of KEYBOARD FAIL on the next line of the CRT.
- Timer Test - The timer will be started for a 5-millisecond delay with the timer interrupt enabled. If a timer interrupt does not occur before 6 milliseconds, interrupts will be disabled and the message TIMER FAIL displayed.
- Battery Test - This test will sample the battery low status. If the battery voltage level is low, BATTERY LOW will be displayed. This is not an error condition, but indicates the battery should be replaced before NVM is lost.
- Serial Ports - If this option is present, this test will transfer 128 characters to the UART on ports A and B which are conditioned to echo rather than transmit all data. The data is tested as it is received. Transmission speed is fixed at 9600 baud. A failure of the test results in displaying PORT A or PORT B FAIL.
- TEST Switch - The TEST switch on the main logic board is tested. If not enabled, it will go to the next section. If enabled, it will:
  - Keyboard Clock - The keyboard clock is fed into a timer chip, the timer is tested to see if it runs. If not, the message KBD CLOCK FAIL will be displayed.

- Keyboard Loopback - The keyboard UART, transmitter, and receiver will be tested. A total of 128 characters from 00 to 7F hex will be transmitted. They should be looped back through the switch and tested as they are received. The message EXT KBD LOOPBACK FAIL will be displayed if an error occurs.
- The message TEST SWITCH ENABLED will be displayed.
- Internal Modem Test - If the 1200/1200 Baud internal modem option is installed, a call will be made to address 8009 to check for a C3.
- Serial Port Test Switch - If the test switch on the dual serial interface board is in the TEST position, the message SERIAL PORT TEST SWITCH ENABLED will be displayed.
- Diagnostic ROM Pack - If a ROM PACK containing a diagnostic is installed, a call will be made to the ROM PACK diagnostic input. The ROM PACK diagnostic should perform a ROM checksum routine, test any additional hardware used and display any error messages, the ROM pack name, and revision. If an error occurs, the call is returned with NZ condition active, otherwise with Z active.
- Revision Level - The section displays the current revision level of the resident firmware. Note: The release and revision numbers may be different than shown.

```

CHARACTER RAM FAIL
RAM FAIL XXXX XX XX
GRAPHIC FAIL XXXX XX XX
GRAPHIC FAIL
ROM FAIL XX XX XX
NVM FAIL
COMM FAIL
KEYBOARD FAIL
TIMER FAIL
BATTERY LOW
PORT A FAIL
PORT B FAIL
KBD CLOCK FAIL
EXT KBD LOOPBACK FAIL
TEST SWITCH ENABLED
INTERNAL MODEM FAIL
SERIAL PORT TEST SWITCH ENABLED
(DIAGNOSTIC ROM PACK MESSAGES HERE)
RES REV 3.0

```

Figure A-1. Diagnostic Display Test 1 If Everything Failed

- Alarm - Successful completion of test 1 results in the audible alarm sounding for one-quarter second at a soft level, then one-quarter second at a loud level and followed by another one-quarter second at a soft level. See Figure A-1 for the internal diagnostic failure format after test. This figure shows all possible failures. A blank screen indicates there are no failures.

## TEST 2

Test 2 can be initiated from the keyboard in local character mode or upon receipt of the Initiate Test command from the host while running in resident CYBER mode (RS, SYN). Test 1 is rerun. If an error occurs, the error flag will be set.

- Host Initiated - At the completion of the test, if the error flag is set, an error response is sent to the host (STX, ACK, NAK). The error message will not remain on the screen. If the error flag is not set, a positive response is sent (STX, ACK, ACK) to the host and the screen will be cleared.
- Locally Initiated - If the operator presses CTRL, =, V (RS, SYN) while in local CYBER mode, the test will be run. As long as no errors are detected, the test will loop and keep running. This can only be cleared by pressing RESET. If an error occurs, the test will halt displaying the failure and the RESET must be pressed to exit.

## TEST 3

Test 3 is initiated if the operator presses the F8 key while the Mode Selection Menu is being displayed.

- Graphic Video - If the graphics option is present, the graphics video will be enabled and the graphics RAM will be filled with an alternate dot pattern. This display will switch between 480 and 512 scans at approximately a 1-second rate. Pressing any key will disable the graphics video and continue the test.
- Alignment Raster - This test enters an alignment pattern around the outer edge of the display area.
- ROM Character Generator - Six lines will be displayed as follows:

- 32 Control codes
- 33 Numeric and special characters
- 32 Uppercase alpha and special characters
- 31 Lowercase and special characters
- 32 Foreign character symbols
- 32 Line drawing characters

NOTE

If a foreign character set is selected, they will appear in their assigned locations.

- Attribute Test - A line (BLINK DIM UNDERSCORE INVERSE BLANK) will be displayed with each word having the associated bit set in background. If BLANK is seen on the CRT, the function is not working.
- Keyboard Test - This test displays KEYBOARD TEST on one line on the CRT. As the operator presses a key, the hex code received from the key will be displayed after the words KEYBOARD TEST.

NOTE

The keyboard sends a hex code whenever a key is pressed or released. Bit 2<sup>7</sup> is clear whenever a key is pressed and the same code with 2<sup>7</sup> set when the key is released. The code sent by the keyboard are not ASCII codes. The following is an example.

KEYBOARD TEST 55 (when a key is pressed)  
KEYBOARD TEST D5 (when key is released)

- Indicator Test - The eight indicators that are controlled by the firmware will be stepped on and off in about one and one-half seconds. After the last indicator has been lit, the cycle will be repeated.
- Touchpanel Test - The touchpanel interrupt will be enabled. When the screen is touched, an interrupt occurs, and the cursor will be moved to the area touched.

- External Loopback - A message displays near the bottom of the screen explaining how to run external loopback. It displays TO RUN EXTERNAL LOOPBACK - ENABLE TEST SWITCHES.

When the TEST switch at rear of terminal is enabled, the following tests will be looped on:

- The UART clock for the keyboard I/F will be tested and the message KBD CLOCK OK or KBD CLOCK FAIL will be displayed.
- PARALLEL PORT - If a graphic printer is installed, it must be powered-on or an error will occur. A 55 hex and AA hex will be sent to the printer which is conditioned to echo data. If incorrect data is received back or no response received, the error message PARALLEL PORT FAIL will be displayed and there will be no further test on this port. If no error is detected, the message PARALLEL PORT OK is displayed.

If the graphic printer is not installed, a test will be made for the presence of the flexible disk. A read ID will be sent to the disk. If an incorrect status is received, the message PARALLEL PORT FAIL will be displayed. If the correct status is received, the message PARALLEL PORT OK will be displayed.

- KEYBOARD LOOPBACK - KEYBOARD RUNNING will be displayed. A group of 128 characters from 00 hex to 7F hex will be looped back continuously. If an error occurs, the word RUNNING will change to FAIL.
- COMMUNICATIONS LOOPBACK - COMM RUNNING will be displayed. A group of 128 characters from 00 hex to 7F hex will be looped back continuously. If an error occurs, the word RUNNING will change to FAIL.
- SERIAL PORT A or B - If the Dual Serial Interface board is installed, the message PORT A (or B) RUNNING will be displayed. The 128 characters from 00 hex to 7F hex will be looped back continuously. If an error occurs, the word RUNNING will change to FAIL.

#### NOTE

The TEST/NORMAL switch on the Dual Serial Interface board must be switched to TEST before starting the test or an invalid error will occur.

To exit test 3, the operator must press the RESET switch (see Figure A-2 for display format of test).

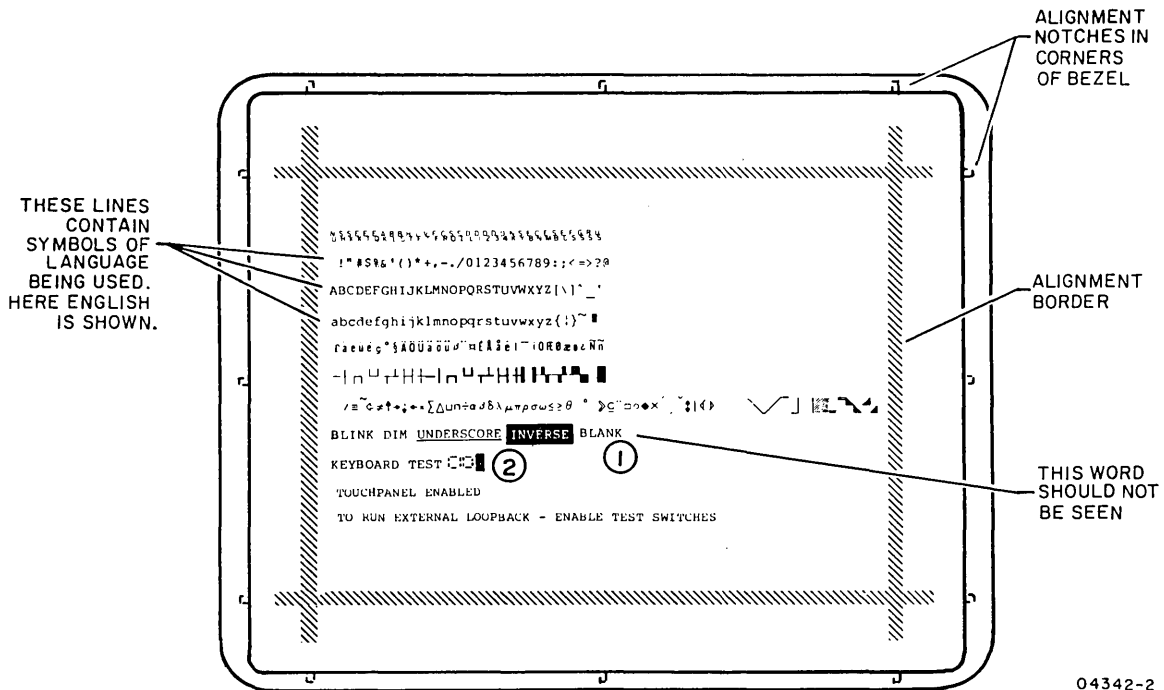

- ① This space should be empty. If the word BLANK appears here, or any other data, an error has occurred.
- ② The cursor will initially be in this location.

Figure A-2. Diagnostic Display Test 3

## INTERFACES

- Test 1 - The only operator interface required to run test 1 is to power on unit or press RESET. Operator can verify failures by displayed messages.
- Test 2 - Host selectable in CYBER mode only, and operator selectable in local CYBER mode by pressing CTRL, =, V.
- Test 3 - The operator is required to press F8 while the Mode Selection Menu is displayed. The operator can verify all symbol shapes, indicators, and keyboard. Symbols will be displayed according to language selected. Figure A-2 shows English selected. To run external loopback, the operator must pull the TEST switch.

## ABORTS AND RECOVERY

- Test 1 - If an error occurs, the remainder of that section is aborted, an error message is displayed, and the test will continue. Pushing RESET will rerun test 1.
- Test 2 - If initiated while online and an error occurs, test 2 is aborted and a negative response is sent to the host. If initiated while local and an error occurs, Test 2 will halt with message displayed. Operator must press RESET to recover.
- Test 3 - If an error occurs during loopback, the failing section will no longer be run, the test will continue running all good sections. Operator must press RESET or TEST switch to end test.

## ERRORS

- Test 1 - Errors display on the screen. If no error occurs, nothing is displayed.
- Test 2 - An error message is sent back to the host.
- Test 3 - Operator verification required, except during external loopback.

## PERFORMANCE

- Test 1 - Requires less than 6 seconds to run.
- Test 2 - Same as Test 1.
- Test 3 - No time limit, test ends when RESET is pressed.



---

MEMORY LAYOUT

The terminal has more than 64K bytes of RAM and ROM in its maximum configuration, since a 16-bit address bus allows only 64K of direct addressing, memory bank controls are added.

Figure B-1 shows all of the present memory broken up into 16K banks. The 64K of addressing is broken up in 4 blocks (see Figure B-2). Block 0 starts at address 0000; block 4 starts at 4000; block 8 starts at 8000; and block C starts at C000. Banks can be selected into certain blocks to achieve the desired mode configuration. See Figure B-3 for some mode configurations.

When the terminal is powered on or reset, banks 0, 6, 5 and 4 are selected in blocks 0, 4, 8, and C, respectively. The following bank selections will take place in the resident firmware depending upon type of load.

- CYBER Mode - No bank selection is performed.
- Load from ROM Pack - No bank selection is performed since ROM pack is selected in block 8.
- Load from Host - When the ASCII loader is selected, banks 2 and 3 are selected in blocks 4 and 8, respectively. This could accommodate a load from 4000 of bank 1, and all of bank 3. At the completion of the load, control is transferred to the first address designated in the load. If the loaded controlware does not want to use the ASCII display (banks 0 and 4), it must select the desired bank configuration.
- Load from Disk - When the disk loader is selected banks 2 and 3 are selected in blocks 4 and 8, respectively. At the completion of the disk load, control is transferred to the address specified by the first 2 words from the disk. If the loaded controlware does not want to use the ASCII display (banks 0 and 4), it must select the desired bank configuration.
- If the controlware being loaded is going to use the Graphic RAM, it must first move the controlware into banks 1 and 2 (block 0, 4), then select the Graphic RAM banks 7, 8 (block 8.C).

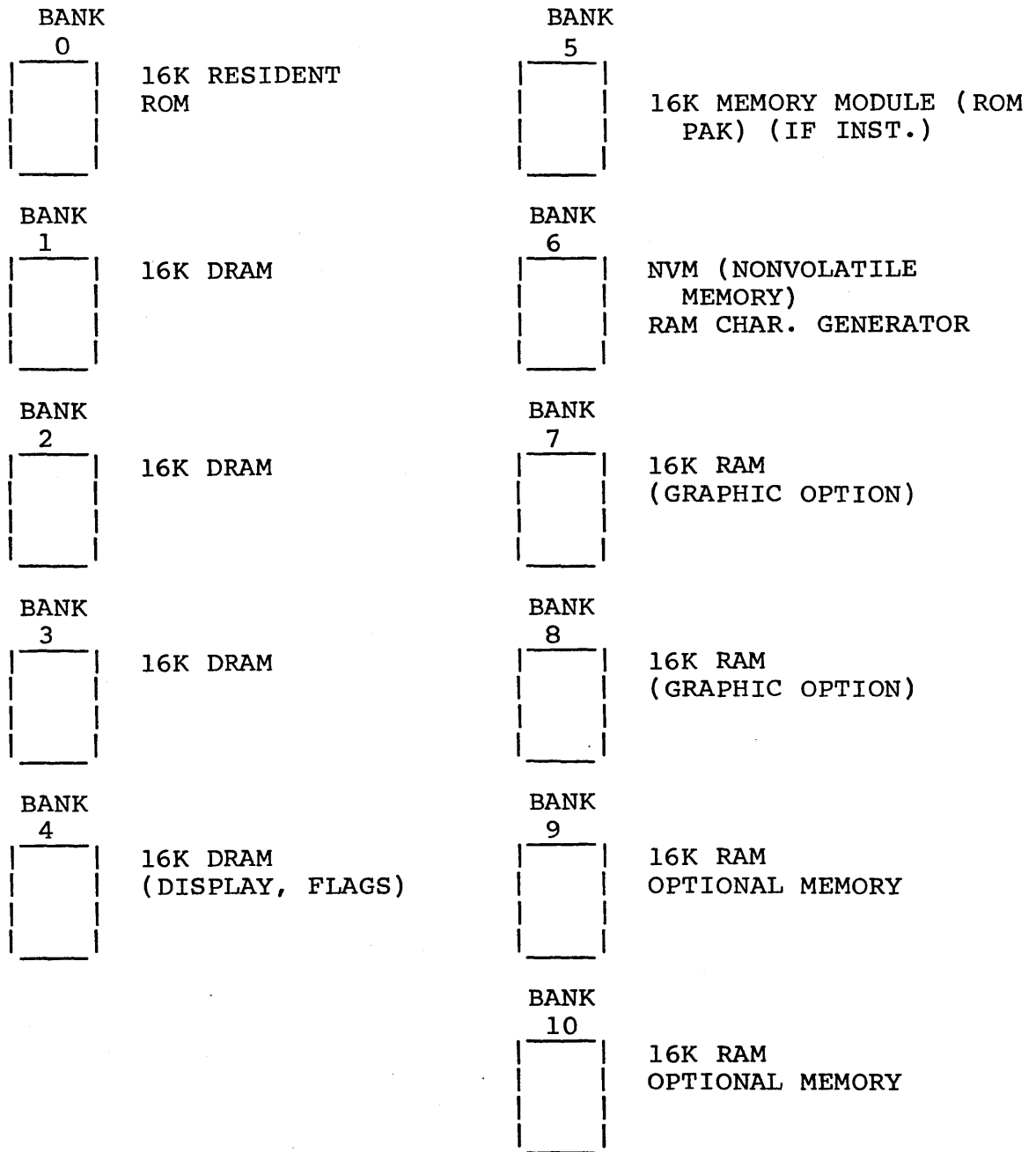

Figure B-1. Bank Configurations

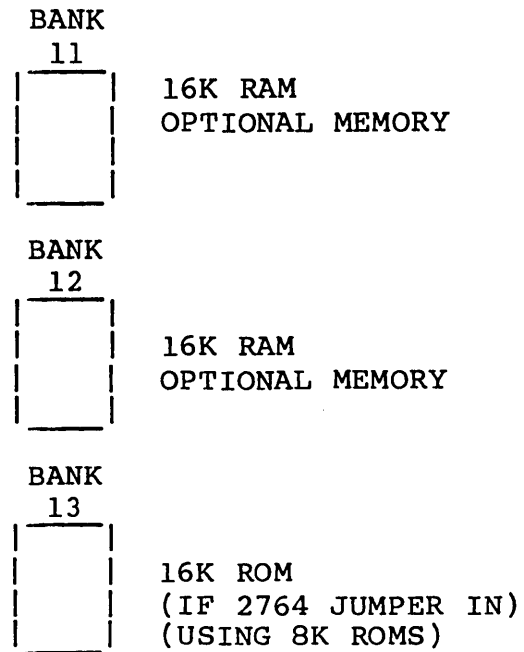
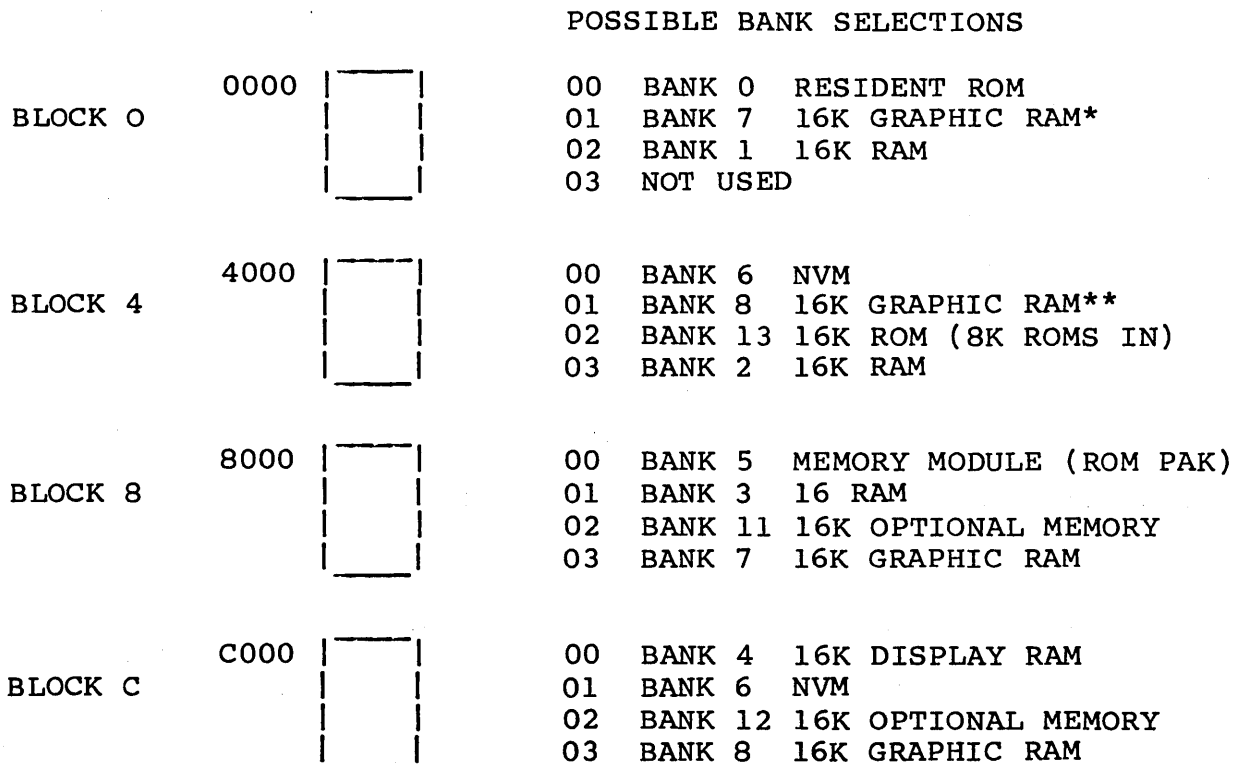

Figure B-1. Bank Configurations (Contd)



\*DEFAULTS TO BANK 9 IF GRAPHIC OPTION NOT INSTALLED.  
 \*\*DEFAULTS TO BANK 10 IF GRAPHIC OPTION NOT INSTALLED.

Figure B-2. Block Configuration

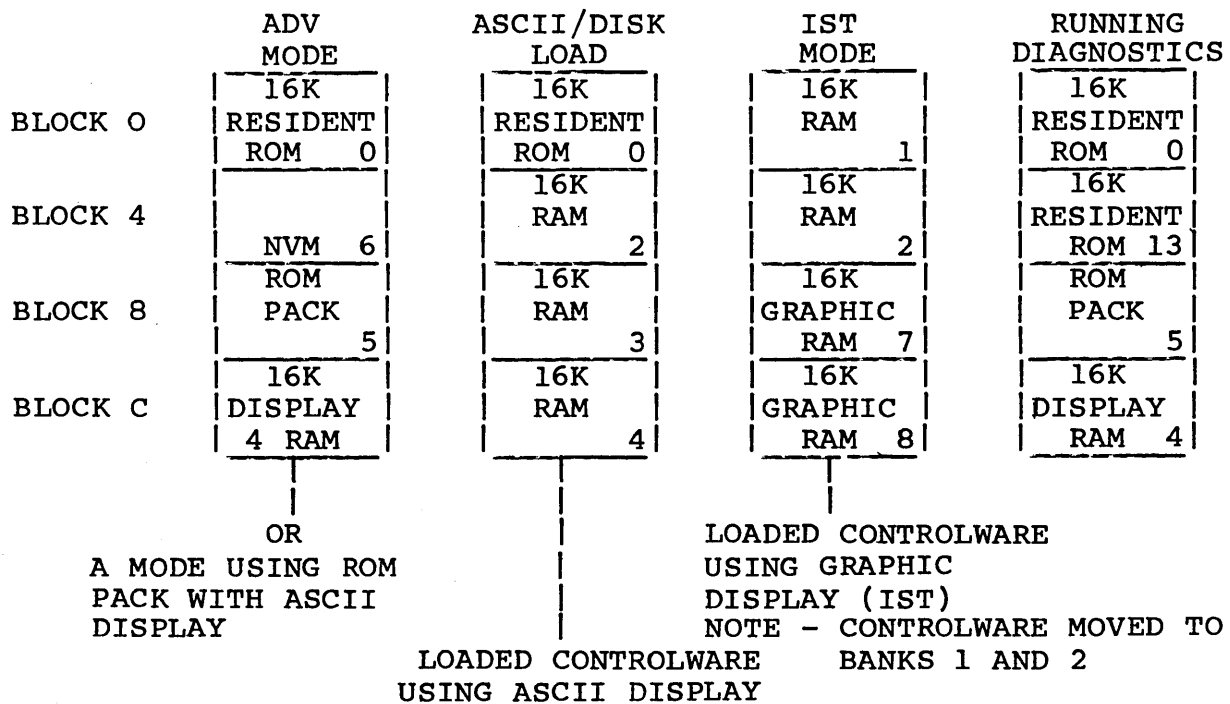

Figure B-3. Memory Configurations

BANK 4 LAYOUT

Bank 4 contains 16K of dynamic random-access memory (DRAM). The ASCII display hardware uses this bank of memory for display refresh. The CYBER mode uses this bank also for flags, buffers, stack pointer, and interrupt table. Table B-1 shows the layout.

Bank 4 contains 16K of DRAM that is used by CYBER mode to display information. The data is arranged in lines. A line can be anywhere in the 16K area, but must start on an even address. The data is stored at even addresses and the attributes are stored at the next odd addresses.

A table is set up in the middle of the memory that tells the hardware where each line starts. See table B-2 for an example of how the table and display DRAM are set up in CYBER mode.

TABLE B-1. BANK 4 LAYOUT

ADDRESS		SIZE
C000 CFFF	DISK OPERATING CONTROLWARE	4096
D000 D80F	HOST LOADABLE CODES/CONTROLWARE	2064
D810 D8FF	HOST LOADABLE AREA TABLE	240
D900 DB0F	2 STATUS LINES	528
DB10 DB1F	KEYBOARD INPUT BUFFER	16
DB20 DEFF	COMM INPUT BUFFER	992
DF00 DFBF	COMM OUTPUT BUFFER	192
DFC0 DFFF	STACK POINTER	64
E000 E03B	DISPLAY TABLE	60
E03C E03F	LOAD FLAGS	4
E040 E0FF	ACTIVE RAM AND FLAGS	192
E100 E10F	INTERRUPT TRAPS	16
E110 FFFF	30 X 132 X 2 DISPLAY DATA	7920

TABLE B-2. INITIAL DISPLAY MEMORY LAYOUT

ADDR   v	TABLE		DISPLAY RAM
E000	1 0		E110
E001	E 1	LINE 1	DATA+ATTRI LINE 1
E002	1 8		
E003	E 2	LINE 2	E218 2
E004	20		
E005	E3	LINE 3	E320 3
E006	28		
E007	E4	LINE 4	E428 4
E008	30		
E009	E5	LINE 5	E530 5
E00A	38		
E00B	E6	LINE 6	E638 6
E00C	40		
E00D	E7	LINE 7	E740 7
E00E	48		
E00F	E8	LINE 8	E848 8
E010	50		
E011	E9	LINE 9	E950 9
E012	58		
E013	EA	LINE 10	EA58 10
E014	60		
E015	EB	LINE 11	EB60 11
E016	68		
E017	EC	LINE 12	EC68 12
E018	70		
E019	ED	LINE 13	ED70 13
E01A	78		
E01B	EE	LINE 14	EE78 14
E01C	80		
E01D	EF	LINE 15	EF80 15
E01E	88		
E01F	F0	LINE 16	F088 16
E020	90		
E021	F1	LINE 17	F190 17
E022	98		
E023	F2	LINE 18	F298 18
E024	A0		
E025	F3	LINE 19	F3A0 19
E026	A8		
E027	F4	LINE 20	F4A8 20
E028	B0		
E029	F5	LINE 21	F5B0 21
E02A	B8		
E02B	F6	LINE 22	F6B8 22
E02C	C0		
E02D	F7	LINE 23	F7C0 23
E02E	C8		

TABLE B-2. INITIAL DISPLAY MEMORY LAYOUT (CONTD)

E02F	F8	LINE 24	F8C8	24
E030	D0			
E031	F9	LINE 25	F9D0	25
E032	D8			
E033	FA	LINE 26	FAD8	26
E034	E0			
E035	FB	LINE 27	FBE0	27
E036	E8			
E037	FC	LINE 28	FCE8	28
E038	F0			
E039	FD	LINE 29	FDF0	29
E03A	F8			
E03B	FE	LINE 30	FEF8	30
			FFFF	

USER INTERFACE TO RESIDENT SUBROUTINES

The resident ROM firmware contains routines that can be used by user loaded controlware. A jump table has been placed at the beginning so that changes can be made to the resident firmware without requiring all external users to change their programs. The table in B-3 shows the fixed address that an external user can call. Note: These addresses are to remain fixed and any new jumps are to be added to the end of the list.

TABLE B-3. ENTRY POINT JUMP LISTING

<u>ADDRESS</u>	<u>NAME</u>	<u>DESCRIPTION</u>
0000	INIT	; INITIALIZATION
0003	INIT00	; INITIALIZATION 00
0006	INIT01	; INITIALIZATION 01
0009	INIT02	; INITIALIZATION 02
000C	CRT80	; SET CRT TO 80 CHR/LINE
000F	CRT132	; SET CRT TO 132 CHR/LINE
0012	CINIT	; COMM INITIALIZATION
0015	KINIT	; KEYBOARD INITIALIZATION
0018	PINIT	; PRINTER INITIALIZATION
001B	INTDIS	; INTERRUPT DISABLE
001E	INTENA	; INTERRUPT ENABLE
0021	CMTRAP	; COMM INTERRUPT TRAP
0024	KBTRAP	; KEYBOARD INTERRUPT TRAP
0027	TMTRAP	; TIMER INTERRUPT TRAP
002A	TPTRAP	; TOUCHPANEL INTERRUPT TRAP
002D	ADVCR	; ADVANCE CURSOR
0030	ADVMD	; ADVANCED MODE
0033	ALARM	; ALARM
0036	ALARMI	; ALARM IF ENABLED

TABLE B-3. ENTRY POINT JUMP LISTING (CONTD)

<u>ADDRESS</u>	<u>NAME</u>	<u>DESCRIPTION</u>
0039	BDISPN	; DISPLAY B - PERFORM FUNCTION
003C	BFTB	; COMM BUFFER TO B
003F	BLDADD	; BUILD ADDRESS
0042	CLEAR	; CLEAR
0045	CLREOL	; CLEAR TO END OF LINE
0048	CLREOP	; CLEAR TO END OF PAGE
004B	CRDOWN	; CURSOR DOWN
004E	CRGRTN	; CARRIAGE RETURN
0051	CRLEFT	; CURSOR LEFT
0054	CRLNFD	; CARRIAGE RETURN LINE FEED
0057	CRUP	; CURSOR UP
005A	DISPB	; DISPLAY B - STORE ON SCREEN
005D	DLYEN1	; DELAY ENABLE 1
0060	DLYEN2	; DELAY ENABLE 2
0063	DSTRNG	; DATA STRING
0066	HASCII	; HEX TO ASCII
0069	KBDAS	; CONVERT NEXT KEYBOARD CODE TO ASCII
006C	KBDASC	; KEYBOARD TO LOWERCASE ASCII
006F	KINPUT	; KEYBOARD INPUT
0072	MODENE	; DISPLAY MODE NOT ENABLED
0075	PABI	; PORT A BI-DIRECTIONAL
0078	PBBI	; PORT B BI-DIRECTIONAL
007B	PRINTB	; PRINT B
007E	RESET	; RESET
0081	SCROLL	; SCROLL
0084	SEND	; SEND NEXT CODE FROM COMM BUFFER
0087	SENDB	; STORE B IN COMM SEND BUFFER
008A	SETDE	; SET CURSOR TO DE
008D	SETCR	; SET CURSOR
0090	ST TM	; START DELAY TIMER
0093	TABBK	; TAB BACKWARDS
0096	TABFW	; TAB FORWARD
0099	TABCLR	; TAB CLEAR
009C	TABSET	; TAB SET
009F	TPINP	; TOUCHPANEL INPUT
00A2	SENDB8	; STORE B IN COMM SEND BUFFER
00A5	MNTOR	; USER ENTRY TO MONITOR
00A8	ADVINI	; ADVANCED MODE INITIALIZATION
00AB	KBDINP	; ADVANCED MODES KEYBOARD INPUT
00AE	CMTRPU	; COMM INTERRUPT TRAP-USER
00B1	KBTRPU	; KEYBOARD INTERRUPT TRAP-USER
00B4	TMTRPU	; TIMER INTERRUPT TRAP-USER
00B7	TPTRPU	; TOUCHPANEL INTERRUPT TRAP-USER
00BA	TIPRAM	; MOVE TERMINAL INSTALLATION
00BD	CRTOUT	; OUTPUT VALUES TO 5037 CRT CONTROLLER



## Common Variables

Common variables and flags are stored in Bank 4 and can be read or changed by the resident or user programs. They are broken up in terminal parameters, mode parameters and flags (table B-4).

The terminal parameters are moved from NVM to the RAM area during initialization (before any mode is selected). The mode parameters are moved to the RAM area when the mode has been determined (before the mode has been loaded). The flags can be cleared by calling Advanced Mode Initialization (ADVINI).

TABLE B-4. COMMON VARIABLES IN RESIDENT FIRMWARE

```
;*****  
;  
;      M O D E   I N S T A L L A T I O N   R A M / E Q U  
;  
;*****  
E040  RAMST   .EQU  0E040H  
E040  MBYTE1 .EQU  RAMST  
0001  MODEEN .EQU  01      ; MODE ENABLED  
0002  SECEN  .EQU  02      ; SECURITY ENABLED  
0004  OPSLSF .EQU  04      ; OPERATOR SELECT SOURCE/FILE  
0008  LDEN   .EQU  08      ; LOAD ENABLED  
E041  MBYTE2 .EQU  MBYTE1+1  
0001  LDDISK .EQU  01      ; LOAD FROM DISK  
0002  INTMDM .EQU  02      ; USE INTERNAL 1200 BAUD MODEM  
0004  CLPEN  .EQU  04      ; CURRENT LOOP ENABLED  
0008  AUTODL .EQU  08      ; AUTO DIAL  
E042  MBYTE3 .EQU  MBYTE2+1  
0001  H8BIT  .EQU  01      ; HOST 8 BITS  
0002  HPEN   .EQU  02      ; HOST PARITY ENABLED  
0004  HPEVEN .EQU  04      ; HOST PARITY EVEN  
0008  H2STOP .EQU  08      ; HOST 2 STOP BITS  
E043  MBYTE4 .EQU  MBYTE3+1  
0001  DTRSW  .EQU  01      ; DTR SWITCHED  
0002  RTSSW  .EQU  02      ; RTS SWITCHED  
0004  RPTDIS .EQU  04      ; REPEAT DISABLED  
0008  DTONLY .EQU  08      ; DATA ONLY OPERATION  
E044  MBYTE5 .EQU  MBYTE4+1  
0001  HOMELL .EQU  01      ; HOME LOWER LEFT  
0002  AUTOLF .EQU  02      ; AUTO LINE FEED ENABLED  
0004  PACEEN .EQU  04      ; PACING ENABLED  
0008  BIASEN .EQU  08      ; BIAS ENABLED
```

TABLE B-4. COMMON VARIABLES IN RESIDENT FIRMWARE

```

E045  MBYTE6 .EQU  MBYTE5+1
      ;          01          ; NOT USED
      ;          02          ; NOT USED
      ;          04          ; NOT USED
0008  RUNPAK .EQU  08          ; 0=RUN CYBER 1= RUN ROM PAK
      ;*****
      ;          O P E R A T O R   P A R A M E T E R S
      ;*****
E046  OBYTE1 .EQU  MBYTE6+1
0001  LOCAL  .EQU  01          ; LOCAL
0002  PTSEL  .EQU  02          ; PRINTER SELECTED
0004  MRGEN  .EQU  04          ; MARGIN ALERT ENABLED
0008  ALERTL .EQU  08          ; ALERT LOUD
E047  OBYTE2 .EQU  OBYTE1+1
0001  SFLOCK .EQU  01          ; SHIFT LOCK
      NPADIV .EQU  02          ; NUMERIC PAD SHIFTED
0004  ROLLSC .EQU  04          ; ROLL SCREEN
000B  PAGESC .EQU  0BH        ; .PAGE SCROLL
0008  NATIVE .EQU  08          ; NATIVE MODE / LARGE CYBER
E048  OBYTE3 .EQU  OBYTE2+1
0001  BGLITE .EQU  01          ; BACKGROUND LIGHT
0002  CRBOX  .EQU  02          ; CURSOR BOX
0004  CRSLD  .EQU  04          ; CURSOR SOLID ON
      ;          .EQU  08          ; NOT USABLE
E049  OBYTE4 .EQU  OBYTE3+1
0001  FULL   .EQU  01          ; FULL DUPLEX
0002  CL132  .EQU  02          ; 132 CHARACTERS PER LINE
0004  LN30   .EQU  04          ; 30 LINES
0008  TRANS  .EQU  08          ; TRANSPARENT
      ;*****
      ;          M O R E   M O D E   P A R A M E T E R S
      ;*****
E04A  ADILE  .EQU  OBYTE4+1   ; AUTO-DIAL NUMBER
E056  DFILE  .EQU  ADILE+12   ; DEFAULT FILE NUMBER
E058  TBAUD  .EQU  DFILE+2   ; TRANSMIT BAUD RATE
E059  RBAUD  .EQU  TBAUD+1   ; RECEIVE BAUD RATE
E05A  SECURE .EQU  RBAUD+1   ; SECURITY CODE
E060  OEND   .EQU  OE060H     ; END OF OPERATOR PARAMETERS
      ;*****
      ;          T E R M I N A L   P A R A M E T E R S
      ;*****
E060  TBYTE1 .EQU  OEND
0001  RAM64K .EQU  01H        ; 64K RAM OPTION IN
0002  TPOPT  .EQU  02H        ; TOUCH PANEL OPTION IN
0004  DSOPT  .EQU  04H        ; DUAL SERIAL OPTION IN
0008  GPOPT  .EQU  08H        ; GRAPHIC PRINTER OPTION IN
E061  TBYTE2 .EQU  TBYTE1+1
0001  FDOPT  .EQU  01H        ; FLEXIBLE DISK OPTION IN

```

TABLE B-4. COMMON VARIABLES IN RESIDENT FIRMWARE (CONTD)

```

0002  PIOPT  .EQU  02H      ;
0004  IMOPT  .EQU  04H      ; INTERNAL 1200 MODEM OPTION IN
0008  ISOKBD .EQU  08H      ; ISO 3243 KEYBOARD OPTION IN
E062  TBYTE3 .EQU  TBYTE2+1
0001  GOPT   .EQU  01H      ; GRAPHIC OPTION IN
0002  PAROPT .EQU  02H      ; PARALLEL OPTION IN
0004  R232CL .EQU  04H      ; RS232/CURRENT LOOP OPTION IN
E063  TBYTE4 .EQU  TBYTE3+1
0001  ASELEN .EQU  01H      ; AUTO SELECT ENABLE
0002  DLSRTS .EQU  02H      ; DELAY ON PRINTER SRTS
E064  TBYTE5 .EQU  TBYTE4+1
E065  TBYTE6 .EQU  TBYTE5+1
E066  ASEL   .EQU  TBYTE6+1 ; AUTO SELECT 0-7 (DEFAULT MODE)
E067  XDELTA .EQU  ASEL+1   ; SCREEN MOVE X DELTA
E068  YDELTA .EQU  XDELTA+1 ; SCREEN MOVE Y DELTA 0-F
E069  LANG   .EQU  YDELTA+1 ; LANGUAGE 0-7
E06A  ID     .EQU  LANG+1   ; TERMINAL ID NUMBER 0000-FFFF
E06E  CHAPAR .EQU  ID+4     ; CHANNEL A PARAMETERS
0008  BIDIR  .EQU  08H      ; BI-DIRECTIONAL PORT
0004  PARDIS .EQU  04H      ; PARITY DISABLED
0002  PAREV  .EQU  02H      ; PARITY EVEN
0001  SB2    .EQU  01H      ; 2 STOP BITS
E06F  CHABD  .EQU  CHAPAR+1 ; CHANNEL A BAUD 0-F
E070  CHBPAR .EQU  CHABD+1  ; CHANNEL B PARAMETERS
E071  CHBBD  .EQU  CHBPAR+1 ; CHANNEL B BAUD 0-F
E080  TEEND  .EQU  0E080H   ; TERMINAL EQUATE END
;*****
;      BI-DIRECTIONAL PORT
;*****
E080  BDATAR .EQU  TEEND     ; BI-DIR DATA IN/OUT
0001  IER    .EQU  01H      ; INTERRUPT ENABLE REGISTER
0002  IIR    .EQU  02H      ; INTERRUPT ID REGISTER INPUT
0003  LCR    .EQU  03H      ; LINE CONTROL REGISTER OUTPUT
0004  MCR    .EQU  04H      ; MODEM CONTROL REGISTER OUTPUT
0005  LSR    .EQU  05H      ; LINE STATUS REGISTER INPUT
0006  MSR    .EQU  06H      ; MODEM STATUS REGISTER INPUT
;
;*****
;      COMM I/O STORED IN RAM
;*****
E081  CDATAR .EQU  BDATAR+1 ; COMM DATA IN/OUT
;
;*****
;      PRINTER I/O STORED IN RAM
;*****
E082  PDATAR .EQU  CDATAR+1 ; PRINTER DATA IN/OUT
;

```

TABLE B-4. COMMON VARIABLES IN RESIDENT FIRMWARE (CONTD)

```

;*****
;
;       I N P U T   B U F F E R S
;
;*****
E083  BFCNT   .EQU  PDATAR+1    ; NUMBER OF CHARACTERS IN COMM BUFFER
E085  BFINAD  .EQU  BFCNT+2    ; ADDRESS OF NEXT OPEN SLOT IN BUFFER
E087  BFOTAD  .EQU  BFINAD+2   ; ADDRESS OF NEXT CHARACTER TO BE TAKEN
;                                     FROM COMM INPUT BUFFER
E089  KBCNT   .EQU  BFOTAD+2   ; NUMBER OF CHARACTERS IN KEYBOARD
;                                     BUFFER
E08A  KBINAD  .EQU  KBCNT+1    ; ADDRESS OF NEXT OPEN SLOT IN BUFFER
E08C  KBOTAD  .EQU  KBINAD+2   ; ADDRESS OF NEXT CHARACTER TO BE TAKEN
;                                     FROM KEYBOARD INPUT BUFFER
E08E  TXCNT   .EQU  KBOTAD+2   ; NUMBER OF CHARACTERS IN TRANSMIT
;                                     BUFFER
E08F  TXINAD  .EQU  TXCNT+1    ; ADDRESS OF NEXT OPEN SLOT IN BUFFER
E091  TXOTAD  .EQU  TXINAD+2   ; ADDRESS OF NEXT CHARACTER TO BE TAKEN
;                                     FROM TRANSMIT BUFFER
;*****
;
;       D E L A Y S
;
;*****
E093  ALRACT  .EQU  TXOTAD+2   ; 250 MSEC ALARM DELAY ACTIVE
001F  ALRTM   .EQU  31         ; 31 X 8 = 248
E094  BRKACT  .EQU  ALRACT+1   ; 250MSEC. BREAK DELAY ACTIVE
001F  BRKTM   .EQU  31         ; 31 X 8 = 248
E095  KBDACT  .EQU  BRKACT+1   ; 1 SEC. KEYBOARD DELAY IS ACTIVE
007D  KBDTM   .EQU  125        ; 125 X 8 = 1 SEC
E096  KBRACT  .EQU  KBDACT+1   ; 60MS . KEYBOARD REPEAT IS ACTIVE
0008  KBRTM   .EQU  8          ; 8 X 8 = 64
E097  PCDACT  .EQU  KBRACT+1   ; 8 MS. PACING DELAY ACTIVE
E098  PNTACT  .EQU  PCDACT+1   ; 200MSEC. PRINTER DELAY ACTIVE
0019  PNTTM   .EQU  25         ;
E099  TXDACT  .EQU  PNTACT+1   ; 8MS. TRANSMIT DELAY IS ACTIVE
E09A  UD1ACT  .EQU  TXDACT+1   ; USER DELAY 1 ACTIVE
E09B  UD1ADD  .EQU  UD1ACT+1   ; USER DELAY 1 ADDRESS
E09D  UD2ACT  .EQU  UD1ADD+2   ; USER DELAY 2 ACTIVE
E09E  UD2ADD  .EQU  UD2ACT+1   ; USER DELAY 2 ADDRESS
;*****
;
;       I N T E R R U P T   M A S K
;
;*****
E0A0  INTMSK  .EQU  UD2ADD+2   ; INTERRUPT MASK
;
0001  INTCM   .EQU  01H        ; INT. 0 COMM MASK

```

TABLE B-4. COMMON VARIABLES IN RESIDENT FIRMWARE (CONTD)

```

0002 INT21 .EQU 02H ; INT. 1 21 BIT (PCN) MASK
0004 INTDP .EQU 04H ; INT. 2 DUAL RS232 PORT MASK
0008 INTPP .EQU 08H ; INT. 3 PARALLEL PORT MASK
0010 INTTP .EQU 10H ; INT. 4 TOUCHPANEL MASK
0020 INTKB .EQU 20H ; INT. 5 KEYBOARD MASK
0040 INTTM .EQU 40H ; INT. 6 TIMER MASK
0080 INTPE .EQU 80H ; INT. 7 PARITY ERROR
;*****
;
; KEYBOARD TABLE
;
;*****
EOA1 KNSNC .EQU INTMSK+1 ; ADDRESS OF NO SHIFT, NO CONTROL TABLE
EOA3 KSNC .EQU KNSNC+2 ; ADDRESS OF SHIFT, NO CONTROL TABLE
EOA5 KNSC .EQU KSNC+2 ; ADDRESS OF NO SHIFT, CONTROL TABLE
EOA7 KSC .EQU KNSC+2 ; ADDRESS OF SHIFT, CONTROL TABLE
;*****
;
; DISPLAY RAM
;
;*****
EOA9 ATTRIB .EQU KSC+2 ; ATTRIBUTES WORD
0001 BLANK .EQU 01H ; 2**0=BLANK
0002 UNDLN .EQU 02H ; 2**1=UNDERSCORE
0004 INVERS .EQU 04H ; 2**2=INVERSE
0008 BLINK .EQU 08H ; 2**3=BLINK
0010 DIM .EQU 10H ; 2**4=DIM
0020 MODIFY .EQU 20H ; 2**5=MODIFIED DATA
VALID .EQU 40H ; 2**6=VALIDATE CHARACTER
0080 PROTD .EQU 80H ; 2**7=PROTECT
EOAA ATTSAV .EQU ATTRIB+1 ; A PLACE TO SAVE ATTRIB
EOAB BLKMD .EQU ATTSAV+1 ; BLOCK MODE ACTIVE
EOAC BLKSND .EQU BLKMD+1 ; BLOCK SEND ACTIVE
EOAD BSCRPE .EQU BLKSND+1 ; BACKSPACE CURSOR IN PARAMETER ENTRY
MODE
EOAE CCDSR .EQU BSCRPE+1 ; CURRENT COMM DSR
EOAF CEOL .EQU CCDSR+1 ; 1= CLEAR TO EOL ACTIVE
EOB0 CHNCHG .EQU CEOL+1 ; CHANGE IN NUMBER OF CHARACTERS
EOB1 CHRCNT .EQU CHNCHG+1 ; CHARACTER COUNT 0-4F, 0-83
EOB2 CHR SAV .EQU CHRCNT+1 ; A PLACE TO SAVE CHARACTER COUNT
EOB3 CLRTYP .EQU CHR SAV+1 ; TYPE OF CLEAR
;
; 00= ALL
; 02= UNDERSCORE
; 08= BLINK
; 10= DIM
; 1F= NORMAL
EOB4 COMPNT .EQU CLRTYP+1 ; COMM PRINT ACTIVE
EOB5 CONT .EQU COMPNT+1 ; 1=CONTROL KEY ACTIVE

```

TABLE B-4. COMMON VARIABLES IN RESIDENT FIRMWARE (CONTD)

E0B6	CPSLK	.EQU	CONT+1	; 0=CAPS LOCK NOT ACTIVE
E0B7	CURSOR	.EQU	CPSLK+1	; CURSOR ADDRESS
E0B9	DLMENA	.EQU	CURSOR+1	; DELIMITER ENABLED
E0BA	DRVADD	.EQU	DLMENA+1	; 0= DRIVER NOT LOADED, ELSE ADDRESS OF
				DRIVER
E0BC	DSPDIS	.EQU	DRVADD+2	; DISPLAY DISABLED
E0BD	ERROR	.EQU	DSPDIS+1	; 2**0 = SECURITY CODE INCORRECT
E0BE	FLDIDS	.EQU	ERROR+1	; FIELD ID SENT
E0BF	FLDSCR	.EQU	FLDIDS+1	; 1=FIELD SCROLL ACTIVE
E0C0	GRACHR	.EQU	FLDSCR+1	; GRAPHIC CHARACTER
E0C1	HDCSER	.EQU	GRACHR+1	; HOST DEFINED CODE SEQUENCE
E0C2	HMSGV	.EQU	HDCSER+1	; HOST MESSAGE ACTIVE
E0C3	HMSGSV	.EQU	HMSGV+1	; HOST MESSAGE STORAGE
E0C7	INDON	.EQU	HMSGSV+4	; INDICATOR ON ACTIVE
E0C8	KBCODE	.EQU	INDON+1	; KEYBOARD CODE FROM TABLE
E0C9	KBINP	.EQU	KBCODE+1	; 1=KEYBOARD INPUT ACTIVE
E0CA	KBLKD	.EQU	KBINP+1	; 2**0=KEYBOARD LOCKED
				2**1=COMM LOCKED
E0CB	LASTCD	.EQU	KBLKD+1	; LAST CODE FROM KEYBOARD
E0CC	LASTKY	.EQU	LASTCD+1	; LAST KEY FROM KEYBOARD
E0CD	LASTLN	.EQU	LASTKY+1	; LAST LINE, 23 OR 29
E0CE	LIGHTS	.EQU	LASTLN+1	; CURRENT LIGHTS, 1=ON 0=OFF
E0CF	LOCK	.EQU	LIGHTS+1	; 1 = FIRST TIME DOWN, 2 = SECOND TIME
				DOWN
E0D0	LOCKLT	.EQU	LOCK+1	; 0 = LOCK LIGHT OFF, 2 = LOCK LIGHT ON
E0D1	LNCNT	.EQU	LOCKLT+1	; CURRENT LINE COUNT 0-17
E0D2	LNNCHG	.EQU	LNCNT+1	; CHANGE IN NUMBER OF LINES
E0D3	LNSAV	.EQU	LNNCHG+1	; A PLACE TO SAVE LINE COUNT
E0D4	LNSIZE	.EQU	LNSAV+1	; LINE SIZE, 79 OR 131
E0D5	MLTCNT	.EQU	LNSIZE+1	; THE COUNTER USED WHEN MULTIPLE INPUT-
				ACTIVE
E0D6	MLTACT	.EQU	MLTCNT+1	; MULTIPLE CODE SEQUENCE ACTIVE
E0D7	MLTADD	.EQU	MLTACT+1	; CALL ADDRESS STORED HERE
E0D9	MODEST	.EQU	MLTADD+2	; MODE START IN CMOS OR RAM
E0DA	PCRLF	.EQU	MODEST+1	; PRINT CR, LF
E0DB	PNTNXT	.EQU	PCRLF+1	; THIS CODE IS TO BE PRINTED NEXT
E0DC	POSPRO	.EQU	PNTNXT+1	; POSITION IS PROTECTED
E0DD	PRINTA	.EQU	POSPRO+1	; 1= PRINT ALL ACTIVE
				; 3= PRINT NORMAL ACTIVE
E0DE	PROTE	.EQU	PRINTA+1	; PROTECT IS ENABLED
E0DF	RPTACT	.EQU	PROTE+1	; 1=REPEAT ACTIVE
E0E0	RSRCV	.EQU	RPTACT+1	; RS LAST CODE RECEIVED
E0E1	RXOFF	.EQU	RSRCV+1	; RECEIVED X-OFF
E0E2	SAVEA	.EQU	RXOFF+1	; STORAGE LOCATION A
E0E3	SAVEB	.EQU	SAVEA+1	; STORAGE LOCATION B
E0E4	SAVEHL	.EQU	SAVEB+1	; STORAGE LOCATION HL
E0E5	SCRSV	.EQU	SAVEHL+1	; STORAGE LOCATION FOR SCROLL

TABLE B-4. COMMON VARIABLES IN RESIDENT FIRMWARE (CONTD)

```

EOE6  SHIFT  .EQU  SCRSV+1      ; 2**0 = SHIFT KEY DOWN
      ;
      ;          2**1 = SHIFT LOCK ACTIVE
EOE7  SPFLAG .EQU  SHIFT+1      ; 1= LINE TESTED, NOT ALL SPACES TO EOL
EOE8  SRLFST .EQU  SPFLAG+1    ; 1ST LINE OF SCROLL FIELD . 0-17
EOE9  SROLLST .EQU  SRLFST+1   ; LAST LINE OF SCROLL FIELD . 1-18
EOEA  STALN  .EQU  SROLLST+1   ; STATUS LINE ACTIVE
EOEB  SXOFF  .EQU  STALN+1     ; SENT X-OFF
EOEC  TABLE .EQU  SXOFF+1     ; 0 = ADV .TBL, 1=TABLE 1, 2=TABLE 2
EOED  TABST  .EQU  TABLE+1    ; 1 = TAB SET ACTIVE
EOEE  TIPE   .EQU  TABST+1     ; TERMINAL INSTALLATION PARA . ENTRY
EOEF  TOGAL  .EQU  TIPE+1      ; 2**4=0, 2**5=1, 2**6=TOGAL
EOF0  TXEMPF .EQU  TOGAL+1     ; TRANSMIT EMPTY
EOF1  XPOS   .EQU  TXEMPF+1    ; X POSITION FROM COMM
EOF2  BANKS  .EQU  XPOS+1      ; CURRENT BANKS SELECTED
EOF3  T3RUN  .EQU  BANKS+1     ; TIMER 3 RUNNING
EOF4  T3TCV  .EQU  T3RUN+1     ; TIMER 3 TIME CONSTANT VARIABLE
EOF5  FNCODE .EQU  T3TCV+1     ; FUNCTION KEY CODE TO SEND AFTER
      ;          BLOCK SEND
      ;
EOF6  BAUDCH .EQU  FNCODE+1    ; BAUD RATE CHANGED IN OPERATOR ENTRY
EOF7  PTXOFF .EQU  BAUDCH+1    ; X-OFF RECEIVED FROM PRINTER
EOF8  NOPTR  .EQU  PTXOFF+1    ; NO PRINTER ASSIGNED
      ; *****
      ;
      ;          L O A D   F L A G S
      ;
      ; *****
      ;
EOFC  LINFO  .EQU  0E03CH      ; LOAD INFO
0001  ASCII  .EQU  01H        ; ASCII LOADER
0002  DISKL  .EQU  02H        ; DISK LOADER
0004  ROML   .EQU  04H        ; ROM PACK
0010  RS/232/C .EQU  10H      ; USING RS/232/C HOST INT.
0020  CLINT  .EQU  20H        ; USING CURRENT LOOP HOST INT.
0040  I1200  .EQU  40H        ; USING INTERNAL 1200/1200
0080  P21 12 .EQU  80H        ;
EOFD  FILEN .EQU  LINFO+1     ; FILE NUMBER
EOFE  MDACT  .EQU  FILEN+1    ; MODE ACTIVE
0007  MD     .EQU  07H        ; MODE
EOFF  ERRORF .EQU  MDACT+1    ; ERROR FLAG
0001  DERROR .EQU  01H        ; DIAGNOSTIC ERROR
0002  BATTL  .EQU  02H        ; BATTERY LOW
FFFF  RAMEND .EQU  0FFFFH

```

## RESIDENT SUBROUTINES

### INIT Initialization

This routine is entered after power-on or depressing of the reset switch.

In general INIT will:

- Set up the 8255 to have all ports as outputs.
- Set the Stack Pointer to E000 hex.
- Select Banks 0, 6, 5, 4.
- Turn off alarm, enable ASCII video with internal clock, disable graphic video.
- Move terminal installation parameters from NVM to active RAM flags.
- Go to Test 1.
- After returning from Test 1.
- Select Bank 0, 6, 5, 4.
- Clear Flags - Except LIGHTS and ERROR F.
- Select Interrupt Mode 2.
- Enable Timer and Keyboard Interrupt.
- Test Error Flag
  - Go to Mode Select without clear if error set (MDSLNC).
- Test Auto Select
  - Go to Mode Select with clear if not enabled (MODESL).
  - Go to Default mode select if set (DFMODE).



## INIT00 Initialization 00

This routine is used to set up for interrupts.

In general INIT00 will:

- Clear timer 3 of interrupts.
- Set (T3TCV) for 8 ms time constant.
- Call enable blink (ABLKE) output in 8255.
- Move the interrupt trap addresses to the interrupt trap table at E100 hex.
- Select Mode 2 interrupts.
- Call keyboard initialization (KINIT).
- Set interrupt mask to allow keyboard and timer interrupts.
- Return.

## INIT01 Initialization 01

This routine is used to set up the 5037 for 30 lines by 80 characters.

In general INIT01 will:

- Turn off keyboard lock light.
- Call CRT80 to select 30 lines by 80 characters.
- Select blinking, box cursor with normal background.
- Calls INIT02 to clear comm send and receive buffers.
- Return.

## INIT02 Initialization 02

This routine is used to reset comm send and receive buffers.

In general INIT02 will:

- Clear comm send and receive buffer counts (BFCNT, TXCNT).
- Set comm send and receive buffer pointers to start (BFINAD, BFOTAD, TXINAD, TXOTAD).
- Return.

#### CRT80 Set CRT to 80 Char/Line

This routine is used to set up the 5037 CRT controller chip for 80 characters per line.

In general CRT80 will:

- Select 80 characters in Port C of the 8255.
- Set (LNSIZE) = 4F hex (79).
- Test (OBYTE4) for 24 or 30 lines
  - Output 7 values to the 5037 depending on 24/30 lines, (XDELTA) and (YDELTA).
- Call clear screen (CLEAR).
- Return.

#### CRT132 Set CRT to 132 Char/Line

This routine is used to set up the 5037 CRT controller chip for 132 characters per line.

In general CRT132 will:

- Select 132 characters in Port C of 8255.
- Set (LNSIZE) = 83 hex (131).
- Test (OBYTE4) for 24 or 30 lines
  - Output 7 values to the 5037 depending on 24/30 lines, (XDELTA) and (YDELTA).
- Call clear screen (CLEAR).
- Return.

## CINIT Comm Initialization

This routine is used to select and set up the proper 8250 UART for Comm interface. There are two possible Comm interfaces.

1. The Resident Data set.
2. The 1200/1200 Auto-Dial modem.

In general CINIT will:

- First determine which interface is going to be used. If the option card is not installed for the interface selected, control is sent to Mode Not Enabled (MODENE).
- The flag (CDATAR) is set to the device number for the 8250 selected. 40 = Resident Interface, C0 = Internal Modem.
- The interrupt trap table is set to CMTRAP. The transmit baud rate is sent to the 8250. Timers 1 and 2 are set for the receive baud rate. (Needed for resident only.)
- Output to the 8250 line control register LCR to select 7/8 bits, parity enabled/disabled, parity even/odd, and 1/2 stop bits.
- Enable receive data interrupt in the 8250.
- Light or clear the DSR indicator.
- Output to the 8250 modem control register MCR to select proper data terminal ready (DTR).
- Request to send (RTS) and secondary RTS (SRTS).
- Clear interrupts in the 8250.
- Delay about one half second to allow 8250 to settle.
- Return.

## KINIT Keyboard Initialization

The routine is used to set up the 8250 UART to the keyboard.

In general KINIT will:

- Clear keyboard buffer count (KBCNT).
- Set buffer in and out addresses to start (KBINAD) (KBOTAD).
- Set 8250 to 9600 baud.
- Select 8 bits, 1 stop bit, odd parity.
- Select receive data interrupt in 8250.
- Output to the modem control register to select language and alert volumn.
- Call unlock keyboard (KBDUNL).
- Select the residents keyboard tables.
- Clear interrupts.
- Return.

#### PINIT Printer Initialization

This routine is used to set up the proper 8250 on the Dual Serial Board to talk to a serial printer.

In general PINIT will:

- Test (CHAPAR) if printer is on Port A
  - Set (PDATAR) = 80 if Port A - Jump over Test B.
- Test (CHBPAR) if printer is on Port B
  - Set (PDATAR) = 90 if Port B.
- If neither have a printer, clear printer selected flag (OBYTEL).
- Output baud rate to selected Port.
- Set up the Line Control Register LCR for 7/8 bits = 7 if parity enabled else 8 bits, parity enabled/disabled, parity even/odd and 1/2 stop bits.
- Set up the modem control register MCR with DTR, RTS and Carrier On.

- Disable interrupts in the 8250.
- Delay 1/2 second to settle the 8250.
- Return.

#### INTDIS Interrupt Disable

This routine will disable the mask for a specified interrupt.

In general INTDIS will:

- Get the current interrupt mask.
- Remove the proper mask bit.
- Save new mask (INTMSK).
- Output new mask to Port B of the 8255.
- Return

#### INTENA Interrupt Enable

This routine will enable the mask for the device specified and store the address of the trap.

In general INTENA will:

- Store DE in the proper interrupt trap table.
- Get the current interrupt mask (INTMSK).
- Add the proper bit in B.
- Save new mask (INTMSK).
- Output new mask to Port B of the 8255.
- Return.

### CMTRAP Comm Interrupt Trap

This routine will input one character from the Comm 8250, test it for errors, and store the proper code in the receive buffer.

In general, CMTRAP will:

- Input the data from the proper Comm interface (CDATAR).
- Accept the data only if
  - Data only is active
  - DSR and CO are active
  - DSR and Constant RTS are active
  - DSR and Switched RTS and full duplex.
- If a Break is received
  - Sound the alarm
  - Drop RTS if needed
  - Clear send and receive buffers.
- Place a parity error code (FF) in buffer if
  - Overrun error
  - Parity error
  - Framing error
  - Break received.
- Enable interrupts.
- Return.

### KBTRAP Keyboard Interrupt Trap

This routine will input one code from the keyboard 8250 UART and place it into the keyboard buffer. If code has an error status set, the code is not put into the buffer.

### TMTRAP Timer Interrupt Trap

This routine is entered whenever the timer interrupt occurs. It tests to see which delays are active. It will take the appropriate action when a delay has finished. If a delay is not finished, the timer will be started again.

Each delay has a flag indicating the delay is active. The number stored in an active flag is the number of times remaining to go through the timer before the delay is finished.

Example: The alarm is a 250-ms delay. The timer length set by CYBER mode is 8 ms. Therefore 250 divided by 8 equals 32. 32 decimal equals 20 hex. So, to sound the alarm in 250 ms:

- The alarm must be turned on
- 20 stored in the active flag (ALRACT)
- The Start Timer (STTM) called.

The length of the timer can be changed by a user by storing the time constant in location (T3TCV) before calling (STTM).

Here is a list of delays and what happens when each times out.

- User delay 2 (UD2ACT) - A call is made to address stored in (UD2ADD) when finished.
- Keyboard delay (KBDACT) - This is a 1-second delay which starts the Keyboard Repeat delay when finished.
- Keyboard Repeat delay (KBRACT) - A call is made to KBDRPT to process another character, and the Repeat delay is started again.
- Alarm delay (ALRACT) - The alarm will be turned off when finished.
- Transmit delay (TXDACT) - A call is made to SENDTM to drop RTS when finished.
- Printer delay (PNTACT) - The (PNTACT) is cleared when finished.
- Pacing delay (PCDACT) - The (PCDACT) is cleared when finished.
- Break delay (BRKACT) - The Break signal is dropped from the Comm interface when finished.
- User delay 1 (UD1ACT) - A call is made to address stored in (UD1ADD) when finished.

#### NOTE

A user can call DLYEN1 or DLYEN2 to start user delays 1 or 2.

## TPTRAP Touchpanel Interrupt Trap

This routine will move the cursor under the area touched and send the XY position on the Comm line.

In general TPTRAP will:

- Save all registers.
- Call TPINP.
- Move cursor to DE.
- Send RS, M, X, Y and CR if enabled.
- Restore all registers.
- Return.

### NOTE

The user can call TPINP if it is not desired to move the cursor and send the XY position.

## ADVCR Advance Cursor

This routine will advance the cursor to the next position.

- The alarm is sounded when the cursor enters the eighth position from end of line or last line and the margin alert is enabled.
- If cursor is at the end of line it is moved to the start of next line.
- If cursor is at the end of the last line:
  - It is moved to upper left if page mode is selected.
  - The screen is scrolled if scroll mode is selected.

## ADVMD Advanced Mode (CYBER Mode)

This is the entry point to advanced mode (CYBER Mode). It does not return if called. See the definition of CYBER Mode if needed.



### ALARM Alarm for 250 ms

This routine will turn on the alarm and start the alarm delay for 250 ms.

### ALARMI Alarm if Margin Bell Enabled

This routine will call ALARM if a keyboard input is active and the margin alert parameter flag is active.

### BDISPN Display B

This routine will display (or process) the code in the B register. Function code will be processed.

### BFTB Buffer to B

This routine will take the next code out of the Comm buffer and return with the code in the B register and interrupt disabled.

### BLDADD Build Address

This routine will calculate the starting address of a line.

### CLEAR Clear Screen

This routine will clear 30 lines by 132 character per line, enable the blink, and clear the attribute word. The cursor will be reset to home position.

### CLREOL Clear to End of Line

This routine will clear data from current position to the end of line.

- If protect is enabled - only unprotected data is cleared.
- The background code is cleared - except in Block mode with keyboard input the modified bit is set.

#### CLREOP Clear to End of Page

This routine will clear data from current position to the End of Page.

- If protect is enabled - only unprotected data is cleared.
- The background code is cleared - except in Block mode with keyboard input the modified bit is set.

#### CRDOWN Cursor Down

This routine will move the cursor to the same relative position on the next line. If cursor is on the last line:

- Page mode - move cursor to top line.
- Roll mode - scroll screen and move cursor to start of last line.

#### CRGRTN Carriage Return

This routine will move the cursor to the beginning of the current line. If the Auto Line Feed parameter is active the cursor is moved to the beginning of the next line.

#### CRLEFT Cursor Left

This routine will move the cursor left one position. If in the first position of a line it will move to the last position of the line above. If in the first position of top line it will move to last position of last line.

### CRLNFD Carriage Return Line Feed

This routine will move the cursor to the first position of current line and call CRDOWN.

### CRUP Cursor Up

This routine will move the cursor up one line in the same relative position. If on the top line, cursor is moved to same position on bottom line.

### DISPB Display the Code in B

This routine will store the code in the B register at the current cursor position and store the current attributes in the background memory:

- If the current position is protected, a keyboard input alarm will sound and code not stored.
- If the graphic flag is active, 2\*\*7 is added to codes between 20 and 3F hex.
- If keyboard input is active, the modified bit is added to the background code.

The cursor is advanced to next position if code was stored.

#### NOTE

Function codes are displayed.

### DLTEN1 Delay Enable 1

This routine will save the number of times the user wants to go through the timer (8 ms if not modified) and save the address it will call when the delay is finished. When the delay is finished, a call will be made to the user address and the user must do a return as soon as possible.

## DLYEN2 Delay Enable 2

Same as DLYEN1.

## DSTRNG Data String

This routine will take data from memory starting at address in HL and call BDISPN. HL is incremented after each call until an FF hex code is found.

## HASCII Hex to ASCII Conversion

This routine will convert the lower 4 bits in the A register to its ASCII value.

## KBDAS Keyboard to ASCII

This routine will wait for the next keyboard interrupt by calling KINPUT. If the code is not a Shift, Lock, or Control key, the appropriate code will be taken from the keyboard table.

## KBDASC Keyboard to Lower Case ASCII

This routine will select the proper code from the No-Shift No-Control Keyboard table and return with code in A.

## KINPUT Keyboard Input

This routine will loop waiting for a code in the keyboard buffer. It will input the code to register B and return.

## MODENE Mode Not Enabled

This routine will display "MODE NOT ENABLED" on line 27 and display the mode selection menu.

This routine must have 30 lines selected. This can be done by calling INITO1 before jumping to MODENE.

This routine will not return, it requires the operator to fix any problem and select another mode.

#### PABI Port A Bidirectional

This routine will set up Port A as the bidirectional RS-232-C port. It requires HL to be present to BDATAR.

In general PABI will:

- Store 80 at (HL).
- Output baud rate to the 8250 UART.
- Set up the Line Control (LCR) for
  - 7/8 bits = 7 if parity enabled also 8 bits
  - Parity enabled/disabled
  - Parity even/odd
  - One or two stop bits.
- Set up the Modem Control Register (MCR) with DTR, RTS and Carrier On.

#### PBBI Port B Bidirectional

Same as PABI except for Port B is initialized.

#### PRINTB Printer Code in B Register

This routine will send the code in the B register to the printer if printer is selected and the UART has a data ready. It will loop waiting for data ready.

#### RESET Reset Cursor

This routine will move the cursor to the upper-left or lower-left depending on the cursor home parameter.

## SCROLL Scroll Screen

This routine will scroll a field. The top and bottom lines must be preset.

(SRLFST) = Top line to scroll.  
(SRLBST) = Bottom line to scroll.  
(FLDSCR) = Direction of Scroll 0 = scroll up, 1 = scroll down. The cursor is moved to lower left if total scroll up.

## SEND Send Next Code From Comm Buffer

This routine will send one byte of data if:

- Pacing delay not active.
  - The host has not sent an X-OFF code.
  - UART Has a data request.
  - Data only parameter active.
  - DTR and DSR and RTS and CTS are active.
- If DSR is not active the keyboard is locked.

The routine will first send data from transmit buffer. If nothing is in the buffer the send is assumed to be a block mode send and the code is then taken from the screen.

## SENDB Send the Code in B Register

This routine will place the code in the B register into the transmit buffer if online is active.

Return with NZ if local.  
Return with Z if online and code is in buffer.

Before placing the code in the buffer bit 7 is cleared if space parity selected or set if mark parity selected.

### NOTE

This routine will only send a 7-bit code. To send 8-bits see SENDB8.

### SETDE Set Cursor to Location in DE

This routine will move the cursor to location specified by DE.  
D = Character Count, E = Line Count.

### SETCR Set Cursor

This routine will move the cursor to the location specified by  
Character Count (CHRCNT) and Line Count (LNCNT).

### STTM Start Timer

This routine will start the delay timer by outputting the variable  
count stored in (T3TCV). This location is set for 8 ms during  
initialization. If the timer is currently running it will not be  
restarted.

### TABBK

This routine will move the cursor backwards to the next tab set  
position or to the start of the next non-dim field if protect is  
disabled or to the start of the next unprotected field if protect  
is enabled. The cursor will stop at upper-left if not found. If  
the cursor is at upper-left it will start search from lower-right  
corner.

### TABFW Tab Forward

This routine will move the cursor forward to the next tab set  
position or to the next non-dim position following a DIM position  
if protect is disabled or to the next unprotected position  
following a protected position if protect is enabled. The cursor  
will be moved to upper-left if none are found.

### TABCLR Tab Clear

This routine will clear the current column as a tab stop.

### TABSET Tab Set

This routine will set the current column as a tab stop.

### TPINP Touchpanel Input

This routine will input touchpanel data and return with the actual data in B, the character count in D and the line count in E.

### SENDB8 Send the 8-Bit Code in B Register

This routine will place the code in the B register into the transmit buffer if online is active.

Return with NZ if local.

Return with Z if online and code in buffer.

### MNTOR User Entry to Monitor

This entry will make one pass through the MDNITOR Routine and return. The monitor will:

- Print one character if print is active.
- Process one character if data in receive buffer.
- Process one keyboard code if data in keyboard buffer.
- Send one code if data in send buffer.
- Send one code if block mode send active.
- Update the DSR indicator.

### ADVINI Advanced Mode Initialization

This routine will do the following initialization before returning:



- Clear RAM flags and host load table.
- Set up to use resident keyboard tables.
- Turn off keyboard lock light.
- Set up the 5037 according to 24/30 lines and 80/132 characters.
- Select cursor type.
- Call INIT00.
- Call INIT02.
- Call PINIT.
- Select keyboard and timer interrupt masks.
- Call CINIT.

#### KBDINP Keyboard Input (CYBER Mode)

This routine will process the next keyboard code using all of the CYBER mode function table.

In general it will:

- Input the next code.
- Convert code using tables.
- Send the proper CYBER mode code(s) by placing them in the send buffer.
- If half duplex - process code(s) internally.

#### CMTRPU Comm Interrupt Trap for User

This routine does the same as CMTRAP except it will not enable interrupts before returning.

### KBTRPU Keyboard Interrupt Trap for User

The routine is the same as KBTRAP except it will not enable interrupts before returning.

### TMTRPU Timer Interrupt Trap for User

This routine does the same as TMTRAP except registers must be saved before calling and it will not enable interrupts before returning.

### TPTRPU Touchpanel Interrupt Trap for User

This routine does the same as TPTRAP except it will not enable interrupts before returning.

### TIPRAM Move Terminal Installation Parameters to RAM

This routine will move the terminal installation parameters from NVM to their active locations in RAM.

Bank 6 must be selected in Block 4 and Bank 1 must be selected in Block C before calling this routine.

### CRTOUT CRT Output

This routine will output seven values to the 5037 CRT controller chips. A register pair is used to point to the starting value in memory.

### Programming Considerations

## General Guidelines

1. Refer to table B-3 (earlier in this appendix) for entry points to callable routines.
2. Never read from or write into NVM directly. Always use Bank 4 parameters.
3. All user callable routines will not enable or disable interrupts (except BFTB will return with interrupts disabled).
4. All user callable routines will not change interrupt mask (except interrupt enable and disabled).
5. All user callable routines will not change bank selects (except the initialization routines).
6. Bank 0 must be selected in Block 0 and Bank 4 must be selected in Block C when using any callable routines.

## Position the Cursor

There are many ways to position the cursor to a desired position.

1. SETDE - Place the character count in Register D, the line count in Register E and call SETDE.
2. DSTRNG - In a display string of data the X, Y positioning can be used. Example using a system configured to small CYBER, 80 characters per line, bias off. Move cursor to line 4, character 0 and display HELP.

ASCII - DLE, X, Y, H, E, L, P  
HEX - 10, 03, 48, 45, 4C, 50, FF

Load (HL) will starting address of hex codes in memory and call DSTRNG.

3. CRDOWN - Call CRDOWN to do DOWN ARROW.
4. CRGRTN - Call CRGRTN to do carriage return.
5. CRLEFT - Call CRLEFT to backspace.
6. CRLNFD - Call CRLNFD to do carriage return and line feed.
7. CRUP - Call CRUP to do up arrow.

## Displaying One Character

There are two ways to display a character.

1. DISPB - To display the code in B without reacting to control codes call DISPB.
2. BDISPN - To display the code in B while reacting to control codes call BDISPN.

## Display a String of Characters

Store the message in memory, terminating it properly. Call DSTRNG.

## Get one Code From Keyboard

When it has been determined there is something in the keyboard buffer:

1. KINPUT - Call this to get the raw code from the keyboard.
2. KB DAS - Call this to convert the raw code into an ASCII code.

## Transmit Data

Transmitting data is a two step operation.

1. SENDB - Call this routine to place the code in Register B into the transmit buffer.
2. SEND - If there is something in the transmit buffer call this routine to send the next code if conditions are ready.

## Receive Data

The initial set up has the host receive interrupt enabled. The interrupt (CMTRPU) will input one code and put it into the receive buffer.

BFTB - This route can be called to take the next code from the buffer and put it into B.

## Delays

There are two user delays. A timer is run that has a user defined time constant. The user defines the number of times through the timer and the address to be called when finished.

1. The timers time constant is initialized to 8 ms. This can be changed by storing a new time constant variable at (T3TCV). Example for a 5 ms time constant:  $5000\ 000 = 42666 \cdot T3TCV$   
 $117 = T3TCV$
2. DLYEN1 or DLYEN2 - Call these routines with the proper register set to number of times through the timer and the proper registers set to address to call when finished.

## Restrictions and Limitations

This firmware does not support the graphic option. It is intended to have a ROM pack or external loaded controlware to support the graphic option.



---

The following paragraphs describe the physical, electrical, and functional requirements of the RS-232-C/CCITT V.24 Interface.

#### PHYSICAL AND ELECTRICAL REQUIREMENTS

The interface signals conform to EIA Standard RS-232-C and CCITT Recommendation V.24 as applied to asynchronous telecommunications.

All levels are referenced to Signal Ground and must not exceed +15 volts.

For the Received Data circuit, a voltage more negative than -3 volts is interpreted as a marking condition; a voltage more positive than +3 volts is interpreted as spacing condition. During periods of no receiver activity, the Received Data circuit is expected to be held to a marking condition.

For control circuits originating at the modem, a voltage more negative than -3 volts open circuit is interpreted as an off condition; a voltage more positive than +3 volts is interpreted as an on condition.

For the Transmitted Data circuit, the terminal provides a voltage equal to, or greater than -5 volts as a marking condition and a voltage equal to or greater than +5 volts as a spacing condition. During periods of no transmission activity, the Transmitted Data circuit is held to a marking condition.

For control signals originating at the terminal, a voltage equal to or greater than -5 volts is provided as an off condition; a voltage equal to or greater than +5 volts is provided as an on condition.

Recommended maximum cable (P/N 61409028-32) length is 15.2 metres (50 feet). The connector is a 25 pin female AMP part 745114-2 or equivalent.

## FUNCTIONAL REQUIREMENTS

Interface circuit definitions are provided as follows:

- Protective Ground (Pin 1) - Protective ground is electrically connected to the terminal frame and to the power source protective ground through the terminal ac power system.
- Transmitted Data (TXD) (Pin 2) - The Transmitted Data signal transfers data from the terminal to the modem. Data is transmitted as a 10- or 11-bit serial word and supports 7- or 8-bit data. In the order of transmission, the data word contains: a start bit (spacing), data bits 2<sup>0</sup> through 2<sup>6</sup> for 7-bit data and 2<sup>0</sup> through 2<sup>7</sup> for 8-bit data, a parity bit, and one or two stop bits (marking) for 7-bit data and 1 stop bit for 8-bit data. The number of stop bits is selected by operator parameter bit selection. Within the field created by the start and stop bits, a marking condition is provided for a binary one indication and a spacing condition is provided as binary zero indication. Rate of transmission is determined by the Transmit Data Rate Select parameter setting. Within the field created by the start and stop bits, a marking condition is provided for a binary one indication and a spacing condition is provided as binary zero indication. Rate of transmission is determined by the Transmit Data Rate Select parameter setting. The transmit rate is independent of the receive data rate.
- Received Data (RXD) (Pin 3) - The Receive Data signal transfers data from the modem to the terminal. The received data word contains, in the order of reception: a start bit (spacing), data bits 2<sup>0</sup> through 2<sup>6</sup> for 7-bit data or 2<sup>0</sup> through 2<sup>7</sup> for 8-bit data a parity bit, and a stop bit(s) (marking) 1 or 2 for 7-bit mode and 1 for 8-bit mode. Rate of reception is determined by the Receive Data Rate select parameter setting. Within the field created by the start and stop bits, a marking condition is interpreted as a binary one and a spacing condition is interpreted as a binary zero.
- Request to Send (RTS) (Pin 4) - This signal is generated by the terminal to condition the modem for data transmission. The transition of this signal from OFF to ON instructs the modem to enter the transmit mode. The transition of this signal from ON to OFF instructs the modem to complete the transmission on the communication channel of all data previously transferred on the terminal/modem interface and then to assume a nontransmit mode.



Once this signal has been turned OFF, it must not be turned ON again until Clear to Send has been turned OFF.

- Clear to Send (CTS) (Pin 5) - This signal is generated by the modem to indicate that the modem is ready to transmit data. The ON state of this signal is a response to the ON state of Request to Send, indicating that the modem is in the transmit mode. The OFF state of this signal is a response to the OFF state of Request To Send, indicating that all information previously transferred on the terminal/modem interface has been transferred to the communication channel and the modem is in the nontransmit mode.
- Data Set Ready (DSR) (Pin 6) - This signal is generated by the modem to indicate its status. The "ON" state signifies that the modem is connected to a communication channel; is not in test, talk or dial mode; and had completed all operations required of it to establish a connection to a remote modem. The ON state does not signify that a connection has actually been established. The OFF state indicates that the terminal must disregard all other interface signals except Ring Indicator. The OFF state of this signal must not impair the operation of the Ring Indicator or Data Terminal Ready Signals.
- Signal Ground (Pin 7) - Signal Ground establishes the common ground reference potential for the control and data signals.
- Received Line Signal Detector (Carrier On) (Pin 8) - This signal is generated by the modem. The ON state indicates that the modem is receiving a signal on the communication channel which meets the "Suitability Criteria" of the modem.
- Secondary Request to Send (Pins 11 & 19) - The modem generates this signal to indicate the condition of the unmodulated carrier on the secondary channel. The ON state indicates that a carrier signal is present. The OFF state indicates the absence of the carrier.
- Data Terminal Ready (DTR) (Pin 20) - This signal is generated by the terminal to indicate to the modem that the terminal is ready to receive or transmit information and that the modem may connect to or remain connected to the communication channel.
- Ring Indicator (Pin 22) - The modem generates this signal. It indicates to the terminal that a ringing signal is being received on the communication channel.
- Data Signal Rate Selector (Pin 23) - The Data Signal Rate Selector circuit is maintained in the on condition when power is applied to the terminal.



---

This appendix describes the functional characteristics of the Display Terminal when operating as an ASCII graphics terminal using the communications protocol of the Tektronix 401X Terminal. These characteristics come from controlware loaded into the terminal. In this mode, the terminal simulates the operation of the Tektronix 401X terminal series, but is not completely compatible due to certain hardware and controlware constraints.

### EQUIPMENT CONFIGURATION

Equipment configurations for the 401X/graphics mode are listed as follows:

- Minimum Configuration (typical)
  - 721-30 (CC638-A) Terminal (includes touchpanel and graphics feature)
- Maximum Configuration
  - Terminal listed under Minimum Configuration
  - Graphics printer
  - Parallel Interface option
  - Dual asynchronous interface option
  - Matrix printer

### GRAPHICS OPERATION

The following description of graphics operation defines initial conditions upon selection, the bypass condition, and describes the operational modes that can be selected while in graphics operation.

#### SELECTION AND DESELECTION OF GRAPHICS OPERATION

Upon completion of a load operation, the terminal controlware is initialized to alphanumeric operation. (All terminals downline loading this controlware from CDSN will automatically receive the latest released version.)

Graphics operation can be selected by receipt of an ESC SOH code sequence from the ASCII host system or by operator selection on the status line.

Graphics operation can be deselected by receipt of an ESC STX code sequence.

#### INITIAL CONDITIONS

Certain initial conditions exist when ASCII operation is selected. These initial conditions are:

- The screen is erased.
- The terminal is in alpha mode.
- The alpha cursor is in the home position (upper left corner).
- Normal size characters will be displayed.
- Character writing is overstrike write.
- The terminal is set to LINE mode and CAPS is selected.

#### BYPASS CONDITION

The bypass condition inhibits data from being displayed on the screen, thus allowing data to be transmitted to the computer without it being written on the screen. The following program commands set and clear the bypass condition.

- Set bypass

ESC CAN  
ESC SUB

- Clear Bypass

BEL	ESC BEL
BS	ESC BS
CR	
HT	ESC HT
LF	
VT	ESC VT
	ESC FF
US	ESC US

KEYBOARD FOR GRAPHICS OPERATION

The keyboard has a standard Viking X layout with the ASCII graphics-unique characters and certain ASCII control codes on the front surfaces of the keycaps as shown in figures 3-2 and 3-3. Figure 3-10 shows the keystation assignments.

Alphanumeric Keys

The terminal can generate all 96 of the ASCII alphanumeric codes. These codes are generated as shown in table D-1.

Upper case alphabetic symbols and other shifted symbols are generated by holding down either SHIFT key simultaneously while pressing the desired data key.

TABLE D-1. ASCII KEY CHARACTERS AND CODES

KEY NO.	CHARTER GENERATED		ASCII CODE (HEX)	
	LOWER	UPPER	LOWER	UPPER
1	PRINT	PRINT	**	**
2	SET UP	SET UP	**	**
3			*	*
4			*	*
5			*	*
6			*	*
7			*	*
8			*	*
9			*	*
10			*	*
11			*	*
12	ESC	ESC	1B	1B
13			*	*
14			*	*
15			*	*
16	, (ISO) → (ANSI)	~ (ISO) ↑ (ANSI)	60 09	7E 09
17	1	!	31	21
18	2	@	32	40
19	3	#	33	23
20	4	\$	34	24
21	5	%	35	25
22	6		36	5E
23	7	&	37	26
24	8	*	38	2A

TABLE D-1. ASCII KEY CHARACTERS AND CODES (CONTD)

KEY NO.	CHARTER GENERATED		ASCII CODE (HEX)	
	LOWER	UPPER	LOWER	UPPER
25	9	(	39	28
26	0	)	30	29
27	-	¯		
28	=	+	3D	2B
29	(ISO) (ANSI)	(ISO) (ANSI)	08	08
30			60	7E
31			08	08
32			*	*
33	q	Q	0A	0A
34	w	W	71	51
35	e	E	77	57
36	r	R	65	75
37	t	T	72	52
38	y	Y	74	54
39	u	U	79	59
40	i	I	75	55
41	o	O	69	49
42	p	P	6F	4F
43	[	]	70	50
44		:	5B	5D
45		*	5C	7C
46		*	*	*
47			**	**
48	a	A	61	41
49	s	S	73	53
50	d	D	64	44
51	f	F	66	46
52	g	G	67	47
53	h	H	68	48
54	j	J	6A	4A
55	k	K	6B	4B
56	l	L	6C	4C
57	;	:	3B	3A
58	'	"	27	22
59			7B	7D
60	CR	CR	0D	0D
61			*	*
62			**	**
63	(ISO) (ANSI)	(ISO) (ANSI)	**	**
64	z	Z	7A	5A
65	x	X	78	58
66	c	C	63	43
67	v	V	76	56
68	b	B	62	42
69	n	N	6E	4E

TABLE D-1. ASCII KEY CHARACTERS AND CODES (CONTD)

KEY NO.	CHARTER GENERATED		ASCII CODE (HEX)	
	LOWER	UPPER	LOWER	UPPER
70	m	M	6D	4D
71	, (ISO)	, (ISO)	2C	2C
72	, (ANSI)	< (ANSI)	2C	3C
	. (ISO)	. (ISO)	2E	2E
73	. (ANSI)	> (ANSI)	2E	3E
	/	?	2F	3F
74			**	**
75	CR	CR	0D	0D
76			**	**
77	SPACE	SPACE	20	20
78	DEL	CR	7F	0D
79			*	*
80			*	*
81	BS	BS	08	08
82			*	*
83	LF	LF	0A	0A
84	(PAGE)	(RESET)	**	**
85	B	BS	08	08
86			*	*
87	DEL	DEL	7F	7F
88			*	*
89			*	*
90			*	*
91			*	*
92	ESC	LF	1B	0A
93			**	**
94	7	7	37	37
95	8	8	38	38
96	9	9	39	39
97	4	4	34	34
98	5	5	35	35
99	6	6	36	36
100	1	1	31	31
101	2	2	32	32
102	3	3	33	33
103	,	,	2C	2C
104	0	0	30	30
105	.	.	2E	2E
106	CR	CR	0D	0D

\*Unused  
\*\*Local Function

## Control Character Keys

The terminal can generate ASCII control characters as shown in Control Codes and Escape Sequences for Graphics Operation paragraph. This lists the allowable characters, indicates the modes that use them, and describes their functions.

Control characters are generated from the keyboard by holding down the CTRL key (or in some cases, the CTRL and SHIFT keys) simultaneously while pressing the desired data key. Control characters CR, LF, BS and HT may also be generated by pressing the CR, LF, BS or TAB key respectively. The ERASE key also generates a BS character. The ERASE key additionally erases the displayed character when in LOCAL or HALF.

### DEL Key

The DEL key generates a DEL (Rubout) character.

### BREAK Key

Pressing the BREAK key generates a break condition by holding the transmitted data line in a spacing state for 250 milliseconds. This key is also used to recover from error conditions if one of the print options is active.

## Function Select Keys

While operating in Graphics operation, local function select keys may be used to select the various functions internal to the terminal. They do not send any data to the host. Table D-2 lists these keys and indicates their use.

## GRAPHICS OPERATION MODES

When Graphics operation is selected, one of five modes can be chosen. These modes are alpha, graph, point plot, graphics input (GIN), and block mode.



TABLE D-2. FUNCTION SELECT KEYS FOR GRAPHICS OPERATION

FUNCTION SELECT	DESCRIPTION
Ⓢ	Alternate depressions cause all letter keys to transmit codes for uppercase ASCII only, or to transmit uppercase or lowercase ASCII depending on the SHIFT keys.
□	Clears display, resets terminal to alpha mode and positions alpha cursor to home position (upper-left corner of display). Does not clear selected character size.
M REL	Resets terminal to alpha mode, positions alpha cursor to home position (upper-left corner of display), and selects normal character size.

The primary use of each mode is:

- Alpha - display characters.
- Graph - draw a line between two sets of coordinates or perform random positioning.
- Point Plot - display one point at the intersection of two coordinates.
- GIN - input coordinates and status to the host computer.
- Block - write or erase rectangular blocks.

Control codes are used to select a mode and to select certain functions within that mode. The Control Codes and Escape Sequences paragraph is a summary of the ASCII operation control codes. Figure D-2 shows those control codes and sequences used to select a mode. The following paragraphs provide detailed descriptions of the operational modes and define the control codes that select functions within the modes. Figure D-1 illustrates character codes for graphics operation.

BITS				CONTROL		HIGH X & Y GRAPHIC INPUT		LOW X		LOW Y	
B7	B6	B5	B4	B3	B2	B1					
0	0	0	0	NUL	DLE	SP	Ø	@	P	\	p
0	0	0	1	SOH	DC1	!	1	A	Q	a	q
0	0	1	0	STX	DC2	"	2	B	R	b	r
0	0	1	1	ETX	DC3	#	3	C	S	c	s
0	1	0	0	EOT	DC4	\$	4	D	T	d	t
0	1	0	1	ENQ	NAK	%	5	E	U	e	u
0	1	1	0	ACK	SYN	&	6	F	V	f	v
0	1	1	1	BEL BELL	ETB	'	7	G	W	g	w
1	0	0	0	BS BACK SPACE	CAN	(	8	H	X	h	x
1	0	0	1	HT	EM	)	9	I	Y	i	y
1	0	1	0	LF	SUB	*	:	J	Z	j	z
1	0	1	1	VT	ESC	+	;	K	[	k	{
1	1	0	0	FF	FS	,	<	L	\	l	!
1	1	0	1	CR RETURN	GS	-	=	M	]	m	}
1	1	1	0	SO	RS	.	>	N	^	n	~
1	1	1	1	SI	US	/	?	O	_	o	RUBOUT (DEL)

02868

Figure D-1. Character Codes for Graphics Operation

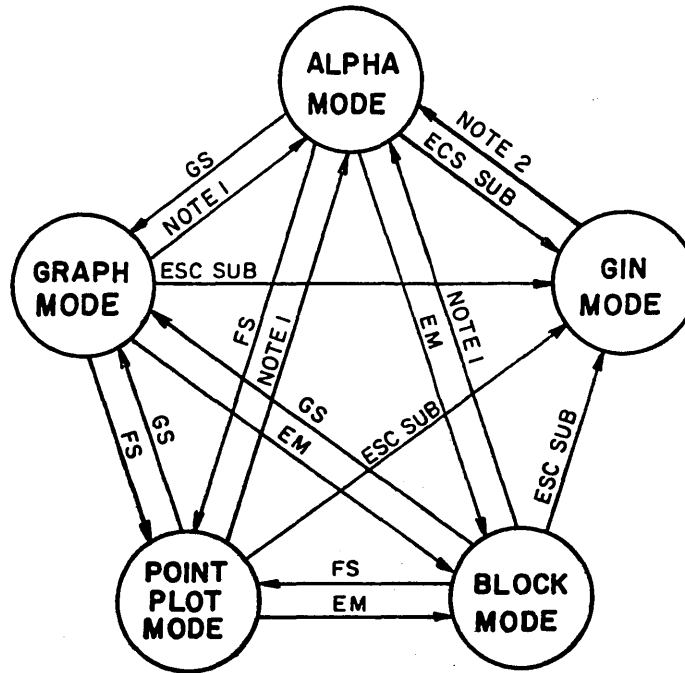

NOTE 1: US, CR, ESC FF, KEYBOARD PAGE, AND KEYBOARD RESET.  
 NOTE 2: CR, ESC FF, KEYBOARD PAGE, AND KEYBOARD RESET.

02864-3

Figure D-2. Permissible Operating Mode Changes

### ALPHA MODE

In alpha mode, the terminal displays the 95 displayable ASCII characters. The DEL (rubout) code is ignored in alpha mode.

A blinking cursor occupies the lower dots of the character matrix and marks the position on the display screen where the next character will be entered. After the symbol is entered, the cursor moves one position to the right. When the end of a line is reached, the cursor moves to the leftmost position on the line below. When the bottom line has been completed, the cursor moves to the first position of the top line. The cursor is nondestructive. Cursor home position is at X = 0, Y = 752.

Characters are written on the display screen in an overstrike write mode unless otherwise selected from the host system.

## Transition to Alpha Mode

Control characters and keys that can be used for transition to alpha mode are:

- CR - This control character resets the terminal to alpha mode, positions the alpha cursor to the leftmost position in the current line, and clears the bypass condition.
- ESC FF - This control character sequence resets the terminal to alpha mode, positions the alpha cursor to the leftmost top line (home position), clears the display, and clears the bypass condition.
- US - This control character resets the terminal to alpha mode, leaves the alpha cursor at the last graph-mode address, and clears the bypass condition. This character is nonfunctional in GIN mode, so it cannot be used to transfer from GIN mode to alpha mode.
- $\square$  - Pressing the  $\square$  key resets the terminal to alpha mode, positions the alpha cursor to home position, and clears the display. This function operates locally in the terminal.
- M REL - Pressing the M REL key resets the terminal to alpha mode, positions the alpha cursor to home position, and re-establishes initial conditions. This function operates locally in the terminal.

## Alpha-Mode Control Characters

In alpha mode, the following ASCII control characters are operational. All other control characters are ignored.

- Carriage Return (CR) - This character moves the cursor to the leftmost position in the current line and clears the bypass condition.
- Line Feed (LF) - This character moves the cursor down one line and clears the bypass condition. When the cursor reaches the bottom line, the cursor moves to the same column position in the top line.

- Backspace (BS) - This character moves the cursor one position to the left and clears the bypass condition. When the beginning of the line is reached, the cursor moves to the last position of the line above. When the first position of the top line is reached, the cursor moves to the last position of the bottom line.
- Horizontal Tabulation (HT) - This character moves the cursor one position to the right and clears the bypass condition. Spacing past the end of a line causes the cursor to move to the beginning of the next lower line. If the cursor is in the last position of the bottom line, it moves to the home position.
- Vertical Tabulation (VT) - This character moves the cursor up one line and clears the bypass condition. When the top line is reached, the cursor moves to the same column position in the bottom line.
- Bell (BEL) - This character sounds the audible alarm and clears the bypass condition.

### Alpha-Mode Escape Sequences

Escape sequences allow deselection of previously selected functions and transmission of status and cursor position. These sequences begin with an ESC control code which causes the terminal to examine the next character to determine if it is valid in an escape sequence. Valid sequences are:

- ESC DC1 - While in alpha mode, this control code sets inverse video for characters. The inverse of the characters dot pattern represented by the ASCII code is written into display memory.
- ESC DC2 - While in alpha mode, this control code sets character overstrike write. The dot pattern represented by the ASCII code is superimposed in display memory.
- ESC DC3 - While in alpha mode, this control code sets character overstrike erase. The dot pattern represented by the ASCII code is erased from display memory.
- ESC DC4 - While in alpha mode, this control code sets clear write. The dot pattern occupying the display position is first erased and the dot pattern represented by the ASCII code is written into display memory.
- ESC CAN - This sequence selects the bypass condition to inhibit data from being processed by the display.

- ESC ENQ - This sequence causes the terminal to transmit terminal status and the X-Y address of the left end of the alpha cursor to the host system. Bypass is not affected. If a screen-copy operation is active when this sequence is received, the terminal transmission is deferred until the copy operation terminates. The following character sequence is transmitted.

<u>Byte</u>	<u>Item</u>	<u>Data</u>
1	Terminal Status	35 hex*
2	High bits of X address	5 MSB X + 20 hex
3	Low bits of X address	5 LSB X + 20 hex
4	High bits of Y address	5 MSB Y + 20 hex
5	Low bits of Y address	5 LSB Y + 20 hex
6	CR	0D hex

\*25 hex if graphics printer is attached and ready to print and communications-print mode is not selected.

- ESC ETB - This sequence initiates a screen copy operation (see section 3.1.2.8.1). Bypass condition and selected mode are not affected. The alpha cursor is inhibited until the copy operation terminates.
- ESC 7 - Selects large (7 by 9) size characters.
- ESC 8 - Selects normal (5 by 9) size characters.

### Transition from Alpha Mode

For required control codes and escape sequences to transfer to other modes, refer to the section describing the mode. Figure D-2 shows permissible mode changes.

### GRAPH MODE

In graph mode, the terminal writes and erases vectors in response to ASCII code sequences. To set vector coordinate positions, the 10-bit X coordinate and 10-bit Y coordinate must be converted to ASCII characters as shown in the coordinate conversion chart at the end of this appendix.

These characters are interpreted by the terminal to define a vector. The reception of the low X coordinate initiates a vector operation. The Coordinate Conversion Chart at the end of this appendix shows which coordinates must be sent when coordinate values change.

### Transition to Graph Mode

The control character used for transition to graph mode is Group Separator (GS). It sets the terminal to graph mode and restores any previous graph-mode coordinates.

Initial coordinates set immediately after the GS character, which sets graph mode, do not cause a vector to be written unless GS is immediately followed by a BEL character. This is called a dark or unwritten vector. The GS character can be sent at any time to allow the coordinate base position to be changed without writing a solid-line vector write.

The terminal retains the last high Y, low Y, and high X addresses when switched to another mode. When returning to graph mode, only low X must be received to reset the terminal to its previous coordinates.

### Graph Mode Escape Sequences

Escape sequences begin with an ESC control character. Valid escape sequences for graph mode are:

- ESC DC1 - Causes the terminal to erase the specified vector(s). All other characteristics of graph mode remain the same.
- ESC DC2 - Causes the terminal to write the specified vector(s). All other characteristics of graph mode remain the same.
- ESC DC3 - Causes the terminal to erase the specified vector(s). All other characteristics of graph mode remain the same.
- ESC DC4 - Causes the terminal to write the specified vector(s). All other characteristics of graph mode remain the same.

- ESC ENQ - Causes the terminal to transmit terminal status and graph-mode X-Y beam position. Bypass is not affected. If a screen-copy operation is active when this sequence is received, the terminal transmission is deferred until the copy operation terminates. The following character sequence is transmitted.

<u>Byte</u>	<u>Item</u>	<u>Data</u>
1	Terminal Status	39 hex*
2	High bits of X address	5 MSB X + 20 hex
3	Low bits of X address	5 LSB X + 20 hex
4	High bits of Y address	5 MSB Y + 20 hex
5	Low bits of Y address	5 LSB Y + 20 hex
6	CR	0D hex

\*29 hex if graphics printer is attached and ready to print and communications-print mode is not selected.

- ESC ETB - Initiates a screen copy operation. Bypass condition and selected mode are not affected.

### Transition from Graph Mode

For required control characters and escape sequences to transfer to other modes, refer to the section describing the mode. Figure D-2 shows permissible mode changes.

### POINT-PLOT MODE

In point-plot mode, only a point is written or erased at the specified X,Y coordinate.

### Transition to Point-Plot Mode

Point plot is selected by the File Separator (FS) control character. It sets the terminal to point plot mode and restores any previous point plot mode coordinates.



## Point-Plot-Mode Escape Sequences

Selection of writing or erasing is accomplished by one of four escape sequences:

- ESC DC1 - Erase a point(s)
- ESC DC2 - Write a point(s)
- ESC DC3 - Erase a point(s)
- ESC DC4 - Write a point(s)
- ESC ENQ - Causes the terminal to transmit terminal status and point-plot X-Y beam position. Bypass is not affected. If a screen-copy operation is active when this sequence is received, the terminal transmission is deferred until the copy operation terminates. The following character sequence is transmitted.

<u>Byte</u>	<u>Item</u>	<u>Data</u>
1	Terminal Status	31 hex*
2	High bits of X address	5 MSB X + 20 hex
3	Low bits of X address	5 LSB X + 20 hex
4	High bits of Y address	5 MSB Y + 20 hex
5	Low bits of Y address	5 LSB Y + 20 hex
6	CR	0D hex

\*21 hex if graphics printer is attached and ready to print and communications-print mode is not selected.

- ESC ETB - Initiates a screen copy operation. Bypass condition and selected mode are not affected.

## Transition From Point-Plot Mode

For required control characters and escape sequences to transfer to other modes, refer to the section describing the mode.

## GRAPHICS INPUT (GIN) MODE

The graphics input mode is interactive in that it involves computer requests for information and the terminal's response to the requests.

A crosshair cursor, which appears as a blinking plus sign, is enabled in GIN mode. The intersect address of the crosshair cursor is the position of the X and Y coordinates. The cursor is nondestructive.

During GIN mode, an ESC ETB sequence initiates a screen copy operation. Bypass condition and selected mode are not affected. The crosshair cursor is inhibited until the copy operation terminates.

### Transition to GIN Mode

The ESC SUB sequence selects GIN mode, activates the bypass condition, enables the crosshair cursor, and enables the touchpanel. This sequence should not be entered from the keyboard when online to the ASCII host.

### Cursor Positioning in GIN Mode

The position of the cursor can be moved by three methods:

- Gross Positioning - This method is achieved via the touchpanel. The display screen is sectioned into 256 touch-sensitive areas, each 32 dots by 32 dots, which, when touched, position the cursor to the center of the affected area.
- Coarse Positioning - The shifted arrow keys on the keyboard move the cursor four dots in the direction of the arrow.
- Fine Positioning - The unshifted arrow keys on the keyboard move the cursor one dot in the direction of the arrow.

### GIN Mode Transmission

Each of the following three methods of initiating transmission to the host computer also resets the terminal to alpha mode. Bypass is not cleared until a subsequent character or character sequence which clears bypass is received. Terminal status cannot be transmitted while in GIN mode.

- Character Keys Other than Arrow Keys or CR Key - All character keys other than the arrow keys or CR key cause transmission of the entered character and X-Y position of the crosshair cursor. The following character sequence is transmitted.

<u>Byte</u>	<u>Item</u>	<u>Data</u>
1	Keyboard Key	Keyboard Character
2	High bits of X address	5 MSB X + 20 hex
3	Low bits of X address	5 LSB X + 20 hex
4	High bits of Y address	5 MSB Y + 20 hex
5	Low bits of Y address	5 LSB Y + 20 hex
6	CR	0D hex

- CR Key - The CR key causes transmission of the character corresponding to the arrow key last used to position the crosshair cursor, followed by the X-Y position of the crosshair cursor. The transmitted character sequence is the same as above except that Byte 1 contains the arrow key character rather than the keyboard character.
- ESC ENQ - Causes transmission of the X-Y position of the crosshair cursor. The transmitted character sequence is the same as shown above except that Byte 1 is not transmitted.

### Transition from GIN Mode

ESC FF, ESC ENQ and ESC ETB are the only escape sequences allowed in GIN mode.

### PARAMETER SETTING

There are three types of parameters available. The first two are terminal installation and mode installation parameters. Refer to section 4. The initial state of each operator parameter is set in the mode installation parameters. The operator parameters are moved into an Active RAM section and can only be temporarily changed by the operator or host. The operator cannot change the NVM values.

To change the operator parameters, the operator must press SETUP while in an operating mode. An X-Off code will be sent to the host. Eight parameters will be written on the bottom line. To change any parameter, the operator must press the FUNCTION key number that precedes the word. The alternate state will then be displayed. If there are more parameters, F10 will say more select. Pressing F10 will display eight new parameters. If there are no more parameters, F10 will say MODE SELECT. Pressing F1 at any time will exit the operation and send an X-On to the host.

The only keys operational in this mode are:

- F1 return - return to mode.
- F2-F9 - alternate state of that parameter.
- F10 - display next group or go to MODE SELECTION MENU.

All other keys are inoperable. See figure 4-5 for advanced Mode Operator Parameters.

#### PRINT OPTIONS

A CL607 (40003-208/209) Graphic Printer is optionally supported by this controlware. Printing may be in a screen-copy mode or in a communications print mode. Both print modes cannot be active at the same time.

#### SCREEN-COPY MODE

In screen-copy mode the printer will make a dot-for-dot reproduction of information on the terminal display screen. When present in the resident controlware, the screen-print controlware is available for use at any time during Graphics operation.

#### Making a Screen Copy

The operator makes a screen copy by pressing the SHIFT-PRINT keys on the terminal keyboard. Prior to this the printer must have been made ready for operation by pressing the PRINT switch on the printer so that the indicator in that switch is lit. When the copy is complete, the printer will form feed. The printer is then ready to make another copy.

In graphics operation, the host computer system may initiate the screen copy by sending an ESC ETB character sequence to the terminal. Operation of the screen copy is the same as if the operator had started the operation.

### Stopping a Screen Copy Early

A screen copy may be aborted by pressing the BREAK key. The screen copy will be aborted and the printer will form feed. No signal is transmitted to the communications line.

### Printer Errors in Screen-Copy Mode

During a screen-copy operation certain error conditions can occur in the printer. When this occurs, one of the following error messages will flash on and off in the lower righthand corner of the display screen.

- DESELECT - This means that the printer is offline; that is, the indicator is turned off in the PRINT switch on the printer.
- PAPER - This means that the printer has a paper loading problem or that the platen yoke is not closed. This may be corrected by correcting the paper problem, closing the platen yoke, and pressing the FEED switch on the printer to stop it from blinking.
- REJECT - This condition will occur only if a hardware problem exists.

Recovery from these errors is accomplished by correcting the error or by pressing either the STOP key or the SHIFT-STOP keys. The screen copy will immediately terminate and the error message on the screen will be turned off. No signal will be transmitted to the communications line. All other keyboard keys are ignored while an error message is flashing.

### Duty Cycle Protection

The printer duty cycle is kept under 50 percent by a gradual slowdown algorithm built into the screen-copy controlware. In this algorithm, a running average is kept of the density of the screen copy. A separate average is kept for each of the solenoids in the printer. For each solenoid, the following is done when printing each row of data:

- a. Count the number of dots on in this row (0 to 42).
- b. Add this number to the running average for this solenoid.
- c. If the running average is greater than 2560 (greater than 50-percent duty cycle over the last 128 rows), then print at reduced speed.
- d. Adjust the running average:  $\text{new average} = \text{old average} - (\text{average}/128)$ .

This algorithm is not perfect in the sense of checking for exactly 50-percent duty cycle. In general, the slowdown will begin around 40-percent duty cycle.

### Screen-Copy Performance

Nominal time for a screen copy to be made is 35 seconds. High-density (dark) images on paper may cause the printer to slow to 0.3 to 0.5 times its rated speed. This is to prevent the printer solenoids from overheating. The maximum print time for a totally dark image is about 120 seconds. Duty-cycle slowdown should be rarely, if ever, seen by a user. The fastest possible screen-copy time is about 4 seconds.

Screen-copy time depends on the number of horizontal rows of the screen which have dots turned on. If a row has one or more dots turned on, that row will have a print time of 65 milliseconds. If no dots are turned on in a row, that row will be printed in about 5 milliseconds. These times will be slowed if the duty cycle algorithm has slowed down the printer.

### COMMUNICATIONS-PRINT MODE

In communications-print mode, the printer will print alphanumeric data as it is received from the communications line. The data will also be displayed normally on the terminal display screen. When present in the resident controlware, the communications-print controlware is available for use at any time during Graphics operation.

## Selecting Communications-Print Mode

The operator selects communications-print mode by pressing the CTRL-SHIFT-PRINT keys. A PRINT message will appear in the lower right corner of the screen if the Status Display Line is turned on. This message will remain active until the communications-print mode is deselected.

While the mode is active, ASCII characters received from the communications line (and also those generated from the keyboard if in HALF duplex) will be sent to the printer for printing as well as being displayed.

Since the printer is a line printer rather than a character printer, actual printing of a line of characters will not occur until the printer receives a CR or LF character. Once a line of characters is printed, the printer is advanced to the next line, so that overstrike printing of characters is not allowed. Lines may be printed at 6 or 8 lines to the inch as determined by a switch setting in the printer.

## Deselecting Communications-Print Mode

The operator deselects communications-print mode by pressing the CTRL-SHIFT-PRINT keys when no errors are present. The PRINT message at the lower right corner of the screen will turn off, and terminal operation may proceed as if no printer were present.

If an error condition is present in the printer, the mode may be terminated by pressing the STOP key or the SHIFT-STOP keys. See the following section for more information.

## Printer Errors in Communications-Print Mode

During communications-print mode certain error conditions can occur in the printer. When this occurs, one of the following error messages will flash on and off in the lower righthand corner of the display screen. While an error message is displayed, data will be displayed normally on the display screen but will not be sent to the printer.

- DESELECT - This means that the printer is offline; that is, the indicator is turned off in the PRINT switch on the printer.
- PAPER - This means that the printer has a paper loading problem or that the platen yoke is not closed. This may be corrected by correcting the paper problem, closing the platen yoke, and pressing the FEED switch on the printer to stop it from blinking.
- REJECT - This condition will occur only if a hardware problem exists.

Recovery from these errors is accomplished by correcting the error or by pressing the BREAK key.

If the error is corrected, the flashing error message on the screen will turn off and communications printing will resume.

If the BREAK key was pressed, the communications-print mode will immediately terminate and the PRINT message and flashing error message will both turn off. No signal will be transmitted to the communications line. All other keyboard keys operate normally.

### Communications-Print Performance

The printer will print at a maximum of 115 lines per minute regardless of how many printable characters are on a line. Hence the printer should be able to keep up with a 1200-baud transfer rate if there are at least 65 characters per line. It should be able to keep up with a 300 baud line if there are at least 16 characters per line. This limitation is due to the printer and not the controlware. The controlware contains a 256-character receive buffer so that the communications line can get ahead of the printer by up to 256 characters without losing data. If the communications line gets more than 256 characters ahead of the printer, data will be lost.

### INTERFACES

The operator interface is divided into three major parts. These are data entry, data display, and operator control and status monitoring.



## DATA ENTRY INTERFACE

Operator data entry to the terminal is done via the keyboard or the touchpanel.

The keyboard consists of data keys, plus SHIFT and CTRL keys. Pressing a key results in transmission of a character indentifying the key that was pressed. The CTRL and SHIFT keys are used to modify the character generated when held down simultaneously when another key is pressed. A layout of the keyboard is shown in figure 3-2. Key characters generated by various key combinations are shown in table D-1 and table D-2.

The touchpanel consists of 256 touch sensitive areas overlaying the display screen in a 16 by 16 square array. Touching the touchpanel results in transmission of the coordinate touched.

The touchpanel and keyboard keys with arrows on them (a,q,w,e,d,c,x,z) are used for positioning the crosshair cursor when in Graphics Input (GIN) mode.

The touchpanel may also be used by the operator to perform various terminal parameter selections.

## DATA DISPLAY INTERFACE

Data display is performed by the CRT display screen. The screen is divided into a 512 by 512 array of dots or 512 x 480 (dependent on switch setting on graphics PCB), each of which may be on (bright) or off (dark). Data from the ASCII host system or from the terminal keyboard may be displayed as dots, lines or characters.

Normal size characters fit within a 6 by 14 dot matrix, with most characters not exceeding a dot matrix size of 5 by 9 dots and with no character exceeding a dot matrix size of 5 by 12 dots. Screen format for characters is 34 lines with 85 characters per line. The Normal Size Characters and Codes paragraph at the end of this section illustrates the dot matrix format of normal size characters on the display screen.

Large size characters fit within an 8 by 16 dot matrix, with most characters not exceeding a dot matrix size of 7 by 9 dots and with no character exceeding a dot matrix size of 7 by 12 dots. Screen format for characters is 30 lines with 64 characters per line. The Large Size Characters and Codes paragraph at the end of this appendix illustrates the dot matrix format of large size characters on the display screen.

## STATUS MONITORING

The touchpanel may be used by the operator to change various terminal parameter selections. The indicators on the front panel (figure 3-1) show status of the communications line being used. The ERROR light shows that a communications error has occurred and automatic recovery is being attempted by the controlware. The ERROR light will be off when no errors occur or when a successful communication error recovery has been accomplished. The other indicators show the status of the DTR, RTS, DSR, RCV, and XMT data lines between the terminal and the modem or acoustic coupler being used.

## ABORTS AND RECOVERY

The operator may force an exit from the graphics mode of operation to the timeshare mode of operation if there is a timeshare mode in the loaded controlware. This is accomplished by using the GRAPH/TTY field on the status display line.

Pressing RESET causes the terminal to reload controlware. Pressing Manual Release will reinitialize this controlware, except that status line fields will not be changed. If a print option is active, the operator may stop printing at any time.

## ERRORS

If a parity error is detected on receive data in graphics mode, the ERROR light will turn on. The ERROR light will stay on until a character with correct parity is received. Error correction or retransmission is not supported in the graphics mode.

During idle time the controlware performs a checksum operation on the controlware characters. If this checksum should fail, the words BLOCK FAILURE will appear on the right, center part of the display screen. The operator must then press RESET to recover. This will cause the firmware to initiate a controlware reload. Whether or not this is successful will depend on whether or not the network supports terminal controlware loading. Printer errors may occur while one of the print options is active.

## PERFORMANCE

This controlware can communicate with an ASCII host system at an input and output rate of up to 2400 bits per second (240 characters per second) in a half duplex or full duplex mode of operation.

The controlware can generate a straight line vector in less than 17.5 milliseconds and can generate character data at a rate of up to 500 characters per second.

## FIRMWARE COMMON VARIABLES

The firmware common variables constitute the only interface to other software products. The loaded controlware sets the CKSUMTBL variable to the beginning address of the controlware checksum table immediately after control is passed to the controlware after loading is finished. If the RESETFLG variable does not contain a value of 3C hex on entry to the controlware, the controlware returns to the timeshare mode if there is one, and performs a full controlware initialization, after which the RESETFLG variable is set to a value of 3C hex. The controlware does not alter the value of the other firmware variables.

## RESTRICTIONS AND LIMITATIONS

The printer prints at a maximum of 115 lines per minute in communications-print mode. There is a 256-character receiver buffer, but the ASCII host should make provision to prevent overrun of this buffer or data will be lost both on the printout and on the display.

Due to certain hardware and controlware limitations, the following differences exist between the graphics mode of this terminal and that of the Tektronix terminals.

- a) The screen resolution of this terminal is 512 by 512 dots while that of the Tektronix terminals is 780 by 1024 dots. Hence coordinates received by the terminal are scaled down by a factor of 2 before being utilized for display purposes. Since the Y coordinate is limited to 780, the bottommost part of the display screen is not used. Y coordinates are biased upward by a value of 122 after scaling but before being used by the display screen.
- b) The crosshair cursor in GIN mode on this terminal is displayed as a + sign, rather than as vertical and horizontal lines which extend the full height and width of the screen. This was to make it easier to implement a non-destructive cursor on this terminal. Since there are no thumbwheel controls on this terminal, the method of manually positioning the crosshair is also different. It is accomplished by using the touchpanel and arrow keys on the keyboard.
- c) Character sizes are different relative to screen size than on the Tektronix terminals. Only two character sizes are supported.
- d) Alternate character set is not supported by this terminal.
- e) Margin 2 operation is not supported by this terminal.
- f) Operations performed by the enhanced graphics module on the Tektronix terminals are not supported except for point plot mode.
- g) Communications data rate is limited to 2400 bps by the controlware.
- h) Automatic characters after transmission of status or cursor position can be selected using hardware jumpers on the Tektronix 401X series of terminals. These characters are either:
  - CR and EOT - clears bypass via execution of CR if echoed from the host computer.

TABLE D-3. CONTROL CODES AND ESCAPE SEQUENCES FOR GRAPHICS OPERATION

ASCII CHAR.	HEX CODE	KEYING SEQUENCE	*EFFECT WITH ESC CONDITION CLEAR	*EFFECT WITH ESC CONDITION SET
NUL	00	CTRL SH P or CTRL @	No Effect.	Leaves ESC condition set.
SOH	01	CTRL A	No Effect.	Selects Graphics operation and initializes the terminal
STX	02	CTRL B	No Effect.	No Effect.
ETX	03	CTRL C	No Effect.	Selects Timeshare operation and initializes the terminal.
EOT	04	CTRL D	No Effect.	No Effect.
ENQ	05	CTRL E	No Effect.	<p><u>Alpha Mode</u> - Causes the terminal to transmit status and alpha cursor position and selects bypass condition.</p> <p><u>Graph/Point Plot Mode</u> - Causes terminal to transmit status and beam position and selects bypass condition.</p> <p><u>GIN Mode</u> - Causes terminal to transmit status and the GIN cursor position and selects bypass condition.</p>
ACK	06	CTRL F	No Effect.	No Effect.
BEL	07	CTRL G	<p><u>Alpha Mode</u> - Clears bypass condition and sounds audible alarm.</p> <p><u>Graph Mode</u> - Following GS, causes the first vector to be written, clears bypass condition, and sounds audible alarm.</p>	<p><u>Alpha Mode</u> - Clears bypass condition and sounds audible alarm.</p> <p><u>Graph Mode</u> - Following GS, causes the first vector to be written, clears bypass condition, and sounds audible alarm.</p>

TABLE D-3. CONTROL CODES AND ESCAPE SEQUENCES FOR GRAPHICS OPERATION (CONTD)

ASCII CHAR.	HEX CODE	KEYING SEQUENCE	*EFFECT WITH ESC CONDITION CLEAR	*EFFECT WITH ESC CONDITION SET
BS	08	or ERASE or CTRL H	Moves the cursor one position to the left and clears bypass condition. If at leftmost position on a line, cursor moves to rightmost position on line above. If at first position of topmost line, cursor moves to last position of bottom line. ERASE additionally erases character.	Moves the cursor one position to the left and clears bypass condition. If at leftmost position on a line, cursor moves to rightmost position on line above. If at first position of topmost line, cursor moves to last position of bottom line. ERASE additionally erases character.
HT	09	TAB or CTRL H	Moves the cursor one position to the right and clears bypass condition. If at rightmost position on a line, cursor moves to leftmost position on next lower line. If at last position of bottom line, cursor moves to leftmost position of top line.	Moves the cursor one position to the right and clears bypass condition. If at rightmost position on a line, cursor moves to leftmost position on next lower line. If at last position of bottom line, cursor moves to leftmost position of top line.
LF	0A	LF or CTRL J	Moves the cursor down one line and clears bypass condition. If at bottom line, cursor moves to bottom line.	No effect. Leaves ESC condition set.
VT	0B	CTRL K or	Moves the cursor up one line and clears bypass condition. If at top line, cursor moves to bottom line.	Moves the cursor up one line and clears bypass condition. If at top line, cursor moves to bottom line.
FF	0C	CLEAR or CTRL L	No Effect.	Clears screen, selects Alpha Mode, moves position to upper-left corner of display, and clears bypass condition.
CR	0D	CR or CTRL M	Moves cursor to leftmost position of current line, resets the terminal to Alpha Mode and clears bypass condition.	Leaves ESC condition set.
SO	0E	CTRL N	No Effect.	No Effect.
SI	0F	CTRL O	No Effect.	No Effect.
DLE	10	CTRL P	No Effect.	No Effect.
DC1	11	CTRL Q	No Effect.	Alpha Mode - Selects inverse video write. Other Modes - Selects erase.

TABLE D-3. CONTROL CODES AND ESCAPE SEQUENCES FOR GRAPHICS OPERATION (CONTD)

ASCII CHAR.	HEX CODE	KEYING SEQUENCE	*EFFECT WITH ESC CONDITION CLEAR	*EFFECT WITH ESC CONDITION SET
DC2	12	CTRL R	No Effect.	<u>Alpha Mode</u> - Selects overstrike write. Other Modes - Selects write.
DC3	13	CTRL S	No Effect.	<u>Alpha Mode</u> - Selects overstrike erase. Other Modes - Selects erase.
DC4	14	CTRL T	No Effect.	<u>Alpha Mode</u> - Selects rewrite. Other Modes - Selects write.
NAK	15	CTRL U	No Effect.	No Effect.
SYN	16	CTRL V	No Effect.	No Effect.
ETB	17	CTRL W	No Effect.	Make screen copy.
CAN	18	CTRL X	No Effect.	Selects bypass condition.
EM	19	CTRL Y	No Effect.	No Effect.
SUB	1A	CTRL Z	No Effect.	Selects GIN mode and selects bypass condition.
ESC	1B	ESC or CTRL [ or CTRL SH K	Sets ESC condition (Beginning of an ESC sequence).	Leaves ESC condition set.
FS	1C	CTRL or CTRL SH L	Selects point plot mode and clears bypass condition.	Selects point-plot mode and clears bypass condition.
GS	1D	CTRL ] or CTRL SH M	Selects graph mode and clears bypass condition.	Selects graph mode and clears bypass condition.
RS	1E	CTRL or CTRL SH N	No Effect.	No Effect.
US	1F	CTRL _ or CTRL SH-O	<u>GIN Mode</u> - No effect. <u>Other Modes</u> - Selects alpha mode and clears bypass condition.	<u>GIN Mode</u> - No effect. <u>Other Modes</u> - Selects alpha mode and clears bypass condition.
7	37	7	See Note 1.	Selects large alpha characters
8	38	8	See Note 1.	Selects normal alpha characters
9	39	9	See Note 1.	Selects normal alpha characters
:	3A	:	See Note 1.	Selects normal alpha characters

TABLE D-3. CONTROL CODES AND ESCAPE SEQUENCES FOR GRAPHICS OPERATION (CONTD)

ASCII CHAR.	HEX CODE	KEYING SEQUENCE	*EFFECT WITH ESC CONDITION CLEAR	*EFFECT WITH ESC CONDITION SET
;	3B	;	See Note 1.	Selects normal alpha characters
All Others	--		See Note 1.	No Effect.

\*ESC Condition is initiated by receipt of an ESC character and terminates following the receipt of the following character unless otherwise shown.

Note 1: Code is displayable character in alpha mode, or part of a coordinate in point-plot and graph modes.

The load coordinate instruction and the point plot, draw line, and block modes all require sets of coordinates. To set coordinate positions, the 10-bit X coordinate and the 10-bit Y coordinate must be converted to ASCII characters as shown below:

BYTE	BIT 7	BIT 6	BITS 5 THROUGH 1*
High Y	0	1	5 MSB of Y Coordinate**
Low Y	1	1	5 LSB of Y Coordinate
High X	0	1	5 MSB of X Coordinate**
Low X	1	0	5 LSB of X Coordinate

\*MSB is most significant bit; LSB is least significant bit.

\*\*Since the resolution of this terminal is 512 by 512, the MSB (bit 10) of each coordinate is outside the screen display area. Coordinates exceeding 511 yield unpredictable results. If the scale mode is selected, all X and Y coordinates are scaled down by a factor of two, and the Y coordinate is then biased upward by 122.



The terminal retains the last high Y, low Y, and High X addresses when switched to other operations not requiring coordinate information. When returning to an operation requiring coordinate information, only low X must be received by the terminal to reset to its previous coordinates.

It is not necessary that all four ASCII characters describing the coordinate be transmitted. The following table D-4 shows the coordinate byte transmission requirements.

A coordinate conversion chart is shown in table D-5.

TABLE D-4. BYTE TRANSMISSION REQUIREMENTS

BYTES WHICH CHANGE				BYTE TRANSMISSION REQUIRED			
HIGH Y	LOW Y	HIGH X	LOW X	HIGH Y	LOW Y	HIGH X	LOW X
			X				X
		X			X	X	X
	X				X		X
X				X			X
		X	X		X	X	X
	X		X		X		X
X			X	X			X
	X	X			X	X	X
X		X		X	X	X	X
X	X		X	X	X		X
	X	X	X		X	X	X
X		X	X	X	X	X	X
X	X		X	X	X		X
X	X	X		X	X	X	X
X	X	X	X	X	X	X	X
Sending to Initial							
Address					X	X	X
Returning to Remembered							X
Address							

TABLE D-5. COORDINATE CONVERSION CHART (ASCII OPERATIONS)

LOW ORDER X			X or Y COORDINATE									LOW ORDER Y		
ASCII	DEC.	HEX										HEX	DEC.	ASCII
@	64	40	0	32	64	96	128	160	192	224	60	96		
A	65	41	1	33	65	97	129	161	193	225	61	97	a	
B	66	42	2	34	66	98	130	162	194	226	62	98	b	
C	67	43	3	35	67	99	131	163	195	227	63	99	c	
D	68	44	4	36	68	100	132	164	196	228	64	100	d	
E	69	45	5	37	69	101	133	165	197	229	65	101	e	
F	70	46	6	38	70	102	134	166	198	230	66	102	f	
G	71	47	7	39	71	103	135	167	199	231	67	103	g	
H	72	48	8	40	72	104	136	168	200	232	68	104	h	
I	73	49	9	41	73	105	137	169	201	233	69	105	i	
J	74	4A	10	42	74	106	138	170	202	234	6A	106	j	
K	75	4B	11	43	75	107	139	171	203	235	6B	107	k	
L	76	4C	12	44	76	108	140	172	204	236	6C	108	l	
M	77	4D	13	45	77	109	141	173	205	237	6D	109	m	
N	78	4E	14	46	78	110	142	174	206	238	6E	110	n	
O	79	4F	15	47	79	111	143	175	207	239	6F	111	o	
P	80	50	16	48	80	112	144	176	208	240	70	112	p	
Q	81	51	17	49	81	113	145	177	209	241	71	113	q	
R	82	52	18	50	82	114	146	178	210	242	72	114	r	
S	83	53	19	51	83	115	147	179	211	243	73	115	s	
T	84	54	20	52	84	116	148	180	212	244	74	116	t	
U	85	55	21	53	85	117	149	181	213	245	75	117	u	
V	86	56	22	54	86	118	150	182	214	246	76	118	v	
W	87	57	23	55	87	119	151	183	215	247	77	119	w	
X	88	58	24	56	88	120	152	184	216	248	78	120	x	
Y	89	59	25	57	89	121	153	185	217	249	79	121	y	
Z	90	5A	26	58	90	122	154	186	218	250	7A	122	z	
[	91	5B	27	59	91	123	155	187	219	251	7B	123		
\	92	5C	28	60	92	124	156	188	220	252	7C	124		
]	93	5D	29	61	93	125	157	189	221	253	7D	125		
^	94	5E	30	62	94	126	158	190	222	254	7E	126		
_	95	5F	31	63	95	127	159	191	223	255	7F	127	RUBOUT (DEL)	
DECIMAL			32	33	34	35	36	37	38	39				
ASCII			SP	!	"	#	\$	%	&	'				
HEXADECIMAL			20	21	22	23	24	25	26	27				
			High Order X & Y											

**INSTRUCTIONS:** Find coordinate value in body of chart; follow that column to bottom of chart to find decimal value, hex value, or ASCII character which represents the High Y or High X byte; go to the right in the row containing the coordinate value to find the Low Y byte or go to the left to find the Low X byte. EXAMPLE: 200Y, 48 X equals 38 104 33 80 in decimal code equals & h ! P in ASCII code equals 26 68 21 50 in hexadecimal code.

TABLE D-5. COORDINATE CONVERSION CHART (ASCII OPERATIONS) (CONTD)

LOW ORDER X			X or Y COORDINATE								LOW ORDER Y		
ASCII	DEC.	HEX									HEX	DEC.	ASCII
@	64	40	256	288	320	352	384	416	448	480	60	96	
A	65	41	257	289	321	353	385	417	449	481	61	97	a
B	66	42	258	290	322	354	386	418	450	482	62	98	b
C	67	43	259	291	323	355	387	419	451	483	63	99	c
D	68	44	260	292	324	356	388	420	452	484	64	100	d
E	69	45	261	293	325	357	389	421	453	485	65	101	e
F	70	46	262	294	326	358	390	422	454	486	66	102	f
G	71	47	263	295	327	359	391	423	455	487	67	103	g
H	72	48	264	296	328	360	392	424	456	488	68	104	h
I	73	49	265	297	329	361	393	425	457	489	69	105	i
J	74	4A	266	298	330	362	394	426	458	490	6A	106	j
K	75	4B	267	299	331	363	395	427	459	491	6B	107	k
L	76	4C	268	300	332	364	396	428	460	492	6C	108	l
M	77	4D	269	301	333	365	397	429	461	493	6D	109	m
N	78	4E	270	302	334	366	398	430	462	494	6E	110	n
O	79	4F	271	303	335	367	399	431	463	495	6F	111	o
P	80	50	272	304	336	368	400	432	464	496	70	112	p
Q	81	51	273	305	337	369	401	433	465	497	71	113	q
R	82	52	274	306	338	370	402	434	466	498	72	114	r
S	83	53	275	307	339	371	403	435	467	499	73	115	s
T	84	54	276	308	340	372	404	436	468	500	74	116	t
U	85	55	277	309	341	373	405	437	469	501	75	117	u
V	86	56	278	310	342	374	406	438	470	502	76	118	v
W	87	57	279	311	343	375	407	439	471	503	77	119	w
X	88	58	280	312	344	376	408	440	472	504	78	120	x
Y	89	59	281	313	345	377	409	441	473	505	79	121	y
Z	90	5A	282	314	346	378	410	442	474	506	7A	122	z
[	91	5B	283	315	347	379	411	443	475	507	7B	123	
\	92	5C	284	316	348	380	412	444	476	508	7C	124	
]	93	5D	285	317	349	381	413	445	477	509	7D	125	
^	94	5E	286	318	350	382	414	446	478	510	7E	126	
-	95	5F	287	319	351	383	415	447	479	511	7F	127	RUBOUT (DEL)
DECIMAL			40	41	42	43	44	45	46	47			
ASCII			(	)	*	+	,	-	.	/			
HEXADECIMAL			28	29	2A	2B	2C	2D	2E	2F			
			High Order X and Y										

TABLE D-5. COORDINATE CONVERSION CHART (ASCII OPERATIONS) (CONTD)

LOW ORDER X			X or Y COORDINATE								LOW ORDER Y		
ASCII	DEC.	HEX									HEX	DEC.	ASCII
@	64	40	512	544	576	608	640	672	704	736	60	96	
A	65	41	513	545	577	609	641	673	705	737	61	97	a
B	66	42	514	546	578	610	642	674	706	738	62	98	b
C	67	43	515	547	579	611	643	675	707	739	63	99	c
D	68	44	516	548	580	612	644	676	708	740	64	100	d
E	69	45	517	549	581	613	645	677	709	741	65	101	e
F	70	46	518	550	582	614	646	678	710	742	66	102	f
G	71	47	519	551	583	615	647	679	711	743	67	103	g
H	72	48	520	552	584	616	648	680	712	744	68	104	h
I	73	49	521	553	585	617	649	681	713	745	69	105	i
J	74	4A	522	554	586	618	650	682	714	746	6A	106	j
K	75	4B	523	555	587	619	651	683	715	747	6B	107	k
L	76	4C	524	556	588	620	652	684	716	748	6C	108	l
M	77	4D	525	557	589	621	653	685	717	749	6D	109	m
N	78	4E	526	558	590	622	654	686	718	750	6E	110	n
O	79	4F	527	559	591	623	655	687	719	751	6F	111	o
P	80	50	528	560	592	624	656	688	720	752	70	112	p
Q	81	51	529	561	593	625	657	689	721	753	71	113	q
R	82	52	530	562	594	626	658	690	722	754	72	114	r
S	83	53	531	563	595	627	659	691	723	755	73	115	s
T	84	54	532	564	596	628	660	692	724	756	74	116	t
U	85	55	533	565	597	629	661	693	725	757	75	117	u
V	86	56	534	566	598	630	662	694	726	758	76	118	v
W	87	57	535	567	599	631	663	695	727	759	77	119	w
X	88	58	536	568	600	632	664	696	728	760	78	120	x
Y	89	59	537	569	601	633	665	697	729	761	79	121	y
Z	90	5A	538	570	602	634	666	698	730	762	7A	122	z
[	91	5B	539	571	603	635	667	699	731	763	7B	123	
\	92	5C	540	572	604	636	668	700	732	764	7C	124	
]	93	5D	541	573	605	637	669	701	733	765	7D	125	
^	94	5E	542	574	606	638	670	702	734	766	7E	126	
-	95	5F	543	575	607	639	671	703	735	767	7F	127	RUBOUT (DEL)
DECIMAL			48	49	50	51	52	53	54	55			
ASCII			1	1	2	3	4	5	6	7			
HEXADECIMAL			30	31	32	33	34	35	36	37			
High Order X and Y													

TABLE D-5. COORDINATE CONVERSION CHART (ASCII OPERATIONS) (CONTD)

LOW ORDER X			X or Y COORDINATE								LOW ORDER Y		
ASCII	DEC.	HEX									HEX	DEC.	ASCII
@	64	40	768	800	832	864	896	928	960	992	60	96	
A	65	41	769	801	833	865	897	929	961	993	61	97	a
B	66	42	770	802	834	866	898	930	962	994	62	98	b
C	67	43	771	803	835	867	899	931	963	995	63	99	c
D	68	44	772	804	836	868	900	932	964	996	64	100	d
E	69	45	773	805	837	869	901	933	965	997	65	101	e
F	70	46	774	806	838	870	902	934	966	998	66	102	f
G	71	47	775	807	839	871	903	935	967	999	67	103	g
H	72	48	776	808	840	872	904	936	968	1000	68	104	h
I	73	49	777	809	841	873	905	937	969	1001	69	105	i
J	74	4A	778	810	842	874	906	938	970	1002	6A	106	j
K	75	4B	779	811	843	875	907	939	971	1003	6B	107	k
L	76	4C	780	812	844	876	908	940	972	1004	6C	108	l
M	77	4D	781	813	845	877	909	941	973	1005	6D	109	m
N	78	4E	782	814	846	878	910	942	974	1006	6E	110	n
O	79	4F	783	815	847	879	911	943	975	1007	6F	111	o
P	80	50	784	816	848	880	912	944	976	1008	70	112	p
Q	81	51	785	817	849	881	913	945	977	1009	71	113	q
R	82	52	786	818	850	882	914	946	978	1010	72	114	r
S	83	53	787	819	851	883	915	947	979	1011	73	115	s
T	84	54	788	820	852	884	916	948	980	1012	74	116	t
U	85	55	789	821	853	885	917	949	981	1013	75	117	u
V	86	56	790	822	854	886	918	950	982	1014	76	118	v
W	87	57	791	823	855	887	919	951	983	1015	77	119	w
X	88	58	792	824	856	888	920	952	984	1016	78	120	x
Y	89	59	793	825	857	889	921	953	985	1017	79	121	y
Z	90	5A	794	826	858	890	922	954	986	1018	7A	122	z
[	91	5B	795	827	859	891	923	955	987	1019	7B	123	
\	92	5C	796	828	860	892	924	956	988	1020	7C	124	
]	93	5D	797	829	861	893	925	957	989	1021	7D	125	
^	94	5E	798	830	862	894	926	958	990	1022	7E	126	
_	95	5F	799	831	863	895	927	959	991	1023	7F	127	RUBOUT (DEL)
DECIMAL			56	57	58	59	60	61	62	63			
ASCII			8	9	:	;	<	=	>	?			
HEXA DECIMAL			38	39	3A	3B	3C	3D	3E	3F			
			High Order X and Y										

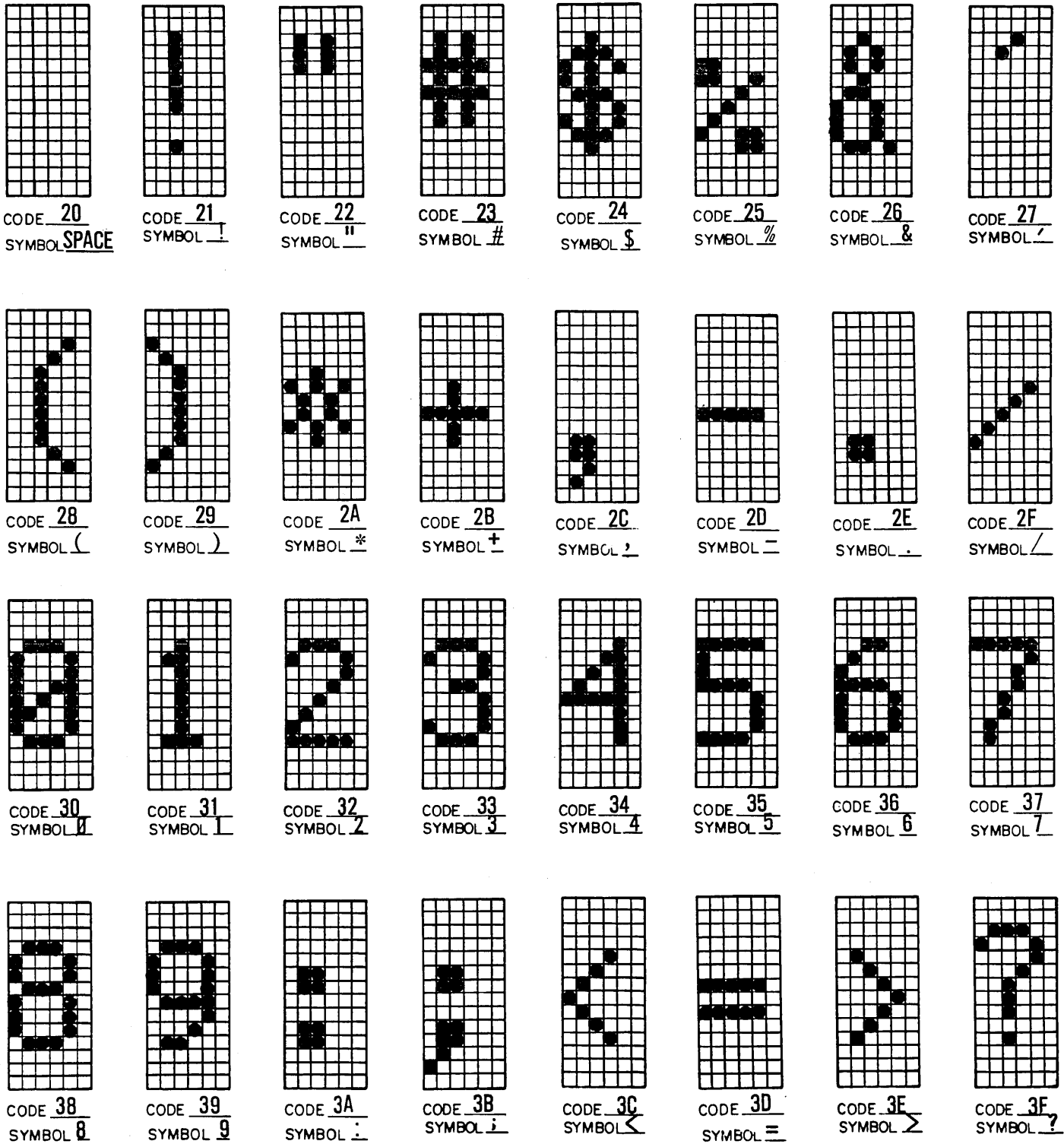

03964

Figure D-3. Normal Size Characters and Codes (Sheet 1 of 3)

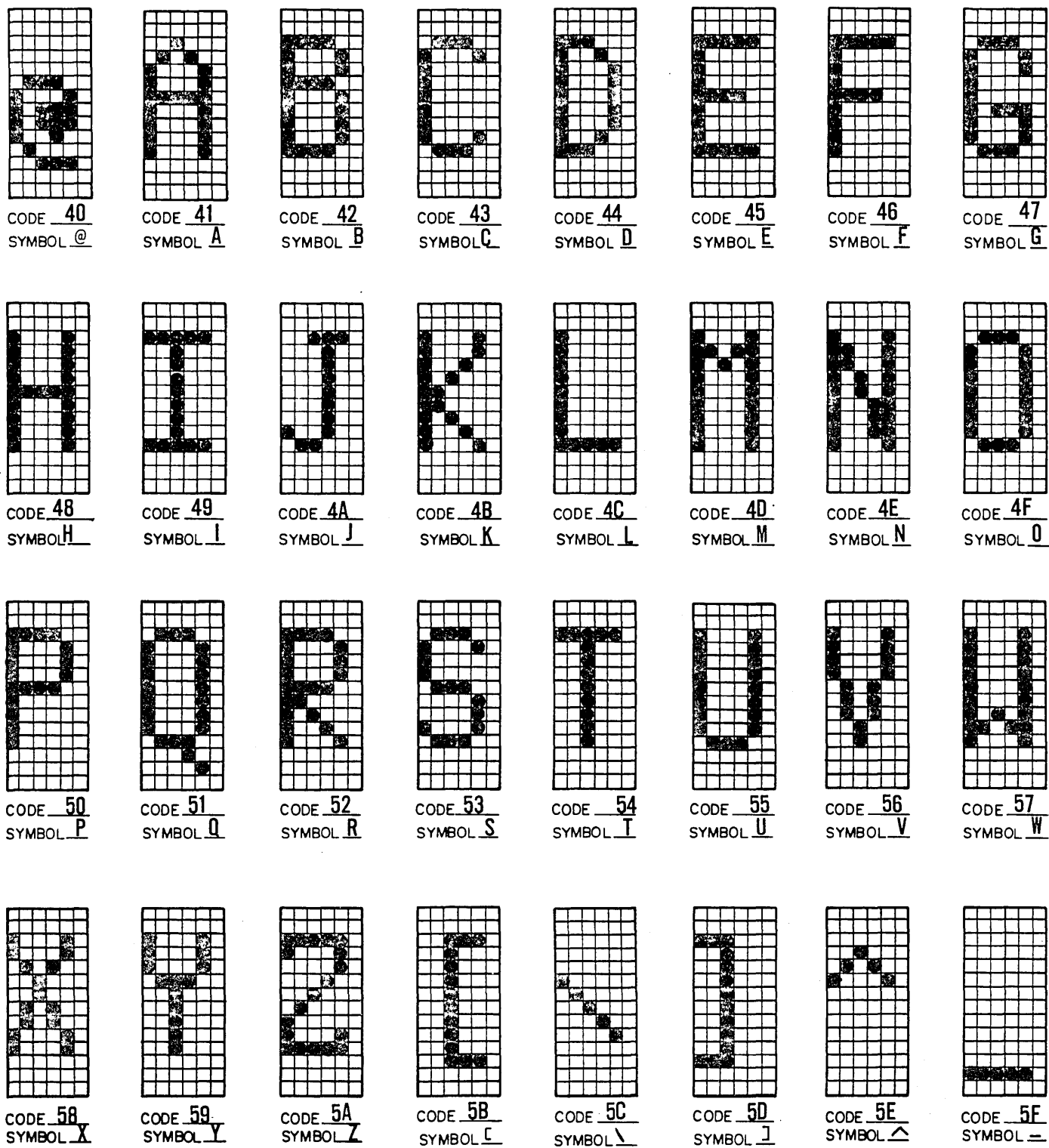

03965

Figure D-3. Normal Size Characters and Codes (Sheet 2 of 3)

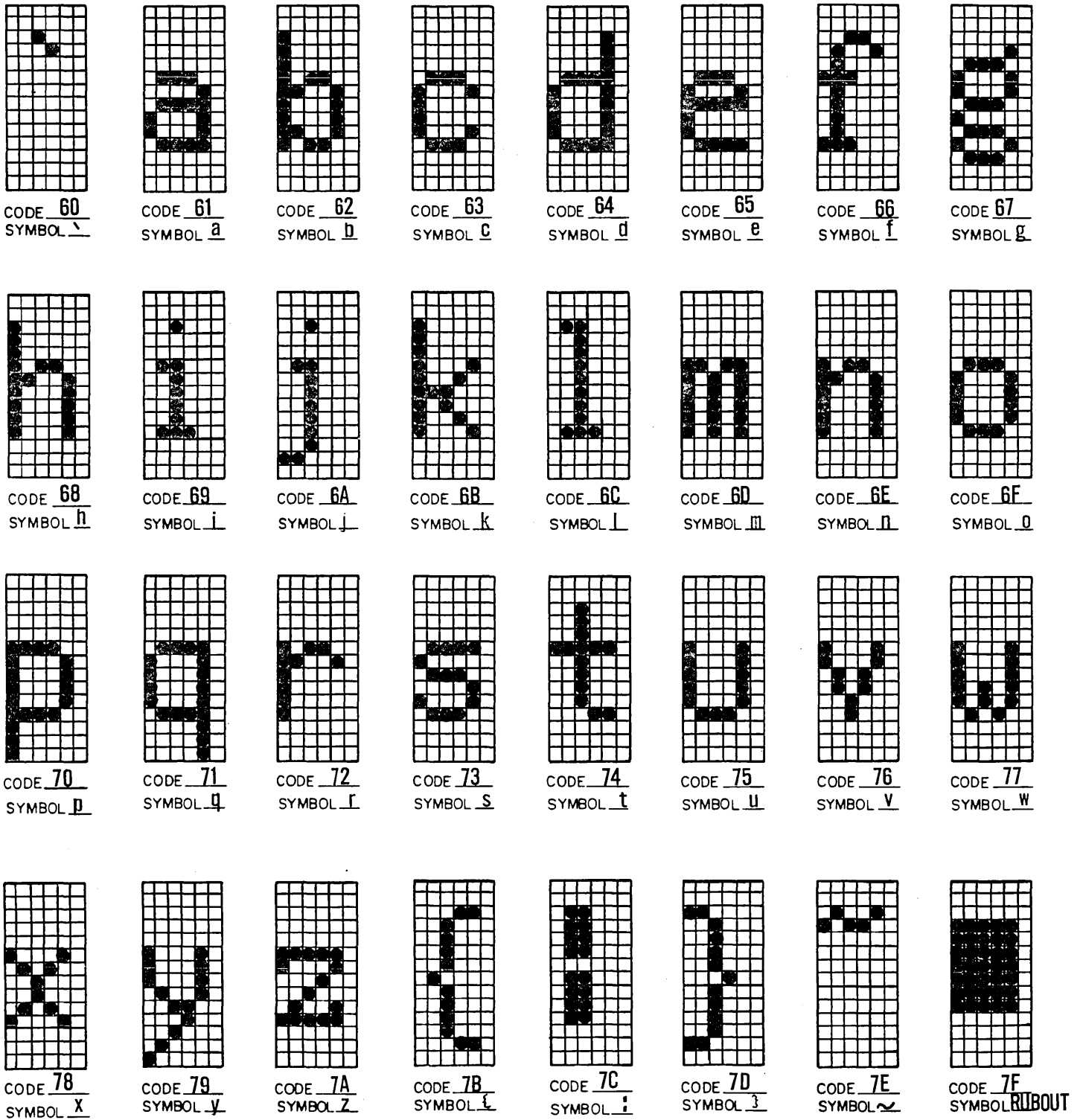

03966

Figure D-3. Normal Size Characters and Codes (Sheet 3 of 3)



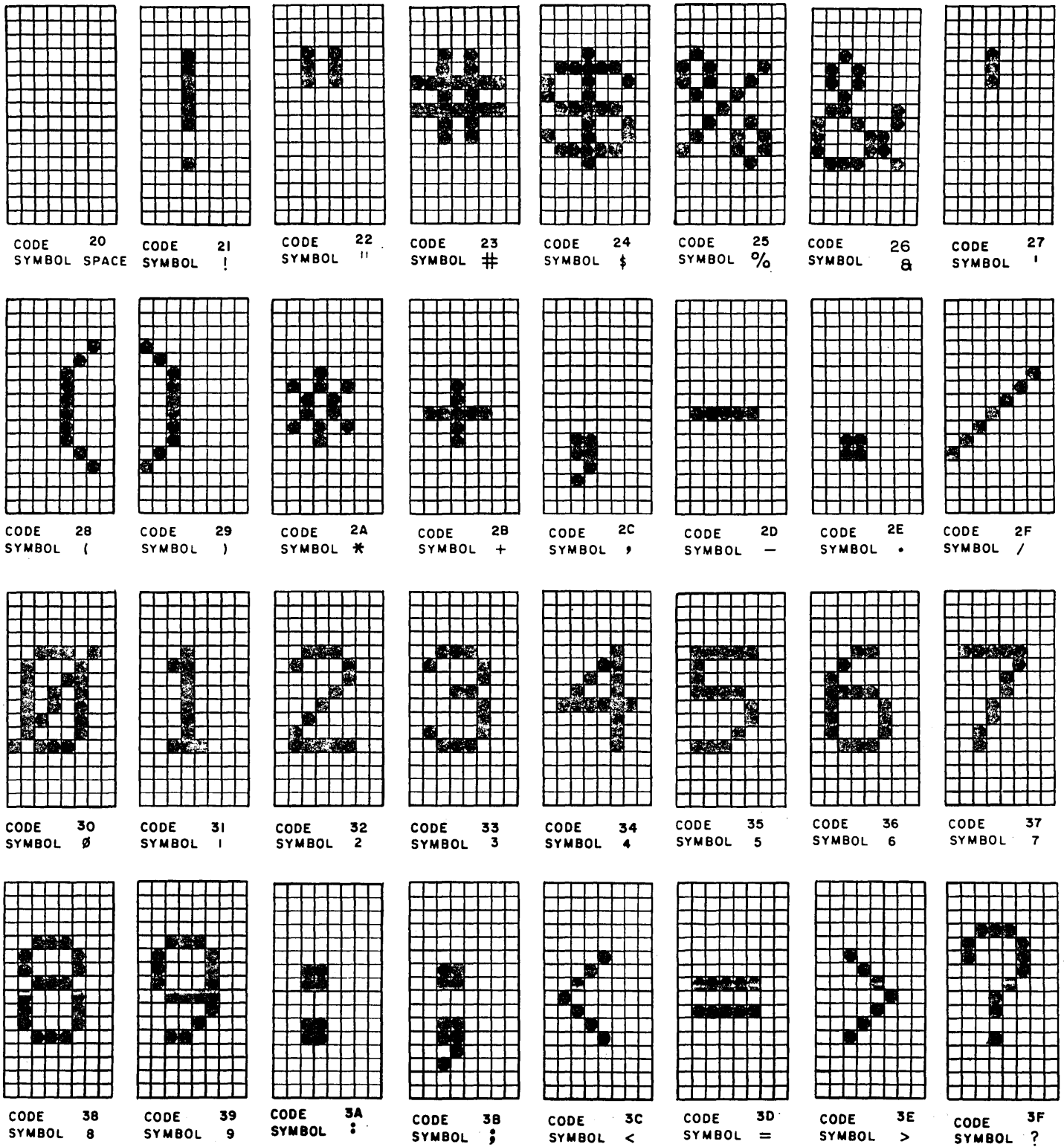

03967

Figure D-4. Large Size Characters and Codes (Sheet 1 of 3)

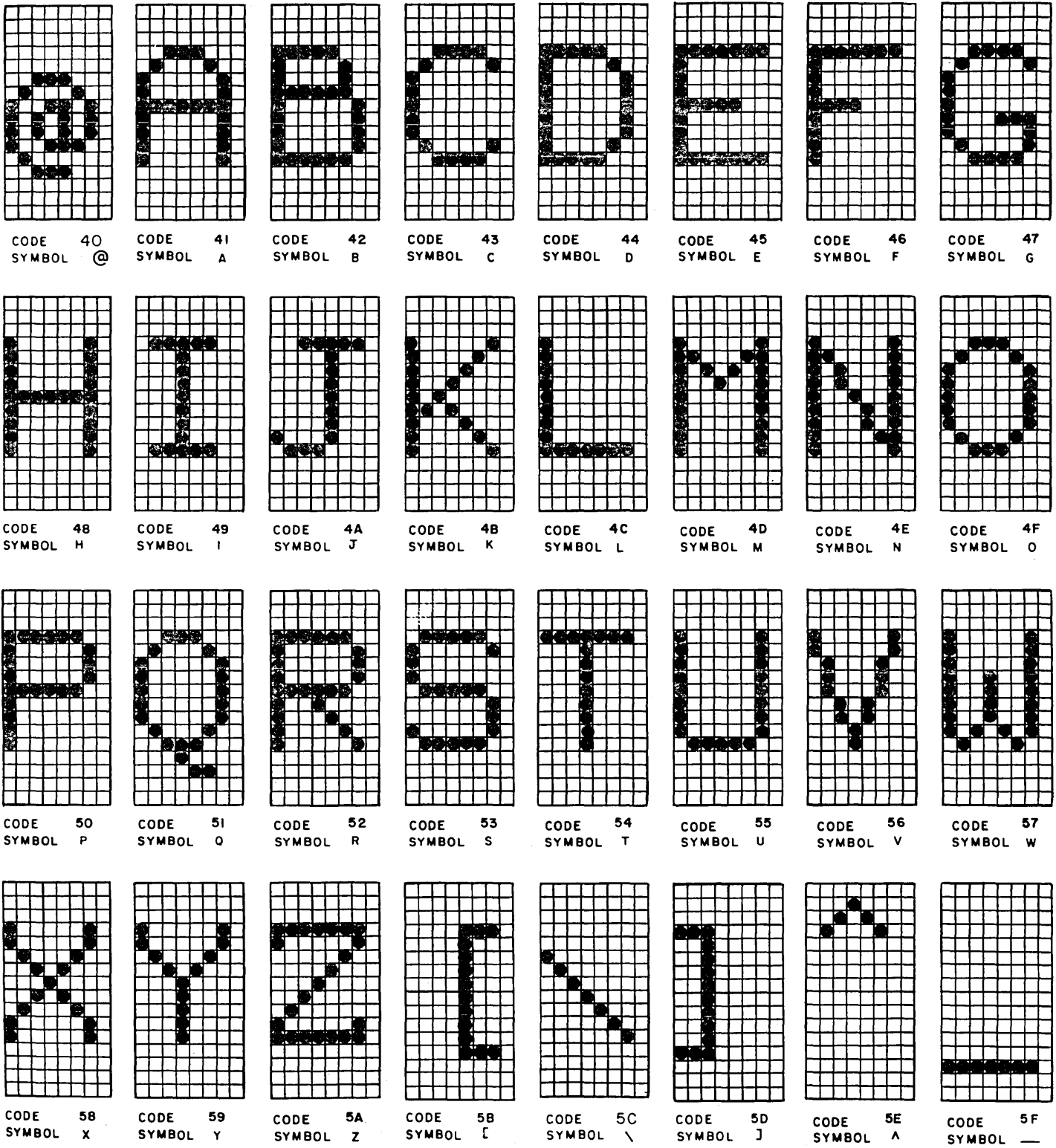

03968

Figure D-4. Large Size Characters and Codes (Sheet 2 of 3)

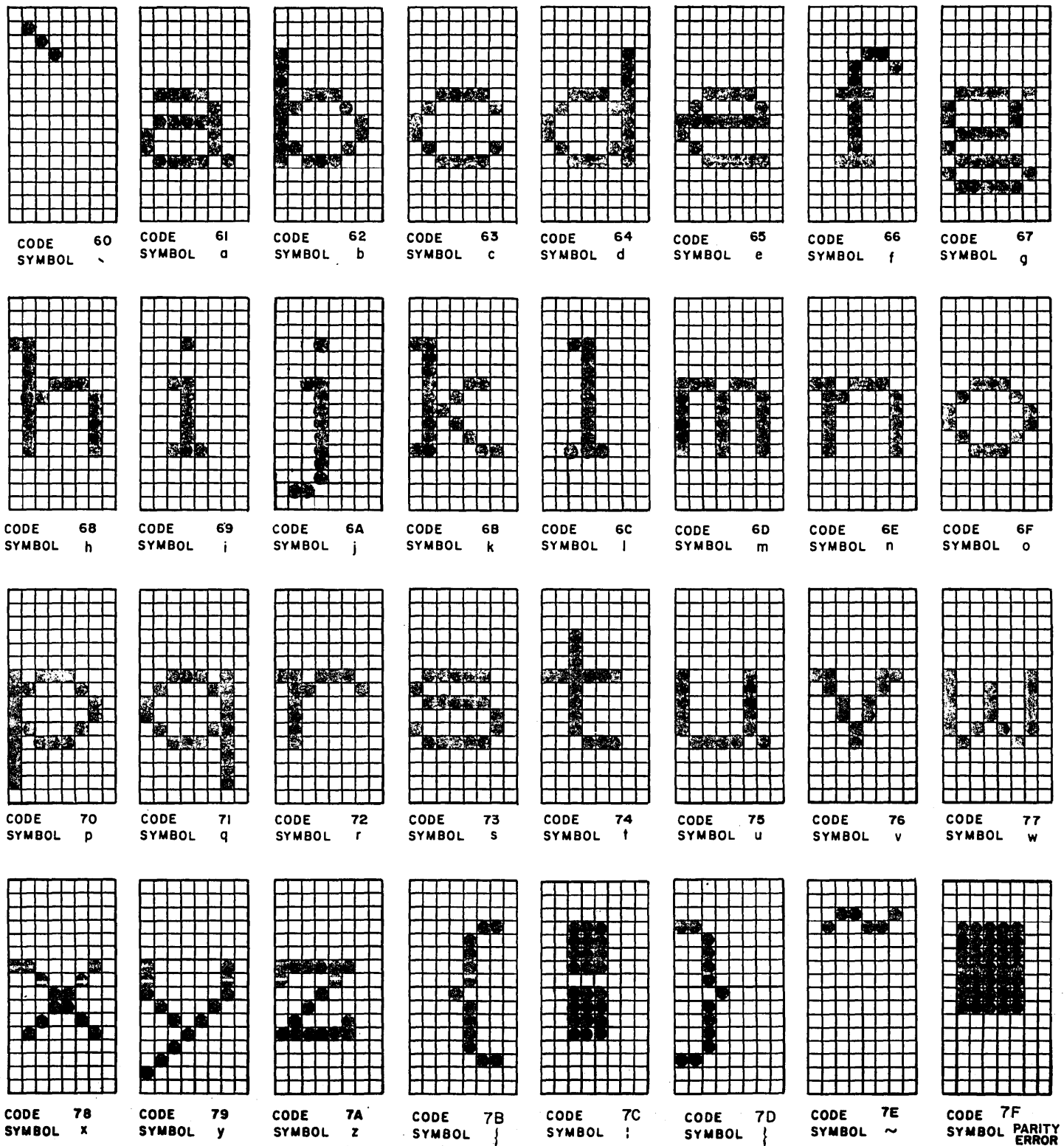

03969

Figure D-4. Large Size Characters and Codes (Sheet 3 of 3)



COMMENT SHEET

MANUAL TITLE: 721-X0 Display Terminal Hardware Reference Manual

PUBLICATION NO.: 62940020

REVISION: D

NAME: \_\_\_\_\_

COMPANY: \_\_\_\_\_

STREET ADDRESS: \_\_\_\_\_

CITY: \_\_\_\_\_ STATE: \_\_\_\_\_ ZIP CODE: \_\_\_\_\_

This form is not intended to be used as an order blank. Control Data Corporation welcomes your evaluation of this manual. Please indicate any errors, suggested additions or deletions, or general comments below (please include page number references).

STAPLE

STAPLE

FOLD

FOLD



NO POSTAGE  
NECESSARY  
IF MAILED  
IN THE  
UNITED STATES

**BUSINESS REPLY MAIL**  
FIRST CLASS      PERMIT NO. 8241      MINNEAPOLIS, MINN.

POSTAGE WILL BE PAID BY

**CONTROL DATA CORPORATION**

**Technical Publications Department**

**2401 North Fairview Avenue**

**St. Paul, Minnesota 55113**

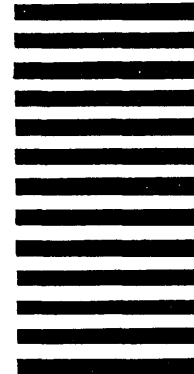

CUT ALONG LINE

FOLD

FOLD

03377





CONTROL DATA CORPORATION