

---

**CONTROL DATA®**  
**CYBER 70 SERIES MODELS 72/73/74**  
**6000 SERIES**  
**COMPUTER SYSTEMS**

---

**KRONOS® 2.1**  
**OPERATOR'S GUIDE**

## DSD COMMAND INDEX

<u>DSD COMMAND</u>	<u>PAGE</u>	<u>DSD COMMAND</u>	<u>PAGE</u>
A.	3-4, 4-3	LOCK.	3-31
A, .	3-4	LPxx, yy.	3-6
A, ACCOUNT FILE.	3-5, 4-3	LQxx, yy.	3-6
ACCOUNT, xx.	3-5, 4-5	n. MAGNET.	3-26
ACNcc.	3-34	MAINTENANCE.	3-28
A, ERROR LOG.	3-5, 4-3	MCHcc.	3-35
n. ASSIGN, xx.	3-14	Memory Entry Commands	3-34
AUTO.	3-28	MESSAGE, ccc...ccc.	3-13
BLITZ.	3-33	MSAL, c, f <sub>1</sub> xx, ..., f <sub>n</sub> xx.	3-12
n. CFO. ccc...ccc.	3-13	oANcc.	3-35
CHECK POINT SYSTEM.	3-31	OFFxx.	3-17
n. COMMENT. ccc...ccc.	3-13	ONxx.	3-17
CPxx, yy.	3-6	n. OFFSWx.	3-13
CRxx, yy.	3-5	n. ONSWx.	3-13
DATE. yy/mm/dd.	3-32	PURGE, xxx.	3-12
DAYFILE, xx.	3-5, 4-5	PURGEALL, t.	3-12
DEBUG.	3-32	QUEUE, ot, qt, qp <sub>1</sub> xxxx, ..., qp <sub>n</sub> xxxx.	3-7
DELAY, t <sub>1</sub> xxx, ..., t <sub>n</sub> xxx.	3-11	REPEATxx.	3-25
DCHcc.	3-35	REPEATxx, yy.	3-25
DCNcc.	3-35	RERUNxx.	3-7
DIAL, nnnn, ccc...ccc.	3-13	RERUNxx, yyyy.	3-25
n. DIS.	3-31	n. RERUN, xxxx.	3-7
DISABLE, x.	3-28	ROLLIN, xxx.	3-6
DISPLAY, xxx.	4-26	n. ROLLOUT.	3-6
Display Selection Commands	4-1	n. ROLLOUT, xxxx.	3-6
n. DROP.	3-13	SERVICE, ot, p <sub>1</sub> xxx, ..., p <sub>n</sub> xxx.	3-9
DUMP, xx, yy.	3-6	SET, cccc.	4-2
E, x.	4-13	STEP.	3-32
ENABLE, x.	3-28	STEP, xx.	3-32
ENDxx.	3-25	n. STEP.	3-33
ENDxx, yy.	3-25	n. STEP, xx.	3-33
ENID, yy, zzz.	3-5	n. STOP.	3-28
n. ENPR, xx.	3-7	SUPPRESSxx.	3-25
ENQP, xxxx, yyy.	3-7	SYSGO.	3-33
n. ENQP, xxxx.	3-7	TELEX.	3-26
n. ENTL, xxxx.	3-7	TEMP, xx.	3-17
ERRLOG, xx.	3-5, 4-5	TIME, hh. mm. ss.	3-32
n. EXPORTL.	3-26	TRANEX.	3-28
FCNcc.	3-35	UNLOAD, xx.	3-15
FCNcc, xxxx.	3-35	UNLOCK.	3-31
n. GO.	3-13	UNSTEP.	3-33
H, x.	4-22	VSN, xx.	3-15
IANcc.	3-35	VSN, xx, aaaaaa.	3-15
IDLE.	3-30	WARN.	3-14
INITIALIZE, xx.	3-18	WARN, ccc...ccc.	3-13
n. IO.	3-26	X. name.	3-31
K. ccc...ccc.	3-31	X. name, xxxxx.	3-31
L. ccc...ccc.	3-31	X. name(ccc...ccc)	3-31
LDC, nnnn.	3-35	99.	3-33
LOAD, xx, yy.	3-5	n. *ccc...ccc	3-13

---

**CONTROL DATA®**  
**CYBER 70 SERIES MODELS 72/73/74**  
**6000 SERIES**  
**COMPUTER SYSTEMS**

---

**KRONOS® 2.1**  
**OPERATOR'S GUIDE**



## PREFACE

---

The KRONOS® Time-Sharing System was developed by Control Data Corporation to provide remote interactive job processing for CONTROL DATA® CYBER 70 Series Model 72, 73, and 74 Computer Systems and for CONTROL DATA® 6000 Series Computer Systems. This interactive job processing capability is provided in addition to the local and remote batch processing capabilities available under KRONOS.

This manual describes the procedures which the console operator must follow to successfully control system operation. This information includes the commands available to the operator, deadstart procedures, permanent file and system utility operation, and a description of time-sharing and system operation.

The following manuals contain additional information about the KRONOS Time-Sharing System that may prove useful to the console operator.

<u>Control Data Publication</u>	<u>Publication No.</u>
Control Data 6400/6500/6600 Computer Systems Reference Manual	60100000
Control Data CYBER 70/Model 72 Computer System Reference Manual	60347000
Control Data CYBER 70/Model 73 Computer System Reference Manual	60347200
Control Data CYBER 70/Model 74 Computer System Reference Manual	60347400
KRONOS 2.1 Reference Manual	60407000
KRONOS 2.1 Installation Handbook	60407500
KRONOS 2.1 Time-Sharing User's Reference Manual	60407600
KRONOS 2.1 Instant Manual	60407200
Transaction Subsystem Reference Manual	60407900
Transaction Subsystem Operator's Guide Addendum	60408000
CYBERLINK Interchange Reference Manual	60373300
CYBERLINK Interchange Operator's Guide	60408400

This product is intended for use only as described in this document. Control Data cannot be responsible for the proper functioning of undescribed features or undefined parameters. The operator messages contained in Appendix B of this document are incomplete. A subsequent revision to this document will include complete information concerning operator messages.



# CONTENTS

---

SECTION 1	INTRODUCTION	1-1
	System Configuration	1-1
SECTION 2	DEADSTART	2-1
	Summary of Deadstart Procedures	2-1
	Keyboard Entries	2-2
	Mounting the Deadstart Tape	2-2
	Setting the Deadstart Panel	2-3
	Selecting the Deadstart Tape Equipment	2-5
	Selecting the Deadstart Function	2-5
	Selecting the CMRDECK	2-7
	Entering Word 14	2-7
	System Deadstart Procedures	2-11
	Automatic System Deadstart	2-11
	System Deadstart With Options Displayed	2-16
	Preparing for Recovery Deadstart	2-23
	Initializing the System	2-25
	Initiating Job Processing	2-28
	Error Processing	2-29
	General	2-30
	System Initialization	2-31
	Recovery	2-31
	System Library Building	2-32
SECTION 3	OPERATION UNDER DSD CONTROL	3-1
	Console Operation Under DSD	3-1
	Special Characters	3-2
	DSD Commands	3-4
	Dayfile Commands	3-4
	Job Processing Control Commands	3-5
	Peripheral Equipment Control Commands	3-14
	BATCHIO Buffer Point Commands	3-25
	Subsystem Control Commands	3-25
	System Control Commands	3-28
	Memory Entry Commands	3-34
	Channel Control Commands	3-34
SECTION 4	DSD DISPLAYS	4-1
	Display Selection	4-1
	Display Screen Headers	4-2
	Dayfile (A) Displays	4-3
	Job Status (B) Display	4-8
	Storage (C, D, F, G) Displays	4-10
	Equipment Status (E) Display	4-13
	EST Display	4-14
	Mass Storage Tables Display	4-16
	Resource Mounting Preview Display	4-18
	Tape Status Display	4-20

	File Name Table (H) Display	4-22
	BATCHIO (I) Display	4-24
	Control Point Status (J) Display	4-25
	Central Programmable (K and L) Displays	4-26
	File (N) Display	4-26
	PP Communications Area (P) Display	4-26
	Job Queues (Q) Display	4-27
	Export Status (R) Display	4-28
	System Control Information (S) Display	4-30
	Time-Sharing Status (T) Display	4-33
	Monitor Functions (Y) Display	4-35
	Directory (Z) Display	4-36
SECTION 5	PERMANENT FILE UTILITIES	5-1
	Archive File	5-1
	PFDUMP Procedures	5-1
	PFLOAD Procedures	5-6
SECTION 6	SYSTEM UTILITY OPERATION	6-1
	DMQ (Dump Queue Files)	6-1
	LDQ (Load Queue Files)	6-1
	STAGE (Stage Tape Files to Disk)	6-2
	FLAW (Reserve Tracks)	6-4
SECTION 7	OPERATION UNDER DIS CONTROL	7-1
	DIS Dayfile (A) Display	7-3
	DIS Job Status (B) Display	7-4
	DIS Memory Displays	7-5
	DIS Directory (Z) Display	7-7
	Console Operation	7-8
	Display Selection Commands	7-9
	DIS Keyboard Entries	7-9
	PP Call Commands	7-12
APPENDIX A	DISPLAY CODE CHARACTER SET	A-1
APPENDIX B	OPERATOR MESSAGES	B-1
APPENDIX C	END OF OPERATION SHUTDOWN	C-1
APPENDIX D	PERIPHERAL EQUIPMENT OPERATION	D-1
APPENDIX E	ACCESS COMMANDS	E-1

#### FIGURES

2-1	Deadstart Panel	2-4
2-2	Flowchart Synopsis of KRONOS Deadstart	2-27
3-1	Console Keyboard	3-1



3-2	K Display for INITIALIZE Command	3-23
4-1a	System Dayfile (A) Display	4-6
4-1b	Account Dayfile (A) Display	4-7
4-1c	Error Log Dayfile (A) Display	4-8
4-2	Job Status (B) Display	4-10
4-3	Central Memory (C) Display	4-12
4-4	Central Memory (F) Display	4-13
4-5a	Equipment Status (E) Display	4-15
4-5b	Mass Storage Tables (E) Display	4-18
4-5c	Resource Mounting Preview (E) Display	4-19
4-5d	Tape Status (E) Display	4-21
4-6	File Name Table (H) Display	4-23
4-7	BATCHIO Status (I) Display	4-24
4-8	Control Point Status (J) Display	4-25
4-9	PP Communications Area (P) Display	4-27
4-10	Job Queues (Q) Display	4-28
4-11	Export Status (R) Display	4-29
4-12	System Control Information (S) Display	4-32
4-13	Time-Sharing Status (T) Display	4-34
4-14	Monitor Functions (Y) Display	4-35
4-15	Directory (Z) Display	4-36
5-1	Initial Left Screen K Display	5-2
5-2	Left Screen K Display for PFDUMP Utility	5-3
5-3	Right Screen K Display	5-4
5-4	Left Screen K Display for PFLOAD Utility	5-9
6-1	STAGE Utility K Display	6-3
6-2	FLAW Utility K Display	6-5
7-1	DIS Dayfile (A) Display	7-3
7-2	DIS Job Status (B) Display	7-4
7-3	DIS Data Storage (E) Display	7-5
7-4	DIS Program Storage (F) Display	7-6
7-5	DIS Directory (Z) Display	7-7
D-1	Card Reader Switches	D-2
D-2	415 Card Punch Switches	D-4
D-3	501 Line Printer Switches	D-5
D-4	501 Line Printer	D-6
D-5	512 Line Printer Switches	D-8
D-6	512 Line Printer Controls	D-9
D-7	604 and 607 Tape Unit Switches	D-13
D-8	657 and 659 Tape Unit Switches	D-14
D-9	Console Switches	D-16

#### TABLES

2-1	KRONOS 2.1 Deadstart Program	2-3
2-2	Levels of System Deadstart	2-23
2-3	Mass Storage Device Recovery	2-33
3-1	Device Definition Options	3-23
3-2	Track Flawing Options	3-24



# INTRODUCTION

1

---

The KRONOS Time-Sharing System provides four types of job processing:

- Local batch processing; jobs can be entered and executed at the central site using all of the central site peripheral equipment attached to the computer.
- Remote batch processing; jobs can be submitted from remotely located 200 User Terminals or 731-12/732-12 Remote Batch Terminals.
- Deferred batch processing; jobs entered from an interactive terminal can be submitted to the batch queue for processing; their output can be routed to user-specified peripheral equipment.
- Interactive terminal processing; jobs can be entered from an ASCII code or correspondence code compatible terminal.

## SYSTEM CONFIGURATION

KRONOS supports the following equipment. The specific configuration may vary, but consists of elements of the following equipment.

- Peripheral processor units (PPUs) — 10, 14, 17, and 20 PPU configurations of CDC CYBER 70/Model 72, 73, and 74 computers and 7, 8, 9, 10, and 20 PPU configurations of 6000 series computers.
- Central exchange jump/monitor exchange jump (CEJ/MEJ) — many CDC CYBER 70 series and 6000 series computers are equipped with the CEJ/MEJ option. This option improves job performance and should be used if it is available.
- 6612 Display Console
- Mass storage — a minimum of 60 million characters of mass storage on any of the following devices.

6603 Disk System

6638 Disk System

863 Drum Storage

854 Disk Storage Drive (854 disk groups are also supported)

Extended Core Storage (ECS)

814 Disk File

821 Data File

844 Disk Storage Subsystem

A dedicated permanent file device is recommended in addition to system mass storage.

- Peripheral equipment — any of several combinations of the following peripheral equipment.
  - 501 and 512 Line Printers
  - 405 Card Reader
  - 415 Card Punch
  - 604, 607, 657, and 659 Magnetic Tape Units
  - 6671 Multiplexers for communication with 200 User Terminals and 731-12/732-12 Remote Batch Terminals
  - 6671 or 6676 Multiplexers for communication with interactive terminals
- Distributive data path (DDP) — the DDP option enables PPU's to read and write ECS directly rather than use the normal indirect transfers via central memory.

KRONOS gives the operator considerable latitude in controlling performance of the overall system, yet it can proceed with very little operator activity. Efficiency of the entire system can be increased significantly by a knowledgeable operator.

The operator console is used for communication between the operator and the computer system. Both KRONOS and the programs running under control of KRONOS use the two display screens to bring information to the attention of the operator. The operator responds to or otherwise instructs the operating system by entering information via the console keyboard.

Two KRONOS routines, DSD and DIS, provide the software interface between the console hardware and other internal software. Their function is to maintain a current display of system and job status and to process commands the operator types at the keyboard. DSD is the system display routine; information pertaining to all jobs appears on the screens. DIS is the job display routine; the screens show data from a single job only. DSD has control of the console until the operator brings in DIS.

At all times DSD occupies PP1, one of the 7 to 20 peripheral processor units in the system. PP0 always contains the system monitor routine MTR that oversees all KRONOS activities. DIS resides in a PP assigned by monitor at the time it is called.

Under DSD, the normal operating mode, the operator can address the system or any of the jobs under system control. Once a particular job begins execution, however, operator intervention is limited to responding to job requests for equipment assignment or other actions, changing priority or field length, and stopping execution permanently or temporarily.

In contrast, DIS operating mode gives the operator more control of job execution. Operator action is required to advance each control card in the job. Since the operator can add control card instructions from the keyboard, the job need not execute exactly as it entered the system. Commands to DIS include those that allow changes in register contents shown in the exchange jump package, as well as those that control such items as field length or time limit.

Operators can use the DIS capability for entering control cards to perform utility tasks or dumping permanent files. DIS is used most often by system analysts. Section 7 details procedures for using DIS.

---

Deadstart is the process by which the KRONOS system is made operational and ready to process jobs. Under normal circumstances, this is a function performed by the system operator. System deadstart can be a fully automatic procedure or it can involve considerable operator intervention. It is assumed that a deadstart tape exists, which is configured to meet site requirements. The deadstart tape is a reel of magnetic tape containing the programs which constitute the KRONOS Operating System and its product set members (such as BASIC, FORTRAN, COMPASS, etc.). In addition, the deadstart tape contains programs necessary to establish KRONOS and its product set on the system equipment as well as maintenance routines used to test the condition of certain system equipment. The deadstart tape is not dependent upon a specific equipment configuration. That is, the same deadstart tape can be used for any supported equipment configuration.

## SUMMARY OF DEADSTART PROCEDURES

Generally, the following summary is intended to provide a brief overview of the procedures necessary to deadstart KRONOS. The more experienced operator may wish to use this summary as a checklist during deadstart. Detailed information concerning all phases of the deadstart process is provided throughout the remainder of this section. It is assumed that power is applied on all required equipment and that the equipment is functioning properly. If at any time loss of power or equipment failure is encountered, consult the site analyst or customer engineer.

1. Ensure that all mass storage devices are mounted and/or available.
2. Mount the deadstart tape (refer to Mounting the Deadstart Tape).
  - Check to ensure that write enable ring is not on reel.
  - Mount the tape, select the correct density, and ready the unit.
3. Set the deadstart panel (refer to Setting the Deadstart Panel).
  - Select the correct deadstart function.
  - Select the correct CMRDECK.
  - Select appropriate system devices unless CMRDECK and/or IPRDECK modification is to be performed.
  - All variable fields on the deadstart panel are indicated by blanks in the accompanying illustration. For reference, fill in blanks with values used most frequently.

0001	111	101	—	—
0002	111	111	—	—
0003	—	000	00_	—
0004	111	111	—	—
0005	000	000	001	000
0006	111	111	—	—
0007	001	100	000	000
0010	111	100	—	—
0011	111	001	—	—
0012	110	110	000	110
0013	000	—	—	—
0014	—	—	—	—

4. Activate the deadstart switch (refer to System Deadstart Procedures).
5. Initialize the system and initiate job processing (refer to topics of same name). A flowchart synopsis of KRONOS deadstart (Figure 2-2) is included at the end of this section under Initiating Job Processing.

## KEYBOARD ENTRIES

The following statements apply to operator/console communication during deadstart.

Refer to the illustration of console keyboard at the beginning of section 3.

- Entries typed from the console keyboard are displayed on the bottom of the left console screen as they are entered.
- The BKSP key deletes the previous character typed.
- The left blank key deletes the current line being typed (left blank is third key from right on top row of keyboard).
- The following message may appear above the console entry if the entry is unrecognizable: ILLEGAL ENTRY. An arrow points to the first field in error.

## MOUNTING THE DEADSTART TAPE

Included in the following procedure are the steps necessary to ready the KRONOS deadstart tape in preparation for a system (or maintenance) deadstart.

1. Before mounting the deadstart tape, check the back of the reel to ensure that the write enable ring has been removed.
2. Mount the deadstart tape on a 604, 607, 657, or 659 magnetic tape transport. Thread the tape through the appropriate guides, under the head assembly, and onto the takeup reel.
3. Set the density selector on the tape unit to that specified on the label attached to the deadstart tape reel. If a 659 tape unit is being used, a density of 1600 bpi will always be indicated when the tape is positioned at load point. The correct density is indicated when the tape moves off load point.

4. Select the physical tape unit number (0 through 7) by rotating the selector switch at the top of the unit. Make certain that the number selected is not the number indicated on another tape unit connected to the system.
5. Press the LOAD and READY switches on the tape unit. The tape should move forward to load point and stop. The indicator light in the READY switch should turn on when the tape is available for access.

## SETTING THE DEADSTART PANEL

The deadstart panel (Figure 2-1) contains a 12 by 12 matrix of toggle switches labeled DEAD START PROGRAM. Each row of switches (numbered 0001 through 0014 octal) represents a 12-bit PPU instruction word in this program. Thus, by setting these switches in a prescribed manner, the operator effectively creates the deadstart program. The program is subsequently loaded into PPU 0 memory and executed whenever the deadstart switch is activated.

The function of the deadstart program is as follows:

- Identifies the tape unit, controller, and channel number to be used to access the deadstart tape (specified in words 0001 through 0011).
- Selects any deadstart options specified in words 0013 and 0014.
- Reads the first record from the deadstart tape (system tape preloader routine). The function of this routine is to initiate processing the remainder of the deadstart tape according to the options specified on the deadstart panel (words 0013 and 0014).

Table 2-1 illustrates the deadstart panel switch positions for the KRONOS 2.1 deadstart program.

TABLE 2-1. KRONOS 2.1 DEADSTART PROGRAM

Word	Switch (Bit) Positions											
	11	10	9	8	7	6	5	4	3	2	1	0
0001	1	1	1	1	0	1	c	c	c	c	c	c
0002	1	1	1	1	1	1	c	c	c	c	c	c
0003	e	e	e	0	0	0	0	0	u	u	u	u
0004	1	1	1	1	1	1	c	c	c	c	c	c
0005	0	0	0	0	0	0	0	0	1	0	0	0
0006	1	1	1	1	1	1	c	c	c	c	c	c
0007	0	0	1	1	0	0	0	0	0	0	0	0
0010	1	1	1	1	0	0	c	c	c	c	c	c
0011	1	1	1	0	0	1	c	c	c	c	c	c
0012	1	1	0	1	1	0	0	0	0	1	1	0
0013	0	0	0	x	x	x	x	x	x	y	y	y
0014	r	r	r	p	p	p	s	s	s	s	s	s

The switch positions indicated by a 1 (switch in up position) or a 0 (switch in down position) are mandatory settings. However, the switch positions for fields represented by alphabetic characters are determined by each installation. Each of these fields is described in the topics that follow. Space is provided at the beginning of this section (Summary of Procedures for Deadstart) to include these switch positions.

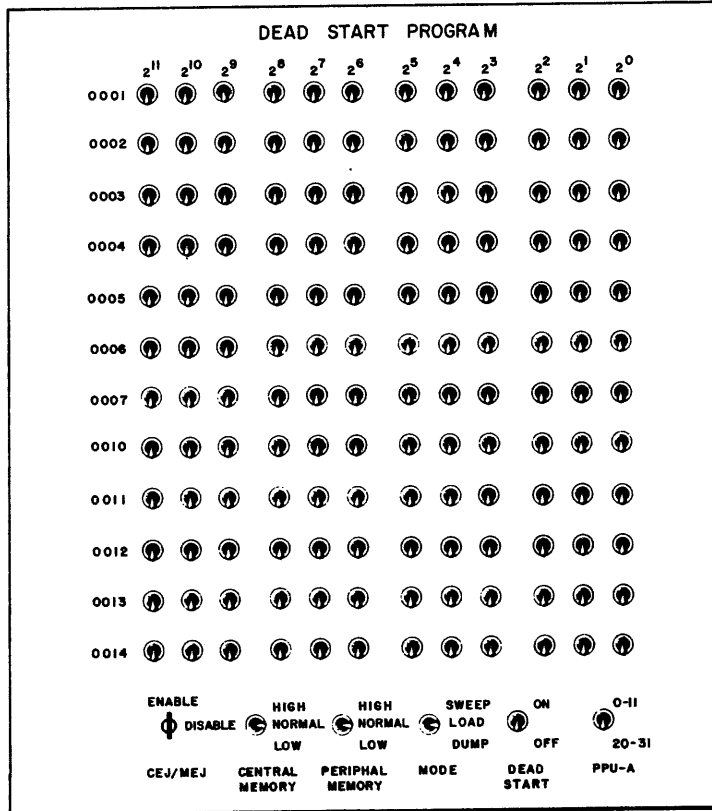

Figure 2-1. Deadstart Panel

NOTE

Before activating the deadstart switch (on console or deadstart panel) ensure that the maintenance switch labeled MODE on the deadstart panel is set to the LOAD position.



## SELECTING THE DEADSTART TAPE EQUIPMENT

The magnetic tape transport on which the deadstart tape is mounted, its associated controller, and the channel used to access this equipment is identified by setting the switches shown in the unshaded area of the deadstart panel illustrated.

0001	111 101	ccc ccc	
0002	111 111	ccc ccc	ccc ccc
0003	eee 000 00	u uuu	Represents the channel number used to access the deadstart tape equipment.
0004	111 111	ccc ccc	
0005	000 000	001 000	eee
0006	111 111	ccc ccc	Represents the tape controller number to which the tape unit is connected.
0007	001 100	000 000	
0010	111 100	ccc ccc	u uuu
0011	111 001	ccc ccc	Represents the physical unit number of the tape unit on which the deadstart tape is mounted (number is indicated on selector switch at top of unit).
0012	110 110	000 110	
0013	000 xxx	xxx yyy	
0014	rrr ppp	sss sss	

For example, assume that channel 13, tape controller 5, and tape unit 3 were to be used. In this case, the corresponding switches on the deadstart panel would be set as follows (1 indicates that switch is placed in up position):

```
ccc ccc    001  011
eee        101
u uuu      0   011
```

The numbers are set to their binary form as each switch represents one bit in a 12-bit PPU instruction word.

## SELECTING THE DEADSTART FUNCTION

Generally, the term deadstart refers to the function performed after the deadstart switch is activated. There are two basic categories of deadstart functions that can be performed.

- System deadstart      This is the process by which the KRONOS system is made operational and ready to process jobs.
- Maintenance deadstart      This function allows KRONOS to be used to perform hardware or software maintenance tasks. Only one maintenance task can be selected at a time. In addition, processing of user jobs is not possible (system deadstart required).

The deadstart function to be performed is selected by setting the switches shown in the unshaded area of the deadstart panel illustrated.

0001	111	101	ccc	ccc
0002	111	111	ccc	ccc
0003	eee	000	00u	uuu
0004	111	111	ccc	ccc
0005	000	000	001	000
0006	111	111	ccc	ccc
0007	001	100	000	000
0010	111	100	ccc	ccc
0011	111	001	ccc	ccc
0012	110	110	000	110
0013	000	xxx	xxx	yyy
0014	rrr	ppp	sss	sss

yyy

Specifies deadstart function. Values 000, 001, 010, and 011 are valid (1 indicates switch is in up position). Refer to the following description for function associated with each value.

Value of yyy

Associated Function

- 000       Selects automatic system deadstart. If system device is specified in word 14 (refer to Entering Word 14), deadstart proceeds automatically and operator intervention is not required. For complete information concerning automatic system deadstart, refer to the procedure described later in this section under System Deadstart Procedures.
- 001       Selects system deadstart with options displayed. When this function is selected, an options display appears on the left console screen and deadstart proceeds as directed by the operator. For complete information concerning system deadstart with options displayed, refer to the procedure described later in this section under System Deadstart Procedures.
- 010       Selects maintenance deadstart task that displays the contents of PPU 0 (zero) memory on both console screens. This function is generally used by the site analyst or customer engineer (CE) to enter sample PPU programs (for example, to test peripheral devices on the system). To perform another deadstart function, it is necessary to reset this field (yyy) on the deadstart panel and activate the deadstart switch.
- 011       Selects maintenance deadstart task to perform deadstart dump. This function allows the contents of PPU memory and/or central memory to be dumped to a specified line printer. Refer to section 3 in part II of the KRONOS Installation Handbook for deadstart dump procedures. To perform another deadstart function, it is necessary to reset this field (yyy) on the deadstart panel and activate the deadstart switch.

During a system deadstart with options displayed (yyy=001 on deadstart panel), five of the options available are maintenance deadstart functions. Included are the maintenance functions described here (PPU 0 memory display and deadstart dump). When either of these options are selected via the deadstart panel switches (yyy), it is necessary to reset the switches in order to perform another deadstart function. However, when these functions are selected via the options display, it is not necessary to reset the deadstart panel to perform another deadstart function. Simply activate the deadstart switch and the options display reappears. Additional options can then be selected and/or the system deadstart can be performed. Refer to the procedure for system deadstart with options displayed for a description of the options available.

## SELECTING THE CMRDECK

The equipment configuration to be used for KRONOS operations is defined by a CMRDECK read from the deadstart tape. Up to 64 CMRDECKs can be included on the deadstart tape (numbered 0 through 63). This provides an installation with the ability to select one of several equipment configurations when the system is deadstarted. However, it is important to note that the CMRDECK to be used is only selected during a level 0 (initial) deadstart. Should it become necessary to perform a level 1, 2, or 3 (recovery) deadstart, the CMRDECK selected during the most recent level 0 deadstart must be used. Refer to the discussion under Entering Word 14 for information concerning the levels of deadstart.

The number of the CMRDECK to be used is selected by setting the switches shown in the unshaded area of the deadstart panel illustrated.

0001	111	101	ccc	ccc
0002	111	111	ccc	ccc
0003	eee	000	00u	uuu
0004	111	111	ccc	ccc
0005	000	000	001	000
0006	111	111	ccc	ccc
0007	001	100	000	000
0010	111	100	ccc	ccc
0011	111	001	ccc	ccc
0012	110	110	000	110
0013	000	xxx	xxx	yyy
0014	rrr	ppp	sss	sss

xxx xxx Specifies the CMRDECK number (0 through 63) to be used.

For example, assume that CMRDECK number 0 is to be used to define the equipment configuration at deadstart. In this case, the corresponding switches on the deadstart panel would be set as follows (0 indicates that switch is placed in down position):

xxx xxx 000 000

It is not necessary to specify the CMRDECK on the deadstart panel if system deadstart with options displayed is selected in word 13 (yyy=001). In this case, the options provided allows the operator to specify the CMRDECK to be used from the console keyboard. In addition, values entered via the options display have precedence over those specified on the deadstart panel. For example, bits 3 through 8 of word 13 on the deadstart panel (xxx xxx) could be set to select the CMRDECK most frequently used by an installation. Another CMRDECK could then be selected when necessary via the options display during a level zero deadstart.

## ENTERING WORD 14

Setting the deadstart panel switches for word 14 has significance only when performing a system deadstart (refer to Selecting the Deadstart Function). Three unique fields exist that must be considered when entering word 14. The switches which represent these fields are shown in the unshaded area of the deadstart panel illustrated.

0001	111 101 ccc ccc	sss sss	Specifies the mass storage devices on which the system library is to reside.
0002	111 111 ccc ccc		
0003	eee 000 00u uu		
0004	111 111 ccc ccc	ppp	Specifies the central processor control options.
0005	000 000 001 000		
0006	111 111 ccc ccc		
0007	001 100 000 000		
0010	111 100 ccc ccc	rrr	Specifies the level of system deadstart to be performed.
0011	111 001 ccc ccc		
0012	110 110 000 110		
0013	000 xxx xxx yyy		
0014	rrr ppp sss sss		

It is not necessary to enter word 14 on the deadstart panel if system deadstart with options displayed is selected in word 13 (yyy=001). In this case, the options provided allow the operator to enter all values for word 14 from the console keyboard. Values entered via the options display have precedence over those specified on the deadstart panel. For example, the switches for word 14 on the deadstart panel could be set to specify values most frequently used by an installation and then modified when necessary via the options display.

Individual descriptions of each field in word 14 are given in the following discussion. All valid switch positions are described. A 1 indicates that the corresponding switch is placed in the up position; a 0 indicates the down position.

0014  rrr  ppp  sss  sss                      Select System Device(s)

These switches (bits 0 through 5) correspond to the mass storage devices defined in the first six entries (ordinals 0 through 5) of the equipment status table (EST). Each switch placed in the up position specifies that the system library will reside on the corresponding mass storage device. If more than one device is specified, system efficiency can be greatly improved because more than one system file can then be accessed at the same time. However, all devices specified must be of the same type.

When it is desired to make modifications to the CMRDECK during deadstart, no system device can be specified on the deadstart panel (sss sss=000 000). In this case, a CMRDECK instruction display (CMRINST) appears on the console screens and provides the operator with all valid CMRDECK entries. One of these is the SYSTEM entry whereby any of the same type of mass storage devices assigned to the first 17<sub>8</sub> EST entries can be defined as system devices. A maximum of six system devices can be specified via the deadstart panel switches. For additional information concerning CMRDECK modification during deadstart, refer to System Deadstart Procedures described later in this section.

In summary, three opportunities exist for the operator to select the system device(s).

1. Place one or more of the six rightmost switches of word 14 on the deadstart panel (sss sss) in the up position.
2. Select option to enter word 14 via the options display (refer to description of Deadstart With Options Displayed later in this section).
3. Specify the SYSTEM entry when making CMRDECK modifications.

If the operator does not specify a system device, the system library will reside on the mass storage device assigned to the first entry of the EST by default.

0014 rrr ppp sss sss

### Select Central Processor Options

Value of ppp  
(bits 6-8)

Description

Bit 6 = 0	Indicates that CPU 0 (zero) is available in the system (switch in down position). This switch has significance only for dual CPU systems and is normally left in this position.
= 1	Indicates that CPU 0 is not available in the system (switch in up position). On dual CPU systems, this allows use of the system when CPU 0 is down. However, if either CPU is disabled in a dual CPU system, detection of the compare move unit (CMU) is also disabled. Disabling CPU 1 on single CPU systems inhibits detection of the CMU (bit 7 placed in up position). CPU 0 and CPU 1 should not be disabled simultaneously (bits 6 and 7 both placed in up position).
Bit 7 = 0	Indicates the CPU 1 is available in the system (switch in down position). This switch has significance only for dual CPU systems and is normally left in this position. If bits 6 and 7 are both set to zero (switches in down position), the system will automatically determine if both CPUs are available and initialize accordingly.
= 1	Indicates that CPU 1 is not available in the system (switch in up position). On dual CPU systems, this allows use of the system when CPU 1 is down. However, if either CPU is disabled in a dual CPU system, detection of the compare move unit (CMU) is also disabled. Disabling CPU 1 on single CPU systems inhibits detection of the CMU. CPU 0 and CPU 1 should not be disabled simultaneously (bits 6 and 7 both placed in up position).
Bit 8 = 0	Indicates that CEJ/MEJ option is enabled (switch in down position).
= 1	Disables CEJ/MEJ option (switch in up position). This is not recommended since KRONOS will automatically determine if the CEJ/MEJ option is present and initialize accordingly. Thus, this switch should always be set to the down position (bit 8 = 0). System failure may result if the CEJ/MEJ option is present in the system and is disabled in this manner.

If it is necessary to disable the CEJ/MEJ option for maintenance purposes, the keylock switch labeled CEJ/MEJ at the bottom of the dead-start panel should be used (refer to Figure 2-1 earlier in this section).

Value of rrr  
(bits 9-11)

Description

000

Indicates an initial or level 0 (zero) deadstart in which the system is loaded from the deadstart tape. This is not considered to be a recovery deadstart although permanent files are recovered automatically. An attempt to recover permanent files is made on all levels of system deadstart. Level zero deadstart is normally specified under the following conditions.

- For the first deadstart following a period in which the system has been inoperative, or has been used for purposes other than KRONOS operations.
- When a system malfunction has occurred and other levels of system deadstart prove ineffective.

If it becomes necessary to redeadstart the system (for example, due to system malfunction), it is recommended that a level 3 recovery deadstart be attempted. If level zero is selected, all jobs and active files are lost and the system is reloaded from the deadstart tape.

001

Indicates a level 1 recovery deadstart whereby the system, all jobs, and all active files are recovered from checkpoint information on mass storage. Permanent files are also recovered. A level 1 recovery deadstart is normally performed following a system malfunction that destroys the contents of central memory. Level 1 recovery is effective only if the DSD command CHECK POINT SYSTEM (refer to section 3) has been issued prior to the system malfunction. In addition, if a significant amount of system activity has taken place since the last checkpoint was performed, the checkpoint information may no longer be reliable. In this case, it is recommended that a level zero (initial) deadstart be performed. It may be desirable to perform a level 1 recovery deadstart temporarily (where possible) in order to dump accounting information (refer to DSD command ACCOUNT in section 3).

Unless the operator is certain that the contents of central memory was destroyed by the system malfunction, he should always attempt to perform a level 3 recovery deadstart (rrr=011) before attempting level 1 recovery.

010

Indicates a level 2 recovery deadstart whereby all jobs and active files are recovered from checkpoint information on mass storage. However, no attempt is made to recover the system. Instead, the system is loaded from the deadstart tape as in level 0 deadstart. In all other respects, level 2 recovery deadstart is identical to that described for a level 1 recovery deadstart (refer to preceding description).

Level 2 recovery deadstart is normally used in system test situations and is not recommended for the normal KRONOS production environment.

Value of rrr  
(bits 9-11)

Description

011	Indicates a level 3 recovery deadstart whereby the system, all jobs, and all active files are recovered from central memory tables. Permanent files are also recovered. A level 3 recovery deadstart is normally performed following an equipment malfunction (for example, channel or PPU hung) providing the system remains intact. It is recommended that a level 3 recovery deadstart be attempted before resorting to level 1 or level 0 deadstart.
-----	----------------------------------------------------------------------------------------------------------------------------------------------------------------------------------------------------------------------------------------------------------------------------------------------------------------------------------------------------------------------------------------------------------------------------------------------------------

For additional information concerning levels of deadstart, refer to Preparing for Recovery Deadstart later in this section under System Deadstart Procedures.

## SYSTEM DEADSTART PROCEDURES

Either of two system deadstart procedures can be selected by setting bits 0 through 2 of word 13 on the deadstart panel (yyy). The options available are:

- Automatic system deadstart (yyy=000)
- System deadstart with options displayed (yyy=001)

Each of these procedures essentially performs the same function. The only difference is the measure of operator control. Although considerable intervention is allowed when the procedure for automatic system deadstart is selected, the options provided in the latter procedure extend operator control significantly. It should be noted that nearly all operator control during system deadstart is preliminary. That is, the operator merely specifies the conditions of deadstart. Once this is done, deadstart proceeds automatically and operator intervention is not required again until the system is initialized unless an error is encountered (refer to Initializing the System). Generally, this automatic process consists of the following steps.

1. Validate labels on all mass storage devices. This is done to ensure that the configuration matches that specified in the CMRDECK being used.
2. Build central memory tables that reflect information contained in the device labels (level zero deadstart only). If a recovery deadstart is being performed, the central memory tables can be recovered from checkpoint information on mass storage (level 1, 2) or verified against information in device labels if central memory is found to be intact (level 3).
3. Load base operating system (core system) programs into central memory. Again, the level of deadstart determines the amount of loading to be performed.

Deadstart progress can be monitored on the console display screens. If errors are encountered during deadstart, a descriptive message is displayed on the right console screen and deadstart halts. Refer to Error Processing at the end of this section for complete information and corrective action.

## AUTOMATIC SYSTEM DEADSTART

Although this procedure can be fully automatic, some measure of operator intervention is also possible. This is usually limited to modification of the CMRDECK being used. Under normal circumstances, this is necessary only when initializing a mass storage device or selecting an IPRDECK (installation parameters) other than the one currently specified in the CMRDECK.

The following procedure assumes that all mass storage devices are mounted and/or available, the deadstart tape is mounted properly, and the deadstart panel is set correctly (refer to Mounting the Deadstart Tape and Setting the Deadstart Panel earlier in this section).

1. This step summarizes the settings for words 13 and 14 on the deadstart panel. Check to ensure that the fields in these words are set as follows:
  - a. Word 13, bits 0 through 2 (yyy) must be set to 000.
  - b. Word 13, bits 3 through 8 (xxx xxx) must be set to specify the CMRDECK number to be used.
  - c. Word 14, bits 0 through 5 (sss sss) specifies the mass storage devices (corresponding to EST ordinals 0 through 5) on which the system library is to reside. If more than one device is specified, they must be of the same type. If a system device is specified, the deadstart procedure is fully automatic. If CMRDECK modifications are to be made, this field must be set to zero (sss sss=000 000).
  - d. Word 14, bits 6 through 8 (ppp) specifies the central processor control options. This field is normally set to 000.
  - e. Word 14, bits 9 through 11 (rrr) specifies the level of deadstart to be performed.

Refer to topics under Setting the Deadstart Panel for complete information.

2. Initiate deadstart process.

Initiate the deadstart process by momentarily activating the deadstart switch (2 to 3 seconds). Either the pushbutton switch on the console (located in the center of the console just below the display screens) or the toggle switch labeled DEAD START on the lower portion of the deadstart panel may be used.

If one or more system devices were specified in bits 0 through 5 of word 14 (fully automatic procedure), proceed to step 6. Otherwise, continue with the following step.

3. Modify CMRDECK.

If bits 0 through 5 of word 14 are set to zero (sss sss=000 000), an instruction display entitled CMRINST appears on the console screens immediately after activating the deadstart switch. All valid CMRDECK entries are defined in this display. Several of the entries listed are assigned system default values. These values are assumed if the entries do not appear in the CMRDECK being used. To view the contents of the CMRDECK being used, press the right blank key (rightmost key on top row of console keyboard - refer to illustration at beginning of section 3). The CMRINST display is returned by pressing the right blank key again. The display alternates each time the right blank key is pressed.

CMRDECK modification is accomplished by entering the appropriate changes or additions from the console keyboard. These entries can be made when either CMRDECK or CMRINST is being displayed. Each console entry supersedes the value currently specified in the CMRDECK (or default value in CMRINST). However, the modified CMRDECK remains in effect only until the next deadstart is performed. That is, changes to the CMRDECK are not recovered across deadstart unless a new deadstart tape is created to reflect those changes.

Since the extent of operator responsibility to effect CMRDECK modifications may vary from one installation to another, the following items describe only the more common operator entries. Refer to section 4 in part II of the KRONOS Installation Handbook for complete information concerning all CMRDECK entries.



- a. IPD entry. This entry allows the operator to select an alternate IPRDECK (installation parameters) from the deadstart tape. Up to 4096 decimal IPRDECKs can be included on the KRONOS deadstart tape (numbered 0 through 4095). If an IPD entry is not included in the current CMRDECK display, the first IPRDECK on the deadstart tape is selected by default (IPD=0 on CMRINST display). Type this entry in the following format.

IPD=n. (CR) (n is the alternate IPRDECK number)

- b. INITIALIZE entry. The purpose of this entry is to blank label a mass storage device during a level 0 deadstart. This entry is valid only when entered from the console keyboard. That is, the INITIALIZE entry cannot be included as part of the CMRDECK on the deadstart tape.

Before any mass storage device defined in the CMRDECK (by an EQ entry) can be used, it must have a label that can be recognized by KRONOS. Existing labels are normally recovered automatically during all levels of system deadstart. However, should the existing label be destroyed (for example, during maintenance operations on the device) or a new mass storage device be added to the system, a new label must be created. This is the function of the INITIALIZE entry to CMRDECK. When the new label is created, all previously existing information on the device, including permanent files, is effectively lost. Type this entry in the following format.

INITIALIZE, xx, nc. (CR)

- xx 1 to 2 digit number specified in EQ entry for device (for example, EQ05...). This is also the EST ordinal for the device.
- nc Optional 1 to 3 octal digit parameter that specifies the number of catalog tracks allowed on the device if other than default. This parameter applies only if the device being initialized is to be a permanent file master device (that is, if permanent file catalogs will reside on the device). The default values for each mass storage device type are:

<u>Device</u>	<u>EQ Designator</u>	<u>Default No.</u>
813/814	DF	100
821	DH	100
841	MD	20
844	DI	20
853/854	DD	4
863	DC	2
6603	DA	10
6638	DB	10
ECS	DE	2
ECS with DDP	DP	2

If other than the default value is desired, the legal range is 1 through 200<sub>8</sub>, and must be a power of 2.

If permanent files are to reside on the device being initialized, the CMRDECK must contain a PF entry for that device. The PF entry corresponds to the EST ordinal specified in the EQ entry, and indicates that permanent files can reside on the device. If the CMRDECK displayed contains a PF entry for the device being initialized, a new PF entry is not required unless the existing entry is to be altered, or the associated EQ entry is altered. Modification of an existing EQ entry clears all other

associated entries, except a SYSTEM entry (PF, INITIALIZE, etc., are cleared). In addition, if PF entries do not currently exist in the CMRDECK, initializing a permanent file device will clear the PF entry in the device's label. Thus, it is necessary to reestablish the PF entry via the console keyboard if the device is to remain a permanent file device. For this reason, it is recommended that the PF entry for all mass storage devices used for permanent files be resident in the CMRDECK. Although this is recommended, it is not required. Refer to section 4 in part II of the KRONOS Installation Handbook for complete information concerning the PF entry to CMRDECK.

If the EQ entry in the CMRDECK displayed indicates that the status of a particular mass storage device is OFF when the INITIALIZE entry is made, initialize status is maintained and occurs automatically when the DSD command ON is entered for that device during normal system operation.

It should be noted that initialization of mass storage devices can also be accomplished during normal system operation via the DSD command INITIALIZE (refer to description of command in section 3).

- c. SYSTEM entry. This entry enables the operator to specify the mass storage devices on which the KRONOS system library is to reside. If CMRDECK modification was not necessary, this specification would normally have been made on the deadstart panel (bits 0 through 5 of word 14). The SYSTEM entry is valid only when entered from the console keyboard. That is, it cannot be included as part of the CMRDECK on the deadstart tape. In addition, new system devices can only be specified during a level 0 deadstart. For recovery deadstart levels 1 and 2, the system devices specified must be the same as those specified during the previous level 0 deadstart. The CMRDECK is ignored and the current equipment configuration is retained if level 3 recovery deadstart is selected.

Any mass storage device defined by an EQ entry in the CMRDECK (numbered 0 through 17 octal) can be specified as a system device. However, the following restrictions exist.

- EQ entry defining device in CMRDECK cannot have status set to OFF.
- EQ entry defining device in CMRDECK cannot have a corresponding REMOVE entry. In this case, the device would be termed removable and as such, not suitable for a system device.
- If more than one device is specified as a system device, all devices specified must be of the same type.

Throughput can be greatly improved by specifying more than one system device because more than one system file can then be accessed at the same time. For example, if just two system devices are used instead of one, the time required to access system programs can be reduced by as much as one half. All mass storage devices of the same type can be specified as system devices. Specifying system devices via the deadstart panel (word 14) restricts the total number that can be specified to six.

Type this entry in the following format.

SYSTEM=xx<sub>1</sub>,...,xx<sub>n</sub>. (CR)

xx      1 to 2 digit number specified in EQ entry for device  
(for example, EQ05...). This is also the EST ordinal for  
the device.

NOTE

If a SYSTEM entry is not made (that is, no system devices defined), the system library will reside on the mass storage device defined in EST ordinal zero by default.

After completing all CMRDECK modifications, the operator may also modify the IPRDECK being used. The specific IPRDECK to be used, if other than default, was selected in item a of this step (IPD entry). The IPRDECK contains installation parameters which describe the mode of system operation. It is important for the operator to note that nearly all IPRDECK entries are also valid DSD commands. Therefore, IPRDECK modification is seldom required during deadstart since DSD commands can be used to make the same changes during normal system operation as the need arises. Installation parameters changed during normal system operation (via DSD commands) are not retained across any level of system deadstart. All valid DSD commands are described in section 3 of this manual.

If it is necessary to modify the IPRDECK, continue with step 4. Otherwise, proceed to step 5.

4. Modify IPRDECK.

When the CMRDECK or CMRINST is currently being displayed, type

NEXT. (CR)

An instruction display entitled IPRINST appears on the console screens immediately after pressing the carriage return key (CR). All valid IPRDECK entries are defined in this display. Most of these entries are also valid DSD commands. To view the contents of the IPRDECK being used, press the right blank key. The IPRINST display is returned by pressing the right blank key again. The display alternates each time the right blank key is pressed.

IPRDECK modification is accomplished by entering the appropriate changes or additions from the console keyboard. These entries can be made when either IPRINST or IPRDECK is being displayed. Each console entry supersedes the value currently specified in the IPRDECK. However, the modified IPRDECK remains in effect only until the next level 0 deadstart is performed. That is, changes to the IPRDECK are not recovered across level 0 deadstart unless a new deadstart tape is created to reflect those changes.

For complete information concerning IPRDECK entries, refer to section 5 in part II of the KRONOS Installation Handbook and also section 3 of this manual (DSD commands).

5. To signal that all modifications to the CMRDECK and/or IPRDECK have been completed, the operator types

GO. (CR)

6. If a level 0 or level 2 system deadstart is being performed, the deadstart tape is rewound to load point before the system library is loaded. The system library is automatically loaded from the deadstart tape to each mass storage device specified as a system device. In the event that no system device was specified, the system is loaded to the mass storage device defined by EST ordinal 0 (first entry in EST).

If a level 1 or level 3 recovery deadstart is specified, the system library is not loaded from the deadstart tape. In this case, the deadstart tape is rewound to load point and is not accessed again until another deadstart operation is performed. The system library is recovered from checkpoint information on mass storage. Central memory resident (CMR) tables such as the file name table (FNT), equipment status table (EST), and track reservation table (TRT) are either recovered from checkpoint information (level 1) or from central memory (level 3).

If a deadstart error occurs, a descriptive message appears on the right console screen, and depending upon the nature of the error, deadstart processing may halt. Refer to Error Processing at the end of this section for complete information and corrective action. In addition, if the system is being loaded from the deadstart tape (level 0, 2 only), the name of each system library program is also displayed on the right console screen as it is being loaded. This allows the operator to monitor deadstart progress.

The left console screen contains the message ENTER DATE YY/MM/DD. and indicates that the operator may begin system initialization (refer to Initializing the System later in this section). System initialization can be performed while the system is being loaded.

## SYSTEM DEADSTART WITH OPTIONS DISPLAYED

The following procedure differs only slightly from that described for Automatic System Deadstart. In fact, the only difference is that an options display is provided to enable greater operator control over the deadstart process. It is assumed that all mass storage devices are mounted and/or available, the deadstart tape is mounted properly, and words 0001 through 0014 on the deadstart panel have been set correctly (refer to Mounting the Deadstart Tape and Setting the Deadstart Panel earlier in this section).

1. This step summarizes the settings for words 13 and 14 on the deadstart panel.

Check to ensure that bits 0 through 2 of word 13 (yyy) is set to 001. This is a mandatory setting. The remaining field in word 13 and all fields of word 14 are optional since the options display allows the operator to specify values for these fields from the console keyboard. However, it is recommended that these fields be set on the deadstart panel in order to establish default values. In this case, the options display can be used when it is required to alter the default values established on the deadstart panel.

2. Initiate deadstart process.

Initiate the deadstart process by momentarily activating the deadstart switch (2 to 3 seconds). Either the pushbutton switch on the console (located in center of console just below the display screens) or the toggle switch labeled DEAD START on lower portion of deadstart panel may be used.

3. Select appropriate options from options display.

The deadstart options display illustrated appears on the left console screen immediately after activating the deadstart switch. Each of the options may be selected

simply by entering the corresponding one or two character code on the console keyboard. Each option is described individually following the illustration.

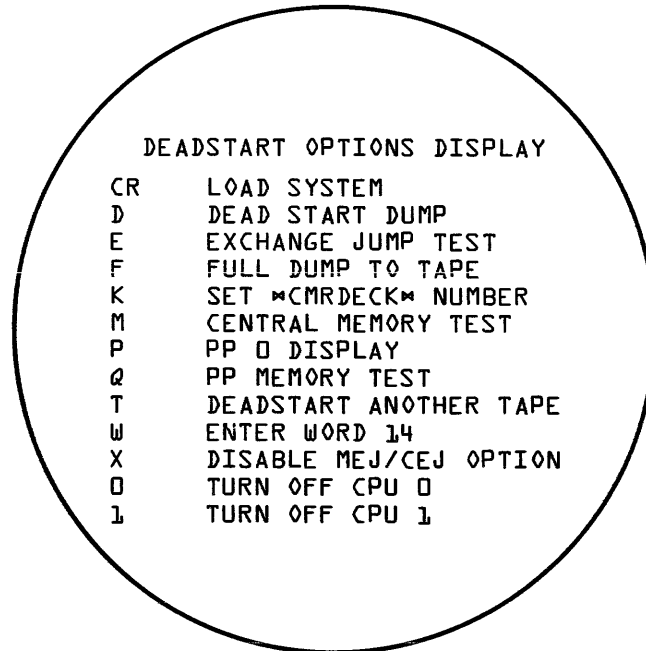

Option

Description

CR Load System. Pressing the carriage return key (CR) when deadstart options are displayed causes system deadstart processing to continue. Additional options cannot be selected after this entry. This has special significance with respect to the K, W, X, 0, and 1 options. That is, if values specified for word 13 or word 14 on the deadstart panel are to be modified, the changes must be completed before entering this option.

Operator intervention after the CR option is entered is the same as that described in the procedure for Automatic System Deadstart. Continue with one of the following steps in that procedure.

- a. If bits 0 through 5 of word 14 are set to zero via the deadstart panel switches or by using the W option (no system device specified), continue with step 3 in the procedure for Automatic System Deadstart (disregard comment in first sentence concerning the deadstart switch).
- b. If one or more system devices are specified in bits 0 through 5 of word 14, continue with step 6 in the procedure for Automatic System Deadstart.

D Dead Start Dump. This option temporarily changes the deadstart function from system to maintenance deadstart. Deadstart dump is a maintenance task that can be used to selectively dump the contents of PPU memory and/or central memory to a specified line printer.

Option

Description

Refer to section 3 in part II of the KRONOS Installation Handbook for deadstart dump procedures.

When this maintenance task is completed, simply activate the deadstart switch again. The options display reappears and additional options can then be selected.

- E Exchange Jump Test. This option temporarily changes the deadstart function from system to maintenance deadstart. The maintenance task performed tests the exchange jump package to determine the reliability of the hardware.

NOTE

The exchange jump test alters the contents of central memory. Thus, a level 3 recovery deadstart cannot be performed if this option is selected.

When this maintenance task is completed, simply activate the deadstart switch again. The options display reappears and additional options can then be selected.

- F Full Dump to Tape. This option temporarily changes the deadstart function from system to maintenance deadstart. Full dump to tape is a maintenance task that can be used to dump the contents of all PPUs' memory as well as central memory to magnetic tape. ECS can optionally be dumped. Later, all or part of this dump can be printed for observation. Refer to section 3 in part II of the KRONOS Installation Handbook for full dump to tape procedures.

When this maintenance task is completed, simply activate the deadstart switch again. The options display reappears and additional options can then be selected.

- K Set CMRDECK Number. This option displays the current CMRDECK number, specified by bits 3 through 8 of word 13 on the deadstart panel, and allows selection of an alternate CMRDECK. If a level 1 or level 2 recovery deadstart is to be performed, the CMRDECK selected during the most recent level 0 deadstart must be used. The CMRDECK is ignored and the current equipment configuration is retained if a level 3 recovery deadstart is performed.

The display produced temporarily replaces the options display and consists of the following one line message that appears in the center of the screen.

```
SET CMRDECK 00,
                 |
                 | (current CMRDECK number)
```

The operator then enters the number of the alternate CMRDECK to be used. The number entered replaces the number currently displayed. Pressing the carriage return key (CR) returns the options display and additional options can then be selected.

For additional information concerning CMRDECK selection, refer to Selecting the CMRDECK earlier in this section.

Option

Description

M Central Memory Test. This option temporarily changes the deadstart function from system to maintenance deadstart. The maintenance task performed tests the reliability of central memory.

NOTE

The central memory test alters the contents of central memory. Thus, a level 3 recovery deadstart cannot be performed if this option is selected.

When M is entered, the deadstart options display is replaced by the central memory test options display. This display provides options to select the memory test pattern to be used.

When this maintenance task is completed, simply activate the deadstart switch again. The deadstart options display reappears and additional options can then be selected.

P PP 0 Display. This option temporarily changes the deadstart function from system to maintenance deadstart. The maintenance task performed displays the contents of PPU 0 (zero) memory on both console screens. This option is generally used by the site analyst or customer engineer (CE) to enter sample PPU programs (for example, to test peripheral devices on the system).

When this maintenance task is completed, simply activate the deadstart switch again. The options display reappears and additional options can then be selected.

Q PP Memory Test. This option temporarily changes the deadstart function from system to maintenance deadstart. The maintenance task performed tests memory reliability for each PPU in the system.

When this maintenance task is completed, simply activate the deadstart switch again. The options display reappears and additional options can then be selected.

T Deadstart Another Tape. This option allows an alternate deadstart tape to be used. The alternate deadstart tape unit must be connected to the same channel as the current deadstart tape unit.

The options display is temporarily replaced by the following one line message that appears in the center of the screen.

DEAD START TAPE 0000

Option

Description

The operator then enters the tape unit and controller number in the following format.

e0uu

e Represents the tape controller number to which the tape unit is connected.

uu Represents the physical unit number of the tape unit on which the alternate deadstart tape is mounted (number is indicated on selector switch at top of unit).

The numbers entered replace the zeros currently displayed. When the carriage return key (CR) is pressed, the options display from the alternate deadstart tape appears on the left console screen. New options can then be selected.

W Enter Word 14. This option is available to modify any or all values set in word 14 on the deadstart panel.

The options display is temporarily replaced by the following one line message that appears in the center of the screen. This is the octal image of the values currently specified in word 14.

WORD 14 rpss

(current value of word 14)

r Designates current level of system deadstart.

p Designates current central processor control options. If this is the only field to be altered, refer to description of X, 0, or 1 option.

ss Designates current system devices. ss represents bits 0 through 5 of word 14 and also corresponds to the devices defined by EST entries 0 through 5.

The operator then enters the new value (octal) for each field. All fields must be entered even if only one is to be altered. In addition, the values are entered from right to left (value for r entered first). Refer to Entering Word 14 earlier in this section for complete information concerning all fields of word 14.

After entry is complete, press the carriage return key (CR) to return the options display. Additional options can then be selected.



Example:

This example illustrates how level 0 (initial deadstart can be selected if level 3 recovery deadstart is currently specified in word 14 on the deadstart panel. Assume that word 14 is set as follows on the deadstart panel (typical setting):

	r	p	s	s	
0014	011	000	000	011	(1 indicates switch in up position)

- r Indicates level 3 recovery deadstart.
- p Indicates no central processor options set.
- ss Indicates system resides on devices defined by entries 0 and 1 in EST.

To select a level 0 system deadstart, enter the W option from the options display. The resulting display is

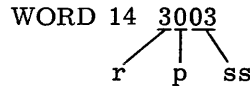

The value 3003 is the octal equivalent of the word 14 switch settings (binary) shown.

Level 0 deadstart can now be specified by entering the following value.

0003

The resulting display is

WORD 14 0003

Pressing the carriage return key (CR) returns the options display and additional deadstart options can then be selected. When the CR option is selected, the level 0 system deadstart is performed.

- X Disable MEJ/CEJ Option. The X option can be used to disable the CEJ/MEJ option if it is enabled on the deadstart panel (switch for bit 8 of word 14 set to down position). There is no visual indication that this option has been entered. That is, the options display remains on the screen and additional options can be entered immediately. In addition, pressing the carriage return key (CR) after entering this option will initiate loading of the system (refer to description of CR option).

Use of this option is not recommended since KRONOS will automatically determine if the CEJ/MEJ option is present in the system hardware and initialize accordingly. System failure may result if the CEJ/MEJ option is disabled either by setting the switch for bit 8 of word 14 to the up position, or by entering this option.

If it is necessary to disable the CEJ/MEJ option for maintenance purposes, the keylock switch labeled CEJ/MEJ on the lower portion of the deadstart panel should be used. Also, this must be done before activating the deadstart switch.

0  
(zero)

Turn Off CPU 0. This option can be used to disable CPU 0 if it is currently enabled on the deadstart panel (switch for bit 6 of word 14 set to down position). There is no visual indication that this option has been entered. That is, the options display remains on the screen and additional options can be entered immediately. In addition, pressing the carriage return key (CR) after entering this option will initiate loading of the system (refer to description of CR option).

On dual CPU systems, this option allows use of the system when CPU 0 is down. If either CPU is disabled in a dual CPU system, detection of the compare move unit (CMU) is also disabled. Disabling CPU 1 on single CPU systems inhibits detection of the CMU. CPU 0 and CPU 1 should not be disabled simultaneously.

If both CPU 0 and CPU 1 are enabled on the deadstart panel and are not disabled using the 0 or the 1 option, the system will automatically determine if both CPUs are available and initialize accordingly.

1

Turn Off CPU 1. This option can be used to disable CPU 1 if it is currently enabled on the deadstart panel (switch for bit 7 of word 14 set to down position). There is no visual indication that this option has been entered. That is, the options display remains on the screen and additional options can be entered immediately. In addition, pressing the carriage return key (CR) after entering this option will initiate loading of the system (refer to description of CR option).

On dual CPU systems, this option allows use of the system when CPU 1 is down. If either CPU is disabled in a dual CPU system, detection of the compare move unit (CMU) is also disabled. Disabling CPU 1 on single systems inhibits detection of the CMU. CPU 0 and CPU 1 should not be disabled simultaneously.

If both CPU 0 and CPU 1 are enabled on the deadstart panel and are not disabled using the 0 or the 1 option, the system will automatically determine if both CPUs are available and initialize accordingly.

In summary, it may be helpful to observe the following guidelines when selecting deadstart options and determining the order in which they should be entered.

1. Since it is necessary to redeadstart upon completion of a maintenance task, options that select maintenance tasks should always be entered first (refer to description of D, E, F, M, P, and Q option). For example, if other options were entered prior to selecting a maintenance task, they would be cleared when the deadstart switch is activated.

However, it is generally not required to select a maintenance task. In addition, these options are used primarily by the system analyst or customer engineer.

2. If it is necessary to specify an alternate deadstart tape (refer to description of T option), this should be done after the last maintenance task has completed.
3. Enter options necessary to alter the values of word 13 and/or word 14 on the deadstart panel (refer to description of K, W, X, 0, and 1 options).
4. Enter the CR option last. This causes system deadstart processing to continue. Refer to the description of the CR option for complete information.

## PREPARING FOR RECOVERY DEADSTART

During system operation, there are times that an error occurs that prevents further system activity and that cannot be corrected by operator action. Often the situation can be corrected by deadstarting the system and recovering prior activity. The success of such a recovery depends upon the severity of the problem and to what extent system information has been destroyed. There are three levels of recovery deadstart available (levels 1 to 3). Table 2-2 lists each deadstart level, including level 0 (initial deadstart), and describes the extent of recovery possible.

TABLE 2-2. LEVELS OF SYSTEM DEADSTART

Deadstart Level	Information Recovered			
	Jobs	Active Files	Perm. Files	System
0	No	No	Yes	No
1	Recovered from last checkpoint	Recovered from last checkpoint	Yes	Recovered from last checkpoint
2	Recovered from last checkpoint	Recovered from last checkpoint	Yes	No
3	Recovered from CM copy of FNT†	Recovered from CM copy of FNT	Yes	Yes

The following topics provide general information concerning each level of system deadstart and recommended steps of preparation.

### LEVEL 3 RECOVERY

A level 3 recovery deadstart is typically performed following an equipment malfunction (for example, channel or PPU hung) providing the system remains intact. Basically, the file name table (FNT), track reservation table (TRT), equipment status table (EST), and control point areas of central memory must be intact in order to successfully perform a level 3 recovery deadstart. However, unless it can be determined that central memory is no longer intact, it is recommended that level 3 recovery be attempted before another deadstart level is selected. This is recommended because current system activity, as it existed at the time of the malfunction, can best be recovered by performing a level 3 recovery deadstart. The following rules apply.

† Jobs in central memory (CM) at this time will be restarted. The INPUT file is rewound and put back in the input queue.

1. Deadstart options E and M cannot be specified if the procedure for System Deadstart With Options Displayed is used. Both the E and M option (exchange jump test and central memory test, respectively) alter the contents of central memory making a level 3 recovery deadstart impossible.
2. Level 3 recovery deadstart is impossible after an attempted checkpoint recovery (level 1), or after an aborted level 0 (initial) deadstart.

Often, many errors encountered during a level 3 recovery deadstart can be avoided by entering the following DSD commands before beginning the system deadstart procedure (that is, before activating the deadstart switch).

1. ONSW1.	Enters all time-sharing uses into recovery state. This and the following commands are necessary only if TELEX (time-sharing executive routine) is active.
1. STOP.	Drops TELEX
IDLE.	Idles active control points and prevents scheduling of new jobs to a control point.
CHECK POINT SYSTEM.	Rolls out all jobs and writes contents of central memory tables to mass storage.
UNLOCK.	Necessary only if console is currently locked.
STEP.	Prevents the system from processing PPU requests. This stops all central memory I/O operations.

### LEVEL 1 RECOVERY

When a system malfunction that destroys the contents of central memory is encountered, a level 1 recovery deadstart can be selected. However, this should be done with extreme caution because recovery is from checkpoint information on mass storage. If there is any question concerning the reliability of the checkpoint information, perform a level 0 (initial) deadstart. Failure to do this may jeopardize the integrity of permanent files. In the event that the checkpoint information is not reliable, it may be possible to perform a level 1 recovery deadstart on a temporary basis in order to dump accounting information (refer to DSD command ACCOUNT in section 3). Unless the operator is certain that the contents of central memory was destroyed by the system malfunction, he should first attempt to perform a level 3 recovery deadstart.

The following rules apply when performing a level 1 recovery deadstart.

1. The DSD command CHECK POINT SYSTEM (refer to section 3) must be issued prior to the system malfunction. If a significant amount of system activity has taken place since the last checkpoint was performed, the checkpoint information on mass storage, used in level 1 recovery, may no longer be reliable. If a checkpoint is not performed prior to system malfunction, error messages will be issued to the error log dayfile upon completion of a level 1 recovery deadstart (message ROLLIN FILE BAD is common).
2. The mass storage equipment configuration must be the same as specified during the most recent level 0 deadstart. That is, the same CMRDECK must be used.
3. The system devices (mass storage devices on which the system library resides) must be the same as specified during the most recent level 0 deadstart.

To recover all jobs and active files during a level 1 recovery deadstart the operator should attempt to enter the following DSD commands prior to beginning the system deadstart procedure (that is, before activating the deadstart switch).

- |                     |                                                                                                                                                          |
|---------------------|----------------------------------------------------------------------------------------------------------------------------------------------------------|
| 1. ONSW1.           | Enters all time-sharing uses into recovery state. This and the following command are necessary only if TELEX (time-sharing executive routine) is active. |
| 1. STOP.            | Drops TELEX                                                                                                                                              |
| IDLE.               | Idles active control points and prevents scheduling of new jobs to a control point.                                                                      |
| CHECK POINT SYSTEM. | Rolls out all jobs and writes contents of central memory tables to mass storage.                                                                         |

### LEVEL 2 RECOVERY

Level 2 recovery deadstart is normally used in system test situations and is not recommended for the normal KRONOS production environment. If level 2 recovery is selected, all jobs and active files are recovered from checkpoint information on mass storage as in level 1 recovery. However, no attempt is made to recover the system. Instead, the system is loaded from the deadstart tape as in level 0 deadstart. In all other respects, level 2 recovery is identical to that described for level 1 in the preceding description, and all rules apply.

### LEVEL 0 DEADSTART

Level 0 or initial deadstart is used in cases where a recovery deadstart is not possible. This is a complete or initial load from the deadstart tape. Only permanent files are recovered (permanent files are recovered on all levels of system deadstart). All jobs and active files are lost and the system is reloaded from the deadstart tape.

## **INITIALIZING THE SYSTEM**

Each time a system deadstart function is performed, it is necessary to initialize the system. Essentially, this consists of entering the current date and time. The system uses the date and time (updated every second) for dayfile messages and to update permanent file catalogs and directories for files being accessed. This includes the creation, last modification, and last access date and time for each permanent file in the system. Thus, it is extremely important to enter the correct date and time in order to accurately maintain these system records. If a level 3 recovery deadstart is being performed, it is possible to recover the date and time from the previous system deadstart. However, this is not recommended since the new date and time recorded for system records would no longer be accurate.

When the system loading (or recovery) phase of deadstart begins, the following one line message appears in the center of the left console screen and requests entry of the current date.

ENTER DATE YY/MM/DD.

The operator types the current date, followed by a carriage return (CR), in the following format.

yy/mm/dd. (CR)  
yy year; 0-99  
mm month; 1-12  
dd day; 1-n (n is the number of days in the month)

To recover the previous date on a level 3 recovery deadstart, enter carriage return (CR) alone. For all other levels of deadstart, pressing CR without first entering the date causes the system to assume the date when the deadstart tape was created.

When the system has accepted the date entry, it displays the following request for entry of the current time.

ENTER TIME HH.MM.SS.

The operator types the current time followed by a carriage return (CR) in the following format.

hh.mm.ss. (CR)  
hh hour; 0-23  
mm minute; 0-59  
ss second; 0-59

To recover the previous time on a level 3 recovery deadstart (time entered during last deadstart plus time accumulated until this deadstart), enter carriage return (CR) alone. For all other levels of deadstart, pressing (CR) without first entering the time causes the system to set the time to 00.00.00.

The time entry completes system initialization. Normal job processing is initiated automatically by DSD commands specified in the IPRDECK. If a level 1 or level 3 recovery deadstart is being performed, the system recovers all jobs and active files and resumes normal operation immediately. However, if an initial deadstart (level 0) or level 2 recovery deadstart is being performed, job processing may not be initiated immediately. This depends upon the length of time required to load the system from the deadstart tape (progress can be monitored on the right console screen). If tape loading has not completed when the time entry is made, the DSD commands specified in IPRDECK are displayed on the lower portion of the left screen and are flashed. In the period of time until tape loading completes, one or more of the DSD commands can be cleared by pressing the left blank key (third key from right on top row of keyboard) as many times as is necessary to clear the flashing entry. Clearing a command prevents it from being executed when tape loading completes. In this case, the commands necessary to initiate job processing must be entered manually from the console keyboard (refer to Initiating Job Processing).

When tape loading is complete, the deadstart tape is rewound to load point and is not referenced again during operation unless another deadstart is necessary. The operator can clear, unload, and remove the deadstart tape and use the tape unit for other operations. The flow-chart (Figure 2-2) provides a summary of the KRONOS deadstart functions described in this section.

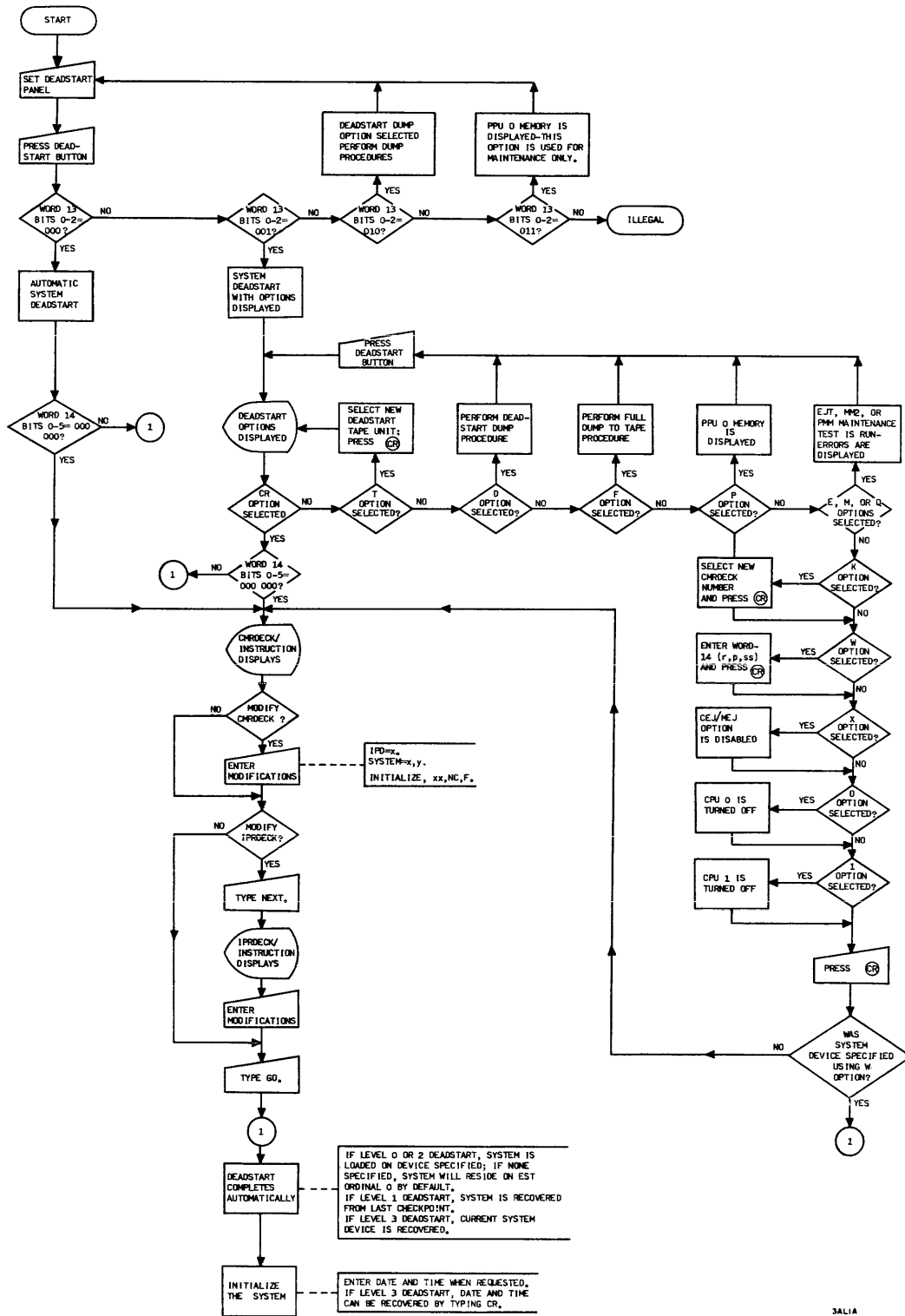

Figure 2-2. Flowchart Synopsis of KRONOS Deadstart

## INITIATING JOB PROCESSING

Control point assignment is automatic under KRONOS. Once deadstart is complete, processing proceeds with little or no operator intervention. As mentioned in the previous topic, the DSD commands necessary to initiate job processing are set up in the IPRDECK. If the operator decides to clear the initial DSD commands, he must manually initiate job processing. This is done by typing...

AUTO. (CR)

on the console keyboard. If all standard subsystems are set to be enabled in the IPRDECK, KRONOS automatically calls those subsystems to specific control points as follows:

<u>Control Point Number</u>	<u>Job Name</u>	<u>Activity</u>
1	TELEX.	Time-sharing subsystem executive routine
2	TRANEX.	Transaction subsystem executive routine
3	NEXT.	Available for automatic system assignment
.	.	
.	.	
.	.	
n-3	NEXT.	
n-2	MAGNET.	Magnetic tape subsystem executive routine
n-1	BATCHIO.	Central site automatic batch input/output
n	EXPORTL.	Export/Import; remote batch job input/output
n+1	SYSTEM.	

However, the operator may instead enter the DSD command.

MAINTENANCE. (CR)

which performs the same function as AUTO but additionally assigns several maintenance routines (FST, ALS, RAN, CT3, CU1, and MY1) at pool processor control points and runs them as normal jobs with minimum queue and CPU priorities. These routines are CPU or central memory test routines designed to detect hardware errors. These routines display error messages either at the control point on the B display (refer to section 4) or enter messages in the system error log. The error log can be displayed by typing

A, ERROR LOG. (CR)

The operator should monitor these routines from time to time. If a maintenance routine displays a message such as

MY1 - PROGRAM STOP AT 123

a hardware malfunction has occurred and a customer engineer should be called. It is recommended that these programs be run. System performance is not severely affected.

If an initial (level 0) deadstart was performed, it is necessary to enter the following command.

X.ISF. (CR)

This is a DSD command that calls the ISF program to initialize system files. This command must be entered either from the console or from IPRDECK if the system validation file (VALIDUX) is to be used. The system checks the VALIDUX file when a user tries to access KRONOS to determine if he is a valid user.



## ERROR PROCESSING

Often, problems that may arise during deadstart may be detected visually. The following list describes two such problems and the possible cause.

<u>Problem</u>	<u>Cause</u>
Tape moves but stops before any display is activated.	<ul style="list-style-type: none"><li>● There is a parity on one of the first records of the deadstart tape.</li><li>● The deadstart tape is not an I-mode unlabeled tape.</li><li>● A 7-track tape is mounted on a 9-track drive or vice versa.</li></ul>
Tape does not move.	<ul style="list-style-type: none"><li>● If the unit select switch light on the deadstart tape unit is on, the correct unit is selected but the deadstart panel is set incorrectly. Often it is the load address in word 12 that is not set correctly.</li><li>● If the unit select switch light is not on, check the channel, controller, and unit selections on the deadstart panel.</li><li>● Two or more units may have the same physical unit number.</li><li>● Unit is not ready.</li></ul>

The following topics contain an explanation of the error message that can occur during system deadstart. These error messages are grouped into four categories:

- General - can occur at any time during deadstart.
- System Initialization - occurs during the initial deadstart sequence (before the first deadstart tape rewind).
- Recovery - occurs during deadstart recovery or during recovery of mass storage devices.
- System Library Building - occurs during the building of the system library.

For a proper understanding of the problems which may occur during deadstart, there are several basic concepts with which the operator should be familiar. For example, because most errors that occur involve mass storage devices, the operator should be familiar with their use in the system. Each mass storage device has a label that contains descriptive information about its contents. For certain levels of recovery deadstart, this information must be consistent with corresponding information contained in central memory or provided through deadstart procedures. Conflicts can result in deadstart error messages. An attempt is made to recover all mass storage devices defined in the EST during all levels of system deadstart. The specific recovery function performed depends upon the level of deadstart selected. Table 2-3 describes the recovery function performed for each deadstart level as well as the type of errors that can be encountered. The system response to errors and the recommended operator action are also listed.

For all deadstart messages described on the following pages, dt is the device type and xx is the EST ordinal of the device.

Refer to Appendix B for information concerning all KRONOS operator messages.

## GENERAL

The following general messages may occur during deadstart.

<u>Message</u>	<u>Description</u>
ERROR dt xx, location	<p>A disk error has occurred. Location refers to the location of the error within the device. An error of this type for a 6638 Disk File could be ERROR DB01, P17, H14, S116. If the operator desires to continue, he enters GO. Information being written to disk at this time, however, might not be valid.</p> <p>Another deadstart can also be attempted, with the track locked out by use of the proper CMRDECK entries (such as RTK). If disk errors persist, consult a customer engineer.</p>



Reserving a track on a permanent file device without initialization can result in loss of permanent file information (for instance, a TRT linkage error can occur).

SYSTEM TAPE PARITY ERROR.	<p>The operator can continue by typing GO., in which case information transferred from tape might not be valid; or he can attempt another deadstart at a different tape density or on a different tape unit, or with a different tape. Check to ensure that deadstart tape is unlabeled I-mode tape, and that the tape unit on which it is mounted is the correct type (that is, 7- or 9-track).</p>
---------------------------	------------------------------------------------------------------------------------------------------------------------------------------------------------------------------------------------------------------------------------------------------------------------------------------------------------------------------------------------------------------------------------------------------

## SYSTEM INITIALIZATION

The following messages can occur during the initialization phase of deadstart.

<u>Message</u>	<u>Description</u>
NO SYSTEM DEVICE DEFINED.	The mass storage device to which the system is to be loaded has not been specified. Define a mass storage device as equipment 0; specify another mass storage device with the SYSTEM=n command; or attempt another deadstart and specify a system device with bits 0 through 5 of word 14 of the deadstart panel.
SYSTEM TAPE FORMAT ERROR.	Text defined by deadstart parameters ( or in CMRDECK) does not exist on the deadstart tape.
TRACK BUFFER FULL.	Too many reserved track entries in CMRDECK. No more entries will be accepted.
EQ0 NOT MASS STORAGE.	The system must be configured with EST ordinal 0 as a mass storage device.
CMRDECK NOT ON TAPE.	The CMRDECK specified on deadstart panel or option display cannot be found on the deadstart tape.

## RECOVERY

The following error messages can occur during a recovery deadstart.

<u>Message</u>	<u>Description</u>
EST/FNT LENGTHS CONFLICT, RECOVERY OF DEVICE IMPOSSIBLE.	The length of the FNT or EST of the system defined by CMRDECK conflicts with the system being recovered from disk. Attempt another deadstart without recovery (level 0).
SYSTEM TABLE FILE DESTROYED.	The system file being recovered from disk was destroyed. Recovery is impossible. Attempt another deadstart without recovery (level 0).

Refer to Table 2-3 for information concerning recovery of mass storage devices during all levels of system deadstart.

## SYSTEM LIBRARY BUILDING

The following error messages can occur while the system library is being built.

<u>Message</u>	<u>Description</u>
DETECTED IN DIRECTORY.	System file error. Start of the system library was not found. Attempt another deadstart with no recovery (level 0).
DETECTED IN CLD.	Disk resident overlay (OVL) or absolute (ABS) program is not formatted correctly.
DETECTED IN PLD.	System file error. Disk resident PP program is not formatted correctly. Deadstart from another tape unit or at a different density. If the error persists, use another deadstart tape.
DETECTED IN RCL.	Central memory resident overlay (OVL) or absolute (ABS) program is not formatted correctly. Deadstart from another tape unit or at a different density. If the error persists, use another deadstart tape.
DETECTED IN RPL.	Central memory resident PP program is not formatted correctly. Deadstart from another tape unit or at a different density. If the error persists, use another deadstart tape.
LIBRARY TABLE ERROR.	Blank entry was not found in the library table or in the directory within the field length at the deadstart control point. Try another deadstart. If the problem persists, consult an analyst.
MASS STORAGE TOO SMALL FOR SYSTEM.	Try another deadstart using a larger system mass storage device or use a deadstart tape generating a smaller system library.
RANDOM ADDRESS ERROR.	Random address is not on file. Attempt another deadstart. If the error persists, consult an analyst.

TABLE 2-3. MASS STORAGE DEVICE RECOVERY

Recovery Function	Level of Deadstart	Description of Error	Type of Device	System Response to Error	Operator Action
Chain removable devices with consecutive physical unit numbers. This applies only to 341 (MD), 844 (DI), and 854 (DD) devices. This will allow a multispindle pack (for example, MD-3) to be mounted on devices defined in EST as single spindle devices (for example, MD-1). Definition for devices in EST is changed to reflect a multispindle device.	0, 1, 2	Label verification error - label on remaining spindles of multispindle pack could not be verified.	Removable	All units are returned to their original status in EST and device with label specifying multispindle pack is left unavailable (U status set in MST). The labels on remaining devices that were chained are then checked to determine if they are valid.	Examine the MST display after deadstart is complete to determine corrective action.
Read track reservation table (TRT) into central memory.	0	TRT could not be read successfully.	All	The following message appears on the right console display and deadstart processing halts. LENGTH OF DEVICES TRT BAD - RECOVERY OF DEVICE IMPOSSIBLE.	Type GO. to proceed. If this is done, the device is initialized using parameters in existing label; permanent files will be lost.
	1, 2	TRT could not be read successfully.	Removable (no active direct access files)	Error code TL and status U set in MST; device is left unavailable.	Examine the MST display after deadstart is complete to determine corrective action.
			Nonremovable or removable with active direct access files.	The following message appears on the right console display and deadstart processing halts. LENGTH OF DEVICES TRT BAD - RECOVERY IMPOSSIBLE.	Perform level 0 deadstart and initialize the device.
Edit TRT to remove non-permanent file information.	0	Edit was not successful. This could be caused by specifying a new RTK entry (flawed track) in CMRDECK.	All	The following message appears on the right console display and deadstart processing halts. PERM. FILE LINKAGE ERROR RECOVERY OF DEVICE IMPOSSIBLE.	Type GO. to proceed. If this is done, the device is initialized using parameters in existing label; permanent files will be lost. If RTK entry was specified, rereadstart and omit RTK entry.
Clear interlock data for direct access files.	0	Failure to read legal system sector. The TRT indicates track is beginning of direct access chain but first sector was not a system sector.	All	Increment count of direct access files purged. However, space for file is not released. Message appears in dayfile in following format. EQxxxxnnnnDIRECT ACCESS FILES PURGED. xx EST ordinal of device. nnnn Number of files purged.	Examine dayfile after deadstart completes.
		Interlock data specified file was in WRITE mode and last sector for file in TRT was not an EOI sector.	All	Clear interlocks for file and rewrite system sector. Issue following message to error log and system dayfile: LENGTH ERROR filename uindex. filename Name of file on which error was encountered. uindex User index of file owner. Also, increment count of direct access file errors. The following message appears in the system dayfile. EQxxxxnnnnDIRECT ACCESS FILE ERRORS. xx EST ordinal of device. nnnn Total number of length errors.	Examine system and error log dayfiles after deadstart completes. The number of LENGTH ERROR messages issued and the count of DIRECT ACCESS FILE ERRORS should match. To recover files in error: 1. ATTACH old file. 2. PURGE old file. 3. DEFINE new file with old file name 4. COPY old file to new file.

TABLE 2-3. MASS STORAGE DEVICE RECOVERY (Cont'd)

Recovery Function	Level of Deadstart	Description of Error	Type of Device	System Response to Error	Operator Action
Read and verify the label on each mass storage device against that specified by the E <sub>1</sub> definition for the device in CMRDECK.	0	Device being recovered is not ready and therefore, cannot be read.	Removable	Error code NR and status U set in MST; device is left unavailable.	None
			Nonremovable	Wait and retry. Error message is flashed on the right screen display.	Check to ensure that all nonremovable devices are ready.
		Read error occurred when attempting to read label (parity error, surface error, etc.).	All	Advance to next track and try to read. A predetermined number of tracks will be searched if error persists. If this number is exceeded, the device is treated as if a bad label existed - see description of Bad Label Error.	None
		Label verification error - the label was read but could not be verified. For example, label indicates device is first unit of a three-unit multispindle pack (MI)-3, but units 2 of 3 and/or 3 of 3 are not present.	Nonsystem device	Error code CF and status U set in MST; device is left unavailable.	Examine MST display after deadstart is complete to determine corrective action.
			System device (nonremovable with system residence)	1. If permanent files do not reside on the device, it is initialized automatically using parameters in existing label. 2. If permanent files reside on the device, the following message appears on the right console display and deadstart processing halts. CONTINUING DESTROYS PFS - RECOVERY OF DEVICE IMPOSSIBLE.	None Type GO. to proceed. If this is done, the device is initialized using parameters in existing label (permanent files will be lost), or redeadstart without system on this device.
		Bad label - information read was not recognized as a label sector.	Nonsystem device	Error code LE and status U set in MST; device is left unavailable.	Device must be initialized after deadstart if it is to be used (refer to DSD command INITIALIZE).
	System device (nonremovable with system residence)		Device is initialized automatically. Any permanent files that reside on device will be lost.	None	
	1, 2, 3	Label verification error - the label was read but could not be verified. For example, label indicates device is first unit of a three-unit multispindle pack (MI)-3, but units 2 of 3 and/or 3 of 3 are not present.	Removable (no active direct access files)	Error code indicates cause of error and status U set in MST; device is left unavailable.	Examine MST display after deadstart is complete to determine corrective action.
			Nonremovable or removable with active direct access files	The following message appears on the right console display and deadstart processing halts. ERROR ON DEVICE WITH ACTIVE FILES - RECOVERY IMPOSSIBLE. NOTE Active direct access files are attached when checkpoint was taken (level 1, 2) or when deadstart was initiated. It is assumed that all nonremovable devices have active direct access files.	Perform level 0 deadstart or re-define configuration to match that of system being recovered.

The operator communicates with the KRONOS system through the console keyboard (Figure 3-1). As characters are entered from the console, the accumulated entry is displayed on the lower left portion of the left display screen. The operator can then check entries before initiating execution by pressing the carriage return (CR) key.

Each keyboard entry to DSD is a single line. Most command entries end with a period. When the carriage return (CR) key is pressed, a command is examined for legality and then executed if acceptable. If the command is found to be acceptable, the keyboard entry is cleared; otherwise, an error message appears above the entry. In this case, the operator can press either the erase key (left blank key) which clears both the command entered and the error message, or the backspace (BKSP) key which deletes only the last character typed. Using the BKSP key allows the operator to delete the entry to the position of the error and enter the correction.

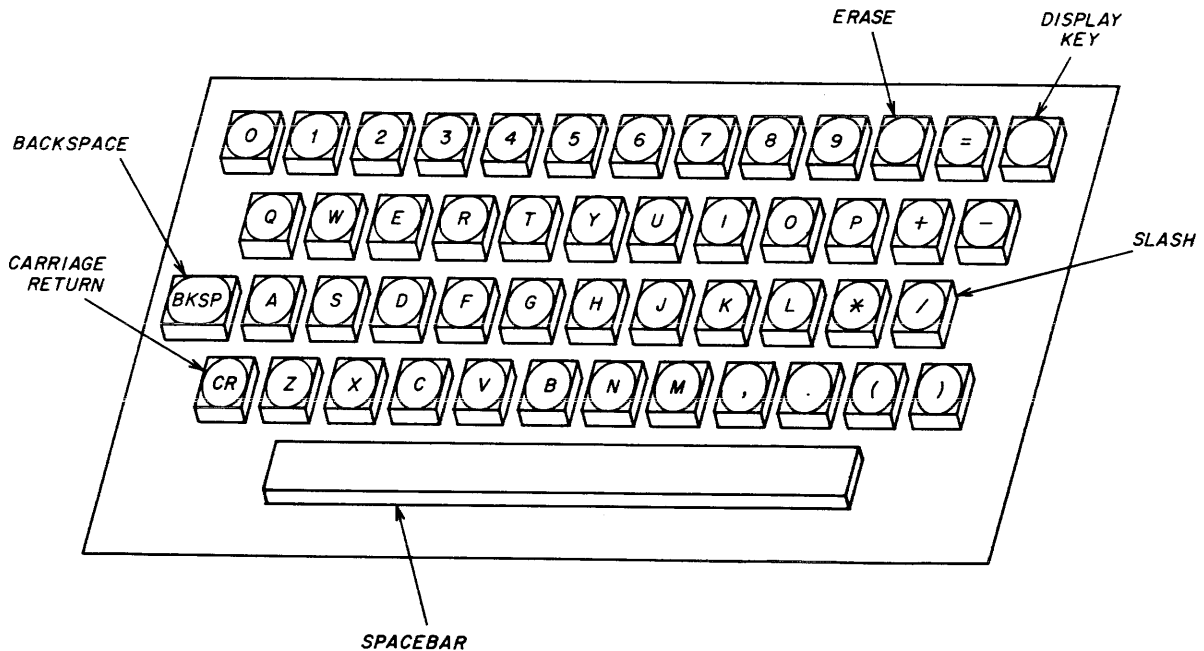

Figure 3-1. Console Keyboard

**CONSOLE OPERATION UNDER DSD**

The keyboard is used to initiate and control equipment assigned and job progress. DSD processes keyboard entry of commands as follows: As each character is typed at the console, the accumulated entry is checked by DSD for a match against the table of possible commands. When DSD recognizes the accumulated type-in as unique, the remaining portion of the command is filled in by DSD. In general, DSD fills in the rest of the command after

3 to 5 characters have been entered. If the character entered is not within the legal range, or not recognized as part of a legal command, it is rejected and not displayed.

**Example:**

To request that the error log dayfile be displayed on the left console screen, the appropriate DSD command is A, ERROR LOG. The operator begins by typing A. DSD checks this input but cannot recognize the command since seven other commands also begin with the letter A. The operator then enters the comma (,). Because two other commands also begin with these characters, DSD still cannot recognize the command. However, when the operator enters E, the command becomes unique and DSD fills in the remainder of the entry on the display (RROR LOG.). If the operator does not wait for DSD to complete the command, but continues to type in the remaining characters himself, those characters will be ignored.

DSD signals that a keyboard entry is complete by intensifying individual characters in rotation. At this time, the operator can press the carriage return key. DSD checks the command and begins execution if it is found to be acceptable. Upon successful execution, the command is erased from the display screen. However, if DSD has to wait for a resource to become available (such as a channel), or if the command was not acceptable, one of the following messages will be displayed above the command.

<u>Message</u>	<u>Meaning</u>
ILLEGAL ENTRY	Command not recognized by DSD. Operator must either correct or reenter the command.
SYSTEM BUSY - DISK	DSD is waiting for an overlay to be loaded from a mass storage device.
SYSTEM BUSY - PPU	DSD is waiting for a PPU to be assigned so that it can execute a command.
SYSTEM BUSY - MTR	DSD is waiting for a response from the system.

If such a message persists for any length of time, the operator can terminate execution of the command by pressing the left blank (erase) or BKSP (backspace) key.

**SPECIAL CHARACTERS**

In addition to the keyboard commands, the following characters have special meaning to DSD when they are entered as the first character.

<u>Key</u>	<u>Action Initiated</u>
*	Alternates display control between DSD and DIS each time the key is pressed.
=	Alternates the left screen display between its absolute and relative setting (not applicable to all displays).
+	Advance left screen display as follows: Memory displays (C, D, F, G)      Advance display address by 40 (octal). E display            Advance equipment index to next page.



<u>Key</u>	<u>Action Initiated</u>
+ (cont.)	H display Advance file index to next page.
	N display Advance display file by one sector.
	R, T displays Advance terminal index to next page.
	Other displays Advance control point number.
-	Decrement left screen display as follows:
	Memory displays (C, D, F, G) Decrement display address by 40 (octal).
	E display Advance equipment index to next page.
	H display Advance file index to next page.
	N display Backspace display file by one sector.
	R, T displays Reset terminal index to first page.
	Other displays Decrement control point number.
(	Advance right screen display as described for + (plus) character.
)	Decrement right screen display as described for - (minus) character.
/	Advances left screen memory display by the value in the lower 18 bits of the first word displayed.
right blank (display)	Advances the left screen display sequence established by SET, ssss command (refer to section 4).
left blank (erase)	Clears current keyboard entry and any resultant error messages.
BKSP (clear)	Delete last character typed and any error message.
CR (carriage return)	Normally initiates execution of an entered command. However, pressing carriage return as the first character of a line results in message REPEAT ENTRY being displayed on the error message line of the left screen. The following command entry is processed but is not erased after completion. That command is executed each time the carriage return key is pressed. To clear the repeat entry mode, press the left blank (erase) key.

## DSD COMMANDS

After the system has successfully been deadstarted, the operator can enter the DSD commands necessary to provide optimum performance and reliability for its users. There are ten general categories of DSD commands available for this purpose:

- Dayfile Commands
- Job Processing Control Commands
- Peripheral Equipment Control Commands
- BATCHIO Buffer Point Commands
- Subsystem Control Commands
- System Control Commands
- Memory Entry Commands
- Channel Control Commands

It should be noted that although all DSD commands (approximately 100) are generally available to the operator, many of them are seldom, if ever, used in a normal production environment. In fact, a large number of the DSD commands are typically used only by the system analyst for maintenance or debugging purposes. These commands include all memory entry and channel control commands as well as several commands in the other categories listed.

When unusual problems arise, it is often a good rule that the operator not attempt corrective action unless he has considerable experience in that area or has received specific instructions relating to the current problem. If not, he should consult a systems analyst to determine corrective action. Attempts to correct a system problem can often destroy information required to eliminate repetition of the problem.

The manner in which the DSD commands are entered and the use of special keyboard characters is described at the beginning of this section. In addition, command formats are fixed field, but embedded blanks are allowed in octal fields. Leading spaces in operator entries are not allowed.

Since the commands that follow are arranged according to function rather than alphabetically, the operator may wish to use the alphabetical command index provided inside the front cover for a quick page reference.

## DAYFILE COMMANDS

The following are the dayfile control commands available to the operator. Refer to section 4 for a description of the dayfile displays.

<u>Command</u>	<u>Description</u>
A.	Resets the A display to the beginning of the dayfile buffer. Since only the most recent dayfile messages appear on the A display, entering this command allows the operator to examine previous dayfile messages. Note that this command is effective only if the A display is currently selected.
A, .	Resets the A display to the system dayfile when the error log dayfile, account dayfile, or one of the control point dayfiles are currently being displayed. Note that the + and - keys are used to page the A display through each control point, forward and backward, respectively.

<u>Command</u>	<u>Description</u>
DAYFILE, xx.	Request that system dayfile be dumped to equipment defined by EST ordinal xx. If equipment specified is a mass storage device, the dayfile will be dumped to the print queue.
A, ACCOUNT FILE.	Displays the account dayfile on the left console screen. Refer to section 4 for description and illustration of account dayfile display.
ACCOUNT, xx.	Requests that account dayfile be dumped to equipment defined by EST ordinal xx. If equipment specified is a mass storage device, the account dayfile is dumped to the print queue.
A, ERROR LOG.	Displays the error log dayfile on the left console screen. Refer to section 4 for a description and illustration of the error log dayfile.
ERRLOG, xx.	Requests that error log dayfile be dumped to equipment defined by EST ordinal xx. If equipment specified is a mass storage device, the error log dayfile is dumped to the print queue.

## **JOB PROCESSING CONTROL COMMANDS**

Under normal circumstances, control over job processing is performed automatically by the system. Although the following commands may not be used frequently, they provide an added measure of control over job processing. It should be noted that several of the commands described here change internal system parameters which control job scheduling and execution. Careful consideration must be given regarding their use since job flow and overall system performance can be effected. Refer to the individual command descriptions for further information.

<u>Command</u>	<u>Description</u>
LOAD, xx, yy.	Requests that a job be loaded from equipment defined by EST ordinal xx (normally tape unit). The job is assigned a numeric identifier yy which can range from 00 to 67 octal. Examine the E display (refer to section 4) to determine the EST ordinal of the equipment to be used.
CR, xx, yy.	Assigns a numeric identifier yy to the card reader defined by EST ordinal xx. The value of the identifier can range from 00 to 67 octal. All subsequent jobs loaded from card reader xx will be assigned the identifier yy.
ENID, yy, zzz.	Enter identifier. This command assigns a numeric identifier yy to a queue type file defined by FNT ordinal zzz. The FNT ordinal is determined by examining the H display (refer to section 4). Valid queue type files to which an identifier may be assigned are listed in the H display as IN (input), PR (print), and PH (punch). The value of the identifier can range from 00 to 67 octal.

<u>Command</u>	<u>Description</u>
CP, xx, yy.	Assigns a numeric identifier yy to the card punch defined by EST ordinal xx. The value of the identifier can range from 00 to 67 octal. In this manner, all files in the punch queue with an identifier equal to yy are directed to card punch xx. Refer to description of LOAD, CR, and ENID commands to assign an identifier to a job or queue type file.
LP, xx, yy. or LQ, xx, yy.	Assigns a numeric identifier yy to the line printer defined by EST ordinal xx. The value of the identifier can range from 00 to 67 octal. In this manner, all files in the print queue with an identifier equal to yy are directed to line printer xx. Refer to description of LOAD, CR, and ENID commands to assign an identifier to a job or queue type file. The LP command directs output to 501, 505, or 512 line printers where the LQ command directs output only to a 512 line printer.
DUMP, xx, yy.	Requests that all files in the print queue with an assigned identifier yy be dumped to equipment defined by EST ordinal xx. Examine the H display (refer to section 4) to determine the identifier associated with current files in the print queue. The EST ordinal of the equipment to be used can be determined by examining the E display (section 4). Refer to the description of the LOAD, CR, and ENID commands to assign an identifier to a job or queue type file.
n. ROLLOUT.	Removes job currently assigned to control point n and places it in the rollout queue. The queue priority for the job is set to 1. This is a special queue priority value which indicates that the job will not be scheduled back to a control point automatically. That is, operator action is required to return the job to a control point (refer to description of ROLLIN, xxx. command).
n. ROLLOUT, xxxx.	Removes job currently assigned to control point n and places it in the rollout queue for xxxx seconds. The job is automatically scheduled back to a control point after this period of time. However, the operator can return the job to a control point before the time specified by xxxx has elapsed (refer to description of ROLLIN, xxx. command).
ROLLIN, xxx.	Allows the job defined by FNT ordinal xxx to be scheduled to an available control point. This is done by assigning maximum queue priority (MXPS) to the job. Examine the H display (refer to section 4) to determine the FNT ordinal of the job.

The following job control commands effect scheduling and execution of jobs in the system. These commands are normally used only by the site analyst although the operator may also be required to use them periodically. However, the operator should not enter these commands unless specifically directed to do so. Improper use of these commands can drastically hamper job flow as well as system performance. In certain cases, jobs may be lost.

<u>Command</u>	<u>Description</u>
n. ENTL, xxxxx.	Enter time limit of xxxxx for job currently assigned to control point n. The value of xxxxx can range from 0 - 77777 octal (values 77770 to 77777 are considered infinite). The value entered is rounded up to a multiple of 10 <sub>8</sub> . This command overrides the time limit specified when the job entered the system. The current time limit can either be increased (up to maximum value) or decreased.
n. ENPR, xx.	Enter CPU priority xx for job currently assigned to control point n. The value of xx can range from 07 to 70 octal. This command overrides the CPU priority set by the SERVICE command. The current CPU priority can be either increased (up to maximum value) or decreased. Note that this command is valid only if the queue priority for the job does not exceed MXPS.†
n. ENQP, xxxxx.	Enter queue priority of xxxxx for the job currently assigned to control point n. The value of xxxxx can range from MNPS† (minimum queue priority) to MXPS (maximum queue priority).† This command overrides the queue priority established by the QUEUE command. The current queue priority can be either increased or decreased. This command is valid only if the current queue priority for the job does not exceed MXPS.
ENQP, xxxxx, yyy.	Enters a queue priority of xxxxx for a queue type file defined by FNT ordinal yyy. The FNT ordinal is determined by examining the H display (refer to section 4).† The value of xxxxx can range from MNPS to MXPS.† The value specified overrides the current queue priority for the file. The current queue priority can either be increased or decreased using this command.
n. RERUN, xxxxx.	This command terminates the job currently assigned to control point n, then reruns the job from the beginning with a queue priority of xxxxx. The value of xxxxx can range from MNPS to MXPS.† This value overrides the current queue priority for the job.
QUEUE, ot, qt, qp <sub>1</sub> xxxx, ..., qp <sub>n</sub> xxxx.	This command is used to alter the queue priorities associated with the input, rollout, and output queues for each job origin type. Examine the S display (refer to section 4) to determine the priority values currently associated with each job origin type.

<u>ot</u>	<u>Job Origin Type</u>
SY	System
BC	Local batch
TX	TELEX
EI	Export/Import (remote batch)
MT	Multiterminal

† The released values for MNPS and MXPS are 0100 and 7760 octal, respectively. These values are subject to future change.

<u>Command</u>	<u>Description</u>	
QUEUE, ot, qt, qp <sub>1</sub> xxxx, ..., qp <sub>n</sub> xxxx. (cont.)	<u>qt</u>	<u>Job Queue Type</u>
	IN	Input
	RO	Rollout
	OT	Output
	<u>qp</u>	<u>Queue Priority</u>
	LPxxxx	Lowest priority at which a job can enter the queue and still be aged (MNPS < xxxx < MXPS).†
	OPxxxx	Original (entry) priority. This is the priority associated with the job when it initially enters the specified queue. The value of xxxx is normally within the boundaries specified by LP and UP.
	UPxxxx	Highest priority a job can reach in the specified queue; aging stops when this priority is reached. The job is also given this priority when initially assigned to a control point. The value of xxxx is normally greater than LP and OP but cannot exceed MXPS.†
	INxxxx	Number of scheduler cycles before incrementing the job priority by one.

The priority associated with each queue is established via QUEUE command entries in the IPRDECK for each job origin type. These entries normally reflect the ideal queue priorities for the job mix of the particular installation. The values specified in the IPRDECK are considered critical to optimum system performance and are not normally altered. However, when necessary, the changes are usually temporary and the original values will be reset. The following space is provided to record the original values (specified in the S display) for that purpose. For additional information concerning the QUEUE command, refer to section 5 in part II of the KRONOS Installation Handbook.

ORIGIN TYPE	PRIORITIES FOR EACH QUEUE TYPE											
	INPUT QUEUE				ROLLOUT QUEUE				OUTPUT QUEUE			
	OP	LP	UP	IN	OP	LP	UP	IN	OP	LP	UP	IN
SY												
BC												
TX												
EI												
MT												

† The released values for MNPS and MXPS are 0100 and 7760 octal, respectively. These values are subject to future change.

Command

Description

SERVICE, ot, p<sub>1</sub>xxxx,  
..., p<sub>n</sub>xxxx.

This command is used to alter the service limits associated with each job origin type.

ot                      Job Origin Type

SY                      System  
BC                      Local batch  
TX                      TELEX  
EI                      Export/Import (remote batch)  
MT                      Multiterminal

p<sub>i</sub>                      Service Limits

PRxx                      CPU priority (01 ≤ xx ≤ 70<sub>8</sub>). Jobs with highest priority get CPU first. All job origin types except SY and MT are normally set to the same CPU priority. System jobs (SY) are run at the lowest CPU priority. Multiterminal (MT) jobs are normally set to a higher CPU priority since they require little CPU time.

CPxx                      CPU time slice (milliseconds \*64). This parameter specifies the maximum amount of time a job of the specified origin type can use the CPU before its queue priority is set to the lower boundary.

CMxxxx                      Central memory time slice in seconds. This parameter specifies the maximum amount of time a job of the specified origin type can remain at a control point before it becomes eligible to be rolled out. The value of xxxx can range from 0 to 7777 octal.

NJxxxx                      Maximum number of jobs. For TELEX origin jobs, this parameter specifies the number of terminals that can be logged into the system. The NJ parameter has no meaning for other job origin types.

FLxxxx                      Maximum field length/100 for any job of the specified job origin type. Jobs with field length requirements that exceed this value are not scheduled to a control point. It is important to note that this parameter only effects the scheduling of jobs to a control point. Jobs currently assigned to a control point that exceed this value will not be aborted. However, if the job is rolled out, it will not be scheduled back to a control point. This parameter is

typically used to limit the memory requirement for jobs of a specific job origin type during certain hours of the day. For example, the FL parameter may be used to specify a maximum field length for all batch origin jobs between the hours of two and four in the afternoon.

- AMxxxxx Maximum field length/100 for all jobs of the specified job origin type. This parameter is used to partition central memory by limiting the total field length available to each job origin type. For example, if scheduling a job to a control point exceeds the field length specified for its job origin type, it may not be scheduled until the required field length is available. This means that a lower priority job from a different origin may be scheduled first. However, a job that would normally exceed the field length for its job origin type can be scheduled to a control point if there are not enough jobs to fill the field length specified for another job origin type. The system will always attempt to use central memory to its greatest capacity.
- FCxxxxxxx Number of permanent files allowed. The value of xxxxxx can range from 1 to 777777 octal. The value entered is rounded down to the nearest 100<sub>8</sub>.
- CSxxxxxxx Cumulative size in PRUs allowed for all indirect access permanent files. The maximum value that can be entered is 777777 octal. This value is multiplied by 100 octal to determine the actual limit allowed.
- FSxxxxxxx Size in PRUs allowed for individual indirect access permanent files. The maximum value that can be entered is 777777 octal. This value is rounded down to the nearest 1000 octal PRUs.

The service limits associated with each job origin type are established via SERVICE command entries in the IPRDECK. These entries normally reflect the ideal service limits for the job mix of the particular installation. The values specified in the IPRDECK are important to optimum system performance and are not normally altered. However, when changes are necessary they are usually temporary and the original values will be reset. The following space is provided to record the original values for that purpose. For additional



information concerning the SERVICE command, refer to section 5 in part II of the KRONOS Installation Handbook.

ORIGIN TYPE	SERVICE LIMITS								
	PR	CP	CM	NJ	FL	AM	FC	CS	FS
SY									
BC									
TX									
EI									
MT									

DELAY,  $t_1$ xxxx, ...,  $t_n$ xxxx.

This command is used to alter current system delay parameters. Examine the S display (refer to section 4) to determine the current delay parameter values.

$t_i$	Delay
JSxxxx	Job scheduler interval in seconds. This parameter specifies the interval at which the job scheduler and priority increment routines are called. The scheduler may also be called at other times.
CRxxxx	CPU recall period in milliseconds. This parameter specifies the amount of time a job remains in recall when an RCL request is placed in RA+1.
ARxxxx	PPU auto recall interval in milliseconds. This parameter specifies the time interval at which peripheral processor units (PPUs) in auto recall are recalled.
JAxxxx	Job advance interval in milliseconds. This parameter specifies the time interval at which the system checks to determine if the advance job routine (1AJ) has been called.
CSxxxx	CPU job switch interval in milliseconds. This parameter specifies the amount of time the CPU executes any one job if several jobs of equal CPU priority all require the CPU.

The value for each system delay parameter is established via a DELAY command entry in the IPRDECK. This entry normally reflects the ideal parameter values for the job mix of the particular installation. The following space is provided to record the original values (specified in the S display) in the event that any are altered temporarily. For additional information concerning the DELAY command,

Command

Description

DELAY, t<sub>1</sub>xxxx, . . . ,  
t<sub>n</sub>xxxx. (cont.)

refer to section 5 in part II of the KRONOS Installation Handbook.

DELAY VALUES	
AR	
CS	
CR	
JA	
JS	

MSAL, C, f<sub>1</sub>xx, . . . , f<sub>n</sub>xx.

Assign job files of type f<sub>i</sub> to mass storage device defined by EST ordinal x<sub>i</sub>. The mass storage device specified must be nonremovable and its current status must be ON. Examine the E display to determine the EST ordinal and status of the device to be used. The E, M (MST) display can be examined to determine if the device is nonremovable. If the C parameter is entered, the values specified by the MSAL entry in the IPRDECK (if any) are cleared. If the C parameter is omitted, and an MSAL entry was specified in the IPRDECK, the new values are added to those already specified.

<u>f<sub>i</sub></u>	<u>File Type</u>
LO	local
IN	input
OT	output
RO	rollout
LG	LGO

PURGE, xxx.

Purge queue type file defined by FNT ordinal xxx from the system. The FNT ordinal is determined by examining the H display (refer to section 4).

PURGEALL, t.

Purge all files of queue type t from the system.

<u>t</u>	<u>Type</u>
I	Input
O	Output
P	Punch
R	Rollout (sets error priority and is aborted when rolled back in)
T	Time/event rollout (sets error priority and is aborted when rolled back in)

<u>Command</u>	<u>Description</u>
n. DROP.	Drops the job currently assigned to control point n. The job's current output and dayfile (if any) are printed and the job is eliminated from the system. Extreme caution should be observed in the use of this command. Before pressing the carriage return key (CR), check to ensure that the correct control point number has been specified.

The following job control commands are used to respond to a job currently assigned to a control point.

n. COMMENT. ccc...ccc. or n. *ccc...ccc.	Enters comment ccc...ccc (120 characters maximum) in the dayfile for control point n.
n. CFO. ccc...ccc.	This command allows the operator to send a message ccc...ccc (36 characters maximum) to the program currently assigned to control point n. The program pauses while the operator enters the message which is placed in locations RA+70 <sub>8</sub> through RA+74 <sub>8</sub> of the program's field length.
n. ONSWx.	Turns on sense switch x (1 ≤ x ≤ 6) at control point n. Refer to Subsystem Control Commands in this section for definition of sense switches that can be set for the TELEX and Export/Import subsystems.
n. OFFSWx.	Turns off sense switch x (1 ≤ x ≤ 6) at control point n.
n. GO.	Clears the pause bit at control point n. A job may set the pause bit if an error is encountered or if an operator response is required. The pause bit causes the job to loop until it is cleared via entry of this command.

The following job control commands apply only to jobs of TELEX origin (that is, jobs that originate from a time-sharing terminal). TELEX must be active at control point 1.

MESSAGE, ccc...ccc.	Changes current header message output to terminal when user logs-in to ccc...ccc (48 characters maximum). This message also appears at the TELEX control point on the B display (refer to section 4).
DIAL, nnnn, ccc...ccc.	Sends message ccc...ccc (48 characters maximum) to terminal currently using line number nnnn. Examine the T display (refer to section 4) to determine the appropriate line number. The message will not interrupt job execution or output. The terminal user will receive the message after the next READY status.
WARN, ccc...ccc.	Sends message ccc...ccc (48 characters maximum) to all terminals currently logged into the system. The message is received after the next READY status. Each subsequent terminal to log into the system will also receive this message. This continues until either a new message is entered or the message is cleared (refer to following command). In addition, the current message also appears at the TELEX control point on the B display.

<u>Command</u>	<u>Description</u>
WARN, ccc...ccc. (cont.)	<p>It should be noted that the message specified by ccc...ccc is only part of the information transmitted to the time-sharing terminals. That is, the system automatically sends a statement that precedes the message. This statement appears as follows:</p> <p style="text-align: center;">hh. mm. ss. WARNING</p> <p style="text-align: center;">current time (hours. minutes. seconds)</p> <p>This command is typically used to notify TELEX users of an interruption in service or system shutdown. For example, if the operator enters</p> <p style="text-align: center;">WARN, SYSTEM SHUTDOWN IN FIVE MINUTES.</p> <p>the following information would be transmitted to all terminals</p> <p style="text-align: center;">hh. mm. ss. WARNING</p> <p style="text-align: center;">SYSTEM SHUTDOWN IN FIVE MINUTES.</p>
WARN.	<p>Clears message entered by the WARN, ccc...ccc. command. Unless this command is entered, the existing message (if any) will continue to be transmitted to each new terminal that logs into the system.</p>

## PERIPHERAL EQUIPMENT CONTROL COMMANDS

The commands described in this category provide overall control of the peripheral equipment available to the KRONOS system. The operator should become familiar with the following DSD displays which are closely associated with the use of these and other commands described throughout this section.

- Equipment status table (EST) display
- Mass storage table (MST) display
- Tape status display
- Resource mounting preview display

A complete description of each of these displays is given in section 4 of this manual.

<u>Command</u>	<u>Description</u>
n. ASSIGN, xx.	<p>Assigns equipment defined by EST ordinal xx (normally tape unit) to job at control point n. This command is entered in response to a flashing REQUEST message at that control point. Use of this command should not normally be required since assignment of a tape unit is performed automatically when a volume serial number (VSN) is specified in the job request. Generally, this command has been retained to provide upward compatibility with previous versions of KRONOS.</p>

Command

Description

VSN, xx, aaaaaa.

Assign VSN aaaaaa (1 to 6 characters) to magnetic tape unit defined by EST ordinal xx. This command allows the operator to specify a VSN for a mounted, unlabeled tape so that it may be assigned and referenced automatically. For example, when a job specifies a VSN in the request for an unlabeled tape, an entry for that job appears in the resource mounting preview display (E, P). This display indicates the job name, the required VSN, and specifies if the tape is to be mounted on a 7-track (MT) or 9-track (NT) tape unit. If the correct tape is not currently mounted, the operator mounts the tape on an available unit (of correct track type), readies the unit, and then enters this command. The system equates the VSN entered by the operator with that specified by the job and assigns the tape automatically upon demand.

If a job specifies a VSN in the request for a labeled tape, assignment occurs automatically, without operator intervention, unless the correct tape is not mounted. In this case, an entry is formed in the resource mounting preview display which describes the tape to be mounted. When the tape is mounted and the tape unit made ready, assignment occurs automatically without additional operator intervention.

The operator should monitor the resource mounting preview display on a regular basis for a list of VSNs and packnames (for disk packs) which active jobs will need to have mounted so that they may eventually complete. The operator should also monitor the tape status display (E, T) periodically to determine the current status of each tape unit (units available, drive status, VSNs associated with currently mounted tapes, jobs assigned to, etc. ).

NOTE

If two or more unassigned tapes having identical VSNs are mounted on units of same track type (MT or NT), a flashing REQUEST control card image appears on the B display and the operator must assign one of the tapes using the ASSIGN command.

VSN, xx.

Clears current VSN for tape unit defined by EST ordinal xx and then checks to determine if a VSN is specified on that tape. This command is valid only if the tape unit specified is not currently assigned.

UNLOAD, xx.

Logically removes a magnetic tape unit or removable mass storage device from the operating environment while the operator dismounts a tape or disk pack. The device to be unloaded is defined by EST ordinal xx (examine the E display to determine EST ordinal).

Command

Description

UNLOAD, xx. (cont.)

Magnetic tape units: If a tape is currently assigned to a job, it cannot be unloaded. If this is attempted, the UNLOAD command is ignored and the following message appears on the left console screen

UNIT NOT AVAILABLE

Examine the tape status display (refer to section 4) before entering the UNLOAD command to determine if the tape to be unloaded is currently assigned to a job. If the tape is not currently assigned, entering this command unloads the specified tape.

Mass storage devices: The UNLOAD command is effective only for mass storage devices defined as removable. The MST display (refer to section 4) indicates which mass storage devices are defined as removable. If a nonremovable device is specified, this command is ignored and the following message appears on the left console screen

ILLEGAL EQUIPMENT

If a removable device is selected, the UNLOAD command prevents new users from accessing files on the device. Users currently accessing files on the device are allowed to continue. The COUNT field in the MST display indicates the number of users currently accessing files on the device. The operator should monitor this display because he is given only 1 minute (approximately) in which to make the device physically not ready after the last user releases his files. If this is not accomplished within the given time, the system will automatically activate the device again and allow new user access. If more time is desired in which to make the device not ready, enter the following command

DISABLE, REMOVABLE PACKS. (CR)

If this is done, automatic label checking will not be performed for removable devices. Thus, the device cannot be activated again until the following command is entered.

ENABLE, REMOVABLE PACKS. (CR)

Refer to System Control Commands for a complete description of these commands.

Caution should be observed to ensure that all users have released their attached files on the device before it is physically removed from the system. If the pack is dismounted before all users have released their files (user count in MST display  $\neq$  0) the following may occur:

Command

Description

UNLOAD, xx. (cont.)

- Mass storage device status errors
- Permanent file errors when pack is remounted at some later date.
- If another pack has been mounted, accesses made by a previously attached user may destroy information on the new pack or the user may retrieve information from the new device which he is not necessarily privileged to access. Mass storage device status errors are also possible in this situation.

It is also important to examine the current status codes listed in the MST display for the device to be removed. Delay removal of the device if a check-point request is currently pending (C status set in MST). When the check has completed, the C status is cleared and the device may then be removed.

OFFxx.

Logically turns off device defined by EST ordinal xx. This command allows the operator to logically remove a device from the operating environment. Examine the E display to determine the EST ordinal and current status (ON or OFF) of the device. If xx specifies a mass storage device and the system library or temporary files (local, rollout, etc.) reside on that device, it should not be turned off. Examine the MST display (refer to section 4) to determine which mass storage devices have system residency or allow system allocation of temporary files. In addition, if an MSAL entry is currently specified for a mass storage device, it is cleared when that device is turned off. The MSAL designation is not reset automatically when the device is turned back on and must be reset manually (if necessary) via the DSD command MSAL (refer to Job Processing Control Commands).

ONxx.

Logically turns on device defined by EST ordinal xx. This command allows the operator to activate a device currently having OFF status in the EST. Examine the E display to determine the EST ordinal and current status (OFF or ON) of the device.

TEMP, xx.

Reverses current set or clear condition of temporary file status for mass storage device defined by EST ordinal xx. When temporary file status is set, the system can use the specified device for allocation of temporary (local, rollout, etc.) files. This command is not valid if the device specified is not available in the system or is defined as removable. Examine the MST display (refer to section 4) to determine:

1. EST ordinal of device
2. If device is available in system

Command

Description

TEMP, xx. (cont.)

3. If device is defined as removable
4. If temporary file status is currently selected (set) for the device

INITIALIZE, xx.

Sets initialize status for mass storage device defined by EST ordinal xx (examine E display to determine correct EST ordinal). This command provides the capability to initialize and flaw tracks on any mass storage device during normal system operation. Entry of this command does not in itself initialize the specified device. It merely sets initialize status for the device so that it may be initialized. The procedure involved in initializing the device is outlined later in this description. The following describes system activity when initialization occurs.

If the label on the device to be initialized is bad or cannot be recognized, a new label is created and all current data on the device is lost. If the label is found to be good, it is updated and all permanent file information is cleared. In this case, system library or temporary files (local, rollout, etc.) residing on the device are not disturbed. If the device being initialized is a master device, the system scans all other mass storage devices in the family that contain direct access files and releases the space for files with catalogs on this device. If the device being initialized contains direct access files, the system scans all other master devices and sets the catalog entries on those devices to indicate that the files were purged. All or part of the permanent file system can be initialized and then reloaded if necessary (refer to Permanent File Utilities in section 5).

The INITIALIZE command can also be used to reconfigure certain removable devices (841, 844, 854) to suit user needs. For example, if a user currently has two single unit 841 packs (MD-1's), both packs can be initialized and linked together to form a multi-spindle device (MD-2). However, this can only be done if the current single unit devices are mounted on consecutive physical unit numbers and the status for those devices is defined as removable (examine the MST display). In this case, the INITIALIZE command must be entered to set initialize status for each device to be chained. Current multispindle devices can also be initialized providing all packs that form the multi-spindle device are mounted in ascending order on consecutive physical unit numbers and the device (physical unit) on which each pack is mounted is defined as removable and available for access. Moreover, it is only necessary to enter the INITIALIZE command for the first unit of a current multispindle device. Examine the MST display to determine this information.



Command

Description

INITIALIZE, xx. (cont.)

NOTE

Examine the COUNT field in the MST before entering the INITIALIZE command. The user count for the device must be zero before this command is valid.

The following procedure describes the steps necessary to initialize, and (if necessary) flaw tracks on a mass storage device.

1. Enter the INITIALIZE command for the device(s) to be initialized followed by a carriage return. Examine the B display for the following message

REQUEST\*K\*DISPLAY.

Note the number of the control point displaying the message.

2. Activate the K display for that control point by typing

K, n. (CR) (n is control point number)

The K display (Figure 3-2) appears on the left console screen. All parameters required to initialize, and (if necessary) flaw the specified device are entered through the K display.

The top half of the K display lists all valid parameters used in initializing a device (under OPTION column). Refer to Table 3-1 for a description of each option. Flaw entries (RTK, STK, and TTK) are described on the bottom half of the display. Refer to Table 3-2 for additional information. The EST ordinal of the device to be initialized is listed in the center of the display under INITIALIZE EQUIPMENT.

3. Enter the INITIALIZE command for each additional device to be initialized. This can also be done before activating the K display. In either case, only the first device specified will initially be listed (by EST ordinal) in the K display. Thus, to update the K display to show additional devices, enter the following command

K. RERUN. (CR)

If more than one device is listed, they are initialized one at a time as they appear in the list from left to right. Multispindle devices (more than one EST ordinal) are considered one device.

Command

Description

INITIALIZE, xx. (cont.)

4. The system has already checked the label on each mass storage device. If the label was found to be good, it is necessary to enter parameters (requested in messages that appear in the K display) to identify the device. This is to ensure that the device selected is indeed the correct device to be initialized. The messages appear automatically and are displayed until the correct parameter is entered. If an incorrect parameter is entered, it is ignored. Refer to Table 3-1 for a description of each parameter. Examine the MST display to determine the current parameter values.

The following possible messages may be displayed and the appropriate response should be entered. If none of these appear, the device label was not recognized or was found to be bad. In this event, proceed to step 5.

- ENTER OLD FAMILY NAME

This message appears only if more than one family of permanent file devices are currently active in the system. Enter the following response

K. FN=family name. (CR) †

- ENTER OLD DEVICE NUMBER

This message appears if the device to be initialized is a permanent file family device. Enter the following response

K. DN=device number. (CR) †

- ENTER OLD PACK NAME

This message appears only if the device to be initialized is an auxiliary device. Enter the following response

K. FN=pack name. (CR) †

†All parameter entries must be prefixed by K period (K. ). However, when pressing (CR) after the first parameter entry, everything but the K. is erased. This allows another parameter to be entered without first having to enter K.

Command

Description

INITIALIZE, xx. (cont.)

- ENTER OLD USER NUMBER

This message appears only if the auxiliary device to be initialized is a private auxiliary device (associated with a specific user number). Enter the following response

K. UN=user number. (CR) †

If it is discovered that the wrong device was specified in the INITIALIZE command, initialize status for that device can be cleared by entering

K. CLEAR. (CR) †

The leftmost device in the list of devices to be initialized is cleared. One of the preceding messages will then be displayed for the next device to be initialized (if any) providing the label on that device is good.

5. When the following message appears on the K display, enter the parameters which specify the new characteristics to be associated with the device when it is initialized (refer to Tables 3-1 and 3-2).

ENTER PARAMETERS

The new parameters can be entered one at a time or as a string. For example:

K. option<sub>1</sub>=value<sub>1</sub>, . . . , option<sub>n</sub>=value<sub>n</sub>. (CR)

or

K. option<sub>1</sub>=value<sub>1</sub>. (CR)

K. option<sub>2</sub>=value<sub>2</sub>. (CR)

K. option<sub>n</sub>=value<sub>n</sub>. (CR)

If flaw entries are to be specified (refer to Table 3-2), they must be entered singly as illustrated in the last example. If the label on the device being initialized was good, all current flaws on that device are normally recovered. However, if the label was not recognized or was bad, the flaw entries cannot be recovered and must be entered (if necessary) using this mechanism. A maximum of 20 octal flaw entries are permitted. For additional information concerning flaw entries, refer to the description of the FLAW utility in section 6.

†All parameter entries must be prefixed by K period (K.). However, when pressing (CR) after the first parameter entry, everything but the K. is erased. This allows another parameter to be entered without first having to enter K.

Command

Description

INITIALIZE, xx. (cont.)

If the NP option is specified (NP#0), the device is to be initialized as a multispindle device. In this case, the number of packs specified by NP indicate the number of spindles to be linked. This is the next n number of devices waiting to be initialized. Each device must be mounted on consecutive physical unit numbers. If the units are configured correctly, the labels on each unit are checked. If any label is not recognized or is bad, that unit is free for initialization and chaining. However, if the label is good, the message

ENTER IDENTITY OF EQxx

appears in the K display (xx is the EST ordinal of the device). One of the following responses is required

- K. FN=family name, DN=device number. (CR)
- K. DN=device number. (CR)
- K. FN=pack name. (CR)
- K. FN=pack name, UN=user number. (CR)

This is a precautionary measure to ensure that the devices specified are the correct devices to be chained.

6. After all necessary parameters have been entered for a specific device, enter the following command to proceed with initialization

K. GO. (CR)

If there are remaining devices waiting to be initialized, steps 4 through 6 of this procedure are repeated for each device.

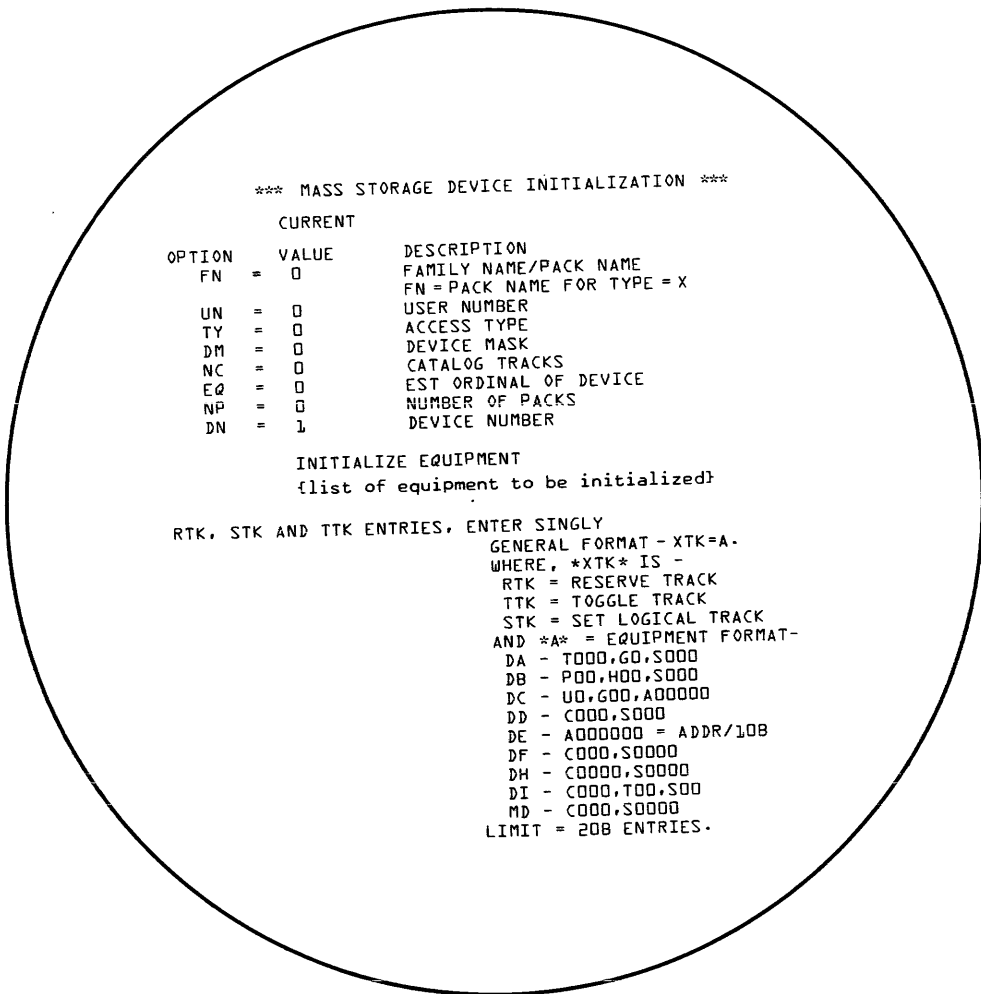

Figure 3-2. K Display for INITIALIZE Command

TABLE 3-1. DEVICE DEFINITION OPTIONS

Option	Description
FN=	1 to 7 character family name. Specifies the permanent file family in which the initialized device is to be included. Default is no family name. If TY=X, this option specifies a 1 to 7 character packname to be associated with an auxiliary device.
UN=	1 to 7 character user number. This option is specified only when initializing an auxiliary device (TY=X). If specified, the device is considered to be a private auxiliary device. Only the user number specified will be allowed to create files on the device (perform SAVE, REPLACE, or DEFINE requests).
DM=	Three octal digit device mask (0 to 377). This option is required whenever a permanent file master device is being initialized. It defines which users will have this device as their master device. This option cannot be entered if TY=X.

TABLE 3-1. DEVICE DEFINITION OPTIONS (cont.)

Option	Description
NC=	Octal number of catalog tracks (power of two). This option is used only if the number of catalog tracks specified as system default for the device type is not satisfactory. The maximum value is 200 <sub>8</sub> . Refer to System Deadstart Procedures in section 2 for default values.
EQ=	EST ordinal of device to be initialized. For multispindle devices, this must be the first of NP consecutive units.
NP=	Number of physical units to be included in a multispindle device. Default is 1.
DN=	Two-octal digit logical device number (1 to 77) that will uniquely identify the device in its permanent file family. This option is not entered if TY=X or FN option omitted.
TY=I	Initialized device may contain only indirect access permanent files. This must be a master device (DM≠0).
TY=D	Initialized device may contain direct and indirect access permanent files. IF DM=0, then only direct access files may reside on the device. Indirect access files can only reside on a master device (that is, DM≠0).
TY=X	Initialized device is an auxiliary device. This is a mass storage device that is not part of a permanent file family. It is a supplementary permanent file storage device that may be privately owned (UN option specified) or may be shared by many users (UN not specified). Auxiliary devices may contain direct or indirect access permanent files.

TABLE 3-2. TRACK FLAWING OPTIONS

Option	Description
RTK	Converts input physical address to a logical address and sets track reservation table (TRT) to indicate that track is a reserved, flawed track.
TTK	Input is the same as RTK option but track reservation is toggled. That is, if the track was previously not reserved, this option produces the same results as the RTK option. If the track was previously reserved as a flawed track, that reservation is removed.
STK	Performs the same function as RTK except that input address is a logical address (no conversion required).

## BATCHIO BUFFER POINT COMMANDS

The following commands are valid only if the BATCHIO subsystem is currently assigned to a control point. The BATCHIO subsystem controls the local batch peripheral devices (card readers, card punches, and line printers). A BATCHIO buffer point is a buffer established for each of the local batch peripheral devices. The buffer points remain constant as long as the equipment status table (EST) is not changed. Current activity of each buffer point can be monitored on the BATCHIO (I) display. Refer to section 4 for information concerning the I display.

<u>Command</u>	<u>Description</u>
ENDxx.	Terminates current operation at BATCHIO buffer point xx. BATCHIO will then assign the next available file to that buffer point (if line printer or card punch buffer point) or accept a new job from that buffer point (if card reader buffer point).
ENDxx, yy.	Terminate current operation at BATCHIO buffer point xx. The yy parameter clears any portion of the repeat count specified for that buffer point (refer to REPEAT commands). For example, if the current operation at buffer point xx had been set to be repeated five times (operation performed six times), entering a value of 03 for yy would only permit the operation to be performed three times. If the repeat count is canceled, this command performs the same function as the preceding command.
REPEATxx.	Repeat the current operation at BATCHIO buffer point xx one time.
REPEATxx, yy.	Repeat the current operation at BATCHIO buffer point xx the number of times specified by yy. The maximum value that can be entered for yy is 77 octal.
RERUNxx.	Terminate current operation at BATCHIO buffer point xx and reenter the job in the correct queue at a default queue priority.
RERUNxx, yyyy.	Terminate current operation at BATCHIO buffer point xx and reenter the job in the correct queue with a queue priority specified by yyyy (MNPS ≤ yyyy ≤ MSPS).
SUPPRESSxx.	Suppresses automatic printer carriage control at BATCHIO buffer point xx (must be line printer buffer point). Examine the I display to determine the correct buffer point. This command stops the page eject function on the line printer to provide a continuous listing.

## SUBSYSTEM CONTROL COMMANDS

The commands that follow provide control over which subsystems are to be used. When a system deadstart is performed, parameters specified in the IPRDECK determine which subsystem will initially be available. Scheduling other subsystems to a control point or terminating a current subsystem is dependent upon operator action.

When a subsystem is scheduled to a control point, any job currently assigned to that control point will be rolled out if its queue priority is MXPS or less. However, if the job has a

queue priority greater than MXPS, it cannot be rolled out and the command used to call the subsystem would not be valid. In this case, the operator could either terminate the job (if subsystem required that control point) or specify another control point. Under normal circumstances the job should not be terminated unless the operator has received specific instructions to do so.

<u>Command</u>	<u>Description</u>						
n. EXPORTL.	<p>Calls Export/Import subsystem to control point n. This should be the control point immediately preceding the system (last) control point. This command is not valid if a job currently assigned to control point n has a queue priority greater than MXPS. Activity at the EXPORTL control point can be monitored on the R display (refer to section 4).</p> <p>The disposition of Export/Import punch files is controlled by setting sense switches as follows:</p> <table border="0" style="margin-left: 40px;"> <thead> <tr> <th style="text-align: left;"><u>Entry</u></th> <th style="text-align: left;"><u>Response</u></th> </tr> </thead> <tbody> <tr> <td>n. ONSW1.</td> <td>Sends all punch files to local batch (on site) card punch.</td> </tr> <tr> <td>n. ONSW2.</td> <td>Purge all punch files.</td> </tr> </tbody> </table> <p style="margin-left: 80px;">n - Control point number for EXPORTL</p> <p>Sense switch 1 has precedence over sense switch 2. Export/Import punch files are ignored if neither is set.</p>	<u>Entry</u>	<u>Response</u>	n. ONSW1.	Sends all punch files to local batch (on site) card punch.	n. ONSW2.	Purge all punch files.
<u>Entry</u>	<u>Response</u>						
n. ONSW1.	Sends all punch files to local batch (on site) card punch.						
n. ONSW2.	Purge all punch files.						
n. IO.	<p>Calls the BATCHIO subsystem to control point n. This should be the second from last control point. For example, if the system (last) control point is number 24, BATCHIO should be assigned to control point 22. This command is not valid if a job currently assigned to control point n has a queue priority greater than MXPS. BATCHIO must be active in order to use any of the local batch peripheral devices. Activity at the BATCHIO control point can be monitored on the I display (refer to section 4).</p>						
n. MAGNET.	<p>Calls the magnetic tape subsystem to control point n. This should be the third from last control point. For example, if the system (last) control point is number 24, MAGNET should be assigned to control point 21. This command is not valid if a job currently assigned to control point n has a queue priority greater than MXPS. MAGNET (the KRONOS magnetic tape executive) must be active in order for tape processing to take place. Unit numbers on tape units must not be changed after MAGNET is initialized. Tape usage can be monitored on the tape status and preview displays (refer to description of E display in section 4).</p>						
TELEX.	<p>Calls the TELEX subsystem to control point 1. This command is not valid if a job currently assigned to control point 1 has a queue priority greater than MXPS. TELEX (the KRONOS Time-Sharing Executive) must be active in order to enter jobs from a time-sharing terminal. Activity at the TELEX control point can be monitored on the T display (refer to section 4).</p>						



Several options are available to control the operation of TELEX. These options are selected by setting sense switches after TELEX is activated. Normal operation does not require sense switches to be set.

<u>Entry</u>	<u>Response</u>
1. ONSW1.	When TELEX is terminated (with a 1. STOP command), enter users into recover state and inhibit restarting operations.
1. ONSW2.	Enable TELEX to use the delay queue feature. This allows response time to appear more consistent to users by delaying response in a lightly loaded system. Analysts can set this parameter by altering assembly constants within TELEX.
1. ONSW3.	Abort TELEX on all abnormal conditions. This ensures that TELEX does not continue to operate if an internal malfunction occurs. This should be used with sense switch 5 to enable an analyst to determine the problem. Some conditions cause TELEX to abort even though sense switch 3 is not set.
1. ONSW4.	Verify all user's working files upon recovery. Normally, only the user's rollout file (file containing all current system information) is verified when the user recovers.  This option causes the system to check all working files for the proper length. This option should be used only when it is suspected that information on mass storage has been destroyed, and is activated automatically when TELEX aborts. If the operator thinks that mass storage is intact, this switch can be disabled (1. OFFSW4. ).
1. ONSW5.	Call DMP, which dumps information to the OUTPUT file and releases the OUTPUT file after TELEX is dropped or aborted. This option provides a listing which may assist an analyst in determining the problem that existed when TELEX dropped or aborted. This sense switch should normally be set if sense switch 3 is set.

<u>Command</u>	<u>Description</u>
TRANEX.	Calls the TRANEX subsystem to control point 2. This command is not valid if a job currently assigned to control point 2 has a queue priority greater than MXPS. For complete information concerning the TRANEX subsystem, refer to the Transaction Subsystem Operators Guide Addendum.
n. STOP.	Drops (terminates) subsystem currently assigned to control point n. This command must also be entered in order to drop any job with a queue priority greater than MXPS.

Refer to the System Control Commands ENABLE, DISABLE, AUTO, and MAINTENANCE for additional information concerning subsystem control.

### SYSTEM CONTROL COMMANDS

The following DSD commands control the KRONOS operating system as well as the subsystems which run under KRONOS. Several of these commands are typically used only by the site analyst for debugging purposes when the system is in an abnormal state. Others may be used frequently by the operator to maintain system integrity in a normal production environment. Appropriate cautions are included with individual command descriptions in cases where the command is not normally used by the operator or is not recommended for use in a production environment.

<u>Command</u>	<u>Description</u>
AUTO.	Calls specific subsystems to control points and initiates automatic job processing. The IPRDECK used at dead-start time determines which subsystems will be activated by default. However, any of those subsystems can be disabled or others enabled through use of the DISABLE and ENABLE commands. Individual subsystems can also be called to a control point or removed independent of the AUTO command by using the Subsystem Control Commands described earlier in this section. For additional information concerning the AUTO command, refer to Initiating Job Processing in section 2.
MAINTENANCE.	This command performs the same function as the AUTO command but additionally assigns several maintenance routines at pool processor control points and runs them with minimum queue and CPU priorities. Refer to Initiating Job Processing at the end of section 2 for complete information concerning this command.
ENABLE, x. or DISABLE, x.	Enables or disables one of the following options. If the ENABLE command is entered and the option specified by x is currently enabled, the command is ignored. Likewise, the DISABLE command is ignored if the option is already disabled.

<u>Command</u>	<u>Description</u>
ENABLE, x. or DISABLE, x. (cont.)	<p>x = ACCOUNT</p> <p>Enable or disable processing of ACCOUNT card. This option may be disabled to allow running of jobs without ACCOUNT cards. In this case, the ACCOUNT card is accepted, if present, but is not mandatory. This option is normally enabled when running in a normal production environment.</p> <p>= AUTOROLL</p> <p>Enable or disable automatic rollout of jobs. This option improves time-sharing operation but could be disabled if running in a batch environment.</p> <p>= BATCHIO<sup>†</sup></p> <p>Enable or disable BATCHIO subsystem. If not running local batch, disabling BATCHIO frees a control point for other use.</p> <p>= EI200<sup>†</sup></p> <p>Enable or disable Export/Import (EXPORTL) subsystem. If not running remote batch, disabling EI200 frees a control point for other use.</p> <p>= MAGNET<sup>†</sup></p> <p>Enable or disable magnetic tape subsystem (MAGNET). If magnetic tape operations are not used, disabling MAGNET frees a control point for other use.</p> <p>= PRIORITY AGING</p> <p>Enable or disable priority aging. Disabling this option causes larger jobs to be scheduled before smaller jobs of equal priority. There may be environments in which it is advantageous to run the larger jobs first (for example, a nontime-sharing environment).</p>

---

<sup>†</sup>Entering the DISABLE command for a subsystem does not immediately drop the subsystem. Likewise, a subsystem is not immediately called to a control point by the ENABLE command. Instead, the subsystem specified by x is either enabled or disabled upon entry of the next AUTO or MAINTENANCE command.

<u>Command</u>	<u>Description</u>
ENABLE, x. or DISABLE, x. (cont. )	= REMOVABLE PACKS Enable or disable automatic label checking for mass storage devices defined as removable. Examine the MST display (refer to section 4) to determine which mass storage devices (if any) are defined as removable. If this option is disabled, all removable devices subsequently introduced into the system cannot be accessed. This option must be enabled to perform label verification before those devices can be accessed.
	= TELEX† Enable or disable time-sharing subsystem (TELEX). If not running time-sharing, disabling TELEX frees a control point for other use.
	= TRANEX† Enable or disable transaction subsystem (TRANEX). If transaction subsystem is not being used, disabling TRANEX frees a control point for other use.
	= VALIDATION Enable or disable user validation. Disabling this option causes the ACCOUNT card to be ignored even if present. This allows jobs to run with no VALIDUX (account validation) file. The console must be unlocked (refer to UNLOCK command) in order to enable or disable this option. Account validation is normally enabled when running in a production environment.
IDLE.	Idles all but the last control point (system is permanently assigned to the last control point). This command prevents any new jobs from being scheduled to a control point but does not terminate job currently assigned. If a job is rolled out while this command is in effect, it will not be scheduled back to a control point until the AUTO or MAINTENANCE command is entered.

†Entering the DISABLE command for a subsystem does not immediately drop the subsystem. Likewise, a subsystem is not immediately called to a control point by the ENABLE command. Instead, the subsystem specified by x is either enabled or disabled upon entry of the next AUTO or MAINTENANCE command.

<u>Command</u>	<u>Description</u>														
CHECK POINT SYSTEM.	Rolls out all jobs and writes contents of central memory tables to mass storage. This command is typically entered in preparation for a level 1 recovery deadstart. In this case, it is recommended that the IDLE command be entered before entering this command. This ensures that no new jobs will be scheduled to a control point after the checkpoint information has been written. If the IDLE command is not entered, job scheduling resumes automatically after the checkpoint information has been written. For additional information concerning the CHECK POINT SYSTEM command, refer to Preparing for Recovery Deadstart in section 2.														
n, DIS.	Calls the job display package (DIS) to control point n. The A and B display for DIS automatically appear on the left and right console screen, respectively. Refer to section 7 for complete information concerning the DIS package.														
X, name. or X, name(ccc...ccc) or X, name, xxxxx.	Calls a system program or utility specified by name to an available control point. If parameters are to be passed to the program (for example, COMPASS or MODIFY), the second form of the command is used where (ccc...ccc) specifies the parameters. In both the first and second form of the command, a default field length of 60000 octal is assumed. If a field length greater than the default is required, the third form of the command is used. The field length is specified by xxxxx.														
K, ccc...ccc. or L, ccc...ccc.	Allows entry of data ccc...ccc in CPU buffer for control when K or L display is active. Refer to section 4 for information concerning the K and L display.														
UNLOCK.	<p>Unlocks the console keyboard. When this command is active, the message UNLOCKED appears in the header of the left screen display. Although all DSD commands can be entered when the console is unlocked, the following commands are restricted to entry only when the console is unlocked.</p> <table border="0" style="margin-left: 40px;"> <tr> <td>● DEBUG.</td> <td>● STEP.</td> </tr> <tr> <td>● DATE, yy/mm/dd.</td> <td>● STEP, xx.</td> </tr> <tr> <td>● TIME, hh, mm, ss.</td> <td>● n, STEP.</td> </tr> <tr> <td>● DISABLE, VALIDATION.</td> <td>● n, STEP, xx.</td> </tr> <tr> <td>● ENABLE, VALIDATION.</td> <td>● UNSTEP.</td> </tr> <tr> <td>● All memory entry commands</td> <td></td> </tr> <tr> <td>● All channel control commands</td> <td></td> </tr> </table>	● DEBUG.	● STEP.	● DATE, yy/mm/dd.	● STEP, xx.	● TIME, hh, mm, ss.	● n, STEP.	● DISABLE, VALIDATION.	● n, STEP, xx.	● ENABLE, VALIDATION.	● UNSTEP.	● All memory entry commands		● All channel control commands	
● DEBUG.	● STEP.														
● DATE, yy/mm/dd.	● STEP, xx.														
● TIME, hh, mm, ss.	● n, STEP.														
● DISABLE, VALIDATION.	● n, STEP, xx.														
● ENABLE, VALIDATION.	● UNSTEP.														
● All memory entry commands															
● All channel control commands															
LOCK.	<p>The console is typically locked when the system is being used in a production environment.</p> <p>Locks the console keyboard. This is a software function which prevents entry of restricted commands (refer to UNLOCK command for list of restricted commands). All other DSD commands can be entered when the console is locked. The console is normally locked when the system is being used in a production environment.</p>														

<u>Command</u>	<u>Description</u>
DATE. yy/mm/dd.	<p>This command is used to change the current system date. The console must be unlocked before entry of this command is permitted (refer to UNLOCK command).</p> <p>yy year; 0 - 99  mm month; 1 - 12  dd day; 1 - n (n is the number of days in the month)</p>
TIME. hh. mm. ss.	<p>This command is used to change the current system time. The console must be unlocked before entry of this command is permitted (refer to UNLOCK command).</p> <p>hh hour; 0 - 23  mm minute; 0 - 59  ss second; 0 - 59</p>
DEBUG.	<p>Reverses the current set or clear condition of debug mode. When debug mode is set, the message DEBUG appears in the header of the left screen display. Debug mode provides system origin privileges to validated users and allows modifications to be made to the running system. The console must be unlocked before entry of this command is permitted (refer to UNLOCK command). In addition, use of debug mode is not commonly allowed in normal production environment.</p>
STEP.	<p>This command sets monitor in step mode. This stops all central memory I/O operations and prevents the system from processing PPU requests when the next monitor function is encountered. Pressing the space bar releases the present step and stops again for each subsequent monitor function. The console must be unlocked before entry of this command is permitted. In addition, this command is generally used by the site analyst for debugging purposes and should not be used in a normal production environment. The operator should enter this command only when preparing for a level 3 recovery deadstart (refer to section 2).</p>
STEP, xx.	<p>Sets step mode for monitor function xx. This stops all central memory I/O operations and prevents the system from processing PPU requests when monitor function xx is encountered. Pressing the spacebar releases the present step and stops again at the next function xx. The console must be unlocked before entry of this command is permitted (refer to UNLOCK command). In addition, this command is generally used only by the site analyst for debugging purposes and should not be used in a normal production environment. The operator should not enter this command unless specifically directed to do so.</p>

<u>Command</u>	<u>Description</u>
n. STEP. or n. STEP, xx.	Sets monitor in step mode for control point n. If xx is present, step mode is set for that monitor function. These commands perform the same function as that described for STEP. and STEP, xx. except only one control point is affected. The console must be unlocked before entry of these commands is permitted. In addition these commands are generally used only by the site analyst for debugging purposes. The operator should not enter these commands unless specifically directed to do so. Only one control point can be placed in step mode at a time.
UNSTEP.	Clears step mode. This command clears the effect of the STEP., STEP, xx., n. STEP., and n. STEP, xx. commands. The console must be unlocked before entry of this command is permitted (refer to UNLOCK command).
SYSGO.	Clears pause bit at system control point. The system sets a pause bit when certain system errors are encountered and stops processing until that bit is cleared. The operator should not enter this command unless it has previously been determined to be the correct response for the particular error. The SYSGO command is effective only when the pause bit is set at the system control point. To clear the pause bit at other control points, enter the n. GO. command (refer to Job Processing Control Commands earlier in this section).
BLITZ.	Drops all but the last control point (system is permanently assigned to the last control point). The command n. DROP. performs the same function for a job at an individual control point (refer to Job Processing Commands). The Subsystem Control Command n. STOP. is used to drop a subsystem at an individual control point. To resume job processing after entering BLITZ it is necessary to enter the AUTO or MAINTENANCE command. The operator should not enter this command unless specifically directed to do so.
99.	This command disables or enables syntax overlay processing. That is, depending upon current status, syntax overlay processing is either turned off or turned on (normal condition). When disabled, DSD does not load overlays to check syntax. This should only be done when the system is in an abnormal state to prevent PPUs from being requested when they cannot perform the necessary tasks (for example, when a system disk channel is hung). Moreover, this command is normally used only by the site analyst for debugging purposes. The operator should not enter this command unless he is given specific instructions concerning its use.

## MEMORY ENTRY COMMANDS

The following commands are used to change the contents of central memory. These commands are typically used only by the site analyst. Extreme caution must be observed when using these commands to avoid damage to the system or user jobs. The console keyboard must be unlocked in order to enter any of these commands (refer to UNLOCK command).

Bytes are numbered 0 to 4 from left to right. The address and contents are assembled right-justified with leading zero fill. Leading zeros may be omitted. Again, the console must be unlocked to change memory under DSD. Formats for octal memory entry commands are as follows:

<u>Command</u>	<u>Description</u>
aaaaaa, nnnn. . . n.	Change contents of location aaaaaa to nnnn. . . n. (20 digits).
aaaaaa, b, nnnn.	Change contents of byte b at location aaaaaa to nnnn.
aaaaaa, Dnnnn. . . n.	Change contents of location aaaaaa with left-justified zero filled display code characters nnnn. . . n.
aaaaaa#nnnn. . . n.	Change contents of location aaaaaa to nnnn. . . n. and increment or decrement aaaaaa by 1 (altered only if the message REPEAT ENTRY. is displayed above the entry. This is accomplished by pressing <b>CR</b> before entering the command).
aaaaaa#b, nnnn.	Change the contents of byte b at address aaaaaa to nnnn. The address aaaaaa is incremented or decremented by 1 (altered only if the message REPEAT ENTRY. is displayed above the entry).

## CHANNEL CONTROL COMMANDS

The following commands provide the capability to control activity on a specified data channel in circumstances where abnormal hardware and/or system operation is detected. These commands are typically used only by the site analyst or customer engineer since they directly effect the operation of system peripheral equipment. Extreme caution must be exercised if any of these commands are entered during normal system operation. In addition, the console keyboard must be unlocked before entry of any of these commands is permitted (refer to description of UNLOCK command). DSD does not reserve the channel specified in any of the channel control commands. The channels are numbered 0 to 13 octal in a 10 PPU system and 0 to 13, 20 to 33 in a 20 PPU system.



At no time should the operator enter any of the following channel control commands unless specifically directed to do so.

<u>Command</u>	<u>Description</u>
ACNcc.	Activate channel cc. This command alerts and prepares peripheral equipment on channel cc for the exchange of data.



<u>Command</u>	<u>Description</u>
DCNcc.	Deactivate channel cc. As a result, peripheral equipment on channel cc stops and any current I/O operation is terminated.
DCHcc.	Drop channel cc. This is a software function to release the current reservation of channel cc.
MCHcc.	Master clears and removes all 3000-series peripheral equipment selections on channel cc (6681 function code 1700 <sub>8</sub> is issued).
IANcc.	Input to pseudo A register from channel cc.
LDC, nnnn.	Load pseudo A register with nnnn (normally a peripheral equipment function code). The current value of nnnn is the rightmost field in the header of the right screen display (adjacent to channel status).
OANcc.	Output contents of pseudo A register to channel cc.
FCNcc, xxxx.	Output function code xxxx to channel cc.
FCNcc.	Output a zero function code (no activity) to channel cc. This releases all equipment selections on that channel.

The operator and the system communicate through the console keyboard and two or more console display screens. The two major display programs are system display, controlled by the DSD program, and control point job display, controlled by the DIS program (refer to section 7).

KRONOS provides information about job and system status through displays on the console screens. Data entered from the keyboard is also displayed. A permanent record, or system dayfile, of all system/console communication is retained by KRONOS and may be printed at operator request.

The display console is controlled by DSD, which permanently resides in peripheral processor 1. The primary functions of DSD are to maintain a current display of system status and to process keyboard entries from the operator. At the console keyboard, the operator may assign equipment, exercise control over job scheduling and execution, initiate utility programs, and select displays.

## DISPLAY SELECTION

Any of the DSD displays can be selected by the console command† :

x. (CR)

or

xy. (CR)

where x and y represent the letter designation of the displays; x appears on the left screen and y appears on the right. If x and y are identical, both screens display the same information. The displays available to the operator are:

<u>Letter Designation</u>	<u>Display</u>	<u>Description</u>
A	Dayfile† †	Chronological history of system operations
B	Job status	Current status of all jobs assigned to control points
C,D	Central memory† †	Portions of the contents of central memory in five groups of four octal digits
E	Equipment status	Status of peripheral devices
F,G	Central memory† †	Portions of the contents of central memory in four groups of five octal digits
H	File Name Table (FNT)	List of FNT entries for all active files in the system
I	BATCHIO status	Status of central site unit record devices

† Typing a letter for a display that does not exist brings the Z display to both screens.

† † This display is control-point oriented. Paging forward and backward through the display for each control point is achieved with the + and - keys, respectively. The number of the control point also appears at the top next to the letter designator (for example, A5).

<u>Letter Designation</u>	<u>Display</u>	<u>Description</u>
J	Control point status†	Status of the specified control point
K, L	CPU programmable†	Dynamic operator/CPU communication
N	File display	Contents of any file assigned to a control point.
O	Transaction status	Status of Transaction Subsystem. Refer to the Transaction Subsystem Operator's Guide Addendum for complete information.
P	PP communications area	Current contents of PP registers
Q	Queue status	Status of input, output, and rollout queues
R	Export/Import status	Status of remote batch operations
S	System control information	Parameters used to control job flow
T	Time-sharing status	Status of time-sharing users
Y	Monitor functions	List of all monitor mnemonics and codes
Z	Directory	List of the letter designators and descriptions of all DSD displays

The following DSD command allow the operator to preselect the left screen display sequence.

SET, ssss. (CR)  
 ssss Letter designating any four of the DSD displays listed. Note that four display identifiers must be specified.

Pressing the right blank key after this command is entered causes the first display specified to appear on the left console screen. Pressing the key again selects the second display. The next display in the specified sequence appears on the left console screen each time the right blank key is pressed.

## DISPLAY SCREEN HEADERS

Standard system headers appear on each of the display screens. The left screen header provides the following information.

- Time and date (specified by the DSD TIME and DATE commands)
- Comment lines (specified by the NAME entry in CMRDECK)
- Job count represented by a four-character sequence number ranging from AAAA to 9999. A job count of AAAD indicates that four jobs are being or have been processed.

† This display is control-point oriented. Paging forward and backward through the display for each control point is achieved with the + and - keys, respectively. The number of the control point also appears at the top next to the letter designator (for example, A5).

- Console status (either UNLOCKED or blank). Refer to section 3 for a description of the LOCK and UNLOCK commands.
- System modification status (either DEBUG or blank). Refer to section 3 for a description of the DEBUG command.

The right screen header provides the following information.

- Contents of the P register
- Control point to which the CPU is assigned
- Status of the channels
- Amount of unassigned central memory

In addition, at the bottom of the right screen, each peripheral processor is represented by an entry for the program currently running and the control point to which the program is assigned. PP0 and PP1 are dedicated to monitor (MTR) and DSD, respectively.

Any display can appear on the left or the right screen, and therefore, can have a left screen or a right screen header. Figures 4-1a and 4-2 illustrate the left and right screen headers, respectively. All other displays are shown without a header.

## DAYFILE (A) DISPLAYS

Dayfile messages are saved in four different files. A system history is kept on the system dayfile. An accounting record is kept on the account dayfile for possible further processing (for example, customer billing). System error messages such as disk errors are recorded on the error log dayfile. Control point dayfiles record the operations of each job.

The dayfiles are brought to the screen by typing:

<u>DSD Command</u>	<u>Dayfile</u>
A.	System
A, ACCOUNT FILE.	Account
A, ERROR LOG.	Error log

A control-point dayfile is displayed by entering the DIS command (refer to section 7):

A.

or by entering the DSD command:

A.

and paging to the desired dayfile with the + or - key.

Dayfile messages are added to one of the dayfiles when:

- A control card is processed or a system action occurs which is not in direct response to a control card statement (such as an error message).
- An error is detected.
- A comment is entered either via a COMMENT control card or MESSAGE macro.
- The operator enters a message.

When a job terminates, messages are sent to the account dayfile recording the resources charged to the job. In addition, control-point dayfile entries are printed at the end of job output. The system dayfile, which includes entries for all jobs processed, is available as a record of all action taken since deadstart. The A display shows the most recent entries; the operator can obtain the entire contents by dumping the file to a printer, punch, or tape unit.

Messages on the A display appear in the following formats.

System dayfile messages:

time. jobname. message.

Account dayfile standard messages:

time. jobname. resources used, amount used, units.

Account dayfile permanent file messages:

time. jobname. PF, action taken, filename, optional user number.

Account dayfile user profile control messages:

time. jobname. resources used, charge number, project number.

Error log dayfile messages:

time. jobname. message.

The time is the time of day as entered into the system at deadstart or by a TIME command to DSD. For example, if the system is deadstarted at 8:00 a.m., and the time is entered at deadstart, the time in 10 minutes is 08. 10. 00. If the time was not entered at deadstart, the time in 10 minutes is 00. 10. 00. The time is followed by the name of the job associated with the message and the message itself. As a job is processed, messages are sent to the dayfile by PP programs or central programs.

The job name is a combination of several parameters which describe the job. The first seven characters are the system-assigned job name, and the eighth character indicates the origin of the job. The job name is constructed as follows:

#### System Origin Jobs

The first field consists of the first four characters of the utility function specified. If fewer than four characters are entered, the field is zero-filled. The next field consists of the three rightmost characters of the job sequence number, which ranges from AAA to 999. For example, if the operator enters X.PFS, the job name may be PFS0AACS. If X.STAGE is entered, the job name may be STAGAADS.

#### Batch Origin Jobs

The job name consists of the first four characters of the job card and the three rightmost characters of the job sequence number. If fewer than four characters are entered, the field is zero-filled. The eighth character for batch origin jobs is B.

## Remote Batch and Terminal Origin Jobs

The first four characters are derived from the user number supplied by the user when he logs into the system. The next three characters represent the number of the terminal on which the user is logged in for time-sharing jobs and the job sequence number for remote batch jobs. The eighth character is T for time-sharing jobs and E for remote batch jobs.

Each control card executed, including the job card, is printed at the end of the output from the job. The dayfile may be observed as follows:

- On the console screen (A display), the file is moved up the display screen as messages are generated.
- At the end of a job's printed output, all dayfile messages associated with that job are printed.

If the A display is on the left screen, the operator can alternate between the system dayfile and a control-point dayfile using + and - keys. The + and - keys page the A display through each control-point dayfile forward and backward, respectively. After the last control point, the display returns to the system dayfile.

The operator can dump a dayfile and release its mass storage space by typing:

<u>DSD Command</u>	<u>Dayfile</u>
DAYFILE, xx.	System
ACCOUNT, xx.	Account
ERRLOG, xx.	Error Log

where xx is the equipment status table (EST) ordinal (refer to the E display) of the equipment to which the dayfile is to be dumped. This equipment must be ready and immediately available for the dayfile dump.

Figure 4-1a illustrates the system dayfile display, Figure 4-1b illustrates the account dayfile display, and Figure 4-1c illustrates the error log dayfile display.

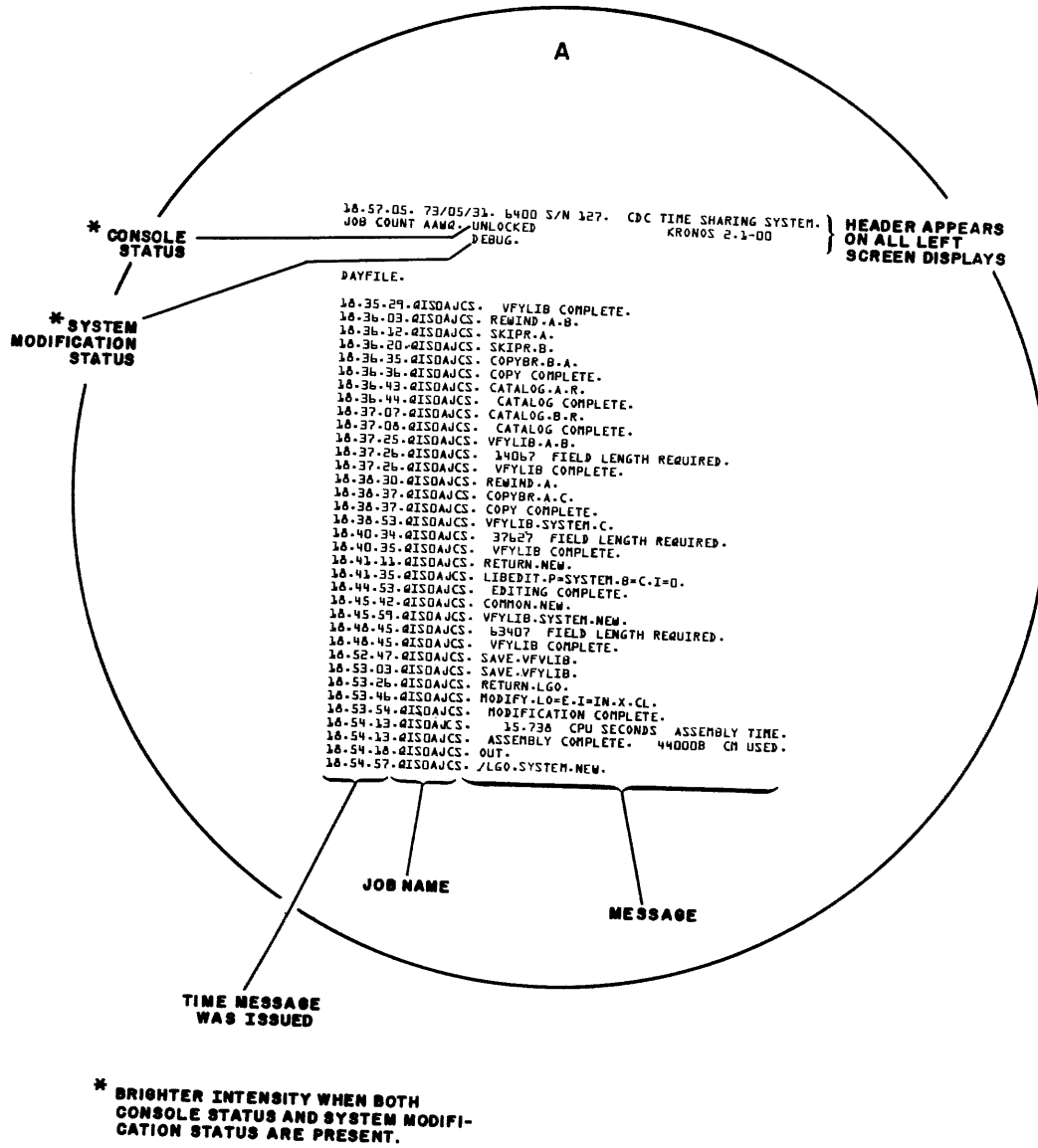

Figure 4-1a. System Dayfile (A) Display

A

18.57.22. 73/05/31. 6400 S/N 127. CDC TIME SHARING SYSTEM.  
JOB COUNT AAUQ. UNLOCKED KRONOS 2.1-00  
DEBUG.

ACCOUNT FILE.

17.59.59.AAEIAQHB. CM	0.026 KWH.
17.59.59.AAEIAQHB. MS	1.556 KPR.
18.00.04.AAEIAQHB. LP	0.041 KLN.
18.00.22.AAEI00ST. USER	PETHAAS LOG OFF.
18.00.22.AAEI00ST. CP	0.100 SEC.
18.00.22.AAEI00ST. CM	
18.00.22.AAEI00ST. MS	0.002 KPR.
18.00.22.AAEI00ST. T0	1.629 KCH.
18.00.22.AAEI00ST. TI	0.106 KCH.
18.01.01.DIS0ASDS. PF	GET INB.
18.09.05.DIS0ASDS. PF	REPLACE INB.
18.16.17.QIS0AJCS. PF	ATTACH RESEXDF.
18.16.17.QIS0AJCS. PF	ATTACH RESEXDF.
18.16.17.QIS0AJCS. PF	ATTACH RESEXDF.
18.16.17.QIS0AJCS. PF	ATTACH RESEXVF.
18.16.38.DIS0AAOS. PF	ATTACH RESEXVF.
18.16.38.DIS0AAOS. PF	ATTACH RESEXVF.
18.16.38.DIS0AAOS. PF	ATTACH RESEXDF.
18.16.50.DIS0AAOS. PF	ATTACH RESEXDF.
18.17.07.DIS0AAOS. PF	ATTACH RESEXVF.
18.17.07.DIS0AAOS. PF	ATTACH RESEXVF.
18.17.11.DIS0ASDS. CP	1.528 SEC.
18.17.11.DIS0ASDS. CM	0.002 KWH.
18.17.12.DIS0ASDS. MS	0.068 KPR.
18.17.28.DIS0AAOS. PF	ATTACH RESEXVF.
18.17.28.DIS0AAOS. PF	ATTACH RESEXVF.
18.17.28.DIS0AAOS. PF	ATTACH RESEXDF.
18.18.00.DIS0AAOS. PF	ATTACH RESEXDF.
18.18.18.DIS0AAOS. PF	ATTACH RESEXDF.
18.21.38.DIS0ATMS. PF	GET PRPFU.
18.33.08.QIS0AJCS. LP	1.437 KLN.
18.52.47.QIS0AJCS. PF	SAVE VFVLIB.
18.53.03.QIS0AJCS. PF	SAVE VFYLIB.
18.55.57.QIS0AJCS. LP	1.799 KLN.

Figure 4-1b. Account Dayfile (A) Display





**A**

16.31.44. 73/05/01. 6400 S/N 127. CDC TIME SHARING SYSTEM.  
JOB COUNT AAC0. UNLOCKED KRONOS 2.1-00  
DEBUG.

ERROR LOG.

MT.C12-5-01.MMM51.RD. .S0.3207. 0000.  
16.19.19.QIS0AANS. MT.C12.F06.E00.8001033. PARITY  
16.19.20.QIS0AANS. MT.C12-5-01.MMM51.RD. .S0.3207. 0000  
16.19.20.QIS0AANS. MT.C12.F06.E00.8001034. PARITY  
16.19.20.QIS0AANS. MT.C12-5-01.MMM51.RD. .S0.3207. 0000  
16.19.20.QIS0AANS. MT.C12.F06.E00.8001035. PARITY.  
16.19.20.QIS0AANS. MT.C12-5-01.MMM51.RD. .S0.3207. 0000  
16.19.20.QIS0AANS. MT.C12.F06.E00.8001036. PARITY.  
16.19.21.QIS0AANS. MT.C12-5-01.MMM51.RD. .S0.3207. 0000  
16.19.21.QIS0AANS. MT.C12.F06.E00.8001037. PARITY.

Figure 4-1c. Error Log Dayfile (A) Display

**JOB STATUS (B) DISPLAY**

DSD displays the status of control points. The number of control points is specified at deadstart time (23 maximum). One control point is added to the number specified and is dedicated to system use. A control point entry appears in the following format.

- n job jobname pr qpr fl s mes
- n Control point number. A job is assigned to a control point when it is residing in central memory.
- job FNT ordinal of the job. All jobs are assigned an entry in the FNT (refer to the H display).

jobname Name assigned by the system to uniquely identify the job. The job name consists of a 7-character identifier with an eighth character appended to signify the job origin type. The five job origin types are:

- S System job
- T Time-sharing job
- B Local batch job
- E Remote batch job (Export/Import)
- M Multiterminal job

pr CPU priority (the job priority for the CPU)

qpr Queue priority (the queue priority is used to control the scheduling of the jobs from the queues)

fl Field length/100 of job being processed

s CPU status:

- A Control point using CPUA
- B Control point using CPUB (dual CPU systems only)
- W Control point waiting for CPU
- X Control point is in recall
- I Control point is in auto recall (waiting for completion of system request: I/O tape, assign, etc.)

blank CPU not needed at this control point

mes First 30 characters of the message area for the control point. Messages requiring operator intervention, control cards being processed, and error messages are displayed here. If a message requires operator action, it is periodically intensified by the system.

Figure 4-2 illustrates the job status (B) display.

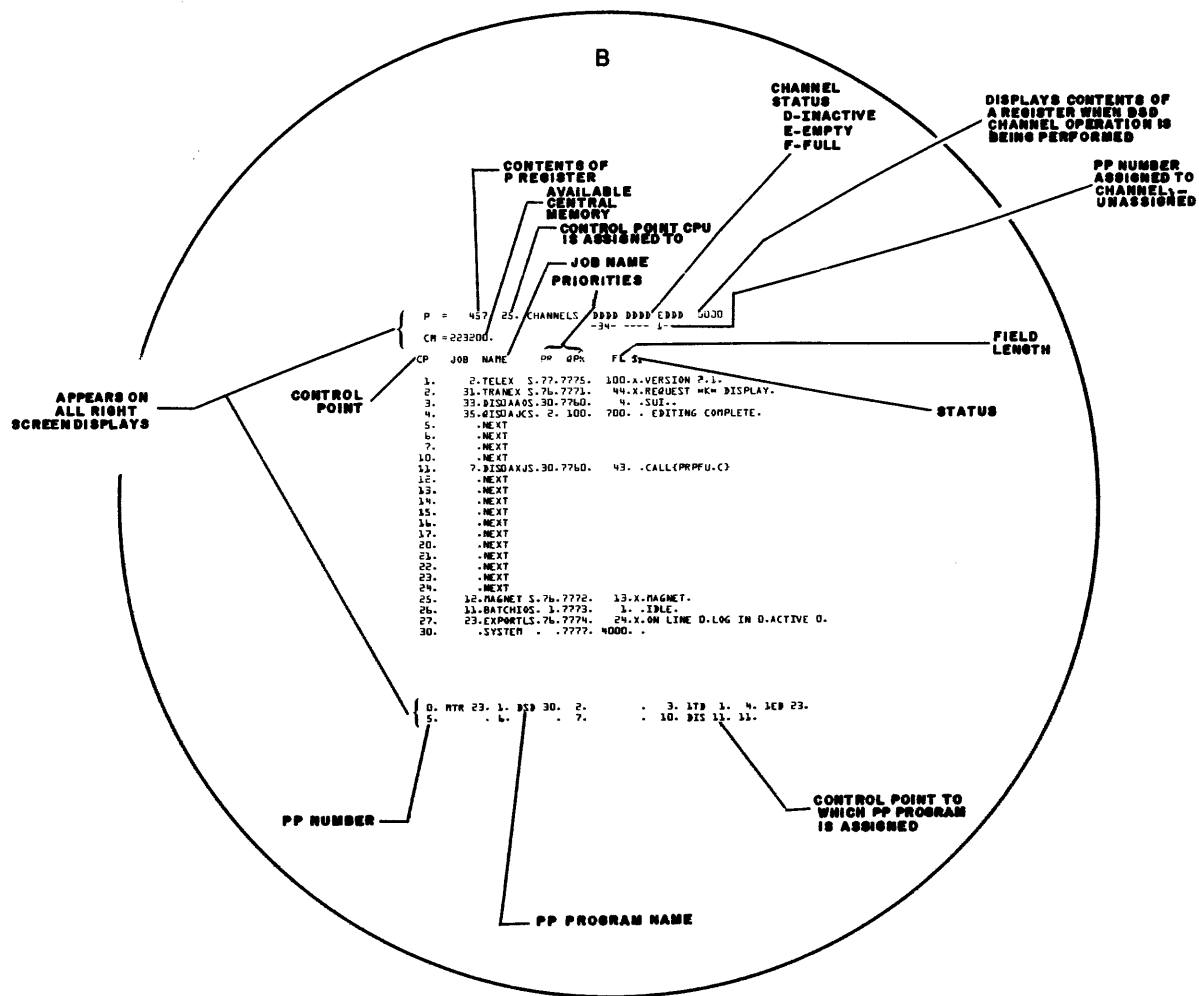

Figure 4-2. Job Status (B) Display

## STORAGE (C,D,F,G) DISPLAYS

These displays are used primarily to observe central memory. Each storage display consists of four groups of eight central memory words, with the groups numbered 0 through 3. The format of each line of the display is:

address            octal word            display code equivalent

The octal words in the C and D displays are shown in five groups of four octal digits; words in the F and G displays have four groups of five digits. The characters equivalent to the display-coded octal digits appear to the right of the octal word. Blanks appear for any character with an octal display code above 57, as well as for display codes of 00, 53, and 55.

The C, D, F, and G displays can be brought to the screens with the xy. entry (x and y are C, D, F, or G). The address of the words displayed also can be specified in the command that brings the display to the left screen. The format of the command is:

xz, address.

where z is the group number.

Eight words beginning at the specified address will appear at the appropriate group on display x if z is 0, 1, 2, or 3. All four groups of a display can be changed at once to 32 contiguous words by typing x4, address. When the memory display is on the left screen, the address can be stepped forward or backward 40 octal locations by pressing the + or - key; the right screen is paged with the left and the right parenthesis keys.

Memory displays can be set to advance or decrement by a constant by using C5 and C6 entries. For example:

- |               |                                                                                                      |
|---------------|------------------------------------------------------------------------------------------------------|
| (CR)          | Causes the REPEAT ENTRY message to appear (refer to section 3).                                      |
| C5, 101. (CR) | Increments present C display by 101. Each successive carriage return increments the displays by 101. |

C6 is used in the same manner to decrement by the value specified. Either absolute addresses or addresses relative to a control point can be displayed. Pressing the = key alternates the display between absolute and relative settings when the display is on the left screen. When addresses relative to a control point are displayed, the control point number appears next to the display identifier (for example, D15). The selection of addresses for any group of the C, D, F, and G displays remain in force even though the display is not on either screen. For instance, if the regular format of xy. is used to recall the C display to the screen, the addresses shown are those specified by the last call in the format Cz, address. For example, if the A and B displays are on the left and right screens and the operator types in the following sequence, the displays change as follows:

- |           |                                                                                                                                                                                       |
|-----------|---------------------------------------------------------------------------------------------------------------------------------------------------------------------------------------|
| C40.      | The A display on the left screen is replaced by the C display showing the words at addresses 0 through 37.                                                                            |
| C3, 1234. | The fourth group of words on the display changes from the words at 30 through 37 to those at 1234 through 1243.                                                                       |
| AB.       | The B display remains on the right screen; the C display is replaced by the A display on the left screen.                                                                             |
| CB.       | The C display is brought back to the left screen still showing the words at 0 through 7 (group 0), 10 through 17 (group 1), 20 through 27 (group 2), and 1234 through 1243 (group 3). |

Figure 4-3 illustrates the C and D central memory displays. Figure 4-4 illustrates the F and G central memory displays.

C

ADDRESS	MEMORY CONTENTS					DISPLAY CODE EQUIVALENT
000000	0000	0000	0000	0000	0000	
000001	0002	2156	0012	0004	4000	BQ. J DS
000002	0003	6312	0000	0027	6200	C J W
000003	6320	0001	7417	0000	0003	P A O C
000004	6600	7600	0000	0001	3340	AOS
000005	6500	6600	6504	0000	0000	D
000006	0003	6111	0000	0001	3410	C I A1H
000007	0003	6265	0003	7302	0000	C C B
000010	0000	0000	0000	0000	0000	
000011	0000	0000	0000	0000	0000	
000012	0000	0000	0000	0000	0000	
000013	0000	0000	0000	0000	0000	
000014	0000	0000	0000	0000	0000	
000015	0000	0000	0000	0000	0000	
000016	0000	0000	0000	0000	0000	
000017	0000	0000	0000	0000	0000	
000020	0000	0000	0000	0000	0377	C
000021	2331	2324	0515	5555	0000	SYSTEM
000022	0000	0000	0001	0102	2700	AABW
000023	0000	0000	0000	0000	2067	P
000024	0000	0010	1000	0010	0010	HH H H
000025	0000	0000	0000	0000	0000	
000026	0000	0000	0042	3634	3534	73121
000027	0000	0000	0305	0120	3147	CEAPYH
000030	5534	4157	3540	5736	4457	16.25.39.
000031	5542	3650	3340	5033	3457	73/05/01.
000032	5541	3733	3355	2350	1655	6400 S/N
000033	3435	4257	5503	0403	5524	127. CDC T
000034	1115	0555	2310	0122	1116	IME SHARIN
000035	0755	2331	2324	0515	5700	G SYSTEM.
000036	0000	0000	0000	0000	0000	
000037	0000	0000	0000	0000	0000	

FIVE GROUPS  
OF FOUR  
CHARACTERS

Figure 4-3. Central Memory (C) Display

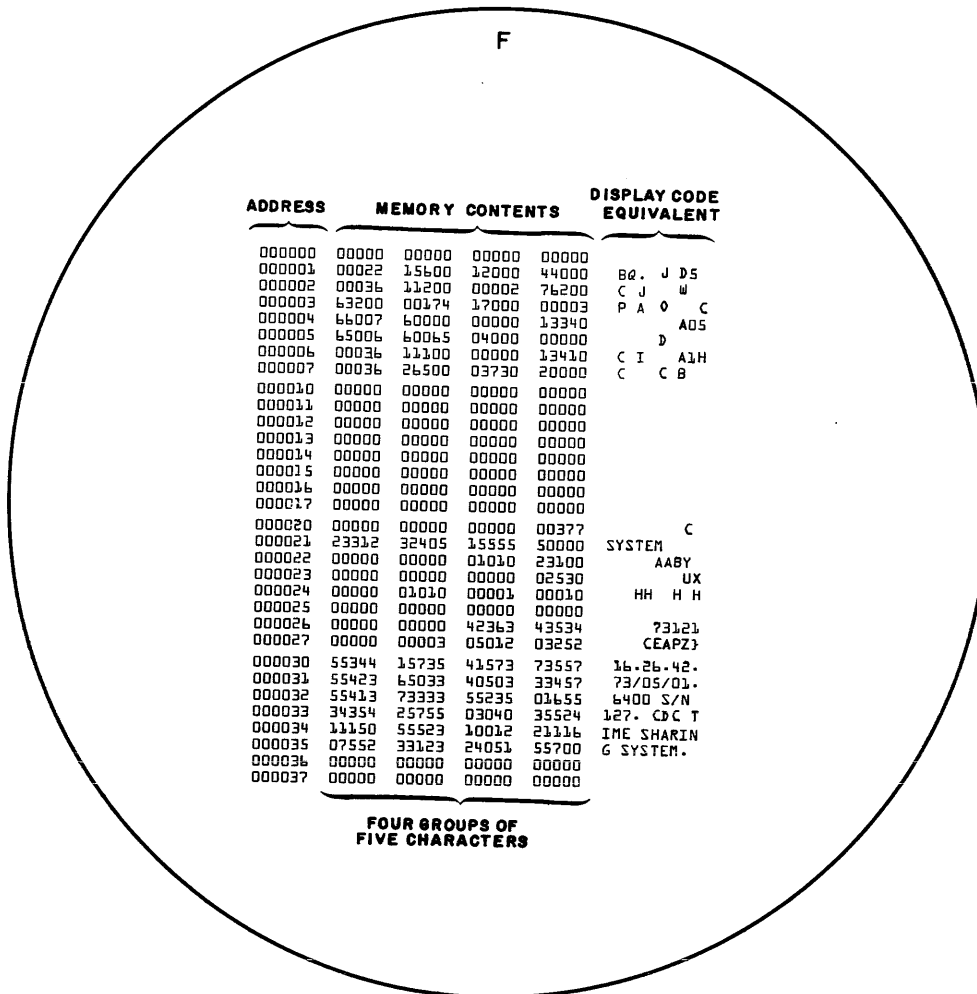

Figure 4-4. Central Memory (F) Display

## EQUIPMENT STATUS (E) DISPLAY

The E display lists the status of peripheral equipment. The type of information supplied varies according to the subdisplay specified.

Command	Display
E. or E, A.	Equipment status table (EST)
E, M.	Mass storage tables (MST)
E, P.	Resource mounting preview
E, T.	Tape status

### NOTE

If the MST (E, M), resource mounting preview (E, P), or tape status (E, T) is currently being displayed, the E, A command must be entered to display the EST (E. command is ignored in this case).

## EST DISPLAY

The EST display lists the status of all devices in the equipment status table. Each entry appears in the following format.

no	type	stat	eq	un	channels
no		EST ordinal			
type		Device type			
stat		Equipment status (ON or OFF)			
eq		Equipment number			
un		Unit number (serves as ID code for unit record devices)			
channels		Channel(s) on which equipment is available			

A control point number precedes the equipment number in each entry if that piece of equipment is assigned to a control point. Following the channel number entry is an entry that specifies the remaining tracks for mass storage devices or an alternate channel for magnetic tape units. The identifier code (un parameter) provides a method of grouping peripheral devices when a site has several units. Output from a job read in through a card reader with identifier xx can only be directed to a device with the same identifier. Changing the identifier code via the SETID control card or an LP DSD command can direct program output to a special printer (for example, for form control or multiple copy forms). The following device types can appear in the second column of the equipment status display.

CP	415 Card Punch
CR	405 Card Reader
DA	6603 Disk System
DB	6638 Disk System
DC	863 Drum Storage
DD	854 Disk Storage Drive
DE	Extended Core Storage
DF	814 Disk File
DH	821 Data File
DI	844 Disk Storage Subsystem
DP	Distributive Data Path to ECS
DS	6612 Console Display
LP	501 Line Printer
LQ	512 Line Printer
MD	841 Multiple Disk Drive
MT	Magnetic Tape Drive
NE	Null equipment
ST	Remote Batch Multiplexer (6671)
TT	Time-sharing Multiplexer (6676 or 6671)

Figure 4-5a illustrates the EST display

E

EQUIPMENT STATUS TABLE. ADDRESS = 6500. INDEX = .

NO. TYPE STAT EQ UN CHANNELS

NO.	TYPE	STAT	EQ	UN	CHANNELS	TKS
0.	DB	ON	. 1.	0.	0.	2303.
1.	DB	ON	. 1.	0.	3.	2636.
2.	MD	ON	. 6.	0.	4.	240.
3.	MD	ON	. 6.	1.	4.	674.
10.	DS	ON	11.	7.	0.	10.
11.	CR	ON	. 4.	0.	13.	.
12.	CP	ON	. 5.	0.	13.	.
20.	LP	ON	. 6.	0.	13.	.
21.	LP	ON	. 3.	0.	13.	.
22.	LP	OFF	. 7.	0.	13.	.
37.	TT	OFF	. 7.	1.	2.	.
40.	TT	ON	1.	7.	0.	1.
50.	MT	ON	. 5.	0.	12.	.
51.	MT	ON	4.	5.	1.	12.
52.	MT	ON	. 5.	2.	12.	.
53.	MT	ON	3.	5.	3.	12.
60.	MT	ON	. 4.	0.	12.	11.
61.	NT	ON	. 4.	1.	12.	11.
62.	NT	ON	. 4.	2.	12.	11.
63.	NT	ON	. 4.	3.	12.	11.
64.	NT	ON	. 4.	4.	12.	11.
70.	SC	ON	4.	7.	1.	6.
71.	SC	ON	3.	7.	2.	6.
76.	TE	ON	. 0.	0.	0.	.
77.	NE	ON	. 0.	0.	0.	.

REMAINING TRACKS

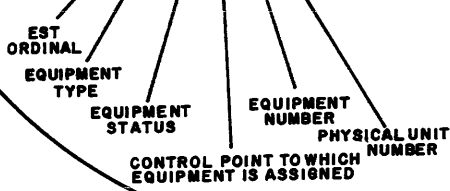

Figure 4-5a. Equipment Status (E) Display



## MASS STORAGE TABLES DISPLAY

The MST display provides detailed status information about all mass storage devices. Each entry in the display appears in the following format.

```
eq   type   u   dn   status           fy/pk   user   msk   mup   count
```

```
eq           EST ordinal
```

```
type        Device type:
```

```
DA    6603 Disk System
```

```
DB    6638 Disk System
```

```
DC    863 Drum Storage
```

```
DD    854 Disk Storage Drive
```

```
DE    Extended Core Storage
```

```
DF    814 Disk File
```

```
DH    821 Data File
```

```
DI    844 Disk Storage Subsystem
```

```
DP    Distributive Data Path to ECS
```

```
MD    841 Multiple Disk Drive
```

```
u          First physical unit number of this equipment
```

```
dn         Device number (uniquely identifies a device within a family of
           permanent file devices)
```

```
status    Status conditions; any combination of conditions can exist; the following
           codes are listed in the order in which they appear on the display.
```

```
S        System resides on this device.
```

```
P        Permanent files reside on this device.
```

```
R        Device is removable.
```

```
C        Checkpoint requested for specified device. The operator
           should ensure that C status is not present before dismounting
           a removable device or issuing an OFF command to logically
           remove it.
```

```
U        Device is unavailable.
```

```
D        Direct access files reside on this device.
```

```
I        Initialization requested.
```

```
N        This device is temporarily in unload status, and therefore,
           not available for permanent file access ( for example, the
           operator is changing packs on a physically removable per-
           manent file device).
```

```
X        Device is an auxiliary permanent file device.
```

```
T        System allocation of temporary files is allowed on this
           device.
```

```
A        Alternate system device
```

```
O        Catalog track overflowed
```

fy/pk	If the device is a member of a family of permanent file devices, its family name is displayed. If the device is an auxiliary permanent file device, its pack name is displayed.
user	User number of the owner of the private auxiliary device
msk	Device user mask
mup	Multiunit position in the form m/n, where m is the unit's position amount n total units. However, if the device is defined in CMRDECK as a multiunit device, only the first of n units will be displayed.
count	Number of direct access files attached

In addition, if an error is detected, the system displays (and periodically intensifies) an error code following the count field.

LE	Label error (unrecognizable label)
CE	Configuration error (active device has one of the units in error)
IL	Incorrect label (the label on an active device is incorrect)
NR	Not ready
LK	Error in TRT linkage detected when recovering PFS; no recovery possible; can occur only when introducing removable devices after deadstart.
TL	Length of device's TRT is in error; no recovery possible
DN	Device number conflicts with that of another device in the family
PN	Duplicate pack name exists
UM	User mask for family does not uniquely equal 377 <sub>8</sub>
OF	Device has OFF status
IN	Device has initialize status set (only if set via deadstart)

Figure 4-5b illustrates the mass storage tables display.

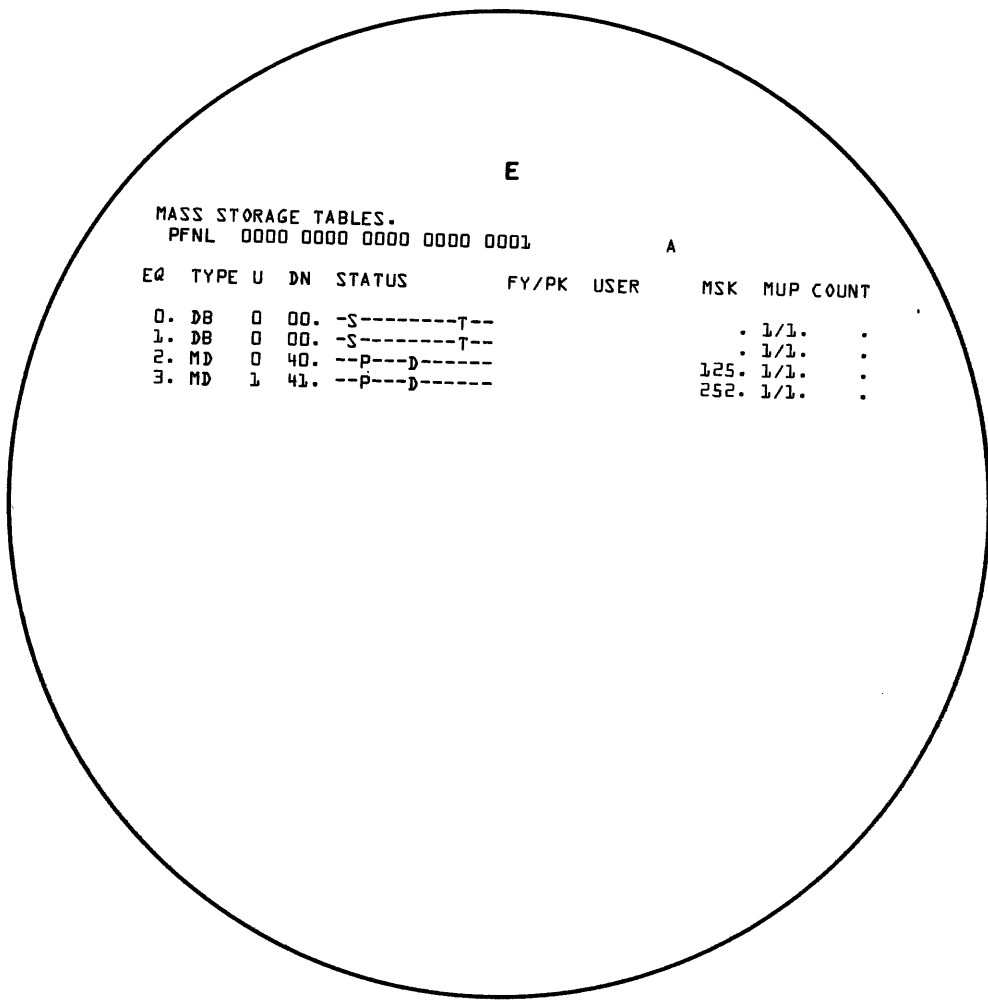

Figure 4-5b. Mass Storage Tables (E) Display

### RESOURCE MOUNTING PREVIEW DISPLAY

The preview display identifies the tapes and packs needed to satisfy user's requests. Each line in the display appears in the following format.

jobname	vsn	eq	jobname	vsn	eq
jobname	Name of the job that will use the specified tape or pack				
vsn	1- to 6-character volume serial number of the required tape or 1- to 7-character pack name of the required pack. The volume serial number is obtained from the volume header label of an ANSI labeled tape or specified by the operator via the VSN command (refer to section 3) for an unlabeled tape.				

eq

Resource type:

MT Magnetic Tape Unit (7-track)  
NT Magnetic Tape Unit (9-track)  
DDi 854 Disk Storage Drive ( $1 \leq i \leq 4$ )  
Dii 844 Disk Storage Subsystem ( $1 \leq i \leq 8$ )  
MDi 841 Multiple Disk Drive ( $1 \leq i \leq 8$ )

Figure 4-5c illustrates the preview display.

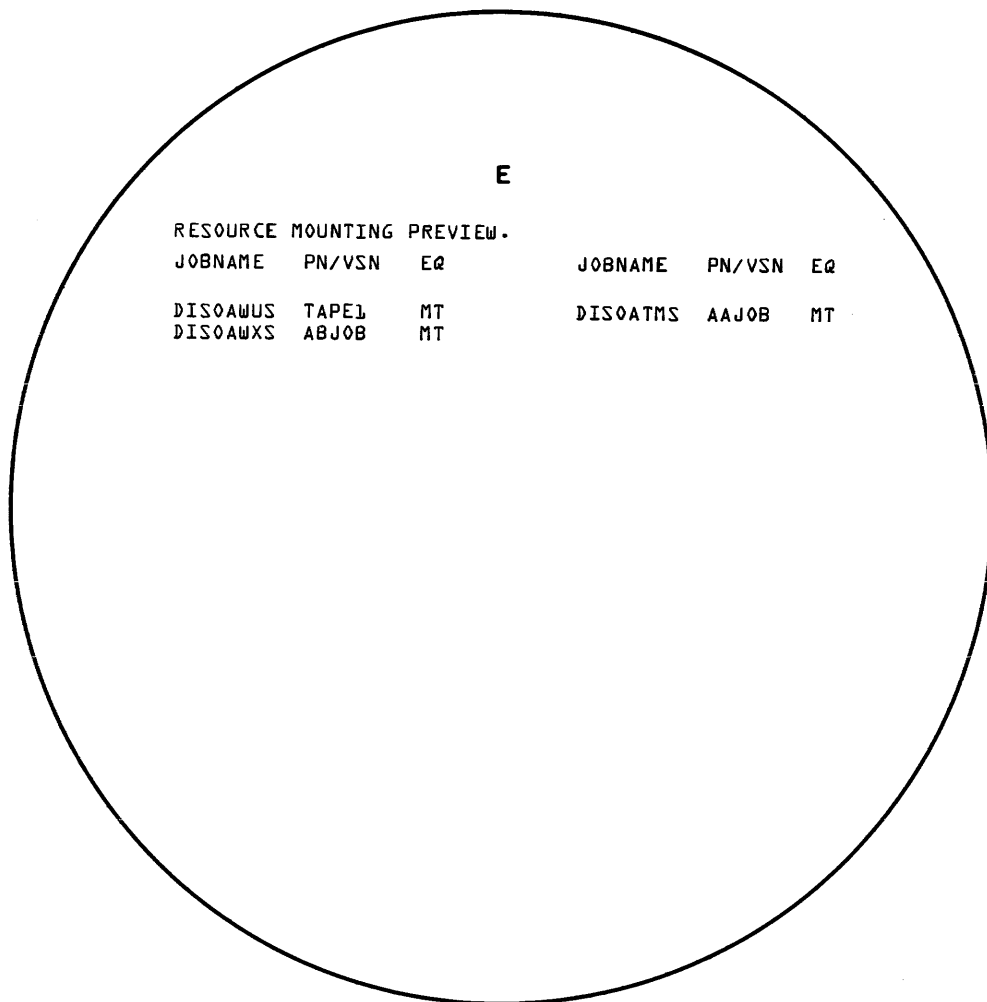

E

RESOURCE MOUNTING PREVIEW.

JOBNAME	PN/VSN	EQ	JOBNAME	PN/VSN	EQ
DISOAWUS	TAPE1	MT	DISOATMS	AAJOB	MT
DISOAWXS	ABJOB	MT			

Figure 4-5c. Resource Mounting Preview (E) Display

## TAPE STATUS DISPLAY

The tape status display provides a summary of the status of all magnetic tape units in the system. Each entry appears in the following format.

eq	vsn	den	r	f	cp	jobname	status	fileid
eq							Identifies the equipment being used:	
		MTuu					7-track; uu is the unit number	
		NTuu					9-track; uu is the unit number	
vsn							Volume serial number of the mounted tape	
den							Density (bpi/cpi):	
		200					200 bpi (implies 7-track)	
		556					556 bpi (implies 7-track)	
		800					800 bpi/cpi (7- or 9-track)	
		1600					1600 cpi (implies 9-track)	
r							Ring status (IN if the write enable ring is in; blank if the ring is out)	
f							Data format:	
		I					Internal	
		SI					SCOPE Internal	
		X					External	
		S					SCOPE Stranger	
		L					SCOPE Long Record	
		E					Line Image	
		B					Blocked	
		F					Foreign	
cp							Control point to which the specified job is assigned	
jobname							Name of the job to which the tape unit is assigned	
status							Status of the tape unit:	
		READY					Unit is ready	
		IDLE					Unit is idle	
		LOADPT					Tape is positioned at load point	
		ROLLED					Job using tape unit has been rolled out	
		DOWN					Unit has been logically removed from the operating environment via the OFF command	
fileid							File identifier obtained from tape label	

Figure 4-5d illustrates the tape status display.

E							
EQ	VSN	DEN	R	F	CP	JOB	STATUS
MT50	#####0 UNLABELED	800					IDLE
MT51	#####1 UNLABELED	800	IN	I	4.	DISOAJCS	LOADPT
MT52		800					IDLE
MT53	#####3 UNLABELED	800		I	3.	DISOAAOS	NOTRDY
NT60		1600					IDLE
NT61		1600					IDLE
NT62		1600					IDLE
NT63		1600					IDLE
NT64		1600					IDLE

Figure 4-5d. Tape Status (E) Display

## FILE NAME TABLE (H) DISPLAY

With the H display the operator can obtain information about a file such as its status, type, and the control point to which it is assigned. When the display is on the left screen, the + or - key can be used to step the display forward or backward one page. More than one page exists if the message:

MORE FILES FOLLOW.

appears at the bottom of the display. The format of each line is:

```
no   name   cp   ty   eq   pr   id   stat
```

no Unique number (FNT ordinal) assigned to the file by the system when the file is created and retained by that file as long as it is in the system

name File name

cp Control point to which the file is assigned

ty File type (an asterisk following the file type indicates a read-only file):

CM	Common file
IN	Input file
FA	Fast-attach file
LI	Library file (read-only common file)
LO	Local file
PM	Direct access permanent file
PR	Print file
PT	Primary terminal file
PH	Punch file
RO	Rollout file
SY	System file
TE	Timed-event rollout file

eq EST ordinal of the device on which the file resides

pr Queue priority (for queue type files only)

id File identifier associated with the file

stat Last file status. Some common statuses† are:

0051	Rewound binary	}	Odd specifies inactive. Even specifies active.
0053	Rewound coded		
0027	End-of-record written		
0033	End-of-file read		
1031	End-of-information read		
0061	Unload		

†Refer to section 7 of the KRONOS 2.1 Reference Manual for a complete description of file status information.

The H display can also be set to indicate only files of a certain file type. For example:

H,x.

- x A All files
- C Common files
- I Input files
- O Output files
- P Punch files
- R Rollout files
- n Control-point number

Entering H,C. for all common files followed by H,15. displays all common files for control point 15. Entering H,0.(zero) restores the display of all common files. To return to the main FNT display, enter H,A.

Figure 4-6 illustrates the file name table (H) display.

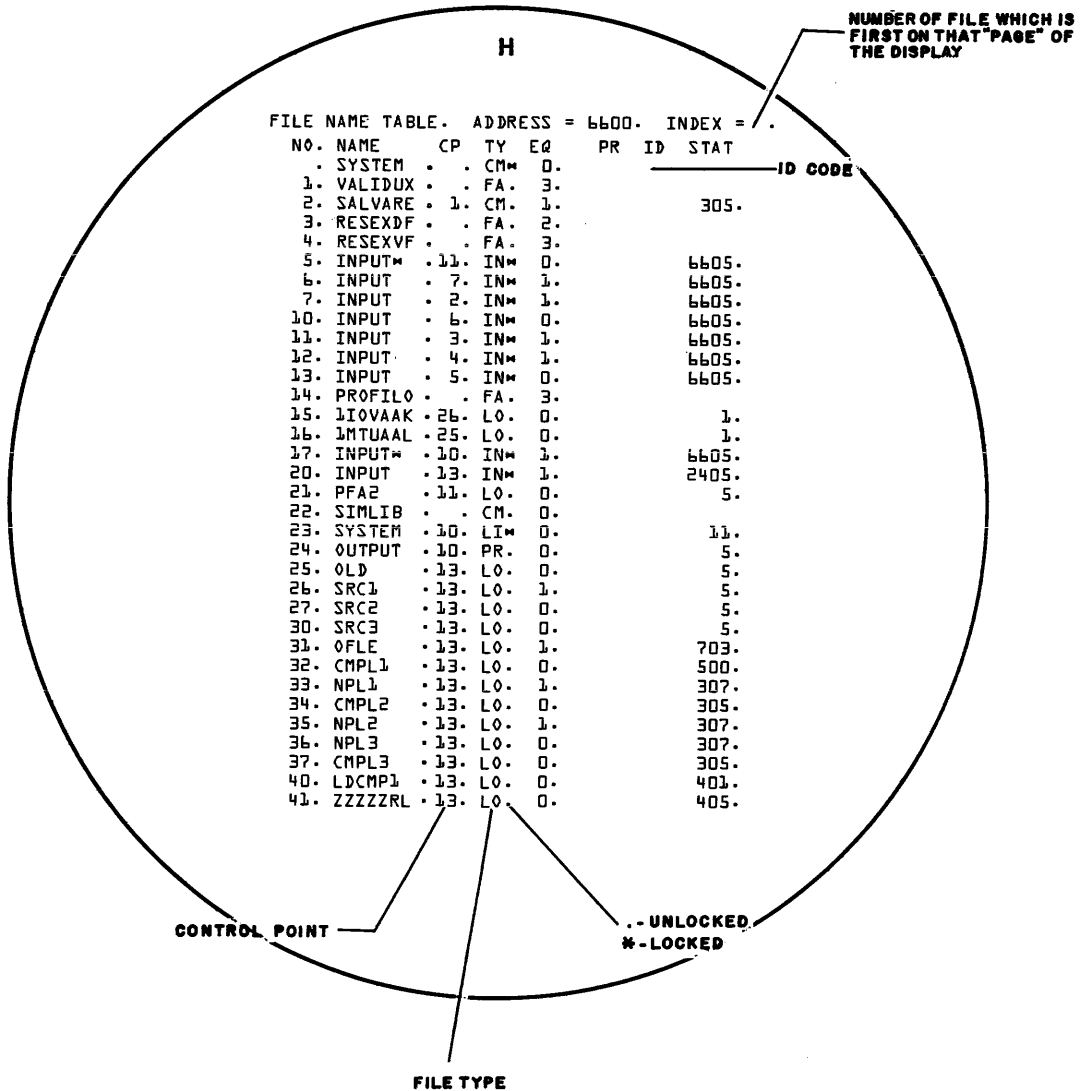

Figure 4-6. File Name Table (H) Display



## BATCHIO (I) DISPLAY

The BATCHIO display shows the status of BATCHIO unit record devices. Each entry is in the following format.

bp	jobname	eq	rct	status
bp	Buffer point. A buffer point is established for each unit record device and remains constant as long as the EST table is not changed.			
jobname	System job name (name of job using the device)			
eq	Peripheral equipment (mnemonic and EST ordinal); for example:			
	CR11	Card reader		
	CP12	Card punch		
	LP20	Line printer		
rct	Repeat count (refer to the REPEAT command in section 3)			
status	Equipment status (for example, NOT READY; NOT READY status could be caused by STOP button pushed).			

At the BATCHIO control point (B display), a message appears whenever a device is active. The message appears as:

```
n  BUFFERS ACTIVE
      n      Number of buffer points active
```

Figure 4-7 illustrates the BATCHIO status (I) display.

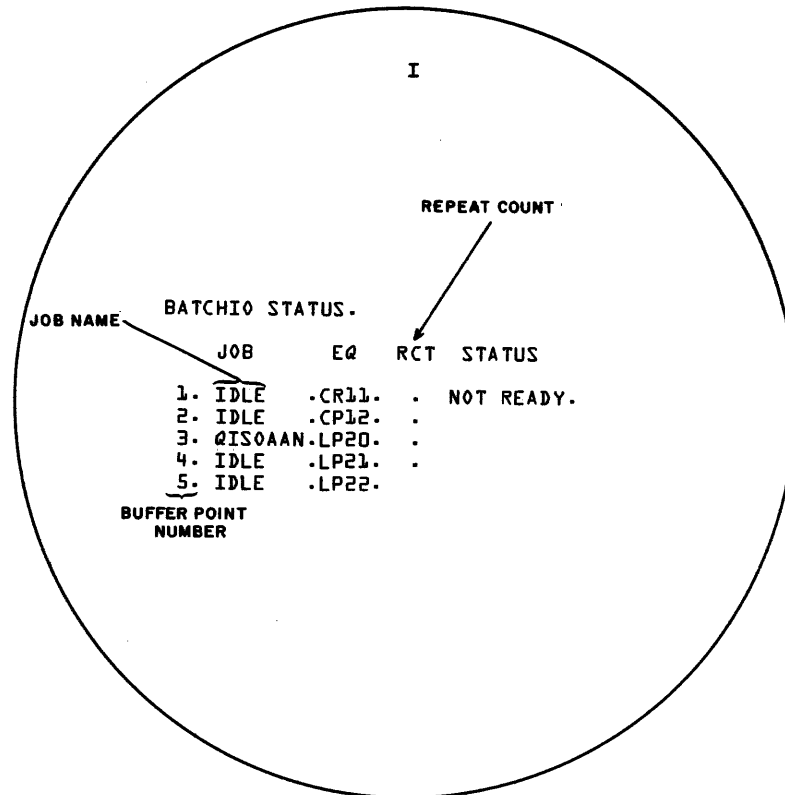

Figure 4-7. BATCHIO Status (I) Display

## CONTROL POINT STATUS (J) DISPLAY

The J display is used to show the status of control points. All of the control cards for a job are displayed, allowing the operator to anticipate future job requirements. The next control card to be processed is intensified. The J display shows control point parameters: control point number, job name, time limit, accumulated CPU time, CPU status, contents of P register, reference address, field length, and equipment assigned to the control point.

Figure 4-8 illustrates the control point status (J) display.

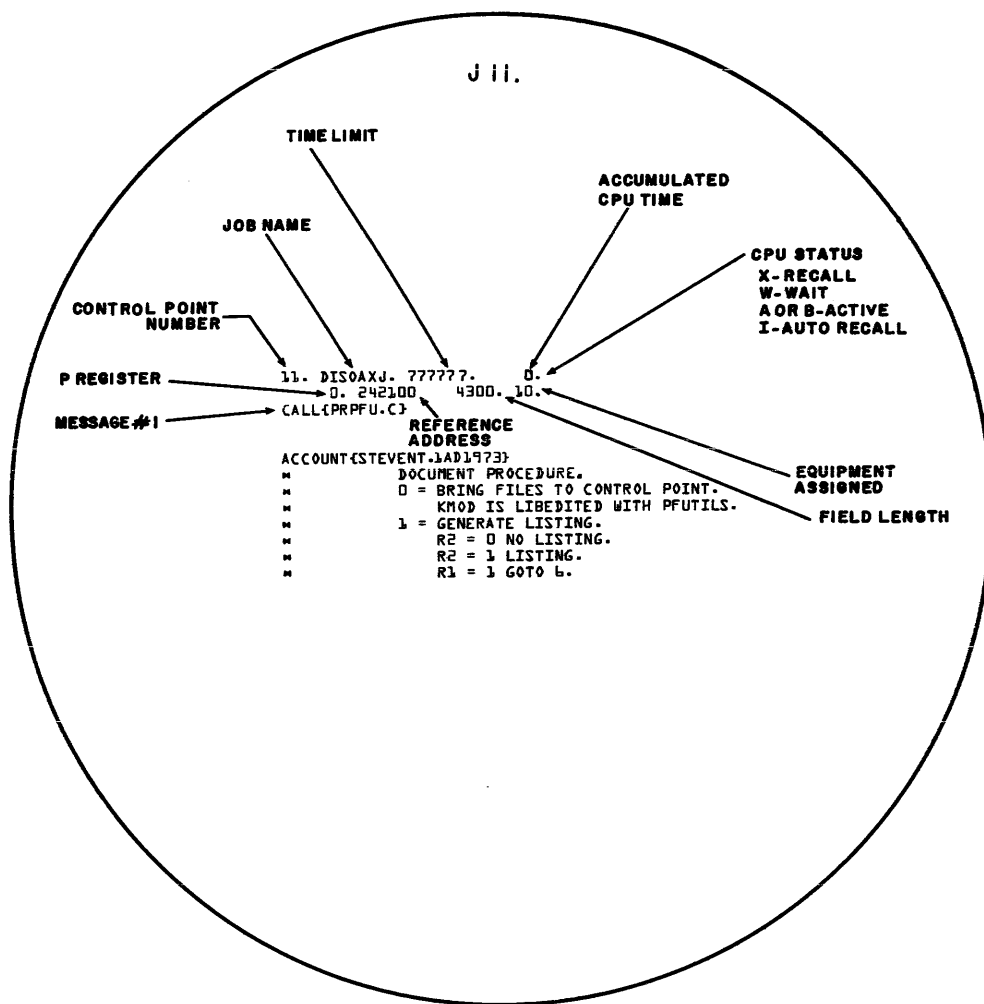

Figure 4-8. Control Point Status (J) Display

## CENTRAL PROGRAMMABLE (K AND L) DISPLAYS

With these displays, a job at a control point can place information on the console screen and receive information from the keyboard. The information entered is not executed by DSD, but is used by the job. The job first issues a request message on the B display, asking the operator to bring up the K or L display. The operator should type:

K, n. or L, n.

where n is the control point number of the requesting job. When the display is attached to control point n, the type-in (K. followed by data) is transferred to a specified area of the job field length when the carriage return terminates the type-in. The job can request and accept information from the operator with great flexibility. Normally, these displays are used for utility programs (refer to sections 5 and 6). Note that these displays are control-point oriented. That is, paging forward or backward through the display for each control point is accomplished with the + and - keys, respectively. The number of the control point also appears at the top of display next to the letter designator (for example, K5).

## FILE (N) DISPLAY

The operator can display a file on the left screen by typing:

DISPLAY, xxx.

where xxx is the FNT ordinal (refer to the H display). The file is displayed on the N display. Any subsequent commands:

N.

cause file xxx to be displayed. At the top of the display is the file name, the control point to which the file is attached, and the file status (blank, EOR, and EOF). Paging through the file is accomplished by using the + and - keys. Approximately 100 central memory words of the file are displayed at a time.

The data being displayed is contained in the second 100<sub>g</sub> words of the system control point area. In addition, words 76<sub>g</sub> and 77<sub>g</sub> contain file status and disk linkage information, respectively.

## PP COMMUNICATIONS AREA (P) DISPLAY

The P display shows the first three words of each peripheral processor's communication area.

Line 1	Input register; normally contains the first three characters of the program name. The fourth character is the control point. This is followed by the input parameters (FET address, function call, etc).
Line 2	Output register; one of the system requests (RCHM, SFBM, etc.).
Line 3	First word of message buffer; the first 10 characters of the last message issued.

The name of the current monitor function being issued by a peripheral processor is displayed to the left of its output register. Normally, this display is used by system programmers for debugging purposes. Paging forward or backward through the display is accomplished with the + and - keys, respectively. Note that this is effective only for 20 PPU systems. In this case, two pages are required; the first page contains PPUs 0 through 11 octal and the second page contains PPUs 20 through 31 octal.

Figure 4-9 illustrates the PP communications area (P) display.

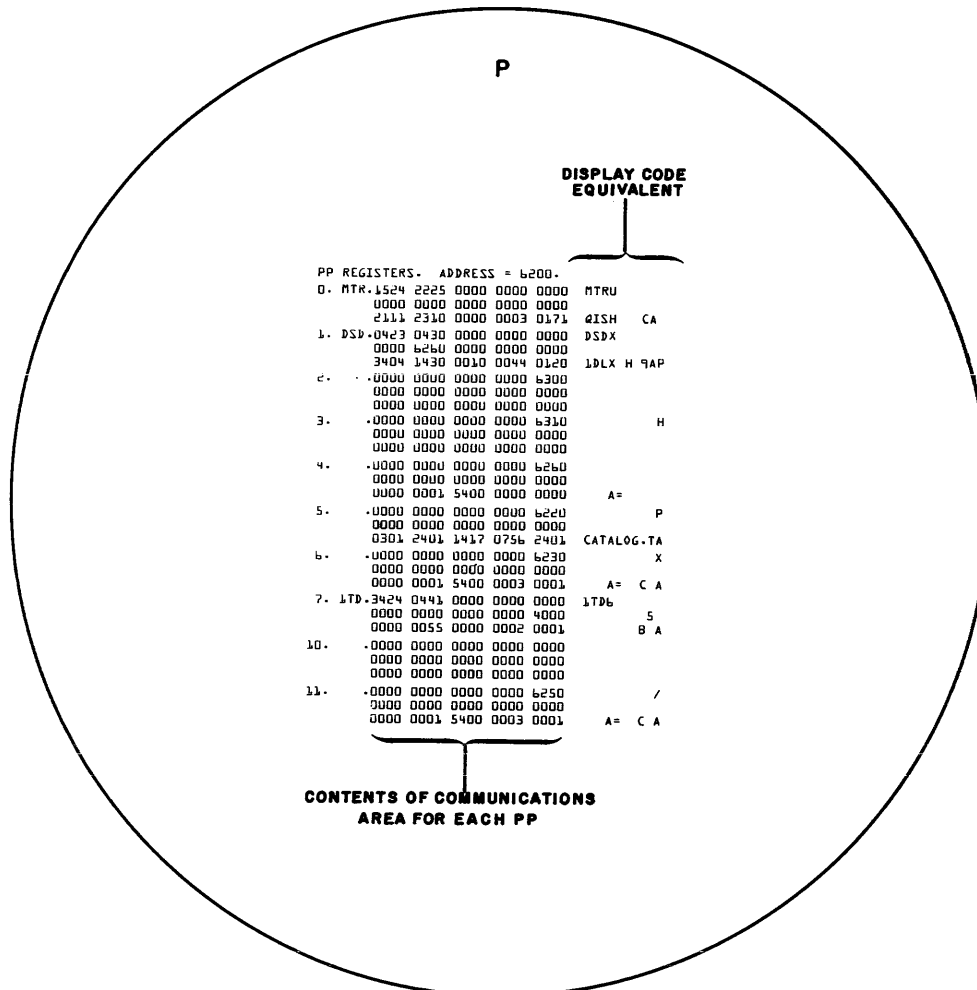

Figure 4-9. PP Communications Area (P) Display

### JOB QUEUES (Q) DISPLAY

The Q display shows the status of the input, rollout, and output queues. Three columns are displayed, one for each queue. Each entry is in the following format.

no	jobname	queue priority	field length/100
no	FNT ordinal of the job (same as on H display)		
jobname	System-assigned job name		
queue priority	Priority assigned to the job within the queue		
field length/100	Job field length divided by 100 required to be assigned to central memory		

For timed-event rollout files, the entry is followed by two asterisks.

Figure 4-10 illustrates the job queues display.

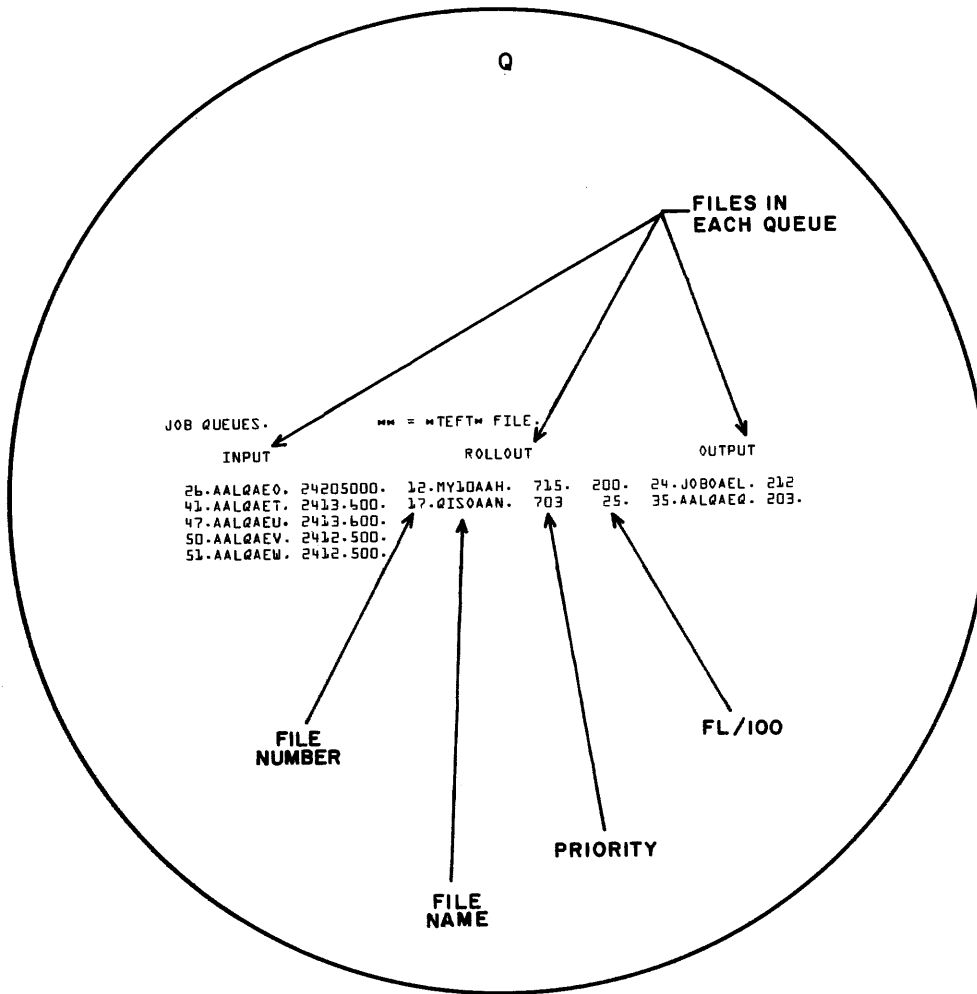

Figure 4-10. Job Queues (Q) Display

## EXPORT STATUS (R) DISPLAY

The R display shows the current status of users logged in on 200 user terminals or 731-12 or 732-12 remote batch terminals. A header line contains the total number of users since Export was initialized and the current number of active users. Each entry appears in the following format.

line	login	user	read	print	jobsin	jobsout
line	Multiplexer line on which the user is logged in					
login	Time the user logged in					
user	User number of current user					

```

read          Reader status:
              IDLE
              NOT READY
              Name of job being read
print        Printer status:
              SUSPENDED
              IDLE
              Name of the job being printed
jobsin       Number of jobs input since login
jobsout      Number of jobs output since login

```

Figure 4-11 illustrates the Export status display.

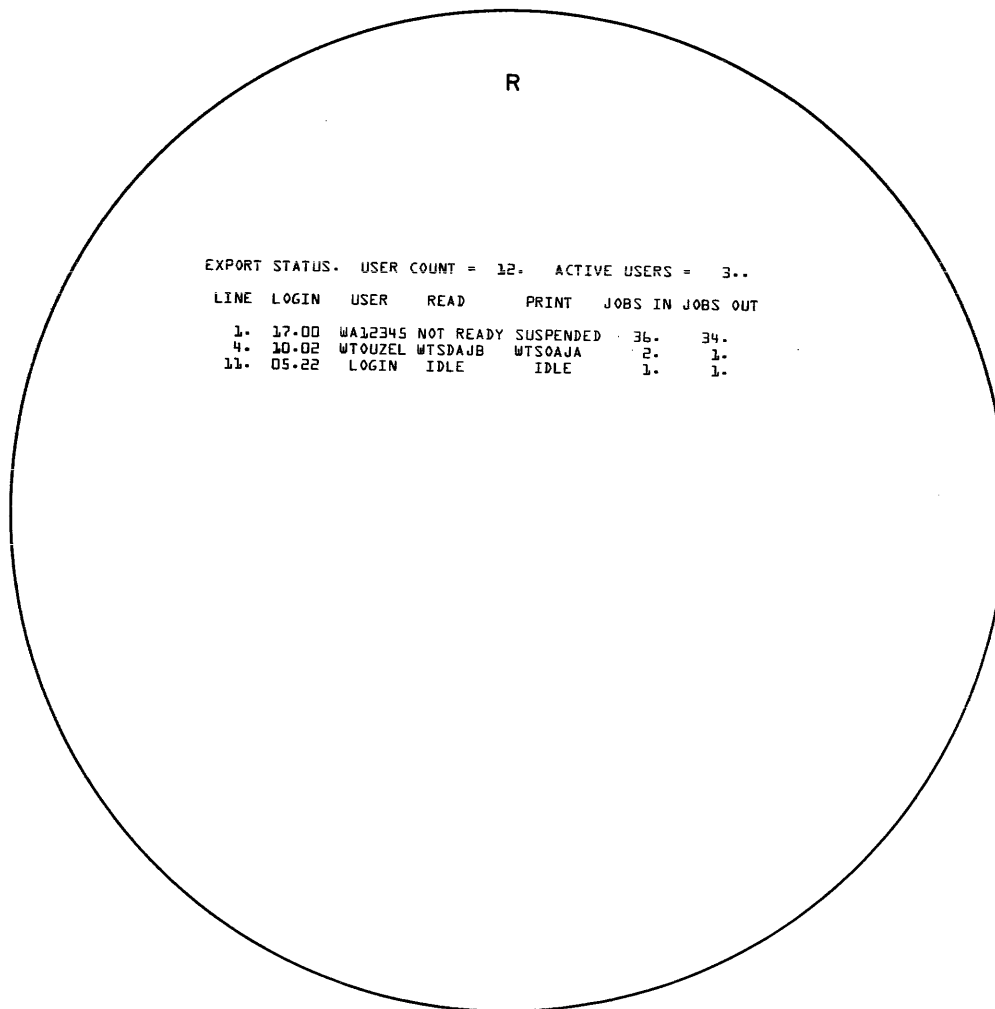

Figure 4-11. Export Status (R) Display

## SYSTEM CONTROL INFORMATION (S) DISPLAY

The S display shows the parameters used to control job flow for the various origin types. Each entry appears in the following format.

jobtype	queue	op	lp	up	in
jobtype	Job origin type:				
	SY	System			
	BC	Local batch			
	TX	Time-sharing			
	EI	Export/Import			
	MT	Multiterminal			
queue	Queue type; one of each of the following for each job type:				
	IN.	Input			
	RO.	Rollout			
	OT.	Output			
op	Original priority (priority at which job is initially set in the queue)				
lp	Lowest priority at which a job can be entered and aged				
up	Highest priority a job can reach in the queue; aging stops when this priority is reached. (Job is also given this priority when initially assigned to central memory.)				
in	Interval at which jobs are aged while in the queue.				

Refer to section 3 for further information about these parameters.

At the bottom of the display are five entries controlling the time or delay in system operations. These are installation parameters used to control system operation.

JS	Job scheduler delay interval (seconds)
CR	CPU program recall (milliseconds)
AR	PPU auto recall (milliseconds)
JA	Job advance (milliseconds)
CS	CPU switch (milliseconds)

The system status word is displayed at the bottom of the S display in five groups of four octal digits. The display code equivalent is shown at the right of the control word. The bits of the control word that may be set and the meaning of each are listed (refer to section 3 for a description of the commands that can be used to change these conditions).

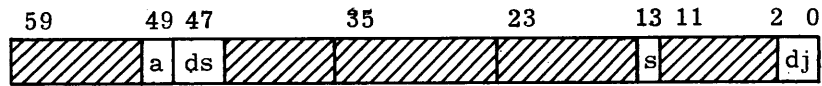

a account verification:

<u>Bit Set</u>	<u>Significance</u>
49	Ignore ACCOUNT card; allows job to be run without an ACCOUNT card. Accepts the card if it is there, but one is not required.
48	Disable validation; allows jobs to run with no VALIDUS file. The ACCOUNT card is ignored even if present.

ds Disable subsystem:

<u>Bit Set</u>	<u>Significance</u>
47	Disable BATCHIO processing
46	Disable time-sharing processing
45	Disable Export/Import processing

s Console/system modification status:

<u>Bit Set</u>	<u>Significance</u>
13	Console is unlocked
12	System is in debug mode

dj Disable job flow parameters:

<u>Bit Set</u>	<u>Significance</u>
2	Disable priority aging
1	Disable job scheduler
0	Disable auto roll

Figure 4-12 illustrates the system control information (S) display.



S

SYSTEM CONTROL INFORMATION.

JOB TYPE	QUEUE	OP	PRIORITIES		IN
			LP	UP	
SY.	IN.	6600.	700.	3000.	1.
	R0.	6000.	100.	1000.	1.
	OT.	400.	100.	7700.	1.
BC.	IN.	2400.	2000.	4010.	1.
	R0.	2400.	1010.	4004.	1.
	OT.	200.	100.	7000.	1.
EI.	IN.	3400.	2400.	4010.	1.
	R0.	3400.	1400.	4006.	1.
	OT.	200.	100.	7600.	1.
TX	IN.	4000.	3770.	7006.	1.
	R0.	4004.	3740.	7000.	1.
	OT.	200.	100.	7000.	1.
MT.	IN.	6774.	6700.	7400.	1.
	R0.	6774.	4000.	7400.	1.
	OT.	6000.	100.	7700.	1.

DELAYS.

JS	CR	AR	JA	CS
1.	10	1000.	10.	10.

CONTROL 0001 1200 0000 0002 0000 AJ B

Figure 4-12. System Control Information (S) Display

## TIME-SHARING STATUS (T) DISPLAY

The T display shows the status of time-sharing users. A header line contains the number of successful logins and the number of currently active and logging-in users. Each entry is in the following format.

line	userno	status	lastop	system
line		Line number on which the user is logged in (ports 0 to 3 are reserved; port 4 is physical port 0 on the first multiplexer used).		
userno		User number		
status		Mode of terminal operation:		
		E	Execution	
		C	Command	
		B	Begin job	
		R	Rolled out	
		I	Input	
		O	Output	
		blank	Not used	
lastop		Last command entered		
system		Subsystem currently being used:		
		BAS	BASIC	
		BAT	Batch	
		EXE	Execute	
		FOR	Time-sharing FORTRAN	
		NUL	None	

Figure 4-13 illustrates the time-sharing status (T) display.

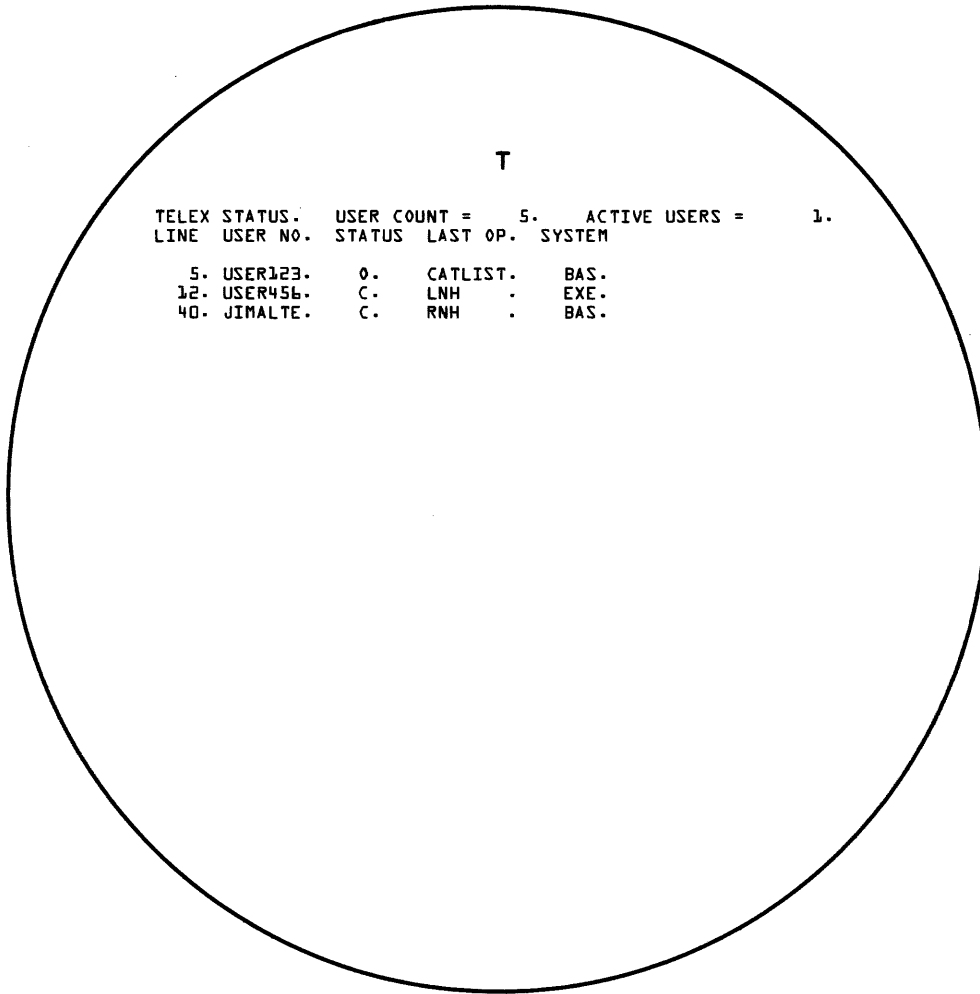

T

TELEX STATUS. USER COUNT = 5. ACTIVE USERS = 1.  
LINE USER NO. STATUS LAST OP. SYSTEM

5.	USER123.	0.	CATLIST.	BAS.
12.	USER456.	C.	LNH .	EXE.
40.	JIMALTE.	C.	RNH .	BAS.

Figure 4-13. Time-Sharing Status (T) Display

## MONITOR FUNCTIONS (Y) DISPLAY

The Y display lists all monitor function mnemonics and their respective codes. Codes 1 through 31 represent PP monitor functions; codes 32 through 77 represent CP monitor functions. Figure 4-14 illustrates the Y display.

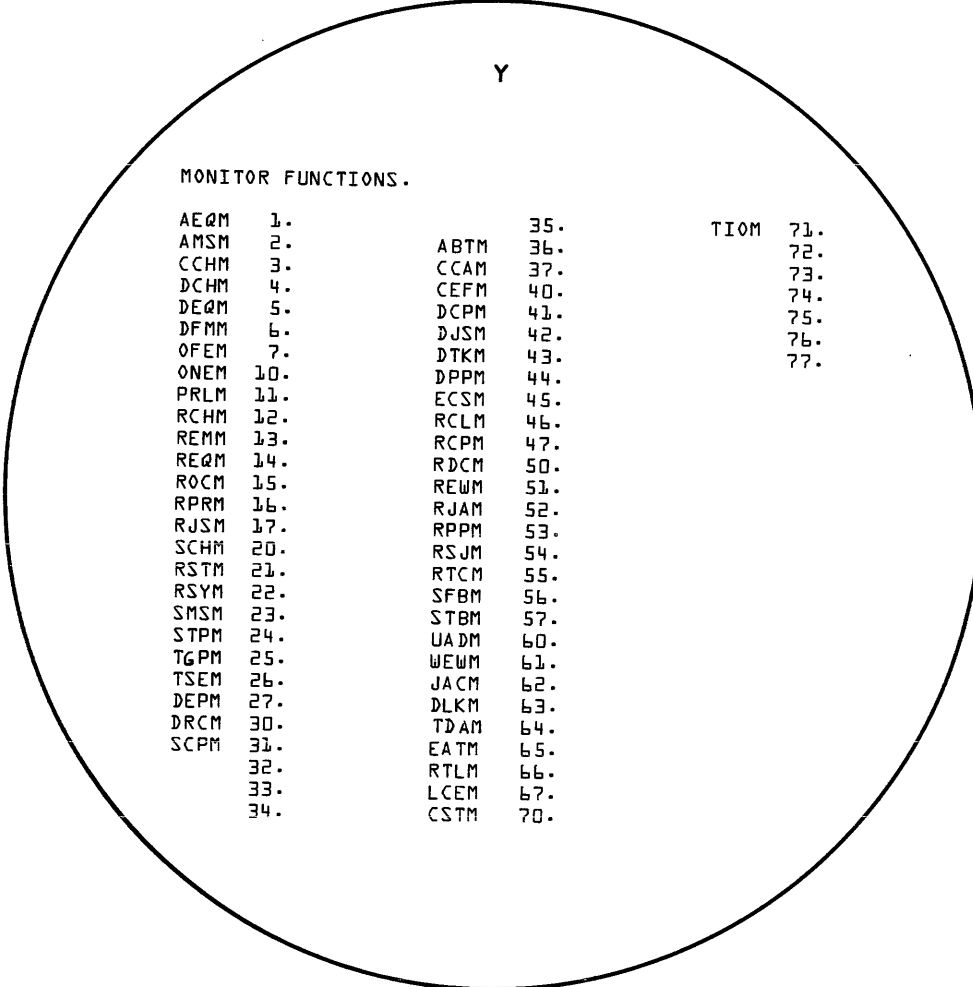

Y

MONITOR FUNCTIONS.

AEQM	1.				
AMSM	2.				
CCHM	3.				
DCHM	4.				
DEQM	5.				
DFMM	6.				
OFEM	7.				
ONEM	10.				
PRLM	11.				
RCHM	12.				
REMM	13.				
REQM	14.				
ROCM	15.				
RPRM	16.				
RJSM	17.				
SCHM	20.				
RSTM	21.				
RSYM	22.				
SMSM	23.				
STPM	24.				
TGPM	25.				
TSEM	26.				
DEPM	27.				
DRCM	30.				
SCPM	31.				
	32.				
	33.				
	34.				
		35.			
		ABTM	36.		
		CCAM	37.		
		CEFM	40.		
		DCPM	41.		
		DJSM	42.		
		DTKM	43.		
		DPPM	44.		
		ECSM	45.		
		RCLM	46.		
		RCPM	47.		
		RDCM	50.		
		REWM	51.		
		RJAM	52.		
		RPPM	53.		
		RSJM	54.		
		RTCM	55.		
		SFBM	56.		
		STBM	57.		
		UADM	60.		
		WEWM	61.		
		JACM	62.		
		DLKM	63.		
		TDAM	64.		
		EATM	65.		
		RTLK	66.		
		LCEM	67.		
		CSTM	70.		
				TIOM	71.
					72.
					73.
					74.
					75.
					76.
					77.

Figure 4-14. Monitor Functions (Y) Display

## DIRECTORY (Z) DISPLAY

The Z display lists the DSD displays available to the console operator. This display is brought to the screen whenever the operator types:

Z.

or enters a letter designator not among those listed. Figure 4-15 illustrates the directory (Z) display.

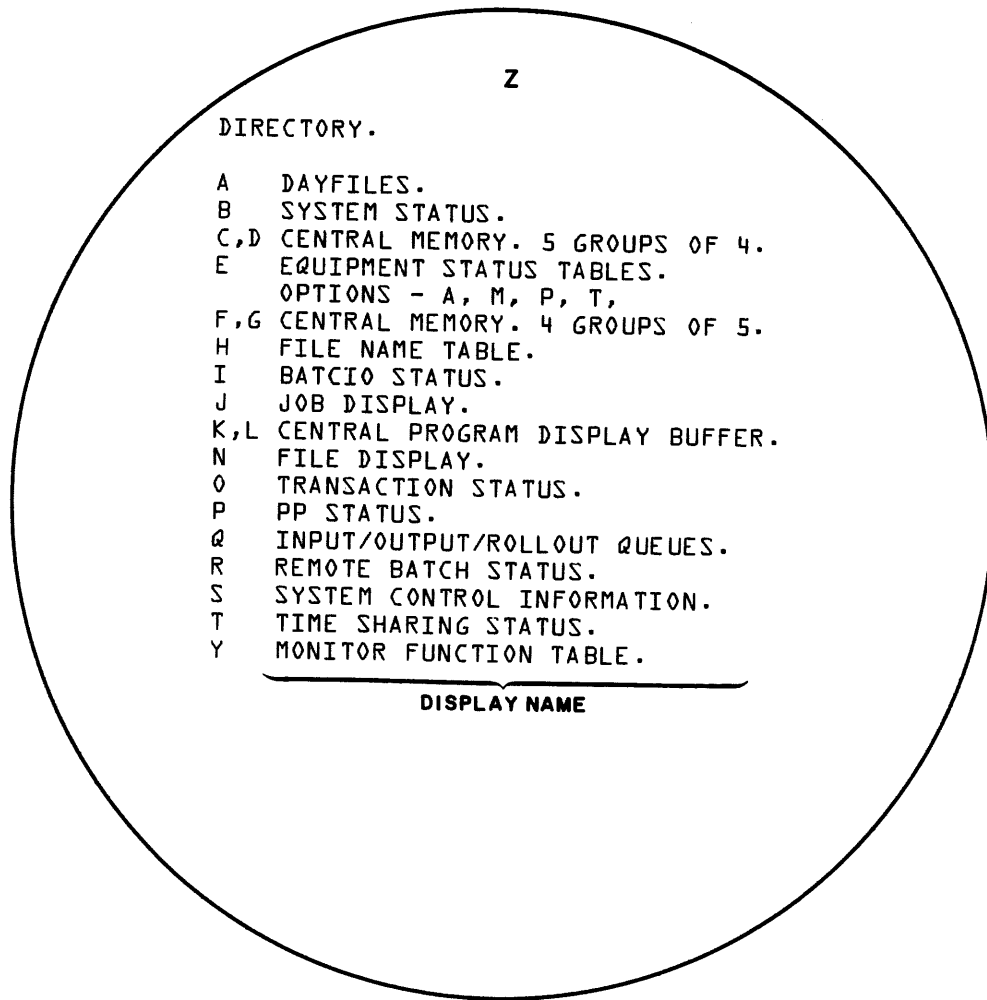

Figure 4-15. Directory (Z) Display

---

The permanent file supervisor (PFS) controls five utility programs that are used to maintain the KRONOS permanent file system. The function of each utility program is as follows:

- PFDUMP      Dump permanent files. This utility copies permanent files residing on mass storage to an archive file on a backup storage device (typically magnetic tape). Archive files created by PFDUMP may be reloaded by the PFLOAD utility.
- PFLOAD      Load permanent files. This utility loads files from an archive file onto a mass storage permanent file device.
- PFCAT      Catalog permanent file device. This utility catalogs permanent file catalog tracks and generates a report. The possible reports are...
  1. Listing of catalog file with files grouped by user index.
  2. Statistical report on device usage.
- PFATC      Catalog archive file. This utility generates a catalog of permanent files stored on an archive file.
- PFCOPY      Copy archive file(s) to control point. This utility extracts permanent files from an archive file created by PFDUMP and copies them to one or more files at a control point.

For a detailed description of operation and the use of optional parameters for each utility program listed, refer to section 2 in part IV (System Maintenance) of the KRONOS Installation Handbook. The information and procedures contained in this section describe only the more commonly used features of the PFDUMP and PFLOAD utilities.

### ARCHIVE FILE

The permanent files accumulated on mass storage can be dumped in whole or in part to a backup device (typically magnetic tape) as assurance against a device malfunction that may result in loss of permanent files, or to free a device temporarily for preventive maintenance. Each PFDUMP operation creates a multirecord archive file on which each physical record represents a permanent file that was part of the dump. The PFLOAD utility can then be used to reload the permanent files present on the archive file. The status of files loaded becomes that which existed at the time the archive file was created.

### PFDUMP PROCEDURES

Dumping of permanent files to a backup archive file may be accomplished through keyboard entry to a K display (under DSD control only), or by direct keyboard entry under DSD or DIS control.

The following procedure describes K display usage for PFDUMP operations under DSD control:

1. Call PFS (permanent file supervisor) by typing

X.PFS. (CR)

2. Examine the DSD job status (B) display. When PFS is scheduled to a control point, it is indicated on the B display. The message...

REQUEST \*K\* DISPLAY

appears in the message field for that control point.

3. Activate the K display for that control point by typing

K,n. (CR) (n is control point number)

The K display (Figure 5-1) appears on the left console screen. Instructions at the bottom of the display describe how to select the utility function to be performed.



Figure 5-1. Initial Left Screen K Display

- Select the PFDUMP utility by typing

K. DU. (CR)

When this entry is executed, the initial left screen K display (Figure 5-1) is automatically replaced with the PFDUMP K display (Figure 5-2). This display lists and defines option parameters which may be selected for the PFDUMP utility. † The center column (CURRENT VALUE) lists the default value assumed for each option not selected. The PFDUMP operation is performed according to the criteria specified by these options. The letters TCE appearing after the LO option and CAMIDBP after the OP option indicate the legal values that may be specified for those options. The right screen K display (Figure 5-3) defines the values listed for both options and describes the method of entry. To activate the right screen K display, type

KK. (CR)

*** PERMANENT FILE UTILITY OPTIONS ***		
OPTION	CURRENT VALUE	DESCRIPTION
UT	DU	UTILITY DESIRED
FN	0	FAMILY NAME
PN	0	PACK NAME
DN	0	DEVICE NUMBER
T	TAPE	ARCHIVE FILE NAME
LO	0	LIST OPTIONS VALID - TCE
L	OUTPUT	OUTPUT FILE NAME
OP	0	UTILITY OPTIONS VALID - CAMIDBP
NT	?-TRACK	NINE TRACK
DE	0	0-DFLT,1-556,2-200,3-800,4-1600
NR	REWIND	NO REWIND
NU	UNLOAD	NO REWIND - UNLOAD
SF	0	SKIP FILE
N	-- N/A --	NUMBER OF FILES TO PROCESS
DT	0	DATE YYMMDD
TM	0	TIME HHMMSS
UI	0	USER INDEX
PF	0	PERMANENT FILE NAME
V	NO VERIFY	VERIFY FILE GENERATION
VF	PFVER	VERIFY FILE NAME
DI	-- N/A --	DESTINATION UI
DD	-- N/A --	DESTINATION DEVICE NUMBER
MF	-- N/A --	MASTER FILE NAME
UN	0	USER NUMBER

NOTE - N/A DENOTES INVALID PARAMETER

FILE NAME	USER INDEX

OPTIONS DEFINED ON RIGHT SCREEN DISPLAY

Figure 5-2. Left Screen K Display for PFDUMP Utility

† Refer to section 2 in part IV of the KRONOS Installation Handbook for complete information concerning use of PFDUMP options.



5. Enter PFDUMP parameters in the following format.

K.option<sub>1</sub>=value<sub>1</sub>, option<sub>2</sub>=value<sub>2</sub>, ..., option<sub>n</sub>=value<sub>n</sub>. (CR)

If it is desired to dump all permanent files residing on the normal family of permanent file devices, no options need be specified (there is typically only one family of permanent file devices present in the system). This is considered a full permanent file system dump. In this case, the default value for all options will be assumed. For example, the dump will be written to an archive file named TAPE. If the archive file is to reside on magnetic tape, a 7-track tape unit must be assigned (see step 6); system default density is assumed.



Figure 5-3. Right Screen K Display

If it is desired to dump only those files that have been created or modified after a specified date, a selective dump is used. That is, the OP=M option is specified along with a date and time origin (DT=date and TM=time). No other options need be specified. In this case, the parameter entry would be as follows:

K. OP=M, DT=yymmdd, TM=hhmmss. (CR)

yymmdd Date (year, month, and day)

hhmmss Time of day (hours, minutes, and seconds) after which all new or modified permanent files will be dumped.

6. Initiate PFDUMP processing by typing

K.GO. (CR)

When PFDUMP begins processing, it requests assignment of the device on which the archive file is to reside. This is indicated by a flashing REQUEST message that appears on the B display.

7. Assign the appropriate device by entering the following DSD command.

n. ASSIGN, xx. (CR)

n Control point requesting assignment.

xx EST ordinal of the device to be assigned.

It is also possible to call PFDUMP and specify appropriate options without using the K displays. This is accomplished with a single keyboard entry in the following format.

X. PFDUMP(option<sub>1</sub>=value<sub>1</sub>, option<sub>2</sub>=value<sub>2</sub>, ..., option<sub>n</sub>=value<sub>n</sub>) (CR)

Refer to the illustrations of K displays (Figures 5-2 and 5-3) for a list and description of all valid options. It should be noted that if an error is encountered in this entry, control will be returned to PFS and the REQUEST \*K\* DISPLAY message appears on the DSD B display. Parameters may then be entered via the K display as described in the preceding procedure.

## PFLOAD PROCEDURES

The PFLOAD utility is used to load permanent files onto an initialized mass storage permanent file device from an archive file created by the PFDUMP utility. It is also possible to load files onto a device on which permanent files currently reside (device not initialized). However, for the purposes of this discussion, it is assumed that the mass storage device to be loaded is initialized (refer to the description of the INITIALIZE command in section 3). For information concerning loading to a device on which permanent files currently reside (noninitial load), refer to section 2 in part IV of the KRONOS Installation Handbook.

The PFLOAD procedures contained in this section pertain only to two types of loading; a full permanent file load or an incremental load. Each type is described briefly as follows:

- Full permanent file system load. A full load is performed by reloading an archive file that contains a full permanent file system dump. Either the entire permanent file system or a specific device within the permanent file family may be reloaded.
- Incremental load. An incremental load is initiated from the most recent selective dump archive file. The selective dump archive contains only the permanent files which had been modified or created after a date and time specified in the PFDUMP procedure. Thus, the first step of an incremental load is to restore the most recently created or modified files to the permanent file system. After the first selective dump archive file has been processed, additional archive files may be loaded (selective or not) to complete loading of the permanent file system (or a specific device within the permanent file family).

A check is made when incrementally loading each permanent file to determine if the file has already been loaded, or if the file was purged before the most recent selective dump archive file was created. This check is possible because catalog images of all files active in the permanent file system are written as the first record (or records) of each selective dump archive file. This record is called the catalog image record (CIR). When an incremental load is initiated (described in the procedure that follows), the CIR from the most recent selective dump archive file is read to a random mass storage file and the permanent files residing on that archive are loaded. Then, subsequent archive files are read in the reverse order in which they were dumped. Each permanent file residing on an archive is compared with the CIR. If a match is found on the CIR, the file is loaded (unless options specified in the call to PFLOAD prohibit loading) and that entry in the CIR is cleared. Each time a file is loaded from an archive file, its corresponding entry in the CIR is cleared. Thus, when a file is encountered on an archive file with no corresponding entry on the CIR, that file is skipped because it has either been purged or previously loaded.

Loading of permanent files from an archive file can be accomplished through keyboard entry to a K display (under DSD control only), or by direct keyboard entry under DSD or DIS control.

The following procedure describes K display usage for PFLOAD operations under DSD control.

1. Call PFS (permanent file supervisor) by typing

X. PFS. (CR)

2. Examine the DSD job status (B) display. When PFS is scheduled to a control point, it is indicated on the B display. The message...

REQUEST \*K\* DISPLAY

appears in the message field for that control point.

3. Activate the K display for that control point by typing

K, n. (CR) (n is control point number)

The K display (Figure 5-1 under PFDUMP Procedures) appears on the left console screen. Instructions at the bottom of the display describe how to select the utility function to be performed.

4. Select the PFLOAD utility by typing

K.LD. (CR)

When this entry is executed, the initial left screen K display (Figure 5-1) is automatically replaced with the PFLOAD K display (Figure 5-4). This display lists and defines option parameters which may be selected for the PFLOAD utility. † The center column (CURRENT VALUE) lists the default value assumed for each option not selected. The PFLOAD operation is performed according to the criteria specified by these options. The letters TCE appearing after the LO option and CAMIDBRNEO after the OP option indicate the legal values that may be specified for those options. The right screen K display (Figure 5-3 under PFDUMP Procedures) defines the values listed for both options and describes the method of entry. To activate the right screen K display, type

KK. (CR)

5. Enter PFLOAD parameters in the following format.

K.option<sub>1</sub>=value<sub>1</sub>, option<sub>2</sub>=value<sub>2</sub>, . . . , option<sub>n</sub>=value<sub>n</sub>. (CR)

If it is desired to perform a full permanent file system load, it is possible that no options need be specified. However, this is true only if the default values were used for the FN (family name) and T (archive file name) options when the full dump archive file was created by PFDUMP. Also, if the archive file was created on magnetic tape, as is normally done, a 7-track tape unit was used by default. If these options were other than default when the archive file was created, the same options must be specified when reloading.

It is also possible to perform a full load to a selected permanent file device by specifying the DN option as follows:

K.DN=nn. (CR) (nn is the device number)

If it is desired to perform incremental load operations, the OP=M option is specified. This entry is as follows:

K.OP=M. (CR)

or

K.DN=nn, OP=M. (CR)

In the first form, a full incremental load is specified. Only the selected device specified by nn is incrementally loaded if the second form is entered.

† Refer to section 2 in part IV of the KRONOS Installation Handbook for complete information concerning use of PFLOAD options.

6. Initiate PFLOAD by typing

K.GO. (CR)

When PFLOAD begins processing, the following message appears at the bottom of the left screen K display requesting assignment of the archive file to be loaded.

ASSIGN TAPE.

This is also indicated by a flashing REQUEST message that appears on the B display.

7. Assign the appropriate device on which the archive file resides by entering the following DSD command.

n. ASSIGN, xx. (CR)

n Control point requesting assignment.  
xx EST ordinal of the device to be assigned.

A check is made to determine if the mass storage device(s) to be loaded are initialized. If they are not, the following message appears at the bottom of the left screen K display and PFLOAD halts.

DEVICE NOT INITIALIZED.

If the intention is to load an initialized device, each device to be loaded must be initialized and the PFLOAD utility reinitiated. Loading of a device on which permanent files already exist can also be performed (refer to section 2 of part IV in the KRONOS Installation Handbook for further information).

If a full incremental load is being performed, the following message appears at the bottom of the left screen K display after loading of the first (most recent) selective dump archive file is completed.

ENTER E TO TERMINATE LOADING.  
L TO LIST REMAINING FILES.  
GO TO RESUME INCREMENTAL LOAD.

To list the names of remaining files that have not yet been loaded, enter

K.L. (CR)

The other entries that can be made are self-explanatory.

It is also possible to call PFLOAD and specify appropriate options without using the K displays. This is accomplished with a single keyboard entry in the following format.

X. PFLOAD(option<sub>1</sub>=value<sub>1</sub>, option<sub>2</sub>=value<sub>2</sub>, ..., option<sub>n</sub>=value<sub>n</sub>) (CR)

Refer to the illustrations of K displays (Figures 5-3 and 5-4) for a list and description of all valid options. If an error is encountered in this entry, control will be returned to PFS and the REQUEST \*K\* DISPLAY message appears on the DSD B display. Parameters may then be entered via the K display as described in the preceding procedure.

\*\*\* PERMANENT FILE UTILITY OPTIONS \*\*\*

OPTION	CURRENT VALUE	DESCRIPTION
UT	LD	UTILITY DESIRED
FN	= 0	FAMILY NAME
PN	= 0	PACK NAME
DN	= 0	DEVICE NUMBER
T	= TAPE	ARCHIVE FILE NAME
LO	= 0	LIST OPTIONS VALID - TCE
L	= OUTPUT	OUTPUT FILE NAME
OP	= 0	UTILITY OPTIONS VALID - CAMIDBRNEO
NT	= 7-TRACK	NINE TRACK
DE	= 0	0-DFLT,1-556,2-200,3-800,4-1600
NR	REWIND	NO REWIND
NU	-- N/A ---	NO REWIND - UNLOAD
SF	= 0	SKIP FILE
N	= 1	NUMBER OF FILES TO PROCESS
DT	= 0	DATE YYMMDD
TM	= 0	TIME HHMMSS
UI	= 0	USER INDEX
PF	= 0	PERMANENT FILE NAME
V	-- N/A --	VERIFY FILE GENERATION
VF	-- N/A --	VERIFY FILE NAME
DI	= 0	DESTINATION UI
DD	= 0	DESTINATION DEVICE NUMBER
MF	-- N/A --	MASTER FILE NAME
UN	= 0	USER NUMBER

NOTE - N/A DENOTES INVALID PARAMETER

FILE NAME	USER INDEX

**OPTIONS DEFINED ON RIGHT SCREEN DISPLAY**

Figure 5-4. Left Screen K Display for PFLOAD Utility

---

This section describes the operation of the system utility programs DMQ, LDQ, FLAW, and STAGE.

## DMQ (DUMP QUEUE FILES)

DMQ searches the file name table (FNT) and copies all queue files of the type specified to a selected dump file. All files dumped by DMQ may later be reloaded by the LDQ utility.

The call to DMQ may be accomplished by keyboard entry in the following format (entry is valid under DSD or DIS control).

X. DMQ(FN=lfm, QT=qt, OT=ot, ID=id, JN=jobname, NR, ER)

lfm	Name of file (1 to 7 characters) to which queue type files will be copied. Default is SCR.
qt	Queue type PR print PH punch IN input AL all queue types
ot	Job origin type SY system BC local batch EI remote batch (Export/Import)
id	Identifier (00 to 67 octal)
jobname	Specific job to be dumped (7 characters). Default is no jobname.
NR	No rewind of file lfm (default is rewind).
ER	Files in error will not be dumped (default is dump error files).

## LDQ (LOAD QUEUE FILES)

LDQ reloads queue type files which have previously been dumped by the DMQ utility.

The call to LDQ may be accomplished by keyboard entry in the following format (entry is valid under DSD or DIS control).

X. LDQ(lfm, NR, ER)

lfn            Dump file containing queue files to be loaded. Default is LOAD.  
 NR            No rewind of file lfn (default is rewind).  
 ER            Files in error will remain local.

## STAGE (STAGE TAPE FILES TO DISK)

STAGE is used to copy tape files onto a mass storage device and make the file a locked common file.

Staging may be accomplished through keyboard entry to the K display (under DSD control only), or by direct keyboard entry under DSD or DIS control. Direct keyboard entry is in the following format.

X. STAGE(lfn, T=xx, NR, NU, N=n, DR, VSN=vsn, F=format, D=den, tt)

lfn            Name of mass storage file to which tape file is copied.  
 xx            EST ordinal of magnetic tape unit to be used. This parameter is specified only when tape containing file to be copied is unlabeled (X format and default density).  
 NR            No rewind before copy takes place (default is rewind).  
 NU            No unload after copy (default is automatic unload).  
 n            Number of files to copy.  
 DR            Drop job after copy.  
 vsn           Volume serial number (1 to 6 characters) of labeled tape to be copied.  
 format       Format of data on tape file to be copied. Only binary mode formats I (internal), SI (SCOPE internal), and X (external) are supported.  
 den           Tape density:  
               200      200 bpi (implies 7-track)  
               556      556 bpi (implies 7-track)  
               800      800 bpi/cpi (7- or 9-track)  
               1600     1600 cpi (implies 9-track)  
 tt            Track type:  
               MT       7-track tape (default)  
               NT       9-track tape



If neither T nor VSN parameter is specified, a flashing REQUEST message for file lfn appears on the B display and the operator must assign tape unit to control point indicated. If a common file already exists with the same name as specified by lfn, the system issues the following message.

DUPLICATE COMMON FILE NAME.

If staging is done using the K display (Figure 6-1), enter X.STAGE. and then enter K,n. where n is the control point requesting the K display. To enter options via the K display, type K. and the desired options followed by a period. Only one line of parameters may be entered; therefore, all desired options must be entered at once, separated by commas.

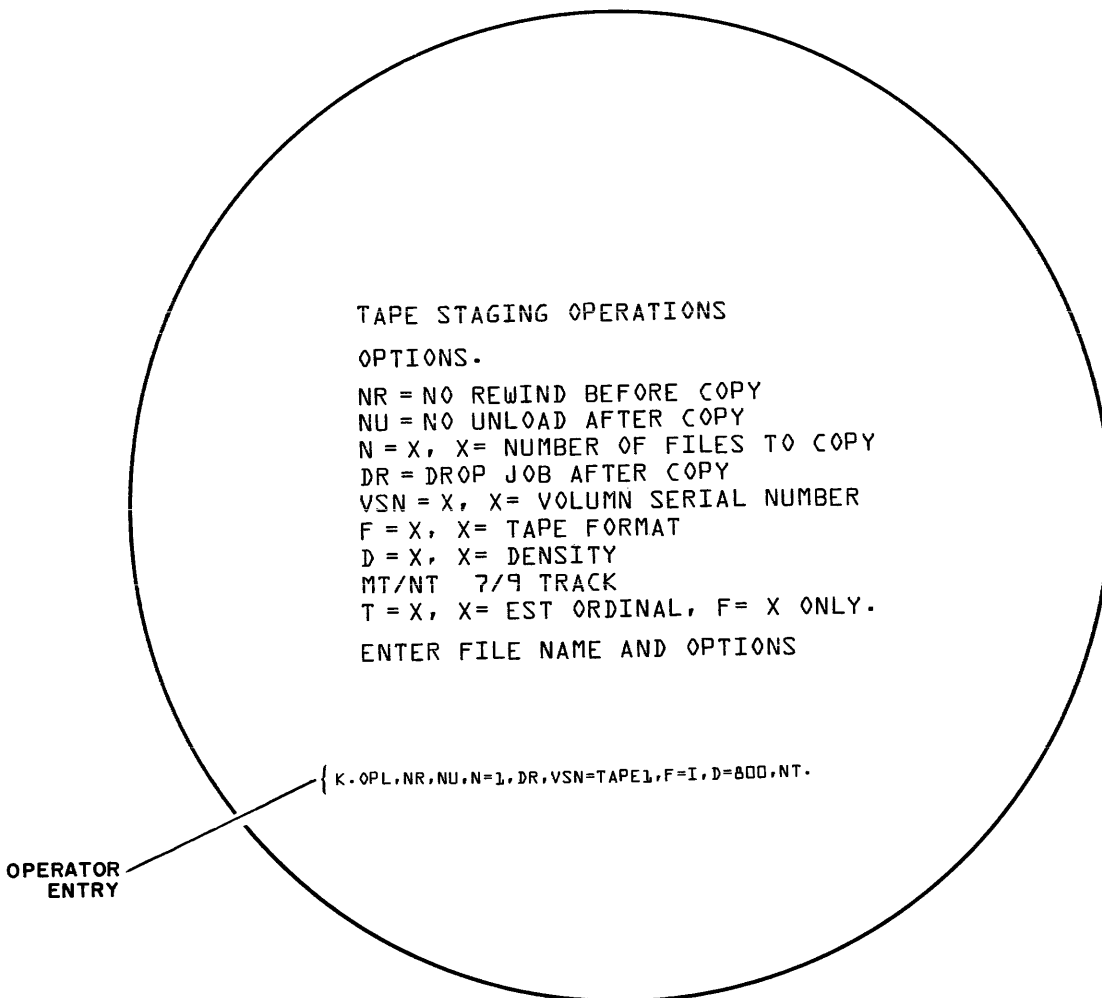

Figure 6-1. STAGE Utility K Display

## FLAW (RESERVE TRACKS)

The FLAW utility provides the capability to reserve tracks on any mass storage device during normal system operation. Each entry identifies an area of mass storage that is unusable (flawed area) and prevents the system from accessing it. Obtain flaw addresses from the customer engineer or the system analyst.

FLAWing tracks on mass storage devices is accomplished using the K display (Figure 6-2). Note that all console entry is performed under DSD control. The sequence is as follows:

1. Call FLAW utility by typing  
X. FLAW. (CR)
2. Bring K display to left console screen by typing  
K, n. (CR)  
where n is the control point number requesting the K display (message REQUEST\* K\*DISPLAY appears at control point n on B display).
3. Specify mass storage device on which tracks are to be flawed. Enter  
K. EQ=xx. (CR)  
where xx is the EST ordinal of the mass storage device.
4. Enter flaws. A maximum of 20 octal flaw entries is allowed for each call to the FLAW utility. In addition, there are three types of flaw entries that may be specified. The general format for K display entry is

K. xTK=ta. (CR)

where:

xTK	Specifies type of flaw entry.
RTK	Converts input physical address to a logical address and sets track reservation table (TRT) to indicate that track is a reserved, flawed track.
TTK	Input is the same as RTK but track reservation is toggled. That is, if the track was previously not reserved, this entry produces the same results as RTK. If the track was previously reserved as a flawed track, that reservation is removed.
STK	Performs the same function as RTK except that input address is a logical address (no conversion required).
ta	Specifies track address according to equipment format.
Txxx, Gx, Sxxx	Track address for 6603 Disk System (DA)
Pxx, Hxx, Sxxx	Track address for 6638 Disk System (DB)
Ux, Gxx, Axxxxx	Track address for 863 Drum Storage (DC)
Cxxx, Sxxx	Track address for 853/854 Disk Drive (DD)
Axxxxxx	Block (track) address/10 <sub>8</sub> for ECS (DE)
Cxxx, Sxxxx	Track address for 814 Data File (DF)
Cxxxx, Sxxxx	Track address for 821 Data File (DH)
Cxxx, Txx, Sxx	Track address for 844 Disk Storage Subsystem (DI)
Cxxx, Sxxxx	Track address for 841 Multiple Disk Drive (MD)

Legend: xxx is octal number of track (T, P), head group (G, H), sector (S), unit (U), address (A), or cylinder (C).

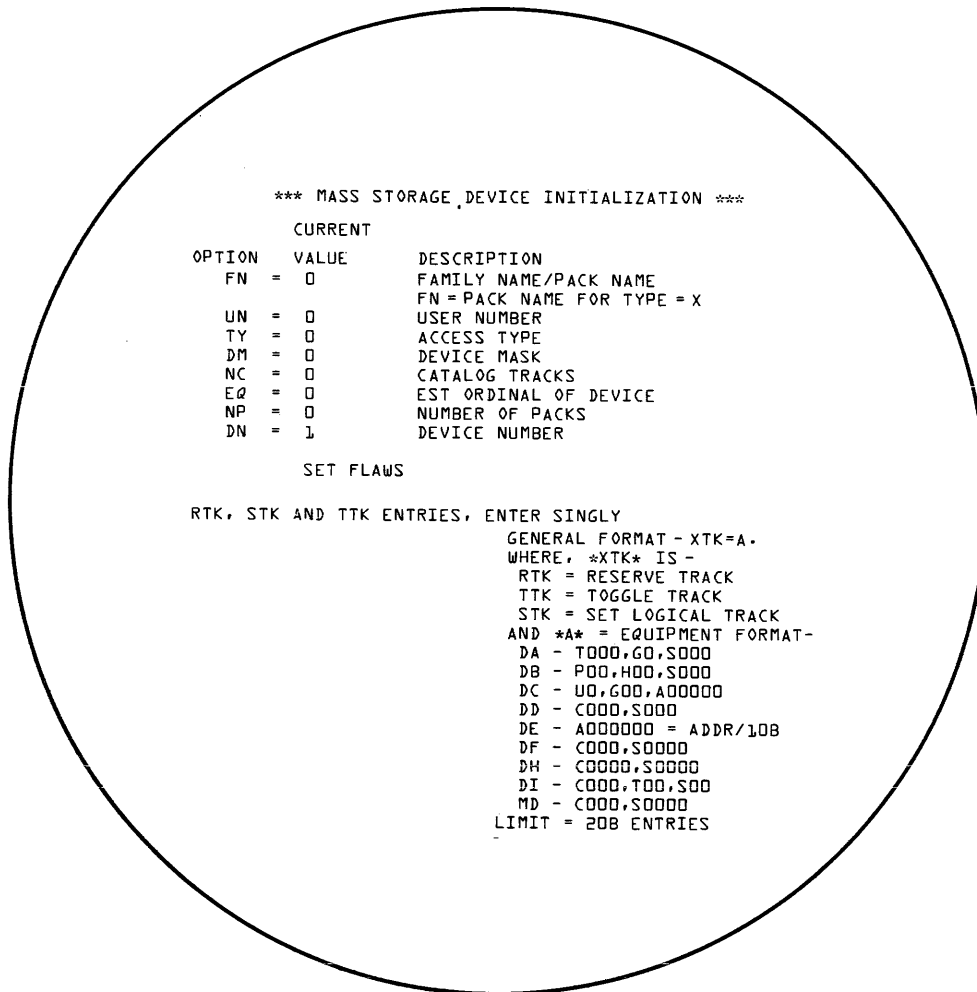

Figure 6-2. FLOW Utility K Display

- Initiate flawing of specified device by typing

K.GO. (CR)

The FLOW utility provides two messages in the system dayfile which indicate the results of the flawing operation. The first message is

xx TRACKS FLAWED.

where xx is the octal number of tracks that were successfully flawed. The second message appears only if some of the flaws specified were not processed. This occurs when the track specified for flawing is already reserved by the system (but not as a flawed track). In this case, the message

xx FLAWS NOT PROCESSED,  
list.

also appears in the system dayfile. In this message, xx is the octal number of flaws not processed, and list is a list of the logical tracks that were not flawed.

The entries described here are similar to those entered in CMRDECK for flawing a device at deadstart time. However, the flaw entries specified via the FLAW utility or DSD command INITIALIZE (refer to section 3) are not recovered if the device is initialized at deadstart time. Only the flaw entries specified in CMRDECK will be recovered. If a device is initialized during normal system operation (INITIALIZE command), all flaws specified in devices TRT, including those entered via FLAW utility or INITIALIZE command, will be recovered providing device has a good label at time of initialization. If label is bad, or cannot be recognized, all current flaws are cleared.

DIS, similar to DSD, displays information of a single job assigned to a control point. Under DIS, the B display shows the exchange jump area for the job. Central memory addresses relative to the job's reference address are used for the data and program displays.

DIS is brought to a control point to monitor the progress of a job by any of the following methods.

- Control card in the form DIS.
- Operator call to DIS by typing n.DIS. for the job active at control point n.
- Operator call to DIS by typing X.DIS, fl. (fl=field length desired) or X.DIS. This brings DIS to an empty control point to initiate utility programs.

When DIS is controlling the console, the \* key is used to alternate the display between DSD and DIS. DIS permanently returns control to DSD when DROP. is typed; the job is not dropped unless no control cards remain.

When DIS is called to a control point, automatic control card processing stops and the A and B displays for DIS appear on the left and right console screens, respectively. Keyboard entry is necessary to begin execution of succeeding control cards. Unless automatic control card processing is reenabled, execution of the job stops after each control card is processed. That is, only one control card can be processed at a time. Under DIS, the B display shows only the condition of the control point to which it is assigned, including upcoming control statements. When the job is not using the central processor, a copy of its exchange package is displayed. Displays available under DIS are selected in the same manner as DSD displays. Refer to Console Operation in this section for information concerning display selection commands and DIS keyboard entries.

The displays available under DIS are:

<u>Display</u>	<u>Description</u>
A	Dayfile messages and files attached to the control point
B	Job status, control cards, and the exchange package
C, D	Data storage: 5 groups of 4 octal digits per group with display code translation (same as DSD C and D display)
E	Data storage: 4 groups of 5 octal digits with display code translation
F, G	Program storage: 4 groups of 5 octal digits per group with COMPASS mnemonic translation
H	Control point file name table
J	Job display (same as the DSD B display)
K	Equipment status table (same as the DSD E display)

<u>Display</u>	<u>Description</u>
L	System file name table (same as the DSD H display)
N	Blank screen
P	PP registers (same as the DSD P display)
Q	Input/output/rollout queues (same as the DSD Q display)
T, U	Text display; shows the text of information in core
V	Central memory buffer
Y	Monitor functions. This display shows the mnemonics and the values of all monitor functions (same as the DSD Y display)
Z	Directory

## DIS DAYFILE (A) DISPLAY

Figure 7-1 illustrates the DIS dayfile display. The figure shows the dayfile messages for the control point to which DIS is currently assigned. All files currently attached to that control point are also displayed. Although this figure shows the A display on the left console screen, it may also be displayed on the right screen. All DIS displays may appear on either console screen. The header information illustrated in Figure 7-1 appears on all left screen displays.

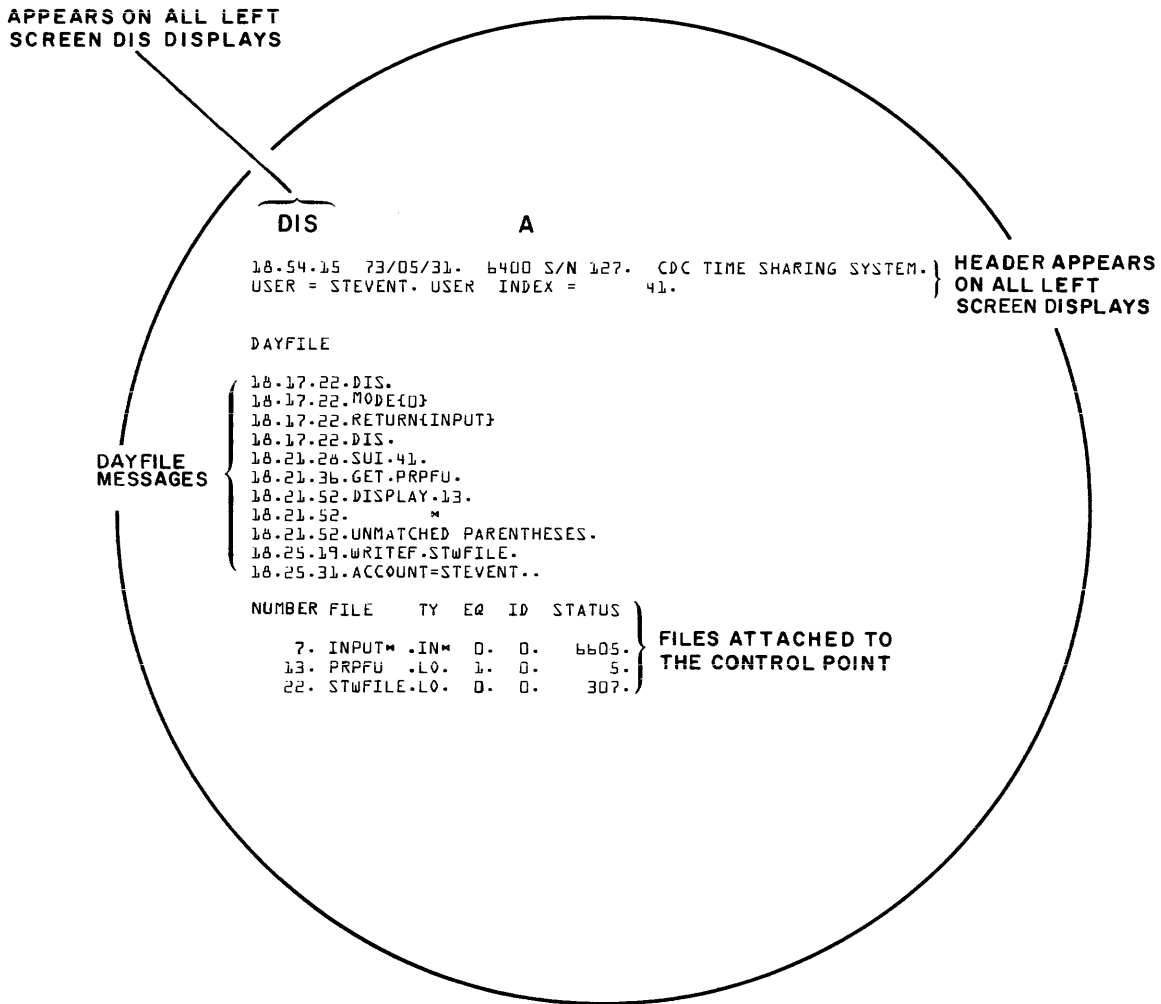

Figure 7-1. DIS Dayfile (A) Display

## DIS JOB STATUS (B) DISPLAY

Figure 7-2 illustrates the DIS job status display. The figure shows the job status, current message buffer, job control cards, and exchange package. The job status is a two-line entry in which the first line identifies the control point to which the job is assigned (11), the job identification (DIS0AXJS), CPU priority (30), queue priority (7760), time limit (777777), accumulated CPU time (0 seconds), and the CPU status. The second line of job status contains the central memory reference address (RA=242100), the job's field length (4300), and assigned equipment (10 - the display console).

Although this figure shows the B display on the right console screen, it may also be displayed on the left screen. All DIS displays may appear on either console screen. The header information illustrated in Figure 7-2 appears on all right screen displays. In addition, at the bottom of the right screen, each PPU is represented by an entry for the program currently running and the control point to which the program is assigned (PPU status information in figure). PPU 0 and PPU 1 are dedicated to monitor (MTR) and DSD, respectively. The header and PPU status information for DIS right screen displays is identical to that displayed for DSD right screen displays (refer to description of DSD B display in section 4 for complete information).

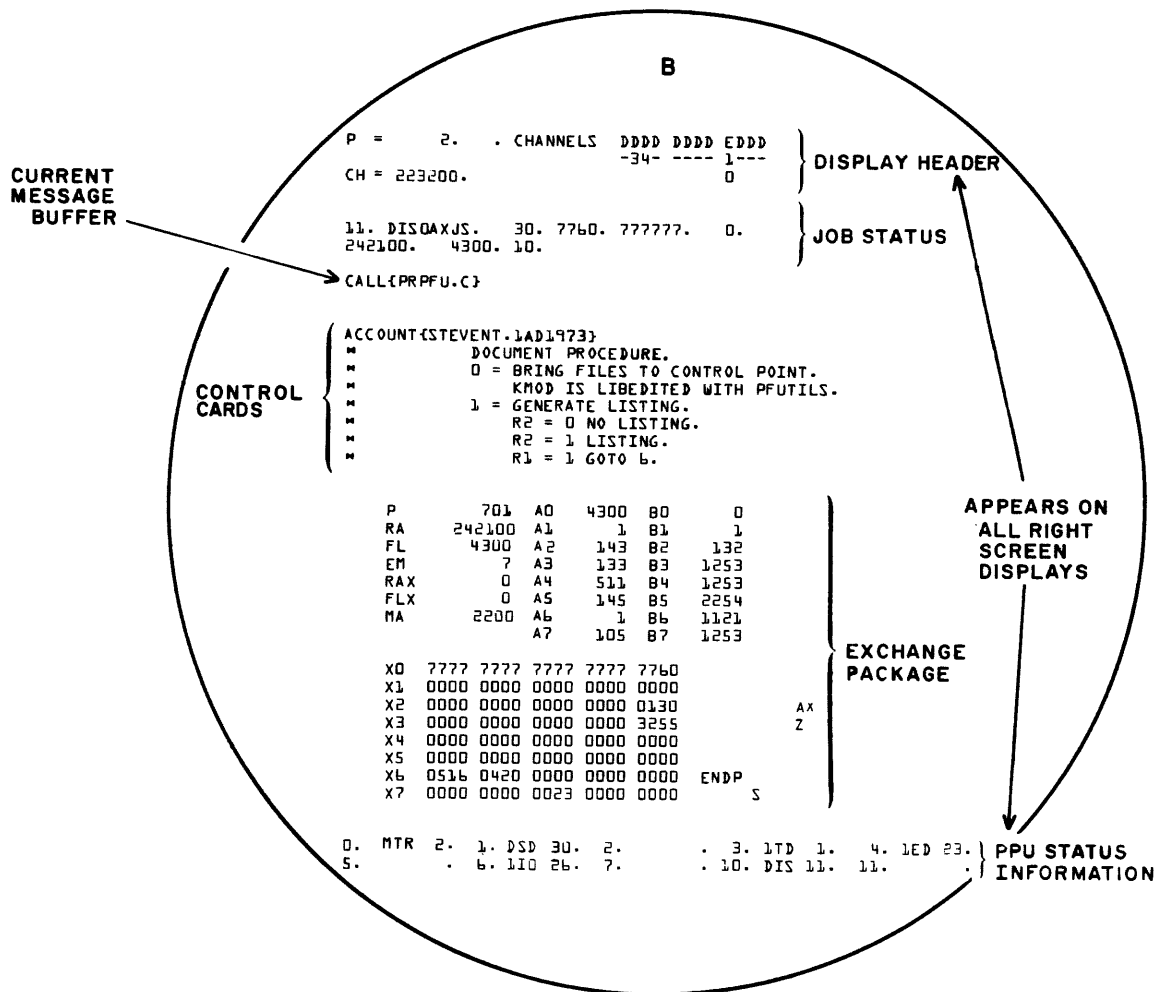

Figure 7-2. DIS Job Status (B) Display



## DIS MEMORY DISPLAYS

Figure 7-3 illustrates the DIS data storage (E) display. The contents of each central memory word is displayed in four groups of five octal digits along with the display code equivalent. Refer to Figure 4-3 in section 4 for an illustration of the DSD C/D displays (same as DIS C/D displays).

DIS		E		
17.05.15. 73/05/01. 6400 S/N 127. CDC TIME SHARING SYSTEM.				
USER =		. USER INDEX =		0.
000100	00000	00000	00000	00000
000101	03171	51505	16240	00226 COMMENT BV
000102	15170	40500	00000	00117 MODE AO
000103	16170	53011	24000	00126 NOEXIT AV
000104	17160	53011	24000	00133 ONEXIT AD
000105	17162	32700	00000	00134 ONSW AL
000106	17060	62327	00000	00156 OFFSW A.
000107	22061	40000	00000	00157 RFL A.
000110	22171	41417	25240	00166 ROLLOUT A
000111	23052	42022	00000	00171 SETPR A
000112	23052	42414	00000	00200 SETTLE A
000113	23251	10000	00000	00210 SUI BH
000114	23271	12403	10000	00134 SWITCH AL
000115	25230	50320	25000	00217 USECPU BO
000116	22061	45400	00000	00314 RFL= CL
000117	51200	00064	61100	00001 IP H A
000120	73720	66700	51500	00002 F I/ B
000121	03070	00230	01000	00252 CG BXA B}
000122	03140	00230	72767	77767 CL BX
000123	51000	00000	01230	00024 I AS T
000124	02132	32000	00000	00175 BKSP A
000125	03171	51517	16000	00202 COMMON BB
000126	04112	32017	23050	00227 DISPOSE BW
000127	05261	10324	00000	00352 EVICT C}
000130	14170	31300	00000	00357 LOCK C.
000131	17252	40000	00000	00364 OUT C
000132	22051	40501	23050	00371 RELEASE C
000133	22051	60115	05000	00406 RENAME DF
000134	22052	71116	04000	00425 REWIND DS
000135	22052	42522	16000	00416 RETURN DN
000136	23131	12005	11000	00444 SKIPFI D9
000137	23131	12006	00000	00451 SKIPF D{

Figure 7-3. DIS Data Storage (E) Display

Figure 7-4 illustrates the DIS program storage (F) display. The F and G displays show the contents of central memory and the COMPASS mnemonic translation.

DIS		F	
17.05.26. 73/05/01. 6400 S/N 127. CDC TIME SHARING SYSTEM.			
USER =		USER INDEX = 0.	
000100	00000	00000	00000 PS
000101	03171	51505	16240 00226 NZ X PS
000102	55170	40500	00000 00117 BXXM-X FXXMX PS
000103	16170	53011	24000 00126 BXX+-X SAX+B NX XB PS
000104	17160	53011	24000 00133 BXX--X SAX+B NX XB PS
000105	17162	32700	00000 00134 BXX--X BXX+X PS
000106	17060	62327	00000 00156 BXX--X SBX+K PS
000107	22061	40000	00000 00157 LX XB FXXMX PS
000110	22171	41417	25240 00166 LX XB RXXMX ZX XB PS
000111	23052	42022	00000 00171 AX XB DXXMX PS
000112	23052	42414	00000 00200 AX XB DXXMX PS
000113	23251	10000	00000 00210 AX XB BX X PS
000114	23271	12403	10000 00134 AX XB BXX+X BX X PS
000115	25230	50320	25000 00217 ZX XB SAA+K PS
000116	22061	45400	00000 00314 LX XB RXX/X PS
000117	51200	00064	61100 00001 SAB+K SBB+K
000120	73720	66700	51500 00002 SXX+B SAB+K
000121	03070	00230	01000 00252 ZR X RJ/RWE
000122	03140	00230	72767 77767 NZ X SXX+K
000123	51000	00000	01230 00024 SAB+K RJ/RWE
000124	02132	32000	00000 00175 JPB+K PS
000125	03171	51517	16000 00202 NZ X BXX+-X PS
000126	04112	32017	23050 00227 EQ BB AX XB PS
000127	05261	10324	00000 00352 NE BB PS
000130	14170	31300	00000 00357 BX -X FXX-X PS
000131	17252	40000	00000 00364 BXX--X FXXMX PS
000132	22051	40501	23050 00371 LX XB FXXMX AX XB PS
000133	22051	60115	05000 00406 LX XB SBA+K PS
000134	22052	71116	04000 00423 LX XB SXX+K PS
000135	22052	42522	16000 00416 LX XB DXXMX BXX+-X PS
000136	23131	12005	11000 00444 AX XB BXX+X BXXMX PS
000137	23131	12006	00000 00451 AX XB BXX+X PS

Figure 7-4. DIS Program Storage (F) Display

## DIS DIRECTORY (Z) DISPLAY

Figure 7-5 illustrates the DIS directory display. The Z display lists all displays available under DIS control.



Figure 7-5. DIS Directory (Z) Display

## CONSOLE OPERATION

Unlike DSD, DIS is not interpretive. The operator must complete every type-in and signal DIS to act upon the message by pressing the carriage return key. The following rules apply to all DIS commands.

- Spaces in an octal field are ignored, but may be inserted for readability.
- All octal fields are assembled right-justified with leading zero fill; excess octal digits are ignored.

In addition to the keyboard commands, the following characters have special meaning when entered as the first character.

<u>Key</u>	<u>Action Initiated</u>
right blank	Steps the left screen display sequence established by the SET command (refer to Display Selection Commands).
left blank	Clears current DIS keyboard entry and/or AUTO MODE (automatic control card processing).
*	If DSD has relinquished the main display console to DIS, * acts as a quick hold, and DIS drops the display channel so that DSD can use it.
+ or -	When one of the memory displays is on the left screen, typing the + or - keys moves the memory display back and forth by 40 octal locations.
(	Breakpoint program to (P+1).
)	Breakpoint program to (P-1).
=	Toggle memory references between absolute and relative.



Central memory changes made while in absolute mode are placed in absolute core addresses.

For example, 100, 1, 4000. is entered into core at RA+100 in relative mode and at central memory address 100 in absolute mode.

/ Advance left screen memory display address by the value in the lower 18 bits of the first word displayed.

. Sets AUTO MODE (initiates automatic control card processing). This key performs the same function as the RCS command described under DIS Keyboard Entries in this section.

The following messages may appear above the type-in.

<u>Message</u>	<u>Meaning</u>
ILLEGAL ENTRY.	Command is not executable.
REPEAT ENTRY.	Entry is not cleared by a carriage return.
OUT OF RANGE.	Memory entry address is greater than the field length.
SYSTEM BUSY - DISK.	Disk is busy while loading an overlay.
SYSTEM BUSY - PPU.	DIS is waiting for a PPU to be assigned in order to execute the keyboard entry.
JOB ACTIVE.	Previous request not completed.
AUTO MODE.	Control card buffer is read automatically. Automatic control card processing can be selected by the RCS command or pressing the period (.) key.
DIRECT CPU INPUT.	N. command has been entered and all data entered from the keyboard is being passed directly to central memory.

## DISPLAY SELECTION COMMANDS

The operator indicates the displays to be shown on the left and right screens on the console by the following commands. A carriage return should follow the type-in.

<u>Command</u>	<u>Action Initiated</u>
xy.	Brings the x and y displays to the left and right screens, respectively.
xg, nnnnn.	Brings the x memory display to the left screen if it is not already there, and sets the address field to nnnnn. x must be C, D, E, F, or G. g is the group number (0 through 4).
SET, ssss...s.	Sets the left screen display sequence; ssss...s consists of one to eight display identifiers. The sequence is toggled by the right blank key. For example, SET, ACEDH.

## DIS KEYBOARD ENTRIES

If a job is currently active (CPU active, waiting, on recall, or PPU active), many commands are not accepted; JOB ACTIVE is displayed.

<u>Command</u>	<u>Action Initiated</u>
BKPA, xxxxxx.	Breakpoint to address xxxxxx in the program with assigned PPU's. Central processor execution begins at the current value of P and stops when P = xxxxxx. PPU's attached to the control point may still be active. DIS clears xxxxxx to stop the program at that point. The breakpoint may be cleared by setting the breakpoint address to a new value.

<u>Command</u>	<u>Action Initiated</u>
BKP, xxxx.	Breakpoint to address xxxx in the program. Execution stops when P = xxxx, and DIS is the only PPU active at the control point.
CALL(lfn)	Calls procedure file specified by lfn. The system first searches for a local file of the name specified. If it is not found, the system library is searched and then indirect access permanent files under the user index currently set.
DCP.	Drops the central processor and displays the exchange jump area on the B display.
DIS.	Reloads main DIS overlay.
DROP.	Drops DIS, but normal execution of the job continues (it does not drop the job unless no activity remains).
ELS. cccc.	Enters control statement cccc in the control card buffer after the last control statement, if there is space.
ENAi, xxxxxx.	Sets register Ai = xxxxxx in the exchange jump area.
ENBi, xxxxxx.	Sets register Bi = xxxxxx in the exchange jump area.
ENEM, x.	Sets exit mode to x ( $0 \leq x \leq 7$ ).
ENFL, xxxxxx	Sets FL = xxxxxx in the exchange jump area. (Storage is moved, if necessary.)
ENP, xxxxxx	Sets P = xxxxxx (next instruction address).
ENPR, xx	Sets job priority to xx ( $1 \leq xx \leq 70_8$ ).
ENS. cccc.	Allows entry of control statement cccc as the next unexecuted statement in the control card buffer. The statement can then be processed using RNS, RSS, or DROP. ENS clears the control card buffer of previous statements. This command is valid only when AUTO MODE is not set.
ENTL, xxxxxx	Sets the job time limit to xxxxxx. 77777 is infinite.
ENXi, xxxxx xxxxx xxxxx xxxxx.	Sets register Xi = xxxxx xxxxx xxxxx xxxxx in the exchange jump area.
ENXi, Lzzz...zzz.	Enters Xi register with xxx...xxx left-justified.
ENXi, Dccc...ccc.	Enters Xi register with ccc...ccc display code characters.
ENXi, b, zzzz.	Enters byte b of the Xi register with zzzz.
ERR.	Sets error flag, terminates job execution, and clears AUTO MODE if set.
GO.	Restarts a program which has paused.

<u>Command</u>	<u>Action Initiated</u>
GOTOccc...ccc.	Sets AUTO MODE and transfers control to statement or tag defined by ccc...ccc.
HOLD.	DIS relinquishes the display console, but the job is held at the present status. The console must be reassigned to continue the use of DIS.
M. ccc...ccc.	Enters ccc...ccc as a program command. Data is stored at RA+CCDR.
N. ccc...ccc.	Sets DIRECT CPU INPUT mode. Characters entered from keyboard are passed one character at a time, right-justified, directly into central memory at RA+CCDR. Pressing the left blank key clears DIRECT CPU INPUT mode.
OFFSWx.	Turns off sense switch x for the job ( $1 \leq x \leq 6$ ).
ONSWx.	Sets sense switch x for the job ( $1 \leq x \leq 6$ ).
O26.	Calls O26 to a control point. Obtain DOCUMENT of O26 for complete operating instructions.
RCP.	Requests central processor. Depending on job priority, execution begins at the next program address for a job suspended by a DCP request.
RCS.	Sets AUTO MODE and initiates automatic control card processing. All succeeding control cards are read and executed automatically until an SCS command or an error is encountered or until job completion. A period (.) may also be used to initiate automatic control card processing.
RNS.	Reads and executes the next control statement in the DIS control card buffer.
ROLLOUT.	Allows the job to roll out. This should be issued when the message ROLLOUT REQUESTED appears.
ROLLOUT, xxxx.	Places job in rollout queue for xxxx seconds. The job is automatically rolled back in after this period of time.
RSS.	Reads the next control statement and stops prior to CPU execution. This is used to initiate breakpointing of a program.
RSS, ccc...ccc.	Reads statement ccc...ccc and stops before execution. Action is similar to ENS. ccc...ccc. followed by RSS. except that the control card buffer is not cleared.
RE, xx.	Releases reservation of equipment xx (xx may not be the display assigned to DIS). Use this command with caution. Although the equipment can still be accessed, other control points may assign the equipment and operate with it.
SCS.	Clears AUTO MODE and stops automatic control card processing.

<u>Command</u>	<u>Action Initiated</u>
T, xxxxxx.	Changes the T display to start at address xxxxxx.
U, xxxxxx.	Changes the U display to start at address xxxxxx.
UCC=c	Sets the uppercase character to c (default is *).
V, xxxxxx.	Changes the V display to start at address xxxxxx.
X. ccc...ccc.	Executes ccc...ccc as the next control statement.
* xxx.	If an asterisk (*) is followed by a blank and xxx is encountered during automatic control card processing (AUTO MODE), xxx is interpreted as a direct DIS command rather than a control card. For example, * C4,100. will set the left screen display to the central memory C display at address 100. Using this feature, it is possible to set up procedure files that use DIS to breakpoint a program to a desired stopping point.
xxxx.	xxxx is processed as a control card if it is not a recognizable DIS command.
x, y.	Changes the contents of the word at x (relative to its RA) to y. Leading zeros may be dropped. †  If in absolute mode (toggled by = key), the entry is at central memory absolute location x.
x, b, y.	Enters y in byte b (0 through 4 from left) of memory location x.
x, Dccc.	Changes the contents of word x (relative to RA) to the display coded value of character string ccc. The entry is left-justified with trailing zero fill.
x, Lyy...yy.	Enters yy...yy left-justified in memory location x.
x, +yy...yy.	Enters yy...yy in memory location x and leaves x+1,+ in the display for entry into the next memory location.

## PP CALL COMMANDS

Any PPU program with a name that begins with a letter may be called to the control point by DIS. In the following list, nam denotes the name of a PPU program, and n is the control point.

Keyboard Entry	Format of PPU Call Initiated
nam.	18/3Lnam, 6/n, 36/0
nam, xxx.	18/3Lnam, 6/n, 18/0, 18/xxx
nam, xxx, yyy.	18/3Lnam, 6/n, 18/xxx, 18/yyy

† This command should be used with extreme care.



# DISPLAY CODE CHARACTER SET

A

Display Code	Character	Display Code	Character
00	(unused)	40	5
01	A	41	6
02	B	42	7
03	C	43	8
04	D	44	9
05	E	45	+
06	F	46	-
07	G	47	*
10	H	50	/
11	I	51	(
12	J	52	)
13	K	53	\$
14	L	54	=
15	M	55	blank
16	N	56	,
17	O	57	.
20	P	60	≡
21	Q	61	[
22	R	62	]
23	S	63	:
24	T	64	≠
25	U	65	→
26	V	66	v (and)
27	W	67	^ (or)
30	X	70	↑
31	Y	71	↓
32	Z	72	<
33	0	73	>
34	1	74	≤
35	2	75	≥
36	3	76	¬ (not)
37	4	77	;

**OPERATOR MESSAGES**

**B**

---

<u>Message</u>	<u>Routine Issuing Message</u>	<u>Description</u>	<u>Operator Action</u>
ACCESSED AFTER yy/mm/dd. hh. mm. ss.	PFDUMP PFLOAD	Informative message.	
ACTIVE xx.	1LS	Informative message. xx Indicates the number of terminals active.	
ALL FILES FOR USER INDEX xxxxxx.	PFDUMP PFLOAD	Informative message. xxxxxx User index identification	
ALTERNATE DEVICE NOT FOUND.	PFLOAD	Device residency specified in catalog not available in this system and destination device is not specified. This message is accompanied by status error.	
ALTERNATE DEVICE NOT FOUND.	PFU	PFU is unable to locate an alternate device in the system.	
ANY LOADING TO THIS POINT INCOMPLETE - A REINITIALIZE AND RELOAD IS REQUIRED.	PFLOAD	Fatal system error, PFLOAD is aborted.	1. Initialize a device. 2. Retry the load.
ARGUMENT ERROR.	RESEX	Control card error message. Arguments in control card or external call are incorrect.	Check control card syntax.
ASSEMBLING filename	COMPASS	Informative message only.	
ASSIGN TAPE.	PFLOAD	A tape is required to process permanent file (PF) functions.	Make sure a dump tape is assigned and that the proper label information being requested is in the label. This is label verification on the label generated by PFDUMP.

<u>Message</u>	<u>Routine Issuing Message</u>	<u>Description</u>	<u>Operator Action</u>
BAD SYSTEM SECTOR (filenam) (user index)	PFDUMP	File skipped.	Call analyst to fix file system sector.
BOTH FAMILY AND PACK NAME	PFS	Family and pack name may not both be specified	Reenter parameters for utility specified.
xx BUFFERS ACTIVE.	IIO	Informative message; indicates the number of buffers in use by BATCHIO xx Number of buffers	
BUFFER CONTROL WORD ERROR.	PFU	Word count of a sector to be read from central memory exceeds the word count limit for a sector.	Contact site analyst.
BUFFER OUT OF RANGE.		Buffer outside of field length.	
CATALOG CONTROL WORD MISSING	PFLOAD	Either encountered other than a catalog control word as the initial control word of the file, or the entire catalog entry is not present.	Retry or use another set of tapes.
CATALOG INDEX OUT OF RANGE.	PFDUMP	Location of catalog buffer is not in buffer range.	Retry PF dump.
CATALOG COMPLETE.	CATALOG	Informative message; completion of cataloging.	
CATALOG TRACK NOT FOUND.	PFU	In attempting to interlock a catalog track, PFU could not find track.	
CATALOGING filenam.	CATALOG	Informative message.	
CATLIST COMPLETE.	CATLIST	Informative message.	
CHECK DAYFILE FOR ERRORS.	PFLOAD PFDUMP	Informative operator message.	

<u>Message</u>	<u>Routine Issuing Message</u>	<u>Description</u>	<u>Operator Action</u>
CLEANUP SALVARE FILE.		TELEX has begun to release all system resources currently assigned to terminals in the recovery state. This occurs only when TELEX is dropped (1.STOP. command).	
COMPILING filename.	RUN23 (all compilers)	Informative message.	
CONTINUING DESTROYS PFS RECOVERY OF DEVICE IMPOSSIBLE.	RMS	<p>Issued during level 0 deadstart recovery for mass storage device when label on device to contain system and which contains PFS cannot be recovered.</p> <p>If PFS are not on a device, the device is automatically initialized; if on device, proceed with operator action.</p> <p>Failure to recover could be that the correct configuration is not available. That is, MD-3 label required, but MD-1 is available.</p>	<p>Either type GO to initialize device with parameters specified in existing label. Deadstart continues and PFS will be destroyed.</p> <p>or</p> <p>Reconfigure for proper configuration and re-deadstart.</p>
CONVERTING decknam.	LIST80 UPMOD	Informative message only.	
COPYING filename.	LIBGEN COPYB SYSEDIT LIBEDIT MODIFY	Informative message only.	
COPYING OUTPUT.	DOCUMENT	Informative message only.	

<u>Message</u>	<u>Routine Issuing Message</u>	<u>Description</u>	<u>Operator Action</u>
CPxx, XMSN PARITY ERROR.	2PC	ERRLOG message for 3446/415. A transmission parity error was detected during the operation.  xx EST ordinal yy Channel number zz Function  Customer engineer should be notified.	
CPxx, COMPARE ERROR.	2PC	ERRLOG message for 3446/415. A card compare error was detected during the operation.  xx EST ordinal	Check deck for offset cards. If card is bad, replace and reenter deck.
CPxx, NOT READY.	1CD 2PC	Card punch is not ready  xx EST ordinal	Ready punch
CPM ARG. ERROR.	CPM	Error in arguments to CPM.	User must process.
x. CPU SCANS.	1LS	Informative message about Export/Import condition.	
CRxx BINARY CARD ERROR.	2RC	Binary checksum error on card	Retry  If error persists, call the customer engineer.
CRxx, COMPARE ERROR. - RE-READ 1 CARD.	1CD 2RC	Reader has a card compare error.  xx EST ordinal	Reread the last card in the output stacker.
CRxx, NOT READY.	1CD 2RC	Reader is not ready.  xx EST ordinal	Ready card reader.
CRxx, RE-READ x CARD(S).	2RC	Error in cards read from card reader xx.	Reread the last x cards in the output stacker.

<u>Message</u>	<u>Routine Issuing Message</u>	<u>Description</u>	<u>Operator Action</u>
CREATED AFTER yy/mm/dd.hh.mm.ss.	PFDUMP PFLOAD	Informative message only.	
CREATING decknam.	MODIFY	Informative message only.	
DAF BUSY (filenam) (user index)	PFDUMP	File skipped; file cannot be dumped because it is attached in write mode.	<ol style="list-style-type: none"> <li>1. Release file from write status.</li> <li>2. Dump file.</li> </ol>
DAF ZERO LENGTH (filenam) (user index).	PFDUMP	File skipped; file has no length and cannot be dumped.	<ol style="list-style-type: none"> <li>1. Correct file length.</li> <li>2. Dump file.</li> </ol>
DEMAND EXCEEDED.	RESEX	Control card or resource assignment (tape and pack) error. User attempted to exceed demand.	
DEMAND FILE ERROR.	RESEX	Resource execution error. Demand file entry does not match job identification. If one job gets this error, others will also.	
DEMAND INSTALLATION ERROR.	RESEX	Control card or resource assignment (tape and pack) error. Demand exceeds the number of installation units.	
DEMAND VALIDATION ERROR.	RESEX	Control card or resource assignment (tape and pack) error. Demand exceeds user validation limits.	
DESTINATION DEVICE NOT FOUND.	PFLOAD	Fatal system error, PFLOAD aborts.	Specify correct destination device and perform load.
DETECTED IN CLD.		Error while building system library. Disk resident overlay (OVL) or absolute (ABS) program is not formatted correctly.	

<u>Message</u>	<u>Routine Issuing Message</u>	<u>Description</u>	<u>Operator Action</u>
DETECTED IN DIRECTORY.		System file error occurred while building system library. Start of the system library was not found.	Attempt another deadstart with no recovery (level 0).
DETECTED IN PLD.		System file error occurred while building system library. Disk resident PP program is not formatted correctly.	Deadstart from another tape unit or at a different density. If the error persists, use another deadstart tape.
DETECTED IN RCL.		Error while building system library. Central memory resident overlay (OVL) or absolute (ABS) program is not formatted correctly.	
DETECTED IN RPL.		Error while building system library. Central memory resident PP program is not formatted correctly.	
DEVICE NOT INITIALIZED.	PFU	PFLOAD is attempting to load permanent files to an uninitialized master device.	Either initialize device or specify OP=N on PFLOAD parameters.
DEVICE SPECIFIED NOT FOUND.	PFDUMP PFLOAD	Device number (DN) specified was not defined in system. Job aborts.	Retry with a defined DN.
DIxx, Nyy, STnnnn, Un Cnnnn Tnn Snn.	6DI	System error message. xx Equipment number yy Number of times operation attempted STnnnn Status Un Unit Cnnnn Cylinder Tnn Track Snn Sector	Call customer engineer.
DIxx, sssssssssssssssssssssss.	6DI	xx Equipment number s - s 144 bits of detail status	Call customer engineer.



<u>Message</u>	<u>Routine Issuing Message</u>	<u>Description</u>	<u>Operator Action</u>
DIRECT TOO LONG (filenam) (user index).	PFDUMP	File truncated; file will be loaded and the length corrected in the catalog entry	
DIRECT TOO SHORT (filenam) (user index).	PFDUMP	File padded with EOFs; file will be loaded with trailing EOFs deleted and length updated in catalog entry.	
DUMP OR DROP.	1LS	E/I request to operator.	Dump or drop the job.
DUMPING (filenam) (user index)	PFDUMP	Informative message; the filename for user index is being retrieved from mass storage device.	
DUMPING - DIRECT ACCESS FILES ONLY.	PFDUMP	Informative message only.	
DUMPING - INDIRECT ACCESS FILES ONLY.	PFDUMP	Informative message only.	
DUPLICATE FILE NAME.	PFU	The specified file is already at a control point.	Either Ignore if file at control point is the correct file or Return file at control point and retry.
EDITING filenam.	OPLEDIT	Informative message only.	
EMPTY CATALOG.	CATLIST	Catalog is empty.	
ENTER E TO TERMINATE LOADING. L TO LIST REMAINING FILES. GO TO RESUME INCREMENTAL LOAD.	PFLOAD	This message occurs as a result of a complete load of an archive file during incremental load operations.	Described in message.

<u>Message</u>	<u>Routine Issuing Message</u>	<u>Description</u>	<u>Operator Action</u>
ENTERED PARAMETER IS ILLEGAL.	PFS	Parameter is not in legal format.	Check dayfile for more detail on error.  Reenter correct parameter via K display.
EQxx nnnn DIRECT ACCESS FILE ERRORS.	REC	Count of files on device xx (EST ordinal) whose interlock information specified file was in write access mode and last sector in system allocation table (TRT) was read and found not to be EOI. This count should match number of PF error messages issued.  xx EST ordinal nnnn Count of files	Interrogate files in error.
EQxx nnnn DIRECT ACCESS FILES PURGED.	REC	Count of files on device xx (EST ordinal) encountered whose system sector was not legal. This will not include those files purged because purge status was set in interlock information.  xx EST ordinal nnnn Count of files	
EQxx nnnn DIRECT ACCESS FILES RECOVERED.	REC	Count of direct access permanent files successfully recovered on device xx (EST ordinal).  xx EST ordinal nnnn Count of files	
EQxx EQyy CONFLICTING DN.	4DC	Two devices in the same family have the same device number and system library resides on one of them.  xx and yy are EST ordinals of devices.	Deactivate one of the devices and re-deadstart.

<u>Message</u>	<u>Routine Issuing Message</u>	<u>Description</u>	<u>Operator Action</u>
EQxx EQyy CONFLICTING PN.	4DC	Two auxiliary devices have the same packname. xx and yy are EST ordinals of devices.	Deactivate one of the devices and redeadstart.
EQxx EQyy CONFLICTING UM.	4DC	Two devices in the same family have the same bits set in the device mask and system library resides on one of them. xx and yy are EST ordinals of devices.	Deactivate one of the devices and redeadstart.
EQxx TRACK LIMIT.	CIO	Program is waiting for a track in order to continue processing of the file. No remaining tracks available on EST ordinal specified by EQxx.	Attempt to drop some active jobs.
EQ0 NOT MASS STORAGE.	SET	The system must be configured with EST ordinal 0 as a non-removable mass storage device.	Correct configuration to specify EST ordinal 0 as system device and re-autoload.
EQUIPMENT NOT AVAILABLE.	RESEX	Tape assignment error. Equipment is not available.	
ERROR dt xx, location.		A disk error occurred during deadstart. dt Device type xx EST ordinal location Location of the error within the device. An error of this type could be: ERROR DB01, P17, H14, S116	To continue: Type GO Information being written to disk at this time, however, may not be valid.  To deadstart: Attempt another deadstart with the track locked out by use of the correct CMRDECK entries (such as RTK).  If disk errors persist, consult a customer engineer.

<u>Message</u>	<u>Routine Issuing Message</u>	<u>Description</u>	<u>Operator Action</u>
ERROR IN CATALOG IMAGE ON PFDUMP TAPE.	PFLOAD	Fatal system error; PFLOAD is aborted.	Either retry or use backup tape.
ERROR IN CATALOG MAP BITS.	MSI	Bits for all devices do not total 3778.	Either reset DM parameter or if override is desired enter K.GO.
ERROR ON ACTIVE DEVICES.	CMS	Error detected on device that has active files. This can occur if the wrong pack is removed when interchanging devices.	Replace proper rack.
ERROR ON DEVICE WITH ACTIVE FILES-RECOVERY IMPOSSIBLE.	RMS	Issued on levels 1, 2, and 3 deadstart if label cannot be verified and active files are on a device.  If no active files are on a device, it is set unavailable in MST and deadstart continues.	Redeadstart using level 0.
ERROR(S) IN jobname.	COMPASS	The COMPASS assembler detected errors in the job called jobname.	
EST/FNT LENGTHS CONFLICT, RECOVERY OF DEVICE IMPOSSIBLE.		Error during a deadstart recovery. The length of the FNT or EST of the system defined by CMRDECK conflicts with the system being recovered from disk.	Attempt another deadstart without recovery (level 0).
FAMILY/PACK NOT FOUND.	PFS	Family or pack not defined in PF system.	
FET POINTERS OUT OF BOUNDS.	PFU	Out pointer is greater than limit pointer.	

<u>Message</u>	<u>Routine Issuing Message</u>	<u>Description</u>	<u>Operator Action</u>
FILE TRUNCATED (filenam) (user index)	PFLOAD	File on archive tape is too short with padded EOFs. File is truncated and the length in the catalog is updated to reflect the smaller size.	
FILENAME xxxxxxxx USER INDEX yyyyyy	PFDUMP PFLOAD	Informative message only. xxxxxxx Filename yyyyyy User index	
FILE NOT FOUND.	CATLIST	Informative message; File specified not found on the PF device.	
FORMAT ERROR.	PFLOAD	Error encountered on dump tape.	Check that dump tape is assigned and proper label information is in the label.
GENERATING CATALOG IMAGE.	PFDUMP	Informative operator message.	
GENERATING LIBRARY DIRECTORY.	SYSEDT	Informative message only.	
GETTING filenam.	GTR	Informative message only.	
IDENT CARD MISSING.	COMPASS	IDENT card was not found in job being processed (user must process).	
IDLE.	I10	BATCHIO idle if no I/O buffers in use.	
ILLEGAL CATALOG TRACK COUNT.	PFLOAD	Fatal system error; PFLOAD is aborted. Number of catalogs is not a power of 2.	
ILLEGAL EXTERNAL CALL.	RESEX	Resource execution error. RESEX does not recognize external call.	

<u>Message</u>	<u>Routine Issuing Message</u>	<u>Description</u>	<u>Operator Action</u>
ILLEGAL FUNCTION.	PFS	Illegal utility specified; abort condition.	Retry PFS entry with correct utility specified.
ILLEGAL USER ACCESS.	RESEX	Control card or resource assignment (tape and pack) error. User is not validated for resource(s).	
IMPROPER ACCESSIBILITY.	RESEX	Tape assignment error. Accessibility mismatch.	
INDIRECT TOO LONG (filenam) (user index).	PFDUMP	Informative message; file truncated. File will be loaded with correct length in catalog entry.	
INDIRECT TOO SHORT (filenam) (user index).	PFDUMP	Informative message; file padded with EOFs. File will be loaded with trailing EOFs omitted and update length in catalog entry.	
INITIALIZATION IN PROGRESS	PFDUMP	Cannot access device because device is going to be initialized.	Retry dump.
INPUT CYCLES.	1LS	Informative message about Export/Import condition.	
INSERTING filenam.	LIBEDIT	Informative message only.	
JOBS HUNG.		Informative operator message; TELEX has encountered some TELEX origin jobs at control points and is attempting to roll them out. This message is normally displayed only for a short period of time.	
1LS ABT (INT) AT P = x.	1LS	Informative message that Export has aborted. x Coded P register	

<u>Message</u>	<u>Routine Issuing Message</u>	<u>Description</u>	<u>Operator Action</u>
1LS MODE1 FROM PP AT P = x.	1LS	PP detected a mode 1 error at P register address in 1LS. x P register address	Call site analyst.
LABEL BAD.	PFLOAD	Bad label was encountered, PFLOAD aborts.	Make sure a dump tape is being assigned and that the proper label information being requested is in the label.
LENGTH OF DEVICES TRT BAD. RECOVERY IMPOSSIBLE.	RMS	Issued if unsuccessful read of TRT from mass storage to CM on levels 0, 1, and 2 deadstart. Recovery impossible.	Levels 1 and 2: Redeadstart using level 0. Level 0: Enter GO to initialize device with parameters in label; permanent files are lost.
LENGTH ERROR (filenam) (user index).	REC	End of linkage in TRT for direct access file is not an EOI sector.  filenam      Name of direct access file on which error was encountered  user index    User index identifier	
LFM ERROR nn.	RESEX	Resource execution error. Error detected in call to LFM for operator assignment of equipment.  nn - LFM error number.	

<u>Message</u>	<u>Routine Issuing Message</u>	<u>Description</u>	<u>Operator Action</u>
LIBRARY TABLE ERROR.		Error while building system library. Blank entry was not found in the library table or in the directory within the field length at the deadstart control point.	Attempt another deadstart. If the problem persists, consult an analyst.
LOADING filenam.	SYSDIT	Informative message only.	
LOADING (filenam) (user index)	PFLOAD	Identification of the current file being loaded.	
LOADING - DIRECT ACCESS FILES ONLY.	PFLOAD	Informative message only.	
LOADING - INDIRECT ACCESS FILES ONLY.	PFLOAD	Informative message only.	
LOADING FROM xxx TO yyy.	PFLOAD	Informative message only. xxx Device mask of tape being loaded yyy Device mask of device to be loaded	
LOGIN xx.	1LS	Informative message. xx Indicates the number of terminals logged in	
LOST REFERENCES.	COMPASS	References in cross-reference table processing were lost.	
LPxx, NO PAPER.	1CD 2LP	Printer has a paper out condition. xx Printer (501/505/512)	Correct paper condition
LPxx, NOT READY.	1CD 2LP	Printer is not ready. xx Printer (501/505/512)	Ready printer
LQxx. NO PAPER.	1CD 2LP	Printer is out of paper. xx 512 printer	Correct paper condition



<u>Message</u>	<u>Routine Issuing Message</u>	<u>Description</u>	<u>Operator Action</u>
LQxx. NOT READY.	1CD 2LP	Printer is not ready. xx 512 printer	Ready printer
MASS STORAGE TOO SMALL FOR SYSTEM.		Error while building system library.	Attempt another deadstart using a larger system mass storage device or use a deadstart tape generating a smaller system library.
MISSING EOR.	PFLOAD	Logical EOR missing - invalid data. File is truncated and length of file is updated in catalog.	Retry or use another set of tapes.
MODIFIED AFTER yy/mm/dd. hh.mm.ss.	PFDUMP PFLOAD	Informative message; dumped files modified after given date.	
MS. DRIVER MAX. CYCLE.	1LS	Informative message.	
MT/NT CONFLICT.	RESEX	Tape assignment error. MT/NT specification disagrees or MT (7-track) densities used for NT (9-track) and vice versa.	
NO DATA BLOCK.	PFLOAD	DATA control word was not found when expecting data for the current file; length is set to zero.	Retry or use another set of tapes.
NO DEVICE SPECIFIED.	PFU	Device number specified but was lost before call to utility processor.	
NO EOI FOR FILE.	PFLOAD	Next catalog was found before EOI was detected for the current file. Length is updated in catalog entry.	Retry or use another set of tapes.
NO FILES PROCESSED.	PFLOAD PFDUMP	Informative operator message.	

<u>Message</u>	<u>Routine Issuing Message</u>	<u>Description</u>	<u>Operator Action</u>
NO JOBS IN SYSTEM.		Informative message; TELEX has successfully deactivated all terminal-originated activities that were in the system.	
NO PF DEVICE IN EST.	PFDUMP PFLOAD	No PF device is specified; job aborts.	Define PF equipment
NO SYSTEM DEVICE DEFINED.		The mass storage device to which the system is to be loaded has not been defined.	Define a mass storage device as equipment 0 and specify another mass storage device with the SYSTEM=n command.  or Attempt another deadstart and specify a system device with bits 0 through 5 of word 14 of the deadstart panel.
NOT SYSTEM JOB.	PFU	Calling program is not system origin or does not have system origin privileges with debug set to ON.	
NO USER INDEXES ON TAPE MATCH DEVICE MASK.	PFLOAD	Fatal system error; PFLOAD is aborted.	Check mask being loaded to and from.  Retry load.
OPERATOR DROP.	PFU	PFU unable to clear the utility interlock.	The operator may drop the job.
OUTPUT CYCLES.	1LS	Informative message about Export/Import condition.	

<u>Message</u>	<u>Routine Issuing Message</u>	<u>Description</u>	<u>Operator Action</u>
OVERCOMMITMENT ALGORITHM ERROR.	RESEX	Resource execution error. Overcommitment algorithm has failed internally. If one job gets this error, others will also.	
PACKNAME (packnam) LOADED.	PFLOAD	Informative operator message.	
PARITY ERR (lfn) (user index).	PFLOAD	Parity error was encountered on tape while loading file lfn. File is skipped.	Same situation as NO DATA BLOCK depending when parity error was encountered. Other means must be used to load file.  Retry or use another set of tapes.
PARITY ERROR IN CATALOG IMAGE RECORD.	PFLOAD	Fatal system error; PFLOAD is aborted.	Retry or use backup tape.
PERM. FILE LINKAGE ERROR, RECOVERY OF DEVICE IMPOSSIBLE.	RMS	TRT edit resulted in error. Can not edit TRT correctly to remove non-PF chains.	Enter GO to initialize with parameters as described in the label.
PERMIT RI RANGE ERR (filenam) (user index).	PFDUMP	Nonfatal system error message.	
PERMITS MISSING.	PFLOAD	Occurs when no permit block present but there was a previous permit random index in the catalog, or when entire permit block not read up yet and next word is not a permit control word.	
PERMITS PRESENT THAT SHOULD NOT BE.	PFLOAD	Permit block found on tape, but no previous permit random index was found in the catalog - invalid data. File is not loaded.	Retry or use another set of tapes.

<u>Message</u>	<u>Routine Issuing Message</u>	<u>Description</u>	<u>Operator Action</u>
P. F. DEVICE (xx) DUMPED.	PFDUMP	Informative operator message. xx Device number	
P. F. DEVICE (xx) LOADED.	PFLOAD	Informative message. xx Device number	
PFDUMP yy/mm/dd. hh.mm.ss.	PFDUMP	Informative message.	
PFDUMP DEVICE (xx) FAMILY (fy).	PFDUMP	Identifies family device being dumped. xx Device number fy Family name	
PFDUMP DEVICE MASK xxx.	PFDUMP	Informative operator message.	
PFDUMP DEVICE (xx) PACK (pk).	PFDUMP	Identifies auxiliary device being dumped. xx Device number pk Packname	
PFLOAD ABORTED.	PFLOAD	Fatal system error.	
PFLOAD DEVICE (xx) FAMILY (fy)	PFLOAD	Informative operator message. xx Device number fy Family name	
PFLOAD DEVICE (xx) PACK (pk)	PFLOAD	Informative operator message. xx Device number pk Packname	
PF SPECIFIED BUT UI NOT.	PFS	Filename designated but no associated user index is entered.	
PFU - PARAMETER ERROR.	PFU	Data in a PFU call is in error.	Consult site analyst.

<u>Message</u>	<u>Routine Issuing Message</u>	<u>Description</u>	<u>Operator Action</u>
POINTER ERROR - RECOVERY IMPOSSIBLE.		Informative message; TELEX has encountered incorrect internal pointers during recovery. These pointers could be the terminal table pointer or POT pointer. Recovery terminates and reloading is attempted.	
PP HUNG.	CPUMTR	One or more PPUs have attempted to perform an illegal operation. The PPU becomes hung because its output register was not cleared.	The recommended procedure is to perform deadstart dump of low core and all PPUs and then redeadstart.
PROPER SELECTIVE DUMP TAPE NOT ASSIGNED.	PFLOAD	This message occurred as a result of an operator input at the K display during incremental load operations.	
RANDOM ADDRESS ERROR.		Error while building system library. Random address is not on file.	Attempt another deadstart. If the error persists, consult an analyst.
READING filenam.	DOCUMENT VFYLIB LIBEDIT VERIFY	Informative message only.	
READING (filenam) (user index)	PFLOAD	Informative message only.	
RECOPYING filenam.	LIBEDIT	Informative message only.	
dt-n RECOVERED DNxx FNyyyyyy.	CMS	System dayfile message issued when device number xx for family yyyyyy has been recovered as device type dt-n.	None
dt-n RECOVERED PNxxxxxxx.	CMS	System dayfile message issued when auxiliary device xxxxxx has been recovered as device type dt-n.	None

<u>Message</u>	<u>Routine Issuing Message</u>	<u>Description</u>	<u>Operator Action</u>
RECOVERING. dtnn.	RMS	During recovery of devices at deadstart, this message is followed by other messages dependent upon the recovery.  dt Device type nn EST ordinal	None
RECOVERING PF EQxx. TRK nnnn.	REC	Indicates equipment track being recovered. Level 0 recovery only during interlocks for direct access files.  xx EST ordinal nnnn Logical track number	None
RECOVERY COMPLETE.		Informative message; TELEX has successfully completed the selected form of recovery.	
RECOVERY IN PROGRESS.		Informative message; TELEX has entered the recovery procedure to an abort or termination.	
REENTER NL OR IL PARAMETERS IF DESIRED.	PFLOAD	This message occurred as a result of an operator input at the K display during incremental load operations.	
REEL SEQUENCE ERROR.	PFLOAD	Date or time specified on current archive file not prior to that specified on last archive file loaded on incremental load.	Make sure a dump tape is being assigned and that the proper label information being requested is in the label.
REQUEST filename, EQx.	LFM, SFM	Job is requesting assignment of equipment type x to filename.	Assign equipment to control point.
REQUEST 512 PRINTER.	LQL	Job is requesting assignment of a 512 printer.	Assign a 512 printer.

<u>Message</u>	<u>Routine Issuing Message</u>	<u>Description</u>	<u>Operator Action</u>
REQUEST DISPLAY (xxx).	DIS	O26 or DIS or program name is waiting for the display to be assigned. xxx O26 File editor DIS name Program name	Assign
REQUEST *K* DISPLAY.	PF Utilities MODVAL STAGE PROFILE MSI	The K display is requested at that control point.	Enter K, n. n Control point number
REQUESTED FILE NOT AVAILABLE.	PFU	No FNT entry for the file requested was found.	Consult site analyst.
RESOURCE DEMAND ERROR.	RESEX	Control card or resource assignment (tape or pack) error. Resource demand request causes overcommitment or user has more assigned units than new demand.	
RESOURCE ENVIRONMENT ERROR.	RESEX	Resource execution error. Possible mass storage table (MST) or unit descriptor table (UDT) errors caused failure when building internal resource environment. If one job gets this error, others will also.	
RESOURCE PF ERROR nn filename.	RESEX	Resource execution error. PFM error nn is detected on file specified by filename when attaching resource file.	
RESOURCE TYPE ERROR.	RESEX	Control card or resource assignment error (tape or pack) error. Resource type is not recognized.	

<u>Message</u>	<u>Routine Issuing Message</u>	<u>Description</u>	<u>Operator Action</u>
SCANNING deckname.	KRONREF LIBGEN	Informative message.	
SET NUMBER OF SECTORS IN 3.	MST	MST is requesting sector count TC to be entered in relative location 3.  This occurs only when sense switch is specified.	
SKIPPING filename.	GTR COPYB SYSEEDIT LIBEDIT MODIFY	Informative message only.	
STAGING filename.	STAGE	Informative message only.	
STATUS ERR (filename) (user index).	PFDUMP PFLOAD	Bad device or status error on direct access file (filename); file skipped. This is a non-fatal system error.	
STORAGE REQUIRED.	COMPASS	More storage is required for cross-reference table processing.	
SUB-SYSTEM COMMUNICATION ERROR.	RESEX	Resource executive error. RESEX is unable to communicate with subsystem by monitor calls RSB or SIC. Magnetic tape subsystem (MAGNET) may no longer be active.	
SYSTEM TABLE FILE DESTROYED. RECOVERY OF DEVICE IMPOSSIBLE.		Error during a recovery deadstart. The system file being recovered from disk was destroyed. Recovery is impossible.	Attempt another deadstart without recovery (level 0).



<u>Message</u>	<u>Routine Issuing Message</u>	<u>Description</u>	<u>Operator Action</u>
SYSTEM TAPE FORMAT ERROR.		This message may occur during the initialization phase of deadstart.  Text defined by deadstart parameters (or in CMRDECK) does not exist on the deadstart tape.	
SYSTEM TAPE PARITY ERROR.		Parity error occurred when reading the deadstart tape.	To continue, type GO. However, transferred information may not be valid.  or Attempt another deadstart at a different tape density, tape unit, or with a different tape.
TAPE BLOCK DEFINITION ERROR.	RESEX	Tape assignment error. RESEX is unable to define word count, overflow, and unused bits from format and FC/CC.	
TAPE ERROR (filenam) (user index)	PFLOAD	When certain errors occur, the file is noted and skipped, and loading is resumed. Same situation as parity error.	Inform site analyst.
TAPE LABEL ID ERROR.	PFLOAD	Identification PFDUMP not found in label.	Check to see if dump tape is assigned and proper label information is in the label.
TAPE PARITY ERROR.	PFLOAD	Parity error encountered. File name unknown. Tape is skipped to next EOR. Same situation as parity error.	Inform site analyst.

<u>Message</u>	<u>Routine Issuing Message</u>	<u>Description</u>	<u>Operator Action</u>
TAPE SEQUENCE ERROR.	PFLoad	This message occurred as a result of an operator input at the K display during incremental load operations (refer to description of REEL SEQUENCE message).	
TELEX WAITING.	1TD	TELEX is waiting for enough storage to be loaded.	
TELEX ABNORMAL - xxx, nnnnnn.		TELEX has encountered an abnormal situation. If sense switch 3 is set, TELEX attempts to enter active users into recovery state, aborts, and reloads automatically. xxx      TELEX routine requesting the abort nnnnnn   Contents of B2 register - usually contains a terminal number	
TELEX INITIALIZATION ABORT.		This occurs during TELEX initialization if any job remains in the system queues with multi-terminal or TELEX origin type. This situation should not exist because TELEX normally clears all jobs of these types when terminated. If the terminal configuration (EST entries) has been changed since termination, it is impossible to reload TELEX and recover users. This restriction is necessary because users are identified on the recovery file by a port number.	

<u>Message</u>	<u>Routine Issuing Message</u>	<u>Description</u>	<u>Operator Action</u>
TELEX RECOVERY.		Informative message; whenever TELEX is aborted, it attempts to enter active users into recovery state and recover all system space currently occupied by active users.	
TELEX TERMINATE.		TELEX was stopped and not re-started. This message is issued when TELEX is dropped (1.STOP. command).	
TERMINAL nnn, JOB LOST.		Informative message; an abnormal situation has occurred during TELEX recovery. An attempt is made to terminate a job from the system because the active user logged in at terminal nnn cannot locate it. Recovery continues, but that user will be unable to recover.	
TRACK BUFFER FULL.	SET	Too many reserved track entries in CMRDECK. No more entries will be accepted.	
UNRECOVERED PARITY ERROR-(filenam) ENTER K.GO TO CONTINUE. K.END TO ABORT.	PFDUMP	Nonfatal system error filenam name of archive or verify file on which error was detected.	Self explanatory.
USER DOES NOT RESIDE ON MASTER DEVICE.	PFDUMP	User index specified does not reside on device specified; this is a fatal system error causing PFDUMP to abort.	
USER INDEX NOT ON DEVICE.	PFLOAD	Fatal system error; PFLOAD aborts.	
USER NUMBER INVALID.	PFS	User number cannot be converted to user index correctly.	

<u>Message</u>	<u>Routine Issuing Message</u>	<u>Description</u>	<u>Operator Action</u>
VERIFYING rename.	VERIFY	Informative message only.	
WAIT FNT SPACE.	OBF	DEF is waiting for a free entry in the file name table.	Drop some active jobs.
WAIT FOR CATALOG INTERLOCK.	PFDUMP	Informative operator message.	
WAIT FOR TOTAL INTERLOCK.	PFLOAD	Informative message only. Permanent file requests are currently active. PFLOAD will automatically continue when interlock or device is successful.	
WAITING FOR COMMON FILE xxxxxxx.	LFM	Job is waiting for common file to become available. xxxxxxx Common file name	
WAITING FOR STORAGE.	TELEX DIS EXPORT BATCHIO	Job processing is waiting for memory to be made available.	
WAIT LOGOFFS COMPLETE.		Informative message; TELEX is entering active users into the recovery file or logging them out.	
WPE UNRECOVERED - ABORT.	PFDUMP	Operator has aborted PFDUMP when WPE unrecovered detected on archive file.	

## END OF OPERATION SHUTDOWN

C

---

Since the method used to terminate KRONOS operations is generally dependent upon the requirements of a specific installation, the actual procedure for shutdown may differ from one installation to another. The following procedure is included as an example and suggests guidelines that can be used to ensure the orderly termination of KRONOS processing. This procedure should not be confused with the shutdown procedures performed in preparation for a recovery deadstart (refer to Preparing for Recovery Deadstart in section 2).

1. Select the DSD job status (B) display to monitor control activity.
2. If the TELEX subsystem is active at control point 1, provide advanced notice of shutdown time to active time-sharing users by entering the DSD command WARN. For example:

WARN, SYSTEM SHUTDOWN IN FIVE MINUTES, PLEASE LOG-OFF. (CR)

This message is transmitted to all time-sharing terminals upon completion of the current operation.

3. Prevent new time-sharing users from logging into the system by entering the following DSD command.

SERVICE, TX, NJ0. (CR)

The NJ parameter specifies the number of active lines allowed for TELEX (TX) jobs and is set to zero (NJ0).

4. Drop the CYBERLINK subsystem if it is currently assigned to a control point. This is done by typing

n. STOP. (CR)

n Control point number to which CYBERLINK is assigned.

Operator information concerning the CYBERLINK subsystem is not included as part of this manual (refer to the CYBERLINK Interchange Operator's Guide).

5. Drop the TRANEX subsystem if active at control point 2. This is done by typing

2. STOP. (CR)

Operator information concerning the Transaction Subsystem (TRANEX) is not included as part of this manual (refer to the Transaction Subsystem Operator's Guide Addendum).

6. If the TELEX subsystem is active at control point 1, examine the TELEX status (T) display to determine if there are still active users. When there are no longer active users indicated on the T display, drop TELEX by typing

1. STOP. (CR)

7. Drop EXPORTL (Export/Import subsystem) if it is currently assigned to a control point. This is done by typing

n.STOP. (CR)

n Control point number to which EXPORTL is assigned.

If transmission to a remote batch terminal is terminated by dropping EXPORTL, the file being transmitted is rewound and placed back in the output queue. All other files currently scheduled for transmission to remote batch terminals are returned to the output queue.

8. Examine the equipment status (E) display to determine the EST ordinal of the local card readers (CR), card punches (CP), and the line printers (LP and/or LQ). Disable automatic system assignment of the devices mentioned (logically turn devices off) by entering the following DSD command.

OFFxx. (CR)

xx EST ordinal of the device being disabled.

If the specified device is active when this command is entered, the current operation is allowed to complete before the device is disabled. Doing this prevents any new output type files from being scheduled to the BATCHIO control point.

9. Prevent any new jobs in the input queue from being scheduled to a control point by dumping the input queue. This is accomplished through use of the DMQ system utility (refer to description of DMQ in section 6). Doing this allows jobs currently scheduled to control points to run to completion. In addition, jobs in the rollout queue will be scheduled back to a control point and allowed to complete.
10. Monitor control point activity on the B display. Wait for all jobs to run to completion and then dump the output queues (print and punch queues). This is also accomplished through use of the DMQ system utility (refer to description in section 6).
11. If permanent files are to be dumped, enable a line printer to receive output reports. This is done by entering the following DSD command.

ONxx. (CR)

xx EST ordinal of the line printer to be enabled (logically turned on).

Refer to the description of the PFDUMP permanent file utility in section 5 for procedures to dump permanent files.

12. If the system is not to be used after KRONOS shutdown, proceed to step 13. However, if the system is to be used for reasons other than normal KRONOS processing, perform the following steps.
  - a. Examine the MST (E, M) display to determine if status code C (checkpoint requested) is set for any mass storage device. Wait until the checkpoint operation has completed before proceeding (C status cleared).
  - b. Dismount the deadstart tape (if currently mounted), and activate the deadstart switch. The display screens should become blank indicating that the system hardware is idle. The system is now ready for other use.

- c. Prevent subsequent users of the system from accessing mass storage permanent file devices. This is accomplished by dismounting disk packs (841, 844, and 854 only) or making the devices unavailable (not ready) for system access.

- 13. If the system is not to be used after KRONOS operations have ended, enter the following DSD commands.

DISABLE, BATCHIO.	Ⓞ
DISABLE, EI200.	Ⓞ
DISABLE, MAGNET.	Ⓞ
DISABLE, TRANEX.	Ⓞ
DISABLE, TELEX.	Ⓞ
MAINTENANCE.	Ⓞ

Doing this disabled all subsystems and allows maintenance tests to run while the system is not being used. It is recommended that the display screen intensity be turned down before leaving the system.

## PERIPHERAL EQUIPMENT OPERATION

D

---

### 405 CARD READER OPERATION

Once the MAIN POWER switch on the card reader is lighted, the reader can be loaded and started as follows:

1. Set guide edge of input feed hopper and output stacker for length of card. Narrow half of each tray may be removed, turned end-for-end, and reassembled as necessary.
2. Load cards into hopper, placing column 1 at right as cards face entrance of read station.
3. Check input wall of secondary and main output stackers. If standard cards are used, hinged card-stopping blocks should be positioned to form a flush surface at each input wall. If short cards are used, the hinged block assemblies must be pivoted to protrude from the wall surfaces of each stacker.
4. At feed hopper, set card-stopping pin to protrude from the face plate if short cards are used; turn pin in clockwise direction to form flush wall if long cards are used.
5. If short cards are to be read, press the 51 COLUMN switch until it lights.
6. To check operation:

If MAN is not lighted on the AUTO/MAN switch, press the switch to place the equipment in the manual mode.

If STOP is not lighted on the RUN/STOP switch, press the switch so that STOP lights.

Press the MOTOR POWER switch. Light should turn on and the input hopper begin vibrating.

Press RELOAD MEMORY switch to clear the internal card buffer. No light exists.

Press READY switch until it lights.

Press SINGLE PICK switch to cause the first card to be read and transferred to the output stacker. No light exists. If the card does not move properly, check the read station for an obstruction.

Press MOTOR POWER to stop the vibrators and replace card in the input hopper.

7. To allow cards to be read:

Press RUN/STOP so that STOP lights, if necessary.

Press AUTO/MAN so that AUTO lights.

Press MOTOR POWER so that it lights.

Press RELOAD MEMORY. It does not light.

Press READY until it lights.



The switches and indicators on the reader (Figure D-1) are explained in the following paragraph. They differ slightly depending upon the type of controller (3649 or 3447). The controllers are an integral part of the card reader equipment.

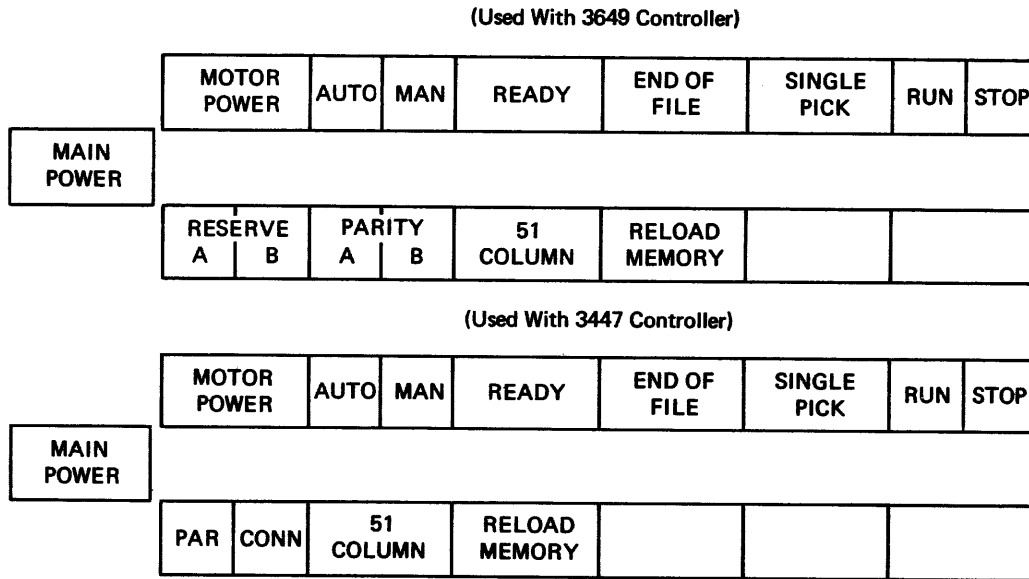

Figure D-1. Card Reader Switches

- |             |                                                                                                                                                                                                                                                                                                                             |
|-------------|-----------------------------------------------------------------------------------------------------------------------------------------------------------------------------------------------------------------------------------------------------------------------------------------------------------------------------|
| MAIN POWER  | Controls all primary power and turns on the photocell light source. It is lighted when power is on. It must be on before subsequent operations are effective.                                                                                                                                                               |
| MOTOR POWER | Controls power to the drive motors, the vacuum-pressure system, and the hopper-stacker vibrators. It must be on before the READY status is effective. It is lighted when on.                                                                                                                                                |
| AUTO/MAN    | Selects manual or program controlled modes of operation. The switch must be in the AUTO position when the reader is to be controlled by KRONOS. Changing switch position to MAN disables KRONOS control, allowing the operator to manually cycle cards.                                                                     |
| READY       | The switch lights to indicate the ready condition. When the switch is pressed, the first card is read into buffer memory. Thereafter, the reader is under KRONOS control. If the input hopper is empty, error conditions exist on the device, the output stacker is not closed or it is full, a NOT READY condition exists. |
| END OF FILE | Causes the reader to generate an end-of-file status bit after the last card in the input tray is read. It lights when set. If the last card in the input tray is not the last card in the file being read into the system, this switch should be off.                                                                       |
| SINGLE PICK | Cycles a single card through the reader when the AUTO/MAN switch is in MAN position. It does not light.                                                                                                                                                                                                                     |

RUN/STOP	The card feed may be controlled manually when the AUTO/MAN switch is in MAN position. The set side is lighted.
RESERVE A/B (3649 Controller only)	One side lights as one of the two converters attached to the controller reserves reader access.
PARITY A/B (3649 Controller only)	This light appears only when a parity error occurs during the transmission of a connect or function code. An error message will appear on the console screen.
PAR/CONN (3447 Controller only)	Similar to the RESERVE and PARITY switches of the 3649 Controller in that one side lights for a parity error and the other when the reader is connected to the controller channel.
51 COLUMN	Allows short (51-column) cards to be read. It is lighted when set.
RELOAD MEMORY	Feeds data from a new card into card reader memory buffer when pressed, providing AUTO/MAN is in AUTO. It does not light. It should be pressed prior to each READY. Inside the right front door are several lights that indicate malfunction. If FEED/FAIL is lighted, a card is not acceptable or a card jam exists. Lifting the read station panel will expose the card guides.

The PRE-READ and COMPARE lights indicate that the pre-read and read stations do not interpret a card identically. An attempt should be made to reread the card.

#### 415 CARD PUNCH OPERATION

The controller for the card punch, 3644 or 3446, is in a separate cabinet. It has the equipment number switch that establishes the equipment number for the punch in the EST display. With the exception of the lights mentioned in the following paragraph, controller switches are the responsibility of the customer engineer.

Once the MAIN POWER and MOTOR POWER switches on the card punch are lighted, operation is initiated as follows:

1. Place cards face down in input hopper with row 9 toward rear.
2. Check that chip box and output stacker are not full.
3. Advance two cards into the punch and read stations by pressing the SINGLE PICK switch twice.
4. Check the controller equipment. If either the NOT READY or FAIL TO FEED light is on, cards have not advanced into the punch and read stations.

The card punch is then ready for operation.

Switches on the card punch (Figure D-2) have the following functions.

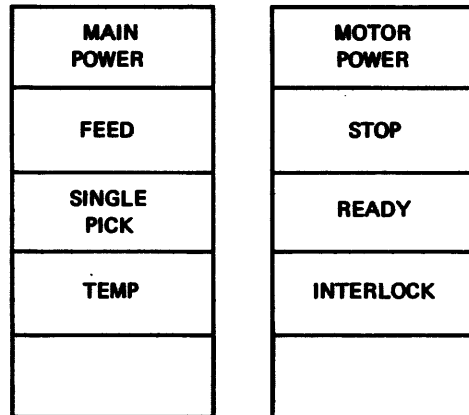

Figure D-2. 415 Card Punch Switches

MAIN POWER	This switch applies power to the cooling fans and the power supplies. It is lighted when power is on.
MOTOR POWER	This switch applies power to the punch motor. It is lighted when power is on.
FEED	This indicator lights when a card jam exists. A message CPuu NOT READY appears at the console. A customer engineer should be called to remove the jammed card.
STOP	With this switch, the operator can cause the punch to become not ready. It lights when pressed to stop system control.
SINGLE PICK	This switch advances cards one station in the input hopper-punch-read-output cycle. It lights until the advance is complete.
READY	This switch clears punch logic and puts it in automatic mode for system control. It lights when the punch is in a ready condition. If it does not light when pressed, conditions such as feed failure and full output stack should be examined and corrected.
TEMPERATURE	If this light is on, the temperature of the punch exceeds operation requirements. A customer engineer should be consulted.
INTERLOCK	This switch lights if the head panel, hood panel, or right door is open. All should be closed during operation.
STACKER FULL	This switch lights when the output stacker is filled. It resets automatically when cards are removed from the stacker.

## 501 LINE PRINTER OPERATION

The 501 Line Printer is controlled by a 3256 or 3659 Controller located apart from the printer. Manual controls on the printer are shown in Figure D-3.

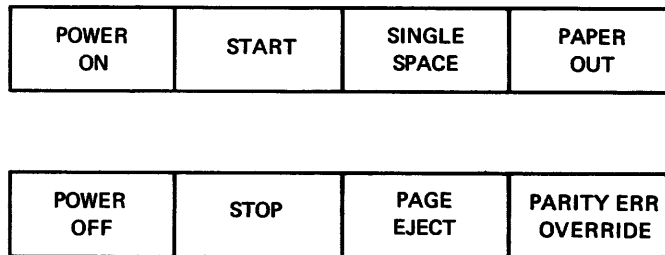

Figure D-3. 501 Line Printer Switches

Once the POWER ON switch is lighted, operation can be controlled by switches.

SINGLE SPACE	Prints a single blank line under manual control.
PAGE EJECT	Under manual control, advances to top of next page as determined by format loop control.
START	Readies printer for system control. It is lighted when selected.
STOP	Stops printer control, resulting in LPuu NOT READY message on the console display.
PAPER OUT	When lighted, paper supply is exhausted. Printer becomes not ready.
PARITY ERR OVERRIDE	When lighted, indicates that parity error override switch has been set on the controller and no operator action is required when a parity error occurs.
POWER OFF	Shuts off main power supply.

## PAPER LOADING

Loading paper is described below. Controls on the back of the printer are shown in Figure D-4. Usually only steps I-5, 7, and 11 are necessary when the printer runs out of paper.

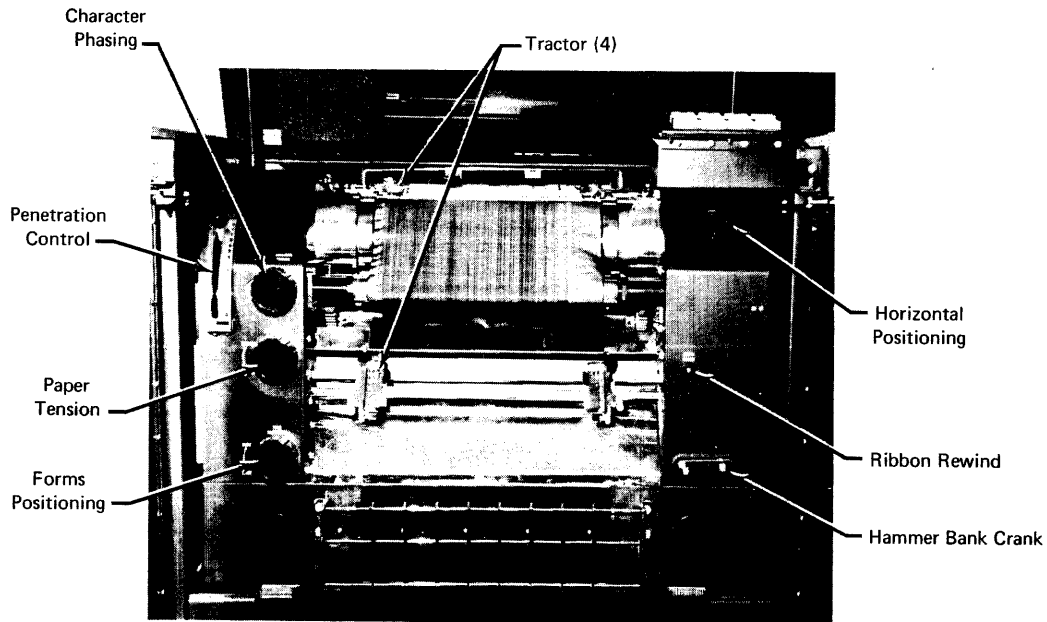

Figure D-4. 501 Line Printer

1. Turn hammer bank crank two to three turns counterclockwise to separate the print drum and hammer bank.
2. Press PAGE EJECT switch on control panel.
3. Raise hinged pressure plates of all four tractors to insert paper forms.  
If the width of the forms is changed, loosen extended locking screws (long shafts) of upper and lower right tractors. Both right and left tractors should be adjusted to an equal distance from center.  
When left edge of paper is positioned, tighten extended locking screws to fix upper and lower left tractors in position.
4. Insert paper between lower side of print drum and hammer bank, extending paper to upper tractors.
5. Turn hammer crank fully clockwise.
6. Engage perforated edges of paper with drive pins of left and right tractors.  
If the form width is changed, set vernier thumb screw of upper and lower right tractors to approximate position. Tighten extended locking screws to set general position of these tractors.

7. Close pressure plates.  
If form width has changed, set horizontal paper tension by varying the vernier thumb screws of right tractors, and vertical tension by paper tension control knob. These adjustments cause the tractor pins to move.
8. Press SINGLE SPACE switch several times and observe paper holes and action of paper tear switches.  
If vertical paper tension is too loose, whipping action will result, activating paper tear switches. If vertical paper tension is too tight, paper holes will tear and elongate in the vertical direction. Adjust paper tension control at left panel.  
If horizontal paper tension is too tight, the outer edges of paper holes will tear. Adjust vernier thumb screw at both upper and lower right-hand tractors.
9. Press START switch and observe position of type with respect to top of paper form. If print is not properly positioned within one line of the correct location, paper must be removed from tractors, moved up or down as required, and reinserted on tractor drive pins.
10. If paper forms are ruled, initiate print operation and adjust forms positioning control to locate printed line relative to ruled paper line. All four tractors move in a vertical direction a maximum range of 1/2 inch.  
The horizontal positioning control knob moves the form up to 15/32 inch relative to print drum; it does not affect horizontal tension.
11. To resume printing press START switch.  
When the paper form is changed, the character phasing control may need to be adjusted so that characters print fully. The penetration control knob adjusts the print mechanism to accommodate thickness of forms.

#### RIBBON REPLACEMENT

1. Turn hammer bank crank two or three turns in the counterclockwise direction to obtain necessary clearance between print drum and hammer bank assembly.
2. Press ribbon rewind switch and hold until ribbon is transferred to outer roll.
3. Slacken ribbon by manually turning outer roll several revolutions in forward direction.
4. Grasp outer roll and push toward left side of printer. The drive cap at the right end of roll disengages, permitting removal of roll.
5. Unwind remaining ribbon from inner roll. Pull free end of ribbon from aperture between drum and hammer assembly. Discard worn ribbon and roll.
6. Remove inner roll by pushing to left until drive cap at the right end of roll disengages. Reinstall in outer position.
7. Place new roll in the inner position so the ribbon leaves from bottom of roll. Be sure slot on right end of roll engages drive cap pin.
8. Insert two sheets of paper between print drum and hammer assembly. Attach the leader of the new ribbon roll to the outer sheets. Draw paper and ribbon through aperture, toward front of printer.

9. Detach ribbon leader from paper. Pull ribbon leader over outer roll and fasten to the roll. Wind a few turns onto the roll, taking up slack by rotating roll several revolutions. Be sure slot in right end of roll engages drive cap pin.
10. Press ribbon rewind pushbutton. Ribbon should move at a steady rate and wind evenly.
11. If the ribbon telescopes during the loading procedure, grasp the ribbon firmly in both hands and place the end against a table. Press slowly and firmly until the ribbon is recentered on its core.
12. If ribbon becomes caught in print drum, turn power off immediately.

### 512 LINE PRINTER OPERATION

The 512 Printer combines the printer and its controller in one cabinet. Paper supplies in front of the machine pass upward between the printer gate on the front door and the print head in the cabinet and emerge at the back. Operator manual controls on the back duplicate four switches on the front to facilitate removing paper.

Front panel controls in Figure D-5 include indicator lights for the controller as well as the manual operation switches.

POWER OFF	STOP	PAGE EJECT	6 LINE	8 LINE	CONN	TRANS PAR	MEM PAR	SYNC ERROR
POWER ON	START	SINGLE SPACE	ERROR OVERRIDE		SINGLE CYCLE	PPGM ERROR	PRINT ERROR	
THERMAL	DC POWER	GATE	PAPER FAULT	PAPER MOTION	HAMMER FUSE	MEMORY BUSY	IMAGE PARITY	

Figure D-5. 512 Line Printer Switches

Indicators on the bottom row light to pinpoint conditions that make the printer inoperative. Some conditions can be corrected by the operator; others require customer engineer action.

- |              |                                                 |
|--------------|-------------------------------------------------|
| GATE         | Printer arm assembly should be closed fully.    |
| PAPER FAULT  | Paper tear, jam, or supply should be corrected. |
| PAPER MOTION | Power on should be pressed.                     |

When the POWER ON switch is lighted indicating power to the printer itself, the printer is manually controlled by:

- |              |                                                     |
|--------------|-----------------------------------------------------|
| START        | Readies printer.                                    |
| STOP         | Makes printer not ready.                            |
| PAGE EJECT   | Advances paper to top of form under manual control. |
| SINGLE SPACE | Prints single blank line under manual control.      |
| POWER OFF    | Turns off all power to equipment.                   |

Other indicators on the panel denote status or identify error conditions.

### PAPER LOADING

To load paper into the 512 Printer (Figure D-6) when it has run out:

1. Open front printer gate.
2. Remove old paper supply with PAGE EJECT switch.
3. Open pressure plate on upper and lower left and right tractors.

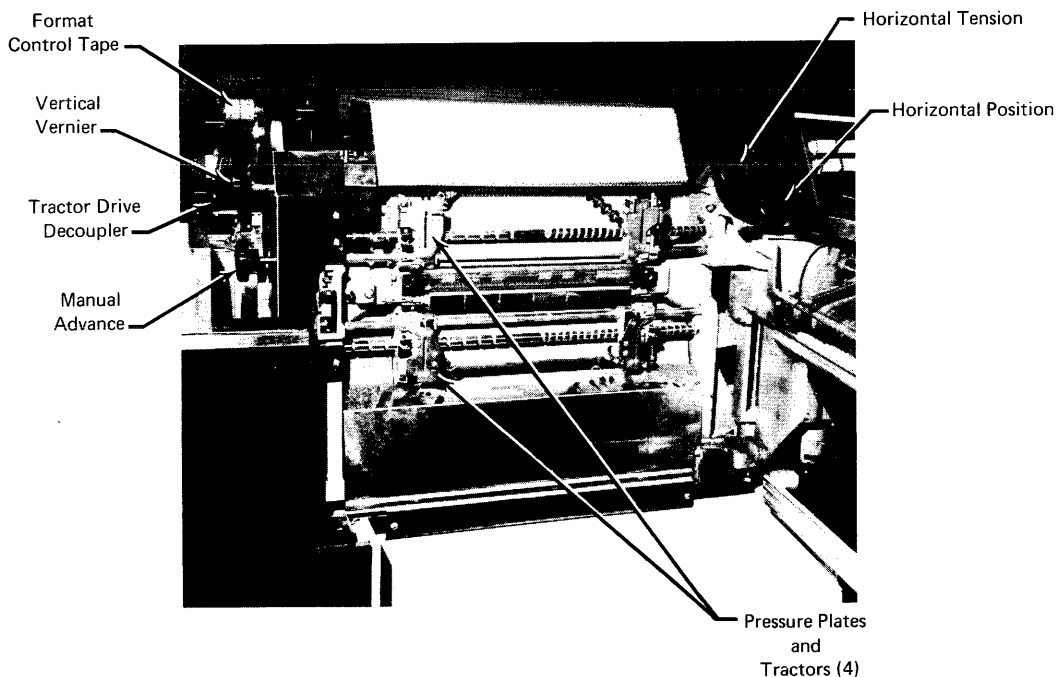

Figure D-6. 512 Line Printer Controls



4. Raise paper vertically from supply box and place into upper and then lower paper tractors.
5. Close all four pressure plates.
6. Close front panel securely.
7. Press START to resume system control. If printing does not begin at top of form, reposition paper in the tractors.

Loading forms of a different width or thickness involves the following:

1. Move the tractors to the approximate position by squeezing the detent release and sliding the tractors to the required position. Detents must reengage in their new positions. The left and right tractors must be aligned vertically.
2. Place the forms into the upper left paper tractor. Close the pressure plate over the forms to secure them.
3. In the same manner, place the forms into the lower left paper tractor.
4. Move both right paper tractors into the approximate position by rotating the horizontal tension control.
5. Place the forms into the right paper tractor. Secure the forms in place with the pressure plate.
6. In the same manner, place the forms in the lower right paper tractor.
7. Adjust the horizontal tension control so the forms do not buckle (too loose) and the tractor pins do not stretch the perforated holes (too tight).
8. Close the forms alignment scale against the paper. When the train is opened at least 45 degrees from the paper line, the line finder rises so that the plastic strip indicates exactly the bottom of the next line to be printed. The column marker indicates the location of the print columns on the forms.
9. Move the horizontal position control to align the forms with the proper print columns.
10. Uncouple the format tape with the tractor drive uncoupler knob above the paper drive motor. Move this knob toward the back of the machine to engage the eight line-per-inch stops or toward the front of the machine to engage the six line-per-inch stops.
11. Use the manual advance knob on the left side of the paper forms to adjust the forms to the approximate vertical position. This knob can move forms for an unlimited length up and down. Detent clicks of six or eight lines per inch can be felt when the paper forms are moved. Stop on the detent click nearest the desired position.
12. Turn the vertical vernier knob for fine adjustment of the paper forms. Forms can be accurately positioned while the printer is idle or printing. The full range of this control is one line.
13. Push PAGE EJECT before recoupling the format tape.
14. Recouple (step 10) the format tape and close the train gate to synchronize the top of the paper form with the top of form hole (channel 1) in the format tape. At this time, the printer is mechanically ready to print.

Printing adjustments are made as follows:

1. Push the paper exit drive release control to allow the paper forms to slide between the rollers. Use this control to free the paper forms from the paper exit drive system to adjust paper forms horizontally; reverse paper forms toward the paper supply source.
2. Adjust the forms stacker bar so that the paper forms fan fold properly. The stack bar can be released with the detent on the left side of the bar.
3. The forms thickness control is on the left side near the train gate latch. This control provides even top-to-bottom character density when properly set.
4. The print density control is near the format tape assembly. Adjusting to minimal acceptable print density prolongs ribbon life and prevents forms from embossing. The horizontal or vertical vernier controls can be used to position the forms while the machine is printing.

#### RIBBON CHANGE

1. Unlatch the train gate cover.
2. Unlatch the train gate or printer gate from the print head.
3. Move the line finder against the print head.
4. Grasp the ribbon rolls with the left hand on the upper roll and the right hand on the lower roll.
5. Push the rolls toward the hinged side of the gate and lift them out together.
6. Lift the ribbon out and away from the type array arm.
7. After the new ribbon is unwrapped, grasp one roll in the left hand and the other roll in the right hand.
8. Bring the ribbon against the print gate. The ribbon does not go around the line finder. The line finder should be closed against the print heads so the ribbon does not pass between the line finder and the print head.
9. Insert the ribbon rolls by pushing them against the right ribbon support spools.
10. Ease the ribbon rolls into place against the left ribbon support spools. Make sure the keys on the left-hand ribbon spools fit into the slots on the ribbon rolls. Rotate upper roll to remove slack.

#### TAPE UNIT OPERATION

KRONOS 2.1 supports unit models 604, 607, and 657 for 1/2-inch 7-track magnetic tape and the 659 model for 1/2-inch 9-track tape. User procedures are basically the same; differences are explained in the following paragraphs.

All models have a unit select switch at the top of the cabinet. This switch has positions 0 to 7, and for the 607, STANDBY. A unit in STANDBY status cannot be accessed by the system. Each unit that is on should have a unique number set.

The system and the operator identify a unit by its EST ordinal as shown in the E display. Installations usually configure the system so the last digit of an ordinal for a tape drive is the same as the unit select switch setting, making it easier to equate the two. Other than to set a unit to STANDBY, this select switch can be ignored during operation. It lights red when the unit is reserved on a data channel.

Procedures for loading a tape after power is on:

1. Open door.
2. Check that supply reel has been file protected as necessary, with the write enable ring in or out.
3. Mount reel on supply hub to the right, facing the unit. Push the reel firmly in place by applying pressure near the hub rather than the edge of the reel; lock it by closing the latch or tightening the knob in the center of a 604 or 607 reel by turning it clockwise.
4. Thread tape from supply reel to takeup reel. For the 607, make sure that tape load arms are in up position. Pull tape from supply reel to reach takeup reel. Thread tape on the outside of the supply tape load arm, over the head assembly, around the outside of the takeup load arm, and over the top of the takeup reel. Release tape and spin the takeup reel hub two or three times. Tape should not stick out from reel. Slide tape under head assembly and snap tape load arms down.

For the other units, pull tape from supply reel to takeup reel. Thread tape on the outside of the tape guide roller, under the head assembly, around the outside of a second guide, and over the top of the takeup reel. Release tape and spin the takeup reel two or three times. Tape should not stick out from reel.

5. If the system is not processing jobs, set UNIT SELECT switch (0 to 7 or STANDBY) if necessary. The UNIT SELECT switch should not be changed while there is a possibility that the scheduler routine is accessing the unit.
6. Press CLEAR switch.
7. Press LOAD switch or on the 657 and 659, LOAD FORWARD. Tape drops in columns, moves forward, and stops on load point marker. LOAD indicator lights. If tape continues moving forward for more than 3 or 4 seconds, either no load point marker was placed on the tape, or the operator manually wound the marker onto the takeup reel during step 4.
8. Press READY switch.
9. Close door.

To unload the tape when it has not been unloaded under program control:

1. From console keyboard, enter DSD command UNLOAD, xx. (xx is EST ordinal of tape unit). All tape is drawn automatically from the takeup reel and wound on the supply reel (UNLOAD indicator on 604 and 607 lights).
2. Open door.
3. Loosen supply reel hub knob of 604 or 607 turning counterclockwise, or lift latch of hub. Remove reel. To keep the pressurized locking gasket in place, the latch should not be closed when no reel is mounted.
4. Check if write enable ring needs to be removed and if reel is labeled adequately prior to storage.

## 604 AND 607 TAPE UNITS

The other switches on a 604 and 607 Tape Drive are shown in Figure D-7.

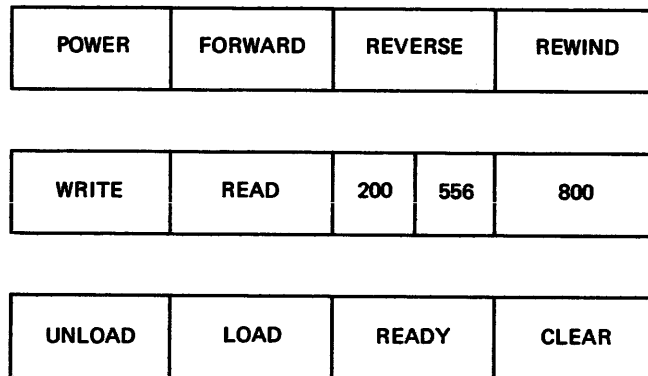

Figure D-7. 604 and 607 Tape Unit Switches

POWER	When power is applied to the unit, this switch is lighted.
FORWARD	When FORWARD is pressed, the tape begins to move forward, stopping when the CLEAR switch is pressed or the end-of-tape marker is sensed. It lights during tape motion.
REVERSE	When REVERSE is pressed, the tape begins to move backward onto the supply reel, stopping when the CLEAR switch is pressed or the load point marker is sensed. It lights during tape motion.
REWIND	When REWIND is pressed, the tape rewinds from the takeup reel to the supply reel, stopping at the load point. It lights during tape motion.
WRITE	This indicator lights when the tape is being written.
READ	This indicator lights when the tape is being read.
200/556	Pressing this switch selects recording density, 200 or 556 bytes per inch.
800	Pressing this switch selects a recording density of 800 bytes per inch; it is lighted when selected.
UNLOAD	When UNLOAD is pressed, tape moves to the supply reel. The switch lights when the status is unloaded. The CLEAR switch must be pressed before UNLOAD.
LOAD	When LOAD is pressed, tape moves from supply reel to takeup reel; tape stops and the switch lights at the load point marker.
READY	This switch places the unit under processor rather than manual control. It is lighted when ready status exists.
CLEAR	When CLEAR is pressed, it initiates a master clear of processor control and places the unit under manual control. It is lighted when selected.

To simulate an unloaded condition on the 604 and 607 without removing all tape from the takeup reel, simultaneously push the CLEAR and UNLOAD switches. The unload condition is simulated, but tape does not move. To place the unit in operational status, remove all tape from the vacuum columns by revolving the takeup reel clockwise and the supply reel counter-clockwise. Snap the tape load arms down and push the LOAD switch. The tape moves forward and stops on the nearest load point marker. The LOAD indicator lights.

If all tape is unwound from the supply reel:

1. Snap the tape load arms up, if necessary.
2. Guide tape around the tape load arms over the head assembly and wrap approximately 10 turns around the supply reel.
3. Slide tape under head assembly.
4. Press the LOAD switch.
5. As soon as the FORWARD indicator lights, press the CLEAR switch and then the REVERSE switch. Tape will rewind on the nearest load point marker.

The following information is applicable when a number of load point or end-of-tape markers are used on a single tape.

To move forward from a reflective marker and stop at nearest end-of-tape marker, push the FORWARD switch.

To move forward from a reflective marker and stop at nearest load point or end-of-tape marker, press the FORWARD and then the LOAD switch. The LOAD indicator lights if motion stops at load point marker.

To reverse from a reflective marker and stop at nearest load point marker, first press CLEAR and then REVERSE (or REWIND) switches.

Tape motion may be stopped at any time by pressing the CLEAR switch. An unload operation may be performed according to procedures previously indicated.

#### 657, 659 TAPE UNITS

Switches on these units have functions similar to those of the 607.

LOAD and FORWARD are combined in a single switch; the WRITE and READ indicators are removed.

A reel with a write ring inserted will light the WRITE ENABLE indicator. The 659 unit has density settings of 800 and 1600 cpi. The 657 has densities of 200, 556, and 800 bpi.

POWER	WRITE ENABLE	READY	CLEAR	LOAD FORWARD	REWIND	REVERSE	200	556	800
-------	-----------------	-------	-------	-----------------	--------	---------	-----	-----	-----

Figure D-8. 657 and 659 Tape Unit Switches

## 854 DISK DRIVE OPERATION

To ready the 854 disk pack after power is on:

1. Lift the disk drive unit cover as far as possible to provide maximum loading clearance.
2. Place the pack on the spindle and turn the cover handle clockwise to a full stop position. The pack should be tight on the spindle so that its protective cover lifts off easily.
3. Close the disk drive unit cover and press the START switch on the front of the drive unit. This switch causes the unit to perform an initial seek operation which positions and loads the read/write heads and brings the unit to the ready state in approximately 30 seconds.

To unload:

1. Lift disk drive unit cover.
2. If necessary, wait until pack stops spinning.
3. Engage the protective cover over the disk pack and rotate the cover three times in a counterclockwise direction to release the pack from the spindle. It can then be lifted from the drive unit.

## 841 MULTIPLE DISK DRIVE OPERATION

To ready an 871 disk pack on the 841 Multiple Disk Drive after power is on:

1. Pull open the drawer that contains the pack spindle.
2. Place the pack on the spindle and turn the cover handle clockwise to a full stop position. The pack should be tight on the spindle so that its protective cover lifts off easily.
3. Close the drawer and press the START switch on the front of the drive unit. This causes the SPIN switch to light and the unit to perform an initial seek operation which positions the read/write heads.

The unit is ready for operation when the UNIT number switch lights.

To unload:

1. Press the START switch. The light in the switch goes off.
2. Wait until the lights for the UNIT number switch and the SPIN switch go off before attempting to open the drawer, then pull open the drawer.
3. Engage the protective cover over the disk pack and rotate the cover three times in a counterclockwise direction to release the pack from the spindle. Then it can be lifted from the drive unit.

## CONSOLE SCREEN CONTROL

Controls on a panel below the display screens (Figure D-9) allow the operator to change the characteristics of displayed characters.

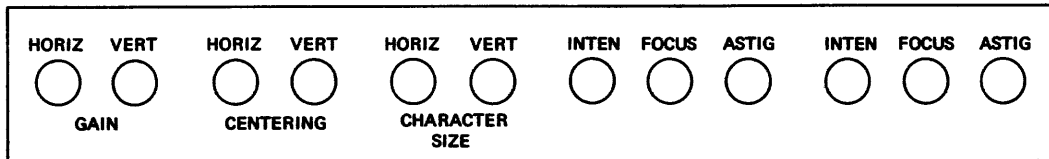

Figure D-9. Console Switches

Controls to the left affect both screens:

**GAIN**                      Varies width (HORIZ) or height (VERT) of area of display.

**CENTERING**              Varies horizontal and vertical position of display.

**CHARACTER SIZE**        Varies width and height of characters.

The sets of three knobs affect the right and left screens individually.

**INTEN**                      Varies brightness of display.

**FOCUS**                     Changes clarity in center areas of display.

**ASTIG**                     Changes clarity at edges of display.

## ACCESS COMMANDS

E

The ACCESS commands enable the KRONOS service center computer and personnel system access to communicate with users from a time-sharing terminal.

The following command must be entered before the user is allowed to use the ACCESS commands.

<u>Command</u>	<u>Description</u>
ACCESS (CR)	The system replies READY, if the user is validated to use the ACCESS commands. If the user is not validated, the message, ILLEGAL COMMAND, is returned.

After the READY response, the user may enter any of the following commands.

DIAL, nnnn, sss (CR)	Sends a one-line message to the terminal specified by the multiplexer port number nnnn.
----------------------	-----------------------------------------------------------------------------------------

The possible system responses to this command are:

- READY When the message has been sent.
- TTY NOT ACTIVE When the desired terminal is inactive.
- OUTPUT BUSY When terminal to which message is directed is currently transmitting; message is not issued.

MONITOR, nnnn (CR)	Connects the calling terminal with the terminal specified by the multiplexer port number nnnn. The input and output from terminal nnnn is output at the monitoring terminal.
--------------------	------------------------------------------------------------------------------------------------------------------------------------------------------------------------------

A possible system reply to this command is:

- TTY NOT ACTIVE The terminal being requested is inactive.

When a user is monitoring another user, he may communicate directly with the other user by entering text whenever the other user is not receiving output. When a carriage return is entered, the line of text is sent to the user being monitored. This allows easy two-way interaction between users.

Only ASCII code terminals may monitor another time-sharing terminal. Binary input and output cannot be monitored.



<u>Command</u>	<u>Description</u>
USER, usernum (CR)	<p>Monitoring of another user terminates any of the following conditions.</p> <ul style="list-style-type: none"> <li>• The monitored user logs off or disconnects. (If a user logs off, the monitoring terminal is disconnected at the same time the disconnect code is sent to the terminal being monitored.)</li> <li>• The monitoring user terminates output.</li> <li>• The monitoring user enters STOP (CR)</li> </ul> <p>Allows a user to determine to which terminal number user usernum is currently connected.</p>

## INDEX

- A. Command 3-4
- A display
  - DIS 7-3
- A Display, dayfile (DSD) 4-3
- A display, resetting 3-4
- A register set command 7-10
- A, ERROR LOG command 2-28
- Absolute vs relative settings 3-2
- ACCESS commands E-1
- ACCOUNT command 3-5
- ACCOUNT, disable/enable processing 3-29
- Account dayfile display 3-4, 5
- Accounting information dump 2-10
- Account validation, disable/enable 3-30
- ACN command 3-34
- Activate channel 3-34
- Advancing the left screen display 3-2; 7-8
- Aging by priority, enable/disable 3-29
- Allocation of temporary files 3-17
- Alternating display control 3-2
- Archive file 5-1
- ASSIGN command 3-14
- Assigning identifier to
  - Card reader 3-5
  - Card punch 3-6
  - Line printer 3-6
  - Queue file 3-5
- Assigning
  - Equipment to control point 3-14
  - Identifiers 3-5, 6
  - Job files to mass storage 3-12
  - VSN to tape 3-15
- Asterisk as uppercase flag 7-12
- Asterisk to alternate display 7-1
- Asterisk used as quick hold 7-8
- AUTO command(DSD) 3-28, 29, 30
- AUTO MODE command 7-11
- AUTO MODE select key 7-8
- Automatic
  - Control card processing 7-11
  - Label checking, mass storage 3-16, 18
  - Printer carriage control suppression 3-25
  - Rollout of jobs, disable/enable 3-29
  - Scheduling of subsystems (see AUTO command)
  - Tape assignment 3-14, 15
- B display, job status (DIS) 7-4
- B display, job status (DSD) 4-8
- B register set command 7-10
- Backspace (BKSP) key 3-1, 3
- BATCHIO buffer point commands 3-25
- BATCHIO (I) display 3-26; 4-24
- BATCHIO subsystem
  - Activating 2-26, 28, 29
  - Control point 2-28
  - Deactivating 3-28, 29, 33; C-2
- Batch job, queue priorities 3-7
- Batch jobs, service limits 3-9
- BKP command 7-10
- BKPA command 7-9
- BKSP (backspace) key 3-1, 2, 3
- Blank screen selection 7-2
- BLITZ command 3-33
- Breakpoint command 7-9, 10
- Breakpoint keys 7-8
- Breakpoint program 7-8
- Buffer point, BATCHIO
  - End operation 3-25
  - Repeat operation 3-25
  - Rerun job 3-25
- C display
  - DIS 7-1
- C display (DSD) 4-10
- Calling to control point
  - DIS (job display package) 3-31
  - Subsystems 3-26, 28
  - System programs/utilities 3-31; 5-1, 6; 6-1, 2, 4
- CALL command 7-10
- Card punch switches D-3
- Card punch operations 415 D-3
- Card reader switches 405 D-1
- Card reader operation 405 D-1
- Cards, short D-1
- Cards, loading D-1
- Carriage return (CR) key 3-1, 3
- Catalog image of file 5-6
- Catalog image record 5-6
- Catalog tracks, maximum on device 2-13
- CEJ/MEJ option 1-1; 2-9
- Central exchange jump/monitor exchange jump 1-1; 2-9
- Central memory buffer display 7-2
- Central memory, change contents 3-34

- Central memory time slice 3-9
- Central memory (M) deadstart option 2-19
- Central processor request 7-11
- Central memory table build 2-11
- Central processor control options 2-8
- Central programmable (K and L) displays 4-26
- CFO command 3-13
- Chain removable devices (packs) 3-18, 22
- Changing
  - Contents of central memory 3-34
  - System date 3-32
  - System time 3-32
  - TELEX header message 3-13
- Channel,
  - Activate 3-34
  - Deactivate 3-35
  - Drop 3-35
  - Master clear 3-35
  - Output function code to 3-35
- Channel control commands 3-34
- Checking labels, mass storage 3-16, 18
- Checkpoint request 3-17
- CHECK POINT SYSTEM command 2-10, 24, 25; 3-31
- CIR 5-6
- Clearing
  - Auto control card processing 7-8, 10, 11
  - Current keyboard entry 3-3; 7-8
  - Current VSN 3-15
  - MSAL entry (see OFF command)
  - Pause bit for job 3-13
  - Step mode (see UNSTEP command)
  - System pause 3-33
  - Warning message 3-14
- CMRDECK
  - Flaw entries 6-6
  - K option 2-18
  - Modification 2-12
  - Selection 2-7
- Commands, ACCESS E-1
- Commands, DSD
  - Channel control 3-34
  - Dayfile 3-4, 5
  - Entry of 3-1, 2
  - Index to (see inside front cover)
  - Job processing control 3-5
  - Memory entry 3-34
  - Peripheral equipment control 3-14
  - Restricted entry of 3-31
  - Subsystem control 3-25
  - System control 3-28
- Commands, DIS 7-9, 10, 11, 12
- COMMENT command 3-13
- Communication, operator/user E-1
- Communications area display 4-26
- Configuration for deadstart tape 2-1
- Configuration of system 1-1
- Configure removable devices 3-18
- Console
  - Keyboard illustration 3-1
  - Keyboard locking 3-31
  - Keyboard unlocking 3-31
  - Operations (DIS) 7-8
  - Operations (DSD) 3-1
  - Screen control D-16
  - Switches D-16
- Control card display 7-4
- Control
  - Channel 3-34
  - Job processing 3-5
  - Peripheral equipment 3-14
  - Subsystem 3-25
  - System 3-28
- Control point
  - Assigning equipment to 3-14
  - Assignment for subsystems 3-26, 28
  - Automatic assignment 2-28
  - Clear pause bit 3-13
  - Dropping 3-13, 28, 33
  - File name table 7-1
  - Idling 3-30
  - Setting sense switches 3-13, 26, 27
  - Status (J) display 4-25
- Control statement entry command 7-10
- Controls, line printer
  - 501 line printer D-6
  - 512 line printer D-9
- CP command 3-6
- CPU
  - Availability setting 2-9
  - Job switch interval 3-11
  - Priority 3-7, 9
  - Recall period 3-11
  - Time slice 3-9
- CR command 2-17; 3-5
- Create multispindle device (pack) 3-18, 22
- CYBERLINK, dropping C-1
- D deadstart option 2-7
- D display
  - DIS 7-1
- D Display (DSD) see storage displays
- Data storage display (DIS) 7-5
- DATE command 3-32
- Date entry 2-25
- DAYFILE command 3-5
- Dayfile commands 3-4
- Dayfile, comments entered 3-13
- Dayfile (S) display 3-4; 4-3; 7-3
- Dayfile messages 4-4, 6; 7-3
- DCH command 3-35
- DCN command 3-35
- DCP command 7-10

- Deactivate channel 3-35
- Deadstart
  - Automatic 2-11
  - CMRDECK 2-7
  - Definition 2-1
  - Equipment 2-5
  - Function 2-5
  - Initialization 2-25
  - Keyboard entries 2-2
  - Maintenance 2-5
  - Mounting of tape 2-2
  - Panel settings 2-3
  - Procedure choices 2-1
  - Recovery 2-23
  - Summary of procedures 2-1
  - System 2-5
  - System deadstart with option displayed 2-16
  - Tape 2-2, 5
- Deadstart another tape (T) option 2-19
- Deadstart dump 2-6
  - D option 2-17
- Deadstart messages
  - General 2-30
  - Recovery 2-31
  - System initialization 2-31
  - System library building 2-32
- Deadstart options
  - Guidelines 2-22
  - List 2-17
- Deadstart recovery 2-8, 10
- DEAD START PROGRAM switches 2-3
- DEBUG command 3-32
- Decrementing the left screen display 3-3
- DELAY command 3-11
- Delay parameters, changing 3-11
- Delete keyboard entry 3-1, 2; 7-8
- Device assignment, automatic 3-14, 15; C-2
- DDP 1-2
- DIAL command 3-13; E-1
- DIRECT CPU INPUT mode 7-11
- Directory (Z) display (DIS) 7-7
- Directory (Z) display (DSD) 4-36
- DIS command 3-31; 7-10
- DIS keys, special 7-8
- DIS operation 7-1
- DIS vs DSD 1-1
- DISABLE command 3-16, 28, 29, 30
- Disable MEJ/CEJ (x) option 2-21
- Disk operation
  - 854 disk drive D-15
  - 841 multiple disk drive D-15
- Dismounting removable packs, errors 3-16, 17
- Display
  - Advancing display screens 3-2, 3; 7-8
  - Code character set A-1
  - Console screen controls D-16
  - Decrementing display screens 3-3; 7-8
  - Screen headers (DSD) 4-2, 6, 10; 7-3, 4
  - Selection (DIS) 7-9
  - Selection (DSD) 4-1
- Displaying the account dayfile 3-5
- Displaying the error log dayfile 3-5
- Displaying the system dayfile 3-4
- Displays (DIS) 7-2
- Displays under DIS 7-1
- Distributive data path 1-2
- DMQ system utility 6-1
- Drop central processor 7-10
- DROP command 3-13; 7-10
- Dropping
  - A channel 3-35
  - A control point 3-13
  - A subsystem 3-28; C-1
  - All control points 3-33
- DSD commands 2-24; 3-4
- DSD control 3-1
- DSD, special characters 3-2
- DSD vs DIS 1-1
- DUMP command 3-6
- Dumping
  - Account dayfile 3-5
  - Error log dayfile 3-5
  - Permanent files 5-1; C-2
  - Print files 3-6; 6-1
  - Queue files 6-1
  - System dayfile 3-5
- E deadstart option 2-18
- E display (DIS) 7-5
- E display (DSD) 4-13
- ECS 1-1
- ELS command 7-10
- ENABLE command 3-16, 28, 29, 30
- ENAi command 7-10
- ENBi command 7-10
- END command 3-25
- End current operation at BATCHIO buffer point 3-25
- End of operation shutdown C-1
- ENEM command 7-10
- ENFL command 7-10
- ENID command 3-5
- ENP command 7-10
- ENPR command 3-7; 7-10
- ENQR command 3-7
- ENS command 7-10
- Enter message in,
  - Dayfile job's field length 3-13
- Entering data to K display 3-31
- ENTL command 3-7; 7-10
- Entry of commands (DIS) 7-9

Entry of commands (DSD) 3-1, 2  
 ENXi command 7-10  
 Equal sign to toggle memory mode 7-8  
 Equipment  
     Assign to control point 3-14  
     Release command 7-11  
     Status table display 3-17, 25; 4-14;  
         7-1  
 ERR command 7-10  
 Error flag set command 7-10  
 Error log dayfile 3-5; 4-8  
 Error processing during deadstart 2-29  
 EST display 3-17, 25; 4-14; 7-1  
 EST entries defined 2-8  
 Example of DSD command entry 3-2  
 Exchange package display 7-4  
 Exit mode set command 7-10  
 Exchange jump test (E) option 2-18, 24  
 Export/Import jobs, service limits 3-9  
 Export/Import jobs, queue priorities 3-7  
 Export status (R) display 3-26; 4-28  
 EXPORTL command 3-26  
 EXPORTL (Export/Import) subsystem  
     Activating 3-26, 28, 29  
     Control point 2-28  
     Deactivating 3-28, 29, 33; C-2  
  
 F deadstart option 2-18  
 F display (DIS) 7-6  
 F display (DSD), see storage displays  
 Family of permanent devices 5-4  
 FCN command 3-35  
 Field length set command 7-10  
 Field length, maximum 3-9, 10  
 File, archive 5-1  
 File (N) display 4-26  
 File name table display (DIS) 7-1, 2  
 File name table display (DSD) 4-22  
 Files at control point 4-22, 26; 7-1, 2, 3  
 Files, dumping print 3-6  
 FLAW utility 6-4  
 Flaw tracks on mass storage device 3-18,  
     21; 6-4  
 FNC command 3-35  
 FNT display 4-22; 6-1; 7-1, 2  
 Full dump to tape (F) option 2-18  
 Full permanent file system load 5-6  
 Function code output to channel 3-35  
  
 G display (DIS) 7-6  
 G display (DSD), see storage displays  
 GO command 3-13; 7-10  
 GOTO command 7-11

H display (DIS) 7-1  
 H display, file name table (DSD) 4-22  
 Header message, change 3-13  
 Headers, display screen (DSD) 4-2  
 Highest priority 3-8  
 HOLD command 7-11  
  
 I display (BATCHIO) 3-25, 26; 4-24  
 IAN command 3-35  
 ID, assigning  
     Card reader 3-5  
     Card punch 3-6  
     Line printer 3-6  
 IDLE command 3-30  
 Incremental load of permanent files 5-6  
 Index, DSD commands (see inside front cover)  
 Inhibit auto printer carriage control 3-25  
 Inhibit job scheduling (see IDLE command)  
 INITIALIZE command 3-18 through 3-24  
 INITIALIZE entry 2-13  
 INITIALIZE, flaw recovery 3-21; 6-6  
 Initialize status 3-18  
 Initializing mass storage devices 2-13; 3-18  
 Input queue, purge 3-12  
 Input to pseudo A register 3-35  
 Interval, delay  
     CPU job switch 3-11  
     CPU recall 3-11  
     Job advance 3-11  
     Job scheduler 3-11  
     PPU auto recall 3-11  
 IO command 3-26  
 IPD entry 2-13  
 IPRDECK modification 2-15  
 IPRINST instruction display 2-15  
  
 J display, control point status (DSD) 4-25  
 J display (DIS) 7-1  
 Job  
     Advance interval 3-11  
     Field length, maximum 3-9, 10  
     Files, assign to mass storage 3-12  
     Logging a 3-5  
     Origin 3-7, 8, 9, 10, 11; 6-1  
     Processing control commands 3-5  
     Queue, priorities of 3-7  
     Queues (Q) display 4-27  
     Rolling in a 3-6  
     Rolling out a 3-6  
     Running a 3-7  
     Scheduler interval 3-11  
     Scheduling a 3-6  
     Status display 4-8, 10; 7-1  
     Switch, CPU 3-11

K command 3-31  
 K display, central programmable (DSD) 4-26  
 K display (DIS) 7-1  
 K deadstart option 2-18  
 K display for,  
     FLAW utility 6-4,5  
     INITIALIZE command 3-19,23  
     PF\_DUMP operations 5-2,3,4  
     PF\_LOAD operations 5-6,9  
     STAGE utility 6-3  
 Keyboard, console  
     Deadstart entries 2-2  
     Entries, clearing 3-3; 7-8  
     Entry of commands 3-2,4; 7-9  
     Illustration 3-1  
     Locking 3-31  
     Unlocking 3-31  
 KRONOS character set A-1

L command 3-31  
 L display, central programmable display (DSD) 4-26  
 L display (DIS) 7-2  
 Label checking for removable packs (see ENABLE/DISABLE commands)  
 Label checking, mass storage 3-16,18  
 Label validation 2-11  
 Labeled tape, automatic assignment 3-15  
 LDC command 3-35  
 LDQ system utility 6-1  
 Left blank key 3-1,2,3  
 Left parenthesis to control breakpoint 7-8  
 Level 1 recovery 2-10,24  
 Level 2 recovery 2-10,25  
 Level 3 recovery 2-11,23  
 Limit, time 3-7  
 Limits, service 3-9  
 Line printer controls  
     501 line printer D-6  
     512 line printer D-9  
 Line printer operations  
     501 D-5  
     512 D-8  
 Line printer switches  
     501 D-5  
     512 D-8  
 Link removable packs 3-18,22  
 List remaining files 5-8  
 LOAD command 3-5  
 LOAD, default lfn for LDQ 6-2  
 Load pseudo A register 3-35  
 Load system (CR) option 2-17  
 Loading a job 3-5  
 Loading paper  
     501 printer D-6  
     512 printer D-9

Loading tape D-12  
 Local batch jobs,  
     Queue priorities 3-7  
     Service limits 3-9  
 LOCK command 3-31  
 Logically turn equipment off 3-17  
 Logically turn equipment on 3-17  
 Login, preventing C-1  
 Loss of permanent files during initialization 3-18  
 Lowest priority 3-8  
 LP command 3-6  
 LQ command 3-6

M deadstart option 2-19,24  
 M command 7-11  
 MAGNET command 3-26  
 MAGNET subsystem  
     Activating 3-26,28,29  
     Control point 2-28  
     Dropping 3-28,29,33  
 Magnetic tape, loading D-12  
 Magnetic tape unit operation D-11  
 Magnetic tape unit switches  
     604 tape unit D-13  
     607 tape unit D-13  
     657 tape unit D-14  
     659 tape unit D-14  
 Magnetic tape, unloading 3-15,16; D-12  
 MAINTENANCE command 2-28; 3-28,29,30  
 Maintenance deadstart 2-5  
 Maintenance tasks 2-6  
 Mass storage device initialization  
     During deadstart 2-13  
     During normal operation 3-18  
 Mass storage device operation  
     854 disk drive D-15  
     841 multiple disk drive D-15  
 Mass storage requirements 1-1  
 Mass storage tables (MST) display 4-16  
     Use of 3-16,17  
 Master clear channel 3-35  
 Maximum field length 3-9,10  
 Maximum number of permanent files 3-10  
 Maximum number of TELEX origin jobs 3-9  
 Maximum size (PRUs) of  
     All indirect access files 3-10  
     Individual indirect access file 3-10  
 MCH command 3-35  
 Memory displays (DIS) 7-5  
 Memory displays (DSD) 4-10  
 Memory entry commands 3-34  
 Memory mode key 7-8  
 MESSAGE command 3-13  
 Messages, operator B-1

Messages, operator to terminal user 3-13;  
     E-1  
 MNPS, released value of 3-7  
 Mode, DEBUG 3-32  
 Mode, Step 3-32  
 MODE switch setting 2-4  
 Modifying system (see DEBUG command)  
 MONITOR command E-1  
 Monitor function step mode 3-32  
 Monitor functions (Y) display 4-35; 7-2  
 Monitoring of deadstart 2-11  
 Mounting deadstart tape 2-2  
 Mounting multispindle packs 3-18  
 MSAL command 3-12  
 MST (E) display, use of 3-16, 17  
 Multispindle devices (packs)  
     Configuring 3-18, 22  
     Mounting 3-18  
 Multiterminal jobs  
     Queue priorities 3-7  
     Service limits 3-9  
 MXPS, released value of 3-7

N command 7-11  
 N display  
     DIS 7-2  
     File displays 4-26  
 NEXT control point 2-28  
 Next statement command 7-12  
 Number of permanent files, maximum 3-10  
 Number of TELEX jobs, maximum 3-9

OAN command 3-35  
 OFF command 3-17  
 OFFSW command 3-13; 7-11  
 ON command 3-17  
 ONSW command 3-13, 26, 27; 7-11  
 Operator/user communication E-1  
 Operator messages B-1  
 Operation under DIS 7-1  
 Operation under DSD 3-1  
 Options display deadstart 2-6  
 Original priority 3-8  
 Output contents of pseudo A register 3-35  
 Output function code to channel 3-35  
 Output queue, purge 3-12  
 Output zero function code 3-35  
 Overlay processing, syntax (disable/enable)  
     3-33  
 O26 command 7-11

P deadstart option 2-19  
 P display  
     PP communications area display 4-26  
     DIS 7-2  
 P register set command 7-10

Paging the A display 3-4  
 Paper loading  
     501 printer D-6  
     512 printer D-10  
 Pause bit, clear 3-13, 33  
 Period to initiate automatic processing 7-11  
 Peripheral equipment 1-2  
 Peripheral equipment,  
     control commands 3-14  
     monitoring displays 3-14, 4-14, 16,  
     18, 20  
 Peripheral equipment operation D-1  
 Peripheral processor units 1-1  
 Permanent files  
     Device, dedicated 1-1  
     Dumping C-2, 5-1  
     Loading 5-6  
     Maximum number 3-10  
     Maximum size C (PRUs) 3-10  
     Supervisor 5-1  
 PFDUMP  
     Procedures 5-1  
 PF entry for device 2-13  
 PFLOAD Procedures 5-6  
 PFS 5-1  
 PP communications area (P) display 4-26  
 PPU 1-1  
 PPU auto recall interval 3-11  
 PPU call commands 7-12  
 PP Memory test (Q) deadstart option 2-19  
 PPU register contents, see P display  
 PP0 display (P) deadstart option 2-19  
 Preview display, resource mounting 4-18  
 Preview (E) display 3-15, 3-26  
 Print files, dumping 3-6  
 Printer carriage control  
     501 D-5  
     512 D-8  
 Printer carriage control, suppress 3-25  
 Printer operations  
     501 D-5  
     512 D-8  
 Priority aging (enable/disable) 3-29  
 Priority, CPU 3-7, 3-9  
 Priority, queue 3-7  
 Priority set command 7-10  
 Procedure file call 7-10  
 Procedure to initialize mass storage  
     device 2-13; 3-19  
 Program entry command 7-11  
 Program storage displays, see Card D  
     displays

PRU's maximum number for  
   All indirect access files 3-10  
   Individual indirect access file 3-10  
 Pseudo A register  
   Input to 3-35  
   Load 3-35  
   Output from 3-35  
 Punch queue, purge 3-12  
 PURGE command 3-12  
 PURGEALL command 3-12

Q deadstart option 2-19  
 Q display  
   DIS 7-2  
   job queues 4-27  
 QUEUE command 3-7  
 QUEUE display, see Q display  
 QUEUE files  
   dumping 6-1  
   purging 3-12  
   reloading 6-1  
 Queue priority 3-7  
 Queue type 6-1  
 Quick hold key 7-8

R Display, Export status 3-26; 4-28  
 RCS command 7-8, 7-11  
 RE command 7-11  
 Read next control statement (see RNS  
   command)  
 Read next statement and stop (see RSS  
   command)  
 Reconfigure removable devices 3-18  
 Recovery state, TELEX 3-27  
 Reenter job in queue (see RERUN command)  
 Release equipment on channel (see FCN  
   command)  
 Release reservation of channel (see DCH  
   command)  
 Remote batch jobs, queue priorities 3-7  
 Remote batch jobs, service limits 3-9  
 Remove device from system, logically  
   (see OFF command)  
 Removable devices, configuring 3-18  
 Removable mass storage, unloading 3-15, 16  
 REPEAT command 3-25  
 Repeat current operation at BATCHIO  
   buffer point 3-25  
 RERUN command 3-7

Reserve (flaw) tracks on mass storage  
   device 3-18, 22  
 Reserve tracks 6-4  
 Resetting the A display 3-4  
 Resource Mounting Preview (E) display  
   3-15, 26; 4-18  
 Restart program command (see GO command)  
 Restricted command entry (see UNLOCK  
   command)  
 Resume processing after pause 3-13  
 Ribbon replacement  
   501 printer D-7  
   512 printer D-11  
 Right parenthesis to control breakpoint 7-8  
 RNS command 7-11  
 ROLLIN command 3-6  
 Rollout, automatic (disable/enable) 3-29  
 ROLLOUT command 3-6; 7-11  
 Rollout queue, purge 3-12  
 RSS command 7-11  
 RTK flaw entry (see FLAW utility)  
 Run maintenance tests 3-28

S display 3-11  
 S display, system control information 4-30  
 SCR default lfn 6-1  
 SCS command 7-11  
 Selective dump of permanent files 5-5  
 Sense switches  
   Turn on 3-13, 26, 27; 7-11  
   Turn off 3-13; 7-11  
 Sense switch commands (See OFFSW and  
   ONSW commands)  
 Sense switches for Export/Import 3-26  
 Sense switches for TELEX 3-27  
 SERVICE command 3-9  
 Service limits 3-9  
 Service limits in IPRDECK 3-10  
 SET command 7-8, 9  
 Set TELEX sense switches 3-27  
 Setting, Deadstart Panel 2-3  
 Setting, debug mode 3-32  
 Setting, step mode 3-32  
 Short cards D-1  
 Shutdown procedures C-1  
 Size, maximum PRUs for  
   All indirect access files 3-10  
   Individual indirect access file 3-10  
 Special characters, DSD 3-2  
 Stage tape files to disk 6-2  
 STAGE utility 6-2



STEP command 3-32  
 Step mode 3-32  
 Step sequence key 7-8  
 STK flaw entry (see FLAW utility)  
 STOP command 3-28  
 Storage (C, D, F, G) displays 4-10  
 Subsystem, assignment to control point 3-26, 28  
 Subsystems available  
   BATCHIO 3-25, 26  
   EXPORTL (Export/Import) 3-26  
   MAGNET 3-26  
   TELEX 3-26, 27  
   TRANEX 3-28  
 Subsystem control commands 3-25  
 Subsystem, disable/enable 3-29, 30  
 Suppress auto printer carriage control 3-25  
 SUPPRESS command 3-25  
 Switches  
   Console D-16  
   Sense 3-13, 26, 27; 7-11  
   405 card reader D-1  
   415 card punch D-4  
   501 line printer D-5  
   512 line printer D-8  
   604 tape unit D-13  
   607 tape unit D-13  
   657 tape unit D-14  
   659 tape unit D-14  
 Syntax overlay processing (disable/enable) 3-33  
 SYSGO command 3-33  
 System configuration 1-1  
 System control commands 3-28  
 System control information (S) display 3-11; 4-30  
 SYSTEM control point 2-28  
 System date, changing 3-32  
 System dayfile  
   Display 3-4  
   Dumping 3-5  
 System deadstart 2-5  
 SYSTEM entry 2-14  
 System file name table display (see L display)  
 System idling 3-30  
 System library residence, default 2-15  
 System jobs, service limits 3-9  
 System modification (see DEBUG command)  
 System origin jobs, queue priorities 3-7  
 System program/utility selection 3-31  
 System time, changing 3-32  
  
 T command 7-12  
 T deadstart option 2-19  
 T display (DIS) 7-2  
 T display, time-sharing status (DSD) 3-26; 4-33  
  
 Tape, loading D-12  
 Tape status display 3-26; 4-20  
 Tape unit operation D-11  
   604 tape unit D-13  
   607 tape unit D-13  
   657 tape unit D-14  
   659 tape unit D-14  
 Tape unit switches  
   604 tape unit D-13  
   607 tape unit D-13  
   657 tape unit D-14  
   659 tape unit D-14  
 Tape, unloading 3-15, 16; D-12  
 TELEX command 3-26  
 TELEX control point 2-28  
 TELEX jobs  
   Queue priorities 3-7  
   Recovery 3-27  
   Service limits 3-9  
 TELEX status (T) display 3-26; 4-33  
 TELEX subsystem  
   Activating 3-26, 28, 30  
   Deactivating 3-28, 30, 33; C-1  
 TEMP command 3-17  
 Temporary mass storage files 3-17  
 Terminal  
   Clear message entered 3-14  
   Send message to 3-13  
 Terminate job scheduling (see IDLE command)  
 Terminate KRONOS operations C-1  
 Terminate operation at BATCHIO buffer point 3-25  
 Terminate subsystem 3-28, 29  
 Test, maintenance 3-28  
 Text in core 7-2  
 TIME command 3-32  
 Time entry 2-26  
 Time/event rollout queue, purge 3-12  
 Time limit set command 3-7; 7-10  
 Time-sharing jobs, queue priorities 3-7  
 Time-sharing jobs, service limits 3-9  
 Time-sharing status (T) display 3-26; 4-33  
 Time slice  
   Central memory 3-9  
   CPU 3-9  
 Track reservation 3-18, 21; 6-4  
 TRANEX subsystem  
   Activating 3-28, 30  
   Control point 2-28  
   Deactivating 3-28, 30, 33; C-1  
 TTK flaw entry (see FLAW utility)  
 Turn CPU off options 2-22  
 Turn equipment off, logically 3-17  
 Turn equipment on, logically 3-17  
 Turn sense switch off 3-13  
 Turn sense switch on 3-13, 26, 27

U command 7-12  
U display  
    DIS 7-2  
UCC command 7-12  
Unlabeled tape, assignment to job 3-14, 15  
UNLOAD command 3-15  
Unloading  
    854 disk drive D-15  
    841 multiple disk drive D-15  
Unloading a removable mass storage device  
    3-15, 16  
Unloading tape 3-15, 16; D-12  
UNLOCK command 3-31  
USER command E-2  
User/operator communication E-1  
User recovery, TELEX 3-27  
User validation (disable/enable) 3-30  
Utility/system program selection 3-31  
Utilities, system 6-1

V command 7-12  
V display  
    DIS 7-2  
Validation of ACCOUNT card (enable/disable)  
    3-30  
VALIDUX file 2-28  
Volume Serial Number (VSN)  
    Assign to tape 3-15  
    Clear 3-15  
    Definition 4-18  
VSN (Volume Serial Number) command 3-15

W deadstart option 2-20  
WARN command 3-13, 14; C-1  
Word 14 2-7  
Word 14 deadstart (W) option 2-20

X deadstart option 2-21  
X command 7-12  
X.ISF command 2-28  
X.name command 3-31  
X register set command 7-10

Y display  
    DIS 7-2  
Y display, monitor functions (DSD) 4-35

Z display  
    DIS 7-7  
Z display, directory (DSD) 4-36  
Zero function code output to channel 3-35

51 COLUMN switch D-1  
99 command 3-33

# COMMENT SHEET

MANUAL TITLE CDC CYBER 70/6000 Series Computer Systems  
KRONOS 2.1 Operator's Guide

PUBLICATION NO. 60407700 REVISION A

FROM: NAME: \_\_\_\_\_  
BUSINESS ADDRESS: \_\_\_\_\_

## COMMENTS:

This form is not intended to be used as an order blank. Your evaluation of this manual will be welcomed by Control Data Corporation. Any errors, suggested additions or deletions, or general comments may be made below. Please include page number references and fill in publication revision level as shown by the last entry on the Record of Revision page at the front of the manual. Customer engineers are urged to use the TAR.

CUT ALONG LINE

PRINTED IN U.S.A.

AA3419 REV. 11/69

NO POSTAGE STAMP NECESSARY IF MAILED IN U. S. A.  
FOLD ON DOTTED LINES AND STAPLE

STAPLE

FOLD

FOLD

FIRST CLASS  
PERMIT NO. 8241  
MINNEAPOLIS, MINN.

**BUSINESS REPLY MAIL**  
NO POSTAGE STAMP NECESSARY IF MAILED IN U.S.A.

POSTAGE WILL BE PAID BY  
**CONTROL DATA CORPORATION**  
Technical Publications Department  
4201 North Lexington Avenue  
Arden Hills, Minnesota

55112



CUT ALONG LINE

FOLD

FOLD



**CORPORATE HEADQUARTERS, 8100 34th AVE. SO., MINNEAPOLIS, MINN. 55440**  
**SALES OFFICES AND SERVICE CENTERS IN MAJOR CITIES THROUGHOUT THE WORLD**

LITHO IN U.S.A.