

XCLAIM™ 3D PLUS

User's Guide

Version 1.0 - 18 December 1998

P/N: 107-40177-10

Copyright © 1996-1999, ATI Technologies Inc.

ATI and XCLAIM are trademarks and/or registered trademarks of ATI Technologies Inc. All other company and/or product names are trademarks and/or registered trademarks of their respective manufacturers. Pricing, availability, features, performance and specifications are subject to change without notice. Product may not be exactly as shown in the diagrams.

All rights reserved, including those to reproduce this manual or parts thereof, in any form without the express written permission of ATI Technologies Inc.

Disclaimer

While every precaution has been taken in the preparation of this document, ATI Technologies Inc. assumes no liability to any party for errors or omissions contained in the Software or related documentation, any interruption of service, loss or interruption of business or anticipatory profits or for incidental or consequential damages in connection with the furnishing, performance, or use of the Software and related documentation.

ATI Technologies Inc. reserves the right to make changes without further notice to a product or system described herein to improve reliability, function or design.



Table of Contents

1. Getting Started	1
Introduction.....	1
What You'll Need.....	2
Related Documentation.....	2
2. Installing Your Hardware	3
Installing your XCLAIM™ 3D PLUS.....	4
About Monitor Sensing.....	9
3. Installing Your Software	11
About ATI Software	11
Installing Software	11
4. Multimedia Features.....	13
Viewing 3D Graphics	14
ATI Displays Control Panel.....	15
Using QuickTime Playback.....	25
Using Mac2TV™ Video Out.....	26
Using Digital Flat Panel (DFP) Support	32
A. Troubleshooting Tips.....	35
Before Contacting Customer Support.....	35
Solutions to Common Problems	35
B. Specifications	39
Video Mode Table	39
DFP Mode Table.....	40
TV Mode Table.....	40
3D Mode Table	41
Specifications.....	42
C. Compliance Information	45
D. Glossary.....	49



Getting Started

Introduction

XCLAIM™ 3D PLUS represents the next generation in 3D rendering and video acceleration for your PCI-based Mac OS computer. Equipped with all the 3D hardware drawing capabilities in demand by 3D designers, your new graphics accelerator is five products in one:

- QuickDraw 3D accelerator providing superior 3D rendering performance and advanced imaging and filtering techniques.
- QuickDraw accelerator supporting resolutions of 1600x1200 in millions of colors.
- QuickTime playback accelerator for full screen, full motion, TV quality video.
- Mac2TV™ video out enabling big screen presentations, game play and movie output to tape.
- Digital flat panel support for crisper, clearer images, and virtually no eyestrain from prolonged viewing.

The ATI Displays control panel provides quick access to all of XCLAIM™ 3D PLUS' easy-to-use features, and you have instant access to help using Apple Guide.



A glossary of the bold terms used throughout this manual is available in the “Glossary” on page 49 of this user guide and also in the ATI Guide.

What You'll Need

The XCLAIM™ 3D PLUS card runs with the following minimum system requirements:

- Power Macintosh or Mac OS compatible computer, with PowerPC processor, with a PCI expansion slot
- Mac OS 7.5.5 or later software
- Apple monitor or VGA-style monitor
- QuickTime 2.5 or later
- QuickDraw 3D 1.5.1 or later
- Minimum 16MB of system memory (QuickDraw 3D requires 16MB of system memory)



XCLAIM™ 3D PLUS and ATI Multimedia components are Mac OS 8 to Mac OS 8.5 compatible.

Related Documentation

The README file summarizes the latest product revisions. Click the README icon on the installation disk to open this file.

The XCLAIM™ 3D PLUS card comes with ATI Guide, which provides online help about using the features of your card. You can access the ATI Guide either by clicking on the Apple Guide icon  on the ATI Displays control panel, or by clicking on the ATI icon on the menu bar and choosing ATI Guide.



Installing Your Hardware

XCLAIM™ 3D PLUS fits into connectors called expansion slots, inside your computer.

Your Mac OS computer has one or more slots, each designed to accept Peripheral Component Interconnect (PCI) cards.



WARNING

- The manufacturer assumes no liability for any damage, caused directly or indirectly, by improper installation of components by unauthorized service personnel. **If you do not feel comfortable performing the installation, consult a qualified technician.**
- Make sure power is off during installation; otherwise, damage to system components, the graphics accelerator card, and injury to yourself may result.



The following procedure details the installation of a card in a typical Mac OS PCI-based tower. If your computer does not match this configuration, please refer to the expansion card installation instructions that came with your computer.



IMPORTANT

- If your computer stops responding (hangs) after installing the XCLAIM™ 3D PLUS card, you may have an incompatible graphics accelerator extension. This can occur when Mac OS software was installed, or other ATI graphic accelerator cards.
- Restart your computer and hold down the SHIFT key during startup. This disables all extensions from loading. After disabling extensions, you can update the graphics accelerator extension by installing the software included with your card. For more information about installing the software, see “Installing Software” on page 11

Installing your XCLAIM™ 3D PLUS

- 1 Turn off your computer, and disconnect the monitor cable.
- 2 Remove the computer cover. If necessary, consult your computer system manual for removal instructions.

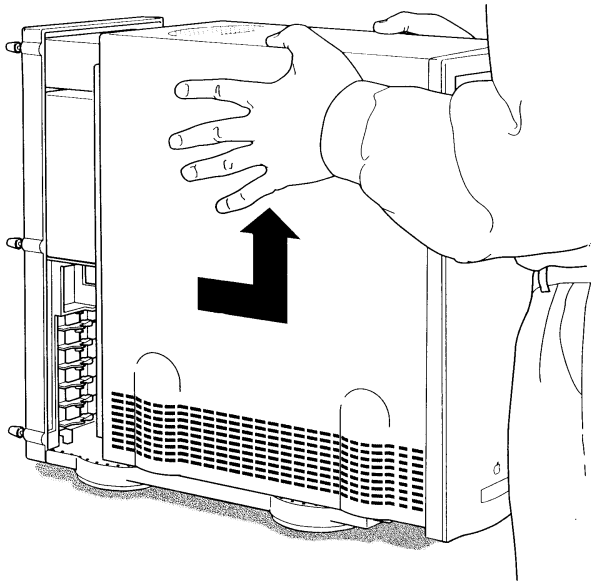

- 3 Choose the PCI expansion slot you wish to use.
- 4 Touch the metal part of the power supply case.

Touching the grounded portion of the power supply case will discharge your body's static electricity.

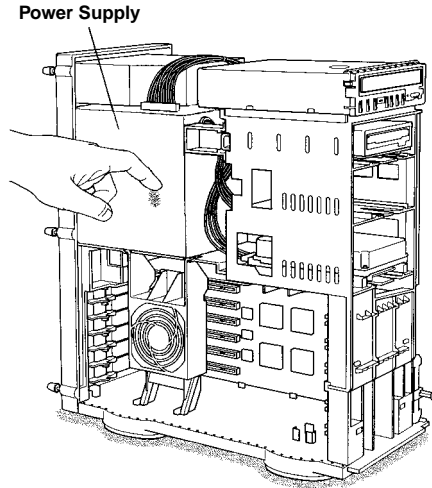

- 5 Lower the auxiliary fan.

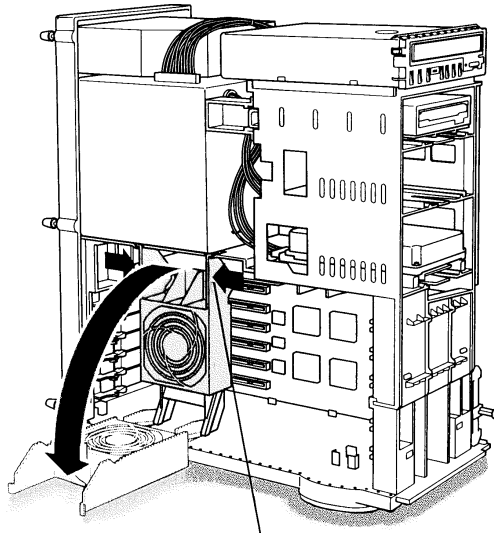

To lower the fan, squeeze the sides to unlatch it.

- 6** Remove the metal access cover from the expansion slot you want to use.

1. To release the access port cover, pull the two levers next to the access port apart

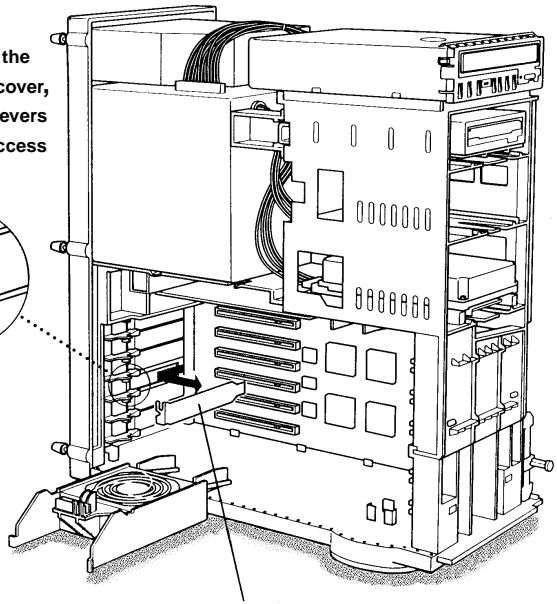
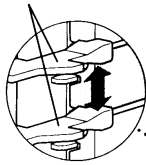

2. Slide the access port cover out and away from the access port.

- 7** Align the connector on the card with the PCI expansion slot and press firmly until fully seated.

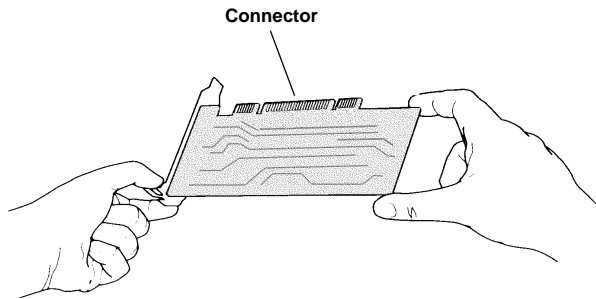

Do not force the card. The card should fit snugly into the expansion slot.

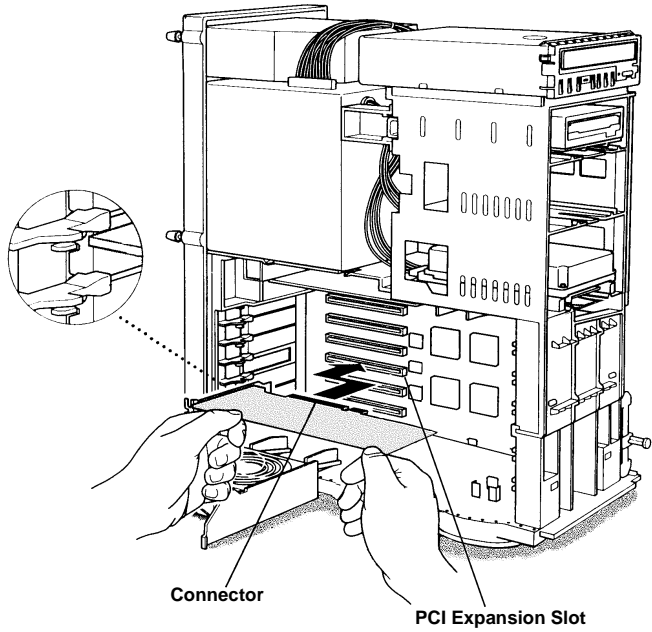

- 8 Replace the auxiliary fan.
- 9 Replace the computer cover.

10 Connect the monitor cable to the card.

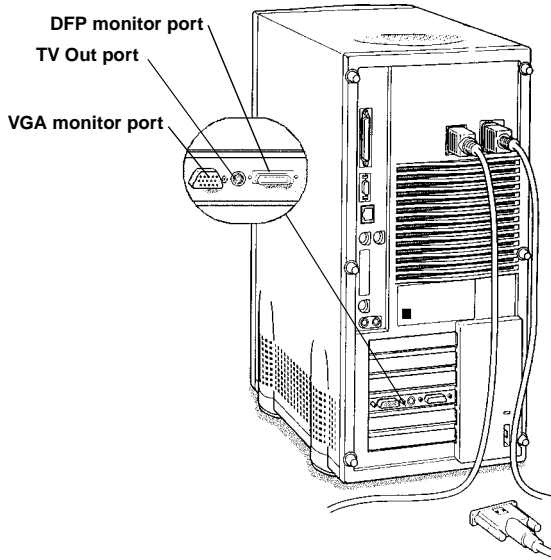

If you have a VGA monitor, connect it to the VGA monitor port. If you have a TV monitor, connect it to the TV Out port. If you have a digital flat panel, connect it to the DFP port.



To connect an Apple monitor to the XCLAIM™ 3D PLUS card, you will need a Wonder adapter. Simply connect your Apple monitor connector to the Wonder adapter, and then plug the Wonder adapter into the VGA monitor port.

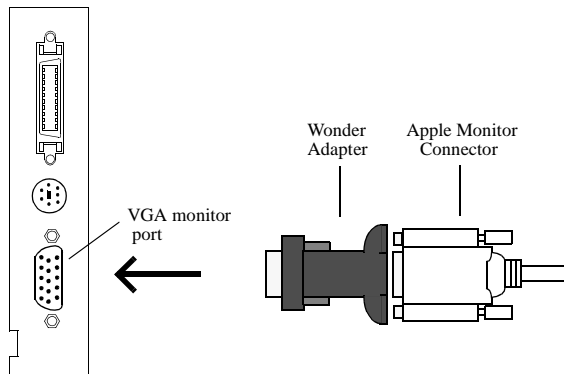

Installation of your XCLAIM™ 3D PLUS card is now complete and you are ready to install the software. See “Installing Your Software” on page 11.

About Monitor Sensing

Apple’s Monitor Sensing specification allows graphics cards to identify the attached monitor. If you are using an Apple monitor, you need to connect it to a Wonder Adapter. The XCLAIM™ 3D PLUS will detect your Apple monitor based upon the monitor sense code. It then auto-configures itself and enables all resolutions supported by the monitor. Since the XCLAIM™ 3D PLUS relies on this sense code to correctly auto-configure during startup, the monitor must supply the appropriate sense code.

If the adapter supplies the sense code information for only one resolution, then that resolution will be the only one available, even if the monitor supports multiple resolutions. A resolution of 640x480 is usually the default resolution. Therefore, when using an adapter to supply the sense code, it must be designed to supply the proper code for the monitor you are using it with; otherwise, the XCLAIM™ 3D PLUS cannot correctly auto-configure itself for the attached monitor.

Although the XCLAIM™ 3D PLUS card does not output Sync-on-Green (SOG) signals directly, adapters are available that can overlay the Composite Synchronization Signal and send it through the Green video signal line so that you can use an SOG monitor. Monitors requiring an SOG signal usually have only three BNC connectors (RGB).

For more information about obtaining a sense code or synchronization signal adapter, contact ATI Customer Support or ask your dealer. For information about how to contact ATI Customer Support, select the ATI button on the ATI Displays control panel.

3

Installing Your Software

About ATI Software

XCLAIM™ 3D PLUS requires several additional components be added to your System folder. The XCLAIM™ 3D PLUS Installer application does this for you, installing the following components:



ATI Displays Control Panel

The ATI Displays control panel lets you configure your card and access software and hardware features. These features are described in the section “ATI Displays Control Panel” on page 15.



ATI Multimedia Components

ATI’s Multimedia Components are placed in the Extensions folder, located within the System folder. They enable all of the advanced features of your card, including 3D and 2D acceleration.



ATI Guide File

The ATI Guide file is the online help for the ATI Displays control panel. It is placed in the Extensions folder within the System folder. For more information about using the ATI Guide, see “ATI Guide” on page 24.

Installing Software

- 1 Insert the ATI Installation disk.
- 2 Double-click on the XCLAIM™ 3D PLUS  Installer icon.

The ATI splash and legal notice screens appear.

- 3 Follow the instructions that appear on the screen.

Under most circumstances, you should click Standard Install. However, if you only want to install certain parts of the ATI multimedia software, click Custom Install.

Upon completion of the installation process, a file containing a list of installed files and their location on your hard disk is created allowing you to locate any file installed during the installation process.



The installer application checks your system to determine if you have the latest versions of the required software. If you do not have the appropriate Apple software, a dialog appears explaining what software needs to be installed.

- 4 To complete the installation, you must restart your computer.

When you see a message that the installation was successful, click Restart.

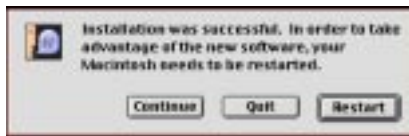

Your computer restarts.

or

To perform further installations, click Continue.

The XCLAIM™ 3D PLUS Standard Install window appears.

or

To return to Finder, click Quit.

You need to manually restart your computer to complete the installation of XCLAIM™ 3D PLUS' software.



Multimedia Features

Your XCLAIM™ 3D PLUS turns your PCI-based Mac OS computer into a 3D and 2D graphics powerhouse. You can use your new graphics accelerator card to do the following:

- Watch full screen, full motion, TV-quality video using QuickTime playback acceleration
- Render 3D worlds and animation in real time, using embedded 3D hardware drawing capabilities
- Enjoy true-color performance up to 1600x1200 in millions of colors
- Develop high-performance, high-resolution, true-color 3D graphics with full QuickDraw 3D RAVE (Rendering Acceleration Virtual Engine) support
- Play arcade-style 3D games and experience virtual reality at home or in cyberspace using QuickDraw 3D acceleration
- Output movies to tape or play games on television with Mac2TV™ video out
- Output your computer's display to a Digital Flat Panel for clearer, crisper images, and virtually no eyestrain from prolonged viewing.

The following information describes these new multimedia features in more detail and suggests ways you can optimize your machine to get the most out of your new card.

Viewing 3D Graphics

XCLAIM™ 3D PLUS' QuickDraw 3D Acceleration supports the following advanced 3D graphics capabilities:

- QuickDraw 3D RAVE Support
- Perspective correct texture mapping functions
- Single pass Bilinear/Trilinear filtering
- 16-bit z-buffering (a process that removes hidden surfaces)
- Flat and Gouraud shading
- MIP-Mapping
- Alpha blending and fog effects
- Specular highlights
- Shadows and Spotlights
- Texture lighting
- Video texture and texture lighting

These features make it possible to quickly render 3D graphics, produce atmospheric effects, calculate light and color shading, and determine which objects are in the foreground and which are in the background.

XCLAIM™ 3D PLUS only displays 3D graphics in thousands and millions of colors. When you use 256 colors, there are too few colors to display complex 3D textures, so 3D acceleration is not supported.

You can use the 3D Memory Monitor to see how memory on your XCLAIM™ 3D PLUS is allocated when displaying 3D graphics. This allows you to optimize 3D performance. You can also adjust the compression of textures using the 3D Texture Compression feature.

ATI Displays Control Panel

The ATI Displays control panel provides access to the advanced 3D features that XCLAIM™ 3D PLUS has to offer. To open the ATI Displays control panel, choose Control Panels from the Apple menu, and then choose ATI Displays; or click the ATI icon on the menu bar, and select ATI Displays from the ATI Config Menu.

- About ATI Config Menu...
- ATI Displays
- ATI Guide

For detailed instructions on how to set up and use these features, please refer to the ATI Guide, which can be accessed through the ATI Displays control panel and the ATI Config Menu.



Status Area



Look in the Status Area to determine your current monitor, screen resolution, and color depth. To change these settings, use the Monitors feature.



Identify Displays

If you have more than one display connected to your computer, you can identify and configure each display. The ATI Displays control panel identifies all the displays connected to your computer, but only configures displays that are connected to ATI cards.



Display Details

The Details window gives you information about specific software components needed to enable each of XCLAIM™ 3D PLUS' features. Check the Details window to determine the files and version numbers of the software components installed in your system folder during the installation process. Using the pull-down menu, the Details window also lists the Mac OS multimedia software required for XCLAIM™ 3D PLUS, such as QuickDraw 3D.

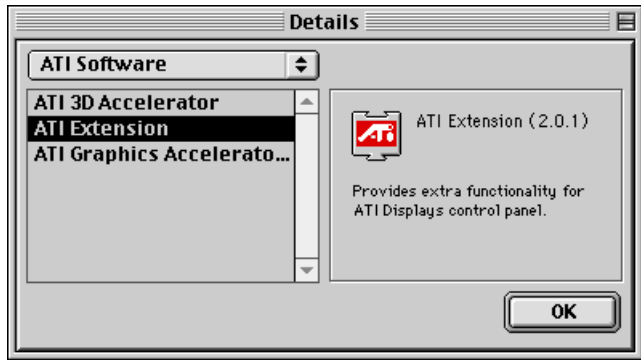

Monitors

The Monitors feature provides access to the standard Mac OS Monitors & Sound control panel. You can use the Monitors & Sound control panel to select color depths and resolutions, and set up multiple monitors. For more information on the Monitors & Sound control panel refer to the Mac OS Guide that comes with your computer.



Keyboard Shortcuts

This feature allows you to use a pop-up menu to change your desktop settings without exiting your current application. You can configure, enable or disable shortcut features when you click the Shortcut icon in the control panel.

The ATI Popup Menu only displays the valid and safe modes available for the attached monitor(s). Additional modes may be accessed through the Monitors & Sound control panel or the Control Strip.



Different ATI cards offer distinct keyboard shortcut options, so not all shortcuts appear on every ATI card.

Popup Menu and Hot Keys remain inactive when dialogs appear on the screen. For example, while using the Monitors & Sound control panel, the Popup Menu and Hot Keys are disabled.

Keyboard Shortcuts		
Function	Shortcut Keys	ATI Products
<input checked="" type="checkbox"/> Popup Menu	Control + Shift + Mouse-Click	3D+



VGA Monitors

If you have a VGA monitor connected to your XCLAIM™ 3D PLUS card, the VGA icon may be active. Some VGA monitors use a Display Data Channel (DDC) allowing XCLAIM™ 3D PLUS to automatically determine the resolutions the monitor supports. Your XCLAIM™ 3D PLUS card uses the DDC information to automatically provide the supported resolutions in the Monitors & Sound control panel and the Control Strip. If your VGA monitor doesn't use DDC, the VGA Monitors icon is active and you must use it to select your monitor from a list of standard monitors.



If the VGA icon is dimmed, your computer has detected an Apple-type monitor, or a DDC compliant VGA monitor connected to your XCLAIM™ 3D PLUS card. You do not have to make a selection.

To Select a VGA Monitor

- 1 Select VGA Monitors from the ATI Displays control panel.
- 2 Select your VGA model from the list of monitors in the left panel of the VGA Monitors dialog box.

A list of resolutions supported by your VGA monitor appears in the right panel of the VGA Monitors dialog box.



You cannot select the monitor resolution using the VGA Monitors dialog box. You must use the standard Mac OS Monitors & Sounds control panel.

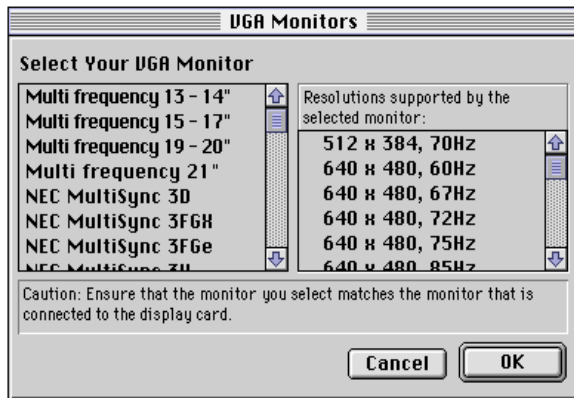



3D Texture Compression

Using the 3D features of the XCLAIM™ 3D PLUS accelerator you can adjust the amount of 3D texture compression used. Because of the amount of memory some 3D textures use from the XCLAIM™ 3D PLUS accelerator, you may want to increase the amount of compression used. When you increase compression, additional offscreen memory becomes available, but there can be some loss in the image quality.

Adjusting Texture Compression

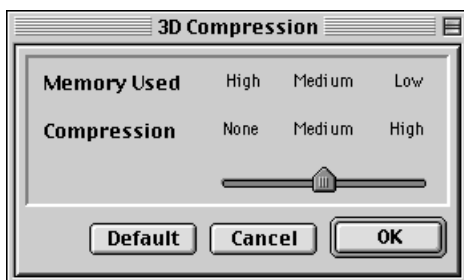

Setting texture compression to None provides the best image quality for your 3D textures, but requires additional offscreen memory for the 3D textures.

Medium texture compression compresses 32-bit textures to 16-bit, thus reducing the memory required by a texture in half.

High compression compresses 32- and 16-bit textures to 8-bit. High texture compression saves the most memory, but the loss in data may affect the image quality.



3D Memory Monitor

XCLAIM™ 3D PLUS supports advanced 3D features including **MIP-mapping**, **Gouraud shading**, **fog effects**, and **texture mapping**. The 3D Memory Monitor shows how available memory in the accelerator card is allocated when displaying 3D graphics.

Using the 3D Memory Monitor

When you open 3D graphics on your Mac OS computer, run the 3D Memory Monitor to see how your XCLAIM™ 3D PLUS has allocated 3D memory.

To open the 3D Memory Monitor

- 1 Select Control Panels from the Apple Menu.
- 2 Select ATI Displays.
- 3 Click on the 3D Memory icon.

When you open a 3D application window, you can see how the additional memory required for 3D graphics is allocated.

The 3D Memory Monitor shows you how the memory on your XCLAIM™ 3D PLUS has been allocated between display, textures, and buffers. If you use all the available memory on the XCLAIM™ 3D PLUS card, your Mac OS computer drops 3D textures and substitutes Gouraud shading.

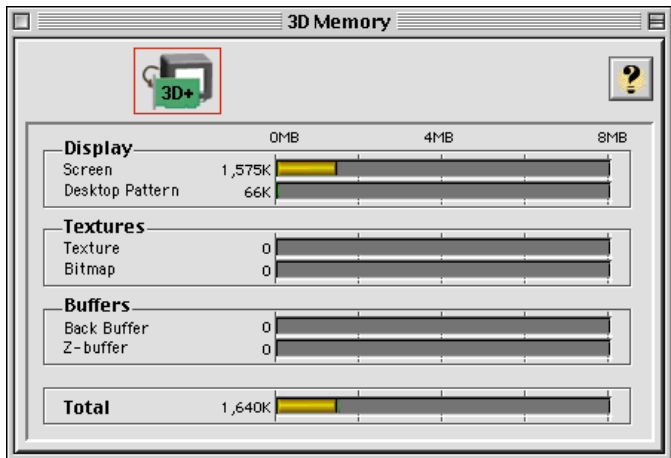

Display

The **Screen bar** indicates the amount of graphics memory allocated to the display's resolution and color depth. The **Desktop Pattern bar** indicates the amount of memory used by your desktop pattern.

To reduce the memory allocated to Display memory:

- change the color depth from millions to thousands
- decrease your screen resolution

Textures

The **Texture bar** indicates the number and size of texture maps loaded by 3D applications to add realism to 3D models and environments. The **Bitmap bar** indicates the memory allocated to non-3D elements like 2D graphics. To reduce the memory allocated to Texture memory:

- reduce the amount of textures in your 3D graphic
- adjust 3D texture compression (“Adjusting Texture Compression” on page 19.)

Buffers

The **Back Buffer bar** and the **Z-buffer bar** are directly related to the size of the 3D window.

To reduce the memory allocated to Buffer memory:

- reduce the size of the display window containing 3D graphics
- reduce the number of the display windows containing 3D graphics



3D Quality

Texture mapping helps provide realistic quality images by placing photo-realistic images or textures on a 3D object. When these textured objects appear in the High Quality Setting, additional texture filtering, or blending takes place. In some applications or games, this additional texture filtering may not be desirable. For this reason, ATI provides the 3D quality option to toggle the 3D texture filtering routines off and on.

You should experiment with this setting to get the best quality and performance from your application or game.



Selection:

- **High** - Additional 3D texture filtering is enabled providing a premium rendering mode.
- **Standard** - Provides standard texture filtering.



The default setting for 3D Quality is Standard.



3D Sync

Your XCLAIM™ 3D PLUS graphics accelerator provides superior 3D performance by performing many tasks in **offscreen memory** including graphic rendering. Depending on the 3D scene, the refresh rate of your computer monitor, and the game or application, you may notice some slight horizontal flickering or “tearing”. This flicker is caused by the different rates at which the display performs a complete screen redraw, and when images located in offscreen memory are moved to the display buffer. Synchronizing the redraw and the write to the display buffer provides a flicker-free 3D window.

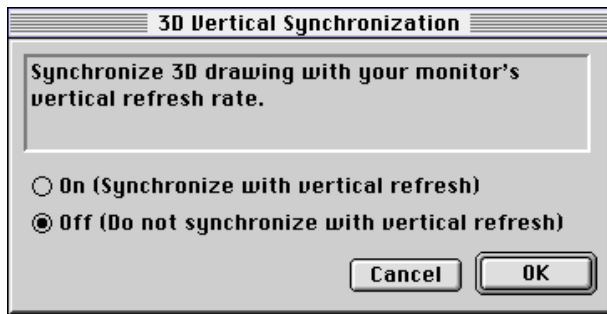

- **On (Synchronize with vertical refresh)** - Provides a flicker-free 3D window. The display is synchronized with the vertical refresh, so there isn't any flickering or “tearing” in the 3D window.
- **Off (Do not synchronize with vertical refresh)** - Provides a boost in performance, but in some games and applications it can introduce flickering or “tearing” in the 3D window.

You should experiment with these settings to find the proper setting for your application.



ATI Guide

The ATI Guide is an additional source of information when you are using the ATI Displays control panel.

Access the ATI Guide by clicking on the Apple Guide icon  on the ATI Displays control panel, or by clicking the ATI icon on the menu bar, and selecting ATI Guide from the ATI Config Menu.

About ATI Config Menu...

ATI Displays
ATI Guide

The ATI Guide stays in front of other windows on the screen so the instructions are always visible. To move the ATI Guide window to another location, drag it by the title bar.

Select a topic from the main ATI Guide window to get detailed instructions for a specific task. To return to the main ATI Guide window, click the Topics icon in the lower-left corner of the Guide window. When you're finished using ATI Guide, click the close box.

Customer Support



You can obtain Customer Support information by clicking the ATI icon in the ATI Displays control panel. You can also generate a problem report.



Please refer to the ATI Guide for additional instructions on generating a problem report.

Before contacting ATI, please complete this report, and have it handy for reference. Important information about your computer is automatically included when you generate the report.

Using QuickTime Playback

XCLAIM™ 3D PLUS' QuickTime playback acceleration allows you to stretch even the smallest movies to full screen size without compromising frame rate or image quality.

XCLAIM™ 3D PLUS' hardware scaler maintains the original quality of your QuickTime movie when scaling to a larger size – even full screen.

XCLAIM™ 3D PLUS' QuickTime playback acceleration displays in millions of colors, even if the current color depth setting is 256 colors. When the monitor is set to display in grayscale, QuickTime movies are accelerated in grayscale, not converted to color. When scaling video, XCLAIM™ 3D PLUS uses special hardware techniques (alpha blending and chroma interpolation) to enhance the video quality instead of just repeating pixels.



To use XCLAIM™ 3D PLUS' playback acceleration, you must have QuickTime version 2.5 or greater installed on your computer.

Optimizing Video Playback

When you scale a movie, your computer switches from QuickTime's software scaler to XCLAIM™ 3D PLUS' hardware scaler to produce better results. However, QuickTime will not switch to hardware scaling in the following situations:

- playing video in double size
Try manually scaling the video slightly off exactly double the size.
- pausing the video
- using single frame advance
- watching the video in reverse
- playing a video that has not been saved in Cinepak or Indeo compressed format
- insufficient memory available

QuickTime clips must be in Cinepak (the most common QuickTime movie format) or Indeo format to be scaled by XCLAIM™ 3D PLUS. To determine if a video will be accelerated using XCLAIM™ 3D PLUS' hardware scaler, check the video format.

To check the format of a video

- 1 Open the movie using Apple Movie Player.
- 2 Select Get Info.
- 3 From the 1st pull down menu, select Video Track.
- 4 From the 2nd pull down menu, select Format.
- 5 Read the format type. Remember, only Cinepak and Indeo formats use XCLAIM™ 3D PLUS' QuickTime acceleration and hardware scaler.



Some multimedia titles on CD-ROM incorporate QuickTime clips that do not allow movies to be stretched during playback. These QuickTime clips cannot be accelerated while viewing the multimedia title.

Using Mac2TV™ Video Out

XCLAIM™ 3D PLUS' Mac2TV™ Video Out feature allows you to output your computer's display to your TV or VCR. Anything you can display on your monitor can be output to TV.

- View computer output directly on your television in either NTSC or PAL formats with advanced flicker reduction and artifact suppression
- Connect using Composite or S-Video output capabilities
- Mac2TV™ provides a big-screen experience for playing games, giving presentations, and browsing the Internet.

Using XCLAIM™ 3D PLUS' Video Out Connector

Your XCLAIM™ 3D PLUS includes Mac2TV™ Video Out. You can use this feature to connect your XCLAIM™ 3D PLUS to a TV or VCR.

To output your computer's display to a TV

- 1 Turn off your computer and TV.
- 2 Ensure your XCLAIM™ 3D PLUS card is installed correctly.
- 3 Looking at the back of your Mac, locate your XCLAIM™ 3D PLUS card.

- 4 Connect the video out adapter to the Video Out of your XCLAIM™ 3D PLUS card. (See diagram below.)

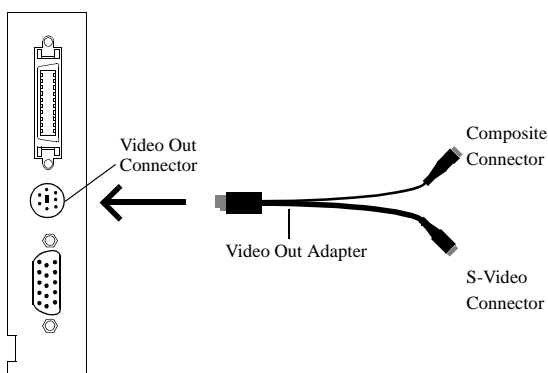

- 5 Determine if your TV has an S-Video or Composite video input connection.
- 6 Attach one end of an S-Video or Composite cable to the video out adapter and the other to the Video in connector of your TV.



*Although the video out adapter has two connectors for S-Video and Composite cables, you only need to connect one to your TV, either Composite **or** S-Video. If your TV has both input connections, S-Video will produce best results.*

You can connect two TVs to your XCLAIM™ 3D PLUS card using both output connectors on the video out adapter. One TV must support the Composite format and the other must support the S-Video format. Both TV's will display the same image simultaneously.

- 7 Turn on your Mac and your TV.



Now that you have connected your XCLAIM™ 3D PLUS card to a TV, you need to enable Mac2TV™. For more information, see “Enabling Mac2TV™” on page 29.

To connect your computer's display to a VCR to record to video tape

- 1 Turn off your computer and VCR.
- 2 Ensure your XCLAIM™ 3D PLUS card is installed correctly.

- Looking at the back of your Mac, locate your XCLAIM™ 3D PLUS card.
- Connect the video out adapter to the Video Out of your XCLAIM™ 3D PLUS card. (See diagram below.)

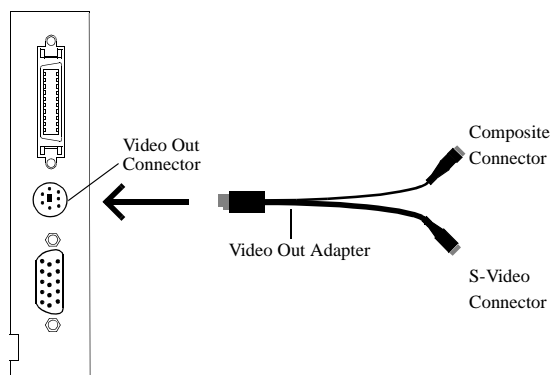

- Determine if your VCR has an S-Video or Composite video input connection.
- Attach one end of an S-Video or Composite cable to the video out adapter and the other to the Video in connector of your VCR.



*Although the video out adapter has two connectors for S-Video and Composite cables, you only need to connect one to your VCR, either Composite **or** S-Video. If your VCR has both input connections, S-Video will produce best results.*

You can connect a TV and a VCR to your XCLAIM™ 3D PLUS card using both output connectors on the video out adapter. One must support the Composite format and the other must support the S-Video format.

- Turn on your Mac, VCR, and TV.



If you are connecting your XCLAIM™ 3D PLUS card to a VCR, make sure that your VCR is connected to a television that you can use as your computer's display. For information about connecting a television to your VCR, see the documentation supplied with your VCR.

Now that you have connected your XCLAIM™ 3D PLUS card to a VCR, you need to enable Mac2TV™.

Enabling Mac2TV™



WARNING

- When you initially turn on Mac2TV™ Video Out, your monitor display will be dimmed. Monitors which do not support the 60 Hz vertical refresh rate required by video equipment may be damaged when Mac2TV™ is enabled. Dimming your monitor is a safety feature, protecting your monitor from any potential damage.
- Many newer Apple and VGA multi-frequency monitors are capable of supporting the 60 Hz vertical refresh rate at several resolutions. If you are certain that your monitor supports this refresh rate (check your monitor User's Guide), restore the monitor display by choosing one of the simulscan modes shown in the Monitors and Sound control panel and the control strip. Older versions of ATI graphics accelerator cards may be able to restore the monitor display by pressing ⌘-Option-m-o together.

- 1 Open the ATI Displays control panel.
- 2 Click on the Mac2TV™ icon.
- 3 In the Video Output box, click Video Output On.



A message appears, warning you your monitor will be dimmed.



- 4** Click OK.

A message appears on your TV stating that your display has been successfully switched to TV.



- 5** Click OK.

If you do not click OK to the message on the TV, your display will return to your monitor after a few seconds.

Changing Display Configurations

Using a TV as your only display

If you are using television display only, disconnect your monitor from your XCLAIM™ 3D PLUS card. XCLAIM™ 3D PLUS detects that you have a TV attached and automatically starts with Mac2TV™ display enabled.

Optimizing Mac2TV™

You can optimize your TV display using the video out preferences. Viewing images on your TV can be improved by changing the contrast, brightness, or size of your display.

To set the video out preferences, click the Mac2TV™ icon on the ATI Displays Control Panel.



Hue, saturation, and brightness are the three qualities which constitute what we normally refer to as “color”.

- **Hue**, often used as a synonym for “color”, is the quality that distinguishes among red, green, yellow, and so on.
- **Saturation** is the amount of color present that distinguishes pale or washed-out colors from vivid ones.
- **Brightness** is related to the amount of light emitted by your display or reflected from an object. This quality enables you to describe an object as “bright” or “dim”.

Hue is generally not adjusted. Depending on the TV, however, it may be necessary or desirable to adjust the hue to approximate the monitor’s display.

Anti-Flicker reduces the amount of display flicker. Display flicker is both a distraction and tiring to your eyes, and is most pronounced when text is being displayed.

Dot Crawl is an undesirable characteristic of many Composite televisions that is seen as thin, jagged edges moving around objects on the screen. The “Frozen” setting freezes, or eliminates, the dot crawl, and is especially useful for viewing pictures or stills. S-video equipment does not exhibit this effect.

Contrast is a ratio of how far the whitest whites are from the blackest blacks. If the contrast is too high, the image may look stark, like pure white squares on a jet-black background. If the contrast is too low, the image may look gray or washed out.

Reducing Edge Distortion

When using a television for your display, you may see some edge distortion on the left and right side of your television screen. This effect depends on your television and the application you are running.

To reduce edge distortion, you can:

- increase the horizontal size by clicking the right Size arrow, or
- reduce the brightness by adjusting the brightness slider.

Viewing Text on Television

Due to the different technology used in the manufacturing of televisions and monitors, standard text may look too small on your television. You can compensate for this by using larger fonts.

To change your font size

- 1 Click the Apple menu.
- 2 Select Control Panels.
- 3 Select Views.
- 4 Choose a larger font size.

Using Digital Flat Panel (DFP) Support

XCLAIM™ 3D PLUS' DFP support feature allows you to output your computer's display to your DFP display, providing you with:

- Crisper, clearer images.
- A true flat screen.
- Virtually no eyestrain from prolonged viewing.

Using XCLAIM™ 3D PLUS' DFP Connector

Your XCLAIM™ 3D PLUS includes support for DFP. You can use this feature to connect your XCLAIM™ 3D PLUS to a Digital Flat Panel display.

To output your computer's display to a DFP display

- 1 Turn off your computer and DFP display.
- 2 Ensure your XCLAIM™ 3D PLUS card is installed correctly.
- 3 Looking at the back of your Mac, locate your XCLAIM™ 3D PLUS card.
- 4 Connect the DFP cable to the DFP connector on your XCLAIM™ 3D PLUS card. (See diagram below.)

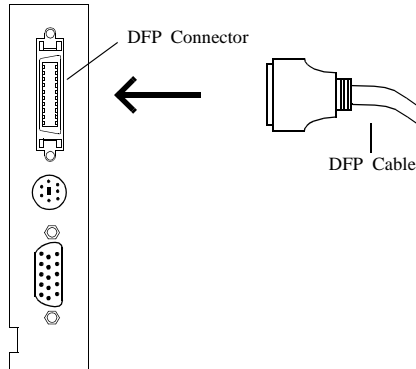

- 5 Locate the DFP connector on your DFP display.
- 6 Attach one end of your DFP cable to the DFP connector on your XCLAIM™ 3D PLUS card and the other end to the DFP connector on your DFP display.
- 7 Turn on your Mac and your DFP display.

Your DFP display is automatically enabled.



Troubleshooting Tips

Before Contacting Customer Support

If you have a general question, or encounter problems with your card, please review this information completely before contacting Customer Support.

You can create a problem report from the ATI Displays control panel. Please refer to the ATI Guide for instructions on generating this problem report, and for general troubleshooting tips not covered in this section.

Before contacting ATI, please complete the problem report, and have the report file either on-screen or printed out for reference. Important information about your system is automatically included when you generate the report.

Solutions to Common Problems

Why can't I get a resolution higher than 640x480?



If the monitor is connected to the VGA monitor port on your XCLAIM™ 3D PLUS card...

- go to the ATI Displays control panel, click “VGA Monitors”, and select a monitor type which matches the specifications of your monitor. This allows more resolutions to be available for selection in the standard Monitors control panel.

I am using a monitor adapter to supply the sense code, but I only get one resolution, even though I have a multiscan monitor. Why?

- When you use your monitor adapter, it is sending a single fixed frequency sync signal to the monitor. If your adapter provides multiple sense codes, adjust it for another resolution sense code, and restart your computer. If your monitor adapter doesn't allow you to adjust the resolution

sense code, you should purchase an adapter that does. Contact an Apple retailer for availability of adjustable monitor adapters.

I have a monitor with three BNC connectors. Why won't it work with my XCLAIM™ 3D PLUS card?

- Monitors that only have three BNC connectors require a synchronization (“sync”) signal to be sent down the green line. This is called Sync-on-Green (SOG). ATI accelerator cards do not output an SOG signal. Adapters are available for your Mac OS computer to convert the separate sync signal from the ATI card to an SOG signal for the monitor. Check with your local Apple Authorized Dealer for availability of SOG adapters.

I have a monitor with five BNC connectors. Why won't it work with my XCLAIM™ 3D PLUS card?

- For a cable with five BNC connectors, ensure that they are all connected to the monitor. If only three of the cables are connected (i.e., R, G, and B), the monitor is expecting a Sync-on-Green (SOG) signal.
- Some monitors may have a switch to set the monitor to either SOG or separate sync. If the switch is set to SOG, the monitor will show a scrambled display. Setting the switch to separate/composite sync may resolve the problem.
- A number of BNC cables, even though they are designed for Mac OS computers, do not supply the sense code needed by the graphics card. Using an adapter which sets the appropriate sense code should solve the problem.

After selecting a VGA monitor type in the VGA Monitors dialog, I couldn't change the resolution in the Resolutions Supported scroll list.

- This scroll list in the ATI Displays control panel only shows the available resolutions for the monitor type selected, and will not allow you to select and change resolutions. Changing resolutions can only be done through the standard Monitors & Sound control panel, Control Strip module, or by using the Popup Menu supplied with the XCLAIM™ 3D PLUS card.

Can the XCLAIM™ 3D PLUS work in all Power Macintosh computers?

- No, the XCLAIM™ 3D PLUS only works with PCI-based Power Macintosh computers. The minimum system requirements are listed in "What You'll Need" on page 2.

After installing XCLAIM™ 3D PLUS, I noticed some sound distortion. Why?

- Disabling Virtual Memory in the Memory control panel may resolve this problem. Certain Mac OS computers may experience sound corruption while using QuickDraw 3D accelerated applications even with Virtual Memory turned off.
- Installing the ATI Sound Catalyst extension corrects sound corruption in certain Macintosh computers. Additional information on the Sound Catalyst extension is available in the Read Me document in the Sound Catalyst folder.
- If you still have sound related problems, check with the manufacturer of your Mac OS computer for any sound related software updates they may have.



B Specifications

Video Mode Table

The video mode table below lists the color depth capabilities for the supported resolutions on your XCLAIM™ 3D PLUS card.

Please consult your monitor's specifications to determine which resolutions are available with your display.

Display Resolution	Vertical Refresh Hz	Maximum Colors at 8MB
512 x 384	70	millions
640 x 480	60, 67, 72, 75, 85, 90, 100, 120	millions
640 x 870	75	millions
800 x 600	56, 60, 72, 75, 85, 90, 100, 120	millions
832 x 624	75	millions
1024 x 768	60, 70, 75, 85, 90, 100, 120	millions
1152 x 870	75	millions
1280 x 960	75	millions
1280 x 1024	60, 75, 85	millions
1600 x 1200	60, 65, 70, 75	millions

DFP Mode Table

The DFP mode table below lists the color depth capabilities for the supported resolutions on your XCLAIM™ 3D PLUS card.

Please consult your DFP display's specifications to determine which resolutions are available with your display.

Display Resolution	Vertical Refresh Hz	Maximum Colors at 8MB
640 x 480	60	millions
800 x 600	60	millions
1024 x 768	60	millions

TV Mode Table

The TV mode table below lists the color depth capabilities for the supported resolutions on your XCLAIM™ 3D PLUS card for both NTSC and PAL.

Please consult your TV's specifications to determine which resolutions are available with your display.

Display Resolution	NTSC	PAL	Max Colors at 8MB
	Vertical Refresh Hz	Vertical Refresh Hz	
512 x 384	60	50	millions
640 x 480	60	50	millions
720 x 480	60	--	millions
720 x 576	--	50	millions
800 x 600	60	50	millions
832 x 624	60	50	millions
1024 x 768	60	50	millions

3D Mode Table

The 3D mode table measures the number of full screen 3D windows that are possible to display at a given resolution. For example, a value of 2.75 means that there is enough memory left over in the current mode to run 2 full screen 3D windows and another at 3/4 the size of full screen. A value of 0.40 means that largest 3D window will be just less than 1/2 the size of full screen.

In the following table, 3D windows are considered to use a back buffer and z-buffer and no texture compression. You could increase the number of full screen 3D windows possible by using texture compression.



3D acceleration is not supported when your color depth is 256 colors. In this color depth, there are too few colors to display complex 3D textures.

Resolution	Colors	8MB
512 x 384	Thousands	10.00
512 x 384	Millions	6.25
640 x 480	Thousands	6.25
640 x 480	Millions	3.75
800 x 600	Thousands	3.75
800 x 600	Millions	2.25
832 x 624	Thousands	3.50
832 x 624	Millions	2.00
1024 x 768	Thousands	2.00
1024 x 768	Millions	1.00
1152 x 870	Thousands	1.50
1152 x 870	Millions	0.75

Specifications

System Requirements

- Power Macintosh or Mac OS compatible computer with a PCI slot.

Operating System

- Mac OS software (version 7.5.5 or higher).
- QuickTime (version 2.5 or higher).
- QuickDraw 3D (version 1.5.1 or higher).

Graphics Controller

- ATI RAGE LT PRO — 64-bit graphics and multimedia accelerator chip.

Video Display Buffer

- 8MB memory.
- 64-bit memory interface.

Bus

- 32-bit PCI local bus compliant with PCI version 2.1 specification.

Sync Signals

- Separate horizontal and vertical sync at TTL levels.
- Composite sync at TTL levels.

Video Memory Address

- Supports PCI Multimedia Standard.
- Supports 16MB relocatable memory aperture.

TV Out

- NTSC and PAL output.
- Composite, S-Video connectors.

Display Support

- Standard VGA support.
- Apple DB-15 with adapter.
- VESA Digital Flat Panel (DFP)
- DDC 1/2b/2b+
- VESA DPMS

Video Interrupt

- PCI interrupt request enabled; interrupt is auto configured by system.

Power

- +5V $\pm 5\%$, @ 1.3A typical.

Environment

- Ambient Temperature: 50° to 122° F (10° to 50° C) operation. 32° to 162° F (0° to 70° C) storage.
- Relative Humidity: 5% to 90% non-condensing operation. 0% to 95% storage.

MTBF

- 300,000 hours.

EMC Certification

- FCC Class B
- CE MARK Class B

Safety

- PCB made from UL-listed flame retardant material.



Compliance Information

FCC Compliance Information

This device is in conformity with part 15 of the FCC Rules. Operation of this product is subject to the following two conditions: (1) this device may not cause harmful interference, and (2) this device must accept any interference received, including interference that may cause undesired operation.

This equipment has been tested and found to comply with the limits for a Class B digital device, pursuant to Part 15 of the FCC Rules. These limits are designed to provide reasonable protection against harmful interference in a residential installation.

This equipment generates, uses and can radiate radio frequency energy and, if not installed and used in accordance with manufacturer's instructions, may cause harmful interference to radio communications. However, there is no guarantee that interference will not occur in a particular installation.

If this equipment does cause harmful interference to radio or television reception, which can be determined by turning the equipment off and on, the user is encouraged to try to correct the interference by one or more of the following measures:

- Re-orient or relocate the receiving antenna.
- Increase the separation between the equipment and receiver.
- Connect the equipment to an outlet on a circuit different from that to which the receiver is connected.

Consult the dealer or an experienced technician for help.

- The use of shielded cables for connection of the monitor to the graphics card is required to ensure compliance with FCC regulations.
- Changes or modifications to this unit not expressly approved by the party responsible for compliance could void the user's authority to operate this equipment.

Industry Canada Compliance Statement

ICES-003 This Class B digital apparatus meets all requirements of the Canadian Interference-Causing Equipment Regulations.

Cet appareil numérique de la Classe B Respecte toutes les exigences du Règlement sur le matériel brouiller du Canada.

CE Compliance Information

EMC Directive 89/336/EEC and Amendment 92/31/EEC, Class B Digital Device

EN 50081-1, Generic Emissions Standard for Residential, Commercial and Light Industrial Products

(EN 55022/CISPR 22, Limits and Methods of Measurement of Radio Interference Characteristics Information Technology Equipment) *Warning: This is a Class B product. In a domestic environment this product may cause radio interference in which case the user may be required to take adequate measures.*

EN 50082-1, Generic Immunity Standard for Residential, Commercial and Light Industrial Products

(IEC 801-2, IEC 801-3, IEC 801-4)

Directive EMC 89/336/CEE et amendement 92/31/CEE,
dispositif numérique de Classe B

EN 50081-1, Norme sur les émissions génériques pour les
produits domestiques, commerciaux et industriels légers

(EN 55022/CISPR 22, Limites et méthodes de mesure des
caractéristiques d'interférences radiophoniques, Matériel des
technologies de l'information) *Mise en garde: ceci est un
produit de Classe B. Il risque produire des interférences
radiophoniques dans un environnement domestique auquel cas
l'utilisateur peut se voir demandé de prendre des mesures
adéquates.*

EN 50082-1, Norme sur l'immunité générique pour produits
domestiques, commerciaux et industriels légers.

(CEI 801-2, CEI 801-3, CEI 801-4)

EMC Richtlinie 89/336/EEC und Änderung 92/31/EEC,
Digitales Gerät der Klasse B

EN 50081-1, Allgemeiner Emissions-Standard für Haushalt-
und kommerzielle Produkte sowie Erzeugnisse der
Leichtindustrie

(EN 55022/CISPR 22, Beschränkungen und Verfahren der
Messung von informationstechnischen Ausrüstungen mit
Funkstörmerkmalen)

Warnung: Dies ist ein Erzeugnis der Klasse B. Dieses Erzeugnis
kann Funkstörungen im Wohnbereich verursachen; in diesem
Fall können entsprechende Maßnahmen seitens des Benutzers
erforderlich sein.

EN 50082-1. Allgemeiner Unempfindlichkeits-Standard für
Haushalt- und kommerzielle Produkte sowie Erzeugnisse der
Leichtindustrie

(IEC 801-2, IEC 801-3, IEC 801-4)



0111

Glossary

Alpha blending

When an image has an alpha value for each pixel, this tells how much to blend the colors from the image with the background colors. The lower the alpha values the more transparent the image looks.

Anti-aliasing

Method used to remove the jaggedness of an image. When anti-aliasing is used, the edges of an image appear smooth and usually somewhat blurry.

Back buffer

A type of **offscreen memory** used to provide smooth video and 2D graphics acceleration. This technique uses two frame buffers, often referred to as "double-buffering". While one buffer is being displayed, a second buffer of the same size, the "back" buffer, holds the frame being worked on.

Once a new frame is ready in the back buffer it is copied to the front buffer - the display screen. In this way, you will only see complete, smooth frames, and not the operations performed on them.

In order to increase performance, all memory used for back buffers are on your ATI graphic accelerator card.

Bilinear Filtering

When texture mapping is performed an image can become very "blocky" or "pixelated" when the texture is viewed close up. Bilinear filtering samples four texture pixels, takes the weighted average of these pixels and applies the average of these "texels". This blended color is used to provide a smoother looking texture.

Bitmap

A bitmap is a graphics or character representation composed of individual pixels, arranged horizontally in rows. A monochrome bitmap uses one bit per pixel (bpp). Color bitmaps may use up to 32-bpp, depending on the number of colors desired.

Buffers

Your ATI accelerator card includes on-board memory which is used in a number of ways. Buffers are portions of this memory used as temporary storage on your card. One large buffer is always used to display the screen you see; this is the "display buffer". The rest of **offscreen** memory is used by applications as **back buffers**, **z-buffers**, and texture buffers.

Color Depth	Color depth is the number of color shades available on your display. The color depth of your monitor usually includes; 256 colors (8-bpp), Thousands of colors (16-bpp), and Millions of colors (32-bpp), and is also measured in bits per pixel (bpp). You can switch your color depth using the ATI Popup Menu, Apple's Control Strip, or the Monitors & Sound control panel. Higher bit-depths require more display buffer memory.
	Note: The ATI 3D Accelerator only functions in Thousands and Millions of colors modes.
Fog	The blending of an object with a fixed color as objects or pixels increase distance away from the viewer.
Frame Buffer	Memory buffer used to store the image being displayed.
Gouraud Shading	One of the more sophisticated shading methods used to produce a smooth lighting effect across a 3D object. A specific color is used at each vertice of a triangle or polygon, and interpolated across the entire face.
MIP Map	Multum In Parvum (Latin) means "many in one." It is a method of increasing quality of a texture map by storing multiple resolutions of the same image and dynamically switching between them depending on the size and depth of the object being textured.
Offscreen Memory	An area of memory used to preload and place images so that they can be quickly drawn on the screen. Offscreen memory refers to all the memory on your ATI accelerator card that is not taken up by the front buffer, which holds the display screen that you see.
Pixel, Pel	Picture element. Smallest addressable area of the computer screen. Pixels on computer displays are square; pixels on NTSC televisions have a 4:3 aspect ratio.
Refresh Rate	Also referred to as "vertical refresh rate". The rate at which a monitor or television can redraw the screen from top to bottom. NTSC television systems have a refresh rate of approximately 60 Hz (but only draw one-half of the video frame in one pass); computer displays typically have refresh rates of 75 Hz or more. At a refresh rate of 70 Hz and lower, screen flicker is often noticeable.
Specular Highlight	The bright, usually small, intense light reflected from a 3-D surface with a high refraction value.

Texture Mapping

Mapping, or placing, an image onto an object. Images of realistic surfaces are placed on 3D models to create a richer and more complex visual effect.

Trilinear Filtering

Sampling method used to produce the most realistic looking 3D objects. Trilinear filtering averages one of the bilinear filter MIP Map levels along with the standard MIP Map samples.

z-buffer

A z-buffer is an area of off-screen memory used to hold “depth” information. For each dot, or pixel, in the display buffer, there is a corresponding dot in the z-buffer which holds the depth (z) value for the display pixel. The depth data helps the ATI accelerator card decide what 3D objects are in front off other 3D objects.

The larger the 3D window, the larger the z-buffer is in memory.

